

# Digital Fiber Amplifier Unit

## E3X-DA-S

### Stable Detection with Advanced Fiber Amplifier Units



- A wide range of added value with standard models with one input and two outputs, and ultra-long-term APC models with an APC life of approximately 20 years.
- Power turning to easily set the optimum light level.
- Automatic Power Control (APC) is always enabled to stabilize emitter power with high accuracy.
- GIGA RAY for stable detection with the highest level of power in this class even for low-reflective objects and large objects.
- The E3X-DA0-S supports an EtherCAT Sensor Communications Unit or CompoNet Sensor Communications Unit.



For the most recent information on models that have been certified for safety standards, refer to your OMRON website.

### Ordering Information

#### Fiber Amplifier Units

Pre-wired Models and Wire-saving Connector Models [Dimensions→page 27]

Type	Appearance	Connecting method	Model		Applicable wire-saving connector (sold separately)	
			NPN output	PNP output	Type	Model
Standard models		Pre-wired (2 m)	E3X-DA21-S 2M	E3X-DA51-S 2M	---	---
		Wire-saving connector *1	E3X-DA7-S *2	E3X-DA9-S *2	Master connector	E3X-CN21
Ultra-long-term APC models		Pre-wired (2 m)	E3X-DA21R-S 2M	E3X-DA51R-S 2M	---	---
		Wire-saving connector *1	E3X-DA7R-S	E3X-DA9R-S	Slave connector	E3X-CN22
High-speed response models		Pre-wired (2 m)	E3X-DA21F-S 2M	E3X-DA51F-S 2M	---	---
		Wire-saving connector *1	E3X-DA7F-S	E3X-DA9F-S	Master connector	E3X-CN11
					Slave connector	E3X-CN12

\*1. A Wire-saving connector sold separately is required.

\*2. These models allow you to use an E3X-DRT21-S VER.3 Sensor Communications Unit. When using the E3X-DRT21-S VER.3, use an E3X-CN02 Connector without a Cable for the Wire-saving Connector.





Sensor Communications Unit Connector Models (for EtherCAT and CompoNet) [Dimensions→page 29]

Type	Appearance	Connecting method	Model	Applicable Sensor Communications Unit
Standard model		Connector for Sensor Communications Unit	E3X-DA0-S	E3X-ECT
				E3X-CRT

## Accessories (sold separately)

Wire-saving Connectors (Required for models for Wire-saving Connectors.)

Protection stickers attached [\[Dimensions→page 29\]](#)

Type	Appearance	Cable length	No. of conductors	Model
Master connector		2 m	4	E3X-CN21
Slave connector			2	E3X-CN22
Master connector			3	E3X-CN11
Slave connector			1	E3X-CN12

**Note:** The E3X-CN11/12 can also be used to connect to the E3X-DA□-S (□: 7/9) or the E3X-DA□R-S (□: 7/9), but the output lines will support only 1 channel. Output function for channel 2 or APC alarm output function will be disabled.

### Mounting Brackets [\[Dimensions→page 30\]](#)

Appearance	Model	Quantity
	E39-L143	1

### End Plate [\[Dimensions→page 30\]](#)

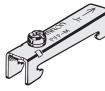
Appearance	Model	Quantity
	PFP-M	1

## Product Overview

●: Strong point of the model ○: Provided ---: Not provided

Item	Types Connecting method Models	Standard models*1		Ultra-long-term APC models		High-speed response models	
		Pre-wired	Wire-saving connector	Pre-wired	Wire-saving connector	Pre-wired	Wire-saving connector
		E3X-DA21-S E3X-DA51-S	E3X-DA7-S E3X-DA9-S	E3X-DA21R-S E3X-DA51R-S	E3X-DA7R-S E3X-DA9R-S	E3X-DA21F-S E3X-DA51F-S	E3X-DA7F-S E3X-DA9F-S
Input/output	External input	1 input	---	1 input	---	---	
	Output	2 outputs		1 output and 1 APC alarm output		1 output	
Performance	Sensing distance with E32-T11R	280 to 2,000 mm (Depends on response time)		140 to 1,000 mm (Depends on response time)		280 mm (Only Super-high-speed Mode)	
	Sensing distance with E32-D11R	100 to 840 mm (Depends on response time)		50 to 420 mm (Depends on response time)		100 mm (Only Super-high-speed Mode)	
	Giga Power (GIGA RAY)	● (Margin: × 160)		○		○	
	High-speed response*2 (fastest response time)	○ (80 μs)		○ (80 μs)		● (46 μs)	
Function	Power tuning	○		○		○	
	Automatic power control (APC)	○		● (Ultra-long-term APC)		○	
	Timer	○		○		○	
	ATC	○		○		○	
	Key lock	○		○		○	
	Easy key lock (switchable)	---		○		○	
	APC margin display	---		○		---	
	Slow-motion display	---		---		○	

\* 1.2. Except for the response time, the Sensor Communications Unit Connector Models for EtherCAT and CompoNet have the same I/O, performance, and functions as the Standard, Wire-saving Connector Models.  
(The fastest response time of the Sensor Communications Units Connector Models is 250 μs.)

# Ratings and Specifications

## Fiber Amplifier Units

Item	Type Model	Standard models		Ultra-long-term APC models E3X-DA□R-S (□: 21/51/7/9)	High-speed response models E3X-DA□F-S (□: 21/51/7/9)
		Standard models	Model for Sensor Communications Unit		
		E3X-DA□S (□: 21/51/7/9)	E3X-DA0-S*1		
Light source (wavelength)	Red,4-element LED (625 nm)				
Power supply voltage	12 to 24 VDC ±10%, ripple (p-p) 10% max.	Supplied from the connector through the Sensor Communications Unit	12 to 24 VDC ±10%, ripple (p-p) 10% max.		
Power consumption	Normal mode : 960 mW max. (Current consumption: 40 mA max. at 24 VDC, 80 mA max. at 12 VDC) Power saving ECO1: 720 mW max. (Current consumption: 30 mA max. at 24 VDC, 60 mA max. at 12 VDC) Power saving ECO2: 600 mW max. (Current consumption: 25 mA max. at 24 VDC, 50 mA max. at 12 VDC)				
Control output / APC alarm output *1	Load power supply voltage: 26.4 VDC max.; NPN/PNP open collector; load current: 50 mA max.; residual voltage: 2 V max.				
External input *2	No-voltage input (contact/transistor)*3	---	No-voltage input (contact/transistor)*3	---	
Protection circuits	Power supply reverse polarity protection, output short-circuit protection and output reverse polarity protection				
Re-sponse time	Super-high-speed Mode *4	Operate or reset: 80 μs	---	Operate or reset: 80 μs	NPN output: Operate: 46 μs, Reset: 48 μs PNP output: Operate: 51 μs, Reset: 53 μs
	High-speed Mode	Operate or reset: 250 μs			
	Standard Mode	Operate or reset: 1 ms			
	High-resolution Mode	Operate or reset: 4 ms			
	Tough Mode	Operate or reset: 16 ms			
Sensitivity setting	Teaching or manual method				
Functions	Power tuning	Light emission power and reception gain, digital control method			
	Differential detection	Switchable between Single-edge and Double-edge Detection Modes. Single edge: Set to 250 μs, 500 μs, 1 ms, 10 ms, or 100 ms. Double edge: Set to 500 μs, 1 ms, 2 ms, 20 ms, or 200 ms			---
	Automatic power control (APC)	Always enabled. High-speed control of emission current Wide-range APC for the E3X-DA□R-S			
	Timer	Select from timer disabled, OFF-delay, ON-delay, One-shot, or ON-delay + OFF-delay timer 1 ms to 5 s (1 to 20 ms set in 1-ms increments, 20 to 200 ms set in 10-ms increments, 200 ms to 1 s set in 100-ms increments, and 1 to 5 s set in 1-s increments)			
	ATC	Provided			
	APC margin display	---	Provided	---	
	Slow-motion display	---	Provided		
	Zero reset	Negative values can be displayed. (Threshold value is shifted.)			
	Resetting settings	Select from initial reset (factory defaults) or user reset (saved settings).			
	Mutual interference prevention	Possible for up to 10 units *5			---
	ECO Mode *6	Select from OFF (digital display lit), ECO1 (digital display dimmed), and ECO2 (digital display OFF).			
	External input setting *2	Select from teaching operations, power tuning, zero reset, emitter OFF, or ATC start.			---
	Output setting	Select from output for each channel, area output, or self-diagnosis.			---
Indicator	Operation indicator for channel 1 (orange) Operation indicator for channel 2 (orange)		Operation indicator for channel 1 (orange) APC alarm output indicator (orange)		Operation indicator for channel 1 (orange) Power tuning indicator (orange)

\*1. The E3X-DA0-S Amplifier Unit allows you to use an E3X-ECT EtherCAT Sensor Communications Unit or E3X-CRT CompoNet Sensor Communications Unit.

\*2. Only for Pre-wired models.

\*3. The following details apply to inputs.

	Contact input (relay or switch)	Non-contact input (transistor)
NPN	ON: Shorted to 0 V (sourcing current: 1 mA max.). OFF: Open or shorted to Vcc.	ON: 1.5 V max. (sourcing current: 1 mA max.) OFF: Vcc - 1.5 V to Vcc (leakage current: 0.1 mA max.)
PNP	ON: Shorted to Vcc (sinking current: 3 mA max.). OFF: Open or shorted to 0 V.	ON: Vcc - 1.5 V to Vcc (sinking current: 3 mA max.) OFF: 1.5 V max. (leakage current: 0.1 mA max.)

\*4. The communications function and mutual interference prevention function are disabled if the detection mode is set to Super-high-speed mode.

\*5. Mutual interference prevention is enabled if Fiber Amplifier Units are connected together. It is also enabled in the same way if E3X-DA-S-series Units and E3C-LDA-series Units are used together. If power tuning is enabled, mutual interference prevention can be used for up to six units.

\*6. For the standard models E3X-DA□S (□: 21/51/7/9/0), the rated sensing distance is approximately 1/2 and the incident level is approximately 1/3 of the normal levels when ECO mode is enabled.

# E3X-DA-S

Item	Model	E3X-DA□-S (□: 21/51/7/9)	E3X-DA0-S	E3X-DA□R-S (□: 21/51/7/9)	E3X-DA□F-S (□: 21/51/7/9)
Digital display		Select from incident level + threshold or other 6 patterns (Refer to 6. <i>Display switch</i> on page 21.)			
Display orientation		Switching between normal / reversed display is possible.			
Key lock		Key lock		Key lock / Easy key lock.	
Ambient illumination (Receiver side)		Incandescent lamp: 10,000 lx max. Sunlight: 20,000 lx max.			
Maximum connectable Units		16 (The ambient temperature specification depends on the number of connected units.)*7			
Ambient temperature range		Operating: Groups of 1 to 2 Amplifiers: -25 to 55°C Groups of 3 to 10 Amplifiers: -25 to 50°C Groups of 11 to 16 Amplifiers: -25 to 45°C*8 Storage: -30 to 70°C (with no icing or condensation)			
Ambient humidity range		Operating and storage: 35% to 85% (with no condensation)			
Insulation resistance		20 MΩ min. (at 500 VDC)			
Dielectric strength		1,000 VAC at 50/60 Hz for 1 minute			
Vibration resistance (Destruction)		10 to 55 Hz with a 1.5-mm double amplitude for 2 hours each in X, Y, and Z directions	10 to 150 Hz with a 0.7-mm double amplitude for 80 min each in X, Y, and Z directions	10 to 55 Hz with a 1.5-mm double amplitude for 2 hours each in X, Y, and Z directions	
Shock resistance (Destruction)		500 m/s <sup>2</sup> for 3 times each in X, Y, and Z directions	200 m/s <sup>2</sup> for 3 times each in X, Y, and Z directions	500 m/s <sup>2</sup> for 3 times each in X, Y, and Z directions	
Degree of protection		IEC 60529 IP50 (with Protective Cover attached)			
Connection method		Pre-wired (standard cable length: 2 m) or wire-saving connector	Connector for Sensor Communications Unit	Pre-wired (standard cable length: 2 m) or wire-saving connector	
Weight (packed state)		Pre-wired Models: Approx. 100 g, Wire-saving Connector Models: Approx. 55 g	Approx. 55 g	Pre-wired Models: Approx. 100 g, Wire-saving Connector Models: Approx. 55 g	
Materials	Case	Polybutylene terephthalate (PBT)			
	Cover	Polycarbonate (PC)			
Accessories		Instruction Manual			

\*7. The maximum number of connectable Units is 30 when the E3X-ECT is used with the E3X-DA0-S.

\*8. The following temperature ranges apply for operation when an E3X-ECT or E3X-CRT Sensor Communications Unit is used with the E3X-DA0-S:  
Groups of 1 or 2 Amplifier Units: 0 to 55°C, Groups of 3 to 10 Amplifier Units: 0 to 50°C, Groups of 11 to 16 Amplifier Units: 0 to 45°C, Groups of 17 to 30 Amplifier Units (with the E3X-ECT): 0 to 40°C.

## Wire-saving Connectors

Item	Model	E3X-CN21/22/11	E3X-CN12
Rated current		2.5 A	
Rated voltage		50 V	
Contact resistance		20 mΩ max. (20 mVDC max., 100 mA max.) (The figure is for connection to the Fiber Amplifier Unit and the adjacent connector. It does not include the conductor resistance of the cable.)	
No. of insertions		Destruction: 50 times (The figure for the number of insertions is for connection to the Fiber Amplifier Unit and the adjacent connector.)	
Materials	Housing	Polybutylene terephthalate (PBT)	
	Contacts	Phosphor bronze / gold-plated nickel	
Weight (packed state)		Approx. 55 g	Approx. 25 g

## Sensing Distance

E3X-DA□-S (□: 21/51/7/9/0) ▪ E3X-DA□F-S(□: 21/51/7/9)  
Threaded Models

Sensing method	Sensing direction	Size	Model	Sensing distance (mm)				
				Tough mode	High-resolution mode	Standard mode	High-speed mode	Super-high-speed mode
Through-beam	Right-angle	M4	E32-T11N 2M	2,000	1,400	1,000	700	280
			E32-LT11N 2M	4,000 *	4,000 *	3,500	2,300	920
	Straight		E32-T11R 2M	2,000	1,400	1,000	700	280
			E32-LT11 2M	4,000 *	4,000 *	4,000 *	2,700	1,080
			E32-LT11R 2M	4,000 *	4,000 *	3,500	2,300	920
Reflective	Right-angle	M3	E32-C31N 2M	110	80	50	46	14
			E32-C21N 2M	290	150	130	90	39
		M4	E32-D21N 2M	840	600	350	240	100
			M6	E32-C11N 2M	780	560	350	320
		E32-LD11N 2M		840	600	350	240	100
		Straight	M3	E32-D21R 2M	140	100	60	40
	E32-C31 2M			330	240	150	100	44
	E32-C31M 1M							
	M4		E32-D211R 2M	140	100	60	40	16
			M6	E32-D11R 2M	840	600	350	240
	E32-CC200 2M			1,400	1,000	600	400	180
	E32-LD11 2M			860	610	360	250	110
	E32-LD11R 2M		840	600	350	240	100	

\* The fiber length is 2 m on each side, so the sensing distance is given as 4,000 mm.

## Cylindrical Models

Sensing method	Size	Sensing direction	Model	Sensing distance (mm)				
				Tough mode	High-resolution mode	Standard mode	High-speed mode	Super-high-speed mode
Through-beam	1 dia.	Top-view	E32-T223R 2M	450	300	250	150	60
	1.5 dia.		E32-T22B 2M	680	480	400	220	90
	3 dia.		E32-T12R 2M	2,000	1,400	1,000	700	280
		Side-view	E32-T14LR 2M	750	550	450	260	100
Reflective	1.5 dia.	Top-view	E32-D22B 2M	140	100	60	40	16
	1.5 dia. + 0.5 dia.		E32-D43M 1M	28	20	12	8	4
	3 dia.		E32-D22R 2M	140	100	60	40	16
			E32-D221B 2M	300	220	140	90	40
			E32-D32L 2M	700	500	300	200	90
	3 dia. + 0.8 dia.		E32-D33 2M	70	50	30	20	8

## Flat Models

Sensing method	Sensing direction	Model	Sensing distance (mm)				
			Tough mode	High-resolution mode	Standard mode	High-speed mode	Super-high-speed mode
Through-beam	Top-view	E32-T15XR 2M	2,000	1,400	1,000	700	280
	Side-view	E32-T15YR 2M	750	550	450	260	100
	Flat-view	E32-T15ZR 2M					
Reflective	Top-view	E32-D15XR 2M	840	600	350	240	100
	Side-view	E32-D15YR 2M	200	140	100	52	24
	Flat-view	E32-D15ZR 2M					

**Note:** The High-speed Mode cannot be used with the E3X-DA0-S.

# E3X-DA-S

## E3X-DA□-S (□: 21/51/7/9/0) ▪ E3X-DA□F-S(□: 21/51/7/9) Sleeve Models

Sensing method	Sensing direction	Model	Sensing distance (mm)				
			Tough mode	High-resolution mode	Standard mode	High-speed mode	Super-high-speed mode
Through-beam	Side-view	E32-T24R 2M	170	120	100	50	20
		E32-T24E 2M	450	300	250	150	60
	Top-view	E32-T21-S1 2M	510	360	300	170	68
		E32-T33 1M	150	110	90	50	20
		E32-TC200BR 2M	2,000	1,400	1,000	700	280
Reflective	Side-view	E32-D24R 2M	70	52	30	20	8
		E32-D24-S2 2M	120	80	53	45	14
	Top-view	E32-D43M 1M	28	20	12	8	4
		E32-D331 2M	14	10	6	4	2
		E32-D33 2M	70	50	30	20	8
		E32-D32-S1 0.5M	63	43	27	18	7
		E32-D31-S1 0.5M					
		E32-DC200F4R 2M	140	100	60	40	16
		E32-D22-S1 2M	250	170	110	72	30
		E32-D21-S3 2M					
		E32-DC200BR 2M	840	600	350	240	100
		E32-D25-S3 2M	250	170	110	72	30

### Small-spot, Reflective

Type	Spot diameter	Center distance (mm)	Model	Sensing distance (mm)				
				Tough mode	High-resolution mode	Standard mode	High-speed mode	Super-high-speed mode
Variable spot	0.1 to 0.6 dia.	6 to 5	E32-C42 1M + E39-F3A	Spot diameter of 0.1 to 0.6 mm at 6 to 15 mm.				
	0.3 to 1.6 dia.	10 to 30	E32-C42 1M + E39-F17	Spot diameter of 0.3 to 1.6 mm at 10 to 30 mm.				
Parallel light	4 dia.	0 to 20	E32-C31 2M + E39-F3C E32-C31N 2M + E39-F3C	Spot diameter of 4 mm max. at 0 to 20 mm.				
Integrated lens	0.1 dia.	5	E32-C42S 1M	Spot diameter of 0.1 mm at 5 mm.				
	6 dia.	50	E32-L15 2M	Spot diameter of 6 mm at 50 mm.				
Small-spot	0.1 dia.	7	E32-C41 1M + E39-F3A-5	Spot diameter of 0.1 mm at 7 mm.				
	0.5 dia.		E32-C31 2M + E39-F3A-5	Spot diameter of 0.5 mm at 7 mm.				
			E32-C31N 2M + E39-F3A-5					
	0.2 dia.	17	E32-C41 1M + E39-F3B	Spot diameter of 0.2 mm at 17 mm.				
	0.5 dia.		E32-C31 2M + E39-F3B	Spot diameter of 0.5 mm at 17 mm.				
			E32-C31N 2M + E39-F3B					
3 dia.	50	E32-CC200 2M + E39-F18	Spot diameter of 3 mm at 50 mm.					
		E32-C11N 2M + E39-F18						

**Note:** The High-speed Mode cannot be used with the E3X-DA0-S.

## E3X-DA□-S (□: 21/51/7/9/0) ■ E3X-DA□F-S(□: 21/51/7/9)

## High-power Beam

Type	Sensing direction	Aperture angle	Model	Sensing distance (mm)				
				Tough mode	High-resolution mode	Standard mode	High-speed mode	Super-high-speed mode
Through-beam Integrated lens	Right-angle	15 °	E32-LT11N 2M	4,000 *2	4,000 *2	3,500	2,300	920
	Top-view	10 °	E32-T17L 10M	20,000 *1	20,000 *1	20,000 *1	20,000 *1	8,000
		15 °	E32-LT11 2M	4,000 *2	4,000 *2	4,000 *2	2,700	1,080
	E32-LT11R 2M		4,000 *2	4,000 *2	3,500	2,300	920	
Side-view	30 °	E32-T14 2M	4,000 *2	4,000 *2	4,000 *2	4,000 *2	1,800	
Through-beam models with lenses	Right-angle	12 °	E32-T11N 2M + E39-F1	4,000 *2	4,000 *2	4,000 *2	4,000 *2	2,000
		6 °	E32-T11N 2M + E39-F16	4,000 *2	4,000 *2	4,000 *2	4,000 *2	3,600
	Top-view	12 °	E32-T11R 2M + E39-F1	4,000 *2	4,000 *2	4,000 *2	4,000 *2	2,000
		6 °	E32-T11R 2M + E39-F16	4,000 *2	4,000 *2	4,000 *2	4,000 *2	3,600
	Side-view	60 °	E32-T11R 2M + E39-F2	1,450	1,040	800	500	200
	Top-view	12 °	E32-T11 2M + E39-F1	4,000 *2	4,000 *2	4,000 *2	4,000 *2	1,860
		6 °	E32-T11 2M + E39-F16	4,000 *2	4,000 *2	4,000 *2	4,000 *2	4,000 *2
	Side-view	60 °	E32-T11 2M + E39-F2	2,300	1,640	1,320	860	320
	Top-view	12 °	E32-T51R 2M + E39-F1	4,000 *2	4,000 *2	4,000 *2	3,900	1,500
		6 °	E32-T51R 2M + E39-F16	4,000 *2	4,000 *2	4,000 *2	4,000 *2	4,000 *2
	Side-view	60 °	E32-T51R 2M + E39-F2	1,400	1,000	720	500	200
	Top-view	12 °	E32-T81R-S 2M + E39-F1	4,000 *2	4,000 *2	4,000 *2	2,700	1,000
		6 °	E32-T81R-S 2M + E39-F16	4,000 *2	4,000 *2	4,000 *2	4,000 *2	1,800
	Side-view	60 °	E32-T81R-S 2M + E39-F2	1,000	720	550	360	140
	Top-view	12 °	E32-T61-S 2M + E39-F1	4,000 *2	4,000 *2	4,000 *2	4,000 *2	1,800
		6 °	E32-T61-S 2M + E39-F16	4,000 *2	4,000 *2	4,000 *2	4,000 *2	3,100
	Side-view	60 °	E32-T61-S 2M + E39-F2	1,680	1,200	900	600	240
	Top-view	12 °	E32-T51 2M + E39-F1-33	4,000 *2	4,000 *2	4,000 *2	2,300	1,400
6 °		E32-T51 2M + E39-F16	4,000 *2	4,000 *2	4,000 *2	4,000 *2	4,000 *2	
Reflective Integrated lens	Top-view	4 °	E32-D16 2M	40 to 2,800	40 to 2,000	40 to 1,400	40 to 900	40 to 480

\*1. The fiber length is 10 m on each side, so the sensing distance is given as 20,000 mm.

\*2. The fiber length is 2 m on each side, so the sensing distance is given as 4,000 mm.

## Narrow View

Sensing method	Sensing direction	Aperture angle	Model	Sensing distance (mm)				
				Tough mode	High-resolution mode	Standard mode	High-speed mode	Super-high-speed mode
Through-beam	Side-view	1.5 °	E32-A03 2M	3,220	2,300	1,780	1,200	500
			E32-A03-1 2M					
		3.4 °	E32-A04 2M	1,280	920	680	450	200
		4 °	E32-T24SR 2M	4,000 *	2,960	2,200	1,460	580
			E32-T24S 2M	4,000 *	3,500	2,600	1,740	700
			E32-T22S 2M	4,000 *	4,000 *	3,800	2,500	1,000

\* The fiber length is 2 m on each side, so the sensing distance is given as 4,000 mm.

**Note:** The High-speed Mode cannot be used with the E3X-DA0-S.

## E3X-DA□-S (□: 21/51/7/9/0) ▪ E3X-DA□F-S (□: 21/51/7/9) Detection without Background Interference

Sensing method	Sensing direction	Model	Sensing distance (mm)				
			Tough mode	High-resolution mode	Standard mode	High-speed mode	Super-high-speed mode
Limited-reflective	Flat-view	E32-L16-N 2M	0 to 15				0 to 12
		E32-L24S 2M	0 to 4				
	Side-view	E32-L25L 2M	5.4 to 9 (center 7.2)				

## Transparent Object Detection (Retro-reflective)

Sensing method	Feature	Size	Model	Sensing distance (mm)				
				Tough mode	High-resolution mode	Standard mode	High-speed mode	Super-high-speed mode
Retro-reflective	Film detection	M3	E32-C31 2M + E39-F3R + E39-RP37	250			200	–
	Square	–	E32-R16 2M	150 to 1,500				
	Threaded Models	M6	E32-R21 2M	10 to 250				
	Hex-shaped		E32-LR11NP 2M + E39-RP1	1,350	1,270	1,200	1,000	550

## Transparent Object Detection (Limited-reflective)

Sensing method	Feature	Sensing direction	Model	Sensing distance (mm)				
				Tough mode	High-resolution mode	Standard mode	High-speed mode	Super-high-speed mode
Limited-reflective	Small size	Flat-view	E32-L24S 2M	0 to 4				
	Standard		E32-L16-N 2M	0 to 15			0 to 12	
	Glass substrate alignment, 70 °C		E32-A08 2M	10 to 20			–	
	Standard/long-distance		E32-A12 2M	12 to 30			–	
	Side view form	Side-view	E32-L25L 2M	5.4 to 9 (center 7.2)				
	Glass substrate mapping, 70 °C	Top-view	E32-A09 2M	15 to 38			–	

## Chemical-resistant, Oil-resistant

Sensing method	Type	Sensing direction	Model	Sensing distance (mm)				
				Tough mode	High-resolution mode	Standard mode	High-speed mode	Super-high-speed mode
Through-beam	Oil-resistant	Right-angle	E32-T11NF 2M	4,000 *1	4,000 *1	4,000 *1	4,000 *1	2,200
	Chemical/oil-resistant	Top-view	E32-T12F 2M	4,000 *1	4,000 *1	4,000 *1	4,000 *1	1,600
			E32-T11F 2M	4,000 *1	4,000 *1	4,000 *1	2,600	1,000
		Side-view	E32-T14F 2M	1,400	1,000	800	500	200
	Chemical/oil-resistant at 150 °C	Top-view	E32-T51F 2M	4,000 *1	3,600	2,800	1,800	700
Reflective	Semiconductors: Cleaning, developing, and etching; 60°C	Top-view	E32-L11FP 2M	8 to 20 mm from tip of lens (Recommended detection distance: 11 mm), 19 to 31 mm from center of mounting hole A (Recommended detection distance: 22 mm)				
	Semiconductors: Resist stripping; 85°C		E32-L11FS 2M	8 to 20 mm from tip of lens (Recommended detection distance: 11 mm), 32 to 44 mm from center of mounting hole A (Recommended detection distance: 35 mm)				
	Chemical/oil-resistant		E32-D12F 2M	– *2	320	190	130	60
	Chemical-resistant cable		E32-D11U 2M	840	600	350	240	100

\*1. The fiber length is 2 m on each side, so the sensing distance is given as 4,000 mm.

\*2. Even if there is no sensing object, the sensor will detect light that is reflected by the fluorescein.

**Note:** The High-speed Mode cannot be used with the E3X-DA0-S.



E3X-DA□-S (□: 21/51/7/9/0) ▪ E3X-DA□F-S(□: 21/51/7/9)

**Bending-resistant**

Sensing method	Size	Model	Sensing distance (mm)				
			Tough mode	High-resolution mode	Standard mode	High-speed mode	Super-high-speed mode
Through-beam	1.5 dia.	E32-T22B 2M	680	480	400	220	90
	M3	E32-T21 2M					
	M4	E32-T11 2M	2,500	1,800	1,350	900	360
	Square	E32-T25XB 2M	500	360	300	170	70
Reflective	1.5 dia.	E32-D22B 2M	140	100	60	40	16
	M3	E32-D21 2M					
	3 dia.	E32-D221B 2M	300	220	140	90	40
	M4	E32-D21B 2M					
	M6	E32-D11 2M	840	600	350	240	100
	Square	E32-D25XB 2M	240	170	100	60	30

**Heat-resistant**

Sensing method	Heat-resistant temperature	Model	Sensing distance (mm)					
			Tough mode	High-resolution mode	Standard mode	High-speed mode	Super-high-speed mode	
Through-beam	100 °C	E32-T51R 2M	1,600	1,100	800	560	225	
	150 °C	E32-T51 2M	2,800	2,000	1,500	1,000	400	
	200 °C	E32-T81R-S 2M	1,000	720	550	360	140	
	350 °C	E32-T61-S 2M	1,680	1,200	900	600	240	
Reflective	100 °C	E32-D51R 2M	670	480	280	190	80	
	150 °C	E32-D51 2M	1,120	800	450	320	144	
	200 °C	E32-D81R-S 2M	420	300	180	120	54	
	300 °C	E32-A08H2 2M	10 to 20					–
		E32-A09H2 2M	20 to 30 (center 25)					–
	350 °C	E32-D611-S 2M	420	300	180	120	54	
		E32-D61-S 2M						
	400 °C	E32-D73-S 2M	280	200	120	80	36	

**Area Beam**

Sensing method	Type	Sensing width	Model	Sensing distance (mm)				
				Tough mode	High-resolution mode	Standard mode	High-speed mode	Super-high-speed mode
Through-beam	Area	11 mm	E32-T16PR 2M	3,100	2,200	1,700	1,120	440
			E32-T16JR 2M	2,750	2,000	1,500	960	380
		30 mm	E32-T16WR 2M	4,000 *	3,400	2,600	1,700	680
Reflective	Array	11 mm	E32-D36P1 2M	700	500	300	200	90

\* The fiber length is 2 m on each side, so the sensing distance is given as 4,000 mm.

**Liquid-level Detection**

Sensing method	Tube diameter	Feature	Model	Sensing distance (mm)				
				Tough mode	High-resolution mode	Standard mode	High-speed mode	Super-high-speed mode
Tube-mounting	3.2/6.4/9.5 dia	Stable residual quantity detection	E32-A01 5M	Applicable tube: Transparent tube with a diameter of 3.2, 6.4, or 9.5 mm, Recommended wall thickness: 1 mm				
	8 to 10 dia	Mounting at multi levels	E32-L25T 2M	Applicable tube: Transparent tube with a diameter of 8 to 10 mm, Recommended wall thickness: 1 mm				
	No restrictions	Large tubes	E32-D36T 2M	Applicable tube: Transparent tube (no restrictions on diameter)				
Liquid contact (heat-resistant up to 200 °C)	–	–	E32-D82F1 4M	Liquid-contact Type				

**Note:** The High-speed Mode cannot be used with the E3X-DA0-S.

# E3X-DA-S

## E3X-DA□-S (□: 21/51/7/9/0) ▪ E3X-DA□F-S(□: 21/51/7/9) Vacuum-resistant

Sensing method	Heat-resistant temperature	Model	Sensing distance (mm)				
			Tough mode	High-resolution mode	Standard mode	High-speed mode	Super-high-speed mode
Through-beam	120 °C	E32-T51V 1M	720	520	400	260	100
		E32-T51V 1M + E39-F1V	2,000 *	2,000 *	2,000 *	1,360	520
	200 °C	E32-T84SV 1M	1,760	1,250	950	640	260

\* The fiber length is 1 m on each side, so the sensing distance is given as 2,000 mm.

## FPD, Semiconductors, and Solar Cells

Sensing method	Application	Operating temperature	Model	Sensing distance (mm)				
				Tough mode	High-resolution mode	Standard mode	High-speed mode	Super-high-speed mode
Limited-reflective	Glass presence detection	70 °C	E32-L16-N 2M	0 to 15				0 to 12
	Glass substrate alignment		E32-A08 2M	10 to 20				–
		Glass substrate mapping	300 °C	E32-A08H2 2M	12 to 30			
	70 °C		E32-A12 2M	15 to 38				–
			300 °C	E32-A09 2M	20 to 30			
	Wet processes: Cleaning, Resist developing and etching	60 °C	E32-L11FP 2M	8 to 20 mm from tip of lens (Recommended detection distance: 11 mm), 19 to 31 mm from center of mounting hole A (Recommended detection distance: 22 mm)				
	Wet process: Resist stripping	85 °C	E32-L11FS 2M	8 to 20 mm from tip of lens (Recommended detection distance: 11 mm), 32 to 44 mm from center of mounting hole A (Recommended detection distance: 35 mm)				
Through-beam	Wafer mapping	70 °C	E32-A03 2M	3,220	2,300	1,780	1,200	500
			E32-A03-1 2M					
			E32-A04 2M	1,280	920	680	450	200
			E32-T24SR 2M	4,000 *	2,960	2,200	1,460	580
			E32-T24S 2M	4,000 *	3,500	2,600	1,740	700

\* The fiber length is 2 m on each side, so the sensing distance is given as 4,000 mm.

**Note:** The High-speed Mode cannot be used with the E3X-DA0-S.

**E3X-DA□R-S (□:21/51/7/9)**  
**Threaded Models**

Sensing method	Sensing direction	Size	Model	Sensing distance (mm)				
				Tough mode	High-resolution mode	Standard mode	High-speed mode	Super-high-speed mode
Through-beam	Right-angle	M4	E32-T11N 2M	1,000	700	500	350	140
			E32-LT11N 2M	3,200	2,300	1,750	1,150	460
	Straight		E32-T11R 2M	1,000	700	530	350	140
			E32-LT11 2M	3,800	2,700	2,050	1,350	540
			E32-LT11R 2M	3,200	2,300	1,750	1,150	460
Reflective	Right-angle	M3	E32-C31N 2M	55	40	25	23	7
			E32-C21N 2M	145	75	65	45	20
		M4	E32-D21N 2M	420	300	175	120	50
			E32-C11N 2M	390	280	175	160	50
		M6	E32-LD11N 2M	420	300	170	120	50
			E32-D21R 2M	70	50	30	20	8
	Straight	M3	E32-C31 2M	165	120	75	50	22
			E32-C31M 1M					
			E32-D211R 2M					
		M6	E32-D11R 2M	420	300	170	120	50
			E32-CC200 2M	700	500	300	200	90
			E32-LD11 2M	430	305	180	125	55
			E32-LD11R 2M	420	300	170	120	50

**Cylindrical Models**

Sensing method	Size	Sensing direction	Model	Sensing distance (mm)				
				Tough mode	High-resolution mode	Standard mode	High-speed mode	Super-high-speed mode
Through-beam	1 dia.	Top-view	E32-T223R 2M	220	160	130	75	30
	1.5 dia.		E32-T22B 2M	340	240	200	110	45
	3 dia.		E32-T12R 2M	1,000	700	530	350	140
		Side-view	E32-T14LR 2M	370	270	210	130	50
Reflective	1.5 dia.	Top-view	E32-D22B 2M	70	50	30	20	8
	1.5 dia. + 0.5 dia.		E32-D43M 1M	15	11	6	4	2
	3 dia.		E32-D22R 2M	70	50	30	20	8
			E32-D221B 2M	150	110	70	45	20
			E32-D32L 2M	350	250	150	100	45
	3 dia. + 0.8 dia.		E32-D33 2M	35	25	16	10	4

**Flat Models**

Sensing method	Sensing direction	Model	Sensing distance (mm)				
			Tough mode	High-resolution mode	Standard mode	High-speed mode	Super-high-speed mode
Through-beam	Top-view	E32-T15XR 2M	1,000	700	530	350	140
	Side-view	E32-T15YR 2M	370	270	210	130	50
	Flat-view	E32-T15ZR 2M					
Reflective	Top-view	E32-D15XR 2M	420	300	170	120	50
	Side-view	E32-D15YR 2M	100	70	40	26	12
	Flat-view	E32-D15ZR 2M					

# E3X-DA-S

## E3X-DA□R-S (□:21/51/7/9) Sleeve Models

Sensing method	Sensing direction	Model	Sensing distance (mm)				
			Tough mode	High-resolution mode	Standard mode	High-speed mode	Super-high-speed mode
Through-beam	Side-view	E32-T24R 2M	85	60	50	25	10
		E32-T24E 2M	225	150	125	75	30
	Top-view	E32-T21-S1 2M	255	180	150	85	34
		E32-T33 1M	75	55	45	25	10
		E32-TC200BR 2M	1,000	700	530	350	140
Reflective	Side-view	E32-D24R 2M	35	26	15	10	4
		E32-D24-S2 2M	60	40	26	23	7
	Top-view	E32-D43M 1M	15	11	6	4	2
		E32-D331 2M	7	5	3	2	0.8
		E32-D33 2M	35	25	16	10	4
		E32-D32-S1 0.5M	31	21	13	9	3
		E32-D31-S1 0.5M					
		E32-DC200F4R 2M	70	50	30	20	8
		E32-D22-S1 2M	125	85	55	36	15
		E32-D21-S3 2M					
E32-DC200BR 2M	420	300	170	120	50		
E32-D25-S3 2M	125	85	55	36	15		

### Small-spot, Reflective

Type	Spot diameter	Center distance (mm)	Model	Sensing distance (mm)				
				Tough mode	High-resolution mode	Standard mode	High-speed mode	Super-high-speed mode
Variable spot	0.1 to 0.6 dia.	6 to 15	E32-C42 1M + E39-F3A	Spot diameter of 0.1 to 0.6 mm at 6 to 15 mm.				
	0.3 to 1.6 dia.	10 to 30	E32-C42 1M + E39-F17	Spot diameter of 0.3 to 1.6 mm at 10 to 30 mm.				
Parallel light	4 dia.	0 to 20	E32-C31 2M + E39-F3C E32-C31N 2M + E39-F3C	Spot diameter of 4 mm max. at 0 to 20 mm.				
Integrated lens	0.1 dia.	5	E32-C42S 1M	Spot diameter of 0.1 mm at 5 mm.				
	6 dia.	50	E32-L15 2M	Spot diameter of 6 mm at 50 mm.				
Small-spot	0.1 dia.	7	E32-C41 1M + E39-F3A-5	Spot diameter of 0.1 mm at 7 mm.				
	0.5 dia.		E32-C31 2M + E39-F3A-5	Spot diameter of 0.5 mm at 7 mm.				
			E32-C31N 2M + E39-F3A-5					
	0.2 dia.	17	E32-C41 1M + E39-F3B	Spot diameter of 0.2 mm at 17 mm.				
	0.5 dia.		E32-C31 2M + E39-F3B E32-C31N 2M + E39-F3B	Spot diameter of 0.5 mm at 17 mm.				
3 dia.	50	E32-CC200 2M + E39-F18 E32-C11N 2M + E39-F18	Spot diameter of 3 mm at 50 mm.					

**E3X-DA□R-S (□:21/51/7/9)**  
**High-power Beam**

Type	Sensing direction	Aperture angle	Model	Sensing distance (mm)				
				Tough mode	High-resolution mode	Standard mode	High-speed mode	Super-high-speed mode
Through-beam Integrated lens	Right-angle	15 °	E32-LT11N 2M	3,200	2,300	1,750	1,150	460
	Top-view	10 °	E32-T17L 10M	20,000 *1	20,000 *1	20,000 *1	10,000	4,000
		15 °	E32-LT11 2M	3,800	2,700	2,050	1,350	540
	E32-LT11R 2M		3,200	2,300	1,750	1,150	460	
Side-view	30 °	E32-T14 2M	4,000 *2	4,000 *2	3,400	2,250	900	
Through-beam models with lenses	Right-angle	12 °	E32-T11N 2M + E39-F1	4,000 *2	4,000 *2	3,700	2,400	970
		6 °	E32-T11N 2M + E39-F16	4,000 *2	4,000 *2	4,000 *2	4,000 *2	1,800
	Top-view	12 °	E32-T11R 2M + E39-F1	4,000 *2	4,000 *2	3,700	2,400	970
		6 °	E32-T11R 2M + E39-F16	4,000 *2	4,000 *2	4,000 *2	4,000 *2	1,800
	Side-view	60 °	E32-T11R 2M + E39-F2	725	520	400	250	100
	Top-view	12 °	E32-T11 2M + E39-F1	4,000 *2	4,000 *2	3,600	2,300	930
		6 °	E32-T11 2M + E39-F16	4,000 *2	4,000 *2	4,000 *2	4,000 *2	2,300
	Side-view	60 °	E32-T11 2M + E39-F2	1,150	820	660	430	160
	Top-view	12 °	E32-T51R 2M + E39-F1	4,000 *2	3,900	2,900	1,900	760
		6 °	E32-T51R 2M + E39-F16	4,000 *2	4,000 *2	4,000 *2	3,600	1,400
	Side-view	60 °	E32-T51R 2M + E39-F2	700	500	360	250	100
	Top-view	12 °	E32-T81R-S 2M + E39-F1	4,000 *2	2,650	2,100	1,300	520
		6 °	E32-T81R-S 2M + E39-F16	4,000 *2	4,000 *2	3,600	2,300	900
	Side-view	60 °	E32-T81R-S 2M + E39-F2	500	360	280	180	70
	Top-view	12 °	E32-T61-S 2M + E39-F1	4,000 *2	4,000 *2	3,400	2,200	900
		6 °	E32-T61-S 2M + E39-F16	4,000 *2	4,000 *2	4,000 *2	3,900	1,500
	Side-view	60 °	E32-T61-S 2M + E39-F2	840	600	450	300	120
	Top-view	12 °	E32-T51 2M + E39-F1-33	4,000 *2	3,400	2,660	1,150	700
6 °		E32-T51 2M + E39-F16	4,000 *2	4,000 *2	4,000 *2	4,000 *2	2,600	
Reflective Integrated lens	Top-view	4 °	E32-D16 2M	40 to 1,400	40 to 1,000	40 to 700	40 to 450	40 to 240

\*1. The fiber length is 10 m on each side, so the sensing distance is given as 20,000 mm.

\*2. The fiber length is 2 m on each side, so the sensing distance is given as 4,000 mm.

**Narrow View**

Sensing method	Sensing direction	Aperture angle	Model	Sensing distance (mm)				
				Tough mode	High-resolution mode	Standard mode	High-speed mode	Super-high-speed mode
Through-beam	Side-view	1.5 °	E32-A03 2M	1,610	1,150	890	600	250
			E32-A03-1 2M					
		3.4 °	E32-A04 2M	640	460	340	225	100
		4 °	E32-T24SR 2M	2,100	1,500	1,100	750	300
			E32-T24S 2M	2,400	1,750	1,300	870	350
E32-T22S 2M	3,500	2,500	1,900	1,250	500			

**Detection without Background Interference**

Sensing method	Sensing direction	Model	Sensing distance (mm)				
			Tough mode	High-resolution mode	Standard mode	High-speed mode	Super-high-speed mode
Limited-reflective	Flat-view	E32-L16-N 2M	0 to 15				0 to 12
		E32-L24S 2M	0 to 4				
	Side-view	E32-L25L 2M	5.4 to 9 (center 7.2)				

**E3X-DA□R-S (□:21/51/7/9)**  
**Transparent Object Detection (Retro-reflective)**

Sensing method	Feature	Size	Model	Sensing distance (mm)				
				Tough mode	High-resolution mode	Standard mode	High-speed mode	Super-high-speed mode
Retro-reflective	Film detection	M3	E32-C31 2M + E39-F3R + E39-RP37	250	200	150	100	50
	Square	–	E32-R16 2M	150 to 1,500				
	Threaded Models	M6	E32-R21 2M	10 to 250				
	Hex-shaped		E32-LR11NP 2M + E39-RP1	675	630	600	500	275

**Transparent Object Detection (Limited-reflective)**

Sensing method	Feature	Sensing direction	Model	Sensing distance (mm)				
				Tough mode	High-resolution mode	Standard mode	High-speed mode	Super-high-speed mode
Limited-reflective	Small size	Flat-view	E32-L24S 2M	0 to 4				
	Standard		E32-L16-N 2M	0 to 15				0 to 12
	Glass substrate alignment, 70 °C		E32-A08 2M	10 to 20				
	Standard/long-distance		E32-A12 2M	12 to 30				
	Side view form	Side-view	E32-L25L 2M	5.4 to 9 (center 7.2)				
	Glass substrate mapping, 70 °C	Top-view	E32-A09 2M	15 to 38				

**Chemical-resistant, Oil-resistant**

Sensing method	Type	Sensing direction	Model	Sensing distance (mm)				
				Tough mode	High-resolution mode	Standard mode	High-speed mode	Super-high-speed mode
Through-beam	Oil-resistant	Right-angle	E32-T11NF 2M	4,000 *1	4,000 *1	4,000 *1	3,100	1,200
	Chemical/oil-resistant	Top-view	E32-T12F 2M	4,000 *1	4,000 *1	3,000	2,000	800
			E32-T11F 2M	3,500	2,500	2,000	1,300	520
		Side-view	E32-T14F 2M	700	500	400	250	100
	Chemical/oil-resistant at 150 °C	Top-view	E32-T51F 2M	2,500	1,800	1,400	900	350
Reflective	Semiconductors: Cleaning, developing, and etching; 60°C	Top-view	E32-L11FP 2M	8 to 20 mm from tip of lens (Recommended detection distance: 11 mm), 19 to 31 mm from center of mounting hole A (Recommended detection distance: 22 mm)				
	Semiconductors: Resist stripping; 85°C		E32-L11FS 2M	8 to 20 mm from tip of lens (Recommended detection distance: 11 mm), 32 to 44 mm from center of mounting hole A (Recommended detection distance: 35 mm)				
	Chemical/oil-resistant		E32-D12F 2M	– *2	160	95	65	30
	Chemical-resistant cable		E32-D11U 2M	420	300	170	120	50

\*1. The fiber length is 2 m on each side, so the sensing distance is given as 4,000 mm.

\*2. Even if there is no sensing object, the sensor will detect light that is reflected by the fluororesin.

**Bending-resistant**

Sensing method	Size	Model	Sensing distance (mm)				
			Tough mode	High-resolution mode	Standard mode	High-speed mode	Super-high-speed mode
Through-beam	1.5 dia.	E32-T22B 2M	340	240	200	110	45
	M3	E32-T21 2M					
	M4	E32-T11 2M	1,250	900	680	450	180
	Square	E32-T25XB 2M	250	180	150	85	35
Reflective	1.5 dia.	E32-D22B 2M	70	50	30	20	8
	M3	E32-D21 2M					
	3 dia.	E32-D221B 2M	150	110	70	45	20
	M4	E32-D21B 2M					
	M6	E32-D11 2M	420	300	170	120	50
	Square	E32-D25XB 2M	120	85	50	30	15

**E3X-DA□R-S (□:21/51/7/9)**  
**Heat-resistant**

Sensing method	Heat-resistant temperature	Model	Sensing distance (mm)				
			Tough mode	High-resolution mode	Standard mode	High-speed mode	Super-high-speed mode
Through-beam	100 °C	E32-T51R 2M	800	560	425	280	110
	150 °C	E32-T51 2M	1,400	1,000	760	500	200
	200 °C	E32-T81R-S 2M	500	360	280	180	70
	350 °C	E32-T61-S 2M	840	600	450	300	120
Reflective	100 °C	E32-D51R 2M	330	240	135	95	40
	150 °C	E32-D51 2M	560	400	230	160	72
	200 °C	E32-D81R-S 2M	210	150	90	60	27
	300 °C	E32-A08H2 2M	10 to 20				
		E32-A09H2 2M	20 to 30 (center 25)				
	350 °C	E32-D61-S 2M	210	150	90	60	27
		E32-D61-S 2M					
	400 °C	E32-D73-S 2M	140	100	60	40	18

**Area Beam**

Sensing method	Type	Sensing width	Model	Sensing distance (mm)				
				Tough mode	High-resolution mode	Standard mode	High-speed mode	Super-high-speed mode
Through-beam	Area	11 mm	E32-T16PR 2M	1,550	1,100	840	560	220
			E32-T16JR 2M	1,370	980	750	480	190
		30 mm	E32-T16WR 2M	2,000	1,700	1,300	850	340
Reflective	Array	11 mm	E32-D36P1 2M	350	250	150	100	45

**Liquid-level Detection**

Sensing method	Tube diameter	Feature	Model	Sensing distance (mm)				
				Tough mode	High-resolution mode	Standard mode	High-speed mode	Super-high-speed mode
Tube-mounting	3.2/6.4/9.5 dia	Stable residual quantity detection	E32-A01 5M	Applicable tube: Transparent tube with a diameter of 3.2, 6.4, or 9.5 mm, Recommended wall thickness: 1 mm				
	8 to 10 dia	Mounting at multi levels	E32-L25T 2M	Applicable tube: Transparent tube with a diameter of 8 to 10 mm, Recommended wall thickness: 1 mm				
	No restrictions	Large tubes	E32-D36T 2M	Applicable tube: Transparent tube (no restrictions on diameter)				
Liquid contact (heat-resistant up to 200 °C)	–	–	E32-D82F1 4M	Liquid-contact Type				

**Vacuum-resistant**

Sensing method	Heat-resistant temperature	Model	Sensing distance (mm)				
			Tough mode	High-resolution mode	Standard mode	High-speed mode	Super-high-speed mode
Through-beam	120 °C	E32-T51V 1M	360	260	200	130	50
		E32-T51V 1M + E39-F1V	1,890	1,350	1,000	680	260
	200 °C	E32-T84SV 1M	880	630	480	320	130

# E3X-DA-S

## E3X-DA□R-S (□:21/51/7/9) FPD, Semiconductors, and Solar Cells

Sensing method	Application	Operating temperature	Model	Sensing distance (mm)				
				Tough mode	High-resolution mode	Standard mode	High-speed mode	Super-high-speed mode
Limited-reflective	Glass presence detection	70 °C	E32-L16-N 2M	0 to 15				0 to 12
	Glass substrate alignment		E32-A08 2M	10 to 20				
		300 °C	E32-A08H2 2M	12 to 30				
	Glass substrate mapping	70 °C	E32-A12 2M	15 to 38				
			E32-A09 2M	20 to 30 (center 25)				
	Wet processes: Cleaning, Resist developing and etching	60 °C	E32-L11FP 2M	8 to 20 mm from tip of lens (Recommended detection distance: 11 mm), 19 to 31 mm from center of mounting hole A (Recommended detection distance: 22 mm)				
Wet process: Resist stripping	85 °C	E32-L11FS 2M	8 to 20 mm from tip of lens (Recommended detection distance: 11 mm), 32 to 44 mm from center of mounting hole A (Recommended detection distance: 35 mm)					
Through-beam	Wafer mapping	70 °C	E32-A03 2M	1,610	1,150	890	600	250
			E32-A03-1 2M					
			E32-A04 2M	640	460	340	225	100
			E32-T24SR 2M	2,100	1,500	1,100	750	300
			E32-T24S 2M	2,400	1,750	1,300	870	350



# I/O Circuit Diagrams

## NPN Output

Model	Operation mode	Timing charts	Operation selector	Output circuit
E3X-DA21-S E3X-DA21R-S E3X-DA21F-S	Light-ON	ch1/ Incident light ch2 No incident light Operation indicator ON (orange) OFF Output transistor ON OFF Load Operate (e.g., relay) Reset (Between brown and black (orange) leads)	LIGHT ON (L-ON)	<b>E3X-DA21-S</b> <p>*1. For the E3X-DA21R-S, this is the APC alarm output. This output does not exist on the E3X-DA21F-S. *2. This input does not exist the E3X-DA21F-S.</p>
	Dark-ON	ch1/ Incident light ch2 No incident light Operation indicator ON (orange) OFF Output transistor ON OFF Load Operate (e.g., relay) Reset (Between brown and black (orange) leads)	DARK ON (D-ON)	
E3X-DA7-S E3X-DA7R-S E3X-DA7F-S	Light-ON	ch1/ Incident light ch2 No incident light Operation indicator ON (orange) OFF Output transistor ON OFF Load Operate (e.g., relay) Reset (Between brown and black (orange) leads)	LIGHT ON (L-ON)	<b>E3X-DA7-S</b> <p>* For the E3X-DA7R-S, this is the APC alarm output. This output does not exist on the E3X-DA7F-S.</p>
	Dark-ON	ch1/ Incident light ch2 No incident light Operation indicator ON (orange) OFF Output transistor ON OFF Load Operate (e.g., relay) Reset (Between brown and black (orange) leads)	DARK ON (D-ON)	

## PNP Output

Model	Operation mode	Timing charts	Operation selector	Output circuit
E3X-DA51-S E3X-DA51R-S E3X-DA51F-S	Light-ON	ch1/ Incident light ch2 No incident light Operation indicator ON (orange) OFF Output transistor ON OFF Load Operate (e.g., relay) Reset (Between blue and black (orange) leads)	LIGHT ON (L-ON)	<b>E3X-DA51-S</b> <p>*1. For the E3X-DA51R-S, this is the APC alarm output. This output does not exist on the E3X-DA51F-S. *2. This input does not exist the E3X-DA51F-S.</p>
	Dark-ON	ch1/ Incident light ch2 No incident light Operation indicator ON (orange) OFF Output transistor ON OFF Load Operate (e.g., relay) Reset (Between blue and black (orange) leads)	DARK ON (D-ON)	
E3X-DA9-S E3X-DA9R-S E3X-DA9F-S	Light-ON	ch1/ Incident light ch2 No incident light Operation indicator ON (orange) OFF Output transistor ON OFF Load Operate (e.g., relay) Reset (Between blue and black (orange) leads)	LIGHT ON (L-ON)	<b>E3X-DA9-S</b> <p>* For the E3X-DA9R-S, this is the APC alarm output. This output does not exist on the E3X-DA9F-S.</p>
	Dark-ON	ch1/ Incident light ch2 No incident light Operation indicator ON (orange) OFF Output transistor ON OFF Load Operate (e.g., relay) Reset (Between blue and black (orange) leads)	DARK ON (D-ON)	

**Note:** 1. Operation with area settings is as follows:  
 LIGHT ON: ON when the incident level is between the thresholds for channels 1 and 2.  
 DARK ON: OFF when the incident level is between the thresholds for channels 1 and 2.  
 2. Timing Charts for Timer Settings (T: Set Time)

ON delay	OFF delay	One-shot	ON delay and OFF delay

T<sub>1</sub>: ON-delay set time  
 T<sub>2</sub>: OFF-delay set time  
 T<sub>1</sub> and T<sub>2</sub> can be set separately.

# E3X-DA-S

## Nomenclature

### Fiber Amplifier Units

E3X-DA□-S (□: 21/51/7/9/0)

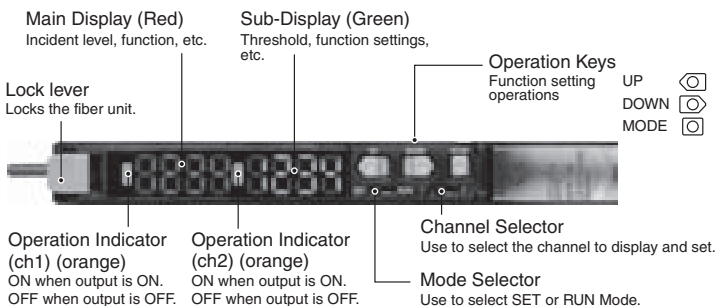

**Note:** Nomenclature and operating procedures for the E3X-DA□R-S and E3X-DA□F-S (□: 21/51/7/9) are given on pages 19 and 20.

## Operating Procedure

### 1 Setting the Operation Mode

The operation mode is set in SET Mode.  
→ Refer to 5. Setting Functions on page 20.

Set the Channel Selector Switch to the desired channel before making any adjustments or settings.

### 2 Adjusting the Power (RUN Mode)

The current incident light level can be adjusted near the power tuning target value (default: 2,000).

\* Confirm that the MODE Key setting is PTUN (power tuning). The default setting is PTUN.

→ Refer to 5. Setting Functions on page 20.

\* If power tuning is executed while SHS is selected for the detection function, the minimum power will be set.

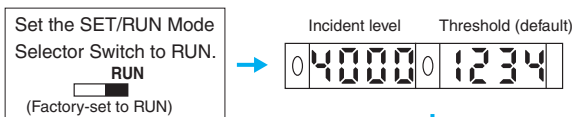

Release the key after the progress bar is displayed.

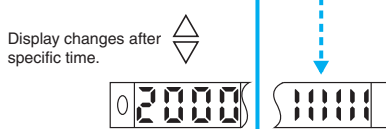

This completes the adjustment.



To restore the default power setting:

\* Press the DOWN Key right after pressing the MODE Key.

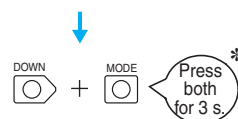

"OFF" will flash twice.

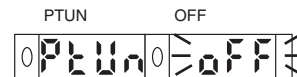

This restores the default setting.

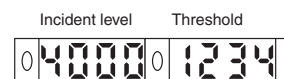

\* Setting Errors

An error has occurred if one of the following displays appears after the progress bar is displayed.

Display	Error	Action
Flashes twice 0 Ptun 0   over	<b>Over Error</b> The incident light level is too low for the power tuning target value.	The power will not be tuned. The power can be increased up to approximately 5 times the incident light value.
Flashes twice 0 Ptun 0   botm	<b>Bottom Error</b> The incident light level is too high for the power tuning target value.	The power will be turned to the minimum level. The power can be decreased down to approximately 1/20th the incident light value.

### 3 Setting Thresholds Manually (RUN Mode)

A threshold can be set manually. A threshold can also be adjusted manually after teaching to fine-tune it.

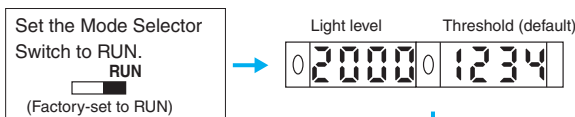

Increases threshold. Decreases threshold.

\* Even if the display method is changed, the threshold will appear on the sub-display when the key is pressed.

4 Teaching the Threshold (SET Mode)

- \* There are five methods that can be used for teaching, as described below. Use the method most suitable for the application.
- \* Two-point teaching, positioning teaching, and automatic teaching can be performed in RUN Mode. For operating procedures, refer to the *Instruction Manual* provided with the product.
- \* An error has occurred if OVER or LO is displayed on the sub-display. If that occurs, repeat the operation from the beginning.

4-1. Setting the Threshold at Maximum Sensitivity

The threshold can be set to the maximum sensitivity. This is useful when the longest detection distance is required.

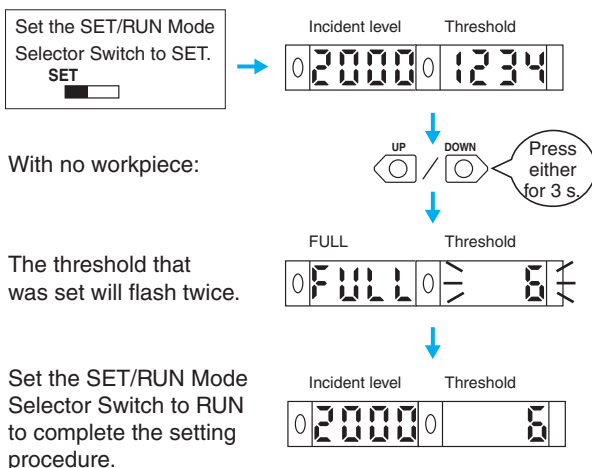

4-2. Teaching a Through-beam Fiber Unit without a Workpiece

You can set the threshold to below the incident light level without a workpiece by the percentage set for the teaching level.

→ Refer to 5. Setting Functions on page 20.

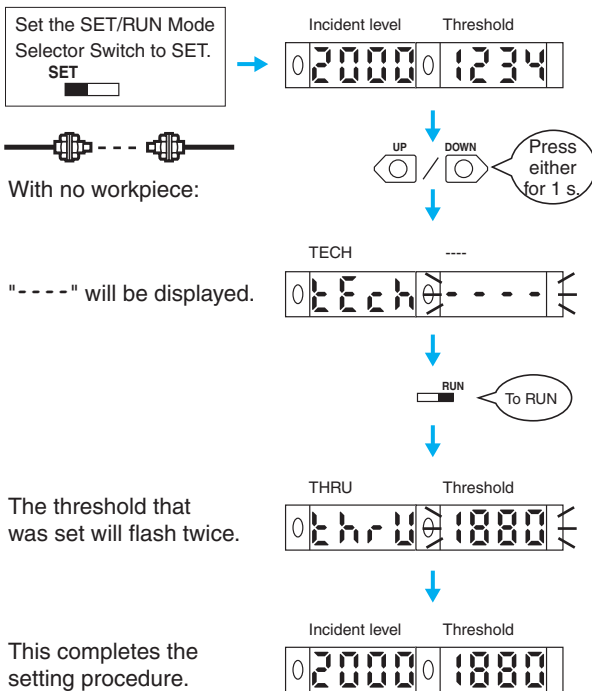

4-3. Teaching a Reflective Fiber Unit without a Workpiece

You can set the threshold to above the incident light level without a workpiece by the percentage set for the teaching level.

→ Refer to 5. Setting Functions on page 20.

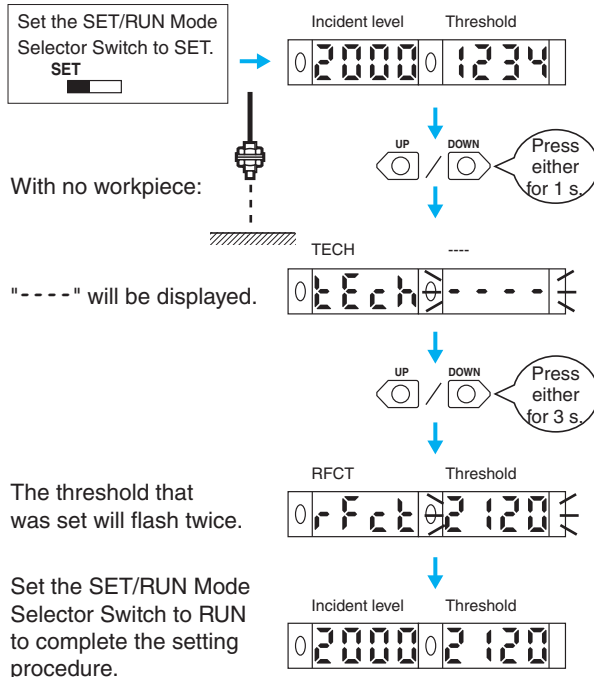

4-4. Two-point Teaching

4-5. Positioning Teaching

Two points in the following figures are detected, and the intermediate point of the light levels for the two points is set as the threshold.

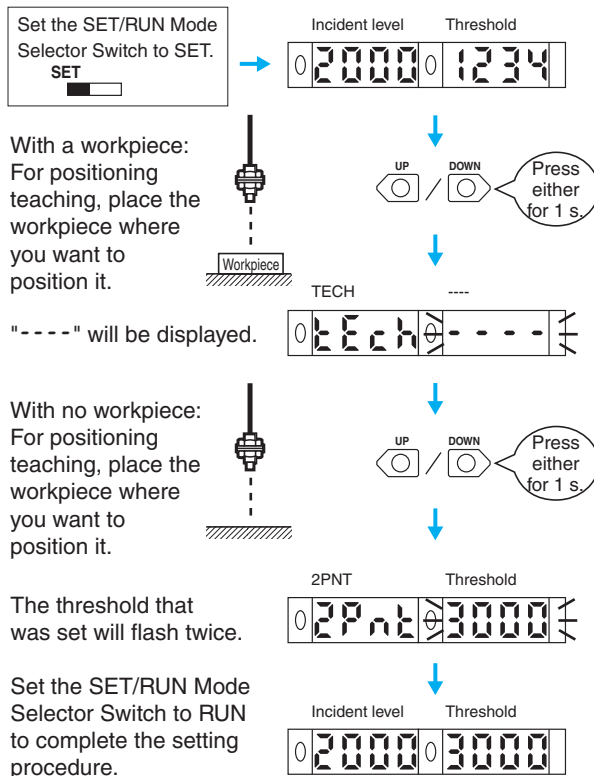

5 Setting Functions (SET Mode)

\* The function transition boxes show the default settings.  
 \* More functions may be displayed depending on the detailed settings.

Moving between Functions → Refer to 4. Teaching the Threshold on page 19.

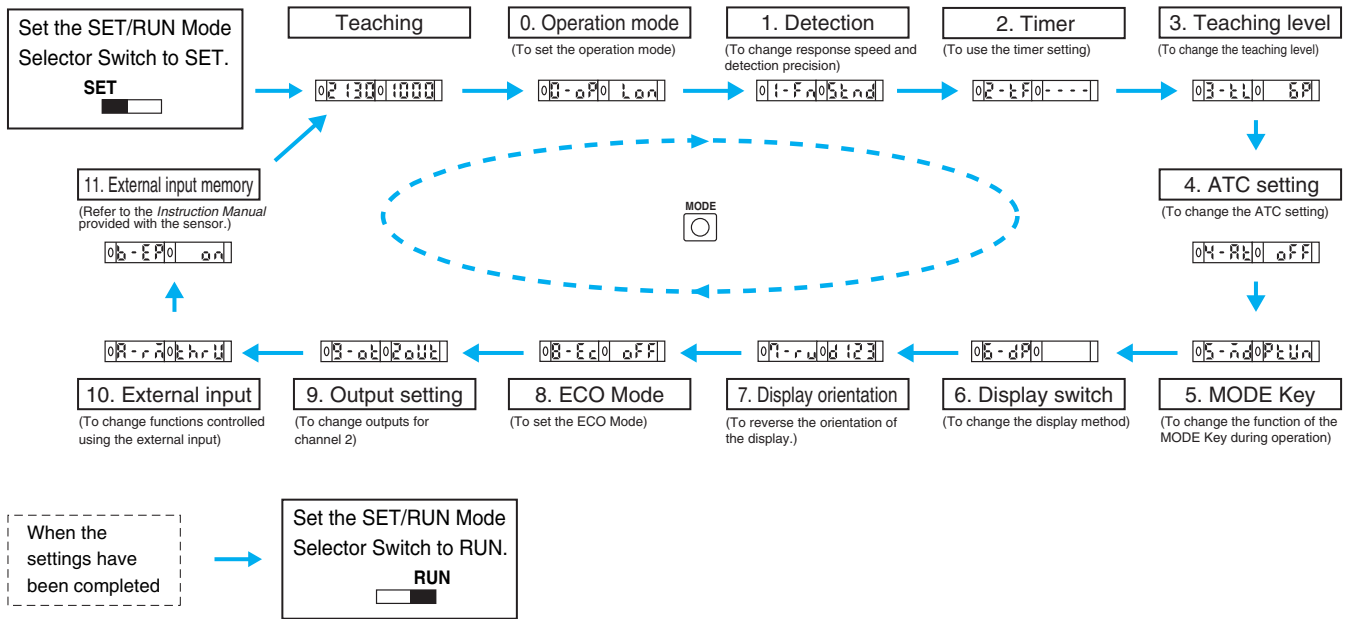













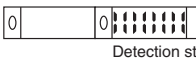

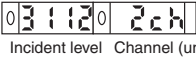

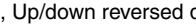
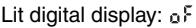
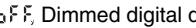
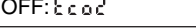

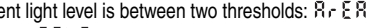
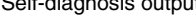
Functions

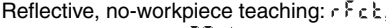
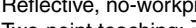
Use the UP and DOWN Keys to change the settings.

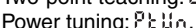
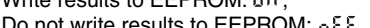
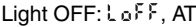
Function *	Setting (display)	Description
0. Operation mode	Light ON: 1 0 n, Dark ON: d 0 n	→ Refer to 1. Setting the Operation Mode on page 18.
1. Detection *	Super-high-speed: 5 H 5, High-speed: H 5, Standard: 5 k n d, High-resolution: H r E 5, Tough: t 9, Differential operation: d t F F	Used to change the response speed or detection precision.
	Differential edge (differential operation selected) Single edge: _ f ~, Double edge: _ n _	Used to set the edge to be detected.
	Differential time Single edge...250 μs: 1, 500 μs: 2, 1 ms: 3, 10 ms: 4, 100 ms: 5, Double edge...500 μs: 1, 1 ms: 2, 2 ms: 3, 20 ms: 4, 200 ms: 5	Used to set the differential response time.
2. Timer	Timer disabled: - - - -, OFF-delay timer: 0 F F d, ON-delay timer: 0 n - d, One-shot timer: t 5 h t, ON-delay + OFF-delay timer: 0 n 0 F	Used to enable or disable timers.
	Time (timer enabled) 1 to 20 ms: 1-ms increments, 20 to 200 ms: 10-ms increments, 200 ms to 1 s: 100-ms increments, 1 to 5 s: 1-s increments	Used to change timer settings when timers are enabled. The timer can be set from 1 to 5,000 ms.
3. Teaching level	Setting range: 0 P to 9 9 P	Used to change the threshold setting when teaching a Through-beam Fiber Unit without a workpiece or teaching a Reflective Fiber Unit without a workpiece.
4. ATC setting	ATC enabled: 0 n, ATC disabled: 0 F F	Used to enable or disable the ATC function.
	Setting at Power-ON (ATC ON) No setting: 0 F F, ATC start processing: R t c, Power tuning and ATC start processing: P t R t	Used to set the processing to be performed when the power is turned ON.
5. MODE Key *	Executes power tuning: P t u n, Executes a zero reset: 0 r 5 t, Two-point teaching: 2 P n t, Automatic teaching: R u t 0, ATC start: R t c	Used to change the function of the MODE Key during RUN operation.
	Power tuning target value (performing power tuning) Setting range: 100 to 3,900 (increments of 100) Maximum power: F u l l	Used to set target values during power tuning. → Refer to 2. Adjusting the Power on page 18.

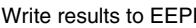
\* The detection settings and MODE Key settings are the same for channel 1 and channel 2. Other functions can be set separately for each channel.

Function	Setting (display)	Description
6. Display switch	 Incident level Threshold	Used to display the incident light level and the threshold.
	 % incident level Threshold	Used to display the incident light level as a percentage of the threshold and the threshold.
	 PEAK BOTM Fixed interval	Used to display the peak and bottom levels of incident light within a set time. (Updated every 2 s.)
	 L-PE D-BT	Use to display the incident light peak level and no incident light bottom level. (Refreshed when output turns ON or OFF.)
	 Detection status	Analog bar display. The current detection status is displayed as an analog bar. The bar will lengthen from the right as ON status is reached. (ON: Red, OFF: Green)
	 Current incident level PEAK Fixed interval Current incident level Peak incident level	Used to display the current incident light level and the peak incident light level. Display changes at a fixed interval.
	 Incident level Channel (unit number)	Used to display the incident light level and the channel (unit number).
7. Display orientation	Normal display:  , Up/down reversed display: 	Used to reverse the orientation of the display.
8. ECO Mode	Lit digital display:  , Dimmed digital display:  , OFF: 	Used to enable or disable the ECO mode.
9. Output setting	Each channel:  , Output when the incident light level is between two thresholds:  , Self-diagnosis output: 	Used to change the output details for channel 2. This setting will be disabled if the detection function is set to DIFF (i.e., differential operation) and the output will be used for an alarm output.
10. External input	Through-beam, no-workpiece teaching:  , Reflective, no-workpiece teaching:  , Two-point teaching:  , Automatic teaching:  , Power tuning:  , Zero reset:  , Light OFF:  , ATC start: 	Used to change the functions to be controlled using the external input. (Refer to the <i>Instruction Manual</i> provided with the sensor.)
11. External input memory	Write results to EEPROM:  , Do not write results to EEPROM: 	Used to set writing the results. (Refer to <i>Instruction Manual</i> provided with the product.)

6 Convenient Functions

6-1. Setting the Digital Display to Zero (Zero Reset)

The incident light level on the main display can be set to 0. The incident light level and the threshold will both be shifted. This is useful when you want to set the reference display to zero.

\* Change the function to 0RST (zero reset) with the MODE Key. The default setting is PTUN.  
 → Refer to 5. Setting Functions on page 20.

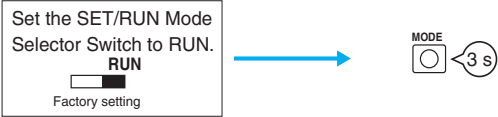

To return to original value for incident light level:

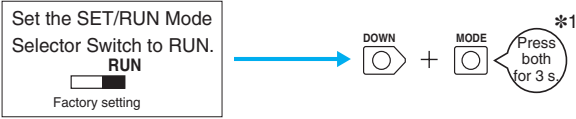

6-2. Locking the Keys (Key Lock)

All key operations can be disabled.

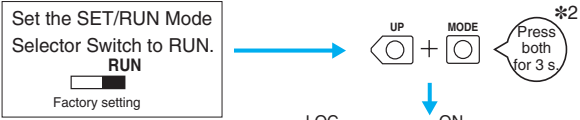

“LOC ON” will flash twice and key operations will be disabled.

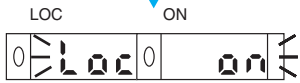

To release the lock:

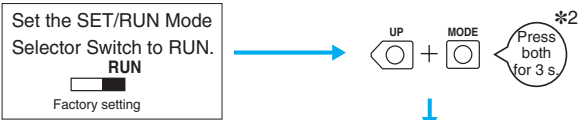

“LOC OFF” will flash twice and key operations will be enabled.



\* If a key is pressed while key operations are locked, “LOC ON” will flash twice on the display to indicate that key operations have been disabled.

\*1. Press the DOWN Key right after pressing the MODE Key.  
 \*2. Press the UP Key right after pressing the MODE Key.

6-3. Resetting Settings (Initial Reset or User Reset)

All settings can be returned to the factory defaults or to user-saved settings.

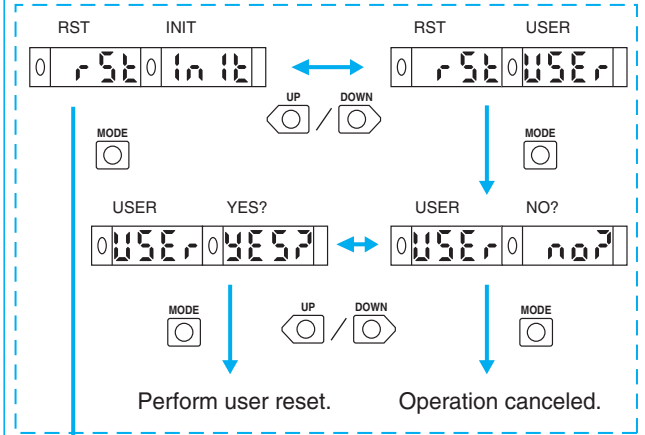

(The steps within the dotted lines can be used if settings have been saved by the user.)

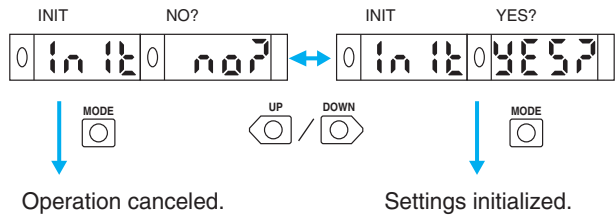

Saving User Settings

The current settings can be saved.

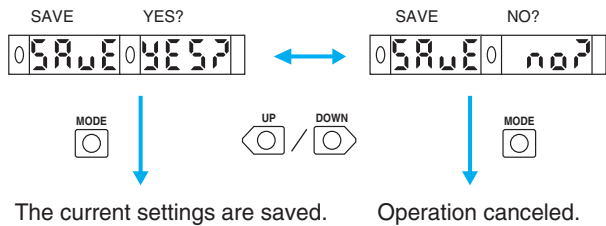

# Nomenclature

## Fiber Amplifier Units

E3X-DA□R-S (□: 21/51/7/9)

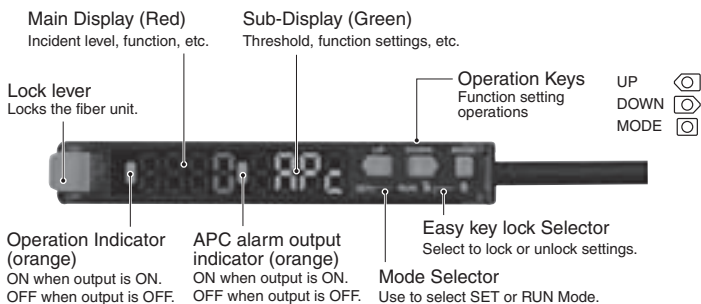

## Operating Procedure

Basic operating procedures are given on pages 14 to 18. For details, refer to the Instruction Manual provided with the product. This section shows functions specific to the E3X-DA□R-S.

### 1 Locking the Keys (Easy Key Lock)

Before shipment, all key operation except for the MODE Keys can be disabled.



**Note:** Do not switch the lock while in SET Mode. Doing so will disable changing settings. If the lock is switched to in SET Mode, return to the unlock state, and then make the setting again.

#### Unlocking

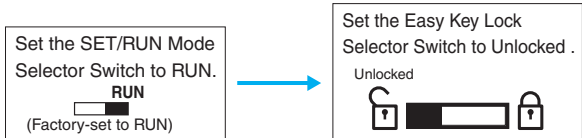

### 2 Displaying the APC Margin

Displaying the APC margin can be useful for planning maintenance. When the APC margin is 0%, APC alarm output will turn ON, and the APC alarm output indicator will light regardless of the operation of the APC margin display.

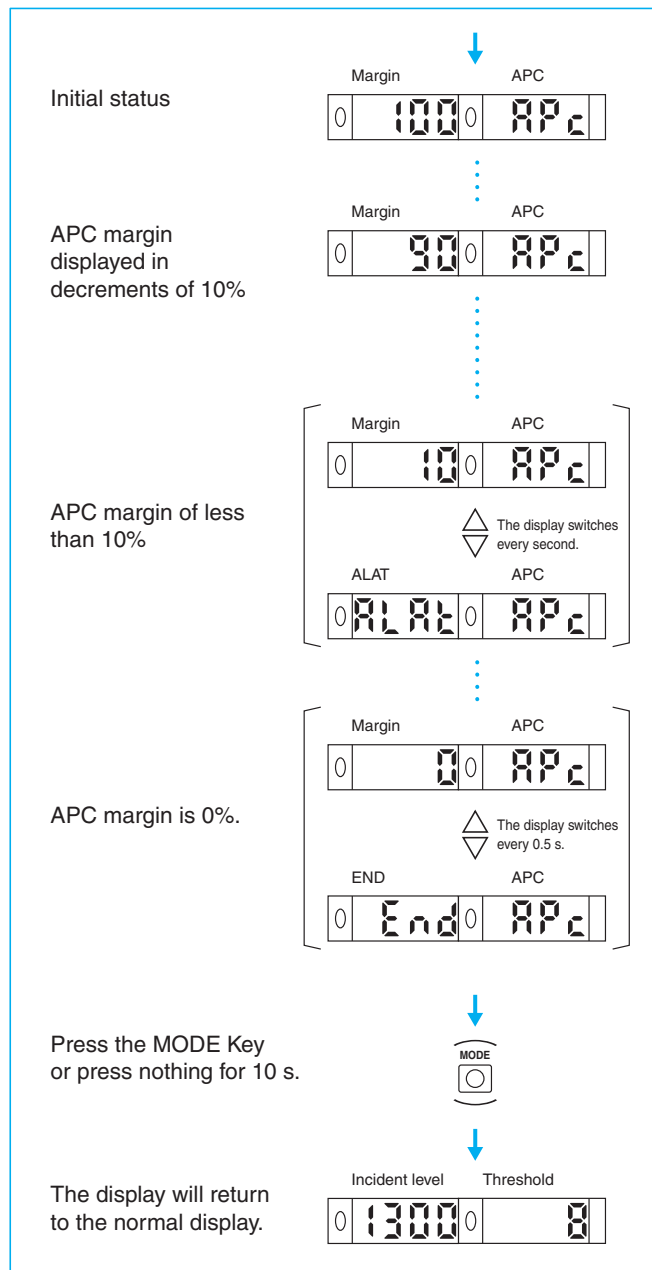
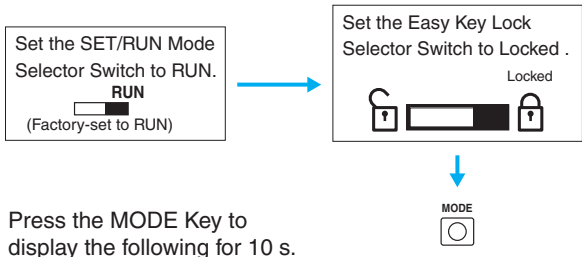

# E3X-DA-S

## Nomenclature

### Fiber Amplifier Units

E3X-DA□F-S (□: 21/51/7/9)

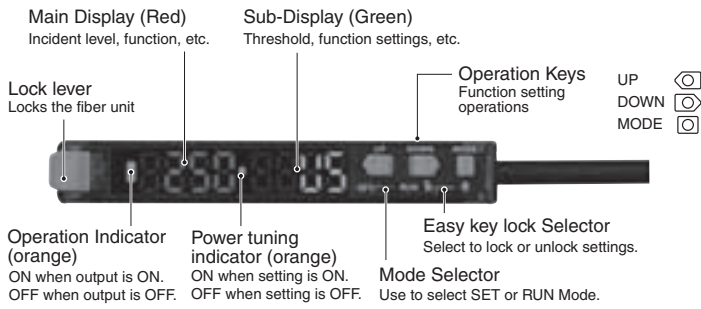

## Operating Procedure

Basic operating procedures are as given on pages 14 to 18. For details, refer to the Instruction Manual provided with the product. This section shows functions specific to the E3X-DA□F-S.

### 1 Locking the Keys (Easy Key Lock)

Before shipment, all key operation except for the MODE Keys can be disabled.

Set the SET/RUN Mode Selector Switch to RUN.  
**RUN**  
(Factory-set to RUN)

→

Set the Easy Key Lock Selector Switch to Locked.  
Locked

**Note:** Do not switch the lock while in SET Mode. Doing so will disable changing settings. If the lock is switched to in SET Mode, return to the unlock state, and then make the setting again.

**Unlocking**

Set the SET/RUN Mode Selector Switch to RUN.  
**RUN**  
(Factory-set to RUN)

→

Set the Easy Key Lock Selector Switch to Unlocked.  
Unlocked

### 2 Displaying the Change of the incident level

Changes of the incident level for high-speed workpiece detection can be displayed. This enables checking the margin level of light received and the workpiece ON time in slow motion.

Set the SET/RUN Mode Selector Switch to RUN.  
**RUN**  
(Factory-set to RUN)

→

Set the Easy Key Lock Selector Switch to Locked.  
Locked

Turn OFF the output or convey the workpieces.

Incident level

Threshold

0 3 1 1 2 ◦ 2 0 0 0

Press the MODE key.

MODE

"A" is displayed when the output is ON or until approximately 10 s has elapsed. (Key operations will not be accepted in the status.)

A

0 ◦ A

"STAT" will be displayed and the slow-motion display will start.

STAT

0 5 t A t ◦

The incident level in intervals of 17 μs will be displayed for approximately 20 s every 160 ms (between 0.5 ms before ON to 1.5 ms after ON).

Incident level

Threshold

0 3 1 1 2 ◦ 2 0 0 0

⋮

Incident level

Threshold

0 1 0 0 0 ◦ 2 0 0 0

⋮

Incident level

Threshold

0 2 0 0 0 ◦ 2 0 0 0

MODE

Output ON time

Unit: μs

0 2 5 0 ◦ 0 5

END

0 E n d ◦

Incident level

Threshold

0 3 1 1 2 ◦ 2 0 0 0

<b>Error Display</b>	The following will be displayed if the ON time exceeds 1,500 μs.	The following will be displayed if the change in the light amount is low. *	* This may also be displayed when detecting a workpiece with a small change in light amount or a slow workpiece of 1,500 μs or longer.
	OVER      US	NON      DETC	
	<div style="border: 1px solid black; padding: 5px; text-align: center;"> <p>0 o v e r ◦ 1 5 0 0</p> </div>	<div style="border: 1px solid black; padding: 5px; text-align: center;"> <p>0 n o n ◦ d e t c</p> </div>	



## Safety Precautions

To ensure safe operation, be sure to read and follow the *Instruction Manual* provided with the sensor.

### WARNING

This product is not designed or rated for ensuring safety of persons either directly or indirectly. Do not use it for such purposes.



### CAUTION

Do not use the sensor with voltage in excess of the rated voltage. Excess voltage may result in malfunction or fire.



Never use the sensor with an AC power supply. Otherwise, explosion may result.



### Precautions for Safe Use

The following precautions must be observed to ensure safe operation of the sensor.

1. Do not use the sensor in an environment where explosive or flammable gas is present.
2. Do not use the sensor in a location subject to splattering with water, streams, oils, or chemicals.
3. Do not attempt to disassemble, repair, or modify the sensor.
4. Do not apply voltages or currents that exceed the rated range to the sensor.
5. Do not use the sensor in an ambient atmosphere or environment that exceeds the ratings.
6. Wire the power supply correctly, including the polarity.
7. Connect the load correctly.
8. Do not short-circuit the load at both ends.
9. Do not use the sensor if the case is damaged.
10. Dispose of the sensor as industrial waste.
11. Do not use the sensor in locations subject to direct sunlight.

### Precautions for Correct Use

Do not use the product in atmospheres or environments that exceed product ratings.

## Fiber Amplifier Unit

### Designing

#### Operation after Turning Power ON

The sensor is ready to detect 200 ms after the power supply is turned ON. If the sensor and load are connected to separate power supplies, be sure to turn ON the sensor first.

Time may be required for the incident level to stabilize after the power supply is turned ON.

#### Operation at Power OFF

A pulse may be output when the power supply is turned OFF. Turn OFF the power supply to the load or the load line before turning OFF the power supply to the sensor.

#### Mutual Interference Protection Function

Mutual interference prevention is enabled if Amplifier Units are connected together. It is also enabled in the same way if E3X-DA-S-series Units and E3C-LDA-series Units are used together.

## Mounting

### Connecting and Disconnecting Wire-saving Connectors

#### Mounting Connectors

1. Insert the Master or Slave connector into the Amplifier Unit until it clicks into place.

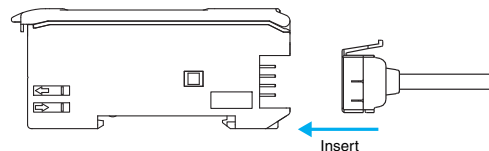

2. Attach the protective seals (provided as accessories) to the sides of master and slave connectors that are not connected.

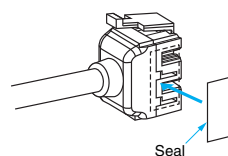

**Note:** Attach the seals to the sides with grooves.

#### Removing Connectors

1. Slide the slave Amplifier Unit away from the other unit.
2. After the Amplifier Unit has been separated, press down on the lever on the connector and remove it. (Do not attempt to remove a connector without first separating the Amplifier Unit from the other Units.)

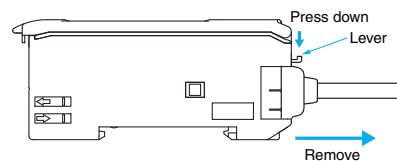

### Adding and Removing Fiber Amplifier Units

#### Adding Fiber Amplifier Units

1. Mount the Amplifier Units one at a time onto the DIN track.

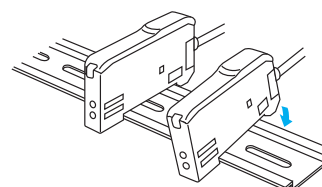

2. Slide the Amplifier Units together, line up the clips, and press the Amplifier Units together until they click into place.

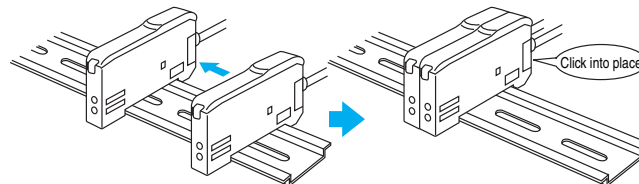

#### Removing Fiber Amplifier Units

Slide Amplifier Units away from each other, and remove from the DIN track one at a time. (Do not attempt to remove Amplifier Units from the DIN track without separating them first.)

- Note:**
1. The specifications for ambient temperature will vary according to the number of Amplifier Units used together. For details, →refer to *Ambient temperature range* on page 4.
  2. Always turn OFF the power supply before joining or separating Amplifier Units.

## Mounting the End Plate (PFP-M)

Use an End Plate if the Amplifier Unit might move due to vibration.

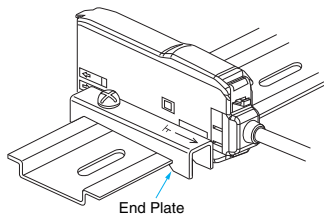

## Fiber Unit Connection

The E3X Amplifier Unit has a lock lever for easy connection of the Fiber Unit. Connect or disconnect the fiber units using the following procedures:

### 1. Connecting Fiber Units

Open the protective cover, insert the fiber units according to the fiber unit insertion marks on the side of the Amplifier Unit, and lower the lock lever.

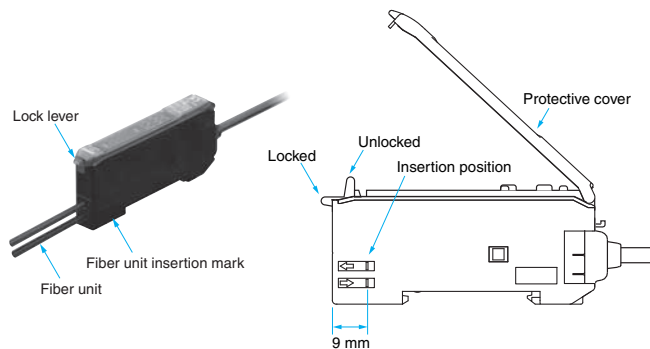

**Note:** Do not pull on the fiber unit, apply pressure on it, or otherwise subject it to excessive force when it is attached to the Amplifier Unit.

**Note:** If one of the fibers from the Fiber Unit is labeled as the Emitter fiber, such as with a Coaxial Sensor, insert that fiber into the Emitter section. Refer to *Dimensions for the Fiber Unit* to see if there is an Emitter fiber label.

### Fiber Units with E39-F9 Attachment

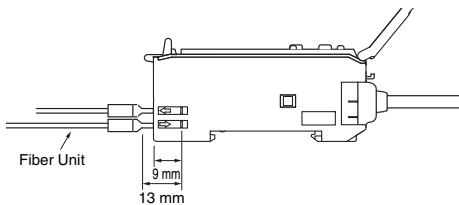

### Fiber Units That Cannot Be Free-Cut (with Sleeves)

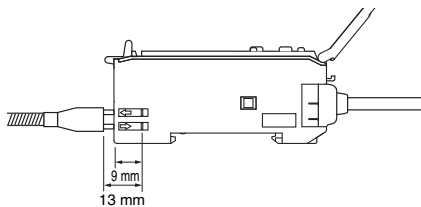

### 2. Disconnecting Fiber Units

Remove the protective cover and raise the lock lever to pull out the fiber units.

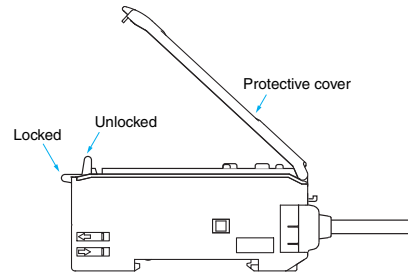

**Note:** 1. To maintain the fiber unit properties, confirm that the lock is released before removing the fiber units.  
2. Be sure to lock or unlock the lock lever within an ambient temperature range between  $-10^{\circ}\text{C}$  and  $40^{\circ}\text{C}$ .

## Adjusting

### Mutual Interference Protection Function

The values that appear on the digital display may fluctuate somewhat due to light from other sensors. If this occurs, you can stabilize detection by setting a threshold that is close to half way between the incident levels with and without a sensing object.

### Output Short-circuits Protection

OVER/CUR will flash on the display if the output short-circuit protection function operates due to a load short-circuit in a control output. If this occurs, check the load connections.

### EEPROM Writing Error

If the data is not written to the EEPROM correctly due to a power failure or static-electric noise, initialize the settings with the keys on the Amplifier Unit. ERR/EEP will flash on the display when a writing error has occurred.

### Optical Communications

Several Amplifier Units can be slid together and used in groups. Do not, however, slide the Amplifier Units or attempt to remove any of the Amplifier Units during operation.

## Others

### Protective Cover

Always keep the protective cover in place when using the Amplifier Unit.

### Mobile Console

The E3X-MC11-SV2 Mobile Console does not currently support the new Tough Mode and ON-delay + OFF-delay timer. You also cannot use the E3X-MC-S.

### Sensor Communications Unit

Using CompoNet

Use the E3X-CRT Sensor Communications Unit.

To connect this Sensor Communications Unit, you must use the E3X-DA0-S Amplifier Unit.

Using EtherCAT

Use the E3X-ECT Sensor Communications Unit.

To connect this Sensor Communications Unit, you must use the E3X-DA0-S Amplifier Unit.

Using DeviceNet

Use the E3X-DRT21-S Version 3 or later Sensor Communications Unit.

To connect this Sensor Communications Unit, you must use the E3X-DA7-S or E3X-DA9-S Amplifier Unit.

## Dimensions

Tolerance class IT16 applies to dimensions in this data sheet unless otherwise specified.

### Fiber Amplifier Units

#### Pre-wired Models

- E3X-DA21-S
- E3X-DA51-S
- E3X-DA21R-S
- E3X-DA51R-S
- E3X-DA21F-S
- E3X-DA51F-S

#### Digital Display Area

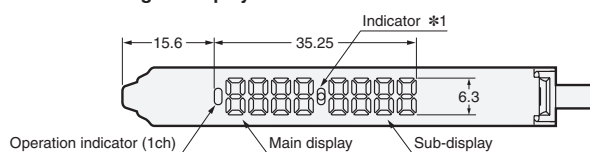

\*1. The indicators are as follows:

E3X-DA21-S	Operation indicator (2 ch)
E3X-DA51-S	APC alarm output indicator
E3X-DA21R-S	Power tuning indicator
E3X-DA51R-S	
E3X-DA21F-S	
E3X-DA51F-S	

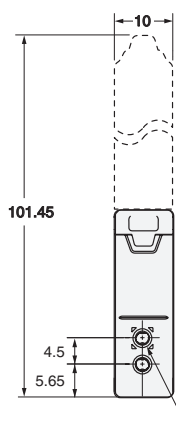

#### DIN track mounting

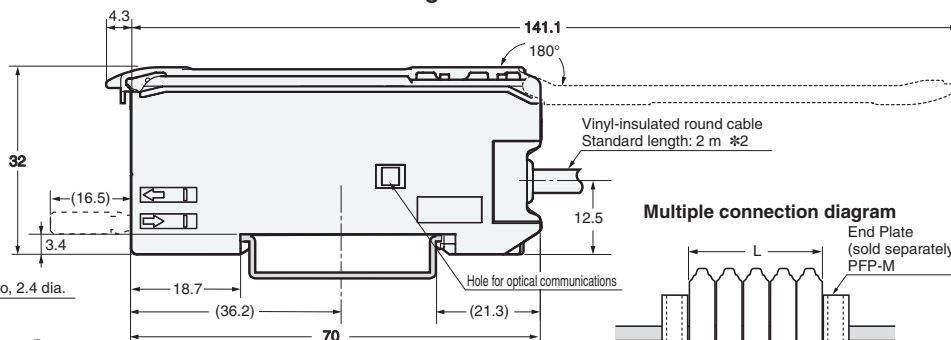

#### Multiple connection diagram

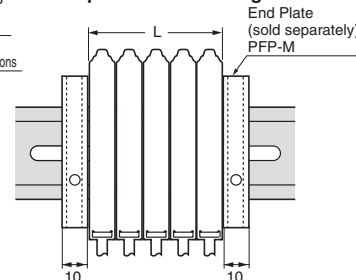

The number of expansion	L (mm)
1	10
2	20
3	30
4	40
5	50
6	60
7	70
8	80
9	90
10	100

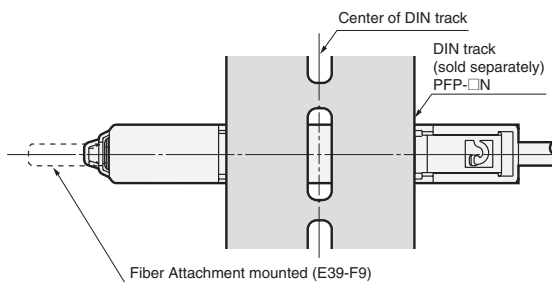

#### With Mounting Bracket Attached

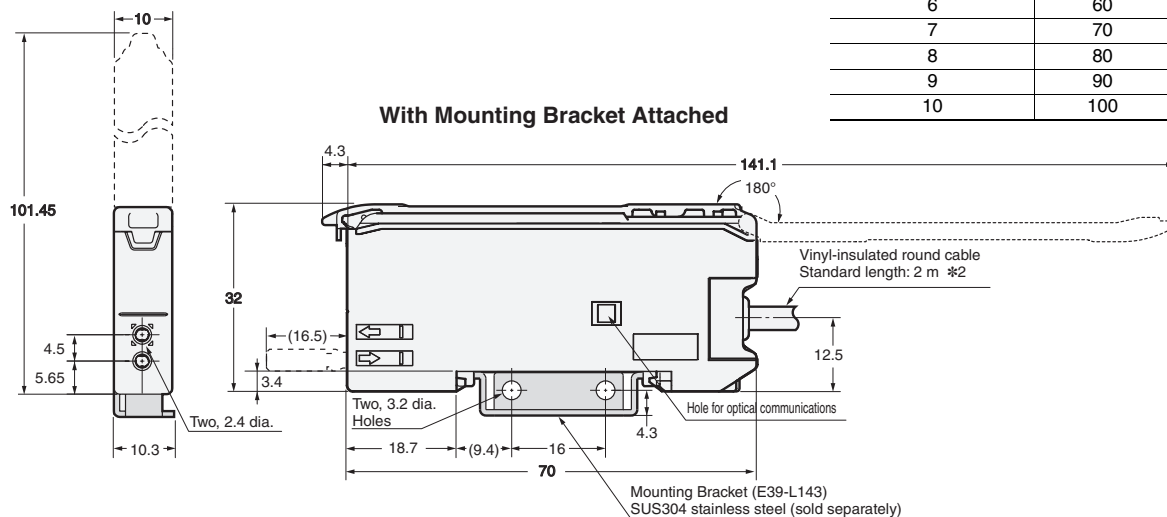

#### Mounting Holes

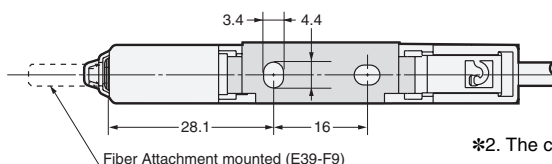
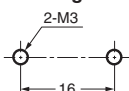

\*2. The cable specifications are as follows:

E3X-DA21-S	4 dia. cable / 5 conductors (Conductor cross section: 0.2 mm <sup>2</sup> , Insulator diameter: 1.1 mm)
E3X-DA51-S	
E3X-DA21R-S	
E3X-DA51R-S	
E3X-DA21F-S	4 dia. cable / 3 conductors (Conductor cross section: 0.2 mm <sup>2</sup> , Insulator diameter: 1.1 mm)
E3X-DA51F-S	

**Note:** When using E39-L143 Mounting Brackets, there will be small gaps between the Fiber Amplifier Units if they are mounted side by side.

# E3X-DA-S

## Wire-saving Connector Models

- E3X-DA7-S
- E3X-DA9-S
- E3X-DA7R-S
- E3X-DA9R-S
- E3X-DA7F-S
- E3X-DA9F-S

### Digital Display Area

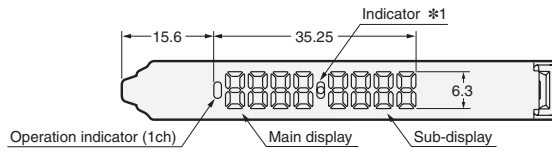

\*1. The indicators are as follows:

E3X-DA7-S	Operation indicator (2 ch)
E3X-DA9-S	APC alarm output indicator
E3X-DA7R-S	APC alarm output indicator
E3X-DA9R-S	Power tuning indicator
E3X-DA7F-S	Power tuning indicator
E3X-DA9F-S	Power tuning indicator

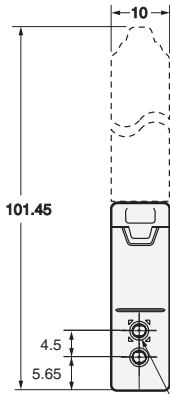

### DIN track mounting

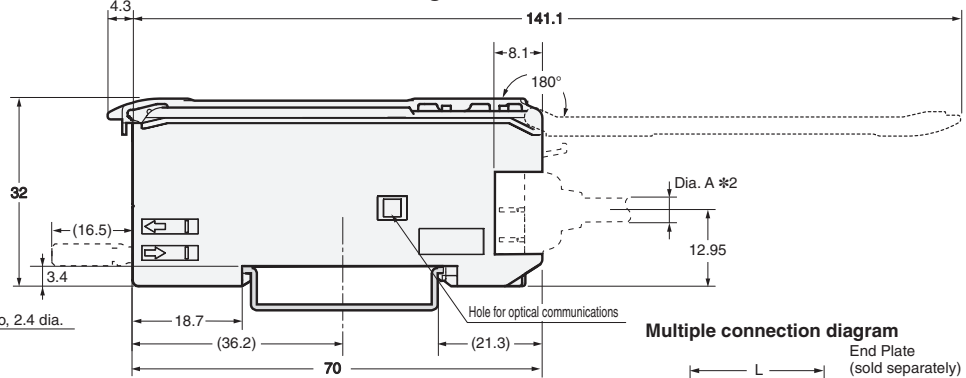

### Multiple connection diagram

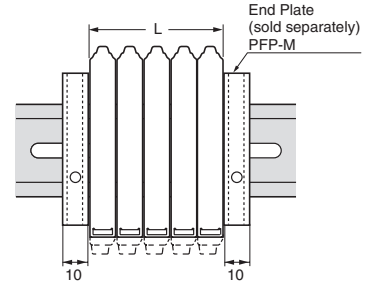

The number of expansion	L (mm)
1	10
2	20
3	30
4	40
5	50
6	60
7	70
8	80
9	90
10	100

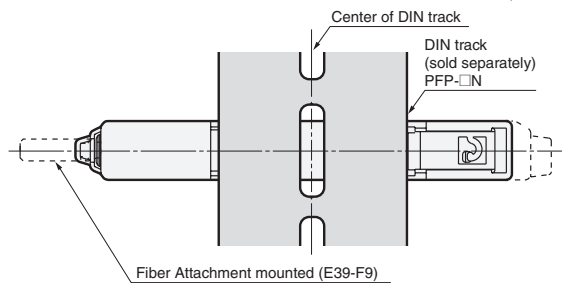

### With Mounting Bracket Attached

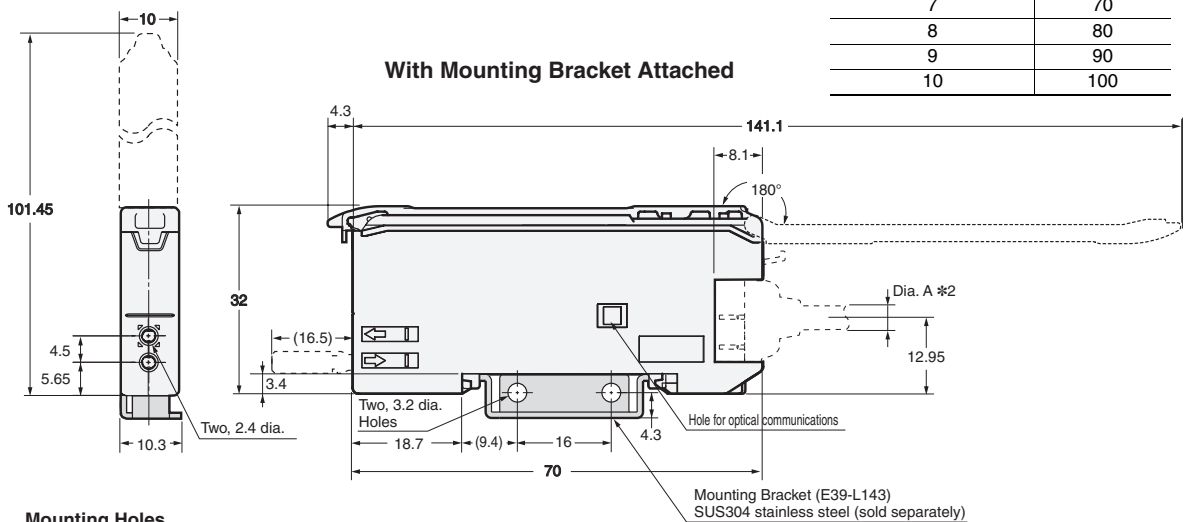

### Mounting Holes

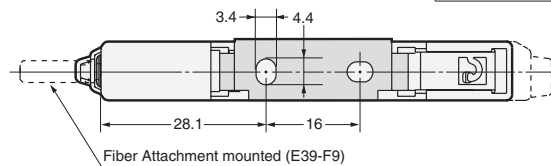
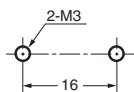

\*2. The cable diameters are as follows:

E3X-CN21 (4 conductors)	4.0 dia.
E3X-CN22 (2 conductors)	
E3X-CN11 (3 conductors)	
E3X-CN12 (1 conductor)	2.6 dia.

**Note:** When using E39-L143 Mounting Brackets, there will be small gaps between the Fiber Amplifier Units if they are mounted side by side.

Sensor Communications Unit Connector Models (for EtherCAT and CompoNet)  
E3X-DA0-S

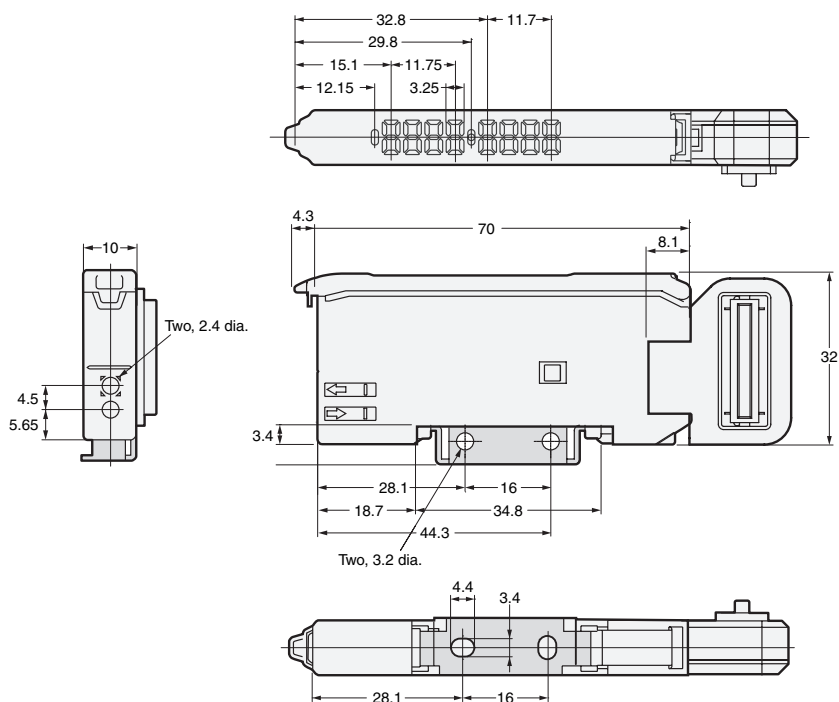

Wire-saving Connectors

Master Connector  
E3X-CN21

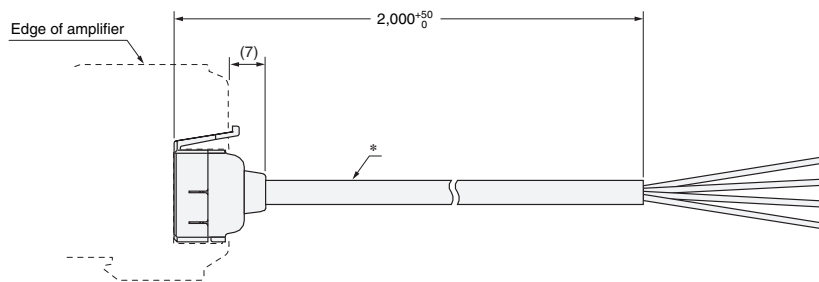

\* E3X-CN21: 4-dia. vinyl-insulated round cable with 4 conductors (Conductor cross section: 0.2 mm<sup>2</sup>, Insulator diameter: 1.1 mm)

Slave Connector  
E3X-CN22

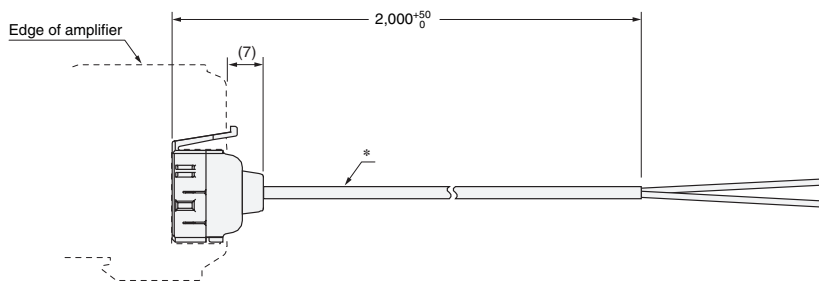

\* E3X-CN22: 4-dia. vinyl-insulated round cable with 2 conductors (Conductor cross section: 0.2 mm<sup>2</sup>, Insulator diameter: 1.1 mm)

# E3X-DA-S

## Master Connector E3X-CN11

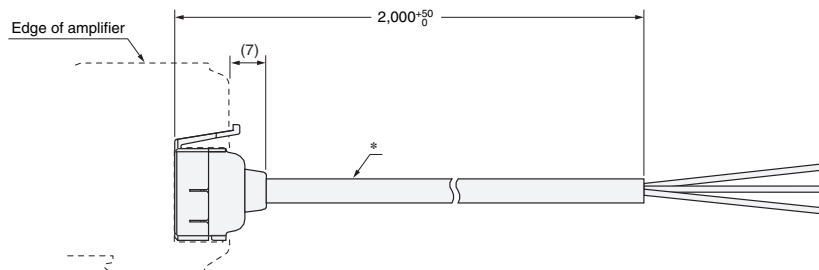
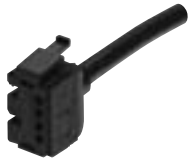

\* Cable 4-dia. vinyl-insulated round cable with 3 conductors (Conductor cross section: 0.2 mm<sup>2</sup>, Insulator diameter: 1.1 mm)

## Slave Connector E3X-CN12

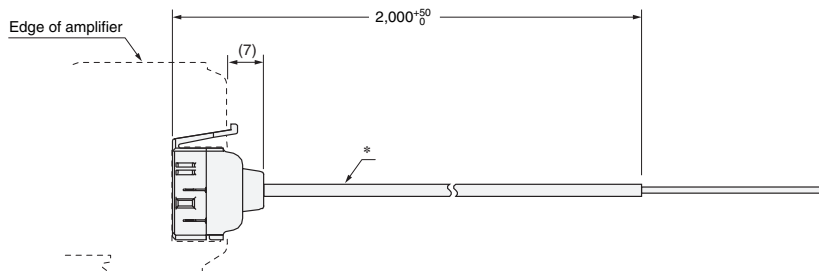

\* Cable 2.6-dia. vinyl-insulated round cable with 1 conductors (Conductor cross section: 0.2 mm<sup>2</sup>, Insulator diameter: 1.1 mm)

## Accessories (sold separately)

### Mounting Brackets E39-L143

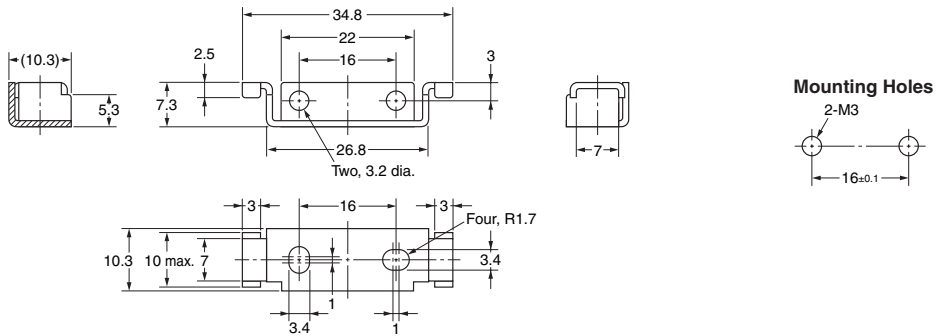
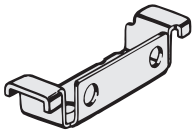

Material: Stainless steel (SUS304)

### End Plate PFP-M

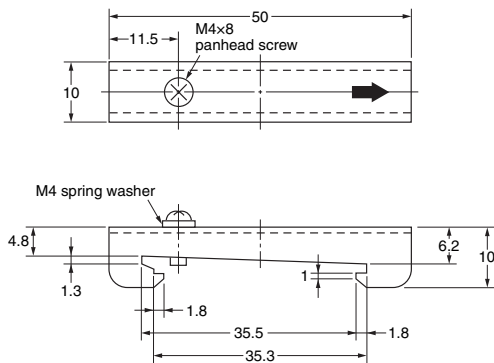
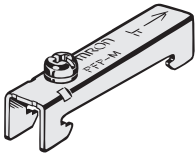

For information on Fiber Units, refer to the Fiber Sensors Best Selection Catalog (Cat. No. E353).

## **READ AND UNDERSTAND THIS DOCUMENT**

Please read and understand this document before using the products. Please consult your OMRON representative if you have any questions or comments.

## **WARRANTY**

OMRON's exclusive warranty is that the products are free from defects in materials and workmanship for a period of one year (or other period if specified) from date of sale by OMRON.

OMRON MAKES NO WARRANTY OR REPRESENTATION, EXPRESS OR IMPLIED, REGARDING NON-INFRINGEMENT, MERCHANTABILITY, OR FITNESS FOR PARTICULAR PURPOSE OF THE PRODUCTS. ANY BUYER OR USER ACKNOWLEDGES THAT THE BUYER OR USER ALONE HAS DETERMINED THAT THE PRODUCTS WILL SUITABLY MEET THE REQUIREMENTS OF THEIR INTENDED USE. OMRON DISCLAIMS ALL OTHER WARRANTIES, EXPRESS OR IMPLIED.

## **LIMITATIONS OF LIABILITY**

OMRON SHALL NOT BE RESPONSIBLE FOR SPECIAL, INDIRECT, OR CONSEQUENTIAL DAMAGES, LOSS OF PROFITS OR COMMERCIAL LOSS IN ANY WAY CONNECTED WITH THE PRODUCTS, WHETHER SUCH CLAIM IS BASED ON CONTRACT, WARRANTY, NEGLIGENCE, OR STRICT LIABILITY.

In no event shall responsibility of OMRON for any act exceed the individual price of the product on which liability is asserted.

IN NO EVENT SHALL OMRON BE RESPONSIBLE FOR WARRANTY, REPAIR, OR OTHER CLAIMS REGARDING THE PRODUCTS UNLESS OMRON'S ANALYSIS CONFIRMS THAT THE PRODUCTS WERE PROPERLY HANDLED, STORED, INSTALLED, AND MAINTAINED AND NOT SUBJECT TO CONTAMINATION, ABUSE, MISUSE, OR INAPPROPRIATE MODIFICATION OR REPAIR.

## **SUITABILITY FOR USE**

THE PRODUCTS CONTAINED IN THIS DOCUMENT ARE NOT SAFETY RATED. THEY ARE NOT DESIGNED OR RATED FOR ENSURING SAFETY OF PERSONS, AND SHOULD NOT BE RELIED UPON AS A SAFETY COMPONENT OR PROTECTIVE DEVICE FOR SUCH PURPOSES. Please refer to separate catalogs for OMRON's safety rated products.

OMRON shall not be responsible for conformity with any standards, codes, or regulations that apply to the combination of products in the customer's application or use of the product.

At the customer's request, OMRON will provide applicable third party certification documents identifying ratings and limitations of use that apply to the products. This information by itself is not sufficient for a complete determination of the suitability of the products in combination with the end product, machine, system, or other application or use.

The following are some examples of applications for which particular attention must be given. This is not intended to be an exhaustive list of all possible uses of the products, nor is it intended to imply that the uses listed may be suitable for the products:

- Outdoor use, uses involving potential chemical contamination or electrical interference, or conditions or uses not described in this document.
- Nuclear energy control systems, combustion systems, railroad systems, aviation systems, medical equipment, amusement machines, vehicles, safety equipment, and installations subject to separate industry or government regulations.
- Systems, machines, and equipment that could present a risk to life or property.

Please know and observe all prohibitions of use applicable to the products.

NEVER USE THE PRODUCTS FOR AN APPLICATION INVOLVING SERIOUS RISK TO LIFE OR PROPERTY WITHOUT ENSURING THAT THE SYSTEM AS A WHOLE HAS BEEN DESIGNED TO ADDRESS THE RISKS, AND THAT THE OMRON PRODUCT IS PROPERLY RATED AND INSTALLED FOR THE INTENDED USE WITHIN THE OVERALL EQUIPMENT OR SYSTEM.

## **PERFORMANCE DATA**

Performance data given in this document is provided as a guide for the user in determining suitability and does not constitute a warranty. It may represent the result of OMRON's test conditions, and the users must correlate it to actual application requirements. Actual performance is subject to the OMRON Warranty and Limitations of Liability.

## **CHANGE IN SPECIFICATIONS**

Product specifications and accessories may be changed at any time based on improvements and other reasons.

It is our practice to change model numbers when published ratings or features are changed, or when significant construction changes are made. However, some specifications of the product may be changed without any notice. When in doubt, special model numbers may be assigned to fix or establish key specifications for your application on your request. Please consult with your OMRON representative at any time to confirm actual specifications of purchased products.

## **DIMENSIONS AND WEIGHTS**

Dimensions and weights are nominal and are not to be used for manufacturing purposes, even when tolerances are shown.

## **ERRORS AND OMISSIONS**

The information in this document has been carefully checked and is believed to be accurate; however, no responsibility is assumed for clerical, typographical, or proofreading errors, or omissions.

## **PROGRAMMABLE PRODUCTS**

OMRON shall not be responsible for the user's programming of a programmable product, or any consequence thereof.

## **COPYRIGHT AND COPY PERMISSION**

This document shall not be copied for sales or promotions without permission.

This document is protected by copyright and is intended solely for use in conjunction with the product. Please notify us before copying or reproducing this document in any manner, for any other purpose. If copying or transmitting this document to another, please copy or transmit it in its entirety.

**OMRON Corporation Industrial Automation Company**

Tokyo, JAPAN

Contact: [www.ia.omron.com](http://www.ia.omron.com)

**Regional Headquarters**

**OMRON EUROPE B.V.**

**Sensor Business Unit**

Carl-Benz-Str. 4, D-71154 Nufringen, Germany  
Tel: (49) 7032-811-0/Fax: (49) 7032-811-199

**OMRON ELECTRONICS LLC**

One Commerce Drive Schaumburg,  
IL 60173-5302 U.S.A.  
Tel: (1) 847-843-7900/Fax: (1) 847-843-7787

**OMRON ASIA PACIFIC PTE. LTD.**

No. 438A Alexandra Road # 05-05/08 (Lobby 2),  
Alexandra Technopark,  
Singapore 119967  
Tel: (65) 6835-3011/Fax: (65) 6835-2711

**OMRON (CHINA) CO., LTD.**

Room 2211, Bank of China Tower,  
200 Yin Cheng Zhong Road,  
PuDong New Area, Shanghai, 200120, China  
Tel: (86) 21-5037-2222/Fax: (86) 21-5037-2200

**Authorized Distributor:**

© OMRON Corporation 2010 All Rights Reserved.  
In the interest of product improvement,  
specifications are subject to change without notice.

CSM\_7\_2\_0915

Cat. No. E396-E1-03

Printed in Japan  
(0510)