

Root[®]
with noninvasive blood pressure
and temperature



For Sale in the USA

These operating instructions provide the necessary information for proper operation of all models of the Root. There may be information provided in this manual that is not relevant for your system. General knowledge of pulse oximetry and an understanding of the features and functions of Root are prerequisites for its proper use. Do not operate Root without completely reading and understanding these instructions.

Notice: Purchase or possession of this device does not carry any express or implied license to use with replacement parts which would, alone or in combination with this device, fall within the scope of one of the relating patents.

Caution: Federal (USA) law restricts this device to sale by or on the order of a physician.

Note: Cleared Use Only: The device and related accessories are cleared by the Food and Drug Administration (FDA) and are CE Marked for noninvasive patient monitoring and may not be used for any processes, procedures, experiments or any other use for which the device is not intended or cleared by the applicable regulatory authorities, or in any manner inconsistent with the directions for use or labeling.

For professional use. See instructions for use for full prescribing information, including indications, contraindications, warnings, and precautions.

Wireless Radio
FCC ID:VFK-RDS7A

IC:7362A-RDS7A IC Model: RDS-7A

Masimo Corporation
40 Parker
Irvine, CA 92618, USA
Tel.: 949-297-7000
Fax.: 949-297-7001
www.masimo.com



EU authorized representative for Masimo Corporation:



MDSS GmbH
Schiffgraben 41
D-30175 Hannover, Germany



ETL Intertek certification.

Conforms to ANSI/AAMI ES 60601-1 and certified to CAN/CSA STD C22.2 No. 60601-1, IEC 60601-2-49, ISO 80601-2-56, and IEC 80601-2-30

Patents: www.masimo.com/patents.htm

© 2016 Masimo Corporation

Root, SedLine, Radical-7, rainbow, SET, Signal Extraction Technology, Masimo and  are federally registered trademarks of Masimo Corporation.

MOC-9, Iris, Radius-7, and ISA are trademarks of Masimo Corporation. The use of the trademark Patient SafetyNet is under license from University HealthSystem Consortium. All other trademarks and registered trademarks are property of their respective owners.

Contents

About this Manual	7
Product Description, Features, and Indications for Use	9
Product Description and Features	9
Indications for Use	9
Contraindication	10
Safety Information, Warnings, and Cautions	11
Safety Warnings and Cautions	12
Performance Warnings and Cautions	14
Cleaning and Service Warnings and Cautions	16
Compliance Warnings and Cautions	16
Chapter 1: Description	19
Features	20
Chapter 2: Setting Up	23
Unpacking and Inspection	23
Guidelines for Setting Up	23
Power On	24
Initial Battery Charging	25
Radical-7 Connection	26
Radius-7 Connection	27
Nurse Call Connection	27
Attach the Probe Well	28
Attach the Temperature Probe	28
Attach NIBP Cuff	28
Chapter 3: Operation	29
About the Status Bar	29
About the Main Screen	31
Using the Touchscreen Interface	32
Menu Navigation	35
Understanding Windows	36
Accessing Main Menu Options	42
Alarm Interface	68

- Trend Download----- 73
- Screenshot Capture----- 73
- Lights ----- 75
- Chapter 4: Temperature Measurement ----- 79
 - Operation - Temperature ----- 79
 - Temperature Probes ----- 82
- Chapter 5: NIBP Measurement----- 85
 - Patient Measurement Mode ----- 85
 - Cuff Selection and Placement ----- 85
 - Patient Conditions----- 87
 - Operation - NIBP----- 88
- Chapter 6: Admit and Discharge to Patient SafetyNet ----- 95
 - Not Admitted ----- 96
 - Discharging a Patient ----- 97
 - Admitting a Patient ----- 98
 - Not Monitoring Message ----- 100
 - Monitoring Resumed Message ----- 101
- Chapter 7: Radius-7----- 103
- Chapter 8: MOC-9 ----- 105
 - Using MOC-9 Ports ----- 105
- Chapter 9: Iris----- 107
 - Iris Status Screen ----- 108
 - Using Iris Connectivity Ports ----- 109
- Chapter 10: Messages ----- 111
- Chapter 11: Troubleshooting ----- 115
 - Troubleshooting Radical-7, Radius-7, and MOC-9 Modules----- 115
 - Troubleshooting Root ----- 115
- Chapter 12: Specifications ----- 117
 - Measurement Accuracy ----- 117
 - Display Ranges ----- 118
 - NIBP Pressurization Ranges ----- 119
 - Electrical ----- 119
 - Environmental----- 120

Touchscreen Display-----	120
Alarms-----	121
Nurse Call Specifications-----	121
Connectors-----	122
Wireless Specifications-----	122
Compliance-----	124
Guidance and Manufacturer's Declaration-Electromagnetic Emissions-----	127
Guidance and Manufacturer's Declaration-Electromagnetic Immunity-----	128
Recommended Separation Distances-----	131
Symbols-----	132
Chapter 13: Service and Maintenance-----	135
Cleaning-----	135
Replacing the Fuses-----	135
Power-On Self Test-----	136
NIBP Module Calibration-----	136
NIBP Air Leak Test-----	137
Zero Point Calibration-----	137
Span Point Calibration-----	137
Overpressure Test-----	138
Nurse Call Setting Connections-----	139
Battery Test-----	139
Repair Policy-----	140
Return Procedure-----	140
Contacting Masimo-----	140
Limited Warranty-----	141
Exclusions-----	141
Limitation of Warranty-----	142
Sales & End-User License Agreement-----	142
Restrictions-----	143
Index-----	145

About this Manual

This manual explains how to set up and use Root®. Important safety information relating to general use of Root appears in this manual. Read and follow any warnings, cautions, and notes presented throughout this manual. The following are explanations of warnings, cautions, and notes.

A *warning* is given when actions may result in a serious outcome (for example, injury, serious adverse effect, death) to the patient or user.

WARNING: This is a sample of a warning statement.

A *caution* is given when any special care is to be exercised by the patient or user to avoid injury to the patient, damage to this instrument or damage to other property.

CAUTION: This is a sample of a caution statement.

A *note* is given when additional general information is applicable.

Note: This is a sample of a note.

Product Description, Features, and Indications for Use

Product Description and Features

Root® is a patient monitoring and connectivity platform. It offers multiple high-impact innovations for broad applications across the continuum of care.

- Instantly interpretable, high-visibility display of Masimo's breakthrough SET® and rainbow® SET measurements.
- Intuitive, touchscreen navigation for easy and adaptable use in any hospital environment.
- Flexible measurement expansion through Masimo Open Connect (MOC-9™).
- Designed for third-party measurement expansion to allow other companies to add to the platform measurements.
- Built-in network connectivity gateway through Iris™ for standalone devices such as IV pumps, ventilators, beds, and other patient monitors.
- Docking and charging station for Radical-7® and Radius-7™ Battery Module.
- Integrated noninvasive blood pressure (NIBP) technology.
- Integrated temperature technology.

For all prescribing information and instructions for use of the compatible medical devices that are connected to Root, see Operator's Manual or Instructions for Use for the specific medical device.

Indications for Use

The Masimo Root Monitoring System is indicated for use by healthcare professionals for the monitoring of multiple physiological parameters in healthcare environments. The Masimo Root Monitoring System, when used with the optional ISA module, is not intended to be used in road ambulances.

The Masimo Root Monitoring System can communicate with network systems for supplemental remote viewing and alarming (e.g., at a central station).

The optional Masimo Radical-7 Pulse CO-Oximeter and Accessories are indicated for the continuous non-invasive monitoring of functional oxygen saturation of arterial hemoglobin (SpO₂), pulse rate, carboxyhemoglobin saturation (SpCO), methemoglobin saturation (SpMet), total hemoglobin concentration (SpHb), and/or respiratory rate (RRa). The Masimo Radical-7 Pulse CO-Oximeter and accessories are indicated for use with adult, pediatric, and neonatal patients during both no motion and motion conditions, and for patients who are well or poorly perfused in hospitals, hospital-type facilities, mobile, and home environments. In addition, the Masimo Radical-7 Pulse CO-Oximeter and accessories are indicated to provide the continuous non-invasive monitoring data obtained from the Masimo Radical-7 Pulse CO-Oximeter and accessories of functional oxygen saturation of arterial hemoglobin (SpO₂) and pulse rate to multi-parameter devices for the display of those devices.

The optional Masimo Radius-7 Wearable Pulse Oximeter and Accessories are indicated for the continuous non-invasive monitoring of functional oxygen saturation of arterial hemoglobin

(SpO₂), pulse rate, and/or respiratory rate (RRa). The Masimo Radius-7 Wearable Pulse Oximeter and accessories are indicated for use with adult, and pediatric patients during both no motion and motion conditions, and for patients who are well or poorly perfused in hospitals, and hospital-type facilities.

The optional ISA product family consists of three types of sidestream gas analyzers (ISA CO₂, ISA AX+ and ISA OR+), intended to be connected to other medical backboard devices for monitoring of breath rate and the following breathing gases:

ISA CO₂: CO₂

ISA AX+: CO₂, N₂O, Halothane, Isoflurane, Enflurane, Sevoflurane and Desflurane

ISA OR+: CO₂, O₂, N₂O, Halothane, Isoflurane, Enflurane, Sevoflurane and Desflurane

ISA CO₂, ISA AX+ and ISA OR+ are intended to be connected to a patient breathing circuit for monitoring of inspired/expired gases during anesthesia, recovery and respiratory care. The intended environment is the operating suite, intensive care unit and patient room. ISA CO₂ is also intended to be used in road ambulances. The intended patient population is adult, pediatric and infant patients.

The optional SedLine Sedation Monitor is indicated for use in the operating room (OR), intensive care unit (ICU), and clinical research laboratory. It is intended to monitor the state of the brain by real-time data acquisition and processing of EEG signals. The system includes the Patient State Index (PSI), a proprietary computed EEG variable that is related to the effect of anesthetic agents.

The optional temperature module is indicated to measure temperature (oral, adult axillary, pediatric axillary, and rectal) of adult and pediatric patients. The device is intended to be used by clinicians and medically qualified personnel. It is available for sale only upon the order of a physician or licensed health care provider.

The optional non-invasive blood pressure (NIBP) module is indicated for the noninvasive measurement of arterial blood pressure in healthcare environments. The NIBP module is designed to measure blood pressure for patient population described in the following table:

Patient Population	Approximate Age Range
Newborn (neonate)	Birth to 1 month of age
Infant	1 month to 2 years of age
Child	2 to 12 years of age
Adolescent	12-21 years of age
Adult	21 years of age and older

Contraindication

None.

Safety Information, Warnings, and Cautions

Note: Pediatric population does not include neonates.

Note: When the ISA module is used with Root, the combination of the ISA module and Root is not indicated for use outside the healthcare facility.

CAUTION: Root is to be operated by, or under the supervision of, qualified personnel only. The manual, accessories, directions for use, all precautionary information, and specifications should be read before use. Refer to Operator's Manuals of Patient SafetyNet, Radical-7, Radius-7, ISA, and SedLine for additional safety information, warnings, and cautions.

Safety Warnings and Cautions

WARNING: Do not use Root if it appears or is suspected to be damaged.

WARNING: Do not adjust, repair, open, disassemble or modify Root. Injury to personnel or equipment damage could occur. Return Root for servicing.

WARNING: Do not use Root during or nearby magnetic resonance imaging (MRI) or in an MRI environment.

WARNING: Do not place Root or accessories in any position that might cause it to fall on the patient.

WARNING: To ensure safety, avoid stacking multiple devices or placing anything on the device during operation.

WARNING: To reduce the risk of explosion, only replace battery with Masimo supplied parts.

WARNING: Do not start or operate the Root unless the setup was verified to be correct.

WARNING: To ensure safety, only use Masimo authorized devices with Root.

WARNING: Explosion Hazard: Do not use the Root in the presence of flammable anesthetics or other flammable substance in combination with air, oxygen-enriched environments, or nitrous oxide.

WARNING: Fire Hazard: To protect against fire hazard, replace only with fuses of same type, current rating, and voltage rating.

WARNING: Do not remove the back panel of the device. This could cause injury to personnel or device damage.

WARNING: Electrical Shock Hazard: To protect against injury, follow the directions below:

- Avoid placing the device on surfaces with visible liquid spills.
- Do not soak or immerse the device in liquids.
- Do not attempt to sterilize the device.
- Use cleaning solutions only as instructed in this Operator's Manual.
- Do not attempt to clean the Root while monitoring patient.

WARNING: Electrical Shock Hazard: Injury to personnel could occur. Do not plug in or remove the power cord with wet hands. Ensure that your hands are clean and dry before touching the power cord.

WARNING: When positioned on a flat surface, the device should be secured with a mounting system recommended by Masimo.

WARNING: As with all medical equipment, carefully route patient cabling to reduce the possibility of patient entanglement or strangulation.

WARNING: Frequently check the blood pressure monitoring site to ensure adequate circulation.

WARNING: Always use single-use disposable probe covers to limit patient cross-contamination and/or patient discomfort.

WARNING: Only use Root in neonatal mode with a neonatal blood pressure cuff to measure blood pressure on neonates.

WARNING: Neonatal blood pressure measurements must always use a 3 meter hose in order to avoid overpressure error caused by lack of air volume within the overall pneumatic system.

WARNING: Before use, verify the color of the removable probe well to confirm the proper application site: Red (rectal), Blue (oral/axillary).

WARNING: Do not apply the cuff to a limb that is on the same side of a mastectomy.

WARNING: Do not use or stop blood pressure measurements if the patient appears to be affected by the pressurization of the cuff due to a physical condition (i.e. pregnant, pre-eclamptic, etc.)

WARNING: Too frequent blood pressure measurements can cause injury to the patient due to blood flow interference.

WARNING: Do not attach the cuff to a limb being used for IV infusions or any other intravascular access, therapy or an arterio-venous (A-V) shunt. The cuff inflation can temporarily block blood flow, potentially causing harm to the patient.

CAUTION: Applying the blood pressure cuff over a wound can cause further injury.

CAUTION: A compressed or kinked connection hose may cause continuous cuff pressure resulting in blood flow interference and potentially harmful injury to the patient.

CAUTION: Do not place the Root where the controls can be changed by the patient.

CAUTION: To ensure patient isolation, connect only Masimo devices that have been designed for Root.

CAUTION: Equipment intended to be connected to signal input/signal output ports should comply with applicable electrical safety standards to further minimize the risk of electric shock. Only devices that have been configured to operate with Root may function properly when connected.

CAUTION: Only use the AC power cable provided by Masimo. Using a different AC power cable could cause damage to Root. Check the power cord and plug to ensure that it is intact and undamaged.

CAUTION: To avoid risk of electrical shock, this equipment must only be connected to a supply mains with a protective earth connection. Do not under any circumstances remove the grounding conductor from the power plug.

CAUTION: Use a grounded outlet for proper equipment grounding. A hospital-grade outlet is required.

CAUTION: Do not place Root where the appliance inlet or the AC power plug cannot be readily disconnected.

Note: Disconnect the device from AC mains by removing the AC power cord connector from the device inlet.

Note: If there is any doubt about the integrity of the protective earth conductor arrangement, operate Root on internal battery power until the AC power supply protective conductor is fully functional.

Note: Do not monitor more than a single patient at a time on Root.

Note: It is recommended that Root is attached to an AC power source when it is not in use to ensure that the battery remains fully charged.

Note: For medical technologies that require AC power, the battery should be adequately charged to ensure backup power in case of AC power disruption.

Performance Warnings and Cautions

WARNING: Root should not be used as the sole basis for medical decisions. It must be used in conjunction with clinical signs and symptoms.

WARNING: Root may be used during defibrillation, but this may affect the accuracy or availability of the parameters and measurements.

WARNING: Root may be used during electrocautery, but this may affect the accuracy or availability of the parameters and measurements.

WARNING: Wireless communication of alarms to a secondary monitoring station should not be relied upon as a primary alarm.

WARNING: Do not place the Root against a surface that may cause the alarm to be muffled.

WARNING: Radical-7 may not fully charge in a high ambient temperature environment.

WARNING: The use of any other probe cover may produce temperature measurement errors or may result in inaccurate readings.

WARNING: Do not take axillary temperature through the patient's clothing, direct probe-cover-to-skin contact is required.

WARNING: Before applying the cuff on the patient, confirm the cuff size is appropriate.

WARNING: When a blood pressure measurement error code occurs, any blood pressure values reported should be disregarded.

WARNING: Always ensure settings including alarms are appropriate for each patient prior to use.

WARNING: When using multiple devices in the same or similar environment, use of the same patient profile (including the same alarm presets) to avoid confusion that can lead to patient harm.

CAUTION: When setting alarms, consideration should be made to selecting clinically significant values to avoid settings that would prevent the alarms from being useful.

CAUTION: Ensure probe well is properly in place.

CAUTION: Biting the probe tip while taking a temperature may result in damage to the probe.

CAUTION: If the blood pressure cuff is on the same limb as monitoring equipment (i.e., pulse oximeter probe), the pressurization within the cuff can cause temporary loss of function of the monitoring equipment.

CAUTION: Long-term continuous temperature monitoring, greater than 5 minutes, is not recommended.

CAUTION: Use of the incorrect probe at the measurement site will result in temperature errors.

CAUTION: Ensure the speaker is not covered.

CAUTION: Before using Root under high intensity surgical lights, confirm that the display settings allow for clear display of measurements.

CAUTION: Do not connect to an electrical outlet controlled by a wall switch or dimmer.

CAUTION: Do not place the Root on electrical equipment that may affect the device, preventing it from working properly.

CAUTION: Failure to charge Root promptly after a Low Battery alarm may result in the device shutting down.

CAUTION: To minimize radio interference, other electrical equipment that emits radio frequency transmissions should not be in close proximity to Root.

CAUTION: If the Radical-7 or Radius-7 stops communicating with Root, parameters and measurements will not show on the Root; however, this will not affect Radical-7's or Radius-7's ability to monitor the patient.

CAUTION: In order to establish and maintain Root's minimum Quality of Service, the following network specifications should be met before and after installation:

- **Wired Network Connection**
During Ping Test, passing result if:
 - a. At least 98% of packets have latency \leq 30 milliseconds, and
 - b. No more than 2 % packets loss.
- **Wireless Network Connection**
During Ping Test, passing result if:
 - a. At least 98% of packets have latency \leq 100 milliseconds,
 - b. No more than 2 % packets loss, and
 - c. Primary access point signal strength at least -67 dBm.

CAUTION: The wireless quality of services may be influenced by the presence of other devices that may create radio frequency interference (RFI). Some RFI devices to consider are as follows: electrocautery equipment, cellular telephones, wireless PC and tablets, pagers, RFID, MRI electrically powered wheelchair, etc. When used in the presence of potential RFI devices, consideration should be taken to maximize separation distances and to observe for any potential signs of interference such as loss of communication or reduced Wi-Fi signal strength.

Note: The wireless communication status between Root and Patient SafetyNet is displayed by Patient SafetyNet.

Note: Root is provided with a Wi-Fi signal indicator as an indication of Wi-Fi communication.

Note: Root's alarm capabilities have been designed to be independent of the Wi-Fi communication feature in order to preserve Root's primary alarms.

Note: Verify the compatibility of the temperature probe and probe cover before use with Root.

Cleaning and Service Warnings and Cautions

WARNING: Electrical Shock Hazard: The Root battery should be installed and/or removed from Root only by qualified personnel.

WARNING: Do not use petroleum-based or acetone solutions, or other harsh solvents, to clean the Root. These substances affect the device's materials and device failure can result.

CAUTION: Do not touch, press, or rub the display panels with abrasive cleaning compounds, instruments, brushes, rough-surface materials, or bring them into contact with anything that could scratch the display.

CAUTION: Do not submerge the Root in any cleaning solution or attempt to sterilize by autoclave, irradiation, steam, gas, ethylene oxide or any other method. This will seriously damage the device.

CAUTION: To prevent damage to the temperature probe do not autoclave.

CAUTION: Electrical shock and flammability hazard: Before cleaning, always turn off the device and disconnect from any AC power source.

CAUTION: An operator may only perform maintenance procedures specifically described in the manual. Refer servicing to qualified service personnel trained in the repair of this equipment.

CAUTION: Electrical Shock Hazard: Carry out periodic tests to verify that leakage currents of patient-applied circuits and the system are within acceptable limits as specified by the applicable safety standards. The summation of leakage currents must be checked and in compliance with IEC 60601-1 and UL60601-1. The system leakage current must be checked when connecting external equipment to the system. When an event such as a component drop of approximately 1 meter or greater or a spillage of blood or other liquids occurs, retest before further use. Injury to personnel could occur.

Note: Excessive cleaning solution can flow into the device and cause damage to internal components.

Compliance Warnings and Cautions

WARNING: Changes or modifications not expressly approved by Masimo shall void the warranty for this equipment and could void the user's authority to operate the equipment.

WARNING: Do not incinerate the battery.

WARNING: In accordance with international telecommunication requirements, the frequency band of 2.4 GHz and 5.15 to 5.25 GHz is only for indoor usage to reduce potential for harmful interference to co-channel mobile satellite systems.

CAUTION: Consideration to the compliance of the IEC 60601-1-1 standard should be made when configuring Root as part of a Medical System.

CAUTION: Disposal of Product: Comply with local laws in the disposal of the device and/or its accessories.

Note: Use Root in accordance with the Environmental Specifications section in the Operator's Manual.

Note: This device complies with Part 15 of the FCC Rules. Operation is subject to the following two conditions: (1) This device may not cause harmful interference, and (2) this

device must accept any interference received, including interference that may cause undesired operation.

Note: This equipment has been tested and found to comply with the limits for a Class A digital device, pursuant to part 15 of the FCC Rules. These limits are designed to provide reasonable protection against harmful interference when the equipment is operated in a commercial environment. This equipment generates, uses and can radiate radio frequency energy and, if not installed and used in accordance with the instruction manual, may cause harmful interference to radio communications. Operation of this equipment in a residential area is likely to cause harmful interference in which case the user will be required to correct the interference at his own expense.

In order to maintain compliance with FCC regulations, shielded cables must be used with this equipment. Operation with non-approved equipment or unshielded cables is likely to result in interference to radio and TV reception. If this equipment does cause harmful interference to radio or television, which can be determined by turning the equipment off and on, the user is encouraged to try to correct the interference by one or more of the following measures:

- Reorient or relocate the receiving antenna.
- Increase the separation between the equipment and receiver.
- Connect the equipment into an outlet on a circuit different from that to which the receiver is connected.
- Consult the dealer or an experienced radio/TV technician for help.

Note: To satisfy RF exposure requirements, this device and its antenna must operate with a separation distance of at least 20 cm from all persons and must not be co-located or operating in conjunction with any other antenna or transmitter.

Note: This equipment has been tested and found to comply with the Class A limits for medical devices according to the EN 60601-1-2: 2007, Medical Device Directive 93/42/EEC. These limits are designed to provide reasonable protection against harmful interference in a hospital environment.

Note: This Class A digital apparatus complies with Canadian ICES-003.

Note: Root is not intended for use during patient transport outside the healthcare facility.

Chapter 1: Description

Root can be used in the following ways:

- As a docking station and charger for Radical-7 and Radius-7 Battery Module.
- As a bedside monitoring display for parameters on Radical-7, Radius-7, and MOC-9 modules.
- As a bedside monitor for continuous or non-continuous NIBP and temperature.
Note: Continuous Mode will take a measurement every one (1) second.
- As a connectivity gateway for standalone devices.

Features

Front View



Ref.	Feature	Description
1	Docking Station	Provides a docking station for the Radical-7 and Radius-7 (Note: Battery Charging Adapter required for Radius-7). While docked, the Radical-7 can communicate monitored parameters and measurements.*
2	Root Display and Touchscreen	Provides a frontal display and interface for user interactions.
3	Home Button	Provides access to the Main Screen.
4	Root Charging Indicator	Shows an indication of the battery charge for Root.
5	AC Power Indicator	Shows an indication of AC power connection Root.
6	Radical-7 Charging Indicator	Shows an indication of battery charge for the Radical-7 in the Docking Station.

**Only the touchscreen version of the Radical-7 is able to communicate monitored parameters and measurements. All other versions can only charge in the docking station but not communicate with Root.*

Back View

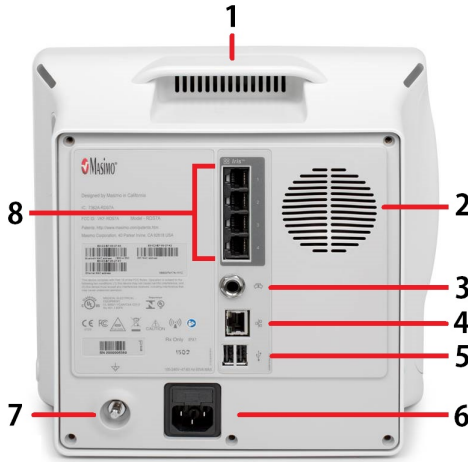

Ref.	Feature	Description
1	Handle	Allows the user to transport Root.
2	Speaker	Provides audible notification.
3	Nurse Call Connector	Provides a connection to a Nurse Call system.
4	Ethernet Port	Provides a network connection to Root using an RJ-45 cable.
5	USB Ports (2)	Provide USB 2.0 connectivity.
6	Power Entry Module	Contains the input connector for a hospital grade AC power cord and the fuse holder.
7	Equipotential Ground Connector	Provides optional functional earthing for Root to eliminate potential differences. The use of the Equipotential Ground Connector should be in accordance with IEC 60601-1.
8	Iris Connectivity Ports (4)	Provide connection for standalone devices.

Side Views



Right side

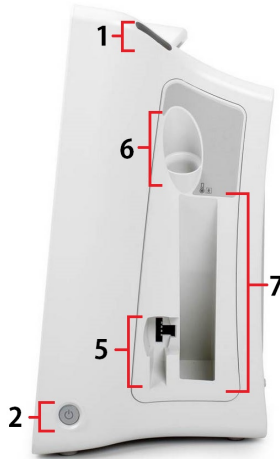

Left side

Ref.	Feature	Description
1	System Status Lights	Provides an indication of system messages and alarm priority. See System Status Lights on page 75.
2	Power Button	Places Root in Power On, Sleep, and Power Off modes.
3	MOC-9 Ports (3)	Provide connectivity for MOC-9 modules.
4	NIBP Nib	Connection port for NIBP Hose.
5	Temperature Probe Port	Allows connection of temperature probe to Root.
6	Temperature Probe Well Holder	Provides dock for temperature probe when not measuring.
7	Probe Covers Holder	Holds extra probe covers for quick access.

Chapter 2: Setting Up

Unpacking and Inspection

To unpack and inspect Root

1. Remove Root from the shipping carton and examine it for signs of shipping damage or exposed electronics.
2. Confirm that you have all components for the Root by checking all materials against the packing list:
 - Root
 - AC power cord

Note: Save all packing materials, invoice and bill of lading. These may be required to process a claim with the carrier.

If anything is missing or damaged, contact Masimo's Technical Service Department. See **Return Procedure** on page 140.

Guidelines for Setting Up

Root has a built-in bracket interface that allows it to be mounted on a pole or roll stand.

When setting up Root, follow these guidelines:

- Place on a stable, hard, flat, and dry surface near the patient.
- Maintain a minimum of three (3) centimeters (one [1] inch) of free space around Root.
- Ensure that the back panel speaker is not covered to avoid a muffled alarm sound.
- Charge Root's battery fully before use. See **Initial Battery Charging** on page 25.

Root should not be operated outside the environmental conditions listed in the specifications section. See **Environmental** on page 120.

Power On

The Power Button can be used for Power On, Sleep, and Power Off. To Power On, press the Power Button for two (2) seconds until a single audible tone sounds.



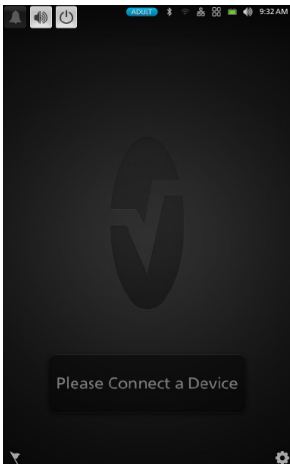

Once Root turns on, if no Radical-7, Radius-7, or MOC-9 module is connected, the Root display shows the following message: *Please Connect a Device*. The user is now able to connect Radical-7, Radius-7, and MOC-9 module.



For information about Sleep Mode and Power Off, see ***Sleep and Power Off*** on page 77.

Initial Battery Charging

To charge the battery for the first time

1. Securely plug the AC power cord into power entry module.
2. Plug the hospital grade AC power cord into an AC power source.
3. Verify that Root's battery is charging by ensuring that the AC Power Indicator (1) is green and the Battery icon on the Status Bar (2) is solid green or has the charging symbol. See **AC Power Indicator** on page 76 and **About the Status Bar** on page 29.

(1)

(2)
4. The Root Charging Indicator remains orange while the battery is charging and will illuminate green when Root is fully charged. See **Root Battery** on page 47 and **About the Status Bar** on page 29.

See **Safety Information, Warnings, and Cautions** on page 11.

Radical-7 Connection

It is recommended that Root be powered on before performing the steps below.

- Snap the Radical-7 into the Docking Station.
- If the Radical-7 is not yet turned on, press the power button on the Radical-7 to power it on.
- When properly connected, the Radical-7 Charging Indicator light will illuminate. An illuminated Radical-7 Battery icon will also appear in the Status Bar.
- Root display will show active measurements and parameters.



For Radical-7 charging conditions, see **Radical-7 and Radius-7 Charging Indicator** on page 77.

Radius-7 Connection

It is recommended that Root be powered on before performing the steps below.

1. Ensure the Radius-7 Battery Charging Adapter is properly docked in the Docking Station area of Root.
2. Activate the Bluetooth radio on Root. (for more information see Operator's Manual for Radius-7).
3. Place the Radius-7 Battery Module into the charging area of the Radius-7 Battery Charging Adapter.
4. Root will emit a tone when pairing has completed (see Operator's Manual for Radius-7 for more information).
5. When properly connected, an illuminated Radius-7 Battery icon will appear in the Status Bar, and the rainbow Window will appear on the Root display.



Nurse Call Connection

Use a Nurse Call connection cable to connect to a Nurse Call System.



To connect to a Nurse Call System

1. Identify the Nurse Call connection end (1/4 inch round female connector) of the cable.
2. Insert the Nurse Call connection cable securely into the compatible port on Root.
3. Depending on the connection type of the Nurse Call System, it may be necessary to orient the other end of the Nurse Call connection cable to fit correctly into the system connection.
4. For more information, see **Device Output** on page 50.

Attach the Probe Well

1. Align the probe well with the tabs facing up and down and insert the probe well into the temperature module.
Note: The probe well snaps into place when it is fully seated.
2. Insert the temperature probe into the probe well.

Attach the Temperature Probe

1. Hold the temperature probe cable connector with the spring tab on the right and insert it into the probe port of the temperature module.
2. Push the cable connector into place until it clicks.
3. Place probe cover onto the temperature probe and dock in the probe well.

Attach NIBP Cuff

1. Attach a necessary adapter to the end of the cuff hose.
2. Connect blood pressure cuff to the NIBP Nib located on the side of Root.

Chapter 3: Operation

The information in this chapter assumes that Root is set up and ready for use. This chapter provides necessary information for proper operation of the device. Do not operate Root without completely reading and understanding these instructions.

About the Status Bar

At the top of the Main Screen is the Status Bar with interactive icons. Each icon provides a shortcut to a menu item or an action on Root. An example is shown below.



Ref.	Feature	Description
1	Alarm Silence	Displays alarm status and temporarily mutes all audible alarms for Root, Radical-7, Radius-7, and MOC-9 modules. See Alarm Silence on page 70.
2	Audio Pause	Displays Audio Pause status and temporarily silences an alarm event. See Audio Pause on page 71.
3	Standby Mode	Allows for patient monitoring to be temporarily suspended. Available when using Root with Radius-7. See Standby Mode on page 72.
4	Profiles	Provides access to the <i>Profiles</i> screen. The example shown illustrates that Profiles is currently set to <i>Adult</i> for an adult patient. See Profiles on page 53.
5	Bluetooth	Provides access to the <i>Bluetooth</i> screen. If this icon is visible, then Bluetooth connectivity has been enabled. See Bluetooth on page 46.
6	Wi-Fi	Provides access to the <i>Wi-Fi</i> screen. If this icon is visible, then Wi-Fi connectivity has been enabled. The icon itself also indicates the strength of the wireless signal. See Wi-Fi on page 45.

Ref.	Feature	Description
7	Ethernet	Provides access to the <i>Ethernet</i> screen. If this icon is visible, then Ethernet connectivity has been enabled. See <i>Ethernet</i> on page 46.
8	Iris	Provides access to the <i>Iris</i> screen. The example shown above indicates that standalone devices are connected to Ports 1, 2, and 3 and the information is being sent to Patient SafetyNet or Connectivity Gateway. The color of the icon matches the status colors of connected standalone devices on the Iris screen. See <i>Iris</i> on page 53.
9	Radical-7 or Radius-7 Battery	Displays charging status for Radical-7 or Radius-7 and provides access to the <i>Battery Radical</i> screen. The example shows that the battery is currently charging. See <i>Radical-7 and Radius-7 Charging Indicator</i> on page 77.
10	Root Battery	Displays charging status for Root and provides access to the <i>Battery Root</i> screen. The example shows that the battery is currently charging. See <i>Root Charging Indicator</i> on page 76.
11	Sounds	Provides access to the <i>Sounds</i> screen to adjust alarm and pulse tone volume. This icon does not indicate the actual volume level of the alarm and pulse tone. See <i>Sounds</i> on page 56.
12	Current Time	Displays the current time and provides access to the <i>Localization</i> screen which contains settings related to local time, language and geography. See <i>Localization</i> on page 44.

About the Main Screen



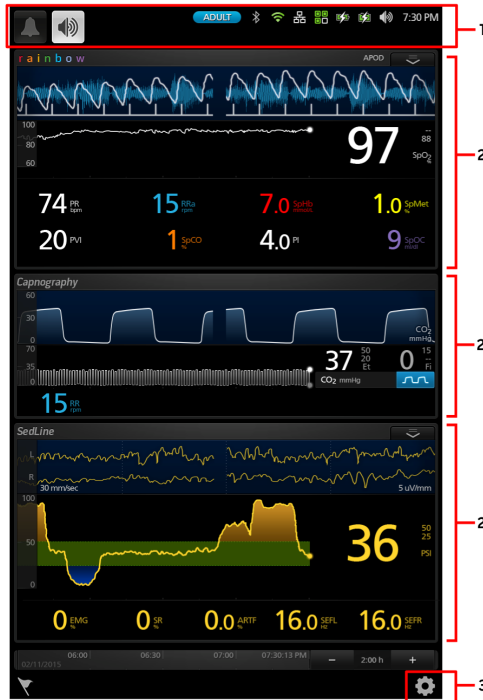





The Main Screen consists of several features. The following shows the Main Screen when three different devices are connected: Radical-7 (top) showing rainbow® parameters and measurements, ISA module (middle) showing capnography measurements, and SedLine module (bottom) showing brain function measurements.

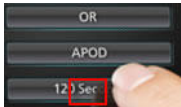

Ref.	Feature	Description
1	Status Bar	Displays system status as well as icons that provide shortcuts to menu items or actions. See About the Status Bar on page 29.
2	Windows	Provides a dynamic, user-configurable display area for all the data from connected medical devices.
3	Main Menu icon	Provides access to the configuration options for Root and connected medical devices. See Accessing Main Menu Options on page 42.

Using the Touchscreen Interface

Using the gestures described below, the user is able to customize the viewing experience, including displaying the highest priority parameters and measurements. The availability of navigation features is dependent on the connected medical devices.

Action	Illustration	Example	Description
Press			Touch and release. Action performed once finger is released.
Slide			Touch, move (left, right, up or down), and release. Moves an object across the display.
Swipe			Touch, move (left, right, up or down), and release quickly.
Pinch			Touch, move, and release via two touch points. Moving touch points apart zooms in, and moving them together zooms out.
Drag and Drop		See <i>Customizing Windows</i> on page 40.	Touch, hold, drag an object to desired position, and drop it by releasing.

Below is a list of all the different types of controls available on Root and the various ways to interact with each type of control.

Control	Applicable Actions	Description
Toggle	Slide knob	Switches between toggle states
	Press left or right of toggle	Quickly moves knob left or right
Labeled Toggle	Slide knob	Switches between toggle states
	Press left or right of toggle	Quickly moves knob left or right
	Press label	Quickly moves knob left or right
Spinner	Press center (focused) tile	When closed, expands the spinner When open, collapses the spinner
	Swipe up or down	When open, scrolls through spinner tiles
	Press unfocused tile	When open, scrolls tile into center (focused) position
	Press anywhere outside spinner	When open, collapses spinner
Slider	Slide knob	Moves knob
	Press anywhere along slider path	Quickly moves knob to Tap position
Slider Spinner	Slide knob	Moves knob
	Press anywhere along slider path	Quickly moves knob to Tap position
	Press center (focused) tile	When closed, expands the spinner When open, collapses the spinner
	Swipe up/down	When open, scrolls through spinner tiles
	Press unfocused tile	When open, scrolls tile into center (focused) position

Control	Applicable Actions	Description
	Press anywhere outside spinner	When open, collapses spinner
Button	Press	Performs action (as defined by the button description)
Icon Menu	Press tile	Opens menu specified by tile
	Swipe left or right (anywhere)	Scrolls icons left or right
	Press bottom indicator icon	Quickly centers tile corresponding to indicator icon
Window	Press parameter or measurement	When no parameter or measurement alarm is present, opens parameter or measurement menu When parameter or measurement alarm is present, silences parameter or measurement alarm
	Press and hold	Enables parameter and measurement drag and drop
Well	Press parameter or measurement	When no parameter or measurement alarm is present, opens parameter or measurement menu When parameter or measurement alarm is present, silences parameter or measurement alarm
	Press and hold	Enables parameter and measurement drag and drop
Live Waveform	Swipe down	Separates pleth and acoustic waveforms
	Swipe up	Combines pleth and acoustic waveforms
Trend Line	Pinch in	Zooms in
	Pinch out	Zooms out
	Pan	Changes time range
	Press y-axis	Opens parameter or measurement trend menu
Trend Zoom	Press '+'	Increases time range

Control	Applicable Actions	Description
	Press 'L'	Decreases time range
	Press time label	Resets time range to default
Alarm Silence icon	Press	Silences all alarms
Audio Pause icon	Press	Enables Audio Pause
Other Status Bar icons	Press	Opens relevant menu
Back Arrow	Press	Exits menu, abandons any changes

Menu Navigation

When navigating through menus and configuring settings, all changes must be confirmed by selecting **OK**. To cancel the changes, select **Cancel**. Any screen requiring selection of option(s) will time out after one (1) minute of inactivity and return to the Main Screen.

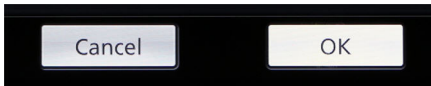

To navigate to the previous screen, press the arrow at the top left corner of the touchscreen.



To return to the *Main Screen*, at any time, press the **Home Button** at any time. The Home Button is always illuminated when Root is powered on.



Understanding Windows

Root creates a Window for Radical-7, Radius-7, and compatible medical devices that are connected to Root. Parameters or measurements can be expanded or minimized within a Window to customize view. Radical-7 Windows are shown in the examples below.

Windows provide waveforms along with either a Trend View or an Analog View. Trend View displays each parameter or measurement alongside a graph of its values over time. Analog View displays values in relation to alarm ranges.

Details about the displayed information of parameters and measurements can be found in the directions for use or Operator's Manual of Radical-7, Radius-7, and MOC-9 modules.

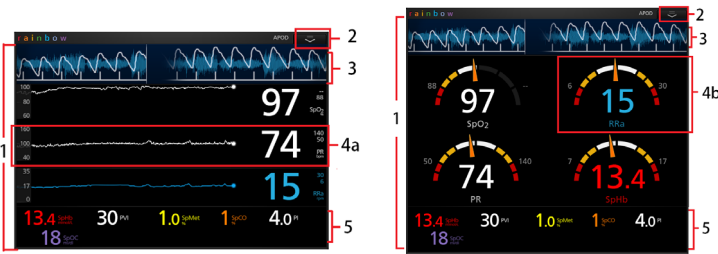

Trend View

Analog View

Ref.	Feature	Description
1	Window	The area where all data from a docked Radical-7, Radius-7, or connected MOC-9 module are displayed.
2	Drop-down Menu	This menu allows the user to change between Trend View and Analog View. For NIBP and Temperature, the drop-down menu allows access to additional settings. Sensitivity settings can also be selected through the drop-down menu.
3	Waveform	Shows a parameter or measurement over time (only for Radical-7, Radius-7, and MOC-9 modules).
4a	Trend Display	(Available only in Trend View) Parameters and measurements are shown as Trend Displays in Trend View. A parameter or measurement's Trend Display includes its Value Range, Numeric Value, Alarm Limits and Parameter label. See Using Trend View on page 37.

4b	Analog Gauge	(Available only in Analog View) Parameters and measurements are shown as Analog Gauges in Analog View. A parameter's Analog Gauge includes its Alarm Limits, Numeric Value, Parameter Label, as well as Alarming, Caution and Normal Ranges. See Using Analog View on page 38.
5	Well	Displays parameters and measurements which are not shown as Trend Displays or Analog Gauges.

Using Trend View

In Trend View, a parameter or measurement is displayed as a graph of its values over time.

The following diagram and table describe key features of a parameter's Trend Display in Trend View.



Ref.	Feature	Description
1	Value Range	Indicates current viewing of the parameter or measurement. Press to access the Trend menu where the minimum and maximum of the range can be modified.
2	Trend Graph	Displays parameter and measurement over a period of time. Zoom in and out of a Trend Graph by pinching out and in.
3	Numeric Value	Indicates current reading of the parameter or measurement.
4	Alarm Limits	Indicate high and low alarm limits for the parameter or measurement, if supported.
5	Parameter or Measurement Label	Indicates the name of the parameter or measurement.

Using Analog View

The Analog View shows parameter and measurement data as a needle pointing to graduations in a circular array around a dial. This view provides indications of change that can be interpreted at a quick glance.

Analog View displays alarming and normal ranges of a parameter or measurement. These indicators can be used to alert clinicians to a patient's condition. To understand specific parameters or measurements, refer to the directions for use or operator's manuals for Radical-7, Radius-7, and the appropriate MOC-9 module(s).

The following diagrams and tables describe key features of a parameter's Gauge in Analog View.

When alarm limits for a specific parameter or measurement are set, the corresponding Analog gauge re-orient itself.

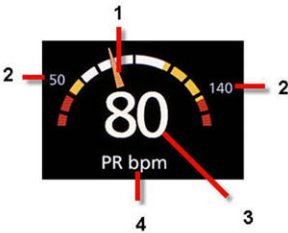

General features of the Analog View are:

Ref.	Feature	Description
1	Needle	Indicates current status of a parameter or measurement.
2	Alarm Limits	Indicate high and low alarm limits for the parameter or measurement.
3	Numeric Value	Indicates current reading of the parameter or measurement.
4	Parameter or Measurement Label	Indicates the name of the parameter or measurement.



Specific ranges of the Analog View are:

Ref.	Feature	Color	Description
1	Normal Range	White	Area of the display range where an alarm will not be triggered.
2	Caution Range	Yellow	Area of the display range that provides a caution indicator.
3	Alarming Range	Red	Area of the display range where an alarm will be triggered.

Some ranges display as quarter circles, others display as half circles. A quarter circle displays when the value has a physiologic normal level at one end of the range. A half circle displays when the value has a physiologic normal level in the middle of the display range.

In the example below, the SpO₂ gauge is shown as a quarter circle, where values lower than 88% will trigger an alarm, and the PR gauge is shown as a half circle, where values below 50 bpm and above 140 bpm will trigger an alarm.



Quarter Circle



Half Circle

Customizing Windows

Windows can be customized by expanding and minimizing parameters and measurements in both Trend View and Analog View. When a parameter is minimized, it is only displayed in the Well with its Numeric Value and Parameter Label. When a parameter is expanded, it will be shown as either a Trend Display or Gauge.

To expand a parameter or measurement

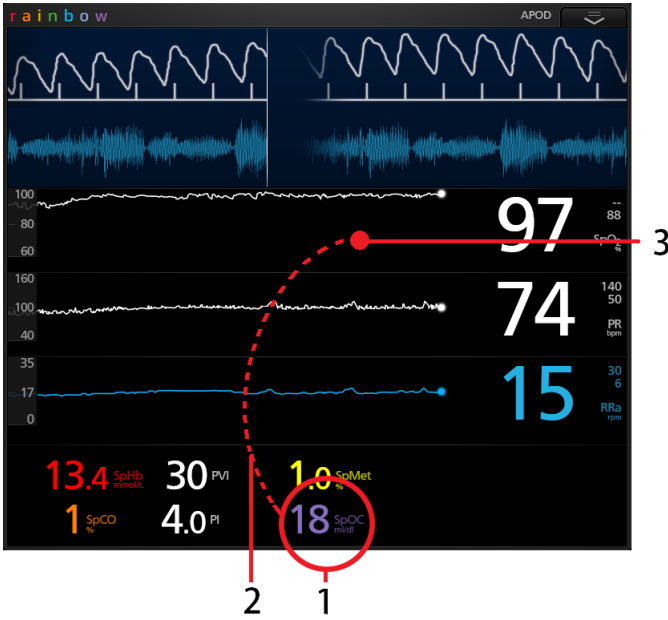

Order	Instruction
Step 1	Press and hold the Numeric Value until it dims.
Step 2	Drag the Numeric Value over any Trend Display.
Step 3	Release the Numeric Value.

Minimizing a parameter or measurement

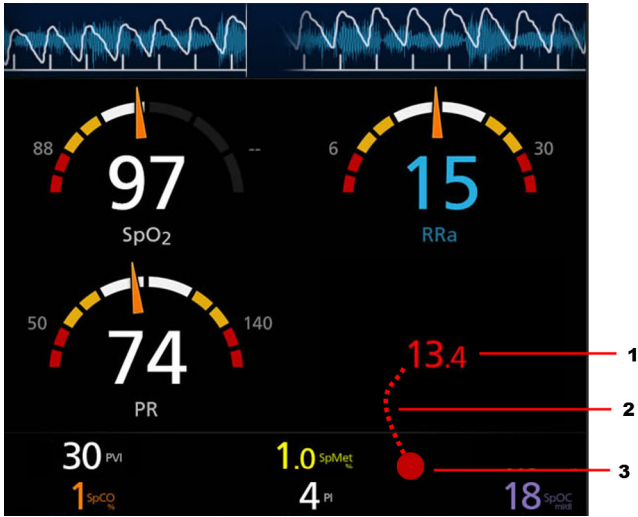

Order	Instruction
Step 1	Press and hold the Numeric Value until it shrinks.
Step 2	Drag the Numeric Value to the Well.
Step 3	Release the Numeric Value.

Accessing Main Menu Options

To access the Main Menu options

At the bottom right corner of the touchscreen, press the **Main Menu** icon.



The **Main Menu** options are:



Device Settings

See *Device Settings* on page 43.



About

See *About* on page 52.



Trend Settings

See *Trend Settings* on page 52.



Profiles

See *Profiles* on page 53.



Iris

See *Iris* on page 53.



Layout

See *Layout* on page 54.



Sounds

See *Sounds* on page 56.



NIBP

See *NIBP* on page 61.



Temperature

See *Temperature* on page 57.

Device Settings



The **Device Settings** menu allows the user to view and customize settings for Root.

The **Device Settings** options are:



Localization

See **Localization** on page 44.



Wi-Fi

See **Wi-Fi** on page 45.



Ethernet

See **Ethernet** on page 46.



Bluetooth

See **Bluetooth** on page 46.



Root Battery

See **Root Battery** on page 47.



Radical-7 Battery

See **Radical-7 and Radius-7 Battery** on page 47.



Brightness

See **Brightness** on page 48.



Access Control

See **Access Control** on page 48.



Device Output

See **Device Output** on page 50.

Localization



Use the Localization screen to view the current date and time and configure settings related to local time, language and geography. The user can also access the *Localization* screen by pressing the current time on the Status Bar. See ***About the Status Bar*** on page 29.

Option	Description	Factory Default Setting	Configurable Settings
Language	Selects the language display for Root.	English	Choose from available languages.
Date Format	Sets the display format for current date.	mm/dd/yy	mm/dd/yy or dd/mm/yy
Time	Sets the display format for current time.	12 hour	12 hour or 24 hour
Line Frequency	Sets to match regional power line frequency.	60 Hz	50 Hz or 60 Hz
Date	Sets the current date.	N/A	N/A
Time	Sets the current time.	N/A	N/A

Wi-Fi



The Wi-Fi radio allows for networked communication of data and alarm signals between Root and a secondary patient monitoring station, Masimo's Patient SafetyNet over an IEEE 802.11 a/b/g wireless network. The wireless data transmission is an optional network data transmission to the wired network data transmission, using Root's integral Ethernet Port.

Root uses only configured MAC addresses to establish wireless communications to prevent unauthorized connections to other wireless devices. As risk mitigation to the loss of the wireless communication, Root's alarm capabilities have been designed to be independent of the Wi-Fi communication feature in order to preserve Root's primary alarms.

Use the Wi-Fi screen to enable or disable Wi-Fi connectivity. When Root is connected to a Wi-Fi network, the Wi-Fi icon on the Status Bar conveys the strength of the connection. See **About the Status Bar** on page 29.

Option	Description	Factory Default Setting	Configurable Settings
Wi-Fi	Enables or disables Wi-Fi connectivity.	Off	On or Off
Additional fields in the <i>Wi-Fi</i> screen display read-only settings about the Wi-Fi connection that cannot be configured by the user.			

Your Masimo sales representative can provide necessary information regarding an initial Wi-Fi connection. For more information, see the Patient SafetyNet Operator's Manual.

Ethernet



Use the Ethernet screen to enable or disable Ethernet connectivity. When Ethernet connectivity is enabled, the Ethernet icon will appear in the Status Bar. See **About the Status Bar** on page 29.

Option	Description	Factory Default Setting	Configurable Settings
Ethernet	Enables or disables Ethernet connectivity.	On	On or Off
Additional fields in the Ethernet screen display read-only settings about the Ethernet connectivity that cannot be configured by the user.			

Bluetooth



The Bluetooth radio allows for the detection of the close proximity of Masimo's MyView Presence Tag. Root's detection of Masimo's MyView Presence Tag is an optional feature that allows for the display of predetermined customized settings by a clinician. Root utilizes only configured MAC addresses to establish Bluetooth communication to prevent unauthorized connection to other Bluetooth enabled devices.

Use the Bluetooth screen to enable or disable Bluetooth connectivity. When Bluetooth connectivity is enabled, the Bluetooth icon will appear in the Status Bar. See **About the Status Bar** on page 29.

Option	Description	Factory Default Setting	Configurable Settings
Bluetooth	Enables or disables Bluetooth connectivity.	Off	On or Off
Presence Monitoring	Used in conjunction with MyView Presence Tag.	Off	On or Off

For more information on how to configure MyView Presence Tag, see the Patient SafetyNet Operator's Manual.

Root Battery



Use the Root Battery screen to view the specific percentage of charge on the battery. The user can also access Root's Battery screen by pressing the Battery icon on the Status Bar. See ***About the Status Bar*** on page 29.

Option	Description
State of Charge	Provides a read-only display of battery level remaining.
Battery Diagnostics	Allows trained personnel to access battery diagnostic information.

Radical-7 and Radius-7 Battery



Use the Battery screen to view the specific percentage of charge on the Radical-7 or Radius-7's battery. For Radical-7, the user can also access the Battery screen by pressing the Battery icon on the Status Bar. See ***About the Status Bar*** on page 29.

Option	Description
State of Charge	Provides a read-only display of battery level remaining.
Battery Diagnostics	Allows trained personnel to access battery diagnostic information.

Brightness



Use the Brightness screen to adjust the brightness of the Root display.

Option	Description	Factory Default Setting	Configurable Settings
Auto Brightness	Allows automatic adjustment of Root's display brightness based on ambient light.	Off	On or Off
Brightness	Adjust the brightness level of the Root display by sliding the button (4 is brightest).	4	1, 2, 3, 4

Access Control



Access Control contains configurable options and settings that require a password.

To enter Access Control

1. Press the  key.

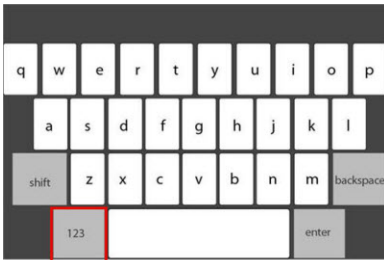

2. When the numeric screen displays, enter the following numbers: **6 2 7 4**
 Asterisks (****) will be displayed.
 To undo an entry, press **Backspace**.

3. Press **Enter** to access the password protected screen.

Note: The password will have to be entered every time this screen is accessed.

Option	Description	Factory Default Setting	Configurable Settings
All Mute Enabled	Enable parameter Alarm Silence menu option. See Sounds on page 56.	Off	On or Off
Lock Alarm Volume	Sets the lowest alarm volume level.	Off	3, 4, or Off
Standby Enabled	Enable's option for Standby Mode. See Standby Mode on page 72.	Off	On or Off
Standby Reminder Tone Interval	Allows for time interval of 30 sec, 1 min, 2 min, 3 min, 5 min, 10 min, or 15 min, as well as Off.	30 sec	30 sec, 1 min, 2 min, 3 min, 5 min, 10 min, 15 min, Off
Save as Adult	Saves current profile parameter as the Adult Profile.	N/A	Press Save to load.
Save as Pediatric	Saves current profile parameter as the Pediatric Profile.	N/A	Press Save to load.
Save as Neo	Saves current profile parameter as the Neonatal Profile.	N/A	Press Save to load.
Factory Defaults	Options are restored to factory values.	N/A	Press Restore .

Device Output



A Nurse Call can be triggered based on alarm, low Signal IQ events or both. In addition, Nurse Call Polarity can be inverted to accommodate local Nurse Call station requirements.

Option	Description	Factory Default Setting	Configurable Settings
Nurse Call Trigger	Controls the source of monitoring which sets off the trigger.	Alarms	Alarms, Signal IQ Alarms, and Signal IQ
Nurse Call Polarity	Controls the mechanism of action for triggering to occur. Should be changed to accommodate institutional Nurse Call settings.	Normal	Normal or Inverted
USB Port 1	Controls the output type for USB Port 1.	None	None, IAP, IntelliBridge, and ASCII 1
USB Port 2	Controls the output type for USB Port 2.	IAP	None, IAP, IntelliBridge, and ASCII 1
IntelliBridge Output	Controls the data type output for IntelliBridge.	Radical	Radical, Radical Module A, SedLine, and SedLine Numerics Only

Note: The Nurse Call feature is disabled when Audio Pause is enabled and Nurse Call Trigger is set to *Alarms*. For more information about Audio Pause, see **Audio Pause** on page 71.

IntelliBridge Connectivity

IntelliBridge connectivity allows Root to transmit parameters and waveforms to Philips multi-parameter patient monitors that support Philips IntelliBridge device interfacing modules. This option allows parameters and waveforms on Root to be displayed on a Philips monitor and, if applicable, transmitted to the electronic medical record system.

Masimo parameter and waveforms from SET®, rainbow SET® and SedLine® channels are supported.

Note: Root supports the transmission of data only. Validations of the retrieval and display of data transmitted is the responsibility of the IntelliBridge manufacturer.

Parameters Supported

IntelliBridge connectivity allows for up to six (6) parameters and two (2) waveforms or eight (8) parameters and no waveform to be displayed on Philips monitors.

Channel	Supported Parameters	Waveforms
SET®	SpO2, PR, PI, PVI	Pleth
rainbow®	RRa®, SpHb®, SpCO®, SpOC™, SpMet®	RR
SedLine	PSI™, SR, EMG, ARTF, SEFR, SEFL	(EEG) L1, L2, R1, R2, L1L2, R1R2

About



Use the *About* screen to view the serial number as well as software and hardware version information about Root. These details may be helpful during troubleshooting.

Option	Description
Serial Number	Displays the serial number for the device.
MCU 1	Displays software version number.
Processor	Displays processor version number.
MCU 2	Displays software version number.
MIB	Displays MOC-9 interface revision.

Information about Radical-7, Radius-7, and MOC-9 modules will display in a separate list. These fields are read-only and cannot be configured by the user.

Trend Settings



Use the Trend Settings screen to configure trend viewing on the Main Screen and trend data storage on Root.

Option	Description	Factory Default Setting	Configurable Settings
Default Duration	Duration captured by Trend Graph.	2 hours	15, 30, 45 minutes 1, 2, 4, 8, 12, 24 hours
Clear Trends	Delete all stored trend data.	N/A	Press Clear to delete all stored trend data.

To configure trend settings of specific parameters and measurements, see Directions for Use or Operator's Manuals for Radical-7, Radius-7, and appropriate MOC-9 module(s).

Profiles



Use the Profiles screen to select patient type.

Option	Description	Factory Default Setting	Configurable Settings
Profile Name	Identifies the Profiles setting in the device.	Adult	Adult, Pediatric, Neonatal, Custom
Patient Category	Identifies the patient category type.	Adult	Adult, Pediatric, Neonatal

Root can be configured for various patient types by using the Profiles feature. Profile selection controls the management of patient configuration settings on Root. The settings of the three default profiles (Adult, Pediatric, and Neonatal) configure parameter alarms, averaging time, and sensitivity modes.

Custom profiles can also be created to accommodate usage in any hospital care area. See the Masimo Instrument Configuration Tool Directions for Use for information on adding Profiles.

For more information regarding Profiles, see the Instructions for Use or Operator's Manuals for Radical-7, Radius-7, and appropriate MOC-9 module(s).

Iris



The status of the four (4) Iris Connectivity Ports as well as the connection type (for example, monitor, pump, ventilator) will be displayed on the Iris Status screen. See **Iris Status Screen** on page 108.

Layout



Use the Layout screen to select sizing options for Windows and Trend Displays.

Additional Settings



There are different ways to display the parameters and measurements by changing the Layout Style.

Note: This feature only applies to Trend View. See *Using Trend View* on page 37.

Option	Description	Factory Default Setting	Configurable Settings
Layout Style	Controls the sizing of Trend Displays.	Fixed	Fixed or Dynamic

The following diagram and tables explain the differences between Fixed and Dynamic modes for a Trend View.

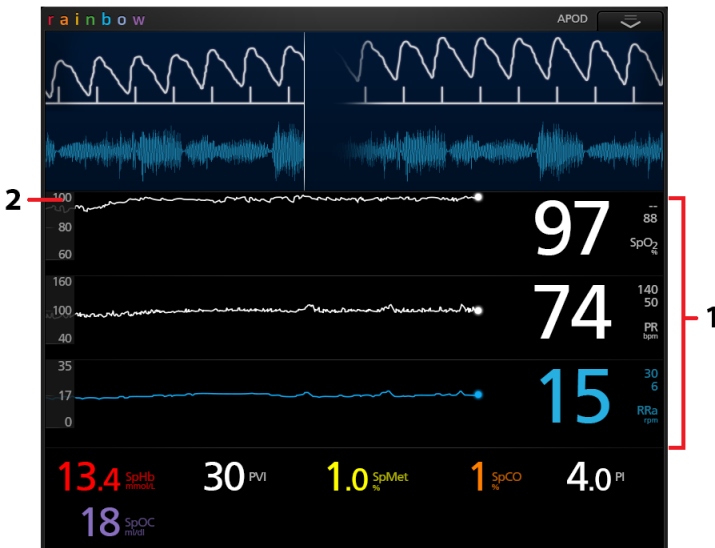

Fixed

Ref.	Description
1	A set number of Trend Displays can be shown at the same time and all Trend Displays are fixed in size. Every additional parameter or measurement expanded will replace an existing Trend Display. For more information about expanding parameters, see Customizing Windows on page 40.
2	Size of each Trend Display is fixed.

Dynamic

Ref.	Description
1	Size of all Trend Displays decreases or increases to accommodate parameter(s) expanded or minimized. All Trend Displays are always evenly sized.* For more information about expanding and minimizing parameters, see Customizing Windows on page 40.
2	*Size of each Trend Display is automatically adjusted.

**When the number of Trend Displays reaches maximum viewing capacity, additional parameters expanded will result in the replacement of existing Trend Displays.*

Available Layout

When only Radical-7, Radius-7, or a single MOC-9 module is connected to Root, the Available Layout will be 100%. When Radical-7 and/or multiple devices are connected, the user will have the option to select from several pre-configured layouts.

Sounds



Use the Sounds screen to control the volume level of sounds and duration of audio pause for Root.

Option	Description	Factory Default Setting	Configurable Settings
Alarm Volume	Sets the alarm volume level.	Highest volume	Slide towards the left to decrease volume to silence.
Pulse Tone Volume	Sets the pulse tone volume level.	Highest volume	Slide towards the left to decrease volume to silence.
Audio Pause Duration	Sets the length of time that the audible alarm remains silenced, when Audio Pause is enabled. See Audio Pause on page 71.	2 minutes	1, 2, 3 minutes, Permanent*, Permanent with Reminder*. If <i>Permanent</i> is selected, there will be no audible alarms when Audio Pause is enabled, but visual alarms will still display. If <i>Permanent with Reminder</i> is selected, a tone will sound every three (3) minutes as a reminder that <i>Permanent</i> is active when Audio Pause is enabled.

*Requires the **all mute enabled** option to be toggled to **ON** in the Access Control menu. See **Access Control** on page 48.

Temperature

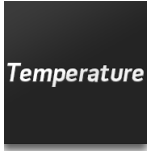

The **Temperature** menu allows the user to view and customize settings for the Temperature module by changing any of the following options:



Alarms

See *Alarms for Temperature* on page 58.



Trends

See *Trends for Temperature* on page 59.



Additional Settings

See *Additional Settings for Temperature* on page 60.

Alarms for Temperature



From the **Temperature** screen, touch **Alarms**, and then change any of the following options:

Options	Description	Alarm Priority	Factory Default Settings	Configurable Options
High Limit (°F)	The High Limit is upper threshold that triggers an alarm.	High	Off	80.20-109.9 in steps of 0.1, or Off When set to Off, alarm is disabled
Low Limit (°F)	Low Limit is the lower threshold that triggers an alarm.	High	Off	80.1-109.8 in steps of 0.1, or Off When set to Off, alarm is disabled
High Limit (°C)	The High Limit is upper threshold that triggers an alarm.	High	Off	26.9-43.2 in steps of 0.1, or Off When set to Off, alarm is disabled
Low Limit (°C)	Low Limit is the lower threshold that triggers an alarm.	High	Off	26.8-43.1 in steps of 0.1, or Off When set to Off, alarm is disabled
Silence Duration	Temporarily suspend audible alarms for a period of time.	None	2 min	30 sec, 1 min, 2 min, 5 min

Trends for Temperature



From the **Temperature** screen, touch **Trends**, and then change any of the following options:

Options	Description	Factory Default Settings	Configurable Options
Y-Axis Max (°F)	The Temperature Trend Max. The upper limit a measurement will be shown.	110.0	80.1-110.0 in steps of 0.1
Y-Axis Min (°F)	The Temperature Trend Min. The lower limit a measurement will be shown.	80.0	80.0-109.9 in steps of 0.1
Y-Axis Max (°C)	The Temperature Trend Max. The upper limit a measurement will be shown.	43.3	26.8-43.3 in steps of 0.1
Y-Axis Min (°C)	The Temperature Trend Min. The lower limit a measurement will be shown.	26.7	26.7-43.2 in steps of 0.1

Additional Settings for Temperature



From the **Temperature** screen, touch **Additional Settings**, and then change any of the following options:

Options	Description	Factory Default Settings	User Configurable Settings
Unit of Measure	The unit of measure for temperature.	°F	°F, °C
Probe Mode	A patient-specific probe setting.	Oral	Oral, Adult Ax, Pediatric Ax
Continuous Monitoring	Provides continuous temperature readings through a direct measurement. Direct measurement is used to continuously read temperatures until it reaches the thermal steady state. (unchanging).	Start	None

Note: No menu is given when rectal probe is used.

NIBP

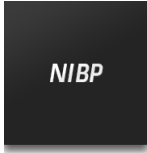

The **NIBP** menu allows the user to view and customize settings for the NIBP module by changing any of the following options:



Parameter Settings

See *Parameter Settings for NIBP* on page 62.



Intervals

See *Intervals for NIBP* on page 67.



Calibration

See *Calibration for NIBP* on page 67.

Parameter Settings for NIBP

From the **NIBP** screen, touch **Parameter Settings**, and then change individual parameter settings/alarms by selecting one the following parameters:



Systolic/Diastolic

See *Systolic/Diastolic (SYS/DIA)* on page 63.



Pulse Rate

See *Pulse Rate (PR)* on page 65.

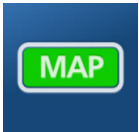

Mean Arterial Pressure

See *Mean Arterial Pressure (MAP)* on page 66.

Systolic/Diastolic (SYS/DIA)



From the **Systolic/Diastolic** screen, touch **Alarms**, and then change any of the following options:

Options	Description	Alarm Priority	Factory Default Settings	Configurable Options
Systolic High Limit	The High Limit is upper threshold that triggers an alarm.	High	220	42-259 in steps of 1, or Off When set to Off, alarm is disabled
Systolic Low Limit	Low Limit is the lower threshold that triggers an alarm.	High	75	41-258 in steps of 1, or Off When set to Off, alarm is disabled
Diastolic High Limit	The High Limit is upper threshold that triggers an alarm.	High	110	22-199 in steps of 1, or Off When set to Off, alarm is disabled
Diastolic Low Limit	Low Limit is the lower threshold that triggers an alarm.	High	35	21-198 in steps of 1, or Off When set to Off, alarm is disabled

Trends for NIBP



From the **Systolic/Diastolic** screen, touch **Trends**, and then change any of the following options:

Options	Description	Factory Default Settings	Configurable Options
Y-Axis Max	The NIBP Trend Max. The upper limit a measurement will be shown.	260	21-260 in steps of 1
Y-Axis Min	The NIBP Trend Min. The lower limit a measurement will be shown.	20	20-259 in steps of 1

Pulse Rate (PR)



From the **Pulse Rate** screen, touch **Alarms**, and then change any of the following options:

Options	Description	Alarm Priority	Factory Default Settings	Configurable Options
High Limit	The High Limit is upper threshold that triggers an alarm.	High	120	40-215 in steps of 5, or Off When set to Off, alarm is disabled
Low Limit	Low Limit is the lower threshold that triggers an alarm.	High	50	35-210 in steps of 5, or Off When set to Off, alarm is disabled

Mean Arterial Pressure (MAP)



From the **Mean Arterial Pressure** screen, touch **Alarms**, and then change any of the following options:

Options	Description	Alarm Priority	Factory Default Settings	Configurable Options
High Limit	The High Limit is upper threshold that triggers an alarm.	High	120	28-219 in steps of 1, or Off When set to Off, alarm is disabled
Low Limit	Low Limit is the lower threshold that triggers an alarm.	High	50	27-218 in steps of 1, or Off When set to Off, alarm is disabled

Intervals for NIBP



From the **NIBP** screen, touch **Intervals**, and then change any of the following options:

Options	Description	Factory Default Settings	User Configurable Settings
Set Mode	The mode of measurement for NIBP.	Manual	Manual, Automatic, Stat
Interval	Note: Option available when Automatic mode is selected. Automatic interval measurement mode will take blood pressure measurements once every desired interval.	15 min	2 min, 3 min, 4 min, 5 min, 10 min, 15 min, 30 min, 60 min, 90 min
Stat Duration	Note: Option available when Stat mode is selected. Stat interval measurement mode will take blood pressure measurements continuously for the desired duration.	10 min	5 min, 10 min

Calibration for NIBP



The **Calibration** option on the **NIBP** menu allows a qualified service professional to access calibration settings and tools for the NIBP module. For more information, see **Chapter 13: Service and Maintenance** on page 135.



Note: This section is provided as a reference and intended for qualified service professionals only.

Alarm Interface

Alarms can have different priority levels and come from different sources. The following tables describe alarm behaviors in more detail.

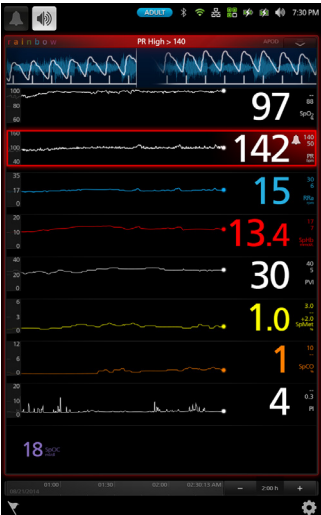
Priority	Alarm Sound
High	10-pulse burst
Medium	3-pulse burst

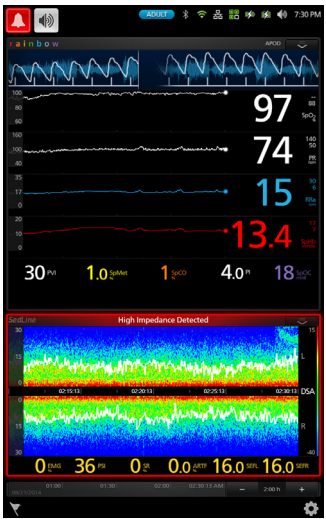
Alarm Source	Example	Explanation
Parameter Level		<p>The example shown here is a PR alarm as the reading (142) exceeds the upper alarm limit (140). Note that the borders of both the PR Trend Display as well as the Window are illuminated red, and the explanation of the alarm is shown at the top of the Window (High PR > 140).</p>





Alarm Source	Example	Explanation
<p>Window Level</p>		<p>The example shown here is a "High Impedance" alarm in the lower Window. Note that the border of the Window illuminates red, and the explanation of the alarm is shown at the top of the Window (High Impedance Detected).</p>
<p>System Level</p>		<p>The example shown here is a "Low Battery" alarm. Note that the border of the entire Root display is illuminated red, and the explanation of the alarm is shown in the Status Bar (Low Battery).</p>

For more details about specific alarms on Radical-7, Radius-7, and MOC-9 modules, see Directions for Use or Operator's Manuals for Radical-7, Radius-7, and MOC-9 modules.

Alarm Silence

The Alarm Silence icon is an indicator as well as a functional button. It always indicates the presence of alarms, and it can be used to temporarily suspend audible alarms for a pre-configured amount of time, known as Silence Duration.

Silence Duration configurations vary across different parameters and measurements. For more information about Silence Duration, refer to the instructions for use or Operator's Manuals for Radical-7, Radius-7, and appropriate MOC-9 module(s).

Icon Appearance	Description	Visual Alarms
	There are currently no active alarms, and no alarms have been silenced.	No
	There are currently no active alarms, but at least one alarm has been and is still silenced.	No
	There is currently at least one active alarm that has not been silenced.	Yes
	There is currently at least one active alarm, but all active alarms are silenced.	Yes

Audio Pause

Audio Pause temporarily suspends all audible alarms on Root. When it is active, visual alarms are not impacted and will still display. The Audio Pause icon is located on the left side of the Status Bar – do not confuse with the Sounds icon on the right side of the Status Bar. See ***About the Status Bar*** on page 29.

By default, Audio Pause is inactive, and the icon appears in the following way:



Audio Pause inactive

To activate Audio Pause, press the icon. It will turn red and the remaining Audio Pause Duration time counts down next to the icon. The default duration for Audio Pause is 120 seconds. In the example below, Audio Pause is activated, and there are 15 seconds left until Audio Pause is inactive again.

To configure Audio Pause, see ***Sounds*** on page 56.



Audio Pause active. 15 seconds until Audio Pause is inactive.

Note: When Audio Pause is activated, powering off and then powering on Root will return Audio Pause to its default inactive state.

Standby Mode

Standby Mode allows for patient monitoring to be temporarily suspended. The Standby icon (see image below) is located in the top-left corner of the screen.

To enable Standby Mode (suspend monitoring)

1. On Root, open the **Access Control** menu.
2. Swipe the **standby enabled** button to **ON**. Return to the home screen on Root, and the Standby icon will appear on the screen in the top-left corner.
3. Press the Standby icon, and a notification message will appear on the screen indicating that monitoring is suspended (see image below).

To exit Standby Mode (resume monitoring)

- Tap anywhere on the screen.

WARNING: When Root is in Standby Mode, monitoring is suspended and no alarms will be active, with the exception of the low battery alarm.

Note: Standby Mode will not affect any devices using Root's Iris Connectivity to Masimo Patient SafetyNet.

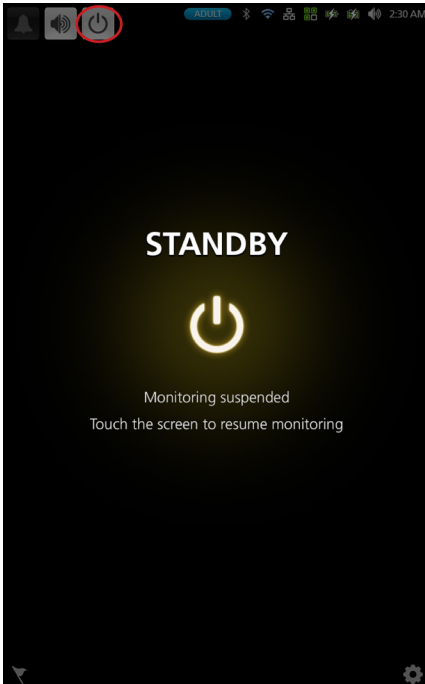

Trend Download

Root can store up to 96 hours of trend data captured at 2-second intervals from Radical-7, Radius-7, and MOC-9 modules. Trend data from Root can be transferred to a computer via USB for evaluation.

Trend data is stored in non-volatile memory, so it is not erased when Root is shut off. Trend data download is initiated using the Masimo Instrument Configuration Tool, which converts the data to a .TXT or .CSV file.

Screenshot Capture

The user is able to take screenshots of Root displays and download them as .png files onto a USB drive. To ensure quick downloads, the number of screenshots that can be stored in Root is limited to 20; once the limit is reached, every new screenshot taken will replace the oldest screenshot taken.

Note: Download the images onto a USB drive to avoid loss of the screenshots.

Note: There must be a folder titled "screen_shot" in the USB drive with a FAT or FAT32 system file to enable the download of the screenshots.

Capturing Screenshots

To take a screenshot, swipe across the Root screen from right to left using three fingers simultaneously (see image below). A confirmation flash will appear on the entire screen and a status message will be displayed briefly at the top of the Root screen. The status message indicates the filename of the screenshot taken.

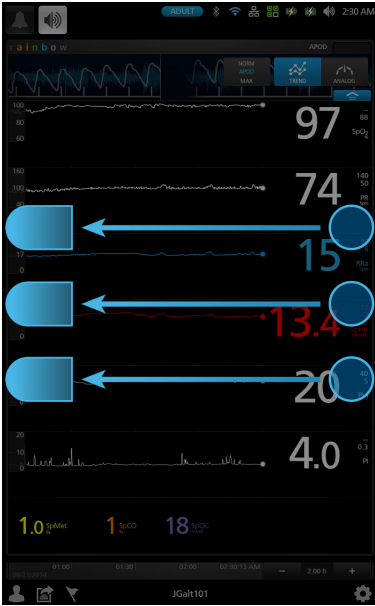

Downloading Screenshots

To download the screenshots:

1. Remove any sensors connected to the patient to stop monitoring, and acknowledge any alarms triggered on Root.
2. Plug the USB drive into one of the two USB ports that are located on the back side of Root, and the screenshots will automatically begin to download. A status message will display briefly at the top of the Root screen to indicate the start of the download.

Note: There must be a folder titled "screen_shot" in the USB drive with a FAT or FAT32 system file to enable the download of the screenshots.
3. A confirmation status message will display briefly at the top of the Root screen when the file transfer is complete.
4. Unplug the USB drive from Root.

To import the screenshots from the USB drive onto a computer, open the folder titled "screen_shot" (from the USB drive) on the computer to access the .png files.

Lights

System Status Lights

The System Status Lights provide visual indications of alarms and system messages. The lights will illuminate in different colors depending on the state of the device.

To locate the System Status Lights, see **Side Views** on page 22.

System Status Light

Light Status	Alarm Priority	Indication
None	None	Monitoring has not started.
Green	None	There is currently no active alarms.
Flashing Yellow	Medium	There is an active alarm of medium priority.
Flashing Red	High	There is an active alarm of high priority.

The alarm priority is determined by the Radical-7, Radius-7, and MOC-9 module(s) that are connected to Root. The following are system level alarm messages that accompany System Status Lights when Radical-7, Radius-7, and MOC-9 modules are not connected:

Status Light Message	Alarm Priority
Low battery	Medium
Service required	High

AC Power Indicator



Whenever Root is connected to an AC power source, the AC power indicator illuminates.

Light Status	Indication
Green	Root is connected to an AC power source.
Off	Root is not connected to an AC power source.

Root Charging Indicator



Whenever Root is connected to an AC power source, if not fully charged, its battery will charge.

Light Status	Battery Indication
Green	Battery is fully charged.
Orange	Battery is charging.
Red	Battery charging error.
Off	Battery is not being charged. Root is not connected to AC power source.

Radical-7 and Radius-7 Charging Indicator



When Root is connected to an AC power source, it is able to charge a correctly docked Radical-7 or Radius-7. This is true whether the device is powered on, in Sleep Mode, or powered off. Conversely, when Root is not connected to AC power, it will not charge the device.

The light status provides a visual indication of the battery condition:

Light Status	Battery Indication
Green	Battery is fully charged.
Orange	Battery is charging.
Red	Battery is unable to charge.
Off	Battery is fully charged, not being charged.

Sleep and Power Off

To put Root in the Sleep Mode or Power Off Mode, follow these steps:

State	Description
Sleep Mode	Press and hold the Power Button for two (2) seconds until one (1) audible tone sounds. Sleep Mode conserves power while enabling a quicker startup sequence.
Power Off Mode	Press and hold the Power Button for eight (8) seconds, until two (2) audible tones sound. The Home Button will flash, and the Power Button will flash orange. Power Off Mode completely shuts down Root and results in a longer startup sequence.

Chapter 4: Temperature Measurement

Root takes a temperature measurement through the use of a temperature probe. The temperature probe is designed for use on adult and pediatric patients. Patient temperature can be measured via an oral/axillary or rectal probe.

Operation - Temperature

Spot Check Mode

Spot Check mode provides a one-time predictive measurement that takes a temperature in approximately 6 to 15 seconds, before a steady state temperature is achieved. Predictive measurements reduce the time required for measurement by using algorithms to predict what the temperature would be if the probe were left in place until steady state is achieved.

Continuous Mode

Continuous mode provides continuous temperature readings through a direct measurement. Direct measurement is used to continuously read temperatures until it reaches the thermal steady state (unchanging). The thermal steady state is achieved through an oral or rectal measurement in approximately 3 minutes and through an axillary measurement in approximately 5 minutes.

Taking Temperature Measurement

1. Ensure that the correct measurement site is selected before measurement.

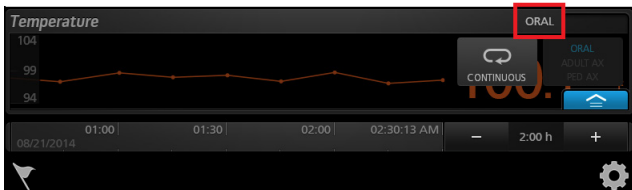

Note: If a rectal probe is attached, the **Site** button will not appear.

Note: The site selection toggle is disabled once the probe has been placed on the site. The toggle will be re-enabled once the probe has been returned to the probe well holder.

- To change the measurement site, touch the **Main Menu** icon , then select



Temperature Settings



Select **Additional Settings**, then select the desired measurement site through **Probe Mode**. The measurement site can also be changed using the action menu.

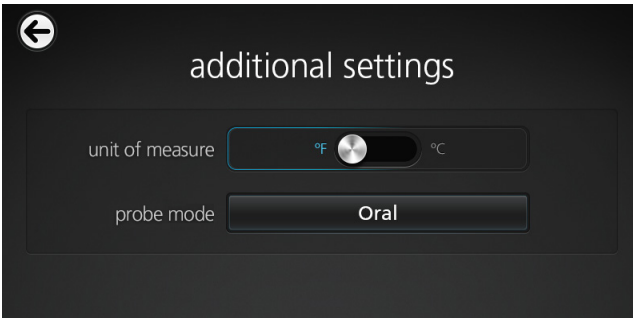

- Remove the temperature probe from the probe well holder to initiate spot check.

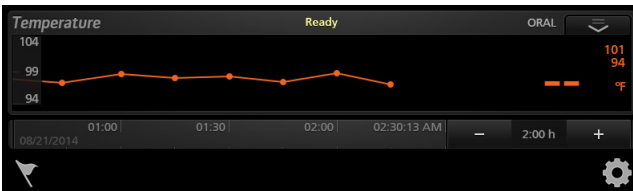

Note: Ready status will display in the status bar and sound will play.

- Apply a single-use disposable probe cover to the temperature probe before measurement.

WARNING: The use of any other probe cover may produce temperature measurement errors or may result in inaccurate readings.

- Place the temperature probe on the site to begin spot check.

WARNING: Before use, verify the color of the probe cover eject button on the temperature probe to confirm the proper application site: Red (rectal), Blue (oral/axillary).

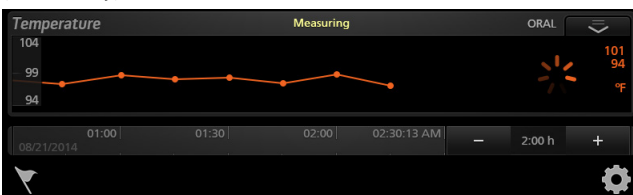

Note: Measuring status displayed in the status bar.

- Wait for measurement to complete or return the probe to stop measurement.

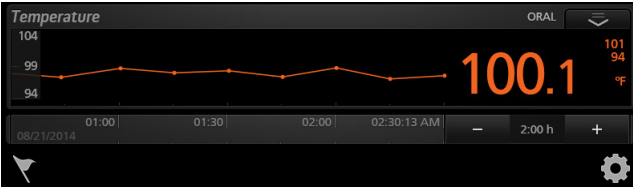

Note: Once measurement is successfully completed, value is displayed.

- If continuous monitoring is not needed, dock the temperature probe in the probe well holder to reset measurement.
- To continuously monitor temperature, touch the drop-down menu  and



then select **Continuous** mode.

Note: Monitor mode can only be enabled if the probe has not been removed from the measurement site during spot check.

Note: Another spot check cannot be performed until the probe is first returned to the probe well holder.

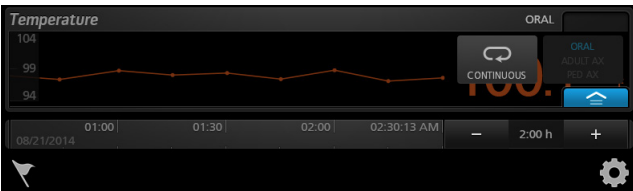

- Dock the temperature probe in the probe well holder to end temperature monitoring.

Temperature Probes

Two types of probes are available for use with the Root: an oral/axillary probe and a rectal probe.

Root will automatically detect the probe type when connected: oral/axillary or rectal.

- Adult axillary Spot Check Mode (predictive) temperatures are measured using the oral/axillary probe in combination with the Root in Adult axillary mode. A temperature reading is provided in approximately 12-15 seconds.
- Pediatric axillary Spot Check Mode (predictive) temperatures are measured using oral/axillary probes in combination with the Root in Pediatric axillary mode. A temperature reading is provided in approximately 10-13 seconds.
 - For oral temperatures, place the probe tip under the patient's tongue on either side of the mouth to reach the sublingual pocket and ask the patient to close his/her lips.

Sublingual Pocket Location



- For axillary temperatures, lift the patient's arm so that the entire axilla is easily seen and place the probe as high as possible in the axilla. Do not allow the probe tip to come into contact with the patient until the probe is placed in the measurement site. Any prior contact between the probe tip and the tissue with another material may cause inaccurate readings. Verify that axillary tissue completely surrounds the probe tip and place the arm snugly at the patient's side. Firmly hold the probe in place and keep the tip of the probe in contact with the tissue throughout the measurement process.
- Remove the probe after the temperature measurement is complete and firmly press the ejection button on the top of the probe to release the probe cover.
- Return the probe to the probe well.
- Rectal temperatures are measured using rectal probes which give a Spot Check Mode (predictive) temperature in approximately 10-13 seconds.
 - For rectal temperatures, separate the patient's buttocks with one hand. Use the other hand to gently insert the probe only 5/8 in. (1.5 cm) inside the rectum (less for infants and children). The use of a lubricant is optional. Tilt the probe so that the tip is in contact with tissue. Continue to separate the buttocks and hold the probe in place throughout the measurement process.
 - Remove the probe after the temperature measurement is complete and firmly press the ejection button on the top of the probe to release the probe cover.
 - Return the probe to the probe well and wash your hands.

Regularly wipe the probe with a cloth dampened with warm water and a mild detergent solution, a 70% isopropyl alcohol solution, or a 10% chlorine bleach solution.

Supported Masimo Probes and Probe Covers

Accessory
Temperature Probe Covers, 10 Boxes (25ct. each)
Probe/Well Kit, Oral
Probe/Well Kit, Rectal

Chapter 5: NIBP Measurement

Root provides noninvasive blood pressure readings through an oscillometric method.

An oscillometric method of blood pressure measurement is a noninvasive method that monitors the amplitude of cuff pressure changes during cuff deflation to determine arterial blood pressure. The NIBP module is designed for use on adult, pediatric, and neonatal patients.

Patient Measurement Mode

Below is a table that provides a method for selecting the appropriate NIBP patient category. To change patient category see **Profiles** on page 53.

Weight	Patient Category	Maximum Pressure
Greater than 75lbs (34kg)	Adult	280 mmHg
Between 15.4-75lbs (7-34kg)	Pediatric	280 mmHg
Less than 15.4lbs (7kg)	Neonatal	140 mmHg

Cuff Selection and Placement

Root uses a quick connect hose with a blood pressure cuff to measure NIBP. Based on the Cuff Type that is selected, use the following approved blood pressure cuff chart to choose sizes.

Accessory	Length
NIBP Patient Hose, Male Quick Connect	3 meters (9.8 feet)
NIBP Patient Hose, Female Bayonet	3 meters (9.8 feet)
Cuff Type	Size (color), Range - cm
Reusable Masimo Blood Pressure Cuff	Child (green), 12 - 19 Small Adult (turquoise), 17 - 25 Adult (navy blue), 23 - 33 Large Adult (burgundy), 31 - 40

Disposable Neonatal Blood Pressure Cuff	Neonate #1, 3 - 6
	Neonate #2, 4 - 8
	Neonate #3, 6 - 11
	Neonate #4, 7 - 13
	Neonate #5, 8 - 15

To ensure the correct cuff size

Wrap the cuff around the arm.

INDEX



The index line should align within the cuff range markings

If the index line does not fit within the range markings, select a larger or smaller cuff.

To place a cuff on the measurement site

Wrap the cuff around the arm making sure that the Artery Marker is aligned over the brachial artery as shown in the image below. If possible, do not wrap the cuff over the patient's clothing. The cuff should fit snug to the patient's arm for maximum oscillometric signal quality. An appropriate sized cuff should be placed on the non-dominant arm where the lower edge of the cuff is located 2 cm above the antecubital fossa (interior bend of the elbow).

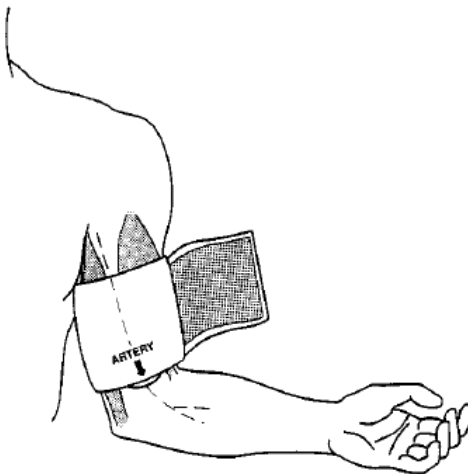

Ensure that the air hose from the monitor to the cuff is not compressed, crimped, or damaged.

Patient Conditions

When measuring the patient's blood pressure, it is recommended that the patient be in Normal Use position.

Ensure that the following conditions are met before taking the patient's blood pressure:

- Patient is comfortably seated
- Patient's legs are uncrossed
- Patient's feet are flat on the floor
- Patient's back and arm are supported
- The middle of the cuff is at the level of the right atrium of the heart

Blood pressure measurements can be affected by the patient's position, physiological condition, and environmental factors.

Physiological conditions that can affect blood pressure measurements include, but are not limited to, cardiac arrhythmias, arterial sclerosis, poor perfusion, diabetes, age, pregnancy, pre-eclampsia, renal diseases, trembling, or shivering.

Note: It is recommended to notify the patient to relax and not talk during the measurement.

Note: It is recommended that 5 minutes should elapse before the first reading is taken.

Operation - NIBP

Root works by noninvasively monitoring the amplitude of cuff pressure changes during cuff deflation to determine arterial blood pressure. The cuff pressure is first elevated above the patient systolic blood pressure level. The cuff will then begin to deflate at a certain rate. The initial rise in the amplitude of pressure fluctuations during cuff deflation corresponds closely to the systolic blood pressure. As the cuff is further deflated, the pressure fluctuations increase in amplitude until a peak is reached which is usually referred to as the mean arterial pressure (MAP). As cuff deflation continues, the diastolic pressure can be determined based upon the rapidly diminishing amplitude of the pressure fluctuations.

Spot Check Measurement

To spot check measure NIBP

1. Ensure that the correct patient profile is selected before measurement.



WARNING: Only use Root in Neonatal mode with a neonatal blood pressure cuff to measure blood pressure on neonates.

Note: The **Patient Category** determines the initial inflation pressure of NIBP. Ensure that the proper patient profile and subsequent patient category are appropriate for the intended patient to be measured.

2. To change the patient profile, touch the **Main Menu** icon  then select **Profiles**



Touch the **Profile Name** to select the desired patient profile.

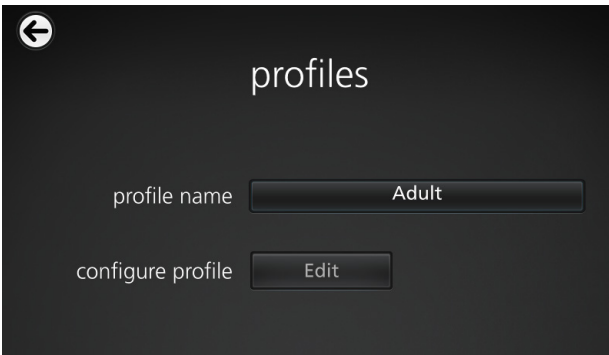

3. Properly place the blood pressure cuff on patient. See *Cuff Selection and Placement* on page 85.
4. Touch the **Start** button to begin measurement.



5. Wait for measurement to complete or touch the **Stop** button to stop measurement.

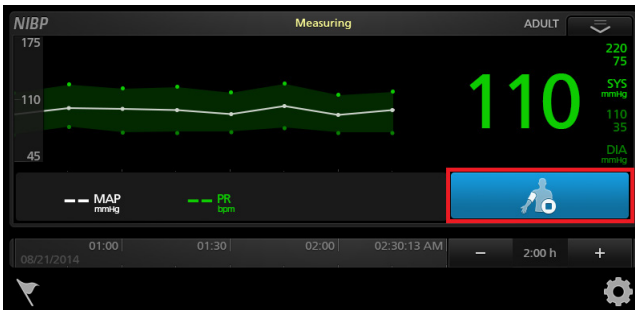

Note: Measuring status displayed in the status bar.

6. Wait for measurement values to appear to ensure that spot check is complete.

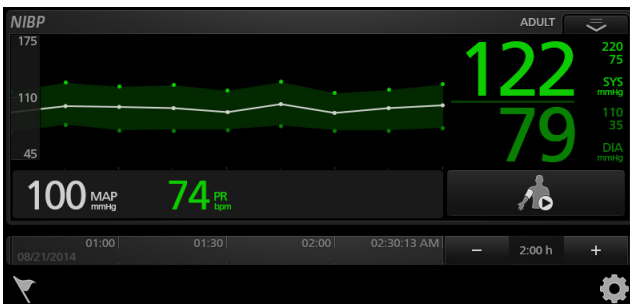

Automatic Interval Measurement

Automatic interval measurement mode will take blood pressure measurements once every desired interval.

To measure blood pressure in Automatic interval mode

1. Ensure that the correct patient profile is selected before measurement.





WARNING: Only use Root in Neonatal mode with a neonatal blood pressure cuff to measure blood pressure on neonates.

2. To change the patient profile, touch the **Main Menu** icon  then select **Profiles**

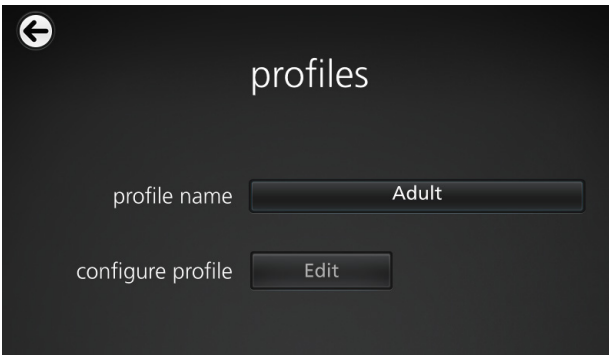

Touch the **Profile Name** to select the desired patient profile.



3. Properly place the blood pressure cuff on patient. See *Cuff Selection and Placement* on page 85.
4. To enable **Automatic** mode, touch the **Main Menu** icon , then select **NIBP**



Settings

On the **Intervals** screen, change **Set Mode** to **Automatic**, and then select the desired **Interval**. The measurement mode can also be changed using the action menu.

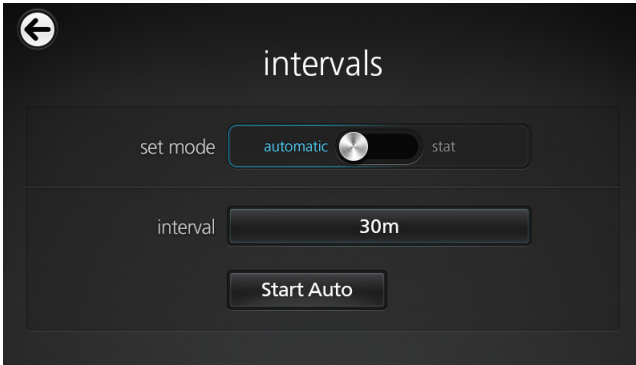

WARNING: Too frequent blood pressure measurements can cause injury to the patient due to blood flow interference.

5. To begin measurement, touch the **Start Auto** button and then press the arrow at the top-left corner of the touchscreen to return to the **Main View**.
6. Wait for measurement to complete or touch the **Stop** button to stop the measurement.

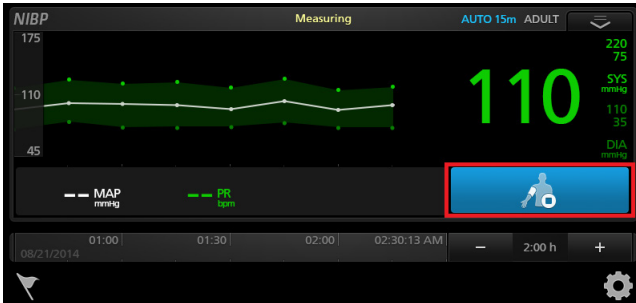

Note: Once finished measuring, values will appear and the next measurement will begin after the specified interval.



Stat Interval Measurement

Stat interval measurement mode will take blood pressure measurements continuously for the desired duration.

To measure blood pressure in Stat interval mode

1. Ensure that the correct patient profile is selected before measurement.





WARNING: Only use Root in Neonatal mode with a neonatal blood pressure cuff to measure blood pressure on neonates.

2. To change the patient profile, touch the **Main Menu** icon , then select **Profiles**

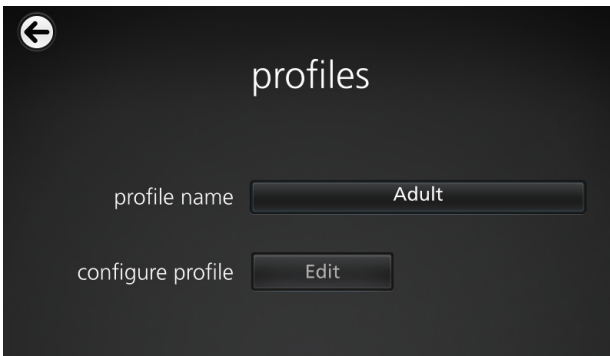

Touch the **Profile Name** to select the desired patient profile.



3. Properly place the blood pressure cuff on patient. See *Cuff Selection and Placement* on page 85.
4. To enable **Stat** mode, touch the **Main Menu** icon , then select **NIBP Settings**



On the **Intervals** screen, change **Set Mode** to **Stat**, and then select the desired **Stat Duration**. The measurement site can also be changed using the action menu.

WARNING: Too frequent blood pressure measurements can cause injury to the patient due to blood flow interference.

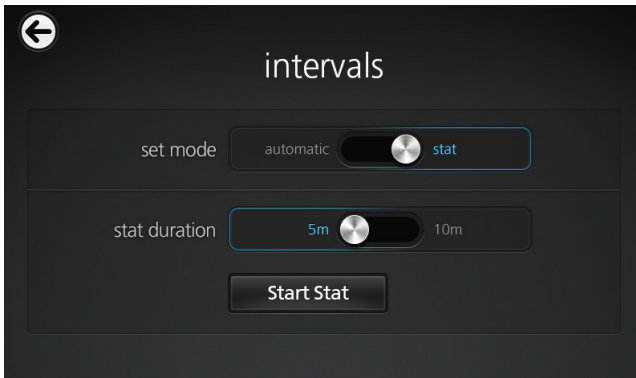

5. To begin measurement, touch the **Start Stat** button and then press the arrow at the top-left corner of the touchscreen to return to the **Main View**.
6. Wait for measurement to complete or touch the **Stop** button to stop the measurement.

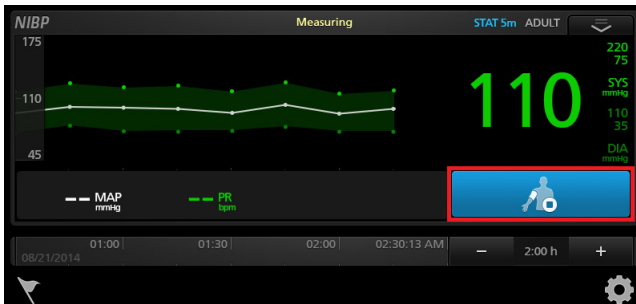

Note: Once measurement is completed and values appear, the next measurement will begin and repeat until duration time has elapsed.

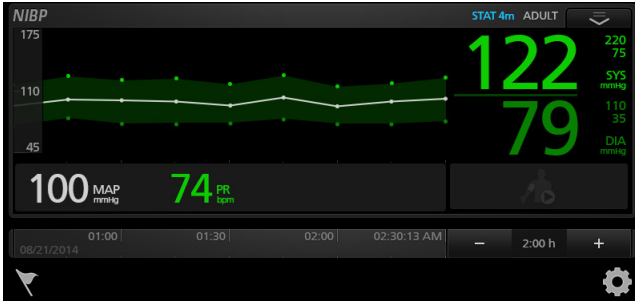

Chapter 6: Admit and Discharge to Patient SafetyNet

The Admit/Discharge icon is located at the bottom left of the screen and allows for clinicians to admit or discharge patient's on Masimo Patient SafetyNet directly from Root.

Note: In order to use this feature Masimo Patient SafetyNet software version 5.0.1.0 or higher is required.

Not Admitted

A **Not Admitted** (see Fig 1.) message will appear on the Root screen when the sensor is placed onto a patient and a patient has not yet been admitted on the Root. Press the **Admit** button on the screen to admit the patient or press skip and the patient data will not be transmitted to the Masimo Patient Safety Net.

Fig. 1

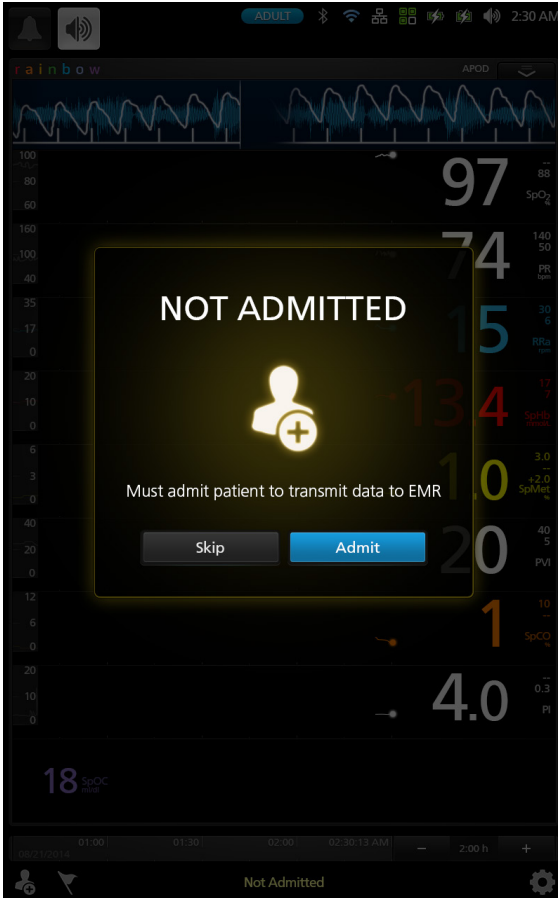

Discharging a Patient

To discharge a patient:

1. Press the discharge icon  on the bottom left of the screen to open the patient screen.
2. Select the **Discharge** button on the bottom of the screen (see Fig. 2).
3. A confirmation message will appear (See Fig. 3). Press **Discharge** on the screen.

Fig. 2

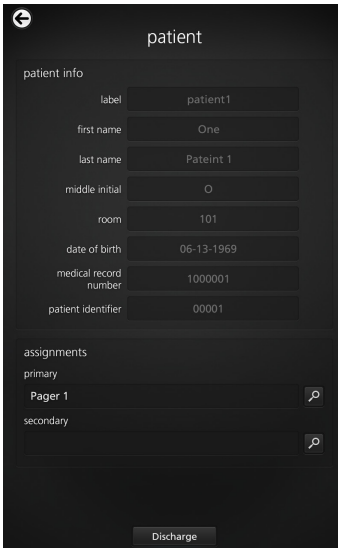
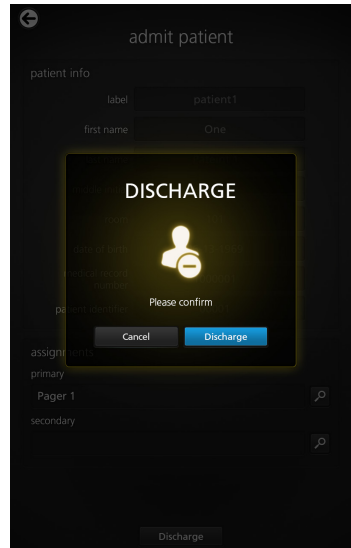

Fig. 3



Admitting a Patient

To admit a patient:

1. Press the admit icon  on the bottom left of the screen to open the patient screen.
2. Select the patient name by pressing the search button on the screen (see Fig. 4).
3. Select the search icon and select the patient's name from the list (see Fig. 5) or filter by typing patient's last name and select the patient from the list.

Fig. 4

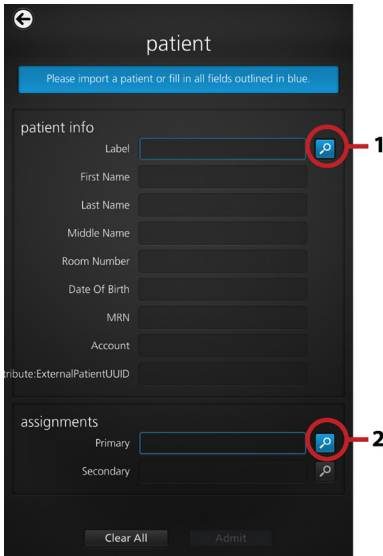
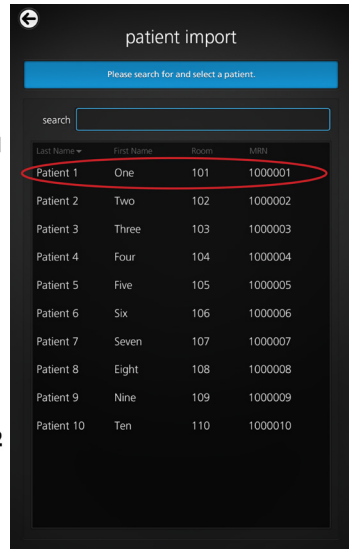
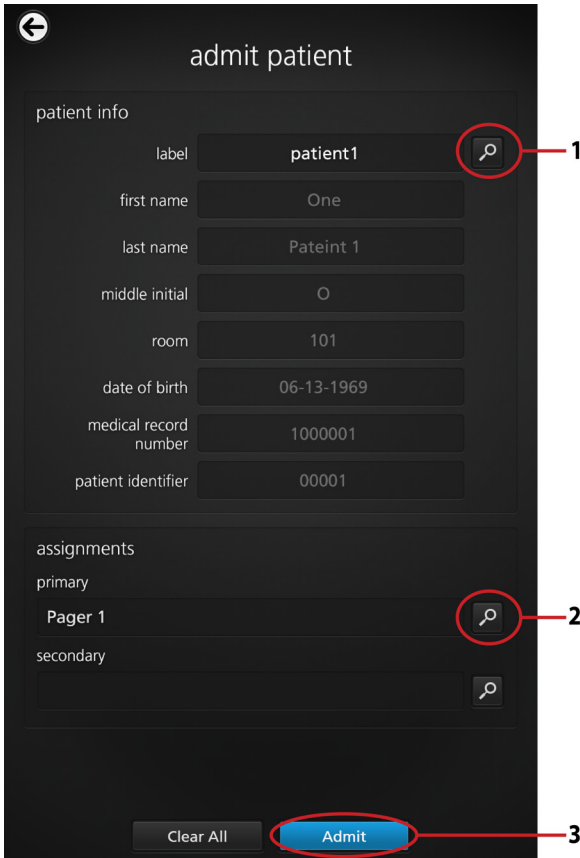

Fig. 5



In the assignment section of the admit patient menu (see Fig. 6), select the primary pager then press **Admit** on the screen as shown in the image below.

Fig. 6



Not Monitoring Message

When the sensor is off the patient for an extended period of time, a **Not Monitoring** message will appear on the screen (see Fig. 7). Acknowledge the message by pressing **Cancel** or **Discharge**. Press **Discharge** to discharge the patient that is currently admitted on the Root, or press **Cancel** to keep the same patient admitted.

Fig. 7

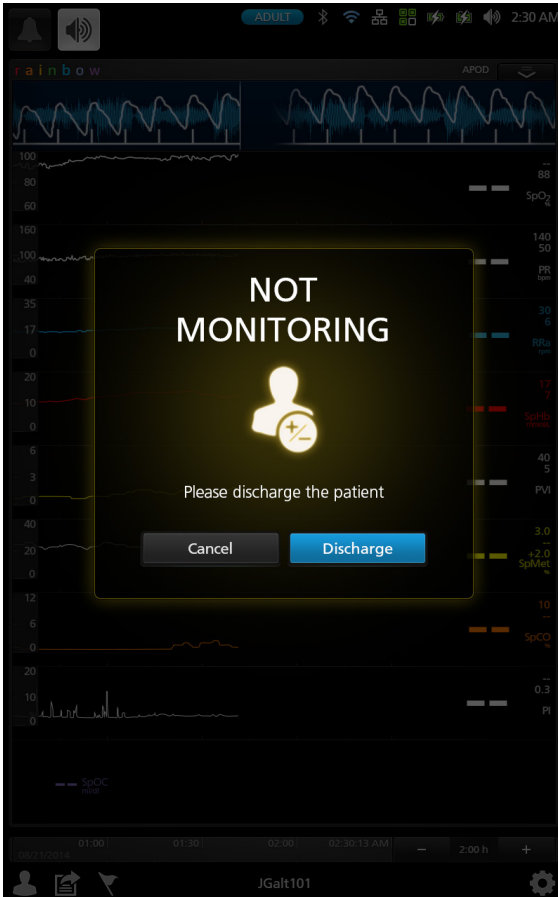

Monitoring Resumed Message

When the sensor is taken off and placed back onto a patient, a **Monitoring Resumed** message will appear on the Root screen (see Fig. 8).

If this is a new patient, press **Discharge** on the screen to discharge the previous patient. If the same patient is being monitored, press **Confirm** to continue monitoring the same patient.

Fig. 8

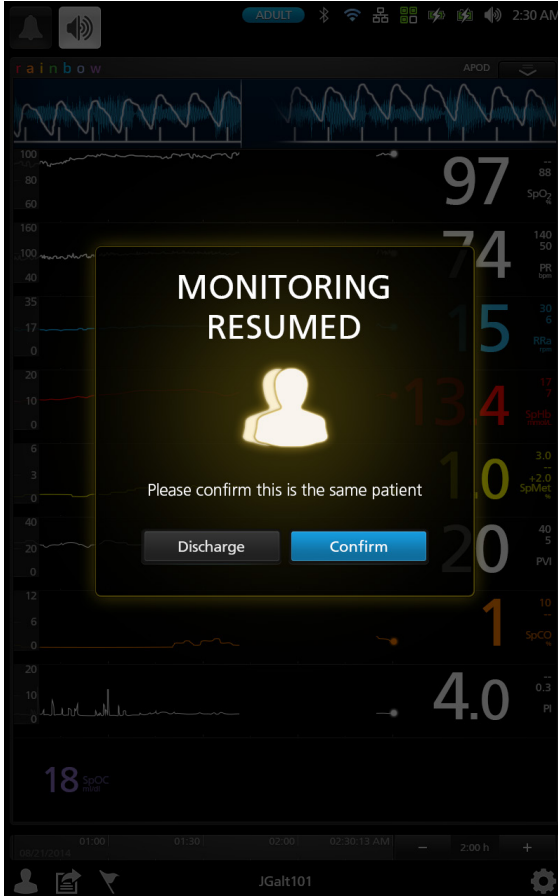

Chapter 7: Radius-7

The Radius-7 is a patient wearable device for continuous monitoring when the patient is ambulatory. It measures arterial oxygen saturation (SpO₂), pulse rate (PR), perfusion index (PI), and Pleth Variability Index (PVI®) along with Acoustic Respiration Rate (RRa®). It uses a Bluetooth® connection to transfer parameter data to Root. When Radius-7 is connected to Root via Bluetooth, the device automatically creates a Window that displays all the data from Radius-7.

Root also acts as a charging station for Radius-7. Radius-7 is docked onto Root via a Battery Charging Adapter. See Radius-7 Operator's Manual for more information.

Chapter 8: MOC-9

Flexible measurement expansion is enabled through MOC-9. It can display parameters and measurements captured by SedLine, ISA Capnography, and third-party technologies in an all-in-one view on Root.

When any MOC-9 module is connected, Root automatically creates a Window that displays all the data from that module. The example below shows the "SedLine" and "Capnography" Windows which display data from the SedLine brain function monitoring and ISA capnography MOC-9 modules that are connected to Root.



Using MOC-9 Ports

Use a MOC-9 cable to connect other MOC-9 modules to Root.



To use an MOC-9 Port

1. Identify the MOC-9 end of the cable.
2. Orient the cable to fit correctly into an MOC-9 Port.
3. Insert the MOC-9 cable securely into any of the three (3) compatible ports on Root.

Chapter 9: Iris

Iris allows a variety of standalone devices to connect to Root. Patient data can be passed through Root to Patient SafetyNet or Connectivity Gateway, which can send the data to electronic health records.

Below is an example of one way Root can be used in a network setting using Patient SafetyNet. Root receives and may display information from Radical-7, MOC-9 modules, as well as standalone devices.

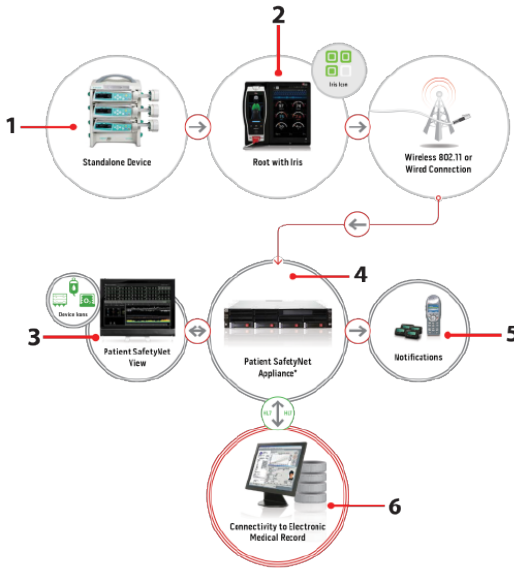

Ref.	Description
1	Standalone devices connected via Iris (e.g., monitor, pump, ventilator)
2	Root
3	MOC-9 modules
4	Patient SafetyNet or Masimo Connectivity Gateway
5	Notification devices
6	Electronic Health Records system

Iris Status Screen

Information about Iris Connectivity Ports are displayed on this screen, which is accessible by selecting the Iris option on the Main Menu.

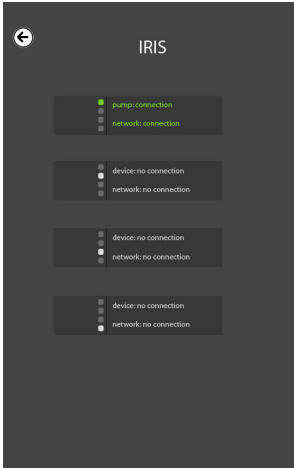

Connection Status Color	Description of Connection
Green	Standalone device is successfully connected to Root, and Root is successfully connected to a Patient SafetyNet or Connectivity Gateway.
Yellow	Standalone device is successfully connected to Root; however, Root is not successfully connected to a Patient SafetyNet or Connectivity Gateway.
Gray	No standalone device is connected to the Iris Connectivity Port.

Additionally, the Ports are also mapped to the Iris icon on the Status Bar. When a standalone device is connected to Root via one of the Ports, the corresponding part of the icon will be lit green or yellow. In the example below, a standalone device is connected to Iris Connectivity Port 1.



Status and connection type are read-only and not configurable by the user. For more information on Iris connectivity, see Instructions for Use or Operator’s Manual for the appropriate version of Masimo Patient SafetyNet.

Using Iris Connectivity Ports

Use Iris Adapters and RJ-45 cables to connect standalone devices to Root.

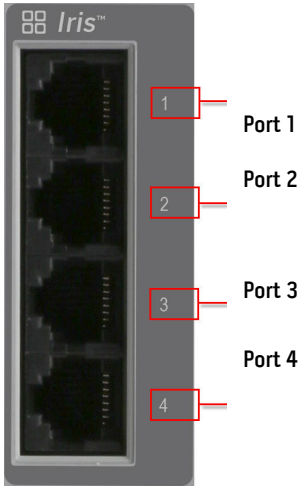

To connect a standalone device via an Iris Connectivity Port:

1. Connect the RS-232 end of the Iris Adapter to the standalone device.
2. Connect the RJ-45 end of the Iris Adapter to any of the four (4) compatible Iris Connectivity Ports on Root using a RJ-45 cable.

Chapter 10: Messages

The following messages are specific to Root:

Message	Explanation	Next Step
Battery Charge is Low.	The internal battery needs to be charged. System Status Lights flash yellow.	Charge Root's battery using AC power.
MOC-9 module Disconnected (e.g. SedLine Disconnected)	A MOC-9 module is disconnected from Root.	Reconnect module or acknowledge message by pressing the Alarm Silence icon.
Radical-7 Disconnected	Radical-7 is disconnected from Root.	Reconnect Radical-7 or acknowledge message by pressing the Alarm Silence icon.
Radius-7 Disconnected	Radius-7 is disconnected from Root.	Reconnect Radius-7 or acknowledge message by pressing the Alarm Silence icon.
Check Probe	Probe is not responsive.	Check probe tip condition. Re-insert probe into probe well or check for alignment problem. If problem persists, replace the probe. If problem still persists, contact Customer Service.
Retake Measurement	An error has occurred in the process of taking a patient temperature measurement.	Try another measurement cycle. If problem persists, replace probe.
Check Ambient Temperature	Ambient temperature may be too high or too low.	Verify ambient temperature does not exceed operating specification. Check internal temperature at probe well.
Replace Probe	Probe is not responsive due to not being calibrated or damaged.	Replace probe.
Temperature Out of Range	Patient or environmental temperature conditions may be too low for a temperature measurement.	Verify patient temperature is not outside of the measurement range. Verify ambient temperature does not exceed operating specification. If conditions are valid and problem

Message	Explanation	Next Step
		<p>persists, replace probe.</p> <p>If problem still persists, contact Customer Service.</p>
Temperature Out of Range	Patient or environmental temperature conditions may be too high for a temperature measurement.	<p>Verify patient temperature is not outside of the measurement range.</p> <p>Verify ambient temperature does not exceed operating specification.</p> <p>If conditions are valid and problem persists, replace probe.</p> <p>If problem still persists, contact Customer Service.</p>
Module Error	Module communication error.	<p>Power cycle the device.</p> <p>If problem still persists, contact Customer Service.</p>
Connect Probe	Temperature Probe has been disconnected or is not responsive.	Reconnect Temperature Probe and try another measurement cycle.
Check Cuff (Weak Signal)	Weak or no signal measured during blood pressure measurement.	<p>Check that the hose is connected.</p> <p>Check that the correct size cuff is being applied.</p> <p>Check that the cuff is in the correct position.</p> <p>Check that there is no excessive clothing between arm and cuff.</p> <p>Retake another measurement.</p> <p>Check that the cuff is not leaking air.</p> <p>If problem still persists, contact Customer Service.</p>
Check Cuff (Artifact)	Motion may be affecting ability to take measurement.	
Check Cuff (Out of Range)	Measurement is out of range.	
Check Cuff (Measurement Timeout)	Weak Signal when measurement is being taken.	
Check Cuff (Pneumatic Blockage)	May be a blockage in the air hose.	
Check Cuff (Inflate Timeout)	May be a blockage in the air hose.	
Check Cuff (Safety Timeout)	Weak Signal when measurement is being taken.	

Message	Explanation	Next Step
Check Cuff (Overpressure)	May be due to a faulty cuff.	
Calibration Required	Blood pressure measurement transducer may be out of range or there has been a calibration data failure.	Perform calibration procedures per User Manual. If problem still persists, contact Customer Service.

For additional messages, see Instructions for Use or Operator's Manuals for Radical-7, Radius-7, and MOC-9 modules.

Chapter 11: Troubleshooting

Troubleshooting Radical-7, Radius-7, and MOC-9 Modules

For information on troubleshooting values that are provided from Radical-7, Radius-7, and MOC-9 modules, refer to their respective Instructions for Use or Operator's Manuals.

Troubleshooting Root

Symptom	Possible Cause	Correction
Root does not turn on.	Power Button not pressed long enough.	Press Power Button for two (2) seconds.
	The battery may be depleted.	Connect Root to AC power to charge battery.
	One of the fuses is not operating properly.	Replace the fuse. See Replacing the Fuses on page 135.
Root turns on, but Main Screen is dim or blank.	The brightness setting is not correct.	Adjust the brightness setting. See Brightness on page 48. If the condition persists, Root requires service. Contact Masimo Technical Support. See Return Procedure on page 140.
Touch functionality is not responsive.	Internal failure.	Root requires service. Contact Masimo Technical Support. See Return Procedure on page 140.
Not displaying data from Radical-7, Radius-7, or MOC-9 modules.	Connection error.	Ensure that the connections are securely in place and properly plugged in, or that the cable is not defective. For Radius-7, ensure that the device is paired with Root via Bluetooth. Refer to Operator's Manual of Radius-7 for more information.
Iris screen does not display connection status for standalone devices.	Connection error.	Unplug and replug the Iris Adapter.

Symptom	Possible Cause	Correction
Iris screen does not display connection status for standalone devices.	Connection error.	If the problem persists, refer to instructions for use or operator's manual for the connected standalone devices or Iris section of the instructions for use or operator's manual for the appropriate version of Patient SafetyNet.
Root has a continuous speaker tone.	Internal failure.	To silence an alarm, press the Power Button for eight (8) seconds. If alarm continues to sound, Power Off Root. Root requires service. See Return Procedure on page 140.
Power Button does not respond when pressed.	Power Button may need to be pressed for a longer time.	To Power On when turned off or in Sleep Mode, press Power Button for two (2) seconds. To Power Off when turned on or in Sleep Mode, press the Power Button for eight (8) seconds.
	Internal failure.	Root requires service. See Return Procedure on page 140.
Home Button does not work when pressed.	Internal failure.	Root requires service. See Return Procedure on page 140.
Battery does not charge.	AC power cable may be disconnected.	Unplug and replug AC power cable.
Root Charging Indicator illuminates red.	Internal failure.	Root requires service. See Return Procedure on page 140.
Nurse Call does not communicate.	Connection error.	Unplug and replug Nurse Call connector. See Nurse Call Setting Connections on page 139.

Chapter 12: Specifications

This chapter contains specifications of Root.

For information on the specifications of Radical-7, Radius-7, MOC-9 modules, and standalone devices, see Directions for Use or Operator's Manuals for these devices.

Measurement Accuracy

NIBP

Pressure Transducer	
Between 0 mmHg and 300 mmHg	±3mmHg

Temperature*

Temperature				
Between 80°F and 110°F (26.7°C and 43.3°C)	All patient populations			±0.2 °F (0.11°C)
Temperature Measurement Site/Mode	Number of Subjects	Clinical Bias (°C)	Limits of Agreement	Clinical Repeatability
Oral	106	0.01	0.63	0.14
Rectal	105	-0.12	0.59	0.29
Pediatric Axillary	117	-0.03	0.56	0.14
Adult Axillary	105	0.13	0.43	0.14

**Test Report #:2010036 Test Report of Clinical Investigation to demonstrate that the SureTemp® Plus thermometer meets the essential performance of clinical thermometers for body temperature measurement as described in ISO 80601-2-56:2009*

Display Ranges

NIBP

Patient Population	Measurement	Display Range
Adult	Systolic	40-260 mmHg
	Diastolic	20-200 mmHg
	MAP	26-220 mmHg
Pediatric	Systolic	40-230 mmHg
	Diastolic	20-160 mmHg
	MAP	26-183 mmHg
Neonatal	Systolic	40-130 mmHg
	Diastolic	20-100 mmHg
	MAP	26-110 mmHg

Temperature

Measurement	Display Range
Temperature	80-110°F (26.7-43.3°C)

Pulse Rate

Measurement	Display Range
Pulse Rate (PR)	30-220 bpm

NIBP Pressurization Ranges

Weight	Patient Category	Initial Pressurization	Maximum Pressure
Greater than 75 lbs (34 kg)	Adult	160 mmHg	280 mmHg
Between 15.4 - 75 lbs (7 - 34 kg)	Pediatric	140 mmHg	280 mmHg
Less than 15.4 lbs (7 kg)	Neonatal	90 mmHg	140 mmHg

Electrical

Root	
AC Power requirements	100-240 VAC~, 47-63 Hz, 180 VA (Max)
Fuses (2)	2 Amp, Metric, (5x20mm), 250V, 1500A Breaking Capacity
Battery	
Type	10.8V Lithium Ion (Nominal)
Capacity	4 hours*
Maximum Charging Time	4 hours

*This represents approximate run time at the lowest brightness, using a fully charged battery.

Environmental

Root	
Operating Temperature	50°F to 104°F (10°C to 40°C)
Transport/Storage Temperature	-4°F to 122°F (-20°C to 50°C)
Operating Humidity	15% to 95%, non-condensing
Storage Humidity	15% to 95%, non-condensing
Operating Air Pressure	500 mbar to 1060 mbar -1000 ft to 18,000 ft (-304 m to 5,486 m)

Touchscreen Display

Characteristic	Description
Type	Backlit Active Matrix TFT LCD
Resolution	1280 x 800 pixels
Size	10.1 in (25.65 cm) Diagonal
Color	24 bit RGB
Touchscreen Type	Multi-Touch P-Cap

Alarms

Audio Alarm Type	System Status Light Color	Audio Description
High Priority	Flashing Red	10-pulse burst, pulse spacing: 0.250s, 0.250s, 0.500s, 0.250s, repeat time:10s
Medium Priority	Flashing Yellow	3-pulse burst, pulse spacing: 0.375s, 0.375s, repeat time: 7s
Low Priority	Yellow	1-pulse burst, repeat time: 5s

Nurse Call Specifications

The Nurse Call relays have the following electrical specifications per switch:

Parameter	Specification
Max Voltage	36 VDC or 24 VAC peak

Connectors

Connector	Type	Number of Ports
Ethernet	10/100 Mbps	1
Nurse Call	1/4 inch round female	1
MOC-9	Masimo Connector	3
USB	USB 2.0	2
Iris	RS-232/RJ-45	4
NIBP	Male Quick Connect	1
Temperature	MOLEX 52271-0690	1

Wireless Specifications

Communication (Wi-Fi)	
Type	WLAN Radio: IEEE 802.11 a/b/g
Frequency	802.11a: 5180-5240 MHz, 5745-5825 MHz 802.11b/g: 2412-2462 MHz
Max Peak Output Power	WLAN 17 dBm
Classification of Output Power Rating	Conducted
Output Power Type	Fixed at the Factory
Modulation Types	OFDM, BPSK, CCK
Modulation Signals	Analog and Digital

Communication (Wi-Fi)	
Available Data Rates	802.11a - 6, 9, 12, 18, 24, 36, 48, 54 Mbps. 802.11b - 1, 2, 5.5, 11 Mbps. 802.11g - 6, 9, 12, 18, 24, 36, 48, 54 Mbps.

Communication (Bluetooth)	
Type	Bluetooth
Frequency	2402-2480 MHz
Max Peak Output Power	Bluetooth 1.3 dBm
Classification of Output Power Rating	Conducted
Output Power Type	Fixed at the Factory
Modulation Types	DH5
Modulation Signals	Analog and Digital
Available Data Rates	Bluetooth 1 Mbps

Security and Authentication	
Encryption	64/128-bit WEP, Dynamic WEP, WPA-TKIP, WPA2-AES
Authentication	Open System, Shared Key, Pre-Shared Key (PSK), 802.1X: LEAP, PEAP< TTLS, TLS, EAP-FAST

Radio Compliance	
USA	FCC ID: VKF-RDS7A Model - RDS-7A
Canada	IC:7362A-RDS7A IC Model: RDS-7A RSS-210
Europe	EN 300 328 EN 301 893 EN 301 489-1 EN 301 489-17 R & TTE Directive

Compliance

Electrical Safety
ANSI/AAMI ES 60601-1:2005
CAN/CSA C22.2 No. 60601-1:2008
EN 60601-1: 1990 + A1: 1993 + A2:1995
IEC 60601-1: 2005
IEC 60601-2-49:2011
IEC 80601-2-30:2009
ISO 80601-2-56:2012

NIBP Module Standards
AAMI SP10:2002
ISO 81060-2:2009
EN 1060-1:1996 +A2:2009
EN 1060-3:1997 +A2:2009
EN 1060-4:2004

EMC Compliance
EN 60601-1-2, Class A

Radio Compliance	
USA	FCC ID: VKF-RDS7A Model - RDS-7A
Canada	IC:7362A-RDS7A IC Model: RDS-7A RSS-210
Europe	EN 300 328 EN 301 893 EN 301 489-1 EN 301 489-17 R & TTE Directive

Equipment Classification per IEC 60601-1	
Type of Protection	Class I (on AC power)
	Internally powered (on battery power)
Degree of Protection of Electrical Shock	Defibrillation proof BF-Applied Parts with the exception to the applied parts that are provided with the BF Applied Part marking.
Protection against harm from liquid ingress	IPX1 Protection against liquid drops falling vertically.
Mode of Operation	Continuous Operation

Guidance and Manufacturer's Declaration-Electromagnetic Emissions

Guidance and Manufacturer's Declarations - Electromagnetic Emissions		
The ME Equipment is intended for use in the electromagnetic environment specified below. The customer or the user of the ME Equipment should assure that it is used in such an environment.		
Emission Test	Compliance	Electromagnetic Environment - Guidance
RF Emissions CISPR 11	Group 1	ME Equipment uses RF energy only for its internal function. Therefore, its RF emissions are very low and are not likely to cause any interference in nearby electronic equipment.
RF Emissions CISPR 11	Class A	For hospital environment only. Not intended for use in a domestic environment.
Harmonic Emissions IEC 61000-3-2	Class A	
Voltage Fluctuations / Flicker Emissions IEC 61000-3-3	Complies	

Guidance and Manufacturer's Declaration-Electromagnetic Immunity

Guidance and Manufacturer's Declaration - Electromagnetic Immunity			
The ME Equipment is intended for use in the electromagnetic environment specified below. The customer or the user of the ME Equipment should assure that it is used in such an environment.			
Immunity Test	IEC 60601 Test Level	Compliance Level	Electromagnetic Environment - Guidance
Electrostatic discharge (ESD) IEC 61000-4-2	+6 kV contact +8 kV air	+6 kV contact +8 kV air	Floors should be wood, concrete or ceramic tile. If floors are covered with synthetic material, the relative humidity should be at least 30%.
Electrical fast transient/burst IEC 61000-4-4	+2 kV for power supply lines. +1 kV for input/output lines.	--	Mains power quality should be that of a typical commercial or hospital environment.
Surge IEC 61000-4-5	+1 kV - differential mode +2 kV - common mode	--	Mains power quality should be that of a typical hospital environment.
Voltage dips, short interruptions and voltage variations on power supply input lines. IEC 61000-4-11	100% for 0.5 cycle 60% for 5 cycles 30% for 25 cycles 100% for 5 seconds	--	Mains power quality should be that of a typical commercial or hospital environment. Root provides a battery for continued operation during power mains interruption for a maximum of 4 hours.
Power frequency (50 / 60 Hz) magnetic field. IEC 61000-4-8	3 A/m	3 A/m	Power frequency magnetic fields should be at levels characteristic of typical location in a typical hospital environment.

Guidance and Manufacturer's Declaration - Electromagnetic Immunity			
<p>Conducted RF IEC 61000-4-6</p>	<p>3 Vrms 150 kHz to 80 MHz</p>	<p>3 Vrms</p>	<p>Portable and mobile RF communications equipment should be used no closer to any part of the ME Equipment, including cables, than the recommended separation distance calculated from the equation applicable to the frequency of the transmitter.</p> <p>Recommended separation distance</p> $d = \left[\frac{3,5}{V_1} \right] \sqrt{P}$ $d = \left[\frac{3,5}{E_1} \right] \sqrt{P}$ <p style="text-align: right;">80 MHz to 800 MHz</p> $d = \left[\frac{7}{E_1} \right] \sqrt{P}$ <p style="text-align: right;">800 MHz to 2.5 GHz</p> <p>where P is the maximum output power rating of the transmitter in watts (W) according to the transmitter manufacturer and d is the recommended separation distance in meters (m).</p> <p>Field strengths from fixed RF transmitters, as determined by an electromagnetic site survey^a, should be less than the compliance level in each frequency range^b.</p> <p>Interference may occur in the vicinity of equipment marked with the following symbol:</p> <div style="text-align: center;">  </div>
<p>Radiated RF IEC 61000-4-3</p>	<p>3 V/m 80 MHz to 2.5 GHz</p>	<p>3 V/m</p>	
<p>Note 1: At 80 MHz and 800 MHz, the higher frequency range applies.</p> <p>Note 2: These guidelines may not apply in all situations. Electromagnetic propagation is affected by absorption and reflection from structures, objects and people.</p>			

Guidance and Manufacturer's Declaration - Electromagnetic Immunity

(a) Field strengths from fixed transmitters, such as base stations for radio (cellular/cordless) telephones and land mobile radios, amateur radio, AM and FM radio broadcast and TV broadcast cannot be predicted theoretically with accuracy. To assess the electromagnetic environment due to fixed RF transmitters, an electromagnetic site survey should be considered. If the measured field strength in the location in which the ME Equipment is used exceeds the applicable RF compliance level above, the ME Equipment should be observed to verify normal operation. If abnormal performance is observed, additional measures may be necessary, such as re-orienting or relocating the ME Equipment.

















(b) Over the frequency range 150 kHz to 80 MHz, field strengths should be less than [V1] V/m.













Recommended Separation Distances

Recommended Separation Distance Between Portable and Mobile RF Communication Equipment and the ME Equipment			
The ME Equipment is intended for use in an electromagnetic environment in which radiated RF disturbances are controlled. The customer or the user of the ME Equipment can help prevent electromagnetic interference by maintaining a minimum distance between portable and mobile RF communications equipment (transmitters) and the ME Equipment as recommended below, according to the maximum output power of the communication equipment.			
Rated maximum output power of transmitter (W)	Separation Distance According to Frequency of Transmitter (m)		
	150 K Hz to 80 MHz $d = 1.17 \cdot \sqrt{P}$	80 MHz to 800 MHz $d = 1.17 \cdot \sqrt{P}$	800 MHz to 2.5GHz $d = 2.33 \cdot \sqrt{P}$
0.01	0.12	0.12	0.23
0.1	0.37	0.37	0.74
1	1.17	1.17	2.33
10	3.7	3.7	7.37
100	11.7	11.7	23.3
For transmitters rated at a maximum output power not listed above, the recommended separation distance d in meters (m) can be estimated using the equation applicable to the frequency of the transmitter, where P is the maximum output power rating of the transmitter in watts (W) according to the transmitter manufacturer.			
Note 1: At 80 MHz and 800 MHz, the higher frequency range applies. Note 2: These guidelines may not apply in all situations. Electromagnetic propagation is affected by absorption and reflection from structures, objects and people.			

Symbols

The following symbols are found on Root or its packaging and are defined below. Some of the interfaces and symbols are not available on all versions.

Symbols	Definition	Symbols	Definition
	Follow Instructions for Use		Separate Collection for Electronic Waste
	Manufacturer		Storage Temperature Limitation Storage Altitude Limitation
	Date of Manufacture		Storage Humidity Limitation
	Non-ionizing Electromagnetic Radiation		Keep Dry
IPX1	IPX1 Protection Against Liquid Drops Falling Vertically		Fragile/Breakable, Handle with Care
Rx ONLY	Federal (USA) Law Restricts this Device to Sale by Or on the Order of a Physician		Fuse Replacement. See <i>Replacing the Fuses.</i>
	ETL Intertek Certification		Equipotential Ground Terminal
FC	Federal Communications Commission (FCC) licensing		Iris Connection
IC Model	Industry Canada Registered Model		USB port
	Mark of Conformity to European Medical Device Directive 93/42/EEC		AC Current

Symbols	Definition	Symbols	Definition
	Authorized representative in the European community		Nurse Call Interface
	Wireless Features Can be Used in Member States with the restriction of indoor use in France		Defibrillation Proof Type BF
 CAUTION	Caution		Type BF Applied Part
	Product contains no natural rubber latex		Product contains no PVC (polyvinyl chloride) material
	Artery symbol and arrow should be placed over brachial or femoral artery		Index Line
	Cuff index line must fall within range markings for an accurate measurement		Arm Circumference
	Instructions/Directions for Use/Manuals are available in electronic format @ http://www.Masimo.com/TechDocs Note: eIFU is not available for CE mark countries.		

Chapter 13: Service and Maintenance

This chapter contains information about cleaning, battery operation, performance verification, service, repair and warranty.

Cleaning

Root is a non-sterile and reusable device. The surface of the Root should be cleaned when the device is visibly dirty, before and after each procedure, and/or according to hospital practice.

To surface clean, wipe down the outer surface of Root using any of the following:

- Cidex Plus (3.4% glutaraldehyde)
- 10% bleach solution
- 70% isopropyl alcohol solution

Do not allow liquids to enter the interior of Root. Using the recommended cleaning solutions on the touchscreen will not affect the performance of Root.

Replacing the Fuses

If a power-related problem causes one or both of the fuses to fail, the fuse(s) will need to be replaced. Replace fuse(s) with UL Listed fuses rated, 250V, 2 amp, metric, 5x20 mm and with a breaking capacity of minimum 1500A.

WARNING: To ensure safety, only replace with appropriately rated fuses.

The fuses can be removed by hand or with a 5-millimeter or 3/16-inch screwdriver.

To replace the fuse(s)

1. Power Off Root completely. Do not put in Sleep Mode. See ***Sleep and Power Off*** on page 77.
2. Remove the AC power cord from the Power Entry Module in the back panel.
3. Remove the fuse holder by pulling it forward from the Power Entry Module.
4. Remove a fuse by gently pulling the top of the fuse away from the center and then pulling up. The fuse should easily be removed. Do not force.
5. Place a new fuse in the fuse holder.
6. If replacing both fuses, repeat steps 4 and 5 for the second fuse.
7. Slide the fuse holder back into the Power Entry Module and press firmly to make sure it is secure.

Root is ready to be reconnected to AC power. If the fuses fail shortly after replacement, Root requires service. See ***Repair Policy*** on page 140.

Power-On Self Test

To conduct a Power-On Self Test

1. Connect Root to AC power, and verify that the AC Power Indicator is illuminated.
2. Power On Root. Within five (5) seconds, all available indicators will illuminate, the device will emit a tone, and the Masimo logo will display.

NIBP Module Calibration

Note: This section is provided as a reference and intended for qualified service professionals only.

Pass Criteria

International standards for automated NIBP devices require that the maximum static pressure accuracy shall be ± 3 mmHg or 2% or the reading, whichever is greater. This is a stringent requirement and all test equipment must be in excellent working order to properly perform this test. It is important to verify the calibration before changing it. Historical data has shown that the transducers rarely need to be re-calibrated although we still suggest that the calibration be verified annually.

Procedure

1. Enter NIBP menu, select "Calibration".
2. Connect a manometer, volume and the hand bulb to the Module using "T" adapters and connection tubing.
3. Touch the "Test" button on the display to start the calibration.
4. Apply various pressures (between 0 mmHg and 280 mmHg) to the Module with the hand bulb. Verify that the Module pressure is equal to the manometer pressure (± 3 mmHg). If the Module pressure does not agree with the manometer pressure (± 3 mmHg), perform the Zero Point Calibration and the Span Point Calibration. Then perform this calibration again.
5. Calibration is now complete.

NIBP Air Leak Test

Note: This section is provided as a reference and intended for qualified service professionals only.

Pass Criteria

International standards for automated NIBP devices require that air leakage within the pneumatic system must not exceed 6mmHg/minute.

Procedure

1. Connect the manometer and rigid volume (500 mL bottle) to the air hose connection using "T" adapters and connection tubing.
2. Touch the "Test" button on the display to start the test.
3. Wait for the countdown timer to reach 0 second.
4. Check the "Result" section, if the leak rate is greater than 6 mmHg/min, contact customer service.

Zero Point Calibration

Note: This section is provided as a reference and intended for qualified service professionals only.

Calibration Steps

1. Enter NIBP menu, select "Calibration", and select Zero Point Calibration.
2. Connect a manometer, volume and the hand bulb to the Module using "T" adapters and connection tubing.
3. Apply 0 (zero) mmHg to the module.
4. Touch the "Calibrate" to start the zero point calibration.
5. Results are displayed for Zero Point Calibration.
6. Calibration is completed.

Span Point Calibration

Note: This section is provided as a reference and intended for qualified service professionals only.

Calibration Steps

1. Enter NIBP menu, select "Calibration", and select Span Point Calibration.
2. Connect a manometer, volume and the hand bulb to the Module using "T" adapters and connection tubing.
3. Apply 250 mmHg to the module.
4. Touch the "Calibrate" to start the span point calibration.
5. Results are displayed for Span Point Calibration.
6. Calibration is completed.

Overpressure Test

Note: This section is provided as a reference and intended for qualified service professionals only.

Pass Criteria

International standards for automated NIBP devices require that the pressure must not exceed 300 mmHg on adults and pediatric patients and 150 mmHg on neonatal patients with a tolerance of 10% for 15 seconds or greater than 10% for 3 seconds. The overpressure pass criteria for the Advantage module are:

Adults, Pediatrics $300 \pm 10\text{mmHg}$

Neonates $150 \pm 5\text{mmHg}$

Test Method

The steps outlined below are for manually performing an overpressure test. Some or all of these steps may be incorporated into a service tool provided by the medical device manufacturer.

1. Connect a manometer, volume and hand bulb to Module using "T" adapters.
2. Touch the "Test" button on the display.
3. Increase the pressure to approximately 250mmHg using the hand bulb.
4. VERY SLOWLY increase the pressure from 280 to the overpressure point. Once it is reached, the valves will open and the pressure will rapidly reduce to 0mmHg.
5. If one of the overpressure values is not within the pass criteria above, return the module for service to an authorized service center.

Nurse Call Setting Connections

For maximum flexibility, either normally open or normally closed signals are available. During an alarm condition or a low Signal IQ event, depending on the configuration of the device output, the normally open pin will be connected to the common pin and the normally closed pin will be disconnected. In addition, the Nurse Call Polarity can be inverted to accommodate various nurse call station requirements.

Only qualified personnel should connect one of these two signals to a hospital's Nurse Call system.

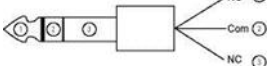
Cable Description	Nurse Call Event	Menu Setting
	2 contacts normally opened	Nurse Call Polarity Normal
	2 contacts normally closed	Nurse Call Polarity Inverse
	1 and 2 contacts normally opened 2 and 3 contacts normally closed	Nurse Call Polarity Normal
	1 and 2 contacts normally closed 2 and 3 contacts normally opened	Nurse Call Polarity Inverse
	1 and 2 contacts normally closed 2 and 3 contacts normally opened	Nurse Call Polarity Inverse

Battery Test

To conduct a Battery Test

1. Fully charge Root by connecting it to AC power.
2. Verify that the Root Charging Indicator is illuminated.
3. When Root is fully charged, the Root Charging Indicator turns off.
4. Power On Root and verify that the Root Battery Indicator icon on the Status Bar shows a full charge.

Repair Policy

Masimo or an authorized Service Department must perform warranty repair and service. Do not use malfunctioning equipment. Have the device repaired.

Clean contaminated and/or dirty equipment before returning, following the cleaning procedure described in **Cleaning** on page 135. Make sure the equipment is fully dry before packing.

To return the device for service, see **Return Procedure** on page 140.

Return Procedure

Clean contaminated/dirty equipment before returning, following instructions in **Cleaning** on page 135. Make sure the equipment is fully dry before packing. Call Masimo at 800-326-4890 and ask for Technical Support. Ask for an RMA number. Package the equipment securely, in the original shipping container if possible, and enclose or include the following information and items:

- A letter describing in detail any difficulties experienced with the Root. Include the RMA number in the letter.
- Warranty information, a copy of the invoice or other applicable documentation must be included.
- Purchase order number to cover repair if the Root is not under warranty, or for tracking purposes if it is.
- Ship-to and bill-to information.
- Person (name, telephone/Telex/fax number, and country) to contact for any questions about the repairs.
- A certificate stating the Root has been decontaminated for bloodborne pathogens.
- Return the Root to the shipping address listed in **Contacting Masimo** on page 140.

Contacting Masimo

Masimo Corporation
40 Parker
Irvine, California 92618

Tel:+1 949 297 7000
Fax:+1 949 297 7001

Limited Warranty

Masimo warrants to the original end-user purchaser the Masimo-branded hardware product (Root®) and any software media contained in the original packaging against defects in material and workmanship when used in accordance with Masimo's user manuals, technical specifications, and other Masimo published guidelines for a period of 12 months and any batteries for six (6) months from the original date the Product was obtained by the end-user purchaser.

Masimo's sole obligation under this warranty is the repair or replacement, at its option, of any defective Product or software media that is covered under the warranty.

To request a replacement under warranty, Purchaser must contact Masimo and obtain a returned goods authorization number so that Masimo can track the Product. If Masimo determines that a Product must be replaced under warranty, it will be replaced and the cost of shipment covered. All other shipping costs must be paid by purchaser.

Exclusions

The warranty does not apply to any non-Masimo branded product or any software, even if packaged with the Product, or any Product that was: (a) not new or in its original packaging when supplied to purchaser; (b) modified without Masimo's written permission; (c) supplies, devices, or systems external to the Product; (d) disassembled, reassembled, or repaired by anyone other than a person authorized by Masimo; (e) used with other products, like new sensors, reprocessed sensors, or other accessories, not intended by Masimo to be used with the Product; (f) not used or maintained as provided in the operator's manual or as otherwise provided in its labeling; (g) reprocessed, reconditioned, or recycled; and (h) damaged by accident, abuse, misuse, liquid contact, fire, earthquake or other external cause.

No warranty applies to any Product provided to Purchaser for which Masimo, or its authorized distributor, is not paid; and these Products are provided AS-IS without warranty.

Limitation of Warranty

Except as otherwise required by law or altered by the purchase agreement, the above warranty is the exclusive warranty that applies to the Product and software media, and Masimo does not make any other promises, conditions, or warranties regarding the Product. No other warranty applies, express or implied, including without limitation, any implied warranty of merchantability, fitness for a particular purpose, satisfactory quality, or as to the use of reasonable skill and care. See the licensing terms for the terms and conditions that apply to and Software accompanying the Product. Additionally, Masimo will not be liable for any incidental, indirect, special, or consequential loss, damage, or expense arising from the use or loss of use of any Products or Software. In no event shall Masimo's liability arising from any Product or Software (under contract, warranty, tort, strict liability, or otherwise) exceed the amount paid by purchaser for the Product or Software. The above limitations do not preclude any liability that cannot legally be disclaimed by contract.

Sales & End-User License Agreement

This document is a legal agreement between you ("purchaser") and Masimo Corporation ("Masimo") for the purchase of this Product ("Product") and a license in the included or embedded Software ("Software") except as otherwise expressly agreed in a separate contract for the acquisition of this Product, the following terms are the entire agreement between the parties regarding your purchase of this Product. If you do not agree to the terms of this agreement, promptly return the entire Product, including all accessories, in their original packages, with your sales receipt to Masimo for a full refund.

Restrictions

1. **Copyright Restrictions:** The Software and the accompanying written materials are copyrighted. Unauthorized copying of the Software, including Software that has been modified, merged, or included with other software, or the written materials is expressly forbidden. Purchaser may be held legally responsible for any copyright infringement that is caused or incurred by Purchaser's failure to abide by the terms of this Agreement. Nothing in this License provides any rights beyond those provided by 17 U.S.C. §117.
2. **Use Restrictions:** Purchaser may physically transfer the Product from one location to another provided that the Software is not copied. Purchaser may not electronically transfer the Software from the Product to any other device. Purchaser may not disclose, publish, translate, release, distribute copies of, modify, adapt, translate, reverse engineer, decompile, disassemble, or create derivative works based on the Software or the written materials.
3. **Transfer Restrictions:** In no event may Purchaser transfer, assign, rent, lease, sell, or otherwise dispose of the Product or the Software on a temporary basis. Purchaser shall not assign or transfer this License, in whole or in part, by operation of law or otherwise without Masimo's prior written consent; except that the Software and all of Purchaser's rights hereunder shall transfer automatically to any party that legally acquires title to the Product with which this Software is included. Any attempt to assign any rights, duties or obligations arising hereunder other than as set forth in this paragraph shall be void.
4. **U.S. Government Rights:** If Purchaser is acquiring Software (including the related documentation) on behalf of any part of the United State Government, the following provisions apply: the Software and documentation are deemed to be "commercial software" and "commercial computer software documentation," respectively pursuant to DFAR Section 227.7202 FAR 12.212, as applicable. Any use, modification, reproduction, release, performance, display or disclosure of the Software (including the related documentation) by the U.S. Government or any of its agencies shall be governed solely by the terms of this Agreement and shall be prohibited except to the extent expressly permitted by the terms of this Agreement.

Index

A

About • 42, 52
About the Main Screen • 31
About the Status Bar • 25, 29, 31, 44, 45, 46, 47, 71
About this Manual • 7
AC Power Indicator • 25, 76
Access Control • 43, 48, 56
Accessing Main Menu Options • 31, 42
Additional Settings for Temperature • 57, 60
Admitting a Patient • 98
Alarm Interface • 68
Alarm Silence • 29, 70
Alarms • 121
Alarms for Temperature • 57, 58
Attach NIBP Cuff • 28
Attach the Probe Well • 28
Attach the Temperature Probe • 28
Audio Pause • 29, 50, 56, 71
Automatic Interval Measurement • 90

B

Back View • 21
Battery Test • 139
Bluetooth • 29, 43, 46
Brightness • 43, 48, 115

C

Calibration for NIBP • 61, 67
Capturing Screenshots • 74
Chapter 1
 Description • 19
Chapter 10
 Messages • 111
Chapter 11

 Troubleshooting • 115
Chapter 12
 Specifications • 117
Chapter 13
 Service and Maintenance • 67, 135
Chapter 2
 Setting Up • 23
Chapter 3
 Operation • 29
Chapter 4
 Temperature Measurement • 79
Chapter 5
 NIBP Measurement • 85
Chapter 6
 Admit and Discharge to Patient SafetyNet • 95
Chapter 7
 Radius-7 • 103
Chapter 8
 MOC-9 • 105
Chapter 9
 Iris • 107
Cleaning • 135, 140
Cleaning and Service Warnings and Cautions • 16
Compliance • 124
Compliance Warnings and Cautions • 16
Connectors • 122
Contacting Masimo • 140
Contraindication • 10
Cuff Selection and Placement • 85, 89, 91, 93
Customizing Windows • 32, 40, 55

D

Device Output • 27, 43, 50
Device Settings • 42, 43
Discharging a Patient • 97
Display Ranges • 118
Downloading Screenshots • 74

E

- Electrical • 119
- Environmental • 23, 120
- Ethernet • 30, 43, 46
- Exclusions • 141

F

- Features • 20
- Front View • 20

G

- Guidance and Manufacturer's Declaration-Electromagnetic Emissions • 127
- Guidance and Manufacturer's Declaration-Electromagnetic Immunity • 128
- Guidelines for Setting Up • 23

I

- Indications for Use • 9
- Initial Battery Charging • 23, 25
- IntelliBridge Connectivity • 51
- Intervals for NIBP • 61, 67
- Iris • 30, 42, 53
- Iris Status Screen • 53, 108

L

- Layout • 42, 54
- Lights • 75
- Limitation of Warranty • 142
- Limited Warranty • 141
- Localization • 30, 43, 44

M

- Mean Arterial Pressure (MAP) • 62, 66
- Measurement Accuracy • 117

- Menu Navigation • 35
- Monitoring Resumed Message • 101

N

- NIBP • 42, 61
- NIBP Air Leak Test • 137
- NIBP Module Calibration • 136
- NIBP Pressurization Ranges • 119
- Not Admitted • 96
- Not Monitoring Message • 100
- Nurse Call Connection • 27
- Nurse Call Setting Connections • 116, 139
- Nurse Call Specifications • 121

O

- Operation - NIBP • 88
- Operation - Temperature • 79
- Overpressure Test • 138

P

- Parameter Settings for NIBP • 61, 62
- Parameters Supported • 51
- Patient Conditions • 87
- Patient Measurement Mode • 85
- Performance Warnings and Cautions • 14
- Power On • 24
- Power-On Self Test • 136
- Product Description and Features • 9
- Product Description, Features, and Indications for Use • 9
- Profiles • 29, 42, 53, 85
- Pulse Rate (PR) • 62, 65

R

- Radical-7 and Radius-7 Battery • 43, 47
- Radical-7 and Radius-7 Charging Indicator • 26, 30, 77

Radical-7 Connection • 26
Radius-7 Connection • 27
Recommended Separation Distances • 131
Repair Policy • 135, 140
Replacing the Fuses • 115, 135
Restrictions • 143
Return Procedure • 23, 115, 116, 140
Root Battery • 25, 43, 47
Root Charging Indicator • 30, 76

S

Safety Information, Warnings, and Cautions • 11, 25
Safety Warnings and Cautions • 12
Sales & End-User License Agreement • 142
Screenshot Capture • 73
Side Views • 22, 75
Sleep and Power Off • 24, 77, 135
Sounds • 30, 42, 49, 56, 71
Span Point Calibration • 137
Spot Check Measurement • 88
Standby Mode • 29, 49, 72
Stat Interval Measurement • 92
Symbols • 132
System Status Lights • 22, 75
Systolic/Diastolic (SYS/DIA) • 62, 63

T

Taking Temperature Measurement • 79
Temperature • 42, 57
Temperature Probes • 82
Touchscreen Display • 120
Trend Download • 73
Trend Settings • 42, 52
Trends for NIBP • 64
Trends for Temperature • 57, 59

Troubleshooting Radical-7, Radius-7, and MOC-9 Modules • 115
Troubleshooting Root • 115

U

Understanding Windows • 36
Unpacking and Inspection • 23
Using Analog View • 37, 38
Using Iris Connectivity Ports • 109
Using MOC-9 Ports • 105
Using the Touchscreen Interface • 32
Using Trend View • 36, 37, 54

W

Wi-Fi • 29, 43, 45
Wireless Specifications • 122

Z

Zero Point Calibration • 137



38280/9274A-0316