

*Liebert® ITA™ User
Manual – 10kVA UPS*



Safety Precautions

This user manual contains the information concerning the installation and operation of Liebert® ITA 10kVA UPS (hereinafter referred to as UPS).

Please carefully read this user manual prior to installation.



1. The UPS must be installed and commissioned by engineers designated by the manufacturer or its agent. Failure to observe this could result in personnel safety risk, UPS malfunction and invalidation of warranty.
2. The UPS has been designed for commercial and industrial use only, and is not recommended for use in life support applications.
3. This is a Class A UPS product. In a residential environment, this product may nevertheless cause radio interference, in that case, the user is required to take additional measures to reduce the interference.
4. Never dispose of the battery module in a fire because it may explode and endanger personnel safety when exposed to flame.



1. The standard UPS has the external battery module, the output terminals of the UPS may carry live voltage even when the UPS is not connected to AC mains.
2. Before moving or re-wiring the UPS, disconnect all the inputs and make sure that the UPS is completely shutdown. Or else, the output end may carry live voltage.
3. The operating environment and the storage method will affect the life and reliability of the UPS, it is not recommended to use the UPS for a long time in the following environments:
 - Places where the temperature and relative humidity are outside the technical specification (temperature: 0°C ~ 40°C, relative humidity: 5%RH ~ 95%RH).
 - Places where direct sunlight and near heat source are present.
 - Places where vibrations or shocks are present.
 - Places where dusty, corrosive substances, salts or flammable gases are present.
4. Keep the air inlet and outlet well-ventilated. Poor ventilation will increase the internal temperature, which will shorten the life of the UPS components and that of the UPS.
5. Liquid or other irrelevant external objects are prohibited inside the UPS.
6. In case of a fire, a dry chemical fire extinguisher is essential. Using a foam fire extinguisher will cause an electric shock.
7. The life of the battery module will be shortened with the rise of the ambient temperature. To ensure normal UPS operation and enough back-up time, the battery module should be replaced periodically. Only Emerson-authorized technicians are permitted to replace the battery module.
8. If the UPS will remain idle for a long time, it must be stored in a dry environment. The storage temperature should be -20°C ~ +55°C for standard UPS (with battery modules), and be -40°C ~ +70°C for long back-up UPS (with no battery modules).
9. The UPS is a professional equipment with a total rated power larger than 1kW. The equipment complies with IEC 61000-3-12 provided that the short-circuit ratio is larger than or equal to 250 at the interface point between the user's power supply and the power grid. It is the responsibility of the installer or user of the equipment to ensure, by consultation with the power supply department if necessary, that the UPS is connected only to a power supply with a short-circuit ratio R_{scc} larger than or equal to 250.
10. The UPS output cable must be not longer than 10m.
11. The backfeed protection unit is external. For the using method, refer to *UF-BFP-63A Backfeed Protection Unit User Manual*.
12. In Normal mode, the output neutral line of the UPS is connected with the input neutral line. Upon the mains failure, the output neutral line will be suspended, which results in the output neutral line unconnected.



Conformity and standards

The UPS complies with CE 2006/95/EC (LV Safety) and 2004/108/EC (EMC), and with the following product standards for UPS:

- IEC 62040: 2008 General and safety requirements
- IEC62040-2: EMC requirements, Class C2 compliant
- IEC62040-3: Performance requirements and test methods

The UPS installation should follow the above instructions and use the accessories specified by the manufacturer.



Warning: high leakage current

1. Reliable earth connection is essential before the input power (AC mains and battery included) is connected.
2. Earth leakage current is bigger than 3.5mA, and less than 5% of the input current.
3. Transient and steady-state earth leakage currents, which may occur when starting the equipment, should be taken into account when selecting instantaneous RCCB or RCD.
4. Note that the earth leakage current of the load will flow through the RCCB or RCD.
5. This equipment must be earthed in accordance with the local electrical codes.



Warning: backfeed voltage

Before operating the circuit, isolate the UPS firstly, and then check the dangerous voltage between the ports, and that between the ports and earth.



Maintainable components

1. All internal maintenance and servicing procedures of the equipment should be carried out only by trained personnel. Components behind the protective cover which can only be removed by using a tool are restricted to service personnel.
2. The UPS meets the safety requirements completely in operator access area. Only service personnel can contact with the hazardous voltage inside the UPS. However, the risk of contacting these voltages is minimized because the components with hazardous voltage may be contacted only by using a tool to remove the protective cover. No risk will exist if you follow the general norms and in accordance with the procedures recommended in this manual on equipment operation.



Warning: battery high voltage

1. All the physical service and maintenance of the battery are performed by the trained technicians.
2. Operation on the battery will result in electric shock and high short-circuit current, therefore, before operating the battery, the following should be observed:
 - Remove the watches, rings and other metal objects.
 - Use the tools with insulation handle.
 - Wear rubber gloves and shoes.
 - Avoid to place the tools and metal objects on the battery surface.
 - Cut off the charge power supply before connecting or disconnecting the battery terminals.
 - Check whether the battery is earthed accidentally, if yes, please disconnect the earthing. Contacting any earth battery parts will result in electric shock. Therefore, make sure that the battery is not earthed during installation and maintenance.
3. Battery manufacturers provide the details of the precautions to be observed when working on, or in the vicinity of the batteries. These precautions should be followed implicitly at all times. Attention should be paid to the recommendations concerning local environmental conditions and the provision of protective clothing, first aid and fire-fighting facilities.

Contents

Chapter 1 Product Introduction	1
1.1 Features.....	1
1.2 Model Configurations	1
1.3 Appearance And Components	2
1.3.1 Appearance	2
1.3.2 Components	2
1.4 Operating Principle	3
1.5 UPS State And Operation Mode	3
1.5.1 Normal Mode	4
1.5.2 Bypass Mode.....	4
1.5.3 Battery Mode	5
1.5.4 ECO Mode.....	5
1.5.5 Fault State	5
1.5.6 Maintenance Bypass Mode	5
1.6 Specifications	6
Chapter 2 Single UPS Installation And Commissioning	8
2.1 Unpacking Inspection.....	8
2.2 Installation Preparation	8
2.2.1 Location	8
2.2.2 Environmental Requirements	8
2.2.3 Installation Tools.....	10
2.3 External Protective Devices	10
2.3.1 Battery Input	10
2.3.2 UPS Output	10
2.4 Mechanical Installation.....	10
2.4.1 Tower Installation	10
2.4.2 Rack Installation	12
2.5 Connecting Power Cables	15
2.5.1 Connecting I/O Cables.....	16
2.5.2 Connecting Battery Cables.....	20
2.5.3 Connecting 10A Charger Cable.....	23
2.6 Single UPS Commissioning	24
2.6.1 Check Before Startup	24
2.6.2 Single UPS Parameters Setting.....	25
2.6.3 Normal Mode Startup.....	25
2.6.4 Battery Mode Startup.....	26

Chapter 3 Parallel UPS Installation And Commissioning	28
3.1 Features.....	28
3.2 Requirements	28
3.3 Mechanical Installation.....	28
3.4 Connecting Cables.....	29
3.4.1 Connecting I/O Cables.....	29
3.4.2 Connecting Parallel Signal Cables	30
3.5 Setting Parallel Addresses.....	31
3.6 Commissioning Parallel System.....	31
3.6.1 Check Before Startup	31
3.6.2 Startup Commissioning For Parallel System	31
Chapter 4 Display Panel.....	33
4.1 LED Display Panel	33
4.1.1 UPS State Indicators	33
4.1.2 UPS Load Battery Capacity And Fault Orientation Indicators.....	33
4.1.3 Control Keys	35
4.2 LCD Display Panel.....	35
Chapter 5 UPS Operation Instructions	38
5.1 Check Before Power-On.....	38
5.2 UPS Power-On	38
5.3 Turning On UPS.....	39
5.4 Battery Self-test	39
5.4.1 Battery Power-On Self-test.....	40
5.4.2 Battery Manual Self-test	40
5.4.3 Battery Periodic Self-test	40
5.5 Turning Off UPS.....	41
5.6 UPS Power-off	42
5.7 Transferring UPS Operation Mode.....	42
5.7.1 Transferring UPS To Bypass Mode From Normal Mode Manually	42
5.7.2 Transferring UPS To Bypass Mode From Overload Protection	42
5.7.3 Transferring UPS To Inverter Mode From Bypass Mode Manually	42
5.7.4 Transferring UPS To Battery Mode From Mains Failure.....	43
5.7.5 Transferring UPS To Bypass Mode From Inner Overheating Protection	43
5.7.6 Transferring UPS Fault State Upon Output Short Protection.....	43
5.7.7 Transferring UPS To Maintenance Bypass Mode From Inverter Mode	43
5.7.8 Transferring UPS To Inverter Mode From Maintenance Bypass Mode	43
5.8 UPS Complete Shutdown	44
5.9 Auto Startup.....	44
5.10 UPS Monitoring.....	44

Chapter 6 Communication.....	45
6.1 Connecting USB Communication Cable	45
6.2 Installing Communication Assembly (Optional).....	45
6.2.1 SIC Card.....	45
6.2.2 JBUS/MODBUS Adapter Card	45
6.2.3 RS485 Card.....	46
6.2.4 RS232 Card.....	46
6.2.5 Dry Contact Card.....	46
6.2.6 Extended Dry Contact Card.....	46
6.3 Connecting REPO Cable	46
Chapter 7 Maintenance And Troubleshooting	47
7.1 Fan Maintenance	47
7.2 Battery Maintenance	47
7.3 Cleaning UPS	48
7.4 Checking UPS Status	48
7.5 Checking UPS Functions	48
7.6 Troubleshooting	48
Chapter 8 Options	51
8.1 Option List.....	51
8.2 Battery Module.....	51
8.2.1 List Of Battery Module Options.....	51
8.2.2 Appearance Of Battery Module	52
8.2.3 Backup Timetable Of Standard Battery Module For Single UPS	53
8.3 POD	53
8.3.1 1-Input 1-Output 1 + 1 Parallel POD.....	53
8.3.2 3-Input 1-Output 1 + 1 Parallel POD.....	54
8.3.3 3-Input 1-Output 3 + 1 Parallel POD.....	55
8.3.4 Output Power Distribution Unit	56
8.4 Complete Set Of Cables	57
8.4.1 Parallel Signal Cables.....	57
8.4.2 Battery Cables	57
8.5 Guide Rail For Rack Installation.....	57
8.6 Communication Options And Monitoring Options	57
8.7 10A Charger	58
8.8 Assembly Of LCD Display Panel.....	59
8.9 Battery Shared Module Of UF-BSO-0100 ITA UPS.....	60
Appendix 1 Operation Guide For UPS Parallel Power Distribution	62
Appendix 2 Glossary	63

Chapter 1 Product Introduction

The Liebert® ITA 10kVA UPS (UPS for short) is an intelligent online UPS system with sine wave output developed by Emerson Network Power Co., Ltd. The UPS offers reliable and high quality AC power to the precision instrument.

The UPS uses modular design, and rack/tower installation can be used depending on your requirements. It is applicable to supplying AC power to small scale computer center, network, communication system, automatic control system and precision instrument.

This chapter introduces the features, model configurations, appearance, components and operating principle of the UPS.

1.1 Features

The UPS features include:

- Compatible with two mains input modes: 3-phase and single-phase input mode, with automatic input recognition function
- Capable of parallel connection to achieve up to 3 + 1 parallel redundant power
- High-frequency double conversion topology structure, with high input power factor, wide input voltage range, and output immune to power grid interference, thus adaptable to areas with unstable mains supply
- High power density
- Full digital control technology based on DSP to achieve high system reliability with self-protection and fault diagnosis functions
- Excellent intelligent battery management to extend the battery life
- Display panel with both LCD and LED indication to help you learn about the UPS operation status and operating parameters
- 2U thickness. Tower installation and rack installation are optional to meet different installation requirements
- Capable of ECO power supply mode, which helps you save energy to the maximum extent
- Flexible network management with Emerson monitoring software
- Fan fault self-test and automatic recognition functions
- SNMP card optional, providing network communication function
- Capable of connecting multiple battery strings, extending the power supply time of battery mode

1.2 Model Configurations

Two types are available for the UPS: standard model and long back-up model. The model configurations are listed in Table 1-1.

Table 1-1 Model configurations

Model	Type	Product number	Weight (net weight/gross weight, kg)	Size (W × H × D, mm)	Description
Standard model	UHA1R-0100	01200775	20.8/24.8	435 × 85 × 660	Configured with battery modules. See 8.2 <i>Battery Module</i> for the structure and connection of the battery modules
Long back-up model	UHA1R-0100L	01200770	21.5/25	435 × 85 × 660	You need to select the battery modules according to the requirements or connect the external battery modules by yourself

1.3 Appearance And Components

1.3.1 Appearance

The UPS appearance is shown in Figure 1-1.



Figure 1-1 UPS appearance

1.3.2 Components

Front panel

As shown in Figure 1-2, the UPS front panel provides ventilation holes and display panel.

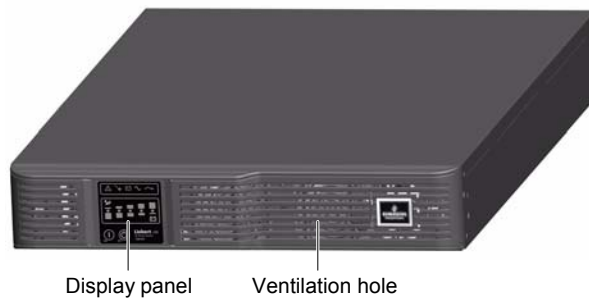

Figure 1-2 UPS front panel

Rear panel

As shown in Figure 1-3, the UPS rear panel provides DIP switch, parallel port, ventilation hole, bypass terminal block, input MCB, bypass MCB, battery port, USB port, REPO port, 10A charger control port, intelligent card slot and I/O terminal block.

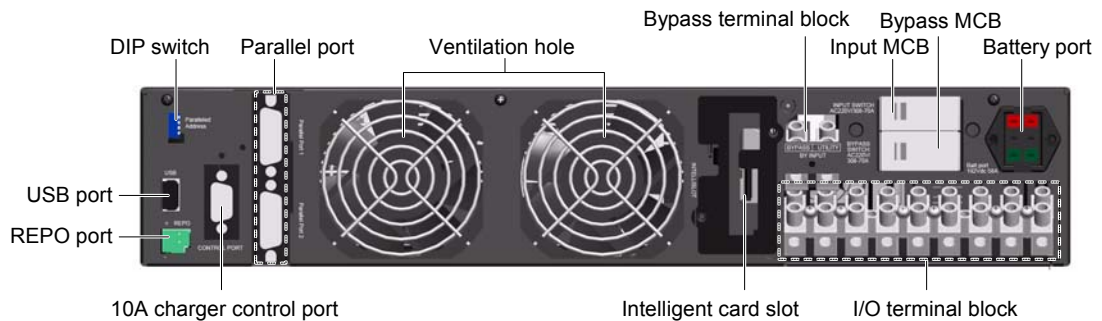

Figure 1-3 UPS rear panel



Note

Non-authorized personnel are prohibited from opening the UPS chassis cover.

1.4 Operating Principle

The operating principle of the UPS is shown in Figure 1-4.

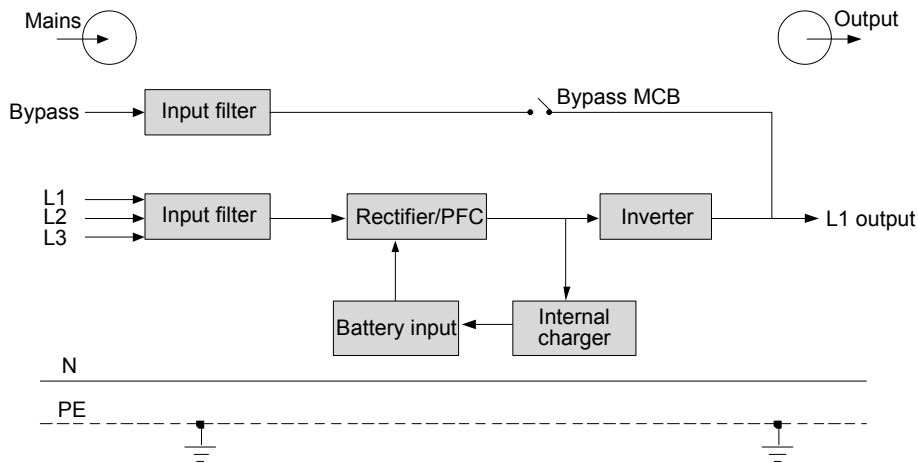

Figure 1-4 UPS operating principle

1. The UPS is composed of mains input, I/O filter, rectifier/PFC, inverter, bypass, internal charger, battery input and UPS output.
2. When the mains is normal, close the bypass MCB, and the internal charger will charge the battery. Before the UPS is turned on, the output voltage is zero. After the UPS is turned on, the electronic transfer switch connects the inverter to the load, and the mains supplies DC power to the inverter through the rectifier/PFC circuit. The inverter then converts DC power into pure sine wave AC power, and supplies the AC power to the load through the electronic transfer switch.
3. When the mains is abnormal, the rectifier/PFC circuit boosts the battery voltage and supplies it to the inverter. The inverter then converts it into pure sine wave AC power, and supplies the AC power to the load through the electronic transfer switch.
4. After the mains restores, the UPS will automatically transfer from Battery mode to Normal mode, the mains supplies DC power to the inverter through the rectifier/PFC circuit, and then the electronic transfer switch supplies the AC power to the load.

1.5 UPS State And Operation Mode

The UPS state and operation mode include: Normal mode, Bypass mode, Battery mode, ECO mode, Fault state and Maintenance Bypass mode.

The operation schematic diagrams of Normal mode, Bypass mode, Battery mode and Maintenance Bypass mode are shown in Figure 1-5.



Note

Only when the UPS output power distribution unit (POD for short) is configured, the Maintenance Bypass mode is valid.

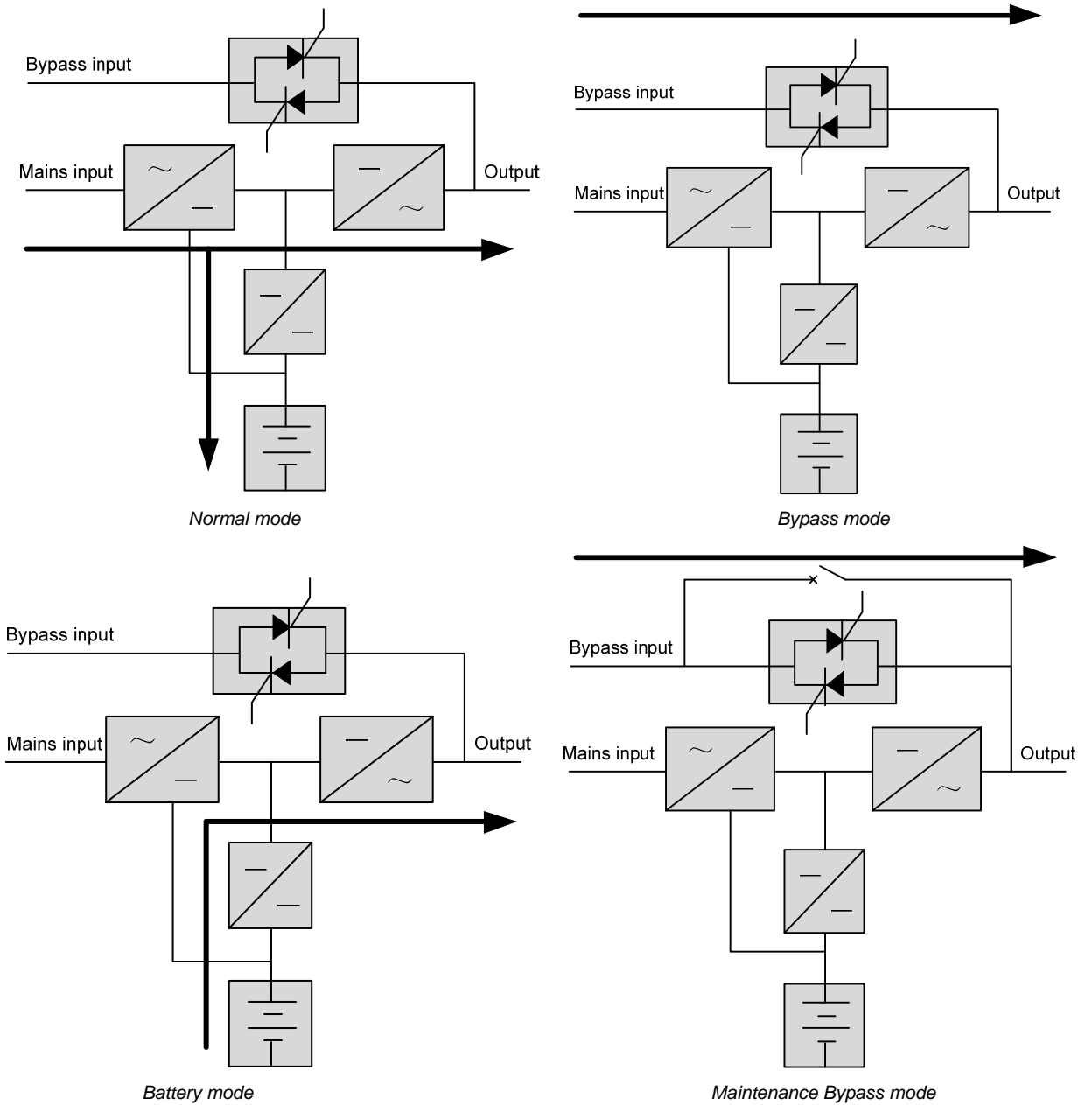



Figure 1-5 Operation schematic diagram

1.5.1 Normal Mode

When the mains input is normal, the load is supplied with voltage-stabilizing and frequency-stabilizing power by the mains after processing of the rectifier and the inverter, and meanwhile, the charger is charging the battery, the operation mode is Normal mode. In Normal mode, the mains indicator and the inverter indicator are on.

1.5.2 Bypass Mode

If the overload overtime, inverter or rectifier fault appears during the UPS operation in Normal mode, the UPS will transfer to Bypass mode, that is, the load is powered by the bypass source, which comes directly from the mains input. If the rectifier is normal, the internal charger will charge the battery. In Bypass mode, the inverter indicator is off; the mains indicator and the inverter indicator are on.

 Note

In case of mains failure or mains voltage out of range (120Vac ~ 253/264/276Vac) in Bypass mode, the UPS will turn off and stop the output.

1.5.3 Battery Mode

Upon mains failure, rectifier overload or mains voltage out of range (120Vac ~ 288Vac), the rectifier and the internal charger will stop running, and the battery will supply power to the load through the inverter. The battery indicator and the inverter indicator are on, and the buzzer alarms every 3.3 seconds, which notifies you that the UPS is in Battery mode.



Note

1. The battery has been fully charged before delivery. However, transportation and storage will inevitably cause some capacity loss. Therefore, it is required to charge the battery for eight hours before the UPS is put into operation for the first time, to ensure the adequate back-up time for the battery.
2. The battery cold start can also be used to start the UPS from Battery (charged) mode upon mains failure. Therefore, the battery power can be used independently for improving the system availability to some extent.
3. In Battery mode, when the battery voltage is low, the buzzer beeps rapidly (once per second), and the corresponding measures must be done in time.

1.5.4 ECO Mode

In ECO mode, when the bypass voltage is within 220Vac \pm 10% and the frequency is within 50Hz \pm 2Hz, the load is supplied by the bypass and the bypass indicator is on. When the bypass voltage is abnormal, the load is supplied by the inverter. The ECO mode is an energy-saving operation mode. For power equipment insensitive to power grid quality, you can use ECO mode for power supply through the bypass to reduce the power loss.

When the bypass voltage is normal, the inverter is in no-load state. The load is supplied by the bypass and the bypass indicator is on.



Note

1. In ECO mode, if the bypass failure or abnormal bypass voltage appears when the output is not overloaded, the UPS will transfer to Normal mode. However, if the bypass failure or abnormal bypass voltage appears when the output is overloaded, the UPS will not transfer to Normal mode, but will shut down the bypass.
2. In ECO mode, the efficiency of the UPS is up to 97%.
3. Different voltage types have different voltages and frequency ranges.

1.5.5 Fault State

In Normal mode, the UPS will transfer to the Bypass mode if the inverter failure or UPS overtemperature appears. In Battery mode (with no bypass mains), the UPS will turn off and stop the output if the inverter failure or UPS overtemperature appears. If a UPS failure occurs, the fault indicators will turn on, the buzzer will keep beeping, and the corresponding indicator will blink.



Note

In Fault state, if the bypass fails or the bypass voltage is abnormal when the output is not overloaded, except for the faults which can cause turn-off, the UPS will transfer to the inverter for supply power, such as radiator over-hot. However, if the bypass fails or the bypass voltage is abnormal when the output is overloaded, the UPS will not transfer to the inverter for supply power, and will turn off the bypass.

1.5.6 Maintenance Bypass Mode

If maintenance and repair for the UPS are needed, you can switch the load to the Maintenance Bypass through the maintenance bypass MCB, and the power to the load is not interrupted. The maintenance bypass MCB is located on the front panel of the POD, and the capacity meets the requirements of the total load capacities. Refer to *Liebert® ITA 10kVA UPS Parallel Power Distribution Unit User Manual* for the detailed introductions of the POD.



Note

When the UPS has malfunctions and can not work normally, please get in touch with the nearest Emerson branch office or local service center. It is prohibited to repair the UPS by yourself, otherwise the personnel injury and damage to the equipment will occur.

1.6 Specifications

The specifications are listed in Table 1-2.

Table 1-2 Specifications

Item		Standard model	Long back-up model
		UHA1R-0100	UHA1R-0100L
Input	Rated voltage	Single-phase: 220Vac, 3-phase: 380Vac, voltage type of 230Vac and 240Vac is available	
	Voltage range	176Vac ~ 288Vac, at full load 120Vac ~ 176Vac, linear derating 120Vac, at half load	
	Frequency	50/60Hz ± 5Hz	
	Power factor	Single-phase: ≥ 0.99, 3-phase: ≥ 0.95	
Output	Rated power	10kVA/9kW (25°C ~ 40°C)	
	Voltage	220/230/240Vac ± 3%	
	Frequency	In Normal mode: the output tracks the bypass frequency when the bypass frequency is within 50/60Hz ± 5Hz; In Battery mode, the output frequency is within 50/60Hz ± 0.2Hz; Bypass frequency tracking range: ±10%	
	Frequency tracking rate	0.2Hz/s (default), 1Hz/s	
	Power factor	0.9 (10kVA)	
	Crest factor	3:1	
	Voltage harmonic distortion	≤ 3% (linear load), ≤ 5% (non-linear load)	
	Load regulation rate	2%	
	Power grid regulation rate	2%	
	Dynamic response recovery time	60ms	
	Overload capacity	105% ~ 125% rated load, 5min; 125% ~ 150% rated load, 1min; above 150% rated load, 500ms (Normal mode); 105% ~ 125% rated load, 60s; above 125% rated load, 500ms (Battery mode)	
	Bypass voltage	120Vac ~ 253/265/276Vac	
	Mains efficiency	93%	
Battery	Type	Sealed, lead-acid, maintenance-free battery (12V/7Ah)	
	Cell No.	16 × 2	
	Rated voltage	192Vdc	
	Recharge duration (standard UPS)	Six hours to 90% rated capacity	Depended on the external battery capacity
	Charge current	2A	4A
Transfer time	Mains ↔ Battery	0ms	
	Inverter ↔ Bypass	≤ 4ms	
Noise	≤ 50dB		
Panel display mode	LED/LCD (optional)		
Safety	CCEE (GB4943-1995)/GB4943		
Storage	Standard GB/T4798.1-86		
Transportation	Standard GB/T4798.12-96		
EMC	Conduction emission	IEC/EN 62040-2	
	Immunity	I ≤ 16A, IEC/EN61000-3-3; 16A < I ≤ 75A, IEC/EN61000-3-11	
	Harmonic current	I ≤ 16A, IEC/EN61000-3-2; 16A < I ≤ 75A, IEC/EN61000-3-12 YD/T1095-2001 level 2 15%	

Item		Standard model	Long back-up model
		UHA1R-0100	UHA1R-0100L
Surge protection		IEC/EN 61000-4-5, endurance level 4 (4kV) (live line to earth), level 3 (2kV) (among live lines)	
Protection level		IP20	
Ambient condition	Operating temperature	0°C ~ 40°C	
	Storage temperature	-40°C ~ +70°C (battery excluded); -20°C ~ +55°C (battery included)	
	Relative humidity	5% ~ 95%, non-condensing	
	Altitude	< 1500m, derating in accordance with GB/T3859.2 when higher than 1500m	
Size	W × H × D	435mm × 85mm × 660mm	
Weight	Standard model	24.8kg	
	Long back-up model	25kg	

Chapter 2 Single UPS Installation And Commissioning

This chapter introduces the installation, cable connection and commissioning of the single UPS.

Each site has its peculiarity, so this chapter provides the guidance with general installation procedures and methods for the installation engineer who should conduct the installation according to the actual conditions.



Warning: professional installation

1. The UPS should be installed by an Emerson-authorized engineer according to the information contained in this chapter. If any problem is found, please get in touch with Emerson local service center immediately.
2. The UPS shall not be powered on without approval of the commissioning engineer.
3. The UPS installation must be carried out by professionals strictly. For other equipment which is not introduced in this manual, the detailed information about mechanical installation and electrical installation are delivered with the equipment.

2.1 Unpacking Inspection

After the UPS arrival, you should unpack it and check the following items:

1. Visually inspect the UPS appearance for transportation damage. If any problem is found, please notify the carrier immediately.
2. Check the accessories and models against the delivery list. If any problem is found, please notify the dealer immediately.

2.2 Installation Preparation

2.2.1 Location

To extend the UPS life, the chosen place must offer:

- Convenient wiring
- Adequate operator access area
- Good ventilation to meet the heat dissipation requirements
- No corrosive gas, like sulfur dioxide
- No excessive moisture or heat source
- No excessive dust
- Compliance with fire-fighting requirements
- Operating temperature compliant with the specifications, see Table 1-2 for details

2.2.2 Environmental Requirements

UPS room

The UPS is designed for indoor installation, which should be installed in a clean and well-ventilated environment, to keep the environmental temperature within the specifications.

The internal fans provide forced air cooling for the UPS. Cooling air enters the UPS through the ventilation holes on the rear panel, and exhausts the hot air through the front ventilation holes. Therefore, do not obstruct the ventilation holes. Maintain at least 200mm clearances between the front, rear, top, bottom, side panels of the UPS and the wall or adjacent equipment (see Figure 2-1), to avoid obstructing the UPS ventilation and heat dissipation. Otherwise, the UPS internal temperature will rise, which will shorten the UPS life.

If necessary, an indoor exhaust fan should be installed to keep the indoor temperature from rising. An air filter should be used in a dusty environment where the UPS is to be operated.

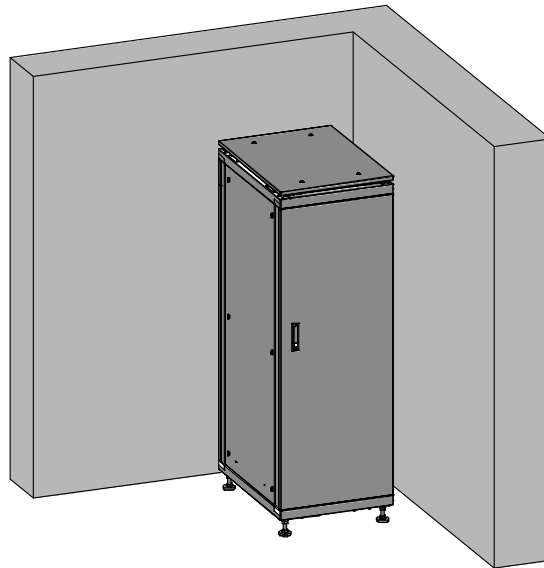

General view

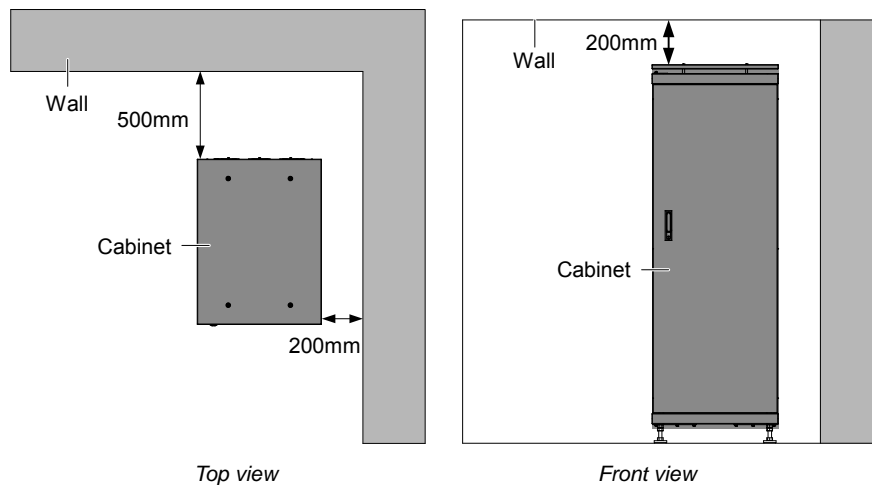

Figure 2-1 Cabinet installation clearances



Note

1. The UPS should be installed only on the concrete surface or other non-flammable surfaces.
2. As shown in Figure 2-1 (top view), the demonstration of the clearance between the rear panel of the cabinet and the wall is 500mm. The clearance should not be less than 200mm, it needs to be considered according to the actual situation for the sake of maintenance convenience.

Battery room

A small amount of hydrogen and oxygen will be generated at the end of battery charging, therefore, you must ensure that the fresh air ventilation of the battery installation environment meets the EN50272-2001 requirements.

The battery ambient temperature should keep constant, because the ambient temperature is the main factor to affect the battery capacity and life. The battery standard operating temperature is 20°C, operation above this temperature will shorten the battery life, and operation below this temperature will reduce the battery capacity. If the battery average temperature in operation rises from 20°C to 30°C, the battery life will be reduced by 50%; if the battery temperature in operation exceeds 40°C, the battery life will be decreased exponentially. In general, the allowable environmental temperature of the battery is 15°C ~ 25°C. The battery should be kept away from heat and ventilation holes.

When the UPS uses an external battery, you must install a battery protective device (such as a fuse or a circuit breaker) in areas near the battery, and use the shortest wiring distance for the connection between the protective device and the battery.

Storage environment

When the UPS does not need to be installed immediately, the UPS must be stored indoors to be protected from the excessive moisture or overtemperature environment. The battery requires dry and low temperature, well-ventilated environment for storage, and the most suitable storage temperature is 20°C ~ 25°C.

 Warning: battery hazards
<p>During the battery storage, the battery must be periodically charged according to the battery instructions. When the battery is charged, you can connect the UPS to the mains temporarily to charge and activate the battery.</p>

2.2.3 Installation Tools

Prepare installation tools according to Table 2-1. The tools must be insulated and ESD-proof processed prior to use.

Table 2-1 Installation tools list

Installation tool	Specification	Application
Cross screwdriver	EJ5100mm	Remove the screws of the top protective cover of the UPS, or open the chassis
Wire-pressure plier	YT-12	Press wires for I/O terminal block
Diagonal plier	MTC3C	Make I/O cables
Slotted screwdriver	EJ375mm	Connect I/O cables

2.3 External Protective Devices

The circuit breaker or other protective devices must be installed at the external AC input end of the UPS. This section provides the general guidance for qualified installation engineer. The qualified installation engineer should learn about the local wiring regulations and other related information.

2.3.1 Battery Input

If the battery module option is provided by Emerson, the battery module has a built-in overcurrent protective device. Otherwise, the external battery cabinet should equip a DC compatible circuit breaker to provide overcurrent protection for the UPS and its batteries.

2.3.2 UPS Output

A protective device must be installed for the UPS output power distribution. The protective device must be different from the input power distribution protection air breaker, and should provide overload protection (see Table 2-4).

2.4 Mechanical Installation

Two installation modes are available: tower installation and rack installation. You can select an appropriate installation mode according to the actual conditions.

2.4.1 Tower Installation

1. Adjust the display panel.
 - 1) Press the spring buckles on two sides of the display panel at the same time, and pull out the display panel.
 - 2) Rotate the display panel 90° counter clockwise.
 - 3) Insert the display panel into the plastic bracket.

The operation procedures of the display panel are shown in Figure 2-2 when the mode is changed from the rack installation to the tower installation.

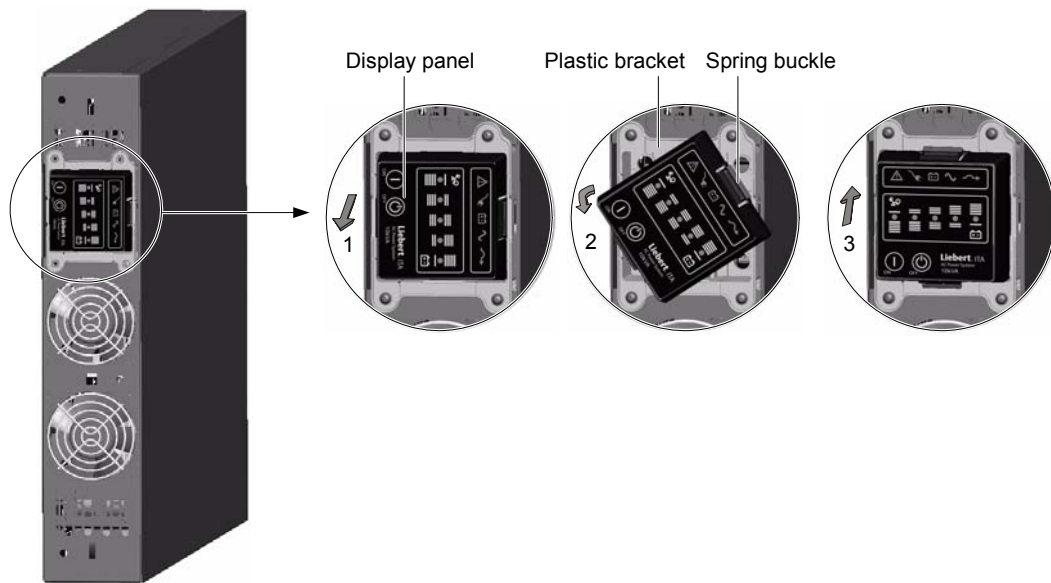

Figure 2-2 Adjusting display panel



Note

1. For the tower installation, you need to adjust the display panel; for the rack installation, ignore this step.
2. When adjusting the display panel, you do not need to open the chassis of the UPS.
3. When adjusting the display panel, you must turn off the UPS.

2. Install the plastic panel.

1) Take out the plastic panel from the UPS package.

2) Align the plastic panel with the UPS display panel, and gently press the metal buckles on both sides of the plastic panel into the square holes on the UPS front panel according to the direction shown in Figure 2-3.

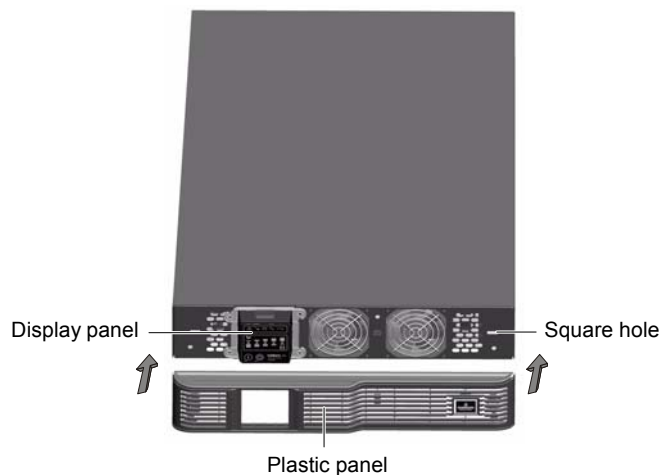

Figure 2-3 Installing plastic panel



Note

You do not need to take off the UPS when removing the plastic panel. Press the two ends of the plastic panel with hands, and gently pull out the plastic panel to remove it.

3. Take out the support bases from the accessories, assemble a pair of support bases together through the fastenings, as shown in Figure 2-4, and put them onto the flat installation table.



Figure 2-4 Installing support base

4. If battery module installation is necessary, take out the support base extensions delivered with the battery module, and then assemble the support base extensions and the support bases together through the fastenings, as shown in Figure 2-5.

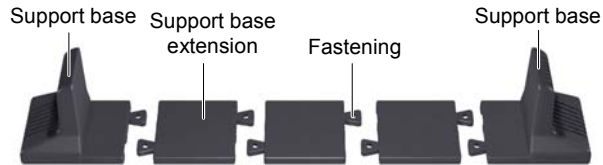

Figure 2-5 Installing support base with support base extension

5. Place the UPS and the battery module (if configured) on the support bases and support base extensions. Each UPS needs two pairs of the support bases, as shown in Figure 2-6.

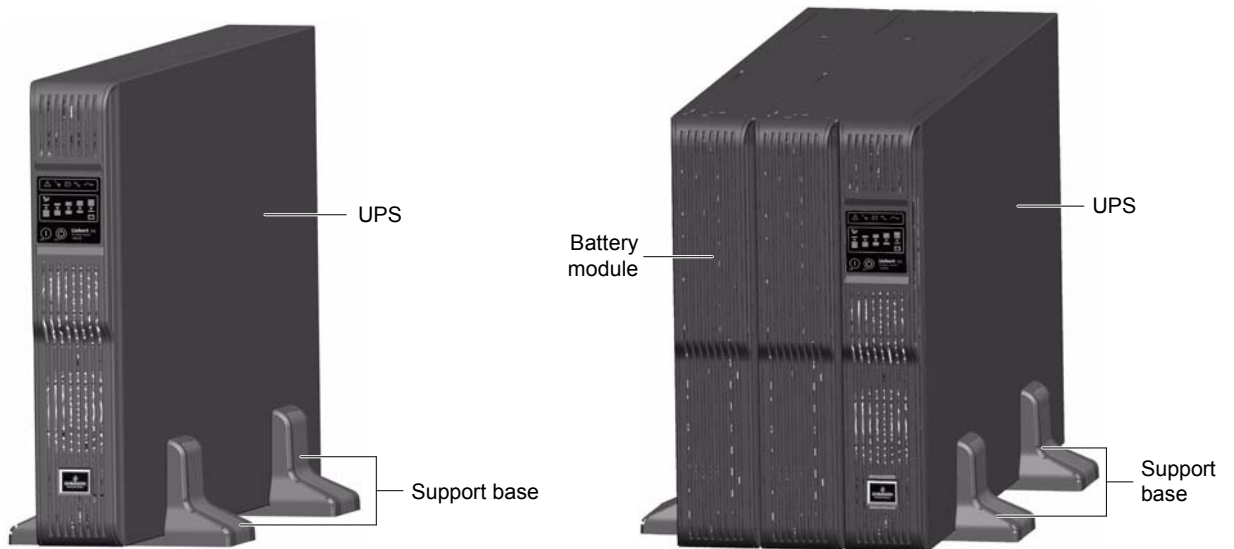

Figure 2-6 Installing UPS and battery module

2.4.2 Rack Installation

Installation procedures for UPS

1. Install the plastic panel, refer to 2.4.1 *Tower Installation* for the procedures.
2. Take out the two brackets and six M4 × 10 screws from the accessories of the UPS, and fix the two brackets onto the battery module using the M4 × 10 screws through installation hole 1, as shown in Figure 2-7.

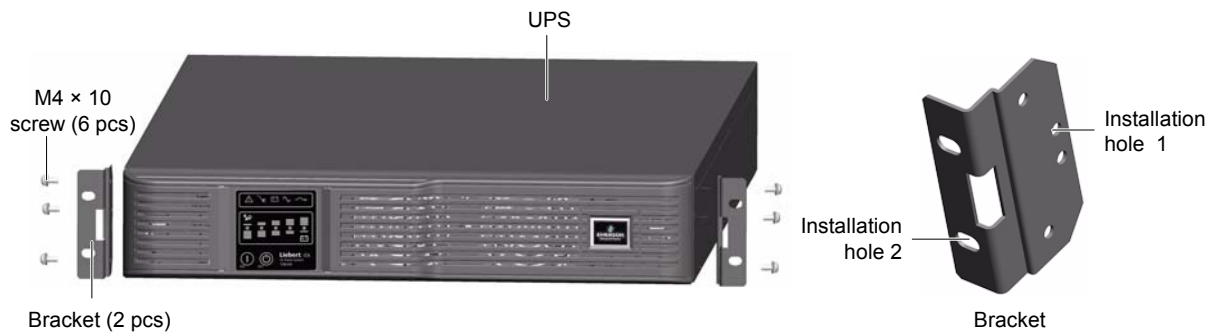

Figure 2-7 Installing brackets



Note

It is prohibited to move the UPS through the brackets.

3. Install the guide rails.

The installation procedures of the guide rails are as follows:

1) Take out the guide rails (one left guide rail and one right guide rail), guide rail screws and panel screws from the package, distinguish the left guide rail and right guide rail according to Figure 2-8, and confirm its retractable function respectively.

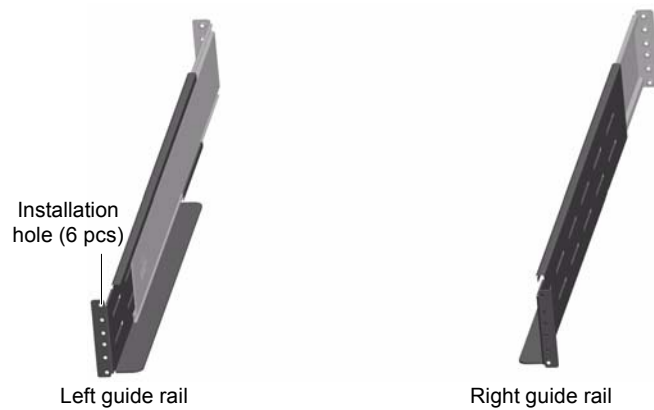

Figure 2-8 Appearance of guide rail

Distinguish the guide rail screw and the panel screw according to Figure 2-9.

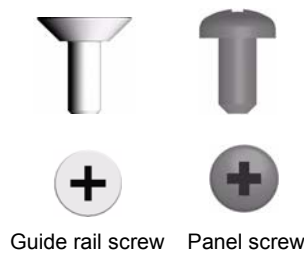

Figure 2-9 Guide rail screw and panel screw

2) Adjust the length of the guide rails according to the dimensions of the rack.

3) Align the installation holes of the guide rail with the square holes of the rack, fix the guide rail onto the rack with the guide rail screws, each left guide rail and right guide rail need four guide rail screws, as shown in Figure 2-10.

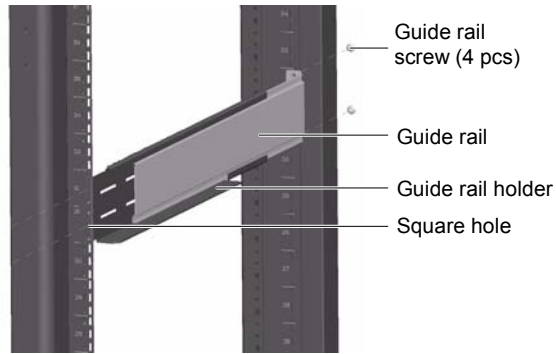

Figure 2-10 Installing guide rail



Note

1. The guide rail holder must be close to the front of the rack.
2. Each end of one guide rail has six installation holes (see Figure 2-8), do not use the two installation holes in the middle when fixing the guide rail. It is recommended to use the two installation holes at the top and at the bottom (from top to bottom, installation hole 1 and installation hole 6).

The guide rail installation is finished, as shown in Figure 2-11.

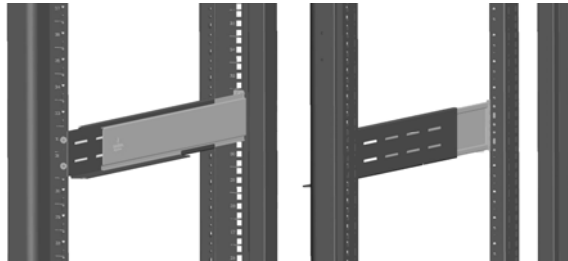

Figure 2-11 Guide rail installation complete

4. Place the UPS on the guide rails in the rack, and push it completely into the rack. Use four M6 × 16 screws to fix the UPS in the rack through the installation hole 2 of the brackets, as shown in Figure 2-12.

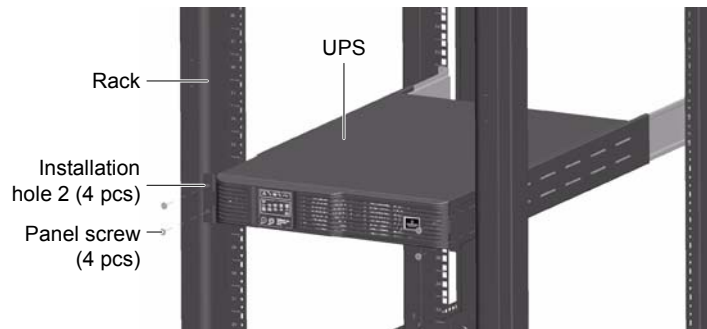

Figure 2-12 Installing UPS

Installation procedures for UPS with battery modules

The installation method of the battery module is the same as that of the UPS. Repeat the installation procedures of the UPS to install and fix the battery modules and the UPS in the rack one by one, as shown in Figure 2-13.

Because the battery module is heavy, you should pay attention to the following items in installation:

- Install the battery modules first, start the installation from the bottom, and then place the UPS onto the top, as shown in Figure 2-13.
- It is prohibited to move the UPS and battery modules through the brackets.
- Two persons or more are required for the installation.

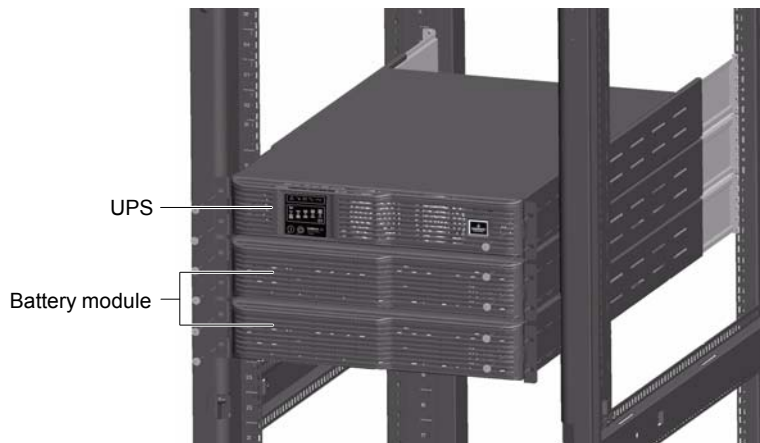

Figure 2-13 Installing UPS with battery modules

2.5 Connecting Power Cables

The I/O cables, battery cables and 10A charger cables (optional) are required for connection. When connecting the cables, you should follow the local wiring regulations, take the environment situation into account, and refer to Table 3B of IEC60950-1.

The maximum current in different operating modes is listed in Table 2-2, the recommended minimum cable CSA is listed in Table 2-3. Select the appropriate cables according to Table 2-2 and Table 2-3.

Table 2-2 Max. steady state AC and DC current

Model	Rated current (A)						Battery discharging current upon min. battery voltage
	Mains input current ^{1,2} upon battery charging with max. ability			Total output current ² at full load			
	220V	230V	240V	220V	230V	240V	
10kVA (1-input 1-output)	55	55	55	46	44	42	64
10kVA (3-input 1-output)	19	19	19	46	44	42	64

Note:
When the battery cables are selected, according to the current value shown in this table, the max. allowable voltage drop is 4Vdc. Do not ring the cables to avoid increasing the electromagnetic interference.
1: The input mains current of the rectifier and the bypass.
2: Non-linear load (switch mode power) affects the neutral cable design of the output and the bypass. The neutral cable current may exceed the rated phase current, up to 1.732 times as large as the rated current

Table 2-3 Single UPS cable CSA (unit: mm², ambient temperature: 25°C)

Model	Input	Output	Neutral cable	PE	Battery
10kVA (1-input 1-output)	10	10	10	10	16
10kVA (3-input 1-output)	10	10	10	10	16

The recommended I/O MCB capability of the UPS is listed in Table 2-4. Select the MCBs according to your requirements.

Table 2-4 UPS I/O MCB selection

Model	Input interface	Recommended capability of input external MCB	Battery MCB	Output interface	Recommended capability of output external MCB
10kVA (1-input 1-output)	Terminal block	125A	DC63A	Terminal block	70A
10kVA (3-input 1-output)	Terminal block	125A	DC63A	Terminal block	70A



1. The UPS is high leakage current equipment, it is not recommended to configure the MCB with leakage current protection function.
2. To ensure the reliable connection, the pipe type connection terminal (accessory of the UPS) is required for all cable connections.

2.5.1 Connecting I/O Cables

The I/O cables of the UPS should be connected through the I/O terminal block located on the UPS rear panel. Remove the protective cover A of the I/O terminal block shown in Figure 2-14 to reveal the I/O terminal block.



Figure 2-14 Protective cover A of the I/O terminal block

Figure 2-15 gives the terminals layout of the I/O terminal block.

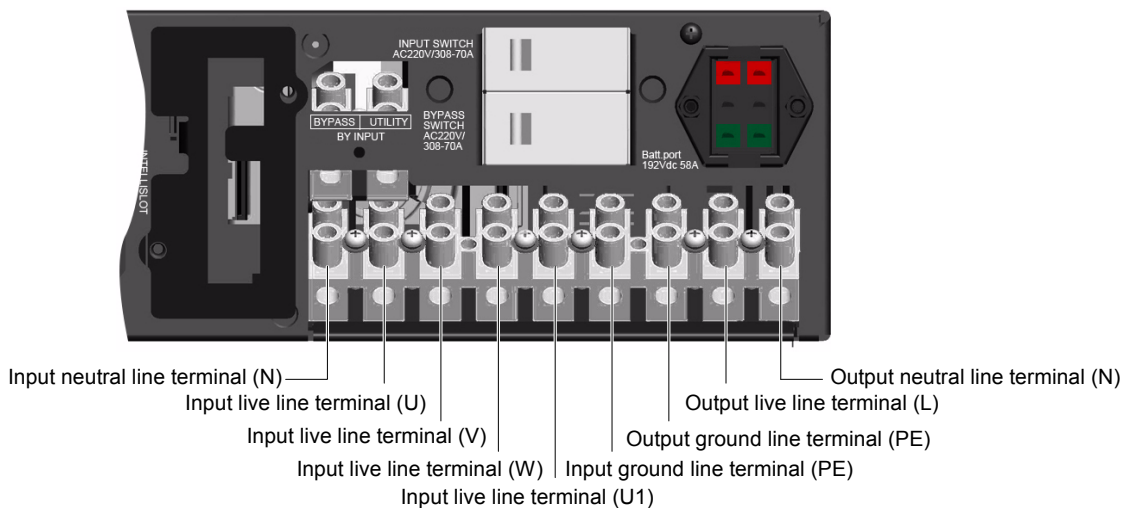

Figure 2-15 Terminals layout of the I/O terminal block



1. Do not reverse-connect the input neutral line and the input live line.
2. Do not use a wall socket to feed power to the UPS. Otherwise, the socket may be burned.
3. Make sure that the connection of the neutral line, live line and earth line is correct and reliable when connecting the output cables. For the sake of safety, the earth line must be connected firstly.
4. Install a three-pole or quadrupole linkage breaker on the mains input neutral line and live line to facilitate cutting power under emergency conditions. Use correct power distribution method (see Figure 2-16) to ensure safety of the UPS and user's equipment.

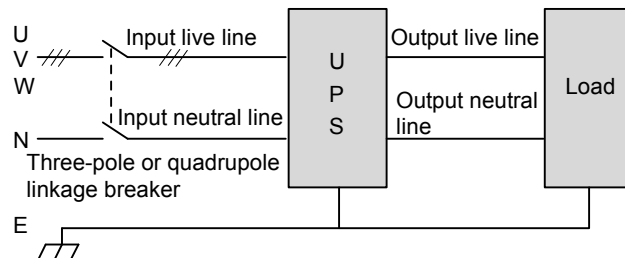

Figure 2-16 Correct power distribution method

After the cable connection, install the protective cover B of the I/O terminal block to protect the I/O terminal block. The protective cover B of the I/O terminal block is shown in Figure 2-17.



Figure 2-17 Protective cover B of the I/O terminal block

Before installing the protective cover B of the I/O terminal block, remove the iron plates on the cable entry holes, and install the bushings (label: 21101494, accessories). After the cable connection, fix the protective cover B of the I/O terminal block.

According to user's requirements, the I/O cable connections are divided into four types: 1-input 1-output, common source configuration (factory default); 1-input 1-output, split-bypass configuration; 3-input 1-output, common source configuration; 3-input 1-output, split-bypass configuration.

The I/O cable connection procedures for the four types are described in the following.

- 1-input 1-output, common source configuration (factory default)

1. Make sure that all the external I/O MCBs of the UPS are open.
2. Remove the protective cover of the bypass terminal block, and then remove the protective cover A of the I/O terminal block.
3. Remove the plates on three cable entry holes of the protective cover B according to the cable direction.
4. Pass all the cables to be connected to the I/O terminal block through the cable entry holes of the protective cover B according to the actual situation.
5. Connect the main input N line, L line and PE line respectively to the input neutral line terminal (N), input live line terminal (U), input earth line terminal (PE) of the UPS I/O terminal block, and tighten the fixing screws, as shown in Figure 2-18.
6. Connect the output L line, N line and PE line respectively to the output live line terminal (L), output neutral line terminal (N) and output earth line terminal (PE) of the UPS I/O terminal block, and tighten the fixing screws, as shown in Figure 2-18.
7. Install the protective cover B of the I/O terminal block, and then restore the protective cover of the bypass terminal block.

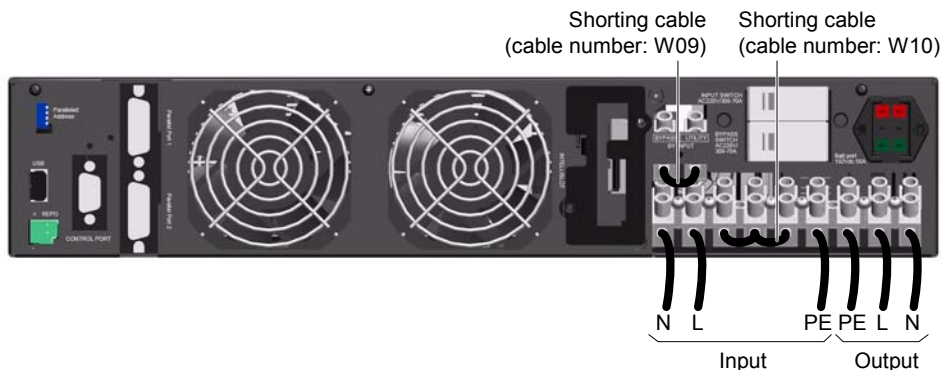

Figure 2-18 Cable connection for 1-input 1-output, common source configuration

● 1-input 1-output, split-bypass configuration

1. Make sure that all the external I/O MCBs of the UPS are open.
2. Remove the protective cover of the bypass terminal block, and then remove the protective cover A of the I/O terminal block.
3. Remove the plates on three cable entry holes of the protective cover B according to the cable direction.
4. Pass all the cables to be connected to the I/O terminal block through the cable entry holes of the protective cover B according to the actual situation.
5. Connect the main input N line, L line and PE line respectively to the input neutral line terminal (N), input live line terminal (U), input earth line terminal (PE) of the UPS I/O terminal block, and tighten the fixing screws, as shown in Figure 2-19.
6. Remove the shorting cable (cable number: W09, see Figure 2-18), connect the input bypass line to the BYPASS terminal of the bypass terminal block, and tighten the fixing screws, as shown in Figure 2-19.
7. Connect the output L line, N line and PE line respectively to the output live line terminal (L), output neutral line terminal (N) and output earth line terminal (PE) of the UPS I/O terminal block, and tighten the fixing screws, as shown in Figure 2-19.
8. Install the protective cover B of the I/O terminal block, and then restore the protective cover of the bypass terminal block.

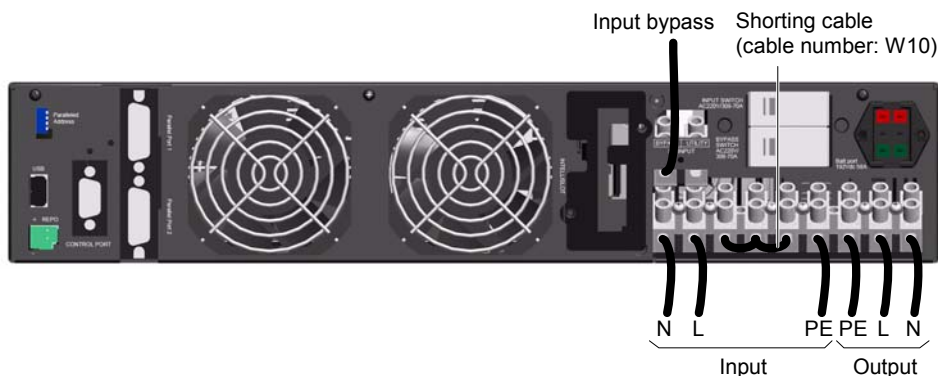

Figure 2-19 Cable connection for 1-input 1-output, split-bypass configuration



Note

For split-bypass configuration, an upstream MCB (125A MCB is recommended) must be used at the bypass input end.

● 3-input 1-output, common source configuration



Warning

The factory default power distribution mode of the UPS is 1-input 1-output. If you need to change the power distribution mode of the main UPS to 3-input 1-output, conduct the steps described in the following to change the power distribution mode to 3-input 1-output, and then continue the installation and commissioning.

1. Make sure that all the external I/O MCBs of the UPS are open.
2. Remove the protective cover of the bypass terminal block, and then remove the protective cover A of the I/O terminal block.
3. Remove the plates on three cable entry holes of the protective cover B according to the cable direction.
4. Pass all the cables to be connected to the I/O terminal block through the cable entry holes of the protective cover B according to the actual situation.
5. Remove the shorting cable (cable number: W10, see Figure 2-19) from the UPS I/O terminal block.
6. Connect the main input live line (phase A, phase B and phase C), N line and PE line respectively to the input live line terminal (U), input live line terminal (V), input live line terminal (W), input neutral line terminal (N) and input earth line terminal (PE) of the UPS I/O terminal block, and tighten the fixing screws. The input live line terminal (U1) is not connected, as shown in Figure 2-20.
7. Connect the output L line, N line and PE line respectively to the output live line terminal (L), output neutral line terminal (N) and output earth line terminal (PE) of the UPS I/O terminal block, as shown in Figure 2-20.
8. Install the protective cover B of the I/O terminal block, and then restore the protective cover of the bypass terminal block.

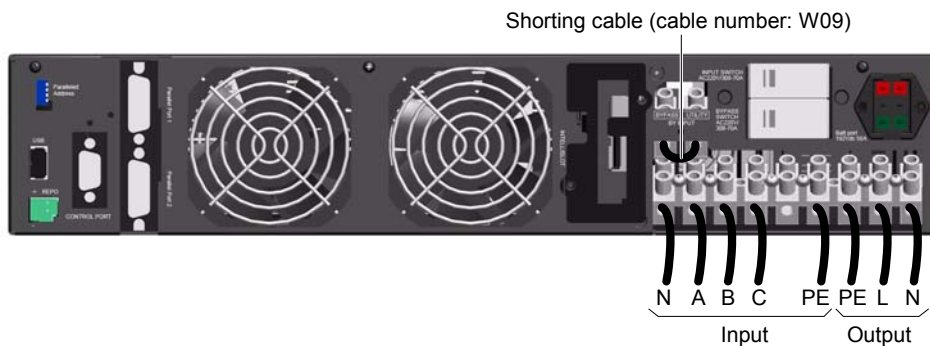

Figure 2-20 Cable connection for 3-input 1-output, common source configuration

● 3-input 1-output, split-bypass configuration

1. Make sure that all the external I/O MCBs of the UPS are open.
2. Remove the protective cover of the bypass terminal block, and then remove the protective cover A of the I/O terminal block.
3. Remove the plates on three cable entry holes of the protective cover B according to the cable direction.
4. Pass all the cables to be connected to the I/O terminal block through the cable entry holes of the protective cover B according to the actual situation.
4. Remove the shorting cable (cable number: W10, see Figure 2-19) from the UPS I/O terminal block.
5. Connect the main input live line (phase A, phase B and phase C), N line and PE line respectively to the input live line terminal (U), input live line terminal (V), input live line terminal (W), input neutral line terminal (N) and input earth line terminal (PE) of the UPS I/O terminal block, and tighten the fixing screws. The input live line terminal (U1) is not connected, as shown in Figure 2-21.
6. Remove the shorting cable (cable number: W09, see Figure 2-20), connect the input bypass line to the BYPASS terminal of the bypass terminal block, and tighten the fixing screws, as shown in Figure 2-21.
7. Connect the output L line, N line and PE line respectively to the output live line terminal (L), output neutral line terminal (N) and output earth line terminal (PE) of the UPS I/O terminal block, and tighten the fixing screws, as shown in Figure 2-21.
8. Install the protective cover B of the I/O terminal block, and then restore the protective cover of the bypass terminal block.



Figure 2-21 Cable connection for 3-input 1-output, split-bypass configuration

! Note

For split-bypass configuration, an upstream MCB (125A MCB is recommended) must be used at the bypass input end.

2.5.2 Connecting Battery Cables

External battery string connection principle diagram of the self-distribution

The default battery number of the UPS is 16 cells. The principle diagram is shown in Figure 2-22.

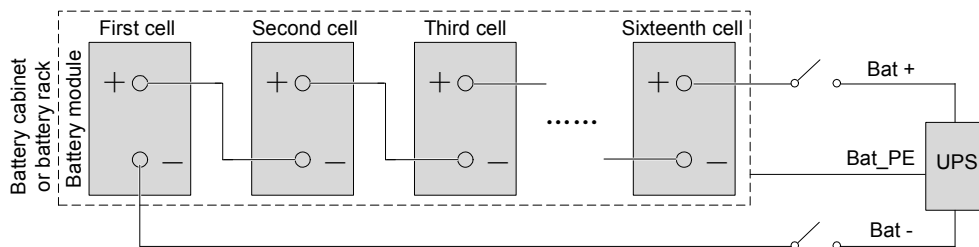

Figure 2-22 Battery module connection principle diagram

! **!** Warning

1. As shown in Figure 2-22, a DC battery MCB must be added between the battery string and the main UPS.
2. The Bat_PE of the UPS must be connected to the metal enclosure of the battery cabinet directly and reliably, and the wiring of the Bat + and the Bat - should be laid side by side and be the same direction to make sure that only one point for the system is earthed.

Notes

Before connecting the battery cables, check that:

1. The battery string comprises batteries of the same manufacturer, same model, and same use state.
2. The battery number complies with the UPS specifications, that is, sixteen 12V batteries are connected in series.
3. Confirm with a voltmeter that the battery string voltage is about 200Vdc after the series connection.

! Note

1. Non-professionals are prohibited from connecting the battery cables.
2. It is prohibited to reverse the positive pole and negative pole of the battery.
3. Different UPSs cannot use the same battery string. Otherwise, the UPS will be damaged.
4. The battery cable length of the standard UPS is 0.5m, and that of the long back-up UPS is 1.5m. It cannot be extended unlimitedly ($\leq 3m$).
5. Turn off the UPS before replacing the battery and connecting the battery cables.

Connecting battery cables of standard UPS

The standard UPS provides a battery cable A (length: 0.5m), which is used to connect the battery module to the UPS, as shown in Figure 2-23.

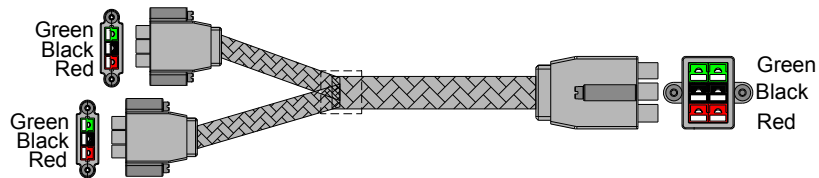

Figure 2-23 Battery cable A

The connection procedures are as follows:

1. Make sure that all the external I/O MCBs of the UPS are open.
2. Confirm with a voltmeter that no DC voltage is present on the battery ports shown in Figure 1-3 on the rear panel of the UPS.
3. Take out the battery cable A from the UPS accessories, connect the red, black and green terminal of one end of the battery cable A to the corresponding terminal of the battery port on the rear panel of the UPS, and connect the other end of the battery cable A to one of the battery ports of the two battery modules, as shown in Figure 2-24.

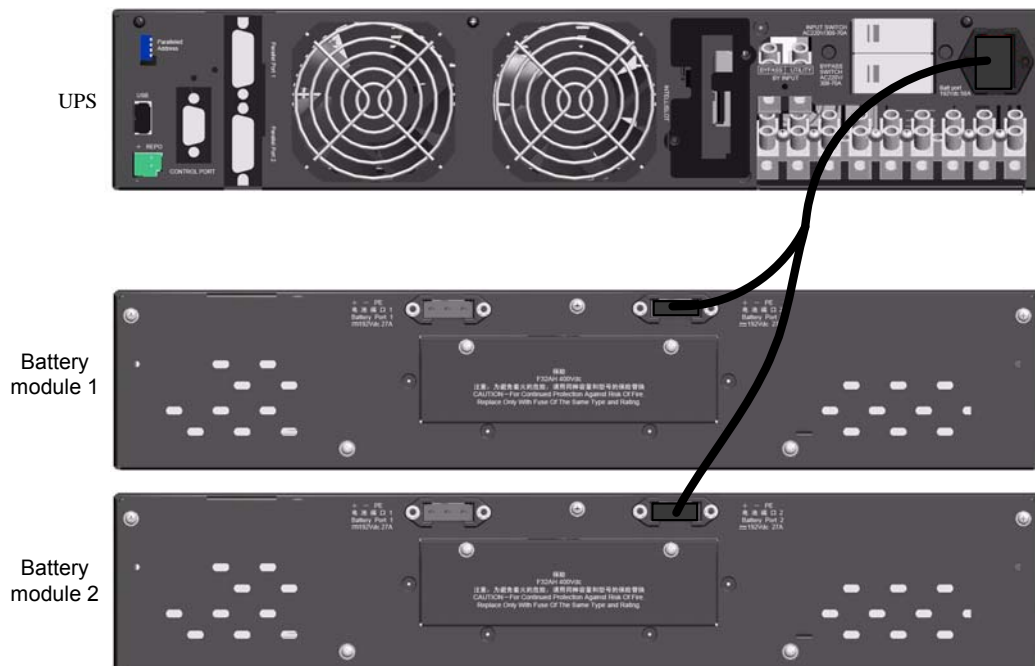

Figure 2-24 Battery cable connection for standard UPS

Connecting battery cable of long back-up UPS (battery cabinet is used)

The long back-up UPS provides a battery cable B (length: 1.5m), which has a PP45 plug at one end, and three OT terminals at the other end, as shown in Figure 2-25. It is used to connect the battery cabinet to the UPS.

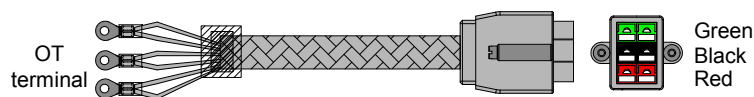

Figure 2-25 Battery cable B

The connection procedures are as follows:

1. Disconnect the input MCB of the external battery cabinet.
2. Connect the red line and the black line of the OT terminals to the positive pole and the negative pole of the battery input MCB respectively, and connect the yellow-green line to the metal enclosure of the battery cabinet. Make sure that the wiring of the red line, black line and yellow-green line should be laid side by side and be the same direction.



Note

If the OT terminal does not match the connection terminals of the battery input MCB, cut the OT terminal and peel the battery cable B to an appropriate length of copper core, and then connect the battery cable B to the battery input MCB.

3. Use the user-prepared red line and black line to connect the positive pole and the negative pole of the battery input MCB to the positive pole and the negative pole of the battery string respectively.
4. Insert the PP45 plug into the battery port on the rear panel of the UPS, as shown in Figure 2-25.

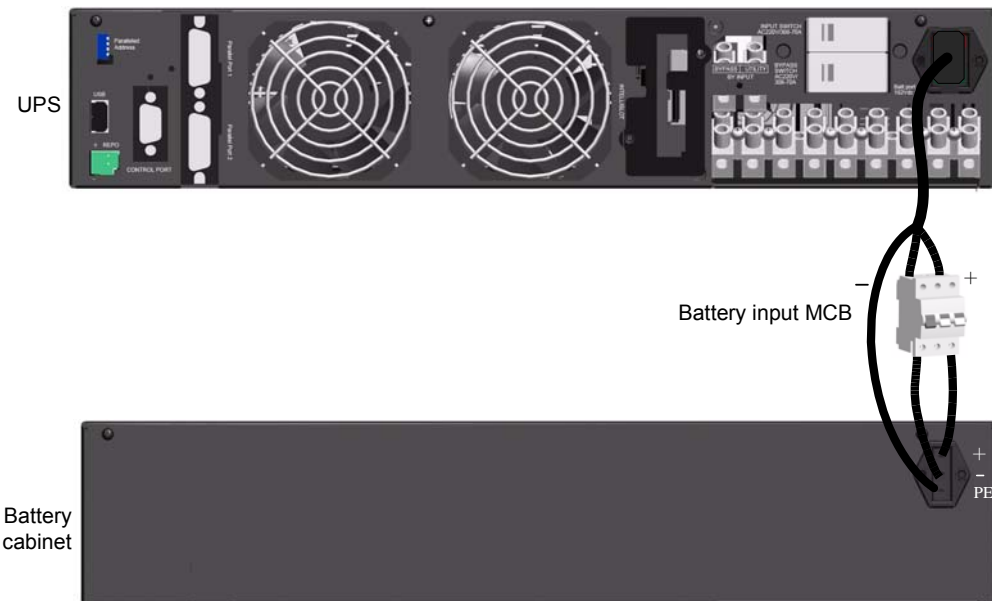

Figure 2-26 Battery cable connection for long back-up UPS

Connecting long back-up UPS to standard battery modules

When the long back-up UPS is connected to the standard battery modules, a battery cable A shown in Figure 2-23 should be used.

The connection procedures are as follows:

1. Make sure that all the external I/O MCBs of the UPS are open.
2. Confirm with a voltmeter that no DC voltage is present on the battery ports shown in Figure 1-2 on the rear panel of the UPS.
3. Connect the red, black and green terminal at one end of the battery cable A to the corresponding terminals of the battery port on the rear panel of the UPS, and connect the other end of the battery cable A to one of the battery ports of the battery module 1 and the battery module 2, as shown in Figure 2-27.
4. Insert one end of the battery module accessory cable to the other port of the battery module 2, and the other end to one of the ports of the battery module 3. Repeat the preceding procedures.

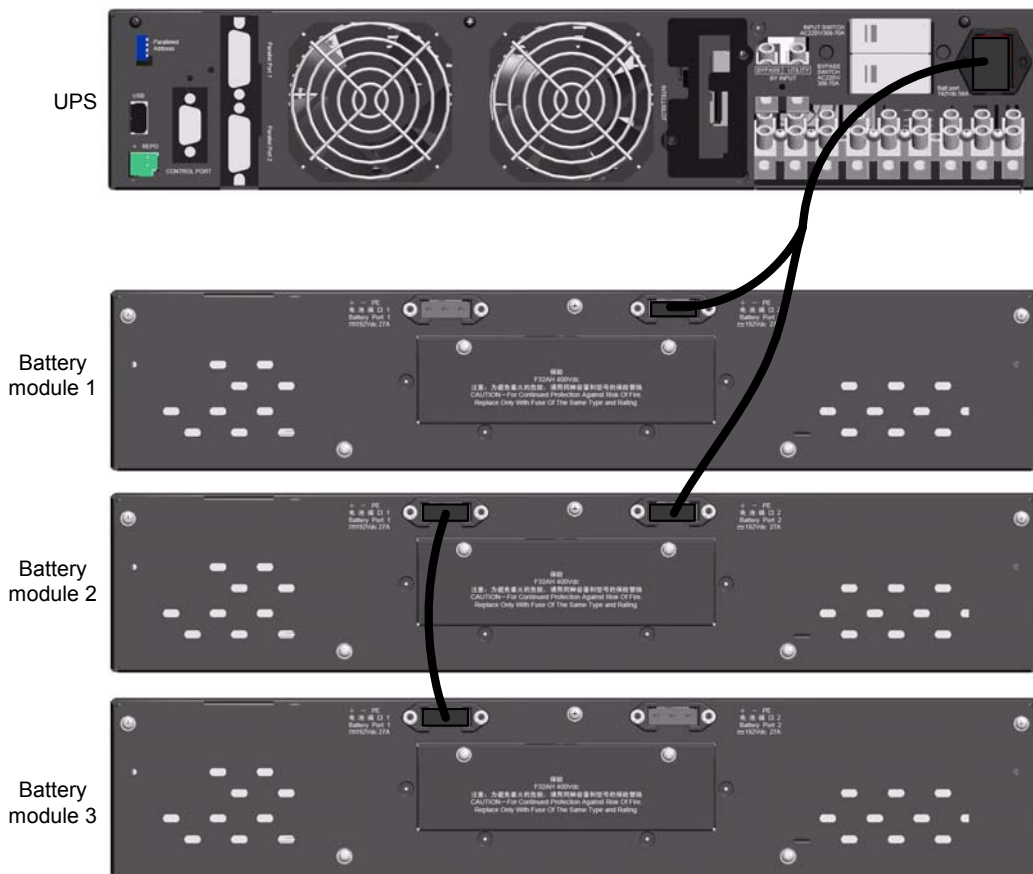

Figure 2-27 Cable connection of long back-up UPS and standard battery module



Note

1. For standard UPS, the battery cables A is the accessory. For the long back-up UPS, the battery cables A is the option.
2. The maximum allowable charging current of the battery modules is 2.16A, and that of the long back-up UPS is 4A. When the long back-up UPS uses the battery modules of the standard UPS, the number of the battery modules should be larger than 3.

2.5.3 Connecting 10A Charger Cable

The 10A charger is optional; its cable connection procedures are as follows:

1. Take out the 10A charger cable (DB9) from the package of the 10A charger, remove the protective cover of the control port on the rear panel of the 10A charger, insert one end of the cable into the control port, and fasten the fixing screws of the cable.
2. Remove the protective cover of the 10A charger control port on the rear panel of the UPS, insert the other end of the cable into the 10A charger control port, as shown in Figure 2-28, and fasten the fixing screws of the cable.



Figure 2-28 Cable connection of 10A charger

 Note
<ol style="list-style-type: none"> 1. Refer to <i>UF-BCH192/10 Charger Module User Manual</i> for other connections between the 10A charger and the UPS. 2. Keep the protective cover of the control port of the 10A charger appropriately. When the control port is not used, restore the protective cover to its original place to avoid electrical shock. 3. The maximum allowable charging current of the battery modules is 2.16A, and that of the 10A charger is 10A. When the long back-up UPS uses the battery modules of the standard UPS and the battery shared module, the number of the battery modules should be larger than 8.

After the cable connection, find the label shown in Figure 2-29 on the enclosure of the UPS and click ‘√’ after ‘AC INPUT’ according to the actual situation for easy maintenance.

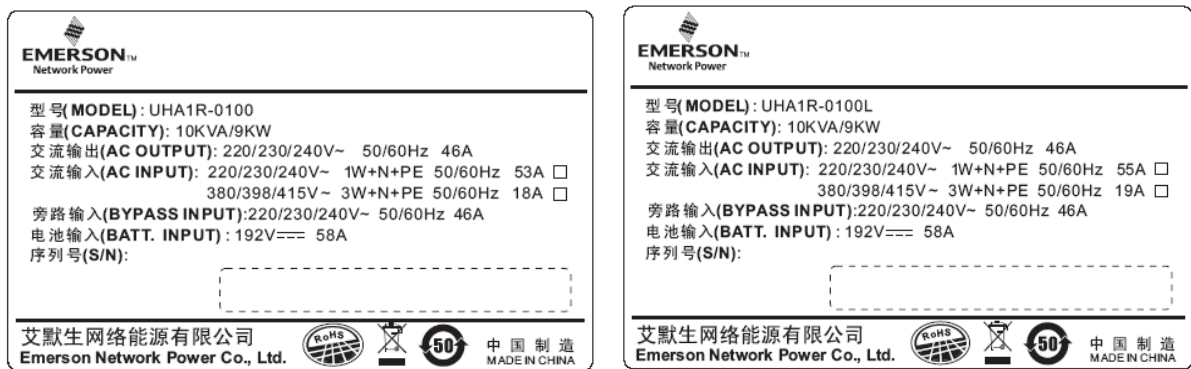

Figure 2-29 Label

2.6 Single UPS Commissioning

2.6.1 Check Before Startup

1. Check and confirm that the power distribution mode of the main UPS and the POD (if configured) is correct, that the connections of the power cables and the signal cables are correct and there is no short circuit.
2. Check that the battery installation and the cable connection are correct, that the positive pole and the negative pole of the battery are correct.
3. Measure and confirm that the mains voltage and frequency are normal.
4. The output terminals of the UPS and the POD (if configured) are energized upon the startup. If the load is connected with the output terminals, make sure that the power to the load is safe.

2.6.2 Single UPS Parameters Setting

Parameters setting of LED display panel

1. Output voltage level setting

The UPS can set the level of the output voltage (220V/230V/240V are optional), and the default value is 220V. It is prohibited from setting the value yourself. If the setting needs to be changed, please contact the agents.

2. Other settings

Set other parameters through the SiteMonitor monitoring software. Refer to the SiteMonitor guideline attached in the VCD for its installation and usage. The settable parameters are listed in Table 2-5.

Table 2-5 Settable parameters

Parameter	Description	Default
Self-test cycle	Set the self-test cycle of the battery	Disabled
ECO function	Set whether ECO function is enabled	Enabled
EOD startup	Set whether startup is automatic	Enabled

Parameters setting of LCD display panel

The parameters of the single UPS can be set through the LCD display panel; the settable parameters are listed in Table 2-6.

Table 2-6 Parameter setting of single UPS

Parameter	Description	Default
Output voltage	Set the output voltage level	220V
Self-test cycle	Set the self-test cycle of the battery	Disabled
ECO function	Set whether the ECO function is enabled	Disabled
EOD startup	Set whether startup is automatic	Enabled
Language	Set the LCD display language	Chinese

2.6.3 Normal Mode Startup

1. Close the UPS external I/O MCBs and the input MCB on the rear panel of the UPS (see Figure 1-3) one by one, and make sure that the battery is connected reliably.

	Warning
<p>After the external output MCB of the UPS is closed, the output terminal block of the UPS and the power distribution end of the load will be live, pay attention to the personnel safety to avoid electrical shock. Check whether the power supply to the load is safe.</p>	

2. Power on the UPS to enter the UPS self-test status (including the battery self-test), all the LED indicators blink, and the buzzer beeps at intervals. After the self-test is finished, the UPS enters the standby mode, and the mains indicator turns on, as shown in Figure 2-30.

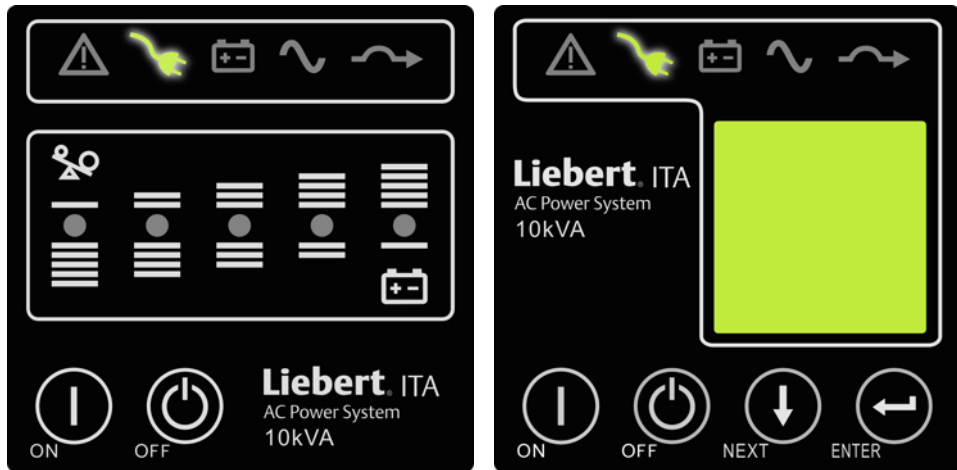

Figure 2-30 Indicator status

3. Press the ON/SILENCE key for more than one second, and wait for about 30 seconds, the UPS will enter the inverter standby mode automatically, at this time, the inverter indicator blinks. After the UPS has output, the inverter indicator will turn on, as shown in Figure 2-31

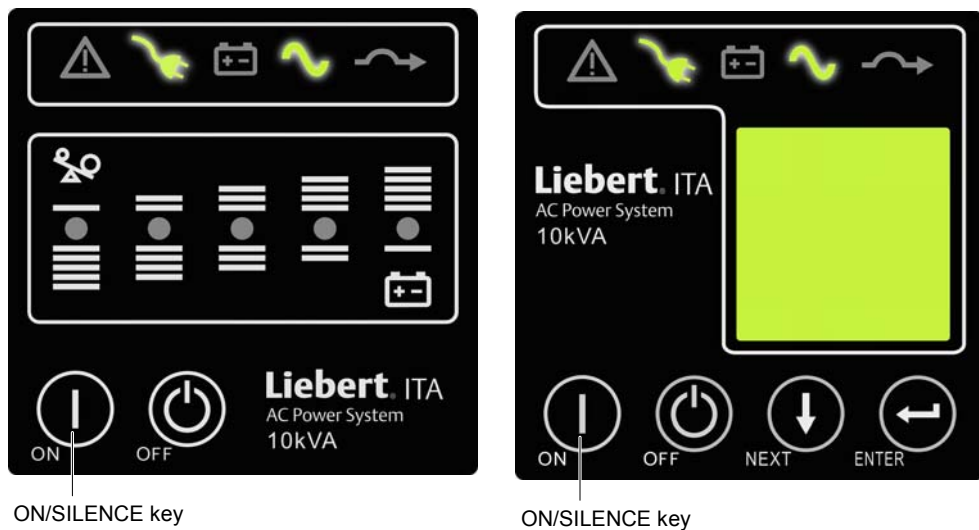

Figure 2-31 Indicator status

4. Measure whether the inverter output voltage is normal.

2.6.4 Battery Mode Startup

1. Close the battery MCB, press the ON/SILENCE key for more than one second, the UPS will start up and enter the self-test status (including the battery self-test). All LED indicators blink, the buzzer beeps at intervals. After the self-test is finished, the UPS will enter the standby mode.
2. Press the ON/SILENCE key for more than one second, and wait for about 30 seconds, the UPS will enter the inverter standby mode automatically, at this time, the inverter indicator blinks. After the UPS has output, the inverter indicator will turn on, as shown in Figure 2-32.

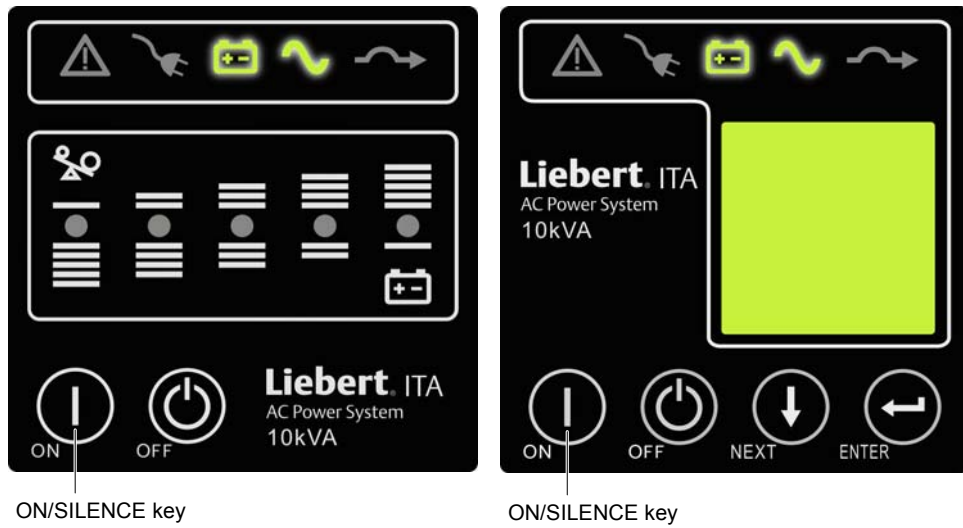

Figure 2-32 Indicator status

Chapter 3 Parallel UPS Installation And Commissioning

The UPS parallel system provides the user with $N + 1$ ($1 \leq N \leq 3$) parallel configuration, N stands for the basic parallel sets, 1 stands for the redundant sets.

The POD is compulsory for the UPS parallel system, it can provide safe and reliable power distribution function for user. The UPS parallel system provides the user with 1 + 1 parallel POD and 3 + 1 parallel POD.

This chapter introduces the mechanical installation, setting parallel address, connecting parallel cables and POD cables.

3.1 Features

1. The software and the hardware of each UPS in the parallel system are the same as those of the single UPS. The detailed parameters can be set through the background software (for service engineers only). For all UPSs of the parallel system, the requirements of the parameter settings are same.
2. The parallel cables form a ring connection to provide reliability and redundancy for the system.

3.2 Requirements

A UPS system composed of multiple parallel-connected UPSs is equivalent to a large UPS system. Nevertheless, it provides increased system reliability. To ensure equal utilization of all UPSs and compliance with relevant wiring regulations, the following requirements must be met:

1. All single UPSs must have the same capacity and must be connected to the same main and bypass source.
2. The bypass input power and the rectifier input power must be connected to the same input terminal.
3. The outputs of all single UPSs must be connected to the same output bus.

3.3 Mechanical Installation

Taking the rack installation of the 3 + 1 parallel system with battery modules for example, the mechanical installation method of the parallel system is as follows:

1. The installation method of 3 + 1 parallel UPS is the same as that of the single UPS. Refer to 2.4 *Mechanical Installation* for details.
2. As shown in Figure 3-1, to facilitate the cable connection and operation, the battery module should be installed at the bottom; the UPS and the battery module should be installed in turn, and the POD should be installed on the top.
3. The installation method of the POD is the same as that of the UPS.

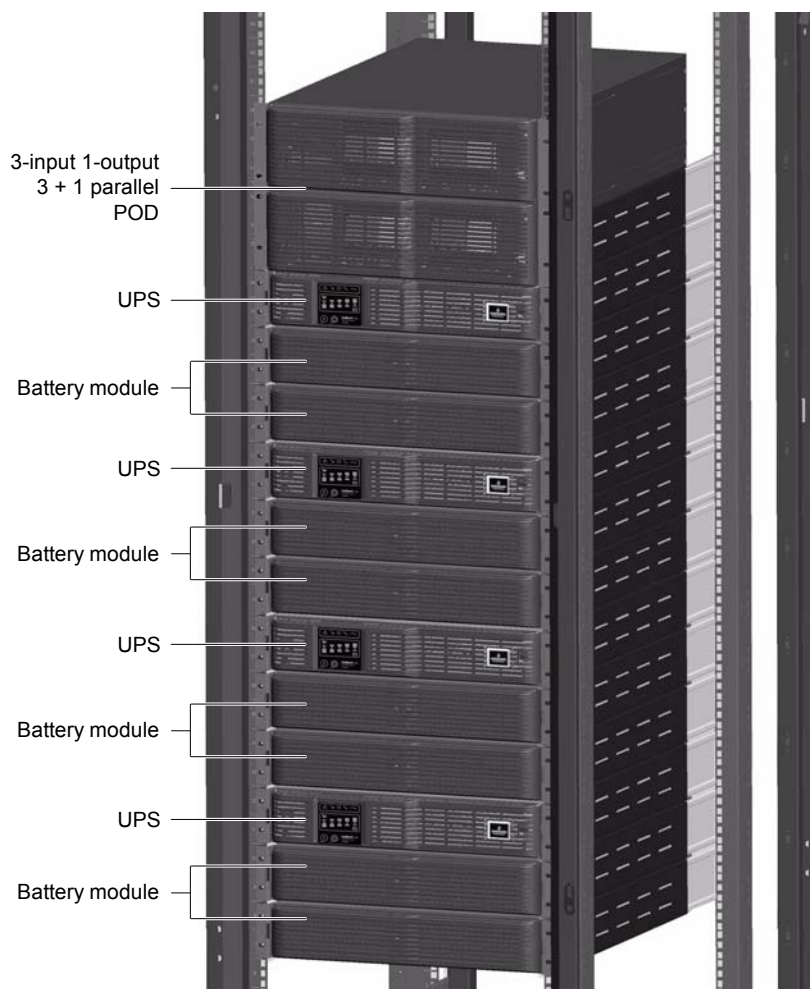

Figure 3-1 Installation of the 3 + 1 parallel system with battery modules

3.4 Connecting Cables

Each single UPS of the parallel system needs to configure the MCB and cables respectively, refer to Table 2-3 and Table 2-4 for the specifications of the MCB and cables.

3.4.1 Connecting I/O Cables

There are two modes for UPS parallel power distribution: using the POD (optional) provided by Emerson and self-distribution.

According to the user requirements, the I/O cable connections are divided into two types: 1-input 1-output (default) and 3-input 1-output.

Using POD power distribution

The UPS parallel system uses the POD provided by Emerson to perform power distribution. Refer to *Liebert® ITA 10kVA UPS Parallel Power Distribution Unit User Manual* delivered with the POD for the power cable connection.

Self-distribution

The block diagram of four-UPS parallel system is shown in Figure 3-2. Refer to 2.5.1 *Connecting I/O Cables* for the cable connection of each UPS. When using the self-distribution, refer to Table 2-3 and Table 2-4 to select the MCBs and the cables.

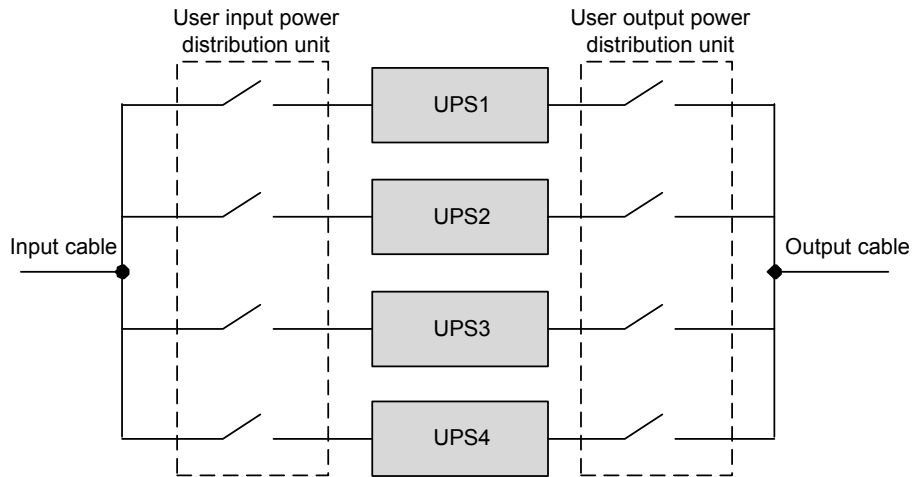

Figure 3-2 Block diagram of four-UPS parallel system

3.4.2 Connecting Parallel Signal Cables

The parallel system provides parallel signal cables (option). The parallel signal cables form a ring connection through the parallel ports on the rear panel of the UPS. The cable connection schematic diagram of the 3 + 1 parallel system is shown in Figure 3-3. The parallel port of the UPS is DB15 male port (pin shape), and the parallel cable port is DB15 female port (hole shape).

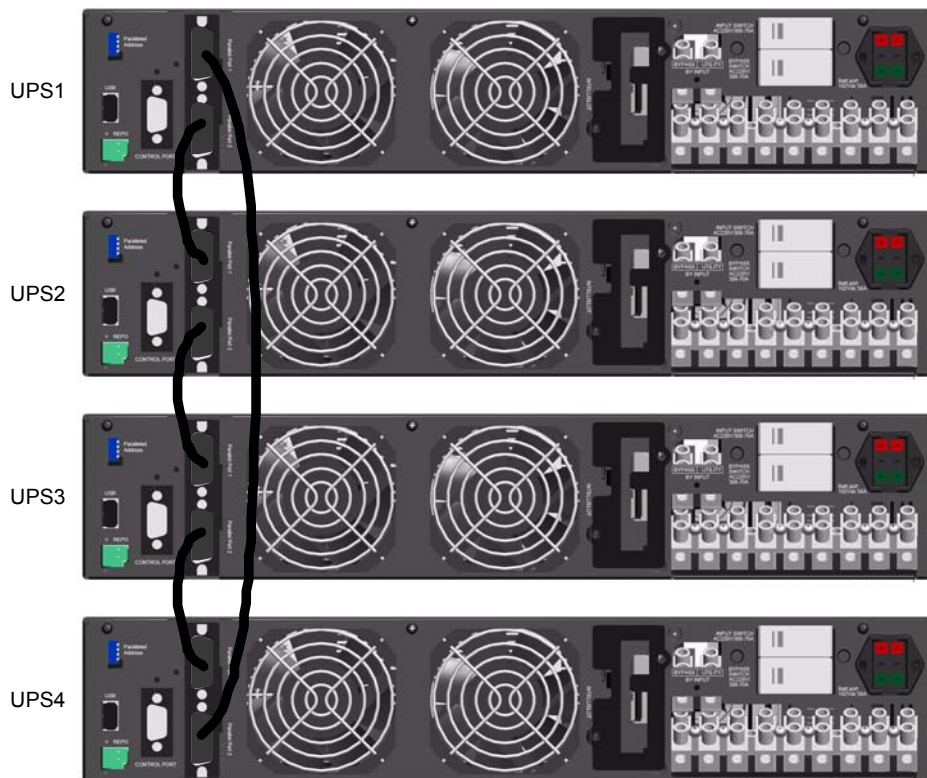



Figure 3-3 Cable connection schematic diagram of 3 + 1 parallel system

 Note

The parallel signal cables provided by Emerson must be used for the parallel system.

3.5 Setting Parallel Addresses

The parallel addresses for all UPSs in the parallel system should be set. The parallel addresses can be set through the DIP switch on the front panel of the UPS (see Figure 1-3). Remove the cover of the DIP switch to reveal the DIP switch, as shown in Figure 3-4. Set the DIP switch according to Table 3-1.

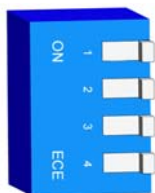

Figure 3-4 DIP switch

Table 3-1 DIP switch settings

Parallel addresses	Parallel 1#	Parallel 2#	Parallel 3#	Parallel 4#
DIP switch position				



1. The parallel address for each UPS must be unique.
2. The default setting of all the DIP switch is OFF. However, you should set the DIP switch position for the parallel system according to the descriptions listed in Table 3-1. Otherwise, a UPS fault will occur.

3.6 Commissioning Parallel System

Refer to *Liebert® ITA 10kVA UPS Parallel Power Distribution Unit User Manual* for details of the parallel system commissioning.

3.6.1 Check Before Startup

1. Check and confirm that the power distribution mode of the main UPS is correct; that the connections of the power cables and the signal cables are correct and there is no short circuit. Check that the power distribution mode of the POD and the cable connection are correct and there is no short circuit.
2. Check that the battery installation and cable connection are correct and there is no short circuit, and that the positive pole and negative pole of the battery are correct.
3. Check that the phase sequence of the main, bypass and output of each UPS is correct and accordant. Ensure that the parallel cable connection is reliable, and that the user load is not connected during power-on, to check all the working status of the parallel system.
4. Measure and confirm that the mains voltage and frequency are normal.
5. The output terminals of the UPS and the POD are energized upon the startup. If the load is connected with the output terminals, make sure that it is safe to feed power to the load.

3.6.2 Startup Commissioning For Parallel System

1. Power on and commission each UPS of the parallel system respectively, namely start one UPS each time, and other UPSs are in close status, the specific commissioning procedures are as follows:

- 1) Close the external input MCB, output MCB, battery MCB and the input MCB of one UPS, the UPS is powered on. Ensure that other UPSs are in close status. (If the POD is configured, close the corresponding input MCB and output MCB of the POD).



Warning

After output MCBs of the POD are closed, the UPS I/O terminal block, POD I/O terminal block and load will be live, pay attention to the personal safety to avoid electric shock. Confirm that it is safe to feed power to the load.

- 2) Power on the UPS to enter the self-test status (including the battery self-test), all the LED indicators blink, and the buzzer beeps at intervals. After the self-test is finished, the UPS enters the standby mode, and the mains indicator turns on.
- 3) Press the ON/SILENCE key for more than one second, and wait for about 30 seconds, the UPS will enter the inverter standby mode automatically, at this time, the inverter indicator blinks. After the UPS has output, the inverter indicator will turn on.
- 4) Measure whether the inverter output voltage is normal.
- 5) If the UPS works normally, turn off the UPS.
- 6) Repeat the preceding step1) ~ setp5) to power on and commission other UPSs respectively.



Note

Carry out the parallel commissioning after confirming that each UPS is working normally.

2. After confirming that each UPS has been powered on and is working normally, commission the parallel system. The specific procedures are as follows:
 - 1) Close the external input MCB, output MCB, battery MCB and the input MCB of one UPS (if the POD is configured, close the corresponding input MCB and output MCB of the POD), the UPS is powered on, at the same time, make sure that other UPSs are in close status. After the self-test is finished, press the ON/SILENCE key for more than one second, and wait for about 30 seconds, after the UPS has output, the inverter indicator will turn on. Measure that the inverter output voltage is normal.
 - 2) Close the input MCB, external input MCB, output MCB and battery MCB of the second UPS (if the POD is configured, close the corresponding input MCB and output MCB of the POD). Follow the preceding steps to start the inverter of the second UPS, check that there is no alarm on the LED display screen, and confirm that the UPS parallel works normally.
 - 3) Follow the method to start the inverter of the third or the fourth UPS to connect the UPS into the parallel system.



Warning

During the startup of the parallel system, confirm that the external output MCB of each UPS has been closed, and that all the inverter output of the UPSs has been connected parallelly.

Chapter 4 Display Panel

This chapter introduces the functions and use of the components on the UPS display panel, and provides LED display information, control keys, indicators and LCD display information, including LCD screen types, detailed menu messages, prompt windows message and UPS alarm list.

4.1 LED Display Panel

The LED display panel provides LED indicators and control keys, as shown in Figure 4-1.

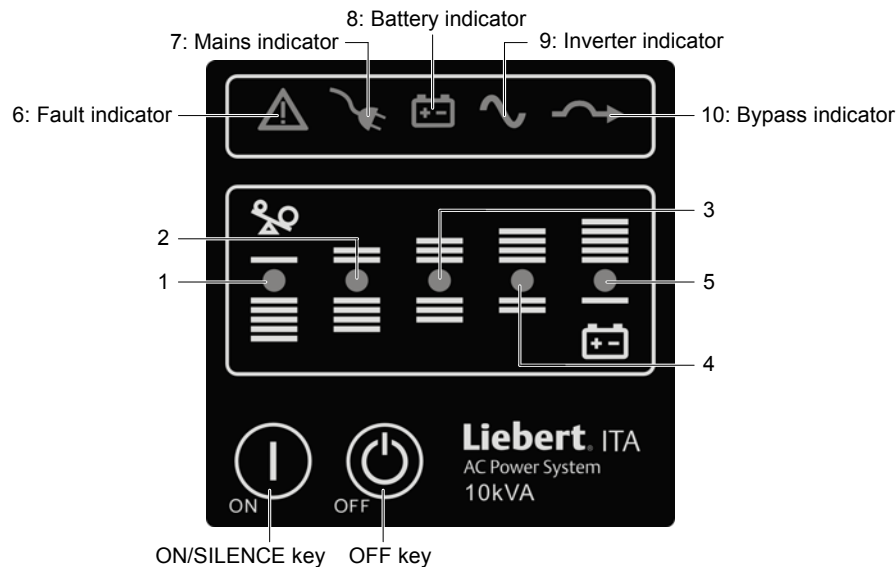

Figure 4-1 LED display panel

The ten indicators are divided into two groups according to the applications.

1. UPS state indicators: fault indicator, mains indicator, battery indicator, bypass indicator and inverter indicator. The fault indicator is red and other indicators are green.
2. UPS load battery capacity and fault orientation indicators: includes five indicators, of which four indicators are green and one indicator is yellow. The yellow indicator indicates UPS load over-capacity or battery capacity extra-low.

4.1.1 UPS State Indicators

The UPS state indicators (see Figure 4-1) indicate the UPS operation and fault state, as described in Table 4-1.

Table 4-1 UPS state indicators

Indicator No.	Indicator name	Color	Description
6	Fault indicator	Red	On in the event of fault, and off otherwise
7	Mains indicator	Green	On when the mains is normal, off during mains failure, and blinks when mains voltage outside specifications
8	Battery indicator	Green	On when the battery is supplying power, off when the battery is not supplying power, and blinks when the battery is faulty
9	Inverter indicator	Green	On when the inverter is supplying power, and off otherwise
10	Bypass indicator	Green	On when the bypass is supplying power, and off otherwise

4.1.2 UPS Load Battery Capacity And Fault Orientation Indicators

The UPS load battery capacity and fault orientation indicators indicate the load situation of the UPS. In Battery mode, they indicate battery capacity. Upon UPS failure, they work with the UPS state indicators to indicate fault type of the UPS.

Ten LED indicators cooperate to indicate the operation state and fault type of the UPS, as described in Table 4-2.

Table 4-2 Indicators combining to indicate the fault type of the UPS

SN	Operation state		Indicator No. (see Figure 4-1)										Alarm	
			1	2	3	4	5	6	7	8	9	10		
1	Normal mode	5% ~ 25% load capacity	●							●		●		
2		26% ~ 50% load capacity	●	●						●		●		
3		51% ~ 75% load capacity	●	●	●					●		●		
4		76%~ 95% load capacity	●	●	●	●				●		●		
5		96% ~ 105% load capacity	●	●	●	●	●			●		●		
6		> 105% load capacity	●	●	●	●	●			●		●		□2Hz
7	Battery mode	0% ~ 25% battery capacity					●			●	●		□1Hz	
8		26% ~ 50% battery capacity				●				●	●		□1/3Hz	
9		51% ~ 75% battery capacity			●	●				●	●		□1/3Hz	
10		76% ~ 95% battery capacity		●	●	●				●	●		□1/3Hz	
11		> 96% battery capacity	●	●	●	●				●	●		□1/3Hz	
12	Bypass mode	< 105% load capacity	◎	◎	◎	◎	◎			●		●		
13		> 105% load capacity	●	●	●	●	●			●		●	□2Hz	
14	Inverter standby	< 105% load capacity	◎	◎	◎	◎	◎			●		◻	●	
15		> 105% load capacity	●	●	●	●	●			●		◻	●	□2Hz
16	Non-operation mode									◎				
17	Short fault						◻	●					◇	
18	Charger failure					◻		●	◎	◎	◎	◎	◇	
19	Fan/overtemperature fault				◻			●	◎	◎	◎	◎	◇	
20	Parallel current sharing failure			◻				●	◎	◎	◎	◎	◇	
21	Rectifier failure (bus high fault)		◻					●	◎	◎	◎	◎	◇	
22	EPO fault							●					◇	
23	Battery fault (high voltage)		◎	◎	◎	◎	◎		◎	◻	◎	◎		
24	Battery fault (no battery, reverse connection)		◎	◎	◎	◎	◎	●	◎	◻	◎	◎	◇	
25	Other failures (auxiliary supply failure and inverter failure)		◎	◎	◎	◎	◎	●	◎	◎	◎	◎	◇	

Note: ○: off; ●: on; ◻: flashes; ◎: ensures according to the current operation mode of the UPS; ◇: alarm lasting; □: alarm; when the UPS is in Normal mode, the mains indicator and inverter indicator are on. The short fault, charger failure and EPO fault can be recoverable after shutdown of the UPS

Note
 Indicator 5 is yellow, indicator 6 is red and other indicators are green.

4.1.3 Control Keys

The two control keys include ON/SILENCE key and OFF key. Their functions are given in Table 4-3.

Table 4-3 Functions of the control keys

Control keys	Functions
ON/SILENCE key	<ol style="list-style-type: none"> 1. Starting the inverter: Pressing and holding this key for 1s starts the inverter. 2. Silencing alarm: In Battery mode, or upon overload or fault, the UPS has an audible alarm, pressing and holding this key for 1s silences the alarm. 3. Initiating battery manual self-test: When the UPS is in Normal mode, pressing and holding this key for 4s initiates battery manual self-test
OFF key	<ol style="list-style-type: none"> 1. Turning off the inverter: When the UPS is in Normal mode or Battery mode, pressing and holding this key for 1s turns off the inverter, and the UPS output transfers to Bypass mode. 2. UPS accessing to standby state: When the UPS is in Bypass mode, pressing and holding this key for 10s turns off UPS bypass output, then the UPS accesses to the standby state



Note

Pressing and holding the ON/SILENCE key for 1s silences the alarm, and doing the same operation can resume the alarm beep.

4.2 LCD Display Panel

The LCD display panel provides LED indicators, a LCD display screen and control keys, as shown in Figure 4-2.

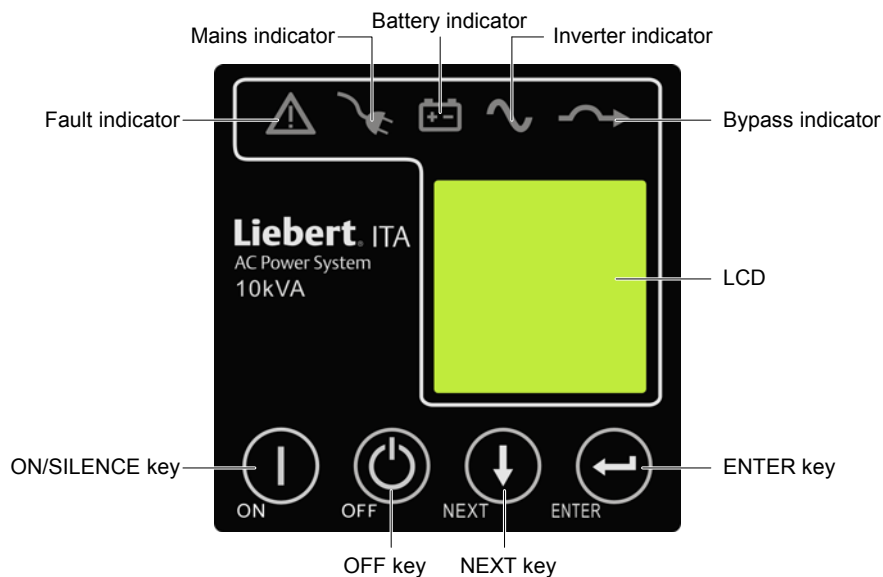

Figure 4-2 LCD display panel

The functions of the control keys are listed in Table 4-4.

Table 4-4 Functions of the control keys

Control keys	Functions
ON/SILENCE key	<ol style="list-style-type: none"> 1. Starting the inverter: When the inverter is off, pressing and holding this key for 1s starts the inverter. 2. Silencing alarm: When the UPS has an audible alarm, pressing and holding this key for 1s silences the alarm. 3. Initiating battery manual self-test: When the UPS is in Normal mode, pressing and holding this key for 4s initiates battery manual self-test
OFF key	<ol style="list-style-type: none"> 1. Turning off the inverter: When the UPS is in Normal mode or Battery mode, pressing and holding this key for 1s turns off the inverter, and the UPS output transfers to Bypass mode. 2. UPS accessing to standby state: When the UPS is in Bypass mode, pressing and holding this key for 10s turns off UPS bypass output, then the UPS accesses to standby state
NEXT key	Pressing and holding this key continuously for less than 1s shifts menu items, the selected contents will be displayed highlighted. Pressing and holding this key continuously for more than 1s turns on/turns off the backlight on the LCD

Control keys	Functions
ENTER key	Pressing and holding this key continuously for less than 1s enters the selected menu. Pressing and holding this key continuously for more than 1s returns to previous menu

The interfaces of the LCD display screen include start interface and menu interface.

1. Start interface

The start interface displays the UPS series, product type and company name for about 20 seconds. The start interface is shown in Figure 4-3.

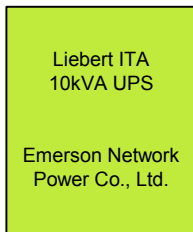

Figure 4-3 Start interface

2. Menu interface

The menu interface includes running interface, alarm message interface and setting interface, the main menu interface is shown in Figure 4-4.

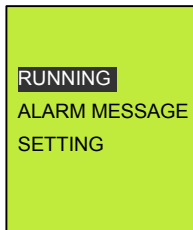
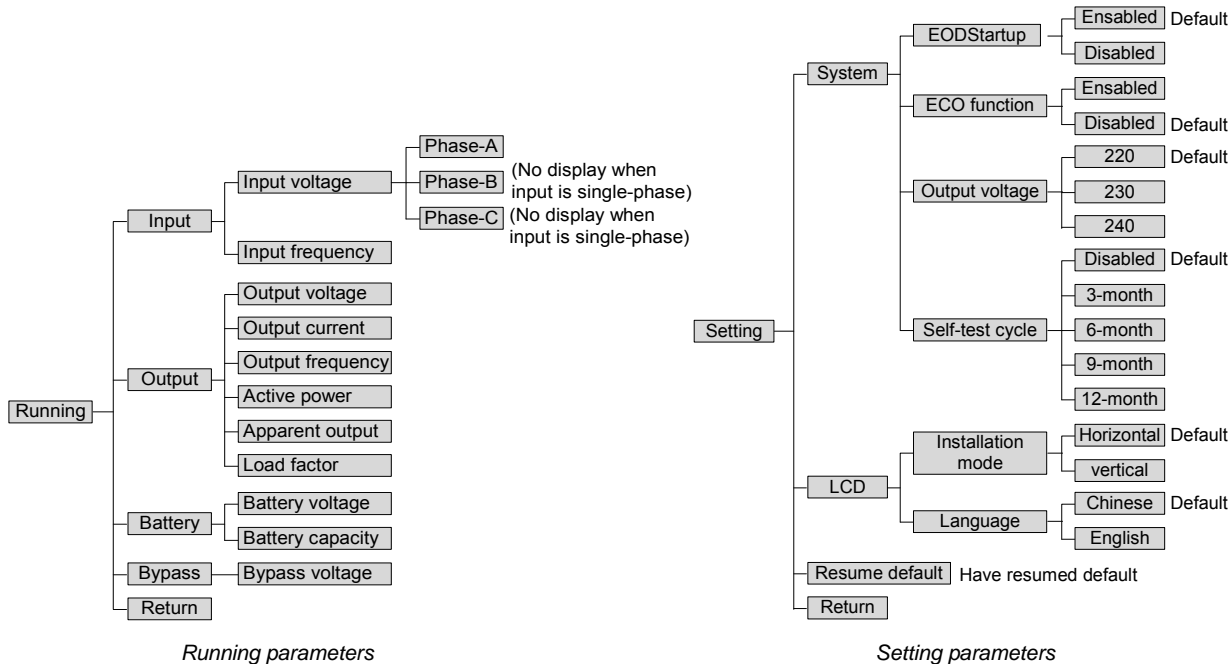
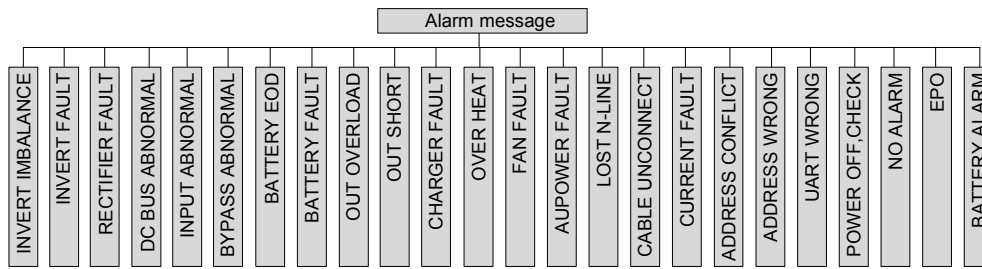

Figure 4-4 Main menu interface

You can enter the corresponding interfaces through the control keys on the LCD display panel. The structure diagrams of each level menu are shown in Figure 4-5. The interfaces are refreshed every other second.





Alarm parameters

Figure 4-5 Structure diagram of the menu interface

The parameters of the single UPS can be set through the LCD display panel; the parameters are listed in Table 4-5.

Table 4-5 Parameter settings of the single UPS

Parameter	Description	Default
Output voltage	Set the level of the output voltage	220V
Self-test cycle	Set the self-test cycle of the battery	Disabled
ECO function	Set whether the ECO function is active	Disabled
EOD startup	Set whether the startup is automatic	Enabled
Language	Set the LCD displayed language	Chinese

Chapter 5 UPS Operation Instructions

This chapter introduces checking content, power-on, turning on UPS and daily operation procedures of the UPS before the power-on of UPS.



During the operation, the buzzer alarm may appear at any moment. Press the ON/SILENCE key for one second to silence the audible alarm, and press this button for one second again to resume the alarm beep.

 Note
<p>1. If the UPS is fed with AC from a generator, conduct the operations according to the following instructions: start up the generator, and do not start up the load of the UPS first. Connect the UPS to the generator, and switch on the loads one by one when the generator operates stably. To ensure the reliable operation of the generator, it is recommended that the load of the UPS should be less than 30% of the generator capacity. It is recommended that the selected generator should be 1.5 times ~ 2 times of the UPS rated capacity.</p> <p>2. The battery has been fully charged before delivery. However, the transportation and storage may cause some charge loss. It is required to charge the battery for eight hours before the UPS is used for the first time to ensure adequate back-up time.</p>

5.1 Check Before Power-On

Before the UPS is powered on, check the following items:

1. Check that the UPS input and output cables are connected properly and reliably, and the UPS input cables are not connected reversely.
2. Check that the positive and negative poles of the battery cables are correct.
3. Check that the communication cables are connected properly.

  Warning
<p>The UPS output terminals will be live when the start-up procedures of the UPS are performed. If the load is connected to the output terminals of the UPS, confirm with the user that whether it is safe to feed power to the load. Ensure that the load is safely isolated with the output terminals of the UPS, if the load is not ready for accepting the power.</p>

5.2 UPS Power-On

After the UPS input and output cables is connected, the UPS will start up and conduct the UPS self-test, including self-test of the battery, if the mains input voltage is within 120Vac ~ 253/264/276Vac. After the self-test is complete, the UPS enters the standby mode, the mains indicator is on, as shown in Figure 5-1.

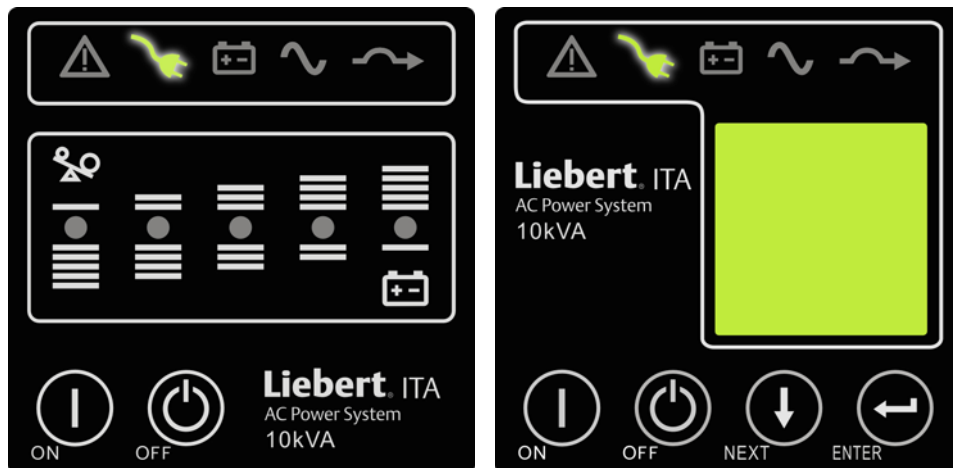

Figure 5-1 Indicator status

5.3 Turning On UPS

After the UPS is powered on, press and hold the ON/SILENCE key for more than one second. After about 30 seconds, the UPS will transfer to the normal standby mode automatically, at this moment, the inverter indicator will blink.

After the UPS has output, the inverter indicator will turn on, as shown in Figure 5-2.

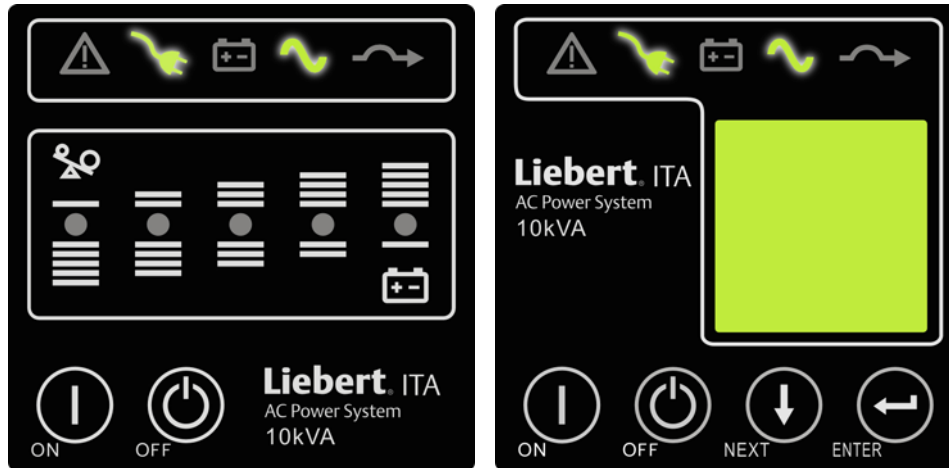

Figure 5-2 Indicator status

Pressing the OFF key for one second to confirm that the UPS operates in Bypass mode, the interface is shown in Figure 5-3.

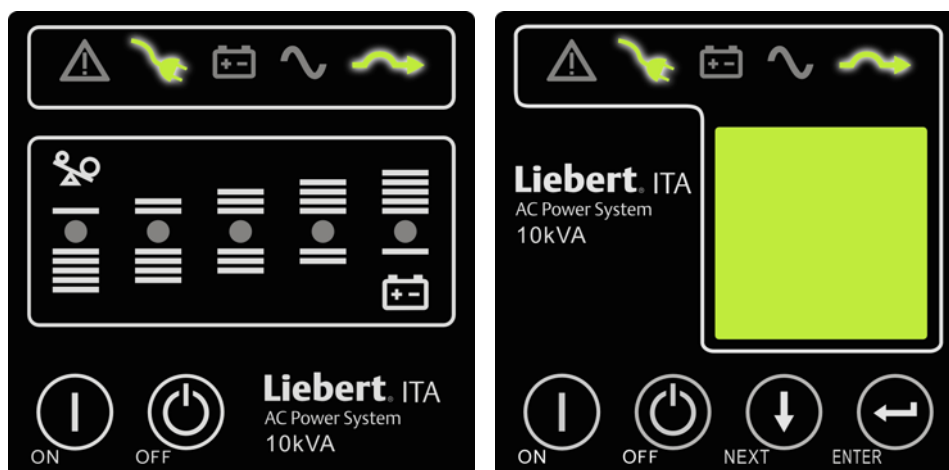

Figure 5-3 Indicator status

It is recommended that the load capacity should not exceed 70% of the rated load to ensure the normal operation of the UPS in the case of the sudden short-time extra-load, and to prolong the life time of the UPS at the same time.



Note

1. If the UPS transfers from Normal mode to Bypass mode for three times within one hour due to the overload, the UPS will remain in Bypass mode for one hour and afterwards cannot transfer back to Normal mode until the overload fault is removed.
2. The single UPS startup is divided into Normal mode startup and Battery mode startup, refer to 2.6.3 *Normal Mode Startup* and 2.6.4 *Battery Mode Startup* for details.
3. For details of startup of the parallel UPS, refer to 3.6.2 *Startup Commissioning For Parallel System*.
4. In Bypass mode, the load is powered by the mains supply directly instead of the pure power of the inverter output.

5.4 Battery Self-test

The battery self-test includes battery power-on self-test, battery manual self-test and battery periodic self-test.

5.4.1 Battery Power-On Self-test

To ensure normal battery connection, the UPS will conduct self-test for the battery connection every time the UPS is powered on. If the battery is not connected, reversely connected or abnormal, the fault indicator will turn on and the battery indicator will blink to remind you to check the battery connection. At this moment, the UPS cannot start up. After the battery connection fault is removed, press and hold the ON/SILENCE key for more than four seconds to silence the alarm and start up the UPS. The indicator status is shown in Figure 5-4. If the battery voltage is too high, only the battery indicator blinks.

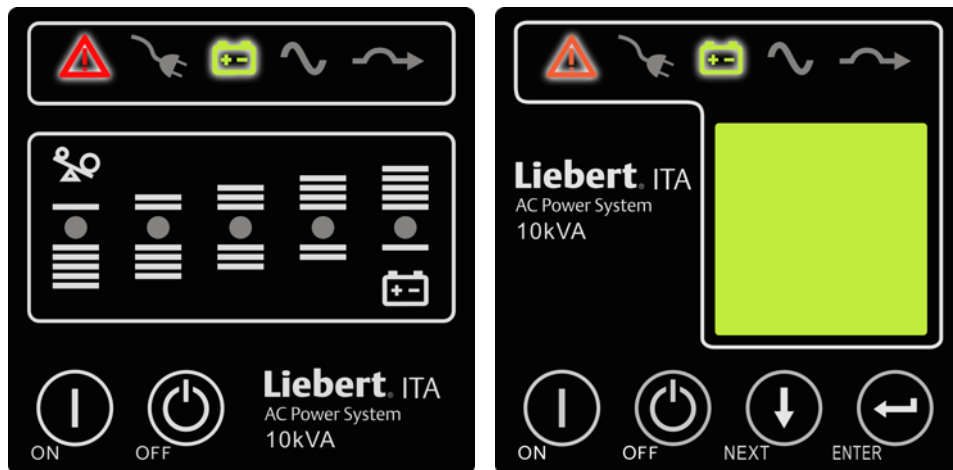

Figure 5-4 Indicator status

5.4.2 Battery Manual Self-test

The battery manual self-test includes the battery in-position test and the battery state test.

In normal state, when the mains input is normal, the inverter output is not overloaded, meanwhile the single cell voltage is not less than 12V, press and hold the ON/SILENCE key for four seconds, the battery will start self-test, the battery indicator will turn on. After the self-test, the battery indicator will turn off. Upon battery faults (battery not connected or battery failure), the fault indicator will turn on, the battery indicator will blink, as shown in Figure 5-5.

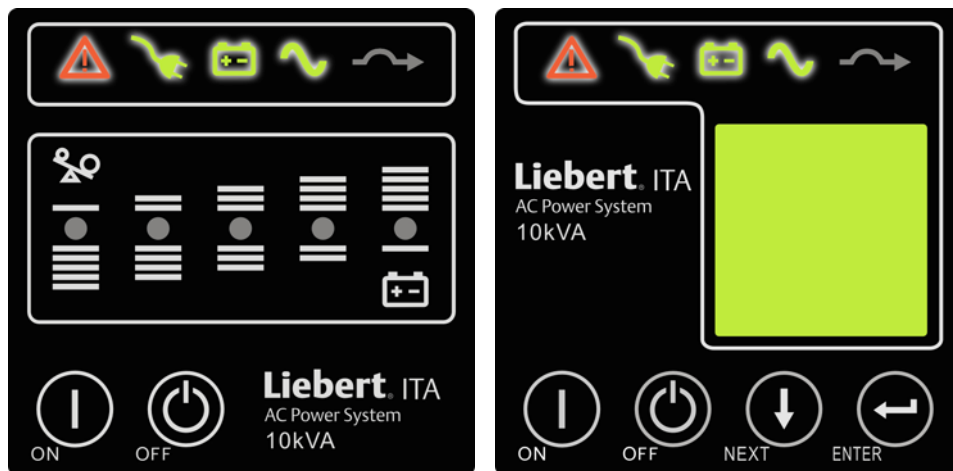

Figure 5-5 Indicator status

5.4.3 Battery Periodic Self-test

You can set the battery self-test cycle through the monitoring software. The self-test cycle respectively is disabled, three months, six months, nine months and twelve months.

In normal state, when the mains input is more than 176V, the inverter works normally, meanwhile the single cell voltage is not less than 12V, the battery will conduct the self-test if the set self-test cycle time arrives. When the battery self-test starts, the battery indicator will turn on; upon battery faults (battery not connected or battery failure), the fault indicator will turn on, the battery indicator will blink, as shown in Figure 5-5.



Note

1. The battery state information will be renovated after each time the battery self-test is complete. Confirm the battery fault information of the self-test upon battery undercharge by conducting the self-test again after the battery has been fully charged.
2. Follow the sequence to start up the UPS: connect the battery first, connect the mains next, and press the ON/SILENCE key at last.

5.5 Turning Off UPS

Turning off UPS includes turning off UPS in Normal mode, turning off UPS in Battery mode, turning off UPS in Bypass mode and turning off UPS in EPO mode.

Turning off UPS in Normal mode

Press and hold the OFF key for one second until the buzzer beeps, the UPS inverter stops working, and transfers to Bypass mode. At this moment, the mains indicator and bypass indicator will turn on; press and hold the OFF key for 10 seconds, the UPS enters the standby state. At this moment, the UPS is not powered off completely, the mains indicator is on, as shown in Figure 5-6. If you need to power off the UPS completely, disconnect the mains input of the UPS.

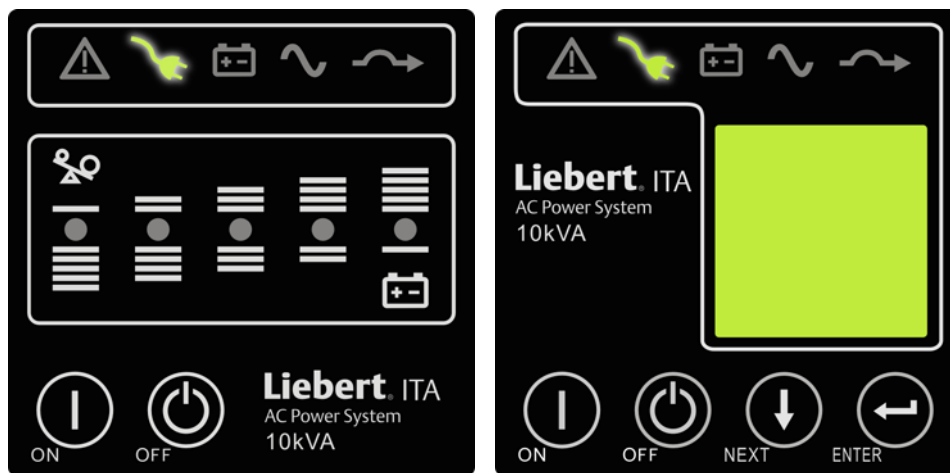

Figure 5-6 Indicator status

Turning off UPS in Battery mode

Press and hold the OFF key for one second, then the UPS is turned off, the output is terminated, the load is powered off and the Battery indicator is off, as shown in Figure 5-7. If you need to power off the UPS completely, press and hold the OFF key for 10 seconds.

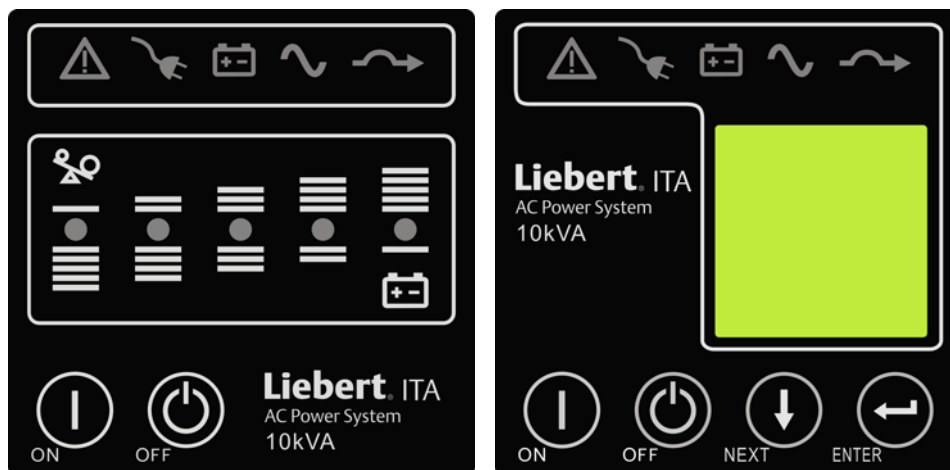

Figure 5-7 Indicator status

Turning off UPS in Bypass mode

Press and hold the OFF key for 10 seconds, the UPS stops output and enters the standby state. At this moment, the UPS is not powered off completely. If you need to power off the UPS completely, disconnect the mains input of the UPS.

Turning off UPS in EPO mode

The EPO switch is used to shut down the UPS upon emergency conditions, such as fire or flood. The system will turn off the rectifier, inverter, and stop powering the load (including the inverter and bypass output) immediately, and the battery will stop charging or discharging.

If the UPS still has main input, the UPS control circuit will remain alive, and the UPS output has been shut down. The external main input MCB of the UPS should be disconnected, if you need to remove all mains power of the UPS.

5.6 UPS Power-off

The method of powering off the UPS is as follows:

1. After the UPS is turned off, disconnect the input cable plug, or open the upstream switch of the UPS. At this moment, all the indicators will turn off and the fan will stop (if the battery is configured, the fan will stop 20 seconds later), and the power-off of the UPS is complete.
2. If the UPS has an external battery, set the external battery switch to OFF position.

After the UPS is powered off, the output will be terminated, and the load will be powered off.

5.7 Transferring UPS Operation Mode

In normal condition, the UPS should be set to Normal mode. In the event of the mains failure, the UPS will transfer to Battery mode automatically, and will not terminate the UPS output. In the event of the overload, the UPS will transfer to Bypass mode automatically, and will not terminate the output. In the event of inverter fault and overtemperature in the UPS, the UPS will transfer to operate in Faulty state automatically.

5.7.1 Transferring UPS To Bypass Mode From Normal Mode Manually

In Normal mode, press and hold the OFF key for one second to transfer the UPS to Bypass mode.

Refer to 1.5 *UPS State And Operation Mode* for the detailed introduction of the Normal mode, Bypass mode, Battery mode and Maintenance Bypass mode.

5.7.2 Transferring UPS To Bypass Mode From Overload Protection

When the UPS load exceeds the rated value and preset time, the UPS will transfer to Bypass mode from Normal mode, and send out hurried alarm sound every 0.5 second. At this moment, the UPS output voltage is the mains voltage, and the redundant loads must be removed until the UPS does not generate the overload alarm again. Wait for five minutes, the output voltage will transfer to the Normal mode automatically. To protect the load and the UPS, the UPS cannot transfer to Bypass mode from overload protection for more than three times within one hour, otherwise, the output will remain in Bypass mode and transfer back to Inverter mode one hour later.



Note

In the Bypass mode, the load is powered directly by the mains supply instead of the pure power of the inverter output.

5.7.3 Transferring UPS To Inverter Mode From Bypass Mode Manually

In Bypass mode, press and hold the ON key for two seconds. After the inverter operates normally, the UPS will transfer to Inverter mode.

5.7.4 Transferring UPS To Battery Mode From Mains Failure

In the event of mains failure, the UPS will transfer to Battery mode. The UPS will turn off automatically if it works until the battery power is depleted. When the mains restores, the UPS will turn on automatically, and enter Normal mode. This function is designed for unattended operation. If the UPS is turned off manually when it is working in Battery mode, then it needs to be turned on manually after the mains restores, and it cannot turn on automatically.

5.7.5 Transferring UPS To Bypass Mode From Inner Overheating Protection

Too high ambient temperature or poor ventilation of the UPS may result in the high temperature in the UPS. At this moment, the UPS output will transfer to Bypass mode, the fault indicator will on, indicator 3 will blink (see Figure 4-1 for the position), and the UPS will beep for a long time. At this moment, you should cut off the UPS input power supply, remove the obstacles in the air channel, or increase the clearance between the UPS and the wall. After the UPS is cooled, connect the UPS to the mains again and restart it.

5.7.6 Transferring UPS Fault State Upon Output Short Protection

If the UPS load is shorted, the UPS output will be cut off, the fault indicator will be on, the yellow indicator of the load indicator will blink, and the UPS will beep for a long time. At this moment, you should disconnect the short connected load from the UPS, cut off the input power and wait for ten minutes until the UPS turns off automatically (or turn off the UPS by pressing the OFF key manually after 10 seconds). After the short circuit fault is eliminated, connect the UPS to the mains again and restart it.

5.7.7 Transferring UPS To Maintenance Bypass Mode From Inverter Mode

When the UPS is operating in Inverter Output mode, follow the procedures below to transfer the load to Maintenance Bypass mode from Inverter Output mode.



Note

1. Before conducting the transfer, first ensure that the bypass is normal and synchronizes with the inverter. Failure to meet above requirements may cause power supply interruption of the load in short time.
2. To realize this function, you need to select a POD or configure a maintenance bypass MCB by yourself.

1. Press and hold the OFF key for one second.

The inverter indicator turns off, the buzzer beeps. The load transfers to static bypass, and the inverter turns off.

2. Close the maintenance bypass MCB on the front panel of the POD, the load power is supplied by the maintenance bypass.



Warning

If you need to maintain the UPS, wait for about 10 minutes until the capacitance and voltage of the internal DC bus finish discharging.

3. Open the input MCB and output MCB of the UPS.

5.7.8 Transferring UPS To Inverter Mode From Maintenance Bypass Mode

After the UPS maintenance is finished, follow the procedures below to transfer the load to Inverter mode from Maintenance Bypass mode.



Warning

Because no auxiliary contact information of the maintenance bypass MCB is imported to the UPS, the UPS operation restoration after maintenance must be carried out strictly in accordance with the procedures below, otherwise the equipment may be damaged.

1. Close the output MCB on the front panel of the POD.
2. Close the main input MCB and bypass input MCB on the front panel of the POD.

3. Wait until the UPS operates in Bypass mode, and open the maintenance bypass MCB on the front panel of the POD.
4. Press and hold the ON/SILENCE key for more than one second, the UPS will transfer to the Inverter mode.

5.8 UPS Complete Shutdown

For the UPS system equipped with POD, if you need to turn off the UPS completely, transfer the UPS to the Maintenance Bypass mode from the Inverter mode according to the procedures in 5.7.7 *Transferring UPS To Maintenance Bypass Mode From Inverter Output Mode*, to ensure that the use of the load during UPS power-off will not be affected. If the load needs no power supply, open the maintenance bypass MCB directly, as shown in Figure 5-8.

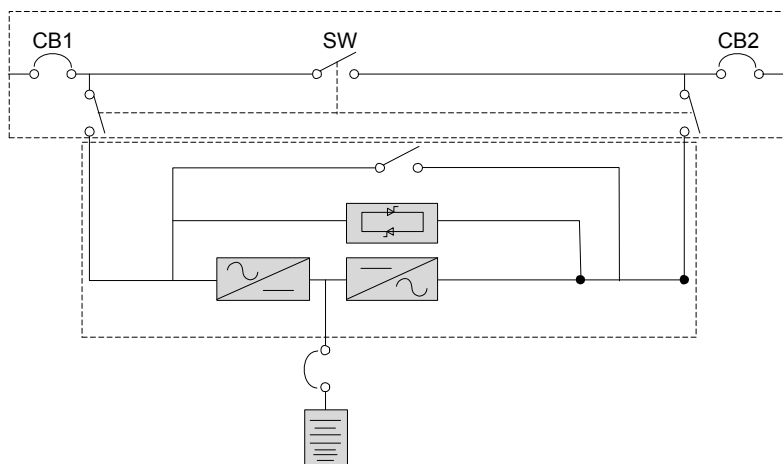



Figure 5-8 Configuration of single UPS with external maintenance bypass

For the UPS system equipped with power supply by user, if you need to isolate the UPS from AC power, open the external input MCB.

 Warning
To avoid physical injury, turn off the maintenance power.

5.9 Auto Startup

In case of mains failure, the UPS will supply power to the load through the battery, until the battery discharges to the end-of-discharge (EOD) voltage, and the UPS will terminate the output.

The UPS will restart automatically and restore the output power supply after meeting the following conditions.

- The mains restores after battery EOD
- The UPS EOD Auto Start function is set

 Note
1. The EOD Auto Start function is set for the UPS products by default if there is no special customized requirement. 2. If the Auto Start function is not set, you can start the UPS manually by pressing the ON/SILENCE key.

5.10 UPS Monitoring

For the operation methods of the UPS background monitoring, refer to SiteMonitor monitoring software delivered with the UPS.

Chapter 6 Communication

This chapter gives a brief introduction to the UPS communication.

The communication ports include USB port and intelligent card port, which cannot be used at the same time.

6.1 Connecting USB Communication Cable

See Figure 1-3 for the location of USB port.

The procedures for connecting the USB communication cable are as follows:

1. Take out the USB communication cable from the accessories.
2. Insert one end of the USB communication cable to the USB port on the rear panel of the UPS.
3. Insert the other end of the USB communication cable to the USB port of the upstream equipment.

Before the communication, you need to install the USB driver in the installation CD.

The USB port can be connected to single SiteMonitor monitoring software. For the installation, configuration and using methods of the SiteMonitor monitoring software, refer to the user manual in the installation CD.

6.2 Installing Communication Assembly (Optional)

The UPS provides an intelligent card port (see Figure 6-1), which is used to install communication assembly, including SIC card, dry contact card, extended dry contact card, RS485 card, RS232 card and MODBUS card.

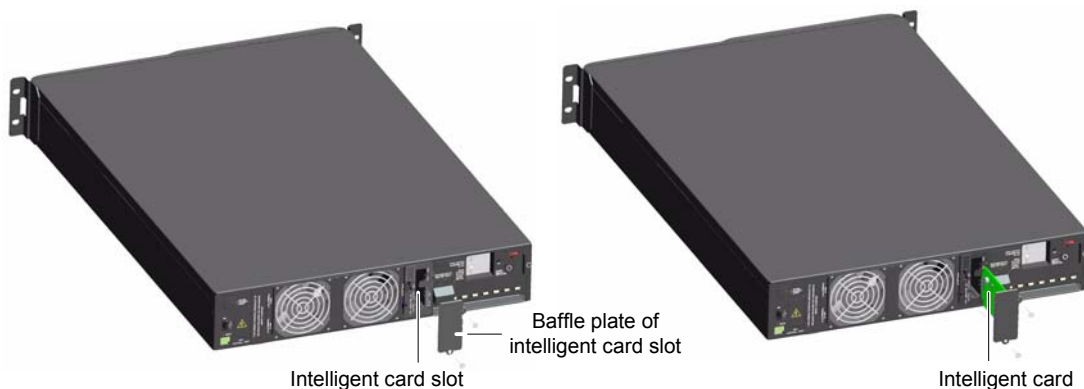

Figure 6-1 Intelligent card installation

6.2.1 SIC Card

SIC card is a network management card, which provides the UPS, air conditioner, STS, SPM, and other intelligent devices produced by Emerson with network communication capability. The SIC card can also cooperate with the Network Shutdown program developed by Emerson to provide safe automatic shutdown function for the computers, in which the Network Shutdown is installed, to protect data and reduce loss.

For the detailed installation and operation guide of the SIC card, refer to the relevant user manual.

6.2.2 JBUS/MODBUS Adapter Card

Through the user background monitoring software, the UPS JBUS/MODBUS adapter card (adapter card for short) enables the user to use JBUS/MODBUS (RTU) protocol to manage the UPS and the field lighting power system (FLP for short) devices of Emerson. The adapter card can also enable the user to obtain the devices working status by acquiring various electrical parameters, running state and fault types of the devices.

For the detailed installation and operation guide of the adapter card, refer to the relevant user manual.

6.2.3 RS485 Card

The RS485 card should be used together with the Liebert® ITA series UPS of Emerson to realize the signal transform from RS232 to RS485.

For the detailed installation and operation guide of the RS485 card, refer to the relevant user manual.

6.2.4 RS232 Card

The RS232 card should be used together with the Liebert® ITA series UPS of Emerson. It only supports RS232 protocol communication, and the maximum length of the communication cable cannot exceed 15 meters.

6.2.5 Dry Contact Card

The dry contact card can provide the remote with four routes of relay switch signal outputs: UPS on Battery, Battery low, UPS on Bypass or in Standby, UPS Faulty. Each dry contact output provides both normally open and normally closed ports for user to select. The dry contact card can also receive three routes of switch signal inputs, two of which control the UPS turn-on and UPS turn-off respectively, the third is reserved.

For the detailed installation and operation guide of the dry contact card, refer to the relevant user manual.

6.2.6 Extended Dry Contact Card

Besides the functions of the UPS contact card, the extended dry contact card can also provide RS232 and RS484 communication functions to support JBUS/MODBUS (RTU) communication protocol, and provide four routes of analog value acquisition function.

For the detailed installation and operation guide of the extended dry contact card, refer to the relevant user manual.

6.3 Connecting REPO Cable

In case of emergency, close the REPO switch provided by user to shut down the rectifier and inverter, and the UPS is powered off. In normal condition, the REPO switch cannot cut off the UPS input power. If a switch with electronic control tripping function is used at the UPS upstream input, the REPO switch can help this switch trip and thus cut off the UPS input power. The specific position of the REPO port is shown in Figure 1-3, and the REPO cable connection is shown in Figure 6-2.

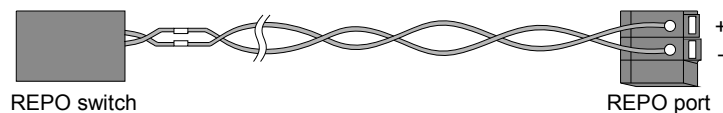

Figure 6-2 REPO cable connection

The procedures for connecting the cables are as follows:

1. Use the slotted screwdriver to press down the yellow buckle in the REPO port.
2. Insert the two ends of the copper-core cable with the peeled insulation leather into the REPO port respectively, and loosen the yellow buckle to finish the connection of the REPO cables. Ensure that the REPO cable is firmly connected to avoid no action or wrong action due to accidental dropping or wrong contact.
3. For the parallel UPSs, when connecting the REPO cable, user should parallel connect the '+' on the REPO port with one end of the electronic switch, parallel connect the '-' of the REPO port with the other end of the electronic switch. Pay attention to the difference between the port silkscreen '+' and '-' during the connection.

When the REPO switch at the user end closes, the UPS will generate an alarm and cut off the output immediately. The UPS will not return to the normal operation state automatically. At this moment, you must clear the REPO switch state and start up the UPS manually.



Note

1. It is recommended to use $0.82\text{mm}^2 \sim 0.33\text{mm}^2$ (signal cable of 18AWG ~ 33AWG) copper-core cable.
2. If a switch with electronic control tripping function is configured to user upstream, when the REPO signal takes action, you need to close the upstream MVB again before restarting the UPS.

Chapter 7 Maintenance And Troubleshooting

This chapter introduces the UPS maintenance, including fan maintenance, battery maintenance, UPS cleaning, UPS state checking, UPS functions checking and troubleshooting.

7.1 Fan Maintenance

The UPS fans can run for 20000 hours ~ 40000 hours continuously. The higher the ambient temperature is, the shorter the life time of the fan will be.

During the UPS operation, periodically check the status of all fans once every half year to confirm that the airflow can blow out from the ventilation holes on the rear panel of the UPS.

7.2 Battery Maintenance



Note

1. Never short the battery, otherwise a fire will occur.
2. Never open the battery so as to prevent the electrolyte from hurting human body. If you touch the electrolyte inadvertently, wash the area immediately with plenty of clean water and go to hospital.

The internal battery of the battery module option uses sealed, maintenance-free, lead-acid battery. The battery life time depends on ambient temperature, charging and discharging time. High-temperature environment or deep discharge will shorten the battery life time.

To ensure the battery life time, the following maintenance should be conducted periodically:

- Maintain the ambient temperature between 15°C and 25°C
- Prevent the battery from small current discharge. The continuous operation time of the UPS battery is prohibited to exceed twenty four hours in any condition
- Charge the battery for at least twelve hours when the UPS is not used for a long time or the battery has not been charged or discharged for three months continuously. In high-temperature environment, charge the battery for at least twelve hours when the battery has not been charged or discharged for two months continuously



Note

1. Periodically check that the screws that fix the battery connection parts is tightened. If any screw is loose, tighten it immediately.
2. Ensure that all safety equipment are complete and that the functions are normal, especially that the settings of battery management parameters are normal.
3. Measure and record the temperature inside the battery room.
4. Check whether the battery ports are damaged or hot, and whether the enclosures or covers are damaged.

If the liquid leakage or damage to the battery occurs, place the battery in the anti-vitriolic tank and conduct rejection treatment according to local regulations.

Waste lead-acid battery is dangerous waste material, and one of the national emphases to control waste battery pollution. Its storage, transportation, utilization, disposal must observe national and local laws, regulations and other criterions about the dangerous waste materials and waste battery pollution prevention and cure.

According to related national regulations, the waste lead-acid battery should be recycled and it is forbidden to use other disposal methods. Throwing away randomly the waste and old lead-acid battery or other improper disposal methods may result in serious environmental pollution, which will be investigated the relevant legal responsibility.

As the lead-acid battery supplier, Emerson has built perfect service network and recycle system for the waste battery to assist the user to deal with the waste and old lead-acid battery by law. Contact Emerson or nearby office to obtain the detailed information of Emerson recycle system about waste and old battery.

Emerson will not be liable for any environment results caused by improper disposal for the waste and old battery products, if the user does not comply with the notice in this chapter or use the waste and old battery recycle system provided by Emerson.

7.3 Cleaning UPS

Clean the UPS periodically, especially the ventilation holes, to ensure that the airflow can circulate freely in the UPS chassis. Clean the UPS with a vacuum cleaner, if necessary. Confirm that no object obstruct the ventilation of the UPS.

7.4 Checking UPS Status

It is recommended to check the UPS operation status once every half year.

The checking content includes:

1. Check whether the UPS is faulty: Is the fault indicator on? Is the UPS giving any fault alarm?
2. Check whether the UPS works in Bypass mode. Normally, the UPS should operate in Normal mode, if it operates in Bypass mode, find out the reason, such as operator intervention, overload, internal faults, and so on.
3. Check whether the battery is discharging. When the mains is normal, the battery should not discharge, if the UPS operates in Battery mode, find out the reason, such as mains failure, battery test, operator intervention, and so on.

7.5 Checking UPS Functions

 Notice
The operation procedures for checking the UPS functions may cause power interruption to load.

It is recommended to check the UPS functions once every half year.

Before conducting the functions check, confirm that the mains is normal and backup the data. The procedures are as follows:

1. Press the OFF key, check whether the buzzer, indicators and LCD are displayed normally.
2. Press the ON/SILENCE key to check again whether the indicators and LCD are displayed normally, and whether the UPS has been transferred to Inverter mode.
3. After the UPS operates in Inverter mode (inverter indicator is on), press and hold the ON/SILENCE key for four seconds to start the battery self-test to check whether the battery is normal. If any battery problem is found, find out the reasons immediately and take measures to solve the problem.

7.6 Troubleshooting

In case of UPS abnormality and fault, first check and remove the fault according to the instruction in Table 7-1. If the problem still exists, seek technical support or service by contacting Emerson service hotline 4008876510 or local dealer.

Table 7-1 Troubleshooting

No.	Fault	Cause Analysis	Disposal Method
1	Mains switch is closed, but the UPS provides not display on the display panel. The system does not conduct self-test	Input power is not connected to the UPS	Check that the UPS input cables are connected properly
		Input voltage is too low	Use a voltmeter to confirm that the UPS input voltage is within specifications
2	The mains is normal, but the mains indicator is off, and the UPS is in Battery mode	UPS mains switch is open	Close UPS mains switch
		Input cables improperly connected	Check that the UPS input cables are connected properly
3	No UPS alarm generates, but the UPS has no output voltage	Output cables improperly connected	Ensure that the output cables are connected properly

No.	Fault	Cause Analysis	Disposal Method
4	After ON/SILENCE key is pressed, the UPS does not start up	Time of pressing the ON/OFF key is too short	Continuously press and hold ON/OFF key for more than one second until the buzzer beeps
		Overload	Remove all loads and restart the UPS
5	The mains indicator blinks	Mains voltage or frequency is out of the UPS input range	Be careful of the battery backup time, if the UPS operates in Battery mode
6	The buzzer beeps every 0.5 second, and the LED displays OUT OVERLOAD	Overload	Remove some non-priority loads when the rectifier or mains normal voltage is overloaded
7	The fault indicator is on, LED displays BATTERY FAULT, and the battery indicator blinks	External battery switch is open	Close the external battery switch
		External battery cable improperly connected	Check and confirm that the external battery cables are connected properly
		Reversely connect the external battery	Confirm the correctness of the polarities of the external battery cables connection
		Battery damaged	Contact local service center of Emerson to replace the battery
8	The fault indicator is on, and the LED displays CHARGER FAULT	Charger failed	Contact local service center of Emerson to replace or maintain the charger
9	Battery discharge time is shorter than the standard time	Battery is not fully charged	When the mains is normal, charge the battery for more than 8 hours, and retest the discharge time
		Battery capacity is depleted	Contact the local service center of Emerson to replace the battery
10	The buzzer beeps for a long time, the fault indicator is on, and the LED displays OVER HEAT/FAN FAULT	UPS internal over heat/fan fault	<ol style="list-style-type: none"> 1. Ensure that the fan is not blocked, and the airflow blows from the ventilation holes on the rear panel of the UPS; 2. Ensure that the clearance between rear panel & side panel of the UPS and the wall or the adjacent equipment is bigger than 200mm; 3. Ensure that the ventilation holes on the front panel, side panel, base plate and rear panel are not obstructed; 4. Wait for 10 minutes to restart the UPS
11	The buzzer beeps for a long time, the fault indicator is on, and the LED displays 'OUT SHORT'	The UPS output short circuit	After the load short circuit fault is removed, the UPS is powered off and restart
12	The buzzer beeps for a long time, the fault indicator is on, and the LED displays RECTIFIER FAULT, INVERTER FAULT, AUPOWER FAULT or OUT SHORT	UPS internal fault	Contact the local service center of Emerson, if the UPS needs to be maintained
13	Abnormal noise or smell in the UPS chassis	UPS internal fault	Turn off the UPS immediately, cut off power output, and contact local service center of Emerson to acquire technical support
14	In Battery mode, yellow indicator is on, the buzzer beeps for a long time, and the UPS is ready to be turned off owing to the low battery capacity	Low battery capacity, the UPS is about to turn off, and the load is about to power off	<ol style="list-style-type: none"> 1. Save the load data immediately and finish the shutdown operation of propriety load to avoid data lost or damaged; 2. Connect the input terminals of the UPS to the back-up AC power
15	The fault indicator is on, and the buzzer beeps for a long time	Parallel address is wrong	<ol style="list-style-type: none"> 1. Open the UPS mains switch; 2. Reset the parallel configuration address

No.	Fault	Cause Analysis	Disposal Method
16	The fault indicator is on, the buzzer beeps for a long time, indicator 1 of the load indicator is normally on, and indicator 2 of the load indicator blinks	Parallel current sharing fault	1. Open the upstream switch of the UPS mains and upstream MCB of the battery; 2. Check that whether the metal enclosure of the power cabinet is reliably connected to the Bat_PE of the UPS, and the wiring of the battery cables should be laid side by side and be the same direction
17	The fault indicator is on, the buzzer beeps for a long time, and the LED displays RECTIFIER FAULT, DC BUS ABNORMAL	Overload	Remove some loads, and restart the UPS after about 5 minutes
		UPS internal fault	Turn off the UPS, cut off the input power and contact the dealer

If you need to report the UPS fault to Emerson or the dealer, please record and inform the UPS model and code (the bar code on the back of the UPS chassis). If the UPS is a long back-up UPS, you should also provide the battery configuration information.

Chapter 8 Options

This chapter introduces the options of the UPS.

8.1 Option List

The option list is given in Table 8-1.

Table 8-1 Option list

Name	Model	Remark	ROHS
Battery module	U16-07C1	Battery module with built-in 16-cell 12V batteries	ROHS
	U20-24C2	You need to select a battery cabinet with two layers (dimension: 460mm × 820mm × 810mm)	ROHS
	U20-38C3	You needs to select a battery cabinet with three layers (dimension: 460mm × 790mm × 1090mm)	ROHS
	U20-65C3	You need to select a battery cabinet with three layers (dimension: 660mm × 1000mm × 1090mm)	ROHS
	U20-100C3	You need to select a battery cabinet with three layers (dimension: 660mm × 1000mm × 1270mm)	ROHS
POD	UF-POD113U11	1-input 1-output rack model 10kVA UPS 1 + 1 parallel POD	ROHS
	UF-POD113U31	3-input 1-output rack model 10kVA UPS 1 + 1 parallel POD	ROHS
	UF-POD316U31	3-input 1-output rack model 10kVA UPS 3 + 1 parallel POD	ROHS
	UF-POD-0100	Rack model 10kVA UPS output power distribution unit	ROHS
Guide rail/bracket	UF-RMKIT2438	Slide guide rail assembly for ITA series UPS	R5
LCD assembly	UF-LCD-ITA-0100	LCD assembly for 10kVA UPS	R5
Complete set of cables	UH62SA1SL3	Parallel signal cable for Liebert® ITA 5kVA/6kVA/10kVA UPS	ROHS
	UHA2SA1SL4	Battery cable for Liebert® ITA 10kVA UPS (optional only for long back-up UPS, standard configuration for standard UPS)	ROHS
Communication options	UF-SNMP810	SIC card assembly for Intellislot UPS	ROHS
	UF-DRY320	Extended dry contact card assembly for UPS	R5
	UF-DRY310	Dry contact card and its options for UPS	R5
	UF-MODBUS210	MODBUS assembly for Liebert NX and ITA UPS	R5
	UF-RS485	RS232 to RS485 communication assembly for ITA UPS	R5
	UF-RS232	RS232 communication card options for Liebert® ITA UPS	R5
Monitoring options	UPS02R100	SiteMonitor network license monitoring software (Number of users ≤ 5)	ROHS
	UPS03R100	SiteMonitor network license monitoring software (Number of users ≤ 20)	ROHS
	UPS04R100	SiteMonitor network liscence monitoring software (limitless)	ROHS
Charger module	UF-BCH192/10	10A charger (optional only for long back-up UPS)	R5
Battery shared assembly	UF-BSO-0100	Battery shared module (optional only for 10kVA long back-up UPS)	R5

8.2 Battery Module

8.2.1 List Of Battery Module Options

The list of battery module options is given in Table 8-2.

Table 8-2 Battery options

Model	Name	Description
U16-07C1	Battery module (2U)	Built-in 16-cell 12V/7.2A batteries, used to prolong the system running time. Note: It is recommended to extend four battery modules, at least two every time. The accessory of the battery module includes a cable, used to connect the extended battery module



Note

1. The battery circuit and AC input are not insulated, therefore hazardous voltage may exist between the battery ports and the earth. Never touch them by hand to avoid an electric shock.
2. Refer to 2.5.2 *Connecting Battery Cables* for the method of connecting the battery module. If user needs longer cable, please consult the dealer.

8.2.2 Appearance Of Battery Module

You can adjust the direction of the plastic panel on the battery module by yourself according to your actual need. The appearance of the battery module is shown in Figure 8-1.



Figure 8-1 Appearance of the battery module

There is no display panel on the front panel of the battery module, and the plastic panel can be removed, as shown in Figure 8-2.



Figure 8-2 Removing the plastic panel

There are battery ports, battery fuse box and ventilation holes on the rear panel of the battery module, as shown in Figure 8-3.

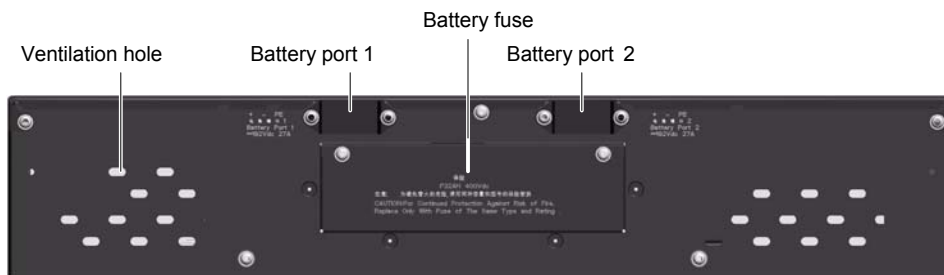

Figure 8-3 Rear panel of the battery module

8.2.3 Backup Timetable Of Standard Battery Module For Single UPS

When the UPS works in Battery mode, at full load, the backup time of two battery modules (15Ah/192V) in standard configuration is about five minutes. Adding the number of the battery modules can prolong the backup time. See Table 8-3 for the backup timetable of different battery modules upon full load.

Table 8-3 Backup timetable of standard battery module for single UPS

Number of the battery module	Capacity	9000W	7000W	5000W	3000W	2000W	1400W
2	15Ah	5.5m	8m	14m	30m	55m	1h20m
3	22Ah	12m	17m	26m	52m	1h30m	2h25m
4	30Ah	18m	23m	40m	1h15m	1h50m	3h10m
5	36Ah	21m	26m	45m	1h25m	2h14m	3h33m
6	43Ah	24m	33m	52m	1h43m	2h48m	3h49m
7	50Ah	26m	35m	55m	1h50m	2h50m	4h
8	56Ah	35m	50m	1h10m	1h59m	2h55m	4h15m
9	65Ah	42m	55m	1h20m	2h15m	3h25m	4h55m
10	72Ah	50m	1h7m	1h30m	2h35m	3h55m	5h40m



Note

The data in Table 8-3 is only for your reference, because the battery backup time is affected by the battery parameters, factories and models, aging degree and other factors.

8.3 POD

The POD is an option for the UPS. It can provide safe and reliable power distribution function for users. The POD options list is given in Table 8-4.

Table 8-4 POD options list

Model	Name	Dimension (Width × Height × Depth, mm)
UF-POD113U11	1-input 1-output 1 + 1 parallel POD	435 × 130 × 640
UF-POD113U31	3-input 1-output 1 + 1 parallel POD	435 × 130 × 640
UF-POD316U31	3-input 1-output 3 + 1 parallel POD	435 × 260 × 640
UF-POD-0100	Output power distribution unit	435 × 85 × 100

8.3.1 1-Input 1-Output 1 + 1 Parallel POD

The appearance of the 1-input 1-output 1 + 1 parallel POD is shown in Figure 8-4.



Figure 8-4 Appearance of the 1-input 1-output 1 + 1 parallel POD

Remove the plastic panel to reveal the operation panel of the 1-input 1-output parallel POD, as shown in Figure 8-5.

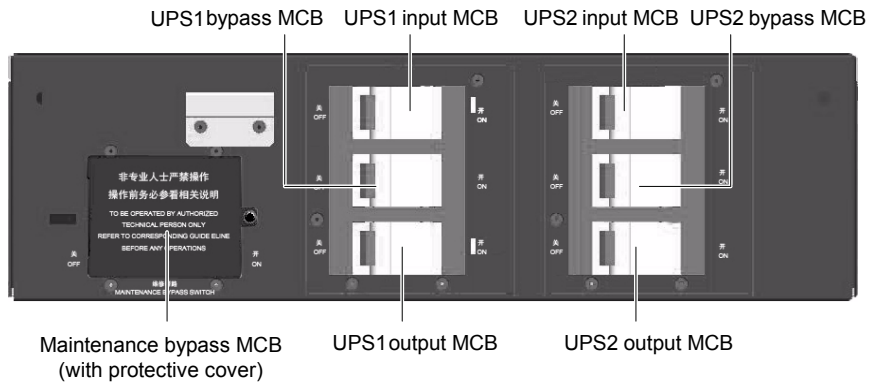

Figure 8-5 Operation panel of the 1-input 1-output 1 + 1 parallel POD

The rear panel of 1-input 1-output parallel POD is shown in Figure 8-6.

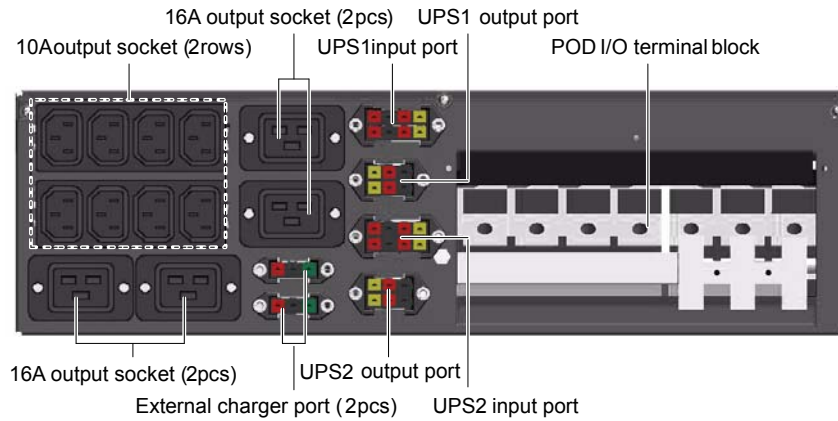

Figure 8-6 Rear panel of the 1-input 1-output 1 + 1 parallel POD

8.3.2 3-Input 1-Output 1 + 1 Parallel POD

The appearance of the 3-input 1-output 1 + 1 parallel POD is shown in Figure 8-7.

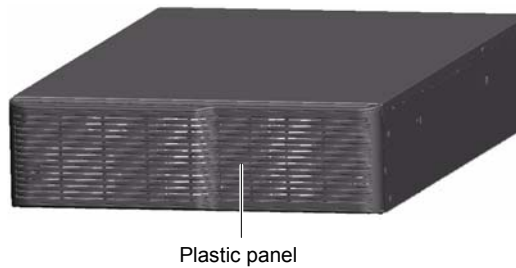

Figure 8-7 3-input 1-output 1 + 1 parallel POD

Remove the plastic panel to reveal the operation panel of 3-input 1-output 1 + 1 parallel POD, as shown in Figure 8-8.

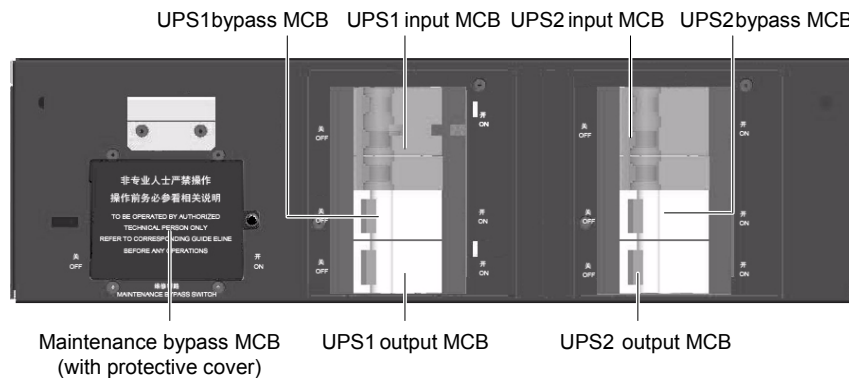

Figure 8-8 Operation panel of the 3-input 1-output 1 + 1 parallel POD

The real panel of the 3-input 1-output 1 + 1 parallel POD is shown in Figure 8-9.

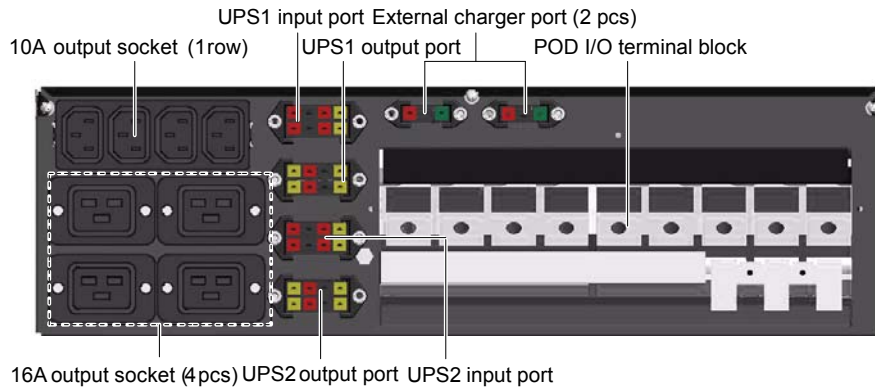

Figure 8-9 Rear panel of the 3-input 1-output 1 + 1 parallel POD

8.3.3 3-Input 1-Output 3 + 1 Parallel POD

The appearance of the 3-input 1-output 3 + 1 parallel POD is shown in Figure 8-10.

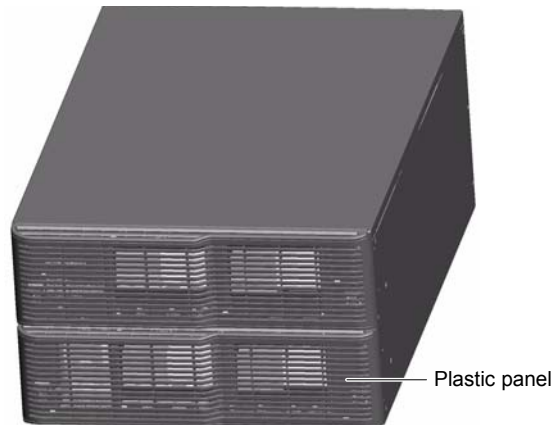

Figure 8-10 Appearance of the 3-input 1-output 3 + 1 parallel POD

Remove the plastic panel to reveal the operation panel of the 3-input 1-output 3 + 1 parallel POD, as shown in Figure 8-11.

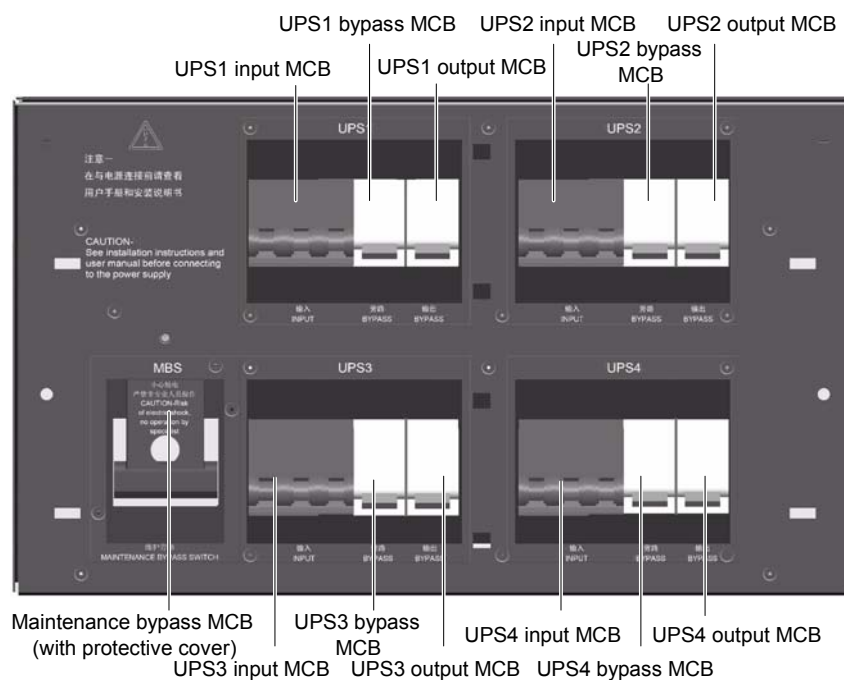

Figure 8-11 Operation panel of the 3-input 1-output 3 + 1 parallel POD

The rear panel of the 3-input 1-output 3+1 parallel POD is shown in Figure 8-12.

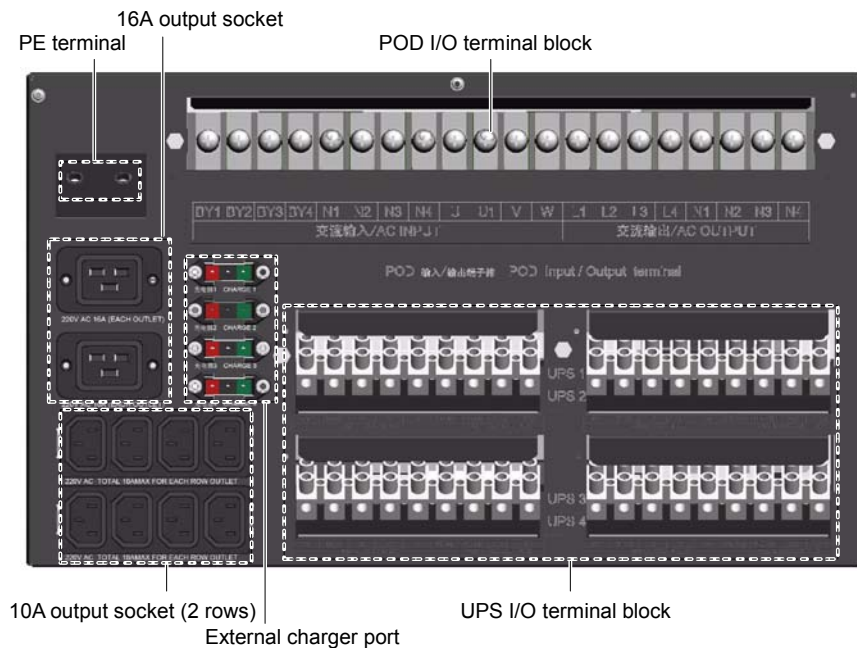

Figure 8-12 Rear panel of the 3-input 1-output 3 + 1 parallel POD

8.3.4 Output Power Distribution Unit

The appearance of the output power distribution unit is shown in Figure 8-13.



Figure 8-13 Appearance of the output power distribution unit

The operation panel of the output POD is shown in Figure 8-14.

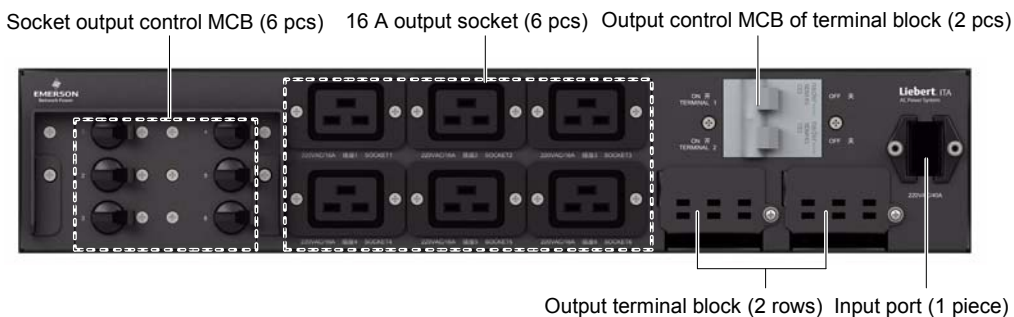



Figure 8-14 Operation panel of the output power distribution unit

8.4 Complete Set Of Cables

8.4.1 Parallel Signal Cables

The parallel signal cable is compulsory in the parallel system, and its description is given in Table 8-5. Refer to 3.4.2 *Connecting Parallel Signal Cables* for the connection of the parallel signal cables.

Table 8-5 Parallel signal cable description

Model	Name	Description	Appearance
UH62SA1SL3	Parallel signal cable	For N + 1 parallel system, N + 1 pieces of parallel signal cables are required to be configured. For example, 2 pcs of parallel signal cables for 1 + 1 parallel system, 3 pcs of parallel signal cables for 2 + 1 parallel system, 4 pcs of parallel signal cables for 3 + 1 parallel system	

8.4.2 Battery Cables

The battery cable is an option when the long back-up UPS is selected. When you select standard UPS, the battery cable is the accessory in standard configuration, see Table 8-6 for its description. Refer to 2.5.2 *Connecting Battery Cables* for the detailed operation.

Table 8-6 Battery cable description

Model	Name	Description	Appearance
UHA2SA1SL4	Battery cable	When standard UPS is selected, the battery cable is configured in the UPS accessories, and there is no need to select it again; When the long back-up UPS is selected, and the UPS is required to configure with a standard battery module U16-07C1, the battery cable needs to be selected	

8.5 Guide Rail For Rack Installation

The guide rail for rack installation is used in the rack installation of UPS, POD (optional) and battery module (optional). See Table 8-7 for its description. Refer to 2.4.2 *Rack Installation* for the rack installation procedures.

Table 8-7 Guide rail for rack installation

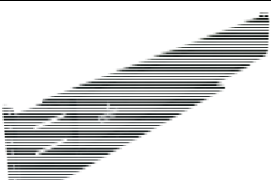



Model	Name	Description	Appearance
UF-RMKIT2438	Guide rail for rack installation	A set of guide rail includes a left guide rail and a right guide rail, and its bearing is 50kg. The guide rail is used for the selected rack installation. It is applicable to various server cabinets, UPSs, modularized batteries and PODs with standard dimension	

8.6 Communication Options And Monitoring Options

The communication options and the monitoring options are listed in Table 8-8.

Table 8-8 Communication options and monitoring options

Name	Model	Description	Appearance
SIC card (can be connected to the net port type of temperature/humidity sensor)	UF-SNMP810	Conduct web remote monitoring for the UPS through TCP/IP protocol and Internet; Support remote safety shutdown function; Provide an extended net port, cascade at most 8 temperature/humidity sensors	

Name	Model	Description	Appearance
RS485 card	UF-RS485	Be used to connect the UPS to RDU-A controller, or connect to the cascade-communication in parallel system	
MODBUS card	UF-MODBUS210	Be selected when the UPS is connected to the controller system of the building	
Dry contact card	UF-DRY310	Provide 4 routes of relay signal outputs and 3 routes of digital signal inputs	
Extended dry contact card	UF-DRY320	Provide 4 routes of relay signal outputs, 3 routes of digital signal inputs; Provide also RS232 and RS485 communication functions, and 4 routes of analog signal acquisition function	
RS232 card	UF-RS232	Only support RS232 protocol communication, and the maximum cable length of the communication cable should not exceed 15m	
Remote monitoring software	SiteMonitor	SiteMonitor PC license monitoring software (used for single and parallel UPS, monitors on site, a CD delivered with the UPS, and a network shutdown program for the server is provided in it)	
		SiteMonitor network license monitoring software (number of user ≤ 5)	
		SiteMonitor network license monitoring software (number of user ≤ 20)	
		SiteMonitor network license monitoring software (limitless)	

8.7 10A Charger

The 10A charger is an option for the long back-up UPS, and its description is given in Table 8-9.

Table 8-9 Description of 10A charger module

Model	Name	Description	Dimension (width × height × depth, mm)	Weight
UF-BCH192/10	10A charger	Charge for battery with large capacity, and used together with Liebert® ITA 5kVA, 6kVA, 10kVA UPS to shorten the charging time	435 × 85 × 380	12kg

The appearance of the 10A charger is shown in Figure 8-15.

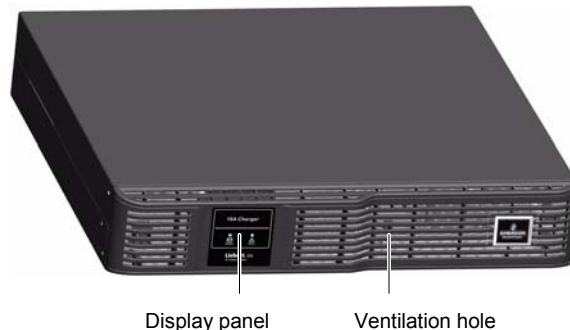

Figure 8-15 Appearance of 10A charger

The rear panel of the 10A charger is shown in Figure 8-16.

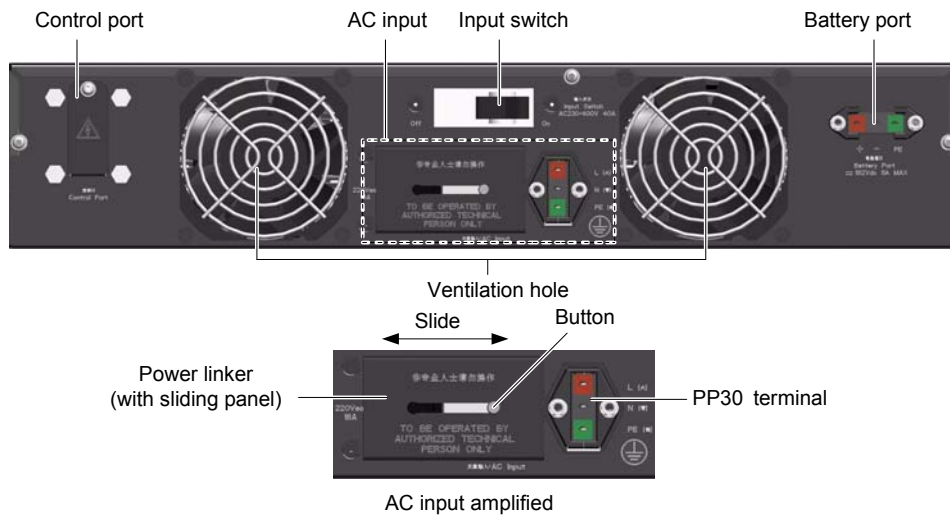

Figure 8-16 Rear panel of 10A charger



Note

Unauthorized personnel are prohibited from opening the cover of the 10A charger.

8.8 Assembly Of LCD Display Panel

UF-LCD-ITA-0100 is an option for LCD display panel of the ITA 10kVA UPS, and its commissioning has been completed before delivery. You need to install the assembly of the LCD display panel corresponding to the UPS. Refer to 4.2 *LCD Display Panel* for the menu structure, function description and interface of the LCD display panel assembly. The appearance of the LCD display panel assembly is shown in Figure 8-17.



Figure 8-17 Appearance of LCD display panel assembly

The LCD display panel has been installed before delivery. If you need a LCD display panel (optional), remove the LED display panel first, and then install the LCD display panel.



Note

Before replacing the display panel, you must ensure that the UPS has been powered off, the bypass MCB, input MCB and external output MCB are open.

The replacement procedures are as follows:

1. Make sure that the UPS is powered off, bypass MCB and I/O MCBs are open, and the battery cables has been disconnected.
2. Press the two ends of the UPS plastic panel by hand, gently pull the plastic panel outwards to remove it, as shown in Figure 8-18 (a).

3. Remove four M3 × 10 screws, which are used to fix the LED display panel on the UPS chassis, take out the LED display panel and relevant cables from the UPS chassis, as shown in Figure 8-18 (b). Disconnect the three cables that are connected to the LED display panel to remove the LED display panel.
4. Connect the three cables of the LCD display panel, use four M3 × 10 screws to fix the LCD panel, as shown in Figure 8-18 (c).
5. Install the plastic panel, as shown in Figure 8-18 (d).

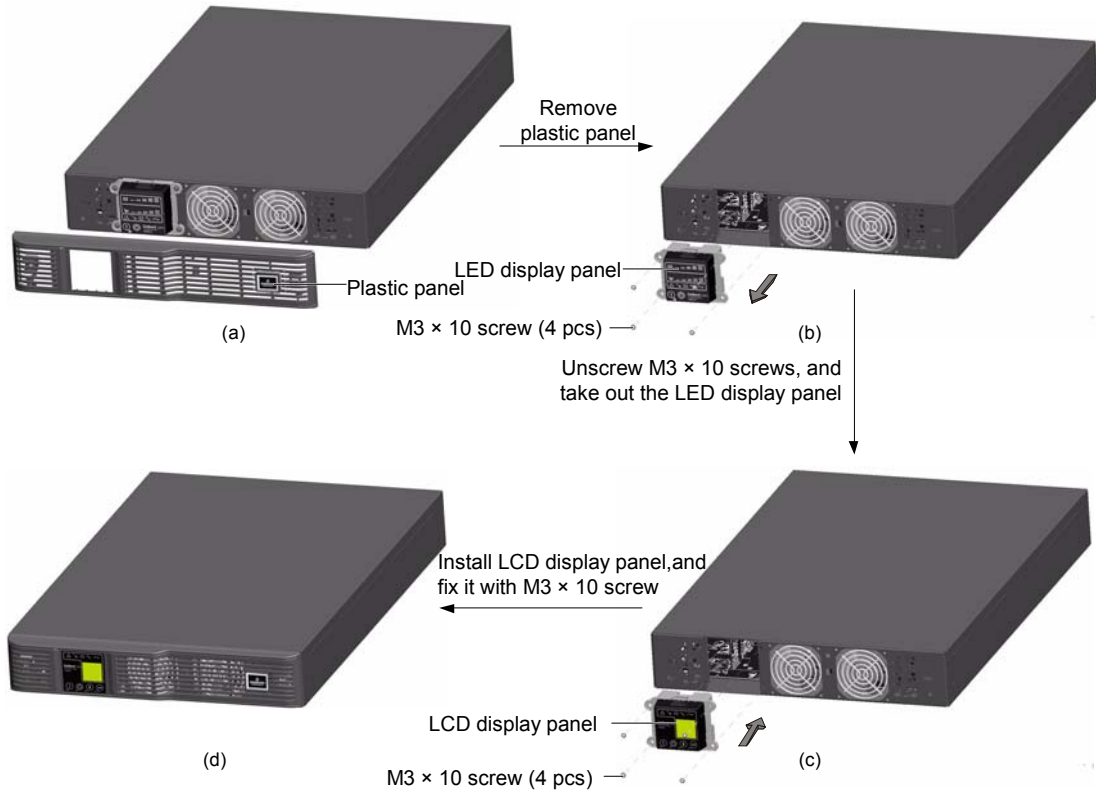



Figure 8-18 Installation of LCD display panel

 Note
<ol style="list-style-type: none"> 1. When the display panel assembly is replaced, the UPS chassis cover does not need to be opened. 2. The Rotation method of the LCD display panel is completely the same as that of the LED display panel, please see 2.4.1 Tower Installation for reference.

8.9 Battery Shared Module Of UF-BSO-0100 ITA UPS

The UF-BSO-0100 ITA UPS battery shared module (battery shared module for short) is only applicable to the parallel system of the 10kVA long back-up UPS. Through this battery shared module, a battery string with large capacity can provide power for multiple 10kVA UPSs at the same time.

The appearance of the battery shared module is shown in Figure 8-19. See Table 8-10 for its description.

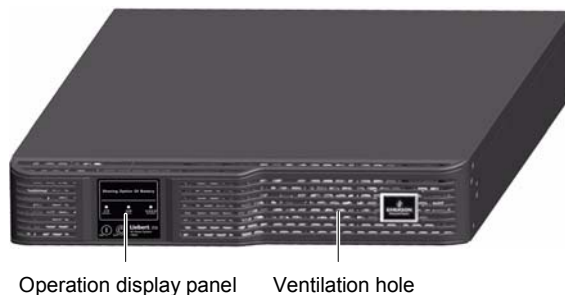

Figure 8-19 Appearance of the battery shared module

Table 8-10 Description of the battery shared module

Model	Name	Description	Dimension (length × width × height)	Weight
UF-BSO-0100	Battery shared module	The battery shared module is used when the battery with large capacity needs to provide power for multiple 10kVA UPSs	377mm × 435mm × 85mm	9kg

The rear panel of the battery shared module is shown in Figure 8-20.

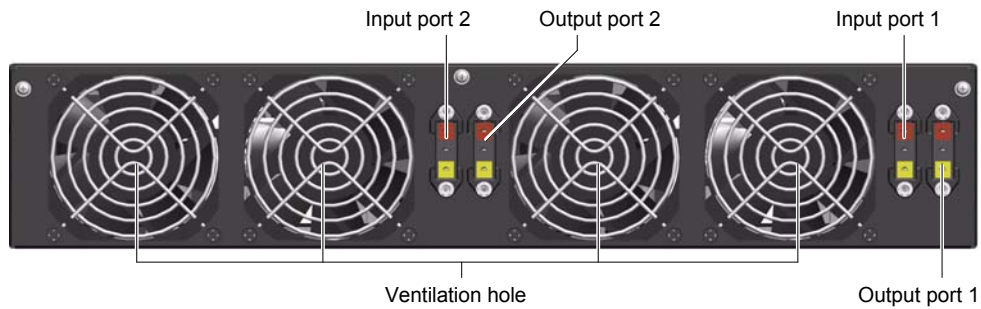

Figure 8-20 Rear panel of the battery shared module

For details of the battery shared module, refer to *UF-BSO-0100 ITA UPS Battery Shared Module User Manual*.

Appendix 1 Operation Guide For UPS Parallel Power Distribution

Power Distribution

Taking 1 + 1 parallel for example, the schematic diagram of the power distribution is shown in Figure 1.

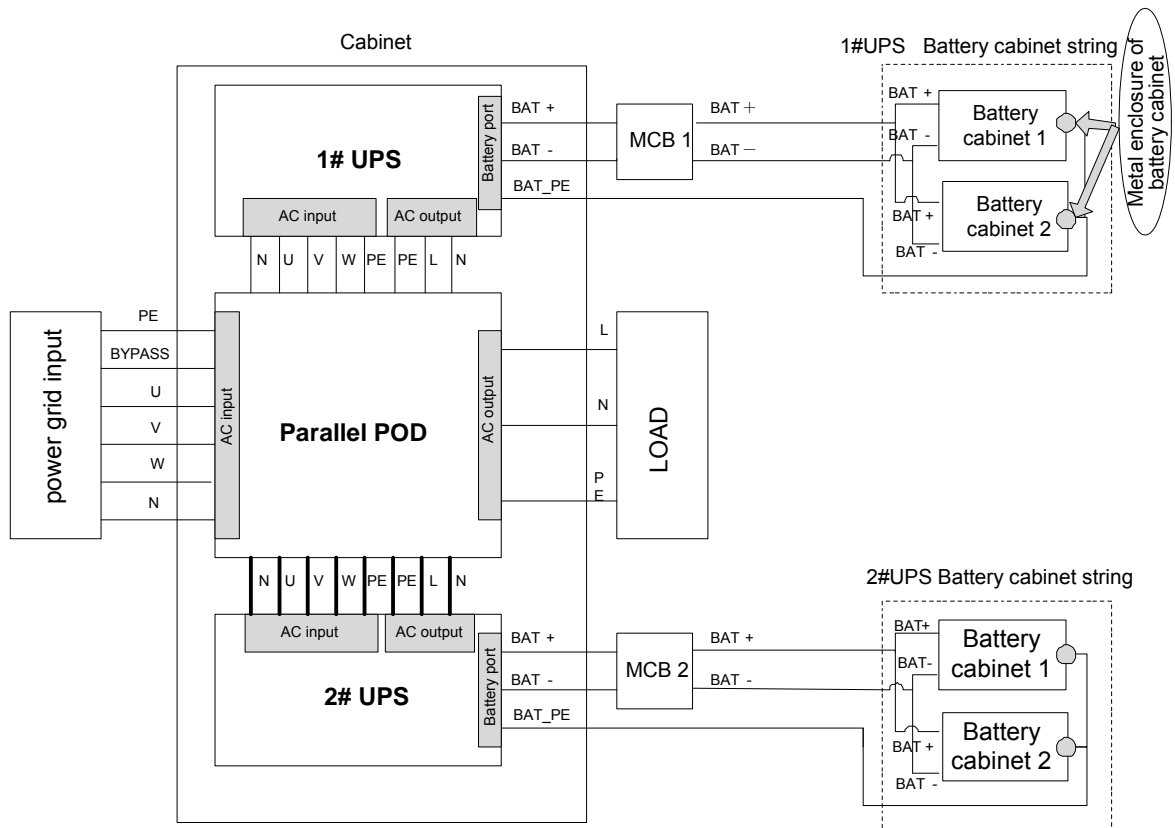

Note: To ensure that only one point of the whole system is earthed, the mains PE has been connected with the BAT_PE through the cables in the UPS; The cable BAT_PE must be reliably connected to the metal enclosure of the battery cabinet, and the wiring of the BAT + and the BAT - should be laid side by side and be the same direction.

Figure 1 Schematic diagram of power distribution

Appendix 2 Glossary

AC: Alternating current

DC: Direct current

DSP: Digital signal processor

EOD: End of discharge

EPO: Emergency power off

LCD: Liquid crystal display

LED: Light-emitting diode

LV: Low voltage

MCB: Miniature circuit breaker

I/O: Input/output

PE: Protective earth

POD: Power distribution unit

RCCB: Residual current circuit breaker

RCD: Residual current detector

REPO: Remote emergency power off

SPM: Server power management system

STS: Static transfer system

UPS: Uninterruptible power system

Emerson Network Power, a business of Emerson

(NYSE:EMR), a global company that leads by applying a unique combination of industry expertise, technology, and resources to make the future of our customers' enterprises and networks possible.

Emerson Network Power provides innovative solutions and expertise in areas including AC and DC power and precision cooling systems, embedded computing and power, integrated racks and enclosures, power switching and controls, infrastructure management and connectivity. All solutions are supported globally by local Emerson Network Power service technicians.

While every precaution has been taken to ensure the accuracy and completeness of this literature, Emerson Network Power assumes no responsibility and disclaims all liability for damages resulting from use of this information or for any errors or omissions.

All rights reserved throughout the world.

Specifications subject to change without notice.

All names referred to are trademarks or registered trademarks of their respective owners