

M2 Vessel Systems Monitor (M2-VSM)

PN 1850

Installation Checklist

- Check for components included
- Read Warning and Cautions
- Read QuickStart Installation Guide for mounting instructions
- Read System Overview, Mounting Considerations, Detailed Wiring, and Sensing Description
- Read QuickStart Installation Guide for installation notes
- Follow Initial System Setup instructions
- Configure Displays
- Configure Alarms

Specifications

Display Size 55mm x 28mm

Power Supply 7V–70V DC
 Power Consumption 0.3W–1.0W*
 NMEA 2000 Load Equivalency 1

DC Voltage

Voltages 12V, 24V, 36V, 48V
 Range 7V–70V DC
 Resolution 0.01V DC
 Voltage Accuracy +/- 1%

DC Current

Shunt Included 1 x PN 8255 (500A / 50mV)
 Range -500A to 500A
 Current Accuracy +/- 1%
 Resolution (100 to 500) 1A
 Resolution (0.0 to 99.9) 0.1A
 Alarm Activation High and Low Voltage, High Current, and Low Battery

AC Voltage

Range 50V–250V AC (RMS)
 Resolution 1V AC

AC Current

Range 0A to 150A (300A optional)**
 Resolution (100 to 150) 1A
 Resolution (0.0 to 99.9) 0.1A
 Current Transformer 1 x PN 8256 (150A / 50mA)
 Alarm Activation High and Low Voltage, Current, and Frequency

Frequency

Range 40Hz–90Hz
 Resolution 1Hz

Power

Range 0W–45kW
 Resolution (0W–9990W) 10W
 Resolution (10kW–45kW) 0.1kW

Tanks†

Alarm High/Low Levels
 Senders North American 240Ω-33Ω
 European 10Ω-180Ω
 Blue Sea Systems Ultrasonic
 Custom

Sender Resolution 1%
 Custom Tank Shapes Auto Calibration
 Alarm Notification Run time per hour
 Cycles per 24-hour
 Cycle Counter

Regulatory

Monitor face is IP66 – protected against powerful water jets when installed according to instructions

* Variable with voltage, display intensity, and sleep mode

** Will achieve 300A with an optional current transformer PN 1829

† Compatible with bilge monitors with external float switches or with automatic bilge switches that indicate on status via a 12V output.

Components Included

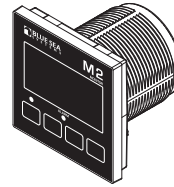

M2 Head Unit

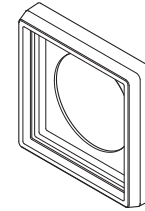

Surface Mount Bezel and Seal

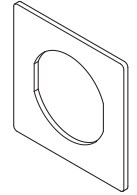

Surface Mount Gasket



Surface Mount Cover

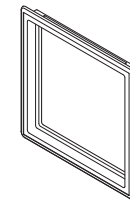

Flat Mount Bezel

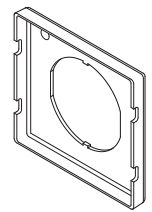

Flat Mount Clamp



Mounting Ring



Mounting Nut

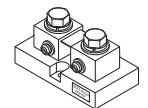

PN 8255 Shunt (1X)

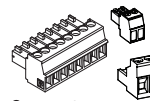

Connectors



Screwdriver
Retail Package Only



AC Current Transformer
8256

360 Panel Mounting Kit PN 1525 (sold separately)

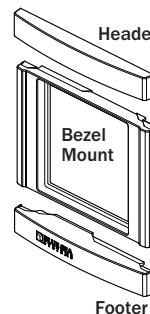

Header



Bezel Mount

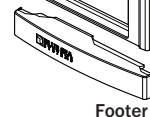

Footer

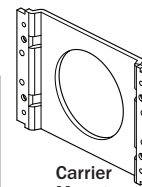

Carrier Mount

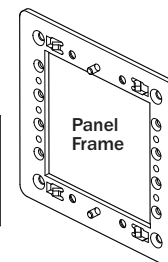

Panel Frame

 #6-32 x 1/4" Flat Head Machine Screws (4X)

 #6-32 x 3/8" Flat Head Machine Screws (4X)

Resource Information

State-of-Charge (SOC) <http://blueseas.com/viewresource/1324>

AC Current Measurement <http://blueseas.com/viewresource/86>

Warning and Caution Symbols

WARNING: The  symbol refers to possible injury to the user or significant damage to the meter if the user does not follow the procedures.

CAUTION: The  symbol refers to restrictions and rules with regard to preventing damage to the meter.

WARNING

- Verify that all AC sources are disconnected before connecting or disconnecting the current transformer. Failure to do so will generate lethal voltages on the current transformer.
- If you are not knowledgeable about electrical systems, have an electrical professional install this unit. The diagrams in these instructions pertain to the installation of M2 Digital Meters and not to the overall wiring of the vessel.
- If an inverter is installed on the vessel, its power leads must be disconnected at the battery before the meter is installed.
- If an AC generator is installed on the vessel, it must be stopped and rendered inoperable before the meter is installed.
- Verify that no other DC or AC sources are connected to the vessel's wiring before installing the meter.

CAUTION

- The back of the unit is not waterproof. Do not install where the back of the meter is exposed to water.

Installation

1. The M2 VSM must be connected to a non-switched circuit to ensure accurate and consistent State-of-Charge monitoring.
2. Make all connections to the meter's terminal block before connecting the terminal block to the unit.
Keep hands away from the terminal block when applying power to the meter.
3. As the final DC connection, insert a fuse into the in-line fuse holder on the wire to the positive (+) battery terminal.

Mounting Templates

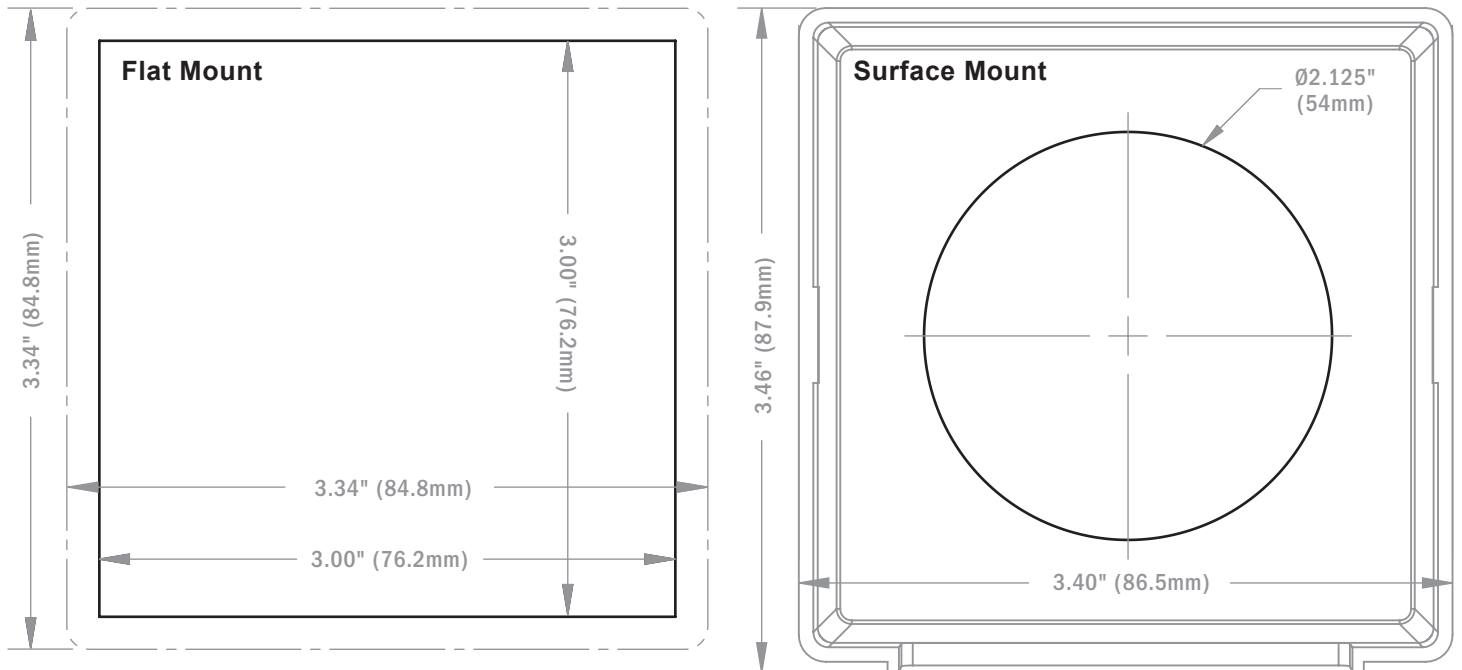

Mounting Considerations

M2 Digital Meters have three mounting methods: Surface mount, Flat panel mount, and 360 panel mount. When surface mounted per instructions the unit face is waterproof to IP66. Flat panel and 360 mounting systems are not waterproof. The unit should not be flat panel or 360 mounted if used in an exposed location. For all mountings, the back of the unit is not waterproof and must be kept dry.

Flat Mount

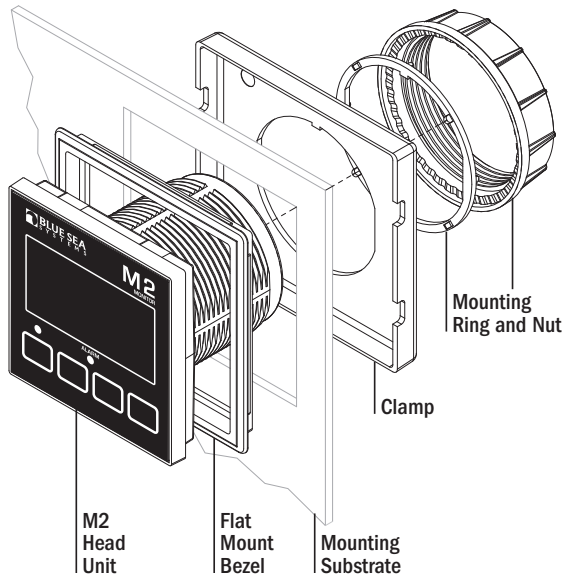

360 Panel Mount PN 1525

STEP 1
Use 1/4" Mounting Screws

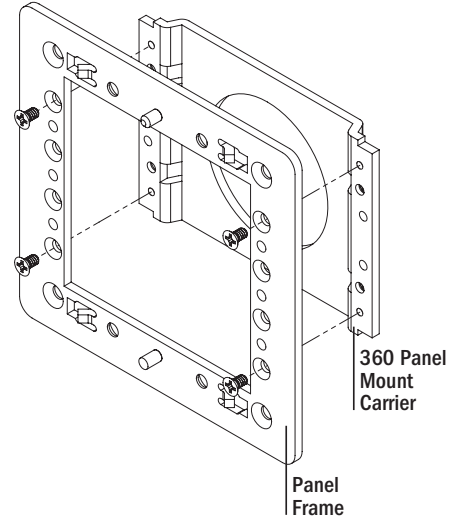

STEP 2
Snap header and footer into mounting clips and post. Snap the mounting bezel into place with the flat edge up.

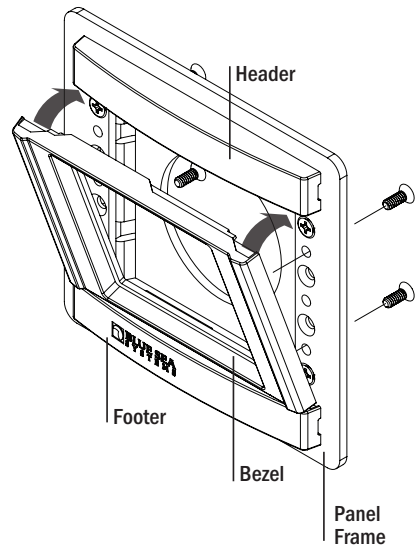

STEP 3

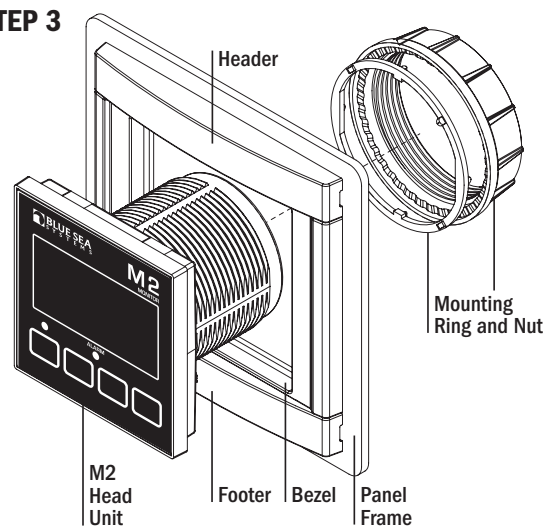

Surface Mount

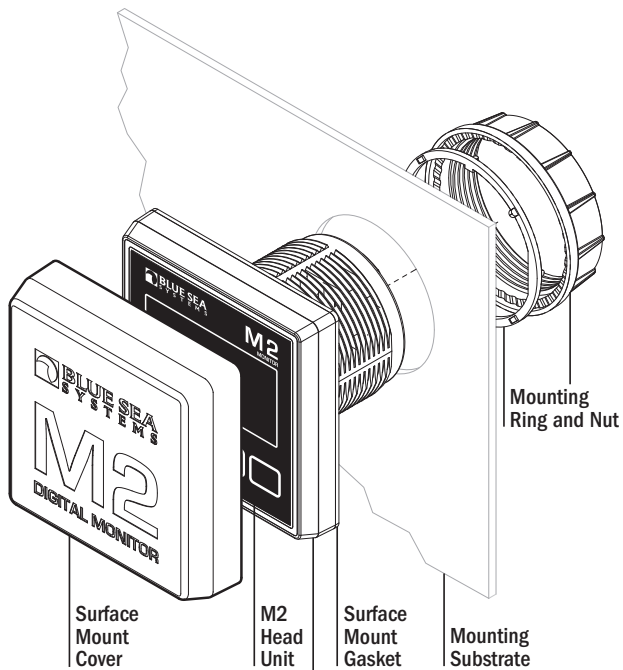

NOTE: During installation use cover to align the bezel and gasket

Surface Mount Bezel and Seal

Functions

DC Functions

- Monitor the voltages of up to two battery banks and current draw on one battery bank.
- Provides battery State-of-Charge (SoC), capacity, amp hours (Ah) remaining, and charge cycles.

AC Functions

- Monitors the voltages, current draws, frequency, and power of one AC source.

Tank/Bilge Functions

- Monitor up to two tanks or bilges
- Provides High/Low level alarms for each tank
- Keeps track of total bilge run time in the last hour
- Keeps track of the total number of bilge cycles in the last 24 hours.
- Keeps track of the average number of 24-hr bilge cycles in the last week
- Keeps track of the total number of bilge cycles

Connections

IMPORTANT! The Sensing Description section of this manual gives important details to the location of sensors in the AC and DC electrical systems of the boat. Improper location and configuration of sensors can result in erroneous readings and possible damage to components.

Pin-out Table

Connector Pin Assignment Table

A. 2 Pin Connector* 3.5mm	Function
1	Battery 1-
2	Battery 1+
B. 2 Pin Connector** 5mm	Function
1	AC Voltage - Neutral
2	AC Voltage - Hot
C. 8 Pin Connector* 3.5mm	Function
1	DC Negative <i>required connection</i>
2	DC Supply/Battery 2+ <i>required connection</i>
3	Tank/Bilge 1
4	Tank/Bilge 2
5	DC Shunt 1-
6	DC Shunt 1+
7	AC Current Transformer - ***
8	AC Current Transformer + ***
USB	USB Slave
M5	NMEA 2000

* Supports wire sizes from 16-26 AWG

** Supports wire sizes from 12-24 AWG

*** Caution - Incorrect connections may damage the monitor

Detailed Wiring

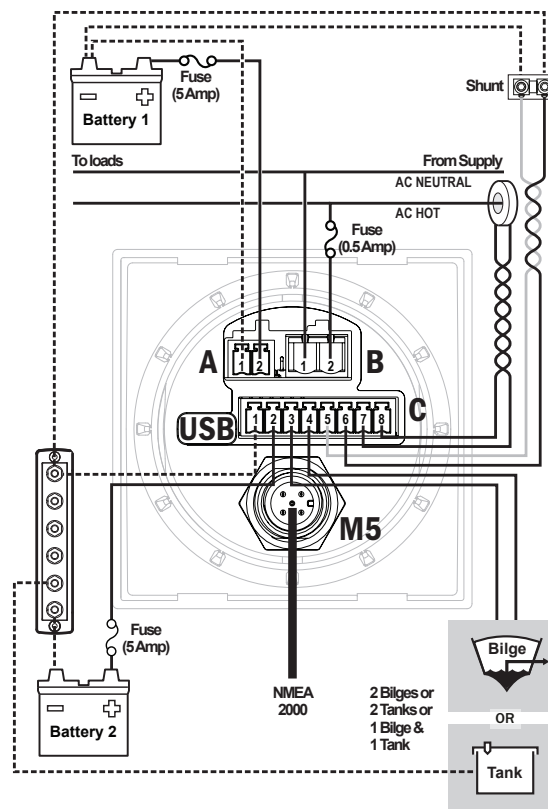

Meter Power Supply Connections

All meters must have pins 1 (DC Neg.) and 2 (DC Pos.) connected. These pins are used to provide power to the meter. Connect pin 1 to ground and pin 2 to a 12V to 48V power source. Pin 2 is also used to monitor the voltages on bank 2. The current draw from the meter is less than 50 mA (typically around 20 mA if the back-light is off). It would take more than 2 months to drain a 100 Ah battery to 50%. If a battery is going to be left unattended for more than two months, it is recommended to disconnect the battery from the meter.

DC Connections

DC Current

The M2 VSM Meters require the use of a shunt. Shunts must be connected between the negative terminal on Battery 1 and the main negative bus. All loads and charge sources should have their negative terminals on the main negative bus, with the exception of the M2 negative source which must be connected directly to the battery side of the shunt. Shunt sense wires must be a twisted pair from the shunt to the M2 Meter for proper calculation of State-of-Charge (SoC). Twisted pair wire can be purchased from electrical supply companies or made by twisting by hand or with an electric drill motor. The current (Amperage) reading for Battery 1 should be negative when it is not being charged and DC power is being used (loads are active). If not, reverse the twisted pair DC shunt sense leads.

It is possible to connect the DC shunt on the positive side of the circuit with a Shunt Shifter (8242), (for example on the output side of an alternator) however the measurements will only be accurate to +/- 4%, as opposed to +/-1% on the negative side.

DC Voltage

DC positive (+) voltage supply wires for M2 Meters should be directly connected to the positive battery terminal with a dedicated wire before any other connections. This will ensure correct voltage and SoC monitoring. Use an appropriate in-line fuse (5A suggested) on the positive wire. A twisted pair should be used for V1.

AC Connections

AC Current

In most cases, the AC Current Transformer should be located on the main AC line wire before any other devices. See <http://blueseas.com/viewresource/86> for more information on AC Current Transformer location.

The Current Transformer does not indicate polarity. The leads should be twisted to reduce the effects of interference from other electrical circuits.

AC Voltage

The AC supply HOT (Line, or "Ungrounded Conductor") connection should be protected with a fast-acting fuse of 0.25A to 0.5A to protect against shorts.

Bilge Sensor

Connect "switch on" lead of bilge pump to the M2 VSM unit. This wire should read +12/24V when running and 0V when off.

Tank Sender

The M2 VSM is compatible with three sender protocols.

Resistive 2 Wire Senders:

- 10 – 180 Ω VDO—Typical of Europe
- 240 – 33 Ω Teleflex—North America

Ultrasonic 3 Wire Senders:

- Blue Sea Systems PN 1810 and PN 1811.

Blue Sea Systems ultrasonic sender PN 1810 is used for water, waste, and diesel fuel tanks up to 32" (812mm) in depth. Blue Sea Systems ultrasonic sender PN 1811 is used for gasoline tanks up to 24" (609mm) in depth. When connecting the tank sender to ground it is important to connect them as directly as possible to the main negative bus to prevent high loads such as battery chargers from affecting the tank readings. The M2 VSM will not produce accurate readings if a second gauge is connected to the same tank sender. Install a sender for each gauge if you wish to read a tank level from more than one location. The Blue Sea Systems ultrasonic sender requires an external power source. When power to the sender is lost, the M2 VSM will read the tank as full, and may trigger the tank's high level alarm. For each tank the sender must be specified, and the shape of the tank set as rectangular or auto-calibrated before accurate readings are displayed.

Blue Sea Systems Ultrasonic Sender 1810, 1811

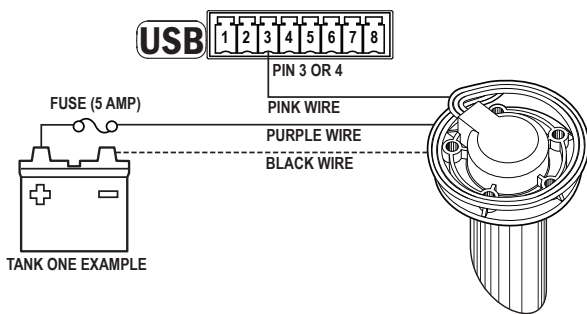

Resistive 2 Wire Sender

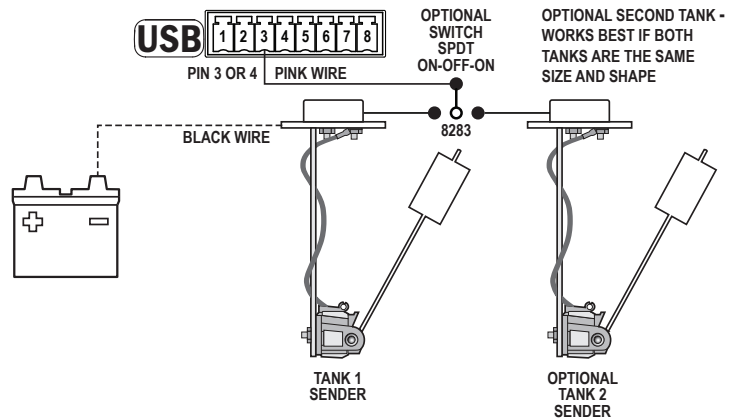

Getting Started

Example Screens

When an M2 Meter is initially powered up, it will display the Blue Sea Systems Logo and the serial number of the meter. After a couple of seconds, the unit will display a high-level System Summary screen.

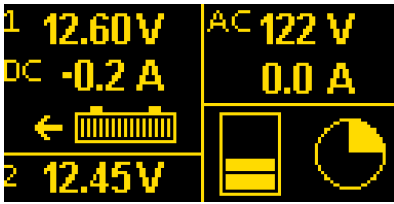

With AC

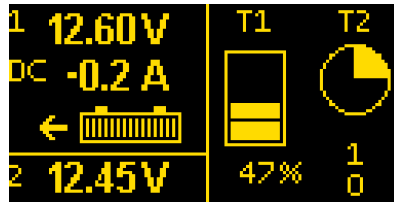

Without AC

Pressing any button will display a temporary pop-up menu. Select an option by pressing the button beneath it. The pop-up menu will disappear after the first button is pressed.

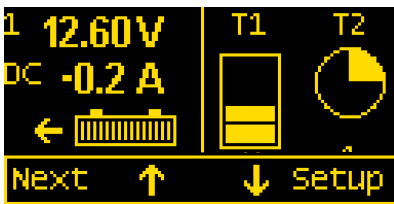

The menu system is a two dimensional matrix. Pressing the **UP** ↑ or **DOWN** ↓ arrow buttons will transition the display between the System Summary, screen which displays summary information for each of the “voltage”, “current”, or “sensor” channels.

Press the **Next** button to display more detailed information about an input channel, or to show a single parameter such as “voltage” in the display (see example below).

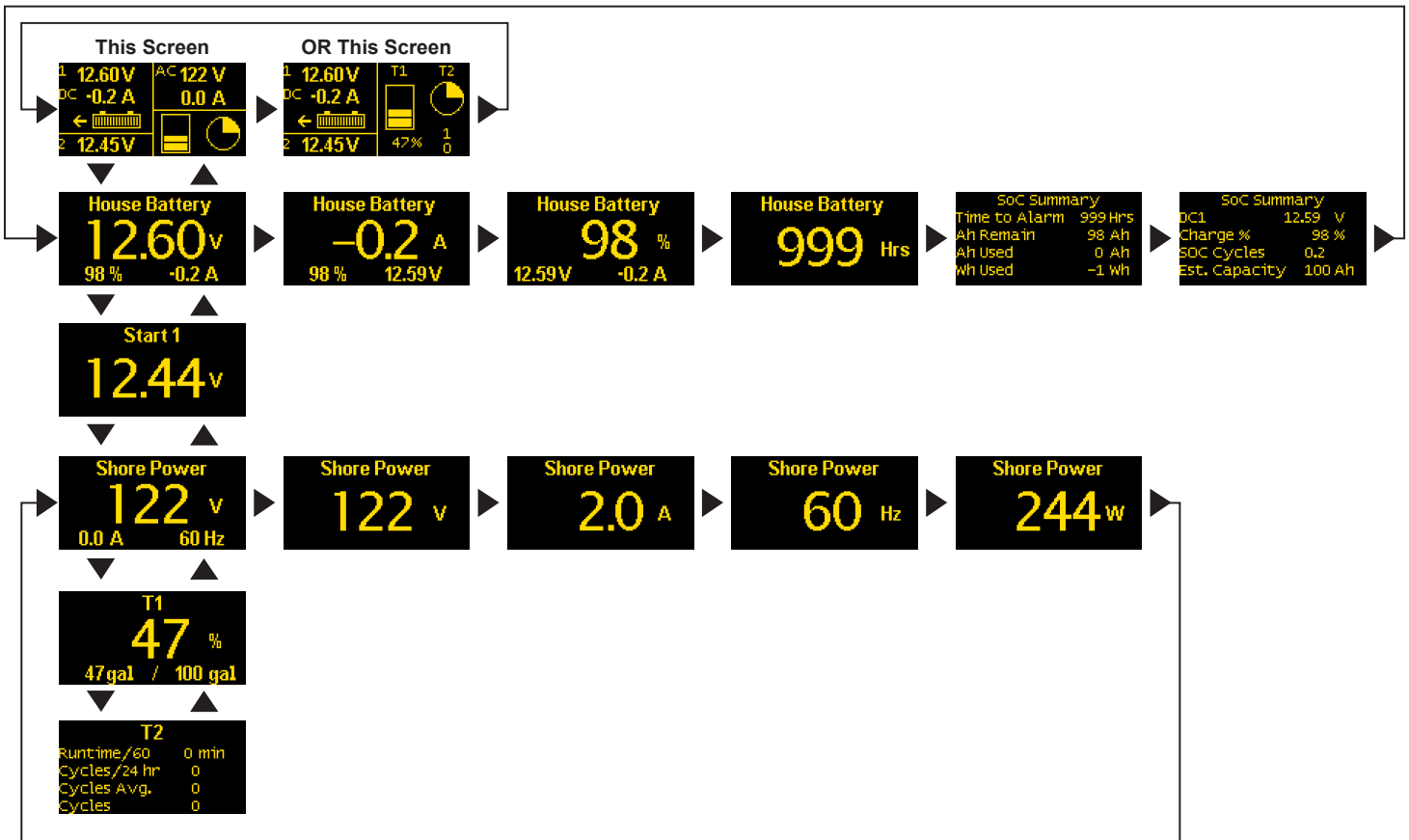

Main Screens

Summary Screen

The main summary screen display shows the state of the M2-VSM at a glance. On the left it displays the voltage, current, and state-of-charge for Battery 1, and the voltage for Battery 2. The arrow to the left of the battery display indicates if that battery is being charged → or discharged ←.

If AC is present, the display will display voltage and current as well as a graphical representation of the tank level, and/or the bilge runtime over the last hour. In the above examples, the bilge ran 15 minutes over the last hour.

If AC is not present, the AC display shuts off. Depending on the tank setup, the tank levels are now displayed in percent or volume. The Bilge has two additional fields. The top number is the total number of cycles in the last 24-hours. The bottom number displays the number of cycles over the last seven days divided by 7. This is the daily average. Compare this count with the 24-hour count to see if the bilge is running more or less often.

For example, in B2 the 24-hour count is 42, while the Avg is 15. This tells you that the bilge is running more often than normal.

SOC Summary Screens

The 1850 provides summary information about the state-of-charge (SOC) of the main battery (DC1).

- **Time to Alarm** - If an SOC alarm is set, this displays the estimated time before the alarm goes off (exclusive of delays). If no alarm is set, this is the estimated time until the battery is completely empty.
- **Ah Remain** - Estimated remaining capacity of the battery.
- **Ah Used** - This is the actual Ah removed from the battery since the last full charge including all discharge and charge cycles.
Note that **Ah Used** and **Ah Remain** will add up to be less than the capacity of the battery since the efficiency of removing energy from a battery varies depending on the rate of discharge.
- **Wh Used** - Watt hours used.
- **SOC Cycles** - The number of times that a battery has been charged and discharged. A discharge to 50% only counts as 0.5 cycles.
- **Est. Capacity** - If a battery is discharge below 80% and allowed to rest (current < 0.1A for 3 hours), the M2 can estimate the capacity of the battery. This feature is still experimental and works well for some installations. For best results, set the temperature to the actual battery temperature.
Note: The M2 will not automatically update the user's capacity setting.

Bilge Display

The bilge function displays the following information:

1. The total number of cycles in the last 24 hours.
2. The 24-hour average over the last 7 days.
3. The total number of cycles since the cycle counter was reset.

Shortcut Menu

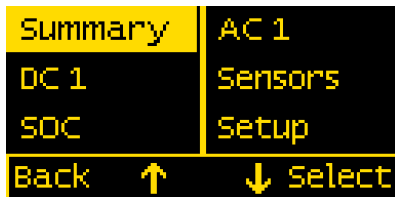

Press the Menu button to bring up a shortcut menu for additional summary screens as well as access to the Setup menus. Press the **UP** ↑ and **DOWN** ↓ arrow buttons to move the cursor over the options and press the **Select** button to see a selected display. To return to the previous display, press the **Back** button.

Configuration

Setup Menu

Meter settings can be configured from the Setup menu. This menu can be accessed by pressing the **Menu** button and then scrolling to and selecting Setup. Press the **UP** ↑ and **DOWN** ↓ arrow buttons to move the cursor. The different setup options are described below.



NMEA Setup

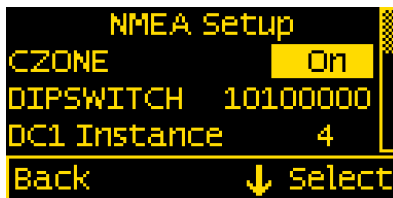

CZone Configuration

To use CZone, first configure the DIPSWITCH setting to match the setting that was defined in the CZone configuration tool. Then turn the CZone menu to **ON**. The meter will reboot and pull the configuration information from the network. Note that the NMEA cable must be connected to a live CZone network with proper configuration data. The CZone configuration file will automatically populate most configuration data for the M2 VSM including: NMEA 2000 instances, battery voltage, battery type, battery capacity, full charge volts, full charge amps, and tank/bilge configuration.

NMEA 2000 Configuration

For non-CZone systems, the user will have to enter NMEA 2000 instance information for DC1, DC2, AC1, and the Tanks (if used). The user should configure the instance information before connecting to the N2K network to prevent conflicts.

Alarm Setup

The meter supports two types of alarms, local alarms that are only displayed on the meter and CZone alarms that are displayed on CZone displays and can be used to configure CZone switching. CZone alarms are configured in the CZone configuration tool while local alarms are configured on the meter. The meter's alarm can be set to trigger under certain conditions of battery voltage, current, state-of-charge, tank level, or bilge activity. In addition, each alarm can be put on a delay to prevent false triggers. Alarms can be set from the Alarm Setup menu. To get there, first navigate to the Setup menu. Then scroll to Alarm Setup and press the Select button.

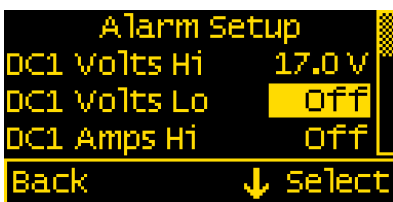

Setting Alarms

The M2 Meter family provides monitoring capability of input channels. The meter can monitor Voltage, Current, Frequency, Tanks, and Bilge. Alarms are triggered if a channel is above or below a certain user selected threshold value. The following example indicates how to setup an over voltage Alarm.

1. Go to the Alarm Setup menu.
2. Scroll to the desired input channel (i.e, DC1 Volts Hi).
3. Press the **Select** button and the cursor should start blinking.
4. Set the voltage threshold using the ← and → buttons. (Holding down the buttons allows faster selection.)
5. Press the **Enter** button to save the change or the **Cancel** button to cancel any change.

NOTE: A low voltage threshold cannot be set above a high voltage threshold. Likewise, a high voltage threshold cannot be set below the low voltage threshold. The meter will automatically increase or decrease the voltage thresholds to enforce this.

In the above example, an alarm will sound anytime DC1 voltage is greater than or equal to 17V.

Silent Alarm

This turns off the alarm buzzer. Alarms will only show on the main screen.

Voltage Alarm

Voltage alarms can be set to detect high (Hi) or low (Lo) voltage conditions.

Current Alarm

The current alarm can be set to detect over current conditions.

State-of-Charge (SoC) Alarm

The State-of-Charge alarm can be set to detect low State-of-Charge conditions.

Tank Alarm

Alarms can be set to detect tank levels.

Bilge Alarm

Bilge alarms can be set to detect if the run-time exceeds a certain value in at 60-minute period (Bilge Time Hi) or if the number of cycles in a 24-hour period exceeds a threshold (Bilge Cycle Hi).

Alarm Delay

An alarm delay can be specified so that alarms don't immediately trigger. This can be useful when monitoring a starting battery, so that the alarm doesn't trigger every time an engine is started.

The hold off timer operates as a count-up/count-down timer. When the input exceeds the alarm value, the timer will start counting up until it reaches the delay time. When it reaches the delay timer, an alarm will sound. If the alarm condition goes away before the delay timer has been met, the timer will count down until the timer is zero again. For example; if the Alarm Delay is set for 5 minutes and an alarm condition is active for 4 minutes then inactive for 1 minute, if the alarm condition is active again, the alarm will sound in 2 minutes (5 minutes - 4 minutes + 1 minute). Note that there is only one delay per channel.

Clearing Alarms

When an alarm occurs, the buzzer will sound, the red **ALARM LED** will light. The screen will display which alarm was triggered, the alarm set point and the current value. Pressing any button silences the buzzer and another button press returns to the previous display.

Until the cause of the alarm is resolved, the **ALARM LED** will remain **ON** and the channel that triggered the alarm (Voltage, Current, State-of-Charge, or Frequency) will blink.

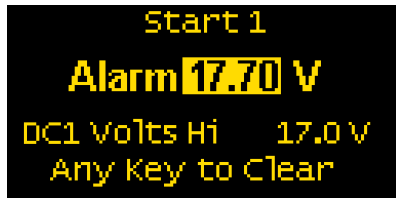

Viewing Alarms Status

For any active alarm, the parameter will flash if it is displayed. To view a complete list of active alarms, press **Menu>Setup>Alarm Setup**. Any active alarm will flash. You may have to scroll through the menu to see all of the alarms.

Display Setup

The meter display settings can be accessed from the Display Setup menu. From the setup screen, scroll to Display Setup and press the **Select** button.

The different display settings are described below. To change a setting, press **Enter** and press the **LEFT ←** or **RIGHT →** arrow buttons to view the available setting options. Press **Enter** to save the setting. Press **Cancel** to cancel a change.

None of these settings are modified by CZone.

Brightness

This setting is for adjusting the brightness of the display. The value is a percentage where 0 % is dimmest and 100 % is brightest.

Sleep Timer

Following a certain period of inactivity, the meter will enter a sleep mode and will turn off the display. Any button may be pressed to exit the sleep mode and restore the display. The **Sleep Timer** sets the number of minutes from 0 to 600 before entering sleep mode. This feature will be disabled by changing the setting to **OFF**.

Dim Timer

In addition to sleep mode, the meter can also dim its display after a period of inactivity. The duration of delay in minutes from 0 to 600 can be adjusted with this setting. This feature will be disabled by changing the setting to **OFF**. By continuously pressing the **LEFT ←** button the meter can be placed in **AUTO** dim mode. In this mode the meter will automatically dim after two minutes when the ambient light is low (night mode). When the light increases, the meter will revert to its normal brightness.

Units

Select either **Impri** (imperial) or **Mtrc** (metric). These are the units used to specify the battery temperature and fluid volume.

Demo Mode

With **Demo Mode ON**, the meter displays factory programmed values for the Battery Voltages, Current, and State-of-Charge. Changing the setting to **OFF** returns the meter to display actual measured values. This mode is typically used for commercial or promotional purposes. Note: Alarm settings will still respond to the actual settings and not the Demo settings. To enter Demo Mode, press **Menu>Setup>Display Setup>Demo Mode**. Press the **LEFT ←** or **RIGHT →** arrow buttons to toggle Demo Mode **ON** or **OFF**.

Changing System Labels

The M2 allows the user to change the labels that are displayed above each channel. Each channel can have a maximum of 16 characters however in the summary screens only the first 5 characters of the bilge and tank are displayed. If CZone is configured, then the labels will be overwritten by CZone.

Changing Label Names

To change the name of a battery, follow the instructions below:

1. Navigate to the setup menu for the desired battery (such as DC1 Setup). **Menu->Setup->DC1 Setup**
2. In the battery setup menu, move the cursor to battery name to be changed (indicated by the >> symbol)
3. Press **Select** to enter the name editing mode.
4. Use the **LEFT ←** and **RIGHT →** arrow buttons to move the cursor over the characters.
5. When the cursor is over a character, press **Enter** to edit that character. The cursor will start blinking.
6. Use the **UP ↑** and **DOWN ↓** arrow buttons to select a new character and press **Ok** to set that character.
7. Once all desired characters have been changed, press the **Cancel** button to exit the name editing mode.

DC1 Setup

The meter provides setup settings for each battery. To access these settings, first go to the Setup menu. Scroll to the desired battery label followed by Setup (such as DC1 Setup), then press **Select**. **NOTE:** Some settings may not be available for all batteries.

The battery setup settings are described below. To make a change, scroll to setting and press **Enter**. Press the **LEFT** ← or **RIGHT** → arrow buttons to view the available setting options. Press **Enter** to save the setting. Press **Cancel** to cancel a change.

Enable

To display the battery and its measurements, change this setting to **ON**. If enable is **OFF**, the battery along with its measured values will not be displayed. However, any associated alarm settings are still active. To de-activate the alarm, disable them in the Alarm Setup menu.

Set State-of-Charge (SoC) to FULL

When this option is selected, the meter will consider the battery's present State-of-Charge to be **FULL**. To do this, scroll to **Ok** and press **Select**. The screen will then return to the meter summary display.

Battery Voltage

This setting indicates the nominal voltage of the battery. The options are 12V, 24V, 36V, & 48V. This is automatically set by CZone.

Bat. Type

This setting indicates the battery type. The available options are listed below:

- FLStd - Standard Flooded Lead Acid Batteries
- AGM - Standard Absorbed Glass Mat (AGM) Batteries
- TPPL - Thin Plate Pure Lead AGM Batteries
- GEL - Gel Batteries
- FLRsv - Flooded Acid Reserve. Premium Flooded Lead Acid Batteries such as Rolls.
- FLLoM - Flooded Low Maintenance. Sealed Flooded Lead Acid Batteries
- FFFL - Firefly AGM Batteries

Bat. Capacity

This setting indicates the capacity of the battery in amp-hours. The available range is 0A to 5000A. This is automatically set by CZone.

Full Chrg Volts

This setting indicates the voltage at which the battery is considered to be fully charged. The available range is 0.1 V to 70.0V. This should be set to the absorption voltage of your charger. If you don't know the absorption voltage, you can figure the absorption voltage out by observing the output voltage of the charger once it enters the absorption phase. If you have multiple charging sources, set it to the higher absorption voltage. In extremely hot or cold temperatures the absorption voltage will need to be set slightly higher (for cold) or slightly lower (for hot). This is automatically set by CZone.

Example 1. In Blue Seas Systems' P12 Charger this parameter is called the *Absorb Voltage*. For lead acid values, the default value is 14.5 V DC. So in the M2 the **Full Chrg Volts** setting would be set slightly smaller than the 14.5 V (14.4 V).

Example 2. An unknown 10 A charger is connected to a partially discharged battery. Initially the meter should read approximately 10 A of charging current with the voltage increasing over time. At some point (around 14.5-14.8 V DC) the voltage should stabilize and the charging current will start decreasing. This voltage is the Full Charge Voltage. Set the **Full Chrg Volts** to 0.1 V below the observed voltage.

Full Chrg Amps

In addition to Voltage, the user can set the Charging Current at which the battery is considered fully charged. The value is a percentage between 0.0 % and 10.0 % of the battery's set Amp-hour capacity. This value should be set to 0.2% higher than the End of Absorption Amps. That is the current where the battery charger switches from Absorb to Float stage. Values are typically 2% for AGM and 3% for Lead Acid. As a battery ages, this percentage may need to be increased. This is automatically set by CZone.

Charge Eff.

This setting is for indicating the battery's percent charge efficiency. The value may be set between 0% and 100%. The user can adjust the charge efficiency up or down depending on the age and/or type of battery that they are using. AGM Batteries tend to be much more efficient than Lead Acid Batteries. If the M2 meter indicates 100% before the charger is done with its bulk charge then the efficiency is likely too high. Try decreasing it a couple percent. If the M2 meter never indicates full charge then efficiency is likely too low. Try increasing it a couple percent. This is automatically set by CZone.

The charge efficiency can be calculated as follows:

1. Set the **Charge Eff.** Value to 100%.
2. Discharge the battery somewhere between 25% to 50%.
3. Check the SoC summary screen and note the **Ah Used** value (it will be a negative number). This is **Discharge Amps**.
4. Charge the battery using a 3-stage charger.
5. When the charger goes from Absorption to Bulk, the battery is considered fully charged.
6. Check the SoC screen again and note the **Ah Used** (it will be a positive number). This is **Charge Amps**.
7. The new Charge Efficiency value is calculated by **Discharge Amps/Charge Amps**.
8. Set the **Charge Eff.** value to the value above

For example, if we had a 100 Ah battery, we would remove 50 Ah at roughly C/20 (5 Amps for 10 hours). We would then charge the battery and when we transition to float, we might see 4 **Ah Used**. So the charge efficiency would be $50/(50 + 4)$ or 92.5% efficiency.

Temperature

Specify the lowest temperature that the batteries will be exposed to. As temperature drops, the effective capacity of batteries also drops. The M2 calculates the battery capacity based on this worst case temperature. This number could be adjusted seasonally to provide better accuracy

SoC Volt. Sync

This setting allow the M2 to estimate the current State-of-Charge after the battery has rested for a period of time. In certain situations where small charges are affecting the voltage reading (some solar installations would do this), the synchronization will estimate the SOC incorrectly. In that case, turn this feature off.

Shunt Value

The M2 is shipped with a single 500A/50mV shunt (the ratio is 10000:1). The shunt value assumes that the full scale shunt output voltage is 50 mV. To use a shunt with a smaller output voltage use the following formula: $\text{Shunt Value} = (\text{New Shunt Ratio}) / 20$. For example to use a 400A/20mV shunt (Note: 20mV = 0.02V), you would set Shunt Value to $(400A/0.02) / 20 = 1000A$.

Zero Shunt

Menu->Setup->DC1 Setup->Zero Shunt. To zero out the shunt, connect both of the current sense wires to the negative bus bar side of the shunt. Then press the **Reset** button on the M2 Meter to confirm the action.

State-of-Charge (SoC) Cycles

Menu->Setup->DC1 Setup->SoC Cycles. The SoC Cycles option allows the user to reset the battery's recorded SoC cycles to 0. To do this, scroll to and press **Select** on SoC Cycles. Text will appear asking to confirm or cancel the reset request. Press **Yes** to confirm or **No** to cancel the action.

State-of-Charge (SoC) Default Settings

To reset the battery's State-of-Charge settings to the default values, press **Select** on SoC Defaults. Text will then appear asking to confirm or cancel the reset request. Press **Yes** to confirm or **No** to cancel. The following changes will occur after a reset:

1. SoC Cycles will be reset to 0
2. SoC is Reset to 98%

DC2 Setup

Enable

Turn the channel on or off. If Enable is set to **OFF** then the channel will not be displayed in the main menus. The alarm functions for that channel will not be disabled. To disable the alarm for a channel, set the alarm for each channel to **OFF**.

AC1 Setup

Enable

To display the channel and its measurements, change this setting to **ON**. If enable is **OFF**, the channel along with its measured values will not be displayed. However, any associated alarm settings are still active. To de-activate the alarm, disable them in the Alarm Setup menu.

Toggle A/V

Switch the Current and Voltage display on the channel's Summary Screen. If this option is set to **OFF** then Voltage will be displayed in the center field. If the option is set to **ON** Current will be displayed in the center field.



Example: Toggle A/V Set to OFF

Full Scale Amps

The M2 is shipped with a 150A AC/50mA AC current transformer (the ratio is 3000:1). The full scale output is based on transformers with a maximum output value of 50mA AC. A different value transformer can be calculated with the following formula: Full Scale Amps = New Ratio / 20. For example to replace the standard transformer with a 100A/20mA transformer (Note: 20mA = 0.02A): $(100A / 0.02) / 20 = 250A$.

Tank / Bilge Setup

The meter has two inputs that can be configured as either a bilge or tank. To access these settings, first go to the Setup menu.

Scroll to the desired input. The tank setup settings are described below.

To make a change, scroll to setting and press **Enter**. Press the **LEFT** ← or **RIGHT** → buttons to view the available setting options.

Press **Enter** to save the setting. Press **Cancel** to cancel a change.

Select

Define what is connected to the input: **Bilge**, **Tank**, or **Off**. If CZone is enabled, then CZone will configure this field. If select is **OFF**, the input along with its measured values will not be displayed. However, any associated alarm settings are still active. To de-activate the alarm, disable them in the Alarm Setup menus.

Bilge Functions

Cycle Reset

Reset the bilge cycle counter to zero.

Tank Functions

Volume

Set the volume. CZone will automatically configure this setting.

Show Percent

If this value is **ON**, then tank values will displayed as a percentage. If the value is **OFF** then it will be displayed in either gallons or liters.

Sensor Type

This setting presets the Resistance Lo and Resistance Hi values based on the type of sender attached to the meter. The CZone configuration tool will set this automatically. The available options are listed below:

- USA– North American Standard type of sender between with a resistance between 240 and 33 ohms.
- Euro – European Standard type of sender with a resistance between 10 and 180 ohms
- 1810 – Blue Sea Systems Ultrasonic Tank Sender for Diesel, Water & Waste.
- 1811 – Blue Sea Systems Ultrasonic Tank Sender for Gasoline Only
- Cstm – Indicates the Resistance Lo or Resistance Hi value has been manually changed.

Resistance Lo/Resistance Hi

The tank meter operates by reading the resistance of the tank sender. The resistance value (in ohms) can be entered here for an empty tank (Resistance Lo) and for a full tank (Resistance Hi). Changing either of these values when the **Sender Type** is set to either 1810 or 1811 will give unpredictable results when an Ultrasonic Tank Sender is used.

Tank Depth (Only used with 1810 and 1811 Senders)

This setting indicates the depth of the tank in inches. This setting is not affected by switching the units in **Setup->Display->Units**. Also note that this setting is only used for ultrasonic senders.

Tank Shape

- Rect – Standard Rectangular Tank
- Tri – Triangular Shaped Tank. Good for tanks in Bilges.
- Auto – This setting only shows up after the tank has been auto calibrated. Changing this value back to Rect or Tri will overwrite the auto-cal values.
- Cstm – This setting indicates that the User has manually changed the tank settings.

Custom Tank Shapes

The M2 Tank Meter can define custom tank shapes. This can be done two ways by either using the Auto Calibrate feature or manually entering the tank Parameters. For CZone systems, custom shapes are defined in the configuration tool.

Manually Entering Custom Tank Shapes

The M2 Tank Meter has five setup points that can help define odd sized shapes. Each of the set points allows the actual volume of the tank to be defined for various sensor readings. For example, setting the Sensor 20% value to 10%, indicates that when the tank sensor reads 20% the tank is really just 10% full. Similar set points are available at 40%, 60%, 80%, and 100%.

If a tank can be completely emptied, then to calculate the set points do the following:

1. Empty the tank. (If the tank cannot be completely emptied, the estimation works best if the tank is emptied with the sensor reading under 20%.)
2. Set the tanks shape to Rect. (Rectangular)
3. Set the tank to display percentage.
4. Add liquid to the tank until the meter reads 20%.
5. Record the actual number of gallons added to the tank.
6. Keep on adding liquid and record the number of gallons added when the meter reads 40%, 60%, 80% and 100%.
7. Press **Setup->Tank X Setup** and scroll down to **Sensor 20%**.
8. Enter the following value: (Tank Capacity – Total Gallons Added + Gallons Added at 20%)/(Tank Capacity)
9. Repeat Step 8 for 40%, 60%, 80% and 100%.

Example: Triangle Tank

A user has a triangle fuel tank that has a tank capacity of 50 gallons. The tank isn't completely empty and the meter reading is less than 20% in Rectangular mode. The user adds fuel until the meter reads 20%. The amount of fuel added was 1 gallon, at 40% he has added 7 gallons, at 60% he has added 17 gallons, at 80% he has added 31 gallons and at 100% he has added 49 gallons. The total gallons added is 49 gallons.

To calculate the Sensor 20% value we use the equation in step 8 above: (50g – 49g + 1g)/50g = 4%.

To calculate the Sensor 40% value we use the equation in step 8 above: (50g – 49g + 7g)/50g = 16%.

Likewise we can calculate the rest of the values (60% & 80%) as shown in the table.

Rectangular Tank Reading	Gallons Added at X%	Sensor X%	Custom Tank Reading
100%	49 gallons	100%	50 gallons
80%	31 gallons	64%	32 gallons
60%	17 gallons	36%	18 gallons
40%	7 gallons	16%	8 gallons
20%	1 gallon	4%	2 gallons
0%	0 gallons	-	0 gallons

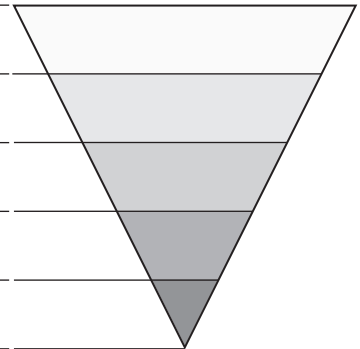

Note: It is possible to have the tank full before the sensor reads 100% by inputting a value into the Sensor 100% field that is greater than 100%. For example if the sensor reading for a full tank is 90% and Sensor 80% is calculated to be 75% then Sensor 100% can be calculated with the following:

$$\begin{aligned}
 \text{Sensor 100\%} &= \text{Sensor 80\%} + 20\% * \frac{100\% - \text{Sensor 80\%}}{\text{fullValue\%} - 80\%} \\
 &= 75\% + 20\% * \frac{100\% - 75\%}{90\% - 80\%} \\
 &= 125\%
 \end{aligned}$$

Using Auto-Calibrate

The Auto-Calibrate function requires the tank to be filled at a constant rate and for the sensor reading be initially less than 15%. For grey, waste, and water tanks a hose can be used to provide a constant flow. Diesel and gas tanks can be more difficult because foaming may cause the user to slow down filling once the tank is almost full. If foaming is a problem then use the manual method described above.

1. **Select Setup->Tank(1-4)->Auto Calibrate->Ok**

2. If the sensor reads more than 15% an error message will be displayed along with the sensor reading. At this point the tank can be emptied or the back button can be pressed to exit the auto calibrate procedure.



3. If the sensor is less than 15% then an option to start the calibration process is given.

4. Press the **Start** button and start filling the tank at a constant rate.



5. The timer will start counting as the tank fills. In addition the sender will indicate that the tank is getting filled. When the tank reaches 100% the timer will automatically stop. Press the **Finish** button to accept the calibration values or the Cancel to abandon the changes. If the tank is full before the sender reaches 100% then press **Finish**.

6. After the **Finish** button is pressed the M2 will populate Sensor 20% - Sensor 100% with the proper calibration values. Scroll down to inspect the values.

Version Info

The Version Info option in the Setup menu displays the product name, serial number, and software version. This information will be displayed on a screen after scrolling to Version Info and pressing **Select**. Pressing any button will return to the Setup menu.

Factory Reset

The Factory Reset option in the Setup menu allows the user to restore the meter's factory default settings. First scroll to Factory Reset and press **Select**. Text will appear asking to confirm or cancel the reset request. Press **Yes** to confirm or **No** to cancel the reset.

PGN's Used with 1850

PGN Number	Description	Fields
127506	DC Detailed Status	State-of-Charge (Time remaining will follow)
127508	Battery Status	Battery Voltage, Battery Current
127503	AC Input Status	Voltage, Current, Real Power
127504	AC Output Status	Voltage, Current, Real Power
127505	Fuid Level	Type, Level, Capacity

PGN Number	Description
59392	ISO Acknowledgement
59904	ISO Request
160160	ISO Transport Protocol, Data Transfer
60416	ISO Transport Protocol, Connection Management
60928	ISO Address Claim
65240	ISO Commanded Address
126208	Request Group Function
126993	Heartbeat

CZone Proprietary PGN's		
65280	PGN_ZONE_COMMAND_MESSAGE	Circuits
65281	PGN_ZONE_FEEDBACK_MESSAGE	Feedback on Circuits
65284	PGN_CZONE_STATUS_MESSAGE	Connection and device info (serial/firmware/..)
65288	PGN_ZONE_COMMAND_MESSAGE	
65290	PGN_CONFIG_CLAIM	Config file request
65291	PGN_DATA_BLOCK_FEEDBACK	Config file
65293	PGN_SI_RAW_DATA_REQUEST_MESSAGE	Not used for MV
65295	PGN_CZ_ALARM_MESSAGE	Alarm PGN
65297	PGN_CZONE_ENGINEERING_MSG	Config tool communication
130816	PGN_DATA_BLOCK	For Config.Transfer

Software Upgrade

New Method

1. This upgrade method only works with Windows 7 PCs and above, and MAC OSX 10.8 and above.
2. Download the new firmware from <http://www.blueseas.com/m2firmware>.
3. Extract the firmware.bin file from zip file.
4. Remove all connections from the meter.
5. Plug a USB micro cable into the back of the meter.
6. While holding the 2nd button from the left connect the USB cable to a PC or a MAC

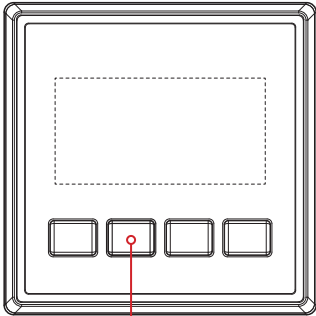

While holding the 2nd button from the left connect the USB cable to a PC or a MAC

7. The computer will create a new drive on the computer. Note: If the PC doesn't recognize the M2-VSM, then try using a different cable.
 - a. On a PC, the new drive will have be labeled as CRP_DISABLED (D:) where "D:" is the drive letter and may be a different letter.

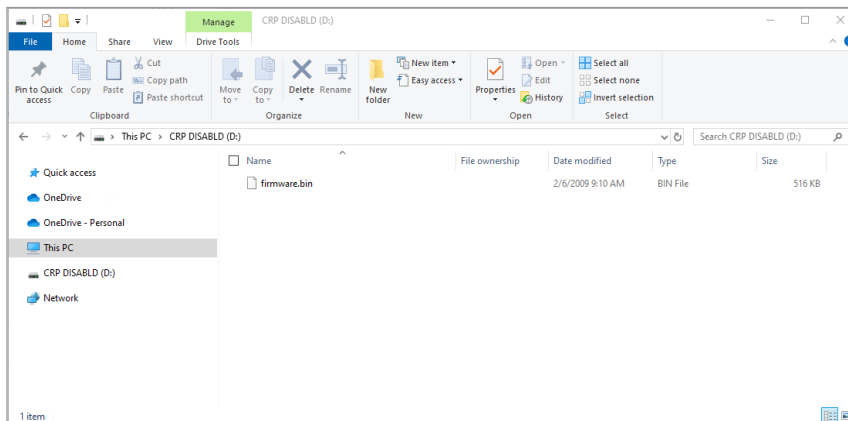

b. On a MAC...

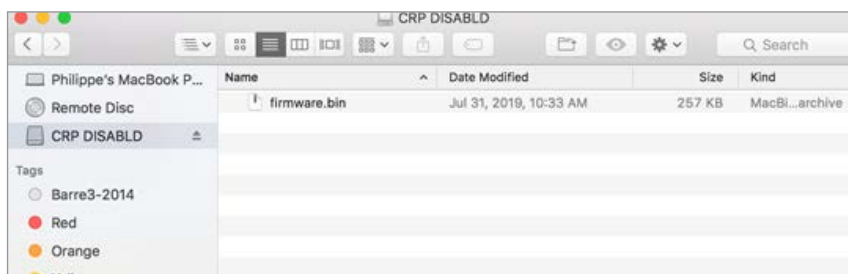

8. Delete the firmware.bin file from the M2-VSM folder.
 - a. On a PC, select the file with your mouse and press the delete key.
 - b. On a Mac, select the file with your mouse and move to trash.

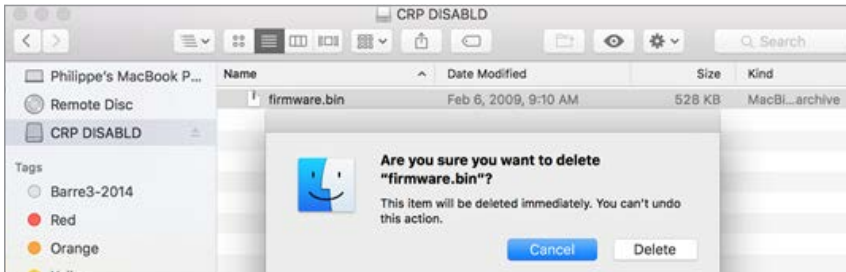
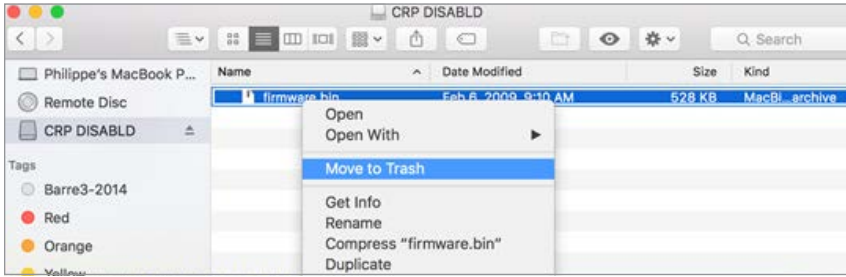

9. Copy the new firmware.bin file to the M2-VSM folder.
10. Unplug the USB cable from the computer.
11. You can plug the usb cable back into the computer to verify the new firmware. The M2-VSM should power up and you can navigate to **Setup->Version** Info to verify the new SW Revision.



4600 Ryzex Way
 Bellingham, WA 98226 USA

p 360.738.8230
 f 360.734.4195
 conductor@blueseas.com
 blueseas.com

