

W & M SERIES

IDH MAX® &
Electromechanical Locks

STANLEY
Security Solutions

TABLE OF CONTENTS		Page	Page
IDH MAX® introduction	2	40HW electrified how-to-order	8
IDH MAX® features	2	8KW/9KW electrified specification	10
IDH Max® and IDH Max® 1300 comparison chart	3	8KW/9KW electrified how-to-order	10
HM, KM, HW & KW options	3	8KW/9KW electrified functions	10
40HM IDH MAX® specifications, how-to-order	4	Trim variations	11
40HM IDH MAX® functions	5	Electrified accessories	12,13
93KM IDH MAX® specifications, how-to-order	6	Terminology	13
Quick Connect, how-to-order	7, 20	1W electric switch lock introduction	14
93KM IDH MAX® functions	7	Optional boxes	14
40HW/8KW/9KW electrified lock introduction	7	1W electric switch lock how-to-order	14
40HW electrified specification	7	1W electric switch locks	15-19
40HW electrified functions	8-9		

IDH MAX® – INTRODUCTION

The IDH MAX® from Stanley Security Solutions offers convenience and efficiency for your electrified lock applications. Instead of installing reader devices, installing electrified strikes, installing door contacts and installing request-to-exit devices, you can now install the IDH MAX® in cylindrical or mortise lock applications. With IDH MAX® all of the formerly separate equipment needed to control access are self-contained in a single installation. The complexity of multiple wire runs is drastically reduced.

You can let Stanley Security Solutions show you how to MAXimize your access control system with the IDH MAX®! For the name and location of your local office, visit our web site at www.bestaccess.com. IDH MAX® and W series locks are compatible with Stanley's NT500, B.A.S.I.S. and most other Access Control Systems. The IDH Max® 1300 option will only work with the B.A.S.I.S. system and only on electrically unlocked "EU" functions.

IDH MAX® – FEATURES

IDH Max® Features

- Includes latch status, door status and request to exit features
NOTE: Latch Status not available on Deadbolt functions
- The 1300 option eliminates the need for a PIM (Panel Interface Module)
- Requires only one 4 conductor wire run
- Reduces number of components installed and visible at the door (PIR, RQE push buttons and door contacts)
- Installation time is reduced
- The RQE switch senses the inside lever/knob rotation.
- All of the door components are housed in one manufacturer's hardware
- With the elimination of components, only the lockset is visible at the door
- The reader is integrated into the lockset escutcheon
- Available in magnetic stripe and proximity readers
- Available in all popular lever/knob styles and finishes
- Operates with BEST interchangeable core as a mechanical override
- Integrates with many manufacturer's on-line EAC equipment

Mortise Features

- Lock case meets the requirements as listed in the ANSI/BHMA A156.13 standard for Series 1000, Grade 1 Operational and Grade 2 Security locks
- UL listed for GYQS Electrically controlled single point locks or latches for use on 3 hr, A label doors (4' x 10'). The listing applies for both U.S. and Canadian applications
- Door contact, request-to-exit, and latch status sensors positioned inside lock case
- The door contact magnet is installed behind the strike and out of site (except when deadbolt option is ordered)
- All sensors are standard in IDH Max mortise locks
- The heavy duty design of the mortise lock results in less field maintenance and part failures

Mortise Features (continued)

- Twist off lever spindle design protect internal lock parts from damage and failure.
- Oil impregnated stainless steel 3/4" anti-friction latchbolt reduces door closing force and wear.

Cylindrical Features

- Non-handed levers allow for ease of installation
- Lock chassis meets the requirements as listed in the ANSI/BHMA A156.2, standard for Series 4000 Grade 1 locks
- UL listed for GYQS Electrically controlled single point locks or latches for use on 3 hr, A label single doors (4' x 10') GYJB. The listing applies for both U.S. and Canadian applications
- Request-to-exit sensor positioned inside lock trim
- The ISC (Intelligent System Controller) is embedded behind the escutcheon secured and out of site
- Request-to-exit and door contact sensors are standard in IDH MAX cylindrical locks

Magnetic Stripe Electronic Lock Features

- Durable material has teflon-like characteristics for increased life and wear resistance
- Variable read rate allows for easy usage

Proximity Card Reader Features

- HID and Motorola/Indala proximity cards supported
- Usable in most environmental/exterior applications.

1300 Option Features

- Eliminates need for small panel interface module
- Eliminates reader interface board
- Incorporates 3 modules into a single electronics board inside IDH Max escutcheon trim
- Connects directly to ACP via 2 wire RS485 connection

IDH MAX® & IDH MAX® 1300 COMPARISON CHART

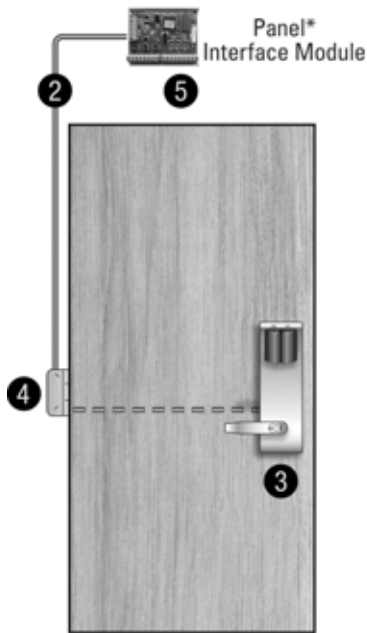

IDH MAX®

1. Prep door for IDH MAX®
2. Run single 4 conductor wire for IDH MAX®
3. Install IDH MAX®
4. Install electrified hinge
5. Mount PIM

* Operates with most control panel hardware, including B.A.S.I.S. control panels.

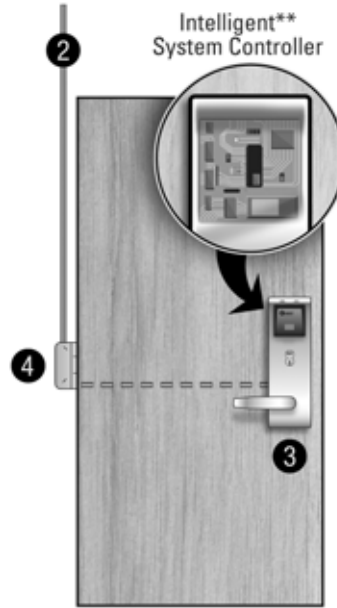

IDH MAX® 1300

1. Prep door for IDH MAX®
2. Run single 4 conductor wire for IDH MAX® 1300
3. Install IDH MAX® 1300 which includes Intelligent System
4. Install electrified hinge

** Operates with B.A.S.I.S. control panels only.

HM, KM, HW & KW – OPTIONS

AL– Besides complying with a wide variety of accessibility codes and ordinances, lever handles are available with a special abrasive feature. Abrasive strip on the lever immediately identifies warnings on doors to hazardous areas for the blind.

BRK– When excessive force (approx. 300 inch lbs.) is applied to #4, #6 keyed knobs, they “breakaway” and spin freely, thus allowing entrance only by key. Simple part replacement returns lock to functional usage.

C– The easy to use quick connect system enables efficient installation to the respective BEST Lock electrical options ordered.

IDH– The Integrated Door Hardware groups three components into one hardware package. 1. Door status switch (normally closed)
2. Request-to-Exit switch (normally open) 3. Electrically controlled locking mechanism.

KNL– Knurl feature is available only on #6 knobs. The knurling is machined into the outer edge of the knob. The knurled feature can be used for blind, safety, or accessibility applications.

LL– Lead lined feature can be used to protect against X-rays. Since the majority of lead lined doors contain the lead in the surface of the door, the knob lockset provide lead lining for the holes cut in the door when preparing the door for the trim.

LM– The Lost Motion feature allows the lever handle to turn freely when it is locked without retracting the latchbolt assembly. This feature makes over-torque abuse more difficult to achieve.

SH– Security head provided for all exposed screws.

ROE– Cylindrical or Mortise locksets can be supplied with a request-to-exit switch. A normally open switch provides momentary switch closure when the inside lever/knob is rotated.

TAC– Grooves are machined into knobs to improve grip or to be used as a warning in hazardous areas. This option can be used for blind, safety or accessibility applications.

Thick door– Specify thickness if other than 1 3/4” .

TL– Tactile levers may be used in areas where improved grip is required or as a warning in hazardous or Safety First areas. Grooves are machined into the back of the hand grasp portion of the lever to improve grip and/or provide a sensory warning. This option can be used for blind, safety, or accessibility applications.

1300– Integrated BAS1300/LNL1300 reader electronics board or (ISC) Intelligent System Controller is embedded behind the escutcheon secured and out of site. Functions with B.A.S.I.S./Mercury on-line equipment only.

NOTE: 1300 option not available on any “EL” electrically locked functions.

40HM IDH MAX® – SPECIFICATIONS

MECHANICAL

Case– Heavy wrought steel, 5 7/8" H x 4 1/4" D x 1" W steel parts are zinc dichromate plated for corrosion protection.

Faceplate– Brass or bronze, 8" H x 1 1/4" W x 1/16" T. Lock face automatically adjusts to proper bevel during installation.

Strike– Brass, bronze or stainless steel base material, 4 7/8" H x 1 1/4" W x 3/32" T.

Fits standard door frame cut out as specified in ANSI A115.1. Universal (non-handed) strike supplied standard with lock.

Backset: 2 3/4"

Door thickness– For doors 1 3/4" – 3" thick. (specify thickness when ordering)

Installation– Lock requires modified door prep to mount the trim. Faceplate dimensions fit standard door preparation as specified in ANSI A115.1.

Lockset is easily reversible to match door handing without opening the mortise case.

Latchbolt– Solid stainless steel, 3/4" throw. Latch is oil-impregnated for anti-friction operation. Reversible without opening case.

Deadbolt– Solid stainless steel, 1" throw.

Auxiliary bolt– Stainless steel, non-handed.

Escutcheons: 10 1/2" H x 3 5/16" W x 1" D (1" at the top, sloping down to 3/4" at the bottom)

Knobs– Diameter: 2 1/8" Projection on door: 2 7/8"

#4, #6 knobs: Material machined from brass or bronze.

Lever handle– Brass, bronze or stainless steel. (Lever #3, #14 and #15 conform to California Titles 19 and 24.)

Mounting– Knob and lever attached with hardened set screw on inside knob or inside lever.

Finish– **605**-bright brass, clear coated; **606**-satin brass, clear coated; **611**-bright bronze, clear coated; **612**-satin bronze, clear coated;

613-oxidized satin bronze, oil rubbed; **625**-bright chromium plated; **626***-satin chromium plated; **629**-bright stainless steel;

630-satin stainless steel; **690****-dark bronze.

* 613 finish is designed to wear over time, providing an "antique" appearance.

** 690 finish will continue as a dark brown appearance over time.

Antimicrobial Finishes 626AM – Satin Chrome Plated with UltraShield Antimicrobial coating; **630AM** – Satin Stainless Steel with UltraShield Antimicrobial coating



45HM IDH MAX® Mortise

ELECTRONIC

Maximum current draw: 1.1 Amp for 50 milliseconds **Typical current draw (hold condition):** 650 milliAmps **Voltage:** 10.2 to 13.2 V (DC only)

Magnetic Stripe Card Reader:

Read Rate: 5 inches per second to 50 inches per second.

Card thickness: ISO standard .030" ± .003 thick. Compliance to FCC, Canadian, and European EMC requirements; for interference FCC Class A digital apparatus.

Proximity Reader:

ANSI/BHMA A156.25 compliant. Compatible with Motorola / Indala and HID proximity cards. ABA and Wiegand output.

Weatherproof bezel and gasket provide protection for outdoor use. (Usable in most environmental/exterior applications)

Card Read Range: 0 – 3 inches. Compliance to US FCC, Canadian FCC, and European EMC requirements







ESD Protection: 15 Kilo Volt

40HM IDH MAX® – HOW TO ORDER

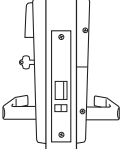
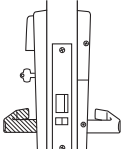
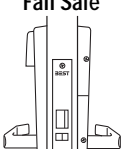
45HM	7	DEU	14	MS	626	RH	KNL
Series	Core Housing	Function	Lever/Knob Style	Trim Style † †	Finishes †	Handing	Options†
45HM-IDH Max™ Mortise	0– Keyless or less cylinder, 7– 7 pin IC housing accepts all BEST cores	DEL– single key latch, fail safe DEU– single key latch, fail secure NXEL– keyless, latch, fail safe NXEU– keyless, latch, fail secure TDEL– single key deadbolt, fail safe TDEU– single key deadbolt, fail secure LEL– keyless, deadbolt, fail safe LEU– keyless, deadbolt, fail secure (page 5)	Levers ⌘14– curved return ⌘15– curved angle return ⌘16– curved no return ⌘17– gullwing no return Knobs 4– round (page 11)	MS–magnetic stripe PM–proximity Motorola PH– proximity HID MSA– other cylinder PHA– other cylinder PMA– other cylinder (page 11)	605 606 611 612 613 618 619 625 626 690 Antimicrobial Finishes 626AM – Satin Chrome Plated with UltraShield Antimicrobial coating 630AM – Satin Stainless Steel with UltraShield Antimicrobial coating	RH RHRB LH LHRB	C – quick connect SH – security head screws TAC – tactile lever Thick Door – specify thickness if other than 1 3/4" 7/8" LTC – flat lip strike 1300* – B.A.S.I.S. direct connect

†See H Series catalog for details. ††Standard readers use Best concealed cylinder; Adaptation trim can accept other manufacturers cylinders. *(NOTE: 1300 option not available on any "EL" electrically locked functions).

40HM IDH MAX® – FUNCTIONS

Function	Latch	Outside Knob/Lever		Inside Knob/Lever	
		Operated by	Locked by	Unlocked by	Locked by
 <p>DEL-Locked Fail Safe</p>	<ul style="list-style-type: none"> • Outside knob/lever when power is removed from the solenoid • Outside key • Inside knob/lever <p>Latchbolt is deadlocked by an auxiliary latch</p>	Applying power to the solenoid; remains locked while power is on.	Removing power from the solenoid	Cannot be locked	Always unlocked
Powered by 12V DC. temperature control module is not needed.					
 <p>DEU-Unlocked Fail Secure</p>	<ul style="list-style-type: none"> • Outside knob/lever when power is removed from the solenoid • Outside key • Inside knob/lever <p>Latchbolt is deadlocked by an auxiliary latch</p>	Removing power from the solenoid	Applying power to the solenoid; remains unlocked while power is on.	Cannot be locked	Always unlocked
Powered by 12V DC. temperature control module is not needed.					
 <p>NXEL-Locked Fail Safe</p>	<ul style="list-style-type: none"> • Outside knob/lever when power is removed from the solenoid • Outside key • Inside knob/lever <p>Latchbolt is deadlocked by an auxiliary latch</p>	Applying power to the solenoid; remains locked while power is on.	Removing power from the solenoid	Cannot be locked	Always unlocked
Powered by 12V DC. temperature control module is not needed.					
 <p>NXEU-Unlocked Fail Secure</p>	<ul style="list-style-type: none"> • Outside knob/lever when power is removed from the solenoid • Outside key • Inside knob/lever <p>Latchbolt is deadlocked by an auxiliary latch</p>	Removing power from the solenoid	Applying power to the solenoid; remains unlocked while power is on.	Cannot be locked	Always unlocked
Powered by 12V DC. temperature control module is not needed.					
 <p>TDEL-Locked Fail Safe</p>	<ul style="list-style-type: none"> • Outside key • Outside knob/lever when power is removed from the solenoid. • Inside knob/lever <p>Latchbolt is deadlocked by an auxiliary latch</p>	Applying power to the solenoid; remains locked while power is on. Deadbolt operated by: • Outside key • Inside thumb turn	Removing power from the solenoid Deadbolt and Latchbolt retracted simultaneously by: • Inside knob/lever • Outside knob/lever when power is removed	Cannot be locked	Always unlocked
Powered by 12V DC. temperature control module is not needed.					
 <p>TDEU-Unlocked Fail Secure</p>	<ul style="list-style-type: none"> • Outside knob/lever when power is removed from the solenoid • Outside key • Inside knob/lever <p>Latchbolt is deadlocked by an auxiliary latch</p>	Removing power from the solenoid Deadbolt operated by: • Outside key • Inside thumb turn	Applying power to the solenoid; remains unlocked while power is on. Deadbolt and Latchbolt retracted simultaneously by: • Inside knob/lever • Outside knob/lever when power is applied	Cannot be locked	Always unlocked
Powered by 12V DC. temperature control module is not needed.					
 <p>LEL-Locked Fail Safe</p>	<ul style="list-style-type: none"> • Outside knob/lever when power is removed from the solenoid • Inside knob/lever <p>Latchbolt is deadlocked by an auxiliary latch</p>	Applying power to the solenoid; remains locked while power is on. Deadbolt extended by: Inside thumb turn	Removing power from the solenoid Deadbolt retracted by: • Inside thumb turn • Inside knob/lever retracts the deadbolt and latchbolt simultaneously • Outside lever when power is removed	Cannot be locked	Always unlocked
Powered by 12V DC. temperature control module is not needed.					
 <p>LEU-Unlocked Fail Secure</p>	<ul style="list-style-type: none"> • Outside knob/lever when power is removed from the solenoid • Outside key • Inside knob/lever <p>Latchbolt is deadlocked by an auxiliary latch</p>	Removing power from the solenoid Deadbolt extended by: Inside thumb turn	Applying power to the solenoid; remains locked while power is on. Deadbolt retracted by: • Inside thumb turn • Inside knob/lever retracts the deadbolt and latchbolt simultaneously • Outside knob/lever when power is applied	Cannot be locked	Always unlocked
Powered by 12V DC. temperature control module is not needed.					

Shading indicates a ridged lever/knob in a non-energized state.

9KM IDH MAX® – SPECIFICATIONS MECHANICAL

- Materials**– Internal parts are brass, zinc or corrosion-treated steel.
- Chassis**– 2 1/16" diameter to fit 2 1/8" diameter hole in door.
- Strike**– Brass, bronze, or stainless steel base material; STK 2 3/4" H standard, S3 4 7/8" H.
Fits standard door frame cut out as specified in ANSI A115.1. Strike box supplied as standard.
- Backset**– 2 3/4" standard, 3 3/4" and 5" available.
- Door thickness**– Standard lock configuration designed for doors 1 3/4" – 2 1/4" thick.
- Installation**– Lock dimensions requires modified door prep ANSI A156.2 Series 4000, Grade 1 to mount housing.
- Latchbolt**– 1/16" throw.
- Escutcheons**: 10 1/2" H x 3 5/16" W x 1" D (1" at the top, sloping down to 3/4" at the bottom).
- Knobs**– Diameter: 2 1/8" Projection on door: 2 7/8" #4, #6 knobs: Material machined from brass or bronze.
- Lever handle**– Made from high-quality zinc alloy. Body is approximately 1 5/8" in diameter: Handle is approximately 4 3/4" in length (from center-line of chassis). Lever styles 14 and 15 return to a minimum of 1/2" of door surface. Lever 16 does not return.
- Finish**– **605**-bright brass, clear coated; **606**-satin brass, clear coated; **611**-bright bronze, clear coated; **612**-satin bronze, clear coated; **613***-oxidized satin bronze, oil rubbed **625**-bright chromium plated; **626**-satin chromium plated; **690****-dark bronze.
* 613 finish is designed to wear over time, providing an "antique" appearance.
** 690 finish will continue as a dark brown appearance over time.



93KM IDH MAX® Cylindrical

Antimicrobial Finishes

- 626AM** – Satin Chrome Plated with UltraShield Antimicrobial coating
- 630AM** – Satin Stainless Steel with UltraShield Antimicrobial coating

ELECTRONIC

- Maximum current draw**: 850 MilliAmps, for 50 milliseconds
- Typical current draw (hold condition)**: 550 milliAmps
- Voltage**: 10.2 to 13.2 V (DC only)

Magnetic Stripe Card Reader:

- Read Rate**: 5 inches per second to 50 inches per second.
- Card thickness**: ISO standard .030" ± .003 thick. Compliance to FCC, Canadian, and European EMC requirements; for interference FCC Class A digital apparatus.

Proximity Reader:

- ANSI/BHMA A156.25 compliant, Compatible with Motorola / Indala and HID proximity cards, ABA and Wiegand output Weatherproof bezel and gasket provide protection for outdoor use. (Usable in most environmental/exterior applications).
- Card Read Range**: 0 – 3 inches. Compliance to US FCC, Canadian FCC, and European EMC requirements
- ESD Protection**: 15 Kilo Volt

9KM/8KM IDH MAX® – HOW TO ORDER

9KM3	7	DDEU	14	MS	STK	626	TL
Series Backset	Core Housing	Function	Lever/Knob Style	Trim Style	Strike Package	Finishes*	Options
Lever 9KM3– 2 3/4" 9KM4– 3 3/4" 9KM5– 5" Knob 8KM3– 2 3/4" 8KM4– 3 3/4" 8KM5– 5"	0– keyless 7– 7 pin housing accepts all BEST® cores	DDEU– electrically unlocked DDEL– electrically locked	Levers ⚙️14– curved return ⚙️15– curved angle return ⚙️16– curved no return Knobs 4– round 6– tulip	MS–magnetic stripe PM– proximity Motorola PH– proximity HID	STK– 2 3/4" ANSI S3– 4 7/8" ANSI	605 606 611 612 613 618 619 625 626 690 Antimicrobial Finishes 626AM – Satin Chrome Plated with UltraShield Antimicrobial coating 630AM – Satin Stainless Steel with UltraShield Antimicrobial coating	8KM: BRK – breakaway knob KNL – knurled knob TAC – tactile knob 9KM: AL – abrasive lever LM – lost motion TL – tactile lever Note: specify inside (I), outside (O), or both (B) for AL, TL, TAC, KNL options Both 8KM & 9KM: C – quick connect SH – security head screws 3/4 – 3/4" throw latch 1300 – B.A.S.I.S. direct connect **
		(page 7)	(page 11)	(page 11)			(page 3)

* Handles and trim are made from a zinc alloy, and have been plated to be equivalent in appearance to the finishes listed. ** 1300 option not available on any "EL" electrically locked functions.

9KM IDH MAX® – FUNCTIONS

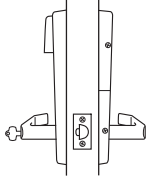
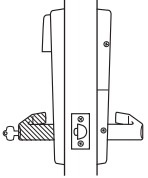
Function	Latch	Outside Knob/Lever		Inside Knob/Lever	
		Locked by	Unlocked by	Locked by	Unlocked by
DDEL-Locked 	<ul style="list-style-type: none"> Rotating the inside knob/lever, Rotating the outside knob/lever— only when power is off, Turning the key in the outside knob/lever. Latchbolt is deadlocked	Applying power to the solenoid; remains locked while power is on.	Removing power from the solenoid	Cannot be locked	Always unlocked
		Powered by 12V DC. Temperature control module (TCM) is not needed.			
DDEU-Unlocked 	<ul style="list-style-type: none"> Rotating the inside knob/lever, Rotating the outside knob/lever— only when power is on, Turning the key in the outside knob/lever. Latchbolt is deadlocked	Removing power from the solenoid	Applying power to the solenoid; remains unlocked while power is on.	Cannot be locked	Always unlocked
		Powered by 12V DC. Temperature control module (TCM) is not needed.			

Shading indicates a ridged lever/knob in a non-energized state.

40HW/8KW/9KW ELECTRIFIED LOCK INTRODUCTION

The 40HW, 8KW, and 9KW electromechanical locks provide fail-safe (electrically locked) and fail-secure (electrically unlocked) operation. They also provide a way to lock and unlock the door from a remote location for safety, security, or convenience through an individual switch, switch lock, relay, access control system, or other automatic control system. More importantly, these locks exhibit the same features and meet the same standards and specifications as our mechanical 40H mortise and 8K/9K heavy duty cylindrical locksets.

HOW TO ORDER STANLEY QUICK CONNECT PRE-WIRED PLUG-IN CONNECTORS

To order the Stanley Quick Connect pre-wired plug-in connectors, include the "C" suffix for the BEST Locks. See page 24 for more details on how the Stanley Quick Connect systems works.

Example:

BEST Locks

45HW 7 DEL 14H 626 RH DS 



BEST Locks

9KW 37 DEU 15CS TK 626 24 V 



40HW ELECTRIFIED – SPECIFICATIONS

Types:

- 12 volts AC or DC — 0.60 amps
- 24 volts AC or DC — 0.45 amps
- All EU functions: Electrically Unlocked (Fail Secure)
- All EL functions: Electrically Locked (Fail Safe)

Approval Listings:

- UL listed for GYQS Electrically-controlled singlepoint locks or latches.
- This product has been approved by the California State Fire Marshal (CSFM) pursuant to section 13144.1 of the California Health and Safety Code.
- Approved by the city of New York Board of Standards and Appeals under calendar number 49-88-SA. See CSFM listing No. 4136-1175:101 for allowable values and/or conditions for use concerning material presented in this document. It is subject to re-examination, revisions and possible cancellation.

NOTE: All w-series locks require the use of a (TCM) Temperature Control Module. TCM and TCM connector are supplied standard with every order.



**40HW Mortise
Electrically-Operated Lockset**

40HW ELECTRIFIED – HOW TO ORDER



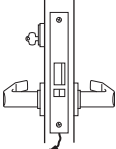
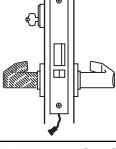
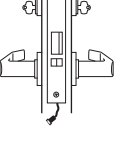
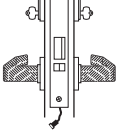

45HW	7	NXEU	12	J	612	LH	RQE
Series	Core Housing	Function	Lever Style	Trim Style	Finishes†	Handing	Options†
45HW– lever 47HW– lever high security	45HW: 0– keyless or less cylinder, 7– 7 pin IC housing accepts all BEST cores 47HW: 7– 7 pin (accepts 5C cores only)	45HW/47HW: DEL–single key latch, fail safe DEU– single key latch, fail secure WEL–double key latch, fail safe WEU– double key latch, fail secure TDEL–single key deadbolt, fail safe TDEU–single key deadbolt, fail secure TWEL–double key deadbolt, fail safe TWEU–double key deadbolt, fail secure 45HW only: NXEL–keyless, latch, fail safe NXEU–keyless, latch, fail secure LEL– keyless, deadbolt, fail safe LEU– keyless, deadbolt, fail secure (pages 8–9)	Levers Ⓔ3– solid tube/ return Ⓔ12– solid tube/ no return Ⓔ14– curved return Ⓔ15– contour/ angle return Ⓔ16– curved/no return Ⓔ17– gullwing no return Knobs: 4– round (page 11)	45HW: H– 2 3/4" flat J– wrought M– forged N– forged concealed cylinder* S– 3 1/2" flat R– 2 3/4" concave 47HW: M– forged (page 11)	45HW: 605 606 611 612 613 618 619 625 626 690 47HW: 626 630 (page 11)	RH RHRB LH LHRB	AL – abrasive lever C – quick connect LL – lead lined LS – latch status DS – door status RQE – request to exit SH – security head screws TL – tactile lever Thick Door – specify thickness if other than 1 3/4" (1 3/4" min x 4" max) 12V–Specify 12 Volt System (standard lock voltage is 24V) (page 3)

* "N" trim not available on double keyed functions. †See H Series catalog for details.

40HW ELECTRIFIED – FUNCTIONS

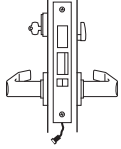
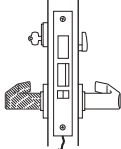
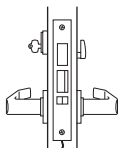
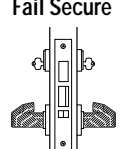
Function	Latch	Outside Knob/Lever		Inside Knob/Lever	
	Operated by	Locked by	Unlocked by	Locked by	Unlocked by
 DEL–Locked Fail Safe	<ul style="list-style-type: none"> • Outside knob/lever when power is removed from the solenoid • Outside key • Inside knob/lever <p>Latchbolt is deadlocked by an auxiliary latch</p>	Applying power to solenoid; remains locked while power is on	Removing power from solenoid	Cannot be locked	Always unlocked
Powered by 12 or 24 volts AC/DC & 0.60 or 0.45 amps, continuous duty. Temperature control module (TCM) included.					
 DEU–Unlocked Fail Secure	<ul style="list-style-type: none"> • Outside knob/lever when power is applied to the solenoid • Outside key • Inside knob/lever <p>Latchbolt is deadlocked by an auxiliary latch</p>	Removing power from solenoid	Applying power to solenoid; remains unlocked while power is on	Cannot be locked	Always unlocked
Powered by 12 or 24 volts AC/DC & 0.60 or 0.45 amps, continuous duty. Temperature control module (TCM) included.					
 WEL–Locked Fail Safe	<ul style="list-style-type: none"> • Inside and Outside knob/lever when power is removed from the solenoid • Inside/Outside key <p>Latchbolt is deadlocked by an auxiliary latch</p>	Applying power to solenoid; remains locked while power is on	Removing power from solenoid	Applying power to the solenoid; remains locked while power is on	Removing power from the solenoid
Temperature control module (TCM) included.					
Powered by 12 or 24 volts AC/DC & 0.60 or 0.45 amps, continuous duty. Applying voltage locks inside & outside knobs/levers simultaneously.					
 WEU–Unlocked Fail Secure	<ul style="list-style-type: none"> • Inside and Outside knob/lever when power is applied to the solenoid • Inside/Outside key <p>Latchbolt is deadlocked by an auxiliary latch</p>	Removing power from solenoid	Applying power to solenoid; remains unlocked while power is on	Removing power from solenoid	Applying power to solenoid; remains unlocked while power is on
Powered by 12 or 24 volts AC/DC & 0.60 or 0.45 amps, continuous duty. Removing voltage locks inside & outside knobs/levers simultaneously. Temperature control module (TCM) included.					

40HW ELECTRIFIED – FUNCTIONS (CONTINUED)

Function	Latch	Outside Knob/Lever		Inside Knob/Lever	
		Operated by	Locked by	Unlocked by	Locked by
 <p>TDEL-Locked Fail Safe</p>	<ul style="list-style-type: none"> • Outside key • Outside knob/lever when power is removed from the solenoid <p>Latchbolt is deadlocked by an auxiliary latch</p>	Applying power to solenoid; remains locked while power is on Deadbolt operated by: <ul style="list-style-type: none"> • Outside key • Inside thumb turn 	Removing power from solenoid Deadbolt and latchbolt retracted simultaneously by: <ul style="list-style-type: none"> • Inside knob/lever • Outside knob/lever when power is removed. 	Cannot be locked	Always unlocked
	Powered by 12 or 24 volts AC/DC & 0.60 or 0.45 amps, continuous duty. Temperature control module (TCM) included.				
 <p>TDEU-Unlocked Fail Secure</p>	<ul style="list-style-type: none"> • Outside key • Outside knob/lever when power is applied to the solenoid <p>Latchbolt is deadlocked by an auxiliary latch</p>	Removing power from solenoid Deadbolt operated by: <ul style="list-style-type: none"> • Outside key • Inside thumb turn 	Applying power to solenoid; remains unlocked while power is on Deadbolt and latchbolt retracted simultaneously by: <ul style="list-style-type: none"> • Inside knob/lever • Outside knob/lever when power is applied. 	Cannot be locked	Always unlocked
	Powered by 12 or 24 volts AC/DC & 0.60 or 0.45 amps, continuous duty. Temperature control module (TCM) included.				
 <p>TWEL-Locked Fail Safe</p>	<ul style="list-style-type: none"> • Outside & inside key • Outside & Inside knob/lever when power is removed from the solenoid <p>Latchbolt is deadlocked by an auxiliary latch</p>	Applying power to solenoid; remains locked while power is on Deadbolt operated by: <ul style="list-style-type: none"> • Outside or inside key • Outside & Inside knob/lever when power is removed from the solenoid 	Removing power from solenoid	Applying power to solenoid; remains locked while power is on	Removing power from solenoid
	Powered by 12 or 24 volts AC/DC & 0.60 or 0.45 amps, continuous duty. Applying voltage locks inside & outside knobs/levers simultaneously. Temperature control module (TCM) included.				
 <p>TWEU-Unlocked Fail Secure</p>	<ul style="list-style-type: none"> • Outside & inside key • Outside & Inside knob/lever when power is applied to the solenoid <p>Latchbolt is deadlocked by an auxiliary latch</p>	Removing power from solenoid Deadbolt operated by: <ul style="list-style-type: none"> • Outside or inside key • Outside & Inside knob/lever when power is applied to the solenoid 	Applying power to solenoid; remains unlocked while power is on	Removing power from solenoid	Applying power to solenoid; remains unlocked while power is on
	Powered by 12 or 24 volts AC/DC & 0.60 or 0.45 amps, continuous duty. Removing voltage locks inside & outside knobs/levers simultaneously. Temperature control module (TCM) included.				
 <p>NXEL-Locked Fail Safe</p>	<ul style="list-style-type: none"> • Outside knob/lever when power is applied to the solenoid • Inside knob/lever <p>Latchbolt is deadlocked by an auxiliary latch</p>	Applying power to solenoid; remains locked while power is on Deadbolt extended by: Inside thumb turn	Removing power from solenoid	Cannot be locked	Always unlocked
	Powered by 12 or 24 volts AC/DC & 0.60 or 0.45 amps, continuous duty. Temperature control module (TCM) included.				
 <p>NXEU-Unlocked Fail Secure</p>	<ul style="list-style-type: none"> • Outside knob/lever when power is applied to the solenoid • Inside knob/lever <p>Latchbolt is deadlocked by an auxiliary latch</p>	Removing power from solenoid	Applying power to solenoid; remains unlocked while power is on	Cannot be locked	Always unlocked
	Powered by 12 or 24 volts AC/DC & 0.60 or 0.45 amps, continuous duty. Temperature control module (TCM) included.				
 <p>LEL-Locked Fail Safe</p>	<ul style="list-style-type: none"> • Outside knob/lever when power is removed from the solenoid • Inside knob/lever <p>Latchbolt is deadlocked by an auxiliary latch</p>	Applying power to the solenoid; remains locked while power is on Deadbolt extended by: Inside thumb turn	Removing power from the solenoid Deadbolt retracted by: <ul style="list-style-type: none"> • Inside thumb turn • Inside knob/lever retracts the deadbolt and latchbolt simultaneously • Outside knob/lever when power is removed 	Cannot be locked	Always unlocked
	Powered by 12 or 24 volts AC/DC & 0.60 or 0.45 amps, continuous duty. Temperature control module (TCM) included.				
 <p>LEU-Unlocked Fail Secure</p>	<ul style="list-style-type: none"> • Outside knob/lever when power is applied to the solenoid • Inside knob/lever <p>Latchbolt is deadlocked by an auxiliary latch</p>	Removing power from the solenoid Deadbolt extended by: Inside thumb turn	Applying power to the solenoid; remains unlocked while power is on Deadbolt retracted by: <ul style="list-style-type: none"> • Inside thumb turn • Inside knob/lever retracts the deadbolt and latchbolt simultaneously • Outside knob/lever when power is applied 	Cannot be locked	Always unlocked
	Powered by 12 or 24 volts AC/DC & 0.60 or 0.45 amps, continuous duty. Temperature control module (TCM) included.				

ATTENTION: Locksets that secure both sides of the door are controlled by building codes and the Life Safety Code®. In an emergency exit situation, failure to quickly unlock the inside lever could be hazardous or even fatal.

8KW & 9KW ELECTRIFIED LOCKS – SPECIFICATIONS

Types:

- 12 volts AC/DC when used with supplied TCM — 0.50 amps
- 24 volts AC/DC when used with supplied TCM — 0.18 amps
- **All EU functions:** Electrically Unlocked (Fail Secure)
- **All EL functions:** Electrically Locked (Fail Safe)

Approval Listings:

- UL listed for GYQS Electrically-controlled singlepoint locks or latches.
- This product has been approved by the California State Fire Marshal (CSFM) pursuant to section 13144.1 of the California Health and Safety Code.
- Approved by the city of New York Board of Standards and Appeals under calendar number 730-89-SA. See CSFM listing No. 4136-1175:103. It is subject to re-examination, revision and possible cancellation.

Door thickness:

Standard lock configuration designed for doors 1 3/4" – 2 1/4" thick.

NOTE: All W-series locks require the use of a (TCM) Temperature Control Module. A TCM and TCM connector are supplied standard with every order.



93KW Cylindrical Electrically-Operated Lockset

8KW & 9KW ELECTRIFIED LOCKS – HOW TO ORDER

9KW3	7	DEU	14	K	STK	626	TL
Series	Core Housing	Function	Lever Style	Trim Style	Strike Package	Finishes*	Options
8KW: 8KW3– 2 3/4" 8KW4– 3 3/4" 8KW5– 5" 9KW: 9KW3– 2 3/4" 9KW4– 3 3/4" 9KW5– 5"	0– keyless 7– 7 pin housing accepts all BEST® cores	DEU– electrically-unlocked DEL– electrically-locked (See Below)	8KW: 4– round 6– tulip 9KW: ♿14– curved return ♿15– contour angle return ♿16– curved no return (page 11)	C– 3" convex D– 3 1/2" convex K– 3" convex –no ring L– 3 1/2" convex –no ring (page 11)	STK– 2 3/4" ANSI S3– 4 7/8" ANSI	605 606 611 612 613 618 619 625 626 690	8KW only: BRK– breakaway knob KNL– knurled knob TAC– tactile knob 9KW only: AL– abrasive lever LM– lost motion RQE– request-to-exit TL– tactile lever Note: specify inside (I), outside (O), or both (B) for AL, TL, TAC, KNL options 8KW & 9KW: C – quick connect LL– lead lined SH– security head screws 3/4– 3/4" throw latch 12V– Specify 12 Volt System (standard lock voltage is 24V) (page 3)

* Handles are made from a zinc alloy, and have been plated to be equivalent in appearance to the finishes listed.

8KW & 9KW ELECTRIFIED LOCKS – FUNCTIONS

Function	Latch	Outside Knob/Lever		Inside Knob/Lever	
	Operated by	Locked by	Unlocked by	Locked by	Unlocked by
DEL-Locked 	<ul style="list-style-type: none"> • Rotating the inside knob/lever • Rotating the outside knob/lever—only when power is off • Turning the key in the outside knob/lever. 	Applying power to the solenoid; remains locked while power is on.	Removing power from the solenoid	Cannot be locked	Always unlocked
Locks are powered by 12 or 24 volts AC/DC at 0.50 amps or 0.18 amps. Temperature control module (TCM) included					
DEU-Unlocked 	<ul style="list-style-type: none"> • Rotating the inside knob/lever, • Rotating the outside knob/lever—only when power is on, • Turning the key in the outside knob/lever. 	Removing power from the solenoid	Applying power to the solenoid; remains unlocked while power is on.	Cannot be locked	Always unlocked
Locks are powered by 12 or 24 volts AC/DC at 0.50 amps. or 0.18 amps. Temperature control module (TCM) included					

Shading indicates a ridged lever/ knob in a non-energized state.

KNOB STYLES

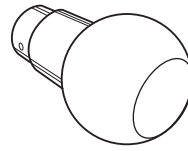

#4 knob

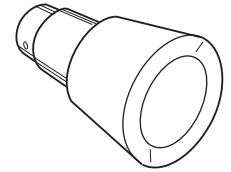

#6 knob

LEVER STYLES

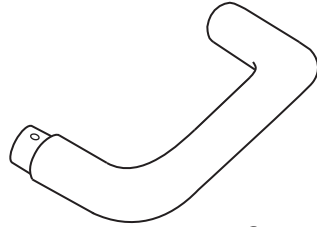

#3 lever

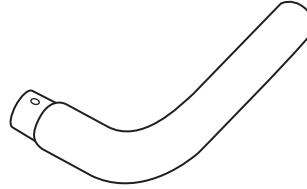

#12 lever

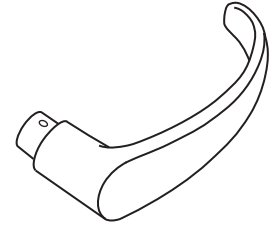

#14 lever

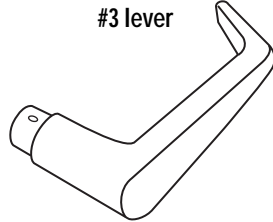

#15 lever

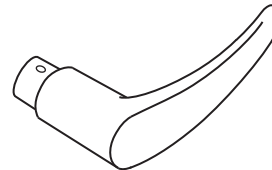

#16 lever

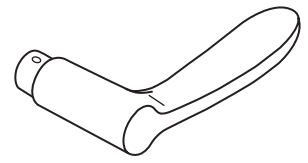

#17 lever

MORTISE ROSE TRIMS

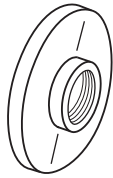

H rose



R rose

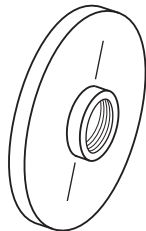

S rose

CYLINDRICAL ROSE TRIMS



C rose

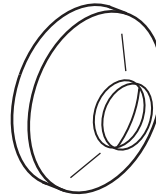

D rose



K rose

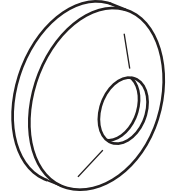

L rose

ESCUTCHEON TRIM VARIATIONS

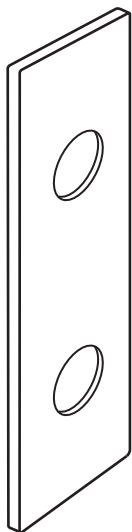

J escutcheon

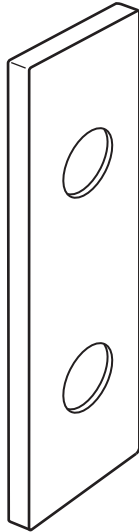

M escutcheon

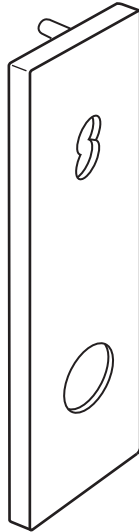

N escutcheon

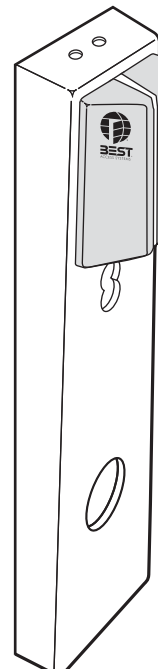

MS escutcheon

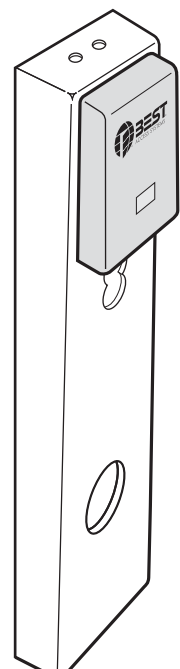

Prox escutcheon

ELECTRIFIED ACCESSORIES**8W599****Features:**

- Offers exceptionally high power for its compact size
- UL listed
- Thermally fused
- Convenient 4 point mounting provision allows rapid installation in a standard 1/2" knockout
- Foot-mounts for surface installation
- Pre-stripped pigtails provided for quick primary connection
- Secondary connection by screw terminals
- Sturdy nylon bobbin construction
- Cadmium plated finish

Specifications:

Primary voltage: 120 VAC (Wire Leads)

Secondary voltage: 24 VAC (Screw Terminals)

Secondary VA: 40 volts-amperes

Dimensions: 2 1/4" x 2 1/8" x 2 15/16"

To order specify: 8W599

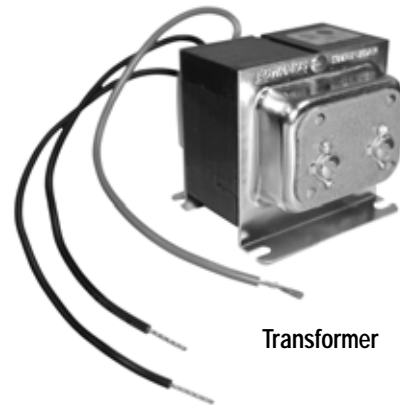

Transformer

Function/Application:

Transforms 120 volts AC to 24 volts AC. (To get 24 volts DC, use with 8WCON, AC to DC converter.) Typically used as a power supply for electrically-operated locks.

8WCON**Features:**

- 400 Ampere surge capability
- Electrically isolated base
- UL recognized
- Single-phase, full wave bridge

Specifications:

Average forward current: 25 amps

Case: Plastic case with an electrically isolated aluminum base

Polarity: Terminal designation embossed on case: +DC output, -DC output, AC not marked

Mounting position: Bolt down. Gain the highest heat transfer efficiency through the surface opposite the terminals. Use silicone heat sink compound on mounting surface for maximum heat transfer.

Terminals: Suitable for "fast-on" connections. Readily solderable and corrosion resistant. Soldering is recommended for applications greater than 15 amperes.

Mounting torque: 20 inch-pounds maximum

Case size: 1.030 x 1.030 inches

Temperature range: -85° to 347°F (-65° to + 175°C)

To order specify: 8WCON

AC to DC Converter
Full wave bridge rectifier**Function/Application:**

Converts AC (alternating current) to DC (direct current) for locking circuit applications. (Typically used with 8W599 transformer.)

8WBU-1-A / 8WBU-1-N**Features:**

- Positive "snap" feedback
- Industrial-grade switch designed for rugged control applications.
- Factory assembled with trimplate
- Standard or narrow plate available
- 1 3/16" dia. mushroom head—red in color

Specifications:

Electrical rating: 28VDC or 115 VAC, 10A resistive, 5A inductive, 3A lamp load (see terminology on the back cover)

Switch type: SPST-NO-DB, FORM-X contacts, 25,000 cycles at full load, 50,000 cycles mechanical life

Mounting hole: 5/8" (.625) dia.

Switch dim.: 1.187 dia. x 1.528 overall length

Standard wall plate: 2 3/4" x 4 1/2"

Narrow wall plate: 1 1/2" x 4 1/2"

Material/finish: Satin stainless steel

Wire leads: Two 6" long 20 AWG insulated wire leads

To order specify: 8WBU-1-A standard plate 8WBU-1-N narrow plate

8WBU-1-A
Standard plate8WBU-1-N
Narrow plate**Function/Application:**

Normally open push-button switch provides momentary switch closure when pressed. Typically used to momentarily energize electrified locks or strikes or used as a request-to-exit switch on access control systems.

Features

- All circuitry completely sealed

Specifications**Wire leads:**

Input – 24 AWG – Stranded wire with PVC insulation (approx. 44" in length)

Output – 24 AWG – Stranded wire with Teflon insulation (approx. 2.6" in length)

Input Voltage: 12 or 24 volts AC or DC

Output Voltage: Full voltage out @ 1 amp maximum for 0.5 seconds then 30% of voltage out for 5 seconds

Output protection: Short circuit current limiting set at one (1) amp.

Operating temp: -4 to 158°F (-20 to 70°C)

Size: 1/2" x 2 1/4" x 1/2"

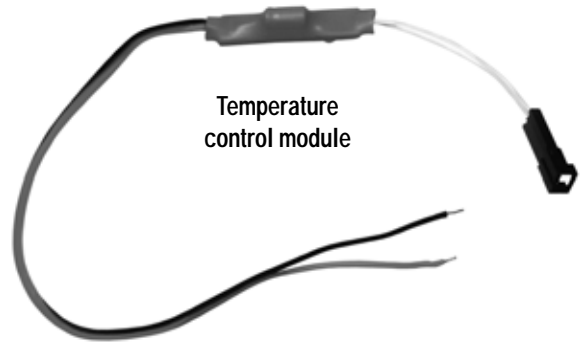
**Function/Application**

A temperature control module (TCM) reduces the amount of current flow to a lockset one second after energizing, thereby lowering the temperature of the lockset trim. A (TCM) also converts AC power to DC power and should be used on all electrified mortise and cylindrical locksets.

NOTE: The TCM is not used with any IDH-Max function.

TERMINOLOGY

Closed – A state in which a connection exists between the common terminal and another terminal on the switch. See Open also.

Common terminal – A terminal on a switch whose contact can be connected to one or more terminals on the switch.

Door status – A switch that monitors whether the door is open or closed. This switch is used to detect a forced entry, or a door that is propped open.

Inductive load – An electrical device such as a motor, relay, or solenoid.

NOTE: this type of load can cause arcing across switch contacts and may burn the contacts. See *Resistive load and Lamp load also*.

Latchbolt status – A switch that monitors whether the latch is engaged or retracted. This switch is used to detect a forced entry, or a latch that has been taped open.

Lamp load – An electrical device that produces light using a tungsten filament, such as an incandescent light bulb.

Note: this type of load can cause surges of current upon contact closure. This may cause the contacts to weld together. See *Inductive load and Resistive load also*.

Maintained – Remaining in a given state until the switch lever or button is actuated. Actuating the switch lever or button causes the switch to change to another maintained state.

Momentary – Remaining in a given state only as long as an external force is applied to the switch lever or button.

NC – (Normally Closed) Switch contacts that are closed as long as no external force is applied to the switch lever or button.

NO – (Normally Open) Switch contacts that are open as long as no external force is applied to the switch lever or button.

Open – A state in which no connection exists between the common terminal or any other terminal on the switch.

Pole – The number of independent circuits in a switch. For example, a double-pole, single-throw switch can control two separately powered motors. See *Throw also*.

Resistive load – An electrical device, such as a heater, having none of the characteristics of an inductive or lamp load. This type of load is the least severe on the switch because only a small amount of arcing occurs when the switch contacts open and close. See *Inductive load and Lamp load also*.

ROE – Request-to-exit. A switch that allows the user to exit without setting off an alarm. Turning the inside knob or lever actuates the switch and, when wired to an alarm system, sends a signal to disable or sound an alarm, start a timer, etc.

Throw – The number of circuits, or contacts controlled by each pole. For example, a single-pole, double-throw switch can control a motor with two contacts—a forward contact, and a reverse contact. See *Pole also*.

1300 – Integrated BAS1300/LNL1300 reader electronics board or (ISC) Intelligent System Controller is embedded behind the escutcheon secured and out of site. Functions with B.A.S.I.S./Mercury on-line equipment only.

ELECTRIC SWITCH LOCK – INTRODUCTION

Stanley Security Solutions offers a line of electric switch locks available in various “on-off” and “momentary” keyed switch functions. Circuitry variations are available in single, double and triple pole with varied voltage and amperage ratings. Units may be keyed into any BEST® system. The BEST interchangeable core offers versatility and adaptability for new and existing electrical controls, panels, machines, etc.

Features

- Double D lock cylinder prevents slipping and turning
- Screw terminals on all switch locks (except the 1W7A1) provides ease of installation
- All switches are UL recognized or listed

Note on functionality: Switch lock keys can only be removed in the 12 o'clock position.

How to select a switch lock

1. Determine the electrical requirements for the device being controlled:

- Voltage** (for example: 115 VAC or 24 VDC)
- Current or horsepower** (for example: 6 amps or 1/2 horsepower)
- Type of load**
 - Resistive (for example, heater elements)
 - Inductive (for example, motors, large transformers)
 - Lamp (for example, incandescent lights)

2. Determine the switch configuration (poles and throws) and key removal condition:

- Poles** To determine the number of poles, find how many wires from the power source need to be switched on and off by the switch lock.
- Throws** To determine the number of throws, find how many wires to the device the switch needs to control. For example, if a switch needs two different “on” conditions (low and high speed), two throws are needed. Or if the device is simply an “on-off” type (only one wire), you need one throw.

NOTE: A switch throw may be left unwired and used as an “off” condition.

- Key removal** To determine the key removal condition, ask the question, “When the key is removed, should the switch be “off”, or could the switch be either “on” or “off” ?” Although the key can only be removed in the 12 o'clock position, the switch itself may be left in two or three positions. Check each switch lock for key removal switch positions.

3. Use the information collected and find the switch lock that best meets the requirements. Refer to the following catalog pages for a description of each switch lock. If environmental conditions make it necessary that the switch lock be housed in an electrical box, see the **Optional boxes** below for the box that best suits the switch lock and your application.

OPTIONAL BOXES

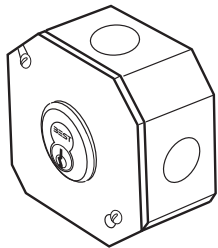

OC1
Standard octagon
3 1/2" x 3 1/2" x 1 5/8"

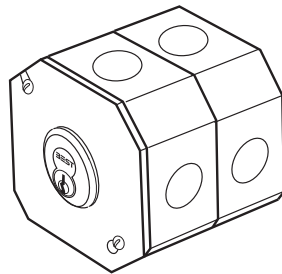

OC2
Deep octagon
3 1/2" x 3 1/2" x 3 1/4"

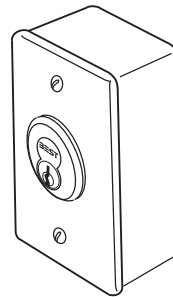

INT
Interior box
4" x 2 1/8" x 1 7/8"

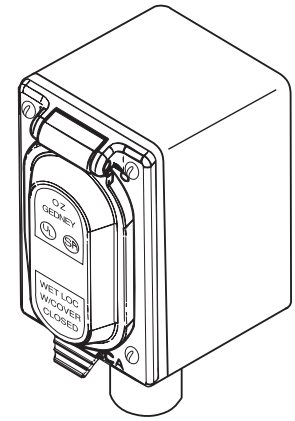

SWR
Standard weather
resistant box
4 5/8" x 2 7/8" x 3"

HOW TO ORDER – 1W ELECTRIC SWITCH LOCK

1W	7	B1	626	SWR
Series	Core Housing	Function	Finishes	Box
1W	7- 7 pin housing accepts all BEST® cores	see pages 15-19	605 606 611 612 613 619 622 625 626 690	OC1 OC2 INT SWR

1W ELECTRIC SWITCH LOCKS

1W7A1

Contacts	Silver or gold flash
Contact rating	28 VDC, 10 amps resistive 28 VDC, 3 amps inductive, lamp 125 VAC, 10.1 amps resistive 250 VAC, 10.1 amps resistive
Horsepower rating	125 VAC, 1/4 HP
Operating temperature	-85°F to +257°F (-65° to +125°C)
Switch type	SPDT (Single pole-double throw)
Switch lock action	Maintained
Number of switches per assembly	One



1W7A1

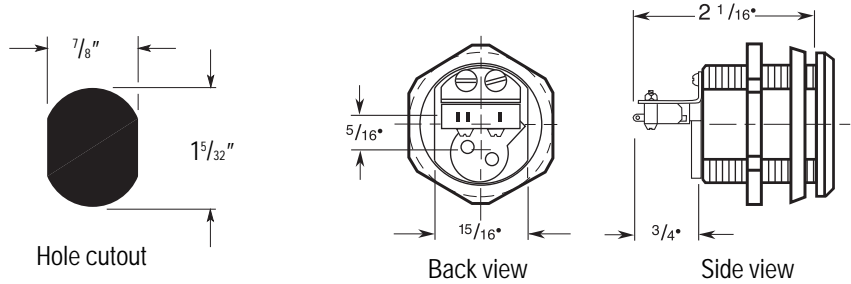

Key & switch positions

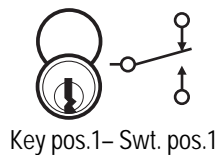

Key pos. 1- Swt. pos. 1

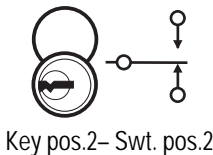

Key pos. 2- Swt. pos. 2

Remove key

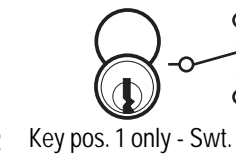

Key pos. 1 only - Swt. pos. 1

Optional boxes

- SWR
- INT
- OC2

1W7B1 & 1W7J1

Contact rating	30 VDC, 15 amps, resistive 125 VDC, 0.6 amps, resistive 250 VDC, 0.3 amps, resistive 125 VAC, 15 amps, resistive 25 VAC, 5 amps, lamp 250 VAC, 15 amps, resistive
Horsepower rating	125-250 VAC, 1/2 HP
Operating temperature	up to +176°F (+80°C)
Switch type	SPDT (Single pole-double throw)
Switch lock action	Maintained
Number of switches per assembly	1W7B1: One 1W7J1: Two



1W7B1—One switch

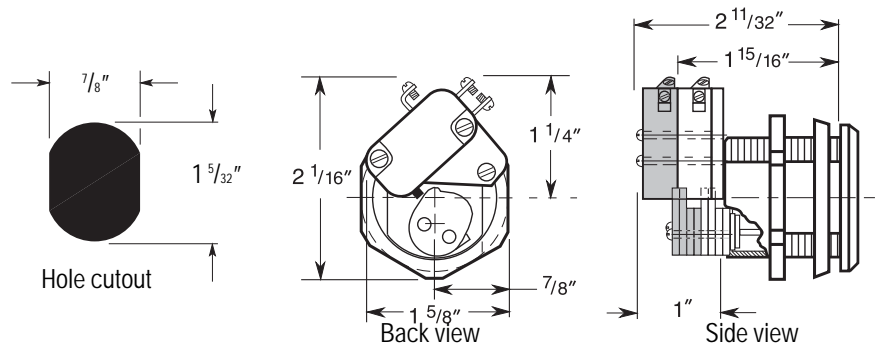

The shaded area shows the additional 1W7J1 switch and cam length.

Key & switch positions

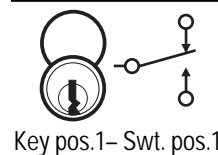

Key pos. 1- Swt. pos. 1

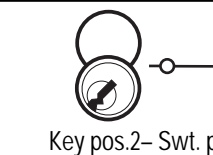

Key pos. 2- Swt. pos. 2

Remove key

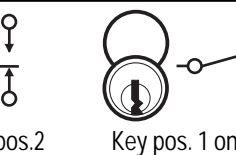

Key pos. 1 only
Swt. pos. 1

Optional boxes

- OC1 (1W7B1 only)
- OC2
- INT
- SWR



1W7J1—Two switches

1W ELECTRIC SWITCH LOCKS

1W7B2 & 1W7J2

Contact rating	30 VDC, 15 amps, resistive 125 VDC, 0.6 amps, resistive 250 VDC, 0.3 amps, resistive 125 VAC, 15 amps, resistive 125 VAC, 5 amps, lamp 250 VAC, 15 amps, resistive
Horsepower rating	125–250 VAC, 1/2 HP
Operating temperature	up to +176°F (+80°C)
Switch type	SPDT (Single pole-double throw)
Switch lock action	Maintained
Number of switches per assembly	1W7B2: One 1W7J2: Two



1W7B2—One switch



1W7J2—Two switches

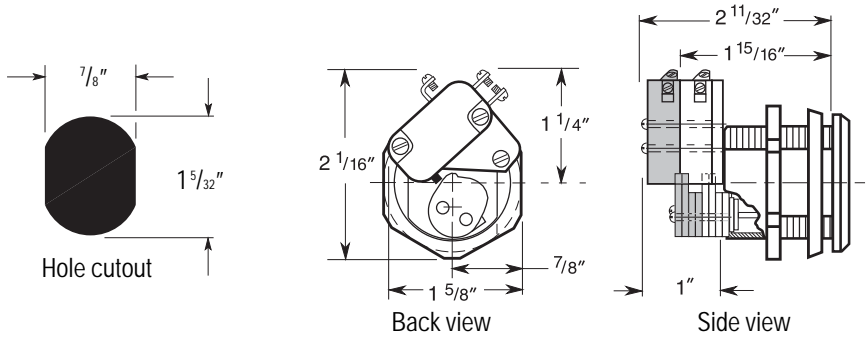

The shaded area shows the additional 1W7J2 switch and cam length.

Key & switch positions

Remove key

Optional boxes



Key pos.1– Swt. pos.1



Key pos. 2 Swt. pos. 2
(360°CCW)



Key pos. 1 and 2
Swt. pos. 1 and 2

- OC1 (1W7B2 only)
- OC2
- INT
- SWR

1W7B3 & 1W7J3

Contact rating	30 VDC, 15 amps, resistive 125 VDC, 0.6 amps, resistive 250 VDC, 0.3 amps, resistive 125 VAC, 15 amps, resistive 125 VAC, 5 amps, lamp 250 VAC, 15 amps, resistive
Horsepower rating	125–250 VAC, 1/2 HP
Operating temperature	up to +176°F (+80°C)
Switch type	SPDT (Single pole-double throw)
Switch lock action	Momentary
Number of switches per assembly	1W7B3: One 1W7J3: Two

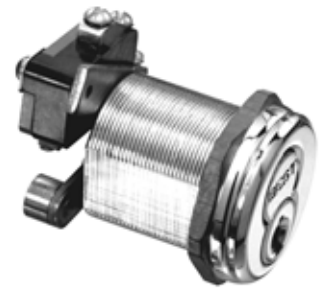

1W7B3—One switch

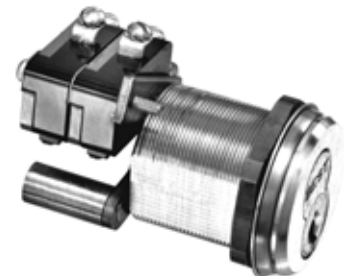

1W7J3—Two switches

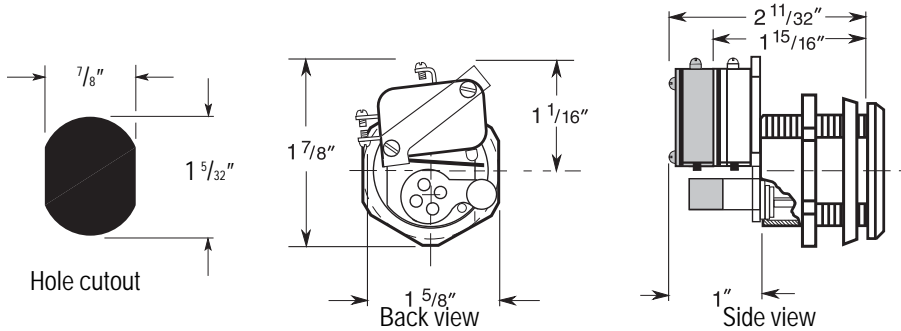

The shaded area shows the additional 1W7J3 switch and cam length.

Key & switch positions

Remove key

Optional boxes



Key pos.1– Swt. pos.1



Key pos.2– Swt. pos.2



Key pos.1– Swt. pos.1

- OC1 (1W7B3 only)
- OC2
- INT
- SWR

1W ELECTRIC SWITCH LOCKS

1W7D2

Contact rating 110 VAC or VDC, 16 amps, resistive
 220 VAC or VDC, 8 amps, resistive
Horsepower rating 1 HP @ 125-250 VAC or VDC
Operating temperature 0°F to +150°F (-18°C to +66°C)
Switch type DPST (Double pole-single throw)
Switch lock action Maintained
Number of switches per assembly One



1W7D2

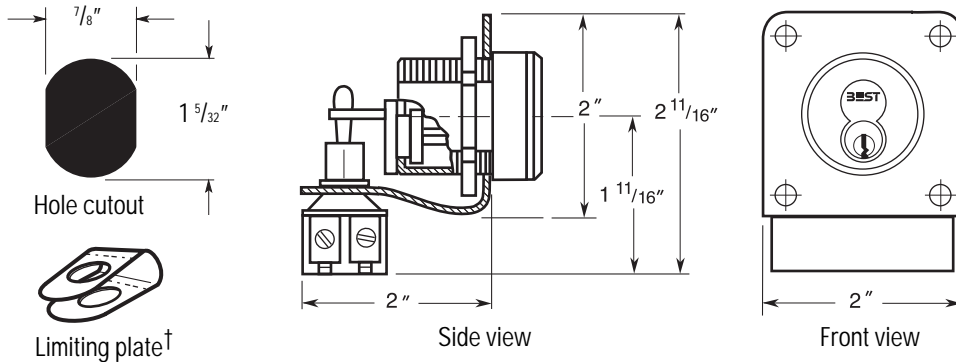

Key & switch position

Remove key Optional boxes

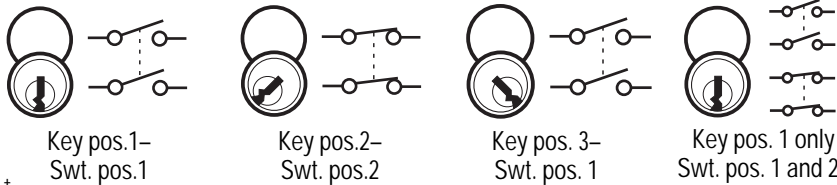

SWR

† Installing the limiting plate limits key removal to switch position 1 or 2. The key is always removed in the vertical position (key position 1).

1W7C2

Contact rating 110 VAC or VDC, 10 amps, lamp
 220 VAC or VDC, 5 amps, resistive
Operating temperature -40°F to +150°F (-40° to +65°C)
Switch type SPST (Single pole-single throw)
Switch lock action Maintained
Number of switches per assembly One



1W7C2

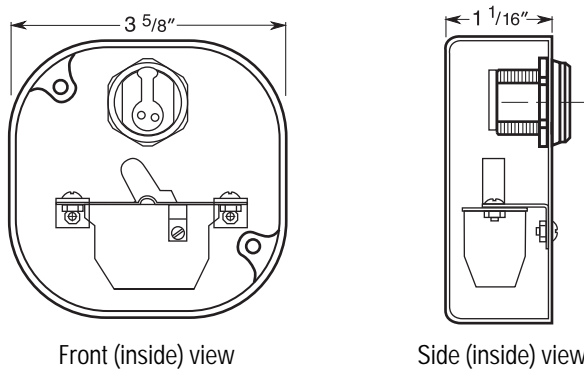

Key & switch positions

Remove key Optional boxes

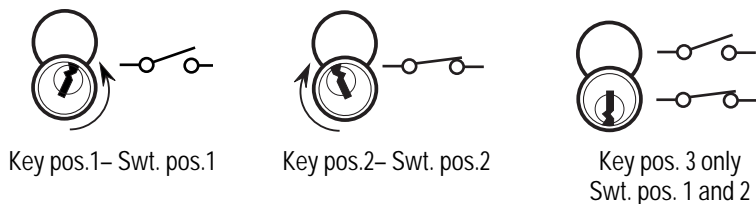

OC1

1W ELECTRIC SWITCH LOCKS

1W7E2

Contact rating	110 VAC, 15 amps, resistive
	220 VAC, 10 amps, resistive
Horsepower rating	125–250 VAC or VDC, 3/4 HP; 1, 2, or 3 phase
Operating temperature	0 to +150°F (-18°C to 66°C)
Switch type	TPDT (Triple pole-double throw)
Switch lock action	Maintained
Number of switches per assembly	One



1W7E2

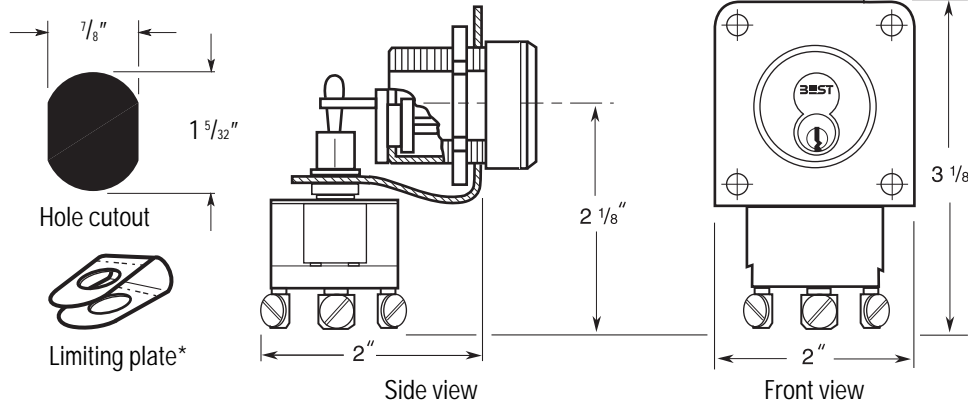

Key & switch positions

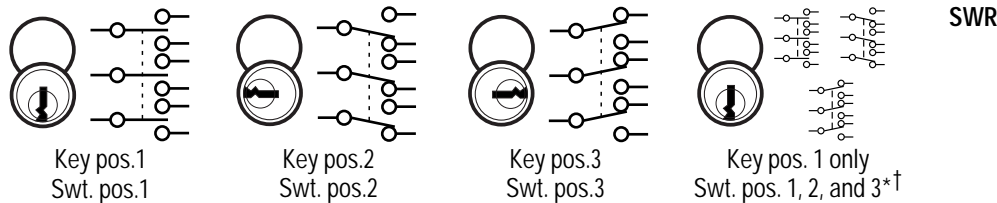

*Installing the limiting plate limits key removal to switch position 2, or 3. The key is always removed in the vertical position (key position 1).

1W7K4

Contact rating	110 VAC, 15 amps, resistive
	220 VAC, 10 amps, resistive
Horsepower rating	250 VAC, 1/2 HP
Operating temperature	up to +221°F (+105°C)
Switch type	DPDT (Double pole-double throw)
Switch lock action	Momentary
Number of switches per assembly	One



1W7K4

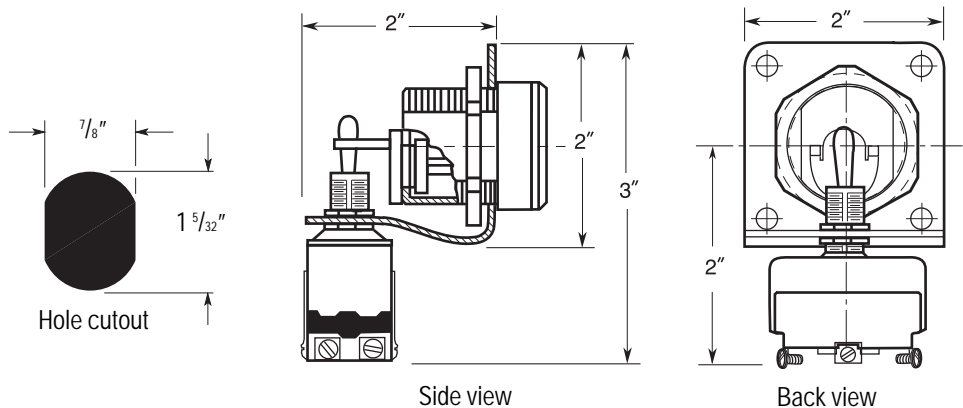

Key & switch positions

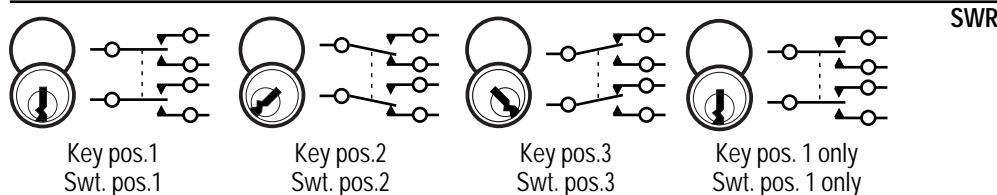

1W ELECTRIC SWITCH LOCKS

1W7L2

1W ELECTRIC SWITCH LOCKS

Contact rating 110 VAC or VDC, 12 amps, resistive
 220 VAC or VDC, 6 amps, resistive
 Operating temperature up to +221°F (+105°C)
 Switch type SPDT (Single pole-double throw)
 Switch lock action Maintained
 Number of switches per assembly One

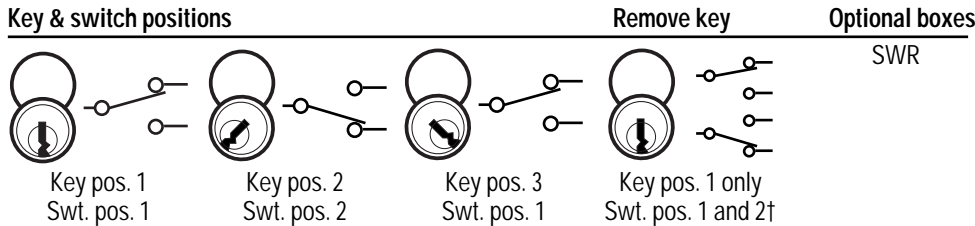
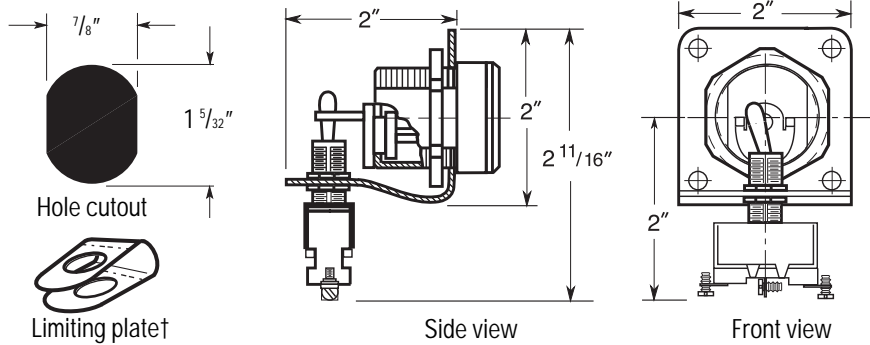

†Installing the limiting plate limits key removal to switch position 1 or 2. The key is always removed in the vertical position (key position 1).

Contact rating 30 VDC, 15 amps, resistive
 125 VDC, 0.6 amps, resistive
 250 VDC, 0.3 amps, resistive
 125 VAC, 15 amps, resistive
 125 VAC, 5 amps, lamp
 250 VAC, 15 amps, resistive
 Horsepower rating 125–250 VAC, 1/2 HP
 Operating temperature up to +176°F (+80°C)
 Switch type SPDT (Single pole-double throw)
 Switch lock action Momentary
 Number of switches per assembly 1W7P4: Two 1W7R4: Four

1W7P4 & 1W7R4

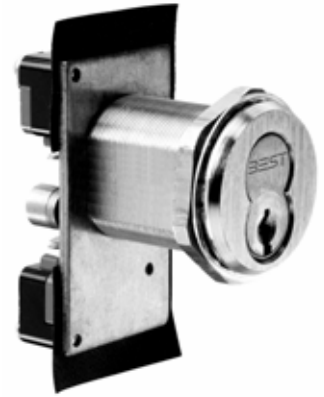

1W7P4—two switches



1W7R4—four switches

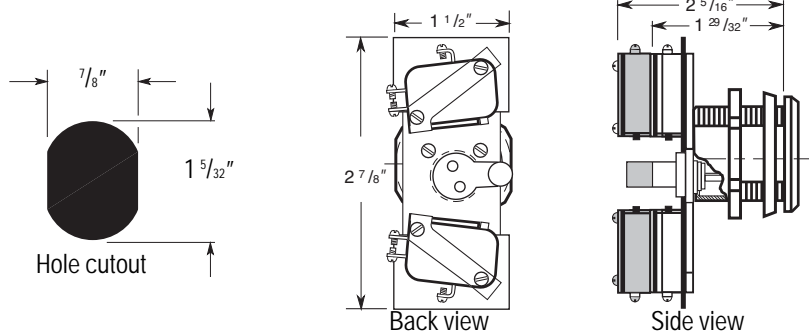

The shaded area shows the additional 1W7R4 switches and cam length.

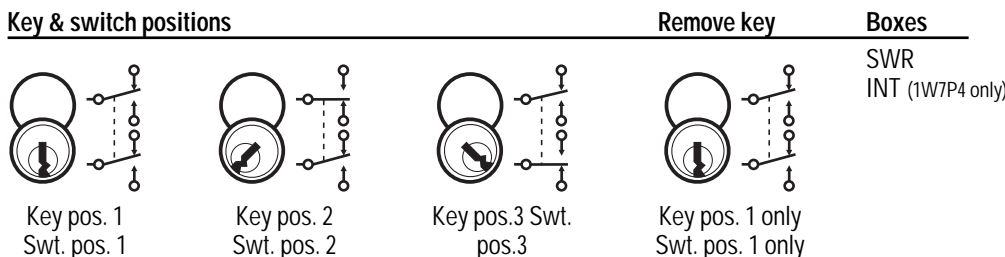

SWR
INT (1W7P4 only)

STANLEY QUICK CONNECT SYSTEM



Stanley Quick Connect plug-in connectors must be used with the following components to work as a complete plug-and-play system:

1. Specify appropriate PRECISION or BEST electrified products
2. Specify correct wire harness length from door hardware to electric power transfer device or electrified hinge
3. Specify either the NEW electric power transfer (EPT-12C) or the NEW electrified hinge (CECB179-12C)
4. Specify correct wire harness length from power transfer or electrified hinge to wire extension (WH-6E)
5. Choose wire harness extension to connect to power source

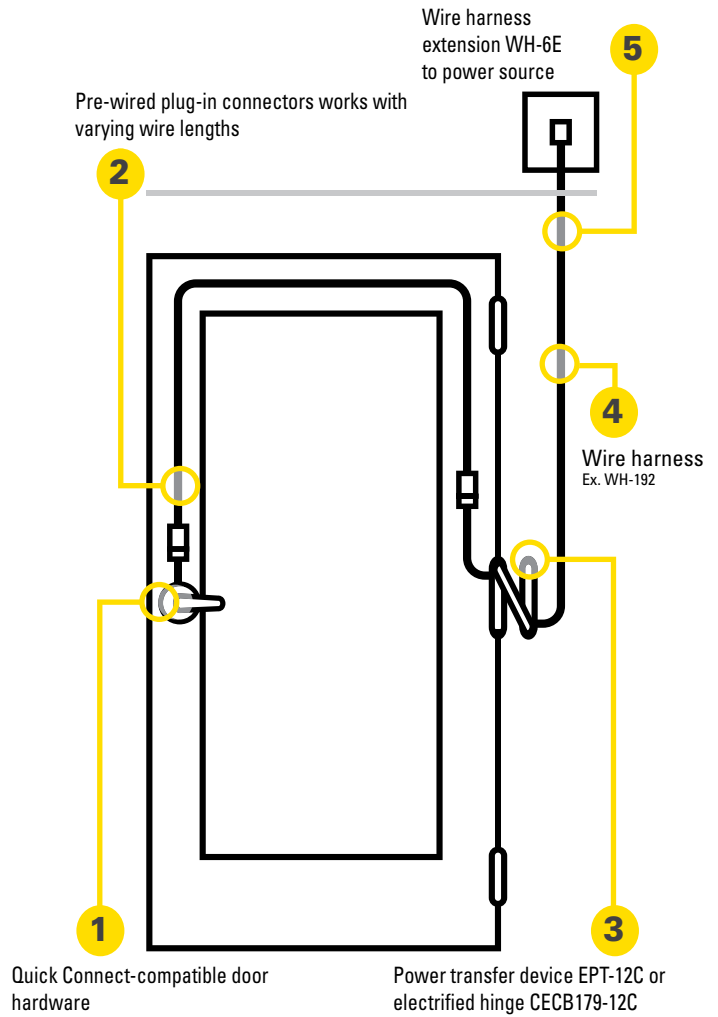

HOW TO ORDER

To order the StanleyQuick Connect pre-wired plug-in connectors, include the "C" suffix for the BEST electrified locks. See example below.

Example:

BEST Locks
45HW 7 DEL 14H 626 RH DS **C**



BEST Locks
9KW 37 DEU 15CS TK 626 24 V **C**



Stanley Security Solutions, a business division of Stanley Black & Decker, is a provider of integrated access control and security solutions for institutional, commercial and industrial businesses and organizations. Stanley Security Solutions delivers a comprehensive suite of security products, software and integrated systems with a strong emphasis on service. Stanley Security Solutions is committed to extending its position as a leading comprehensive resource for a broad and extensive array of solutions that span the entire security spectrum.