

Emissions Test Report

EUT Name: eero 6 and eero 6 Extender

Model No.: N010001 and Q010001

CFR 47 Part 15.247: 2020 and RSS 247 Issue 2, 2017

Prepared for:

eero LLC
660 3rd Street
San Francisco, CA 94107 U.S.A.

Prepared by:

TUV Rheinland of North America, Inc.
1279 Quarry Lane
Pleasanton, CA 94566
Tel: (925) 249-9123
Fax: (925) 249-9124
<http://www.tuv.com/>

Report/Issue Date: June 17, 2020
Revision Number 0
Project Number: 234155861
Report Number: 32062470.001

Statement of Compliance

Applicant: eero LLC
660 3rd Street
San Francisco, CA 94107

Requester / Applicant: eero LLC
+1 415-738-7972

Name of Equipment: eero 6 and eero 6 Extender
Model No. N010001 and Q010001

Type of Equipment: Intentional Radiator

Application of Regulations: CFR 47 Part 15.247: 2020 and RSS 247 Issue 2, 2017

Test Dates: June 5, 2020 to June 10, 2020

Guidance Documents:

Emissions: ANSI C63.10-2013, KDB 558074 D01 DTS Measurement Guidance v05r02

Test Methods:

Emissions: ANSI C63.10-2013, KDB 558074 D01 DTS Measurement Guidance v05r02

The electromagnetic compatibility test and documented data described in this report has been performed and recorded by TUV Rheinland, in accordance with the standards and procedures listed herein. As the responsible authorized agent of the EMC laboratory, I hereby declare that the equipment described above has been shown to be compliant with the EMC requirements of the stated regulations and standards based on these results. If any special accessories and/or modifications were required for compliance, they are listed in the Executive Summary of this report.

This report must not be used to claim product endorsement by A2LA or any agency of the U.S. Government. This report contains data that are not covered by A2LA accreditation. This report shall not be reproduced except in full, without the written authorization of TUV Rheinland of North America.



Kerwinn Corpuz

James Borrott

Test Engineer

Date June 17, 2020

Reviewer Signatory

Date August 31, 2020



Industry
Canada

Industrie
Canada

Testing Cert #3331.02

US1131

2932M

Table of Contents

1	Executive Summary	7
1.1	Scope	7
1.2	Purpose	7
1.3	Summary of Test Results	8
1.4	Special Accessories	8
1.5	Equipment Modifications	8
2	Laboratory Information	9
2.1	Accreditations & Endorsements	9
2.1.1	US Federal Communications Commission	9
2.1.2	NIST / A2LA	9
2.1.3	Canada	9
2.1.4	Japan – VCCI	9
2.1.5	Acceptance by Mutual Recognition Arrangement	9
2.2	Test Facilities	10
2.2.1	Emission Test Facility	10
2.2.2	Immunity Test Facility	10
2.3	Measurement Uncertainty	10
2.3.1	Sample Calculation – radiated & conducted emissions	11
2.3.2	Measurement Uncertainty	11
	Measurement Uncertainty - EMC Immunity	12
2.4	Calibration Traceability	12
3	Product Information	13
3.1	Product Description	13
3.2	Equipment Configuration	13
3.3	Operating Mode	13
3.4	Unique Antenna Connector	14
3.4.1	Results	14
3.5	Duty Cycle	15
3.5.1	Results	15
4	Emissions	16
4.1	Output Power Requirements	16
4.1.1	Test Method	16
4.1.2	Results	17
4.2	Occupied Bandwidth	20
4.2.1	Test Method	20
4.2.2	Results	21
4.3	Peak Power Spectral Density	25
4.3.1	Test Method	25
4.3.2	Results	26

Table of Contents

4.4	Out of Band Emissions	29
4.4.1	Test Method	29
4.4.2	Results	30
4.5	Transmit Spurious Emissions	34
4.5.1	Test Methodology	34
4.5.2	Transmitter Spurious Emission Limit	35
4.5.3	Test Results	35
4.5.4	Sample Calculation	49
4.6	AC Conducted Emissions	50
4.6.1	Test Methodology	50
4.6.2	Test Results	50
5	Test Equipment List	55
5.1	Equipment List	55
6	EMC Test Plan	56
6.1	Introduction	56
6.2	Customer	56
6.3	Equipment Under Test (EUT)	57
6.4	Test Specifications	60

Index of Tables

Table 1: Summary of Test Results 8

Table 2: RF Output Power at the Antenna Port – Test Results 17

Table 3: Occupied Bandwidth – Test Results 21

Table 4: Peak Power Spectral Density – Test Results 26

Table 5: Out of Band Emissions – Test Results 30

Table 6: Transmit Spurious Emission at Band-Edge Requirements 36

Table 7: AC Conducted Emissions – Test Results 50

Table 8: Customer Information 56

Table 9: Technical Contact Information 56

Table 10: EUT Specifications 57

Table 11: Interface Specifications 58

Table 12: Supported Equipment 58

Table 13: Description of Sample used for Testing 58

Table 14: Description of Test Configuration used for Radiated Measurement. 58

Table 15: Final Test Mode for 2402 MHz to 2480MHz Band (Bluetooth LE) 59

Table 16: Test Specifications 60

1 Executive Summary

1.1 Scope

This report is intended to document the status of conformance with the requirements of the CFR 47 Part 15.247: 2020 and RSS 247 Issue 2, 2017 based on the results of testing performed on June 5, 2020 to June 10, 2020 on the eero 6 and eero 6 Extender Model N010001 and Q010001 manufactured by eero LLC This report only applies to the specific samples tested under the stated test conditions. It is the responsibility of the manufacturer to assure that additional production units of this model are manufactured with identical or EMI equivalent electrical and mechanical components. This report is further intended to document changes and modifications to the EUT throughout its life cycle. All documentation will be included as a supplement.

1.2 Purpose

Testing was performed to evaluate the EMC performance of the EUT in accordance with the applicable requirements, procedures, and criteria defined in the application of regulations and application of standards listed in this report. The 2402 MHz to 2480 MHz frequency band is covered in this document.

1.3 Summary of Test Results

Table 1: Summary of Test Results

Test	Test Method ANSI C63.10	Test Parameters	Measured Value	Result
Spurious Emission in Transmitted Mode	CFR47 15.209, CFR47 15.247 (d), RSS-GEN Sect.8.9	Class B	-2.34 dB (Margin)	Complied
Restricted Bands of Operation	CFR47 15.205, RSS GEN Sect.8.10	Class B		Complied
AC Power Conducted Emission	CFR47 15.207, RSS-GEN Sect.8.8	Class B	-9.63 dB (Margin)	Complied
Occupied Bandwidth	CFR47 15.247 (a2), RSS GEN 6.7, RSS 247 Sect.5.2 (a)	≥ 500 kHz	0.694 MHz (DTS) 1.054 MHz (99%)	Complied
Maximum Output Power	CFR47 15.247 (b), RSS 247 Sect. 5.4 (d)	30 dBm w/ 6 dBi antenna	+19.55 dBm	Complied
Peak Power Spectral Density	CFR47 15.247 (e), RSS 247 Sect. 5.2 (b)	8 dBm/ 3 kHz	-2.29 dBm	Complied
Out of Band Emission	CFR47 15.247 (d), RSS 247 Sect.5.5	-30 dB	-21.02 dB (Margin)	Complied

1.4 Special Accessories

No special accessories were necessary in order to achieve compliance.

1.5 Equipment Modifications

None

2 Laboratory Information

2.1 Accreditations & Endorsements

2.1.1 US Federal Communications Commission



TUV Rheinland of North America at 1279 Quarry Ln, Pleasanton, CA 94566 is recognized by the commission for performing testing services for the general public on a fee basis. These laboratory test facilities have been fully described in reports submitted to and accepted by the FCC (US1131). The laboratory scope of accreditation includes: Title 47 CFR Parts 15, 18, and 90. The accreditation is updated every 3 years.

2.1.2 NIST / A2LA



TUV Rheinland of North America is accredited by the National Voluntary Laboratory Accreditation Program, which is administered under the auspices of the National Institute of Standards and Technology. The laboratory has been assessed and accredited in accordance with ISO Guide 17025:2017 and ISO 9002 (Lab Code Testing Cert #3331.02). The scope of laboratory accreditation includes emission and immunity testing. The accreditation is updated annually.

2.1.3 Canada



TUV Rheinland of North America at the 1279 Quarry Ln, Pleasanton, CA 94566 address is accredited by Industry Canada for performing testing services for the general public on a fee basis. This laboratory test facilities have been fully described in reports submitted to and accepted by Industry Canada (File Number 2932M). This reference number is the indication to the Industry Canada Certification Officers that the site meets the requirements of RSS 212, Issue 1 (Provisional). The accreditation is updated every 3 years.

2.1.4 Japan – VCCI



The Voluntary Control Council for Interference by Information Technology Equipment (VCCI) is a group that consists of Information Technology Equipment (ITE) manufacturers and EMC test laboratories. The purpose of the Council is to take voluntary control measures against electromagnetic interference from Information Technology Equipment, and thereby contribute to the development of a socially beneficial and responsible state of affairs in the realm of Information Technology Equipment in Japan. TUV Rheinland of North America at 1279 Quarry Ln, Pleasanton, CA 94566 has been assessed and approved in accordance with the Regulations for Voluntary Control Measures.

VCCI Registration No. for Pleasanton: A-0326

2.1.5 Acceptance by Mutual Recognition Arrangement



The United States has an established agreement with specific countries under the Asia Pacific Laboratory Accreditation Corporation (APLAC) Mutual Recognition Arrangement. Under this agreement, all TUV Rheinland at 1279 Quarry Ln, Pleasanton, CA 94566 test results and test reports within the scope of the laboratory NIST / A2LA accreditation will be accepted by each member

country.

2.2 Test Facilities

All of the test facilities are located at 1279 Quarry Lane, Pleasanton, California 94566, USA.

2.2.1 Emission Test Facility

The Semi-Anechoic chamber and AC Line Conducted measurement facility used to collect the radiated and conducted data has been constructed in accordance with ANSI C63.7:1992. The site has been measured in accordance with and verified to comply with the theoretical normalized site attenuation requirements of ANSI C63.4-2014, at a test distance of 3 and 5 meters. The site is listed with the FCC and accredited by A2LA (Lab Code Testing Cert #3331.02). The 3/5-meter semi-anechoic chamber used to collect the radiated data has been verified to comply with the theoretical normalized site attenuation requirements of ANSI C63.4-2014, at a test distance of 3 meter and 5 meters. A report detailing this site can be obtained from TUV Rheinland of North America.

2.2.2 Immunity Test Facility

ESD, EFT, Surge, PQF: These tests are performed in an environmentally controlled room with a 3.7 m x 4.8 m x 3.175 mm thick aluminum floor connected to PE ground.

For ESD testing, tabletop equipment is placed on an insulated mat with a surface resistivity of 10^9 Ohms/square on a 1.6 m x 0.8 m x 0.8 m high non-conductive table with a 3.175 mm aluminum top (Horizontal Coupling Plane). The HCP is connected to the main ground plane via a low impedance ground strap through two 470-k Ω resistors. The Vertical Coupling Plane consists of an aluminum plate 50 cm x 50 cm x 3.175 mm thick. The VCP is connected to the main ground plane via a low impedance ground strap through two 470-k Ω resistors.

For EFT, Surge, PQF, the HCP and VCP are removed.

RF Field Immunity testing is performed in a 7.3m x 4.3m x 4.1m anechoic chamber.

RF Conducted and Magnetic Field Immunity testing is performed on a 4.8m x 3.7m x 3.175mm thick aluminum ground plane.

All test areas allow a minimum distance of 1 meter from the EUT to walls or conducting objects.

2.3 Measurement Uncertainty

Two types of measurement uncertainty are expressed in this report, per *ISO Guide To The Expression Of Uncertainty In Measurement*, 1st Edition, 1995.

The Combined Standard Uncertainty is the standard uncertainty of the result of a measurement when that result is obtained from the values of a number of other quantities; it is equal to the positive square root of the sum of the variances or co-variances of these other quantities, weighted according to how the measurement result varies with changes in these quantities. The term *standard uncertainty* is the result of a measurement expressed as a standard deviation.

2.3.1 Sample Calculation – radiated & conducted emissions

The field strength is calculated by subtracting the Amplifier Gain and adding the Cable Loss and Antenna Correction Factor to the measured reading. The basic equation is as follows:

$$\text{Field Strength (dB}\mu\text{V/m)} = \text{RAW} - \text{AMP} + \text{CBL} + \text{ACF}$$

Where: RAW = Measured level before correction (dB μ V)

AMP = Amplifier Gain (dB)

CBL = Cable Loss (dB)

ACF = Antenna Correction Factor (dB/m)

$$\mu\text{V/m} = 10^{\frac{\text{dB}\mu\text{V/m}}{20}}$$

Sample radiated emissions calculation @ 30 MHz

Measurement +Antenna Factor–Amplifier Gain+Cable loss=Radiated Emissions (dBuV/m)

$$25 \text{ dBuV/m} + 17.5 \text{ dB} - 20 \text{ dB} + 1.0 \text{ dB} = 23.5 \text{ dBuV/m}$$

2.3.2 Measurement Uncertainty

Per CISPR 16-4-2	U _{lab}	U _{cispr}
Radiated Disturbance @ 10 meters		
30 – 1,000 MHz	2.25 dB	4.51 dB
Radiated Disturbance @ 3 meters		
30 – 1,000 MHz	2.26 dB	4.52 dB
1 – 6 GHz	2.12 dB	4.25 dB
6 – 40 GHz	2.47 dB	4.93 dB
Conducted Disturbance @ Mains Terminals		
150 kHz – 30 MHz	1.09 dB	2.18 dB
Disturbance Power		
30 MHz – 300 MHz	3.92 dB	4.3 dB

Voltech PM6000A

The estimated combined standard uncertainty for harmonic current and flicker measurements is \pm 5.0%.	Per CISPR 16-4-2 Methods
--	--------------------------

Measurement Uncertainty - EMC Immunity

The estimated combined standard uncertainty for ESD immunity measurements is \pm 8.2%.	Per IEC 61000-4-2
The estimated combined standard uncertainty for radiated immunity measurements is \pm 4.10 dB.	Per IEC 61000-4-3
The estimated combined standard uncertainty for conducted immunity measurements with CDN is \pm 3.66 dB	Per IEC 61000-4-6
The estimated combined standard uncertainty for power frequency magnetic field immunity is \pm 2.9%.	Per IEC 61000-4-8
The estimated combined standard uncertainty for EFT fast transient immunity measurements is \pm 2.6%.	Per IEC 61000-4-4
The estimated combined standard uncertainty for surge immunity measurements is \pm 2.6%.	Per IEC 61000-4-5
The estimated combined standard uncertainty for voltage variation and interruption measurements is \pm 1.74%.	Per IEC 61000-4-11

Measurement Uncertainty – Radio Testing

The estimated combined standard uncertainty for frequency error measurements is \pm 3.88 Hz
The estimated combined standard uncertainty for carrier power measurements is \pm 0.70 dB.
The estimated combined standard uncertainty for adjacent channel power measurements is \pm 1.47 dB.
The estimated combined standard uncertainty for modulation frequency response measurements is \pm 0.46 dB.
The estimated combined standard uncertainty for transmitter conducted emission measurements is \pm 2.06 dB

The expanded uncertainty at a level of 95% confidence is obtained by multiplying the combined standard uncertainty by a coverage factor of 2. Compliance criteria are not based on measurement uncertainty.

2.4 Calibration Traceability

All measurement instrumentation is traceable to the National Institute of Standards and Technology (NIST). Measurement method complies with ANSI/NCSL Z540-1-1994 and ISO Standard 17025:2017. Equipment calibration records are kept on file at the test facility.

3 Product Information

3.1 Product Description

The Model N010001 and Q010001, eero 6 and eero 6 Extender, is a 2x2 home WiFi router. It is intended to operate as a dual band (2.4GHz and 5GHz) wireless router over 20 MHz, 40 MHz and 80 MHz channels. The router will be in compliance with regulatory standards of regions it will be operating in.

Model differences:

N010001, eero 6 Gateway, contains two RJ45 ports and USB-C AC/DC adapter port.

Q010001, eero 6 Extender, USB-C AC/DC adapter port; No RJ45 ports. BLE/802.15.4 RF circuitry has been removed.

Both have the same WLAN radio hardware.

Model N010001 is considered worst case and used for testing.

3.2 Equipment Configuration

A description of the equipment configuration is given in the Test Plan Section. The EUT was tested as called for in the test standard and was configured and operated in a manner consistent with its intended use. The EUT was connected to rated power and allowed to reach intended operating conditions. The placement of the EUT system components was guided by the test standard and selected to represent typical installation conditions.

In the case of an EUT that can operate in more than one configuration, preliminary testing was performed to determine the configuration that produced maximum radiation.

The final configuration was selected to produce the worst case radiation for emissions testing and to place the EUT in the most susceptible state for immunity testing.

3.3 Operating Mode

A description of the operation mode is given in the Test Plan Section. In the case of an EUT that can operate in more than one state, preliminary testing was performed to determine the operating mode that produced maximum radiation.

The final operating mode was selected to produce the worst case radiation for emissions testing and to place the EUT in the most susceptible state for immunity testing.

3.4 Unique Antenna Connector

An intentional radiator shall be designed to ensure that no antenna other than that furnished by the responsible party shall be used with the device. The use of a permanently attached antenna or of an antenna that uses a unique coupling to the intentional radiator shall be considered sufficient to comply with the provisions of this Section. The manufacturer may design the unit so that a broken antenna can be replaced by the user, but the use of a standard antenna jack or electrical connector is prohibited. This requirement does not apply to carrier current devices or to devices operated under the provisions of CFR47 Parts 15.211, 15.213, 15.217, 15.219, or 15.221.

3.4.1 Results

The N010001 has 3 internal antennas. BLE and ZigBee uses 1 Stamped Metal, Planar Inverted F, Antenna and 2 Flex PCB for WiFi in the band 2.4 GHz and 5 GHz.

The Q010001 has 2 internal antennas, 2 Flex PCB for WiFi in the band 2.4 GHz and 5 GHz.

Max Antenna Gain		Antenna Type		
	dBi			
BLE/ZigBee (2.4-2483.5 GHz)	3.46	Stamped metal, Planar Inverted F		
Wi-Fi			<u>Antenna 1 (dBi)</u>	<u>Antenna 2 (dBi)</u>
2.4-2483.5 GHz	3.72	Flexible Printed Circuit Board (FPCB)	3.72	3.25
U-NII-1 (5.15-5.25 GHz)	3.42	Flexible Printed Circuit Board (FPCB)	2.52	3.42
U-NII-2A (5.25-5.35 GHz)	2.37		1.69	2.37
U-NII-2C (5.47-5.725 GHz)	3.57		2.72	3.57
U-NII-3 (5.725-5.85 GHz)	4.17		4.04	4.17

3.5 Duty Cycle

The N010001, were measured for the duty cycle.

3.5.1 Results

Mode	On Time (ms)	Period (ms)	Duty Cycle (%)	Duty Factor (dB)
Standard	100	0	100	0

Notes: EUT was configured and measured for the duty cycle. All measurements use 100% duty cycle.



Figure 1: BLE Duty Cycle

4 Emissions

Testing was performed in accordance with CFR 47 Part 15.247: 2020 and RSS 247 Issue 2, 2017. These test methods are listed under the laboratory's A2LA Scope of Accreditation. This test measures the levels emanating from the EUT, thus evaluating the potential for the EUT to cause radio frequency interference to other electronic devices. Procedures described in section 8 of the standard were used.

4.1 Output Power Requirements

The maximum output power requirement is the maximum equivalent isotropic radiated power delivering at the transmitting antenna under specified conditions of measurements in the presence of modulation.

The maximum output power and harmonics shall not exceed CFR47 Part 15.247 (b):2020 and RSS 247: 2017 Sect. 5.4.(d).

The maximum transmitted powers are

Band 2400-2483.5 MHz: 1 W

4.1.1 Test Method

The ANSI C63.10-2013 Section 11.9.2.2.2. conducted method was used to measure the channel power output. The preliminary investigation was performed at different data rate/ chain to determine the highest power output for each mode. The worst findings were conducted on 3 channels in each operating range per CFR47 Part 15.247(b): 2020 and RSS 247 Sect. 5.4 (d). This test was conducted on 3 channels of Sample. The worst mode result indicated below.

Test Setup:

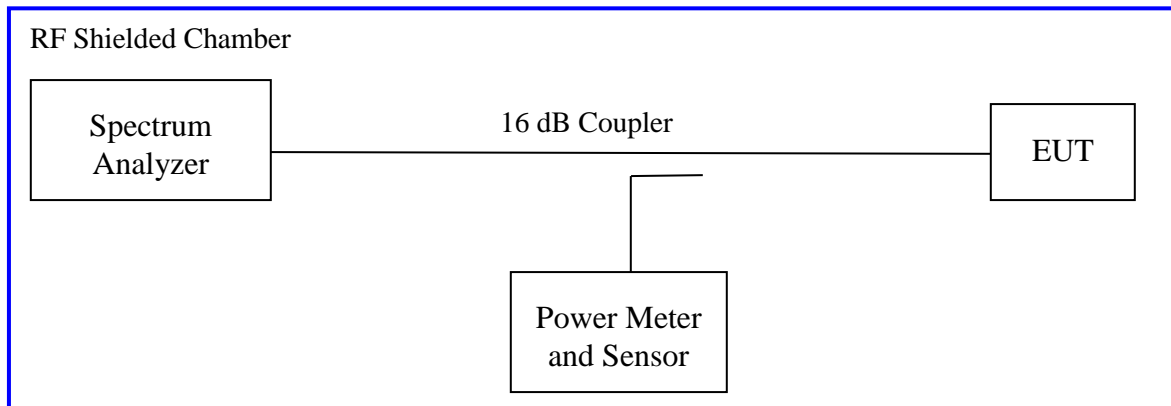

Method AVGSA-1 of "KDB 558074 – DTS Measurement Guidance v05r02" applies since the EUT continuously transmits with duty cycle greater than 98%. Sample detector was used.

4.1.2 Results

As originally tested, the EUT was found to be compliant to the requirements of the test standard(s).

Table 2: RF Output Power at the Antenna Port – Test Results

Test Date: June 10, 2020			Test By: Kerwinn Corpuz		
Test Method: Conducted Measurements			Power Setting: Fixed at 20 dBm		
Antenna Type: Stamped Metal			Max. Antenna Gain: 3.46 dBi		
Operating Mode: Uncorrelated			Signal State: Modulated at 1 Mbps		
Ambient Temp.: 21 °C			Relative Humidity: 37%		
Wireless Router (Bluetooth LE)					
Frequency (MHz)	Limit [dBm]	Output [dBm]	Duty Cycle [dB]	∑ Power [dBm]	Margin [dB]
2402	+30.00	19.55			-10.45
2440	+30.00	19.24			-10.76
2480	+30.00	18.87			-11.13
Note: The EUT transmitted at 100% duty cycle. The highest power output observed was at 1 Mbps					

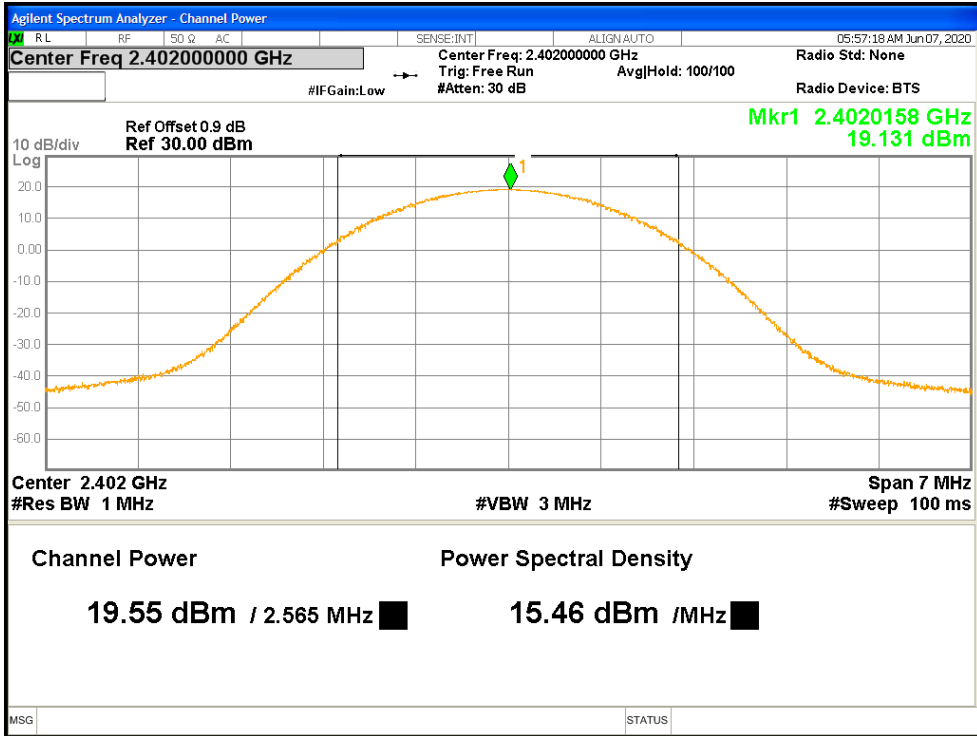

Figure 2: BLE Maximum Conducted Output Power at 2402 MHz

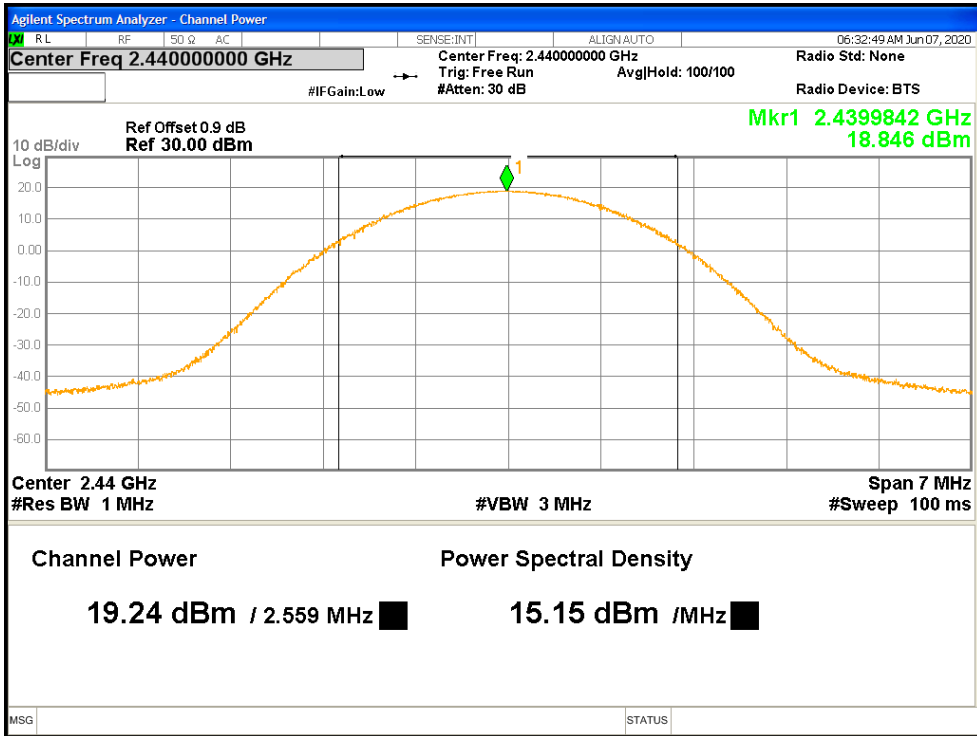

Figure 3: BLE Maximum Conducted Output Power at 2440 MHz

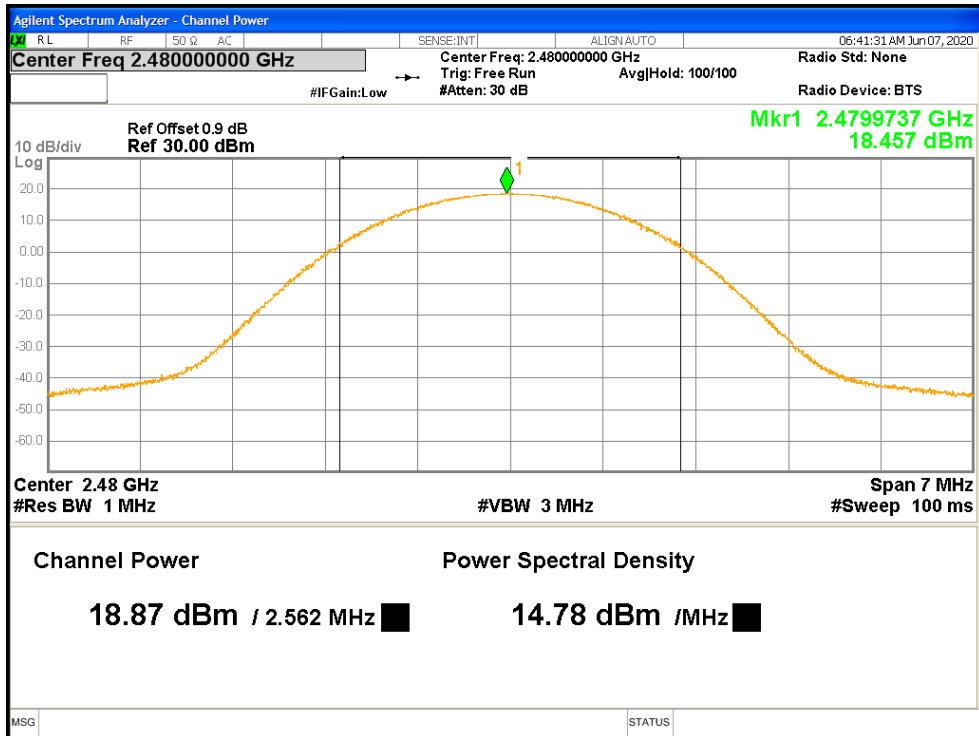

Figure 4: BLE Maximum Conducted Output Power at 2480 MHz

4.2 Occupied Bandwidth

The occupied bandwidth is measured at an amplitude level reduced from the reference level by a specified ratio. The reference level is the level of the highest amplitude signal observed from the transmitter at the fundamental frequency.

The 99% bandwidth is the bandwidth in which 99% of the transmitted power occupied.

The minimum 6 dB bandwidth shall be at least 500 kHz.

The bandwidth shall be at least 500 kHz per Section CFR47 15.247(a2) 2020 and RSS 247 Sect.5.2 (a): 2017

4.2.1 Test Method

The conducted method was used to measure the occupied bandwidth according to ANSI C63.10:2013 Section 11.8.1. The measurement was performed with modulation per CFR47 15.247(a) (2) 2020 and RSS Gen Sect. 6.7 2019. The preliminary investigation was performed to find the narrowest 6 dB bandwidth for each operational mode at different data rates. This worst finding was performed on 3 channels in each operating frequency range; 2400 MHz to 2483.5 MHz. This test was conducted on 3 channels in each mode of Sample. The worst sample result indicated below.

Test Setup:

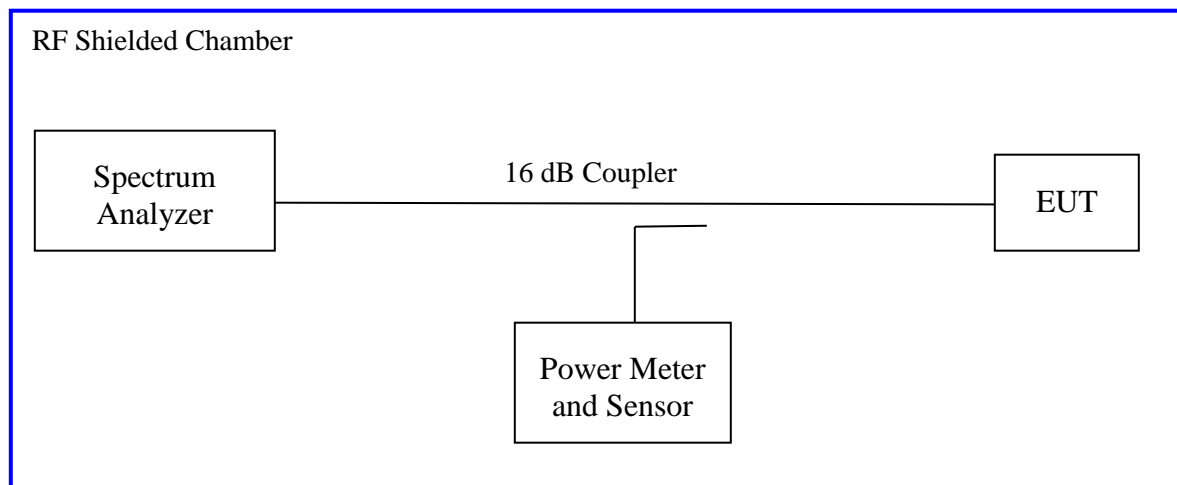

4.2.2 Results

As originally tested, the EUT was found to be compliant to the requirements of the test standard(s).

Table 3: Occupied Bandwidth – Test Results

Test Date: June 10, 2020		Test By: Kerwinn Corpuz		
Test Method: Conducted Measurements		Power Setting: Fixed at 20 dBm		
Antenna Type: Stamped Metal		Max. Antenna Gain: 3.46 dBi		
Operating Mode: Uncorrelated		Signal State: Modulated at 1 Mbps		
Ambient Temp.: 21 °C		Relative Humidity: 37%		
Wireless Router (Bluetooth LE)				
Frequency (MHz)	Limit (kHz)	99% Bandwidth (MHz)	6 dB Bandwidth (MHz)	Results
2402	500	1.054	0.689	Pass
2440	500	1.051	0.694	Pass
2480	500	1.051	0.693	Pass
Note: The narrower bandwidth was measured at 1 Mbps and 100% duty cycle				



Figure 5: DTS Bandwidth-Transmitter -2402 MHz

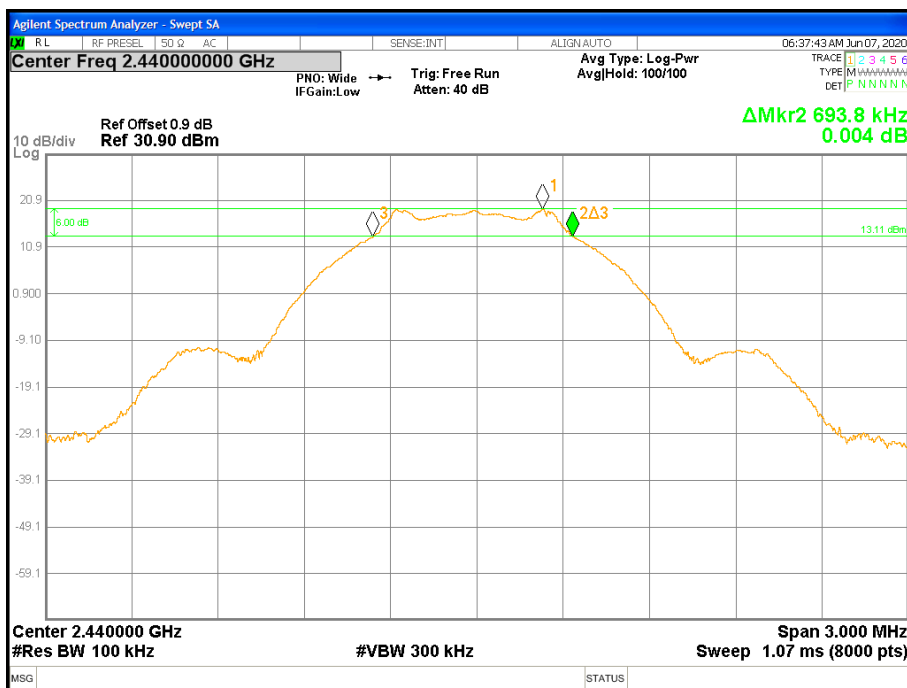

Figure 6: DTS Bandwidth-Transmitter -2440 MHz



Figure 7: DTS Bandwidth-Transmitter -2480 MHz

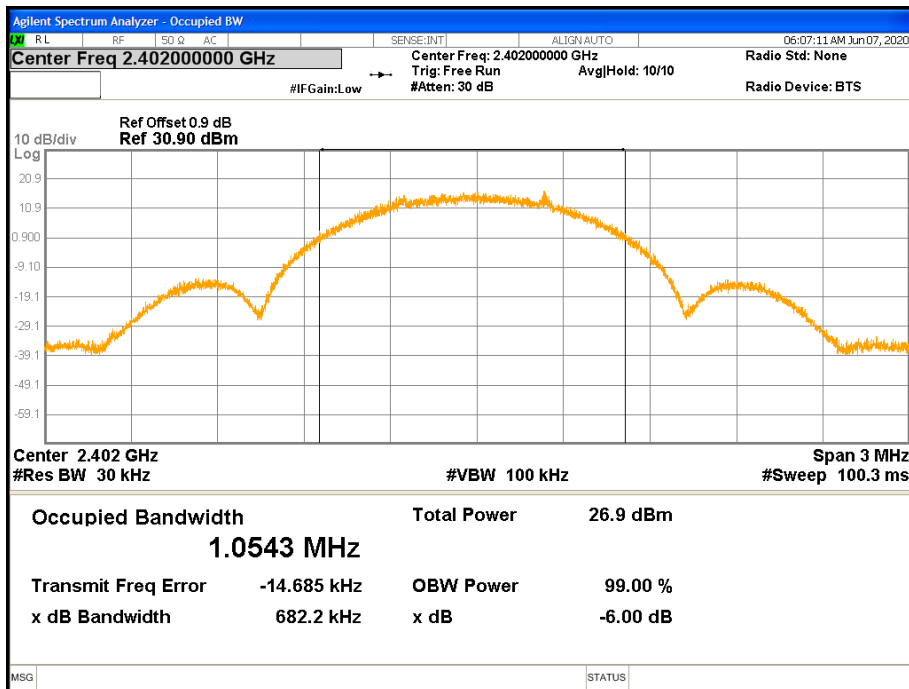

Figure 8: 99% Bandwidth-Transmitter -2402 MHz

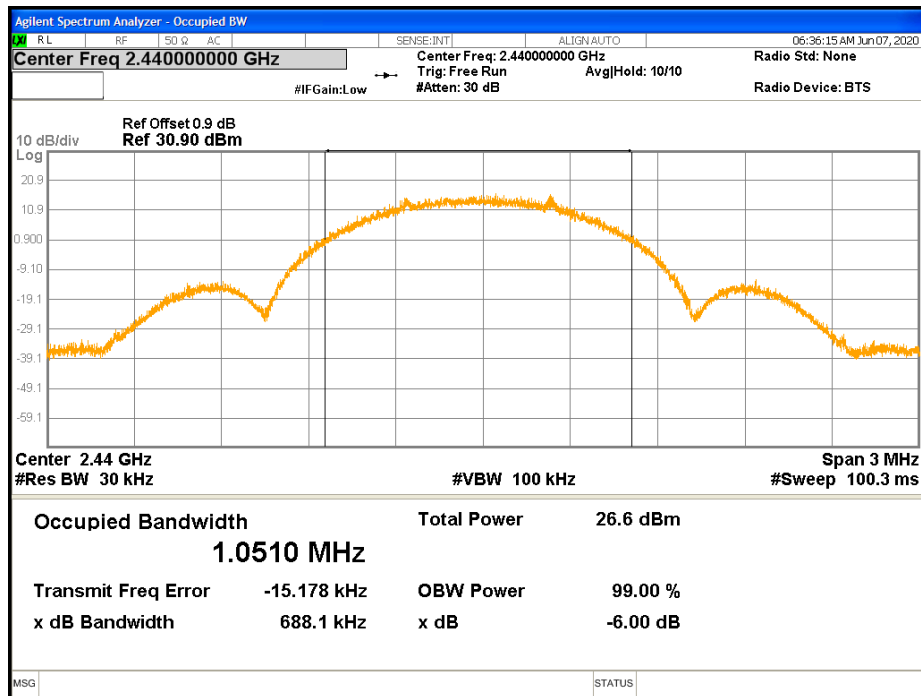

Figure 9: 99% Bandwidth-Transmitter -2440 MHz

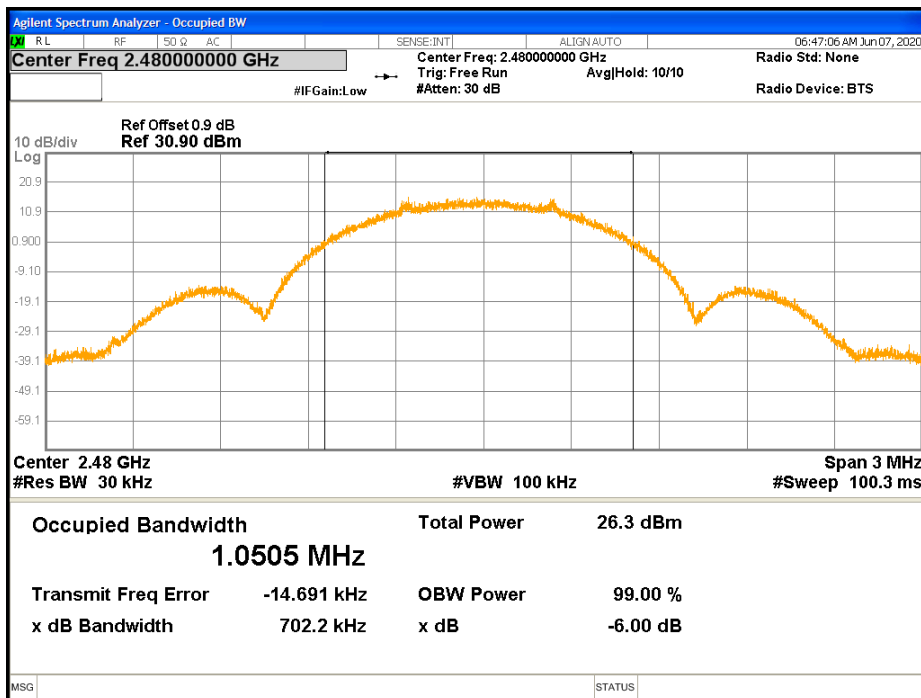

Figure 10: 99% Bandwidth-Transmitter -2480 MHz

4.3 Peak Power Spectral Density

According to the CFR47 Part 15.247 (e) and RSS 247 Sect.5.2 (b), the power spectral density conducted from the intentional radiator to the antenna shall not be greater than 8 dBm in any 3 kHz band during any time interval of continuous transmission.

4.3.1 Test Method

The conducted method was used to measure the channel power output per ANSI C63.10-2013 Section 11.10.3. The measurement was performed with modulation per CFR47 Part 15.247 (e) and RSS 247 Sect.5.2 (b). The pre-evaluation was performed to find the worst modes. The worst findings were conducted on 3 channels in each operating frequency range of 2400 MHz to 2483.5 MHz. This test was conducted on 3 channels of Sample. The worst sample result indicated below.

Test Setup:

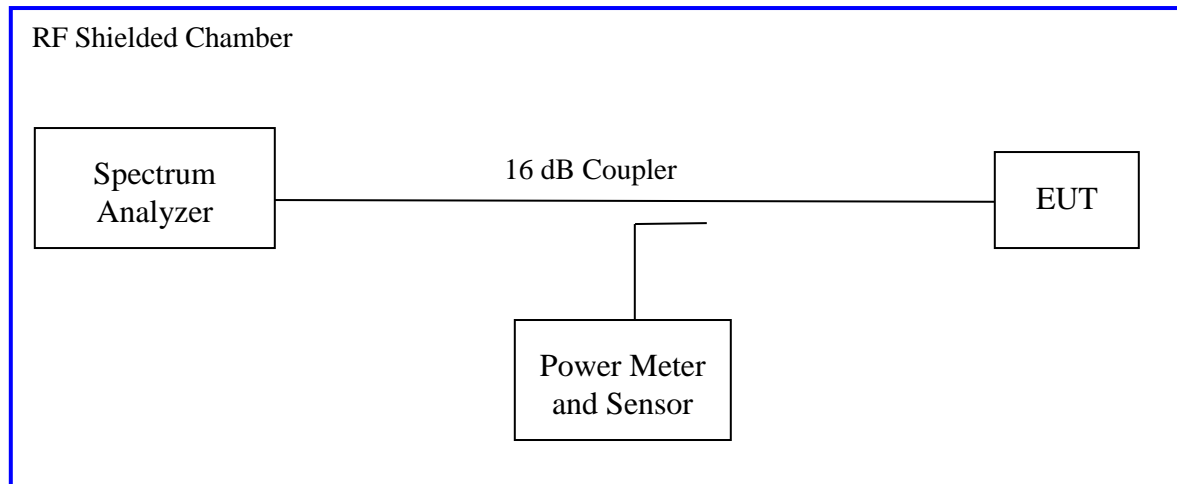

4.3.2 Results

As originally tested, the EUT was found to be compliant to the requirements of the test standard(s).

Table 4: Peak Power Spectral Density – Test Results

Test Date: June 10, 2020			Test By: Kerwinn Corpuz			
Test Method: Conducted Measurements			Power Setting: Fixed at 20 dBm			
Antenna Type: Stamped Metal			Max. Antenna Gain: 3.46 dBi			
Operating Mode: Uncorrelated			Signal State: Modulated at 1 Mbps			
Ambient Temp.: 21 °C			Relative Humidity: 37%			
Wireless Router (Bluetooth LE)						
Freq. (MHz)	Config.	Output [dBm]	CF [dB]	Max. PPSD [dBm]	Limit [dBm]	Margin [dB]
2402	BLE	12.94	-15.23	-2.29	8.00	-10.29
2440	BLE	12.67	-15.23	-2.56	8.00	-10.56
2480	BLE	12.41	-15.23	-2.82	8.00	-10.82
Note: CF accounted for the measured RBW. The bandwidth ratio is $10 \cdot \log(3\text{kHz}/100\text{kHz})$ or -15.23 dB. EUT transmitted at 100% duty cycle.						

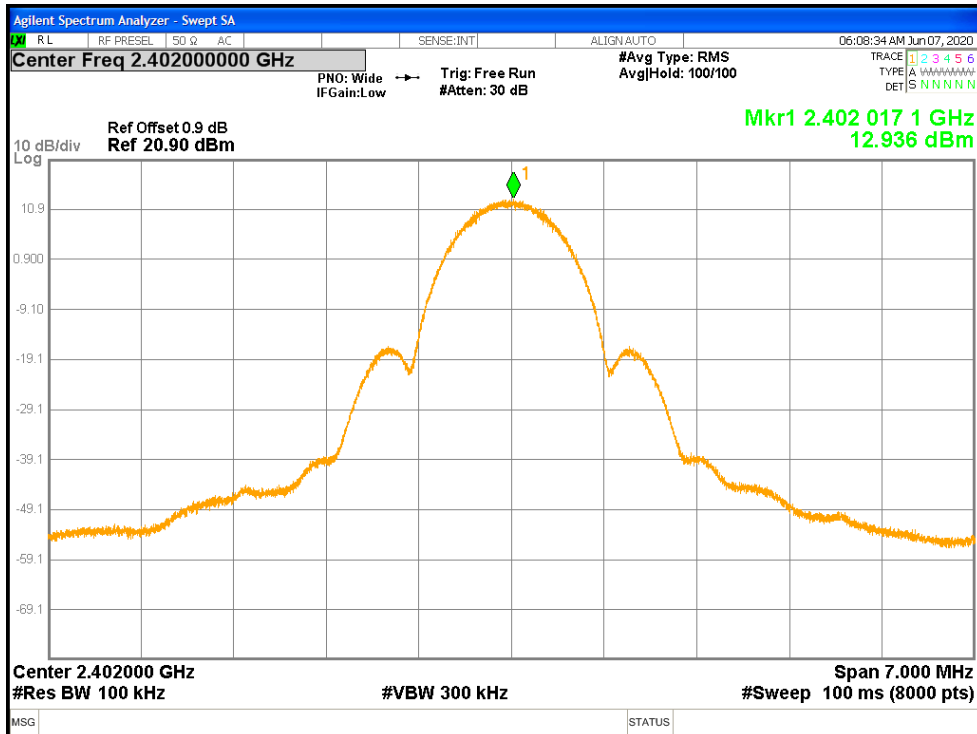

Figure 11: BLE Maximum Power Spectral Density-2402 MHz

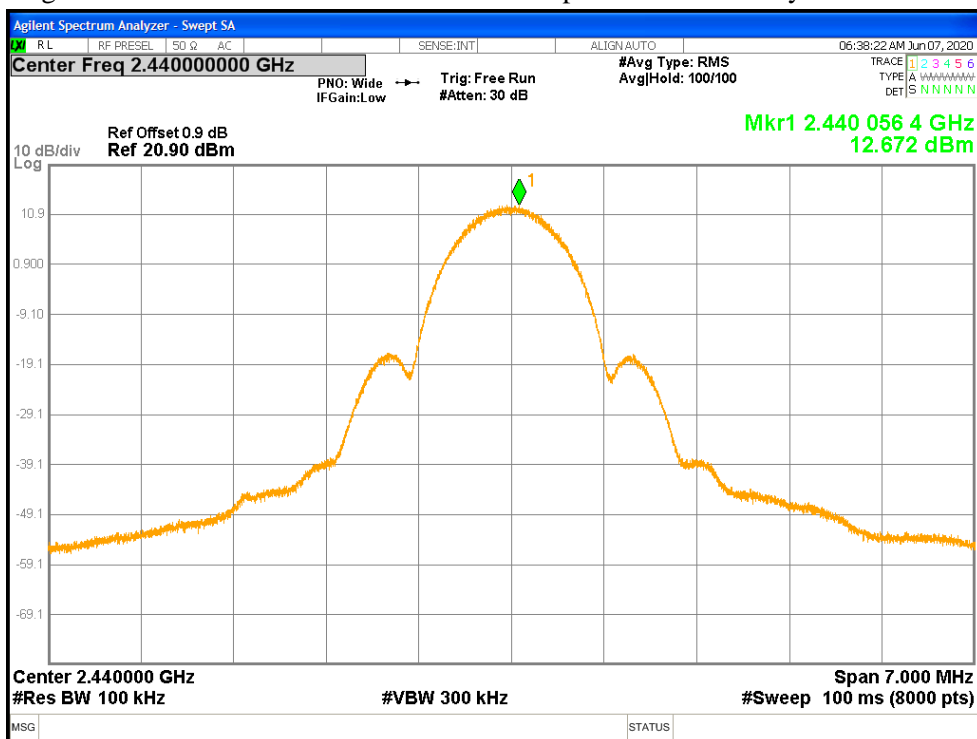

Figure 12: BLE Maximum Power Spectral Density-2440 MHz

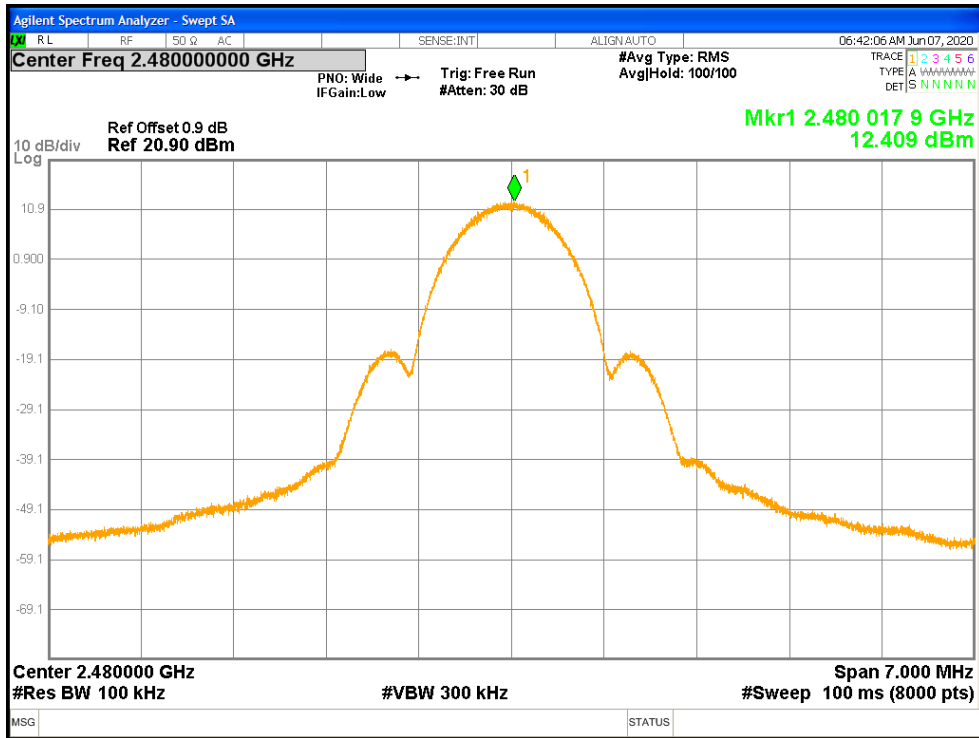

Figure 13: BLE Maximum Power Spectral Density-2480 MHz

4.4 Out of Band Emissions

The setup was identical to RF output power measurement. Intentional radiators operating under the alternative provisions to the general emission limits, must be designed to ensure that the 20 dB or 30 dB bandwidth of the emission, or whatever bandwidth may otherwise be specified in the specific rule section under which the equipment operates, is contained within the frequency band designated in the rule section under which the equipment is operated. The requirement to contain the designated bandwidth of the emission within the specified frequency band includes the effects from frequency sweeping, frequency hopping and other modulation techniques that may be employed as well as the frequency stability of the transmitter over expected variations in temperature and supply voltage. If the frequency stability is not specified in the regulations, it is recommended that the fundamental emission be kept within at least the central 80% of the permitted band in order to minimize the possibility of out-of-band operation.

Since the transmitter complies with the conducted power limits base on the use of RMS averaging per CFR47 Part 15.247(b)(3), any frequency outside the band of 2400MHz to 2483.5MHz, the power output level must be below 30db from the in-band transmitting signal; CFR 47 Part 15.215, 15.247(d) and RSS-247 Sect.5.5.

4.4.1 Test Method

The conducted method was used to measure the out-of-band emission requirement. The measurement was performed with modulation per CFR47 15.247(4) (d) 2020 and RSS-247 Sect.5.5: 2017. This test was conducted on 3 channels of Sample. The worst sample result indicated below.

Test Setup:

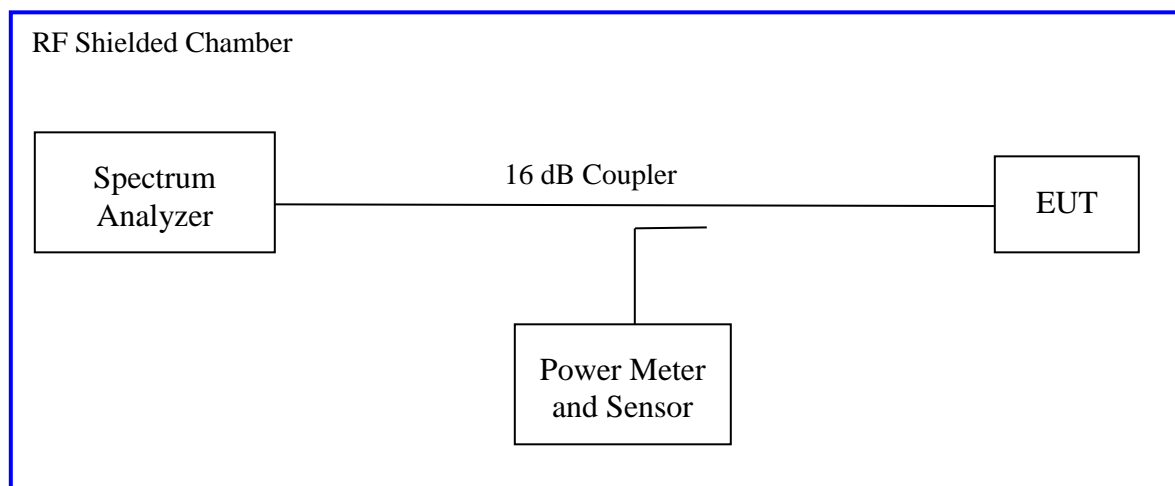

4.4.2 Results

As originally tested, the EUT was found to be compliant to the requirements of the test standard(s).

Table 5: Out of Band Emissions – Test Results

Test Date: June 10, 2020		Test By: Kerwinn Corpuz	
Test Method: Conducted Measurements		Power Setting: Fixed at 20 dBm	
Antenna Type: Stamped Metal		Max. Antenna Gain: 3.46 dBi	
Operating Mode: Uncorrelated		Signal State: Modulated at 1 Mbps	
Ambient Temp.: 21 °C		Relative Humidity: 37%	
Wireless Router (Bluetooth LE)			
Operating Channel	Out of Band Level (dBm)	30 dBc Level (dBm)	Margin (dB)
2402 MHz	-31.58	-10.56	-21.02
2440 MHz	-34.33	-10.94	-23.39
2480 MHz	-34.56	-11.15	-23.41
<p>Note: dBc is defined as the level below the main carrier. The band-edge level must be lower than the 30dBc level. The maximum out of band emission on each individual output is at least 30 dB below the maximum in-band PSD on that output. (*) The band-edge is compared to the highest -30dBc level of the test mode.</p>			

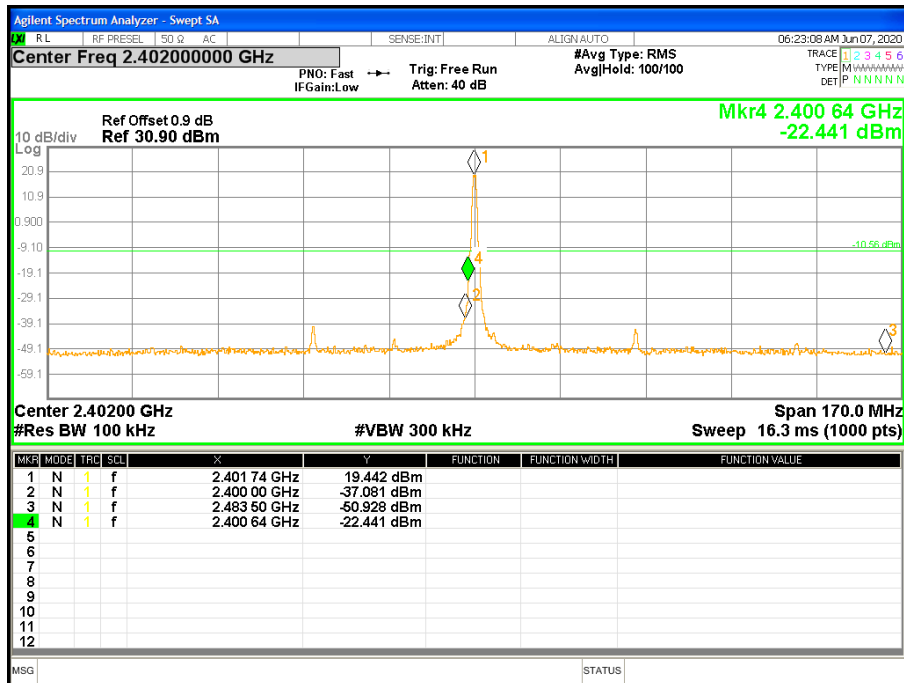

Figure 14: BLE Conducted Band Edge at 2402 MHz

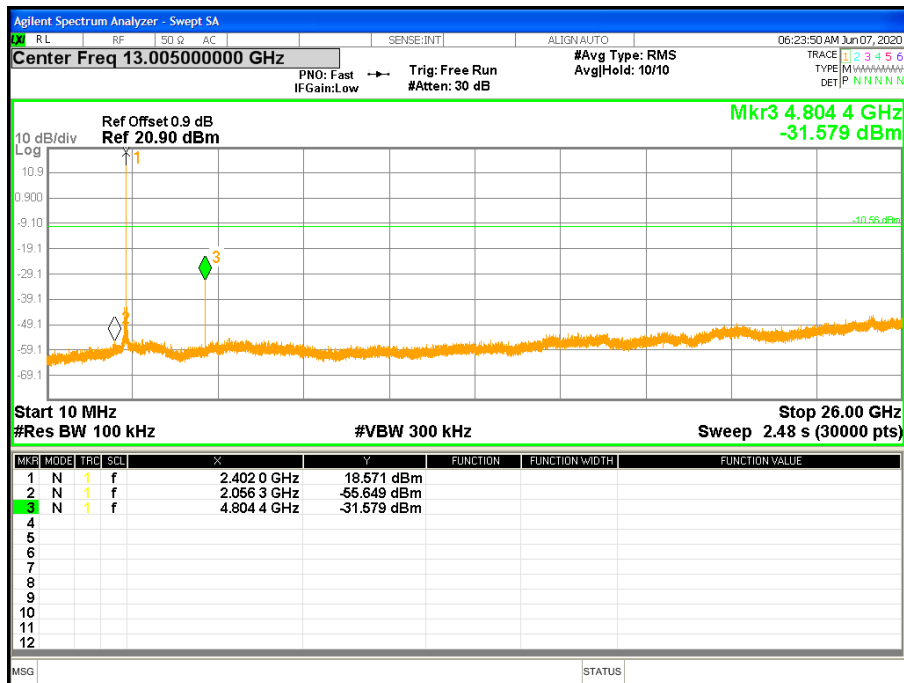

Figure 15: BLE Out of band Emission at 2402 MHz

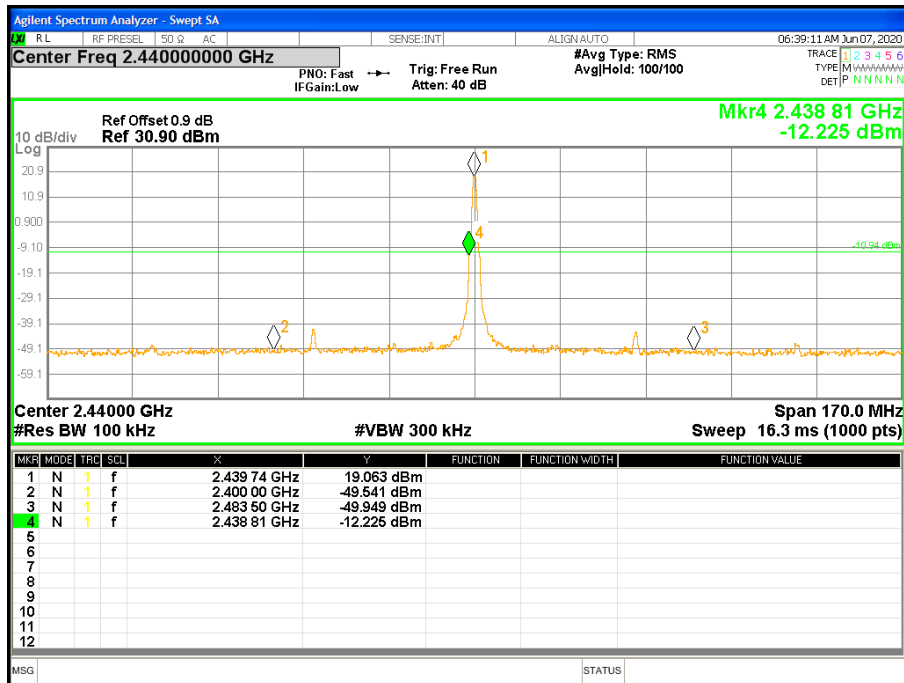

Figure 16: BLE Conducted Band Edge at 2440 MHz

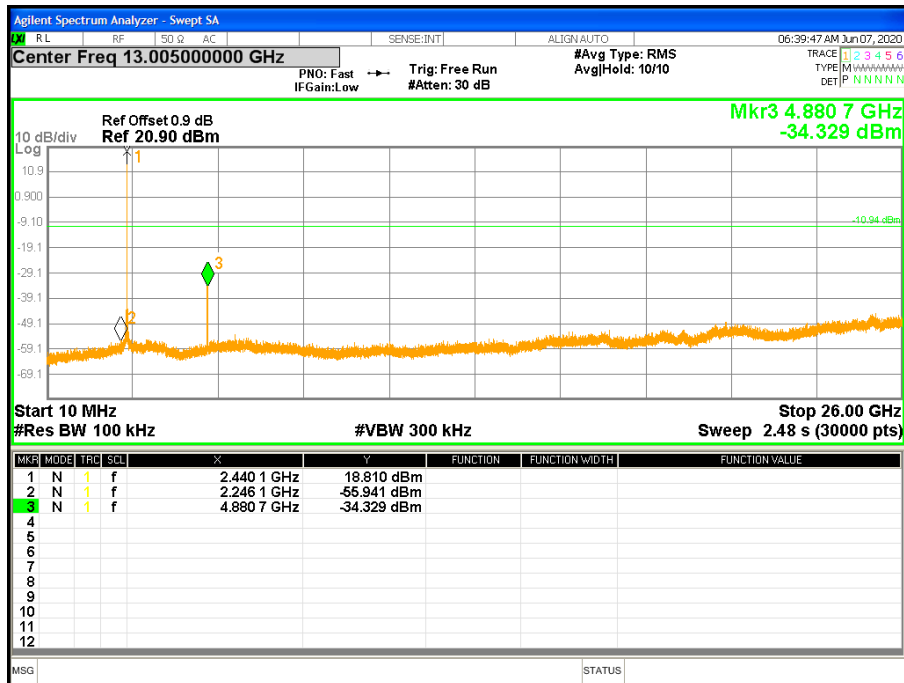

Figure 17: BLE Out of band Emission at 2440 MHz

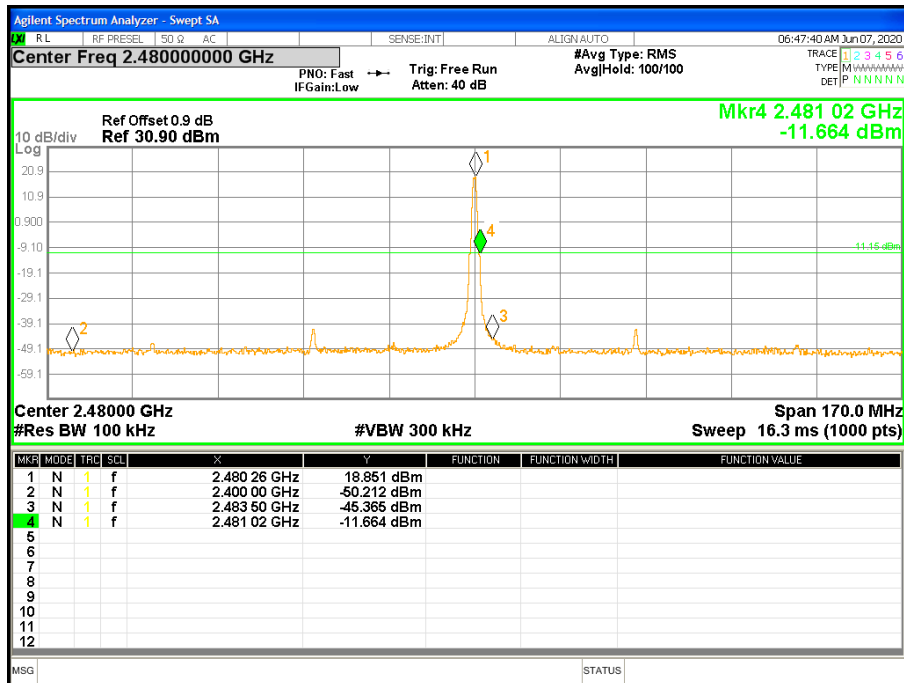

Figure 18: BLE Conducted Band Edge at 2480 MHz

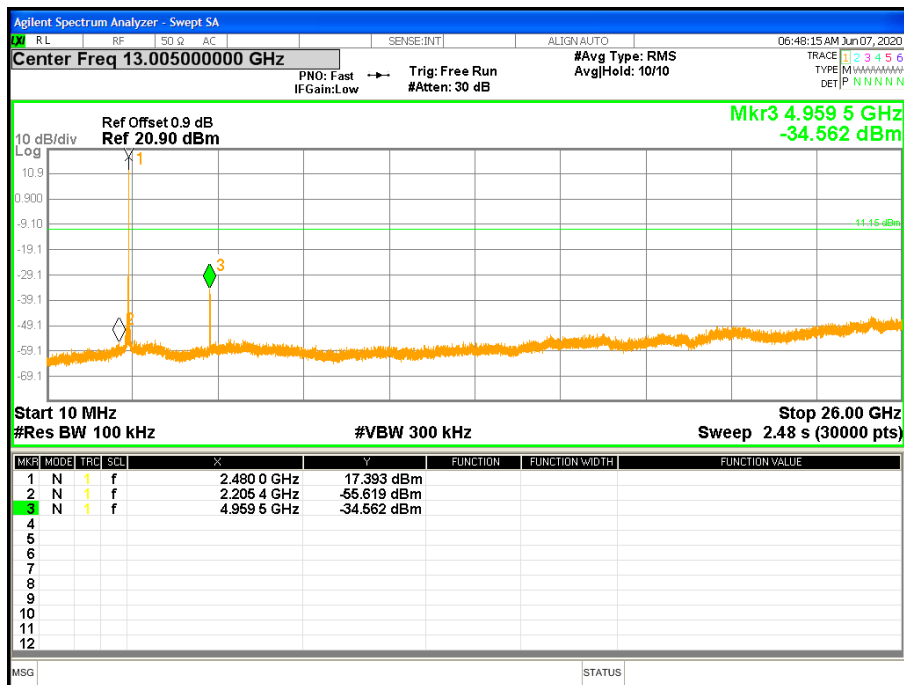

Figure 19: BLE Out of band Emission at 2480 MHz

4.5 Transmit Spurious Emissions

Transmitter spurious emissions are emissions outside the frequency range of the equipment when the equipment is in transmit mode; per requirement of CFR47 15.205, 15.209, 15.247(d), RSS-Gen Sect. 8.9, RSS-Gen Sect. 8.10.

4.5.1 Test Methodology

4.5.1.1 Preliminary Test

A test program that controls instrumentation and data logging was used to automate the preliminary RF emission test procedure. The frequency range of interest was divided into sub-ranges to yield a frequency resolution of approximately 120 kHz and provide a reading at each frequency for no more than 12° of turntable rotation. For each frequency sub-range the turntable was rotated 360° while peak emission data was recorded and plotted over the frequency range of interest in horizontal and vertical antenna polarization's.

Preliminary emission profile testing was performed inside the anechoic chamber. The EUT was placed on a 1.0m x 1.5m non-conductive table 80cm (<1 GHz) and 150cm (>1 GHz) above the floor. The EUT was positioned as shown in the setup photographs. The receiving antenna was placed at a distance of 3m at a fixed height of 1m. Measurement equipment was located outside of the chamber. A video camera was placed inside the chamber to view the EUT.

Pres-scans were performed to determine the worst case configuration for data rate; 1 Mbps and 2 Mbps

4.5.1.2 Final Test

For each frequency measured, the peak emission was maximized by manipulating the receiving antenna from 1 to 4 meters above the ground plane and placing it at the position that produced the maximum signal strength reading. The turntable was then rotated through 360° while observing the peak signal and placing the EUT at the position that produced maximum radiation. The six highest emissions relative to the limit were measured unless such emissions were more than 20 dB below the limit. If less than six emissions are within 20 dB of the limit, than the noise level of the receiver is measured at frequencies where emissions are expected. Multiples of all oscillator and microprocessor frequencies were also checked.

Final testing was performed on an NSA compliant test site. The EUT was placed on a 1.0m x 1.5m non-conductive table 80cm (<1 GHz) and 150cm (>1 GHz) above the ground plane. The placement of EUT and cables were the same as for preliminary testing and is shown in the setup photographs.

The final scans performed on the worst axis, Y-Axis, for three operating channels in each operating mode;

2402 MHz, 2440 MHz, and 2480 MHz

4.5.1.3 Deviations

None.

Test Setup:

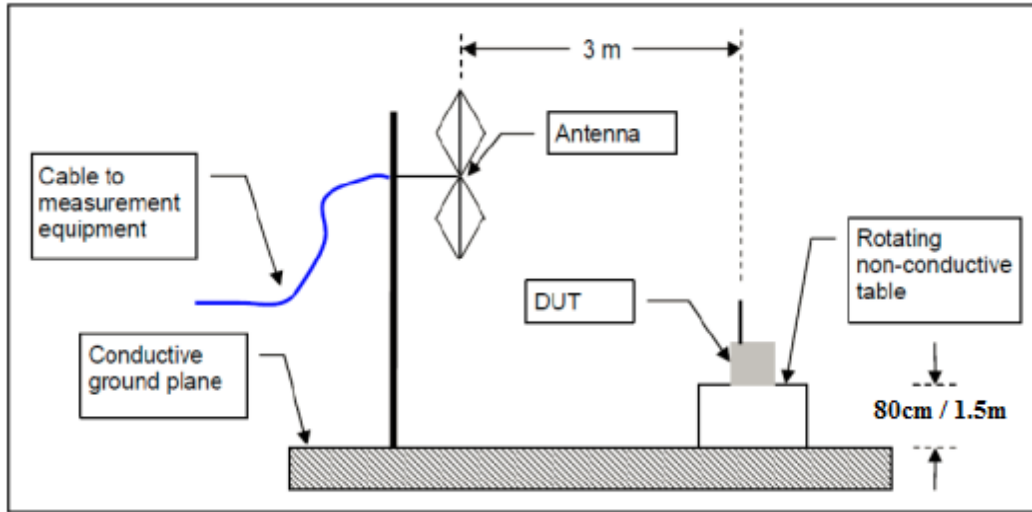

4.5.2 Transmitter Spurious Emission Limit

The spurious emissions of the transmitter shall not exceed the values in CFR47 Part 15.205, 15.209: 2020 and RSS Gen Sect. 8.10: 2019.

Frequency (MHz)	Field strength (microvolts/meter)	Measurement distance (meters)
0.009-0.490	2400/F (kHz)	300
0.490-1.705	24000/F (kHz)	30
1.705-30.0	30	30
30-88	100 **	3
88-216	150 **	3
216-960	200 **	3
Above 960	500	3

All harmonics and spurious emission which are outside of the restricted band shall be 20dB below the in-band emission.

4.5.3 Test Results

The final measurement data was taken under the worst case operating modes, configurations, and/or cable positions. It also reflects the results including any modifications and/or special accessories listed in Sections 1.4 and test plan.

As originally tested, the EUT was found to be compliant to the requirements of the test standard(s).

Table 6: Transmit Spurious Emission at Band-Edge Requirements

Test Date: June 5, 2020					Test By: Kerwinn Corpuz				
Test Method: Radiated Measurements					Power Setting: Fixed at 20 dBm				
Antenna Type: Stamped Metal					Max. Antenna Gain: 3.46 dBi				
Operating Mode: Uncorrelated					Signal State: Modulated at 1 Mbps				
Ambient Temp.: 21 °C					Relative Humidity: 39%				
Band-Edge Results (Bluetooth LE)									
Freq.	Edge Freq.	Pol	Ant.	Tbl.	Det.	Level	Limit	Margin	Note
MHz	MHz	V/H	cm	Deg	Pk/Avg	dBuV/m	dBuV/m	dB	
2402	2388.09	V	100	47	Pk	58.46	74.00	-15.54	Plot 20: Lower Edge
2402	2386.12	V	100	47	Avg	45.49	54.00	-8.51	Plot 21: Lower Edge
2402	2386.02	H	152	140	Pk	59.31	74.00	-14.69	Plot 22: Lower Edge
2402	2386.09	H	152	140	Avg	45.31	54.00	-8.69	Plot 23: Lower Edge
2480	2483.52	V	106	84	Pk	62.83	74.00	-11.17	Plot 24: Upper Edge
2480	2483.50	V	106	84	Avg	48.65	54.00	-5.35	Plot 25: Upper Edge
2480	2483.50	H	117	141	Pk	62.14	74.00	-11.86	Plot 26: Upper Edge
2480	2483.50	H	117	141	Avg	50.02	54.00	-3.98	Plot 27: Upper Edge
<p>Note: The emissions were measured at the adjacent restricted band of the fundamental signal. All the band-edge measurements met the restricted band requirements of CFR47 15.205 Band-edge measurement plots use a wider span than 2 MHz to evaluate additional spectrum bands for in-band leakage and spurious emission.</p>									

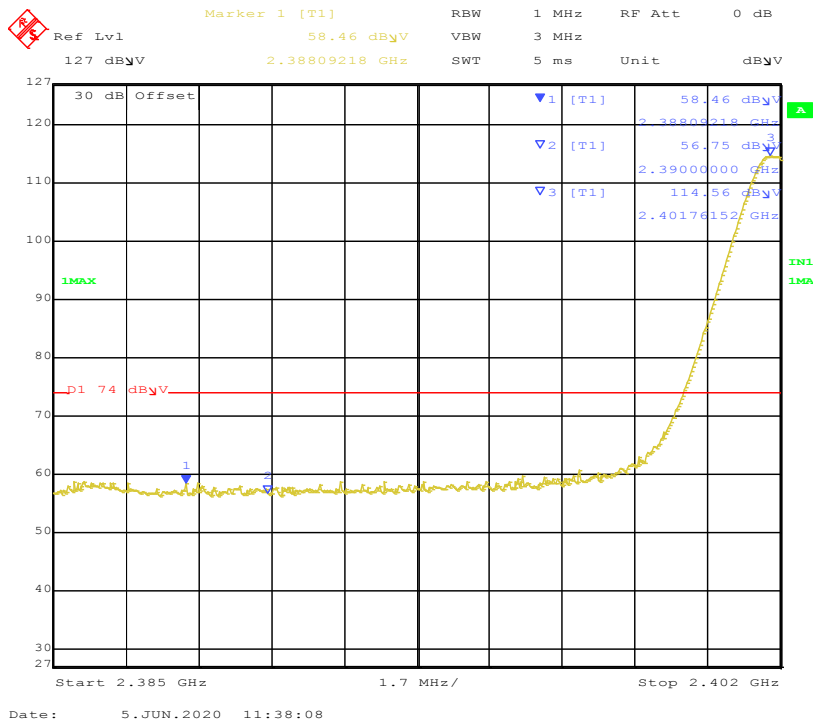

Figure 20: Band-edge-2402 MHz-V-Pk

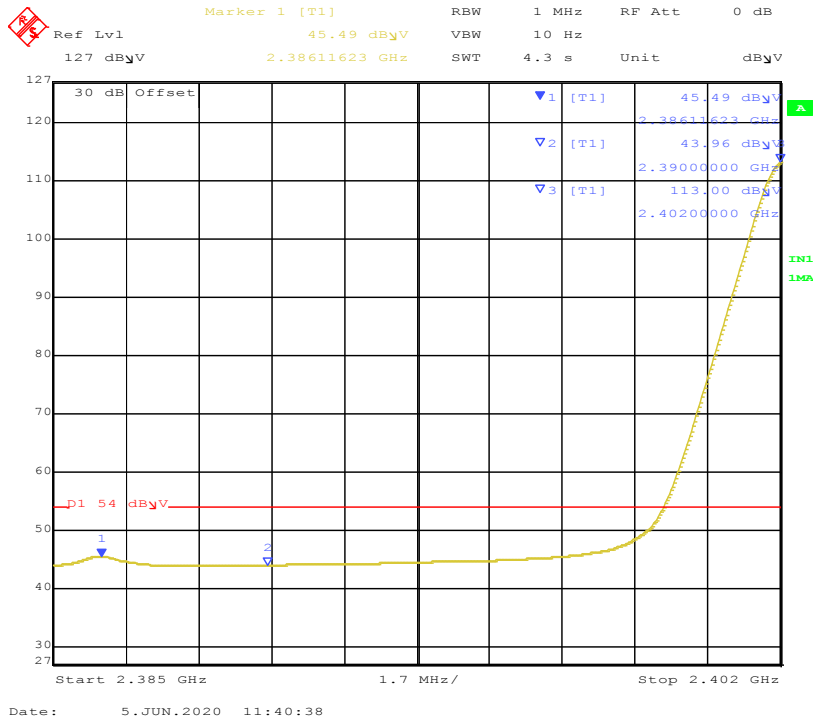

Figure 21: Band-edge-2402 MHz-V-Avg

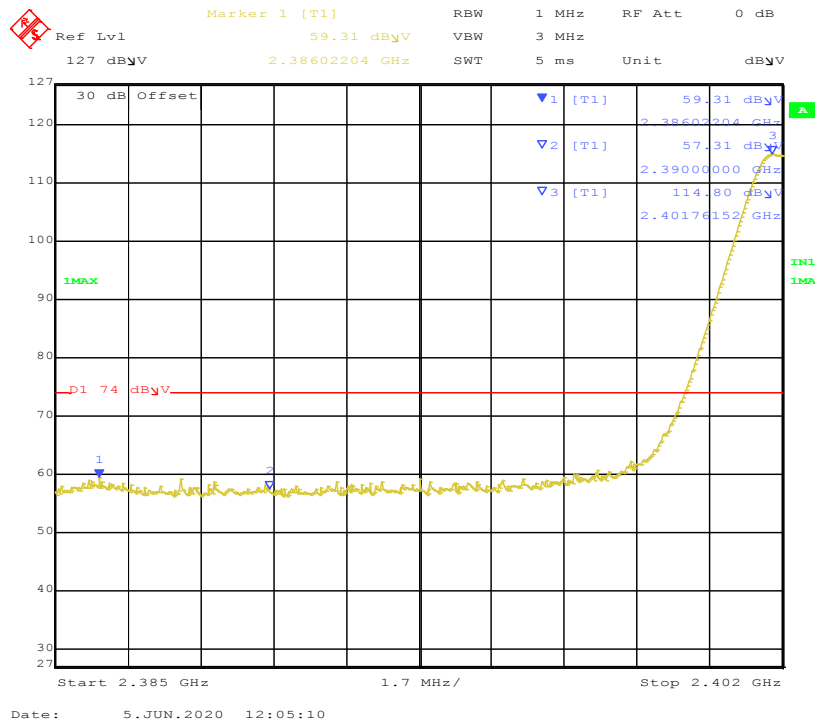

Figure 22: Band-edge-2402 MHz-H-Pk

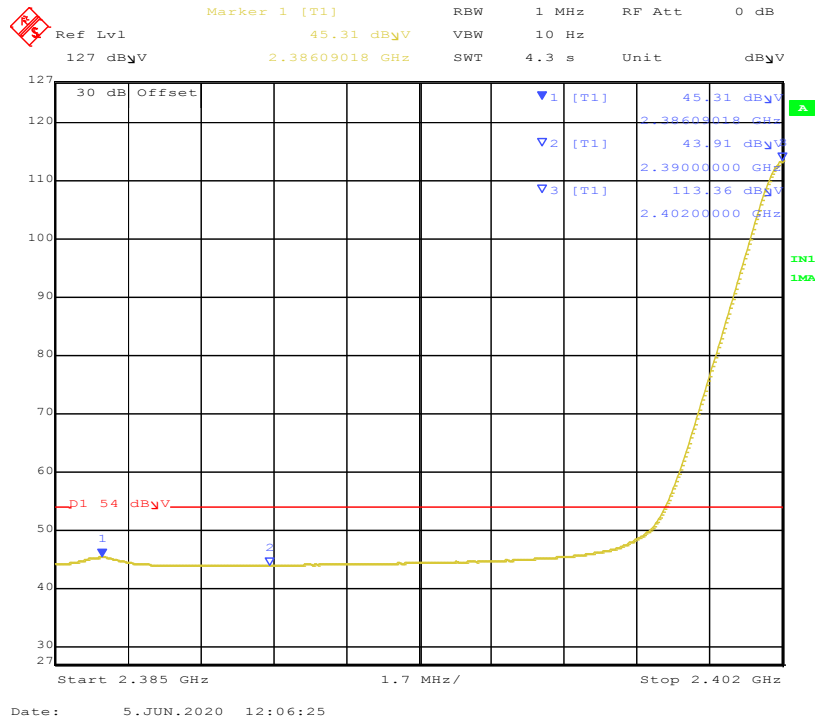

Figure 23: Band-edge-2402 MHz-H-Avg

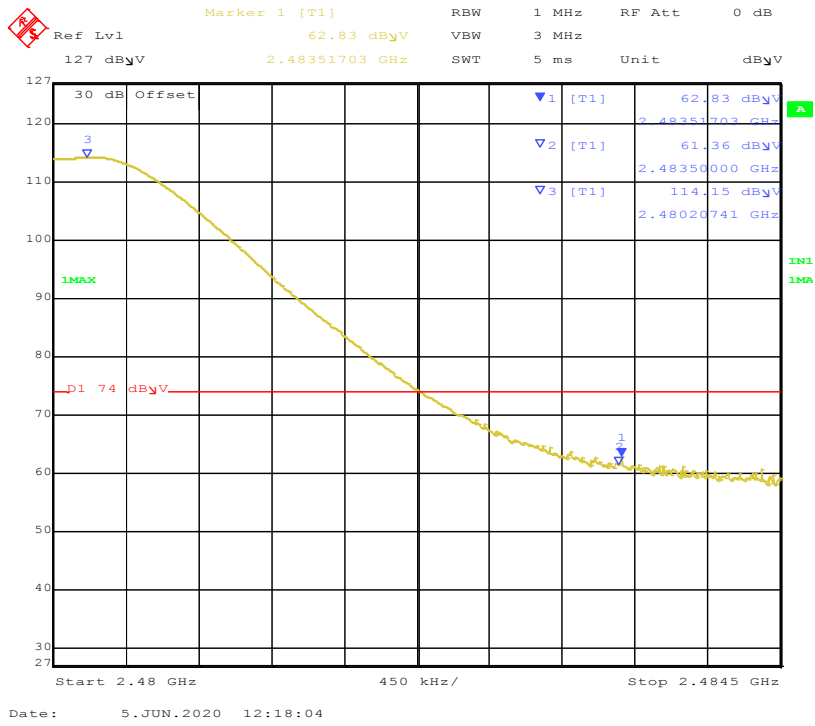

Figure 24: Band-edge-2480 MHz-V-Pk

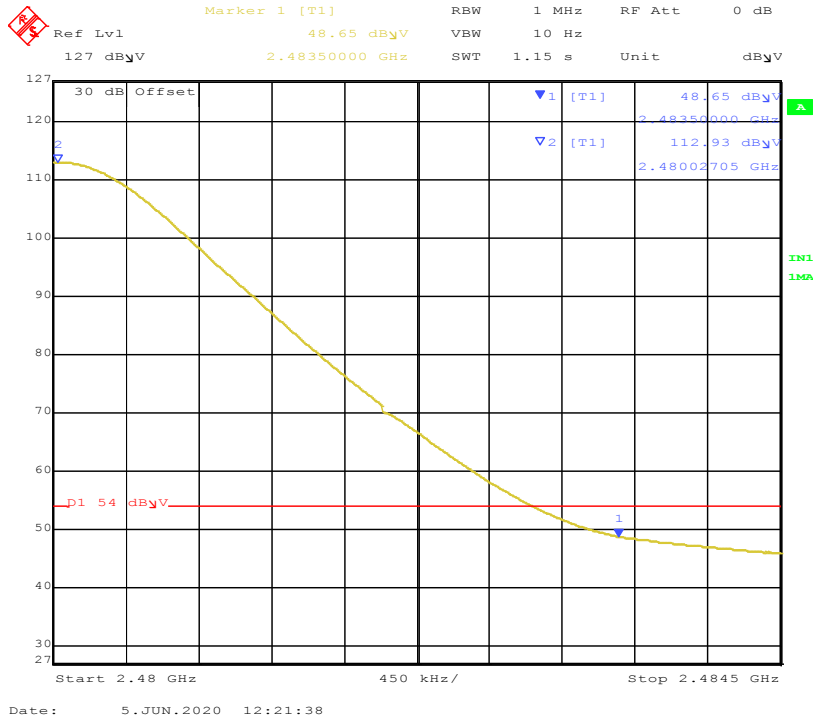

Figure 25: Band-edge-2480 MHz-V-Avg

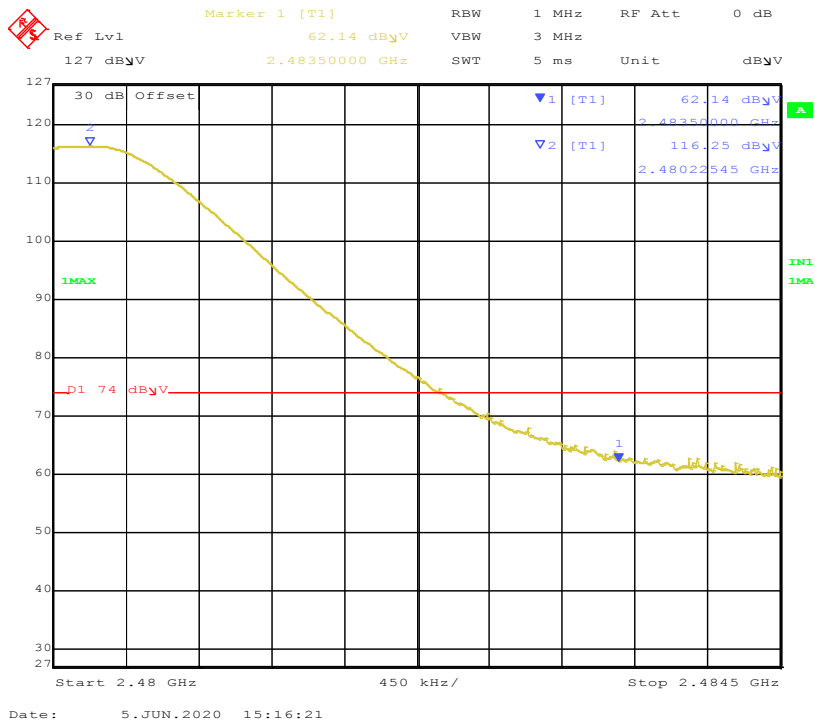

Figure 26: Band-edge-2480 MHz-H-Pk

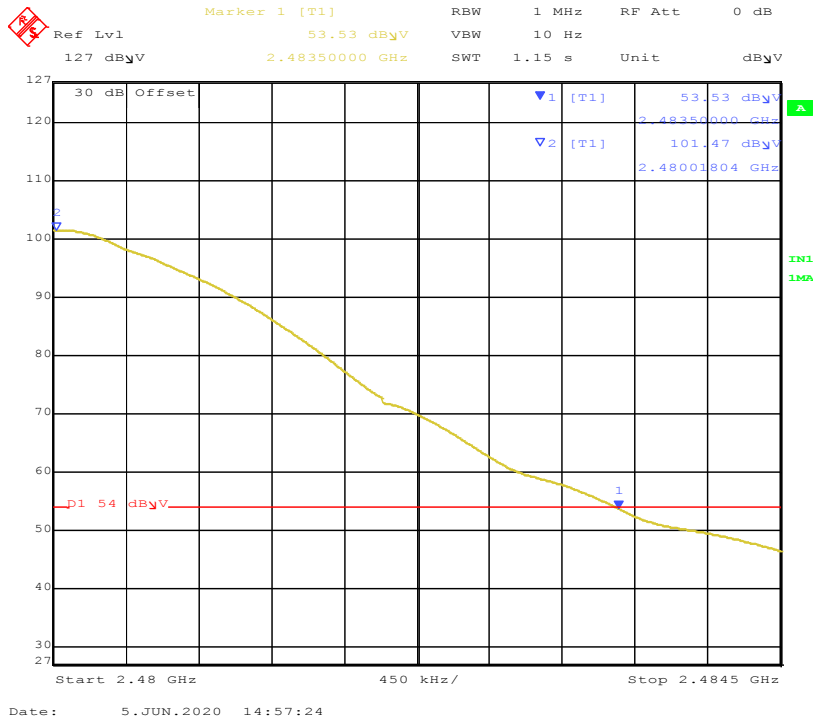

Figure 27: Band-edge-2480 MHz-H-Avg

SOP 1 Radiated Emissions												Tracking # 32062470.001 Page 1 of 8		
EUT Name		eero 6 and eero 6 Extender					Date		June 9, 2020					
EUT Model		N010001					Temp / Hum in		21°C / 38%rh					
EUT Serial		NA4V-0034-0FZS-B958					Temp / Hum out		N/A					
EUT Config.		BLE, 1 Mbps					Line AC / Freq		110Vac / 60 Hz					
Standard		CFR47 Part 15 Subpart C / RSS-GEN					RBW / VBW		See Note					
Dist/Ant Used		3m / JB3 and EMCO 6502					Performed by		Kerwinn Corpuz					
9 kHz to 1 GHz, Transmit at 2440 MHz														
Freq.	Raw	Cbl	AF	Level	Det.	Pol.	Hght.	Azt	Limit	Margin	Result			
MHz	dBuV/m	dB	dB	dBuV/m		H/V	cm	deg	dBuV/m	dB				
0.60	32.24	2.27	10.40	44.91	Pk	V	100	158	71.97	-27.06	Pass			
1.07	27.81	2.30	10.60	40.71	Pk	V	100	101	67.02	-26.31	Pass			
200.12	41.51	3.28	-15.17	29.62	QP	H	158	274	43.50	-13.88	Pass			
42.75	33.16	2.59	-16.03	19.72	QP	V	149	158	40.00	-20.28	Pass			
63.82	54.86	2.70	-20.41	37.15	QP	V	190	224	40.00	-2.85	Pass			
71.25	50.33	2.76	-19.98	33.11	QP	V	165	152	40.00	-6.89	Pass			
106.15	41.78	2.90	-16.22	28.46	QP	V	103	330	43.50	-15.04	Pass			
163.26	35.11	3.16	-15.72	22.56	QP	V	114	74	43.50	-20.94	Pass			
Spec Margin = Level - Limit, Level = Raw+ Cbl+ CF ± Uncertainty CF= Amp Gain + ANT Factor														
Combined Standard Uncertainty $u_c(y) = \pm 3.2$ dB Expanded Uncertainty $U = ku_c(y)$ $k = 2$ for 95% confidence														
Note: The worst case emission was observed on Channel 2440 MHz. RBW and VBW set per ANSI C63.4 and C63.10. Emissions below 30 MHz, detected noise floor.														

SOP 1 Radiated Emissions

Tracking # 32062470.001 Page 2 of 8

EUT Name	eero 6 and eero 6 Extender	Date	June 9, 2020
EUT Model	N010001	Temp / Hum in	21°C / 38%rh
EUT Serial	NA4V-0034-0FZS-B958	Temp / Hum out	N/A
EUT Config.	BLE, 1 Mbps; transmit at 2440 MHz	Line AC / Freq	110Vac / 60 Hz
Standard	CFR47 Part 15 Subpart C / RSS-GEN	RBW / VBW	See Note
Dist/Ant Used	3m / 6502 & JB3	Date	Kerwinn Corpuz

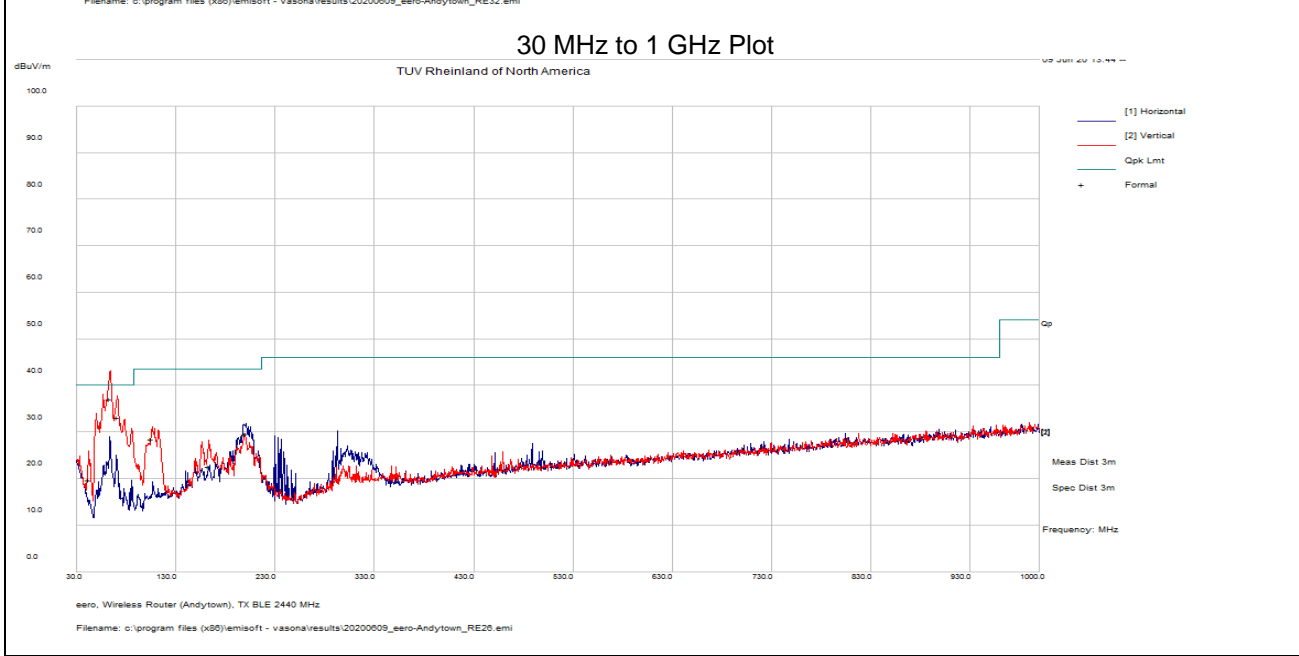
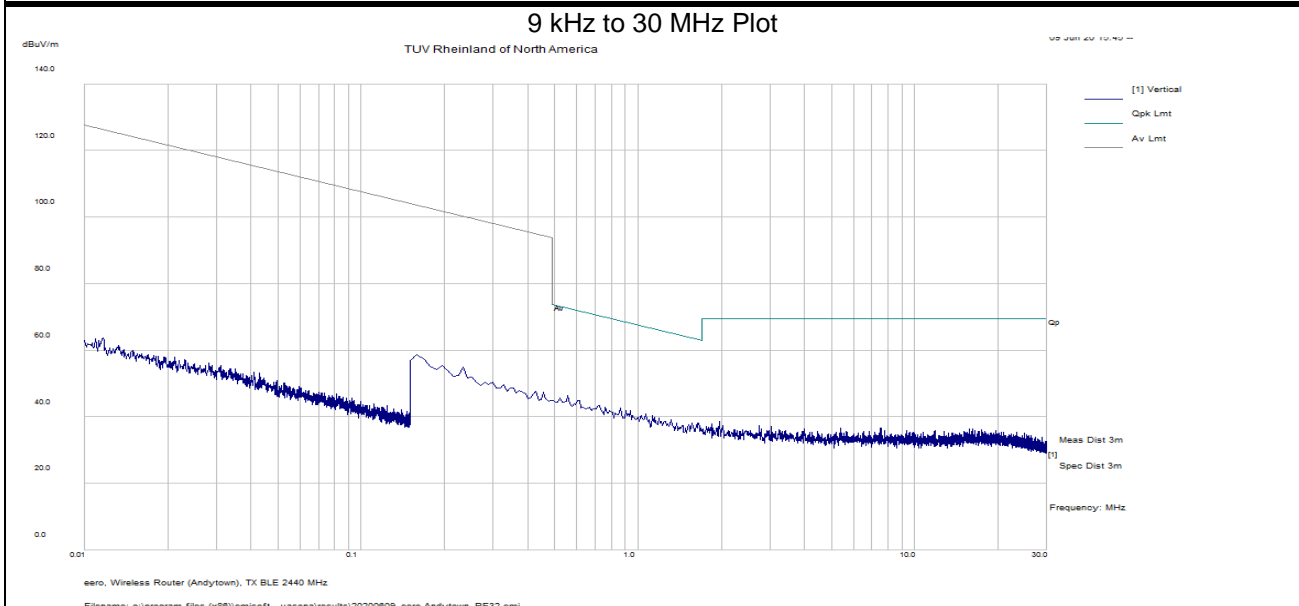

Notes: RBW and VBW set per ANSI C63.4 and C63.10.

SOP 1 Radiated Emissions		Tracking # 32062470.001 Page 3 of 8	
EUT Name	eero 6 and eero 6 Extender	Date	June 8, 2020
EUT Model	N010001	Temp / Hum in	21°C / 39%rh
EUT Serial	NA4V-0034-0FZS-B958	Temp / Hum out	N/A
EUT Config.	BLE, 1 Mbps; TX at 2402 MHz (Low Channel)	Line AC / Freq	110Vac / 60 Hz
Standard	CFR47 Part 15 Subpart C / RSS-GEN	RBW / VBW	1 MHz / 3 MHz
Dist/Ant Used	3m / EMCO-3115, 1m / ComPower-AHA840	Performed by	Kerwinn Corpuz

Emission band 1 – 18 GHz											
Freq	Raw	Cbl	AF	Level	Det	Pol	Hght	Azt	Limit	Margin	Comment
MHz	dBuV/m	dB	dB	dBuV/m		H/V	cm	deg	dBuV/m	dB	
17919.20	55.07	4.11	-7.97	51.20	Pk	H	172	88	74.00	-22.80	Spurious
17919.20	43.60	4.11	-7.97	39.74	Avg	H	172	88	54.00	-14.26	Spurious
4803.46	77.08	1.89	-23.59	55.39	Pk	V	179	110	74.00	-18.62	Harmonics
4803.46	70.54	1.89	-23.59	48.85	Avg	V	179	110	54.00	-5.15	Harmonics
9606.99	66.71	2.78	-16.06	53.43	Pk	V	241	36	74.00	-20.57	Harmonics*
9606.99	57.83	2.78	-16.06	44.55	Avg	V	241	36	54.00	-9.45	Harmonics*
12011.18	68.52	3.18	-17.01	54.69	Pk	V	224	52	74.00	-19.31	Harmonics
12011.18	59.51	3.18	-17.01	45.67	Avg	V	224	52	54.00	-8.33	Harmonics
14410.51	65.45	3.48	-13.85	55.08	Pk	V	185	32	74.00	-18.92	Harmonics*
14410.51	55.86	3.48	-13.85	45.49	Avg	V	185	32	54.00	-8.51	Harmonics*

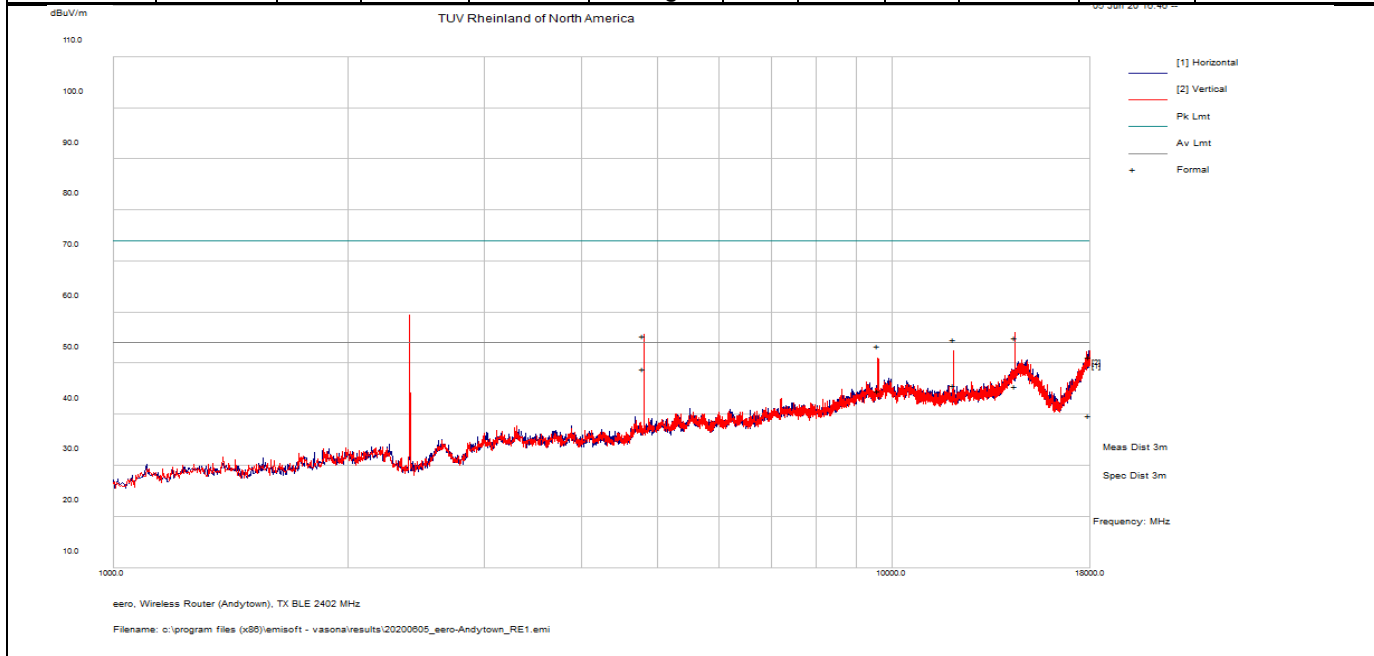

Spec Margin = Level - Limit, Level = Raw+ Cbl+ CF ± Uncertainty
 CF= Amp Gain + ANT Factor
 Combined Standard Uncertainty $u_c(y) = \pm 3.2\text{dB}$ Expanded Uncertainty $U = ku_c(y)$ $k = 2$ for 95% confidence
 Notes: All emissions passed the spurious emission limit.
 (*) Non-restricted band emission.
 Emission at 2402 MHz is the fundamental.

SOP 1 Radiated Emissions				Tracking # 32062470.001 Page 4 of 8			
EUT Name	eero 6 and eero 6 Extender			Date	June 8, 2020		
EUT Model	N010001			Temp / Hum in	21°C / 39%rh		
EUT Serial	NA4V-0034-0FZS-B958			Temp / Hum out	N/A		
EUT Config.	BLE, 1 Mbps; TX at 2440 MHz (Mid Channel)			Line AC / Freq	110Vac / 60 Hz		
Standard	CFR47 Part 15 Subpart C / RSS-GEN			RBW / VBW	1 MHz / 3 MHz		
Dist/Ant Used	3m / EMCO-3115, 1m / ComPower-AHA840			Performed by	Kerwinn Corpuz		

Emission band 1 – 18 GHz											
Freq	Raw	Cbl	AF	Level	Det	Pol	Hght	Azt	Limit	Margin	Comment
MHz	dBuV/m	dB	dB	dBuV/m		H/V	cm	deg	dBuV/m	dB	
17966.19	55.17	4.10	-7.73	51.54	Pk	H	173	222	74.00	-22.46	Spurious
17966.19	43.12	4.10	-7.73	39.49	Avg	H	173	222	54.00	-14.51	Spurious
4880.43	76.56	1.90	-23.14	55.32	Pk	V	123	58	74.00	-18.68	Harmonics
4880.43	70.24	1.90	-23.14	49.00	Avg	V	123	58	54.00	-5.00	Harmonics
9760.91	69.41	2.89	-15.79	56.51	Pk	V	221	44	74.00	-17.49	Harmonics*
9760.91	61.07	2.89	-15.79	48.17	Avg	V	221	44	54.00	-5.83	Harmonics*
12201.12	69.53	3.31	-16.92	55.91	Pk	V	269	48	74.00	-18.09	Harmonics
12201.12	60.90	3.31	-16.92	47.29	Avg	V	269	48	54.00	-6.72	Harmonics
17081.51	63.14	3.88	-13.64	53.39	Pk	V	270	0	74.00	-20.62	Harmonics*
17081.51	53.50	3.88	-13.64	43.74	Avg	V	270	0	54.00	-10.26	Harmonics*

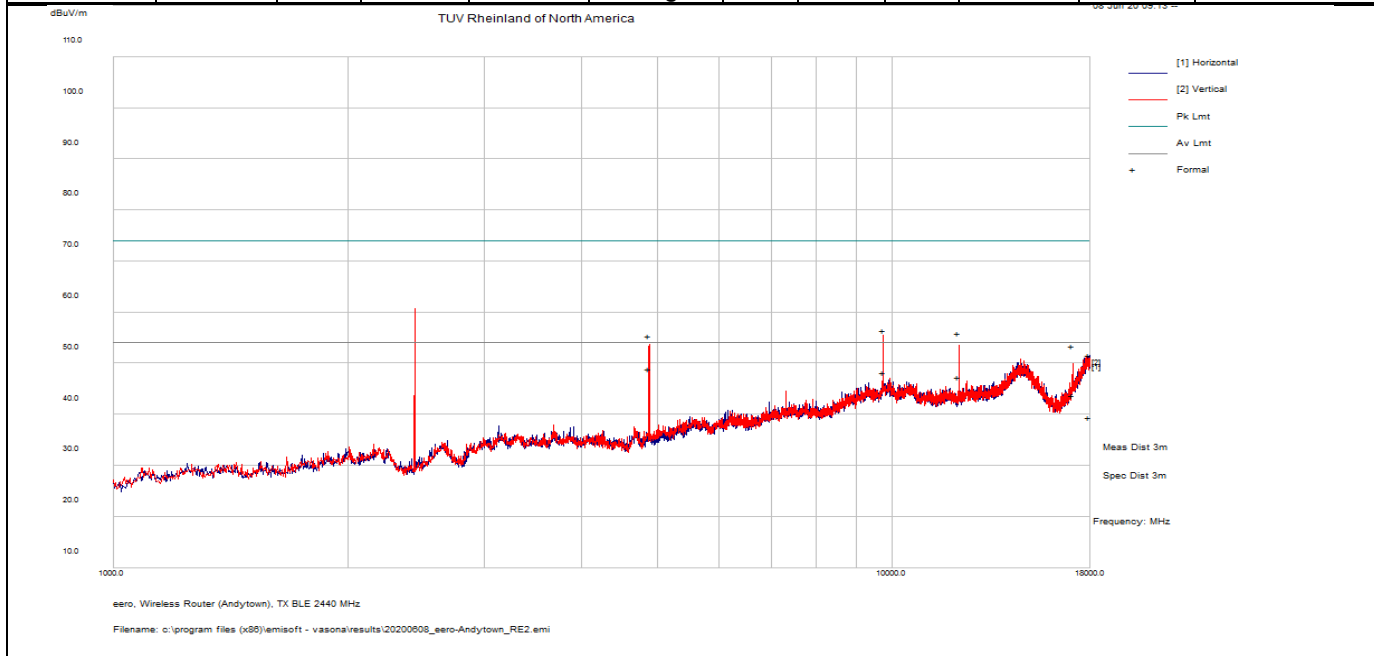

Spec Margin = Level - Limit, Level = Raw+ Cbl+ CF ± Uncertainty
 CF= Amp Gain + ANT Factor
 Combined Standard Uncertainty $u_c(y) = \pm 3.2\text{dB}$ Expanded Uncertainty $U = ku_c(y)$ $k = 2$ for 95% confidence
 Notes: All emissions passed the spurious emission limit.
 (*) Non-restricted band emission.
 Emission at 2440 MHz is the fundamental.

SOP 1 Radiated Emissions				Tracking # 32062470.001 Page 5 of 8			
EUT Name	eero 6 and eero 6 Extender			Date	June 8, 2020		
EUT Model	N010001			Temp / Hum in	21°C / 39%rh		
EUT Serial	NA4V-0034-0FZS-B958			Temp / Hum out	N/A		
EUT Config.	BLE, 1 Mbps; TX at 2480 MHz (Hi Channel)			Line AC / Freq	110Vac / 60 Hz		
Standard	CFR47 Part 15 Subpart C / RSS-GEN			RBW / VBW	1 MHz / 3 MHz		
Dist/Ant Used	3m / EMCO-3115, 1m / ComPower-AHA840			Performed by	Kerwinn Corpuz		

Emission band 1 – 18 GHz											
Freq	Raw	Cbl	AF	Level	Det	Pol	Hght	Azt	Limit	Margin	Comment
MHz	dBuV/m	dB	dB	dBuV/m		H/V	cm	deg	dBuV/m	dB	
4960.42	73.23	1.85	-23.10	51.98	Pk	V	115	62	74.00	-22.02	Spurious
4960.42	66.75	1.85	-23.10	45.50	Avg	V	115	62	54.00	-8.50	Spurious
9920.82	70.49	2.96	-15.63	57.83	Pk	V	236	46	74.00	-16.17	Harmonics*
9920.82	62.50	2.96	-15.63	49.84	Avg	V	236	46	54.00	-4.16	Harmonics*
12398.64	69.66	3.16	-17.02	55.80	Pk	V	219	62	74.00	-18.20	Harmonics
12398.64	61.16	3.16	-17.02	47.29	Avg	V	219	62	54.00	-6.71	Harmonics
14881.41	62.24	3.63	-12.89	52.98	Pk	V	227	336	74.00	-21.02	Harmonics*
14881.41	50.22	3.63	-12.89	40.96	Avg	V	227	336	54.00	-13.04	Harmonics*
17952.44	55.00	4.09	-7.82	51.27	Pk	V	162	252	74.00	-22.73	Harmonics
17952.44	43.21	4.09	-7.82	39.49	Avg	V	162	252	54.00	-14.51	Harmonics

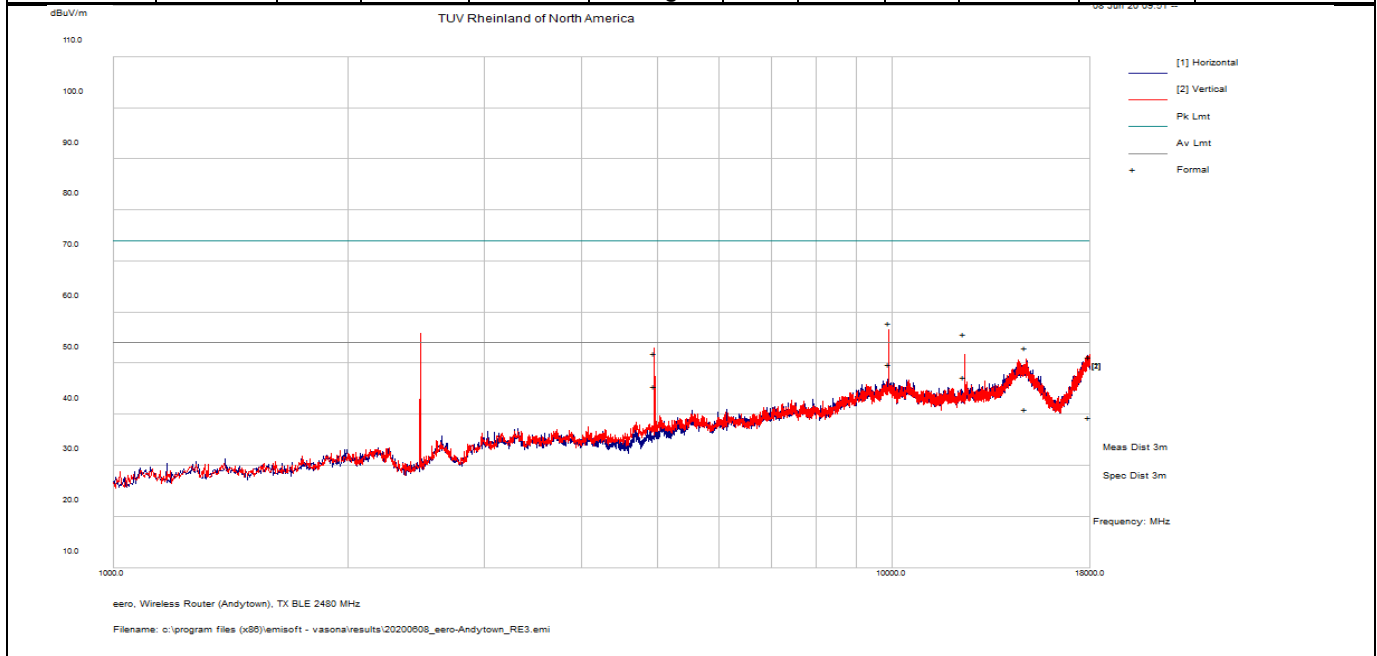

Spec Margin = Level - Limit, Level = Raw+ Cbl+ CF ± Uncertainty
 CF= Amp Gain + ANT Factor
 Combined Standard Uncertainty $u_c(y) = \pm 3.2\text{dB}$ Expanded Uncertainty $U = ku_c(y)$ $k = 2$ for 95% confidence
 Notes: All emissions passed the spurious emission limit.
 (*) Non-restricted band emission.
 Emission at 2480 MHz is the fundamental.

SOP 1 Radiated Emissions

Tracking # 32062470.001 Page 6 of 8

EUT Name	eero 6 and eero 6 Extender	Date	June 9, 2020
EUT Model	N010001	Temp / Hum in	21°C / 38%rh
EUT Serial	NA4V-0034-0FZS-B958	Temp / Hum out	N/A
EUT Config.	BLE, 1 Mbps; TX at 2402 MHz (Low Channel)	Line AC / Freq	110Vac / 60 Hz
Standard	CFR47 Part 15 Subpart C / RSS-GEN	RBW / VBW	1 MHz / 3 MHz
Dist/Ant Used	3m / EMCO-3115, 1m / ComPower-AHA840	Performed by	Kerwinn Corpuz

Emission band 18 – 25 GHz

Freq	Raw	Cbl	AF	Level	Det	Pol	Hght	Azt	Limit	Margin	Comment
MHz	dBuV/m	dB	dB	dBuV/m		H/V	cm	deg	dBuV/m	dB	
24758.60	43.22	8.18	2.46	53.86	Pk	H	208	150	74.00	-20.14	Spurious
24758.60	31.50	8.18	2.46	42.14	Avg	H	208	150	54.00	-11.86	Spurious
19217.90	52.19	7.20	0.13	59.52	Pk	V	160	20	74.00	-14.48	Harmonics
19217.90	43.34	7.20	0.13	50.67	Avg	V	160	20	54.00	-3.33	Harmonics
21620.22	48.95	7.80	0.40	57.15	Pk	V	160	44	74.00	-16.85	Harmonics*
21620.22	38.90	7.80	0.40	47.09	Avg	V	160	44	54.00	-6.91	Harmonics*
24017.17	44.18	8.08	2.33	54.59	Pk	V	184	10	74.00	-19.41	Harmonics*
24017.17	32.65	8.08	2.33	43.06	Avg	V	184	10	54.00	-10.94	Harmonics*

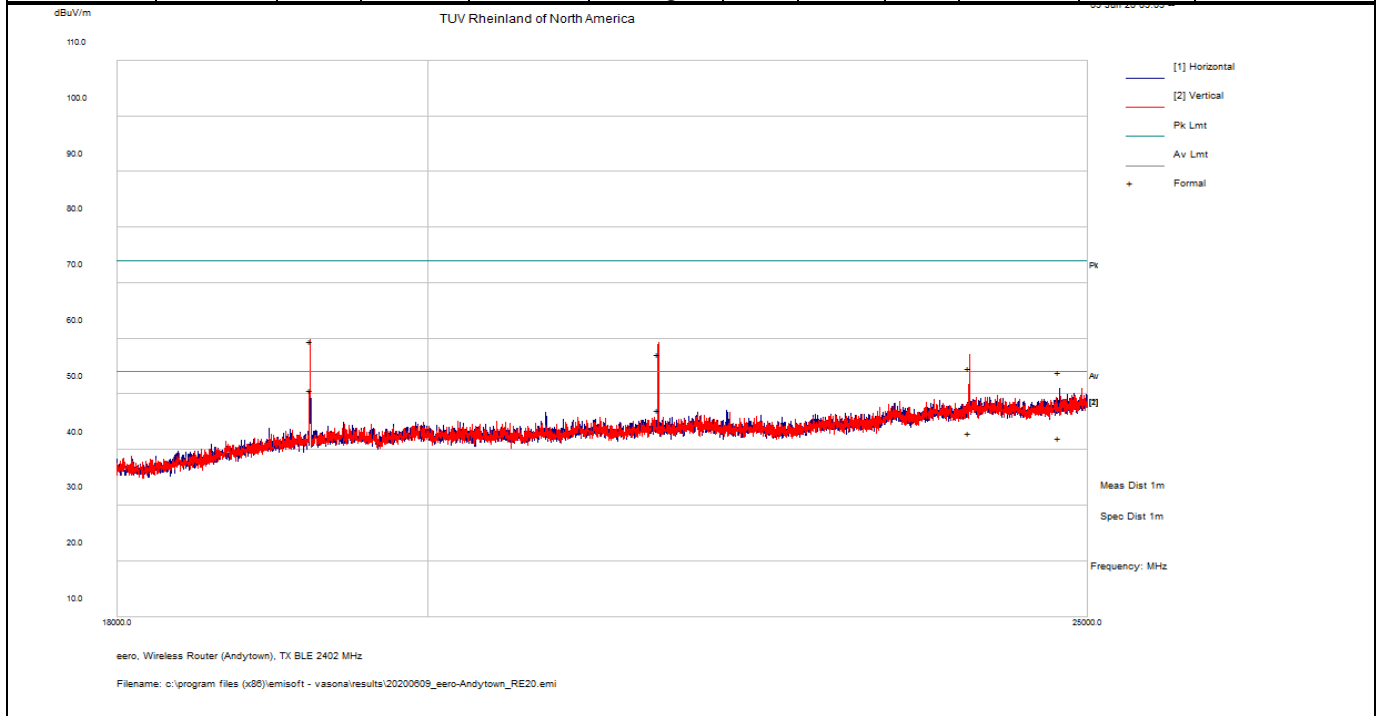

Spec Margin = Level - Limit, Level = Raw+ Cbl+ CF ± Uncertainty
 CF= Amp Gain + ANT Factor
 Combined Standard Uncertainty $u_c(y) = \pm 3.2\text{dB}$ Expanded Uncertainty $U = ku_c(y)$ $k = 2$ for 95% confidence
 Notes: All emissions passed the spurious emission limit.
 (*) Non-restricted band emission.

SOP 1 Radiated Emissions

Tracking # 32062470.001 Page 7 of 8

EUT Name	eero 6 and eero 6 Extender	Date	June 9, 2020
EUT Model	N010001	Temp / Hum in	21°C / 38%rh
EUT Serial	NA4V-0034-0FZS-B958	Temp / Hum out	N/A
EUT Config.	BLE, 1 Mbps; TX at 2440 MHz (Mid Channel)	Line AC / Freq	110Vac / 60 Hz
Standard	CFR47 Part 15 Subpart C / RSS-GEN	RBW / VBW	1 MHz / 3 MHz
Dist/Ant Used	3m / EMCO-3115, 1m / ComPower-AHA840	Performed by	Kerwinn Corpuz

Emission band 18 – 25 GHz

Freq	Raw	Cbl	AF	Level	Det	Pol	Hght	Azt	Limit	Margin	Comment
MHz	dBuV/m	dB	dB	dBuV/m		H/V	cm	deg	dBuV/m	dB	
19517.77	51.66	7.26	0.95	59.87	Pk	V	163	34	74.00	-14.13	Harmonics
19517.77	42.35	7.26	0.95	50.56	Avg	V	163	34	54.00	-3.44	Harmonics
21957.68	52.91	7.70	0.72	61.33	Pk	V	128	50	74.00	-12.67	Harmonics*
21957.68	43.24	7.70	0.72	51.66	Avg	V	128	50	54.00	-2.34	Harmonics*
24397.28	48.83	8.08	2.29	59.21	Pk	V	122	72	74.00	-14.80	Harmonics*
24397.28	37.78	8.08	2.29	48.15	Avg	V	122	72	54.00	-5.85	Harmonics*
24803.29	44.12	8.21	2.43	54.76	Pk	V	108	174	74.00	-19.24	Spurious
24803.29	31.63	8.21	2.43	42.27	Avg	V	108	174	54.00	-11.73	Spurious

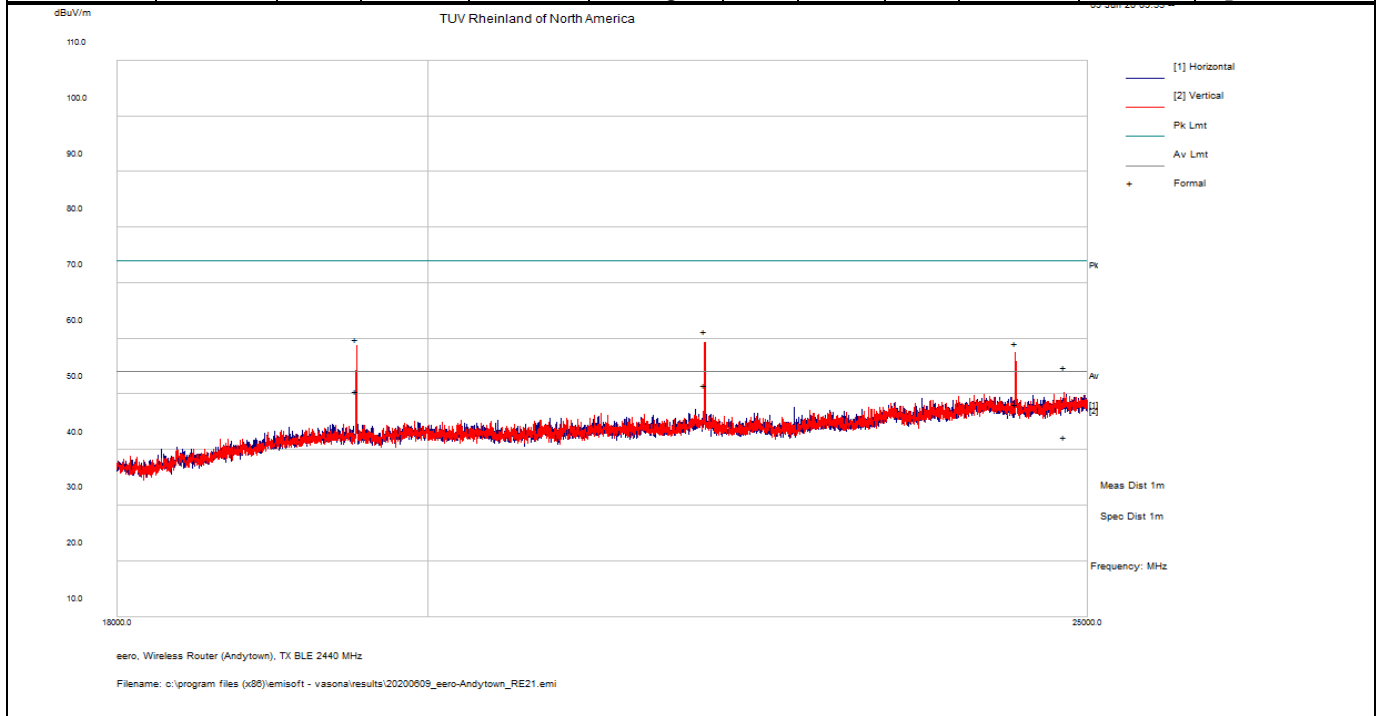

Spec Margin = Level - Limit, Level = Raw+ Cbl+ CF ± Uncertainty
 CF= Amp Gain + ANT Factor

Combined Standard Uncertainty $u_c(y) = \pm 3.2\text{dB}$ Expanded Uncertainty $U = ku_c(y)$ $k = 2$ for 95% confidence

Notes: All emissions passed the spurious emission limit.
 (*) Non-restricted band emission.

SOP 1 Radiated Emissions

Tracking # 32062470.001 Page 8 of 8

EUT Name	eero 6 and eero 6 Extender	Date	June 9, 2020
EUT Model	N010001	Temp / Hum in	21°C / 38%rh
EUT Serial	NA4V-0034-0FZS-B958	Temp / Hum out	N/A
EUT Config.	BLE, 1 Mbps; TX at 2480 MHz (Hi Channel)	Line AC / Freq	110Vac / 60 Hz
Standard	CFR47 Part 15 Subpart C / RSS-GEN	RBW / VBW	1 MHz / 3 MHz
Dist/Ant Used	3m / EMCO-3115, 1m / ComPower-AHA840	Performed by	Kerwinn Corpuz

Emission band 18 – 25 GHz

Freq	Raw	Cbl	AF	Level	Det	Pol	Hght	Azt	Limit	Margin	Comment
MHz	dBuV/m	dB	dB	dBuV/m		H/V	cm	deg	dBuV/m	dB	
19841.89	49.29	7.30	0.99	57.58	Pk	V	170	32	74.00	-16.42	Harmonics
19841.89	39.70	7.30	0.99	47.99	Avg	V	170	32	54.00	-6.01	Harmonics
22317.67	44.11	7.70	0.86	52.67	Pk	V	132	108	74.00	-21.33	Harmonics
22317.67	32.83	7.70	0.86	41.40	Avg	V	132	108	54.00	-12.61	Harmonics
24797.24	47.67	8.21	2.44	58.32	Pk	V	129	43	74.00	-15.68	Harmonics*
24797.24	36.52	8.21	2.44	47.17	Avg	V	129	43	54.00	-6.83	Harmonics*
24867.64	44.70	8.18	2.30	55.18	Pk	V	147	234	74.00	-18.82	Spurious
24867.64	31.94	8.18	2.30	42.42	Avg	V	147	234	54.00	-11.58	Spurious

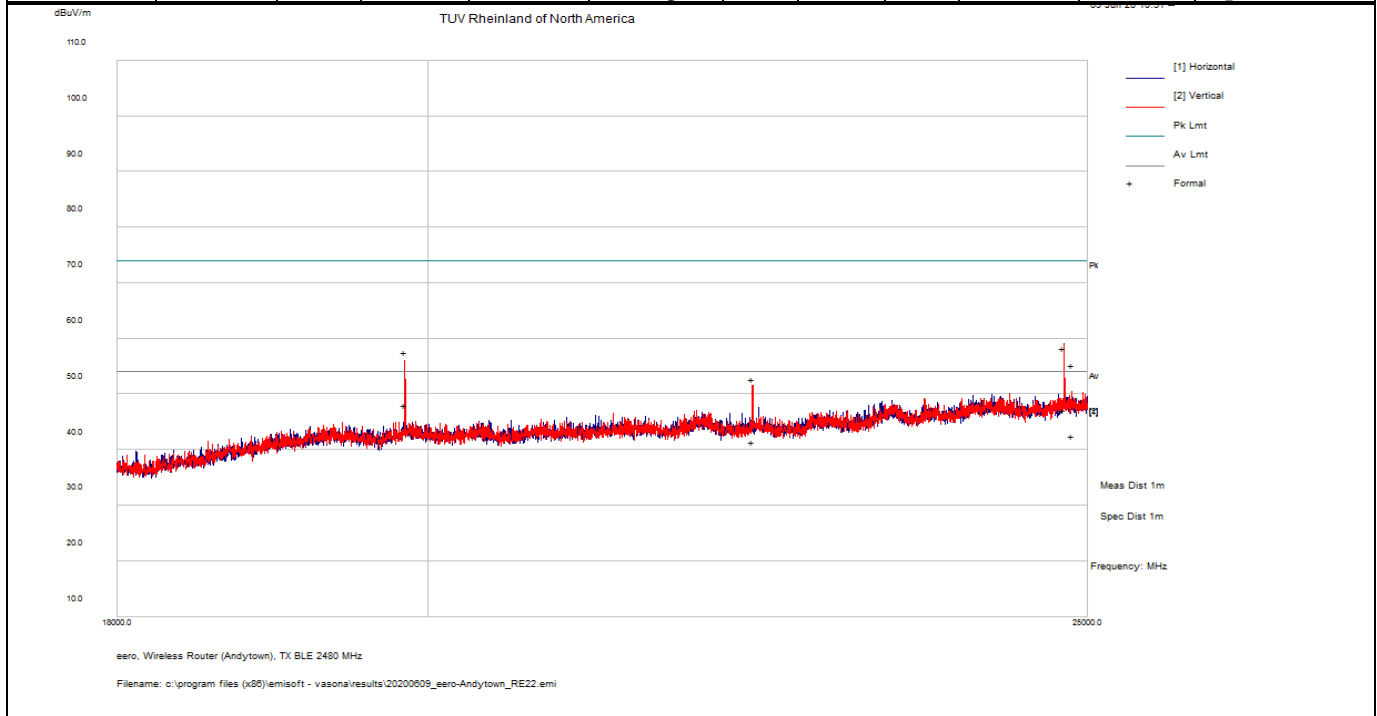

Spec Margin = Level - Limit, Level = Raw+ Cbl+ CF ± Uncertainty
 CF= Amp Gain + ANT Factor
 Combined Standard Uncertainty $u_c(y) = \pm 3.2\text{dB}$ Expanded Uncertainty $U = ku_c(y)$ $k = 2$ for 95% confidence
 Notes: All emissions passed the spurious emission limit.
 (*) Non-restricted band emission.

4.5.4 Sample Calculation

The field strength is calculated by subtracting the Amplifier Gain and adding the Cable Loss and Antenna Correction Factor to the measured reading. The basic equation is as follows:

$$\text{Field Strength (dB}\mu\text{V/m)} = \text{FIM} - \text{AMP} + \text{CBL} + \text{ACF}$$

Where: FIM = Field Intensity Meter (dB μ V)

AMP = Amplifier Gain (dB)

CBL = Cable Loss (dB)

ACF = Antenna Correction Factor (dB/m)

$$\mu\text{V/m} = 10^{\frac{\text{dB}\mu\text{V/m}}{20}}$$

4.6 AC Conducted Emissions

Testing was performed in accordance with ANSI C63.10: 2013. These test methods are listed under the laboratory's A2LA Scope of Accreditation.

This test measures the levels emanating from the EUT's AC input port, thus evaluating the potential for the EUT to cause radio frequency interference to other electronic devices.

The AC conducted emissions of equipment under test shall not exceed the values in CFR47 Part 15.207: 2020 and RSS Gen: 2019 Sect. 8.8.

4.6.1 Test Methodology

A test program that controls instrumentation and data logging was used to automate the AC Power Line Conducted emission test procedure. The frequency range of interest was divided into sub-ranges such as to yield a frequency resolution of 9 kHz. Each phase and neutral of the AC power line were measured with respect to ground. Measurements were performed using a set of 50µH / 50Ω LISNs.

Testing is performed in Lab 5. The setup photographs clearly identify which site was used. The vertical ground plane used in the semi-anechoic chamber is a 2m x 2m solid aluminum frame and panel, and it is bonded to the horizontal ground plane.

In the case of tabletop equipment, the EUT is placed on a 1.0m x 1.5m non-conductive table 80cm above the ground plane and 40cm from a vertical ground reference plane. The rear of the EUT was positioned flush with the backside of the table and directly over the LISNs. The power and I/O cables were routed over the edge of the table and bundled approximately 40cm from the ground plane. Support equipment was powered from a separate LISN.

4.6.1.1 Deviations

There were no deviations from this test methodology.

4.6.2 Test Results

As originally tested, the EUT was found to be compliant to the requirements of the test standard(s).

Table 7: AC Conducted Emissions – Test Results

Test Conditions: Conducted Measurement		Test Date: June 10, 2020
Antenna Type: Integrated		Power Level: See Test Plan
AC Power: 110Vac / 60 Hz		Configuration: Tabletop
Ambient Temperature: 22° C		Relative Humidity: 35% RH
Configuration	Frequency Range	Test Result
Line 1 (Hot)	0.15 to 30 MHz	Pass
Line 2 (Neutral)	0.15 to 30 MHz	Pass

SOP 2 Conducted Emissions						Tracking # 32062470.001 Page 1 of 4			
EUT Name		eero 6 and eero 6 Extender				Date		June 10, 2020	
EUT Model		N010001				Temp / Hum in		23° C / 35% rh	
EUT Serial		NA4V-0034-0FZS-B958				Temp / Hum out		N/A	
EUT Config.		BLE, 1 Mbps; TX at 2440 MHz (Mid Channel)				Line AC / Freq		110 Vac/60 Hz	
Standard		CFR47 Part 15.207 / RSS-GEN Sect. 8.8				RBW / VBW		9 kHz / 30 kHz	
Lab/LISN		Lab #5 /Com-Power, Line 1				Performed by		Kerwinn Corpuz	
Frequency	Raw	Limiter	Ins. Loss	Level	Detector	Line	Limit	Margin	Result
MHz	dBuV	dB	dB	dBuV		Line	dBuV	dB	
0.170	37.01	9.95	0.08	47.04	QP	Live	64.98	-17.94	Pass
0.170	19.41	9.95	0.08	29.44	Avg	Live	54.98	-25.54	Pass
0.199	35.47	9.95	0.07	45.49	QP	Live	63.65	-18.16	Pass
0.199	19.66	9.95	0.07	29.68	Avg	Live	53.65	-23.96	Pass
0.256	31.30	9.96	0.06	41.31	QP	Live	61.56	-20.25	Pass
0.256	15.48	9.96	0.06	25.50	Avg	Live	51.56	-26.07	Pass
0.437	26.78	9.97	0.04	36.80	QP	Live	57.12	-20.32	Pass
0.437	18.11	9.97	0.04	28.13	Avg	Live	47.12	-18.99	Pass
0.530	36.35	9.98	0.04	46.37	QP	Live	56.00	-9.63	Pass
0.530	19.90	9.98	0.04	29.92	Avg	Live	46.00	-16.08	Pass
1.396	23.28	10.00	0.04	33.32	QP	Live	56.00	-22.68	Pass
1.396	14.48	10.00	0.04	24.52	Avg	Live	46.00	-21.48	Pass
Spec Margin = QP./Ave. - Limit, ± Uncertainty									
Combined Standard Uncertainty $u_c(y) = \pm 2.18$ dB Expanded Uncertainty $U = ku_c(y)$ $k = 2$ for 95% confidence									
Notes: EUT was setup as table top equipment									

SOP 2 Conducted Emissions

Tracking # 32062470.001 Page 2 of 4

EUT Name	eero 6 and eero 6 Extender	Date	June 10, 2020
EUT Model	N010001	Temp / Hum in	23° C / 35% rh
EUT Serial	NA4V-0034-0FZS-B958	Temp / Hum out	N/A
EUT Config.	BLE, 1 Mbps; TX at 2440 MHz (Mid Channel)	Line AC / Freq	110 Vac/60 Hz
Standard	CFR47 Part 15.207 / RSS-GEN Sect. 8.8	RBW / VBW	9 kHz / 30 kHz
Lab/LISN	Lab #5 /Com-Power, Line 1	Performed by	Kerwinn Corpuz

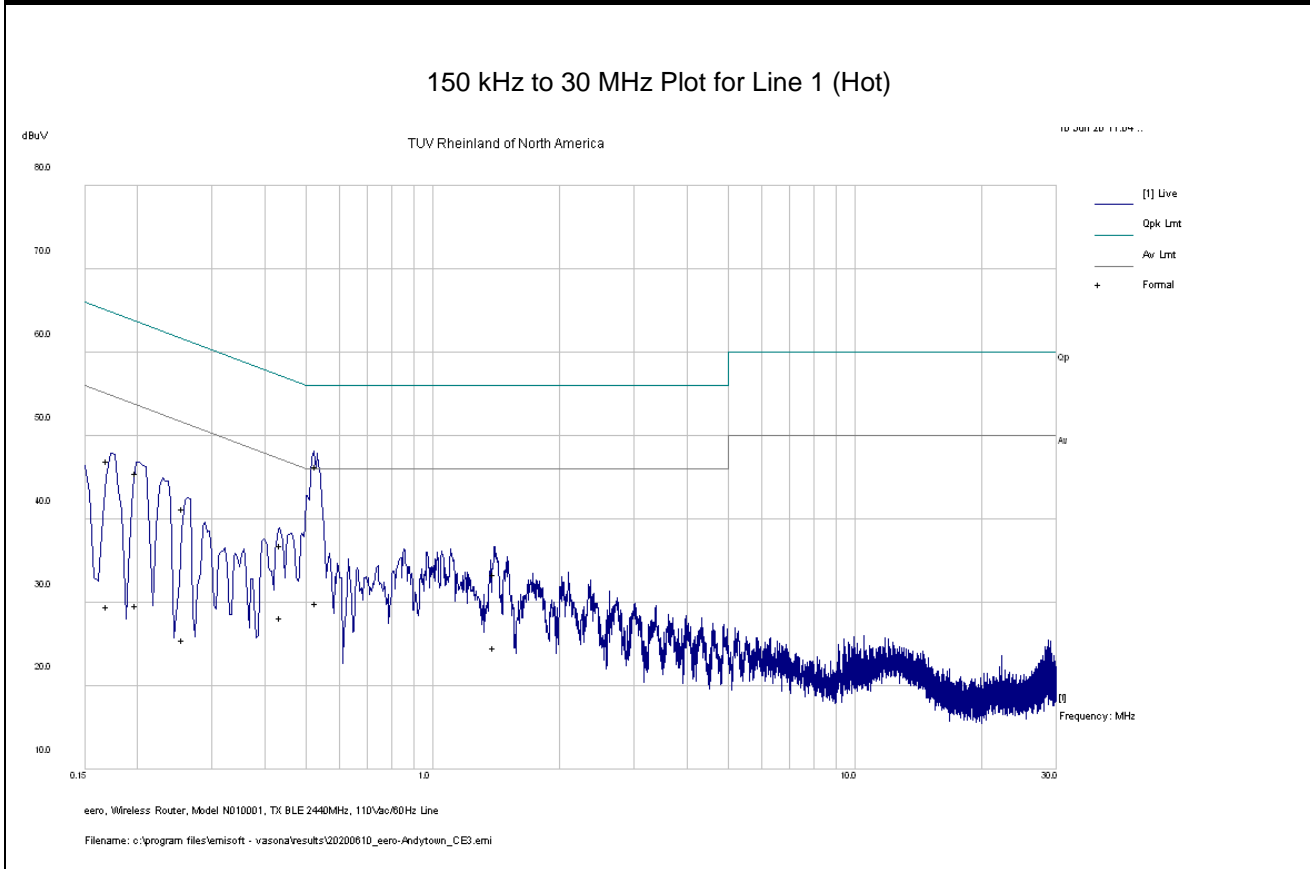

Notes: Meets FCC Class B limit.

SOP 2 Conducted Emissions						Tracking # 32062470.001 Page 3 of 4				
EUT Name	eero 6 and eero 6 Extender					Date	June 10, 2020			
EUT Model	N010001					Temp / Hum in	23° C / 35% rh			
EUT Serial	NA4V-0034-0FZS-B958					Temp / Hum out	N/A			
EUT Config.	BLE, 1 Mbps; TX at 2440 MHz (Mid Channel)					Line AC / Freq	110 Vac/60 Hz			
Standard	CFR47 Part 15.207 / RSS-GEN Sect. 8.8					RBW / VBW	9 kHz / 30 kHz			
Lab/LISN	Lab #5 /Com-Power, Line 2					Performed by	Kerwinn Corpuz			
Frequency	Raw	Limiter	Ins. Loss	Level	Detector	Line	Limit	Margin	Result	
MHz	dBuV	dB	dB	dBuV		Line	dBuV	dB		
0.176	35.71	9.95	0.08	45.74	QP	Neutral	64.69	-18.95	Pass	
0.176	17.01	9.95	0.08	27.04	Avg	Neutral	54.69	-27.64	Pass	
0.200	35.21	9.95	0.07	45.23	QP	Neutral	63.62	-18.39	Pass	
0.200	16.76	9.95	0.07	26.78	Avg	Neutral	53.62	-26.84	Pass	
0.229	33.35	9.95	0.06	43.36	QP	Neutral	62.50	-19.14	Pass	
0.229	14.59	9.95	0.06	24.61	Avg	Neutral	52.50	-27.90	Pass	
0.429	29.60	9.97	0.04	39.61	QP	Neutral	57.27	-17.66	Pass	
0.429	14.51	9.97	0.04	24.52	Avg	Neutral	47.27	-22.75	Pass	
0.528	34.63	9.98	0.04	44.65	QP	Neutral	56.00	-11.35	Pass	
0.528	14.84	9.98	0.04	24.86	Avg	Neutral	46.00	-21.14	Pass	
0.851	26.58	9.99	0.04	36.61	QP	Neutral	56.00	-19.39	Pass	
0.851	15.62	9.99	0.04	25.65	Avg	Neutral	46.00	-20.35	Pass	
0.176	35.71	9.95	0.08	45.74	QP	Neutral	64.69	-18.95	Pass	
0.176	17.01	9.95	0.08	27.04	Avg	Neutral	54.69	-27.64	Pass	
Spec Margin = QP./Ave. - Limit, ± Uncertainty										
Combined Standard Uncertainty $u_c(y) = \pm 2.18$ dB Expanded Uncertainty $U = ku_c(y)$ $k = 2$ for 95% confidence										
Notes: EUT was setup as table top equipment										

SOP 2 Conducted Emissions

Tracking # 32062470.001 Page 4 of 4

EUT Name	eero 6 and eero 6 Extender	Date	June 10, 2020
EUT Model	N010001	Temp / Hum in	23° C / 35% rh
EUT Serial	NA4V-0034-0FZS-B958	Temp / Hum out	N/A
EUT Config.	BLE, 1 Mbps; TX at 2440 MHz (Mid Channel)	Line AC / Freq	110 Vac/60 Hz
Standard	CFR47 Part 15.207 / RSS-GEN Sect. 8.8	RBW / VBW	9 kHz / 30 kHz
Lab/LISN	Lab #5 /Com-Power, Line 2	Performed by	Kerwinn Corpuz

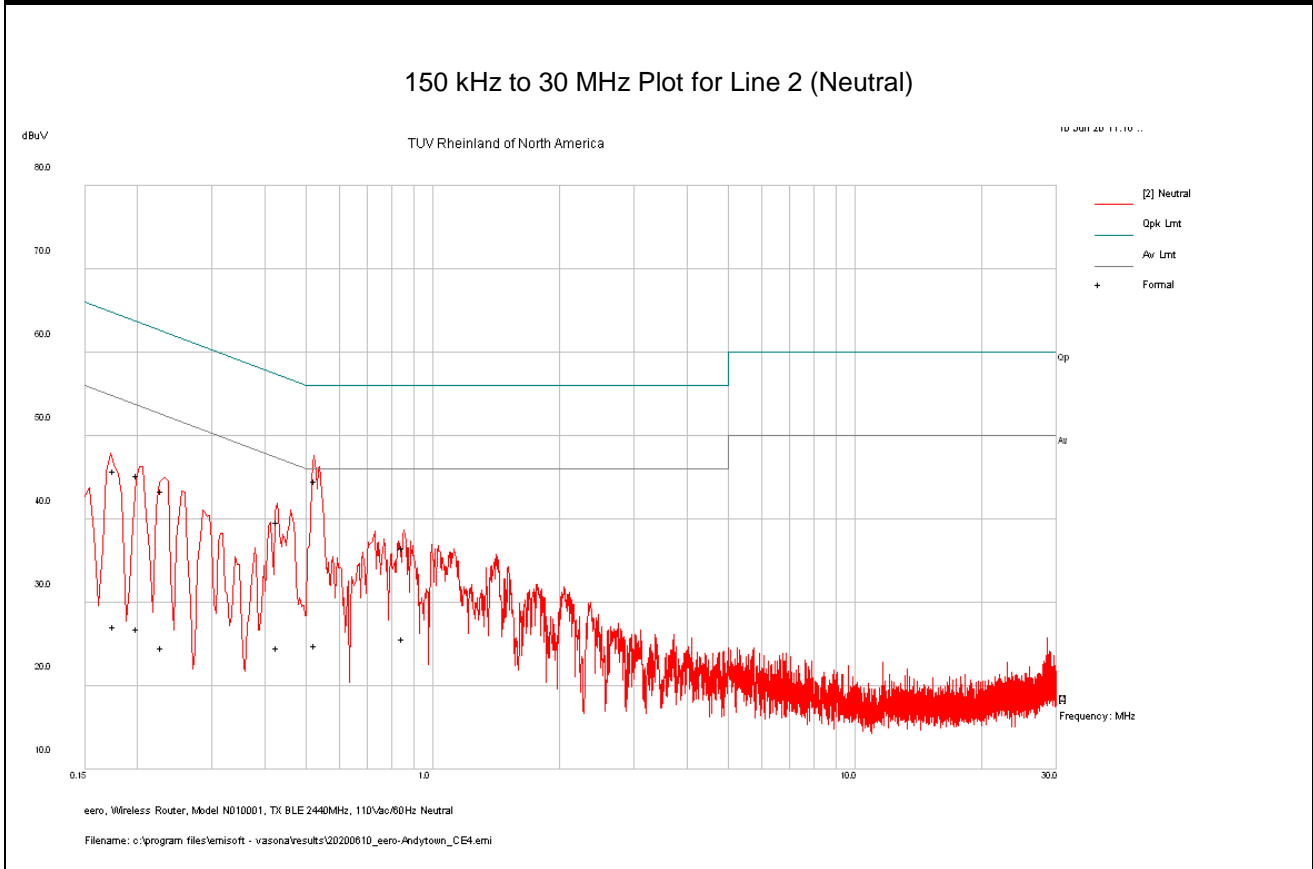

Note: Meets FCC Class B Limit.

5 Test Equipment List

5.1 Equipment List

Equipment	Manufacturer	Model #	Serial/Inst #	Last Cal mm/dd/yyyy	Next Cal mm/dd/yyyy
Loop Antenna	EMCO	6502	62531	07/01/2019	07/01/2021
Bilog Antenna	Sunol Sciences	JB3	A102606	08/01/2018	08/01/2020
Horn Ant. (1-18GHz)	Sunol Sciences	3115	9211-3969	06/20/2019	06/20/2021
Horn Ant. w/ Pre-Amp	Com-Power	AHA-840	105005	08/26/2019	08/26/2020
EMI Receiver	Agilent	N9038A	MY52260210	02/15/2020	02/15/2021
Spectrum Analyzer	Agilent	N9030A	MY52350885	10/26/2019	10/26/2020
EMI Receiver	Rohde & Schwarz	ESIB40	100180	09/20/2019	09/20/2020
Preamplifier	Sonoma Inst.	310	185516	02/12/2020	02/12/2021
Preamplifier	Miteq	TTA1800-30-HG	184252	02/12/2020	02/12/2021
RF Power Meter	Agilent	E4418A	MY45103902	02/13/2020	02/13/2021
Power Sensor	Agilent	8481A	US37295801	02/13/2020	02/13/2021
Thermometer	Extech Instruments	SD700	A095319	03/18/2020	03/18/2021
Thermo Chamber	Espec	BTZ-133	0613436	12/20/2019	12/20/2020
Signal Generator	Anritsu	MG3694A	042803	02/13/2020	02/13/2021
Notch Filter	Micro-Tronics	BRM50702	37	VBU	VBU

* Calibration of equipment past due for re-calibration will be performed expeditiously. If any equipment is found to be out of tolerance at that time, affected customers will be notified accordingly.

6 EMC Test Plan

6.1 Introduction

This section provides a description of the Equipment Under Test (EUT), configurations, operating conditions, and performance acceptance criteria. It is an overview of information provided by the manufacturer so that the test laboratory may perform the requested testing.

6.2 Customer

Table 8: Customer Information

Company Name	eero LLC
Address	660 3rd Street
City, State, Zip	San Francisco, CA 94107
Country	USA

Table 9: Technical Contact Information

Name	eero LLC
E-mail	cliff@eero.com
Phone	+1 415-738-7972

6.3 Equipment Under Test (EUT)

Table 10: EUT Specifications

EUT Specification	
AC Power Input	100-240V AC, 50 – 60 Hz, 0.5A
DC Power Input	5 VDC, 3 A, 15W
Environment	Indoor
Operating Temperature Range:	0 to 35 degrees C
Multiple Feeds:	<input type="checkbox"/> Yes and how many <input checked="" type="checkbox"/> No
Product Marketing Name (PMN)	N010001 and Q010001
Hardware Version Identification Number (HVIN)	N010001 and Q010001
Firmware Version Identification Number (FVIN)	eeroOS 5.0.0
Operating Mode	Bluetooth LE
Transmitter Frequency Band	2402 MHz to 2480 MHz
Max. Measured Power Output	+19.55 dBm
Power Setting @ Operating Channel	+20 dBm (max)
Antenna Type	Stamped Metal, Planar Inverted F (3.46 dBi)
Modulation Type	<input type="checkbox"/> AM <input type="checkbox"/> FM <input type="checkbox"/> DSSS <input type="checkbox"/> OFDM <input checked="" type="checkbox"/> Other describe: GFSK
Date Rate	1 Mbps and 2 Mbps
TX/RX Chain (s)	1
Directional Gain Type	<input checked="" type="checkbox"/> Uncorrelated <input checked="" type="checkbox"/> No Beam-Forming <input type="checkbox"/> Other describe:
Type of Equipment	<input checked="" type="checkbox"/> Table Top <input type="checkbox"/> Wall-mount <input type="checkbox"/> Floor standing cabinet <input type="checkbox"/> Other
Note: 1. eero test image 4470b6a83278; Fri may 29 18:01:48 UTC 2020. 2. Support laptop interface software: PTC_QPG7015M_RPi v1.3.0.0.	

Table 11: Interface Specifications

Interface Type	Cabled with what type of cable?	Is the cable shielded?	Maximum potential length of the cable?	Metallic (M), Coax (C), Fiber (F), or Not Applicable?
RJ45	Terminated to Host Ethernet Port	<input checked="" type="checkbox"/> No	<input checked="" type="checkbox"/> Metric:2m	<input checked="" type="checkbox"/> N/A

Table 12: Supported Equipment

Equipment	Manufacturer	Model	Serial	Used for
Laptop	DELL	Latitude 5420	GBGHMQ1	Set test mode

Table 13: Description of Sample used for Testing

Device	Serial Number	Configuration	Used For
N010001	NA4V-0034-0FZS-B958	Radiated Sample	Radiated Emissions. Conducted Emission
N010001	NA4V-003K-J9V4-FP58	Conducted Sample	Output Power, Occupied Bandwidth, Conducted Spurious Emissions, Peak Power Spectral Density

Note: Conducted sample, a soldered pigtail was in place of the stamped metal antenna for test purposes only.

Table 14: Description of Test Configuration used for Radiated Measurement.

Device	Antenna	Mode	Setup Description
N010001	Integrated	Transmit & Receive	N010001 positioned tabletop.

Note: This is the final setup configuration used for testing on its normal positioned.

Table 15: Final Test Mode for 2402 MHz to 2480MHz Band (Bluetooth LE)

Test	N010001
Occupied Bandwidth	2402, 2440, 2480 MHz @ 1 Mbps
Output Power	2402, 2440, 2480 MHz @ 1 Mbps
Peak Power Spectral Density	2402, 2440, 2480 MHz @ 1 Mbps
Out-of-Band (-30 dBr)	2402, 2440, 2480 MHz @ 1 Mbps
Band-Edge (Radiated)	2402, 2480 MHz @ 1 Mbps
Transmitted Spurious Emission	2402, 2440, 2480 MHz @ 1 Mbps
AC Conducted Emission	2440 MHz @ 1 Mbps
Note: EUT transmits at 100% duty cycle.	

6.4 Test Specifications

Table 16: Test Specifications

Emissions and Immunity	
Rules & Regulations / Standard	Requirement
CFR 47 Part 15.247: 2020	All
RSS 247 Issue 2, 2017	All

END OF REPORT