

Panasonic®

Owner's Manual Digital Wireless Stereo Earphones

Model No. **RZ-S500W**
RZ-S300W

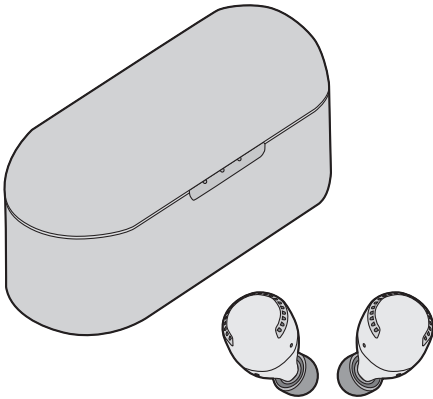

RZ-S500W

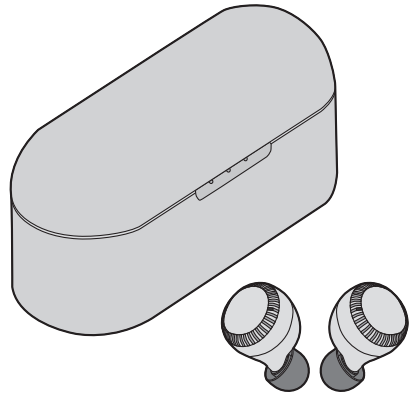

RZ-S300W

Thank you for purchasing this product.
Please read these instructions carefully before using this product, and save this manual for future use.

**Register online at <http://shop.panasonic.com/support>
(U.S. customers only)**

If you have any questions, visit:

In the U.S.A.:

<http://shop.panasonic.com/support>

In Canada:

www.panasonic.ca/english/support

IMPORTANT SAFETY INSTRUCTIONS

Read these operating instructions carefully before using the unit. Follow the safety instructions on the unit and the applicable safety instructions listed below. Keep these operating instructions handy for future reference.

- 1 Read these instructions.
- 2 Keep these instructions.
- 3 Heed all warnings.
- 4 Follow all instructions.
- 5 Do not use this apparatus near water.
- 6 Clean only with dry cloth.
- 7 Do not block any ventilation openings. Install in accordance with the manufacturer's instructions.
- 8 Do not install near any heat sources such as radiators, heat registers, stoves, or other apparatus (including amplifiers) that produce heat.
- 9 Do not defeat the safety purpose of the polarized or grounding-type plug. A polarized plug has two blades with one wider than the other. A grounding-type plug has two blades and a third grounding prong. The wide blade or the third prong are provided for your safety. If the provided plug does not fit into your outlet, consult an electrician for replacement of the obsolete outlet.
- 10 Protect the power cord from being walked on or pinched particularly at plugs, convenience receptacles, and the point where they exit from the apparatus.
- 11 Only use attachments/accessories specified by the manufacturer.
- 12 Use only with the cart, stand, tripod, bracket, or table specified by the manufacturer, or sold with the apparatus. When a cart is used, use caution when moving the cart/apparatus combination to avoid injury from tip-over.
- 13 Unplug this apparatus during lightning storms or when unused for long periods of time.
- 14 Refer all servicing to qualified service personnel. Servicing is required when the apparatus has been damaged in any way, such as power-supply cord or plug is damaged, liquid has been spilled or objects have fallen into the apparatus, the apparatus has been exposed to rain or moisture, does not operate normally, or has been dropped.



Safety precautions



A lithium ion battery that is recyclable powers the product you have purchased. Please call 1-800-8-BATTERY for information on how to recycle this battery.

For US and Canada only
Pour les É.-U. et le Canada seulement

THE FOLLOWING APPLIES ONLY IN THE U.S.A. AND CANADA.

This device complies with Part 15 of FCC Rules and Innovation, Science and Economic Development Canada's licence-exempt RSS(s). Operation is subject to the following two conditions:

- (1) this device may not cause interference, and
- (2) this device must accept any interference, including interference that may cause undesired operation.

RZ-S500W

FCC ID: ACJ-RZ-S500W

Model: RZ-S500W

IC: 216A-RZS500W

RZ-S300W

FCC ID: ACJ-RZ-S300W

Model: RZ-S300W

IC: 216A-RZS300W

This transmitter must not be co-located or operated in conjunction with any other antenna or transmitter.

(For the U.S.A. only)

This equipment complies with FCC radiation exposure limits set forth for an uncontrolled environment and meets the FCC radio frequency (RF) Exposure Guidelines as this equipment has very low levels of RF energy.

(For Canada only)

RZ-S500W RZ-S500W has been tested and found to comply with ISED radiation exposure limits set forth for an uncontrolled environment and meets RSS-102 of the ISED radio frequency (RF) Exposure rules.

RZ-S300W This equipment complies with ISED radiation exposure limits set forth for an uncontrolled environment and meets RSS-102 of the ISED radio frequency (RF) Exposure rules as this equipment has very low levels of RF energy.

THE FOLLOWING APPLIES ONLY IN THE U.S.A.

FCC Note:

This equipment has been tested and found to comply with the limits for a Class B digital device, pursuant to Part 15 of the FCC Rules. These limits are designed to provide reasonable protection against harmful interference in a residential installation. This equipment generates, uses, and can radiate radio frequency energy and, if not installed and used in accordance with the instructions, may cause harmful interference to radio communications.

However, there is no guarantee that interference will not occur in a particular installation. If this equipment does cause harmful interference to radio or television reception, which can be determined by turning the equipment off and on, the user is encouraged to try to correct the interference by one or more of the following measures:

- Reorient or relocate the receiving antenna.
- Increase the separation between the equipment and receiver.
- Connect the equipment into an outlet on a circuit different from that to which the receiver is connected.
- Consult the dealer or an experienced radio/TV technician for help.

FCC Caution: To assure continued compliance, follow the attached installation instructions and use only shielded interface cables when connecting to peripheral devices.

Any changes or modifications not expressly approved by the party responsible for compliance could void the user's authority to operate this equipment.

This device complies with Part 15 of the FCC Rules. Operation is subject to the following two conditions:

- (1) This device may not cause harmful interference, and
- (2) this device must accept any interference received, including interference that may cause undesired operation.

Supplier's Declaration of Conformity

RZ-S500W

Trade Name: Panasonic

Model No.: RZ-S500W

Responsible Party:

RZ-S300W

Trade Name: Panasonic

Model No.: RZ-S300W

Panasonic Corporation of North America

Two Riverfront Plaza, Newark, NJ 07102-5490

Support Contact: <http://shop.panasonic.com/support>

THE FOLLOWING APPLIES ONLY IN CANADA.

CAN ICES-3(B)/NMB-3(B)

■ **Unit**

WARNING:

To reduce the risk of fire, electric shock or product damage,

- Do not expose this unit to rain, moisture, dripping or splashing.
- Do not place objects filled with liquids, such as vases, on this unit.
- Use the recommended accessories.
- Do not remove covers.
- Do not repair this unit by yourself. Refer servicing to qualified service personnel.

Avoid the use in the following conditions

- High or low extreme temperatures during use, storage or transportation.
- Disposal of a battery into fire or a hot oven, or mechanically crushing or cutting of a battery, that can result in an explosion.
- Extremely high temperature and/or extremely low air pressure that can result in an explosion or the leakage of flammable liquid or gas.

- Avoid using or placing this unit near sources of heat.
- Do not listen with this unit at high volume in places where you need to hear sounds from the surrounding environment for safety, such as at railroad crossings, and construction sites.
- Keep this unit away from something susceptible to the magnetism. Such devices as a clock may not operate correctly.
- Be aware that this unit (earphones) may get warm while charging or immediately after charging. Depending on your constitution and health status, putting the earphones on may trigger adverse reactions such as skin redness, itching, and rash if the earphones have just been taken out of the charging cradle and are still warm.

CAUTION!

To reduce the risk of fire, electric shock or product damage,

- Do not install or place this unit in a bookcase, built-in cabinet or in another confined space. Ensure this unit is well ventilated.
- Do not obstruct this unit's ventilation openings with newspapers, tablecloths, curtains, and similar items.
- Do not place sources of naked flames, such as lighted candles, on this unit.

■ **Built-in battery**

- Do not heat or expose to flame.
- Do not leave the unit in a car exposed to direct sunlight for a long period of time with doors and windows closed.

■ **Earphones/Earpieces**

- Keep the earphones and the earpieces out of reach of children and pets to prevent swallowing. After use, put them in the charging cradle and close the lid for storage.
- Securely attach the earpieces. If they are left in the ears after coming off, injury or sickness may be caused.

• Keep the earphones clean. After use, make sure there is no earwax, foreign matter, etc., attached to the earpieces. If there is earwax, foreign matter, etc., attached, remove the earpieces from the earphones and clean them. (→ 30, "Earpiece cleaning")

- If you clean the earpieces (B) while they are attached to the earphones, you may damage the protective mesh on the earphones (A).
- Remove earwax, foreign matter, etc., that has attached to the protective mesh of the earphones by blowing on it, etc. You may block the protective mesh if you try to remove with a cotton swab, etc., which can lead to malfunctions.
- If hair styling product, make-up, etc., gets onto the earphones, wipe off immediately with a soft dry cloth. (Do not touch the protective mesh as this can have an effect on audio characteristics.)

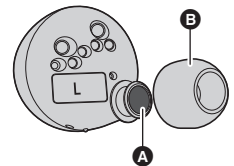

- Store the earphones in the charging cradle to protect them from foreign matter, etc., getting on them.
- Keep your ears clean. Earwax and other foreign matter attached to the holes of the earpieces can change the acoustic characteristics, such as making the sound smaller, and also be the cause of malfunctions.

■ Allergies

- Discontinue use if you experience discomfort with the earphones or any other parts that directly contact your skin.
- Continued use may cause rashes or other allergic reactions.

■ Precautions for listening with the Earphones

- Excessive sound pressure from earphones and headphones can cause hearing loss.
- Do not use your earphones at a high volume. Hearing experts advise against continuous extended play.
- If you experience a ringing in your ears, reduce volume or discontinue use.
- Do not use while operating a motorized vehicle. It may create a traffic hazard and is illegal in many areas.
- You should use extreme caution or temporarily discontinue use in potentially hazardous situations.

This unit may receive radio interference caused by mobile telephones during use. If such interference occurs, please increase separation between this unit and the mobile telephone.

Use only the supplied USB charging cord when connecting to a computer.

The symbols on this product (including the accessories) represent the following: --- DC



Conforms to
UL STD 62368-1.
Certified to CAN/CSA STD
C22.2 No.62368-1.
Conforme à la norme CAN/CSA
C22.2 No.62368-1.

Intertek
4004466



About Bluetooth®

Panasonic bears no responsibility for data and/or information that is compromised during a wireless transmission.

■ Frequency band used

This unit uses the 2.4 GHz frequency band.

■ Certification of this unit

- This unit conforms to frequency restrictions and has received certification based on frequency laws. Thus, a wireless permit is not necessary.
- The actions below are punishable by law in some countries:
 - Taking apart/modifying this unit.
 - Removing specification indications.

■ Restrictions of use

- Wireless transmission and/or usage with all Bluetooth® equipped devices is not guaranteed.
- All devices must conform to standards set by Bluetooth SIG, Inc.
- Depending on the specifications and settings of a device, it can fail to connect or some operations can be different.
- This unit supports Bluetooth® security features. But depending on the operating environment and/or settings, this security may not be sufficient. Transmit data wirelessly to this unit with caution.
- This unit cannot transmit data to a Bluetooth® device.

■ Range of use

Use this unit at a maximum range of 10 m (33 ft).

The range can decrease depending on the environment, obstacles or interference.

■ Interference from other devices

- This unit may not function properly and troubles such as noise and sound jumps may arise due to radio wave interference if this unit is located too close to other Bluetooth® devices or the devices that use the 2.4 GHz band.
- This unit may not function properly if radio waves from a nearby broadcasting station, etc. is too strong.

■ Intended usage

- This unit is for normal, general use only.
- Do not use this system near an equipment or in an environment that is sensitive to radio frequency interference (example: airports, hospitals, laboratories, etc).

Table of contents

IMPORTANT SAFETY INSTRUCTIONS	2
Safety precautions	3
About Bluetooth®	6
Before use	
<hr/>	
Accessories	8
Maintenance.....	8
(Important) About water resistance	9
How to fit the earphones	10
• How to fit the earphones	10
• Select the earpieces	10
Part names	11
Preparation	
<hr/>	
Charging.....	13
• Using the USB charging cord (supplied) to charge the earphones and the charging cradle	13
• Charging the earphones with the charging cradle	14
• Battery level notification.....	14
Turning the earphones on and off	15
Using the app “Panasonic Audio Connect”	16
Connecting a Bluetooth® device	17
• Connecting by pairing (registering) your earphones with a Bluetooth® device	17
• Connecting a paired Bluetooth® device	18
Operation	
<hr/>	
Listening to music	19
Making a phone call	20
Using the external sound control.....	21
Useful functions.....	22
• Using the app “Panasonic Audio Connect”.....	22
• Activating voice functions	22
• Using just one earphone	22
Operating with the touch sensors.....	23
Other	
<hr/>	
Restoring to the factory settings.....	24
Copyright, etc.	24
Troubleshooting.....	25
• Sound and audio volume.....	25
• Bluetooth® device connection.....	25
• Phone Calls	25
• General.....	26
• Power supply and charging	26
Specifications	27
When disposing of the product.....	29
Earpiece cleaning.....	30
Useful information	34

Expressions used in this document

- Pages to be referred to are indicated as “→ ○○”.
- The product illustrations may differ from the actual product.
- Unless otherwise indicated, illustrations in these operating instructions are of RZ-S500W.

Marks denoting model names

- Functionality differences between models are indicated with the model marks below.
RZ-S500W: **RZ-S500W** RZ-S300W: **RZ-S300W**

Accessories

Please check and identify the supplied accessories.

To order accessories, contact the dealer from whom you have made your purchase.

1 x USB charging cord

RZ-S500W

1 x Earpieces set (2 each of sizes XS, S, M, L, and XL) (M size fitted to the earphones)

RZ-S300W

1 x Earpieces set (2 each of sizes XS, S, M, and L) (M size fitted to the earphones)

Only for U.S.A.:

To order accessories, refer to “Limited Warranty”.

Maintenance

Clean this unit with a dry and soft cloth.

- When the unit is very dirty, wipe off the dirt with a cloth that has been dipped in water and well wrung, then wipe with a dry cloth.
- Do not use solvents including benzine, thinner, alcohol, kitchen detergent, a chemical wiper, etc. This might cause the exterior case to be deformed or the coating to come off.
- Wipe off dust from the charging terminals with a soft, dry cloth. Do not use pointy objects.

Remove the earpieces from the earphones and get rid of earwax, foreign matter, etc.

- If you clean the earpieces while they are attached to the earphones, you may damage the protective mesh on the earphones. (Do not touch the protective mesh as this can have an effect on audio characteristics.)

Keeping the battery performance

- During the long period of disuse, full charge this unit once every 6 months to keep the battery performance.

(Important) About water resistance

Specifications for this unit are equivalent of IPX4 of IEC 60529, the protection level of electronic device enclosures that protects from splashes, and is not designed to be totally waterproof.

■ About IPX4 (liquid ingress protection level against splashing water)

This unit is compatible to operate after splashing from nozzles approximately 1.8 L/min (0.5 gal/min) of room temperature tap water from every direction approximately 20 cm (8 in) from this unit for 10 minutes.

The charging cradle and the USB charging cord (supplied) are not water resistant.

Water resistance is not guaranteed under all conditions.

■ Cautions for use in places where the unit may get wet (from spray, rain, etc.)

Observe the following precautions. Incorrect operation cause malfunction.

- Do not charge the charging cradle or the earphones while your hands are wet or while there are still water droplets on this unit (earphones or charging cradle).
- Do not use the USB charging cord.
- Do not apply soapy water or detergent or immerse in water.
- If water drops get onto the unit in cold climates, wipe off with a soft, dry cloth.
- If water gets onto the earphones or microphone, wipe off with a soft, dry cloth.
 - Sound may get smaller or get distorted.
 - If there are water drops left in the earpieces, you may hear the sound at reduced volume or you may not be able to hear anything at all. If this is the case, remove the earpieces and get rid of the water drops.

If water does get into the earphones or the charging cradle, cease use and consult your dealer. Malfunction due to improper handling by you will not be covered by the warranty.

How to fit the earphones

Fit the earphones correctly in order to get adequate noise cancelling effect (**RZ-S500W** only) and acoustics. Select and fit the special eartips that suit the sizes of your ears, left and right.

How to fit the earphones

1 Check the orientation (up (a), down) and L (left) and R (right) of the earphones.

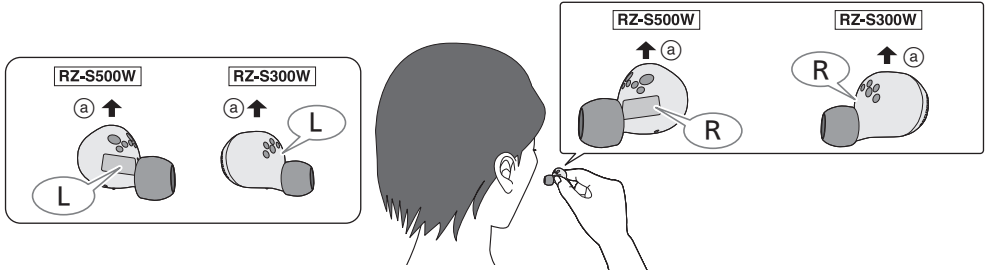

2 Fit firmly by turning the earphones a small amount at a time in the directions indicated by the arrow in the illustration.

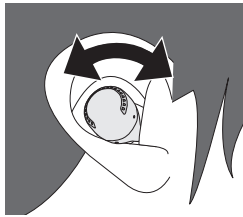

- Confirm that the earphones will not fall from your ears after you have fitted them.
- The left earphone has a raised dot indicating the L side.
- If the earphones fall out easily, replace with eartips (supplied) of a different size.

Select the eartips

How to remove the eartips

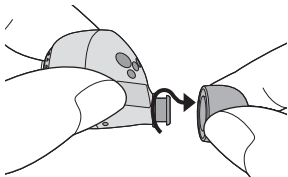

- Hold the eartip with your fingertips and twist slightly to pull it out.

How to attach the eartips

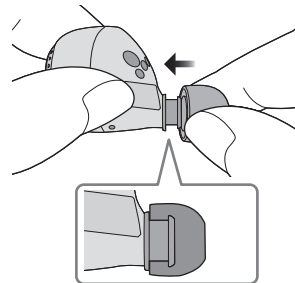

- Make sure the eartips are fitted firmly into your ears and confirm that they are not at an angle.

Part names

Main unit (earphones)

(Earphones hereafter in the instructions)

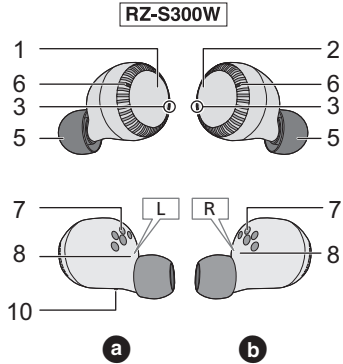
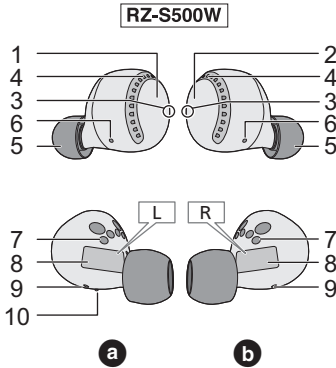

a L side earphone (left) **b** R side earphone (right)

- 1 Touch sensor (L) (left)
- 2 Touch sensor (R) (right)
 - Touching these enables you to perform a variety of operations. (→ 23, “Operating with the touch sensors”)
- 3 Earphone LEDs*1, 3
- 4 **RZ-S500W** Microphone for noise cancelling
- 5 Earpieces
- 6 Microphones for calls
- 7 Charging terminals
- 8 L side (left)/R side (right) indications
- 9 **RZ-S500W** Driver rear ports
- 10 Raised dot indicating the L side

*1 Examples of earphone LED lighting/blinking patterns

Both earphone LEDs (L and R) blink alternately in blue and red	Bluetooth® pairing (registration) standby
Blinking slowly (blue)*2	Bluetooth® connection standby
Blinking twice about every 5 seconds (blue)*2	When connected with Bluetooth® (playing back music/in a call, etc.)
Blinking (blue)*2	A call is being received

*2 The battery is low when it is blinking in red.

*3 Refer to page 13 for information about the earphone LEDs lighting and blinking during charging.

Main unit (charging cradle)

(Charging cradle hereafter in the instructions)

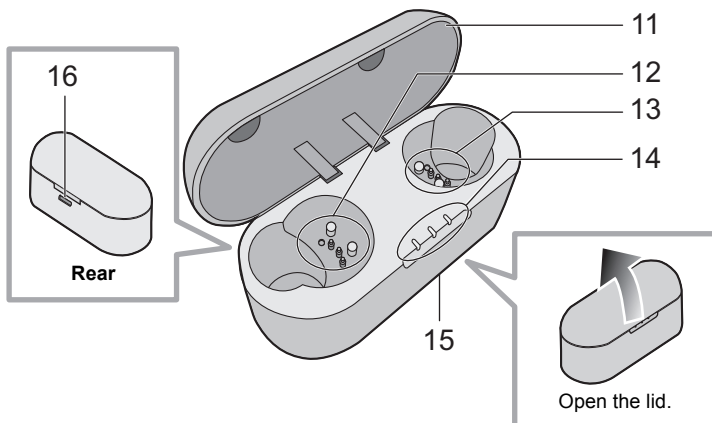

- | | |
|---|---|
| <p>11 Charging cradle lid</p> <p>12 Terminal section (for the L side earphone)</p> <p>13 Terminal section (for the R side earphone)</p> <ul style="list-style-type: none"> • Do not touch the terminal sections with bare hands. <p>14 Charging cradle LEDs*⁴</p> | <p>15 Certification information label (bottom of the charging cradle)</p> <ul style="list-style-type: none"> • The model number is shown on the certification information label. <p>16 Charging terminal</p> <ul style="list-style-type: none"> • Connect the USB charging cord (supplied) to this terminal when charging. (→ 13, “Charging”) |
|---|---|

*4 Refer to page 13 for information about the earphone LEDs lighting and blinking during charging.

Charging

The rechargeable battery (installed in the unit) is not charged initially. Charge the battery before using the unit.

- Proper charging is not possible if there is dust or droplets of water on the terminal sections of the earphones or charging cradle. Remove the dust or water droplets before charging.

Note

- Charge in a room temperature between 10 °C and 35 °C (50 °F to 95 °F).
- It is not possible to turn the power on or connect to Bluetooth® devices during charging.

Using the USB charging cord (supplied) to charge the earphones and the charging cradle

When the earphones have not been put into the charging cradle, the charging cradle itself is charged.

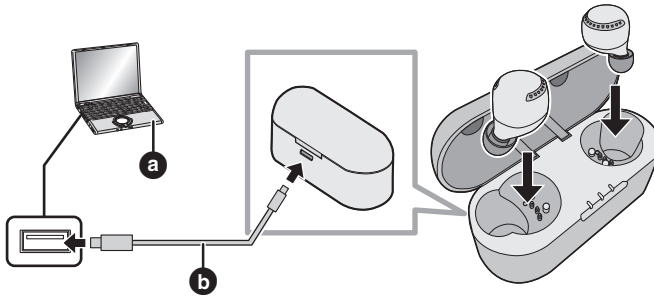

1 Use the USB charging cord (supplied) (b) to connect the charging cradle to a 5.0 V power source (500 mA or higher) (a).

- Charging cradle starts charging:
 - Battery fully charged: 3 white LEDs lights for 4 seconds when the lid is opened and closed.
 - Battery not charged: The charging cradle shows white blinking LED's depending on the amount of the battery charge left.
- Check the direction of the USB charging cord terminals and plug in/out straight holding onto the plug. (It may result in malfunction by the deforming of the terminal if it is plugged in obliquely or in wrong direction.)

2 Put the earphones into the charging cradle.

- In order for proper charging to take place the left and right earphones must be place in their proper positions within the charging cradle.
- The way the earphone LEDs light when you put the earphones into the charging cradle depends on the usage status.

Usage status	Earphone LED lighting/blinking patterns
Charging for the first time (after purchase)	The earphone LEDs light (red) about 5 seconds after you put the earphones into the charging cradle.
Charging any time after the first time (When there is still battery charge)	When you put the earphones into the charging cradle, the earphone LEDs light (red) about 3 seconds, then turn off. After about 5 seconds, the earphone LEDs light (red) again. <ul style="list-style-type: none"> • If the earphone LEDs do not light (red) again, the earphones are fully charged.
When the batteries are depleted (When there is no battery charge at all)	The earphone LEDs light (red) about 5 seconds after you put the earphones into the charging cradle.

3 Confirm that the earphone LEDs (red) have illuminated (charging starts).

- The earphone LEDs light (red) while the earphones are charging. Charging is complete when they turn off.
- Charging time (→ 27, "Specifications")

Note

- Do not use any other USB charging cords except the supplied one. Doing so may cause malfunction.
- Charging may not be performed or may stop if the computer is in or switched to standby or sleep mode.

Charging the earphones with the charging cradle

Earphones can only be charged with a charged charging cradle. You can charge your earphones while you are out, even if there is no power source.

- When the charging cradle is fully charged, it can charge the earphones about 2 times.

1 Put the earphones into the charging cradle.

- The earphones LEDs light (red). Refer to Step 2 on page 13 for how they light.

2 Confirm that the earphone LEDs (red) have illuminated. (charging starts)

- The earphones LEDs light (red) while the earphones are charging. Charging is complete when they turn off.
- It takes approx. 2 hours to charge the earphones from empty to full.

Battery level notification





The LEDs lighting or flashing on this unit indicate the remaining battery charge.

■ Earphones

When the battery level starts to run low while you are using the earphones, the blinking earphone LEDs change from blue to red, then you will be notified by one beep every 5 minutes. When no charge remains, you will hear a guidance message and then the unit automatically turns off.

■ Charging cradle

When you open the charging cradle lid, the charging cradle LEDs light or blink to indicate the charge remaining in the battery.

Status of the charging cradle LEDs		Remaining battery charge
3 light		There is plenty of charge in the battery.
		
1 lights		

- When 1 charging cradle LED is blinking, the charge in the battery is even lower. Charge the unit.
- If the charging cradle LEDs do not light even when you open the charging cradle lid, there is no charge in the battery. Charge the unit.

Turning the earphones on and off

■ To turn the earphones on

Take the earphones out of the charging cradle.

- The earphones turn on. A beep will sound and the earphone LEDs blink (blue)* slowly.
- * The batteries are low when they are blinking in red.

■ To turn the earphones off

Put the earphones into the charging cradle.

- The way the LEDs light when you put the earphones into the charging cradle depends on the usage status. Refer to Step 2 on page 13 for how they light.

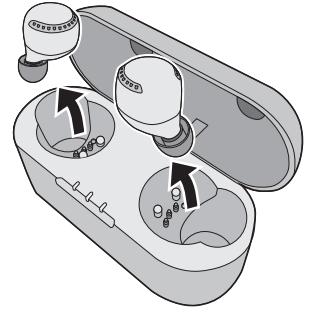

Note

- If something with a magnet in it is brought close to the earphones while they are being used, the earphones may turn off. Move the item with the magnet in it away if this occurs.

Using the app “Panasonic Audio Connect”

By creating a Bluetooth® connection with a smartphone or tablet installed with the “Panasonic Audio Connect” app (free of charge), you can enjoy a wide variety of features, such as the following:

- Software updates
- Customization of various settings (Connection mode setting/Auto power off setting/Guidance language setting, etc.)
- “Switch/Find headphones” function
- Check remaining battery charge
- Access to this document

Preparation

- Turn on the unit.

1 Download the “Panasonic Audio Connect” app (free of charge) to the smartphone or tablet.



Android:
Google Play



iOS:
App Store



2 Start up the “Panasonic Audio Connect” app.

- Follow the on-screen instructions to operate.

Note

- Always use the latest version of the “Panasonic Audio Connect” app.
- There may sometimes be changes made to the operating procedures, displays, etc., on the “Panasonic Audio Connect” app. Refer to the support site for details.

Connecting a Bluetooth® device

Preparation

- Put the earphones into the charging cradle.
- Place the Bluetooth® device within approx. 1 m (3.3 ft) from the unit.
- Check the device operation using its operation instructions as required.
- Using the “Panasonic Audio Connect” app (free of charge) makes connecting with Bluetooth® simple. (→ 16)

Connecting by pairing (registering) your earphones with a Bluetooth® device

1 Take both earphones (L and R) out of the charging cradle.

- When pairing with a device for the first time:
This unit will start to search for a Bluetooth® device to connect to, and the earphone LEDs will light alternately in blue and red.
- When pairing with a device after the first time:
Both earphones should be placed temporarily in the charging cradle for 10 seconds.
After that remove them from the cradle and within 5 seconds while the LED is lit BLUE, touch and hold the sensor (L or R) for 7 seconds until the LED starts flashing Red/Blue, indicating that you have entered the pairing mode.

2 Turn on the Bluetooth® device and enable the Bluetooth® function.

3 From the Bluetooth® menu of the Bluetooth® device, select device name “RZ-S500W” or “RZ-S300W”.

- A BD address (Bluetooth® Device address: an alphanumeric character string that is displayed by and unique to the device) may be displayed before “RZ-S500W” or “RZ-S300W” is displayed.
- If prompted for a passkey, input the passkey “0000 (four zeros)” of this unit.
- When the earphone LEDs blink (blue)* twice at approximately 5 second intervals, pairing has been completed and connection has been established.
* The batteries are low when they are blinking in red.

e.g. **RZ-S500W**

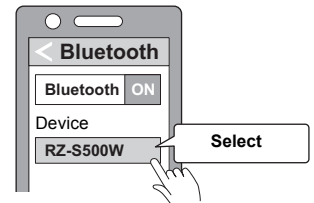

4 Confirm that the earphones and the Bluetooth® device are connected.

Note

- If the connection with the device does not complete within 5 minutes, the pairing mode on the earphones cancels and they transition to connection standby mode. Perform pairing again.
- You can pair a maximum of 10 Bluetooth® devices with the earphones. When you pair a device after the maximum has been exceeded, previous devices are overwritten. To use overwritten devices again, do the pairing again.

Connecting a paired Bluetooth® device

- 1 Take the earphones out of the charging cradle.**
 - The earphone LEDs light (blue) and the earphones turn on about 3 seconds later.
A beep will sound, and the earphone LEDs (blue)* will blink slowly.
* The batteries are low when they are blinking in red.
- 2 Do Steps 2 to 3 of “Connecting by pairing (registering) your earphones with a Bluetooth® device” (→ 17).**
- 3 Confirm that the earphones and the Bluetooth® device are connected.**

Note

- This unit remembers the device lastly connected. Connection may be automatically established after step 1 (see above).

Listening to music

If the Bluetooth® compatible device supports the “A2DP” and “AVRCP” Bluetooth® profiles, music can be played back with remote control operations on the unit.

- A2DP (Advanced Audio Distribution Profile): Transmits audio to the unit.
- AVRCP (Audio/Video Remote Control Profile): Allows remote control of the device using the unit.

1 Connect the Bluetooth® device and the unit. (→ 17, “Connecting a Bluetooth® device”)

2 Select and play the music or the video on the Bluetooth® device.

- The unit's earphones will output the music or the audio of the video being played back.
- For operating procedures during music playback (→ 23, “Operating with the touch sensors”)
- Operating time may become shorter depending on the usage conditions.

■ Attention

- The unit might leak sound depending on the volume level.
- When the volume is increased to near maximum level, music may sound distorted. Decrease the volume until the distortion is cleared.

Making a phone call

With Bluetooth® enabled phones (cell phones or smartphones) that support the “HSP” or “HFP” Bluetooth® profile, you can use the unit for phone calls.

- **HSP (Headset Profile):**

This profile can be used to receive monaural sounds and establish two-way communication using the microphone on the unit.

- **HFP (Hands-Free Profile):**

In addition to the HSP functions, this profile has the incoming and outgoing calls function.

(This unit does not have a function that allows you to make phone calls independently of a Bluetooth® enabled phone.)

- 1 Connect the Bluetooth® device and the unit. (→ 17, “Connecting a Bluetooth® device”)**
- 2 Touch a touch sensor (L or R) on the earphone once to answer an incoming call.**
 - During an incoming call, ringtone will sound from the unit and the earphone LEDs will blink.
 - (HFP only) To reject a phone call, touch and hold a touch sensor (L or R) for about 2 seconds.
- 3 Start talking.**
 - The earphone LEDs will repeatedly blink 2 times during a call.
 - The volume can be adjusted during a phone call.
For operating procedures (→ 23, “Operating with the touch sensors”)
- 4 Touch and hold an earphone touch sensor (L or R) for about 2 seconds to end the call.**

Note

- There may be instances when hands free setting needs to be done on the Bluetooth® enabled phone.
- Depending on the Bluetooth® enabled phone, you may hear incoming and outgoing call ringtones of the phone from the unit.
- You can have the Bluetooth® enabled phone make phone calls by using the microphone of the unit and an app of the Bluetooth® enabled phone. (→ 22, “Activating voice functions”)

Using the external sound control

The external sound control function switches between noise cancelling (**RZ-S500W** only) ambient sound and off. The sound quality is set so that it is optimized for each mode.

1 While wearing the earphones, touch and hold the touch sensor (R) for about 2 seconds.

- The mode is switched each time you touch and hold the touch sensor. (A guidance message will notify you of the mode you switched to.)

RZ-S500W



- The default level setting is "Noise cancelling".

RZ-S300W



- The default level setting is "OFF".

2 Adjust the volume of the playback device.

■ Noise cancelling (**RZ-S500W** only)

Reduces the sounds (noise) you can hear from outside.

- While using the noise cancelling function, a very small amount of noise which is generated from the circuit that reduces noise may be heard, but this is normal and not indicative of any trouble. (This very-low-level noise may be heard in quiet places or in the blank parts between tracks.)

■ Ambient sound

You can hear ambient sound through the microphones embedded in the earphones while enjoying music.

Useful functions

Using the app “Panasonic Audio Connect”

By creating a Bluetooth® connection with a smartphone installed with the “Panasonic Audio Connect” app (free of charge), you can enjoy a wide variety of features, such as changing the settings on the earphones. (→ 16)

Activating voice functions

You can use a touch sensor on the earphone to activate the voice functions (Amazon Alexa, Siri etc.) on your smartphone or similar device.

- 1 Connect the Bluetooth® device and the unit. (→ 17, “Connecting a Bluetooth® device”)**
- 2 Touch and hold the touch sensor (L) on the earphone until the voice function is activated.**
 - The voice assistant function on the Bluetooth® device is activated.

Note

- For details about voice function commands, refer to the operating instructions for the Bluetooth® device.
- The voice function may not work depending on the smartphone, etc., specifications and the app version.

After doing Step 1 above, complete the setup below to use Amazon Alexa as your voice assistant.

- 1 In the “Panasonic Audio Connect” app, select Amazon Alexa as your voice assistant.
 - 2 Touch the “Sign in with Amazon” button.
 - After signing into Amazon, you will need to add headphones in the device setup.
- Install the latest version of the Amazon Alexa app.
 - Alexa is not available in all languages and countries. Alexa features and functionality may vary by location.
 - For more details, refer to the manuals or similar support materials of the apps.

Using just one earphone

By pairing (registering) this unit, you can also use just one of the earphones independently. For example, if you take just the R side earphone out and leave the L side earphone in the charging cradle, the R side earphone will connect to the smartphone. This way, you can listen to music or make a call with one earphone while charging the other. (→ 17, “Connecting a Bluetooth® device”) The sound will be monaural.

- When you are using just one of the earphones, taking the other earphone out of the charging cradle will automatically connect the earphones wirelessly with each other and switch use to both earphones. The sound will be stereo.

Operating with the touch sensors

You can operate the touch sensors on the earphones to change to the Bluetooth® pairing mode, or remote control the Bluetooth® device.

• Depending on the Bluetooth® device or the app, even if you operate the touch sensors on the earphones, some functions may not respond or may operate differently from the descriptions below.

■ List of operations available with the touch sensors

Function	Touch sensor (L)	Touch sensor (R)
Listening to music		
Playback/pause	Touch once	
Raise the volume	Touch rapidly 3 times	–
Lower the volume	Touch rapidly 2 times	–
Forward a track	–	Touch rapidly 2 times
Back a track	–	Touch rapidly 3 times
Making a phone call		
Receive a phone call	Touch once while receiving the call	
Reject a phone call	Touch and hold for about 2 seconds while receiving the call	
End a phone call	Touch and hold for about 2 seconds during the call	
Change control of external sounds	–	Touch and hold for about 2 seconds
Start the voice assistant	Touch and hold for about 2 seconds	–
Set to the Bluetooth® pairing mode*	(→ 17, "Connecting a Bluetooth® device")	
Return to the factory settings	(→ 24, "Restoring to the factory settings")	

* With both earphone LEDs (L and R) blinking alternately in blue and red

Note

- You can also use just one side of the earphones independently. In this case, it is only possible to perform operations available on the side you are using.
- A beep sounds to indicate that you have touched to reach either the maximum or minimum volume level.

Restoring to the factory settings

When you want to delete all pairing device information, etc. in the earphones, you can restore the earphones to the factory settings (original settings upon purchase).

Charge the earphones before restoring the earphones to their factory settings.

- 1 Take the R side earphone out of the charging cradle.**
- 2 While the earphone LED lights blue (about 5 seconds), touch and hold the touch sensor (R) for about 7 seconds.**
 - The earphone LED will light alternately in blue and red.
- 3 Touch and hold the touch sensor (R) for about 10 seconds.**
 - The earphone LED (blue) blinks rapidly, and when the power turns off, the earphone returns to the factory settings.
- 4 Do the same Steps 1 to 3 above for the L side earphone.**

Note

- To re-pair the earphones with a Bluetooth® device, delete the registered information (device name: RZ-S500W or RZ-S300W) on the device, then pair the earphones with the Bluetooth® device again. (→ 17)

Copyright, etc.

The Bluetooth® word mark and logos are registered trademarks owned by Bluetooth SIG, Inc. and any use of such marks by Panasonic Corporation is under license.

Other trademarks and trade names are those of their respective owners.

Apple, the Apple logo and Siri are trademarks of Apple Inc., registered in the U.S. and other countries. App Store is a service mark of Apple Inc.

Google, Android, Google Play, and other related marks and logos are trademarks of Google LLC.

Amazon, Alexa and all related logos are trademarks of Amazon.com, Inc. or its affiliates.

Other system names and product names appearing in this document are in general the registered trademarks or trademarks of the respective developer companies.

Note that the ™ mark and ® mark do not appear in this document.

This product incorporates the open source software other than the software licensed under the GPL V2.0 and/or LGPL V2.1. The software categorized as above are distributed in the hope that it will be useful, but WITHOUT ANY WARRANTY, without even the implied warranty of MERCHANTABILITY or FITNESS FOR A PARTICULAR PURPOSE. Please refer to the detailed terms and conditions thereof shown at the following web page.

<https://panasonic.jp/support/global/cs/audio/download/index.html>

Troubleshooting

Before requesting service, make the following checks. If you are in doubt about some of the check points, or if the remedies indicated in the chart do not solve the problem, refer to “Customer Services Directory” if you reside in the U.S.A., or refer to “CONTACT INFORMATION” if you reside in Canada. (Refer to “Limited Warranty”.)

Sound and audio volume

No sound.

- Make sure that the earphones and the Bluetooth® device are connected correctly. (→ 17)
- Check if music is playing on the Bluetooth® device.
- Make sure that the earphones are turned on and the volume is not set too low.
- Pair and connect the Bluetooth® device and the earphones again. (→ 17)
- Check if the Bluetooth® compatible device supports “A2DP” profile. For details on profiles, see “Listening to music” (→ 19). Also refer to the operating manual for the Bluetooth® compatible device.

Low volume.

- Also raise the volume on the Bluetooth® device, not just on the earphones.
- Make sure there is no earwax, foreign matter, etc., attached to the earpieces of the earphones.
Remove the earpieces from the main unit (earphones) and refer to “Earphones/Earpieces” (→ 4) to clean them.

Sound from the device is cut off. / Too much noise. / Sound quality is bad.

- Sound may be disrupted if signals are blocked. Do not fully cover the earphones with the palm of your hand, etc.
- The device may be out of the 10 m (33 ft) communication range. Move the device closer to the earphones.
- Remove any obstacle between the earphones and the device.
- Switch off any wireless LAN device when not in use.

Bluetooth® device connection

The device cannot be connected.

- You can pair a maximum of 10 Bluetooth® devices with the earphones. When you pair a device after the maximum has been exceeded, previous devices are overwritten. To use overwritten devices again, do the pairing again.
- Delete the pairing information for this unit from the Bluetooth® device, then pair them again. (→ 17)

Phone Calls

The voice of the person on the other end of the call is small.

- Also raise the volume on the Bluetooth® device, not just on the earphones.

Cannot make a phone call.

- Check if the Bluetooth® compatible device supports “HSP” or “HFP” profile. For details on profiles, see “Listening to music” (→ 19) and “Making a phone call” (→ 20). Also refer to the operating manual for the Bluetooth® enabled phone.
- Check the audio settings on the Bluetooth® compatible telephone, and if the setting does not allow communication with this unit, change the setting. (→ 17)

General

Cannot operate the earphones.

- Try turning the power off and on. (→ 15)

The left and right batteries deplete at different rates.

- There may be some difference between left and right due to signal and usage conditions.

Amazon Alexa is not responding.

- Make sure that the Amazon Alexa app is activated.
- Make sure that the voice assistant is set to Amazon Alexa.
- Make sure that data communication is enabled on the mobile device.
- Make sure that the device is paired with the Amazon Alexa app.

Power supply and charging

Cannot charge the unit.

- Is the USB charging cord connected firmly to the USB terminal of the computer? (→ 13)
- Have the earphones been put into the charging cradle correctly? (→ 13)
- If the earphone LEDs do not light even after putting the earphones into the charging cradle, then there is no charge remaining in the charging cradle battery. First charge the charging cradle.
- Make sure to charge in a room temperature between 10 °C and 35 °C (50 °F to 95 °F).
- Make sure the computer is turned on and is not on standby or sleep mode.
- Is the USB port you are currently using working properly? If your computer has other USB ports, unplug the connector from its current port and plug it into one of the other ports.
- If the measures mentioned above are not applicable, unplug the USB charging cord and plug it in again.
- Is the unit already fully charged? The charging cradle LEDs will turn off immediately if the unit is fully charged.
- If the charging time and operating time get shorter, the batteries in the earphones and charging cradle may be getting depleted. (Charging cycles for built-in batteries: about 500 times each)

The earphones or charging cradle get warm during charging.

- The earphones and charging cradle may get warm while charging, but this is normal.

The earphones do not turn on.

- After placing once into the charging cradle and the earphone LEDs light (red), take them out again.

The charging cradle LEDs do not light even when you open the charging cradle lid.

- There is no charge in the battery. Use the USB charging cord (supplied) to charge. (→ 13)
- Take the earphones out of the charging cradle, and after unplugging the USB charging cord, close the lid and leave it for 3 minutes. Then open the lid of the charging cradle and confirm that the power turns on.

Specifications

■ General

	RZ-S500W	RZ-S300W
Power supply (Charging cradle)	DC 5 V, 500 mA	
Internal Battery	Earphones: 3.7 V, Lithium polymer 85 mAh Charging cradle: 3.7 V, Lithium polymer 800 mAh	Earphones: 3.7 V, Lithium polymer 55 mAh Charging cradle: 3.7 V, Lithium polymer 800 mAh
Operating time^{*1} (Earphones)	Approx. 6.5 hours (Noise cancelling: ON, AAC) Approx. 7.5 hours (Noise cancelling: OFF, AAC) Approx. 6 hours (Noise cancelling: ON, SBC) Approx. 7 hours (Noise cancelling: OFF, SBC)	Approx. 7.5 hours (AAC) Approx. 7 hours (SBC)
Quick charge Operating time^{*1} (Earphones)	15 min. charge, Approx. 70 min. (Noise cancelling: ON, AAC) 15 min. charge, Approx. 80 min. (Noise cancelling: OFF, AAC) 15 min. charge, Approx. 60 min. (Noise cancelling: ON, SBC) 15 min. charge, Approx. 70 min. (Noise cancelling: OFF, SBC)	15 min. charge, Approx. 90 min. (AAC) 15 min. charge, Approx. 80 min. (SBC)
Operating time^{*1} (Earphones + Charging cradle)	Approx. 19.5 hours (Noise cancelling: ON, AAC) Approx. 22.5 hours (Noise cancelling: OFF, AAC) Approx. 18 hours (Noise cancelling: ON, SBC) Approx. 21 hours (Noise cancelling: OFF, SBC)	Approx. 30 hours (AAC) Approx. 28 hours (SBC)
Waiting Time^{*1} (Earphones)	Approx. 7.5 hours (Noise cancelling: ON) Approx. 12 hours (Noise cancelling: OFF, Auto power off does not work)	Approx. 24 hours (Auto power off does not work)
Charging time^{*2} (25 °C (77 °F))	Earphones: Approx. 2 hours Charging cradle: Approx. 2.5 hours Earphones with Charging cradle: Approx. 4 hours	
Charging temperature range	10 °C to 35 °C (50 °F to 95 °F)	
Operating temperature range	0 °C to 40 °C (32 °F to 104 °F)	
Operating humidity range	35 %RH to 80 %RH (no condensation)	
Mass (Weight)	Earphone: Approx. 7 g (0.25 oz) (one side only: L and R are the same) Charging cradle: Approx. 45 g (1.6 oz)	Earphone: Approx. 4 g (0.14 oz) (one side only: L and R are the same) Charging cradle: Approx. 45 g (1.6 oz)

*1 It may be shorter depending on the operating conditions.

*2 The time required to charge the battery from empty to full.

■ Bluetooth® section

Bluetooth® system specification	Ver. 5.0
Wireless equipment classification	Class 1
Max RF Power	11 dBm
Frequency band	2402 MHz to 2480 MHz
Supported profiles	A2DP, AVRCP, HSP, HFP
Supported codec	SBC, AAC
Operating distance	Up to 10 m (33 ft)

■ Earphones section

	RZ-S500W	RZ-S300W
Driver units	8 mm (5/16 in)	6 mm (1/4 in)
Microphone	Mono, MEMS Microphone	

■ Charging cradle section

Charging terminal	USB Type-C Shape
--------------------------	------------------

■ Accessory section

	RZ-S500W	RZ-S300W
USB Charging Cord (Input Plug: USB A Shape, Output Plug: USB Type-C Shape)	Approx. 0.5 m (1.6 ft)	
Earpieces set	XS, S, M, L, XL each 2 pcs., (Size M Attached)	XS, S, M, L each 2 pcs., (Size M Attached)

■ Water resistant

Water resistant	IPX4 equivalent (earphones only)
------------------------	----------------------------------

• Specifications are subject to change without notice.

When disposing of the product

The built-in batteries are a valuable recyclable resource. When disposing of this product, recycle in accordance with local environmental laws and regulations.

Refer to the specifications in this document for information about the batteries.

Earpiece cleaning

Regular cleaning is necessary to continue using the earpieces comfortably. Earwax and other foreign matter attached to the holes of the earpieces can change the acoustic characteristics, such as making the sound smaller, and also be the cause of malfunctions.

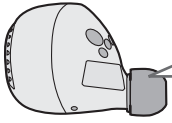

Check the earpiece type,
select between **A** and **B** below.

A Type without sponge

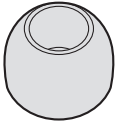

(→ 31, “**A** Type without sponge”)

B Type with sponge

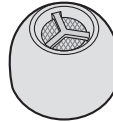

(→ 32, “**B** Type with sponge”)

A Type without sponge**1 Remove the earpieces.**

- Grip the earpieces and twist gently as you pull off.
- If you clean the earpieces while they are attached to the earphones, you may damage the protective mesh on the earphones.

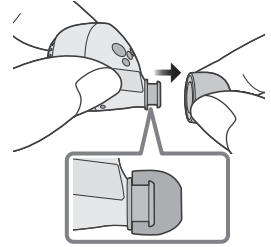
**2 Use cotton swabs, etc., to gently wipe the inside and outside of the earpieces to remove foreign matter.**

- Regularly use a diluted neutral detergent to hand wash the earpieces, and wipe off the moisture well after washing. (→ 33, “When the earpieces are very dirty”)
- If you clean the earpieces while they are attached to the earphones, you may damage the protective mesh on the earphones.

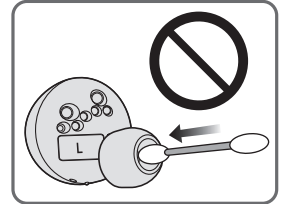
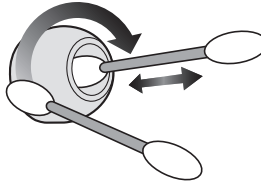
**3 Remove earwax, foreign matter, etc., that has attached to the protective mesh of the earphones by blowing on it, etc.**

- If hair styling product or make-up gets onto the earphones, wipe off immediately with a soft dry cloth. (Do not touch the protective mesh as this can have an effect on audio characteristics.)
- You may block the protective mesh if you try to remove with a cotton swab, etc., which can lead to malfunctions.

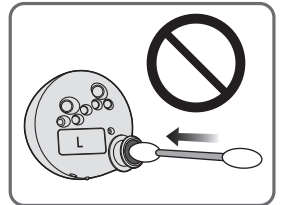
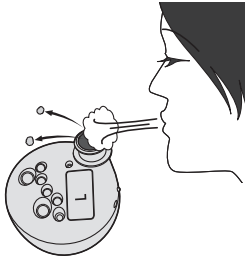
**4 Attach the earpieces.**

- Make sure the earpieces are fitted firmly onto the earphones and confirm that they are not at an angle.
- Store the earphones in the charging cradle to protect them from foreign matter, etc., getting on them.

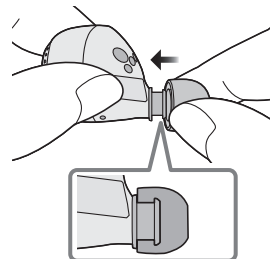

B Type with sponge**1 Remove the earpieces.**

- Grip the earpieces and twist gently as you pull off.
- If you clean the earpieces while they are attached to the earphones, you may damage the protective mesh on the earphones.

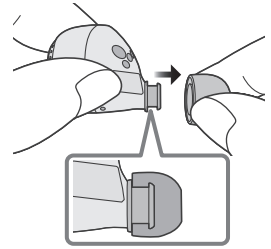
**2 Use cotton swabs, etc., to gently wipe the outside of the earpieces to remove foreign matter.**

- Regularly use a diluted neutral detergent to hand wash the earpieces, and wipe off the moisture well after washing. (→ 33, “When the earpieces are very dirty”)
- If you clean the earpieces while they are attached to the earphones, you may damage the protective mesh on the earphones.

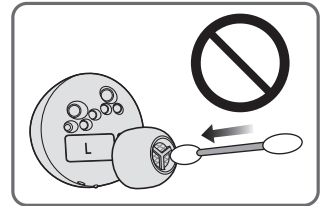
**3 Remove earwax, foreign matter, etc., that has attached to the protective mesh of the earphones by blowing on it, etc.**

- If hair styling product or make-up gets onto the earphones, wipe off immediately with a soft dry cloth. (Do not touch the protective mesh as this can have an effect on audio characteristics.)
- You may block the protective mesh if you try to remove with a cotton swab, etc., which can lead to malfunctions.

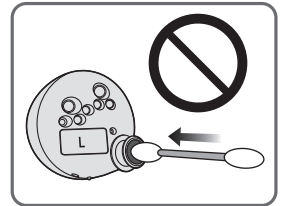
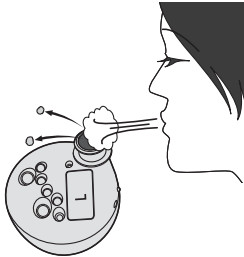
**4 Attach the earpieces.**

- Make sure the earpieces are fitted firmly onto the earphones and confirm that they are not at an angle.
- Store the earphones in the charging cradle to protect them from foreign matter, etc., getting on them.

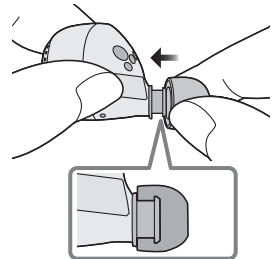

■ When the earpieces are very dirty**1 Wash the earpieces with the tips of your fingers.**

(Using a diluted neutral detergent in warm water is effective.)

- Do not remove the sponges from the earpieces.

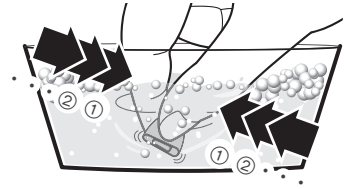
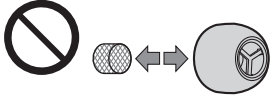
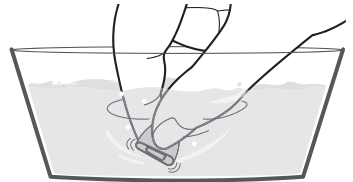
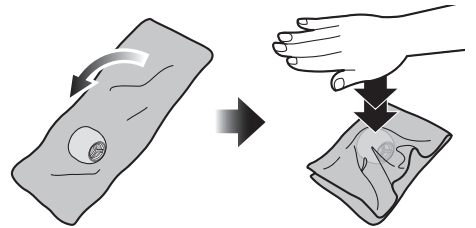
**2 Rinse well with clean water after washing.****3 Put in between a soft, dry cloth, press firmly 3 to 5 times to ensure the moisture is eliminated.**

Useful information

Customer Service

Customer Service Directory

Obtain products information and operative assistant; localize the closer distributor or Service Center; buy spare parts and accessories by our Web Site to Latin America or calling our Contact Center:

COUNTRY	WEB SITE	CONTACT CENTER
Panama	www.panasonic.com/pa/soporte/	800-7262
Colombia	www.panasonic.com/co/soporte/	01-8000-947262
Ecuador	www.panasonic.com/pa/soporte/	1-800-726276
Costa Rica	www.panasonic.com/pa/soporte/	800-7262737
El Salvador	www.panasonic.com/pa/soporte/	800-7262
Guatemala	www.panasonic.com/pa/soporte/	1-801-811-7262
Uruguay	www.panasonic.com/pa/soporte/	0-800-7262
Paraguay	www.panasonic.com/pa/soporte/	Web Site
Chile	www.panasonic.com/cl/soporte/	800-390-602 022-797-5000
Peru	www.panasonic.com/pe/soporte/	0800-00726
Venezuela	www.panasonic.com/pa/soporte/	Web Site
Mexico	www.panasonic.com/mx/soporte/	800-847-7262 55-5000-1200
Argentina		0800-333-7262 0810-321-7262
Dominican Rep.	www.panasonic.com/pa/soporte/	809-200-8000

For Caribbean countries that speak English please enter this web site in order to find information of our products and operative assistant:
www.panasonic.com/caribbean

Panasonic Corporation of North America
Two Riverfront Plaza, Newark, NJ 07102-5490
<http://shop.panasonic.com>

Panasonic Canada Inc.
5770 Ambler Drive, Mississauga, Ontario L4W 2T3
www.panasonic.com

© Panasonic Corporation 2020

Panasonic Corporation
<http://www.panasonic.com>

En

PNQP1537WA
F0620MH3071