



A TEREX BRAND

Operator's Manual

Serial Number Range

GS™-4655

from GS55D-101

AUS
Australia

with
Maintenance
Information

First Edition
Second Printing
Part No. 1294977GT

Contents

Introduction 1
Symbol and Hazard Pictorials Definitions..... 6
General Safety 8
Personal Safety..... 11
Work Area Safety..... 12
Legend 20
Controls..... 21
Inspections 24
Operating Instructions..... 38
Transport and Lifting Instructions 47
Maintenance 52
Specifications 54

Copyright © 2019 Terex Corporation

First Edition First Printing, December 2019

Genie is a registered trademark of Terex South Dakota, Inc. in the U.S.A. and many other countries. "GS" is a trademark of Terex South Dakota, Inc.

These machines comply with AS 1418.10

Introduction

About this manual

Genie appreciates your choice of our machine for your application. Our number one priority is user safety, which is best achieved by our joint efforts. This book is an operation and daily maintenance manual for the user or operator of a Genie machine.

This manual should be considered a permanent part of your machine and should remain with the machine at all times. If you have any questions, contact Genie.

Product Identification

The machine serial number is located on the serial label.

Serial number stamped on chassis

Serial label located on chassis

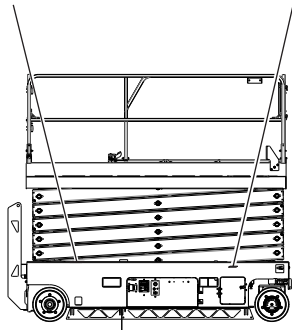

Intended Use and Familiarization Guide

The intended use of this machine is to lift personnel, including tools, and materials to an aerial work site. Before operating the machine, it's the operator's responsibility to read and understand this familiarization guide.

- Each person must be trained to operate a Mobile Elevated Work Platform (MEWP).
- Familiarization with the MEWP must be given to each person who is authorized, competent and trained.
- Only trained and authorized personnel should be permitted to operate the machine.
- The operator is responsible to read, understand, and obey the manufacturer's instructions and safety rules provided in the Operator's Manual.
- The Operator's Manual is located in the manual storage container, at the platform.
- For specific product applications, see **Contacting The Manufacturer.**

Introduction

Platform controls symbology and related machine movement:



Lift function enable button



Drive function enable button



Platform up/down (when lift function selected)



Drive forward/reverse (when drive function selected)



Steer right/left (when drive function selected)



Area of operation, indoor use button



Area of operation, outdoor use button

Ground controls symbology and related machine movement:



Lift function enable button



Platform up/down button

Sequential functions and movement:

- Drive and steer.

Interlocked functions:

- Elevated drive speed.
- Elevated drive in an off-level condition.
- All platform and ground controls.

Limitations of use:

- The intended use of this machine is to lift personnel, including tools, and materials to an aerial work site.
- Do not elevate the platform unless the machine is on firm level ground.

Introduction

Bulletin Distribution and Compliance

Safety of product users is of paramount importance to Genie. Various bulletins are used by Genie to communicate important safety and product information to dealers and machine owners.

The information contained in the bulletins is tied to specific machines using the machine model and serial number.

Distribution of bulletins is based on the most current owner on record along with their associated dealer, so it is important to register your machine and keep your contact information up to date.

To ensure safety of personnel and the reliable continued operation of your machine, be sure to comply with the action indicated in a respective bulletin.

To view any open bulletins for your machine, visit us on the web at www.genielift.com.

Contacting the Manufacturer

At times it may be necessary to contact Genie. When you do, be ready to supply the model number and serial number of your machine, along with your name and contact information. At minimum, Genie should be contacted for:

Accident reporting

Questions regarding product applications and safety

Standards and regulatory compliance information

Current owner updates, such as changes in machine ownership or changes in your contact information. See Transfer of Ownership, below.

Transfer of Machine Ownership

Taking a few minutes to update owner information will ensure that you receive important safety, maintenance and operating information that applies to your machine.

Please register your machine by visiting us on the web at www.genielift.com or by calling us toll free at 1-800-536-1800.

Introduction



Danger

Failure to obey the instructions and safety rules in this manual will result in death or serious injury.

Do Not Operate Unless:

- You learn and practice the principles of safe machine operation contained in this operator's manual.
 - 1 Avoid hazardous situations.**
 - Know and understand the safety rules before going on to the next section.**
 - 2 Always perform a pre-operation inspection.
 - 3 Always perform function tests prior to use.
 - 4 Inspect the workplace.
 - 5 Only use the machine as it was intended.
- You read, understand and obey the manufacturer's instructions and safety rules—safety and operator's manuals and machine decals.
- You read, understand and obey employer's safety rules and worksite regulations.
- You read, understand and obey all applicable governmental regulations.
- You are properly trained to safely operate the machine.

Introduction

Safety Sign Maintenance

Replace any missing or damaged safety signs. Keep operator safety in mind at all times. Use mild soap and water to clean safety signs. Do not use solvent-based cleaners because they may damage the safety sign material.

Hazard Classification

Decals on this machine use symbols, color coding, and signal words to identify the following:



Safety alert symbol—used to alert you to potential personal injury hazards. Obey all safety messages that follow this symbol to avoid possible injury or death.



Indicates a hazardous situation which, if not avoided, will result in death or serious injury.



Indicates a hazardous situation which, if not avoided, could result in death or serious injury.















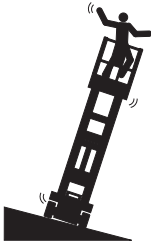
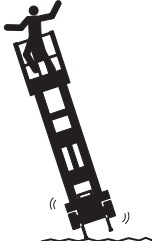
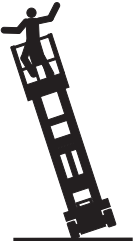
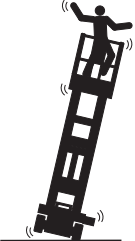
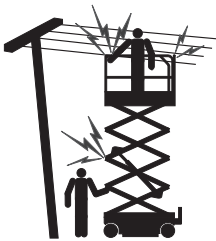



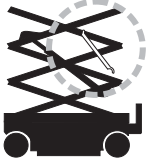
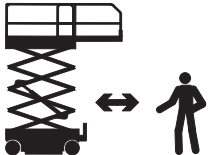

Indicates a hazardous situation which, if not avoided, could result in minor or moderate injury.





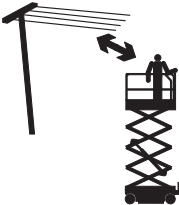





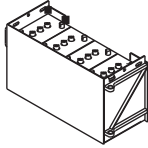

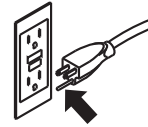

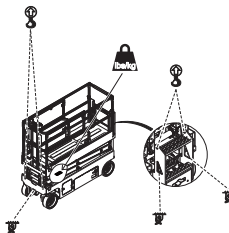

Indicates a property damage message.

Symbol and Hazard Pictorials Definitions

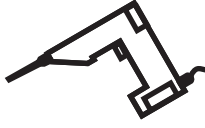
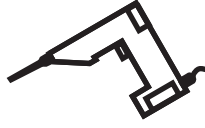
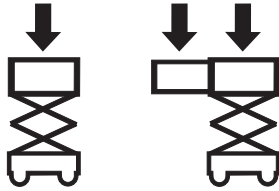
| | | | | |
|---|---|---|--|---|
|  |  |  |  |  |
| Read the operator's manual | Read the service manual | Crush hazard | Crush hazard | Collision hazard |
|  |  |  |  |  |
| Tip-over hazard | Tip-over hazard | Tip-over hazard | Tip-over hazard | Electrocution hazard |
|  |  |  |  |  |
| Electrocution hazard | Explosion hazard | Fire hazard | Burn hazard | Skin injection hazard |
|  |  |  |  |  |
| Engage safety arm | Keep away from moving parts | Keep clear of outriggers and tires | Move machine to level ground | Close chassis tray |
|  |  |  |  |  |
| Lower the platform. | Do not set up where it cannot be leveled with outriggers | Maintain required clearance | Access by trained and authorized personnel only | Use a piece of cardboard or paper to search for leaks |

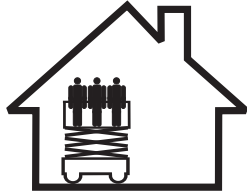
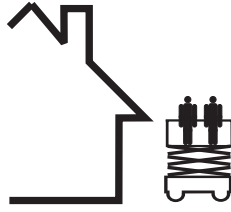
Symbol and Hazard Pictorials Definitions

| | | | | |
|---|--|--|---|--|
|  <p>Batteries used as counterweights</p> |  <p>Chock the wheels</p> |  <p>No smoking</p> |  <p>Grounded AC 3-wire only</p> |  <p>Replace damaged wires and cords</p> |
|  <p>Wheel load</p> |  <p>Lifting & tie down instructions</p> |  <p>Lifting point</p> |  <p>Lanyard anchorage points</p> |  <p>Wind speed</p> |
|  <p>Tiedown</p> |  <p>Release brakes</p> |  <p>Engage brake</p> |  <p>Voltage rating for power to platform</p> |  <p>Pressure rating for air line to platform</p> |
|  <p>Maximum capacity</p> | |  <p>Manual force</p> |  <p>Indoor</p> | |
|  <p>Outdoor</p> | |  <p>Platform Overload</p> | | |

General Safety

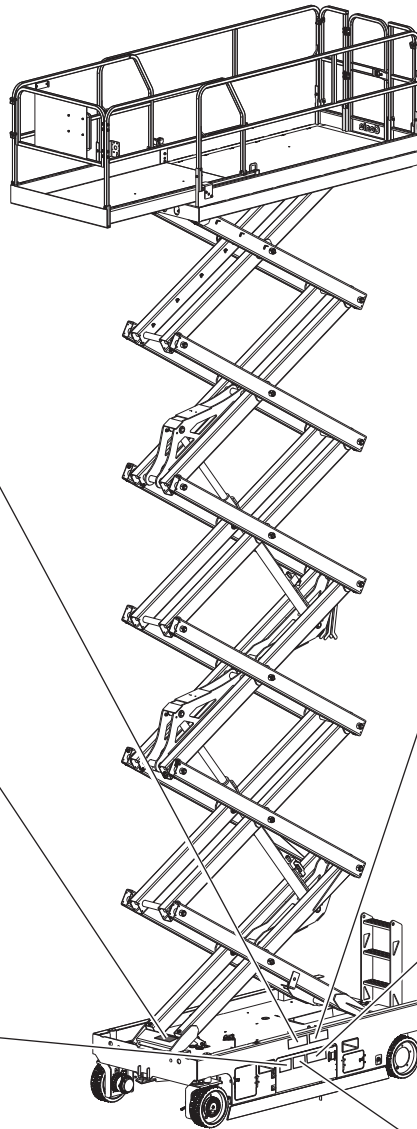

82561

▲ DANGER

Crushing Hazard
Death or serious injury can result from contact with moving scissor arms.

Engage safety pin before performing maintenance or repair.

See service manual.

1294707

▲ DANGER

Electrocution Hazard
Death or injury can result from contacting electrical power lines. The scissor lift is not electrically grounded. Always use proper safety practices when working near power lines. The safety interlock must be engaged before operation.

| Model | Weight | Height | Reach |
|---------|--------------------|-----------------|-----------------|
| 1294707 | 1,200 lbs / 544 kg | 11.5 ft / 3.5 m | 11.5 ft / 3.5 m |
| 1294708 | 1,200 lbs / 544 kg | 11.5 ft / 3.5 m | 11.5 ft / 3.5 m |
| 1294709 | 1,200 lbs / 544 kg | 11.5 ft / 3.5 m | 11.5 ft / 3.5 m |
| 1294710 | 1,200 lbs / 544 kg | 11.5 ft / 3.5 m | 11.5 ft / 3.5 m |
| 1294711 | 1,200 lbs / 544 kg | 11.5 ft / 3.5 m | 11.5 ft / 3.5 m |
| 1294712 | 1,200 lbs / 544 kg | 11.5 ft / 3.5 m | 11.5 ft / 3.5 m |
| 1294713 | 1,200 lbs / 544 kg | 11.5 ft / 3.5 m | 11.5 ft / 3.5 m |
| 1294714 | 1,200 lbs / 544 kg | 11.5 ft / 3.5 m | 11.5 ft / 3.5 m |
| 1294715 | 1,200 lbs / 544 kg | 11.5 ft / 3.5 m | 11.5 ft / 3.5 m |
| 1294716 | 1,200 lbs / 544 kg | 11.5 ft / 3.5 m | 11.5 ft / 3.5 m |
| 1294717 | 1,200 lbs / 544 kg | 11.5 ft / 3.5 m | 11.5 ft / 3.5 m |
| 1294718 | 1,200 lbs / 544 kg | 11.5 ft / 3.5 m | 11.5 ft / 3.5 m |
| 1294719 | 1,200 lbs / 544 kg | 11.5 ft / 3.5 m | 11.5 ft / 3.5 m |
| 1294720 | 1,200 lbs / 544 kg | 11.5 ft / 3.5 m | 11.5 ft / 3.5 m |
| 1294721 | 1,200 lbs / 544 kg | 11.5 ft / 3.5 m | 11.5 ft / 3.5 m |
| 1294722 | 1,200 lbs / 544 kg | 11.5 ft / 3.5 m | 11.5 ft / 3.5 m |
| 1294723 | 1,200 lbs / 544 kg | 11.5 ft / 3.5 m | 11.5 ft / 3.5 m |
| 1294724 | 1,200 lbs / 544 kg | 11.5 ft / 3.5 m | 11.5 ft / 3.5 m |
| 1294725 | 1,200 lbs / 544 kg | 11.5 ft / 3.5 m | 11.5 ft / 3.5 m |
| 1294726 | 1,200 lbs / 544 kg | 11.5 ft / 3.5 m | 11.5 ft / 3.5 m |
| 1294727 | 1,200 lbs / 544 kg | 11.5 ft / 3.5 m | 11.5 ft / 3.5 m |
| 1294728 | 1,200 lbs / 544 kg | 11.5 ft / 3.5 m | 11.5 ft / 3.5 m |
| 1294729 | 1,200 lbs / 544 kg | 11.5 ft / 3.5 m | 11.5 ft / 3.5 m |
| 1294730 | 1,200 lbs / 544 kg | 11.5 ft / 3.5 m | 11.5 ft / 3.5 m |
| 1294731 | 1,200 lbs / 544 kg | 11.5 ft / 3.5 m | 11.5 ft / 3.5 m |
| 1294732 | 1,200 lbs / 544 kg | 11.5 ft / 3.5 m | 11.5 ft / 3.5 m |
| 1294733 | 1,200 lbs / 544 kg | 11.5 ft / 3.5 m | 11.5 ft / 3.5 m |
| 1294734 | 1,200 lbs / 544 kg | 11.5 ft / 3.5 m | 11.5 ft / 3.5 m |
| 1294735 | 1,200 lbs / 544 kg | 11.5 ft / 3.5 m | 11.5 ft / 3.5 m |
| 1294736 | 1,200 lbs / 544 kg | 11.5 ft / 3.5 m | 11.5 ft / 3.5 m |
| 1294737 | 1,200 lbs / 544 kg | 11.5 ft / 3.5 m | 11.5 ft / 3.5 m |
| 1294738 | 1,200 lbs / 544 kg | 11.5 ft / 3.5 m | 11.5 ft / 3.5 m |
| 1294739 | 1,200 lbs / 544 kg | 11.5 ft / 3.5 m | 11.5 ft / 3.5 m |
| 1294740 | 1,200 lbs / 544 kg | 11.5 ft / 3.5 m | 11.5 ft / 3.5 m |
| 1294741 | 1,200 lbs / 544 kg | 11.5 ft / 3.5 m | 11.5 ft / 3.5 m |
| 1294742 | 1,200 lbs / 544 kg | 11.5 ft / 3.5 m | 11.5 ft / 3.5 m |
| 1294743 | 1,200 lbs / 544 kg | 11.5 ft / 3.5 m | 11.5 ft / 3.5 m |
| 1294744 | 1,200 lbs / 544 kg | 11.5 ft / 3.5 m | 11.5 ft / 3.5 m |
| 1294745 | 1,200 lbs / 544 kg | 11.5 ft / 3.5 m | 11.5 ft / 3.5 m |
| 1294746 | 1,200 lbs / 544 kg | 11.5 ft / 3.5 m | 11.5 ft / 3.5 m |
| 1294747 | 1,200 lbs / 544 kg | 11.5 ft / 3.5 m | 11.5 ft / 3.5 m |
| 1294748 | 1,200 lbs / 544 kg | 11.5 ft / 3.5 m | 11.5 ft / 3.5 m |
| 1294749 | 1,200 lbs / 544 kg | 11.5 ft / 3.5 m | 11.5 ft / 3.5 m |
| 1294750 | 1,200 lbs / 544 kg | 11.5 ft / 3.5 m | 11.5 ft / 3.5 m |
| 1294751 | 1,200 lbs / 544 kg | 11.5 ft / 3.5 m | 11.5 ft / 3.5 m |
| 1294752 | 1,200 lbs / 544 kg | 11.5 ft / 3.5 m | 11.5 ft / 3.5 m |
| 1294753 | 1,200 lbs / 544 kg | 11.5 ft / 3.5 m | 11.5 ft / 3.5 m |
| 1294754 | 1,200 lbs / 544 kg | 11.5 ft / 3.5 m | 11.5 ft / 3.5 m |
| 1294755 | 1,200 lbs / 544 kg | 11.5 ft / 3.5 m | 11.5 ft / 3.5 m |
| 1294756 | 1,200 lbs / 544 kg | 11.5 ft / 3.5 m | 11.5 ft / 3.5 m |
| 1294757 | 1,200 lbs / 544 kg | 11.5 ft / 3.5 m | 11.5 ft / 3.5 m |
| 1294758 | 1,200 lbs / 544 kg | 11.5 ft / 3.5 m | 11.5 ft / 3.5 m |
| 1294759 | 1,200 lbs / 544 kg | 11.5 ft / 3.5 m | 11.5 ft / 3.5 m |
| 1294760 | 1,200 lbs / 544 kg | 11.5 ft / 3.5 m | 11.5 ft / 3.5 m |
| 1294761 | 1,200 lbs / 544 kg | 11.5 ft / 3.5 m | 11.5 ft / 3.5 m |
| 1294762 | 1,200 lbs / 544 kg | 11.5 ft / 3.5 m | 11.5 ft / 3.5 m |
| 1294763 | 1,200 lbs / 544 kg | 11.5 ft / 3.5 m | 11.5 ft / 3.5 m |
| 1294764 | 1,200 lbs / 544 kg | 11.5 ft / 3.5 m | 11.5 ft / 3.5 m |
| 1294765 | 1,200 lbs / 544 kg | 11.5 ft / 3.5 m | 11.5 ft / 3.5 m |
| 1294766 | 1,200 lbs / 544 kg | 11.5 ft / 3.5 m | 11.5 ft / 3.5 m |
| 1294767 | 1,200 lbs / 544 kg | 11.5 ft / 3.5 m | 11.5 ft / 3.5 m |
| 1294768 | 1,200 lbs / 544 kg | 11.5 ft / 3.5 m | 11.5 ft / 3.5 m |
| 1294769 | 1,200 lbs / 544 kg | 11.5 ft / 3.5 m | 11.5 ft / 3.5 m |
| 1294770 | 1,200 lbs / 544 kg | 11.5 ft / 3.5 m | 11.5 ft / 3.5 m |
| 1294771 | 1,200 lbs / 544 kg | 11.5 ft / 3.5 m | 11.5 ft / 3.5 m |
| 1294772 | 1,200 lbs / 544 kg | 11.5 ft / 3.5 m | 11.5 ft / 3.5 m |
| 1294773 | 1,200 lbs / 544 kg | 11.5 ft / 3.5 m | 11.5 ft / 3.5 m |
| 1294774 | 1,200 lbs / 544 kg | 11.5 ft / 3.5 m | 11.5 ft / 3.5 m |
| 1294775 | 1,200 lbs / 544 kg | 11.5 ft / 3.5 m | 11.5 ft / 3.5 m |
| 1294776 | 1,200 lbs / 544 kg | 11.5 ft / 3.5 m | 11.5 ft / 3.5 m |
| 1294777 | 1,200 lbs / 544 kg | 11.5 ft / 3.5 m | 11.5 ft / 3.5 m |
| 1294778 | 1,200 lbs / 544 kg | 11.5 ft / 3.5 m | 11.5 ft / 3.5 m |
| 1294779 | 1,200 lbs / 544 kg | 11.5 ft / 3.5 m | 11.5 ft / 3.5 m |
| 1294780 | 1,200 lbs / 544 kg | 11.5 ft / 3.5 m | 11.5 ft / 3.5 m |
| 1294781 | 1,200 lbs / 544 kg | 11.5 ft / 3.5 m | 11.5 ft / 3.5 m |
| 1294782 | 1,200 lbs / 544 kg | 11.5 ft / 3.5 m | 11.5 ft / 3.5 m |
| 1294783 | 1,200 lbs / 544 kg | 11.5 ft / 3.5 m | 11.5 ft / 3.5 m |
| 1294784 | 1,200 lbs / 544 kg | 11.5 ft / 3.5 m | 11.5 ft / 3.5 m |
| 1294785 | 1,200 lbs / 544 kg | 11.5 ft / 3.5 m | 11.5 ft / 3.5 m |
| 1294786 | 1,200 lbs / 544 kg | 11.5 ft / 3.5 m | 11.5 ft / 3.5 m |
| 1294787 | 1,200 lbs / 544 kg | 11.5 ft / 3.5 m | 11.5 ft / 3.5 m |
| 1294788 | 1,200 lbs / 544 kg | 11.5 ft / 3.5 m | 11.5 ft / 3.5 m |
| 1294789 | 1,200 lbs / 544 kg | 11.5 ft / 3.5 m | 11.5 ft / 3.5 m |
| 1294790 | 1,200 lbs / 544 kg | 11.5 ft / 3.5 m | 11.5 ft / 3.5 m |
| 1294791 | 1,200 lbs / 544 kg | 11.5 ft / 3.5 m | 11.5 ft / 3.5 m |
| 1294792 | 1,200 lbs / 544 kg | 11.5 ft / 3.5 m | 11.5 ft / 3.5 m |
| 1294793 | 1,200 lbs / 544 kg | 11.5 ft / 3.5 m | 11.5 ft / 3.5 m |
| 1294794 | 1,200 lbs / 544 kg | 11.5 ft / 3.5 m | 11.5 ft / 3.5 m |
| 1294795 | 1,200 lbs / 544 kg | 11.5 ft / 3.5 m | 11.5 ft / 3.5 m |
| 1294796 | 1,200 lbs / 544 kg | 11.5 ft / 3.5 m | 11.5 ft / 3.5 m |
| 1294797 | 1,200 lbs / 544 kg | 11.5 ft / 3.5 m | 11.5 ft / 3.5 m |
| 1294798 | 1,200 lbs / 544 kg | 11.5 ft / 3.5 m | 11.5 ft / 3.5 m |
| 1294799 | 1,200 lbs / 544 kg | 11.5 ft / 3.5 m | 11.5 ft / 3.5 m |
| 1294800 | 1,200 lbs / 544 kg | 11.5 ft / 3.5 m | 11.5 ft / 3.5 m |

31060

▲ DANGER

Tip-over Hazard
Altering or disabling limit switches can result in machine tip-over. Machine tip-over will result in death or serious injury.

Do not alter or disable limit switch(es).

31060 C

1263543

▲ WARNING

Improper operation or maintenance of this equipment can result in death or serious injury.

Access by trained and authorized personnel only.

1290675

▲ DANGER

Exposure to 7 Burn Hazard: Surface of scissor lift can become so hot that it will cause death, burns or blindness.

Keep all open flames and sparks away. Wear personal protection equipment, including face shield, gloves and long sleeve shirt.

READ MANUALS: Read all manuals prior to operation. DO NOT OPERATE equipment if you do not understand the information in the manuals. Consult your supervisor, this manual or the manufacturer.

1290675 A

1292748

▲ DANGER

Tip-over hazard.
Failure to replace batteries with proper weight batteries will result in death or serious injury.

Batteries are used as counterweight and are critical to machine stability. Each battery must weigh 52 lbs / 23 kg. Battery box including batteries must weigh a minimum of 415 lbs / 188 kg.

415 lbs / 188 kg

1292748 A

General Safety

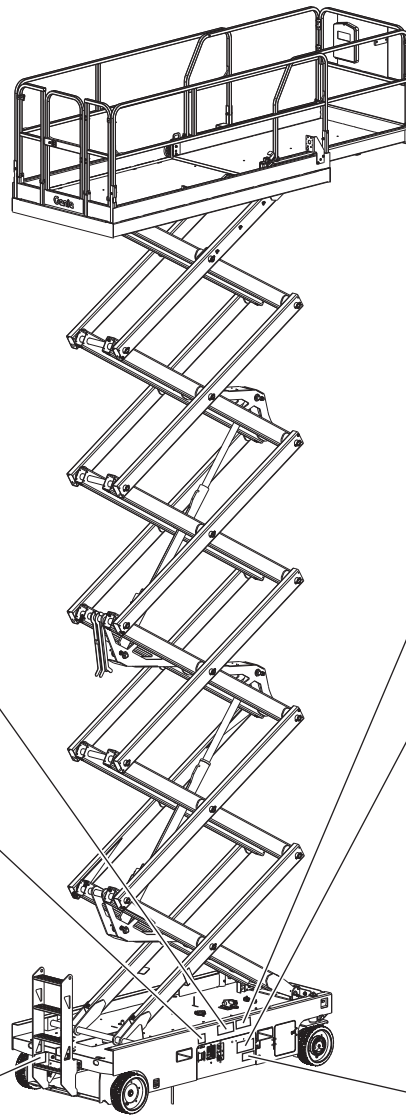

1294707

⚠ DANGER

Electrocution Hazard
 Death or injury can result from contacting electric power lines.
 This machine is not electrically insulated.
 Always contact the electric power line owner. The electric power shall be disconnected if the power lines moved or insulated before machine operation begins.

| Line voltage | Required clearance |
|-----------------|--------------------|
| 1 to 30kV | 1.0m 3.28ft |
| 30kV to 60kV | 1.5m 4.92ft |
| 60kV to 100kV | 2.0m 6.56ft |
| 100kV to 300kV | 3.0m 9.84ft |
| 300kV to 500kV | 3.8m 12.47ft |
| 500kV to 1000kV | 4.5m 14.76ft |

82561

⚠ DANGER

Crushing Hazard
 Death or serious injury can result from contact with moving scissor arms.

Engage safety arm before performing maintenance or repair.

See service manual.

1292960

⚠ DANGER

Collision Hazard
 Failure to release machine brakes releasing brakes will result in loss of control.

1. Make sure machine is on a firm, level surface or ground.
2. Check wheels.
3. Release brakes.

INSTRUCTIONS

Block Release Operation After machine is raised:
 1. Check wheels to prevent machine from rolling.
 2. Be sure which line is properly secured to ground before you attach another line.
 3. Use key switch to ground motor.
 4. Use high switch on.

1263543

⚠ WARNING

Improper operation or maintenance of this equipment can result in death or serious injury.

Access by trained and authorized personnel only.

1290659

⚠ DANGER

Electrocution / Fire Hazard
 Death or serious injury will result from use of improper or damaged cord and outlet.

Connect charger to a grounded AC 3-wire electrical outlet only.
 Before each use, inspect for damaged cord, cables and wires. Replace damaged items before operating.

1294685

⚠ WARNING

Annual Inspection Record
 Failure to complete required inspections could result in death or serious injury.

Scheduled maintenance inspections must be completed as specified in the appropriate service manual.

Use the chart to record the date of the annual inspection and the inspector and the machine owner.

Use the maintenance inspection report in the service manual for required recordkeeping. Keep records on all inspections for 100 years.

Maintenance inspections must be completed by a person trained and qualified in the experience of the machine owner.

| DATE | INSPECTOR | MACHINE NUMBER |
|--------------------|-----------|----------------|
| Date of inspection | Inspector | Machine Number |
| | | |
| | | |
| | | |
| | | |



General Safety

28236

WARNING

Read and understand Operator's Manual, Responsibilities Manual and Safety Manual and all safety signs before using or maintaining machine. If you do not understand the information in the manuals, consult your supervisor, the owner or the manufacturer.

Improper operation or maintenance can result in serious injury or death.

1294707

DANGER

Electrocution Hazard
Death or injury can result from contacting electric power lines. This machine is not electrically insulated. Always contact the electric power line owner. The electric power shall be disconnected or the power lines moved or insulated before machine operation begins.

| Line voltage | Maximum platform height |
|--------------|-------------------------|
| 0 to 300V | 1.83 m / 6.00 ft |
| 300 to 330V | 1.83 m / 6.00 ft |
| 330 to 345V | 2.08 m / 6.83 ft |
| 345 to 360V | 2.08 m / 6.83 ft |
| 360 to 375V | 2.34 m / 7.68 ft |
| 375 to 480V | 2.34 m / 7.68 ft |

44736

DANGER

Tip-over Hazard
If tilt alarm sounds, unit is on a severe slope. Death or serious injury could occur.

- 1 Lower the platform.
- 2 Move the machine to level surface.

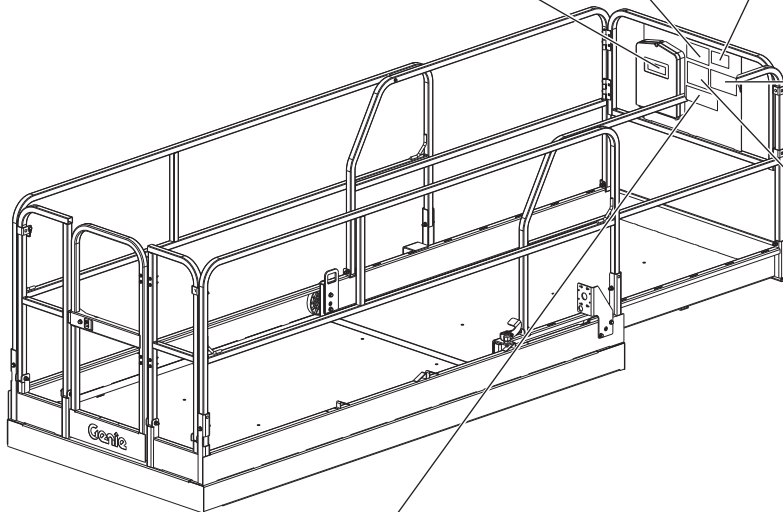

1294635

DANGER

Platform Overload LED Indicator Light

A flashing DL on the LED diagnostic readout indicates the platform is overloaded. No functions will operate and an alarm will sound.

- 1 Push in the Red Emergency stop button to the off position.
- 2 Remove weight from the platform.
- 3 Pull out the Red Emergency Stop button to the on position.

Tip-over Hazard
Do not overload platform. Platform overload will result in death or serious injury.

1293165

DANGER

Tip-over Hazard
Lifting over the machine will result in death or serious injury.

Do not stand or sit on the platform
Only use the platform when the machine is on firm, level surface.

WARNING

Fall Hazard
Platform on the machine can result in death or serious injury.

Do not sit, stand or climb on the platform
Platform is not designed for use as a seat, work surface or other structure.

WARNING

Crush Hazard
Contact with overhead structures could result in death or serious injury.

Do not use overhead structures
Use only for intended distribution or other precise tasks.

1290655

| DANGER | | Indoor | Maximum platform with level 0° high / 0° incline | Maximum platform with level 0° high / 0° incline | Maximum platform with level 0° high / 0° incline | Maximum platform with level 0° high / 0° incline | Platform extended height |
|---------------|--|--------|--|--|--|--|--------------------------|
| | | | 770 lbs / 350 kg | 770 lbs / 350 kg | 770 lbs / 350 kg | 770 lbs / 350 kg | 475 lbs / 214 kg |
| | | | 770 lbs / 350 kg | 770 lbs / 350 kg | 770 lbs / 350 kg | 770 lbs / 350 kg | 475 lbs / 214 kg |

Personal Safety

Personal Fall Protection

Personal fall protection equipment (PFPE) is not required when operating this machine. If PFPE is required by job site or employer rules, the following shall apply:

All PFPE must comply with applicable governmental regulations and must be inspected and used in accordance with the manufacturer's instructions.

Work Area Safety

⚠ Electrocuting Hazards

This machine is not electrically insulated and will not provide protection from contact with or proximity to electrical current.



Obey all local and governmental regulations regarding required clearance from electrical power lines. At a minimum, the required clearance contained in the chart below must be followed.

| Line Voltage | Required Clearance | |
|---------------|--------------------|---------|
| 0 to 50KV | 10 ft | 3.05 m |
| 50 to 200KV | 15 ft | 4.60 m |
| 200 to 350KV | 20 ft | 6.10 m |
| 350 to 500KV | 25 ft | 7.62 m |
| 500 to 750KV | 35 ft | 10.67 m |
| 750 to 1000KV | 45 ft | 13.72 m |

Allow for platform movement, electrical line sway or sag, and beware of strong or gusty winds.



Keep away from the machine if it contacts energized power lines. Personnel on the ground or in the platform must not touch or operate the machine until energized power lines are shut off.

Do not operate the machine during lightning or storms.

Do not use the machine as a ground for welding.

⚠ Tip-over Hazards

Occupants, equipment and materials shall not exceed the maximum platform capacity or the maximum platform capacity of the platform extension.

Maximum capacity

| Model | Platform extended | | | Maximum occupants |
|---------|--------------------|---------------|----------------|-------------------|
| | Platform retracted | Platform only | Extension only | |
| GS-4655 | 770 lbs | 470 lbs | 300 lbs | Indoor - 3 |
| | 350 kg | 214 kg | 136 kg | Outdoor - 2 |

Platform retracted



Platform extended



Extension only Platform only

The weight of options and accessories, such as panel carriers, will reduce the rated platform capacity and must be subtracted from the platform capacity. See the decals with the options and accessories.

If using accessories, read, understand and obey the decals, instructions and manuals with the accessory.

Work Area Safety



Do not raise the platform unless the machine is on a firm, level surface.



Do not operate the machine in strong or gusty winds. Do not increase the surface area of the platform or the load. Increasing the area exposed to the wind will decrease machine stability.



Do not depend on the tilt alarm as a level indicator. The tilt alarm sounds on the chassis only when the machine is on a severe slope.

If the tilt alarm sounds:

Lower the platform. Move the machine to a firm, level surface. If the tilt alarm sounds when the platform is raised, use extreme caution to lower the platform.

Do not drive over 0.5 mph / 0.8 km/h with the platform raised.

Follow ratings for allowable side force and number of occupants shown below.

Do not raise the platform when wind speeds may exceed 28 mph / 12.5 m/s. If wind speeds exceed 28 mph / 12.5 m/s when the platform is raised, lower the platform and do not continue to operate the machine.

Outdoor use: Do not operate the machine outdoors with the indoor use button selected.



Do not drive the machine on or near uneven terrain, unstable surfaces or other hazardous conditions with the platform raised.

Do not use the machine as a crane.

Do not push the machine or other objects with the platform.

Do not contact adjacent structures with the platform.

Do not tie the platform to adjacent structures.

Do not place loads outside the platform perimeter.

Do not operate the machine with the chassis trays open.

Work Area Safety



Do not push off or pull toward any object outside of the platform.



Do not place or attach fixed or overhanging loads to any part of this machine.

| Model | Maximum allowable side force | Maximum occupants |
|---------|------------------------------|---------------------------|
| GS-4655 | 90 lbs/400N | Indoor - 3 Outdoor - 2 |

Do not alter or disable the limit switches.

Do not alter or disable machine components that in any way affect safety and stability.

Do not replace items critical to machine stability with items of different weight or specification.

Do not use batteries that weigh less than the original equipment. Batteries are used as counterweight and are critical to machine stability. Each battery must weigh 82 lbs/37 kg. Battery tray including batteries must weigh a minimum of 415 lbs/188 kg.

Do not modify or alter a mobile elevated work platform without prior written permission from the manufacturer. Mounting attachments for holding tools or other materials onto the platform, toeboards, or guard rail system can increase the weight in the platform and the surface area of the platform or the load.



Do not place ladders or scaffolds in the platform or against any part of this machine.

Do not transport tools and materials unless they are evenly distributed and can be safely handled by person(s) in the platform.

Do not use the machine on a moving or mobile surface or vehicle.

Be sure the tires are in good condition and the lug nuts tightened.

Work Area Safety

⚠️ Crushing Hazard

Keep hands and limbs out of scissors.

Keep hands clear when folding rails.

Do not work under the platform or in the scissor links without the safety arm in place.

Use common sense and planning when operating the machine with the controller from the ground. Maintain safe distances between the operator, the machine and fixed objects.

⚠️ Operation on Slopes Hazards

Do not drive the machine on a slope that exceeds the slope and side slope rating of the machine. Slope rating applies to machines in the stowed position.

| Model | Maximum slope rating, stowed position | Maximum side slope rating, stowed position |
|---------|---------------------------------------|--|
| GS-4655 | 25% (14°) | 25% (14°) |

Note: Slope rating is subject to ground conditions with one person in the platform and adequate traction. Additional platform weight may reduce slope rating. See Driving on a Slope in the Operating Instructions section.

⚠️ Fall Hazards

The guard rail system provides fall protection. If occupant(s) of the platform are required to wear personal fall protection equipment (PFPE) due to job site or employer rules, PFPE and its use shall be in accordance with the PFPE manufacturer's instructions and applicable governmental requirements. Use approved lanyard attachment point provided.



Do not sit, stand, or climb on the platform guard rails. Maintain a firm footing on the platform floor at all times.



Do not climb down from the platform when raised.

Keep the platform floor clear of debris.

Close the entry gate before operating.

Do not operate the machine unless the guard rails are properly installed and the entry is secured for operation.

Do not enter or exit the platform unless the machine is in the stowed position.

Work Area Safety

⚠ Collision Hazards

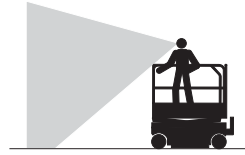

Be aware of limited sight distance and blind spots when driving or operating.

Be aware of extended platform position when moving the machine.

The machine must be on a level surface or secured before releasing the brakes.

Operators must comply with employer, job site, and governmental rules regarding use of personal protective equipment.



Check the work area for overhead obstructions or other possible hazards.



Be aware of crushing hazards when grasping the platform guard rail.

Observe and use color-coded direction arrows on the platform controls and the platform decal plate for drive and steer functions.



Do not lower the platform unless the area below is clear of personnel and obstructions.



Limit travel speed according to the condition of the ground surface, congestion, slope, location of personnel, and any other factors which may cause collision.

Do not operate a machine in the path of any crane or moving overhead machinery unless the controls of the crane have been locked out and/or precautions have been taken to prevent any potential collision.

No stunt driving or horseplay while operating a machine.

Work Area Safety

⚠ Bodily Injury Hazard

Do not operate the machine with a hydraulic oil or air leak. An air leak or hydraulic leak can penetrate and/or burn skin.

Improper contact with components under any cover will cause serious injury. Only trained maintenance personnel should access compartments. Access by the operator is only advised when performing a pre-operation inspection. All compartments must remain closed and secured during operation.

⚠ Explosion and Fire Hazards

Do not operate the machine or charge the battery in hazardous locations or locations where potentially flammable or explosive gases or particles may be present.

⚠ Damaged Machine Hazards

Do not use a damaged or malfunctioning machine.

Conduct a thorough pre-operation inspection of the machine and test all functions before each work shift. Immediately tag and remove from service a damaged or malfunctioning machine.

Be sure all maintenance has been performed as specified in this manual and the appropriate Genie service manual.

Be sure all decals are in place and legible.

Be sure the operator's, safety, and responsibilities manuals are complete, legible, and in the storage container located on the machine.

⚠ Component Damage Hazards

Do not use any battery charger greater than 24V to charge the batteries.

Do not use the machine as a ground for welding.

Work Area Safety

⚠ Battery Safety

Burn Hazards



Batteries contain acid. Always wear protective clothing and eye wear when working with batteries.

Avoid spilling or contacting battery acid. Neutralize battery acid spills with baking soda and water.

Do not expose the batteries or the charger to water or rain during charging.

Explosion Hazards

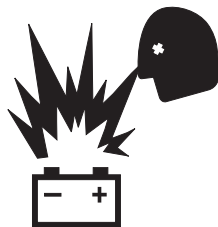

Keep sparks, flames, and lighted tobacco away from batteries. Batteries emit explosive gas.

The battery tray should remain open during the entire charging cycle.



Do not contact the battery terminals or the cable clamps with tools that may cause sparks.



Component Damage Hazard

Do not use any battery charger greater than 24V to charge the batteries.

Electrocution/Burn Hazards



Connect the battery charger to a grounded, AC 3-wire electrical outlet only.

Inspect daily for damaged cords, cables and wires. Replace damaged items before operating.

Avoid electrical shock from contact with battery terminals. Remove all rings, watches and other jewelry.

Tip-over Hazard

Do not use batteries that weigh less than the original equipment. Batteries are used as counterweight and are critical to machine stability. Each battery must weigh 82 lbs/37 kg. Battery tray including batteries must weigh a minimum of 415 lbs/188 kg.

Lifting Hazard

Use the appropriate number of people and proper lifting techniques when lifting batteries.

Work Area Safety

Lockout After Each Use

- 1 Select a safe parking location—firm level surface, clear of obstruction and traffic.
- 2 Lower the platform.
- 3 Turn the key switch to the off position and remove the key to secure from unauthorized use.
- 4 Charge the batteries.

Legend

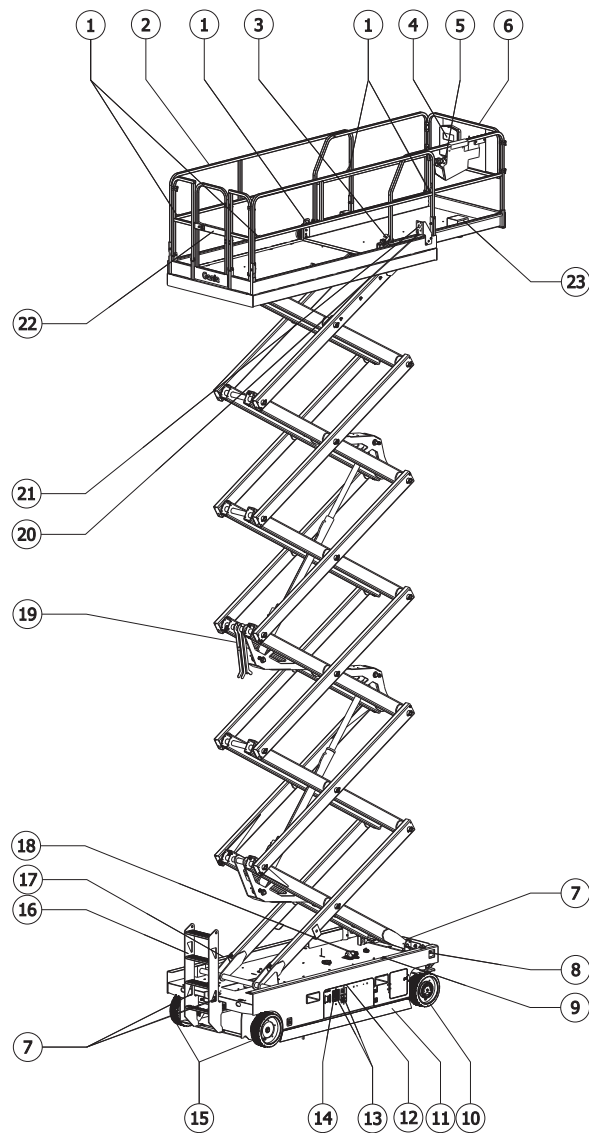

- 1 Lanyard anchorage points
- 2 Platform guard rails
- 3 Platform extension release pedal
- 4 Manual storage container
- 5 Platform controls
- 6 Platform extension
- 7 Transport tie-down
- 8 Emergency lowering knob
- 9 Flashing beacon
- 10 Steer tire
- 11 Pothole guard
- 12 LCD readout
- 13 Ground controls
- 14 Brake release switch (hydraulic side)
- 15 Non-steer tire
- 16 Entry ladder / transport tie-down
- 17 Battery charger (on battery side of machine)
- 18 Tilt alarm
- 19 Safety arm
- 20 Air line to platform (optional)
- 21 GFCI outlet
- 22 Platform entry gate
- 23 Foot switch (if equipped)

Controls

The ground control station is to be used as a means to raise the platform for functions tests and for storage purposes. The ground control station can be used in the event of an emergency to rescue an incapacitated person in the platform.

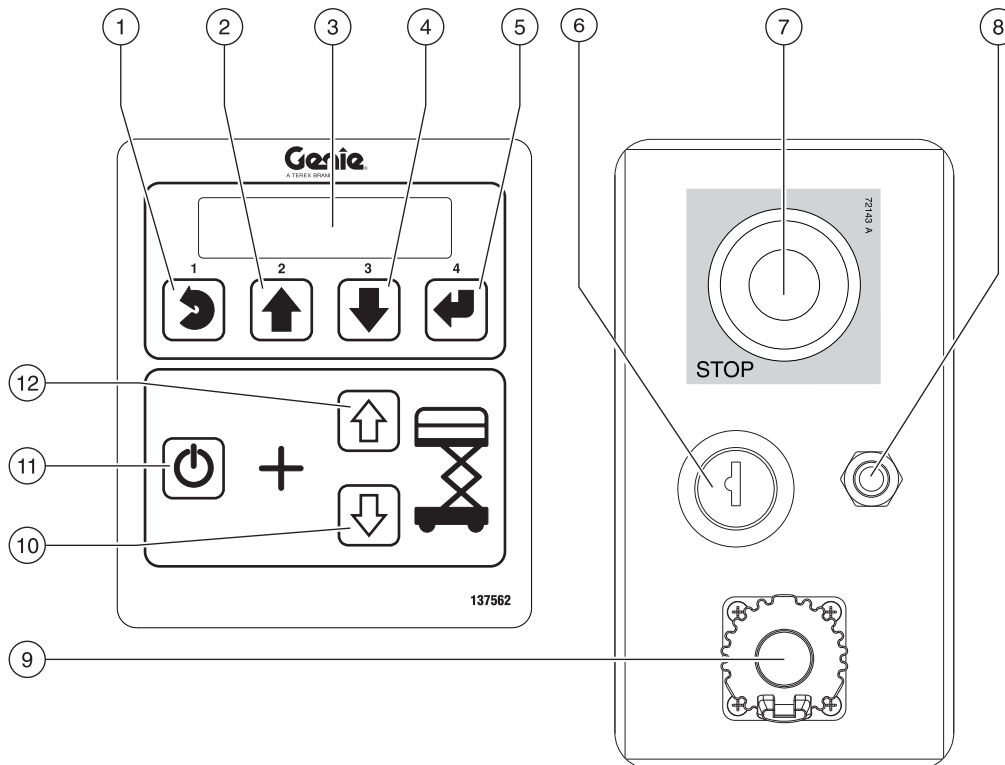

Ground Control Panel

- | | |
|--|---|
| <ul style="list-style-type: none"> 1 Menu escape button 2 Menu up button 3 LCD diagnostic readout 4 Menu down button 5 Menu enter button 6 Key switch for platform/off/ground selection Turn the key switch to the platform position and the platform controls will operate. Turn the key switch to the off position and the machine will be off. Turn the key switch to the ground position and the ground controls will operate. | <ul style="list-style-type: none"> 7 Red Emergency Stop button Push in the red Emergency Stop button to the off position to stop all functions. Pull out the red Emergency Stop button to the on position to operate the machine. 8 7A breaker for electrical circuits 9 Tech Pro Link Connector 10 Platform down button 11 Lift function enable button Press and hold this button to activate the lift function. 12 Platform up button |
|--|---|

Controls

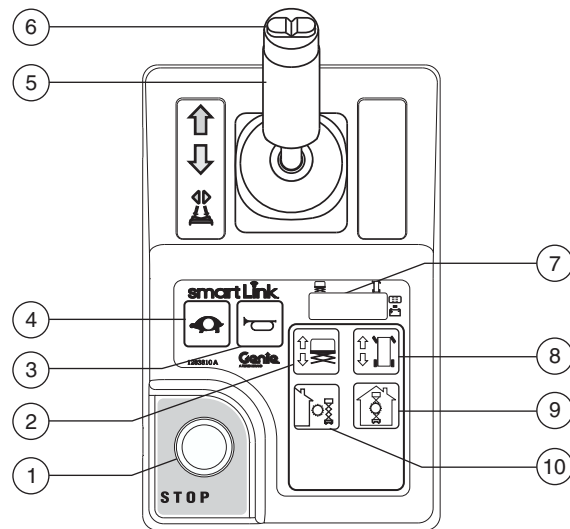

Platform Control Panel

1 Red Emergency Stop button

Push in the red Emergency Stop button to the off position to stop all functions. Pull out the red Emergency Stop button to the on position to operate the machine.

2 Lift function button

Push this button to activate the lift function.

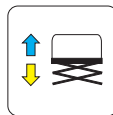

3 Horn button

Press the horn button and the horn will sound. Release the horn button and the horn will not sound.



4 Drive speed select button

Press this button to activate the slow drive function. The indicator light will be on when slow drive is selected.



Controls

- 5 Proportional control handle and function enable switch for drive, steer, and lift functions

Lift function: Press and hold the function enable switch to enable the lift function on the platform control handle. Move the control handle in the direction indicated by the blue arrow and the platform will raise. Move the control handle in the direction indicated by the yellow arrow and the platform will lower. The descent alarm should sound while the platform is lowering.

Drive function: Press and hold the function enable switch to enable the drive function on the platform control handle. Move the control handle in the direction indicated by the blue arrow on the control panel and the machine will move in the direction that the blue arrow points. Move the control handle in the direction indicated by the yellow arrow on the control panel and the machine will move in the direction that the yellow arrow points.

- 6 Thumb rocker switch for steer function

Press the left side of the thumb rocker and the machine will turn in the direction the blue triangle points on the platform control panel.



Press the right side of the thumb rocker and the machine will turn in the direction the yellow triangle points on the platform control panel.



- 7 LED diagnostic readout, battery charge indicator and lift/drive mode indicator

- 8 Drive function button

Push this button to activate the drive function.

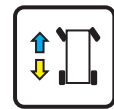

- 9 Indoor use button

Press this button for indoor use

Note: Selecting indoor use achieves maximum platform height, 46 ft/13.92 m



- 10 Outdoor use button

Press this button for outdoor use

Note: Selecting outdoor use reduces the maximum platform height to 21 ft 6 in/6.5 m

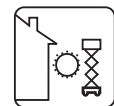

Inspections



Do Not Operate Unless:

- You learn and practice the principles of safe machine operation contained in this operator's manual.
 - 1 Avoid hazardous situations.
 - 2 Always perform a pre-operation inspection.**
- Know and understand the pre-operation inspection before going on to the next section.**
- 3 Always perform function tests prior to use.
- 4 Inspect the workplace.
- 5 Only use the machine as it was intended.

Pre-operation Inspection Fundamentals

It is the responsibility of the operator to perform a pre-operation inspection and routine maintenance.

The pre-operation inspection is a visual inspection performed by the operator prior to each work shift. The inspection is designed to discover if anything is apparently wrong with a machine before the operator performs the function tests.

The pre-operation inspection also serves to determine if routine maintenance procedures are required. Only routine maintenance items specified in this manual may be performed by the operator.

Refer to the list on the next page and check each of the items.

If damage or any unauthorized variation from factory delivered condition is discovered, the machine must be tagged and removed from service.

Repairs to the machine may only be made by a qualified service technician, according to the manufacturer's specifications. After repairs are completed, the operator must perform a pre-operation inspection again before going on to the function tests.

Scheduled maintenance inspections shall be performed by qualified service technicians, according to the manufacturer's specifications and the requirements listed in the responsibilities manual.

Inspections

Pre-operation Inspection

- Be sure that the operator's, safety, and responsibilities manuals are complete, legible and in the storage container located in the platform.
- Be sure that all decals are legible and in place. See Inspections section.
- Check for hydraulic oil leaks and proper oil level. Add oil if needed. See Maintenance section.
- Check for battery fluid leaks and proper fluid level. Add distilled water if needed. See Maintenance section.

Check the following components or areas for damage, improperly installed, or missing parts and unauthorized modifications:

- Electrical components, wiring, and electrical cables
- Hydraulic hoses, fittings, cylinders, and manifolds
- Drive motors
- Wear pads
- Tires and wheels
- Limit switches, alarms and horn
- Alarms and beacons (if equipped)
- Nuts, bolts and other fasteners
- Brake release components

- Safety arm
- Platform extension
- Scissor pins and retaining fasteners
- Platform control joystick
- Battery pack and connections
- Ground strap
- Platform entry gate
- Pothole guards
- Lanyard anchorage points
- Platform overload components

Check entire machine for:

- Cracks in welds or structural components
- Dents or damage to machine
- Excessive rust, corrosion or oxidation
- Verify that all structural and other critical components are present and all associated fasteners and pins are in place and properly tightened.
- Be sure side rails are installed and bolts are fastened.
- Be sure that the chassis trays are closed and latched and the batteries are properly connected.

Note: If the platform must be raised to inspect the machine, make sure the safety arm is in place. See Operating Instructions section.

Inspections



Do Not Operate Unless:

- You learn and practice the principles of safe machine operation contained in this operator's manual.
 - 1 Avoid hazardous situations.
 - 2 Always perform a pre-operation inspection.
 - 3 Always perform function tests prior to use.**

Know and understand the function tests before going on to the next section.

- 4 Inspect the workplace.
- 5 Only use the machine as it was intended.

Function Test Fundamentals

The function tests are designed to discover any malfunctions before the machine is put into service. The operator must follow the step-by-step instructions to test all machine functions.

A malfunctioning machine must never be used. If malfunctions are discovered, the machine must be tagged and removed from service. Repairs to the machine may only be made by a qualified service technician, according to the manufacturer's specifications.

After repairs are completed, the operator must perform a pre-operation inspection and function tests again before putting the machine into service.

Inspections

At the Ground Controls

- 1 Select a test area that is firm, level and free of hazards.
 - 2 Be sure the batteries are connected.
 - 3 Pull out the platform and ground red Emergency Stop button to the on position.
 - 4 Turn the key switch to ground control.
 - 5 Observe the diagnostic LED readout on the platform controls.
- ⊙ Result: The LED should look like the picture below.



- 6 Observe the diagnostic LCD readout on the ground controls.
- ⊙ Result: The LCD should look like the picture below.

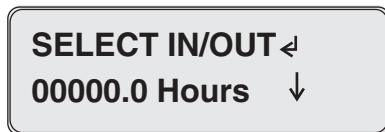

Test Emergency Stop

- 7 Push in the ground red Emergency Stop button to the off position.
- ⊙ Result: No functions should operate.
- 8 Pull out the red Emergency Stop button to the on position.

Test the Up/Down Functions

The audible warnings on this machine and the standard horn all come from the same central alarm. The horn is a constant tone. The descent alarm sounds at 60 beeps per minute. The alarm sounds at 180 beeps per minute when the pothole guards have not deployed and when the machine is not level. An optional automotive-style horn is also available.

- 9 Do not press the lift function enable button.
 - 10 Press the platform up or platform down button.
- ⊙ Result: The lift function should not operate.
- 11 Do not press the platform up or platform down buttons.
 - 12 Press the lift function enable button.
- ⊙ Result: The lift function should not operate.
- 13 Press and hold the lift function enable button, and press the platform up button.
- ⊙ Result: The outdoor area of operation should be selected and the platform should raise.
- 14 Press and hold the lift function enable button, and press the platform down button.
- ⊙ Result: The platform should lower. The descent alarm should sound while the platform is lowering.

Inspections

Test Emergency Lowering

- 15 Activate the up function by pressing the lift enable button and platform up button, and raise the platform approximately 2 ft. / 60 cm.
- 16 Pull the emergency lowering knob located on the right, front of the chassis.
- ⊙ Result: The platform should lower. The descent alarm will not sound.

Test the Tilt Sensor Operation

- 17 Press the ground control down button (button 3)



- ⊙ Result: The ground control LCD screen will display the status of the tilt sensor. The X and Y values (pitch and roll) will be displayed.
- 18 Turn the key switch to platform control.

At the Platform Controls

Test Emergency Stop

- 19 Push in the platform red Emergency Stop button to the off position.
- ⊙ Result: No functions should operate.

Test the Alarm for Tilt Sensor

- 20 Pull out the red Emergency Stop button to the on position.
- 21 Press the horn button.
- ⊙ Result: The platform alarm, chassis alarm, and automotive horn (if equipped) should sound.

Test the Function Enable Switch and the Up/Down Functions

- 22 Do not hold the function enable switch on the control handle.
- 23 Slowly move the control handle in the direction indicated by the blue arrow, then in the direction indicated by the yellow arrow.
- ⊙ Result: No functions should operate.
- 24 Press the lift function button.
- 25 Wait seven seconds for the lift function to time out.
- 26 Slowly move the control handle in the direction indicated by the blue arrow, then in the direction indicated by the yellow arrow.
- ⊙ Result: The lift function should not operate.

Inspections

- 27 Press the lift function button.
- 28 Press and hold the function enable switch on the control handle. Slowly move the control handle in the direction indicated by the blue arrow.

Machines equipped with foot switch: Press and hold the foot switch and press and hold the function enable switch on the control handle at the same time.

- ⊙ Result: The platform should raise. The pothole guards should deploy. The outdoor use button should illuminate.
- 29 Release the control handle.
- ⊙ Result: The platform should stop raising.
- 30 Press and hold the function enable switch on the control handle. Slowly move the control handle in the direction indicated by the yellow arrow.
- ⊙ Result: The platform should lower. The descent alarm should sound while the platform is lowering.

Test the Outdoor Use Button

- 31 Do not press and hold the function enable switch on control handle.
- 32 Press the outdoor use button.
- ⊙ Result: The LED under the outdoor button will illuminate.
- 33 Press the lift function enable button.
- 34 Press and hold the drive/steer function enable switch on the control handle. Slowly move the control handle in the direction indicated by the blue arrow.
- ⊙ Result: The platform should raise to a maximum of 21 ft 6 in/6.5 m and stop. The alarm should sound. The platform controls LED readout should display OHL and the ground controls LCD should display OHL: OUTDOOR HEIGHT LIMIT.

Inspections

Test the Drive Function Button

35 Press the drive function button.



36 Wait seven seconds for the drive function to time out.

37 Slowly move the control handle in the direction indicated by the blue arrow, then in the direction indicated by the yellow arrow.

⊙ Result: No functions should operate.

Test the Steering

Note: When performing the steer and drive function tests, stand in the platform facing the steer end of the machine.

38 Press the drive function button.



39 Press and hold the function enable switch on the control handle.

40 Press the thumb rocker switch on top of the control handle in the direction indicated by the blue triangle on the control panel.

⊙ Result: The steer wheels should turn in the direction indicated by the blue triangle.

41 Press the thumb rocker switch on top of the control handle in the direction indicated by the yellow triangle, on the control panel.

⊙ Result: The steer wheels should turn in the direction indicated by the yellow triangle.

Test Drive and Braking

42 Press the drive function button.



43 Press and hold the function enable switch on the control handle.

Machines equipped with foot switch: Press and hold the foot switch and press and hold the function enable switch on the control handle at the same time.

44 Slowly move the control handle in the direction indicated by the blue arrow on the control panel until the machine begins to move, then return the control handle to the center position.

⊙ Result: The machine should move in the direction that the blue arrow points on the control panel, then come to an abrupt stop when the control handle is returned to the center position.

45 Slowly move the control handle in the direction indicated by the yellow arrow on the control panel until the machine begins to move, then return the control handle to the center position.

⊙ Result: The machine should move in the direction that the yellow arrow points on the control panel, then come to an abrupt stop when the control handle is returned to the center position.

Note: The brakes must be able to hold the machine on any slope it is able to climb.

Inspections

Test Drive Tilt Cutout

Note: Perform this test from the ground with the platform controller. Do not stand in the platform.

- 46 Fully lower the platform.
- 47 Drive the machine onto a slope where the chassis angle is greater than 1.5° side to side.
- 48 Raise the platform to approximately 9 ft/2.74 m.
 - ⊙ Result: The platform should stop and the tilt alarm will sound at 180 beeps per minute. The platform controls LED readout should display LL and the ground controls LCD should display LL: Machine Tilted.
- 49 Press the drive function button.
- 50 Press and hold the function enable switch on the control handle.
- 51 Move the control handle in the direction indicated by the blue arrow, then move the control handle in the direction indicated by the yellow arrow.
 - ⊙ Result: The drive function should not work in either direction.
- 52 Fully lower the platform.
- 53 Drive the machine.
 - ⊙ Result: The machine should drive.
- 54 Return to level ground and raise the platform in excess of approximately 9 ft/2.74 m.
- 55 Drive the machine onto a slope where the pitch angle is greater than 1.5° side to side.
 - ⊙ Result: The machine should stop once the machine reaches 1.5° of chassis tilt and the tilt alarm will sound at 180 beeps per minute. The platform controls LED readout should display LL and the ground controls LCD should display LL: Machine Tilted
- 56 Return to level ground and fully lower the platform.
- 57 Drive the machine onto a slope where the chassis angle is greater than 3° front to back.
- 58 Raise the platform to approximately 9 ft/2.74 m.
 - ⊙ Result: The platform should stop and the tilt alarm will sound at 180 beeps per minute. The platform controls LED readout should display LL and the ground controls LCD should display LL: Machine Tilted.
- 59 Press the drive function button.
- 60 Press and hold the drive/steer function enable switch on the control handle.
- 61 Move the control handle in the direction indicated by the blue arrow, then move the control handle in the direction indicated by the yellow arrow.
 - ⊙ Result: The drive function should not work in either direction.

Inspections

- 62 Fully lower the platform.
- 63 Drive the machine.
- ⊙ Result: The machine should drive.
- 64 Return to level ground and raise the platform in excess of approximately 9 ft/2.74 m.
- 65 Drive the machine onto a slope where the pitch angle is greater than 3° front to back.
- ⊙ Result: The machine should stop once the machine reaches 3° of chassis tilt and the tilt alarm will sound at 180 beeps per minute. The platform controls LED readout should display LL and the ground controls LCD should display LL: Machine Tilted
- ⊙ Fully lower the platform and return to level ground.

Test Elevated Drive Speed

- 66 Raise the platform approximately 9.1 ft/2.78 m from the ground.
- 67 Press the drive function button. 
- 68 Press and hold the function enable switch on the control handle. Slowly move the control handle to full drive position.
- ⊙ Result: The maximum achievable drive speed with the platform raised should not exceed 0.72 ft / 22 cm per second.

If the drive speed with the platform raised exceeds 0.72 ft / 22 cm per second, immediately tag and remove the machine from service.

Test the Pothole Guards

Note: The pothole guards should automatically deploy when the platform is raised. The pothole guards activate limit switches that allow the machine to continue to function. If the pothole guards do not deploy, an alarm sounds and the machine will not drive or steer.

- 69 Raise the platform.
- ⊙ Result: When the platform is raised 9.1 ft/2.78 m from the ground, the pothole guards should deploy.
- 70 Press on the pothole guards on one side, and then the other.
- ⊙ Result: The pothole guards should not move.
- 71 Lower the platform.
- ⊙ Result: The pothole guards should return to the stowed position.
- 72 Place a 2x4 or similar piece of wood under a pothole guard.
- 73 Raise the platform.
- ⊙ Result: Before the platform is raised 12.4 ft/3.78 m from the ground, an alarm should sound. The platform controls LED readout should display PHS and the ground controls LCD should display PHS: Pothole Guard Stuck.

Inspections

74 Press the drive function button.



75 Press and hold the function enable switch on the control handle.

76 Slowly move the control handle in the direction indicated by the blue arrow, then in the direction indicated by the yellow arrow.

⦿ Result: The machine should not move forward or backward.

77 Press the drive function button.



78 Press and hold the function enable switch on the control handle.

79 Press the thumb rocker switch on top of the control handle in the direction indicated by the blue and yellow triangles on the control panel.

⦿ Result: The steer wheels should not turn left or right.

80 Lower the platform.

81 Remove the 2x4 or similar piece of wood.

Inspections



Do Not Operate Unless:

- You learn and practice the principles of safe machine operation contained in this operator's manual.
 - 1 Avoid hazardous situations.
 - 2 Always perform a pre-operation inspection.
 - 3 Always perform function tests prior to use.
 - 4 Inspect the workplace.**

Know and understand the workplace inspection before going on to the next section.

 - 5 Only use the machine as it was intended.

Inspections

Workplace Inspection Fundamentals

The workplace inspection helps the operator determine if the workplace is suitable for safe machine operation. It should be performed by the operator prior to moving the machine to the workplace.

It is the operator's responsibility to read and remember the workplace hazards, then watch for and avoid them while moving, setting up, and operating the machine.

Workplace Inspection Checklist

Be aware of and avoid the following hazardous situations:

- drop-offs or holes
- bumps, floor obstructions, or debris
- sloped surfaces
- unstable or slippery surfaces
- overhead obstructions and high voltage conductors
- hazardous locations
- inadequate surface support to withstand all load forces imposed by the machine
- wind and weather conditions
- the presence of unauthorized personnel
- other possible unsafe conditions

Inspections

Inspection for Decals with Words GS-4655

Determine whether the decals on your machine have words or symbols. Use the appropriate inspection to verify that all decals are legible and in place.

| Part No. | Decal Description | Qty |
|----------|--|-----|
| 28236 | Warning – Improper Operation | 1 |
| 31060 | Danger – Tip-over Hazard, Limit Switch | 1 |
| 43618 | Label – Directional Arrows | 2 |
| 43619 | Label – Safety Arm | 1 |
| 44736 | Danger – Tip-over Hazard, Tilt Alarm | 1 |
| 44981 | Label – Air Line to Platform | 2 |
| 52475 | Label – Transport Tie-down | 5 |
| 72086 | Label – Lifting Point | 4 |
| 72143 | Label – Emergency Stop | 1 |
| 82557 | Label – Platform Controls Location | 1 |
| 82561 | Danger – Crushing Hazard | 2 |
| 82666 | Label - Forklift Pocket | 4 |
| 137605 | Label – Emergency Stop, Platform Control | 1 |
| 137656 | Label – Drive/Steer Direction, Platform Control | 1 |
| 214864 | Instructions – Battery Connection Diagram, | 1 |
| 1263543 | Warning – Compartment Access | 2 |
| 1265361 | Label – Battery Charger Indicator | 1 |
| 1272242 | Label – Machine Registration/Owner Transfer | 1 |
| 1280819 | Label – Warning, Prop 65 | 1 |
| 1281174 | Label – Lanyard Anchorage Point, Fall Arrest/Fall Restrained | 5 |
| 1283810 | Label – Platform Control Panel GS-4655 | 1 |

| Part No. | Decal Description | Qty |
|----------|---|-----|
| 1283878 | Label – Tech Pro Link | 1 |
| 1290655 | Instructions – Maximum Side Force | 1 |
| 1290659 | Danger – Electrocutation Hazard | 1 |
| 1290662 | Label – Chevron Rando | 1 |
| 1290664 | Instructions – Operation, Ground Control | 1 |
| 1290668 | Instructions – Battery Charger Operation | 1 |
| 1290675 | Danger – Explosion/Burn Hazard | 1 |
| 1290699 | Label – Transport Diagram | 2 |
| 1292047 | Label – Power to Platform, 115V | 2 |
| 1292048 | Label – Power to Platform, 230V | 2 |
| 1292049 | Label – Power to Platform, 115V, UK | 1 |
| 1292050 | Label – Power to Platform, 230EU | 1 |
| 1292051 | Label – Emergency Lowering | 1 |
| 1292275 | Label – Electric Drive, E-Drive | 2 |
| 1292746 | Label – Wheel Load, GS-4655 | 4 |
| 1292747 | Label - Tire Specification | 4 |
| 1292748 | Label – Tip-over Hazard, Batteries | 1 |
| 1292960 | Label – Brake Release Safety and Operating Instructions | 1 |
| 1292990 | Label – Release Brake | 1 |
| 1293165 | Danger – Tip-over, Crush Hazard | 1 |
| 1294398 | Label – ANSI/CSA Compliant | 1 |
| 1294635 | Label – Platform Overload LED Indicator Light | 1 |
| 1294685 | Instructions – Annual Inspection | 1 |
| 1294707 | Danger – Electrocutation Hazard | 3 |
| 1296034 | Label – Smartlink Dual Zone | 2 |
| 1301158 | Label – Fault Codes | 1 |
| T112804 | Label – Ground Control Panel | 1 |

* These decals are model, option or configuration specific.

Inspections

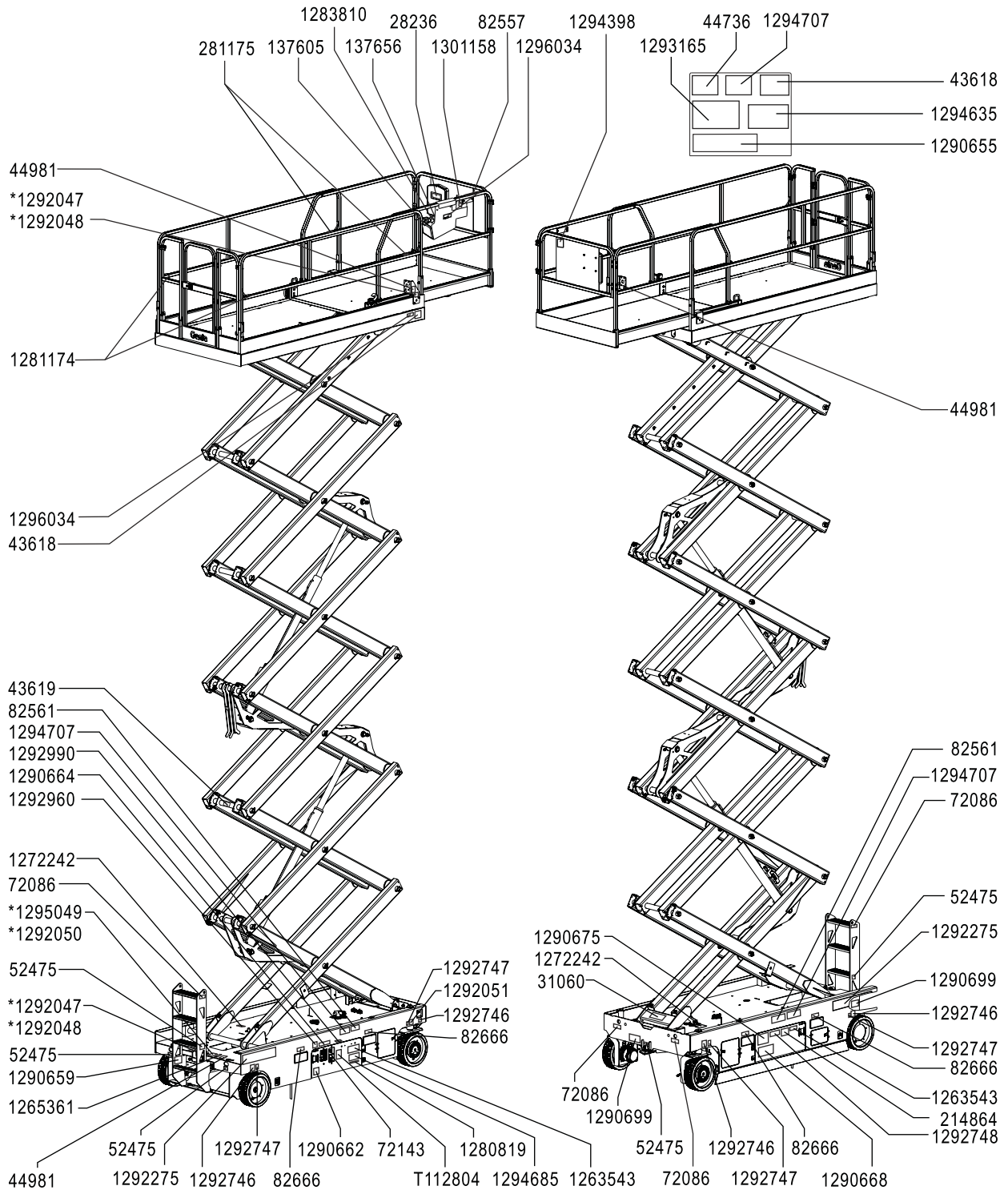

Operating Instructions



Do Not Operate Unless:

- You learn and practice the principles of safe machine operation contained in this operator's manual.
 - 1 Avoid hazardous situations.
 - 2 Always perform a pre-operation inspection.
 - 3 Always perform function tests prior to use.
 - 4 Inspect the workplace.
 - 5 **Only use the machine as it was intended.**

Fundamentals

The Operating Instructions section provides instructions for each aspect of machine operation. It is the operator's responsibility to follow all the safety rules and instructions in the operator's, safety, and responsibilities manuals.

Using the machine for anything other than lifting personnel, along with their tools and materials, to an aerial work site is unsafe and dangerous.

Only trained and authorized personnel should be permitted to operate a machine. If more than one operator is expected to use a machine at different times in the same work shift, they must all be qualified operators and are all expected to follow all safety rules and instructions in the operator's, safety, and responsibilities manuals. That means every new operator should perform a pre-operation inspection, function tests, and a workplace inspection before using the machine.

Operating Instructions

Emergency Stop

Push in the red Emergency Stop button to the off position at the ground controls or the platform controls to stop all functions.

Repair any function that operates when either red Emergency Stop button is pushed in.

Emergency Lowering

- 1 Pull the emergency lowering knob to lower the platform.

Operation from Ground

- 1 Be sure the battery pack is connected before operating the machine.
- 2 Turn the key switch to ground control.
- 3 Pull out both ground and platform red Emergency Stop buttons to the on position.

To Position Platform

- 1 At the control panel, press Enter button to cycle between indoor and outdoor area of operations.
- 2 Press and hold the lift function enable
- 3 Press the platform up or down button.

Operation from Platform

- 1 Be sure the battery pack is connected before operating the machine.
- 2 Turn the key switch to platform control.
- 3 Pull out both ground and platform red Emergency Stop buttons to the on position.

To Position Platform

- 1 Press the Indoor or Outdoor use button.



Note: If no area of operation is selected the Outdoor area of operation will automatically be selected.

- 2 Press the lift function button. On the LED screen, a circle below the lift function symbol will be displayed.



If the control handle is not moved within seven seconds of pushing the lift function button, the circle below the lift function symbol will turn off and lift function will not operate. Press the lift function button again.

- 3 Press and hold the function enable switch on the control handle.
- 4 Machines equipped with foot switch: Press and hold the foot switch and press and hold the function enable switch on the control handle at the same time.
- 5 Move the control handle in the direction indicated by the markings on the control panel.

Operating Instructions

To Steer

- 1 Press the drive function button. On the LCD screen, a circle below the drive function symbol will turn on.

If the control handle is not moved within seven seconds of pushing the drive function button, the circle below the drive function symbol will turn off and drive function will not operate. Press the drive function button again.

- 2 Press and hold the foot switch (if equipped).
- 3 Turn the steer wheels with the thumb rocker switch located on the top of the control handle.



To Drive

- 1 Press the drive function button. On the LCD screen, a circle below the drive function symbol will turn on.

If the control handle is not moved within seven seconds of pushing the drive function button, the circle below the drive function symbol will turn off and drive function will not operate. Press the drive function button again.

- 2 Machines equipped with foot switch: Press and hold the foot switch and press and hold the function enable switch on the control handle at the same time.
- 3 Increase speed: Slowly move the control handle off center.

Decrease speed: Slowly move the control handle toward center.

Stop: Return the control handle to center or release the function enable switch.

Use the color-coded direction arrows on the platform controls and on the platform to identify the direction the machine will travel.

Machine travel speed is restricted when the platform is raised.

Battery condition will affect machine performance. Machine drive speed and function speed will drop when the battery level indicator is flashing.

To select drive speed

The drive controls can operate in two different drive speed modes. When the drive speed button light is on, slow drive speed mode is active. When the button light is off, fast drive speed mode is active.

Press the drive speed button to select the desired drive speed.



Note: When the platform is elevated, the drive speed button light is always on, indicating elevated drive speed.

Operating Instructions

▲ Driving on a slope

Determine the slope and side slope ratings for the machine and determine the slope grade.

Maximum slope rating, stowed position:

| | | | |
|---|---------|-----|-----|
|  | GS-4655 | 25% | 14° |
|---|---------|-----|-----|

Maximum side slope rating, stowed position:

| | | | |
|---|---------|-----|-----|
|  | GS-4655 | 25% | 14° |
|---|---------|-----|-----|

Note: Slope rating is subject to ground conditions with one person in the platform and adequate traction. Additional platform weight may reduce slope rating.

To determine the slope grade:

Measure the slope with a digital inclinometer OR use the following procedure.

You will need:

- carpenter's level
- straight piece of wood, at least 3 feet/1 m long
- tape measure

Lay the piece of wood on the slope.

At the downhill end, lay the level on the top edge of the piece of wood and lift the end until the piece of wood is level.

While holding the piece of wood level, measure the vertical distance from the bottom of the piece of wood to the ground.

Divide the tape measure distance (rise) by the length of the piece of wood (run) and multiply by 100.

Example:

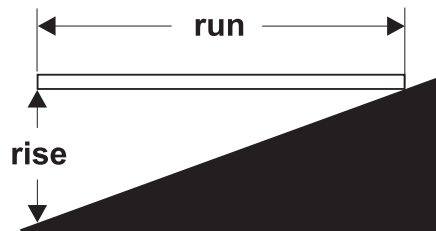

Piece of wood = 144 inches (3.6 m)

Run = 144 inches (3.6 m)

Rise = 12 inches (0.3 m)

$12 \text{ in} \div 144 \text{ in} = 0.083 \times 100 = 8.3\% \text{ grade}$

$0.3 \text{ m} \div 3.6 \text{ m} = 0.083 \times 100 = 8.3\% \text{ grade}$

If the slope exceeds the maximum slope or side slope rating, then the machine must be winched or transported up or down the slope. See Transport and Lifting section.

Operating Instructions

Operational indicator codes

If the platform controls LED or ground controls LCD diagnostic readout displays an operational indicator code such as LL, the fault condition must be repaired or removed before resuming machine operation. Push in and pull out the red Emergency Stop button to reset the system.



LED Readout

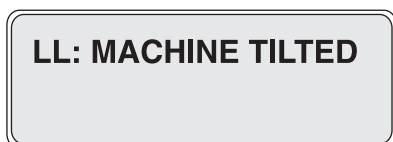

LCD Readout

Operational Indicator Codes

| Code | Condition |
|------|------------------------|
| LL | Off-Level |
| OL | Platform Overloaded |
| CH | Chassis Mode Operation |
| PHS | Pothole Guard Stuck |
| ND | No Drive (option) |
| BR | Manual Brake Release |
| OHL | Outdoor Height Limit |

For further information, please consult the appropriate Genie Service Manual. A code and a description of a code can also be viewed at the ground controls LCD display.

Platform Overload

If the platform controls LED diagnostic readout displays a flashing OL and the ground controls LCD diagnostic readout displays OL: Platform Overloaded, the platform is overloaded and no functions will operate. An alarm will sound.

- 1 Push in the red Emergency Stop button to the off position.
- 2 Remove weight from the platform.
- 3 Pull out the red Emergency Stop button to the on position.



LED Readout



LCD Readout

When the platform is being raised or lowered, a self-check function will be performed near maximum height. The machine may stop and an alarm may sound. If the machine is not overloaded, normal operation will resume.

Overload Recovery

If the ground controls LCD diagnostic readout displays Overload Recovery, the emergency lowering system has been used while the platform was overloaded. For information on how to reset the message, please consult the appropriate Genie Service Manual.

Operating Instructions

Tilt Sensor Activation Settings

| Tilt Sensor Activation Conditions | |
|-----------------------------------|------|
| Chassis Angle (side to side) | 1.5° |
| Chassis Angle (front to back) | 3° |

If the tilt alarm sounds while raising the platform, lower the platform and move the machine to a firm, level surface. If the tilt alarm sounds when the platform is raised, use extreme caution to lower the platform.

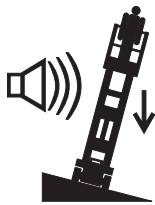

When the platform controls LED readout displays LL, the ground controls LCD displays LL: Machine Tilted, and the tilt alarm sounds at 180 beeps per minute, the following functions are affected: drive, steer, and elevate functions are disabled.



Return the machine to level ground to restore lift functions.

Operation from Ground with Controller

Maintain safe distances between the operator, machine and fixed objects.

Be aware of the direction the machine will travel when using the controller.

Battery Level Indicator

Use the LED diagnostic readout to determine the battery level.

Note: When a blinking LO code appears on the platform controls LED display, the machine must be taken out of service and charged, otherwise all machine functions will be disabled.



Full Charge



Half Charge



Low Charge



LO Flashing

Operating Instructions

How to Use the Safety Arm

- 1 Raise the platform approximately 14 ft / 4.24 m from the ground.
- 2 Rotate the safety arm away from the machine and let it hang down.
- 3 Lower the platform until the safety arm rests securely on the link. Keep clear of the safety arm when lowering the platform.

After Each Use

- 1 Select a safe parking location—firm level surface, clear of obstruction and traffic.
- 2 Lower the platform.
- 3 Turn the key switch to the off position and remove the key to secure from unauthorized use.
- 4 Charge the batteries.

Operating Instructions

How to Fold Down the Guardrails

The platform railing system consists of three fold down rail sections for the extension deck and three sections for the main deck. All six sections are held in place by four wire lock pins.

Note: To assist in the removal and replacement of the wire lock pins, pull or push back on the railing to compress the rubber bumpers.

- 1 Fully lower the platform and retract the platform extension.
- 2 Remove the platform controls.
 - ▲ Fall hazard. Use caution and maintain a firm footing on the platform floor at all times while folding the guard rails.
- 3 From inside the platform, remove the two front wire lock pins.
 - ▲ Keep hands free of pinch points.
- 4 Fold the front rail assembly to left side. Keep hands clear of pinch points.
- 5 Reinsert the two removed pins back into front rail bracket.

- 6 Fold down left side rail assembly together with front rail.
 - ▲ Keep hands free of pinch points.
- 7 Fold down right side rail assembly.
 - ▲ Keep hands free of pinch points.
- 8 At the rear of the main deck, remove the two wire lock pins.
 - ▲ Keep hands free of pinch points.
- 9 Fold down the rear gate and entry side rails as one unit. Keep hands clear of pinch points.
- 10 Reinsert the two removed pins back into each side rail bracket.
- 11 Fold down left side rail assembly. Keep hands clear of pinch points.
- 12 Fold down right side rail assembly. Keep hands clear of pinch points.

How to Raise the Guardrails

Follow the fold down instructions but in reverse order, ensuring all lock pins are in place and installed properly.

Operating Instructions



Battery and Charger Instructions

Observe and Obey:

- Do not use an external charger or booster battery.
- Charge the battery in a well-ventilated area.
- Use proper AC input voltage for charging as indicated on the charger.
- Use only a Genie authorized battery and charger.

To Charge Battery

- 1 Be sure the batteries are connected before charging the batteries.
- 2 Open the battery compartment. The compartment may remain open for the entire charging cycle.

Maintenance-free batteries

- 1 Connect the battery charger to a grounded AC circuit.
- 2 The charger will indicate when the battery is fully charged.

Standard Batteries

- 1 Remove the battery vent caps and check the battery acid level. If necessary, add only enough distilled water to cover the plates. Do not overfill prior to the charge cycle.
- 2 Replace the battery vent caps.
- 3 Connect the battery charger to a grounded AC circuit.
- 4 The charger will indicate when the battery is fully charged.
- 5 Check the battery acid level when the charging cycle is complete. Replenish with distilled water to the bottom of the fill tube. Do not overfill.

Transport and Lifting Instructions





Observe and Obey:

- ☑ Genie provides this securement information as a recommendation. Drivers are solely responsible for making sure machines are properly secured and the correct trailer is selected pursuant to US Department of Transportation regulations, other localized regulations, and their company policy.
 - ☑ Genie customers needing to containerize any lift or Genie product should source a qualified freight forwarder with expertise in preparing, loading and securing construction and lifting equipment for international shipment.
 - ☑ Only qualified mobile elevating work platform operators should move the machine on or off the truck.
 - ☑ The transport vehicle must be parked on a level surface.
 - ☑ The transport vehicle must be secured to prevent rolling while the machine is being loaded.
 - ☑ Be sure the vehicle capacity, loading surfaces and chains or straps are sufficient to withstand the machine weight. Genie lifts are very heavy relative to their size. See the serial label for the machine weight.
- ☑ The machine must be on a level surface or secured before releasing the brakes.
 - ☑ Do not allow the rails to fall when the snap pins are removed. Maintain a firm grasp on the rails when the rails are lowered.
 - ☑ Do not drive the machine on a slope that exceeds the uphill, downhill or side slope rating. See Driving on a Slope in the Operating Instructions section.
 - ☑ If the slope of the transport vehicle bed exceeds the maximum slope rating, the machine must be loaded and unloaded using a winch as described in the brake release operation.

Transport and Lifting Instructions

Brake Release Operation

- 1 Chock the wheels or tracks to prevent the machine from rolling. 
- 2 Be sure the winch line is properly secured to the drive chassis tie points and the path is clear of all obstructions.
- 3 Pull out the red Emergency Stop button at both the ground and platform controls and position the key switch to ground mode.
- 4 Open the hydraulic tray.
- 5 Remove the protective cover from the toggle switch. 
- 6 Move the toggle switch as indicated in the image to engage the brakes. The alarm will turn on when the brakes are released.

After the machine is loaded:

- 1 Chock the wheels to prevent the machine from rolling.
- 2 Move the toggle switch as indicated in the image to engage the brakes. 
- 3 Place the protective cover on the toggle switch.
- 4 Push the red Emergency stop button at both ground and platform controls to off position.

Towing the Genie GS-4655 is not recommended. If the machine must be towed, do not exceed 2.5 mph/4 km/h.

Transport and Lifting Instructions

Securing to Truck or Trailer for Transit

Always use the extension deck lock when the machine is transported.

Turn the key switch to the off position and remove the key before transporting.

Inspect the entire machine for loose or unsecured items.

Use chains or straps of ample load capacity.

Use a minimum of 2 chains or straps.

Adjust the rigging to prevent damage to the chains.

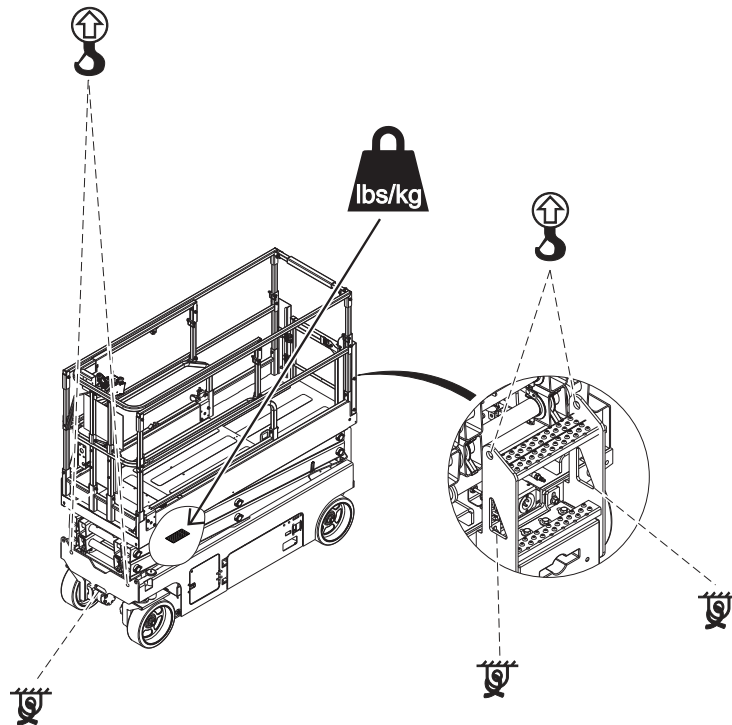

Transport and Lifting Instructions



Observe and Obey:

- ☑ Only qualified riggers should rig and lift the machine.
- ☑ Only qualified forklift operators should lift the machine with a forklift.
- ☑ Be sure the crane capacity, loading surfaces and straps or lines are sufficient to withstand the machine weight. See the serial label for the machine weight.

Lifting the Machine with a Forklift

Be sure the extension deck, controls and component trays are secure. Remove all loose items on the machine.

Fully lower the platform. The platform must remain lowered during all loading and transport procedures.

Use the forklift pockets located on both sides of the machine.

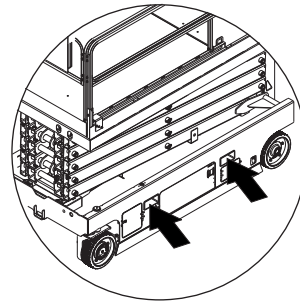

Position the forklift forks in position with the forklift pockets.

Drive forward to the full extent of the forks.

Raise the machine 16 in / 0.4 m and then tilt the forks back slightly to keep the machine secure.

Be sure the machine is level when lowering the forks.

NOTICE

Lifting the machine from the front or rear can result in component damage.

Transport and Lifting Instructions

Lifting Instructions

Fully lower the platform. Be sure the extension deck, controls and component trays are secure. Remove all loose items on the machine.

Determine the center of gravity of your machine using the table and the picture on this page.

Attach the rigging only to the designated lifting points on the machine. There are two 1.7 in/4.4 cm holes on the front of the machine and two holes in the ladder for lifting.

Adjust the rigging to prevent damage to the machine and to keep the machine level.

Center of Gravity Table

| Model | X Axis | Y Axis |
|---------|---------------------|--------------------|
| GS-4655 | 43.6 in 110.7 cm | 37.2 in 94.4 cm |

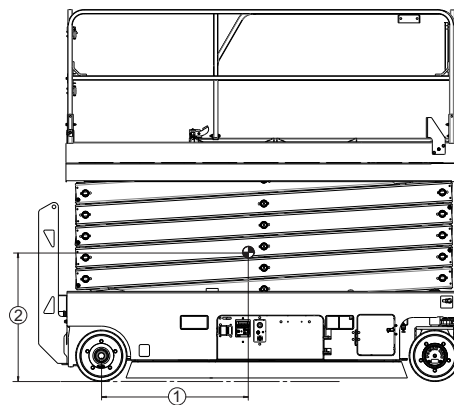
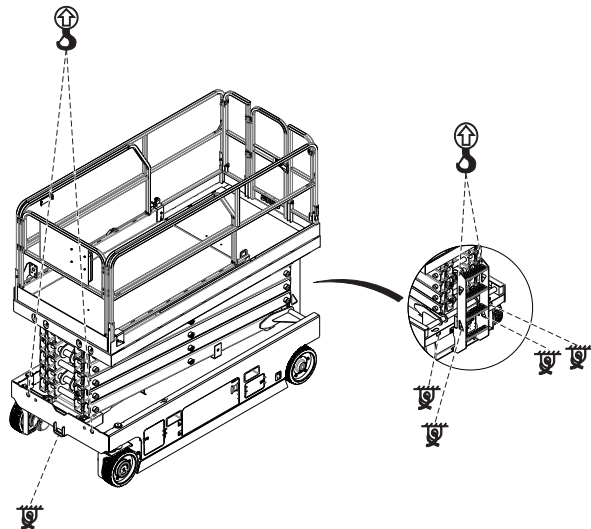

- 1 X Axis
- 2 Y Axis

Maintenance



Observe and Obey:

- ☑ Only routine maintenance items specified in this manual shall be performed by the operator.
- ☑ Scheduled maintenance inspections shall be completed by qualified service technicians, according to the manufacturer's specifications and the requirements specified in the responsibilities manual.
- ☑ Use only Genie approved replacement parts.

Maintenance Symbols Legend

The following symbols have been used in this manual to help communicate the intent of the instructions. When one or more of the symbols appear at the beginning of a maintenance procedure, it conveys the meaning below.



Indicates that tools will be required to perform this procedure.



Indicates that new parts will be required to perform this procedure.

Check the Hydraulic Oil Level



Maintaining the hydraulic oil at the proper level is essential to machine operation. Improper hydraulic oil levels can damage hydraulic components. Daily checks allow the inspector to identify changes in oil level that might indicate the presence of hydraulic system problems.

- 1 Be sure that the machine is on a firm, level surface, free of obstructions, with the platform in the stowed position.
- 2 Visually inspect the oil level in the hydraulic oil tank.
- ⊙ Result: The hydraulic oil level should be between the ADD and FULL marks on the tank.
- 3 Add oil as needed. Do not overfill.

Hydraulic oil specifications

| | |
|--------------------|-----------------------------|
| Hydraulic oil type | Chevron Rando HD equivalent |
|--------------------|-----------------------------|

Maintenance

Check the Batteries



Proper battery condition is essential to good machine performance and operational safety. Improper fluid levels or damaged cables and connections can result in component damage and hazardous conditions.

- ▲ **Electrocution hazard.** Contact with hot or live circuits may result in death or serious injury. Remove all rings, watches and other jewelry.
- ▲ **Bodily injury hazard.** Batteries contain acid. Avoid spilling or contacting battery acid. Neutralize battery acid spills with baking soda and water.

Note: Perform this test after fully charging the batteries.

- 1 Put on protective clothing and eye wear.
- 2 Be sure that the battery cable connections are tight and free of corrosion.
- 3 Be sure that the battery hold-down brackets are in place and secure.

Note: Adding terminal protectors and a corrosion preventative sealant will help eliminate the corrosion on the battery terminals and cables.

Scheduled Maintenance

Maintenance performed quarterly, annually and every two years must be completed by a person trained and qualified to perform maintenance on this machine according to the procedures found in the service manual for this machine.

Machines that have been out of service for more than three months must receive the quarterly inspection before they are put back into service.

Specifications

| Model | GS-4655 | |
|---|-----------------------|---------------|
| Height, working maximum | | |
| Indoor | 51 ft 9 in | 15.95 m |
| Outdoor | 27.5 ft | 8.55 m |
| Height, platform maximum | | |
| Indoor | 45 ft 9 in | 13.95 m |
| Outdoor | 21 ft 6 in | 6.55 m |
| Height, stowed maximum, rails up | 9 ft 1 in | 2.77 m |
| Height, stowed maximum, rails folded | 6 ft 6 in | 1.98 m |
| Platform height, stowed maximum | 5 ft 5 in | 1.64 m |
| Height, guard rails | 3 ft 7 in | 1.1 m |
| Width | 4 ft 7 in | 1.4 m |
| Length, stowed | 10 ft 2 in | 3.11 m |
| Length, platform extended | 13 ft 4 in | 4.06 m |
| Platform extension length | 4 ft | 1.2 m |
| Platform dimensions (length x width) | 9 ft 4 in x 4 ft 5 in | 2.84 x 1.35 m |
| Maximum load capacity | 770 lbs | 350 kg |
| Maximum wind speed | | |
| Indoor | 0 mph | 0 m/s |
| Outdoor | 28 mph | 12.5 m/s |
| Wheelbase | 8 ft 1 in | 2.46 m |
| Turning radius (outside) | 10 ft | 3.05 m |
| Turning radius (inside) | 1 ft | 31 cm |
| Ground clearance | 5.9 in | 15 cm |
| Ground clearance Pothole guards deployed | 0.75 in | 2 cm |
| Weight | 8160 lbs | 3700 kg |
| (Machine weights vary with option configurations. See serial label for specific machine weight.) | | |
| Power source | 24V 300AH | |
| System voltage | 24V | |
| AC outlet in platform | Standard | |
| Maximum hydraulic pressure (functions) | 2900 psi | 200 bar |
| Tire size | 15 x 5 in | |
| Total vibration value to which the hand/arm system is subjected does not exceed 2.5 m/s ² . | | |
| Highest root mean square value of weighted acceleration to which the whole body is subjected does not exceed 0.5 m/s ² . | | |

| Operating temperature | | |
|---|-------------------------|--|
| Minimum | -20°F | -29°C |
| Maximum | 150°F | 66°C |
| Airborne noise emissions | | |
| Sound pressure level at ground workstation | <70 dBA | |
| Sound pressure level at platform workstation | <70 dBA | |
| Maximum slope rating, stowed position | 25% (14°) | |
| Maximum side slope rating, stowed position | 25% (14°) | |
| Note: Slope rating is subject to ground conditions with one person in the platform and adequate traction. Additional platform weight may reduce slope rating. | | |
| Ambient operating temperature | | |
| | -20° F to 120° F | |
| | -29° C to 49° C | |
| Maximum allowable chassis inclination | | |
| Parallel to lift structure | 2.5° | |
| Perpendicular lift lift structure | 1.5° | |
| Drive speeds | | |
| Stowed, maximum | 2.5 mph | 4 km/h |
| Platform raised, maximum | 0.5 mph 40 ft/55 sec | 0.8 km/h 12.2 m/55 sec |
| Floor loading information | | |
| Tire load maximum | 3682 lbs | 1670 kg |
| Tire contact pressure | 210.4 psi | 14.79 kg / cm ² 1451 kPa |
| Occupied floor pressure | 189 psf | 0.09 kg / cm ² 9.03 kPa |

Note: Floor loading information is approximate and does not incorporate different option configurations. It should be used only with adequate safety factors.

Continuous improvement of our products is a Genie policy. Product specifications are subject to change without notice or obligation.

www.genielift.com

Distributed By: