



AIR-COOLED SCREW LIQUID CHILLERS

INSTALLATION, OPERATION, MAINTENANCE

Supersedes 201.21-NM1 (315)

Form 201.21-NM1 (616)

035-20552-000

YCAV STYLE A MODELS YCAV0157-0267, 60 HZ (150-260 TONS) E/V HIGH EFFICIENCY AND S/P STANDARD EFFICIENCY



R134a

Issue Date:
June 30, 2016



IMPORTANT!

READ BEFORE PROCEEDING!

GENERAL SAFETY GUIDELINES

This equipment is a relatively complicated apparatus. During rigging, installation, operation, maintenance, or service, individuals may be exposed to certain components or conditions including, but not limited to: heavy objects, refrigerants, materials under pressure, rotating components, and both high and low voltage. Each of these items has the potential, if misused or handled improperly, to cause bodily injury or death. It is the obligation and responsibility of rigging, installation, and operating/service personnel to identify and recognize these inherent hazards, protect themselves, and proceed safely in completing their tasks. Failure to comply with any of these requirements could result in serious damage to the equipment and the property in

which it is situated, as well as severe personal injury or death to themselves and people at the site.

This document is intended for use by owner-authorized rigging, installation, and operating/service personnel. It is expected that these individuals possess independent training that will enable them to perform their assigned tasks properly and safely. It is essential that, prior to performing any task on this equipment, this individual shall have read and understood the on-product labels, this document and any referenced materials. This individual shall also be familiar with and comply with all applicable industry and governmental standards and regulations pertaining to the task in question.

SAFETY SYMBOLS

The following symbols are used in this document to alert the reader to specific situations:



Indicates a possible hazardous situation which will result in death or serious injury if proper care is not taken.



Identifies a hazard which could lead to damage to the machine, damage to other equipment and/or environmental pollution if proper care is not taken or instructions are not followed.



Indicates a potentially hazardous situation which will result in possible injuries or damage to equipment if proper care is not taken.

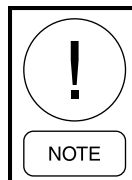

Highlights additional information useful to the technician in completing the work being performed properly.



External wiring, unless specified as an optional connection in the manufacturer's product line, is not to be connected inside the control cabinet. Devices such as relays, switches, transducers and controls and any external wiring must not be installed inside the micro panel. All wiring must be in accordance with Johnson Controls' published specifications and must be performed only by a qualified electrician. Johnson Controls will NOT be responsible for damage/problems resulting from improper connections to the controls or application of improper control signals. Failure to follow this warning will void the manufacturer's warranty and cause serious damage to property or personal injury.

CHANGEABILITY OF THIS DOCUMENT

In complying with Johnson Controls' policy for continuous product improvement, the information contained in this document is subject to change without notice. Johnson Controls makes no commitment to update or provide current information automatically to the manual or product owner. Updated manuals, if applicable, can be obtained by contacting the nearest Johnson Controls Service office or accessing the Johnson Controls QuickLIT website at <http://cgproducts.johnsoncontrols.com>.

It is the responsibility of rigging, lifting, and operating/service personnel to verify the applicability of these documents to the equipment. If there is any question

regarding the applicability of these documents, rigging, lifting, and operating/service personnel should verify whether the equipment has been modified and if current literature is available from the owner of the equipment prior to performing any work on the chiller.

CHANGE BARS

Revisions made to this document are indicated with a line along the left or right hand column in the area the revision was made. These revisions are to technical information and any other changes in spelling, grammar or formatting are not included.



The Control/VSD Cabinet contains lethal High AC and DC voltages. Before performing service inside the cabinet, remove the AC supply feeding the chiller and verify using a non-contact voltage sensor.

The DC Voltage on the VSD DC Bus will take 5 minutes to bleed off, after AC power is removed. Always check the DC Bus Voltage with a Voltmeter to assure the capacitor charge has bled off before working on the system.

- **NEVER short out the DC Bus to discharge the filter capacitors.**
- **NEVER place loose tools, debris, or any objects inside the Control Panel/VSD Cabinet.**
- **NEVER allow the Control Panel VSD Cabinet doors to remain open if there is a potential for rain to enter the panel. Keep doors closed and assure all latches are engaged on each door unless the unit is being serviced.**
- **ALWAYS lockout the disconnect supplying AC to the chiller.**
- **The 1L Line Inductor will reach operating temperatures of over 300° F. DO NOT open panel doors during operation. Assure the inductor is cool whenever working near the inductor with power off.**

TABLE OF CONTENTS

SECTION 1 - GENERAL CHILLER INFORMATION & SAFETY

INTRODUCTION	9
WARRANTY	9
SAFETY	9
Standards for Safety	9
RESPONSIBILITY FOR SAFETY	10
ABOUT THIS MANUAL	10
MISUSE OF EQUIPMENT	10
Suitability for Application	10
Structural Support	10
Mechanical Strength	10
General Access	10
Pressure Systems	11
Electrical	11
Rotating Parts	11
Sharp Edges	11
Refrigerant & Oils	11
High Temperature & Pressure Cleaning	11
Emergency Shutdown	11

SECTION 2 - PRODUCT DESCRIPTION

INTRODUCTION	12
General System Description	12
Compressor	13
Evaporator	14
Condensor	14
Flash Tank Feed / Drain Valve	15
Oil Separator / Oil System	15
Relief Valves	15
Oil Cooling	16
Capacity Controls	16
Power and Control Panel	16
Microprocessor & VSD Controls	16
Display	17
Keypad	17
Unit Switch	17
Variable Speed Drive (VSD)	18
ACCESSORIES & OPTIONS	19
Single Point Circuit Breaker	19
Building Automation System (BAS) Interface	19
Condensor Coil Protection	19
DX COOLER OPTIONS	20
SERVICE VALVE OPTION	20
UNIT ENCLOSURES	20
FANS	20
SOUND REDUCTION OPTIONS	20
VIBRATION ISOLATION	20
UNIT NOMENCLATURE	21
PRODUCT IDENTIFICATION NUMBER	22

SECTION 3 - RIGGING, HANDLING & STORAGE

DELIVERY AND STORAGE	26
INSPECTION	26
MOVING THE CHILLER	26
Lifting Weights	26
UNIT RIGGING	27

SECTION 4 - INSTALLATION

LOCATION REQUIREMENTS	29
OUTDOOR INSTALLATION	29
INDOOR INSTALLATION	29
LOCATION CLEARANCES	30
VIBRATION ISOLATORS	30
Installation	30
SHIPPING BRACES	30
CHILLED LIQUID PIPING	30
General Requirements	30
WATER TREATMENT	32
CONNECTION TYPES & SIZES	32
COOLER CONNECTIONS	32
Option Flanges	32
REFRIGERANT RELIEF VALVE PIPING	33
DUCTWORK CONNECTION	33
General Requirements	33
ELECTRICAL CONNECTION	33
POWER WIRING	34
115 VAC CONTROL SUPPLY TRANSFORMER	34
CONTROL PANEL WIRING	34
VOLTS FREE CONTACTS	35
Chilled Liquid Pump Starter	35
Run Contact	35
Alarm Contact	35
SYSTEM INPUTS	35
Flow Switch	35
Remote Run/Stop	35
Optional Remote Setpoint Offset Temp.	35
Optional Remote Setpoint Offset Sound Limit	35

SECTION 5 - COMMISSIONING

PREPARATION	36
PREPARATION - POWER OFF	36
Inspection	36
Refrigerant Charge	36
Service and Oil Line Valves	36
Compressor Oil	36
Fans	36
Isolation / Protection	36
Control Panel	36
Power Connections	37

TABLE OF CONTENTS (CONT'D)

Grounding.....	37	CHILLER ELECTRONIC COMPONENTS.....	158
Water System.....	37	Keypad.....	158
Flow Switch.....	37	Display.....	159
Temperature Sensor(s).....	37	Chiller Control Board.....	160
Programmed Options.....	38	Relay Output Boards.....	161
Programmed Settings.....	38	VSD (Variable Speed Drive).....	161
Date & Time.....	38	AC to DC Rectifier.....	161
Start / Stop.....	38	SCR Trigger Board.....	162
Setpoint & Remote Offset.....	38	DC Link Filter.....	162
FIRST TIME STARTUP.....	38	1L Line Inductor.....	163
Interlocks.....	38	AC to DC Inverter.....	163
Unit Switch.....	38	Laminated Bus Structure.....	163
Start-Up.....	38	VSD Logic Board.....	164
Oil Pressure.....	38	Control Panel to VSD Communications.....	164
Refrigerant Flow.....	39	IBGT Gate Driver Boards.....	165
Loading.....	39	Current Transformers.....	165
Condensor & Fan Rotation.....	39	DV/DT Output Suppression Network.....	166
Suction Super Heat.....	39	Flash Tank Feed/Drain Valve Controller.....	166
Sub-Cooling.....	39	DC Bus Voltage Isolation Board.....	167
General Operation.....	39	Chiller Circuit Breaker.....	167
		Autotransformer.....	167
		CHILLER CONFIGURATION JUMPERS.....	168
		Number of Compressors Configuration Jumpers.....	168
SECTION 6 - TECHNICAL DATA		VSD LOGIC TO CHILLER MICROPROCESSOR BOARD RS-485 COMMUNICATION CONFIGURATION JUMPERS.....	168
WATER PRESSURE DROP CHARTS.....	40	MAX VSD FREQUENCY.....	169
GLYCOL CORRECTION FACTORS.....	41		
WATER TEMP. AND FLOWS.....	42	SECTION 7 - OPERATION	
PHYSICAL DATA.....	44	OPERATING CONTROLS.....	170
OPERATING LIMITATIONS AND SOUND POWER.....	48	BASIC OPERATING SEQUENCE.....	172
ELECTRICAL DATA.....	49	NUMBER OF COMPRESSORS TO START.....	173
ELECTRICAL NOTES.....	54	General.....	173
ELEMENTARY WIRING DIAGRAM.....	56	Standard IPLV.....	173
CONNECTION DIAGRAM.....	60	Optional Optimized IPLV.....	173
LOCATION LABEL.....	64	MINIMUM VSD COMPRESSOR	
DIMENSIONS.....	66	START/RUN FREQUENCY.....	174
TECHNICAL DATA (CLEARANCES).....	122	Minimum VSD Start Frequency.....	174
WEIGHT DIST. & ISOLATOR MOUNTING.....	124	Minimum VSD Run Frequency.....	174
ISOLATOR MOUNTING POSITIONS.....	125	ACCELERATION/DECELERATION RATE WHEN STARTING & STOPPING	
SEISMIC ISOLATOR INSTALLATION.....	128	COMPRESSORS.....	175
NEOPRENE ISOLATOR POSITION.....	130	VSD Acceleration/ Deceleration Rates.....	175
1" DEFLECTION ISOLATOR INSTALLATION.....	131	STANDARD IPLV CAPACITY CONTROL.....	176
REFRIGERANT FLOW DIAGRAM.....	133	Fuzzy Logic Control.....	177
PROCESS & INSTRUMENTATION DIAGRAM.....	134	Hot Water Starts.....	178
COMPONENT LOCATIONS.....	135	Lag Compressor Operation in Load Limiting.....	178
EQUIPMENT START-UP CHECK SHEET.....	152	OPTIONAL IPLV CAPACITY CONTROL.....	179
Unit Checks (NO power).....	152	Fuzzy Logic.....	180
Panel Checks		Hot Water Starts.....	181
(Power ON-both system switches OFF).....	154	LOAD LIMITING CONTROL.....	182
Programmed Values.....	155		
Chilled Liquid Setpoint.....	155		
Date/Time, Daily Schedule, & Clock Jumper.....	156		
Initial Start-Up.....	156		
Check Subcooling & Superheat.....	156		
Leak Checking.....	157		

TABLE OF CONTENTS (CONT'D)

FLASH TANK DRAIN/FEED VALVE CONTROLLER	185	UNIT SETUP MODE	272
Valve Controller & Control Algorithm	185	DEFAULT PROGRAMMABLE VALUES	274
ECONOMIZER CONTROL	188	SERIAL PORT CONNECTIONS	275
CONDENSER FAN CONTROL	189	ANALOG INPUT CONNECTIONS	276
VSD TEMPERATURE CONTROL/FAN CONTROL OPERATION	191	DIGITAL INPUT CONNECTIONS	278
REMOTE TEMPERATURE RESET CONTROL ..	192	ANALOG OUTPUT CONNECTIONS	280
Local Current Limit Control	193	DIGITAL OUTPUT CONNECTIONS	282
Pull-down Current Limit Setpoint	193	ISN COMMUNICATIONS & TRANSMITTED DATA ..	284
REMOTE CURRENT LIMIT RESET	194		
Sound Limit Controls	196		
		SECTION 9 - MAINTENANCE	
SECTION 8 - MICROPANEL		R-134A CONVERSION TABLES	291
VSD OPERATION & CONTROLS	198	MAINTENANCE	291
VSD Cooling and Cooling Loop	200	General Requirements	291
VSD SAFETIES	204	MAINTENANCE REQUIREMENTS	292
IGBT Gate Driver (Hardware) Fault	207	TROUBLESHOOTING GUIDE	294
Power Supply (Hardware) Fault	209	EVACUATING A SYSTEM	296
UNIT WARNINGS	212	WARRANTY POLICY	297
UNIT SAFETIES	216	New Equipment	297
SYSTEM SAFETIES	218	Reconditioned or Replacement Materials	297
STATUS KEY	224	All Warranties are VIOD if	297
UNIT DATA KEY	228	CHILLED LIQUID & SUCTION TEMP SENSOR INPUT VOLTAGE TABLE	298
SYSTEM DATA KEY	230	OUTSIDE AIR TEMP SENSOR INPUT VOLTAGE TABLE	299
VSD DATA KEY	234	PRESSURE TRANSDUCER OUTPUT VOLTAGE TABLE	300
OPERATING HOURS & START KEYS	236	MOTOR TEMPERATURE SENSOR RESISTANCE TABLE	301
HISTORY KEY	237	COMPRESSOR MOTOR OVERLOAD SETTINGS & MAXIMUM VSD FREQUENCY	302
Unit Data	239	PRINTER WIRING	303
VSD Data	239	Okidata 184	304
System Data	240	Weigh-Tronix IMP Model 2600	304
Compressor Operating Hours & Starts	242	Seiko	304
Chilled Liquid & Cooling Setpoints	242	OPERATING LOG	305
Options	242	Site and Chiller Info	305
Program Values	243	Programmed Values	305
SETPOINTS KEY	245	Unit Operating Temperature, Pressures, & Currents	306
PROGRAM KEY	247	System Operating Conditions	307
OPTIONS KEY	250	Water System Conditions	308
DATE/TIME & SCHEDULE KEY	254	Condensor Conditions	308
Date/Time Key	254	RECOMMENDED SPARE PARTS	309
Schedule Key	255		
Unit Operating Schedule	256		
Sound Limit Schedule	257		
MANUAL OVERRIDE KEY	258		
PRINT KEY	259		
Operating Data Printout	260		
History Data Printout	261		
SERVICE KEY	262		
SYSTEM SWITCHES KEY	268		
SERIAL NUMBER PROGRAMMING	269		
ENABLING OPTIMIZED HIGH IPLV MODE ..	271		

TABLES & FIGURES

Table 1 - Compressors and the Appropriate Jumper Positions.....	168	Fig 1 - PWM Current Waveform	18
Table 2 - VSD Logic Board Address Jumper.....	168	Fig 2 - PWM Voltage Waveform.....	18
Table 3 - Maximum Frequency Jumper	169	Fig 3 - Pipework Arrangement.....	32
Table 4 - Fuzzy Logic Loading/Unloading vs. Error.....	178	Fig 4 - Victaulic Groove.....	32
Table 5 - Fuzzy Logic Loading/Unloading vs. Error.....	181	Fig 5 - Flange Attachment	32
Table 6 - Current Load Limiting/Unloading.....	182	Fig 6 - Single Point Power Supply Connection W/ Field Supplied Circuit Protection.....	49
Table 7 - Discharge Pressure Load Limiting/Unloading.....	182	Fig 7 - Single Point Power Supply Connection W/ Optional Factory Circuit Breaker.....	49
Table 8 - Suction Pressure Load Limiting/Unloading.....	183	Fig 8 - Sample Printout Supplied in the Isolator Package & Chiller Panel Literature Packet.....	124
Table 9 - VSD Internal Ambient Load Limiting/Unloading.....	183	Fig 9 - Refrigerant Flow Diagram	133
Table 10 - VSD Baseplate Temperature Load Limiting/Unloading.....	184	Fig 10 - Processes and Instrumentation	134
Table 11 - Fan Stages & Corresponding Outputs....	189	Fig 11 - Component Locations.....	135
Table 12 - VSD Operating Display Parameters	203	Fig 12 - Control and VSD Cabinet Locations.....	136
Table 13 - Low Differential Oil Pressure Cutout ...	220	Fig 13 - Chiller Control Board, Relay Boards, Microgateway, and Optional Circuit Breaker	137
Table 14 - Start Inhibit Sensor Thresholds.....	222	Fig 14 - Chiller Control Board, Relay Boards, and Microgateway	138
Table 15 - Sensor Min./Max. Outputs.....	232	Fig 15 - VSD Logic Board.....	139
Table 16 - Setpoint Limits.....	246	Fig 16 - VSD Logic Board.....	140
Table 17 - Programmable Operating Parameters	249	Fig 17 - Power Components	141
Table 18 - Printout Types	259	Fig 18 - Fan Contactors & 3T Transformers.....	142
Table 19 - Unit Setup Programmable Values	272	Fig 19 - VSD Components.....	143
Table 20 - Serial Port Connections	274	Fig 20 - VSD Components.....	144
Table 21 - Analog Input Connections	276	Fig 21 - VSD Components.....	145
Table 22 - Digital Input Connections.....	278	Fig 22 - Inverter Power Components.....	146
Table 23 - Analog Output Connections.....	280	Fig 23 - Inverter Power Components.....	147
Table 24 - Digital Output Connections	281	Fig 24 - Inverter Power Components.....	148
Table 25 - Mustang Chiller YORK Talk Control Data.....	284	Fig 24A - Inverter Power Components	148
Table 26 - DXST/ISN Transmitted Data.....	285	Fig 25 - Glycol Pump & Fill Tube Locations	149
Table 27 - Fault Inhibit Codes	287	Fig 26 - Glycol Piping & Fill Tube Locations	150
Table 28 - Operational Status Codes.....	289	Fig 27 - Compressor Components	151
Table 29 - R-134a Pressure to Saturated Temperature Conversion.....	290	Fig 28 - Chiller Control (Cooling) Range.....	172
Table 30 - Temperature Input Voltage Sensor.....	298	Fig 29 - Number of Compressors to Start.....	173
Table 31 - Outside Air Temperature Input Voltage	299	Fig 30 - Minimum VSD Start Frequency	174
Table 32 - Pressure Transducer Input Voltage.....	300	Fig 31 - Minimum VSD Run	174
Table 33 - Motor Temperature Sensor Resistance	301	Fig 32 - LED Locations	186
Table 34 - Compressor Motor Overload Settings & Max. VSD Frequency	302	Fig 33 - Power, Comms LED's	187
		Fig 34 - Power, Comms & System Open/Close LED's	187
		Fig 35 - Standard IPLV Fan Control.....	190
		Fig 36 - High IPLV Fan Control	190
		Fig 37 - Print Cable Chiller to Serial Printer	303

GENERAL CHILLER INFORMATION & SAFETY

INTRODUCTION

YORK YCAV0157-0267 chillers are manufactured to the highest design and construction standards to ensure high performance, reliability and adaptability to all types of air conditioning installations.

The unit is intended for cooling water or glycol solutions and is not suitable for purposes other than those specified in this manual.

Rigging and lifting should only be done by a professional rigger in accordance with a written rigging and lifting plan. The most appropriate rigging and lifting method will depend on job specific factors, such as the rigging equipment available and site needs. Therefore, a professional rigger must determine the rigging and lifting method to be used, and it is beyond the scope of this manual to specify rigging and lifting details.

This manual contains all the information required for correct installation and commissioning of the unit, together with operating and maintenance instructions. The manuals should be read thoroughly before attempting to operate or service the unit.

All procedures detailed in the manuals, including installation, commissioning and maintenance tasks must only be performed by suitably trained and qualified personnel.

The manufacturer will not be liable for any injury or damage caused by incorrect installation, commissioning, operation or maintenance resulting from a failure to follow the procedures and instructions detailed in the manuals.

WARRANTY

YORK International warrants all equipment and materials against defects in workmanship and materials for a period of eighteen months from date of shipment, unless labor or extended warranty has been purchased as part of the contract.

The warranty is limited to parts only replacement and shipping of any faulty part, or sub-assembly, which has failed due to poor quality or manufacturing errors. All claims must be supported by evidence that the failure has occurred within the warranty period, and that the unit has been operated within the designed parameters specified.

All warranty claims must specify the unit model, serial number, order number and run hours/starts. Model and serial number information is printed on the unit identification plate.

The unit warranty will be void if any modification to the unit is carried out without prior written approval from YORK International.

For warranty purposes, the following conditions must be satisfied:

- The initial start of the unit must be carried out by trained personnel from an Authorized YORK Service Center. See Commissioning (Page 36).
- Only genuine YORK approved spare parts, oils, coolants, and refrigerants must be used. Recommendations on spare parts stocking can be found on Page 307.
- All the scheduled maintenance operations detailed in this manual must be performed at the specified times by suitably trained and qualified personnel. See Maintenance Section, Page 288-307.
- Failure to satisfy any of these conditions will automatically void the warranty. See Warranty Policy (Page 295).

SAFETY

Standards for Safety

YCAV chillers are designed and built within an ISO 9002 accredited design and manufacturing organization. The chillers comply with the applicable sections of the following Standards and Codes:

- ANSI/ASHRAE Standard 15, Safety Code for Mechanical Refrigeration.
- ANSI/NFPA Standard 70, National Electrical Code (N.E.C.).
- ASME Boiler and Pressure Vessel Code, Section VIII Division 1.
- ARI Standard 550/590-98, Water Chilling Packages Using the Vapor Compression Cycle.
- ASHRAE 90.1 Energy Standard for Building Except Low-Rise Residential Buildings.
- ARI 370 Sound Rating of Large Outdoor Refrigeration and Air Conditioning Equipment.

In addition, the chillers conform to Underwriters Laboratories (U.L.) for construction of chillers and provide U.L./cU.L. Listing Label.

RESPONSIBILITY FOR SAFETY

Every care has been taken in the design and manufacture of the unit to ensure compliance with the safety requirements listed above. However, the individual rigging, lifting, maintaining, operating or working on any machinery is primarily responsible for:

- Personal safety, safety of other personnel, and the machinery.
- Correct utilization of the machinery in accordance with the procedures detailed in the manuals.

ABOUT THIS MANUAL

The following terms are used in this document to alert the reader to areas of potential hazard.



A **WARNING** is given in this document to identify a hazard, which could lead to personal injury. Usually an instruction will be given, together with a brief explanation and the possible result of ignoring the instruction.



A **CAUTION** identifies a hazard which could lead to damage to the machine, damage to other equipment and/or environmental pollution. Usually an instruction will be given, together with a brief explanation and the possible result of ignoring the instruction.

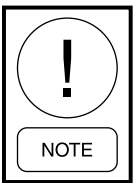

A **NOTE** is used to highlight additional information, which may be helpful to you but where there are no special safety implications.

The contents of this manual include suggested best working practices and procedures. These are issued for guidance only, and they do not take precedence over the above stated individual responsibility and/or local safety regulations.

This manual and any other document supplied with the unit are the property of YORK which reserves all rights. They may not be reproduced, in whole or in part, without prior written authorization from an authorized YORK representative.

MISUSE OF EQUIPMENT

Suitability for Application

The unit is intended for cooling water or glycol solutions and is not suitable for purposes other than those specified in these instructions. Any use of the equipment other than its intended use, or operation of the equipment contrary to the relevant procedures may result in injury to the operator, or damage to the equipment.

The unit must not be operated outside the design parameters specified in this manual.

Structural Support

Structural support of the unit must be provided as indicated in these instructions. Failure to provide proper support may result in injury to the operator, or damage to the equipment and/or building.

Mechanical Strength

The unit is not designed to withstand loads or stresses from adjacent equipment, pipework or structures. Additional components must not be mounted on the unit. Any such extraneous loads may cause structural failure and may result in injury to the operator, or damage to the equipment.

General Access

There are a number of areas and features, which may be a hazard and potentially cause injury when working on the unit unless suitable safety precautions are taken. It is important to ensure access to the unit is restricted to suitably qualified persons who are familiar with the potential hazards and precautions necessary for safe operation and maintenance of equipment containing high temperatures, pressures and voltages.

Pressure Systems

The unit contains refrigerant vapor and liquid under pressure, release of which can be a danger and cause injury. The user should ensure that care is taken during installation, operation and maintenance to avoid damage to the pressure system. No attempt should be made to gain access to the component parts of the pressure system other than by suitably trained and qualified personnel.

Electrical

The unit must be grounded. No installation or maintenance work should be attempted on the electrical equipment without first switching power OFF, isolating and locking-off the power supply. Servicing and maintenance on live equipment must not be attempted. No attempt should be made to gain access to the control panel or electrical enclosures during normal operation of the unit.

Rotating Parts

Fan guards must be fitted at all times and not removed unless the power supply has been isolated. If ductwork is to be fitted, requiring the wire fan guards to be removed, alternative safety measures must be taken to protect against the risk of injury from rotating fans.

Sharp Edges

The fins on the air-cooled condenser coils have sharp metal edges. Reasonable care should be taken when working in contact with the coils to avoid the risk of minor abrasions and lacerations. The use of gloves is recommended.

Frame rails, brakes, and other components may also have sharp edges. Reasonable care should be taken when working in contact with any components to avoid risk of minor abrasions and lacerations.

Refrigerants and Oils

Refrigerants and oils used in the unit are generally non-toxic, non-flammable and non-corrosive, and pose no special safety hazards. Use of gloves and safety glasses is, however, recommended when working on the unit. The build up of refrigerant vapor, from a leak for example, does pose a risk of asphyxiation in confined or enclosed spaces and attention should be given to good ventilation.

Use only the refrigerant specifically designated for the unit. Any other type of refrigerant may cause damage to the equipment and will void the warranty.

High Temperature and Pressure Cleaning

High temperature and pressure cleaning methods (e.g. steam cleaning) should not be used on any part of the pressure system as this may cause operation of the pressure relief device(s). Detergents and solvents, which may cause corrosion, should also be avoided.

Emergency Shutdown

In case of emergency, the control panel is fitted with a Unit Switch to stop the unit in an emergency. When operated, it removes the low voltage 120 VAC electrical supply from the inverter system, thus shutting down the unit.

PRODUCT DESCRIPTION



LD10477

INTRODUCTION

YORK YCAV R134a chillers are designed for water or glycol cooling. All units are designed to be located outside on the roof of a building or at ground level.

The units are completely assembled with all interconnecting refrigerant piping and internal wiring, ready for field installation.

Prior to delivery, the unit is pressure tested, evacuated, and fully charged with refrigerant and oil in each of the two independent refrigerant circuits. After assembly, an operational test is performed with water flowing through the cooler to ensure that each refrigerant circuit operates correctly.

The unit structure is manufactured from heavy gauge, galvanized steel. Many external structural parts are coated with “Champagne” baked-on enamel powder paint. This provides a finish which, when subjected to ASTM B117, 1000 hour, 5% salt spray conditions, shows breakdown of less than 1/8” either side of a scribed line (equivalent to ASTM D1654 rating of “6”).

All exposed power wiring is routed through liquid-tight, non-metallic conduit.

General System Description

The Latitude (YCAV) Air Cooled Chiller line combines the best of modern screw compressor design with the latest technology in variable speed drives. The result is superior control and efficiency in real world conditions. The VSD enables slowing the speed of the compressor to match the load on the system resulting in precise chilled liquid control, minimized sound, maximum energy efficiency, and reduced cost of ownership. The VSD also provides soft starts with no electrical inrush. The lack of heat build-up on start also enables required off time between starts to be reduced to a period of 2 minutes.

The YCAV Air-Cooled Screw Chiller utilizes many components, which are the same or nearly the same as a standard screw chiller of a similar size. This includes modular frame rails, condenser, fans, compressors and evaporator.

The chiller consists of 2 screw compressors in a corresponding number of separate refrigerant circuits, a single shell and tube DX evaporator, an air-cooled condenser, flash tanks, drain/feed valves, oil separators, and compressor mufflers. Oil separators utilize no moving parts and are rated for a 405 PSIG design working pressure. Oil cooling is accomplished by routing oil from the oil separator through several rows of tubes in the air cooled condenser.

An integral liquid cooled, transistorized, PWM, Variable Speed Drive (VSD) is controlled by the chiller microprocessor control panel to start/stop, select compressors to run, and select compressor speed. Power Factor is 95% at part or full load.

The chiller microprocessor communicates with the VSD Logic Board via a 3-wire RS-485 opto coupled data link. The VSD Logic Board runs the number of compressors required to meet the load and the compressors to the speed requested by the chiller microprocessor.

The basic system control architecture is shown in the diagram below:

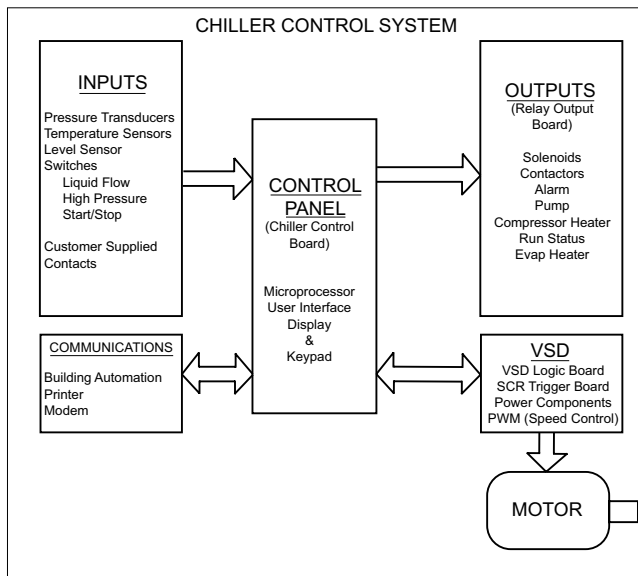

LD10478

The chiller is designed to operate in ambient temperatures of 0°F to 125°F (-18°C to 52°C). Capacity control is capable of reducing chiller capacity to 10% of full load without the need for hot gas bypass.

Compressor

The direct drive semi-hermetic rotary twin-screw MTS compressor is designed for industrial refrigeration applications and ensures high operational efficiencies and reliable performance. Capacity control is achieved by stepless VSD speed changes. No slide valve is required. Smooth capacity control is achieved between 10% and 100% of chiller capacity in most operating conditions. The compressor is a positive displacement type characterized by two helically grooved rotors, which are manufactured from forged steel. The 4 pole motor operates at speeds up to 6000 RPM to direct drive the male rotor, which in turn drives the female rotor on a light film of oil.

Refrigerant gas is injected into the void created by the un-meshing of the five lobed male and seven lobed female rotor. Further meshing of the rotors closes the rotor threads to the suction port and progressively compresses the gas in an axial direction to the discharge port. The gas is compressed in volume and increased in pressure before exiting at a designed volume at the discharge end of the rotor casing. Since the intake and discharge cycles overlap, a resulting smooth flow of gas is maintained. The rotors are housed in a cast iron compressor housing precision machined to provide optimal clearances for the rotors. Contact between the male and female rotor is primarily rolling on a contact band on each of the rotor's pitch circle. This results in virtually no rotor wear and increased reliability, a trademark of the screw compressor.

The MTS compressor incorporates a complete anti-friction bearing design for reduced power input and increased reliability. Separated, cylindrical, roller bearings handle radial loads. Angular-contact ball bearings handle axial loads. Together they maintain accurate rotor positioning at all pressure ratios, thereby minimizing leakage and maintaining efficiency.



LD10481



LD10482

Motor cooling is provided by suction gas from the evaporator flowing across the motor. Redundant overload protection is provided using both internal thermistor and current overload protection on all three phases.

The MTS compressor is lubricated by removing oil from the refrigerant using an external oil separator. The pressurized oil is then cooled in the condenser coils and piped back to the compressor through a removable 0.005" mesh screen oil filter to provide compressor lubrication. The cast iron compressor housing design working pressure is 450 PSIG (31 bar). Each chiller receives a 300 PSIG (21 bar) low side and a 450 PSIG (31 bar) high side factory test. A 350 Watt (115-1-60 Hz) cartridge heater is located in the compressor. The heater is temperature activated to prevent refrigerant condensation.

The following items are also included:

- Acoustically tuned, external discharge muffler to minimize noise, while optimizing flow for maximum performance.
- Discharge shutoff valve.
- Rain-tight terminal box.
- Suction gas screen within the compressor housing.

Evaporator

The system uses a high-efficiency Shell and Tube type Direct Expansion Evaporator. Each of the two (2) refrigerant circuits consists of two (2) passes with the chilled liquid circulating back and forth across the tubes from one end to the other.

The design working pressure of the cooler on the shell side is 150 PSIG (10 bar), and 235 PSIG (16 bar) for the tube (refrigerant) side. The evaporator is constructed and tested in accordance with applicable sections of the ASME Pressure Vessel Code, Section VII, Division (1). Waterside exempt per paragraph U-1, c, (6).

The water baffles are fabricated from galvanized steel to resist corrosion. Removable heads are provided for access to internally enhanced, seamless, copper tubes. Water vent and drain connections are included.

The cooler is equipped with a thermostatically controlled heater for protection to -20°F (-29°C) ambient and insulated with 3/4" (19 mm) flexible closed-cell insulation.

The water nozzles are provided with grooves for mechanical couplings and should be insulated by the contractor after pipe installation.

A 300 PSIG (20.7 bar) waterside design working pressure option is available.

2 compressor chillers utilize a typical 2-pass "E" type evaporator with liquid inlets and suction outlets at the same end. Entering chilled liquid enters the refrigerant liquid inlet end of the cooler and leaving chilled liquid exits at the opposite end.

3 and 4 compressor chillers utilize a single pass "J" type evaporator with liquid inlets at one end and suction outlets at the opposite end. Entering chilled liquid is split and half flow enters at each end of the evaporator with leaving chilled liquid exiting in the center of the evaporator. "J" type evaporators have fewer, longer tubes than a comparable "E" type. This results in a smaller diameter, longer shell. Water flow rate internally in the evaporator is 1/2 of the total loop flow rate since the flow is split between two inlets. This results in a low evaporator water pressure drop.

Condenser

The fin and tube condenser coils are manufactured from seamless, internally enhanced, high-condensing coefficient, corrosion-resistant copper tubes arranged in staggered rows and mechanically expanded into corrosion resistant aluminum alloy fins with full height fin collars. The condenser has a design working pressure of 450 PSIG (31 bar).

Multiple, standard low sound, high efficiency, TEAO motor driven fans move air through the coils. They are dynamically and statically balanced, direct drive with corrosion-resistant glass fiber reinforced composite blades molded into low-noise, full airfoil cross sections, providing vertical air discharge from extended orifices for efficiency and low sound. Fans or pairs of fans are located in a separate compartments separated by "V" panels to prevent cross flow during fan cycling. Guards of heavy-gauge, PVC-coated galvanized steel are provided.

The standard fan motors are high-efficiency, direct drive, 6-pole, 3-phase, Class- "F," current overload protected, totally enclosed (TEAO) type with double-sealed, permanently lubricated ball bearings.

Flash Tank Feed Valve/Drain Valves

A Flash Tank is fitted to both refrigerant circuits. The Flash Tank is a shell type refrigerant reservoir designed to sustain 2 phase refrigerant. The purpose of the Flash Tank is to increase the efficiency of the system. A portion of the liquid fed into the Flash Tank gases off, cooling the remaining liquid in the tank another 25-35°F. Both liquid and gas exist in the flash tank. The refrigerant gas in the flash tank is fed to the economizer port on the compressor at a point on the rotors approximately 1.7X suction when the economizer solenoid is activated. The liquid in the tank is fed to the evaporator.

The vapor feed to the economizer port of the compressor is at an intermediate pressure between discharge and suction (1.7 x suction) and therefore little energy is required to pump it back through the compressor to condenser pressure. This results in a very small loss to system efficiency.

The design working pressure of the flash tank is 450 PSIG (31 bar). The Drain and Feed Valves on the flash tank are activated on start-up. The Feed Valve on the Flash Tank acts like a liquid line solenoid, but also functions to control the liquid level in the flash tank. The Drain Valve functions similar to an electronic expansion valve (EEV). The Drain Valve controls refrigerant flow to the evaporator based on suction superheat. Both valves are stepper motor valves. An economizer solenoid is placed between the flashtank and the economizer port of the compressor. The economizer solenoid valve is generally activated at speeds above 90-120 Hz, depending upon a number of other factors.

Both valves are controlled by 2 phase drive signals from a stand-alone controller in the Control Cabinet. Signals from sensors such as suction pressure and temperature are sent to the Chiller Control Board, which in turn sends control signals to the Drain and Feed Valve Controller. The control algorithm in the Chiller Control Board will attempt to control the liquid level in the flash tank to 35% on the level sensor and the system will fault if the flash tank level exceeds 87.5%.

During operation, it will be noted the flash tank level will typically remain between 30-40% level when the economizer solenoid is ON. The economizer solenoid valve will typically be on most of the time. When the economizer solenoid is OFF, the liquid level will vary greatly as the Drain and Feed Valves directly affect the level as they open and close.

Oil Separator/Oil System

The external oil separators, with no moving parts and designed for minimum oil carry-over, are mounted in the discharge line of the compressor. The high pressure discharge gas is forced around a 90 degree bend. Oil is forced to the outside of the separator through centrifugal action and captured on wire mesh where it drains to the bottom of the oil separator and is then forced into the condenser.

The oil (YORK “L” oil – a POE oil used for all refrigerant applications), flows from the oil separator, through the condenser where it is cooled, and back into the compressor through a replaceable 0.5 micron oil filter at high pressure. This high pressure “oil injection” forces the oil into the compressor, where it is fed to the bearings and rotors for lubrication. After lubricating the bearings, it is injected through orifices on a closed thread near the suction end of the rotors. The oil is automatically injected because of the pressure difference between the discharge pressure and the reduced pressure at the suction end of the rotors. This lubricates the rotors as well as provides an oil seal against leakage around the rotors to ensure refrigerant compression efficiency.

The oil also provides cooling by transferring much of the heat of compression from the gas to the oil, keeping discharge temperatures down and reducing the chance for oil breakdown. Oil injected into the rotor cage flows into the rotors at a point about 1.2x suction. This ensures that a required minimum differential of at least 30 PSID exists between discharge and 1.2x suction, to force oil into the rotor case. A minimum of 10 PSID (0.6 bar) is all that is required to ensure protection of the compressor. The oil pressure safety is monitored as the difference between suction pressure and the pressure of the oil entering the rotor case.

Maximum working pressure of the oil separator is 450 PSIG (31 bar). Oil level should be above the midpoint of the “lower” oil sight glass when the compressor is running. Oil level should not be above the top of the “upper” sight glass.

Relief Valves

Two relief valves are installed in each refrigerant circuit. A 325 PSIG relief valve is located on each Flash Tank and a 250 PSIG relief valve is located on the suction line of the compressor near the evaporator.

Oil Cooling

Oil cooling is provided by routing oil from the oil separator through several of the top rows of the condenser coils and back to the compressor.

Capacity Control

When cooling is needed, one or more compressors, as determined by the system microprocessor based on deviation from setpoint, will start at minimum speed with low inrush current. Variable speed operation of the compressor reduces the capacity and allows smooth balancing of the compressor capacity with the cooling load.

Capacity control is accomplished by varying the number of compressors and the speed of the compressors with the VSD to promote stable, smooth, and precise loading/unloading.

Hot Gas Bypass is not required with VSD control of the compressors.

The chiller is available with Standard IPLV or High IPLV software (EPROM). High IPLV software optimizes the performance of the chiller capacity and fan controls. High IPLV chillers also require additional factory programming.

Power and Control Panel

All controls and the VSD are factory-wired and function tested. The panel enclosures are designed to NEMA 3R (IP65) rating and are manufactured from powder-painted steel with hinged, latched, and gasket sealed outer doors with wind struts for safer servicing.

The Power and Micro Control Panels are combined into a single control/power cabinet and include Compressor VSD Controls, Chiller Microprocessor Controls, Fan Controls, and all other chiller controls.

The Display and Keypad are accessible through an access door without opening the main doors to the electrical cabinet.

Each Power Compartment Contains

Incoming single point power is standard utilizing either a lockable circuit breaker or terminal block, 115VAC control transformer, VSD, fan contactors, ON/OFF unit switch, microcomputer keypad and display, Chiller Control and VSD Logic boards, and relay boards.

Current transformers sense each phase of motor current, and send corresponding signals to the Chiller Logic Board. Current monitoring protects the compressor motors from damage due to: low motor current, high motor current, short circuit current, single phasing, and compressor overload.

Short Circuit Withstand Rating of the chiller electrical enclosure is 30,000 Amps for standard terminal block connection. Ratings are in accordance with UL508C. A Circuit Breaker Option can be added to increase the Short Circuit Withstand Rating to 200/230V = 100,000 Amps, 380/460 V = 65,000 Amps, and 575V = 42,000 Amps.

Microprocessor and VSD Controls

Microprocessors on the Chiller Control Board and VSD Logic Board control starting, stopping, loading, unloading, safeties, and chilled liquid temperature control. Chilled liquid control decisions are a function of temperature deviation from setpoint and the rate of change of temperature.

The standard controls include: brine chilling, thermal storage, run signal contacts, unit alarm contacts, chilled liquid pump control, automatic reset after power failure, automatic system optimization to match operating conditions.

Remote cycling, optional current limiting, optional temperature setpoint reset, and optional remote sound limit can be accomplished by connecting user-supplied signals to the microprocessor.

Unit operating software is stored in non-volatile memory. Field programmed setpoints are retained in lithium battery backed real time clock (RTC) memory for 10 years.

Display

The display consists of a liquid crystal 2 line by 40 characters per line display, with backlighting for outdoor viewing of operating parameters and program points.

Parameters are displayed in 5 languages in either English (°F and PSIG) or Metric (°C and Bars) units, and for each circuit, the following items can be displayed:

- Entering and leaving chilled liquid, and ambient temperature.
- Day, date and time. Daily start/stop times. Holiday and Manual Override status.
- Compressor operating hours and starts. Automatic or manual lead/lag. Lead compressor identification.
- Run permissive status. Compressor run status.
- Anti-recycle timers.
- System suction (and suction superheat), discharge (and discharge superheat), and oil pressures and temperatures.
- Percent full load compressor motor current and average motor current. Compressor motor speed (frequency).
- Cutout status and setpoints for: supply chilled liquid temperature, low suction pressure, high discharge pressure and temperature, high oil temperature, low ambient, and low leaving liquid temperature.
- Unloading limit setpoints for high discharge pressure and compressor motor current.
- Status of: evaporator heater, condenser fans, load/unload timers, and chilled water pump.
- “Out of range” message.
- Up to 10 fault shutdown histories.

Keypad

An operator keypad allows complete control of the system from a central location. The keypad utilizes an overlay to allow use in 5 languages. The keypad is a color-coded, 36 button, sealed keypad with keys for Display, Entry, Setpoints, Clock, Print, Program, Unit ON/OFF and other functions. Details on a few of the keys follow.

Status – Allows viewing present unit or system status displayed by the microprocessor.

Entry – Numeric keypad and supporting keys used to confirm Setpoint changes, cancel inputs, advance day, and change AM/PM.

Setpoints – For setting chilled liquid temperature, chilled liquid range, remote reset temperature range.

Date/Time – Used to set time, daily or holiday start/stop schedule, manual override for servicing, and sound limiting schedule.

Print – Used to display or print operating data or system fault shutdown history for last ten faults. Printouts are generated through an RS-232 port via a separate printer.

Program – For setting low leaving liquid temperature cutout, average motor current limit, and pulldown demand limit.

Displays are also provided for programming low ambient cutout, low suction pressure cutout, superheat setpoint, etc., under the PROGRAM key.

Unit Switch

A master unit switch allows activation or de-activation of the chiller system. Separate system switches for controlling each system are provided as part of the chiller control panel keypad.

Variable Speed Drive (VSD)

The VSD (variable speed drive) is a liquid cooled, transistorized, PWM inverter, which provides speed control to vary the speed of 2, 3 or 4 compressor motors. The VSD changes the duration of the voltage pulses supplied to the motor to enable control of compressor speed to match the system load. A PWM generator, on the VSD Logic Board, with a switching frequency of 3125 Hz modulates the voltage signal to provide a relatively pulses constant V/F ratio. In some cases, the V/F ratio is slightly modified to provide additional torque to the motor. Sample 3 phase current waveforms are shown in FIG. 1 to show the sinusoidal characteristics of the current drawn by the compressor motors.

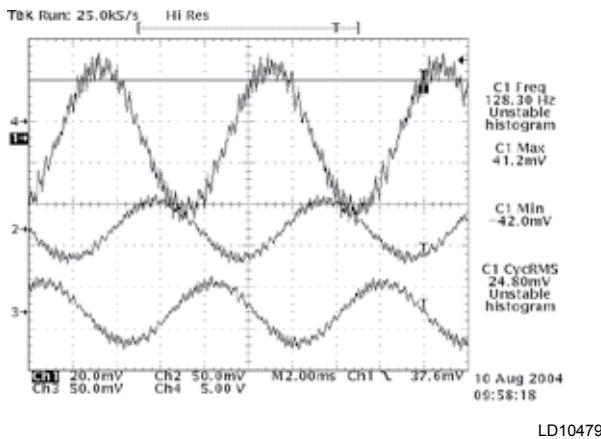

LD10479

FIG. 1 - PWM CURRENT WAVEFORM

A Sample PWM voltage waveforms is shown in FIG. 2. The pulses near the sides of the rectangular groups of waves are notably narrower, representing the lower voltage of a sinusoidal waveform as it rises or falls from the “0” crossing.

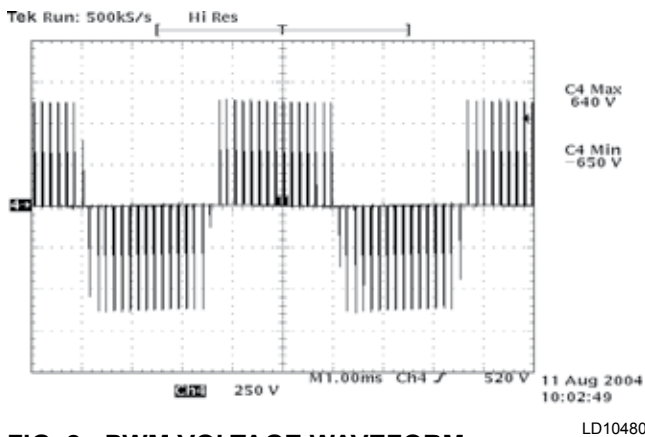

LD10480

FIG. 2 - PWM VOLTAGE WAVEFORM

The power section of the drive is composed of four major blocks consisting of an AC to DC rectifier section with accompanying pre-charge circuit, a DC link filter section, a three phase DC to AC inverter section, and an output suppression network.

The AC to DC rectifier utilizes a semi-converter formed by the connection of three SCR/diode modules (1SCR-3SCR) in a three phase bridge configuration. The modules are mounted on a liquid cooled heatsink. Use of the semi-converter configuration permits implementation of a separate pre-charge circuit to limit the flow of current into the DC link filter capacitors when the drive is switched on and it also provides a fast disconnect from the power mains when the drive is switched off. When the drive is turned off, the SCRs in the semiconverter remain in a non-conducting mode and the DC link filter capacitors remain uncharged. When the drive is commanded to run, the DC link filter capacitors are slowly charged via the semi-converter. The SCR’s are then gated fully on.

Three power fuses (1FU - 3FU), an optional circuit breaker (1SW) and a standard 5% impedance minimum 3 phase line reactor connect the AC to DC converter to the incoming power. Very fast semiconductor power fuses are utilized to ensure that the SCR/diode module packages do not rupture if a catastrophic failure were to occur on the DC link. The SCR Trigger board provides the gating pulses for the SCR’s as commanded by the VSD Logic board.

The DC Link filter section of the drive consists of a group of electrolytic filter capacitors (C1-C6). This capacitor bank effectively smooths the ripple voltage from the AC to DC rectifier while simultaneously providing a large energy reservoir for use by the DC to AC inverter section of the drive. In order to achieve the required voltage capability for the capacitor portion of the filter, filter capacitor “banks” are formed by connecting two groups of parallel capacitors in series to form a capacitor “bank”. In order to assure an equal sharing of the voltage between the series connected capacitors and to provide a discharge means for the capacitor bank when the VSD is powered off, “bleeder” resistors (1RES and 2RES) are connected across the capacitor banks.

The DC to AC inverter section of the VSD serves to convert the rectified and filtered DC back to AC at the magnitude and frequency commanded by the VSD Logic board. The inverter section is actually composed of two to four identical inverter output phase assemblies. These assemblies are in turn composed of 3 pairs of Insulated

Gate Bipolar Transistor (IGBT) modules mounted to a liquid cooled heatsink, and a IGBT Gate Driver Board, which provides the On and Off gating pulses to the IGBT's as determined by the VSD Logic board. In order to minimize the parasitic inductance between the IGBT's and the capacitor banks, copper plates, which electrically connect the capacitors to one another and to the IGBT's are connected together using a "laminated bus" structure.

This "laminated bus" structure is actually composed of a pair of copper bus plates with a thin sheet of insulating material acting as the separator/insulator. The "laminated bus" structure forms a parasitic capacitor, which acts as a small valued capacitor, effectively canceling the parasitic inductance of the bus bars themselves. To further cancel the parasitic inductances, a series of small film capacitors are connected between the positive and negative plates of the DC link.

The VSD output suppression network is composed of a series of capacitors and resistors connected in a three phase delta configuration. The parameters of the suppression network components are chosen to work in unison with the parasitic inductance of the DC to AC inverter sections in order to simultaneously limit both the rate of change of voltage and the peak voltage applied to the motor windings. By limiting the peak voltage to the motor windings, as well as the rate-of-change of motor voltage, we can avoid problems commonly associated with PWM motor drives, such as stator-winding end-turn failures and electrical fluting of motor bearings.

The VSD is cooled by a propylene glycol cooling loop. The loop utilizes a glycol pump, which pumps glycol through the VSD heatsinks to cool the power components. The glycol is then circulated through the condenser to reject the heat from the VSD. The cooled glycol is then circulated back through the loop.

Various ancillary sensors and boards are used to send information back to the VSD Logic board. Each IGBT Power Module within the DC to AC inverter section contains a thermistor heatsink temperature sensor to provide temperature information to the VSD logic board. The Bus Isolator board utilizes three resistors on the board to provide a "safe" impedance (resistance) between the DC link filter capacitors located on the output phase bank assemblies and the VSD logic board. It provides the means to sense the positive, midpoint and negative connection points of the VSD's DC link without apply-

ing high voltage to the VSD Logic Board. A Current Transformer is included on each output phase assembly to provide motor current information to the VSD logic board.

ACCESSORIES AND OPTIONS

Single Point Circuit Breaker

A single-point supply circuit with factory provided circuit breaker protection with lockable external handle located in the panel.

Building Automation System (BAS) Interface

Provides a means to reset the leaving chilled liquid temperature or percent full load amps (current limiting) from a BAS Interface.

The chiller microprocessor board will accept a 4 to 20mA or 0 to 10VDC input from an ISN or BAS.

The chiller is also capable of accepting an RS-485 communications link through the Microgateway.

Condenser Coil Protection

The standard condenser coils have aluminum fins, copper tubes, and galvanized steel supports for generally adequate corrosion resistance. However, these materials are not adequate for all environments.

The following options provide added protection:

Black fin condenser coils – Condenser coils constructed using black epoxy-coated aluminum fin stock for corrosion-resistance for typical seashore locations (not directly exposed to salt spray).

Copper fin condenser coils – Coils constructed with corrosion-resistant copper fins. Not recommended in areas where units may be exposed to acid rain.

Epoxy Coated Condenser Coils – Completed condenser coil assemblies are covered with a cured epoxy coating. Probably the most suitable selection for seashore locations where salt spray may come into contact with the fins, and other corrosive applications except: strong alkalis, oxidizers, and wet bromine, chlorine, and fluorine in concentrations greater than 100 PPM.

DX COOLER OPTIONS

300 PSIG (21 bar) Waterside Design Working Pressure

– The DX cooler waterside is designed and constructed for 300 PSIG (21 bar) working pressure. (Factory-mounted)

1-1/2” (38 mm) Insulation – Double-thickness insulation provided for enhanced efficiency.

Flange Accessory – Consists of raised face flanges to convert grooved water nozzles to flanged cooler connections. Includes companion flanges for field mounting.

Remote DX Cooler – Includes the main condensing unit less the cooler, refrigerant and liquid line devices. The insulated cooler and field accessory kits per refrigerant circuit are supplied separately. The condensing unit is shipped with a dry nitrogen holding charge and the cooler is shipped with a dry nitrogen holding charge.

Flow Switch Accessory – Johnson Controls model F61MG-1C Vapor-proof SPDT, NEMA 4X switch, 150 PSIG (10 bar) DWP, -20°F to 250°F (-29°C to 121°C), with 1” NPT (IPS) connection for upright mounting in horizontal pipe or equivalent. A flow switch must be field-installed with each unit. A 300PSIG (20.7 bar) optional flow switch is available.

SERVICE VALVE OPTION

Suction Service Valve – Provides a suction and economizer service valve on each refrigerant circuit.

UNIT ENCLOSURES

Wire Enclosure – Heavy-gauge welded wire mesh guards mounted on the exterior of the unit (Factory- or field-mounted).

Louvered Panels and Wired Guards – Louvered panels mounted over the exterior condenser coil faces, and heavy-gauge welded wire mesh guards mounted around the bottom of the unit (Factory- or field-mounted).

Louvered Panels (Condenser Coils Only) – Louvered panels are mounted over the exterior condenser coil faces on the sides of the unit to visually screen and protect the coils (Factory- or field-mounted).

Louvered Panels (Full Unit) enclosure – Louvered panels over condenser coils and around the bottom of the unit (Factory- or field-mounted).

FANS

High Static Fans: Fans and motors suitable for High External Static conditions to 100 Pa.

SOUND REDUCTION OPTIONS

Silent Night – This option allows speed limiting of the compressors remotely or locally to reduce acoustic noise. As speed is limited, fewer condenser fans are needed for cooling, reducing noise.

Ultra Quiet Fans – Reduced RPM fan motors and alternative fan selection for low noise applications.

Compressor Blankets – Acoustic compressor sound blankets are optional to reduce compressor noise.

Acoustic Perimeter Enclosures (field mounted) – Perimeter enclosure option provides acoustically tuned panels around the bottom of the chiller to reduce noise.

VIBRATION ISOLATION

Neoprene Pad Isolation – Recommended for normal installations (Field-mounted).

1” (25 mm) Spring Isolators – Level adjustable, spring and cage type isolators for mounting under the unit base rails (Field-mounted).

2” (51 mm) Seismic Spring Isolators – Restrained Spring-Flex Mountings incorporate welded steel housing with vertical and horizontal limit stops. Housings designed to withstand a minimum 1.0 g accelerated force in all directions to 2” (51 mm). Level adjustable, deflection may vary slightly by application (Field-mounted).

UNIT MODEL NUMBER NOMENCLATURE

NOMENCLATURE

The model number denotes the following characteristics of the unit.

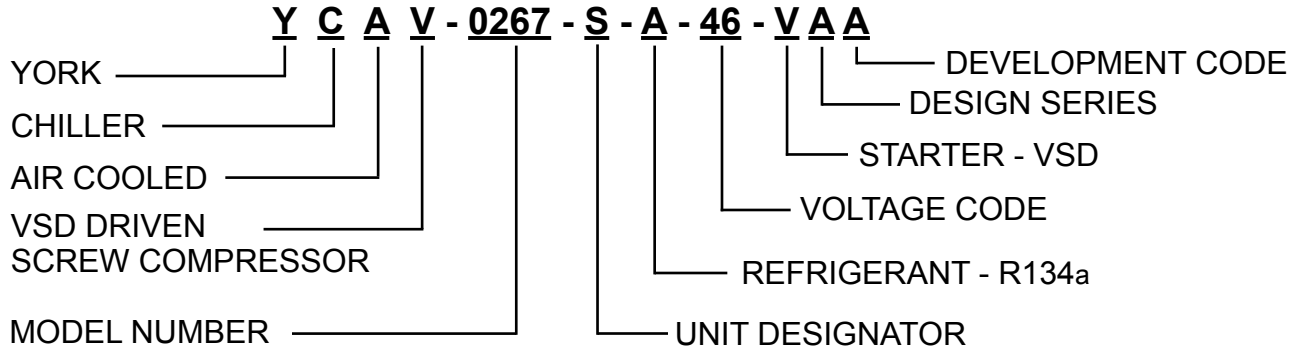

UNIT DESIGNATOR

- E- High Efficiency with Standard IPLV
- S- Standard Efficiency with Standard IPLV
- P- Standard Efficiency with High IPLV
- V- High Efficiency with High IPLV

VOLTAGE CODE

- 17=200-3-60
- 28=230-3-60
- 40=380-3-60
- 46=460-3-60
- 50=380/400/415-3-50
- 58=575-3-60

COMPLETE PIN NUMBER DESCRIPTION

Feature	Description	Option	Description
CONTRACT	Contract Number	NUM	Contract Number = {num}
ORDER	Order Quantity	QTY	Order quantity = {ord_qty}
USA	USA Origin	N	USA origin not required
		Y	USA origin required
SHIP WT	Shipping Weight	LBS	Crane/Rigging Shipping Weight = {lbs}
		KG	Crane/Rigging Shipping Weight = {kg}
MODEL	Model (PIN 1-4)	YCAV	YCAV
CAP	Nominal Capacity (PIN 5-8)	0157	0157
		0177	0177
		0187	0187
		0197	0197
		0207	0207
		0227	0227
		0247	0247
		0267	0267
		0569	0569
		0639	0639
		0679	0679
		0719	0719
		0739	0739
		0819	0819
		0889	0889
0969	0969		
UNIT	Unit Designator (PIN 9)	S	Standard Efficiency, Standard IPLV
		P	Standard Efficiency, Optimized IPLV
		E	High Efficiency/High Ambient Unit, Standard IPLV
		V	High Efficiency/High Ambient Unit, Optimized IPLV
REF.	Refrigerant (PIN 10)	A	R-134a
VOLTS	Voltage (PIN 11, 12)	17	200/3/60
		28	230/3/60
		40	380/3/60
		46	460/3/60
		50	380-415/3/50
		58	575/3/60
STARTER	Starter (PIN 13)	V	Variable Speed Drive
DESIGN	Design Series (PIN 14)	A	Design Series A
DEV	Modification Level (PIN 15)	A	Mod Level A
POWER	Power Fld (PIN 16, 17)	SX	SP Supply TB
		BX	SP Circuit Breaker w/Lockable Handle
		SS	SP Supply TB w/Ind. Sys. Disconnect Switches
		CS	SP Circuit Breaker w/Ind. Sys. Disconnect Switches
		QQ	Special Power Option
TRANS	Control Transformer (PIN 18)	T	Control Transformer required
		Q	Special Transformer or Power Strip required
PFC	Convenience Outlet (PIN 19)	X	No Option Required
		O	Convenience Outlet, 115V GFI (Customer Powered)
		Q	Special quote
AMB	PIN 20	X	No option required
		Q	Special quote

COMPLETE PIN NUMBER DESCRIPTION (CON'T)

Feature	Description	Option	Description
BAS	BAS Interface (PIN 21)	X	No BAS Reset/Offset required
		T	BAS/EMS Temp Reset/Offset
		C	BAS/EMS Current Reset/Offset
		B	BAS/EMS Both Temp and Current Reset/Offset
		M	ISN Microgateway
		Q	Special BAS Reset/Offset required
LCD	LCD (PIN 22)	X	English LCD & Keypad Display (std)
		S	Spanish LCD & Keypad Display
		F	French LCD & Keypad Display
		G	German LCD & Keypad Display
		I	Italian LCD & Keypad Display
		P	Portuguese LCD & Keypad Display
		Q	Special LCD & Keypad Display
RDOUT	Silent Night (PIN 23)	X	No option required
		N	Silent Night sound limiting control option
		Q	Special quote
SAFETY	Safety Code (PIN 24)	L	(Std. 60 Hz) N. American Safety Code (cUL/cETL)
		N	(Std 50 HZ) No listing
		Q	Special Safety Code
SENSOR	PIN 25	X	No option required
		Q	Special quote
PUMP	Pump Control (PIN 26)	X	No Pump Control required
		Q	Special Pump Control required
REMOTE	Remote Ctrl Panel (PIN 27)	X	No Remote Control Panel required
		O	Optiview Remote Control Panel required
		Q	Special Remote Control Panel required
SEQ	Sequence Kit (PIN 28)	X	No Sequence Kit required
		S	Sequence Control & Automatic Lead Transfer = {seq}
		Q	Special Sequence Kit required
TEMP	Water Temp (PIN 29, 30)	NUM	Leaving Water Temp. = {temp} degrees
		TS	Thermal Storage
		QQ	Special LWT requirements
CHICAGO	Chicago Code Kit (PIN 31)	X	No Chicago Code Kit required
		C	Chicago Code Kit required
		S	Service Isolation Valve
		B	Both Isolation Valve and Chicago Code
		Q	Special Chicago Code Kit required
VALVES	Valves (PIN 32)	X	Standard Valves required
		Q	Special Optional Valves required
HGBP	PIN 33	X	No option required
		Q	Special quote
GAUGE	PIN 34	X	No option required
		Q	Special quote
OVERLOAD	PIN 35	X	No option required
		Q	Special quote
PIN36	PIN 36	X	No option required
		Q	Special quote
HTR	Crankcase Heater (PIN 37)	H	Compressor Crankcase Heaters
		Q	Special quote
DWP	DWP (PIN 38)	X	150psig DWP
		3	300psig DWP
		Q	Special DWP

COMPLETE PIN NUMBER DESCRIPTION (CON'T)

Feature	Description	Option	Description
INS	Insulation (PIN 39)	X	3/4" Cooler Insulation
		D	1-1/2" Cooler Insulation
		Q	Special Cooler Insulation
FLANGES	Flanges (PIN 40)	X	No Flanges required
		W	Weld Flange Kit required
		V	Victaulic Flange Kit required
		Q	Special Flanges required
FLOW	Flow Switch (PIN 41)	X	No Flow Switch required
		S	One Flow Switch required
		T	Two Flow Switches required
		U	Three Flow Switches required
		D	One Differential Pressure Switch required
		E	Two Differential Pressure Switches required
		F	Three Differential Pressure Switches required
		Q	Special Switch required
VESSEL	Vessel Codes (PIN 42)	A	ASME Pressure Vessel Codes
		Q	Special Pressure Vessel Codes
CLR	Cooler (PIN 43)	X	Standard Cooler
		R	Remote Cooler
		Q	Special Cooler requirements
PIN44	PIN 44	X	No option required
		Q	Special quote
		X	Aluminum Coils
COILS		C	Copper Fin Coils
		B	Pre-Coated Fin Coils
		P	Post-Coated Dipped Coils
		Q	Special Coils
HEAT	Heat Recovery (PIN 46)	X	Partial Heat Recovery not required
		H	Partial Heat Recovery required
		Q	Special quote
FANMOTORS	Fan Motors (PIN 47)	X	TEAO Fan Motors
		Q	Special Fan Motors
PANEL	Enclosure Panels (PIN 48)	X	No Enclosure Panels required
		1	Wire (Full Unit) Encl Panels (factory)
		2	Wire (Full Unit) Encl Panels (field)
		3	Wire/Louvered Encl Panels (factory)
		4	Wire/Louvered Encl Panels (field)
		5	Louvered (cond only) Encl Panels (factory)
		6	Louvered (cond only) Encl Panels (field)
		7	Louvered (full unit) Encl Panels (factory)
		8	Louvered (full unit) Encl Panels (field)
		Q	Special Enclosure Panels required
ACOUSTIC	Acoustical arrgt (PIN 49)	X	No Sound Enclosure required
		P	Perimeter Sound Package
		B	Acoustic Sound Blanket
		D	Acoustic Sound Blanket & Perimeter Sound Package
		Q	Special Sound Enclosure required
PIN50	PIN 50	X	No option required
		Q	Special quote
PIN51	PIN 51	X	No option required
		Q	Special quote
FANS	Fans (PIN 52)	X	Standard Low Sound Fans
		L	Ultra Quiet Fans
		H	High Static Fans
		Q	Special Sound Fans

COMPLETE PIN NUMBER DESCRIPTION (CON'T)

Feature	Description	Option	Description
PAINT	Overspray Paint (PIN 53)	X	No Final Overspray Paint required
		Q	Special Final Overspray Paint required
ISOL	Isolators (PIN 54)	X	No Vibration Isolators required
		1	1" Deflection Isolators required
		S	Seismic Isolators required
		N	Neoprene Pad Isolators required
		Q	Special Vibration Isolators required
WARRANTY	Warranty (PIN 55)	X	1st Year Parts Only (Std Warranty)
		B	1st Year Parts & Labor
		C	2nd Year Parts Only
		D	2nd Year Parts & Labor
		E	5 Year Compressor Parts Only
		F	5 Year Compressor Parts & Labor
		G	5 Year Unit Parts Only
		H	5 Year Unit Parts & Labor
Q	Special Warranty		
REFRIGERANT WTY	Refrigerant Wty (PIN 56)	X	No Refrigerant Warranty required
		1	1 Year Refrigerant Warranty
		2	2 Year Refrigerant Warranty
		5	5 Year Refrigerant Warranty
SHIP	Ship Instructions (PIN 57)	X	No option required
		A	Buy American Act Compliance
		C	Container Shipping Kit
		B	Both Buy American Act Compliance and Container Shipping Kit
		Q	Special quote
PIN58	PIN 58	X	No option required
		Q	Special quote
PIN59	PIN 59	X	No option required
		Q	Special quote
PIN60	PIN 60	X	No option required
		Q	Special quote
MFG	Plant of Mfg (PIN 61)	R	Plant of Manufacture - Monterrey
LOC	Mfg Location	MEX	Monterrey
		SAT	San Antonio
YW	YorkWorks Version	CV	YorkWorks configuration version {cv}
		UV	YorkWorks upload version {uv}
SQ	Special Quote	Q	Special quote

SECTION 3 - RIGGING, HANDLING AND STORAGE



WARNING

Failure to follow these instructions could result in death, serious injury or equipment damage.

Follow all warnings and instructions in the unit's Manual(s).

EN Installation Instructions for the technician / fitter PL Instrukcja instalacji dla technika / monter SV Installationsguide för installatör / montör CS Pokyny k instalaci pro techniky a montéry	IT Istruzioni d'installazione per il personale specializzato NL Installatiehandleiding voor de vakman / monteur DE Installationsanleitung für die Fachkraft / Monteur ES Instrucciones de instalación para el técnico / contratista especializado	JA 一般仕様・取扱説明書 FR Manuel d'installation pour le spécialiste / monteur RU Инструкция по установке для техника/монтажника ZH 适用于技术人员与安装人员的 安装说明书	
--	--	--	---

1. Follow all applicable regulations and safety practices during rigging and lifting.
2. Prepare and follow written rigging and lifting plan.
3. Rigging must be directed by trained professional rigger.
4. Spreader bars must be used and be long enough to prevent rigging from contacting unit.
5. Use all and only designated lift points according to units manual(s).
6. Locate center of gravity through trial lifts to account for possible variations in unit configuration.
7. Use rigging and lifting techniques that keep unit stable and level.
8. Keep clear of unit when lifted.

035-23962-000 REV A

LD19197



Rigging and lifting should only be done by a professional rigger in accordance with a written rigging and lifting plan. The most appropriate rigging and lifting method will depend on job specific factors, such as the rigging equipment available and site needs. Therefore, a professional rigger must determine the rigging and lifting method to be used, and it is beyond the scope of this manual to specify rigging and lifting details.

LIFTING WEIGHTS

Refer to the unit nameplate for unit shipping weight. Note that weight may vary depending on unit configuration at the time of lifting.

DELIVERY AND STORAGE

To ensure consistent quality and maximum reliability, all units are tested and inspected before leaving the factory. Units are shipped completely assembled and containing refrigerant under pressure. Units are shipped without export crating unless crating has been specified on the Sales Order.

If the unit is to be put into storage, prior to installation, the following precautions should be observed:

- The chiller must be “blocked” so that the base is not permitted to sag or bow.
- Ensure that all openings, such as water connections, are securely capped.
- Do not store where exposed to high ambient air temperatures that may exceed relief valve settings. Refer to *Long-Term Storage Requirement - Field Preparation (Form 50.20-NM7)*.

- The condensers should be covered to protect the coils and fins from potential damage and corrosion, particularly where building work is in progress.
- The unit should be stored in a location where there is minimal activity in order to limit the risk of accidental physical damage.
- To prevent inadvertent operation of the pressure relief devices the unit must not be steam cleaned.
- It is recommended that the unit is periodically inspected during storage.

INSPECTION

Remove any transit packing and inspect the unit to ensure that all components have been delivered and that no damage has occurred during transit. If any damage is evident, it should be noted on the carrier's freight bill and a claim entered in accordance with the instructions given on the advice note.

Major damage must be reported immediately to your local Johnson Controls representative.

MOVING THE CHILLER

Prior to moving the unit, ensure that the installation site is suitable for installing the unit and is easily capable of supporting the weight of the unit and all associated services.



The unit must only be lifted by the base frame at the points provided. Never move the unit on rollers, or lift the unit using a forklift truck.

Care should be taken to avoid damaging the condenser cooling fins when moving the unit.

UNIT REMOVAL FROM SHIPPING CONTAINER

1. Place a clevis pin into the holes provided at the end of each base rail on the unit. Attach chains or nylon straps through the clevis pins and hook onto a suitable lift truck for pulling the unit out of the container.
2. Slowly place tension on the chains or straps until the unit begins to move and then slowly pull the unit from the container. Be sure to pull straight so the sides do not scrape the container.
3. Place a lifting fixture on the forks of the lift truck and reattach the chain or strap. Slightly lift the front of the unit to remove some weight from the floor of the container. Continue pulling the unit with an operator on each side to guide the lift truck operator.
4. Pull the unit until the lifting locations are outside of the container. Place 4 X 4 blocks of wood under the base rails of the unit. Gently rest the unit on the blocks and remove the chains and lift truck.
5. Attach lifting rigging from the crane and slowly complete the removal from the container then lift up and away.



LD19197a

LIFTING USING LUGS

Units are provided with lifting holes in the base frame which accept the accessory lifting lug set as shown in the figure below. The lugs (RH and LH) should be inserted into the respective holes in the base frame and turned so that the spring loaded pin engages into the hole and the flanges on the lug lock behind the hole. The lugs should be attached to the cables/chains using shackles or safety hooks.

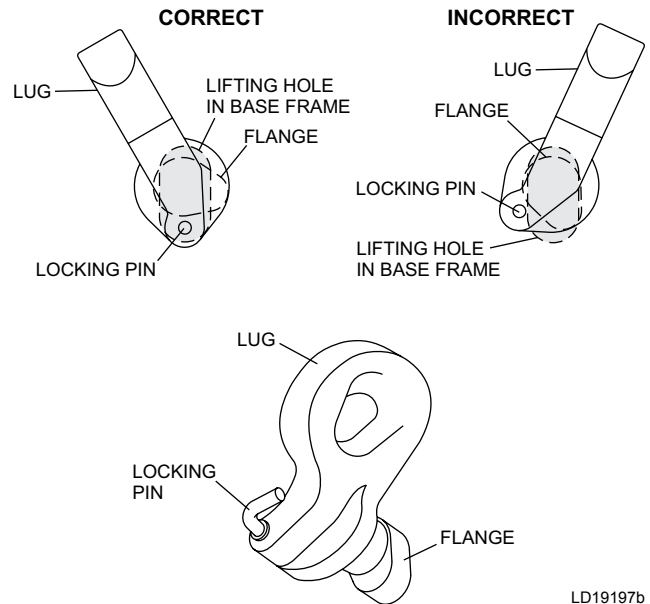

LD19197b

LIFTING USING SHACKLES

The shackles should be inserted into the respective holes in the base frame and secured from the inside.

Use spreader bars to avoid lifting chains hitting the chiller. Various methods of spreader bar arrangements may be used, keeping in mind the intent is to keep the unit stable and to keep the chains from hitting the chiller and causing damage.

Never lift the chiller using a forklift or by hooking to the top rails. Use only the lifting holes provided.

Lifting Instructions are placed on a label on the chiller and on the shipping bag.

UNIT RIGGING

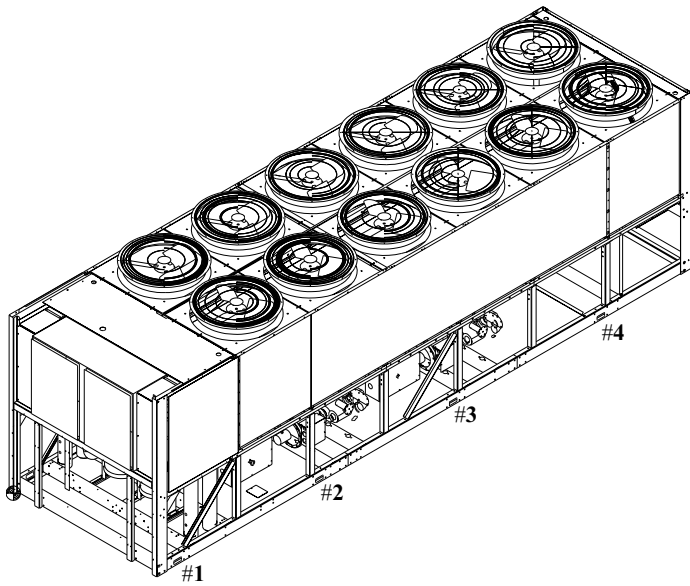

MODEL	LIFT POINTS DIMENSIONS TAKEN FROM ⊕ (NOT ALL POINTS ON ALL UNITS)			
	#1	#2	#3	#4
Std.Eff.				
0157/0569	Y=11.5	Y=96.9	Y=197.8	---
0177/0639	Y=11.5	Y=96.9	Y=197.8	---
0187/0679	Y=11.5	Y=96.9	Y=220.6	---
0207/0739	Y=12.5	Y=96.9	Y=176.6	Y=220.6
0227/0819	Y=12.5	Y=96.9	Y=176.6	Y=220.6
0247/0889	Y=12.5	Y=96.9	Y=176.6	Y=264.6
0267/0969	Y=12.5	Y=96.9	Y=176.6	Y=264.6
High Eff.				
0157/0569	Y=11.5	Y=96.9	Y=197.8	---
0177/0639	Y=11.5	Y=96.9	Y=220.6	---
0187/0679	Y=11.5	Y=96.9	Y=220.6	---
0197/0719	Y=11.5	Y=96.9	Y=220.6	---
0207/0739	Y=11.5	Y=96.9	Y=176.6	Y=264.6
0227/0819	Y=11.5	Y=96.9	Y=176.6	Y=264.6
0247/0889	Y=12.5	Y=96.9	Y=176.6	Y=264.6

NOTE:
UNIT MUST BE LIFTED LEVEL TO PREVENT DAMAGE TO THE STRUCTURAL INTEGRITY OF THE UNIT.

LD10496

NOTE: Weights and approximate center of gravity location shown for base unit. Any options selected may add weight to the unit and affect the center of gravity. Locate the center of gravity through trial lifts to account for possible variations in unit configuration. Contact your nearest Johnson Controls Sales Office for weight data.

INSTALLATION

LOCATION REQUIREMENTS

To achieve optimum performance and trouble-free service, it is essential that the proposed installation site meets the location and space requirements for the model being installed. For dimensions, refer to the Dimensions Section.

It is important to ensure that the minimum service access space is maintained for cleaning and maintenance purposes.

OUTDOOR INSTALLATIONS

The units can be installed at ground level on a suitable flat level foundation easily capable of supporting the weight of the unit, or on a suitable rooftop location. In both cases an adequate supply of air is required. Avoid locations where the sound output and air discharge from the unit may be objectionable.

The location should be selected for minimum sun exposure and away from boiler flues and other sources of airborne chemicals that could attack the condenser coils and steel parts of the unit.

If located in an area accessible to unauthorized persons, steps must be taken to prevent access to the unit by means of a protective fence. This will help to prevent the possibility of vandalism, accidental damage, or possible harm caused by unauthorized removal of protective guards or opening panels to expose rotating or high voltage components.

For ground level locations, the unit must be installed on a suitable flat and level concrete base that extends to fully support the two side channels of the unit base frame. A one-piece concrete slab, with footings extending below the frost line is recommended. To avoid noise and vibration transmission, the unit should not be secured to the building foundation.

On rooftop locations, choose a place with adequate structural strength to safely support the entire operating weight of the unit and service personnel. The unit can be mounted on a concrete slab, similar to ground floor locations, or on steel channels of suitable strength. The channels should be spaced with the same centers as the unit side and front base rails. This will allow vibration isolators to be fitted if required. Isolators are recommended for rooftop locations.

Any ductwork or attenuators fitted to the unit must not have a total static pressure resistance, at full unit airflow, exceeding the capability of the fans installed in the unit.

INDOOR INSTALLATIONS

The unit can be installed in an enclosed plant room, provided the floor is level and of suitable strength to support the full operating weight of the unit. It is essential that there is adequate clearance for airflow to the unit. The discharge air from the top of the unit must be ducted away to prevent re-circulation of air within the plant room. If common ducts are used for fans, non-return dampers must be fitted to the outlet from each fan.

The discharge ducting must be properly sized with a total static pressure loss, together with any intake static pressure loss, less than the available static pressure capability for the type of fan fitted.

The discharge air duct usually rejects outside the building through a louver. The outlet must be positioned to prevent the air being drawn directly back into the air intake for the condenser coils, as such re-circulation will affect unit performance.

LOCATION CLEARANCES

Adequate clearances around the unit(s) are required for the unrestricted airflow for the air-cooled condenser coils and to prevent re-circulation of warm discharge air back onto the coils. If clearances given are not maintained, airflow restriction or re-circulation will cause a loss of unit performance, an increase in power consumption, and may cause the unit to malfunction. Consideration should also be given to the possibility of down drafts, caused by adjacent buildings, which may cause re-circulation or uneven unit airflow.

For locations where significant cross winds are expected, such as exposed roof tops, an enclosure of solid or louver type is recommended to prevent wind turbulence interfering with the unit airflow.

When units are installed in an enclosure, the enclosure height should not exceed the height of the unit on more than one side. If the enclosure is of louvered construction, the same requirement of static pressure loss applies as for ducts and attenuators stated above.

Where accumulation of snow is likely, additional height must be provided under the unit to ensure normal airflow to the unit



Clearance dimensions provided elsewhere are necessary to maintain good airflow and ensure correct unit operation. It is also necessary to consider access requirements for safe operation and maintenance of the unit and power and control panels. Local health and safety regulations, or practical considerations for service replacement of large components, may require larger clearances than those given in the Technical Data Section (Page 122).

INSTALLATION OF VIBRATION ISOLATORS

Optional sets of vibration isolators can be supplied loose with each unit.

Using the Isolator tables shipped with the unit in the information pack, refer to the Dimension Section (Pages 66-121), Weight Distribution and Isolator Mounting Position Section (Pages 124-127) and Isolator types (Pages 128-132). Identify each mount and its correct location on the unit.

Installation

Place each mount in its correct position and lower the unit carefully onto the mounts ensuring the mount engages in the mounting holes in the unit base frame.

On adjustable mounts, transfer the unit weight evenly to the springs by turning the mount adjusting nuts (located just below the top plate of the mount) counterclockwise to raise and clockwise to lower. This should be done two turns at a time until the top plates of all mounts are between 1/4" and 1/2" (6 and 12 mm) clear of top of their housing and the unit base is level.

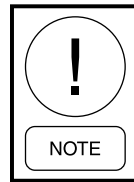

A more detailed installation instruction is provided on Pages 128-132.

SHIPPING BRACES

The chiller's modular design does not require shipping braces.

CHILLED LIQUID PIPING

General Requirements

The following piping recommendations are intended to ensure satisfactory operation of the unit(s). Failure to follow these recommendations could cause damage to the unit, or loss of performance, and may invalidate the warranty.



The maximum flow rate and pressure drop for the cooler must not be exceeded at any time. Refer to the Technical Data Section for details.

The liquid must enter the cooler at the inlet connection. The inlet connection for the cooler is at the control panel end of the cooler.

A flow switch must be installed in the customer piping at the outlet of the cooler and wired back to the control panel using shielded cable.

There should be a straight run of piping of at least 5 pipe diameters on either side. The flow switch should be wired to Terminals 2 and 13 on the 1TB terminal block (See FIG. 17, Page 141). A flow switch is required to prevent damage to the cooler caused by the unit operating without adequate liquid flow.

The flow switch used must have gold plated contacts for low voltage/current operation. Paddle type flow switches suitable for 150 PSIG (10 bar) working pressure and having a 1" N.P.T. connection can be obtained from YORK as an accessory for the unit. Alternatively, a differential pressure switch fitted across an orifice plate may be used, preferably of the high/low limit type.

The chilled liquid pump(s) installed in the piping system(s) should discharge directly into the unit cooler section of the system. The pump(s) may be controlled by the chiller controls or external to the unit. For details, refer to "Electrical Elementary and Connection Diagrams."

Pipework and fittings must be separately supported to prevent any loading on the cooler. Flexible connections are recommended which will also minimize transmission of vibrations to the building. Flexible connections must be used if the unit is mounted on anti-vibration mounts, as some movement of the unit can be expected in normal operation.

Piping and fittings immediately next to the cooler should be readily de-mountable to enable cleaning before operation, and to facilitate visual inspection of the exchanger nozzles.

The cooler must be protected by a strainer, preferably of 40 mesh, fitted as close as possible to the liquid inlet connection, and provided with a means of local isolation.

The cooler must not be exposed to flushing velocities or debris released during flushing. It is recommended that a suitably sized bypass and valve arrangement is installed to allow flushing of the piping system. The bypass can be used during maintenance to isolate the heat exchanger without disrupting flow to other units.

Thermometer and pressure gauge connections should be provided on the inlet and outlet connections of each cooler. Gauges and thermometers are not provided with the unit.

Drain and air vent connections should be provided at all low and high points in the piping to permit drainage of the system and to vent any air in the pipes.

Liquid system lines at risk of freezing, due to low ambient temperatures should be protected using insulation and heater tape and/or a suitable glycol solution. The liquid pump(s) may also be used to ensure liquid is circulated when the ambient temperature approaches freezing point.

Insulation should also be installed around the cooler nozzles. Heater tape of 21 watts per meter under the insulation is recommended, supplied independently and controlled by an ambient temperature thermostat set to switch on at approximately 4°F, above the freezing temperature of the chilled liquid.

Evaporator heater mats are installed under the insulation, and are powered from the chiller's control panel. In sub-freezing conditions, unless the evaporator has been drained or an appropriate water-to-glycol concentration is maintained, high voltage power to the chiller must be kept on to ensure the heater mats assist in evaporator freeze protection. If there is a potential for power loss, Johnson Controls recommends that the evaporator is drained or that water in the chilled water circuit be replaced with an appropriate water-to-glycol concentration.

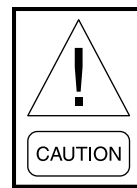

Any debris left in the water piping between the strainer and cooler could cause serious damage to the tubes in the cooler and must be avoided. Be sure the piping is clean before connecting it to the evaporator. Keep evaporator nozzles and chilled liquid piping capped prior to installation to assure construction debris is not allowed to enter.

The installer/user must also ensure that the quality of the water in circulation is adequate, without any dissolved gases, which can cause oxidation of steel parts within the cooler.

WATER TREATMENT

The unit performance provided in the Design Guide is based on a fouling factor of 0.0001 ft²hr°F/Btu (0.018m²/hr °C/kW). Dirt, scale, grease and certain types of water treatment will adversely affect the heat exchanger surfaces and therefore the unit performance. Foreign matter in the water system(s) can increase the heat exchanger pressure drop, reducing the flow rate and causing potential damage to the heat exchanger tubes.

Aerated, brackish or salt water is not recommended for use in the water system(s). YORK recommends that a water treatment specialist should be consulted to determine whether the proposed water composition will adversely affect the evaporator materials of carbon steel and copper. The pH value of the water flowing through the evaporator must be kept in a range between 7 and 8.5.

PIPEWORK ARRANGEMENT

The following is a suggested piping arrangement for single unit installations. For multiple unit installations, each unit should be piped as shown in FIG. 3.

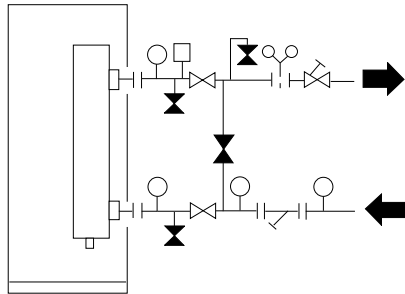

- ⊗ - Isolating Valve - Normally Open
- ⊠ - Isolating Valve - Normally Closed
- ⊘ - Flow Regulating Valve
- ⊙ - Flow Measurement Device
- ⊥ - Strainer
- - Pressure Tapping
- - Flow Switch
- | — Flanged Connection
- | — Pipework

LD10507

FIG. 3 - PIPEWORK ARRANGEMENT

CONNECTION TYPES & SIZES

For connection sizes relevant to individual models refer to the Technical Data Section.

COOLER CONNECTIONS

Standard chilled liquid connections on all coolers are of the Victaulic Groove type (See FIG. 4).

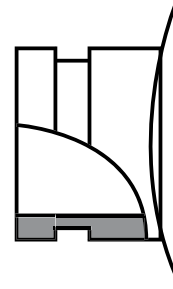

LD10494

FIG. 4 - VICTAULIC GROOVE

Option Flanges

One of two types of flanges may be fitted depending on the customer or local Pressure Vessel Code requirements. These are Victaulic-Adapter flanges, normally supplied loose, or weld flanges, which may be supplied loose or ready-fitted. Victaulic-Adapter and weld flange dimensions are to ISO 7005 - NP10.

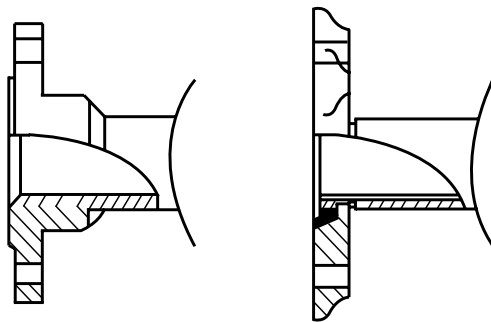

WELD FLANGE

VICTAULIC ADAPTER

LD10495

FIG. 5 - FLANGE ATTACHMENT

REFRIGERANT RELIEF VALVE PIPING

The evaporator is protected against internal refrigerant overpressure by refrigerant relief valves. A pressure relief valve is mounted on each of the main refrigerant lines connecting the cooler to the compressors.

A piece of pipe is fitted to each valve and directed so that when the valve is activated the release of high pressure gas and liquid cannot be a danger or cause injury. For indoor installations, pressure relief valves should be piped to the exterior of the building.

The size of any piping attached to a relief valve must be of sufficient diameter so as not to cause resistance to the operation of the valve. Unless otherwise specified by local regulations. Internal diameter depends on the length of pipe required and is given by the following formula:

$$D^5 = 1,447 \times L$$

Where:

D = minimum pipe internal diameter in cm

L = length of pipe in meters

If relief piping is common to more than one valve, its cross-sectional area must be at least the total required by each valve. Valve types should not be mixed on a common pipe. Precautions should be taken to ensure the outlets of relief valves or relief valve vent pipes remain clear of obstructions at all times.

DUCTWORK CONNECTION

General Requirements

The following ductwork recommendations are intended to ensure satisfactory operation of the unit. Failure to follow these recommendations could cause damage to the unit, or loss of performance, and may invalidate the warranty.

When ducting is to be fitted to the fan discharge it is recommended that the duct should be the same cross-sectional area as the fan outlet and straight for at least three feet (1 meter) to obtain static regain from the fan. Ductwork should be suspended with flexible hangers to prevent noise and vibration being transmitted to the structure. A flexible joint is also recommended between the duct attached to the fan and the next section for the same reason. Flexible connectors should not be allowed to concertina.

The unit is not designed to take structural loading. No significant amount of weight should be allowed to rest on the fan outlet flange, deck assemblies or condenser coil module. No more than 3 feet (1 meter) of light construction ductwork should be supported by the unit. Where cross winds may occur, any ductwork must be supported to prevent side loading on the unit.

If the ducts from two or more fans are to be combined into a common duct, back-flow dampers should be fitted in the individual fan ducts. This will prevent re-circulation of air when only one of the fans is running.

Units are supplied with outlet guards for safety and to prevent damage to the fan blades. If these guards are removed to fit ductwork, adequate alternative precautions must be taken to ensure persons cannot be harmed or put at risk from rotating fan blades.

ELECTRICAL CONNECTION

The following connection recommendations are intended to ensure safe and satisfactory operation of the unit. Failure to follow these recommendations could cause harm to persons, or damage to the unit, and may invalidate the warranty.



No additional controls (relays, etc.) should be mounted in the control panel. Power and control wiring not connected to the control panel should not be run through the control panel. If these precautions are not followed it could lead to a risk of electrocution. In addition, electrical noise could cause malfunctions or damage the unit and its controls.



After power wiring connection, do not switch on mains power to the unit. Some internal components are live when the mains are switched on and this must only be done by “Authorized” persons familiar with starting, operating, and troubleshooting this type of equipment

POWER WIRING

All electrical wiring should be carried out in accordance with local regulations. Route properly sized cables to cable entries on the unit.

In accordance with local codes, NEC codes and U.L. Standards, it is the responsibility of the user to install over current protection devices between the supply conductors and the power supply terminals on the unit.

To ensure that no eddy currents are set up in the power panel, the cables forming the 3-phase power supply must enter via the same cable entry.



All sources of supply to the unit must be taken via a common point of isolation (not supplied by YORK).

Copper power wiring only should be used for supplying power to the chiller. This is recommended to avoid safety and reliability issues resulting from connection failure at the power connections to the chiller. Aluminum wiring is not recommended due to thermal characteristics that may cause loose terminations resulting from the contraction and expansion of the wiring. Aluminum oxide may also build up at the termination causing hot spots and eventual failure. If aluminum wiring is used to supply power to the chiller, AL-CU compression fittings should be used to transition from aluminum to copper. This transition should be done in an external box separate to the power panel. Copper conductors can then be run from the box to the chiller.

POWER SUPPLY WIRING

Units require only one 3-phase supply, plus earth ground.

Connect the 3-phase supplies to the terminal block or optional circuit breaker located in the panel using lug sizes detailed in the Technical Data Section. See FIG. 17, Page 141 and FIG. 13, Page 137.

Connect a ground wire from the chiller panel ground lug to the incoming line supply ground.

115VAC CONTROL SUPPLY TRANSFORMER

A 3-wire high voltage to 115VAC supply transformer is standard in the chiller. This transformer is mounted in the Cabinet and steps down the high voltage supply to 115VAC to be used by the Controls, VSD, Feed & Drain Valve Controller, valves, solenoids, heaters, etc.

The high voltage for the transformer primary is taken from the chiller input. Fusing is provided for the transformer.



Removing high voltage power to the chiller will remove the 115VAC supply voltage to the control panel circuitry and the evaporator heater. In cold weather, this could cause serious damage to the chiller due to evaporator freeze-up. Do not remove power unless alternate means are taken to ensure operation of the evaporator heater.

CONTROL PANEL WIRING

All control wiring utilizing contact closures to the control panel terminal block is nominal 115VAC and must be run in shielded cable, with the shield grounded at the panel end only, and run in water tight conduit. Run shielded cable separately from mains cable to avoid electrical noise pick-up. Use the control panel cable entry to avoid the power cables.

Voltage free contacts connected to the panel must be suitable for 115 VAC-10ma (gold contacts recommended). If the voltage free contacts form part of a relay or contactor, the coil of the device must be suppressed using a standard R/C suppressor. The above precautions must be taken to avoid electrical noise, which could cause a malfunction or damage to the unit and its controls.

VOLTS FREE CONTACTS

Voltage free contacts are rated at 115VAC, 100VA resistive load only. Inductive loads must be suppressed across the coil.

Chilled Liquid Pump Starter

Terminals 23 and 24 on 1TB close to start the chilled liquid pump. This contact can be used as a master start/stop for the pump in conjunction with the daily start/stop schedule. Cycle the pumps from the unit panel if the unit will be operational or shut-down during sub-freezing conditions. Refer to the *Evaporator Pump Control on Page 170* for more information on testing the pumps.

Run Contact

Terminals 21 and 22 on 1TB (FIG. 17, Page 141) close to indicate that a system is running.

Alarm Contacts

The Systems 1/3 & 2/4 each have a single voltage-free contact, which will operate to signal an alarm condition whenever any system locks out, or there is a power failure. To obtain system alarm signal, connect the alarm circuit to volt free Terminals 25 & 26 (Sys 1/3), Terminals 27 and 28 (Sys 2/4) of 1TB (FIG. 17, Page 141).

SYSTEM INPUTS

Flow Switch

A chilled liquid flow switch of suitable type MUST be connected between Terminals 2 and 13 of 1TB (FIG. 17, Page 141) to provide protection against loss of liquid flow, which will cause evaporator freeze-up if the chiller is permitted to run. The flow switch circuitry is a 115VAC circuit. Contacts must be rated for low current (10ma). Gold contacts should be used.

Remote Run / Stop

A Remote Run/Stop input is available for each pair of systems (1/3 & 2/4). These inputs require a dry contact to start and stop the system. System 1/3 remote dry contacts are connected between Terminals 2 and 15 of 1TB (FIG. 17, Page 141) and System 2/4 dry contacts are connected between Terminals 2 and 16 of 1TB (FIG. 17, Page 141). If remote start/stop is not utilized, a jumper must be placed across the terminals to allow the system to run. The remote run/stop circuitry is a 115VAC circuit. Contacts must be rated for low current (10ma). Gold contacts should be used.

Remote Print

Closure of suitable contacts connected to Terminals 2 and 14 of 1TB (FIG. 17, Page 141) will cause a hard copy printout of Operating Data/Fault History to be made if an optional printer is connected to the RS-232 port. The remote print circuitry is a 115VAC circuit. Contacts must be rated for low current (10ma). Gold contacts should be used.

Optional Remote Setpoint Offset – Temperature

A current or voltage signal connected to Terminals 17 and 18 will provide a remote offset function of the chilled liquid setpoint, if required. See FIG. 17, Page 141 for the input location and Page 192 for a description of the option.

Optional Remote Setpoint Offset – Current

A current or voltage signal connected to Terminals 19 and 20 will provide remote setting of the current limit setpoint, if required. See FIG. 17, Page 141 for the input location and Page 194 for a description of the option.

Optional Remote Setpoint Offset – Sound Limiting

A current or voltage signal connected to Terminals 40 and 41 will provide remote setting of sound limit setpoint, if required. See FIG. 17, Page 141 for the input location and Page 196 for a description of the option.

COMMISSIONING

PREPARATION

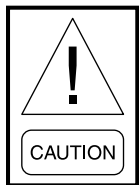

Commissioning of this unit should only be carried out by YORK Authorized personnel.

Commissioning personnel should be thoroughly familiar with the information contained in this literature, in addition to this section.

Perform the commissioning using the detailed checks outlined in the EQUIPMENT START-UP CHECK SHEET on Page 152 as the commissioning procedure is carried out.

PREPARATION – GENERAL

The following basic checks should be made with the customer power to the unit switched OFF.



Proper electrical lock out and tag procedures must be followed.

Inspection

Inspect unit for installation damage. If found, take action and/or repair as appropriate.

Refrigerant Charge

Packaged units are normally shipped as standard with a full refrigerant operating charge. Check that refrigerant pressure is present in both systems and that no leaks are apparent. If no pressure is present, a leak test must be undertaken, the leak(s) located and repaired. Remote systems and units are supplied with a nitrogen holding charge. These systems must be evacuated with a suitable vacuum pump/recovery unit as appropriate to below 500 microns.

Do not liquid charge with static water in the cooler. Care must also be taken to liquid charge slowly to avoid excessive thermal stress at the charging point. Once the vacuum is broken, charge into the condenser coils with the full operating charge as given in the Technical Data Section.

Service and Oil Line Valves

Open each compressor suction, economizer, and discharge service valve. If valves are of the back-seat type, open them fully (counterclockwise) then close one turn of the stem to ensure operating pressure is fed to pressure transducers. Open the liquid line service valve and oil return line ball valve fully in each system.

Compressor Oil

To add oil to a circuit - connect a YORK hand oil pump (Part No. 470-10654-000) to the 1/4" oil charging valve on the oil separator piping with a length of clean hose or copper line, but do not tighten the flare nut. Using clean oil of the correct type ("L" oil), pump oil until all air has been purged from the hose then tighten the nut. Stroke the oil pump to add oil to the oil system. The oil level should be between the middle of the lower and middle of the upper sight glasses of the oil separator. Approximately 4-5 gallons is present in the each refrigerant system, with typically 1-2 gallons in each oil separator. Oil levels in the oil separators above the top sight glass in either oil separator should be avoided and may cause excessive oil carryover in the system. High oil concentration in the system may cause nuisance trips resulting from incorrect readings on the level sensor and temperature sensors. Temperature sensor errors may result in poor liquid control and resultant liquid overfeed and subsequent damage to the compressor.

Fans

Check that all fans are free to rotate and are not damaged. Ensure blades are at the same height when rotated. Ensure fan guards are securely fixed.

Isolation / Protection

Verify all sources of electrical supply to the unit are taken from a single point of isolation. Check that the maximum recommended fuse sizes given in the Technical Data Section has not been exceeded.

Control Panel

Check the panel to see that it is free of foreign materials (wire, metal chips, etc.) and clean out if required.

Power Connections

Check that the customer power cables are connected correctly to the terminal blocks or optional circuit breaker. Ensure that connections of power cables within the panels to the circuit breaker or terminal blocks are tight.

Grounding

Verify that the unit's protective ground terminal(s) are properly connected to a suitable grounding point. Ensure that all unit internal ground connections are tight.

Water System

Verify the chilled liquid system has been installed correctly, and has been commissioned with the correct direction of water flow through the cooler. The inlet should be at the refrigerant piping connection end of the cooler. Purge air from the top of the cooler using the plugged air vent mounted on the top of the cooler body. Flow rates and pressure drops must be within the limits given in the Technical Data Section. Operation outside of these limits is undesirable and could cause damage.

If mains power must be switched OFF for extended maintenance or an extended shutdown period, the compressor suction, discharge and economizer service stop valves should be closed (clockwise). If there is a possibility of liquid freezing due to low ambient temperatures, the coolers should be drained or power should be applied to the chiller. This will allow the cooler heater to protect the cooler from freezing down to -20°F . Before placing the unit back in service, valves should be opened and power must be switched on (if power is removed for more than 8 hours) for at least 8 hours (24 hours if ambient temperature is below 86°F [30°C]) before the unit is restarted.

Flow Switch

Verify a chilled water flow switch is correctly fitted in the customer's piping on the cooler outlet, and wired into the control panel correctly using shielded cable.

There should be a straight run of at least 5 pipe diameters on either side of the flow switch. The flow switch should be connected to terminals 2 and 13 in the panel.

Temperature Sensor(s)

Ensure the leaving liquid temperature sensor is coated with heat conductive compound (Part No. 013-00890-000) and is inserted to the bottom of the water outlet sensor well in the evaporator. This sensor is part of the

pump control freeze protection operation. It provides some freeze protection and must always be fully inserted in the water outlet sensor well.

Programmed Options

Verify that the options factory-programmed into the Micro Panel are in accordance with the customer's order requirements by pressing the OPTIONS Key on the keypad and reading the settings from the display.

Programmed Settings

Ensure the system cutout and operational settings are in accordance with the operating requirements by pressing the PROGRAM key.

Date and Time

Program the date and time by first ensuring that the CLK jumper JP2 on the chiller control board is in the ON position. See FIG. 14, Page 138. Then press the DATE/TIME key and set the date and time. (See Page 252.)

Start/Stop Schedule

Program the daily and holiday start/stop by pressing the SCHEDULE key. (See Page 253.)

Setpoint and Remote Offset

Set the required leaving chilled liquid temperature setpoint and control range under the SETPOINTS Key. The chilled liquid temperature control settings need to be set according to the required operating conditions.

If remote temperature reset (offset) is to be used, the maximum reset required must be programmed by pressing the SETPOINTS Key. (See Page 243.)

FIRST TIME START-UP



During the commissioning period there should be sufficient heat load to run the unit under stable full load operation to enable the unit controls, and system operation to be set up correctly, and a commissioning log taken. Be sure that the chiller is properly programmed and the System Start-up Checklist (Page 152) is completed.

Interlocks

Verify that liquid is flowing through the cooler and that heat load is present. Ensure that any remote run interlocks are in the run position and that the daily schedule requires the unit to run or is overridden.

Unit Switch

Place the “Unit Switch” on the keypad to the ON position.

Start-up

Press the SYSTEM SWITCHES Key and place the system switch for System 1 to the ON position. There may be a few seconds delay before the first compressor starts because of the anti-recycle timer). Be ready when each compressor starts, to switch the UNIT Switch OFF immediately, if any unusual noises or other adverse conditions develop.

When a compressor is running, the controller monitors oil pressure, motor current, and various other system parameters such as discharge pressure, chilled liquid temperature, etc. Should any problems occur, the control system will immediately take appropriate action and display the nature of the fault.

Oil Pressure

When a compressor starts, press the relevant ‘System Pressures’ key and verify that oil differential pressure (oil pressure-suction pressure) develops immediately. If oil pressure does not develop, the automatic controls will shut down the compressor. Under no circumstances should a restart attempt be made on a compressor, which does not develop oil pressure immediately. Switch the UNIT Switch to the OFF position.

Refrigerant Flow

When a compressor starts, a flow of liquid refrigerant will be seen in the liquid line sight glass. After several minutes of operation, and provided a full charge of refrigerant is in the system, the bubbles will disappear and be replaced by a solid column of liquid.

Loading

Once the unit has been started, all operations are fully automatic. After an initial period at minimum capacity, the control system will adjust the unit load depending

on the chilled liquid temperature and rate of temperature change. If a high heat load is present, the controller will increase the speed of the compressor(s).

Condenser and Fan Rotation

Once a compressor is running, discharge pressure rises as refrigerant is pumped into the air-cooled condenser coils. This pressure is controlled by stages of fans to ensure maximum unit efficiency while maintaining sufficient pressure for correct operation of the condensers and the lubrication system.

As discharge pressure rises, the condenser fans operate in stages to control the pressure. Verify that the fans operate in the correct direction of rotation and operation is correct for the type of unit.

Suction Superheat

Check suction superheat at steady full compressor load only. Measure suction temperature with a thermocouple on the copper line about 6” (150 mm) before the compressor suction service valve. Measure suction pressure at the suction transducer access valve or the compressor suction service valve. Superheat should be 10°F to 12°F (5.55 to 6.67°C) and should be reasonably close to the panel display. Superheat setting is programmable on the control panel, but is not mechanically adjustable. The Flash Tank Drain Valve controller modulates the 2-phase drain valve stepper motor to control system superheat. Superheat control is a function of suction pressure and suction temperature measurements from the sensors that are routed to the Chiller Control Board which in turn sends control signals to the Flash Tank Drain and Fill Valve Controller located in the left, back wall of the Chiller Controls Cabinet.

Subcooling

Check liquid subcooling at steady full compressor load only. It is important that all fans are running for the system. Measure liquid line temperature on the copper line at the main liquid line service valve. Measure liquid pressure at the liquid line service valve. Subcooling should be 5 - 7°F (2.77 - 3.88°C). YCAV 0157 subcooling should be 10°F (5.55°C). No bubbles should show in the sight glass. If subcooling is out of range, add or remove refrigerant as required to clear the sight glass. Do not overcharge the unit. Subcooling should be checked with a flash tank level of approximately 35% with a clear sight glass.

General Operation

After completion of the above checks for System 1, switch OFF the 'SYS 1' switch on the keypad and repeat the process for each subsequent system. When all run correctly, stop the unit, switch all applicable switches to the 'ON' position and restart the unit.

Assure all checks are completed in the EQUIPMENT START-UP CHECK SHEET (Pages 152-157). The chiller is then ready to be placed into operation.

WATER PRESSURE DROP

Pressure Drop Through YCAV Evaporators
(English Units)

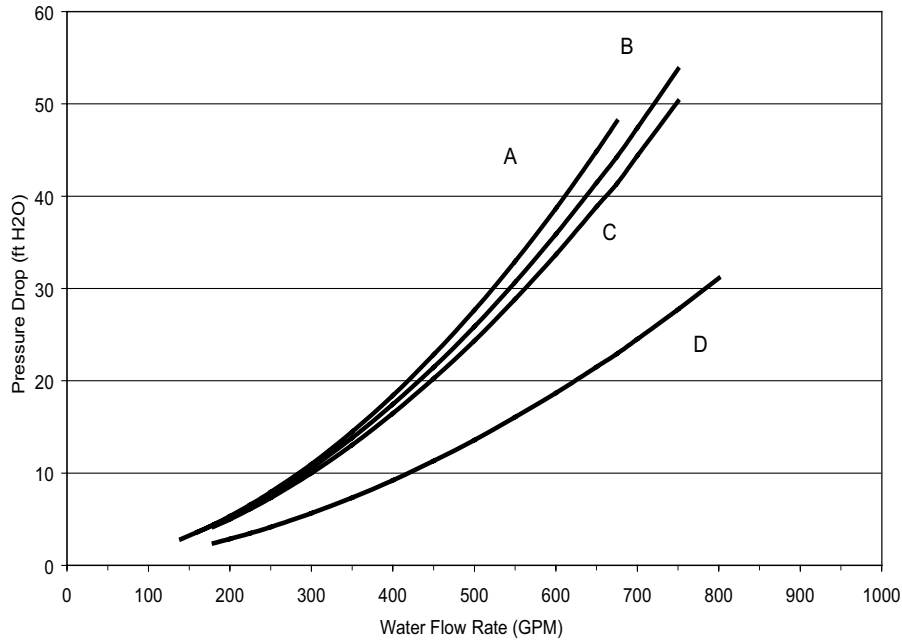

LD10497

Pressure Drop Through YCAV Evaporators
(SI Units)

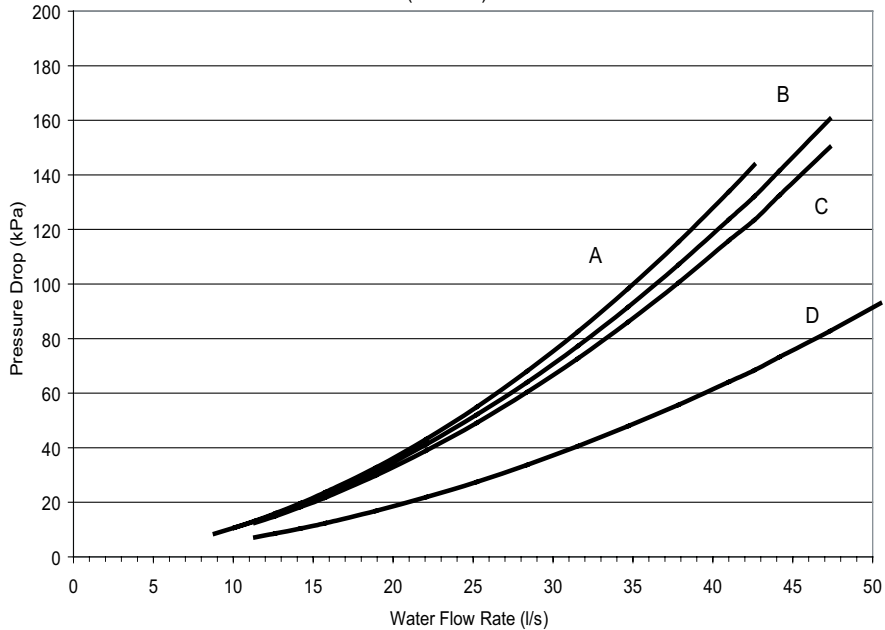

MODEL NUMBER YCAV	COOLER
0157(S/P)	A
0157(E/V), 0177, 0187	B
0207, 0227	C
0247, 0267	D

LD10498

GLYCOL CORRECTION FACTORS

The cooler is designed in accordance with ARI-590-92 which allows for an increase in pressure drop of up to 15% above the design value shown on page 40. Debris in the water may also cause additional pressure drop.

When using glycol solutions, pressure drops are higher than with water (see correction factors to be applied when using glycol solutions). Special care must be taken not to exceed the maximum flow rate allowed.

- A= Correction Factor
- B= Mean Temperature through Cooler
- C= Concentration W/W

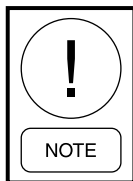

Excessive flow, above the max. GPM, will damage the evaporator.

GLYCOL CORRECTION FACTORS

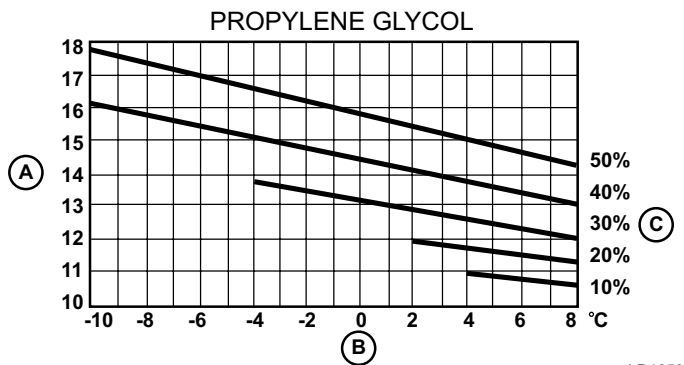
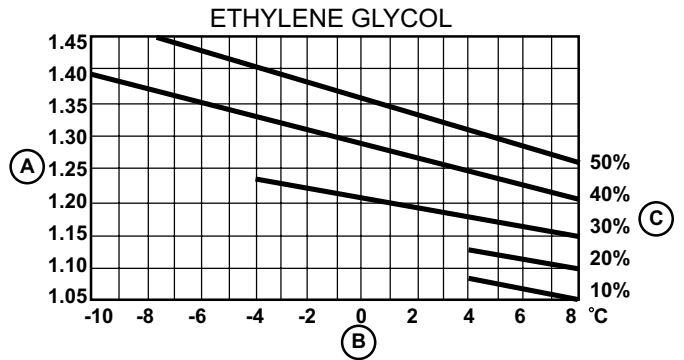

LD10500

WATER TEMPERATURE AND FLOWS

TEMPERATURE AND FLOWS (ENGLISH UNITS)						
MODEL NUMBER YCAV	LEAVING WATER TEMPERATURE (F°)		COOLER FLOW (GPM)		AIR ON CONDENSOR (F°)	
	MIN. ¹	MAX. ²	MIN.	MAX.	MIN.	MAX.
0157	40	60	140	675	0	125
0177	40	60	160	750	0	125
0187	40	60	160	750	0	125
0197	40	60	160	750	0	125
0207	40	60	160	750	0	125
0227	40	60	160	750	0	125
0247	40	60	180	750	0	125
0267	40	60	180	800	0	125

NOTES:

1. For leaving brine temperature below 40°F (4.4°C), contact your nearest YORK office for application requirements.
2. For leaving water temperature higher than 60°F (15.6°C), contact the nearest YORK office for application guidelines.

TEMPERATURE AND FLOWS (SI UNITS)						
MODEL NUMBER YCAV	LEAVING WATER TEMPERATURE (C°)		COOLER FLOW (l/s)		AIR ON CONDENSOR (C°)	
	MIN. ¹	MAX. ²	MIN.	MAX.	MIN.	MAX.
0157	4.4	15.6	8.8	42.6	-17.7	51.7
0177	4.4	15.6	10.1	47.3	-17.7	51.7
0187	4.4	15.6	10.1	47.3	-17.7	51.7
0197	4.4	15.6	10.1	47.3	-17.7	51.7
0207	4.4	15.6	10.1	47.3	-17.7	51.7
0227	4.4	15.6	11.4	47.3	-17.7	51.7
0247	4.4	15.6	11.4	47.3	-17.7	51.7
0267	4.4	15.6	11.4	50.5	-17.7	51.7

NOTES:

1. For leaving brine temperature below 40°F (4.4°C), contact your nearest YORK office for application requirements.
2. For leaving water temperature higher than 60°F (15.6°C), contact the nearest YORK office for application guidelines.

This page intentionally left blank.

PHYSICAL DATA (ENGLISH - High Efficiency)

Refrigerant R-134a	HIGH EFFICIENCY						
	Model Number (YCAV E/V)						
	YCAV0157	YCAV0177	YCAV0187	YCAV0197	YCAV0207	YCAV0227	YCAV0247
General Unit Data							
Number of Independent Refrigerant Circuits	2	2	2	2	2	2	2
Refrigerant Charge, R-134a, Ckt.-1/Ckt.-2, lbs	170/170	185/170	185/185	192/192	225/192	225/225	230/230
Oil Charge, Ckt.-1/Ckt.-2, gal.	4.5/4.5	4.5/4.5	5/5	5/5	5/5	5/5	5/5
Compressors, Semihermetic Screw Qty per Chiller	2	2	2	2	2	2	2
Condensers, High Efficiency Fin/Tube with Integral Subcooler							
Total Chiller Coil Face Area, ft ²	235	264	293	293	323	352	352
Number of Rows	3	3	3	3	3	3	3
Fins per Inch	17	17	17	17	17	17	17
Condenser Fans							
Number, Ckt.-1/Ckt.-2	4/4	5/4	5/5	5/5	6/5	6/6	6/6
Low Sound Fans							
Fan Motor, HP	2	2	2	2	2	2	2
Fan & Motor Speed, revs./min.	1140	1140	1140	1140	1140	1140	1140
Fan Diameter, inches	35.4	35.4	35.4	35.4	35.4	35.4	35.4
Fan Tip Speed, ft./min.	10575	10575	10575	10575	10575	10575	10575
Total Chiller Airflow, cfm	104000	117000	130000	130000	143000	156000	156000
Ultra Quiet Fans							
Fan Motor, HP	2	2	2	2	2	2	2
Fan & Motor Speed, revs./min.	838	838	838	838	838	838	838
Fan Diameter, inches	35.4	35.4	35.4	35.4	35.4	35.4	35.4
Fan Tip Speed, ft./min.	7774	7774	7774	7774	7774	7774	7774
Total Chiller Airflow, cfm	104000	117000	130000	130000	143000	156000	156000
Evaporator, Direct Expansion							
Water Volume, gals.	95.0	95.0	95.0	110.0	110.0	110.0	140.0
Maximum Water Side Pressure, PSIG ¹	150	150	150	150	150	150	150
Maximum Refrigerant Side Pressure, PSIG	235	235	235	235	235	235	235
Minimum Chilled Water Flow Rate, gpm	150	150	150	180	180	180	180
Maximum Chilled Water Flow Rate, gpm	750	750	750	750	750	750	800
Water Connections, inches	10	10	10	10	10	10	10

¹ Optional 300 PSIG Waterside available

PHYSICAL DATA (SI - High Efficiency)

Refrigerant R-134a	HIGH EFFICIENCY						
	Model Number (YCAV _____ E/V)						
General Unit Data	YCAV0157	YCAV0177	YCAV0187	YCAV0197	YCAV0207	YCAV0227	YCAV0247
Number of Independent Refrigerant Circuits	2	2	2	2	2	2	2
Refrigerant Charge, R-134a, Ckt.-1/Ckt.-2, kg.	77/77	84/77	84/84	87/87	102/87	102/102	105/105
Oil Charge, Ckt.-1/Ckt.-2, liters	17/17	17/17	19/19	19/19	19/19	19/19	19/19
Compressors, Semihermetic Screw Qty per Chiller	2	2	2	2	2	2	2
Condensers, High Efficiency Fin/Tube with Integral Subcooler							
Total Chiller Coil Face Area, m ²	21.8	24.5	27.2	27.2	30.0	32.7	32.7
Number of Rows	3	3	3	3	3	3	3
Fins per meter	669	669	669	669	669	669	669
Condenser Fans							
Number, Ckt.-1/Ckt.-2	4/4	5/4	5/5	5/5	6/5	6/6	6/6
Standard Fans							
Fan Motor, HP	2	2	2	2	2	2	2
Fan & Motor Speed, revs./sec.	19.0	19.0	19.0	19.0	19.0	19.0	19.0
Fan Diameter, mm	899	899	899	899	899	899	899
Fan Tip Speed, m/sec.	53.7	53.7	53.7	53.7	53.7	53.7	53.7
Total Chiller Airflow, l/sec.	49082	55218	61353	61353	67488	73624	73624
Low Noise Fans							
Fan Motor, HP	2	2	2	2	2	2	2
Fan & Motor Speed, revs./sec.	14.0	14.0	14.0	14.0	14.0	14.0	14.0
Fan Diameter, mm	899	899	899	899	899	899	899
Fan Tip Speed, m/sec.	39	39	39	39	39	39	39
Total Chiller Airflow, l/sec.	49082	55218	61353	61353	67488	73624	73624
Evaporator, Direct Expansion							
Water Volume, liters	359.6	359.6	359.6	416.4	416.4	416.4	529.9
Maximum Water Side Pressure, Bar ¹	10	10	10	10	10	10	10
Maximum Refrigerant Side Pressure, Bar	16	16	16	16	16	16	16
Minimum Chilled Water Flow Rate, l/sec.	9.5	9.5	9.5	11.4	11.4	11.4	11.4
Maximum Chilled Water Flow Rate, l/sec.	47.3	47.3	47.3	47.3	47.3	47.3	50.5
Water Connections, inches	10	10	10	10	10	10	10

¹Optional 21 Bar Waterside available

PHYSICAL DATA (ENGLISH - Standard Efficiency)

Refrigerant R-134a	STANDARD EFFICIENCY						
	Model Number (YCAV _____ S/P)						
	YCAV0157	YCAV0177	YCAV0187	YCAV0207	YCAV0227	YCAV0247	YCAV0267
General Unit Data							
Number of Independent Refrigerant Circuits	2	2	2	2	2	2	2
Refrigerant Charge, R-134a, Ckt.-1/Ckt.-2, lbs	162/162	170/170	185/170	192/175	192/192	230/195	230/230
Oil Charge, Ckt.-1/Ckt.-2, gal.	4.5/4.5	4.5/4.5	5/5	5/5	5/5	5/5	5/5
Compressors, Semi-hermetic Screw Qty per Chiller	2	2	2	2	2	2	2
Condensers, High Efficiency Fin/Tube with Integral Subcooler							
Total Chiller Coil Face Area, ft ²	235	235	264	264	293	323	352
Number of Rows	3	3	3	3	3	3	3
Fins per Inch	17	17	17	17	17	17	17
Condenser Fans							
Number, Ckt.-1/Ckt.-2	4/4	4/4	5/4	5/4	5/5	6/5	6/6
Low Sound Fans							
Fan Motor, HP	2	2	2	2	2	2	2
Fan & Motor Speed, revs./min.	1140	1140	1140	1140	1140	1140	1140
Fan Diameter, inches	35.4	35.4	35.4	35.4	35.4	35.4	35.4
Fan Tip Speed, ft./min.	10575	10575	10575	10575	10575	10575	10575
Total Chiller Airflow, cfm	104000	104000	117000	117000	130000	143000	156000
Ultra Quiet Fans							
Fan Motor, HP	2	2	2	2	2	2	2
Fan & Motor Speed, revs./min.	838	838	838	838	838	838	838
Fan Diameter, inches	35.4	35.4	35.4	35.4	35.4	35.4	35.4
Fan Tip Speed, ft./min.	7774	7774	7774	7774	7774	7774	7774
Total Chiller Airflow, cfm	104000	104000	117000	117000	130000	143000	156000
Evaporator, Direct Expansion							
Water Volume, gals.	67.0	95.0	95.0	110.0	110.0	140.0	140.0
Maximum Water Side Pressure, PSIG ¹	150	150	150	150	150	150	150
Maximum Refrigerant Side Pressure, PSIG	235	235	235	235	235	235	235
Minimum Chilled Water Flow Rate, gpm	140	150	150	180	180	180	180
Maximum Chilled Water Flow Rate, gpm	675	750	750	750	750	800	800
Water Connections, inches	8	10	10	10	10	10	10

¹Optional 21 Bar Waterside available

PHYSICAL DATA (SI - Standard Efficiency)

Refrigerant R-134a	STANDARD EFFICIENCY						
	Model Number (YCAV____S/P)						
	YCAV0157	YCAV0177	YCAV0187	YCAV0207	YCAV0227	YCAV0247	YCAV0267
General Unit Data							
Number of Independent Refrigerant Circuits	2	2	2	2	2	2	2
Refrigerant Charge, R-134a, Ckt.-1/Ckt.-2, kg.	74/74	77/77	84/77	87/80	87/87	105/89	105/105
Oil Charge, Ckt.-1/Ckt.-2, liters	17/17	17/17	19/19	19/19	19/19	19/19	19/19
Compressors, Semihermetic Screw Qty per Chiller	2	2	2	2	2	2	2
Condensers, High Efficiency Fin/Tube with Integral Subcooler							
Total Chiller Coil Face Area, m ²	21.8	21.8	24.5	24.5	27.2	30.0	32.7
Number of Rows	3	3	3	3	3	3	3
Fins per meter	669	669	669	669	669	669	669
Condenser Fans							
Number, Ckt.-1/Ckt.-2	4/4	4/4	5/4	5/4	5/5	6/5	6/6
Low Sound Fans							
Fan Motor, HP	2	2	2	2	2	2	2
Fan & Motor Speed, revs./sec.	19.0	19.0	19.0	19.0	19.0	19.0	19.0
Fan Diameter, mm	899	899	899	899	899	899	899
Fan Tip Speed, m/sec.	53.7	53.7	53.7	53.7	53.7	53.7	53.7
Total Chiller Airflow, l/sec.	49082	49082	55218	55218	61353	67488	73624
Ultra Quiet Fans							
Fan Motor, HP	2	2	2	2	2	2	2
Fan & Motor Speed, revs./sec.	14.0	14.0	14.0	14.0	14.0	14.0	14.0
Fan Diameter, mm	899	899	899	899	899	899	899
Fan Tip Speed, m/sec.	39	39	39	39	39	39	39
Total Chiller Airflow, l/sec.	49082	49082	55218	55218	61353	67488	73624
Evaporator, Direct Expansion							
Water Volume, liters	253.6	359.6	359.6	416.4	416.4	529.9	529.9
Maximum Water Side Pressure, Bar ¹	10	10	10	10	10	10	10
Maximum Refrigerant Side Pressure, Bar	16	16	16	16	16	16	16
Minimum Chilled Water Flow Rate, l/sec.	8.8	9.5	9.5	11.4	11.4	11.4	11.4
Maximum Chilled Water Flow Rate, l/sec.	42.6	47.3	47.3	47.3	47.3	50.5	50.5
Water Connections, inches	8	10	10	10	10	10	10

¹Optional 21 Bar Waterside available

OPERATING LIMITATIONS AND SOUND DATA

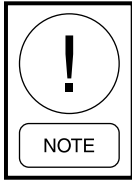

Contact Product Application Marketing for Sound Power Data

ELECTRICAL DATA

2 COMPRESSOR POWER WIRING CONNECTIONS

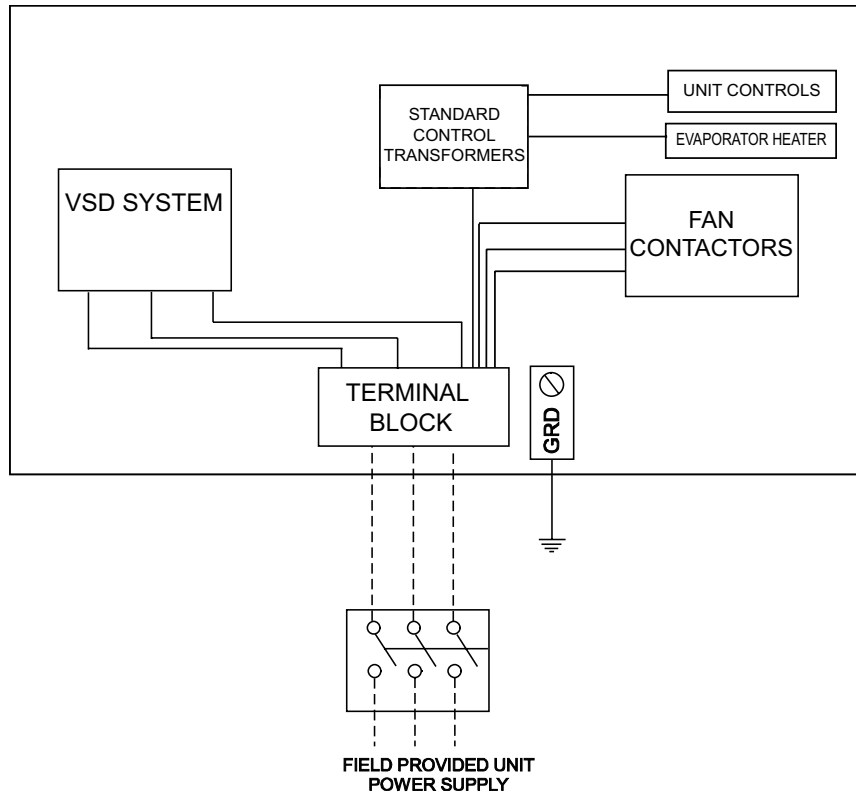

6

LD10598a

FIG. 6 - SINGLE-POINT POWER SUPPLY CONNECTION WITH FIELD SUPPLIED CIRCUIT PROTECTION

VSD CONTROL PANEL

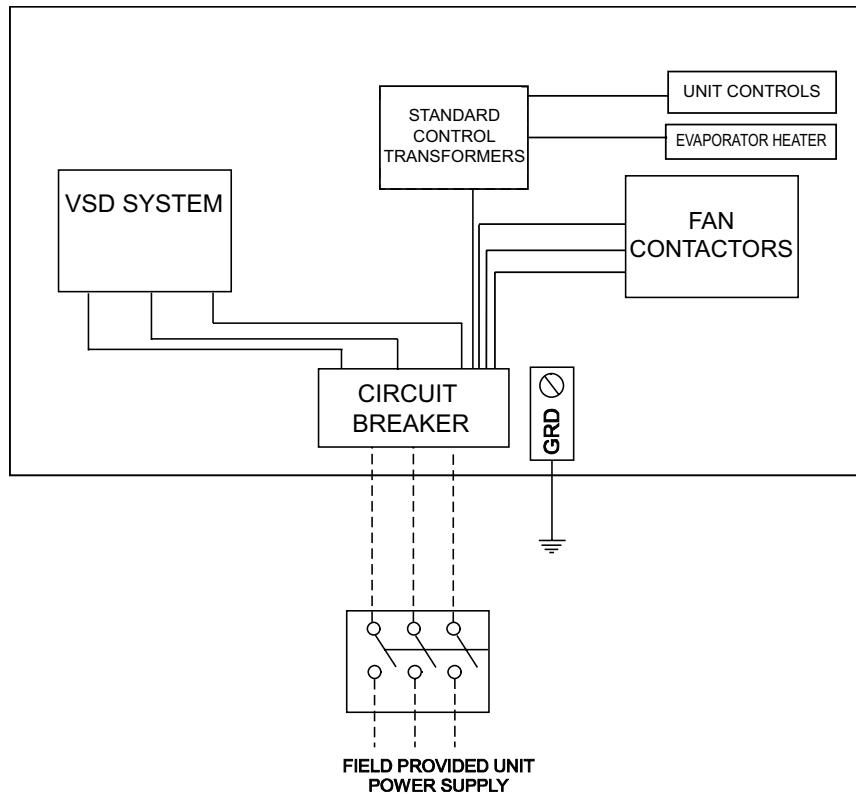

LD10599a

FIG. 7 - SINGLE-POINT POWER SUPPLY CONNECTION WITH OPTIONAL FACTORY CIRCUIT BREAKER

HIGH EFFICIENCY 2-Compressor Units (See FIG. 7)

(One Field Provided Power Supply Circuit to the Chiller.
Field Connection to Factory provided Terminal Block (Standard)
or Circuit Breaker (optional).

Model Number /Nameplate			System 1			System 2			Control KVA ⁸	Unit Short Circuit Withstand (KA)	
			Compressor	Cond. Fans		Compressor	Cond. Fans			Terminal Block (STD)	Circuit Breaker (OPT)
YCAV	Input Volts	Input Freq	RLA ⁶	Qty	FLA (EA)	RLA ⁶	Qty	FLA (EA)			
0157	200	60	254	4	6.5	254	4	6.5	1.8	30KA	100KA
	230	60	220	4	5.6	220	4	5.6	1.8	30KA	100KA
	380	60	139	4	3.5	139	4	3.5	1.8	30KA	65KA
	460	60	110	4	2.8	110	4	2.8	1.8	30KA	65KA
	575	60	88	4	2.2	88	4	2.2	1.8	30KA	42KA
0177	200	60	257	5	6.5	281	4	6.5	1.8	30KA	100KA
	230	60	223	5	5.6	244	4	5.6	1.8	30KA	100KA
	380	60	140	5	3.5	154	4	3.5	1.8	30KA	65KA
	460	60	111	5	2.8	122	4	2.8	1.8	30KA	65KA
	575	60	89	5	2.2	97	4	2.2	1.8	30KA	42KA
0187	200	60	356	5	6.5	242	5	6.5	1.8	30KA	100KA
	230	60	308	5	5.6	210	5	5.6	1.8	30KA	100KA
	380	60	194	5	3.5	132	5	3.5	1.8	30KA	65KA
	460	60	154	5	2.8	105	5	2.8	1.8	30KA	65KA
	575	60	123	5	2.2	84	5	2.2	1.8	30KA	42KA
0197	200	60	326	5	6.5	326	5	6.5	1.8	30KA	100KA
	230	60	283	5	5.6	283	5	5.6	1.8	30KA	100KA
	380	60	178	5	3.5	178	5	3.5	1.8	30KA	65KA
	460	60	141	5	2.8	141	5	2.8	1.8	30KA	65KA
	575	60	113	5	2.2	113	5	2.2	1.8	30KA	42KA
0207	200	60	327	6	6.5	353	5	6.5	1.8	30KA	100KA
	230	60	283	6	5.6	306	5	5.6	1.8	30KA	100KA
	380	60	178	6	3.5	193	5	3.5	1.8	30KA	65KA
	460	60	141	6	2.8	152	5	2.8	1.8	30KA	65KA
	575	60	113	6	2.2	122	5	2.2	1.8	30KA	42KA
0227	200	60	347	6	6.5	347	6	6.5	1.8	30KA	100KA
	230	60	301	6	5.6	301	6	5.6	1.8	30KA	100KA
	380	60	190	6	3.5	190	6	3.5	1.8	30KA	65KA
	460	60	150	6	2.8	150	6	2.8	1.8	30KA	65KA
	575	60	120	6	2.2	120	6	2.2	1.8	30KA	42KA
0247	200	60	449	6	6.5	344	6	6.5	1.8	30KA	100KA
	230	60	389	6	5.6	298	6	5.6	1.8	30KA	100KA
	380	60	245	6	3.5	188	6	3.5	1.8	30KA	65KA
	460	60	193	6	2.8	148	6	2.8	1.8	30KA	65KA
	575	60	155	6	2.2	119	6	2.2	1.8	30KA	42KA

HIGH EFFICIENCY 2-Compressor Units (Con't)

(One Field Provided Power Supply Circuit to the Chiller.
Field Connection to Factory provided Terminal Block (Standard)
or Circuit Breaker (optional).

YCAV	Field Wiring & Protection				Field Wiring Lugs		Field Wiring Lugs	
					STD Terminal Block		OPT Circuit Breaker	
	Min Ckt. Ampacity (MCA) ⁴	Recommended Fuse/Ckt. Brkr Rating ⁵	Max. Inverse Time Ckt. Brkr. Rating ²	Max Dual Element Fuse Size ³	Lugs/Phase ¹	Lug Wire Range	Lugs/Phase ¹	Lug Wire Range
0157	624	700	1600	1000	4	2AWG - 600 kcmil	4	4/0AWG - 500 kcmil
	540	600	1600	1000	4	2AWG - 600 kcmil	4	4/0AWG - 500 kcmil
	341	400	800	600	3	2AWG - 600 kcmil	3	3/0AWG - 400 kcmil
	270	300	700	450	2	2AWG - 600 kcmil	2	2/0AWG - 500 kcmil
	216	250	500	350	2	2AWG - 600 kcmil	2	2/0AWG - 500 kcmil
0177	661	800	1600	1200	4	2AWG - 600 kcmil	4	4/0AWG - 500 kcmil
	572	700	1600	1000	4	2AWG - 600 kcmil	4	4/0AWG - 500 kcmil
	361	400	1000	600	3	2AWG - 600 kcmil	3	3/0AWG - 400 kcmil
	285	350	700	500	2	2AWG - 600 kcmil	2	2/0AWG - 500 kcmil
	229	250	600	400	2	2AWG - 600 kcmil	2	2/0AWG - 500 kcmil
0187	751	1000	1600	1200	4	2AWG - 600 kcmil	4	4/0AWG - 500 kcmil
	651	800	1600	1200	4	2AWG - 600 kcmil	4	4/0AWG - 500 kcmil
	411	500	1000	700	3	2AWG - 600 kcmil	3	3/0AWG - 400 kcmil
	324	400	800	500	2	2AWG - 600 kcmil	2	2/0AWG - 500 kcmil
	260	300	600	450	2	2AWG - 600 kcmil	2	2/0AWG - 500 kcmil
0197	799	1000	1600	1600	4	2AWG - 600 kcmil	4	4/0AWG - 500 kcmil
	692	800	1600	1200	4	2AWG - 600 kcmil	4	4/0AWG - 500 kcmil
	437	500	1000	700	3	2AWG - 600 kcmil	3	3/0AWG - 400 kcmil
	345	400	800	600	2	2AWG - 600 kcmil	2	2/0AWG - 500 kcmil
	277	350	700	450	2	2AWG - 600 kcmil	2	2/0AWG - 500 kcmil
0207	832	1000	1600	1600	4	2AWG - 600 kcmil	4	4/0AWG - 500 kcmil
	721	800	1600	1200	4	2AWG - 600 kcmil	4	4/0AWG - 500 kcmil
	455	500	1200	800	3	2AWG - 600 kcmil	3	3/0AWG - 400 kcmil
	359	400	1000	600	2	2AWG - 600 kcmil	2	2/0AWG - 500 kcmil
	288	350	700	500	2	2AWG - 600 kcmil	2	2/0AWG - 500 kcmil
0227	859	1000	1600	1600	4	2AWG - 600 kcmil	4	4/0AWG - 500 kcmil
	744	1000	1600	1200	4	2AWG - 600 kcmil	4	4/0AWG - 500 kcmil
	470	600	1200	800	3	2AWG - 600 kcmil	3	3/0AWG - 400 kcmil
	371	450	1000	600	2	2AWG - 600 kcmil	2	2/0AWG - 500 kcmil
	297	350	700	500	2	2AWG - 600 kcmil	2	2/0AWG - 500 kcmil
0247	982	1200	1600	1600	4	2AWG - 600 kcmil	4	4/0AWG - 500 kcmil
	851	1000	1600	1600	4	2AWG - 600 kcmil	4	4/0AWG - 500 kcmil
	537	600	1200	1000	3	2AWG - 600 kcmil	3	3/0AWG - 400 kcmil
	424	500	1000	700	2	2AWG - 600 kcmil	2	2/0AWG - 500 kcmil
	340	400	800	600	2	2AWG - 600 kcmil	2	2/0AWG - 500 kcmil

STANDARD EFFICIENCY 2-Compressor Units (See FIG. 6)

(One Field Provided Power Supply Circuit.

Field Connections to Factory provided Terminal Block (Standard), or Individual System Breakers(Optional).

Model Number /Nameplate			System 1			System 2			Control KVA ⁸	Unit Short Circuit Withstand (KA)	
			Compressor	Cond. Fans		Compressor	Cond. Fans			Terminal Block (STD)	Circuit Breaker (OPT)
YCAV	Input Volts	Input Freq	RLA ⁶	Qty	FLA (EA)	RLA ⁶	Qty.	FLA (EA)			
0157	200	60	278	4	6.5	278	4	6.5	1.8	30KA	100KA
	230	60	241	4	5.6	241	4	5.6	1.8	30KA	100KA
	380	60	152	4	3.5	152	4	3.5	1.8	30KA	65KA
	460	60	120	4	2.8	120	4	2.8	1.8	30KA	65KA
	575	60	96	4	2.2	96	4	2.2	1.8	30KA	42KA
0177	200	60	368	4	6.5	244	4	6.5	1.8	30KA	100KA
	230	60	319	4	5.6	211	4	5.6	1.8	30KA	100KA
	380	60	201	4	3.5	133	4	3.5	1.8	30KA	65KA
	460	60	159	4	2.8	105	4	2.8	1.8	30KA	65KA
	575	60	127	4	2.2	84	4	2.2	1.8	30KA	42KA
0187	200	60	376	5	6.5	278	4	6.5	1.8	30KA	100KA
	230	60	325	5	5.6	241	4	5.6	1.8	30KA	100KA
	380	60	205	5	3.5	152	4	3.5	1.8	30KA	65KA
	460	60	162	5	2.8	120	4	2.8	1.8	30KA	65KA
	575	60	130	5	2.2	96	4	2.2	1.8	30KA	42KA
0207	200	60	336	5	6.5	379	4	6.5	1.8	30KA	100KA
	230	60	291	5	5.6	328	4	5.6	1.8	30KA	100KA
	380	60	184	5	3.5	207	4	3.5	1.8	30KA	65KA
	460	60	145	5	2.8	163	4	2.8	1.8	30KA	65KA
	575	60	116	5	2.2	131	4	2.2	1.8	30KA	42KA
0227	200	60	375	5	6.5	375	5	6.5	1.8	30KA	100KA
	230	60	325	5	5.6	325	5	5.6	1.8	30KA	100KA
	380	60	205	5	3.5	205	5	3.5	1.8	30KA	65KA
	460	60	162	5	2.8	162	5	2.8	1.8	30KA	65KA
	575	60	130	5	2.2	130	5	2.2	1.8	30KA	42KA
0247	200	60	448	6	6.5	371	5	6.5	1.8	30KA	100KA
	230	60	388	6	5.6	321	5	5.6	1.8	30KA	100KA
	380	60	245	6	3.5	203	5	3.5	1.8	30KA	65KA
	460	60	193	6	2.8	160	5	2.8	1.8	30KA	65KA
	575	60	155	6	2.2	128	5	2.2	1.8	30KA	42KA
0267	200	60	444	6	6.5	444	6	6.5	1.8	30KA	100KA
	230	60	385	6	5.6	385	6	5.6	1.8	30KA	100KA
	380	60	242	6	3.5	242	6	3.5	1.8	30KA	65KA
	460	60	191	6	2.8	191	6	2.8	1.8	30KA	65KA
	575	60	154	6	2.2	154	6	2.2	1.8	30KA	42KA

STANDARD EFFICIENCY 2-Compressor Units (Con't)

(One Field Provided Power Supply Circuit.
Field Connections to Factory provided Terminal Block (Standard),
or Individual System Breakers(Optional).

YCAV	Field Wiring & Protection				Field Wiring Lugs STD Terminal Block		Field Wiring Lugs OPT Circuit Breaker	
	Minimum Ckt. Ampacity (MCA) ⁴	Recommended Fuse/Ckt. Breaker Rating ⁵	Max. Inverse Time Ckt. Brkr. Rating ²	Max Dual Element Fuse Size ³	Lugs/ Phase ¹	Lug Wire Range	Lugs/ Phase ¹	Lug Wire Range
0157	677	800	1600	1200	4	2AWG - 600 kcmil	4	4/0AWG - 500 kcmil
	587	700	1600	1000	4	2AWG - 600 kcmil	4	4/0AWG - 500 kcmil
	370	450	1000	600	3	2AWG - 600 kcmil	3	3/0AWG - 400 kcmil
	293	350	700	500	2	2AWG - 600 kcmil	2	2/0AWG - 500 kcmil
	234	300	600	400	2	2AWG - 600 kcmil	2	2/0AWG - 500 kcmil
0177	755	1000	2000	1200	4	2AWG - 600 kcmil	4	4/0AWG - 500 kcmil
	654	800	1600	1200	4	2AWG - 600 kcmil	4	4/0AWG - 500 kcmil
	413	500	1000	700	3	2AWG - 600 kcmil	3	3/0AWG - 400 kcmil
	326	400	800	600	2	2AWG - 600 kcmil	2	2/0AWG - 500 kcmil
	261	300	600	450	2	2AWG - 600 kcmil	2	2/0AWG - 500 kcmil
0187	805	1000	2000	1600	4	2AWG - 600 kcmil	4	4/0AWG - 500 kcmil
	698	800	1600	1200	4	2AWG - 600 kcmil	4	4/0AWG - 500 kcmil
	440	500	1000	700	3	2AWG - 600 kcmil	3	3/0AWG - 400 kcmil
	348	400	800	600	2	2AWG - 600 kcmil	2	2/0AWG - 500 kcmil
	279	350	700	450	2	2AWG - 600 kcmil	2	2/0AWG - 500 kcmil
0207	857	1000	2000	1600	4	2AWG - 600 kcmil	4	4/0AWG - 500 kcmil
	742	1000	2000	1200	4	2AWG - 600 kcmil	4	4/0AWG - 500 kcmil
	468	600	1200	800	3	2AWG - 600 kcmil	3	3/0AWG - 400 kcmil
	370	450	1000	600	2	2AWG - 600 kcmil	2	2/0AWG - 500 kcmil
	296	350	700	500	2	2AWG - 600 kcmil	2	2/0AWG - 500 kcmil
0227	908	1200	2000	1600	4	2AWG - 600 kcmil	4	4/0AWG - 500 kcmil
	786	1000	2000	1600	4	2AWG - 600 kcmil	4	4/0AWG - 500 kcmil
	496	600	1200	800	3	2AWG - 600 kcmil	3	3/0AWG - 400 kcmil
	392	450	1000	700	2	2AWG - 600 kcmil	2	2/0AWG - 500 kcmil
	314	350	800	500	2	2AWG - 600 kcmil	2	2/0AWG - 500 kcmil
0247	1002	1200	2000	1600	4	2AWG - 600 kcmil	4	4/0AWG - 500 kcmil
	868	1000	2000	1600	4	2AWG - 600 kcmil	4	4/0AWG - 500 kcmil
	547	700	1600	1000	3	2AWG - 600 kcmil	3	3/0AWG - 400 kcmil
	432	500	1000	700	2	2AWG - 600 kcmil	2	2/0AWG - 500 kcmil
	347	400	800	600	2	2AWG - 600 kcmil	2	2/0AWG - 500 kcmil
0267	1076	1200	2000	2000	4	2AWG - 600 kcmil	4	4/0AWG - 500 kcmil
	932	1200	2000	1600	4	2AWG - 600 kcmil	4	4/0AWG - 500 kcmil
	588	700	1600	1000	3	2AWG - 600 kcmil	3	3/0AWG - 400 kcmil
	464	600	1200	800	2	2AWG - 600 kcmil	2	2/0AWG - 500 kcmil
	372	450	1000	600	2	2AWG - 600 kcmil	2	2/0AWG - 500 kcmil

ELECTRICAL NOTES

1. As standard, all units have single point power connection. Contact factory for information regarding dual point power units.
2. Maximum Inverse Time Circuit Breaker - 250% of the rated input current of the drive per NEC 430.52 (C1).
3. Maximum Dual Element (Time Delay) Fuse - 225% of the rated input current of the drive per NEC 430.52 (C1).
4. MCA - Minimum Circuit Ampacity - 125% of the largest compressor RLA plus 100% of the remaining compressor RLA's plus the sum of all condenser fan FLA's per NEC 440.33
5. Recommended time delay or dual element fuse size - 150% of the largest compressor RLA plus 100% of the remaining compressor RLA's plus the sum of all condenser fan FLA's.
6. RLA - Rated Load Amps - rated in accordance with UL standard 1995.
7. Local codes may take precedence.
8. Control KVA includes operational controls and evaporator heaters.
9. System inrush current is less than RLA due to the use of YORK Variable Speed Drive technology. Typical Compressor Starting Current

(.rst four seconds of startup):

Rated Voltage	Typical Starting Current per Compressor
200/60/3	53A
230/60/3	46A
380/60/3	29A
460/60/3	23A
575/60/3	18A

10. Optional Compressor Service Disconnect switch is available on all units.

11. Voltage Utilization Range:

Rated Voltage	Utilization Range
200/60/3	180-220
230/60/3	208-254
380/60/3	342-402
460/60/3	414-508
575/60/3	520-635

12. Condenser fan FLA applies to both low sound and ultra quiet fans.

LEGEND:

C.B.	CIRCUIT BREAKER
D.E.	DUAL ELEMENT FUSE
DISC SW	DISCONNECT SWITCH
FACT CB	FACTORY-MOUNTED CIRCUIT BREAKER
FLA	FULL LOAD AMPS
HZ	HERTZ
MAX	MAXIMUM
MCA	MINIMUM CIRCUIT AMPACITY
MIN	MINIMUM
MIN NF	MINIMUM NON-FUSED
RLA	RATED LOAD AMPS
S.P. WIRE	SINGLE-POINT WIRING

NOTES:

1. U.L. Label is provided on 60 Hz units for these electrical wiring configurations.
2. — — — — — Dashed Line = Field Provided Wiring.
3. The above recommendations are based on the National Electric Code and using copper conductors only. Field wiring must also comply with local codes.
Group Rated breaker must be HACR type for cUL machines.

This page intentionally left blank.

ELECTRICAL WIRING

ELEMENTARY CONTROL WIRING DIAGRAM

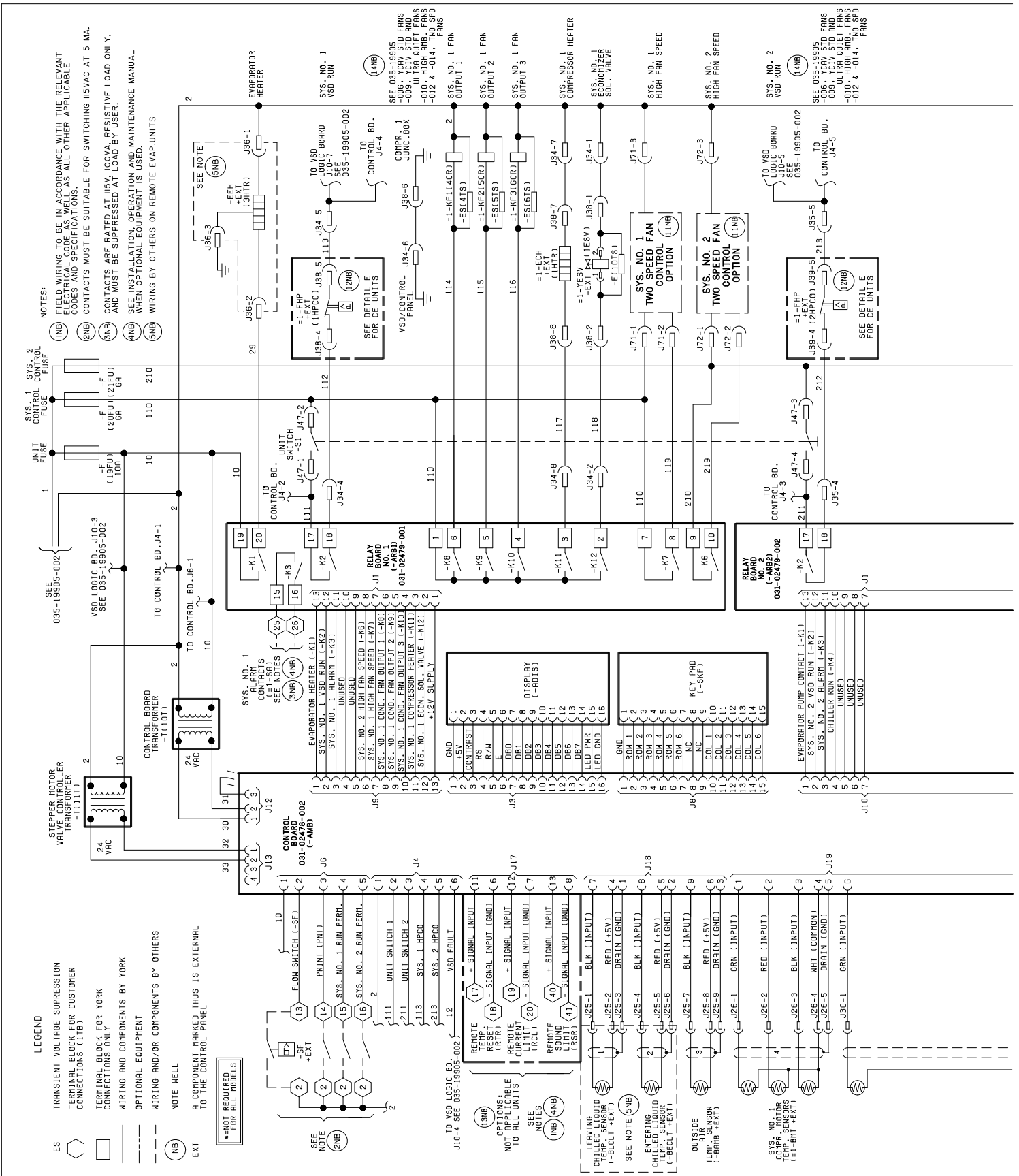

ELEMENTARY CONTROL WIRING DIAGRAM (CON'T)

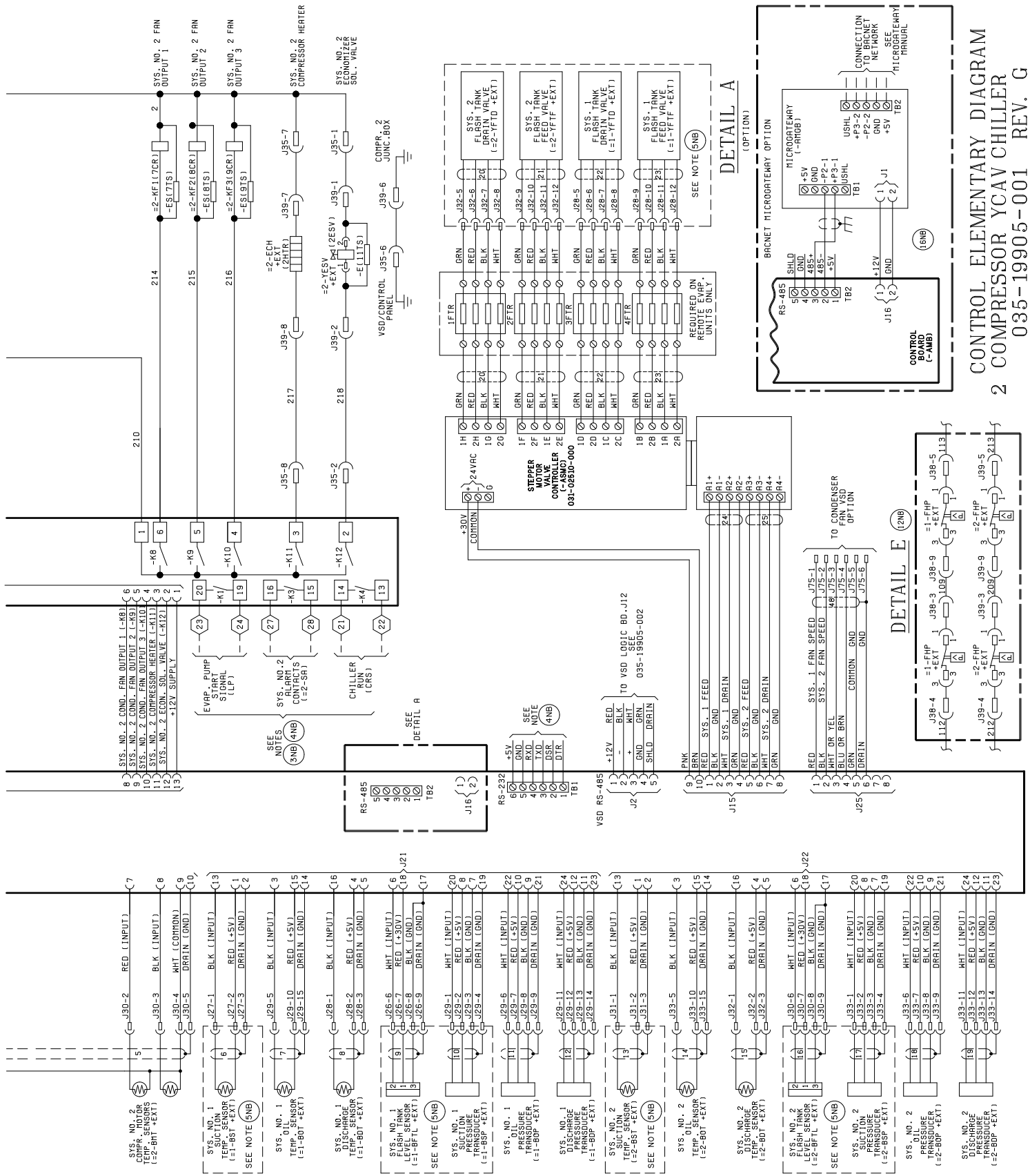

CONTROL ELEMENTARY DIAGRAM
2 COMPRESSOR YCAV CHILLER
035-19905-001 REV. G

ELEMENTARY POWER WIRING DIAGRAM - 2 COMPRESSOR YCAV CHILLER

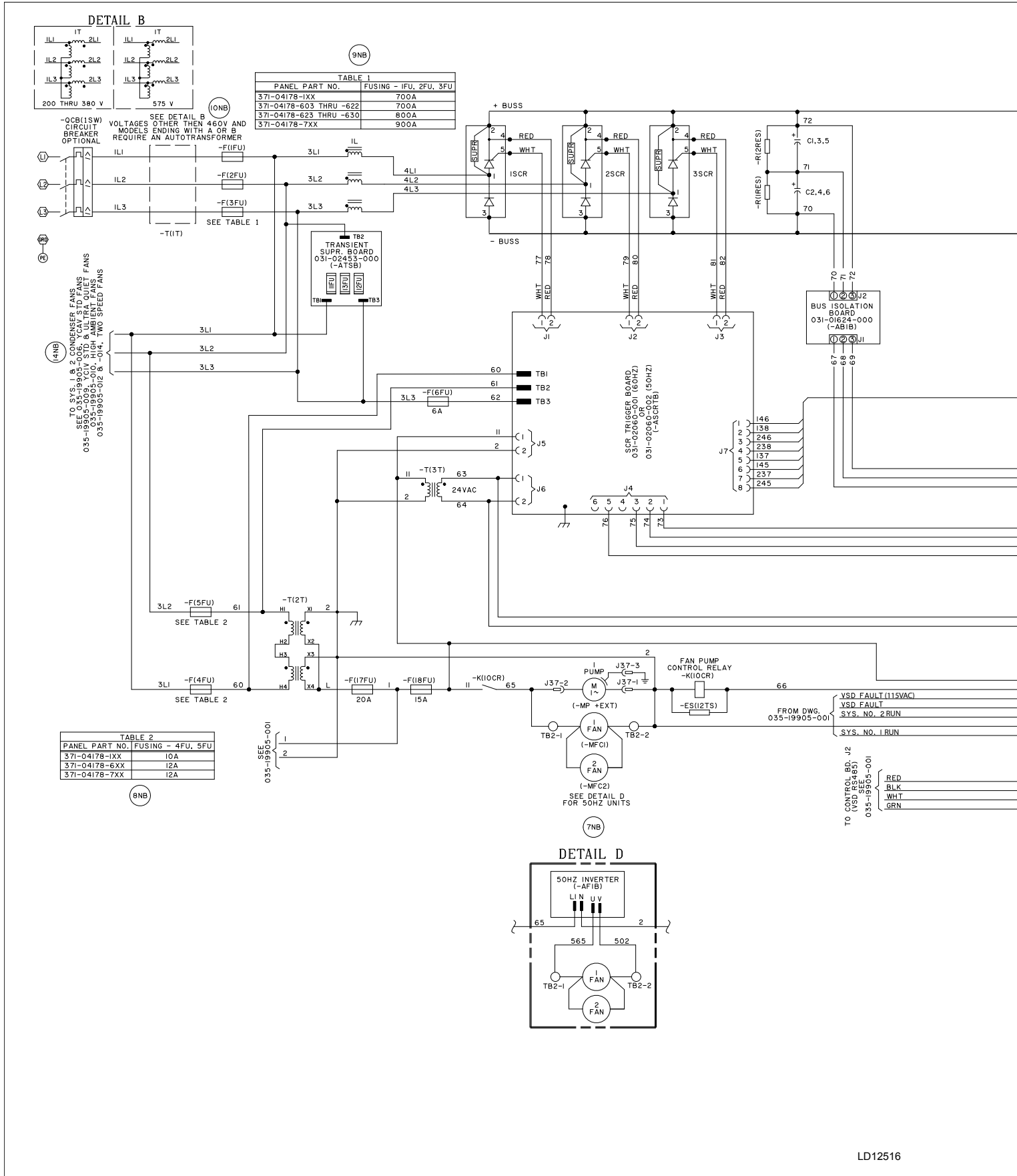

ELEMENTARY POWER WIRING DIAGRAM - 2 COMPRESSOR YCAV CHILLER (CON'T)

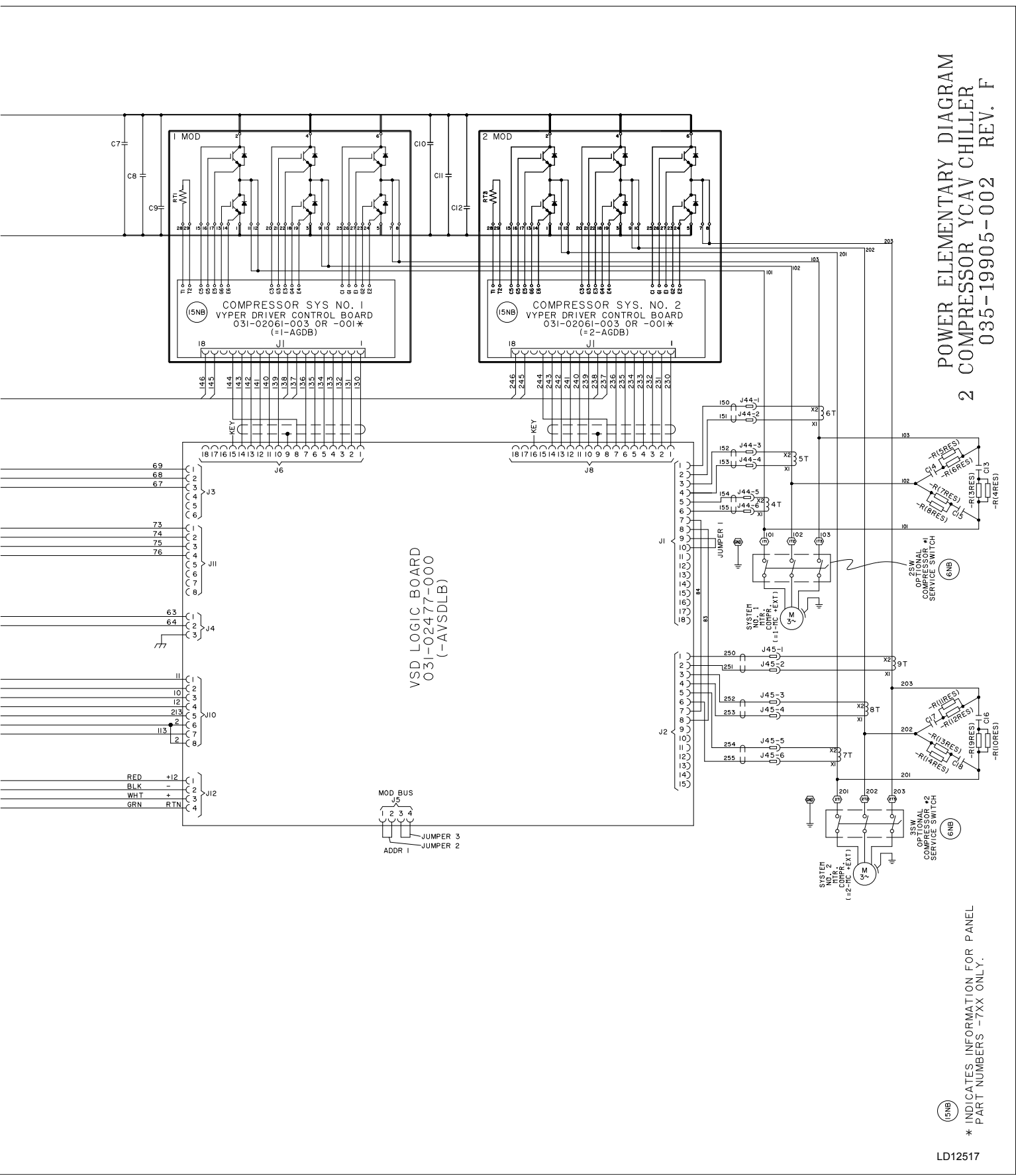

POWER ELEMENTARY DIAGRAM
2 COMPRESSOR YCAV CHILLER
035-19905-002 REV. F

6

(5NB)
* INDICATES INFORMATION FOR PANEL
PART NUMBERS -7XX ONLY.

LD12517

CONNECTION WIRING DIAGRAM - 2 COMPRESSOR YCAV CHILLER

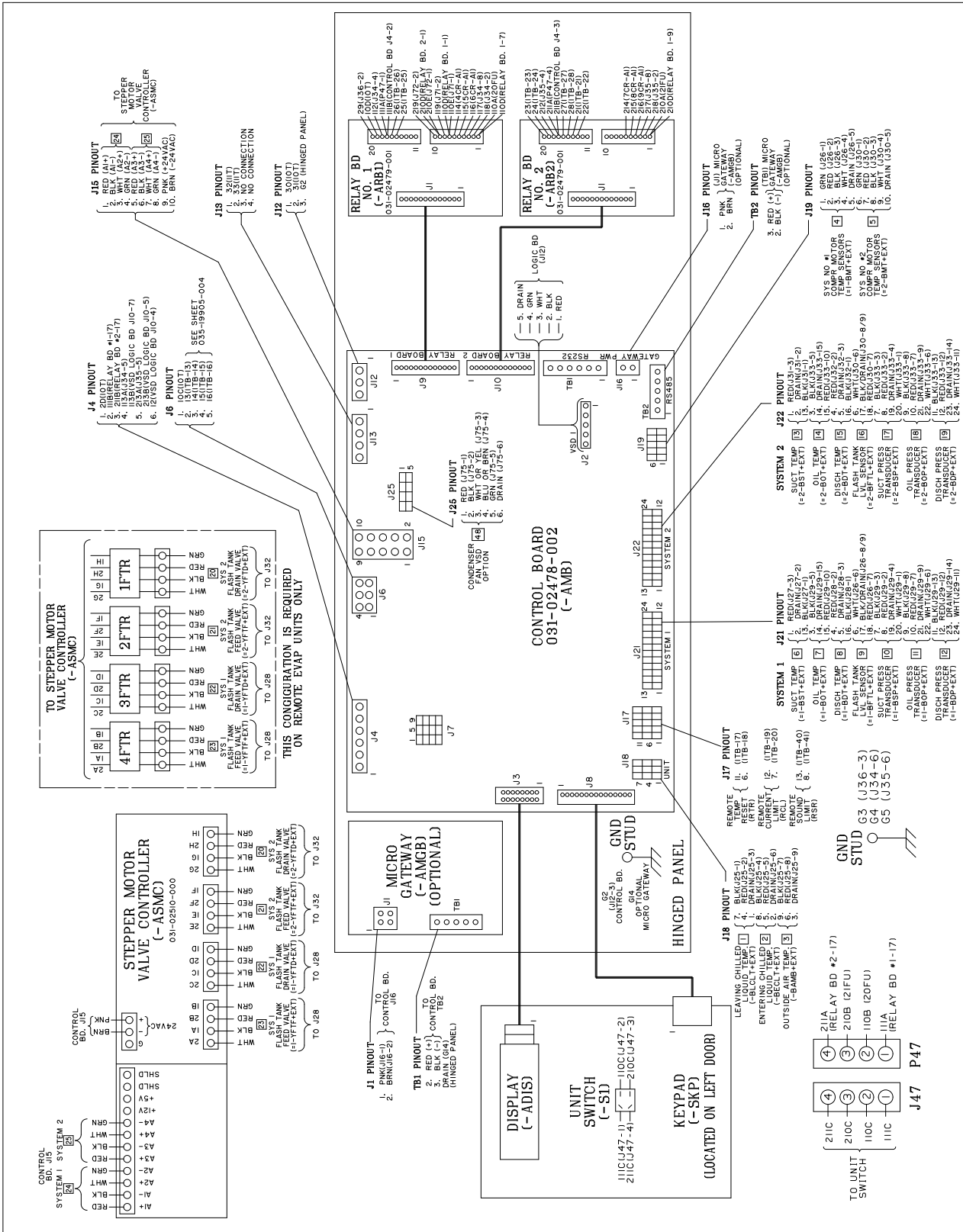

LD12514

CONNECTION WIRING DIAGRAM - 2 COMPRESSOR YCAV CHILLER (CON'T)

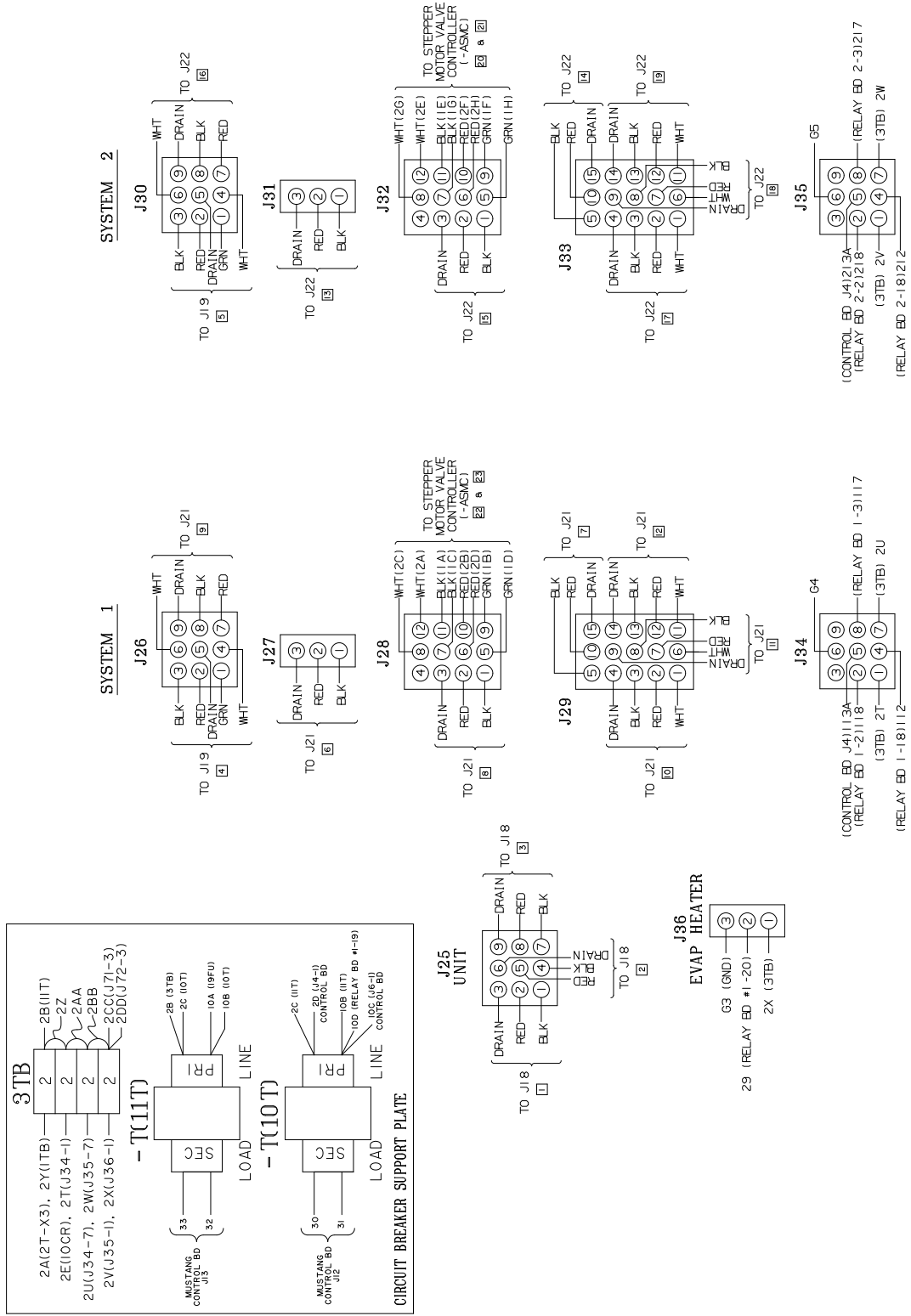

CONTROL WIRING - CONNECTION DIAGRAM
 2 COMPRESSOR YCAV CHILLER
 035-19905-003 REV F

CONNECTION WIRING DIAGRAM - 2 COMPRESSOR YCAV CHILLER

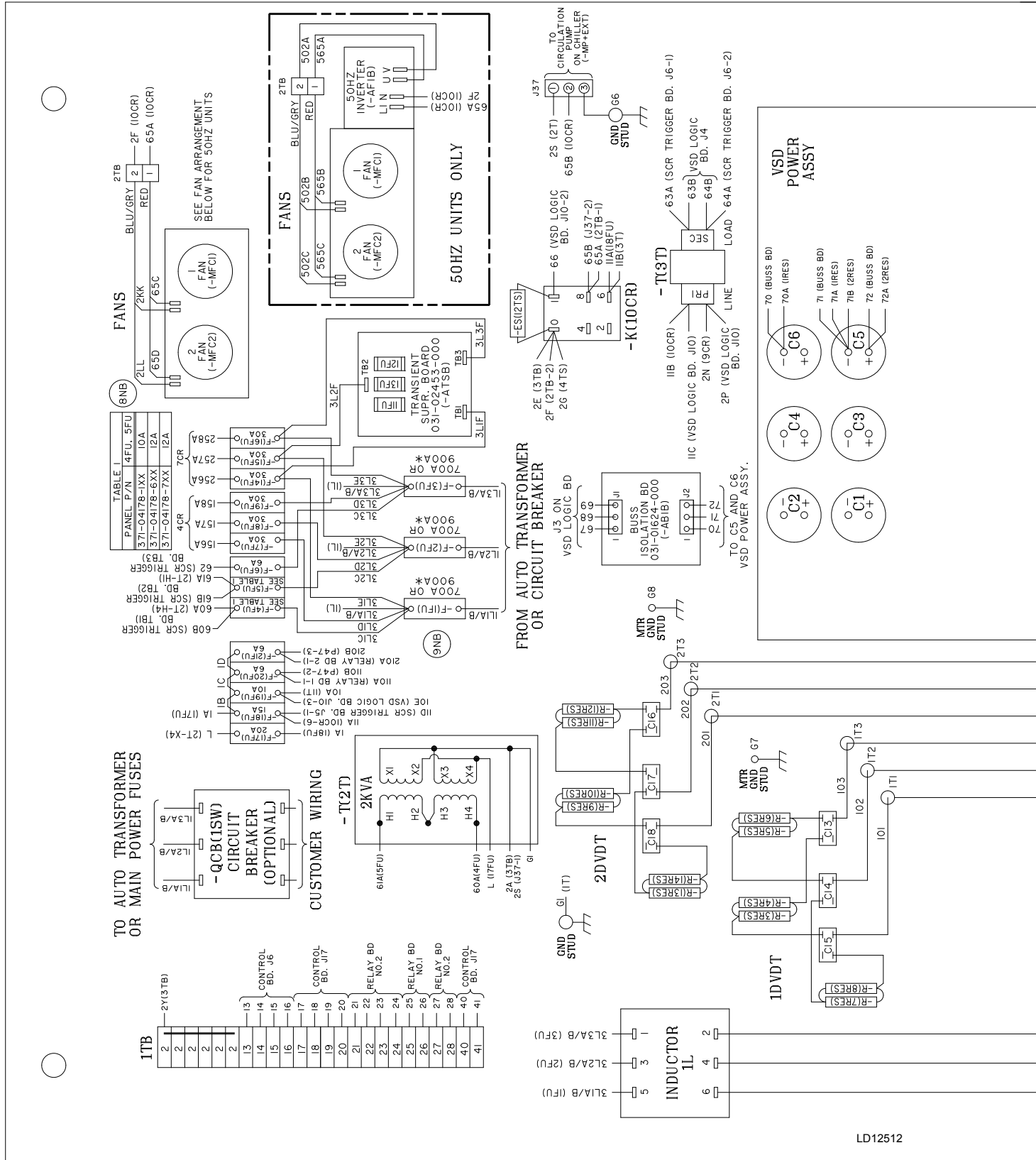

LD12512

CONNECTION WIRING DIAGRAM - 2 COMPRESSOR YCAV CHILLER (CON'T)

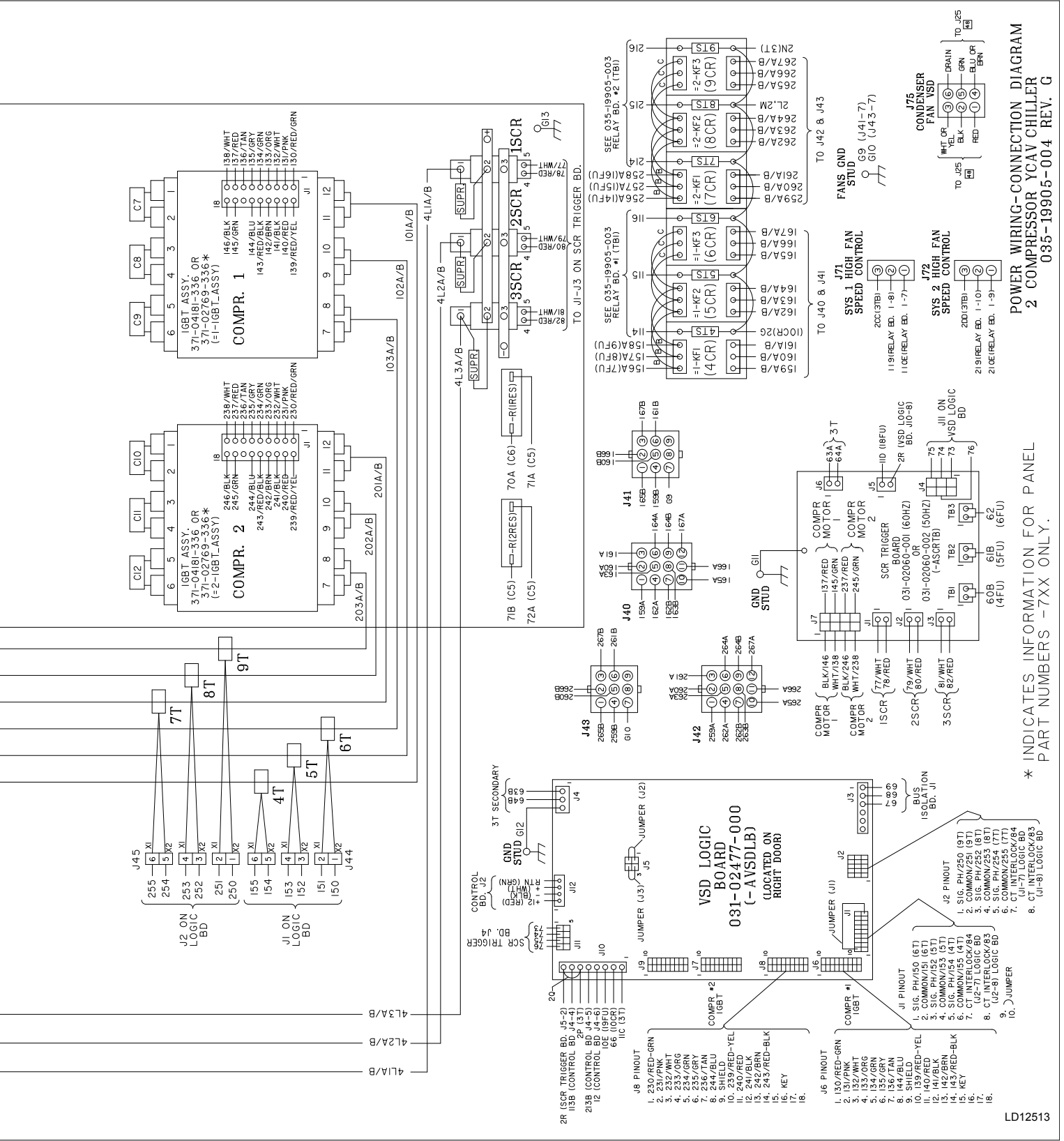

POWER WIRING-CONNECTION DIAGRAM
2 COMPRESSOR YCAV CHILLER
035-19905-004 REV. G

* INDICATES INFORMATION FOR PANEL PART NUMBERS -7XX ONLY.

LOCATION LABEL

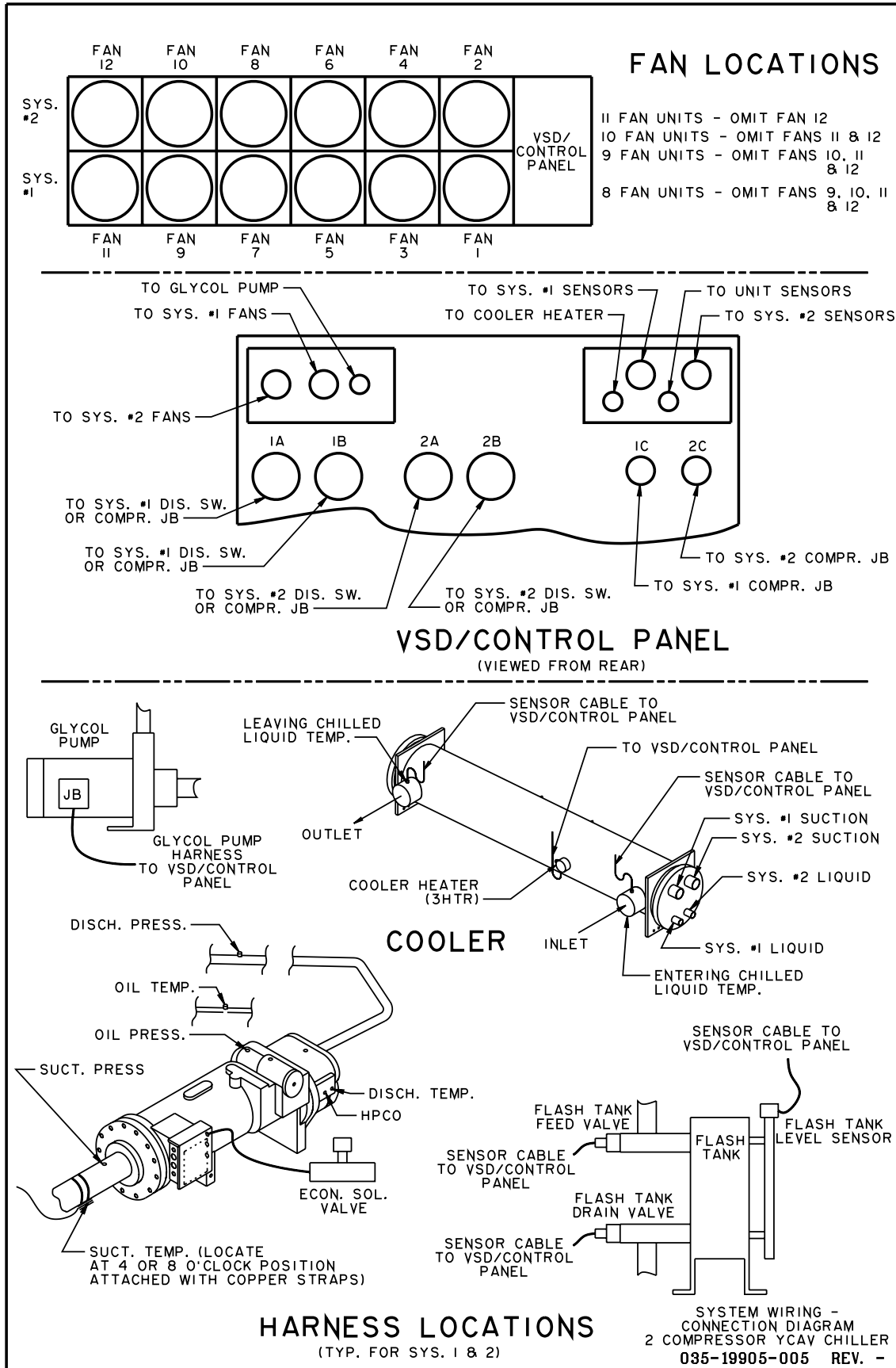

This page intentionally left blank.

DIMENSIONS - YCAV0157S/P Standard Efficiency English

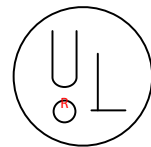
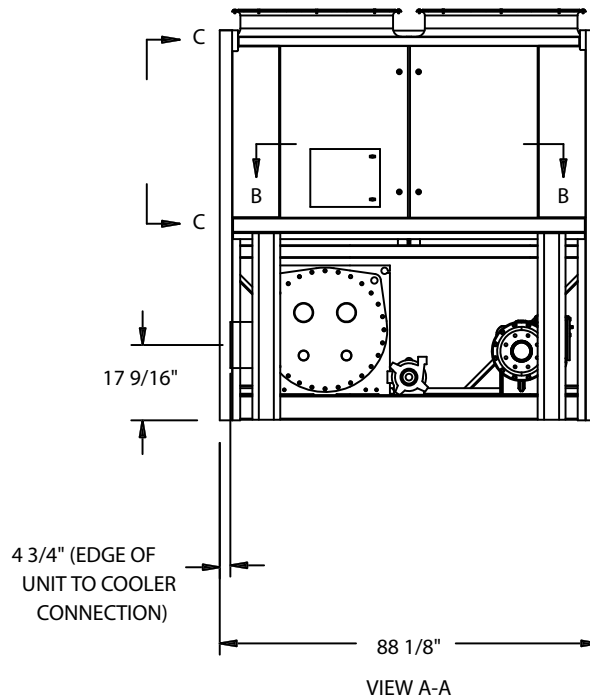
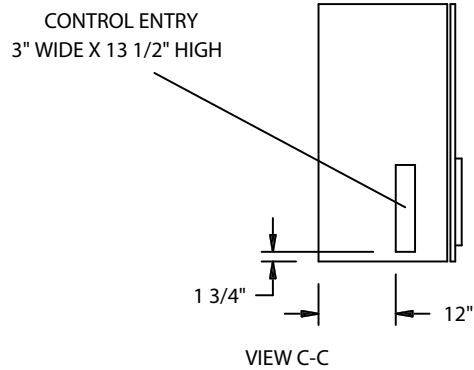
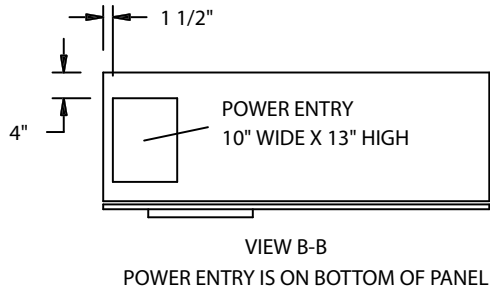

LD10520A

Notes:

1. Placement on a level surface free of obstructions (including snow, for winter operation) or air recirculation ensures rated performance, reliable operation and ease of maintenance. Site restrictions may compromise minimum clearances indicated below, resulting in unpredictable air flow patterns and possible diminished performance. YORK's unit controls will optimize operation without nuisance high pressure safety cutout; however, the system designer must consider potential performance degradation. Access to the unit control center assumes the unit is no higher than on spring isolators. Recommended minimum clearances: side to wall - 6'; rear to wall - 6'; control panel end to wall - 4'; top - no obstructions allowed; distance between adjacent units - 10'. No more than one adjacent wall may be higher than the unit.

DIMENSIONS - YCAV0157S/P Standard Efficiency English (Con't)

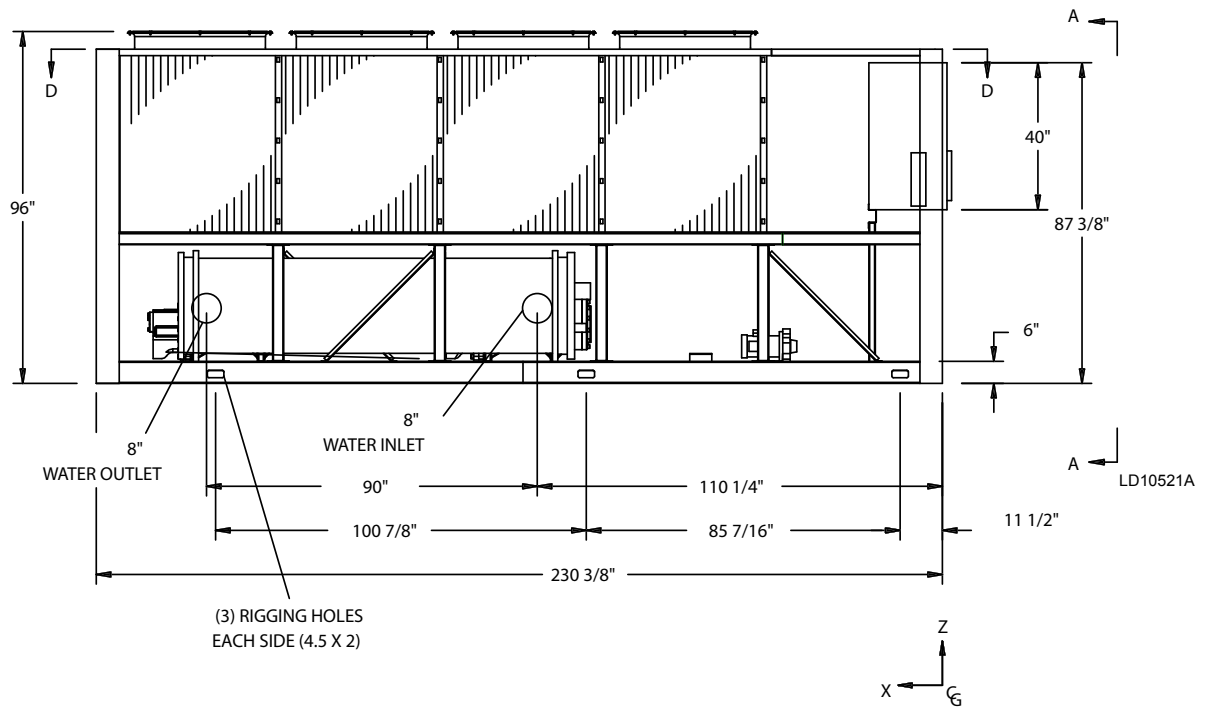
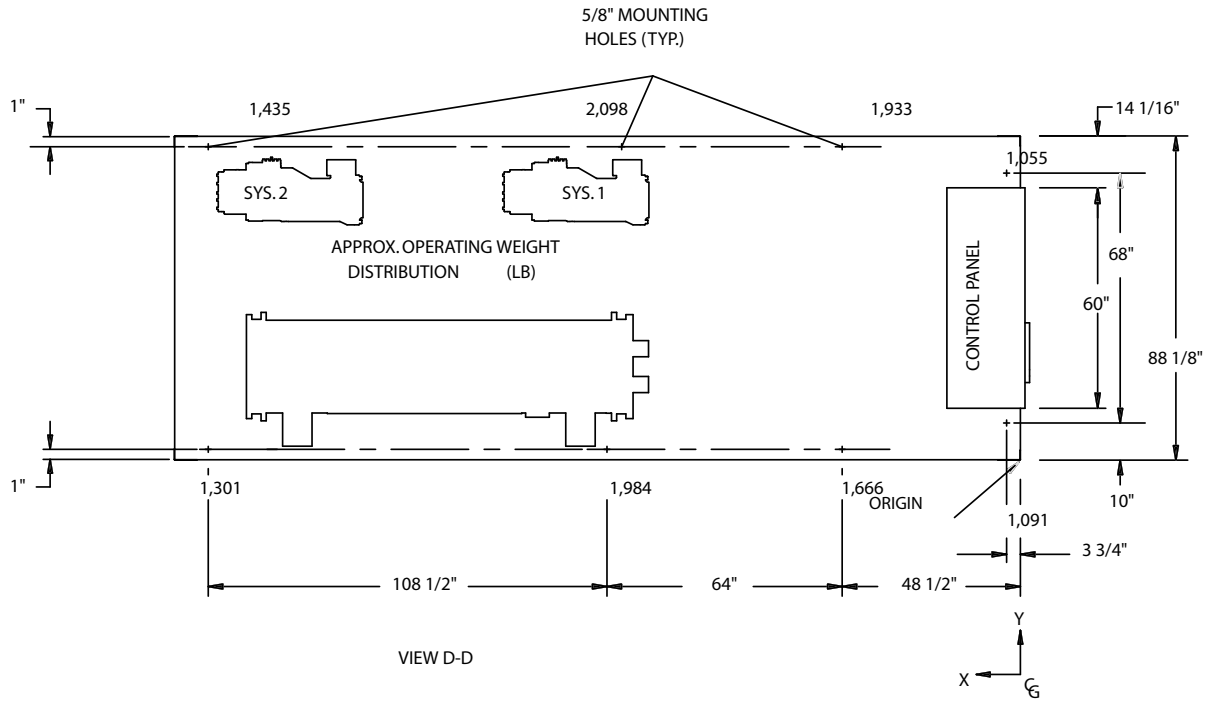

6

DIMENSIONS - YCAV0157E/V High Efficiency English

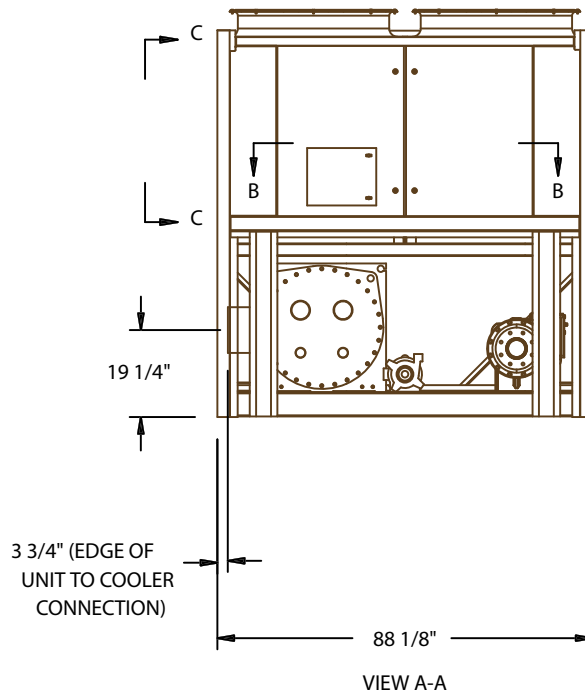
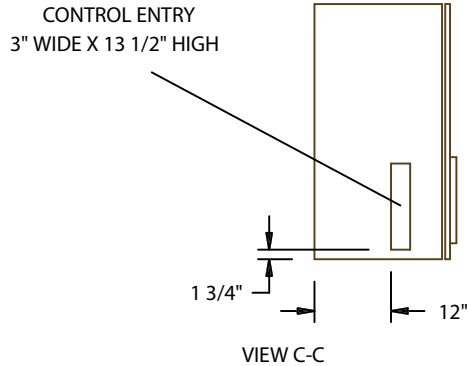
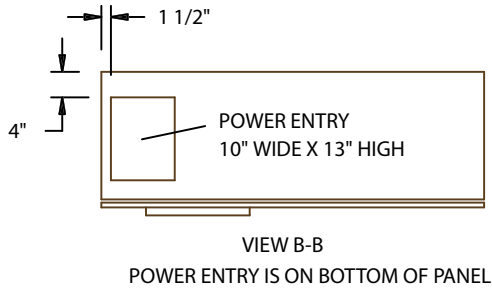

LD10522A

Notes:

1. Placement on a level surface free of obstructions (including snow, for winter operation) or air recirculation ensures rated performance, reliable operation and ease of maintenance. Site restrictions may compromise minimum clearances indicated below, resulting in unpredictable air flow patterns and possible diminished performance. YORK's unit controls will optimize operation without nuisance high pressure safety cutout; however, the system designer must consider potential performance degradation. Access to the unit control center assumes the unit is no higher than on spring isolators. Recommended minimum clearances: side to wall - 6'; rear to wall - 6'; control panel end to wall - 4'; top - no obstructions allowed; distance between adjacent units - 10'. No more than one adjacent wall may be higher than the unit.

DIMENSIONS - YCAV0157E/V High Efficiency English (Con't)

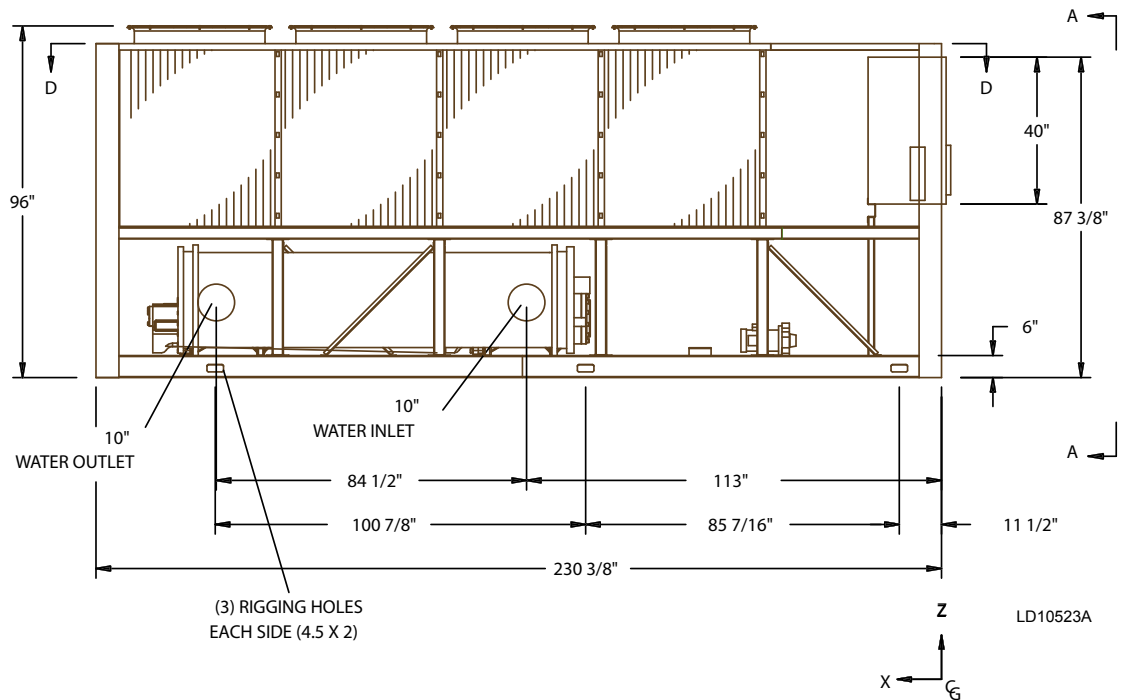
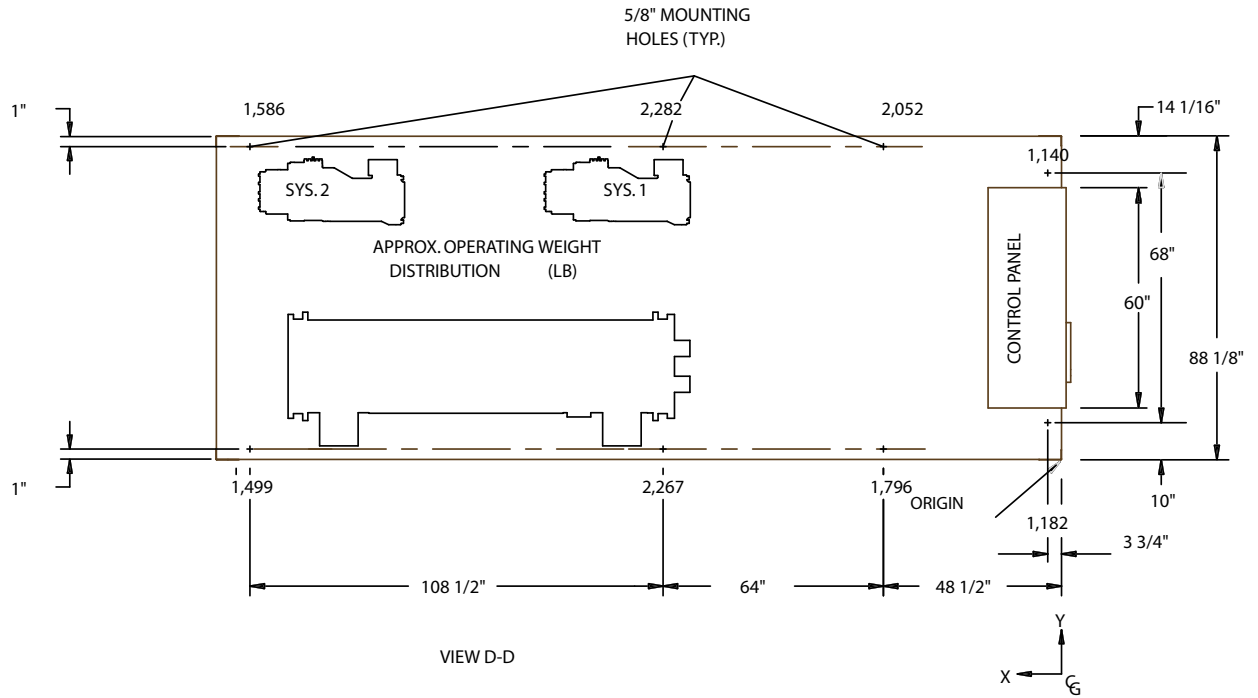

6

DIMENSIONS - YCAV0177S/P Standard Efficiency English

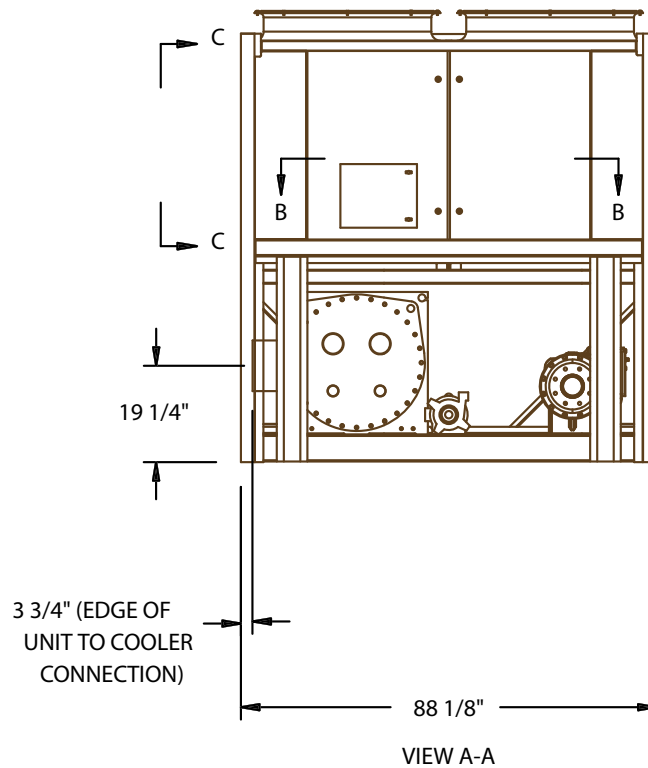
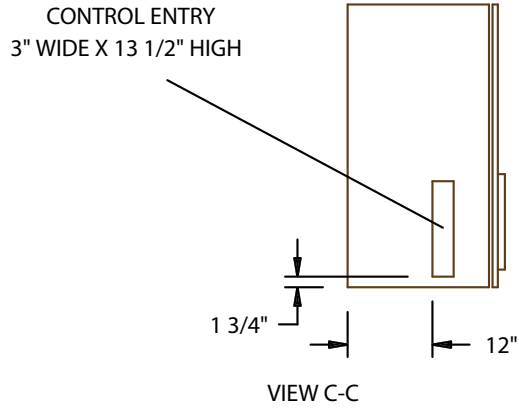
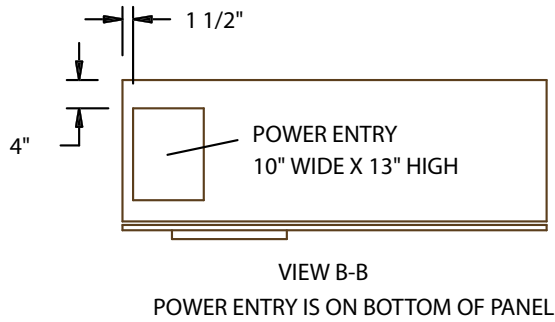

LD10524A

POWER: SINGLE POINT WITH TERMINAL BLOCK

Notes:

1. Placement on a level surface free of obstructions (including snow, for winter operation) or air recirculation ensures rated performance, reliable operation and ease of maintenance. Site restrictions may compromise minimum clearances indicated below, resulting in unpredictable air flow patterns and possible diminished performance. YORK's unit controls will optimize operation without nuisance high pressure safety cutout; however, the system designer must consider potential performance degradation. Access to the unit control center assumes the unit is no higher than on spring isolators. Recommended minimum clearances: side to wall - 6'; rear to wall - 6'; control panel end to wall - 4'; top - no obstructions allowed; distance between adjacent units - 10'. No more than one adjacent wall may be higher than the unit.

DIMENSIONS - YCAV0177S/P Standard Efficiency English (Con't)

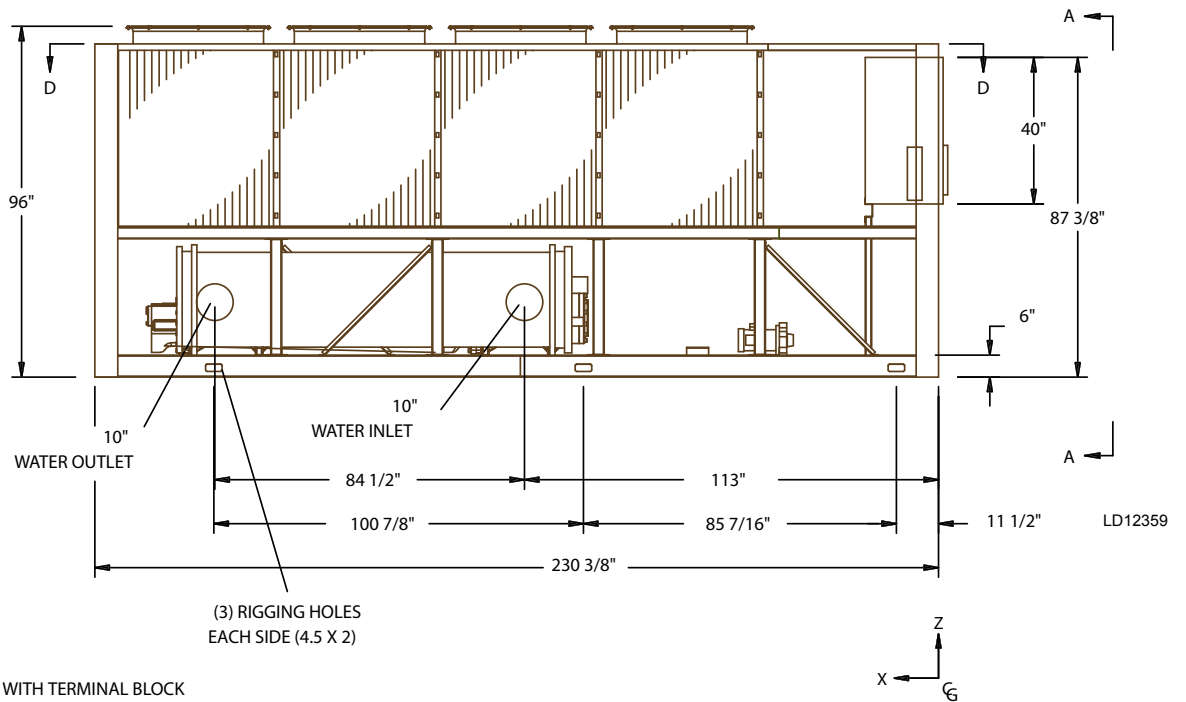
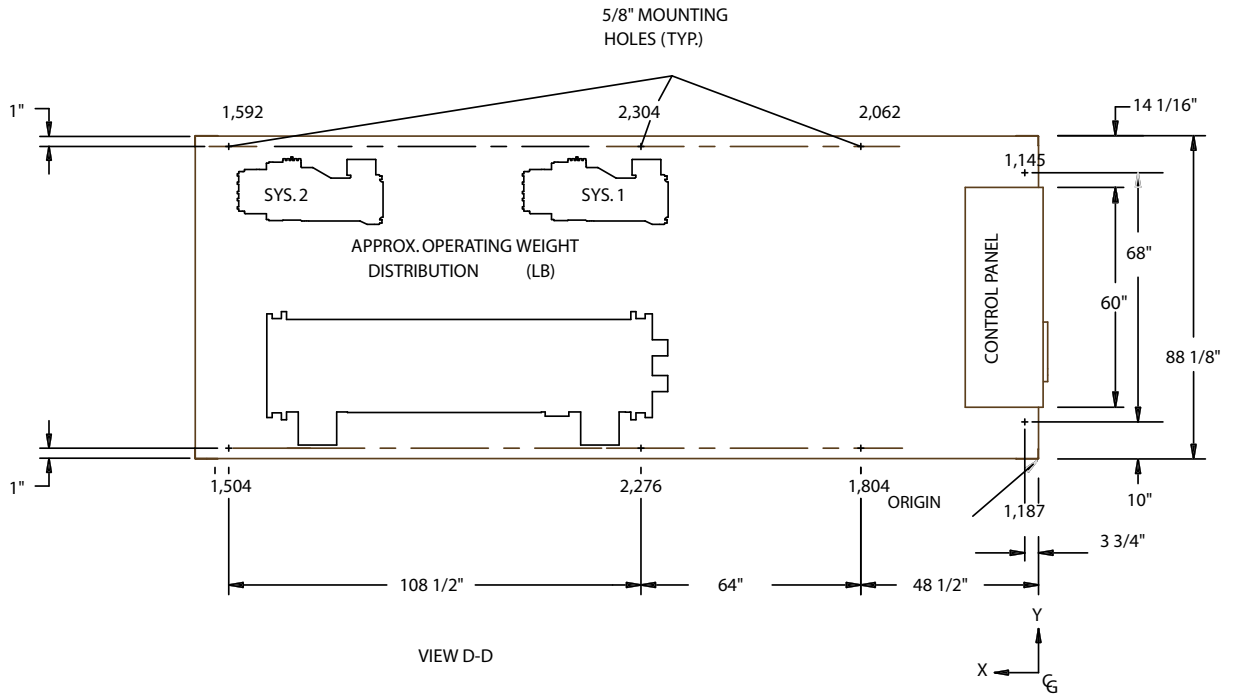

6

DIMENSIONS - YCAV0177E/V High Efficiency English

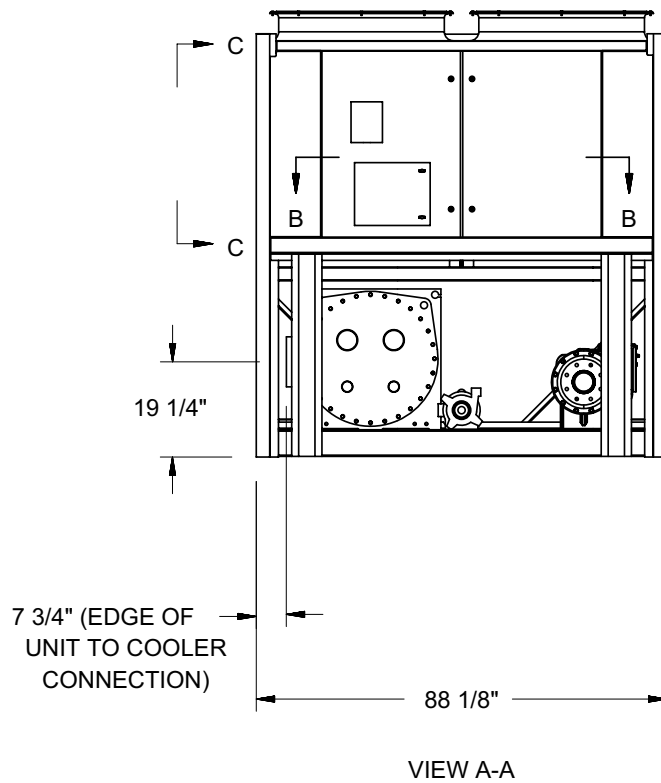
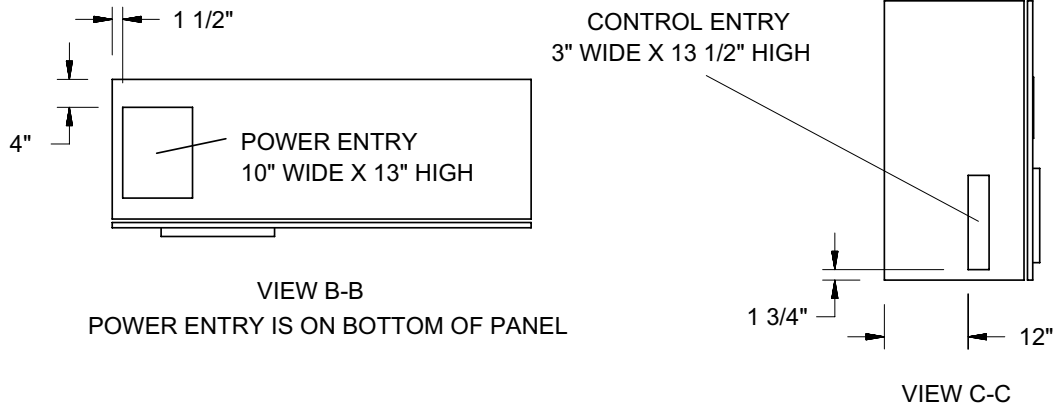

LD10526A

Notes:

1. Placement on a level surface free of obstructions (including snow, for winter operation) or air recirculation ensures rated performance, reliable operation and ease of maintenance. Site restrictions may compromise minimum clearances indicated below, resulting in unpredictable air flow patterns and possible diminished performance. YORK's unit controls will optimize operation without nuisance high pressure safety cutout; however, the system designer must consider potential performance degradation. Access to the unit control center assumes the unit is no higher than on spring isolators. Recommended minimum clearances: side to wall - 6'; rear to wall - 6'; control panel end to wall - 4'; top - no obstructions allowed; distance between adjacent units - 10'. No more than one adjacent wall may be higher than the unit.

DIMENSIONS - YCAV0177E/V High Efficiency English (Con't)

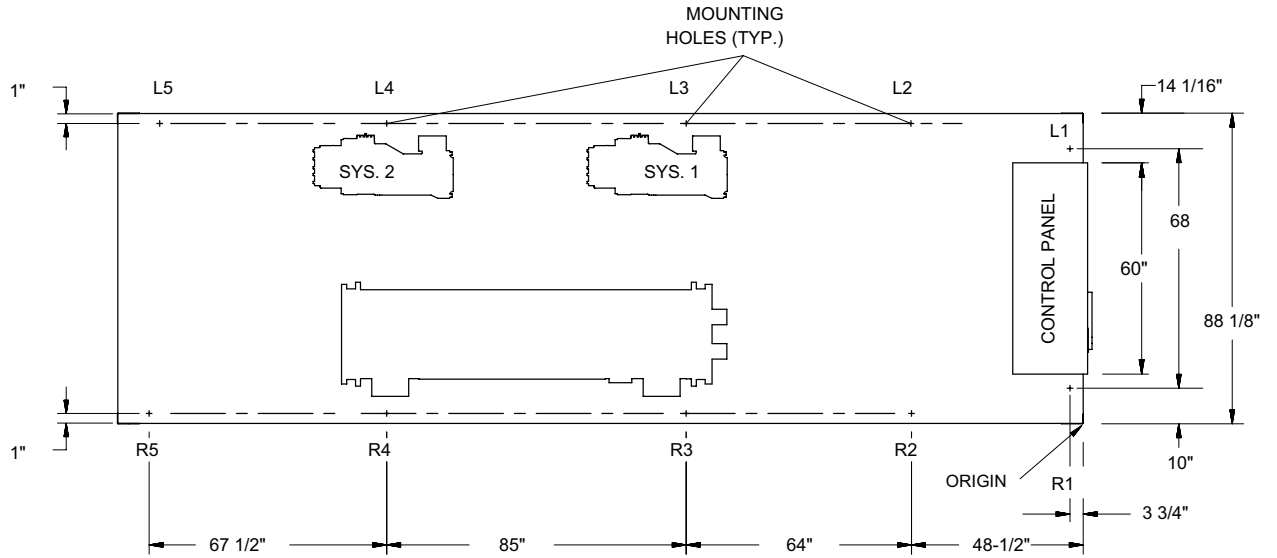

VIEW D-D

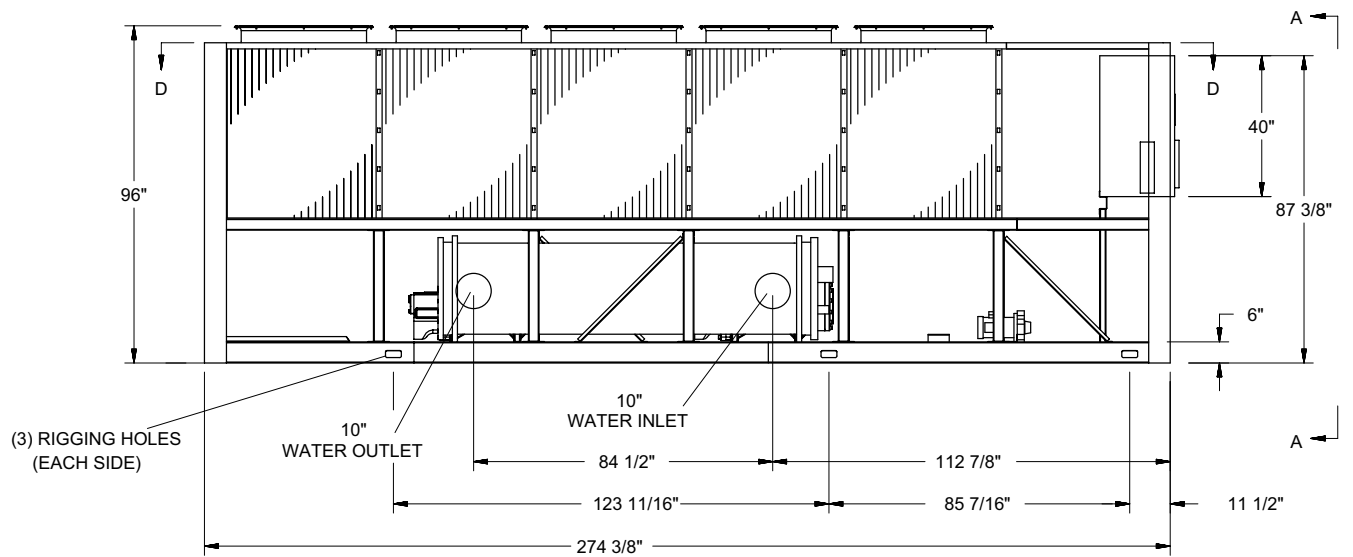

LD10527

DIMENSIONS - YCAV0187S/P Standard Efficiency English

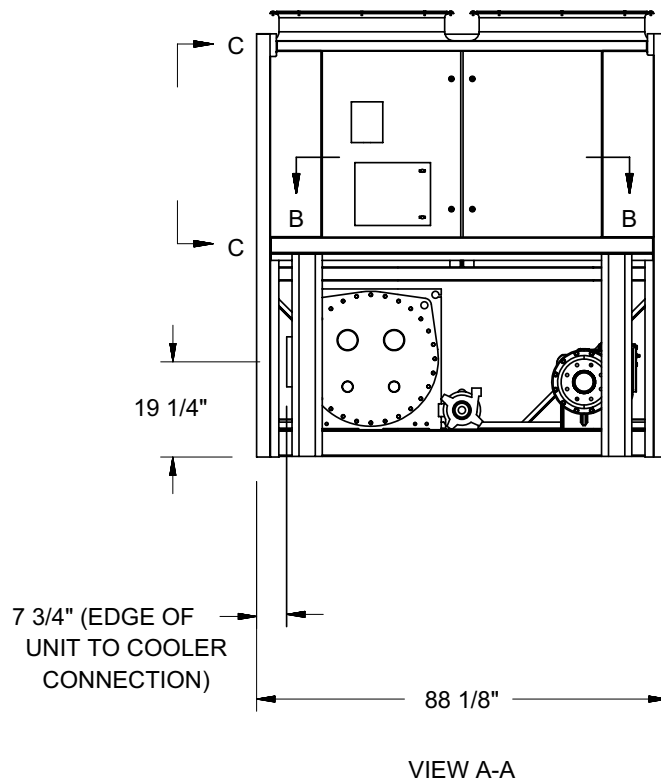
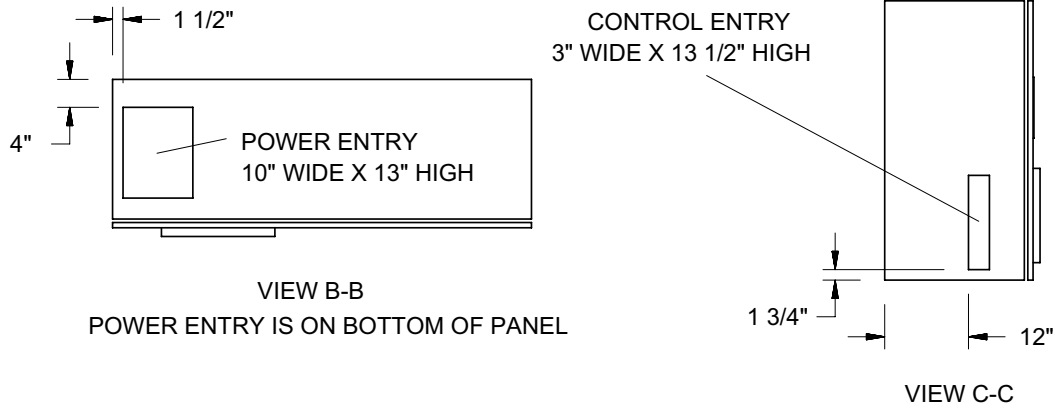

LD10528A

Notes:

1. Placement on a level surface free of obstructions (including snow, for winter operation) or air recirculation ensures rated performance, reliable operation and ease of maintenance. Site restrictions may compromise minimum clearances indicated below, resulting in unpredictable air flow patterns and possible diminished performance. YORK's unit controls will optimize operation without nuisance high pressure safety cutout; however, the system designer must consider potential performance degradation. Access to the unit control center assumes the unit is no higher than on spring isolators. Recommended minimum clearances: side to wall - 6'; rear to wall - 6'; control panel end to wall - 4'; top - no obstructions allowed; distance between adjacent units - 10'. No more than one adjacent wall may be higher than the unit.

DIMENSIONS - YCAV0187S/P Standard Efficiency English (Con't)

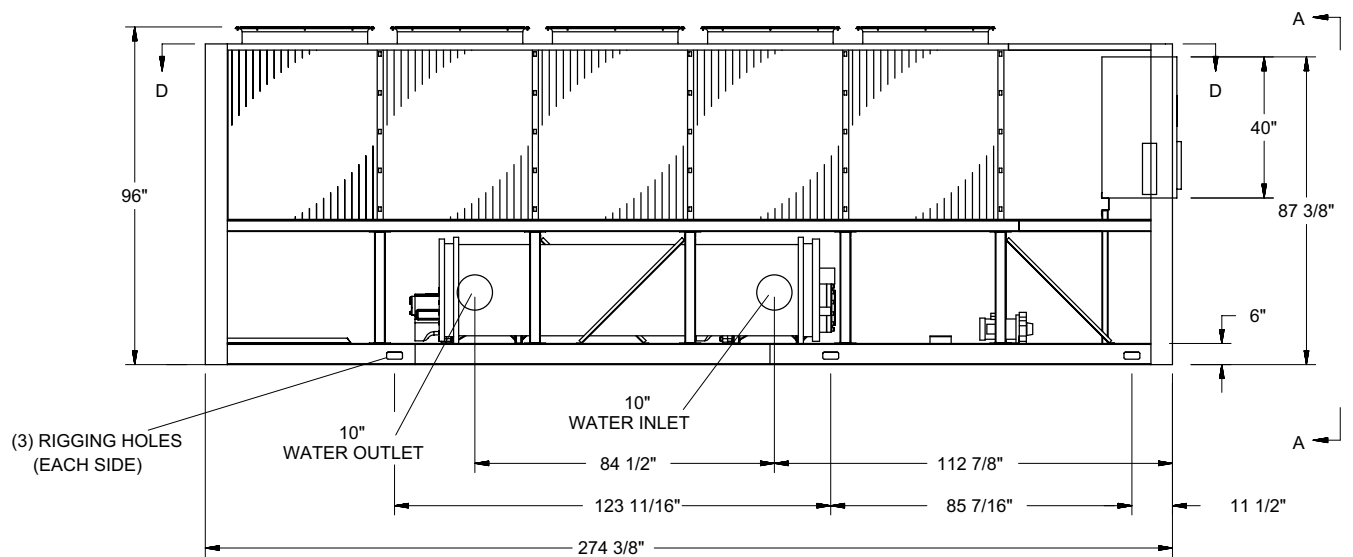
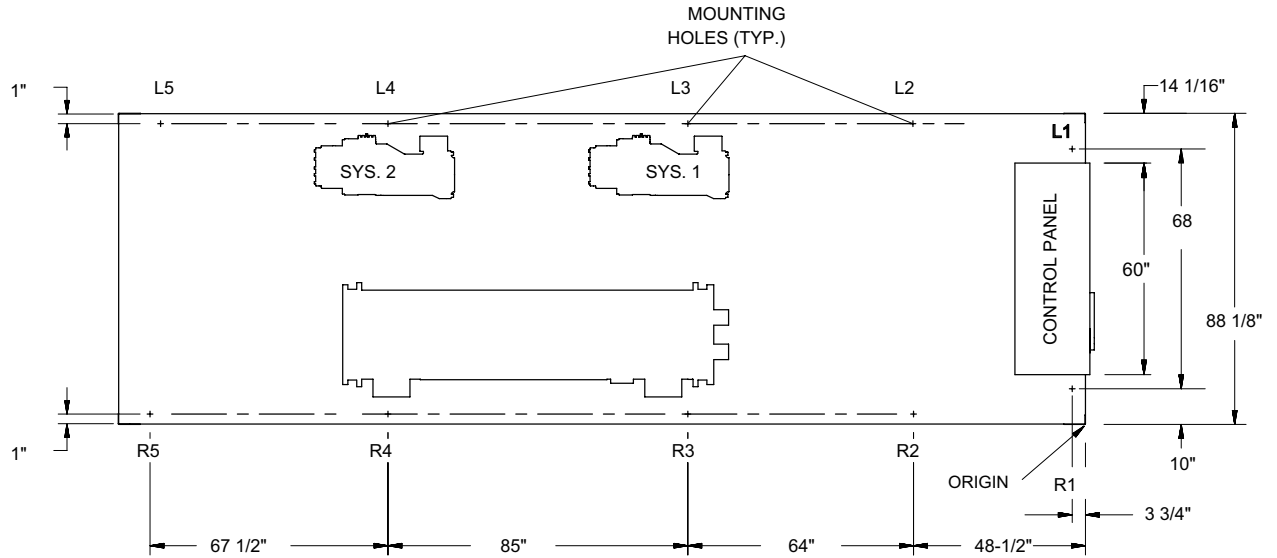

LD10529

DIMENSIONS - YCAV0187E/V High Efficiency English

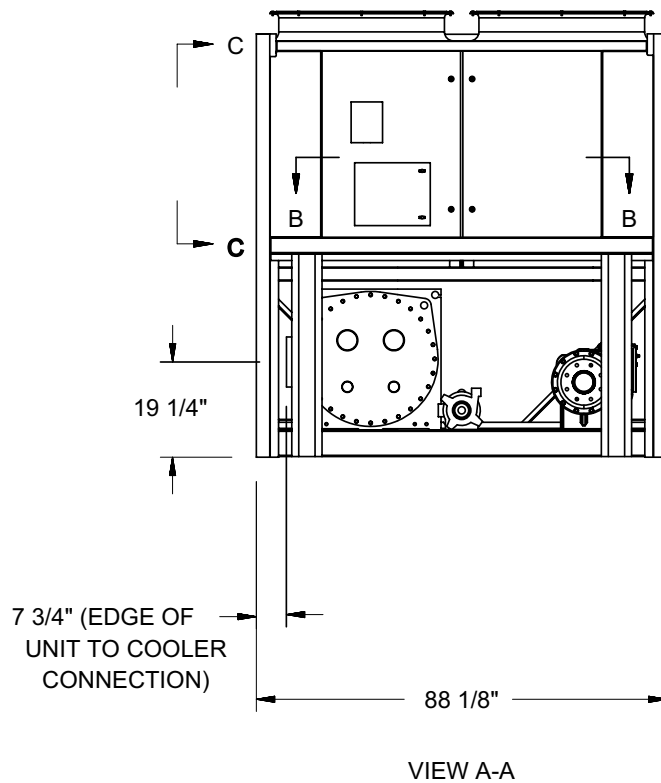
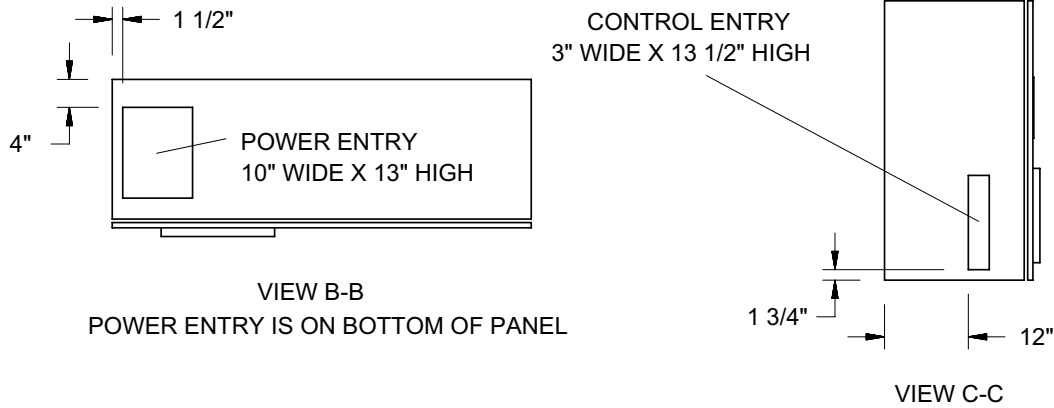

LD10530A

Notes:

1. Placement on a level surface free of obstructions (including snow, for winter operation) or air recirculation ensures rated performance, reliable operation and ease of maintenance. Site restrictions may compromise minimum clearances indicated below, resulting in unpredictable air flow patterns and possible diminished performance. YORK's unit controls will optimize operation without nuisance high pressure safety cutout; however, the system designer must consider potential performance degradation. Access to the unit control center assumes the unit is no higher than on spring isolators. Recommended minimum clearances: side to wall - 6'; rear to wall - 6'; control panel end to wall - 4'; top - no obstructions allowed; distance between adjacent units - 10'. No more than one adjacent wall may be higher than the unit.

DIMENSIONS - YCAV0187E/V High Efficiency English (Con't)

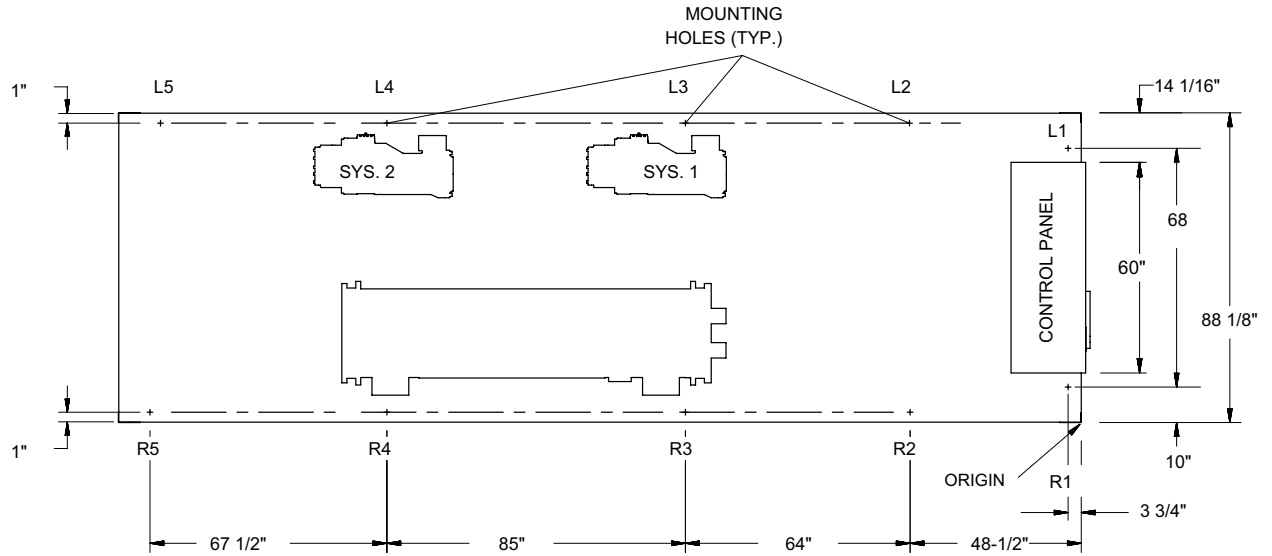

VIEW D-D

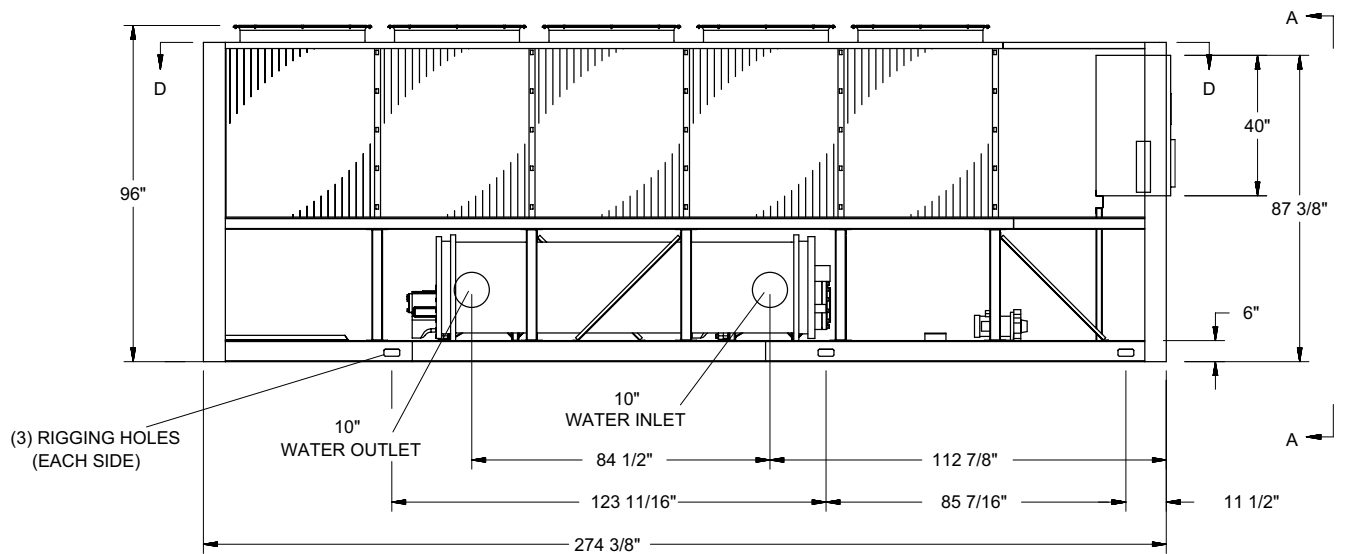

LD10531

DIMENSIONS - YCAV0197E/V High Efficiency English

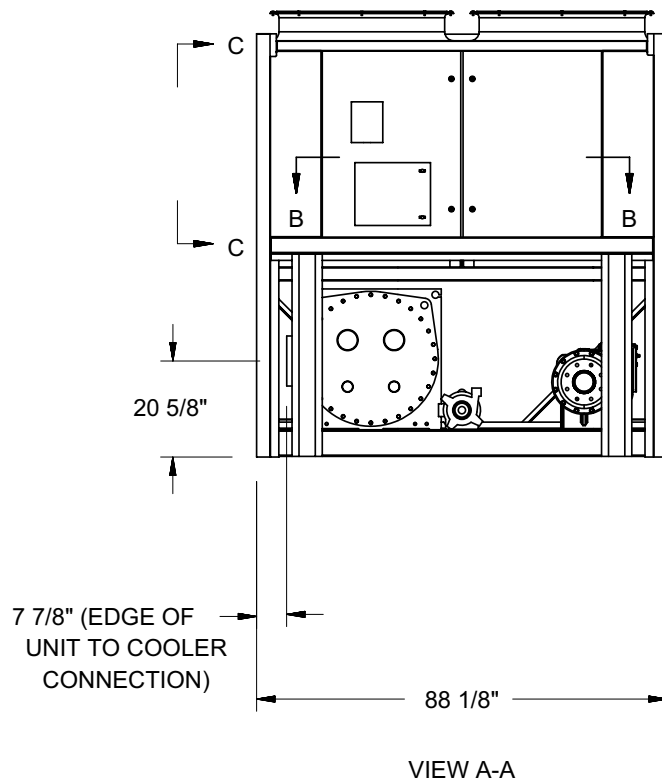
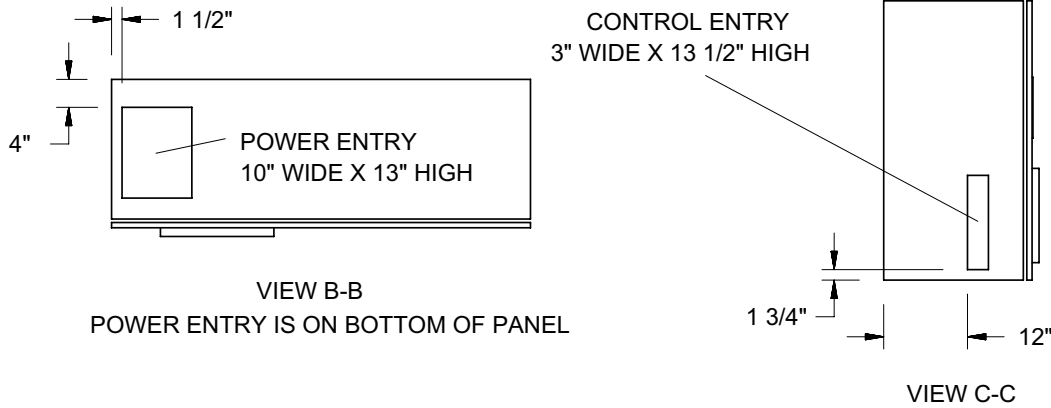

LD10532A

Notes:

1. Placement on a level surface free of obstructions (including snow, for winter operation) or air recirculation ensures rated performance, reliable operation and ease of maintenance. Site restrictions may compromise minimum clearances indicated below, resulting in unpredictable air flow patterns and possible diminished performance. YORK's unit controls will optimize operation without nuisance high pressure safety cutout; however, the system designer must consider potential performance degradation. Access to the unit control center assumes the unit is no higher than on spring isolators. Recommended minimum clearances: side to wall - 6'; rear to wall - 6'; control panel end to wall - 4'; top - no obstructions allowed; distance between adjacent units - 10'. No more than one adjacent wall may be higher than the unit.

DIMENSIONS - YCAV0197E/V High Efficiency English (Con't)

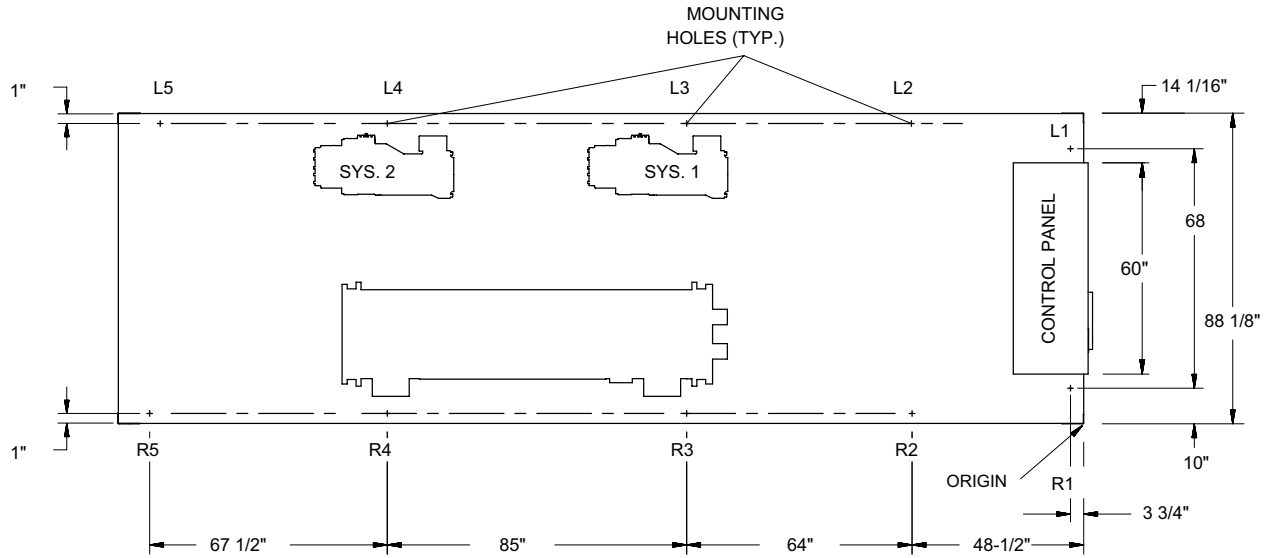

VIEW D-D

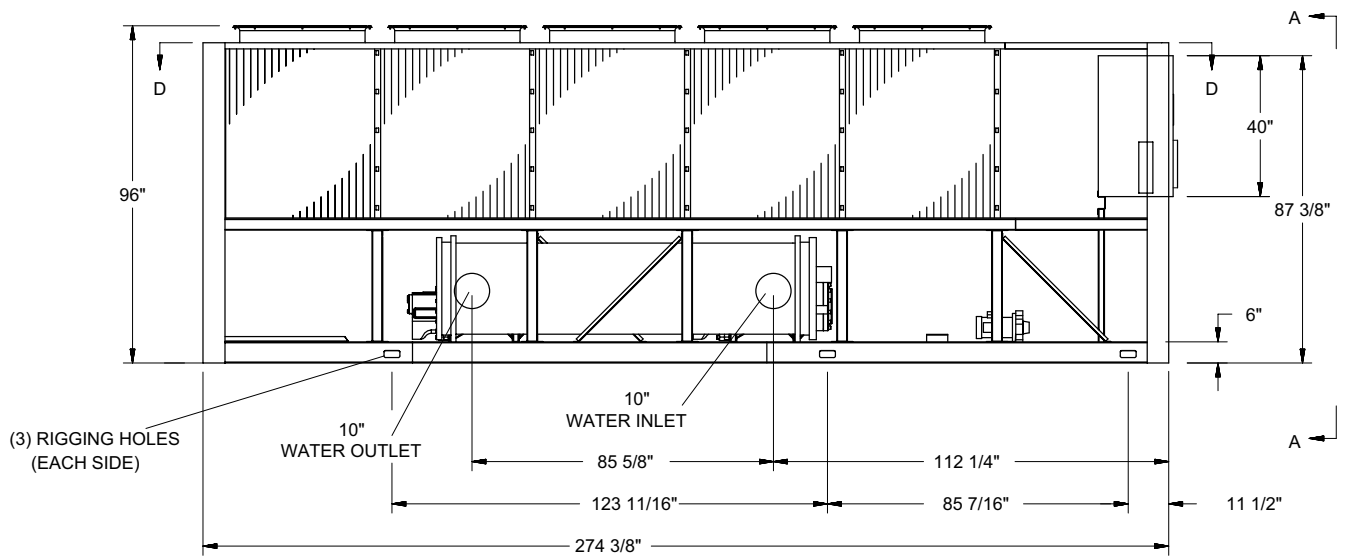

LD10533

DIMENSIONS - YCAV0207S/P Standard Efficiency English

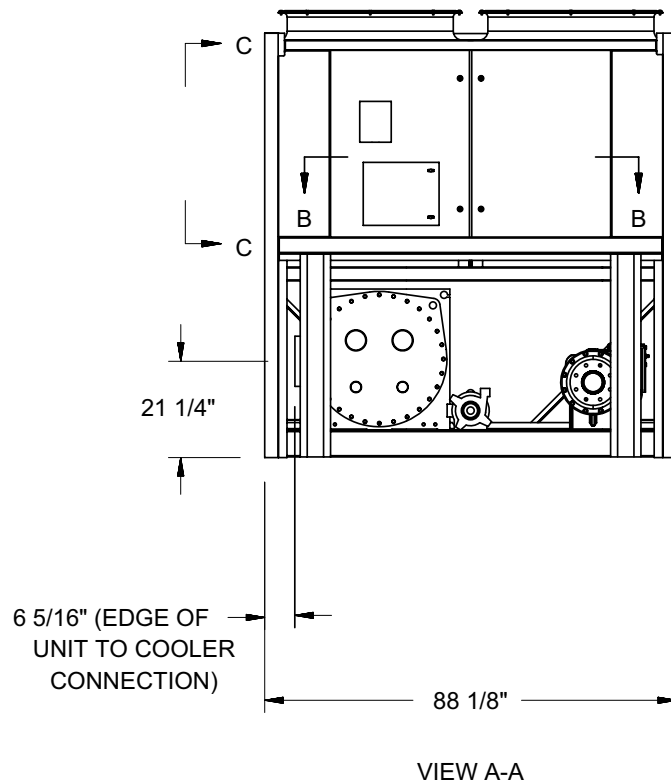
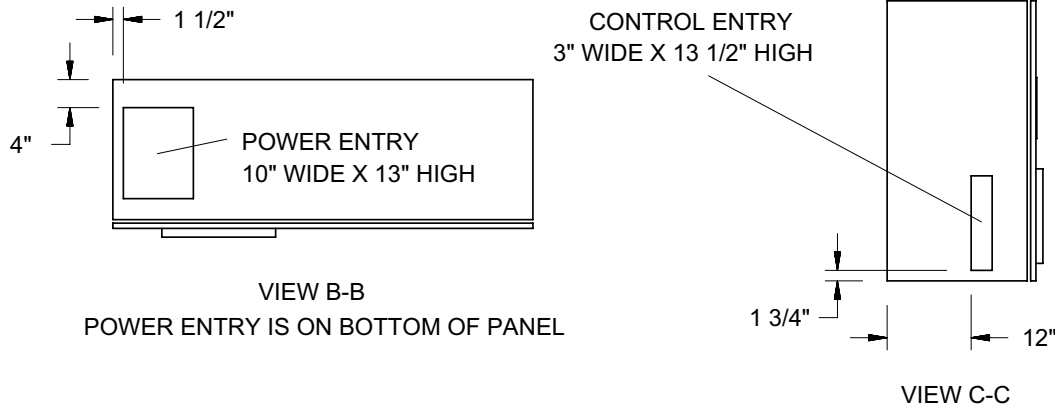

LD10534A

Notes:

1. Placement on a level surface free of obstructions (including snow, for winter operation) or air recirculation ensures rated performance, reliable operation and ease of maintenance. Site restrictions may compromise minimum clearances indicated below, resulting in unpredictable air flow patterns and possible diminished performance. YORK's unit controls will optimize operation without nuisance high pressure safety cutout; however, the system designer must consider potential performance degradation. Access to the unit control center assumes the unit is no higher than on spring isolators. Recommended minimum clearances: side to wall - 6'; rear to wall - 6'; control panel end to wall - 4'; top - no obstructions allowed; distance between adjacent units - 10'. No more than one adjacent wall may be higher than the unit.

DIMENSIONS - YCAV0207S/P Standard Efficiency English (Con't)

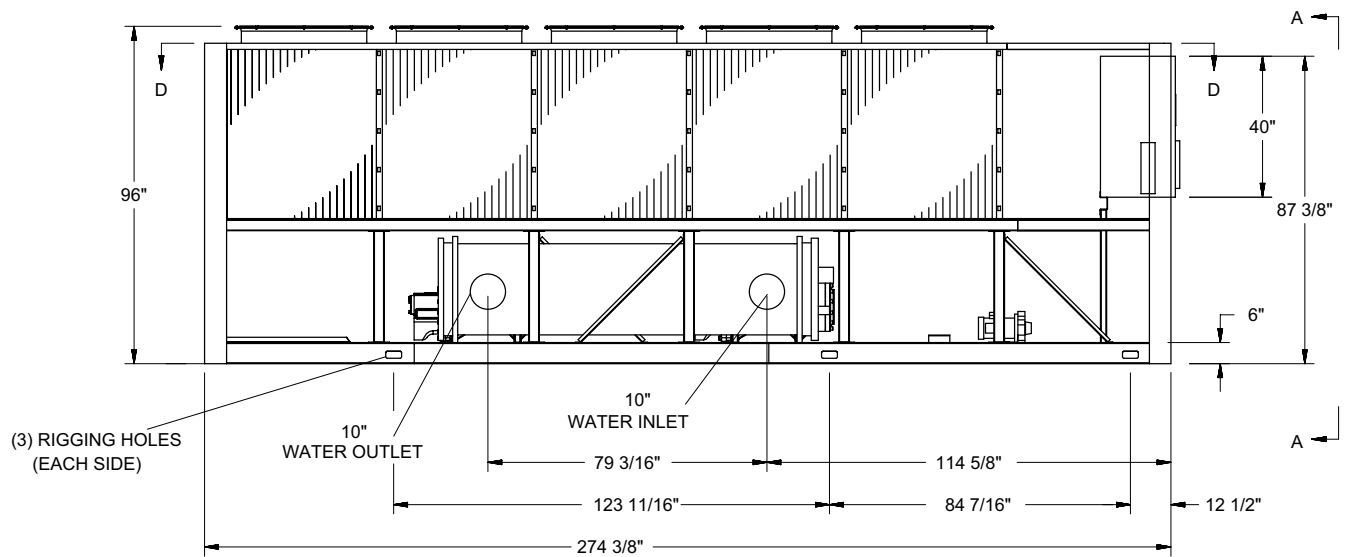
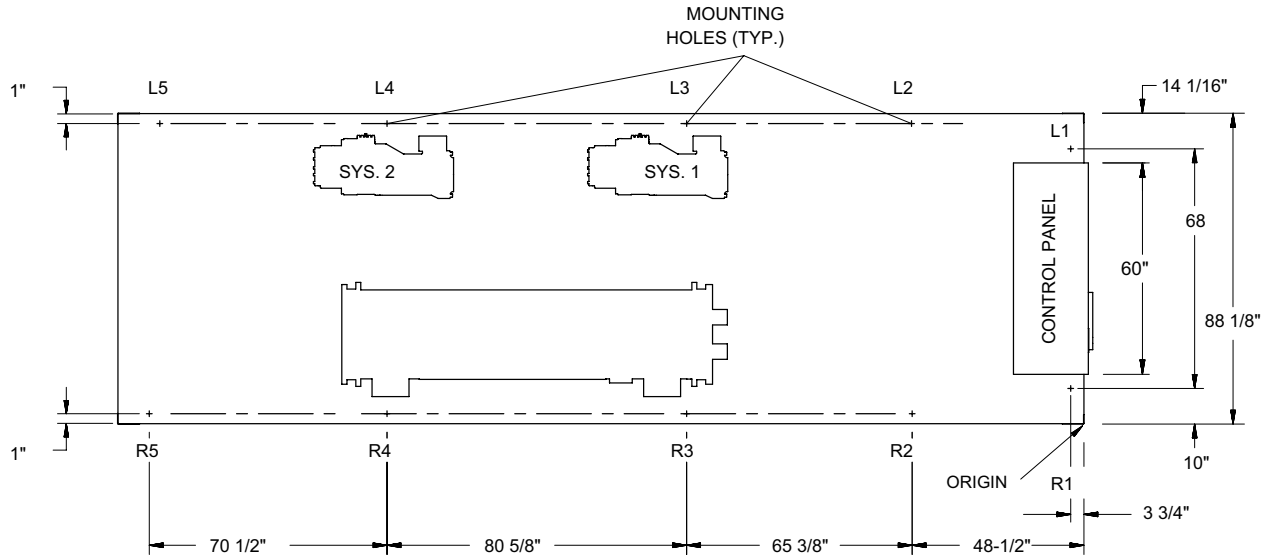

LD10535

DIMENSIONS - YCAV0207E/V HIGH Efficiency English

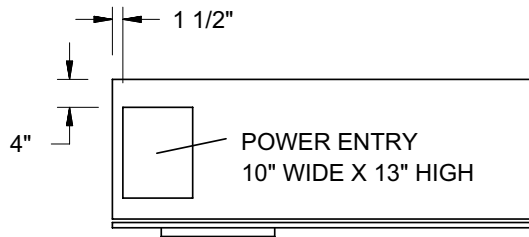

VIEW B-B
POWER ENTRY IS ON BOTTOM OF PANEL

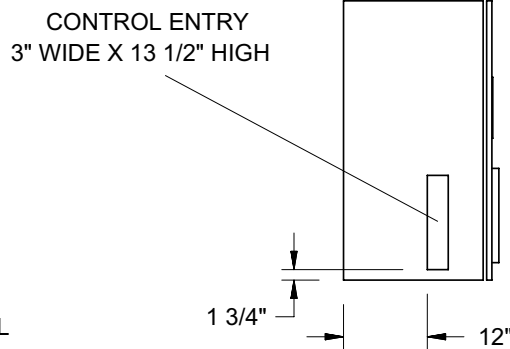

VIEW C-C

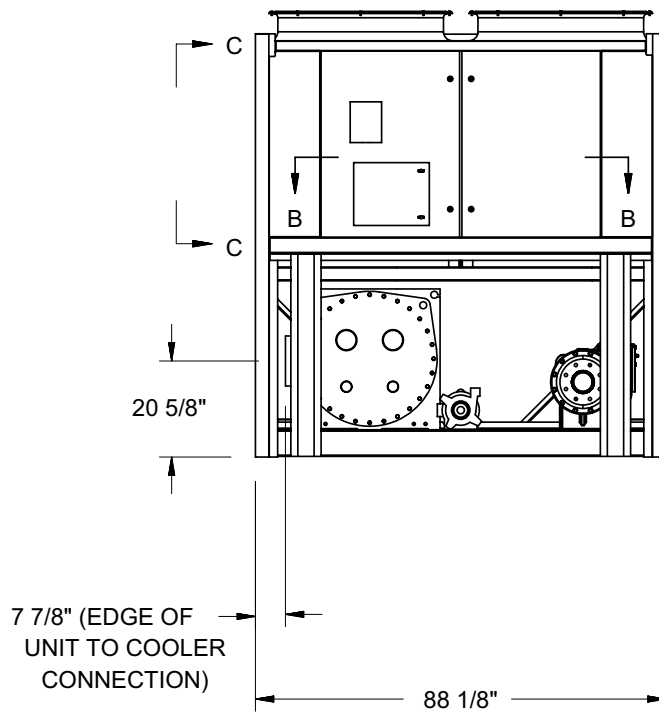

VIEW A-A

LD10536A

Notes:

1. Placement on a level surface free of obstructions (including snow, for winter operation) or air recirculation ensures rated performance, reliable operation and ease of maintenance. Site restrictions may compromise minimum clearances indicated below, resulting in unpredictable air flow patterns and possible diminished performance. YORK's unit controls will optimize operation without nuisance high pressure safety cutout; however, the system designer must consider potential performance degradation. Access to the unit control center assumes the unit is no higher than on spring isolators. Recommended minimum clearances: side to wall - 6'; rear to wall - 6'; control panel end to wall - 4'; top - no obstructions allowed; distance between adjacent units - 10'. No more than one adjacent wall may be higher than the unit.

DIMENSIONS - YCAV0207E/V HIGH Efficiency English (Con't)

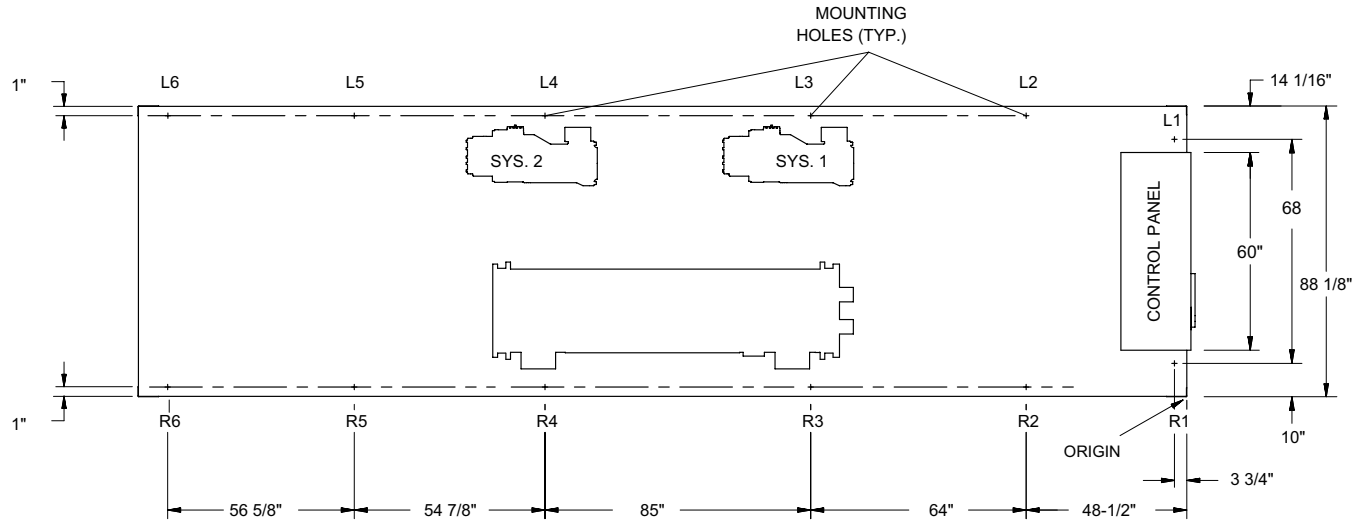

VIEW D-D

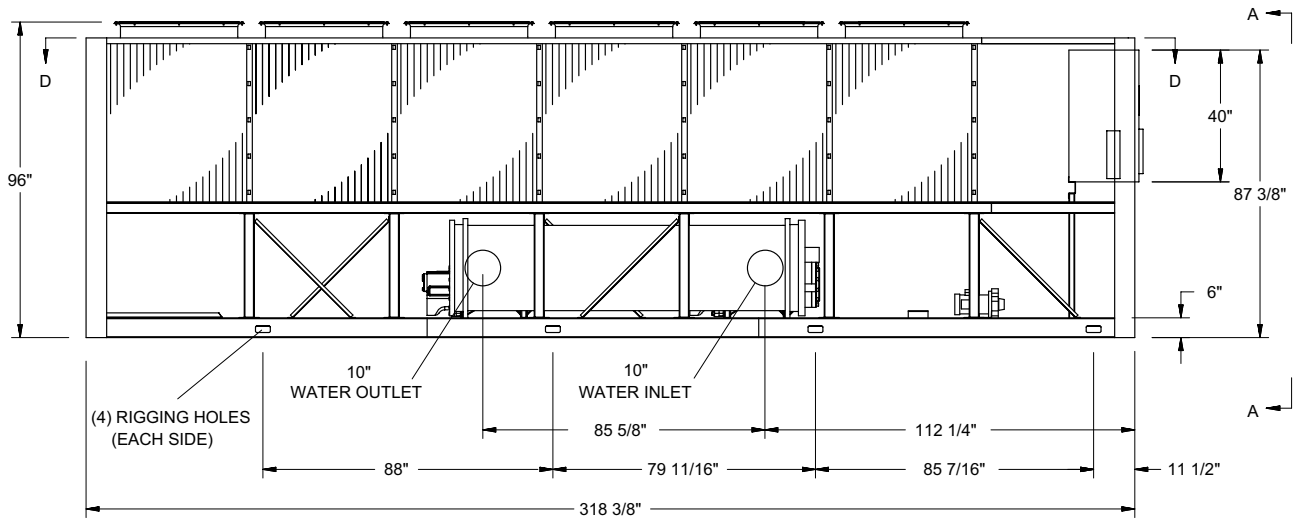

6

LD10537

DIMENSIONS - YCAV0227S/P Standard Efficiency English

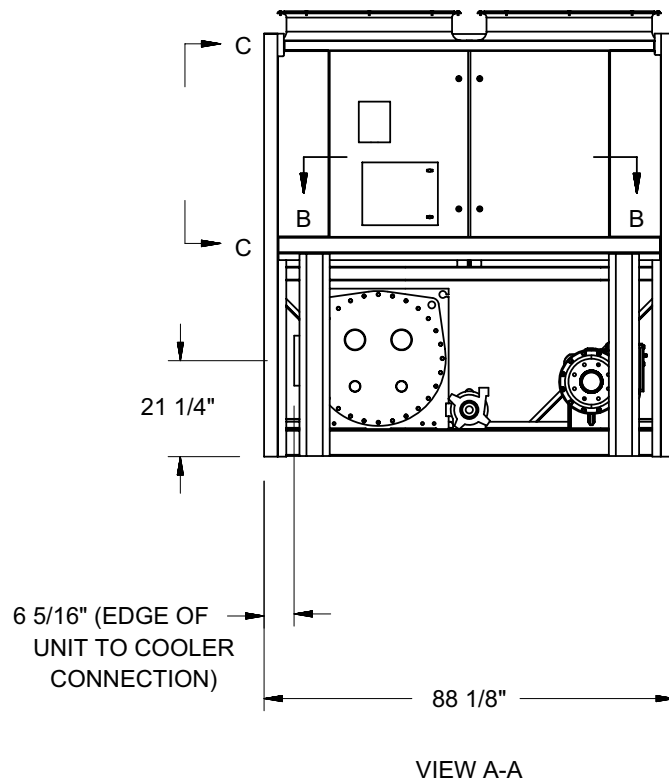
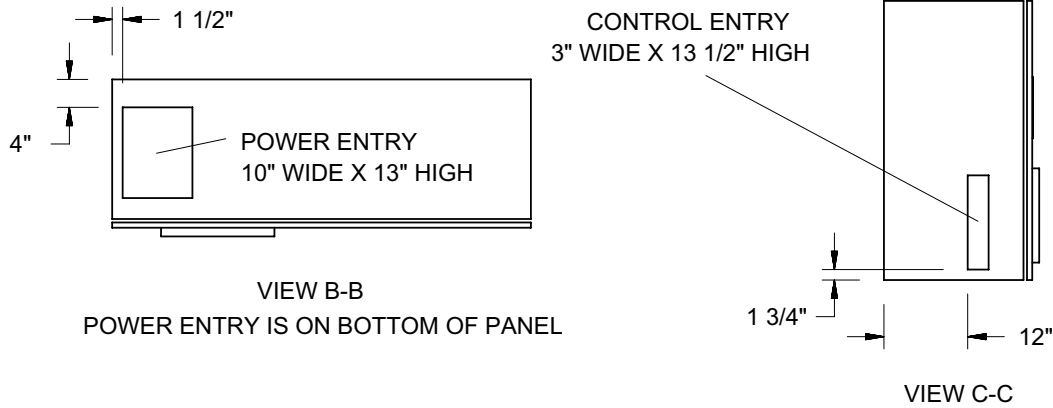

LD10538A

Notes:

1. Placement on a level surface free of obstructions (including snow, for winter operation) or air recirculation ensures rated performance, reliable operation and ease of maintenance. Site restrictions may compromise minimum clearances indicated below, resulting in unpredictable air flow patterns and possible diminished performance. YORK's unit controls will optimize operation without nuisance high pressure safety cutout; however, the system designer must consider potential performance degradation. Access to the unit control center assumes the unit is no higher than on spring isolators. Recommended minimum clearances: side to wall - 6'; rear to wall - 6'; control panel end to wall - 4'; top - no obstructions allowed; distance between adjacent units - 10'. No more than one adjacent wall may be higher than the unit.

DIMENSIONS - YCAV0227S/P Standard Efficiency English (Con't)

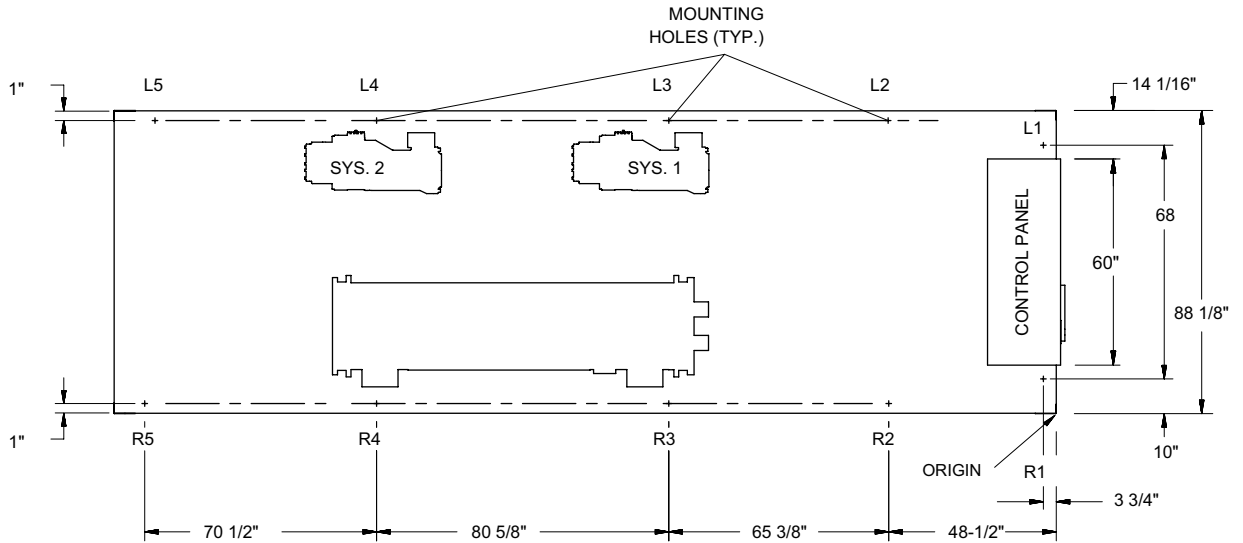

VIEW D-D

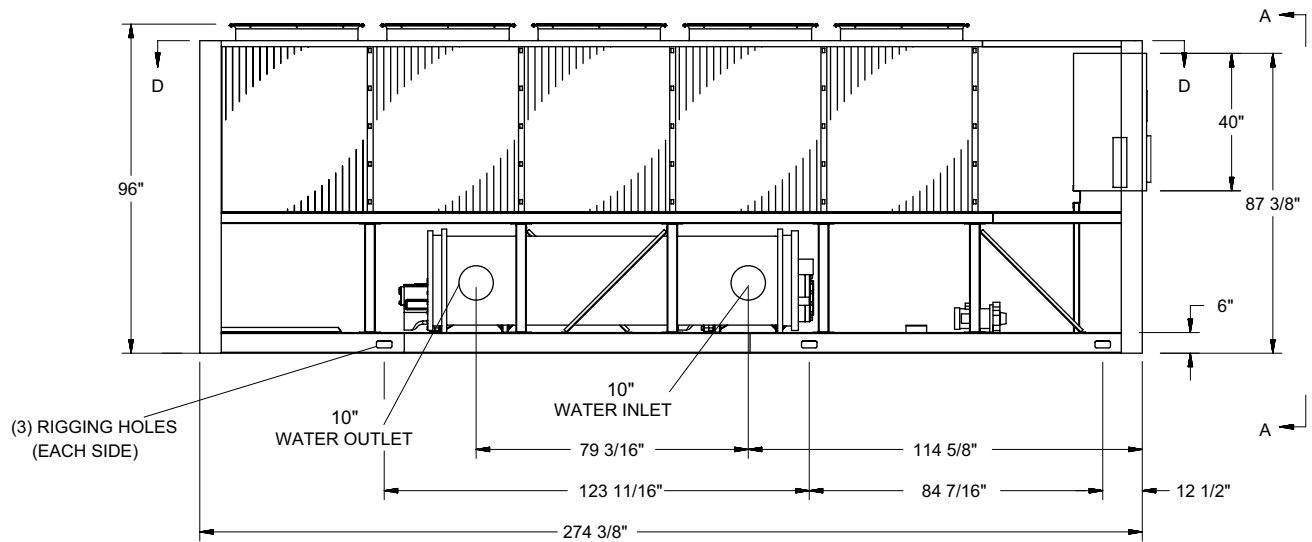

LD10539

DIMENSIONS - YCAV0227E/V High Efficiency English

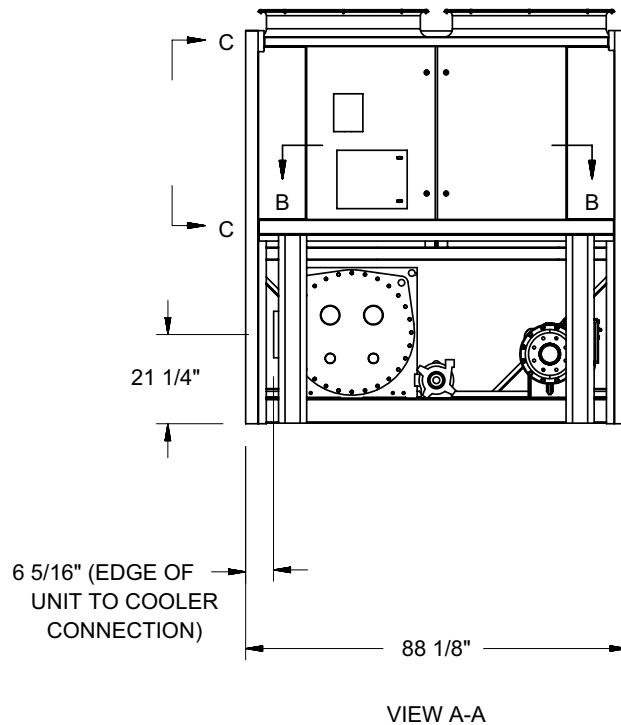
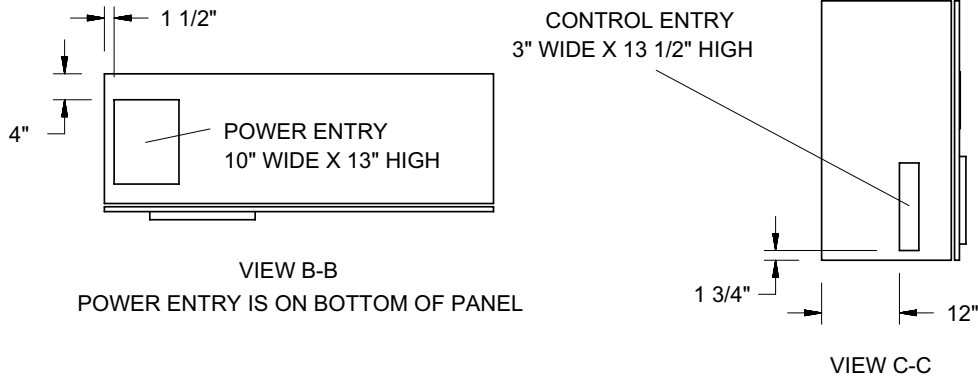

LD10540A

Notes:

1. Placement on a level surface free of obstructions (including snow, for winter operation) or air recirculation ensures rated performance, reliable operation and ease of maintenance. Site restrictions may compromise minimum clearances indicated below, resulting in unpredictable air flow patterns and possible diminished performance. YORK's unit controls will optimize operation without nuisance high pressure safety cutout; however, the system designer must consider potential performance degradation. Access to the unit control center assumes the unit is no higher than on spring isolators. Recommended minimum clearances: side to wall - 6'; rear to wall - 6'; control panel end to wall - 4'; top - no obstructions allowed; distance between adjacent units - 10'. No more than one adjacent wall may be higher than the unit.

DIMENSIONS - YCAV0227E/V High Efficiency English (Con't)

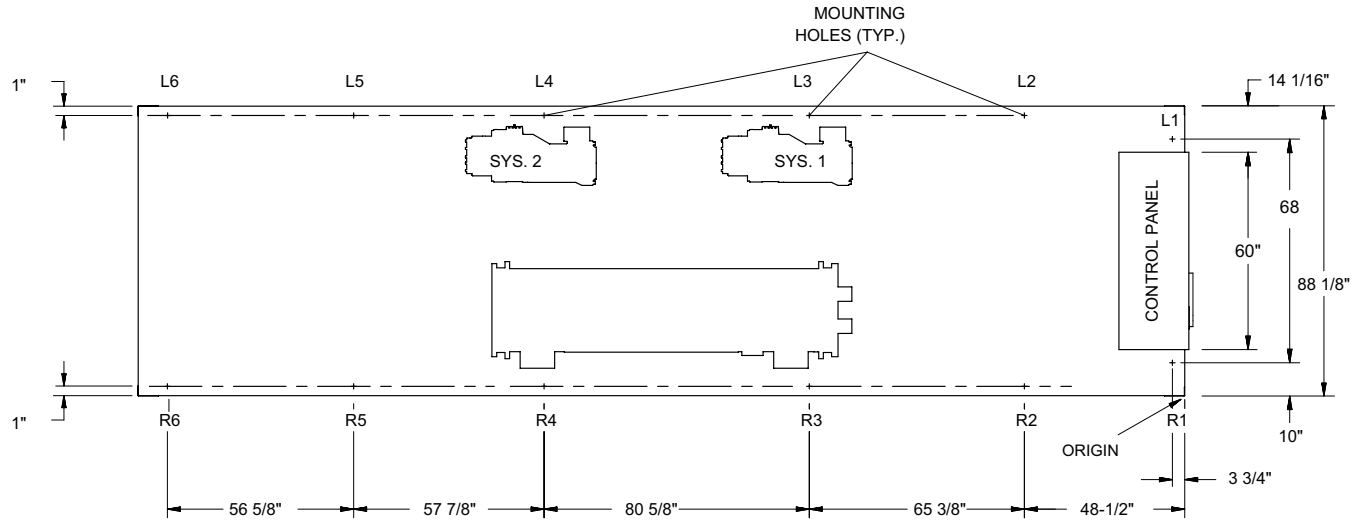

VIEW D-D

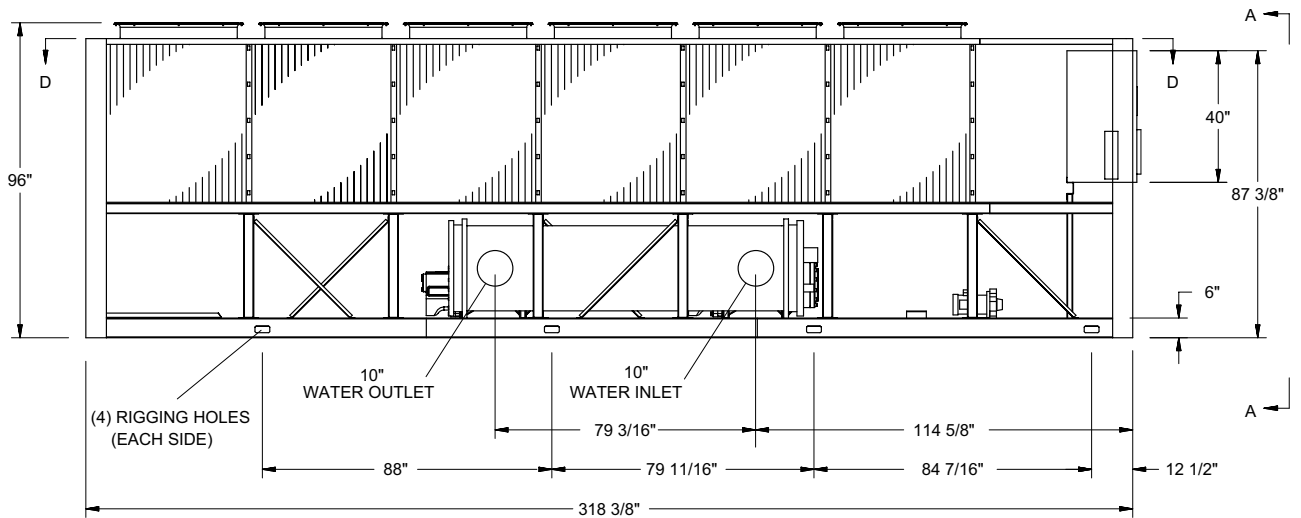

LD10541

DIMENSIONS - YCAV0247S/P Standard Efficiency English

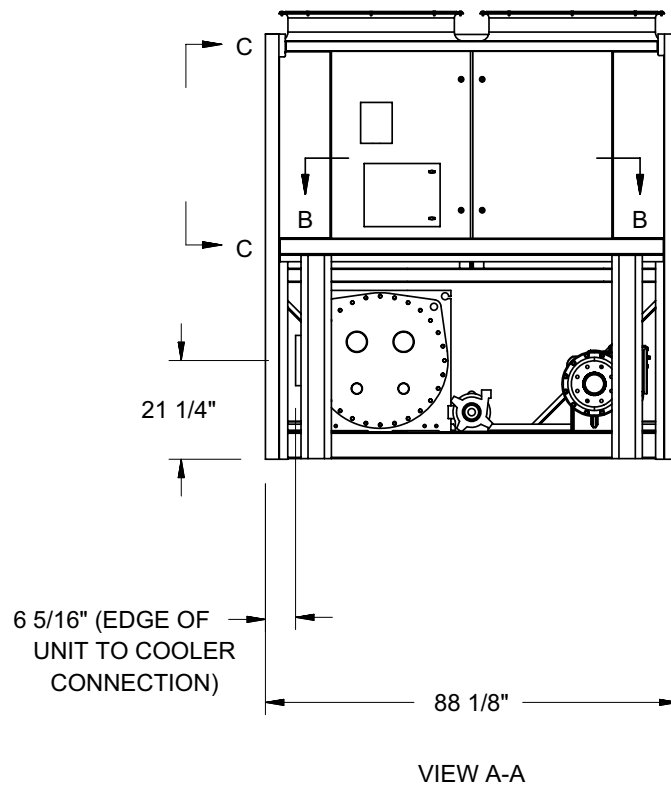
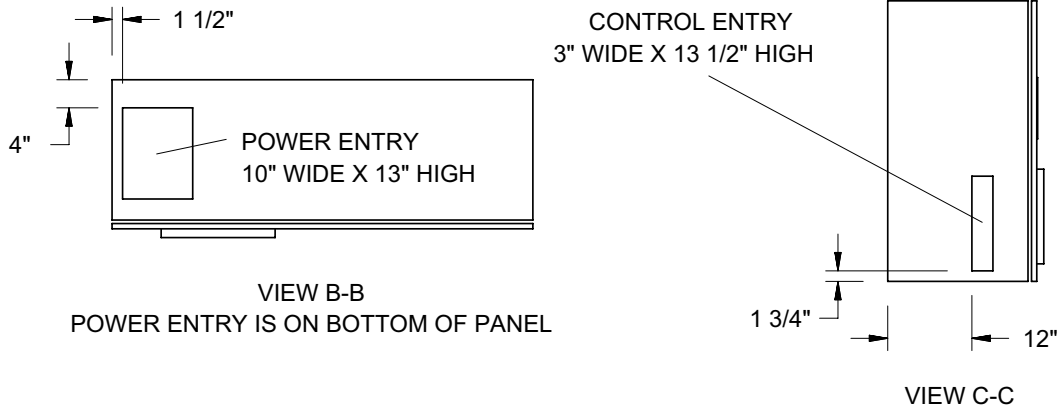

LD10542A

Notes:

1. Placement on a level surface free of obstructions (including snow, for winter operation) or air recirculation ensures rated performance, reliable operation and ease of maintenance. Site restrictions may compromise minimum clearances indicated below, resulting in unpredictable air flow patterns and possible diminished performance. YORK's unit controls will optimize operation without nuisance high pressure safety cutout; however, the system designer must consider potential performance degradation. Access to the unit control center assumes the unit is no higher than on spring isolators. Recommended minimum clearances: side to wall - 6'; rear to wall - 6'; control panel end to wall - 4'; top - no obstructions allowed; distance between adjacent units - 10'. No more than one adjacent wall may be higher than the unit.

DIMENSIONS - YCAV0247S/P Standard Efficiency English (Con't)

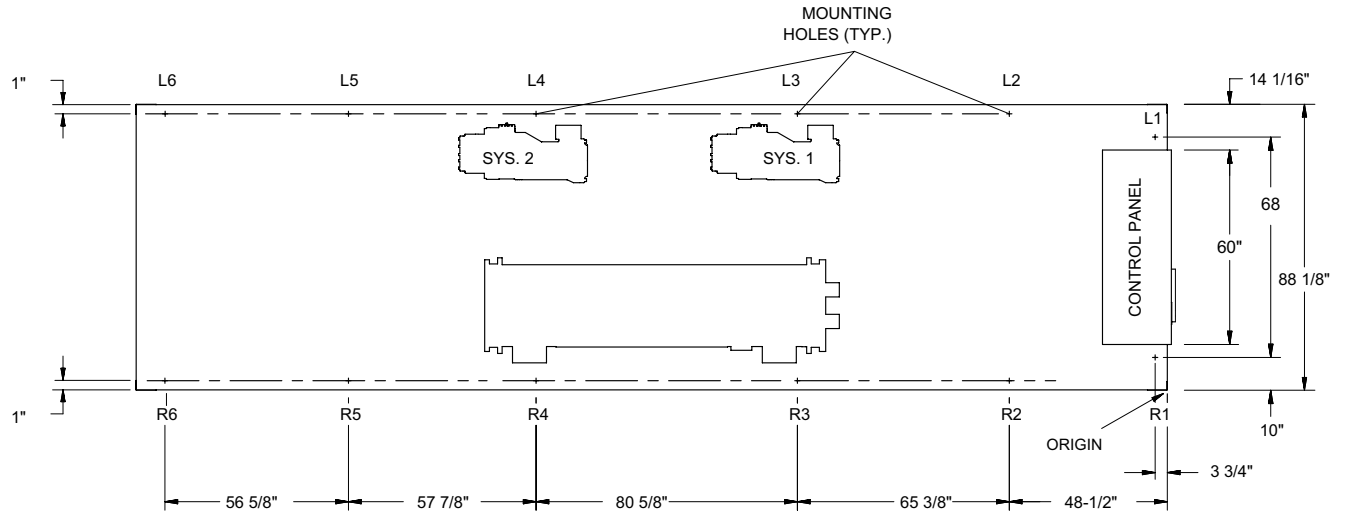

VIEW D-D

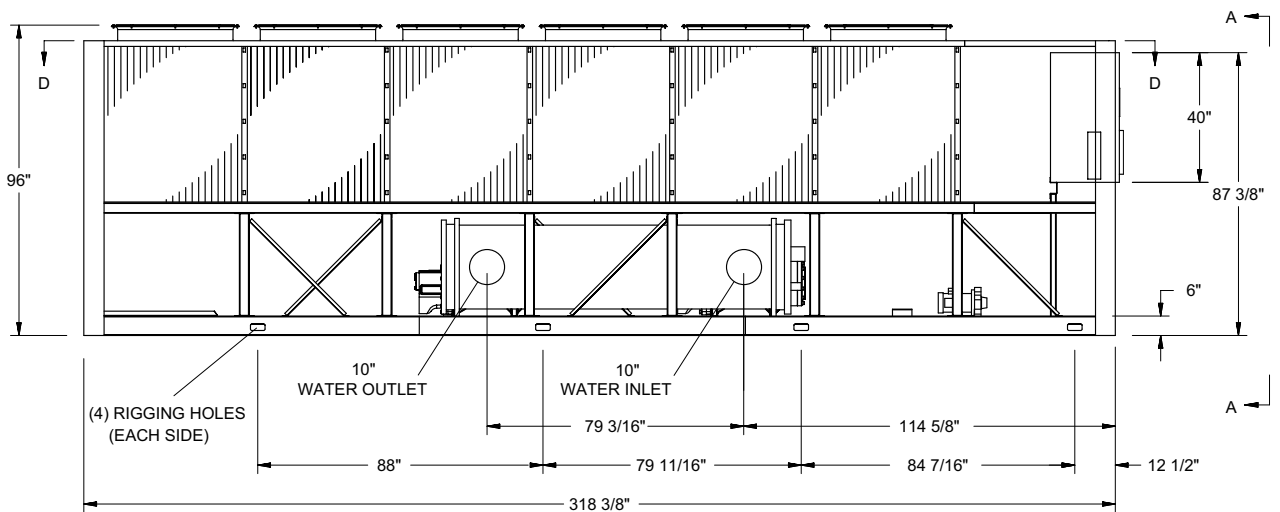

LD10543

DIMENSIONS - YCAV0247E/V High Efficiency English

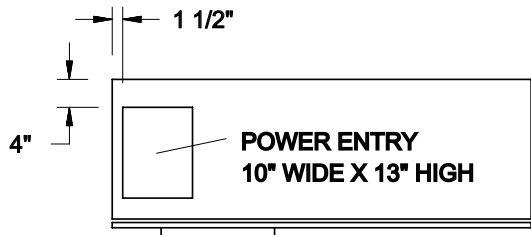

VIEW B-B
POWER ENTRY IS ON BOTTOM OF PANEL

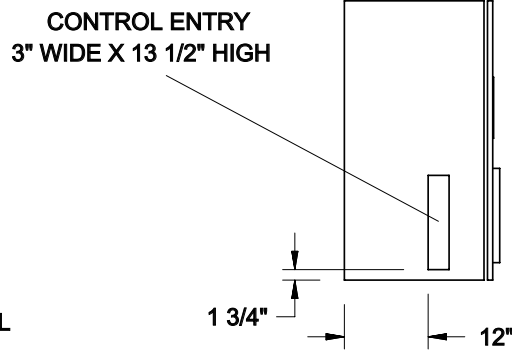

VIEW C-C

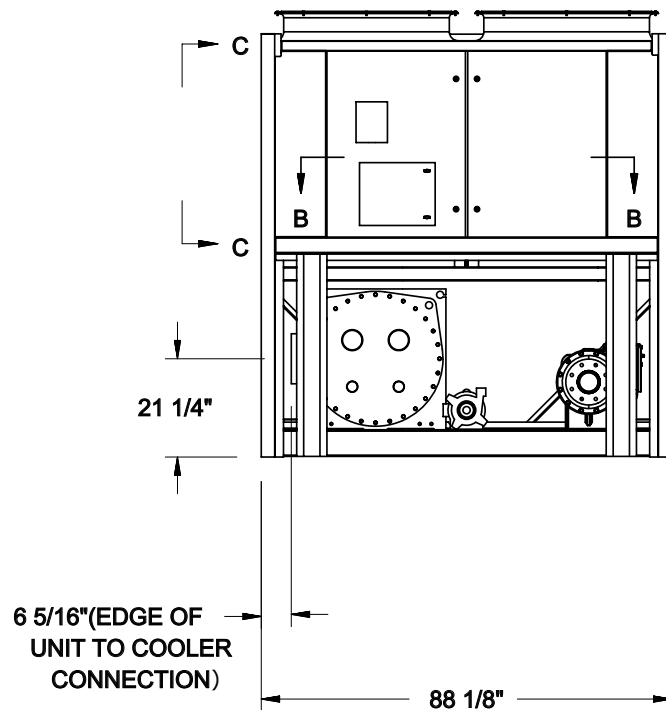

VIEW A-A

LD10544

Notes:

1. Placement on a level surface free of obstructions (including snow, for winter operation) or air recirculation ensures rated performance, reliable operation and ease of maintenance. Site restrictions may compromise minimum clearances indicated below, resulting in unpredictable air flow patterns and possible diminished performance. YORK's unit controls will optimize operation without nuisance high pressure safety cutout; however, the system designer must consider potential performance degradation. Access to the unit control center assumes the unit is no higher than on spring isolators. Recommended minimum clearances: side to wall - 6'; rear to wall - 6'; control panel end to wall - 4'; top - no obstructions allowed; distance between adjacent units - 10'. No more than one adjacent wall may be higher than the unit.

DIMENSIONS - YCAV0247E/V High Efficiency English (Con't)

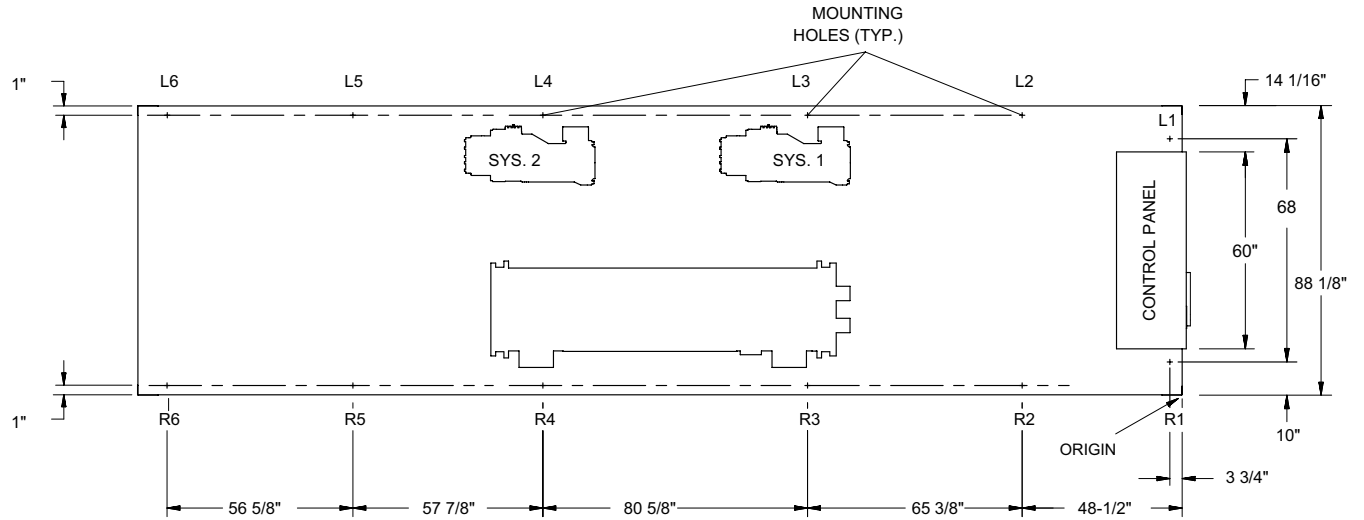

VIEW D-D

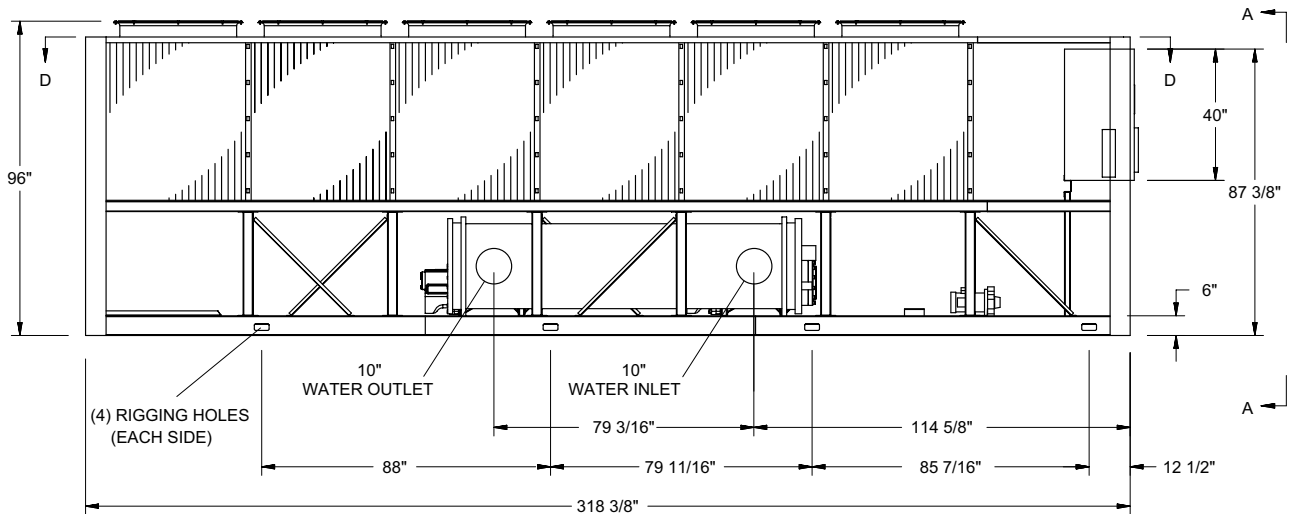

LD10545

DIMENSIONS - YCAV0267S/P Standard Efficiency English

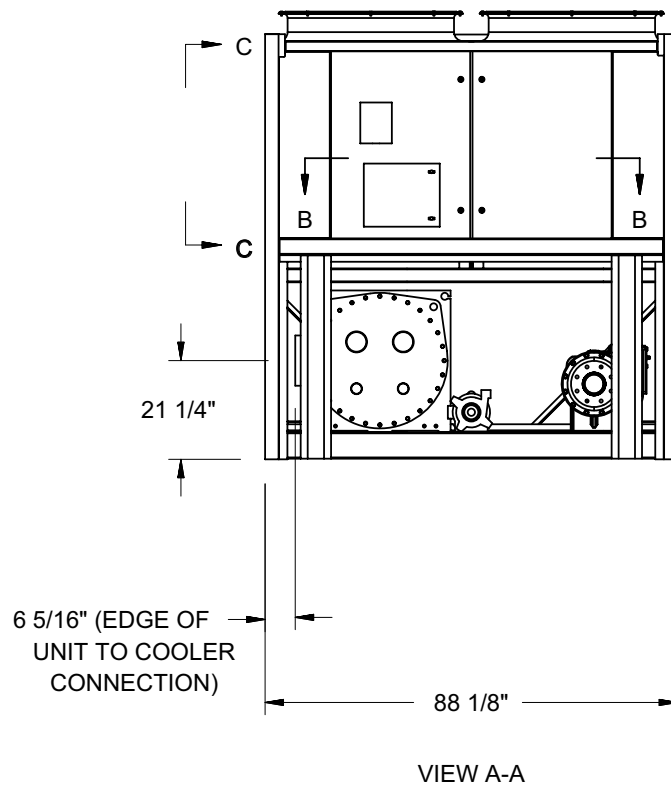
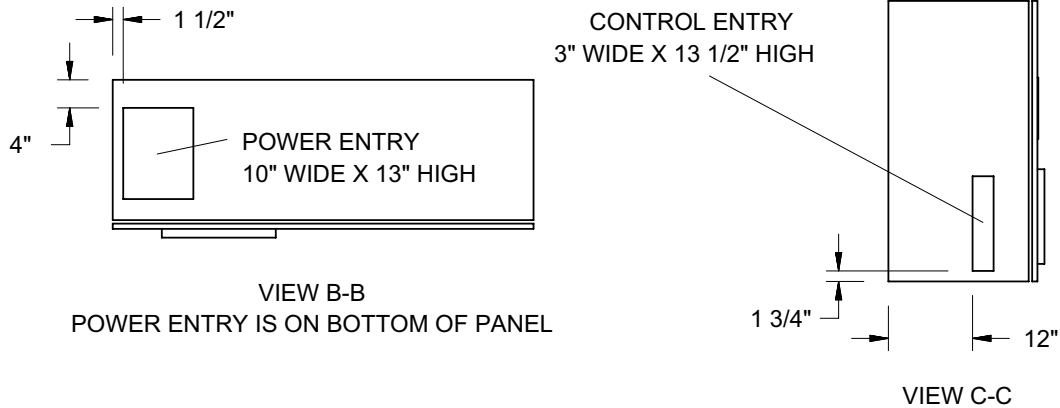

LD10546A

Notes:

1. Placement on a level surface free of obstructions (including snow, for winter operation) or air recirculation ensures rated performance, reliable operation and ease of maintenance. Site restrictions may compromise minimum clearances indicated below, resulting in unpredictable air flow patterns and possible diminished performance. YORK's unit controls will optimize operation without nuisance high pressure safety cutout; however, the system designer must consider potential performance degradation. Access to the unit control center assumes the unit is no higher than on spring isolators. Recommended minimum clearances: side to wall - 6'; rear to wall - 6'; control panel end to wall - 4'; top - no obstructions allowed; distance between adjacent units - 10'. No more than one adjacent wall may be higher than the unit.

DIMENSIONS - YCAV0267S/P Standard Efficiency English (Con't)

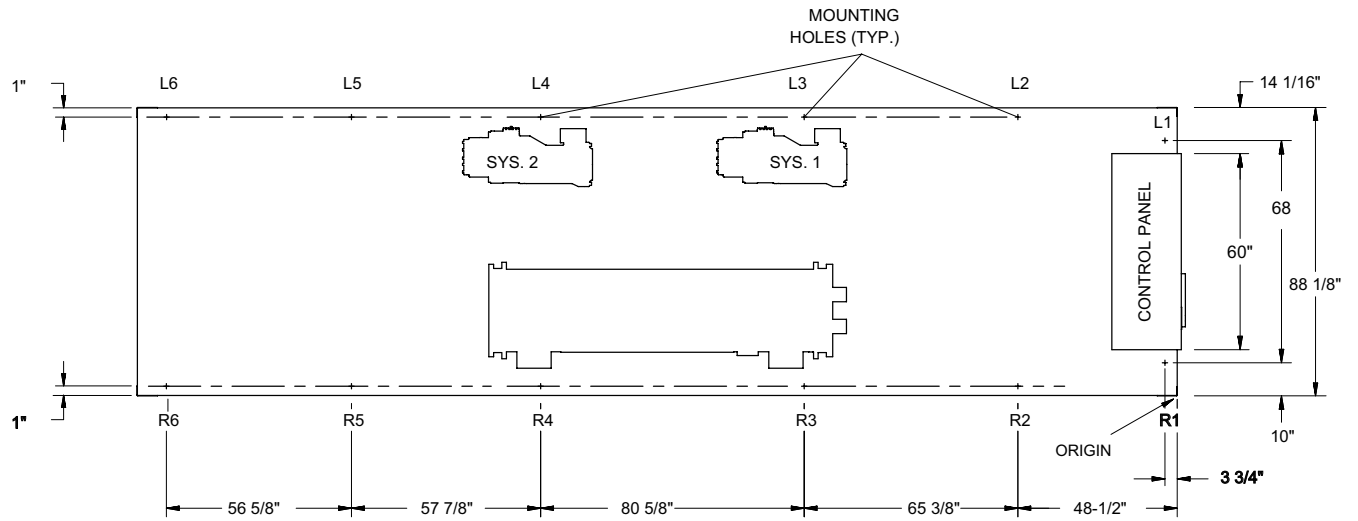

VIEW D-D

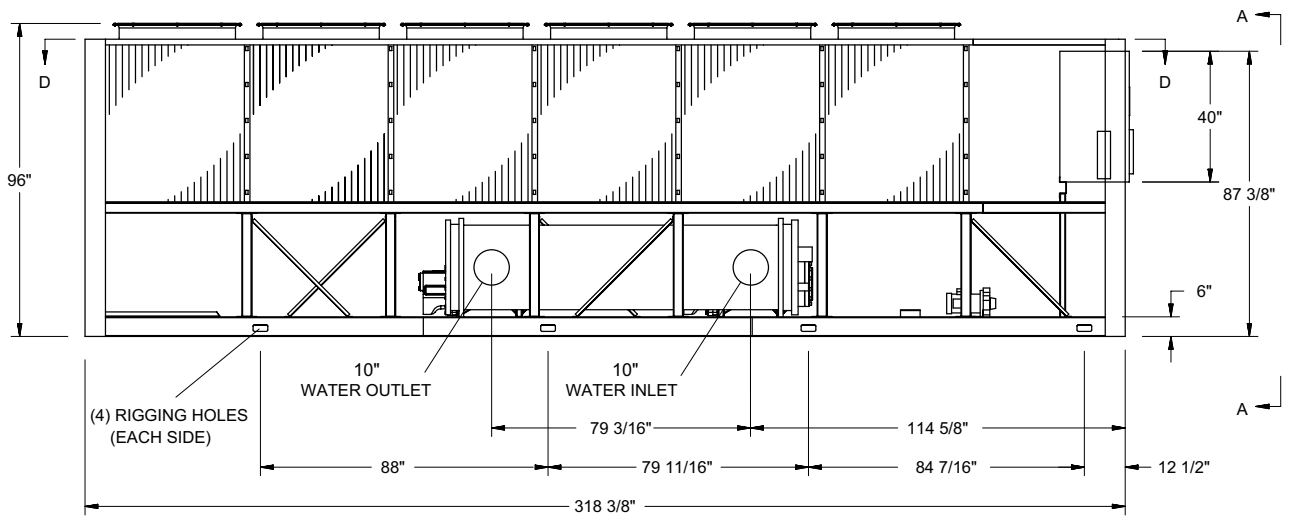

6

LD10547

DIMENSIONS - YCAV0157S/P Standard Efficiency SI

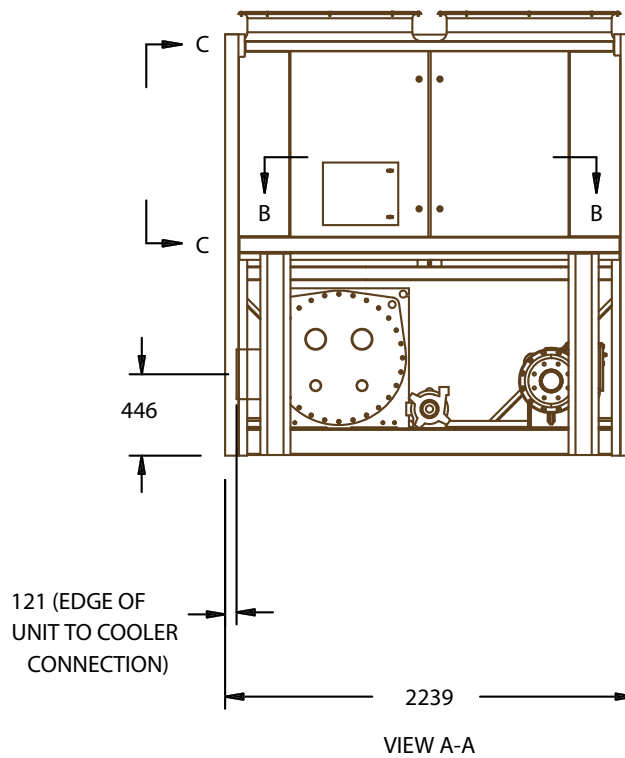
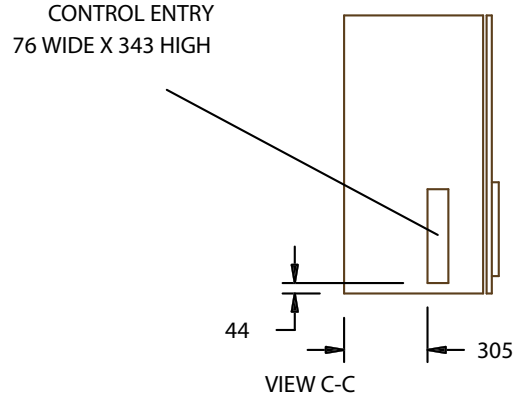
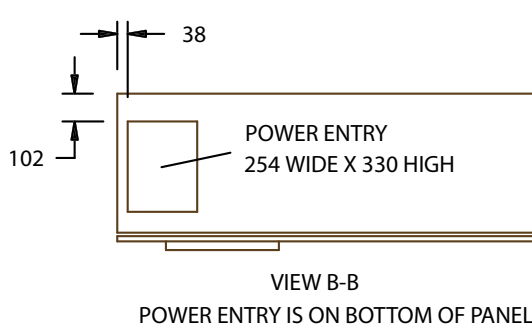

LD10548A

POWER: SINGLE POINT WITH TERMINAL BLOCK

Notes:

1. Placement on a level surface free of obstructions (including snow, for winter operation) or air recirculation ensures rated performance, reliable operation and ease of maintenance. Site restrictions may compromise minimum clearances indicated below, resulting in unpredictable air flow patterns and possible diminished performance. YORK's unit controls will optimize operation without nuisance high pressure safety cutout; however, the system designer must consider potential performance degradation. Access to the unit control center assumes the unit is no higher than on spring isolators. Recommended minimum clearances: side to wall - 2m; rear to wall - 2m; control panel end to wall - 1.2m; top - no obstructions allowed; distance between adjacent units - 3m. No more than one adjacent wall may be higher than the unit.

DIMENSIONS - YCAV0157S/P Standard Efficiency SI (Con't)

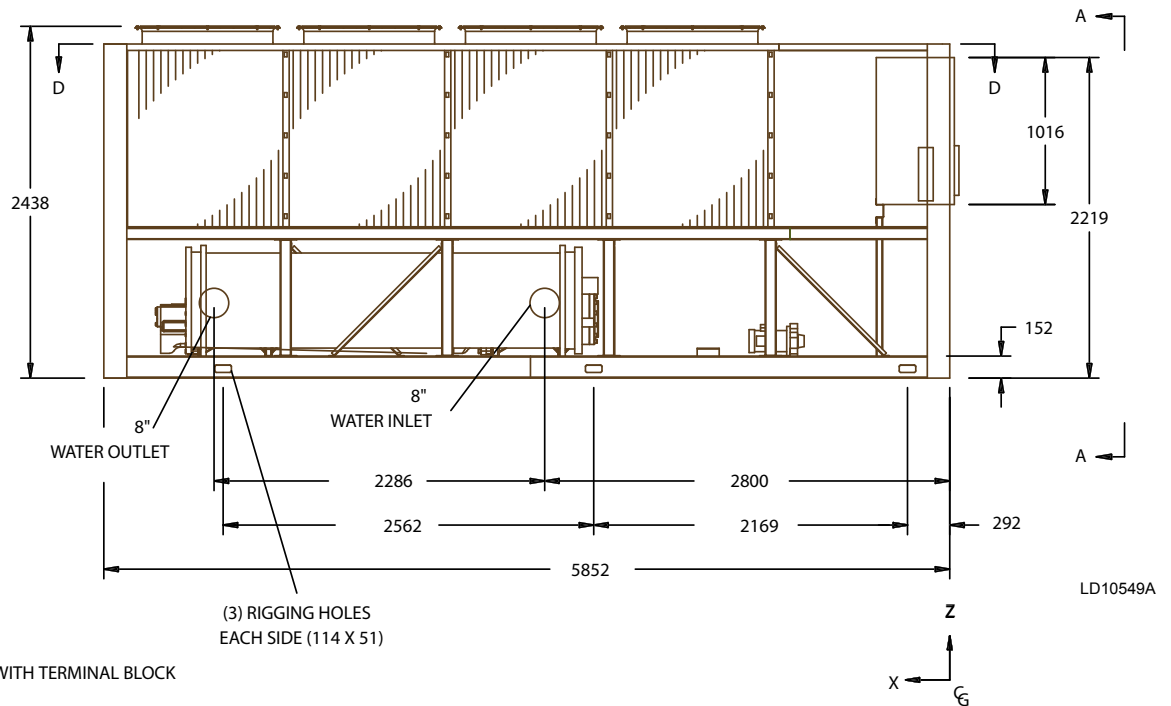
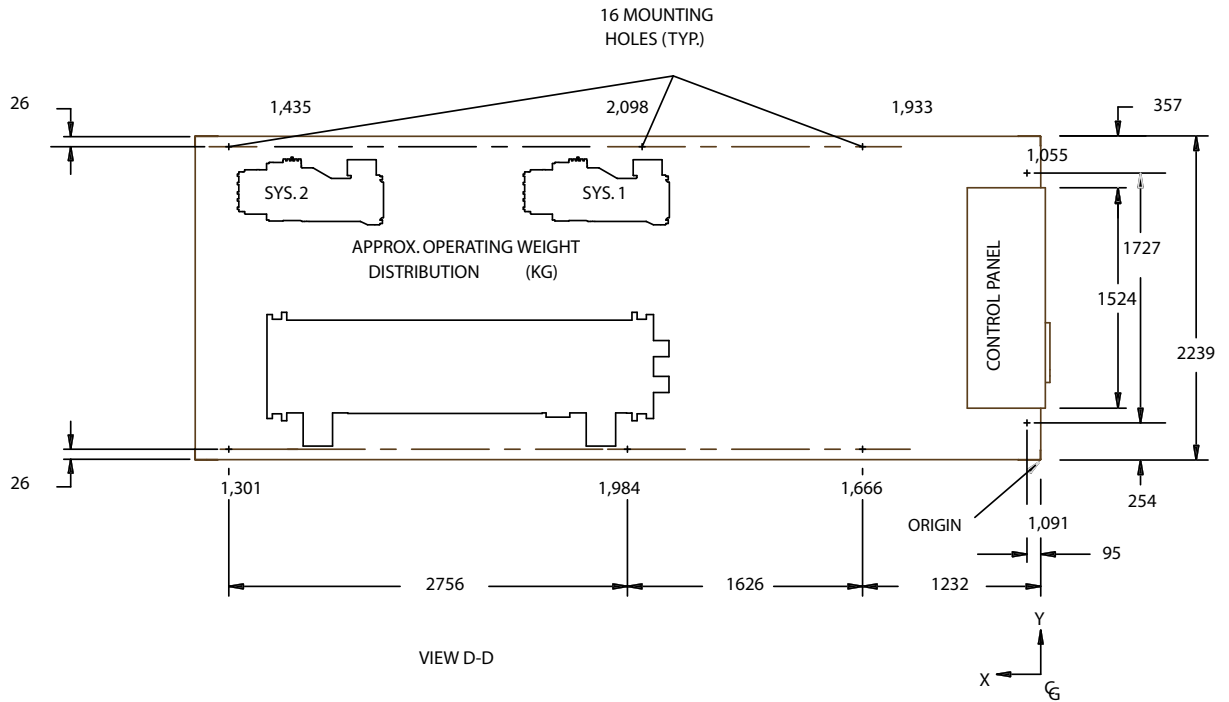

6

DIMENSIONS - YCAV0157E/V High Efficiency SI

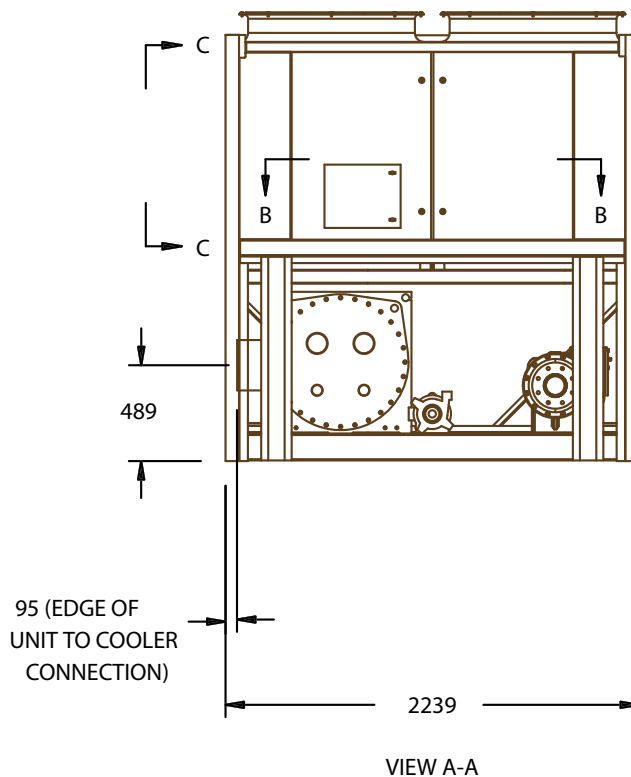
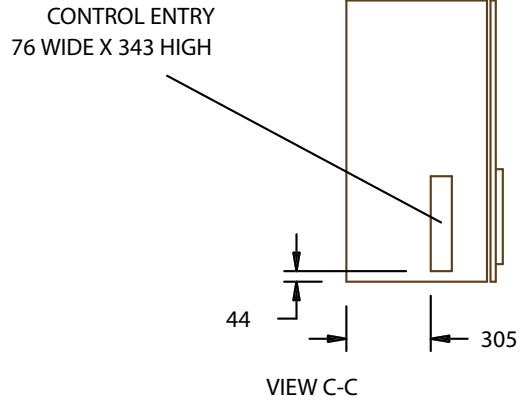
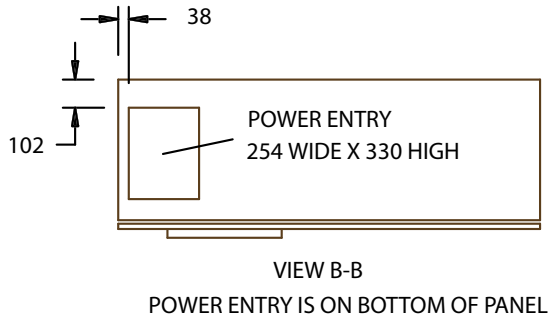

LD10550A

POWER: SINGLE POINT WITH TERMINAL BLOCK

Notes:

1. Placement on a level surface free of obstructions (including snow, for winter operation) or air recirculation ensures rated performance, reliable operation and ease of maintenance. Site restrictions may compromise minimum clearances indicated below, resulting in unpredictable air flow patterns and possible diminished performance. YORK's unit controls will optimize operation without nuisance high pressure safety cutout; however, the system designer must consider potential performance degradation. Access to the unit control center assumes the unit is no higher than on spring isolators. Recommended minimum clearances: side to wall - 2m; rear to wall - 2m; control panel end to wall - 1.2m; top - no obstructions allowed; distance between adjacent units - 3m. No more than one adjacent wall may be higher than the unit.

DIMENSIONS - YCAV0157E/V High Efficiency SI (Con't)

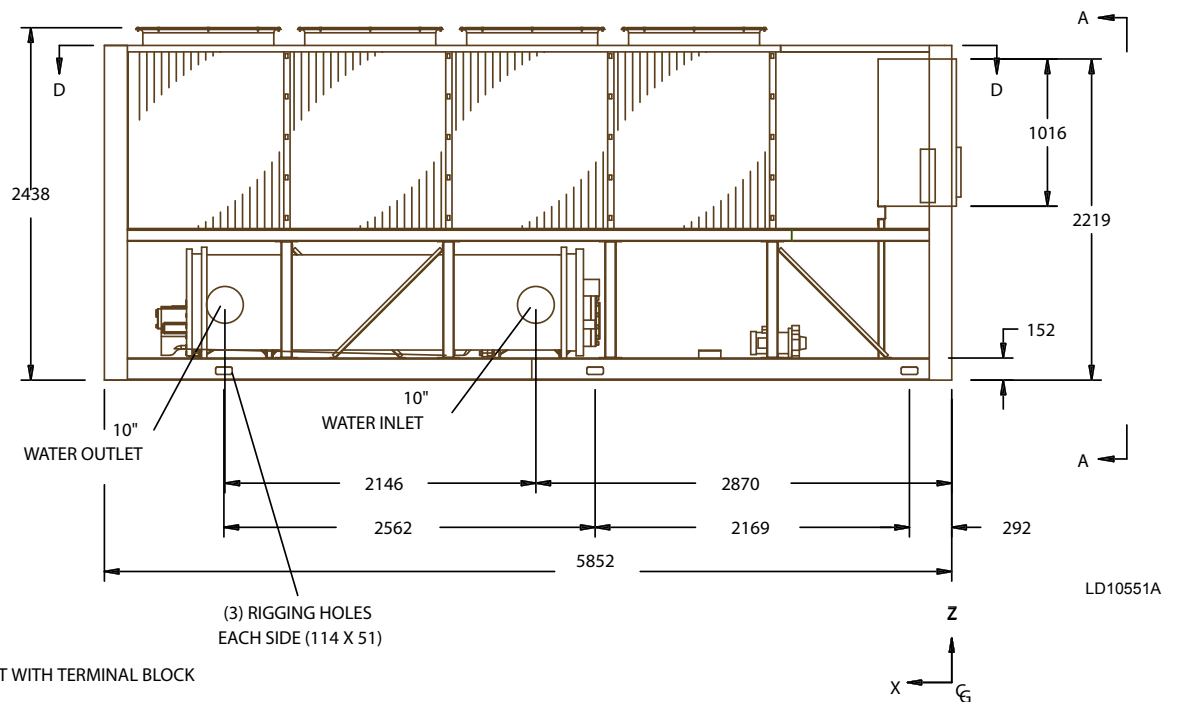
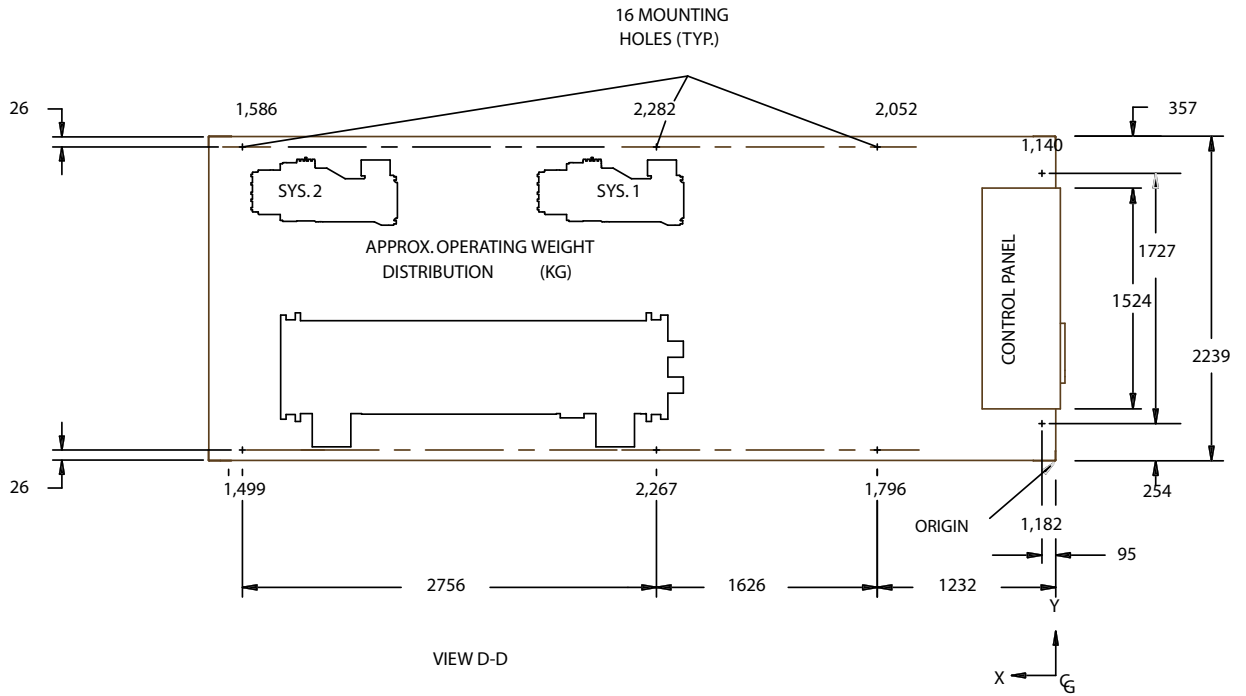

DIMENSIONS - YCAV0177E/V High Efficiency SI (Con't)

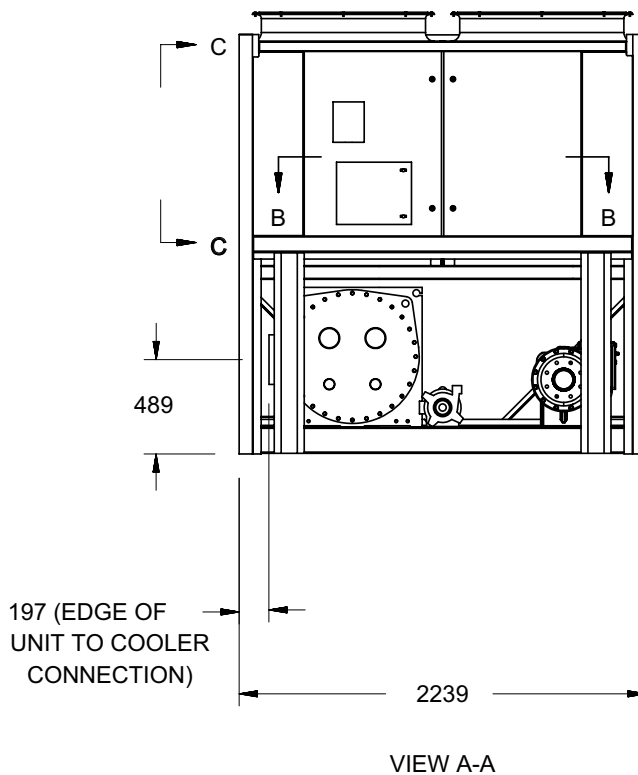
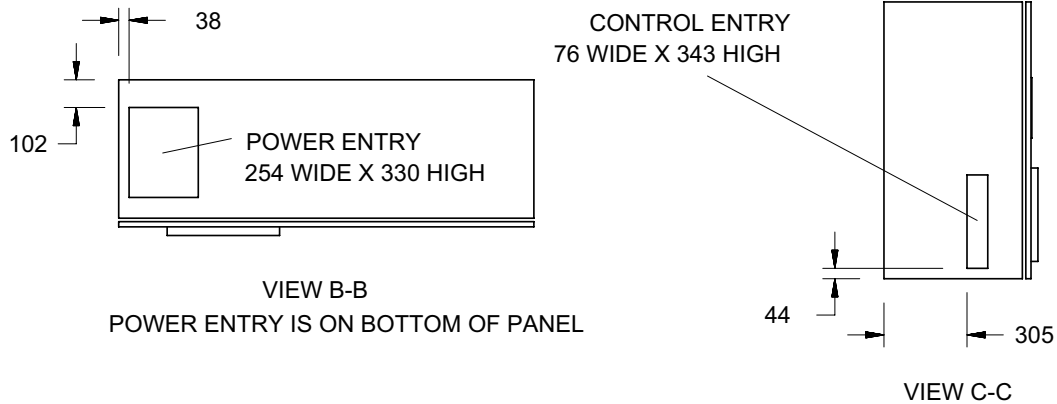

LD10552A

Notes:

1. Placement on a level surface free of obstructions (including snow, for winter operation) or air recirculation ensures rated performance, reliable operation and ease of maintenance. Site restrictions may compromise minimum clearances indicated below, resulting in unpredictable air flow patterns and possible diminished performance. YORK's unit controls will optimize operation without nuisance high pressure safety cutout; however, the system designer must consider potential performance degradation. Access to the unit control center assumes the unit is no higher than on spring isolators. Recommended minimum clearances: side to wall - 2m; rear to wall - 2m; control panel end to wall - 1.2m; top - no obstructions allowed; distance between adjacent units - 3m. No more than one adjacent wall may be higher than the unit.

DIMENSIONS - YCAV0177E/V High Efficiency SI (Con't)

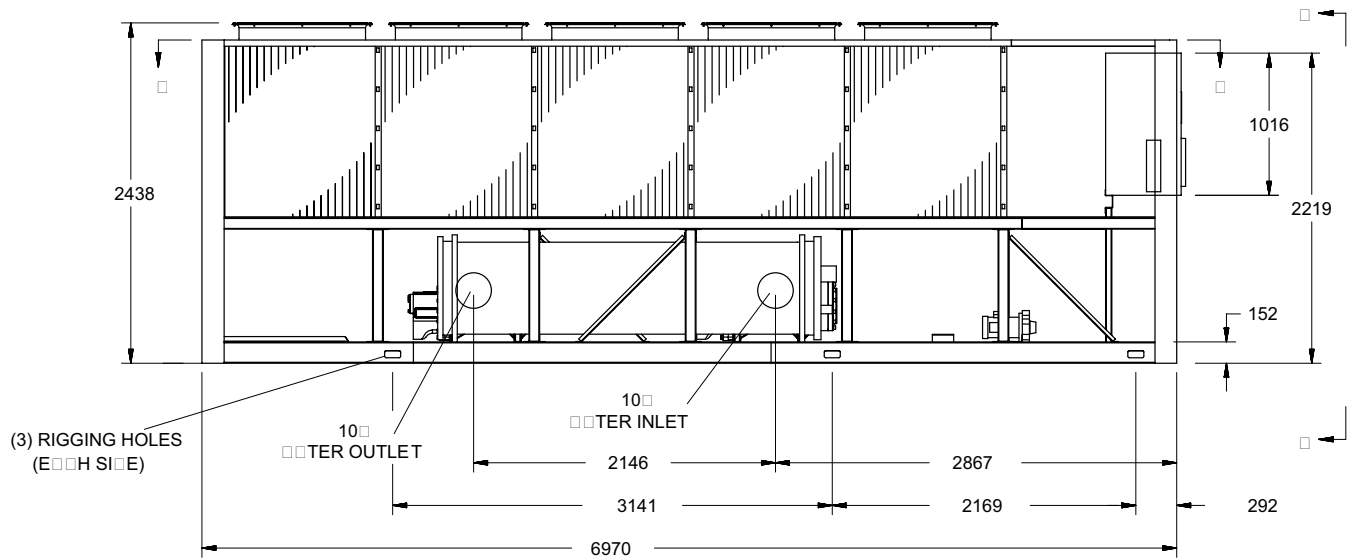
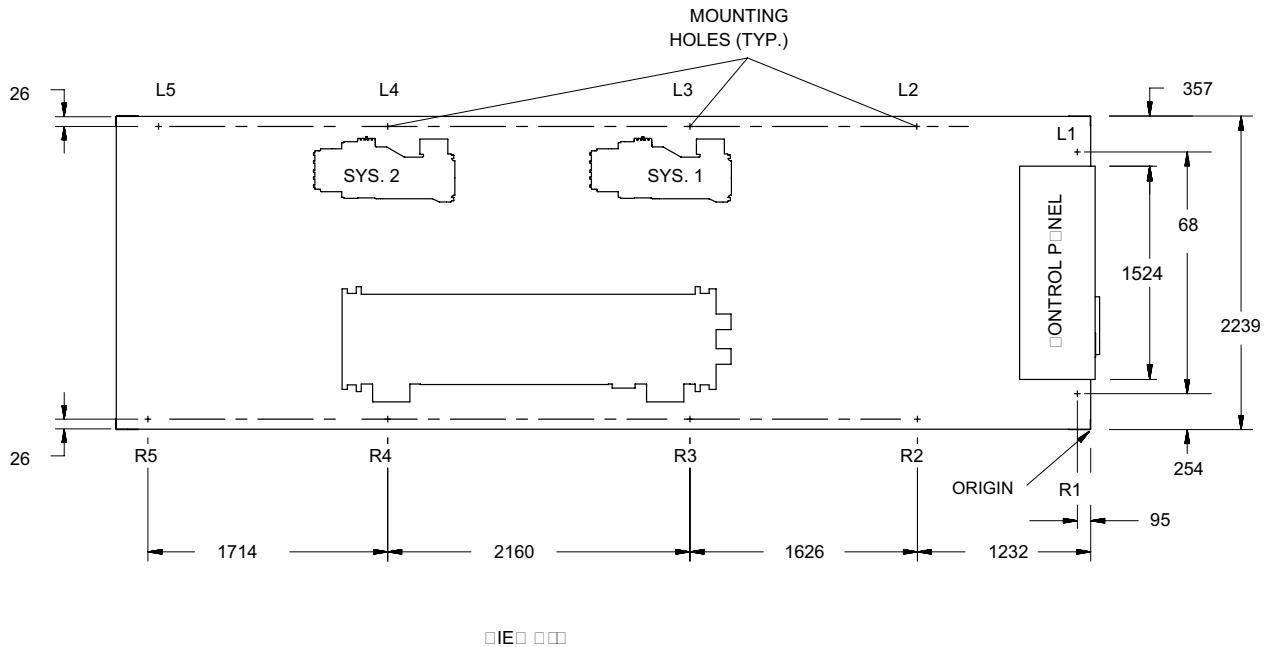

LD10555

DIMENSIONS - YCAV0177S/P Standard Efficiency SI

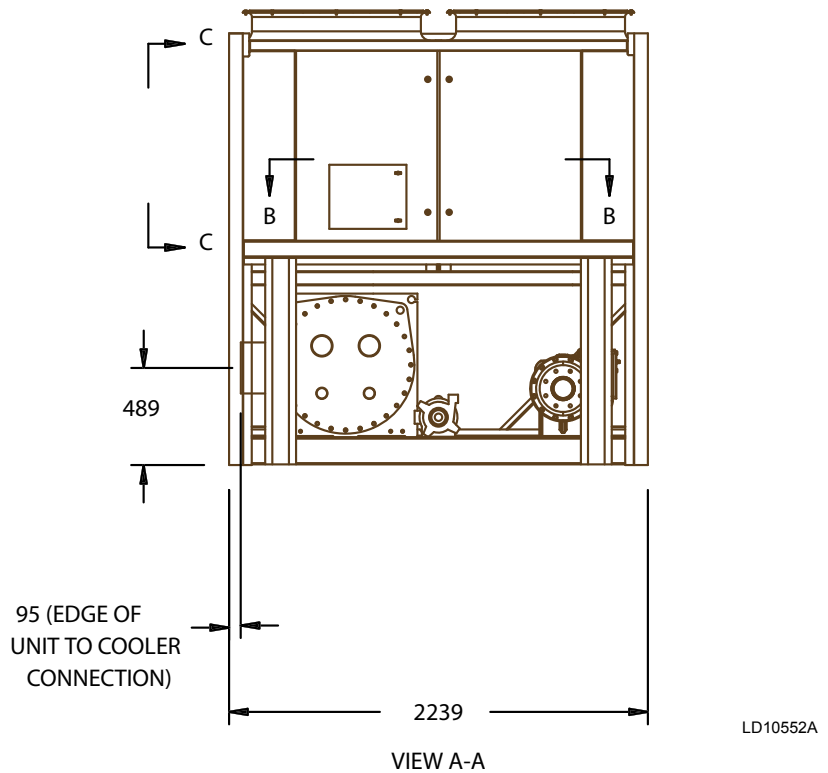
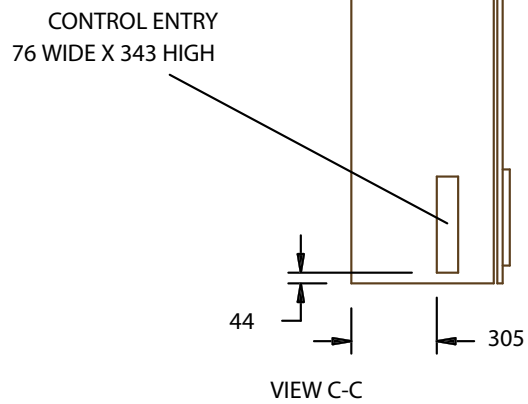
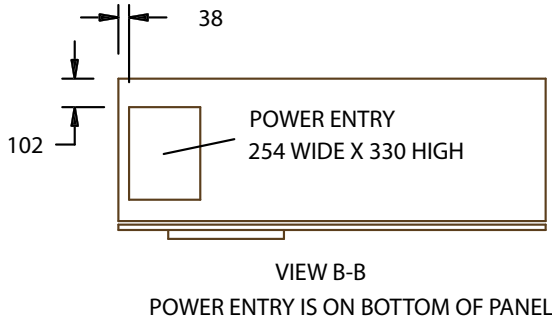

POWER: SINGLE POINT WITH TERMINAL BLOCK

Notes:

1. Placement on a level surface free of obstructions (including snow, for winter operation) or air recirculation ensures rated performance, reliable operation and ease of maintenance. Site restrictions may compromise minimum clearances indicated below, resulting in unpredictable air flow patterns and possible diminished performance. YORK's unit controls will optimize operation without nuisance high pressure safety cutout; however, the system designer must consider potential performance degradation. Access to the unit control center assumes the unit is no higher than on spring isolators. Recommended minimum clearances: side to wall - 2m; rear to wall - 2m; control panel end to wall - 1.2m; top - no obstructions allowed; distance between adjacent units - 3m. No more than one adjacent wall may be higher than the unit.

DIMENSIONS - YCAV0177S/P Standard Efficiency SI (Con't)

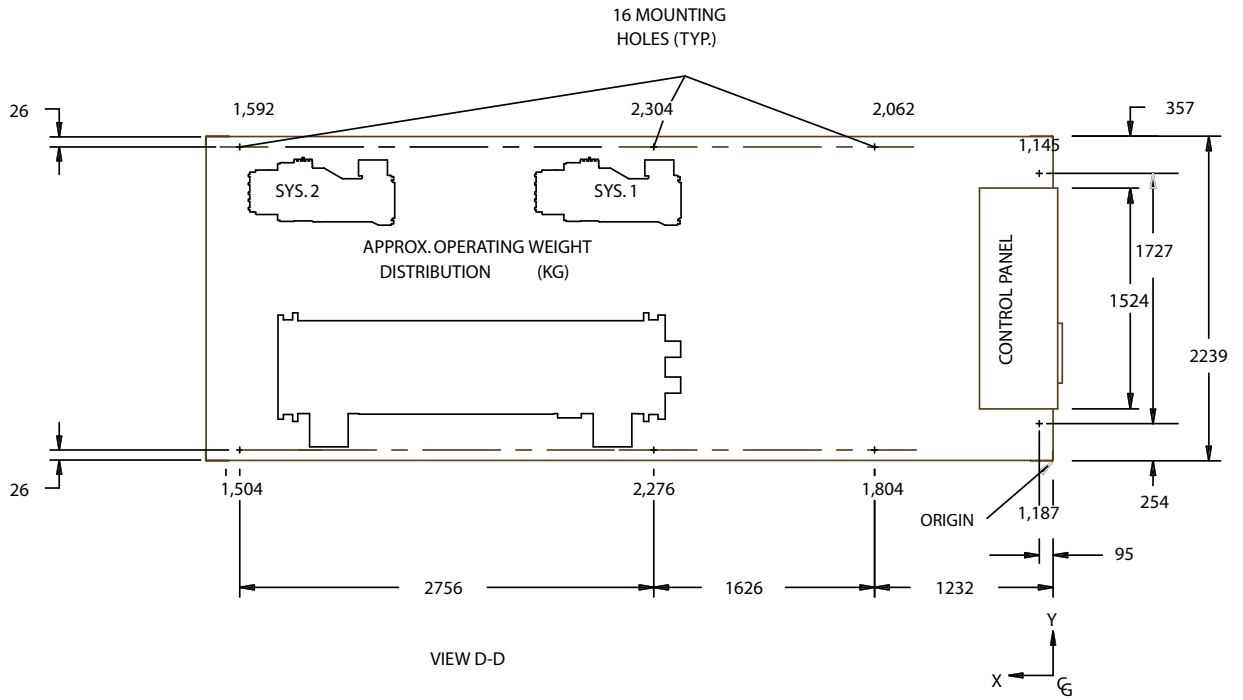

6

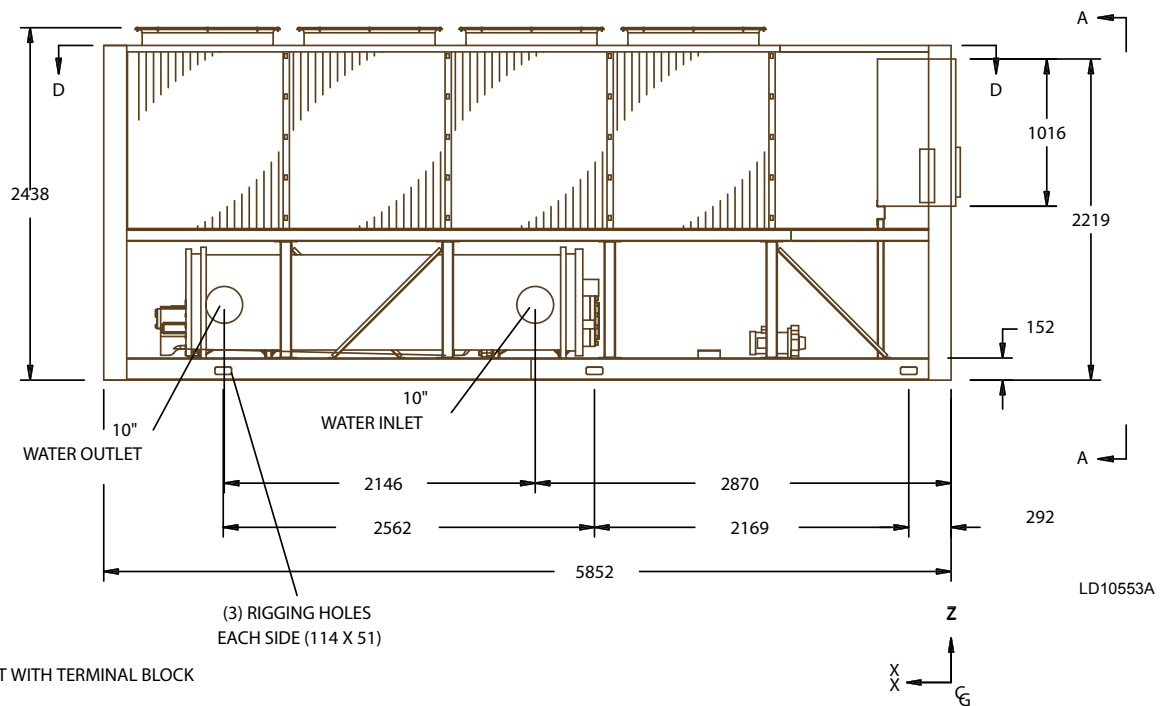

DIMENSIONS - YCAV0187S/P Standard Efficiency SI

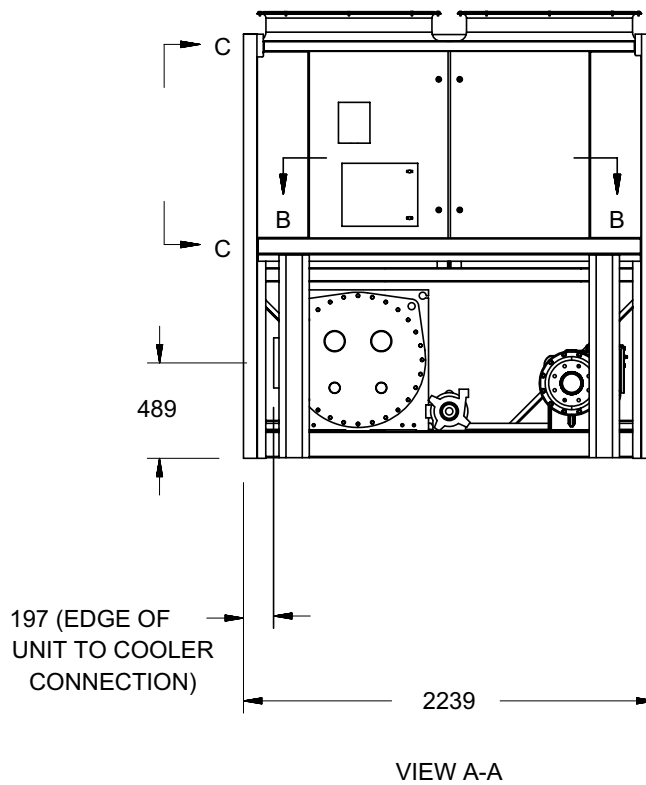
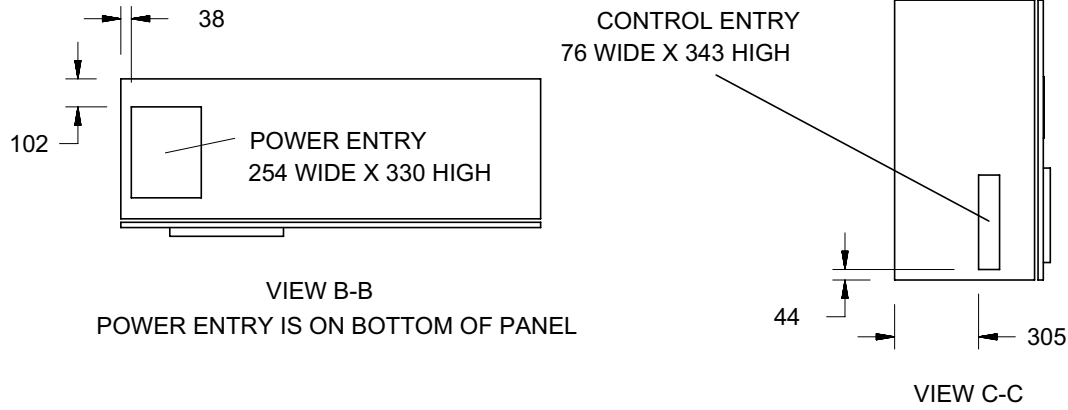

LD10554A

Notes:

1. Placement on a level surface free of obstructions (including snow, for winter operation) or air recirculation ensures rated performance, reliable operation and ease of maintenance. Site restrictions may compromise minimum clearances indicated below, resulting in unpredictable air flow patterns and possible diminished performance. YORK's unit controls will optimize operation without nuisance high pressure safety cutout; however, the system designer must consider potential performance degradation. Access to the unit control center assumes the unit is no higher than on spring isolators. Recommended minimum clearances: side to wall - 2m; rear to wall - 2m; control panel end to wall - 1.2m; top - no obstructions allowed; distance between adjacent units - 3m. No more than one adjacent wall may be higher than the unit.

DIMENSIONS - YCAV0187S/P Standard Efficiency SI (Con't)

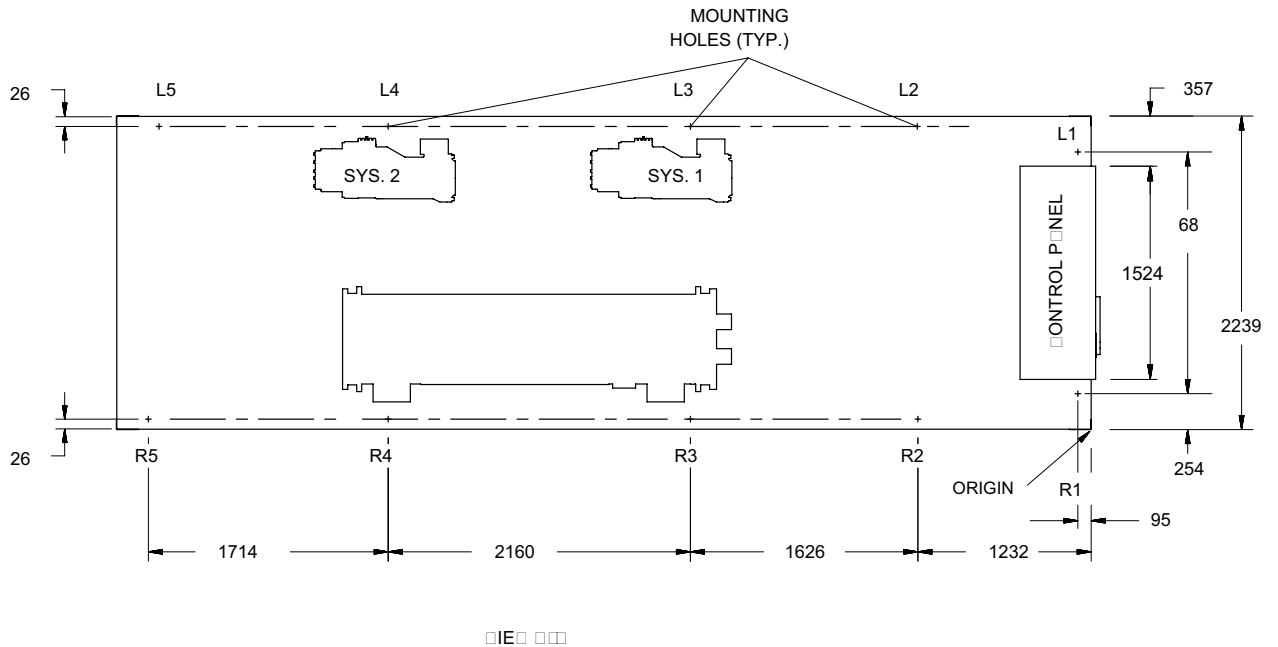

6

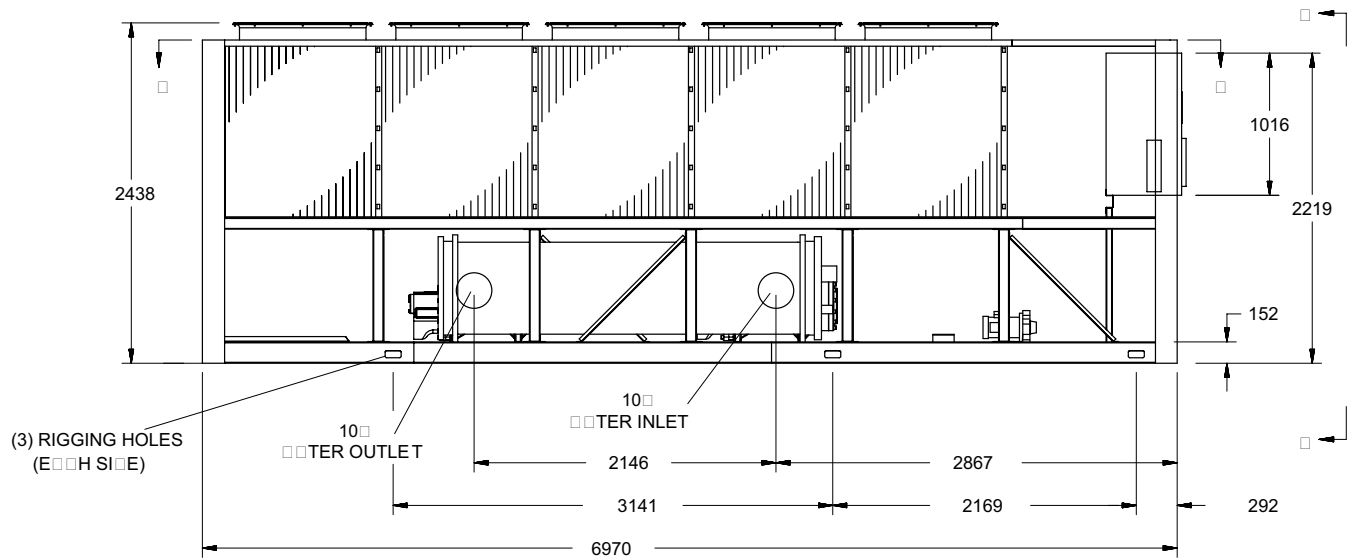

LD10555

DIMENSIONS - YCAV0187E/V High Efficiency SI

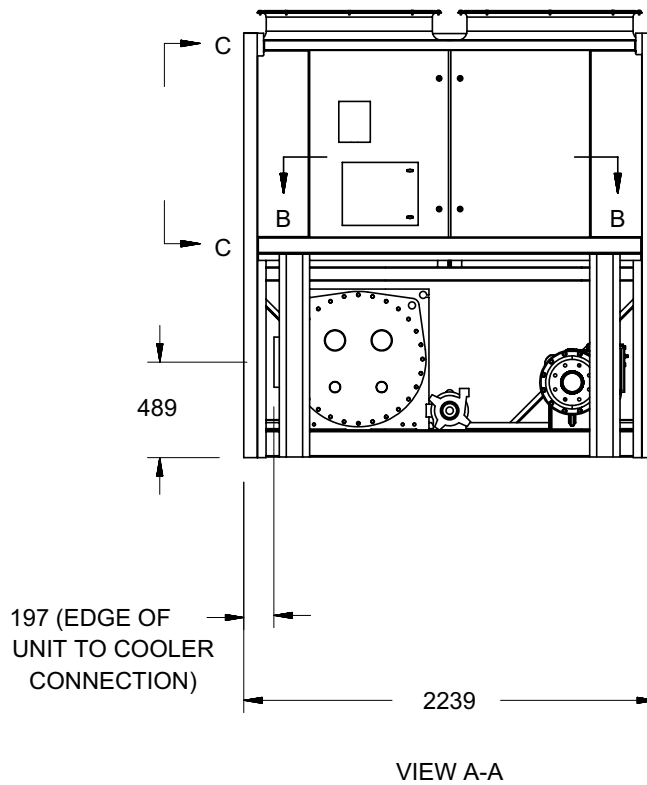
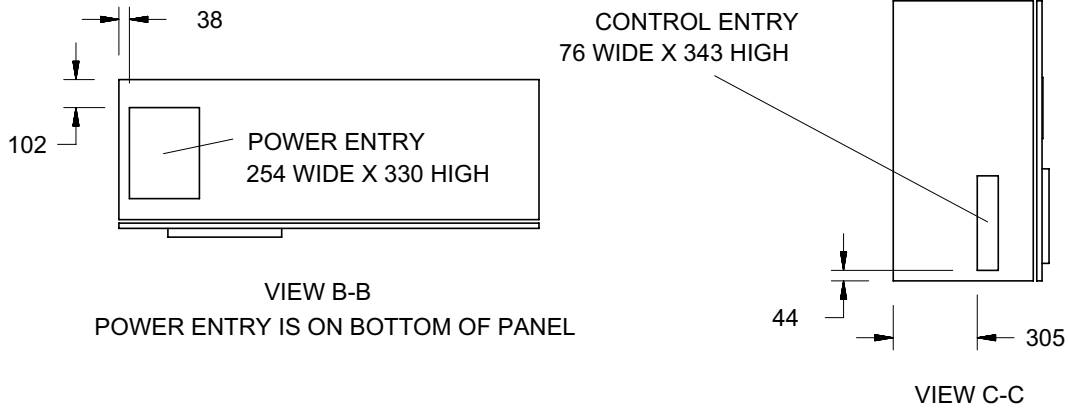

LD10556A

Notes:

1. Placement on a level surface free of obstructions (including snow, for winter operation) or air recirculation ensures rated performance, reliable operation and ease of maintenance. Site restrictions may compromise minimum clearances indicated below, resulting in unpredictable air flow patterns and possible diminished performance. YORK's unit controls will optimize operation without nuisance high pressure safety cutout; however, the system designer must consider potential performance degradation. Access to the unit control center assumes the unit is no higher than on spring isolators. Recommended minimum clearances: side to wall - 2m; rear to wall - 2m; control panel end to wall - 1.2m; top - no obstructions allowed; distance between adjacent units - 3m. No more than one adjacent wall may be higher than the unit.

DIMENSIONS - YCAV0187E/V High Efficiency SI (Con't)

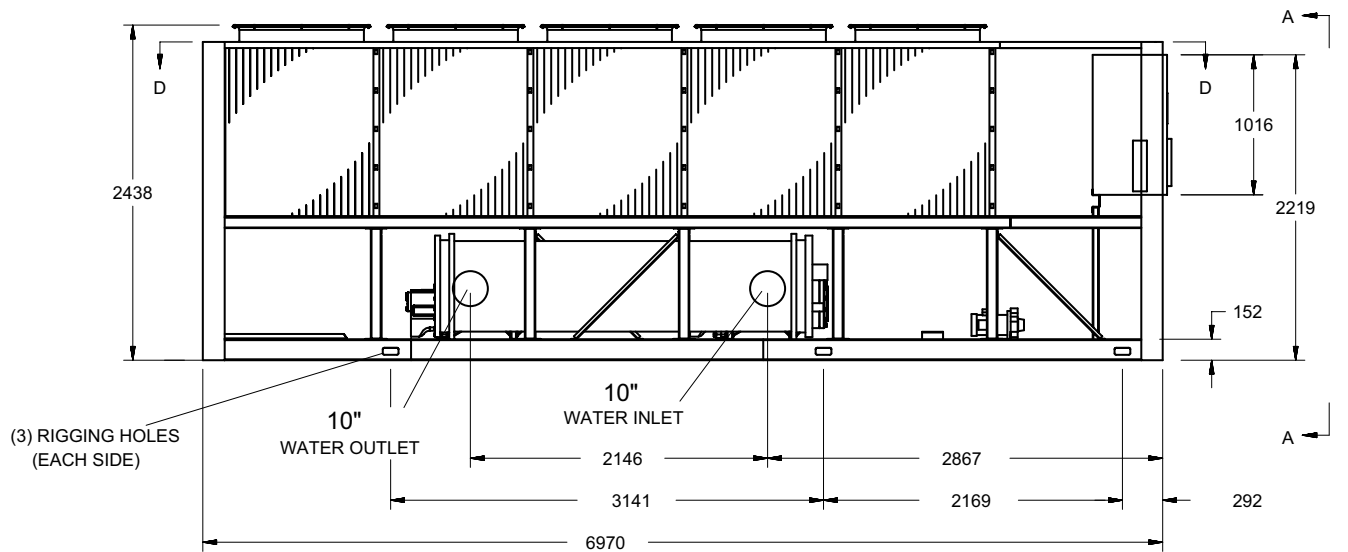
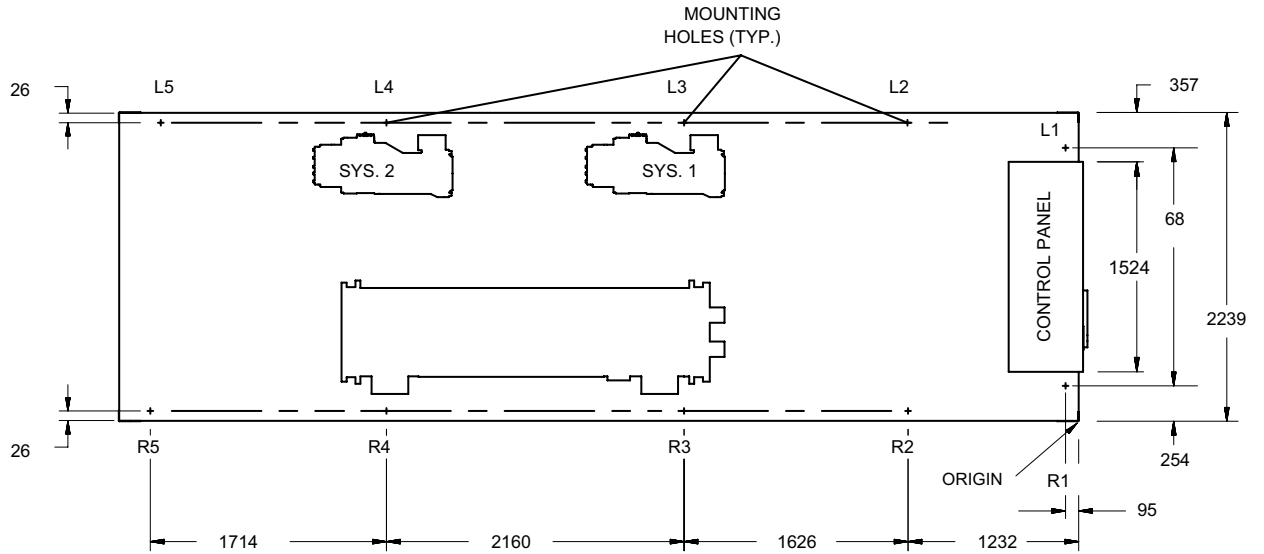

LD10557

DIMENSIONS - YCAV0197E/V High Efficiency SI

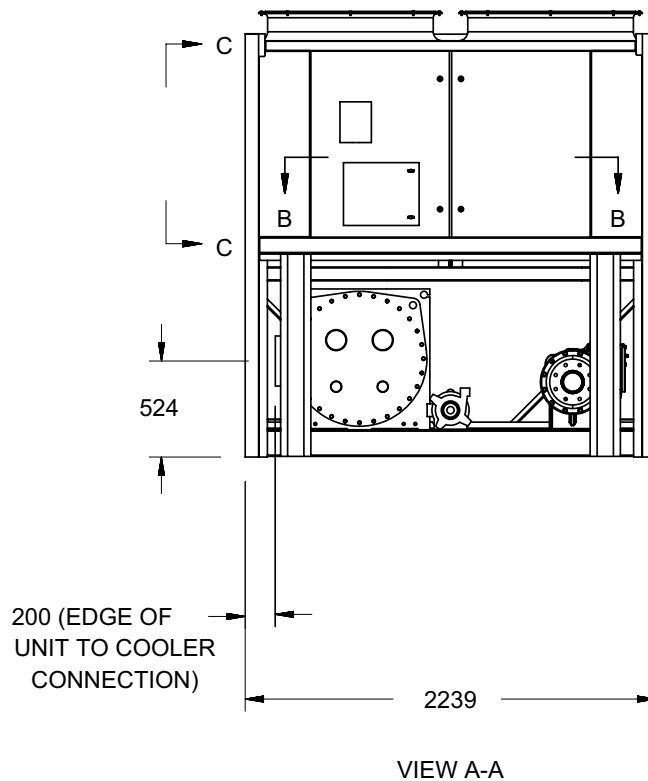
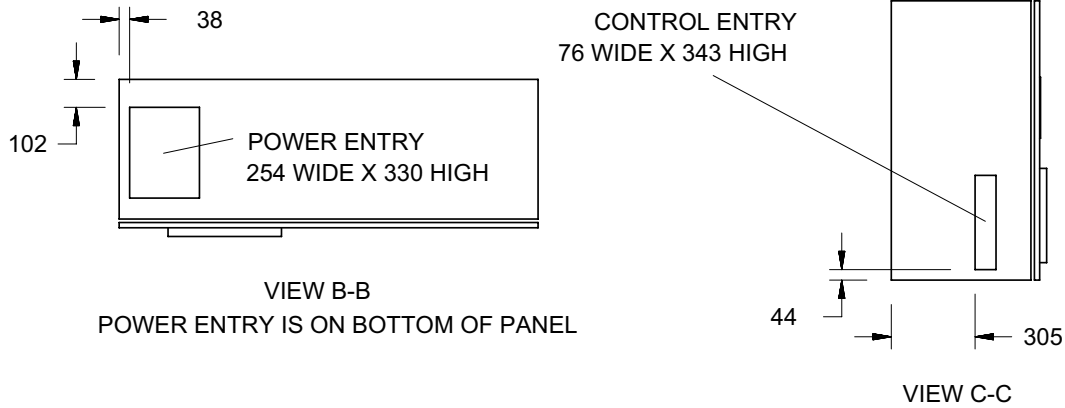

LD10558A

Notes:

1. Placement on a level surface free of obstructions (including snow, for winter operation) or air recirculation ensures rated performance, reliable operation and ease of maintenance. Site restrictions may compromise minimum clearances indicated below, resulting in unpredictable air flow patterns and possible diminished performance. YORK's unit controls will optimize operation without nuisance high pressure safety cutout; however, the system designer must consider potential performance degradation. Access to the unit control center assumes the unit is no higher than on spring isolators. Recommended minimum clearances: side to wall - 2m; rear to wall - 2m; control panel end to wall - 1.2m; top - no obstructions allowed; distance between adjacent units - 3m. No more than one adjacent wall may be higher than the unit.

DIMENSIONS - YCAV0197E/V High Efficiency SI (Con't)

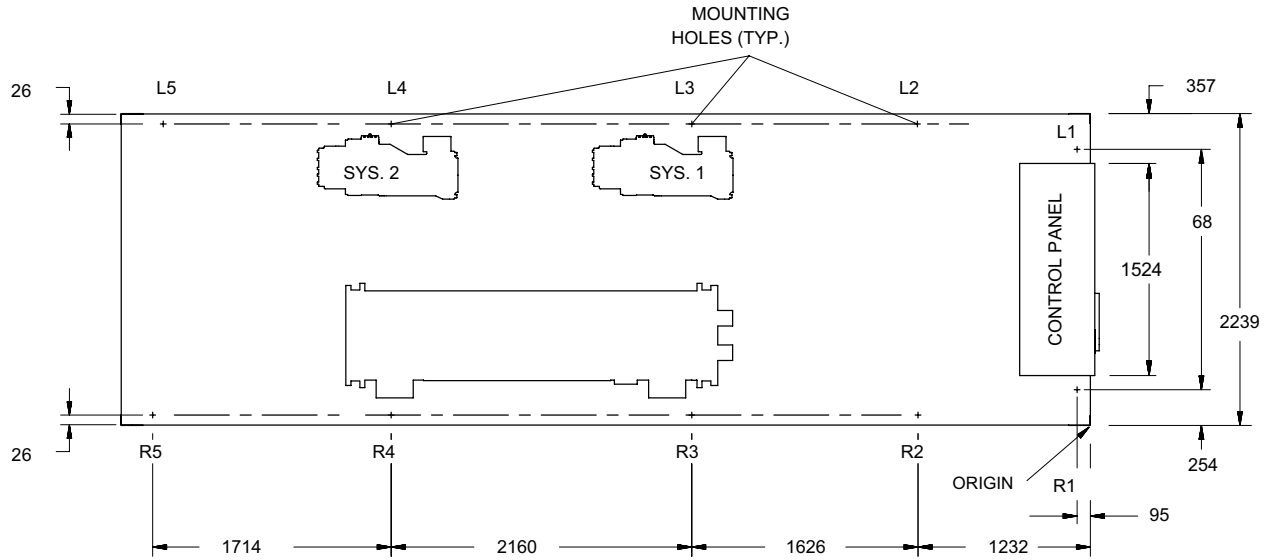

VIEW D-D

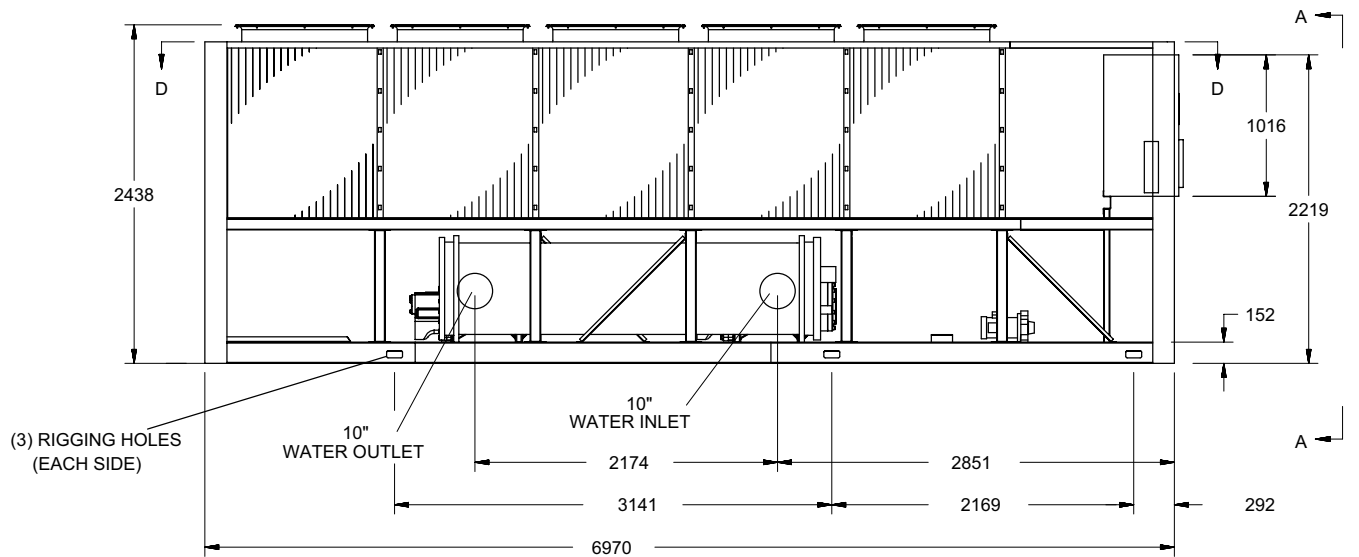

LD10559

DIMENSIONS - YCAV0207S/P Standard Efficiency SI

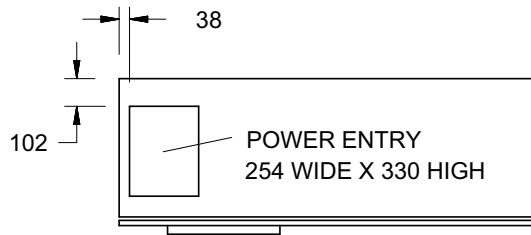

VIEW B-B
POWER ENTRY IS ON BOTTOM OF PANEL

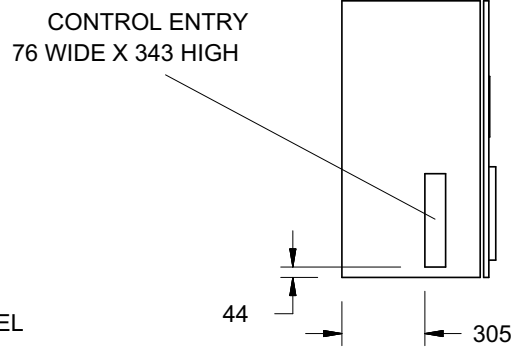

VIEW C-C

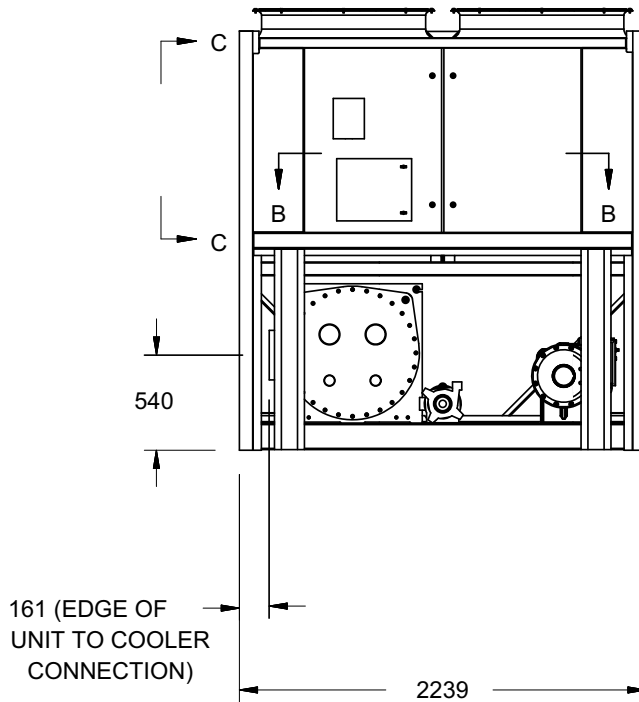

VIEW A-A

LD10560A

Notes:

1. Placement on a level surface free of obstructions (including snow, for winter operation) or air recirculation ensures rated performance, reliable operation and ease of maintenance. Site restrictions may compromise minimum clearances indicated below, resulting in unpredictable air flow patterns and possible diminished performance. YORK's unit controls will optimize operation without nuisance high pressure safety cutout; however, the system designer must consider potential performance degradation. Access to the unit control center assumes the unit is no higher than on spring isolators. Recommended minimum clearances: side to wall - 2m; rear to wall - 2m; control panel end to wall - 1.2m; top - no obstructions allowed; distance between adjacent units - 3m. No more than one adjacent wall may be higher than the unit.

DIMENSIONS - YCAV0207S/P Standard Efficiency SI (Con't)

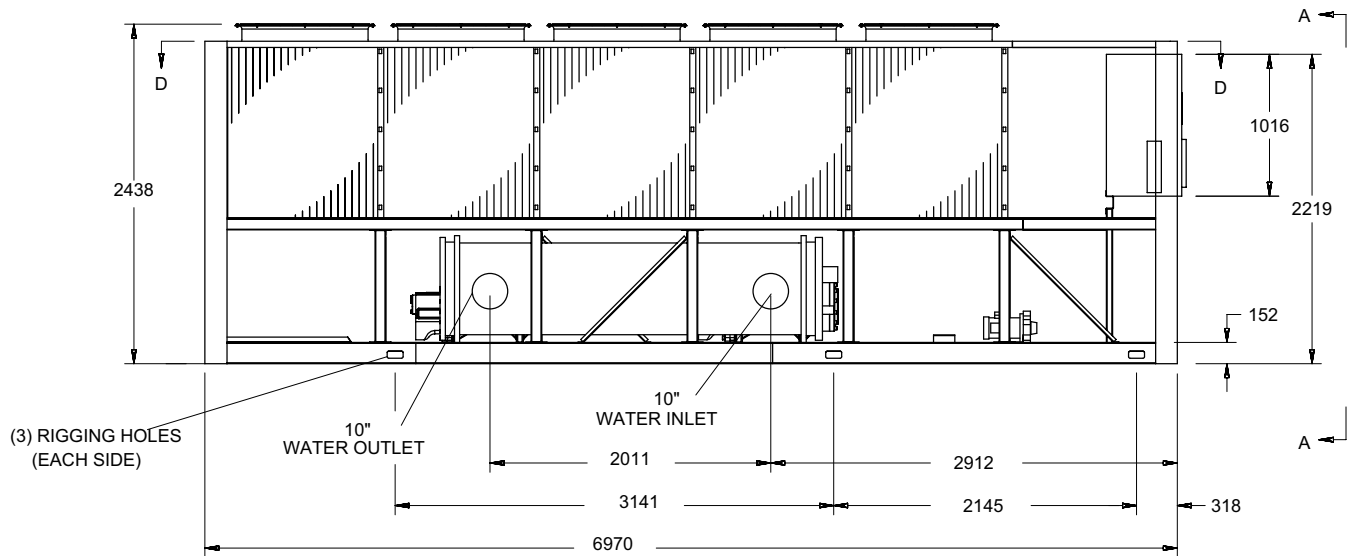
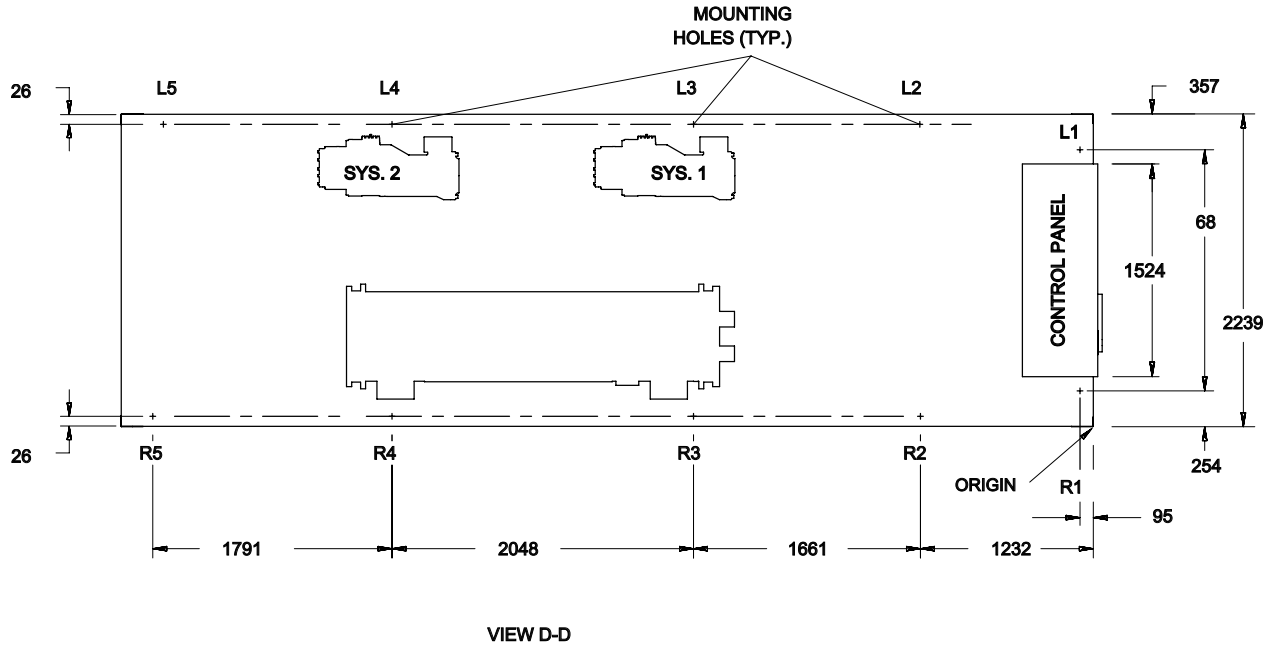

6

LD10561

DIMENSIONS - YCAV0207E/V High Efficiency SI

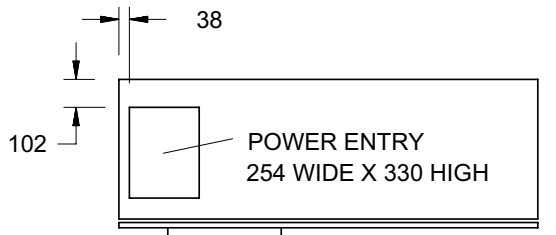

VIEW B-B
POWER ENTRY IS ON BOTTOM OF PANEL

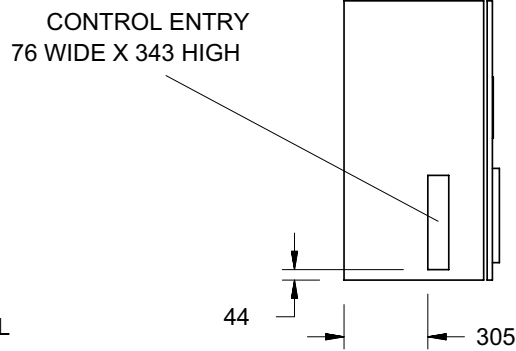

VIEW C-C

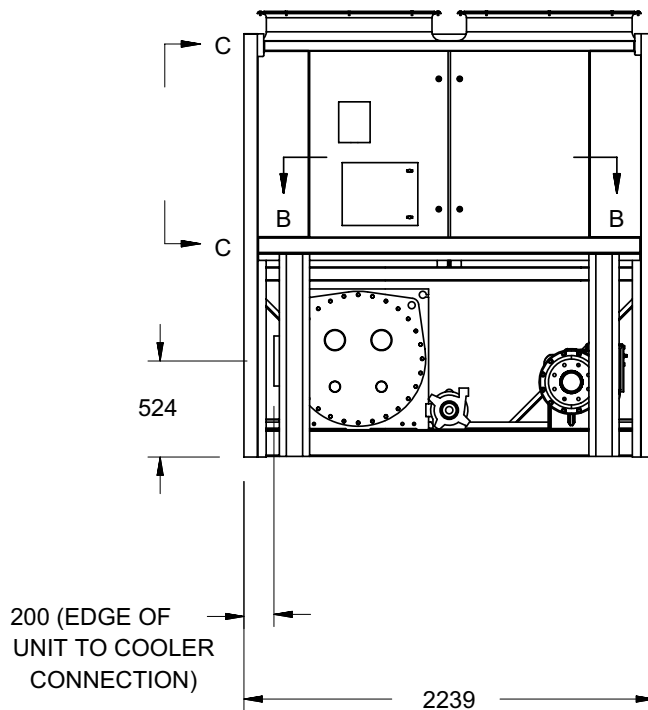

VIEW A-A

LD10562A

Notes:

1. Placement on a level surface free of obstructions (including snow, for winter operation) or air recirculation ensures rated performance, reliable operation and ease of maintenance. Site restrictions may compromise minimum clearances indicated below, resulting in unpredictable air flow patterns and possible diminished performance. YORK's unit controls will optimize operation without nuisance high pressure safety cutout; however, the system designer must consider potential performance degradation. Access to the unit control center assumes the unit is no higher than on spring isolators. Recommended minimum clearances: side to wall - 2m; rear to wall - 2m; control panel end to wall - 1.2m; top - no obstructions allowed; distance between adjacent units - 3m. No more than one adjacent wall may be higher than the unit.

DIMENSIONS - YCAV0207E/V High Efficiency SI (Con't)

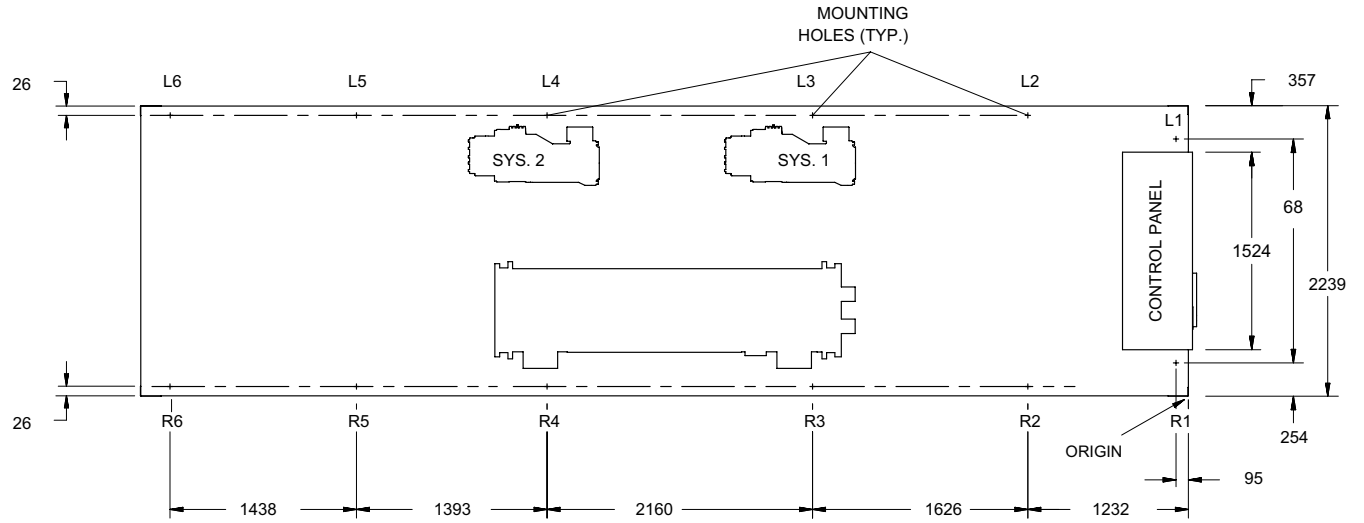

VIEW D-D

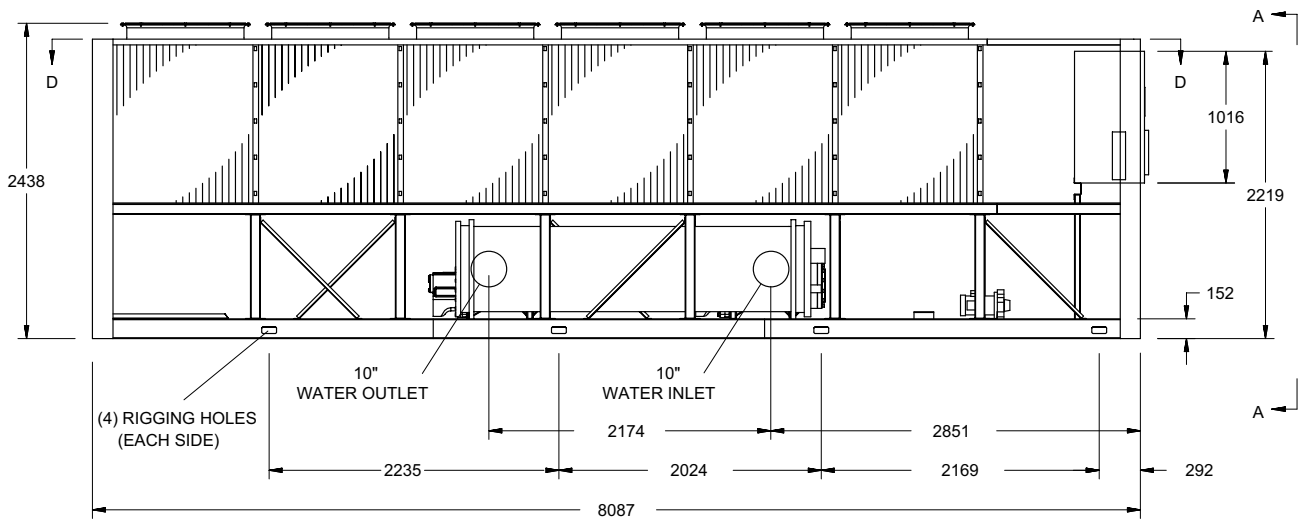

LD10563

DIMENSIONS - YCAV0227S/P Standard Efficiency SI

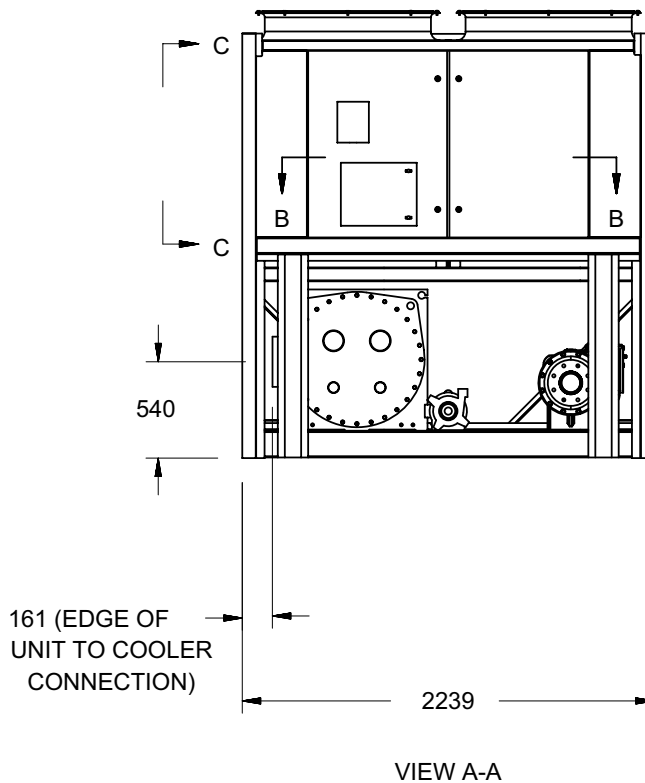
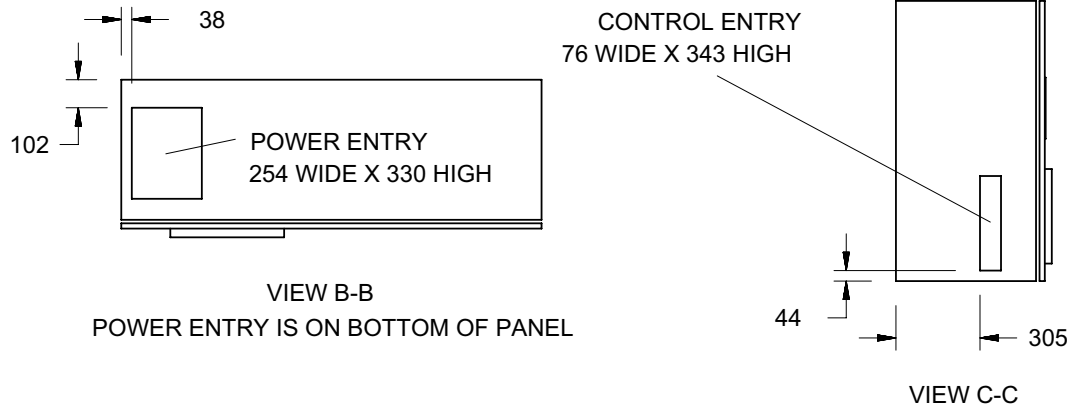

LD10564A

Notes:

1. Placement on a level surface free of obstructions (including snow, for winter operation) or air recirculation ensures rated performance, reliable operation and ease of maintenance. Site restrictions may compromise minimum clearances indicated below, resulting in unpredictable air flow patterns and possible diminished performance. YORK's unit controls will optimize operation without nuisance high pressure safety cutout; however, the system designer must consider potential performance degradation. Access to the unit control center assumes the unit is no higher than on spring isolators. Recommended minimum clearances: side to wall - 2m; rear to wall - 2m; control panel end to wall - 1.2m; top - no obstructions allowed; distance between adjacent units - 3m. No more than one adjacent wall may be higher than the unit.

DIMENSIONS - YCAV0227S/P Standard Efficiency SI (Con't)

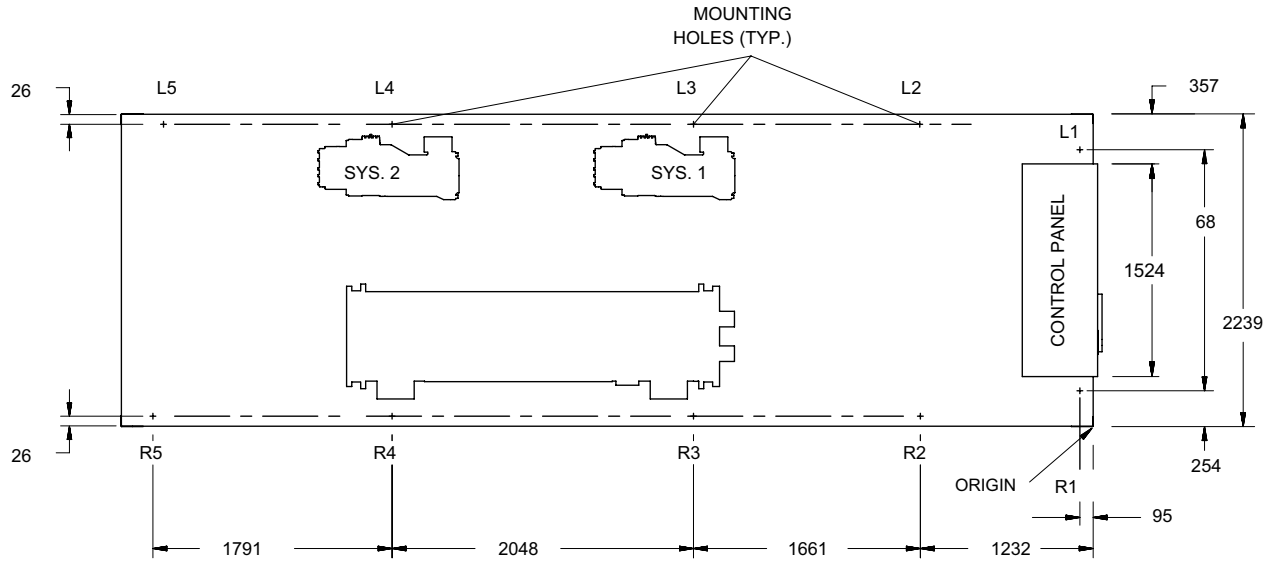

VIEW D-D

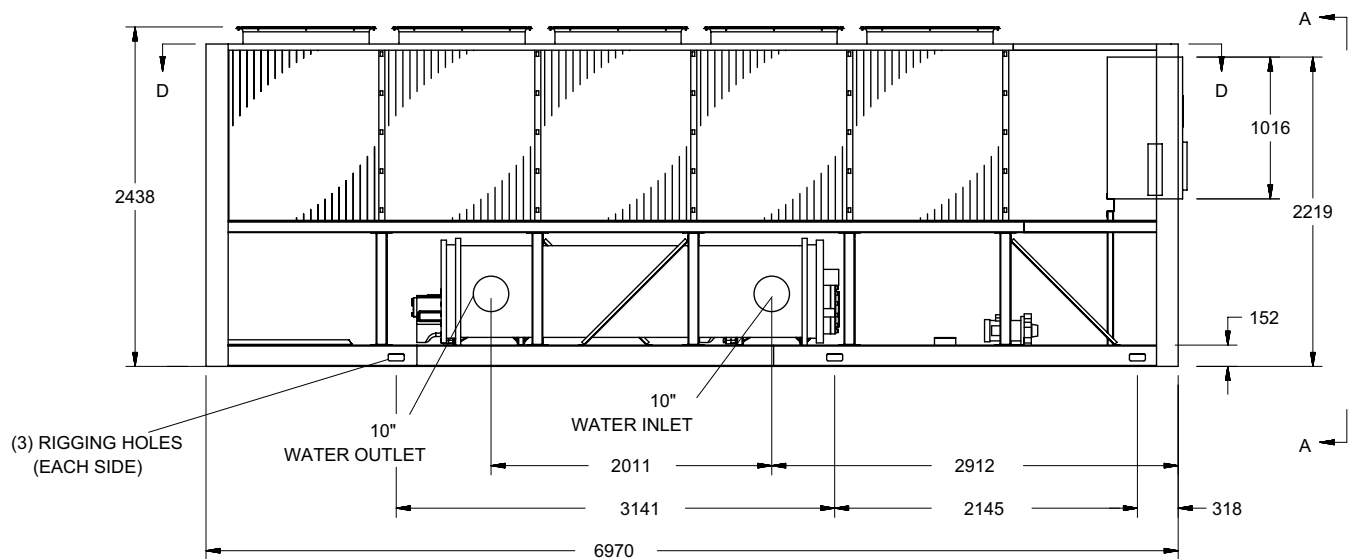

LD10565

DIMENSIONS - YCAV0227E/V High Efficiency SI

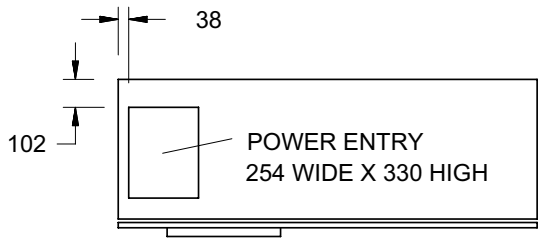

VIEW B-B
POWER ENTRY IS ON BOTTOM OF PANEL

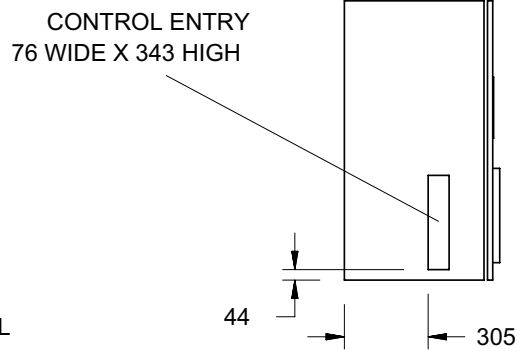

VIEW C-C

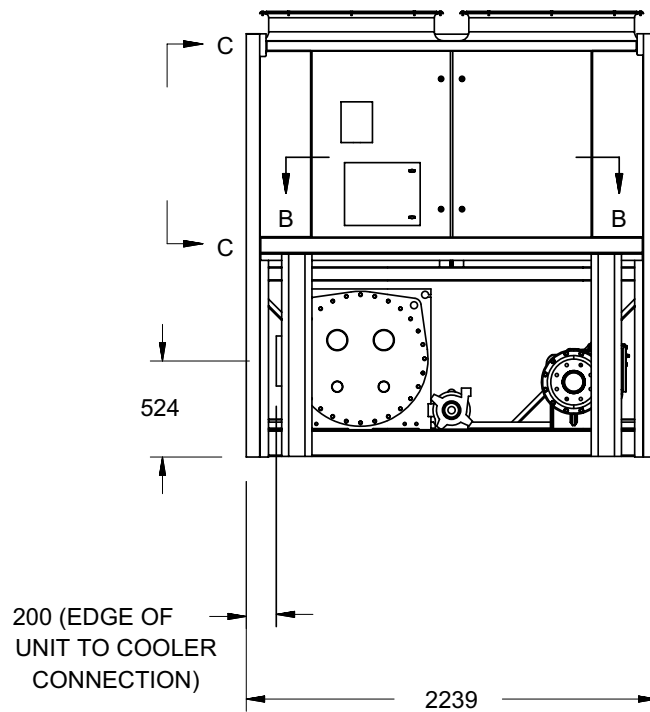

VIEW A-A

LD10566A

Notes:

1. Placement on a level surface free of obstructions (including snow, for winter operation) or air recirculation ensures rated performance, reliable operation and ease of maintenance. Site restrictions may compromise minimum clearances indicated below, resulting in unpredictable air flow patterns and possible diminished performance. YORK's unit controls will optimize operation without nuisance high pressure safety cutout; however, the system designer must consider potential performance degradation. Access to the unit control center assumes the unit is no higher than on spring isolators. Recommended minimum clearances: side to wall - 2m; rear to wall - 2m; control panel end to wall - 1.2m; top - no obstructions allowed; distance between adjacent units - 3m. No more than one adjacent wall may be higher than the unit.

DIMENSIONS - YCAV0227E/V High Efficiency SI (Con't)

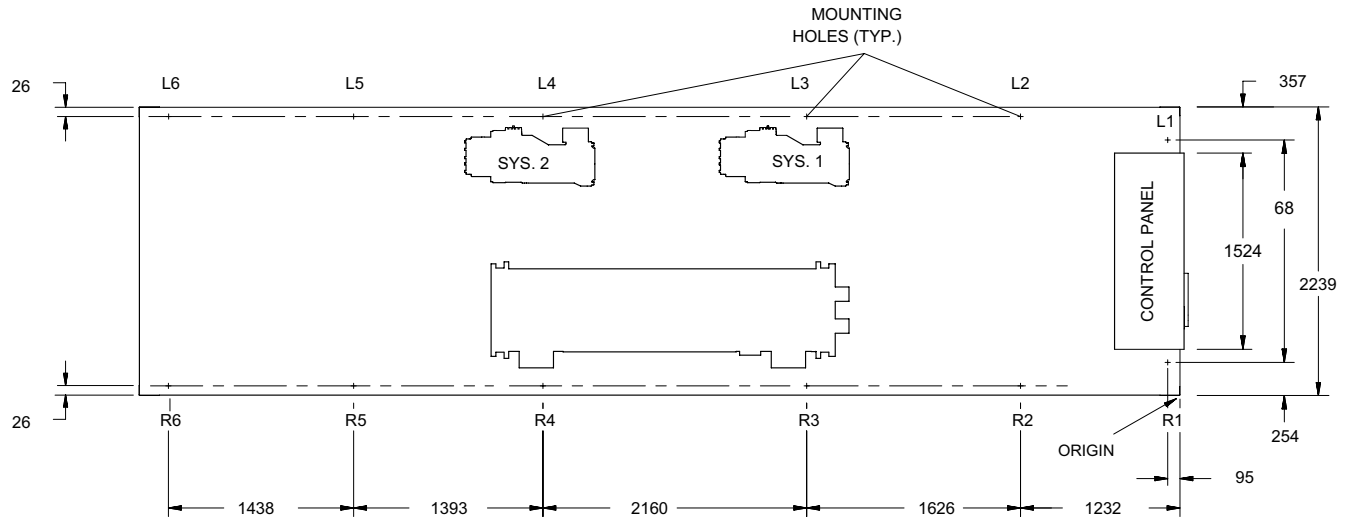

VIEW D-D

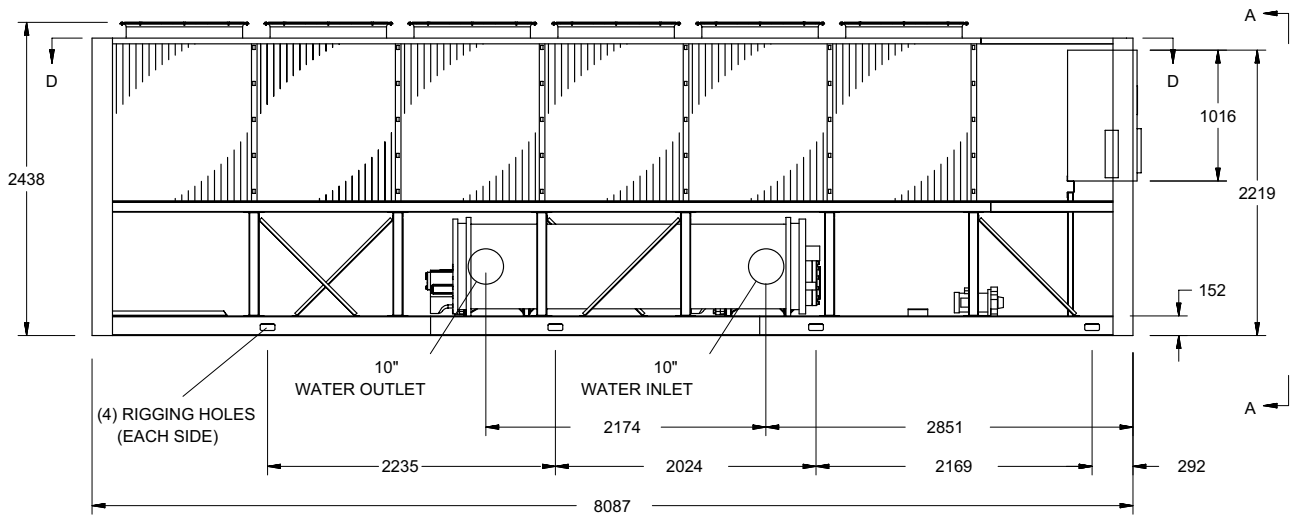

6

LD10567

DIMENSIONS - YCAV0247S/P Standard Efficiency SI

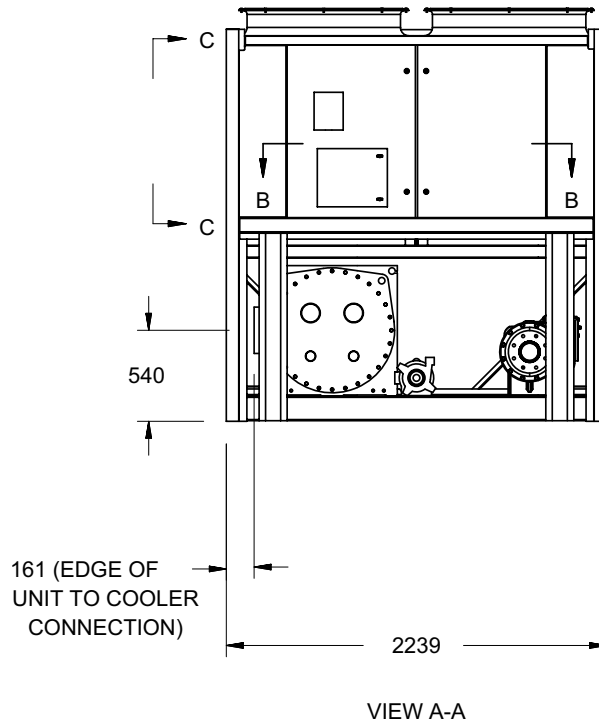
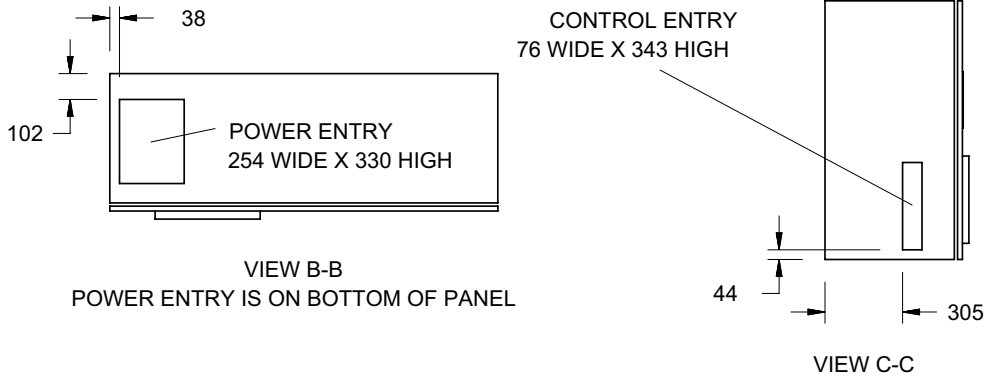

LD10575A

Notes:

1. Placement on a level surface free of obstructions (including snow, for winter operation) or air recirculation ensures rated performance, reliable operation and ease of maintenance. Site restrictions may compromise minimum clearances indicated below, resulting in unpredictable air flow patterns and possible diminished performance. YORK's unit controls will optimize operation without nuisance high pressure safety cutout; however, the system designer must consider potential performance degradation. Access to the unit control center assumes the unit is no higher than on spring isolators. Recommended minimum clearances: side to wall - 2m; rear to wall - 2m; control panel end to wall - 1.2m; top - no obstructions allowed; distance between adjacent units - 3m. No more than one adjacent wall may be higher than the unit.

DIMENSIONS - YCAV0247S/P Standard Efficiency SI (Con't)

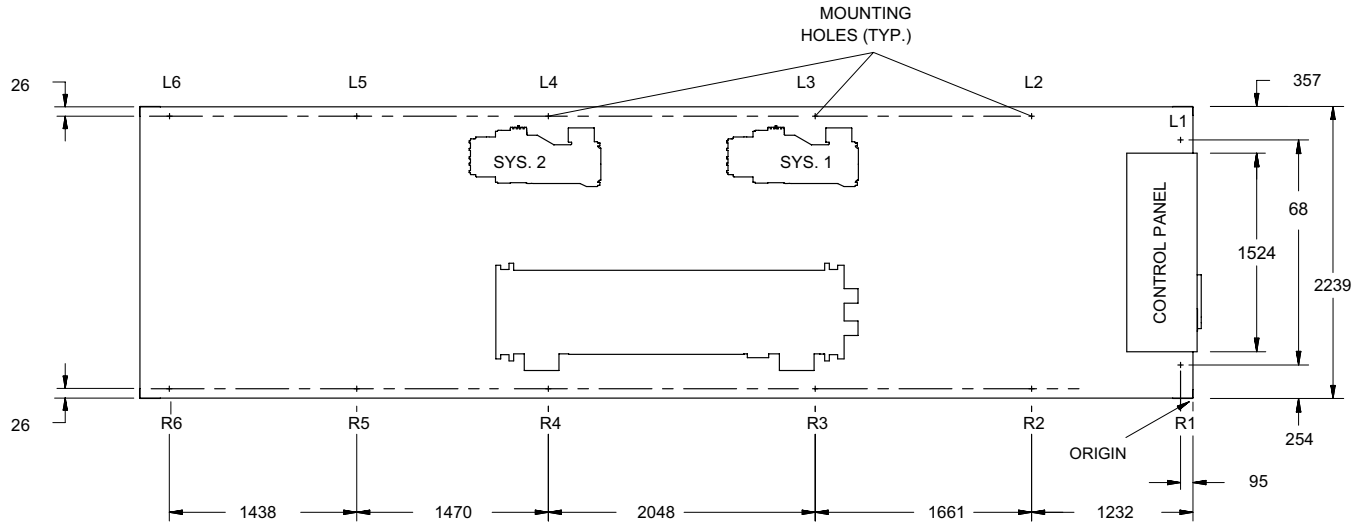

VIEW D-D

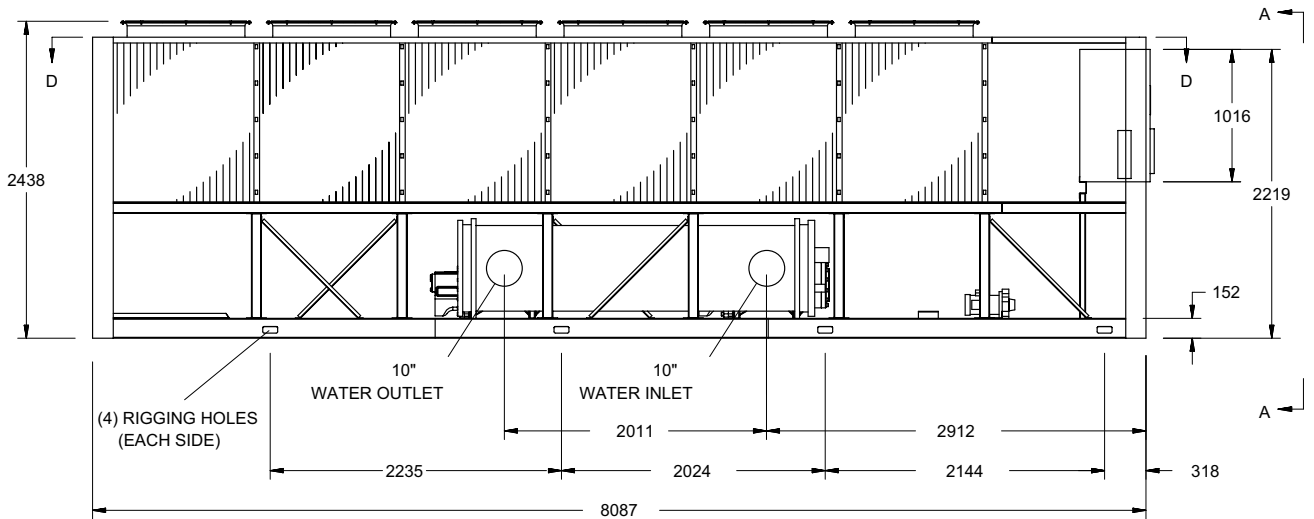

6

LD10574

DIMENSIONS - YCAV0247E/V High Efficiency SI

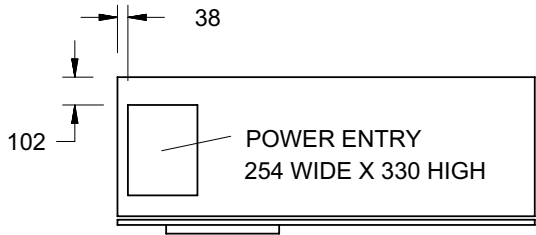

VIEW B-B
POWER ENTRY IS ON BOTTOM OF PANEL

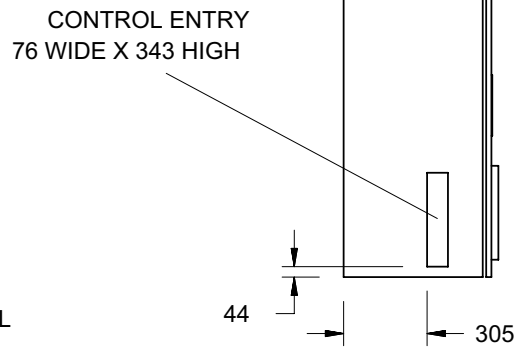

VIEW C-C

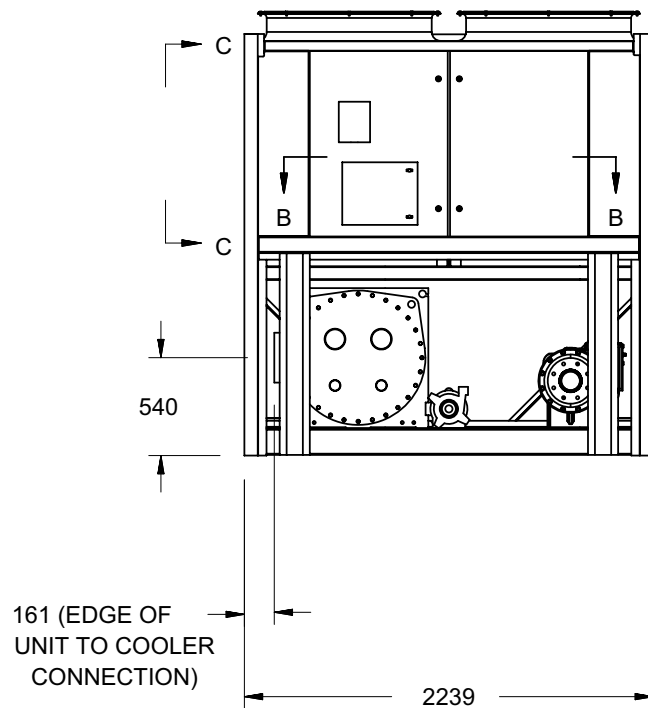

VIEW A-A

LD10570A

Notes:

1. Placement on a level surface free of obstructions (including snow, for winter operation) or air recirculation ensures rated performance, reliable operation and ease of maintenance. Site restrictions may compromise minimum clearances indicated below, resulting in unpredictable air flow patterns and possible diminished performance. YORK's unit controls will optimize operation without nuisance high pressure safety cutout; however, the system designer must consider potential performance degradation. Access to the unit control center assumes the unit is no higher than on spring isolators. Recommended minimum clearances: side to wall - 2m; rear to wall - 2m; control panel end to wall - 1.2m; top - no obstructions allowed; distance between adjacent units - 3m. No more than one adjacent wall may be higher than the unit.

DIMENSIONS - YCAV0247E/V High Efficiency SI (Con't)

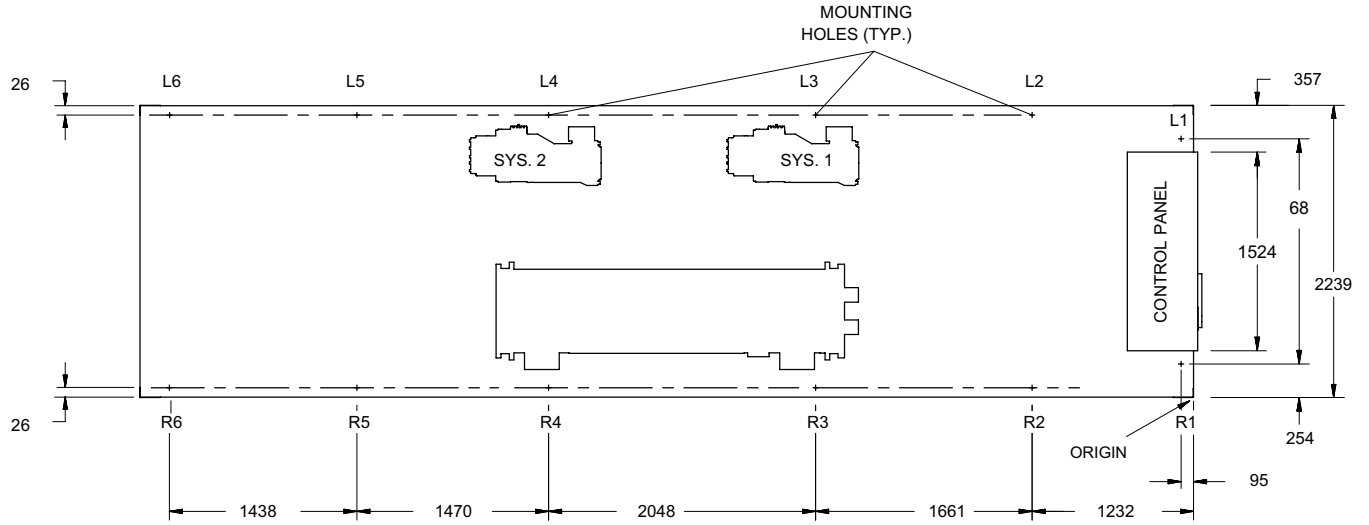

6

VIEW D-D

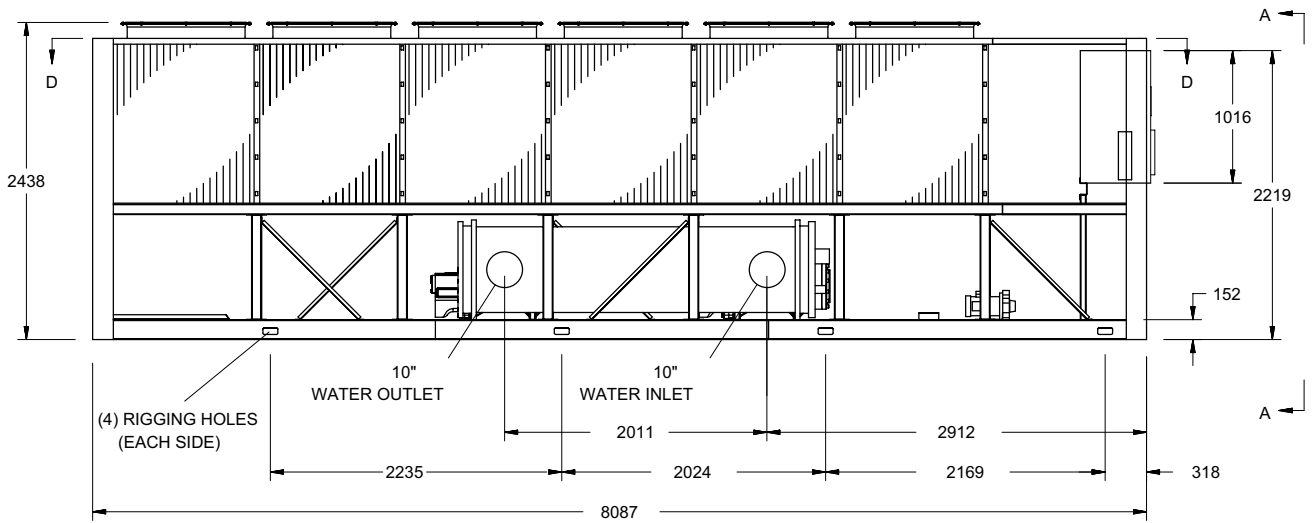

LD10571

DIMENSIONS - YCAV0267S/P Standard Efficiency SI

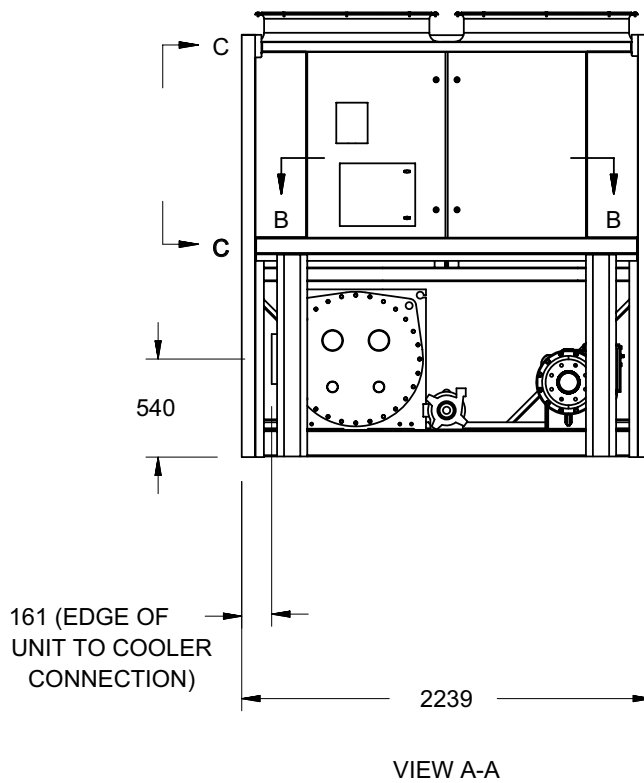
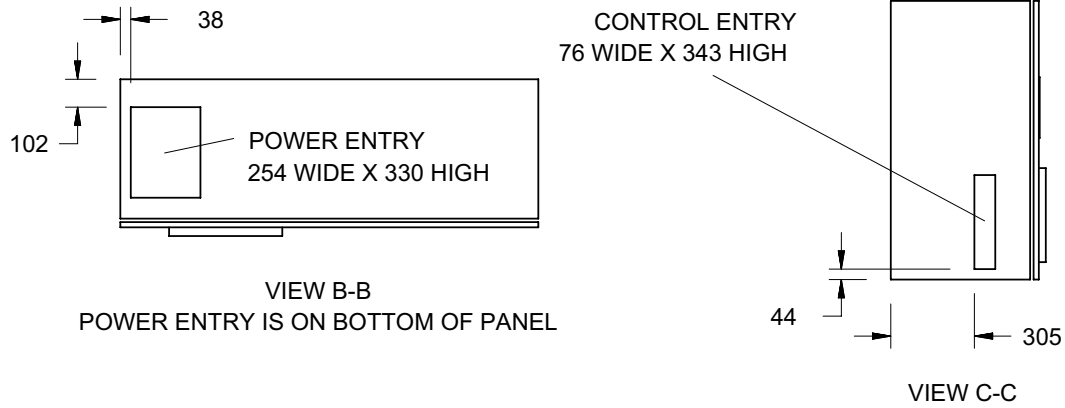

LD10572A

Notes:

1. Placement on a level surface free of obstructions (including snow, for winter operation) or air recirculation ensures rated performance, reliable operation and ease of maintenance. Site restrictions may compromise minimum clearances indicated below, resulting in unpredictable air flow patterns and possible diminished performance. YORK's unit controls will optimize operation without nuisance high pressure safety cutout; however, the system designer must consider potential performance degradation. Access to the unit control center assumes the unit is no higher than on spring isolators. Recommended minimum clearances: side to wall - 2m; rear to wall - 2m; control panel end to wall - 1.2m; top - no obstructions allowed; distance between adjacent units - 3m. No more than one adjacent wall may be higher than the unit.

DIMENSIONS - YCAV0267S/P Standard Efficiency SI (Con't)

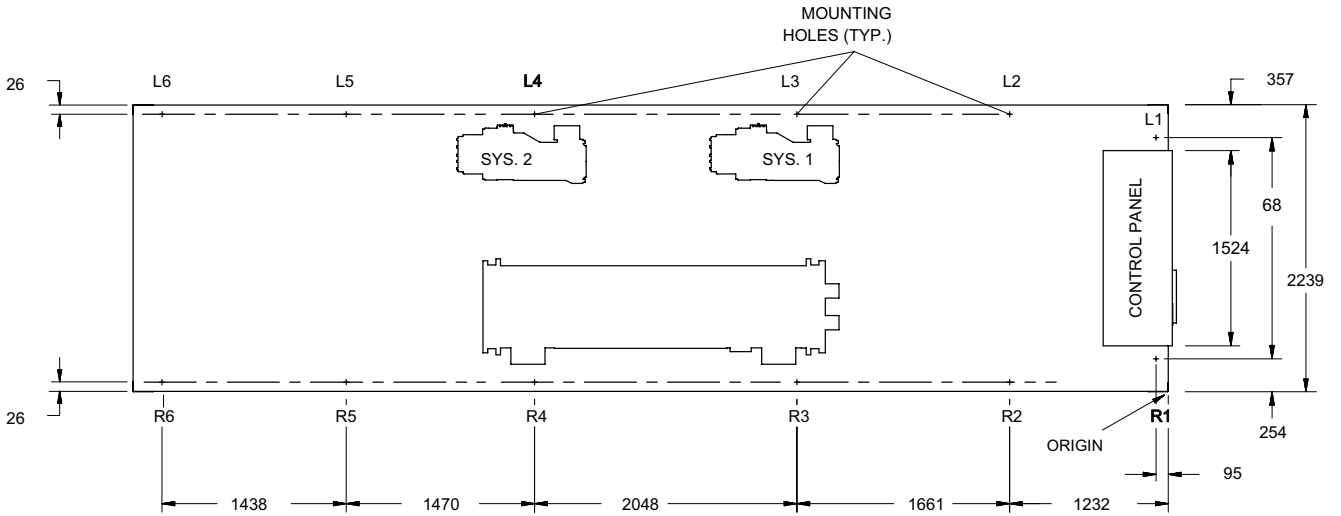

VIEW D-D

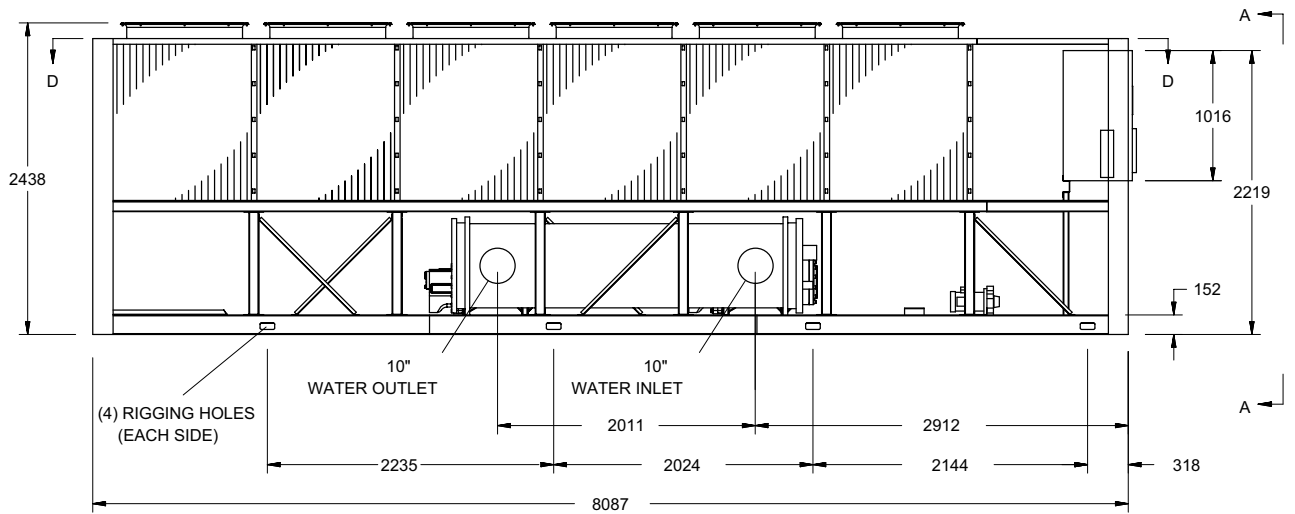

6

LD10573

TECHNICAL DATA - CLEARANCES

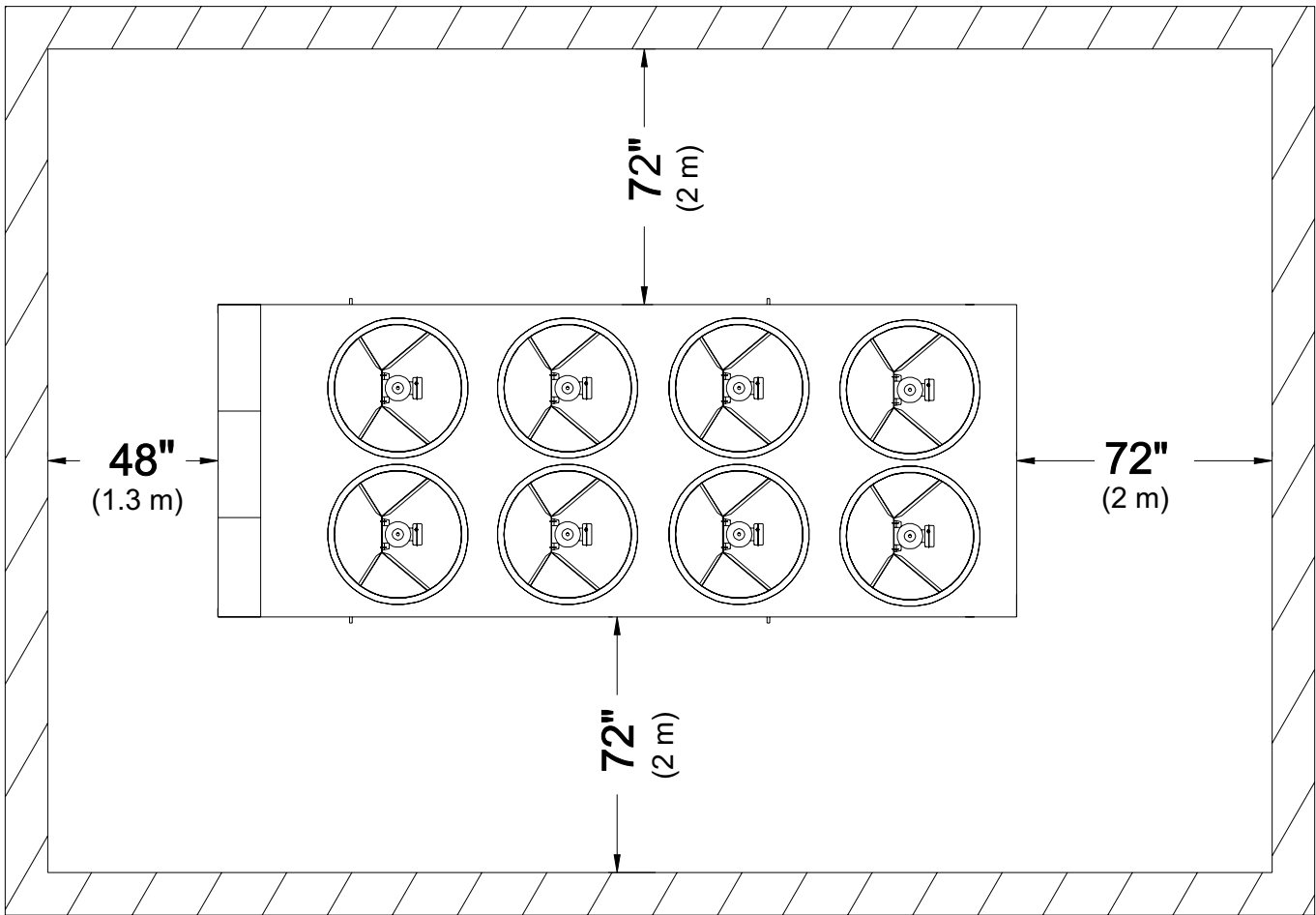

LD10506

NOTES:

1. No obstructions allowed above the unit.
2. Only one adjacent wall may be higher than the unit
3. Adjacent units should be 10 feet (3 Meters) apart.

This page intentionally left blank.

WEIGHT DISTRIBUTION AND ISOLATOR MOUNTING POSITIONS

GENERAL

Weights of specific chiller models vary significantly as options are added. As a result, total weights, weights at individual isolator positions, and actual isolator selection at each position cannot be published due to the thousands of possible combinations. This information will be available when the specific chiller/option selection is made from the local YORK sales office. Be aware, weights will change with each option along with possible isolator changes. Weights and isolators may need to be recalculated when option selections are changed.

Whenever the isolator option is ordered, the isolators will be shipped loose with the chiller. Packed with the isolators and also in the control panel information packet is a drawing and table specifically for each chiller, based on the option selection. The drawing and table will be similar to Figure 8 below. The drawing will show the isolator locations along with weight in pounds and kilograms at the specific location, isolator position, and location measurements for each isolator.

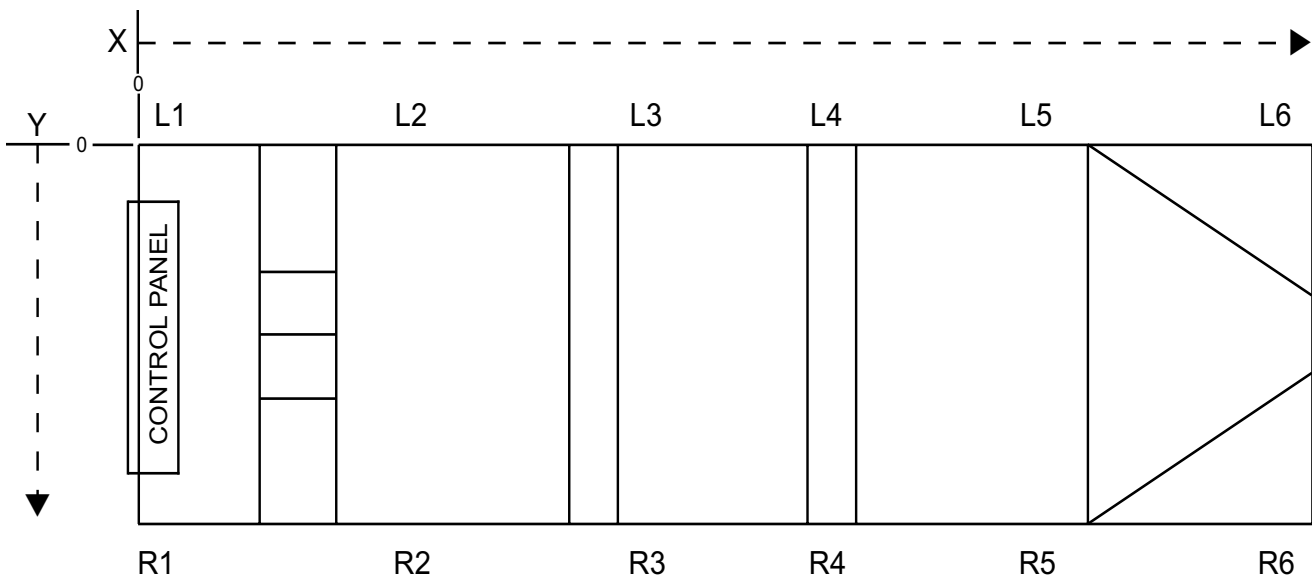

LD10499

Location	X Distance inches (mm)	Y Distance inches (mm)	Vendor Number	Weight
R1	3.75 (95)	78.0 (1981.2)	CIP-C-1350 / Yellow	895.0 (405.97)
L1	3.75 (95)	10.0 (254.0)	CIP-C-1350 / Yellow	895.0 (405.97)
R2	48.5 (1231.9)	87.125 (2213.0)	CIP-C-1750 / Black	1454.0 (659.52)
L2	48.5 (1231.9)	1.03 (26.2)	CIP-C-1750 / Black	1446.0 (655.89)
R3	113.88 (2892.6)	87.125 (2213.0)	CIP-C-1350 / Yellow	1693.0 (769.93)
L3	113.88 (2892.6)	1.03 (26.2)	CIP-C-1350 / Yellow	1575.0 (714.41)
R4	194.5 (4940.3)	87.125 (2213.0)	CIP-C-1350 / Yellow	1595.0 (723.48)
L4	194.5 (4940.3)	1.03 (26.2)	CIP-C-1000 / Black	1480.0 (671.32)
R5	265.0 (6731.0)	87.125 (2213.0)	CIP-C-1000 / Black	775.0 (353.53)
L5	265.0 (6731.0)	1.03 (26.2)	CIP-C-1000 / Black	769.0 (348.81)
R6	309.0 (7848.6)	87.125 (2213.0)	CIP-C-1000 / Black	671.0 (304.36)
L6	309.0 (7848.6)	1.03 (26.2)	CIP-C-1000 / Black	675.0 (306.18)

FIG. 8 - SAMPLE PRINTOUT SUPPLIED IN THE ISOLATOR PACKAGE AND IN THE CHILLER PANEL LITERATURE PACKET

ISOLATOR MOUNTING POSITIONS

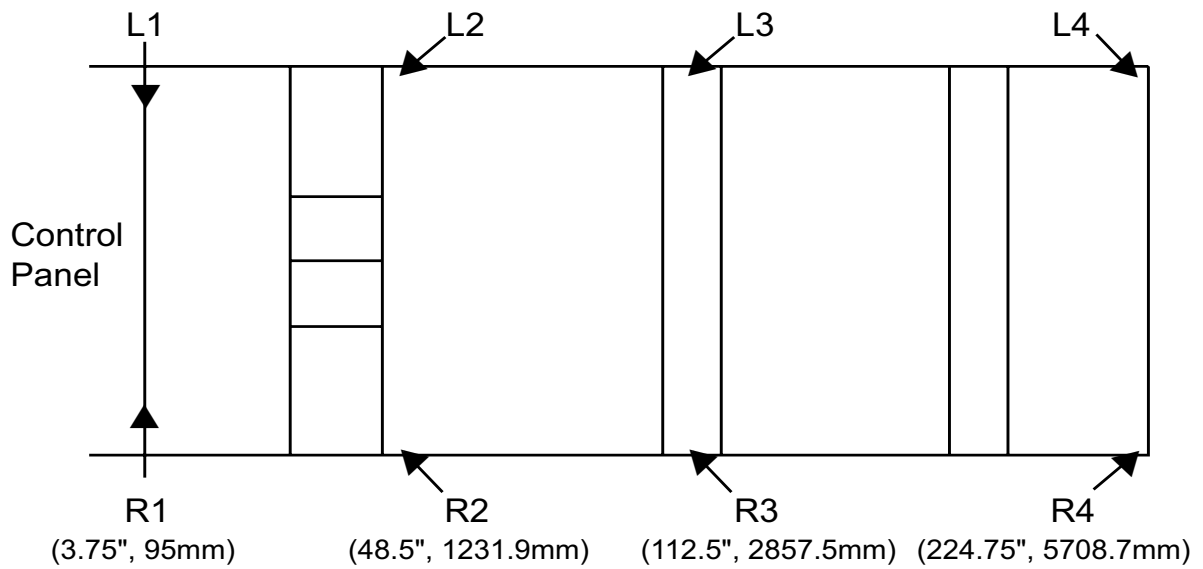

YCAV0157S/P, YCAV0157E/V, and YCAV0177S/P

LD10501

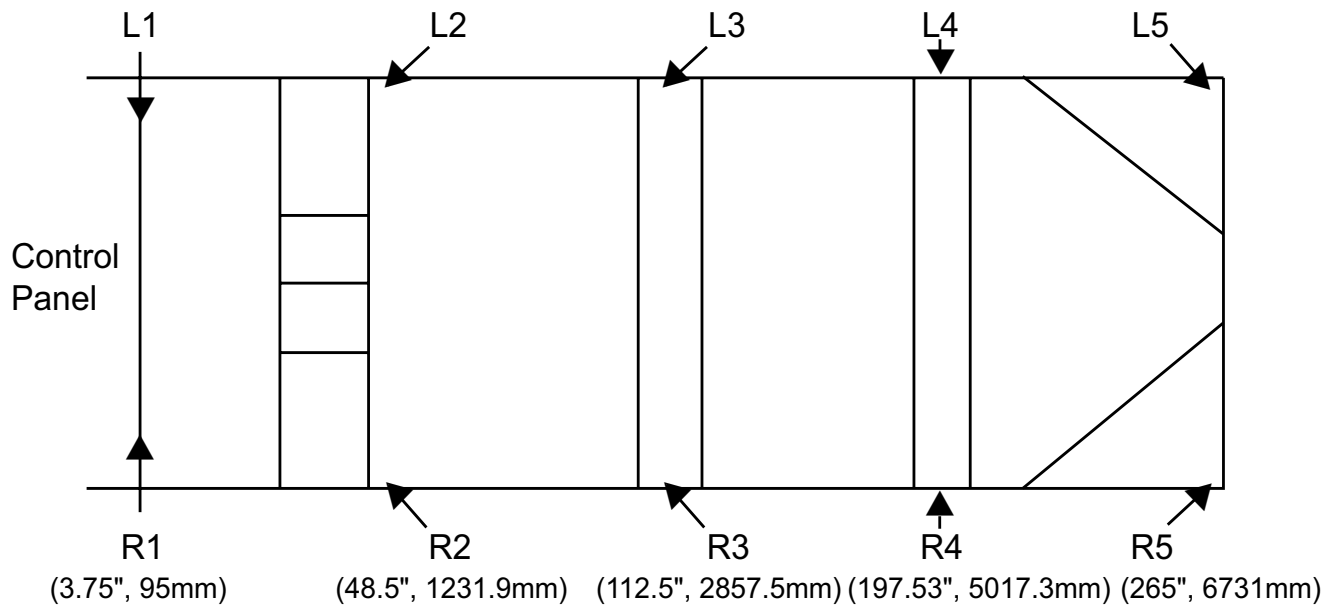

YCAV0177E/V, YCAV0187S/P, YCAV0187E/V, and YCAV0197E/V

LD10502

NOTE: Distances indicated are from the end of the chiller designated as X in FIG.8.

ISOLATOR MOUNTING POSITIONS (CON'T)

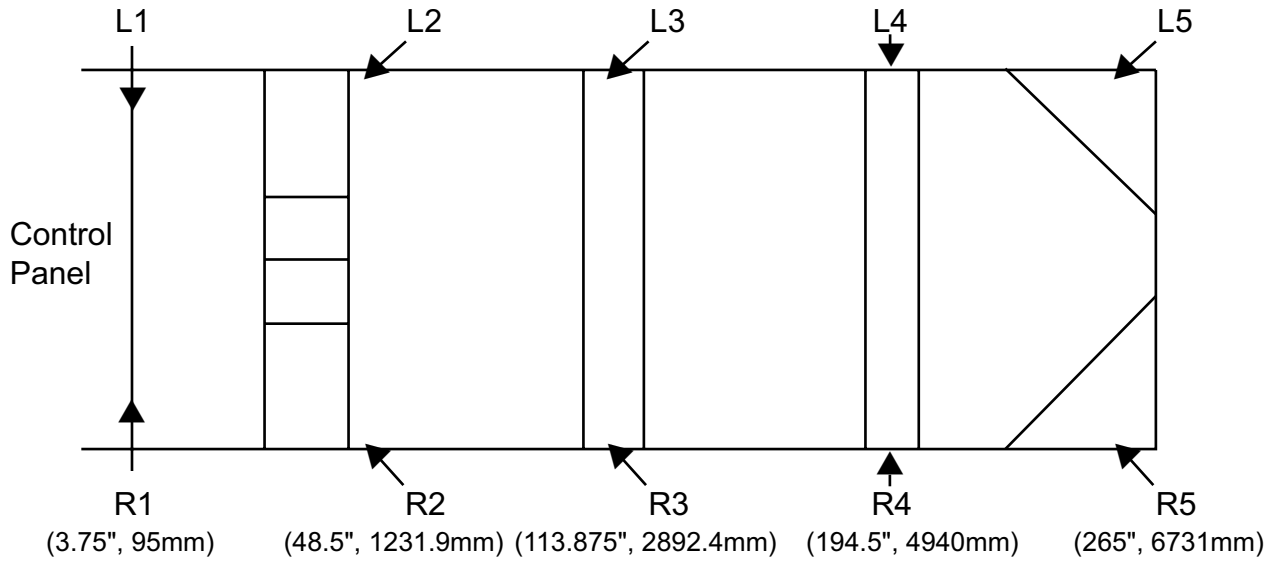

YCAV0207S/P and YCAV0227S/P

LD10504

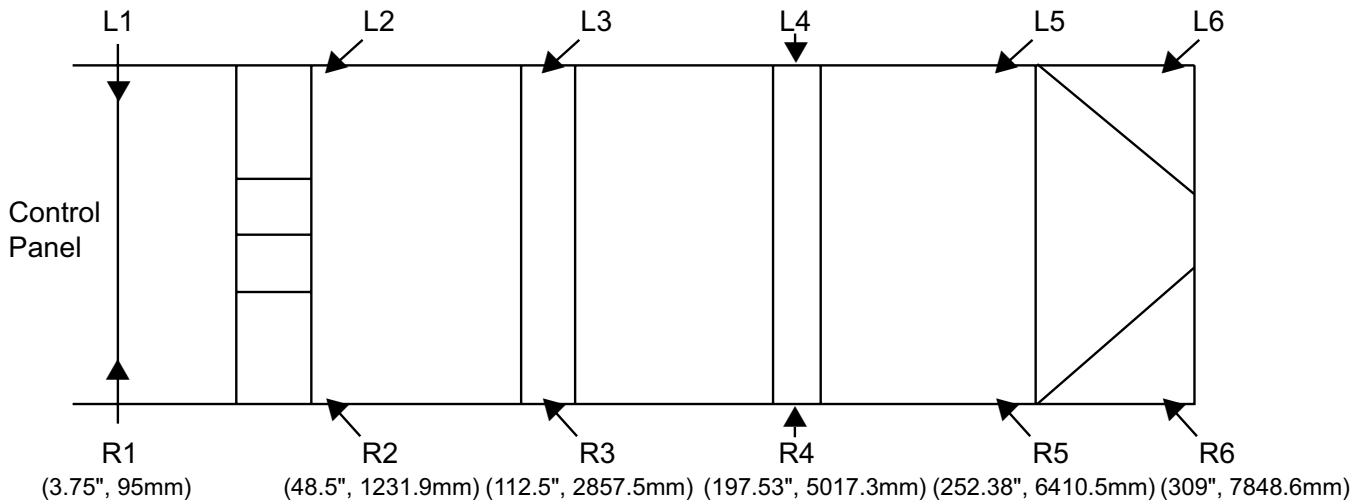

YCAV0207E/V and YCAV0227E/V

LD10503

ISOLATOR MOUNTING POSITIONS (CON'T)

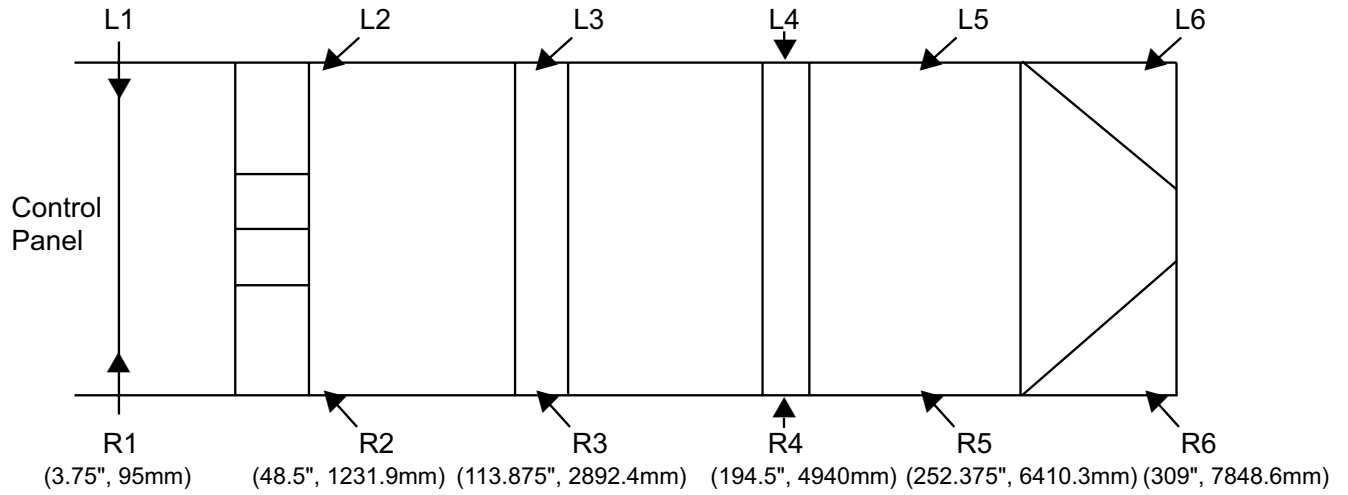

6

YCAV0247S/P, YCAV0247E/V and YCAV0267S/P

LD10508

SLRS SEISMIC ISOLATOR SPECIFICATIONS

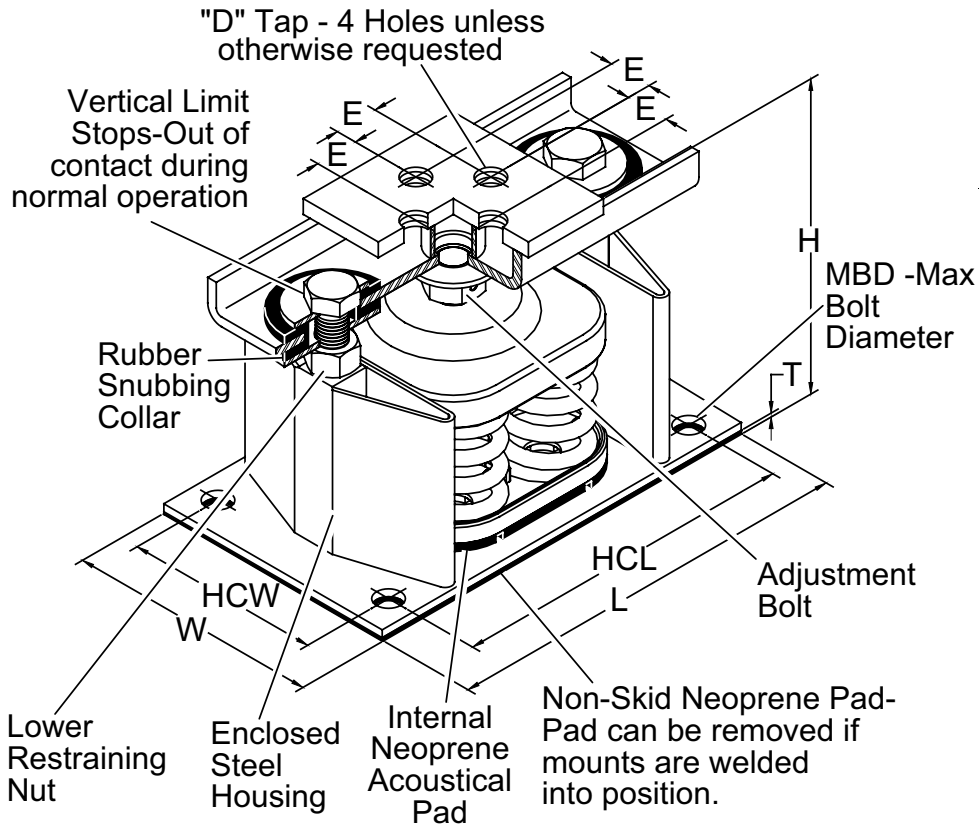

LD10509

NOTES: Illustration above shows a SLRS-4-C2(4 Springs). SLRS-8-2 & C2 have one spring, and SLRS-2-C2 has two springs. SLRS-6-C2 has six springs and SLRS-9-C2 has nine springs.

PIN 54 = S				
*Weight Range (lbs)	*Weight Range (kg)	Vendor P/N	COLOR	YORK P/N
UP TO 358 LBS	Up to 162 kg	SLRS-2-C2-420	Red	029-24585-006
358-442 LBS	162 to 201 kg	SLRS-2-C2-520	White	029-24585-007
443-581 LBS	201 to 264 kg	SLRS-2-C2-660	Black	029-24585-008
582-782 LBS	264 to 335 kg	SLRS-2-C2-920	Blue	029-24585-009
783-1037 LBS	335 to 471 kg	SLRS-2-C2-1220	Green	029-24585-010
1038-1496 LBS	471 to 679 kg	SLRS-2-C2-1760	Gray	029-24585-011
1497-2057 LBS	679 to 933 kg	SLRS-2-C2-2420	Silver	029-24585-012
2058-2618 LBS	933 to 1188 kg	SLRS-2-C2-3080	Gray w/ Red	029-24585-013
2619-3179 LBS	1188 to 1442 kg	SLRS-2-C2-3740	Silver w/ Red	029-24585-014

* Value is de-rated by 15%

SLRS SEISMIC ISOLATOR INSTALLATION AND ADJUSTMENT

TO INSTALL AND ADJUST MOUNTS

1. Supports for mountings must be leveled to installation's acceptable tolerances.
2. Mountings not subjected to seismic or wind forces do not require bolting to supports.
3. Mountings subjected to seismic or wind forces must be bolted or welded in position.
4. If mountings are welded in position, remove lower friction pad before welding.
5. Set mountings with top channels held in place by the lower restraining nuts and limit stops.
6. Place equipment on mountings and secure by bolting or welding.
7. Hold lower restraining nut in place and turn vertical limit stop bolt counter-clockwise until there is a 1/8" gap between the bolt head and the steel washer.
8. Turn adjustment bolt 8 turns on each mount.
9. Take one additional complete turn on each adjustment bolt in sequence until the top plate lifts off of the lower restraining nuts. Take no additional turns on that mount. Continue with equal turns on the other mounts until the top plates lift off of the lower restraining nuts of all mounts.
10. Hold the limit stop bolt in place and turn the lower restraining nut clockwise and tighten it against the stanchion. Repeat the same procedure on all mounts.
11. Top plate should remain at a fixed elevation, plus or minus 1/8".

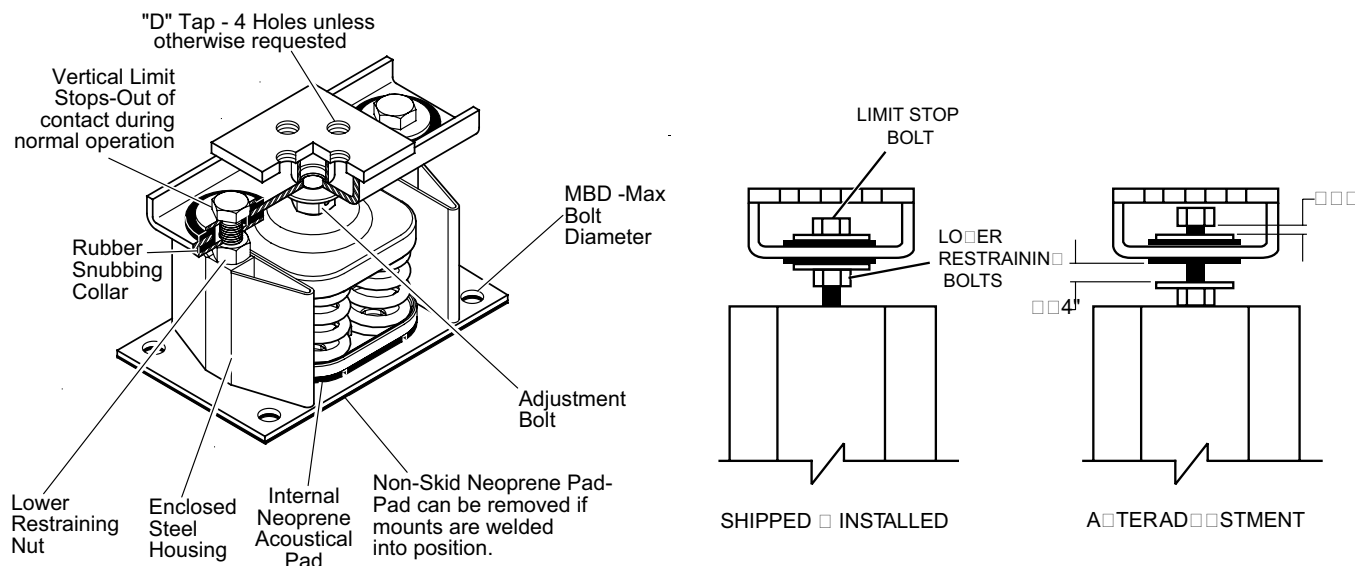

LD10568

ND-X NEOPRENE ISOLATOR SPECIFICATIONS

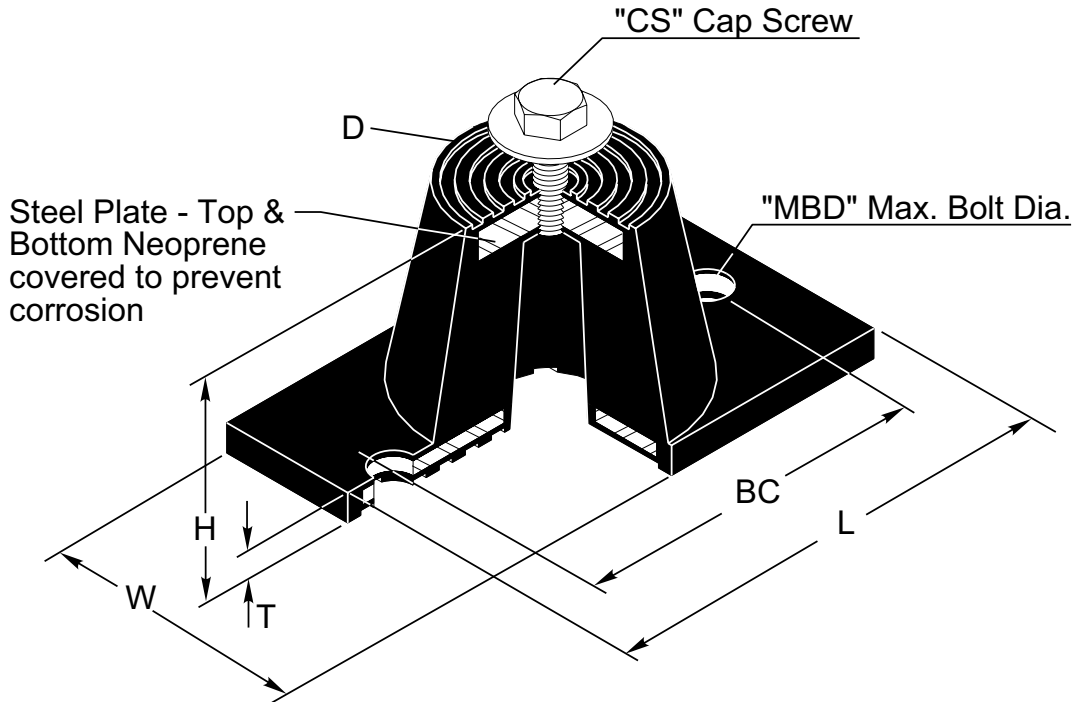

LD10569

ENGLISH								
SIZE	D	H	L	T	W	BC	CS	MBD
ND-C	2-9/16	2-3/4	5-1/2	1/4	2-5/16	4-1/8	1/2-13x1"	1/2"
ND-D	3-3/8	2-3/4	6-1/4	5/16	4	5	1/2-13x1"	1/2"
ND-DS	3-3/8	2-3/4	6-1/4	5/16	4	5	1/2-13x1"	1/2"
SI								
ND-C	65.1	69.9	139.7	6.4	58.7	101.9	1/2-13x1"	13
ND-D	85.7	69.9	158.8	7.9	101.6	127.0	1/2-13x1"	13
ND-DS	85.7	69.9	158.8	7.9	101.6	127.0	1/2-13x1"	13

PIN 54 = N				
**Weight Range (lbs)	**Weight Range (kg)	COLOR	YORK P/N	YORK P/N
UP TO 751 LBS	Up to 341 kg	ND-C	Yellow	029-24584-001
751-1651 LBS	341 to 749 kg	ND-D	Yellow	029-24584-002
1651-3226 LBS	749 to 1463 kg	ND-E	Yellow	029-24584-003

** Value is de-rated by 15%

INSTALLATION OF NEOPRENE MOUNTS

It is not necessary to bolt the mountings to a concrete pad in most cases. Mountings should always be bolted to the chiller rails. When mountings and the chiller are installed on steel framing above the ground, the mountings should be bolted to the steel framework. Lower the chiller on to the mountings evenly to avoid placing excessive weight on individual isolators.

CIP 1" DEFLECTION RESTRAINED MOUNTING SPECIFICATIONS

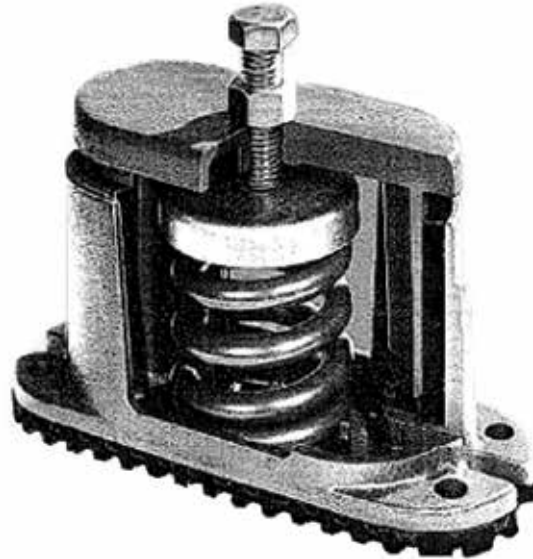

6

LD10576

PIN 54 = 1 (See note below)

For Units With All Load Points Less than 1404 LBS (637 KG)

*Weight Range (lbs)	*Weight Range (kg)	Vendor P/N	Color	YORK P/N
239-384 LBS	108 to 174 kg	CIP-B-450	Red	029-24583-002
384-639 LBS	174 to 290 kg	CIP-B-750	White	029-24583-003
639-851 LBS	290 to 386 kg	CIP-B-1000	Blue	029-24583-004
851-1064 LBS	386 to 483 kg	CIP-B-1250	Gray	029-24583-005
1064-1404 LBS	483 to 637 kg	CIP-B-1650	Black	029-24583-006

For Units With Any Load Point Above 1404 LBS (637 KG)

UP TO 851 LBS	Up to 386 kg	CIP-C-1000	Black	029-24583-007
851-1149 LBS	386 to 521 kg	CIP-C-1350	Yellow	029-24583-008
1149-1489 LBS	521 to 675 kg	CIP-C-1750	Black	029-24583-009
1489-1786 LBS	675 to 810 kg	CIP-C-2100	Yellow w/ Red	029-24583-010
1786-2028 LBS	810 to 920 kg	CIP-C-2385	Yellow w/ Green	029-24583-011
2028-2254 LBS	920 to 1022 kg	CIP-C-2650	Red w/ Red	029-24583-012
2354-2936 lbs	1022 to 1332 kg	CIP-C-2935	Red w/ Green	029-24583-013

* Value is de-rated by 15%

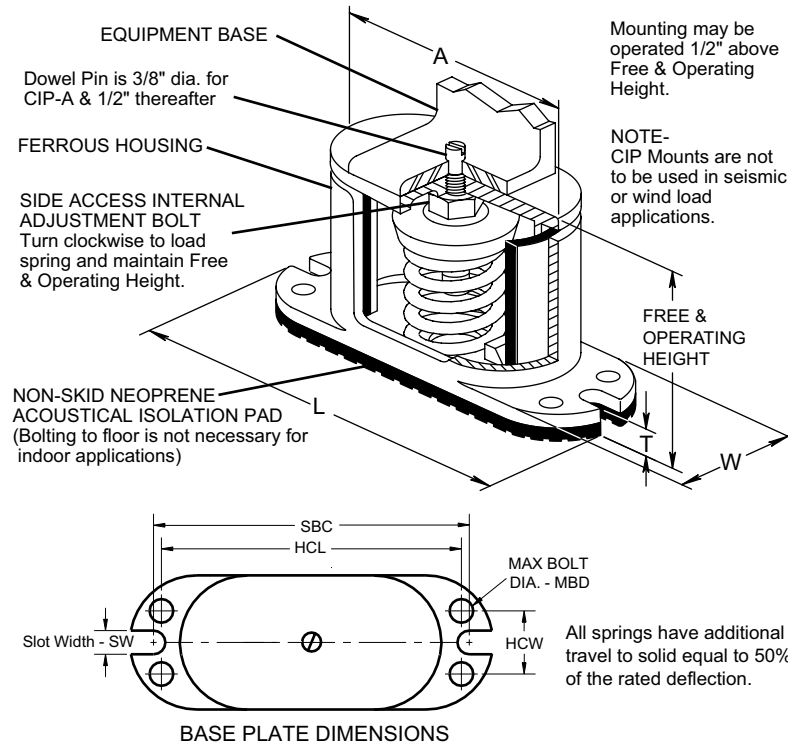

LD10577

TYPE CIP DIMENSIONS (inches)†

Size	A	L	T	W	SW	HCL	HCW	MBD	SBC	Free Ht.	Min Ht.
CIP-B	5 3/4	8 1/4	1/2	2 3/4	7/16	6 1/2	1 1/2	3/8	7 1/4	6 1/8	5 1/4
CIP-C	6 5/8	8 7/8	9/16	3 1/2	7/16	7 1/4	1 3/4	3/8	7 7/8	6 3/4	6 3/4

†Casting dimensions may vary ±1/8"

INSTALLATION OF 1" DEFLECTION MOUNTS

1. Floor or steel frame should be level and smooth.
2. For pad installations, isolators do not normally require bolting. If necessary, anchor isolators to floor through bolt holes in the base plate.
3. Lubricate the threads of adjusting bolt. Loosen the hold down bolts to allow for isolator adjustment.
4. Block the equipment 10mm (1/4") higher than the specified free height of the isolator. To use the isolator as blocking for the equipment, insert a 10mm (1/4") shim between the upper load plate and vertical uprights. Lower the equipment on the blocking or shimmed isolators.
5. Complete piping and fill equipment with water, refrigerant, etc.
6. Turn leveling bolt of first isolator four full revolutions and proceed to each mount in turn.
7. Continue turning leveling bolts until the equipment is fully supported by all mountings and the equipment is raised free of the spacer blocks or shims. Remove the blocks or shims.
8. Turn the leveling bolt of all mountings in either direction in order to level the installation.
9. Tighten the nuts on hold down bolts to permit a clearance of 2mm (1/8") between resilient washer and underside of channel cap plate.
10. Installation is now complete.

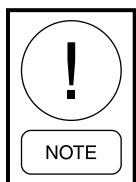

Isolators must be bolted to the sub-structure and the equipment must be bolted to the isolators when outdoor equipment is exposed to wind forces.

REFRIGERANT FLOW DIAGRAM

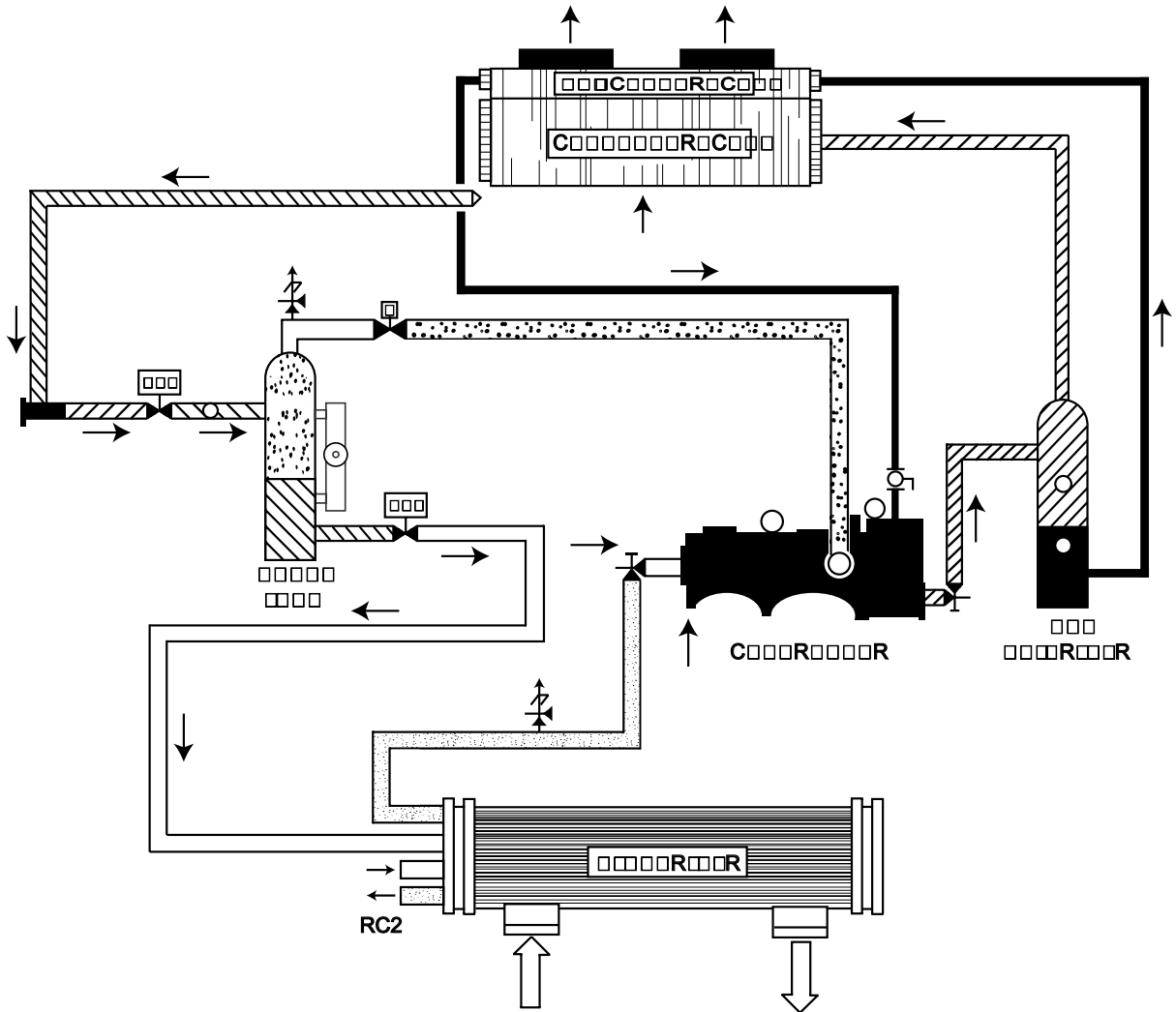

6

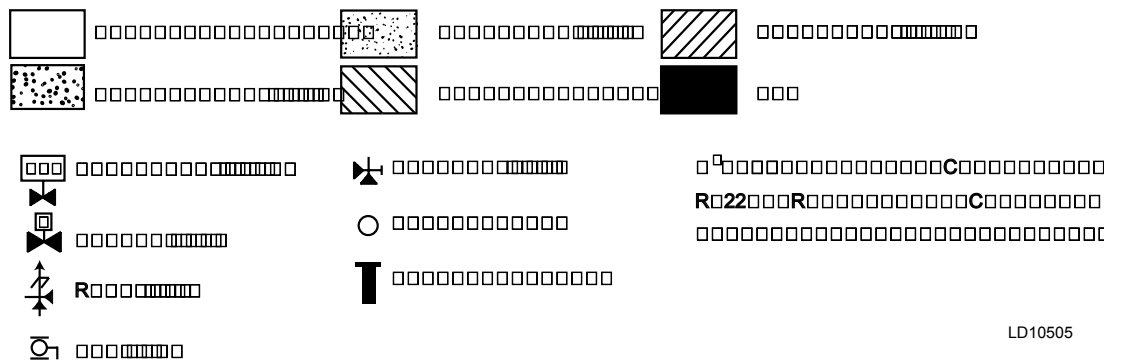

FIG. 9 - REFRIGERANT FLOW DIAGRAM

LD10505

PROCESSES AND INSTRUMENTATION DIAGRAM

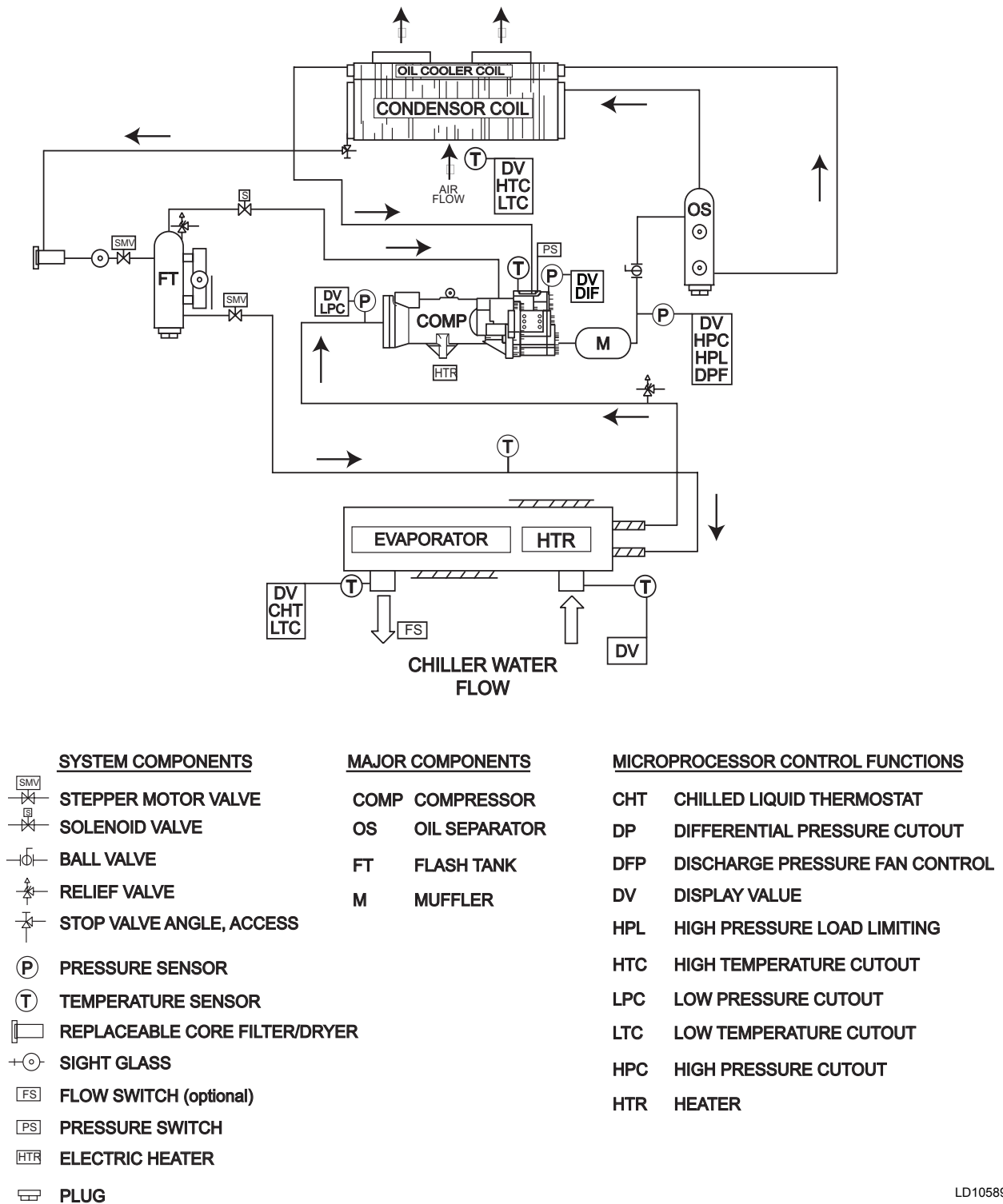
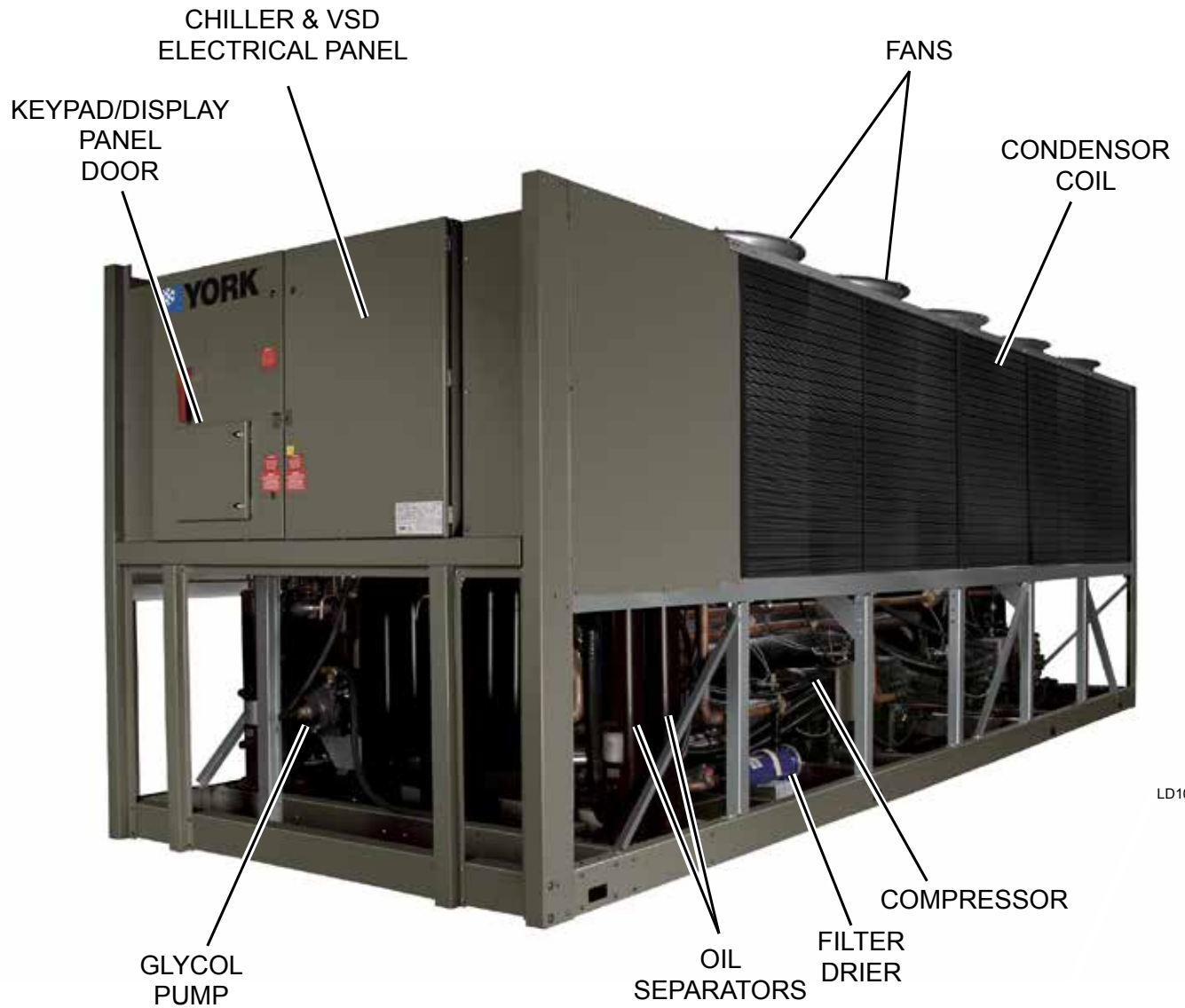

FIG. 10 - PROCESSES AND INSTRUMENTATION DIAGRAM

COMPONENT LOCATIONS



6

LD10477

FIG. 11 - COMPONENT LOCATIONS

COMPONENT LOCATIONS (CON'T)

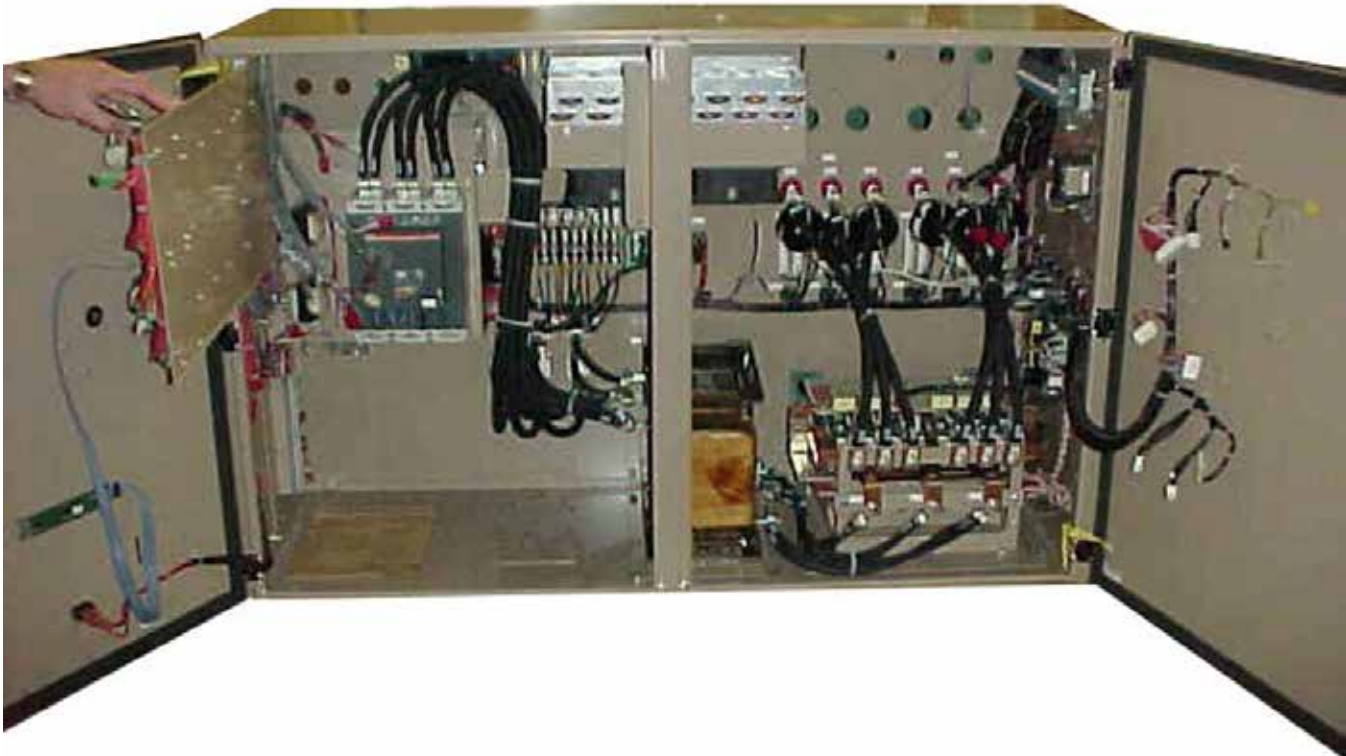

LD10578

FIG. 12 - CONTROL AND VSD CABINET COMPONENTS

COMPONENT LOCATIONS (CON'T)

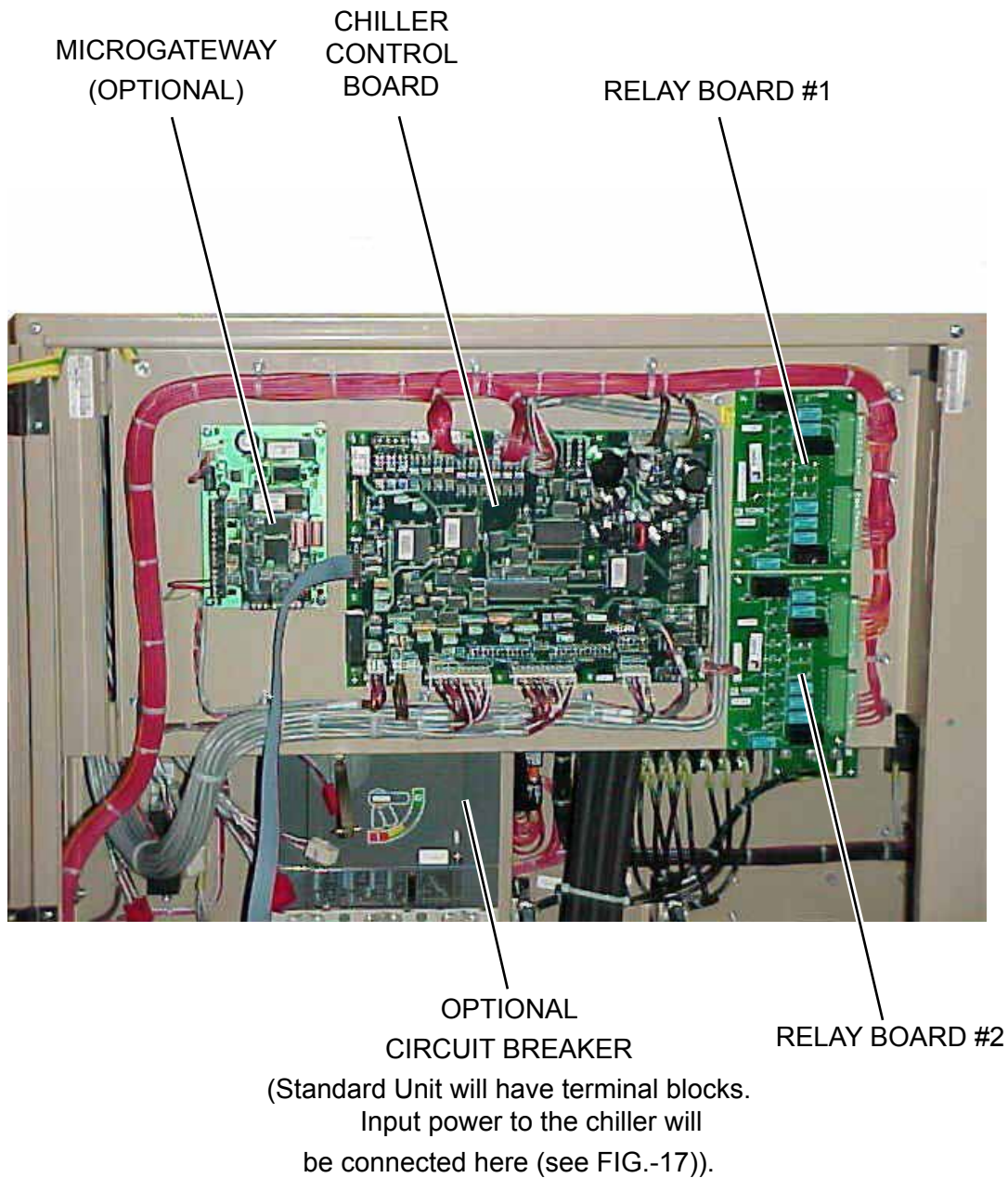

6

LD10579

FIG. 13 - CHILLER CONTROL BOARD, RELAY BOARDS, MICROGATEWAY, AND OPTIONAL CIRCUIT BREAKER

COMPONENT LOCATIONS (CON'T)

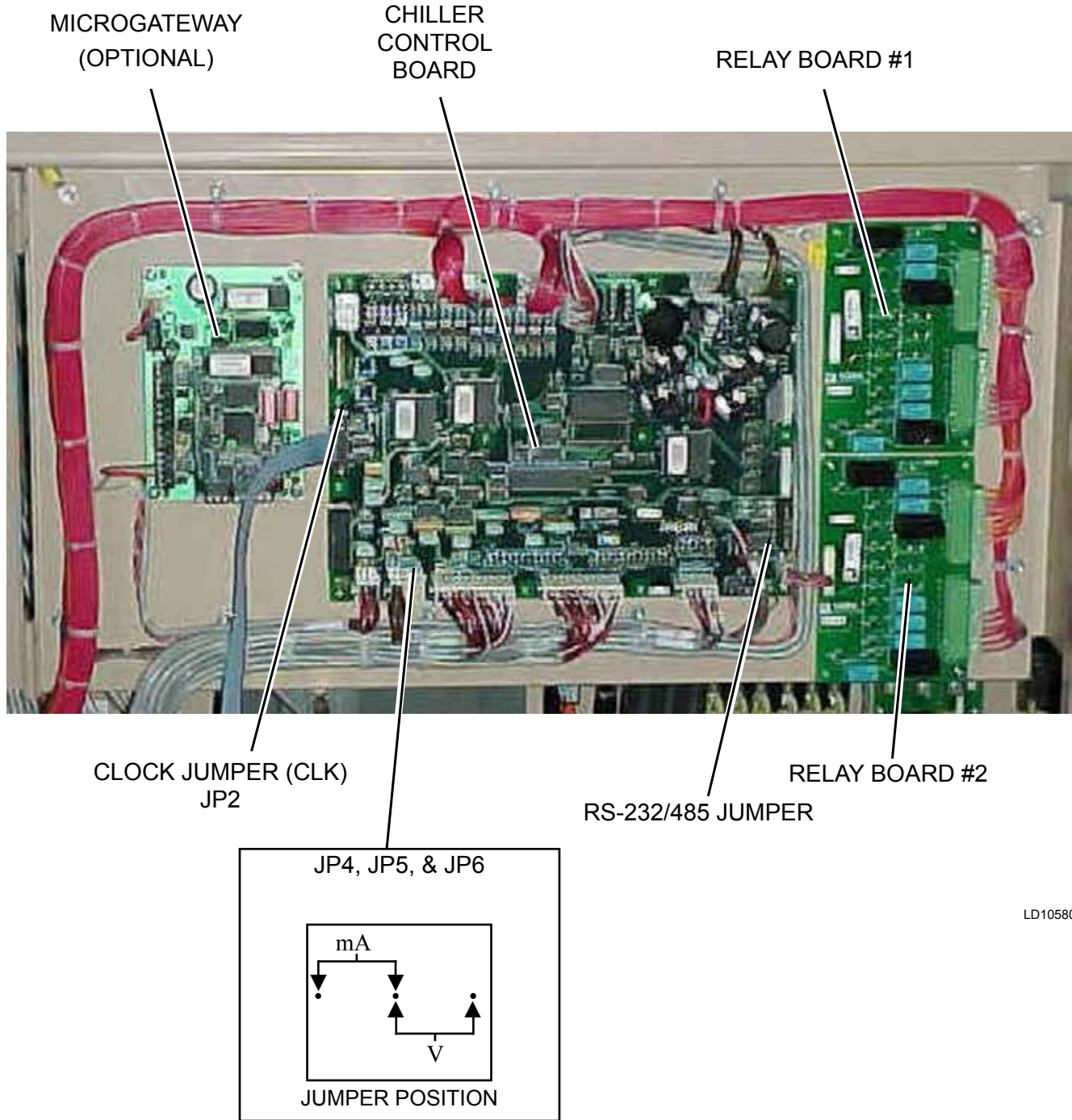

LD10580

FIG. 14 - CHILLER CONTROL BOARD, RELAY BOARDS, AND MICROGATEWAY

COMPONENT LOCATIONS (CON'T)

VSD
LOGIC BOARD

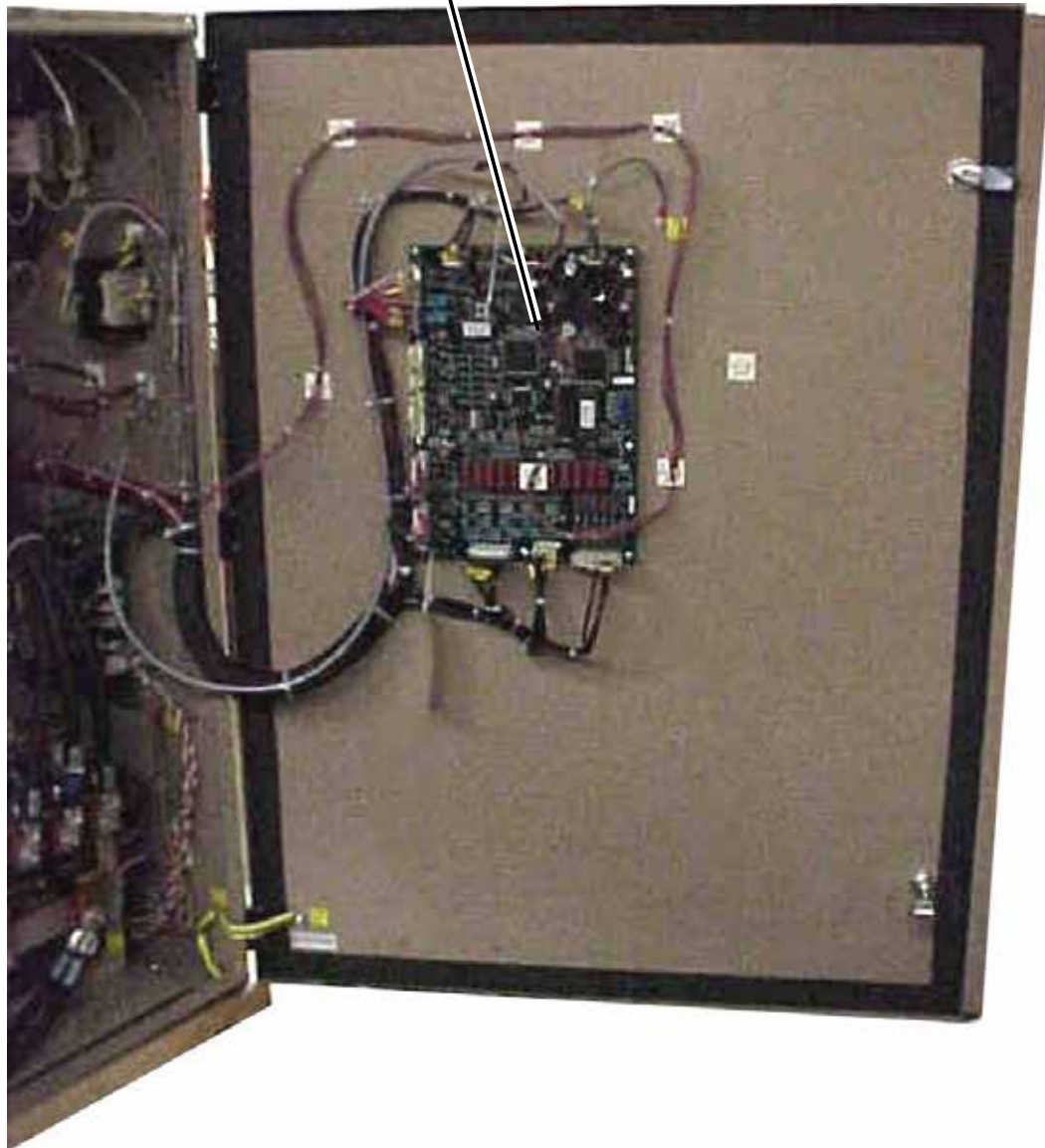

6

LD10582

FIG. 15 - VSD LOGIC BOARD

COMPONENT LOCATIONS (CON'T)

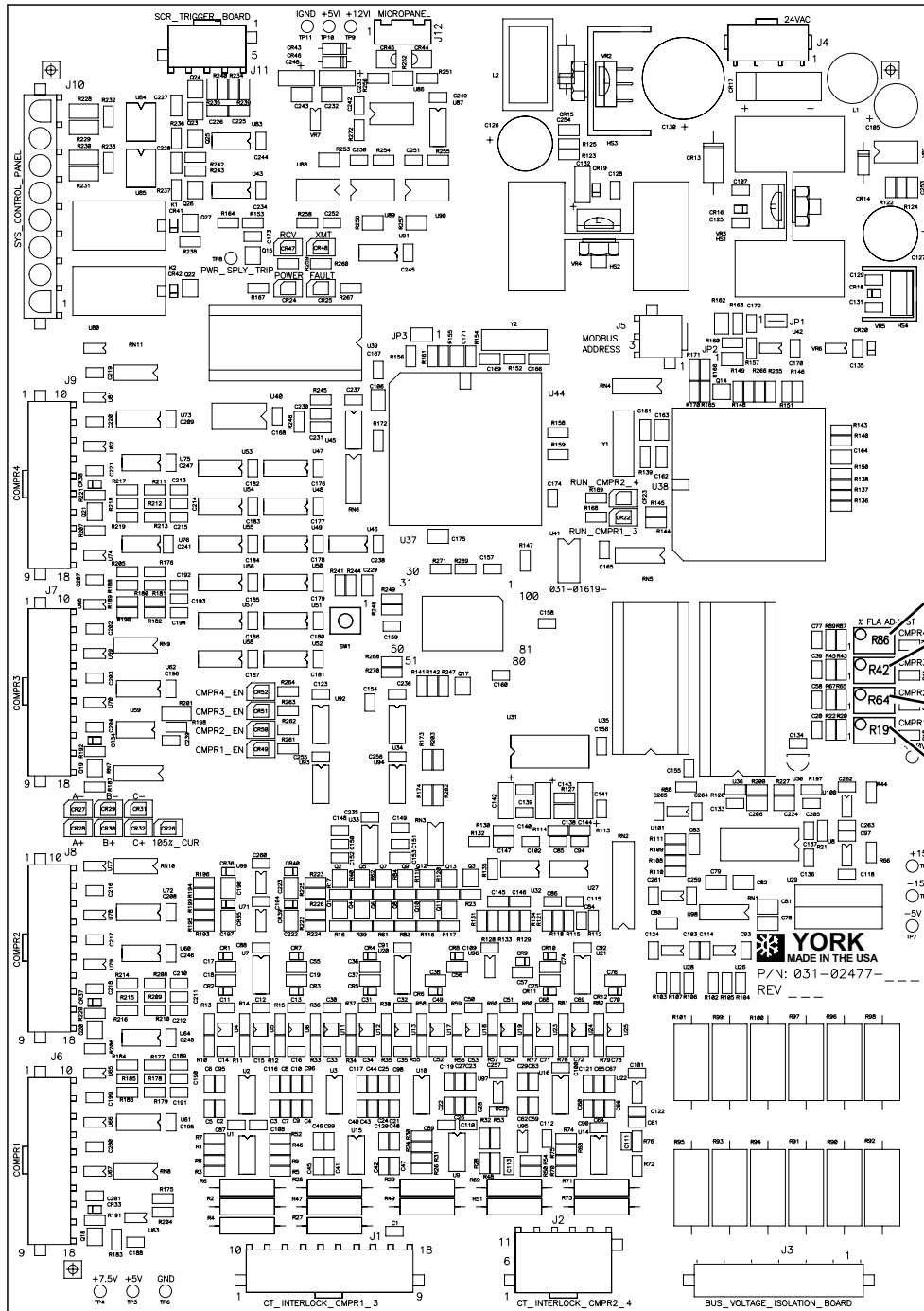

R86
(COMPR 4
Over Load Adjust)

R42
(COMPR 3
Over Load Adjust)

R64
(COMPR 2
Over Load Adjust)

R19
(COMPR 1
Over Load Adjust)

FIG. 16 - VSD LOGIC BOARD

COMPONENT LOCATIONS (CON'T)

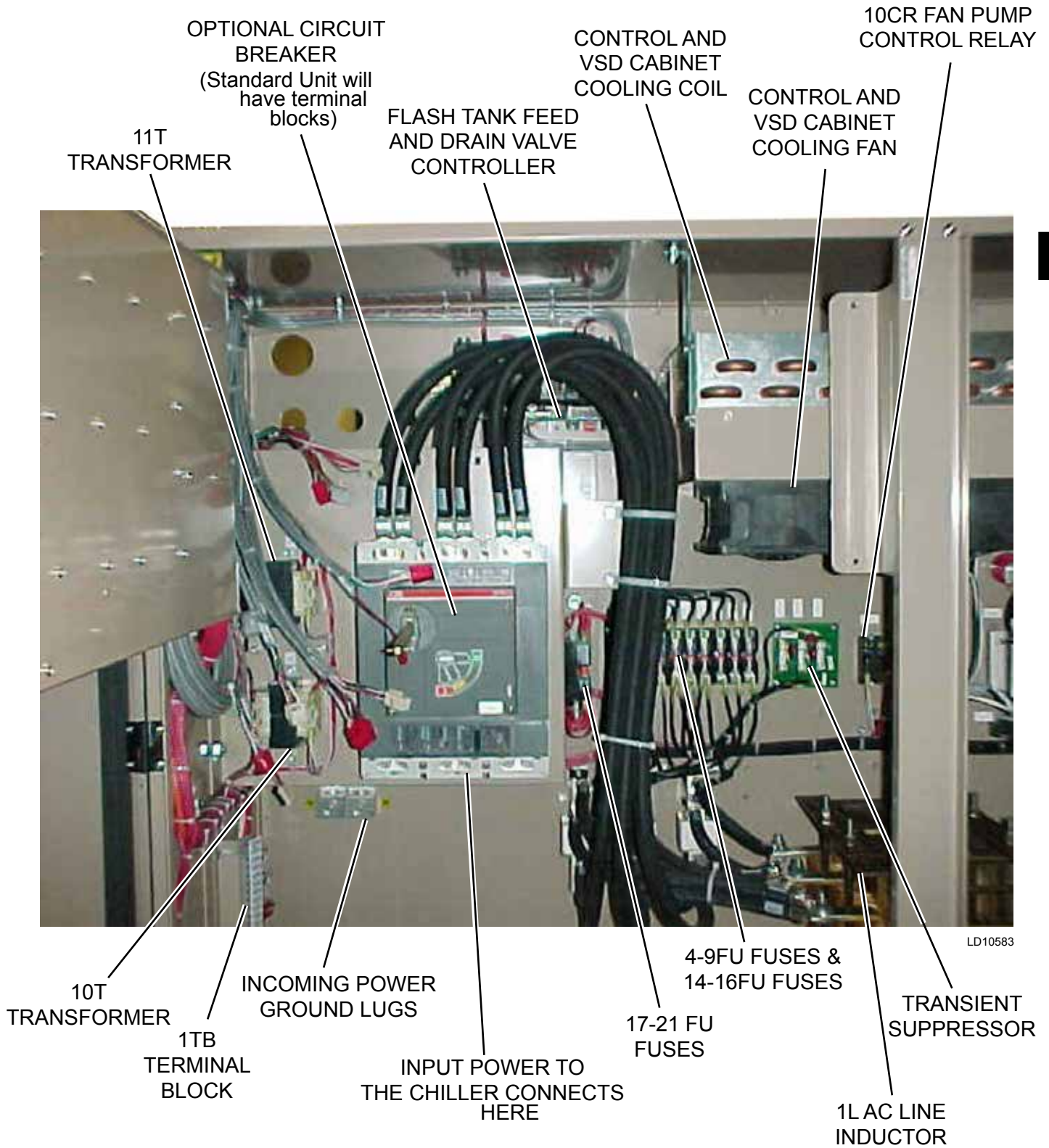

LD10583

FIG. 17 - POWER COMPONENTS

COMPONENT LOCATIONS (CON'T)

FAN CONTACTORS
4CR-9CR



LD10584

3T TRANSFORMER
(24VAC to SCR Gate Driver Board
and VSD Logic Board)

FIG. 18 - FAN CONTACTORS AND 3T TRANSFORMER

COMPONENT LOCATIONS (CON'T)

17-21 FU FUSES
(17 FU: 2T, 18 FU: VSD Logic /
SCR Trigger Board /
Pump Contactor,
19 FU: 10T & 11T,
20 FU: Relay Board #1,
21 FU: Relay Board #2

TRANSIENT
SUPPRESSOR BOARD
(3-Phase Input)

4-9 FU FUSES &
14-16 FU FUSES
(4-6 FU: TB-1-3 SCR
Trigger Board,
7-9 FU: Sys. 1 Fans,
14-16 FU: Sys. 2 Fans)

4-6 CT
CURRENT
TRANSFORMERS

3-8 RES RESISTORS
(Motor Output RC
"DV/DT Network)

COOLING
FAN

COOLING
FAN

10 CR FAN PUMP
CONTROL RELAY

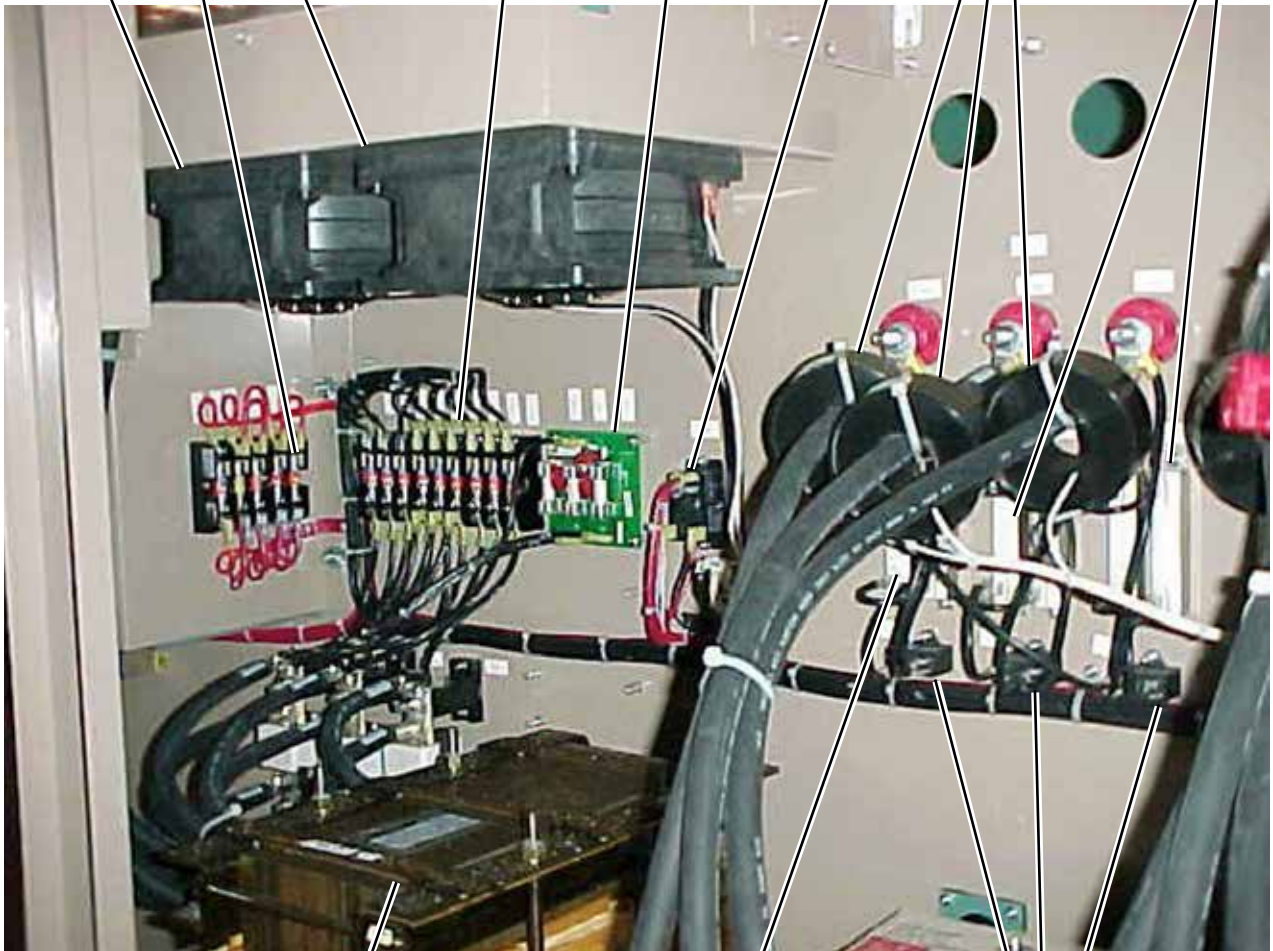

6

1L AC LINE
INDUCTOR

3-8 RES RESISTORS
(Motor Output RC
"DV/DT Network)

CAPACITORS C15-C17
(Motor output RC "DV/DT"
Network)

LD10585

FIG. 19 - VSD COMPONENTS

COMPONENT LOCATIONS (CON'T)

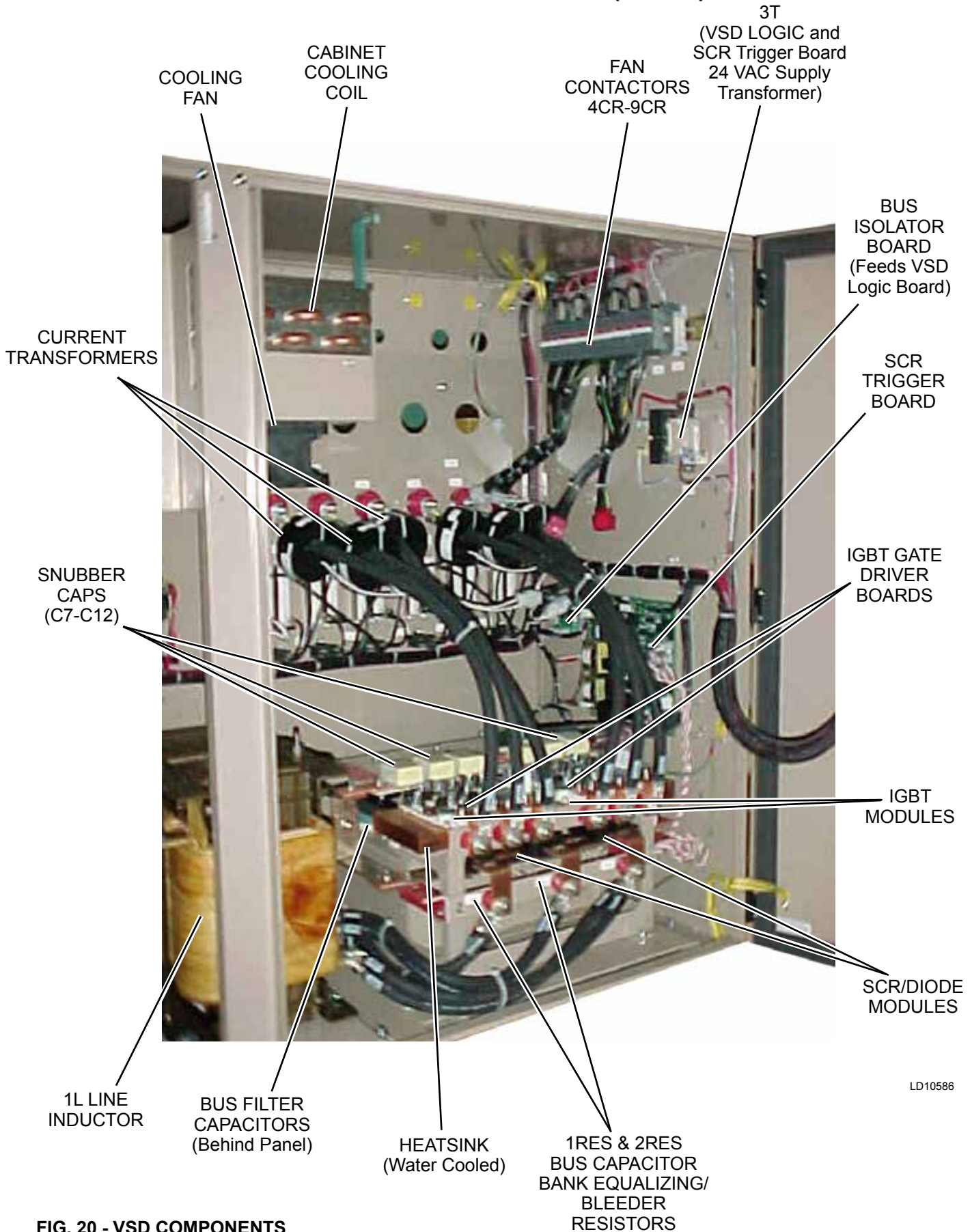

LD10586

FIG. 20 - VSD COMPONENTS

COMPONENT LOCATIONS (CON'T)

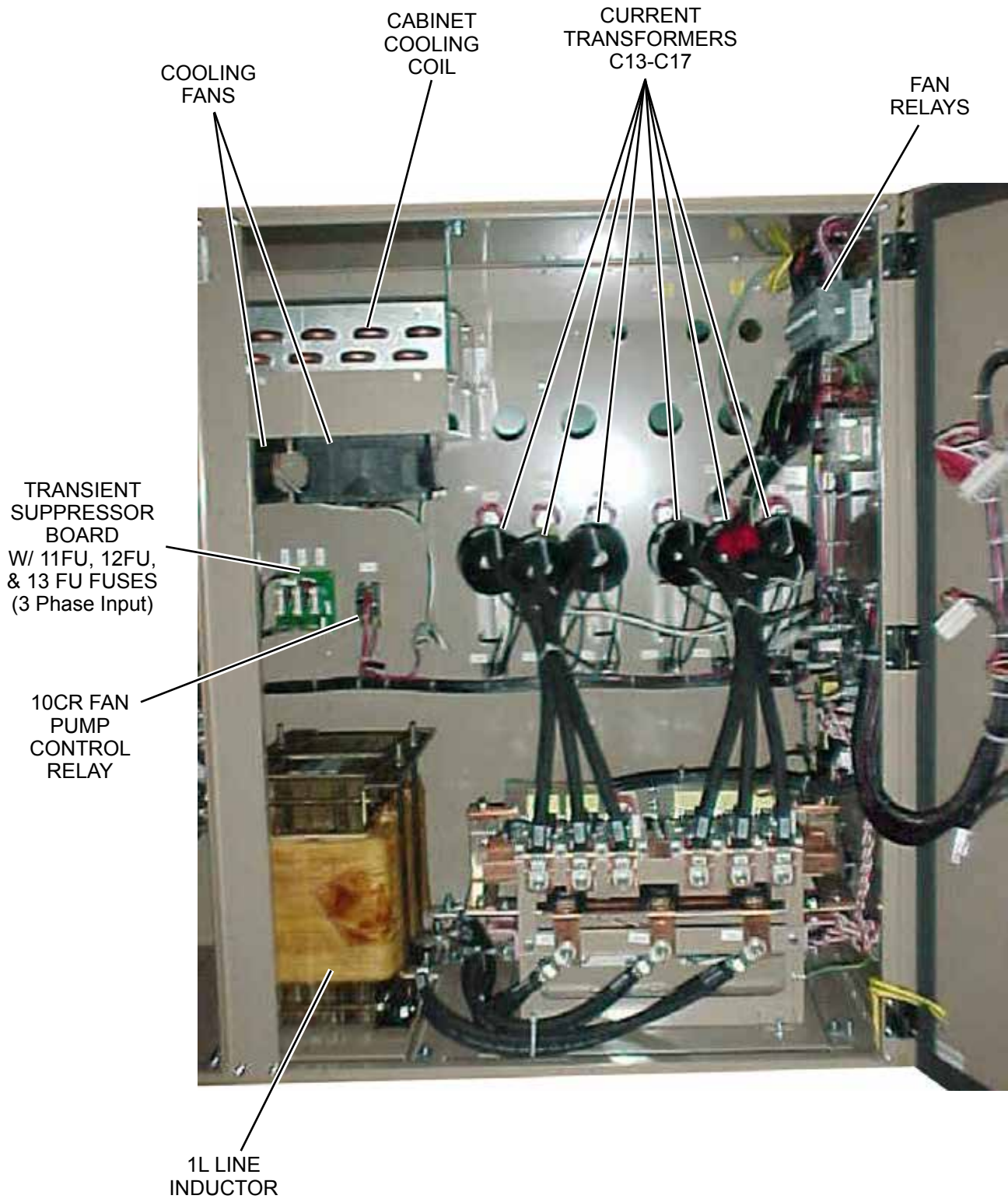

6

LD10587

FIG. 21 - VSD COMPONENTS

COMPONENT LOCATIONS (CON'T)

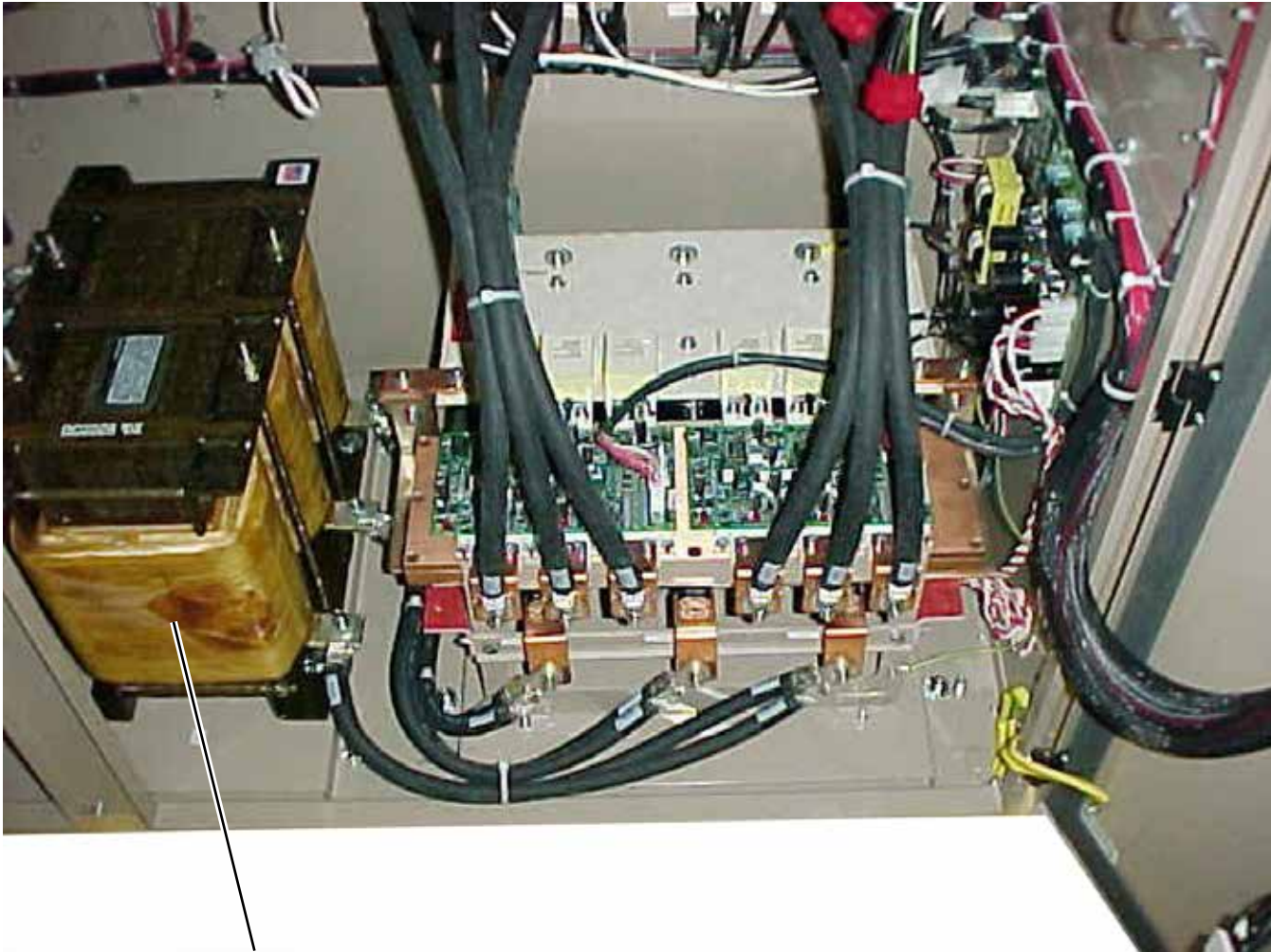

THE LINE INDUCTOR WILL REACH OPERATING TEMPERATURES OF OVER 300° F. DO NOT OPEN PANEL DOORS DURING OPERATION. ASSURE THE INDUCTOR IS COOL WHENEVER WORKING NEAR THE INDUCTOR WITH POWER OFF.

LD10588

FIG. 22 - INVERTER POWER COMPONENTS

COMPONENT LOCATIONS (CON'T)

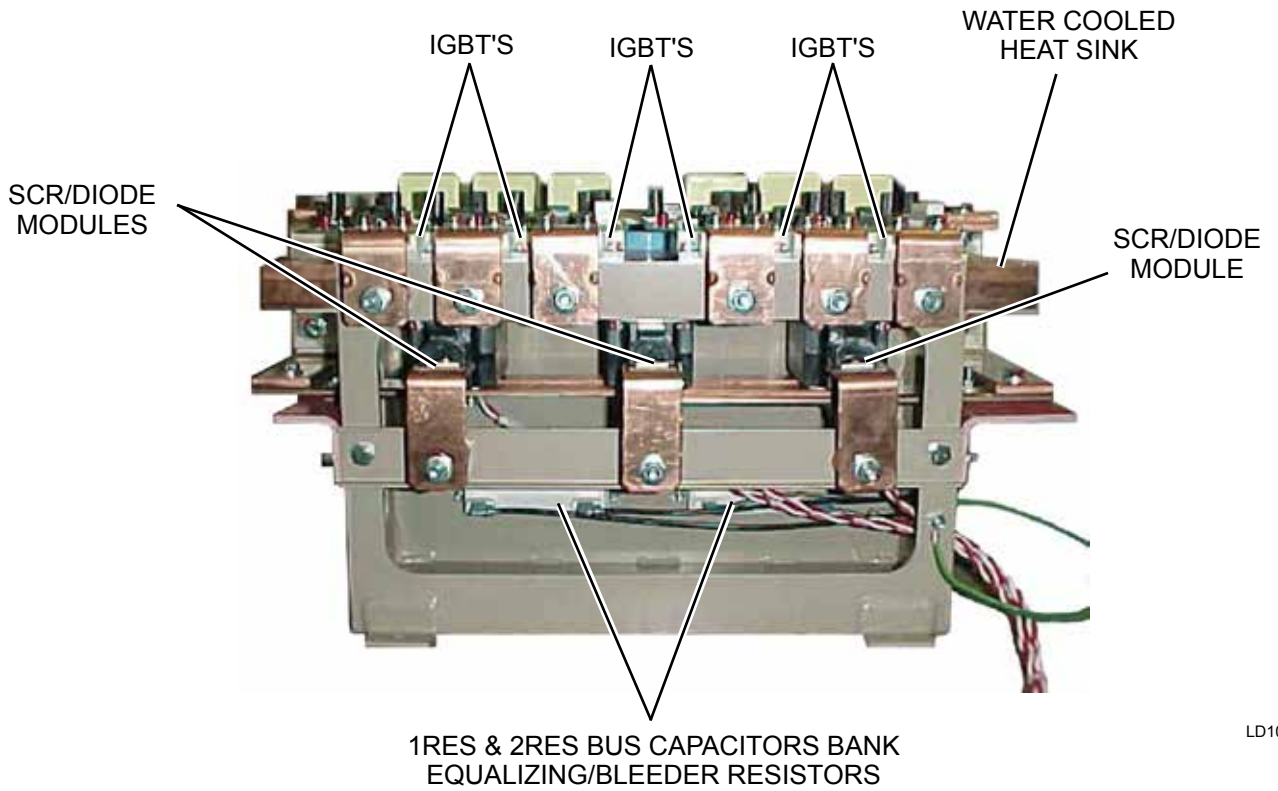

6

LD10591

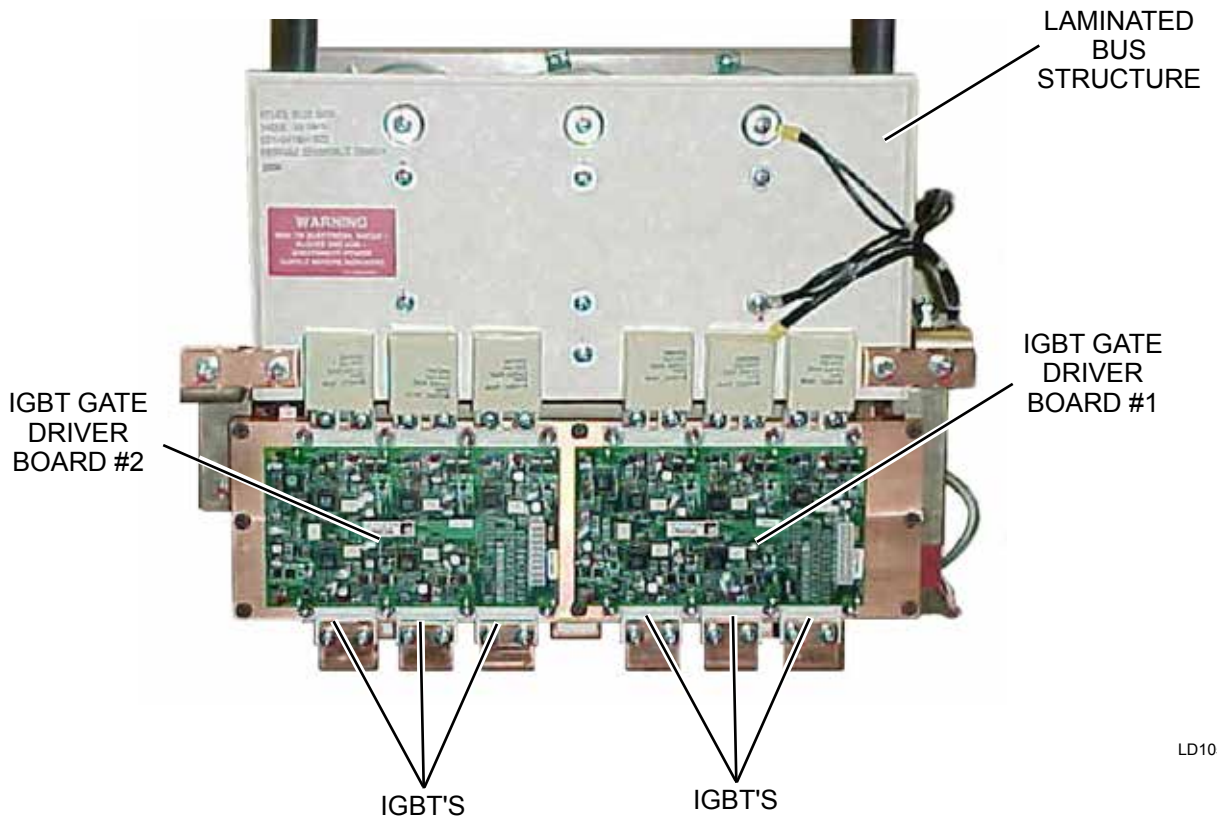

LD10592

FIG. 23 - INVERTER POWER COMPONENTS

COMPONENT LOCATIONS (CON'T)

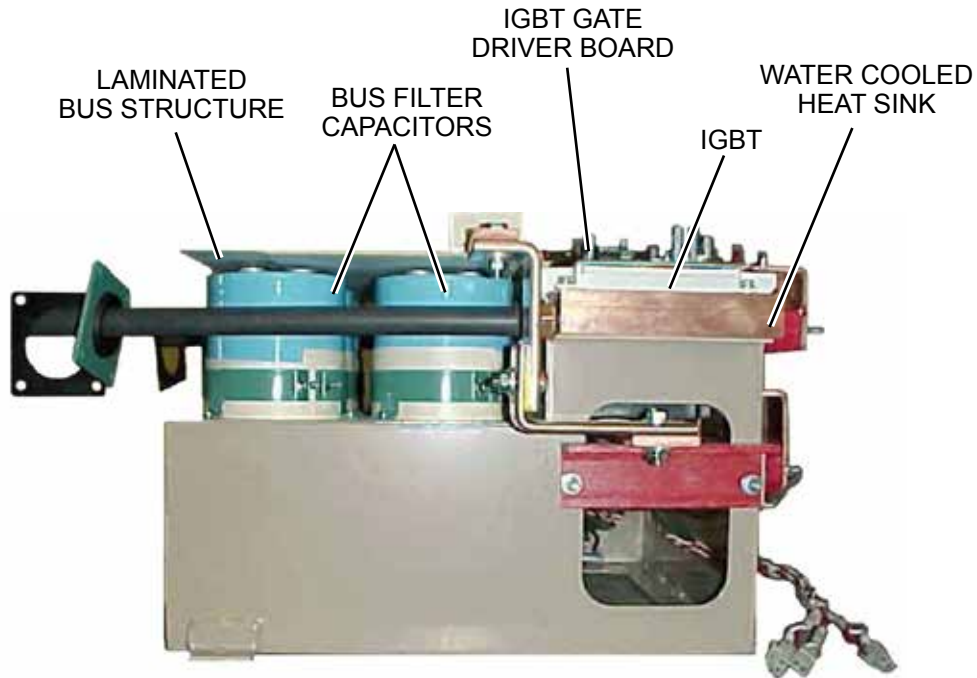

FIG. 24 - INVERTER POWER COMPONENTS

LD10593

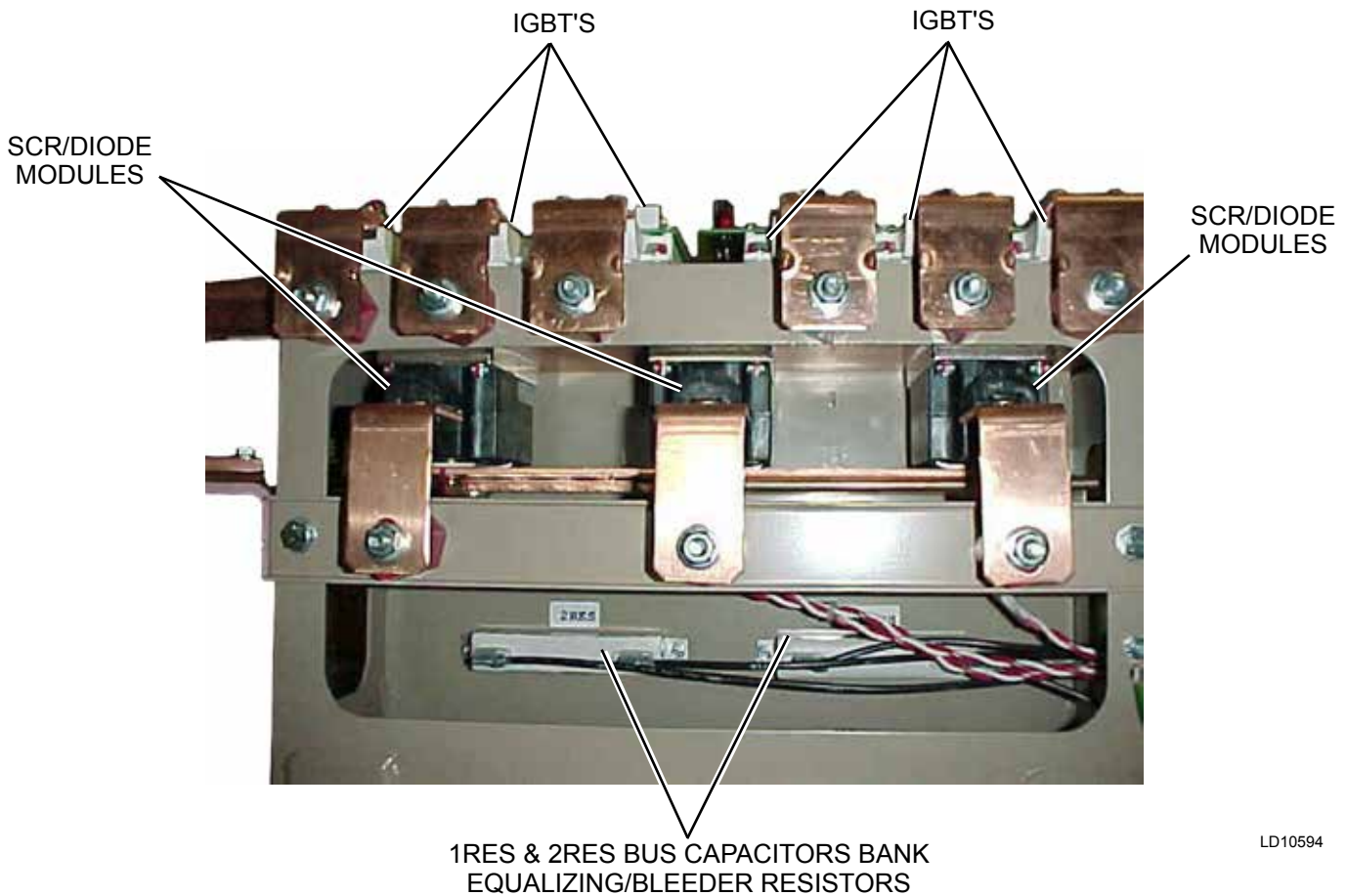
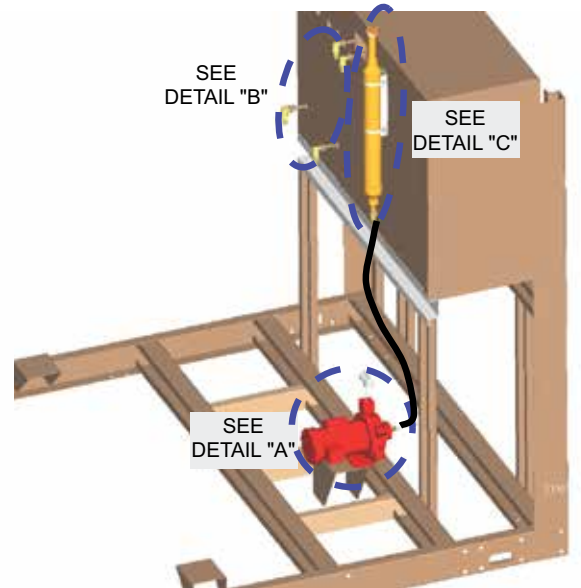
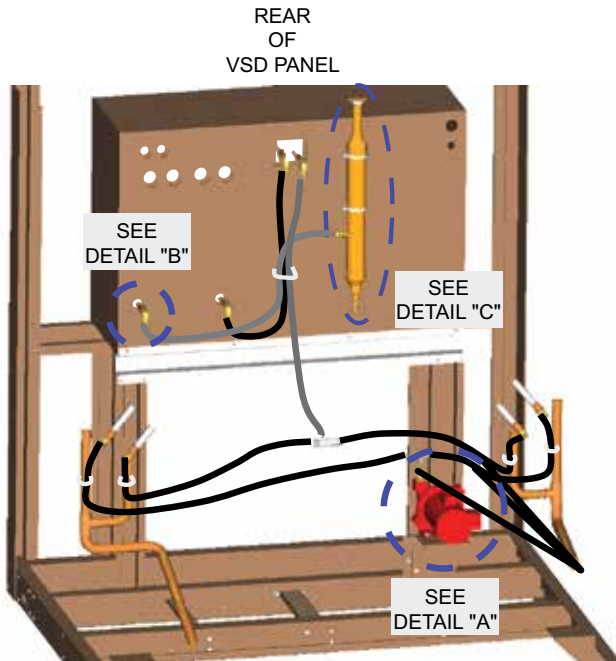

FIG. 24A - INVERTER POWER COMPONENTS

LD10594

GLYCOL SYSTEM COMPONENTS



6

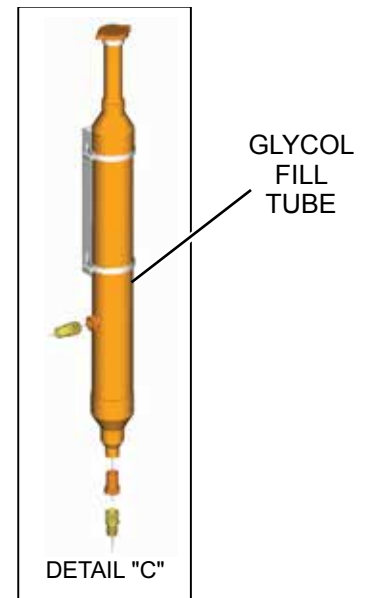
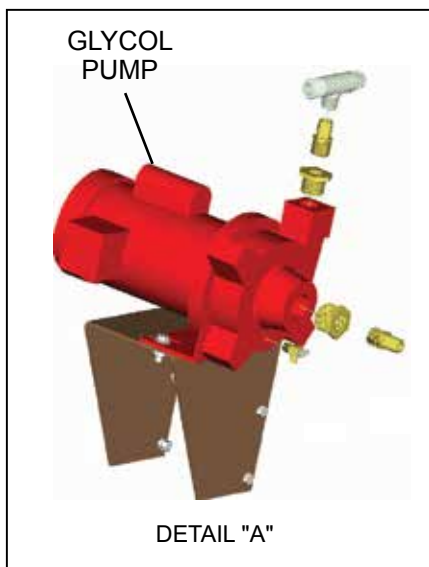
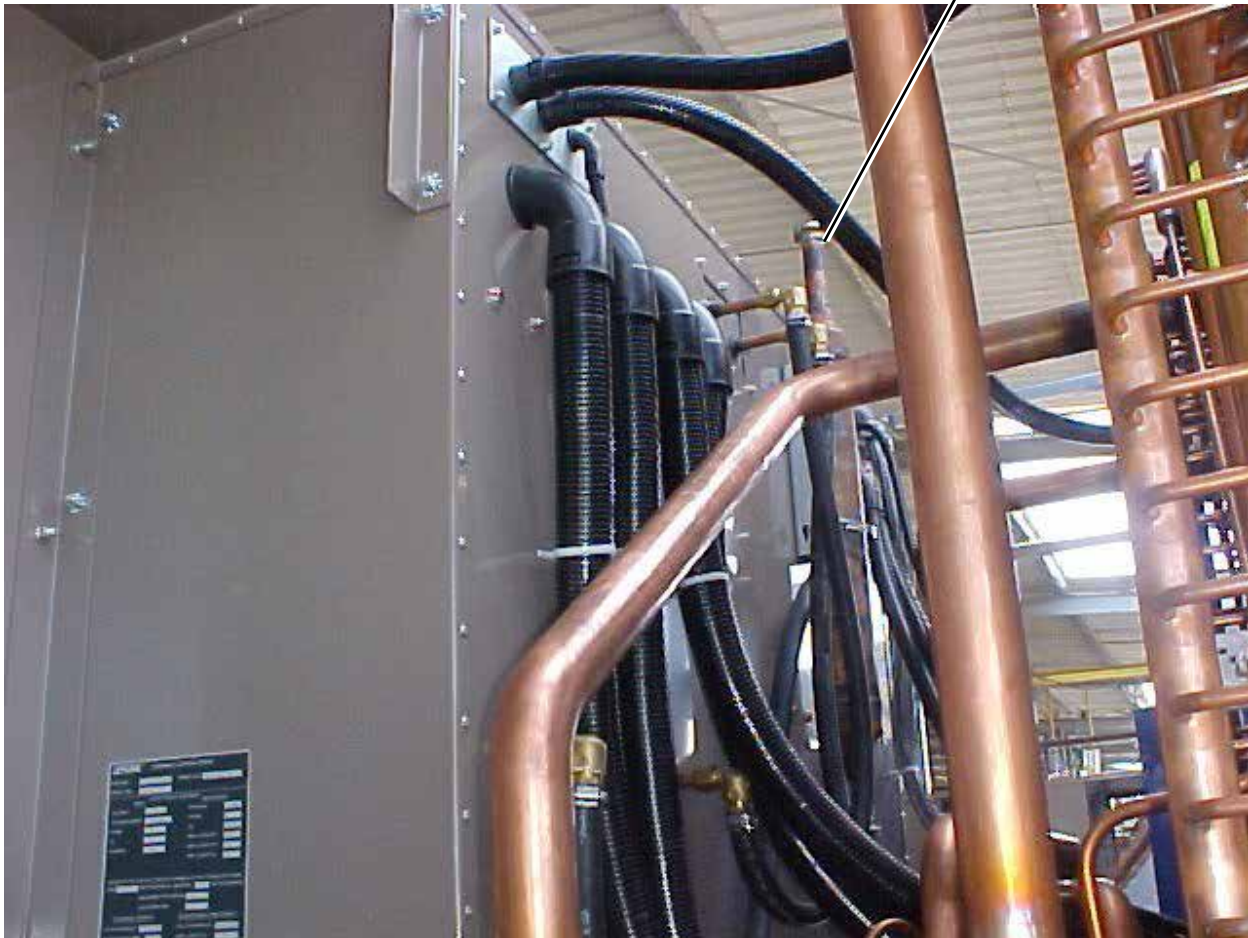

FIG. 25 - GLYCOL PUMP & FILL TUBE LOCATIONS

GLYCOL SYSTEM COMPONENTS (CON'T)

GLYCOL
FILL
TUBE



LD10597

FIG. 26 - GLYCOL PIPING AND FILL TUBE LOCATION

COMPRESSOR COMPONENTS

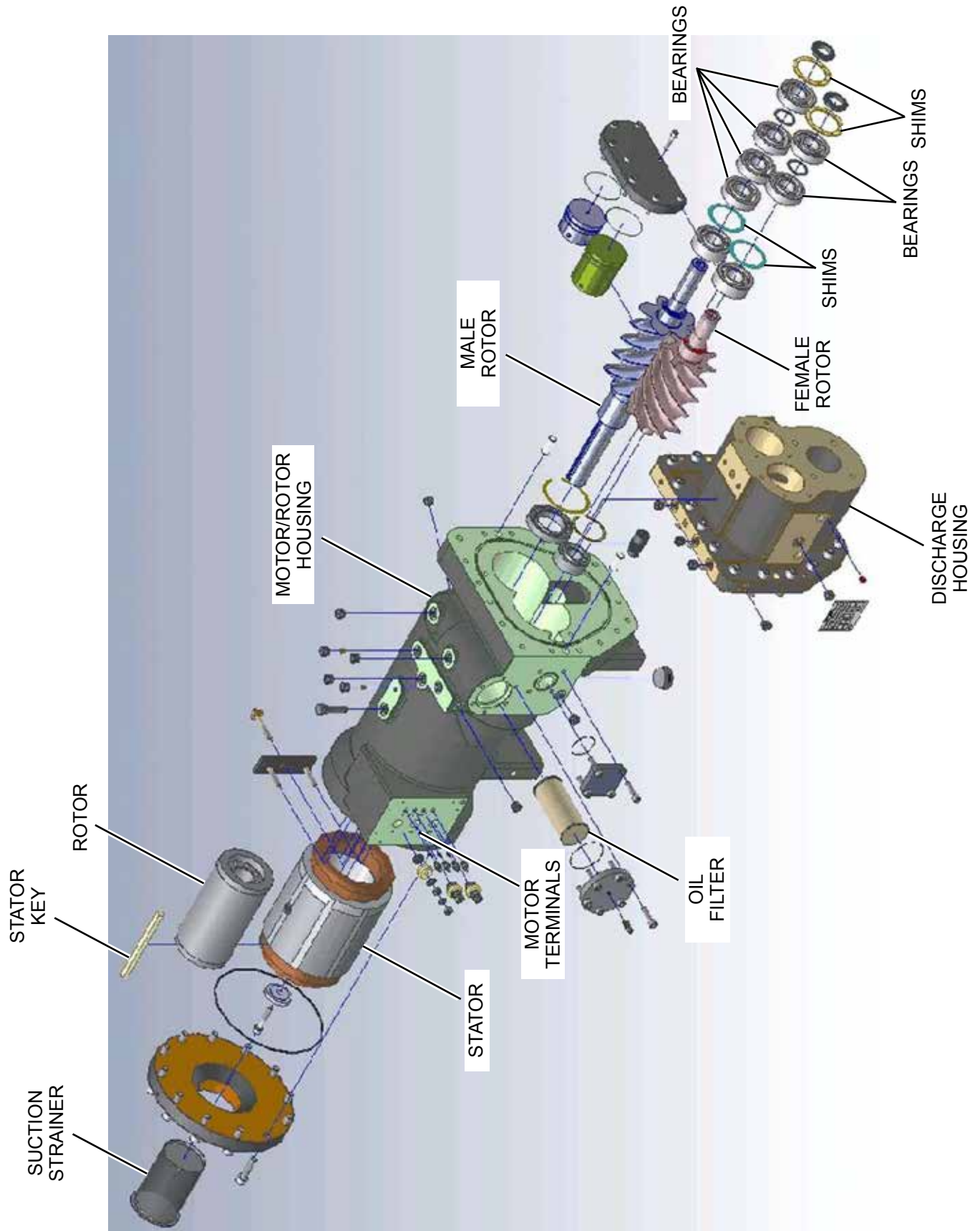

FIG. 27 - COMPRESSOR COMPONENTS

EQUIPMENT START-UP CHECK SHEET

JOB NAME: _____

SALES ORDER #: _____

LOCATION: _____

SOLD BY: _____

INSTALLING
CONTRACTOR: _____

START-UP
TECHNICIAN/
COMPANY: _____

START-UP DATE: _____

CHILLER MODEL #: _____

SERIAL #: _____

COMPRESSOR #1
MODEL#: _____

SERIAL #: _____

COMPRESSOR #2
MODEL#: _____

SERIAL #: _____

COMPRESSOR #3
MODEL#: _____

SERIAL #: _____

COMPRESSOR #4
MODEL#: _____

SERIAL #: _____

UNIT CHECKS (NO POWER)

The following basic checks should be made with the customer power to the unit switched off.



Proper electrical lock out and tag procedures must be followed.

Check the system 24 hours prior to initial start:

1. Inspect the unit for shipping or installation damage.
2. Ensure that all piping has been completed.
3. Assure the unit is properly charged and there are no piping leaks.
4. Open each system suction service valve, discharge service valve, economizer service valve, liquid line stop valve, and oil line ball valve.
5. The oil separator oil level(s) should be maintained so that an oil level is visible in either of the oil separator sight glasses when a compressor is running at high speeds for 10 to 15 minutes. An oil level may not be visible in the sight glasses when the compressor is off and it may be necessary to run the compressor to obtain a level. In shutdown situations and at some load points, much of the oil may be in the condenser and the level in the separators may fall below the bottom sight glass.

On systems with dual oil separators per compressor, one separator may show a lower level or no level, while the other separator shows a level between the 2 sight glasses. This is normal and a level is only required in one separator. Do not add oil to raise the level in the other oil separator.

Oil levels in single separator systems should not go above the top of the upper sight glass. Dual separator systems should also not show oil levels above the top of one of the sight glasses. In the rare situation where oil levels are high, drain enough oil to lower the level to the bottom of the top sight glass.

EQUIPMENT START-UP CHECK SHEET (CON'T)

Sight glasses will vary in type depending upon the manufacturer of the separator. One type will have balls that float in the sight glasses to indicate level. Another type will have a bulls eye glass. The bulls eye glass will tend to appear to lose the lines in the bulls eye when the level is above the glass. Oil level should not be above the top sight glass. In the rare situation where oil levels are high, drain oil to lower the level to the bottom of the top sight glass.

Oil levels in the oil separators above the top sight glass in either oil separator should be avoided and may cause excessive oil carryover in the system. High oil concentration in the system may cause nuisance trips resulting from incorrect readings on the level sensor and temperature sensors. Temperature sensor errors may result in poor refrigerant control and liquid overfeed to the compressor.

In the unlikely event it is necessary to add oil, connect a YORK oil pump to the charging valve on the oil separator, but do not tighten the flare nut on the delivery tubing. With the bottom (suction end) of the pump submerged in oil to avoid entrance of air, operate the pump until oil drips from the flare nut joint, allowing the air to be expelled, and tighten the flare nut. Open the Compressor oil charging valve and pump in oil until it reaches the proper level as described above.

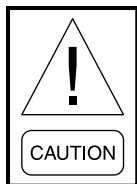

When oil levels are high, adding oil may not visibly increase the level in the separators during operation. This may be an indication the level is already too high and the oil is being pumped out into the system where it will cause heat transfer and control problems.

6. Ensure water pumps are on. Check and adjust water pump flow rate and pressure drop across the cooler.



Excessive flow may cause catastrophic damage to the evaporator.

7. Check the control panel to ensure it is free of foreign material (wires, metal chips, tools, documents, etc.).
8. Visually inspect wiring (power and control). Wiring MUST meet N.E.C. and local codes (See FIG. 13 and 17 Pages 137 and 141).
9. Check tightness of the incoming power wiring inside the power panel and inside the motor terminal boxes.
10. Check for proper size fuses in control circuits.
11. Verify that field wiring matches the 3-phase power requirements of the chiller. (See chiller nameplate Page 21).
12. Be certain all water temperature sensors are inserted completely in their respective wells and are coated with heat conductive compound.
13. Ensure the suction line temperature sensors are strapped onto the suction lines at 4 or 8 O'clock positions.
14. Assure the glycol level in the VSD cooling system is 9-15 inches (23-28 cm) from the top of the fill tube. This check should be performed prior to running the pump.
15. Check to assure the remote start/stop for Sys #1 on Terminals 2 to 15 and Sys #2 on Terminals 2 to 16 are closed on the User Terminal Block 1TB to allow the systems to run. If remote cycling devices are not utilized, place a wire jumper between these terminals.

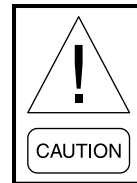

Never run the glycol pump without coolant! Running the glycol pump without coolant may damage the pump seals.

Always fill the system with approved YORK coolant to avoid damage to the pump seals and the chiller.

16. Ensure that the CLK jumper JP2 on the Chiller Control Board is in the ON position (see FIG.-14).
17. Assure a flow switch is connected between Terminals 2 and 13 on the User Terminal Block 1TB in the panel. Throttle back flow to assure the flow switch opens with a loss of flow. It is recommended that auxiliary pump contacts be placed in series with the flow switch for additional protection, if the pump is turned off during chiller

EQUIPMENT START-UP CHECK SHEET (CON'T)

operation. Whenever the pump contacts are used, the coil of the pump starter should be suppressed with an RC suppressor (031-00808-000).

PANEL CHECKS

(POWER ON – BOTH SYSTEM SWITCHES “OFF”)



You are about to turn power on to this machine. Safety is Number One! Only qualified individuals are permitted to service this product. The qualified individual furthermore is to be knowledgeable of, and adhere to, all safe work practices as required by NEC, OSHA, and NFPA 70E. Proper personal protection is to be utilized where and when required.

1. Assure the chiller OFF/ON UNIT switch at the bottom of the keypad is OFF.
2. Apply 3-phase power to the chiller. Turn ON the optional panel circuit breaker if supplied. The customer's disconnection devices can now be set to ON.
3. Verify the control panel display is illuminated.
4. To prevent the compressors from starting, assure that the system switches under the SYSTEM SWITCHES key are in the OFF position.
5. Verify that the voltage supply corresponds to the unit requirement and is within the limits given in the Technical Data Section.
6. Ensure the heaters on each compressor are on using a clamp-on ammeter. Heater current draw is approx. 3A.
7. Verify the “Factory Set” Overload Potentiometers on the VSD Logic Board are set correctly (correct settings are provided on Page 300). Press the VSD DATA key and using the arrow keys, scroll to the compressor overload settings. Verify the “Factory Set” overload potentiometer(s) on the VSD logic board (see FIG. 16) are set correctly. In the unlikely event that they are not set correctly, adjust the potentiometers until the desired values are achieved.



The VSD is powered up and live. High voltage exists in the area of the circuit board on the bus bars, VSD Pole Assemblies, and wiring to the input inductor.

Adjust the potentiometers, if needed, using the table on Page 299. The locations of the potentiometers are shown in FIG. 16, Page 140. The potentiometers are Sys 1=R19, Sys 2=R64, Sys 3=R42, and Sys 4=R86.

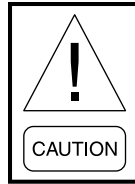

Incorrect settings of the potentiometers may cause damage to the equipment.

Record the Overload Potentiometer settings below:

Compressor Overload Setting:

System 1 = _____ Amps

System 2 = _____ Amps

System 3 = _____ Amps

System 4 = _____ Amps

8. Press the STATUS Key. If the following message appears, immediately contact YORK Product Technical Support. The appearance of this message may mean the chiller has lost important factory programmed information. The serial number and other important data may need to be reprogrammed.

**UNIT WARNING: INVALID SERIAL NUMBER
ENTER UNIT SERIAL NUMBER**

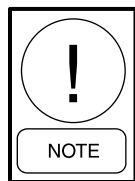

Changing the programming of this feature requires the date and time to be set on the chiller prior to programming. Additional information regarding this message and how to enter the serial number with the factory provided password is outlined in the SERIAL NUMBER PROGRAMMING information on Page 267.

EQUIPMENT START-UP CHECK SHEET (CON'T)

If the following message appears when the STATUS key is pressed, immediately contact YORK Product Technical Support. The appearance of this message indicates the chiller is a HIGH IPLV chiller operating in STANDARD IPLV control.

**UNIT WARNING: OPTIMIZED EFFICIENCY
DISABLED – CONTACT YORK REPRESENTATIVE**

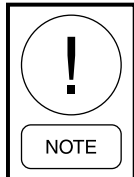

Changing the programming of this feature requires the date and time to be set on the chiller prior to programming. Additional information regarding this message is provided in the ENABLING HIGH IPLV MODE information on Page 269.

9. Program the required options into the Panel for the desired operating requirements. See Page 248. Record the values below:

Display Language = _____

Chilled Liquid Mode = _____

Local/Remote Mode = _____

Display Units = _____

Lead/Lag Control = _____

Remote Temperature Reset = _____

Remote Current Reset = _____

Remote Sound Limit = _____

Low Ambient Cutout = _____



Damage to the chiller could result if the options are improperly programmed.

PROGRAMMED VALUES

10. Program the required operating values into the micro for cutouts, safeties, etc. and record them in the chart below. See Page 245 for details. Record these values in the chart below.

Suction Press Cutout = _____ PSIG (kPa)

Low Ambient Cutout = _____ °F (°C)

Leaving Chilled Liquid Temp Cutout = _____ °F (°C)

Motor Current Limit = _____ % FLA

Pulldown Current Limit Time = _____ MIN

Suction Superheat Setpoint = _____ °F (°C)

Remote Unit ID # = _____

Sound Limit Setpoint = _____ %

CHILLED LIQUID SETPOINT

- 11 Program the Chilled Liquid Setpoint/Range and record:

Local Cooling Setpoint = _____ °F (°C)

Local Cooling Range = _____ to _____ °F (°C)

Maximum Remote Temp Reset = _____ to _____ °F (°C)

DATE/TIME, DAILY SCHEDULE, AND CLOCK JUMPER

- 12 Set the Date and Time.
13. Program the Daily Schedule start and stop times.

EQUIPMENT START-UP CHECK SHEET (CON'T)

14. Place the panel in Service mode and turn on each fan stage one by one. Assure the fans rotate in the correct direction, so air flow exits the top of the chiller.
15. Remove the cap on the fill tube and run the glycol pump to verify the level in the fill tube. Assure the glycol level in the VSD cooling system is 9-15 inches (23-28 cm) from the top of the fill tube while running. The pump can be run by placing the chiller in the SERVICE mode (Page 260). Be sure to re-install the cap before stopping the glycol pump to avoid overflowing the fill tube when the glycol pump is turned off. The glycol system holds about 3.5 gallons of coolant on the largest YCAS0267.

INITIAL START-UP

After the control panel has been programmed and the compressor heaters have been energized for at least 8 hours (ambient temperature > 96°F (36°C)) or 24 hours (ambient temperature < 86°F (30°C)), the chiller may be placed in operation.

1. Turn on the UNIT SWITCH and program the System Switches on the Keypad to the "ON" position.
2. If cooling demand permits, the compressor(s) will start and a flow of refrigerant will be noted in the sight glass, after the anti recycle timer times out and the precharge of the DC Bus is completed. After several minutes of operation, the bubbles in the sight glass will disappear and there will be a solid column of liquid when the drain and feed valves stabilize the flash tank level.
3. Allow the compressor to run a short time, being ready to stop it immediately if any unusual noise or adverse conditions develop. Immediately at start-up, the compressor may make sounds different from its normal high-pitched sound. This is due to the compressor coming up to speed and the initial lack of an oil film sealing the clearances in the rotors. This should be of no concern and lasts for only a short time.
4. Check the system operating parameters. Do this by selecting various displays such as pressures and temperatures. Compare these to test gauge readings.

CHECKING SUBCOOLING AND SUPERHEAT

The subcooling should always be checked when charging the system with refrigerant and/or before

checking the superheat. The subcooling measurement should always be taken with the system loaded, the economizer solenoid energized, and the level in the flash tank reasonably stable with a level of approximately 35%.

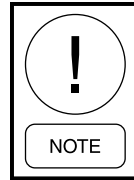

It may be desirable to check subcooling with one compressor running to allow the compressor to operate at full speed for a period of time to stabilize system temperatures and pressures.

When the refrigerant charge is correct, there will be no bubbles in the liquid sight glass with the system operating under full load conditions, and there will be 5 - 7°F (2.77 - 3.78°C) subcooled liquid leaving the condenser. YCAV0157's should have subcooling set at 10°F (5.56°C). An overcharged system should be guarded against. Evidence of overcharge are as follows:

- a. If a system is overcharged, the discharge pressure will be higher than normal. (Normal discharge/condensing pressure can be found in the refrigerant temperature/pressure chart; use entering air temperature +30°F (17°C) for normal condensing temperature.
- b. The temperature of the liquid refrigerant out of the condenser should be about 5-7°F (2.77 - 3.78°C) less than the condensing temperature (The temperature corresponding to the condensing pressure from the refrigerant temperature/pressure chart).

The subcooling temperature of each system should be calculated by recording the temperature of the liquid line at the outlet of the condenser and subtracting it from the recorded liquid line pressure at the liquid stop valve, converted to temperature from the temperature/pressure chart.

SUBCOOLING

Example:

$$\begin{array}{r}
 \text{Liquid line pressure} = \\
 110 \text{ PSIG converted to} \qquad 93^\circ\text{F (33.9}^\circ\text{C)} \\
 \text{Minus liquid line temp.} \qquad \underline{-87^\circ\text{F (30.6}^\circ\text{C)}} \\
 \text{SUBCOOLING} = \qquad \qquad \qquad 6^\circ\text{F (3.3}^\circ\text{C)}
 \end{array}$$

The subcooling should be adjusted to 5 – 7 °F (2.77 – 3.78°C)

EQUIPMENT START-UP CHECK SHEET (CON'T)

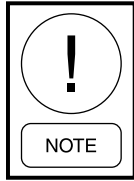

This may be difficult to measure, due to test instrument error and the difficulty generally encountered when measuring subcooling on systems operating with very low condenser subcooling.

- Record the liquid line pressure and it's corresponding temperature, liquid line temperature, and subcooling below:

	SYS 1	SYS 2	
Liq Line Press =	_____	_____	PSIG (kPa)
Temp =	_____	_____	°F (°C)
Liq Line Temp =	_____	_____	°F (°C)
Subcooling =	_____	_____	°F (°C)

Add or remove charge as necessary to obtain a full sight glass fully loaded while keeping subcooling to about 5-7°F (2.77-3.78°C). After an adjustment is made to the charge, the flash tank level may rise or drop from the approx. 35% point. Before another measurement is made, allow the level to stabilize.

After the subcooling is set, the suction superheat should be checked. The superheat should be checked only after steady state operation of the chiller has been established, and the system is running in a fully loaded, stable condition. Correct superheat for a system is 8 - 12°F (4.45 - 6.67°C) and should be reasonably close to the system superheat on the chiller display.

The superheat is calculated as the difference between the actual temperature of the returned refrigerant gas in the suction line entering the compressor and the temperature corresponding to the suction pressure as shown in a standard pressure/temperature chart.

SUPERHEAT

Example:

Suction Temp =	46°F (8°C)
minus Suction Press	
30 PSIG converted to Temp	<u>-35°F (1°C)</u>
	11°F (6°C)

The suction temperature should be taken 6" (13 mm) before the compressor suction service valve, and the suction pressure is taken at the compressor suction service valve.

No superheat adjustments are necessary and the electronically controlled drain valve need not be adjusted in the field. Ensure that superheat is controlling at 8 - 12°F (4.45 - 6.67°C). The purpose of this check is primarily to verify the transducer and suction temperature sensors in a system are providing reasonably accurate outputs to the chiller controls. It also checks the operation of the Feed and Drain Valves.

- Record the suction temperature, suction pressure, suction pressure converted to temperature, and superheat of each system below:

	SYS 1	SYS 2	
Suction Press =	_____	_____	PSIG (kPa)
SP to Temp =	_____	_____	°F (°C)
Suction Temp =	_____	_____	°F (°C)
Superheat =	_____	_____	°F (°C)

- Discharge superheat will typically run approx. 28-30°F. This can be checked on the micropanel display. If the suction superheat drops very low or the economizer feeds liquid into the compressor, the superheat will drop sharply to approx. 2-3°F.

LEAK CHECKING

- Leak check compressors, fittings, and piping to ensure no leaks.

If the chiller is functioning satisfactorily during the initial operating period, no safeties trip and the chiller controls chilled liquid temperature; it is now ready to be placed into service.

CHILLER ELECTRONIC COMPONENTS

KEYPAD

An operator keypad allows complete control of the system from a central location. The keypad offers a multitude of command keys on the left and right side of the keypad to access displays, program setpoints, history data, and initiate system commands. Most keys have multiple displays that can be accessed by repetitively pressing the key or by pressing the ▲, ▼, ◀, and ▶ (ARROW) keys. The keypad utilizes an overlay to convert the keypad to various languages.



LD10605

The keypad also contains keys in the center section for data entry in the various program modes. These keys are listed below:

- 0-9 Keys NUMERIC KEYPAD
- ● PERIOD/DECIMAL
- +/- PLUS/MINUS
- ✓ ENTER
- × CANCEL
- ▲ UP ARROW
- ▼ DOWN ARROW
- ◀ LEFT ARROW
- ▶ RIGHT ARROW

The numeric keys allow keying numeric values into memory.

The ● (PERIOD/DECIMAL) key allows keying a decimal point into numeric values.

The +/- (PLUS/MINUS) key allows making numeric values negative.

The ✓ (ENTER) key stores program changes into memory.

The X (CANCEL) key is used to cancel the data entry operation and returns the programmed value to the original value, before any programming changes were made, when an error is made.

The ▲ (UP ARROW) and ▼ (DOWN ARROW) keys allow scrolling backward (▲) and forward (▼) through items to be programmed under keys such as the PROGRAM or OPTIONS key.

The ▲ (UP ARROW) and ▼ (DOWN ARROW) keys also allow scrolling forward (▼) or backwards (▲) through data display keys that have multiple displays under keys such as UNIT DATA, SYSTEM DATA, HISTORY, PROGRAM, OPTIONS, etc. The arrow keys can be used instead of repeatedly pressing the data key to see the multiple displays under a key. Once the ▲ ▼ (ARROW) keys are pressed and used for scrolling, pressing the original data key will return to the first display message displayed under the data (UNIT DATA, SYSTEM DATA, etc.) keys.

The ◀ ▶ (LEFT & RIGHT ARROW) keys allow scrolling between non-numeric program choices under the OPTION, DATE/TIME, and SCHEDULE keys.

The ◀ (LEFT ARROW) key allows programming the default value when programming numeric values. For changing numeric values, the ▶ (RIGHT ARROW) key has no function.

The ◀ ▶ (ARROW) keys also allow scrolling sideways between the same displays on different systems. For example: Pressing the ▶ (RIGHT ARROW) key while viewing the system #1 suction pressure moves the display to system #2 suction pressure.

CHILLER ELECTRONIC COMPONENTS (CON'T)

Pressing the ◀ (LEFT ARROW) key moves the opposite direction. The arrow keys also allow fast scrolling through data under keys such as HISTORY by enabling the operator to move between subgroups of data such as Unit, System, and VSD data.

Keypad Data Entry Mode

For numeric programmable items, the data entry mode is entered by pressing any of the number keys, the decimal point key, or the +/- key. When the data entry mode is entered, the data from the key press will be entered and the cursor will appear under the position where the data is being entered.

For non-numeric programmable items, data entry mode is entered by pressing the ◀ or ▶ (ARROW) keys. When the data entry mode is entered, the cursor will appear under the first position of the non-numeric string. The programmable choice may be changed by pressing the ◀ or ▶ (ARROW) keys.

To exit the data entry mode and store the programmed value, the ✓ (ENTER) key must be pressed. When the ✓ (ENTER) key is pressed, the cursor will disappear.

The data entry mode may also be exited by pressing the X (CANCEL) key. The programmed data will be returned to it's original value when the X (CANCEL) key is pressed.

When the data entry mode is exited, the cursor will disappear. If any other key is pressed while in the Data Entry Mode, the following display will appear for 2 seconds indicating the user must choose between accepting or canceling the change:

XXXXXXXXXXXX PRESS ✓ TO ACCEPT VALUE OR
X TO CANCEL DATA ENTRY

If the ✓ (ENTER) key was pressed from the data entry mode and the numeric value entered was out of range, the following message will appear for 2 seconds followed by the original data display.

XXXXXXXXXXXX OUT OF RANGE – TRY AGAIN!
XX

DISPLAY

The 80 character (2 lines of 40 characters per line) display is a Liquid Crystal Display (LCD) used for displaying unit parameters, system parameters, and operator messages. The display has an LED backlight background for night viewing and is viewable in direct sunlight.

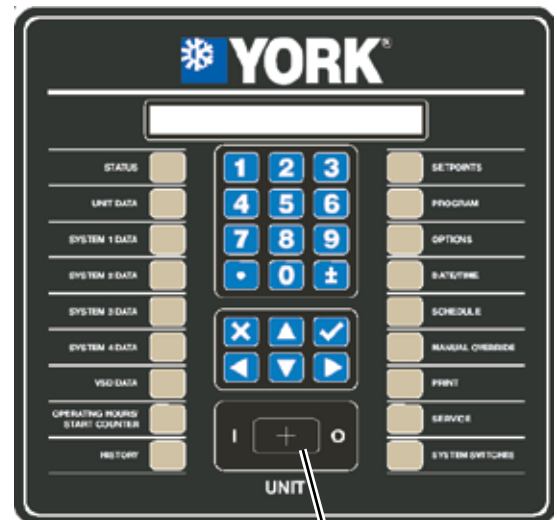

UNIT SWITCH

LD10605

CHILLER ELECTRONIC COMPONENTS (CON'T)

CHILLER CONTROL BOARD

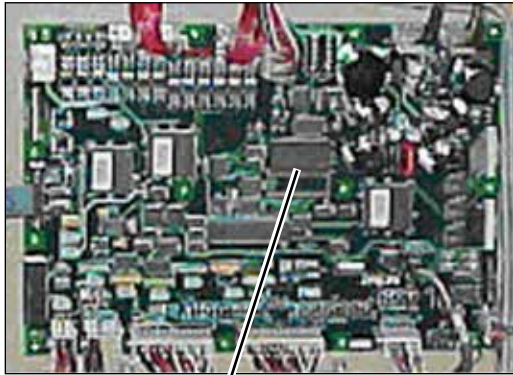

LD10606

RTC

The Chiller Control Board is the controller and master decision maker in the control panel. The on-board microprocessor control is capable of controlling up to 4 compressors. System inputs from pressure transducers and temperature sensors are connected directly to the Chiller Control Board. The Chiller Control Board circuitry multiplexes all of the analog inputs, digitizes them, and scans the inputs to keep a constant watch on chiller operating conditions. Based on this information, the Chiller Control Board issues commands to the Relay Output Board(s), Drain/Feed Valve Controller, and VSD Logic Board to activate and de-activate contactors, solenoids, control valves, set compressor speeds, etc., for chilled liquid and safety control. Keypad commands are acted upon by the Chiller Control Board micro to change setpoints, cutouts, scheduling, operating requirements, and to provide displays.

The Chiller Control Board contains a Real Time Clock integrated circuit chip with an internal battery back up of 8K x 8 bit RAM. The purpose of the battery backed RAM is to assure any programmed values (setpoints, clock, cutouts, history data etc.) are not lost during a power failure, regardless of the time involved in a power outage or shutdown period.

The Chiller Control (Microprocessor) Board contains an onboard power supply, which provides 5VDC regulated to sensors, transducers, display, and other circuit boards. The supply also provides +12VDC to the Relay Output Boards and the +34VDC to the level sensors.

The Chiller Control Board is capable of directly receiving analog inputs from temperature sensors and transducers. An analog to digital converter (A/D) with an onboard 4 channel multiplexer (MUX) allows up to 48 analog inputs to be read. The A/D Converter converts the analog signals to digital signals, which can be read by the onboard microprocessor. On a 2 system chiller, approximately half of these inputs are utilized.

Three integrated circuits on the microprocessor can be configured for digital inputs or outputs (Digital I/O). As inputs, they can read digital (2 level, on/off) inputs like keypad keys, unit switch, high pressure cut-out, flow switch, etc. As outputs they are used for controls like turning on fans, controlling compressor heaters, controlling chiller valves, or other devices requiring on/off control. Up to 72 Digital I/O will be utilized to control the chiller.

The Chiller Control (Microprocessor) Board contains a dual UART (Universal Asynchronous Receiver Transmitter) for RS-485 and RS-232 communications. UART1 is configured for RCC and ISN communications on the external chiller RS-485 port. Data is sent and received at 4800 baud with 1 start bit, 8 data bits, odd parity, and 1 stop bit. The port is shared with the RS-232 interface and at start-up will be initialized to RS-485 communications. UART2 is configured for VSD communications over an internal chiller RS-485 port located within the Control/Power cabinet. UART2 has a higher priority interrupt than UART1. The data is sent and received at a rate of 9600 baud and serves only as the communications between the Chiller Control Board and the VSD Logic Board. Both of these boards are located within the Control/Power panel.

On power-up, the Chiller Control Board will attempt to initialize communications with the VSD Logic Board. The Chiller Control Board will request the number of compressors select and VSD software version. If for some reason the information is not provided, the request will be made over and over again until it is received. Once the data has been received, the Chiller Control Board will not ask for it again. If the communications is not established, a VSD Loss Of Comms fault message will appear on the STATUS display.

CHILLER ELECTRONIC COMPONENTS (CON'T)

Two 8 channel, 8 bit Digital to Analog Converters (D/A Converter) on the Chiller Control Board supply the Feed and Drain Valve Controller signals to allow the controller to position the Flash Tank Feed and Drain Valves. The Feed Valve controls the refrigerant level in the flash tank while the Drain Valves controls superheat. The control voltage to the Feed and Drain Valve Controller has a range of 0-10.28 VDC.

RELAY OUTPUT BOARDS



LD10607

Two or three Relay Output Boards are required to operate the chiller. These boards convert 0-12VDC logic levels outputs from the Chiller Control Board to 115VAC levels used by contactors, relays, solenoid valves, etc., to control system and chiller operation. The common side of all relays on the Relay Output Board is connected to +12VDC.

The open collector outputs of the Chiller Control Board energize the DC relays on the Relay Output Board by pulling one side of the relay coil to ground. When not energized, both sides of the relay coils will be at +12VDC potential.

VSD (Variable Speed Drive)

The VSD is a liquid cooled, transistorized, PWM inverter packaged within the Control/Power cabinet. The inverter is composed of four major sections: the AC to DC rectifier section with precharge circuit, a DC link filter section, a three phase DC to AC inverter section, and an output RC suppression network.

AC TO DC RECTIFIER

The AC to DC Rectifier circuit utilizes a semi-converter made of three SCR/diode modules in a three phase bridge configuration. Each SCR/Diode module contains 1 SCR and 1 diode. The modules are mounted on a liquid cooled heatsink. This circuit rectifies the incoming AC voltage to unfiltered DC, which is filtered by the DC Link Filter.

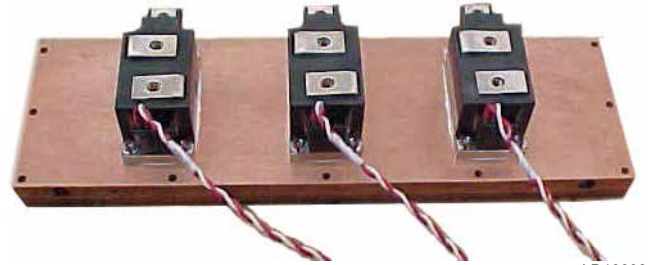

LD10608

A semi-converter (combination SCR/Diode) configuration allows utilizing a separate pre-charge circuit to limit the current in the DC link filter capacitors when the VSD is first switched on. This is accomplished by slowly turning on the SCR's to initially charge the DC Bus. Once charged, the SCR's remain fully gated on during normal operation. This configuration also provides a fast disconnect from main power when the drive is switched off.

When the drive is called to run (leaving chilled liquid temperature is > than the Setpoint + CR), the SCR/Diode modules are turned on by the SCR trigger Board, allowing the DC link filter capacitors to slowly precharge for a period of 20 seconds.

The AC incoming line voltage is rectified by the full three phase semi-converter bridge, made up of three SCR/Diode modules, which provides pulsating DC to the DC link Filter in the VSD.

CHILLER ELECTRONIC COMPONENTS (CON'T)

SCR TRIGGER BOARD

The SCR Trigger Board controls the firing (gating) sequence of the Bridge SCR's.



LD10609

Command for the SCR Trigger Board to begin firing the SCR's is initiated by the VSD Logic Board.

The SCR Trigger Board also monitors the three phase input voltage to detect the loss of an incoming phase.

DC LINK FILTER

The DC Link Filter consists of a bank of electrolytic filter capacitors. The capacitors smooth (filter) ripple voltage resulting from the AC to DC rectification and provides an energy reservoir for the DC to AC inverter. The capacitor filter bank is made up of 2 banks of parallel-connected capacitors wired in series. Series banks of capacitors allow using smaller sized capacitors with lower voltage ratings.

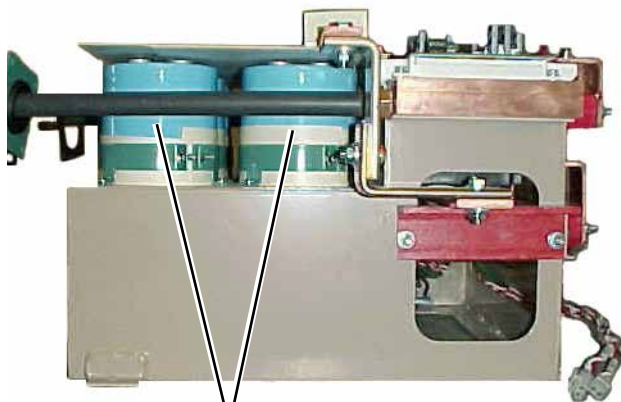

FILTER CAPACITORS

LD10610

The capacitor bank in conjunction with the 1L line inductor forms a low pass LC Filter and provides further smoothing (filters ripple) to the rectified DC.

Equalizing/Bleeder resistors connected across the banks equalize the voltage between the top and bottom capacitors to avoid damaging the capacitors from over voltage. The Equalizing/Bleeder resistors also provide a path for discharge of the capacitors when the drive is switched off. This safely discharges the capacitors in approximately 5 minutes. Always be careful, a bleeder resistor could be open and the bus may be charged.



LD10611

EQUALIZING/BLEEDER RESISTORS



When servicing, always check the DC Bus Voltage across the top and bottom, banks of capacitors with a known functioning voltmeter correctly set to the proper scale before performing service on the inverter. DO NOT rely on the Bleeder Resistors to discharge the capacitor banks without checking for the purpose of safety.

NEVER short out a capacitor bank to discharge it during servicing. If a bleeder resistor is open and a capacitor bank will not discharge, immediately contact YORK Product Technical Support.

CHILLER ELECTRONIC COMPONENTS (CON'T)

1L LINE INDUCTOR

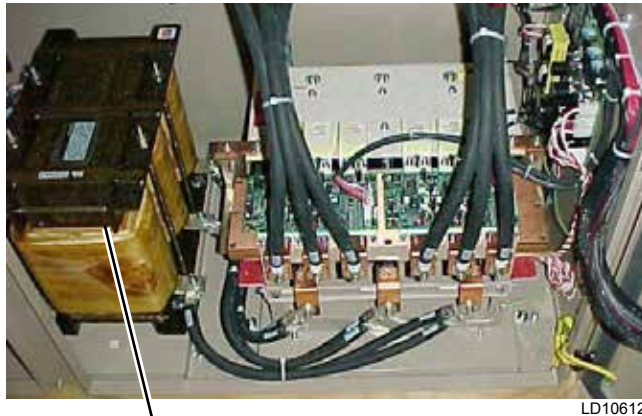

LD10612

1L LINE INDUCTOR

The 5% impedance 1L Line Inductor has multiple functions. 1L forms a low pass LC filter that filters the pulsating DC from the AC to DC converter, to smooth DC voltage. The inductance eliminates notches on the incoming AC line. The inductance also helps protect the SCR's from high voltage incoming line transients, which could damage them. 1L slows down the rate of rise of current if an internal short circuit occurs, reducing the potential damage caused by the short. 1L also reduces the input current total harmonic distortion.

DC TO AC INVERTER

The DC to AC Inverter section converts the rectified and filtered DC back to AC at the equivalent magnitude and frequency to run a compressor at a specific speed. Although a common DC Bus links the compressor drive outputs, each compressor has its own inverter output module. Each inverter output module consists of 6 IGBT's (3 modules) and an IGBT Gate Driver Board, which converts DC to a 3 - phase AC output. The IGBT's are mounted to the liquid cooled heatsink designed to take the heat away from the devices and remove it in the condenser. The IGBT Gate Driver Board provides gating pulses to turn the IGBT's on and off.

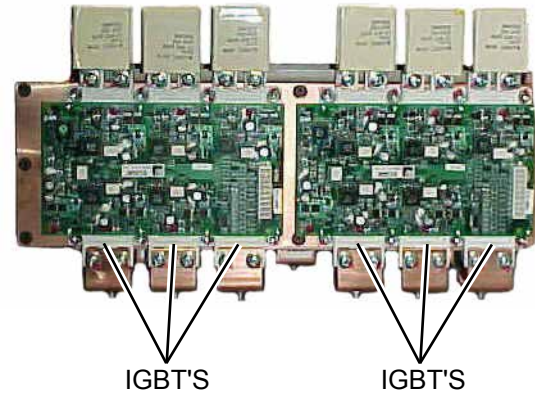

LD10613

LAMINATED BUS STRUCTURE

The Laminated Bus Structure is a group of copper plates sandwiched together that connects the SCR/Diode Modules, Bus Filter Capacitors, and IGBT's. The purpose of the Laminated Bus Structure is to reduce the inductance that would be present in wiring or bus bars often used to connect high voltage components in VSD's. Removing inductance in the circuit reduces the voltage spike that occurs when the IGBT's turn off. These voltage spikes can potentially damage the IGBT's.

LAMINATED BUS STRUCTURE

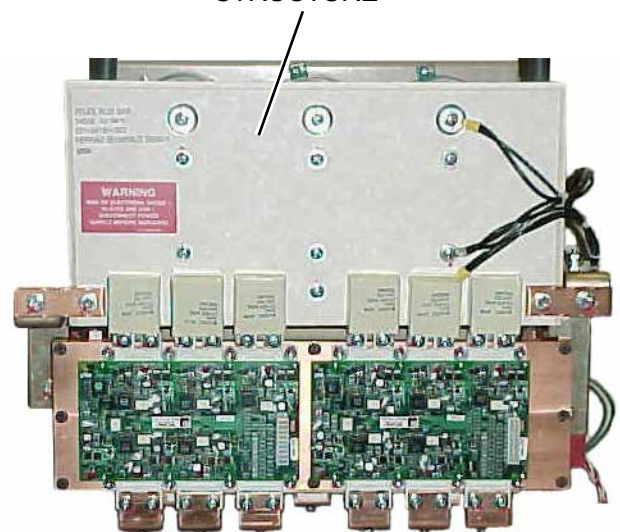

LD10614

CHILLER ELECTRONIC COMPONENTS (CON'T)

VSD LOGIC BOARD



RTC

LD10615

The VSD Logic Board controls VSD functions/operations and communicates through a serial communications line with the Chiller Control Board. Safety and shutdown information stored in the RTC (Battery backed RAM) is reported back to the Chiller Control Board via the communications link. The VSD Logic Board converts the speed and run commands from the Chiller Control Board into the necessary voltage and frequency commands to operate the inverter section. The VSD Logic Board also controls the converter section of the VSD (AC to DC conversion) by controlling the pre-charge function.

The VSD Logic Board contains a second microprocessor for motor control, which generates the PWM signals that control the IGBT's in the inverter section of the VSD.

The VSD Logic Board contains an FPGA (Field Programmable Gate Array) which handles the hardware safeties and can shut down the VSD much faster than the software safeties, since they are not dependent upon running program loops in software. The VSD handles all VSD related safeties including high motor current, overload, DC bus voltage faults, etc.

Inputs to the VSD Logic Board are fed through an onboard multiplexer (MUX) before being sent to the A/D converter. These signals allow the VSD Logic Board to monitor DC Bus voltages, compressor motor currents, VSD internal ambient temperature, IGBT baseplate temperatures, and compressor overload settings.

The VSD Logic Board controls the glycol pump and the cabinet cooling fans. Details on the controls are provided in the VSD Operation and Control section, Page 198.

CONTROL PANEL TO VSD COMMUNICATIONS

Communication between the VSD Logic Board and the Chiller Control Board is made via a three-wire RS-485 opto-coupled data link. Communications between the two boards occurs at the rate of 9600 baud. UART2 of the dual UART located on the Chiller Control Board is dedicated to internal communications and has a higher priority interrupt than the external communications UART1. The Chiller Control Board will control VSD start/stop, selection of which compressors to run, and compressor speed. The VSD Logic Board will run the desired compressors at the speed requested by the Chiller Control Board. The VSD will report back to the Chiller Control Board, shutdown and safety information related to internal VSD operation and the compressor motors.

On power-up, the control panel will attempt to initialize communications with the VSD. The Chiller Control Board will request initialization data from the VSD Logic Board. The initialization data required is the number of compressors and the VSD software version. Once these data points have been received by the control panel, the unit has successfully initialized and will not request them again.

If the Chiller Control Board does not receive initialization data from the VSD Logic Board in 8 seconds or loses communications with the VSD for 8 seconds at any time, the chiller will fault on a communications failure. The Chiller Control Board will continue to send messages to the VSD Logic Board in an attempt to establish communications while the chiller is faulted.

The VSD Logic Board will also monitor a communications loss. If the VSD Logic Board loses communications with the Chiller Microprocessor Board for 8 seconds at any time, the VSD will shut off all compressors and wait for valid comms from the Chiller Control Board.

CHILLER ELECTRONIC COMPONENTS (CON'T)

Once communications is established, the Chiller Control Board will send a data packet on the data link once every second at 9600 baud. This data packet will include run, stop, and speed commands as well as request operating data from the VSD. Operating data returned by the VSD will include individual motor currents, motor %FLA's, output frequency, compressor motor temperature, and fault information related to internal VSD operating parameters such as DC bus voltage, IGBT baseplate temperatures, VSD internal ambient, pre-charge relay status, power supply status, run relay status, motor overload, and supply single phase. The Chiller Control Board will poll the VSD Logic Board for information continuously while the chiller is running.

IGBT GATE DRIVER BOARDS

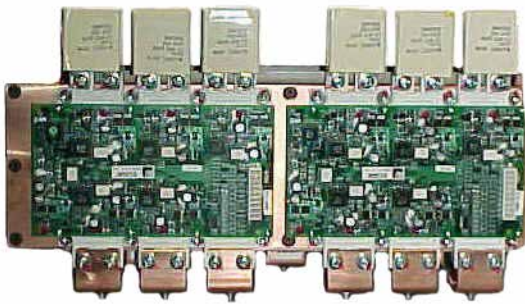

LD10613

The IGBT Gate Driver Boards provide the ON and OFF gating pulses to the IGBT's. The gating signals originate from the VSD Logic Board and are changed in level by the IGBT Gate Driver Board. The IGBT's in the inverter section of the VSD, change the DC Link voltage to a variable Voltage and Frequency output to the motor, to control the compressor motor speed. The IGBT Gate Driver Boards also provides VCE SAT detection (short circuit detection) to safely turn off the IGBT's during a short circuit condition. When a short circuit occurs, the voltage (VCE SAT) across the IGBT increases as a result of the high current. The IGBT Gate Driver Board is an integral part of the IGBT assembly for each compressor.

CURRENT TRANSFORMERS



LD10617

CURRENT
TRANSFORMERS

A current transformer on each phase sends current signals proportional to phase current to the VSD Logic Board. The output of each CT is buffered, scaled, and sent to RMS to DC converters. These signals are then sent to an A-D converter, scaled, and sent to the Chiller Control board for current display and current limiting control.

The highest current is also compared to the setting of the Overload Adjustment Potentiometer on the VSD Logic Board for overload safety sensing.

CHILLER ELECTRONIC COMPONENTS (CON'T)

DV/DT OUTPUT SUPPRESSION NETWORK



LD10618

DV/DT
RESISTORS

DV/DT
CAPACITORS

The dV/dT Output Suppression Network limits the rate of rise of voltage and the peak voltage of the PWM pulses applied to the motor windings. This eliminates the possibility of causing a turn-to-turn short in the motor due to winding insulation breakdown. The suppression network is made up of a 3 phase RC network.

FLASH TANK FEED AND DRAIN VALVE CONTROLLER

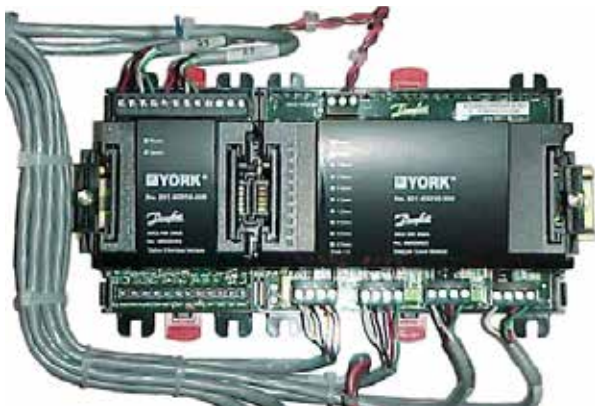

LD10619

The Flash Tank Feed and Drain Valve Controller is a microprocessor driven controller that operates the Feed and Drain Valves based on commands from the Chiller Control Board. The Feed and Drain Valves control the level of liquid in the Flash Tank and the superheat to the evaporator. The controller is a stand-alone valve control module in the Control/VSD panel. The Flash Tank

liquid level is controlled by sequencing a stepper motor valve (Feed Valve) on the inlet of the flash tank. The controller opens and closes the feed valve to control the liquid level of the refrigerant in the Flash Tank based on commands from the Chiller Control Board. Superheat is controlled by sequencing a stepper motor valve (Drain Valve) on the outlet of the Flash Tank. The controller opens and closes the drain valve to control flow to the evaporator and ultimately superheat to the compressor based on commands from the Chiller Control Board.

Drain Valve superheat control is controlled by a PI control algorithm based on suction pressure and suction temperature in the Chiller Control Board software.

The control algorithms will attempt to control the level in the flash tank to approx 35% when the economizer is energized. If the level exceeds 87.5%, the system will fault. The normal 35% level may fluctuate appreciably when the economizer is off as the Flash Tank acts as nothing more than a reservoir as the Drain Valve controls superheat. The level will also vary when the economizer is first energized or a system transient occurs such as fan cycling, etc.

The controller is typically located in the back of the panel behind the power wiring terminal block/circuit breaker or on the wall of the panel on the left side of the cabinet.

CHILLER ELECTRONIC COMPONENTS (CON'T)

DC BUS VOLTAGE ISOLATION BOARD



LD10620

The DC Bus Isolation Board allows the VSD Logic Board to read the voltage on the DC BUS without exposing the VSD Logic Board to the high voltage. Instead, the DC Bus Isolation Board contains a resistor network that forms voltage dividers with resistors on the VSD Logic Board, which steps down the voltages so that scaled down voltages proportional to the full and 1/2 bus voltages can be safely fed to the VSD Logic Board. The DC Bus Isolation Board supplies 3 connections to the VSD Logic Board; plus bus, minus bus and half bus.

AUTOTRANSFORMER



LD10624

AUTOTRANSFORMER

The compressor and fan motors are designed to operate at 460VAC on all voltage units. Whenever a 208VAC 60 Hz, 230VAC 60 Hz, 380VAC 60 Hz, 400VAC 50 Hz, or 575VAC 60 Hz supply is utilized, an autotransformer is used to convert the voltage to 460VAC. On 50 Hz units, a frequency converter also converts the fan voltage from 50 Hz to 60 Hz.

6

CHILLER CIRCUIT BREAKER



LD10623

An Optional Circuit Breaker may be supplied on the input of the system. The incoming power will be fed to the terminals on the circuit breaker. If the circuit breaker option is not selected, incoming power will be fed to terminal blocks. The breaker also provides ground fault protection. 2 and 3 compressor chillers utilize one circuit breaker, while 4 compressor chillers utilize 2 breakers.

CHILLER CONFIGURATION JUMPERS

There are a number of chiller configuration jumpers that are factory wired into wire harnesses or plugs. These jumpers typically never need to be reviewed unless in some unlikely situation, a chiller is incorrectly configured or a loose connection occurs.

Number of Compressors Configuration Jumper

Software packs (EPROM's) are common between 2, 3, and 4 compressor chillers. As a result, the VSD Logic Board must be configured for the actual number of compressors. The chiller is configured for the number of compressors through the use of jumpers, factory plugged into the J1 plug on the VSD Logic Board. This hard wiring configures the VSD Logic Board for the number of compressors on the chiller, avoiding mis-programming. The jumpers are only checked at power-up. If no jumpers are sensed, or an invalid combination is sensed and communicated to the Chiller Control Board, start-up of the unit will be inhibited and an "INVALID NUMBER OF COMPRESSORS SELECTED" warning message will be displayed in the Status display.

TABLE 1 shows the chiller number of compressors and the associated location of the jumpers to program the appropriate compressor configuration.

TABLE 1 - COMPRESSORS AND THE APPROPRIATE JUMPER POSITIONS

# of COMPRESSORS	VSD LOGIC BOARD JUMPER POSITION
2	J1-10 to J1-9
3	J1-11 to J1-9
4	J1-12 to J1-9

VSD LOGIC TO CHILLER MICROPROCESSOR BOARD RS-485 COMMUNICATION CONFIGURATION JUMPERS

The Chiller Control Board and the VSD Logic Boards communicate over an RS-485 link. The communications link requires a matching address to be set up at both ends. The VSD Logic Board communications bus is configured through the use of jumpers, factory plugged into the J5 plug on the VSD Logic Board. The VSD Logic Board will only check the jumper positions once at power-up.

TABLE 2 shows the VSD Logic Board Address configuration and the associated location of the jumpers. The jumpers will vary according to the number of VSD Logic Boards installed. All chillers utilize a single VSD Logic Board and will use VSD Logic Board Address 1.

TABLE 2 - VSD LOGIC BOARD ADDRESS JUMPER

VSD LOGIC BOARD's ADDRESS	VSD LOGIC BOARD JUMPER POSITION
1	J5-1 to J5-2 and J5-3 to J5-4
2	J5-3 to J5-4
3	J5-1 to J5-2
4	NONE

CHILLER CONFIGURATION JUMPERS (CON'T)

MAXIMUM VSD FREQUENCY/ MODEL DESIGNATOR

The model number of the chiller determines the maximum VSD frequency at 100% full speed. The maximum frequency is programmed by factory installed jumpers on the J7 plug of the Chiller Control Board. Three digital inputs determine a binary code, which determines the maximum frequency. The inputs are read as a 0 or low when a jumper is out or a 1 or high when the wire jumper is inserted between the two pins. The jumpers will only be checked once by the Chiller Control Board on power-up.

TABLE 3 shows the Chiller configuration and the associated location of the jumpers.

TABLE 3 - MAXIMUM FREQUENCY / MODEL DESIGNATOR JUMPER

CHILLER CONTROL BOARD MAX. VSD FREQUENCY	J7-1 to J7-2	J7-3 to J7-4	J7-5 to J7-6	YCAV
200 Hz	1	1	0	0157 SA/PA, 0177 EA/VA, 0187 SA/PA, 0227 SA/PA, 0227 EA/VA, 0247 SA/PA, 0247 EA/VA, 0267 SA/PA,
196 Hz	1	1	1	
192 Hz	0	1	0	0187 EA/VA, 0207 EA/VA
188 Hz	0	1	1	
186 Hz	1	0	0	0207 SA/PA, 0157 EA/VA
182 Hz	0	0	0	0177 SA/PA, 0197 EA/VA
178Hz	1	0	1	
178 Hz (Spare)	0	0	1	

OPERATING CONTROLS

Anti-recycle Timer

A typical 5 or 10 minute anti-recycle timer is not necessary to allow compressor motor cooling, due to the VSD's ability to provide a low current inrush start. The system does utilize a fixed 120 second anti-recycle timer to prevent short cycling of systems and to allow positioning the Feed and Drain Valves to a zero (closed) position by the Flash Tank Drain and Feed Valve Controller in the event of a power failure.

On power-up of the control panel, the anti-recycle timer for each system will be set to 120 seconds and must time out before a compressor is allowed to start.

Whenever a system starts, the anti-recycle timer for all systems will be set to 120 seconds and will count down from the time the motor starts. The timer must time out before another compressor is allowed to start.

Whenever a system shuts down, the anti-recycle timer for that system will be set to 120 seconds. The timer must time out before the system is allowed to restart.

Evaporator Pump Control

The evaporator pump dry contacts are energized when any of the following conditions are true:

- If a Low Leaving Chilled Liquid Fault occurs.
- Whenever a compressor is running.
- The Daily Schedule is ON and the Unit Switch is ON.

Even if one of above is true, the pump will not run if the panel has been powered up for less than 30 seconds or if the pump has run in the last 30 seconds to prevent pump motor overheating.

Evaporator Heater Control

The evaporator heater is controlled by ambient air temperature. If no systems are running and the ambient temperature drops below 40°F, the heater is turned on. If no systems are running and the temperature rises above 45°F the heater is turned off. Whenever a system is running, the evaporator heater is turned off. Both evaporator heater outputs will always be turned on

and off together. An under voltage condition will keep the heater off until full voltage is restored to the system.

Pumpdown Control

The VSD assures a smooth slow compressor start. As a result of this, neither pumpdown on start-up or pumpdown on shutdown is required. The Drain and Feed Valves will close when a compressor stops. This is similar to a liquid line solenoid valve closing on a conventional chiller.

Compressor Heater Control

Each compressor has its own heater. The purpose of the heater is to assure refrigerant does not condense in the compressor. There is no oil sump, but refrigerant could possibly condense in the rotors or the motor housing. The heater will be off whenever the respective compressor is running. As soon as the compressor shuts off, the heater will turn on as long as all motor temperature sensors in the compressor read <158°F. The heater will turn off, if any internal compressor motor temperature sensor reads >160°F.

Alarms

Each system has its own alarm. The Alarm output is ON (dry contact closed) when no fault condition is present and OFF (dry contact open) to indicate an alarm situation. The Alarm should be activated (contact open), if any of the following are true.

- A System is faulted or inhibited from starting for more than 5 seconds.
- The Unit is faulted or inhibited from starting for more than 5 seconds.
- A System is locked out.
- The Unit is locked out.
- Power is removed from the chiller.

OPERATING CONTROLS (CON'T)

Chiller Run Contact

The Chiller Run dry contact is closed whenever any system is running. It is open when all systems are shut off.

Unit Switch



LD10605

UNIT
SWITCH

A double pole single throw ON/OFF rocker switch on the front of the control panel is used to turn the entire chiller on and off. When the switch is placed in the OFF position, the entire unit shuts down immediately. One pole of the UNIT Switch contacts is wired to the Sys 1/3 and the other to Sys 2/4 VSD Run Signal input and the Chiller Control Board “Unit Switch X” digital input (X = System 1 or 2). Separate System Fuses are also wired in series with each set of UNIT Switch contacts. If either fuse is pulled or blown, only the system with the good fuse (Input is high) will run. When both inputs are high, the entire chiller will be enabled to run. When both inputs are low, the chiller will be disabled as a Unit Switch OFF Shutdown.

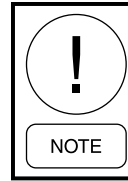

The Unit Switch should never be used to shut down the chiller except in an emergency. When the switch is thrown, the compressors will immediately shut down. Since the compressors are not permitted to come to a controlled stop, the rotors may back-spin, which may result in some unusual compressor noise. The back-spin will not hurt the compressors, but should be avoided.

It is suggested that the System Switches on the keypad be used whenever possible to turn a system off and allow the compressor to complete a controlled shutdown.

7

BASIC OPERATING SEQUENCE

Start Sequence and Loading

To initiate the start sequence of the chiller, the following conditions must be satisfied before the precharge of the DC bus will take place:

- UNIT SWITCH must be ON.
- At least one System Switch is ON
- Run permissive inputs (Remote Cycling Contacts) must be closed.
- No unit faults exist.
- No unit start inhibits exist.
- At least one system not faulted or inhibited.
- The Daily Schedule is calling for the chiller to run.
- The Flow Switch is closed.
- Leaving Chilled Liquid Setpoint is above the Setpoint + CR (Setpoint High Limit).

Once the precharge takes place, if the anti-recycle timer is timed out the chiller control system on the Chiller Control Board will select the number of compressors to start and begin operation of the compressors. The compressor(s) speed will be ramped to the minimum start frequency and increase speed as needed in an effort to regulate the leaving chilled liquid temperature to meet the desired Setpoint.

When a compressor starts, the Feed and Drain Valves on the system will immediately begin to control superheat and the liquid level in the Flash Tank and the Chiller Control Board micro will begin to regulate the speed on the VSD to bring the chilled liquid temperature to within the Control Range (CR). The micro will regulate the speed of the compressor(s) primarily based on temperature offset as the loading timer permits.

The Setpoint is the Leaving Chilled Liquid Temperature midpoint of the Control (Cooling) Range. The Setpoint High Limit is the Setpoint plus the Control Range. The Setpoint Low Limit is the Setpoint minus the Control Range. The chiller will attempt to control within the temperature range programmed by the Setpoint +/- CR.

Starting and stopping of compressors will be handled by the Standard or High IPLV Capacity Control Routine. Loading and unloading will be controlled by temperature offset and rate by the Fuzzy Logic Control Routine.

A graphical representation of the Setpoint and high and low limit (+/- CR) are shown below in FIG. 28:

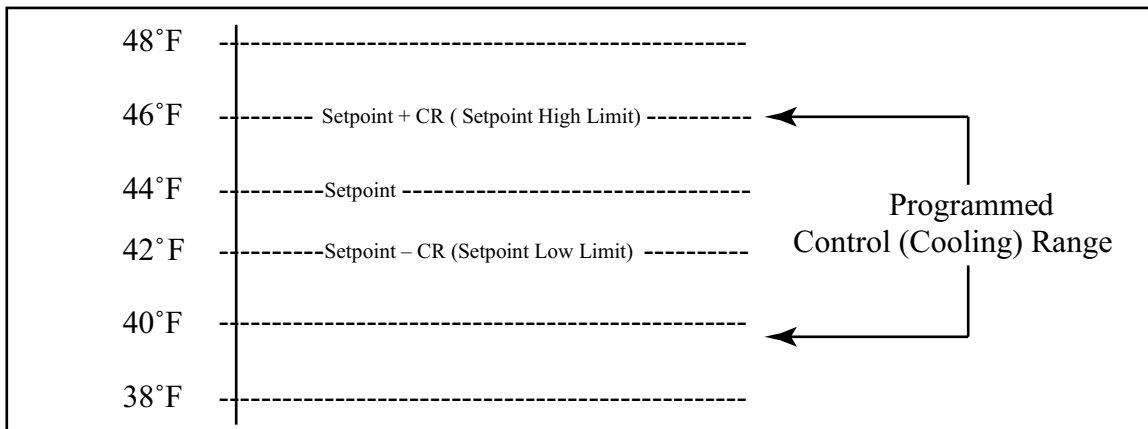

LD10625

FIG. 28 - CHILLER CONTROL (COOLING) RANGE

NUMBER OF COMPRESSORS TO START

GENERAL

The number of compressors to start control logic varies between the standard and optional high IPLV chillers. Standard IPLV chiller control utilizes sequential logic that requires the micro to start 1 compressor at a time and only add a compressor when all running compressors reaches maximum speed. Optional High IPLV chillers have control algorithms that provide “smart” anticipatory control to determine how many compressors need to be started to satisfy the current load. The “smart” logic is capable of reducing short cycling, and reducing loading time on a hot water start, and starting all compressors at the same time.

STANDARD IPLV

The standard IPLV control always starts a single compressor under all circumstances as the first step of loading. The Chiller Control Board does not make decisions on the number of compressors to start based on chilled liquid temperatures and prior compressor operation when starting the chiller. An additional compressor is only started when the lead compressor has reached maximum speed and cooling requirements are not satisfied.

OPTIONAL OPTIMIZED HIGH IPLV

On optimized IPLV chillers, the Number of Compressors to Start Logic will be used to determine how many compressors should be run when the unit starts from the all compressors stopped state. This routine will try to run all the compressors unless it is determined that less will be needed due to light load.

The first step in the sequence is for the micro to set the number of compressors to start equal to the number of compressors in the chiller. The micro will look at two prior conditions relating to the compressor operating time the previous time it ran and how long the last compressor has been off along with two indicators of chilled liquid load requirements (rate of change of chilled liquid temperature and deviation from setpoint.). Temperature deviation is the amount of error compared to the setpoint high limit (Setpoint + CR). Based on this information, the micro will then determine the number of compressors to start. The flowchart in FIG. - 29 describes the compressor starting decision process.

It is desirable to run as many compressors as possible for increased efficiency. Optimized logic will keep as many compressors on line and reduce speed in an effort to optimize the use of the entire evaporator tube surface.

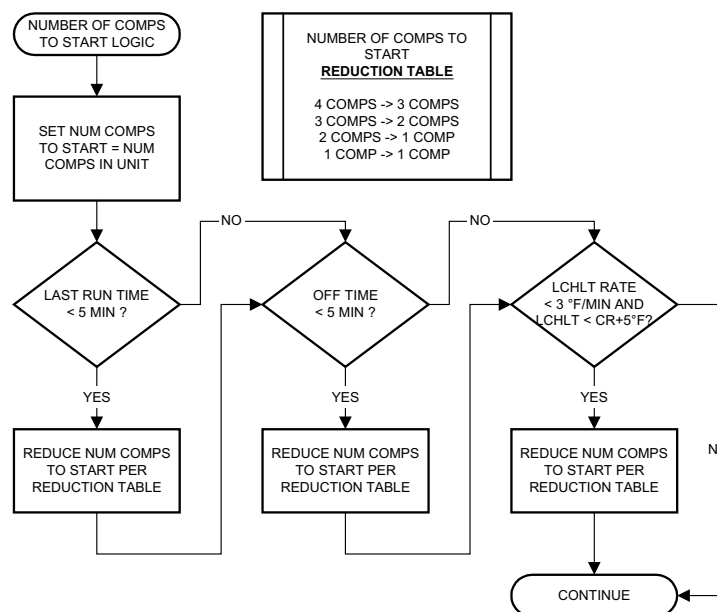

FIG. 29 - NUMBER OF COMPRESSORS TO START

MINIMUM VSD COMPRESSOR START/RUN FREQUENCY

MINIMUM VSD START FREQUENCY

The Minimum VSD Compressor Start Frequency is based on ambient temperature and determines the frequency (speed) the compressor(s) is ramped to at start. At higher ambients, higher speeds are needed to provide adequate motor cooling. At low ambients, higher motor speeds are needed to develop oil pressure differential at start. The temperature ranges and the associated start frequency follows the guidelines below:

- If the ambient temperature is 25°F or less, the Minimum VSD Start Frequency will be 70 Hz.
- If the ambient temperature is 26-40 °F, the Minimum VSD Start Frequency is 60 HZ.
- If the ambient temperature is 41-110 °F, the Minimum VSD Start Frequency will be 50 Hz.
- If the ambient is 110-125 °F, the Minimum VSD Start Frequency is scaled according to the following formula:

$$(3X \text{ Ambient Temperature}) - 280^\circ\text{F}$$

The formula is also represented by the graph in FIG. 30.

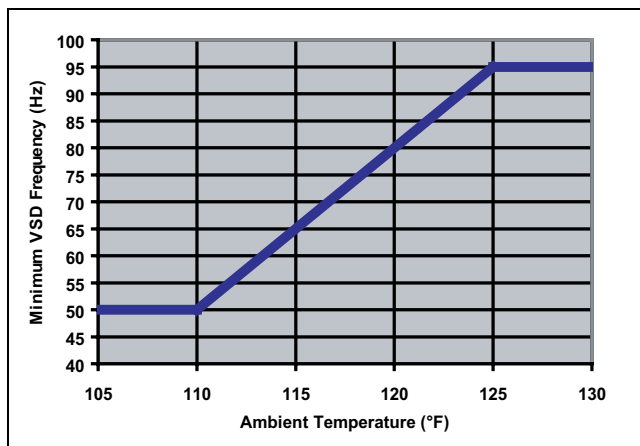

NOTE: The graph above also illustrates the scaled frequency:

LD10627

FIG. 30 - MINIMUM VSD START FREQUENCY

- Above 125°F, the minimum VSD Start Frequency is 95 Hz.

MINIMUM VSD RUN FREQUENCY

The Minimum VSD Compressor Run Frequency is based on ambient temperature and determines the minimum frequency (speed) the compressor(s) is permitted to run as the system unloads. At high ambients, higher motor speeds are needed to cool the compressor motor. The temperature ranges and the associated start frequency follows the guidelines below:

- If the ambient temperature is <110°F, the Minimum VSD Run Frequency will be 50 Hz.
- If the ambient is 110-125°F, the Minimum VSD Run Frequency is scaled according to the following formula:

$$(3X \text{ Ambient Temperature}) - 280^\circ\text{F}$$

The formula is also represented by the graph in FIG. 31.

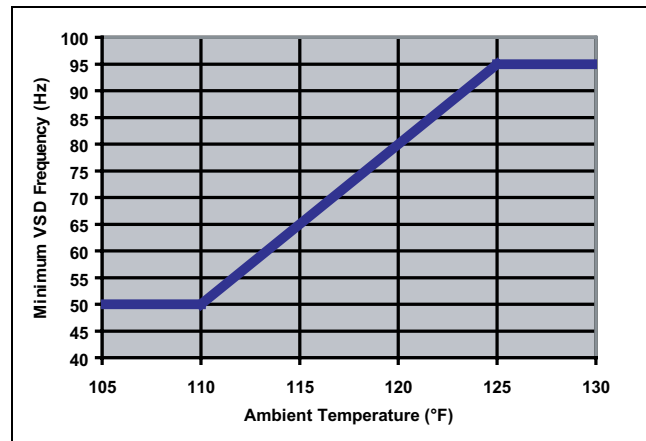

NOTE: The graph above also illustrates the scaled frequency:

LD10628

FIG. 31 - MINIMUM VSD RUN FREQUENCY

- If the ambient temperature is >125°F, the Minimum VSD Run Frequency will be 95 Hz.

ACCELERATION/DECELERATION RATE WHEN STARTING/STOPPING COMPRESSORS

VSD ACCELERATION AND DECELERATION RATES

The acceleration rate changes with frequency and follows the guidelines below:

- Between 0 and 50 Hz, the acceleration is 10 Hz/sec.
- Between 50 and 200 Hz, the acceleration is 30.4 Hz/sec. Even though the accel rate of 30.4 Hz/sec is possible up to 200 Hz, the frequency (speed) is limited by the minimum start frequency and the add a compressor frequency calculation performed by the micro when bringing on an additional compressor.

When decelerating, the deceleration rate changes with frequency and follows the guidelines below:

- Between 200 and 100 Hz, the deceleration time is 30.4 Hz/sec.
- Between 100 and 0 Hz, the deceleration time is 10 Hz/sec.

When a compressor stops, back-spin of the compressor will often occur as the pressure differential between discharge and suction equalizes. This should not be a cause of concern.

STANDARD IPLV CAPACITY CONTROL (Loading/Unloading and starting additional compressors)

“Standard IPLV” Capacity Control is installed in the chiller at the factory using a dedicated EPROM (software), part # 031-02476-001, for “Standard Only” IPLV control. If the LCHLT is > the programmed Setpoint + CR, only a single compressor is permitted to start under standard IPLV control. The compressor will start at the minimum start frequency based on ambient temperature (Page 174). The lead compressor Feed and Drain Valves will immediately begin to control superheat and liquid level in the Flash Tank.

When a compressor starts, the load and unload timers will be set to 30 seconds. During the first 30 seconds of operation after a compressor reaches the start frequency, loading/unloading is inhibited.

After 30 seconds, the control logic looks at the LCHLT temp, compares it to the Setpoint plus CR, and makes decisions to load or unload.

For precise capacity control, the Chiller Control Board microprocessor loads and unloads compressors quickly, as fast as every 2 seconds, in increments of 0.1-1 Hz each time a load or unload change is required. Fixed load and unload timers of 2 sec. are set, after a speed change of 0.1-1 Hz, to minimize undershoot and overshoot.

As additional cooling is required (LCHLT > Setpoint + CR), the Chiller Control Board microprocessor will increase the speed of the compressor at the rate of 0.1-1 Hz every 2 seconds until the load is satisfied. Loading will continue to occur as long as leaving chilled liquid temperature is above the Setpoint + CR.

If the temperature falls very near or within the control range, the Chiller Control Board microprocessor will make decisions regarding speed changes under conditions where the “error” and “rate” conflict. Under these conditions, loading/unloading follows the guidelines described in the Fuzzy Logic Control Section (Page 177).

If the compressor speed exceeds the maximum frequency the compressor is allowed to operate minus 1 hertz for a period of 3 minutes without bringing the leaving chilled liquid temperature to within Setpoint + CR/2, the chiller control will make a decision to start another compressor. At this point, the first compressor will decelerate to a frequency of 5 Hz. Reducing the frequency of the running compressor to 5 Hz enables

the differential between discharge and suction pressure to be reduced to a point where it will not affect motor current when the running compressor is ramped up. It also reduces the possibility of backspin on the running compressor. The next lag compressor will be activated and all compressors will be accelerated to the START FREQ. The START FREQ is specified by the formula:

$$\text{START FREQ} = \frac{\text{Current VSD Freq} \times (\text{Number of Compressor enabled} - 1)}{\text{Number of Compressors enabled}}$$

For example: Current VSD Freq = max freq of the chiller = 200 Hz.
Number of compressors enabled = 2 = Original compressor running, plus the compressor to be added.

In this example, assume a single compressor had been running at the max frequency of 200 Hz without satisfying cooling demand. (2) compressors are now enabled when the second compressor is activated. Placing these values in the formula, the START Frequency = 200 Hz x (2-1)/2 = 100 Hz. The compressors will be accelerated to a start frequency of 100 Hz. Load and unload timers will be set to 30 seconds. The anti-recycle timer will be set to 120 seconds.

If additional cooling is required, after the initial 30 seconds of operation, loading will occur at the rate of 0.1-1 Hz every 2 seconds, unless load limiting occurs.

If the cooling capacity exceeds the demand and temperature continues to drop while in the CONTROL RANGE (CR) with multiple compressors operating, the Chiller Control Board microprocessor will decrease the speed of the compressor(s) at the rate of 0.1-1 Hz every 2 seconds until the LCHLT stabilizes within the CONTROL RANGE. If frequency (speed) drops below the LESS COMP FREQ – 20 Hz or the minimum VSD frequency, whichever is higher, the compressors will be decelerated to a speed of 5 Hz, the last compressor disabled, and the remaining compressor(s) restarted minus one lag compressor. The LESS COMP FREQ is designated as:

$$\text{LESS COMP FREQ} = \frac{\text{Max VSD Freq} \times (\text{Number of compressor enabled} - 1)}{\text{Number of Compressors enabled}}$$

For example: 200 Hz = max freq of the chiller.
Number of compressors enabled before shutdown = 2

STANDARD IPLV CAPACITY CONTROL (CON'T)

(Loading/Unloading and starting additional compressors)

In this example, one compressor will be shut down when the speed of the compressors drops to $200 \text{ Hz} \times (2-1)/2 = 100 \text{ Hz} - 20 \text{ Hz} = 80 \text{ Hz}$.

The restart frequency for the compressor(s) after removing a lag compressor is the OFF FREQ. The OFF FREQ is designated as:

$$\text{OFF FREQ} = \frac{\text{Current VSD Freq} \times (\text{Number of compressors enabled} + 1)}{\text{Number of Compressors enabled}}$$

For example: 80 Hz = current freq of the chiller in the example above.
Number of compressors enabled at shutdown = 1

In the example above, one compressor will restart at 160 Hz as calculated in the formula below:

$$\frac{80 \text{ Hz} \times (1+1)}{1} = 160 \text{ Hz}$$

The load timer will also be set to 30 seconds and the unload timer will be set to 10 seconds.

On 3 and 4 compressor chillers, if frequency (speed) drops below the LESS COMP FREQ – 20 Hz or the minimum VSD frequency, whichever is higher, another lag compressor will be shut down using the same guidelines.

When the system is only operating a single (lead) compressor, if temperature continues to stay below the control range (Setpoint – CR) or continues to drop while in the CONTROL RANGE, the Chiller Control Board microprocessor will unload the compressor at the rate of 0.1-1 Hz every 2 seconds. This will continue until the frequency drops below the Minimum VSD Frequency determined by the ambient temperature. At this point, the lead compressor will be shut down, if temperature is below the Setpoint - CR.

FUZZY LOGIC CONTROL

The fuzzy logic control in software makes decisions to increase or decrease speed according to the error or deviation from Setpoint, and the rate of change of chilled liquid temperature. Before making a change in speed, the Chiller Control Board microprocessor will look at the load and unload timers to assure they are timed out. It also looks to assure there is no load limiting in effect. Each time a change is made, the incremental change in speed is still between 0.1-1 Hz, unless temperatures fall near the leaving chilled liquid cutout.

In most situations, when the chilled liquid temperature is above the Setpoint + CR, the Chiller Control Board microprocessor will continue to increase the speed of the compressor(s) to load the chiller until temperature drops in the general range of the Setpoint High Limit (Setpoint + CR). If the rate of change is dropping too fast and there is potential for overshoot, the Chiller Control Board microprocessor may elect not to continue to increase speed.

In cases where temperature is dropping too fast when temperature is within the desired CONTROL RANGE, the micro will be required to make decisions regarding speed changes under conditions where the “error” and “rate” conflict. For example, the micro may elect to decrease the speed of the compressor(s) if the error is “0” (temperature is at Setpoint), while the rate of change of chilled liquid temperature is falling (negative). The Chiller Control Board microprocessor may also elect to hold the speed when error is “positive” (temperature is above Setpoint, but not above Setpoint + CR) because the rate of change of chilled liquid is “negative” (falling). TABLE 4 illustrates these conditions.

STANDARD IPLV CAPACITY CONTROL (CON'T)

(Loading/Unloading and starting additional compressors)

TABLE 4 - FUZZY LOGIC LOADING/UNLOADING VS. ERROR

	NEGATIVE ERROR	ZERO ERROR	POSITIVE ERROR
NEGATIVE RATE	UNLOAD	UNLOAD	HOLD
ZERO RATE	UNLOAD	HOLD	HOLD
POSITIVE RATE	HOLD	LOAD	LOAD

To avoid overshoot or nuisance trips on the low chilled liquid cutout, when the temperature is below the Setpoint – CR/2, the Chiller Control Board micro will reduce the speed of the compressor(s) to unload the chiller by 2.0 Hz every 2 seconds. If temperature drops to within 1.0°F above the Low Chilled Liquid temp Cutout, the Chiller Control Board microprocessor will unload the compressors at the rate of 4.0 Hz every 2 seconds.

As the temperature rises the micro's fuzzy logic will factor in the rate of change before continuing to unload. If the rate of change is rising too fast and there is potential for a positive overshoot, the Chiller Control Board microprocessor may elect not to continue to decrease speed.

In cases where temperature is rising too fast, when temperature is within the desired CONTROL RANGE, the Chiller Control Board microprocessor will be required to make decisions regarding speed changes under conditions where the "error" and "rate" conflict. For example, the Chiller Control Board microprocessor may elect to increase the speed of the compressor(s) if the error is "0" (temperature is at Setpoint), while the rate of change of chilled liquid temperature is "positive" (rising). The Chiller Control Board microprocessor may also elect to hold capacity when error is "negative" (temperature is below Setpoint) because the rate of change of chilled liquid is "positive" (rising). Table 4 illustrates these conditions and the loading response from the Chiller Control Board microprocessor.

HOT WATER STARTS

On a hot water start under "best" case conditions, assuming power has not been removed and the 120 second timer does not inhibit starting, the design of the control algorithm for a 2compressor Standard IPLV leaving chilled liquid capacity control allows full loading of a chiller in slightly more than 14-1/2 minutes, regardless of the number of compressors. This time period assumes load limiting does not affect the loading sequence and the ambient is above 40°F.

LAG COMPRESSOR OPERATION IN LOAD LIMITING

When a single compressor is operating in current, discharge pressure, suction pressure, VSD internal ambient, or VSD baseplate temperature limiting for more than 5 minutes and chilled liquid temperature is > Setpoint + CR, the Chiller Control Board microprocessor will turn on the lag compressor to bring the chilled liquid temperature within the CONTROL RANGE. After 1 hour the Chiller Control Board microprocessor will shut down the lag compressor and attempt to control temperature with only the lead compressor to satisfy the load.

OPTIONAL HIGH IPLV CAPACITY CONTROL (Loading/Unloading and starting additional compressors)

Optional “High IPLV” Capacity Control is installed in the chiller at the factory using a dedicated EPROM (software), part # 031-02476-002, for “High” IPLV control. It’s purpose is to control compressors as effectively as possible, optimizing control of both the compressors and condenser fans. If the LWT is > the programmed Setpoint + CR, the Chiller Control Board microprocessor will follow the flow chart (Page 173) to determine the number of compressors to start based on the last run time, time off, and the rate of change of chilled liquid temperature. The compressor(s) will start at the minimum start frequency based on ambient temperature (Page 174). The respective system Feed and Drain Valves will immediately begin to control superheat and liquid level in the Flash Tank.

When compressors start, the load and unload timers will be set to 30 seconds. During the first 30 seconds of operation after a compressor reaches the start frequency, loading/unloading is inhibited. After 30 seconds, the control logic looks at the LWT temp, compares it to the Setpoint plus CR, and makes a decision to load or unload.

For precise capacity control, the Chiller Control Board microprocessor loads and unloads compressors quickly, as fast as every 2 seconds, in increments of 0.1-1 Hz each time a load or unload change is required. Fixed load and unload timers of 2 sec. are set, after a speed change of 0.1-1 Hz, to minimize undershoot and overshoot.

As additional cooling is required (LCHLT > Setpoint + CR), the Chiller Control Board microprocessor will increase the speed of the compressor at the rate of 1Hz every 2 seconds until the load is satisfied. Loading will continue to occur as long as leaving chilled liquid temperature is above the Setpoint + CR.

The chiller control board will be make decisions regarding speed changes under conditions where the “error” and “rate” conflict. Under these conditions, loading/unloading follows the guidelines described in the Fuzzy Logic Control Section (Page 177).

If chilled liquid temperature is not satisfied and above

Setpoint + CR, the microprocessor looks to see if any of the lag compressors are not running. If any lag compressor(s) is off, the Chiller Control Board microprocessor looks at the VSD output frequency. If the VSD output frequency is greater than the ADD COMPRESSOR FREQUENCY + 15 Hz or equal to the maximum chiller speed (frequency), the microprocessor starts an additional compressor. The ADD COMPRESSOR FREQUENCY is calculated as:

For example: A single compressor had been running

ADD COMPRESSOR FREQUENCY	= $\frac{\text{Minimum Start Freq} \times (\text{Number of Compressors Running} + 1)}{\text{Number of Compressors Running}}$
--------------------------	--

without satisfying cooling demands. Assume the minimum VSD start frequency based on ambient is 50 Hz for this example. The number of compressors running in the formula will equal to 1. Placing the values into the formula: $50 \text{ Hz} \times (1+1)/1 = 100 \text{ Hz}$. The add compressor frequency will equal 100 Hz. Since the controls are designed to add a compressor at a frequency 15 Hz above this point, a compressor will be added if the speed reaches 115 Hz.

When a compressor is to be added, the Chiller Control Board microprocessor decelerates the compressor VSD frequency to 5 Hertz. This enables the differential between discharge and suction pressure to be reduced to a point where it will not affect motor current when the compressor is restarted. It also reduces the chance for backspin on the running compressor. The next lag compressor is activated and all compressors are accelerated to the START FREQUENCY. The START FREQUENCY is calculated as:

START FREQUENCY	= $\frac{\text{Current VSD Freq} \times (\text{Number of Compressors Running} - 1)}{\text{Number of Compressors Running}}$
-----------------	--

OPTIONAL HIGH IPLV CAPACITY CONTROL (CON'T) (Loading/Unloading and starting additional compressors)

With 2 compressors now running and a current VSD frequency of 115 HZ, the start frequency will be computed as:

$$\frac{115 \text{ Hz} \times (2-1)}{2} = \frac{115}{2} = 58 \text{ Hz}$$

When the compressors restart, loading and unloading is inhibited for 30 seconds after the compressor(s) reaches the start frequency, as is the case on any compressor start. The anti-recycle timer will be set to 120 sec.

In a situation where a single compressor on a 2 compressor chiller is running and is in load limiting for any reason, and $LCHLT > \text{Setpoint} + CR$ for < 5 minutes, but > 30 seconds, the micro will reset the load/unload timers to 2 seconds every "potential" load cycle. When $LCHLT > \text{Setpoint} + CR$ for > 5 minutes, the micro will enable the lag compressor just as it were not satisfied and determine a second compressor was required to handle the load, since the lead compressor is load limited.

If the cooling capacity exceeds the demand ($LCHLT < \text{Setpoint} - CR/2$) and multiple compressors are operating, the Chiller Control Board microprocessor will decrease the speed of the compressors at the rate of 0.1-1 Hz every 2 seconds until the $LCHLT$ rises to within the control range. If temp remains below $\text{Setpoint} - CR/2$, rate is falling, and speed falls to the minimum VSD frequency as determined by the ambient, the VSD will decelerate all compressors to 5 Hertz. The last lag compressor will be shut down. The remaining compressors will be restarted minus the lag compressor. The lead compressor will restart and accelerate to the STOP COMP FREQ designated as:

$$\text{STOP COMP FREQ} = \frac{\text{Minimum VSD Freq} \times (\text{Number of Compressors Running} + 1)}{\text{Number of Compressors Running}}$$

In this example: Number of compressors running = 1
Minimum VSD Freq. = 50 Hz

In the example above, one compressor will restart at 100 Hz as indicated in the formula below:

$$\frac{50\text{Hz} \times (1+1)}{1} = 100 \text{ Hz}$$

The load timer will also be set to 30 seconds and the unload timer will be set to 10 seconds.

On 3 and 4 compressor chillers, if temperature stays below the Setpoint minus the Control Range/2, another lag compressor will be shut down using the same guidelines.

When the system is only operating a single (lead) compressor, if temperature continues to stay below the control range ($\text{Setpoint} - CR$), the Chiller Control Board microprocessor will unload the compressor at the rate of 1Hz every 2 seconds. This will continue until the frequency drops below the Minimum VSD Frequency determined by the ambient temperature. At this point, the lead compressor will be shut down.

FUZZY LOGIC CONTROL

The fuzzy logic control in software makes decisions to load or unload according to the error or deviation from Setpoint, and the rate of change of chilled liquid temperature. Before making a change in speed, the logic will look at the load and unload timers to assure they are timed out. It also looks to assure there is no load limiting in effect. Each time a change is made, the incremental change in speed is still 0.1-1 Hz, unless temperatures fall near the leaving chilled liquid cutout.

In most situations, when the chilled liquid temperature is above the $\text{Setpoint} + CR$, the Chiller Control Board microprocessor will continue to increase the speed of the compressor(s) to load the chiller until temperature drops in the general range of the Setpoint High Limit. As the temperature drops and approaches the Setpoint High Limit ($\text{Setpoint} + CR$), the micro's fuzzy logic will begin factoring in the rate of change before continuing to load. If the rate of change is dropping too fast and there is potential for overshoot, the Chiller Control Board microprocessor may elect not to continue to increase speed.

OPTIONAL HIGH IPLV CAPACITY CONTROL (CON'T)

(Loading/Unloading and starting additional compressors)

In cases where temperature is dropping too fast, when temperature is within the desired control range, the Chiller Control Board microprocessor will be required to make decisions regarding speed changes under conditions where the “error” and “rate” conflict. For example, the Chiller Control Board microprocessor may elect to reduce the speed of the compressor(s) if the error is “0” (temperature is at Setpoint), while the rate of change of chilled liquid temperature is “negative” (falling). The Chiller Control Board microprocessor may also elect to hold capacity when error is “positive” (temperature is above Setpoint, but not above Setpoint + CR) because the rate of change of chilled liquid is “negative” (falling). TABLE 5 illustrates these conditions.

TABLE 5 - FUZZY LOGIC LOADING/UNLOADING VS. ERROR

	NEGATIVE ERROR	ZERO ERROR	POSITIVE ERROR
NEGATIVE RATE	UNLOAD	UNLOAD	HOLD
ZERO RATE	UNLOAD	HOLD	HOLD
POSITIVE RATE	HOLD	LOAD	LOAD

When temperature is significantly below the Setpoint – CR/2, the Chiller Control Board microprocessor will reduce the speed of the compressor(s) to unload the chiller by 2.0 Hz every 2 seconds. If temperature drops to within 1.0°F above the Low Chilled Liquid Temperature Cutout, the Chiller Control Board microprocessor will unload at the rate of 4.0 Hz every 2 seconds.

As the temperature rises toward Setpoint – CR, the Chiller Control Board microprocessor’s fuzzy logic will begin factoring in the rate of change before continuing to unload. If the rate of change is rising too fast and there is potential for overshoot, the Chiller Control Board microprocessor may elect not to decrease speed.

In cases where temperature is rising too fast, when temperature is within the desired control range, the Chiller Control Board microprocessor will be required to make decisions regarding speed changes under conditions where the “error” and “rate” conflict. For example, the Chiller Control Board microprocessor may elect to increase the speed of the compressor(s) if the error is “0” (temperature is at Setpoint), while the rate of change of chilled liquid temperature is “positive” (rising). The Chiller Control Board microprocessor may also elect to hold capacity when error is “negative” (temperature is below Setpoint) because the rate of change of chilled liquid is “positive” (rising). TABLE 5 illustrates these conditions and the response from the Chiller Control Board microprocessor.

HOT WATER STARTS

On a hot water start under "best" case conditions, assuming power has not been removed and the 120 sec timer does not inhibit starting, the design of the control algorithm for a 2 compressor High IPLV leaving chilled liquid capacity control allows full loading of a chiller in slightly more than 6 minutes, regardless of the number of compressors, if all the compressors start at the same time. This time period assumes load limiting does not affect the loading sequence and the ambient is above 40°F.

LOAD LIMITING CONTROL

LOAD LIMITING

The Load Limiting Controls are intended to prevent a system from reaching a safety trip level. Load limiting controls prevent loading or unload compressors to prevent tripping on a safety. Limiting controls operate for Motor Current %FLA, Suction Pressure, Discharge Pressure, VSD Baseplate Temperature, and VSD Internal Ambient Temperature.

All running system's load limit control values are checked every 2 seconds. Load limiting prevents a system from loading (no increase even though cooling demand requires loading) when the specific operating parameter is within a specific range of values. If the value is above the range where loading is inhibited, the logic will unload the chiller based on the amount (%) the limit has been exceeded. Load limiting affects all compressors, even though only one system may be affected.

If more than one operating parameter is exceeding the value where unloading is required, the value with the highest amount of unloading will determine the unloading. All load limiting controls are active at start-up except suction pressure limiting.

Motor Current Load Limiting/Unloading

Motor current load limiting helps prevent the system from tripping on the motor overload safety. The motor "Current Limit Setpoint" is based on %FLA motor current and is programmable under the Program key or may be set by a remote device. Motor current load limiting prevents the system from loading even though increased loading may be required when the current is between the "Current Limit Setpoint - 2%" and the "Current Limit setpoint". Between the "Current Limit Setpoint" and the "Current Limit Setpoint + 5%", the system will unload every 2 seconds according to the amount current is exceeding the "Current Limit Setpoint". At the "Current limit Setpoint", 0 Hz reduction in speed will take place and at the "Current Limit Setpoint + 5%", a 10 Hz speed reduction will take place. Between the "Current Limit Setpoint" and "Current Limit Setpoint + 5%", unloading will occur according to the TABLE 6 :

TABLE 6 - CURRENT LIMIT LOAD LIMITING/UNLOADING

CURRENT LIMIT SETPOINT	UNLOADING
Current Limit Setpoint -2% to +0%	0 Hz
Current Limit Setpoint +1%	2 Hz
Current Limit Setpoint +2%	4 Hz
Current Limit Setpoint +3%	6 Hz
Current Limit Setpoint +4%	8 Hz
Current Limit Setpoint +5%	10 Hz

Discharge Pressure Load Limiting/Unloading

Discharge pressure load limiting protects the condenser from experiencing dangerously high pressures. A system is permitted to load normally as long as the discharge pressure is below the High Discharge Pressure Cutout - 20 PSIG. Between Cutout - 20PSIG and Cutout - 15 PSIG loading is inhibited even though increased loading may be required. Between Cutout -15 PSIG and the Discharge Pressure Cutout, forced unloading is performed every 2 seconds according to TABLE 7 below. The discharge pressure unload point is fixed at 255 PSIG.

TABLE 7 - DISCHARGE PRESSURE LOAD LIMITING/UNLOADING

DISCHARGE PRESSURE	UN-LOADING
Discharge Pressure Cutout- 20 PSIG & Discharge Pressure Cutout- 15 PSIG	0 Hz
Discharge Pressure Cutout- 13.5 PSIG	1 Hz
Discharge Pressure Cutout- 12 PSIG	2 Hz
Discharge Pressure Cutout- 10.5 PSIG	3 Hz
Discharge Pressure Cutout- 9 PSIG	4 Hz
Discharge Pressure Cutout- 7.5 PSIG	5 Hz
Discharge Pressure Cutout- 6 PSIG	6 Hz
Discharge Pressure Cutout- 4.5 PSIG	7 Hz
Discharge Pressure Cutout- 3 PSIG	8 Hz
Discharge Pressure Cutout- 1.5 PSIG	9 Hz
Discharge Pressure Cutout- 0 PSIG	10 Hz

LOAD LIMITING CONTROL (CON'T)

Suction Pressure Load Limiting/Unloading

Suction pressure load limiting helps to protect the evaporator from freezing. A system is permitted to load normally as long as the Suction Pressure is above the Suction Pressure Cutout + 2 PSIG. Between Cutout + 2 PSIG and the Cutout, loading is inhibited, even though increased loading is required. Between the Suction pressure Cutout and Suction Pressure Cutout – 10 PSIG, forced unloading is performed every 2 seconds according to TABLE 8 below. This situation would occur if the suction pressure cutout transient override control is in effect (See Low Suction Pressure Cutout, Page 217). The suction pressure cutout is programmed under the Program key. The default Suction Pressure Cutout is set at 24.0 PSIG.

TABLE 8 - SUCTION PRESSURE LOAD LIMITING/UNLOADING

SUCTION PRESSURE	UN-LOADING
Suction Pressure is between Cutout +2 PSIG & Suction Pressure Cutout	0 Hz
Suction Pressure Cutout- 1 PSIG	1 Hz
Suction Pressure Cutout- 2 PSIG	2 Hz
Suction Pressure Cutout- 3 PSIG	3 Hz
Suction Pressure Cutout- 4 PSIG	4 Hz
Suction Pressure Cutout- 5 PSIG	5 Hz
Suction Pressure Cutout- 6 PSIG	6 Hz
Suction Pressure Cutout- 7 PSIG	7 Hz
Suction Pressure Cutout- 8 PSIG	8 Hz
Suction Pressure Cutout- 9 PSIG	9 Hz
Suction Pressure Cutout- 10 PSIG	10 Hz

Suction pressure load limiting is active at start-up, to only prevent loading of the compressors. Suction pressure limit unloading will not occur until the system run time reaches 5 minutes of operation to allow the system to stabilize.

VSD Internal Ambient Temperature Load Limiting

VSD Internal Ambient temperature limiting helps prevent the unit from tripping on the high internal cabinet temperature safety. A system is permitted to load normally as long as the VSD Internal Ambient is below the VSD Internal Ambient Cutout – 3°F. Between VSD Internal Ambient Cutout – 3°F and the VSD Internal Ambient Cutout – 2°F, loading is inhibited, even though increased loading is required. Between the VSD Internal Ambient Cutout – 2°F and the VSD Internal Ambient Cutout, forced unloading is performed every 2 seconds according to TABLE 9 below. The VSD Internal Ambient Safety Cutout is 158°F.

TABLE 9 - VSD INTERNAL AMBIENT LOAD LIMITING/UNLOADING

VSD INTERNAL AMBIENT TEMPERATURE	UN-LOADING
Internal Ambient Temp. is between Cutout- 3°F & Internal Ambient Cutout- 2°F	0 Hz
Internal Ambient Cutout- 1.8°F	1 Hz
Internal Ambient Cutout- 1.6°F	2 Hz
Internal Ambient Cutout- 1.4°F	3 Hz
Internal Ambient Cutout- 1.2°F	4 Hz
Internal Ambient Cutout- 0°F	5 Hz
Internal Ambient Cutout- 0.8°F	6 Hz
Internal Ambient Cutout- 0.6°F	7 Hz
Internal Ambient Cutout- 0.4°F	8 Hz
Internal Ambient Cutout- 0.2°F	9 Hz
Internal Ambient Cutout	10 Hz

LOAD LIMITING CONTROL (CON'T)

VSD Baseplate Temperature Load Limiting

VSD Baseplate load limiting helps protect the unit from tripping on the high VSD Baseplate Temp Safety. A system is permitted to load normally as long as the VSD Baseplate temperature is below the VSD Baseplate Temperature Cutout – 8°F. Between the VSD Baseplate Temperature Cutout – 8°F and the VSD Baseplate Temperature Cutout – 4°F, loading is inhibited, even though increased loading is required. Between the VSD Baseplate Temperature Cutout – 4°F and the cutout, forced unloading is performed every 2 seconds according to TABLE 10 below:

TABLE 10 - VSD BASEPLATE TEMPERATURE LOAD LIMITING/UNLOADING

VSD BASEPLATE TEMPERATURE	UN-LOADING
Baseplate Temp. is between Cutout- 8°F & Cutout- 4°F	0 Hz
Baseplate Temp. Cutout- 3.6°F	1 Hz
Baseplate Temp. Cutout- 3.2°F	2 Hz
Baseplate Temp. Cutout- 2.8°F	3 Hz
Baseplate Temp. Cutout- 2.4°F	4 Hz
Baseplate Temp. Cutout- 2.0°F	5 Hz
Baseplate Temp. Cutout- 1.6°F	6 Hz
Baseplate Temp. Cutout- 1.2°F	7 Hz
Baseplate Temp. Cutout- 0.8°F	8 Hz
Baseplate Temp. Cutout- 0.4°F	9 Hz
Baseplate Temp. Cutout	10 Hz

FLASH TANK DRAIN AND FEED VALVE CONTROLLER

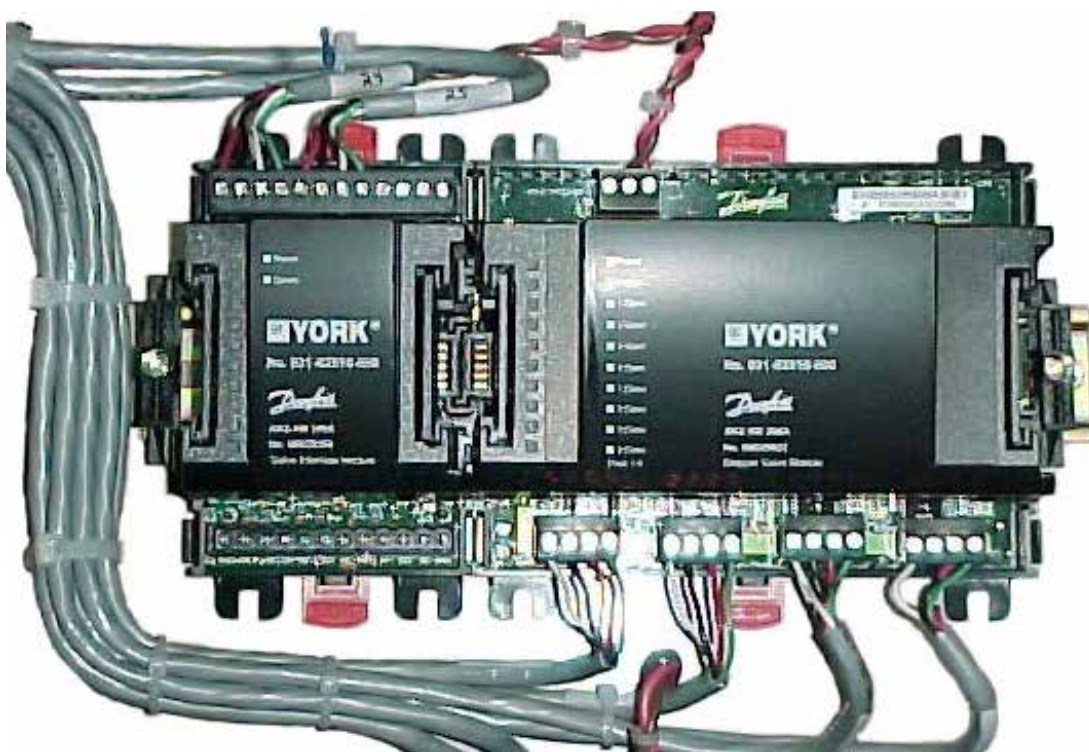

LD10619

VALVE CONTROLLER AND CONTROL ALGORITHM OPERATION

The Flash Tank Feed and Drain Valve PI Controller(s) plays a dual role of supplying drive signals to control the opening and closing of both the Flash Tank Feed and Drain Valves. These valves control the liquid level in the Flash Tank and the suction superheat of the compressor. The Flash Tank Feed and Drain Valve Controller receives analog signals from the Chiller Control Board to position the Feed and Drain Valves. The Chiller Control Board PI (Proportional plus Integral) control algorithm in the Chiller Control Board software determines the open % for the Drain and Feed valves. A D/A converter on the Chiller Control Board converts the 0-110.0% signal to an output voltage between 0 VDC and 10.28 VDC and sends it to the Drain and Feed Controller. This voltage is then converted to a valve position by the Drain and Feed Valve Controller and a 2 phase (4 wire), signal drives the Feed Valve open or closed. Power for the Valve Controller comes from a 30VDC supply from the Chiller Control Board.

The Feed Valve is a stepper motor valve that controls the liquid flow from the condenser to assure the liquid

level in the Flash Tank is maintained at a proper level. The Level Sensor is a rod inserted into the reservoir connected to the side of the Flash Tank. The sensing rod has an active range of about 12". The control algorithm looks at feedback from the Level Sensor and compares it to the fixed level setpoint in the control algorithm. This control strategy attempts to keep the level in the Flash Tank to approx 35% of the usable portion of the sensing rod. In reality, this is approximately a 50% level in the Flash Tank. As the level in the Flash Tank fluctuates, the control algorithm varies the voltage to the Controller, which in turn sends a 2 phase stepped drive signal to open or close the Feed Valve as needed. As the Flash Tank level varies farther from the setpoint, the gain of the control algorithm increases for faster response. In some cases, the Feed Valve will fully open or fully close if the levels become too low or too high. When properly charged, the condenser subcooling will be approx. 5-7°F at design conditions as the Feed Valve controls refrigerant flow into the Flash Tank.

The Drain Valve is also a stepper motor valve. Like the Feed Valve, the controller receives a 0 - 10.28 VDC signal from the Chiller Control Board. The controller then converts the signal to a valve position and a 2 phase signal drives the Drain valve open or closed.

FLASH TANK DRAIN AND FEED VALVE CONTROLLER

The Drain Valve, Controller, and Chiller Control Board Algorithm combination functions as an Electronic Expansion Valve (EEV). The controller receives an analog 0-10.28VDC signal sent from the Chiller Control Board, which is based on system suction pressure and suction temperature. These operating parameters are used to compute and control suction superheat according to the Setpoint programmed into the panel under the PROGRAM Key. After computing the superheat, the signal to the controller is adjusted and the controller subsequently positions the Drain Valve to control the superheat. The gain of the control algorithm is adjusted to aid in correcting for superheat error.

The Chiller Control Board Algorithm assures the level in the flash tank does not become too high. The level setpoint for control is 35%. Levels normally run 30-40% with the economizer solenoid energized (open). With the solenoid closed, levels may vary significantly from the 30-40% level. If the level exceeds 85% of the full level, the system will shut down on a fault.

The Feed and Drain Valves in a system open and begin to control as soon as a compressor starts. When the compressor shuts down, the valves are driven to their closed position.

MOP Setpoint Control For Hot Water Starts

Maximum Operating Pressure control overrides superheat control of the Drain Valve when the MOP Setpoint is exceeded on hot water starts. The fixed setpoint is 68°F Saturated Suction Temp (SST). When this value is exceeded, the Drain Valve switches superheat control to suction pressure control equal to 68°F SST.

Moderate To High Ambient MOP Setpoint Control.

In moderate to high ambients, the suction line may be warmed by the ambient, contributing to inaccurate suction superheat measurement at start-up. To avoid this situation, the MOP control utilizes suction pressure control at start-up, which overrides superheat control. For the first minute of run time, the MOP Setpoint is set to:

$$\frac{\text{RCHLT} - \text{Superheat Setpoint} - 1.0^{\circ}\text{F}}{\text{Run Time in Seconds}}$$

After the first minute of operation, the MOP Setpoint is ramped from the current calculated value to 68°F over the next minute. At this point, normal superheat control based on the programmed setpoint resumes.

Low Ambient MOP Setpoint Control

In low ambient start-ups, suction pressure is erratic and pressure differentials across the compressor may be low, resulting in low oil differential faults. The Low Ambient MOP setpoint control assures adequate differential is developed between discharge and suction to push oil through the oil cooling system and the compressor.

For the first 5 minutes of system run time, the MOP Setpoint is set to the saturated suction temperature equal to 15PSIG below discharge pressure, which overrides superheat control. The control algorithm will not allow suction pressure control below the cutout. The low limit of the suction pressure is the low suction pressure cutout. After 5 minutes of system run time, the MOP Setpoint is set at 68°F and superheat control based on the programmed setpoint resumes.

Actual MOP Setpoint

The actual MOP Setpoint used by the controller is the minimum of three calculations; the fixed MOP Setpoint, the moderate to high ambient setpoint, and the low ambient setpoint.

Valve Controller LED's

The Drain and Feed Valve stepper motor controller is equipped with a pair of LED's on the left side of the module and 10 LED's in the center of the module (FIG. 32). These LED's may be useful during troubleshooting.

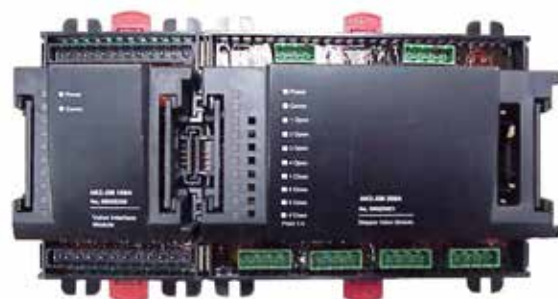

FIG. 32 - LED LOCATIONS

LD10629

FLASH TANK DRAIN AND FEED VALVE CONTROLLER

A pair of LED's on the left side of the module (FIG. 33) indicate when the module is powered. The Power LED should be lit at all times.



FIG. 33 - POWER AND COMMS LED'S

LD10630

A column of 10 LED's runs from top to bottom on the right side module (FIG. 34).

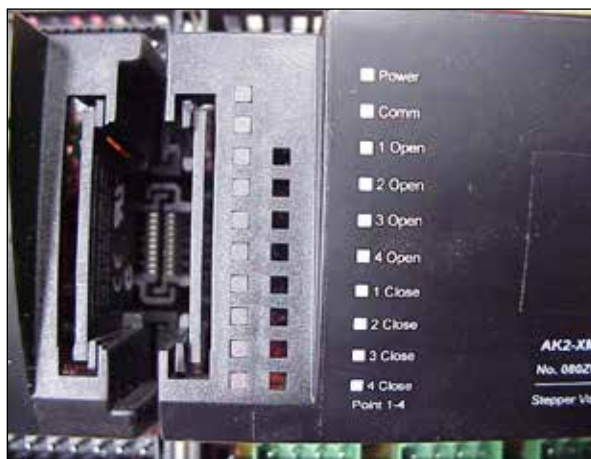

FIG. 34 -POWER, COMMS AND SYSTEM OPEN/ CLOSE LED'S

LD10631

A pair of LED's on the top of the module (FIG. 34) indicate when the module is powered and when the module is communicating with the Chiller Control Board. The Power LED should be lit at all times.

The Open and Close LED's on each system indicate when the Feed and Drain valves are being driven open or closed in an effort to control Flash Tank level and suction superheat. These valves will light "momentarily"

when the valves are being pulsed. In most cases other than start-up, they may appear to not light at all. The valves that are controlled by the outputs associated with the LED's are decoded using the table below:

- 1 Open = System #1 or 3 Feed Valve Open
- 2 Open = System #1 or 3 Drain Valve Open
- 3 Open = System #2 or 4 Feed Valve Open
- 4 Open = System #2 or 4 Drain Valve Open
- 5 Close = System #1 or 3 Feed Valve Close
- 6 Close = System #1 or 3 Drain Valve Close
- 7 Close = System #2 or 4 Feed Valve Close
- 8 Close = System #2 or 4 Drain Valve Close

On 3 and 4 compressor chillers, a second module will control systems #3 and #4.

Due to the short duration of the open and close stepper pulses, LED lighting will be difficult to observe. In rare cases where validation of the controller output and valve movement needs to be checked, the valves can be operated in Service Mode. When operated in Service Mode, visual indication of the LED's lighting will be more obvious. Generally, no audible noise is evident as the valves open and close unless the valve is being run against it's stop. It is possible to obtain an indication of valve movement by touch, when a valve is opening or closing.



Manually operating the Feed and Drain Valves in Service Mode can drain or overflow the Flash Tank. This could cause valve movements and levels in the Flash Tank to act out of the ordinary when a system first starts, until the Chiller Control Board brings the Flash Tank level and superheat under control. This may also be evident in the Flash Tank level and open/close % on the displays. It may also cause the liquid line or Flash Tank sight glasses to empty or the Flash Tank sight glass to fill.

Careless use of manual control could cause liquid damage to the compressor when it is started.

ECONOMIZER CONTROL

ECONOMIZER CONTROL

The Economizer Solenoid controls a vapor feed to the economizer port on the compressor from the top of the Flash Tank. When the valve is open, refrigerant gases off in the Flash Tank providing additional subcooling to the liquid in the tank. The subcooled liquid is then fed to the evaporator resulting in additional system capacity and efficiency.

In normal operation, the Economizer Solenoid on a compressor will be turned on whenever the VSD frequency is > 120 Hz, the flash tank level is $< 75\%$, motor current $< 80\%$ FLA, motor temperature sensors are all less than $< 150^{\circ}\text{F}$, and the economizer timer is timed out. Whenever the Economizer Solenoid is turned on, the compressor load timer is set to 35 seconds and economizer timers for every system are set to 30 seconds, unless they are already above 30 seconds.

In low ambient temperatures $< 40^{\circ}\text{F}$, run time on the respective compressor is < 5 minutes, and the Flash Tank level is $< 75\%$, the system Economizer Solenoid is turned on. Under these conditions, the VSD frequency and the motor temp sensor readings are not factors that could overload the compressor. Energizing the Economizer Solenoid also helps start a system in low ambients and prevents low suction pressure and low oil differential faults by increasing the load.

At ambients above 40°F , once on, the Economizer Solenoid will remain energized until the VSD frequency drops below 90 Hz. Below 90 Hz, the solenoid will be turned off, regardless of the time remaining on the economizer timers. Under these conditions, the economizer timers will be set to "0" when the solenoids are de-energized. Below 100 Hz, if the economizer timer has timed out, the Economizer Solenoids will be turned off, the unload timer will be set to 30 seconds, the economizer timer will be set to 30 seconds if < 30 sec.

If a motor temperature sensor exceeds 240°F , the Economizer Solenoid will de-energize to avoid overheating the hot motor. When the economizer solenoid is de-energized, the compressor unload timer is set to 30 seconds and the economizer solenoid timer is set to 60 seconds. All other economizer timers for other systems are set to 30 seconds, if they are already < 30 seconds.

The Economizer Solenoid timer prevents the solenoid from cycling too often.

Whenever a compressor is to be turned off, all system Economizer Solenoids will be de-energized when the compressor(s) ramp down. The solenoids on the compressors that will be ramped back up, if any, will remain off for 30 seconds before the Chiller Control Board allows the solenoids to re-energize. Once on, the economizer solenoid(s) must remain on for 30 seconds as determined by the economizer timer for each system.

CONDENSOR FAN CONTROL

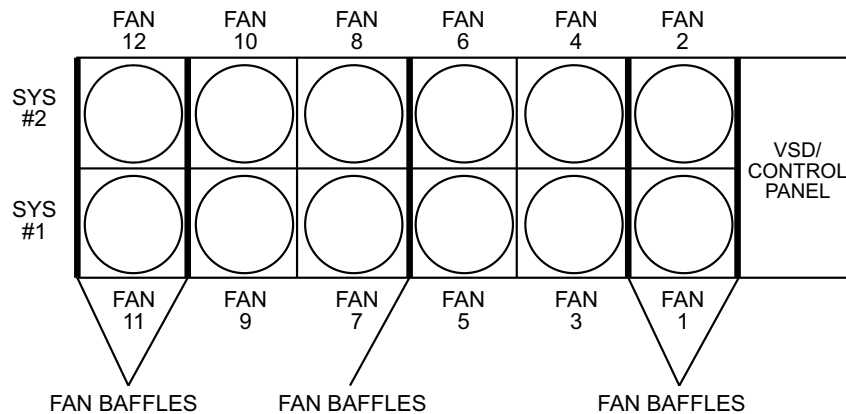

FAN LOCATIONS

- 11 FAN UNITS - OMIT FAN 12
- 10 FAN UNITS - OMIT FANS 11 & 12
- 9 FAN UNITS - OMIT FANS 10,11 & 12
- 8 FAN UNITS - OMIT FANS 9,10,11 & 12

LD10632

Condenser Fan control on each system is based on discharge pressure. There are up to five possible stages of fan control utilizing 3 outputs per system. Depending upon the chiller model, there will be 4,5, or 6 fans per system. The fan nearest the discharge liquid header will always be the first fan on a system to start. As fan stages increment or decrement, a single fan or pair of fans contained within a pair of fan baffles will be turned on or off. The diagram above shows the location of the fan baffles. These baffles will not change location regardless of the number of fans on a chiller.

The fan control algorithm in the Chiller Control Board software will not skip steps as fan stages are staged up and down. The delay between turning on or off fan stages as discharge pressure rises and falls is 5 seconds. The controller increments or decrements the fan stage by one stage based on discharge pressure and fan delay time.

TABLE 11 shows the fan staging and the outputs for each fan stage on 4, 5, and 6 fan systems. The microprocessor fan outputs and the fan contactors will be the same regardless of the number of fans. The fan wiring will change to permit operation of 4,5, or 6 fans.

TABLE 11 - FAN STAGES AND CORRESPONDING OUTPUTS

4 FANS	5 FANS	6 FANS	OUTPUT	CONTACTORS
Stage 1 (1 Fan ON) Sys 1 Fan 1 Sys 2 Fan 2	Stage 1 (1 Fan ON) Sys 1 Fan 1 Sys 2 Fan 2	Stage 2 (2 Fans ON) Sys 1 Fans 1 & 11 Sys 2 Fans 2 & 12)	1	Sys 1: 4CR Sys 2: 7CR
Stage 2 (2 Fans ON) Sys 1 Fans 3 & 5 Sys 2 Fans 4 & 6	Stage 2 (2 Fans ON) Sys 1 Fans 3 & 5 Sys 2 Fans 4 & 6	-	2	Sys 1: 5CR Sys 2: 8CR
Stage 3 (3 Fans ON) Sys 1 Fans 1, 3, & 5 Sys 2 Fans 2, 4 & 6	Stage 3 (3 Fans ON) Sys 1 Fans 1, 3, & 5 Sys 2 Fans 2, 4, & 6	Stage 4 (4 Fans ON) Sys 1 Fans 1, 3, 5, & 11 Sys 2 Fans 2, 4, 6, & 12	1 and 2	Sys 1: 4CR & 5CR Sys 2: 7CR & 8CR
-	Stage 4 (4 Fans ON) Sys 1 Fans 3, 5, 7, & 9 Sys 2 Fans 4, 6, 8, & 10	-	2 and 3	Sys 1: 5CR & 6CR Sys 2: 8CR & 9CR
Stage 4 (4 Fans ON) Sys 1 Fans 1, 3, 5, & 7 Sys 2 Fans 2, 4, 6, & 8	Stage 5 (5 Fans ON) Sys 1 Fans 1, 3, 5, 7, & 9 Sys 2 Fans 2, 4, 6, 8, & 10	Stage 6 (6 Fans ON) Sys 1 Fans 1, 3, 5, 7, 9, & 11 Sys 2 Fans 2, 4, 6, 8, 10, & 12	1, 2, and 3	Sys 1: 4CR, 5CR, & 6CR Sys 2: 7CR, 8CR, & 9CR

CONDENSOR FAN CONTROL (CON'T)

Fan on and off control points will vary for standard and optional optimized IPLV chillers. Unless controls dictate all fans running due to high VSD ambient temperatures, fans will sequence on when a compressor runs and discharge pressure rises. During compressor ramp up or ramp down when compressors are staged, the current fan stage will be held.

The number of fans is factory programmable under the password protected Unit Setup Mode.

Standard IPLV Fan Control

Fan staging ON and OFF points will be determined by the ambient temperature. The fan stage will be incremented, unless the 5 second timer between fan stages is still timing when the discharge pressure rises above the Fan ON Press. The fan stage is decremented, unless the 5 second timer between fan stages is still timing when the discharge pressure falls below the Fan OFF Press. When a fan stage is incremented, the fan delay timer is set to 5 seconds, and the Fan ON pressure is ramped 20 PSIG over the original ON point back to the original value over the next 20 seconds. When a fan stage is decremented, the fan delay timer is set to 5 seconds, and the Fan OFF pressure is ramped 20 PSIG below the original Fan OFF point, back to the original value over the next 20 seconds. The ON and OFF points will vary as ambient temperature changes. FIG. 35 below shows the fan ON and OFF points relative to ambient temperature.

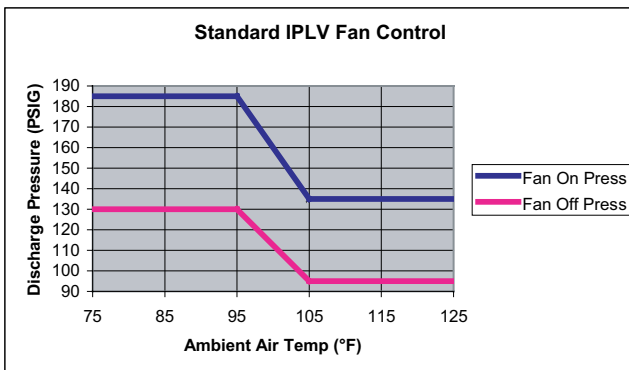

LD10633

FIG. 35 - STANDARD IPLV FAN CONTROL

Optimized IPLV Fan Control

Fan staging on and off points will be determined by the ambient temperature. The fan stage will be incremented, unless the 5 second timer between fan stages is still timing when the discharge pressure rises above the Fan ON Press. The fan stage is decremented, unless the 5 second timer between fan stages is still timing when the discharge pressure falls below the Fan OFF Press. When a fan stage is incremented, the fan delay timer is set to 5 seconds, and the Fan ON pressure is ramped 20 PSIG over the original ON, point back to the original value over the next 20 seconds. When a fan stage is decremented, the fan delay timer is set to 5 seconds, and the Fan OFF pressure is ramped 20 PSIG below the original Fan OFF point, back to the original value over the next 20 seconds. The ON and OFF points will vary as ambient temperature changes. FIG. 36 below shows the fan ON and OFF points relative to ambient temperature.

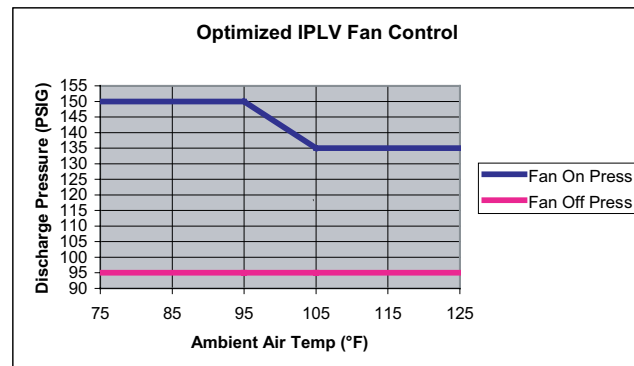

LD10634

FIG. 36 - HIGH IPLV FAN CONTROL

High VSD Cabinet Ambient Temperature Fan Operation

All condenser fans on all systems will run when the chiller is off and enabled to run, if the VSD internal ambient temperature is higher than 5°F below the VSD Cabinet Ambient Temperature Cutout of 158°F (158°F - 5°F = 153 °F). When the fans turn on in this situation, the fan outputs will cycle one at a time with a 100 ms delay between fan starts. When the VSD internal ambient falls below the "Restart Temperature" (158°F Cutout - 10°F = 148 °F), the fans will all be turned off without a delay.

VSD TEMPERATURE CONTROL, OPERATION OF THE COOLANT PUMP, AND VSD CABINET COOLING FANS

The Coolant pump and VSD Cabinet Cooling Fans will run to cool the VSD whenever any of the following conditions are met:

- VSD Comp IGBT Baseplate Temperature on a 2 or 4 compressor unit is greater than 10°F below the cutout (Cutout [218°F]-10°F =208°F). When the VSD internal ambient falls below the restart temperature (Cutout [218°F] - 15°F = 203°F), the fans and pump will be turned off without a time delay.
- VSD Comp IGBT Baseplate Temperature on a 3 compressor unit is greater than 10°F below the cutout (Cutout [232°F] - 10°F = 222°F). When the VSD internal ambient falls below the restart temperature (Cutout - 15°F = 217°F), the fans and pump will be turned off without a time delay.
- Pre-charge Enable 1 from the Chiller Logic Board is ON.
- Pre-charge Enable 2 from the Chiller Logic Board is ON.
- VSD Internal Ambient Temp > 158°F (Cutout) – 10°F = 148°F. When the Internal Ambient Temp falls < 158°F (Cutout) - 15°F = 143 °F the VSD cooling fans and glycol pump will turn off.
- Condenser Fans (as needed) and VSD coolant pump/fans will run whenever a compressor is running. Under these conditions, the condenser fans will run to control discharge pressure and the VSD coolant pump/fans will run to cool the IGBT baseplate and internal cabinet. Additional condenser fans will be brought on, if the IGBT baseplate temperatures or internal cabinet ambient rises to 5°F below the cutout. Condenser fans will turn off, if the compressor turns off provided VSD cooling is not required. The glycol pump and cabinet fan may continue to run, if VSD cooling is required.
- Glycol Pump and Cabinet Cooling Fans will also run in the Service Mode if the Fan/Pump Run Bit is Set.

REMOTE TEMPERATURE RESET CONTROL

Temperature Reset Control

Temperature Reset Control is used to reset the actual LCHLT (Leaving Chilled Liquid Temperature) setpoint used in capacity control. There are several ways to change the LCHLT setpoint. The first is by re-programming the Local Cooling Setpoint under the SETPOINTS key. This is the value the unit will control the LCHLT to if neither of the other methods is active.

Remote Temperature Limit Reset is only possible if the option is enabled by both the OPTIONS Key selection and in the factory programmable password protected Unit Setup Mode.

Remote ISN Setpoint Control

The Remote Leaving Chilled Liquid Setpoint Cooling Setpoint can be set via the ISN comms. The control panel will only accept a remote setpoint from the ISN if the control panel is in Remote Control Mode (under the OPTIONS KEY). If the control panel is in Local Control Mode, the ISN setpoint will be ignored and the Remote Cooling Setpoint is set to the Local Cooling Setpoint. The minimum and maximum allowable reset values will be the same as the minimum and maximum allowable programmable values for the Local Cooling Setpoint. If these values are exceeded by the ISN, the minimum or maximum value will be used.

Contact a local YORK ISN Representative for details on ISN controls and capabilities.

Remote Temperature Reset

The Remote Leaving Chilled Liquid Cooling Setpoint can be reset via the Remote Temperature Reset analog input. A zero signal input (0% input) equates to a 0°F offset to the Local Cooling Setpoint. A full scale signal input (100% input) equates to a "positive" offset to the Local Cooling setpoint equal to the programmable Maximum Remote Temp Reset. The offset is linear and may be adjusted anywhere between the 0% and 100% points. The maximum setpoint allowed is the maximum programmable Local Cooling Setpoint and will be capped at this value, if the calculated setpoint with temperature offset exceeds this value.

This input may be used either in Local or Remote Control Mode. This feature will only operate if enabled under the UNIT SETUP and the OPTIONS Key. The input will be ignored if the Remote Temp Reset is disabled under the OPTIONS key or if there are valid ISN comms while in Remote Control Mode. Once a change to the input is registered, a timer is set to the value of the Remote Inputs Service Time as programmable under the Unit Setup Mode at the factory for the default value of 15 minutes. The low limit is 5 minutes and the high limit is 60 minutes. The Remote input will be ignored until this timer expires. The timer assures that rapid changes in a remote reset signal don't result in poor temperature control or excessive compressor cycling. In most instances, this timer will not need to be changed, since reset more often than 15 minutes will create problems with chilled liquid temperature control. Factory Service should be contacted if a timer change is required.

Control Board jumper JP4 must be positioned correctly to receive either a voltage (0-10VDC or 2-10VDC) or current (0-20mA or 4-20mA) signal. Place the jumper in the "V" position for a voltage signal or mA for a current signal (See FIG. 14, P136). The software must be configured under the OPTIONS key for the specific type of input signal to be used.

The maximum temperature reset is achieved at either 10 VDC or 20 mA. Sending the minimum signal (0 VDC, 2 VDC, 0 mA, or 4 mA based on the OPTIONS key setting) causes the setpoint to revert back to its local programmed value. If the setpoint reset causes the setpoint to go over the maximum programmable value, it will be set to the maximum programmable setpoint.

REMOTE TEMPERATURE RESET CONTROL (CON'T)

0 – 10 VDC Reset Input

A 0 VDC signal produces a 0°F reset. A 10 VDC signal produces the maximum remote temp reset (programmable under the SETPOINTS key). The setpoint reset is ramped linearly between these limits as the input varies between 0 VDC and 10 VDC. In order for this input to work properly, the Remote Temperature Reset must be programmed for 0 – 10 VDC input (OPTIONS key) and Chiller Control Board jumper JP4 placed in the “V” position.

2 – 10 VDC Reset Input

A 0 - 2 VDC signal produces a 0°F reset. A 10 VDC signal produces the maximum remote temp reset (programmable under the SETPOINTS key). The setpoint reset is ramped linearly between these limits as the input varies between 2 VDC and 10 VDC. In order for this input to work properly, the Remote Temperature Reset must be programmed for 2 – 10 VDC input (OPTIONS key) and Chiller Control Board jumper JP4 placed in the “V” position.

0 – 20 mA Reset Input

A 0 mA signal produces a 0°F reset. A 20 mA signal produces the maximum remote temp reset (programmable under the SETPOINTS key). The setpoint reset is ramped linearly between these limits as the input varies between 0 mA and 20 mA. In order for this input to work properly, the Remote Temperature Reset must be programmed for 0 – 20 mA input (OPTIONS key) and Chiller Control Board jumper JP4 placed in the “mA” position.

4 – 20 mA Reset Input

A 0 - 4 mA signal produces a 0°F reset. A 20 mA signal produces the maximum remote temp reset (programmable under the SETPOINTS key). The setpoint reset is ramped linearly between these limits as the input varies between 4 mA and 20 mA. In order for this input to work properly, the Remote Temperature Reset must be programmed for 4 – 20 mA input (OPTIONS key) and Chiller Control Board jumper JP4 placed in the “mA” position.

7

LOCAL CURRENT LIMIT CONTROL

LOCAL CURRENT LIMIT CONTROL

Local Current Limit Control is used to set the actual Current Limit Setpoint. This is accomplished by changing the Local Current Limit Setpoint under the PROGRAM key. This is the value at which the unit will begin to current limit and override capacity control if remote reset is not actively overriding this control. If any other current limit methods are active, the lowest value will be used.

Keep in mind that limiting current may interfere with capacity control, pulling down chilled liquid temperatures on hot water starts, and maintaining chilled liquid setpoints.

PULLDOWN CURRENT LIMIT SETPOINT

The Pulldown Current Limit Setpoint can be set under the PROGRAM key. This current limit setpoint is only active on startup for the time defined by the Pulldown Current Limit Time under the PROGRAM key. After the run time has exceeded this time, the Pulldown Current Limit Setpoint is ignored.

This control is useful in limiting current pulldown demand during peak usage periods where electric costs are highest.

Keep in mind that limiting current may interfere with capacity control, pulling down chilled liquid temperatures on hot water starts, and maintaining chilled liquid setpoints.

REMOTE CURRENT LIMIT RESET CONTROL

Remote Current Limit Reset

Remote Current Limit Reset is used to reset the actual current limit setpoint used in current limit control. There are several ways to change the current limit setpoint. The first is by reprogramming the Local Current Limit Setpoint under the PROGRAM key. This is the value the unit will control the current limit to if neither of the other methods is active.

Remote Current Limit Reset is only possible if the option is enabled by both the OPTIONS Key selection and in the factory programmable password protected Unit Setup Mode.

Remote ISN Current Limit Setpoint

The ISN Current Limit Setpoint can be set via the ISN comms. The control panel will only accept a Current Limit Setpoint from the ISN if the control panel is in Remote Control Mode (under the OPTIONS KEY). If the control panel is in Local Control Mode, the ISN setpoint will be ignored. The minimum and maximum allowable values will be the same as the minimum and maximum allowable reset values for the Current Limit Setpoint under the PROGRAM key. If these values are exceeded, the minimum or maximum value will be used.

Contact a local YORK ISN Representative for details on ISN controls and capabilities.

Remote Current Limit Reset

The Current Limit Setpoint can be set reset via the Remote Current Limit analog input. A zero signal input (0% input) equates to the maximum current limit setpoint as defined under the PROGRAM key Current Limit Setpoint. A full scale signal input (100% input) equates to the minimum current limit setpoint as defined under the PROGRAM key Current Limit Setpoint. The current limit value is linear and may be adjusted anywhere between the maximum and minimum points of 0 (no offset) and 100% (max. current limiting).

This input may be used either in Local or Remote Control Mode. This input will be ignored if the Remote Current Limit is disabled under the OPTIONS key. Once a change to the input is registered, a timer is set to the value of the Remote Inputs Service Time as programmable under the Unit Setup Mode at the factory for the default value of 15 minutes. The low limit is 5 minutes and the high limit is 60 minutes. The Remote input will be ignored until this timer expires. The timer assures that rapid changes in a remote reset signal don't result in poor temperature control or excessive compressor cycling. In most instances, this timer will not need to be changed, since reset more often than 15 minutes will create problems with chilled liquid temperature control. Factory Service should be contacted if a timer change is required.

Control board jumper JP5 must be positioned correctly to receive either a voltage (0-10VDC or 2-10VDC) or current (0-20mA or 4-20mA) signal. Place the jumper in the "V" position for a voltage signal or mA for a current signal (See FIG. 14, P136). The software must be configured under the OPTIONS key for the type of input signal to be used.

The minimum current limit setpoint is achieved at either 10 VDC or 20 mA. Sending the minimum signal (0 VDC, 2 VDC, 0 mA, or 4 mA based on the OPTIONS key setting) causes the current limit to revert back to its maximum value.

REMOTE CURRENT LIMIT RESET CONTROL (CON'T)

0 – 10 VDC Reset Input

A 0 VDC signal sets the current limit to the maximum value. A 10 VDC signal sets the current limit to the minimum value. The current limit is ramped linearly between these limits as the input varies between 0 VDC and 10 VDC. In order for this input to work properly, the Remote Current Limit must be programmed for 0 – 10 VDC input (OPTIONS key) and Chiller Control Board jumper JP5 placed in the “V” position.

2 – 10 VDC Reset Input

A 0 - 2 VDC signal sets the current limit to the maximum value. A 10 VDC signal sets the current limit to the minimum value. The current limit is ramped linearly between these limits as the input varies between 2 VDC and 10 VDC. In order for this input to work properly, the Remote Current Limit must be programmed for 2 – 10 VDC input (OPTIONS key) and Chiller Control Board jumper JP5 placed in the “V” position.

0 – 20 mA Reset Input

A 0 mA signal sets the current limit to the maximum value. A 20 mA signal sets the current limit to the minimum value. The current limit is ramped linearly between these limits as the input varies between 0 mA and 20 mA. In order for this input to work properly, the Remote Current Limit must be programmed for 0 – 20 mA input (OPTIONS key) and Chiller Control Board jumper JP5 placed in the “mA” position.

4 – 20 mA Reset Input

A 0 - 4 mA signal sets the current limit to the maximum value. A 20 mA signal sets the current limit to the minimum value. The current limit is ramped linearly between these limits as the input varies between 4 mA and 20 mA. In order for this input to work properly, the Remote Current Limit must be programmed for 4 – 20 mA input (OPTIONS key) and Chiller Control Board jumper JP5 placed in the “mA” position.

SOUND LIMIT CONTROL (LOCAL AND REMOTE RESET CONTROL)

Sound Limiting and Local Sound Limit Setpoint

Sound limit control to reduce overall chiller noise levels at specified times of the day is accomplished by setting a Sound Limit Setpoint. There are several ways to set the Sound Limit Setpoint. The first is by changing the Local Sound Limit Setpoint under the PROGRAM key. This is the value the unit will use for sound limiting, if neither of the other methods is active. If any other sound limit methods are active, the lowest value will be used. A sound limit of 0% will allow the unit to run up to the unit's maximum frequency. A sound limit of 100% will not allow the unit to run above the minimum frequency. All other sound limit values are linear between these 2 points.

A sound limit schedule must be programmed under the Schedule key when sound limiting is utilized. The schedule defines the time period that sound limiting will be active.

Sound Limiting is only possible if the option is enabled by both the OPTIONS Key selection and the factory programmable password protected Unit Setup Mode.

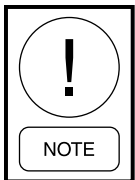

If Sound Limiting is disabled under the Unit Setup Mode, nothing relating to Sound Limiting will show up on any display screen or printout.

ISN Sound Limit Setpoint

The ISN Sound Limit Setpoint can be set via the ISN II comms. The control panel will only accept a Sound Limit Setpoint from the ISN if the control panel is in Remote Control Mode. If the control panel is in Local Control Mode, the ISN setpoint will be ignored. The minimum and maximum allowable values will be the same as the minimum and maximum allowable values for the Sound Limit Setpoint under the PROGRAM key. If these values are exceeded, the minimum or maximum value will be used.

Contact a local YORK ISN Representative for details on ISN controls and capabilities.

Remote Sound Limit

The Sound Limit Setpoint can be set via the Remote Sound Limit analog input. A zero signal input (0% input) equates to the minimum sound limit setpoint as defined under the PROGRAM key Sound Limit Setpoint. A full scale signal input (100% input) equates to the maximum sound limit setpoint as defined under the PROGRAM key Sound Limit Setpoint. The input is linear and may be adjusted between 0% (minimum sound limiting) and 100% (maximum sound limiting) points.

This input may be used either in Local or Remote Control Mode. The input will be ignored if the Remote Sound Limit is disabled under the OPTIONS key. Once a change to the input is registered, a timer is set to the value of the Remote Inputs Service Time as programmable under the Unit Setup Mode at the factory for the default value of 15 minutes. The low limit is 5 minutes and the high limit is 60 minutes. The Remote input will be ignored until this timer expires. The timer assures that rapid changes in a remote reset signal don't result in poor temperature control and excessive compressor cycling. In most instances, this timer will not need to be changed, since reset more often than 15 minutes will create problems with chilled liquid temperature control. Factory Service should be contacted if a timer change is required.

Control board jumper JP6 must be positioned correctly to receive either a voltage (0-10VDC or 2-10VDC) or current (0-20mA or 4-20mA) signal. Place the jumper in the "V" position for a voltage signal or mA for a current signal (See FIG. 14, P136). The software must be configured under the OPTIONS key for the type of input signal to be used.

The maximum sound limit is achieved at either 10 VDC or 20 mA. Sending the minimum signal (0 VDC, 2 VDC, 0 mA, or 4 mA based on the OPTIONS key setting) causes the sound limit to be set to its minimum (no limiting) value.

SOUND LIMIT CONTROL (CON'T) **(LOCAL AND REMOTE RESET CONTROL)**

0 – 10 VDC Reset Input

A 0 VDC signal produces a 0% sound limit (no change to max VSD freq). A 10 VDC signal produces a 100% sound limit (max VSD freq = min VSD freq). The sound limit is ramped linearly between these limits as the input varies between 0 VDC and 10 VDC. In order for this input to work properly, the Remote Sound Limit must be programmed for 0 – 10 VDC input (OPTIONS key) and Chiller Control Board jumper JP6 placed in the “V” position.

2 – 10 VDC Reset Input

A 0 - 2 VDC signal produces a 0% sound limit (no change to max VSD freq). A 10 VDC signal produces a 100% sound limit (max VSD freq = min VSD freq). The sound limit reset is ramped linearly between these limits as the input varies between 2 VDC and 10 VDC. In order for this input to work properly, the Remote Sound Limit must be programmed for 2 – 10 VDC input (OPTIONS key) and Chiller Control Board jumper JP6 placed in the “V” position.

0 – 20 mA Reset Input

A 0 mA signal produces a 0% sound limit (no change to max VSD freq). A 20 mA signal produces a 100% sound limit (max VSD freq = min VSD freq). The sound limit reset is ramped linearly between these limits as the input varies between 0 mA and 20 mA. In order for this input to work properly, the Remote Sound Limit must be programmed for 0 – 20 mA input (OPTIONS key) and Chiller Control Board jumper JP6 placed in the “mA” position.

4 – 20 mA Reset Input

A 0 - 4 mA signal produces a 0% sound limit (no change to max VSD freq). A 20 mA signal produces a 100% sound limit (max VSD freq = min VSD freq). The sound limit reset is ramped linearly between these limits as the input varies between 4 mA and 20 mA. In order for this input to work properly, the Remote Sound Limit must be programmed for 4 – 20 mA input (OPTIONS key) and Chiller Control Board jumper JP6 placed in the “mA” position.

VSD OPERATION AND CONTROLS

VSD Logic Board

The VSD Logic Board communicates with the chiller Chiller Control Board via comms and controls the VSD functions. It converts the frequency and run commands from the Chiller Control Board into the necessary voltage and frequency commands to operate the inverter section. It also controls the converter section of the drive (AC Line to DC Buss conversion) by controlling the pre-charge function.

The VSD Logic Board contains a 2nd microprocessor (motor controller) that generates the PWM signals that control the IGBT outputs in the inverter section of the VSD.

An FPGA handles the hardware safeties that can shut down the VSD much faster than the software safeties. The VSD Logic Board handles all of the VSD related safeties, which includes motor current, BUS voltage, and other safeties.

The VSD Logic Board reports shutdown information back to the Chiller Control Board via the RS-485 communication link.

2, 3, and 4 compressor chillers all use the same software. The microprocessor determines whether the chiller is a 2, 3, or 4 compressor chiller by electronically checking for a factory-installed jumper in the system wiring harness. The micro checks for the jumper located in the J1 plug wiring harness at power-up. If no jumper or more than one jumper is sensed, the microprocessor will inhibit start-up. Details regarding the location of the jumper are provided on Page 168 in the CHILLER CONFIGURATION JUMPERS section.

VSD Start/Run Initiation

Following a successful precharge of the DC Bus and a run command from the Chiller Control Board, the VSD Logic Board microprocessor will determine the motor output voltage (% modulation) and the output frequency required based on the operating frequency command from the Chiller Control Board. This information will then be sent to the PWM generator located on the VSD Logic Board.

On start-up, the output frequency from the VSD to the motor(s) will be increased from 0 Hz to the operating frequency commanded by the Chiller Control Board. The rate of change of the frequency will also be controlled by the VSD Logic Board.

The rate of change of the output frequency at start-up, during acceleration is 10 Hz/sec between 0 and 50 Hz and 30.4 Hz/sec above 50 hertz. The maximum rate of change of the output frequency during deceleration between 200-100 Hz is 30.4 Hz/sec, and 100-0 Hz is 10 Hz/sec.

The VSD Logic Board and its PWM generator will receive operating frequency and voltage commands from the Chiller Control Board based on the load. When a frequency (speed) change is requested from the Chiller Control Board, the chiller micro will send the change to the VSD Logic Board and the VSD Logic Board will acknowledge it accepted the change. Loading and unloading will take place at the rate of 0.1-1Hz every 2 seconds.

PWM Generator Type and Carrier Frequency

The PWM generator is responsible for providing asymmetrical uniform sampled PWM waveforms to the compressor motor at a carrier frequency of 3125 Hz by turning on and off the inverter IGBT's. The waveform generated is equivalent to a specific V/F ratio at a given speed based on the voltage and frequency commands from the Chiller Control Board. The PWM Generator receives operating frequency and voltage commands from the VSD Logic Board control processor.

Short Circuit Protection Minimum Output Pulse Width and Interlock Delay

The PWM generator is programmed to drop all "on" pulses in less than 10 microseconds (and all matching "off" pulses in the mirrored waveform) to permit time for the IGBT gate drivers to detect and self extinguish an inverter short circuit condition.

VSD OPERATION AND CONTROLS (CON'T)

Modulating Frequency

The modulating frequency range will range from 0 to 200 Hz. The modulating frequency waveform consists of a sinusoidal waveform summed together with 16.66% of the third harmonic component of the sinusoidal waveform. Utilization of this waveform as the modulating waveform will permit the drive to generate a fundamental line to line voltage equal to the DC bus voltage divided by 1.414.

Maximum VSD Frequency

The maximum VSD frequency will vary for each chiller model. The microprocessor board determines the frequency according to jumpers factory installed in the wiring on the J7 plug of the microprocessor board. The location of these jumpers is interpreted as a binary value, which presently allows 7 speed selections plus a default. The maximum frequency may vary from 178 to 200 Hz. If the J7 plug is not installed, the speed will default to 178 Hz. Details on the location of the jumpers and the associated maximum speed are provided on Page 169 in the CHILLER CONFIGURATION JUMPERS section.

VSD % Modulation

The voltage and frequency commands issued by the VSD Logic Board microprocessor are determined by the frequency command from the Chiller Control Board. The VSD output is a PWM signal (FIG. 2), which has effects on the motor comparable to an AC voltage sinusoidal waveform. To change the speed of an AC motor, the frequency of the AC voltage must be changed. Whenever frequency is changed, the voltage is changed in a linear ratio. Maintaining a relatively constant V/F ratio as speed changes assures motor losses and overheating do not occur.

The output voltage of the VSD is not a sinusoidal waveform. Instead, the PWM generator provides an output that simulates a true AC waveform by repetitively turning on and off the voltage to the motor to create an average voltage that is equal to a lower AC voltage at lower frequencies and a higher voltage at higher frequencies. The PWM generator also changes the % modulation of the waveform to simulate the frequency change to maintain the V/F ratio with motor speed changes.

The PMW generator is programmed to essentially operate a linear volts/Hz ratio over the 0 – 200 Hz frequency range. The complex control algorithm modifies the voltage command to boost the voltage of the V/F ratio at lower speeds to provide additional torque.

The 100% modulation operating point occurs at a fundamental frequency of 189.6 Hz. As the output frequency increases above 189.6 Hz, the drive operates in an over-modulated mode. For example, at 200 Hz fundamental modulating frequency the PWM waveform is over-modulated by approximately 18%. This will yield a fundamental output line to line voltage applied to the motor terminals at maximum output frequency that is equal to the input line to line voltage applied to the drive (provided the DC bus current remains continuous).

VSD OPERATION AND CONTROLS (CON'T)

VSD COOLING AND COOLING LOOP

The VSD generates heat in the IGBT power modules and the SCR/Diode assemblies, which must be removed. The heat not only heats the modules but also the Micro/VSD cabinet.

The VSD is cooled by a glycol loop and circulating pump. The glycol cooling loop feeds a liquid cooled heatsink called a chillplate that cools the IGBT's and SCR/Diode modules. The coolant is pumped by a circulator pump through the heatsink where it absorbs heat in several passes of tubes on the lower rows of the inside condenser coils where the condenser fans remove the heat picked up from the modules. The coolant is then pumped back to the modules. The glycol loop also provides cooling for the Micro/VSD cabinet. The baseplates of the power components are mounted to the glycol cooled heatsinks in the cooling loop. The cooling loop also circulates the glycol through a cooling coil in the cabinet. A fan blows air from the cabinet across the cooling coil to cool the electronics in the cabinet.



Never run the glycol pump without coolant! Running the glycol pump without coolant may damage the pump seals

Always fill the system with approved coolant to avoid damage to the pump seals and other components.

Heat transfer characteristics of the coolant are very critical. Substituting coolant or adding water will result in cooling loop performance loss and chiller shutdown.

The glycol coolant level in the VSD cooling system should be maintained 9-15 inches (23-38 cm) from the top of the fill tube. This check should be performed prior to running the pump. The pump can be test run by placing the chiller in Service Mode. It is advisable to fill the tube to the required level before starting the glycol pump because it may empty when the pump starts. The level should be topped off as needed while running. Be sure to re-install the cap before stopping the glycol pump to avoid overflowing the fill tube when the glycol pump is turned off.

Glycol coolant has a defined operating life. System coolant should be changed 5 years from date of shipment of the equipment. Mixing other coolants or water with the special glycol will reduce the life of the coolant, and cause VSD overheating and damage.

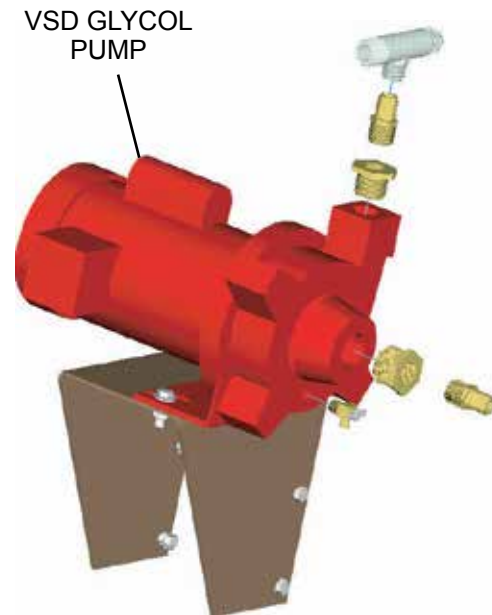

LD10635

VSD OPERATION AND CONTROLS (CON'T)

The VSD fan and glycol pump will run if any of the following conditions listed below are true, provided the VSD has been powered up for less than 30 seconds and the pump has not run in the last 30 seconds. The 30 second limitations prevent pump motor overheating.

- 2 and 4 Compressor Baseplate temp is > Cutout (218°F) – 10°F.
- 3 Compressor IGBT Baseplate temp is > Cutout (232°F) – 10°F.
- Pre-charge Enable 1 from the chiller Logic Board is ON.
- Pre-charge Enable 2 from the chiller Logic Board is ON.
- VSD Internal Ambient Temp > Cutout – 10°F.
- Any compressor is running.
- Service Mode Fan/Pump Run is enabled.

The VSD fan/glycol pump will turn off when ALL of the following conditions are true:

- Compressor 1/3 IGBT Baseplate temp is < Cutout – 15°F.
- Compressor 2/4 IGBT Baseplate temp is < Cutout – 15°F.
- Pre-charge Enable 1 from the chiller Logic Board is OFF.
- Pre-charge Enable 2 from the chiller Logic Board is OFF.
- VSD Internal Ambient Temp < Cutout – 15°F.
- No compressors are running.
- Service Mode Fan/Pump is disabled.

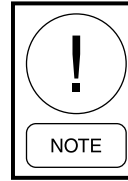

In some cases, the condenser fans may be turned on by the micro, when no compressors are running, to keep the power components and Control/VSD Cabinet from overheating.

IGBT Module Baseplate Temperature Sensing

Each IGBT module has an internal 5Kohm thermistor built in to measure the temperature of the module. Up to 4 thermistors are connected to the VSD logic board (one per compressor). The highest module temperature of compressors 1 and 3 are sent to the logic board along with the highest module temperature of compressors 2 and 4. If the temperature exceeds the software trip point, the unit will shut down on a safety. See High Baseplate Temperature Fault (P. 206) for details.

VSD Internal Ambient Temperature Sensing



LM 34
SENSOR

LD10636

A National LM34 temperature sensor located on the VSD Logic Board is used to measure the internal ambient temperature of the Control Panel/VSD enclosure. It has an output voltage that is linearly proportional to the temperature in degrees Fahrenheit. If the temperature exceeds the software trip point, the unit will shut down on a safety. See High VSD Ambient Temperature Fault (Page208) for details.

VSD OPERATION AND CONTROLS (CON'T)

Pre-charge

When cooling is required (LCWT>SPHL), leaving chilled liquid temp is greater than the setpoint high limit), the chiller Control Board will send a Pre-Charge Enable (2 enables on a 4 comp unit) via comms to the VSD Logic Board. The VSD's DC bus voltage(s) across the Bus Filter Capacitors will slowly be increased to the proper level (>500VDC) through firing of the SCR Trigger Board(s) and the associated pre-charge enable control signal(s). The pre-charge time interval is fixed at 20 seconds. The purpose of the precharge is to limit current when charging an uncharged capacitor bank. When uncharged, the capacitor bank looks like an electrical short. The bus is brought up slowly by only turning on the SCR's during the trailing half of the + and - portion of the incoming AC sine wave. Following is the status message displayed while the precharge is taking place.

SYS X VSD DC BUS PRECHARGE

Following successful completion of the pre-charge interval, the SCR's on the AC to DC semi-converter (SCR/Diode Modules) will be gated fully on by the SCR Trigger Board and the DC bus will be brought up to its full potential. After pre-charge has been successfully completed, the SCR's will stay fully on until the Chiller Control Board turns off the Pre-Charge Enable via comms.

There will be a Unit Pre-charge Enable for 2 and 3 compressor units and separate System Pre-charge Enables for 4 compressor units.

The pre-charge will only take place when all of the following conditions are true, otherwise it is disabled:

- Daily Schedule is ON.
- Unit Switch is ON.
- System Switch(es) are ON.
- Run Permissive(s) are Enabled.
- Flow Switch indicates flow.
- LCHLT > Setpoint High Limit.
- Unit not faulted / locked out.

Run Mode / Unit Restart

In order to initiate a system run, two conditions must be met. At least 1 of the 2 systems run signals from the control panel must be present and at least 1 of the 4 possible Compressor RUN bits must be set in the serial communications link between the VSD Logic Board and the Chiller Control Board. Following successful completion of pre-charge and receipt of the system run signals, the motor output voltage (% modulation) and output frequency commands will be determined by the VSD microprocessor located on the VSD Logic Board. These two parameters will be sent to the PWM generator located on the VSD Logic Board for waveform processing at a rate of once every 10 msec.

The voltage and frequency commands issued by the VSD microprocessor are determined by the operating frequency command received on the communications link from the Chiller Control Board and by the present operating frequency of the drive. Upon receipt of a legitimate run command communication, the VSD's output frequency will be increased from 0 Hz to the operating frequency command from the communications link.

DC Bus Voltage Sensing and Scaling

Full DC Bus voltage and ½ DC Bus voltages are sensed for up to 2 DC Buses. 2 and 3 compressor chillers share a common DC Bus, while 4 compressor chillers utilize 2 DC Buses (1/3 and 2/4). The DC Bus is wired to the DC Bus Isolation Board, the voltage is divided down through a resistance voltage divider, and the reduced voltage is fed to the VSD Logic Board for safety monitoring.

VSD OPERATION AND CONTROLS (CON'T)

Current Sensing and Scaling

Individual current transformers on each leg sense three phases of output current on each compressor. These signals are buffered, divided by 2, and filtered by an RMS to DC converter. The highest of the currents in the three phases of each compressor leaving the RMS converters is then sent to an A-D converter scaled, monitored by the VSD Logic Board overload and high current protection circuitry, and sent to the Chiller Control Board for display as the compressor current.

In order to set the motor overload level (determined by the setting of the OVERLOAD ADJUST potentiometer on the VSD Logic Board), the voltage level on the wipers of the four OVERLOAD ADJUST potentiometers is continuously sensed by the VSD Logic Board for current protection and sent to the Chiller Control Board for both display purposes and for current limiting control. This parameter is the 105% FLA value.

VSD Transmitted Operating parameters

VSD operating parameters will be transmitted to the Chiller Control Board over the RS-485 communications link between the 2 boards. These values will be displayed on the control panel display. The data and display format are outlined in the TABLE 12 below:

TABLE 12 - VSD OPERATING DISPLAY PARAMETERS

DATA	DISPLAY FORMAT
Highest Phase of Compressor Motor Current in Amperes RMS (per Compressor)	XXX Amps
VSD Output Frequency	XXX.X Hz
Motor Overload Setting (105% FLA potentiometer setting) in amperes RMS (per Compressor)	XXX Amps
DC Bus Voltage in DC Volts (maximum of 2)	XXX Volts
VSD Internal Ambient Temperature	XXX.X°F (or °C)
IBGT Power Assembly Power Module Highest Baseplate Temperature (maximum of 2)	XXX.X°F (or °C)
Pre-Charge Enable Signal (maximum of 2)	On or OFF
VSD cooling Fan/Pump	On or OFF
Compressor Run Status (maximum of 4)	On or OFF

VSD SAFETIES (FAULTS)

VSD operating conditions are monitored by both software algorithms and hardware circuitry. Both types exist as a result of the need for both extremely fast protection requirements such as a short circuit condition or a slow reacting trip such as a slow rising overload condition. To eliminate nuisance unit trips, the sensor inputs for the VSD's operating parameters are averaged four times before "Software" generated unit/system fault trips from the VSD Logic Board are initiated. These faults cause single compressor or total unit controlled "ramped" shutdown. Other parameters that are not fed to the VSD Logic Board microprocessor are protected by "Hardware" generated fault trips. Hardware trips involve electronic circuitry that measures voltages or currents and activate level sensitive comparators connected to programmable gate arrays on the VSD Logic Board FPGA (Field Programmable Gate Array). These safeties operate extremely fast and provide "immediate" shutdown, because they are not dependent upon software program loops that operate in seconds or fractions of a second. Outputs from the gate arrays provide a digital signal to indicate whether a safety threshold has been reached.

Immediate Fault shutdowns are often accompanied by audible motor backspin due to equalizing of the differential between discharge and suction when the compressor is turned off while rotating at high speeds. This should not cause concern and will not damage the chiller.

Each fault outlined in the descriptions that follow will indicate whether it is a hardware or software generated fault.

It will be noted the "ramped" shutdown results in minimal compressor backspin and noise associated with backspin. "Immediate" shutdowns will result in compressor backspin and a higher noise level based upon the differential pressure between discharge and suction.

When a VSD fault occurs, the VSD Logic Board captures VSD data in the onboard battery backed RAM. At the same time, the VSD Board "Fault Relay" will open, signaling the Chiller Control Board microprocessor to save a snapshot of system data. The VSD Logic Board then transmits the fault data to the Chiller Control Board microprocessor on the next comms between the two boards. If the Chiller Control Board receives the comms fault indication before the Fault Relay signal, it will immediately save a snapshot of system data when the comms fault is recognized. This also enables the

micro to capture fault data if the Fault relay fails. Both the system and VSD fault data are then stored in the Chiller Control Board history buffers. Any additional faults that may occur during shutdown on the first fault or between the first fault and the next comms will also be stored and transmitted to the Chiller Control Board along with the original fault data. This data will be stored as "ALL FAULT" data.

When the control panel acknowledges a fault (via the fault acknowledge bit in comms) the fault relay will be reset (closed) by the VSD Logic Board and the fault indication flag (in comms) will be reset.

The fault relay will not open when a non-running fault occurs. In this case, the system will be inhibited from running until the fault condition is corrected. An inhibit message will be displayed on the panel display indicating the system is not allowed to run. Examples of this type of fault would be the High Internal Ambient fault and the VSD CT Plug Fault. When the chiller receives the transmitted fault data via comms, it will save a snapshot of system data in the history buffer even though the chiller is not running.

Some faults will be unit faults; other faults will be system (specific compressor or compressor pairs) faults, depending upon the number of compressors in the chiller. Most faults will shut down the unit/ system and allow restart once the fault clears and the 120 sec anti-recycle timer times out. These faults will allow up to 3 faults in 90 minutes before locking out the unit/system. Other faults lock out the unit/system after only a single fault. Details on individual faults are provided in the following explanations.

A start inhibit will take place if a VSD fault condition exists and a compressor that is not running is called to start. The start inhibit will be cleared when the fault condition goes away and the compressor will be permitted to start.

VSD SAFETIES (FAULTS) (CON'T)

Pre-charge Low DC Bus Voltage (Software) Fault

The DC bus voltage must reach at least 50 VDC within four seconds and 500 VDC within 19 seconds after the pre-charge signal has been asserted. If not, the unit/system will shut down on a fault.

This is an auto-restart safety that will lock out on the 3rd fault in 90 minutes. The fault will be a unit fault for 2 or 3 compressor chillers. The Status display fault message is shown below:

**UNIT YYYYYYYY
PRECHARGE - LOW DC BUS VOLTAGE**

The Low DC Bus voltage fault will be a unit fault for 2 and 3 compressor units or a system fault for System 1/3 or 2/4 for 4 compressor units. The reason for this is two inverter power sections with separate DC Bus circuitry for each inverter section is utilized on a 4 compressor unit. One section serves systems 1 and 3 while another serves systems 2 and 4. The Status display fault message is shown below:

SYS X YYYYYYYY PRECHARGE - LOW DC BUS VOLT

X indicates the system and YYYYYYYY indicates the system is in a "FAULT" condition and will restart when the fault clears or "LOCKOUT" and will not restart until the operator clears the fault using the keypad.

PRE-CHARGE DC BUS VOLTAGE IMBALANCE (SOFTWARE) FAULT

The 1/2 DC bus voltage magnitude must remain within +/- 100VDC of the total DC bus voltage divided by two during the pre-charge interval. If not, the unit/system shall shut down on a fault.

This safety will lock out on the 1st fault. The fault will be a unit fault for 2 or 3 compressor units. The Status display fault message is shown below:

The fault will be a system 1/3 or 2/4 fault for 4 com-

**UNIT YYYYYYYY
PRECHARGE - DC BUS VOLTAGE IMBALANCE**

pressor units. Two key presses of the STATUS key are required to show the fault on both systems. The Status display fault message is displayed below:

X indicates the system and YYYYYYYY indicates the

SYS X YYYYYYYY PRECHARGE-BUS VOLT IMBAL

system is in a "LOCKOUT" condition and will not restart until the operator clears the fault using the keypad.

High DC Bus Voltage (Hardware) Fault

The high DC bus voltage trip level is determined by hardware on the VSD Logic Board and is designed to trip the unit at 766 +/- 30 VDC. If the DC bus exceeds this level, the unit/system will fault and shut down immediately.

This safety is an auto-restart safety that will lock out on the 3rd fault in 90 minutes. The fault will be a unit fault for 2 or 3 compressor units. Two key presses of the STATUS KEY are required to show the fault on both systems. Below is the control panel Status display fault message:

**UNIT YYYYYYYY
HIGH DC BUS VOLTAGE**

The fault will be a system 1/3 or 2/4 fault on 4 compressor units. Below is the Status display fault messages for all systems: Two key presses of the STATUS Key are required to show the fault on both systems.

SYS X YYYYYYYY HIGH DC BUS VOLTAGE

X indicates the system and YYYYYYYY indicates the system is in a "FAULT" condition and will restart when the fault clears or "LOCKOUT" and will not restart until the operator clears the fault using the keypad.

VSD SAFETIES (FAULTS) (CON'T)

Low DC Bus Voltage (Software) fault

The low DC bus voltage trip level is set at 500 VDC. If the DC bus drops below this level the unit/system will fault and immediately shut down.

The low DC bus voltage cutout is an auto-restart safety that will lock out on the 3rd fault in 90 minutes. The fault is a unit fault for 2 or 3 compressor units. Below is an example of the Status display fault message:

```
UNIT YYYYYYYY
LOW DC BUS VOLTAGE
```

The low DC bus voltage cutout is a system fault (1/3 or 2/4) on 4 compressor units. Two key presses of the STATUS key are required to show the fault on both systems. Below is a sample Status display system fault message:

```
SYS X YYYYYYYY LOW DC BUS VOLTAGE
```

X indicates the system and YYYYYYYY indicates the system is in a "FAULT" condition and will restart when the fault clears or "LOCKOUT" and will not restart until the operator clears the fault using the keypad.

DC Bus Voltage Imbalance (Software) Fault

The 1/2 DC bus voltage magnitude must remain within +/- 100 VDC of the total DC bus voltage divided by two. If the 1/2 DC bus magnitude exceeds the +/- 100 VDC tolerances, the unit/system will fault and immediately shut down.

This safety will lock out on the 1st fault. The fault will be a unit fault for 2 or 3 compressor units. Below is the Status display fault message:

```
UNIT YYYYYYYY
DC BUS VOLTAGE IMBALANCE
```

The fault will be a system 1/3 or 2/4 fault on 4 compressor units. Two key presses of the STATUS key are required to show the fault on both systems. Below is a sample Status display fault message:

```
SYS X YYYYYYYY DC BUS VOLTAGE IMBALANCE
```

X indicates the system and YYYYYYYY indicates the system is in a "LOCKOUT" condition and will not restart until the operator clears the fault using the keypad.

High Motor Current (Hardware) Fault

The three output lines to each phase of the compressor motor are monitored via three current transformers within the VSD. The unit's three phases of instantaneous output current will be compared to a predetermined limit, which is contained in hardware. The nominal peak current trip level is 575.5 Amps (554A min., 597A max.). 380VAC, 60Hz and 400VAC, 50Hz nominal peak current trip level is 649.5 Amps (626 Amps min., 674 Amps max.). The variation in trip point is the result of component tolerances on the VSD Logic Board. If the peak current limit is exceeded, the unit will fault and shutdown immediately.

This fault is an auto-restart safety that will lock out system on the 3rd fault in 90 minutes. The fault will be an individual system/compressor fault for all units. Following is a sample Status display fault message:

```
SYS X YYYYYYYY HIGH MOTOR CURRENT
```

X indicates the system and YYYYYYYY indicates the system is in a "FAULT" condition and will restart or "LOCKOUT" and will not restart until the operator clears the fault using the keypad.

VSD SAFETIES (FAULTS) (CON'T)

Motor Current Overload (Software) Fault

The Motor Current Overload will compare the highest of the 3 phases of motor current per compressor to the compressor's 105 % FLA ADJUST (overload) potentiometer setting on the VSD Logic Board. If the current exceeds the setting continuously for 20 seconds, the compressor will trip.

This safety will lock out a system on the 1st fault and shut down with a controlled ramped shutdown. The fault will be an individual system/compressor fault for all systems. A sample Status display fault is shown below:

SYS X YYYYYYYY MOTOR CURRENT OVERLOAD

X indicates the system and YYYYYYYY indicates the system is in a "LOCKOUT" condition and will not restart until the operator clears the fault using the keypad.

Motor Current Overload (Hardware) Fault

The Motor Current Overload will compare the highest of the 3 phases of motor current per compressor to the compressor's overload ADJUST potentiometer setting. If the current exceeds the setting continuously for 30 seconds, all compressors will fault and shut down immediately.

The fault will be a unit fault and will lock out all systems on the first fault. A sample Status display fault is shown below:

**UNIT YYYYYYYY
MOTOR CURRENT OVERLOAD**

YYYYYYYY indicates the unit is in a "Lockout" condition and will not restart until the operator clears the fault using the keypad.

IGBT GATE DRIVER (HARDWARE) FAULT

The unit's phase bank assembly(s) contains one IGBT gate driver control board per compressor. These boards monitor the saturation voltage drop across each of the six IGBT's while gated on. If the IGBT's saturation voltage exceeds the prescribed limit, the gate driver will make the determination that a short circuit is present. This in turn will cause the system to trip. During normal operation, the voltage drop across a saturated IGBT is low. When a short or shoot occurs, the extremely high current causes the voltage across the device to increase. When the electronic hardware on the IGBT Gate Driver Board senses the current rise, it immediately turns off all IGBT's in the module and the system will shut down immediately.

Additionally, if the IGBT's Gate Driver board's power supply voltage falls below the permissible limit, this same fault will be generated.

This is an auto-restart safety that will lock out on the 3rd fault in 90 minutes. The fault will be a system fault for all units. Following is the Status display fault messages for all systems.

SYS X YYYYYYYY GATE DRIVER

X indicates the system and YYYYYYYY indicates the system is in a "FAULT" condition and will restart or "LOCKOUT" and will not restart until the operator clears the fault using the keypad.

High Baseplate Temperature (Software) Fault

Each phase bank assembly contains one liquid cooled heatsink to cool both the inverter power modules and the converter SCR/Diode modules. Each compressor's inverter power module (6 IGBT's & Gate Driver Board) contains an internal temperature sensor (5K ohm at 25 Deg. °C) to monitor the baseplate temperature.

On two compressor chillers, the outputs from System 1 and System 2 sensors are each compared in software to a limit of 218°F. If either sensor exceeds this limit, the unit will fault and shut down with a controlled ramped shutdown.

VSD SAFETIES (FAULTS) (CON'T)

On 3 compressor chillers, the baseplate temperatures on compressors 1 and 3 are OR'd together and the highest of the two temperatures compared in software to a limit of 232°F. Compressor #2 will have its individual power module sensor compared in software to a limit of 232°F. If the limit is exceeded by either of the 2 inputs, the unit will fault and shut down with a controlled ramped shutdown.

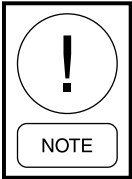

3 compressor chillers operate at higher baseplate temperature compared to 2 or 4 compressor chillers.

On 4 compressor chillers, the baseplate temperatures on compressors 1 and 3 are OR'd together and the highest of the two temperatures compared in software to a limit of 218°F. The baseplate temperatures on compressors 2 and 4 are OR'd together and the highest of the two temperatures compared in software to a limit of 218°F. If the limit is exceeded by either of the 2 inputs, the unit will fault and shut down with a controlled ramped shutdown.

This is an auto-restart safety that will lock out on the 3rd fault in 90 minutes. The fault will be a system fault for all units. Below are the Status display fault messages for all systems.

SYS X YYYYYYYY HIGH VSD BASEPLATE TEMP

X indicates the system and YYYYYYYY indicates the system is in a "FAULT" condition and will restart when the fault clears or "LOCKOUT" and will not restart until the operator clears the fault using the keypad.

After a fault, the fan(s) and water pump will remain energized until the inverter power module base plate temperature(s) falls below 165°F. The system will be allowed to restart when the inverter power module base plate temperatures drop below this value.

It is possible for an internal sensor to fail and not sense temperature without causing a high baseplate sensor fault.

High VSD Internal Ambient Temperature (Software) Fault

The VSD Logic board contains a temperature sensor, which monitors the unit's internal ambient temperature. If the VSD internal ambient temperature rises above the cutout of 158°F, the unit will fault and shut down with a controlled ramped shutdown.

This safety will not cause a lockout. The fault will be a unit fault for all units. Following is the Status display fault message.

UNIT YYYYYYYY

HIGH VSD INTERNAL AMBIENT TEMP

The unit will be allowed to restart when the internal ambient temperature drops 10°F below the cutout.

YYYYYYYY indicates the unit is in a "Fault" condition and will restart when the condition clears.

Single Phase Input (Hardware) Fault

The VSD's SCR Trigger Control board contains circuitry that checks the three phase mains for the presence of all three-line voltages. If any of the line voltages are not present, the system will immediately shut down on a fault.

This fault will not cause a lockout. The fault will be a unit fault for 2 or 3 compressor units. Below is the Status display fault message.

UNIT YYYYYYYY

SINGLE PHASE INPUT VOLTAGE

The fault will be a system fault 1/3 or 2/4 for 4 compressor units. Two key presses of the STATUS key are required to show the fault on both systems. Below is the fault message for all systems.

SYS X YYYYYYYY SINGLE PHASE INPUT VOLTS

X indicates the system and YYYYYYYY indicates the system is "FAULT" and will restart when the single phase condition clears.

VSD SAFETIES (FAULTS) (CON'T)

POWER SUPPLY (HARDWARE) FAULT

Various DC power supplies which power the VSD Logic Board are monitored via hardware located on the logic board. If any of these power supplies fall outside their allowable limits, the unit will immediately shut down on a fault.

This is an auto-restart safety that will restart after the fault clears and lock out on the 3rd fault in 90 minutes. The fault will be a unit fault for all units. Below is the Status display fault message.

```
UNIT YYYYYYYY
VSD LOGIC BOARD POWER SUPPLY
```

YYYYYYY indicates the system is in a "FAULT" condition and will restart when the fault clears or "LOCK-OUT" and will not restart until the operator clears the fault using the keypad.

Run Relay (Software) Fault

Upon receipt of either of the two types of run commands (hardware and software) a 5 second timer will commence timing. The hardware run signal comes from the SYS X VSD Run Signal to the VSD Logic Board. The software run signal comes through the comms from the Chiller Control Board. If the missing run signal is not asserted within the 5-second window, the system will fault. In addition, if either run signal is disabled while the VSD is running, the remaining run signal must be disabled within 5 seconds after the VSD is shut down or the system will fault. If running, the unit will fault and shut down with a controlled ramped shutdown.

Control Panel Info: This is an auto-restart safety that will autostart after the 120 second anti-recycle timer times out and will lock out on the 3rd fault in 90 minutes. The fault will be a system fault for 2 compressor units. On 3 and 4 compressor units, the fault is combined as a 1/3 or 2/4 system fault. Below are the fault messages for all systems.

```
SYS X YYYYYYYY VSD RUN RELAY
```

X indicates the system and YYYYYYYY indicates the system is in a "FAULT" condition and will restart when the fault clears or "LOCKOUT" and will not restart until the operator clears the fault using the keypad.

VSD Logic Board Failure (Software) Fault

Upon receipt of the voltage and frequency commands, the PWM generator will acknowledge receipt of the command. If the system microprocessor does not receive the handshake within 1.5 seconds of issuing the command, the unit will trip. This safety is only active during precharge and during running of a compressor. It is not active when all the compressors are shut down and the precharge is disabled. If the VSD Logic Board Fault occurs while the chiller is running, all systems will immediately shut down on a fault. On 4 compressor chillers, with two VSD Logic Boards, only the systems connected to the respective VSD Logic Board will the fault will be shut down.

This is an auto-restart safety that will auto restart after the 120 second anti-recycle timer times out and lock out on the 3rd fault in 90 minutes. The fault is a unit fault for all units. Following is the fault message.

```
UNIT YYYYYYYY
VSD LOGIC BOARD FAILURE
```

VSD CT Plug (Hardware) Fault

Jumpers are installed in each CT plug on the VSD Logic Board to feed back signals to indicate if the plugs are installed or not. If either plug is not installed, a low value is read on the digital input and the unit will immediate shutdown on a fault or will not run if off.

This is an auto-restart safety that will restart after the 120 second anti-recycle timer times out and lock out on the 3rd fault in 90 minutes. The fault is a unit fault for all units. Following is the fault message.

```
UNIT YYYYYYYY
VSD CT PLUG FAULT
```

YYYYYYY indicates the system is in a "FAULT" condition and will restart or "LOCKOUT" and will not restart until the operator clears the fault using the keypad.

VSD SAFETIES (FAULTS) (CON'T)

VSD Fault Data

When a fault has occurred, the VSD Logic Board will capture fault data. This data will be stored in the on-board battery backed RAM for safekeeping and transferred to the panel via the communications link as soon as possible.

A fault code will be set for the fault that initiated the system shutdown. This fault will appear as a specific fault in the Status message.

Any faults that occur after the initial fault, which occur within the comms transmission time frame following the inception of the first fault, will be stored and transmitted to the Micro Logic Board together with the first fault data. These faults will appear in the "All Fault" display in the History.

A snapshot of the operating parameters of the VSD is continuously updated in battery-backed memory once every program loop. Upon receipt of a first fault, the snapshot of the operating parameters will be stored in memory and are transmitted to the panel as the fault data.

Fault Relay/Fault Acknowledge Bit

Control of the Fault Relay is from the VSD Logic Board. The Fault Relay on the VSD will be closed during a non-fault condition.

When a running or pre-charge fault occurs on the VSD, the fault relay will immediately open. The relay will not open for non-running faults that occur.

When the Chiller Control Board sees the VSD fault relay open, it will immediately take a snapshot of system data and save it to the history buffer.

A fault acknowledge bit from the Chiller Control Board is sent to the VSD via comms after receiving valid fault data from the VSD. When the VSD Logic Board receives the fault acknowledge via comms from the panel it will reset (close) the Fault Relay. The fault acknowledge is reset by the Chiller Control Board after the Fault Relay is closed by the VSD Logic Board.

VSD Fault Compressor Start Inhibit

If a VSD fault condition exists while the compressor is not running or pre-charging, the Chiller Control Board will not try to start the faulted compressor(s). The start inhibit will be automatically cleared when the fault condition goes away.

This Page Intentionally Left Blank

UNIT WARNINGS

Unit Warning Operation

Unit warnings are caused when a condition is present requiring operator intervention to restart the unit. All setpoints, program values, and options should be checked before operating the unit. Warnings are not logged to the history buffer. If a unit warning is in effect, the message will be displayed to the operator when the Status key is pressed.

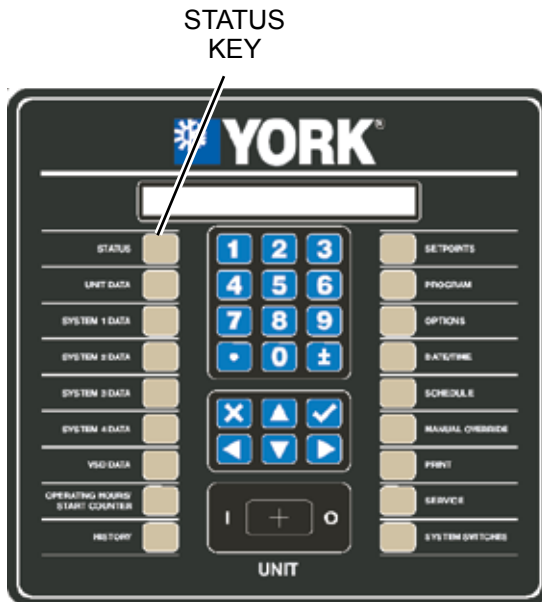

LD10605

Low Battery Warning

The LOW BATTERY WARNING can only occur at unit power-up. On micropanel power-up, the RTC battery is checked to see if it is still operational. If it is, normal unit operation is allowed. If the battery voltage is determined to be low, the following warning message is displayed indefinitely.

UNIT WARNING: !! LOW BATTERY !!
CHECK SETPOINTS/PROGRAM/OPTIONS/TIME

If a low battery condition exists, all programmed setpoints, program values, time, schedule, and history buffers will have been lost. These values will all be reset to their default values, which may not be the desired operating values. Once a bad battery is detected, the unit will be prevented from running until the MANUAL OVERRIDE key is pressed. Once the MANUAL OVERRIDE key is pressed, the anti recycle timers will be set to the programmed default anti recycle time to allow the operator sufficient time to check setpoints, program values, etc.

If a low battery is detected, it should be replaced as soon as possible. The programmed values will all be lost and the unit will be prevented from running on the next power interruption. The RTC/Battery is located on the Chiller Logic Board on *page 213*.

MICROBOARD (331-03478-XXX)

The 331-03478-xxx microboard was developed as a direct replacement for the 031-02478-xxx line of microboards. No adapter harness is required when replacing a 02478 with the new 03478. The 03478 uses the IPUII processor card and provides some new features for the chillers that the 02478 did not have. The 03478 program resides in flash memory instead of EPROM. Program updates are accomplished by loading the new program from an SD card inserted into the SD card reader/writer. This same SD card reader/writer also allows the user to datalog the operating parameters to an SD card every 5 seconds. This information is invaluable when troubleshooting unit and system problems since it allows the service technician to view operating parameters prior to a unit fault. Details on the new datalogging capability are explained in the OPTIONS Key area of this manual. A Real Time Clock/BRAM keeps time and setpoints during power outages.

POWER SUPPLIES AND LEDS

The 03478 has LEDs to indicate various states of operation of the microboard.

STATUS – Flashes every ½ second to indicate that the base board processor is running its program.

POWER – On solid indicates that the base board +12V and +5V power supplies are operational.

TX1 – Red LED flashes when transmitting data out Port 1 TB3 (Future native communications BAS port)

RX1 – Green LED flashes when receiving data in Port 1 TB3 (Future native communications BAS port)

TX2 – Red LED that flashes when transmitting data out Port 2 (E-Link TB2 or printer TB1)

RX2 – Green LED that flashes when receiving data in Port 2 (E-Link TB2 or printer TB1)

VSD_TX – Red LED that flashes when transmitting data out Port 3 to the VSD Logic board

VSD_RX – Green LED that flashes when receiving data in Port 3 from the VSD Logic board

24VAC power is applied to the 331-03478-xxx microboard connector J12 and is then used to create the various DC power sources required by the microboard circuitry.

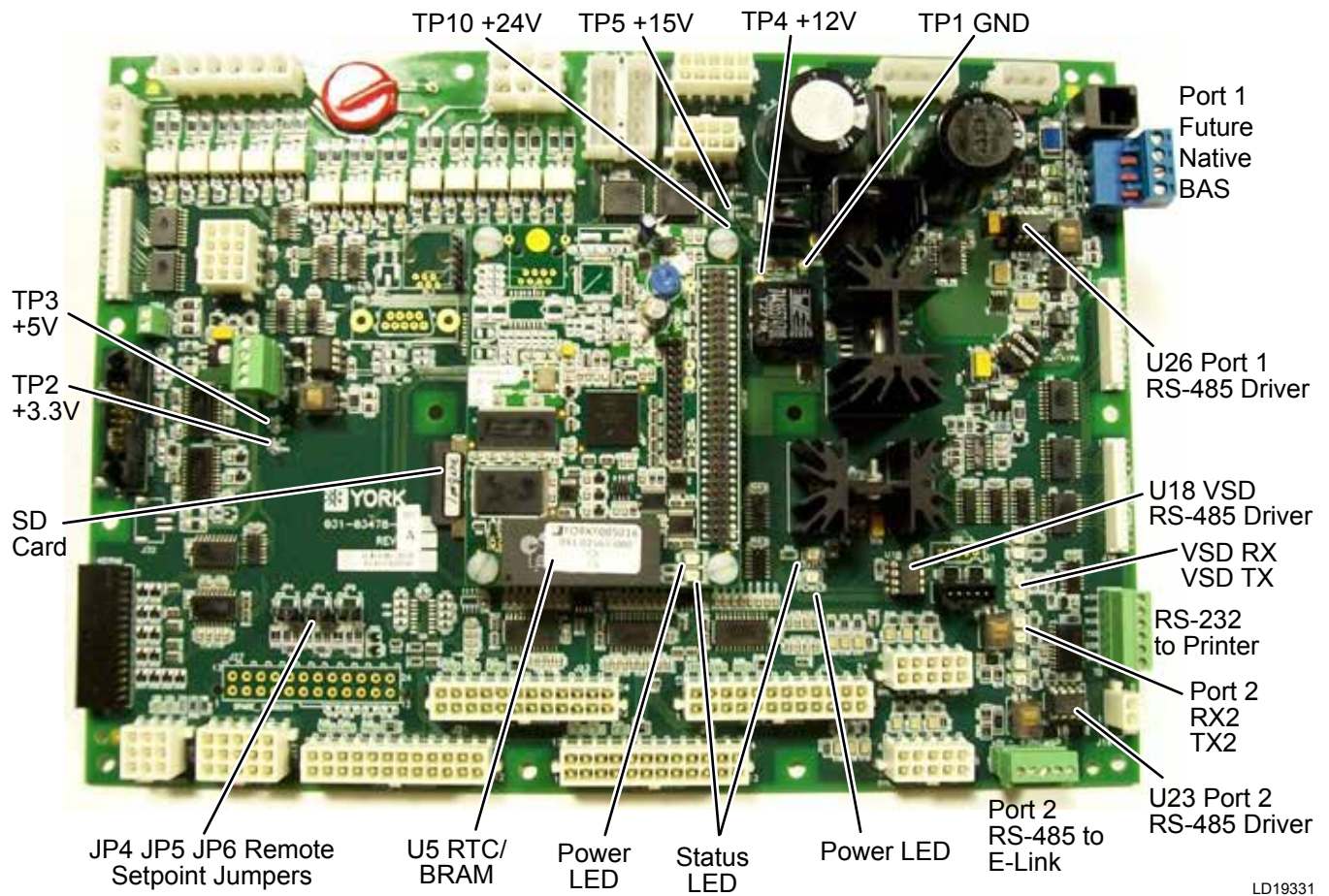

NEW 331-03478-XXX MICROBOARD

If the chiller control is malfunctioning, the power supply test points should be measured to determine the status of the microboard.

POWER SUPPLY TEST POINTS

TP1 GND (Measure TP2, TP3, TP4 and TP5 in reference to this Test Point)

TP2 +3.3V [3.2 to 3.4VDC] provides power to the processors

TP3 +5V [4.8 to 5.2VDC] power communication ports 2,3 and 4 and analog sensors

TP4 +12V [11.64 to 12.36VDC] powers the display and backlight and is regulated to become the +5V

TP5 +15V [11.3 to 16.6VDC] powers the analog outputs to the EEV valves

CONFIGURATION JUMPERS

The same configuration jumpers that existed on the 02478 are provided on the 03478.

JP4 Remote Temp Reset jumper position Pins 1 to 2 (left) = 4-20 mA, Pins 2 to 3 (right) = 0-10 VDC

JP5 Remote Current Limit jumper position Pins 1 to 2 (left) = 4-20 mA, Pins 2 to 3 (right) = 0-10 VDC

JP6 Remote Sound Limit jumper position (Pins 1 to 2 (left) = 4-20 mA, Pins 2 to 3 (right) = 0-10 VDC

COMMUNICATION PORTS

TB3 Port 1 Native BAS RS-485.

SW1 RS-485 Biasing Switch for Port. Set to ON if Chiller is in an End Of Line position on the network.

U26 is the Port 1 RS-485 Driver Chip. It is socketed to allow field replacement. RX1 and TX1 LEDs illuminate to indicate Port 1 communications activity.

E-LINK

SW2 RS-485 Biasing Switch for E-link Port 2, should be in the OFF position.

TB2 is the Port 2 RS-485 E-Link Communications Port. RX2 and TX2 LEDs illuminate to indicate the Port 2 communications activity. U23 is the Port 2 RS-485 Driver Chip. It is socketed to allow field replacement. J16 provides +12VDC to power the E-Link.

VSD

J2 VSD#1 and J1 VSD#2 connections headers for RS-485 communications to the Variable Speed Drive(s).

VSD RX and VSD TX LEDs illuminate to indicate the VSD communications activity. U18 is the VSD Port RS-485 Driver Chip. It is socketed to allow field replacement.

PROGRAM UPDATE

The Application software and BACnet database are stored in the IPU II Flash memory. Copying a new version of software and/or database from the SD Flash card changes the IPU II Flash. The new application software must be named SOFTWARE.BIN. The new BACnet database must be named DATABASE.BIN. These files must be located in the root directory of the SD Flash card. The software can be updated without updating the database. In this case, the existing database will be used with the new software. The database cannot be updated without updating the software.

To update the Program:

1. Copy the new software in to the root directory of the SD card.
2. Rename this new program file SOFTWARE.BIN.
3. Turn the Unit Switch OFF.
4. Insert the SD card in to the SD card Reader/Writer slot.
5. Press the OPTIONS Key and then press the Down Arrow Key until FLASH CARD UPDATE DISABLED is displayed.
6. Press the RIGHT ARROW Key to change the DISABLED to ENABLED
7. Press the ENTER Key to start the update. Once the ENTER Key is pressed the message FLASH CARD UPDATING PLEASE WAIT... is displayed until the update has been completed. The keypad and display will not respond during the flash update.



Do not reset or power down the chiller until the update is finished. Interrupting the Flash Update procedure can corrupt the program file and render the control board inoperative.

8. After the software is finished updating, the controller will automatically reboot.
9. If an error occurs during the update, an error message will be displayed where XXXX is the Error Code

FLASH CARD UPDATE ERROR XXXXX

FLASH CARD UPDATE ERROR CODE	DEFINITION
0	Okay
10	Flash card not found.
11	SOFTWARE.BIN file not found
14	SOFTWARE.BIN file larger than expected.
15	RAM to IPU Flash transfer of DATABASE.BIN failed.
16	RAM to IPU Flash transfer of SOFTWARE.BIN failed.
17	Could not allocate sufficient memory to read or write file.
99	Internal software error.

10. After the update is completed and the controller reboots, the keypad and display will return to full functionality. The SD card may be left in place for datalogging or else replaced with another SD card dedicated for datalogging.
11. To remove the SD card, GENTLY press the card in slightly then release the pressure. The card should then pop out slightly to allow removal.

DATA LOGGING

A 2GB SD card (p/n 031-03466-000) may be inserted into the 03478 IPU II SD card slot to record the chiller operating parameters at 5 second intervals. The data is stored in a folder named RMYYYMM where YYYY is the year and MM is the month the data was recorded. The controller creates a file for each day within this folder with the format YYYYMMDD.csv where DD equals the day of the month in addition to the Y Year and M Month fields. For example: The folder named RM201503 is a folder created in March of 2015. Within this folder would be a file for each day of that month that the datalogging is running. If a review of the History Report shows that an abnormal event occurred on March 3rd at 2:05pm, the user can import the 20150303.csv file into Excel and look at the system parameter details leading up to the 2:05pm event.



Follow all JCI Safety Directives when inserting or removing the SD card since the card is located inside the control cabinet.

To start the Data Logging, insert the SD card into the SD card slot on the 03478 IPU II board. The label on the SD card should be facing outwards.

Once the SD card is inserted and the unit is powered up, press the OPTIONS key. Then press the Down Arrow key to advance to the DATA LOG TO FLASHCARD selection. Next press the Right Arrow key to select ON

DATA LOGGING

HOUR	MIN	SEC	SYS 1 SUCT PRESS	SYS 1 DSCH PRESS	SYS 1 OIL PRESS	SYS 1 SUCT TEMP	SYS 1 SAT SUCT TEMP	SYS 1 SUCT SHEAT	SYS 1 MTR CURR FLA	SYS 1 DSCH TEMP	SYS 1 SAT DSCH TEMP	SYS 1 DSCH SHEAT	SYS 1 OIL TEMP	SYS 1 COMP STATUS	SYS 1 ECON	SYS 1 FAN STAGE	SYS 1 MOTOR TEMP1
			PSIG	PSIG	PSIG	<?>F	<?>F	<?>F	AMPS	<?>F	<?>F	<?>F	<?>F				
0	0	10	82.6	84.4	84.4	93	77.5	15.5	0	83	78.6	4.4	82	OFF	OFF	0	107.9
11	0	15	82.6	84.4	84.4	93	77.5	15.5	0	83	78.6	4.4	82	OFF	OFF	0	107.9
11	22	20	82.6	84.4	84.4	93	77.5	15.5	0	83	78.6	4.4	82	OFF	OFF	0	107.9
11	22	25	82.6	84.4	84.4	93	77.5	15.5	0	83	78.6	4.4	82	OFF	OFF	0	107.9
11	22	30	82.6	84.4	84.4	93	77.5	15.5	0	83	78.6	4.4	82	OFF	OFF	0	107.9
11	22	35	82.5	84.4	84.4	93	77.4	15.6	0	83	78.6	4.4	82	OFF	OFF	0	107.9

then press the ENTER key to start the Data Log. A 2GB SD card will hold about 8 months worth of data. A smaller card may be used that will hold less data but should be tested for compatibility. The controller operating system does not support SD cards larger than 2GB. When the SD card becomes full, the oldest date file is automatically deleted and a new day log file is written in its place. To stop the data logging and retrieve the SD card, press the OPTION key and then the Down Arrow key to display the DATA LOG TO FLASHCARD option and then use the Right Arrow key to select OFF then press the ENTER key. Again, follow the JCI Safety Directives to stop the chiller, power off the unit and open the control cabiner door to retrieve the SD card. Once inside the control cabinet, lightly press in on the SD card and then release the pressure. The SD card should pop out slightly to allow removal. You may then copy the files to a PC for analysis or email the file to someone. The files are saved as a CSV format which can be read by Excel. Below is a sample of some of the data imported from a YCIV Chiller. Once the file is read in to Excel, you can hide unrelated columns or plot desired parameters to analyze the data.

Invalid Number of Compressors Warning

The INVALID NUMBER OF COMPRESSORS SELECTED Warning will occur after the VSD has been initialized, if no "Number of Compressors Select" jumpers are installed or if more than 1 jumper is installed. The following warning message will be displayed indefinitely.

**UNIT WARNING:
INVALID NUMBER OF COMPRESSORS SELECTED**

To clear this warning, both the control panel and VSD control voltage must be turned off and the jumpers properly installed in the VSD wiring harness. See Page 168 for more details on jumper installation.

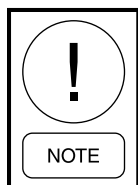

These jumpers are factory installed in the wire harness plug and should not require changes.

Invalid Serial Number Warning

If the INVALID SERIAL NUMBER message appears, immediately contact YORK Product Technical Support. The appearance of this message may mean the chiller has lost important factory programmed information. The serial number can be entered using the Service Key.

**UNIT WARNING: INVALID SERIAL NUMBER
ENTER UNIT SERIAL NUMBER**

Additionally, when this appears, an Optimized IPLV chiller will only run in Standard IPLV control mode. Optimized IPLV cannot be enabled unless the serial number is programmed into the unit using the special password supplied by YORK Product Technical Support. Once the password is entered, a second password will be needed to activate the optimized IPLV control (see Page 269).

This status message can be bypassed to view additional messages under the STATUS key by pressing the STATUS key repeatedly to scroll through as many as three STATUS messages that could possibly be displayed at any time.

Optimized Efficiency Disabled

If the OPTIMIZED EFFICIENCY DISABLED message appears, immediately contact YORK Product Technical Support or YORK ES Commercial. The appearance of this message means an optimized chiller is programmed for standard control.

**UNIT WARNING: OPTIMIZED EFFICIENCY
DISABLED - CONTACT YORK REPRESENTATIVE**

Optimized IPLV cannot be enabled unless a special password is entered. Once the password is entered and the option is enabled using the Service Key, the message will disappear (see Page 262).

This status message can be bypassed to view additional messages under the STATUS key by pressing the STATUS key repeatedly to scroll through as many as three STATUS messages that could possibly be displayed at any time.

UNIT SAFETIES

Unit Safety Operation

Unit faults are safeties that cause all running compressors to be shut down, if a safety threshold is exceeded for 3 seconds. Unit faults are recorded in the history buffer along with all data on the unit and system operating conditions. Unit faults are auto reset faults where the unit will be allowed to restart automatically after the fault condition is no longer present. The only exception is any of the VSD related unit faults. If any 3 VSD unit faults occur within 90 minutes, the unit will be locked out on the last fault. A VSD lockout condition requires a manual reset using the system switches. Both system switches must be cycled off and on to clear a VSD unit lockout fault. If a unit safety is in effect, the message will be displayed to the operator when the Status key is pressed.

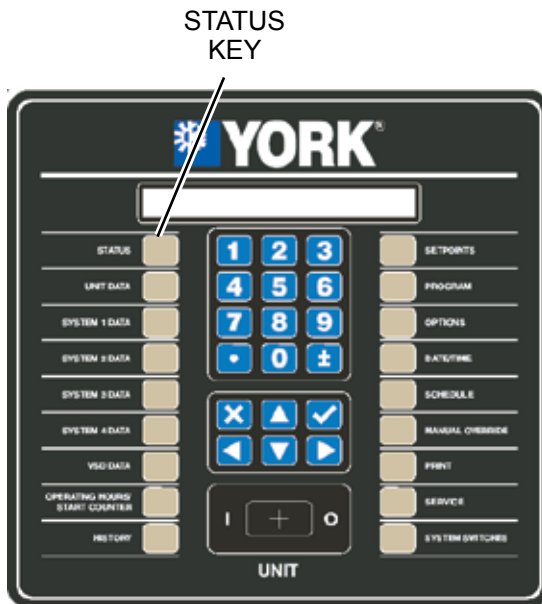

LD10605

In the descriptions of the fault displays that follow, the fault message will show a YYYYYYYY to indicate that a system is in a “FAULT” condition and will restart when the fault clears or “LOCKOUT” and will not restart until the operator clears the fault using the keypad.

If a control panel safety occurs after the VSD fault, but before the fault is reset, the control panel fault is an ALL FAULT of the VSD fault, meaning it will be registered as such in the History because it occurred while the VSD was shutting down or while the systems were shut down. All faults do not store operating data at the time of the fault.

If a “VSD” fault occurs during the fault rampdown or while the systems are shut down, the VSD fault will be registered as a new fault. The reason for this is the belief any VSD fault should be registered with a full account of the systems data at the time of the fault.

High Ambient Temp Fault

If the ambient temperature rises above 130 F, the chiller will shut down with a controlled ramped shutdown. Restart will automatically occur, if demand allows, when temperature falls 2°F below the cutout (128°F). This fault cannot cause a lockout. The fault display message will be present only during the time when the ambient temperature is causing a fault condition. A sample display is shown below:

UNIT YYYYYYYY
HIGH AMBIENT TEMP

The unit will also be inhibited from starting any time the temperature is above 128°F.

Low Ambient Temp Fault

If the ambient temperature falls below the programmable Low Ambient Temp Cutout the chiller will shut down with a controlled ramped shutdown. This fault will only occur if the Low Ambient Cutout is “ENABLED” under the OPTIONS key. Restart can occur, if demand allows, when temperature rises 2°F above the cutout. This fault cannot cause a lockout. The fault display message will be present only during the time when the ambient temperature is causing a fault condition. A sample display is shown below:

UNIT YYYYYYYY
LOW AMBIENT TEMP

The unit is also inhibited from starting any time the temperature is below the cutout + 2°F.

UNIT SAFETIES (CON'T)

Low Leaving Chilled Liquid Temp Fault

The Low Leaving Chilled Liquid Temp Cutout helps to protect the chiller from an evaporator freeze-up should the chilled liquid temp drop below the freeze point. This situation could occur under low flow conditions or if the micro panel setpoint values are improperly programmed. Any time the leaving chilled liquid temperature (water or brine) drops below the programmable cutout point, the chiller will fault and shutdown with a controlled ramped shutdown. Restart can occur, if demand allows, when chilled liquid temperature rises 4°F above the cutout. This fault cannot cause a lockout. A sample shutdown message is shown below:

```
UNIT YYYYYYYY
LOW LEAVING CHILLED LIQUID TEMP
```

The unit is inhibited from starting any time the chilled liquid temperature is below the cutout + 4°F.

VSD Communications Failure Fault

The VSD Communications Failure is to prevent the unit from trying to run, if the Chiller Control Board never initializes communications with the VSD Logic Board. The unit will also shut down with a controlled ramped shutdown if the Chiller Control Board loses communications with the VSD Logic Board while the chiller is operating.

On power-up, the Chiller Microprocessor Board will attempt to initialize communications with the VSD Logic Board. The control panel will request data from the VSD, which includes the number of compressors and the VSD software version. Once these data points have been received by the Chiller Control Board, and has been successfully initialized, the Chiller Control Board will not request them again. If the comms connection fails to occur, the Chiller Control Board will prevent the chiller from operating and a fault message will be displayed.

During normal operation, if the control panel Chiller Control Board receives no valid response to messages for 8 seconds, the unit will shut down all compressors on a Comms fault. The Chiller Control Board will continue to send messages to the VSD while faulted. The unit will be inhibited from starting until communications is established. The fault will automatically reset when the

Chiller Control Board receives a valid response from the VSD for a data request. Shown below is an example of a Comms Failure fault message:

```
UNIT YYYYYYYY
VSD COMMUNICATIONS FAILURE
```

SYSTEM SAFETIES (FAULTS)

System Safety (Fault) Operation

System safeties are faults that cause individual systems to be shut down if a safety threshold is exceeded for 3 seconds. System faults are auto reset faults in that the system will be allowed to restart automatically after the 120 second anti-recycle timer times out. The only exception is after any 3 faults on the same system occur within 90 minutes, that system will be “locked out” on the last fault. The lockout condition requires a manual reset using the system switch. The respective system switch must be cycled off and on to clear the lockout fault. See TABLE 17 for the programmable limits for many of the cutouts.

When multiple systems are operating and a system fault occurs, the running systems will ramp down and the faulted system will be shut off and the previously operating will restart if required after the fault clears and/or the 120 second anti-recycle timer times out.

In the descriptions of the fault displays that follow, the fault message will show a YYYYYYYY to indicate that a system is in a “FAULT” condition and will restart when the fault clears, or “LOCKOUT” and will not restart until the operator clears the fault using the keypad. If a system safety is in effect, the message will be displayed to the operator when the Status Key is pressed.

In some cases, a control panel fault will occur after a VSD fault, possibly during system shutdown or at some later time. This is known as an “ALL FAULT” and these faults will be recorded as such under the HISTORY information stored at the instant of the primary fault. In some cases, this information may be valuable in troubleshooting the primary fault. An example of the “ALL FAULT” history message is shown on Page 236 under the HISTORY Key. When an “ALL FAULT” occurs, associated history information will not be stored. If an additional fault does not occur, the “ALL FAULTS” display will indicate NONE. In cases where a VSD fault occurs during the rampdown of a control panel fault (ie: low suction pressure, low water temp, etc.), the VSD fault will be stored as a new fault with the associated fault information stored at the instant the VSD fault occurred (ie: IGBT Gate Drive, Single Phase Input, VSD CT Plug, etc.). The control panel fault that occurred prior to the VSD fault will be stored with the associated complete data related to the fault as a numerically lower numbered history in the history buffers.

High Discharge Pressure Cutout (Software) Fault

The High Discharge Pressure Cutout is a software fault. A system will fault and shut down with a controlled ramped shutdown on high discharge pressure when the discharge pressure rises above 274 PSIG for 0.5 seconds. The system will be allowed to restart when the discharge pressure falls to 259 PSIG. The system will also be inhibited from starting if the pressure is above 259 PSIG. The fault message for this safety is shown below:

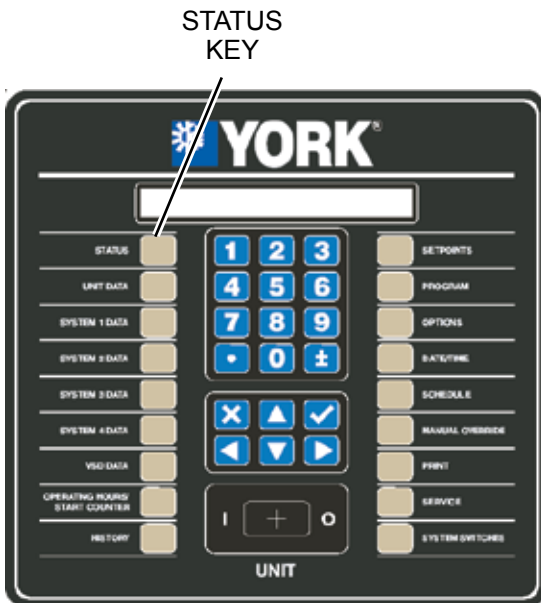

SYS X YYYYYYYY HIGH DISCHARGE PRESSURE

X indicates the system and YYYYYYYY indicates the system is in a “FAULT” condition and will restart when the 120 second anti-recycle timer times out, or “LOCKOUT” and will not restart until the operator clears the fault using the keypad.

LD10605

SYSTEM SAFETIES (FAULTS)(CON'T)

High Discharge Pressure Cutout (HPCO)(Hardware) Fault

The mechanical High Pressure Cutout protects the system from experiencing dangerously high discharge pressure. A system will fault and shut down immediately when the mechanical high pressure cutout contacts open. The fault will occur immediately and not wait 3 seconds, which is typical of most system faults. The HPCO is wired in series with the VSD Run Signal and will only be checked by the Chiller Control Board when the system is running. The mechanical cutout opens at 297+/-8 PSIG and closes at 230 +/-10 PSIG. The Status display fault message for this system is shown below:

SYS X YYYYYYYY HPCO FAULT

X indicates the system and YYYYYYYY indicates the system is in a “FAULT” condition and will restart when the 120 second anti-recycle timer times out or “LOCK-OUT” and will not restart until the operator clears the fault using the keypad.

Low Suction Pressure Cutout (Software) Fault

The programmable Low Suction Pressure Cutout is a secondary back-up for the flow switch and protects against operation with low refrigerant charge, which helps protect the chiller from an evaporator freeze-up, should the system attempt to run with a low refrigerant charge. The Status display fault message for this cut-out is shown below:

SYS X YYYYYYYY LOW SUCTION PRESSURE

X indicates the system and YYYYYYYY indicates the system is in a “FAULT” condition and will restart when the the 120 second anti-recycle timer times out or “LOCKOUT” and will not restart until the operator clears the fault using the keypad. Typically, the cutout will be set at 24 PSIG for chilled water applications.

The cutout is ignored for the first 30 seconds of system run time. During the next 3 minutes of run time the cutout point is linearly ramped from 10% of the cutout value up to the programmed cutout point. If at any time during the first 3 minutes of operation the suction pres-

sure falls below the ramped cutout point, the system will shut down with a controlled ramped shutdown.

The cutout pressure during operating periods of 30 seconds to 210 seconds is ramped and can be calculated by:

$$\text{Cutout} = \frac{(\text{Programmed Cutout} \times \text{Run Time})}{200} - 1.2 \text{ PSIG}$$

After the first 3 minutes and 30 seconds of run time, if the suction pressure falls below the cutout as a result of a transient in the system, a transient timer is set at 30 seconds and a linearly ramped cutout is set starting at 10% of the programmed cutout. If over the next 30 seconds, the suction pressure does not stay above the ramped cutout, which ramps between 10% of the cutout and the programmed cutout over the 30 second period, the system will fault on low suction pressure.

Low Motor Current Cutout Fault

The Motor Current Cutout shuts the system down with a controlled ramped shutdown when the microprocessor detects the absence of motor current (<10%FLA), usually indicating that a compressor is not running. This safety is ignored for the first 10 seconds of operation.

The status display fault message for this safety is shown below:

SYS X YYYYYYYY LOW MOTOR CURRENT

X indicates the system and YYYYYYYY indicates the system is in a “FAULT” condition and will restart when the 120 second anti-recycle timer times out or “LOCK-OUT” and will not restart until the operator clears the fault using the keypad.

SYSTEM SAFETIES (FAULTS)

High Differential Oil Pressure Cutout Fault

The High Differential Oil Pressure Cutout protects the compressor from low oil flow and insufficient lubrication, possibly from a dirty oil filter. A system will fault and shut down with a controlled ramped shutdown when its Discharge to Oil Differential Pressure rises above the cutout of 65 PSID. This safety is ignored for the first 90 seconds of run time. This safety measures the pressure differential between discharge and oil pressure, which is the pressure drop across the oil filter. The Status display fault message for this safety is shown below:

SYS X YYYYYYYY HIGH DIFF OIL PRESSURE

X indicates the system and YYYYYYYY indicates the system is in a "FAULT" condition and will restart when the 120 second anti-recycle timer times out or "LOCK-OUT" and will not restart until the operator clears the fault using the keypad.

Low Differential Oil Pressure Cutout Fault

The Low Differential Oil Pressure Cutout protects the compressor from low oil flow and insufficient lubrication. A system will fault and shut down with a controlled ramped shutdown when it's differential between oil and suction pressure falls below the cutout. This safety assures that the compressor is pumping sufficiently to push oil through the oil cooling circuit and through the internal compressor lubrication system. The Status display fault message for this safety is shown below:

SYS X YYYYYYYY LOW DIFF OIL PRESSURE

X indicates the system and YYYYYYYY indicates the system is in a "FAULT" condition and will restart when the 120 second anti-recycle timer times out or "LOCK-OUT" and will not restart until the operator clears the fault using the keypad.

The safety is ignored for the first 60 seconds of run time. After the first 60 seconds of operation, the cutout is linearly ramped from 0 PSID to 30 PSID in 5 to 10 minutes based on ambient temperature. See TABLE 13 for the ramp times for the given ambient temperatures.

TABLE 13 - LOW DIFFERENTIAL OIL PRESSURE CUTOUT

AMBIENT TEMPERATURE	RAMP TIME
> 50°F	5 Minutes
> 45°F	6 Minutes
> 40°F	7 Minutes
> 35°F	8 Minutes
> 30°F	9 Minutes
>=30°F	10 Minutes

A 30 second safety bypass below 50 Hertz is employed during rampdown. The bypass is primarily needed under conditions where another compressor is being brought on and the running compressor is being ramped down to 5 Hertz to add the additional compressor due to load requirements. Under these conditions, the slow speed of the running compressor(s) causes the oil differential to become very low, especially if the water temperature is high and the suction pressure is high. The bypass assures the compressor(s) will not trip on a nuisance low oil differential fault.

High Discharge Temperature Cutout Fault

The High Discharge Temperature Cutout protects the motor and compressor from overheating. A system will fault and shut down with a controlled ramped shutdown when its Discharge Temperature rises above 250°F. A system will also be inhibited from starting if the discharge temperature is above 200°F. The Status display fault message for this safety is shown below:

SYS X YYYYYYYY HIGH DSCHARGE TEMP

X indicates the system and YYYYYYYY indicates the system is in a "FAULT" condition and will restart when the 120 second anti-recycle timer times out or "LOCK-OUT" and will not restart until the operator clears the fault using the keypad.

SYSTEM SAFETIES (FAULTS) (CON'T)

High Oil Temperature Cutout Fault

The High Oil Temperature Cutout protects the compressor from insufficient lubrication. A system will fault and shut down with a controlled ramped shutdown when its oil temperature rises above 225°F. The system will be inhibited from starting if the oil temperature is above 175°F. The Status display fault message for this safety is shown below:

SYS X YYYYYYYY HIGH OIL TEMP

X indicates the system and YYYYYYYY indicates the system is in a “FAULT” condition and will restart when the fault clears or “LOCKOUT” and will not restart until the operator clears the fault using the keypad.

Low Suction Superheat Cutout Fault

The Low Suction Superheat Cutout helps protect the compressor from liquid floodback due to low suction superheat. This safety is ignored for the first 30 seconds of compressor operation. Low suction superheat will fault a system when any one of the following conditions occur:

- After the first 30 seconds of run time, if the suction superheat falls below 2.0°F, the discharge superheat is < 15°F, and the run time is < 5 minutes, the superheat safety will be ignored for the next 30 seconds followed by setting the superheat cutout to 0°F and linearly ramping it up to 2.0°F over the next 60 seconds. If at any time during these 60 seconds the suction superheat falls below the ramped cutout, the system will fault and shut down with a controlled ramped shutdown.
- If the suction superheat < 2°F, the discharge superheat < 15°F for 10 seconds, and the run time is = or > 5 minutes, the system will fault and shutdown with a controlled ramped shutdown.
- If the suction superheat < 0.5°F and discharge superheat is > 15°F for 60 seconds and run time = or > 5 minutes, the system will fault and shutdown with a controlled ramped shutdown.
- If suction superheat < 5°F for 10 minutes, the system will fault and shutdown with a controlled ramped shutdown.

The Status display fault message for this safety is shown below:

SYS X YYYYYYYY LOW SUCTION SUPERHEAT

X indicates the system and YYYYYYYY indicates the system is “FAULT” and will restart after the 120 second anti-recycle timer times out or “LOCKOUT” and will not restart until the operator clears the fault.

Low Discharge Superheat Cutout Fault

The Low Discharge Superheat Cutout helps protect the compressor primarily from liquid floodback through the economizer line due to a high flash tank level. It also provides protection from liquid floodback through the suction line in conjunction with the low superheat safety. This safety is ignored for the first 5 minutes of compressor operation.

After the first 5 minutes of run time, if the discharge superheat falls below 10.0°F for 5 minutes, the system will fault and shut down with a controlled ramped shutdown.

The Status display fault message for this safety is shown below:

SYS X YYYYYYYY LOW DISCHARGE SUPERHEAT

X indicates the system and YYYYYYYY indicates the system is in a “FAULT” condition and will restart when the 120 second anti-recycle timer times out or “LOCKOUT” and will not restart until the operator clears the fault using the keypad.

SYSTEM SAFETIES (FAULTS)

Sensor Failure Cutout Fault

The Sensor Failure Cutout prevents the system from running when a critical sensor (transducer, level sensor, or motor winding temp sensor) is not functioning properly and reading out of range. This safety is checked at start-up and will prevent the system from running if one of the sensors has failed.

The sensor failure safety will also fault and shutdown a system while in operation, if a safety threshold is exceeded or a sensor reads out of range (high or low). Following is the Status display fault message.

**SYS X YYYYYYYY SENSOR FAILURE:
ZZZZZZZZZZ**

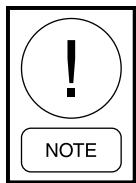

X indicates the specific system. YYYYYYYY will either indicate the system is in a “FAULT” condition and will restart when the fault clears, or “LOCKOUT” after 3 faults and will not restart until the operator clears the fault using the keypad.

ZZZZZZZZZZ indicates the failed sensor below:

- SUCT PRESS
- OIL PRESS
- DSCH PRESS
- LEVEL SENSOR
- MOTOR TEMP X *

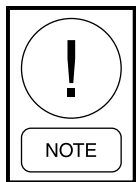

**The Unit Setup Mode allows a specific motor temperature sensor to be ignored, if it fails.*

The start inhibit thresholds for each sensor are shown in TABLE 14:

TABLE 14 - START INHIBIT SENSOR THRESHOLDS

SENSOR	LOW THRESHOLD	HIGH THRESHOLD
SUCTION TRANSDUCER	0.3VDC	4.7VDC
OIL TRANSDUCER	0.3VDC	4.7VDC
DISCHARGE TRANSDUCER	0.3VDC	4.7VDC
LEVEL SENSOR	3.0ma	21.0ma
MOTOR TEMP. SENSOR	0°F	240°F

High Motor Temperature Cutout Fault

The High Motor Temperature Cutout prevents a compressor from running when its motor temperature is too high. A system will fault and shut down when any compressor motor temperature sensor rises above 250°F. The system will be inhibited from starting if its motor temperatures sensors indicate temperatures above 240°F. If any single temperature sensor is being ignored under the Unit Set-up Mode, that sensor will not be utilized when evaluating motor temperature.

Below is a sample Status display fault message:

SYS X YYYYYYYY HIGH MOTOR TEMP

X indicates the system and YYYYYYYY indicates the system is in a “FAULT” condition and will restart when the fault clears or “LOCKOUT” and will not restart until the operator clears the fault using the keypad.

SYSTEM SAFETIES (FAULTS) (CON'T)

High Flash Tank Level Cutout Fault

The Flash tank level Cutout prevents the system from running when the liquid level in the flash tank is too high. The safety will be ignored for the first 15 seconds of system operation.

A fault will occur if the tank level is greater than 85% for 10 seconds.

Below is a sample Status fault display fault message:

SYS X YYYYYYYY HIGH FLASH TANK LEVEL

X indicates the system and YYYYYYYY indicates the system is in a “FAULT” condition and will restart when the 120 second anti-recycle timer times out or “LOCK-OUT” and will not restart until the operator clears the fault using the keypad.

System Control Voltage Cutout Fault

The System Control Voltage Cutout alerts the operator the 115VAC Control voltage to one of the systems is missing. This could be due to a system fuse that has been removed or is blown. The affected system will fault and shut down immediately when the 115VAC supply is lost.

The safety will “not” shut down a system if the Unit Switch is OFF, which electrically removes the 115VAC to “all” systems. The safety is only used to indicate a situation where a single system is missing the 115VAC. The safety will not cause a lockout and the system fault will reset when power is returned. A sample message is shown below:

SYS X YYYYYYYY CONTROL VOLTAGE

X indicates the system and YYYYYYYY indicates the system is in a “FAULT” condition and will restart when the fault clears or “LOCKOUT” and will not restart until the operator clears the fault using the keypad.

STATUS KEY

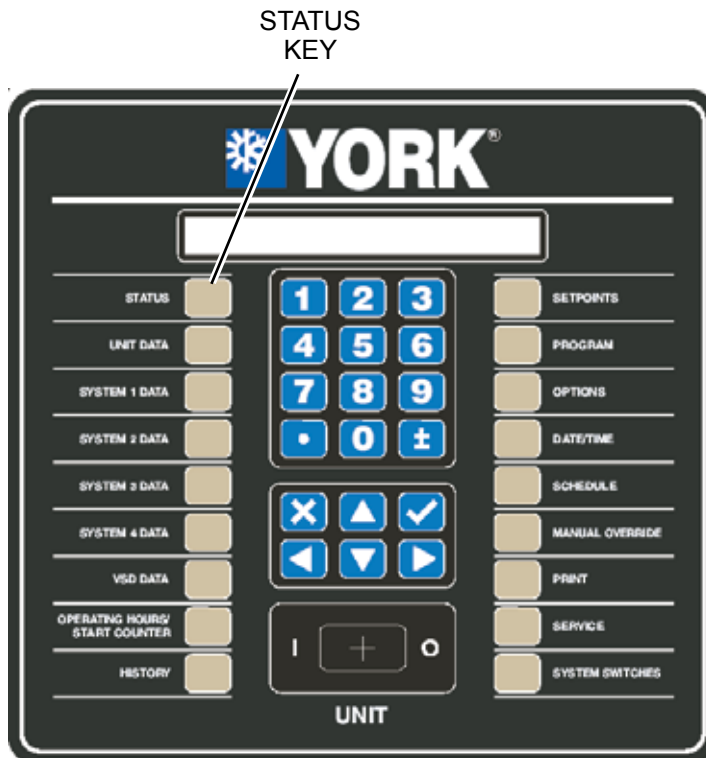

LD10605

STATUS Key Operation

The STATUS Key displays the current chiller or system operational status. The messages displayed include running status, cooling demand, system faults, unit faults, VSD faults, unit warnings, external device status, load limiting, anti-recycle timer, status of unit/system switches, and a number of other messages. Pressing the STATUS key will enable the operator to view the current status of the chiller. The display will show one message relating to the “highest priority” information as determined by the microprocessor. The STATUS key must be pressed twice to view both system 1/2 and system 3/4 data. There are three types of status data, which may appear on the display: General Status messages, Unit Safeties, and System Safeties.

When power is first applied to the control panel, the following message displaying YORK International Corporation, the EPROM version, date, and time will be displayed for 2 seconds, followed by the appropriate general status message:

(C)2004 YORK INTERNATIONAL CORPORATION
C.XXX.XX.XX 18-SEPT-2005 12:45: AM

Unit status messages occupy 2 lines of the Status message display. If no unit status message applies, individual status messages for each system will be displayed. On 3 and 4 compressor units, the STATUS key must be pressed twice to display the status of all systems.

Any time the STATUS key is pressed or after the EPROM message disappears at power-up, a status display indicating chiller or system status will appear.

STATUS KEY (CON'T)

Multiple STATUS messages may appear and can be viewed by pressing the STATUS key repeatedly to allow scrolling through as many as three STATUS messages, that could possibly be displayed at any time on a 2 compressor chiller or 4 messages that could be displayed on a 3 or 4 compressor chiller.

Examples of the typical Status messages are shown below:

General Status Messages

UNIT STATUS MANUAL OVERRIDE

This message indicates the chiller is operating in MANUAL OVERRIDE mode. This message is a priority message and cannot be overridden by any other STATUS message. When in Manual Override, no other status message will ever be present.

UNIT STATUS UNIT SWITCH OFF SHUTDOWN

This message indicates the UNIT SWITCH is in the off position and not allowing the unit to run.

UNIT STATUS DAILY SCHEDULE SHUTDOWN

This message indicates that either the daily or holiday schedule programmed is keeping the chiller from running.

UNIT STATUS REMOTE CONTROLLED SHUTDOWN

This message indicates that either an ISN or RCC has turned the chiller off and is not allowing it to run.

UNIT STATUS FLOW SWITCH SHUTDOWN

This message indicates the flow switch is not allowing the chiller to run. There is a 1 second delay on this safety to assure the flow switch did not momentarily open.

UNIT STATUS VSD COOLING SHUTDOWN

This message indicates the chiller is shutdown, but running all the condenser fans, VSD glycol pump, and VSD fan in an effort to bring the internal VSD ambient temperature down to an acceptable level before allowing the chiller to start.

SYS X REMOTE RUN CONTACT IS OPEN

This message indicates the remote start/stop contact is open. There is a 1 second delay on this safety to assure the remote contacts did not momentarily open.

SYS X SYSTEM SWITCH IS OFF

This message indicates the system switch (software via keypad) is turned off. The system will not be allowed to run until the system switch is turned ON via the keypad.

SYS X NOT RUNNING

This message indicates the system is not running because the chilled liquid is below the setpoint or the micro has not loaded the lead system far enough into the loading sequence to bring the lag system on. This message will be displayed on the lag system until the loading sequence is ready for the lag system to start.

SYS X COOLING DEMAND SHUTDOWN

This message is only displayed in the Normal Shutdown History display to indicate a capacity control shutdown.

SYS X COMPRESSOR RUNNING

This message indicates the system is running as a result of cooling demand.

STATUS KEY

SYS X SHUTTING DOWN

The compressor shutting down message indicates the respective system is ramping down in speed prior to shutting off. This message is displayed after the software run signal is disabled until the VSD notifies the Chiller Control Board the compressor is no longer running.

SYS X ANTI-RECYCLE TIMER = XXX SEC

This message indicates the amount of time left on the respective system anti-recycle timer and the system is unable to start until the timer times out.

SYS X DISCHARGE PRESSURE LIMITING

The Discharge Pressure Limiting message indicates the discharge pressure load limit or discharge pressure unloading is in effect.

SYS X SUCTION PRESSURE LIMITING

The Suction Pressure Limiting message indicates the suction pressure load limit or suction pressure unloading is in effect.

SYS X MOTOR TEMP LIMITING

The Motor Temp Limiting message indicates the motor temp load limit or motor temp unloading is in effect.

SYS X MOTOR CURRENT LIMITING

The motor current limiting message indicates the motor current load limit or motor current unloading is in effect.

SYS X PULLDOWN MOTOR CURRENT LIMITING

The pulldown motor current limiting message indicates the pulldown motor current load limit or pulldown motor current unloading is in effect based on the programmed setpoint.

SYS X ISN CURRENT LIMITING

The ISN Current Limiting message indicates the motor current load limit or motor current unloading is in effect through the use of the YORKTalk setpoint.

SYS X REMOTE MOTOR CURRENT LIMITING

The Remote Motor Current Limiting message indicates the motor current load limit or motor current unloading is in effect through the use of the remote setpoint offset. The setpoint may be offset using a remote voltage or a current signal. The remote current limit must be activated for this function to operate.

SYS X VSD BASEPLATE TEMP LIMITING

The VSD Baseplate Temp Limiting message indicates the VSD Baseplate temp is high and load limit or unloading is in effect.

SYS X VSD INTERNAL AMBIENT TEMP LIMITING

The VSD Internal Ambient Temp Limiting message indicates the VSD internal ambient temp is high and load load limit or unloading is in effect.

SYS X SOUND LIMITING

The sound limiting message indicates the sound load limit is in effect based on the locally programmed sound limit from the keypad. The sound limit must be activated for this function to operate.

SYS X ISN SOUND LIMITING

The ISN sound limiting message indicates the sound load limit is in effect based on the ISN transmitted sound limit setpoint. The sound limit must be activated for this function to operate.

STATUS KEY (CON'T)

SYS X REMOTE SOUND LIMITING

The Remote sound limiting message indicates the sound load limit is in effect based on the Remote controlled sound limit setpoint. The setpoint may be offset using a remote voltage or current signal. The sound limit option must be activated for this function to operate.

Unit Safety (Fault) Status Messages

A complete listing of the unit safeties and the corresponding status messages is provided on Page 216.

System Safety (Fault) Status Messages

A complete listing of the system safeties and the corresponding status messages is provided on Page 218.

VSD Safety (Fault) Status Messages

A complete listing of VSD safeties and the corresponding status messages is provided on Page 204.

Unit Warning Messages

A complete listing of the unit warnings and the corresponding status messages is provided on Page 212.

UNIT DATA KEY

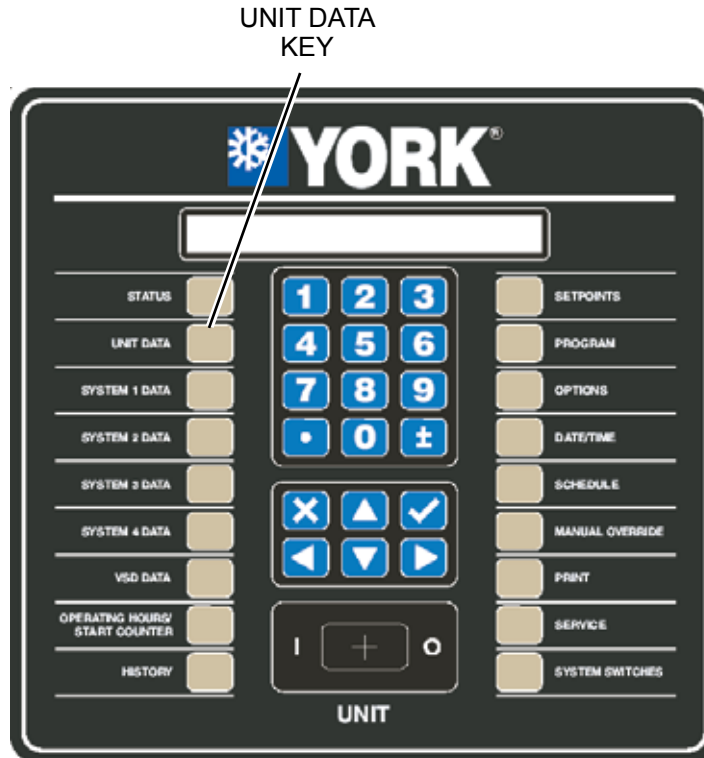

LD10605

GENERAL

The UNIT DATA Key provides the user with displays of unit temperatures, and unit related data. Displays can be selected by repeatedly pressing the UNIT DATA key or the ▲ or ▼ Arrow Keys.

UNIT DATA Key Operation

The first key press displays Evaporator Leaving and Return Chilled Liquid Temps.

UNIT CHILLED LIQUID LEAVING = XXX.X °F
ENTERING = XXX.X °F

The next key press of the UNIT DATA key or the ▼ (ARROW) key displays the ambient air temperature.

UNIT
OUTSIDE AMBIENT AIR TEMP = XXX.X °F

The next key press will display the time remaining on the load and unload timers.

UNIT **LOAD TIMER = XXX SEC**
UNLOAD TIMER = XXX SEC

The next key press displays the error in temperature between the actual leaving chilled liquid temperature and the setpoint temperature. The display also shows the rate of change of the chilled liquid temperature.

UNIT **TEMP ERROR = XXX.X °F**
RATE = XXX.X °F/M

The next key press displays the system designated as the lead system and the Flow Switch status (ON or OFF).

UNIT **LEAD SYSTEM NUMBER = X**
FLOW SWITCH = XXX

UNIT DATA KEY (CON'T)

The next key press displays the status of the evaporator pump and heater, where XXX is either ON or OFF.

```
UNIT          EVAP PUMP RUN = XXX
              EVAP HEATER = XXX
```

The next key press displays the status of Active Remote Control.

```
UNIT ACTIVE REMOTE CONTROL = XXXXXX
TYPE: RCC ISN CURR TEMP SOUND
```

XXXXXX is either ACTIVE or NONE.

If no remote keys are active, the items on the second line are all blanked out. Any remote items that are active will be displayed, while the inactive items will be blanked out.

The types of remote control are listed below:

- NONE: No remote control is actively controlling the chiller, however, remote monitoring by a remote device may still be active.
- RCC: A Remote Control Center is providing remote control. The chiller is in remote mode.
- ISN: YorkTalk via ISN. The chiller in remote mode.
- CURR: Remote Current Limiting is enabled.
- TEMP: Remote Temperature Reset is enabled.
- SOUND: Remote Sound Limiting is enabled.

The next key press displays the sound limit values as set under the PROGRAM Key by the Local, ISN, and the Remote Sound Limit Inputs. Any sound limits that are inactive will display XXX instead of a numeric value.

```
UNIT SOUND LIMIT          LOCAL = XXX %
              ISN = XXX          REMOTE = XXX %
```

SYSTEM DATA KEYS 1-4

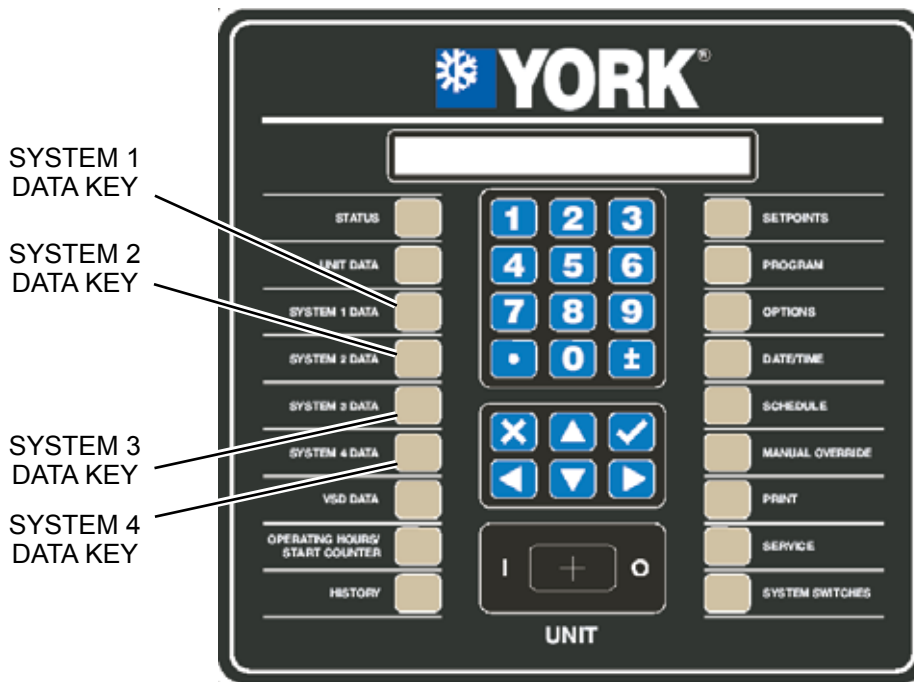

LD10605

GENERAL

The data keys provide the user with many displays of individual system temperatures, pressures, and other operating data. These keys have multiple displays, which can be seen by repeatedly pressing the SYSTEM DATA or the ▲ or ▼ (ARROW) keys. An explanation of each key and its messages is provided below.

SYSTEM 1 DATA Key operation

The SYSTEM 1 DATA key provides the user with access to system 1 operating parameters. The following is a list of the data in the order in which it appears.

The first key press of the SYSTEM X DATA key displays all of the measured system pressures (oil, suction, and discharge).

**SYS 1 PRESSURES OIL = XXXX PSIG
SUCTION = XXXX DISCHARGE = XXXX PSIG**

The second key press of the SYSTEM DATA Key or the ▼ (DOWN ARROW) key displays all of the measured system temperatures (oil, suction, and discharge).

**SYS 1 TEMPERATURES OIL = XXX.X °F
SUCTION = XXX.X DISCHARGE = XXX.X °F**

The next key press displays the suction temperature and all of the calculated suction temperatures (saturated suction and system superheat).

**SYS 1 SUCTION TEMP = XXX.X °F
SUPERHEAT = XXX.X SAT TEMP = XXX.X °F**

The next key press displays the discharge temperature and all of the calculated discharge temperatures (saturated discharge and discharge superheat).

**SYS 1 DISCHARGE TEMP = XXX.X °F
SUPERHEAT = XXX.X SAT TEMP = XXX.X °F**

The next key press displays the system 1 motor thermistor temperatures.

**SYS 1 MOTOR TEMPS T1 = XXX.X °F
 T2 = XXX.X °F T3 = XXX.X °F**

SYSTEM DATA KEYS 1-4 (CON'T)

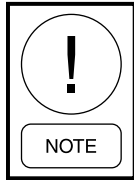

If any motor temp sensor is being ignored, (Selectable under Unit Setup Mode), that sensor's value will be displayed as XXXXX.

The next key press indicates the % of compressor loading and status of the economizer solenoid as determined by the operating frequency.

**SYS 1 COMPRESSOR SPEED = XXX.X %
ECONOMIZER SOLENOID = XXX**

XXX indicates whether the economizer solenoid is either ON or OFF.

The next key press displays the liquid level in the flash tank and an indicator of the % the Flash Tank Feed Valve is open.

**SYS 1 FLASH TANK LEVEL = XXX.X %
FEED VALVE PERCENT OPEN = XXX.X %**

The next key press displays the system suction superheat and an indicator of the % the Flash Tank Drain Valve is open.

**SYS 1 SUCTION SUPERHEAT = XXX.X °F
DRAIN VALVE PERCENT OPEN = XXX.X %**

The next key press displays the system fan stage and the status of the compressor heater.

**SYS 1 CONDENSER FANS ON = X
COMPRESSOR HEATER = XXX**

X = the number of fans ON. XXX indicates either the heater is ON or OFF.

The next key press displays the system run time in days, hours, minutes, and seconds.

**SYS 1 RUN TIME
XX DAYS XX HOURS XX MINUTES XX SECONDS**

The next key press displays the status of several system signals.

**SYS 1 RUN SIGNALS RELAY = XXX
RUN PERM = XXX SOFTWARE = XXX**

XXX indicates either ON or OFF.

SYSTEM 2 - 4 DATA Key Operation

These keys function the same as the SYSTEM 1 DATA key except that it displays data for system 2 through 4.

On a 2 compressor system, the SYSTEM 3 and SYSTEM 4 data keys will display the following messages:

SYS 3 DATA NOT AVAILABLE

SYS 4 DATA NOT AVAILABLE

SYSTEM DATA KEYS 1-4

Sensor Displays

TABLE 15 lists all the sensors attached to the control board associated with system data keys. The minimum and maximum values displayed on the micro display are provided.

If values exceed the limits in the table, a < or > sign will be display along with the minimum or maximum value.

TABLE 15 - SENSOR MIN/MAX OUTPUTS

SENSOR	TYPE	MIN.	MAX.
Suction Pressure	Transducer	0.0 PSIG	125.0 PSIG
Oil Pressure	Transducer	0.0 PSIG	275.0 PSIG
Discharge Pressure	Transducer	0.0 PSIG	275.0 PSIG
Flash Tank Level	Capacitance	0.0%	100 %
Leaving Chilled Liquid Temp.	3Kohm Thermistor	-19.1°F	110.2°F
Return Chilled Liquid Temp.	3Kohm Thermistor	-19.1°F	110.2°F
Ambient Air Temp.	10Kohm Thermistor	-4.6°F	137.9°F
Suction Temp.	3Kohm Thermistor	-4.1°F	132.8°F
Oil Temp.	50Kohm Thermistor	40.3°F	302.6°F
Discharge Temp.	50Kohm Thermistor	40.3°F	302.6°F
Compressor Motor Temp.	10Kohm Thermistor	-30.0°F	302.0°F
Remote Temp. Reset	4-20mA/2-10VDC	0 %	100 %
	0-20mA/0-10VDC		
Remote Current Limit	4-20mA/2-10VDC	0 %	100 %
	0-20mA/0-10VDC		
Remote Sound Limit	4-20mA/2-10VDC	0 %	100 %
	0-20mA/0-10VDC		

This page intentionally left blank.

VSD DATA KEY

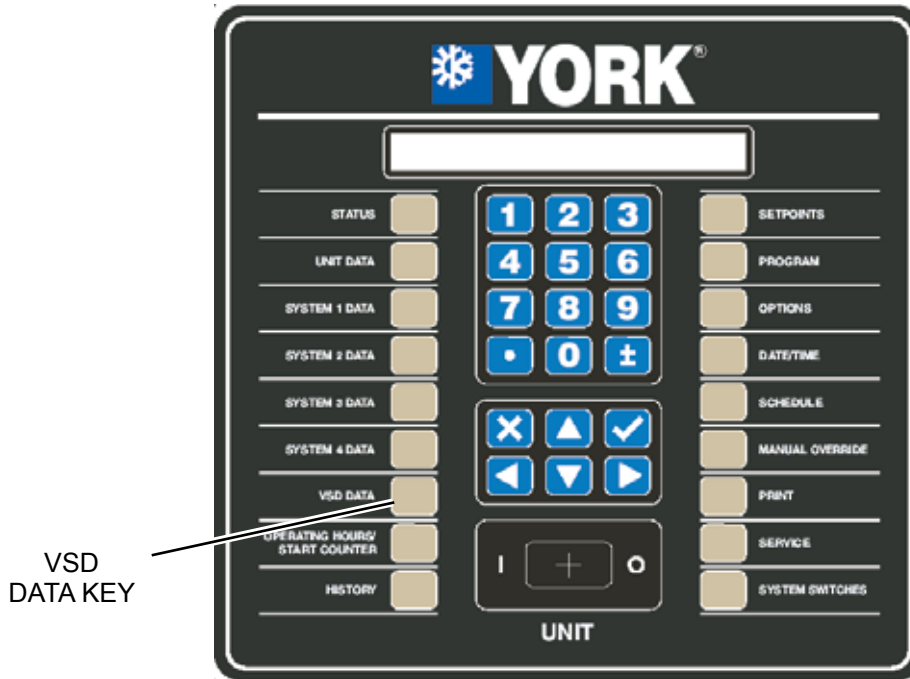

LD10605

GENERAL

The VSD DATA Key provides the user with displays of VSD temperatures, voltages, currents, and other operating data. This key has multiple displays, which can be seen by repeatedly pressing the VSD DATA or the ▲ or ▼ (ARROW) keys. An explanation of each message is provided below.

VSD DATA KEY Operation

The first VSD Data key press displays the actual VSD Output Frequency and Command Frequency.

**VSD FREQUENCY ACTUAL = XXX.X HZ
COMMAND = XXX.X HZ**

The second key press of the VSD DATA Key or the ▼ (ARROW) key displays the compressor %FLA and “calculated” currents in amps for systems 1 and 2. The “calculated” currents are approximate and some error can be expected. Also keep in mind that measuring inverter PWM current is difficult and meter error can be significant.

**VSD COMP 1 = XXX AMPS = XXX %FLA
COMP 2 = XXX AMPS = XXX %FLA**

For 3 and 4 compressor units only, the second key press will display the following message for systems 1 and 3:

**VSD COMP 1 = XXX AMPS = XXX %FLA
COMP 3 = XXX AMPS = XXX %FLA**

For 3 and 4 compressor units only, the next key press displays the compressor %FLA and currents for systems 2 and 4. 3 compressor units will have the 4th compressor information blanked out.

**VSD COMP 2 = XXX AMPS = XXX %FLA
COMP 4 = XXX AMPS = XXX %FLA**

VSD DATA KEY (CON'T)

The next key press displays the current limit values set locally on the panel under the PROGRAM key, remotely by an ISN, and remotely by the Current Limit input. Any current limits that are inactive will display “XXX” instead of a numeric value.

VSD CURRENT LIMIT LOCAL = XXX %FLA
ISN = XXX REMOTE = XXX %FLA

The next key press displays DC bus voltage for 2 and 3 compressor units.. On 4 compressor units, the 2nd message will apply, since two DC bus voltages are present (Systems 1/3 and 2/4).

VSD DC BUS VOLTAGE = XXX VDC

VSD DC BUS VOLTAGES BUS 1 = XXX VDC
BUS 2 = XXX VDC

The next key press displays the Control Panel/VSD Internal Ambient Temperature and VSD Cooling Pump/Fan Status. YYY will indicate ON or OFF.

VSD INTERNAL AMBIENT TEMP = XXX.X °F
COOLING SYSTEM STATUS = YYY

The next key press displays the IGBT highest baseplate temperature for 2 and 3 compressor units. 4 compressor units display temperatures for Systems 1/3 (T1) and Systems 2/4 (T2).

VSD IGBT BASEPLATE TEMPS T1 = XXX °F
T2 = XXX °F

The next key press displays the state of the Precharge signal, where XXX is either ON or OFF. The first display is for 2 and 3 compressor units, the second display shown is for 4 compressor units where Precharge 1 is for compressors 1 and 3 DC Bus and Precharge 2 is for compressors 2 and 4 DC Bus.

VSD PRECHARGE SIGNAL = XXX

VSD PRECHARGE 1 SIGNAL = XXX
VSD PRECHARGE 2 SIGNAL = XXX

The next key press displays the setting of the VSD’s 105% FLA overload potentiometer for Compressor #1 and 2. The settings are determined by the adjustment of the overload potentiometers on the VSD Logic Board. These pots are factory set and should not require changing unless the circuit board is replaced. See TABLE 34 for factory settings.

VSD COMP 1 MOTOR OVERLOAD = XXX AMPS
COMP 2 MOTOR OVERLOAD = XXX AMPS

The next key press displays the setting of the VSD’s 105% FLA potentiometer for Compressor #3 and #4 (3 and 4 compressor units only). The second line will be blanked out on 3 compressor units.

VSD COMP 3 MOTOR OVERLOAD = XXX AMPS
COMP 4 MOTOR OVERLOAD = XXX AMPS

OPERATING HOURS / START COUNTER KEY

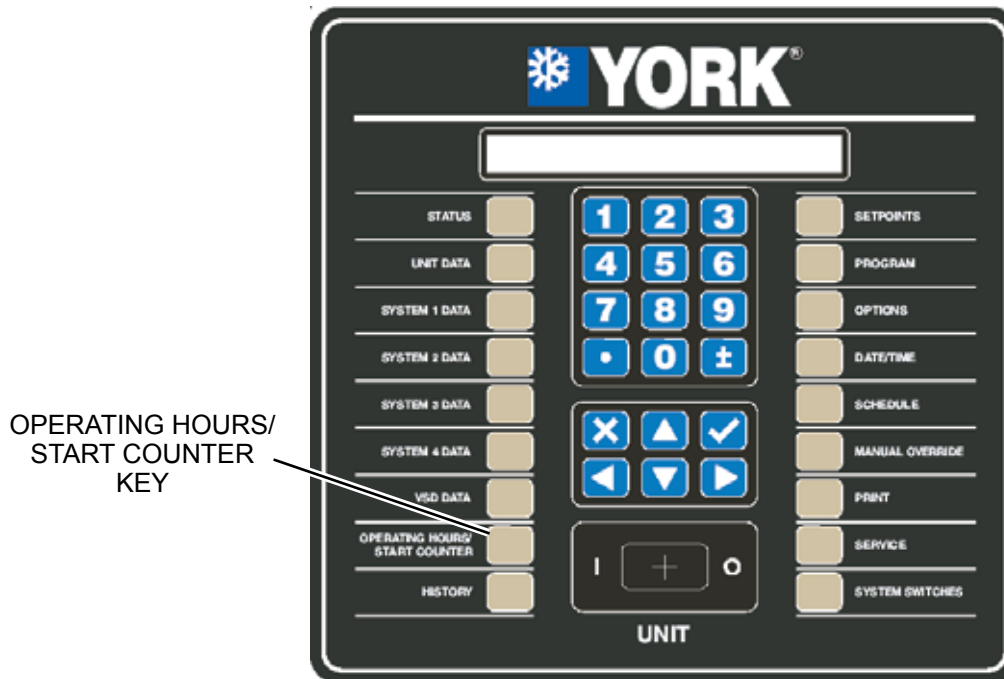

LD10605

Operating Hours/Start Counter Key Operation

Compressor operating hours and compressor starts are displayed with a single key press. The maximum value for both hours and starts is 99,999, at which point they will roll over to 0. A single display is available under this key and is displayed below. On 2 and 3 compressor units, the data and compressor designators for compressors not present are blanked out.

HOURS 1=XXXXX, 2=XXXXX, 3=XXXXX, 4=XXXXX
START 1=XXXXX, 2=XXXXX, 3=XXXXX, 4=XXXXX

HISTORY KEY

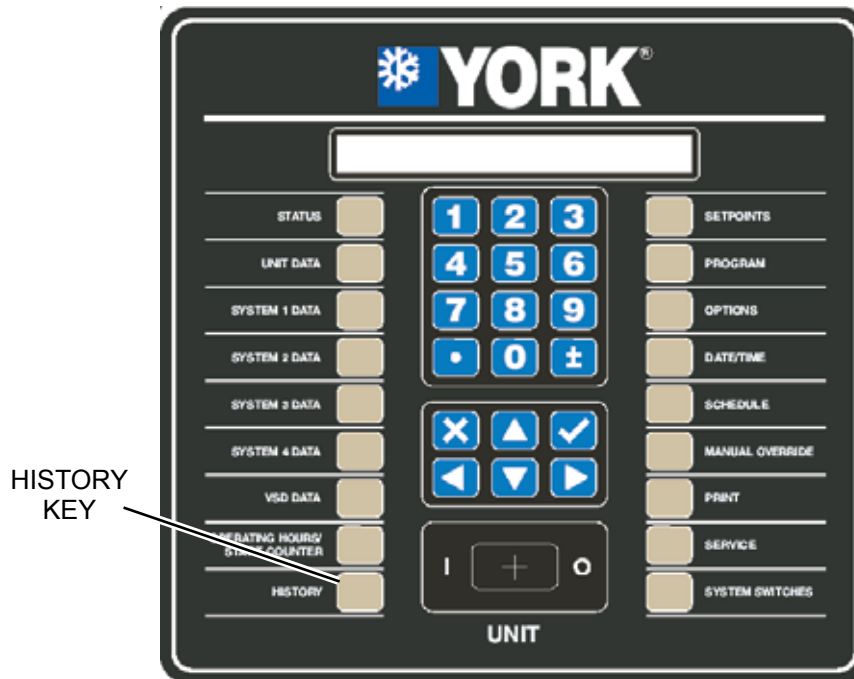

LD10605

HISTORY Key Operation

The HISTORY key provides the user access to many unit and system operating parameters captured at the instant a unit or system safety (fault) shutdown occurs. The history buffer will also capture system data at the time of normal shutdowns such as cycling shutdowns. When the HISTORY key is pressed the following screen is displayed:

```
HISTORY      CHOOSE HISTORY TYPE
◀ ▶  XXXXXXXXXXXXXXXXXXXXXXXXXXXXXXXXXXXX
```

The ◀ and ▶ (ARROW) keys allow choosing between NORMAL SHUTDOWNS and FAULT SHUTDOWNS. “Fault” shutdowns provide information on safety shutdowns, while “Normal” shutdowns provide chiller cycling information on temperature (demand), cycling, remote, system switch, etc., shutdowns that are non-safety related shutdowns. Once the selection is made, the ✓ (ENTER) key must be pressed to enter the selection.

Normal Shutdowns History

If the NORMAL SHUTDOWNS History is selected, the following screen will be displayed:

```
NORM HIST XX 18-JUN-2004 10:34:58 AM
XXXXXXXXXXXXXXXXXXXXXXXXXXXXXXXXXXXXXXXX
```

XX is the normal shutdown number. The display will provide date and time of the shutdown and the reason for the cycling shutdown (YYY....).

The operator can view any of the stored 20 single display normal shutdown history buffers. History buffer number 1 provides the most recent shutdown information and buffer number 20 is the oldest safety shutdown information saved. The ◀ and ▶ (ARROW) keys allow scrolling between each of the history buffers. The ▶ (ARROW) key scrolls to the next normal history shutdown and the ◀ (ARROW) key scrolls to the previous normal history shutdown.

The following display will typically be displayed on a normal shutdown due to shutdown on lack of cooling demand.

```
NORM HIST XX 18-JUN-2004 10:34:58 AM
SYS X COOLING DEMAND SHUTDOWN
```

HISTORY KEY

Fault Shutdowns History

If the FAULT SHUTDOWNS History is selected, the following screen will be displayed:

```

FAULT HIST XX 18-JUN-20004 10:34:58 AM
YYYYYYYYYYYYYYYYYYYYYYYYYYYYYYYYYYYY
    
```

XX is the FAULT HISTORY shutdown number. The display will provide the date, time, and a description of the specific type of fault that occurred (YYY....).

The operator can view any of the stored 10 fault history buffers. History buffer number 1 provides the most recent safety shutdown information and buffer number 10 is the oldest safety shutdown information saved. The ◀ and ▶ arrow keys allow scrolling between each of the FAULT HIST buffers 1-10. The ▲ (UP) and ▼ (DOWN) arrow keys can be used to scroll forwards and backwards through the data in a specific history buffer, once it is displayed.

There is a large amount of data provided under each history. Rather than scroll sequentially through the data in a history, which is possible using the ▼ arrow key, the use of a combination of the ◀, ▶, ▲, and ▼ arrow keys allows fast scrolling to specific data the user desires to view. To use this feature, the user needs to be aware the ◀ and ▶ arrow keys allow scrolling to the top of the data subgroups. Once a specific history is selected, the history data is divided under the subgroups of Unit Data, VSD Data, System Data, Hours/Starts, Setpoints, Options, and Program data. The ◀ and ▶ arrow keys allow moving to the first display under the next or previous subgroup at any time. Once the first display of a subgroup is displayed, the ▲, and ▼ arrow keys allow scrolling through the data in the subgroup. The ▼ arrow key allows scrolling through the data from first to last. When the last piece of data is displayed, the next press of the ▼ arrow key scrolls to the first piece of data in the next subgroup. The ▲ arrow key allows going to the previous display.

Listed below is a description of the fault data displays and their meaning. Data will be displayed in a specific order starting with the Status Display (System Faults only), Fault Display, All Fault Display, Unit Data, VSD Data, System Data, Operating Hours/Starts, Setpoints, Options, and Program Values at the time of the fault.

Status Fault Type

```

SYS X COMPRESSOR RUNNING
SYS X YYYYYYYY HIGH DIFF OIL PRESSURE
    
```

This message indicates the type of system fault. This screen is skipped if a UNIT Fault caused the shutdown.

Unit Fault Type

```

UNIT FAULT
LOW AMBIENT TEMP
    
```

This message indicates the type of unit fault. This screen is skipped if a SYSTEM Fault caused the shutdown.

All Fault Data

```

FAULT HIST XX ALL FAULTS ZZ OF WW
YYYYYYYYYYYYYYYYYYYYYYYYYYYYYYYYYYYY
    
```

The ALL FAULT display indicates whether a fault occurred while the unit is shutting down on another fault.

If a control panel fault occurred while the unit is shutting down on a VSD fault before it is reset, the control panel fault is an ALL FAULT of the VSD fault.

If another VSD fault occurs while the unit is shutting down on a VSD fault, the next VSD fault will be registered as an ALL FAULT of the VSD fault.

If a VSD fault occurs during the ramp down shutdown of a control panel fault, the VSD fault is registered as a new fault, not an ALL FAULT

XX is the history number, YYY is the ALL FAULT description, ZZ is the ALL FAULT number and WW is the total number of All Faults for the current history. Sometimes, multiple faults may occur during the shutdown and multiple displays will be observed when scrolling through the data using the ▼ arrow. In most cases, the ALL FAULT display will indicate NONE. The ALL FAULT display will only indicate the cause of the fault. No additional chiller information will be displayed under the ALL FAULT, since a snapshot of all chiller data was taken at the time of the first fault.

HISTORY KEY (CON'T)

UNIT DATA

Evaporator Leaving and Return Chilled Liquid Temps

UNIT CHILLED LIQUID LEAVING = XXX.X °F
ENTERING = XXX.X °F

This message indicates the leaving and entering chilled liquid temperatures at the time of the fault.

Ambient Air Temperature

UNIT
OUTSIDE AMBIENT AIR TEMP = XXX.X °F

This message indicates the ambient air temperature at the time of the fault.

Load / Unload Timers

UNIT
LOAD TIMER = XXX SEC
UNLOAD TIMER = XXX SEC

This message indicates remaining time on the load and unload timers at the time of the fault.

Chilled Liquid Temperature Error and Rate of Change

UNIT
TEMP ERROR = XXX.X °F
RATE = XXX.X °F/M

This message indicates the temperature error between the actual and the programmed setpoint at the time of the fault and the rate of temperature change.

Programmed Lead System Selection and Flow Switch Status

UNIT
LEAD SYSTEM NUMBER = X
FLOW SWITCH = XXX

time of the fault and whether the flow switch was ON (Closed) or OFF (Open) at the time of the fault.

Evaporator Pump and Evaporator Heater

Status

This message indicates the status of the evaporator pump

UNIT
EVAP PUMP RUN = XXX
EVAP HEATER = XXX

and the evaporator heater at the time of the fault. XXX indicates ON or OFF.

Active Remote Control Status

UNIT ACTIVE REMOTE CONTROL = XXXXXX

This message indicates whether the system was operating under active remote control (RCC, ISN, LOAD, TEMP, or SOUND) or standard control (NONE) at the time of the fault.

UNIT SOUND LIMIT
ISN = XXX
LOCAL = XXX %
REMOTE = XXX %

This message indicates that sound limiting was in effect, the amount, and whether it was local or remotely limited.

VSD DATA

VSD Actual and Command Frequency

VSD FREQUENCY
ACTUAL = XXX.X HZ
COMMAND = XXX.X HZ

This message indicates the VSD actual operating frequency and the command frequency at the time of the fault. Actual and command may not match due to load/unload timers, limitation of 1 Hz per load/unload increment, and to allowable acceleration/deceleration of the motor.

Compressor AMPS and %FLA

VSD COMP 1 = XXX AMPS
COMP 2 = XXX AMPS
= XXX %FLA
= XXX %FLA

The message indicates the compressor %FLA and currents for systems 1 and 2 at the time of the fault.

HISTORY KEY (CON'T)

COMP 1 = XXX AMPS = XXX %FLA
COMP 3 = XXX AMPS = XXX %FLA

COMP 2 = XXX AMPS = XXX %FLA
COMP 4 = XXX AMPS = XXX %FLA

These messages indicate the compressor %FLA and currents for systems 3 and 4 at the time of the fault. For 3 compressor units, the #4 compressor information is blanked out.

VSD Current Limit

VSD CURRENT LIMIT LOCAL = XXX %FLA
ISN = XXX REMOTE = XXX %FLA

This message displays the current limit values as set locally, by an ISN, or a remote current limiting input at the time of the fault.

DC BUS Voltage

VSD DC BUS VOLTAGE = XXX VDC

DC BUS VOLTAGES BUS 1 = XXX VDC
BUS 2 = XXX VDC

This message displays the DC bus voltage at the time of the fault. On 4 compressor units, the 2nd message will apply since two DC bus voltages are present (1/3 and 2/4) at the time of the fault.

VSD Internal Ambient Temp

VSD INTERNAL AMBIENT TEMP = XXX.X °F
COOLING SYSTEM STATUS = YYY

This message displays the VSD/Micro internal ambient cabinet temperature and the cooling system status (ON or OFF) at the time of the fault.

IGBT Baseplate Temperature

VSD IGBT BASEPLATE TEMPS T1 = XXX °F
T2 = XXX °F

This message displays the IGBT highest baseplate temperature for 2 and 3 compressor units at the time of the fault. 4 compressor units display temperatures for 1/3 (T1) and 2/4 (T2).

Precharge Signal Status and VSD Cooling Status

VSD PRECHARGE SIGNAL = XXX

VSD PRECHARGE 1 SIGNAL = XXX
PRECHARGE 2 SIGNAL = XXX

This display provides the state of the precharge signal, where Precharge 1 and Precharge 2 is either ON or OFF at the time of the fault. Precharge 2 is only used on 4 compressor units.

Compressor #1 and #2, 105% FLA Motor Overload Current Setting

VSD COMP 1 MOTOR OVERLOAD = XXX AMPS
COMP 2 MOTOR OVERLOAD = XXX AMPS

This message displays the setting of the VSD's 100% FLA potentiometer for Compressor #1 and #2 at the time of the fault.

Compressor #3 and #4, 105% FLA Current Setting

COMP 3 MOTOR OVERLOAD = XXX AMPS
COMP 4 MOTOR OVERLOAD = XXX AMPS

This message displays the setting of the VSD's 100% FLA potentiometer for Compressor #3 and #4 at the time of the fault.

SYSTEM DATA

System #1 Pressures

SYS 1 PRESSURES OIL = XXXX PSIG
SUCTION = XXXX DISCHARGE = XXXX PSIG

This message displays all of the measured system pressures (oil, suction, and discharge) at the time of the fault.

HISTORY KEY (CON'T)

System # 1 Measured Temperatures

SYS 1 TEMPERATURES OIL = XXX.X °F
SUCTION = XXX.X DISCHARGE = XXX.X °F

This message displays all of the measured system temperatures (oil, suction, and discharge) at the time of the fault.

System #1 Measured Suction Temperature & Calculated Sat Suction Temperature & Superheat

SYS 1 SUCTION TEMP = XXX.X °F
SUPERHEAT = XXX.X SAT REMP = XXX.X °F

This message displays all of the calculated suction temperatures (saturated suction and system superheat) at the time of the fault as well as measured suction temperature.

System #1 Calculated Discharge Temperatures

SYS 1 DISCHARGE TEMP = XXX.X °F
SUPERHEAT = XXX.X SAT REMP = XXX.X °F

This message displays all of the calculated discharge temperatures (saturated discharge and discharge superheat) at the time of the fault as well as measured discharge temperature.

System #1 Motor Temperatures

SYS 1 MOTOR TEMPS T1 = XXX.X °F
T2 = XXX.X T3 = XXX.X °F

This message displays the system 1 motor thermistor temperatures at the time of the fault.

System #1 Compressor Speed and Economizer Solenoid Status

SYS 1 COMPRESSOR SPEED = XXX.X %
ECONOMIZER SOLENOID = XXX

This message indicates the compressor speed and status of economizer solenoid at the time of the fault. The economizer status will be indicated as either ON or OFF.

System #1 Flash Tank Level and Feed Valve % Open

SYS 1 FLASH TANK LEVEL = XXX.X %
FEED VALVE PERCENT OPEN = XXX.X %

This message displays the liquid level in the Flash Tank and indicates the % the Flash Tank Feed Valve is open at the time of the fault.

System #1 Suction Superheat and Flash Tank Drain Valve % open

SYS 1 SUCTION SUPERHEAT = XXX.X °F
DRAIN VALVE PERCENT OPEN = XXX.X %

This message displays the system suction superheat and indicates the % the Flash Tank Drain Valve is open at the time of the fault.

System #1 Fan Stage and Compressor Heater Status

SYS 1 CONDENSER FANS ON = XXX
COMPRESSOR HEATER = XXX

This message displays the actual # of system fans on, and the status of the compressor heater at the time of the fault. The fan display will show the number of fans operating while the compressor heater status will indicate either ON or OFF.

Compressor #1 Run Time

SYS 1 RUN TIME
XX DAYS XX HOURS XX MINUTES XX SECONDS

This message displays the system run time since the last start in days, hours, minutes, and seconds at the time of the fault.

System #1 Run Signals

SYS 1 RUN SIGNALS RELAY = XXX
RUN PERM = XXX SOFTWARE = XXX

This message displays the System Run Signal Relay (Relay Output Board) status, Run Permissive Input status, and the Internal Software (micro command) ON/OFF Start status. The status of each will indicate either ON or OFF.

HISTORY KEY (CON'T)

System 2 - 4 Data

Data for the remaining systems 2 – 4 at the time of the fault is displayed in the same sequence as the system #1 data.

COMPRESSOR OPERATING HOURS AND STARTS

**HOURS 1=XXXXX, 2=XXXXX, 3=XXXXX, 4=XXXXX
START 1=XXXXX, 2=XXXXX, 3=XXXXX, 4=XXXXX**

This message displays compressor operating hours and compressor starts at the time of the fault. On 3 and 4 compressor units, the data and compressor designators for compressors not present will be blanked out.

CHILLED LIQUID SETPOINT COOLING SETPOINTS

**SETPOINTS
LOCAL COOLING SETPOINT = XXX.X °F**

This message displays the programmed cooling setpoint at the time of the fault.

**SETPOINTS
LOCAL CONTROL RANGE = +/- X.X °F**

This message displays the programmed control range at the time of the fault.

Remote Setpoint And Range

**SETPOINTS REMOTE SETPOINT = XXX.X °F
REMOTE CONTROL RANGE = +/- X.X °F**

This message displays the remote setpoint and control range at the time of the fault.

Maximum Remote Temperature Setpoint

**SETPOINTS
MAXIMUM REMOTE TEMP RESET = XXX.X °F**

This message displays the maximum remote reset programmed at the time of the fault.

OPTIONS

Display Language

**OPTIONS DISPLAY LANGUAGE
◀ ▶ XXXXXXXXXXXXXXXXXXXXXXXX**

This message displays the language selected at the time of the fault.

Chilled Liquid Cooling Mode

**OPTIONS CHILLED LIQUID COOLING MODE
◀ ▶ WATER COOLING**

This message displays the chilled liquid temperature mode (water or glycol) selected at the time of the fault.

Local / Remote Control Mode

**OPTIONS CHILLED LIQUID COOLING MODE
◀ ▶ GLYCOL COOLING**

This message indicates whether Local or Remote Control Mode was selected at the time of the fault.

**OPTIONS LOCAL / REMOTE CONTROL MODE
◀ ▶ XXXXXXXXXXXXXXXXXXXXXXXX**

When Remote Control Mode is selected, control of the Chilled Liquid Setpoint is from a remote device such as an ISN/BAS controller.

**OPTIONS DISPLAY UNITS
◀ ▶ XXXXXXXXXXXXXXXXXXXXXXXX**

Display Units Mode

This message indicates whether SI (°C, barg) or Imperial units (°F, PSIG) was selected at the time of the fault.

**OPTIONS LEAD / LAG CONTROL MODE
◀ ▶ XXXXXXXXXXXXXXXXXXXXXXXX**

System Lead/Lag Control Mode

This message indicates the type of lead lag control selected at the time of the fault. 5 choices are available: Automatic, Sys 1 Lead, Sys 2 Lead, Sys 3 Lead, and Sys 4 Lead. The default mode will be AUTOMATIC.

HISTORY KEY (CON'T)

Remote Temperature Reset

One of the 5 messages below indicates whether remote temperature reset was active or disabled at the chiller keypad at the time of the fault. If active, the type of reset signal selected is indicated. If the option is not factory enabled, the option will not appear.

OPTIONS REMOTE TEMP RESET INPUT
◀ ▶ DISABLED

OPTIONS REMOTE TEMP RESET INPUT
◀ ▶ 0.0 TO 10.0 VOLTS DC

OPTIONS REMOTE TEMP RESET INPUT
◀ ▶ 2.0 TO 10.0 VOLTS DC

OPTIONS REMOTE TEMP RESET INPUT
◀ ▶ 0.0 TO 20.0 MILLIAMPS

OPTIONS REMOTE TEMP RESET INPUT
◀ ▶ 4.0 TO 20.0 MILLIAMPS

Low Ambient Temp Cutout

OPTIONS LOW AMBIENT TEMP CUTOUT
◀ ▶ XXXXXXXXXXXXXXXXXXXXX

This message indicates whether the low ambient cutout was enabled or disabled at the time of the fault.

Remote Current Reset

OPTIONS REMOTE CURRENT LIMIT INPUT
◀ ▶ DISABLED

OPTIONS REMOTE CURRENT LIMIT INPUT
◀ ▶ 0.0 TO 10.0 VOLTS DC

OPTIONS REMOTE CURRENT LIMIT INPUT
◀ ▶ 2.0 TO 10.0 VOLTS DC

OPTIONS REMOTE CURRENT LIMIT INPUT
◀ ▶ 0.0 TO 20.0 MILLIAMPS

OPTIONS REMOTE CURRENT LIMIT INPUT
◀ ▶ 4.0 TO 20.0 MILLIAMPS

This message indicates whether remote current reset was active or disabled at the chiller keypad at the time of the fault and if active, the type of reset signal selected. One of the following messages will be indicated: DISABLED (no signal), 0-10VDC, 2-10VDC, 0-20ma, and 4-20ma. If the option is not factory enabled, the option will not appear.

PROGRAM VALUES

Suction Pressure Cutout

This message indicates the suction pressure cutout programmed at the time of the fault.

PROGRAM
SUCTION PRESSURE CUTOUT = XXX.X PSIG

Low Ambient Cutout

This message displays the low ambient temp cutout programmed at the time of the fault.

PROGRAM
LOW AMBIENT TEMP CUTOUT = XXX.X °F

Low Leaving Chilled Liquid Temp Cutout

This message displays the low leaving Chilled liquid temperature cutout programmed at the time of the fault.

PROGRAM
LEAVING LIQUID TEMP CUTOUT = XXX.X °F

Motor Current Limit

This message indicates the motor current limit programmed at the time of the fault.

PROGRAM
MOTOR CURRENT LIMIT = XXX %FLA

8

HISTORY KEY (CON'T)

Pulldown Current Limit

**PROGRAM
PULLDOWN CURRENT LIMIT = XXX %FLA**

This message indicates the pulldown current limit programmed at the time of the fault.

Pulldown Current Limit Time

**PROGRAM
PULLDOWN CURRENT LIMIT TIME = XXX MIN**

This message indicates the pulldown current limit time programmed at the time of the fault.

Suction Superheat Setpoint

**PROGRAM
SUCTION SUPERHEAT SETPOINT = XXX.X °F**

This message indicates the suction superheat setpoint programmed at the time of the fault.

Unit ID Number

**PROGRAM
REMOTE UNIT ID NUMBER = X**

This indicates the unit ID # programmed at the time of the fault.

Sound Limit Setpoint

**PROGRAM
SOUND LIMIT SETPOINT = XXX %**

This indicates the sound limit setpoint programmed at the time of the fault, if the sound limit option is activated at the factory. If the option is not factory activated, the display will not appear.

SETPOINTS KEY

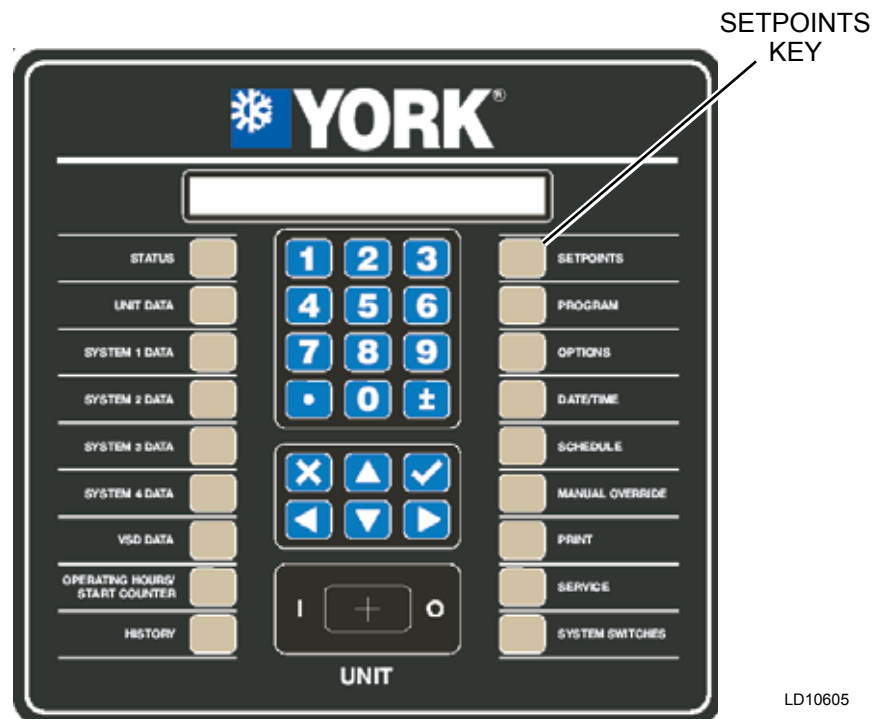

LD10605

SETPOINTS Key Operation

Cooling setpoints and ranges may be programmed by pressing the SETPOINTS key. The first setpoint entry screen will be displayed as shown below. The first line of the display will show the chiller default (DEF), minimum acceptable value (LO) and maximum acceptable value (HI). The second line shows the actual programmed value. TABLE 16 also shows the allowable ranges for the cooling setpoints and control ranges. Note that the Imperial units are exact values while the Metric units are only approximate.

```
SETPOINTS ◀DEF XXXXX LO XXXXX HI XXXXX
LOCAL COOLING SETPOINT = XXX.X °F
```

Pressing the SETPOINTS key a second time or the ▼ (ARROW) key will display the leaving chilled liquid control range, default, and low/high limits.

```
SETPOINTS ◀DEF XXXXX LO XXXXX HI XXXXX
LOCAL CONTROL RANGE = +/- X.X °F
```

Pressing the SETPOINTS key or the ▼ (ARROW) key a third time will display the remote setpoint and cooling range. This display automatically updates about every 2 seconds. This remote setpoint message is shown below:

```
SETPOINTS REMOTE SETPOINT = XXX.X °F
REMOTE CONTROL RANGE = +/- X.X °F
```

If there is no remote setpoint being utilized, the remote setpoint value will be displayed as XXXXXX and the remote control range will display XXX.

Pressing the SETPOINTS key or the , Arrow key a fourth time will bring up a screen that allows the Maximum Remote Temperature Reset to be programmed. This message is shown below:

```
SETPOINTS ◀DEF XXXXX LO XXXXX HI XXXXX
MAXIMUM REMOTE TEMP RESET = XXX.X °F
```

SETPOINTS KEY (CON'T)

The values displayed under each of the key presses may be changed by keying in new values and pressing the ✓ (ENTER) key to store the new value into memory. Where more than one value may be keyed in on a display, a portion of the data that does not need updating may be skipped by pressing the ✓ (ENTER) key. The ✓ (ENTER) key must also be pressed after the last value in the display to store the data into memory.

The ▲ (ARROW) key allows scrolling back through the setpoints displays.

The minimum, maximum, and default values allowed under the SETPOINTS key are provided in TABLE 16, below:

TABLE 16 - SETPOINT LIMITS

PROGRAM VALUE	MODE	LOW LIMIT	HIGH LIMIT	DEFAULT
Leaving Chilled Liquid Setpoint	Water Cooling	40.0°F	60.0°F	44.0°F
		4.4°C	15.6°C	6.7°C
	Glycol Cooling	15.0°F	70.0°F	44.0°F
		-9.4°C	15.6°C	6.7°C
Leaving Chilled Liquid Control Range	-	1.5°F	2.5°F	2.0°F
		0.8°C	1.4°C	1.1°C
Max. Remote Temperature Reset	-	2°F	40°F	20°F
		1°C	22°C	11°C

PROGRAM KEY

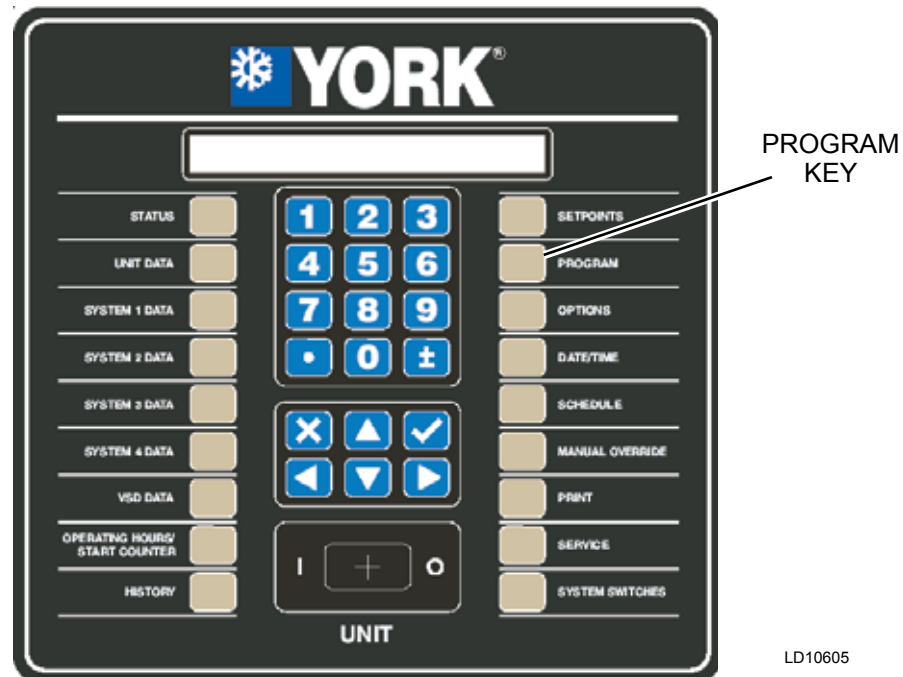

PROGRAM KEY OPERATION

Various operating parameters are programmable by the user. These are modified by pressing the PROGRAM key and then the ✓ (ENTER) key to enter Program Mode. A listing of the limits of the programmable values is found below. Note that the Imperial units are exact values, while Metric units are only approximate.

The ▲ and ▼ (ARROW) keys are used to scroll through the user programmable values. A value may be changed by keying in the new value and pressing the ✓ (ENTER) key to store the new value in memory. The cursor will be displayed on the screen when a number key is pressed. The first line of each message will indicate the chiller default (DEF) value), lowest acceptable programmable value (LO), and highest acceptable programmable value (HI). The user programmable value is programmed on in the second line of the message.

When the PROGRAM Key is first pressed, the following display will appear indicating the user is in the program mode:

```
PROGRAM MODE XXXX
PRESS ENTER KEY TO CONTINUE
```

Pressing the ✓ (ENTER) key again will display the first programmable selection.

Suction Pressure Cutout

```
PROGRAM ◀DEF XXXXX LO XXXXX HI XXXXX
SUCTION PRESSURE CUTOUT = XXX.X PSIG
```

The suction pressure cutout is protects the chiller from a low refrigerant condition. It also helps protect from a freeze-up due to low or no chilled liquid flow. However, it is only a back-up for a flow switch and cannot protect against an evaporator freeze under many conditions. This cutout is programmable and should generally be programmed for 24PSIG (1.65 Barg) for chilled water cooling.

The cutout is programmable between 24.0 – 36.0 PSIG (1.65 – 2.48 Barg) in the Water Cooling mode and 5.0 – 36.0 (0.34 – 2.28 Barg) in the Glycol Cooling mode. The default value for both modes will be 24.0 (1.65 Barg) PSIG.

PROGRAM KEY (CON'T)

Low Ambient Cutout

PROGRAM ◀DEF XXXXX LO XXXXX HI XXXXX
LOW AMBIENT TEMP CUTOUT = XXX.X °F

The low ambient temp cutout allows programming the outdoor temperature at which it is desired to shut down the chiller to utilize other methods of cooling.

The cutout is programmable between -2.0°F (-18.9°C) and 50°F (10.0°C) with a 25°F (-3.9°C) default.

Low Leaving Liquid Temp Cutout

PROGRAM ◀DEF XXXXX LO XXXXX HI XXXXX
LEAVING LIQUID TEMP CUTOUT = XXX.X °F

The leaving chilled liquid temp cutout is programmed to avoid freezing the evaporator due to excessively low chilled liquid temperatures. The cutout is automatically set at 36°F (2.2°C) in the Water Cooling mode and is programmable in the Glycol Cooling mode. In the Glycol Cooling Mode, the cutout is programmable from 11.0°F – 36.0°F (-11.7 – 2.2°C) with a default of 36.0°F (2.2°C).

Motor Current Limit

PROGRAM ◀DEF XXXXX LO XXXXX HI XXXXX
MOTOR CURRENT LIMIT = XXX % FLA

The motor current limit %FLA is programmable. This allows the micro to limit a system before it faults on high current. Typically, the limit point is set at 100%. The unload point is programmable from 30 – 100% with a default of 100%.

Pulldown Current Limit

PROGRAM ◀DEF XXXXX LO XXXXX HI XXXXX
PULLDOWN CURRENT LIMIT = XXX % FLA

The pulldown current limit %FLA is programmable. This allows the micro to limit a system on pulldown limiting for the purpose of peak time energy savings. Typically, the limit point is set at 100%. The pulldown limit point is programmable from 30 – 100% with a default of 100%. Be aware when using pulldown motor current limit, the chiller may not be able to load to satisfy temperature demand

Pulldown Current Limit Time

PROGRAM ◀DEF XXXXX LO XXXXX HI XXXXX
PULLDOWN CURRENT LIMIT TIME = XXX MIN

The pulldown current limit time is programmable. This allows the micro to limit a system on pulldown limiting for a defined period of time for the purpose of peak time energy savings. The pulldown limit point is programmable from 0 – 255 with a default of 0 Min.

Suction Superheat Setpoint

PROGRAM ◀DEF XXXXX LO XXXXX HI XXXXX
SUCTION SUPERHEAT SETPOINT = XXX.X °F

The suction superheat setpoint is programmable from 8.0 – 12.0°F (4.4 – 8.3°C) with a 10.0°F (5.6°C) default. Typically the superheat control will be programmed for 10.0°F . Higher superheats of 10 - 12°F will reduce the risk of liquid carry over and are preferred by some users.

Unit ID Number

PROGRAM ◀DEF XXXXX LO XXXXX HI XXXXX
REMOTE UNIT ID NUMBER = X

For purposes of remote communications, multiple chillers may be connected to an RS-485 communications bus. To allow communications to each chiller, a chiller ID number may be programmed into memory. On a single chiller application, the value will be “0”.

PROGRAM KEY (CON'T)

Sound Limit Setpoint

PROGRAM ◀DEF XXXXX LO XXXXX HI XXXXX
SOUND LIMIT SETPOINT = XXX %

The sound limit setpoint is programmable from 0 – 100 % with a 0% default. 0% allows operating up to the full speed capability of the unit with no sound limiting. Typically the sound limit control setting will be programmed for 0 % unless sound limiting is utilized on the chiller. Sound limiting will only permit the unit to run to a frequency less than the maximum speed capability of the unit. Programming a value of 1% would be the minimum sound limiting that can be programmed and 100% will be the maximum. 100% will only allow the unit speed to operate at the minimum frequency. Usually, the sound limit % will be programmed somewhere between 0 and 100% according to the limiting needed to satisfy the sound requirements of the site. Typically, sound limiting will be utilized in areas sensitive to noise during night-time hours. The sound limit display will only be present if the sound limit option is programmed at the factory.

Default Values

A listing of the low limits, high limits, and default values for each of the programmable values is noted in each display and can be found in TABLE 17. Note that the Imperial units are exact values while the Metric units are only approximate.

TABLE 17 - PROGRAMMABLE OPERATING PARAMETERS

PROGRAM VALUE	MODE	LOW LIMIT	HIGH LIMIT	DEFAULT
Suction Pressure Cutout	Water Cooling	24.0 PSIG	36.0 PSIG	24.0 PSIG
		1.65 Bars	2.48 Bars	1.65 Bars
	Glycol Cooling	5.0 PSIG	36.0 PSIG	24.0 PSIG
		0.34 Bars	2.48 Bars	1.65 Bars
Low Ambient Temp. Cutout	-	-2°F	50.0°F	25.0°F
		-18.9°C	10.0°C	2.2°C
Leaving Chilled Liquid Temp. Cutout	Water Cooling	-	-	36.0°F
		-	-	2.2°C
	Glycol Cooling	11.0°F	36.0°F	36.0°F
		-11.7°C	2.2°C	2.2°C
Motor Current Limit	-	30%	103%	103%
Pulldown Motor Current Limit	-	30%	100%	100%
Pulldown Motor Current Limit Time	-	0 Min	255 Min	0 Min
Suction Superheat Setpoint	-	8.0°F	12.0°F	10.0°F
		4.4°C	6.6°C	5.6°C
Unit ID Number	-	0	7	0
Sound Limit Setpoint	Sound Limit Option Enabled	0%	100%	0%

OPTIONS KEY

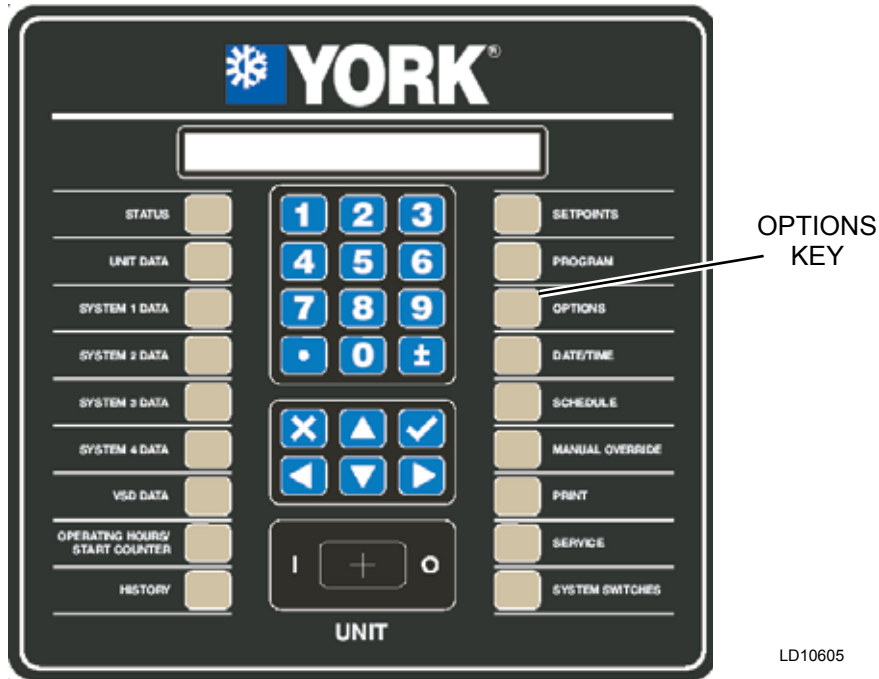

OPTIONS Key Operation

The OPTIONS key provides the user with a display of unit configuration and the capability to modify the configuration. These options can only be viewed under the OPTIONS key. To view the current options settings, press the OPTIONS key. Each press of the OPTIONS key or press of the ▲ or ▼ (ARROW) keys will scroll to the next option setting. The ◀ and ▶ (ARROW) keys allow changing the option choices. The ✓ (ENTER) key must be pressed after a selection is made to save the change in memory.

An explanation of each option message is provided below.

Display Language Selection

The display language can be selected for English, Dutch, German, Italian, and Chinese



The default language will be English.

Chilled Liquid Cooling Mode Selection

The Chilled liquid cooling mode can be selected for Water Cooling or low temperature Glycol Cooling.



When Water Cooling is chosen, the chilled liquid temperature setpoint can only be programmed from 40°F to 70°F



When Glycol Cooling is chosen, the chilled liquid temperature setpoint can be programmed from 10°F to 70°F.

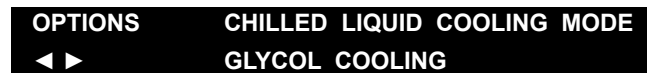

The default Chilled Liquid Mode will be WATER.

OPTIONS KEY (CON'T)

Local / Remote Control Mode Selection

Local or Remote Control Mode allows the user to select the chilled liquid temperature control mode.

```

OPTIONS  LOCAL / REMOTE CONTROL MODE
◀ ▶     XXXXXXXXXXXXXXXXXXXXXXXX
    
```

When LOCAL CONTROL mode is selected, chilled liquid control is from the keypad of the chiller. In local mode, a remote device can read system data, but not reset operating parameters.

```

OPTIONS  LOCAL / REMOTE CONTROL MODE
◀ ▶     LOCAL CONTROL
    
```

When REMOTE CONTROL mode is selected, control of the chilled liquid setpoint is from a remote device such as an ISN/BAS controller.

```

OPTIONS  LOCAL / REMOTE CONTROL MODE
◀ ▶     REMOTE CONTROL
    
```

The default mode will be LOCAL.

Display Units Selection

Imperial or SI display units may be selected for data display.

```

OPTIONS  DISPLAY UNITS
◀ ▶     XXXXXXXXXXXXXXXXXXXXXXXX
    
```

The user may select system operating temperatures and pressures to be displayed in either SI (°C, Barg) or Imperial units (°F, PSIG).

```

OPTIONS  DISPLAY UNITS
◀ ▶     IMPERIAL
    
```

```

OPTIONS  DISPLAY UNITS
◀ ▶     SI
    
```

The default mode is IMPERIAL.

System Lead/Lag Control Mode Selection

The operator may select the type of lead/lag control desired.

```

OPTIONS  LEAD / LAG CONTROL MODE
◀ ▶     XXXXXXXXXXXXXXXXXXXXXXXX
    
```

In most cases, automatic lead/lag will be selected. When automatic lead/lag is selected, the micro will attempt to balance run time by switching the lead compressor whenever all compressors are shut off. If a compressor is not able to run when the micro attempts a start, the micro will select another compressor in an effort to control chilled liquid temperature. Manual lead/lag allows selecting a specific compressor to be the lead. If #2 is selected as the lead in a 3 compressor chiller, the sequence will be 2, 3, and 1.

```

OPTIONS  LEAD / LAG CONTROL MODE
◀ ▶     AUTOMATIC
    
```

The default mode will be AUTOMATIC.

Lag selections of individual systems will appear as:

```

OPTIONS  LEAD / LAG CONTROL MODE
◀ ▶     MANUAL SYS 1 LEAD
    
```

```

OPTIONS  LEAD / LAG CONTROL MODE
◀ ▶     MANUAL SYS 2 LEAD
    
```

```

OPTIONS  LEAD / LAG CONTROL MODE
◀ ▶     MANUAL SYS 3 LEAD
    
```

SYSTEM 3 LEAD may be selected only on 3 and 4 compressor units.

```

OPTIONS  LEAD / LAG CONTROL MODE
◀ ▶     MANUAL SYS 4 LEAD
    
```

SYSTEM 4 LEAD may be selected only on 4 compressor units.

OPTIONS KEY (CON'T)

Remote Temperature Reset Selection

Remote temperature reset from an external source may be tied directly into the chiller microprocessor board.

OPTIONS REMOTE TEMP RESET INPUT
 ◀ ▶ XXXXXXXXXXXXXXXXXXXXXXXX

Selections may be made for DISABLED (no signal), 0-10VDC, 2-10VDC, 0-20ma, and 4-20ma.

OPTIONS REMOTE TEMP RESET INPUT
 ◀ ▶ DISABLED

OPTIONS REMOTE TEMP RESET INPUT
 ◀ ▶ 0.0 TO 10.0 VOLTS DC

OPTIONS REMOTE TEMP RESET INPUT
 ◀ ▶ 2.0 TO 10.0 VOLTS DC

OPTIONS REMOTE TEMP RESET INPUT
 ◀ ▶ 0.0 TO 20.0 MILLIAMPS

OPTIONS REMOTE TEMP RESET INPUT
 ◀ ▶ 4.0 TO 20.0 MILLIAMPS

The default setting for Remote Temp Reset is DISABLED. This display will only appear if the remote temp limit option is enabled at the factory.

Remote Current Limit Input Selection

Remote current limit from an external source may be tied directly into the chiller microprocessor board.

OPTIONS REMOTE CURRENT LIMIT INPUT
 ◀ ▶ XXXXXXXXXXXXXXXXXXXXXXXX

Selections may be made for DISABLED (no signal), 0-10VDC, 2-10VDC, 0-20ma, and 4-20ma.

OPTIONS REMOTE CURRENT LIMIT INPUT
 ◀ ▶ DISABLED

OPTIONS REMOTE CURRENT LIMIT INPUT
 ◀ ▶ 0.0 TO 10.0 VOLTS DC

OPTIONS REMOTE CURRENT LIMIT INPUT
 ◀ ▶ 2.0 TO 10 VOLTS DC

OPTIONS REMOTE CURRENT LIMIT INPUT
 ◀ ▶ 0.0 TO 20.0 MILLIAMPS

OPTIONS REMOTE CURRENT LIMIT INPUT
 ◀ ▶ 4.0 TO 20.0 MILLIAMPS

The default setting for Remote Current Reset is DISABLED. This display will only appear if the remote current limit option is enabled at the factory.

Remote Sound Limit Selection

Remote sound limit from an external source may be tied directly into the chiller microprocessor board.

OPTIONS REMOTE SOUND LIMIT INPUT
 ◀ ▶ XXXXXXXXXXXXXXXXXXXXXXXX

Selections may be made for DISABLED (no signal), 0-10VDC, 2-10VDC, 0-20ma, and 4-20ma.

OPTIONS REMOTE SOUND LIMIT INPUT
 ◀ ▶ DISABLED

OPTIONS REMOTE SOUND LIMIT INPUT
 ◀ ▶ 0.0 TO 10.0 VOLTS DC

OPTIONS REMOTE SOUND LIMIT INPUT
 ◀ ▶ 2.0 TO 10.0 VOLTS DC

OPTIONS REMOTE SOUND LIMIT INPUT
 ◀ ▶ 0.0 TO 20.0 MILLIAMPS

OPTIONS REMOTE SOUND LIMIT INPUT
 ◀ ▶ 4.0 TO 20.0 MILLIAMPS

The default setting for Remote Sound Limit is DISABLED. This display will only appear if the remote sound limit option is enabled at the factory.

Low Ambient Cutout Enable/Disable

The low ambient cutout may be enabled or disabled. When enabled, the chiller will cut off when the low ambient cutout is reached. When disabled, the chiller will run at any temperature.

OPTIONS LOW AMBIENT TEMPERATURE CUTOUT
 ◀ ▶ ENABLED

OPTIONS LOW AMBIENT TEMPERATURE CUTOUT
 ◀ ▶ DISABLED

The default setting for the low ambient cutout will be ENABLED.

This page intentionally left blank.

DATE / TIME & SCHEDULE KEYS

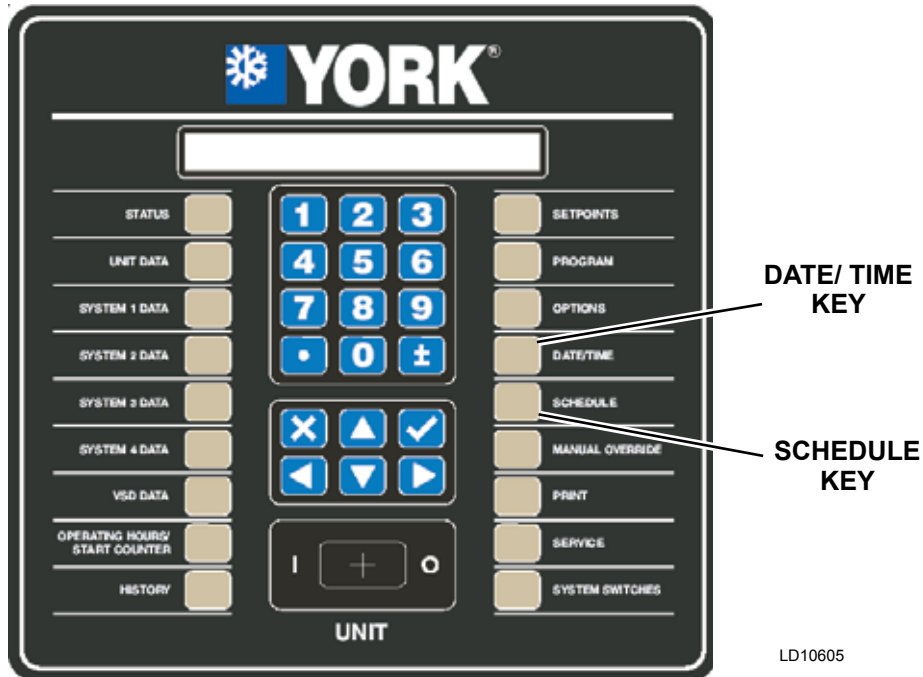

DATE/TIME KEY Key Operation

When the DATE/TIME Key is pressed, the chiller microprocessor will display the date and the time. This feature is useful and required for using the daily schedule. It is also a valuable tool for troubleshooting to allow a technician to determine the time of the fault, which is stored in the history memory buffers. When the DATE/TIME Key is pressed, the first display screen shown below will be displayed:



Whenever any changes are made, the ✓ (ENTER) key must be pressed to store the data.

Pressing the ▲ or ▼ (ARROW) keys allows scrolling to the next programmed item. Pressing the ▼ (DOWN ARROW) key scrolls to the next item that can be programmed and the ▲ (UP ARROW) key scrolls to the previous item.

The day of the week is the first display and can be changed by pressing either the ◀ or ▶ (LEFT OR RIGHT ARROW) key to select the day. After the day is selected, the ✓ (ENTER) key must be pressed to store the data.



Pressing the ▼ (DOWN ARROW) key again scrolls to the day of the month:



The day of the month can be selected by keying in the numerical value to select the day. After the day of the month is selected, the ✓ (ENTER) key must be pressed to store the data.

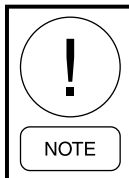

A "0" must be typed in to select dates for days of the 1st through the 9th.

Pressing the ▼ (DOWN ARROW) key again scrolls to month:



DATE / TIME & SCHEDULE KEYS (CON'T)

UNIT OPERATING SCHEDULE

The Unit Operating Schedule is used to enable/disable the chiller unit on time of day. The chiller can be enabled and disabled once each day or it can be programmed to run continuously. Any time the daily or holiday schedule shuts the chiller down, the running system(s) will go through a controlled ramped shutdown. If the UNIT OPERATING SCHEDULE is selected under the CHOOSE SCHEDULE display, the following message will appear:

```
SCHEDULE    UNIT OPERATING
MON START = 06:00 AM  STOP = 10:00 PM
```

The line under the 0 is the cursor. If the start time is wrong, it can be changed by keying in the new time from the numeric keypad. Once the correct values for the START hour and minute are entered, press the ✓ (ENTER) key. The cursor will then move to the AM/PM selection. The meridian (AM/PM) value may be changed by the ◀ (LEFT ARROW) or ▶ (RIGHT ARROW) keys and entered by pressing ✓ (ENTER) key. Repeat this process for the STOP time. Once a schedule is entered, the schedule for the next day will appear. The start and stop time of each day may be programmed differently. To view the schedule without making a change, simply press the SCHEDULE key until the day you wish to view appears. The ▲ (UP ARROW) key will scroll backwards to the previous screen.

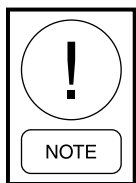

If at any time the schedule is changed for Monday, all the other days will change to the new Monday schedule. This means if the Monday times are not applicable for the whole week, then the exceptional days would need to be re-programmed to the desired schedule.

To program the chiller for 24 hour operation, program the start and stop times of each day of the week for 00:00.

After the SUN (Sunday) schedule appears on the display, a subsequent press of the SCHEDULE or ▲ (UP ARROW) key will display the Holiday schedule. This is a two-part display. The first reads:

```
SCHEDULE    UNIT OPERATING
HOL START = 00:00 AM  STOP = 00:00 PM
```

The holiday times may be set using the same procedure as described above for the days of the week. Be sure to press the ✓ (ENTER) key after setting the START and STOP times to save the change in memory. Pressing the SCHEDULE key a second time, the display will show the individual days:

```
SCHEDULE    UNIT OPERATING
S M T W T F S  HOLIDAY NOTED BY *
```

The line below the empty space is the cursor and will move to the next or previous empty space when the ◀ (LEFT ARROW) or ▶ (RIGHT ARROW) keys and pressed. To set a day for the Holiday Schedule, the cursor must be moved to the space following the day of the week. The * key is then pressed and an “*” will appear in the space signifying that day as a holiday. The Holiday schedule must be programmed weekly. If there is no holiday, the “*” key is also used to delete the “*”. The ✓ (ENTER) key is used to accept the holiday schedule for the entire week.

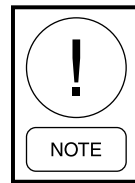

The HOLIDAY SCHEDULE is a temporary schedule. Once the schedule is executed, the selected holidays will be cleared from memory for the following week.

SOUND LIMIT SCHEDULE

The SOUND LIMIT SCHEDULE allows setting the day and time when the user desires using the “SILENT NIGHT” factory programmed option to limit chiller loading and fan operation for reduced audible noise in the surrounding area. If the SOUND LIMIT SCHEDULE is selected under the CHOOSE SCHEDULE display, the following message will appear:

```
SCHEDULE   SOUND LIMIT = XXX %
MON START = 06:00 AM  STOP = 10:00 PM
```

The Sound Limit option can be enabled and disabled once each day or the chiller can be set to run continuously in this mode for sound limiting whenever the chiller is operating. When sound limiting is enabled, the unit will be limited by the Sound Limit setpoint % as set under the PROGRAM key. XXX in the display above will show the Sound Limit Setpoint % programmed under the PROGRAM key. 0% will cause no speed reduction, while 100% only allows running at minimum speed.

The START Time for a specific day (hour and minute) is entered using the same guidelines used for the start/stop schedules, and press the ✓ (ENTER) key to store it into memory. The cursor will then move to the AM/PM selection.

The AM/PM selection may be chosen using the ◀ (LEFT ARROW) or ▶ (RIGHT ARROW) keys and pressing ✓ (ENTER) key to store the value.

This process is repeated for the STOP time.

Once the schedule for a specific day is programmed and entered, the schedule for the next day will appear. The schedule for each day may be programmed the same or differently.

To view the schedule without changing it, simply press the SCHEDULE key or the ▼ (DOWN ARROW) key until the desired day is displayed. The ▲ (UPARROW) key will scroll backwards to the previous screen.

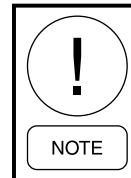

If the schedule is changed for Monday, all other days will change to the Monday schedule. Be aware of this when programming.

MANUAL OVERRIDE KEY

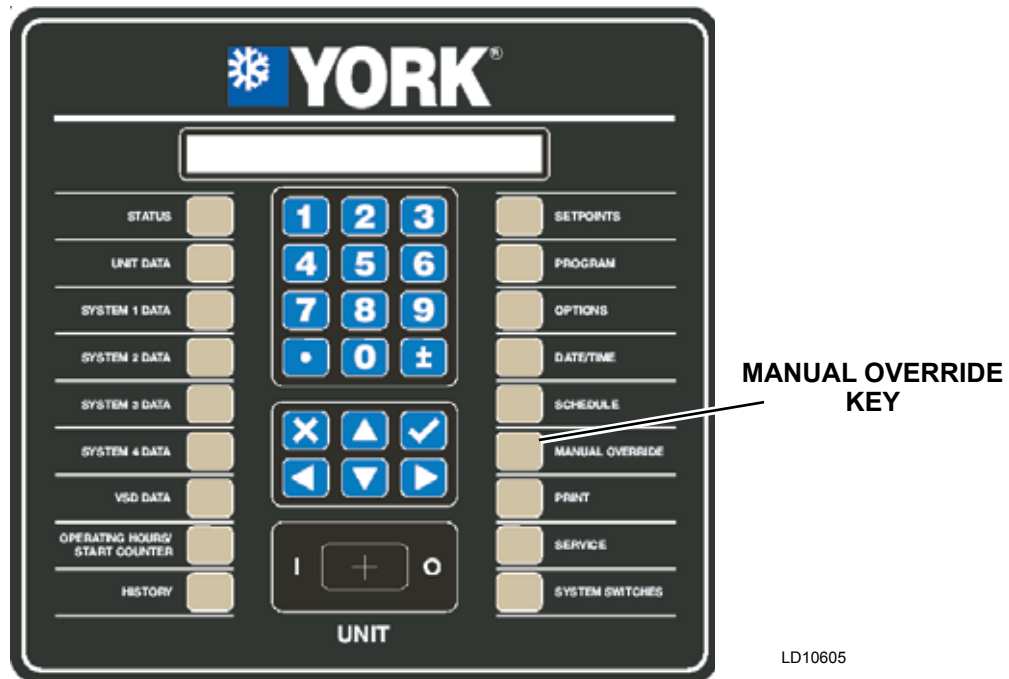

LD10605

MANUAL OVERRRIDE Key Operation

If the MANUAL OVERRRIDE key is pressed during a schedule shutdown, the STATUS display will display the message below. This indicates that the Daily Schedule is being ignored and the chiller will start when chilled liquid temperature allows, Remote Contacts, UNIT switch and SYSTEM switches permitting. This is a priority message and cannot be overridden by anti-recycle messages, fault messages, etc. when in the STATUS display mode. Therefore, do not expect to see any other STATUS messages when in the MANUAL OVERRRIDE mode. MANUAL OVERRRIDE is to only be used in emergencies or for servicing. Manual override mode automatically disables itself after 30 minutes.

MANUAL OVERRRIDE

PRINT KEY

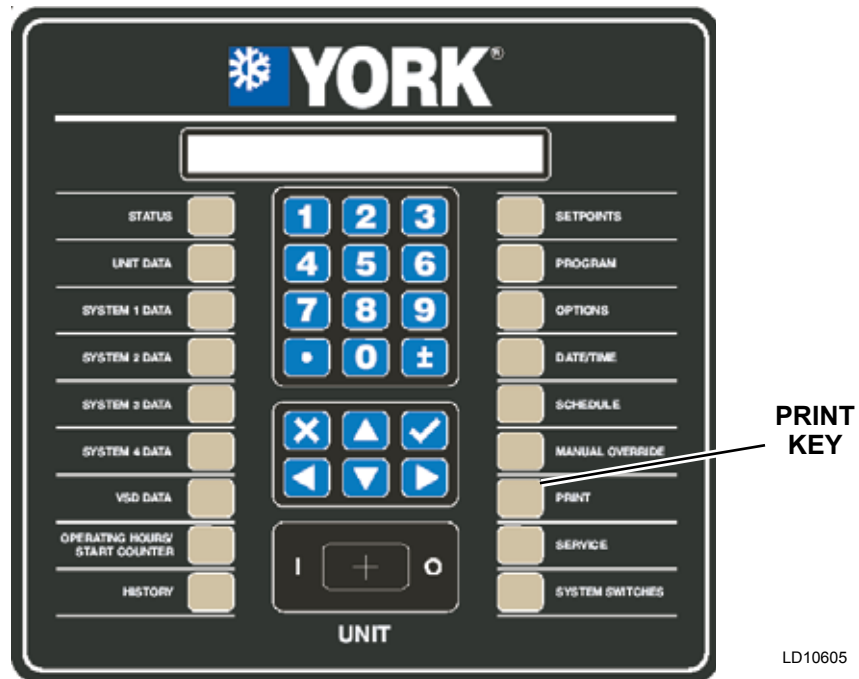

8

PRINT key Operation

The PRINT key is used to initiate a printout of current operating data (real time data), a complete history printout of all history (fault) buffers, a printout of all normal shutdowns (compressor cycling, chiller shutdown, etc.) or history (fault) data printout of a specific fault. History Buffer 1 will always be the most recent fault history printout. Printing may also be canceled by selecting the CANCEL PRINTING option. The following message is displayed when the PRINT key is pressed.



After pressing the PRINT key, the printout type is selected by pressing the ◀ (LEFT ARROW) or ▶ (RIGHT ARROW) keys until the desired printout is displayed.

TABLE 18 shows the available printout types.

TABLE 18 - PRINTOUT TYPES

PRINTOUT TYPES
Operating Data (Default Selection)
All History Buffers
Normal Shutdowns
History Buffer 1
History Buffer 2
History Buffer 3
History Buffer 4
History Buffer 5
History Buffer 6
History Buffer 7
History Buffer 8
History Buffer 9
History Buffer 10
Cancel Printing

The specific printout is initiated by pressing the ✓ (ENTER) key.

PRINT KEY (CON'T)

A sample of the operating data printout is shown below. The operating data printout is a snapshot of current system operating conditions when the printout was selected. The sample shows combined printouts of 2, 3, and 4 circuit units. The actual printout will only show data for the appropriate chiller type.

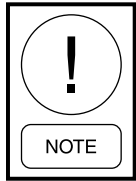

Bold italic text below a line of print is not on the actual printout. Bold italic text indicates information that may not be available on all printouts or is additional information to help explain the difference in a 2/3 or 4-circuit printout.

OPERATING DATA PRINTOUT

YORK INTERNATIONAL CORPORATION
LATITUDE SCREW CHILLER

OPERATING DATA
2:04:14 PM 18 JUN 05

SYS 1
NOT RUNNING
SYS 2
COMPRESSOR RUNNING

OPTIONS

CHILLED LIQUID	W A T E R
LOCAL/REMOTE MODE	R E M O T E
LEAD/LAG CONTROL	A U T O M A T I C
REMOTE TEMP RESET	D I S A B L E D
REMOTE CURRENT LIMIT	0 T O 1 0 V
REMOTE SOUND LIMIT	4 T O 2 0 M A
<i>(if Sound Limiting enabled)</i>	
LOW AMBIENT CUTOUT	E N A B L E D

PROGRAM VALUES

SUCT PRESS CUTOUT	4 4	P S I G
LOW AMBIENT CUTOUT	2 5 . 0	D E G F
LEAVING LIQUID CUTOUT	3 6 . 0	D E G F
MOTOR CURRENT LIMIT	1 0 0	% F L A
PULLDOWN CURRENT LIMIT	1 0 0	% F L A
PULLDOWN LIMIT TIME		0 M I N
SUCTION SUPERHEAT SETP	1 2 . 0	D E G F
UNIT ID NUMBER		0
SOUND LIMIT SETPOINT	1 0 0 %	
<i>(if Sound Limiting enabled)</i>		

UNIT DATA

LEAVING LIQUID TEMP	4 9 . 0	D E G F
RETURN LIQUID TEMP	5 8 . 2	D E G F
TEMP RATE	XXX . X	D E G F / M I N
COOLING RANGE	4 2 . 0 + / - 2 . 0	D E G F
REMOTE SETPOINT	4 4 . 0	D E G F
AMBIENT AIR TEMP	7 4 . 8	D E G F
LEAD SYSTEM		S Y S 2
FLOW SWITCH		O N
EVAPORATOR PUMP RUN		O N
EVAPORATOR HEATER		O F F
ACTIVE REMOTE CONTROL		N O N E

OPERATING HOURS 1=XXXXX, 2=XXXXX
3=XXXXX
(3 circuit)
3=XXXXX, 4=XXXXX
START COUNTER 1=XXXXX, 2=XXXXX
3=XXXXX
(3 circuit)
3=XXXXX, 4=XXXXX
(4 circuit)
SOFTWARE VERSION C . A C S . X X . 0 0

VSD DATA

ACTUAL FREQUENCY	XXX . X	H Z
COMMAND FREQUENCY	XXX . X	H Z
DC BUS VOLTAGE	XXX	V D C
<i>(2 circuit & 3 circuit)</i>		
DC BUS VOLTAGES	XXX XXX	V D C
<i>(4 circuit)</i>		
INTERNAL AMBIENT TEMP	XXX . X	D E G F
COOLING SYSTEM STATUS		X X X
BASEPLATE TEMPS	XXX XXX	D E G F
PRECHARGE SIGNAL		X X X
<i>(2 circuit & 3 circuit)</i>		
PRECHARGE SIGNALS	X X X	X X X
<i>(4 circuit)</i>		
MOTOR OVERLOADS 1/2	XXX XXX	A M P S
MOTOR OVERLOADS 3/4	XXX XXX	A M P S
<i>(3 circuit & 4 circuit)</i>		
SOFTWARE VERSION	C . V S D . X X . 0 0	

SYSTEM 1 DATA

COMPRESSOR STATUS		O F F
RUN TIME	0-0-0-0D-H-M-S	
MOTOR CURRENT	0 AMPS	0 % F L A
SUCTION PRESSURE	1 2 5	P S I G
DISCHARGE PRESSURE	1 3 1	P S I G
OIL PRESSURE	1 3 0	P S I G
SUCTION TEMPERATURE	6 8 . 4	D E G F
DISCHARGE TEMPERATURE	6 8 . 8	D E G F
OIL TEMPERATURE	6 8 . 8	D E G F
SAT SUCTION TEMP	7 1 . 8	D E G F
SUCTION SUPERHEAT	3 . 4	D E G F
SAT DISCHARGE TEMP	7 4 . 5	D E G F
DISCHARGE SUPERHEAT	6 . 3	D E G F
MOTOR TMP	XXX . X XXX . X XXX . X	D E G F
COMPRESSOR SPEED		XXX . X %
ECONOMIZER SOLENOID		O F F
FLASH TANK LEVEL		XXX . X %
FEED VALVE % OPEN		XXX . X %
DRAIN VALVE % OPEN		XXX . X %
CONDENSER FANS ON		0
COMPRESSOR HEATER		O N
RUN PERMISSIVE		O N
VSD RUN RELAY		O F F
VSD SOFTWARE RUN SIGNAL		O F F

SYSTEM 2 DATA

COMPRESSOR STATUS		O N
RUN TIME	0-0-15-26	D-H-M-S
MOTOR CURRENT	104 AMPS	8 7 % F L A
SUCTION PRESSURE	5 7	P S I G
DISCHARGE PRESSURE	2 3 3	P S I G
OIL PRESSURE	2 1 8	P S I G
SUCTION TEMPERATURE	4 2 . 9	D E G F
DISCHARGE TEMPERATURE	1 4 5 . 5	D E G F
OIL TEMPERATURE	1 0 2 . 8	D E G F
SAT SUCTION TEMP	3 1 . 7	D E G F
SUCTION SUPERHEAT	1 1 . 2	D E G F
SAT DISCHARGE TEMP	1 1 2 . 1	D E G F
DISCHARGE SUPERHEAT	3 3 . 4	D E G F

PRINT KEY (CON'T)

```

MOTOR TMP                XXX.X XXX.X XXX.X DEGF
COMPRESSOR SPEED         XXX.X%
LIQUID LINE SOLENOID     ON
FLASH TANK LEVEL         XXX.X%
FEED VALVE % OPEN       XXX.X%
DRAIN VALVE % OPEN      XXX.X%
CONDENSER FANS ON       3
COMPRESSOR HEATER       OFF
RUN PERMISSIVE          ON
VSD RUN RELAY           OFF
VSD SOFTWARE RUN SIGNAL OFF
    
```

UNIT OPERATING SCHEDULE

```

S M T W T F S          * = H O L I D A Y
MON START=00:00AM     STOP=00:00AM
TUE START=00:00AM     STOP=00:00AM
WED START=00:00AM     STOP=00:00AM
THU START=00:00AM     STOP=00:00AM
FRI START=00:00AM     STOP=00:00AM
SAT START=00:00AM     STOP=00:00AM
HOL START=00:00AM     STOP=00:00AM
    
```

SOUND LIMIT SCHEDULE

(This section is printed only if the sound limit schedule is enabled)

```

MON START=00:00AM     STOP=00:00AM
TUE START=00:00AM     STOP=00:00AM
WED START=00:00AM     STOP=00:00AM
THU START=00:00AM     STOP=00:00AM
FRI START=00:00AM     STOP=00:00AM
SAT START=00:00AM     STOP=00:00AM
HOL START=00:00AM     STOP=00:00AM
    
```

HISTORY DATA PRINTOUT

History printouts, when selected, provide stored data relating to all specific system and chiller operating conditions at the time of the fault, regardless of whether a lockout occurred. History information is stored in battery-backed memory on the Chiller Control Board and is not affected by power failures or resetting of faults. Whenever a fault of any type occurs, all system operating data is stored in battery-backed memory at the instant of the fault. The history printout is similar to the operating data printout except for the change in the header information shown below:

YORK INTERNATIONAL CORPORATION
LATITUDE SCREW CHILLER

HISTORY NUMBER 1

2:04:14 PM 18 JUN 04

SYS 1 YYYYYYY

HIGH DSCH PRESS SHUTDOWN

STATUS AT TIME OF SHUTDOWN

```

SYS 1  X X X X X X X X X X X X X X X X X X X X X X X X X X X X X X X
SYS 2  X X X X X X X X X X X X X X X X X X X X X X X X X X X X X X X
    
```

ALL FAULTS

```

X X X X X X X X X X X X X X X X X X X X X X X X X X X X X X X X X X X
X X X X X X X X X X X X X X X X X X X X X X X X X X X X X X X X X X X
    
```

The most recent fault will always be stored as HISTORY BUFFER #1.

SERVICE KEY

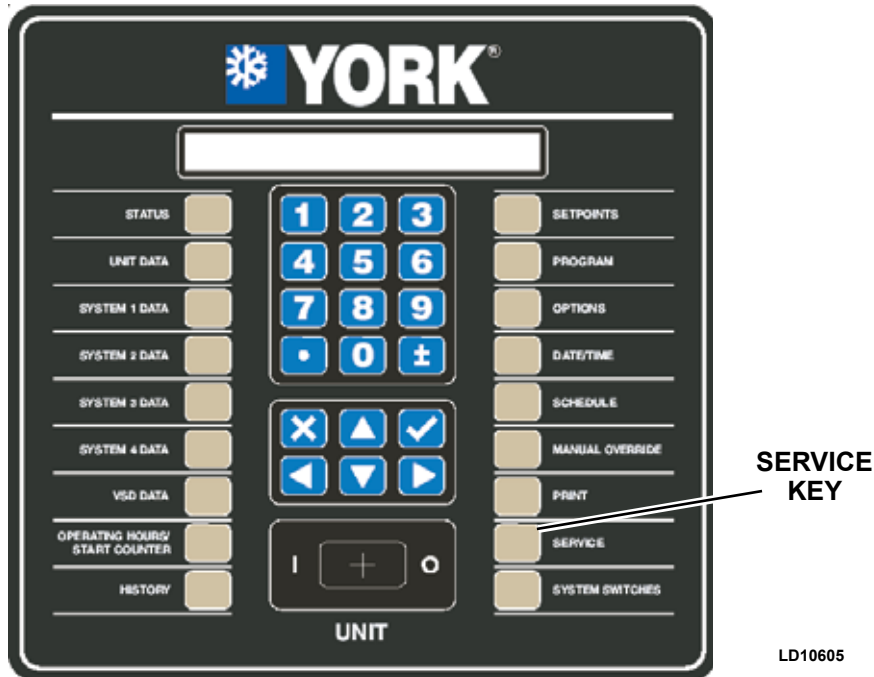

SERVICE Key Operation

The Service Key allows viewing data related to the internal function of the chiller system electronics. Data such as circuit board output status as controlled by the Chiller Control software while operating can be viewed and compared to actual chiller operation in the event servicing is required. The Service Key allows controlling of analog and digital outputs for troubleshooting purposes when the unit is not running. The Unit Serial Number and Optimized IPLV Control mode are also entered using the Service Key.

The ▲ ▼ (ARROW) keys allow scrolling through the displays. The ▼ (ARROW) key scrolls through the displays in the forward direction.

When the SERVICE key is pressed, the following message will appear:

SERVICE MODE XXXX
PRESS ENTER KEY TO CONTINUE

XXXX will display a password, if a numerical password is entered.

Pressing the ✓ (ENTER) key allows “view only” Service Mode operation. All control board I/O will be viewable in this mode. No outputs can be changed. For troubleshooting or start-up commissioning purposes, the Chiller Micro Board and some VSD outputs can be toggled or changed by turning off the UNIT SWITCH, pressing the SERVICE Key, entering password 9675, and pressing the ✓ (ENTER) key. Once the password is entered, the Digital Outputs (DO) can be toggled by pressing the ✓ (ENTER) key. The Analog Outputs can be programmed to output a specific value using the keypad and programming in the desired value, which will usually be noted as a % or VDC. If the UNIT SWITCH is turned back on, the chiller will revert to normal viewable only control.

Displays can be viewed by pressing the ▲ and ▼ (ARROW) keys. The ▼ (ARROW) key scrolls through the displays in the forward direction.

The ◀ and ▶ (ARROW) keys allow jumping from data section to data section to avoid scrolling sequentially through all the data. Once in a data section, the ▲ and ▼ (ARROW) keys allow scrolling through the data under the section. Pressing the ◀ and ▶ (ARROW) keys at any time moves to the top of the next data section.

SERVICE KEY (CON'T)

The data sections are listed below:

- Software Versions
- Analog Inputs
- Digital Inputs
- Digital Outputs
- Analog Outputs
- VSD Logic Digital Output

The software version of the chiller Micro Control Board and the VSD micro are viewable in the first data section.

SERVICE SOFTWARE VERSIONS
CONTROL = C.AXX.ZZ.YY VSD = C.VXX.ZZ.YY

XX, YY, and ZZ will be filled in with alphanumeric characters.

The second data section displays the Analog Inputs (AI). Displays for 3 and 4 compressor chillers are skipped if the unit does not have those systems. These messages will only be displayed in English. The voltage displayed is referenced to common (return, ground) in the system. J12-3 can also be used as common, as well as chassis ground, or the common terminal point on the Chiller Control Board. See the wiring diagrams.

SERVICE AI J17-11 REMOTE TEMP RESET
X.X VDC = XXX.X %

SERVICE AI J17-12 REMOTE CURRENT LIMIT
X.X VDC = XXX.X %

SERVICE AI J17-13 REMOTE SOUND LIMIT
X.X VDC = XXX.X %

The Remote Temp Reset, Remote Current Limit Reset, and Remote Sound Limit inputs have onboard voltage dividers, if the jumper is set for a voltage input. This will cause the voltage read on the display to be less than the voltage on the board header inputs between TB1-17 and 18, TB1-19 and 20, or TB1-40 and 41). To correct for this when measuring voltage at the remote device supplying voltage to the board header while troubleshooting, use the following calculation:

$$\text{Voltage} = 10 \times \text{ADC volts} / 4.5$$

If the input is programmed for a current input, the voltage read by the MUX is displayed. If the input is disabled under the OPTIONS key, the voltage display will display "DISABLED".

The analog inputs display will continue to sequence as follows. The inputs indicate voltages read between the input terminal to the Chiller Logic Board and the plug GND or Drain.

SERVICE AI J17-14 SPARE ANALOG 1
X.X VDC

SERVICE AI J17-15 SPARE ANALOG 2
X.X VDC

SERVICE AI J18-7 LEAVING LIQUID TEMP
X.X VDC = XXX.X °F

SERVICE AI J18-8 RETURN LIQUID TEMP
X.X VDC = XXX.X °F

SERVICE AI J18-9 AMBIENT AIR TEMP
X.X VDC = XXX.X °F

SERVICE AI J19-1 SYS1 MOTOR TEMP T1
X.X VDC = XXX.X °F

SERVICE AI J19-2 SYS1 MOTOR TEMP T2
X.X VDC = XXX.X °F

SERVICE AI J19-3 SYS1 MOTOR TEMP T3
X.X VDC = XXX.X °F

SERVICE AI J19-6 SYS2 MOTOR TEMP T1
X.X VDC = XXX.X °F

SERVICE AI J19-7 SYS2 MOTOR TEMP T2
X.X VDC = XXX.X °F

SERVICE AI J19-8 SYS2 MOTOR TEMP T3
X.X VDC = XXX.X °F

SERVICE AI J20-1 SYS3 MOTOR TEMP T1
X.X VDC = XXX.X °F

SERVICE AI J20-2 SYS3 MOTOR TEMP T2
X.X VDC = XXX.X °F

SERVICE KEY (CON'T)

SERVICE AI J20-3 SYS3 MOTOR TEMP T3
X.X VDC = XXX.X °F

SERVICE AI J20-6 SYS4 MOTOR TEMP T1
X.X VDC = XXX.X °F

SERVICE AI J20-7 SYS4 MOTOR TEMP T2
X.X VDC = XXX.X °F

SERVICE AI J20-8 SYS4 MOTOR TEMP T3
X.X VDC = XXX.X °F

SERVICE AI J21-3 SYS1 OIL TEMP
X.X VDC = XXX.X °F

SERVICE AI J21-6 SYS1 FL TANK LEVEL
X.X VDC = XXX.X %

SERVICE AI J21-13 SYS1 SUCTION TEMP
X.X VDC = XXX.X °F

SERVICE AI J21-16 SYS1 DISCHARGE TEMP
X.X VDC = XXX.X °F

SERVICE AI J21-20 SYS1 SUCTION PRESS
X.X VDC = XXX.X PSIG

SERVICE AI J21-22 SYS1 OIL PRESS
X.X VDC = XXX.X PSIG

SERVICE AI J21-24 SYS1 DISCHARGE PRESS
X.X VDC = XXX.X PSIG

SERVICE AI J22-3 SYS2 OIL TEMP
X.X VDC = XXX.X °F

SERVICE AI J22-6 SYS2 FL TANK LEVEL
X.X VDC = XXX.X %

SERVICE AI J22-13 SYS2 SUCTION TEMP
X.X VDC = XXX.X °F

SERVICE AI J22-16 SYS2 DISCHARGE TEMP
X.X VDC = XXX.X °F

SERVICE AI J22-20 SYS2 SUCTION PRESS
X.X VDC = XXX.X PSIG

SERVICE AI J22-22 SYS2 OIL PRESS
X.X VDC = XXX.X PSIG

SERVICE AI J22-24 SYS2 DISCHARGE PRESS
X.X VDC = XXX.X PSIG

SERVICE AI J23-3 SYS3 OIL TEMP
X.X VDC = XXX.X °F

SERVICE AI J23-6 SYS3 FL TANK LEVEL
X.X VDC = XXX.X %

SERVICE AI J23-13 SYS3 SUCTION TEMP
X.X VDC = XXX.X °F

SERVICE AI J23-16 SYS3 DISCHARGE TEMP
X.X VDC = XXX.X °F

SERVICE AI J23-20 SYS3 SUCTION PRESS
X.X VDC = XXX.X PSIG

SERVICE AI J23-22 SYS3 OIL PRESS
X.X VDC = XXX.X PSIG

SERVICE AI J23-24 SYS3 DISCHARGE PRESS
X.X VDC = XXX.X PSIG

SERVICE AI J24-3 SYS4 OIL TEMP
X.X VDC = XXX.X °F

SERVICE AI J24-6 SYS4 FL TANK LEVEL
X.X VDC = XXX.X %

SERVICE AI J24-13 SYS4 SUCTION TEMP
X.X VDC = XXX.X °F

SERVICE AI J24-16 SYS4 DISCHARGE TEMP
X.X VDC = XXX.X °F

SERVICE AI J24-20 SYS4 SUCTION PRESS
X.X VDC = XXX.X PSIG

SERVICE AI J24-22 SYS4 OIL PRESS
X.X VDC = XXX.X PSIG

SERVICE AI J24-24 SYS4 DISCHARGE PRESS
X.X VDC = XXX.X PSIG

SERVICE KEY (CON'T)

The third data section displays the Digital Inputs (DI) to the Chiller Control Board that can be viewed from the service mode. Displays for systems 3 and 4 are skipped if the systems are not present on the chiller. XXX is replaced with ON or OFF in the actual display. These messages will only be displayed in English.

**SERVICE DI J4-2 UNIT SWITCH 1
STATUS = XXX**

**SERVICE DI J4-3 UNIT SWITCH 2
STATUS = XXX**

**SERVICE DI J4-4 SYS 1 HPCO
STATUS = XXX**

**SERVICE DI J4-5 SYS 2 HPCO
STATUS = XXX**

**SERVICE DI J4-6 VSD FAULT RELAY
STATUS = XXX**

**SERVICE DI J5-1 SYS 3 HPCO
STATUS = XXX**

**SERVICE DI J5-2 SYS 4 HPCO
STATUS = XXX**

**SERVICE DI J5-3 SPARE DIGITAL INPUT 2
STATUS = XXX**

J5 is not present on a 2 compressor Chiller Control Board. The displays above are skipped for a 2 compressor chiller:

**SERVICE DI J6-2 FLOW SWITCH
STATUS = XXX**

**SERVICE DI J6-3 PRINT
STATUS = XXX**

**SERVICE DI J6-4 SYS 1/3 RUN PERM
STATUS = XXX**

**SERVICE DI J6-5 SYS 2/4 RUN PERM
STATUS = XXX**

**SERVICE DI J6-6 SPARE DIGITAL INPUT 1
STATUS = XXX**

**SERVICE DI J7-2 CONFIG INPUT 0
STATUS = XXX**

**SERVICE DI J7-4 CONFIG INPUT 1
STATUS = XXX**

**SERVICE DI J7-6 CONFIG INPUT 2
STATUS = XXX**

**SERVICE DI J7-8 CONFIG INPUT 3
STATUS = XXX**

**SERVICE DI J7-10 CONFIG SPARE INPUT 0
STATUS = XXX**

**SERVICE DI J7-12 CONFIG SPARE INPUT 1
STATUS = XXX**

**SERVICE DO J9-1 EVAP HEATER
RB1 TB1-20 STATUS = XXX**

**SERVICE DO J9-2 SYS 1/3 VSD RUN
RB1 TB1-18 STATUS = XXX**

**SERVICE DO J9-3 SYS 1/3 ALARM
RB1 TB1-16 STATUS = XXX**

**SERVICE DO J9-4 EVAP HEATER 2
RB1 TB1-14 STATUS = XXX**

**SERVICE DO J9-5 SYS 1 SPARE
RB1 TB1-12 STATUS = XXX**

**SERVICE DO J9-6 SPARE 1
RB1 TB1-10 STATUS = XXX**

**SERVICE DO J9-7 SPARE 2
RB1 TB1-8 STATUS = XXX**

**SERVICE DO J9-8 SYS 1 COND FAN OUT 1
RB1 TB1-6 STATUS = XXX**

**SERVICE DO J9-9 SYS 1 COND FAN OUT 2
RB1 TB1-5 STATUS = XXX**

**SERVICE DO J9-10 SYS 1 COND FAN OUT 3
RB1 TB1-4 STATUS = XXX**

**SERVICE DO J9-11 SYS 1 COMP HEATER
RB1 TB1-3 STATUS = XXX**

**SERVICE DO J9-10 SYS 1 ECON SOL VALVE
RB1 TB1-2 STATUS = XXX**

SERVICE KEY (CON'T)

SERVICE DO J10-1	EVAP PUMP RUN
RB1 TB1-20	STATUS = XXX

SERVICE DO J10-2	SYS 2/4 VSD RUN
RB1 TB1-18	STATUS = XXX

SERVICE DO J10-3	SYS 2/4 ALARM
RB1 TB1-16	STATUS = XXX

SERVICE DO J10-4	CHILLER RUN
RB1 TB1-14	STATUS = XXX

SERVICE DO J10-5	SYS 2 SPARE
RB1 TB1-12	STATUS = XXX

SERVICE DO J10-6	SPARE 3
RB1 TB1-10	STATUS = XXX

SERVICE DO J10-7	SPARE 4
RB1 TB1-8	STATUS = XXX

SERVICE DO J10-8	SYS COND 2 FAN OUT 1
RB1 TB1-6	STATUS = XXX

SERVICE DO J10-9	SYS COND 2 FAN OUT 2
RB1 TB1-5	STATUS = XXX

SERVICE DO J10-10	SYS COND 2 FAN OUT 3
RB1 TB1-4	STATUS = XXX

SERVICE DO J10-11	SYS 2 COMP HEATER
RB1 TB1-3	STATUS = XXX

SERVICE DO J10-12	SYS 2 ECON SOL VALVE
RB1 TB1-2	STATUS = XXX

SERVICE DO J11-1	SYS 4 COND FAN OUT 1
RB1 TB1-20	STATUS = XXX

SERVICE DO J11-2	SYS 4 COND FAN OUT 2
RB1 TB1-18	STATUS = XXX

SERVICE DO J11-3	SYS 4 COND FAN OUT 3
RB1 TB1-16	STATUS = XXX

SERVICE DO J11-4	SYS 4 COMP HEATER
RB1 TB1-14	STATUS = XXX

SERVICE DO J11-5	SYS 4 ECON SOL VALVE
RB1 TB1-12	STATUS = XXX

SERVICE DO J11-6	SYS 4 SPARE
RB1 TB1-10	STATUS = XXX

SERVICE DO J11-7	SYS 3 SPARE
RB1 TB1-8	STATUS = XXX

SERVICE DO J11-8	SYS 3 COND FAN OUT 1
RB1 TB1-6	STATUS = XXX

SERVICE DO J11-9	SYS 3 COND FAN OUT 2
RB1 TB1-5	STATUS = XXX

SERVICE DO J11-10	SYS 3 COND FAN OUT 3
RB1 TB1-4	STATUS = XXX

SERVICE DO J11-11	SYS 3 COMP HEATER
RB1 TB1-3	STATUS = XXX

SERVICE DO J11-12	SYS 3 ECON SOL VALVE
RB1 TB1-2	STATUS = XXX

The fifth data section displays the Analog Outputs (AO) that can be viewed from the Service Mode. The Analog Output signals are typically referenced to the common (return, ground) in the system. J12-3 can also be used as common, as well as chassis ground, or the common terminal point on the Chiller Control Board. See the wiring diagrams. GND on the plug. Displays for systems 3 and 4 are skipped if the systems are not present on the chiller. XXX is replaced with ON or OFF in the actual display. The state of these outputs is only viewable unless the password 9675 ✓(ENTER) key was entered from the initial Service Mode display with the UNIT Switch in the OFF position. The chiller will not be permitted to run when the outputs are made active. The outputs can be programmed for a specific % output by keying in the value and pressing the ✓(ENTER) key. These messages will only be displayed in English.

SERVICE AO J15-1	SYS 1 FEED VALVE OUT
XXX.X %	= XX.X VDC

SERVICE AO J15-3	SYS 1 DRAIN VALVE OUT
XXX.X %	= XX.X VDC

SERVICE AO J15-5	SYS 2 FEED VALVE OUT
XXX.X %	= XX.X VDC

SERVICE AO J15-7	SYS 2 DRAIN VALVE OUT
XXX.X %	= XX.X VDC

SERVICE KEY (CON'T)

SERVICE AO J14-1	SYS 3 FEED VALVE OUT
XXX.X %	= XX.X VDC

SERVICE AO J14-2	SYS 3 DRAIN VALVE OUT
XXX.X %	= XX.X VDC

SERVICE AO J14-3	SYS 4 FEED VALVE OUT
XXX.X %	= XX.X VDC

SERVICE AO J14-4	SYS 4 DRAIN VALVE OUT
XXX.X %	= XX.X VDC

SERVICE AO J25-1	SYS 1 SPARE
XXX.X %	= XX.X VDC

SERVICE AO J25-2	SYS 2 SPARE
XXX.X %	= XX.X VDC

SERVICE AO J25-3	SYS 3 SPARE
XXX.X %	= XX.X VDC

SERVICE AO J25-4	SYS 4 SPARE
XXX.X %	= XX.X VDC

The sixth data section displays the “VSD” digital outputs (DO) that can be viewed from the service mode. The Digital Output signals indicate the status of the output. The 0-120VAC digital outputs are referenced to neutral (Wire 2).

SERVICE DO J10-2	VSD COOLING FAN/PUMP
VSD LOGIC	STAUS = XXX

SYSTEM SWITCHES KEY

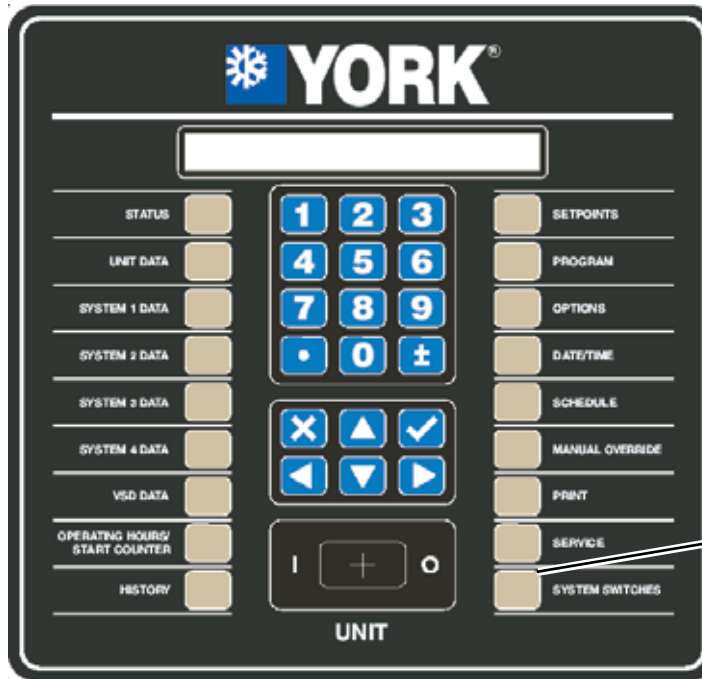

SYSTEM SWITCHES KEY

LD10605

SYSTEM SWITCHES Key Operation

The SYSTEM SWITCHES key allows the operator to turn individual systems ON and OFF. Safety lockouts are also reset by selecting the respective system switch RESET. When the System Switches Key is pressed, the following message will appear:

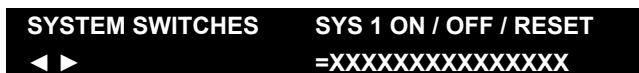

The display indicates the respective system and its on/off /reset switch status. The ▲ ▼ (ARROW) keys allow scrolling to the next and previous system switch (System 1, 2, 3, or 4).

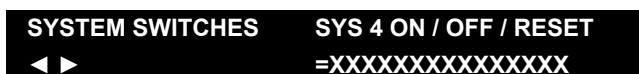
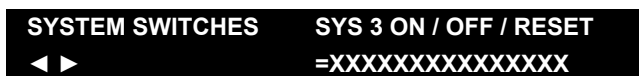
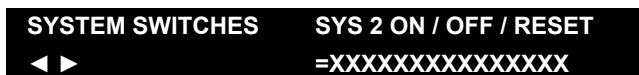

The ◀ (LEFT ARROW) or ▶ (RIGHT ARROW) keys allow scrolling through the choices of:

- SYSTEM OFF (default)
- SYSTEM ON
- RESET (LOCKOUT)

The switch selection is accepted into memory by pressing the ✓ (ENTER) key.

When the “RESET” selection is made and accepted, it will not change the position of the switch (either ON or OFF).

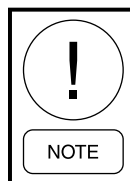

Whenever possible, except in emergencies, always use the associated system switch to turn off a compressor, which allows the compressors to go through a controlled shutdown. Avoid using the "UNIT" switch to turn off the compressors.

SERIAL NUMBER PROGRAMMING

When changing a Chiller Control Board, a Chiller Control Board EPROM, or if a situation occurs where a chiller is not programmed from the factory, the chiller serial number will need to be programmed into the chiller. The serial number is the actual serial number displayed on the unit Data Plate. The serial number will be in a format similar to RABM000000, where the first 4 characters are letters and the next 6 are numbers. The lack of a serial number programmed into the panel will not prevent a chiller from operating, but a High IPLV chiller will only operate in the Standard IPLV mode. The STATUS display will inform the operator a serial number problem exists by displaying the following message:

UNIT WARNING: INVALID SERIAL NUMBER
ENTER UNIT SERIAL NUMBER

If the following message appears, immediately contact YORK Product Technical Support. The appearance of this message may also mean the chiller has lost important factory programmed information and may need to be reprogrammed. Additional STATUS messages can be viewed by pressing the STATUS key repetitively to enable the technician to view any other messages that may be preventing the chiller from operating.

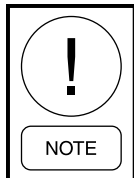

Changing the programming of this feature requires the date and time to be set on the chiller prior to programming. The password is also time sensitive and must be used the same day it is received.

YORK Product Technical Support will provide a factory password to allow programming the serial number into the chiller. You will need to supply Factory Technical Support with the version of the Chiller Control Board EPROM. The version will be written on the EPROM label and typically will be in the format Version C.ACS.XX.XX.

After obtaining the password, the following steps will need to be followed to input the serial number. As the serial number is input, the characters keyed in will appear in the display indicating the panel has recognized the entry.

First press the SERVICE Key. The following message will appear:

SERVICE MODE XXXXX
PRESS ENTER KEY TO CONTINUE

Key in the 5 digit alphanumeric password provided by Product Technical Support and press the ✓ (ENTER) key. The following display will appear:

S/N ENTRY UNIT SERIAL NUMBER POS 1
◀ ▶ X

Key in the first letter (A through Z) of the serial number using the ◀ and ▶ (ARROW) keys and press the ✓ (ENTER) key. Press the ▼ (DOWN ARROW) key to scroll to position 2 and the following message will appear:

S/N ENTRY UNIT SERIAL NUMBER POS 2
◀ ▶ XX

Key in the second letter (A through N) of the serial number using the ◀ and ▶ (ARROW) keys and press the ✓ (ENTER) key. Press the ▼ (DOWN ARROW) key to scroll to position 3 and the following message will appear:

S/N ENTRY UNIT SERIAL NUMBER POS 3
◀ ▶ XXX

Key in the third letter (A through Z) of the serial number using the ◀ and ▶ (ARROW) keys and press the ✓ (ENTER) key. Press the ▼ (DOWN ARROW) key to scroll to position 4 and the following message will appear:

S/N ENTRY UNIT SERIAL NUMBER POS 4
◀ ▶ XXXX

Key in the fourth letter (A through Z) of the serial number using the ◀ and ▶ (ARROW) keys and press the ✓ (ENTER) key. Press the ▼ (DOWN ARROW) key to scroll to positions 5-7 and the following message will appear:

S/N ENTRY UNIT S/N = YYYY XXX ZZZ
UNIT SERIAL NUMBER POS 5-7 = XXX

SERIAL NUMBER PROGRAMMING (CON'T)

At this point, the letters entered for the YYYY inputs should now appear in the top line of the display and should match the first 4 characters of the serial number on the unit Data Plate. The next three digits of the serial number should now be keyed in. Press the ✓ (ENTER) key to store the input. Press the ▼ (DOWN ARROW) key to scroll to positions 8-10 and the following message will appear:

```
S/N ENTRY UNIT S/N = YYYY XXX ZZZ  
UNIT SERIAL NUMBER POS 8-10 = XXX
```

At this point, the letters entered for the YYYY and XXX inputs should now appear in the top line of the display and should match the first 7 characters of the serial number on the unit Data Plate. The next three digits of the serial number should now be keyed in. Press the ✓ (ENTER) key to store the input. The full serial number should now be displayed across the top of the display and the cursor should disappear.

Press the STATUS key to go to the next STATUS display to determine if additional Status messages are preventing the chiller from operating.

ENABLING OPTIMIZED HIGH IPLV MODE

When changing a Chiller Control Board, a Chiller Control Board EPROM, or if a situation occurs where a chiller is not programmed from the factory, the chiller will not be capable of operating High IPLV mode. The serial number of the unit will first need to be programmed into the panel, if the Invalid Serial Number display appears (See Page 267). The Invalid Serial Number message will override the Optimized Efficiency Disabled message. If the chiller was purchased with the High IPLV Option and does not have the High IPLV mode enabled, it will not prevent the chiller from operating, but the chiller will only operate in the Standard IPLV mode. Additional STATUS messages can be viewed by pressing the STATUS key repetitively to enable the technician to view any other messages that may be preventing the chiller from operating.

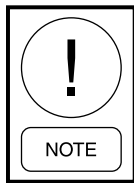

Changing the programming of this feature requires the date and time to be set on the chiller prior to programming the password. The password is also time sensitive and must be used “immediately” when it is received.

The STATUS display will inform the operator when a HIGH IPLV chiller is operating with the High IPLV mode disabled by displaying the following STATUS message:

**UNIT WARNING: OPTIMIZED EFFICIENCY
DISABLED - CONTACT YORK REPRESENTATIVE**

If the message above appears, immediately contact YORK Product Technical Support or YORK ES Commercial for a password to enable the High IPLV mode. You will need to provide YORK Product Technical Support or YORK ES Commercial with the Unit Serial Number located on the chiller nameplate. The date and time will also need to be current on the chiller, and will need to be provided to YORK Product Technical Support or YORK ES Commercial. It is essential YORK Product Technical Support or, YORK ES Commercial is aware of the “local” time to allow adjustments for time differences from Eastern Standard Time.

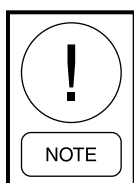

After obtaining the password, the following steps will need to be carried out “immediately” to input the serial number. If the password is not immediately input, the panel will not accept it.

To enable HIGH IPLV Mode, first press the SERVICE Key. The following message will appear:

**SERVICE MODE XXXXX
PRESS ENTER KEY TO CONTINUE**

Key in the 5 digit alphanumeric password provided by YORK Technical Support or YORK ES Commercial and press the ✓ (ENTER) key. The following display will appear:

**IPLV OPTIMIZED EFFICIENCY CONTROL
◀▶XXXXXXXXXXXXXXXXXXXXXXXXXXXX**

When the Optimized (High IPLV) is enabled, the display will indicate, “ENABLED”. When not enabled, the display will indicate, “DISABLED”. Use the ◀ and ▶ (ARROW) keys to enable/disable and press the ✓ (ENTER) key to store the selection.

UNIT SETUP MODE

Unit Setup Mode will allow the programming all of the programmable values that the user should never change. These will either be programmed at the factory or by service personnel on the job.

This mode may be entered by pressing the PROGRAM key, entering the password 4245, and pressing the ✓(ENTER) key. TABLE 19 lists the values that can be programmed in this mode. Details relating to the actual message follow the table.

TABLE 19 - UNIT SETUP PROGRAMMABLE VALUES

SETUP MODE VALUE	PRAGRAMMABLE RANGE	DEFAULT
Sys 1 Number of Cond Fans	4 to 6	6
Sys 2 Number of Cond Fans	4 to 6	6
Sys 3 Number of Cond Fans	4 to 6	6
Sys 4 Number of Cond Fans	4 to 6	6
Compressor 1 Operating hours	0 to 99,999	0
Compressor 2 Operating hours	0 to 99,999	0
Compressor 3 Operating hours	0 to 99,999	0
Compressor 4 Operating hours	0 to 99,999	0
Compressor 1 Starts	0 to 99,999	0
Compressor 2 Starts	0 to 99,999	0
Compressor 3 Starts	0 to 99,999	0
Compressor 4 Starts	0 to 99,999	0
Clear History Buffers	Yes/ No	-
Remote Temp Reset Option	Disabled/Enabled	Disabled
Remote Current Limit Option	Disabled/Enabled	Disabled
Sound Limit Option	Disabled/Enabled	Disabled
Remote Inputs Service Time	5 Min - 60 Min	15 Min
Sys 1 Motor Sensor to Ignore	See Below	None
Sys 2 Motor Sensor to Ignore	See Below	None
Sys 3 Motor Sensor to Ignore	See Below	None
Sys 4 Motor Sensor to Ignore	See Below	None

The following messages will be displayed for the Unit Setup Mode in the order they appear. The first group of displays relates to setup parameters that relate to unit configuration and factory setpoints.

**SETUP MODE ◀ DEF XXXXX LO XXXXX HI XXXXX
SYS 1 NUMBER OF COND FANS = X**

**SETUP MODE ◀ DEF XXXXX LO XXXXX HI XXXXX
SYS 2 NUMBER OF COND FANS = X**

**SETUP MODE ◀ DEF XXXXX LO XXXXX HI XXXXX
SYS 3 NUMBER OF COND FANS = X**

**SETUP MODE ◀ DEF XXXXX LO XXXXX HI XXXXX
SYS 4 NUMBER OF COND FANS = X**

**SETUP MODE ◀ DEF XXXXX LO XXXXX HI XXXXX
COMP 1 OPERATING HOURS = XXXXX**

**SETUP MODE ◀ DEF XXXXX LO XXXXX HI XXXXX
COMP 2 OPERATING HOURS = XXXXX**

**SETUP MODE ◀ DEF XXXXX LO XXXXX HI XXXXX
COMP 3 OPERATING HOURS = XXXXX**

**SETUP MODE ◀ DEF XXXXX LO XXXXX HI XXXXX
COMP 4 OPERATING HOURS = XXXXX**

UNIT SETUP MODE (CON'T)

```

SETUP MODE ◀ DEF XXXXX LO XXXXX HI XXXXX
COMP 1 STARTS                               = XXXXX
    
```

```

SETUP MODE ◀ DEF XXXXX LO XXXXX HI XXXXX
COMP 2 STARTS                               = XXXXX
    
```

```

SETUP MODE ◀ DEF XXXXX LO XXXXX HI XXXXX
COMP 3 STARTS                               = XXXXX
    
```

```

SETUP MODE ◀ DEF XXXXX LO XXXXX HI XXXXX
COMP 4 STARTS                               = XXXXX
    
```

```

SETUP MODE  SYS 1 MOTOR SENSOR TO IGNORE
◀ ▶XXXXXXXXXXXXXXXXXXXXXXXXXXXXXXXXXXXX
    
```

```

SETUP MODE  SYS 2 MOTOR SENSOR TO IGNORE
◀ ▶XXXXXXXXXXXXXXXXXXXXXXXXXXXXXXXXXXXX
    
```

```

SETUP MODE  SYS 3 MOTOR SENSOR TO IGNORE
◀ ▶XXXXXXXXXXXXXXXXXXXXXXXXXXXXXXXXXXXX
    
```

```

SETUP MODE  SYS 4 MOTOR SENSOR TO IGNORE
◀ ▶XXXXXXXXXXXXXXXXXXXXXXXXXXXXXXXXXXXX
    
```

The following setup display is selectable as YES or NO using the ◀ and ▶ (ARROW) keys.

```

SETUP MODE  CLEAR HISTORY BUFFERS?
◀ ▶XXXXXXXXXXXXXXXXXXXXXXXXXXXXXXXXXXXX
    
```

The following (3) setup OPTION displays are selectable as ENABLED or DISABLED using the ◀ and ▶ (ARROW) keys according to the options installed on the chiller:

```

SETUP MODE  REMOTE TEMP RESET OPTION
◀ ▶XXXXXXXXXXXXXXXXXXXXXXXXXXXXXXXXXXXX
    
```

```

SETUP MODE  REMOTE CURRENT LIMIT OPTION
◀ ▶XXXXXXXXXXXXXXXXXXXXXXXXXXXXXXXXXXXX
    
```

```

SETUP MODE  SOUND LIMIT OPTION
◀ ▶XXXXXXXXXXXXXXXXXXXXXXXXXXXXXXXXXXXX
    
```

The following setup OPTION display is selectable as ENABLED or DISABLED using the ◀ and ▶ (ARROW) keys:

```

SETUP MODE ◀ DEF XXXXX LO XXXXX HI XXXXX
REMOTE INPUTS SERVICE TIME   = XX MIN
    
```

The following OPTION displays are selectable as ENABLED or DISABLED using the ◀ and ▶ (ARROW) keys. The choices are:

- NONE (default)
- TEMP SENSOR 1
- TEMP SENSOR 2
- TEMP SENSOR 3

If a motor temperature sensor fails, a single sensor may be ignored by making a program change in the Unit Setup Mode. The default setting is “NONE”, indicating all sensors are being monitored.

DEFAULT PROGRAMMABLE VALUES

To quickly program or reset most of the user programmable values to their default values, press PROGRAM, 6140, ENTER. The following message will then be displayed, allowing a choice to reset the operating parameters to their default values.

DEFAULTS SET PROG VALUES TO DEFAULT?

◀ ▶ **XXX**

YES or NO may be selected for XXX using the ◀ and ▶ (ARROW) keys to change the selection.

Following is a list of the operating parameters that will be reset to their default values:

- Suction Pressure Cutout = 24.0 PSIG
- Low Ambient Air Temp Cutout = 25°F
- Leaving Chilled Liquid Temp Cutout = 36°F
- High Motor Current Limit = 100%
- Pulldown Current Limit = 100%
- Pulldown Current Limit Time = 0 Min.
- Suction Superheat Setpoint = 10°F
- Sound limit Setpoint = 0%

SERIAL PORT CONNECTIONS

TABLE 20 lists the serial ports and the circuit board they are located on. The serial communications lines provide communications to external devices outside the chiller and between microprocessors located in the chiller control panel.

TABLE 20 - SERIAL PORT CONNECTIONS

BOARD	HEADER	PORT TYPE	PORT USE
Chiller Control Board	TB1 / TB2	RS-232 / RS-485	Printer/RCC and ISN
Chiller Control Board	J2 / J1	RS-485	Control Panel <-> VSD #1 / #2
VSD Logic Board	J12	Opto- Coupled RS-485	VSD <-> Control Panel

TB2 allows connectiong to a remote OptiView RCC or Microgateway. The OptiView RCC option is not yet available. The OptiView RCC and Microgateway option cannot both be used. Only one or the other is permitted to be connected to the chller.

ANALOG INPUT CONNECTIONS

TABLE 21 lists the Analog inputs and the circuit board they are located on. Not all of the sensors are installed in every unit, as some of them are optional. The software must read the optional sensors if installed. The Analog input signals are typically referenced to the common (return, ground) in the system.

J12-3 can also be used as common, as well as chassis ground, or the common terminal point on the Chiller Control Board. See the wiring diagrams. The +DC Bus, -DC Bus and ½ DC Bus voltages are measured in reference to one of the other DC Bus points. For example: +DC Bus measured to ½ DC Bus.

TABLE 21 - ANALOG INPUT CONNECTIONS

BOARD	HEADER	ANALOG INPUT
Chiller Control Board	J17-11	Remote Temperature Reset
Chiller Control Board	J17-12	Remote Current Limit
Chiller Control Board	J17-13	Spare 1
Chiller Control Board	J17-14	Spare 2
Chiller Control Board	J17-15	Spare 3
Chiller Control Board	J8-7	Laeving Chilled Liquid Temp Sensor
Chiller Control Board	J8-8	Return Chilled Liquid Temp Sensor
Chiller Control Board	J8-9	Ambient Air Temp Sensor
Chiller Control Board	J19-1	Comp 1 Motor Temperature 1
Chiller Control Board	J19-2	Comp 1 Motor Temperature 2
Chiller Control Board	J19-3	Comp 1 Motor Temperature 3
Chiller Control Board	J19-6	Comp 2 Motor Temperature 1
Chiller Control Board	J19-7	Comp 2 Motor Temperature 2
Chiller Control Board	J19-8	Comp 2 Motor Temperature 3
Chiller Control Board	J21-13	Sys 1 Suction Temperature
Chiller Control Board	J21-3	Sys 1 Oil Temperature
Chiller Control Board	J21-16	Sys 1 Discharge Temperature
Chiller Control Board	J21-6	Sys 1 Flash Tank Level Sensor
Chiller Control Board	J21-20	Sys 1 Suction Pressure
Chiller Control Board	J21-22	Sys 1 Oil Pressure
Chiller Control Board	J21-24	Sys 1 Discharge Pressure
Chiller Control Board	J22-13	Sys 2 Suction Temperature
Chiller Control Board	J22-2	Sys 2 Oil Temperature
Chiller Control Board	J22-16	Sys 2 Discharge Temperature
Chiller Control Board	J22-6	Sys 2 Flash Tank Level Sensor
Chiller Control Board	J22-20	Sys 2 Suction Pressure
Chiller Control Board	J22-22	Sys 2 Oil Pressure
Chiller Control Board	J22-24	Sys 2 Discharge Pressure
Chiller Control Board	J20-1	Comp 3 Motor Temperature 1
Chiller Control Board	J20-2	Comp 3 Motor Temperature 2
Chiller Control Board	J20-3	Comp 3 Motor Temperature 3
Chiller Control Board	J20-6	Comp 4 Motor Temperature 1
Chiller Control Board	J20-7	Comp 4 Motor Temperature 2
Chiller Control Board	J20-8	Comp 4 Motor Temperature

ANALOG INPUT CONNECTIONS (CON'T)

TABLE 21 - ANALOG INPUT CONNECTIONS (CON'T)

BOARD	HEADER	ANALOG INPUT
Chiller Control Board	J23-13	Sys 3 Suction Temperature
Chiller Control Board	J23-3	Sys 3 Oil Temperature
Chiller Control Board	J23-16	Sys 3 Discharge Temperature
Chiller Control Board	J23-6	Sys 3 Flash Tank Level Sensor
Chiller Control Board	J23-20	Sys 3 Suction Pressure
Chiller Control Board	J23-22	Sys 3 Oil Temperature
Chiller Control Board	J23-24	Sys 3 Discharge Pressure
Chiller Control Board	J24-13	Sys 4 Suction Temperature
Chiller Control Board	J24-3	Sys 4 Oil Temperature
Chiller Control Board	J24-16	Sys 4 Discharge Temperature
Chiller Control Board	J24-6	Sys 4 Flash Tank Level Sensor
Chiller Control Board	J24-20	Sys 4 Suction Pressure
Chiller Control Board	J24-22	Sys 4 Oil Pressure
Chiller Control Board	J24-24	Sys 4 Discharge Pressure
VSD Logic Board	J1-1 to J1-2	Comp 1 Phase A Motor Current
VSD Logic Board	J1-3 to J3-4	Comp 1 Phase B Motor Current
VSD Logic Board	J1-5 to J1-6	Comp 1 Phase C Motor Current
VSD Logic Board	J1-13 to J1-14	Comp 3 Phase A Motor Current
VSD Logic Board	J1-15 to J1-16	Comp 3 Phase B Motor Current
VSD Logic Board	J1-17 to J1-18	Comp 3 Phase C Motor Current
VSD Logic Board	J2-1 to J2-2	Comp 2 Phase A Motor Current
VSD Logic Board	J2-3 to J2-4	Comp 2 Phase B Motor Current
VSD Logic Board	J2-5 to J2-6	Comp 2 Phase C Motor Current
VSD Logic Board	J2-9 to J2-10	Comp 4 Phase A Motor Current
VSD Logic Board	J2-11 to J2-12	Comp 4 Phase B Motor Current
VSD Logic Board	J2-13 to J2-14	Comp 4 Phase C Motor Current
VSD Logic Board	J3-1	+DC Bus Voltage 1
VSD Logic Board	J3-2	1/2 DC Bus Voltage 1
VSD Logic Board	J3-3	-Dc Bus Voltage 1
VSD Logic Board	J3-4	-DC Bus Voltage 2
VSD Logic Board	J3-5	1/2 DC Bus Voltage 2
VSD Logic Board	J3-6	+DC Bus Voltage 2
VSD Logic Board	J6-8	Comp 1 IGBT Baseplate Temperature
VSD Logic Board	J7-8	Comp 3 IGBT Baseplate Temperature
VSD Logic Board	J8-8	Comp 2 IGBT Baseplate temperature
VSD Logic Board	J9-8	Comp 4 IGBT Baseplate Temperature
VSD Logic Board	R19	Comp 1 Overload Adjust
VSD Logic Board	R42	Comp 3 Overload Adjust
VSD Logic Board	R64	Comp 2 Overload Adjust
VSD Logic Board	R86	Comp 4 Overload Adjust

DIGITAL INPUT CONNECTIONS

TABLE 22 lists the digital inputs and the circuit board they are located on. The Digital input signals are typically referenced to the common (return, ground) in the system.

J12-3 can also be used as common, as well as chassis ground, or the common terminal point on the Chiller Control Board. See the wiring diagrams.

TABLE 22 - DIGITAL INPUT CONNECTIONS

BOARD	HEADER	ANALOG OUTPUT
Chiller Control Board	J4-2	Unit Switch 1
Chiller Control Board	J4-3	Unit Switch 2
Chiller Control Board	J4-4	Sys 1 HPCO
Chiller Control Board	J4-5	Sys 2 HPCO
Chiller Control Board	J4-6	VSD Fault Relay 1
Chiller Control Board	J5-1	Sys 3 HPCO
Chiller Control Board	J5-2	Sys 4 HPCO
Chiller Control Board	J5-3	VSD Fault Relay (Unused)
Chiller Control Board	J6-2	Flow Switch
Chiller Control Board	J6-3	Print
Chiller Control Board	J6-4	Sys 1/3 Run Permissive
Chiller Control Board	J6-5	Sys 2/4 Run Permissive
Chiller Control Board	J6-6	Spare
Chiller Control Board	J7-1 to J7-2	Config0
Chiller Control Board	J7-3 to J7-4	Config1
Chiller Control Board	J7-5 to J7-6	Config2
Chiller Control Board	J7-7 to J7-8	Config3
Chiller Control Board	J7-9 to J7-10	Spare 0
Chiller Control Board	J7-11 to J7-12	Spare 1
VSD Logic Board	J1-10	2 Compressor Select
VSD Logic Board	J1-11	3 Compressor Select
VSD Logic Board	J1-12	4 Compressor Select
VSD Logic Board	J5-1 to J5-2	
VSD Logic Board	J5-3 to J5-4	
VSD Logic Board	J6-2	Comp 1 Phase A Gate Driver Fault
VSD Logic Board	J6-5	Comp 1 Phase C Gate Driver Fault
VSD Logic Board	J6-12	Comp 1 Phase B Gate Driver Fault
VSD Logic Board	J7-2	Comp 3 Phase A Gate Driver Fault
VSD Logic Board	J7-5	Comp 3 Phase C Gate Driver Fault
VSD Logic Board	J7-12	Comp 3 Phase B Gate Driver Fault
VSD Logic Board	J7-2	Comp 2 Phase A Gate Driver Fault
VSD Logic Board	J7-5	Comp 2 Phase C Gate Driver Fault
VSD Logic Board	J7-12	Comp 2 Phase B Gate Driver Fault
VSD Logic Board	J8-2	Comp 4 Phase A Gate Driver Fault
VSD Logic Board	J8-5	Comp 4 Phase C Gate Driver Fault
VSD Logic Board	J8-12	Comp 4 Phase B Gate Driver Fault

DIGITAL INPUT CONNECTIONS (CON'T)

TABLE 22 - DIGITAL INPUT CONNECTIONS (CON'T)

BOARD	HEADER	ANALOG OUTPUT
VSD Logic Board	J11-2	Phase Loss Fault 1
VSD Logic Board	J11-6	Phase Loss Fault 2
VSD Logic Board	SW1	Test Pushbutton
VSD Logic Board	J10-5 to J10-6	Comp 1/3 Run (from control panel)
VSD Logic Board	J10-7 to J10-8	Comp 2/4 (from control panel)

ANALOG OUTPUT CONNECTIONS

TABLE 23 lists the analog outputs and the circuit board they are located on. The analog output signals are feed to the associated control device from the 2 wires in the associated plug.

TABLE 23 - ANALOG OUTPUT CONNECTIONS

BOARD	HEADER	ANALOG OUTPUT
Chiller Control Board	J15-1 to J15-2	Sys 1 Flash Tank Feed Valve
Chiller Control Board	J15-3 to J15-4	Sys 1 Flash tank Drain Valve
Chiller Control Board	J15-5 to J15-6	Sys 2 flash Tank Feed Valve
Chiller Control Board	J15-7 to J15-8	Sys 2 Flash Tank Drain Valve
Chiller Control Board	J14-1 to J14-6	Sys 3 Flash Tank Feed Valve
Chiller Control Board	J14-2 to J14-7	Sys 3 Flash Tank Drain Valve
Chiller Control Board	J14-3 to J14-8	Sys 4 Flash Tank Feed Valve
Chiller Control Board	J14-4 to J14-9	Sys 4 Flash Tank Feed Valve
Chiller Control Board	J25-1 to J25-5	Sys 1 Condensor Fan Speed (Future)
Chiller Control Board	J25-2 to J25-6	Sys 2 Condensor Fan Speed (Future)
Chiller Control Board	J25-3 to J25-7	Sys 3 Condensor Fan Speed (Future)
Chiller Control Board	J25-4 to J25-8	Sys 4 Condensor Fan Speed (Future)

This page intentionally left blank.

DIGITAL OUTPUT CONNECTIONS

TABLE 24 lists the digital outputs and the plug/terminals of the circuit board they originate from. Not all of the outputs will be used on every unit. Signal levels may be 12VDC, 120VAC, or a dry contact (no voltage) closure). 120VAC signals typically may show only one connection point; the other will be neutral (Wire 2). Outputs which reference multiple boards, such as “Chiller Control Board / Relay Board 1” indicate the signal originates on the Chiller Control Board as a 0-12VDC digital signal (example: J9-1) that is then fed to the Relay board and output as a dry contact closure between TB1-20 and 19. In this case, outputs from both boards are called out in the table.

The 0-120VAC single digital outputs from the Relay Output Boards are referenced to neutral (Wire 2). For example, the fan output on TB1-6 is a single 120VAC output. 0-12VDC outputs from the Chiller Control Board are referenced to common (return, ground) in the system. J12-3 can also be used as common, as well as chassis ground, or the common terminal point on the Chiller Control Board. See the wiring diagrams. Refer to the wiring diagrams whenever there is a requirement for tracing out these signals.

TABLE 24 - DIGITAL OUTPUT CONNECTIONS

BOARD	HEADER	ANALOG OUTPUT
Chiller Control / Relay Board 1	J9-1 / TB1-20 and 19	Evaporator Heater
Chiller Control / Relay Board 1	J9-2 / TB1-18 and 17	Sys 1/3 VSD Run
Chiller Control / Relay Board 1	J9-3 / TB1-16 and 15	Sys 1/3 Alarm
Chiller Control / Relay Board 1	J9-4 / TB1-14 and 13	Evaporator Heater 2
Chiller Control / Relay Board 1	J9-5 / TB1-12 and 11	Sys 1 SPARE
Chiller Control / Relay Board 1	J9-6 / TB1-10 and 9	SPARE
Chiller Control / Relay Board 1	J9-7 / TB1-8 and 7	SPARE
Chiller Control / Relay Board 1	J9-8 / TB1-6	Sys 1 Condensor Fans Output 1
Chiller Control / Relay Board 1	J9-9 / TB1-5	Sys 1 Condensor Fans Output 2
Chiller Control / Relay Board 1	J9-10 / TB1-4	Sys 1 Condensor Fans Output 3
Chiller Control / Relay Board 1	J9-11 / TB1-3	Sys 1 Compressor Heater
Chiller Control / Relay Board 1	J9-12 / TB1-2	Sys 1 Economizer Solenoid Valve
Chiller Control / Relay Board 2	J10-1 / TB1- 20 and 19	Evaporator Pump Start
Chiller Control / Relay Board 2	J10-2 / TB1-18 and 17	Sys 2/4 VSD Run
Chiller Control / Relay Board 2	J10-3 / TB1-18 and 15	Sys 2/4 Alarm
Chiller Control / Relay Board 2	J10-4 / TB1-16 and 14	Chiller Run
Chiller Control / Relay Board 2	J10-5 / TB1-12 and 11	Sys 2 SPARE
Chiller Control / Relay Board 2	J10-6 / TB1-10 and 9	SPARE
Chiller Control / Relay Board 2	J10-7 / TB1-8 and 7	SPARE
Chiller Control / Relay Board 2	J10-8 / TB1-6	Sys 2 Condensor Fans Output 1
Chiller Control / Relay Board 2	J10-9 / TB1-5	Sys 2 Condensor Fans Output 2
Chiller Control / Relay Board 2	J10-10 / TB1-4	Sys 2 Condensor Fans Output 3
Chiller Control / Relay Board 2	J10-11 / TB1-3	Sys 2 Compressor Heater
Chiller Control / Relay Board 3	J10-12 / TB1-2	Sys 2 Economizer Solenoid Valve
Chiller Control / Relay Board 3	J11-1 / TB1-20 and 19	Sys 4 Condensor Fan Output 1
Chiller Control / Relay Board 3	J11-2 / TB1-18 and 17	Sys 4 Condensor Fan Output 2
Chiller Control / Relay Board 3	J11-3 / TB1-16 and 15	Sys 4 Condensor Fan Output 3
Chiller Control / Relay Board 3	J11-4 / TB1-14 and 13	Sys 4 Compressor Heater
Chiller Control / Relay Board 3	J11-5 / TB1-12 and 11	Sys 4 Economizer Solenoid Valve
Chiller Control / Relay Board 3	J11-6 / TB1-10 and 9	Sys 4 SPARE

DIGITAL OUTPUT CONNECTIONS (CON'T)

TABLE 24 - DIGITAL OUTPUT CONNECTIONS (CON'T)

BOARD	HEADER	ANALOG OUTPUT
Chiller Control / Relay Board 3	J11-7 / TB1-8 and 7	Sys 3 SPARE
Chiller Control / Relay Board 3	J11-8 / TB1-6	Sys 3 Condenser Fans Output 1
Chiller Control / Relay Board 3	J11-9 / TB1-5	Sys 3 Condensor Fans Output 2
Chiller Control / Relay Board 3	J11-10 / TB1-4	Sys 3 Condensor Fans Output 3
Chiller Control / Relay Board 3	J11-11 / TB1-3	Sys 3 Compressor Heater
Chiller Control / Relay Board 3	J11-12 / TB1-2	Sys 3 Economizer Solenoid Valve
VSD Logic Board	J6-1	Comp 1 Phase A+ IGBT Gating Signal
VSD Logic Board	J6-3	Comp 1 Phase B- IGBT Gating Signal
VSD Logic Board	J6-4	Comp 1 Phase C+ IGBT Gating Signal
VSD Logic Board	J6-10	Comp 1 Phase A- IGBT Gating Signal
VSD Logic Board	J6-11	Comp 1 Phase B+ IGBT Gating Signal
VSD Logic Board	J6-13	Comp 1 Phase C- IGBT Gating Signal
VSD Logic Board	J6-14	Comp1 Enable
VSD Logic Board	J7-1	Comp 3 Phase A+ IGBT Gating Signal
VSD Logic Board	J7-3	Comp 3 Phase B- IGBT Gating Signal
VSD Logic Board	J7-4	Comp 3 Phase C+ IGBT Gating Signal
VSD Logic Board	J7-10	Comp 3 Phase A- IGBT Gating Signal
VSD Logic Board	J7-11	Comp 3 Phase B+ IGBT Gating Signal
VSD Logic Board	J7-13	Comp 3 Phase C- IGBT Gating Signal
VSD Logic Board	J7-14	Comp 3 Enable
VSD Logic Board	J8-1	Comp 2 Phase A+ IGBT Gating Signal
VSD Logic Board	J8-3	Comp 2 Phase B- IGBT Gating Signal
VSD Logic Board	J8-4	Comp 2 Phase C+ IGBT Gating Signal
VSD Logic Board	J8-10	Comp 2 Phase A- IGBT Gating Signal
VSD Logic Board	J8-11	Comp 2 Phase B+ IGBT Gating Signal
VSD Logic Board	J8-13	Comp 2 Phase C- IGBT Gating Signal
VSD Logic Board	J8-14	Comp 2 Enable
VSD Logic Board	J9-1	Comp 4 Phase A+ IGBT Gating Signal
VSD Logic Board	J9-3	Comp 4 Phase B- IGBT Gating Signal
VSD Logic Board	J9-4	Comp 4 Phase C+ IGBT Gating Signal
VSD Logic Board	J9-10	Comp 4 Phase A- IGBT Gating Signal
VSD Logic Board	J9-11	Comp 4 Phase B+ IGBT Gating Signal
VSD Logic Board	J9-13	Comp 4 Phase C- IGBT Gating Signal
VSD Logic Board	J9-12	Comp 4 Enable
VSD Logic Board	J11-3	Pre-charge Enable 1
VSD Logic Board	J11-7	Pre-charge Enable 2
VSD Logic Board	J10-1 to J10-2	VSD Fan / Pump Run
VSD Logic Board	J10-3 to J10-4	VSD Fault Relay (to control panel)

ISN COMMUNICATIONS

GENERAL

The Chiller Control Board contains a dual UART for RS-485 and RS-232 communications. UART1 is dedicated to RCC and ISN communications over an RS-485 link. UART2 is dedicated to internal communications within the chiller. The RS-485 port is configured for 4800 baud, 1 start bit, 8 data bits, odd parity, and 1 stop bit. Connections for ISN communications are on the Chiller Control Board on TB1/TB2. TB2 on the MicroGateway is utilized for ISN comms connection. P3 is RS485+, P2 is RS485-, and USHL is the shield.

Received Data (Control Data)

The chiller control panel receives 8 data values from the ISN. The first 4 are analog values and the last 4 are digital values. These 8 data values are used as control parameters when in REMOTE mode. When the unit is in LOCAL mode, these 8 values are ignored. If the unit receives no valid ISN transmission for 5 minutes it will revert back to all local control values. TABLE 25 lists the 8 control parameters. These values are found under Feature 54 on the ISN.

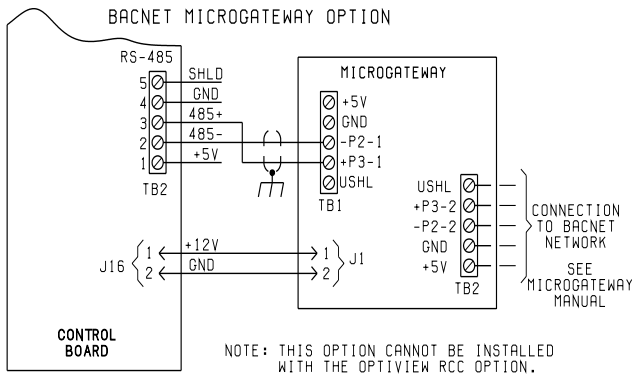

LD10637

When an ISN is communicating with a MicroGateway, always follow the guidelines provided in the YORK MicroGateway instruction form for application to the specific chiller model type.

ISN communications with a 2 compressor chiller involves only 1 section of feature 54 data. ISN communications with a 3 or 4 compressor chiller involves 2 sections of feature 54 to get all the data. Control parameters from the ISN as well system 1, 2, and unit data are handled in the first section. The second section will not be able to do any control but only receive system 3 and 4 (if applicable) data.

TABLE 25 - MUSTANG CHILLER YORK TALK CONTROL DATA

ISN PAGE	LCHLT CONTROL
P03	Setpoint
P04	ISN Current Limit
P05	ISN Sound Limit (Remote Sound Limit Option must be enabled or this point is ignored)
P06	-
P07	Start / Stop
P08	-
P09	-
P10	History Buffer

ISN TRANSMITTED DATA

After receiving a valid transmission from an ISN system, the unit will transmit either operational data or history buffer data depending on the “History Buffer Request” in page 06. Data must be transmitted for every ISN page under Feature 54.

If there is no value to be sent to a particular page, a zero will be sent. TABLE 26 shows the section 1 data values page listings for this unit for system 1, 2 and unit data.

TABLE 26 - DXST / ISN TRANSMITTED DATA (UNIT, SYS 1, SYS 2)

ISN PAGE	CHARACTER	TYPE	DXST CHILLER DATA (UNIT, Sys , Sys 2)
P11	8-11	Analog	Leaving Chilled Liquid Temp.
P12	12-15	Analog	Return Chilled Liquid Temp.
P13	16-19	Analog	VSD Internal Ambient Temp.
P14	20-23	Analog	Sys 1 Suction Temp.
P15	24-27	Analog	Sys 1 Discharge Temp.
P16	28-31	Analog	Outside Ambient Air Temp.
P17	32-35	Analog	Sys 1 Oil Temp.
P18	36-39	Analog	Sys 1 Oil Pressure
P19	40-43	Analog	Sys 1 Suction Pressure
P20	44-47	Analog	Sys 1 Discharge Pressure
P21	48-51	Analog	Sys 1 Compressor % Full Load Amps
P22	52-55	Analog	Sys 1 Total Run Hours
P23	56-59	Analog	Sys 1 Total Number of Starts
P24	60-63	Analog	Sys 1 Highest Motor Temp.
P25	64-67	Analog	Sys 2 Highest Motor Temp.
P26	68-71	Analog	Sys 2 Oil Temp.
P27	72-75	Analog	Sys 2 Oil Pressure
P28	76-79	Analog	Sys 2 Suction Pressure
P29	80-83	Analog	Sys 2 Discharge Pressure
P30	84-87	Analog	Sys 2 Compressor % Full Load Amps
P31	88-91	Analog	Sys 2 Total Run Hours
P32	92-95	Analog	Sys 2 Total Number of Starts
P33	96-99	Analog	VSD Output Frequency
P34	100-103	Analog	Sys 1 Flash Tank Feed Valve % Open
P35	104-107	Analog	Sys 2 Flash Tank Feed Valve % Open
P36	108	Digital	Chiller Run
P37	109	Digital	Chiller Alarm
P38	110	Digital	Evaporator Heater Status
P39	111	Digital	Evaporator Pump Status
P40	112	Digital	Sys 1 Compressor Run Status
P41	113	Digital	Sys 2 Compressor Run Status
P42	114	Digital	Sys 1 Economizer Solenoid Valve Status
P43	115	Digital	Sys 2 Economizer Solenoid Valve Status
P44	116	Digital	-
P45	117	Digital	-
P46	118	Digital	-

ISN TRANSMITTED DATA (CON'T)

TABLE 26 - DXST / ISN TRANSMITTED DATA (UNIT, SYS 1, SYS 2) (CON'T)

ISN PAGE	CHARACTER	TYPE	DXST CHILLER DATA (UNIT, Sys , Sys 2)
P47	119	Digital	-
P48	120	Digital	-
P49	121	Digital	-
P50	122	Digital	Cooling Type: 0=Water, 1=Glycol
P51	123	Digital	Local / Remote Control Mode: 0=Local, 1=Remote
P52	124	Digital	Display Units Mode: 0=Imperial, 1=SI
P53	125	Digital	-
P54	126	Digital	-
P55	127	Digital	-
P56	128	Coded	*Sys 1 Operational Code
P57	129	Coded	*Sys 1 Fault Code
P58	130	Coded	*Sys 2 Operational Code
P59	131	Coded	* Sys 2 Fault Code
P60	132	Coded	Sys 1 Flash Tank Level (%)
P61	133	Coded	Sys 1 Condensor Fan Stage (0-6)
P62	134	Coded	Sys 2 Flash Tank Level (%)
P63	135	Coded	Sys 2 Condensor Fan Stage (0-6)
P64	136	Coded	Lead System Number
P65	137	Coded	Sys 1 & 2 Debug Code
P66	138-141	Analog	Local Leaving Chilled Liquid Setpoint
P67	142-145	Analog	Low Leaving Chilled Liquid Temp. Cutout
P68	146-149	Analog	Sys 1 Flash Tank Drain Valve % Open
P69	150-153	Analog	Sys 2 Flash Tank Drain Valve % Open
P70	154-157	Analog	Low Suction Pressure Cutout
P71	158-161	Analog	VSD DC Bus Voltage
P72	162-165	Analog	Remote Leaving Chilled Liquid Setpoint
P73	166-169	Analog	Sys 1 Discharge Superheat
P74	170-173	Analog	Cooling Range
P75	174-177	Analog	Sys 1 Discharge Superheat
P76	178-181	Analog	Sys 2 Suction Temp
P77	182-185	Analog	Sys 2 Discharge Temp.
P78	186-189	Analog	Sys 2 Suction Superheat
P79	190-193	Analog	Sys 2 Discharge Superheat
P80	194	Digital	-
P81	195	Digital	-
P82	196	Digital	-
P83	197	Digital	-
P84	198	Digital	-

* The operational and fault codes are defined in Tables 27 and 28 (Pages 285-287).

ISN FAULT AND INHIBIT CODES

TABLE 27 contains the fault and inhibit code with it's associated meaning to be used for decoding ISN Operational and Fault Codes on ISN Pages 57 and 59 in Table 26.

The table also classifies each fault/inhibit as a unit or system type and lists which board (Chiller Control Board (panel) or VSD Logic Board) generates the fault/inhibit.

TABLE 27 - FAULT AND INHIBIT CODES

CODE	TYPE	SOURCE	FAULT or INHIBIT CODES
1	Unit	Panel	Low Ambient Temp.
2	Unit	Panel	High Ambient Temp.
3	Unit	Panel	Low Chilled Liquid Temp.
4	Unit	Panel	SPARE 0
5	Unit	Panel	Low RTC Battery Voltage
6	Unit	Panel	Invalid Number of Compressors Selected
7	Unit	Panel	VSD Communications Failure
8	Unit	VSD	Pre-charge Low DC Bus Voltage
9	Unit	VSD	Pre-charge DC Bus Voltage Imbalance
10	Unit	VSD	High DC Bus Voltage
11	Unit	VSD	Low DC Bus Voltage
12	Unit	VSD	DC Bus Voltage Imbalance
13	Unit	VSD	High VSD Ambient Temp.
14	Unit	VSD	Single Phase Input
15	Unit	VSD	VSD Power Supply Fault
16	Unit	VSD	VSD Logic Board Fault
17	Unit	VSD	Motor Current Overload (Hardware)
18	Unit	VSD	CT Plug Fault
19	Unit	-	SPARE 1
20	Unit	-	SPARE 2
21	Unit	-	SPARE 3
22	Unit	-	SPARE 4
23	Unit	-	SPARE 5
24	Unit	-	SPARE 6
25	Unit	-	SPARE 7
26	Unit	-	SPARE 8
27	System	Panel	High Discharge Pressure (Software)
28	System	Panel	High Differential Oil Pressure
29	System	Panel	Low Differential Oil Pressure
30	System	Panel	Low Suction Pressure
31	System	Panel	High Discharge Temp.
32	System	Panel	High Oil Temp.
33	System	Panel	Low Suction Superheat
34	System	Panel	Sensor Failure
35	System	Panel	Low Motor Current
36	System	Panel	High Motor Temperature

ISN FAULT AND INHIBIT CODES (CON'T)**TABLE 27 - FAULT AND INHIBIT CODES (CON'T)**

CODE	TYPE	SOURCE	FAULT or INHIBIT CODES
37	System	VSD	Pre-charge Low DC Bus Voltage
38	System	VSD	Pre-charge DC Bus Voltage Imbalance
39	System	VSD	High Dc Bus Voltage
40	System	VSD	Low DC Bus Voltage
41	System	VSD	DC Bus Voltage Imbalance
42	System	VSD	High Motor Current
43	System	VSD	Motor Current Overload (Software)
44	System	VSD	IGBT Gate Driver Fault
45	System	VSD	High Baseplate Temp.
46	System	VSD	Single Phase Input
47	System	VSD	VSD Run Signal Fault
48	System	Panel	High Discharge Press (Hardware-HPCO)
49	System	Panel	High Flash Tank Level
50	System	Panel	Control Voltage Fault
51	System	Panel	Low Discharge Superheat
52	System	-	SPARE 2
53	System	-	SPARE 3
54	System	-	SPARE 4
55	System	-	SPARE 5
56	System	-	SPARE 6
57	System	-	SPARE 7
58	System	-	SPARE 8
59	System	-	SPARE 9
60	System	-	SPARE 10
61	System	-	SPARE 11
62	System	-	SPARE 12

ISN OPERATIONAL STATUS CODES

TABLE 28 contains the operational status code with it's associated meaning to be used for decoding ISN Operational Codes on Pages 56 and 58 in Table 26.

The table also classifies each status as a unit or system type and lists which board (Chiller Control Board (panel) or VSD logic board) generates the status condition.

TABLE 28 - OPERATIONAL STATUS CODES

CODE	TYPE	SOURCE	FAULT or INHIBIT CODES
63	Unit	Panel	Manual Override
64	Unit	Panel	Daily Schedule Shutdown
65	Unit	Panel	Unit Switch OFF
66	Unit	Panel	Remote Controlled Shutdown
67	Unit	Panel	Loss of External Communications
68	Unit	Panel	Flow Switch Shutdown
69	Unit	Panel	VSD Cooling Shutdown
70	Unit	-	SPARE 1
71	Unit	-	SPARE 2
72	Unit	-	SPARE 3
73	Unit	-	SPARE 4
74	System	Panel	No Run Permissive
75	System	Panel	Anti-Recycle Timer Active
76	System	Panel	System Switch OFF
77	System	Panel	System Not Running
78	System	Panel	System Running
79	System	Panel	Discharge Pressure Limiting
80	System	Panel	Suction Pressure Limiting
81	System	Panel	Motor Current Limiting
82	System	Panel	Motor Temperature Limiting
83	System	Panel	ISN Motor Current Limiting
84	System	Panel	Remote Motor Current Limiting
85	System	Panel	System Pumping Down
86	System	VSD	VSD PreCharging
87	System	Panel	VSD Baseplate Temperature Limiting
88	System	Panel	VSD Internal Ambient Temperature Limiting
89	System	Panel	Sound Limiting
90	System	Panel	ISN Sound Limiting
91	System	Panel	Remote Sound Limiting
92	System	Panel	Pulldown Motor Current
93	System	-	SPARE 7
94	System	-	SPARE 8
95	System	-	SPARE 9
96	System	-	SPARE 10

R-134A CONVERSION TABLES

The following table can be used for converting R-134A pressures to their equivalent saturated temperatures.

TABLE 29 - R-134A PRESSURE TO SATURATED TEMPERATURE CONVERSION

PRESSURE (PSIG)	DEW POINT TEMP. (°F)	PRESSURE (PSIG)	DEW POINT TEMP. (°F)	PRESSURE (PSIG)	DEW POINT TEMP. (°F)
0.0	-14.9	135.0	105.0	270.0	152.0
5.0	-3.0	140.0	107.2	275.0	153.4
10.0	6.7	145.0	109.4	280.0	154.7
15.0	14.9	150.0	111.5	285.0	156.1
20.0	22.2	155.0	113.6	290.0	157.4
25.0	28.7	160.0	115.6	295.0	158.7
30.0	34.6	165.0	117.6	300.0	160.0
35.0	40.0	170.0	119.6	305.0	161.3
40.0	45.0	175.0	131.5	310.0	162.5
45.0	49.6	180.0	123.3	315.0	163.8
50.0	54.0	185.0	125.2	320.0	165.0
55.0	58.1	190.0	126.9	325.0	166.2
60.0	62.0	195.0	128.7	330.0	167.4
65.0	65.7	200.0	130.4	335.0	168.6
70.0	69.2	205.0	132.1	340.0	169.8
75.0	72.6	210.0	133.8	345.0	171.0
80.0	75.9	215.0	135.5	350.0	172.1
85.0	79.0	220.0	137.1	355.0	173.3
90.0	82.0	225.0	138.7	360.0	174.4
95.0	84.9	230.0	140.2	365.0	175.5
100.0	87.7	235.0	141.8	370.0	176.6
105.0	90.4	240.0	143.3	375.0	177.7
110.0	93.0	245.0	144.8	380.0	178.8
115.0	95.5	250.0	146.3	385.0	179.9
120.0	98.0	255.0	147.7	390.0	180.9
125.0	100.4	260.0	149.2	395.0	182.0
130.0	102.7	265.0	150.6	400.0	183.0

MAINTENANCE

GENERAL REQUIREMENTS

The units have been designed to operate continuously, provided they are regularly maintained and operated within the limitations given in this manual. Each unit should be included in a routine schedule of daily maintenance checks by the operator/customer, backed up by regular service inspection and maintenance visits by a suitably qualified Service Engineer.

It is entirely the responsibility of the owner to provide for these regular maintenance requirements and/or enter into a maintenance agreement with a YORK International service organization to protect the operation of the unit. If damage or a system failure occurs due to improper maintenance during the warranty period, YORK shall not be liable for costs incurred to return the unit to satisfactory condition.

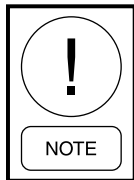

This maintenance section applies to the basic unit only and may, on individual contracts, be supplemented by additional requirements to cover any modifications or ancillary equipment as applicable.



The Safety Section of this manual should be read carefully before attempting any maintenance operations on the unit.

Daily Maintenance

The following maintenance checks should be carried out on a daily basis by the operator/customer. Please note that the units are not generally user serviceable and no attempt should be made to rectify faults or problems found during daily checks unless competent and equipped to do so. If in any doubt, contact your local YORK Service Agent.

Unit Status

Press the 'STATUS' key on the keypad and ensure no fault messages are displayed .

Refrigerant Leaks

Visually check the heat exchangers, compressors and pipework for damage and gas leaks.

Operating Conditions

Read the operating pressures and temperatures at the control panel using the display keys and check that these are within the operating limitations given in the manual.

Compressor Oil Level

Check the compressor oil level after the compressor has been operating on 'FULL LOAD' for approximately half an hour. The oil level should be between the upper and lower sight glasses on the oil separators.

Refrigerant Charge

When a system starts up, or sometimes after a change of capacity, a flow of bubbles will be seen in the liquid line sight glass. After a few minutes of stable operation, the bubbles should clear leaving just liquid refrigerant showing in the sight glass.

Scheduled Maintenance

The maintenance operations detailed in the following table should be carried out on a regular basis by a suitably qualified Service Engineer. It should be noted that the interval necessary between each 'minor' and 'major' service can vary depending on, for instance, application, site conditions and expected operating schedule. Normally a 'minor' service should be carried out every three to six months and a 'major' service once a year. It is recommended that your local YORK Service Center is contacted for recommendations for individual sites.

Chiller / Compressor Operating Log

A Chiller/Compressor Operating Log is supplied on Page 305 for logging compressor and chiller operating data.



YORK[®]

**MAINTENANCE REQUIREMENTS
FOR YCAV CHILLERS**

PROCEDURE	WEEKLY	QUARTERLY	SEMI-ANNUALLY	ANNUALLY	EVERY 5 YEARS	EVERY * HOURS
Check Oil Level in Oil Separator Sight Glass	X					
Check Liquid Line Sight Glass/ Moisture Indicator	X					
Record System Operating Temperatures & Pressures	X					
Check Condensor Coils for dirt / debris and clean as necessary	X					
Check Programmable Operating Setpoints and Safety Cutouts. Assure they are correct for the application		X				
Check Compressor and Evaporator Heater operation		X				
Check for dirt in the Panel. Check Door Gasket sealing integrity		X				
**Check Superheat on the Evaporator and the Economizer feed to the Compressor			X			
**Check Condensor Subcooling			X			
**Leak check the Chiller			X			
**Sample Compressor Oil, check for Acid, and replace if necessary				X		

**YORK[®] MAINTENANCE REQUIREMENTS
FOR YCAV CHILLERS (CON'T)**

PROCEDURE	WEEKLY	QUARTERLY	SEMI-ANNUALLY	ANNUALLY	EVERY 5 YEARS	EVERY * HOURS
**Disconnect Power Source and Lock Out. Check tightness of Power Wiring connections.				X		
Check Glycol concentration on Low Temp. or other applications where freezing may be a problem.				X		
VSD Glycol Change					X	

9

* Reserved for customer use for any special site requirements.

**This procedure must be performed at the specific time by an industry certified technician who has been trained and qualified to work on this type of equipment. A record of this procedure be successfully carried out should be maintained on file by the equipment owner should proof of adequate maintenance be required at a later date for warranty purposes.

TROUBLESHOOTING GUIDE

(Always remove power to the chiller and assure the DC bus voltage has bled off)

PROBLEM	POSSIBLE CAUSE	ACTION
No Display on Control Panel. Unit will NOT Run.	Supply to the Panel is missing.	High Voltage to the Chiller is missing.
		Check 1FU, 2FU, 4FU, 5FU 17FU, or 19FU.
		Check 2T or 10T Transformer.
	Line Fuse is blown.	Check Fuses.
	Chiller Control board is defective.	Replace Chiller Control board
	Display Board defective.	Replace Display Board
Line Fuse Blows.	SCR Diode Module is defective.	Check SCR/Diode Module.
	IGBT Module is defective.	Check IGBT Module.
	VSD Logic Board is defective.	Replace VSD Logic Board.
	SCR Trigger Board is defective	Replace SCR Trigger Board.
Chiller Fault: LOW AMBIENT TEMPERATURE	Ambient temperature is lower than the programmed operating limit.	Check the programmed cutout and determine if it is programmed correctly
	Ambient Sensor is defective.	Check the panel against the thermometer reading of ambient temperature
Chiller Fault: HIGH AMBIENT TEMPERATURE	Ambient Temperature is above the maximum operating limit.	Check outside air temperature.
	Ambient Sensor is defective.	Check the Panel Display against Thermometer reading of Ambient Temperature at the sensor.
Chiller Fault: LOW LEAVING CHILLED LIQUID	Leaving chilled liquid temperature drops faster than the unit can unload.	Check for restricted flow.
		Check for rapid flow changes.
		Water loop is too small.
	Chilled Water Sensor is defective.	Flow is below minimum for chiller.
		Check Sensor against Temp. Guage in water line.
		Check Sensor for intermittent operation.
	Check Wiring for shorts or opens.	
System Fault: CONTROL VOLTAGE	System Fuse is blown.	Check respective system Fuse 20FU or 21FU.
System Fault: HIGH OIL TEMPERATURE	Oil Temperature Sensor is defective.	Check Sensor with infared to determine if reading is reasonable.
	Condensor Fans NOT operating or running backwards.	Check Fans.
	Coils dirty.	Check and clean Coils.

TROUBLESHOOTING GUIDE (CON'T)

(Always remove power to the chiller and assure the DC bus voltage has bled off)

PROBLEM	POSSIBLE CAUSE	ACTION
System Fault: HIGH DISCHARGE PRESSURE	Coils dirty.	Check and clean coils.
	Coils are damaged.	Comb out fins.
	Fans NOT operating.	Check fan fuses.
		Check fan rotation.
		Check fan motor/blade.
System is overcharged.	Remove charge and check subcooling.	
System Fault: HIGH DISCHARGE TEMPERATURE	Discharge Temperature Sensor is defective.	Check Sensor.
	Condensor Fans NOT operating or are running backwards.	Check Fans.
	Coils dirty.	Check and clean Coils.
	High Superheat.	Measure Superheat with guages and thermocouple. Determine cause.
System Fault: HIGH MOTOR TEMPERATURE	High Motor temperature input from one of the sensors	Refrigerant charge low. Check subcooling.
		Excess charge in system, High discharge pressure. Check subcooling.
		High Superheat. Drain/Feed Valves NOT controlling. Isolate cause.
		Motor Sensor reading incorrectly. Program panel to ignore a single sensor.
		Economizer Solenoid energized at low speeds. Valve is leaking through.
System Fault: LOW SUCTION PRESSURE	Low charge.	Check subcooling.
	Transducer reads incorrectly.	Check transducer against a guage.
	Suction Temp. Sensor reads incorrectly.	Check sensor against a thermocouple.
	Low flow.	Check flow.
	Feed or Drain Valve NOT operating	Check Feed and Drain Valve operation. Check superheat.
	Feed or Drain Valve defective.	Check Feed and Drain Valve operation. Check superheat.
System Fault: DISCHARGE PRESSURE LIMITING	Discharge Transducer is defective.	Check transducer against a guage.
	Ambient Temp. very high.	Normal operation.
	Fans NOT operating.	Check fan operation.
	Remote or local discharge pressure load limiting is programmed.	Normal operation.

TROUBLESHOOTING GUIDE (CON'T)

(Always remove power to the chiller and assure the DC bus voltage has bled off)

PROBLEM	POSSIBLE CAUSE	ACTION
System Fault: MOTOR CURRENT LIMITING	High motor current has activated current limiting	Ambient temperature is high, normal response from controller
		Remore or panel limiting is in effect, Normal response.
		Excess charge in system, adjust charge.
		Condensor coils dirty, Clean condensor.
		Fans NOT operating, Check fans.
VSD Fault: High Baseplate Temperature	Coolant level low.	Add coolant.
	Glycol Pump is defective.	Replace Glycol Pump.
	VSD Board is defective	Replace VSD Logic Board.
	IBGT Module is defective.	Check defective IBGT Module.
VSD Fault: Low DC Bus Voltage	SCR / Diode Module is defective.	Check SCR / Diode Module.
	SCR Trigger Board is defective.	Check SCR Trigger board.

EVACUATING A SYSTEM

If a system or a portion of a system needs to be evacuated, it should be evacuated to a minimum of 500 microns. The system should then be able to hold the vacuum for 10 minutes with a maximum rise of 50 microns. If the system is not able to hold a vacuum, recheck the system for leaks.

LIMITED WARRANTY

WARRANTY ON NEW EQUIPMENT

YORK International Corporation (“YORK”) warrants all equipment and associated factory supplied materials, or start-up services performed by YORK in connection therewith, against defects in workmanship and material for a period of eighteen (18) months from date of shipment. Subject to the exclusions listed below, YORK, at its option, will repair or replace, FOB point of shipment, such YORK products or components as it finds defective.

Exclusions: Unless specifically agreed to in the contract documents, this warranty does not include the following costs and expenses:

1. Labor to remove or reinstall any equipment, materials, or components.
2. Shipping, handling, or transportation charges.
3. Cost of refrigerants.

No warranty repairs or replacements will be made until payment for all equipment, materials, or components has been received by YORK.

WARRANTY ON RECONDITIONED OR REPLACEMENT MATERIALS

Except for reciprocating compressors, which YORK warrants for a period of one year from date of shipment, YORK warrants reconditioned or replacement materials, or start-up services performed by YORK in connection therewith, against defects in workmanship or material for a period of ninety (90) days from date of shipment. Subject to the exclusions listed below, YORK, at its option, will repair or replace, FOB point of shipment, such materials or parts as YORK finds defective. However, where reconditioned or replacement materials or parts are placed on equipment still under the original new equipment warranty, then such reconditioned or replacement parts are warranted only until the expiration of such original new equipment warranty.

Exclusions: Unless specifically agreed to in the contract documents, this warranty does not include the following costs and expenses:

1. Labor to remove or reinstall any equipment, materials, or components.
2. Shipping, handling, or transportation charges.
3. Cost of refrigerant.

No warranty repairs or replacements will be made until payment for all equipment, materials, or components has been received by YORK.

ALL WARRANTIES AND GUARANTEES ARE VOID IF:

1. Equipment is used with refrigerants, oil, or antifreeze agents other than those authorized by YORK.
2. Equipment is used with any material or any equipment such as evaporators, tubing, other low side equipment, or refrigerant controls not approved by YORK.
3. Equipment has been damaged by freezing because it is not properly protected during cold weather, or damaged by fire or any other conditions not ordinarily encountered.
4. Equipment is not installed, operated, maintained and serviced in accordance with instructions issued by YORK.
5. Equipment is damaged due to dirt, air, moisture, or other foreign matter entering the refrigerant system.
6. Equipment is not properly stored, protected or inspected by the customer during the period from date of shipment to date of initial start.
7. Equipment is damaged due to acts of GOD, abuse, neglect, sabotage, or acts of terrorism.

THIS WARRANTY IS IN LIEU OF ALL OTHER WARRANTIES AND LIABILITIES, EXPRESS OR IMPLIED IN LAW OR IN FACT, INCLUDING THE WARRANTIES OF MERCHANTABILITY AND FITNESS FOR A PARTICULAR PURPOSE. THE WARRANTIES CONTAINED HEREIN SET FORTH BUYER'S SOLE AND EXCLUSIVE REMEDY IN THE EVENT OF A DEFECT IN WORKMANSHIP OR MATERIALS. IN NO EVENT SHALL YORK'S LIABILITY FOR DIRECT OR COMPENSATORY DAMAGES EXCEED THE PAYMENTS RECEIVED BY YORK FROM BUYER FOR THE MATERIALS OR EQUIPMENT INVOLVED. NOR SHALL YORK BE LIABLE FOR ANY SPECIAL, INCIDENTAL, OR CONSEQUENTIAL DAMAGES. THESE LIMITATIONS ON LIABILITY AND DAMAGES SHALL APPLY UNDER ALL THEORIES OF LIABILITY OR CAUSES OF ACTION, INCLUDING, BUT NOT LIMITED TO, CONTRACT, WARRANTY, TORT (INCLUDING NEGLIGENCE) OR STRICT LIABILITY. THE ABOVE LIMITATIONS SHALL INURE TO THE BENEFIT OF YORK'S SUPPLIERS AND SUBCONTRACTORS.

**CHILLED LIQUID AND SUCTION TEMPERATURE
SENSOR INPUT VOLTAGE**

TABLE 30 - TEMPERATURE INPUT VOLTAGE SENSOR (MEASURED SIGNAL TO SHIELD AT THE SENSOR)

TEMP. (°F)	VOLTAGE	TEMP. (°F)	VOLTAGE	TEMP. (°F)	VOLTAGE
16.1	1.52	35.9	2.19	55.6	2.85
16.7	1.54	36.5	2.21	56.3	2.87
17.3	1.56	37.0	2.23	56.9	2.89
17.9	1.58	37.6	2.25	57.5	2.91
18.5	1.60	38.2	2.27	58.1	2.93
19.1	1.62	38.7	2.29	58.7	2.95
19.7	1.64	39.3	2.30	59.4	2.97
20.3	1.66	39.9	2.32	60.0	2.99
20.9	1.68	40.4	2.34	60.6	3.01
21.5	1.70	41.0	2.36	61.3	3.03
22.1	1.72	41.6	2.38	61.9	3.05
22.7	1.74	42.1	2.40	62.5	3.07
23.3	1.76	42.7	2.42	63.2	3.09
23.9	1.78	43.3	2.44	63.8	3.11
24.5	1.80	43.9	2.46	64.5	3.13
25.0	1.82	44.4	2.48	65.1	3.14
25.6	1.84	45.0	2.50	65.8	3.16
26.2	1.86	45.6	2.52	66.5	3.18
26.8	1.88	46.2	2.54	67.1	3.20
27.3	1.90	46.7	2.56	67.8	3.22
27.9	1.91	47.3	2.58	68.5	3.24
28.5	1.93	47.9	2.60	69.2	3.26
29.0	1.95	48.5	2.62	69.9	3.28
29.6	1.97	49.1	2.64	70.6	3.30
30.2	1.99	49.7	2.66	71.3	3.32
30.8	2.01	50.3	2.68	72.0	3.34
31.3	2.03	50.8	2.70	72.7	3.36
31.9	2.05	51.4	2.71	73.4	3.38
32.5	2.07	52.0	2.73	74.2	3.40
33.0	2.09	52.6	2.75	74.9	3.42
33.6	2.11	53.2	2.77		
34.2	2.13	53.8	2.79		
34.8	2.15	54.5	2.81		
35.3	2.17	55.0	2.83		

OUTSIDE AIR TEMPERATURE SENSOR INPUT VOLTAGE

TABLE 31 - OUTSIDE AIR TEMPERATURE INPUT VOLTAGE (MEASURED SIGNAL TO SHIELD AT THE SENSOR)

TEMP. (°F)	VOLTAGE	TEMP. (°F)	VOLTAGE	TEMP. (°F)	VOLTAGE
0.24	0.68	49.8	2.00	93.3	3.31
1.79	0.71	50.7	2.03	94.4	3.34
3.30	0.74	51.6	2.06	65.6	3.37
4.76	0.77	52.5	2.09	96.8	3.40
6.19	0.80	53.4	2.11	98.0	3.43
7.58	0.83	54.3	2.14	99.2	3.46
8.94	0.85	55.3	2.17	100.4	3.49
10.3	0.88	56.2	2.20	101.6	3.52
11.6	0.91	57.1	2.23	102.9	3.55
12.8	0.94	58.0	2.26	104.2	3.57
14.1	0.97	58.9	2.29	105.5	3.60
15.3	1.00	59.8	2.32	106.8	3.63
16.5	1.03	60.7	2.35	108.1	3.66
17.7	1.06	61.6	2.38	109.5	3.69
18.9	1.09	62.6	2.41	110.9	3.72
20.0	1.12	63.5	2.44	112.3	3.75
21.2	1.15	64.4	2.47	113.8	3.78
22.3	1.18	65.3	2.50	115.2	3.81
23.4	1.21	66.3	2.52	116.7	3.84
24.4	1.24	67.2	2.55	118.3	3.87
25.5	1.26	68.1	2.58	119.9	3.90
26.6	1.26	69.1	2.61	121.5	3.93
27.6	1.32	70.0	2.64	123.2	3.96
28.7	1.35	70.9	2.67	124.9	3.98
29.7	1.38	71.9	2.70	126.6	4.01
30.7	1.41	72.8	2.73	128.4	4.04
31.7	1.44	73.8	2.76	130.3	4.07
32.7	1.47	74.8	2.76		
33.7	1.50	75.8	2.82		
34.7	1.53	76.7	2.85		
35.7	1.56	77.7	2.88		
36.7	1.59	78.7	2.91		
37.6	1.62	79.7	2.93		
38.6	1.65	80.7	2.96		
39.6	1.67	81.7	2.99		
40.5	1.70	82.7	3.02		
41.4	1.73	83.6	3.05		
42.4	1.76	84.6	3.08		
43.3	1.79	85.7	3.11		
44.3	1.82	86.7	3.13		
45.2	1.85	87.8	3.16		
46.1	1.88	88.9	3.19		
47.0	1.91	90.1	3.22		
48.0	1.94	91.1	3.25		
48.9	1.97	92.2	3.28		

PRESSURE TRANSDUCER OUTPUT VOLTAGE

TABLE 32 - PRESSURE TRANSDUCER INPUT VOLTAGE (MEASURED SIGNAL TO RETURN AT THE TRANSDUCER)

Suction Pressure Transducer (125 PSIG)		Discharge Pressure Transducer (275 PSIG)		Discharge Pressure Transducer (275 PSIG)	
Pressure	Voltage	Pressure	Voltage	Pressure	Voltage
0	0.50	0	0.50	140	2.54
5	0.66	5	0.57	145	2.61
10	0.82	10	0.65	150	2.68
15	0.98	15	0.72	155	2.75
20	1.14	20	0.79	160	2.83
25	1.30	25	0.86	165	2.90
30	1.46	30	0.94	170	2.97
35	1.62	35	1.01	175	3.05
40	1.78	40	1.08	180	3.12
45	1.94	45	1.15	185	3.19
50	2.10	50	1.23	190	3.26
55	2.26	55	1.30	195	3.34
60	2.42	60	1.37	200	3.41
65	2.58	65	1.45	205	3.48
70	2.74	70	1.52	210	3.55
75	2.90	75	1.59	215	3.63
80	3.06	80	1.66	220	3.70
85	3.22	85	1.74	225	3.77
90	3.38	90	1.81	230	3.85
95	3.54	95	1.88	235	3.92
100	3.70	100	1.95	240	3.99
105	3.86	105	2.03	245	4.06
110	4.02	110	2.10	250	4.14
115	4.18	115	2.17	255	4.21
120	4.34	120	2.25	260	4.28
125	4.50	125	2.32	265	4.35
		130	2.39	270	4.43
		135	2.46	275	4.50

MOTOR TEMPERATURE SENSOR RESISTANCE

TABLE 33 - MOTOR TEMPERATURE SENSOR RESISTANCE (CHECK AT THE MOTOR)

Temp. (°C)	Rnominal (Ohms)	Rtol (± %)	Rmin (Ohms)	Rmax (Ohms)
-20	97,062	5.00	92,209	101,915
-15	77,941	4.60	69,586	76,296
-10	55,391	4.20	52,996	57,643
-5	42,324	3.85	40,695	43,954
0	32,654	3.50	31,511	33,797
5	25,396	3.15	24,596	26,196
10	19,903	2.80	19,346	20,461
15	15,713	2.50	15,321	16,106
20	12,493	2.20	12,218	12,768
25	10,000	2.00	9,800	10,200
30	8,056	2.40	7,863	8,250
35	6,531	2.70	6,354	6,707
40	5,326	3.00	5,166	5,485
45	4,368	3.25	4,226	4,510
50	3,602	3.50	3,476	3,728
55	2,986	3.75	2,874	3,098
60	2,488	4.00	2,389	2,588
65	2,083	4.25	1,995	2,172
70	1,753	4.50	1,674	1,832
75	1,481	4.75	1,411	1,551
80	1,257	5.00	1,194	1,321
85	1,071	5.20	1,016	1,127
90	916.9	5.40	867.4	966.4
95	787.7	5.60	743.6	831.9
100	679.3	5.80	639.9	718.7
105	587.9	6.00	552.6	623.2
110	510.6	6.20	479.9	542.3
115	445.0	6.40	416.5	473.5
120	389.0	6.60	363.4	414.7
125	341.2	6.70	318.4	364.1
130	300.2	6.90	279.5	320.9
135	264.9	7.10	246.1	283.7
140	234.4	7.30	217.3	251.5
145	208.0	7.40	192.6	223.3
150	185.0	7.50	171.1	198.9

COMPRESSOR MOTOR OVERLOAD & MAX. VSD FREQUENCY

TABLE 34 - COMPRESSOR MOTOR OVERLOAD SETTINGS & MAX. VSD FREQUENCY

2 COMP CHILLER MODELS WITH STANDARD (PIN 52 = X) AND ULTRA QUIET (PIN 52 = L) FANS

CHILLER MODEL (2 COMP) W/ STD & UQ FANS	CHILLER NAME- PLATE VOLTAGE (VAC)	COMPRESSOR 1 OVERLOAD SETTING (AMPS)	COMPRESSOR 2 OVERLOAD SETTING (AMPS)	MAXIMUM VSD FREQUENCY (HZ)
YCAV0157EA/VA	200,230,380,460,575	192	192	186
YCAV0157SA/PA	200,230,380,460,575	196	196	200
YCAV0177EA/VA	200,230,380,460,575	184	197	200
YCAV0177SA/PA	200,230,380,460,575	270	191	182
YCAV0187EA/VA	200,230,380,460,575	250	183	192
YCAV0187SA/PA	200,230,380,460,575	254	198	200
YCAV0197EA/VA	200,230,380,460,575	244	244	182
YCAV0207EA/VA	200,230,380,460,575	234	250	192
YCAV0207SA/PA	200,230,380,460,575	247	273	186
YCAV0227EA/VA	200,230,380,460,575	238	238	200
YCAV0227SA/PA	200,230,380,460,575	255	255	200
YCAV0247EA/VA	200,230,380,460,575	289	238	200
YCAV0247SA/PA	200,230,380,460,575	289	254	200
YCAV0267SA/PA	200,230,380,460,575	289	289	200

PRINTER WIRING

A “serial” printer may be connected to the TB1 connector on the Chiller Logic Board for the purposes of logging data and troubleshooting. Weightronix Imp-2600, Seiko DPU-414, and Okidata Microline 184 printers or equivalents may be used.

Data from the chiller is transmitted at 1200 baud. Wiring diagrams for cables are shown below:

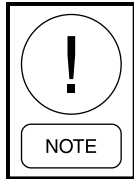

Printer designs change rapidly. The user should use the printer manual for the respective printer for set-up and wiring.

OKIDATA MICROLINE 184

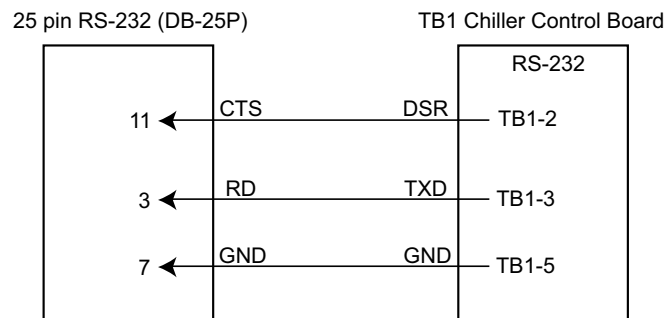

SEIKO DPU-414

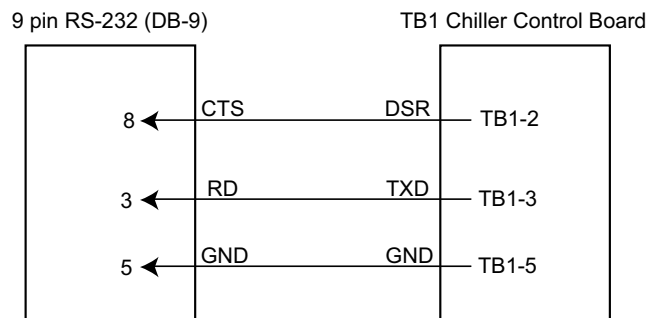

WEIGHTRONIX IMP-24, MODEL 2600

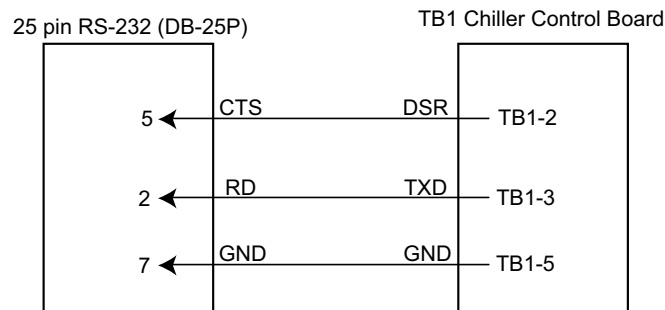

FIG. 37 - PRINT CABLE - CHILLER TO SERIAL PRINTER

PRINTER WIRING

Printer Cables

Printer cables should be shielded coaxial, #18AWG, stranded wire cables, not to exceed 50' in length. On long cable runs or whenever permanent installation is required, the shield of the coax should be tied to the chassis ground at the chiller only, not at the printer.

Printer Setup

The following information may be useful for quick set up of a printer. Specific printer manuals should be utilized, if problems occur, since functions often change as new versions of printers are introduced with enhancements requiring control code, signal programming, and wiring changes.

OKIDATA 184:

Control Board Switch settings:

- SW1 – on: Unslashed 0
- 2 – off: Unslashed 0
- 3 – off: Unslashed 0
- 4 – off: Form Length 11 in.
- 5 – on: Form Length 11 in.
- 6 – off: Auto Line feed off
- 7 – on: 8 bit data
- 8 – off: Enable front panel

With SUPER SPEED Serial Board:

- SW1-1 – on: Odd or even parity
- 1-2 – on: No parity
- 1-3 – on: 8 bit data
- 1-4 – on: Protocol ready/busy
- 1-5 – on: Test select
- 1-6 – on: Print mode
- 1-7 – off: SDD(-) pin 11
- 1-8 – on: SDD(-) pin 11
- 2-1 – on: 1200 baud
- 2-2 – on: 1200 baud
- 2-3 – off: 1200 baud
- 2-4 – off: DSR active
- 2-5 – on: Buffer threshold 32 bytes
- 2-6 – on: Busy signal 200ms
- 2-7 – on: DTR space after power on
- 2-8 – not used

With SUPER SPEED Serial Board:

- SW1 – off: (-) Low when busy
- 2 – off: 1200 baud
- 3 – off: 1200 baud
- 4 – on: 1200 baud
- 5 – not used
- 6 – off: no parity
- 7 – off: Pin 20 & pin 11 act as busy line

WEIGH-TRONIX IMP 24 MODEL 2600:

- SW1 – off: 1200 baud
- 2 – on: 1200 baud

SEIKO:

- DipSW1-1 – off: Input -Serial
- 1-2 – on: Printing speed high
- 1-3 – on: Auto loading - on
- 1-4 – off: Auto LF - off
- 1-5 – on: Setting Command - Enable
- 1-6 – off: Printing density - 100%
- 1-7 – on: Printing density - 100%
- 1-8 – on: Printing density - 100%

- DipSW2-1 – on: Printing Columns - 40
- 2-2 – on: User Font Back-up - on
- 2-3 – on: Character Select - normal
- 2-4 – off: Zero - slash
- 2-5 – on: International character set - American
- 2-6 – on: International character set - American
- 2-7 – on: International character set - American
- 2-8 – off: International character set - American

- DipSW3-1 – on: Data length - bits
- 3-2 – on: Parity Setting - no
- 3-3 – on: Parity condition - odd
- 3-4 – on: Busy control – H/W busy
- 3-5 – on: Baud rate select - 1200
- 3-6 – off: Baud rate select - 1200
- 3-7 – on: Baud rate select - 1200
- 3-8 – off: Baud rate select - 1200

OPERATING LOG SHEET

SITE AND CHILLER INFORMATION

JOB NAME:

START DATE:

LOCATION:

COMPRESSOR # 1 - MODEL #:

COMPRESSOR # 2 - MODEL #:

SALES ORDER #:

COMPRESSOR # 3 - MODEL #:

TECHNICIAN NAME:

COMPRESSOR # 4 - MODEL #:

CHILLER MODEL #:

SERIAL #:

SERIAL #:

PROGRAMMED VALUES

CHILLED LIQUID SETPOINT

Setpoint = _____ °F(°C)

Range = +/- _____ °F(°C)

Display Language = _____

Chilled Liquid Mode = _____

Local/Remote Mode = _____

Display Units = _____

Lead/Lag Control = _____

Remote Temperature Reset = _____

Remote Current Reset = _____

PROGRAMMED CUTOUPS

Suction Pressure Cutout = _____ PSIG (kPa)

Low Ambient Cutout = _____ °F(°C)

Leaving Chilled Liquid Temp. Cutout = _____ °F(°C)

_____ °F(°C)

High Motor Current Unload = _____ %FLA

UNIT OPERATING TEMPERATURES AND PRESSURES

CHILLED LIQUID TEMPERATURES

Entering Temp. = _____ °F(°C)

Leaving Temp. = _____ °F(°C)

OUTDOOR AMBIENT TEMPERATURES

OAT = _____ °F(°C)

VSD FREQUENCY

Actual = _____

Command = _____

VSD BUS VOLTAGE

Bus 1 = _____

Bus 2 = _____

VSD INTERNAL AMBIENT TEMPERATURE

Ambient Temp. = _____ °F(°C)

VSD COOLING SYSTEM STATUS

ON ___ OFF ___

VSD IGBT BASEPLATE TEMPS

T1 = _____ °F(°C)

T2 = _____ °F(°C)

SYSTEM OPERATING TEMPERATURES, PRESSURES, & CURRENTS

SYSTEM PRESSURES

SYS 1 SYS 2 SYS 3 SYS 4
Oil _____ PSIG (kPa)

Suction _____ PSIG (kPa)

Discharge _____ PSIG (kPa)

MOTOR TEMPERATURES

SYS 1 SYS 2 SYS 3 SYS 4
T1 _____ °F(°C)

T2 _____ °F(°C)

T3 _____ °F(°C)

SYSTEM TEMPERATURES

SYS 1 SYS 2 SYS 3 SYS 4
Oil _____ °F(°C)

Suction _____ °F(°C)

Discharge _____ °F(°C)

Sat Suction _____ °F(°C)

Sat Superht _____ °F(°C)

Sat Discharge _____ °F(°C)

Dsch Superht _____ °F(°C)

COMPRESSOR SPEED

SYS 1 SYS 2 SYS 3 SYS 4
Speed _____ %

SYSTEM CURRENT

SYS 1 SYS 2 SYS 3 SYS 4
Current _____ AMPS

SYS 1 SYS 2 SYS 3 SYS 4
Current _____ %FLA

SYSTEM OPERATING CONDITIONS

ECONOMIZER SOLENOID STATUS

	SYS 1	SYS 2	SYS 3	SYS 4
Economizer (ON/OFF)	_____	_____	_____	_____

FEED/DRAIN VALVE % OPEN

	SYS 1	SYS 2	SYS 3	SYS 4
Feed Valve	_____	_____	_____	_____
Drain Valve	_____	_____	_____	_____

FLASH TANK LEVEL

	SYS 1	SYS 2	SYS 3	SYS 4
Flash Tank Level	_____	_____	_____	_____

%

CONDENSOR FAN STAGE (0-6)

	SYS 1	SYS 2	SYS 3	SYS 4
Fan Stage	_____	_____	_____	_____

COMPRESSOR HEATER (ON/OFF)

	SYS 1	SYS 2	SYS 3	SYS 4
Comp Heater	_____	_____	_____	_____

SYSTEM RUN TIME

	Days	Hours	Mins	Sec
System 1	_____	_____	_____	_____
System 2	_____	_____	_____	_____
System 3	_____	_____	_____	_____
System 4	_____	_____	_____	_____

SYSTEM STARTS

	STARTS
SYSTEM 1	_____
SYSTEM 2	_____
SYSTEM 3	_____
SYSTEM 4	_____

OIL SEPARATOR LEVEL

Check Oil Separator Oil Levels

	SYS 1		SYS 2	
	#1	#2	#3	#4
Separator				
Oil Level Top Glass	<input type="radio"/>	<input type="radio"/>	<input type="radio"/>	<input type="radio"/>
Oil Level Bot Glass	<input type="radio"/>	<input type="radio"/>	<input type="radio"/>	<input type="radio"/>

	SYS 3		SYS 4	
	#1	#2	#3	#4
Separator				
Oil Level Top Glass	<input type="radio"/>	<input type="radio"/>	<input type="radio"/>	<input type="radio"/>
Oil Level Bot Glass	<input type="radio"/>	<input type="radio"/>	<input type="radio"/>	<input type="radio"/>

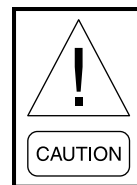

Oil Separator level should be maintained so that an oil level is between the upper and lower sight glasses.

WATER SYSTEM CONDITIONS

EVAPORATOR FLOW

Flow Rate _____ GPM

Evap Pressure Drop _____ FT / LBS
(Circle One)

Glycol Freeze Point _____ °F (°C)

CONDENSOR CONDITIONS

AIR TEMPERATURE

Air ON Temperature _____ °F (°C)

Air OFF Temperature _____ °F (°C)

NOTES

RECOMMENDED SPARE PARTS

DESCRIPTION	MODEL NUMBER YCAV	PART NUMBER
Fan Motor (Standard Low Noise)	-17	024-27322-000
	-28	
	-40	
	-46	
	-50	
	-58	
Fan Motor (Optional Ultra Low Noise)	-17	024-34980-001
	-28	
	-40	
	-46	
	-50	
	-58	
Fan Blade (Standard Low Noise)	ALL	026-35604-000
Fan Blade (Optional Ultra Low Noise)	ALL	026-36532-000
Valve, Control	See Table 4	025-39688-000
Core, Dehydrator	ALL	026-37450-000
Oil, Compressor (Type"L")	R-134a	011-00592-000
VSD Logic Board	ALL	031-02477-000
EPROM-U36	ALL	031-02521-001
EPROM-U39	ALL	031-02522-001
Sensor, Outside Air Temperature	ALL	025-28663-001
Transducer, Pressure (0-275 psig)	ALL	025-29139-003
High Pressure Cutout (297 psig)	ALL	025-39456-000
Transducer, Suction Pressure (0-125 psig)	ALL	025-29583-001
Sensor, EWT, LWT	ALL	025-40334-000
Relay Output Board	ALL	031-02479-002
VSD Logic Board	ALL	031-02477-000
Controller, Valve	ALL	031-02510-000
SCR Trigger Board	60 Hz	031-02060-001
	50 Hz	031-02060-002
Chiller Control Board	ALL	031-02478-002
Level Sensor	ALL	025-39675-002
Feed Drain Valve	ALL	025-37688-000



P.O. Box 1592, York, Pennsylvania USA 17405-1592

Copyright © by Johnson Controls 2016

Form 201.21-NM1 (616)

Issue Date: June 30, 2016

Supersedes: 201.21-NM1 (315)

800-861-1001

www.johnsoncontrols.com

Subject to change without notice. Printed in USA

ALL RIGHTS RESERVED