

adventure, inspired by  
**AIRSTREAM**

# 2018 Atlas Owner's Manual



---

---

**ATLAS**

---

---

## **Disclaimer And Copyright**

All information, illustrations and specifications contained in this manual are based on the latest product information available at the time of publication approval. If and when new materials and production techniques are developed that can improve the quality of its product, or material substitutions are necessary due to availability, Airstream reserves the right to make such changes.

Airstream Atlas Touring Coach Owner's Manual

©2017 Airstream, Inc. All rights reserved

**Publication Date: January 2018**

**REV# 03**

# TABLE OF CONTENTS

<b>INTRODUCTION . . . . .</b>	<b>1-1</b>	<b>SPRINTER VAN . . . . .</b>	<b>7-1</b>
<b>SAFETY . . . . .</b>	<b>2-1</b>	IMPORTANT SPRINTER INFORMATION . . . . .	7-2
SAFETY PRECAUTIONS . . . . .	2-2	FUEL . . . . .	7-2
CHEMICAL SENSITIVITY AND VENTILATION . . . . .	2-2	COMPONENT IDENTIFICATION . . . . .	7-2
ALARMS AND DETECTORS . . . . .	2-3	TIRES . . . . .	7-3
FIRE EXTINGUISHER . . . . .	2-9	CHANGING A TIRE. . . . .	7-5
EMERGENCY EXITS . . . . .	2-9	INSTALLING AND REMOVING A WHEEL . . . . .	7-7
<b>GENERAL INFORMATION . . . . .</b>	<b>3-1</b>	TIRE ROTATION . . . . .	7-8
LIMITED WARRANTY POLICY . . . . .	3-2	AIR RIDE SUSPENSION . . . . .	7-9
SERVICE. . . . .	3-5	<b>DRIVING . . . . .</b>	<b>8-1</b>
CAMPING . . . . .	3-6	LOADING . . . . .	8-2
<b>FLOOR PLANS AND SPECIFICATIONS . . . . .</b>	<b>4-1</b>	SAFETY . . . . .	8-4
FLOOR PLANS . . . . .	4-2	TRAILER TOWING AND DRIVING TIPS . . . . .	8-4
SPECIFICATIONS . . . . .	4-3	TOWING A TRAILER . . . . .	8-6
<b>INTERIOR . . . . .</b>	<b>5-1</b>	TOWING YOUR TOURING COACH . . . . .	8-9
GENERAL INFORMATION AND CLEANING . . . . .	5-3	SAFETY CHECK LIST . . . . .	8-9
ELECTRICAL . . . . .	5-9	<b>MAINTENANCE . . . . .</b>	<b>9-1</b>
ENTERTAINMENT SYSTEMS . . . . .	5-17	MAINTENANCE SCHEDULE . . . . .	9-2
APPLIANCES . . . . .	5-19	SUGGESTED MAINTENANCE AND REPLACEMENT PARTS. . . . .	9-3
<b>EXTERIOR . . . . .</b>	<b>6-1</b>	TIRE CARE . . . . .	9-5
WAXES AND POLISHES . . . . .	6-2	BATTERY (MAINTENANCE FREE) . . . . .	9-6
HOW TO CARE FOR YOUR MOTOR COACH FINISH . . . . .	6-2	LPG SYSTEM . . . . .	9-7
ROADSIDE EXTERIOR FEATURES . . . . .	6-6	PLUMBING . . . . .	9-8
CURBSIDE EXTERIOR FEATURES . . . . .	6-7	DRAIN AND WASTE SYSTEM . . . . .	9-10
EXTERIOR DOORS . . . . .	6-8	WINTERIZING AND STORAGE . . . . .	9-12
AWNING . . . . .	6-9	ELECTRICAL DIAGRAMS . . . . .	9-16
HITCH COVER . . . . .	6-10	FAQS AND ANSWERS . . . . .	9-36





# Section 1

## INTRODUCTION

The Owner's Manual for your new Airstream Atlas is designed to respond to the most frequent inquiries regarding the operation, function, and care of the many systems that enhance your travel and camping experience.

The Airstream Atlas is integrated into a Sprinter Van, designed and manufactured by Mercedes-Benz. Operation of the Sprinter, its engine, power train, and other related components are discussed in the Mercedes-Benz Sprinter Operator's Manual and other literature provided by Mercedes-Benz. As a point of reference, those systems discussed in the Sprinter literature are warranted by Mercedes-Benz or their suppliers.

Airstream realizes our customers possess varying degrees of expertise in the area of maintaining and repairing the appliances in their touring coach. For this reason, the service and trouble-shooting information found in this manual is directed toward those with average mechanical skills. We also realize you may be more familiar in one area than you are in another. Only you know your capabilities and limitations.

We want you to use this manual, and hope you will find the information contained in it helpful; however, should you ever feel you may be "getting in over your head," please see your dealer to have the repairs made.

The operation and care of component parts such as, refrigerator, furnace, water heater and others are briefly explained in this manual.

All information, illustrations, and specifications contained in this manual are based on the latest product information available at the time of publication approval. Airstream reserves the right to make changes if and when new materials and/or production techniques are developed that can improve the quality of its product, or when material substitutions are necessary due to availability.

We have provided many important safety messages in this manual. Always read and obey all safety messages.



### **WARNING**

**A warning is used for a hazardous situation which, if not avoided, could result in death or serious injury to persons.**



### **CAUTION**

**A caution is used to advise caution when performing actions that could result in minor or moderate injury to persons and/or damage to equipment.**

### **NOTE**

**A note is used to address practices not related to personal injury. This applies to hazardous situations involving property damage only.**

Optional items may be available on all, or particular models. Additionally, some optional items can only be included during the manufacturing phase and cannot later be added to the touring coach. The inclusion of optional items information in this manual does not imply or suggest the availability, application, suitability, or inclusion for any specific unit.

### **NOTE**

**Your Mercedes-Benz Sprinter Van Operator's and Warranty Manuals contain important cautions, warnings, operational, and warranty information on the Sprinter and its components. All information in the Sprinter manual should be reviewed and followed for your safety. The Airstream Atlas Owner's Manual may provide additional information and tips on the use of the van as a touring coach; however, no information in the Airstream manual should be interpreted as advice or directions to disregard or void the warnings, cautions, or other information contained in the Sprinter's manuals.**



## Section 2 **SAFETY**

SAFETY . . . . .	.2-1	Carbon Monoxide Detector . . . . .	.2-4
SAFETY PRECAUTIONS . . . . .	.2-2	This Carbon Monoxide Detector Is Not . . . . .	.2-4
Weight distribution . . . . .	.2-2	Important Safety Precautions. . . . .	.2-4
Tire Safety . . . . .	.2-2	What Is Carbon Monoxide . . . . .	.2-5
Appliances and Equipment . . . . .	.2-2	Conditions Which Can Result In Dangerous CO Situations . . . . .	.2-5
Generator Safety . . . . .	.2-2	Symptoms Of Carbon Monoxide Poisoning . . . . .	.2-5
Mold . . . . .	.2-2	Regular maintenance . . . . .	.2-6
CHEMICAL SENSITIVITY AND VENTILATION . . . . .	.2-2	Basic Generator Safety Information . . . . .	.2-6
Chemical Sensitivity . . . . .	.2-2	Liquid Propane Gas (LPG) Detector. . . . .	.2-7
Formaldehyde . . . . .	.2-3	Low Voltage . . . . .	.2-7
Ventilation . . . . .	.2-3	Detector Test . . . . .	.2-7
Do Not Smoke . . . . .	.2-3	Basic LPG Safety Information . . . . .	.2-8
Medical advice . . . . .	.2-3	If You Smell Gas . . . . .	.2-8
ALARMS AND DETECTORS . . . . .	.2-3	FIRE EXTINGUISHER. . . . .	.2-9
Smoke Alarm . . . . .	.2-4	EMERGENCY EXITS . . . . .	.2-9

# Safety

---

## Safety Precautions

Many things can be construed as safety related, but the most important is your common sense. If you are careless with matches, cigarettes, flammable material, or any other hazardous material, you surely realize your potential for accidents is greatly increased.

You will find many safety recommendations in this section and throughout the manual. The following recommendations are the ones we consider to be the most important.

### Weight Distribution

Touring coach's have fresh water and wastewater tanks, a water heater, and storage areas. It gives you great flexibility in loading. With flexibility comes responsibility. If you want to load down all the storage compartments, the amount of fluids may have to be reduced. It is a trade off so plan wisely. Distribute your additional cargo as evenly as possible with the heaviest objects located as low as possible.

Do you really want to carry a full freshwater tank to a RV park 1,000 miles away and then hook up to a city water supply? Even if you're going to a remote area, you can usually fill your water tank shortly before entering the area. Just reducing your load by 10 gallons of water lets you carry an additional 83.5 pounds of cargo.

### Tire Safety

Properly maintained tires improve the steering, stopping, traction, and load-carrying capability of your vehicle. Refer to Section 9 - Maintenance for tire care and safety information. Also, be sure to read the Tire Safety Manual Addendum included with your owner's packet.

### Appliances and Equipment

The appliances (stove) and equipment (hot water heater, furnace, etc.) typically operate on liquified petroleum (LP) gas. LP gas is flammable and is contained under high pressure. Improper use may result in a fire and/or explosion. Make sure to follow all instructions and warnings in this manual as well as those in the specific owner's manuals of the appliances and equipment.

## Generator Safety

Do not operate the generator in an enclosed building or in a partly enclosed area, such as a garage. Be sure to follow all instructions and warnings in this manual and the generator manufacturer's manual. Refer to Section 5 - Interior for generator information.

### Mold

Mold and mold spores exist throughout indoor and outdoor environments. There is no practical way to eliminate all mold and mold spores in the indoor environment; however, the way to control indoor mold growth is to control moisture. Refer to Section 3 - General Information for information on controlling condensation and molds.

## Chemical Sensitivity and Ventilation

### Chemical Sensitivity

Immediately after the purchase of your new recreational vehicle and sometimes after it has been closed up for an extended period of time, you may notice a strong odor and/or experience a chemical sensitivity. This is not a defect in your recreational vehicle. Like your home, there are many different products used in the construction of recreational vehicles, such as carpet, linoleum, plywood, insulation, upholstery, etc. Formaldehyde is also the by-product of combustion and numerous household products, such as some paints, coatings, and cosmetics. However, recreational vehicles are much smaller than your home and therefore, the exchange of air inside a recreational vehicle is significantly less than in a home. These products, when new or when exposed to elevated temperatures and/or humidity, may off-gas different chemicals, including formaldehyde. This off-gassing, in combination with the minimal air exchange, may cause you to experience irritation of the eyes, nose, and throat, as well as sometimes headache, nausea, and a variety of asthma-like symptoms. Elderly persons and young children, as well as anyone with a history of asthma, allergies, or lung problems, may be more susceptible to the effects of off-gassing.

## Formaldehyde

Formaldehyde is a naturally occurring substance and is an important chemical used widely by industries to manufacture building materials and numerous household products. It is also a by-product of combustion and certain other natural processes. Thus, it may be present inside the touring coach. Ventilation of the unit normally reduces the exposure to a comfortable level.

Trace levels of formaldehyde are released from smoking, cooking, use of soaps and detergents, such as carpet shampoos and cosmetics, and many other household products. Some people are very sensitive to formaldehyde while others may not have any reaction to the same levels of formaldehyde. Amounts released decrease over time.

Your Airstream Atlas was manufactured using low formaldehyde-emitting (LFE) wood products, the use of which is typical in the recreation vehicle industry. Formaldehyde has an important role in the adhesives used to bind wood products used in recreation vehicles. The wood products in your coach are designed to emit formaldehyde at or lower than industry guidelines and should not produce symptoms in most individuals.

While LFE wood products typically do not emit formaldehyde at a level that would cause symptoms in most individuals, it is possible, though not likely, for symptoms to occur when the touring coach is not properly ventilated. Ventilation is an essential requirement for touring coach use for many reasons. Any effects of formaldehyde can be greatly reduced by actions such as opening windows, opening roof vents, running the air conditioner, or some combination thereof. In addition, the emission of formaldehyde by these products naturally decreases rapidly over time.

Airstream strongly suggests you take measures to properly ventilate your touring coach on a regular basis. If you have any questions with respect to proper ventilation of your touring coach, please do not hesitate to contact your dealer or Airstream.

## Ventilation

To reduce or lessen exposure to chemicals from off-gassing, it is of utmost importance that you ventilate your recreational vehicle. Ventilation should occur frequently after purchase and at times when the temperatures and humidity are elevated. Remember, off-gassing is accelerated by heat and humidity. Open windows, exhaust vents, and doors. Operate ceiling and/or other fans, roof AC, and use a fan to force stale air out and bring fresh air in. Decreasing the flow of air by sealing the recreational vehicle increases the formaldehyde level in the vehicle's indoor air.

## Do Not Smoke

It is recommended you do not smoke inside your recreational vehicle. In addition to causing damage to your recreational vehicle, tobacco smoke releases formaldehyde and other toxic chemicals.

## Medical Advice

Questions regarding the effects of formaldehyde on your health should be submitted to your doctor or local health department.

## Alarms and Detectors

Parts of this section on the combination Smoke/Carbon Monoxide Detector is a reprint of the manual included with the device and provided to you in the Airstream owner's briefcase. Please read, understand, and follow all aspects of the complete manual before activating and operating the Smoke/Carbon Monoxide Detector. If you have not received the manual, contact your dealership to obtain one, or contact Airstream Customer Relations at 937-596-6111.

### NOTE

**Dangers, Warnings, and Cautions alert you to important operating instructions or to potentially hazardous situations. Pay special attention to these items.**

# Safety

---

## Smoke Alarm

If smoke is detected you will be alerted by 3 beeps, pause, 3 beeps, pause and the detectors LED will flash red as the alarm is sounding. If the alarm does sound exit immediately and call the Fire Department.

The Smoke/Carbon Monoxide Detector will “chirp” once a minute for at least 30 days when the battery is weak. The battery must immediately be replaced with a fresh one.

## Carbon Monoxide Detector

If you hear the Carbon Monoxide alarm move everyone to a source of fresh air. When Carbon Monoxide is detected you will be alerted by 4 beeps, pause, 4 beeps, pause and the detectors LED will flash red as the alarm is sounding. If the alarm does sound exit immediately and call the Fire Department. The manual pertaining to the smoke/Carbon Monoxide detector is included in the paperwork given to you at the dealership. Please read and follow all care, maintenance, and safety information contained in the manual.

Carefully read and understand the contents of the provided instruction manual before using the detector. Store the manual in a safe place for future reference. Pay particular attention to the safety warnings. Pass the manual on to any subsequent users of the alarm.



### WARNING

**Smoke/Carbon Monoxide detectors have a limited life. The unit should be replaced immediately if it is not operating properly. You should always replace an alarm after 7 years from the date of purchase. Write the purchase date on the space provided on the back of unit.**



### WARNING

**This product is intended for use in ordinary, indoor locations of family living units. It is not designed to measure compliance with occupational safety and health administration (OSHA) commercial or industrial standards. Individuals who are at special risk from Carbon Monoxide exposure by reason of age, pregnancy, or medical condition may consider using warning devices which provide audible and visual signals for Carbon Monoxide concentration under 30 ppm. If in doubt, consult your medical practitioner.**



### WARNING

**Activation of your Carbon Monoxide detectors audible horn indicates the presence of Carbon Monoxide that can kill you. Leave the area immediately!**

#### *This Carbon Monoxide Detector Is Not*

- To be seen as a substitute for the proper servicing of fuel-burning appliances.
- To be used on an intermittent basis, or as a portable alarm for spillage of combustion products from fuel-burning appliances.

### NOTE

**This Carbon Monoxide detector is designed for indoor use only. Do not expose to rain or moisture.**

**Do not knock or drop the alarm. Do not open or tamper with the alarm as this could cause a malfunction. The detector will not protect against the risk of Carbon Monoxide poisoning when the batteries are dead or missing. The alarm will only indicate the presence of Carbon Monoxide gas at the sensor. Carbon Monoxide gas may be present in other areas.**

#### *Important Safety Precautions*

- Ideally, it is recommended that a Carbon Monoxide detector should be installed in or near every room that has a fuel burning appliance such as any room heaters, water heaters, cookers, grills, etc.
- Ensure that the alarm horn can be heard by all those who are intended to hear it. Seek medical help if it is suspected that a user of the RV is suffering from Carbon Monoxide poisoning.
- If the alarm sounds, make sure to investigate the problem. Ignoring the alarm may result in sickness, injury or death. (CO may be present even if nothing is seen or smelled by the user.)
- Room spaces should be well ventilated when household cleaning supplies are used as these may cause a false alarm.
- Alarm should be tested once per week. If further details are required, which do not appear in this manual, contact BRK Brands Inc. First Alert.

### What Is Carbon Monoxide

Carbon Monoxide (CO) is a highly poisonous gas that is released when fuels are burned. It is invisible, has no smell, and is therefore very difficult to detect with the human senses. Under normal conditions, in a room where fuel-burning appliances are well maintained and correctly ventilated, the amount of CO released into the room by appliances is not dangerous.

These fuels include wood, coal, charcoal, oil, natural gas, gasoline, kerosene, and propane. Common appliances are often sources of CO. If they are not properly maintained, are improperly ventilated, or malfunction, CO levels can rise quickly. CO is a real danger in air-tight vehicles with added insulation, sealed windows, and other weatherproofing that can trap CO inside.

#### ***The following conditions can result in potentially dangerous CO situations***

1. Excessive spillage or reverse-venting of fuel-burning appliances caused by outdoor conditions, such as:
  - Wind direction and/or velocity, including high gusts of wind.
  - Heavy air in the vent pipes (cold/humid air with extended periods between cycles).
  - Negative pressure differential resulting from use of exhaust fans.
  - Simultaneous operation of several fuel-burning appliances competing for limited internal air.
  - Vent-pipe connections vibrating loose from clothes dryers, furnaces, or water heaters.
  - Obstructions in or unconventional vent-pipe designs which can amplify the above situations.
2. Extended use of un-vented fuel burning devices.
3. Temperature increase that can trap exhaust gases near the ground.

### Symptoms of Carbon Monoxide Poisoning

- Mild Exposure - Slight headache, nausea, vomiting, fatigue (flu-like symptoms).
- Medium Exposure - Throbbing headache, drowsiness, confusion, fast heart rate.
- Extreme Exposure - Convulsions, unconsciousness, heart and lung failure. Exposure to CO can cause brain damage and/or death.



#### **WARNING**

**The Smoke/CO detector is shipped with batteries deactivated. Ask dealer to activate batteries or activate batteries immediately upon delivery. Failure to follow warning will remove your protection.**



#### **WARNING**

**Many causes of reported CARBON MONOXIDE POISONING indicate that while victims are aware that they are not well, they become so disoriented that they are unable to save themselves by either exiting the area or calling for assistance. Also young children and pets may be the first to be affected.**



#### **WARNING**

**Test units in your touring coach after the vehicle has been in storage, before each trip, and at least once a week while in use. If the alarm ever fails to test correctly, have it replaced immediately. If the alarm is not working properly, it cannot alert you to a problem. Failure to test units used in RVs as described may remove your protection.**



# Safety

---

## Regular Maintenance

The Smoke/CO detector has been designed to be as maintenance-free as possible, but there are a few simple things you must do to keep it working properly. Use only listed replacement batteries. The unit may not operate properly with other batteries. Never use rechargeable batteries since they may not provide a constant charge.

- Test it at least once a week.
- Clean the Smoke/CO Alarm at least once a month: gently vacuum the outside of the alarm using your household vacuum's soft brush attachment. A can of clean, compressed air (sold at computer or office supply stores) may also be used. Follow manufacturer instructions for use. Never use water, cleaners, or solvents, since they may damage the unit.
- If the alarm becomes contaminated by excessive dirt, dust, and/or grime, and cannot be cleaned to avoid unwanted alarms, replace the unit immediately.
- Relocate the unit if it sounds frequent unwanted alarms.



### **WARNING**

**The battery door will resist closing unless batteries are installed. This warns you that the unit will not operate without batteries.**



### **WARNING**

**Carbon Monoxide is poisonous and can cause confusion, unconsciousness, and death. Follow all instructions, cautions, and warnings in this section and the generator operator's manual.**



### **WARNING**

**NEVER ignore any alarm. Failure to respond can result in injury or death. The Silence Features are for your convenience only and will not correct a problem. Always check your touring coach for a potential problem after any alarm. Failure to do so can result in injury or death.**

## Basic Generator Safety Information

1. Never sleep in the vehicle with the generator running without ensuring the Carbon Monoxide detector is working. Primary protection against inhaling Carbon Monoxide is daily (every eight hour) inspection for visible and audible generator exhaust system leaks.
2. DO NOT operate the generator in an enclosed building or in a partly enclosed area such as a garage.
3. Review the safety precautions for fuel and exhaust fumes in the generator manual.
4. DO NOT operate the generator when the recreation vehicle is parked in high grass or brush. Heat from the exhaust could cause a fire in dry conditions.
5. DO NOT simultaneously operate generator and a ventilator which could result in the entry of exhaust gas. When exhaust ventilators are used, we recommend that a window on the opposite side of the unit "upwind" of exhaust gases be opened to provide cross ventilation.
6. When parked, orient the vehicle so that the wind will carry the exhaust away from the vehicle. DO NOT open nearby windows, ventilators, or doors into the passenger compartment, particularly those which can be "down wind", even part of the time.
7. DO NOT operate the generator when parked in close proximity to vegetation, snow, buildings, vehicles, or any other object that could deflect the exhaust under or into the vehicle.
8. DO NOT touch the generator when running, or immediately after shutting off. Heat from the generator can cause burns. Allow the generator to cool before attempting maintenance or service.

### **NOTE**

**The generator is located in the exterior curbside rear compartment of the touring coach.**



## Liquid Propane Gas (LPG) Detector

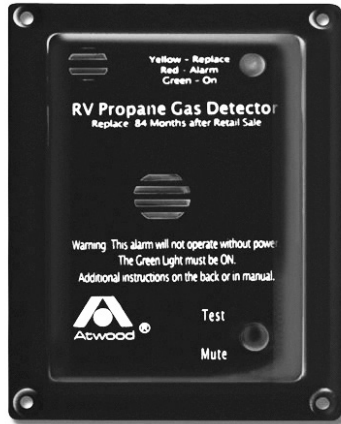

This detector has a seven-year life; see end-of-life notification in LPG detector manual. Please read the entire detector manual before operating the unit.

The LPG detector is located in the galley area. LPG is a mixture of gases produced and sold commercially as a fuel for heating and cooking appliances. LPG is highly flammable and, as a result, can be explosive if ignited under certain circumstances. LPG is heavier than air and, if confined in a closed space, will accumulate close to the floor. The LPG detector is designed to alarm at less than 25 percent of the legal explosive limit. It will provide a visual and audible alarm by sounding an alarm every 5 seconds and lighting the red light emitting diode (LED).

Your LPG detector is wired directly to your touring coach battery and incorporates a 1-amp, in-line fuse. It has no internal battery backup. In normal stand-by mode, the LED indicator will be green.

### Low Voltage

The operating voltage for the detector is 12 VDC. The actual voltage supplied to the detector in a recreational vehicle may drop below the minimum 8 VDC. The detector provides the user with a low voltage warning before reaching that level and will provide additional distinct, clear warnings and alarms after the 8 VDC level is reached. However, if available power supplied to the unit is below the operating voltage of 8 VDC, the detector will not detect gas or provide protection against dangerous levels of LPG.

### Detector Test

The Test/Reset button is used to verify proper alarm function. Executing the test function sounds the alarm and illuminates the red LED. The test will sound the alarm twice, with 4 beeps in 1 second, followed by 5 seconds of silence. By pressing the button, you can verify that the alarm sounds and the LED functions properly.



### WARNING

Activation of this detector indicates the possible presence of LPG, which can cause an explosion and/or fire, causing serious injury or death. This normally indicates a leak in the LPG installation or an LPG appliance. Extinguish all open flames, open your windows and door, and evacuate the unit immediately. Do not activate any electrical switch. Turn off the LPG using the remote shut off switch. Do not re-enter your unit until a qualified repair technician has corrected the problem and certified the system as safe.



### WARNING

It is not recommended that the detector be disconnected from the battery during periods of storage. There is a small heater on the sensor of the device that burns away impurities in the air during periods of normal use. During periods when power is interrupted, impurities can build up on the sensor. When power is returned to the detector, the detector alarm may activate until the impurities are burned off. This could take a number of hours, during which time the alarm will be constantly on.



### WARNING

Have a qualified technician check your LPG system annually or if you detect any signs of leaks or malfunctions.

### NOTE

Refer to Section 5 - Interior and Section 6 - Exterior for additional LPG warnings and safety information.

# Safety

---

## Basic LPG Safety Information

A warning label has been positioned in the cooking area to remind you to provide an adequate supply of fresh air for combustion. Unlike homes, the amount of oxygen supply is limited due to the size of the recreational vehicle, and proper ventilation when using the cooking appliances will avoid dangers of asphyxiation. It is especially important that cooking appliances not be used for comfort heating as the danger of asphyxiation is greater when the appliance is used for long periods of time.

Portable fuel burning equipment, including wood and charcoal grills and stoves, shall not be used inside the recreational vehicle. The use of this equipment inside the recreational vehicle may cause fires or asphyxiation.

A Warning Label has been located near the LP gas container. This label reads: DO NOT FILL CONTAINER(S) TO MORE THAN 80% PERCENT OF CAPACITY. Overfilling the LP gas container can result in uncontrolled gas flow that can cause a fire or explosion. A properly filled container will contain approximately 80 percent of its volume as liquid LP gas.



### **WARNING**

**DO NOT** store LP containers within vehicle. LP containers are equipped with safety devices that vent gas should the pressure become excessive.



### **WARNING**

**DO NOT** use cooking appliances for comfort heating. Cooking appliances need fresh air for safe operation. Before operation, open overhead vent or turn on exhaust fan and open window.

## *If you smell gas*

- Extinguish any open flames, pilot lights and all smoking materials.
- Do not touch electrical switches.
- Shut off the gas supply using the remote shut off switch.
- Open doors and other ventilating openings.
- Leave the area until odor clears.
- Have the gas system checked and leakage source corrected before using again.

LP gas regulators must always be installed with the diaphragm vent facing downward. Regulators that are not in compartments have been equipped with a protective cover. Make sure that regulator vent faces downward and that cover is kept in place to minimize vent blockage that could result in excessive gas pressure causing a fire or explosion.

The regulator at the LP tank is under a gray, plastic cover. The protective cover helps to keep the vent on the regulator from being clogged by wasps or ice, but the regulator should be checked regularly to make sure the vent remains clear.



### **WARNING**

**Do not attempt to seal regulator cover.**



### **WARNING**

**Check vent each time tank is filled to make sure it is clear of obstructions.**



### **WARNING**

**Have a qualified technician check your LP Gas system annually or if you have any signs of leaks or malfunctions.**

### Fire Extinguisher



The fire extinguisher should be checked for charge on a regular basis. Make sure your family, especially the cook, knows how to release the extinguisher storage bracket and how to properly operate the extinguisher. Check with your local fire department for professional advice on its operation and use if you find the directions on the extinguisher unclear. They will be able and willing to assist you and your family.



#### **WARNING**

Read the directions carefully on the fire extinguisher. If there is any doubt on the operation you and your family should practice, then replace or recharge the extinguisher. You will find your local fire department will be happy to assist you and answer any questions.



#### **WARNING**

Do not smoke in bed. Keep matches out of reach of small children. Do not clean with flammable material. Keep flammable material away from open flame. We have all heard these warnings many times, but they are still among the leading causes of fires.

### Emergency Exits

There are three avenues of escape from the touring coach in the event of an emergency, the driver's door, the passenger door, and the side entry door. As always, safety should be one of your top priorities. Make sure you and everyone traveling with you can operate these doors and exit rapidly without light. A little planning and a quick practice session at each camping site is well worth the time it may take. Remember the side entry door steps take a few seconds to extend once the door is opened. If power is unavailable the step may not extend at all. Always look before exiting the side entry door.



#### **WARNING**

At each campsite, make sure you have not parked in such a manner as to block the operation of the doors or the escape avenues by being too close to trees, fences, or other impediments. Scenic views are one reason for traveling, but do not park so the beautiful lake or steep cliff is just outside your doors. Do not block access to the doors from the inside or outside of the vehicle.



## Section 3 **GENERAL INFORMATION**

<p>GENERAL INFORMATION . . . . . 3-1</p> <p>LIMITED WARRANTY POLICY . . . . . 3-2</p> <p style="padding-left: 20px;">Warranty Coverage . . . . . 3-2</p> <p style="padding-left: 20px;">Coverage Ends . . . . . 3-2</p> <p style="padding-left: 20px;">Limitation Of Implied Warranties . . . . . 3-2</p> <p style="padding-left: 20px;">Repair Remedy . . . . . 3-2</p> <p style="padding-left: 20px;">Back-Up Remedy . . . . . 3-2</p> <p style="padding-left: 20px;">What Is Not Covered . . . . . 3-3</p> <p style="padding-left: 20px;">Disclaimer Of Incidental And Consequential Damages . . . . . 3-3</p> <p style="padding-left: 20px;">Obtaining Warranty Service . . . . . 3-4</p> <p style="padding-left: 20px;">Consumer Arbitration Program . . . . . 3-4</p> <p style="padding-left: 20px;">Events That Discharge Airstreams Obligations . . . . . 3-4</p> <p style="padding-left: 20px;">Airstream Limited Warranty Excludes . . . . . 3-4</p> <p style="padding-left: 40px;">Normal Wear . . . . . 3-4</p> <p style="padding-left: 40px;">Accident . . . . . 3-4</p> <p style="padding-left: 40px;">Abuse . . . . . 3-5</p> <p style="padding-left: 40px;">Exposure . . . . . 3-5</p> <p style="padding-left: 40px;">Overload . . . . . 3-5</p> <p style="padding-left: 40px;">Chemical Gassing . . . . . 3-5</p> <p style="padding-left: 40px;">Sprinter Van . . . . . 3-5</p> <p>SERVICE . . . . . 3-5</p> <p style="padding-left: 20px;">Reporting Safety Defects . . . . . 3-6</p>	<p>CAMPING. . . . . 3-6</p> <p style="padding-left: 20px;">Suggested Pre-Travel Check List . . . . . 3-6</p> <p style="padding-left: 40px;">Interior . . . . . 3-6</p> <p style="padding-left: 40px;">Exterior . . . . . 3-6</p> <p style="padding-left: 40px;">Touring Coach Equipment And Accessories . . . . . 3-6</p> <p style="padding-left: 40px;">Motoring Essentials . . . . . 3-6</p> <p>Overnight Stop . . . . . 3-7</p> <p>Overnight Or Weekend Trips . . . . . 3-7</p> <p>Longer Trips . . . . . 3-7</p> <p>Extended Stay . . . . . 3-7</p> <p style="padding-left: 20px;">Leveling . . . . . 3-7</p> <p>Effects Of Prolonged Occupancy . . . . . 3-8</p> <p>About Molds . . . . . 3-9</p> <p style="padding-left: 20px;">What Are Molds . . . . . 3-9</p> <p style="padding-left: 20px;">What Factors Contribute to Mold Growth . . . . . 3-9</p> <p style="padding-left: 20px;">How Can Mold Growth Be Inhibited . . . . . 3-9</p> <p>Waste Water System . . . . . 3-9</p> <p style="padding-left: 20px;">Things Not To Put Into Toilet Or Drains . . . . . 3-9</p> <p style="padding-left: 20px;">Drain System . . . . . 3-9</p> <p>Winter Traveling . . . . . 3-10</p> <p style="padding-left: 20px;">Heated Tanks . . . . . 3-10</p> <p>Safety . . . . . 3-11</p>
---	--

# General Information

---

## Limited Warranty Policy

### This Limited Warranty Covers

(i) The first retail owner and any subsequent owners  
(ii) ONLY those portions of a NEW motorhome not excluded under the section "What is Not Covered", when sold by an authorized dealership; and, (iii) ONLY defects in workmanship performed and/or materials used to assemble those portions of your motorhome not excluded under the section "What is Not Covered". "Defect" means the failure of the workmanship performed and/or materials used to conform with the design and manufacturing specification and tolerances of Airstream. The Limited Warranty is transferable and the subsequent owner's warranty coverage period shall be the unexpired balance of the original warranty coverage period. A completed copy of the Warranty Transfer Form must be submitted to Airstream at the time of resale.

### Coverage Ends

36 months after the first retail owner first takes delivery of the motorhome from an authorized dealership or after the odometer reaches 36,000 miles, whichever occurs first. Any action for breach of this warranty or any implied warranties must be commenced not more than 37 months after breach. Some states do not allow the reduction of the time when a breach of warranty claim must be commenced, so the reduction in time when a breach of warranty claim must be commenced may not apply to you.

### Limitation Of Implied Warranties

Implied warranties arising under applicable law, if any, including but not limited to implied warranties of merchantability or fitness for a particular purpose, are hereby limited in duration to the term of this limited warranty and are limited in scope of coverage to those portions of the motorhome covered by this limited warranty. There are no express warranties or any implied warranties of merchantability on those portions of the motorhome excluded from coverage. There is no warranty of any nature made by Airstream beyond that contained in this limited warranty. No person has authority to enlarge, amend or modify this limited warranty. The dealer is not Airstream's agent. Airstream is not responsible for any undertaking, representation or warranty made by any dealer or others beyond those expressly set forth within this limited warranty. Some states do not allow limitations on how long an implied warranty lasts, so the above limitations may not apply to you.

## Repair Remedy

Airstream's sole and exclusive obligation is to repair any covered defects discovered within the warranty coverage period if: (1) within 10 days of your discovery of a defect you notify Airstream OR an authorized dealership of the defect; AND (2) you deliver your Motorhome to Airstream OR an authorized dealership at your cost and expense.

## Back-Up Remedy

If the primary repair remedy fails to successfully cure any defect after a reasonable number of repair attempts, your sole and exclusive remedy shall be to have Airstream pay an independent service shop of your choice to perform repairs to the defect OR if the defect is incurable, have Airstream pay diminution in value damages. The repair remedy and the back-up remedy must both be exhausted and these remedies must fail to fulfill their essential purpose before you can seek any legal or equitable relief. This limited warranty is not a warranty that promises or extends to future performance because the warranty does not make a representation on how your motorhome will perform in the future but instead represents only what the remedy will be if a defect exists.

Unless prohibited by state law, repairs will not extend the time when you must commence a breach of warranty claim and shall not extend the warranty coverage period. Any performance of repairs after the warranty coverage ends OR any performance of repairs to those portions of your motorhome excluded from coverage shall be considered "good will" repairs. Warranty repairs should be expected. Airstream may use new and/or remanufactured parts and/or components of substantially equal quality to complete a repair. Damage to interior or exterior surfaces, trim, upholstery and other appearance items may occur at the factory during assembly, during delivery of the motorhome to your selling dealer or on the selling dealer's lot. Normally, any damage is detected and corrected at the factory or by the selling dealer during the inspection process. If you discover any damage when you take delivery of your motorhome, you MUST notify your dealer OR Airstream within 10 days of the date of purchase to have damage repaired at no cost to you. Minor adjustments, such as adjustments to the interior or exterior doors, drawers, latches will be performed at no cost to you by your selling dealer during the first 90 days of warranty coverage; thereafter, such adjustments are your exclusive responsibility as normal maintenance.



### What Is Not Covered

1. Tires, batteries, stereo, television, range/stove, furnace, refrigerator, air conditioner, toilet, water heater, microwave, generator, glass breakage, and other materials, parts and components warranted by persons or entities other than Airstream. Please refer to the warranties of component manufacturers for terms and conditions of coverage;
2. Accessories and equipment that are working as designed, but which you are unhappy because of the design
3. Any part or component of the vehicle that was not manufactured or installed by Airstream;
4. Normal deterioration due to wear or exposure, including but not limited to upholstery, flooring rust, corrosion, oxidation, and cosmetic blemishes;
5. Normal maintenance and service items, including but not limited to light bulbs, fuses, lubricants, sealants and seals, door adjustments, and awning tension;
6. After-market equipment or accessories installed on the vehicle after completion of manufacture by Airstream, or any defects or damage caused by such items;
7. Vehicles not purchased through an authorized dealer of Airstream and vehicles purchased directly or indirectly through auction, salvage, repossession, or other non-customary sale means;
8. Defects or damage caused by, in whole or in part, or in any way related to: Accidents, misuse (including off-road use), or negligence; Failure to comply with the instructions set forth in any owner's manual provided with the vehicle; Alteration or modification of the vehicle except such alterations or modifications approved in writing by Airstream; Acts of God or other environmental conditions, such as lightning, hail, salt causing rust, or other chemicals in the atmosphere; De-icing agents or other chemicals applied to the vehicle; Failure to properly maintain or service the vehicle, including but not limited to the maintenance of lubricants, sealants, and seals;

Condensation and the results of condensation including water damage and the growth of mold or mildew. Mold and mildew are natural growths given certain environmental conditions and are not covered by the terms of this Limited Warranty; Use of the motorhome other than for temporary recreation purposes, including but not limited to use of the motorhome for residential, commercial, disaster relief, or rental purposes; The addition of weight to the vehicle that causes the total weight to exceed applicable vehicle weight ratings, or addition of weight causing improper distribution of the weight of the vehicle; Failure to seek and obtain repairs in a timely manner; Failure to use reasonable efforts to mitigate damage caused by defects; Failure to properly ventilate the vehicle; Improper electric power supply or improper vehicle hookup to other facilities; and, Acts or omissions of any person or entity other than Airstream. (Note: It shall be concluded that the motorhome has been used for commercial and/or business purposes if the motorhome owner or user files a tax form claiming any business or commercial tax benefit related to the motorhome, or if the motorhome is purchased, registered or titled in a business name.)

### Disclaimer Of Incidental And Consequential Damages

Airstream disclaims any and all incidental and consequential damages, including but not limited to expenses such as transportation to and from dealerships and Airstream repair facilities, loss of time, loss of pay, loss of use, inconvenience, commercial loss (including but not limited to lost profits), towing charges, bus fares, vehicle rental, service call charges, gasoline expenses, incidental charges such as telephone calls and facsimile transmissions, and expenses for lodging and moisture damage such as mold and mildew as well as rust and corrosion. This disclaimer is independent of any failure of the essential purpose of any warranties provided with the motorhome, and shall survive any determination that a warranty failed of its essential purpose. Some states do not allow the exclusion or limitation of incidental or consequential damages, so the above limitation or exclusion may not apply to you.

# General Information

---

## Obtaining Warranty Service

In order to obtain warranty service under this Limited Warranty, the owner must do all of the following:

1. Owner and dealer representative must complete and return the Customer Performance Checkout within 10 days from delivery of the vehicle,
2. Notify Airstream or one of its authorized, independent dealers of any claimed defect within the warranty period or 10 days thereafter,
3. Provide notification of a defect within 10 days of discovery of that defect, and
4. Promptly return the motorhome to an authorized Airstream dealer or Airstream for repairs.

If you believe a defect covered by this Limited Warranty still exists after an attempted repair by an authorized Airstream dealer, you must contact Airstream at the following address, specifying:

1. The complete serial number of the vehicle,
2. The date of original purchase and the date of original delivery,
3. The name of the selling dealer, and
4. The nature of the problem and the steps or service which have been performed.

Airstream, INC.

428 West Pike Street

P.O. Box 629

Jackson Center, Ohio 45334-0629

Attention: Owner Relations Department

Airstream may direct you to an authorized Airstream dealer, or may request that you bring your motorhome to the Airstream factory in Jackson Center, Ohio for repairs.

Airstream does not control the scheduling of repairs at its authorized Airstream dealers, and repairs at the Airstream factory may not be immediately available. Therefore, you may encounter delays in scheduling repairs and/or completion of repairs. All costs associated with transporting the motorhome for any warranty service shall be the sole responsibility of the owner.

## Consumer Arbitration Program

For recreation vehicles purchased in the State of California, Airstream, Inc. participates in the Consumer Arbitration Program for Recreation Vehicles (CAP-RV). This third-party dispute resolution program is available, at no charge to you, to settle unresolved warranty disputes for recreation vehicles. This dispute resolution program reviews eligible product and service related complaints involving warranty covered components. To find out more about this program, or to request an application/brochure, please call the Arbitration Administration office toll-free 800.279.5343. The CAP-RV program operates as a certified mechanism under the review of the California Arbitration Certification Program. Members of the armed forces who purchased the vehicle in California, or who were stationed in or a resident of California at the time of purchase (regardless of state of purchase) or who are stationed in California at the time of application to this program may utilize the CAP-RV program.

## Events That Discharge Airstream's Obligations Under This Limited Warranty

Misuse or neglect, accidents, unauthorized alteration, failure to provide reasonable and necessary maintenance (see Owner's Manual), damage caused by off road use, collision, fire, theft, vandalism, explosions, overloading in excess of rated capacities, odometer tampering, and use of the motorhome for commercial, business, or rental purposes shall discharge Airstream from any express or implied warranty obligation to repair any resulting defect.

## Airstream Limited Warranty Excludes

### **Normal Wear**

Items such as curtains, upholstery, floor coverings, and window, door, and vent seals will show wear or may even wear out within the 2-year warranty period, depending upon the amount of usage, weather, and atmospheric conditions.

### **Accident**

We strongly urge our dealers and customers to inspect the touring coach upon receipt of delivery for any damage caused by accident while being delivered to the dealer, or while it is on the dealer's lot. Damage of this nature becomes the dealer or customer's responsibility upon acceptance of delivery, unless Airstream is notified and the person making the delivery verifies the damage. Glass breakage, whether obviously struck or mysterious, is always accidental and covered by most insurance policies.



**Abuse**

Lack of customer care and/or improper maintenance will result in early failure for which Airstream cannot be held responsible.

**Exposure**

Deterioration by sunlight is possible to such items as tires, curtains or upholstery. Steel or metal surfaces are subject to the elements, causing rust and corrosion that is normal and beyond the control and responsibility of Airstream.

**Overload**

Overload Damage due to loading beyond capacity or to cause improper balance is not covered by the Airstream Limited Warranty. The Airstream Touring Coach is engineered to properly handle any normal load. There are limits to the amount of load that can be safely transported depending upon speed and road conditions. If these limits have been exceeded, the Airstream Limited Warranty will not cover resulting damage. For additional information on the load capacity of your touring coach, consult your Sprinter and Airstream Owner's Manuals or gross vehicle weight rating plate.

**Chemical Gassing**

Chemical gassing is not a "Defect" in your recreational vehicle and is not covered by the Limited Warranty. Please follow the recommendations in this manual to address this concern.

**Sprinter Van**

Airstream, Inc., does not accept any responsibility in connection with any of its touring coach's for the Sprinter Van or its components. The Sprinter Van and its components are covered by Mercedes-Benz Warranties as explained by Sprinter literature provided. Your Sprinter Van and its components are pre-checked by its manufacturer before delivery to Airstream. All service to the Sprinter Van and its components must be performed by Mercedes-Benz Sprinter designated service points according to the manufacturer's warranty and service policies. The literature provided with each touring coach gives important information concerning its warranty coverage, maintenance, and operation.

The Airstream Atlas Owner's Manual may provide additional information and tips on the use of the van as a touring coach, however, no information, in whole or in part, in any Airstream manual should be interpreted as advice or directions to disregard or void the Warnings, Cautions, Notices, or other information contained in the Sprinter's manuals.

**WARNING**

**Your Mercedes-Benz Sprinter Van Operator's and Warranty Manuals contain important cautions, warnings, operational, and warranty information on the Sprinter and its components. All information in the Sprinter manual should be reviewed and followed for your safety.**

**Service**

Before leaving the factory, every vital part of the touring coach is tested for performance. Each test is signed and certified by an inspector. After the touring coach arrives on your dealer's lot, all vital parts and systems are again tested. When you take delivery of your new touring coach, you will receive a complete check out.

At that time, a specified list of performance checks on your touring coach equipment will be conducted, and any deficiencies you have experienced since taking delivery will be corrected.

Please contact your dealer if your touring coach needs service. Major service under your Airstream Limited Warranty is available through our nationwide network of Airstream Dealer Service Centers. An up-to-date list of Dealer Service Centers will be sent to you with an Owner's Survey shortly after your touring coach is delivered. Our website, [www.Airstream.com](http://www.Airstream.com) also has a dealer locator on it. This list is current as of the date of this publication.

Occasionally, dealerships change or new dealers are added who may not appear on this list. For this reason, it is suggested you contact your local dealer from time to time for an updated list. Additional copies are available if you need them. All centers operate on an appointment basis for the utmost efficiency.

When you require service for your touring coach from the Airstream Factory Service Center or a Certified Dealer Service Center, please contact the service manager for an appointment, and inform them if you are unable to keep the appointment date or wish to change it. Service may be arranged at the Factory Service Center by contacting the Service Coordinator at:

Airstream Factory Service Center

428 West Pike Street

P.O. Box 629

Jackson Center, Ohio 45334-0629

Phone: (937) 596-6111 or (877) 596-6111

# General Information

---

## Reporting Safety Defects

If you believe your vehicle has a defect which could cause a crash or could cause injury or death, you should immediately inform the National Highway Traffic Safety Administration (NHTSA), in addition to notifying Airstream, Inc.

If NHTSA receives similar complaints, it may open an investigation, and if it finds that a safety defect exists in a group of vehicles, it may order a recall and remedy campaign. However, NHTSA cannot become involved in individual problems between you, your dealer, or Airstream Inc.

To contact NHTSA, you may either call the Vehicle Safety Hotline toll-free at 1-888-327-4236 (TTY: 1-800-424-9153), go to <http://www.safercar.gov>, or write to:

Administrator

NHTSA

1200 New Jersey Avenue, S.E.

Washington, DC 20590

You can also obtain other information about motor vehicle safety from <http://www.safercar.gov>.

## Camping

### Suggested Pre-Travel Check List

#### *Interior*

1. Turn off water pump switch.
2. Close windows and vents.
3. Close all interior cabinet doors.
4. Latch refrigerator door. (Seal containers first.)
5. Hold down or securely stack all loose, hard, and sharp objects.
6. Drain toilet bowl.
7. Turn off interior lights.

#### *Exterior*

1. Disconnect and stow electrical hookup cord.
2. Check exterior lighting.
3. Check torque of lug nuts.
4. Check tires for correct pressure.
5. Adjust vehicle mirrors.
6. Pull forward about 50 ft, test brakes, and check site for forgotten objects and cleanliness.

## *Touring Coach Equipment and Accessories*

1. Water hose, 5/8-in. high-pressure, tasteless, odorless, non-toxic (two 25-ft. sections).
2. Y connection - water hose.
3. Holding tank cleaner and deodorizer.
4. Power cord adapter, 30-amp capacity.
5. 30-ft. electric cord, 30-amp capacity.
6. Wheel chocks.
7. Torque wrench.
8. Quality tire gauge.
9. Verify emergency light kit and it is operational. (Found in driver's door.)

## *Motoring Essentials*

1. Touring coach registration.
2. Carry driver's license.
3. In Canada, bring along a non-residence liability insurance card and your passport.
4. In Mexico, you must have special auto insurance.
5. Carry an extra set of the ignition keys in a separate pocket or in your wallet.
6. Keep an operating flashlight with fresh batteries in the glove compartment.
7. Pack so that you can reach tools without completely unpacking.
8. Keep sharp or hard articles securely packed.
9. Do not pack things in the passenger seating area. You will need the maximum space for comfort.
10. Wear easy wash, drip-dry traveling clothes.
11. Do not make your vacation trips a mileage marathon. Stop and relax frequently.
12. Verify first aid kit provided in passenger door is complete and up to date.
13. Carry your pet's dish, food, leash, and health and registration papers.

## Overnight Stop

In time you will develop a knack for spotting wonderful little roadside locations by turning off the main highway and exploring. There are many modern recreational vehicle parks, including State, County, and Federal parks with good facilities, where you may obtain electrical, water, and sewer hookups and connections. Directories are published which describe in detail these parks and tell what is available in the way of services and hookups.

All you need to do to enjoy the self-contained luxury is to:

1. Turn on LP gas supply and light appliance pilots if required.
2. Turn on water pump and open faucets until air is expelled from the system.

Before moving on, turn off the LP gas and water pump. Check your campsite, both for cleanliness and to be sure you have not left anything behind. Make sure everything is properly stowed.

## Overnight or Weekend Trips

On overnight or weekend trips, chances are you will not use up the capacity of the holding tanks. Deplete the water supply if using the system moderately or conservatively. You will need to maintain the level of your battery during this time. If your battery falls to 60 percent capacity, charge the battery by starting your generator.



### **WARNING**

**Frequently depleting the battery below 60% capacity will shorten its lifespan.**

## Longer Trips

On a longer trip, when you have stayed where sewer connections and utility hookups were not available, it will be necessary for you to stop from time to time to dispose of the waste in the holding tank and replenish the water supply. Many truck stops and gas stations, chain and individually owned, have installed sanitary dumping stations for just this purpose. Booklets are available that list these facilities.

When you stop for the night, your Airstream Touring Coach is built to be safely parked in any spot that is relatively level and where the ground is firm. Your facilities are with you. You are self-contained. Try to pick as level a parking spot as possible.

## Extended Stay

Making a long trip is not very different from making a weekend excursion. Since everything you need is right at hand, you are at home wherever you go. When packing for an extended trip, take everything you need, but only what you need.

Hook up to water by attaching a ½ -inch minimum high-pressure water hose to the city water service.

Plug the 120-volt, 30-amp electrical cable into the City Power Service. Be sure you have the wire grounded and have the proper polarity.

To use the generator, you simply start it. All switching is done automatically. The generator can be started from the main Multiplex control panel just inside the entry door. It is easier on your generator and appliances if you'll allow the generator to reach its normal operating speed (about a minute) prior to applying heavy current loads.

Turn on the gas supply. Lighting a top range burner to bleed any air from the system will make it easier to start other appliances including the furnace.

When you stay for extended periods where electric or water hookups are not available, make sure to regularly check on the condition of your 12-volt battery and the contents of your tanks. Both can be viewed from the main Multiplex control panel. Carry drinking water in a clean bucket to refill your tank. When your waste tank nears capacity, move your touring coach to a dumping location.

## Leveling

When you plan to stay in the same place for several days, weeks, or months, you will want your touring coach to be as level as possible. Some appliances, particularly the refrigerator, need to be as close to level as possible to function properly. Check the attitude with a small spirit level set on the floor. If a correction is necessary, you must first level from side to side. This can be done most easily by driving up a small ramp consisting of 2 x 6 boards. Airstream does not recommend placing tires in a hole for leveling. Check the tire section of the chassis portion of this manual for information on tire support.

When leveling, select a spot that has a firm and as level as area possible. Most campgrounds provide this type of parking. Once leveled lower the stabilizer jacks for added support. Never use the stabilizing jacks to level the coach. Refer to Section 6 - Exterior for more information on the stabilizing jacks.

# General Information

---

## Effects of Prolonged Occupancy

Your touring coach was designed primarily for recreational use and short-term occupancy. If you expect to occupy the touring coach for an extended period, be prepared to deal with condensation and the humid conditions that may be encountered. The relatively small volume and tight compact construction of modern recreation vehicles mean that the normal living activities of even a few occupants will lead to rapid moisture saturation of the air contained in the touring coach and the appearance of visible moisture, especially in cold weather.

Just as moisture collects on the outside of a glass of cold water during humid weather, moisture can condense on the inside surfaces of the touring coach during cold weather when relative humidity of the interior air is high. This condition is increased because the insulated walls of a recreation vehicle are much thinner than house walls. Estimates indicate that two adults can vaporize up to one-and-a-half gallons of water daily through breathing, cooking, bathing, and washing. Unless the water vapor is carried outside by ventilation or condensed by a dehumidifier, it will condense on the inside of the windows and walls as moisture, or in cold weather as frost or ice. It may also condense out of sight within the walls or the ceiling where it will manifest itself as warped or stained panels. Appearance of these conditions may indicate a serious condensation problem. When you recognize the signs of excessive moisture and condensation in the touring coach, action should be taken to minimize their effects.

### NOTE

**Your touring coach is not designed, nor intended, for permanent housing. Use of this product for long term or permanent occupancy may lead to premature deterioration of structure, interior finishes, fabrics, carpeting, and drapes. Damage or deterioration due to long-term occupancy may not be considered normal, and may under the terms of the warranty constitute misuse, abuse, or neglect, and may therefore reduce the warranty protection.**

To avoid condensation problems, try to follow these tips to help alleviate excess moisture:

- Allow excess moisture to escape to the outside when bathing, washing dishes, hair drying, laundering, and using appliances and non-vented gas burners. Always use an exhaust fan when cooking.
- Keep the bathroom door closed and the vent or window open when bathing and for a period of time after you have finished.
- If you are experiencing condensation, you may want to reconsider hanging wet clothes in the touring coach to dry.
- In hot weather, start the AC early as it removes excess humidity from the air while lowering the temperature.
- Keep the temperature as reasonably cool during cold weather as possible. The warmer the vehicle, the more cold exterior temperatures and warm interior temperatures will collide on wall surfaces, thus creating condensation.
- Use the ceiling vent to keep air circulating inside the vehicle so condensation and mildew cannot form in dead air spaces. Allow air to circulate inside closets and cabinets (leave doors partially open). Please keep in mind that a closed cabinet full of stored goods prevents circulation and allows the exterior temperature to cause condensation.
- The natural tendency would be to close the vehicle tightly during cold weather. This will actually compound the problem. Simply put, you need to remove some of the warm air and allow some cool outside air to get inside the vehicle so the furnace will not recycle the humid interior air.
- Minimize the use of incandescent lights, which produce heat and contribute to condensation.

### About Molds

#### *What are molds*

Molds are microscopic organisms that naturally occur in virtually every environment, indoors and out. Outdoors, mold growth is important in the decomposition of plants. Indoors, mold growth is unfavorable. Left unchecked, molds break down natural materials, such as wood products and fabrics. Knowing the potential risks is important for any type of homeowner to protect their investment.

#### *What factors contribute to mold growth*

For mold growth to occur, temperatures, indoor or outdoors, must be between 40°F and 100°F and, there must be a source of moisture, such as humidity, standing water, damp materials, etc. Indoors, the most rapid growth occurs with warm and humid conditions.

#### *How can mold growth be inhibited*

By controlling relative humidity, the growth of mold and mildew can be inhibited. In warm climates, use of the air conditioner will reduce the relative humidity. Vents are located in the bathing and cooking areas and constant use is advised during food preparation and bathing, even during colder weather. Additionally, opening a window during these activities will assist in ventilation. In extremely humid conditions, the use of a dehumidifier can be helpful. If using a dehumidifier, please read and follow all manufacturer instructions and recommendations to the use and cleaning of the dehumidifier.

Frequent use of your touring coach or cleaning regularly is an important preventive measure. Further, any spills should be wiped up quickly and dried as soon as possible. Avoid leaving damp items lying about. On safe surfaces, use mold or mildew killing cleaning products. Check sealants regularly, and reseal when necessary to avoid water leaks. Proper preventive maintenance to the touring coach and its accessories, as described both in this manual and in accompanying literature, will provide the best protection to the touring coach.

### Waste Water System

The main parts of the waste water system are the toilet, dual holding tanks, and tank dump valves (see Section 9 - Maintenance for dump valve information). The system is designed to provide complete self-contained toilet facilities, while on the road or parked, without being connected to a sewage line. It may also be used when parked while connected to a sewage hose.

Keep the dump valves closed with either method and empty the tanks when they are nearly full. The idea is to send a large volume of water through the tanks and hose at the same time to float solids away.

After the sewage tank has been emptied, close the gate valves and put approximately 5 gallons of water in the sewage holding tank using the black tank flush inlet. This will spray the interior of the tank with water and help prevent solids from building up in the sewage holding tank. The addition of a deodorizing agent like Aqua-Kem will help prevent odors.

Should you ever have a buildup of solids, close the valves, fill the tanks about 3/4 full with fresh water, drive a distance to agitate the solids, and drain the tanks.

#### *Things Not to Put into Toilet or Drains*

- Facial tissues (they do not dissolve like toilet paper).
- Automotive antifreeze, ammonia, alcohols, or acetone.
- Table scraps or other solids that may clog the drains.

#### *Drain System*

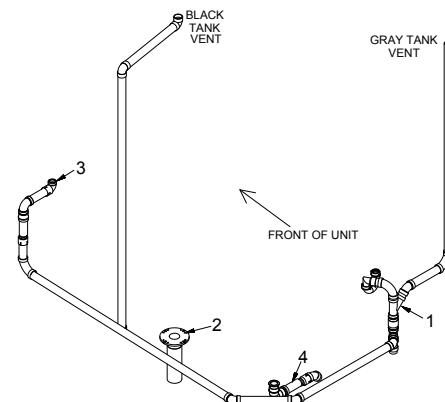

1. Lavatory Drain
2. Black Water Tank (Toilet)
3. Galley Drain
4. Shower Drain



# General Information

## Winter Traveling

Traveling in sub-freezing temperatures will require certain precautions to protect the plumbing system and your personal belongings from being damaged by freezing.

Some states do not allow LPG to be turned on while moving. While traveling in these states, simply use your common sense. How cold is it? How long will it be before you can turn the heat back on? Is the temperature dropping or rising? Remember, when driving at 50 MPH, the wind chill factor will cause the interior of the touring coach to cool much faster than a touring coach that is parked.

1. You must have a plentiful supply of propane gas as the heat from the furnace warms the touring coach and keeps the fresh water lines from freezing.
2. If your stay is longer than overnight, you should endeavor to have 120-volt electricity available. The house battery, fully charged, will not last more than about 15 hours in freezing weather, less (4 hours) with use of the tank heating pads. Of course, you can run your generator to recharge the battery, or even use the generator continually. Keep an eye on your LP Gas or engine fuel according to the type of generator your touring coach is equipped with. Since the generator starts off the house battery, it is recommended to start the generator prior to running the battery down.
3. Minimize use of electricity if 120-volt power source is not available.
4. Leave cabinet doors, wet bath doors, and wardrobe doors slightly open at night to allow circulation of air in and around all components.
5. Save 12-volt power by using non-toxic RV-approved antifreeze in the water holding tanks instead of heating pads to prevent freezing. Quantity of antifreeze needed will vary with ambient temperature and the amount of liquids in tanks.
6. For extended stays in cold weather, insulate all water lines outside the touring coach. You should remember that low temperatures in combination with high winds cause an equivalent chill temperature much below what your thermometer is reading. For instance, with an outside temperature of zero degrees, and the wind velocity of 10 miles per hour, the equivalent chill temperature is -20°F.
7. Remember to remove and drain the exterior shower faucet to prevent freeze damage.

## Heated Tanks



The Atlas Touring Coach has 12-volt heat pads installed with the fresh water, grey water, and black water holding tanks to help prevent freezing. The tank pads are controlled by the Multiplex control panel located on the wall as you enter the touring coach. When the outside temperature is near freezing, simply switch “ON” the holding tank heaters. Built-in sensors will activate the heat pads when the contents of the tank drops to 44°F. Once the liquid is heated and rises to 64°F the heat pads will automatically deactivate. Switch the power “OFF” when the ambient outside temperature remains above freezing or the tanks are empty. Battery power will last about 4 hours unless the unit is plugged into an external AC power source or the generator is ran to operate the inverter/charger. To conserve battery power, RV antifreeze may be used to protect the grey and black tanks.

### NOTE

**Drain and winterize if the water systems are not being used during winter traveling. Refer to Section 9 - Maintenance in this manual for winterizing instructions.**

### Safety

As always, safety should be a top priority. Ensure that you, and everyone traveling with you, can quickly operate the main door in the dark. Plan for other means of escape in case the designated exit is blocked.



#### **WARNING**

**The window operation should be checked before each trip and the latches lubricated with silicon spray or an equivalent lubricant every 3 months.**



#### **WARNING**

**Read the directions on the fire extinguisher carefully. If you have any doubts as to its operation, you and your family should practice, and then replace or recharge the extinguisher. Your local fire department will be able to assist you and answer any questions.**



#### **WARNING**

**Do not smoke inside the touring coach. Keep matches out of reach of small children. Do not clean with flammable material. Keep flammable material away from open flame. Always shut off the LP gas at the bottles when fueling a tow vehicle.**

We have all heard the above warnings many times, yet the situations or occurrences they discuss are still among the leading causes of fires.

Safety information concerning the LPG system of your touring coach is located in Section 6 - Exterior of this manual.





# Section 4

## **FLOOR PLANS AND SPECIFICATIONS**

FLOOR PLANS AND SPECIFICATIONS . . . . .	.4-1
FLOOR PLANS . . . . .	.4-2
Atlas Murphy Suite . . . . .	.4-2
SPECIFICATIONS . . . . .	.4-3
Specification Chart . . . . .	.4-3
Specification Tags. . . . .	.4-4
Tire Size With Maximum Inflation Pressure Cold . . . . .	.4-4

# Floor Plans And Specifications

## Floor Plans

### Atlas Murphy Suite

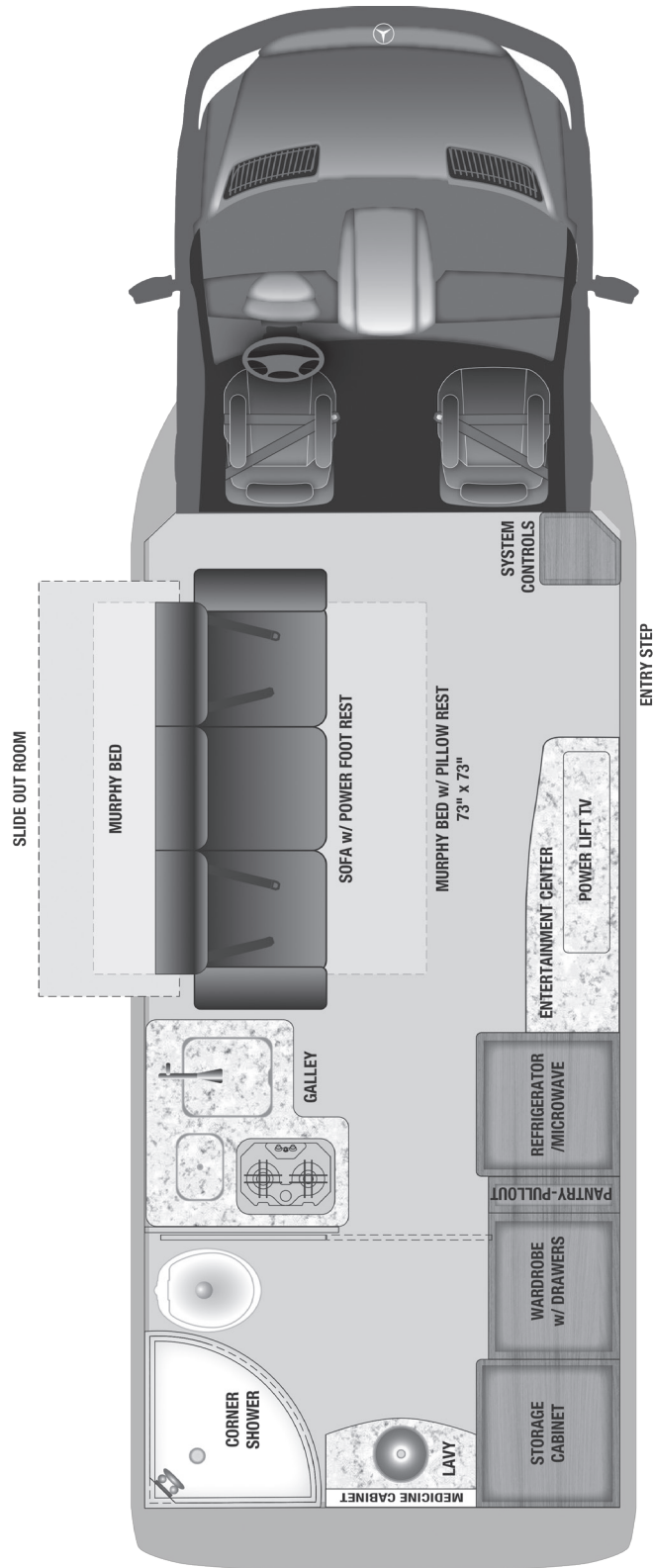

### Specifications

#### Specification Chart

#### NOTE

All weights listed in the Specification Chart are checked and updated throughout the model year.  
Your production coach may vary from weights listed.

Atlas Series	
Model	All Models
Chassis	Mercedes-Benz® Sprinter 3500 Extended
Engine	Mercedes-Benz® 3.0L V6 Turbo Diesel
Emissions	Blue TEC SCR Technology, 50 States - EPA/ CARB Standards
Horsepower/Torque	188 HP/325 lbs Torque
Transmission	5 Speed Automatic
Axle Ratio	3.92
Wheelbase	170"
MPG*	16-18 Estimated Highway
Exterior Overall Length	24' 9"
Exterior Overall Height	10' 6" (with A/C)
Exterior Overall Width	8' 3"
Interior Height	6' 6"
Interior Width	7' 4.5"
GVWR	11,030 lbs
GCWR	15,250 lbs
UBW	10,045 lbs
NCC	985 lbs
Tow Capacity	Up To 5,000 lbs
Fuel Tank	26.4 gallon
Fresh Water Capacity	23 gallon
Gray Water Tank	31 gallon
Black Water Tank	23 gallon
LPG	9.76 gallon
Water Heater (LPG)	60,000 BTU On-Demand
Air conditioner	15,000 BTU
Furnace	16,000 BTU
Refrigerator w/Freezer (12V - 120V)	9.1 cubic feet
Microwave	1.1 cubic feet
Cooktop	2 Burner with Integrated Cover
Generator (Diesel)	Cummins Onan 3.2 kW
Batteries (Coach)	(2) Deep Cycle Maintenance Free Group 24 AGM
Converter/Inverter	50-Amp Multi-stage Charger, 1,000 Watt Inverter
Shore Power	30-Amp/120-Volt Service
Solar Power	300 Watt (3 - 100 Watt Panels)
Bed Size	73" X 73"
Airstream Warranty	3 Years/36,000 Miles
Mercedes-Benz® Warranty	3 Years/36,000 Miles
Mercedes-Benz® Engine Warranty	5 Years/100,000 Miles

# Floor Plans And Specifications

The Unit Base Weight (UBW) and Net Carrying Capacity (NCC) weights listed in the Specification Chart are for the base unit with LP and batteries included.

Gross Vehicular Weight Rating (GVWR) is the maximum permissible weight of this touring coach when fully loaded. It includes all weight at the touring coach axle(s).

UBW is the dry weight of the base unit without options.

Net Carrying Capacity (NCC) is equal to GVWR minus UBW. Gross Axle Weight Rating (GAWR) is the value specified as the load carrying capacity of a single axle system, as measured at the tire-ground interfaces.

## Specification Tags

For precise cargo capacity, refer to the Cargo-Carrying Capacity tag on the inside of the door. The **WEIGHT OF CARGO SHOULD NEVER EXCEED** numbers shown on the tag, which is the maximum weight of cargo you can load and carry in your specific touring coach as built with its options.

Located on the front roadside of your touring coach are the Tire and Loading, and Vehicle Manufacturing tags.

The Tire and Loading information tag lists the Size and Cold Inflation Pressure of the tires on your vehicle, the weight of your touring coach as manufactured, and the GVWR.

The Vehicle Manufacturing tag lists the size of tires and wheel rims, maximum cold inflation pressures, the Vehicle Identification Number (VIN), and GAWR.

For a complete list of capacities, see the Specifications Chart on the previous page.

TIRE AND LOADING INFORMATION RENSEIGNEMENTS SUR LES PNEUS ET LE CHARGEMENT			
The weight of cargo should never exceed 744 kg or 1641 lbs. Le poids du chargement ne doit jamais dépasser 744 kg or 1641 lbs.			
TIRE PNEU	SIZE DIMENSIONS	COLD TIRE PRESSURE PRESSION DES PNEUS A FROID	SEE OWNER'S MANUAL FOR ADDITIONAL INFORMATION  VOIR LE MANUEL DE L'USAGER POUR PLUS DE RENSEIGNEMENTS
FRONT AVANT	LT215/85R16LRE	420 kpa (61 Psi)	
REAR ARRIERE	LT215/85R16LRE	420 kpa (61 Psi)	
SPARE DE SECOURS	LT215/85R16LRE	420 kpa (61 Psi)	
The factory manufactured weight of this motor home is 4259 kgs 9389 (lbs). The GVWR of this motor home is 5,003.00 kgs 11030 (lbs).			

MOTOR HOME OCCUPANT CARGO CARRYING CAPACITY  
VIN:1B2HUWH29EJ303528  
THE COMBINED WEIGHT OF OCCUPANTS AND CARGO SHOULD NEVER EXCEED  
744 kg OR 1641 LBS  
Safety belts equipped seating capacity : 9  
CAUTION:  
A full load of water equals 112 kg or 249 lbs of cargo @ 1kg/L (8.3lb/gal)

## Tire Size with Maximum Inflation Pressure Cold

- LT215/85R16 - 61 psi

## Section 5 INTERIOR

INTERIOR . . . . .	5-1	Slide-Out Room . . . . .	5-7
GENERAL INFORMATION AND CLEANING . . . . .	5-3	Before Operating . . . . .	5-7
Ultra Leather . . . . .	5-3	Extending And Retracting . . . . .	5-7
Impala Suede . . . . .	5-3	Entertainment Cabinet . . . . .	5-7
Cabinets And Overhead Lockers . . . . .	5-3	Pedestal Tables . . . . .	5-8
Aluminum Interior Roof Skin . . . . .	5-3	Privacy Sun Shades . . . . .	5-8
Counter Area . . . . .	5-3	Driver And Passenger Seats . . . . .	5-8
Luxury Woven Vinyl Floor . . . . .	5-4	Power Shades . . . . .	5-8
Protecting Your Floor From Physical Damage . . . . .	5-4	ELECTRICAL . . . . .	5-9
Shower Stall . . . . .	5-4	12-Volt System . . . . .	5-9
Telephone Shower Head . . . . .	5-4	12-Volt Operation . . . . .	5-9
Storage Tips . . . . .	5-4	Power Center . . . . .	5-10
Toilet . . . . .	5-5	Auxiliary Fuse Locations . . . . .	5-10
Deodorizers . . . . .	5-5	Multiplex System . . . . .	5-10
Sinks . . . . .	5-5	Systems Controlled By Firefly . . . . .	5-11
Faucet Cleaning And Care . . . . .	5-5	Ceiling And Directional Lighting . . . . .	5-11
Faucets . . . . .	5-5	120-Volt Power . . . . .	5-12
Lavatory Faucet . . . . .	5-5	Energy Management System (EMS) . . . . .	5-12
Galley Faucet . . . . .	5-5	Circuit Protection . . . . .	5-12
Shower Head . . . . .	5-5	Operation . . . . .	5-12
Shower Handle . . . . .	5-5	Display Panel . . . . .	5-13
Power Sofa . . . . .	5-6	Service . . . . .	5-13
Murphy Bed . . . . .	5-6	Status . . . . .	5-13
Preparing The Sofa . . . . .	5-6	120-Volt Automatic Switch Over Box . . . . .	5-13
Lowering The Bed . . . . .	5-6	Generator/City Power . . . . .	5-13

## Section 5 Interior

Battery Disconnect Switch . . . . .	5-14	APPLIANCES . . . . .	5-19
Battery Separator . . . . .	5-14	Maintenance . . . . .	5-19
Protecting The Charging System . . . . .	5-14	Air Conditioner . . . . .	5-19
Monitor Panel . . . . .	5-14	Heat Pump. . . . .	5-19
Inverter/Charger . . . . .	5-15	Furnace. . . . .	5-20
Converter . . . . .	5-15	Generator . . . . .	5-20
120-Volt Electrical System . . . . .	5-16	Microwave Ovens. . . . .	5-20
City Power . . . . .	5-16	Range . . . . .	5-20
Ground Fault Circuit Interrupter. . . . .	5-16	Refrigerator/Freezer . . . . .	5-20
GFCI Receptacle Test . . . . .	5-17	Operation . . . . .	5-20
GFCI Breaker Test. . . . .	5-17	Start Up . . . . .	5-20
ENTERTAINMENT SYSTEMS. . . . .	5-17	Defrost And Cleaning. . . . .	5-21
TV Antenna . . . . .	5-17	Roof Vent . . . . .	5-21
Cleaning Antenna Housing . . . . .	5-17	Operation . . . . .	5-21
Video. . . . .	5-17	Thermostat And Rain Sensor. . . . .	5-21
TV Operation . . . . .	5-17	Cleaning Instructions . . . . .	5-21
Audio. . . . .	5-18	SeeLevel II Monitor Panel. . . . .	5-22
Privacy Disclaimer. . . . .	5-18	To Read A Water Or Sewer Tank Level . . . . .	5-22
Satellite Antenna Pre-Wiring. . . . .	5-18	To Read The Battery Voltage. . . . .	5-22
Roof Mounted Satellite . . . . .	5-18	To Program The LED Brightness . . . . .	5-22
Portable Satellite Antenna . . . . .	5-18	Skylight. . . . .	5-23
TV Wall Plate Power Supply. . . . .	5-18	Solar System . . . . .	5-23
Operation . . . . .	5-18	Water Heater . . . . .	5-23
		On-Demand Control Center . . . . .	5-23

## General Information and Cleaning

The interior of each Airstream Atlas has been designed for comfort, convenience, durability, and appearance. How you use it and how you take care of it, naturally, depends on you. However, if you learn to operate the interior components and take care of them and the touring coach properly, this knowledge will add to your pleasure, as well as the long life of your touring coach. All material should be professionally dry cleaned to remove any overall soiled condition.

### Ultra Leather

Spot clean regularly with mild soap and water. For stubborn stains, wipe with isopropyl (rubbing alcohol) as soon as possible. Sanitize using a disinfectant such as a 5:1 water/bleach solution. Air dry or dry quickly with a hair dryer on warm setting.

#### NOTE

**Never remove cushion covers for separate dry cleaning or washing. Any tumble cleaning method can destroy the backing, and/or shrink or otherwise damage upholstery fabric.**

### Impala Suede

Any excessive spills should be blotted up quickly after the spill occurs. Using a clean cloth or paper towel, wipe gently. Do not soak fabric with the cleaning solution. Use wet wipes or a cloth dampened with water. Gently wipe the affected area. For more stubborn stains a solution of 95 percent water and 5 percent dish soap can be used. More persistent stains may take a second treatment after allowing the fabric to dry or a solution of Ninety-one percent Isopryl Alcohol. This product is extremely durable with special stain-resistant materials for easy soap and water clean-up.

### Cabinets and Overhead Lockers

The furniture is manufactured from a high-pressure laminate and can be cleaned with soap and water, or you can use a common solvent on tough spots. Furniture polish can be used sparingly. Plexiglass doors must be cleaned with a anti-static cleaner and cloth. Windex or common ammonia products will damage the coating on the surface.

#### NOTE

**Do not use any abrasive material, abrasive cleaners, cloths and pads as there is the possibility they could scratch the surface. A protective pad should always be placed under hot utensils.**

## Aluminum Interior Roof Skin

The metal interior skin on the ceiling is coated with a baked-on acrylic coating. Use soft rags or wash mitts always moving lengthwise with the grain of the aluminum. NEVER rub hard on the coating. Oil, grease, dust, and dirt may be removed by washing with a 5 percent solution of commonly used commercial and industrial multi-purpose detergent in water. Cleaning should be followed by a thorough clean water rinse. Drying the metal with a chamois or a soft cloth may prevent spots and streaks. When washing or waxing the metal, always wipe "with" the grain of the metal. A good grade of nonabrasive automotive paste or liquid wax once a year will increase the life of the finish.

If a substance is found on the coating that cannot be removed by normal washing procedures, Airstream recommends using DX 330 Acryli-Clean made by PPG Industries. Follow all directions and Warnings on the product container. Acryli-Clean should be used by trained personnel only, using the proper equipment under controlled conditions. Use the Acryli-Clean as sparingly as possible to remove oil or grease. Rinse with cool water immediately after use.



#### CAUTION

**Abrasive polishes or cleaning solvents such as automatic dishwasher or acid etch cleaners are too strong and should never be used. Rinse all grit from surface prior to washing. Use soft rags always moving lengthwise with the unit. NEVER rub with excessive pressure on the coating. Even the softest rag will damage the coating if excessive pressure is applied.**

### Counter Area

The solid surface counter tops only require everyday cleaning with a damp cloth or sponge. Dry with a soft cloth or paper towel to prevent spotting. Basic stains can be cleaned with an ammonia-based product such as household glass cleaner or non-abrasive spray-on cleaners for solid surface products. More stubborn stains can be removed by spraying a non-abrasive product such as Formula 409® over the stain and wait for a couple minutes. Scrub in small circular motions with a wet sponge followed by a rinse with clean water and drying with a soft cloth or paper towel. Avoid exposing the counter tops to strong chemicals such as paint removers, acetone, and oven cleaners. Promptly rinse, with water, spots that may have come in contact with these types of cleaners. A protective pad should always be used under hot utensils or pans.



## Luxury Woven Vinyl Floor

One of the best ways to keep the floor looking good is to wipe fabrics off on a weekly basis with clean water. This helps prevent dirt from becoming deeply embedded in the fabric and eliminates the need for more vigorous cleaning. For general or light cleaning, brush off loose dirt and wipe down the floor. Prepare a solution of water and mild soap such as dish washing liquid or household cleaner. Using a soft bristle brush to clean, apply a small amount of water and soap mixture to the stain. Rinse thoroughly until all soap residue is removed. Allow the floor to air dry. For more stubborn stains and mildew, prepare a solution of 1 cup bleach and 1/4 cup mild soap per gallon of water. Apply a small amount of bleach and soap mixture to the stain and blot with a sponge or clean towel. Rinse thoroughly to remove all soap residue. Allow to air dry. A citrus based cleaner like D-Limonene can be used for tough dirt and grease spots. Ammonium based products are NOT recommended. All cleaning products need to be rinsed off thoroughly and air dried after cleaning.



### CAUTION

**Remember to protect the area around your flooring if using a bleach solution. Other fabrics may have an adverse reaction to cleaners containing bleach.**

### NOTE

**The use of certain cleaning agents, including but not limited to powdered abrasives, solvents, and industrial strength cleaners is not recommended. Always follow the manufacturer's instructions. Check that the cleaner/polish is suitable for use with cushioned vinyl floor coverings.**

### *Protecting Your Floor From Physical Damage*

Rubber backing on doormats may result in yellow discoloration of the floor immediately beneath. Choose a natural fiber mat. Rubber feet on furniture may cause staining. Remove them altogether or place coasters or felt pads between them and the floor.

For spirit-based products such as shoe polish, solvents, hair dye, and permanent marker pens, wipe up spots and marks as quickly as possible. This also applies to strongly colored foodstuffs.

Corrosive substances such as acid and alkaline solutions can damage the surface of the floor. Clean up any spills quickly and carefully avoiding direct contact with the substance. Wear protective clothing such as gloves when doing so. Tar from freshly resurfaced or melted roads and pathways, and some inexpensive rubber shoe soles can cause stains. The above materials are likely to cause damage but are not considered restrictive.

## Shower Stall

To clean your fiberglass shower stall unit, use warm water and a liquid detergent. Do not use abrasive cleaners as they may scratch and dull the surface. Stubborn stains can be removed with solvents such as turpentine, paint thinner, or acetone. Restore dulled areas by rubbing with an automotive-type liquid cleaner, and then put the soft glow back into the sides of your unit with a light application of liquid wax. The teak used in the shower is the highest grade available and has been oiled with Interlux™ Premium Teak Oil. To clean use Maritime™ Teak Cleaner, a non-acidic/non-caustic powder cleaner, and rinse with clean water. Use only a soft bristled brush or sponge, always across the grain, for scrubbing. A single coating of teak oil may be re-applied from time to time.

## Telephone Shower Head

The telephone shower head is designed to give maximum flexibility in usage, and provides for water-saving techniques when using your touring coach on self-containment. Normally, the best water conservation procedure is to wet the entire body, turn the water off, apply soap, lather thoroughly, and then rinse the soap off.

## Storage Tips

Cabinets should have the heaviest items stored on the bottom and lighter items overhead. Use unbreakable-type plates and saucers, and consider storing your dish towels around them.

Clothes hung in wardrobes should be kept on hangers that snap over the clothes rods to keep them from bouncing off on rough roads. Try to avoid large bulky coats. Layers of lighter clothing will usually keep you warmer, are more versatile, and are easier to store.



### Toilet

The toilet used in your Airstream Touring Coach is a lightweight, residential size toilet installed directly above the holding tank.

To flush, press the foot pedal, holding the pedal down until all solids have cleared. To add water press the pedal halfway. When you wish to conserve water, hold the hand-spray head over the bowl and hold down the thumb-operated lever. When depressing the pedal, all the water is routed through the hand-spray.

#### NOTE

**When you dump the bowl of the toilet, make sure all paper and solids have cleared the slide mechanism before you allow it to close. Failure to do so can cause the groove for the slide to become jammed and the slide will no longer close completely.**

#### NOTE

**Please see the toilet owner's/user manual for warranty and user tips, and maintenance information.**

### Deodorizers

There are many deodorizers on the market in tablet, liquid, and powder form. These not only combat odor, but also stimulate the bacteria that works to dissolve the solids in your tank.

### Sinks

Cleaning can be accomplished using a mild liquid detergent on a soft cloth. A complete home owner's guide for your sinks is supplied in your owner's packet. Please read these instructions before use.

### Faucet Cleaning and Care

All that is needed to clean your faucet is a soft, damp cloth. Airstream does not recommend the use of scour pads, cleansers, or chemicals. The abrasive nature of these substances could damage the faucet's finish. A non-abrasive car wax will help to protect the finish.

### Faucets

#### Lavatory Faucet



Kohler - Model: K45800-4-BN

Alteo single handle

#### Galley Faucet



Kohler - Model: K-597-VS

Single hole-pull down faucet

#### Shower Head



Kohler - Model: K-99248-BN

Handshower with Eco Boost

#### Shower Handle



Kohler - Model: K-T5322-4-BN

Shower handle

# Interior

## Power Sofa



The sofa has power adjustment controls, located on the outside of each armrest, used to recline each end of the sofa. Also located on each armrest is a set of USB ports for plugging in your electronic devices.

## Murphy Bed

### Preparing the Sofa



The power sofa is also used as the base support for the murphy bed. Clear the surrounding area of any obstructions before you begin. Remove the dinette table and store in the drawer at the base of the sofa. Make sure the sofa is in its normal upright position and not reclined. Press and hold the right arrow switch located on the side of the sofa. Lower the sofa fully until it stops and release the switch. To return the sofa to its upright position press and hold the left arrow switch.

### Lowering the Bed

1. It is recommended that if you are using the Murphy bed with the slide-out wall extended to lower the stabilizing jacks. However, the Murphy bed has been designed for use without the wall extended. In this case the stabilizing jacks will not need to be used.
2. Remove the sofa armrests. The armrests are held on by Velcro and can be stored in the sofa's drawer.
3. Rotate a pull handle in the upper corners of the wall and pull down to lower the bed. While lowering watch for any interference points. If there is any contact raise the bed and fix the interference before lowering again.
4. As the bed is lowered the headboard will flip down to fill the space between the bed and wall. If the headboard fails to lower simply flip it down by hand once the bed is lowered. In some cases, if the headboard wasn't flipped up before the bed was raised, the headboard may become lodged under the bed. If this should happen raise the foot of the bed slightly and flip the headboard up by hand.

To raise the bed follow the lowering steps in reverse order. Be sure to flip up the headboard before raising the bed. This will help prevent it from becoming lodged the next time the bed is lowered.

### NOTE

**Make sure to read, understand, and follow all information, Notes, Cautions, and Warnings in the manual before operating the Murphy bed.**



### WARNING

**Keep your furniture and family safe from fires caused by careless smoking. Do not smoke when drowsy. Remove immediately any flowing ash or a lighted cigarette which falls on furniture. Smoldering smoking material can cause upholstered furniture fires.**

### Slide-Out Room

The Airstream Atlas is equipped with an expandable slide-out room which provides extra living space. The slide-out rooms motor features a stop limit that will automatically stop the motor when the room is fully extended/retracted.

#### NOTE

**Before operating, review all instructions in the Lippert InWall Slidout Owner's Manual provided in your owner's packet**

#### *Before Operating the slide out Room*

1. Ensure the touring coach is properly leveled and supported using the stabilizing jacks.



#### CAUTION

**If the touring coach is not properly leveled before extending the slide-out room, the slide-out mechanism may become damaged.**

2. Make sure there is adequate space beside the touring coach for the slide-out room to be fully extended.
3. Check the interior of the touring coach to ensure there are no obstructions on the floor or leaning against the wall.
4. Check the exterior of the unit to ensure all exterior compartment doors are closed and all obstructions are removed.
5. Make sure all people stand clear before operation.



#### WARNING

**Never drive the touring coach with the slide out room extended.**

### *Extending and Retracting the Slide-out Room*

The control switch is located inside the full height cabinet to the right of the entry door and is labeled for your convenience. The auxiliary section of the main Multiplex control panels "Shades" screen can also be used. Once pressed the screen will display "OPN" or "CLS" next to the Slide Out option.

1. Depress and hold the switch down (Extend) until the room is fully extended. Only when the room is fully extended is it completely weather tight. Leaving the room partially extended can allow moisture and dirt to enter the touring coach.
2. Depress and hold the switch up (Retract) to retract the room. Make sure the room has fully retracted ensuring a complete seal from the outside.

#### NOTE

**Check for worn and cracked weather seals around the slide-out room. Extensive travel and use can cause the seals to deteriorate and may allow moisture and dirt to enter.**

#### NOTE

**When using the Multiplex panel Open/Close will replace Extend/Retract.**

### Entertainment Cabinet

The entertainment cabinet houses a hidden power lifted 40" LED HDTV. When the TV is not in use the cabinet can be used as additional counter space. When you want to watch TV press the TV lift switch located on the side of the entertainment cabinet at the entry door or on the Multiplex control panel on the wall behind the drivers seat next to the sofa. Pressing the TV lift UP button will activate the TV lift bringing the TV up through the cabinet top. When your ready to lower the TV press the DOWN switch and the TV lift will lower into the cabinet closing the counter top lid automatically.



#### CAUTION

**Before activating the TV lift be sure the counter top is clear of any objects. The lift is designed to shut off automatically if the lid is obstructed and cannot open. However, the lid may open with lighter objects covering the lid which could cause damage to the lift mechanism or surrounding area.**

# Interior

## Pedestal Tables

The Atlas Touring Coach has two pedestal tables. One table can be installed in front of the sofa while the other is installed between the driver and passenger seats. The table tops and pedestal legs are designed to be stored in the middle drawer of the sofa base. The tables leg can be inserted into the floor mounted threaded socket and rotated to lock in place. The top is installed by inserting the pedestal leg into the socket installed on the underside of the table top. To remove, simply pull straight up on the table top. The leg is removed by depressing the black button on the floor socket and rotating the table leg.



### WARNING

**Return table tops and pedestals to their respective storage positions before moving the vehicle. In an emergency stop or accident the top and pedestal could cause personal injury and/or death.**

## Privacy Sun Shades

Privacy shades are provided for the front windshield and driver/passenger cab windows. The shades have magnets sewn into them that attach to the van.

Light brushing with an upholstery brush or gentle use of a vacuum cleaner will suffice in most situations. For heavy soiled conditions dry clean only. Washing the shades may void the warranty.

## Driver and Passenger Seats

The driver and passenger heated seats are provided by Sprinter, sent out to be recovered by Airstream to match the interior decor.

The seat adjustment mechanism provided by Sprinter allows the seat to be moved forward or backward and swivel left or right. A release bar under the front of the seat is used to move the seat forward and backward. Pressing down on a handle centered under the front of the seats allows the seat to swivel. Return seat to full upright position before using swivel adjustment. The heated seats are activated by dash-mounted switches.

Lumbar and other seat adjustments are part of the reupholstered Sprinter seat and their operation is explained in the Sprinter manual.

## Power Shades

All Atlas models come with power shades controlled by the Multiplex control panels. The shades feature a mechanical limit switch to prevent accidental loss or change of limits due to power surges or power outages. These presets are set at Airstream and shouldn't need adjusted.

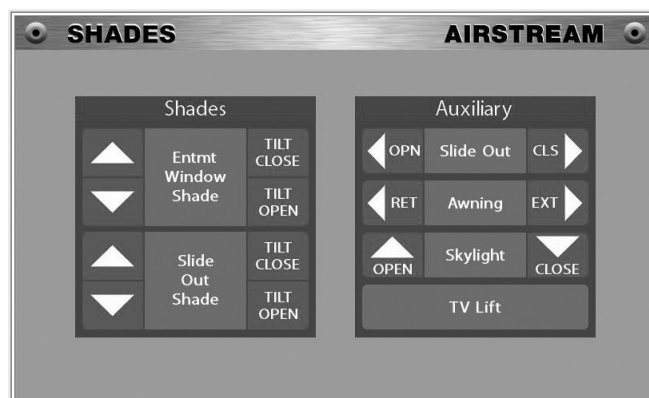

The multiplex main control panel allows for control over each shade. Pressing "shades" on the main control panel will display a screen for operating the entertainment window or slide out window shades. Pressing either the up or down arrow next to the shade you want to control will raise or lower the shade. If the same arrow is pressed before the shade reaches its pre-set limit stop the shade will stop at its current position. To tilt, press the tilt open or tilt close buttons. The shade will tilt a small amount with each tap of the button. The shade must be in its lowered position before tilting.

Refer to the Power Shades owner's manual for tips on cleaning.

## Electrical

### 12-Volt System

The major portion of electrical power in your Airstream is 12 volt. The 12 volt current powers almost everything except the roof A/C, 120-volt receptacles, and microwave. Although these systems are not powered by 12 volt they may have electronic boards which require 12 volt to function.

All 12-volt current is routed to a 12-volt pass-through power stud mounted on the battery box. The power stud is the hub of the 12-volt system tying together the inverter/charger, house battery, and battery separator.

Power from the stud goes to a buss bar holding Type 2 thermal breakers. The thermal breakers then feed electrical components throughout the touring coach.

Power is routed from the battery disconnect switch to the 12-volt distribution panel and through its branch circuits to the rest of the touring coach.



#### **CAUTION**

**Thermal breakers break contact when overheated by a short or overload in the wiring. These breakers automatically reset when cooled down. A breaker continually overheating and breaking contact should be investigated by a qualified service technician.**

### 12-Volt Operation

The only thing you have to do is make sure the house battery does not run down. In normal usage this shouldn't be a problem since you would normally be plugged into an external AC power source at night or when camping. When you're plugged into shoreline power or running the generator the inverter/charger charges the battery and carries much of the load.

Some nights you may not find a place to plug into city power. This should not be a problem; you can comfortably run your lights, water pump, and vents in normal fashion without depleting the battery.

If you are not plugged into city power, and you plan on staying longer than a day or two, you'll want to conserve your battery by using as few lights and appliances as possible. Check the monitor system regularly. If you notice the lights becoming dim or the LED light on the battery disconnect switch blinking it's a good idea to charge the batteries. It's much easier on the battery if you start the generator or run the chassis engine before the battery runs down completely. The generator starts from the house battery. If the house battery becomes depleted, the chassis engine can be started to charge it. It should only take a few minutes before the generator will start.

The engine battery and house battery are isolated from each other by the Battery Separator, preventing the two systems from drawing down simultaneously. They will connect through the Separator if charging from the engine, generator, or inverter/charger is detected.



#### **CAUTION**

**Airstream does not recommend the vehicle engine be run at idle speeds for more than one hour between 15 minute full temperature drive times.**



# Interior

## Power Center



The power center is installed in the lower right hand section of the entertainment cabinet. Open the decorative door for access to 12-volt fuses and 120-volt breakers.

The power center is a completely self-contained 120-volt power distribution and energy management system intended to be used in recreational vehicles. It is housed in a sheet metal enclosure with a removable front panel. It provides circuit protection for all the 120-VAC loads in the touring coach and works with the Energy Management System to minimize the overloading and tripping of circuit breakers.

Refer to Section 9 - Maintenance for important battery maintenance information.



### **WARNING**

**The power center is a centralized power switching, fusing, and distribution center. The potential of lethal electrical shock is present in this box. Inadvertent shorts at this box could result in damage and/or injury. All servicing of this box should be done by a qualified Service Technician.**

### **Auxiliary Fuse Locations**

In addition to the 12-volt fuses and breakers described in the this section, some components have additional fuse protection as supplied or required by their manufacturer. These locations are:

1. LP detector: 1-amp fuse, behind detector.
2. Battery Separator power line to chassis battery: 150-amp in-line fuse, inside Sprinter battery compartment under the driver's floorboard.
3. Battery Separator: 7.5 amp, under the passenger seat.
4. Rear view camera/monitor: 2 fuses (5 amp and 1 amp), located above the dome light. Remove light to access.

5. Sofa: 20 amp fuse for backrest and 15 amp fuses for each of the legs. Fuses are self-resetting and located behind the sofa. 7.5 amp USB ports
6. Water Heater: 5 amp fuse located in front of water heater.

### **NOTE**

**Most fuses will require a qualified technician to access and replace. Contact your dealer or Airstream Service Center.**

## Multiplex System

The Multiplex system provides advanced automation and mobile electrical solutions for your touring coach. Firefly is a multiplex network system designed to combine multiple signals across a media to reduce wires and simplify end user control. The system combines all desired functions and controls of the touring coach into a central location. Regional control panels are installed to operate specific areas.

The switch panels conveniently located throughout the touring coach allow you to turn your lighting on or off, as well as, the ability to dim lighting to a desired level with the touch of a button. Each button is illuminated, when it is pressed, indicating the circuit is either ON or OFF. The button will turn white when the circuit is OFF and blue when it is ON.

### **NOTE**

**Buttons that are controlling circuits such as Light Master and Panel Lights typically Do Not change from blue to white.**

The Light Master button allows you to instantly turn ON or OFF all lighting in the interior of your touring coach. Pressing the Light Master ON button will turn on only the lights that were on when Light Master OFF was pressed. Holding the button ON for more than 1 second will turn on all the interior lighting.

### **NOTE**

**Pressing the Light Master ON after the Light Master OFF button has been held or pushed twice will result in no response. Hold ON to resolve.**

### **NOTE**

**When dimming it is normal for LED lights to flicker. Lights should return to normal once they are set to a desired brightness.**



## Systems Controlled By Firefly

- Lighting (inside and outside)
- Power awning and awning lights
- Slide-out
- Skylight
- Shades
- Climate
- Tank monitoring (Fresh, Black, Grey and LPG)
- Battery voltage
- TV lift
- Water heater
- Tank heaters
- Water pump

The following panel displays are examples of the secondary screens of the main control panel and are a reflection of what might be displayed when an option is selected.

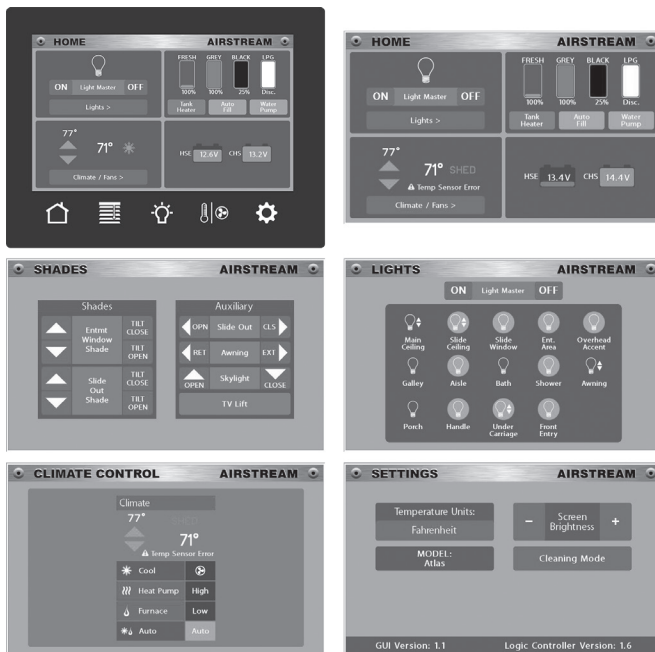

### NOTE

Warning alarms have been incorporated into the Multiplex System to warn of possible hazards. These warning alarms include; cabin door lock, slide-out extended, cabin door open, luggage door locks, chassis battery voltage, and folding step. If an alarm sounds check the main Multiplex control panel for a warning notification before proceeding.

## Ceiling and Directional Lighting

All lighting in the Airstream Atlas is LED and most will require a replacement fixture should it go out or malfunction. Most lighting can be operated from multiple control panels connected to the Multiplex System. The main touch screen control panel is located on the front overhead behind the passenger seat. The Circuit Control Board is located in the lower portion of the full height entry cabinet behind the passengers seat and is accessed by removing the false panel. Other control panels located throughout the touring coach include; on the wall next to the sofa, galley area, and bathroom. These panels control an array of lighting in their respective locations, as well as, the power shades, slide out bed, TV lift, and water pump.

The Multiplex System is self resetting should a circuit trip. The system should never need reset by the owner for any reason. If the main control panel or remote panels are not operating this could indicate a short in the wiring and should only be serviced by a certified technician.

Examples of the regional control panels are shown below. Refer to Section 8 - Maintenance for wiring diagrams

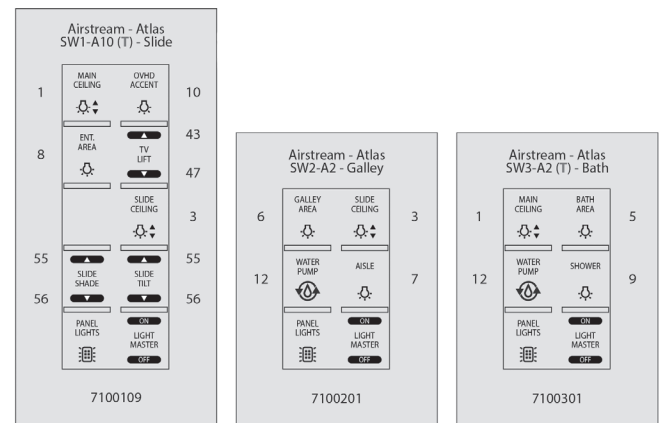

### NOTE

Several Multiplex control panels are installed throughout the touring coach. Many fixtures can be operated on multiple control panels. However, some of the fixtures they control are unique to the area in which they are located. For best use of the Multiplex System Airstream recommends learning the functions of each individual panel. Refer to the owner's manual provided for tips and information on how to use the system.

# Interior

---

## 120-Volt Power

When you're plugged into shoreline power or starting your generator, 120-volt current is fed to an Automatic Switch Over Box. Power from the box runs to the 120-volt circuit breakers through an Energy Management current sensor.

### NOTE

**Make sure to read, understand, and follow all electrical component owner's manuals provided in the owner's packet before operating the touring coach. Observe all operating instructions and Warnings as well as all recommended maintenance schedules and procedures.**

## Energy Management System (EMS)

The Energy Management System is located in the entry cabinet behind the passengers seat. A complete, detailed EMS manual is included with your owner's packet.

The ENERGY MANAGEMENT SYSTEM controls 120-volt operated circuits to help keep the total 120-volt current draw to less than 30 amps. When operating on generator power the 120-volt draw will be less than 26.7 amps. These circuits may be any type load, but are typically heavier loads, those whose use can be "postponed" until a time when current is available for their use.

### Circuit Protection

Circuit protection for ALL 120 VAC loads are standard residential resettable circuit breakers install in the Power Center (120 VAC section). Airstream has pre-installed the correct breakers per RVIA (NEC) listing requirements for the touring coach. The MAIN breaker for the touring coach is 30 amp and feeds the branch-breakers in the breaker box. Shutting off the MAIN breaker will remove power to all branch loads, except for receptacles on the Inverter circuit when the inverter mode is "ENABLED". The Inverter/converter contains a resettable 20 amp input breaker and a 15 amp output breaker. The remaining power center branch-breakers feed individual loads and are defined by the label affixed next to the breakers. The source for 120 VAC power to the Power Center can come from either the Shoreline plug when connected to a camp site or the coach's own generator when running. If both sources are "ON" the power feed to the Power Center will be coming from the generator.

The main and general load branch-breakers are operated similar to a light switch with up as "ON" and down as "OFF". If an overload condition or a short occurs the switch will snap to the "OFF" position. The load for this breaker will now be "OFF". Before resetting the breaker be aware of any device that may have been plugged in or turned "ON" which may have cause the breaker to overload. Unplug or turn "OFF" the possibly faulty device before resetting the breaker. To reset the breaker, firmly push the breaker switch to the "OFF" position then back to the "ON" position. If the breaker snaps back to the "OFF" position while resetting a fault condition still exists and should be serviced by a qualified Service Technician. If the breaker stays "ON" but snaps back to "OFF" after plugging in or turning ON the possibly faulted device a fault condition may exist in that device and should be service by a qualified Technician.

The power center Ground Fault Interrupt Circuit (GFIC) breaker is a special breaker that will provide additional safety to the occupants of the touring coach on the following receptacles; external, galley, lavatory, and entertainment. In addition to short circuit and overload protection the GFIC will shut off the breaker if any current feeding out of the breaker does not return to it. As in the case of a person contacting the electrical energized part of the GFIC circuit and an electrically conductive object not associated with the circuit.

Refer to to Ground Fault Circuit Interrupter and GFCI Breaker Test in this section for more information.

### Operation

In operation, when 120 VAC and 12 VDC are initially applied, the system will energize the relays at one second intervals, closing the normally open contacts on each of the five relays while monitoring the total current. If the total should exceed the service limit, the system will turn off the last load that was turned on. As it does this, it calculates the amount of current that was removed, which is the value for that load. This value is placed in memory. The system has "learned" the amount of current that particular appliance draws. This feature compensates for the difference in current draw over a range of line voltage and ambient temperature, by relearning the load each time it is turned off.

The system now waits until the total current is lower than the service limit, by the amount in memory, before it will turn that load back on. This ensures that there is sufficient current to operate the load.

### Display Panel



The display panel requires little user interaction and is provided to help the user understand power management. The display monitors the total AC current of the touring coach and prevents circuit breaker tripping by momentarily shedding loads. As additional appliances are turned on the system will begin to shed loads. As appliances are turned off, and a minimum of two minutes has expired, the system will automatically restore power to each of the shed loads.

#### Service

The “Select” button allows the service type to be set to either 15, 20, or 30 amps, to match the incoming service.

When power is first applied, the system will be in the 30-amp mode and the screen will display “Service 30A”. Momentarily pressing the “SELECT” button will switch the system to the 20-amp mode. Momentarily pressing the button again will switch the system to 15-amp mode.

Press the “SELECT” button to switch to either 15 or 20-amp service if it is necessary to use an adaptor or you know the shoreline power is 15 or 20 amps, The screen will display either “Service 15A” or “Service 20A”.

The generator supplies 26.7-amp service and is set to switch the system automatically to 26-amp mode whenever the generator is the power source. The screen will display “Generator 26A” when the generator is supplying power.

The Display Panel is protected by a 5-amp automotive-type fuse located behind the Display Panel cover. Remove the screws from the cover to access the fuse.

#### Status

The roof A/C and microwave are set at the factory to be the controlled circuits and are shed in this order.

This means if a power hungry electric grille is plugged into an outlet and the system begins to use more than 30-amps it will begin to shed loads and will shut off the air conditioner first.

### 120-Volt Automatic Switch Over Box

The switch over box automatically switches the 120-volt feed to the Energy Management System Module from shoreline to generator and back as you choose which way to power the touring coach. You simply decide whether to plug into a 120-volt shoreline or start the generator and the box will do the rest. If the generator is accidentally started while plugged into shoreline the box will sense the generator incoming power. Contact points inside the box will switch, cutting the shoreline connection and establishing the generator connection. This protects the system from a possible overload from dual power sources.

#### Generator/City Power

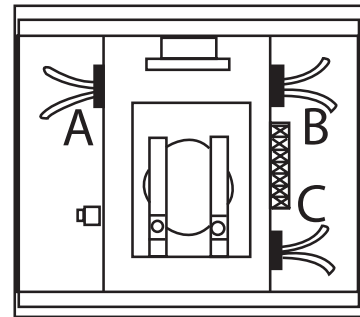

- a. To Energy Management System module main breaker
  - b. From generator
  - c. From shoreline
1. When plugged into shoreline power, the current path is from C to A.
  2. When you start your generator, the points switch and the power flow is from B to A. Stopping the generator releases the points back to shoreline feed.
  3. If you're plugged into shoreline and you start the generator, the points still switch since the generator has the priority, so the current flow is still B to A.

#### NOTE

**Make sure to read and understand all electrical Component owner's manuals provided in the owner's Packet before operating the touring coach. Observe all operating instructions and Warnings as well as all recommended maintenance schedules and procedures.**

# Interior

## Battery Disconnect Switch



The battery disconnect switch is used to separate the batteries from the 12-volt distribution panel and converter charging system. The Atlas battery disconnect switch is equipped with LED indicators. When the light is green the switch is ON and the batteries are charged. When the red LED begins to blink slowly it is an indicator the batteries should be charged. If the red LED begins blinking rapidly the batteries should be charged immediately before battery damage incurs.

### NOTE

**A rapidly blinking red LED indicates the battery charge is below 50 percent and future charging damage may incur. Airstream recommends charging the battery as soon as you notice the light blinking.**

When the touring coach is plugged into an external AC power source the 12-volt distribution panel will receive power from the converter and the batteries will be charged through the converter charging system regardless of if the battery disconnect switch is in the ON/OFF position.

If the touring coach is NOT plugged into an external AC power source and the switch is turned to OFF the batteries are disconnected and the 12-volt distribution panel will not receive power from the converter. The converter will not charge the batteries with the switch in the OFF position with no shoreline power present. The OFF position is intended for storage of the touring coach or when power conservation is desired.

The solar panels will charge the batteries regardless of the battery disconnect switch position. Likewise, if ON or OFF, the generator will charge the batteries.

### NOTE

**As a safety precaution, the electric gas shut-off solenoid closes automatically when 12-volt power is disconnected, cutting gas to appliances. It will reopen when power is restored.**

## Battery Separator

The Battery Separator is located under the passenger's seat. It is designed as a solenoid priority system to protect the chassis charging system from excessive loading, while allowing house batteries to be maintained by the Sprinter charging system.

### Protecting the Charging System

The Battery Separator monitors the battery system to determine if the batteries are being charged. The charging can be accomplished through the inverter/charger or the engine charging system. When the engine battery or house batteries are charging, the Battery Separator will engage, joining the two battery banks. If charging ceases and voltage decreases in either bank, the Battery Separator will disconnect the two banks from each other, protecting the banks from being discharged simultaneously.

### NOTE

**In the event the engine battery is depleted, Sprinter recommends using a trickle charge only when charging the battery. When jumping the engine battery, do not use a power boost. Read and follow battery charging procedures in the Sprinter Owner's manual.**

## Monitor Panel



The "Home" screen of the Multiplex Systems main control panel displays the fluid levels of the Black Water, Grey Water, Fresh Water tanks, and the LP gas tanks. The panel also shows the voltage status of the main (chassis) and the auxiliary (house) batteries.

The fluid monitoring system has been calibrated at the factory for the size tanks the Atlas uses and, therefore, should never need another calibration. The Seelevel monitor located in the entry cabinet can also be used to view fluid levels.



## Inverter/Charger



The Inverter/Charger is a DC to AC inverter and a 50-amp multi-stage battery charger. It has a remote control module mounted in the cabinet at the entry door behind the passengers seat.

The Inverter/Charger charges the batteries and converts 12-VDC to 120-VAC current for distribution to the entertainment devices. To operate your entertainment circuit the inverter must be ON, unless connected to generator or shoreline power.

If power is not needed to the entertainment circuit make sure the inverter is turned OFF to conserve battery power. The inverter will have a slight power draw even when turned off but the power consumption will be even greater if left on.

### NOTE

**Airstream calibrates all settings at the factory and recommends adjustments not be made.**



### WARNING

**An extensive owner's manual for the Inverter/Charger is provided in the Airstream Owner's Packet. Make sure to read, understand, and follow all information, notes, Cautions, and Warnings in the manual before operating the Inverter/Charger.**

## Converter

The Airstream converter system enables you to use the 12-volt lights and equipment whether operating on self-contained battery power or hooked up to 120-volt city power. The 12-volt LED lights give off the same light as regular household bulbs, so that when operating on self-contained battery power, everything works normally except the 120-volt convenience outlets and 120-volt appliances.

### NOTE

**When operating with city power, make very certain that the service is 120 volt, not 240 volt.**

The converter system is a transformer designed to maintain constant output voltages regardless of the variances that occur in city power systems. The design eliminates the need for complex electronic sensing systems to charge the batteries, minimizing the possibility of failures and greatly increasing its overall reliability.

In some older parks and other locations where three-pronged outlets are not available, certain precautions to ensure proper grounding and polarity must be taken. These precautions are listed below:

1. Attach the three-pronged plug to a two-pronged adapter. The third conductor line of this adapter has a short wire lead that must be grounded.
2. For proper grounding, connect the short ground lead to a grounded outlet box or to a cold water pipe. When no water pipe is available, drive a metal rod two feet into the ground and attach the ground lug to it, thus providing the unit with proper grounding.

### NOTE

**When the three-pronged plug can be used, there will be no problems with proper polarity or grounding with a properly-wired shoreline outlet.**

# Interior

---

## 120-Volt Electrical System

### City Power

When your touring coach is hooked up to external AC power, the converter system automatically charges the touring coach batteries with the battery disconnect switch in either position. The speed and degree of charge depends on how much power is used for lights and appliances, as only the surplus goes to charging the battery. If you are making an extended stay, you should keep your touring coach hooked up to a 120-volt current if it is available.

While you are connected to external AC power, the wiring is protected by circuit breakers in the breaker panel. The circuit breaker panel for the 120-volt system is located in the converter. In the event of a failure of a 120-volt circuit, first check your touring coach circuit breakers and the breaker for the outlet into which your touring coach shoreline cord is plugged. If a breaker continues to trip after you have reset it several times, your circuit may be overloaded with appliances or there may be a short in the circuit. Try lessening the load on the circuit. Perhaps an electric griddle, hair dryer, or an electric heater can be turned off. If that does not solve the problem, consult an Airstream Service Center.

The 120-volt electrical system provides power to operate the A/C, converter, and 120-volt receptacles for portable appliances. The power is carded through the 120-volt city power flexible cord to the 120-volt distribution panel, and then is distributed to each appliance or receptacle. Exterior 120 volt outlets are located in the curbside forward utility compartment.

All wire, components, and wiring methods conform to federal and state requirements.

## Ground Fault Circuit Interrupter

Most states require touring coach's with exterior 120-volt receptacles and receptacles close to a water sources, such as a faucet to have a ground fault circuit interrupter (GFCI). When properly installed, the GFCI circuit breaker provides reliable overload and short circuit protection PLUS protection from Ground Faults that might result from contact with a "HOT" load wire and ground.

The system incorporates GFCI breakers that implement an auto self-test functionality. When turned off, these breakers require external AC or generator power to be present before they can be turned back on. If power is present from one of these sources, and the breaker refuses to stay on consult an electrician or certified RV technician.

Each GFCI circuit breaker is calibrated to trip with a ground current of 5 mA or more. Since most persons can feel as little as 2 mA, a distinct shock may be felt if the need for protection exists. However, the shock should be of such short duration that the effects would be reduced to less than the normally dangerous level. However, persons with acute heart problems or other conditions that can make a person particularly susceptible to electric shock may still be seriously injured.

While the GFCI circuit breaker affords a high degree of protection, there is no substitute for the knowledge that electricity can be dangerous when carelessly handled or used without reasonable caution.

GFCIs are proven lifesavers; however, consumers need to take a few minutes each month to do this simple test. By taking action, you can help protect your family from the risk of electric shock.



### **WARNING**

**The GFCI circuit breaker will NOT reduce shock hazard if contact is made between a "HOT" load wire and a neutral wire or 2 "HOT" load wires.**



### **WARNING**

**The GFCI circuit breaker provides protection only to the circuit to which it is connected. It does NOT provide protection to any other circuit.**



### GFCI Receptacle Test

To properly test GFCI receptacles:

- Push the Reset button located on the GFCI receptacle first to assure normal GFCI operation.
- Plug a device, such as a night light, with an ON/OFF switch into the GFCI receptacle and turn the product to the ON position.
- Push the Test button located on the GFCI receptacle. The device should turn off and a red light should illuminate, indicating the GFCI is tripped.
- Push the Reset button again. The device should come on again.

If the device remains on when the Test button is pushed, the GFCI is not working properly or has been incorrectly installed (wired improperly). If your GFCI is not working properly, call a qualified, certified electrician who can assess the situation, rewire the GFCI if necessary, or replace the unit.

#### NOTE

**All GFCI breakers implement an auto self-test function, however, Airstream recommends a manual test be conducted every month. If the test/reset buttons are not located on the GFCI receptacles they will be located inside the power center.**

### GFCI Breaker Test

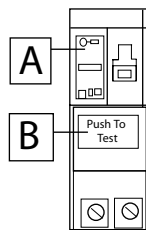

1. With handle A in "ON" position, press PUSH TO TEST button B.
2. Handle A should move to TRIP position, indicating that GFCI breaker has opened the circuit.
3. To restore power move handle A to "OFF" and then to "ON".

## Entertainment Systems

### TV Antenna



Winegard's RoadStar™ omnidirectional antenna provides excellent reception of VHF/UHF TV channels. The TV antennas compact modern styling is unobtrusive and blends well with the designs of recreational vehicles.

The UV stabilized copolymer housing makes the antenna virtually impervious to weathering and color change. The unique omnidirectional characteristics provide excellent reception in areas where stations are in different directions without the need for a complex rotor system. A built-in amplifier provides up to six times the received signal on VHF and nine times the UHF signal ensuring the best possible reception.

#### Cleaning Antenna Housing

The surface of the antenna is a tough laminated ultraviolet shield. Clean only with mild soap and water. Use no solvents, alcohol, or cleaning fluids.

#### Video

The Atlas Touring Coach is equipped with a Samsung LED HDTV and is pre-wired for a Blu-Ray player.

#### TV Operation

The TV is stored in the entertainment cabinets counter top and is raised or lowered by pressing the TV lift UP/DOWN buttons located on the side of the cabinet. A hinged lid will open to allow the TV to raise from the cabinet. The Multiplex control panel located on the wall behind the drivers seat can also control the TV's movement. Press the "TV lift" button's up or down arrows to raise or lower the TV. .

#### NOTE

**Before raising the TV make sure the counter top is clear to avoid damage.**

# Interior

---

## Audio

The Atlas is equipped with a Fusion infotainment system, bringing automotive stereo and navigation up to speed with modern technologies. Refer to the Fusion Owner's Manual provided for information on its use.



### WARNING

**Driving while distracted can result in loss of vehicle control, damage and injury. Airstream recommends you use extreme caution when using any device that may take your focus away from the road. Your primary responsibility is the safe operation of the vehicle.**

### Privacy Disclaimer

When a cellular device is connected to the radio/navigation system, a profile may be created that is linked to that cellular device. Among other things, the profile may contain data about your phone book, text messages, and call history. In addition, the system may create and retain an index of media content from any media device connected. This cellular profile and media index data will remain a part of the audio unit unless they are deleted. Airstream recommends that the profile and media index both be erased if you plan to no longer use the system or the vehicle.

Airstream does not have the capability to access any data contained within the profile at any time. Please refer to the radio/navigation systems owner's manual for their terms and conditions, as well as, detailed directions on how to setup or remove a profile.

## Satellite Antenna Pre-Wiring

### Roof Mounted Satellite

The touring coach is pre-wired with a coax and power cable for a roof mounted satellite antenna. One end of the cable is coiled behind the Multiplex main control panel and is accessed by removing the screws from the side panel inside the front roof locker. The other end is coiled above the microwave. Remove the microwave to access the coax and power leads. A receiver can be placed inside the front roof locker.

### Portable Satellite Antenna



The touring coach is also pre-wired for a portable satellite antenna. The exterior inlet is located in the roadside rear compartment of the touring coach and is labeled for your convenience. The interior pre-wire is located in the front overhead roof locker.

### TV Wall Plate Power Supply



The wall plate/power supply provides 12 VDC to the antenna as well as antenna signals to the TV set. Cable input from the outdoor inlet connects to the wall plate and may be switched so either antenna or cable/satellite signals may be watched.

### Operation

To receive cable signals from the outdoor inlet: Press switch to (OFF) position. The light on the wall plate will go OFF showing that power is no longer connected to the antenna and that the TV is receiving signals from the outdoor inlet. To receive signals from antenna: Press switch to (ON) position. The light on the wall plate will come ON showing that power is connected to the antenna and the TV is receiving signals from the antenna.

Review the manuals included in your owner's packet before operating the system.

## Appliances

All appliances are delivered to Airstream, Inc., with in-depth owner's manuals. Those manuals are included in the delivery case supplied by your dealer. The manuals may contain Warnings, Cautions, and operating instruction that should be read and followed before operating the appliances.

The information contained in the appliances manuals supersedes any information contained in the Airstream Atlas Owner's Manual on appliances. If you believe contradictory information on appliances is contained in this manual, or if any appliance manual(s) have not been provided with your vehicle, contact your dealer, the respective appliance manufacturer, or Airstream Customer Service at 937-596-6111 or write:

Airstream Factory Service Center

428 W. Pike Street

P.O. Box 629

Jackson Center, OH 45334-0629

(937) 596-6111

## Maintenance

Follow the instructions and Warnings noted in the respective appliance and equipment owner's manuals, as well as those mentioned below.

Annual maintenance should be conducted on propane gas appliances and equipment by an authorized dealer or repair facility.

Insects can build nests in the burners of various appliances and equipment. The burner and burner orifice of the propane gas appliances and equipment should be cleaned by an authorized dealer or repair facility any time circumstances or conditions warrant, but no less than on an annual basis.



### WARNING

For additional Liquid Propane Gas (LPG) safety and warning information, refer to Section 2 - Safety and Section 6 - Exterior of this manual.



### WARNING

Most LPG appliances used in recreational vehicles are vented to the outside of the vehicle. When parked close to a gasoline pump, it is possible that gasoline fumes could enter this type of appliance and ignite from the burner flame, **CAUSING A FIRE OR AN EXPLOSION.**

## Air Conditioner

The roof A/C used on Airstream's Atlas has one of the lowest profiles of any A/C on the market today. Coupled with a fiberglass basepan this lower profile and lighter weight means less drag and improved fuel efficiency. In your owner's packet is a set of literature covering all operating and maintenance instructions. If the literature is misplaced, contact the A/C manufacturer or your Airstream dealer for replacement.

Proper voltage to the A/C is critical. A volt meter check may find voltage much lower at a campground shoreline outlet than the needed 110 to 120 volts. Your A/C may not function if the current drops below 105 volts. Low voltage is usually associated with older or poorly maintained motorhome parks. Parking your touring coach so the power cord can be plugged in to a receptacle close to the fuse or circuit breaker box can alleviate low voltage problems. Avoid extension cords and adapters whenever possible. If an extension cord must be used, it should be as short and heavy as possible to provide the most current.

If high temperatures are expected, make an effort to park in a shaded area. Starting the A/C early in the morning also helps. It is more efficient to hold a comfortable temperature than it is to lower the temperature after the interior of the touring coach is already hot.

### Heat Pump

Your air conditioner has a built in heat pump designed to take the chill out of the air. To turn on, select "Climate" from the main Multiplex control panel and set mode to "heat pump". Set the thermostat to your desired temperature.

### NOTE

**Review the air conditioning literature supplied in your owner's packet before proceeding.**

# Interior

---

## Furnace

The manufacturer of the furnace in your touring coach has been well known in the motorhome industry for many years. The furnace burns LP gas, and is powered by 12-volt current from the batteries or power converter when plugged in to city power. Operating instructions are located in your owner's packet. If they should become misplaced, new literature can be ordered directly from the manufacturer or your Airstream dealer. The manufacturer also offers a detailed service guide for your furnace.

The furnace is located below the curbside wardrobe cabinet in the bath area and can be accessed by removing the false panel. The furnace is controlled by the Main Multiplex Control Panel located on the wall at the entry door.



### WARNING

**Carefully read all the manufacturer's instructions prior to operating. NEVER store flammable material next to the furnace or in close proximity to the furnace exhaust outlet on the side of the touring coach.**

### NOTE

**If warranty service is required, use only a service location recommended by the furnace manufacturer or your Airstream dealer.**

## Generator

The diesel generator on the touring coach is mounted in the curbside rear compartment and is ideal for light and medium-duty applications with small size and weight constraints. It features an exceptionally quiet operation, single-side servicing, and an enclosed muffler. The generator can be started or stopped using the switch inside the entry cabinet behind the passenger's seat. Refer to Section 9 - Maintenance Schedule before operating for maintenance and oil changing tips.

### NOTE

**An owner's manual for the generator is provided in the Airstream Owner's Packet. Make sure to read, understand, and follow all information, Notes, Cautions, and Warnings before operating.**

## Microwave Ovens

Refer to the Certified Performance Checkout sheet, included in your owner's packet, for manufacturer, model, and serial number information.

## Range

There is little difference between the operation of home gas ranges and the touring coach's range. If, however, you are used to an electric range, operating confidence can be quickly gained by reading the manufacturer's directions provided in the owner's packet. Manufacturer's service and parts manuals are also available.



### WARNING

**If the operation manual for the range has not been provided with your touring coach, contact the listed manufacturer to obtain. Their manual contains specialized Warnings and Cautions that should be reviewed prior to operating the appliance.**

## Refrigerator/Freezer

Review all refrigerator literature supplied in your owner's packet or stored in the refrigerator prior to operating it.

### Operation

The refrigerator operates on 12-volt current from the battery. All units are supplied with a wide range thermostat designed to sense the evaporator (cold plate) temperature. The coldest position on the thermostat is reached by turning the knob to the right (clockwise); conversely turning the thermostat knob to the left (counterclockwise) yields a warmer setting. The OFF position is reached by turning hard counterclockwise past the click. The reference point is shown with an indicator sticker beside the knob.

### Start up

Turn the power on and set the thermostat between 3 and 4. You can make further adjustments to suit your personal requirements after the box has cooled down. Allow the refrigerator to come down to temperature before loading with product. Adding pre-cooled product will help keep the temperature stable when loading. Setting the thermostat to a higher setting e.g., 7, will not decrease the time required for the unit to cool down to its normal operating temperature.

### NOTE

**The refrigerator requires 12V power to operate. You must have the battery disconnect switch in the use position even if plugged into shore power.**

### **Defrost and Cleaning**

The frequency of defrost is dependant on the number of door openings, the ambient temperature and the humidity level. Typically, it is a good practice to defrost once there is ¼ inch of frost buildup on either side of the evaporator (cold plate). When defrosting, the unit is shut off by turning the thermostat counterclockwise to the OFF (0) position. Prop the door open. We suggest placing a towel in the bottom of the refrigerator to catch excess moisture.

Now that the unit has been defrosted, the interior can be cleaned with a non-abrasive cleaner. Do not use “Brillo” or “SOS” type abrasive pads, as they will score the surfaces. Baking soda is recommended.



### **CAUTION**

**Speeding up the defrost process with a knife or scraper is strongly discouraged due to the likelihood of rupturing the refrigerant circuit.**

### **Roof Vent**



The high-volume roof vent system is designed to quickly exhaust stale, hot air and draw in fresh air. It is great to use when the outside temperature does not call for air conditioning, but heat has built up in your touring coach.

The core of the system is a powerful rotary fan that works with a slightly open window to create a balanced airflow. It is designed for maximum air exchange, minimum sound levels and power consumption. Fresh, clean, natural air is pulled in. Hot, stale, stuffy air is pushed out. The vent can reduce the use of air conditioning allowing you to breath natural, fresh ambient outside air.

### **Operation**

1. Open dome approximately 3 in. or more (ceiling fan has a built-in safety switch that will not allow motor to operate unless dome is partially open).
2. Turn 3-speed knob to desired performance level (3-Low, 2-Medium, 1-High, O-Off).
3. Open window(s) or door for airflow.

The source of airflow is determined by the number of window(s) or doors opened. For best results, close all roof vents and open one window that is the greatest distance from the ceiling fan.

### **NOTE**

**Never place Lindeen™ or a like cover over ceiling fan. Greatly restricted airflow and increased sound levels will occur.**

### **Thermostat and Rain Sensor**

The fan is equipped with a built-in thermostat. Select your comfort setting and the fan will automatically turn on and off as your touring coach heats up and cools down. When the rain sensor becomes wet the dome will close automatically and shut the fan off. Once the sensor has dried out the dome will reopen and the fan will restart.

1. Follow the previous operation steps one through three.
2. Select the desired temperature or comfort level using the thermostats knob. The fan motor will now start and stop automatically as the interior temperature of coach exceeds or drops below the selected level.

### **NOTE**

**Fan motor will not start if temperature selected is warmer than interior temperature of coach.**

### **Cleaning Instructions**

1. Turn fan motor off.
2. Remove the screws around perimeter of screen insert only.
3. Clean screen with soap and water solution, dab dry with a soft cloth, and reinstall.



### **WARNING**

**Do not use petroleum containing additives or solvent based products on any of the vent's components or its corrosion resistant hardware.**



### **CAUTION**

**This product has been manufactured using prime UV stabilized Polymers for maximum toughness and durability. However, the use of non-compatible chemicals will cause cracking and product failure. Please refer to the user's manual provided in your owner's packet for more information.**



## SeeLevel II Monitor Panel



The display is the only system component that is accessed by the user. The display shown above is located in the entry cabinet behind the passengers seat. All user input to the display is done using the four buttons along the bottom of the display.

### NOTE

**The following information is for use of the SeeLevel II Monitor Panel. The Multiplex main control panel can also be used.**

The display receives the information from the three sender pads via a single, two-conductor wire, and displays the level information in percent of full on a three-digit, LED display. When the front panel button for a particular tank is pressed, the display powers up and displays the level for that tank. If the button is pressed and released, the display will show the level for about 5 seconds and then shuts down automatically. If another button is pressed before the display shuts down, then the new level will immediately be shown. If the same button is pressed twice, the display will hold on that tank and continue to show updated levels for 5 minutes before shutting off. This allows the user to monitor the filling or draining of the tank. By pressing two buttons at once, the diagnostic functions can be accessed.

Sender pads are installed and stuck to the sides of the holding tank. The sender pad scans the water level through the tank wall using digital techniques programmed into the sender microprocessor.

### To Read a Water or Sewer Tank Level

1. Press the button corresponding to the tank to be checked and release it, the display will show the levels in percent on the LED display. If no other button is pressed, the display shuts off after about 5 seconds.
2. If another button is pressed before 5 seconds, the display will immediately switch to show the new level or voltage. The 5 second time-out is restarted every time a button is pressed.

3. To continuously display a reading, press and release the desired button, and then press the same button a second time. When the button is released, the display will be on hold mode, which is indicated by the decimal point on the right hand side turning on. While the display is in the hold mode it will recheck the level once per second so the user can watch the level change while the tank is being filled or drained. The display will automatically shut off after 5 minutes in hold mode. To end the hold mode before the 5 minutes is up, press any tank button, and the display will shut off.

### To Read the Battery Voltage

1. Press the BATT button and release it, the display will show the battery (House) voltage on the LED display
2. If no other button is pressed, then the display will shut down after about 5 seconds. If the BATT button is held down, the display will continuously recheck the voltage and show the updated value. The reading may flicker back and forth between two values.
3. If another button is pressed before the 5 second time is up for the BATT button, the display will immediately switch to show the value for the new button. The 5 second time-out is restarted every time a button is pressed.
4. There is no hold mode for the battery voltage

### To Program the LED Brightness

1. The display needs to enter the brightness programming mode. To do this, press and hold the BATT button; the display will show the battery voltage.
2. While continuing to hold the BATT button, press and hold the GREY button. Continue to hold both buttons for approximately 5 seconds until the display shows "bri" to indicate the brightness programming mode. When this occurs, release both buttons.
3. Press the GREY tank button to increase brightness, or the FRESH tank button to decrease brightness
4. When the display shows the correct brightness, press the BATT button to exit the programming mode.



## Skylight

The Atlas Touring Coach is equipped with a weather resistant, insulated skylight. The skylight can be conveniently controlled by the main Multiplex control panels "shades" screen.

## Solar System



Airstream utilizes Go Power Flex-100 solar panels and a Sun Explorer Charger Controller/Display System. The display is mounted in the entry cabinet behind the passengers seat. Manuals on their use are included with the Airstream owner's packet.

Refer to Section 9 - Maintenance for Solar Panel Pre-Wire diagram and information.

## Water Heater

The Atlas Touring Coach is equipped with an on-demand tankless water heater featuring 60K BTU output, freeze protection, and direct spark ignition. The tankless water heater monitors inlet water temperature and flow, and output water temperature and flow.

Below is a representation of normal operating valve settings. When the valve is in the upright position the water valve is open. When winterizing or storing for long periods it is recommended to close the bypass valve by turning the valve a quarter turn. Refer to Section 9 - Maintenance for further winterization and storage instructions.

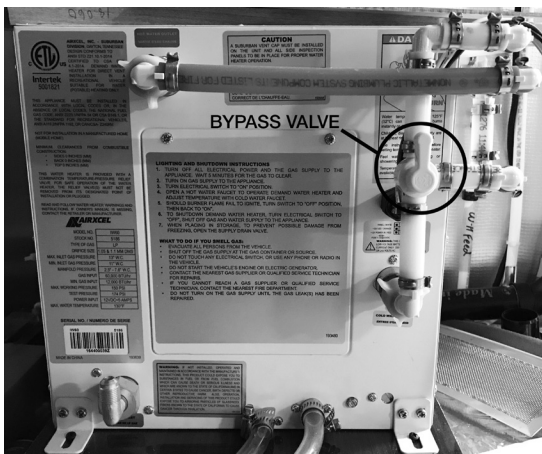

## On-Demand Control Center

The water heater is controlled by the On-Demand Control Center located on the wall above the bathroom sink.



DISPLAY DESCRIPTION		
	BURNERS	
	FLAME	This icon is displayed when FLAME is established.
	BLOWER	This icon is displayed when the BLOWER is running
OFF	TURN OFF WATER HEATER	This icon is displayed when the Water Heater is OFF.
	SETTING TEMP INDICATOR; OUTLET WATER TEMP INDICATOR	A. When setting the water temperature, the temperature display will flash. After SET Temperature is reached, the display stops flashing after a few seconds. B. When the demand for hot water has been terminated, the display will return to the SET Temperature.
BUTTON DESCRIPTION		
	ON/OFF	Power Button. Switch from turning unit ON or turning unit OFF.
	SWITCH	Hold for 5 seconds to switch between degrees (°) Celcius or degrees (°) Fahrenheit
	UP	INCREASE SET Temperature by 1 degree increments. Setting range is 35°C/95°F to 55°C/130°F
	DOWN	DECREASE SET Temperature by 1 degree increments. Setting range is 35°C/95°F to 55°C/130°F

## NOTE

Review the water heater literature supplied in your owner's packet before proceeding.

## CAUTION

This appliance does not have a pilot. It is equipped with an ignition device which automatically lights the burner. Do not try to light the burner by hand.

## WARNING

The water heater has built-in FREEZE PROTECTION and will intermittently cycle the burner when the water temperature is between 1°C/ 35°F to 4.5°C/40°F. To provide this freeze protection, the gas supply must be on, gas must be available and electrical power must be on.



## Section 6 **EXTERIOR**

EXTERIOR . . . . .	.6-1	ROADSIDE EXTERIOR FEATURES . . . . .	.6-6
WAXES AND POLISHES . . . . .	.6-2	CURBSIDE EXTERIOR FEATURES . . . . .	.6-7
HOW TO CARE FOR YOUR TOURING COACH FINISH . . . . .	.6-2	EXTERIOR DOORS . . . . .	.6-8
Washing Your Touring Coach . . . . .	.6-3	Entry Door . . . . .	.6-8
Body Kit . . . . .	.6-3	Screen Door . . . . .	.6-8
Windows . . . . .	.6-3	Utility Compartment Doors . . . . .	.6-8
Alcoa Dura Bright Rims . . . . .	.6-4	Tail Lights . . . . .	.6-8
Cleaning Instructions . . . . .	.6-4	AWNING . . . . .	.6-9
Receptacle, Cable, And USB Ports . . . . .	.6-4	Awning Use In Wind And Rain . . . . .	.6-9
Exterior Folding Step . . . . .	.6-4	Awning Manual Override . . . . .	.6-9
Lock Extended Switch . . . . .	.6-4	Care And Maintenance . . . . .	.6-9
Exterior Shower . . . . .	.6-5	HITCH COVER . . . . .	6-10
City Water Hookup . . . . .	.6-5	How To Remove The Hitch Cover . . . . .	6-10
Power Stabilizing Jacks . . . . .	.6-5	Before Removal . . . . .	6-10
Shoreline Power Supply . . . . .	.6-5	After Removal . . . . .	6-10

# Exterior

---

The exterior cab and chassis portion of your Atlas Touring Coach has been painted by Sprinter. The Airstream up-fitted and body kit portions have been sent out by Airstream to be painted. Care of Sprinter's paint is detailed in their manual. The following additional information is provided by Airstream to help you understand the finish and its care. Following these instructions will provide a long lasting, high-gloss finish for your recreational vehicle. These same procedures can also be applied to your everyday automobile, producing the same long-lasting results.

## NOTE

**Information on finish care may provide additional information and tips on the use of the Sprinter Van as a touring coach, however, no information about the exterior finish of your touring coach in this manual should be interpreted as advice or directions to disregard or void the warnings, cautions, or other information contained in the Sprinter's manuals.**

## Waxes and Polishes

Over 90 percent of all automotive finishes are clear coat. The finish on your touring coach is a state-of-the-art Acrylic Urethane Basecoat/ClearCoat. This means you will wash and polish a clear urethane coating designed to protect the basecoat: the pigmented coating that provides color. As its main function is protecting the basecoat, the clearcoat needs to be maintained especially in harsh environments. Clearcoats do not fade themselves, but appear to fade or lose gloss as the surface becomes contaminated by the environment. If this contamination is not removed frequently, the result will be a dull or low-gloss finish. Occasional washing alone will not adequately remove some forms of contamination and polishing will be required.

Polishes and waxes primarily serve the following purposes:

1. To remove minor surface imperfections caused by water spots and acid rain
2. To remove minor scratches by filling them and leveling the surface
3. To beautify the paint finish appearances with more depth and high-gloss
4. To protect the paint finish from the elements

Do not use products that contain harsh abrasives such as rubbing or polishing compounds. These products should be used by experienced technicians with the proper training and equipment. Most polishes and waxes are designed to clean and polish in one application.

A hand-applied polish or wax will offer outstanding performance and protect the Atlas finish. When applying polish or wax, do so in a shaded area making sure the surface is at the specified temperature according to the polish manufacturer's recommendations. Due to the variations of polishes and waxes, incorporate the following suggestions into the polishing technique:

1. Condition the polishing pad by rubbing a slight amount of polish on it.
2. Use only the amount of polish specified in the label directions.
3. Work a small area at a time.
4. Rinse off and remove dried polish from crevices, trim, and moldings.
5. Follow the products manufacturer's directions.

## How to Care for Your Touring Coach Finish

Keeping your touring coach looking its best at all times involves keeping the paint finish clean and in good condition. This means periodic washing and polishing, as well as getting the paint finish repaired as soon as possible when the paint is damaged or affected in any way. The purpose of the paint finish is twofold:

- Provide an aesthetically pleasing appearance.
- Protect the vehicle from the environment.

Your touring coach is exposed to many environmental conditions that have an adverse effect on the paint finish:

1. Road salts and sodium chloride
2. Road tar/bugs
3. Bird droppings/tree sap
4. Industrial fallout/acid rain/pollution
5. Ultraviolet exposure and moisture

The most common problems resulting from these conditions are corrosion, staining, and chemical spotting. These problems can be minimized through regularly-scheduled washing and polishing.

### Washing Your Touring Coach

Make sure the touring coach's surface temperature is not too hot, under 90°F, and not in direct sunlight. A shady area is ideal for washing your vehicle, as direct sunlight causes water and soap to evaporate too fast, resulting in water spotting. Use a mild soap or detergent.

Most auto care stores carry a car wash shampoo. Try to avoid combination wash-n-wax products as these waxes cause buildup and are designed for smaller surfaces. Have two dedicated sponges or wax mitts: one for the paint finish and one for the wheels and under carriage. Brushes or wash mitts that have plastic bristles are acceptable for use on tires and wheel wells, but are not intended for use on the paint finish. Avoid using such items on painted surfaces, as they will damage the touring coach paint and finish.

Wash from the top and work your way down, frequently rinsing to minimize grit abrasion. Follow with a final rinse of water. This process will remove most contamination from the touring coach's surface. For stubborn stains such as road tar, use an ammonia-based glass cleaner or a small amount of rubbing alcohol on a damp cloth immediately followed by warm soapy water and rinse with clean water. This may not dissolve the road tar, but will loosen tar and bug stains and remove them from the surface. Do not use solvent-based cleaners on bird droppings or tree sap as these are water-based stains and will eventually dissolve using an ammonia-based glass cleaner, warm soapy water and a little "elbow grease." Once again, after removing stubborn stains immediately rinse with clean water.

Drying the touring coach is just as important as washing your vehicle as today's tap water and well water contain many chemicals that could water stain your touring coach's finish. We suggest using a damp natural or synthetic chamois, however, there are other drying products such as lint free micro-fiber towels that work just as well.

Follow these simple cautionary measures, and your new finish will give you maximum gloss and durability.

It is recommended that the caulking and sealant used in external seams and joints such as window frames, light bezels, beltline, and rub-rail molding, etc., be checked regularly. If this material has dried out and becomes cracked or checked, or if a portion has fallen out, it should be replaced with fresh material to prevent possible rain leaks. Caulking and sealing material is available from your touring coach dealer and most RV supply stores.

### Body Kit



The body kit provided by Airstream is made from state-of-the-art high impact plastic. The same material is used in the automotive industry for moldings, bumper guards, and trim. The kit is made to color specifications and requires no paint or finish. The cleaning procedures are the same as the painted finish on the Sprinter body; however, there are several automotive plastic care products on the market for exterior parts that will provide added protection from UV ray damage, dirt, and stains. Find one you like and use it as often as needed to help prevent fading.

### Windows

Clean your touring coach windows the same way you clean the windows in your home. Clean the seals with a damp cloth and mild detergent every 3 to 6 months. Do not use strong solvents, as they will damage the seals. A coat of natural silicone lubricant applied after the seal has dried will keep it flexible. Spread the lubricant evenly with a brush or finger, working it into the surface. This is a good practice for all rubber seals in your touring coach.



### WARNING

**Failure to properly clean and lubricate the window seals could result in the window sticking to the jamb and should only be released by a qualified technician trained in the procedure. Do not force, pry, or apply great pressure to open the window. Failure to heed this warning may cause the window to shatter and/or cause personal injury.**

For replacement of a damaged window, contact an Airstream Service Center.



# Exterior

## Alcoa Dura Bright Rims

### *Cleaning Instructions*

These rims require no chemicals to clean them. Simply use a mild soap, water, clean towel, and rinse. Follow these steps for an easy clean and shine.

1. Rinse the wheel prior to washing with a brush. This will prevent scratching.
2. Mix a mild detergent and water. Any car wash or household detergent will work.
3. Using a soft clean brush and soap solution, clean the rims. (Do not use any abrasive-type brushes or pads.)
4. After cleaning the surface, rinse thoroughly to remove all soap so it will not spot. Towel drying will help this as well.



### **CAUTION**

**When using a power washer, maintain a proper distance from the touring coach. The proper distance is approximately 2.2 ft. when using a round jet nozzle, and 1 ft. when using a 25 degree flat spray jet nozzle. Never point the jet nozzle at moldings, hoses, electrical components, seals, plug connections, etc. Never use round jet nozzles on tires, the pulsating water can damage the sub-structure of tires.**

## Receptacle, Cable, and USB Ports



An exterior receptacle is located in the curbside utility compartment between the wheels and step. Also in this compartment is the exterior cable hook-up, HDMI inlet, and USB ports. A motion sensor light has been installed for your convenience. The light can be manually switched off if needed, however, if switched off the motion sensor will not function.

## Exterior Folding Step



The curbside door has a folding double step with auto retract, step out warning buzzer, and a lock extended switch located just inside the door. Please read, understand, and instruct passengers of the following operational and safety information pertaining to the step.

The steps extend and retract as the door is opened and closed with the engine off and step lock extend switch off. The steps retract automatically and will not extend when the engine is started to prevent damage while in transit.

If the steps do not retract fully, a warning buzzer will sound. The vehicle should not be driven if the steps fail to retract completely.

### **Lock Extended Switch**

To use the lock extended switch, turn the engine off, open the door to extend the steps, and turn the switch on. The steps will now remain extended while opening and closing the door. Turn the switch off to return the steps to normal operating mode.

If you forget to turn the lock extended switch off before starting the engine, the steps will retract when the engine is started, however, they will not extend when the engine is turned off and the door is opened. To reset the steps, turn the engine off and the step lock extended switch off with the door closed.



### **WARNING**

**LOOK BEFORE YOU LEAP. The steps will not extend with the opening of the door when the engine is running. Check that the steps are extended before leaving and entering the vehicle. Failure to follow this warning could result in personal injury.**



### Exterior Shower

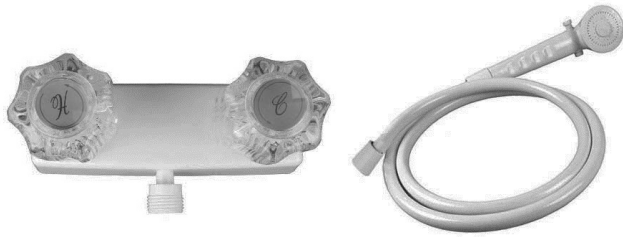

All units are equipped with an exterior shower. This shower consists of a shower hose, shower head, and water valve inside the lockable roadside rear utility compartment. Water is supplied by the pump or city water hookup. To use: thread the hose onto the wall inlet, verify it is securely connected. Press the spout button and rotate the faucet handles to the desired temperature. To remove hose assembly, unscrew the hose from the water valve. Be sure to press the spout button to relieve any residual pressure before removing the hose.

### City Water Hookup



The city water hookup is located in the roadside rear utility compartment of the touring coach. Your plumbing system has a built-in pressure regulator, limited to 50 psi, to protect your lines and faucets from extremely high pressures on some city water systems.

Use a tasteless, odorless, non-toxic, high-pressure hose of at least 1/2-in. diameter designed for motorhome use. The city water inlet is a standard garden hose thread. We suggest you carry two lengths of hose in order to reach hookups farther away than normal, as well as to have a spare.

After hooking up the hose, through the bottom access hatch inside the compartment, turn on the city water valve provided in the park and slowly open a faucet. There will be a lot of spurts and sputtering until all the air is expelled from the touring coach's system. It may take some time before all the air is expelled and a steady flow of water occurs. Once a steady flow is achieved at one faucet, the others should be opened long enough to expel the air in the lines going to them.

The water hookup is also used to fill the fresh water tank. To fill, turn ON the fresh water valve switch located below the shoreline power hookup. A red indicator light will turn on indicating the valve is open. When the switch is ON water is diverted to fill the fresh water tank. The valve will automatically close and the switch will turn OFF when the tank is full. If you wish to carry less than a full tank of water the fill percentage can be viewed on the main Multiplex control panels "Home" screen. Once the fill level reaches your desired percentage switch OFF the fresh water valve switch to close the valve.

### Power Stabilizing Jacks

The Atlas Touring Coach is equipped with a set of two power stabilizing jacks. The jacks are controlled by a switch located in the entry cabinet behind the passenger's seat. The stabilizing jacks should be lowered before the slide-out room is extended. Extending the slide-out room without first leveling and deploying the stabilizing jacks could cause the slide out mechanism to bind and become damaged.

Power stabilizing jacks automatically adjust to the terrain and should only be lowered until they make contact with the ground.



**Stabilizing jacks are designed to stabilize the touring coach only. Misuse of the power jacks to level or lift the touring coach will result in damage to the jacks and potentially the coach.**

### Shoreline Power Supply



The power cord and power inlet are located in the roadside rear utility compartment of the touring coach. The power cord can be passed through the access hatch in the bottom of the compartment allowing the compartments door to close while still being connected to a city power service. Many campgrounds provide less than 30-amp service and your hookup may blow their fuse or circuit breaker. If this happens, reduce the load and replace the fuse or reset the breaker.

### NOTE

**Use only power cords recommended by Airstream.**

# Exterior

## Roadside Exterior Features

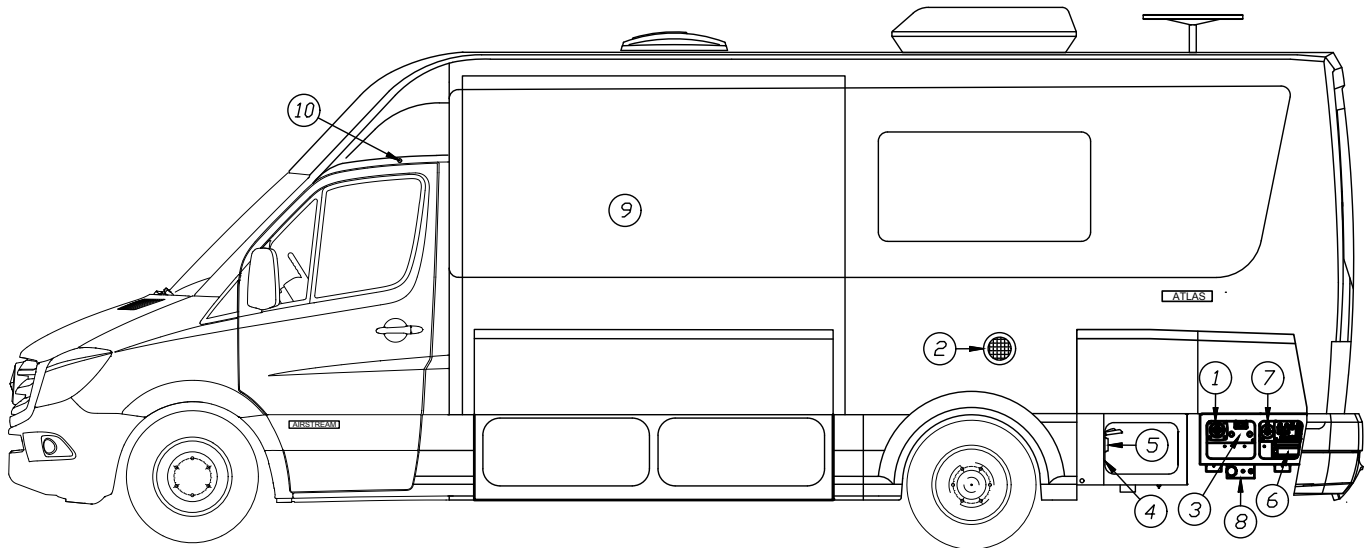

### NOTE

**This is a basic explanation of the location and function of exterior features. More in-depth explanations of certain feature's care and maintenance is include in this manual in other sections.**

1. City water fill with regulator, provides access for city water to your fresh water system. Use ½ inch minimum hose for water supply. Water fill is also used to fill the fresh water tank. Turn on the fresh water valve switch to fill the tank. Use only clean fresh potable water.
2. Hot water tank exhaust vent. When operating, be sure exhaust can escape into a well ventilated area. Air coming from vent can be hot. When parking the touring coach, be sure to have proper clearance in venting area.
3. Exterior shower outlet can be used on the water pump or with the city water hookup after hose assembly is inserted.
4. Fresh water valve switch and Cable/Satellite TV inlet. The Atlas is pre-wired for cable/satellite TV. A portable satellite dish can be connected and used in the cable connection. The fresh water valve switch is used to open/close the valve for filling the fresh water tank.
5. 30-amp power cord inlet. Power cord can be stored inside.
6. Macerator hose reel; contains the switches for the dump valves, macerator pump, and macerator pump high-pressure hose reel.
7. Black tank flush. Used for cleaning out the black tank.
8. LP tank remote fill and shutoff location.
9. Slide-out wall. Extended/retracted using the switch located in the cabinet at the entry door or by the main Multiplex control panel.
10. Exterior door light comes on when the door is open. Can be turned on or off manually via a switch on the dash near the ignition switch.

### Curbside Exterior Features

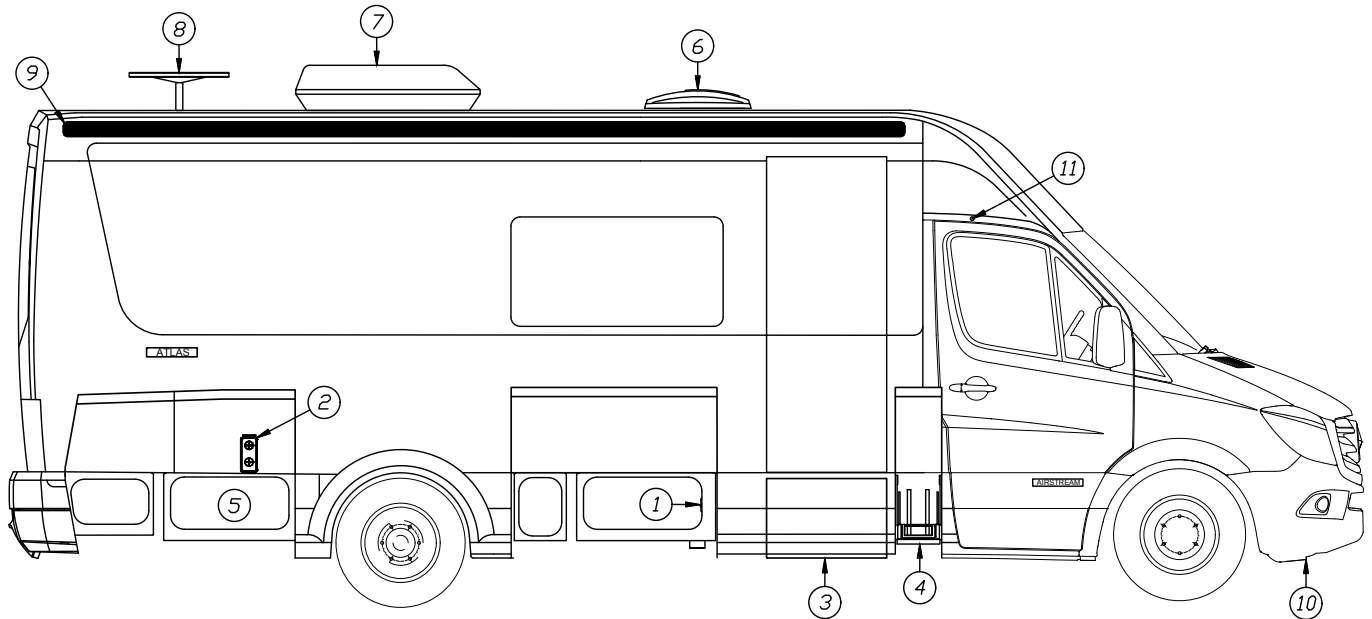

#### NOTE

**This is a basic explanation of the location and function of exterior features. More in-depth explanations of certain feature's care and maintenance is include in this manual in other sections.**

1. Exterior 120-volt outlet provides an exterior GFCI protected electrical source. TV outlet and HDMI port provides reception for an exterior television. It is pre-wired and integrated into the Cable/Satellite TV system.
2. Furnace exhaust vent should be cleaned regularly. When operating furnace, be sure exhaust can escape into a well ventilated area. Air coming from vent can be hot. When parking the touring coach, be sure to have proper clearance in venting area.
3. Folding step with auto extend/retract, step out warning buzzer, and lock extended switch for easy entry into the touring coach.
4. House battery storage compartment.
5. Generator location. All switching is done automatically.
6. Power skylight. Opens and closes via Multiplex System.
7. Roof air conditioner
8. Power boosted omni-directional TV antenna is wired into TV outlets on exterior of coach and inside the front overhead roof locker.
9. Patio awning operating and care instructions are including in this section.
10. Body Kit.
11. Exterior door light comes on when the door is open. Can be turned on or off manually via a switch on the dash near the ignition switch.

# Exterior

## Exterior Doors

### Entry Door

The side entry door is manufactured with a built-in, keyed dead bolt and door lock. The door lock, located below the door handle, is engaged from the inside by a red lever. The dead bolt, located above the door handle, is engaged by rotating the black knob. The door lock can be locked or unlocked using the key fob. The side door will only lock using the key fob if it is closed. To unlock using the key fob quickly double press the unlock button.

For lubrication and out-of-adjustment issues, refer to Section 9 - Maintenance.



### CAUTION

When driving, the door lock and dead bolt must be secured. If it is not locked, the constant vibration of travel may cause the door to open resulting in possible damage.

### Screen Door

*Opened*

*Closed*



The screen door is secured to the threshold of the main door and can be operated independently by sliding and latching it via a magnet catch. This innovated door takes a fresh approach to maximizing fresh air and your view while offering a smooth and steady screen operation.



### CAUTION

Check that the screen door is retracted before closing the exterior door. Failure to follow this caution could result in damage to the screen door.

## Utility Compartment Doors

The Atlas Touring Coach has several hidden utility hatches incorporated into the lower trim on each side of the coach. The compartment doors have no visible latches and are locked/unlocked using the key fob.

The utility compartment doors will lock when the lock button on the key fob is pressed or when the touring coach is in motion.

To unlock the utility doors quickly press the unlock button on the key fob twice. This will unlock the cab doors as well as the utility doors.

### NOTE

To unlock the utility compartment doors at least one cab door must be closed. If both driver and passenger doors are opened the key fob will not unlock the utility doors.

## Tail Lights

Atlas Touring Coach tail lights are hinged and can be opened to access for service. The tail light is held close by a magnet. To open, reach under the bottom edge of the tail light and pull.

*Opened*

*Closed*



### Awning

The awning on Airstream's Atlas is a state of the art power awning. When retracted, the housing provides protection against the elements while blending in with the touring coach sidewall. The canopy can be partially or fully extended for the best shade coverage. The awning manufacturer provides a complete Owner's Operator Manual located in your owner's packet. The power awning is operated from the Multiplex control panels Auxiliary section on the "Shades" screen.

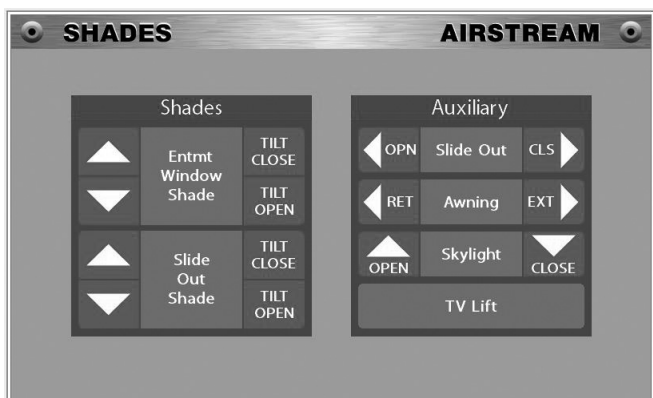

#### NOTE

If extended, the awning will automatically retract when the vehicle is taken out of "Park". When the vehicle is in motion the awning will lock, preventing it from being extended while traveling. The lockout will be reset and the awning can be extended again after the engine has been turned off.

### Awning Use In Wind and Rain

The automatic extra strong awning comes with a Direct Response™ System wind sensor. The Direct Response™ System is an innovative wind sensor system that automatically activates the 12V motor and retracts the awning in strong winds, thus avoiding possible damage to the awning.

The awnings primary use is for sun protection, it is recommended the awning be retracted in case of rain, wind, or snow.

#### NOTE

If wind or extended periods of rain are expected, retract the awning and secure as for travel. The effects of wind and rain on any awning are unpredictable. Severe damage to the vehicle and or the awning may result and cannot be covered by warranty.

### Awning Manual Override

If power to the vehicle is not available, the awning can be safely retracted using the manual override located on the idler (right) end of the case. A ratchet and socket extension has been included and is located under the passenger side compartment floor.

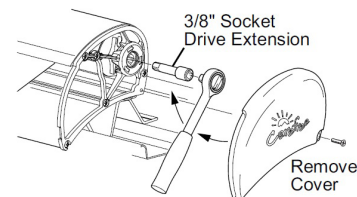

1. Remove the cover from the right end cap and save.
2. Insert the 3/8" socket drive extension and handle into the square drive hole inside the end cap.
3. Turn the handle clockwise until the awning is retracted.
4. Replace the end cap.

#### CAUTION

After closing the awning with the manual override, the lead rail may move out from the case 1/4"-1/2". This is normal and the awning is secure for travel until power is restored or repairs are completed. Do NOT attempt to force the lead rail in with the override, serious damage can occur to the awning.

#### NOTE

Manual override cannot be used to extend the awning.

### Care and Maintenance

1. PERIODIC MAINTENANCE: Like any other part of the touring coach, an owner should periodically inspect the awning. The following items should be checked.
  - a. All mounting brackets are tight.
  - b. Check all pivot points for enlargements of holes or broken rivets.
  - c. Check end caps for cracking and splitting.
  - d. Check that awning rail is tight against coach and all screws are tight.
  - e. Check canopy for loose stitching and possible shrinkage or puckering.
  - f. Clean and lubricate all tension knobs and pivot points.

Fuse Location: Chassis fuse panel under driver's seat.



# Exterior

---

## Hitch Cover

### How To Remove The Hitch Cover

#### *Before Removal*



#### *After Removal*

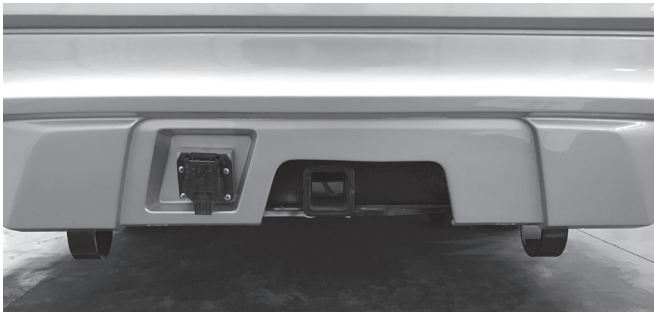

1. Kneel down behind the rear bumper. There are two black wing nuts on each corner of the cover shown below.



2. Rotate each wing nut 1/4 turn, pull down and remove.

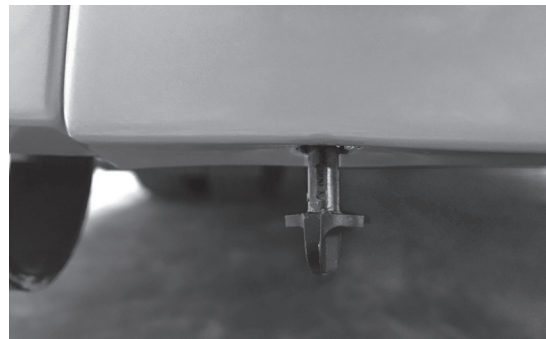

3. Pull straight down to remove the cover. Once removed you can store this in one of the utility compartments. Reverse these instructions to reinstall.





## Section 7

# SPRINTER VAN

SPRINTER VAN . . . . .	7-1	Tires And Wheels . . . . .	7-4
IMPORTANT SPRINTER INFORMATION . . . . .	7-2	Tire Grip . . . . .	7-5
FUEL . . . . .	7-2	Hydroplaning. . . . .	7-5
COMPONENT IDENTIFICATION. . . . .	7-2	CHANGING A TIRE . . . . .	7-5
Sprinter Van Serviced By Mercedes-Benz Sprinter Or Its Suppliers . . . . .	7-2	Flat Tire. . . . .	7-6
Chassis . . . . .	7-2	Precautions When Changing A Wheel . . . . .	7-6
Driver's And Passenger's Seats And Restraint Systems . . . . .	7-2	Procedure . . . . .	7-6
Airstream Components Serviced By Airstream Or Its Suppliers. . . . .	7-2	Jack . . . . .	7-7
Cab Area . . . . .	7-2	INSTALLING AND REMOVING A WHEEL . . . . .	7-7
Living Quarters . . . . .	7-3	Mounting A New Wheel. . . . .	7-7
Electrical Components . . . . .	7-3	Centering Wheels With Wheel Nuts . . . . .	7-7
Exterior . . . . .	7-3	Lowering The Vehicle . . . . .	7-7
Battery Assist . . . . .	7-3	Wheel Bolt Tightening . . . . .	7-8
TIRES . . . . .	7-3	TIRE ROTATION . . . . .	7-8
Vehicle Placard And Tire Inflation Pressure Label . . . . .	7-3	Rotation Pattern For Dual Rear Wheels . . . . .	7-8
Proper Tire Inflation . . . . .	7-4	Support. . . . .	7-8
Under Inflation . . . . .	7-4	Correct . . . . .	7-9
How Overloading Affects Your Tires . . . . .	7-4	Incorrect. . . . .	7-9
		AIR RIDE SUSPENSION. . . . .	7-9
		Manual Adjustments . . . . .	7-9

# Sprinter Van

---

The Airstream Atlas Touring Coach is integrated into a Sprinter Van designed and manufactured by Mercedes-Benz. Operation of the Sprinter, its engine, power train, and other related components are discussed in the Mercedes-Benz Sprinter Owner's Manual and other literature provided by Sprinter. As a point of reference, those systems discussed in this literature are warranted by Mercedes-Benz or their suppliers.

## Important Sprinter Information

Your Mercedes-Benz Sprinter Van Operator's and Warranty Manuals contain important Cautions, Warnings, operational, and warranty information on the Sprinter and its components. All information in the Sprinter manual should be reviewed and followed for your safety. The Airstream Atlas Owner's Manual may provide additional information and tips on the use of the Sprinter Van as a touring coach; however, no information in the Airstream manual should be interpreted as advice or directions to disregard or void the warnings, cautions, or other information contained in the Sprinter manuals. If you believe there is a conflict in information, Warnings, Cautions, or safety-related information between the Sprinter and Airstream manuals, please contact the Airstream customer relations department immediately to resolve the conflict.

## Fuel

The Mercedes-Benz Sprinter Owner's Manual contains important fuel requirement information on using Ultra-Low Sulfur Diesel, Bio fuels, and very low temperature operation. Please read, understand, and follow this information.

## Component Identification

If repairs are needed, it may be difficult to determine which parts are Mercedes-Benz and which are Airstream's responsibility. The following partial lists show the major components of the van and the company responsible for their servicing.

For assistance in locating a service center in the United States:

Customer Assistance Center

Three Mercedes Drive

Montvale, New Jersey 07645-0350

1-877-762-8267

See Mercedes-Benz Sprinter Warranty Information Manual for complete instructions.

## Sprinter Van Serviced by Mercedes-Benz Sprinter or Its Suppliers

### Chassis

Engine	Speed control
Exterior automotive lights	Automotive electrical system
Engine battery	Instrument panel cluster
Power mirrors	Hitch receiver and tow plug
Engine cooling system	Cab doors
Fog lamps	Heated drivers/passenger seats
Transmission	Cab door windows and windshield
Chassis suspension	AM/FM radio antenna
Brakes	Dash AC/heater/defroster
Drive axle and hubs	Cargo door assist handle
Steering assembly, Steering wheel	Lane keeper assist
Heated windshield	Blind spot assist
Automotive fuse panel	High beam assist
Wheels, Tires	Collision prevention assist
Parking brake	Parktronics
Alternator	
Fuel pump	

### Driver's and Passenger's Seats and Restraint Systems

Sprinter provides the swivel pedestals and Airstream provides the seat decorative skirting and recovers the front seats to match the surrounding decor.

### Airstream Components Serviced by Airstream Authorized Service Centers or Airstream suppliers.

#### Cab Area

Driver's and passenger's seat skirting and covers.

Floor Mats

Dash Kit

Rear View Mirror/Monitor

Exterior door lights

### Living Quarters

Fire extinguisher	Three piece sun and privacy shade
Interior furniture	
Appliances in the lounge/lavatory area.	Window Coverings
	Floor covering
Smoke/CO/LP detectors	All plumbing systems

### Electrical Components

Monitor panel and its system	Multiplex System
Inverter/Charger	Living area entertainment center
House batteries	Roof AC
Battery disconnect	TV antenna
Power vents	GPS/Sirius antenna
120-volt system	TVs
12-volt living area system	Fusion Radio

### Exterior

Alcoa Dura Bright Rims	Exterior lights
Exterior body kit	Awning
Power step	

### NOTE

**Please contact Airstream or Onan for a service location if repairs are need for the generator.**

If you need further clarification or information, contact the Airstream Customer Relations Department at (937)596-6111 before contacting a service center for an appointment.

If you wish to write, the address is:

Airstream Inc.  
 Attn: Customer Service  
 428 W. Pike Street  
 P.O. Box 629  
 Jackson Center, Ohio 45334

### Battery Assist

A Battery assist button is located on the dash just below the headlamp switch. If, for any reason, the chassis battery runs low, push and hold this button for at least 60 seconds. While still holding, turn the ignition key to start the engine and continue to hold the button. Release the button after 20 seconds and the engine should continue to run. If the engine fails to continue running repeat the process holding the start assist button for at least 30 seconds after turning the ignition key.

### TIRES

Under inflation or over inflation of tires is dangerous. Under inflation can result in tire flexing, heat build-up, tire overloading, bad handling, bad fuel economy, and uneven wear. Over inflation can result in abnormal wear, bad handling, and harsh ride.

Tire inflation pressures should be checked as per the Mercedes-Benz Sprinter Owner's manual and when significantly changing the load you plan to carry in your touring coach. Set the correct tire pressure before loading the vehicle. Always check tire inflation pressures when the tires are "cold." Inflation recommendation is 61 psi. Front and rear pressures and GVWR are shown for each model, and are based on the GVWR and front and rear axle ratings (GAWRs) printed on your vehicle VIN plate and certification label. Tires must be inflated to these pressures when the vehicle is fully loaded or an axle GAWR is reached.

Proper front end alignment improves tire tread mileage. Your front-end suspension parts should be inspected periodically and aligned when needed. Improper alignment may or may not cause the vehicle to vibrate. However, improper toe alignment will cause front tires to roll at an angle, which will result in faster tire wear. Incorrect caster or camber alignment will cause your front tires to wear unevenly and can cause the vehicle to "pull" to the left or right.

### Vehicle Placard and Tire Inflation Pressure Label

The TIRE AND LOADING INFORMATION placard supplies information on the size and the cold tire inflation pressure for the original equipment tires supplied with your vehicle. Check the Sprinter manual for all weights and tire information placard location.

A MOTORHOME TIRE SAFETY ADDENDUM is included with your Airstream owner's packet. Please take the time to read, understand, and follow the information contained in the booklet.

# Sprinter Van

---

## Proper Tire Inflation

The level of air in your tires affects your vehicle's overall performance. Not even the highest quality tire will perform well if it's not inflated properly. The correct pressure varies from vehicle to vehicle and depends in part upon driver preference. Each vehicle has a recommended inflation pressure, usually found on a placard. Check the Sprinter manual for all weights and tire information and the placard location.

Correct tire inflation is a key component in tire care. The recommended inflation pressures for your tires are indicated on the certification label or in your owner's manual. Since touring coach's can be loaded with many different configurations, the load on each tire will vary. For this reason, air pressure should be checked based on the load on each individual tire. Cold Inflation Pressure should be adjusted to handle the maximum tire load, and all tires on the axle should carry the same inflation pressure. Cold tire inflation pressure is the tire pressure checked in the morning before you drive more than a few miles or before rising ambient temperatures or the sun's radiant heat affect it. Check your tire air pressure at least once a month, before each trip, and each morning you drive during a trip. Tire pressure should be checked cold, as tire pressure ratings have been designed with typical running heat/pressure build up in mind. Make sure the valves and caps are free of dirt and moisture.

## Under Inflation

Under inflation brings a higher risk of susceptibility to damage due to road hazards, reduces tire casing durability, and causes a loss in fuel economy, plus uneven or irregular tire wear. Severe under inflation brings about an increased risk of tread separation, handling difficulties, and possibly tire failure, which is caused by overheating.

### NOTE

**It is a common practice for motorhome owners to lower tire pressure in their search for a smoother ride. This is not only dangerous, it is relatively ineffective, and the difference in ride quality is not significant. When minimum inflation pressure requirements are not met, tire durability and optimum operating conditions are compromised. Tire inflation pressure should always meet at least the minimum guidelines for vehicle weight.**

- It may be necessary to inflate your tires at a truck stop or truck service center in order to achieve adequate air pressure for your coach's needs
- Only permanent air seal metal valve caps should be used.
- Be safe - if a tire has been run 20 percent under inflated, it must be dismantled and inspected by a trained professional. It should not be inflated without a full inspection or without using a safety cage. Use a calibrated gauge. If your tire is rated for higher inflation pressures, a special gauge designed for larger tires will be required.
- Don't bleed air from warm tires to reduce pressure buildup.
- Don't inflate tires to cold psi rating beyond rim specifications.

## How Overloading Affects Your Tires

Tire pressure is what enables your touring coach tires to support loads. Overloading your tires can have serious consequences for passengers and your touring coach. Too much weight can cause stress on your touring coach's suspension system, brake failure, shock absorber damage, handling and steering problems, irregular tire wear and possible tire failure. Excessive loads or under inflation can lead to an excessive amount of heat and tire failure. If you discover that your tires cannot handle the load, lighten the weight of the load on your tires.

## Tires and Wheels

(This section is partially excerpted from the Mercedes-Benz Sprinter Van Operator's Manual.)

Check tires regularly for even tread wear, tread depth (note legal requirements), and signs of external damage. Use only wheels and tires of the same size, make, and pattern.

Do not install tires that are not approved for the size and type of wheel installed on the vehicle itself. Only use those wheel sizes that were delivered to you by your authorized Mercedes-Benz Sprinter dealer.

Use only wheels and tires that have been tested and approved by the vehicle manufacturer.

Break in the tires at moderate speeds for distance of about 65 miles.

**WARNING**

Always replace wheel nuts that are damaged or rusted. Never apply oil or grease to wheel nuts. Damaged wheel hub threads should be repaired immediately. Incorrect mounting bolts or improperly tightened mounting bolts can cause the wheel to come off. This could cause an accident. Make sure to use the correct mounting bolts. Check tightness of wheel nuts regularly and retighten if necessary.

**Tire Grip**

Tire grip is greatly reduced on a wet or icy road. Speed and driving style must therefore be adapted to suit road conditions. In winter, install M + S radial tires. Below a tread depth of 1/8 in., tire grip begins to decrease rapidly on wet roads.

**NOTE**

**California Tire Chain notice: Your motorhome may not be operated with tire chains.**

**Hydroplaning**

Depending on the depth of the water layer on the road, hydroplaning may occur, even at low speeds and with new tires. Reduce vehicle speed, avoid grooves in the road, and apply brakes cautiously in the rain.

The majority of flood-related deaths are caused by people attempting to drive through moving water. Driving into flood waters may be the most dangerous thing one might ever try. Considering the following:

- Most cars will float (and be swept away) in 18-24 inches of moving water. Trucks and SUVs have only 6-12 more inches of clearance. Creeks and rivers can rise very rapidly and the road bottom can also wash away, making the water much deeper than it appears.
- Once cars are swept downstream, they will often roll to one side or perhaps flip over entirely. The driver has a few seconds to escape the vehicle. Many drivers panic as soon as the vehicle submerges and are found later with their seat belt intact.

**Changing A Tire**

(Partially excerpted from the Mercedes-Benz Sprinter Van Operator's Manual)

After changing a wheel, the wheel nuts must be tightened once the vehicle has been driven for about 30 miles.

If new or repainted wheels are fitted, the wheel nuts must be retighten again after about 600 to 3000 miles. Do not use remolded tires.

**WARNING**

**Fitting wheel sizes other than those supplied by Sprinter to the vehicle will change the Sprinter's handling characteristics and may lead to an accident resulting in severe personal injuries, death and property damage.**

**NOTE**

Read the Sprinter manual for wheel torque and wheel tightening procedures.

**WARNING**

**The Mercedes-Benz Sprinter Operator's Manual contains important cautions, warnings, specifications, and operational information on changing, maintaining, and replacing of the tires and wheels. Read, understand, and follow the Sprinter manual sections for changing a tire.**

**CAUTION**

**Changing a tire on a touring coach chassis is a physically demanding procedure. It requires specialized tools and knowledge of safety procedures. Only you can determine your knowledge base and physical ability. Don't take any unnecessary risks. Find a safe area to park your unit, and call a tire service center and supply them with the information in the Sprinter Manual if you have any doubts about changing a tire.**

# Sprinter Van

---

## Flat Tire

If you get a flat tire while driving, gradually decrease your speed. Hold the steering wheel firmly and slowly move to a safe place on the side of the road. The pressure of the spare wheel (not supplied with vehicle) should be checked regularly (at least after every tenth time at the filling station).

The vehicle tool kit and the jack are located in a hatch under the front passenger foot well.



### **WARNING**

**The jack is designed exclusively for jacking up the vehicle at the jack take-up brackets built into either side of the vehicle. To help avoid personal injury, use the jack only to lift the vehicle during a wheel change. Never get beneath the vehicle while it is supported by the jack.**

## Precautions When Changing a Wheel

- Keep hands and feet away from the area under the lifted vehicle.
- Always firmly set parking brake and block wheels before raising vehicle with jack.
- Do not disengage parking brake while vehicle is raised.
- Always use the jack on a level surface.
- Do not jack the vehicle up more than 1-2 in. between the tire and the surface. Otherwise, the vehicle may tip over and may cause serious injury or death to you or others.
- Be sure that the jack arm is fully seated in the jack take-up bracket.
- Always lower the vehicle onto sufficient capacity jack stands before working under the vehicle.
- Do not damage, grease, or oil wheel nuts or stud threads.

## Procedure

- Park the vehicle on a firm, level, non-slippery surface.
- Switch on the hazard warning flasher switch, apply the parking brake, and place the transmission selector in "P".
- Everyone must leave the vehicle before you jack it up.
- Everyone must leave the danger zone before you jack up the vehicle. Danger zones vary with locations. Take a minute and look at what might happen if the vehicle falls off the jack and rolls. Set up your danger zone.
- The vehicle must be safeguarded in accordance with legal regulations (such as using a warning triangle).
- Prevent vehicle from rolling away by blocking wheels with wheel chocks (not supplied with vehicle) or sizable woodblocks or stone. On a level road place one chock in front of and one behind the wheel that is diagonally opposite to the wheel being changed. When changing a wheel on mild uphill or downhill grade, place chocks on the downhill side blocking both wheels of the other axle. Do not jack vehicle up on a steep grade.



### **WARNING**

**Do not change wheels on a steep uphill or downhill grade. The vehicle may begin to move and fall from the jack, which could cause property damage, personal injury, and/or death.**



## Jack

Read, understand, and follow the Mercedes-Benz Sprinter Operator's manual instructions, cautions, and warnings for changing a wheel and jack point locations.

The jack is located together with the vehicle tool kit under the hatch in the front passenger foot well.

- Loosen the wheel nuts before raising the vehicle.
- Close the release valve on the jack.
- Assemble the pump lever provided and insert it into the socket on the jack.
- Secure lever by turning it clockwise in the socket.
- Position the jack under the appropriate jack point and raise the vehicle by pumping the lever.



### WARNING

The jack is intended only for raising the vehicle briefly, for instance when changing a wheel. The jack must be placed on a firm, flat surface only. Do not change wheels on either uphill or downhill grades. Do not crawl under the vehicle while it is raised with the jack. Do not start the engine while the vehicle is jacked up. Do not jack the vehicle up more than 1-2 in. between the tire and the surface. The vehicle may tip over and cause serious injury or death to you or others. Jack stands must always be used while working beneath the vehicle. Failure to follow these precautions could result in property damage, personal injury, and/or death.

## Installing and Removing A Wheel

- Loosen the wheel nuts.
- Jack up the vehicle until the wheel is clear of the ground.
- Unscrew the wheel nuts and remove the wheel (keep the wheel nuts clean).

### NOTE

If the vehicle moves forward or backward while it is being jacked up, lower it, stabilize the vehicle, and repositioned the jack. When the vehicle is jacked up, the jack must stand vertically (plumb-line).

## Mounting a New Wheel

- Before fitting a spare wheel, clean rust and dirt off the contact surfaces of the wheel and the wheel hub and from the wheel nuts.
- Note the specified wheel and tire size, tire load capacity, and speed code.
- Do not change the tire's direction of rotation.
- Do not damage, grease, or oil wheel nuts or their threads.

## Centering Wheels With Wheel Nuts

- If dual assemblies are used, before placement, the inner wheel should be inspected to ensure all ball bearing rings are in the proper position.
- Install the wheel and snug the wheel nuts.
- Slightly tighten wheel nuts.

## Lowering the Vehicle

- Slowly open the jack release valve to lower the vehicle until tire is resting on ground.
- Tighten the wheel nuts in a crosswise pattern, as specified, with a torque wrench. For tire pressure and wheel bolt torque procedures, see the Mercedes-Benz Sprinter Van Operator's Manual.
- Remove the jack and stow it in the vehicle tool kit.
- Check the tire pressure. For tire pressures see the Mercedes-Benz Sprinter Operator's Manual.
- Retighten the wheel nuts to the specified torque with a torque wrench after a distance of approximately 30 miles.



### WARNING

Only certain tires meeting the tire size/load/speed index ratings contained in the Tire Pressure Tables, found in the Index Section of the Mercedes-Benz Sprinter's Operators or Owner's Manual, are certified to conform to FMVSS 120 for the Sprinter Vehicle. Please check the sidewalls of your originally-equipped tires for specific makes/sizes, and speed load ratings when you need to replace your tires. To prevent accident, injury, or possible death, use only the correct tires for your tire replacement.

# Sprinter Van

## Wheel Bolt Tightening

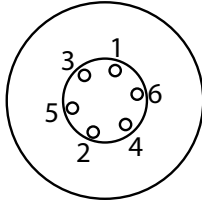

### NOTE

Consult the Mercedes-Benz Sprinter Operators manual for extensive wheel tightening and wheel torque procedures, cautions, and warnings.

Tighten all wheel nuts evenly in the crosswise sequence indicated.



### WARNING

For safety reasons, the wheel tightening torque must be checked immediately after changing a tire and again after 30 miles to 140 ft-lbs. The wheels could otherwise come loose.

## Tire Rotation

Front and rear tires perform different jobs and can wear differently depending on the types of roads driven, driving habits, etc. To obtain the longest tire life, you should inspect and rotate your tires regularly.

Many automotive dealers and tire dealers will perform a free tire inspection to look for uneven or abnormal tire wear.

Tires should be rotated every 6,000 to 8,000 miles. For the longest tire life, any time irregular wear is seen have the tires checked, alignment checked, and tires rotated by your truck or tire dealer. Have the cause of uneven wear corrected.

## Rotation Pattern for Dual Rear Wheels.

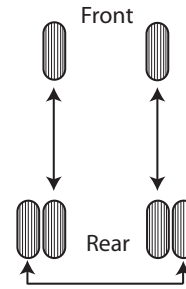

### NOTE

Read the Mercedes-Benz Sprinter Operator's Manual for complete instruction on tire rotation, installation, and maintenance.

### NOTE

Vehicles with aluminum alloy wheels will require tires to be dismounted and remounted so as to leave rims in original locations because the dura bright finish is only applied to one side.

## Support

Since touring coach's may sit for long periods it is important to properly support the tires if blocks are used for leveling.

Extreme caution must be taken to ensure that the tires are fully supported when using blocks to level the touring coach. The load on the tire should be evenly distributed on the block and in the case of duals, evenly distributed on blocks for both tires. If not done, the steel cables in the sidewall of the tires may be damaged and could lead to premature fatigue of the sidewall.

**Correct**

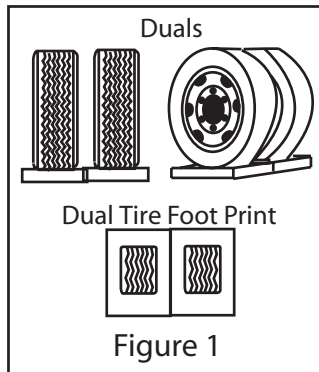

The CORRECT methods are shown in Figure 1. Dual tires are supporting the full load. Please note that the blocks are wider than the tread and longer than the tire's footprint. This provides maximum support to the tires and ensures that the load is evenly distributed throughout the tire's footprint area.

**Incorrect**

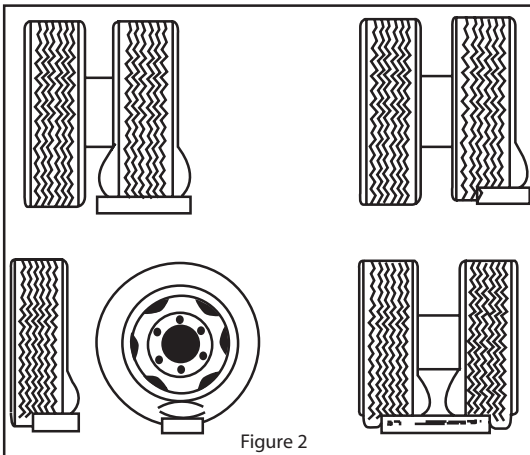

INCORRECT methods are shown in Figure 2: One tire, a portion of one tire, or portions of two tires are supporting the full load.



**WARNING**

Tires that are incorrectly supported may be damaged, which could lead to casing failure resulting in serious injury or property damage. If, on previous occasions, the tires have been incorrectly supported, hidden damage may be present. Please contact your local tire dealer and request an inspection and a determination of possible damage.

### Air Ride Suspension

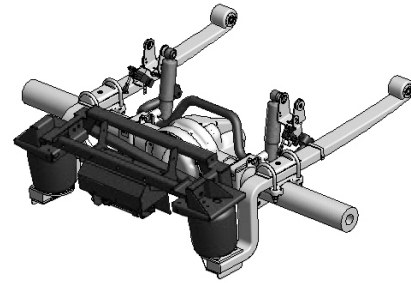

The Atlas Touring Coach is equipped with a rear axle air suspension. The Sprinter van is extremely suited for this air suspension system and is standard on every model.

The full-air rear-axle air-suspension, has an electronic system which automatically monitors and adjusts the height level of the vehicle. This constant monitoring and adjusting will automatically contribute to safer vehicle behavior and better comfort.

The Atlas air ride system has a "ferry ramp" option allowing the touring coach to be driven at max height up to 7 mph, after which the coach will return to its normal ride height.

**NOTE**

Carefully read and understand all manufacturer's instructions provided in your owner's packet prior to operating.

### Manual Adjustments



A remote, located on the B-pillar next to the drivers seat, can be used to manually adjust the air suspension. To manually adjust, while parked set the emergency brake. With the engine running, press and hold the up or down arrows to raise or lower the rear of the van to the desired level. A short press of the up or down buttons will raise or lower the coach to its highest or lowest position.



## Section 8 DRIVING

DRIVING . . . . .	. 8-1	Attaching A Trailer. . . . .	. 8-5
LOADING. . . . .	. 8-2	TOWING A TRAILER . . . . .	. 8-6
Weighing . . . . .	. 8-2	Tracking . . . . .	. 8-6
Vehicle And Trailer Wights And Ratings Definitions . . . . .	. 8-2	Brake Controller . . . . .	. 8-7
Procedure For Weighting A Touring Coach . . . . .	. 8-3	Backing Up . . . . .	. 8-8
Weight Distribution . . . . .	. 8-3	Rearview And Side Monitor System . . . . .	. 8-8
SAFETY . . . . .	. 8-4	Passing. . . . .	. 8-8
Seat Belts . . . . .	. 8-4	Parking Your Touring Coach . . . . .	. 8-9
TRAILER TOWING AND DRIVING TIPS. . . . .	. 8-4	TOWING YOUR TOURING COACH . . . . .	. 8-9
Hitch . . . . .	. 8-4	SAFETY CHECK LIST. . . . .	. 8-9
Loading A Trailer . . . . .	. 8-5	Exterior Check List (Before Entering) . . . . .	. 8-9
Checking Weights Of Vehicle And Trailer . . . . .	. 8-5	Interior Check List (Before Driving) . . . . .	. 8-10

# Driving

## Loading

One of the most critical aspects of safely operating a touring coach is knowing the weight involved and where it is placed. The first thing to determine is how much cargo is being loaded and confirming that it is within the capacity of the equipment being used. Determining WHERE that load is placed is critical to the way your rig will handle on the road.

Do not try to guess what your touring coach weighs loaded. Load your touring coach including water, propane, etc and take it to a public scale. Weigh each axle of your vehicle. Refer to your axle weight and tire limits to see if you are within a safe range. Total all axle weights and make sure you are below the GVWR. If you are not overloaded, make sure your load is balanced. Do not load too much on one side. A balanced load is much easier to tow or drive.

Front to back balance is also important. Step back and look at your touring coach. Make sure there is not too much weight in the front or on the rear of the touring coach. Be sure to secure all items. Loose items can cause damage and can be a safety issue.

The Cargo Carrying capacity tag shown below is installed on every touring coach and can be found on the inside of the door on your vehicle.

MOTOR HOME OCCUPANT AND CARGO CARRYING CAPACITY VIN ##### THE COMBINED WEIGHT OF OCCUPANTS AND CARGO SHOULD NEVER EXCEED XXX kg or XXX lbs Safety belt seating capacity:XXX CAUTION A full load of water equals XXX kg or XXX lbs of cargo @ 1 kg/L (8.3 lb/gal) and the tongue weight of a towed trailer counts as cargo
--

To arrive at “THE COMBINED WEIGHT OF OCCUPANTS AND CARGO SHOULD NEVER EXCEED” number, Airstream weighs the vehicle as finished and adds the weight of full tanks of LP and chassis fuel. That number is subtracted from the GVWR of the touring coach and listed on the tag, The total weight of any and all cargo, including but not limited to dealer or customer modifications or additions, fluids (freshwater and holding tanks), food, clothes, tools, tongue weight of a towed trailer or vehicle, and passengers should never exceed the number listed while the touring coach is in transit.

The “SAFETY BELT SEATING CAPACITY” is the number of passengers that seat belts are provided for.

The “A FULL LOAD OF WATER EQUALS” number is arrived at by multiplying the fresh water tank and water heater capacities by 1Kg/L or 8.3 lb/gal.

When loading the vehicle it is important to keep the GVWR, GAWR, Tire Weight Ratings (listed on the vehicle tire Information placard), and the cargo and occupant capacity in mind and not to exceed these specifications. Your safety depends on not overloading the touring coach, axles, and tires. See the specification section for the weight rating list of these items.

## Weighing

To determine the actual weight of your vehicle with personal cargo and water, it must be weighed on scales as you plan to travel. The most common scales are those used by states to weigh trucks along the highway. In rural areas, grain elevators, gravel pits, and cement outlets are a good source.

### NOTE

**Weighing instructions for this touring coach are explained on the next page. If you have trouble locating scales, a call to your State Highway Patrol will usually find them cooperative in assisting you.**

### Vehicle and Trailer Weights and Ratings Definitions

Gross Vehicle Weight Rating (GVWR) is the maximum permissible weight of the touring coach.

Gross Vehicle Weight (GVW) comprises weight of vehicle including tools, installed accessories, passengers, cargo, and trailer tongue weight. It must never exceed the GVWR.

Gross Axle Weight Rating (GAWR) is the maximum permissible axle weight.

Gross Trailer Weight (GTW) is the maximum permissible trailer weight to be towed.

Trailer Tongue Weight Rating (TWR) is the maximum permissible weight of the trailer tongue. This counts as cargo when loading a touring coach.

### NOTE

**Check the Sprinter manual for all weights and the tire information placard location.**



Front Axle GAWR	GVWR	Rear Axle GAWR	GCWR - GVW
SCALE WEIGHT		Optional Tow Weight	
STEP 1 Front Axle GAW	STEP 2 GVW	STEP 3 Rear Axle GAW	STEP 3a Tow Weight minus Weight of Trailer or Vehicle Towed
INDIVIDUAL WHEEL POSITION WEIGHT			
STEP 4 Left Front Wheel Position	STEP 5 Left Side (Total LF + LR)	STEP 6 Left Rear Wheel Position	
Calculated	Calculated	Calculated	
Right Front Wheel Position Step 1 minus Step 4	Right Front (Total RF + RR) Step 2 minus Step 5	Right Rear Wheel Position Step 3 minus Step 6	

GAWR = Gross Axle Weight Rating

GVWR = Gross Vehicle Weight Rating

GCWR = Gross Combination Weight Rating

### Procedure for Weighing a Touring Coach

Vehicle should be weighed loaded, as you normally travel.

1. Fill in first row from Specification Section - 4 of this manual.
2. Weigh vehicle as shown in row 2 (Scale Weight) and fill in blanks.
3. Weigh one side of vehicle as shown in Individual Wheel Position Weight.
4. Calculate other side as shown in last row.

### NOTE

**Check the Sprinter manual for all weights and tire information placard location.**

### Weight Distribution

Touring coach's have Fresh Water, Black and Gray Water Tanks, and storage areas. It gives you great flexibility in loading. With flexibility comes responsibility. If you want to load down all the storage compartments, the amount of fluids may have to be reduced. It's a trade off so plan wisely. Distribute your additional cargo as evenly as possible with the heaviest objects located as low as possible.

Do you really want to carry a full fresh water tank to a RV park 1,000 miles away and then hook up to a city water supply? Even if you're going to a remote area, you can usually fill your water tank shortly before entering the area. Just reducing your load by 10 gal of water lets you carry an additional 83.5 lb of cargo.

## Safety

### Seat belts

Federally approved seat belts are provided for the use of the driver, front passenger, and the lounge sofa. Most states require by law that all passengers in a motor vehicle use seat belts while in transit. It is strongly recommended that all occupants remain seated with their safety belts firmly attached while the touring coach is in transit. The driver should adjust his or her seat so that he or she is able to reach all controls easily with the belt on, and be able to use all the travel on the foot brake. Seat belts should be placed as low as possible around the hips to prevent sliding out from under them in case of an accident. This places the load of the body on the strong hipbone structure instead of around the soft abdominal area. Remember, there should only be one occupant per seat belt when traveling.

The driver and front passenger seat belt buckle operation is explained in the Sprinter manual.

The lounge sofa seat belt buckles are secured by inserting the male end into the female buckle until the buckles are secured. To release the buckle press the release button on the female end.

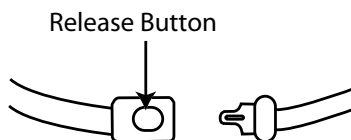

### WARNING

**Become familiar with and follow all directions, advice, and warnings pertaining to seats, seat belt operation, and restraint systems, provided in the Mercedes-Benz Sprinter Operator's Manual. Do not allow passengers to ride anywhere in the touring coach except in seats that are equipped with approved seat belts.**



### WARNING

**Children must be secured in a federally-approved child restraint device. Failure to use proper restraints while in transit can result in severe or fatal injuries. Never place an infant seat that faces to the rear on the front passenger seat. Never place an unbelted infant seat on any seat while in transit.**

Child restraint devices are designed to be secured with lap or lap/shoulder belts. All instructions supplied by the restraint manufacturer must be followed. Statistics have shown children are safer when properly restrained in a rear seating position than in a front seating position.

Don't hesitate when it comes to passenger safety. Make sure all passengers are properly restrained.

## Trailer Towing and Driving Tips

(Some text is partially excerpted from Mercedes-Benz Sprinter Operators Manual.)



### WARNING

**Failure to use proper equipment and driving technique can result in a loss of vehicle control when towing a trailer. Improper towing or failure to follow the instructions contained in this section can result in serious injury. Follow the guidelines below carefully to assure safe trailer operation. Ask your authorized Mercedes-Benz Sprinter or Airstream dealer if you require an explanation of information contained in the manuals.**

### Hitch

Atlas units have hitches and wiring installed from the Mercedes-Benz manufacturer. The Sprinter 7- way connector is used for lights and charge line on a trailer. For further information, please see your authorized Mercedes-Benz Sprinter dealer.

To reduce the possibility of damage, remove the hitch ball adapter from the receiver when not in use.

Since this vehicle is designed and intended primarily as a load-carrying vehicle, towing a trailer will affect handling, durability and economy. Maximum safety and satisfaction depends upon proper use of correct equipment and avoiding overloads and other abusive operation.



### WARNING

**The total weight of the touring coach and trailer must not exceed the GCWR listed in the specification section of this manual. The maximum towing capacity varies according to the size of the touring coach and its GCWR. Vehicles should be properly equipped for towing trailers. Information on trailer hauling capabilities and special equipment required may be obtained from your Mercedes-Benz Sprinter and/or Airstream dealer.**

## Loading a Trailer

When loading a trailer, you should ensure neither the permissible GTW (Gross Tongue Weight), nor the trailer GVWR are exceeded.

Maximum permissible values are listed on the safety compliance certification labels for the vehicle and for the trailer to be towed. For their location, see the Mercedes-Benz Sprinter Operator's Manual. The lowest value listed must be selected when determining how the vehicle and trailer are loaded.

To assist in attaining good handling of the vehicle/trailer combination, it is important that the tongue weight be maintained at approximately 10-15 percent of the loaded trailer weight, but not to exceed the hitch rating. Tongue loads can be adjusted by proper distribution of the load in the trailer, and can be checked by weighing separately the loaded trailer and then the tongue.

The tongue weight at the hitch ball must be added to the GVW to prevent exceeding your Sprinter towed vehicle's rear GAWR.

When towing trailers, touring coach tires should be inflated to the highest pressures shown on the Sprinter Tire Information Placard. See Mercedes-Benz Sprinter Operator's Manual for its location. The Cargo Carrying Capacity (CCC) of this vehicle is reduced by the amount that equals the trailer tongue load on the trailer hitch.

## Checking Weights of Vehicle and Trailer

To assure that the tow vehicle and trailer comply with the maximum permissible weight limits and to know the actual weights, have the loaded vehicle-trailer combination (tow vehicle including driver, passengers, cargo and trailer fully loaded) weighed on a commercial scale as explained earlier in this section.

Also, check the vehicles front and rear axle weights and tongue weight. The values as measured must not exceed the Sprinter weight ratings listed on vehicle information placards and in the Mercedes-Benz Sprinter manual. These ratings are also listed in the Specification section of this manual, Section 4 - Floor Plans And Specifications.

### NOTE

**Check the Mercedes-Benz Sprinter manual for all weights and tire information placard locations.**

## Attaching a Trailer

Please observe maximum permitted trailer dimensions (weight and length).

Most states and all Canadian provinces require safety chains between your tow vehicle and trailer. The chains should be crisscrossed under the trailer tongue. They must be attached to the hitch receiver and not to the vehicles bumper or axle. Be sure to leave enough slack in the chains to permit turning corners.

Most states and all Canadian provinces required a separate brake system for towing trailers.



### WARNING

**The towing vehicle's braking system is rated for operation at GVWR, NOT at the GCWR. A separate, functioning brake system is required for any towed vehicles or trailers weighing more than 1000 lb (450 kg) when fully loaded. NEVER exceed the GVWR, or the GAWR specified on a touring coach certification label. Also, NEVER exceed the weight ratings of a trailer hitch installed on a touring coach. Failure to heed any part of this warning could result in loss of control of the touring coach and towed vehicle or trailer which may cause an accident and serious injury. For specified towed vehicle braking requirements, consult the Mercedes-Benz Sprinter Operator's Manual that comes with the vehicle.**



### WARNING

**Do not connect a trailer brake system (if trailer is so equipped) directly to the vehicle's hydraulic brake system if your vehicle is equipped with anti-lock brakes. If you do, neither the vehicle's brakes nor the trailer's brakes will function properly. Property damage, injury, or death to you or others may be the result.**

The provided vehicle electrical wiring harness for trailer towing has a brake signal wire for hookup to a brake controller. Most states and all Canadian provinces require a breakaway switch on trailers with a separate brake system. The switch activates the trailer brakes in the possible event that the trailer might separate from the tow vehicle. Please consider using a trailer sway control system. For further information, see your authorized Mercedes-Benz Sprinter or Airstream dealer.

# Driving

---

## Towing a Trailer

There are many different laws, including speed limit restrictions, having to do with trailer towing. Make sure that your vehicle-trailer combination will be legal not only for where you reside, but also for where you'll be driving. A good source for this information can be the State Attorney General, State Police, or local authorities.

Before you start driving with a trailer, check the trailer's hitch, breakaway switch, safety chains, electrical connections, lighting, and tires. Also, adjust the mirrors to permit an unobstructed view beyond the rear of the trailer.

If the trailer has brakes using an electric brake controller, start your vehicle and trailer moving slowly, and then apply the brakes manually using the brake controller to be sure the brakes are working properly. Read and follow the controller manufacturer's recommendations.

When towing a trailer, check occasionally to be sure the load is secure, and lighting and trailer brakes (if so equipped) are functioning properly. Always secure items in the trailer to prevent load shifts while driving.

Take into consideration that when towing a trailer, the handling characteristics are different and less stable from those when operating the vehicle without a trailer. It is important to avoid sudden maneuvers.

The vehicle and trailer combination is heavier, and therefore is limited in acceleration ability and requires longer stopping distances. It is more prone to reacting to side wind gusts, and requires more sensitive steering input.

In order to gain skill and an understanding of the vehicle's behavior, you should practice turning, stopping and backing up in an area which is free from traffic.

If possible, do not brake abruptly, but rather engage the brake slightly at first to permit trailer to activate its brake. Then increase the braking force.

We want every owner to be a safe and courteous driver. A few hours of towing practice in a large empty parking lot will make pulling your trailer over the road much easier. Line out two corners for left and right turns. You may also use these corners to practice backing and parking.

## Tracking

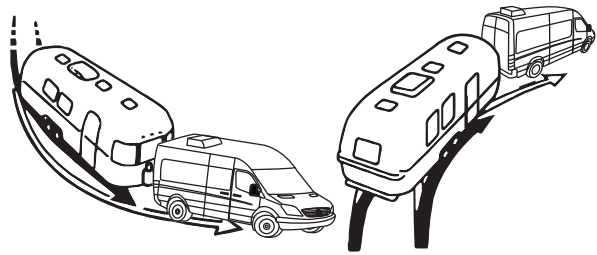

During practice, observe that the tracks made by the trailer wheels are distinctly different from those made by the tow vehicle. Studying this will make it easier for you to correct mistakes. Consider truck- or trailer-type fender or door grip rear view mirrors for maximum visibility. In most states, the law requires them.

After thoroughly inspecting your hitch, brakes, and tires, you should be ready to tow. Check traffic, signal that you are about to pull away, and start slowly. Look often in your mirrors, observe the action of the trailer, and then carefully move into the proper lane of traffic. Remember that the trailer wheels will not follow the path of the tow vehicle wheels; therefore, wider turns are necessary when turning to the left or right.

On freeways or expressways, try to pick the lane you want and stay in it. Always maintain plenty of space between you and the car ahead, at least the length of the tow vehicle plus trailer for every 10 mph. Remember that in order to pass another vehicle, you will need longer to accelerate. You must also allow for the length of the trailer when returning to the right hand lane. On a two-lane road cars may be lining up behind you because you are traveling at a lower speed. It is both courteous and sensible to signal and pull over at the earliest safe opportunity and let them pass.



### WARNING

**Take into consideration that when towing a trailer, the handling characteristics are different and less stable from those with operating the vehicle without a trailer. It is important to avoid sudden maneuvers. Sudden maneuvers may lead to loss of control over the vehicle-trailer combination.**

### Brake Controller

The brake controller (if so equipped) is activated when you apply the brakes of the tow vehicle. Your tow vehicle brakes will automatically apply the trailer brakes first when properly adjusted. This will help keep your tow vehicle and trailer in a straight line and make you stop as if you were driving the tow vehicle alone. If swaying or swerving should occur, briefly operating the controller separate from the vehicle brakes may help correct the situation. Practice this maneuver on a clear highway. Do not wait for an emergency and then grope for the controller.

When towing a trailer, you might encounter a temporary cooling system overload during severe conditions such as hot days when pulling on a long uphill grade, when slowing down after higher speed driving, or driving long idle periods in traffic jams. If the hot indicator light comes on, or the temperature gauge indicates overheating and you have your AC turned on, turn it off. Pull over in a safe place and put on your emergency brake. Don't turn off the engine. Increase the engine idle speed. Lift the engine hood and check for fluid leaks at the radiator overflow outlet. Check to see that all drive belts are intact and the fan is turning. If you have a problem have it fixed at the next opportunity. If there is no problem the light should go off or temperature should come down within one minute. Proceed on the highway a little slower. Ten minutes later resume normal driving.

### NOTE

**If the transmission continually shifts between gears on inclines, manually shift to a lower gear. A lower gear and reduction of speed reduces the chances of engine overloading and/or overheating. When going down a long hill, shift into a lower gear and use the engine's braking effect. Avoid riding the brakes, thus overheating the vehicle and trailer brakes. If the engine coolant rises to an extremely high temperature (e.g. coolant temperature needle approaching the red zone) when the AC is on, turn off the AC. Engine coolant heat can be additionally vented by opening the windows, switching the climate control fan speed to high and setting the temperature control to the maximum hot position.**



### WARNING

**Never open a radiator cap when the tow vehicle is hot. Add coolant when the vehicle is cool.**



### WARNING

**On slippery pavement, do not use engine drag to help slow down as this may cause the rear wheels of the tow vehicle to skid. On icy pavement, drive slowly and if you feel the tow vehicle skidding, gently apply the trailer brakes only. This will bring the tow vehicle and trailer back into a single line. Chains do not help trailer wheels.**

When going downhill in dry weather, downshift so that engine compression will slow the whole rig down. Take dips and depressions in the road slowly and do not resume normal driving speeds until you are sure that the trailer wheels are clear of the dip.

When driving in mud and sand, let the momentum carry the rig through. Apply power gently and use as little as possible. Stay in the tracks of the vehicle ahead and keep the tow vehicle in the highest possible gear. If you are stuck, it is best to tow out the entire rig together without unhitching.

Despite even the best hitch, you will notice that whenever a large bus or truck overtakes your rig the displaced air first pushes the trailer rear slightly to the right and then affects the front. It may be necessary to steer very slightly, momentarily, toward the bus or truck to help compensate for the sway induced by the passing-vehicle. Do not apply the vehicle brakes, as this can tend to exaggerate the situation. You may find, however, that briefly applying the trailer brakes with your manual control will help eliminate sway.



### WARNING

**CHOCK THE TRAILER WHEELS when stopping on a hill or slope. Leaving your tow vehicle in gear is not enough for standstill safety. Do not use trailer brakes as parking brakes.**



# Driving

## Backing Up

In BACKING UP the important thing to remember is to DO EVERYTHING SLOWLY and to correct immediately if you see the trailer turning the wrong way. Concentrate on the rear of the trailer. With your tow vehicle and trailer in a straight line, back up slowly and turn the bottom of the steering wheel in the direction you want the trailer to go. Watch from the window or in the mirror until the rear of the trailer is pointing in the desired direction. Your tow vehicle will be following the trailer in an arc. Straighten the tow vehicle and trailer by turning the steering wheel more sharply, and then when they are in line, straighten the steering wheel.

### BACKING UP

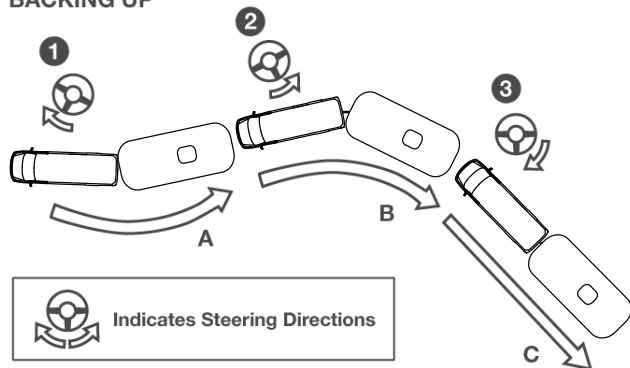

Start in position (A) start. Turning steering wheel as shown in (1). will put you in trailer position (B). Turning steering wheel show in position (2) puts you in trailer position (C). Steering position (3) returns front wheels to straight backing.

### NOTE

**Always try to back to your left because the visibility is much better.**

When you do not make it on the first try it is usually much easier to pull forward to your original straight position and start over.

If your spouse or traveling companion normally directs you when backing they should position themselves forward of the tow vehicle so the driver can easily see them. Their directions should always indicate to the driver the direction the rear of the trailer should go. A little practice in a parking lot with the person giving directions can save a lot of frustration when backing into a campsite.

## Rearview and Side Monitor System

An LCD digital monitor comes standard on all Atlas models and replaces the existing rear view mirror. It comes with a built-in speaker and touch screen buttons to control all settings.

Included in the system are side cameras which are displayed on the digital monitor. Side cameras are activated with the turn signals. Putting on your right turn signal will display the passenger side camera and your left signal will display the drivers side camera. Putting the vehicle in reverse will activate the back-up camera. The rear camera is the primary, and will override the side cameras if the vehicle is placed in reverse. The rear camera can be turned on while driving for use as a rearview mirror.

### NOTE

**Carefully read and understand all manufacturer's instructions provided in your owner's packet prior to operating.**

## Passing

Extreme care must be exercised when passing another vehicle. A vehicle with a trailer attached will require additional passing distance than when driving without a trailer. Because your vehicle and trailer is longer than your vehicle alone, you will also need to go much further ahead of the passed vehicle before you can return to your lane.

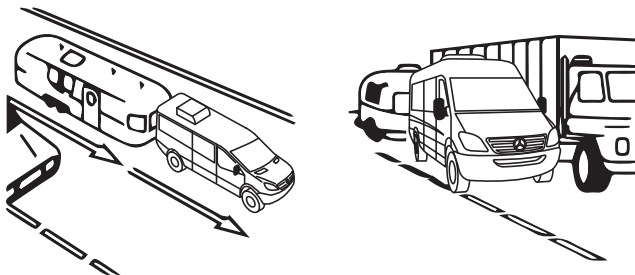



### Parking Your Touring Coach

To reduce the risk of personal injury or damage to the vehicle power train as a result of vehicle/trailer movement, always:

- Keep right foot on the brake pedal.
- Shift gear selector lever to position “N”.
- Have a second person place wheel chocks on downhill side of left and right trailer wheels.
- Slowly release brake pedal allowing vehicle and trailer to roll into chocks until stopped.
- Firmly depress parking brake pedal.
- Move gear selector lever to position “P”.
- On inclines, turn wheels toward the road curb.

### Towing Your Touring Coach

If the key cannot be turned, the ignition lock remains locked and the vehicle cannot be steered. With the engine not running, there is no power assistance for the braking and steering systems. In this case, it is important to keep in mind that a considerably higher degree of effort is necessary to brake and steer the vehicle. The vehicle must not be towed with the front axle raised and key in position two in the ignition lock, as the drive wheels could then lock due to the acceleration skid control (ASR). See the Mercedes-Benz Sprinter Operators Manual for information on the ASR.

#### NOTE

**Considerable damage may occur if the touring coach is improperly lifted for towing purposes. Only qualified professional towing service companies with proper equipment should be used. Observe all cautions and warnings in the Mercedes-Benz Sprinter Operator’s Manual before towing your touring coach.**

#### NOTE

**Do not tow the vehicle if the key cannot be turned in the ignition lock.**

### Safety Check List

Your Airstream Touring Coach should be given a thorough safety check before a trip. Regular use of the following list will provide safe operation of your touring coach and will help you spot any malfunctioning equipment and correct the problem as soon as possible. The list is to help you and may not be all-inclusive.



#### WARNING

**Failure to heed the following items may cause damage to the vehicle or personal injury.**

#### Exterior Check List (Before Entering Vehicle)

1. Check condition of tires and keep tires at recommended inflation pressure per the tire and loading placard on the driver’s door B-pillar.
2. Turn off remote LPG valve switch.
3. Check that macerator hose, city water hookup, TV cable/satellite, and all exterior components are unhooked and properly stowed.
4. Check that all external compartment doors are properly closed, latched and locked.
5. Check that items stored on exterior of vehicle are securely tied down.
6. Verify if any items stored on exterior of vehicle would present a clearance problem.
7. Follow all automotive manufacturer’s recommendations on checking and filling fluid levels.
8. Check exterior lights and general condition of vehicle.

# Driving

---

## Interior Check List (Before Driving)

1. It is important that all doors be completely closed and locked during travel.
2. Turn off living area water pump.
3. Check that refrigerator door is closed and latched if equipped.
4. Check that nothing heavy is stored in overhead or high cabinets, which could fall out and cause injury. Heavy items should be stored in lower cabinets.
5. Stow galley slide shelf and pedestal tables.
6. Check that counter tops, range top, and shelves are clear of even small items that could become projectiles during an emergency braking or accident.
7. Latch the shower doors.
8. Do not cook unless the touring coach is parked and stable. Hot food or liquid could scald due to a sudden stop or accident while traveling.
9. Be sure all LPG controls on the appliances are turned off.
10. Check that any internal stowage is securely held in place
11. Check that lights and switches are set in positions safe for travel.
12. Adjust the driver's seat so that you can easily reach and operate all controls. Make sure seat is locked in position. Do not adjust driver's seat swivel or recline mechanisms while vehicle is moving. The seat could move unexpectedly causing loss of control.
13. Check that all passengers have seat belts on properly.
14. The freedom of movement of the brake and accelerator pedals must not be impaired in any way.
15. Check rear view mirrors adjustment, inside and outside. Adjust window coverings if necessary for maximum visibility.
16. Secure children in a federally-approved child restraint device.

# Section 9 **MAINTENANCE**

<p>MAINTENANCE . . . . . 9-1</p> <p style="padding-left: 20px;">MAINTENANCE SCHEDULE . . . . . 9-2</p> <p style="padding-left: 20px;">SUGGESTED MAINTENANCE AND REPLACEMENT PARTS . . . . . 9-3</p> <p style="padding-left: 40px;">Exterior Care. . . . . 9-4</p> <p>TIRE CARE . . . . . 9-5</p> <p style="padding-left: 20px;">Tire Care Tips . . . . . 9-5</p> <p style="padding-left: 20px;">Tire Inspection And Storage . . . . . 9-5</p> <p>BATTERY (MAINTENANCE FREE). . . . . 9-6</p> <p style="padding-left: 20px;">Battery Amp Draw And Testing . . . . . 9-6</p> <p style="padding-left: 20px;">Battery Cleaning . . . . . 9-6</p> <p style="padding-left: 20px;">Battery Storage. . . . . 9-6</p> <p>LPG SYSTEM . . . . . 9-7</p> <p style="padding-left: 20px;">LPG Tank Remote Fill . . . . . 9-7</p> <p style="padding-left: 20px;">Remote Gas Supply Switch . . . . . 9-7</p> <p style="padding-left: 20px;">LPG Regulator . . . . . 9-8</p> <p style="padding-left: 20px;">LPG Connections . . . . . 9-8</p> <p>PLUMBING . . . . . 9-8</p> <p style="padding-left: 20px;">Water System (Self-Contained) . . . . . 9-8</p> <p style="padding-left: 20px;">Water Pump And Strainer . . . . . 9-9</p> <p style="padding-left: 20px;">Sanitizing . . . . . 9-9</p> <p>DRAIN AND WASTE SYSTEM . . . . . 9-10</p> <p style="padding-left: 20px;">Macerator Pump . . . . . 9-10</p> <p style="padding-left: 40px;">Macerator Applications . . . . . 9-10</p> <p style="padding-left: 40px;">Emptying The Black And Gray Water Holding Tanks . . . . . 9-11</p> <p style="padding-left: 40px;">Macerator Impeller Release Feature . . . . . 9-11</p> <p style="padding-left: 40px;">Manual Operation . . . . . 9-11</p>	<p style="padding-left: 20px;">Extended Stays. . . . . 9-12</p> <p style="padding-left: 20px;">Black Water Tank Flush . . . . . 9-12</p> <p style="padding-left: 40px;">Drain System Cleaning . . . . . 9-12</p> <p>WINTERIZING AND STORAGE . . . . . 9-12</p> <p style="padding-left: 20px;">Touring Coach Winterization. . . . . 9-13</p> <p style="padding-left: 40px;">Water Heater Winterizing . . . . . 9-14</p> <p style="padding-left: 40px;">Pump Winterizing . . . . . 9-14</p> <p>Toilet . . . . . 9-14</p> <p style="padding-left: 20px;">Toilet Winterizing . . . . . 9-14</p> <p style="padding-left: 20px;">Removal. . . . . 9-14</p> <p style="padding-left: 20px;">Maintenance . . . . . 9-15</p> <p style="padding-left: 20px;">Restoring Service . . . . . 9-15</p> <p style="padding-left: 20px;">Exterior Door. . . . . 9-15</p> <p style="padding-left: 40px;">Lubrication . . . . . 9-15</p> <p style="padding-left: 40px;">Adjustments . . . . . 9-15</p> <p>ELECTRICAL DIAGRAMS . . . . . 9-16</p> <p style="padding-left: 20px;">12-Volt Schematics . . . . . 9-16</p> <p style="padding-left: 20px;">12-Volt Standard Parts List . . . . . 9-27</p> <p style="padding-left: 20px;">30-Amp 120-Volt Schematic. . . . . 9-28</p> <p style="padding-left: 20px;">30-Amp 120-Volt Standard Parts List . . . . . 9-29</p> <p style="padding-left: 20px;">Audio/Video Schematic. . . . . 9-30</p> <p style="padding-left: 20px;">Audio/Video Standard Parts List . . . . . 9-31</p> <p style="padding-left: 20px;">Standard 30-Amp Circuit Breaker Layout. . . . . 9-32</p> <p style="padding-left: 20px;">Multiplex Circuit Control Board Layout. . . . . 9-33</p> <p style="padding-left: 20px;">Multiplex Networking Diagram And Switch Panel Layout . . . . . 9-34</p> <p style="padding-left: 20px;">Solar Panel Wiring . . . . . 9-35</p> <p>FAQS AND ANSWERS . . . . . 9-36</p>
---	---

# Maintenance

## Maintenance Schedule



### WARNING

Failure to maintain your touring coach can cause premature and unexpected parts breakage and/or erratic operation that may be hazardous.

### NOTE

See appliance manufacturer's literature for further information.

Every 1,000 miles or 60 days	
Battery	Visually inspect battery and cables for corrosion.
Smoke and CO Alarm	Test and replace battery as required.
Tires	Check tire pressure (See Specifications).
GFI Circuit Breaker	Test and record.

Every 5,000 miles or 90 days	
Door Step	Lubricate and inspect moving parts.
Utility Compartment Door Hinges	Lubricate with light household oil.
LPG Regulator	Check bottom vent for obstructions.
Wheel Lug Nuts	See Specification Chart in this manual for wheel torque ratings.
7-Way Plug	Spray with contact cleaner.

Every 10,000 miles or 6 months	
Tires	Inspect and rotate.
Spare Tire Carrier	Lubricate moving parts.
Windows, and Door Seals	Clean with mild detergent and coat with "Slipicone."
Exterior	Wax

Every year	
Battery	Clean, neutralize, and coat terminals with petroleum jelly.
LPG Tank	Have purged by LPG supplier.
Seams	Check and reseal exterior seams, windows, lights, and vents as needed.

Every 100-150 hours	
Generator	Change oil after the first 20 hours of run time.
	Change oil thereafter every 100-150 hours.

To break in the Onan generator run the generator at 50 percent load for two hours, then at 75 percent load for two hours. Refer to the Onan's manual for more details.

### Suggested Maintenance and Replacement Parts

(Part numbers listed are Airstream part numbers and can be ordered by calling a certified Airstream dealer.)



#### WARNING

**Always replace the bulb or light fixture with the correct bulb for that light or matching fixture. Failure to heed this warning could cause fire, property damage, personal injury, or death.**

#### Exterior 12-Volt Lighting – For additional exterior lights refer to your Chassis Owner’s manual.

License Plate Lamp	PN – 513034
Round Light w/Motion Sensor and ON/OFF Switch	PN – 513068
Yellow Marker/Clearance Light	PN – 513025
Red Marker/Clearance Light	PN – 513026
Light, 3rd Brake w/Eyeball Camera	PN – 513031
Taillight, RH	PN – 513227
Taillight, LH	PN – 513226

**NOTE: Most Exterior Lighting is LED and a replacement fixture will be required.**

#### Interior 12-Volt Lighting

LED Flex Tape Light, 39”	PN – 512659-02
LED Flex Tape Light, 53”	PN – 512659-03
LED Spot Light w/Frosted Lens	PN – 512936
LED Linear Diffused Light, 68”	PN – 513072
LED Flex Tape Light, 86.5”	PN – 513107
LED Linear Utility Light w/Touch Switch	PN – 512908
LED Aisle Light, Motion Activated	PN – 513070
Light, Threaded Docking w/Nut	PN – 513078
Gooseneck Reading Light w/USB Chargers	PN – 513038

**NOTE: Most Interior Lighting is LED and a replacement fixture will be required.**

#### Multiplex System Switch Control Panels

LCD Display	PN – 513074
Keypad, Slide-out	PN – 513075
Keypad, Galley	PN – 513076
Keypad, Bath	PN – 513077

#### Replacement Breakers - USA Breakers

Breaker, Type BR, 20 amp	PN – 510564-20
Breaker, 30 amp, Bryant	PN – 510564-30
Breaker, Type BRD, BD 20-20	PN – 510564-2020
GFI Breaker, Type BR, 20GFI	PN – 510564-20GFI

# Maintenance

Replacement Rivets			
Interior			
Part Number	330164	330134-05	325121-03
Rivet Name	MGL100-U6-9	RV6601-0604S	RV6607-6-8
Head Style	Flush Head	Countersunk	Shaveable
Body Diameter (Inches)	0.187 (3/16)	0.205 (3/16)	0.205 (3/16)
Hole Size	0.191-0.201	0.209-0.221	0.209-0.221
Drill Number	NA	4	4
Grip Range In (Inches)	0.305-.500	0.106-0.250	0.050-0.500
Length Under Head (Max. Inches)	0.929	0.935	1.00
Head Diameter (Nominal)	0.345	0.340	0.469
Head Height (Max. Inches)	0.070	0.103	0.094
Typical Sheer Strength (lb)*	1300	675	675
Typical Tensile Strength (lb)*	950	450	450
*Values shown are a guide only and may vary depending upon the application.			

Replacement Filters	
Air Conditioner	PN – 690699-100

Touch-up Caulking	
Seam-Fil White	PN – 360301-02
Seam-Fil Black	PN – 360301-04
Fil-Stik Black	PN – 28431W-01
Fil-Stik Gray	PN – 28431W-02
Fil-Stik White	PN – 28431W-03

## Exterior Care

The following exterior care products are recommended by Airstream. Read and follow label directions. Exterior sealant should be checked and resealed once a year.

**Walbernize Super Seal (PN - 28433W)** - Use to clean and polish while depositing a reflective, water-proof, glaze finish. Recommend two applications a year.

**Acryl-R Seam Sealer (PN - 28430W-01 [16 oz can-Gray])** - Use anywhere a fine bead of gray sealant is required.

**Acryl-R Seam Sealer (PN - 28430W-04 [16 oz can-White])** - Use anywhere a fine bead of White sealant is required.

**Acryl-R Seam Sealer (PN - 28430W-06 [16 oz can-Clear])** - Use anywhere a fine bead of Clear sealant is required.

**AdSeal Premium Quality Sealant Adhesive (PN - 365330-01 [10 oz tube-White])** - Use anywhere a thicker bead of White sealant is required.

**AdSeal Premium Quality Sealant Adhesive (PN - 365330-02 [10 oz tube-Gray])** - Use anywhere a thicker bead of gray sealant is required.

**AdSeal Premium Quality Sealant Adhesive (PN - 365330-04 [10 oz tube-Black])** - Use anywhere a thicker bead of Black sealant is required.

**Sikaflex 221 Multi-Purpose Polyurethane Sealant (PN - 360180-04 [10 oz tube-Black])** - Use to seal below the rubrail, or anywhere a thicker bead of black sealant is required.

Mercedes Sprinter Touch-up Paint Codes	
Brilliant Silver	9744

Airstream Touch-up Paint Codes	
Base Paint	BASF Glasurit
Brilliant Silver	744
Black	UH
Charcoal	MA359.57



## Tire Care

The most important function of tires is to provide traction while moving and grip when steering or stopping. The tires on your touring coach are designed for highway use and must be properly maintained in order to maximize tire life, as well to provide a safe mode of transportation.

### Tire Care Tips

To reduce the risk of tire failure, we strongly recommend the following:

1. Check the pressure in your tires at least monthly when the tires are cool (after the vehicle has been stopped for 3 hours and then driven less than 1 mi). Do not reduce pressure when tires are hot. Use a tire gauge to check pressure and maintain it at the recommended level.
2. Never overload your tires. Heed the maximum load-carrying capability of your tires.
3. Check your tires frequently for scrapes, bulges, separations, cuts, or snags resulting from use. See your tire dealer immediately if any such condition is discovered.
4. Never operate your vehicle in excess of lawful speeds, the maximum speeds justified by driving conditions, or in excess of speeds recommended for the tires you are using.
5. Make every effort to avoid running over objects that may damage the tire through impact or cutting, such as chuck holes, glass, metal, etc.
6. Never drive on smooth tires. Tires should be removed when 2/32 in. of tread depth remains. In most states, it is illegal to drive with less than 2/32 in. remaining tread depth.
7. Park out of the sun whenever possible when in warm climates. In desert regions, use tire covers to prevent ultra violet light deterioration to tires.

## Tire Inspection and Storage

Before taking your touring coach on a trip or when removing it from an extended storage period, make it a practice to inspect the overall condition of your tires. Check for any type of condition or damage that might result in failure. A thorough check should include both inside and outside sidewalls, tread area, and the condition of hardware such as valve stems, valve caps, and wheels. The tread should be checked for any unusual wear, cracking, penetrations, and/or cuts. An uneven wear pattern can indicate misalignment or worn suspension parts.

Since many touring coach's are used seasonally and sometimes stored for extended times, it is possible that tires will take many years to wear out. Tires, as any rubber product, will age over time. If tires show cracking in the sidewall or tread surfaces that are more than 2/32-in. deep, they should be replaced before your next trip or vacation. Store your touring coach in a cool, dry area away from major heat sources and extreme cold. An enclosed storage area is best with no exposure to electromagnetic sources such as generators or transformers. If you must keep your touring coach outside, cover your tires from direct sunlight. Take your touring coach to your tire dealer for service to check or correct any of these conditions.

### NOTE

**California Tire Chain notice: Your motorhome may not be operated with tire chains.**

# Maintenance

## Battery (Maintenance Free)

Your Airstream Atlas is factory-equipped with a 12V, deep cycle AGM GPL-24T Lifeline battery. The house batteries are stored in the curbside compartment in front of the folding steps.

### Battery Amp Draw and Testing

For maximum battery life in AGM applications, do not discharge the battery below 50%. Discharging the battery to 100% will shorten the batteries life. A battery that is allowed to completely lose its charge will never regain its original power or a full charge. Once a battery is discharged, it will begin to sulfate and lose its capacity and longevity.

For proper load testing the battery should be fully charged and the voltage should be greater than 12.8 volts. A typical load test should be 3 times the amp hours for 15 seconds. At the end of 15 seconds the voltage of the battery should stay above 9.6 volts. If the battery cannot reach a fully charged voltage of 12.8 or greater the batteries will need to be equalized.

#### NOTE

**When checking the state of charge the battery needs to have been disconnected from a charging source and any loads for a minimum of four hours.**



#### WARNING

**When removing the batteries verify that shoreline power is not connected and/or the engine is not running. Risk of electrical shock may be present.**

The following chart shows the approximate % of charge SOC (State of charge) vs. OCV (Open circuit voltage).

State of Charge (%)	OCV per 12V battery
100	12.8 or greater
75	12.5
50	12.2
25	11.9
0	11.6 or less

Listed voltage levels are approximate and give an indication of the state of charge of a battery at rest. As the battery ages these voltage measurements will be lower.

For more information on charging, storing, and servicing your batteries please visit Lifeline's website at [Lifelinebatteries.com](http://Lifelinebatteries.com).

## Battery Cleaning

Battery maintenance is an important issue. Maintain a clean battery top and check terminals and cables for tightness and cleanliness. A dirty battery will dissipate its charge through surface contamination. Clean the battery top with a damp cloth and dry thoroughly.

To ensure maximum battery capacity on the charge and discharge, the battery terminals and the inside portion of the cable connector should be scraped or brushed. The terminals should be tight and free of corrosion. The battery should be cleaned using a baking soda and water mix, with a ratio of two tablespoons of baking soda to a pint of water. The cable connection should be cleaned and tightened regularly.

For battery service or replacement, go to a service station or dealer who sells and services the make of battery installed in your touring coach.

#### NOTE

**Reconnect the battery cables to the correct battery posts.**

## Battery Storage

During the winter, the batteries should be removed from the touring coach and stored in a cool, dry place, where there is no danger of freezing. While in storage, batteries should be boost charged every 90 days or when the open circuit voltage drops to 12.5 volts.

This OCV corresponds to approximately 75% state of charge. The following recommendations may be helpful if the battery is to be stored:

- When storing the battery in a vehicle or vessel, it is not necessary to leave it on charge. Disconnect the negative battery cable. This will prevent inadvertent discharging of the battery which may lead to a complete discharge.
- Fully charge the battery before putting it in storage and store in a cool place.

When storing your Atlas and leaving the house, batteries in place, it is recommended that the vehicle be plugged into a 120-volt, 30-amp shoreline connection for 24 to 48 hours every 30 days.

#### NOTE

**A battery will self-discharge 1-3% per month at 80 degrees.**

### LPG System

Your touring coach is equipped with a permanently-mounted tank for LPG with a remote fill and remote gas supply shut off switch. LPG burns with a clean blue flame. LPG is used where subfreezing temperatures are common, since it boils at -44°F. Keep in mind at these temperatures the BTU is lower than at 30°F. How long a full tank of gas will last is dependent on usage. In cold weather, when you are using the furnace, using large amounts of hot water, or cooking extensively, you will naturally use more LPG than you will in warm weather, or when doing limited cooking. On the average, with normal cooking and other appliance use, you can probably count on a few weeks of usage from the tank, if you are not running your generator.

If you have allowed the tank to run out, air may have gotten into the lines. In this event the air must be allowed to bleed from the lines before lighting appliances. Follow the appliance manufacturer's instructions and light the appliance closest to the LPG supply tank. Then move to the next closest, etc.

### LPG Tank Remote Fill

The LPG tank is filled by accessing the remote fill hookup located in the rear utility compartment on the passenger side. Be sure the fill is free of dirt. It may help to remind your LPG supplier to only use a clean fill hose to fill your tank. Turn off the remote switch when the LPG system is not in use, as it draws 12-volt current from the batteries.



#### WARNING

Only certified LPG suppliers should fill the LPG tank. Turn remote gas supply switch off before filling or refilling LPG tank.



#### WARNING

Always shut off the LPG gas when refueling the touring coach.

### Remote Gas Supply Switch



A remote switch for shutting off the gas to all appliances is located in the curbside rear utility compartment. The switch activates an electric solenoid which opens and closes, shutting the gas off at the tank. This switch should be turned off during the filling of the LPG tank.

Gas lines should be checked periodically for leaks with ammonia-free soapy water.



#### WARNING

Be careful when working around electricity, as it can carry dangerous amperage and cause sparks or combustion.

#### NOTE

The electric gas shut-off solenoid closes automatically when 12-volt power is disconnected. It will reopen when power is restored.



#### WARNING

All LP gas appliances must be turned off during refueling of touring coach fuel tanks and permanently-mounted LPG tank.



#### WARNING

Do not use open flame to search for problems. If gas can be smelled, appliance pilots fail to stay on, or any other abnormal situation occurs, use the remote supply switch to shut off the tank valve immediately and call on a qualified LPG service center or Airstream Service Center.

# Maintenance

---

## LPG Regulator

The LPG regulators used on Airstream Touring Coach's are designed for low-pressure service, with a normal outlet pressure setting of 11.5-in. water column. Only personnel trained in the proper procedures, codes, standards, etc., should service regulators. Have the regulator inspected each time the tank is refilled. Replace any regulator that has had water in the spring case, or shows evidence of external corrosion or corrosion inside the spring case.



### CAUTION

**Moisture in the LPG tank will cause a malfunction of the regulator in controlling proper pressure. This may result in the flame lifting off the burner or going out frequently. Many refueling stations will add approximately ¼ to ½ gal of alcohol allowing moisture to pass through the regulator without the formation of ice crystals.**

## LPG Connections

A quick-connect, low-pressure LPG connection is located under the passenger side rear quarter panel behind the dual wheels. It is a utility connection to use for an outside grill or other LPG appliance. Check that the remote LPG shut off switch is turned completely off. Slide the collar on the female end back and plug the male hose into the connection. Release the collar and check that the hose is properly connected by giving a firm pull on the hose. Turn the LPG remote shut off switch on and recheck all connections to the appliances and quick connection to be sure no leaks are present. Follow all instructions, cautions, and warnings in this manual when connecting and disconnecting appliances.

## Plumbing

### Water System (Self-Contained)

The fresh water system consists of a city water hookup, fresh water tank and drain valve, water pump, hot and cold water lines, water heater, and faucets. Full explanations on the locations and use of these features are explained in this section.

Before using the water system, check that the water heater bypass valve is turned to the use position. The bypass valve is located under the galley in the upper right hand corner, accessed by removing the galley drawers. See Winterizing and Storage for further information on the bypass. Make sure the fresh water tank drain valve is closed.

The water tank can be filled by connecting a potable water hose to the city water inlet and turning on the fresh water valve switch. A high-pressure RV/Marine FDA approved drinking water hose of at least ½-in. diameter made from material that is tasteless, odorless, and non-toxic should be used. It's a good idea to let the water run through the hose for a short time to flush it out. RVers sometimes fill their tanks with "home" water to avoid strange water that may be distasteful to them on short outings. Remember, the more water you carry in the Fresh Water tank, the less cargo carrying capacity you have for other items. The amount of water in the tank may be checked on the Multiplex Control Panel. The fresh water valve switch will automatically turn off when the tank is full.

Because the water heater is tankless it does not need to be filled. However, if the system has not been used for some time or is being used for the first time since draining the lines it is normal for air to have gotten into the lines. To expel the air, open the hot side of either the galley, wet-bath, or exterior shower faucet and turn on the water pump or connect to an exterior city water source. Close the cold side of all faucets. For some time the open faucet will only sputter. This is because the air is being pushed out through the lines. Once the air is expelled a steady stream of water will come from the faucet.

Now open a cold faucet. It will sputter for a short time, but will soon expel a steady stream. All other faucets can now be opened until all air is expelled.

Once the system is filled with water and the faucets are closed, the water pump will shut off. When a faucet is opened, the pump will come back on automatically. If the faucet is just barely open, it is normal for the pump to cycle on and off rapidly.

It is normal for a pump to occasionally cycle when all faucets are off to keep the water pressure at the set point. However, if it cycles frequently (e.g. more than a few times an hour) the plumbing system, pump, and pump strainer should be checked to be sure it is not losing pressure through a slow water leak or back through the pump.

### NOTE

**To prevent equipment damage, the water heater should only be started after the water system is primed and ready for use.**

### NOTE

**Turn the water pump off when the touring coach is left unattended.**

### Water Pump and Strainer

The water pump is controlled by the main Multiplex control panel or the panel located in the galley. Once the switch is turned on, the pump will run until the water pressure reaches approximately 55 psi. At this point, an internal pressure switch will shut it off. When a faucet is opened, the water pressure will drop and the pump will start to run again.

As a general rule, the water pump should be turned off while using a city water hookup; however, the water pressure at some campgrounds may be low. The water pump can be turned on to assist the city water hookup pressure. Be sure there is some water in the fresh water tank. The pump will only use the water that is needed out of the tank to bring the pressure up to the usual standard of 55 psi.

The water pump and strainer are located under the bathroom sink, accessed by opening the doors and removing the back panel. The strainer should be visually checked for accumulation of sand or debris that could affect water flow.

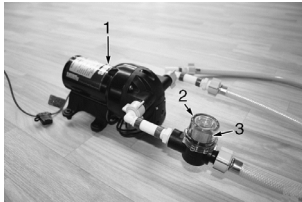

1. Pump
2. Housing Cap
3. Strainer

To clean the strainer screen: With the clear plastic at the top, press on the sides of the strainer releasing the tabs holding the clear plastic top in place, hold the sides in, and pull straight up on the clear plastic top to remove the screen assembly. Rinse all debris from the screen. Replace the screen assembly by aligning the screen in the seating grooves and pressing gently down until tabs catch and hold the clear plastic top in place.

The inlet and outlet hoses and the strainer assembly are held in place by self-sealing, blue, quick-connect fittings. To disconnect a hose or the strainer, grasp the blue tab on the female fitting by the grooved finger edges and pull straight out on the tab. This will release the male fitting connected to the hoses and strainer. Be sure that both the female and male fitting on the disconnect are free of all debris and are not damaged before replacing. Check the pump system for leaks any time the disconnect fittings on the hoses and/or strainer are removed.



### CAUTION

**Failure to check the quick disconnect fitting for water leaks when reinstalling inlet and outlet hoses or the water pump strainer may cause the pump system to leak, causing damage to personal property.**

### Sanitizing

Potable water systems require periodic maintenance to deliver a consistent flow of fresh water. Depending on use and the environment the system is subject to, sanitizing is recommended prior to storing and before using the water system after a period of storage. Systems with new components, or ones that have been subjected to contamination should also be disinfected as follows:

1. Use one of the following methods to determine the amount of common household bleach needed to sanitize the tank.
  - a. Multiply "gallons of tank capacity" by 0.13; the result is the ounces of bleach needed to sanitize the tank.
  - b. Multiply "Liters of tank capacity" by 1.0; the result is the milliliters of bleach needed to sanitize the tank.
2. Mix the proper amount of bleach into a container of water.
3. Pour the correct amount of solution (water/bleach) into the Fresh Water tank and fill with potable water.
4. Open all faucets (hot and cold) allowing the water to run until the distinct odor of chlorine is detected.
5. The standard solution must have 4 hours of contact time to disinfect completely. Doubling the solution concentration will allow for contact time of one (1) hour.
6. When the contact time is completed, drain the tank. Refill with potable water and flush the plumbing of all sanitizing solution.

### NOTE

**The sanitizing procedure outlined above is in conformance with the approved procedures of RVIA ANSI A 119.2 and the U.S. Public Health Service.**



# Maintenance

## Drain and Waste System

Your touring coach has a drain and waste system that includes waste-holding tanks made from corrosion-free, molded plastic, with trouble-free dump valves.

The main (Black Water) holding tank enables you to use the toilet for several days away from disposal facilities. The wastewater from the sinks and shower, drain into the auxiliary (Gray Water) holding tank.

Each tank has its own dump valve with both tanks draining through a common outlet. Therefore, only one sewer hose connection is needed when hooking up to a dump station.

Almost all campgrounds will have dumping facilities. Park directories, such as Woodalls and Rand McNally, also list dumping stations. Furthermore, the navigation systems GPS can be used to locate nearby dumping stations or highlight stations along your route.

Check your monitor panel frequently (main Multiplex control panel or Seelevel monitor). When the Black Water holding tank is completely full, sewage cannot be emptied from the toilet bowl. If the Gray Water holding tank is overfilled, drain water will back up into the shower floor pan and cause an unpleasant cleaning job. Never drain the tanks at any place other than an approved dumping station.

### NOTE

**Never put wet strength paper towels or tissues in your holding tank since they will not dissolve and can catch in the mechanism of the dump valve. Colored toilet tissue is slower to dissolve than white. Most motorhome accessory stores offer tissue designed for RV's that will completely dissolve.**

### Macerator Pump

The portable waste pump is the ideal solution for emptying holding tanks on touring coach's and avoiding dump stations. The macerator section grinds waste down to a particle size of 1/8-in. maximum. The waste pump will macerate and pump all waste and tissue normally found in recreational vehicle waste systems.



### CAUTION

**The waste hose is pressurized when operating the macerator pump. Secure the loose hose end at the disposal facility with supplied inlet adaptors before turning on pump.**

The high-pressure waste hose is stored on an electric hose reel and connected to the Discharge Port Adaptor. It has a threaded, drip-proof valve with a versatile, two-size, threaded adaptor allowing the valve to be connected to 3 sizes of threaded inlets, including an exterior home sewer clean-out. The adaptor snaps over the valve threads. A rubber ring is also provided to lodge into a non-threaded inlet. If the rubber ring seems loose when used, Airstream recommends using some type of weight to further secure the hose.

Each holding tank, the macerator pump, and macerator pump electric hose reel have individual switches which are located in the roadside rear utility compartment. Each valve switch has a light that illuminates to let you know the valve is opened. Pressing a dump valve switch and holding it for 2-3 seconds until it is lit opens a holding tank valve. Pressing it again for 2-3 seconds closes it. The macerator pump has an ON/OFF toggle switch. The reel has a switch for releasing and retracting the hose, once the hose is released it is deployed manually. To retract the hose, press and hold the retract button while guiding the hose in place.

### NOTE

**Do not run Macerator pump more than 15 minutes continuously. Do not run the Macerator pump dry for more than 30 seconds. THE MACERATOR WILL NOT HANDLE HARD SOLID OBJECTS, SANITARY NAPKINS OR RAGS. Never put wet strength paper towels, tissues, or sanitary napkins in your holding tank. They will not dissolve and will jam the mechanism of the dump valve and the macerator pump impeller.**

### Macerator Applications

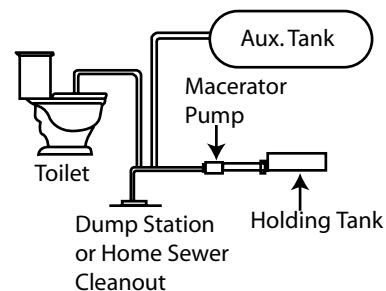

- Empty holding tanks when no dump stations are convenient.
- Transfer waste from holding tank to an auxiliary tank.
- The macerator pump can be used to empty the holding tank into any convenient sewer receiver such as a sewer clean-out at your home.



### Emptying the Black and Gray Water Holding Tanks

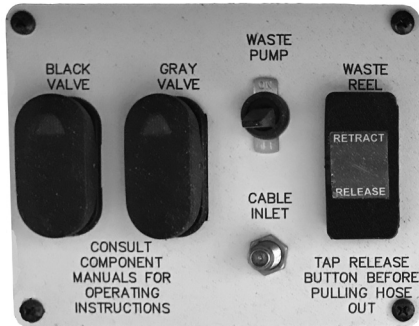

1. Remove the high pressure waste hose by opening the hose reel compartment door and momentarily pressing the “release” switch. Once released the hose can be manually pulled out. Secure the hose at the disposal facility inlet using the threaded or rubber adaptor and open the drip proof valve on the end of the hose.

 **CAUTION**

**The pressure from the macerator pump may push the hose from the inlet if the hose is not secured properly.**

2. Open the Black Water valve. Empty the Black Water tank first and the Gray Water tank second, using the Gray Water to help flush the pump and hose of Black Water sewage.
3. Turn on macerator pump to liquefy and pump out the solids in the tank.
4. When the black tank is empty, turn off the pump.
5. Open the Gray Water tank valve and turn on the pump. Run until just before the pump runs dry. Any trickle of gray water left will remain in discharge hose behind drip proof valve and is typical. Remember, running the pump dry for more than 30 seconds could damage the pump.
6. Turn the drip-proof valve off and remove the hose adaptor from the dump station inlet. Retract the hose into the hose reel by holding the switch in the “retract” position. Be sure to guide the hose back and forth onto the reel evenly. Close the compartment door.

**NOTE**

**Watch all connections while dumping. Close dump valve immediately, turn off pump, and close hose drip-proof valve if a leak is noticed.**

### Macerator Impeller Release Feature

Impeller Release Feature



After long periods of non-use, a stuck impeller can be easily broken loose with a screwdriver inserted in the motor shaft slot. Remove the rubber boot, turn the shaft clockwise, and replace the rubber boot.

### Manual Operation

In case of electric system failure, manually pull/push the arm located under the vehicle to open and close the valve.



# Maintenance

---

## Extended Stays

When you are in a park with a disposal facility, empty the tanks every few days or whenever they become almost full. Pumping a large volume of liquid through the tanks at a time will keep toilet paper and other solids completely washed away. Remember to empty the Black Water tank first and then the Gray Water tank using the Gray Water to flush the system. This practice will avoid the accumulation of solids in the tank, which could lead to an unpleasant cleaning job.

Should solids accumulate, fill the tank about half full with water with the black tank flush, and then drive the touring coach for a few miles. The turbulence and surging of the water will usually dissolve the solids into a suspension so the tank can be drained. Draining the tanks as described will protect them from freezing during storage.

## Black Water Tank Flush



Inside the macerator hose reel utility compartment is a water hose connector for the “black tank flush.” To use, hook up a garden hose and turn it on. Within the tank, a head with multiple holes will spray the interior surface of the tank. Once the tank is about half full, turn the garden hose off and flush the water from the tank using the macerator pump. The gate valve should be closed for the first couple of minutes, and then opened to let the water out in a rush. Repeat as needed. It is recommended the tank flush be used on a regular basis or the holes on the spray head may become clogged.

## Drain System Cleaning

The only cleaning agents that can be used without causing harm to the system are household ammonia and tri-sodium phosphate in small quantities. Do not use any product that contains any portion of petroleum distillates. This type of product will attack the rubber seals of your toilet and dump valve. Also, do not use any dish detergent or abrasive cleaners. All products should be marked as approved for ABS drainage systems.

## Winterizing and Storage

When storing your touring coach, use the same precautions as you would in your own home in regard to perishables, ventilation, winterizing, and rain protection. In addition, for prolonged storage periods, flush out all the drain lines and waste holding tanks. Also drain the entire water system, including the water heater and the Fresh Water tank. Instructions for draining the water system are explained in the following paragraphs on winterizing.

Twice a year, or after a long storage period, we suggest you take your unit into your Airstream dealer for a check-up and cleaning of the gas-operated appliances.

The main consideration in winterizing is to guard against freezing damage to the fresh water lines, the waste drain lines, the waste holding tanks, the water heater, and the batteries.

### NOTE

**Sprinter recommends disconnecting the current to all chassis electric consumers using the battery isolator switch if the vehicle sits for periods longer than 2 months. It is located to the right of the accelerator pedal in the driver’s foot well. Slide the red release down and pull it off the post. This will save jump starts, battery charge ups, and possible battery damage and replacement. The Mercedes-Benz Sprinter Operator’s Manual describes its location, operation, and cautions in detail.**

### NOTE

**In very cold weather, winterizing the touring coach is recommended to prevent damage to the waste systems. Use common sense and winterize as needed.**

### Touring Coach Winterization

1. Level the touring coach from side to side and front to rear, turn the water pump off, and disconnect the city water.
2. Open all the hot and cold water faucets.
3. Open the fresh water tank drain valve and water heater drain valve. The fresh water tank drain valve is located under the touring coach in front of the roadside wheels. Remove the service panel on the back of the water heater to access the drain valve. The water heater is located under the galley and accessed by removing the galley drawers. If a level surface is not available, park the touring coach facing slightly uphill until water draining ceases and then downhill until water draining ceases.
4. Follow the winterizing instructions for your toilet.
5. While the water is draining from the systems remove, drain, and store the wet bath and the exterior shower hoses and shower heads.
6. After the water has stopped running, apply at most 30 lb of air pressure at the city water inlet. This can be accomplished at a service station if no air compressor is available. Air fittings with regulators can be purchased for the city water inlet. Be sure the toilet flush valve, toilet shut off valve, all drain valves, and all faucets are open and the pump outlet hose is disconnected. 50 lb of air pressure can be accomplished only if the water heater bypass valve has been set to its bypass position. If more than 30 lbs of pressure is used on the water heater damage could occur.
7. Water pump: Remove quick-connect outlet fitting from the pump and turn the pump on briefly to pump out any remaining water from the pump head and lines from the tank. Check the water pump strainer to be sure no water remains. There should be very little water if the tank is drained. Be sure to have a catch pan or a rag under the pump to prevent water from spilling into the touring coach. Leave the fittings disconnected from the pump until the system is ready to be used again. Leave a note on the water pump switch that the plumbing is not connected.

8. Remove the house batteries from your touring coach and store in a cool dry place where there is no danger of freezing. It is very important for optimum life of your battery to check it periodically and to keep it fully charged. This is especially true in winter months, when the temperature may drop below freezing. If the period of storage is for 30 days or less, you may turn off the battery disconnect switch rather than remove the battery. Continue to check and recharge the battery as needed, at least weekly in severe weather.

**For additional winterizing protection, add RV, non-toxic antifreeze (approved for drinking water systems) to your water lines using the following procedure:**

1. Reconnect all lines except the one to the pump inlet port and close all drain valves.
2. Turn the water heater bypass valve to its open position, see diagram below. The valve is located under the galley accessed by removing the drawers.

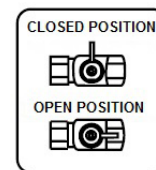

3. Attach a length of hose to the water pump inlet port. This piece of hose should be long enough for the free end to be inserted into and reach the bottom of a RV, non-toxic antifreeze container.
4. Check that all interior water faucets are still open.
5. Insert hose length into container containing, RV, non-toxic antifreeze, turn the pump on, and run the water pump until the RV, non-toxic antifreeze solution fills all water lines. Flush toilet.
6. Open exterior shower faucet until RV, non-toxic antifreeze comes out of the hose, shut off the valve, and remove the drain valve/hose assembly.
7. Close water fixtures as the RV, non-toxic antifreeze begins to come out. Shut off the pump when RV, non-toxic antifreeze has been distributed throughout the system, and then reopen all faucets to relieve pump pressure.
8. Disconnect the hose length from the pump inlet fitting, and reconnect water system inlet line.

# Maintenance

---

## **Water Heater Winterizing**

If the touring coach is to be stored during winter months, the water heater system must be drained to prevent damage from freezing. Once drained RV non-toxic antifreeze can be added.

1. Turn off electrical power to water heater by using the on demand control center or by removing the fuse.
2. Shut off gas supply to water heater.
3. Turn off pressure pump on water system.
4. Open both hot and cold water faucets.
5. Remove service panel to access system drain valve. The water heater is located under the galley and accessed by removing the galley drawers.



6. Turn drain valve knob counterclockwise to drain.
7. Follow the Winterizing and Storage instructions for draining entire water system.

### **NOTE**

**System will have to be refilled with water and all air removed from lines before unit will re-light.**

## **Pump Winterizing**

Plan your winterizing and storage ahead, and be sure the holding tanks are drained and flushed thoroughly. This is very important, as the frozen sewage and water could seriously damage the system. After dumping tanks, add a quart or two of RV, non-toxic antifreeze to one of the holding tanks and start the macerator pump. Run the pump until the RV, non-toxic antifreeze comes out the end of the pump hose. Leave dump valves open. As extra protection, open the toilet valve and add a quart of RV, non-toxic antifreeze to the Black Water tank and pour a quart of RV, non-toxic antifreeze into a sink drain to protect the holding tanks, valves, and pump from residual water freezing.

### **NOTE**

**In very cold weather, winterizing the touring coach is recommended to prevent damage to the waste systems. Use common sense and winterize as needed.**

## **Toilet**

### **Toilet Winterizing**

Draining Method: Turn off the touring coach's water supply. Drain toilet bowl. Disconnect supply line at water valve. Completely drain the toilet's water supply line.

### **NOTE**

**To avoid damage when using air pressure to blow water from the lines, make sure toilet valve is in the open position.**

### **NOTE**

**If water is frozen in the toilet, do not attempt to flush until the ice thaws. Never use automotive type antifreeze.**

### **Removal**

1. Shut off water valve behind toilet or main water supply and flush toilet.
2. Disconnect water supply line from toilet. You will probably find a small mirror very useful.
3. Remove mounting nuts.
4. Cover riser or tank inlet with cardboard to prevent debris from falling into tank.

### **NOTE**

**Always replace flange seal when toilet has been removed.**



**Maintenance**

If the bowl-sealing blade does not operate freely after extended use, it may be restored to its original, smooth operating condition by applying a light film of silicone spray to the blade. To clean the toilet use SeaLand® Toilet Bowl Cleaner or any other high grade, non-abrasive cleaner. Do not use highly concentrated or high acid content household cleaners. They may damage the rubber seals.

**Troubleshooting**

1. Leaks:
  - a. Back of toilet: check water supply line connection at water valve. Secure or tighten as necessary. If leak persists from water valve, replace.
  - b. Vacuum breaker leaks while flushing: make sure vacuum breaker stem is pushed fully into sealing grommet in back of bowl. If leak continues replace vacuum breaker.
  - c. Between closet flange and toilet: check flange nuts for tightness. If leak continues, remove toilet and check flange height. Replace flange seal.
2. Toilet won't hold water:
  - a. Check for and remove any debris from blade-ball seal track.
  - b. Check blade/ball seal compression mechanism. If blade/ball seal is worn, replace.
3. Harder than normal pedal or hand lever operation: Apply light film of toilet seal lubricant or silicone spray to blade/ball. (Note: To avoid damage, do not use spray lubricants other than silicone.)
4. Poor flush: Pedals or hand levers must be held fully open during flush. A good flush should be obtained within 2 to 3 seconds. If problem persists, remove the water supply line and check flow rate. The flow rate should be at least 10 qt (9.5 L) per minute.

**Restoring Service**

1. Re-install the fully charged house battery.
2. Close the holding tank dump valves, water faucets, and fresh water tank drain.
3. Reconnect water pump line.
4. Add water to the fresh water tank.
5. Turn the water pump on.
6. Open and close faucet valves one at a time until water runs clear at all faucets signaling RV, non-toxic antifreeze is flushed out of lines. Go back and recheck water clarity at all faucets.
7. Turn off water pump.
8. Hook up city water, open faucet valves, and recheck water clarity.

Close water heater drain valve and reset water heater bypass valve to normal operating position.

**Exterior Door****Lubrication**

Apply a little paraffin or grease to the striker pockets and a slight amount of household oil to the lock mechanisms to keep the locks operating smoothly. Also, lubricate the hinge pins periodically with household oil. Use the lubricant sparingly and remove any excess immediately.

**Adjustments**

Door adjustments can be affected by:

- The coach being improperly leveled.
- Striker bolt alignment being out of adjustment, (striker bolt is adjustable).

When using the stabilizers (for eliminating movement-not leveling) on your Airstream be sure to check the fit of your door before and after extending stabilizers. The fit of the door can be affected if the coach is not level side to side and front to back.





## 12-Volt Schematic

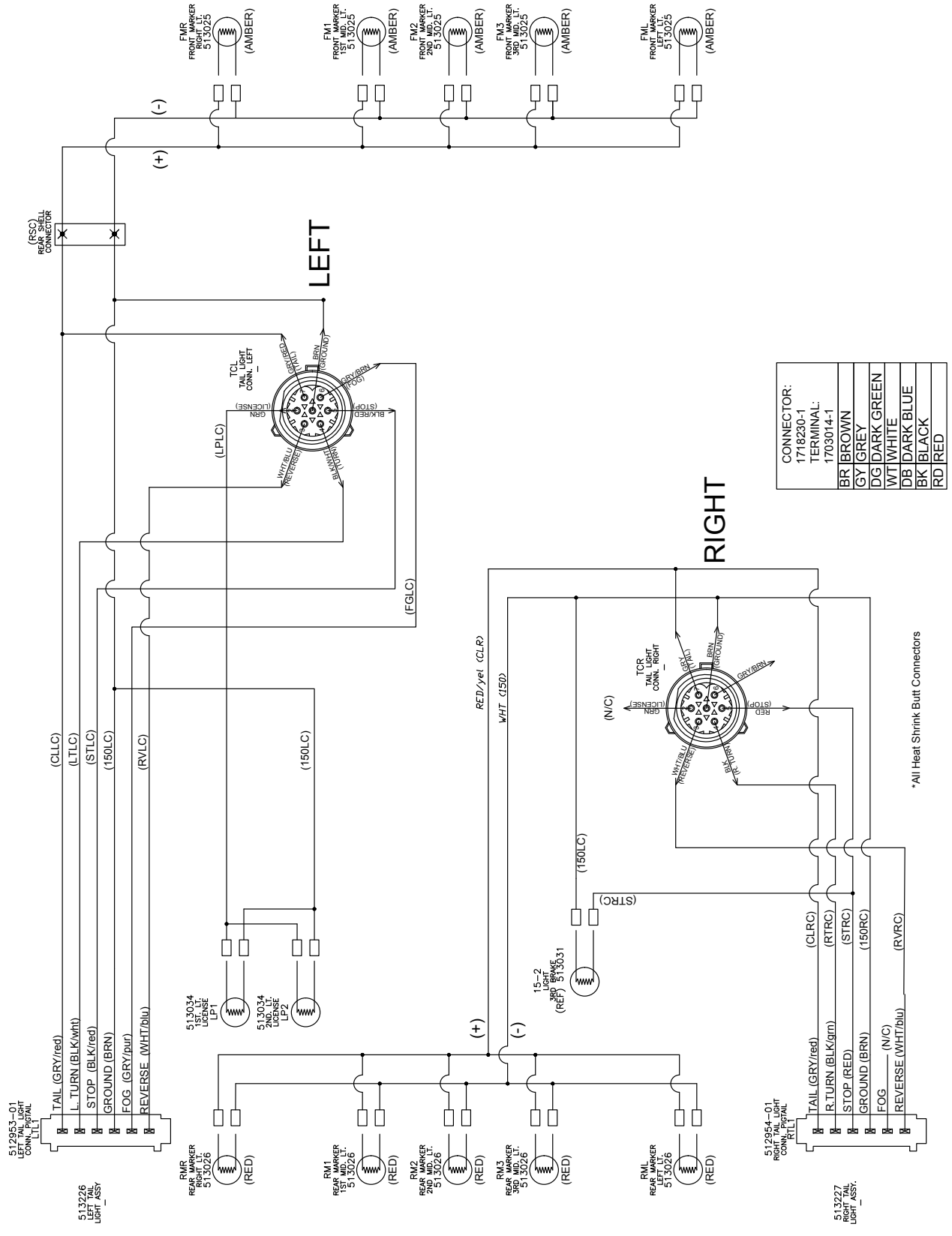

## 12-Volt Schematic

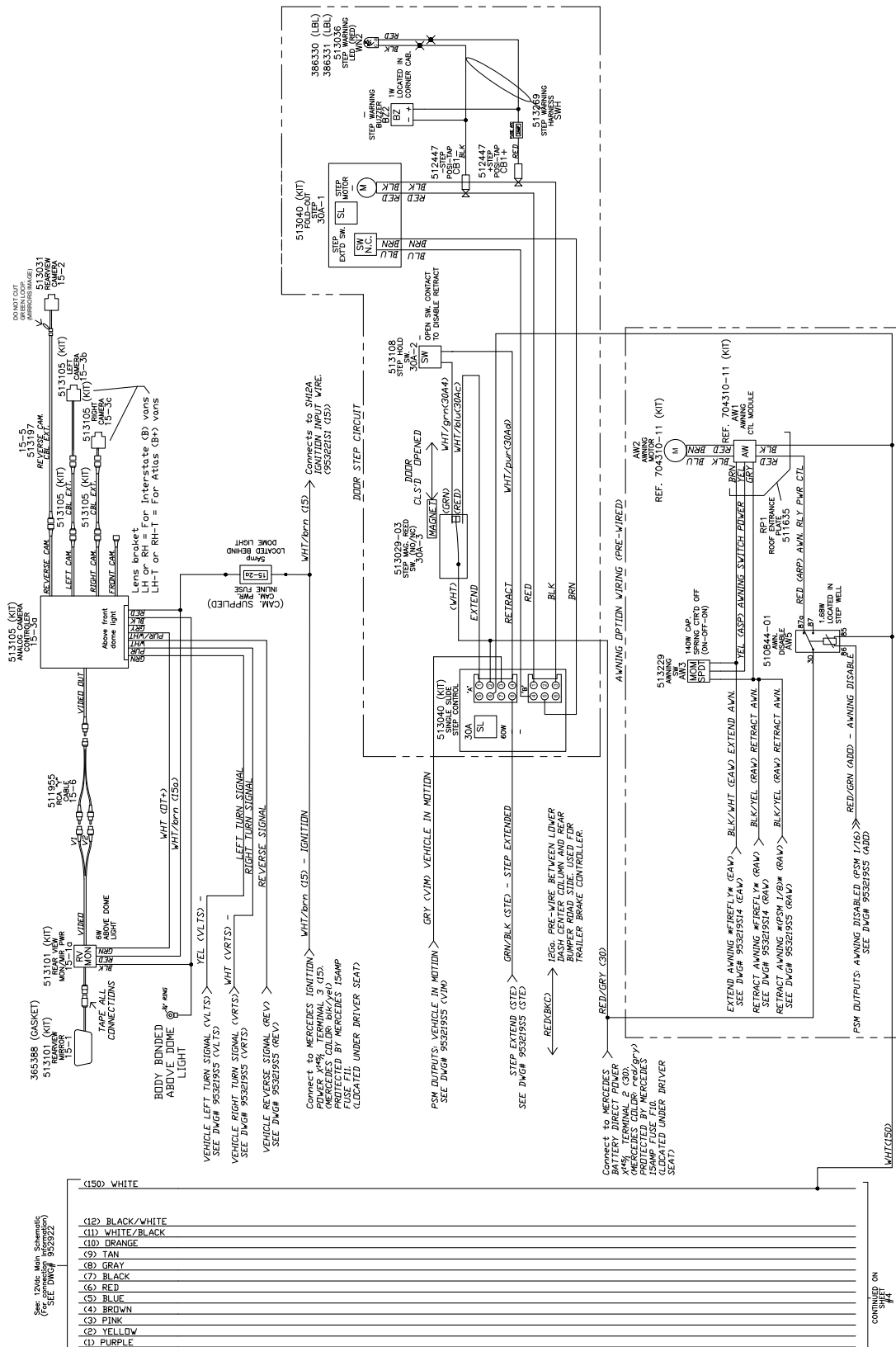



# Maintenance

## 12-Volt Schematic

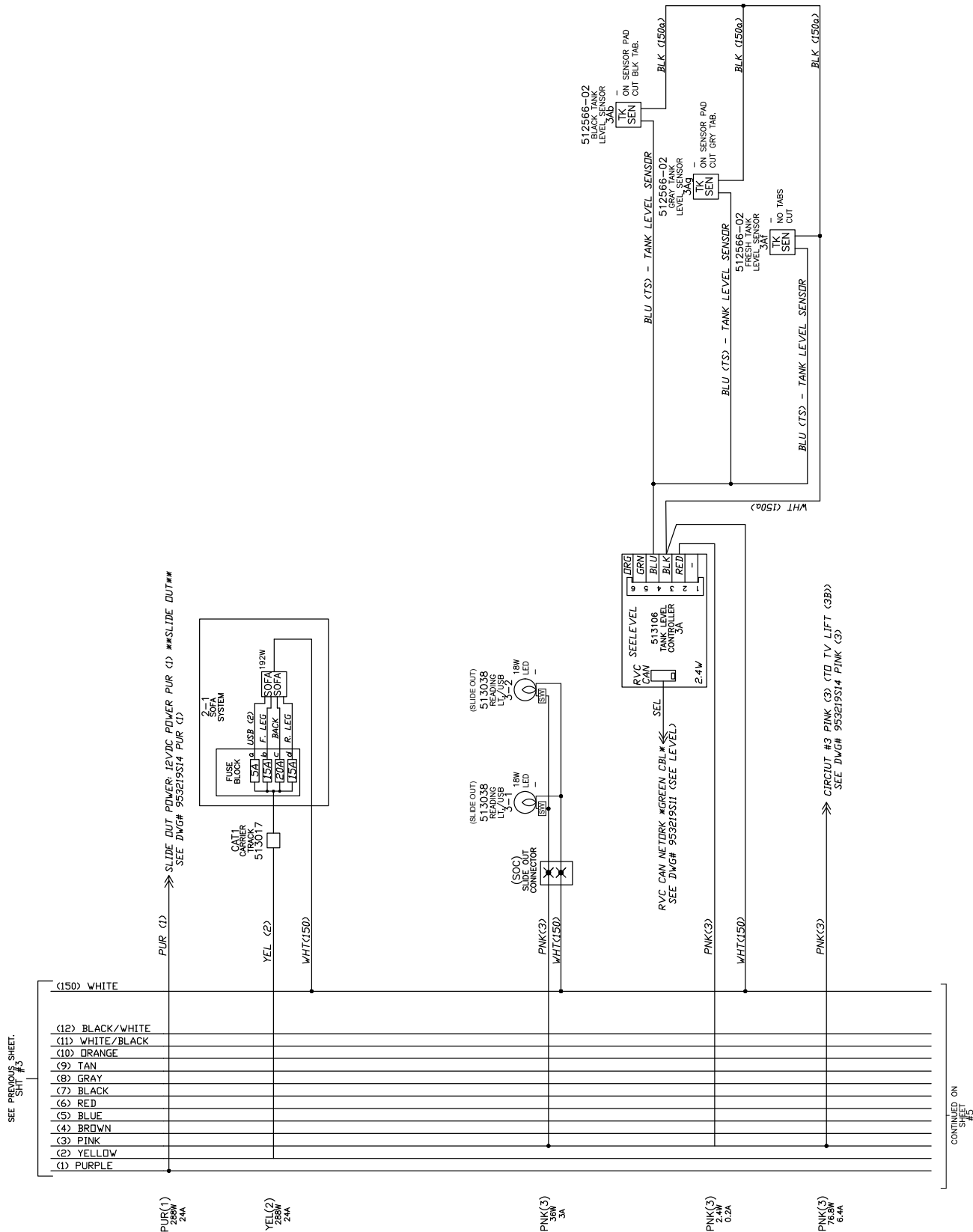

## 12-Volt Schematic

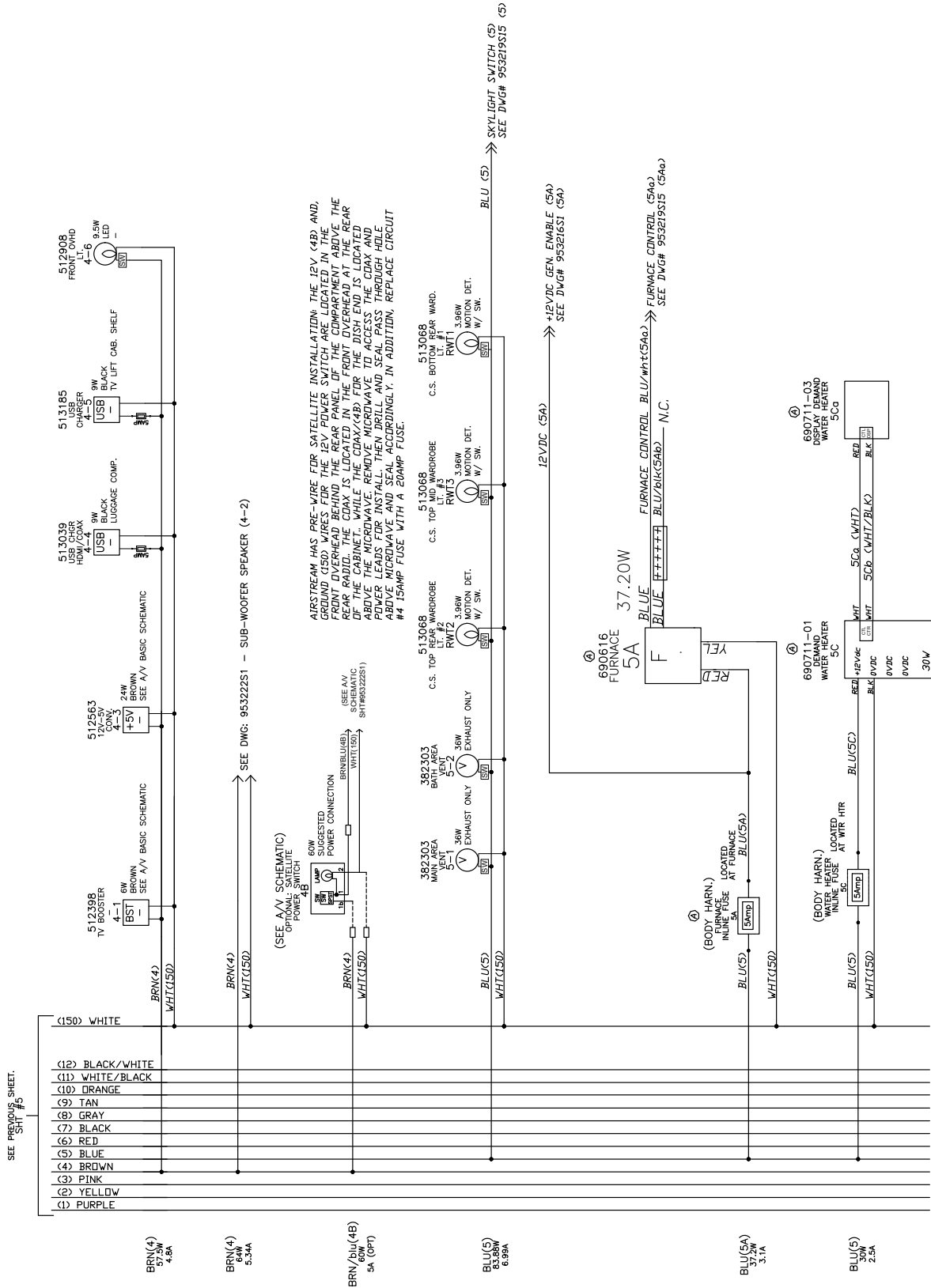

CONTINUED ON SHEET #7





## 12-Volt Schematic

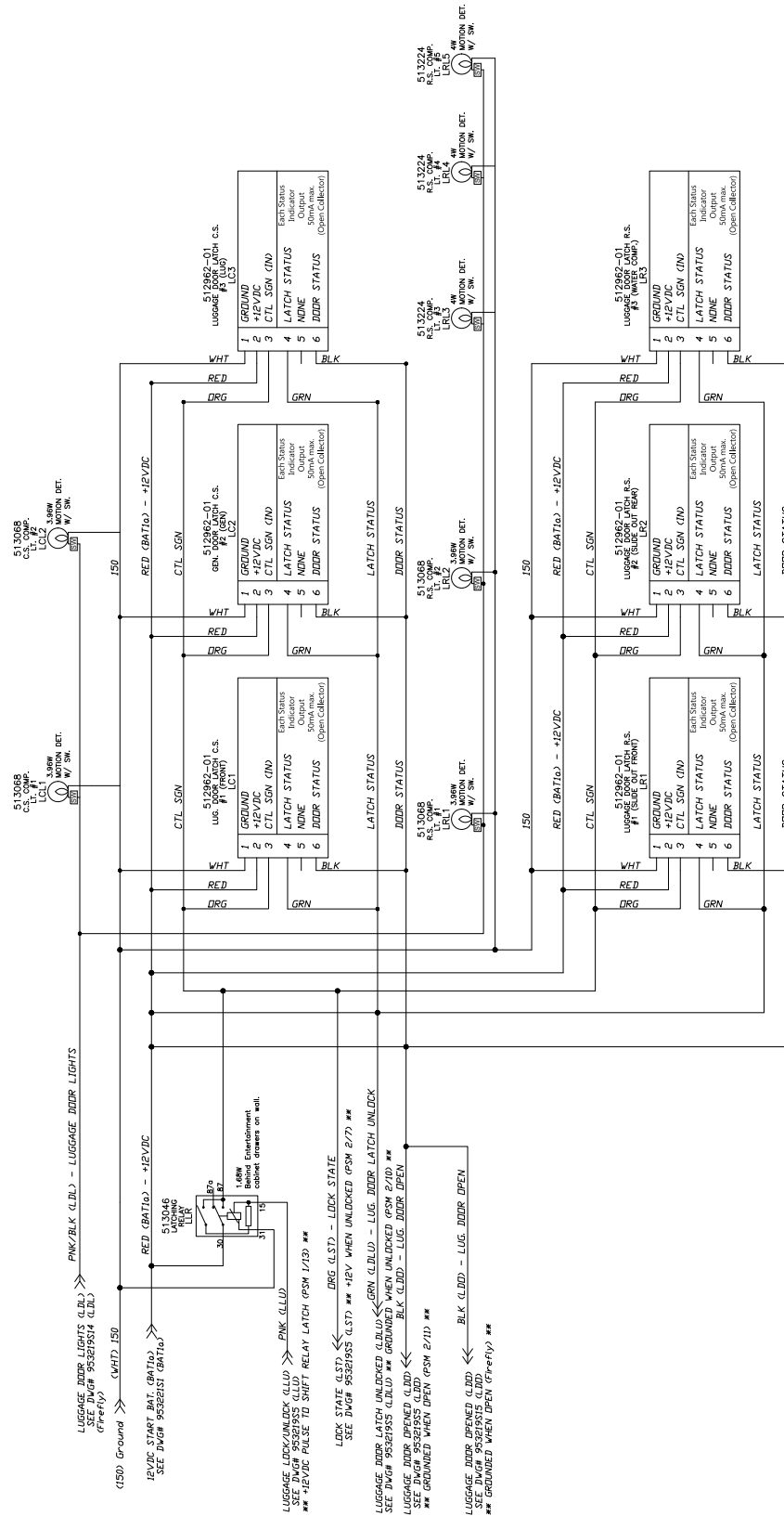



## 12-Volt Schematic

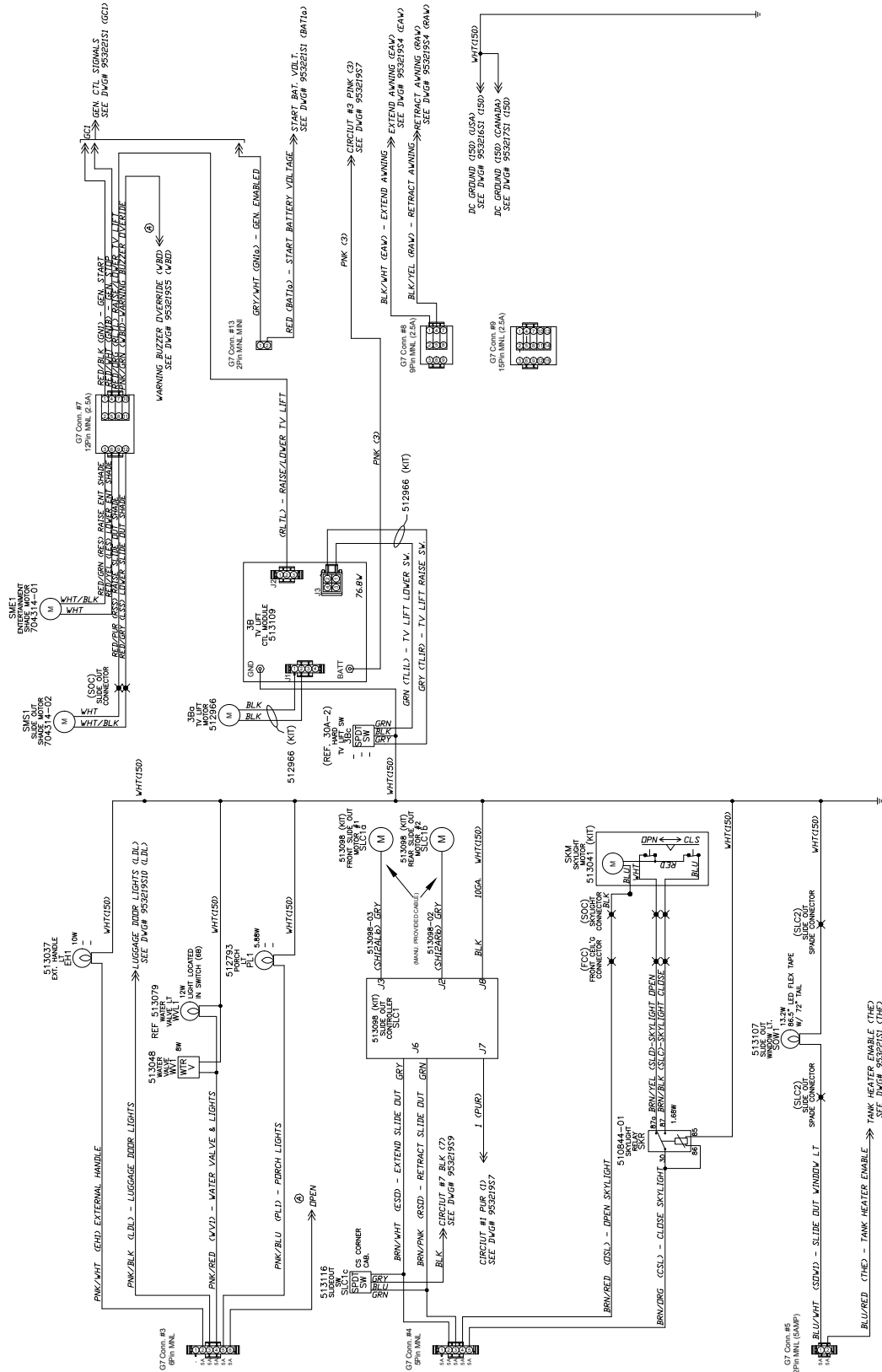

# Maintenance

## 12-Volt Schematic

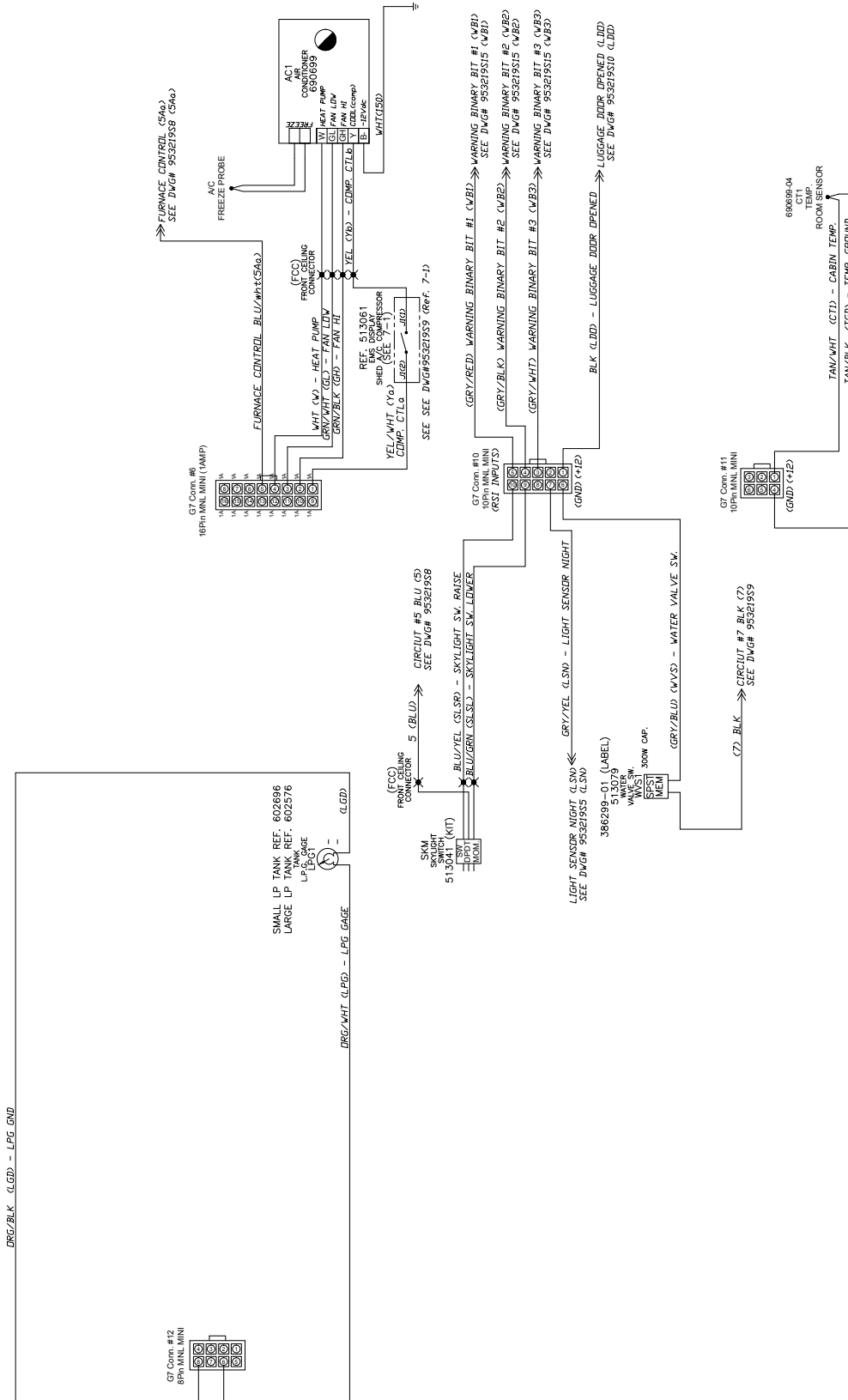

## 12-Volt Standard Parts List

REV.	ITEM	SYM	DESCRIPTION	PN	QTY	UM	NOTES
Aa	1	(CBL1-12)	CABLE KIT, MAIN 12Volt DC	513009-01 RevC	1	KIT	
	2	(MF3, MF3a)	FUSEHOLDER , FOR CBBF FUSE WITH DUAL STUD	512661-01	1	EA	
	3	MF4	FUSEHOLDER , FOR CBBF FUSE WITH SINGLE STUD	512661	1	EA	
B	4	(REF) MF2	FUSE, 7.5AMP, 12VDC, TYPE ATC	500773-07	1	EA	
	5	(REF) SH1Bb-D	6A05 DIODE INCLUDED W/ BODY HARN.		-	EA	SEE HARN.
	6	(SH1D, SH1Da)	KIT-CHARGE CONTROLLER DISPLAY - SOLAR	511846	1	EA	
B	7	GEN1	GENERATOR, ONAN QUIET LP, 3600 WATTS (LP VAPOR)	REF 512950(KIT)	*	EA	LP OPT. ??
B	8	GEN1	GENERATOR, ONAN QUIET DIESEL, 3200 WATTS (DIESEL)	REF 513252(KIT)	*	EA	Diesel OPT. ??
B	9	GNC1	GEN., ONAN GEN. DISPLAY - DIESEL (SEE KIT 513252)	REF 513252(KIT)	*	EA	Diesel OPT. ??
	10	INV1	INV./CONV. 1000W (INV.) - 50AMP (CONV) MAGNUM	512609	1	EA	
	11	INV1-1	INVERTER REMOTE CONTROL MAGNUM	512609-01	1	EA	
	12	M-1, M-1a	BATTERY, LIFELINE 12V TYPE 24 AGM	511828	2	EA	
	13	M-5	SENSOR, BATTERY TEMP. MAGNUM (BTS)	REF 512609-02	REF	EA	
	14	MD1	POWER CENTER, 30A 110Vac/12Vdc	REF 512547	REF 1	EA	
B	15	MF1	FUSE, TYPE BF1-32, 150AMP W/ 5M HOLES	512278-150	1	EA	
	16	MF3, MF3a	FUSE, TYPE: CBBF, 150AMP	512660-150	2	EA	
	17	SH1	DISC., BATTERY MANAGER W/ INTEGRATED FUSES & AU	512995	1	EA	
	18	SH12	FUSE, TYPE BF1-32, 50AMP W/ 5M HOLES	512278-50	1	EA	
	19	(SH12A, SH12AL, SH12AR, SH12AD, SH12AE)	JACK- STABILIZER XL #8450AM KIT W/30A FUSE	382299 (KIT)	1	EA	
Aa	20	SH13	FUSE, TYPE BF1-32, 40AMP W/ 5M HOLES	512278-40	1	EA	
C	21	SH1E, SH1F	BREAKER, UNIVERSAL CIRCUIT, ATO BLADE TYPE 2, 15AMP	512646-15	2	EA	
C	22	SH1A, SH1B, SH1D	BREAKER, UNIVERSAL CIRCUIT, ATO BLADE TYPE 2, 20AMP	512646-20	3	EA	
	23	SH1Ca, SH1Cf	VALVE-ELEC.WASTE (BARKER)	512411	2	EA	
	24	SH1Ch, SH1Ce	SWITCH WATERPROOF (Sigma)	513128	2	EA	
	25	SH1B	SWITCH, WASTE, MACERATOR, MOM. PB	602205-01	1	EA	
	26	SH1Bf	PUMP, WASTE, MACERATOR, SELF-PRIM.	602176	1	EA	
	27	SH1Fa	SWITCH FOR WASTE REEL	512934-01	1	EA	
	28	SH1Fb	WASTE HOSE REEL KIT	512934	1	EA	
	29	SH1Db	ROOF, CONNECTOR 1 MC4 MALE & 1 MC4 FEMALE	513006	1	EA	
	30	SH1Da	HARN., 1 MC4 MALE TO 2 MC4 FEMALE	513007	1	EA	
	31	SH1Dd	HARN., 1 MC4 FEMALE TO 2 MC4 MALE	513008	1	EA	
	32	SH1Df, SH1De	SOLAR PANEL, FLEXABLE, 100 WATT	512805	2	EA	
	33	BAS	SWITCH, MOMENTERY SPST	512546	1	EA	
B	34	SH1Ab	RELAY BOSCH 0 332 209 151	510844-01	1	EA	
	35	SH1Cb, SH1Cg	RELAY SONG CHUAN 896H-1CH-D15W-001-12VDC	513212-01	2	EA	
Aa	36	ST-1	SEPARATOR-BATTERY W/SMART CTL. 175Amp	513208	1	EA	
	37	SH1Abf, SH1Abh, SH1Abi	HEATER PAD - HOLDING TANK	511812	3	EA	
	38	SH1Ea	LABEL, PB "BATTERY ASSIST."	386254	1	EA	
	39	BAT1, M-1	LABEL, WARNING BATTERY GROUND	386291	2	EA	
	40	'SH1aa	SW. ASS'Y., MST DISC. SW (DPDT)& LED MNT "BATTERY L	513004	1	EA	
	41	'SH1a1	LED GREEN 5/21" HOLE PANEL MNT, Wire Leads	513035	1	EA	
	42	SH1a1	LED RED 5/21" HOLE PANEL MNT, Wire Leads	513036	1	EA	
	43	(SH1Ce, SH1Ch, SH1B, SH1Fa)	PANEL, EXT. SW'S & COAX	386296-02	1	EA	
	44	General Use	FIR TREE MOUNT/ TIE ASMY	513110	15	EA	
	45	General Use	MOUNT, Cable Tie Mount-4 Way w/3M	513018	15	EA	
Aa	46	MF4	FUSE, TYPE: CBBF, 200AMP	512660-200	1	EA	
B	47	SH1C	BREAKER, UNIVER. CIRCUIT, ATO BLADE TYPE 2, 5AMP	512646-5	1	EA	
B	48	CV1	CLOSEOUT, READING LIGHT ABS	200773	2	EA	
B	49	M4d_1	SWITCH, MAIN DISC. 12VDC 275AMP MOTORIZED	512604	1	EA	





## 30-Amp 120-Volt Standard Parts list

REV.	ITEM	SYM	DESCRIPTION	PN	QTY	UM	NOTES
	1	6a1-1	OUTLET, EXTERIOR, 120 VOLT	512741	1	EA	no paint
	2	6a1-1	RECEPTACLE-DUPLEX GRAY SELF CONTAINED	511814-01	1	EA	
A, B	3	4a-1	SCOTCHLOK RED WIRE NUT	500015	9	EA	
A	4	5b2-3	MICROWAVE CONTOURE 1500W	690657-08	1	EA	
	5	2a1-1	COLEMAN A/C. W/ DUMB CTL 15kBTU	690699	1	EA	
	6	4a2-1, 4a2-2, 4a2-3, 4a2-4, 5b2-1, 6a1-2 THRU 6a1-4	RECEPTACLE DUPLEX BLACK SELF CONTAINED	511815-01	8	EA	
	7	4a2-1, 4a2-2, 4a2-4, 5b2-1, 6a1-2 THRU 6a1-4	PLATE, RECEPTACLE, STAINLESS STEEL	511912	7	EA	
	8	TRN1 (2), INV1 (1)	CLAMP, ROMEX, 3/8 METAL	500013-01	4	EA	
	9	INV1	INVERTER/CONVERTER 1000 WATT - 50 AMP	REF 512609	*	EA	
A	10	(2 & 3) (BREAKER)	BREAKER BRYANT 20 AMP	510564-20	1	EA	
A	11	6 & 7 (GFIC BREAKER)	BREAKER, TYPE BR, 20GFI, #GFCB-	510564-20GFI	1	EA	
A	12	(4 & 5) (TANDEM BREAKER)	BREAKER, TYPE BRD, BD 20-20	510564-2020	1	EA	
	13	M & 1 (BREAKER)	BREAKER BRYANT 30 AMP	510564-30	1	EA	
	14	MD1a	EMS MINI-PCS I/O MODULE, DONUT	512357-02	1	EA	
	15	MD1	POWER CENTER, 30A 110VAC/12VDC	512547	1	EA	
	16	TRN1	TRANSFER SWTCH 30AMP	510562	1	EA	
	17	CN2	CONDUIT PRESSURE FITTING	511468-01	1	EA	
B	18	GEN1	GENERATOR, ONAN QUIET DIESEL, 3200 WATTS (DIESEL)	REF 513252(KIT)	*	EA	
B	19	GNC1	GEN., ONAN GEN. DISPLAY - DIESEL (SEE KIT 513252)	REF 513252(KIT)	*	EA	
B	20	CN1	Connector, Liquid Tight, 90 Degree, Plastic	511469-01	1	EA	
	21	PLG2	POWER INLET, 30A, 125V, MALE	513087-02	1	EA	no paint
	22	PLG1	POWER CORD 30AMP 45 DEG. ANGLED TWIST, 30', GRY	513127	1	EA	
B	23	0b1	CONDUIT, FLEXIBLE LIQUID TIGHT 1/2"	510857-04	3	FT	
	24	GENERAL USES	CONVOLUTED CONDUIT WITH SLIT 3/8" BLACK	201267-03	150	FT	
	25	5b2-2	FRIDGE/FREEZER 9.1 CU. FT. NOVAKOOL	REF 690692	*	EA	
	26	GENERAL USES	WIRE, #10-2 ROMEX W/GROUND	510152	10	FT	
	27	GENERAL USES	WIRE ROMEX 12-2 WITH GROUND	500040	181	FT	
	28	4a2-3a	SAMSUNG 40" LED SMART TV	REF 690697	*	EA	
	29	4a2-3b	SAMSUNG SOUND BAR HW-J250	REF 690698	*	EA	
B	30	GRD1	GROUND LUG	500038	4	EA	
A, B	31	Oa1	CORD, SJOOW 10-3, 300V 90 DEG. C	512437	14	FT	
B	32	GND1	COPPER, BARE 8Ga.	500839	30	FT	
C	33	ACE, GN1	RELAY, PILOT CONTROL 10A	513258	2	EA	
B	34	CN1	REDUCER, KNOCK-OUT 3/4" - 1/2"	513257-01	2	EA	



## Audio/Video Standard Parts List

REV.	ITEM	SYM	DESCRIPTION	PN	QTY	UM	NOTES
	1	TV2-2	DUAL COAX PLATE WHITE TT	511534	1	EA	
	2	TV1-1	ANTENNA-OMNI3000 -01=WHITE -02=BLACK	512657-02	1	EA	
B	3	SP1-1, SP2-1	6-3/4" BLACK SPEAKER, SHALLOW, FUSION (PAIR)	513225	1	PR	
	4	4-2	SUB WOOFER - POWERED 6.5" WEDGE	511822	1	EA	
	5	IF1	ISOLATION TRANSFORMER, 15 AMP	511608	1	EA	
	6	(RD1, ADP1a, GSP1, CN2-3, BCAN, USB1, AUD2-1)	FUSION RADIO, GPS, MIC w/ Harness	513013 (KIT)	1	EA	
	7	SIR1a	SIRIUS RADIO TUNER	512554	1	EA	
	8	SIR1	SIRIUS ANTENNA w/CABLE	512492-04	1	EA	
	9	4-1	BOOSTER, TV ANTENNA	REF 512398	REF	EA	
	10	EQ1-1	MOUNT, TV, ELECTRIC LIFT	REF 512966	REF	EA	
	11	HDMI2, HDMI3	CABLE, HDMI MALE TO MALE 25FT (PRE-WIRE)	512366-25	2	EA	
	12	HDMI5	CABLE, HDMI MALE TO MALE 8FT	513117-08	1	EA	
	13	HDMI6	CABLE, HDMI MALE TO MALE 10FT	512366-10	1	EA	
	14	TV1-2	SAMSUNG 40" LED SMART TV	690697	1	EA	
	15	SB1-1	SAMSUNG SOUND BAR HW-J250	690698	1	EA	
	16	TV2-1, TVa1b	COAX BARRAL CONNECTOR	510623	2	EA	
	17	TVa1c	Cable, Mini Coax, 6 Feet, Blue	513050	1	EA	
	18	TV2-1	PANEL, EXT. SW'S COAX	REF 386296-02	*	EA	
	19	HCU1	WALL PLATE, BLK 2 GANG, USB CHARGER & HDMI/COAX	REF 513039	REF	EA	
B	20	ANT1-3	ANT, CBL FEMALE MOTOROLA TO EURO (40-EU20)	513188	1	EA	
A	21	HANT	HARN., MERCEDES RADIO ANT. PWR/GND EXTENSION	513198	1	EA	
C	22	ADP1a	ANTENNA, ADAPTOR AFTRMARKET RADIO TO VW	512557	1	EA	
C	23	ANT1-1	ANT, CBL MALE MOTOROLA TO EURO (40-EU10)	513201	1	EA	
Option: Satellite							
	101	SR1	SATELLITE RECIEVER	DEALER SUPPLIED	1	EA	
	102	SAT1	SATELLITE DISH	DEALER SUPPLIED	1	EA	
	103	SAT1b1	PLATE, DUAL CABLE ENTRY (511635)	DEALER SUPPLIED	1	EA	
	104	SAT1a1	COAX BARRAL CONNECTOR (510623)	DEALER SUPPLIED	1	EA	
	105	TV2ab	COAX CABLE W/ "F" CONNECTOR ENDS	DEALER SUPPLIED	??	FT	
	106	TV2ba	COAX CABLE W/ "F" CONNECTOR ENDS	DEALER SUPPLIED	??	FT	
OPTION: BLU-RAY							
	200	HDMI1	CABLE, HDMI MALE TO MALE 2FT (513117-02)	DEALER SUPPLIED	1	EA	
	201	BR1	BLU-RAY DISC/DVD PLAYER, SONY (513256)	DEALER SUPPLIED	1	EA	

# Maintenance

---

## Standard 30-Amp Circuit Breaker Layout

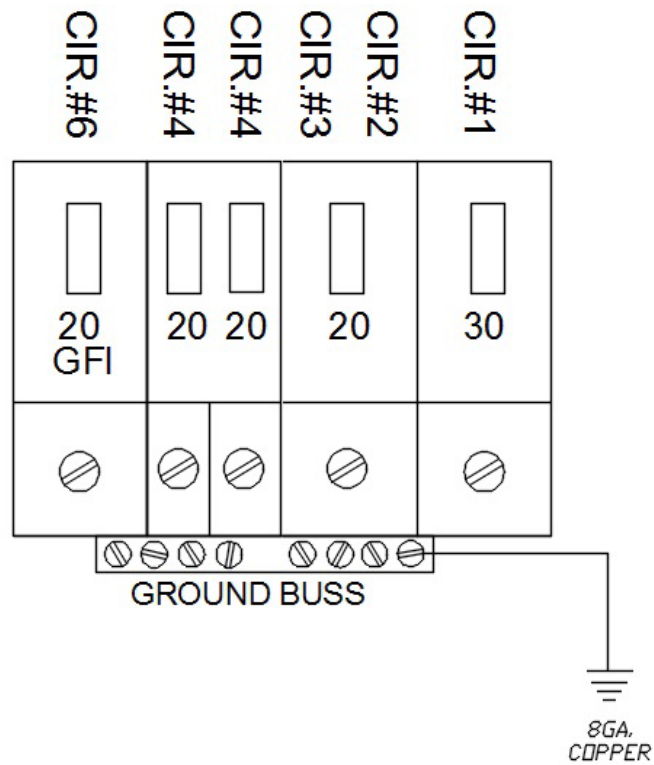

- Circuit 1. 30 amp, Main
  - Circuit 2. 20 amp, Air conditioner
  - Circuit 3. 20 amp, Air conditioner
  - Circuit 4. 20 amp, Inverter
  - Circuit 5. 20 amp, Microwave, EMS
  - Circuit 6. 20 amp GFI, GFCI receptacles.
- Breaker label content may vary.

## Multiplex Circuit Control Board Layout

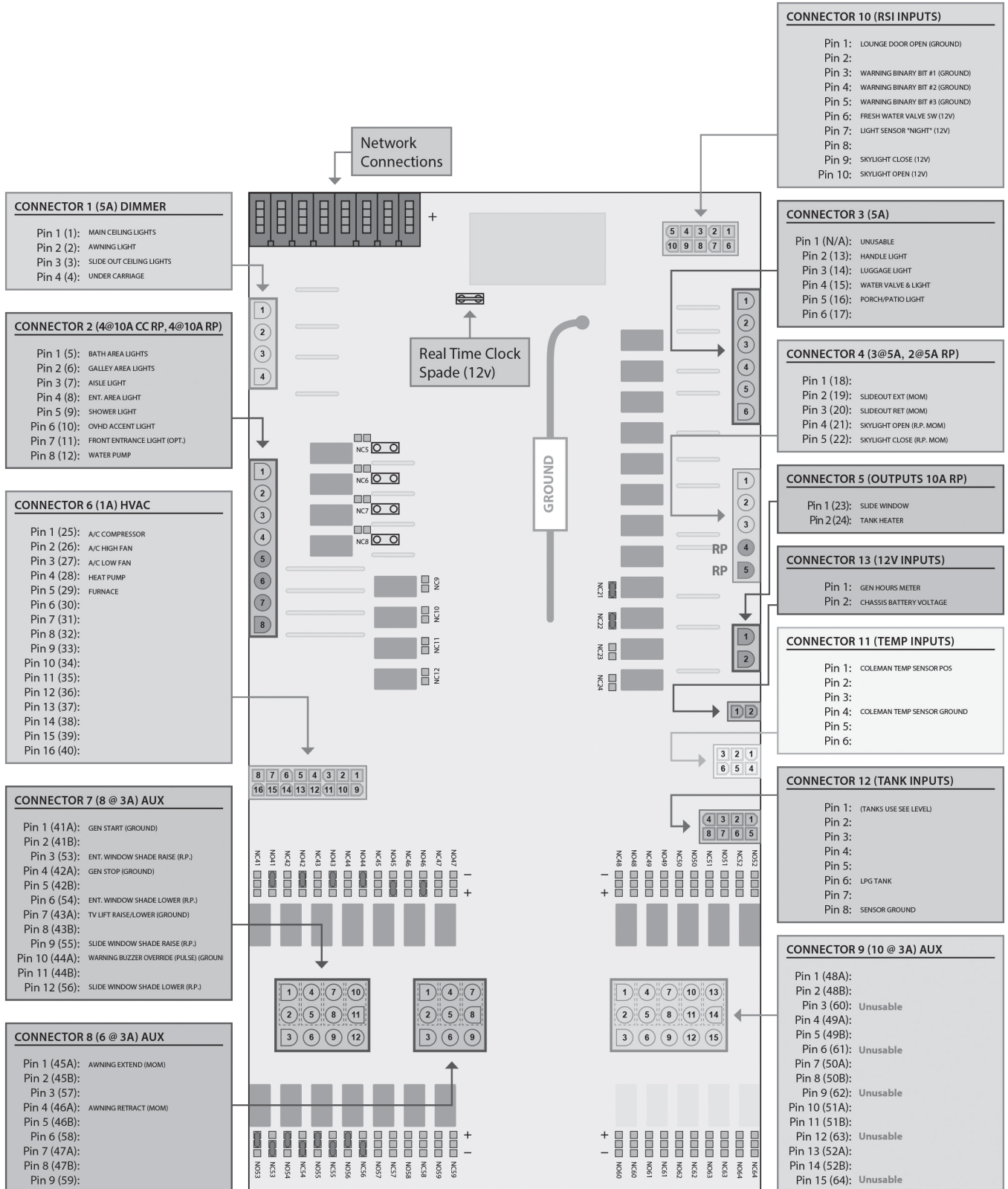

# Maintenance

## Multiplex Networking Diagram and Switch Panel Layout

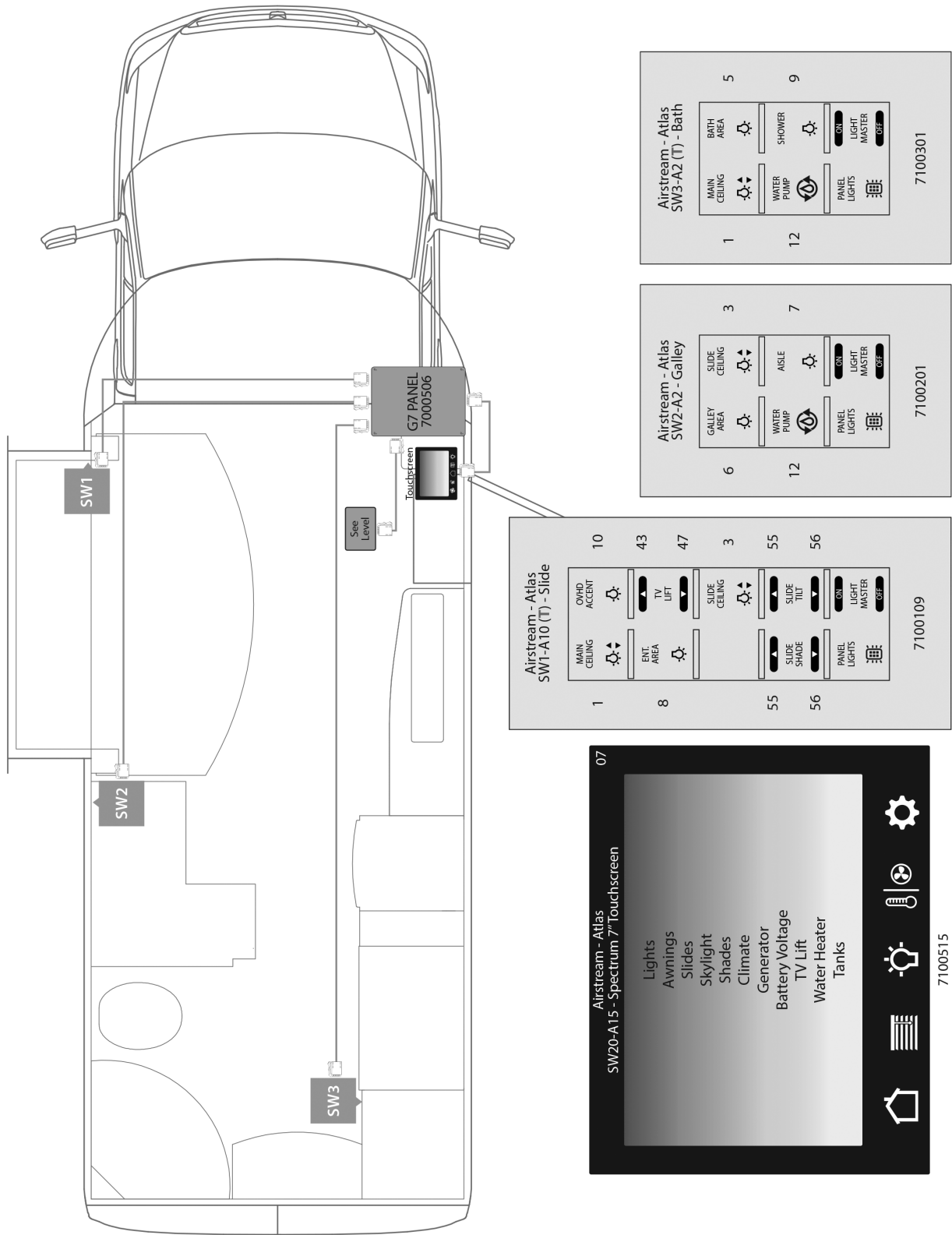



### Solar Panel Wiring

A manual on the use of the solar system is included with the Airstream Owner's Packet. Please read and understand all information before operating the system. The display panel is mounted in the upper portion of the cabinet at the entry door.

The charge controller, located in the cabinet at the entry door, senses the actual battery charge and regulates the charging to prevent over charging. The system requires the 12-volt feed from the battery to operate.

The following diagram depicts the way Airstream wires the solar system and is the recommended wiring for replacement solar systems.

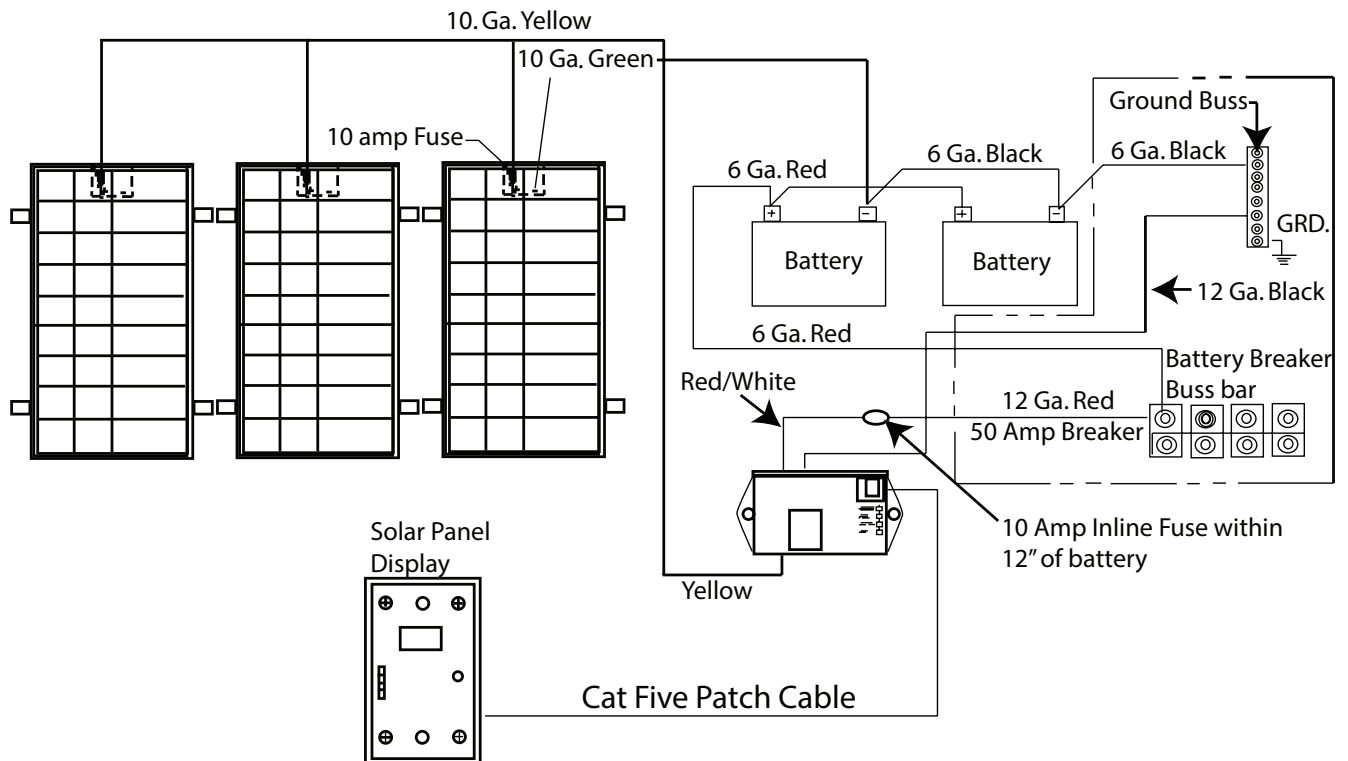

# Maintenance

---

## FAQs and Answers

### Electrical

#### 1. *What should I do to maintain my generator?*

Answer: During the initial break in period, you will need to check your oil every 4 hours during the first 20 hours of operation. Once you reach 20 hours of operation, you will need to change the oil. (Refer to the Onans Owner's manual for more information)

#### 2. *My generator stalls out or quits running if I turn a corner.*

Answer: Make sure you check the oil level. There is a sensor built into the generator that will shut the engine down if it is too low. Turning the corner or stopping quickly while oil is low can cause this to happen.

#### 3. *What size batteries are in my Airstream Atlas?*

Answer: Atlas models have Lifeline GLP-24T series.

#### 4. *My generator will not run properly while I am showing I have fuel in the tank.*

Answer: The generators cut off is roughly 5 gallons. Although it may have a few gallons of fuel left in the tank the generator will not operate with less than 5 gallons. Try adding more fuel and restart the generator.

#### 5. *What is the battery disconnect switch function?*

Answer: The switch is used to eliminate amp draw when the Atlas is not being used or put into storage to preserve battery charge.

#### 6. *Do you recommend using a surge protector when plugged into shore power?*

Answer: Your Airstream is breaker protected. However, with the use of more personal electronic devices and the number of motorhome users in parks, added protection is always a plus.

#### 7. *What is my 1000-watt Magnum inverter powering?*

Answer: It is powering the TV and any additional labeled 120-volt receptacles. This plug is designed for no more than 1000 watts combined power, and is intended for charging things such as laptops, phones, and TV usage. Plugging in items such as vacuums, hair dryers, etc. may harm the system.

#### 8. *I have an alarm going off at my sliding door.*

Answer: Make sure your step and awnings are completely closed. If either of these are not properly closed, and the engine is running, it will cause the alarm to sound.

### Plumbing

#### 1. *Do I need a water regulator?*

Answer: No, your Airstream is equipped with a built in regulator rated for 50 psi.

#### 2. *How do I get fresh water into my Atlas?*

Answer: You can use the on board fresh water tank and 12-volt pump for your water supply when camping in a remote area, or hook to an external water source via potable water hose to exterior water inlet when parked at a campground.

#### 3. *What is the difference between a Gray Water tank and the Black Water tank?*

Answer: The Gray Water tank holds water from shower and sink drains. The Black Water tank holds sewer water from the toilet.

#### 4. *Can I run the macerator pump if there is no water going through it?*

Answer: No, it will burn the macerator up if it is run dry for more the 10-30 seconds. Also, you should not run it more than 15 minutes continuously.

#### 5. *How do I use my Black Water tank flush?*

Answer: First, empty your Black Water tank, and then close your Black Water tank valve. Hook up your hose to the external hookup, run water through for a couple minutes, and then open the valve. Turn macerator pump on to empty the tank. Do this a couple times until the tank is clear. (Do not run macerator pump if tank is empty.)

#### 6. *My Gray Water valve will not open while I have the Black Water valve open.*

Answer: True, you can only have one valve open at a time.

## Audio-Video

### 1. *My TV reception is poor. What can I check?*

Answer: Verify if your antenna booster is set to proper selection (On- for antenna and Off- for cable satellite). You should also make sure connections are tight on your TV.

### 2. *Will my TV and DVD player (user provided) operate while traveling down the highway?*

Answer: Yes, if you have your inverter turned on, the TV will operate.

### 3. *Does the TV play through the dash stereo?*

Answer: No, the TV's audio is not connected to the dash radio.

## Chassis

### 1. *Where is my spare tire located?*

Answer: The Atlas is not equipped with a spare tire or carrier. However, Coach-Net 24/7 roadside assistance has been provided to you for the first two years under the warranty. Owner's will need to re-enroll after the initial two year warranty has expired.

### 2. *How do I jack the Atlas up to change a tire?*

Answer: Please refer to the Mercedes owner's manual.

### 3. *Where can I find my Atlas' serial number?*

Answer: A label is attached on the roadside D B-pillar or the passenger's door. This label will also provide the inflation pressure of the tires and weight specifications.

## Appliances

### 1. *I am planning for a trip in my Airstream. How should I get the refrigerator cooled down?*

Answer: Turn the power on and set the thermostat between 3 and 4. You can make further adjustments to suit your personal requirements after the box has cooled down. Allow the refrigerator to come down to temperature before loading with product. Setting the thermostat to a higher setting, e.g. 7, will not decrease the time required for the unit to cool down to its normal operating temperature. AC/DC units cool at the same rate on DC as on AC. Normal refrigerator operating temperatures are 34°F to 40°F.

### 2. *My air conditioner freezes up. What is the problem?*

Answer: In high humidity conditions, the manufacturer recommends you operate your AC on the high fan setting and all vents should be open to have maximum air flow over the coils; this helps reduce icing. Also, dirty AC filters can restrict air flow and cause the AC to ice up.

## Maintenance

### 1. *Can I have my awning out with heavy winds?*

Answer: No this may cause damage if it is too windy. However, the awning does have a built in sensor that will automatically retract the awning.

### 2. *I want to clean the exterior of my Airstream. What do you suggest?*

Answer: Airstream recommends washing the Atlas using a mild, auto detergent, safe for clear coated surfaces. Airstream recommends washing based on operating conditions, and waxing a minimum of twice a year. Any automotive wax designed specifically for clear coated surfaces will provides good wax protection.



# Index

## A

Air Conditioner 5-19  
Air Ride Suspension 7-9  
Alarms 2-3  
Antennas  
    TV 5-17  
    Satellite 5-18  
Appliances 5-19  
Awning 6-9

## B

Backing Up 8-8  
Battery  
    Cleaning 9-6  
    Storage 9-6  
Battery Disconnect Switch 5-14  
Battery Separator 5-14  
Black Water Tank Flush 9-12  
Brake Controller 8-7

## C

Camping 3-6  
Chemical Sensitivity 2-2  
City Water Hookup 6-5  
Cleaning  
    Exterior 6-2  
    Interior 5-3  
Converter 5-15

## D

Drain Systems 3-9, 9-10

## E

Effects Of Prolonged Occupancy 3-8  
Electrical 5-9  
Electrical Diagrams 9-16  
Energy Management System 5-12  
    Display Panel 5-13  
Exterior Shower 6-5

## F

FAQs and Answers 9-36  
Faucets 5-5  
Fire Extinguisher 2-9  
Floor Plans 4-2  
Fuel 7-2  
Furnace 5-20

## G

Generator 5-20

## H

Heat Pump 5-19  
Hitch 8-4  
Hitch Cover 6-10

## I

Inverter/Charger 5-15

## J

Jack 7-7

## L

Loading 8-2  
LPG System 9-7  
    Detector 2-7  
    Regulator 9-8  
    Remote Fill 9-7

## M

Macerator Pump 9-10  
Maintenance Schedules 9-2  
Microwave Ovens 5-20  
Molds 3-9  
Monitor Panel 5-14  
Multiplex System 5-10  
Murphy Bed 5-6

# Index

---

## O

Overnight Stop 3-7

## P

Pedestal Tables 5-8

Plumbing 9-8

Power Center 5-10

Power Shades 5-8

## R

Range 5-20

Receptacles 5-17

Refrigerator 5-20

Roof Vent 5-21

## S

Safety 2-2, 3-11, 8-4

Screen Door 6-8

Seat Belts 8-4

Service 3-5

Shoreline Power Supply 6-5

Slide-Out Room 5-7

Sofa 5-6

Solar System 5-23

Specification Chart 4-3

Stabilizing Jacks 6-5

Step 6-4

## T

Toilet 5-5

    Winterizing 9-14

Towing

    A Trailer 8-6

    Your Touring coach 8-9

Tires 7-3

    Care 9-5

    Changing 7-5

    Rotation 7-8

TV Operation 5-17

## U

Utility Compartment Doors 6-8

## V

Ventilation 2-3

## W

Warranty 3-2

Waste Water System 3-9

Water Heater 5-23

    Winterizing 9-14

Water Pump

    Strainer Cleaning 9-9

    Winterizing 9-14

Weight Distribution 8-3

Winterizing and Storage 9-12

Winter Traveling 3-10





adventure, inspired by



428 West Pike Street

P.O. Box 629

Jackson Center, OH. 45334-0629

Phone: (937) 596-6111 Fax: (937) 596-6539

[www.airstream.com](http://www.airstream.com)