

AU

SUPERKALL



Design and Quality
IKEA of Sweden





Please refer to
www.IKEA.com/au
and select your local store for local store phone numbers
and opening times.

Contents

SAFETY INFORMATION Installation	3	Care and cleaning	14
First use	9	Troubleshooting	15
Product description	10	Technical information	17
Operation	11	Environmental concerns	18
Daily use	12	IKEA GUARANTEE	19
Hints and tips	13		

Subject to change without notice.

Safety information

Before the installation and use of the appliance, carefully read the supplied instructions. The manufacturer is not responsible for any injuries or damage that are the result of incorrect installation or usage. Always keep the instructions in a safe and accessible location for future reference.

Children and vulnerable people safety

- This appliance is not intended for use by persons (including children) with reduced physical, sensory or mental capabilities, or lack of experience and knowledge, unless they have been given supervision or instruction concerning use of the appliance by a person responsible for their safety. Children should be supervised to ensure that they do not play with the appliance.
- Children aged from 3 to 8 years are allowed to load and unload the appliance provided that they have been properly instructed.
- This appliance may be used by persons with very extensive and complex disabilities provided that they have been properly instructed.
- Children of less than 3 years of age should be kept away from the appliance unless continuously supervised.
- Do not let children play with the appliance.

- Children shall not carry out cleaning and user maintenance of the appliance without supervision.
- Keep all packaging away from children and dispose of it appropriately.

General Safety

- This appliance is intended to be used in household and similar applications such as:
 - Farmhouses; staff kitchen areas in shops, offices and other working environments;
 - By clients in hotels, motels, bed and breakfast and other residential type environments.
- To avoid contamination of food respect the following instructions:
 - do not open the door for long periods;
 - clean regularly surfaces that can come in contact with food and accessible drainage systems;
 - store raw meat and fish in suitable containers in the refrigerator, so that it is not in contact with or drip onto other food.
- **WARNING:** Keep ventilation openings, in the appliance enclosure or in the built-in structure, clear of obstruction.
- **WARNING:** Do not use mechanical devices or other means to accelerate the defrosting process, other than those recommended by the manufacturer.
- **WARNING:** Do not damage the refrigerant circuit.
- **WARNING:** Do not use electrical appliances inside the food storage compartments of the appliance, unless they are of the type recommended by the manufacturer.
- Do not use water spray and steam to clean the appliance.
- Clean the appliance with a moist soft cloth. Only use neutral detergents. Do not use abrasive products, abrasive cleaning pads, solvents or metal objects.

- When the appliance is empty for long period, switch it off, defrost, clean, dry and leave the door open to prevent mould from developing within the appliance.
- Do not store explosive substances such as aerosol cans with a flammable propellant in this appliance.
- If the supply cord is damaged, it must be replaced by the manufacturer, its Authorised Service Centre or similarly qualified persons in order to avoid a hazard.

Safety instructions

Installation



Warning! Only a qualified person must install this appliance.

- Remove all the packaging.
- Do not install or use a damaged appliance.
- Do not use the appliance before installing it in the built-in structure due to safety manner.
- Follow the installation instructions supplied with the appliance.
- Always take care when moving the appliance as it is heavy. Always use safety gloves and enclosed footwear.
- Make sure the air can circulate around the appliance.
- At first installation or after reversing the door wait at least 4 hours before connecting the appliance to the power supply. This is to allow the oil to flow back in the compressor.
- Before carrying out any operations on the appliance (e.g. reversing the door), remove the plug from the power socket.
- Do not install the appliance close to radiators or cookers, ovens or hobs.
- Do not expose the appliance to the rain.
- Do not install the appliance where there is direct sunlight.
- Do not install this appliance in areas that are too humid or too cold.

- When you move the appliance, lift it by the front edge to avoid scratching the floor.

Electrical connection

Warning! Risk of fire and electric shock.

Warning! When positioning the appliance, ensure the supply cord is not trapped or damaged.

Warning! Do not use multi-plug adapters and extension cables.

- The appliance must be earthed.
- Make sure that the parameters on the rating plate are compatible with the electrical ratings of the mains power supply.
- Always use a correctly installed shockproof socket.
- Make sure not to cause damage to the electrical components (e.g. mains plug, mains cable, compressor). Please refer to www.IKEA.com/au and contact our local store for local store phone numbers and opening times or have an electrician to change the electrical components.
- The mains cable must stay below the level of the mains plug.

- Connect the mains plug to the mains socket only at the end of the installation. Make sure that there is access to the mains plug after the installation.
- Do not pull the mains cable to disconnect the appliance. Always pull the mains plug.

Use

Warning! Risk of injury, burns, electric shock or fire.



The appliance contains flammable gas, isobutane (R600a), a natural gas with a high level of environmental compatibility. Be careful not to cause damage to the refrigerant circuit containing isobutane.

- Do not change the specification of this appliance.
- Do not put electrical appliances (e.g. ice cream makers) in the appliance unless they are stated applicable by the manufacturer.
- If damage occurs to the refrigerant circuit, make sure that there are no flames and sources of ignition in the room. Ventilate the room.
- Do not let hot items to touch the plastic parts of the appliance.
- Do not put soft drinks in the freezer compartment. This will create pressure on the drink container.
- Do not store flammable gas and liquid in the appliance.
- Do not put flammable products or items that are wet with flammable products in, near or on the appliance.
- Do not touch the compressor or the condenser. They are hot.
- Do not remove or touch items from the freezer compartment if your hands are wet or damp.
- Do not freeze again food that has been thawed.
- Follow the storage instructions on the packaging of frozen food.
- Wrap the food in any food contact material before putting it in the freezer compartment.

Internal lighting

Warning! Risk of electric shock.

- Concerning the lamp(s) inside this product and spare part lamps sold separately: These lamps are intended to withstand extreme physical conditions in household appliances, such as temperature, vibration, humidity, or are intended to signal information about the operational status of the appliance. They are not intended to be used in other applications and are not suitable for household room illumination.

Care and cleaning

Warning! Risk of injury or damage to the appliance.

- Before maintenance, deactivate the appliance and disconnect the mains plug from the mains socket.
- This appliance contains hydrocarbons in the cooling unit. Only a qualified person must do the maintenance and the recharging of the unit.
- Regularly examine the drain of the appliance and if necessary, clean it. If the drain is blocked, defrosted water collects in the bottom of the appliance.

How to reach us if you need our service

- The IKEA after sales customer service center will assist you on the phone with basic trouble-shooting for your appliances at the time of service call request. Please refer to **www.IKEA.com/au** and select your local store for local store phone numbers and opening times.

Disposal

Warning! Risk of injury or suffocation.

- Disconnect the appliance from the mains supply.
- Cut off the mains cable and discard it.
- Remove the door to prevent children and pets to be closed inside of the appliance.

- The refrigerant circuit and the insulation materials of this appliance are ozone-friendly.
- The insulation foam contains flammable gas. Contact your municipal authority for information on how to discard the appliance correctly.
- Do not cause damage to the part of the cooling unit that is near the heat exchanger.

Installation

Warning! Refer to Safety chapters.

Warning! Refer to installation instruction document to install your appliance.

Warning! Fix the appliance in accordance with installation instruction document to avoid a risk of instability of the appliance.

Warning!
Installation in cabinet
The appliance is intended to be built in a cabinet. Refer to the separate Assembly Instructions for detailed installation.

Inspection checklist

i Please follow the inspection checklist before using your appliance. If any answer is "NO", follow the relevant action. Remember to write down the product serial number and article number as required and attach your receipt to this page.

Product serial number (Ser. No.):
.....
Product article number (Art. No.):
.....
Purchasing date:
.....

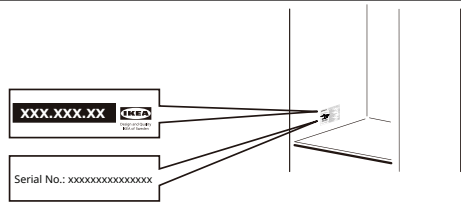

Picture for reference only

To check	If the answer is YES	If the answer is NO
Check if the tube is inside the evaporative tray (refer to section "Evaporative tray").	No action <input checked="" type="checkbox"/>	Put the tube inside the evaporative tray.
Make sure gasket seals all around the door when the door is closed.	No action <input checked="" type="checkbox"/>	Refer to the assembly instruction - door alignment.

To check	If the answer is YES	If the answer is NO
Check if there is no collision between parts/furniture while opening and closing the door.	No action <input checked="" type="checkbox"/>	Refer to the assembly instruction - door alignment.
Install the appliance in the built-in structure.	No action <input checked="" type="checkbox"/>	Follow the assembly instruction for the proper installation.
Make sure that at first installation or after reversing the door the appliance stands in vertical position for at least 4 hours before it is connected to the power supply.	No action <input checked="" type="checkbox"/>	Wait 4 hours before connecting the appliance to the power supply.

Evaporative tray

Before using the appliance make sure that melting water outlet is connected to the evaporative tray above the compressor.

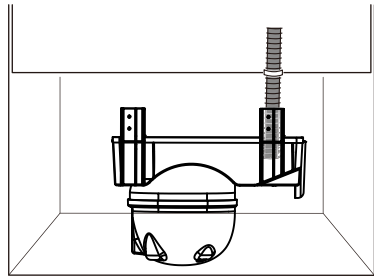



Location

To ensure appliance's best functionality, you should not install the appliance in the nearby of the heat source (oven, stoves, radiators, cookers or hobs) or in a place with direct sunlight. Make sure that air can circulate freely around the back of the cabinet.

This appliance should be installed in a dry, well ventilated indoor position.

This appliance should be installed in a dry, well ventilated indoor where the ambient temperature corresponds to the climate class indicated on the rating plate of the appliance:

Climate class	Ambient temperature
SN	+10°C to +32°C
N	+16°C to +32°C
ST	+16°C to +38°C
T	+16°C to +43°C

-  The correct operation of the appliance can only be guaranteed within the specified temperature range.
-  If you have any doubts regarding where to install the appliance, please turn to the vendor, to our customer service
-  It must be possible to disconnect the appliance from the mains power supply. The plug must therefore be easily accessible after installation.

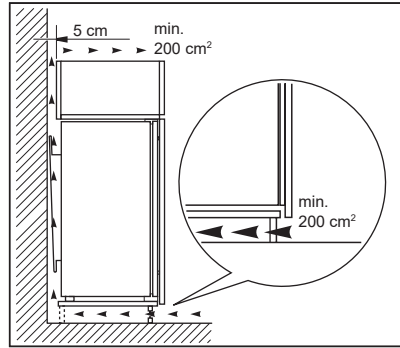

 **Caution!** Refer to the installation instructions for the installation.

Electrical connection

Before plugging in, ensure that the voltage and frequency shown on the rating plate correspond to your domestic power supply.

The appliance must be earthed. The power supply cable plug is provided with a contact for this purpose. If the domestic power supply socket is not earthed, connect the appliance to a separate earth in compliance with current regulations, consulting a qualified electrician.

The manufacturer declines all responsibility if the above safety precautions are not observed.

Ventilation requirements

The air flow behind the appliance must be sufficient.

Door reversibility

Please refer to the separate document with instructions on installation and door reversal.

 **Caution!** At every stage of reversing the door protect the floor from scratching with a durable material.

First use

Cleaning the interior

Before using the appliance for the first time, the interior and all internal accessories should be washed with lukewarm water and some neutral soap to remove the typical smell of a brand-new product, then dried thoroughly.

Caution! The accessories and parts of the appliance are not suitable for washing in a dishwasher.

Caution! Do not use detergents, abrasive powders, chlorine or oil-based cleaners as they will damage the finish.

Product description

Product overview

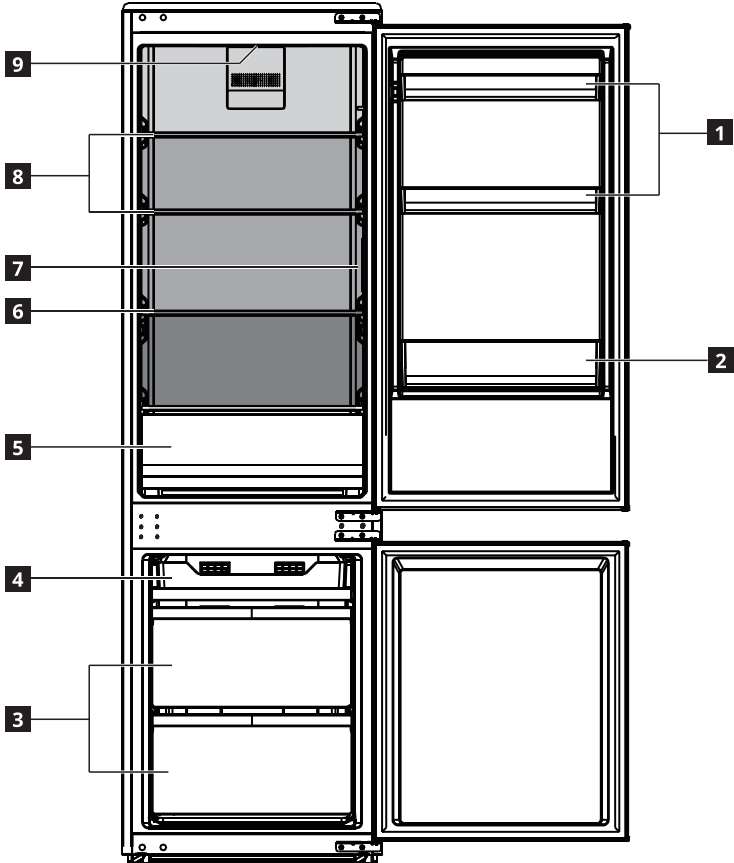

- 1** Door balconies
- 2** Bottle balcony
- 3** Freezer drawers
- 4** Freezer tray
- 5** Vegetable drawer
- 6** Glass shelf

- 7** Control panel
- 8** Glass shelves
- 9** LED lighting
- Least cold zone
- Intermediate temperature zone
- Coldest zone

Operation

Control panel

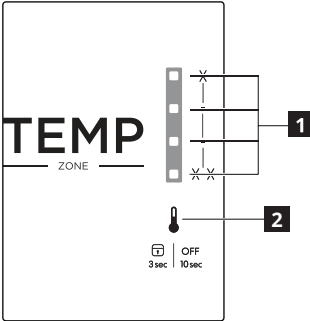

- 1** Temperature indicator
- 2** Function button

Switching on

⚠ Warning! Refer to "Electrical connection" section of the Safety chapter.

Connect the mains plug to the power socket. The display on the control panel turns on. To change temperature, refer to the section for temperature regulation.

When operating the appliance for the first time, set the appliance at a colder temperature and run it without loading any food until it auto stops at the set temperature. Usually it takes 2 or 3 hours, then set a desired temperature and put food in the appliance.

Do not use sharp object to control the touch panel.

Switching off

- To switch the appliance off, press and hold the **2** Function button on the control panel for 10 seconds. After 30 seconds, the appliance will switch off all loads are turned off, and the display and control of the refrigerator will be all off in the power off mode.

- To switch the appliance on again, press the **2** Function button.

To disconnect the appliance from the power supply, disconnect the mains plug from the power socket.

Locking/unlocking

- If the door is closed and no button operation occurs for 30 seconds, the control panel will be locked. Button operation is invalid.
- To unlock the control panel, press and hold the **2** Function button on the control panel for 3 seconds. Button operation is available.

Temperature regulation for refrigerator compartment

- Press the **2** Function button on the control panel to toggle a preset temperature. The four LEDs indicated from * to * corresponds to the following temperatures: 2°C, 4°C, 6°C and 8°C. The appliance will run at the newly set temperature 30 seconds later.

Adjust the temperature setting by keeping in mind that the temperature inside the appliance depends on:

- room temperature
- how often the door is opened
- the quantity of food stored
- the location of the appliance

Important! If the ambient temperature is high or the appliance is fully loaded, and the appliance is set to the lowest temperatures, it may run continuously causing frost to form on the rear wall. In this case a higher temperature must be set to allow automatic defrosting and therefore reduced energy consumption.

Daily use

Freezing calendar

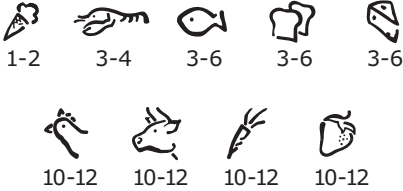

- The symbols show different types of frozen goods.
- The numbers indicate storage times in months for the appropriate types of frozen goods. Whether the upper or lower value of the indicated storage time is valid depends on the quality of the foods and treating before freezing.

Freezing fresh food

- The freezer compartment is suitable for freezing fresh food and storing frozen and deep-frozen food for a long time.
- The freezing process lasts 24 hours: during this period do not add other food to be frozen.

Storage of frozen food

- When first starting-up or after a period out of use, before putting the products in the compartment let the appliance run at least 2 hours on the colder setting.
- Successful freezing depends on the correct packaging. When you close and seal the package you must not allow air or moisture in or out. If you do, you could have food odour and taste transfer throughout the refrigerator, and also dry out frozen food.
- **Note:** Never put bottled food or drinks in the freezer compartment.
- For best performance, leave enough space in the freezer and refrigerator compartment for air to circulate around the packages. Also let enough room at the front so the door can close tightly.

Warning! In the event of accidental defrosting, for example due to a power failure, the defrosted food must be consumed quickly or cooked immediately, cooled and then re-frozen.

Thawing

Deep-frozen or frozen food, prior to being used, can be thawed in the refrigerator compartment or at room temperature, depending on the time available for this operation.

Small pieces may even be cooked still frozen, directly from the freezer: in this case, cooking will take longer.

Storage of food in the refrigerator compartment

- Cover or wrap the food, particularly if it has a strong flavour.
- Position the food so that air can circulate freely around it.

Positioning the door balconies

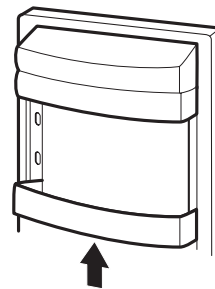

Picture for reference only

- To permit storage of food packages of various sizes, the door balconies can be placed at different heights.
- Carefully remove a door balcony from the support, then reposition it as desired.

Movable shelves

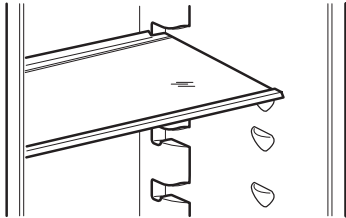

Picture for reference only

- The walls of the refrigerator are equipped with a series of runners so that the safety glass shelves can be positioned as desired.

⚠ Caution! Do not move the glass shelf above the vegetable drawer to ensure correct air

circulation.

Vegetable drawer

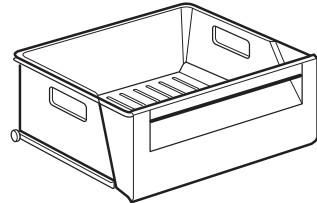

Picture for reference only

- The drawers can be pulled out for cleaning.
- The drawer is suitable for storing fruit and vegetables.
- The drawer can be pulled out for cleaning.

Hints and tips

Normal operating sounds

The following sounds are normal during operation:

- A faint gurgling and bubbling sound from coils sound when refrigerant is pumped.
- A whirring and pulsating sound from the compressor when refrigerant is pumped.
- A sudden cracking noise from inside appliance caused by thermic dilatation (a natural and not dangerous physical phenomenon).

Hints for energy saving

- Do not open the door frequently or leave it open longer than absolutely necessary.
- If the ambient temperature is high and very low internal temperature is set and the appliance is fully loaded, the compressor may run continuously, causing frost or ice on the evaporator. If this happens, set the internal temperature toward warmer one to allow automatic defrosting and so a saving in electricity consumption.

Hints for fresh food refrigeration

- Do not store warm food or evaporating liquids in the refrigerator.
- Cover or wrap the food, particularly if it has a strong flavour.
- Position food so that air can circulate freely

around it.

Hints for refrigeration

Useful hints:

- Meat (all types): wrap in a suitable packaging and place it on the glass shelf above the vegetable drawer. Store meat for at most 1-2 days.
- Cooked foods, cold dishes: cover and place on any shelf.
- Fruit and vegetables: clean thoroughly and place in a special drawer. Bananas, potatoes, onions and garlic must not be kept in the refrigerator if not packed.
- Butter and cheese: place in a special airtight container or wrap in an aluminium foil or a polythene bag to exclude as much air as possible.
- Bottles: close with a cap and place on the door bottle shelf, or (if available) on the bottle rack.

Cautions for Use

- The more food stuff put in or the more and the longer for once the door is opened, the more it needs electric consumption, which even leads malfunction.
- Re-plug in the power plug at the interval of over ten minutes.
- Do not store bottled drink in the freezer,

so as to prevent from being broken and damaging the refrigerator.

- Open the door as less as possible during power-cut.
- When defrosting, never use any sharp or metallic objects to remove the frost on the surface of the evaporator as it will damage the evaporator.
- Do not touch foods and containers in the freezing compartment with your wet hands so as to prevent from being frostbitten.

Hints for freezing

To help you make the most of the freezing process, here are some important hints:

- The freezing process takes 24 hours. No further food to be frozen should be added during this period.
- Freeze only top quality, fresh and thoroughly cleaned, foodstuffs.
- Prepare food in small portions to enable it to be rapidly and completely frozen and to make it possible subsequently to thaw only the quantity required.
- Wrap up the food in aluminium foil or polythene and make sure that the packages are airtight.
- Do not allow fresh, unfrozen food to touch

food which is already frozen, thus avoiding a rise in temperature of the latter.

- Lean foods store better and longer than fatty ones; salt reduces the storage life of food.
- Water ices, if consumed immediately after removal from the freezer compartment, can possibly cause the skin to be freeze burnt.
- It is advisable to show the freezing in date on each individual pack to enable you to keep tab of the storage time.

Hints for storage of frozen food



To obtain the best performance from this appliance, you should:

- Make sure that the commercially frozen foodstuffs were adequately stored by the retailer.
- Make sure that frozen foodstuffs are transferred from the food store to the freezer in the shortest possible time.
- Do not open the door frequently or leave it open longer than absolutely necessary.
- Once defrosted, food deteriorates rapidly and cannot be refrozen.
- Do not exceed the storage period indicated by the food manufacturer.

Care and cleaning

 **Warning!** Refer to Safety chapters.

General warnings

-  **Caution!** Unplug the appliance before carrying out any maintenance operation.
-  This appliance contains hydrocarbons in its cooling unit; maintenance and recharging must therefore only be carried out by authorized technicians.
-  The accessories and parts of the appliance are not suitable for washing in a dishwasher.

Cleaning the interior

Before using the appliance for the first time, the interior and all internal accessories should be washed with lukewarm water and some neutral soap to remove the typical smell of a brand-new product, then dried thoroughly.

 **Caution!** Do not use detergents or abrasive powders, as these will damage the finish.

Initial power on

 **Caution!** Before inserting the power plug in to the outlet and switching on the cabinet for the first time, leave the appliance standing upright for at least 4 hours. This will assure a sufficient amount of time for the oil to return to the compressor. Otherwise the compressor or electronic components may sustain damage.

Periodic cleaning

 **Caution!** Do not pull, move or damage any pipes and/or cables inside the cabinet.

⚠ Caution! Do not damage the cooling system.

⚠ Caution! When moving the cabinet, lift it by the front edge to avoid scratching the floor.

The equipment has to be cleaned regularly:

1. Clean the inside and accessories with lukewarm water and some neutral soap.
2. Regularly check the door seals and wipe clean to ensure they are clean and free from debris.
3. Rinse and dry thoroughly.
4. If accessible, clean the condenser and the compressor at the back of the appliance with a brush. This operation will improve the performance of the appliance and save electricity consumption.

Periods of non-operation

When the appliance is not in use for long periods, take the following precautions:

1. Disconnect the appliance from electricity supply.
2. Remove all food.
3. Defrost (if necessary) and clean the appliance and all accessories.
4. Clean the appliance and all accessories.
5. Leave the door/doors open to prevent unpleasant smells.

⚠ Caution! If you want to keep the appliance switched on, ask somebody to check it once in a while to prevent the food inside from spoiling in case of a power failure.

Defrosting refrigerator compartment

Frost is automatically eliminated from the evaporator of the refrigerator compartment every time the motor compressor stops, during normal use. The defrost water drains out through a trough into a special container at the back of the appliance, over the motor compressor, where it evaporates.

It is important to periodically clean the defrost water drain hole at the back of the refrigerator compartment to prevent the water overflowing and dripping onto the food inside. For this purpose use the tube cleaner provided in the accessory bag.

Defrosting freezer compartment

The freezer compartment has automatic defrosting function.

Due to seasonal changes, a thick layer of frost may form. To defrost manually, observe the followings.

- Disconnect the appliance from the power supply, and leave open the freezer door.
- Remove all foods, ice cube tray and shelf or transfer to refrigerator compartment.
- Clean and wipe out the melted frost with a cloth.
- After defrosting, connect the appliance to the power supply.

⚠ Caution! To avoid damaging the freezer compartment wall, do not use any sharp objects to remove the frost or separate the frozen food.

Troubleshooting

⚠ Warning! Refer to Safety chapters.

What to do if...

Problem	Possible Cause	Solution
The appliance does not operate.	The appliance is switched off.	Switch on the appliance.
	The mains plug is not connected to the mains socket correctly	Connect the mains plug to the mains socket correctly. Refer to "Electrical connection" section of the safety chapter.
	There is no voltage in the mains socket.	Connect a different electrical appliance to the mains socket. Contact a qualified electrician.

Problem	Possible Cause	Solution
The appliance is noisy.	The appliance is not placed stably.	Check if the appliance stands stable.
The lamp does not work.	The lamp is defective.	Refer to "Replacing the lamp".
The compressor operates continually.	Temperature is set incorrectly.	Refer to "Operation" chapter.
	Many food products were inserted at the same time.	Wait some hours and then check the temperature again.
	The room temperature is too high.	Refer to climate class chart on the rating plate.
	Food products placed in the appliance were too warm.	Allow food products to cool to room temperature before storing.
	The door is not closed correctly.	Refer to "Closing the door".
The temperature in the appliance is too low/too high.	The temperature is not set correctly.	Set a higher/lower temperature.
	The door is not closed correctly.	Refer to "Closing the door".
	The food products temperature is too high.	Let the food products temperature decrease to room temperature before storage.
	Many food products are inserted at the same time.	Insert less food products at the same time.
	The thickness of the frost is greater than 0.16"-0.20".	Defrost the appliance.
	The door has been opened often.	Open the door only if necessary.
	There is no cold air circulation in the appliance.	Make sure that there is cold air circulation in the appliance.
There is too much condensed water on the rear wall of the refrigerator.	Door was opened too frequently.	Open the door only when necessary.
	Door was not closed completely.	Make sure the door is closed completely.
	Stored food was not wrapped.	Wrap food in suitable packaging before storing it in the appliance.
Water flows inside the refrigerator.	The drain hole at the back of the appliance is clogged.	Clean the drain hole with a piece of wire.
	Food products prevent water from flowing into the water collector.	Make sure that food products do not touch the rear plate.
Water flows on the floor.	The door is not closed well.	Refer to "Closing the door", or refer to the troubleshooting item below ("The door does not close completely").
	The drip pan cracks.	The IKEA after sales customer service center will assist you on the phone at the time of service call request. Please refer to www.IKEA.com/au and select your local store for local store phone numbers and opening times.
	The defrost water drain is clogged.	Clean the drain hole with a piece of wire.

Problem	Possible Cause	Solution
The door does not close completely.	The shelves are out of position.	Make sure the shelves are in correct position. Refer to "Movable shelves".
	The gaskets are dirty.	Clean the gaskets. Refer to "Care and cleaning".
	The appliance is not level.	Make sure the appliances is installed in level.

Malfunction alarm

If the appliance malfunctions, a LED indicator on the control panel will flash to indicate a fault.

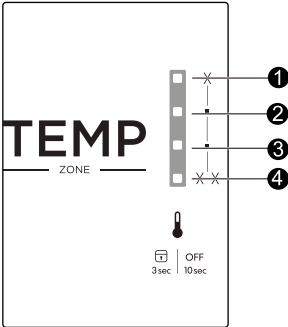

- ❶ flashes: Temperature sensor failure of the refrigerator chamber
- ❷ flashes: Defrosting sensor failure of the refrigerator chamber
- ❸ flashes: Defrosting sensor failure of the freezer chamber
- ❹ flashes: Failure of ambient temperature sensor

❶ If your appliance still is not working properly after making the above checks, the IKEA after sales customer service center will assist you on the phone at the time of service call request. Please refer to www.IKEA.com/au and select your local store for local store phone numbers and opening times.

Closing the door

1. Clean the door gaskets.
2. If necessary, adjust the door. Refer to the separate Assembly Instructions.
3. If necessary, replace the defective door gaskets. Contact the After Sales Service.

Replacing the lamp

The appliance is equipped with a lamp for interior lighting.

Only service is allowed to replace the lighting device.

Please reach out to IKEA, referring to www.IKEA.com/au and select your store for local store phone numbers and opening times.

Technical information

Product category	
Product type	Refrigerator-Freezer
Installation type	Built-in
Product dimensions	
Height	1785mm
Width	540mm
Depth	545mm

Net volume	
Fridge	180L
Freezer	68L
Defrost system	
Fridge	Auto
Freezer	Auto
Energy consumption	303 kWh/y
Energy class	MEPS 3 stars
Voltage	220 - 240 V
Frequency	50 Hz

i The article number and the serial number are situated in the rating plate on the internal left side of the appliance.

Article Number
(8-digit code)

Serial Number (start
with SN, 22-digit code)

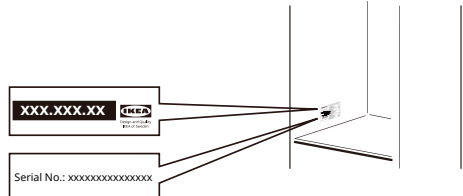

Picture for reference only

Environmental concerns

Recycle materials with the symbol . Put the packaging in relevant containers to recycle it. Help protect the environment and human health by recycling waste of electrical and electronic

appliances. Do not dispose of this product with the household waste. Return the product to your local recycling facility or contact your municipal office.

IKEA GUARANTEE

How long is the IKEA guarantee valid?

This guarantee is valid for five (5) years from the original date of purchase of your appliance at IKEA. The original sales receipt is required as proof of purchase. If service work is carried out under guarantee, this will not extend the guarantee period for the appliance.

Who will execute the service?

IKEA service provider will provide the service through its own service operations or authorized service partner network.

What does this guarantee cover?

The guarantee covers faults of the appliance, which have been caused by faulty construction or material faults from the date of purchase from IKEA. This guarantee applies to domestic use only. The exceptions are specified under the headline "What is not covered under this guarantee?" Within the guarantee period, the costs to remedy the fault e.g. repairs, parts, labour and travel will be covered, provided that the appliance is accessible for repair without special expenditure. On these conditions the respective local regulations are applicable. Replaced parts become the property of IKEA.

The guarantee exists only if the appliance complies and is installed in accordance with:

- The technical specifications.
- The Assembly Instructions and usermanual Safety Information.

IKEA's guarantee is subject to Australian Consumer Law - see Schedule 2 to Competition and Consumer Act, 2010. This guarantee is in addition to (and does not exclude, restrict or modify in any way) any non-excludable statutory warranties in Australia.

What will IKEA do to correct the problem?

IKEA appointed Service Provider will examine the product and decide, at its sole discretion, if it is covered under this guarantee. If considered covered, IKEA Service Provider or its authorized service partner through its own service operations, will then, at its sole discretion, either repair the defective product or replace it with the same or a comparable product.

What is not covered under this guarantee?

- Normal wear and tear.
- Deliberate or negligent damage, damage caused by failure to observe operating instructions, incorrect installation or by connection to the wrong voltage, damage caused by chemical or electro-chemical reaction, rust, corrosion or water damage including but not limited to damage caused by excessive lime in the water supply, damage caused by abnormal environmental conditions.
- Consumable parts including batteries and lamps.
- Non-functional and decorative parts which do not affect normal use of the appliance, including any scratches and possible color differences.
- Accidental damage caused by foreign objects or substances and cleaning or unblocking of filters, drainage systems or soap drawers.
- Damage to the following parts: ceramic glass, accessories, crockery and cutlery baskets, feed and drainage pipes, seals, lamps and lamp covers, screens, knobs, casings and parts of casings. Unless such damages can be proved to have been caused by production faults.
- Cases where no fault could be found during a technician's visit.

- Repairs not carried out by our appointed service providers and/or an authorized service contractual partner or where non-original parts have been used.
- Repairs caused by installation which is faulty or not according to specification.
- The use of the appliance in a non-domestic environment i.e. professional use.
- Transportation damages. If a customer transports the product to his home or another address, IKEA is not liable for any damage that may occur during transport. However, if IKEA delivers the product to the customer's delivery address, then damage to the product that occurs during this delivery will be covered by IKEA.
- Cost for carrying out the initial installation of the IKEA appliance.
- However, if an IKEA appointed Service Provider or its authorized service partner repairs or replaces the appliance under the terms of this guarantee, the appointed Service Provider or its authorized service partner will reinstall the repaired appliance or install the replacement, if necessary.
- Problems caused by incorrect or inadequate venting of the appliance.
- All plumbing and electrical installation, are not the responsibility of IKEA, and customer must complete these work before the execution work.
- The benefits conferred by this express guarantess are in addition to all other conditions, warranties, guarantees, rights and remedies expressed or implied by the Trade Practices Act and similar State and Territory laws and all other obligations and liabilities on the part of the manufacturer or supplier and nothing contained herein shall restrict or modify such rights, remedies, obligations or liabilities.

How country law applies

The IKEA guarantee gives you specific legal rights, which cover or exceed all the local legal demands. However these conditions do not limit in any way consumer rights described in the local legislation.

Our goods come with guarantees that cannot be excluded under the Australian Consumer Law (ACL).

You are entitled to a replacement or refund for a major failure and for compensation for any other reasonably foreseeable loss or damage.

You are also entitled to have the goods repaired or replaced if the goods fail to be of acceptable quality and the failure does not amount to a major failure.

This guarantee is not intended in any way to limit or exclude such rights and remedies that you may have under law.

You can find out more information about the Australian Consumer Law on the ACCC website: www.accc.gov.au

Area of validity

The IKEA guarantee applies only to products purchased and installed in AUSTRALIA . The services will be provided in the framework of the guarantee conditions. An obligation to carry out services in the framework of the guarantee exists only if the appliance complies and is installed in accordance with:

- the technical specifications of the country in which the guarantee claim is made;
- the Assembly Instructions and User Manual Safety Information;

The dedicated AFTER SALES for IKEA appliances

Please don't hesitate to contact IKEA appointed Authorized Service Centre to:

- make a service request under this guarantee;
- ask for clarifications on installation of the IKEA appliance in the dedicated IKEA kitchen furniture;
- ask for clarification on functions of IKEA appliances.

To ensure that we provide you with the best assistance, please read carefully the Assembly Instructions and/or the User Manual before contacting us.

How to reach us if you need our service



The IKEA after sales customer service center will assist you on the phone with basic troubleshooting for your appliances at the time of service call request.

Please refer to
www.IKEA.com/au

and select your local store for local store phone numbers and opening times. Before calling us, assure that You have to hand the IKEA article number (8 digit code) and the Serial Number (22 digit code that can be found on the rating plate) for the appliance of which you need our assistance.



SAVE THE SALES RECEIPT! It is your proof of purchase and required for the guarantee to apply. Note that the receipt reports also the IKEA article name and number (8 digit code) for each of the appliances you have purchased.

Do you need extra help?

For any additional questions not related to After Sales of your appliances please contact your nearest IKEA store call centre. We recommend you read the appliance documentation carefully before contacting us.

