

Mitsubishi Programmable Controller

MELSEC **Q** series

Type QD70 Positioning Module User's Manual

- QD70P4
- QD70P8
- GX Configurator-PT (SW1D5C-QPTU-E)

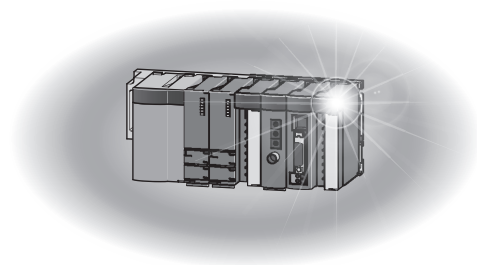

● SAFETY INSTRUCTIONS ●

(Always read these instructions before using this equipment.)

Before using this product, please read this manual and the relevant manuals introduced in this manual carefully and pay full attention to safety to handle the product correctly.

The instructions given in this manual are concerned with this product. For the safety instructions of the programmable controller system, please read the CPU module User's Manual.

In this manual, the safety instructions are ranked as "DANGER" and "CAUTION".



Indicates that incorrect handling may cause hazardous conditions, resulting in death or severe injury.



Indicates that incorrect handling may cause hazardous conditions, resulting in medium or slight personal injury or physical damage.

Note that the  CAUTION level may lead to a serious consequence according to the circumstances. Always follow the instructions of both levels because they are important to personal safety.

Please save this manual to make it accessible when required and always forward it to the end user.

[DESIGN INSTRUCTION]

DANGER

- Provide a safety circuit outside the programmable controller so that the entire system will operate safely even when an external power supply error or programmable controller fault occurs.
Failure to observe this could lead to accidents for incorrect outputs or malfunctioning.
 - (1) Configure an emergency stop circuit and interlock circuit such as a positioning control upper limit/lower limit to prevent mechanical damage outside the programmable controller.
 - (2) The machine OPR operation is controlled by the OPR direction and OPR speed data. Deceleration starts when the near-point dog turns ON. Thus, if the OPR direction is incorrectly set, deceleration will not start and the machine will continue to travel. Configure an interlock circuit to prevent mechanical damage outside the programmable controller.
 - (3) When the module detects an error, deceleration stop will take place.
Make sure that the OPR data and positioning data are within the parameter setting values.

CAUTION

- Do not bundle or adjacently lay the control wire or communication cable with the main circuit or power wire.
Separate these by 100mm (3.94in.) or more.
Failure to observe this could lead to malfunctioning caused by noise.

[MOUNTING INSTRUCTIONS]

CAUTION

- Use the programmable controller in an environment that meets the general specifications contained in the CPU User's Manual.
Using the programmable controller outside the general specification range environment could lead to electric shocks, fires, malfunctioning, product damage or deterioration.
- While pressing the installation lever located at the bottom of module, insert the module fixing tab into the fixing hole in the base unit until it stops. Then, securely mount the module with the fixing hole as a supporting point. Improper loading of the module can cause a malfunction, failure or drop.
For use in vibratory environment, tighten the module with screws.
Tighten the screws within the specified torque range.
Undertightening can cause a drop, short circuit or malfunction.
Overtightening can cause a drop, short circuit or malfunction due to damage to the screws or module.
- Completely turn off the externally supplied power used in the system before mounting or removing the module. Not doing so may damage the product.

[WIRING INSTRUCTIONS]

DANGER

- Always confirm the terminal layout before connecting the wires to the module.

[STARTUP/MAINTENANCE INSTRUCTIONS]

DANGER

- Completely turn off the externally supplied power used in the system before cleaning or tightening the screws.
Failure to turn all phases OFF could lead to electric shocks.

[STARTUP/MAINTENANCE INSTRUCTIONS]

CAUTION

- Never disassemble or modify the module.
Failure to observe this could lead to trouble, malfunctioning, injuries or fires.
- Completely turn off the externally supplied power used in the system before installing or removing the module.
Failure to turn all phases OFF could lead to module trouble or malfunctioning.
- Do not install/remove the module to/from the base unit more than 50 times after the first use of the product. (IEC 61131-2 compliant)
Failure to do so may cause malfunction.
- Before starting test operation, set the parameter speed limit value to the slowest value, and make sure that operation can be stopped immediately if a hazardous state occurs.
- Always make sure to touch the grounded metal to discharge the electricity charged in the body, etc., before touching the module.
Failure to do so may cause a failure or malfunctions of the module.

[DISPOSAL INSTRUCTIONS]

CAUTION

- When disposing of the product, handle it as industrial waste.

REVISIONS

* The manual number is given on the bottom left of the back cover.

Print Date	* Manual Number	Revision
Jun., 2001	SH (NA)-080171-A	First edition
Feb., 2002	SH (NA)-080171-B	<p>Modifications</p> <p>About Manuals, Section 2.3, Section 2.4, Section 4.6.1, Section 5.3, Section 5.7, Section 6.2.2, Section 8.2.3, Section 8.2.4, Section 8.2.5, Section 8.2.6, Section 10.3, Appendix 8</p>
Jul., 2002	SH (NA)-080171-C	<p>Modifications</p> <p>CONTENS, Section .1.1.1, Section 4.2, Section 11.3, Section 11.4, Section 11.5, Section 13.2, Appendix 2, Appendix 8, INDEX</p>
Feb., 2003	SH (NA)-080171-D	<p>Modifications</p> <p>SAFETY INSTRUCTIONS, CONTENTS, Section 2.1, Section 3.1, Section 5.3, Section 6.2.2, Section 6.4, Section 6.5, Appendix 3.3, Appendix 8, INDEX</p>
May, 2003	SH (NA)-080171-E	<p>Modifications</p> <p>CONTENTS, Appendix 6, Appendix 7</p>
Oct., 2003	SH (NA)-080171-F	<p>Modifications</p> <p>CONTENTS, Section 1.2.2, Section 3.3.2, Section 3.4.3, Section 3.4.4, Section 7.5.3, Section 9.1.2, INDEX</p>
Jun., 2004	SH (NA)-080171-G	<p>Modifications</p> <p>SAFETY PRECAUTIONS, Section 2.4, Section 2.5, Section 3.4.3, Section 5.1, Section 5.7, Section 6.4, Section 6.6.1</p>
Feb., 2006	SH (NA)-080171-H	<p>Modifications</p> <p>SAFETY INSTRUCTIONS, Section 2.3, Section 4.3, Section 5.1, Section 6.3.2, Section 6.3.3, Section 11.4, Section 13.2, Appendix 3.3</p>
May, 2006	SH (NA)-080171-I	<p>Modifications</p> <p>Section 7.5.4, Section 11.6, Appendix 3.3</p>
Jan., 2007	SH (NA)-080171-J	<p>Modifications</p> <p>Section 7.4</p>
Jun., 2007	SH (NA)-080171-K	<p>Modifications</p> <p>Section 2.3, Section 3.4.4, Section 4.6.1, Section 10.1, Section 11.2</p>
Jan., 2008	SH (NA)-080171-L	<p>Modifications</p> <p>GENERIC TERMS AND ABBREVIATIONS, Section 2.3 to 2.6, Section 6.2.2</p>

* The manual number is given on the bottom left of the back cover.

Print Date	* Manual Number	Revision
May, 2008	SH (NA)-080171-M	<div data-bbox="627 333 799 367" style="border: 1px solid black; padding: 2px;">Modifications</div> SAFETY INSTRUCTIONS, Compliance with the EMC and Low Voltage Directives, Section 2.3, 2.6, 3.1, 5.4.1, 6.2.1, 6.3.1, 6.3.3
Aug., 2008	SH (NA)-080171-N	<div data-bbox="627 459 799 492" style="border: 1px solid black; padding: 2px;">Modifications</div> Section 2.6, 3.4.2, 5.3, Appendix 1

Japanese Manual Version SH-080138-O

This manual confers no industrial property rights or any rights of any other kind, nor does it confer any patent licenses. Mitsubishi Electric Corporation cannot be held responsible for any problems involving industrial property rights which may occur as a result of using the contents noted in this manual.

© 2001 MITSUBISHI ELECTRIC CORPORATION

INTRODUCTION

Thank you for purchasing the Mitsubishi programmable controller MELSEC-Q series.
Always read through this manual, and fully comprehend the functions and performance of the Q series programmable controller before starting use to ensure correct usage of this product.

CONTENTS

SAFETY INSTRUCTIONS.....	A- 1
REVISIONS.....	A- 4
INTRODUCTION.....	A- 6
CONTENTS.....	A- 6
Using This Manual.....	A- 10
Compliance with the EMC and Low Voltage Directives.....	A- 10
Generic Terms and Abbreviations.....	A- 11
Component List.....	A- 12

SECTION 1 PRODUCT SPECIFICATIONS AND HANDLING

1 PRODUCT OUTLINE 1- 1 to 1- 14

1.1 Positioning control.....	1- 1
1.1.1 Features of QD70.....	1- 1
1.1.2 Mechanism of positioning control.....	1- 2
1.1.3 Outline design of positioning control system.....	1- 4
1.1.4 Communicating signals between QD70 and each module.....	1- 8
1.2 Positioning control.....	1- 10
1.2.1 Outline of starting.....	1- 10
1.2.2 Outline of stopping.....	1- 12

2 SYSTEM CONFIGURATION 2- 1 to 2- 11

2.1 General image of system.....	2- 1
2.2 Component list.....	2- 2
2.3 Applicable systems.....	2- 3
2.4 About Use of the QD70 with the Q12PRH/Q25PRHCPU.....	2- 6
2.5 About Use of the QD70 on the MELSECNET/H Remote I/O Station.....	2- 7
2.6 How to Check the Function Version/Serial No./Software Version.....	2- 8

3 SPECIFICATIONS AND FUNCTIONS 3- 1 to 3- 13

3.1 Performance specifications.....	3- 1
3.2 List of functions.....	3- 2
3.3 Specifications of input/output signal with Programmable Controller CPU.....	3- 4
3.3.1 List of input/output signals with programmable controller CPU.....	3- 4
3.3.2 Details of input signal (QD70 → Programmable controller CPU).....	3- 5
3.3.3 Details of output signals (Programmable controller CPU → QD70).....	3- 6
3.4 Specifications of input/output interfaces with external device.....	3- 7
3.4.1 Electrical specifications of input/output signals.....	3- 7
3.4.2 Signal layout for external device connection connector.....	3- 9
3.4.3 List of input/output signal details.....	3- 10

3.4.4 Input/output interface internal circuit.....	3- 11
--	-------

4 DATA USED FOR POSITIONING CONTROL	4- 1 to 4- 31
--	----------------------

4.1 Type of data	4- 1
4.1.1 Parameters and data required for control.....	4- 1
4.1.2 Setting items for parameters.....	4- 3
4.1.3 Setting items for OPR data	4- 4
4.1.4 Setting items for JOG data.....	4- 5
4.1.5 Setting items for positioning data.....	4- 6
4.1.6 Type and roles of monitor data	4- 7
4.1.7 Type and roles of control data	4- 8
4.2 List of parameters	4- 9
4.3 List of OPR data	4- 14
4.4 List of JOG data	4- 20
4.5 List of positioning data	4- 21
4.6 List of monitor data.....	4- 27
4.6.1 Axis monitor data.....	4- 27
4.6.2 Module information monitor data	4- 29
4.7 List of control data	4- 30
4.7.1 Axis control data	4- 30

5 SETUP AND PROCEDURES BEFORE OPERATION	5- 1 to 5- 20
--	----------------------

5.1 Handling precautions	5- 1
5.2 Procedures before operation	5- 3
5.3 Part identification nomenclature	5- 4
5.4 Wiring	5- 7
5.4.1 Wiring precautions.....	5- 7
5.5 Confirming the wiring	5- 12
5.5.1 Confirmation items at completion of wiring	5- 12
5.6 Switch setting for intelligent function module	5- 14
5.7 Simple reciprocating operation	5- 18

6 UTILITY PACKAGE(GX Configurator-PT)	6- 1 to 6- 19
--	----------------------

6.1 Utility package functions	6- 1
6.2 Installing and Uninstalling the Utility Package	6- 2
6.2.1 Handling precautions	6- 2
6.2.2 Operating environment.....	6- 4
6.3 Utility Package Operation	6- 6
6.3.1 Common utility package operations	6- 6
6.3.2 Operation overview	6- 8
6.3.3 Starting the Intelligent function module utility	6- 10
6.4 Initial setting.....	6- 12
6.5 Auto refresh setting	6- 14
6.6 Monitoring/Test.....	6- 16
6.6.1 Monitoring/Test screen.....	6- 16

7 SEQUENCE PROGRAM USED FOR POSITIONING CONTROL	7- 1 to 7- 20
--	----------------------

7.1 Precautions for creating program	7- 1
--	------

7.2 List of devices used.....	7- 3
7.3 Creating a program	7- 5
7.3.1 General configuration of program.....	7- 5
7.3.2 Positioning control operation program.....	7- 6
7.4 Positioning control program examples	7- 8
7.5 Program details	7- 12
7.5.1 Initialization program	7- 12
7.5.2 Start method setting program	7- 13
7.5.3 Start program.....	7- 13
7.5.4 Sub program.....	7- 19

SECTION 2 CONTROL DETAILS AND SETTING
--

8 OPR CONTROL	8- 1 to 8- 16
----------------------	----------------------

8.1 Outline of OPR control.....	8- 1
8.1.1 Two types of OPR control.....	8- 1
8.2 Machine OPR control.....	8- 2
8.2.1 Outline of the machine OPR operation.....	8- 2
8.2.2 Machine OPR method.....	8- 3
8.2.3 OPR method (1): Near-point dog method	8- 4
8.2.4 OPR method (2): Stopper 1	8- 6
8.2.5 OPR method (3): Stopper 2	8- 8
8.2.6 OPR method (4): Stopper 3	8- 10
8.2.7 OPR method (5): Count 1	8- 12
8.2.8 OPR method (6): Count 2	8- 14
8.3 Fast OPR control.....	8- 16
8.3.1 Outline of the fast OPR control operation.....	8- 16

9 POSITIONING CONTROL	9- 1 to 9- 17
------------------------------	----------------------

9.1 Outline of positioning controls.....	9- 1
9.1.1 Data required for positioning control.....	9- 1
9.1.2 Operation patterns of positioning controls.....	9- 2
9.1.3 Designating the positioning address.....	9- 8
9.1.4 Confirming the current value.....	9- 9
9.2 Setting the positioning data	9- 10
9.2.1 Relation between each control and positioning data	9- 10
9.2.2 1-axis linear control	9- 11
9.2.3 Speed-position switching control	9- 13
9.2.4 Current value changing	9- 16
9.3 Multiple axes simultaneous start control	9- 17

10 JOG OPERATION	10- 1 to 10- 6
-------------------------	-----------------------

10.1 Outline of JOG operation	10- 1
10.2 JOG operation execution procedure	10- 3
10.3 JOG operation example.....	10- 4

11 SUB FUNCTIONS	11- 1 to 11- 13
-------------------------	------------------------

11.1 Outline of sub functions	11- 1
-------------------------------------	-------

11.2 Speed limit function.....	11- 1
11.3 Speed change function.....	11- 2
11.4 Software stroke limit function.....	11- 5
11.5 Acceleration/deceleration processing function.....	11- 8
11.6 Restart function.....	11- 11

12 COMMON FUNCTIONS	12- 1 to 12- 3
----------------------------	-----------------------

12.1 Outline of common functions.....	12- 1
12.2 External I/O signal switching function.....	12- 1
12.3 External I/O signal monitor function.....	12- 2

13 TROUBLESHOOTING	13- 1 to 13- 14
---------------------------	------------------------

13.1 Error and warning details.....	13- 1
13.2 List of errors.....	13- 3
13.3 List of warnings.....	13- 11
13.4 Error check by LED indication.....	13- 13
13.5 Confirming the error definition using system monitor of GX Developer.....	13- 14

APPENDIX	App- 1 to App- 18
-----------------	--------------------------

Appendix 1 External dimension drawing.....	App- 1
Appendix 2 Operation timing and processing time in each control.....	App- 2
Appendix 3 Connection examples with servo amplifiers manufactured by MITSUBISHI Electric Corporation.....	App- 6
Appendix 3.1 Connection example of QD70P□ and MR-H□A.....	App- 6
Appendix 3.2 Connection example of QD70P□ and MR-J2/J2S-□A.....	App- 7
Appendix 3.3 Connection example of QD70P□ and MR-C□A.....	App- 8
Appendix 4 Connection examples with stepping motors manufactured by ORIENTALMOTOR Co., Ltd.....	App- 9
Appendix 4.1 Connection example of QD70P□ and VEXTA UPD.....	App- 9
Appendix 5 Connection examples with servo amplifiers manufactured by Matsushita Electric Industrial Co., Ltd.....	App- 10
Appendix 5.1 Connection example of QD70P□ and MINAS-A series.....	App- 10
Appendix 6 Connection examples with servo amplifiers manufactured by SANYO DENKI Co., Ltd.	App- 11
Appendix 6.1 Connection example of QD70P□ and PZ series.....	App- 11
Appendix 7 Connection examples with servo amplifiers manufactured by YASKAWA Electric Corporation.....	App- 12
Appendix 7.1 Connection example of QD70P□ and Σ -II series.....	App- 12
Appendix 8 Comparisons with type QD75 positioning module.....	App- 13
Appendix 9 List of buffer memory addresses.....	App- 16

INDEX	Index- 1 to Index- 5
--------------	-----------------------------

Using This Manual

- The symbols used in this manual are shown below.

Pr. *	Symbol indicating positioning parameter and OPR parameter item.
OPR.*	Symbol indicating OPR data item.
JOG.*	Symbol indicating JOG data item.
Da. *	Symbol indicating positioning data item.
Md. *	Symbol indicating monitor data item.
Cd. *	Symbol indicating control data item.

(A serial No. is inserted in the * mark.)

- Numeric values used in this manual

- The buffer memory addresses, error codes and warning codes are represented in decimal.
- The X/Y devices are represented in hexadecimal.
- The setting data and monitor data are represented in either decimal or hexadecimal. The data ended by "H" are represented in hexadecimal.
(Example) 10.....Decimal
10H.....Hexadecimal

Compliance with the EMC and Low Voltage Directives

(1) For programmable controller system

To configure a system meeting the requirements of the EMC and Low Voltage Directives when incorporating the Mitsubishi programmable controller (EMC and Low Voltage Directives compliant) into other machinery or equipment, refer to Chapter 9 "EMC AND LOW VOLTAGE DIRECTIVES" of the QCPU User's Manual (Hardware Design, Maintenance and Inspection).

The CE mark, indicating compliance with the EMC and Low Voltage Directives, is printed on the rating plate of the programmable controller.

(2) For the product

To make this product conform to the EMC and Low Voltage Directives, please refer to Section 5.4.1 "Wiring precautions".

Generic Terms and Abbreviations

Unless specially noted, the following generic terms and abbreviations are used in this manual.

Generic term/abbreviation	Details of generic term/abbreviation
Programmable controller CPU	Generic term for programmable controller CPU on which QD70 can be mounted.
AD75	Generic term for type A1SD75P1-S3/P2-S3/P3-S3, AD75P1-S3/P2-S3/P3-S3 Positioning module. The module type is described to indicate a specific module.
QD70	Generic term for type QD70 positioning module QD70P4/QD70P8. The module type is described to indicate a specific module.
QD75	Generic term for positioning module QD75P1, QD75P2, QD75P4, QD75D1, QD75D2, and QD75D4. The module type is described to indicate a specific module.
Peripheral device	Generic term for DOS/V personal computer where following "GX Configurator-PT" and ""GX Developer" have been installed.
GX Configurator-PT	Abbreviation for GX Configurator-PT (SW1D5C-QPTU-E) utility package for QD70 positioning module.
GX Developer	Generic product name for the SWnD5C-GPPW-E, SWnD5C-GPPW-EA, SWnD5C-GPPW-EV and SWnD5C-GPPW-EVA. ("n" is 4 or greater.) "-A" and "-V" denote volume license product and upgraded product respectively.
DOS/V personal computer	IBM PC/AT [®] and compatible DOS/V compliant personal computer.
Personal computer	Generic term for DOS/V personal computer.
Workpiece	Generic term for moving body such as workpiece and tool, and for various control targets.
Axis 1, axis 2, axis 3, axis 4, axis 5, axis 6, axis 7, axis 8	Indicates each axis connected to QD70.
1-axis, 2-axes, 3-axes, 4-axes, 5-axes, 6-axes, 7-axes, 8-axes	Indicates the number of axes. (Example: 2-axes = Indicates two axes such as axis 1 and axis 2, axis 2 and axis 3, and axis 3 and axis 1.)
Windows Vista [®]	Generic term for the following: Microsoft [®] Windows Vista [®] Home Basic Operating System, Microsoft [®] Windows Vista [®] Home Premium Operating System, Microsoft [®] Windows Vista [®] Business Operating System, Microsoft [®] Windows Vista [®] Ultimate Operating System, Microsoft [®] Windows Vista [®] Enterprise Operating System
Windows [®] XP	Generic term for the following: Microsoft [®] Windows [®] XP Professional Operating System, Microsoft [®] Windows [®] XP Home Edition Operating System

Component List

The component list of this product is given below.

Type	Component	Quantity
QD70P4	Type QD70P4 Positioning Module (4-axes open-collector output type)	1
QD70P8	Type QD70P8 Positioning Module (8-axes open-collector output type)	1
SW1D5C-QPTU-E	GX Configurator-PT Version 1 (1-license product) (CD-ROM)	1
SW1D5C-QPTU-EA	GX Configurator-PT Version 1 (Multiple-license product) (CD-ROM)	1

SECTION 1 PRODUCT SPECIFICATIONS AND HANDLING

Section 1 is configured for the following purposes (1) to (4).

- (1) To understand the outline of positioning control, and the QD70 specifications and functions
- (2) To carry out actual work such as installation and wiring
- (3) To set parameters and data required for positioning control
- (4) To create a sequence program required for positioning control

Read "Section 2" for details on each control.

CHAPTER 1	PRODUCT OUTLINE	1- 1 to 1- 14
CHAPTER 2	SYSTEM CONFIGURATION	2- 1 to 2- 9
CHAPTER 3	SPECIFICATIONS AND FUNCTIONS	3- 1 to 3- 13
CHAPTER 4	DATA USED FOR POSITIONING CONTROL.....	4- 1 to 4- 31
CHAPTER 5	SETUP AND PROCEDURES BEFORE OPERATION.....	5- 1 to 5- 20
CHAPTER 6	UTILITY PACKAGE	6- 1 to 6- 19
CHAPTER 7	SEQUENCE PROGRAM USED FOR POSITIONING CONTROL	7- 1 to 7- 20

CHAPTER 1 PRODUCT OUTLINE

This User's Manual provides the specifications, handling, programming methods and other information of the QD70 positioning module used with the MELSEC-Q series CPU module.

When diverting any of the program examples introduced in this manual to the actual system, fully verify that there are no problems in the controllability of the target system.

1.1 Positioning control

1.1.1 Features of QD70

The following are the features of the QD70.

(1) Wide assortment of 4-axes and 8-axes modules

The QD70 is a positioning module used in a multi-axes system that does not need complex control.

It is not compatible with the MELSEC-A series AD70 positioning module in I/O signals, functions, etc.

(2) About positioning control functions

(a) The QD70 has a number of functions required for a positioning control system, such as positioning control to any position and equal-speed control.

1) You can set up to 10 pieces of positioning data, which include positioning address, control method, operation pattern and like, per axis. These positioning data are used to exercise positioning control axis-by-axis.

2) Axis-by-axis positioning control allows linear control (up to 8 axes can be controlled simultaneously). This control can perform positioning termination with one piece of positioning data or exercise continuous positioning control by continuous execution of multiple pieces of positioning data.

(b) As the control method, any of position control, speed-position switching control and current value changing may be specified in each positioning data.

(c) The following six different OPR methods are available for "machine OPR control": near-point dog method (one method), stopper (three methods) and count (two methods).

(d) Varying finely in speed to ensure smooth acceleration/deceleration, the QD70 is suitable for connection to a stepping motor.

(e) You can change the I/O signal logic according to the specifications of the external device.

This allows the input signals to be used with either of "normally open" and "normally closed" contacts, and the output signals to be used according to the specifications of the drive unit.

(3) Fast start processing

Processing at a position control start has been speeded up to shorten the start processing time of one axis to 0.1ms.

At a simultaneous start of multiple axes (the positioning start signals are turned ON at the same time within one scan), there are no starting delays between the axes.

(4) Ease of maintenance

In the QD70, error definitions have been subdivided to improve maintenance performance.

(5) Ease of utility package settings

The optionally available utility package (GX Configurator-PT) allows initial setting and auto refresh setting to be made on the screen, reducing sequence programs and facilitating the confirmation of the setting status and operating status.

1.1.2 Mechanism of positioning control

1

Positioning control using the QD70 is exercised using "pulse signals". (The QD70 is a module that outputs pulses.)

In a positioning control system using the QD70, a variety of software and external devices are used to play their roles as shown below.

The QD70 imports various signals, parameters and data, and exercises control with the programmable controller CPU to realize complex positioning control.

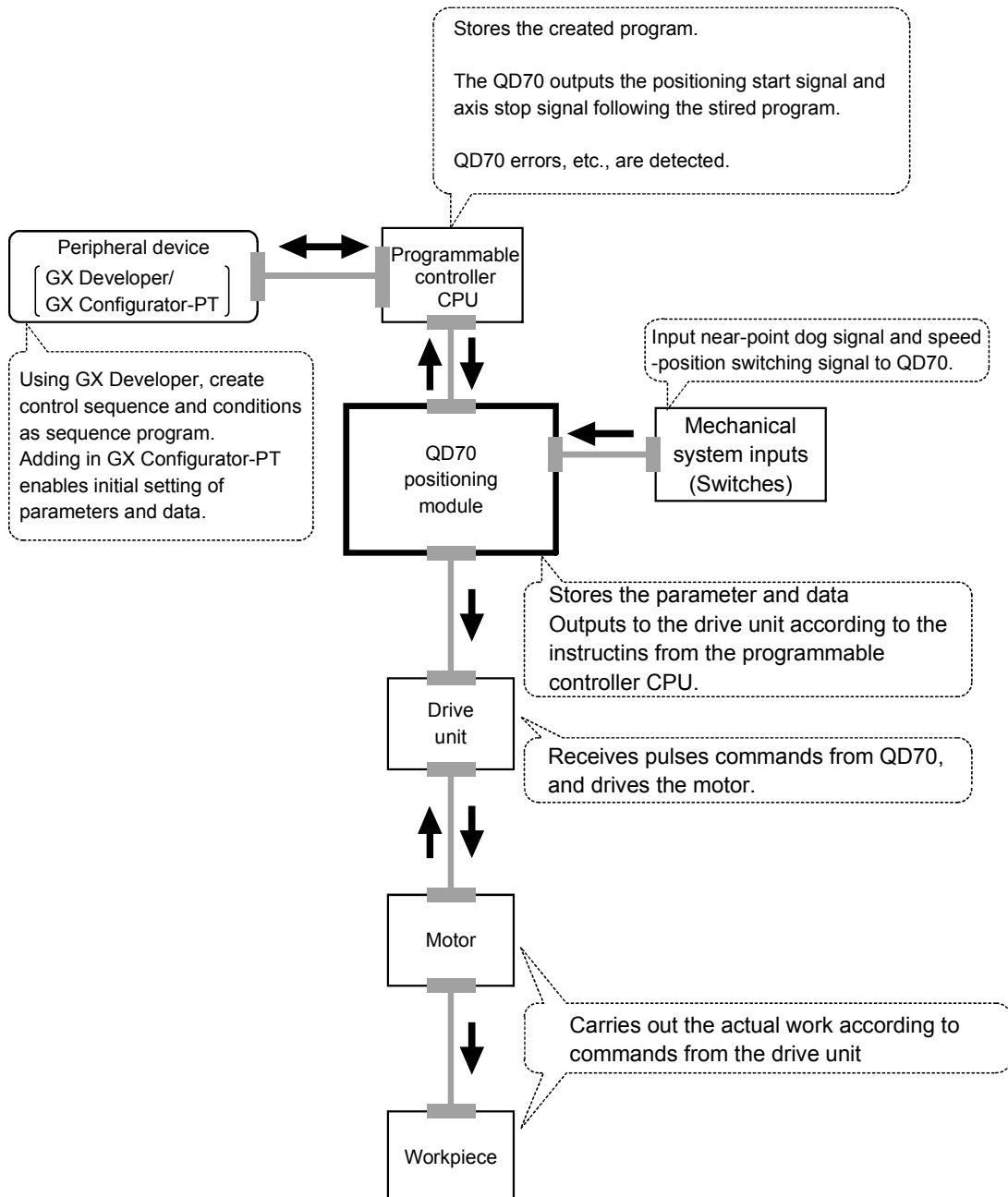

The principle of "position control" and "speed control" operation is shown below.

■ Position control

The total No. of pulses required to move the designated distance is obtained in the following manner.

$$\left(\begin{array}{l} \text{Total No. of pulses} \\ \text{required to move} \\ \text{designated distance} \end{array} \right) = \frac{\left(\begin{array}{l} \text{Designated distance} \\ \text{Movement amount of machine (load)} \\ \text{side when motor rotates once} \end{array} \right)}{\left(\begin{array}{l} \text{Movement amount of machine (load)} \\ \text{side when motor rotates once} \end{array} \right)} \times \left(\begin{array}{l} \text{No. of pulses} \\ \text{required for motor to} \\ \text{rotate once} \end{array} \right)$$

*The No. of pulses required for the motor to rotate once is the "encoder resolution" described in the motor catalog specification list.

When this total No. of pulses is issued from the QD70 to the drive unit, control to move the designated distance can be executed.

The machine side movement amount when one pulse is issued to the drive unit is called the "movement amount per pulse". This value is the min. value for the workpiece to move, and is also the electrical positioning control precision.

■ Speed control

Though the above "total No. of pulses" is an element needed to control the movement amount, speed must be controlled to perform equal-speed operation.

This "speed" is controlled by the "pulse frequency" output from the QD70 to the drive unit.

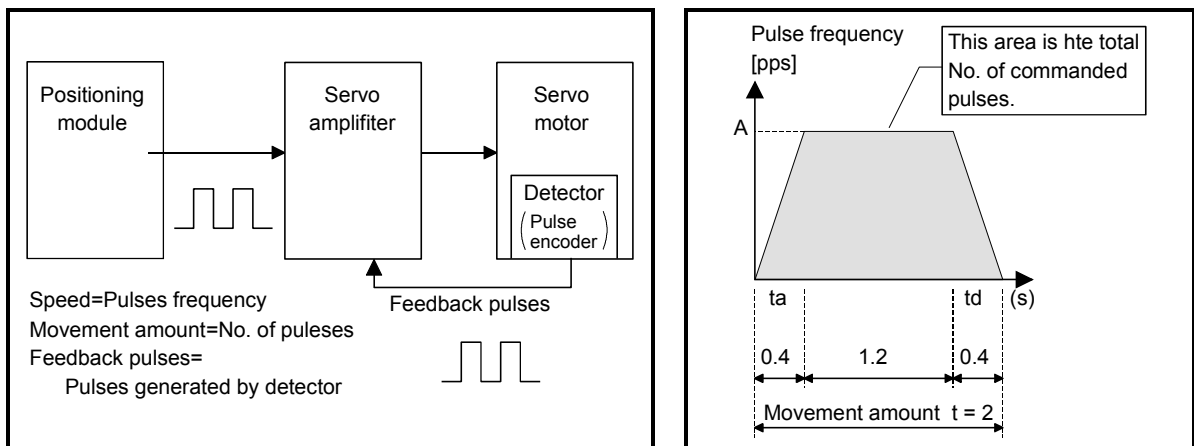

Fig. 1.1 Relationship between position control and speed control

POINT

- The "movement amount per pulse" is the value determined on the machine side. (Refer to Section 1.1.3.)
- The QD70 uses the "total No. of pulses" to control the position, and uses the "pulse frequency" to control the speed.

1.1.3 Outline design of positioning control system

The outline of the positioning control system operation and design, using the QD70, is shown below.

(1) Positioning control system using QD70

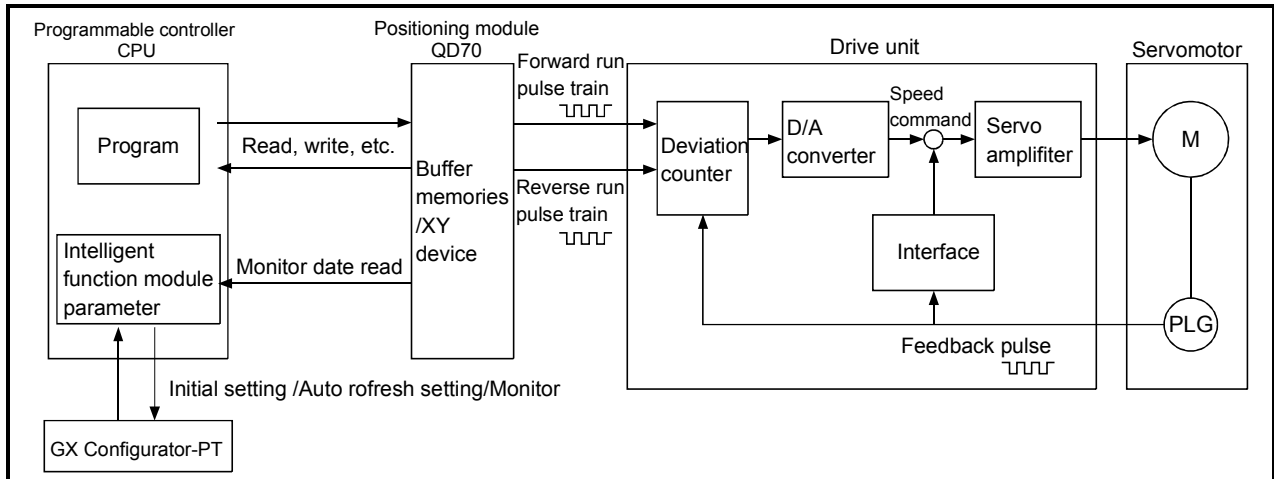

Fig. 1.2 Outline of the operation of positioning control system using QD70

(a) Positioning operation by the QD70

- 1) The QD70 output is a pulse train.
 The pulse train output by the QD70 is counted by and stored in the deviation counter in the drive unit.
 The D/A converter outputs an analog DC current proportionate to the count maintained by the deviation counter (called "pulse droop"). The analog DC current serves as the servomotor speed control signal.
- 2) The servomotor rotation is controlled by the speed control signal from the drive unit.
 As the servomotor rotates, the pulse encoder (PLG) attached to the servomotor generates feedback pulses, the frequency of which is proportionate to the rotation speed.
 The feedback pulses are fed back to the drive unit and decrements the pulse droop, the pulse count maintained by the deviation counter.
 The motor keeps on rotating as the pulse droop is maintained at a certain level.
- 3) When the QD70 terminates the output of a pulse train, the servomotor decelerates as the pulse droop decreases and stops when the count drops to zero.
 Thus, the servomotor rotation speed is proportionate to the pulse frequency, while the overall motor rotation angle is proportionate to the total number of pulses output by the QD70.
 Therefore, when a movement amount per pulse is given, the overall movement amount can be determined by the number of pulses in the pulse train.
 The pulse frequency, on the other hand, determines the servomotor rotation speed (feed speed).

(b) Pulse train output from the QD70

- 1) As shown in Fig. 1.3, the pulse frequency increases as the servomotor accelerates. The pulses are sparse when the servomotor starts and more frequent when the servomotor speed comes close to the target speed.
- 2) The pulse frequency stabilizes when the motor speed equals the target speed.
- 3) The QD70 decreases the pulse frequency (sparser pulses) to decelerate the servomotor before it finally stops the output.
There will be a little difference in timing between the decrease in the pulse frequency and the actual deceleration and stopping of the servomotor.
This difference, called "the stop settling time", is required for gaining a stopping accuracy.

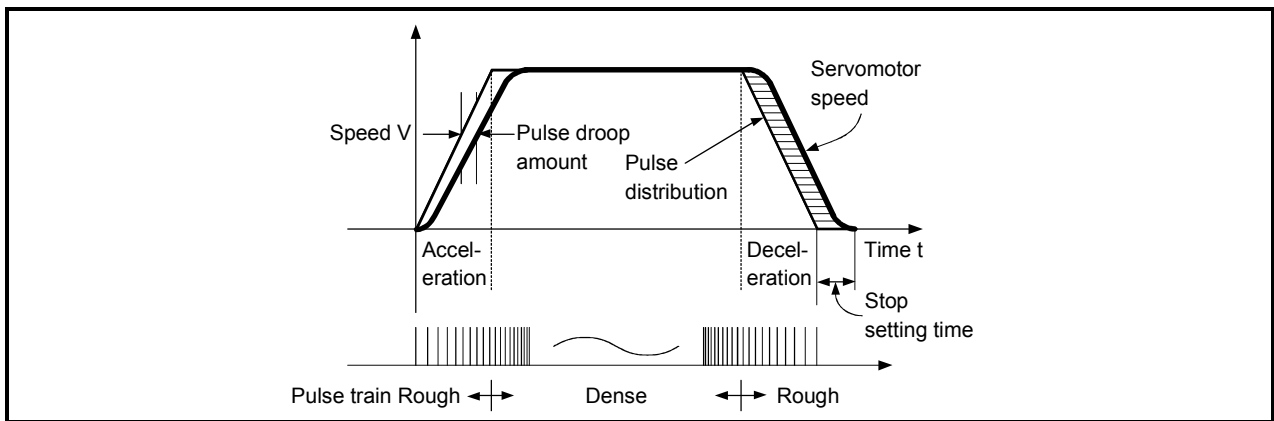

Fig. 1.3 QD70 output pulses

(2) Movement amount and speed in a system using worm gears

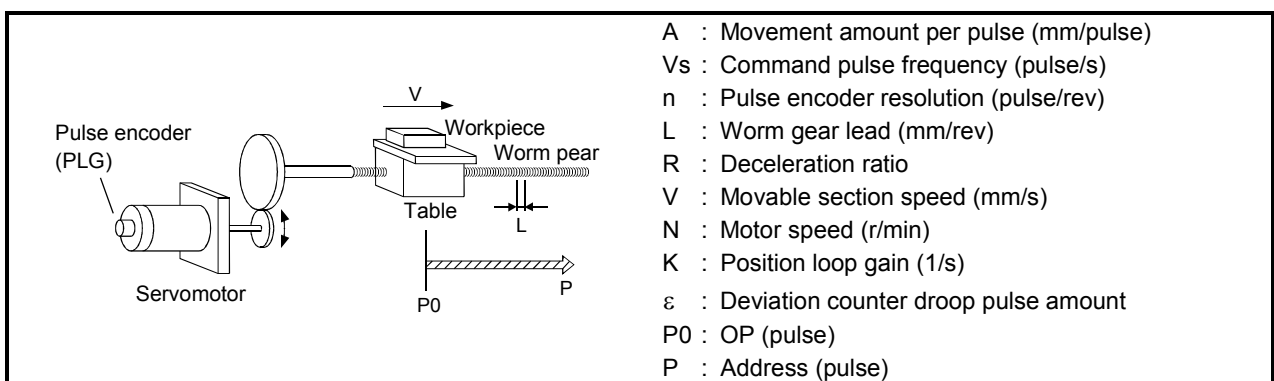

Fig. 1.4 System using worm gears

In the system shown in Fig. 1.4, the movement amount per pulse, command pulse frequency, and the deviation counter droop pulser amount are determined as follows:

1) Movement amount per pulse

The movement amount per pulse is determined by the worm gear lead, deceleration ratio, and the pulse encoder resolution.

The movement amount, therefore, is given as follows: (Number of pulses output) × (Movement amount per pulse).

$$A = \frac{L}{R \times n} \text{ [mm/pulse]}$$

2) Command pulse frequency

The command pulse frequency is determined by the speed of the moving part and movement amount per pulse.

$$V_s = \frac{V}{A} \text{ [pulse/s]}$$

3) Deviation counter droop pulser amount.

The deviation counter droop pulser amount is determined by the command pulse frequency and position loop gain.

$$\varepsilon = \frac{V_s}{K} \text{ [pulse]}$$

1.1.4 Communicating signals between QD70 and each module

The outline of the signal communication between the QD70 (positioning module) and programmable controller CPU, peripheral device (GX Configurator-PT) and drive unit, etc., is shown below.

(A peripheral device communicates with the QD70 via the programmable controller CPU to which it is connected)

Refer to Chapter 3 for details of the I/O signals.

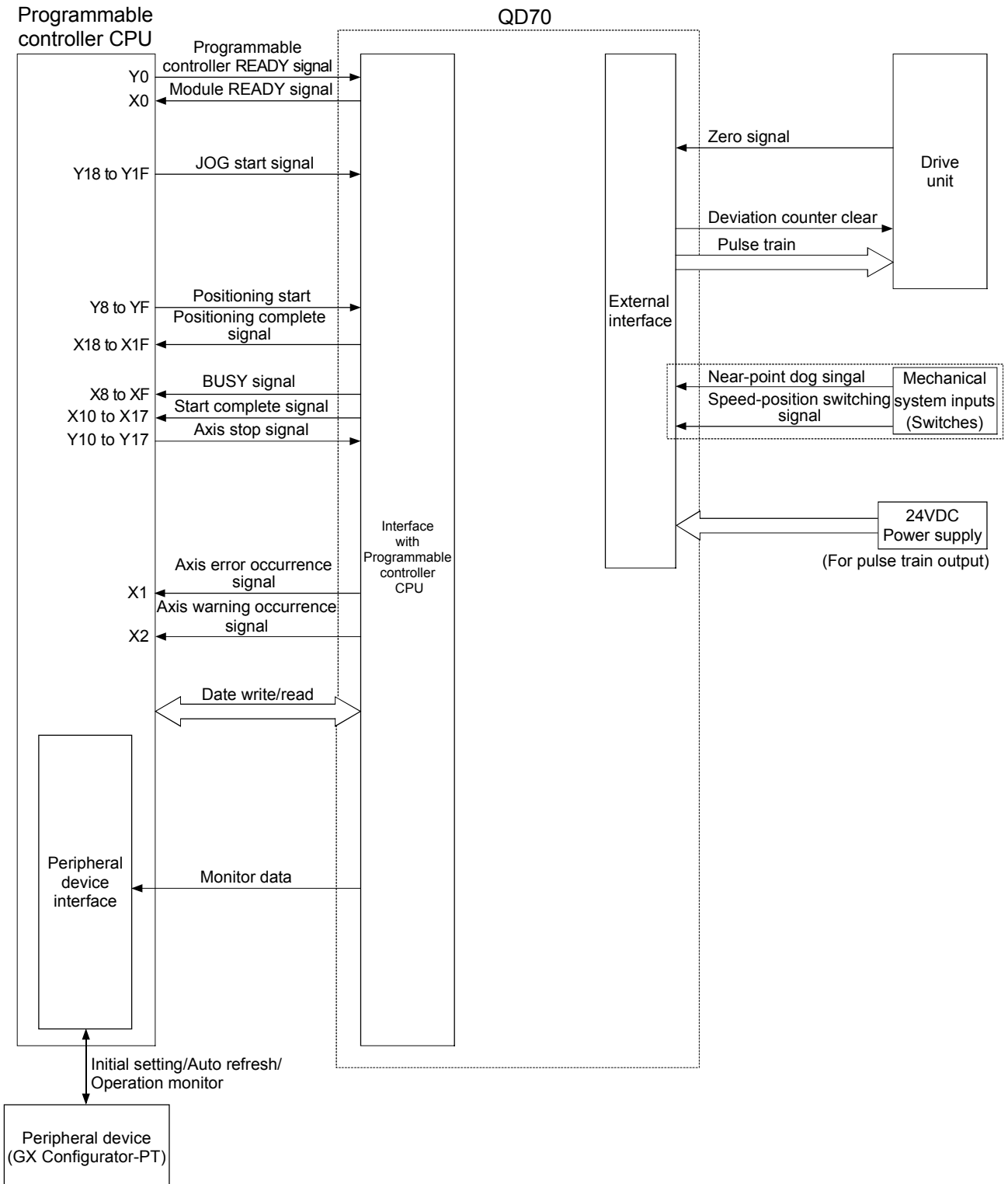

■ QD70 ↔ Programmable controller CPU

The QD70 and programmable controller CPU communicate the following data via the base unit.

Direction Communication	QD70 → Programmable controller CPU	Programmable controller CPU → QD70
Control signal	Signal indication QD70 state. <ul style="list-style-type: none"> • Module READY (X0) • Axis error occurrence (X1) • Axis warning occurrence (X2) • BUSY (X8 to XF) • Start complete (X10 to X17) • Positioning complete (X18 to X1F) 	Signal related to commands. <ul style="list-style-type: none"> • Programmable controller READY (Y0) • Positioning start (Y8 to YF) • Axis stop (Y10 to Y17) • JOG start (Y18 to Y1F)
Data (read/write)	<ul style="list-style-type: none"> • Parameter • OPR data • JOG data • Positioning data • Control data • Monitor data 	<ul style="list-style-type: none"> • Parameter • OPR data • JOG data • Positioning data • Control data

■ QCPU ↔ Peripheral device (GX Configurator-PT)

The QCPU and peripheral device make the following communications. (Refer to Chapter 6 for details.)

Direction Communication	QCPU → Peripheral device	Peripheral device → QCPU
Data	–	<ul style="list-style-type: none"> • Initial setting • Auto refresh setting
Operation monitor	<ul style="list-style-type: none"> • Monitor data (QD70 buffer memory/XY devices) 	–

■ QD70 ↔ Drive unit

The QD70 and drive unit communicate the following data via the external device connection connector.

Direction Communication	QD70 → Drive unit	Drive unit → QD70
Control signal	Signals related to commands <ul style="list-style-type: none"> • Deviation counter clear signal (CLEAR) 	Signal indicating OP <ul style="list-style-type: none"> • Zero signal (PG0)
Pulse train	<ul style="list-style-type: none"> • Pulse train output (PULSE F/ PULSE R) 	–

*: External 24VDC must be supplied to output the pulse train.

■ Mechanical system inputs (switches) ↔ QD70

The input signals from the mechanical system inputs (switches) are entered into the QD70 via the external device connection connector.

Mechanical system inputs (switches)	<ul style="list-style-type: none"> • Near-point dog signal (DOG) • Speed-position switching signal (CHG)
-------------------------------------	--

1.2 Positioning control

1.2.1 Outline of starting

The outline for starting each control is shown with the following flowchart.

* It is assumed that each module is installed, and the required system configuration, etc., has been prepared.

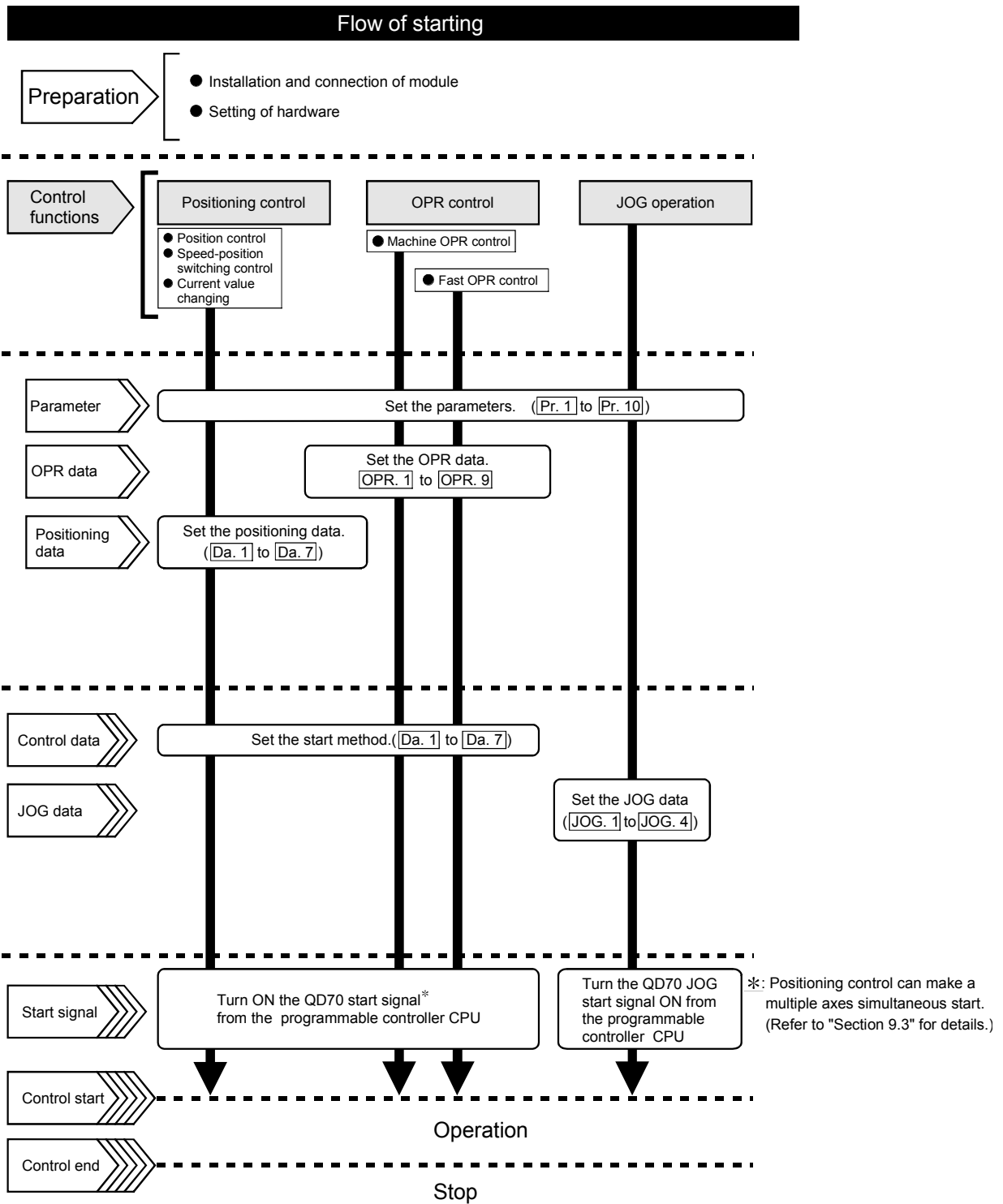

1.2.2 Outline of stopping

The possible causes of a control stop are as follows.

- (1) Control ended normally
- (2) An error occurred in the programmable controller CPU
- (3) An error occurred in the QD70
- (4) The axis stop signal from the programmable controller CPU turned ON

Stop processings performed in the above cases are outlined in the following table.
(Except the case (1) where control stopped normally)

Stop factor		Stopped axis	Axis operation status (Md. 4) after stop	Stop processing		
				OPR control	Positioning control	JOG operation
Programmable controller CPU error		All axes	Error	Deceleration stop		
QD70 error	Software stroke limit upper/lower limit error * 1	Axis by axis	Error	Deceleration stop		
	Other error	Axis by axis	Error	Deceleration stop * 2		
"Axis stop signal" from programmable controller CPU turned ON		Axis by axis	Stopped	Deceleration stop * 3		

*1: By making parameter setting, you can set the software stroke limit valid/invalid. When the stroke limit is set invalid, a deceleration stop is not made. (Refer to Section 4.2.)

*2: If an illegal positioning data setting value caused an error during position control (operation pattern: continuous path control), an immediate stop is made at the positioning data preceding that illegal setting value. (Refer to Section 9.1.2.)

*3: For position control (operation pattern: continuous path control), you can make parameter setting to select the stopping method (position match stop or deceleration stop). (Refer to Section 4.2.)

■ Stop after multiple axes simultaneous start under positioning control

The axes started will not stop simultaneously. The stop command (axis stop signal ON) must be given to each axis.

■ Pulse output operation at stop

When the axis stops due to stop cause occurrence, if there is the pulse being output when the set deceleration stop time has elapsed from the start of deceleration stop, the output as much as 1 pulse will be done.

The following shows the pulse output operation at deceleration stop.

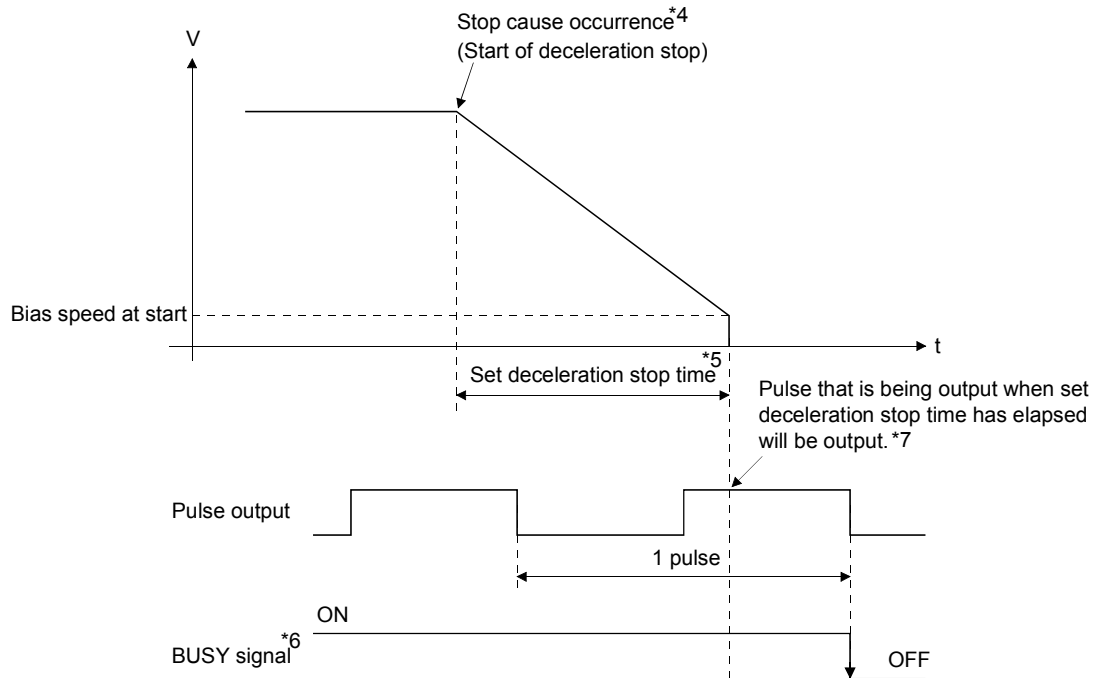

*4: "Stop cause" indicates any of the following.

- Error occurred in the programmable controller CPU or QD70.
- JOG start signal (Y18 to Y1F) has turned OFF during JOG operation.
- Axis stop signal (Y10 to Y17) has turned ON.
- Speed change to speed 0 (pulse/s) (when bias speed at start is 0 (pulse/s))
- Machine OPR control of count 2

*5: "Set deceleration stop time" is any of the following.

- During positioning control : **Da. 4** DEC/STOP time
- At speed change to speed 0 (pulse/s) : **Cd. 9** DEC/STOP time at speed change
- During machine OPR control of count 2 : **OPR. 7** DEC/STOP time at OPR
- During JOG operation : **JOG. 3** JOG DEC time

*6: When the axis is decelerated to a stop by a speed change to speed 0 (pulse/s), the BUSY signal does not turn OFF.

*7: The same operation is performed when an immediate stop cause occurs during machine OPR control (except the case of count 2).

CHAPTER 2 SYSTEM CONFIGURATION

This chapter explains the system configuration of the QD70.

2.1 General image of system

The following is the general configuration including the QD70, programmable controller CPU, peripheral device and others.
 (The numbers in the sketch correspond to the "Nos." in the table in "Section 2.2 Component list" on the next page.)

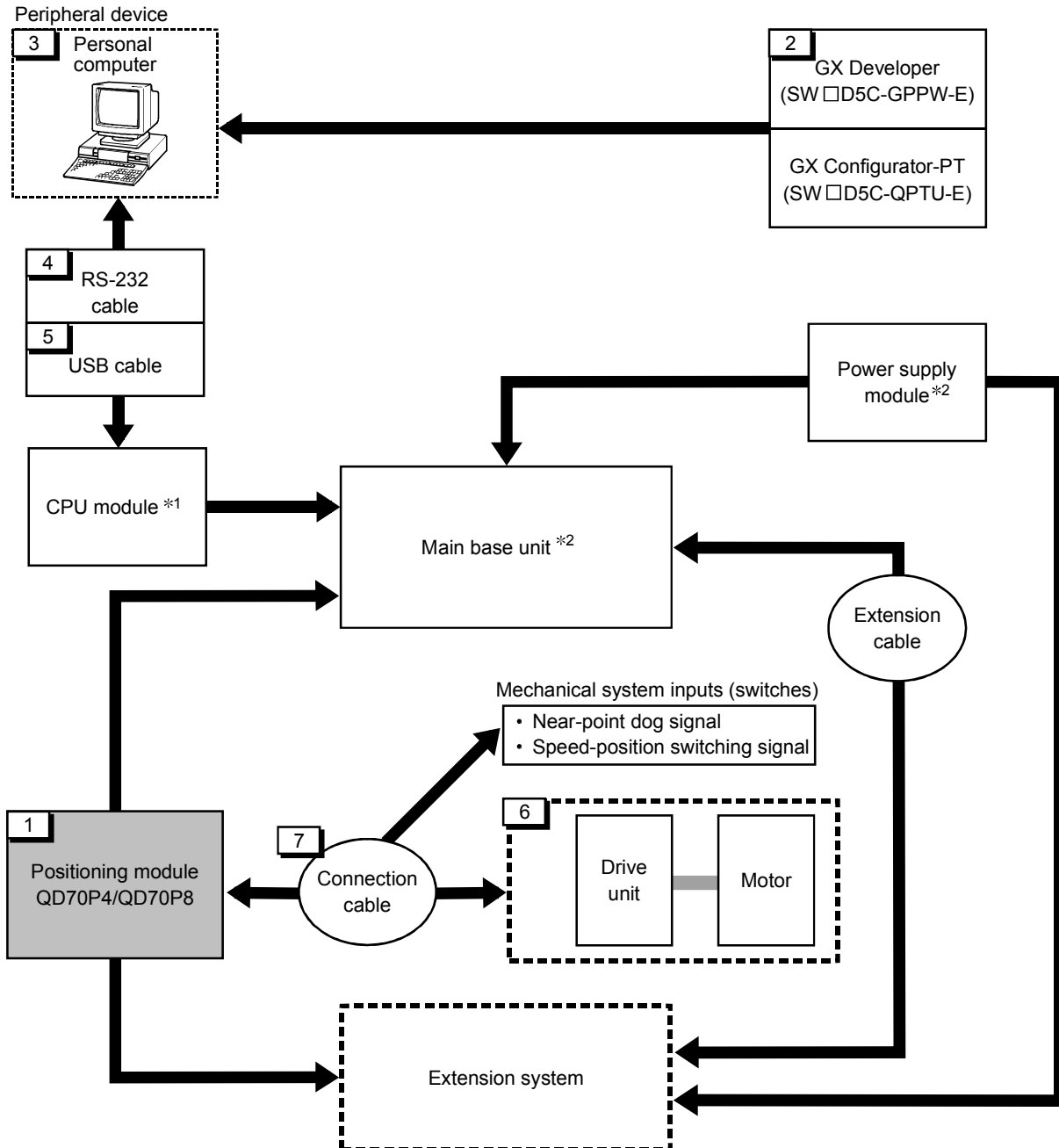

REMARK

*1: For the usable CPU module, refer to "Section 2.3 Applicable system".
 *2: For the usable base unit and power supply module, refer to the CPU Module User's Manual.

2.2 Component list

A positioning system using the QD70 consists of the following components.

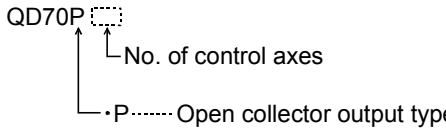
No.	Product	Type	Remarks
1	Positioning module	QD70P4 QD70P8	 <p>QD70P</p> <p>No. of control axes</p> <p>•P..... Open collector output type</p>
2	GX Developer GX Configurator-PT	SW: D5C-GPPW-E SW: D5C-QPTU-E	For details, refer to the GX Developer Operating Manual and "CHAPTER 6 UTILITY PACKAGE (GX Configurator-PT)".
3	Personal computer	DOS/V personal computer	(User-prepared) Refer to the GX Developer Operating Manual for details.
4	RS-232 cable	QC30R2	(User-prepared) RS-232 cable for connection of the CPU module and DOS/V personal computer. Refer to the GX Developer Operating Manual for details.
5	USB cable	-	(User-prepared) USB cable for connection of the CPU module and DOS/V personal computer. Refer to the GX Developer Operating Manual for details.
6	Drive unit	-	(User-prepared) Refer to the drive unit manual for details.
7	Connection cable (for connection of QD70 and drive unit)	-	(User-prepared) Cable for connection of the QD70 and drive unit or mechanical system input signals. (To be fabricated in reference to the connected device manual and Section 3.4.2)

2.3 Applicable systems

This section describes applicable systems.

(1) Applicable modules and base units, and No. of modules

(a) When mounted with a CPU module

The table below shows the CPU modules and base units applicable to the QD70 and quantities for each CPU model.

Depending on the combination with other modules or the number of mounted modules, power supply capacity may be insufficient.

Pay attention to the power supply capacity before mounting modules, and if the power supply capacity is insufficient, change the combination of the modules.

Applicable CPU module		No. of modules *1	Base unit *2		
CPU type	CPU model		Main base unit	Extension base unit	
Programmable controller CPU	Basic model QCPU	Q00JCPU	Up to 8	○	○
		Q00CPU	Up to 24	○	○
		Q01CPU			
	High Performance model QCPU	Q02CPU	Up to 64	○	○
		Q02HCPU			
		Q06HCPU			
		Q12HCPU			
		Q25HCPU			
	Process CPU	Q02PHCPU	Up to 64	○	○
		Q06PHCPU			
		Q12PHCPU			
		Q25PHCPU			
	Redundant CPU	Q12PRHCPU	Up to 53 *3	×	○
		Q25PRHCPU			
	Universal model QCPU	Q02UCPU	Up to 36	○	○
		Q03UDCPU	Up to 64		
		Q04UDHCPU			
		Q06UDHCPU			
		Q13UDHCPU			
Q26UDHCPU					
Q03UDECPU					
Q04UDEHCPU					
Q06UDEHCPU					
Q13UDEHCPU					
Q26UDEHCPU					

○: Applicable ×: N/A

Applicable CPU module		No. of modules *1	Base unit *2		
CPU type	CPU model		Main base unit	Extension base unit	
Programmable controller CPU	Safety CPU	QS001CPU	N/A	×	×
C Controller module		Q06CCPU-V	Up to 64	○	○
		Q06CCPU-V-B			

○: Applicable ×: N/A

*1: Limited within the range of I/O points for the CPU module.

*2: Can be installed to any I/O slot of a base unit.

*3: Use the QD70 whose serial No. (first five digits) is 09012 or later.

(b) Mounting to a MELSECNET/H remote I/O station

The table below shows the network modules and base units applicable to the QD70 and quantities for each network module model.

Depending on the combination with other modules or the number of mounted modules, power supply capacity may be insufficient.

Pay attention to the power supply capacity before mounting modules, and if the power supply capacity is insufficient, change the combination of the modules.

Applicable network module	No. of modules *1	Base unit *2	
		Main base unit of remote I/O station	Extension base unit of remote I/O station
QJ72LP25-25	Up to 64	○	○
QJ72LP25G			
QJ72LP25GE			
QJ72BR15			

○: Applicable ×: N/A

*1: Limited within the range of I/O points for the network module.

*2: Can be installed to any I/O slot of a base unit.

REMARK

The Basic model QCPU or C Controller module cannot create the MELSECNET/H remote I/O network.

(2) Support of the multiple CPU system

When using the QD70 in a multiple CPU system, refer to the following manual first.

- QCPU User's Manual (Multiple CPU System)

Intelligent function module parameters

Write intelligent function module parameters to only the control CPU of the QD70.

(3) Supported software packages

Relation between the system containing the QD70 and software package is shown in the following table.

GX Developer is necessary when using the QD70.

		Software Version	
		GX Developer	GX Configurator-PT
Q00J/Q00/Q01CPU	Single CPU system	Version 7 or later	Version 1.10L or later
	Multiple CPU system	Version 8 or later	
Q02/Q02H/Q06H/ Q12H/Q25HCPU	Single CPU system	Version 4 or later	
	Multiple CPU system	Version 6 or later	
Q02PH/Q06PHCPU	Single CPU system	Version 8.68W or later	Version 1.13P or later
	Multiple CPU system		
Q12PH/Q25PHCPU	Single CPU system	Version 7.10L or later	
	Multiple CPU system		
Q12PRH/Q25PRHCPU	Redundant CPU system	Version 8.45X or later	Version 1.14Q or later
Q02U/Q03UD/ Q04UDH/Q06UDHCPU	Single CPU system	Version 8.48A or later	Version 1.23Z or later
	Multiple CPU system		
Q13UDH/Q26UDHCPU	Single CPU system	Version 8.62Q or later	
	Multiple CPU system		
Q03UDE/Q04UDEH/ Q06UDEH/Q13UDEH/ Q26UDEHCPU	Single CPU system	Version 8.68W or later	
	Multiple CPU system		
If installed in a MELSECNET/H remote I/O station		Version 6 or later	Version 1.10L or later

2.4 About Use of the QD70 with the Q12PRH/Q25PRHCPU

Here, use of the QD70 with the Q12PRH/Q25PRHCPU is explained.

(1) GX Configurator-PT connection

GX Configurator-PT cannot be used when accessing the Q12PRH/Q25PRHCPU via an intelligent function module on an extension base unit from GX Developer. Connect a personal computer with a communication path indicated below.

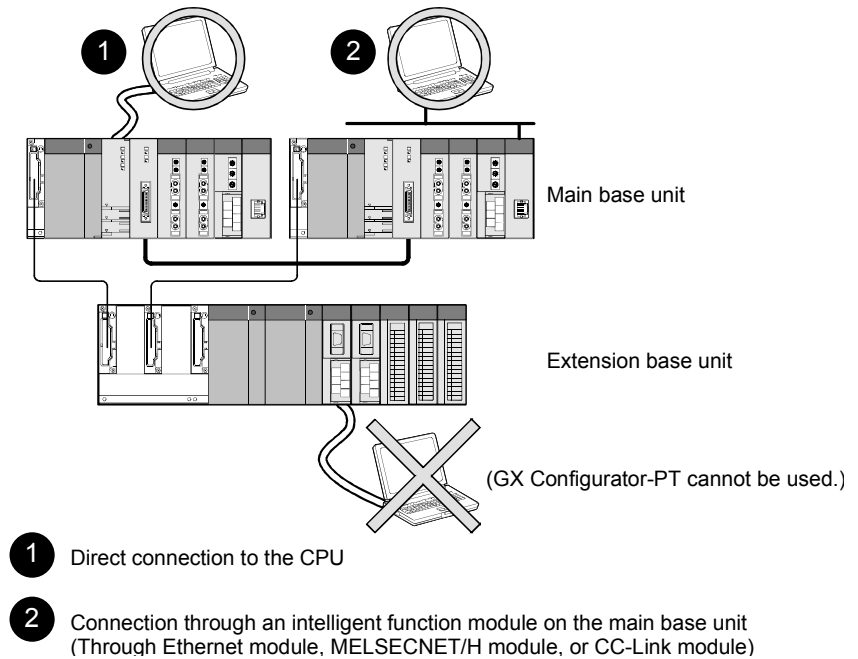

2.5 About Use of the QD70 on the MELSECNET/H Remote I/O Station

Here, use of the QD70 on the MELSECNET/H remote I/O station is explained.

(1) Number of QD70 that can be installed when the remote I/O station is used

See Section 2.3 concerning the number of QD70 that can be installed when the remote I/O station is used.

(2) Limitations when using the remote I/O station

When the QD70 is used on the MELSECNET/H remote I/O station, a delay will occur due to the link scan time. Therefore, fully verify that there will be no problem with controllability in the target system.

Example) Depending on the ON time of the positioning completed signal, the ON status may not be detected due to a delay in the link scan time.

2.6 How to Check the Function Version/Serial No./Software Version

Check the function version and serial No. of the QD70 and the GX Configurator- PT software version by the following methods.

[1] Checking the rating plate on the module side

The rating plate is situated on the side face of the QD70.

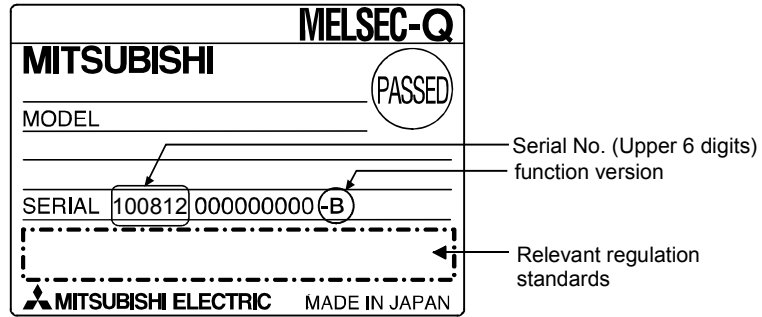

[2] Checking on the front of the module

The serial No. on the rating plate is also indicated on the front of the module (lower part).

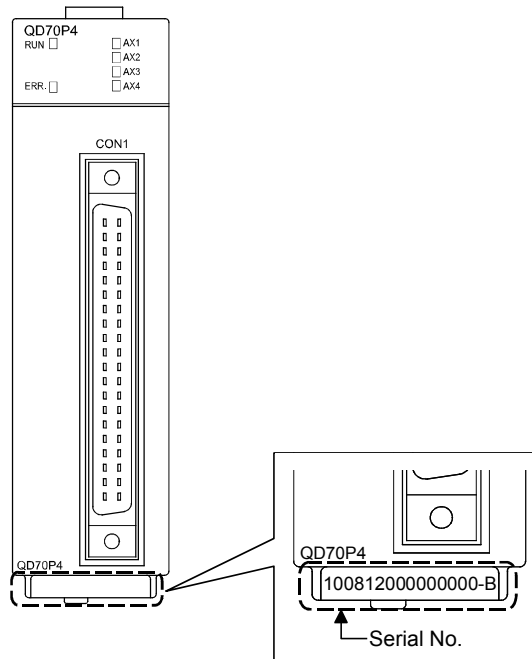

REMARK

The serial number is displayed on the front of the module from August 2008 production. Products manufactured during switching period may not have the serial number on the front of the module.

[3] Confirming the serial number on the system monitor (Product Information List)

To display the screen for checking the serial number and function version, select [Diagnostics] → [System monitor] and click the **Product Inf. List** button in GX Developer.

Slot	Type	Series	Model name	Points	I/O No.	Master PLC	Serial No.	Ver.
PLC	PLC	Q	Q25PHCPU	-	-	-	0610200000000000	C
0-0	Intelli.	Q	QD70P4	32pt	0000	-	0901200000000000	B
0-1	-	-	None	-	-	-	-	-
0-2	-	-	None	-	-	-	-	-
0-3	-	-	None	-	-	-	-	-
0-4	-	-	None	-	-	-	-	-

(a) Production No. display

Since the QD70 does not support the production number display, "-" is displayed.

POINT

The serial No. on the rating plate may be different from the serial No. displayed on the product information screen of GX Developer.

The serial No. on the rating plate indicates the management information of the product.

The serial No. displayed on the product information screen of GX Developer indicates the function information of the product. The function information of the product is updated when a new function is added.

[4] Checking the software version of GX Configurator-PT

The software version of GX Configurator- PT can be checked in GX Developer's "Product information" screen.

[Operating procedure]

GX Developer → [Help] → [Product information]

<GX Developer display screen>

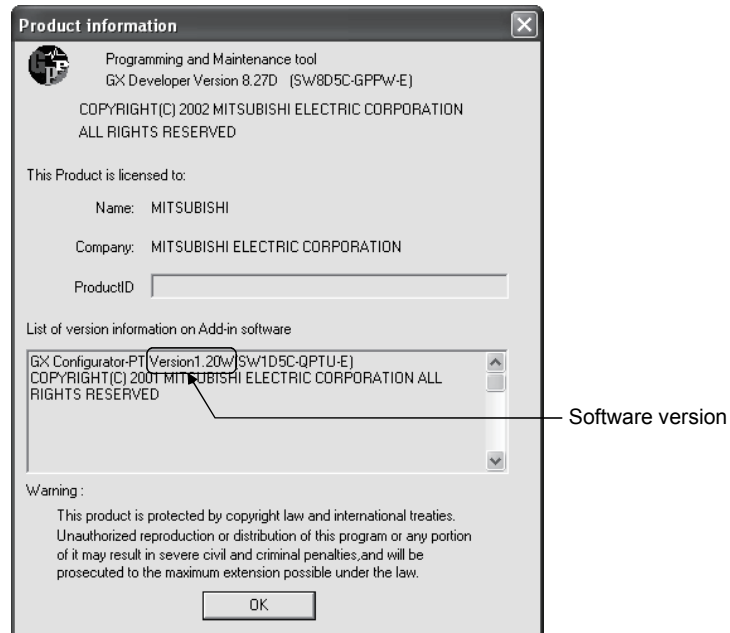

CHAPTER 3 SPECIFICATIONS AND FUNCTIONS

This chapter describes the performance specifications of the QD70 and the specifications of the I/O signals transferred to/from the programmable controller CPU and external device.

For the general specifications of the QD70, refer to the User's Manual (hardware) of the CPU module used.

3

3.1 Performance specifications

Item		Model	QD70P4	QD70P8
No. of control axes			4 axes	8 axes
Interpolation function			No	
Control method			PTP (Point To Point) control, path control (linear only), speed-position switching control	
Control unit			pulse	
Positioning data *1			10 pieces of data (positioning data No. 1 to 10)/axis (can be set using GX Configurator-PT or sequence program)	
Peripheral device/utility package			GX Configurator-PT (option)	
Data backup			No	
Positioning control	Positioning control method		PTP control : Incremental system/absolute system Speed-position switching control : Incremental system Path control : Incremental system/absolute system	
	Positioning control range		[Absolute system] -2147483648 to 2147483647pulse [[Incremental system] -2147483648 to 2147483647pulse [Speed-position switching control] 0 to 2147483647pulse	
	Speed command		0 to 200000pulse/s	
	Acceleration/deceleration processing		Trapezoidal acceleration/deceleration	
	Acceleration/deceleration time		0 to 32767ms	
	Starting time *2	Position control		1-axis start
			4-axes simultaneous start	0.2ms
			8-axes simultaneous start	0.4ms
External wiring connection system			40-pin connector	
Applicable wire size			0.3mm ² or lower (for use of A6CON1 or A6CON4), AWG#24 (for use of A6CON2)	
External device connection connector			A6CON1, A6CON2, A6CON4 (option)	
Pulse output method			Open collector output	
Max. output pulse			200kpps	
Max. connection distance between QD70 and drive unit			2m	
Internal current consumption (5VDC)			0.55A	0.74A
External 24V current consumption (24VDC)			0.065A	0.12A
No. of occupied I/O points			32 points (I/O assignment: Intelligent function module 32 points)	
Weight			0.15kg	0.17kg

*1: Positioning data can be started from No.1 only. (Cannot be started from any of No.2 to No.10.)

*2: A delay may occur depending on the operating conditions and starting conditions (control method, bias speed, ACC/DEC time, etc.) of the other axes.

3.2 List of functions

The following table lists the functions of the QD70.

(Read "SECTION 2 CONTROL DETAILS AND SETTING" for details of the functions.)

Function name		Description	Reference
OPR control	Machine OPR control	Mechanically establishes the positioning control start point using a near-point dog or stopper.	Section 8.2
	Fast OPR control	Positions a target to the OP address (Md. 1 Current feed value) stored in the QD70 using machine OPR control.	Section 8.3
Positioning control	Position control (1-axis linear control)	Positions a target using a linear path to the address set in the positioning data or to the position designated with the movement amount.	Section 9.2.2
	Speed-position switching control	First, carries out speed control, and then carries out position control (positioning control with designated address or movement amount) by turning the "speed-position switching signal" ON.	Section 9.2.3
	Current value changing	Changes the Current feed value (Md. 1) to the address set in the positioning data.	Section 9.2.4
JOG operation		Outputs a pulse to drive unit while the JOG start signal is ON.	Chapter 10
Sub function	Speed limit function	If the command speed exceeds "[Pr. 5] Speed limit value" during control, this function limits the commanded speed to within the "[Pr. 5] Speed limit value" setting range.	Section 11.2
	Speed change function	This function changes the speed at any point during speed control of speed-position switching control or during JOG operation. Set the new speed in the speed change buffer memory ([Pr. 7] New speed value), and change the speed with the Speed change request ([Pr. 6]).	Section 11.3
	Software stroke limit function	If a command outside of the upper/lower limit stroke limit setting range, set in the parameters, is issued, this function will not execute positioning for that command.	Section 11.4
	Acceleration/deceleration processing function	This function adjusts the acceleration/deceleration processing of control.	Section 11.5
	Restart function	This function resumes positioning control during a stop of the axis from where it had stopped.	Section 11.6
Common function	External I/O signal logic switching function	This function changes the external I/O signal logic to match the externally connected device. It can be changed by making the intelligent function module switch setting.	Section 12.2
	External I/O signal monitor function	This function monitors the external I/O signal states using GX Developer.	Section 5.5 Section 12.3

With the "positioning control", whether or not to continuously execute the positioning data can be set with the "operation pattern". Outlines of the "operation patterns" are given below.

Da.1 Operation pattern	Description	Reference
Positioning termination	When "Positioning termination" is set for the operation pattern of the started positioning data, only the designated positioning data will be executed, and then the positioning control will end.	9.1.2
Continuous positioning control	When "continuous positioning control" is set for the operation pattern of the started positioning data, after the designated positioning data is executed, the program will stop once, and then the next following positioning data will be executed.	
Continuous path control	When "continuous path control" is set for the operation pattern of the started positioning data, the designated positioning data will be executed, and then without decelerating, the next following positioning data will be executed.	

3.3 Specifications of input/output signal with Programmable Controller CPU

3.3.1 List of input/output signals with programmable controller CPU

The QD70 uses 32 input points and 32 output points for exchanging data with the programmable controller CPU.

The input/output signals when the QD70 is mounted in slot No. 0 of the main base unit are shown below.

Device X refers to the signals input from the QD70 to the programmable controller CPU, and device Y refers to the signals output from the programmable controller CPU to the QD70.

Signal direction: QD70 → Programmable controller CPU			Signal direction: Programmable controller CPU → QD70		
Device No.	Signal name		Device No.	Signal name	
X0	Module READY		Y0	Programmable controller READY	
X1	Axis error occurrence		Y1	Use prohibited	
X2	Axis warning occurrence		Y2		
X3	Use prohibited		Y3		
X4			Y4		
X5			Y5		
X6			Y6		
X7			Y7		
X8	Axis 1	BUSY	Y8		
X9	Axis 2		Y9	Axis 2	
XA	Axis 3		YA	Axis 3	
XB	Axis 4		YB	Axis 4	
XC	Axis 5		YC	Axis 5	
XD	Axis 6		YD	Axis 6	
XE	Axis 7		YE	Axis 7	
XF	Axis 8		YF	Axis 8	
X10	Axis 1	Start complete	Y10	Axis 1	Axis stop
X11	Axis 2		Y11	Axis 2	
X12	Axis 3		Y12	Axis 3	
X13	Axis 4		Y13	Axis 4	
X14	Axis 5		Y14	Axis 5	
X15	Axis 6		Y15	Axis 6	
X16	Axis 7		Y16	Axis 7	
X17	Axis 8		Y17	Axis 8	
X18	Axis 1	Positioning complete	Y18	Axis 1	JOG start
X19	Axis 2		Y19	Axis 2	
X1A	Axis 3		Y1A	Axis 3	
X1B	Axis 4		Y1B	Axis 4	
X1C	Axis 5		Y1C	Axis 5	
X1D	Axis 6		Y1D	Axis 6	
X1E	Axis 7		Y1E	Axis 7	
X1F	Axis 8		Y1F	Axis 8	

Important
 [Y1 to Y7], and [X3 to X7] are used by the system, and cannot be used by the user.
 If these devices are used, the operation of the QD70 will not be guaranteed.

3.3.2 Details of input signal (QD70 → Programmable controller CPU)

The ON/OFF timing and conditions of the input signals are shown below.

Device No.	Signal name		Description
X0	Module READY		<p>ON: Prepared OFF: Not prepared watch dog timer error</p> <ul style="list-style-type: none"> When the Programmable controller READY signal [Y0] turns from OFF to ON, the parameter and the OPR data setting range is checked. If no error is found, this signal turns ON. (When the axis error occurrence signal [X1] is ON, this signal does not turn ON if the Programmable controller READY signal [Y0] is turned from OFF to ON.) When the Programmable controller READY signal [Y0] turns OFF, this signal turns OFF. When a watch dog timer (WDT) error occurs, this signal turns OFF. This signal is used for interlock in a sequence program, etc.
X1	Axis error occurrence		<p>OFF: No error ON: Error occurrence</p> <ul style="list-style-type: none"> This signal turns ON if an error occurs in any of axes 1 to 8, and turns OFF when "Cd. 1 Axis error reset" is set for all axes. (Use "Md. 10 Error status" to confirm the error status of the corresponding axis.)
X2	Axis warning occurrence		<p>OFF: No warning ON: Warning occurrence</p> <ul style="list-style-type: none"> This signal turns ON if a warning occurs in any of axes 1 to 8, and turns OFF when "Cd. 1 Axis error reset" is set for all axes. (Use "Md. 11 Warning status" to confirm the warning status of the corresponding axis.)
X8 X9 XA XB XC XD XE XF	Axis 1 Axis 2 Axis 3 Axis 4 Axis 5 Axis 6 Axis 7 Axis 8	BUSY * 1	<p>OFF: Not BUSY ON: BUSY</p> <ul style="list-style-type: none"> This signal turns ON at the start of positioning control, OPR control or JOG operation. It turns OFF when the "Da. 7 Dwell time" has passed after positioning control stops. (This signal remains ON during positioning control.) This signal turns OFF at error or stop.
X10 X11 X12 X13 X14 X15 X16 X17	Axis 1 Axis 2 Axis 3 Axis 4 Axis 5 Axis 6 Axis 7 Axis 8	Start complete	<p>OFF: Start incomplete ON: Start complete</p> <ul style="list-style-type: none"> This signal turns ON when the positioning start signal turns ON and the QD70 starts the positioning control process. (The start complete signal also turns ON during OPR control.)
X18 X19 X1A X1B X1C X1D X1E X1F	Axis 1 Axis 2 Axis 3 Axis 4 Axis 5 Axis 6 Axis 7 Axis 8	Positioning complete * 2	<p>OFF: Positioning incomplete ON: Positioning complete</p> <ul style="list-style-type: none"> This signal turns ON for the time set in "Pr. 7 Positioning complete signal output time" from completion of position control of the corresponding axis. (It does not turn ON if 0 is set in "Pr. 7 Positioning complete signal output time".) While ON, this signal turns OFF if a positioning control start (including OPR control) or JOG operation start is made. This signal does not turn ON at the termination of JOG operation. This signal does not turn ON if position control is stopped midway.

Important
<p>*1: The BUSY signal turns ON even when position control of movement amount 0 is executed. However, since the ON time is short, the ON status may not be detected in the sequence program.</p> <p>*2: "Position control complete" of the QD70 refers to the point when the pulse output from QD70 is completed. Thus, even if the QD70's positioning complete signal turns ON, the system may continue operation.</p>

3.3.3 Details of output signals (Programmable controller CPU → QD70)

The ON/OFF timing and conditions of the output signals are shown below.

Device No.	Signal name		Description
Y0	Programmable controller READY		<p>OFF: Programmable controller READY OFF</p> <p>ON: Programmable controller READY ON</p> <p>(a) This signal notifies the QD70 that the programmable controller CPU is normal.</p> <ul style="list-style-type: none"> It is turned ON/OFF with the sequence program. The Programmable controller READY signal is turned ON during positioning control, OPR control and JOG operation. <p>(b) When parameters and OPR data are changed, the Programmable controller READY signal is turned OFF.</p> <p>(c) The following processes are carried out when the Programmable controller READY signal turns from OFF to ON.</p> <ul style="list-style-type: none"> The parameter and OPR data setting range is checked. The module READY signal [X0] turns ON. <p>(d) The following processes are carried out when the Programmable controller READY signal turns from ON to OFF. In these cases, the OFF time should be set to 100ms or more.</p> <ul style="list-style-type: none"> The module READY signal [X0] turns OFF. The operating axis stops.
Y8 Y9 YA YB YC YD YE YF	Axis 1 Axis 2 Axis 3 Axis 4 Axis 5 Axis 6 Axis 7 Axis 8	Positioning start	<p>OFF: Positioning start not requested</p> <p>ON: Positioning start requested</p> <ul style="list-style-type: none"> OPR control and positioning control is started. The positioning start signal is valid at the rising edge, and the operation is started. When the positioning start signal turns ON during BUSY, the operation starting warning will occur (warning code: 10).
Y10 Y11 Y12 Y13 Y14 Y15 Y16 Y17	Axis 1 Axis 2 Axis 3 Axis 4 Axis 5 Axis 6 Axis 7 Axis 8	Axis stop	<p>OFF: Axis stop not requested</p> <p>ON: Axis stop requested</p> <ul style="list-style-type: none"> When the axis stop signal turns ON, the OPR control, positioning control and JOG operation. In these cases, the ON time should be set to 4ms or more. Turning ON the axis stop signal during operation decelerates the axis to a stop. At this time, "[Md. 4] Axis operation status" changes from "Deceleration (Axis Stop ON)" to "Stopped".
Y18 Y19 Y1A Y1B Y1C Y1D Y1E Y1F	Axis 1 Axis 2 Axis 3 Axis 4 Axis 5 Axis 6 Axis 7 Axis 8	JOG start	<p>OFF: JOG not started</p> <p>ON: JOG started</p> <ul style="list-style-type: none"> When the JOG start signal is ON, JOG operation will be carried out at the "[JOG. 1] JOG speed". When the JOG start signal turns OFF, the operation will decelerate and stop. At this time, "[Md. 4] Axis operation status" changes from "Deceleration (JOG Start OFF)" to "Standby". Set the rotation direction in "[JOG. 4] JOG direction flag". (Refer to Chapter 10.)

3.4 Specifications of input/output interfaces with external device

3.4.1 Electrical specifications of input/output signals

■ Input specifications

Signal name	Rated input voltage/current	Working voltage range	ON voltage/ current	OFF voltage/ current	Input resistance	Response time
Zero signal (PG0)	5VDC/18mA	4.5 to 5.5VDC	2.7VDC or more/ 5.5mA or more	1.0VDC or less/ 0.5mA or less	Approx. 270Ω	0.1ms or less
Near-point dog signal (DOG) Speed-position switching signal (CHG)	24VDC/5mA	19.2 to 26.4VDC	17.5VDC or more/3mA or more	7VDC or less/ 0.9mA or less	Approx. 6.8kΩ	1ms or less

■ Output specifications

Signal name	Rated load voltage	Working load voltage range	Max. load current/rush current	Max. voltage drop at ON	Leakage current at OFF	Response time																							
Pulse output (CW/PULSE) Pulse sign (CCW/SIGN)	<ul style="list-style-type: none"> Set the pulse output mode and pulse output logic selection in "intelligent function module switch setting" (Refer to Section 5.6). The following are the relationships between pulse outputs depending on the "pulse output mode" and "pulse output logic selection". 																												
	<table border="1"> <thead> <tr> <th rowspan="3">Pulse output mode</th> <th colspan="4">Pulse output logic selection</th> </tr> <tr> <th colspan="2">Positive logic</th> <th colspan="2">Negative logic</th> </tr> <tr> <th>Forward run</th> <th>Reverse run</th> <th>Forward run</th> <th>Reverse run</th> </tr> </thead> <tbody> <tr> <td>CW CCW</td> <td></td> <td></td> <td></td> <td></td> </tr> <tr> <td>PULSE SIGN</td> <td></td> <td></td> <td></td> <td></td> </tr> </tbody> </table>						Pulse output mode	Pulse output logic selection				Positive logic		Negative logic		Forward run	Reverse run	Forward run	Reverse run	CW CCW					PULSE SIGN				
	Pulse output mode	Pulse output logic selection																											
		Positive logic		Negative logic																									
Forward run		Reverse run	Forward run	Reverse run																									
CW CCW																													
PULSE SIGN																													
The table next page shows the rising/falling edge time and duty ratio. *																													
	5 to 24VDC	4.75 to 30VDC	50mA/1 point/ 200mA 10ms or less	0.5VDC (TYP)	0.1mA or less	—																							
Deviation counter clear (CLEAR)	5 to 24VDC	4.75 to 30VDC	0.1A/1 point/0.4A 10ms or less	1VDC (TYP) 2.5VDC (MAX)	0.1mA or less	2ms or less (resistance load)																							

*: Pulse rising/falling edge time (Unit for "tr" and "tf": μ s, unit for "Duty": %)
 ... When ambient temperature is room temperature.

Load voltage (V)		26.4					
Cable length (m)		1			2		
Load current (mA)	Pulse speed (kpps)	tr (Rising edge)	tf (Falling edge)	Duty	tr (Rising edge)	tf (Falling edge)	Duty
2	200	1.902	0.3178	28.20	2.129	0.2724	28.09
	100	2.869	0.3388	38.44	3.691	0.3549	40.12
	10	3.710	0.3616	50.22	5.187	0.3613	49.63
5	200	1.776	0.3036	35.45	1.763	0.3395	36.48
	100	2.134	0.3285	43.90	2.394	0.3445	41.11
	10	2.357	0.3982	50.88	3.105	0.3899	50.50
10	200	1.336	0.3174	40.92	1.429	0.3228	40.44
	100	1.644	0.3814	48.05	1.812	0.3793	46.40
	10	2.028	0.4197	51.31	1.996	0.4200	51.22
20	200	1.236	0.3807	45.64	1.269	0.3949	45.14
	100	1.772	0.4453	49.90	1.734	0.4660	49.73
	10	1.957	0.4776	51.63	1.727	0.4749	51.55
50	200	1.122	0.6809	51.78	1.019	0.6684	51.42
	100	1.359	0.7407	53.09	1.544	0.7897	52.90
	10	1.750	0.9833	52.05	1.819	0.9130	52.03

Load voltage (V)		4.75					
Cable length (m)		1			2		
Load current (mA)	Pulse speed (kpps)	tr (Rising edge)	tf (Falling edge)	Duty	tr (Rising edge)	tf (Falling edge)	Duty
2	200	0.8352	0.2093	45.21	1.484	0.1924	36.94
	100	1.880	0.2679	44.44	1.848	0.2536	45.03
	10	1.942	0.2765	51.03	2.039	0.2873	51.13
5	200	1.220	0.1726	39.35	1.191	0.2345	41.56
	100	1.422	0.2652	48.15	1.589	0.2631	47.89
	10	1.705	0.2893	51.35	1.604	0.3116	51.40
10	200	0.8736	0.2739	46.99	1.167	0.2519	44.97
	100	1.041	0.3075	49.87	1.371	0.3028	50.02
	10	1.576	0.3295	51.49	1.672	0.3212	51.41
20	200	1.021	0.3479	49.65	0.7345	0.3452	48.94
	100	1.277	0.3671	51.67	1.222	0.3780	52.12
	10	1.473	0.4207	51.84	1.287	0.3999	51.73
50	200	0.8312	0.6302	55.37	0.7978	0.5752	55.34
	100	0.9714	0.6290	55.38	1.025	0.6218	55.64
	10	0.9884	0.7037	52.09	1.105	0.6799	52.05

■ External power source (For driving the pulse output circuit)

Signal name	Rated input voltage	Current consumption
External power source input (+24V/24G)	24VDC (+20%/-15) (Ripple rate within 5%)	QD70P4:0.065A, QD70P8:0.12A

3.4.2 Signal layout for external device connection connector

The specifications of the connector section, which is the input/output interface for the QD70 and external device, are shown below.

The signal layout for the QD70 external device connection connector is shown.

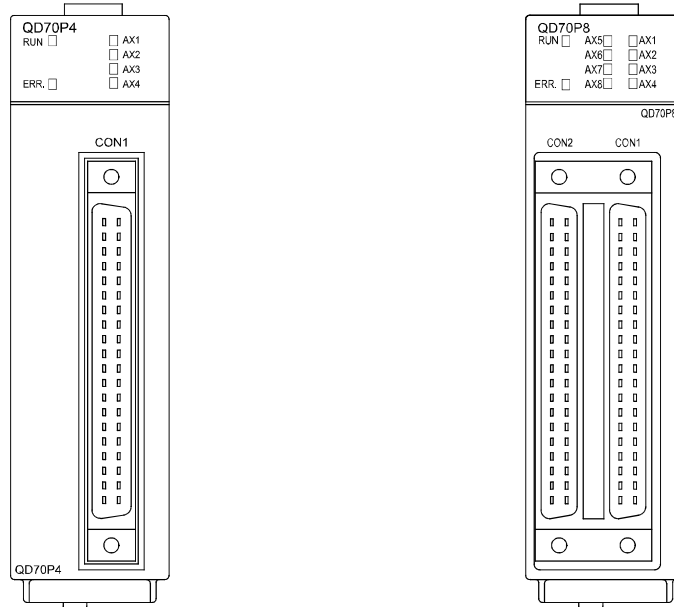

Pin layout	CON 2 (for Axes 5 to 8)				CON 1 (for Axes 1 to 4)																																																															
	Pin No.	Signal name	Pin No.	Signal name	Pin No.	Signal name	Pin No.	Signal name																																																												
<table border="0"> <tr><td>B20</td><td>□ □</td><td>A20</td></tr> <tr><td>B19</td><td>□ □</td><td>A19</td></tr> <tr><td>B18</td><td>□ □</td><td>A18</td></tr> <tr><td>B17</td><td>□ □</td><td>A17</td></tr> <tr><td>B16</td><td>□ □</td><td>A16</td></tr> <tr><td>B15</td><td>□ □</td><td>A15</td></tr> <tr><td>B14</td><td>□ □</td><td>A14</td></tr> <tr><td>B13</td><td>□ □</td><td>A13</td></tr> <tr><td>B12</td><td>□ □</td><td>A12</td></tr> <tr><td>B11</td><td>□ □</td><td>A11</td></tr> <tr><td>B10</td><td>□ □</td><td>A10</td></tr> <tr><td>B9</td><td>□ □</td><td>A9</td></tr> <tr><td>B8</td><td>□ □</td><td>A8</td></tr> <tr><td>B7</td><td>□ □</td><td>A7</td></tr> <tr><td>B6</td><td>□ □</td><td>A6</td></tr> <tr><td>B5</td><td>□ □</td><td>A5</td></tr> <tr><td>B4</td><td>□ □</td><td>A4</td></tr> <tr><td>B3</td><td>□ □</td><td>A3</td></tr> <tr><td>B2</td><td>□ □</td><td>A2</td></tr> <tr><td>B1</td><td>□ □</td><td>A1</td></tr> </table>	B20	□ □	A20	B19	□ □	A19	B18	□ □	A18	B17	□ □	A17	B16	□ □	A16	B15	□ □	A15	B14	□ □	A14	B13	□ □	A13	B12	□ □	A12	B11	□ □	A11	B10	□ □	A10	B9	□ □	A9	B8	□ □	A8	B7	□ □	A7	B6	□ □	A6	B5	□ □	A5	B4	□ □	A4	B3	□ □	A3	B2	□ □	A2	B1	□ □	A1	B20	PG06 COM * 1	A20	PG08 COM * 1	B20	PG02 COM * 1	A20	PG04 COM * 1
	B20	□ □	A20																																																																	
	B19	□ □	A19																																																																	
	B18	□ □	A18																																																																	
	B17	□ □	A17																																																																	
	B16	□ □	A16																																																																	
	B15	□ □	A15																																																																	
	B14	□ □	A14																																																																	
	B13	□ □	A13																																																																	
	B12	□ □	A12																																																																	
	B11	□ □	A11																																																																	
	B10	□ □	A10																																																																	
	B9	□ □	A9																																																																	
	B8	□ □	A8																																																																	
	B7	□ □	A7																																																																	
	B6	□ □	A6																																																																	
	B5	□ □	A5																																																																	
	B4	□ □	A4																																																																	
	B3	□ □	A3																																																																	
	B2	□ □	A2																																																																	
B1	□ □	A1																																																																		
B19	PG06	A19	PG08	B19	PG02	A19	PG04																																																													
B18	PG05 COM * 1	A18	PG07 COM * 1	B18	PG01 COM * 1	A18	PG03 COM * 1																																																													
B17	PG05	A17	PG07	B17	PG01	A17	PG03																																																													
B16	CLEAR6 COM * 2	A16	CLEAR8 COM * 2	B16	CLEAR2 COM * 2	A16	CLEAR4 COM * 2																																																													
B15	CLEAR6	A15	CLEAR8	B15	CLEAR2	A15	CLEAR4																																																													
B14	CLEAR5 COM * 2	A14	CLEAR7 COM * 2	B14	CLEAR1 COM * 2	A14	CLEAR3 COM * 2																																																													
B13	CLEAR5	A13	CLEAR7	B13	CLEAR1	A13	CLEAR3																																																													
B12	CHG6	A12	CHG8	B12	CHG2	A12	CHG4																																																													
B11	CHG5	A11	CHG7	B11	CHG1	A11	CHG3																																																													
B10	DOG6	A10	DOG8	B10	DOG2	A10	DOG4																																																													
B9	DOG5	A9	DOG7	B9	DOG1	A9	DOG3																																																													
B8	COM 5-6 * 3	A8	COM 7-8 * 3	B8	COM 1-2 * 3	A8	COM 3-4 * 3																																																													
B7	PULSE F6	A7	PULSE F8	B7	PULSE F2	A7	PULSE F4																																																													
B6	PULSE COM6 * 4	A6	PULSE COM8 * 4	B6	PULSE COM2 * 4	A6	PULSE COM4 * 4																																																													
B5	PULSE R6	A5	PULSE R8	B5	PULSE R2	A5	PULSE R4																																																													
B4	PULSE F5	A4	PULSE F7	B4	PULSE F1	A4	PULSE F3																																																													
B3	PULSE COM5 * 4	A3	PULSE COM7 * 4	B3	PULSE COM1 * 4	A3	PULSE COM3 * 4																																																													
B2	PULSE R5	A2	PULSE R7	B2	PULSE R1	A2	PULSE R3																																																													
B1	Vacant	A1	Vacant	B1	+24V * 5	A1	+24G * 5																																																													

- * 1: Common for PG0□. (Axis No. 1 to 8 goes into □).
- * 2: Common for CLEAR□. (Axis No. 1 to 8 goes into □).
- * 3: Common for DOG□, CHG□. (Axis No. 1 to 8 goes into □).
- * 4: Common for PULSE F□, PULSE R□. (Axis No. 1 to 8 goes into □).
- * 5: The external power source (24VDC) should be connected in order to output a command pulse.
(When outputting a command pulse of axis 5 to 8, the external power source (24VDC) should be connected to A1 and B1 of the connector CON1 (for axis 1 to 4 use).)

3.4.3 List of input/output signal details

The details of each QD70 external device connection connector are shown below:

Signal name	Pin No.	Symbol	Signal details (Negative logic is selected by external I/O signal logic selection)
Near-point dog signal	A10 B10 A9 B9	DOG	<ul style="list-style-type: none"> This signal is used for detecting the near-point dog during machine OPR control. The near-point dog signal is detected at turning from OFF to ON.
Speed-position switching signal	A12 B12 A11 B11	CHG	<ul style="list-style-type: none"> This signal is input as a control switching signal in speed-position switching control.
Common	A8 B8	COM	<ul style="list-style-type: none"> Common for near-point dog signal and speed-position switching control signal.
Zero signal	A19 B19 A17 B17	PGO	<ul style="list-style-type: none"> Input the zero signal for machine OPR control. Use the pulse encoder's zero signal and so on. Also use this signal when the OPR method is the stopper method and the OPR complete is input from an external source. The zero signal is detected at turning from OFF to ON.
Zero signal common	A20 B20 A18 B18	PGO COM	<ul style="list-style-type: none"> Common for zero signal.
External power input (0V)	A1 (COM1)	24G	<ul style="list-style-type: none"> These signals are used to input 24VDC power for driving the pulse output circuit. (Common to all axes)
External power input (+24V)	B1 (COM1)	+24V	
Pulse output F	A7 B7 A4 B4	PULSE F	<ul style="list-style-type: none"> This signal is used to output command pulses to the open collector compatible drive unit. CW/CCW mode: CW, PULSE/SIGN mode: PULSE
Pulse output R	A5 B5 A2 B2	PULSE R	<ul style="list-style-type: none"> This signal is used to output command pulses to the open collector compatible drive unit. CW/CCW mode: CCW, PULSE/SIGN mode: SIGN
Pulse output common	A6 B6 A3 B3	PULSE COM	<ul style="list-style-type: none"> Common for pulse output F and pulse output R.
Deviation counter clear	A15 B15 A13 B13	CLEAR	<ul style="list-style-type: none"> This signal is output during machine OPR control. (Example) When carry out machine OPR control with stopper 2. <p style="text-align: center;">Near-point dog</p> <p style="text-align: center;">Zero signal OFF ON</p> <p style="text-align: center;">[Pr. 8] Deviation counter clear signal output time</p> <p style="text-align: center;">CLEAR OFF ON</p> <p style="text-align: center;">After feed pulse output stops</p> <ul style="list-style-type: none"> The output time of the deviation counter clear signal is set in "[Pr. 8] Deviation counter clear signal output time". Use the drive unit that can reset the droop pulse amount in the internal deviation counter when the QD70 turns this signal ON. (Note) The deviation counter clear is a signal output by the QD70 during machine OPR control. It cannot be output randomly.
Deviation counter clear common	A16 B16 A14 B14	CLEAR COM	<ul style="list-style-type: none"> Common for deviation counter clear

3.4.4 Input/output interface internal circuit

Shows summary image of the internal circuit of the interface for connection to external devices of the QD70. (For QD70P4, axis 1).

Input/output class	External wiring	Pin No.	Internal circuit	Signal name	
Input		B9		Near-point dog signal	DOG1
		B11		Speed-position switching signal	CHG1
		B8		Common	COM1-2
		B17		Zero signal	PG01
		B18	Zero signal common	PG01 COM	
		A1		External power input (0V)	24G
		B1		External power input (24VDC)	+24V
		Output		B4	
B2	Pulse output R (CCW/SIGN)			PULSE R1	
B3	Pulse output common			PULSE COM1	
B13				Deviation counter clear	CLEAR1
B14				Deviation counter clear common	CLEAR1 COM

*: Either polarity can be connected to the common (COM1-2).

(1) Input signal ON/OFF status

(a) Input signal ON/OFF status

The input signal ON/OFF status is defined by the external wiring and logic setting.

This is explained below with the example of near-point dog signal (DOG).

(The other input signals also perform the same operations as the near-point dog signal (DOG).)

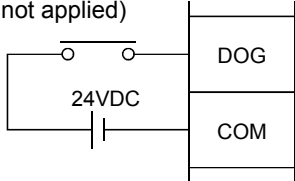
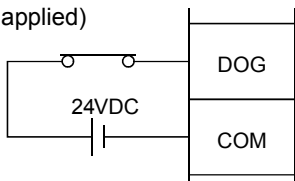
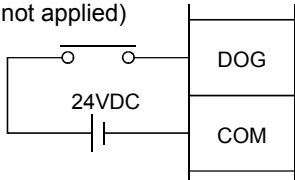
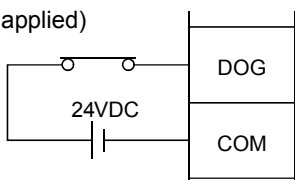
Logic setting*	External wiring	ON/OFF status of near-point dog signal (DOG) as seen from QD70
Negative logic (Initial value)	(Voltage not applied) 	OFF
	(Voltage applied) 	ON
Positive logic (Voltage not applied)	(Voltage not applied) 	ON
	(Voltage applied) 	OFF

*: Set the logic setting using "Switch setting for intelligent function module". For details of the settings, refer to Section 5.6.

(b) Logic setting and internal circuit

In the QD70, the case where the internal circuit (photocoupler) is OFF in the negative logic setting is defined as "input signal OFF".

Reversely, the case where the internal circuit (photocoupler) is OFF in the positive logic setting is defined as "input signal ON".

<Photocoupler ON/OFF status>

When voltage is not applied : Photocoupler OFF

When voltage is applied : Photocoupler ON

CHAPTER 4 DATA USED FOR POSITIONING CONTROL

This chapter explains the specifications of the data to be set to the QD70.

4.1 Type of data

4.1.1 Parameters and data required for control

The parameters and data required to carry out control with the QD70 include the "setting data", "monitor data" and "control data" shown below.

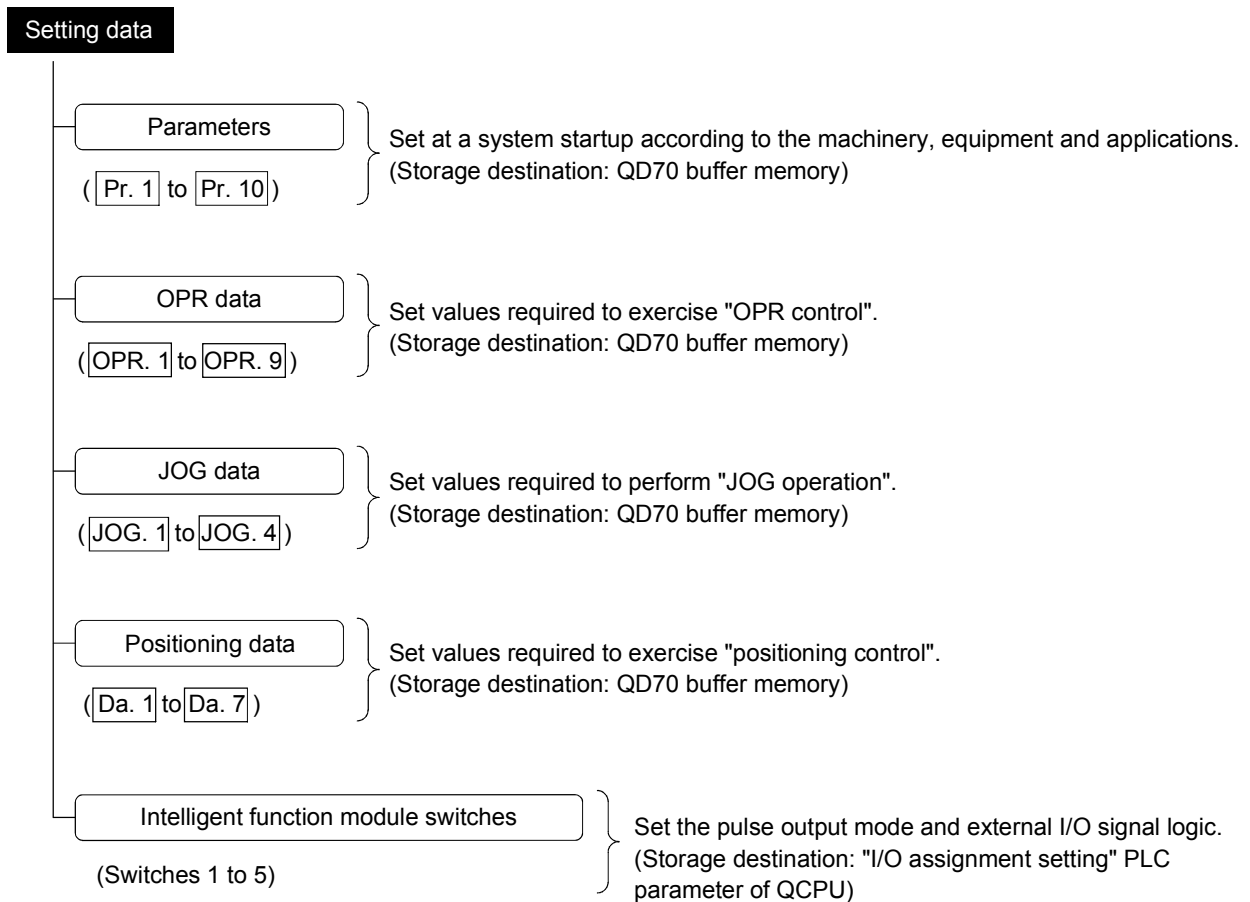

- ◇ The parameters and OPR data are made valid when the Programmable controller READY signal [Y0] turns from OFF to ON.
- ◇ The JOG data or positioning data are made valid when a JOG operation start or positioning control start is made.
- ◇ Use GX Developer to set the intelligent function module switches. (For details, refer to "Section 5.6 Switch setting for intelligent function module".)

Monitor data

- Axis monitor data } Data related to the operations of the running axes, e.g. the current positions and speeds, are monitored.
 (Md. 1 to Md. 9) (Storage destination: QD70 buffer memory)
- Module information monitor data } The error status and warning status of the QD70 are monitored.
 (Md. 10 to Md. 11) (Storage destination: QD70 buffer memory)

4

Control data

- Axis control data } Make operation-related settings and exercise such control as speed changing during operation and operation restart.
 (Cd. 1 to Cd. 9) (Storage destination: QD70 buffer memory)

■ How to set "setting data"

Setting item	Setting means		
	Sequence program	GX Configurator-PT	GX Developer
Parameters	○	○ (initial setting *)	×
OPR data	○	○ (initial setting *)	×
JOG data	○	×	×
Positioning data	○	○ (initial setting *)	×
Intelligent function module switches	×	×	◎

*: Initial setting is made to the intelligent function module parameters of the QCPU.

○: Can be set.

◎: Can be set in the "I/O assignment setting" PLC parameter of the QCPU.

×: Cannot be set.

POINT

- (1) The "setting data" is created for each axis.
- (2) The "setting data" parameters have determined default values, and are set to the default values before shipment from the factory. (Parameters related to axes that are not used are left at the default value.)
- (3) The "setting data" set in the QD70 buffer memory are not backed up. All data are initialized at the time of system power-on or programmable controller CPU reset.

4.1.2 Setting items for parameters

The table below lists items set to the positioning parameters. Setting of parameters is similarly done for individual axes for all controls achieved by the QD70.

For details of controls, refer to SECTION 2 "CONTROL DETAILS AND SETTING". For details of setting items, refer to "4.2 List of parameters".

Parameter	Control	OPR control	Positioning control			JOG operation	Related sub function
			Position control	Speed-position switching control	Current value changing		
Pr. 1	Software stroke limit upper limit value	–	○	○	○	○	Section 11.4
Pr. 2	Software stroke limit lower limit value	–	○	○	○	○	
Pr. 3	Software stroke limit valid/invalid setting	–	○	○	○	○	
Pr. 4	Current feed value during speed control	–	–	○	–	–	–
Pr. 5	Speed limit value	◎	◎	◎	–	◎	Section 11.2
Pr. 6	Bias speed at start	○	○	○	–	○	Section 11.5
Pr. 7	Positioning complete signal output time	○	○	○	–	–	–
Pr. 8	Deviation counter clear signal output time	○	–	–	–	–	–
Pr. 9	PULSE/SIGN method selection setup/hold time	○	○	○	–	○	–
Pr. 10	Stop mode during path control	–	○	–	–	–	–

◎ : Always set

○ : Set as required (Read "–" when not required.)

– : Setting not required. (This is an irrelevant item, so the set value will be ignored. If the value is the default value or within the setting range, there is no problem.)

■ Checking the parameters

Pr. 1 to Pr. 10 are checked for the setting ranges when the "Programmable controller READY signal (Y0)" output from the programmable controller CPU to the QD70 changes from OFF to ON. At this time, an error occurs in the parameter whose value has been set outside the setting range. (For details, refer to "CHAPTER 13 TROUBLESHOOTING".)

4.1.3 Setting items for OPR data

When carrying out "OPR control", the "OPR data" must be set. The setting items for the "OPR data" are shown below.

The "OPR data" are set commonly for each axis.

Refer to "Chapter 8 OPR CONTROL" for details on the "OPR CONTROL", and to section "4.3 List of OPR data" for details on each setting item.

OPR data		OPR control		Machine OPR control				Fast OPR control
		Near-point dog method	Stopper 1	Stopper 2	Stopper 3	Count 1	Count 2	
OPR. 1	OPR method							Data set for machine OPR control are used.
OPR. 2	OPR direction	◎	◎	◎	◎	◎	◎	
OPR. 3	OP address	◎	◎	◎	◎	◎	◎	
OPR. 4	OPR speed	◎	◎	◎	◎	◎	◎	
OPR. 5	Creep speed	◎	◎	◎	◎	◎	◎	
OPR. 6	ACC/DEC time at OPR	◎	◎	◎	◎	◎	◎	
OPR. 7	DEC/STOP time at OPR	◎	◎	◎	◎	◎	◎	
OPR. 8	Setting for the movement amount after near-point dog ON	-	-	-	-	◎	◎	
OPR. 9	OPR dwell time	-	◎	-	-	-	-	

◎ : Always set

- : Setting not required (This is an irrelevant item, so the setting value will be ignored. If the value is the default value or within the setting range, there is no problem.)

■ Checking the OPR data

OPR. 1 to OPR. 9 are checked for the setting ranges when the "Programmable controller READY signal (Y0)" output from the programmable controller CPU to the QD70 changes from OFF to ON. At this time, an error occurs in the OPR data whose value has been set outside the setting range. (For details, refer to "CHAPTER 13 TROUBLESHOOTING".)

4.1.4 Setting items for JOG data

The "JOG data" must be set to perform "JOG operation". The following are the setting items of the "JOG data".

The "JOG data" are set commonly for each axis.

Refer to "CHAPTER 10 JOG OPERATION" for details of "JOG operation" and to "Section 4.4 List of JOG data" for details of the setting items.

JOG data		JOG operation
JOG. 1	JOG speed	◎
JOG. 2	JOG ACC time	◎
JOG. 3	JOG DEC time	◎
JOG. 4	JOG direction flag	◎

◎ : Always set

— : Setting not required (This is an irrelevant item, so the setting value will be ignored. If the value is the default value or within the setting range, there is no problem.)

■ Checking the JOG data

JOG. 1 to JOG. 4 are checked for the setting ranges when JOG operation is started. At this time, an error occurs in the JOG data whose value has been set outside the setting range. (For details, refer to "CHAPTER 13 TROUBLESHOOTING".)

4.1.5 Setting items for positioning data

Positioning data must be set for carrying out any "positioning control". The table below lists the items to be set for producing the positioning data.

1 to 10 positioning data items can be set for each axis.

For details of the positioning controls, refer to "Chapter 9 POSITIONING CONTROL".

For details of the individual setting items, refer to "4.5 List of positioning data".

Positioning data		Positioning control			
		Position control	Speed-position switching control	Current value changing	
Da. 1	Operation pattern	Positioning termination	◎	◎	◎
		Continuous positioning control	◎	◎	◎
		Continuous path control	◎	×	×
Da. 2	Control method	1-axis linear control (ABS) 1-axis linear control (INC)	Speed.Position Ctrl. (Forward) Speed.Position Ctrl. (Reverse)	Current value changing	
Da. 3	ACC/DEC time	◎	◎	—	
Da. 4	DEC/STOP time	◎	◎	—	
Da. 5	Command speed	◎	◎	—	
Da. 6	Positioning address/movement amount	◎	◎	Change destination address	
Da. 7	Dwell time	○	○	○	

◎ : Always set

○ : Set as required (Read "—" when not required.)

× : Setting not possible

— : Setting not required.

(This is an irrelevant item, so the set value will be ignored. If the value is the default value or within the setting range, there is no problem.)

■ Checking the positioning data

Da. 1 to Da. 7 are checked for the setting ranges when positioning control is started. At this time, an error occurs in the positioning data whose value has been set outside the setting range. (For details, refer to "CHAPTER 13 TROUBLESHOOTING".)

4.1.6 Type and roles of monitor data

The monitor data area in the buffer memory stores data relating to the control state of the positioning control system, which are monitored as required while the positioning system is operating.

The following data are available for monitoring.

- Axis operation monitoring:

Monitoring of the current position and speed, and other data related to the movements of axes (through the axis monitor data [Md. 1] to [Md. 9])

- Module information monitoring:

Monitoring of the QD70 error status and warning status (through the module information monitor data [Md. 10] to [Md. 11])

Refer to "Section 4.6 List of monitor data" for details of the monitor data.

Monitor data		Monitor details
[Md. 1]	Current feed value	Monitor the current "current feed value"
[Md. 2]	Movement amount after near-point dog ON	Monitor the movement amount after the near-point dog has turned ON
[Md. 3]	Current speed	Monitor the current speed
[Md. 4]	Axis operation status	Monitor the axis operation state
[Md. 5]	Axis error code	Monitor the latest error code that occurred with the axis
[Md. 6]	Axis warning code	Monitor the latest warning code that occurred with the axis
[Md. 7]	Status	Monitor the flag
[Md. 8]	External I/O signal	Monitor the external input/output signal
[Md. 9]	Executing positioning data No.	Monitor the "positioning data No." currently being executed
[Md. 10]	Error status	Monitor the error status of each axis
[Md. 11]	Warning status	Monitor the warning status of each axis

4.1.7 Type and roles of control data

Operation of the positioning control system is achieved through the execution of necessary controls. (Data required for controls are given through the default values when the power is switched ON, which can be modified as required by the sequence program.)

Controls are performed over system data or machine operation.

- Controlling the operation :

Setting operation parameters, changing speed during operation, restarting operation (through the axis control data [Cd. 1] to [Cd. 9])

Refer to "Section 4.7 List of control data" for details of the control data.

Control data		Control details
[Cd. 1]	Axis error reset	Clear (reset) the axis error code ([Md. 5]) and warning code ([Md. 6]).
[Cd. 2]	OPR request flag OFF request	Change OPR request flag from "ON to OFF".
[Cd. 3]	Start method	Set which control will be executed (start method).
[Cd. 4]	Restart request	Give a restart command during an axis operation stop.
[Cd. 5]	Speed-position switching request	Validate speed-position switching signal from external source.
[Cd. 6]	Speed change request	Issue instruction to change speed in operation to [Cd. 7] value. (Made valid during speed control of speed-position switching control or during JOG operation)
[Cd. 7]	New speed value	Set new speed when changing speed during operation.
[Cd. 8]	ACC/DEC time at speed change	Set the time taken at a speed change to reach the new speed from the old speed.
[Cd. 9]	DEC/STOP time at speed change	Set the time taken at axis stop factor occurrence (axis stop signal ON or error occurrence) to make a stop after reaching "[Pr. 6] Bias speed at start" from the speed after a speed change.

4.2 List of parameters

Item	Setting value, setting range	Default value	Setting value buffer memory address							
			Axis 1	Axis 2	Axis 3	Axis 4	Axis 5	Axis 6	Axis 7	Axis 8
Pr. 1 Software stroke limit upper limit value	-2147483648 to	2147483647	0	100	200	300	400	500	600	700
			1	101	201	301	401	501	601	701
Pr. 2 Software stroke limit lower limit value	2147483647 (pulse)	-2147483648	2	102	202	302	402	502	602	702
			3	103	203	303	403	503	603	703
Pr. 3 Software stroke limit valid/invalid setting	0: Valid ----- 1: Invalid	0	4	104	204	304	404	504	604	704
Pr. 4 Current feed value during speed control	0: No update ----- 1: Update ----- 2: Clear to 0 and no update	0	5	105	205	305	405	505	605	705
			6	106	206	306	406	506	606	706
Pr. 5 Speed limit value	1 to 200000 (pulse/s)	10000	7	107	207	307	407	507	607	707
			8	108	208	308	408	508	608	708
Pr. 6 Bias speed at start	0 to 200000 (pulse/s)	0	9	109	209	309	409	509	609	709
			10	110	210	310	410	510	610	710
Pr. 7 Positioning complete signal output time	0 to 65535 (ms)	300	11	111	211	311	411	511	611	711
Pr. 8 Deviation counter clear signal output time	1 to 32 (ms)	10	12	112	212	312	412	512	612	712
Pr. 9 PULSE/SIGN method selection setup/hold time	0: 10µs	0	13	113	213	313	413	513	613	713
	1: 100µs									
	2: 1ms									
	3: 2ms									
Pr. 10 Stop mode during path control	0: Position match stop ----- 1: Deceleration stop	0	13	113	213	313	413	513	613	713

Pr. 1 Software stroke limit upper limit value

Set the upper limit for the machine's movement range.

Pr. 2 Software stroke limit lower limit value

Set the lower limit for the machine's movement range.

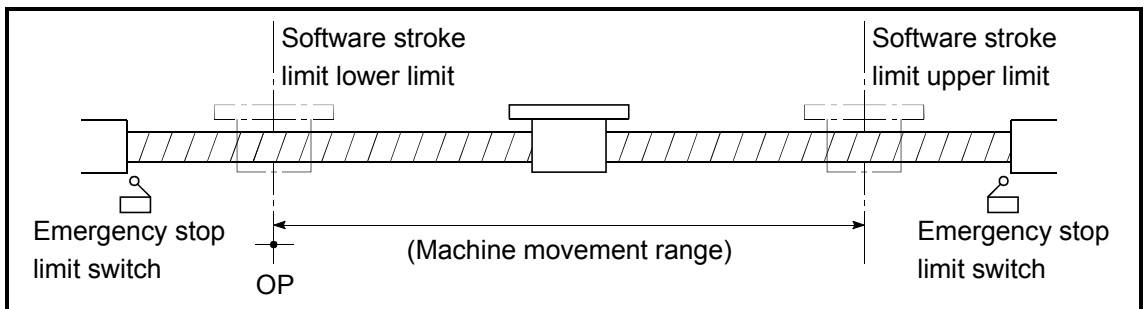

- 1) Generally, the OP is set at the lower limit or upper limit of the stroke limit.
- 2) By setting the upper limit value or lower limit value of the software stroke limit, overrun can be prevented in the software. However, an emergency stop limit switch must be installed nearby outside the range.

Pr. 3 Software stroke limit valid/invalid setting

Set whether to validate the software stroke limit.

- 0: Valid
- 1: Invalid

Pr. 4 Current feed value during speed control

Specify whether you wish to enable or disable the update of "Md. 1 Current feed value" while operations are performed under the speed control (including the speed-position and position-speed switching control).

0: No update

The current feed value will not change.

(The value at the beginning of the speed control will be kept.)

1: Update

The current feed value will be updated.

(The current feed value will change from the initial.)

2: Clear to 0 and no update

The current feed will be set initially to zero and not updated. (The value be kept "0".)

Pr. 5 Speed limit value

Set the maximum speed for OPR control, positioning control and JOG operation. The speed limit value is determined by the following two conditions.

- Motor speed
- Workpiece movement speed

Pr. 6 Bias speed at start

Set the minimum starting speed for OPR control, positioning control and JOG operation. When using a stepping motor or like, set this speed to start the motor smoothly. (A stepping motor does not start smoothly if the motor speed is low at a start.)

Set a value not more than "Pr. 5 Speed limit value". If it is more than "Pr. 5 Speed limit value", the "Setting range outside bias speed" error (error code: 906) will occur.

Pr. 7 Positioning complete signal output time

Set the output time of the positioning complete signal [X18 to X1F] output from the QD70.

Positioning complete indicates that the preset dwell time has elapsed after the QD70 ended pulse output.

If the setting value is 0 (ms) or if the axis stop signal was used to make a stop during JOG operation or speed control of speed-position switching control, the positioning complete signal is not output.

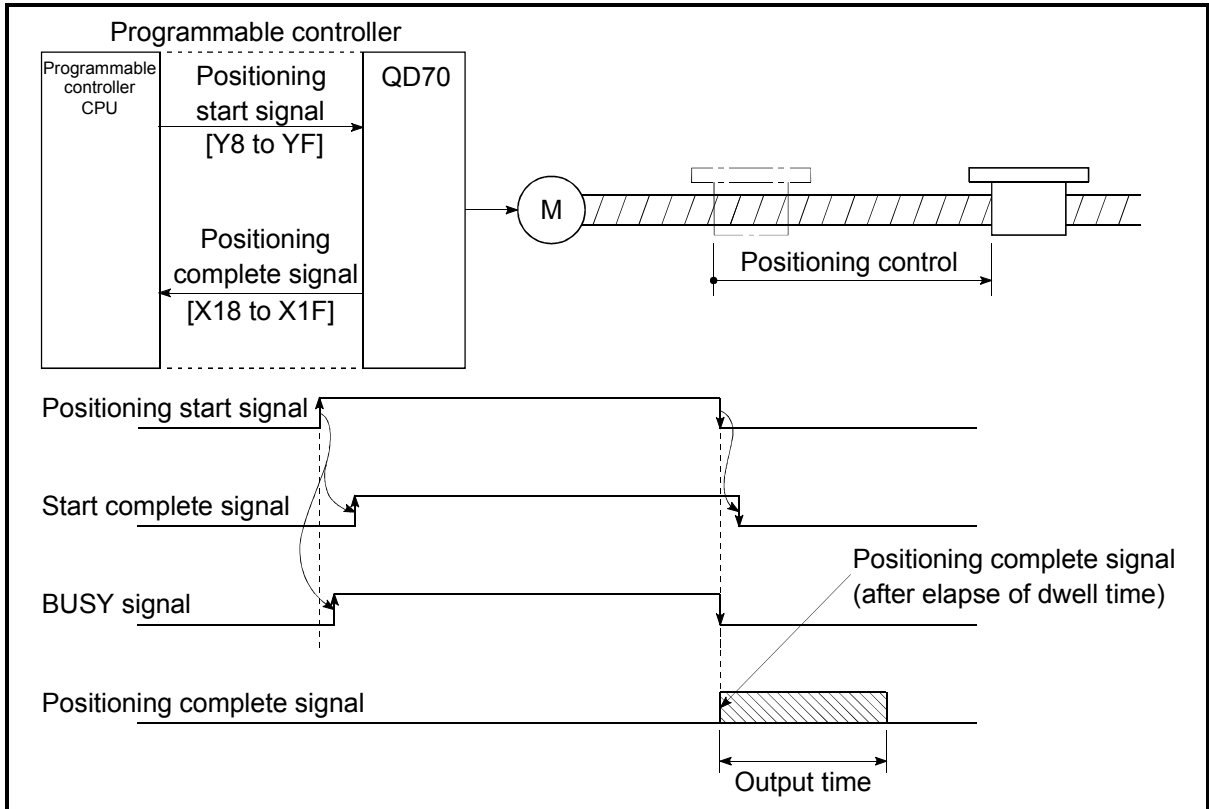

Positioning complete signal output time

Pr. 8 Deviation counter clear signal output time

Set the duration of the deviation counter clear signal output during a machine OPR control operation using any of the following methods: the near-point dog method, stopper 1 to 3, and count 1. (For details, refer to your drive unit manual.)

Pr. 9 PULSE/SIGN method selection setup/hold time

Set the setup/hold time when PULSE/SIGN is selected in the pulse output mode to output inverted pulses.

- 0: 10 μ s
- 1: 100 μ s
- 2: 1ms
- 3: 2ms

The following is an example for negative logic.

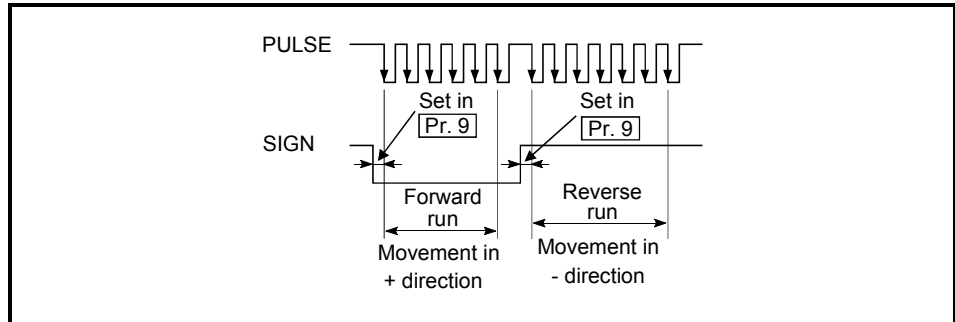

PULSE/SIGN mode (set the pulse output mode with the intelligent function module switch. Refer to Section 5.6.)

Pr. 10 Stop mode during path control

Set the stopping method using the axis stop signal input when the operation pattern for position control is continuous path control.

0: Position match stopDeceleration starts when the axis stop signal is input, and the axis stops immediately when the address preset to the positioning data in execution is reached.

1: Deceleration stopWhen the axis stop signal is input, the axis stops after decelerating to "[Pr. 6] Bias speed at start". (The axis does not stop at the address preset to the positioning data in execution.)

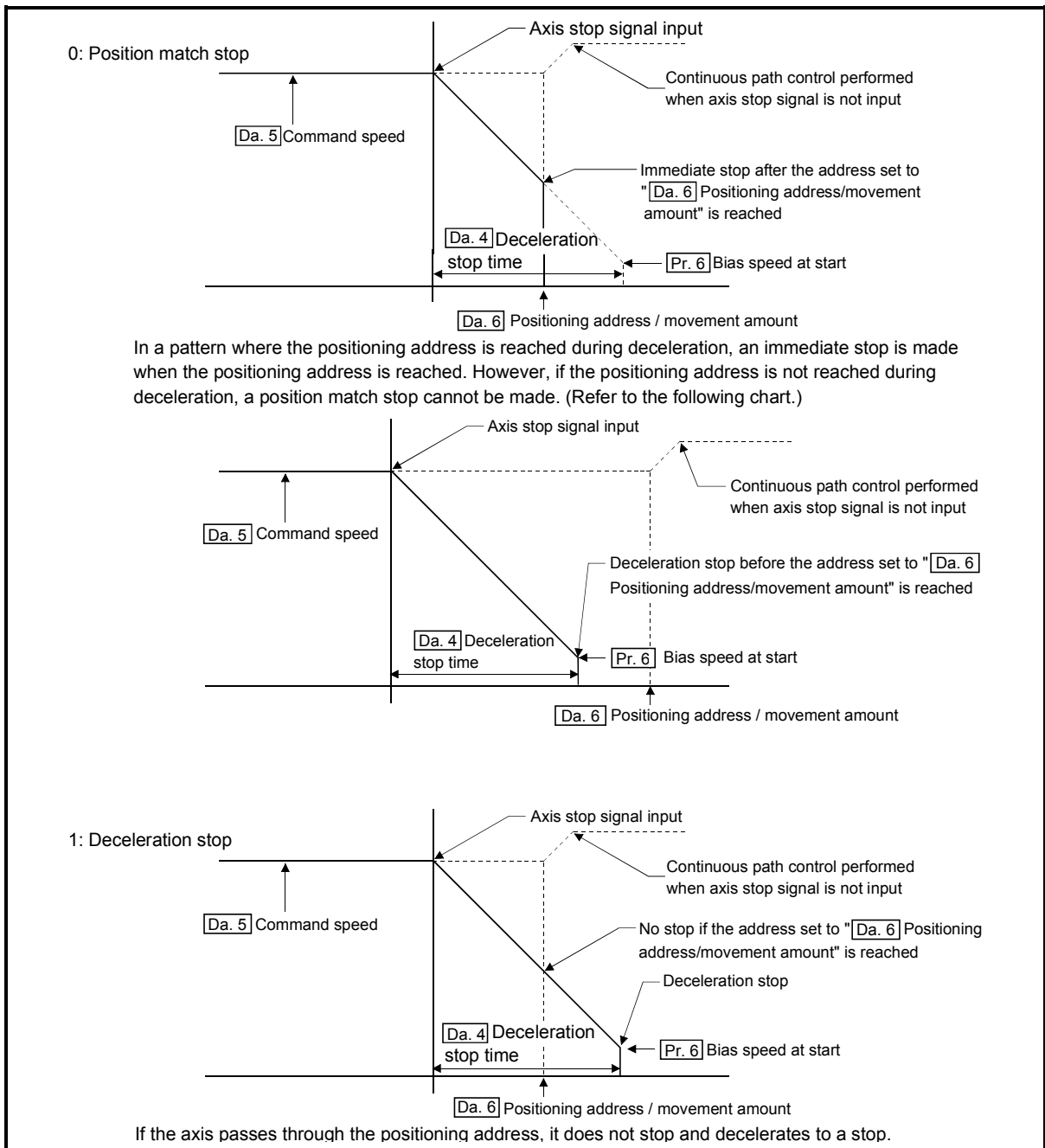

4.3 List of OPR data

Item	Setting value, setting range	Default value	Setting value buffer memory address							
			Axis 1	Axis 2	Axis 3	Axis 4	Axis 5	Axis 6	Axis 7	Axis 8
OPR. 1 OPR method	0: Near-point dog method 1: Stopper 1 2: Stopper 2 3: Stopper 3 4: Count 1 5: Count 2	0	20	120	220	320	420	520	620	720
OPR. 2 OPR direction	0: Forward direction 1: Reverse direction	0	21	121	221	321	421	521	621	721
OPR. 3 OP address	-2147483648 to 2147483647 (pulse) * 1	0	22 23	122 123	222 223	322 323	422 423	522 523	622 623	722 723
OPR. 4 OPR speed	1 to 200000 (pulse/s)	1	24 25	124 125	224 225	324 325	424 425	524 525	624 625	724 725
OPR. 5 Creep speed	1 to 200000 (pulse/s)	1	26 27	126 127	226 227	326 327	426 427	526 527	626 627	726 727
OPR. 6 ACC/DEC time at OPR	0 to 32767 (ms)	1000	28	128	228	328	428	528	628	728
OPR. 7 DEC/STOP time at OPR	0 to 32767 (ms)	1000	29	129	229	329	429	529	629	729
OPR. 8 Setting for the movement amount after near-point dog ON	0 to 2147483647 (pulse)	0	30 31	130 131	230 231	330 331	430 431	530 531	630 631	730 731
OPR. 9 OPR dwell time	0 to 65535 (ms) * 2	0	32	132	232	332	432	532	632	732

* 1: When "0:Valid" is set for "Pr. 3 Software stroke limit valid/invalid setting", the setting range is 0 to 2147483647 (pulse).

* 2: When making setting in a sequence program, set 0 to 32767 in decimal as-is, and 32768 to 65535 in hexadecimal.

OPR. 1 OPR method

Set the "OPR method" for carrying out machine OPR control.

- 0 : Near-point dog method....After decelerating at the near-point dog ON, stop at the zero signal and complete the machine OPR control.
- 1 : Stopper 1.....After decelerating at the near-point dog ON, stop with the stopper, and complete the machine OPR control after the OPR dwell time has passed.
- 2 : Stopper 2.....After decelerating at the near-point dog ON, stop with the stopper, and complete the machine OPR control with the zero signal.
- 3 : Stopper 3.....After starting with the creep speed, stop with the stopper, and complete the machine OPR control with the zero signal.
- 4 : Count 1.....After decelerating at the near-point dog ON, move the designated distance, and complete the machine OPR control with the zero signal.
- 5 : Count 2.....After decelerating at the near-point dog ON, move the designated distance, and complete the machine OPR control.

Note) Refer to "8.2.2 Machine OPR method" for details on the OPR methods.

OPR method

0 : Near-point dog method

- (1) Start machine OPR control.
(Start movement at the "OPR. 4 OPR speed" in the "OPR. 2 OPR direction".)
- (2) Detect the near-point dog ON, and start deceleration.
- (3) Decelerate to "OPR. 5 Creep speed", and move with the creep speed.
(At this time, the near-point dog must be ON.)
- (4) When the first zero signal (one pulse of which is output when the motor turns one revolution) after near-point dog OFF is detected, the pulse output from the QD70 stops and machine OPR control is completed.

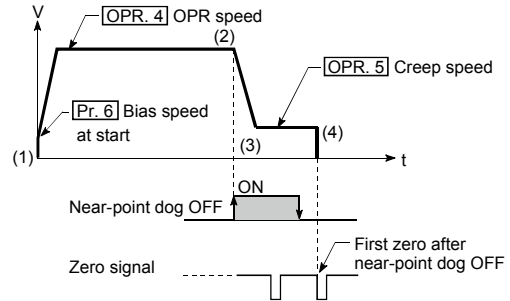

1 : Stopper 1

- (1) Start machine OPR control.
(Start movement at the "OPR. 4 OPR speed" in the "OPR. 2 OPR direction".)
- (2) Detect the near-point dog ON, and start deceleration.
- (3) Decelerate to "OPR. 5 Creep speed", and move with the creep speed.
(At this time, a torque limit is needed for the motor. If there is no torque limit, the motor may fail at (4).)
- (4) The axis contacts against the stopper at "OPR. 5 Creep speed", and then stops.
- (5) When the near-point dog turns ON and the "OPR. 9 OPR dwell time" is passed, the pulse output from the QD70 stops, and machine OPR control is completed.

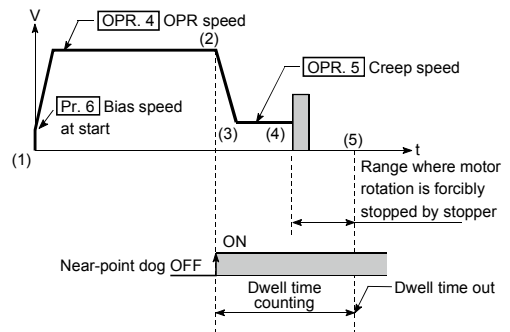

2 : Stopper 2

- (1) Start machine OPR control.
(Start movement at the "OPR. 4 OPR speed" in the "OPR. 2 OPR direction".)
- (2) Detect the near-point dog ON, and start deceleration.
- (3) Decelerate to "OPR. 5 Creep speed", and move with the creep speed.
(At this time, a torque limit is needed for the motor. If there is no torque limit, the motor may fail at (4).)
- (4) The axis contacts against the stopper at "OPR. 5 Creep speed", and then stops.
- (5) When the zero signal (signal output on detection of contact with the stopper) is detected after a stop, the pulse output from the QD70 stops and machine OPR control is completed.

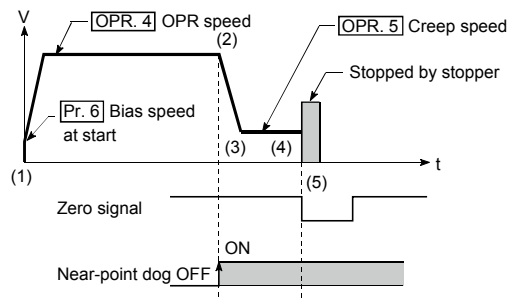

3 : Stopper 3

- (1) Start machine OPR control.
(Start movement at the "[OPR. 5] Creep speed" in the "[OPR. 2] OPR direction". (At this time, a torque limit is needed for the motor. If there is no torque limit, the motor may fail at (2).)
- (2) The axis contacts against the stopper at "[OPR. 5] Creep speed", and then stops.
- (3) When the zero signal (signal output on detection of contact with the stopper) is detected after a stop, the pulse output from the QD70 stops and machine OPR control is completed.

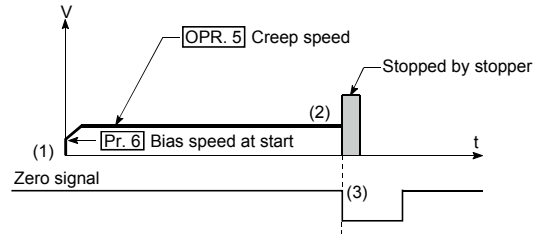

4 : Count 1

- (1) Start machine OPR control.
(Start movement at the "[OPR. 4] OPR speed" in the "[OPR. 2] OPR direction".)
- (2) Detect the near-point dog ON, and start deceleration.
- (3) Decelerate to "[OPR. 5] Creep speed", and move with the creep speed.
- (4) When the first zero signal (one pulse of which is output when the motor turns one revolution) is detected after the movement amount set in "[OPR. 8] Setting for the movement amount after near-point dog ON" has been travelled after near-point dog ON, the pulse output from the QD70 stops and machine OPR control is completed.

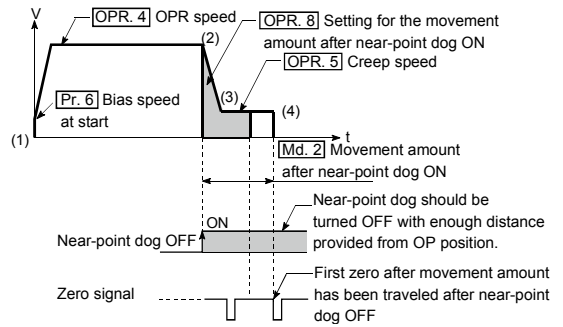

5 : Count 2

- (1) Start machine OPR control.
(Start movement at the "[OPR. 4] OPR speed" in the "[OPR. 2] OPR direction".)
- (2) Detect the near-point dog ON, and start deceleration.
- (3) Decelerate to "[OPR. 5] Creep speed", and move with the creep speed.
- (4) After the near-point dog turns ON and the movement amount set in "[OPR. 8] Setting for the movement amount after near-point dog ON" has passed, the pulse output from the QD70 stops with the first zero signal, and machine OPR control is completed.

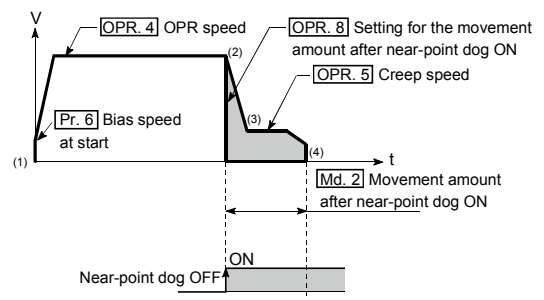

OPR. 2 OPR direction

Set the direction to start movement when starting machine OPR control.

0: Forward direction

Moves in the direction that the address increments. (Arrow 2))

1: Reverse direction

Moves in the direction that the address decrements. (Arrow 1))

Normally, the OP is set near the lower limit or the upper limit, so "OPR. 2 OPR direction" is set as shown below.

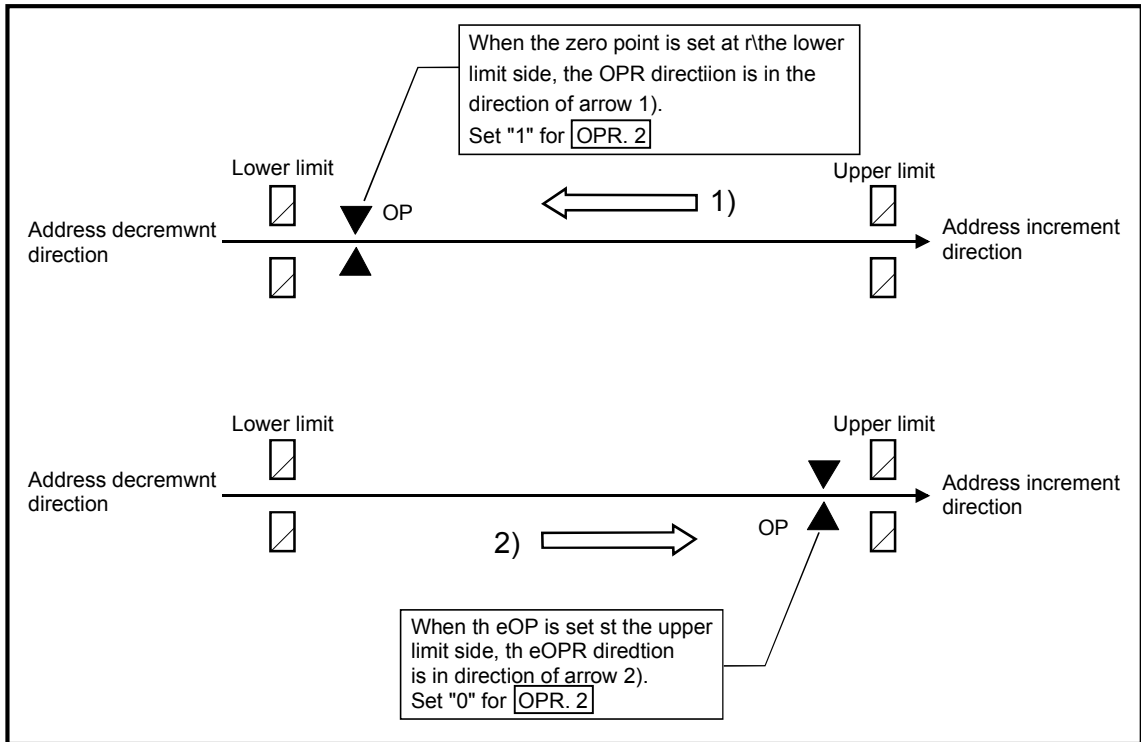

OPR. 3 OP address

Set the address used as the reference point for position control (ABS system). (When the machine OPR control is completed, the stop position address is changed to the address set in "OPR. 3 OP address". At the same time, the "OPR. 3 OP address" is stored in "Md. 1 Current feed value".)

Note) * The setting range for the OP address varies depending on the setting in "Pr. 3 Software stroke limit valid/invalid setting".

"0": Valid": 0 to 2147483647 (pulse)

"1": Invalid": -2147483648 to 2147483647 (pulse)

* When the set value is outside the above range, an "OP address setting out of range" error (Error code: 912) will occur.

OPR. 4 OPR speed

Set the speed for OPR control.

Note) • Set the "OPR speed" to less than "Pr. 5 Speed limit value". If the "speed limit value" is exceeded, the "Setting range outside OPR speed" error (error code: 913) will occur.

• Set the "OPR speed" to a value not less than "Pr. 6 Bias speed at start". If it is less than the "bias speed at start", the "Setting range outside OPR speed" error (error code: 913) will occur.

OPR. 5 Creep speed

Set the creep speed after near-point dog ON (the low speed just before stopping after decelerating from the OPR speed).

The creep speed is set within the following range.

$$(\text{OPR. 4 OPR speed}) \geq (\text{OPR. 5 Creep speed}) \geq (\text{Pr. 6 Bias speed at start})$$

- Note) • The creep speed is related to the detection error when using the OPR method with zero signal, and the size of the collision if a collision occurs during OPR using the stopper.
- Set the "creep speed" to a value not more than "OPR. 4 OPR speed". If the "OPR speed" is exceeded, "the "Setting range outside creep speed" error (error code: 914) will occur.
 - Set the "creep speed" to a value not less than "Pr. 6 Bias speed at start". If it is less than the "bias speed at start", the "Setting range outside creep speed" error (error code: 914) will occur.

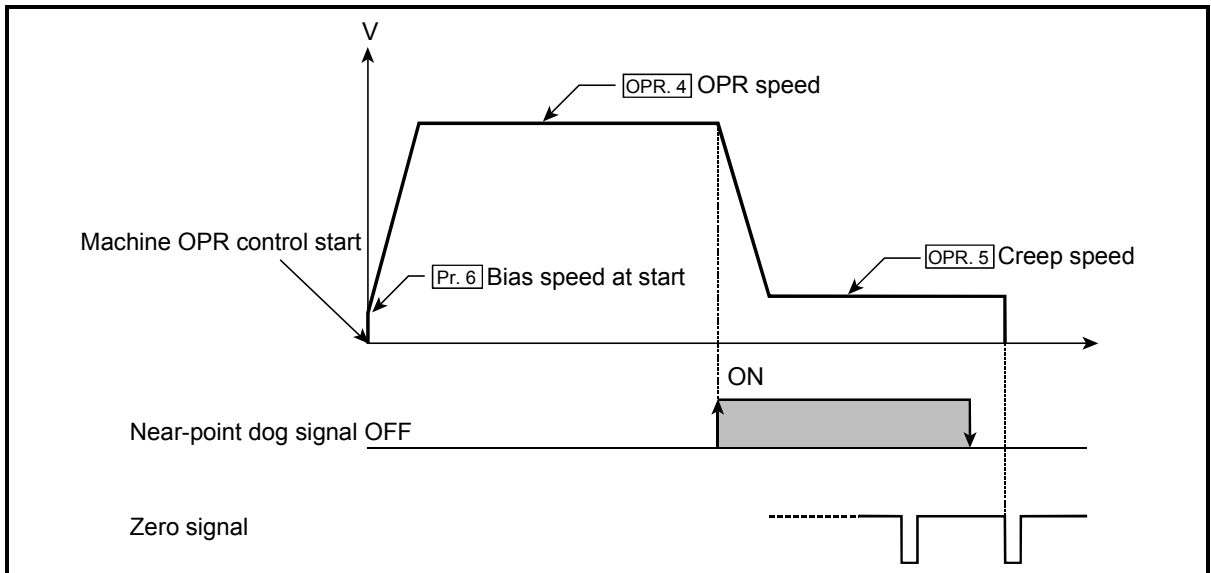

OPR. 6 ACC/DEC time at OPR

Set the time taken under machine OPR control to reach "OPR. 4 OPR speed" from "Pr. 6 Bias speed at start" or to reach "OPR. 5 Creep speed" from "OPR. 4 OPR speed".

(When OPR method is other than "Stopper 3")

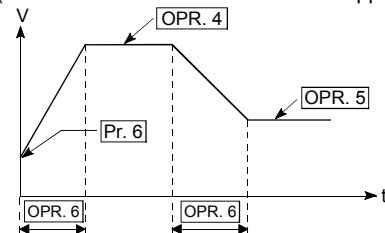

(When OPR method is "Stopper 3")

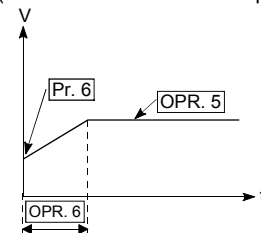

OPR. 7 DEC/STOP time at OPR

Set the time taken to make a stop after reaching "Pr. 6 Bias speed at start" from "OPR. 5 Creep speed" under "Count 2" machine OPR control or to make a stop after reaching "Pr. 6 Bias speed at start" from the speed during machine OPR control at axis stop factor occurrence (axis stop signal ON or error occurrence).

(When OPR method is "Count 2")

(When axis stop signal is turned ON during machine OPR control (Common to all OPR methods))

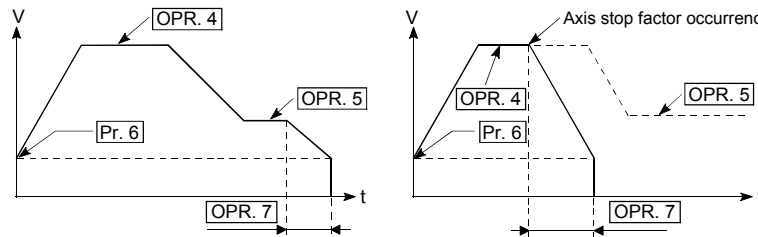

OPR. 8 Setting for the movement amount after near-point dog ON

When the OPR method is Count 1 or 2, set a value not less than the deceleration distance after the near-point dog signal has turned ON.

Setting example of "OPR. 8 Setting for the movement amount after near-point dog ON"

When 10kpulse/s is set in "OPR. 4 OPR speed", 2kpulse/s in "OPR. 5 Creep speed", and 320ms in "OPR. 6 ACC/DEC time at OPR", calculate "OPR. 8 Setting for the movement amount after near-point dog ON" as indicated below.

[Machine OPR control operation]

OPR. 4 OPR speed : Vz=10kpulse/s

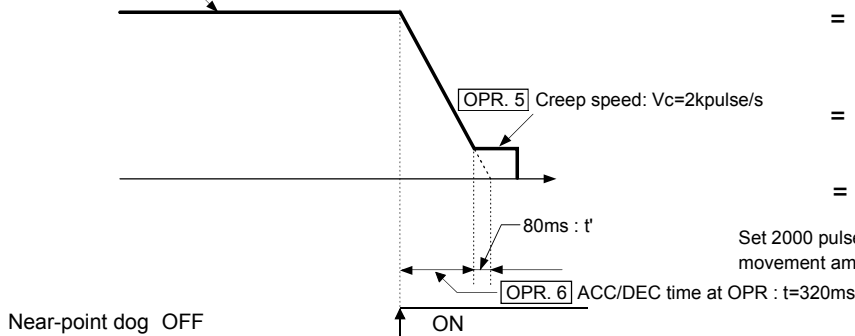

$$[\text{Deceleration distance}] = \frac{1}{2} \times Vz \times \frac{t+t'}{1000}$$

$$= \frac{Vz \times (t+t')}{2000}$$

$$= \frac{10 \times 10^3 \times (320 + 80)}{2000}$$

$$= 2000$$

Set 2000 pulse or more in "OPR. 8 Setting for the movement amount after near-point dog ON".

OPR. 9 OPR dwell time

When the OPR method is Stopper 1, set the time from when the near-point dog turns ON until machine OPR control is completed.

Set not less than the movement time from when the near-point dog turns ON until a stop is made by the stopper.

(When the OPR method is other than "Stopper 1", the "OPR. 9 OPR dwell time" value need not be set.)

4.4 List of JOG data

Item	Setting value, setting range	Default value	Setting value buffer memory address							
			Axis 1	Axis 2	Axis 3	Axis 4	Axis 5	Axis 6	Axis 7	Axis 8
JOG. 1 JOG speed	1 to 200000 (pulse/s)	0	40	140	240	340	440	540	640	740
			41	141	241	341	441	541	641	741
JOG. 2 JOG ACC time	0 to 32767 (ms)	1000	42	142	242	342	442	542	642	742
JOG. 3 JOG DEC time	0 to 32767 (ms)	1000	43	143	243	343	443	543	643	743
JOG. 4 JOG direction flag	0: Forward run JOG	0	44	144	244	344	444	544	644	744
	1: Reverse run JOG									

JOG. 1 JOG speed

Set the speed for JOG operation. (This value is used for both forward run JOG and reverse run JOG.)

Set the JOG speed in the following range.

$(\text{Pr. 5 Speed limit value}) \geq (\text{JOG. 1 JOG speed}) \geq (\text{Pr. 6 Bias speed at start})$

If the "JOG speed" is more than the "speed limit value", it is limited to "Pr. 5 Speed limit value".

If the "JOG speed" is less than "Pr. 6 Bias speed at start", it is limited to "Pr. 6 Bias speed at start".

JOG. 2 JOG ACC time

Set the time taken to reach "JOG. 1 JOG speed" from "Pr. 6 Bias speed at start" at a JOG operation start (JOG start signal ON). (This value is used for both forward run JOG and reverse run JOG.)

JOG. 3 JOG DEC time

Set the time taken to make a stop after reaching "Pr. 6 Bias speed at start" from "JOG. 1 JOG speed" at a JOG operation stop (JOG start signal OFF, error occurrence). (This value is used for both forward run JOG and reverse run JOG.)

JOG. 4 JOG direction flag

Set the forward/reverse direction for JOG operation.

0: Forward run JOG

1: Reverse run JOG

4.5 List of positioning data

Before explaining the positioning data setting items **Da. 1** to **Da. 7**, the configuration of the positioning data will be shown below.

The positioning data stored in the QD70 buffer memory has the following type of configuration.

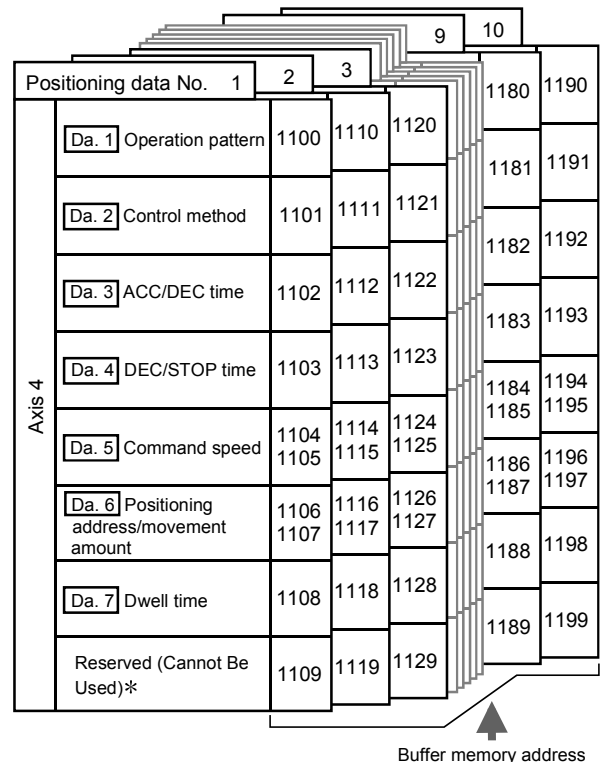
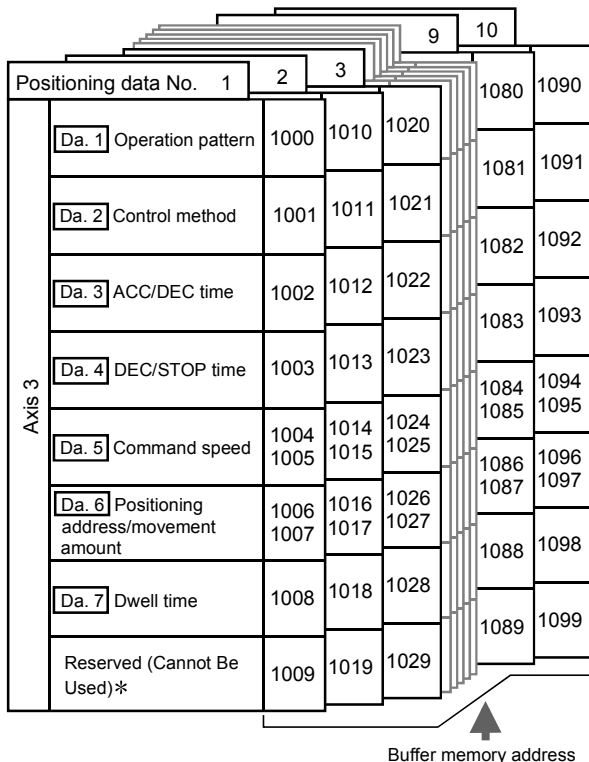
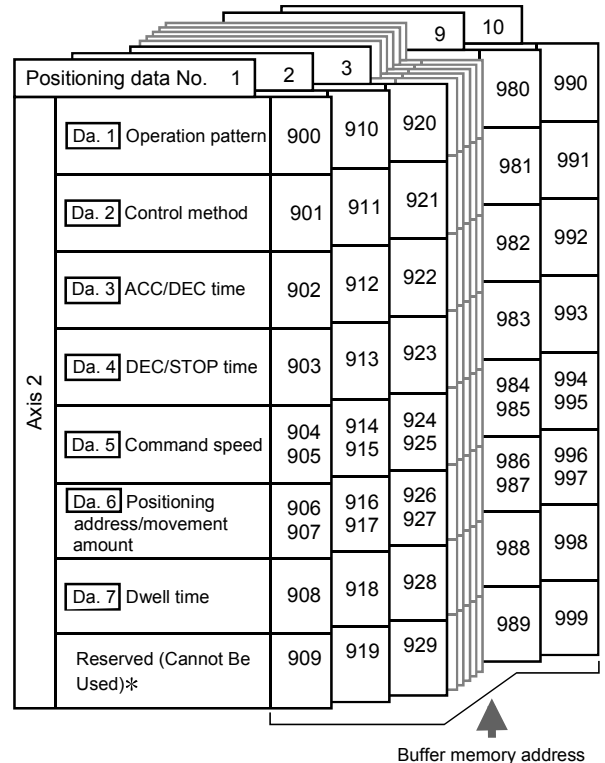
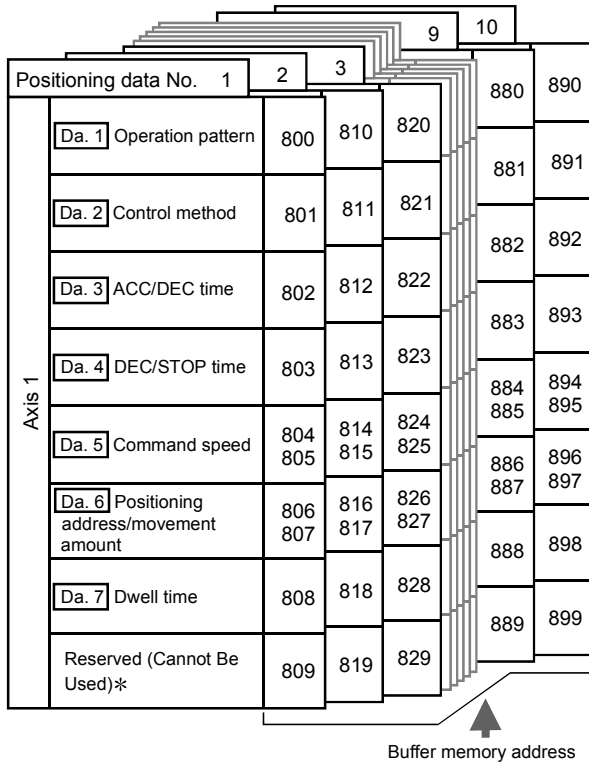

*: Write to Reserved (Cannot be used) is prohibited.

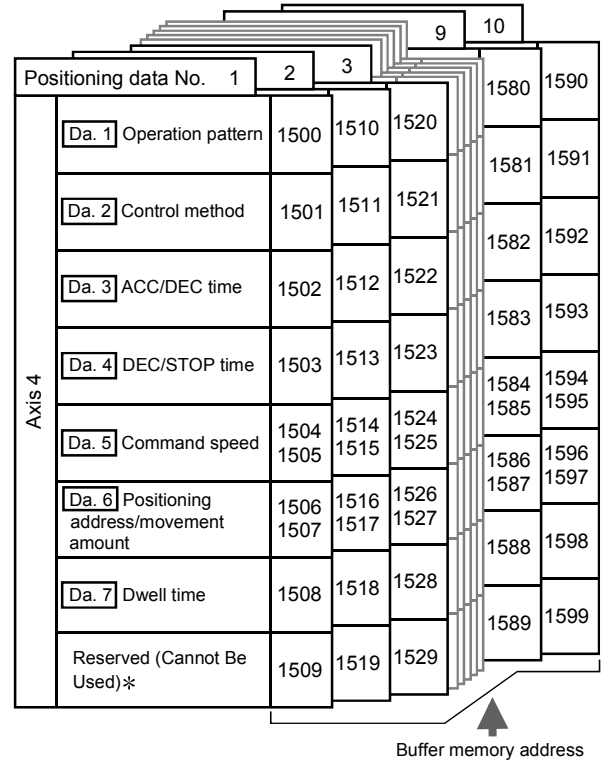
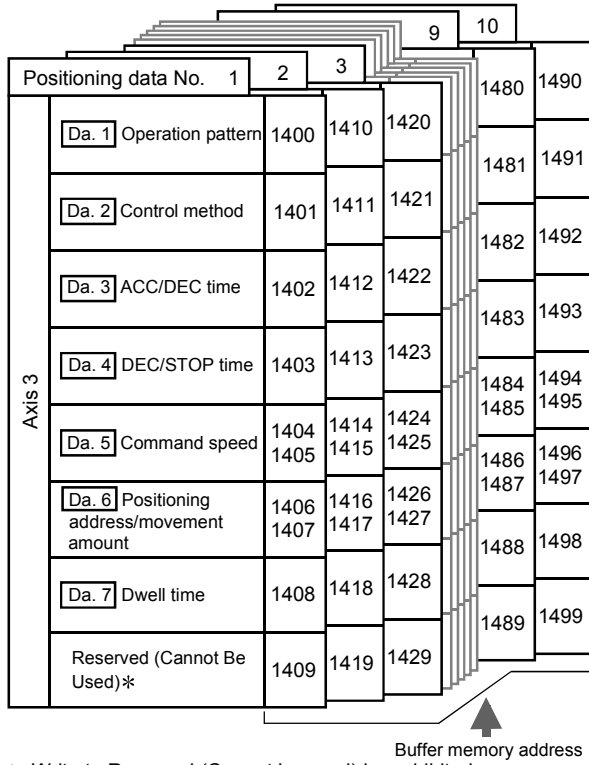
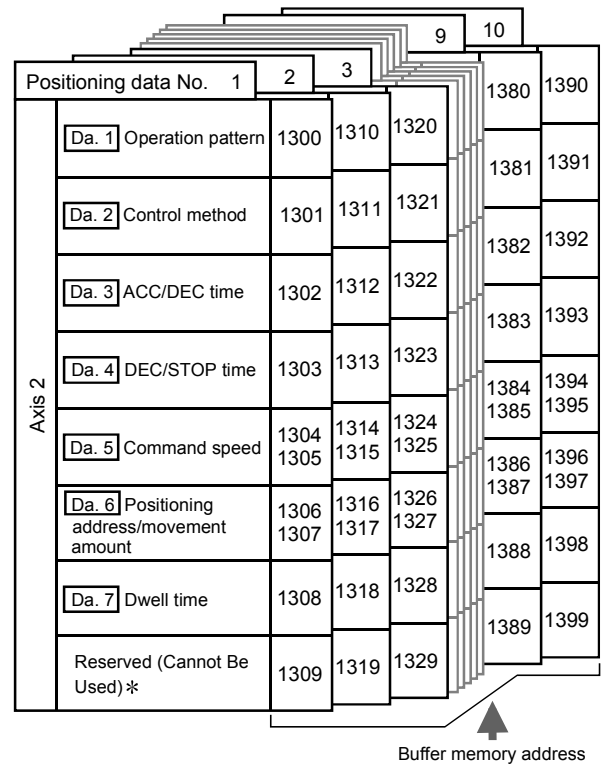
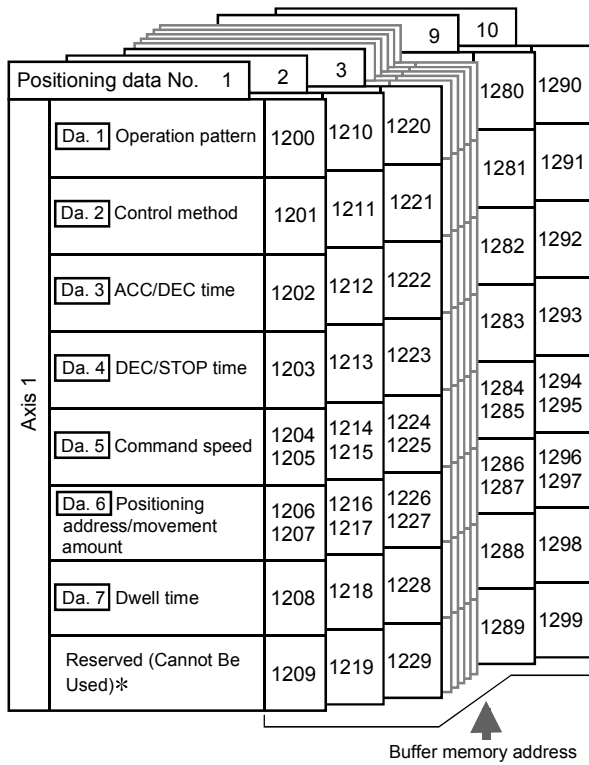

*: Write to Reserved (Cannot be used) is prohibited.

The descriptions that follow relate to the positioning data set items **Da. 1** to **Da. 7**.
 (The buffer memory addresses shown are those of the "positioning data No. 1" for the axes 1 to 8.)

Item	Setting value, setting range	Default value	Setting value buffer memory address							
			Axis 1	Axis 2	Axis 3	Axis 4	Axis 5	Axis 6	Axis 7	Axis 8
Da. 1 Operation pattern	0: Positioning termination	0								
	1: Continuous positioning control		800	900	1000	1100	1200	1300	1400	1500
	2: Continuous path control									
Da. 2 Control method	0: No control method	0								
	1: 1-axis linear control (ABS)									
	2: 1-axis linear control (INC)									
	3: Speed.Position Ctrl. (Forward)		801	901	1001	1101	1201	1301	1401	1501
	4: Speed.Position Ctrl. (Reverse)									
	5: Current value changing									
Da. 3 ACC/DEC time	0 to 32767 (ms)	1000	802	902	1002	1102	1202	1302	1402	1502
Da. 4 DEC/STOP time	0 to 32767 (ms)	1000	803	903	1003	1103	1203	1303	1403	1503
Da. 5 Command speed	0 to 200000 (pulse/s)	0	804	904	1004	1104	1204	1304	1404	1504
			805	905	1005	1105	1205	1305	1405	1505
Da. 6 Positioning address/movement amount	-2147483648 to 2147483647 (pulse)*1	0	806	906	1006	1106	1206	1306	1406	1506
			807	907	1007	1107	1207	1307	1407	1507
Da. 7 Dwell time	0 to 65535 (ms)*2	0	808	908	1008	1108	1208	1308	1408	1508

* 1: 0 to 2147483647 (pulse) when "Da. 2 Control method" is "3: Speed.Position Ctrl. (Forward)" or "4: Speed.Position Ctrl. (Reverse)".
 * 2: When making setting in a sequence program, set 0 to 32767 in decimal as-is, and 32768 to 65535 in hexadecimal.

Da. 1 Operation pattern

The operation pattern designates whether positioning control of a certain data No. is to be ended with just that data, or whether the positioning control for the next data No. is to be carried out in succession.

[Operation pattern]

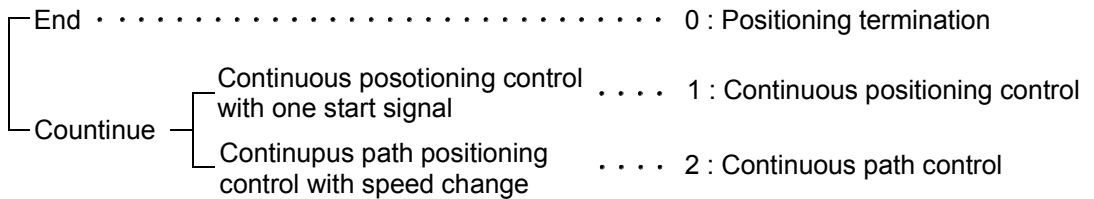

- 1) Positioning termination Set to execute positioning control to the designated address, and then complete positioning control.
- 2) Continuous positioning control Positioning control is carried out successively in order of data Nos. with one start signal.
The operation halts at each position indicated by a positioning data.
- 3) Continuous path control Positioning control is carried out successively in order of data Nos. with one start signal.
The operation does not stop at each positioning data.

Note) Refer to "CHAPTER 9 POSITIONING CONTROL" for details of the operation pattern.

Da. 2 Control method

Set the "control method" for positioning control.

0: No control method

1: 1-axis linear control (ABS)

2: 1-axis linear control (INC)

3: Speed.Position Ctrl. (Forward)..... Speed-position switching control (forward run)

4: Speed.Position Ctrl. (Reverse)..... Speed-position switching control (reverse run)

5: Current value changing

Note) • Refer to "CHAPTER 9 POSITIONING CONTROL" for details of the control method.

- Setting "0: No control method" will result in the "Setting range outside control method" error (error code: 506).

Da. 3 ACC/DEC time, **Da. 4** DEC/STOP time

Set the acceleration/deceleration time for positioning control.

[**Da. 1** Operation pattern" is "0: Positioning termination" or "1: Continuous positioning control"]

Da. 3 ACC/DEC time : Set the time taken to reach "**Da. 5** Command speed" from "**Pr. 6** Bias speed at start".

Da. 4 DEC/STOP time : Set the time taken to make a stop after reaching "**Pr. 6** Bias speed at start" from "**Da. 5** Command speed" at position control completion or axis stop factor occurrence (axis stop signal ON or error occurrence).

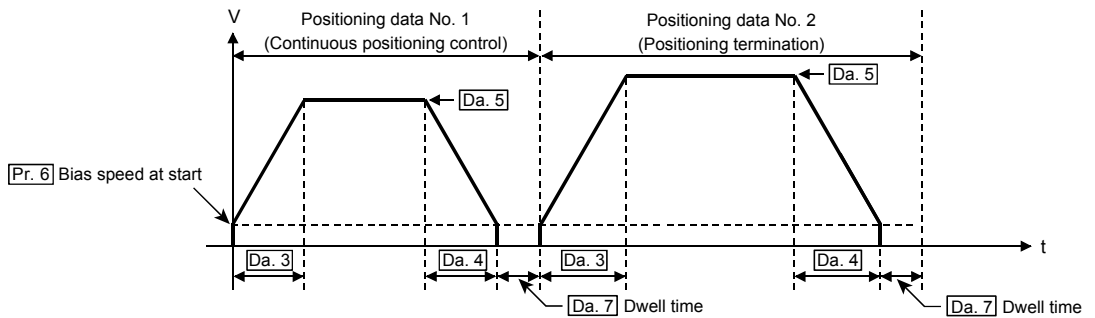

["Da. 1 Operation pattern" is "2: Continuous path control"]

Da. 3 ACC/DEC time : Set the time taken to reach "Da. 5 Command speed" set in the "positioning data to be executed next" from "Da. 5 Command speed" set in the "positioning data currently being executed".

Da. 4 DEC/STOP time : Set any value within the setting range (0 to 32767ms). (This does not function.)

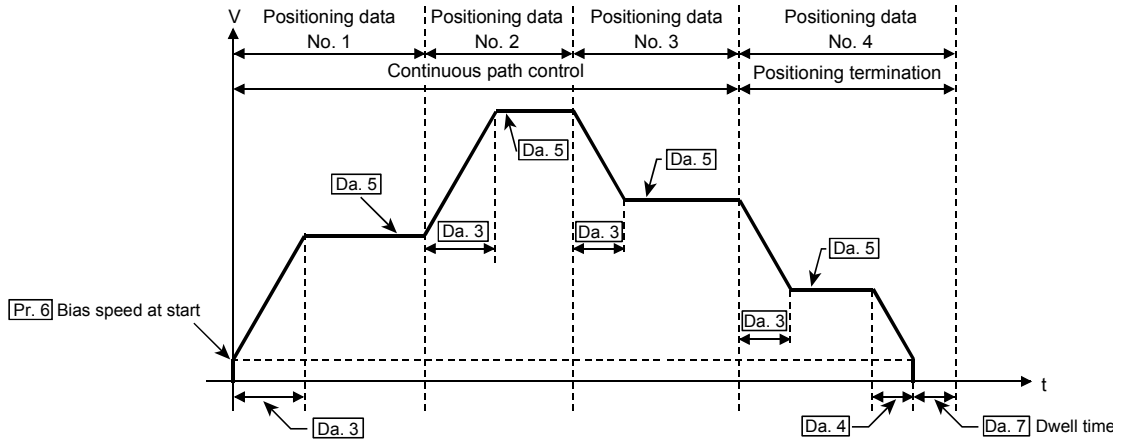

Da. 5 Command speed

Set the speed for positioning control.

If the set command speed exceeds "Pr. 5 Speed limit value", positioning control will be carried out at the speed limit value. If the set command speed is less than "Pr. 6 Bias speed at start", positioning control will be carried out at the bias speed at start.

Da. 6 Positioning address/movement amount

Set the address or movement amount as the target value of positioning control. The setting value differs in the setting range depending on "Da. 2 Control method". ((1) to (3))

(1) 1-axis linear control (ABS), current value changing

Set the value (positioning address) for 1-axis linear control (ABS) or current value changing using the absolute address (address from the OP).

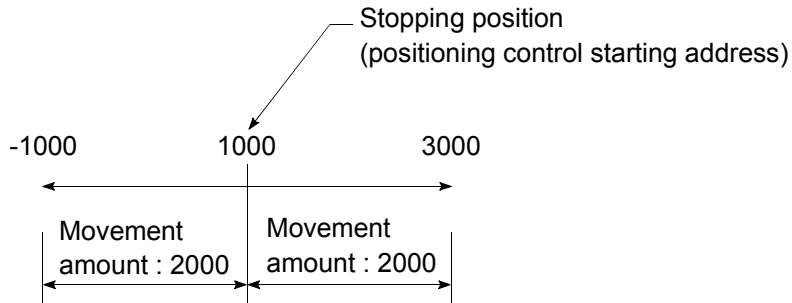

(2) 1-axis linear control (INC)

Set a signed movement amount as the setting value (movement amount) for 1-axis linear control (INC).

When the movement amount is positive: The axis moves in the positive direction (address increasing direction).

When the movement amount is negative: The axis moves in the negative direction (address decreasing direction).

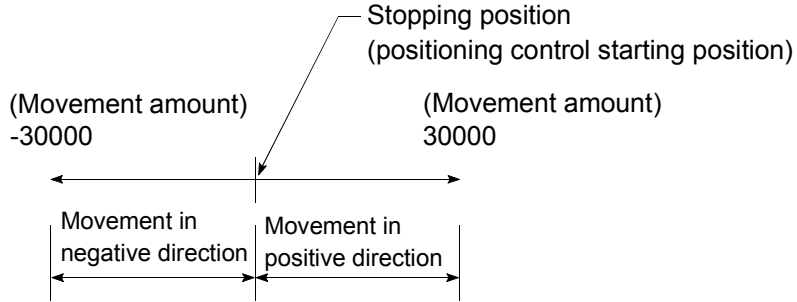

(3) Speed.Position Ctrl. (Forward/Reverse)

Set the movement amount (value more than 0) after speed control has been switched to position control.

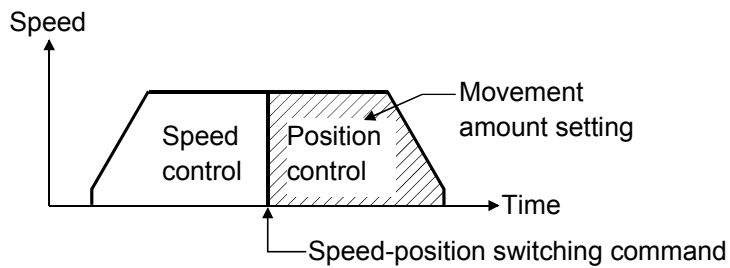

Da. 7 Dwell time

When the "dwell time" is set, the setting details of the "dwell time" will be as follows according to "Da. 1 Operation pattern".

<p>1) When "Da. 1 Operation pattern" in "0 : Positioning termination"</p> <p>Set the time from when the positioning control ends to when the "positioning complete signal" turns ON as "dwell time".</p>	<p>Positioning complete signal OFF</p> <p>ON</p> <p>Da. 7 Dwell time</p>
<p>2) When "Da. 1 Operation pattern" is "1 : Continuous positioning control"</p> <p>Set the time from when position control ends to when the next position control start as the "dwell time".</p>	<p>Next position control</p> <p>Da. 7 Dwell time</p>
<p>3) When "Da. 1 Operation pattern" is "2 : Continuous path control"</p> <p>The setting value irrelevant to the control. (The "dwell time" is 0ms.)</p>	<p>Next position control</p> <p>No dwell time (0ms)</p>

4.6 List of monitor data

4.6.1 Axis monitor data

Item	Storage details	Default value	Storage buffer memory address							
			Axis 1	Axis 2	Axis 3	Axis 4	Axis 5	Axis 6	Axis 7	Axis 8
[Md. 1] Current feed value	<ul style="list-style-type: none"> The current position using the position when OPR is completed as the base is stored. Update timing: 1ms for QD70P4 2ms for QD70P8 On completion of machine OPR control, the OP address is stored. Under speed control of speed-position switching control, whether the current feed value is updated or not or cleared to zero can be selected by parameter setting. The software stroke limit can be activated by parameter setting. If the current value has been changed by the current value change function, the new value is stored. [Range: -2147483648 to 2147483647 pulse] 	0	70 71	170 171	270 271	370 371	470 471	570 571	670 671	770 771
[Md. 2] Movement amount after near-point dog ON	<ul style="list-style-type: none"> At a machine OPR control start, "0" is stored. After a machine OPR control start, the movement amount from near-point dog ON up to machine OPR control completion is stored. (Movement amount: Indicates the movement amount up to completion of machine OPR control when near-point dog ON is defined as "0". For near-point dog-free stopper type method, the value is always "0". [Range: 0 to 2147483647 pulse] 	0	72 73	172 173	272 273	372 373	472 473	572 573	672 673	772 773
[Md. 3] Current speed	<ul style="list-style-type: none"> The current speed is stored. (The fraction is ignored. "0" may be displayed if the speed is less than 1 pulse/s.) Update timing: 1ms for QD70P4 2ms for QD70P8 [Range: 0 to 200000 pulse] 	0	74 75	174 175	274 275	374 375	474 475	574 575	674 675	774 775
[Md. 4] Axis operation status	<p>The operating status of the axis is stored.</p> <p>-1 : Error 0 : Standby 2 : Stopped 3 : JOG Operation 4 : OPR 5 : Position • Control (during speed control of speed-position switching control) 6 : Speed • Position Speed (during position control of speed-position switching control) 7 : Deceleration (Axis Stop ON) 8 : Deceleration (JOG Start OFF) 9 : Fast OPR</p>	0	76	176	276	376	476	576	676	776
[Md. 5] Axis error code	<ul style="list-style-type: none"> At axis error occurrence, the error code corresponding to the error definition is stored. If another error occurs during axis error occurrence, the latest error code is ignored. However, if a system-affecting error (error code: 800 to 840) has occurred, the old error code is overwritten by the newest error code, which is stored. The error codes 800 to 840 are stored into [Md. 5] for all axes. When [Cd. 1] Axis error reset" (axis control data) of the corresponding axis is turned ON, the axis error code is cleared (to zero). (Refer to "Section 13.2" for details of the error codes.) 	0	77	177	277	377	477	577	677	777

Item	Storage details	Default value	Storage buffer memory address																	
			Axis 1	Axis 2	Axis 3	Axis 4	Axis 5	Axis 6	Axis 7	Axis 8										
Md. 6 Axis warning code	<p>At axis warning occurrence, the warning code corresponding to the warning definition is stored.</p> <ul style="list-style-type: none"> The latest warning code is always stored. (When a new axis warning occurs, the old warning code is overwritten.) When "Cd. 1 Axis error reset" (axis control data) of the corresponding axis is turned ON, the axis warning code is cleared (to zero). (Refer to "Section 13.3" for details of the warning codes.) 	0	78	178	278	378	478	578	678	778										
Md. 7 Status	<p>The ON/OFF states of the following flags are stored.</p> <p>The following items are stored.</p> <ul style="list-style-type: none"> OPR request flag (Refer to "Chapter 8" for details) This flag turns ON at power-on or at machine OPR control start, and turns OFF on completion of machine OPR control. OPR complete flag (Refer to "Chapter 8" for details) This flag turns ON on normal completion of machine OPR control, and turns OFF at an OPR control, positioning control or JOG operation start. 0 speed (Refer to "Section 11.3" for details) This flag turns ON when JOG operation or speed control of speed-position switching control is started with the speed set to "0". When a speed change is made, this flag turns ON when a speed change request of new speed value 0 is given, and turns OFF when a speed change request of other than new speed value 0 is given. <table border="1" style="margin-left: auto; margin-right: auto;"> <thead> <tr> <th>Storage item</th> <th>Meaning</th> </tr> </thead> <tbody> <tr> <td>OPR request flag</td> <td></td> </tr> <tr> <td>OPR complete flag</td> <td>0 : OFF 1 : ON</td> </tr> <tr> <td>0 speed</td> <td></td> </tr> </tbody> </table>	Storage item	Meaning	OPR request flag		OPR complete flag	0 : OFF 1 : ON	0 speed		0001 _H	79	179	279	379	479	579	679	779		
Storage item	Meaning																			
OPR request flag																				
OPR complete flag	0 : OFF 1 : ON																			
0 speed																				
Md. 8 External I/O signal	<p>The ON/OFF states of the external I/O signals are stored.</p> <p>The following items are stored.</p> <ul style="list-style-type: none"> Zero signal Near-point dog signal Speed-position switching signal Deviation counter clear signal <table border="1" style="margin-left: auto; margin-right: auto;"> <thead> <tr> <th>Storage item</th> <th>Meaning</th> </tr> </thead> <tbody> <tr> <td>Zero signal</td> <td></td> </tr> <tr> <td>Near-point dog signal</td> <td></td> </tr> <tr> <td>Speed-position switching signal</td> <td>0 : OFF 1 : ON</td> </tr> <tr> <td>Deviation counter clear signal</td> <td></td> </tr> </tbody> </table>	Storage item	Meaning	Zero signal		Near-point dog signal		Speed-position switching signal	0 : OFF 1 : ON	Deviation counter clear signal		0000 _H	80	180	280	380	480	580	680	780
Storage item	Meaning																			
Zero signal																				
Near-point dog signal																				
Speed-position switching signal	0 : OFF 1 : ON																			
Deviation counter clear signal																				
Md. 9 Executing positioning data No.	<ul style="list-style-type: none"> The positioning data No. currently being executed is stored. (The stored value is held until the next start is executed.) When JOG operation or machine OPR control is started, 0 is stored. When fast OPR control is started, 1 is stored. 	0	81	181	281	381	481	581	681	781										

4.6.2 Module information monitor data

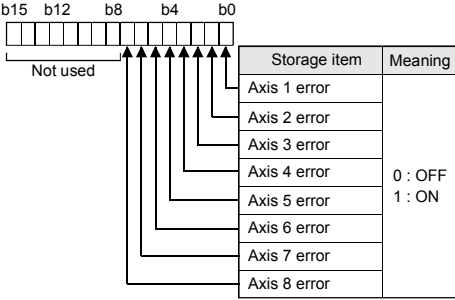
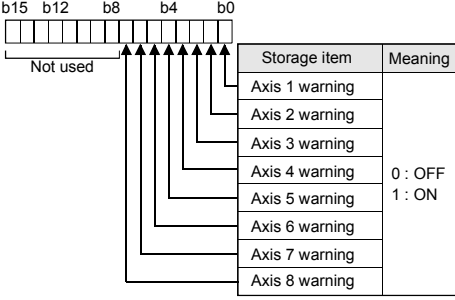
Item	Storage details	Default value	Storage buffer memory address (Common for axis 1 to axis 8)
<p>[Md. 10] Error status</p>	<p>At error occurrence, the bit corresponding to the error occurrence axis turns ON. 0: Normal (OFF) 1: Error (ON) (The error occurrence axis cannot be run) When "[Cd. 1] Axis error reset" (axis control data) of the corresponding axis is turned ON, the error status of the corresponding axis is cleared (to zero). (Refer to "Chapter 13" for details.)</p>  <p>(For the QD70P4, b4 to b7 are "0" fixed.)</p>	<p>0000H</p>	<p>1600</p>
<p>[Md. 11] Warning status</p>	<p>At warning occurrence, the bit corresponding to the warning occurrence axis turns ON. 0: Normal (OFF) 1: Warning (ON) When "[Cd. 1] Axis error reset" (axis control data) of the corresponding axis is turned ON, the warning status of the corresponding axis is cleared (to zero). (Refer to "Chapter 13" for details.)</p>  <p>(For the QD70P4, b4 to b7 are "0" fixed.)</p>	<p>0000H</p>	<p>1601</p>

4.7 List of control data

4.7.1 Axis control data

Item	Setting details	Default value	Setting buffer memory address							
			Axis 1	Axis 2	Axis 3	Axis 4	Axis 5	Axis 6	Axis 7	Axis 8
Cd. 1 Axis error reset	By setting "1", the following operation is performed. <ul style="list-style-type: none"> Axis error occurrence (X1), "Md. 5 Axis error code", axis warning occurrence (X2) or "Md. 6 Axis warning code" is cleared. (X1 and X2 are cleared when "1" is set in Cd. 1 of all axes.) If "Md. 4 Axis operation status" is "Error", the error is cleared and returned to the "Standby" status. (The data automatically changes to "0" after completion of axis error reset or axis warning reset.) 	0	50	150	250	350	450	550	650	750
Cd. 2 OPR request flag OFF request	When the OPR request flag (b0 of Md. 7) is ON, setting "1" forcibly turns this data OFF. (The data automatically changes to "0" after the OPR request flag turns OFF.)	0	51	151	251	351	451	551	651	751
Cd. 3 Start method	Set this data when starting the corresponding control. 0 : Positioning control (starting from No. 1) 9000 : Machine OPR control 9001 : Fast OPR control	0	52	152	252	352	452	552	652	752
Cd. 4 Restart request	<ul style="list-style-type: none"> If positioning control is stopped midway by the axis stop signal (Y10 to Y17) (when "Md. 4 Axis operation status" is "Stopped"), setting "1" restarts positioning control to the end point of the positioning data from where it had stopped. For speed control of speed-position switching control, speed control is exercised at the speed used before the stop. (After completion of restart request acceptance, the data changes to "0" automatically.) 	0	53	153	253	353	453	553	653	753
Cd. 5 Speed-position switching request	Set whether the speed-position switching signal is made valid or not. 0: Invalidates the speed-position switching signal. (Disable) 1: Validates the speed-position switching signal. (Enable)	0	54	154	254	354	454	554	654	754

Item	Setting details	Default value	Setting buffer memory address							
			Axis 1	Axis 2	Axis 3	Axis 4	Axis 5	Axis 6	Axis 7	Axis 8
[Cd. 6] Speed change request	Set "1" to request speed change processing (make the "[Cd. 7] New speed value" value valid) after setting "[Cd. 7] New speed value" for JOG operation or speed control of speed-position switching control. (The data changes automatically to "0" after completion of speed change request acceptance.)	0	55	155	255	355	455	555	655	755
[Cd. 7] New speed value	Set the new speed for JOG operation or speed control of speed-position switching control. • Set the value not more than "[Pr. 5] Speed limit value". • Set the value not less than "[Pr. 6] Bias speed at start". [Setting range: 0 to 200000 pulse/s]	0	56 57	156 157	256 257	356 357	456 457	556 557	656 657	756 757
[Cd. 8] ACC/DEC time at speed change	Set the time taken at a speed change to reach the new speed from the old speed. [Setting range: 0 to 32767ms]	1000	58	158	258	358	458	558	658	758
[Cd. 9] DEC/STOP time at speed change	Set the time taken at axis stop factor occurrence (axis stop signal ON or error occurrence) to make a stop after reaching "[Pr. 6] Bias speed at start" from the speed after a speed change. [Setting range: 0 to 32767ms]	1000	59	159	259	359	459	559	659	759

CHAPTER 5 SETUP AND PROCEDURES BEFORE OPERATION

This chapter describes the procedure up to the operation of the QD70 and the part identification nomenclature and setting and wiring methods of the QD70.

5.1 Handling precautions

This section provides the precautions for handling the QD70.

DANGER

- Completely turn off the externally supplied power used in the system before cleaning or tightening the screws.
Failure to turn all phases OFF could lead to electric shocks.

5

CAUTION

- Use the programmable controller in an environment that meets the general specifications contained in the CPU User's Manual.
Using the programmable controller outside the general specification range environment could lead to electric shocks, fires, malfunctioning, product damage or deterioration.
- Do not directly touch the conductive section and electronic parts of the module.
Failure to observe this could lead to module malfunctioning or trouble.
- Make sure that foreign matter, such as cutting chips or wire scraps, do not enter the module.
Failure to observe this could lead to fires, trouble or malfunctioning.
- Never disassemble or modify the module.
Failure to observe this could lead to trouble, malfunctioning, injuries or fires.
- Completely turn off the externally supplied power used in the system before installing or removing the module.
Failure to turn all phases OFF could lead to module trouble or malfunctioning.
- While pressing the installation lever located at the bottom of module, insert the module fixing tab into the fixing hole in the base unit until it stops. Then, securely mount the module with the fixing hole as a supporting point. Improper mounting of the module may lead to malfunctioning, faults, or dropping.
When using the module in the environment subject to much vibration, secure the module with a screw.
Tighten the screw within the range of the specified tightening torque.
Insufficient tightening may lead to dropping, short-circuit, or malfunctioning.
Excessive tightening may damage the screw or module, leading to dropping, short-circuit, or malfunctioning.

(1) Main body

- The main body case is made of plastic. Take care not to drop or apply strong impacts onto the case.
- Do not remove the QD70 PCB from the case. Failure to observe this could lead to faults.

(2) Cable

- Do not press on the cable with a sharp object.
- Do not twist the cable with force.
- Do not forcibly pull on the cable.
- Do not step on the cable.
- Do not place objects on the cable.
- Do not damage the cable sheath.

(3) Installation environment

Do not install the module in the following type of environment.

- Where the ambient temperature exceeds the 0 to 55°C range.
- Where the ambient humidity exceeds the 5 to 95%RH range.
- Where there is sudden temperature changes, or where dew condenses.
- Where there is corrosive gas or flammable gas.
- Where there are high levels of dust, conductive powder, such as iron chips, oil mist, salt or organic solvents.
- Where the module will be subject to direct sunlight.
- Where there are strong electric fields or magnetic fields.
- Where vibration or impact could be directly applied onto the main body.

5.2 Procedures before operation

This section gives the procedure up to the operation of the QD70.

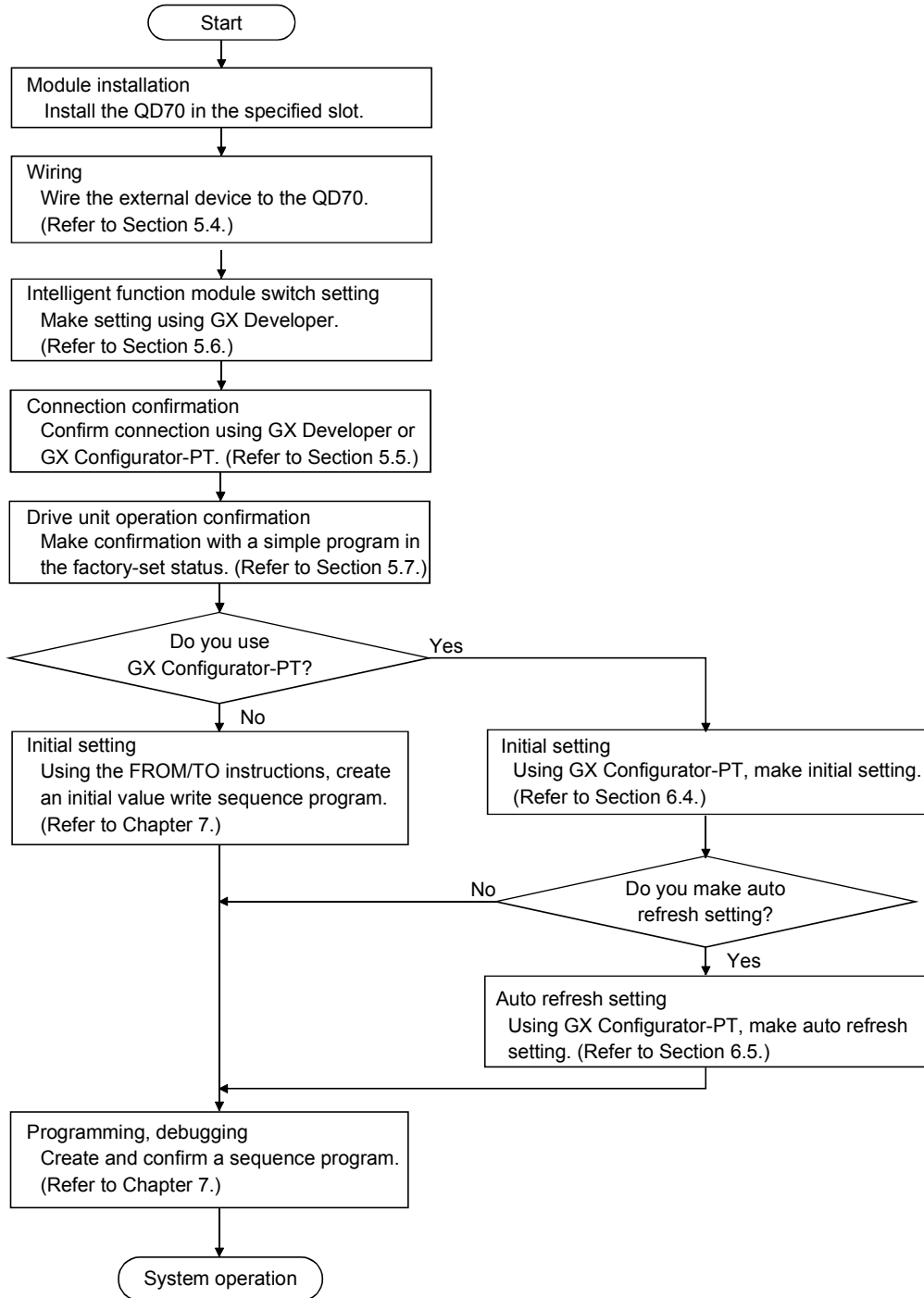

5.3 Part identification nomenclature

(1) The following are the part names of the QD70.

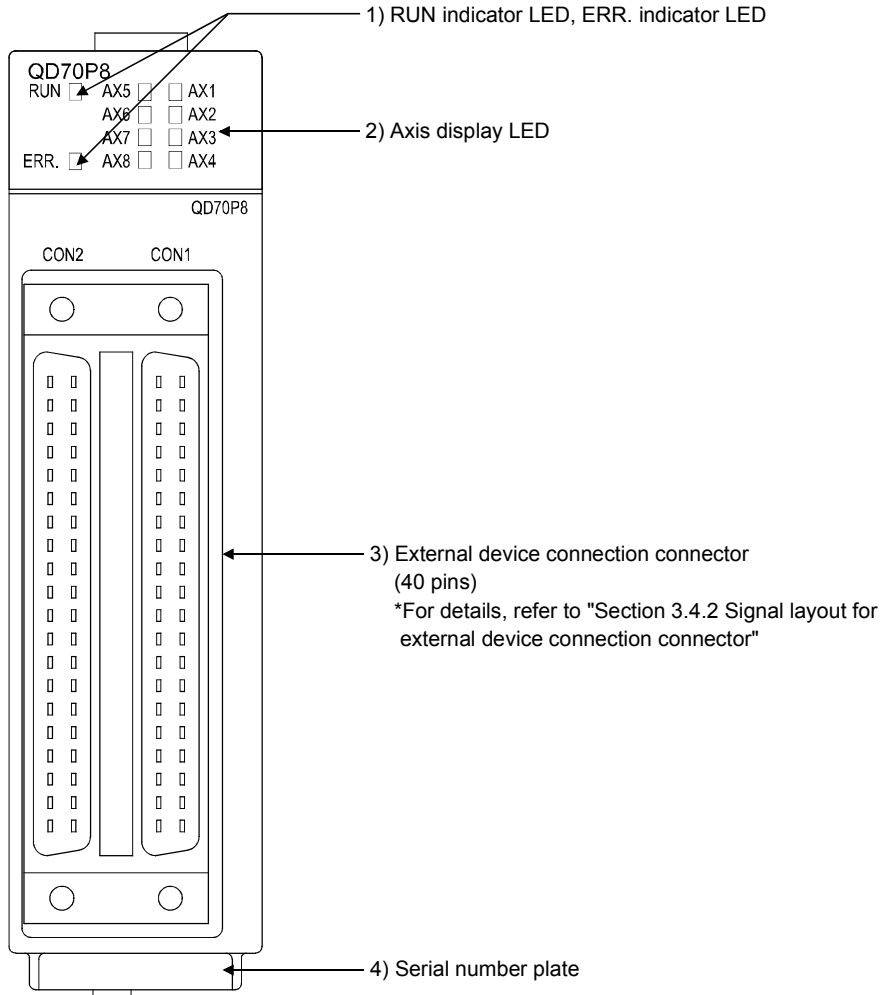

No.	Name	Details
1)	RUN indicator LED, ERR. indicator LED	Refer to the next page.
2)	Axis display LED (Axn, n: Axis No.)	
3)	External device connection connector	Connector for connection of the drive unit and mechanical system inputs.
4)	Serial number plate	Indicates the serial number of the QD70.

(2) The LED display indicates the following operation statuses of the QD70 and axes.

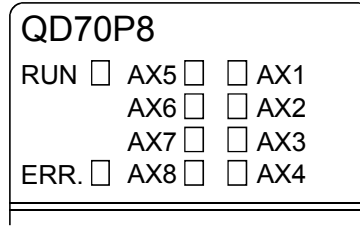

Display	Attention point	Description	Display	Attention point	Description
RUN <input type="checkbox"/> AX5 <input type="checkbox"/> <input type="checkbox"/> AX1 AX6 <input type="checkbox"/> <input type="checkbox"/> AX2 AX7 <input type="checkbox"/> <input type="checkbox"/> AX3 ERR. <input type="checkbox"/> AX8 <input type="checkbox"/> <input type="checkbox"/> AX4	RUN is OFF. ERR. and AX1 to AX8 states are unfixd.	Hardware failure.	RUN <input checked="" type="checkbox"/> AX5 <input type="checkbox"/> <input type="checkbox"/> AX1 AX6 <input type="checkbox"/> <input type="checkbox"/> AX2 AX7 <input type="checkbox"/> <input type="checkbox"/> AX3 ERR. <input type="checkbox"/> AX8 <input type="checkbox"/> <input type="checkbox"/> AX4	AX1 to AX8 are OFF.	The axes are stopped or on standby.
RUN <input checked="" type="checkbox"/> AX5 <input type="checkbox"/> <input type="checkbox"/> AX1 AX6 <input type="checkbox"/> <input type="checkbox"/> AX2 AX7 <input type="checkbox"/> <input type="checkbox"/> AX3 ERR. <input type="checkbox"/> AX8 <input type="checkbox"/> <input type="checkbox"/> AX4	RUN illuminates. ERR. is OFF.	The module operates normally.	RUN <input checked="" type="checkbox"/> AX5 <input type="checkbox"/> <input checked="" type="checkbox"/> AX1 AX6 <input type="checkbox"/> <input type="checkbox"/> AX2 AX7 <input type="checkbox"/> <input type="checkbox"/> AX3 ERR. <input type="checkbox"/> AX8 <input type="checkbox"/> <input type="checkbox"/> AX4	AX1 (or other axis) illuminates.	The corresponding axis is in operation.
RUN <input checked="" type="checkbox"/> AX5 <input type="checkbox"/> <input type="checkbox"/> AX1 AX6 <input type="checkbox"/> <input type="checkbox"/> AX2 AX7 <input type="checkbox"/> <input type="checkbox"/> AX3 ERR. <input checked="" type="checkbox"/> AX8 <input type="checkbox"/> <input type="checkbox"/> AX4	ERR. illuminates.	System error.	RUN <input checked="" type="checkbox"/> AX5 <input type="checkbox"/> <input checked="" type="checkbox"/> AX1 AX6 <input type="checkbox"/> <input type="checkbox"/> AX2 AX7 <input type="checkbox"/> <input type="checkbox"/> AX3 ERR. <input checked="" type="checkbox"/> AX8 <input type="checkbox"/> <input type="checkbox"/> AX4	ERR. flashes. AX1 (or other axis) flashes.	An error occurs on the corresponding axis.

The symbols in the Display column indicate the following statuses:

: Turns OFF. : Illuminates. : Flashes.

(3) The interface of each QD70 is as shown below.

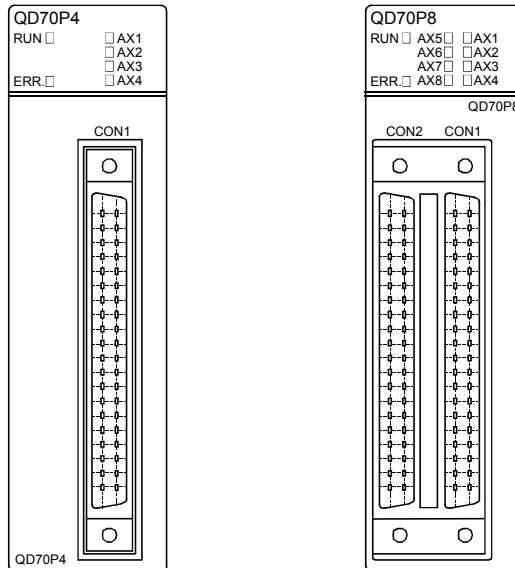

■ External device connection connector

The connectors for use with the QD70 should be purchased separately by the user. The connector types and pressure displacement tool are listed below.

(a) Connector types

Type	Model name
Soldering type, straight out	A6CON1
Pressure displacement type, straight out	A6CON2
Soldering type, usable for straight out and diagonal out	A6CON4

(b) Pressure-displacement tool

Type	Model name	Applicable wire size	Supplier's office
Pressure-displacement tool	FCN-363T-T005/H	AWG#24	<ul style="list-style-type: none"> • FUJITSU AMERICA, INC. 250E Caribbean Drive Sunnyvale, CA 94089 U.S.A Tel: (1-408)745-4900 • FUJITSU EUROPE B.V. Jupiterstaat 13-15, our 2132 Hoofddorp, The Netherland Tel: (31)23-5560910 • FUJITSU EUROPE B.V. Zweiniederlassung Deutschland Schatzbogen 86 D-81829 Munchen Germany Tel: (49)89-42742320 • FUJITSU EUROPE (UK) Network House, Morres Drive, Maidenhead, Berkshire, SL6 4FH United Kingdom Tel: (44)1628-504600 • FUJITSU EUROPE B.V. 127 Chemin Des Bassins, Europarc, Cleteril 94035 Cleteril 94035 France Tel: (33)145139940 • FUJITSU ASIA PACIFIC PTE LIMITED 102E Pasir Panjang Road, #04-01 Citilink Warehouse Complex, Singapore 118529 Tel: (65)375-8560 • FUJITSU HONG KONG CO., LTD. Suite 913 Ocean Centre, 5 Canton Road, TST, Kowloon, Hong Kong Tel: (852)2881-8495

5.4 Wiring

This section explains how to wire the drive unit and mechanical system inputs to the QD70.

The following are the precautions for wiring the QD70. Read these precautions together with "Section 5.1 Handling precautions" to ensure work safety.

5.4.1 Wiring precautions

- (1) Always confirm the terminal layout before connecting the wires to the QD70.
- (2) Correctly solder the external device connection connector. An incomplete soldering could lead to malfunctioning.
- (3) Make sure that foreign matter such as cutting chips and wire scraps does not enter the QD70. Failure to observe this could lead to fires, faults or malfunctioning.
- (4) A protective label is attached on the top of the QD70 to avoid foreign matter such as wire scraps from entering inside during wiring process. Do not remove the label until the wiring is completed. Before starting the system, however, be sure to remove the label to ensure heat radiation.
- (5) Securely mount the external device connection connector to the connector on the QD70 with two screws.
- (6) Do not disconnect the external wiring cable connected to the QD70 or drive unit by pulling the cable section. When the cable has a connector, be sure to hold the connector connected to the QD70 or drive unit. Pulling the cable while it is connected to the QD70 or drive unit may lead to malfunctioning or damage of the QD70, drive unit or cable.
- (7) Do not bundle or adjacently lay the connection cable connected to the QD70 external input/output signals or drive unit with the main circuit line, power line, or the load line other than that for the programmable controller. Separate these by 100mm as a guide. Failure to observe this could lead to malfunctioning caused by noise, surge, or induction.
- (8) If cables to connect to QD70 absolutely must be positioned near (within 100mm) the power line, use a general shielded cable. The shield must be grounded on the QD70 side. (Wiring examples are given on the following pages.)

[Wiring example using shielded cables]

The following are the wiring examples for noise reduction when the A6CON1 connector is used.

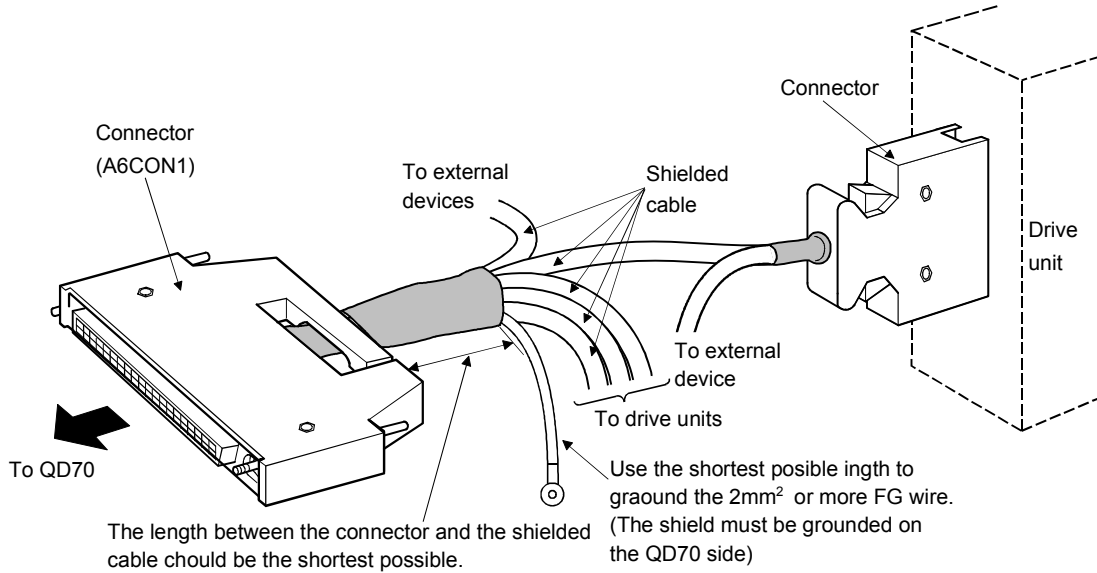

[Processing example of shielded cables]

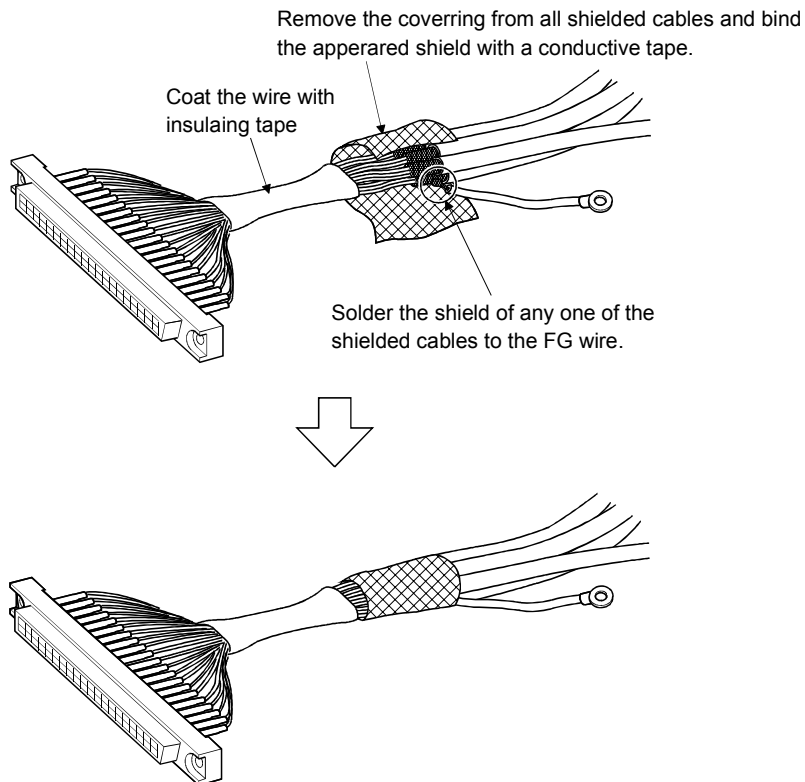

Assembling of connector (A6CON1)

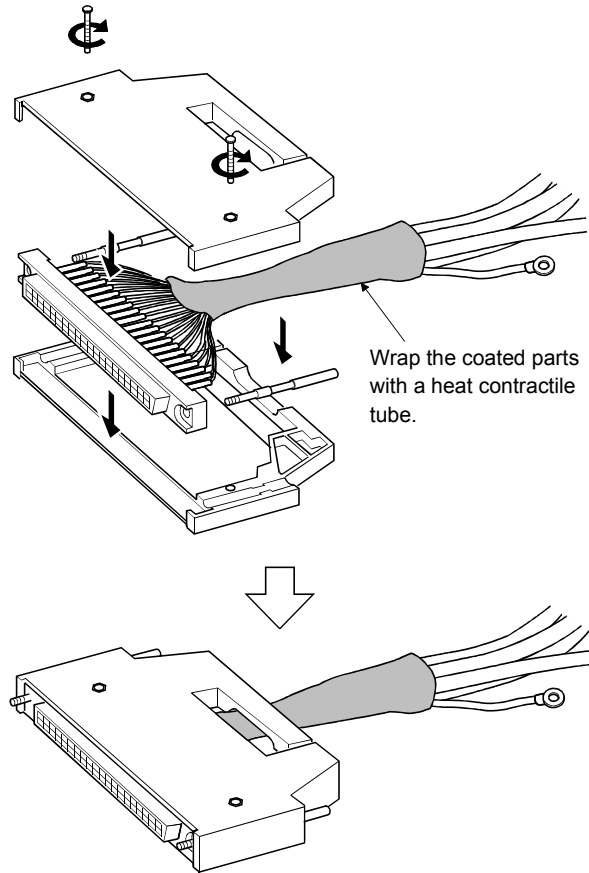

- (9) The cables connected to the QD70 should be placed in a duct or fixed. Not doing so can cause the QD70, drive unit or cables to be damaged when the cables swing, move or are pulled carelessly, for example, or to malfunction due to poor cable connection.
- (10) To comply with the EMC Directive and Low-Voltage Directive, always ground the QD70 to the control box using the shielded cables and AD75CK cable clamping (Mitsubishi Electric make).

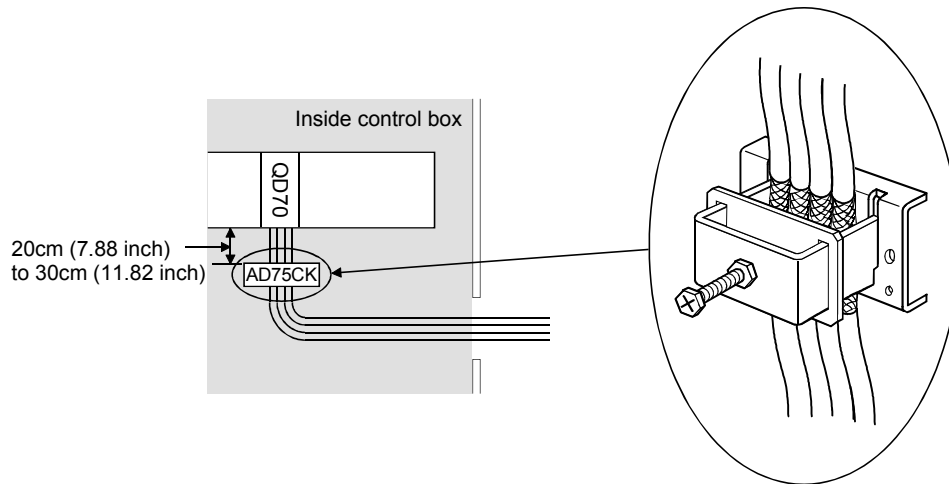

[How to ground shielded cables using AD75CK]

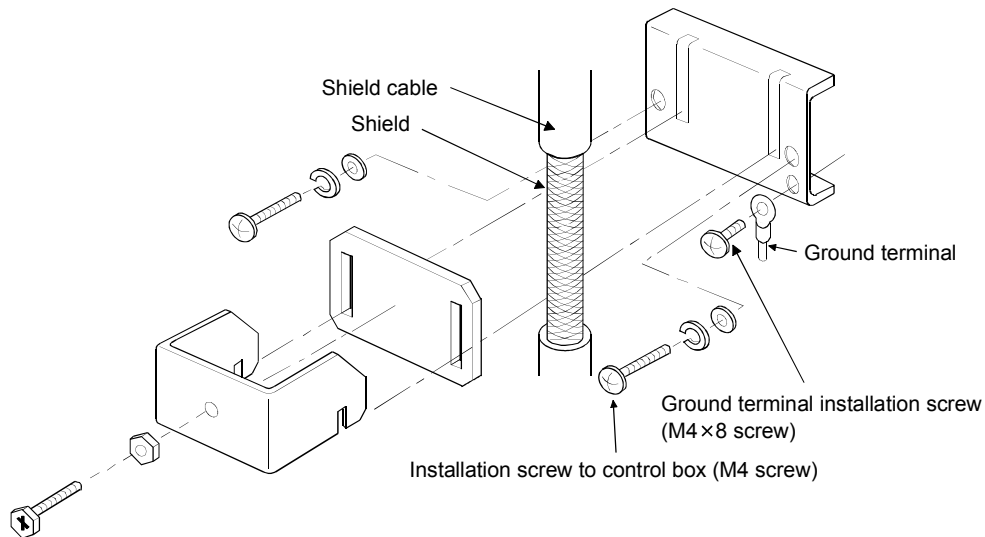

Using the AD75CK, you can tie four cables of about 7mm outside diameter together for grounding.
(For details, refer to the AD75CK-type Cable Clamping Instruction Manual <IB-68682>.)

[Wiring examples using duct (improper example and improved example)]

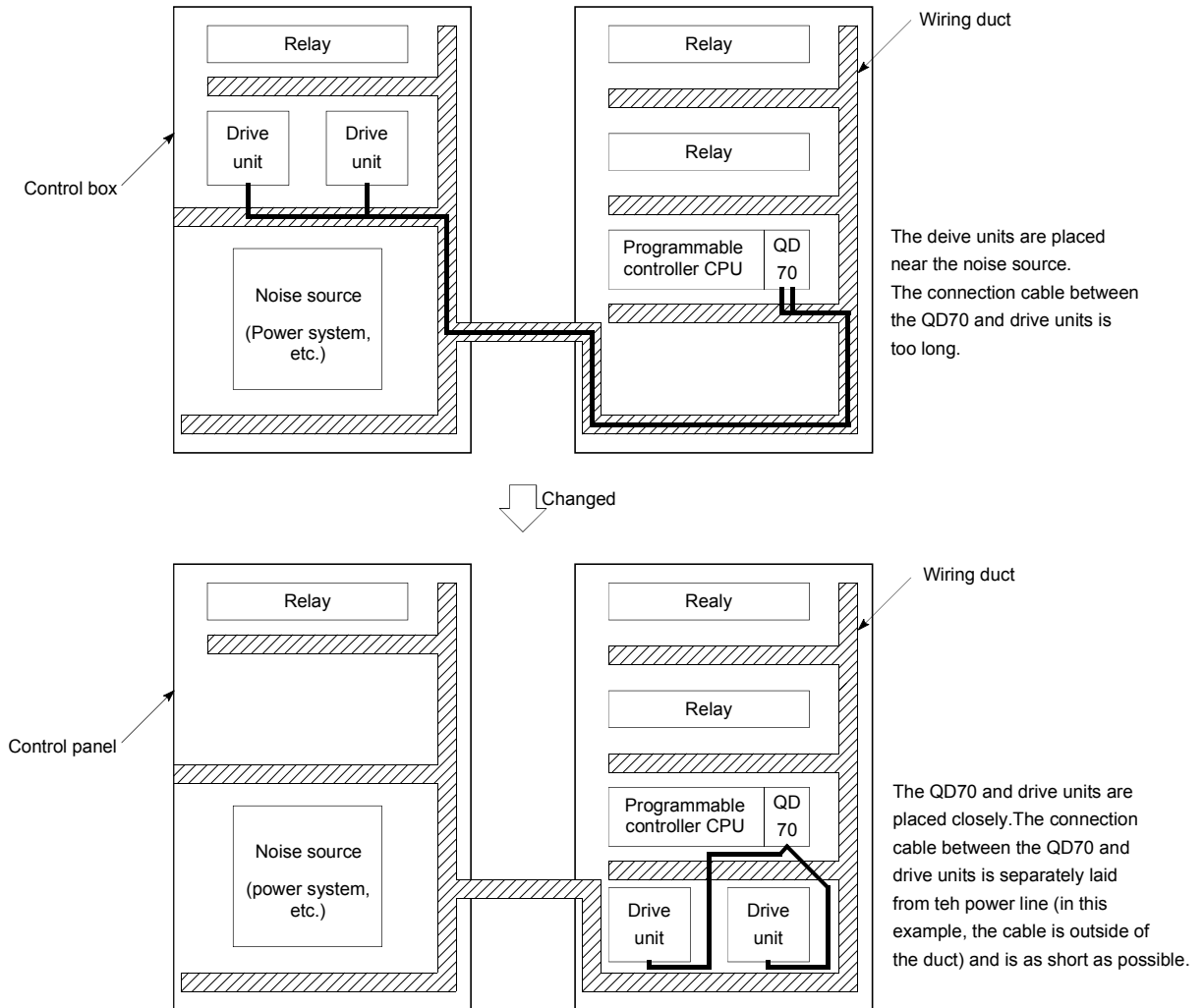

5.5 Confirming the wiring

5.5.1 Confirmation items at completion of wiring

Check the following points when completed with the QD70 installation and wiring.

- Is the module correctly wired? "Connection confirmation"

By making "connection conformation", you can check whether the "QD70 recognizes the external I/O signals such as the near-point dog and speed-position switching signals", for example.

The following is the way to make "connection confirmation".

(1) Method using GX Developer

Read the "Md. 8 External I/O signal" axis monitor data with the monitor function (Buffer memory batch) and check the read values.

Md. 8 External I/O signal	Buffer memory address							
	Axis 1	Axis 2	Axis 3	Axis 4	Axis 5	Axis 6	Axis 7	Axis 8
	80	180	280	380	480	580	680	780

[Bit pattern]

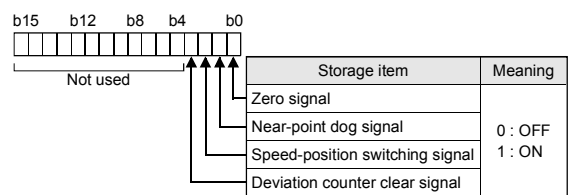

(Example) Checking the external I/O signals of Axis 1

<GX Developer display screen>

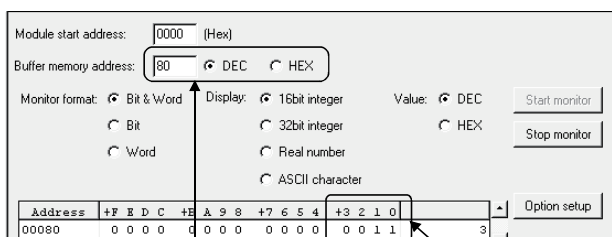

Set the buffer memory address of "Md. 8 External I/O signal" of Axis 1 in decimal.

- b0 (Zero signal ON)
- b1 (Near-point dog signal ON)
- b2 (Speed-position switching signal OFF)
- b3 (Deviation counter clear signal OFF)

The states of the external I/O signals can also be checked by system monitor. For details, refer to "Section 12.3 External I/O signal monitor function".

(2) Method using GX Configurator-PT

Monitor the external I/O signal states on the "Monitor/Test screen".

(For details, refer to "Section 6.6 Monitor/test".)

(Example) Checking the external I/O signals of Axis 1 (1 Axis OPR Monitor)

<GX Configurator-PT display screen>

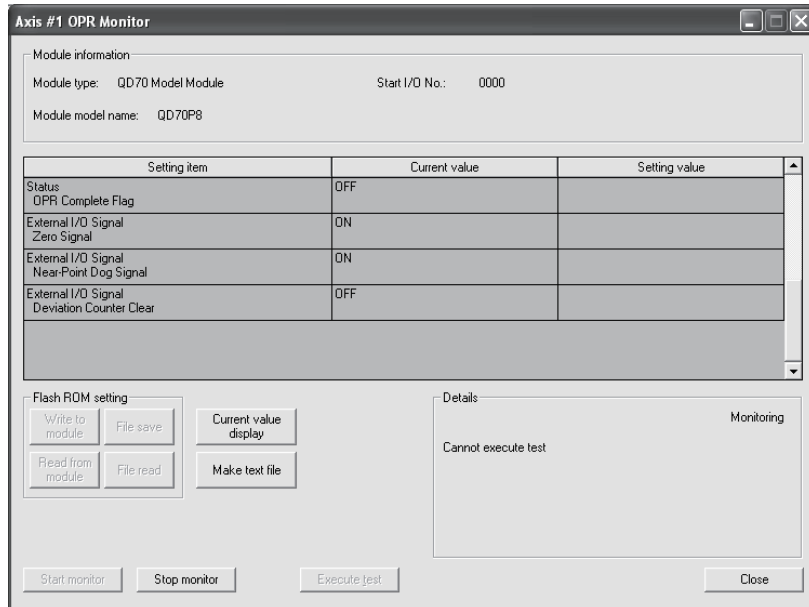
**Important**

If the QD70 is faulty or does not recognize necessary signals, such as the near-point dog and speed-position switching signals, an unexpected accident, e.g. "the axis collides with the stopper without decelerating at the near-point dog during machine OPR control" or "speed control is not switched to position control". Always make "connection confirmation" not only when the positioning control system has been configured but also when any modifications have been made to the system, e.g. modules have been changed or the system has been rewired.

5.6 Switch setting for intelligent function module

By making the intelligent function module switch setting, the QD70 allows you to set the pulse output mode, external I/O signal logic and rotation direction. (However, you cannot set the speed-position switching signal (CHG) logic. It is fixed at the negative logic.)

Make the intelligent function module switch setting in the "I/O assignment setting" PLC parameter of the QCPU using GX Developer.

- There are intelligent function module switches 1 to 5, which are set with 16-bit data.
- When you do not make the intelligent function module switch setting, switches 1 to 5 default to 0.

The settings made with the intelligent function module switches are made valid after power-on or programmable controller CPU reset. You cannot change the settings during operation.

Switch No.	Setting item	Setting details/bit assignment	Default value																												
Switch 1	Pulse output mode	<table border="1" style="width:100%; text-align:center;"> <tr> <td colspan="4">b15</td> <td colspan="4">b8 b7</td> <td colspan="4">b0</td> </tr> <tr> <td>8)</td><td>7)</td><td>6)</td><td>5)</td><td>4)</td><td>3)</td><td>2)</td><td>1)</td> <td>8)</td><td>7)</td><td>6)</td><td>5)</td><td>4)</td><td>3)</td><td>2)</td><td>1)</td> </tr> </table> <p>1 to 8 indicate the axis Nos. 00 : CW/CCW mode 01 : PULSE/SIGN mode</p>	b15				b8 b7				b0				8)	7)	6)	5)	4)	3)	2)	1)	8)	7)	6)	5)	4)	3)	2)	1)	0000
b15				b8 b7				b0																							
8)	7)	6)	5)	4)	3)	2)	1)	8)	7)	6)	5)	4)	3)	2)	1)																
Switch 2	Pulse output logic selection	<table border="1" style="width:100%; text-align:center;"> <tr> <td colspan="4">b15</td> <td colspan="4">b8 b7</td> <td colspan="4">b0</td> </tr> <tr> <td>8)</td><td>7)</td><td>6)</td><td>5)</td><td>4)</td><td>3)</td><td>2)</td><td>1)</td> <td>8)</td><td>7)</td><td>6)</td><td>5)</td><td>4)</td><td>3)</td><td>2)</td><td>1)</td> </tr> </table> <p>Deviation counter clear output logic selection Pulse output logic selection 1 to 8 indicate the axis Nos. 0 : Negative logic 1 : Positive logic</p>	b15				b8 b7				b0				8)	7)	6)	5)	4)	3)	2)	1)	8)	7)	6)	5)	4)	3)	2)	1)	0000
	b15				b8 b7				b0																						
8)	7)	6)	5)	4)	3)	2)	1)	8)	7)	6)	5)	4)	3)	2)	1)																
Deviation counter clear output logic selection																															
Switch 3	Zero signal input logic selection	<table border="1" style="width:100%; text-align:center;"> <tr> <td colspan="4">b15</td> <td colspan="4">b8 b7</td> <td colspan="4">b0</td> </tr> <tr> <td>8)</td><td>7)</td><td>6)</td><td>5)</td><td>4)</td><td>3)</td><td>2)</td><td>1)</td> <td>8)</td><td>7)</td><td>6)</td><td>5)</td><td>4)</td><td>3)</td><td>2)</td><td>1)</td> </tr> </table> <p>Rotation direction setting Zero signal input logic selection 1 to 8 indicate the axis Nos. <Rotation direction setting> <Zero signal input logic selection> 0 : Forward run pulse output increases the current feed value. 0 : Negative logic 1 : Reverse run pulse output increases the current feed value. 1 : Positive logic</p>	b15				b8 b7				b0				8)	7)	6)	5)	4)	3)	2)	1)	8)	7)	6)	5)	4)	3)	2)	1)	0000
	b15				b8 b7				b0																						
8)	7)	6)	5)	4)	3)	2)	1)	8)	7)	6)	5)	4)	3)	2)	1)																
Rotation direction setting																															
Switch 4	Near-point dog signal input logic selection	<table border="1" style="width:100%; text-align:center;"> <tr> <td colspan="4">b15</td> <td colspan="4">b8 b7</td> <td colspan="4">b0</td> </tr> <tr> <td colspan="4"></td> <td>8)</td><td>7)</td><td>6)</td><td>5)</td><td>4)</td><td>3)</td><td>2)</td><td>1)</td> </tr> </table> <p>1 to 8 indicate the axis Nos. 0 : Negative logic 1 : Positive logic</p>	b15				b8 b7				b0								8)	7)	6)	5)	4)	3)	2)	1)	0000				
b15				b8 b7				b0																							
				8)	7)	6)	5)	4)	3)	2)	1)																				
Switch 5	Vacant																														

[Setting example]

Setting item	Setting details								Target signal names	Switch setting
	Axis 8	Axis 7	Axis 6	Axis 5	Axis 4	Axis 3	Axis 2	Axis 1		
Pulse output mode	PULSE/SIGN mode				CW/CCW mode				PULSE F PULSE R	Switch 1: 5500H
Pulse output logic selection	+	-	+	-	+	-	+	-	CLEAR	
Deviation counter clear output logic selection	-	+	-	+	-	+	-	+		PGO
Zero signal input logic selection	-	-	-	-	+	+	+	+	-	
Rotation direction setting	Reverse run pulse output increases the current feed value.				Forward run pulse output increases the current feed value.					
Near-point dog signal input logic selection	+	+	-	-	-	-	+	+	DOG	

+: Positive logic - : Negative logic

[Switch 1] Pulse output mode

Set the pulse output mode that matches the drive unit used.

Use "Switch 2" to change between the positive logic and negative logic of the pulse.

The following are pulse output mode examples.

(1) CW/CCW mode

During forward run, the forward run feed pulse (CW) will be output.

During reverse run, the reverse run feed pulse (CCW) will be output.

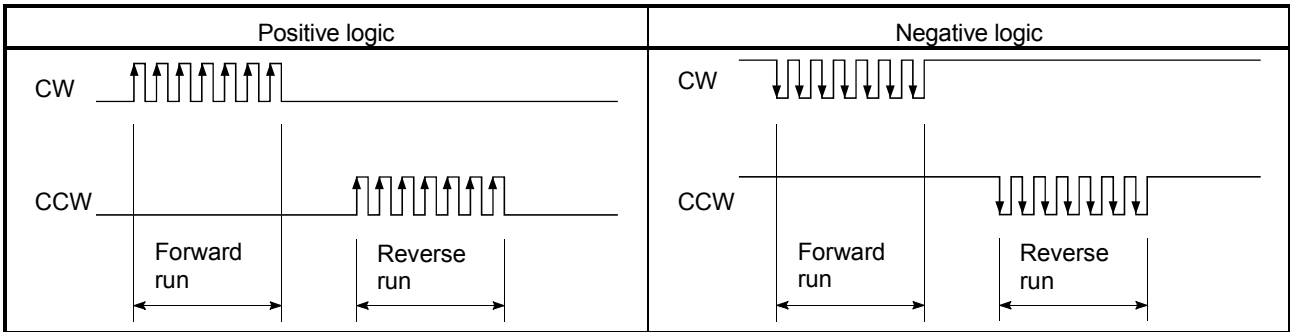

* CW is output from the "PULSE F" external I/O signal and CCW from "PULSE R". (Refer to "Section 3.4.3".)

(2) PULSE/SIGN mode

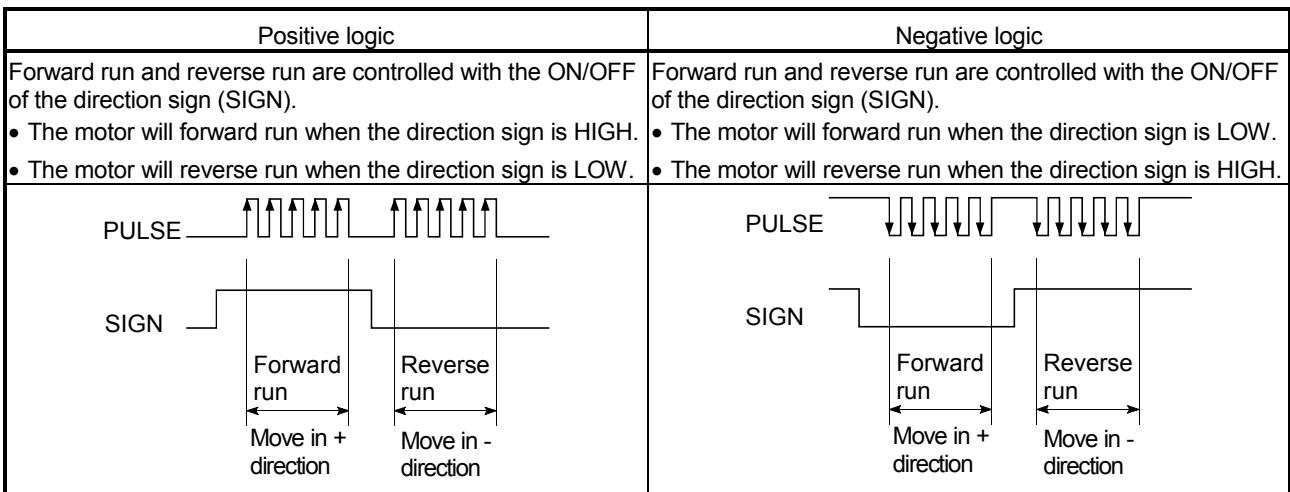

* PULSE is output from the "PULSE F" external I/O signal and SIGN from "PULSE R". (Refer to "Section 3.4.3".)

[Switch 2] Pulse output logic selection, deviation counter clear output logic selection

Set the pulse output signal (PULSE F/PULSE R) logic and deviation counter clear output signal (CLEAR) logic according to the externally connected device.

[Switch 3] Zero signal input logic selection, rotation direction setting

<Zero signal input logic selection>

Set the zero signal (PG0) input logic according to the externally connected device.

<Rotation direction setting>

Set the relation of the motor rotation direction and current value address increment/decrement.

[Setting procedure]

- 1) Set "0", and carry out forward run JOG operation.
("0" is set as the default value.)
- 2) When the workpiece "W" is moving toward the address increment direction, the current setting is O.K.
When the workpiece "W" is moving toward the address decrement direction, set "1".
- 3) Carry out forward run JOG operation again, and if "W" moves toward the increment direction, the setting is complete.

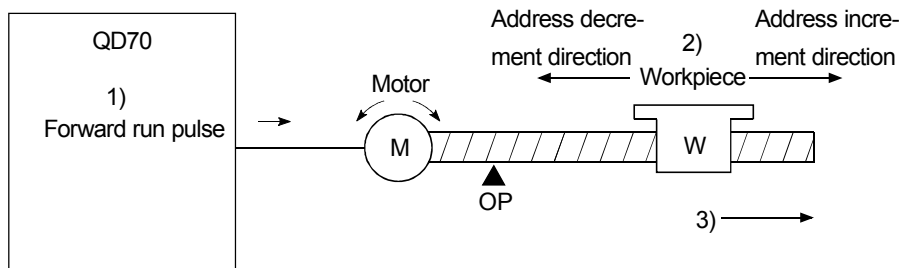
**[Switch 4] Near-point dog signal input logic selection**

Set the near-point dog signal (DOG) input logic according to the externally connected device.

Important

Incorrect setting of any I/O signal logic may disable normal operation. Make the setting carefully when changing the initial setting.

Operating procedure

Using GX Developer, make settings starting with the QCPU PLC parameter "I/O assignment setting" screen.

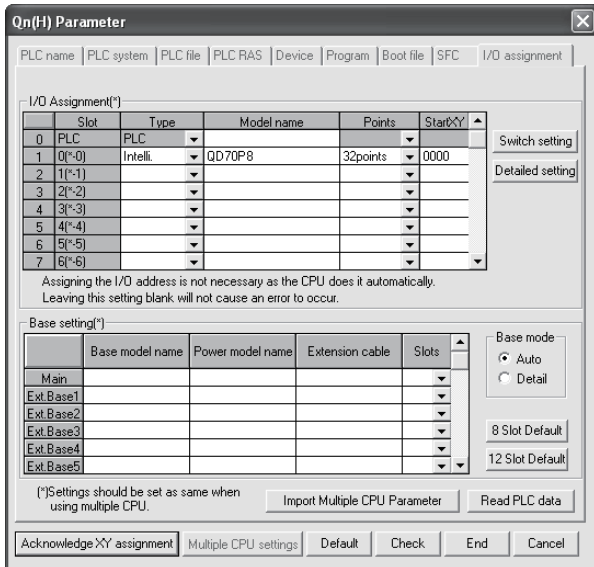

- (a) I/O assignment setting screen
Specify the following for the slot where the QD70 is mounted.

Type : Select "Intelli."
 Model name : Enter the module's model name.
 Points : Select 32 points.
 Start XY : Enter the start I/O signal for the QD70.

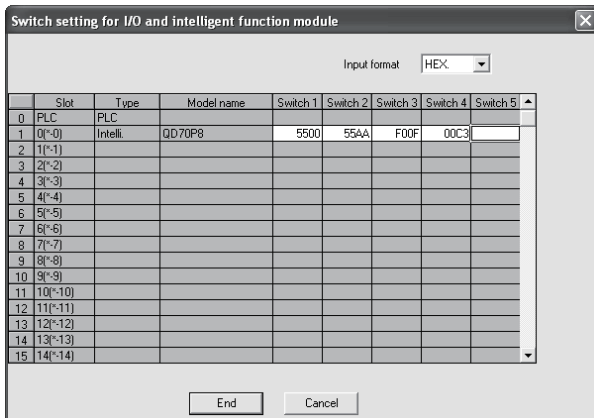

- (b) Switch setting for I/O and intelligent function module
Click on **Switch setting** on the I/O assignment setting screen to display the screen at left and set switches 1 to 4. The setting can easily be done if values are entered in hexadecimal. Change the input format to hexadecimal and enter values.

POINT

The values set in the "I/O assignment setting" PLC parameter of the QCPU can be confirmed using the module's detailed information that can be displayed on the system monitor of GX Developer. Refer to Section 12.3 for details.

5.7 Simple reciprocating operation

Before operating the system, check the operation of the drive unit.

(Make this check after making sure that the installation, wiring, intelligent function module switch setting and connection confirmation of the QD70 are normal. For details of the drive unit, refer to the manual of the drive unit used.)

The following is the way to perform "simple reciprocating operation".

(1) Operation method

Using a sequence program, perform forward run/reverse run of JOG operation.
(Refer to Chapter 10 for details of JOG operation.)

(2) Setting items

Set JOG data in the sequence program. The other data (parameters, positioning data, etc.) may be initial values.

(Change the JOG data setting values according to the machine specifications.)

JOG data	Setting value	Setting details	Buffer memory addresses							
			Axis 1	Axis 2	Axis 3	Axis 4	Axis 5	Axis 6	Axis 7	Axis 8
[JOG. 1] JOG speed	5000pulse/s	Set the speed for JOG operation.	40	140	240	340	440	540	640	740
			41	141	241	341	441	541	641	741
[JOG. 2] JOG ACC time	1000ms	Set the acceleration time for JOG operation.	42	142	242	342	442	542	642	742
[JOG. 3] JOG DEC time	1000ms	Set the deceleration time for JOG operation.	43	143	243	343	443	543	643	743
[JOG. 4] JOG direction flag	0: Forward run JOG 1: Reverse run JOG	Set the rotation direction for JOG operation.	44	144	244	344	444	544	644	744

* Refer to "Section 4.4 List of JOG data" for more information on the setting details.

(3) Reciprocating operation program using JOG operation

The following is a program example for Axis 1.

(When the QD70 is installed in slot 0 of the main base unit)

[Used devices]

Device name	Device	Application	ON details	Remarks	
Special relay	SM400	Normally ON	—	—	
	SM402	ON one scan after RUN	—	—	
QD70 I/O	Input	X0	Module READY	QD70 normal	
		X8	Axis 1 BUSY	Axis 1 running	
	Output	Y0	Programmable controller READY	Programmable controller CPU normal	—
		Y18	Axis 1 JOG start	Axis 1 JOG starting	—
External input (command)	X28	Forward run JOG command	Forward run JOG operation command being given	JOG operation is disabled if X28 and X29 are both ON or both OFF.	
	X29	Reverse run JOG command	Reverse run JOG operation command being given		
Internal relay	M1	JOG operation flag	JOG operation in progress	—	

*
 * Reciprocating operation program using JOG operation
 *
 *
 *
 *
 *
 *
 *
 *
 *

 JOG speed 5000pulse/s
 JOG ACC/DEC time 1000ms
 X28 : Forward run JOG command, X29 : Reverse run JOG command

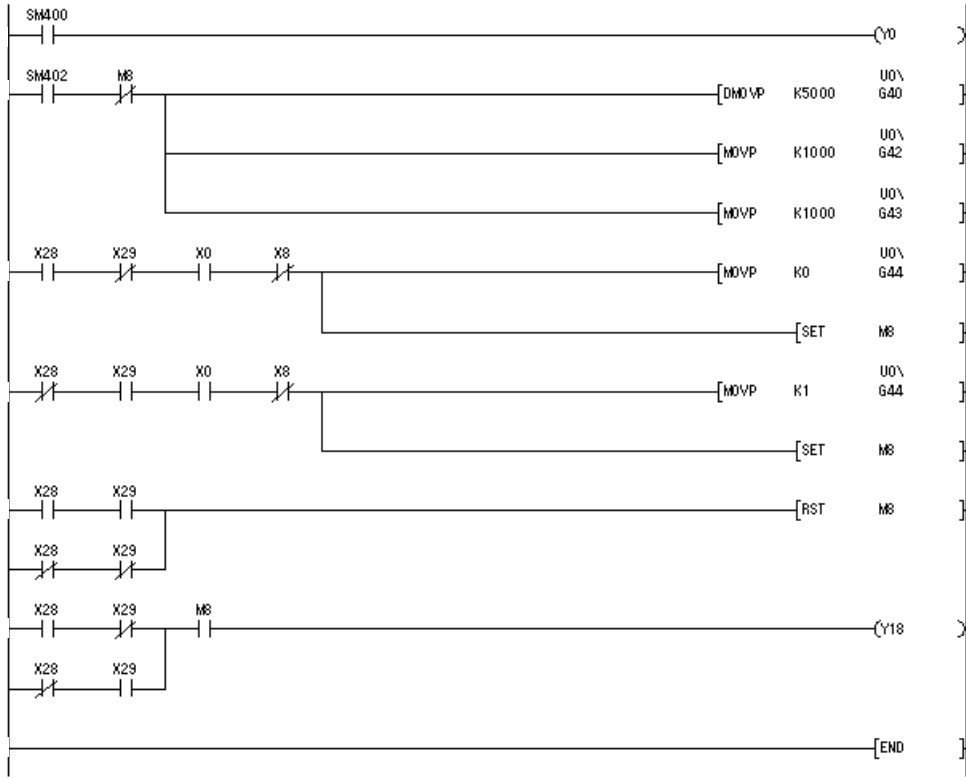

(4) Confirming the operation status
 (a) Method using GX Developer

Read the following axis monitor data with the monitor function (Buffer memory batch).

Axis monitor data	Monitor details	Buffer memory address							
		Axis 1	Axis 2	Axis 3	Axis 4	Axis 5	Axis 6	Axis 7	Axis 8
Md. 1 Current feed value	Monitor the current position.	70 71	170 171	270 271	370 371	470 471	570 571	670 671	770 771
Md. 3 Current speed	Monitor the current speed.	74 75	174 175	274 275	374 375	474 475	574 575	674 675	774 775
Md. 4 Axis operation status	Monitor the operation status "2: JOG Operation" of the axis.	76	176	276	376	476	576	676	776
Md. 5 Axis error code	Monitor the error occurrence definition.	77	177	277	377	477	577	677	777

* For more information on the monitor details, refer to "Section 4.6 List of monitor data".

(Example) Operation status of Axis 1

<GX Developer display screen>

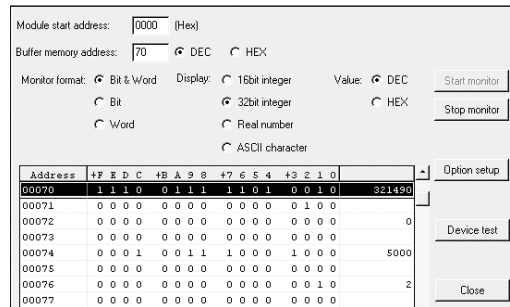

(b) Method using GX Configurator-PT

Monitor the "current feed value", "current speed", "axis operation status" and "axis error code" on the "Monitor/Test screen".
 (For details, refer to "Section 6.6 Monitor/test".)

(Example) Operation monitor of Axis 1 (Axis #1 Monitor/Test)

<GX Configurator-PT display screen>

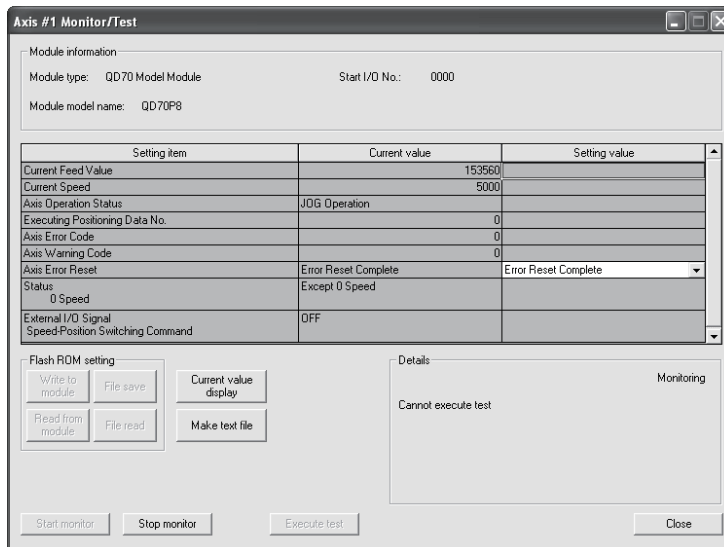

CHAPTER 6 UTILITY PACKAGE (GX Configurator-PT)

The QD70 utility package (GX Configurator-PT) is software designed to make initial setting, auto refresh setting, monitor and others of the QD70 using dedicated screens, without being conscious of the I/O signals and buffer memory.

Use the utility package with GX Developer (SW4D5C-GPPW-E or later).

6.1 Utility package functions

The following table lists the functions of the utility package.

Function	Description	Reference
Initial setting	<p>Make initial setting axis-by-axis for the QD70 to operate. Set the values of the items that need initial setting.</p> <p>[Setting items]</p> <ul style="list-style-type: none"> • Parameters • OPR data • Positioning data <p>(The initially set data are registered to the PLC parameter, and when the programmable controller CPU is placed in the RUN status, they are written to the QD70 automatically.)</p>	Section 6.4
Auto refresh setting	<p>Set the QD70 buffer memory values to be automatically refreshed.</p> <p>[Auto refresh target buffer memory values]</p> <p>[Common to all axes]</p> <ul style="list-style-type: none"> • Error status • Warning status <p>[Axis by axis]</p> <ul style="list-style-type: none"> • Current feed value • Current speed • Axis operation status • Axis error code • Axis warning code • Executing positioning data No. <p>(The values stored in the automatically refreshed QD70 buffer memory are read automatically when the END instruction of the programmable controller CPU is executed.)</p>	Section 6.5
Monitor/test	<p>Monitor/test the buffer memory and I/O signals of the QD70.</p> <ul style="list-style-type: none"> • Axis monitor/test • OPR monitor • X/Y monitor 	Section 6.6

6.2 Installing and Uninstalling the Utility Package

For how to install or uninstall the utility package, refer to "Method of installing the MELSOFT Series" included in the utility package.

6.2.1 Handling precautions

The following explains the precautions on using the Utility package:

(1) For safety

Since the utility is add-in software for GX Developer, read "Safety Precautions" and the basic operating procedures in the GX Developer Operating Manual.

(2) About installation

GX Configurator-PT is add-in software for SW4D5C-GPPW-E or later versions. Therefore, GX Configurator-PT must be installed on the personal computer that has already SW4D5C-GPPW-E or later version installed.

(3) Screen error of Intelligent function module utility

Insufficient system resource may cause the screen to be displayed inappropriately while using the Intelligent function module utility.

If this occurs, close the Intelligent function module utility, GX Developer (program, comments, etc.), and other applications, and then start GX Developer and Intelligent function module utility again.

(4) To start the Intelligent function module utility

(a) In GX Developer, select "QCPU (Q mode)" for PLC series and specify a project.

If any PLC series other than "QCPU (Q mode)" is selected, or if no project is specified, the Intelligent function module utility will not start.

(b) Multiple Intelligent function module utilities can be started.

However, [Open parameters] and [Save parameters] operations under [Intelligent function module parameter] are allowed for one Intelligent function module utility only. Only the [Monitor/test] operation is allowed for the other utilities.

(5) Switching between two or more Intelligent function module utilities

When two or more Intelligent function module utility screens cannot be displayed side by side, select a screen to be displayed on the top of others using the task bar.



(6) Number of parameters that can be set in GX Configurator-PT

When multiple intelligent function modules are mounted, the number of parameter settings must not exceed the following limit.

When intelligent function modules are installed to:	Maximum number of parameter settings	
	Initial setting	Auto refresh setting
Q00J/Q00/Q01CPU	512	256
Q02/Q02H/Q06H/Q12H/Q25HCPU	512	256
Q02PH/Q06PH/Q12PH/Q25PHCPU	512	256
Q12PRH/Q25PRHCPU	512	256
Q02UCPU	2048	1024
Q03UD/Q04UDH/Q06UDH/Q13UDH/ Q26UDH/Q03UDE/Q04UDEH/ Q06UDEH/Q13UDEH/Q26UDEHCPU	4096	2048
MELSECNET/H remote I/O station	512	256

For example, if multiple intelligent function modules are installed to the MELSECNET/H remote I/O station, configure the settings in GX Configurator so that the number of parameter settings for all the intelligent function modules does not exceed the limit of the MELSECNET/H remote I/O station.

Calculate the total number of parameter settings separately for the initial setting and for the auto refresh setting.

The number of parameters that can be set for one module in GX Configurator-PT is as shown below.

Target module	Initial setting	Auto refresh setting
QD70P4	12 (Fixed)	26 (Max.)
QD70P8	24 (Fixed)	50 (Max.)

Example) Counting the number of parameter settings in Auto refresh setting

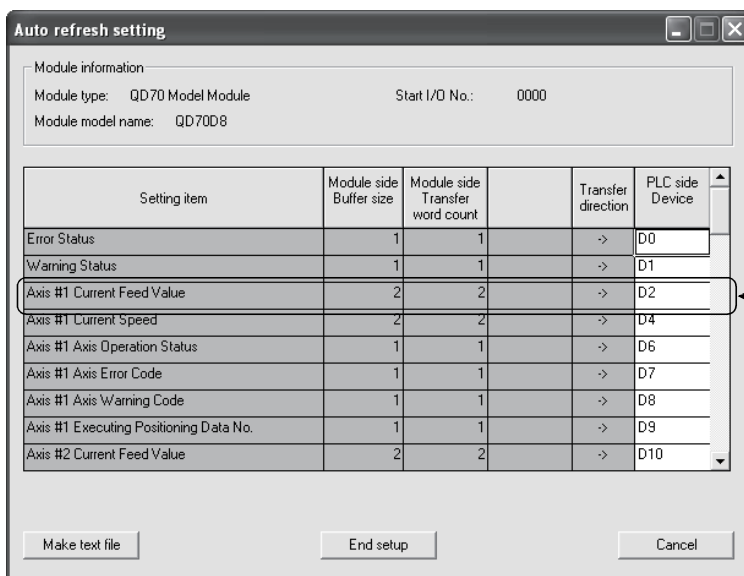

This one row is counted as one setting. Blank rows are not counted. Count up all the setting items on this screen, and add the total to the number of settings for other intelligent function modules to get a grand total.

6.2.2 Operating environment

This section explains the operating environment of the personal computer that runs GX Configurator-PT.

Item	Description	
Installation (Add-in) target *1	Add-in to GX Developer Version 4 (English version) or later *2	
Computer	Windows®-based personal computer	
CPU	Refer to the following table "Used operating system and performance required for personal computer".	
Required memory		
Hard disk space *3	For installation	65 MB or more
	For operation	10 MB or more
Display	800 × 600 dots or more resolution *4	
Operating system	Microsoft® Windows® 95 Operating System (English version) Microsoft® Windows® 98 Operating System (English version) Microsoft® Windows® Millennium Edition Operating System (English version) Microsoft® Windows NT® Workstation Operating System Version 4.0 (English version) Microsoft® Windows® 2000 Professional Operating System (English version) Microsoft® Windows® XP Professional Operating System (English version) Microsoft® Windows® XP Home Edition Operating System (English version) Microsoft® Windows Vista® Home Basic Operating System (English version) Microsoft® Windows Vista® Home Premium Operating System (English version) Microsoft® Windows Vista® Business Operating System (English version) Microsoft® Windows Vista® Ultimate Operating System (English version) Microsoft® Windows Vista® Enterprise Operating System (English version)	

*1: Install GX Configurator-PT in GX Developer Version 4 or higher in the same language.

GX Developer (English version) and GX Configurator-PT (Japanese version) cannot be used in combination, and GX Developer (Japanese version) and GX Configurator-PT (English version) cannot be used in combination.

*2: GX Configurator-PT is not applicable to GX Developer Version 3 or earlier.

*3: At least 15GB is required for Windows Vista®.

*4: Resolution of 1024 × 768 dots or more is recommended for Windows Vista®.

Operating system and performance required for personal computer

Operating system	Performance required for personal computer	
	CPU	Memory
Windows® 95	Pentium® 133MHz or more	32MB or more
Windows® 98	Pentium® 133MHz or more	32MB or more
Windows® Me	Pentium® 150MHz or more	32MB or more
Windows NT® Workstation 4.0	Pentium® 133MHz or more	32MB or more
Windows® 2000 Professional	Pentium® 133MHz or more	64MB or more
Windows® XP Professional (Service Pack 1 or more)	Pentium® 300MHz or more	128MB or more
Windows® XP Home Edition (Service Pack 1 or more)	Pentium® 300MHz or more	128MB or more
Windows Vista® Home Basic	Pentium® 1GHz or more	1GB or more
Windows Vista® Home Premium	Pentium® 1GHz or more	1GB or more
Windows Vista® Business	Pentium® 1GHz or more	1GB or more
Windows Vista® Ultimate	Pentium® 1GHz or more	1GB or more
Windows Vista® Enterprise	Pentium® 1GHz or more	1GB or more

POINT









- The functions shown below are not available for Windows® XP and Windows Vista®.
If any of the following functions is attempted, this product may not operate normally.
 - Start of application in Windows® compatible mode
 - Fast user switching
 - Remote desktop
 - Large fonts (Details setting of Display properties)
 Also, 64-bit version Windows® XP and Windows Vista® are not supported.
- Use a USER authorization or higher in Windows Vista®.

6.3 Utility Package Operation

6.3.1 Common utility package operations

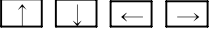
(1) Control keys

Special keys that can be used for operation of the utility package and their applications are shown in the table below.

Key	Application
	Cancels the current entry in a cell. Closes the window.
	Moves between controls in the window.
	Used in combination with the mouse operation to select multiple cells for test execution.
	Deletes the character where the cursor is positioned. When a cell is selected, clears all of the setting contents in the cell.
	Deletes the character where the cursor is positioned.
	Moves the cursor.
	Moves the cursor one page up.
	Moves the cursor one page down.
	Completes the entry in the cell.

(2) Data created with the utility package

The following data or files that are created with the utility package can be also handled in GX Developer. Figure 6.1 shows respective data or files are handled in which operation.

<Intelligent function module parameter>

- (a) This represents the data created in Auto refresh setting, and they are stored in an intelligent function module parameter file in a project created by GX Developer.

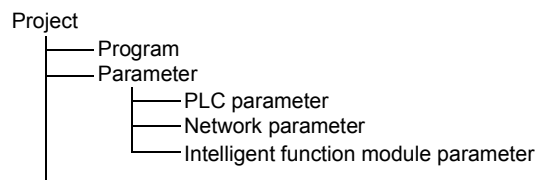

- (b) Steps 1) to 3) shown in Figure 6.1 are performed as follows:

- 1) From GX Developer, select:
[Project] → [Open project] / [Save] / [Save as]
- 2) On the intelligent function module selection screen of the utility, select:
[Intelligent function module parameter] → [Open parameters] / [Save parameters]

- 3) From GX Developer, select:
 [Online] → [Read from PLC] / [Write to PLC] → "Intelligent function module parameters"
 Alternatively, from the intelligent function module selection screen of the utility, select:
 [Online] → [Read from PLC] / [Write to PLC]

<Text files>

- (a) A text file can be created by clicking the **Make text file** button on the initial setting, Auto refresh setting, or Monitor/Test screen. The text files can be utilized to create user documents.

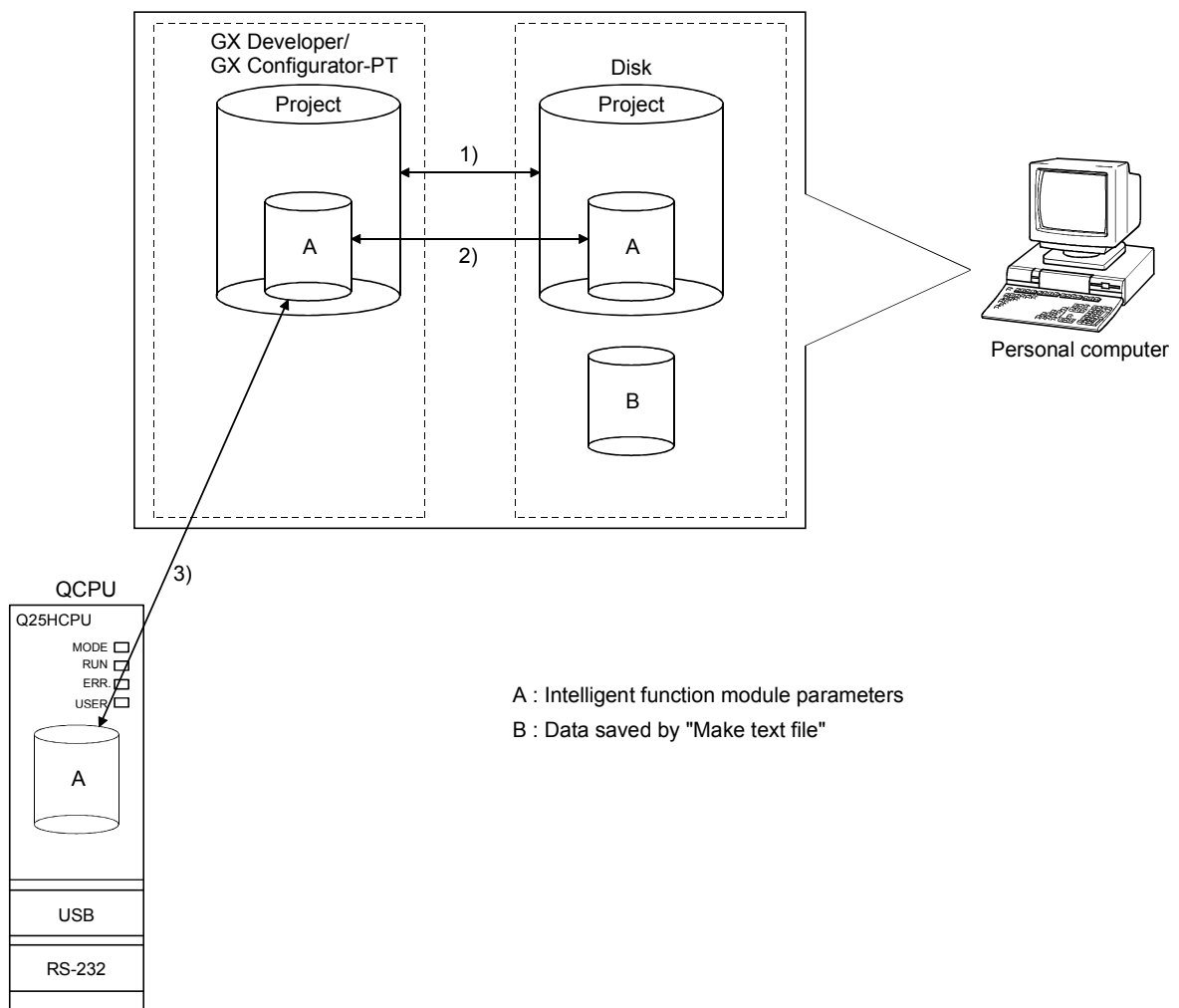
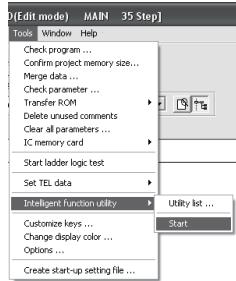

Figure 6.1 Correlation chart for data created with the utility package

6.3.2 Operation overview

GX Developer screen



[Tools] - [Intelligent function utility] - [Start]

Screen for selecting a target intelligent function module

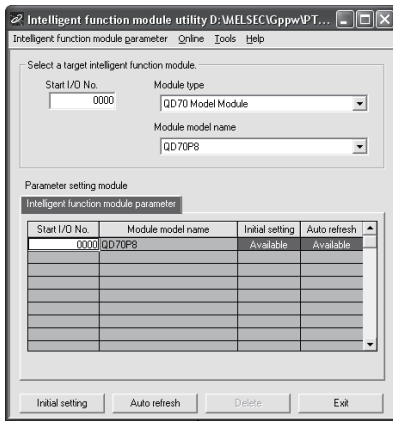

Enter "Start I/O No.", and select "Module type" and "Module model name".

Refer to Section 6. 3. 3

Initial setting

Auto refresh

Initial setting screen

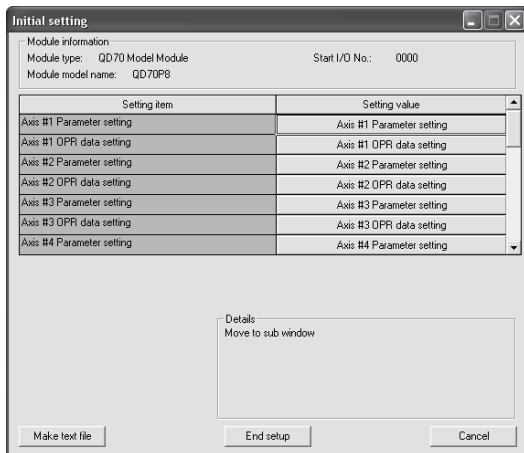

Refer to Section 6. 4

Auto refresh setting screen

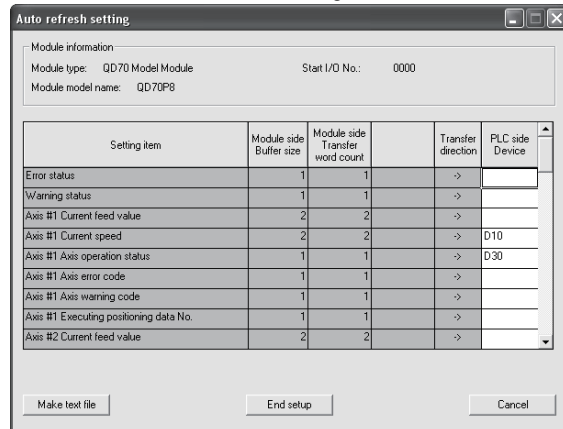

Refer to Section 6. 5

1) [Online] - [Monitor/Test]

Selecting monitor/test module screen

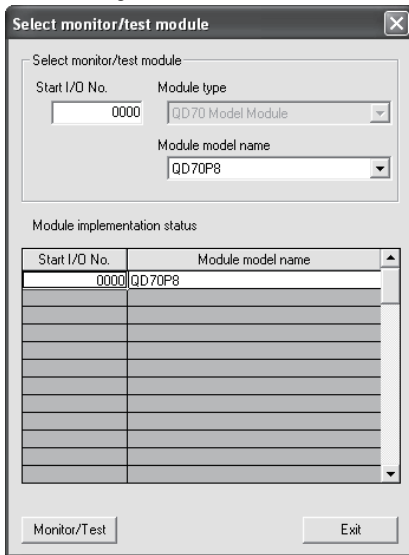

Monitor/Test Select a module to be monitored/tested.

Monitor/Test screen

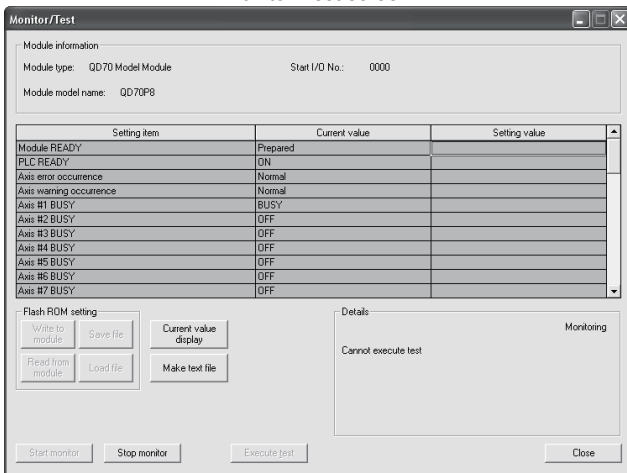

Refer to Section 6. 6

6.3.3 Starting the Intelligent function module utility

[Operating procedure]

Intelligent function module utility is started from GX Developer.

[Tools] → [Intelligent function utility] → [Start]

[Setting screen]

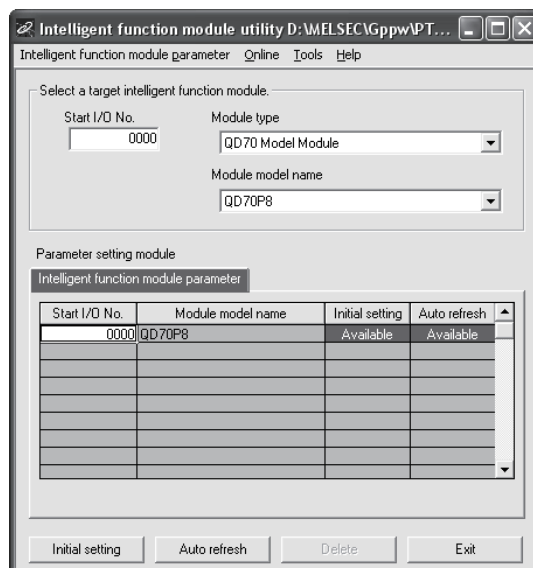

[Explanation of items]

(1) Activation of other screens

Following screens can be displayed from the intelligent function module utility screen.

(a) Initial setting screen

"Start I/O No. *1" → "Module type" → "Module model name" →

Initial setting

(b) Auto refresh setting screen

"Start I/O No. *1" → "Module type" → "Module model name" →

Auto refresh

(c) Select monitor/test module screen

[Online] → [Monitor/Test]

*1 Enter the start I/O No. in hexadecimal.

(2) Command buttons

Delete

Deletes the initial setting and auto refresh setting of the selected module.

Exit

Closes this screen.

(3) Menu bar

(a) File menu

Intelligent function module parameters of the project opened by GX Developer are handled.

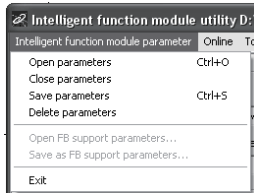

[Open parameters] : Reads a parameter file.

[Close parameters] : Closes the parameter file. If any data are modified, a dialog asking for file saving will appear.

[Save parameters] : Saves the parameter file.

[Delete parameters] : Deletes the parameter file.

[Exit] : Closes this screen.

(b) Online menu

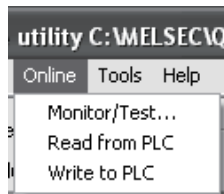

[Monitor/Test] : Activates the Select monitor/test module screen.

[Read from PLC] : Reads the intelligent module parameters from the CPU module.

[Write to PLC] : Writes the intelligent module parameters to the CPU module.

POINT

(1) Saving intelligent function module parameters in a file

Since intelligent function module parameters cannot be saved in a file by the project saving operation of GX Developer, save them on the shown module selection screen.

(2) Reading and writing the intelligent module parameters to and from a PLC using GX Developer.

(a) Intelligent function module parameters can be read from and written into a programmable controller after having been saved in a file.

(b) Set a target programmable controller CPU in GX Developer:
[Online] → [Transfer setup].

(c) When the QD70 is mounted to the remote I/O station, use "Read from PLC" and "Write to PLC" of GX Developer.

(3) Checking the required utility

While the start I/O is displayed on the Intelligent function module utility setting screen, "*" may be displayed for the model name.

This means that the required utility has not been installed or the utility cannot be started from GX Developer.

Check the required utility, selecting [Tools] - [Intelligent function utility] - [Utility list...] in GX Developer.

6.4 Initial setting

[Purpose]

Make initial setting axis-by-axis for the QD70 to operate. The following items are data that need initial setting.

- Parameters
- OPR data
- Positioning data

This initial setting makes sequence program setting unnecessary.

For more information on the setting details, refer to "CHAPTER 4 DATA USED FOR POSITIONING CONTROL".

[Operating procedure]

"Start I/O No. *" → "Module type" → "Module model name" → Initial setting

* Enter the start I/O No. in hexadecimal.

[Setting screen]

<Initial setting of parameters and OPR data>

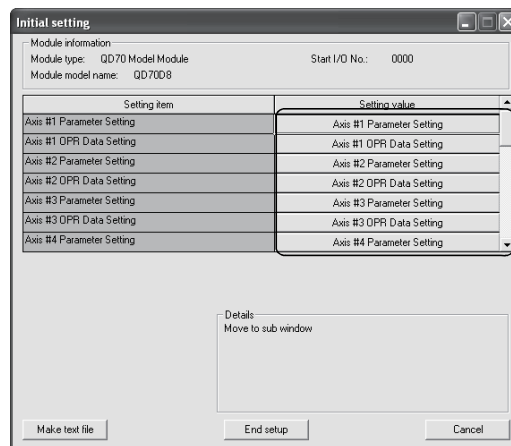

Select items to be moved to sub window.

Move to sub window

Axis #1 Parameter Setting

Axis #1 OPR Data Setting

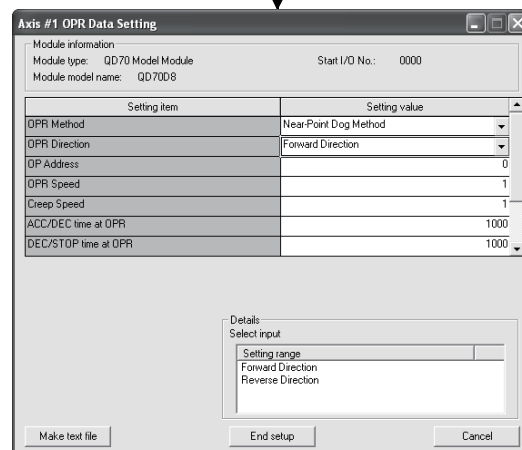
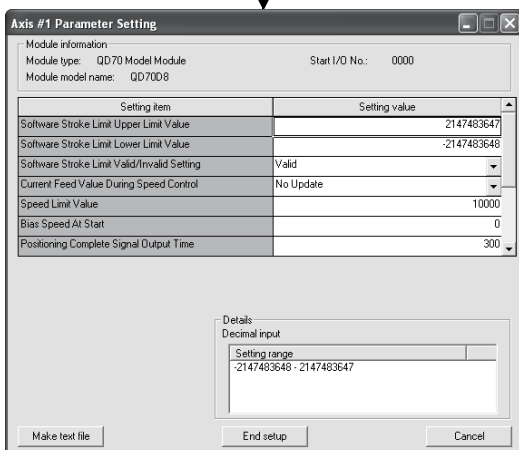

<Initial setting of positioning data>

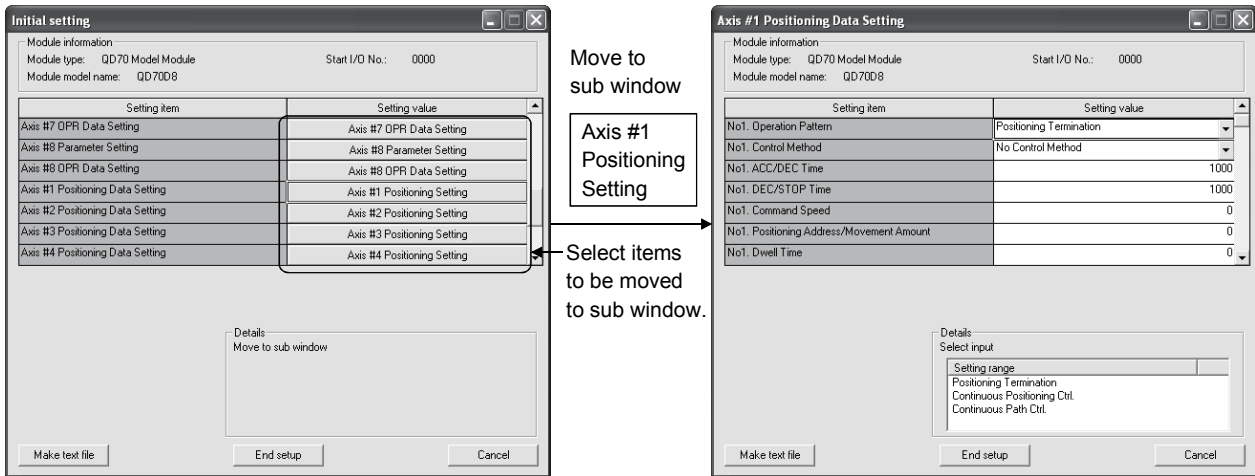

[Explanation of items]

(1) Setting item list

Setting item	
Axis #1 Parameter Setting	
Axis #1 OPR data Setting	
to	
Axis # n Parameter Setting	
Axis # n OPR data Setting	
Axis #1 Positioning Data Setting	
to	
Axis #n Positioning Data Setting	

n indicates the axis No.
QD70P4: 1 to 4 QD70P8: 1 to 8

(2) Command button

- Make text file Creates a file containing the screen data in text file format.
- End setup Saves the set data and ends the operation.
- Cancel Cancels the setting and ends the operation.

POINT

Initial settings are stored in an intelligent function module parameter file. After being written to the CPU module, the initial setting is made effective by either (1) or (2).

- (1) Cycle the RUN/STOP switch of the CPU module: STOP → RUN → STOP → RUN.
- (2) With the RUN/STOP switch set to RUN, turn off and then on the power or reset the CPU module.

If the initialization settings have been written by a sequence program, the initialization settings will be executed during the STOP → RUN of the CPU module. Arrange so that the initial settings written by the sequence program are re-executed during the STOP → RUN of the CPU module.

6.5 Auto refresh setting

[Purpose]

Configure the QD70's buffer memory for automatic refresh.

There are the following setting items as the auto refresh setting parameters.

[Common to all axes]

- Error status
- Warning status

[Axis by axis]

- Current feed value
- Current speed
- Axis operation status
- Axis error code
- Axis warning code
- Executing positioning data No.

This auto refresh setting eliminates the need for reading by sequence programs.

[Operating procedure]

"Start I/O No. *" → "Module type" → "Module model name" → Auto refresh

* Enter the start I/O No. in hexadecimal.

[Setting screen]

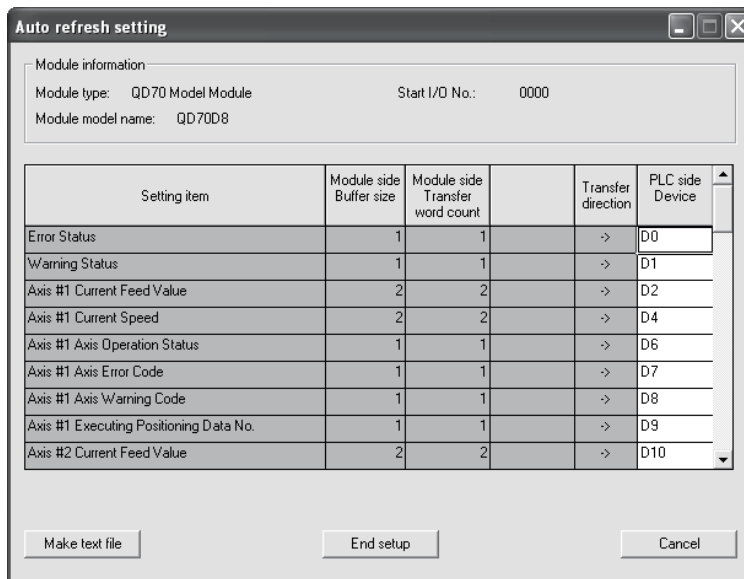

[Explanation of items]

(1) Setting item list

Setting item	
Error status	
Warning status	
Axis #1 Current Feed Value	
Axis #1 Current Speed	
Axis #1 Axis Operation Status	
Axis #1 Axis Error Code	
Axis #1 Axis Warning Code	
Axis #1 Executing Positioning Data No.	
to	
Axis #n Current Feed Value	
Axis #n Current Speed	
Axis #n Axis Operation Status	
Axis #n Axis Error Code	
Axis #n Axis Warning Code	
Axis #n Executing Positioning Data No.	

n indicates the axis No.
QD70P4: 1 to 4 QD70P8: 1 to 8

(2) Items

Module side Buffer size : Displays the buffer memory size of the setting item.

Module side Transfer word count : Displays the number of words to be transferred.

Transfer direction : "←" indicates that data are written from the programmable controller CPU to the buffer memory. "→" indicates that data are loaded from the buffer memory to the programmable controller CPU.

PLC side Device : Enter a CPU module side device that is to be automatically refreshed. Applicable devices are X, Y, M, L, B, T, C, ST, D, W, R, and ZR.

When using bit devices X, Y, M, L or B, set a number that can be divided by 16 points (examples: X10, Y120, M16, etc.)

Also, buffer memory data are stored in a 16-point area, starting from the specified device number. For example, if X10 is entered, data are stored in X10 to X1F.

(3) Command button

Creates a file containing the screen data in text file format.

Saves the set data and ends the operation.

Cancels the setting and ends the operation.

POINTS
<ul style="list-style-type: none"> The auto refresh settings are stored in an intelligent function module parameter file. The auto refresh settings become effective by turning the power OFF and then ON or resetting the CPU module after writing the intelligent function module parameters to the CPU module. The auto refresh settings cannot be changed from sequence programs. However, processing equivalent to auto refresh can be added using the FROM/TO instruction in the sequence program.

6.6 Monitoring/Test

6.6.1 Monitoring/Test screen

[Purpose]

Start buffer memory monitoring/testing and I/O signal monitoring/testing from this screen.

(Refer to "Section 4.6 List of monitor data" for details of monitor data.)

[Operating procedure]

Select monitor/test module screen → "Start I/O No. *" → "Module type" → "Module model name" → **Monitor/test**

* Enter the start I/O No. in hexadecimal.

The screen can also be started from System monitor of GX Developer Version 6 or later.

Refer to the GX Developer Operating Manual for details.

[Setting screen]

<Axis Monitor/Test, OPR Monitor>

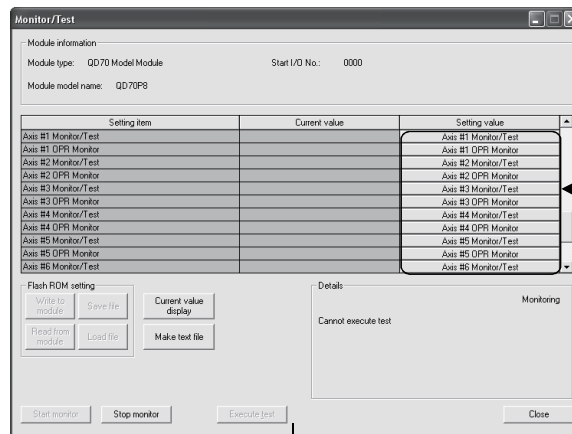

Select items to be moved to sub window.

Move to sub window

Axis #1 Monitor/Test

Axis #6 OPR Monitor

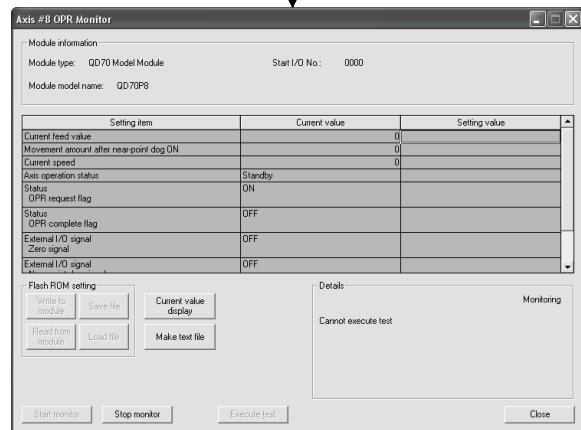
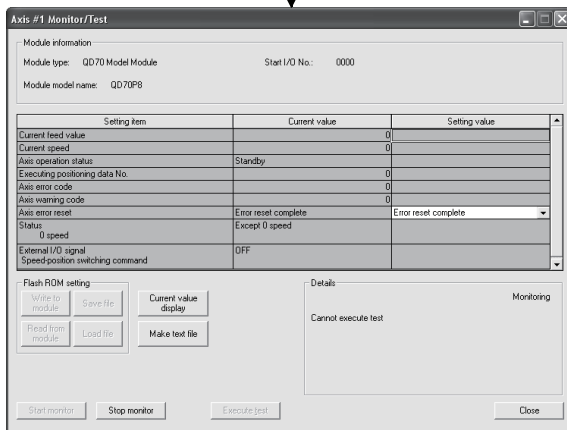

<X/Y Monitor>

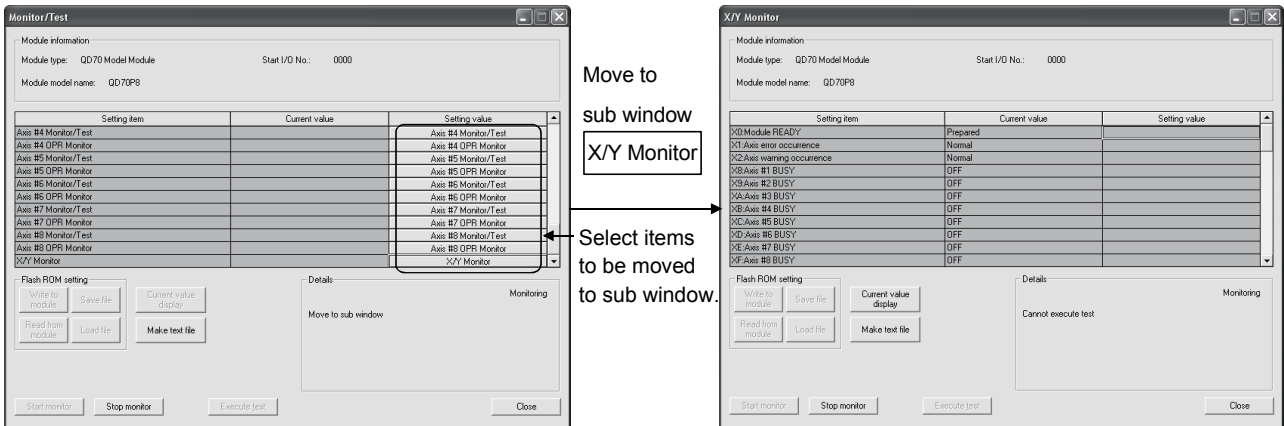

[Explanation of items]

(1) Setting item list

Setting item	
Module READY	
PLC READY	
Axis Error Occurrence	
Axis Warning Occurrence	
Axis #1 BUSY	
to	
Axis #n BUSY	
Axis #1 Error Status	
to	
Axis #n Error Status	
Axis #1 Warning Status	
to	
Axis #n Warning Status	
Axis #1 Monitor/test	
Axis #1 OPR Monitor	
to	
Axis #n Monitor/test	
Axis #n OPR Monitor	
X/Y Monitor	

n indicates the axis No.
 QD70P4: 1 to 4 QD70P8: 1 to 8

(2) Items

- Setting item : Displays I/O signals and buffer memory names.
- Current value : Monitors the I/O signal states and present buffer memory values.
- Setting value : Enter or select values to be written into the buffer memory for test operation (Axis Error Reset).

(3) Command button

Current value display

Displays the current value of the item selected. (This is used to check the text that cannot be displayed in the current value field. However, in this utility package, all items can be displayed in the display fields).

Make text file

Creates a file containing the screen data in text file format.

Start monitor / Stop monitor

Selects whether or not to monitor current values.

Execute test

Performs a test on the selected items (Axis Error Reset).

Click this button after selecting "Error Reset Request" in the Setting value field of "Axis Error Reset" on the Axis monitor/test sub window.

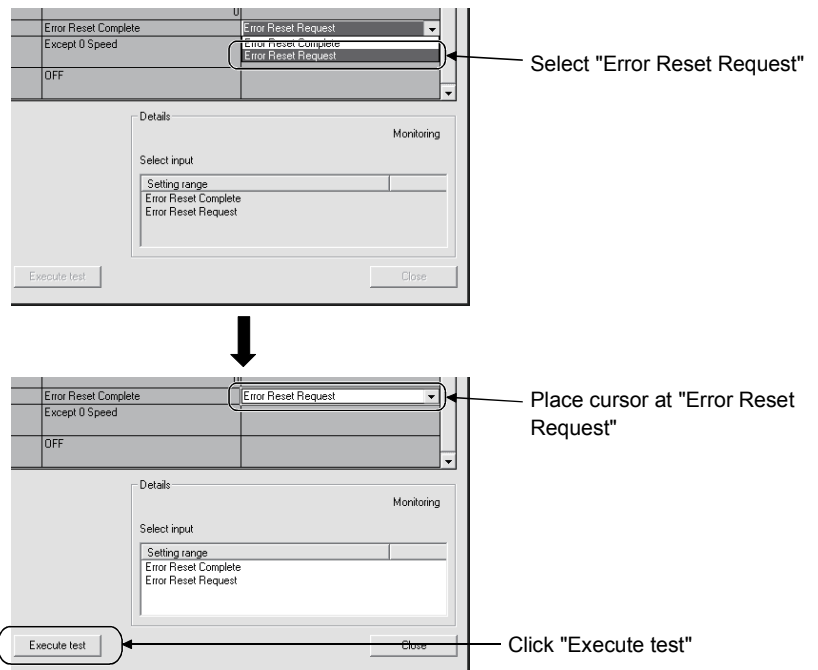

Close

Closes the currently open screen and returns to the previous screen.

CHAPTER 7 SEQUENCE PROGRAM USED FOR POSITIONING CONTROL

This chapter describes sequence programs of the positioning control system using the QD70.

7.1 Precautions for creating program

(1) System configuration

Unless otherwise specified in this section and later, the sequence programs shown are those for the following system.

Refer to Section 7.2 for the applications of the devices used.

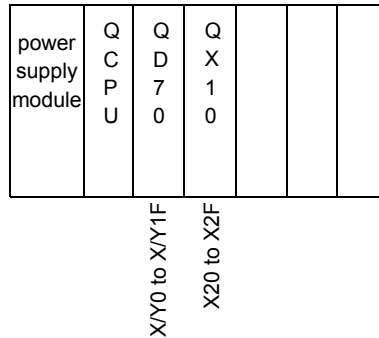

(2) Communication with QD70

There are two methods for communication with QD70 using the sequence program: a method using an "intelligent function device" and a method using a FROM/TO command.

When using the FROM/TO command for communication with QD70, change the circuit incorporating the "intelligent function device" as follows.

- (a) When the circuit uses the "intelligent function device" on the destination (D) side of a MOV command, change the command to a TO command.

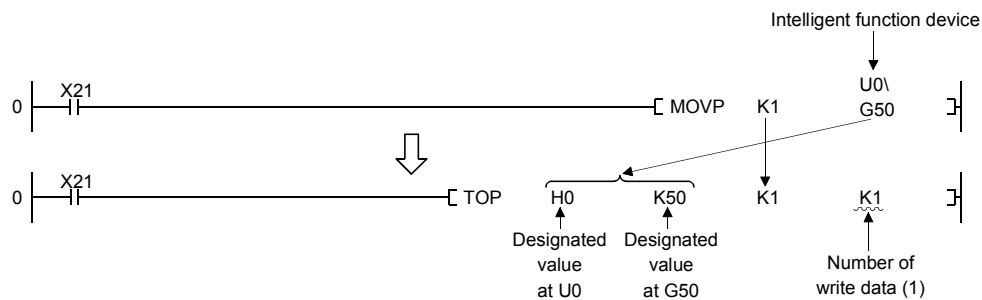

- (b) When the circuit uses the "intelligent function device" on the source(s) side and the destination (D) side of a MOV command, change the command to a FROM command and a TO command.

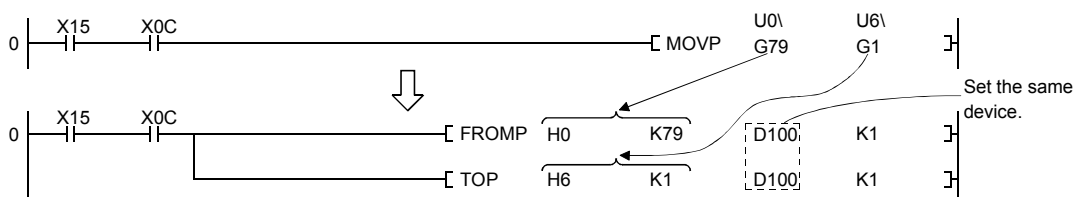

(c) When the circuit uses the "intelligent function device" for a COMPARISON command, change the command to a FROM command and a COMPARISON command.

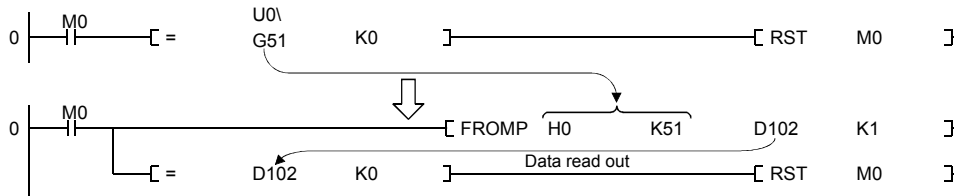

(d) When the circuit uses the "intelligent function device" for a WAND command, change the command to a FROM command and a WAND command.

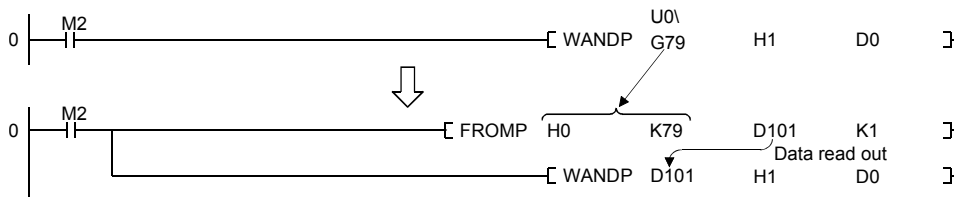

REMARK

Refer to QCPU (Q mode) User's Manual (Functions and Programs Basic Part) for the intelligent function devices.
 Refer to QCPU (Q mode) Programming Manual (Common Commands Part) for detail commands used in those programs.

7.2 List of devices used

In "Section 7.4 Positioning control program examples", the used devices are assigned as indicated in the following table.

The I/O numbers for QD70 indicate those when QD70 is mounted in the 0-slot of the main base.

If it is mounted in the slot other than the 0-slot of the main base, change the I/O number to that for the position where QD70 was installed.

In addition, change the external inputs, internal relays and data registers, according to the system used.

(1) Inputs/outputs, external inputs, and internal relays of QD70

Device name	Device								Application	Details when ON	
	Axis 1	Axis 2	Axis 3	Axis 4	Axis 5	Axis 6	Axis 7	Axis 8			
Inputs/outputs of QD70	Inputs	X0								Module READY signal	QD70 ready
		X1								Axis error occurrence signal	Axis error occurring
		X2								Axis warning occurrence signal	Axis warning occurring
		X8	X9	XA	XB	XC	XD	XE	XF	BUSY signal	BUSY (running)
		X10	X11	X12	X13	X14	X15	X16	X17	Start complete signal	Start complete
	X18	X19	X1A	X1B	X1C	X1D	X1E	X1F	Positioning complete signal	Positioning control complete	
	Outputs	Y0								Programmable controller READY signal	Programmable controller CPU ready
		Y8	Y9	YA	YB	YC	YD	YE	YF	Positioning start signal	Start being requested
		Y10	Y11	Y12	Y13	Y14	Y15	Y16	Y17	Axis stop signal	Stop being requested
		Y18	Y19	Y1A	Y1B	Y1C	Y1D	Y1E	Y1F	JOG start signal	JOG being started
External input (command)	X20								OPR request OFF command	OPR request OFF being commanded	
	X21								Machine OPR control command	Machine OPR control being commanded	
	X22								Fast OPR control command	Fast OPR control being commanded	
	X23								Positioning control start command	Positioning control start being commanded	
	X24								Speed-position switching control command	Speed-position switching control being commanded	
	X25								Speed-position switching enable command	Speed-position switching enable being commanded	
	X26								Speed-position switching disable command	Speed-position switching disable being commanded	
	X27								Positioning control start signal command	Positioning control start signal being commanded	
	X28								Forward run JOG command	Forward run JOG operation being commanded	
	X29								Reverse run JOG command	Reverse run JOG operation being commanded	
	X2A								Speed change command	Speed change being commanded	
	X2B								Restart command	Restart being commanded	
	X2C								Error reset command	Error reset being commanded	
	X2D								Stop command	Stop being commanded	
Internal relay	M0								Parameter/OPR data setting complete	Parameter/OPR data setting complete	
	M1								OPR request OFF command	OPR request OFF being requested	
	M2								OPR request OFF command pulse	OPR request OFF command given	
	M3								OPR request OFF command storage	OPR request OFF command held	
	M4								Fast OPR control command	Fast OPR control being requested	
	M5								Fast OPR control command storage	Fast OPR control command held	
	M6								Positioning control start command pulse	Positioning control start command given	
	M7								Positioning control start command storage	Positioning control start command held	
	M8								JOG operation flag	JOG operation being performed	
	M9								Speed change command pulse	Speed change command given	
	M10								Speed change command storage	Speed change command held	
	M11								Restart command pulse	Restart command given	
	M12								Restart command storage	Restart command held	
	M13								Axis 1 error occurrence flag	Axis 1 error occurring	
	M14								Error reset command pulse	Error reset command given	
M15								Stop command pulse	Stop command given		

(2) Data registers (for Axis 1)

Device name	Device	Data stored	Setting value		
Data register	D0	Parameter	(Pr. 1) Software stroke limit upper limit value)	10000000pulse	
	D1		(Pr. 2) Software stroke limit lower limit value)	-100000000pulse	
	D2			(Pr. 3) Software stroke limit valid/invalid setting)	0 (Valid)
	D3				(Pr. 4) Current feed value during speed control)
	D4		(Pr. 5) Speed limit value)	100000pulse/s	
	D5		(Pr. 6) Bias speed at start)	100pulse/s	
	D6			(Pr. 7) Positioning complete signal output time)	100ms
	D7			(Pr. 8) Deviation counter clear signal output time)	10ms
	D8		(Pr. 9) PULSE/SIGN method selection setup/hold time)	0 (10 μ s)	
	D9		(Pr. 10) Stop mode during path control)	0 (Position match stop)	
	D10	OPR data	(OPR. 1) OPR method)	0 (Near-point dog method)	
	D11		(OPR. 2) OPR direction)	0 (Forward direction)	
	D12		(OPR. 3) OP address)	0pulse	
	D13		(OPR. 4) OPR speed)	20000pulse/s	
	D14		(OPR. 5) Creep speed)	1000pulse/s	
	D15		(OPR. 6) ACC/DEC time at OPR)	1000ms	
	D16		(OPR. 7) DEC/STOP time at OPR)	1000ms	
	D17		(OPR. 8) Setting for the movement amount after near-point dog ON)	3000pulse	
	D18		(OPR. 9) OPR dwell time)	100ms	
	D19		Positioning data No. 1	(Da. 1) Operation pattern)	0 (Positioning termination)
	D20	(Da. 2) Control method)		1 (1-axis linear control (ABS))	
	D21	(Da. 3) ACC/DEC time)		1000ms	
	D22	(Da. 4) DEC/STOP time)		1000ms	
	D23	(Da. 5) Command speed)		30000pulse/s	
	D24	(Da. 6) Positioning address/movement amount)		250000pulse	
	D25	(Da. 7) Dwell time)		100ms	
	D26	OPR request flag (Md. 7) Status (bit 0))	-		
	D27	(Cd. 3) Start method)	Refer to Section 7.5.2		
	D28	(Cd. 6) Speed change request)			
	D29	(Cd. 7) New speed value)		Refer to Section 7.5.4	
	D30				(Cd. 8) ACC/DEC time at speed change)
	D31	(Cd. 9) DEC/STOP time at speed change)		-	
	D32	Axis 1 error status (Md. 10) Error status (bit 0))	-		
	D33	(Md. 5) Axis error code)	-		

7.3 Creating a program

This section explains "positioning control operation programs" actually used. The programs designed to perform the functions described in "SECTION 2 CONTROL DETAILS AND SETTING" are installed in the "positioning control operation programs" explained in "Section 7.3.2". (To monitor control, add a necessary monitor program according to the system. Refer to "Section 4.6 List of monitor data" for monitor items.)

7.3.1 General configuration of program

The general configuration of the "positioning control operation program" is shown below.

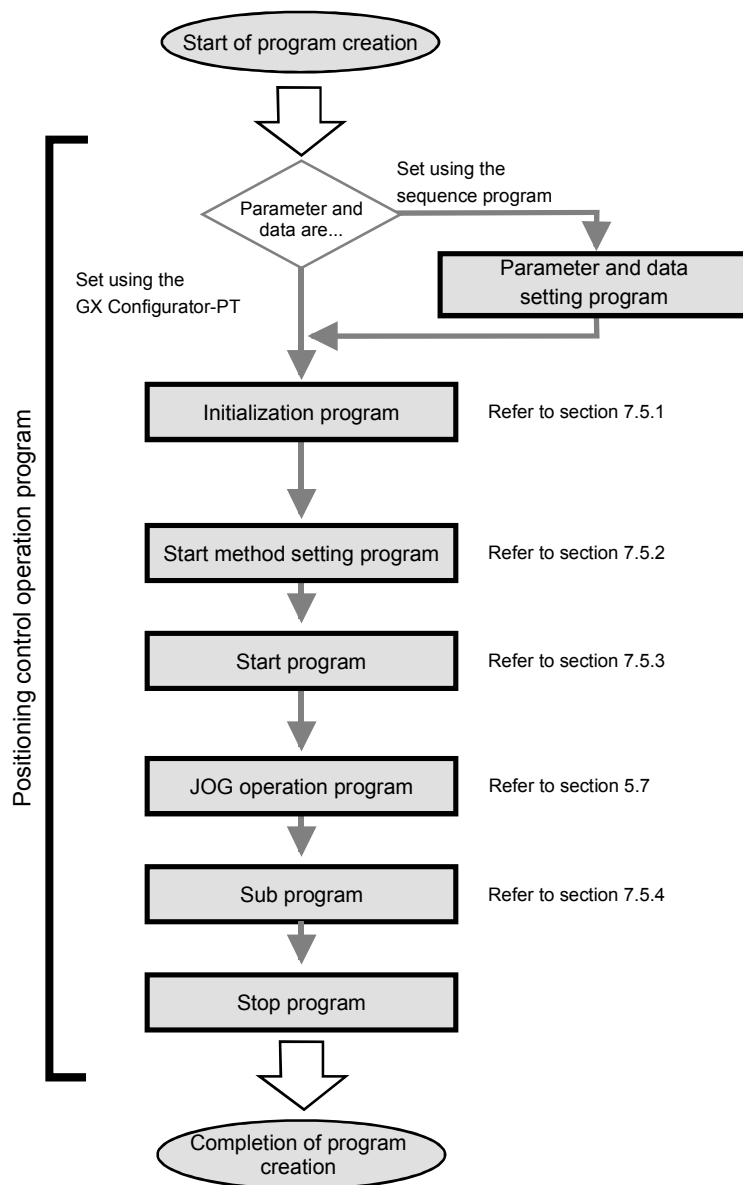

7.3.2 Positioning control operation program

The following are individual programs which comprise the "positioning control operation programs". When creating a program, refer to the explanation item of the corresponding program and "Section 7.4 Positioning control program example" and create an operation program according to the positioning control system. (The following programs are numbered. It is recommended to comprise the programs in order of these numbers.)

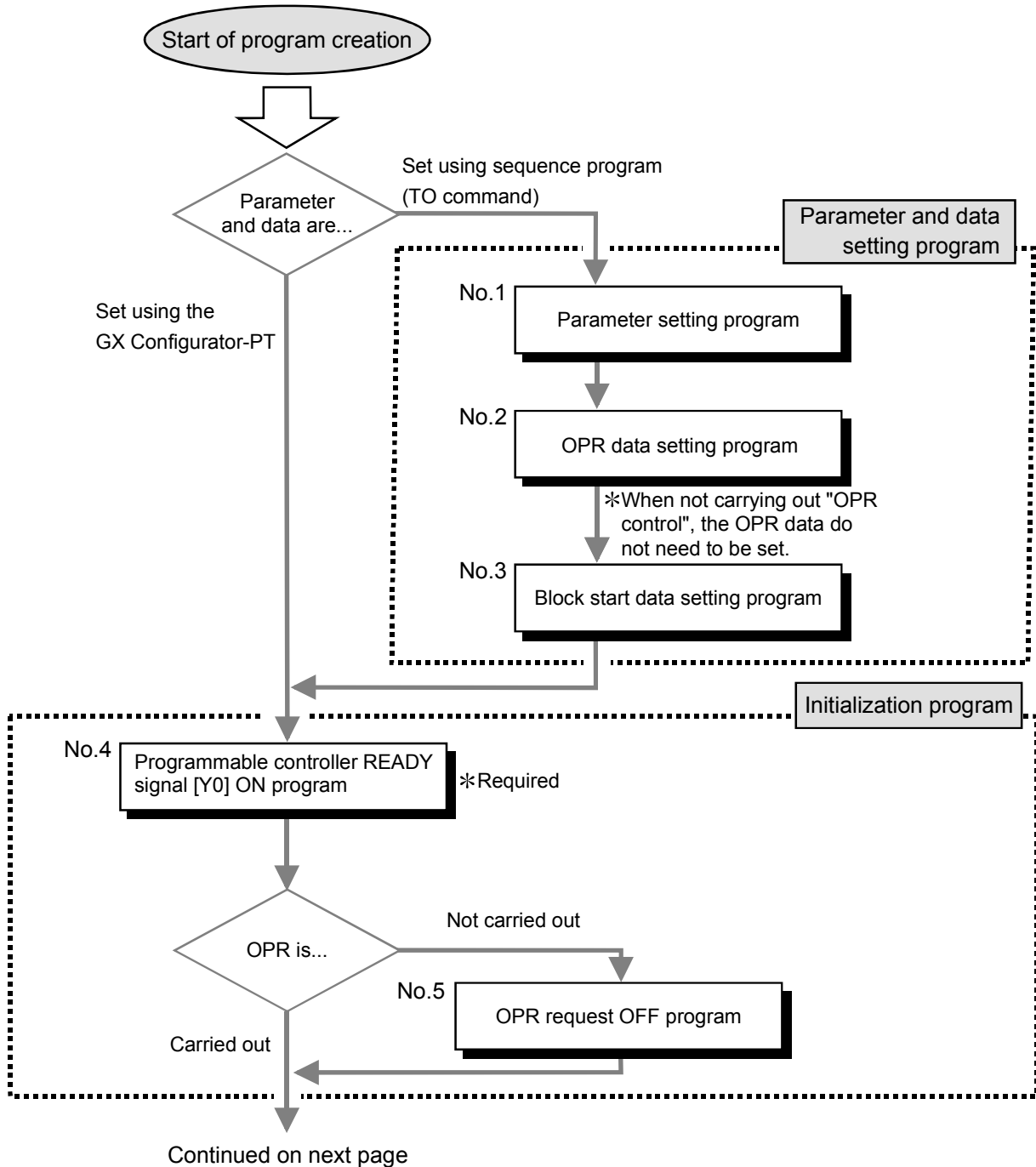

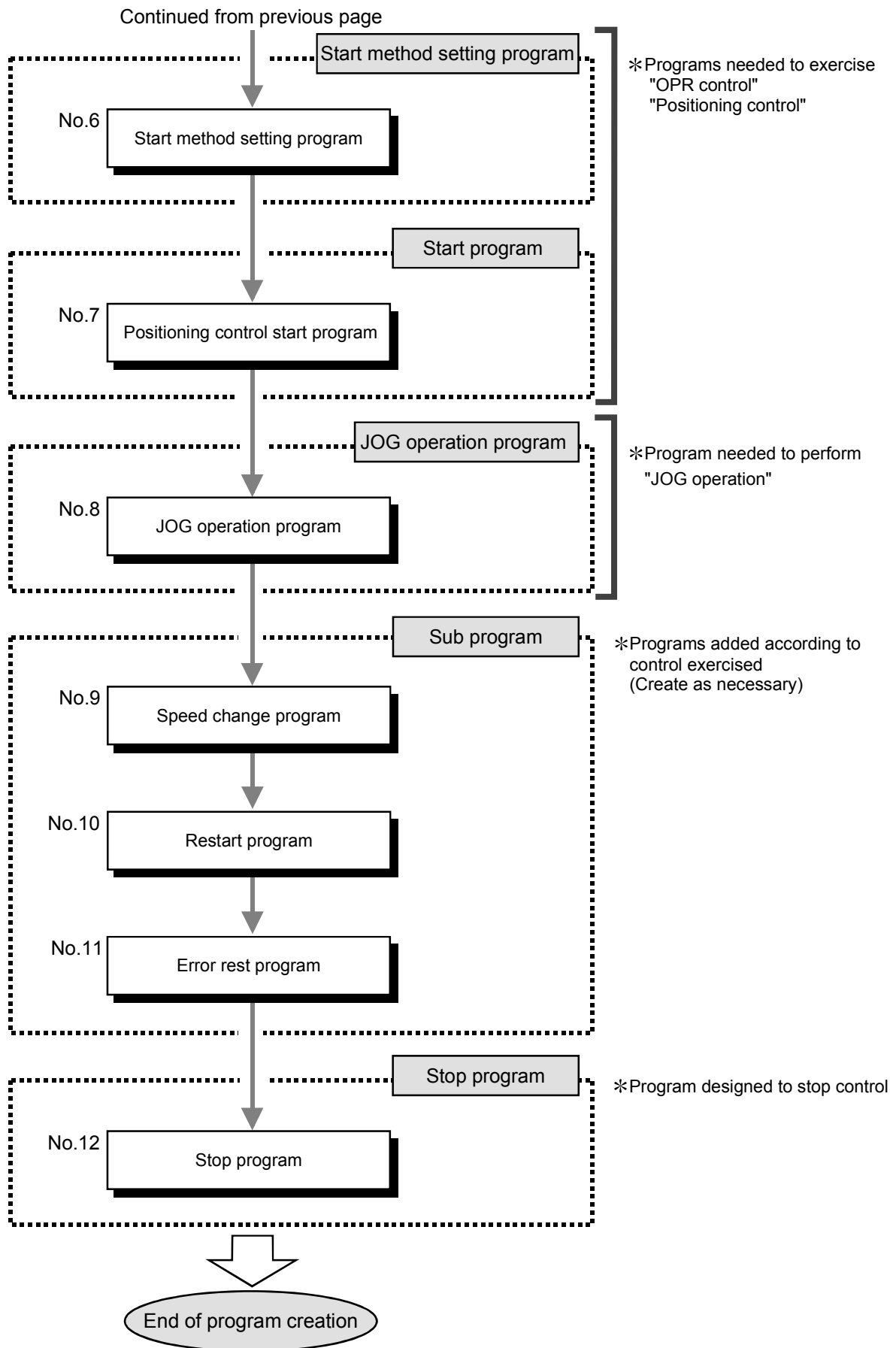

7.4 Positioning control program examples

An example of the "Axis 1" positioning control program is given in this section.

----- [No.1] to [No.3] parameter and data setting program -----

*When setting the parameters or data with the sequence program, set them in the QD70 using the TO command from the programmable controller CPU. (Carry out the settings while the programmable controller READY signal [Y0] is OFF.)

*When setting the parameters or data with the GX Configurator-PT, the [No.1] to [No.3] program is not necessary.

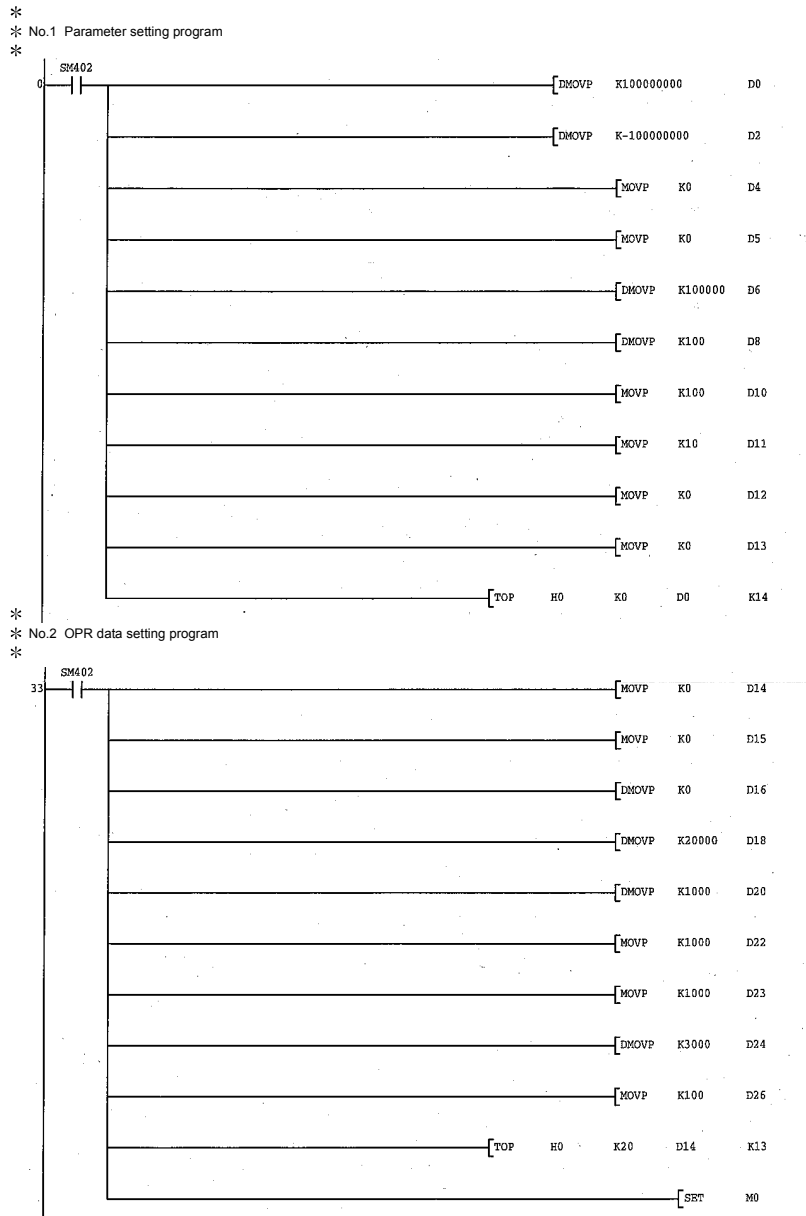

*
 * No.3 Positioning data setting program
 * (For positioning data No. <Axis 1>)
 *

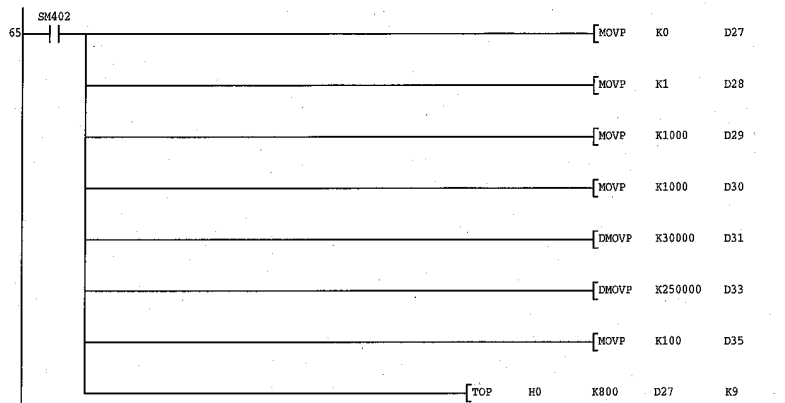

*
 * No.4 Programmable controller READY signal [Y0] ON program
 * (M0 contact is not needed when GX Configurator-PT is used to
 * make initial setting of parameters, OPR data and positioning data.)
 *



*
 * No.5 OPR request OFF program
 *

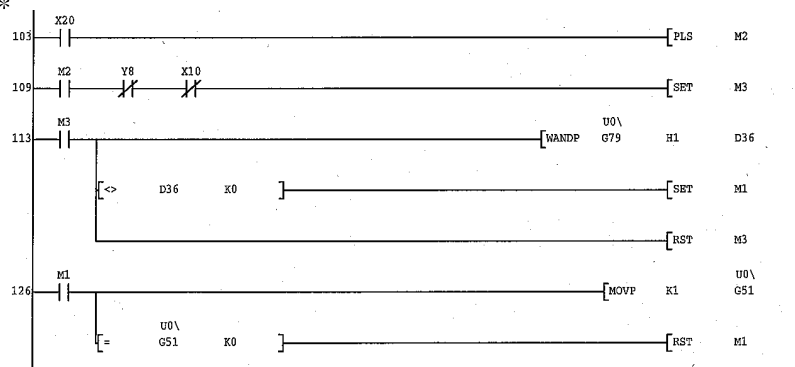

*
 * No.6 Start method setting program
 *

* (1) Machine OPR

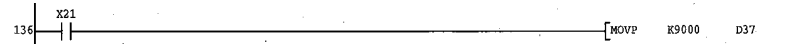

* (2) Fast OPR

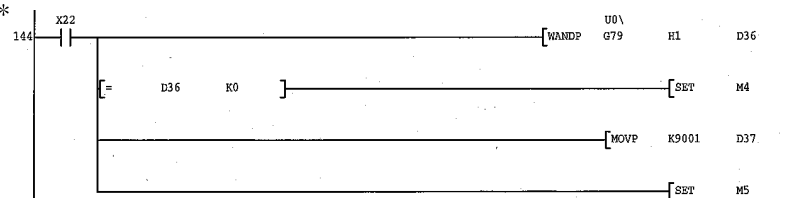

* (3) Positioning control (Starting from No. 1)



* (4) Speed-position switching control

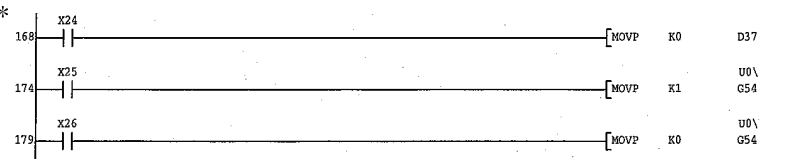

*
 * (5) Turning OFF fast OPR control command and fast OPR control command storage
 * (Not needed when fast OPR control is not used)
 *

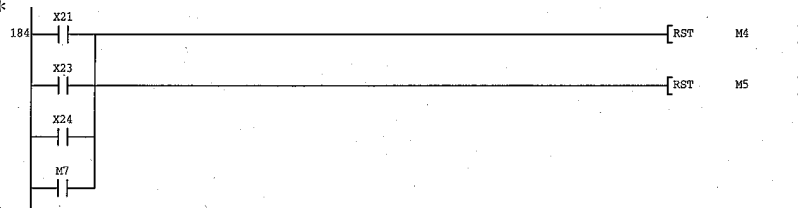

*
 * No.7 Positioning control start program
 * (M4 and M5 contacts are not needed when fast OPR control is not carried out)
 * (M8 contact is not needed when JOG operation is not performed)

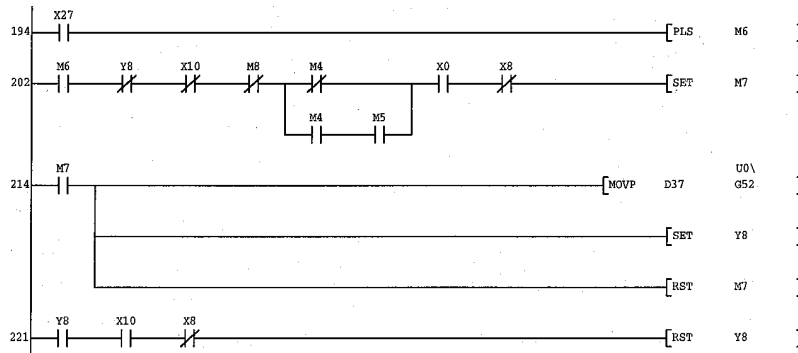

*
 * No.8 JOG operation program
 *

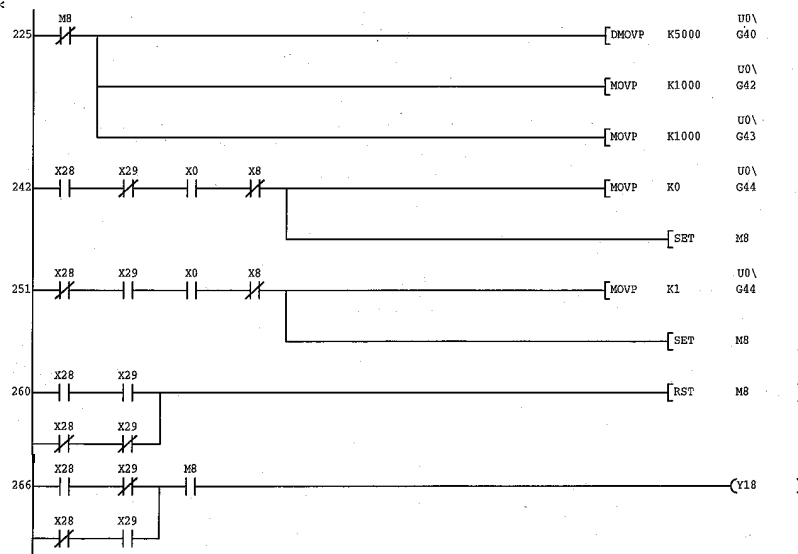

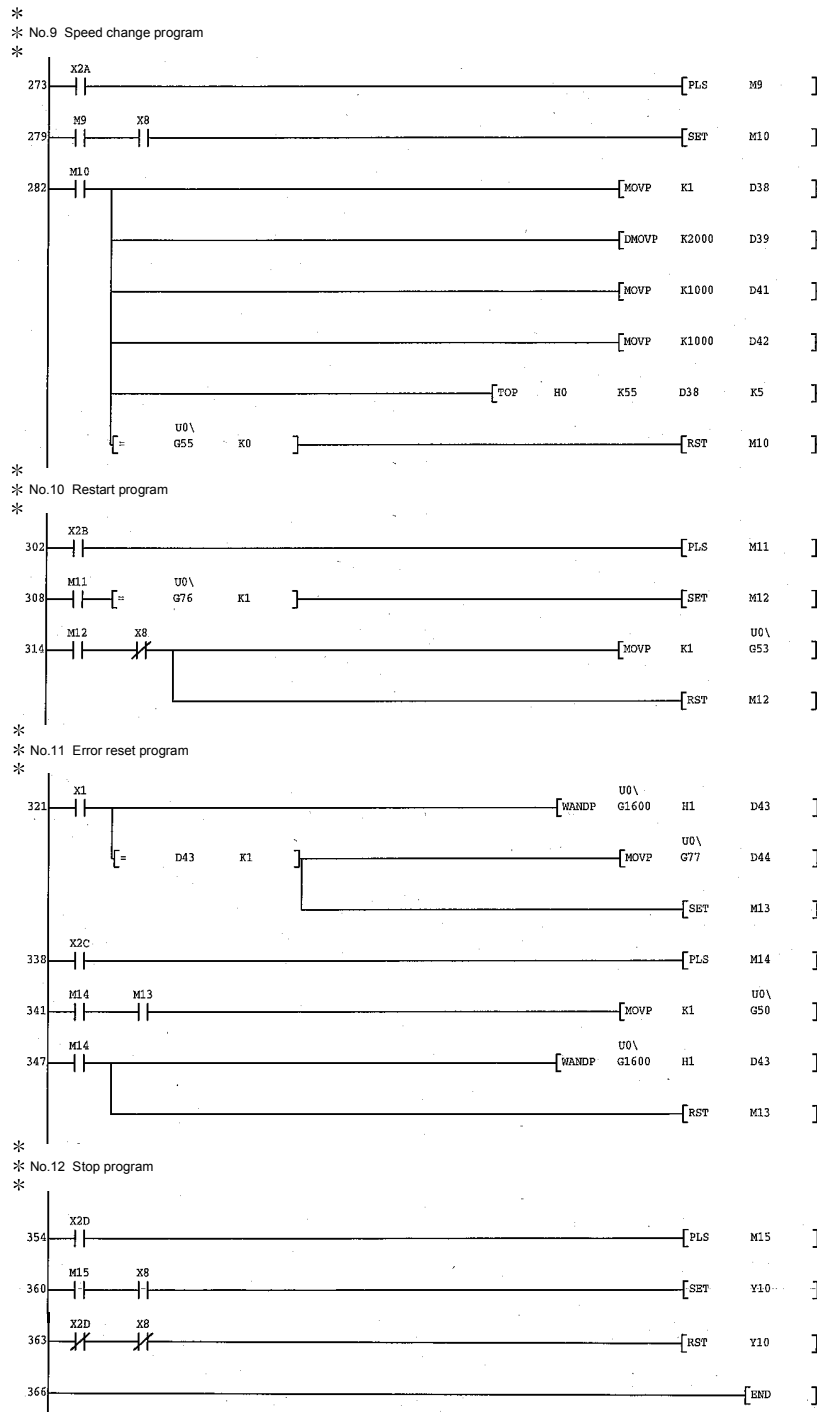

7.5 Program details

7.5.1 Initialization program

OPR request OFF program

This program forcibly turns OFF the "OPR request flag" ([Md. 7] Status: b0) which is ON.

When using a system that does not require OPR control, assemble the program to cancel the "OPR request" made by the QD70 when the power is turned ON, etc.

■ Data requiring setting

Set the following data to use the OPR request flag OFF request.

Setting item	Setting details	Buffer memory address							
		Axis 1	Axis 2	Axis 3	Axis 4	Axis 5	Axis 6	Axis 7	Axis 8
[Cd. 2] OPR request flag OFF request	1: Turn OFF the OPR request flag.	51	151	251	351	451	551	651	751

* Refer to section "4.7 List of control data" for details on the setting details.

■ OPR OFF requesting timing chart

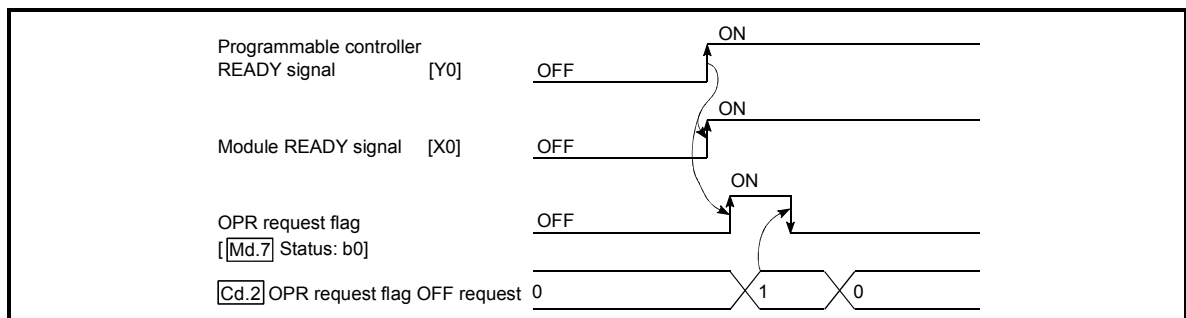

Fig. 7.1 OPR OFF requesting timing chart

7.5.2 Start method setting program

This program sets which control, out of "OPR" control or "positioning control" to execute.

■ Data requiring setting

(1) Set "Cd. 3 Start method" according to the control to be started.

Setting item	Setting value	Buffer memory address							
		Axis 1	Axis 2	Axis 3	Axis 4	Axis 5	Axis 6	Axis 7	Axis 8
Cd. 3 Start method	0 : Positioning control (starting from No. 1)	52	152	252	352	452	552	652	752
	9000 : Machine OPR control								
	9001 : Fast OPR control								

* Refer to "Section 4.7 List of control data" for more information on the setting details.

(2) Set the following control data for "speed-position switching control".

Setting item	Setting value	Buffer memory address							
		Axis 1	Axis 2	Axis 3	Axis 4	Axis 5	Axis 6	Axis 7	Axis 8
Cd. 5 Speed-position switching request	1: The speed-position switching signal is made valid (enabled).	54	154	254	354	454	554	654	754

* Refer to "Section 4.7 List of control data" for more information on the setting details.

7.5.3 Start program

This program is designed to start OPR control or positioning control using the positioning start signal [Y8 to YF]. (Refer to Chapters 8 and 9 for details of OPR control and positioning control.)

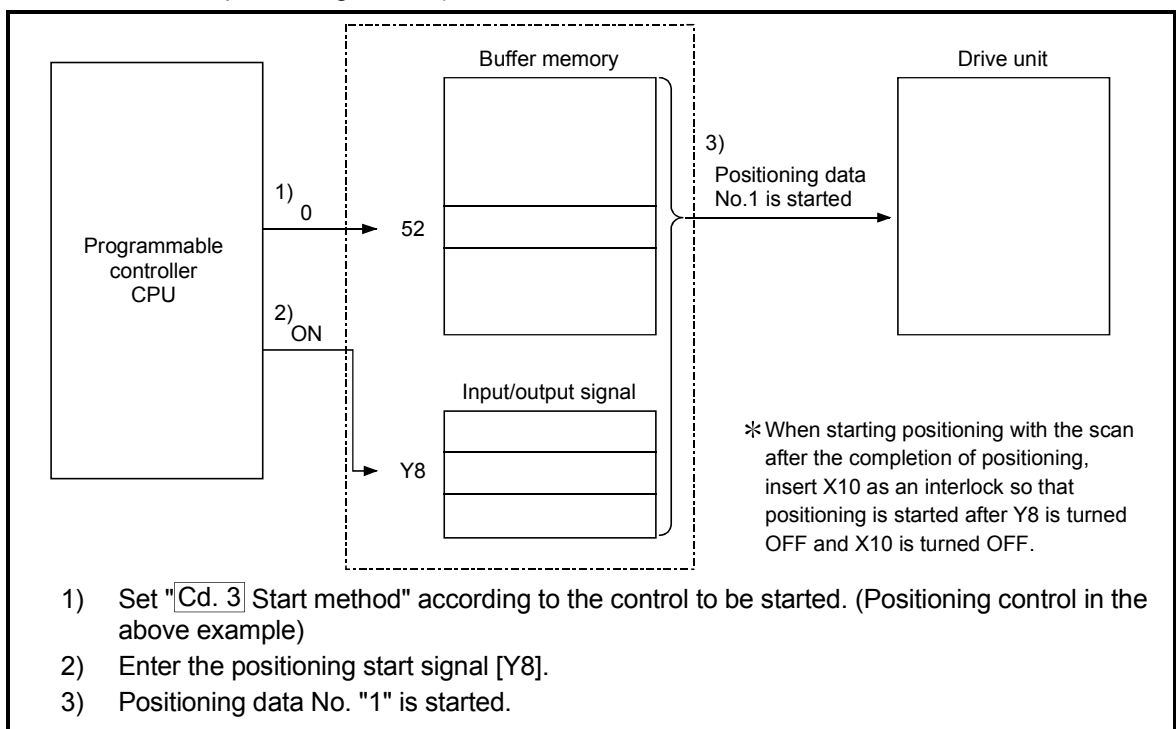

Fig. 7.2 Procedures for starting control (for axis 1)

■ Starting conditions

To start the control, the following conditions must be satisfied.

The necessary start conditions must be incorporated in the sequence program so that the control is not started when the conditions are not satisfied.

Signal name		Signal state		Device							
				Axis 1	Axis 2	Axis 3	Axis 4	Axis 5	Axis 6	Axis 7	Axis 8
Interface signal	Programmable controller READY signal	ON	Programmable controller CPU ready	Y0							
	Module READY signal	ON	QD70 ready	X0							
	Axis error occurrence signal	OFF	No error	X1							
	Axis stop signal	OFF	Axis stop signal being OFF	Y10	Y11	Y12	Y13	Y14	Y15	Y16	Y17
	Start complete signal	OFF	Start complete signal being OFF	X10	X11	X12	X13	X14	X15	X16	X17
	BUSY signal	OFF	QD70 not operating	X8	X9	XA	XB	XC	XD	XE	XF

■ Operation when starting

- (1) When the positioning start signal turns ON, the start complete signal and BUSY signal turn ON, and the OPR control or positioning control starts.
It can be seen that the axis is operating when the BUSY signal is ON.
- (2) When the positioning start signal turns OFF, the start complete signal also turns OFF.
If the positioning start signal is ON even after OPR control positioning control is completed, the start complete signal will remain ON.
- (3) If the positioning start signal turns ON again while the BUSY signal is ON, the warning "operating start (warning code: 10)" will occur.
- (4) The process taken when positioning control is completed will differ according to case (a) and (b) below.
 - (a) When next positioning control is not to be carried out
 - After the preset time of the dwell time has elapsed, positioning control is completed.
 - On completion of positioning control, the BUSY signal turns OFF and the positioning complete signal turns ON. However, it does not turn ON if the positioning complete signal output time is "0".
 - When the positioning complete signal output time elapses, the positioning complete signal turns OFF.
 - (b) When next positioning is to be carried out
 - After the preset time of the dwell time has elapsed, next positioning control is started.

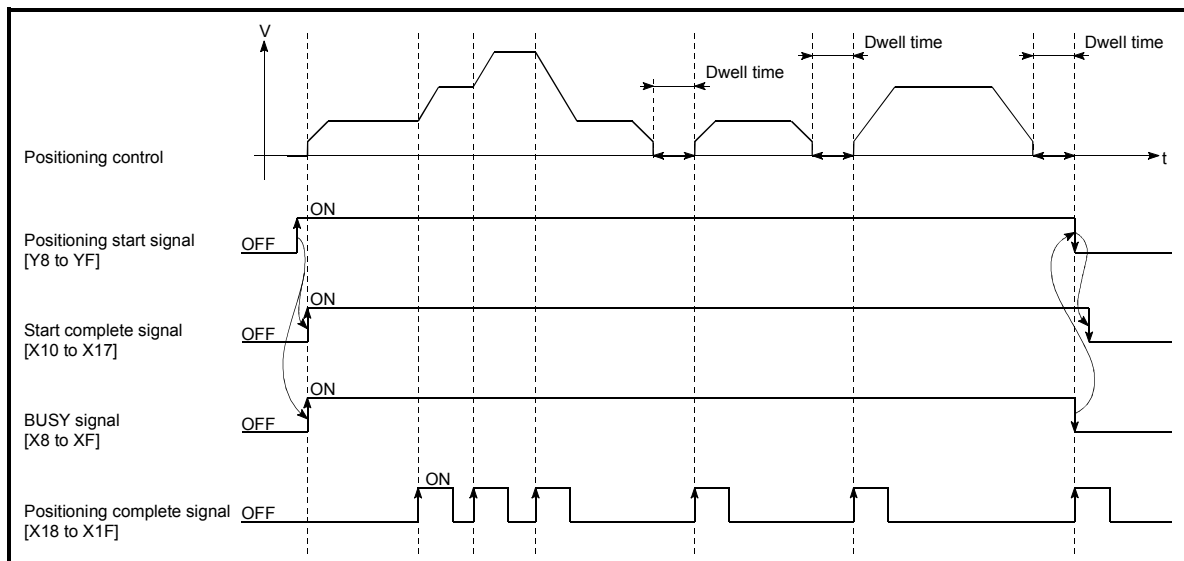

Fig. 7.3 ON/OFF timing of each signal at start of positioning control

POINT

The BUSY signal [X8 to XF] turns ON even when position control of movement amount 0 is executed. However, since the ON time is short, the ON status may not be detected in the sequence program.
(The ON status of the start complete signal [X10 to X17] and positioning complete signal [X18 to X1F] can be detected in the sequence program.)

■ Starting time chart

The time chart for starting each control is shown below.

(1) Machine OPR control starting timing chart

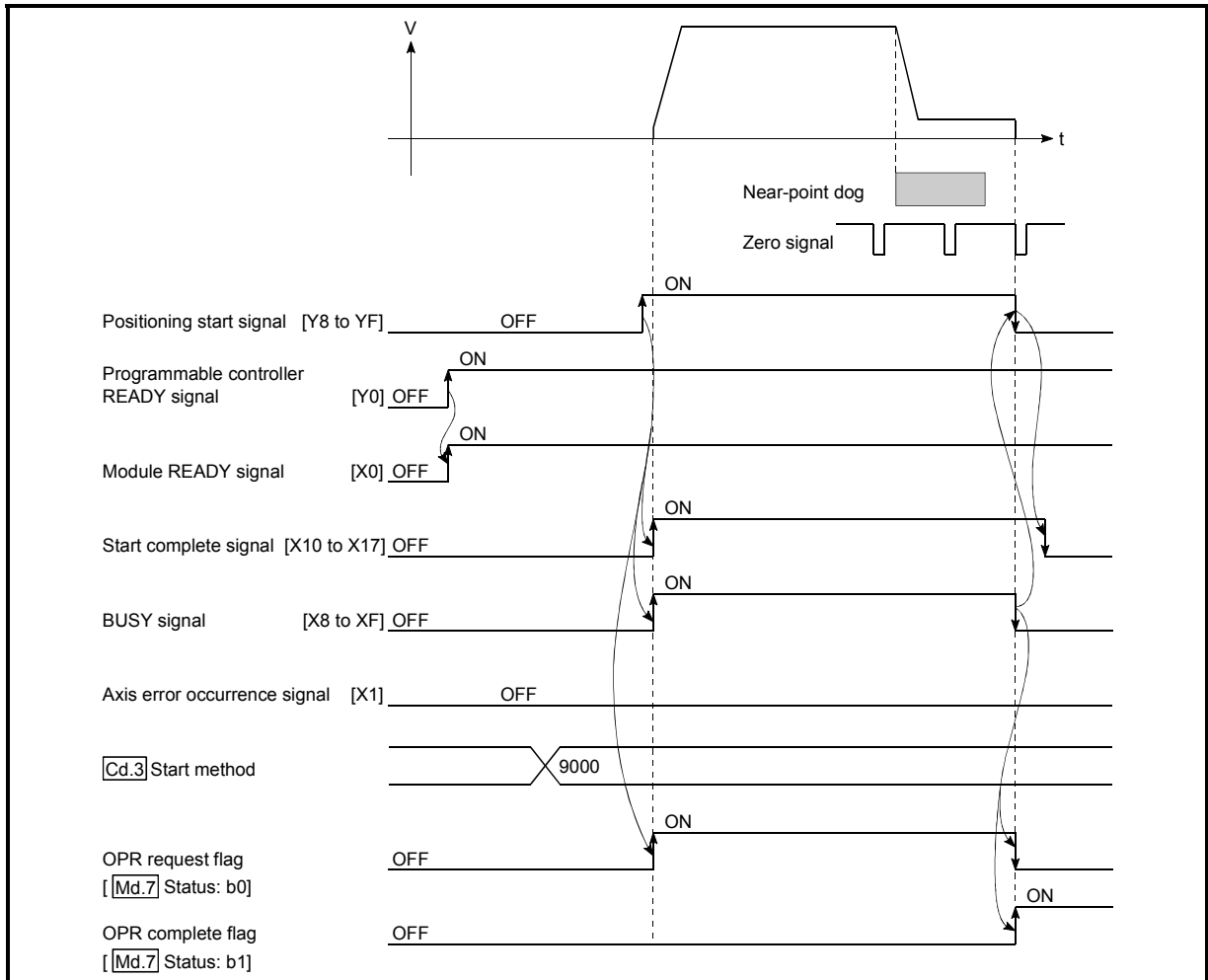

Fig. 7.4 Machine OPR control starting timing chart

(2) Fast OPR control starting timing chart

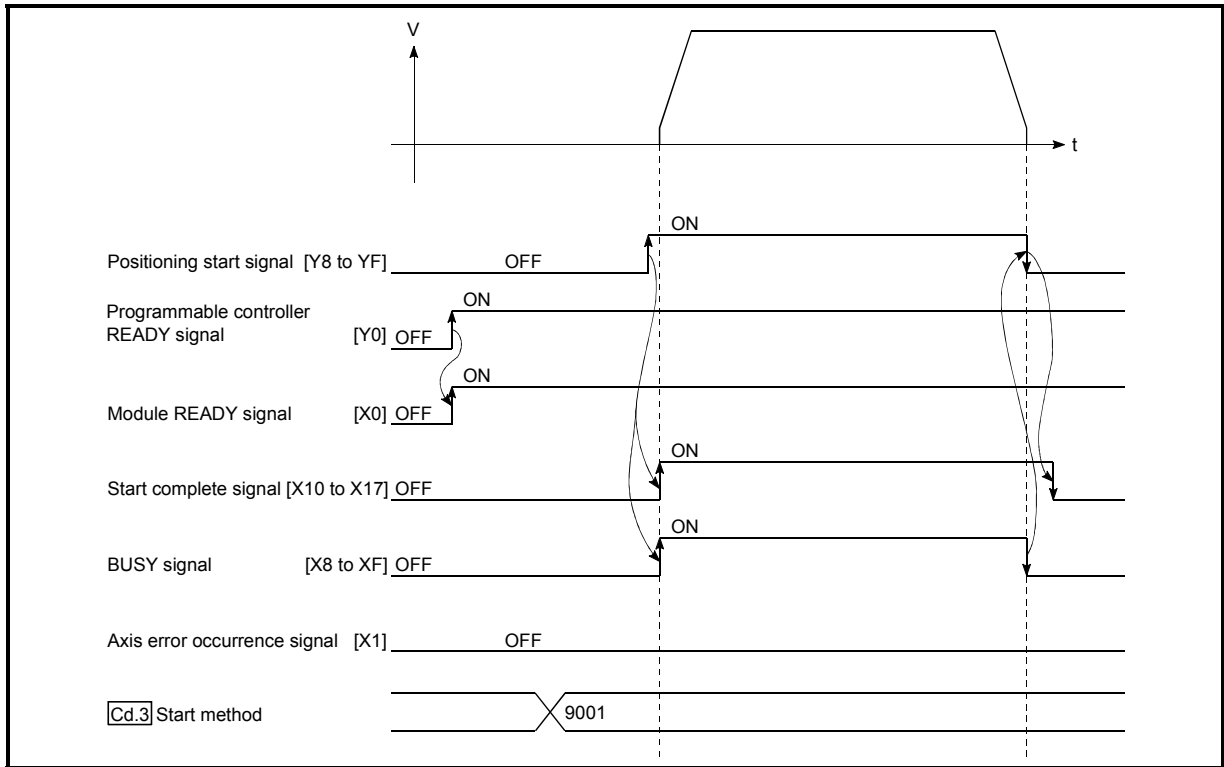

Fig. 7.5 Fast OPR starting timing chart

(3) Positioning control starting timing chart

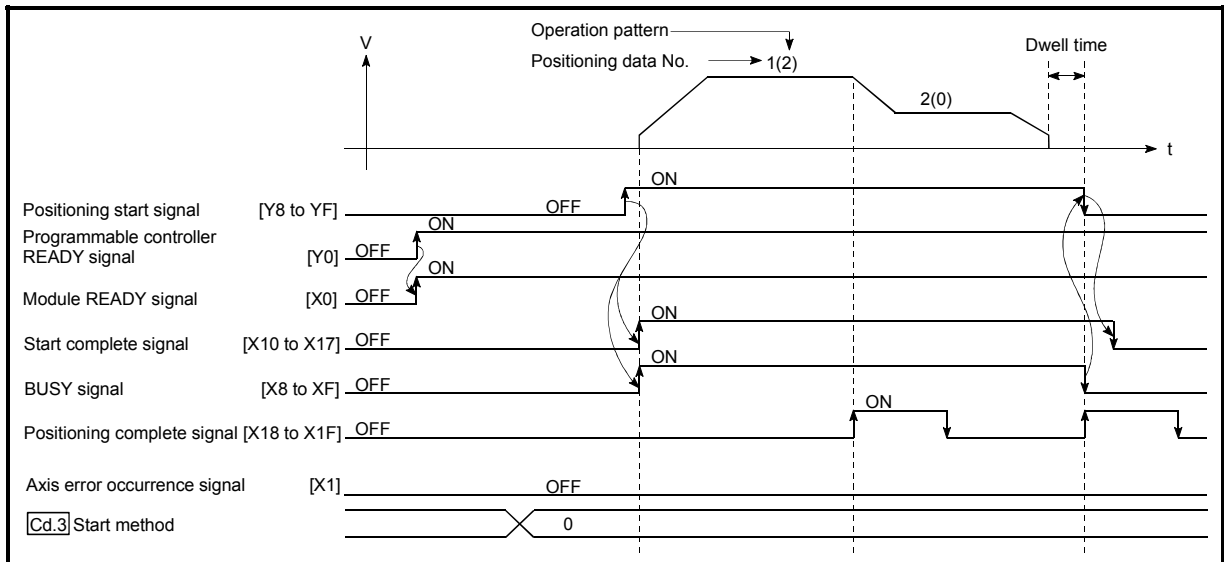

Fig. 7.6 Positioning control starting timing chart

(4) Speed-position switching control starting timing chart

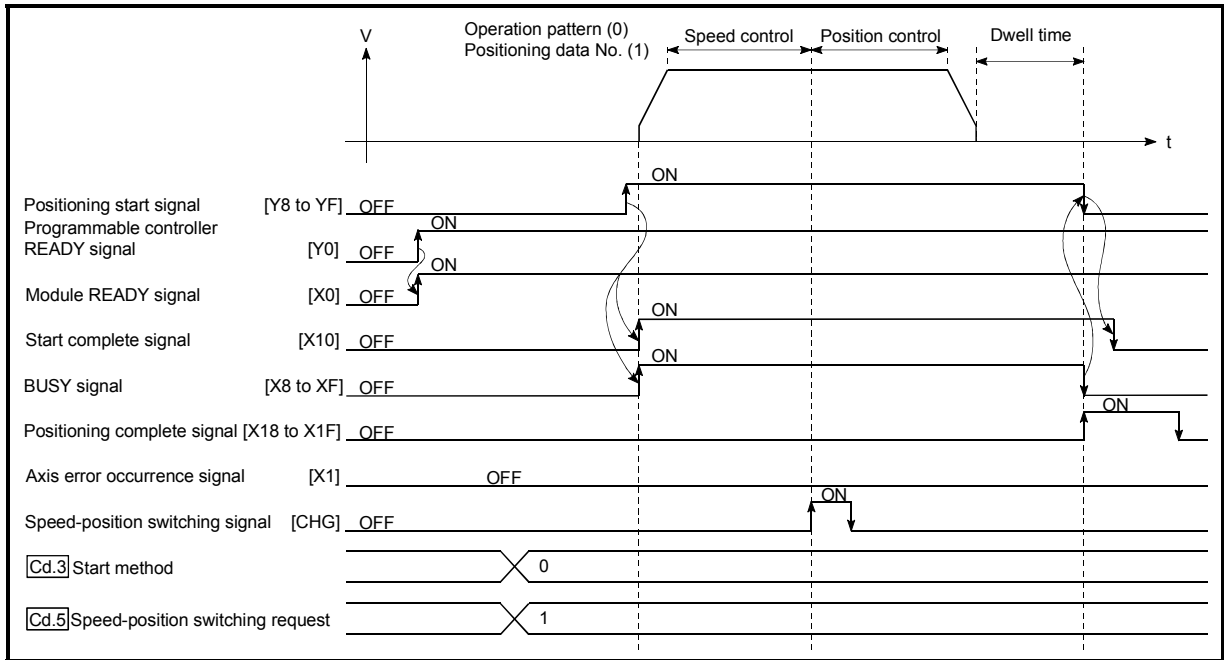

Fig. 7.7 Speed-position switching control starting timing chart

POINT

For positioning control or OPR control, multiple axes can be started simultaneously. In this case, turn ON the positioning start signals of the target axes within the same scan. (However, after multiple axes have been started simultaneously, they cannot be stopped simultaneously.)

7.5.4 Sub program

Speed change program

This program is used to change the speed within the "Pr. 5 Speed limit value" range at any point during speed control of speed-position switching control or during JOG operation.

Set the new speed in "Cd. 7 New speed value". A speed change is executed according to "Cd. 6 Speed change request".

The acceleration and deceleration times after speed change are the values set in "Cd. 8 ACC/DEC time at speed change" and "Cd. 9 DEC/STOP time at speed change".

(Refer to "Section 11.3 Speed change function" for details of the speed change function.)

■ Data requiring setting

Set the following data.

Setting item	Setting value	Buffer memory address									
		Axis 1	Axis 2	Axis 3	Axis 4	Axis 5	Axis 6	Axis 7	Axis 8		
Cd. 6	Speed change request	1: With speed change		55	155	255	355	455	555	655	755
Cd. 7	New speed value	2000pulse/s		56	156	256	356	456	556	656	756
				57	157	257	357	457	557	657	757
Cd. 8	ACC/DEC time at speed change	1000ms		58	158	258	358	458	558	658	758
Cd. 9	DEC/STOP time at speed change	1000ms		59	159	259	359	459	559	659	759

* Refer to "Section 4.7 List of control data" for more information on the setting details.

■ Speed changing timing chart

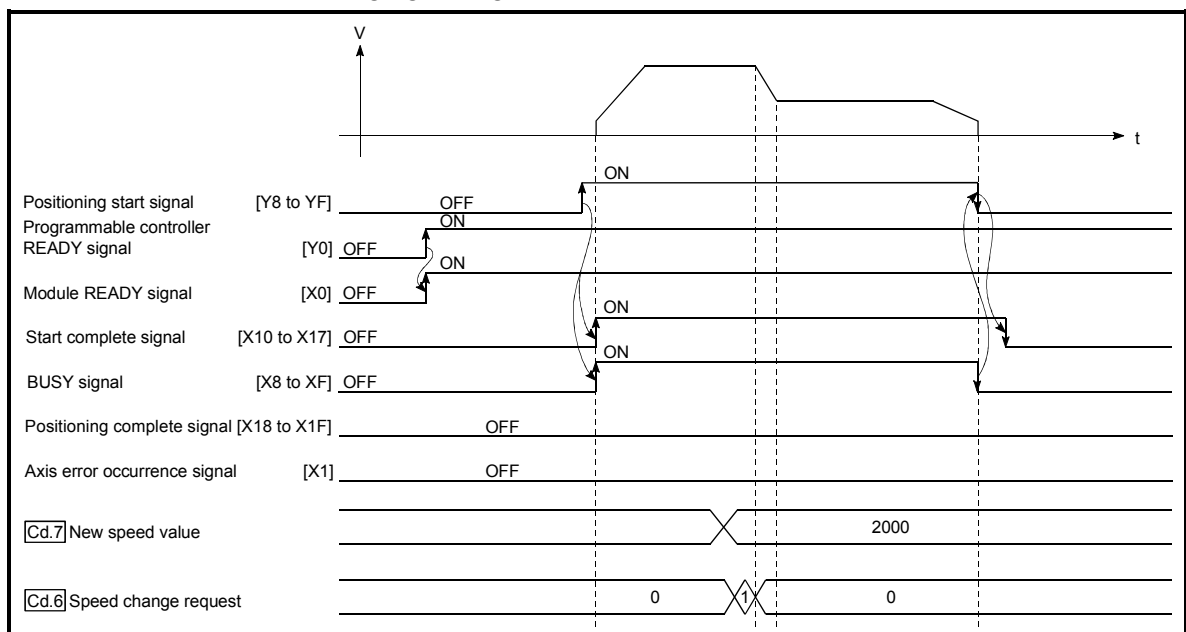

Fig. 7.8 Speed changing timing chart (for speed control of speed-position switching control)

Restart program

This program is used to resume position control by "Cd. 4 Restart request" from the stop position to the end point of the positioning data when the axis has been stopped by the axis stop signal during operation under position control or speed control of speed-position switching control (excluding position control).

■ Data requiring setting

Set the following data.

Setting item	Setting value	Buffer memory address							
		Axis 1	Axis 2	Axis 3	Axis 4	Axis 5	Axis 6	Axis 7	Axis 8
Cd. 4 Restart request	1: With restart request	53	153	253	353	453	553	653	753

* Refer to "Section 4.7 List of control data" for more information on the setting details.

■ Start conditions

When a restart is to be made, "Md. 4 Axis operation status" must be "1: Stopped" and the following conditions satisfied. (Necessary conditions are included in the sequence program as interlocks.)

Signal name	Signal state	Device									
		Axis 1	Axis 2	Axis 3	Axis 4	Axis 5	Axis 6	Axis 7	Axis 8		
Interface signal	Programmable controller READY signal	ON	Y0								
	Module READY signal	ON	X0								
	Axis error occurrence signal	OFF	X1								
	Axis stop signal	OFF	Axis stop signal being OFF	Y10	Y11	Y12	Y13	Y14	Y15	Y16	Y17
	Start complete signal	OFF	Start complete signal being OFF	X10	X11	X12	X13	X14	X15	X16	X17
	BUSY signal	OFF	QD70 not operating	X8	X9	XA	XB	XC	XD	XE	XF

■ Restarting timing chart

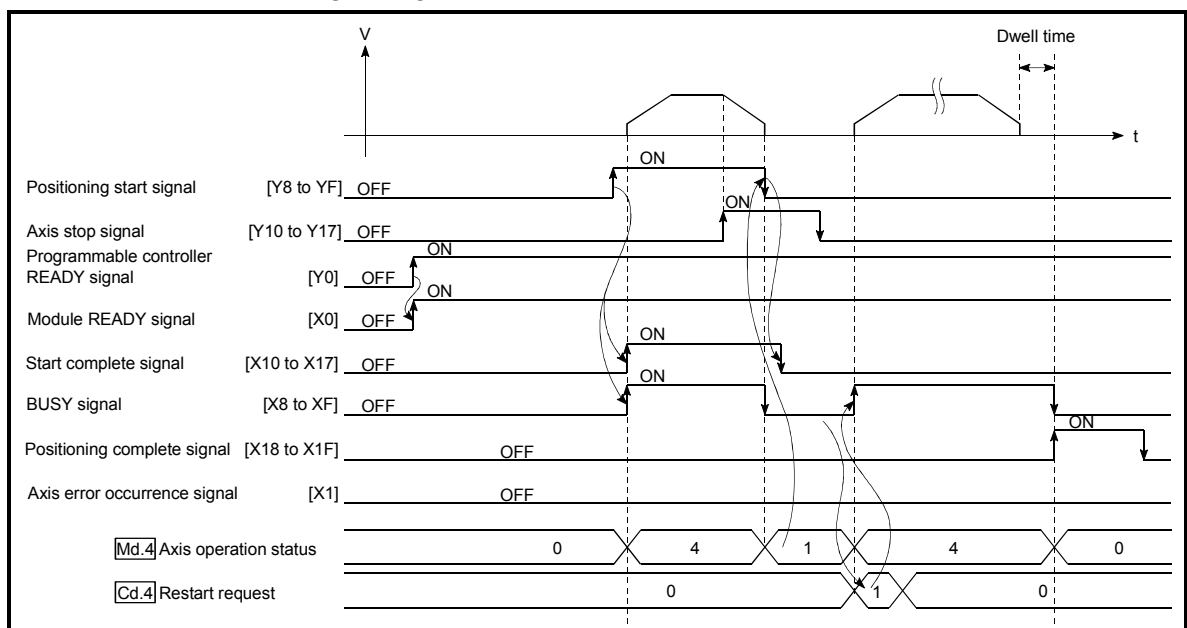

Fig. 7.9 Restarting timing chart (for position control)

SECTION 2 CONTROL DETAILS AND SETTING

Section 2 is configured for the following purposes shown in (1) to (3).

- (1) Understanding of the operation and restrictions of each control.
- (2) Carrying out the required settings in each control
- (3) Dealing with errors

The required settings in each control include parameter setting, positioning data setting, control data setting by a sequence program, etc.

Carry out these settings while referring to "CHAPTER 4 DATA USED FOR POSITIONING". Also refer to "CHAPTER 7 SEQUENCE PROGRAMS USED IN POSITIONING CONTROL" the sequence programs required in each control, and consider the entire control program configuration when creating each program.

CHAPTER 8 OPR CONTROL	8- 1 to 8- 16
CHAPTER 9 POSITIONING CONTROL	9- 1 to 9- 17
CHAPTER 10 JOG OPERATION	10- 1 to 10- 6
CHAPTER 11 SUB FUNCTIONS	11- 1 to 11- 13
CHAPTER 12 COMMON FUNCTIONS.....	12- 1 to 12- 3
CHAPTER 13 TROUBLESHOOTING	13- 1 to 13- 14

CHAPTER 8 OPR CONTROL

This chapter details the OPR control of the QD70.

8.1 Outline of OPR control

8.1.1 Two types of OPR control

"OPR control" is exercised to set up a position (= OP) as a reference for carrying out positioning control.

It is used to return a machine system at any position other than the OP to the OP when the QD70 issues a "OPR request"* with the power turned ON or others, or after a positioning control stop.

In the QD70, the following two types of control are defined as "OPR control" in the sequence of OPR operation.

Either of these two types of OPR control can be executed by setting the "OPR data", setting "9000" or "9001" in "Cd. 3 Start method", and turning ON the positioning start signal.

- (1) Establish a positioning control OP
"Machine OPR control" (Start method: 9000)
- (2) Carry out position control toward the OP
"Fast OPR control" (Start method: 9001).

* The "machine OPR control" in (1) above must always be carried out before executing the "fast OPR control" in (2).

■ When OPR control is not needed

In the system that does not require OPR control, setting "1" in "Cd. 2 OPR request flag OFF request" forcibly turns OFF the "OPR request flag" (Md. 7 Status: b0). When OPR control is not to be exercised, operation starts using the position at power-on (Md. 1 Current feed value) as "0".

Also, the "OPR data (OPR. 1 to OPR. 9)" must all be set to the initial values or the values that will not result in an error.

REMARK

OPR request *

The "OPR request flag" (Md. 7 Status signal: b0) must be turned ON in the QD70, and a machine OPR control must be executed in the following cases.

- When the power is turned ON
- When machine OPR control is started

The "OPR request flag" turns OFF and the "OPR complete flag" (Md. 7 Status signal: b1) turns ON if the machine OPR control is executed and is completed normally.

8.2 Machine OPR control

8.2.1 Outline of the machine OPR operation

Important
<p>(1) Always set the OP in the same direction as viewed from any position in the workpiece moving area (set the OP near the upper or lower limit of the machine).</p> <p>(2) Correctly set the OPR direction as the direction in which the workpiece moves toward the OP.</p> <p>(3) When the following two conditions hold, operation is performed at the OPR speed since the near-point dog is not detected at a machine OPR control start.</p> <ul style="list-style-type: none"> • Machine OPR control is started in the position where the near-point dog is OFF. • The near-point dog does not exist in the OPR direction as seen from the position where machine OPR control is started. <p>In such a case, perform JOG operation to move the axis to the position where the near-point dog exists in the OPR direction and the near-point dog is OFF. (Refer to Chapter 10 for details of JOG operation.)</p> <p>(4) In deceleration operation from the OPR speed, the data used as the deceleration time differs between "deceleration made by turning ON the near-point dog" and "deceleration made by turning ON the axis stop signal". (Refer to "Section 4.3 List of OPR data" for details.)</p> <p>Make setting with full consideration given to the influence on the machine.</p>

■ Machine OPR operation

In a machine OPR control, a near-point dog and zero signal are used to establish a machine OP.

None of the address information stored in the QD70, programmable controller CPU, or drive unit is used at this time. The position mechanically established after the machine OPR control is regarded as the "OP" to be the starting point for positioning control.

The method for establishing an "OP" by a machine OPR control differs according to the method set in "[OPR. 1] OPR method".

The following shows the operation when starting machine OPR control.

1)	The machine OPR control is started.
2)	The operation starts according to the speed and direction set in the OPR data ([OPR. 1] to [OPR. 9]).
3)	The "OP" is established by the method set in "[OPR. 1] OPR", and the machine stops. (Refer to sections "8.2.2" to "8.2.8")
4)	If "a" is set as "[OPR. 3] OP address", "a" will be stored as the current position in the "[Md. 1] Current feed value" which is monitoring the position.
5)	The machine OPR control is completed.

* Refer to "Section 4.3 List of OPR data" for details of OPR data.

The "[OPR. 3] OP address" is a fixed value set by the user.

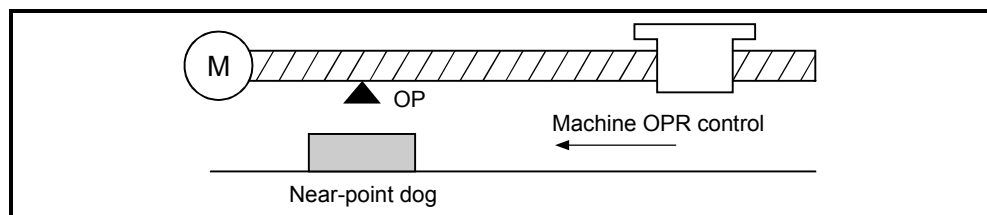

Fig. 8.1 Example of a machine OPR control

8.2.2 Machine OPR method

The method by which the machine OP is established (method for judging the OP position and machine OPR completion) is designated in the machine OPR control according to the configuration and application of the positioning control system. The following table shows the six methods that can be used for this OPR method. (The OPR method is one of the items set in the OPR data. It is set in "OPR. 1 OPR method" of the OPR data.)

OPR. 1 OPR method	Description
Near-point dog method	Deceleration starts when the near-point dog turns from OFF to ON. (Speed is decreased to "OPR. 5 Creep speed") The axis stops on detection of the first zero signal (one pulse of which is output when the motor turns one revolution, e.g. Zero signal output from the drive unit) after the near-point dog has turned from OFF to ON, and on completion of the deviation counter clear output, machine OPR control is completed.
Stopper 1	The stopper position is defined as the OP. After deceleration is started when the near-point dog turns from OFF to ON, the axis is brought into contact with the stopper at "OPR. 5 Creep speed" to a stop. After the stop, the time preset in "OPR. 9 OPR dwell time" elapses, and on completion of the deviation counter clear output, machine OPR control is completed.
Stopper 2	The stopper position is defined as the OP. After deceleration is started when the near-point dog turns from OFF to ON, the axis is brought into contact with the stopper at "OPR. 5 Creep speed" to a stop. After the stop, the zero signal (signal that is output on detection of contact with the stopper) is detected, and on completion of the deviation counter clear output, machine OPR control is completed.
Stopper 3	The stopper position is defined as the OP. The axis starts at "OPR. 5 Creep speed" from the beginning, and is brought into contact with the stopper at "OPR. 5 Creep speed" to a stop. After the stop, the zero signal (signal that is output on detection of contact with the stopper) is detected, and on completion of the deviation counter clear output, machine OPR control is completed.
Count 1	Deceleration is started when the near-point dog turns from OFF to ON, and the axis moves at "OPR. 5 Creep speed". After the axis has moved the distance preset in "OPR. 8 Setting for the movement amount after near-point dog ON" from the position where the near-point dog turned from OFF to ON, it stops on detection of the zero signal (one pulse of which is output when the motor rotates one revolution, e.g. Zero signal output from the drive unit), and on completion of the deviation counter clear output, machine OPR control is completed.
Count 2	Deceleration is started when the near-point dog turns from OFF to ON, and the axis moves at "OPR. 5 Creep speed". The axis stops after moving the distance preset in "OPR. 8 Setting for the movement amount after near-point dog ON" from the position where the near-point dog turned from OFF to ON, and on completion of the deviation counter clear output, machine OPR control is completed.

■ Wiring of signals required for each OPR method

OPR method \ I/O signal	Near-point dog method	Stopper 1	Stopper 2	Stopper 3	Count 1	Count 2
Zero signal (PG0)	○	—	○	○	○	—
Near-point dog (DOG)	○	○	○	—	○	○
Deviation counter clear (CLEAR)	○	○	○	○	○	○

○: Wiring required —: Wiring not required

REMARK

Creep speed

The stopping accuracy is poor when the machine suddenly stops from fast speeds. To improve the machine's stopping accuracy, its must change over to a slow speed before stopping. This speed is set in the "OPR. 5 Creep speed".

8.2.3 OPR method (1): Near-point dog method

The following shows an operation outline of the "near-point dog method" OPR method.

■ Operation chart

1)	Machine OPR control is started. (Acceleration starts in the direction set in "OPR. 2 OPR direction" at the time set in "OPR. 6 ACC/DEC time at OPR", and the axis moves at "OPR. 4 OPR speed".)
2)	Near-point dog ON is detected and deceleration starts at the time set in "OPR. 6 ACC/DEC time at OPR".
3)	The machine decelerates to the "OPR. 5 Creep speed", and subsequently moves at that speed. (At this time, the near-point dog must be ON.)
4)	On detection of the first zero signal after near-point dog OFF, the pulse output from the QD70 stops immediately and the "deviation counter clear output" is output to the drive unit. (The "deviation counter clear signal output time" is set in [Pr. 8].)
5)	After a "deviation counter clear signal" is output to the drive unit, the OPR complete flag ([Md. 7] Status: b1) turns from OFF to ON and the OPR request flag ([Md. 7] status: b0) turns from ON to OFF.

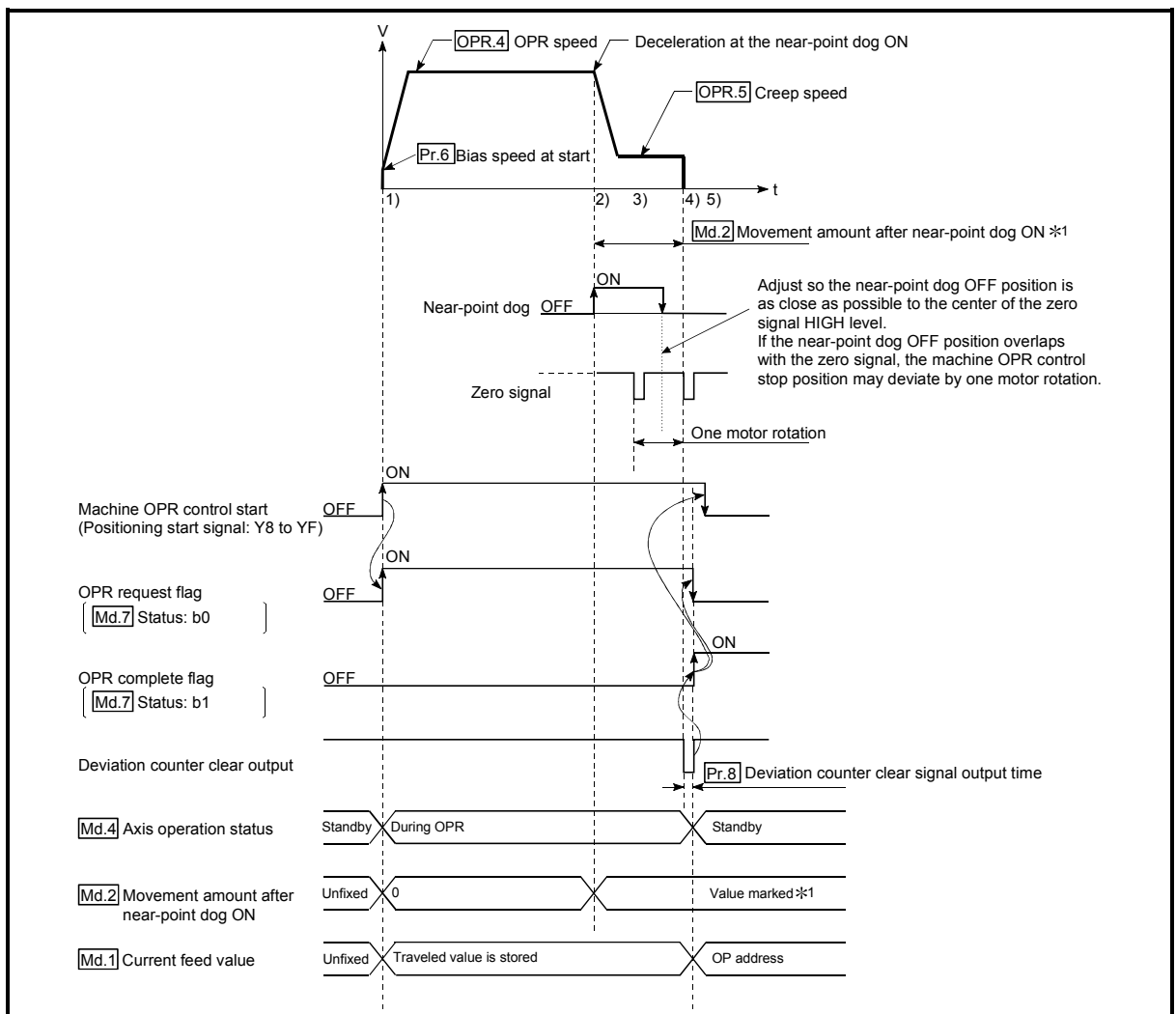

Fig. 8.2 Near-point dog method machine OPR control

■ Restrictions

A pulse generator with a zero signal is required.

When using a pulse generator without a zero signal, generate a zero signal using an external signal.

■ Precautions during operation

(1) When the near-point dog is ON, starting the axis will cause the "Start during near-point dog ON" error (error code: 201). Perform JOG operation to move the axis to the position where the near-point dog turns OFF.

(2) The near-point dog must be ON during deceleration from "OPR. 4 OPR speed" "OPR. 5 Creep speed".

The following is the operation performed if the near-point dog turns OFF before deceleration to the creep speed.

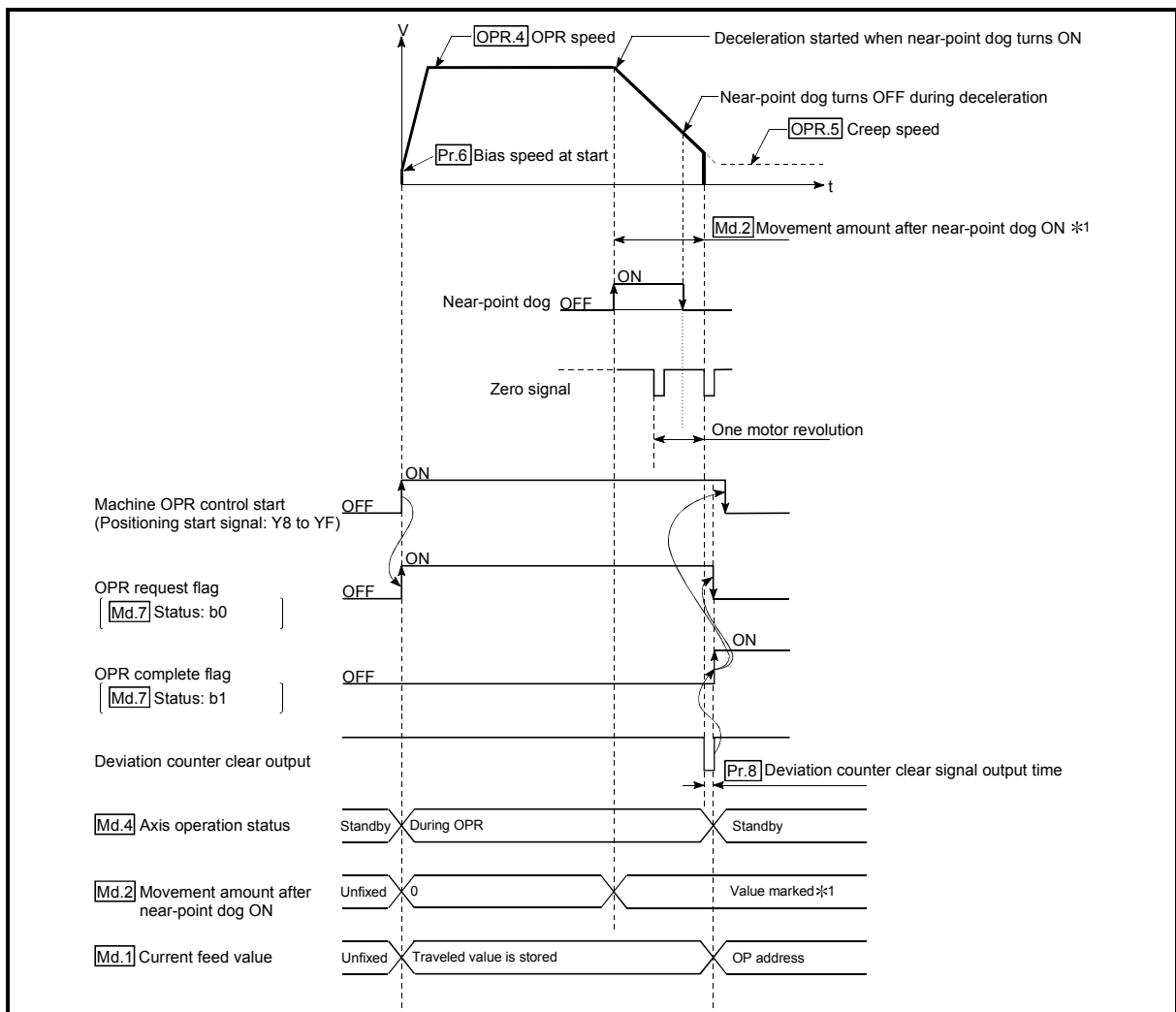

Fig. 8.3 Operation when the near-point dog is turned OFF before the creep speed is reached

(3) If the axis stop signal is turned ON during operation performed at "OPR. 4 OPR speed", the axis decelerates to a stop at the time set in "OPR. 7 DEC/STOP time at OPR".

8.2.4 OPR method (2): Stopper 1

The following shows an operation outline of the "stopper 1" OPR method.

■ Operation chart

1)	Machine OPR control is started. (Acceleration starts in the direction set in "OPR. 2 OPR direction" at the time set in "OPR. 6 ACC/DEC time at OPR", and the axis moves at "OPR. 4 OPR speed".)
2)	Near-point dog ON is detected and deceleration starts at the time set in "OPR. 6 ACC/DEC time at OPR".
3)	Speed is reduced to "OPR. 5 Creep speed" and the axis then moves at the creep speed. (At this time, the motor torque must be limited. If the torque is not limited, the motor may fail at 4.)
4)	The machine presses against the stopper at the creep speed and stops.
5)	When "OPR. 9 OPR dwell time" elapses after near-point dog ON, the pulse output from the QD70 stops immediately and the "deviation counter clear output" is output to the drive unit. (The "deviation counter clear signal output time" is set in [Pr. 8].)
6)	After a "deviation counter clear output" is output to the drive unit, the OPR complete flag ([Md. 7] Status: b1) turns from OFF to ON, and the OPR request flag ([Md. 7] Status: b0) turns from ON to OFF.

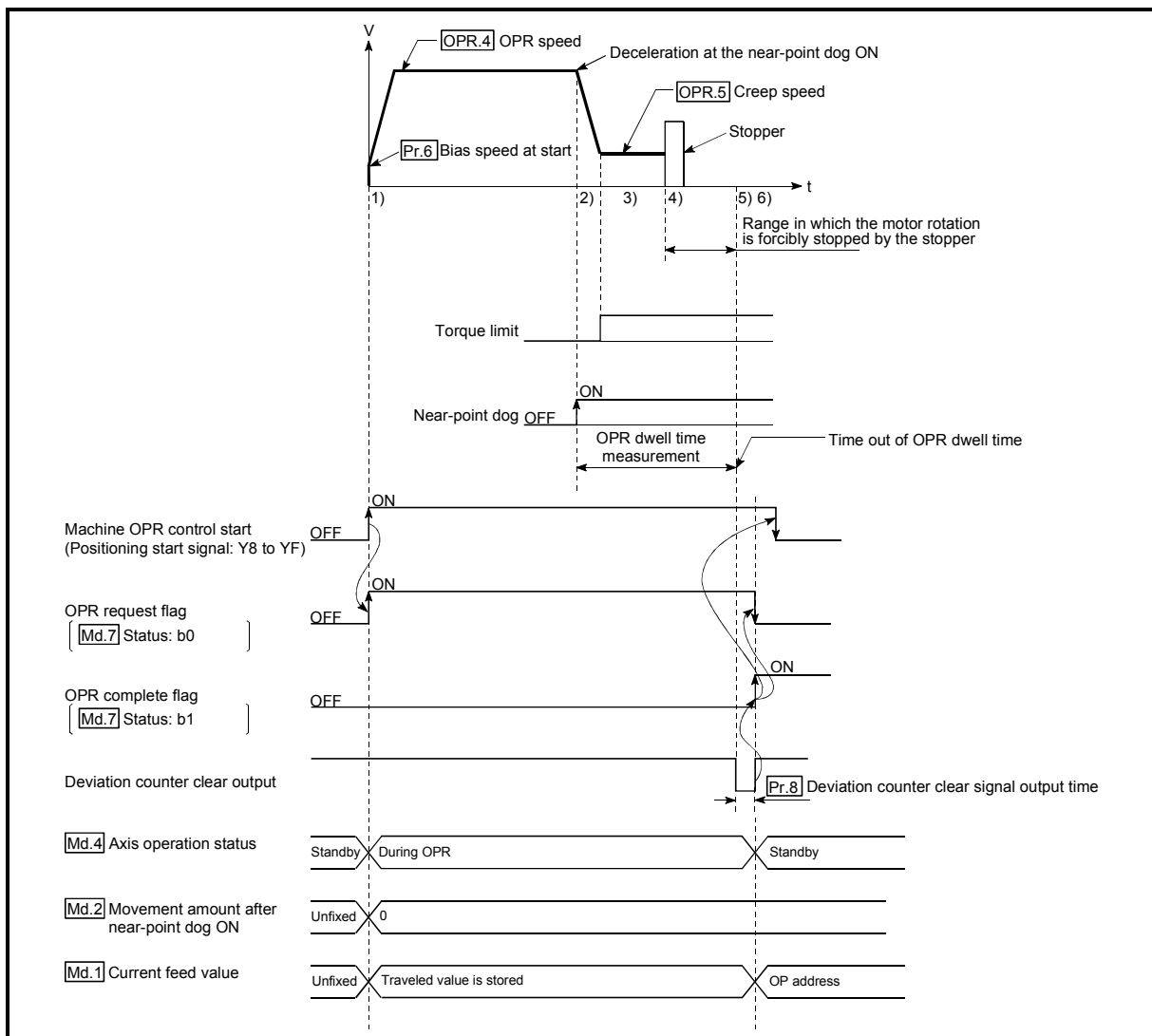

Fig. 8.4 Stopper 1 machine OPR control

■ Restrictions

- (1) Always limit the motor torque after the "OPR. 5 Creep speed" is reached. If the torque is not limited, the motor may fail when the machine presses against the stopper. (Refer to section "12.4.2 Torque limit function".)
(For a torque limit, refer to the manual of the drive unit used.)

■ Precautions during operation

- (1) Set a value in the "OPR. 9 OPR dwell time" that is equal to or higher than the movement time from the near-point dog ON to the time the machine presses against the stopper.
- (2) The following is the operation performed if "OPR. 9 OPR dwell time" elapses during deceleration from "OPR. 4 OPR speed".

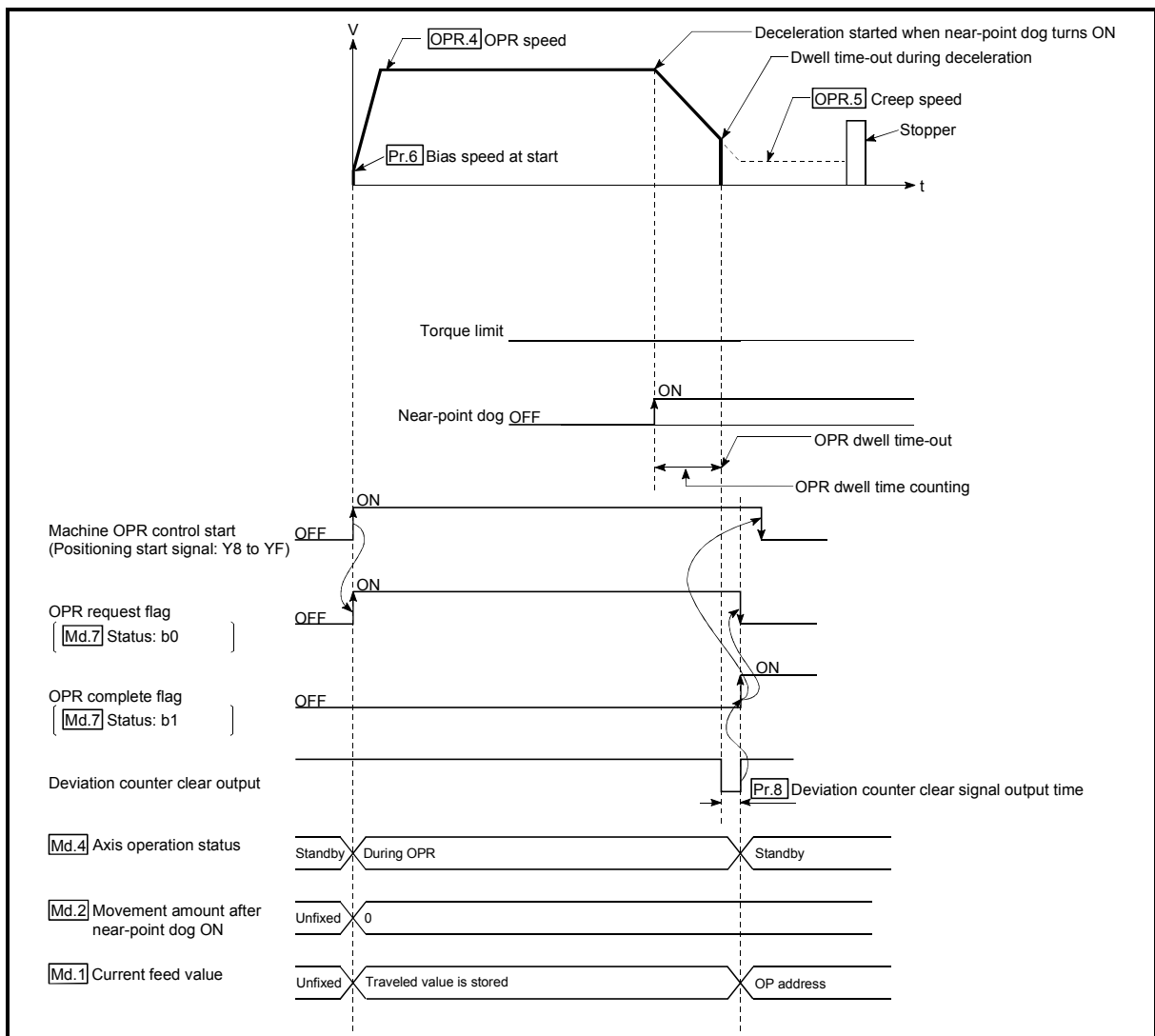

Fig. 8.5 Operation when the dwell time elapses during deceleration from the OPR speed

- (3) If the axis is started during near-point dog ON, it starts at "OPR. 5 Creep speed".
- (4) If the axis stop signal is turned ON during operation performed at "OPR. 4 OPR speed", the axis decelerates to a stop at the time set in "OPR. 7 DEC/ STOP time at OPR".

8.2.5 OPR method (3): Stopper 2

The following shows an operation outline of the "stopper 2" OPR method.

■ Operation chart

1)	Machine OPR control is started. (Acceleration starts in the direction set in "OPR. 2 OPR direction" at the time set in "OPR. 6 ACC/DEC time at OPR", and the axis moves at "OPR. 4 OPR speed".)
2)	Near-point dog ON is detected and deceleration starts at the time set in "OPR. 6 ACC/DEC time at OPR".
3)	Speed is reduced to "OPR. 5 Creep speed" and the axis then moves at the creep speed. (At this time, the motor torque must be limited. If the torque is not limited, the motor may fail at 4.)
4)	The machine presses against the stopper at the creep speed and stops.
5)	On detection of the zero signal after the stop, the pulse output from the QD70 stops immediately and the "deviation counter clear output" is output to the drive unit. (The "deviation counter clear signal output time" is set in [Pr. 8].)
6)	After a "deviation counter clear output" is output to the drive unit, the OPR complete flag ([Md. 7] Status: b1) turns from OFF to ON, and the OPR request flag ([Md. 7] Status: b0) turns from ON to OFF.

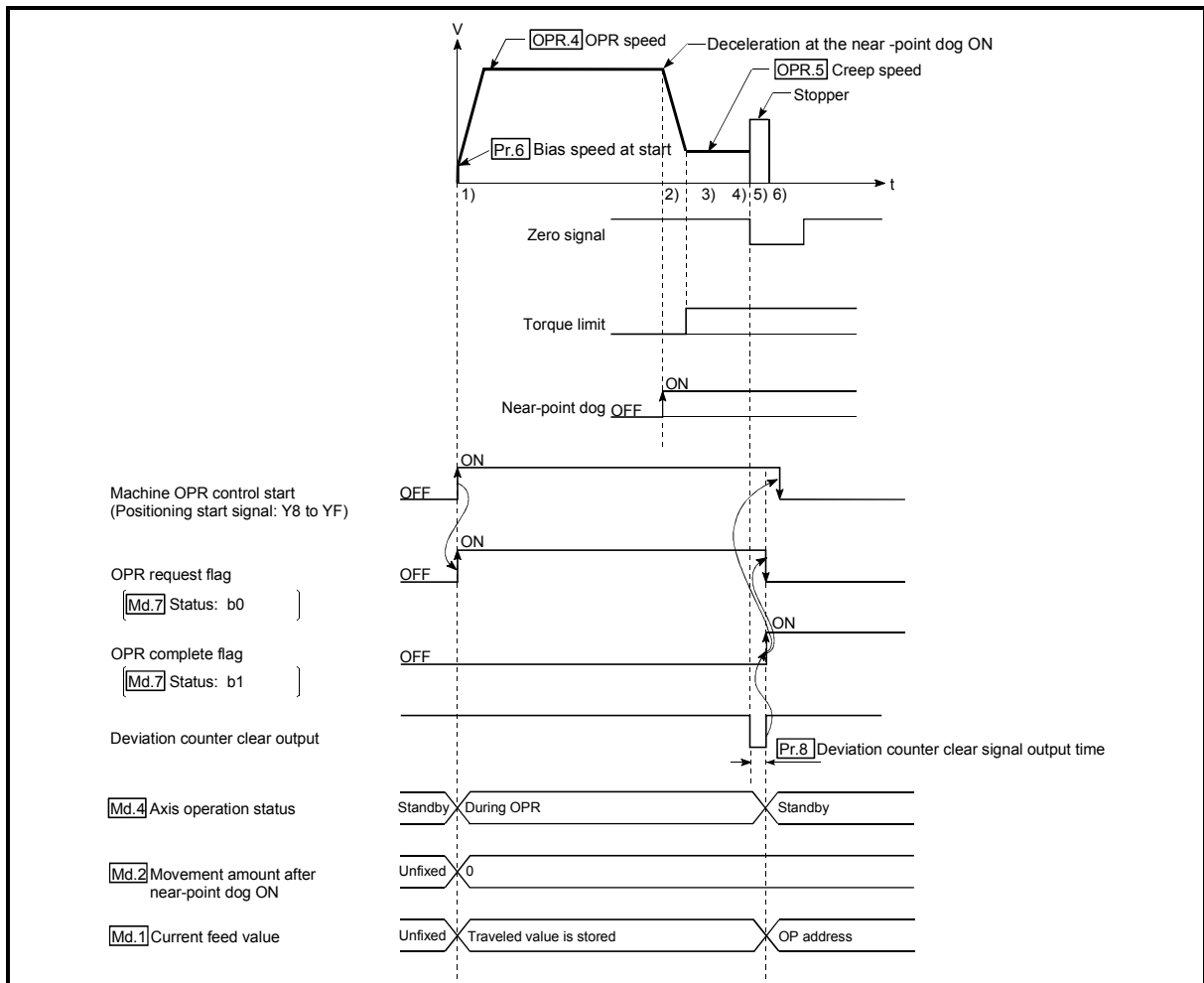

Fig. 8.6 Stopper 2 machine OPR control

■ Restrictions

- (1) Always limit the motor torque after the "OPR. 5 Creep speed" is reached. If the torque is not limited, the motor may fail when the machine presses against the stopper.
(For a torque limit, refer to the manual of the drive unit used.)
- (2) Use an external input signal as the zero signal.

■ Precautions during operation

- (1) Input a zero signal from an external source after the machine presses against the stopper.
The following is the operation performed if the zero signal is input before deceleration to "OPR. 5 Creep speed".

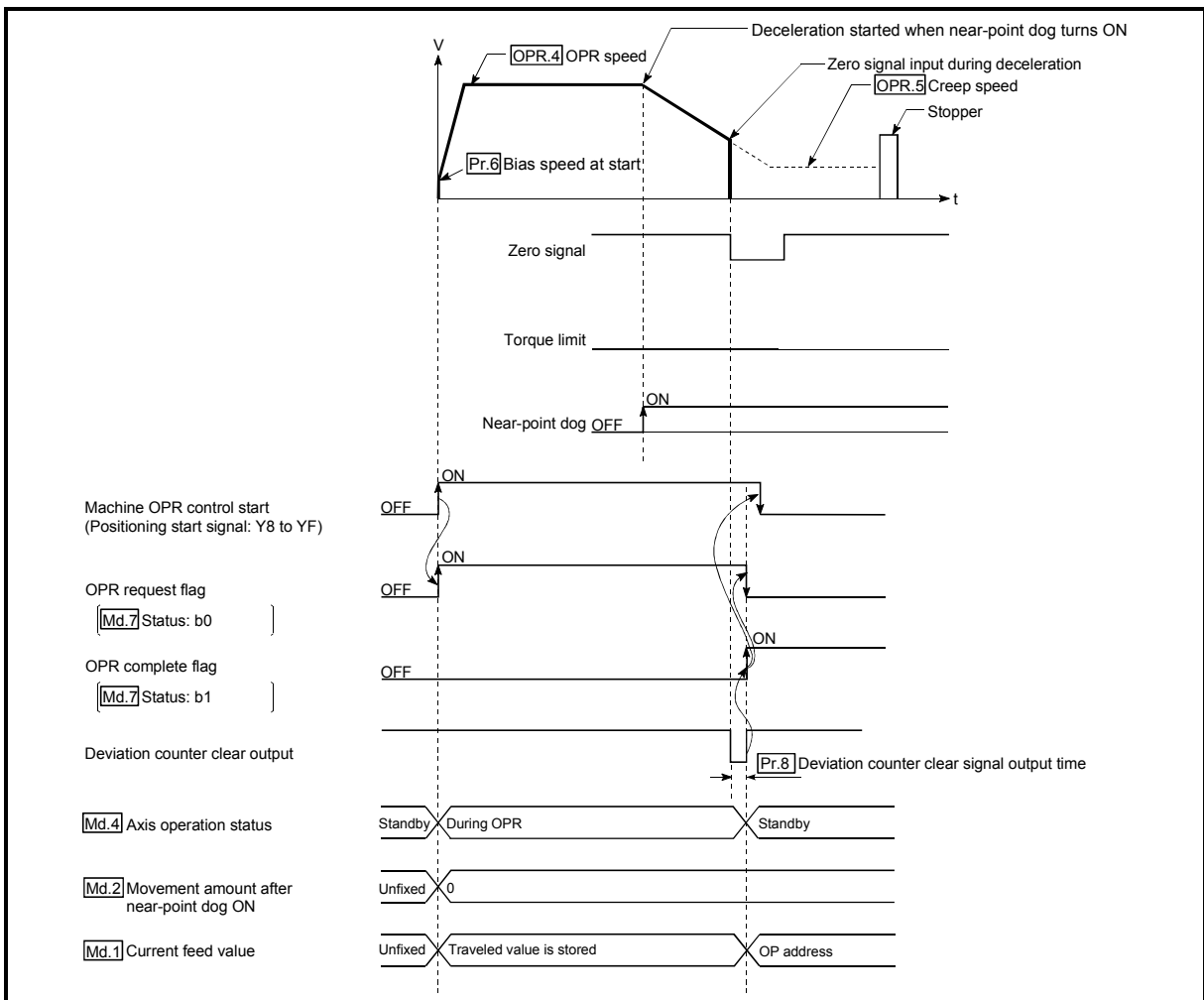

Fig. 8.7 Operation performed if zero signal is input before deceleration to creep speed

- (2) The near-point dog must be turned ON until it presses against the stopper.
- (3) If the axis is started during near-point dog ON, it starts at "OPR. 5 Creep speed".
- (4) If the axis is started during zero signal ON, the "Zero signal ON" error (error code: 202) occurs.
- (5) If the axis stop signal is turned ON during operation performed at "OPR. 4 OPR speed", the axis decelerates to a stop at the time set in "OPR. 7 DEC/STOP time at OPR".

8.2.6 OPR method (4): Stopper 3

The following shows an operation outline of the "stopper 3" OPR method.
 The "stopper 3" method is effective when a near-point dog has not been installed.
 (Note that the operation is carried out from the start at the "OPR. 5 Creep speed", so it will take some time until the machine OPR control completion.)

■ Operation chart

1)	Machine OPR control is started. (Acceleration starts in the direction set in "OPR. 2 OPR direction" at the time set in "OPR. 6 ACC/DEC time at OPR", and the axis moves at "OPR. 5 Creep speed". At this time, the motor torque must be limited. If the torque is not limited, the motor may fail at 2.)
2)	The machine presses against the stopper at the creep speed and stops.
3)	On detection of the zero signal after the stop, the pulse output from the QD70 stops immediately and the "deviation counter clear output" is output to the drive unit. (The "deviation counter clear signal output time" is set in [Pr. 8].)
4)	After a "deviation counter clear output" is output to the drive unit, the OPR complete flag ([Md. 7]Status: b1) turns from OFF to ON, and the OPR request flag ([Md. 7]Status: b0) turns from ON to OFF.

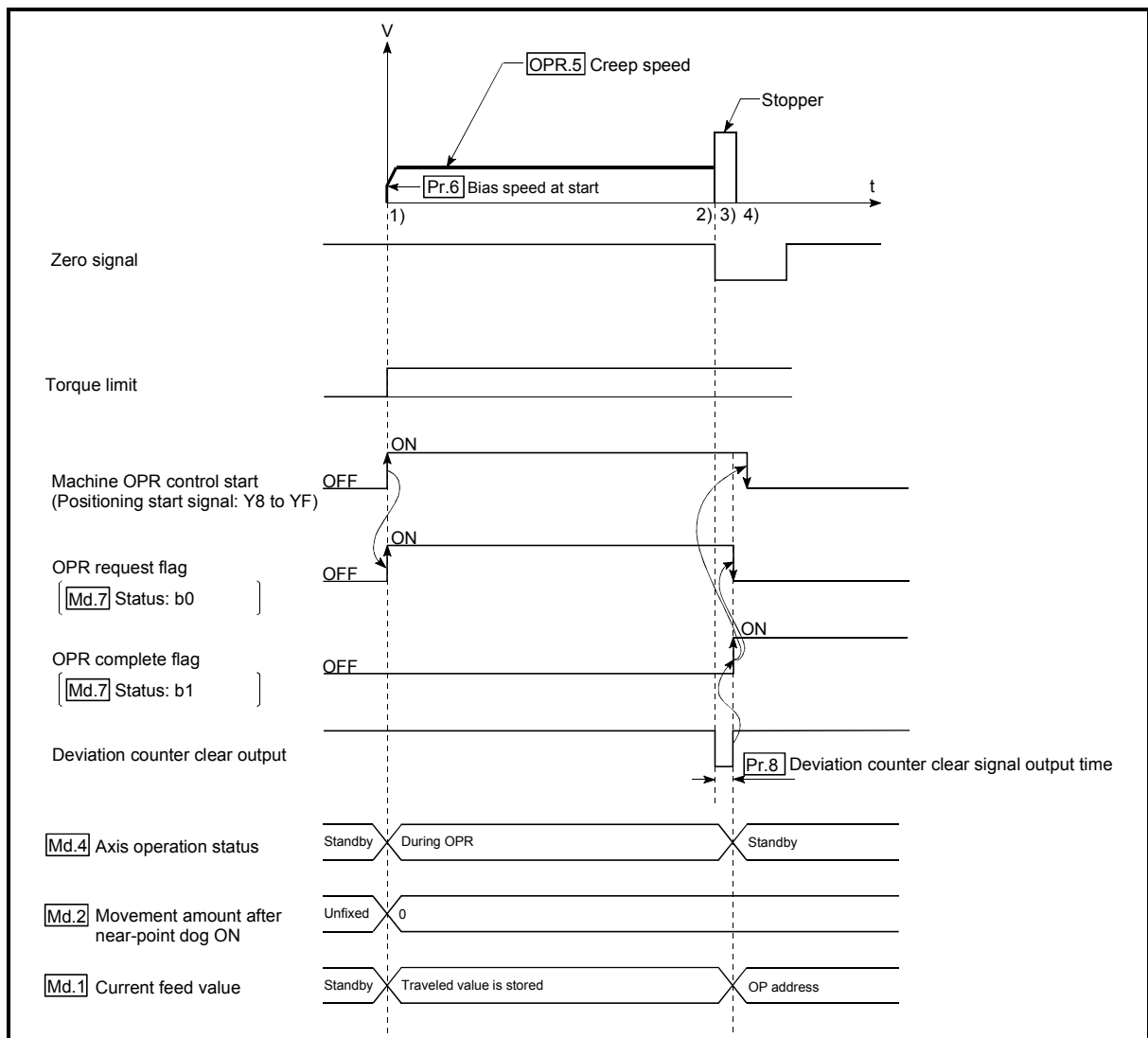

Fig. 8.8 Stopper 3 machine OPR control

■ Restrictions

- (1) Always limit the motor torque.
If the torque is not limited, the motor may fail when the machine presses against the stopper.
(For a torque limit, refer to the manual of the drive unit used.)
- (2) Use an external input signal as the zero signal.

■ Precautions during operation

- (1) If the zero signal is input before the workpiece stops at the stopper, the workpiece will stop at that position, and that position will become the OP.

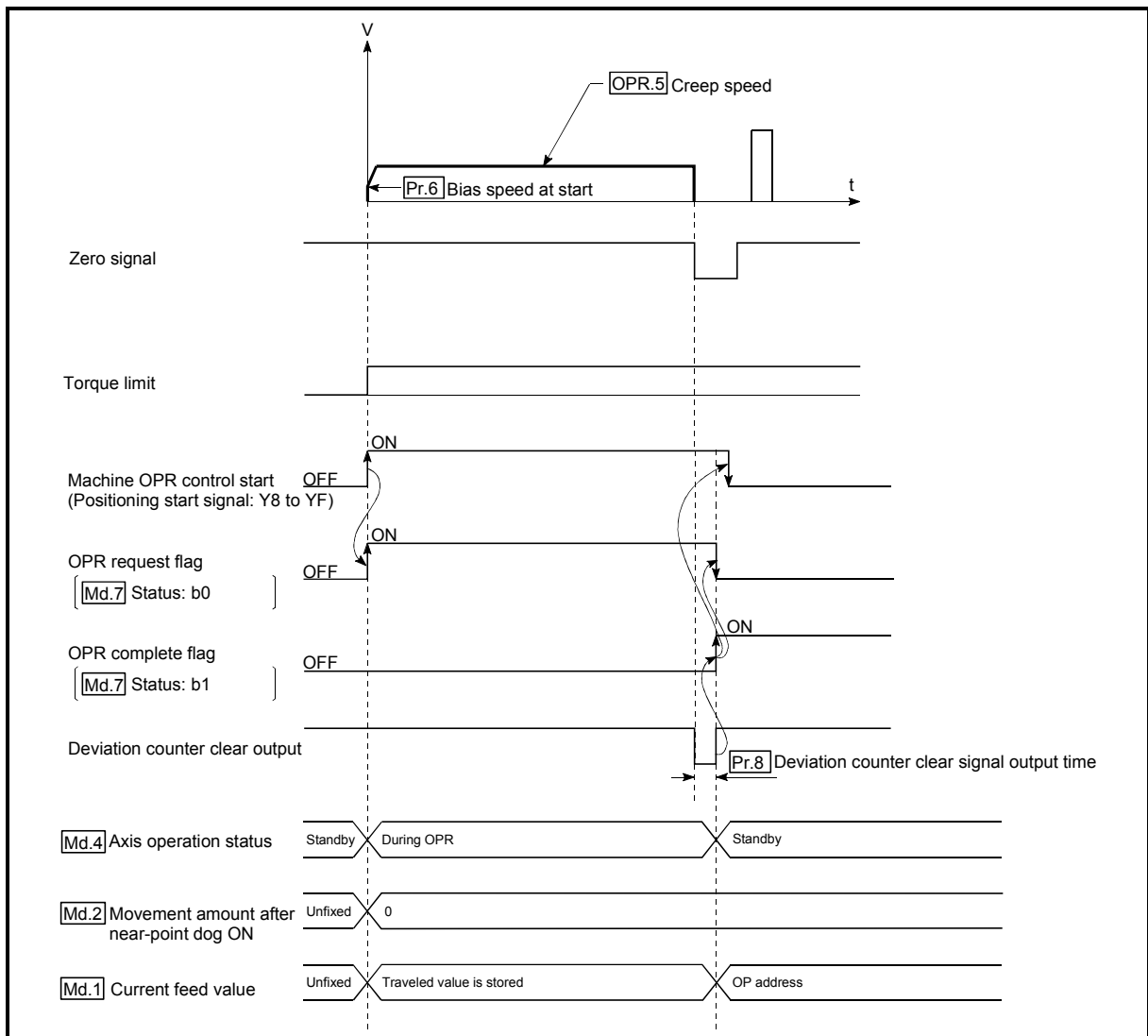

Fig. 8.9 When the zero signal is input before the stop at the stopper

- (2) If the axis is started during zero signal ON, the "Zero signal ON" error (error code: 202) occurs.

8.2.7 OPR method (5): Count 1

The following shows an operation outline of the "count 1" OPR method.

■ Operation chart

1)	Machine OPR control is started. (Acceleration starts in the direction set in "OPR. 2 OPR direction" at the time set in "OPR. 6 ACC/DEC time at OPR", and the axis moves at "OPR. 4 OPR speed".)
2)	Near-point dog ON is detected and deceleration starts at the time set in "OPR. 6 ACC/DEC time at OPR".
3)	The machine decelerates to the "OPR. 5 Creep speed", and subsequently moves at that speed.
4)	On detection of the first zero signal after the axis has traveled the movement amount set in "OPR. 8 Setting for the movement amount after near-point dog ON", the pulse output from the QD70 stops immediately and the "deviation counter clear output" is output to the drive unit. (The "deviation counter clear signal output time" is set in [Pr. 8].)
5)	After a "deviation counter clear output" is output to the drive unit, the OPR complete flag ([Md. 7] Status: b1) turns from OFF to ON, and the OPR request flag ([Md. 7] Status: b0) turns from ON to OFF.

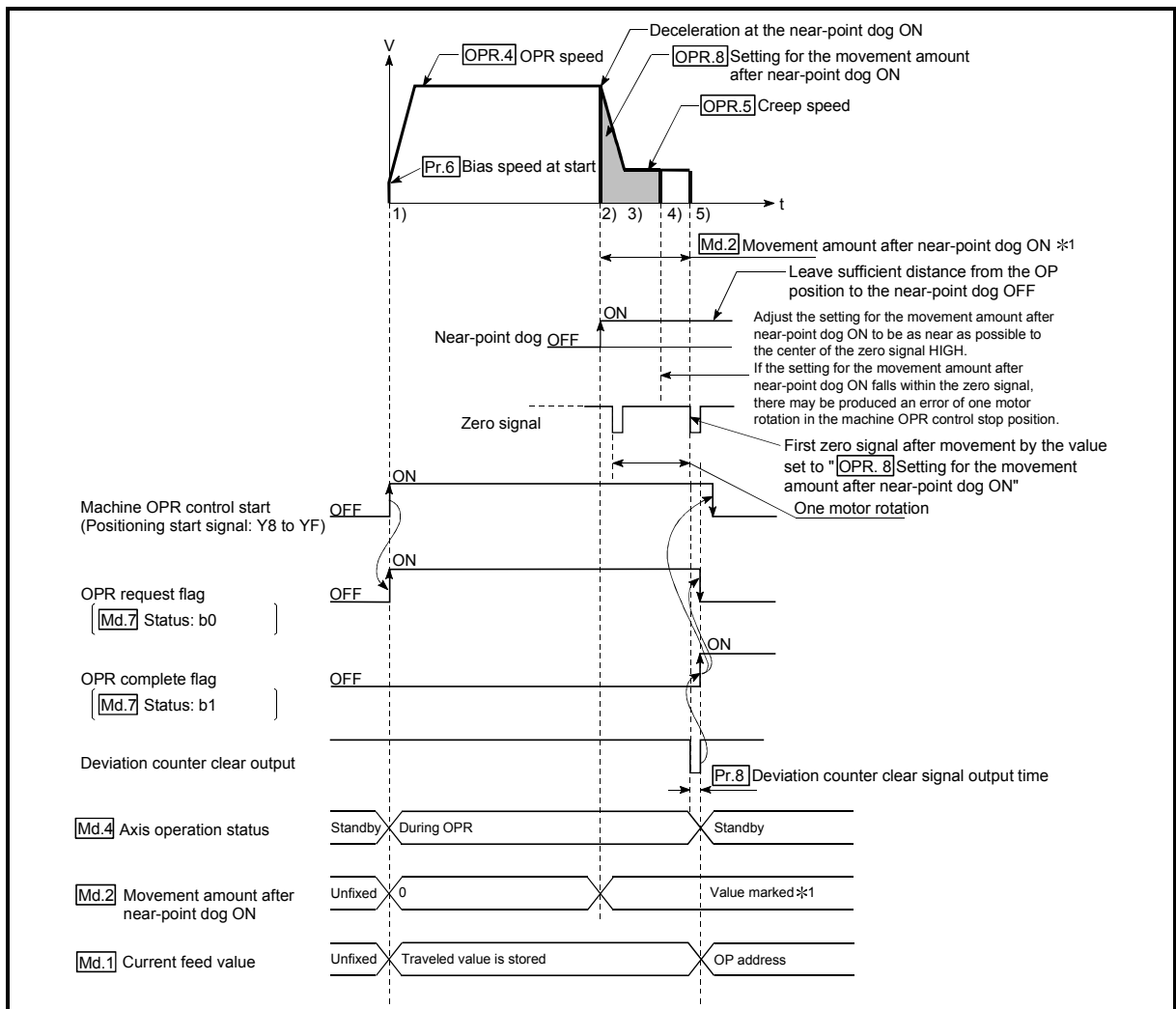

Fig. 8.10 Count 1 machine OPR control

■ Restrictions

A pulse generator with a zero signal is required.

When using a pulse generator without a zero signal, generate a zero signal using an external signal.

■ Precaution during operation

- (1) If "OPR. 8 Setting for the movement amount after near-point dog ON" is less than the deceleration distance from "OPR. 4 OPR speed" to "OPR. 5 Creep speed", machine OPR control is completed normally.
- (2) When the near-point dog is ON, starting the axis will cause the "Start during near-point dog ON" error (error code: 201). Perform JOG operation to move the axis to the position where the near-point dog turns OFF.
- (3) If the axis stop signal is turned ON during operation performed at "OPR. 4 OPR speed", the axis decelerates to a stop at the time set in "OPR. 7 DEC/STOP time at OPR".

8.2.8 OPR method (6): Count 2

The following shows an operation outline of the "count 2" OPR method.
 The "count method 2)" method is effective when a "zero signal" cannot be received.

■ Operation chart

1)	Machine OPR control is started. (Acceleration starts in the direction set in "OPR. 2" OPR direction" at the time set in "OPR. 6" ACC/DEC time at OPR", and the axis moves at "OPR. 4" OPR speed".)
2)	Near-point dog ON is detected and deceleration starts at the time set in "OPR. 6" ACC/DEC time at OPR".
3)	The machine decelerates to the "OPR. 5" Creep speed", and subsequently moves at that speed.
4)	As soon as the axis has traveled the movement amount set in "OPR. 8" Setting for the movement amount after near-point dog ON" after near-point dog ON, the pulse output from the QD70 stops (at this time, the axis decelerates to a stop from "OPR. 5" Creep speed" at the time set in "OPR. 7" DEC/STOP time at OPR") and the "deviation counter clear output" is output to the drive unit. (The "deviation counter clear signal output time" is set in Pr. 8.)
5)	After a "deviation counter clear output" is output to the drive unit, the OPR complete flag (Md. 7>Status: b1) turns from OFF to ON, and the OPR request flag (Md. 7>Status: b0) turns from ON to OFF.

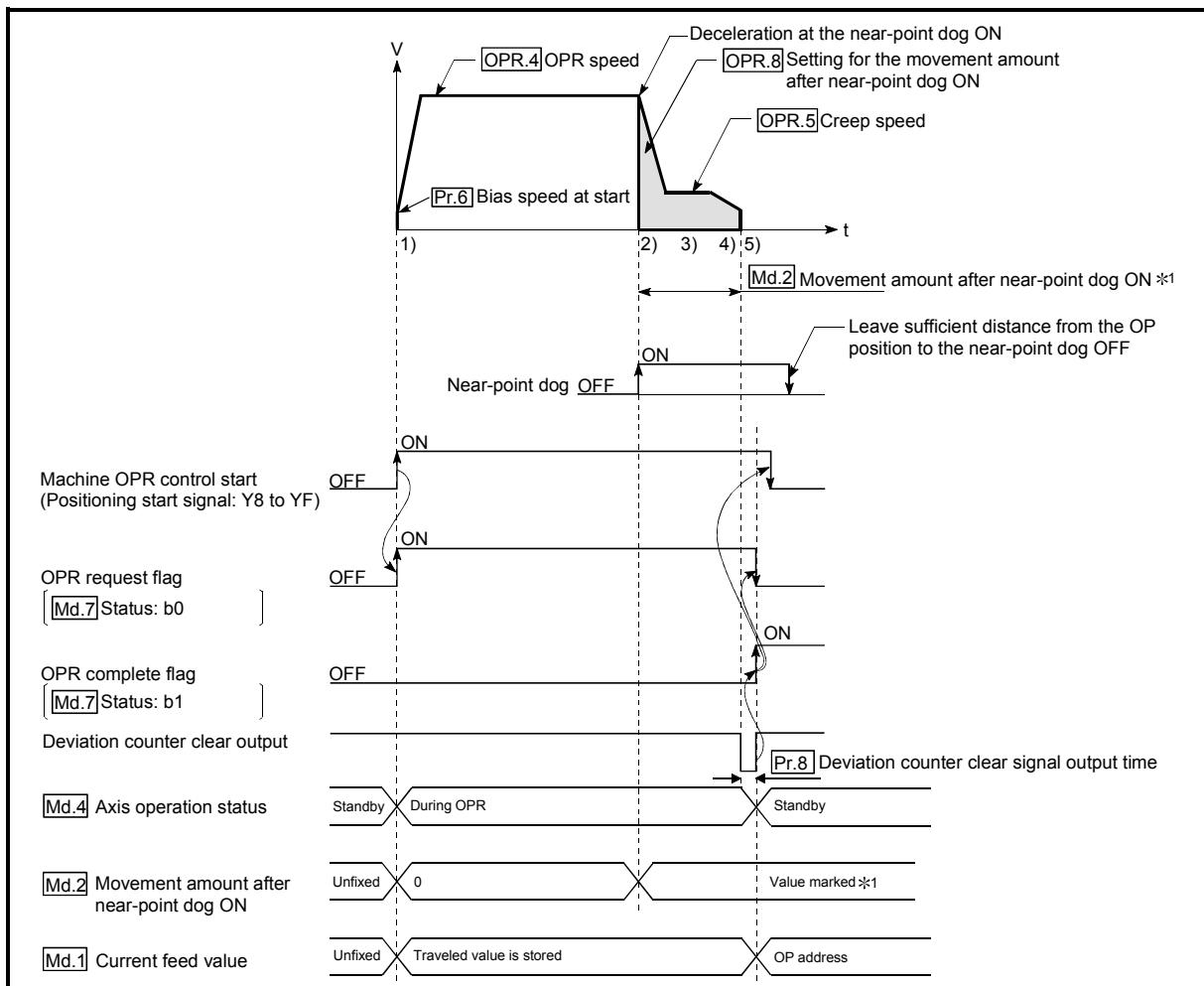

Fig. 8.11 Count 2 machine OPR control

■ Precaution during operation

- (1) If "OPR. 8 Setting for the movement amount after near-point dog ON" is less than the deceleration distance from "OPR. 4 OPR speed" to "OPR. 5 Creep speed", machine OPR control is completed normally.
- (2) When the near-point dog is ON, starting the axis will cause the "Start during near-point dog ON" error (error code: 201). Perform JOG operation to move the axis to the position where the near-point dog turns OFF.
- (3) If the axis stop signal is turned ON during operation performed at "OPR. 4 OPR speed", the axis decelerates to a stop at the time set in "OPR. 7 DEC/STOP time at OPR".

8.3 Fast OPR control

8.3.1 Outline of the fast OPR control operation

■ Fast OPR operation

In a fast OPR control, positioning control is carried out by a machine OPR control to the "[Md. 1] Current feed value" stored in the QD70.

By setting "9001" in "[Cd. 3] Start method" and turning ON the positioning start signal (Y8 to YF), fast OPR control performs position control at high speed without using the positioning data and near-point dog, zero and other signals.

The following is the operation performed at a fast OPR control start.

- 1) Set "9001" in "[Cd. 3] Start method" and turn ON the positioning start signal (Y8 to YF).
- 2) Position control is started to reach "[Md. 1] Current feed value" according to the OPR data ([OPR. 1] to [OPR. 9]) defined when machine OPR control was carried out.
- 3) Fast OPR control is completed.

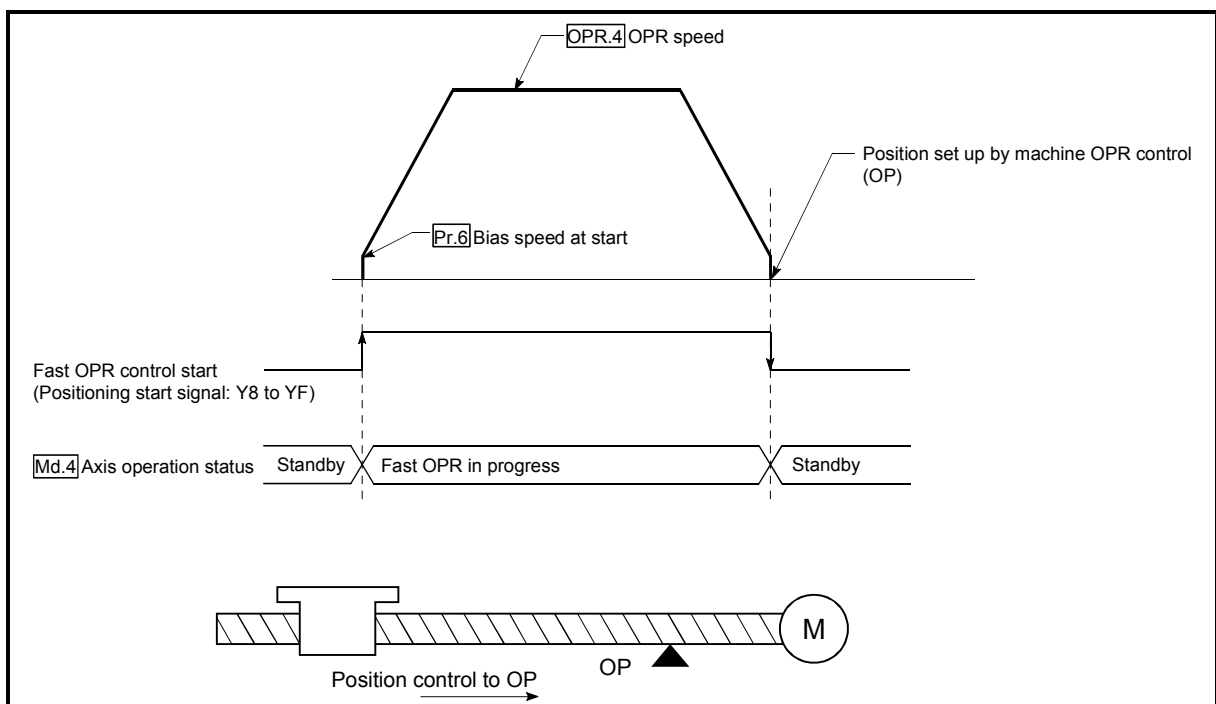

Fig. 8.12 Fast OPR control

■ Precautions for operation

- (1) Start fast OPR control after setting up the machine OP by exercising machine OPR control.
If fast OPR control is started without machine OPR control being exercised, the "Machine OPR not execute" error (error code: 203) will occur.
- (2) In fast OPR control, the "OPR compete flag" ([Md. 7] Status: b1) and "[Md. 2] Movement amount after near-point dog ON" are unchanged.
- (3) On completion of fast OPR control, "[OPR. 3] OP address" is not stored into "[Md. 1] Current feed value".

CHAPTER 9 POSITIONING CONTROL

This chapter details the positioning control (control functions using positioning data) of the QD70.

9.1 Outline of positioning controls

"Positioning control" uses the "positioning data" stored in the QD70.

Position control, speed-position switching control and current value changing are executed by setting the necessary items of these "positioning data".

As the control method of "positioning control", set the "Da. 2 Control method" setting item of the positioning data.

Any of the following controls can be defined as "positioning control" depending on the setting of "Da. 2 Control method".

Positioning control	Da. 2 Control method	Description
	Position control (1-axis linear control)	
Speed-position switching control	Speed.Position Ctrl. (Forward) Speed.Position Ctrl. (Reverse)	Speed control is first carried out, and the "speed-position switching signal" is then turned ON to perform position control (positioning control of the specified movement amount).
Current value changing	Current value changing	The current feed value (Md. 1) is changed to the address set to the positioning address.

9.1.1 Data required for positioning control

The following table shows an outline of the "positioning data" configuration and setting details required to carry out the "positioning controls".

Setting item		Setting details
Positioning data	Da. 1 Operation pattern	Set how consecutive positioning data (example: positioning data No. 1, No. 2, No. 3 ...) will be controlled. (Refer to Section 9.1.2.)
	Da. 2 Control method	Set the control method defined for "positioning control". (Refer to Section 9.1.)
	Da. 3 ACC/DEC time	Set the acceleration/deceleration time for positioning control.
	Da. 4 DEC/STOP time	Set the deceleration stop time for positioning control.
	Da. 5 Command speed	Set the speed for exercising control.
	Da. 6 Positioning address/movement amount	Set the target value or movement amount for position control, or the movement amount or new current value for position control of speed-position switching control. (Refer to Section 9.1.3.)
	Da. 7 Dwell time	Set the time taken from when the workpiece has stopped on completion of position control until the QD70 judges completion of position control.

* The setting details of Da. 1 to Da. 7 vary with "Da. 2 Control method" in whether setting is required or not and details. (Refer to "Section 9.2 Setting the positioning data".)

REMARK

- 10 pieces of the positioning data (positioning data No. 1 to 10) can be set per axis.

9.1.2 Operation patterns of positioning controls

"Positioning control" starts with positioning data No. 1 and allows you to set in "Da. 1 Operation pattern" whether the subsequent consecutive data will be executed continuously or not. There are the following three different "operation patterns" [1] to [3].

- Termination ——— [1] Positioning termination (operation pattern: 0)
- Continuation ——— [2] Continuous positioning control (operation pattern: 1)
- [3] Continuous path control (operation pattern: 2)

The following shows examples of operation patterns when "1-axis linear control (ABS)" is set in positioning data No. 1 to No. 6 of axis 1. Details of each operation pattern are shown on the following pages.

<Operation example when "1-axis linear control (ABS)" is set in the positioning data of axis 1>

(Setting details)

Positioning data No.1	Positioning control to address [A] at command speed [a]	Operation pattern = 2: Continuous path control	Start Control stop
No.2	Positioning control to address [B] at command speed [b]	Operation pattern = 2: Continuous path control	
No.3	Positioning control to address [C] at command speed [a]	Operation pattern = 1: Continuous positioning control	
No.4	Positioning control to address [D] at command speed [b]	Operation pattern = 1: Continuous positioning control	
No.5	Positioning control to address [E] at command speed [a]	Operation pattern = 0: Positioning termination	
No.6	Positioning control to address [F] at command speed [a]	Operation pattern = 2: Continuous path control	

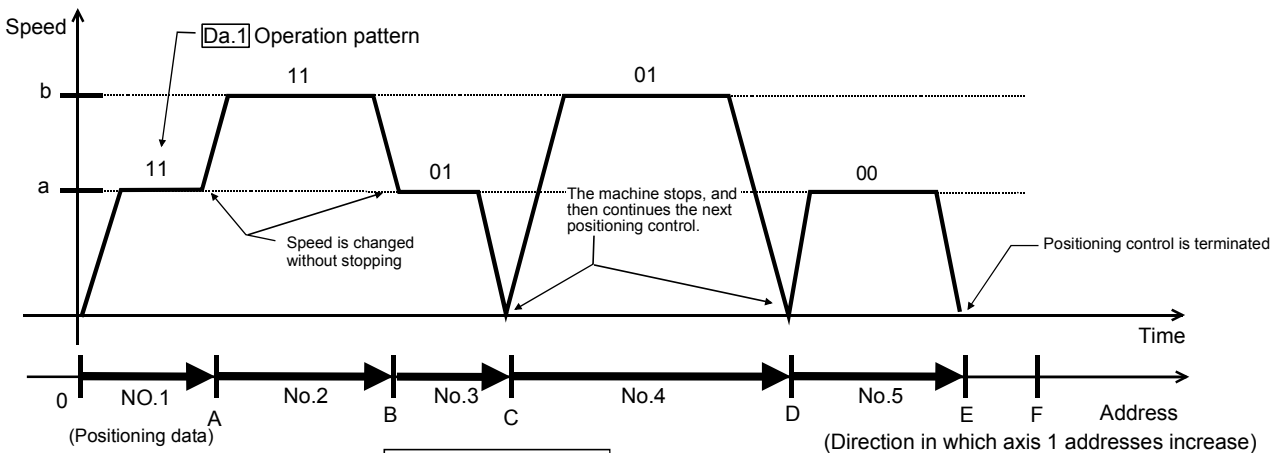

(One motor is driven, and positioning control is carried out to an addresses designated in one direction.)

POINT

- The positioning data of the QD70 is started from positioning data No. 1 by setting "0" in "Cd. 3 Start method".
(It cannot be started from any positioning data of No. 2 to No. 10.)
- The BUSY signal [X8 to XF] turns ON even when position control of movement amount 0 is executed. However, since the ON time is short, the ON status may not be detected in the sequence program.

[1] Positioning termination

Set this to carry out only the positioning control of the specified one piece of data. When the dwell time has been specified for position control, position control is completed after the specified time has elapsed.

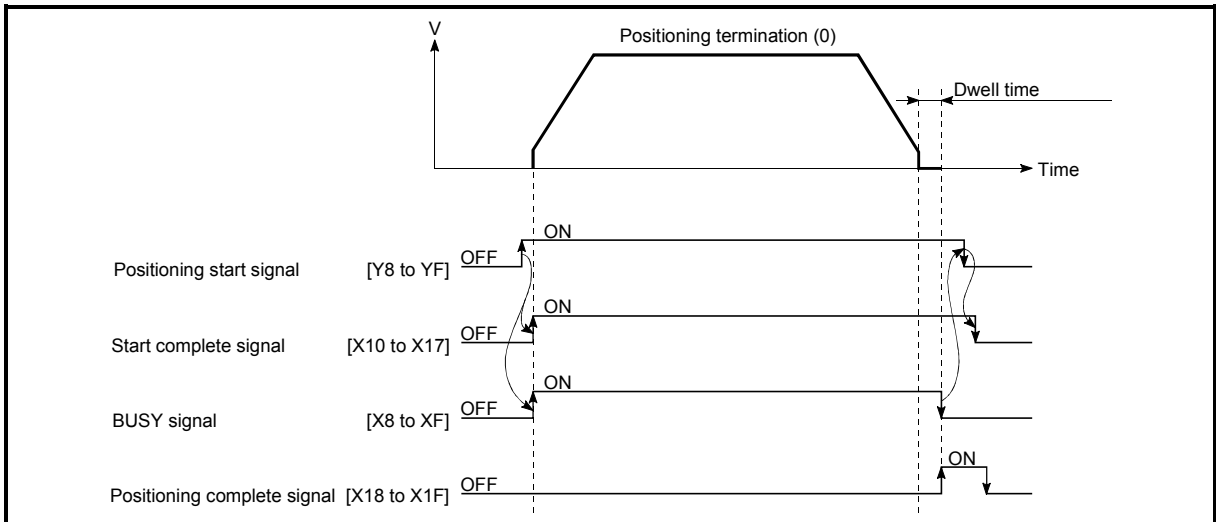

Fig. 9.1 Operation at positioning termination

[2] Continuous positioning control

- (1) The machine always automatically decelerates each time the positioning control is completed. Acceleration is then carried out after the QD70 command speed reaches 0 to carry out the next positioning data operation. When the dwell time has been specified for position control, acceleration is started after specified time has elapsed.
- (2) In operation by continuous positioning control (operation pattern "1"), the next positioning data No. is automatically executed. Always set operation pattern "0" in the last positioning data to terminate the positioning control. If the operation pattern is set to continue ("1" or "2"), the operation will continue until operation pattern "0" is found. If the operation pattern "0" cannot be found, the operation may be carried out until the positioning data No. 10. If the operation pattern of the positioning data No. 10 is not terminated, the operation will be started again from the positioning data No. 1.

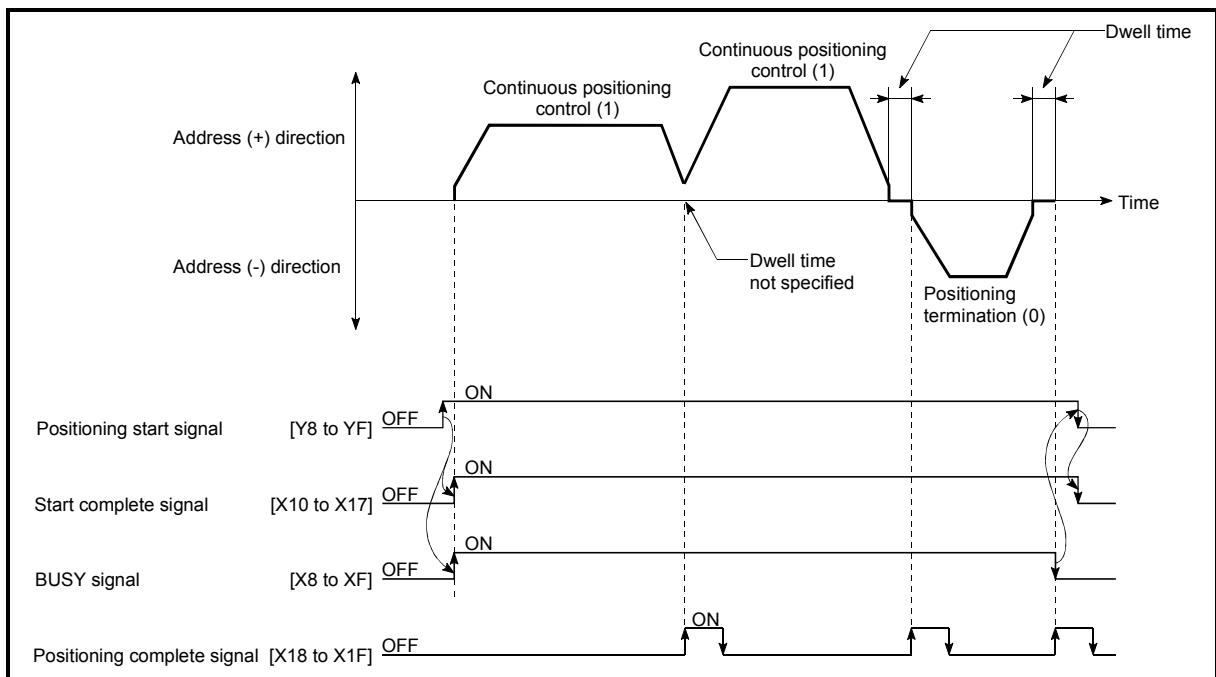

Fig. 9.2 Operation during continuous positioning control

POINT

The "Insufficient movement amount" warning (warning code: 41) occurs if the movement amount of the currently executed positioning data is too small to reserve the calculation processing time (approx. 2ms) of the next positioning data in the operation pattern of "1: Continuous positioning control".

The execution of the next positioning data is started on completion of the calculation. (The axis remains stopped until the calculation is completed. However, the BUSY signal does not turn OFF.)

In this case, the warning can be avoided by adding 2ms to the setting value of "Da. 7 Dwell time".

[3] Continuous path control

(1) Operation of continuous path control

- (a) A speed change is made between the command speeds of the "positioning data No. currently executed" and "positioning data No. to be executed next" without a deceleration stop.
A speed change is not made if the current speed is equal to the next speed.
- (b) Dwell time will be ignored, even if set.
- (c) In operation performed by continuous path control (operation pattern "2"), the positioning control of the next data No. is automatically exercised. Always set the operation pattern "0" in the last positioning data to terminate the positioning control.
If the operation pattern is continuation ("1" or "2"), operation will continue until the operation pattern "0" is found. If the operation pattern "0" is not found, operation is performed up to the positioning data No. 10. If the operation pattern of the positioning data No. 10 is not terminated, operation is started again from the positioning data No. 1.
- (d) A speed change at positioning data No. switching is made at the beginning of the next positioning control.

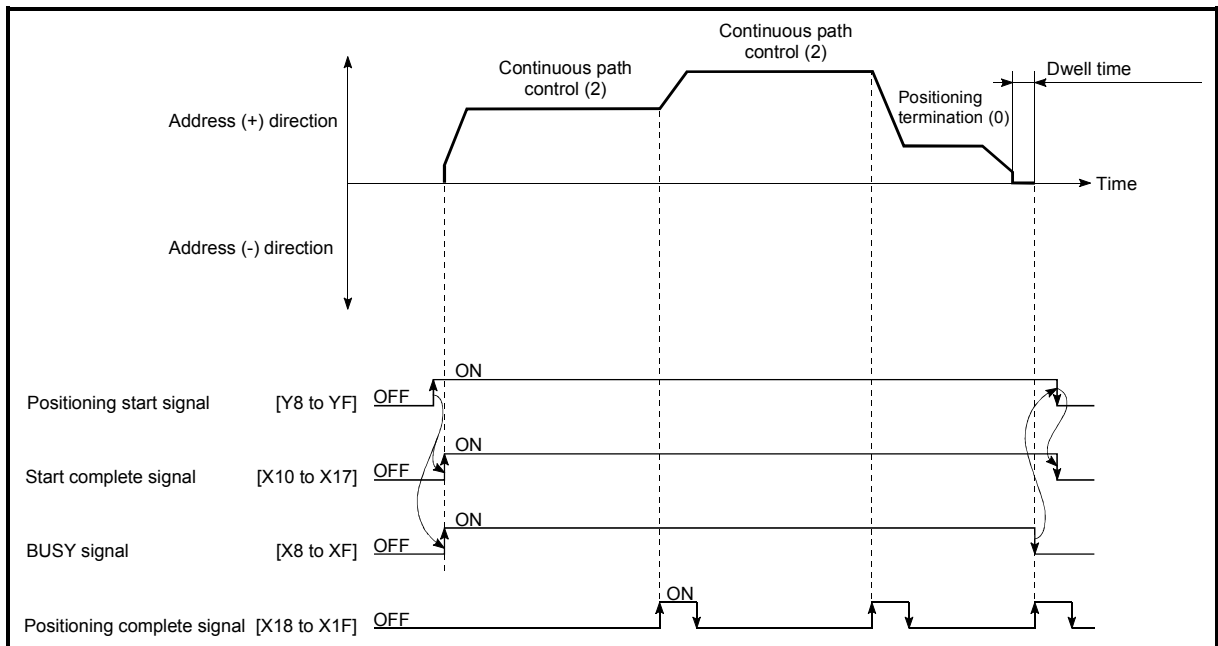
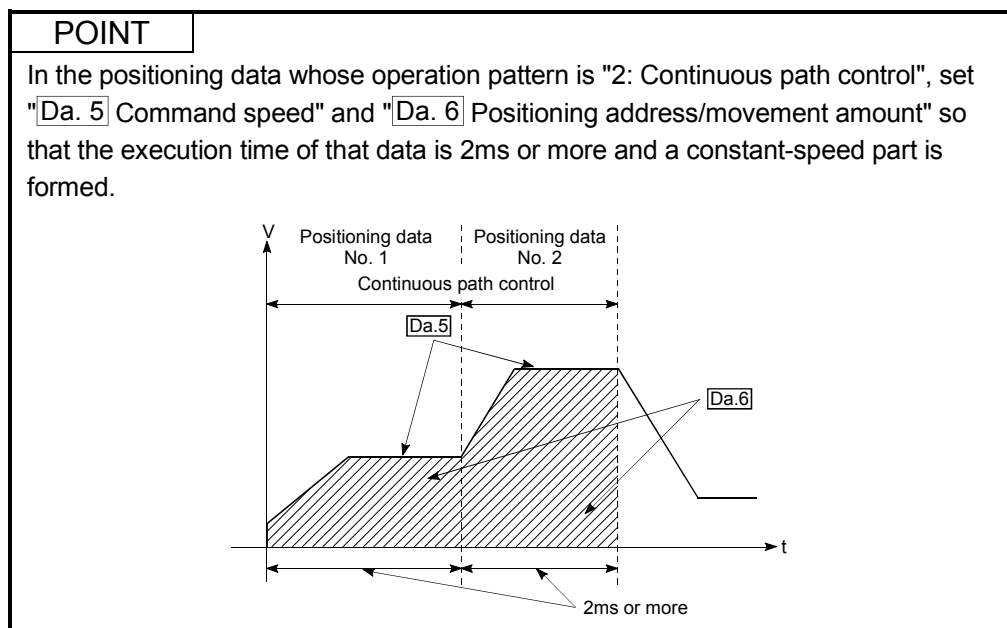

Fig. 9.3 Operation for continuous path control

(2) Errors

If any of the following errors occurs during operation in the operation pattern of "2: Continuous path control", the axis stops immediately on completion of executing the previous positioning data.

- (a) The moving direction in the currently executed positioning data differs from the moving direction in the next positioning data
"Illegal direction for continuous path control" error (error code: 510)
- (b) The movement amount to be executed in the next positioning data is small and a constant-speed status does not exist.
"Insufficient movement amount for continuous path control" error (error code: 511)
- (c) The movement amount in the currently executed positioning data is small and the calculation of the next positioning data cannot be performed until completion of positioning control.
"Not complete calculation for continuous path control" error (error code: 512)



(3) Speed changing

- (a) If the command speed of the "positioning data currently executed" differs from that of the "positioning data to be executed next", acceleration or deceleration is made on completion of the positioning control of the "positioning data currently executed" to switch to the speed set in the "positioning data to be executed next".
- (b) The acceleration/deceleration processing to the command speed set in the "positioning data to be executed next" uses "Da. 3 ACC/DEC time" set in the "positioning data to be executed next".
When the command speeds are the same, speed changing is not made.
(For details, refer to "Section 4.5 List of positioning data".)

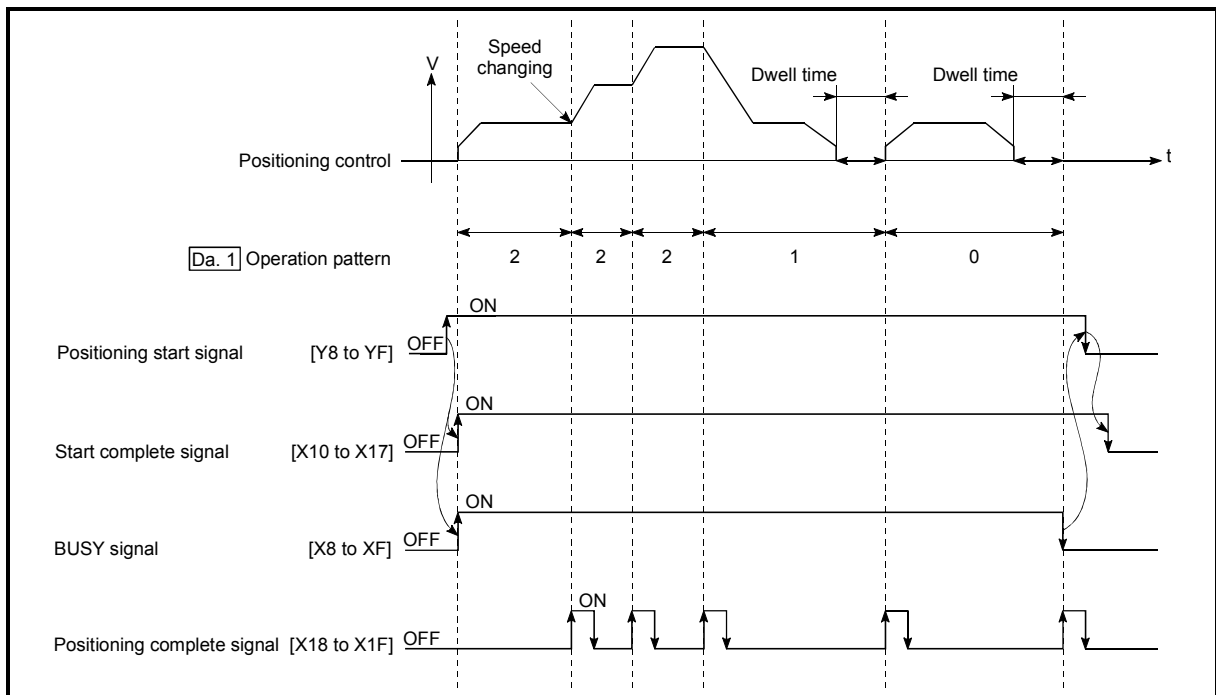

Fig. 9.4 Speed changing operation

(4) Stopping method for continuous path control

When the axis stop signal is input during operation in the operation pattern of "2: Continuous path control", select the stopping method in "Pr. 10 Stop mode during path control".

(For details, refer to "Section 4.2 List of parameters".)

■ Continuous operation of more than 10 pieces of positioning data

Since the number of positioning data that can be executed by the QD70 axis-by-axis is up to 10 pieces, perform continuous operation of more than 10 pieces of data in the following procedure.

1) Initial setting

Set "1: Continuous positioning control" or "2: Continuous path control" in "Da. 1 Operation pattern" of positioning data No. 1 to No. 10.

2) Positioning data rewrite during operation

During operation, read "Md. 9 Executing positioning data No." and rewrite the positioning data of the "read value - 1" No. (However, when "Md. 9 Executing positioning data No." is "1", rewrite the positioning data No. 10. (Refer to "Section 4.6 List of monitor data" for details of "Md. 9 Executing positioning data No.".)

POINT

When the time required to execute the positioning data No. 1 to No. 10 continuously is assume to be "a", a maximum of delay "a" will occur if "a" is small, until the new positioning data is made valid. Hence, set "Da. 5 Command speed" and "Da. 6 Positioning address/movement amount" so that the execution time of each positioning data is 2ms or more.

9.1.3 Designating the positioning address

The following shows the two methods for commanding the position in control using positioning data.

■ Absolute system

Positioning control is carried out to a designated position (absolute address) having the OP as a reference. This address is regarded as the positioning address. (The start point can be anywhere.)

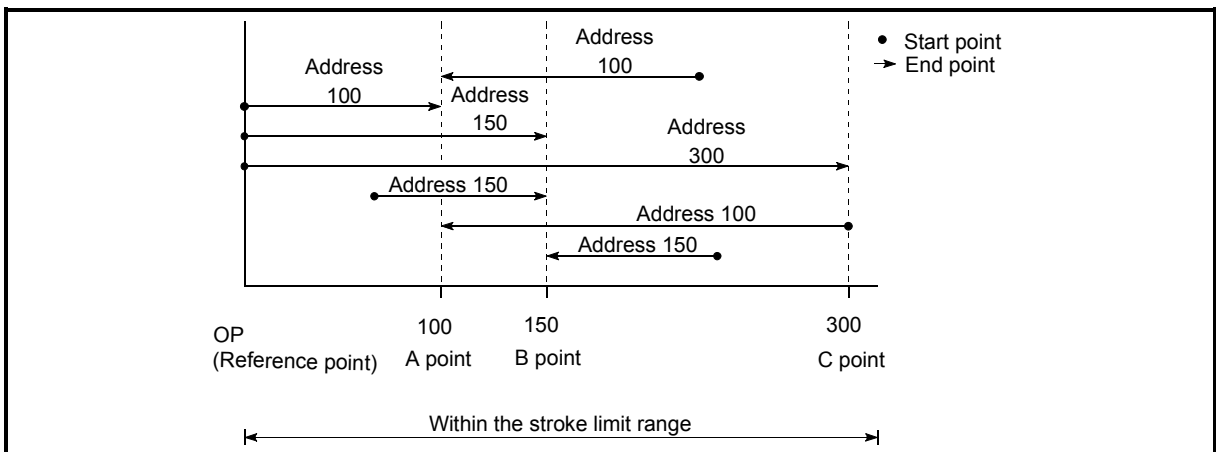

Fig. 9.5 Absolute system positioning control

■ Incremental system

The position where the machine is currently stopped is regarded as the start point, and positioning control is carried out for a designated movement amount in a designated movement direction.

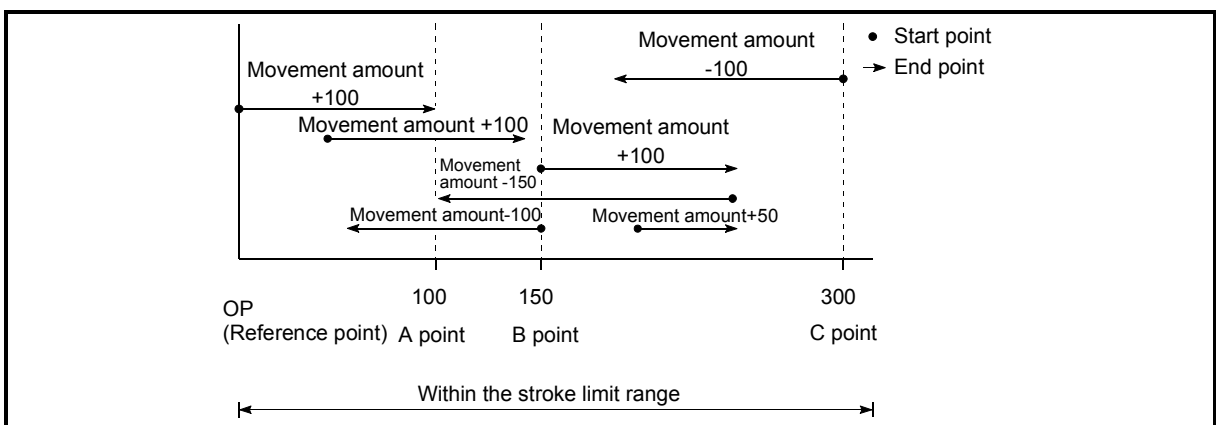

Fig. 9.6 Incremental system positioning control

9.1.4 Confirming the current value

■ Values showing the current value

The following address is used as value to show the position in the QD70.
 This address (current feed value) is stored in the monitor data area, is used in monitoring the current value display, etc.

Current feed value	<ul style="list-style-type: none"> • This is the value stored in "[Md. 1] Current feed value". • This value has an address established with a "machine OPR control" as a reference, but the address can be changed by changing the current value to a new value. • Update timing QD70P4: 1ms QD70P8: 2ms
--------------------	--

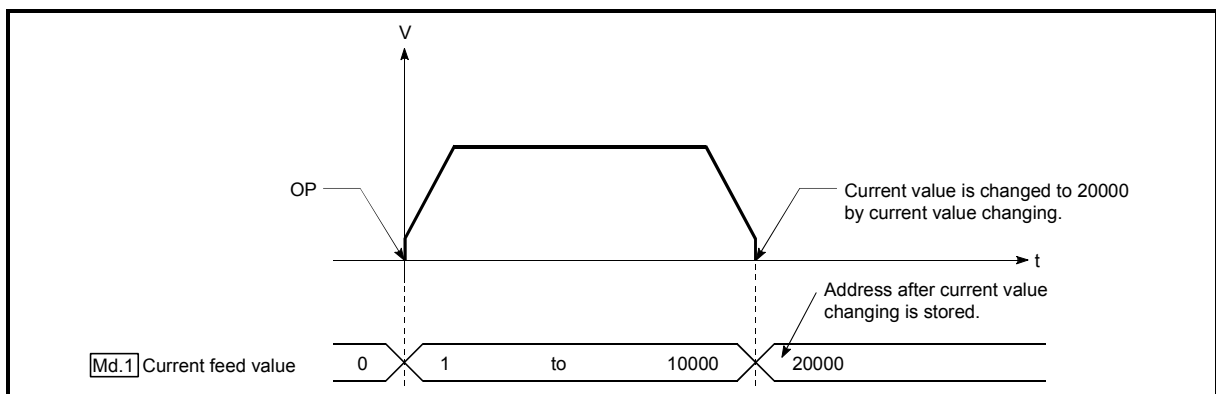

Fig. 9.7 Current feed value

■ Restrictions

- 1) If the "current feed value" stored is used for control, an error of 1ms (for the QD70P4) or 2ms (for the QD70P8) is produced at the update timing of the current value.
- 2) The "current feed value" is controlled by a signed numerical value. (Range: -2147483648 to 2147483647 pulse) Hence, continuation of counting up will cause an overflow and continuation of counting down will cause an underflow. Normal operation cannot be performed in an overflow or underflow status. If there is a possibility of an overflow or underflow, set the software stroke limit function valid. (Refer to "Section 11.4 Software stroke limit function" for details.)

■ Monitoring the current value

The "current feed value" is stored in the following buffer memory address, and can be read using a "DFRO (P) command" from the programmable controller CPU.

	Buffer memory addresses							
	Axis 1	Axis 2	Axis 3	Axis 4	Axis 5	Axis 6	Axis 7	Axis 8
[Md. 1] Current feed value	70	170	270	370	470	570	670	770
	71	171	271	371	471	571	671	771

Example

* Program in which the axis 1 current feed value is read to D104 and D105

*

```

0 | X40 |-----| DFRO H0 K70 D104 K1 | <Read current feed value to D104 and D105>
    
```

9.2 Setting the positioning data

9.2.1 Relation between each control and positioning data

The setting requirements and details for the setting items of the positioning data to be set differ according to the "Da. 2 Control method".

The following are the setting items of the positioning data for each control. Refer to Section 9.2.2 and later for operation details and setting of each control.

Positioning control		Position control	Speed-position switching control	Current value changing
Positioning data setting item				
Da. 1	Operation pattern	Positioning termination	◎	◎
		Continuous positioning control	◎	◎
		Continuous path control	◎	×
Da. 2	Control method	1-axis linear control (ABS) 1-axis linear control (INC)	Speed.Position Ctrl. (Forward) Speed.Position Ctrl. (Reverse)	Current value changing
Da. 3	ACC/DEC time	◎	◎	—
Da. 4	DEC/STOP time	◎	◎	—
Da. 5	Command speed	◎	◎	—
Da. 6	Positioning address/movement amount	◎	◎	Change destination address
Da. 7	Dwell time	○	○	○

◎ : Always set ○: Set as required ("—" when not set)

× : Setting not possible (If setting is made, an error (error code 502: New current value change not possible, error code 503: Continuous path control not possible) will occur at a start.)

— : Setting not required (Setting value is invalid. Use the initial values or setting values within a range where no error occurs.)

9.2.2 1-axis linear control

In "1-axis linear control" ("Da. 2 Control method" = 1-axis linear control (ABS), 1-axis linear control (INC), one motor is used to carry out position control in a set axis direction.

[1] 1-axis linear control (ABS linear 1)

■ Operation chart

In absolute system 1-axis linear control, addresses established by a machine OPR control are used. Position control is carried out from the current stop position (start point address) to the address (end point address) set in "Da. 6 Positioning address/movement amount".

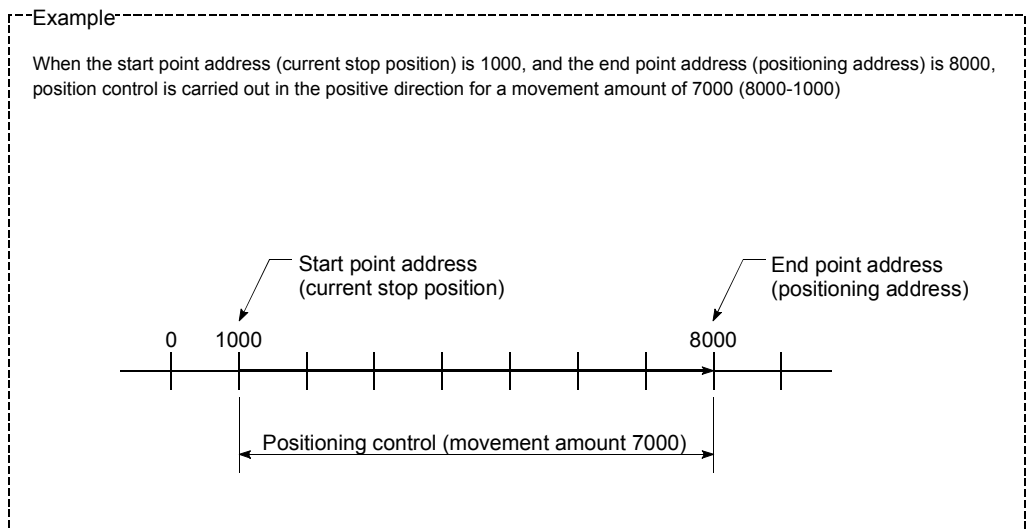

■ Positioning data setting example

The following table shows setting examples when "1-axis linear control (ABS)" is set in positioning data No. 1 of axis 1.

	Setting item	Setting example	Setting details
Axis 1 positioning data No. 1	Da. 1 Operation pattern	Positioning termination	Set "Positioning termination" assuming the next positioning data will not be executed.
	Da. 2 Control method	1-axis linear control (ABS)	Set absolute system 1-axis linear control.
	Da. 3 ACC/DEC time	1000ms	Set the acceleration/deceleration time for position control.
	Da. 4 DEC/STOP time	1000ms	Set the deceleration stop time for position control.
	Da. 5 Command speed	50000pulse/s	Set the speed during movement to the positioning address.
	Da. 6 Positioning address/movement amount	8000pulse	Set the positioning address.
	Da. 7 Dwell time	500ms	Set the time the machine dwells after the position control stop (pulse output stop) to the output of the positioning complete signal.

* Refer to "Section 4.5 List of positioning data" for the setting details.

[2] 1-axis linear control (INC)

■ Operation chart

In incremental system 1-axis linear control, addresses established by a machine OPR control are used. Position control is carried out from the current stop position (start point address) to a position at the end of the movement amount set in "Da. 6 Positioning address/movement amount". The movement direction is determined by the sign of the movement amount.

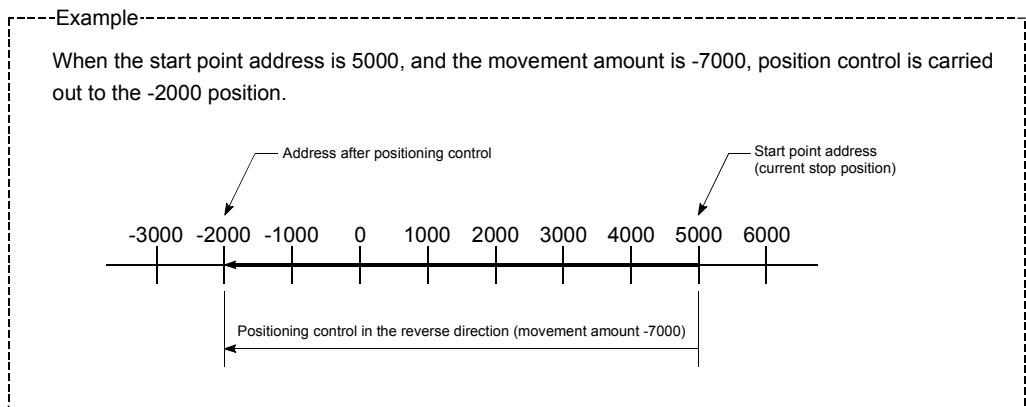
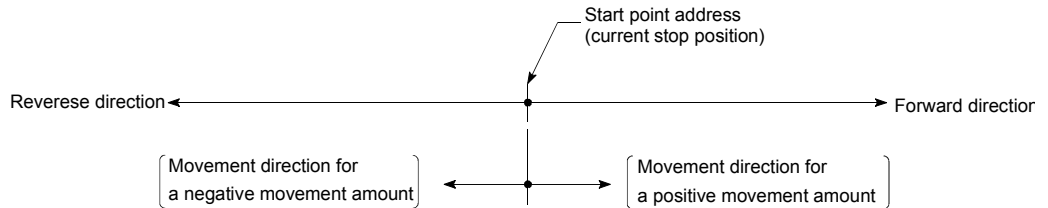

■ Positioning data setting example

The following table shows setting examples when "1-axis linear control (INC)" is set in positioning data No. 1 of axis 1.

		Setting item	Setting example	Setting details
Axis 1 positioning data No. 1	Da. 1	Operation pattern	Positioning termination	Set "Positioning termination" assuming the next positioning data will not be executed.
	Da. 2	Control method	1-axis linear control (INC)	Set incremental system 1-axis linear control.
	Da. 3	ACC/DEC time	1000ms	Set the acceleration/deceleration time for position control.
	Da. 4	DEC/STOP time	1000ms	Set the deceleration stop time for position control.
	Da. 5	Command speed	50000pulse/s	Set the speed during movement.
	Da. 6	Positioning address/movement amount	-7000pulse	Set the movement amount.
	Da. 7	Dwell time	500ms	Set the time the machine dwells after the position control stop (pulse output stop) to the output of the positioning complete signal.

* Refer to "Section 4.5 List of positioning data" for the setting details.

9.2.3 Speed-position switching control

In "speed-position switching control" ("Da. 2 Control method" = Speed. Position Ctrl. (Forward), Speed. Position Ctrl. (Reverse)), the pulses of the speed set in "Da. 5 Command speed" are kept output on the axial direction set to the positioning data. When the "speed-position switching signal" is input, position control of the movement amount set in "Da. 6 Positioning address/movement amount" is exercised.

"Speed-position switching control" is available in two different types: "Speed. Position Ctrl. (Forward)" which starts the axis in the forward direction and "Speed. Position Ctrl. (Reverse)" which starts the axis in the reverse direction.

■ Switching over from speed control to position control

- (1) The control is switched over from speed control to position control by the external signal "speed-position switching signal (CHG)".
- (2) To switch from speed control to position control, "Cd. 5 Speed-position switching request" must be turned ON in addition to the setting of the positioning data. If "Cd. 5 Speed-position switching request" and the speed-position switching signal are ON at a start, only position control is carried out.

■ Operation chart

The following chart shows the operation timing for speed-position switching control.

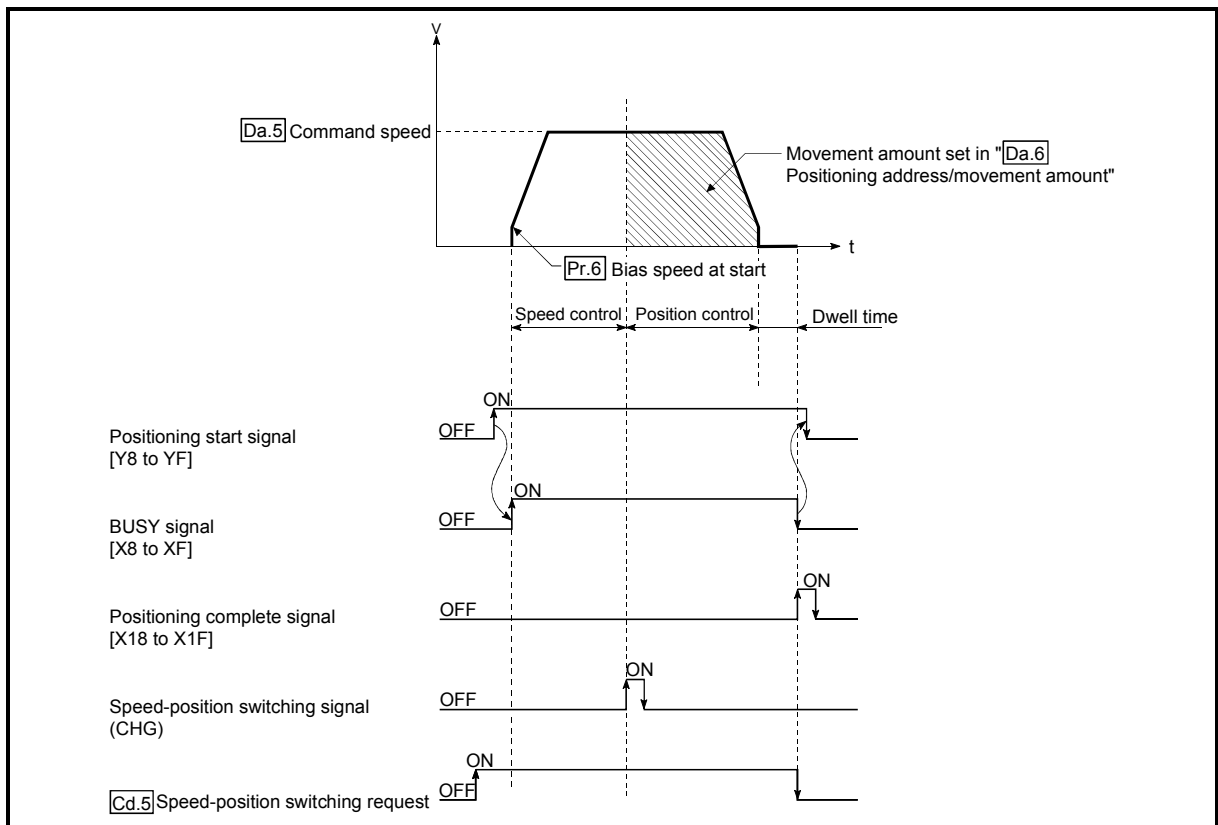
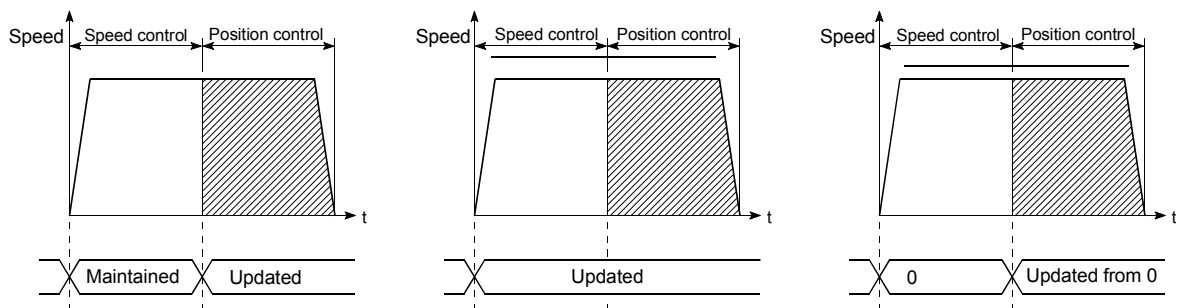

Fig. 9.8 Speed-position switching control operation timing

■ Current feed value during speed-position switching control (INC mode)

The following table shows the "Md. 1 Current feed value" during speed-position switching control corresponding to the "Pr. 4 Current feed value during speed control" settings.

"Pr. 4 Current feed value during speed control" setting	Md. 1 Current feed value
0: No update	The current feed value at control start is maintained during speed control, and updated from the switching to position control.
1: Update	The current feed value is updated during speed control and position control.
2: Clear to 0 and no update	The current feed value is cleared (set to "0") at control start, and updated from the switching to position control.



(a) Current feed value not updated

(b) Current feed value updated

(c) Current feed value zero cleared

■ Speed-position switching signal setting

Set the following item to use the speed-position switching signal "CHG".

Setting item	Setting value	Setting details	Buffer memory address							
			Axis 1	Axis 2	Axis 3	Axis 4	Axis 5	Axis 6	Axis 7	Axis 8
Cd. 5 Speed-position switching request	1	Set "1": Validates (enables) the speed-position switching signal".	54	154	254	354	454	554	654	754

* Refer to "Section 4.7 List of control data" for more information on the setting details.

■ Restrictions

- (1) If "Continuous path control" is set in "[Da. 1] Operation pattern", the "Continuous path control not possible" error (error code: 503) occurs, disabling a start.
- (2) "Speed-position switching control" cannot be set in "[Da. 2] Control method" of the positioning data if "Continuous path control" is set in "[Da. 1] Operation pattern" of its preceding positioning data. (For example, if the operation pattern of positioning data No. 1 is "Continuous path control", "Speed-position switching control" cannot be set in positioning data No. 2.) If such setting has been made, the "Continuous path control not possible" error (error code: 503) occurs, resulting in a deceleration stop.
- (3) Under speed control of speed-position switching control, the software stroke limit range is checked only when "1: Update" has been set in "[Pr. 4] Current feed value during speed control".
If the movement amount has exceeded the software stroke limit range during speed control at the setting of other than "1: Update", the "Software stroke limit +, -" error (error code: 103 or 104) occurs, resulting in a deceleration stop.
- (4) If the setting value of "[Da. 6] Positioning address/movement amount" is negative, the "Setting range outside" (error code: 513) occurs.
- (5) If the movement amount of position control set in "[Da. 6] Positioning address/movement amount" is less than the deceleration distance from "[Da. 5] Command speed", deceleration processing is started at the input of the speed-position switching signal.
- (6) To suppress the variation of the stopping position after switching to position control, turn ON the speed-position switching signal in the stable speed region (constant-speed status).
- (7) If "0" has been set in "[Pr. 6] Bias speed at start", starting operation at the setting of "0" in "[Da. 5] Command speed" for speed control of speed-position switching control will result in the following.
 - 0 speed ([Md. 7] Status: b2) turns ON.
 - Though the axis is at a stop, "[Md. 4] Axis operation status" is "Speed.Position Speed" and the BUSY signal remains ON. (Turning ON the axis stop signal turns OFF the BUSY signal and changes "[Md. 4] Axis operation status" to "Stopped".)

* In this case, setting other than "0" in "[Cd. 7] New speed value" and "1" in "[Cd. 6] Speed change request" turns OFF 0 speed ([Md. 7] Status: b2), enabling operation to be continued.

■ Positioning data setting examples

The following table shows setting examples when "speed-position switching control by forward run" is set in positioning data No. 1 of axis 1.

Setting item		Setting example	Setting details
Axis 1 positioning data No. 1	[Da. 1] Operation pattern	Positioning termination	Set "Positioning termination" assuming the next positioning data will not be executed. ("Continuous path control" cannot be set in "speed-position switching control".)
	[Da. 2] Control method	Speed.Position Ctrl. (Forward)	Set speed-position switching control by forward run.
	[Da. 3] ACC/DEC time	1000ms	Set the acceleration/deceleration time for speed-position switching control.
	[Da. 4] DEC/STOP time	1000ms	Set the deceleration stop time for speed-position switching control.
	[Da. 5] Command speed	50000pulse/s	Set the speed to be controlled.
	[Da. 6] Positioning address/movement amount	10000pulse	Set the movement amount after the switching to position control.
	[Da. 7] Dwell time	500ms	Set the time from when a stop (pulse output stop) is made under position control until the positioning complete signal is output. (The setting value is ignored if a stop is made under speed control.)

* Refer to "Section 4.5 List of positioning data" for the setting details.

9.2.4 Current value changing

Current value changing performs control to change "Md. 1 Current feed value" to any address.

■ Operation chart

The following chart shows the operation timing for a current value changing. The "Md. 1 Current feed value" is changed to the value set in "Da. 6 Positioning address/movement amount" when the positioning start signal turns ON.

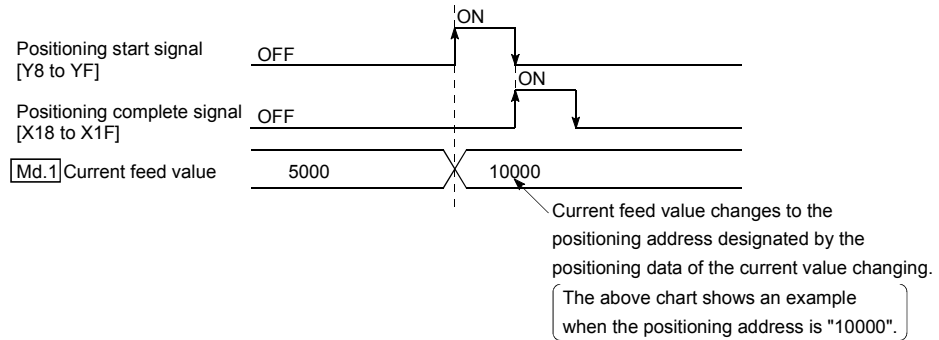

■ Restrictions

- (1) If "Continuous path control" is set in "Da. 1 Operation pattern", the "New current change not possible" error (error code: 502) occurs. ("Continuous path control" cannot be set for current value changing.)
- (2) "Current value changing" cannot be set in "Da. 2 Control method" of the positioning data when "continuous path control" has been set in "Da. 1 Operation pattern" of the immediately prior positioning data. (For example, if the operation pattern of positioning data No. 1 is "continuous path control", "current value changing" cannot be set in positioning data No. 2.)
 If such setting has been made, the "New current change not possible" error (error code: 502) occurs, resulting in a deceleration stop.
- (3) If the value set in "Da. 6 Positioning address/movement amount" (New current value) is outside the setting range of the software stroke limit upper and lower limit values (Pr. 1, Pr. 2), the "Software stroke limit +, -" error (error code: 103, 104) occurs and current value changing cannot be made.

■ Positioning data setting examples

The following table shows the setting examples when "current value changing" is set in the positioning data No. 1 of axis 1.

Setting item		Setting example	Setting details
Axis 1 positioning data No. 1	Da. 1	Operation pattern	Positioning termination Set "Positioning termination" assuming that the next positioning data will be executed. ("Continuous path control" cannot be set by current value change.)
	Da. 2	Control method	Current value changing Set the current value changing.
	Da. 3	ACC/DEC time	– Setting not required (Setting value is ignored.)
	Da. 4	DEC/STOP time	– Setting not required (Setting value is ignored.)
	Da. 5	Command speed	– Setting not required (Setting value is ignored.)
	Da. 6	Positioning address/movement amount	10000pulse Set the address to which address change is desired.
	Da. 7	Dwell time	500ms Set the time from completion of current value changing until the positioning complete signal is output.

* Refer to "Section 4.5 List of positioning data" for the setting details.

9.3 Multiple axes simultaneous start control

The QD70 allows the axes to be started simultaneously on a pulse level by turning ON the positioning start signals (Y8 to YF) within the same scan during positioning control.

■ Precautions

- (1) The speed limit function is valid on an axis basis.
- (2) To perform stop processing, the stop command (axis stop signal ON) must be given to the corresponding axis. Note that the axes do not stop simultaneously.
- (3) JOG operation cannot start the axes simultaneously.
- (4) If an error occurs in any axis, note that it will be processed on the corresponding axis.

CHAPTER 10 JOG OPERATION

This chapter details the JOG operation of the QD70.

10.1 Outline of JOG operation

Important

When performing JOG operation near the moving range, provide a safety circuit externally.

* If an external safety circuit is not provided, the workpiece may exceed the moving range, causing accidents.

"JOG operation" is a control method to move a workpiece by only desired movement amount, without using the positioning data (the pulse is kept output while the JOG start signal is ON). It is used to move the workpiece to within the software stroke limit range if operation has been stopped by the positioning control system connection confirmation or by the software stroke limit function.

■ JOG operation

In JOG operation, turning ON the JOG start signal [Y18 to Y1F] outputs pulses from the QD70 to the drive unit while it is ON to move the workpiece in the direction set in "[JOG. 4] JOG direction flag".

The following is an example of JOG operation.

1)	Turning ON the JOG start signal starts acceleration in the direction set in "[JOG. 4] JOG direction flag" at the acceleration time set in "[JOG. 2] JOG ACC time". At this time, the BUSY signal turns from OFF to ON.
2)	When the accelerating workpiece reaches the speed set in "[JOG. 1] JOG speed", the workpiece continues moving at this speed. (The workpiece moves at constant speed at 2) to 3.)
3)	Turning OFF the JOG start signal starts deceleration from the speed set in "[JOG. 1] JOG speed" at the deceleration time set in "[JOG. 3] JOG DEC time".
4)	When the speed falls to 0, the workpiece stops. At this time, the BUSY signal turns from ON to OFF.

10

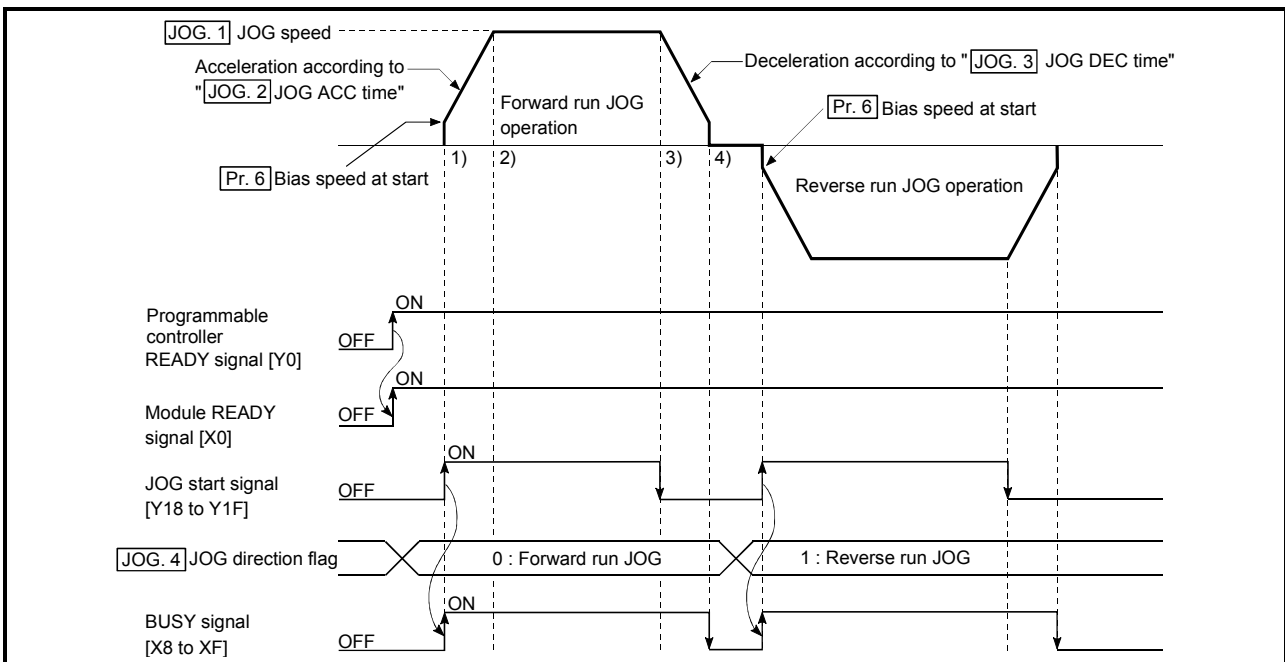

Fig. 10.1 JOG operation starting timing chart

■ JOG operation monitor

When using GX Developer to directly monitor the buffer memory, refer to "Section 4.6 List of monitor data".

When using the monitor function of GX Configurator-PT to monitor, refer to "Section 6.6 Monitor/test".

■ Precautions during operation

Before starting JOG operation, you must know the following information.

- (1) Set the JOG data before starting JOG.
(Setting cannot be changed during JOG operation.)
- (2) Setting a great value to "[JOG. 1] JOG speed" from the beginning is dangerous. For safety, set a small value at first and check the movement. After that, gradually increase the value and adjust the speed optimal for control.
- (3) If "[JOG. 1] JOG speed" is higher than the speed set in "[Pr. 5] Speed limit value", operation is performed at "[Pr. 5] Speed limit value" and the "Outside speed" warning (warning code: 20) occurs.
- (4) If "[JOG. 1] JOG speed" is lower than "[Pr. 6] Bias speed at start", operation starts at "[Pr. 6] Bias speed at start" and the "Outside speed" warning (warning code: 20) occurs.

If "[Pr. 6] Bias speed at start" is "0", starting JOG operation with the setting of "0" in "[JOG. 1] JOG speed" results in the following.

- 0 speed ([Md. 7] Status: b2) turns ON.
- The BUSY signal turns ON. (When the JOG start signal turns OFF, the BUSY signal turns OFF and "[Md. 4] Axis operation status" changes to "Standby".)
- * In this case, making a speed change with the setting of other than "0" in "[Cd. 7] New speed value" and "1" in "[Cd. 6] Speed change request" turns OFF 0 speed ([Md. 7] Status: b2), enabling operation to be continued.

- (5) If a warning occurs, JOG operation is continued.

■ Error during operation

If operation is stopped by the software stroke limit function, JOG operation can be performed to move the workpiece to within the software stroke limit range after an axis error reset. (Refer to "Section 11.4" for details.)

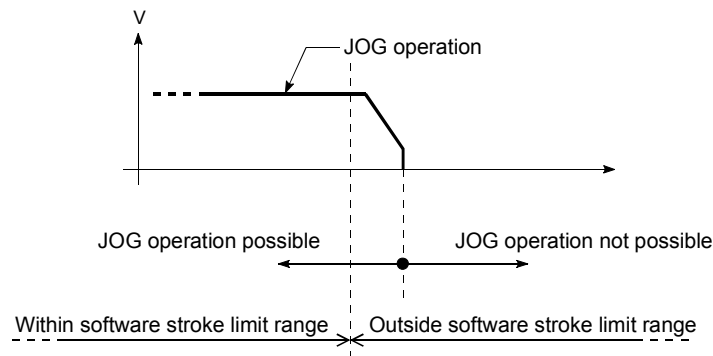

10.2 JOG operation execution procedure

The JOG operation is carried out by the following procedure.

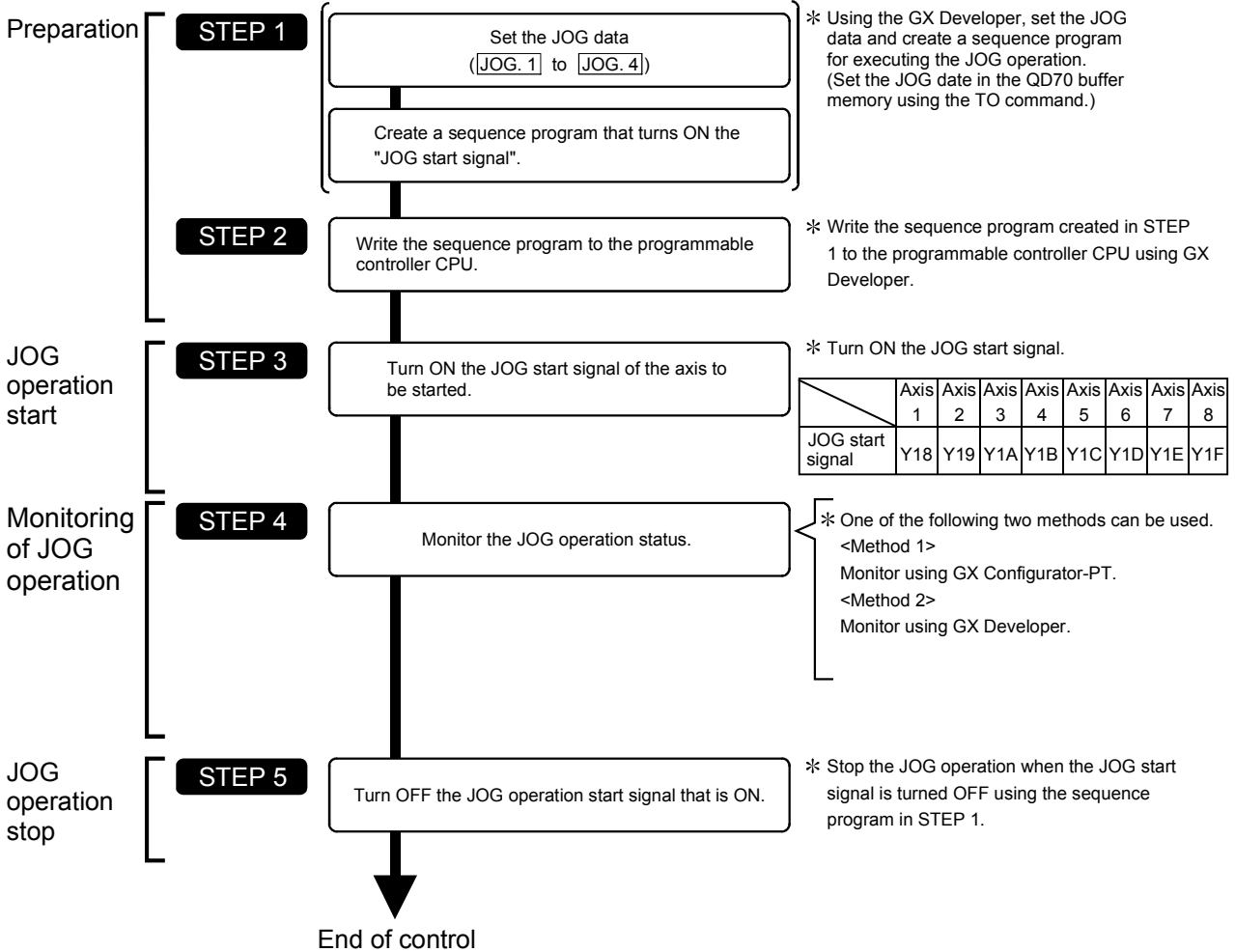

Refer to "Section 5.7 Simple reciprocating operation" for details of a JOG operation starting program.

REMARK

- It is assumed that an external safety circuit and other mechanical elements have already installed.
- Preset the external I/O signal logic, pulse output mode and pulse rotation direction with the intelligent function module switches. (For details, refer to "Section 5.6 Switch setting for intelligent function module".)
- Make parameter setting as necessary.

10.3 JOG operation example

(1) When "axis operation signal" is turned ON during JOG operation

When the "axis operation signal" is turned ON during JOG operation, JOG operation results in a "deceleration stop". Turning ON the JOG start signal when the axis stop signal is ON results in the "Stop signal ON at start" error (error code: 102) and does not start JOG.

It can be started by resetting the axis error, then turning OFF the axis stop signal, and turning the JOG start signal from OFF to ON again.

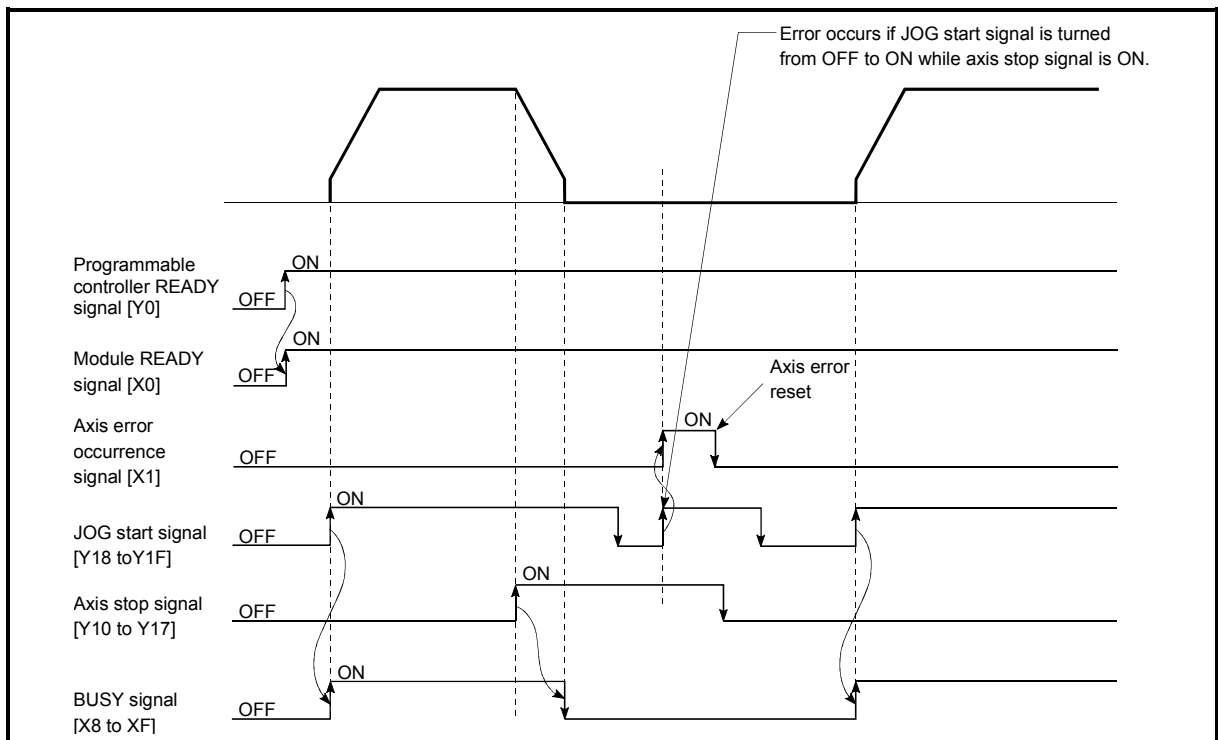

Fig. 10.2 Operation when the axis stop signal is turned ON during JOG operation

(2) When JOG direction flag is changed to reverse run JOG command during forward run JOG operation

When "JOG. 4 JOG direction flag" is changed to the reverse run JOG command during forward run JOG operation, forward run JOG operation is continued. In this case, the reverse run JOG command is made valid when the JOG start signal turns ON after the BUSY signal of the QD70 turned OFF. However, when forward run JOG operation is stopped by the axis stop signal or stopped due to an axis error, reverse run JOG operation is not performed if "JOG. 4 JOG direction flag" is changed to the reverse run JOG command.

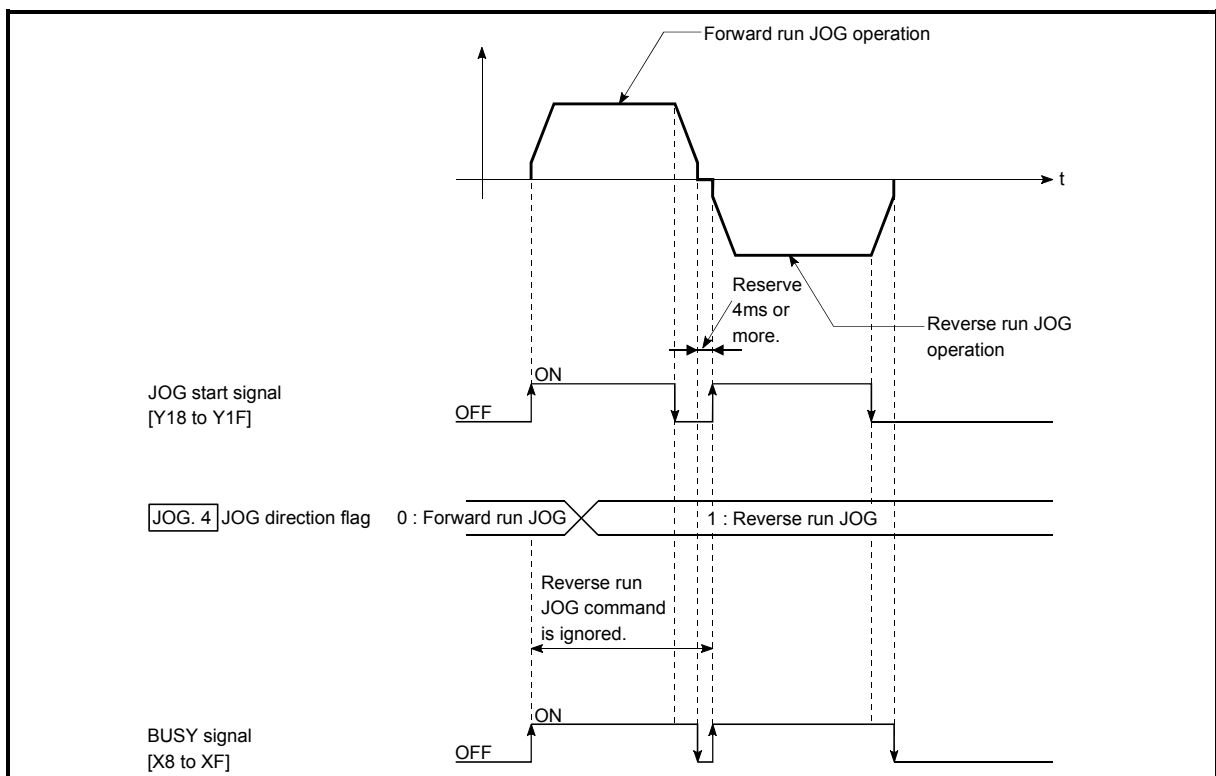

Fig. 10.3 Operation performed when JOG direction flag is changed to reverse run JOG command during forward run JOG operation

REMARK

- When switching between forward run and reverse run, turn the JOG start signal from OFF to ON when the BUSY signal is OFF.
- When switching between forward run and reverse run, reserve at least 4ms as the time to turn the JOG start signal from OFF to ON. (Refer to Fig. 10.3.)

- (3) When the "JOG start signal" is turned ON again during deceleration caused by the ON → OFF of the "JOG start signal"

The JOG start signal is ignored when the "JOG start signal" is turned ON again during deceleration that was started by turning the "JOG start signal" from ON to OFF.

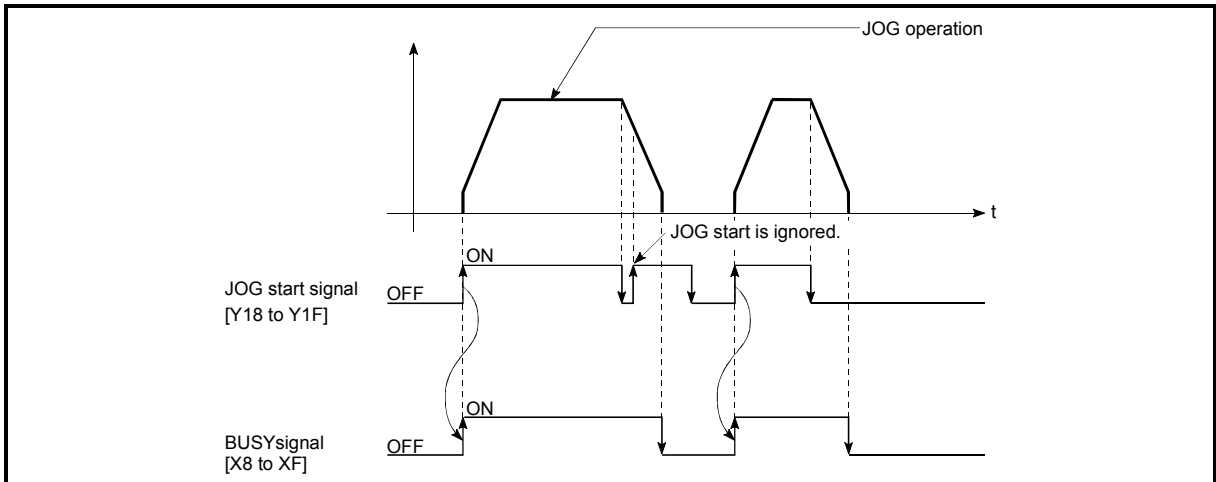

Fig. 10.4 Operation when the JOG start signal is turned ON during deceleration

- (4) When "axis stop signal" is turned OFF after a stop made by turning ON "axis stop signal" with "JOG start signal" ON

JOG operation is not performed when the "axis stop signal" is turned OFF again after a stop that was made by turning ON the "axis stop signal" with the "JOG start signal" ON.

JOG operation can be started by turning the "JOG start signal" from OFF to ON again.

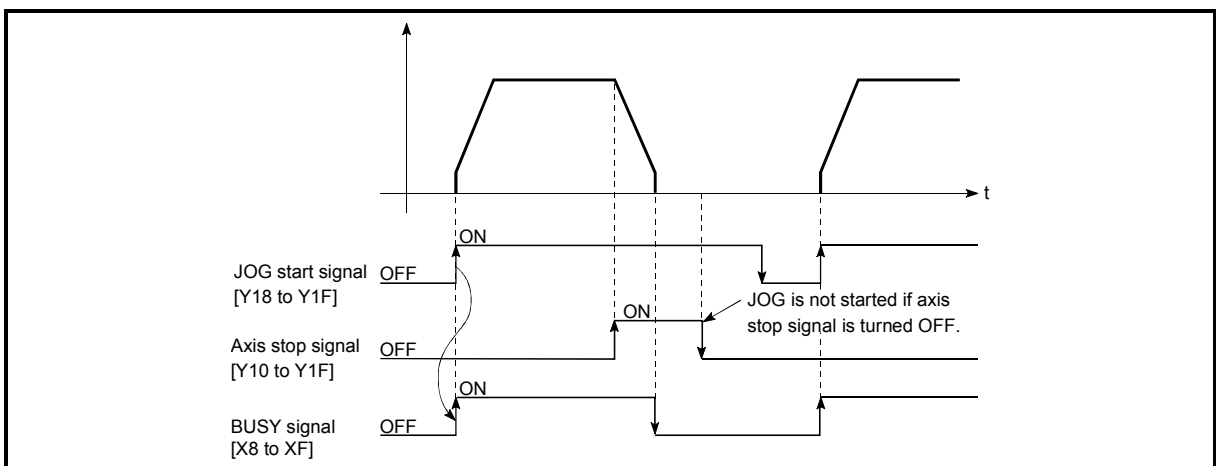

Fig. 10.5 Operation performed when axis stop signal is turned from ON to OFF with JOG start signal ON

CHAPTER 11 SUB FUNCTIONS

This chapter details the sub functions of the QD70.

11.1 Outline of sub functions

The "sub functions" are used to limit control and add functions, for example, for execution of OPR control, positioning control and JOG operation. These sub functions are executed by parameter setting, sequence programs, etc.

There are the following "sub functions".

Sub functions	Details
Speed limit function	If the command speed exceeds "[Pr. 5] Speed limit value" during control, this function limits the commanded speed to within the "[Pr. 5] Speed limit value" setting range.
Speed change function	This function changes speed at any point during speed control of speed-position switching control or during JOG operation. Set the changed speed in the speed change buffer memory ([Cd. 7] New speed value), and change the speed with the speed change request ([Cd. 6] Speed change request).
Software stroke limit function	If a command outside of the upper/lower limit stroke limit setting range, set in the parameters, is issued, this function will not execute positioning control for that command.
Acceleration/deceleration process function	This function adjusts the acceleration/deceleration processing of control.
Restart function	This function resumes positioning control from where it had stopped while the axis is at a stop.

11.2 Speed limit function

The speed limit function limits the command speed to a value within the "speed limit value" setting range when the command speed during control exceeds the "speed limit value".

The details shown below explain about the "speed limit function".

- [1] Relation between the speed limit function and various controls
- [2] Setting the speed limit function

[1] Relation between the speed limit function and various controls

The following table shows the relation of the "speed limit function" and various controls.

Control type		Speed limit function	Speed limit value	Operation when speed limit value is exceeded
OPR control	Machine OPR control	◎	[Pr. 5] Speed limit value	Does not operate. "Out of OPR speed setting range (error code: 913)" error or "Out of creep speed setting range (error code: 914)" error occurs.
	Fast OPR control	◎		
Positioning control	Position control (1-axis linear control)	◎	[Pr. 5] Speed limit value	"Out of speed range" warning (warning code: 20) occurs, and the axis is controlled by the speed limit value.
	Speed-position switching control	◎		
	Current value changing	—	Setting value invalid	—
JOG operation		◎	[Pr. 5] Speed limit value	"Out of speed range" warning (warning code: 20) occurs, and the axis is controlled by the speed limit value.

◎ : Always set

— : Setting not required (Setting value is invalid. Use the initial values or setting values within a range where no error occurs.)

[2] Setting the speed limit function

To use the "speed limit function", set the "speed limit value" in the parameters shown in the following table, and write it to the QD70.

(The "speed limit value" depends on the motor used. Set it according to the motor used.)

The setting is made valid when the Programmable controller READY signal [Y0] turns from OFF to ON.

Setting item	Setting value	Setting details	Factory-set initial value
[Pr. 5] Speed limit value	→	Set the speed limit value (max. speed during control).	10000 (pulse/s)

* Refer to section "4.2 List of parameters" for setting details.

11.3 Speed change function

The "speed change function" is designed to change the speed within the "[Pr. 5] Speed limit value" range at any point during speed control of speed-position switching control or during JOG operation.

Set a new speed in "[Cd. 7] New speed value" and make a speed change using "[Cd. 6] Speed change request".

The acceleration and deceleration times after a speed change are the values set in "[Cd. 8] ACC/DEC time at speed change" and "[Cd. 9] DEC/STOP time at speed change".

The details shown below explain about the "speed change function".

- [1] Control details
- [2] Precautions during control

[1] Control details

The following is the operation performed during a speed change for JOG operation.

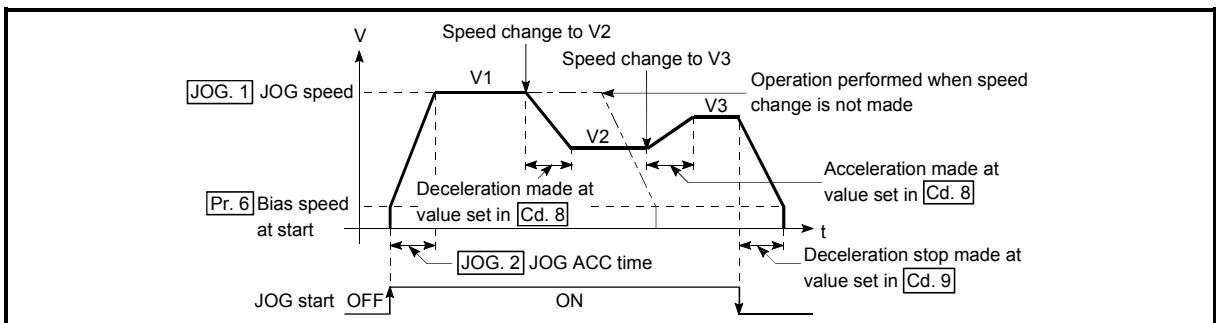

Fig. 11.1 Speed change operation

[2] Precautions during control

- (1) The time required to reach a new speed from an old speed at speed change is "[Cd. 8] ACC/DEC time at speed change".

For a deceleration stop made by axis stop signal ON or JOG start signal OFF after the new speed is reached following a speed change request, the time required to make a stop after reaching "[Pr. 6] Bias speed at start" from the operating speed is "[Cd. 9] DEC/STOP time at speed change".

However, if the new speed ([Cd. 7] New speed value) is less than the old speed, the time required to make a stop from axis stop signal ON or JOG start signal OFF may exceed the preset deceleration stop time ([Cd. 9]) when a deceleration stop is made by axis stop signal ON or JOG start signal OFF right after the speed change command (before "[Cd. 7] New speed value" is reached). (See below.)

Note that the deceleration stop time is the "time required to make a stop from the target speed", and not the "time required to make a stop from the current speed". If axis stop signal ON or JOG start signal OFF occurs before the target speed is reached, the time required to make an actual stop is determined by the "current speed (speed at axis stop signal ON or JOG start signal OFF)" and "slope of deceleration from the target speed to a stop (slope of deceleration found from the target speed ([Cd. 7]) and deceleration stop time ([Cd. 9]))".

When it is necessary to make a stop in a short time before the target speed is reached, make adjustment using the [Cd. 9] value.

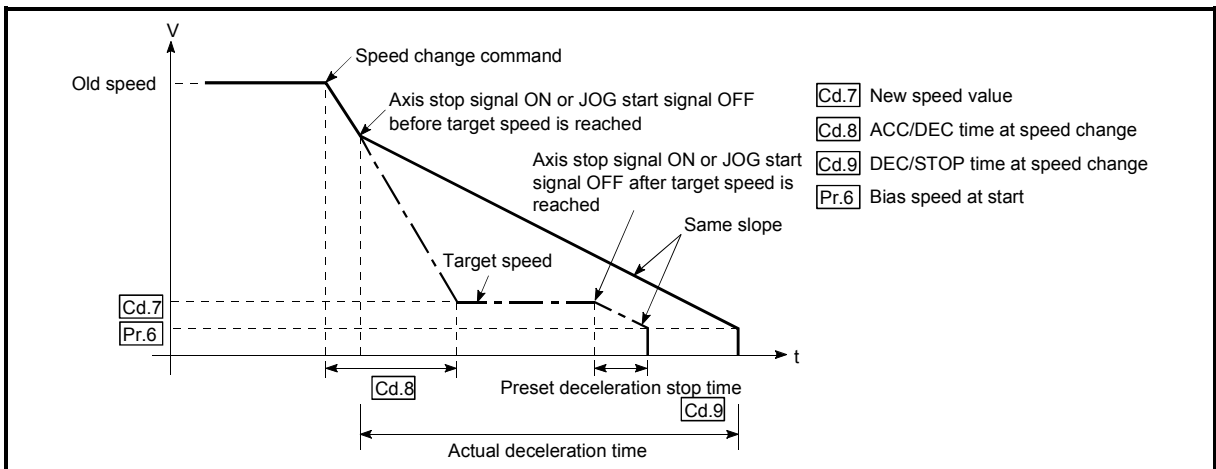

Fig. 11.2 Operation performed when axis stop signal ON or JOG start signal OFF occurs before new speed value is reached

- (2) When "0" is set in "Pr. 6 Bias speed at start", making a speed change with the setting of "0" in "Cd. 7 New speed value" results in the following.

- A deceleration stop is made and 0 speed (Md. 7 Status: b2) turns ON.
 - The axis stops but "Md. 4 Axis operation status" is "Speed.Position Speed" or "JOG Operation" and the BUSY signal remains ON. (When the axis stop signal is turned ON, the BUSY signal turns OFF and "Md. 4 Axis operation status" changes to "Stopped".)
- * In this case, making a speed change with the setting of other than "0" in "Cd. 7 New speed value" and "1" in "Cd. 6 Speed change request" turns OFF 0 speed (Md. 7 Status: b2), enabling operation to be continued.

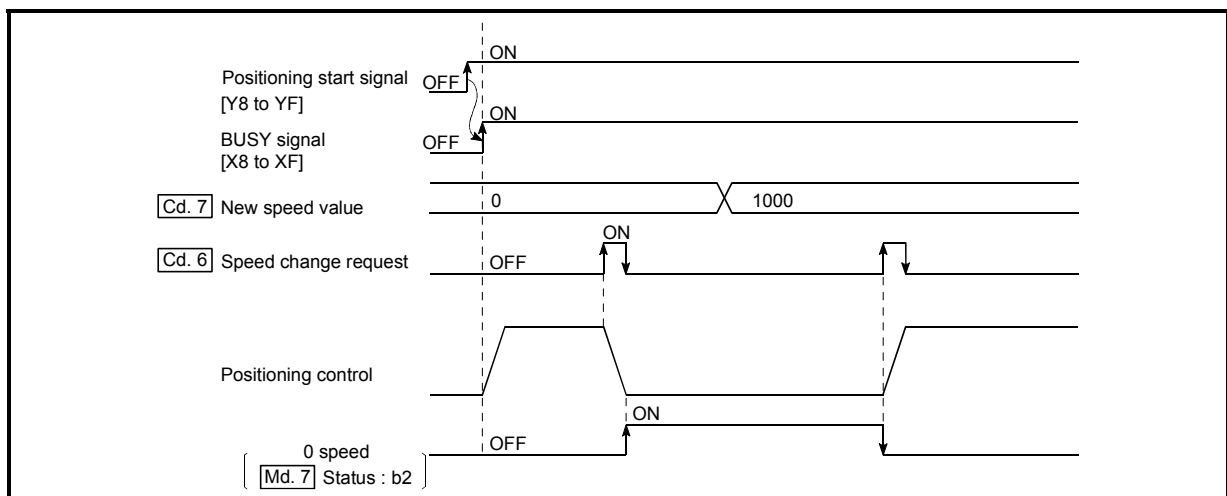

Fig. 11.3 Speed change at new speed value "0" (during speed control of speed-position switching control)

- (3) A speed change cannot be made during the following deceleration. (The speed change request is ignored.)
- During deceleration started by turning ON the axis stop signal
 - During deceleration started by turning OFF the JOG start signal
- (4) If the speed change request is made during position control of speed-position switching control or during OPR control, the "Speed change not possible" warning (warning code: 22) occurs and a speed change cannot be made.
- (5) If the value set in "Cd. 7 New speed value" is equal to or higher than "Pr. 5 Speed limit value", the "Outside speed" warning (warning code: 20) occurs and the speed is controlled at "Pr. 5 Speed limit value".
If the value set in "Cd. 7 New speed value" is lower than "Pr. 6 Bias speed at start", the "Outside speed" warning (warning code: 20) occurs and the speed is controlled at "Pr. 6 Bias speed at start".

- (6) If the axis is stopped by the axis stop signal after a speed change has been made during speed control of speed-position switching control, the speed at a restart is as set in "Da. 5 Command speed".

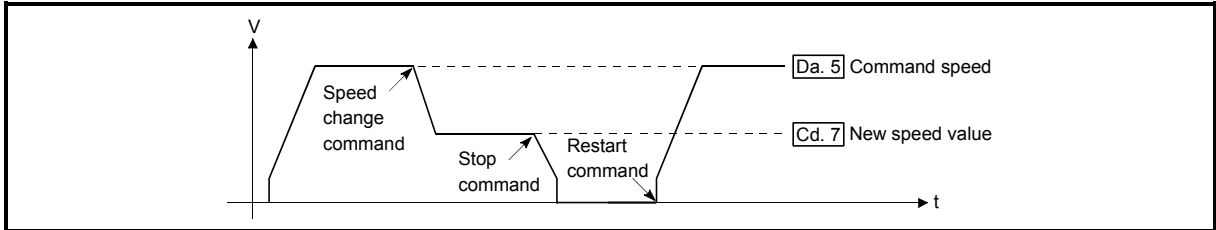

Fig. 11.4 Restart speed after speed change during speed control of speed-position switching control

11.4 Software stroke limit function

The "software stroke limit function" is designed not to execute the movable command to outside the setting range that has been set by the upper and lower limits of the workpiece movable range using the address (Md. 1 Current feed value) established by the machine OPR control.

- The "software stroke limit function" is valid for "Md. 1 Current feed value" and "Da. 6 Positioning address/movement amount" (New current value).
- The "software stroke limit function" is made valid at an operation start and during operation.

The upper and lower limits of the moveable range of the workpiece are set in "Pr. 1 Software stroke limit upper limit value"/ "Pr. 2 Software stroke limit lower limit value".

The details shown below explain about the "software stroke limit function".

- [1] About movable range
- [2] Software stroke limit check details
- [3] Relation between the software stroke limit function and various controls
- [4] Precautions during software stroke limit check
- [5] Setting the software stroke limit function

[1] About movable range

The following drawing shows the moveable range of the workpiece when the software stroke limit function is used.

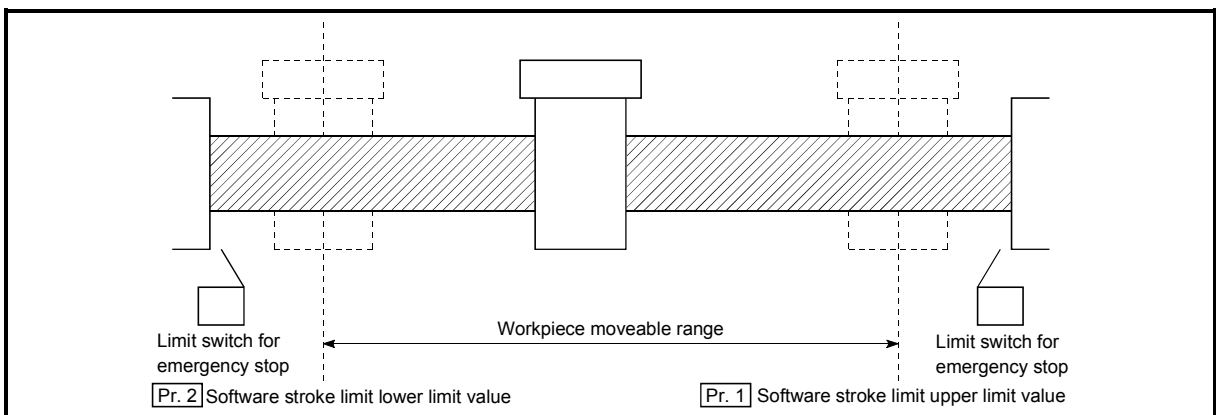

Fig. 11.5 Workpiece moveable range

[2] Software stroke limit check details

Check details		Processing at error
1)	"Md. 1 Current feed value" outside the software stroke limit range is defined as an "error".	An "error" occurs. (Error code: 103, 104)
2)	"Da. 6 Positioning address/movement amount" (New current value) outside the software stroke limit range is defined as an "error".	

[3] Relation between the software stroke limit function and various controls

The following are the relationships between the software stroke limit function and various controls when "0: Valid" is set in "Pr. 3 Software stroke limit value valid/invalid setting".

Control type		Software stroke limit check	Processing at check
OPR control	Machine OPR control	—	Check not carried out.
	Fast OPR control	—	
Positioning control	Position control (1-axis linear control)	◎	Checks 1) and 2) in the previous section [2] are carried out. (At operation start) The axis does not start if the software stroke limit range is exceeded. (During operation) The axis comes to an immediate stop when it exceeds the software stroke limit range.
	Speed-position switching control	○	For speed control: Checks 1) and 2) in the previous section [2] are carried out. (At operation start) The axis does not start if the software stroke limit range is exceeded. (During operation) The axis decelerates to a stop when it exceeds the software stroke limit range.
		◎	For position control: Checks 1) and 2) in the previous section [2] are carried out. The axis decelerates to a stop when it exceeds the software stroke limit range.
	Current value changing	◎	The current value will not be changed if the new current value is outside the software stroke limit range.
JOG operation		◎	Checks 1) and 2) in the previous section [2] are carried out. (At operation start) The axis can be started only toward the software stroke limit range (movable range). (During operation) The axis decelerates to a stop when it exceeds the software stroke limit range.

◎ : Check valid

○ : Check is not made if the current feed value is not updated (Refer to "Pr. 4 Current feed value during speed control") during speed control of speed-position switching control.

— : Check not carried out (check invalid).

[4] Precautions during software stroke limit check

- (1) A machine OPR control must be executed beforehand for the "software stroke limit function" to function properly.
- (2) If an error is detected in the "continuous path control" operation pattern of positioning control, the axis comes to an immediate stop upon completion of the execution of the positioning data that precedes the positioning data where the error occurred.

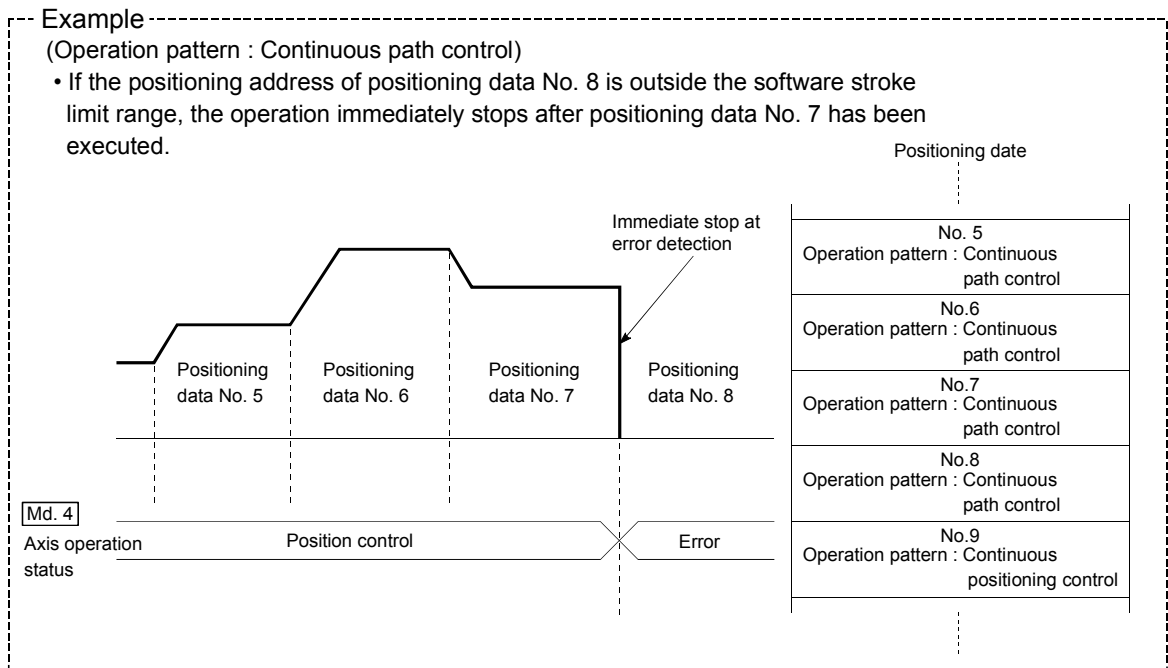

[5] Setting the software stroke limit function

To use the "software stroke limit function", set the required values in the parameters shown in the following table, and write them to the QD70. The set details are validated at the rising edge (OFF → ON) of the Programmable controller READY signal (Y0).

Setting item	Setting value	Setting details	Factory-set initial value
Pr. 1 Software stroke limit upper limit value	→	Set the upper limit value of the moveable range.	2147483647
Pr. 2 Software stroke limit lower limit value	→	Set the lower limit value of the moveable range.	-2147483648
Pr. 3 Software stroke limit valid/invalid setting	0: Valid	Set whether the software stroke limit is validated or invalidated.	0: valid

* Refer to section "4.2 List of parameters" for setting details.

Make setting so that the condition of (**Pr. 1** Software stroke limit upper limit value) > (**Pr. 2** Software stroke limit lower limit value) is satisfied.

If the setting made does not satisfy the above condition, the "Software stroke limit upper/lower limit value error" error (error code: 901) occurs.

11.5 Acceleration/deceleration processing function

The "acceleration/deceleration processing function" is designed to adjust acceleration/deceleration when OPR control, positioning control or JOG operation is performed.

Adjusting the acceleration/deceleration processing according to control enables finer control.

The acceleration/deceleration adjusting items that can be set are "bias speed at start", "target speed", "acceleration time" and deceleration time".

The following will be explained for the "acceleration/deceleration processing function".

- [1] Control details
- [2] Precautions for control

[1] Control details

The following is the operation of the acceleration/deceleration processing function of the QD70.

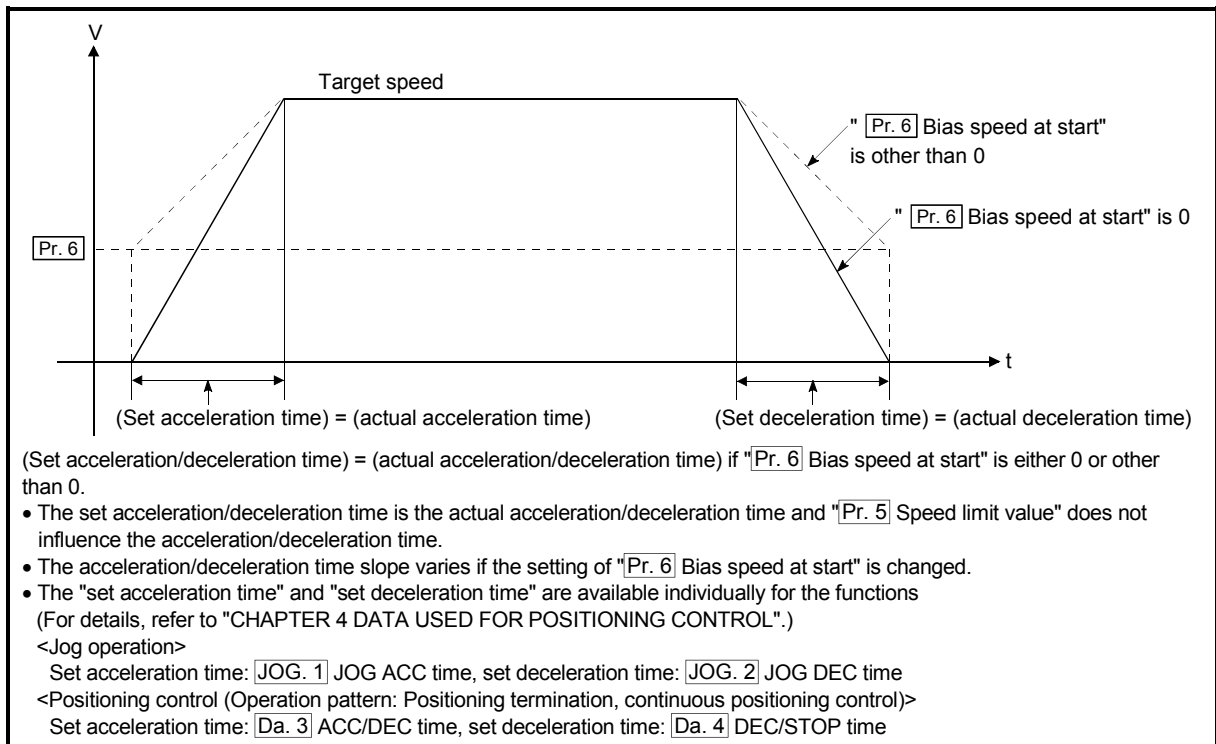

Fig. 11.6 Operation of acceleration/deceleration processing function of QD70

■ Slope of acceleration/deceleration

The slope of acceleration/deceleration is calculated by the following expression.

$$\frac{|(\text{Target speed}) - (\text{bias speed at start})|}{(\text{Set acceleration time}/\text{set deceleration time})}$$

POINT

For the QD70, the acceleration/deceleration slope is determined by the three data of "bias speed at start", "target speed" and "acceleration/deceleration time". Fully note this when changing the setting values.
 (A sharp acceleration/deceleration slope may affect the machine.)

The following is the operation of the acceleration/deceleration processing function during position control or speed changing in the operation pattern of continuous path control.

<For position control in operation pattern of continuous path control>

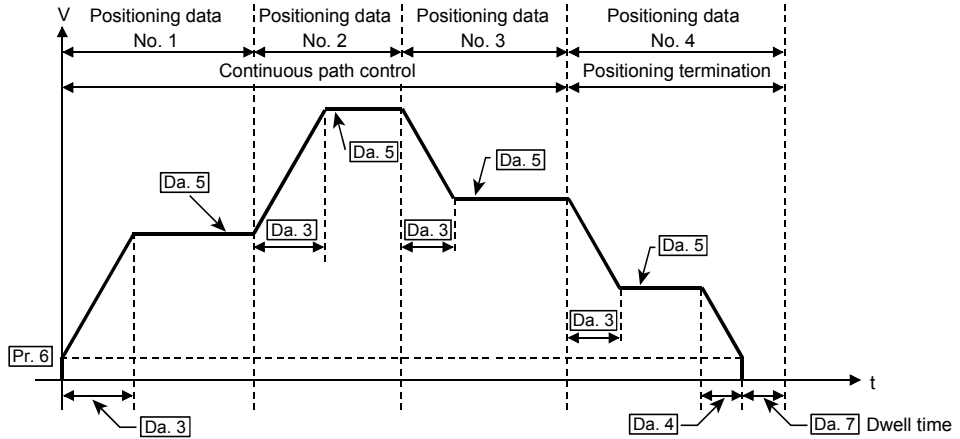

<For speed change under speed control of speed-position switching control (positioning data No. 1)>

(Refer to "Section 11.3" for speed change during JOG operation.)

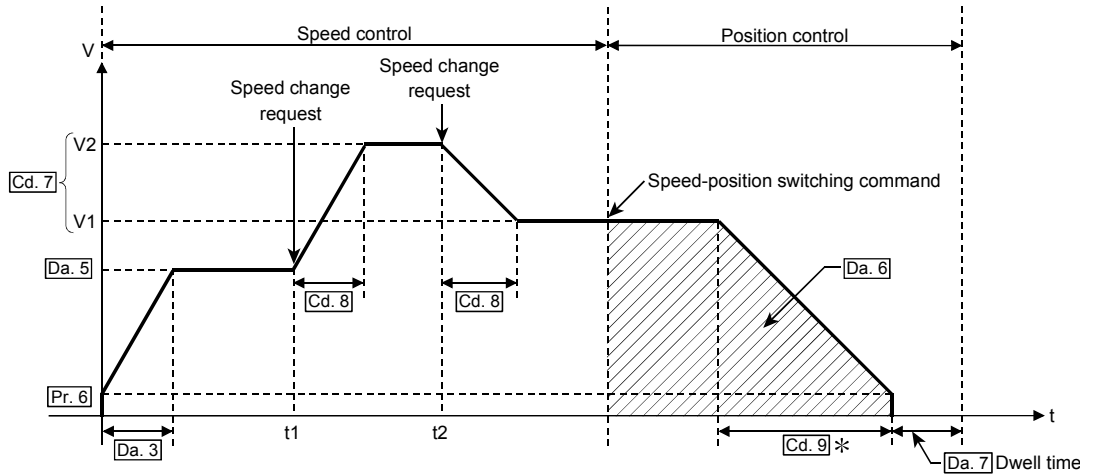

Pr. 6 Bias speed at start, Da. 3 ACC/DEC time, Da. 4 DEC/STOP time

Da. 5 Command speed, Da. 6 Positioning address/movement amount

Cd. 7 New speed value (V1: New speed value at time t1, V2: New speed value at time t2)

Cd. 8 ACC/DEC time at speed change, Cd. 9 DEC/STOP time at speed change

*: If a speed change is not made during speed control, deceleration is made at "Da. 4 DEC/STOP time".

The following is the operation performed during machine OPR control in each OPR method.

<When OPR method is any of "near-point dog method", "stopper 1", "stopper 2" and "count 1">

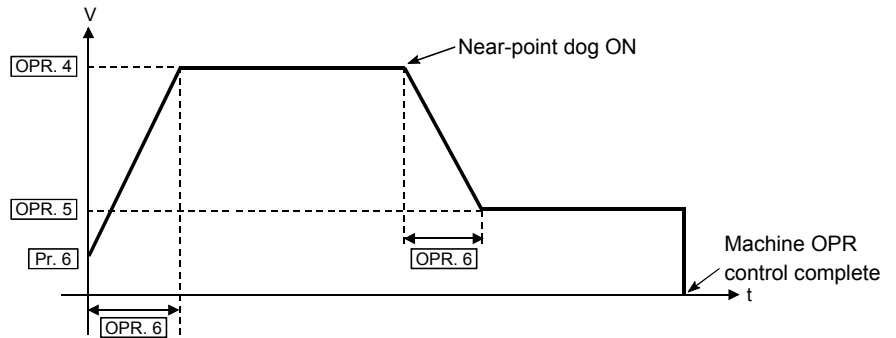

<When OPR method is "stopper 3">

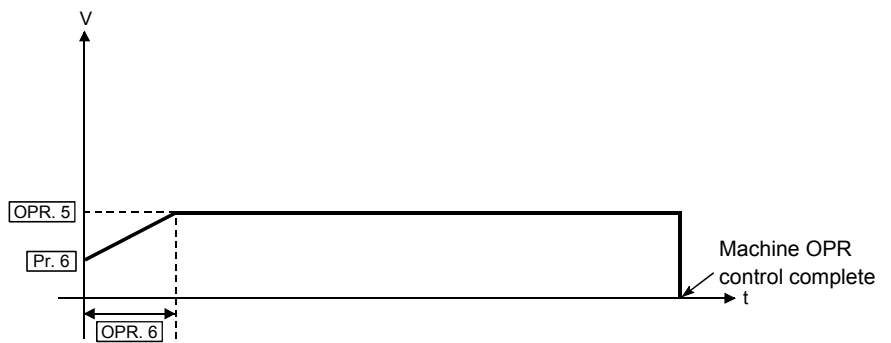

<When OPR method is "count 2">

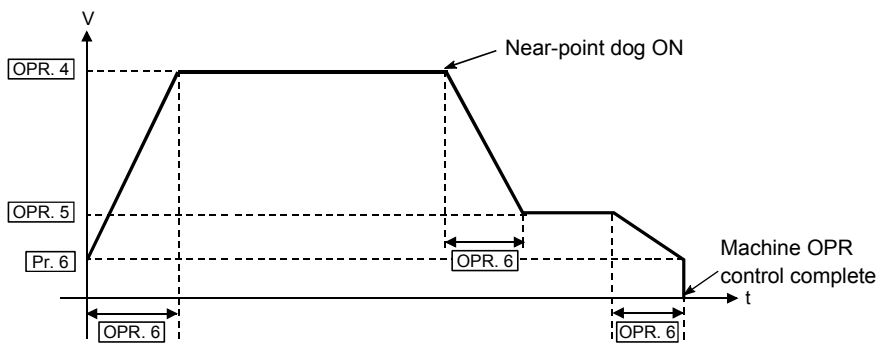

Pr. 6 Bias speed at start, OPR. 4 OPR speed, OPR. 5 Creep speed
 OPR. 6 ACC/DEC time at OPR, OPR. 7 DEC/STOP time at OPR

[2] Precautions for control

- (1) At the set speed of 1 (pulse/s), the set acceleration/deceleration time is ignored.
- (2) In the acceleration/deceleration pattern where the movement amount is small relative to the acceleration/deceleration time and a constant-speed part does not exist, operation is not performed at the set acceleration/deceleration time. In such a case, review the setting details.
- (3) If operation is performed with 0 set as the bias speed at start in the control method of "1-axis linear control (ABS)" or "1-axis linear control (INC)" positioning control, an error "Movement amount shortage at 0 bias speed" (error code: 514) may occur due to shortage of the movement amount. Perform either of the following operations (a), (b) as the corrective action at error occurrence.
 - (a) Set 1 (pulse/s) or more to "Pr. 6 bias speed at start".
 - (b) If the movement amount is 32 (pulse) or less, set the value equal to or less than the initial value (1000ms) to "Da. 3 ACC/DEC time" and "Da. 4 DEC/STOP time".

11.6 Restart function

When the axis is stopped by the axis stop signal during operation, position control is resumed from the stop position to the end of the positioning data by "Cd. 4 Restart request".

[Position control that can be restored]

The restart function can be used only when the axis is stopped during operation under position control or speed control of speed-position switching control.

[Position control that cannot be restored]

When the axis has been stopped during operation under position control of speed-position switching control, do not restart it.

If the axis is restarted, it will not be stopped at the end point of the positioning data. Refer to [2]-(5) in this section for operation details.

The following will be described for the "restart function".

- [1] Control details
- [2] Precautions for control

[1] Control details

(1) Restart during position control

Setting "1: With restart request" in "Cd. 4 Restart request" when "Md. 4 Axis operation status" is "Stopped" resumes position control from the stop position to the end point of the positioning data where the axis had stopped, independently of the absolute or incremental system.

[Example for incremental system]

The following is the operation performed when the axis is stopped during execution of position control (1-axis linear control) at the axis 1 movement amount of 600 and a restart request is executed after the axis stop signal turns OFF.

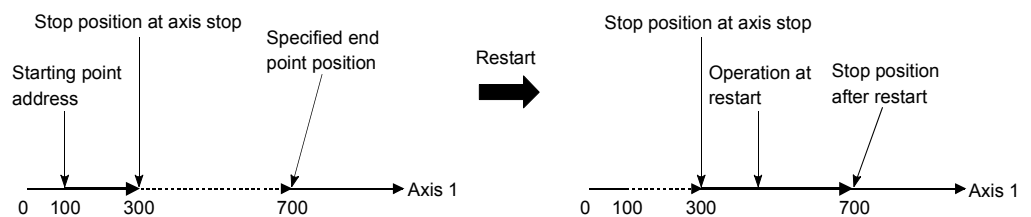

(2) Restart during speed control

Speed control is resumed at the speed used before a stop made by the axis stop signal [Y10 to Y17].

(3) When restart is not made during position control

When "Md. 4 Axis operation status" is "Stopped", turning ON the positioning start signal [Y8 to YF] starts position control from the current stop position.

[Example for incremental system]

The following is the operation performed when the axis is stopped during execution of position control (1-axis linear control) at the axis 1 movement amount of 600 and position control is started after the axis stop signal turns OFF.

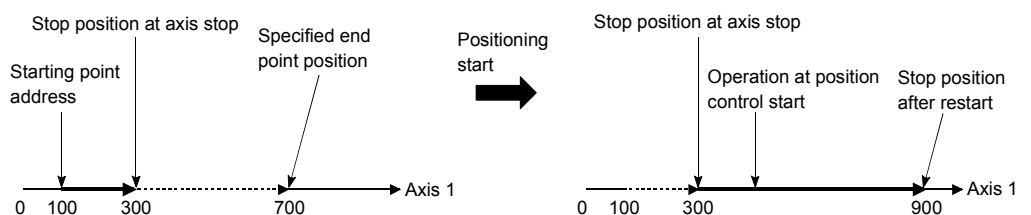

[2] Precautions for control

- (1) Setting "1: With restart request" in "[Cd. 4] Restart request" when "[Md. 4] Axis operation status" is other than "Stopped" results in the "Restart not possible" warning (warning code: 11).
- (2) If "1: With restart request" is set in "[Cd. 4] Restart request" when the axis stop signal [Y10 to Y17] is ON, the "Stop signal ON at start" error (error code: 102) occurs and a restart is not made.
- (3) If the positioning data is changed after the axis has been stopped by the axis stop signal [Y10 to Y17], a restart cannot be made properly.
- (4) The restart function is not performed in the following cases.
(The "Restart not possible" warning (warning code: 11) occurs.)
 - During OPR control
 - During JOG operation
- (5) For speed-position switching control, the axis is always restarted by speed control whichever speed control or position control is used for the operation before the axis is stopped by the axis stop signal.
The following shows operations under speed-position switching control after restart.
 - (a) When the speed-position switching signal (CHG) is OFF at restart
The axis is started with speed control, and position control of the movement amount set in "[Da. 6] Positioning address/movement amount" is executed from the position where the speed-position switching signal is turned ON.

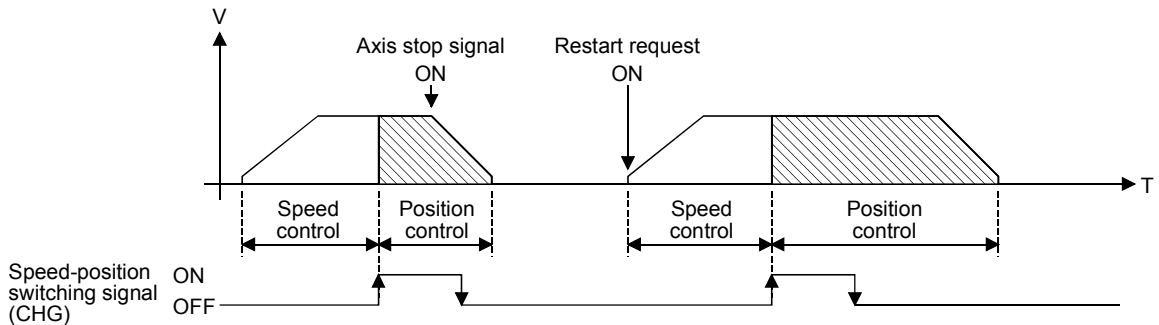

- (b) When the speed-position switching signal (CHG) is ON at restart
The axis is restarted with speed control and then position control switched immediately, and position control of the movement amount set in "[Da. 6] Positioning address/movement amount" is executed from the position where the axis is restarted.

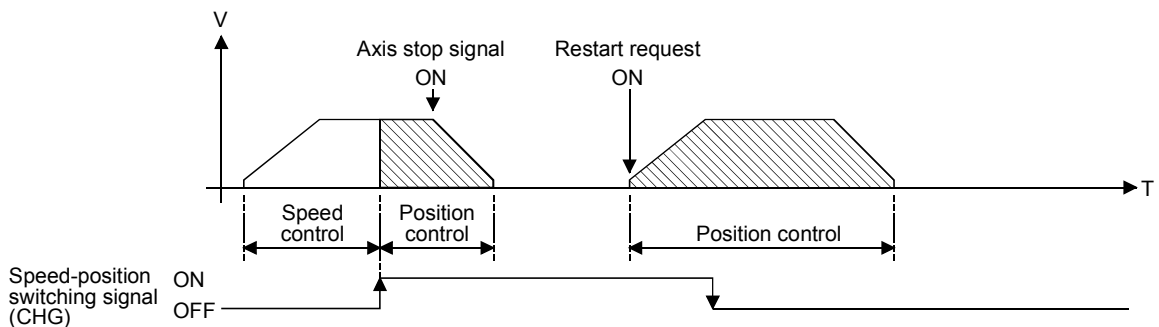

CHAPTER 12 COMMON FUNCTIONS

This chapter details the common functions of the QD70.

12.1 Outline of common functions

"Common functions" are executed according to the user's requirements, regardless of the control system, etc. These common functions are executed by GX Developer. For details of GX Developer, refer to the GX Developer Operating Manual.

The following table shows the functions included in the "common functions".

Common function	Details	Means
External I/O signal logic switching	This function changes the external I/O signal logic according to the device connected to the QD70.	Switch setting on the QCPU PLC parameter "I/O assignment" screen using GX Developer (Intelligent function module switches)
External I/O signal monitor	This function monitors the states of the external I/O signals.	This function monitors the external I/O signal monitor information in the module's detailed information which can be displayed on the system monitor of GX Developer.

12.2 External I/O signal switching function

This function switches the signal logic according to the equipment connected to the QD70.

The following external I/O signals can be changed in logic.

I/O class	Signal name	Symbol	Remarks
Input	Zero signal	PGO□	□ of the symbol indicates the axis No. (1 to 8).
	Near-point dog signal	DOG□	
Output	Pulse output F	PULSE F□	
	Pulse output R	PULSE R□	
	Deviation counter clear	CLEAR□	

The following will be described for the "external I/O signal logic switching function".

- [1] Setting details
- [2] Precautions for setting

[1] Setting details

Make switch setting (intelligent function module switches) of the "I/O assignment screen" PLC parameter of the QCPU using GX Developer. For details of the setting, refer to "Section 5.6 Switch setting for intelligent function module".

[2] Precautions for setting

- (1) The values set are made valid after power-on or programmable controller CPU reset.
They cannot be changed during operation.
- (2) If each signal logic is set erroneously, the operation may not be carried out correctly.
Before setting, check the specifications of the equipment to be used.

12.3 External I/O signal monitor function

The "external I/O signal monitor function" monitors the module information, external I/O signal monitor information and intelligent function module switch setting states in the "H/W Information" of the module's detailed information that can be displayed on the system monitor of GX Developer (SW7D5C-GPPW-E or later).

[Setting procedure]

Choose [Diagnostics] → [System monitor] → "QD70 module" and choose "Module's detailed information" → H/W Information .

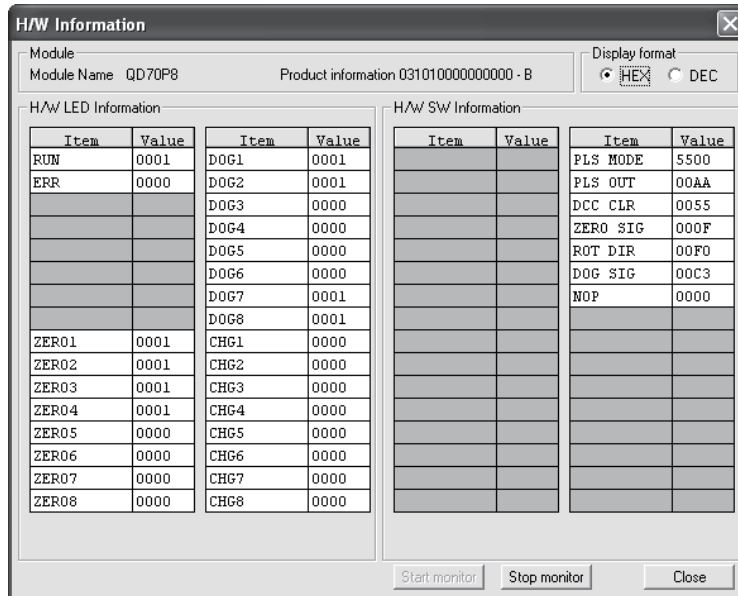

[H/W LED Information]

H/W LED information displays the following information.

Item	Signal name	Value	Item	Signal name	Value
RUN	"RUN" LED of QD70	0: LED off	DOG4	Near-point dog signal of Axis 4	0: OFF, 1: ON
ERR	"ERR." LED of QD70	1: LED on, flicker	DOG5	Near-point dog signal of Axis 5	
ZERO1	Zero signal of Axis 1	0: OFF, 1: ON	DOG6	Near-point dog signal of Axis 6	
ZERO2	Zero signal of Axis 2		DOG7	Near-point dog signal of Axis 7	
ZERO3	Zero signal of Axis 3		DOG8	Near-point dog signal of Axis 8	
ZERO4	Zero signal of Axis 4		CHG1	Speed-position switching signal of Axis 1	
ZERO5	Zero signal of Axis 5		CHG2	Speed-position switching signal of Axis 2	
ZERO6	Zero signal of Axis 6		CHG3	Speed-position switching signal of Axis 3	
ZERO7	Zero signal of Axis 7		CHG4	Speed-position switching signal of Axis 4	
ZERO8	Zero signal of Axis 8		CHG5	Speed-position switching signal of Axis 5	
DOG1	Near-point dog signal of Axis 1	CHG6	Speed-position switching signal of Axis 6		
DOG2	Near-point dog signal of Axis 2	CHG7	Speed-position switching signal of Axis 7		
DOG3	Near-point dog signal of Axis 3	CHG8	Speed-position switching signal of Axis 8		

[H/W SW Information]

The setting states of the intelligent function module switches are displayed.

Item	Signal name	Corresponding switch		Value
PLS MODE	Pulse output mode	Switch 1		Refer to "Section 5.6 Switch setting for intelligent function module" for details.
PLS OUT	Pulse output logic selection	Switch 2	8 lower bits	
DCC CLR	Deviation counter clear output signal logic selection		8 upper bits	
ZERO SIG	Zero signal input logic selection	Switch 3	8 lower bits	
ROT DIR	Rotation direction setting		8 upper bits	
DOG SIG	Near-point dog signal input logic selection	Switch 4		
NOP	—	Switch 5		

CHAPTER 13 TROUBLESHOOTING

This chapter describes the details of errors and warnings that may occur during use of the QD70.

13.1 Error and warning details

[1] Errors

■ Types of errors

Errors detected by the QD70 include parameter and OPR data setting range errors and errors at the operation start or during operation.

(1) Parameter and OPR data setting range errors

The parameters and the OPR data are checked when the power is turned ON and at the rising edge (OFF → ON) of the Programmable controller READY signal [Y0]. An error will occur if there is a mistake in the parameter and the OPR data setting details at that time.

When this kind of error occurs, the module READY signal does not turn ON.

To cancel this kind of error, set the correct value in the parameter and the OPR data for which the error occurred, and then turn ON the Programmable controller READY signal [Y0].

(2) Errors at the operation start or during operation

These are errors that occur at the operation start or during operation when the OPR control, positioning control or JOG operation is used.

If an error occurs on any axis at a start, that axis does not start and "Md. 4 Axis operation status" changes to "Error".

If an error occurs on any axis during operation, that axis decelerates to a stop and "Md. 4 Axis operation status" changes to "Error".

■ Error storage

If an error occurs, the axis error occurrence signal turns ON and the error code corresponding to the error definition is stored into "Md. 5 Axis error code".

Also, the bit of "Md. 10 Error status" corresponding to the error occurrence axis turns ON.

Axis No.	Axis error occurrence signal	"Md. 5 Axis error code" buffer memory address	Md. 10 Error status	
			Buffer memory address	bit
1	X1	77	1600	0
2		177		1
3		277		2
4		377		3
5		477		4
6		577		5
7		677		6
8		777		7

* Refer to "Section 4.6 List of monitor data" for the setting details.

If another error occurs during axis error occurrence, the latest error code is ignored. However, if any of the system-affecting errors (error codes: 800 to 840) occurs, the old error code is overwritten by the newest error code.

(Error codes 800 to 840 are stored into "Md. 5 Axis error code" of all axes.

[2] Warnings

■ Types of warnings

A warning occurs during OPR control, positioning control or JOG operation.

If a warning occurs, operation is continued. Also, if a warning occurs, "Md. 4 Axis operation status" remains unchanged.

■ Warning storage

If a warning occurs, the axis warning occurrence signal turns ON and the warning code corresponding to the warning definition is stored into "Md. 6 Axis warning code".

Also, the bit of "Md. 11 Warning status" corresponding to the warning occurrence axis turns ON.

Axis No.	Axis warning occurrence signal	"Md. 6 Axis warning code" buffer memory address	Md. 11 Warning status	
			Buffer memory address	bit
1	X2	78	1601	0
2		178		1
3		278		2
4		378		3
5		478		4
6		578		5
7		678		6
8		778		7

* Refer to "Section 4.6 List of monitor data" for the setting details.

The latest error code is always stored.

[3] Resetting errors and warnings

Setting "1" in "Cd. 1 Axis error reset" performs the following processing and then cancels the error/warning status.

- The axis error occurrence signal (X1) is turned OFF ("1" is set in Cd. 1 of all axes).
- The axis warning occurrence signal (X2) is turned OFF ("1" is set in Cd. 1 of all axes).
- "Md. 4 Axis operation status" changes from "Error" to "Standby".
- "Md. 5 Axis error code" is cleared to zero.
- "Md. 6 Axis warning code" is cleared to zero.

[4] Confirming the error and warning definitions

The error and warning definitions can be confirmed in "Md. 5 Axis error code" and "Md. 6 Axis warning code". To confirm them, GX Developer or GX Configurator-PT is needed. For details, refer to "Section 13.5 Confirming the error definitions using system monitor of GX Developer" or "CHAPTER 6 UTILITY PACKAGE (GX Configurator-PT)". (Refer to Section 13.2 and Section 13.3 for details of the error codes and warning codes.)

13.2 List of errors

The following table shows the error details and remedies to be taken when an error occurs.

Error code	Error name	Error	Operation status at error occurrence
000	Normal status	—	—
100	Faults	Hardware is faulty.	The system stops
101	QD70 not prepared	Start was made when the QD70 was not ready.	Start is not made.
102	Stop signal ON at start	A start request was given when the axis stop signal (Y10 to Y17) is ON.	
103	Software stroke limit +	<ul style="list-style-type: none"> Positioning control was carried out in a position in excess of "[Pr. 1] Software stroke limit upper limit value". "[Md. 1] Current feed value" or "[Da. 6] Positioning address/movement amount" (New current value) has exceeded "[Pr. 1] Software stroke limit upper limit value". 	At start: Start is not made. At current value changing analysis: Current value changing is not made. During operation: <ul style="list-style-type: none"> During speed control (including speed control of speed-position switching control) or JOG operation, the axis decelerates to a stop as soon as "[Md. 1] Current feed value" exceeds the software stroke limit range. During position control (including position control of speed-position switching control), the axis decelerates to a stop as soon as "[Md. 1] Current feed value" or "[Da. 6] Positioning address/movement amount" exceeds the software stroke limit range.
104	Software stroke limit -	<ul style="list-style-type: none"> Positioning control was carried out in a position in excess of "[Pr. 2] Software stroke limit lower limit value". "[Md. 1] Current feed value" or "[Da. 6] Positioning address/movement amount" (New current value) has exceeded "[Pr. 2] Software stroke limit lower limit value". 	
105	Programmable controller READY OFF during operation	The Programmable controller READY signal (Y0) turned OFF during operation.	The axis decelerates to a stop.
110	Programmable controller READY OFF during writing	The Programmable controller READY signal (Y0) turned OFF immediately after turning ON.	—
201	Start during near-point dog ON	With "[OPR. 1] OPR method" being any of near-point dog method, count 1 and count 2, machine OPR control was started when the near-point dog was ON.	Machine OPR control is not carried out.
202	Zero signal ON	With "[OPR. 1] OPR method" being either of stopper 2 and stopper 3, the zero signal is input when machine OPR control is started.	
203	Machine OPR not execute	Fast OPR control was started though machine OPR control was not yet carried out.	Fast OPR control is not exercised.

Related buffer memory address									Setting range	Remedy
Axis 1	Axis 2	Axis 3	Axis 4	Axis 5	Axis 6	Axis 7	Axis 8			
—	—	—	—	—	—	—	—	—	—	—
—	—	—	—	—	—	—	—	—	—	<ul style="list-style-type: none"> • Check that there is no influence from noise. • Check hardware for possibility of fault.
—	—	—	—	—	—	—	—	—	—	<p>After switching power from OFF to ON/resetting the programmable controller CPU, turn ON the Programmable controller READY signal (Y0) again, make sure that the module READY signal (X0) is ON, and then make a start. (The module is faulty if the module READY signal (X0) does not turn ON.)</p>
—	—	—	—	—	—	—	—	—	—	Check whether the axis stop signal (Y10 to Y17) is ON or OFF and turn OFF the axis stop signal that is ON.
Pr. 1 Software stroke limit upper limit value									-2147483648 to 2147483647 (pulse)	<p>At start: Perform JOG operation (Refer to Chapter 10) to change "Md. 1 Current feed value" to within the software stroke limit range.</p> <p>Current value changing: Change the new current value to within the software stroke limit range (Refer to Section 9.2.4).</p> <p>During operation: Correct "Da. 6 Positioning address/movement amount" (Refer to Section 4.5).</p>
0	100	200	300	400	500	600	700			
1	101	201	301	401	501	601	701			
Pr. 2 Software stroke limit lower limit value										
2	102	202	302	402	502	602	702			
3	103	203	303	403	503	603	703			
Da. 6 Positioning address/movement amount (Refer to Section 4.5)										
—	—	—	—	—	—	—	—	—	—	Review the sequence program that turns ON/OFF the Programmable controller READY signal (Y0).
—	—	—	—	—	—	—	—	—	—	Perform JOG operation (Refer to Chapter 10) to move the axis to the position where the near-point dog turns OFF, and then start machine OPR control (Refer to Section 8.2.3, Section 8.2.7 and Section 8.2.8).
—	—	—	—	—	—	—	—	—	—	After turning OFF the zero signal, start machine OPR control (Refer to Section 8.2.5 and Section 8.2.6).
5	152	252	352	452	552	652	752	<p>Cd. 3 Start method</p> <p>0 : Positioning control</p> <p>9000 : Machine OPR control</p> <p>9001 : Fast OPR control</p>		Before starting fast OPR control, perform machine OPR control (Refer to Section 8.2).

Error code	Error name	Error	Operation status at error occurrence	
501	Setting range outside start method	The setting value of "[Cd. 3] Start method" is other than 0, 9000 and 9001.	Start is not made.	
502	New current change not possible	<ul style="list-style-type: none"> "[Da. 1] Operation pattern" is "Continuous path control" in the positioning data whose "[Da. 2] Control method" is "Current value changing". "[Da. 2] Control method" is "Current value changing" in the positioning data following the positioning data whose "[Da. 1] Operation pattern" is "Continuous path control". 	Current value changing is not made.	
503	Continuous path control not possible	<ul style="list-style-type: none"> "[Da. 1] Operation pattern" is "Continuous path control" in the positioning data whose "[Da. 2] Control method" is "Speed.Position Ctrl.". "[Da. 1] Operation pattern" is "Continuous path control" in the positioning data preceding the positioning data whose "[Da. 2] Control method" is "Speed.Position Ctrl.". 	Start is not made.	
504	Setting range outside operation pattern	The setting value of "[Da. 1] Operation pattern" is outside the setting range.		
505	Speed 0 error	At a position control start, "[Da. 5] Command speed" of the positioning data is "0".		
506	Setting range outside control method	The setting value of "[Da. 2] Control method" is outside the setting range.		
507	Setting range outside ACC/DEC time	Any of the "[OPR. 6] ACC/DEC time at OPR", "[JOG. 2] JOG ACC time", "[Da. 3] ACC/DEC time" and "[Cd. 8] ACC/DEC time at speed change" setting values is outside the setting range.		
508	Setting range outside DEC/STOP time	Any of the "[OPR. 7] DEC/STOP time at OPR", "[JOG. 3] JOG DEC time", "[Da. 4] DEC/STOP time" and "[Cd. 9] DEC/STOP time at speed change" setting values is outside the setting range.		
510	Illegal direction for continuous path control	When "[Da. 1] Operation pattern" is "Continuous path control" for position control, "[Da. 6] Positioning address/movement amount" has been set to reverse the operation direction.		The axis stops as soon as the execution of the preceding positioning data is completed.
511	Insufficient movement amount for continuous path control	When "[Da. 1] Operation pattern" is "Continuous path control" for position control, "[Da. 6] Positioning address/movement amount" is too small to form a constant-speed part.		The axis stops as soon as the execution of the preceding positioning data is completed.
512	Not complete calculation for continuous path control	When "[Da. 1] Operation pattern" was "Continuous path control" for position control, positioning control ended soon since "[Da. 6] Positioning address/movement amount" in current execution was small, and the calculation processing of the next positioning data was not in time.		
513	Setting range outside movement amount at speed-position switching control	In "[Da. 2] Control method" of "Speed-position switching control", a negative value is set in "[Da. 6] Positioning address/movement amount".	At start : Start is not made. During operation : After switching to position control, the axis decelerates to a stop.	

Related buffer memory address									Setting range	Remedy
Axis 1	Axis 2	Axis 3	Axis 4	Axis 5	Axis 6	Axis 7	Axis 8			
5	152	252	352	452	552	652	752	<p>Cd. 3 Start method</p> <p>0 : Positioning control</p> <p>9000 : Machine OPR control</p> <p>9001 : Fast OPR control</p>	Set " Cd. 3 Start method" to within the setting range (Refer to Section 4.7).	
<p>Refer to "Section 4.3 List of OPR data".</p> <p>Refer to "Section 4.4 List of JOG data".</p> <p>Refer to "Section 4.5 List of positioning data".</p> <p>Refer to "Section 4.7 List of control data".</p>									<p>OPR. 6 ACC/DEC time at OPR</p> <p>0 to 32767 (ms)</p> <p>OPR. 7 DEC/STOP time at OPR</p> <p>0 to 32767 (ms)</p> <p>JOG. 2 JOG ACC time</p> <p>0 to 32767 (ms)</p> <p>JOG. 3 JOG DEC time</p> <p>0 to 32767 (ms)</p> <p>Da. 1 Operation pattern</p> <p>0: Positioning termination</p> <p>1: Continuous positioning control</p> <p>2: Continuous path control</p> <p>Da. 2 Control method</p> <p>0: No control method,</p> <p>1: 1-axis linear control (ABS)</p> <p>2: 1-axis linear control (INC)</p> <p>3: Speed.Position Ctrl. (Forward)</p> <p>4: Speed.Position Ctrl. (Reverse)</p> <p>5: Current value changing</p> <p>Da. 3 ACC/DEC time</p> <p>0 to 32767 (ms)</p> <p>Da. 4 DEC/STOP time</p> <p>0 to 32767 (ms)</p> <p>Da. 5 Command speed</p> <p>0 to 200000 (pulse/s)</p> <p>Da. 6 Positioning address/movement amount</p> <p>0 to 2147483647 (pulse)</p> <p>(For speed-position switching control)</p> <p>Cd. 8 ACC/DEC time at speed change 0 to 32767 (ms)</p> <p>Cd. 9 DEC/STOP time at speed change 0 to 32767 (ms)</p>	<ul style="list-style-type: none"> When "Da. 2 Control method" is "Current value changing" or "Speed.Position Ctrl.", do not set "Continuous path control" in "Da. 1 Operation pattern". Do not set "Current value changing" or "Speed.Position Ctrl." in "Da. 2 Control method" of the positioning data following the positioning data where "Continuous path control" has been set in "Da. 1 Operation pattern". (Refer to Section 9.2.3 and Section 9.2.4.)
									Set " Da. 1 Operation pattern" to within the setting range.	
									Set " Da. 5 Command speed" to other than "0".	
									Set " Da. 2 Control method" to within the setting range.	
									Set OPR. 6 , JOG. 2 , Da. 3 and Cd. 8 to within the setting range.	
									Set OPR. 7 , JOG. 3 , Da. 4 and Cd. 9 to within the setting range.	
Correct " Da. 6 Positioning address/movement amount" (Refer to Section 9.1.2).										
<p>Refer to "Section 4.5 List of positioning data".</p>									<p>Da. 6 Positioning address/movement amount</p> <p>-2147483648 to 2147483647 (pulse)</p> <p>(For position control)</p>	<p>Correct "Da. 6 Positioning address/movement amount" (Refer to Section 9.1.2).</p>
									<p>Da. 6 Positioning address/movement amount</p> <p>0 to 2147483647 (pulse)</p> <p>(For speed-position switching control)</p>	

Error code	Error name	Error	Operation status at error occurrence
514	Movement amount shortage at 0 bias speed	The movement amount is short when operation is performed with 0 set to "Pr. 6 Bias speed at start" in the "Da. 2 control method" setting of "1-axis linear control (ABS)" or "1-axis linear control (INC)".	Start is not made.
800	Hold error	The setting made for the QD70 is "Hold" in the "Error time output mode" parameter of the CPU module.	Start is not made.
810	Switch setting error	The intelligent function module switch setting made on GX Developer is in error.	
820	Programmable controller CPU error	The programmable controller CPU resulted in an error.	
830	Programmable controller CPU watch dog timer error	The watchdog timer error of the programmable controller CPU occurred.	At start: Start is not made. During operation: The axis decelerates to a stop.
840	Module error	A module power-off error occurred.	
901	Software stroke limit upper/lower limit value error	(Upper limit value) ≤ (lower limit value) in the software stroke limit upper/lower limit values.	The module READY signal (X0) does not turn ON.
902	Setting range outside PULSE/SIGN method selection setup/hold time	The setting value of "Pr. 9 PULSE/SIGN method selection setup/hold time" is outside the setting range.	
903	Setting range outside software stroke limit	The setting value of "Pr. 3 Software stroke limit valid/invalid setting" is outside the setting range.	
904	Setting range outside current feed value during speed control	The setting value of "Pr. 4 Current feed value during speed control" is outside the setting range.	
905	Setting range outside speed limit value	The setting value of "Pr. 5 Speed limit value" is outside the setting range.	
906	Setting range outside bias speed	<ul style="list-style-type: none"> The setting value of "Pr. 6 Bias speed at start" is outside the setting range. The setting value of "Pr. 6 Bias speed at start" is higher than "Pr. 5 Speed limit value". 	
907	Setting range outside deviation counter clear signal output time	The setting value of "Pr. 8 Deviation counter clear signal output time" is outside the setting range.	

Related buffer memory address								Setting range	Remedy
Axis 1	Axis 2	Axis 3	Axis 4	Axis 5	Axis 6	Axis 7	Axis 8		
[Pr. 6] Bias speed at start								0 to 200000 (pulse/s)	<ul style="list-style-type: none"> • Set 1 pulse/s or more to "[Pr. 6] bias speed at start". • If the movement amount is 32 pulse or less, set the value equal to or less than the initial value (1000ms) to "[Da. 3] ACC/DEC time" and "[Da. 4] DEC/STOP time". (Refer to Section 11.5.)
8	108	208	308	408	508	608	708		
9	109	209	309	409	509	609	709	[Da. 3] ACC/DEC time 0 to 32767 (ms) [Da. 4] DEC/STOP time 0 to 32767 (ms) [Da. 6] Positioning address / movement amount -2147483648 to 2147483647 (pulse) (For position control)	
Refer to "Section 4.5 List of positioning data".									
—	—	—	—	—	—	—	—	—	Change the setting of the "Error time output mode" of PLC parameter to "Clear". (Refer to the QCPU User's Manual.)
—	—	—	—	—	—	—	—	—	Set the intelligent function module switches to within the setting ranges (refer to Section 5.6).
—	—	—	—	—	—	—	—	—	Switch power from OFF to ON or reset the programmable controller CPU. (Refer to the QCPU User's Manual.)
—	—	—	—	—	—	—	—	—	
—	—	—	—	—	—	—	—	—	
[Pr. 1] Software stroke limit upper limit value								-2147483648 to 2147483647 (pulse)	Make setting to satisfy (upper limit value) > (lower limit value). (Refer to Section 11.4.)
0	100	200	300	400	500	600	700		
1	101	201	301	401	501	601	701		
[Pr. 2] Software stroke limit lower limit value									
2	102	202	302	402	502	602	702	[Pr. 9] PULSE/SIGN method selection setup/hold time 0: 10μs, 1: 100μs 2: 1ms, 3: 2ms [Pr. 3] Software stroke limit valid/invalid setting 0: Valid, 1: Invalid [Pr. 4] Current feed value during speed control 0: No update, 1: Update 2: Clear to 0 and no update [Pr. 5] Speed limit value 1 to 200000 (pulse/s)	
3	103	203	303	403	503	603	703		
12	112	212	312	412	512	612	712		
4	104	204	304	404	504	604	704		
5	105	205	305	405	505	605	705		
6	106	206	306	406	506	606	706	[Pr. 5] Speed limit value 1 to 200000 (pulse/s)	
7	107	207	307	407	507	607	707		
[Pr. 5] Speed limit value								1 to 200000 (pulse/s)	Change the setting to within the setting range and to not more than "[Pr. 5] Speed limit value", and turn the Programmable controller READY signal (Y0) from OFF to ON.
6	106	206	306	406	506	606	706		
7	107	207	307	407	507	607	707	[Pr. 6] Bias speed at start	
8	108	208	308	408	508	608	708		
9	109	209	309	409	509	609	709	0 to 200000 (pulse/s)	
11	111	211	311	411	511	611	711	[Pr. 8] Deviation counter signal output time 1 to 32 (ms)	Change the setting to within the setting range and turn the Programmable controller READY signal (Y0) from OFF to ON.

Error code	Error name	Error	Operation status at error occurrence
910	Setting range outside OPR method	The setting value of "[OPR. 1] OPR method" is outside the setting range.	The module READY signal (X0) does not turn ON.
911	Setting range outside OPR direction	The setting value of "[OPR. 2] OPR direction" is outside the setting range.	
912	Setting range outside OP address	The setting value of "[OPR. 3] OP address" is outside the setting range.	
913	Setting range outside OPR speed	<ul style="list-style-type: none"> • The setting value of "[OPR. 4] OPR speed" is outside the setting range. • The setting value of "[OPR. 4] OPR speed" is lower than "[Pr. 6] Bias speed at start". • The setting value of "[OPR. 4] OPR speed" is higher than "[Pr. 5] Speed limit value". 	
914	Setting range outside creep speed	<ul style="list-style-type: none"> • The setting value of "[OPR. 5] Creep speed" is outside the setting range. • The setting value of "[OPR. 5] Creep speed" is higher than "[OPR. 4] OPR speed". • The setting value of "[OPR. 5] Creep speed" is lower than "[Pr. 6] Bias speed at start". 	
915	Setting range outside ACC/DEC time at OPR	The setting value of "[OPR. 6] ACC/DEC time at OPR" is outside the setting range.	
916	Setting range outside DEC/STOP time at OPR	The setting value of "[OPR. 7] DEC/STOP time at OPR" is outside the setting range.	
917	Setting range outside setting for the movement amount after near-point dog ON	The setting value of "[OPR. 8] Setting for the movement amount after near-point dog ON" is outside the setting range.	
918	Setting range outside stop mode during path control	The setting value of "[Pr. 10] Stop mode during path control" is outside the setting range.	

Related buffer memory address								Setting range	Remedy
Axis 1	Axis 2	Axis 3	Axis 4	Axis 5	Axis 6	Axis 7	Axis 8		
20	120	220	320	420	520	620	720	OPR. 1 OPR method 0: Near-point dog method 1: Stopper 1 2: Stopper 2, 3: Stopper 3 4: Count 1, 5: Count 2	Change the setting to within the setting range and turn the Programmable controller READY signal (Y0) from OFF to ON.
21	121	221	321	421	521	621	721	OPR. 2 OPR direction 0: Forward direction 1: Reverse direction	
22 23	122 123	222 223	322 323	422 423	522 523	622 623	722 723	OPR. 3 OP address The setting range varies depending on the value set for "Pr. 3 Software stroke limit valued /invalid setting" "0: valid" : 0 to 214783647 "1:invalid":-214783647 to 214783647	
24 25	124 125	224 225	324 325	424 425	524 525	624 625	724 725	OPR. 4 OPR speed OPR. 5 Creep speed 1 to 200000 (pulse/s)	Change the setting to within the setting range, to not more than "Pr. 5 Speed limit value" and to not less than "Pr. 6 Bias speed at start", and turn the Programmable controller READY signal (Y0) from OFF to ON.
26 27	126 127	226 227	326 327	426 427	526 527	626 627	726 727	OPR. 4 OPR speed OPR. 5 Creep speed 1 to 200000 (pulse/s)	Change the setting to within the setting range, to not more than "OPR. 4 OPR speed" and to not less than "Pr. 6 Bias speed at start", and turn the Programmable controller READY signal (Y0) from OFF to ON.
28	128	228	328	428	528	628	728	OPR. 6 ACC/DEC time at OPR OPR. 7 DEC/STOP time at OPR 0 to 32767 (ms)	Change the setting to within the setting range and turn the Programmable controller READY signal (Y0) from OFF to ON.
29	129	229	329	429	529	629	729	OPR. 6 ACC/DEC time at OPR OPR. 7 DEC/STOP time at OPR 0 to 32767 (ms)	
30 31	130 131	230 231	330 331	430 431	530 531	630 631	730 731	OPR. 8 Setting for the movement amount after near-point dog ON 0 to 2147483647 (pulse/s)	
13	113	213	313	413	513	613	713	Pr. 10 Stop mode during path control 0: Position match stop 1: Deceleration stop	

13.3 List of warnings

The following table shows the warning details and remedies to be taken when a warning occurs.

Warning code	Warning name	Warning	Operation status at warning occurrence
000	Normal status	—	—
10	Start during operation	The start request is issued while the axis is BUSY.	Continue the operation.
11	Restart not possible	<ul style="list-style-type: none"> • A restart request was made when "[Md. 4] Axis operation status" is other than "Stopped". • During OPR control or JOG operation, a restart request was made when "[Md. 4] Axis operation status" is other than "Stopped". 	Operation is continued.
20	Outside speed	The set speed or "[Cd. 7] New speed value" is lower than "[Pr. 6] Bias speed at start" or higher than "[Pr. 5] Speed limit value".	The speed is controlled at "[Pr. 6] Bias speed at start" or "[Pr. 5] Speed limit value".
22	Speed change not possible	A speed change request was given during other than speed control of speed-position switching control and JOG operation.	Operation is continued.
41	Insufficient movement amount	The calculation processing time of the next positioning data was not reserved in "[Da. 1] Operation pattern" of "Continuous positioning control".	The axis decelerates to a stop once upon completion of the execution of the positioning data in current execution, and operation resumes upon completion of the calculation processing of the next positioning data. (The BUSY signal does not turn OFF if the axis has stopped.)

Related buffer memory address									Setting range	Remedy
Axis 1	Axis 2	Axis 3	Axis 4	Axis 5	Axis 6	Axis 7	Axis 8			
—	—	—	—	—	—	—	—	—	—	—
—	—	—	—	—	—	—	—	—	—	Normalize the start request ON timing.
53	153	253	353	453	553	653	753	Cd. 4 Restart request 1: Make restart	<ul style="list-style-type: none"> Do not make a restart request in "Md. 4 Axis operation status" of other than "Stopped". Do not make a restart request during OPR control or JOG operation. 	
Pr. 5 Speed limit value									1 to 200000 (pulse/s)	Change the set speed or "Cd. 7 New speed value" to not less than "Pr. 6 Bias speed at start" and to not more than "Pr. 5 Speed limit value".
6	106	206	306	406	506	606	706			
7	107	207	307	407	507	607	707			
Pr. 6 Bias speed at start									0 to 200000 (pulse/s)	
8	108	208	308	408	508	608	708			
9	109	209	309	409	509	609	709			
55	155	255	355	455	555	655	755	Cd. 6 Speed change request 1: Make speed change	Do not make a speed change during position control or during OPR control.	
Refer to "Section 4.5 List of positioning data".									Da. 1 Operation pattern 0: Positioning termination 1: Continuous positioning control 2: Continuous path control Da. 6 Positioning address/movement amount -2147483648 to 2147483647 (pulse) (For position control)	Correct "Da. 6 Positioning address/movement amount" or change "Da. 1 Operation pattern" to "Positioning termination". (Refer to Section 9.1.2.)

13.4 Error check by LED indication

The states of QD70 and each axis control can be confirmed by the LEDs located on the front panel of the QD70 main module.

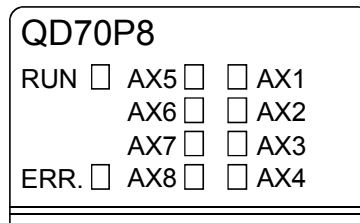

Each axis can be monitored by the states of the LEDs.
The operation and indications of the LEDs are as shown below.

Details of indication Goes OFF <input type="checkbox"/> Goes ON <input checked="" type="checkbox"/> Flashes <input checked="" type="checkbox"/>	Points to be confirmed	Error	Remedy
RUN <input type="checkbox"/> AX5 <input type="checkbox"/> AX1 AX6 <input type="checkbox"/> AX2 AX7 <input type="checkbox"/> AX3 ERR. <input type="checkbox"/> AX8 <input type="checkbox"/> AX4	Extinguishment of RUN LED (The states of ERR. and AX1 to AX8 are undefined)	The hardware is faulty.	If the RUN LED does not light up even when the power is turned ON, the module may be out of order. Replace the module with a new one.
RUN <input checked="" type="checkbox"/> AX5 <input type="checkbox"/> AX1 AX6 <input type="checkbox"/> AX2 AX7 <input type="checkbox"/> AX3 ERR. <input type="checkbox"/> AX8 <input type="checkbox"/> AX4	Lighting of RUN LED, Extinguishment of ERR LED	The module is normal.	—
RUN <input checked="" type="checkbox"/> AX5 <input type="checkbox"/> AX1 AX6 <input type="checkbox"/> AX2 AX7 <input type="checkbox"/> AX3 ERR. <input checked="" type="checkbox"/> AX8 <input type="checkbox"/> AX4	Lighting of ERR LED	System error	An operation condition setting error or installation programmable controller CPU type error occurs. (The setting and programmable controller CPU types are outside the specification range.) Set the programmable controller CPU type to a one contained in the specification.
RUN <input checked="" type="checkbox"/> AX5 <input type="checkbox"/> AX1 AX6 <input type="checkbox"/> AX2 AX7 <input type="checkbox"/> AX3 ERR. <input type="checkbox"/> AX8 <input type="checkbox"/> AX4	Extinguishment of AX1 to AX8 LEDs	During axis stop, during axis standby	—
RUN <input checked="" type="checkbox"/> AX5 <input type="checkbox"/> AX1 AX6 <input type="checkbox"/> AX2 AX7 <input type="checkbox"/> AX3 ERR. <input type="checkbox"/> AX8 <input type="checkbox"/> AX4	Lighting of AX1 (Same even if the other axis is lit)	During axis operation	This lights up from the positioning control start until the positioning control is completed, stopped temporarily, or stopped by error (corresponding at a ratio of 1 : 1 to BUSY signals).
RUN <input checked="" type="checkbox"/> AX5 <input checked="" type="checkbox"/> AX1 AX6 <input type="checkbox"/> AX2 AX7 <input type="checkbox"/> AX3 ERR. <input checked="" type="checkbox"/> AX8 <input type="checkbox"/> AX4	Flashing of ERR LED Flashing of AX1 LED (Same even if the other axis flashes)	Axis error	Check the error observed on the GX Configurator-PT, or the buffer memory batch processing monitor of the GX Developer and correct the applicable parameters and positioning data.

13.5 Confirming the error definitions using system monitor of GX Developer

Choosing Module's detailed information in the system monitor of GX Developer allows you to confirm the error code at axis error occurrence.

(1) Operation of GX Developer

Choose [Diagnostics] → [System monitor] → "QD70 module" and choose Module's Detailed Information.

(2) Confirmation of error code

The error code stored in "Md. 5 Axis error code" appears in the latest error code field. (Any of axes 1 to 8)

(By pressing the Error History button, the error code of the error that has occurred in each axis is displayed in order of axes 1 to 8. Note that this display does not give a history.)

Module's Detailed Information

Module
 Module Name QD70P8 Product information 031010000000000 - B
 I/O Address 0
 Implementation Position Main Base 0Slot

Module Information
 Module access Possible I/O Clear / Hold Settings ----
 Status of External Power Supply ---- Noise Filter Setting ----
 Fuse Status ---- Input Type ----
 Status of I/O Address Verity Agree Remote password setting status ----

Error Display

No.	Error Code
1	1103
2	3506

Present Error 103

Display format
 HEX DEC

The display sequence of the error history is from the oldest error. The latest error is displayed in the line as under.

Error contents - Disposal

Contents: []
 Disposal: []

H/W Information... Start monitor Stop monitor Close

[Error display details] [Present Error]
 Means error code 103
 "Software stroke limit +".

Error code of Axis n
 Axis n (1 ≤ n ≤ 8)

[Display format] Select "Decimal".
 (The error codes indicated in "Section 13.2 List of errors" are in decimal.)

APPENDIX

Appendix 1 External dimension drawing

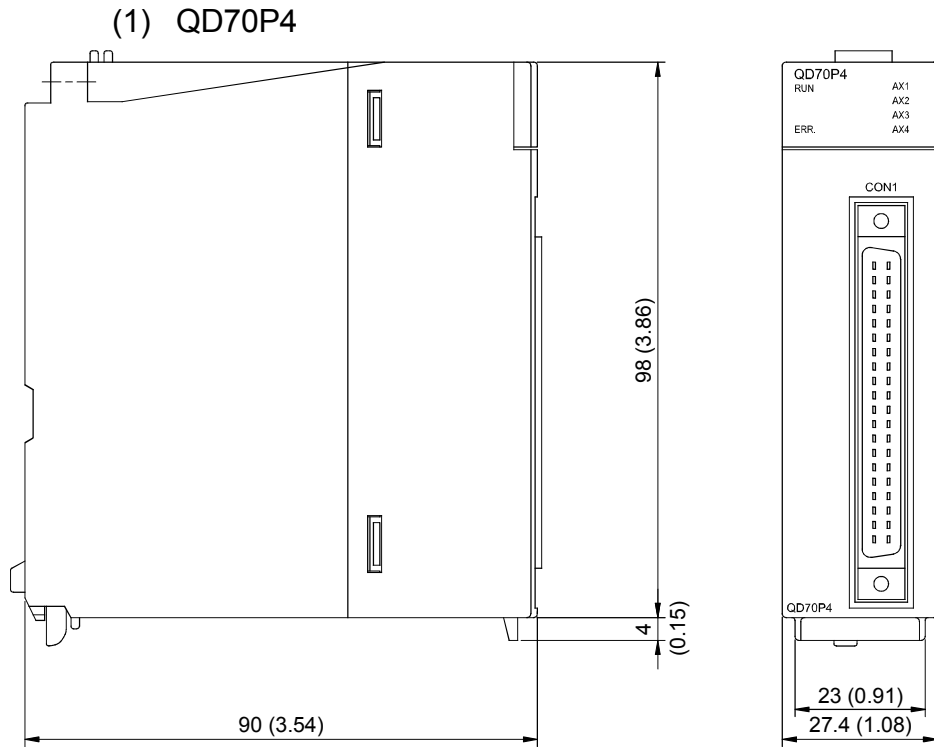

Unit: mm (inch)

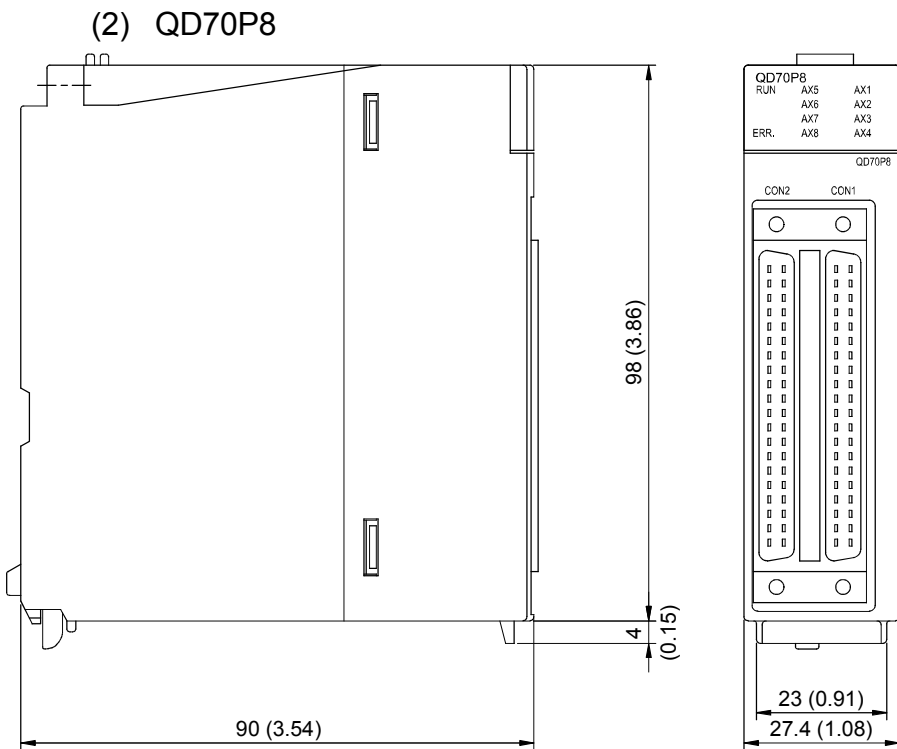

Unit: mm (inch)

Appendix 2 Operation timing and processing time in each control

(1) Operation timing and processing time of machine OPR control

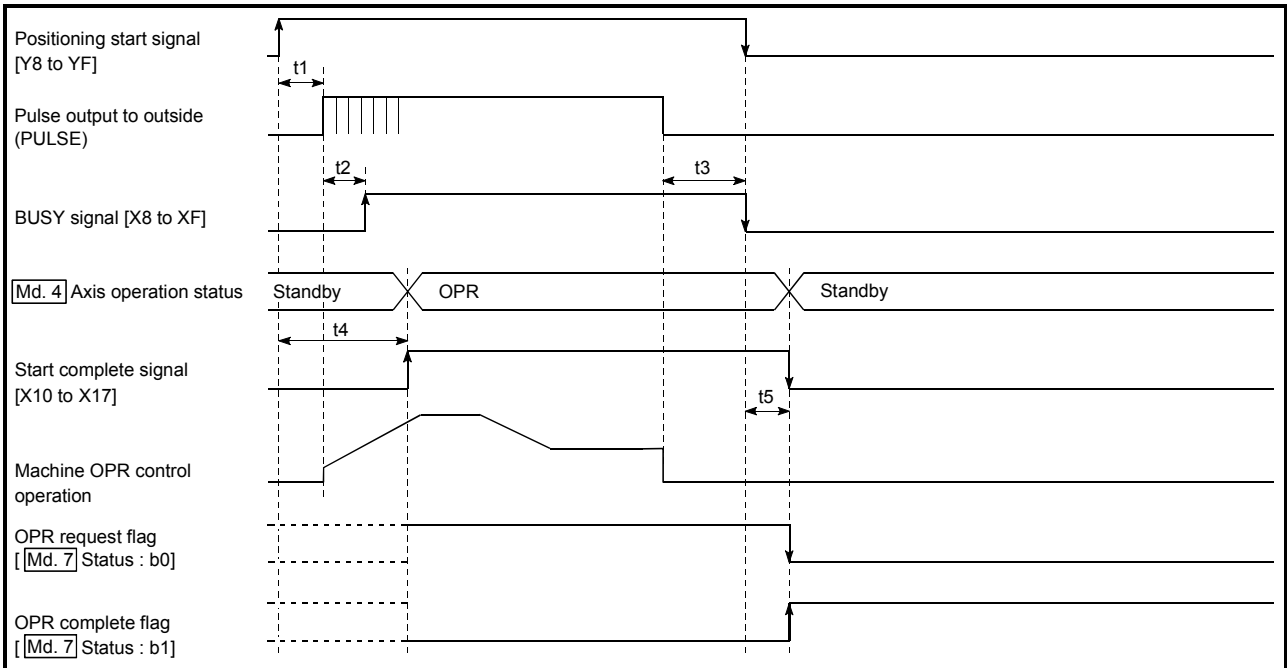

t1	t2	t3	t4	t5
0.3 to 0.5ms	0.2ms	0 to 2ms	0 to 2ms	0 to 2ms

A delay may occur in t1 depending on the operating conditions of the other axes.

(2) Operation timing and processing time of fast OPR control

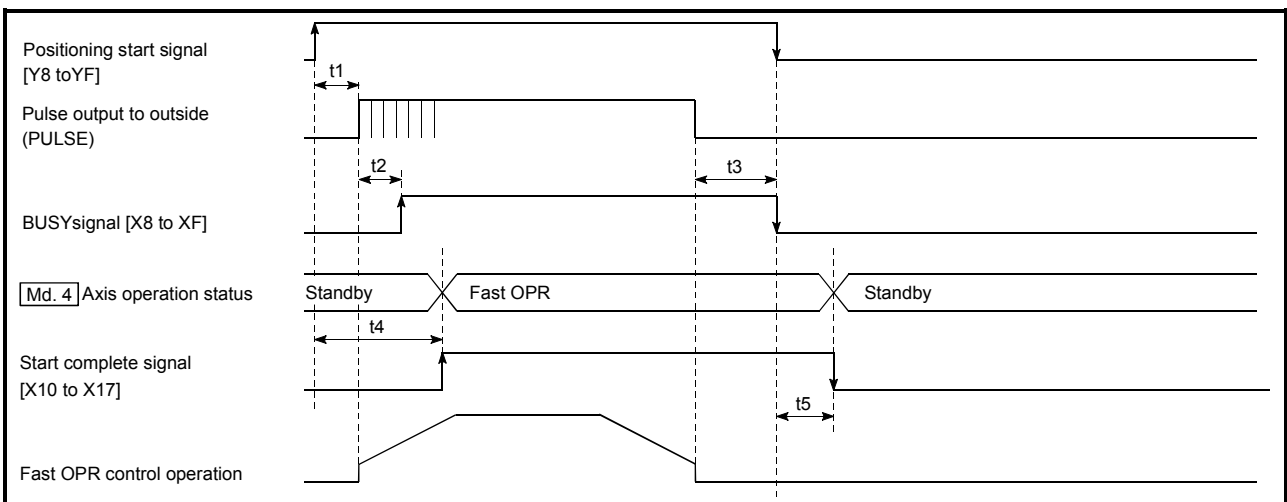

t1	t2	t3	t4	t5
0.3 to 0.5ms	0.2ms	0 to 2ms	0 to 2ms	0 to 2ms

A delay may occur in t1 depending on the operating conditions of the other axes.

(3) Operation timing and processing time of position control

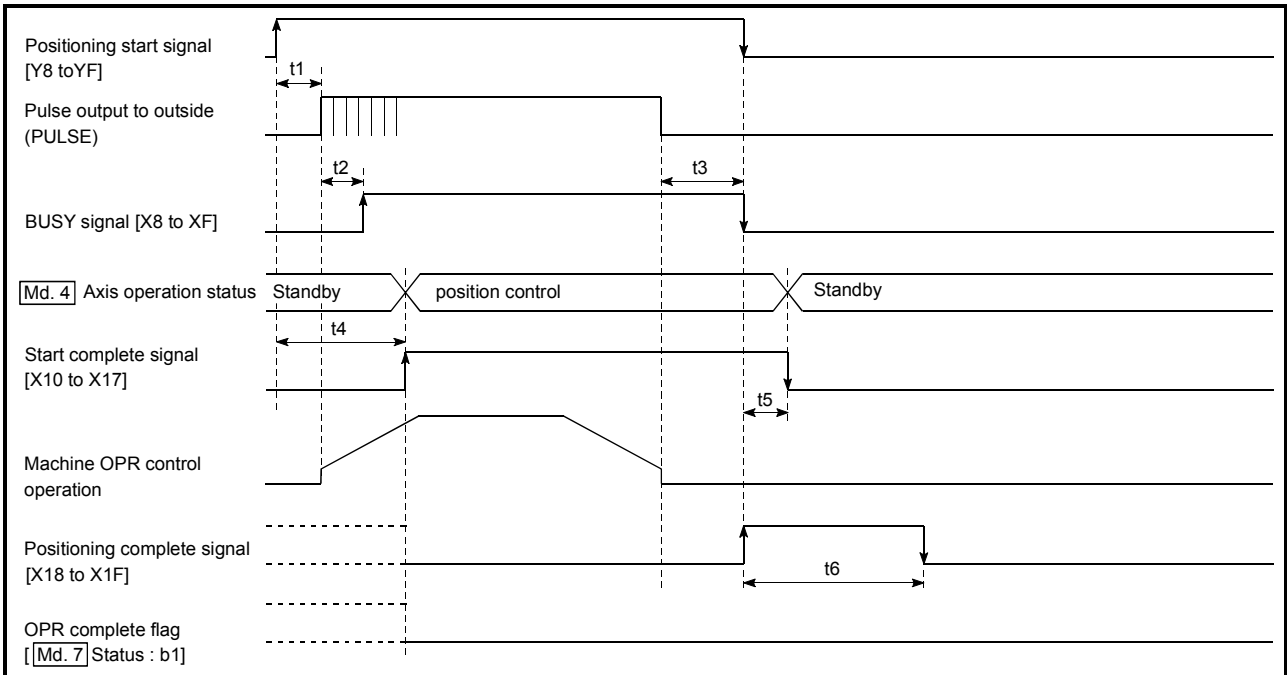

t1*	t2	t3	t4	t5	t6
0.1 to 0.5ms	0.2ms	0 to 2ms	0 to 2ms	0 to 2ms	As set in parameter

*: t1 at simultaneous start of multiple axes

Number of started axes	t1
1 axis	0.1ms
4 axes	0.2ms
8 axes	0.4ms

A delay may occur depending on the operating conditions and starting conditions (control method, bias speed, ACC/DEC time, etc.) of the other axes.

(4) Operation timing and processing time of speed-position switching control

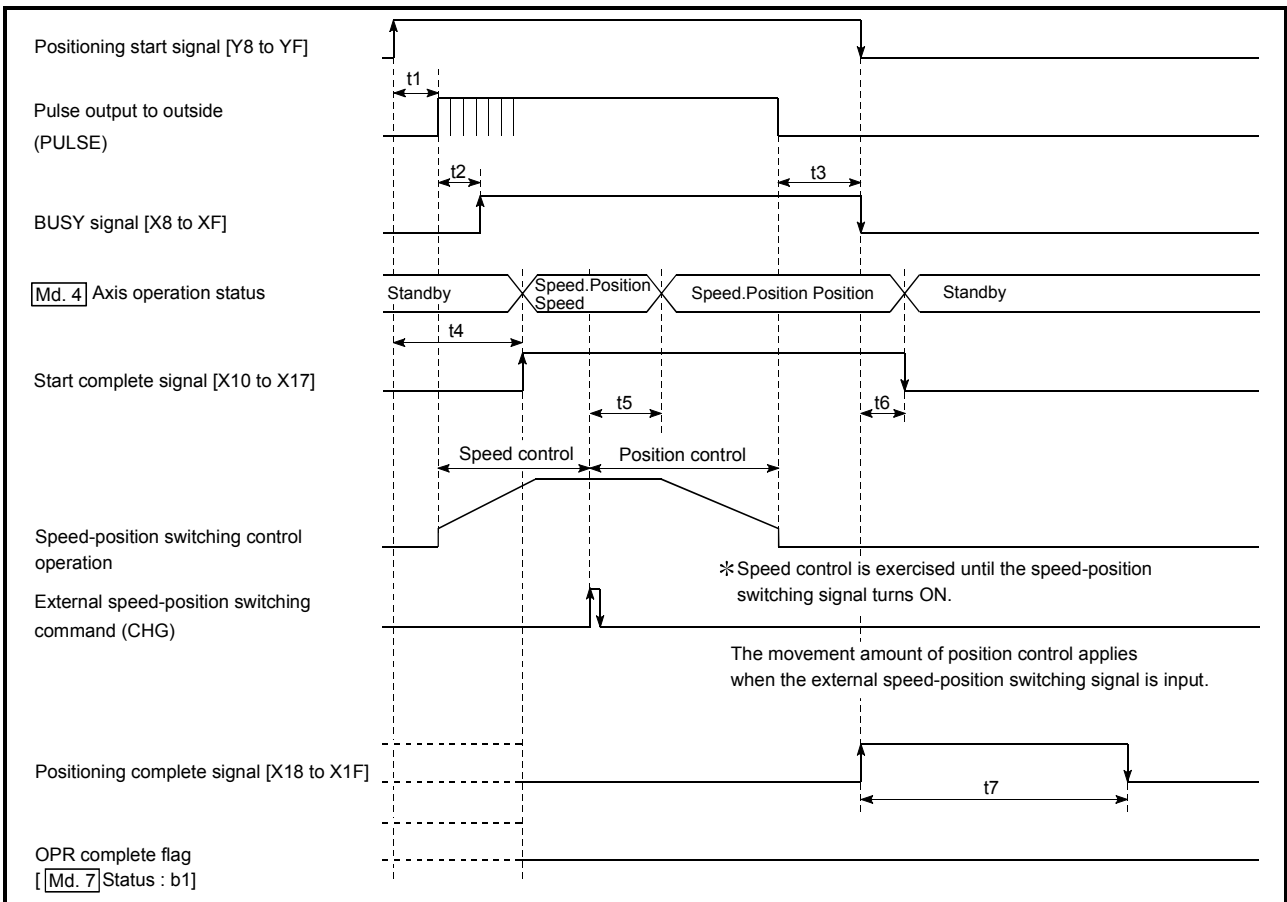

t1	t2	t3	t4	t5	t6	t7
0.3 to 0.5ms	0.2ms	0 to 2ms	0 to 2ms	0 to 2ms	0 to 2ms	As set in parameter

A delay may occur in t1 depending on the operating conditions of the other axes.

(5) Operation timing and processing time of JOG operation

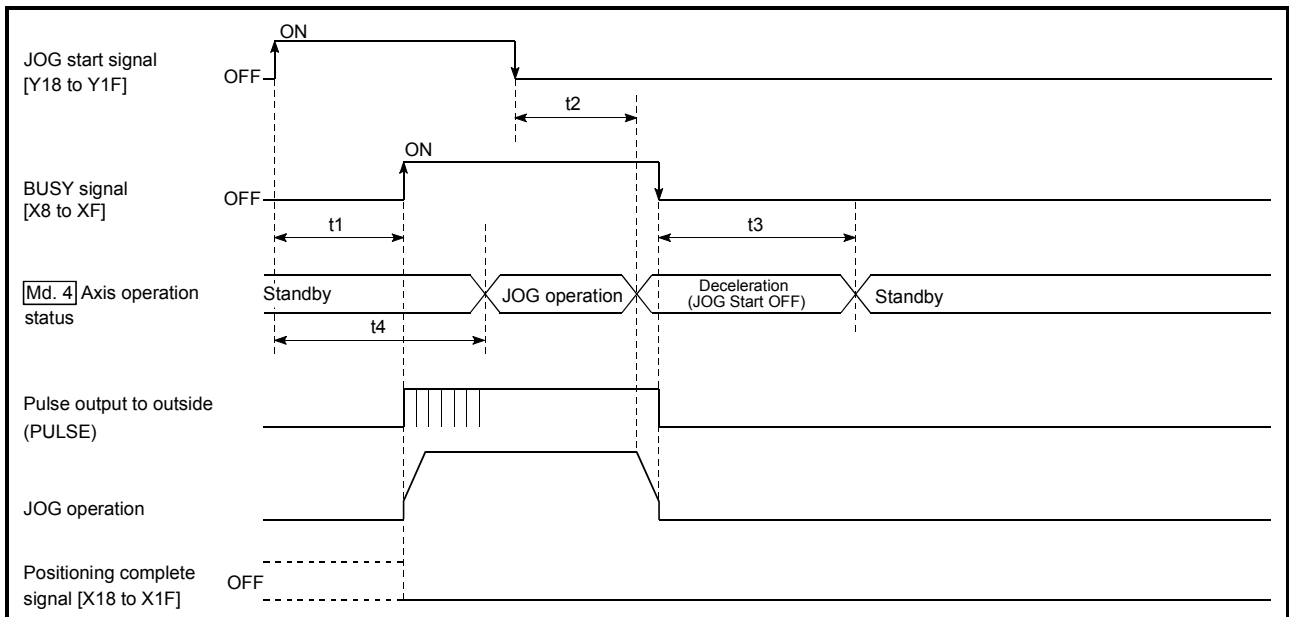

t1	t2	t3	t4
0 to 2.5ms	0 to 2ms	0 to 2ms	0 to 4ms

A delay may occur in t1 depending on the operating conditions of the other axes.

Appendix 3 Connection examples with servo amplifiers manufactured by MITSUBISHI Electric Corporation

Appendix 3.1 Connection example of QD70P□ and MR-H□A

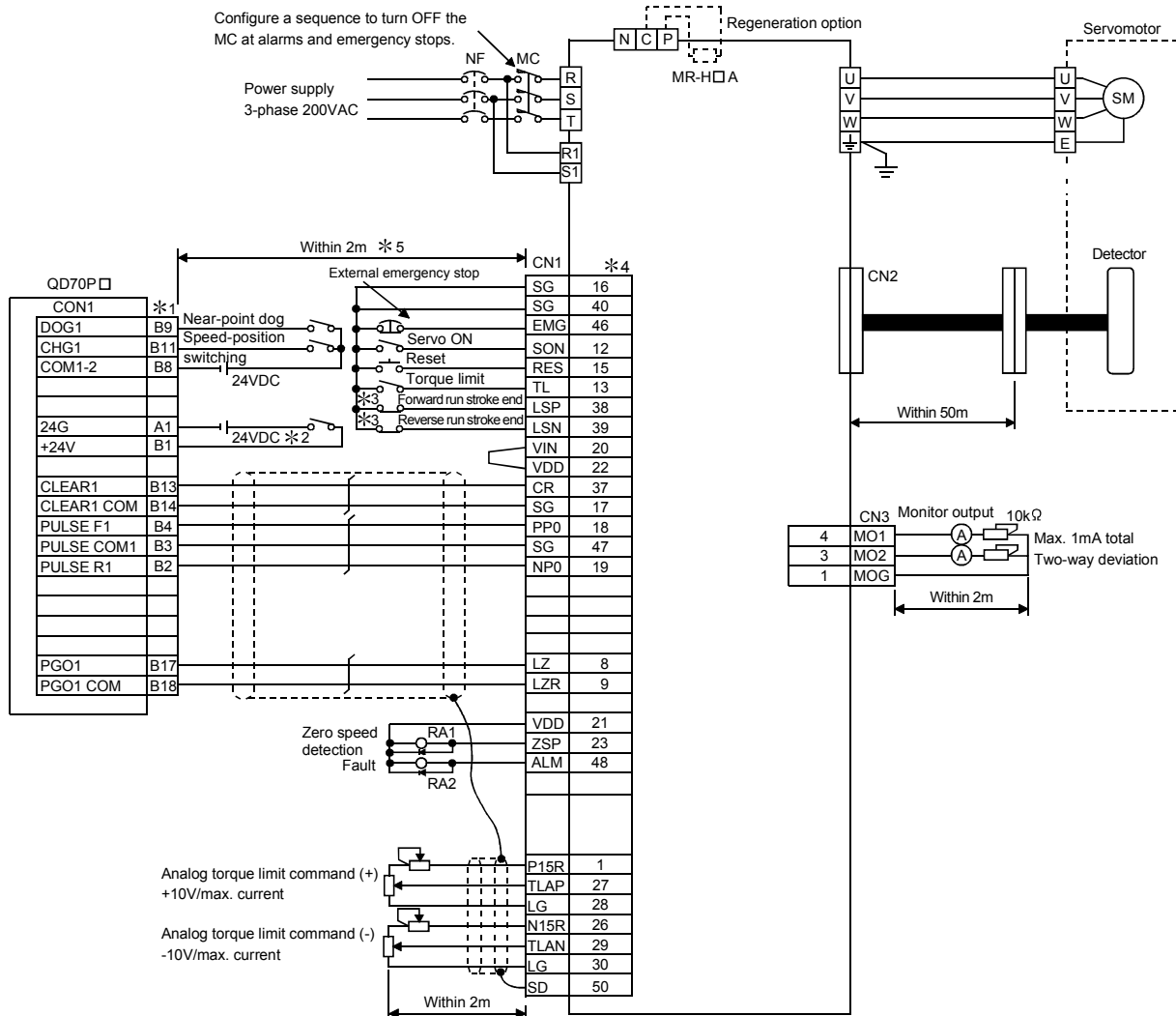

REMARK

- *1: The logic of each I/O terminal can be changed by making switch setting for intelligent function module (Refer to Section 5.6). (The above example assumes that all terminals are set to the negative logic.)
The above example assumes connection to Axis 1. (For the pin layout for connection to any of Axes 2 to 8, refer to "Section 3.4.2 Signal layout for external device connection connector".)
- *2: To output the command pulse (PULSE F/PULSE R), always connect an external power source (24VDC). (When outputting the command pulse of any of Axes 5 to 8, also connect to A1 and B1 of the CON1 connector provided for Axes 1 to 4.)
- *3: These are limit switches for servo amplifier (for stop).
- *4: For details of connection, refer to the MR-H series Servo Amplifier Instruction Manual.
- *5: This indicates the distance between the QD70P□ and servo amplifier.

Appendix 3.3 Connection example of QD70P□ and MR-C□A

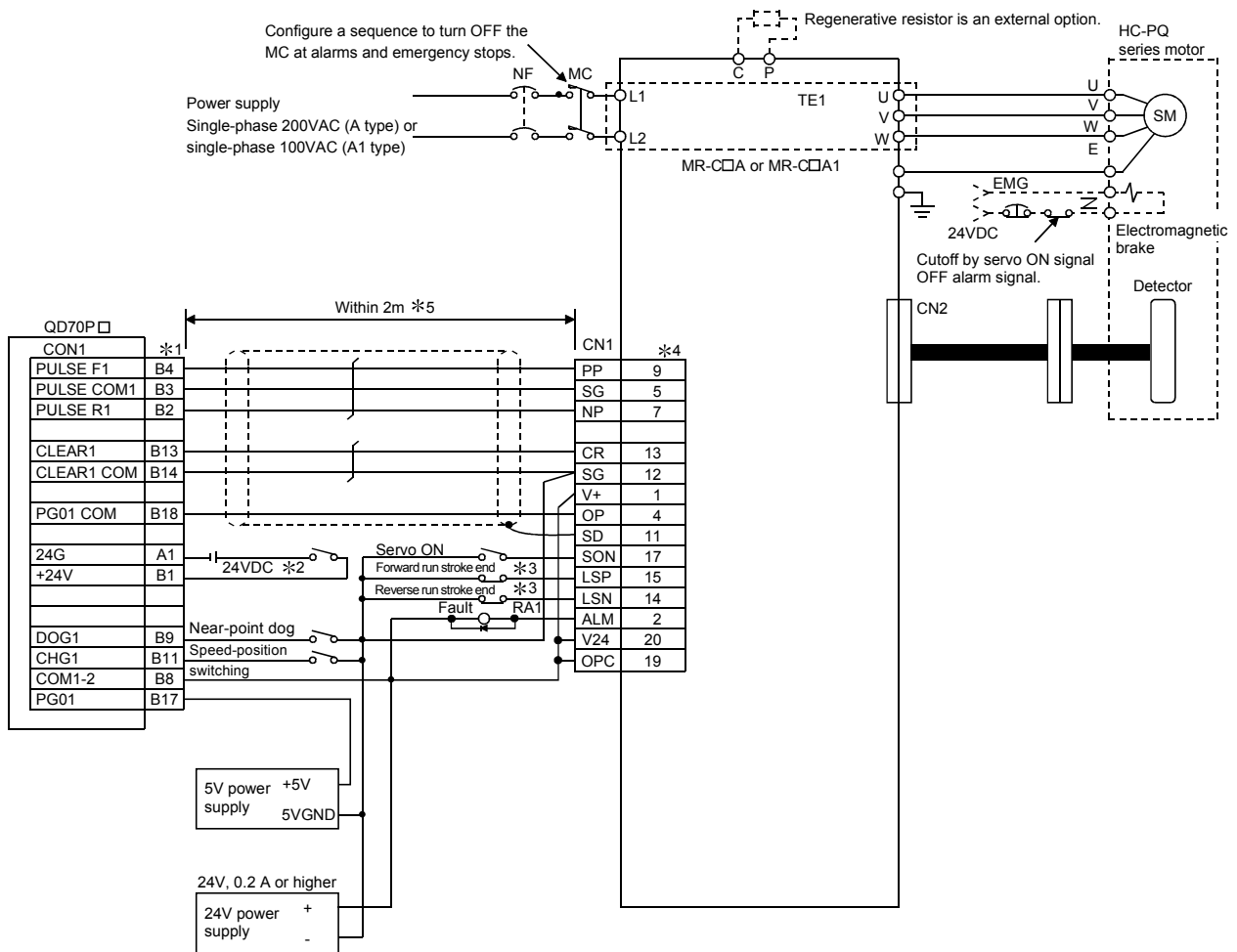

REMARK

- *1: The logic of each I/O terminal can be changed by making switch setting for intelligent function module (Refer to Section 5.6). (The above example assumes that all terminals are set to the negative logic.)
The above example assumes connection to Axis 1. (For the pin layout for connection to any of Axes 2 to 8, refer to "Section 3.4.2 Signal layout for external device connection connector".)
- *2: To output the command pulse (PULSE F/PULSE R), always connect an external power source (24VDC). (When outputting the command pulse of any of Axes 5 to 8, also connect to A1 and B1 of the CON1 connector provided for Axes 1 to 4.)
- *3: These are limit switches for servo amplifier (for stop).
- *4: For details of connection, refer to the MR-C series Servo Amplifier Instruction Manual.
- *5: This indicates the distance between the QD70P□ and servo amplifier.

Appendix 4 Connection examples with stepping motors manufactured by ORIENTALMOTOR Co., Ltd.

Appendix 4.1 Connection example of QD70P□ and VEXTA UPD

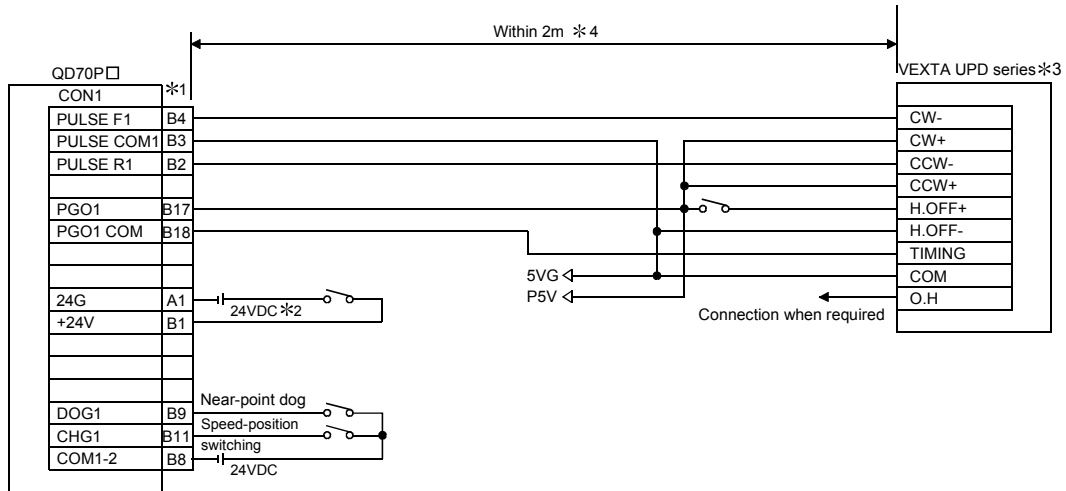

REMARK

- *1: The logic of each I/O terminal can be changed by making switch setting for intelligent function module (Refer to Section 5.6). (The above example assumes that all terminals are set to the negative logic.)
The above example assumes connection to Axis 1. (For the pin layout for connection to any of Axes 2 to 8, refer to "Section 3.4.2 Signal layout for external device connection connector".)
- *2: To output the command pulse (PULSE F/PULSE R), always connect an external power source (24VDC). (When outputting the command pulse of any of Axes 5 to 8, also connect to A1 and B1 of the CON1 connector provided for Axes 1 to 4.)
- *3: Refer to the manual of the stepping motor drive for the stepping motor drive side wiring other than the above and for the shield of each signal cable.
- *4: This indicates the distance between the QD70P□ and VEXTA UPD series.

Appendix 5 Connection examples with servo amplifiers manufactured by Matsushita Electric Industrial Co., Ltd.

Appendix 5.1 Connection example of QD70P□ and MINAS-A series

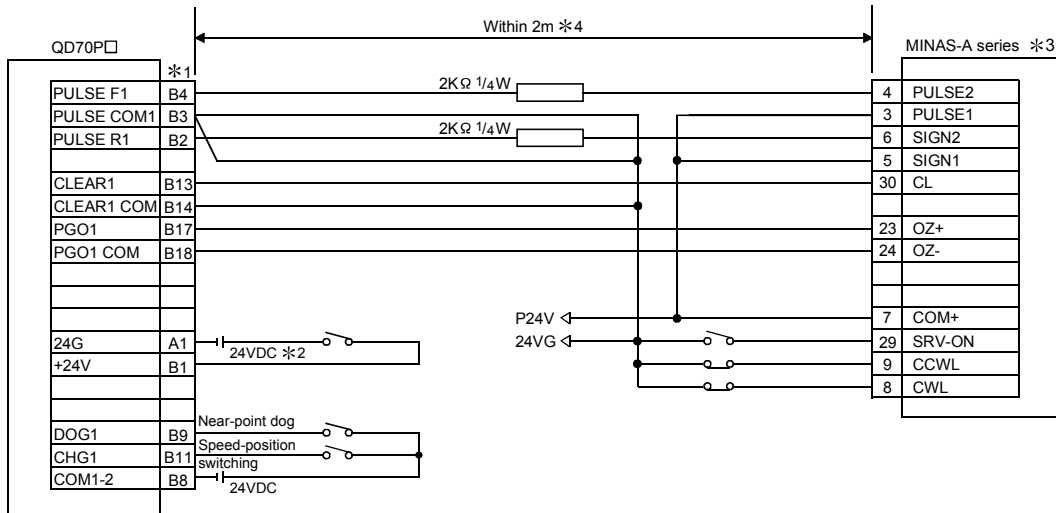

REMARK

- *1: The logic of each I/O terminal can be changed by making switch setting for intelligent function module (Refer to Section 5.6). (The above example assumes that all terminals are set to the negative logic.)
The above example assumes connection to Axis 1. (For the pin layout for connection to any of Axes 2 to 8, refer to "Section 3.4.2 Signal layout for external device connection connector".)
- *2: To output the command pulse (PULSE F/PULSE R), always connect an external power source (24VDC). (When outputting the command pulse of any of Axes 5 to 8, also connect to A1 and B1 of the CON1 connector provided for Axes 1 to 4.)
- *3: Refer to the manual of the servo amplifier for the servo amplifier side wiring other than the above and for the shield of each signal cable.
- *4: This indicates the distance between the QD70P□ and MINAS-A series.

Appendix 7 Connection examples with servo amplifiers manufactured by YASKAWA Electric Corporation

Appendix 7.1 Connection example of QD70P□ and Σ-II series

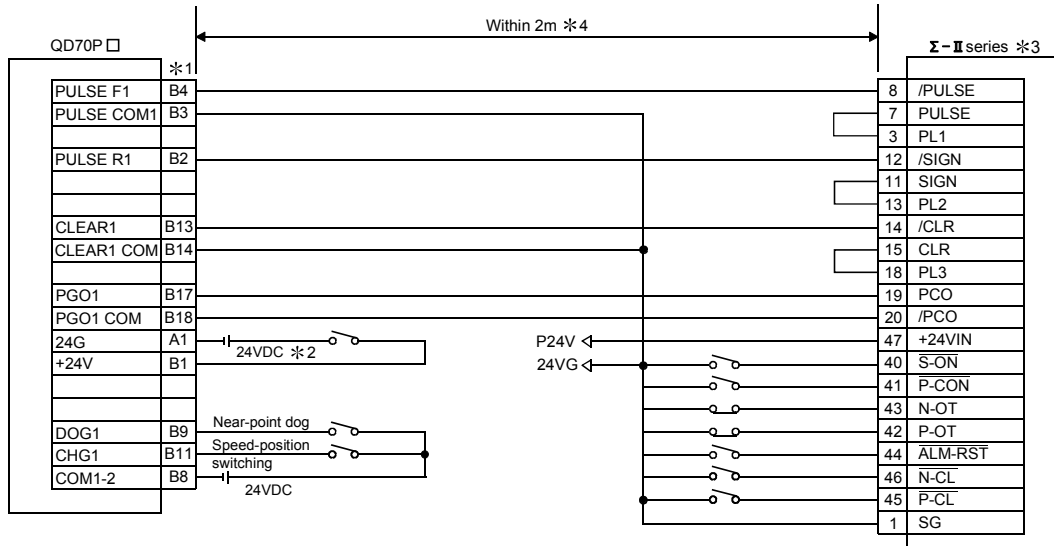

REMARK

- *1: The logic of each I/O terminal can be changed by making switch setting for intelligent function module (Refer to Section 5.6). (The above example assumes that all terminals are set to the negative logic.)
The above example assumes connection to Axis 1. (For the pin layout for connection to any of Axes 2 to 8, refer to "Section 3.4.2 Signal layout for external device connection connector".)
- *2: To output the command pulse (PULSE F/PULSE R), always connect an external power source (24VDC). (When outputting the command pulse of any of Axes 5 to 8, also connect to A1 and B1 of the CON1 connector provided for Axes 1 to 4.)
- *3: Refer to the manual of the servo amplifier for the servo amplifier side wiring other than the above and for the shield of each signal cable.
- *4: This indicates the distance between the QD70P□ and Σ-II series.

Appendix 8 Comparisons with type QD75 positioning module

Model		QD70P4	QD70P8	QD75P1 QD75D1	QD75P2 QD75D2	QD75P4 QD75D4	
Number of control axes		4 axes	8 axes	1 axis	2 axes	4 axes	
Control unit		pulse		mm, inch, degree, pulse			
Number of positioning data		10 /axis * ¹		600 /axis * ¹			
Position control interpolation function	2-axes linear interpolation	×	×	×	○	○	
	3-axes linear interpolation			×	×	○	
	4-axes linear interpolation			×	×	○	
	2-axes circular interpolation			×	○	○	
Positioning control method	Position control	ABS system	○	○			
		INC system	○	○			
		Fixed-feed	×	○			
	Speed control	1 axis	×	×	○	○	○
		2-axes linear interpolation			×	○	○
		3-axes linear interpolation			×	×	○
		4-axes linear interpolation			×	×	○
	Speed-position switching control		○	○			
	Position-speed switching control		×	○			
Current value changing		○	○				
Positioning control range		<ABS system> -2147483648 to 2147483647pulse <INC system> -2147483648 to 2147483647pulse <Speed-position switching control> 0 to 2147483647pulse (INC system)		<ABS system> -214748364.8 to 214748364.7μm -21474.83648 to 21474.83647inch 0 to 359.99999degree -2147483648 to 2147483647pulse <INC system (Fixed-feed)> -214748364.8 to 214748364.7μm -21474.83648 to 21474.83647inch -21474.83648 to 21474.83647degree -2147483648 to 2147483647pulse <Speed-position, position-speed switching control> 0 to 214748364.7μm 0 to 21474.83647inch 0 to 21474.83647degree /0 to 359.99999degree * ² 0 to 2147483647pulse			
Speed command range		1 to 200000pulse/s		0.01 to 20000000.00mm/min 0.001 to 2000000.000inch/min 0.001 to 2000000.000degree/min 1 to 1000000pulse/s			
High-level positioning control		No		Block start, condition start, wait start, simultaneous start, repeat start			
Machine OPR control function		○ (6 types)		○ (6 types)			
JOG operation		○		○			
Inching operation		×		○			
Manual pulse generator function		No		1 pulse generator/module			
Acceleration/deceleration processing	Automatic trapezoidal acceleration/deceleration	○		○			
	S-pattern acceleration/deceleration	×		○			
Acceleration/deceleration time		Acceleration time and deceleration time can be set. (0 to 32767ms)		Acceleration time and deceleration time can be set. (1 to 8388608ms)			

Item		Model		QD75P1	QD75P2	QD75P4
		QD70P4	QD70P8	QD75D1	QD75D2	QD75D4
Sub functions	OPR sub function	No		OPR retry, OP shift		
	Compensation function	No		Electronic gear, backlash compensation, near pass *3		
	Control limit function	Speed limit, software stroke limit		Speed limit, torque limit, software stroke limit, hardware stroke limit		
	Control details change function	Speed change		Speed change, override, torque limit value change		
	Absolute position restoration function	×		○		
	Other sub functions	Restart		Restart, continuous operation interrupt, step, skip, M code output, teaching, target position change, command in-position, pre-reading start		
Start command		Y device of programmable controller CPU		Y device of programmable controller CPU, external command signal, start command from peripheral device		
Stop command		Y device of programmable controller CPU		Y device of programmable controller CPU, external command signal, stop command from peripheral device		
Stop method	Deceleration stop	○		○		
	Sudden stop	×		○		
	Immediate stop	○		○		
Current value monitor data		Current feed value		Current feed value, machine feed value		
Error display		Error LED		Error LED		
History data storage (Start, error, warning)		No		Yes (3 types, 16 pcs./axis)		
Data storage destination		No (Backup not possible)		Flash ROM (Battery-free backup)		
Peripheral device/software		GX Configurator-PT *4		GX Configurator-QP		
Connection connector	A6CON1 (soldering type, straight out, option)		A6CON1 (soldering type, straight out, option)			
	A6CON2 (pressure-displacement type, straight out, option)		A6CON2 (pressure-displacement type, straight out, option)			
	A6CON4 (soldering type, usable for straight out and diagonal out, option)		A6CON4 (soldering type, usable for straight out and diagonal out, option)			
Applicable wire size	A6CON1, A6CON4: 0.3mm ²		A6CON1, A6CON4: 0.3mm ²			
	A6CON2: AWG#24		A6CON2: AWG#24			
Command pulse output type		Open collector		QD75P□: Open collector QD75D□: Differential driver		
Max. output pulse		200kpps		For connection to open collector : 200kpps For connection to differential driver: 1Mpps		
Max. connection distance to servo		2m		For connection to open collector : 2m For connection to differential driver: 10m		
Internal current consumption [5VDC]		0.55A	0.74A	QD75P1: 0.4A QD75D1: 0.52A	QD75P2: 0.46A QD75D2: 0.56A	QD75P4: 0.58A QD75D4: 0.82A
Number of occupied I/O points		32 points		32 points		
Number of slots occupied by module		1		1		
Weight		0.15kg	0.17kg	0.15kg	0.15kg	0.16kg

○: Possible, ×: Not possible

*1 The positioning data starting method changes depending on the model.

QD70P□ : Positioning data can be started from No. 1 only. (Cannot be started from any of No. 2 to No. 10.)

QD75P□/QD75D□ : Positioning data can be started from any of No. 1 to No. 600.

*2 When the unit is "degree", the control method is the INC system/ABS system under speed-position switching control.

*3 The near pass function is valid for continuous path control only.

*4 Added into GX Developer for use. (Refer to Chapter 6.)

Comparison of acceleration/deceleration processing function method

Item	QD75	QD70 (Refer to Section 11.5 for details)			
		Speed change	Position control in operation pattern of continuous path control	Machine OPR control	Other than the three items on the left
Set acceleration time	Time taken to reach the speed limit value from speed 0	Time taken to reach the new speed from the old speed.	Time taken to reach the new speed from the command speed before positioning data No. changing.	Time taken to reach the OPR speed from the bias speed at start.	Time taken to reach the set speed from the bias speed at start.
Set deceleration time	Time taken to reach speed 0 from the speed limit value			Time taken to reach the creep speed from the OPR speed.	Time taken to reach the bias speed at start from the set speed.

Operation of acceleration/deceleration processing function of QD70

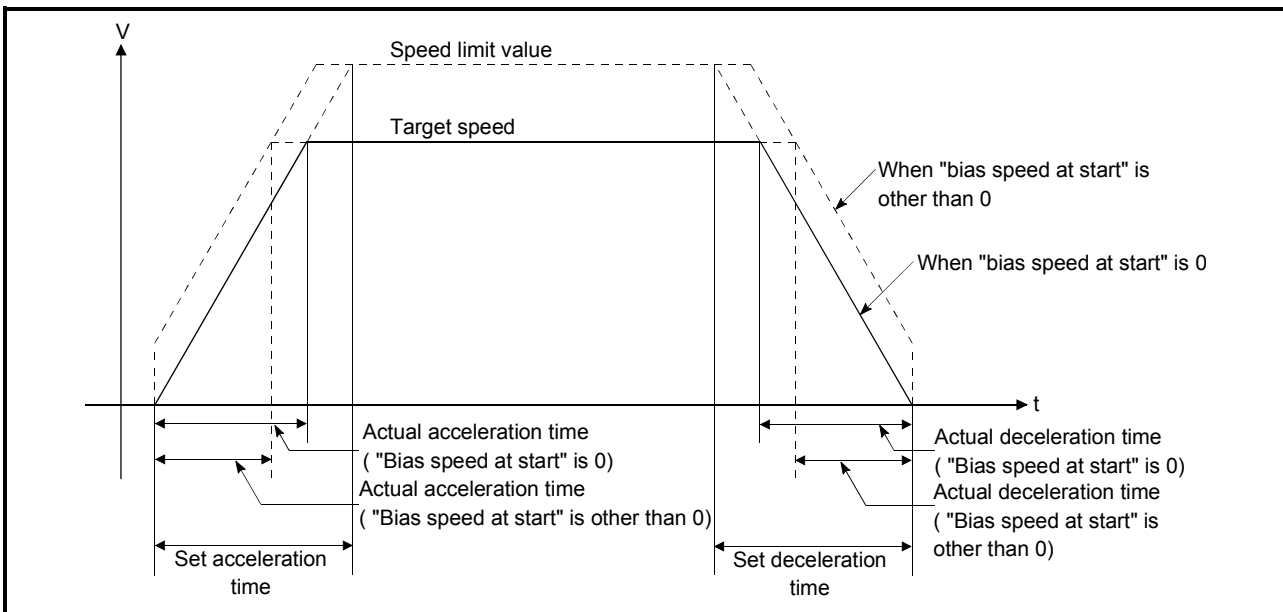

*: The operation of the acceleration/deceleration processing function of the AD75 is the same as that of the QD75.
 (For comparison between the QD75 and AD75, refer to the QD75P/QD75D Positioning Module User's Manual.)

Appendix 9 List of buffer memory addresses

Buffer memory address								Item	Memory area	
Axis 1	Axis 2	Axis 3	Axis 4	Axis 5	Axis 6	Axis 7	Axis 8			
0	100	200	300	400	500	600	700	Pr. 1 Software stroke limit upper limit value	Parameter	
1	101	201	301	401	501	601	701			
2	102	202	302	402	502	602	702	Pr. 2 Software stroke limit lower limit value		
3	103	203	303	403	503	603	703			
4	104	204	304	404	504	604	704	Pr. 3 Software stroke limit valid/invalid setting		
5	105	205	305	405	505	605	705	Pr. 4 Current feed value during speed control		
6	106	206	306	406	506	606	706	Pr. 5 Speed limit value		
7	107	207	307	407	507	607	707			
8	108	208	308	408	508	608	708	Pr. 6 Bias speed at start		
9	109	209	309	409	509	609	709			
10	110	210	310	410	510	610	710	Pr. 7 Positioning complete signal output time		
11	111	211	311	411	511	611	711	Pr. 8 Deviation counter clear signal output time		
12	112	212	312	412	512	612	712	Pr. 9 PULSE/SIGN method selection setup/hold time		
13	113	213	313	413	513	613	713	Pr. 10 Stop mode during path control		
14	114	214	314	414	514	614	714	Reserved (Cannot be used)*		
to	to	to	to	to	to	to	to			
19	119	219	319	419	519	619	719			
20	120	220	320	420	520	620	720		OPR. 1 OPR method	OPR data
21	121	221	321	421	521	621	721		OPR. 2 OPR direction	
22	122	222	322	422	522	622	722	OPR. 3 OP address		
23	123	223	323	423	523	623	723			
24	124	224	324	424	524	624	724	OPR. 4 OPR speed		
25	125	225	325	425	525	625	725			
26	126	226	326	426	526	626	726	OPR. 5 Creep speed		
27	127	227	327	427	527	627	727			
28	128	228	328	428	528	628	728	OPR. 6 ACC/DEC time at OPR		
29	129	229	329	429	529	629	729	OPR. 7 DEC/STOP time at OPR		
30	130	230	330	430	530	630	730	OPR. 8 Setting for the movement amount after near-point dog ON		
31	131	231	331	431	531	631	731			
32	132	232	332	432	532	632	732	OPR. 9 OPR dwell time		
33	133	233	333	433	533	633	733	Reserved (Cannot be used)*		
to	to	to	to	to	to	to	to			
39	139	239	339	439	539	639	739			
40	140	240	340	440	540	640	740	JOG. 1 JOG speed	JOG data	
41	141	241	341	441	541	641	741			
42	142	242	342	442	542	642	742	JOG. 2 JOG ACC time		
43	143	243	343	443	543	643	743	JOG. 3 JOG DEC time		
44	144	244	344	444	544	644	744	JOG. 4 JOG direction flag		
45	145	245	345	445	545	645	745	Reserved (Cannot be used)*		
to	to	to	to	to	to	to	to			
49	149	249	349	449	549	649	749			

*: Write to "Reserved (Cannot be used)" is prohibited.

Buffer memory address								Item	Memory area	
Axis 1	Axis 2	Axis 3	Axis 4	Axis 5	Axis 6	Axis 7	Axis 8			
50	150	250	350	450	550	650	750	Cd. 1	Axis error reset	Axis control data
51	151	251	351	451	551	651	751	Cd. 2	OPR request flag OFF request	
52	152	252	352	452	552	652	752	Cd. 3	Start method	
53	153	253	353	453	553	653	753	Cd. 4	Restart request	
54	154	254	354	454	554	654	754	Cd. 5	Speed-position switching request	
55	155	255	355	455	555	655	755	Cd. 6	Speed change request	
56	156	256	356	456	556	656	756	Cd. 7	New speed value	
57	157	257	357	457	557	657	757			
58	158	258	358	458	558	658	758	Cd. 8	ACC/DEC time at speed change	
59	159	259	359	459	559	659	759	Cd. 9	DEC/STOP time at speed change	
60	160	260	360	460	560	660	760	Reserved (Cannot be used)*		
to	to	to	to	to	to	to	to			
69	169	269	369	469	569	669	769			
70	170	270	370	470	570	670	770	Md. 1	Current feed value	Axis monitor data
71	171	271	371	471	571	671	771	Md. 2	Movement amount after near-point dog ON	
72	172	272	372	472	572	672	772			
73	173	273	373	473	573	673	773	Md. 3	Current speed	
74	174	274	374	474	574	674	774			
75	175	275	375	475	575	675	775	Md. 4	Axis operation status	
76	176	276	376	476	576	676	776			
77	177	277	377	477	577	677	777	Md. 5	Axis error code	
78	178	278	378	478	578	678	778			
79	179	279	379	479	579	679	779	Md. 6	Axis warning code	
80	180	280	380	480	580	680	780			
81	181	281	381	481	581	681	781	Md. 7	Status	
82	182	282	382	482	582	682	782			
to	to	to	to	to	to	to	to	Md. 8	External I/O signal	
99	199	299	399	499	599	699	799			
								Md. 9	Executing positioning data No.	
								Reserved (Cannot be used)*		

*: Write to "Reserved (Cannot be used)" is prohibited.

Buffer memory address								Item	Memory area
Axis 1	Axis 2	Axis 3	Axis 4	Axis 5	Axis 6	Axis 7	Axis 8		
800	900	1000	1100	1200	1300	1400	1500	Da. 1 Operation pattern	No. 1
801	901	1001	1101	1201	1301	1401	1501	Da. 2 Control method	
802	902	1002	1102	1202	1302	1402	1502	Da. 3 ACC/DEC time	
803	903	1003	1103	1203	1303	1403	1503	Da. 4 DEC/STOP time	
804	904	1004	1104	1204	1304	1404	1504	Da. 5 Command speed	
805	905	1005	1105	1205	1305	1405	1505		
806	906	1006	1106	1206	1306	1406	1506	Da. 6 Positioning address/movement amount	
807	907	1007	1107	1207	1307	1407	1507		
808	908	1008	1108	1208	1308	1408	1508	Da. 7 Dwell time	
809	909	1009	1109	1209	1309	1409	1509	Reserved (Cannot be used)*	
810	910	1010	1110	1210	1310	1410	1510	No. 2	Positioning data
819	919	1019	1119	1219	1319	1419	1519		
820	920	1020	1120	1220	1320	1420	1520	No. 3	
829	929	1029	1129	1229	1329	1429	1529		
830	930	1030	1130	1230	1330	1430	1530	No. 4	
839	939	1039	1139	1239	1339	1439	1539		
840	940	1040	1140	1240	1340	1440	1540	No. 5	
849	949	1049	1149	1249	1349	1449	1549		
850	950	1050	1150	1250	1350	1450	1550	No. 6	
859	959	1059	1159	1259	1359	1459	1559		
860	960	1060	1160	1260	1360	1460	1560	No. 7	
869	969	1069	1169	1269	1369	1469	1569		
870	970	1070	1170	1270	1370	1470	1570	No. 8	
879	979	1079	1179	1279	1379	1479	1579		
880	980	1080	1180	1280	1380	1480	1580	No. 9	
889	989	1089	1189	1289	1389	1489	1589		
890	990	1090	1190	1290	1390	1490	1590	No. 10	
899	999	1099	1199	1299	1399	1499	1599		
1600								Md. 10 Error status	Module information monitor data
1601								Md. 11 Warning status	

*: Write to "Reserved (Cannot be used)" is prohibited.

INDEX

[Numeral]

0 speed	4-28
1-axis linear control (ABS)	9-11
1-axis linear control (INC)	9-12

[A]

AD70	1- 1
AD75	A-11
AD75CK	5-10
Absolute system	9- 8
Acceleration/deceleration processing function	11- 8
Actual acceleration/deceleration time	11- 8
Applicable system	2- 3
Applicable wire size	3- 1
Auto refresh setting	6-14
Axis control data	4-30
Axis display LED	5- 4
Axis error occurrence signal	3- 5
Axis monitor data	4-27
Axis stop signal	3- 6
Axis warning occurrence signal	3- 5

[B]

BUSY signal	3- 5
-------------------	------

[C]

CPU module	2- 3
CW/CCW mode	5-15
Cable clamping	5-10
Cd. 1 Axis error reset	4- 8
Cd. 2 OPR request flag OFF request	4- 8
Cd. 3 Start method	4- 8
Cd. 4 Restart request	4- 8
Cd. 5 Speed-position switching request	4- 8
Cd. 6 Speed change request	4- 8
Cd. 7 New speed value	4- 8
Cd. 8 ACC/DEC time at speed change	4- 8
Cd. 9 DEC/STOP time at speed change	4- 8
Common functions	12- 1
Component list	2- 2
Confirming the current value	9- 9
Confirming the wiring	5-12
Connection confirmation	5-12
Connector	5- 4

Continuous path control	9- 5
Continuous positioning control	9- 4
Count 1 machine OPR control	8-12
Count 2 machine OPR control	8-14
Current feed value	9- 9
Current value changing	9-16

[D]

DOS/V personal computer	A-11
Da. 1 Operation pattern	4- 6
Da. 2 Control method	4- 6
Da. 3 ACC/DEC time	4- 6
Da. 4 DEC/STOP time	4- 6
Da. 5 Command speed	4- 6
Da. 6 Positioning address/movement amount	4- 6
Da. 7 Dwell time	4- 6
Deceleration stop	1-12
Details of input signals (QD70 to programmable controller CPU)	3- 5
Details of output signals (programmable controller CPU to QD70)	3- 6
Deviation counter clear signal	3- 7
Deviation counter droop pulse amount	1- 5

[E]

Electrical specifications	3- 7
Error and warning details	13- 1
Error reset program	7-12
External 24V current consumption	3- 1
External I/O logic switching function	12- 1
External I/O signal monitor	12- 1
External device connection connector	5- 6
External dimension drawing	App- 1
External power source input	3- 8

[F]

Fast OPR control	8-16
Fast OPR control starting timing chart	7-20

[G]

GX Configurator-PT	A-10
GX Developer	A-10
General configuration of program	7- 6
General image of system	2- 1

[H]

Handling precautions	5- 1
How to check the function version	2- 8

[I]

- I/O assignment setting 5-17
- Immediate stop 9- 6
- Incremental system 9- 8
- Initial setting 6-12
- Initial setting program 7-15
- Input/output interface internal circuit 3-11
- Input/output interface specifications 3- 7
- Installing and uninstalling 6- 2
- Intelligent function module parameters 6- 6
- Internal circuit 3-11
- Internal current consumption 3- 1

[J]

- JOG data list 4-20
- JOG operation 10- 1
- JOG operation program 7-11
- JOG operation starting timing chart 10- 1
- JOG start signal 3- 6
- JOG. 1** JOG speed 4- 5
- JOG. 2** JOG ACC time 4- 5
- JOG. 3** JOG DEC time 4- 5
- JOG. 4** JOG direction flag 4- 5

[L]

- LED display function 13-13
- List of OPR data 4-14
- List of buffer memory addresses App-16
- List of control data 4-30
- List of devices 7- 3
- List of errors 13- 3
- List of functions 3- 2
- List of input/output signals 3- 4
- List of monitor data 4-27
- List of parameters 4- 9
- List of positioning data 4-21
- List of warnings 13-11

[M]

- MELSECNET/H 2- 4
- Machine OPR control 8- 2
- Machine OPR control starting timing chart... 7-19
- Max. connection distance 3- 1
- Max. output pulse 3- 1
- Md. 1** Current feed value 4- 7
- Md. 2** Movement amount after near-point dog ON 4- 7
- Md. 3** Current speed 4- 7

- Md. 4** Axis operation status 4- 7
- Md. 5** Axis error code 4- 7
- Md. 6** Axis warning code 4- 7
- Md. 7** Status 4- 7
- Md. 8** External I/O signal 4- 7
- Md. 9** Executing positioning data No. 4- 7
- Md. 10** Error status 4- 7
- Md. 11** Warning status 4- 7
- Mechanism of positioning control 1- 2
- Module READY signal 3- 5
- Module information monitor data 4-27
- Module's detailed information 5-17
- Monitor/test 6-16
- Movement amount per pulse 1- 3
- Multiple CPU system 2- 5
- Multiple axes simultaneous start control 9-17

[N]

- Near-point dog method machine OPR control 8- 4
- Near-point dog signal 3- 7
- No. of control axes 3- 1
- Number of mountable modules 2- 3
- No. of occupied I/O points 3- 1

[O]

- OPR complete flag 4-28
- OPR data setting program 7- 9
- OPR method 8- 3
- OPR method (1): Near-point dog method 8- 4
- OPR method (2): Stopper 1 8- 6
- OPR method (3): Stopper 2 8- 8
- OPR method (4): Stopper 3 8-10
- OPR method (5): Count 1 8-12
- OPR method (6): Count 2 8-14
- OPR request 8- 1
- OPR request OFF program 7-10
- OPR request flag 4-28
- OPR. 1** OPR method 4- 4
- OPR. 2** OPR direction 4- 4
- OPR. 3** OP address 4- 4
- OPR. 4** OPR speed 4- 4
- OPR. 5** Creep speed 4- 4
- OPR. 6** ACC/DEC time at OPR 4- 4
- OPR. 7** DEC/STOP time at OPR 4- 4
- OPR. 8** Setting for the movement amount after near-point dog ON 4- 4
- OPR. 9** OPR dwell time 4- 4

Operating environment	6- 4
Operation pattern	9- 2
Operation timing and processing time of JOG operation.....	App- 5
Operation timing and processing time of fast OPR control	App- 2
Operation timing and processing time of machine OPR control	App- 2
Operation timing and processing time of position control	App- 3
Operation timing and processing time of speed-position switching control	App- 4
Outline design of positioning control system.	1- 4
Outline of OPR control	8- 1
Outline of starting	1-10
Outline of stopping	1-12

[P]

Programmable controller CPU	A-11
Programmable controller READY signal	3- 6
Programmable controller READY signal [Y0] ON program	7-10
PLC parameter	4- 2
PULSE/SIGN mode.....	5-14
Parameter setting program	7- 9
Part identification nomenclature	5- 4
Performance specifications.....	3- 1
Peripheral device.....	A-11
Personal computer	A-11
Position match stop.....	4-13
Positioning complete signal	3- 5
Positioning control operation program.....	7- 7
Positioning control program examples	7- 9
Positioning control start program.....	7-11
Positioning data setting program	7-10
Positioning start signal	3- 6
Positioning termination.....	9- 3
Pr. 1 Software stroke limit upper limit value.	4- 3
Pr. 2 Software stroke limit lower limit value .	4- 3
Pr. 3 Software stroke limit valid/invalid setting	4- 3
Pr. 4 Current feed value during speed control	4- 3
Pr. 5 Speed limit value	4- 3
Pr. 6 Bias speed at start	4- 3
Pr. 7 Positioning complete signal output time	4- 3

Pr. 8 Deviation counter clear signal output time	4- 3
Pr. 9 PULSE/SIGN method selection setup/hold time.....	4- 3
Pr. 10 Stop mode during path control	4- 3
Precautions	
Handling precautions	5- 1
Precautions at completion of wiring.....	5-12
Precautions for creating program	7- 1
Wiring precautions	5- 7
Precautions at completion of wiring	5-12
Precautions for creating program.....	7- 1
Procedures before operation.....	5- 3
Processing time	
Operation timing and processing time of JOG operation.....	App- 5
Operation timing and processing time of fast OPR control.....	App- 2
Operation timing and processing time of machine OPR control.....	App- 2
Operation timing and processing time of position control	App- 3
Operation timing and processing time of speed-position switching control.....	App- 4
Program details.....	7-12
Program example	
Error reset program.....	7-12
JOG operation program	7-11
OPR data setting program	7- 9
OPR request OFF program	7-10
Programmable controller READY signal [Y0] ON program	7-10
Parameter setting program	7- 9
Positioning control start program.....	7-10
Positioning data setting program	7-10
Restart program	7-12
Speed change program	7-12
Start method setting program	7-10
Stop program.....	7-12

[Q]

QD70	A-11
QD70 features.....	1- 1
QD70-to-each module signal communication	1- 8
QD75	A-11

[R]

Rated plate	2- 8
Remote I/O station	2- 4

Restart function	11-11
Restart program	7-12
Restarting timing chart	7-23

[S]

SERIAL	2- 8
Setting data	4- 1
Setting items for OPR data	4- 4
Setting items for parameters	4- 3
Setting items for positioning data	4- 6
Setting the positioning data	9-10
Signal	
Axis error occurrence signal	3- 5
Axis stop signal	3- 6
Axis warning occurrence signal	3- 5
BUSY signal	3- 5
Deviation counter clear signal	3- 7
JOG start signal	3- 6
Module READY signal	3- 5
Near-point dog signal	3- 7
Programmable controller READY signal ...	3- 6
Positioning complete signal	3- 5
Positioning start signal	3- 6
Speed-position switching signal	3- 7
Start complete signal	3- 5
Zero signal	3- 7
Signal layout for connector	3- 9
Signal names	3- 4
Simple reciprocating operation	5-18
Slot	2- 4
Software version	2- 5, 2-10
Specifications of input/output signals	3- 4
Speed change function	11- 2
Speed change program	7-12
Speed limit function	11- 1
Speed-position switching control	9-13
Speed-position switching control starting timing chart	7-21
Speed-position switching signal	3- 7
Start complete signal	3- 5
Start method	4-30
Start method setting program	7-10
Start program	7-14
Starting the utility	6-10
Stop program	7-12
Stop settling time	1- 4
Stopper 1 machine OPR control	8- 6
Stopper 2 machine OPR control	8- 8

Stopper 3 machine OPR control	8-10
Sub functions	11- 1
Switch setting for intelligent function module	5-14
System monitor	13-14

[T]

Timing chart	
Fast OPR control starting timing chart	7-20
JOG operation starting timing chart	10-1
Machine OPR control starting timing chart	7-19
OPR OFF requesting timing chart	7-13
Positioning control starting timing chart	7-20
Restarting timing chart	7-23
Speed changing timing chart	7-22
Speed-position switching control starting timing chart	7-21
Torque limit	8- 6
Types and roles of control data	4- 8
Types and roles of monitor data	4- 7
Types of data	4- 1
Types of errors	13- 1
Types of warnings	13- 2

[U]

Utility package	6- 1
-----------------------	------

[W]

Wiring	5- 7
Wiring precautions	5- 7
Workpiece	A-11

[X]

X/Y monitor	6-17
X0 (module READY)	3- 5
X1 (axis error occurrence)	3- 5
X2 (axis warning occurrence)	3- 5

[Z]

Zero signal	3- 7
-------------------	------

WARRANTY

Please confirm the following product warranty details before using this product.

1. Gratis Warranty Term and Gratis Warranty Range

If any faults or defects (hereinafter "Failure") found to be the responsibility of Mitsubishi occurs during use of the product within the gratis warranty term, the product shall be repaired at no cost via the sales representative or Mitsubishi Service Company.

However, if repairs are required onsite at domestic or overseas location, expenses to send an engineer will be solely at the customer's discretion. Mitsubishi shall not be held responsible for any re-commissioning, maintenance, or testing on-site that involves replacement of the failed module.

[Gratis Warranty Term]

The gratis warranty term of the product shall be for one year after the date of purchase or delivery to a designated place.

Note that after manufacture and shipment from Mitsubishi, the maximum distribution period shall be six (6) months, and the longest gratis warranty term after manufacturing shall be eighteen (18) months. The gratis warranty term of repair parts shall not exceed the gratis warranty term before repairs.

[Gratis Warranty Range]

- (1) The range shall be limited to normal use within the usage state, usage methods and usage environment, etc., which follow the conditions and precautions, etc., given in the instruction manual, user's manual and caution labels on the product.
- (2) Even within the gratis warranty term, repairs shall be charged for in the following cases.
 1. Failure occurring from inappropriate storage or handling, carelessness or negligence by the user. Failure caused by the user's hardware or software design.
 2. Failure caused by unapproved modifications, etc., to the product by the user.
 3. When the Mitsubishi product is assembled into a user's device, Failure that could have been avoided if functions or structures, judged as necessary in the legal safety measures the user's device is subject to or as necessary by industry standards, had been provided.
 4. Failure that could have been avoided if consumable parts (battery, backlight, fuse, etc.) designated in the instruction manual had been correctly serviced or replaced.
 5. Failure caused by external irresistible forces such as fires or abnormal voltages, and Failure caused by force majeure such as earthquakes, lightning, wind and water damage.
 6. Failure caused by reasons unpredictable by scientific technology standards at time of shipment from Mitsubishi.
 7. Any other failure found not to be the responsibility of Mitsubishi or that admitted not to be so by the user.

2. Onerous repair term after discontinuation of production

(1) Mitsubishi shall accept onerous product repairs for seven (7) years after production of the product is discontinued.

Discontinuation of production shall be notified with Mitsubishi Technical Bulletins, etc.

(2) Product supply (including repair parts) is not available after production is discontinued.

3. Overseas service

Overseas, repairs shall be accepted by Mitsubishi's local overseas FA Center. Note that the repair conditions at each FA Center may differ.

4. Exclusion of loss in opportunity and secondary loss from warranty liability

Regardless of the gratis warranty term, Mitsubishi shall not be liable for compensation of damages caused by any cause found not to be the responsibility of Mitsubishi, loss in opportunity, lost profits incurred to the user by Failures of Mitsubishi products, special damages and secondary damages whether foreseeable or not, compensation for accidents, and compensation for damages to products other than Mitsubishi products, replacement by the user, maintenance of on-site equipment, start-up test run and other tasks.

5. Changes in product specifications

The specifications given in the catalogs, manuals or technical documents are subject to change without prior notice.

6. Product application

- (1) In using the Mitsubishi MELSEC programmable controller, the usage conditions shall be that the application will not lead to a major accident even if any problem or fault should occur in the programmable controller device, and that backup and fail-safe functions are systematically provided outside of the device for any problem or fault.
- (2) The Mitsubishi programmable controller has been designed and manufactured for applications in general industries, etc. Thus, applications in which the public could be affected such as in nuclear power plants and other power plants operated by respective power companies, and applications in which a special quality assurance system is required, such as for Railway companies or Public service purposes shall be excluded from the programmable controller applications.

In addition, applications in which human life or property that could be greatly affected, such as in aircraft, medical applications, incineration and fuel devices, manned transportation, equipment for recreation and amusement, and safety devices, shall also be excluded from the programmable controller range of applications.

However, in certain cases, some applications may be possible, providing the user consults their local Mitsubishi representative outlining the special requirements of the project, and providing that all parties concerned agree to the special circumstances, solely at the users discretion.

Microsoft, Windows, Windows NT, and Windows Vista are registered trademarks of Microsoft Corporation in the United States and other countries.

Pentium and Celeron are trademarks of Intel Corporation in the United States and other countries.

Ethernet is a registered trademark of Xerox Corporation in the United States.

Other company names and product names used in this document are trademarks or registered trademarks of respective companies.

SPREAD

Copyright (C) 1996 FarPoint Technologies, Inc

SH(NA)-080171-N(0808)MEE

MODEL: QD70P-U-S-E

MODEL CODE: 13JR39

MITSUBISHI ELECTRIC CORPORATION

HEAD OFFICE : TOKYO BUILDING, 2-7-3 MARUNOUCHI, CHIYODA-KU, TOKYO 100-8310, JAPAN
NAGOYA WORKS : 1-14, YADA-MINAMI 5-CHOME, HIGASHI-KU, NAGOYA, JAPAN

When exported from Japan, this manual does not require application to the
Ministry of Economy, Trade and Industry for service transaction permission.

Specifications subject to change without notice.