

EXPERIMENT MANUAL

ARCHITECTURAL ENGINEERING



THAMES & KOSMOS



Franckh-Kosmos Verlags-GmbH & Co. KG, Pfizerstr. 5-7, 70184 Stuttgart, Germany | +49 (0) 711 2191-0 | www.kosmos.de
Thames & Kosmos, 301 Friendship St., Providence, RI, 02903, USA | 1-800-587-2872 | www.thamesandkosmos.com
Thames & Kosmos UK LP, 20 Stone Street, Cranbrook, Kent, TN17 3HE, UK | 01580 713000 | www.thamesandkosmos.co.uk

>>> IMPORTANT INFORMATION

Safety Information

Warning! Not suitable for children under 3 years. Choking hazard — small parts may be swallowed or inhaled. Strangulation hazard — long flexible rods may become wrapped around the neck.

Store the experiment material and assembled models out of the reach of small children.

Keep packaging and instructions as they contain important information.

Assembly Tips

Anchor pins and connectors

Take a careful look at the different components. The small pieces, especially the two different lengths of gray anchor pins, can all look pretty similar at first glance. When you assemble the models, it's important to use the right ones.



Flexible rods

The flexible rods are a key feature of this engineering kit. There are two lengths: 5-hole and 7-hole. They can be twisted and bent into many different shapes.

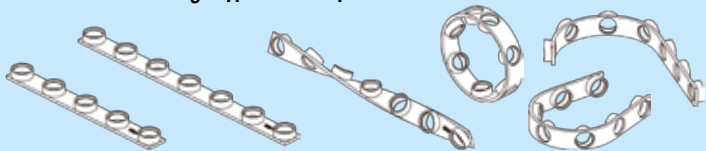

You can connect the flexible rods together end to end with the two-to-one converters to make longer lengths. It's easier to do this if you lay the rods on a flat surface and press the two-to-one converter down into the holes.

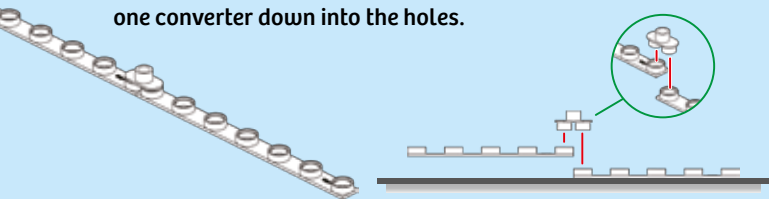

Do not fold the flexible rods and crease the folds. They will be permanently deformed if they are bent too much. Do not remove the anchor pins by twisting or pulling the flexible rods.

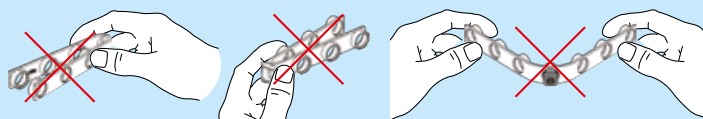

Half-hexagon connectors

The angle between the two pegs on the half-hexagon connector is 120°. With three of these and three rods of the same length, you can make an isosceles triangle.



Dear Parents and Supervising Adults,

Before starting the experiments, read through the instruction manual together with your child and discuss the safety information. Check to make sure the models have been assembled correctly. Assist your child with the experiments, especially with reading the assembly diagrams and putting pieces together that may require more dexterity or hand strength than the child currently possesses.

We hope you and your child have a lot of fun with the experiments!

Anchor pin lever

When you want to take your model apart again, you will need the anchor pin lever. Use the narrow end of the lever (A side) to remove the anchor pins from rods and flexible rods.



Use the wide end of the lever (B side) to pry pieces apart, as shown with the two-to-one converter here.

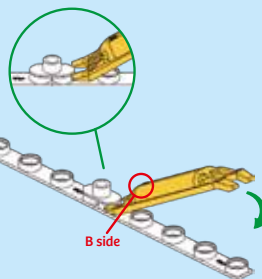

You can also use the A side of the lever to push pieces apart through holes, as shown with the two-to-one converter here.

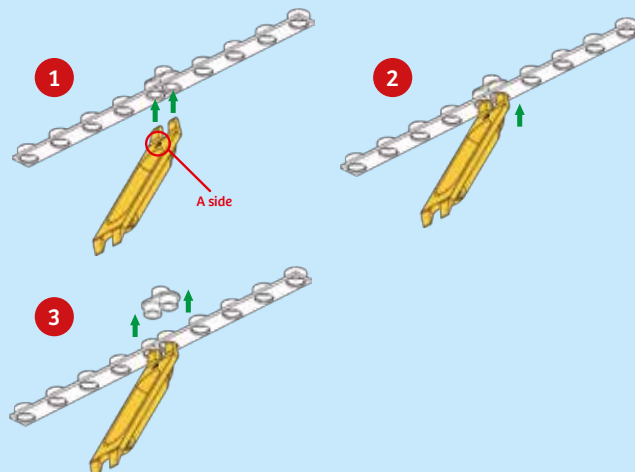

See the inside back cover of this manual for tips on resetting deformed flexible rods and adjusting the flexible rods to look perfect in the models.

What's inside your experiment kit:

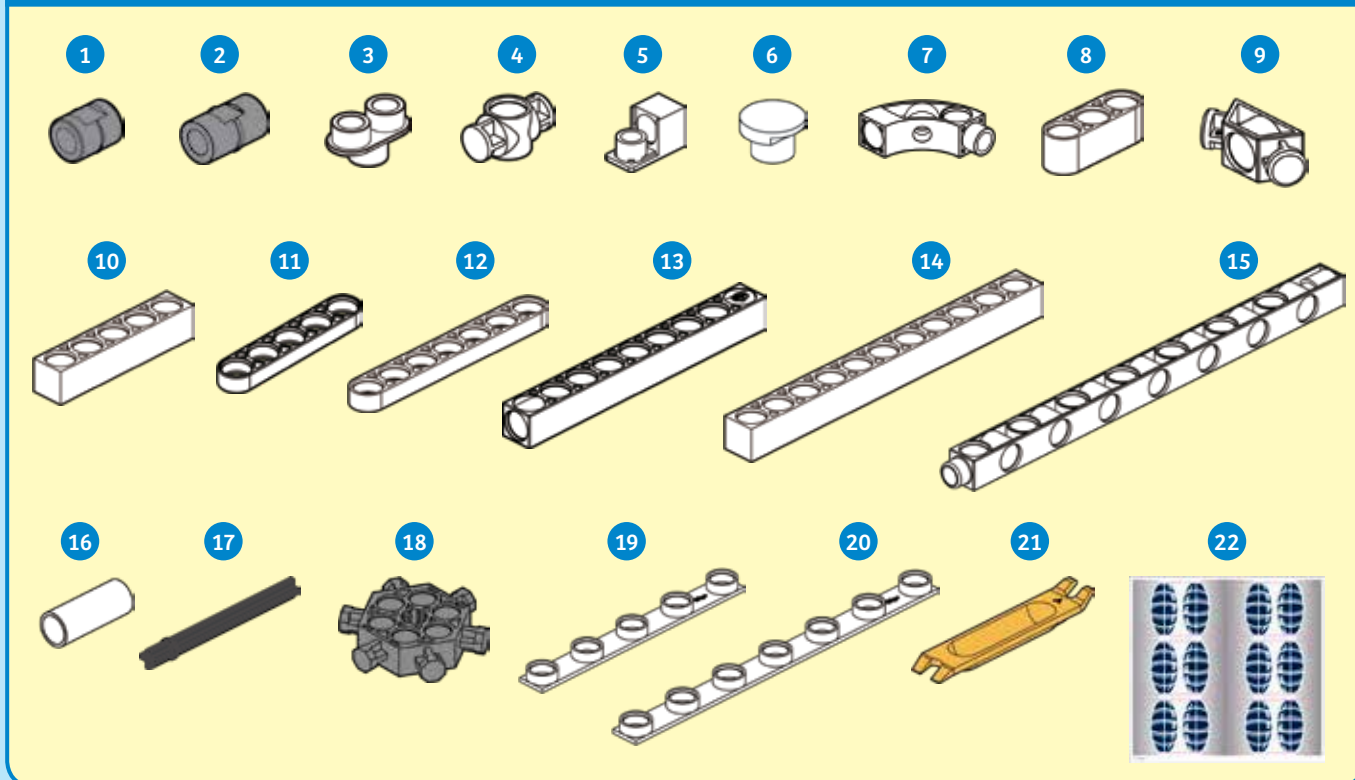

Checklist: Find – Inspect – Check off

✓	No.	Description	Qty.	Item No.
<input type="radio"/>	1	Short anchor pin, gray	50	7344-W10-C2S
<input type="radio"/>	2	Long anchor pin, gray	10	7061-W10-C1S
<input type="radio"/>	3	Two-to-one converter, white	50	7061-W10-G1W
<input type="radio"/>	4	1-hole connector, white	12	7430-W10-B1W
<input type="radio"/>	5	90-degree converter Y, white	2	7061-W10-Y1W
<input type="radio"/>	6	Button pin, white	24	7061-W10-W1W
<input type="radio"/>	7	Curved rod, white	4	7061-W10-V1W
<input type="radio"/>	8	3-hole wide rounded rod, white	6	7404-W10-C1W
<input type="radio"/>	9	Half-hexagon connector, white	24	7432-W10-B1W
<input type="radio"/>	10	5-hole rod, white	16	7413-W10-K2W
<input type="radio"/>	11	5-hole flat rounded rod, white	6	7443-W10-C1W
<input type="radio"/>	12	7-hole flat rounded rod, white	6	7404-W10-C3W
<input type="radio"/>	13	9-hole cross rod, white	4	7407-W10-C2W
<input type="radio"/>	14	11-hole rod, white	8	7413-W10-P1W
<input type="radio"/>	15	15-hole dual rod, white	4	7413-W10-Z1W
<input type="radio"/>	16	Tube, 20 mm, white	12	7400-W10-G2W
<input type="radio"/>	17	Axle, 70 mm, black	1	7061-W10-Q1D
<input type="radio"/>	18	Hexagonal hub connector, gray	1	7445-W10-A1S
<input type="radio"/>	19	5-hole flexible rod, white	32	7432-W10-A1W
<input type="radio"/>	20	7-hole flexible rod, white	32	7432-W10-A2W
<input type="radio"/>	21	Anchor pin Lever	1	7061-W10-B1Y
<input type="radio"/>	22	Die-cut cardboard sheet	3	K16#7432

GOOD TO KNOW!

If you are missing any parts, please contact Thames & Kosmos customer service.

US: techsupport@thamesandkosmos.com
 UK: techsupport@thamesandkosmos.co.uk

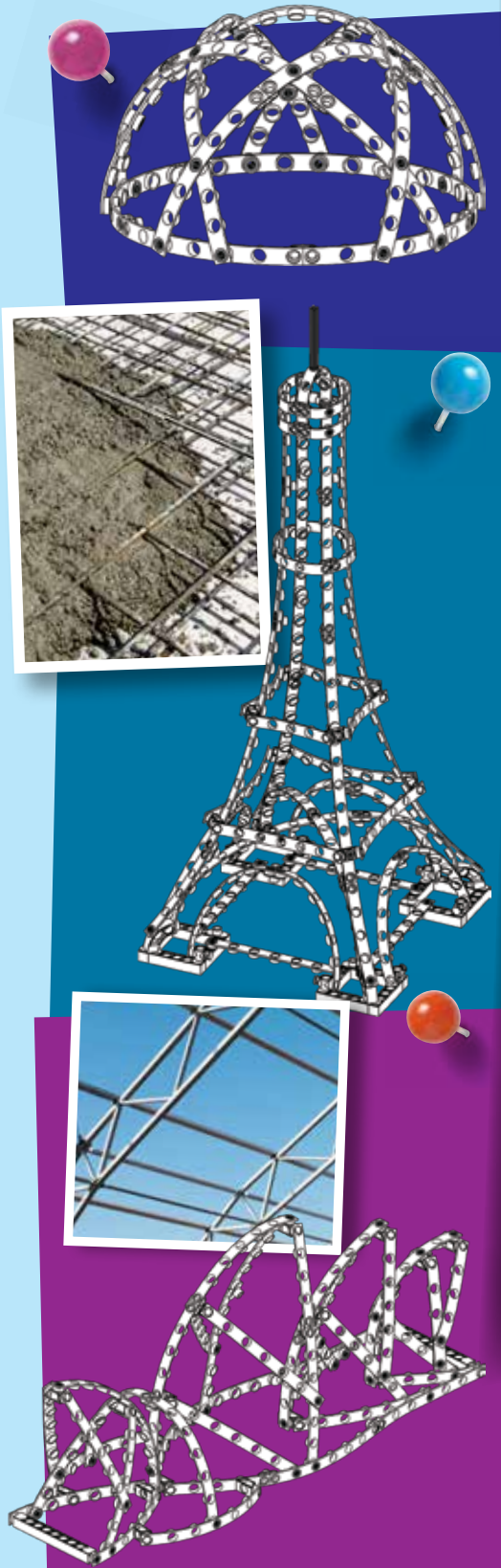

Important Information and Assembly Tips Inside front cover

Kit Contents..... 1

Table of Contents 2

What Is Architectural Engineering? 3

Models of Basic Architectural Elements:

Square and braced square 4

Cylinder and braced cylinder 5

Flexed triangle and convex polyhedron 6

Forces and Loads 7

Triangle and triangular prism 8

Square and rectangular prism 9

Flat pentagon 10

Dome made of pentagons 11

Flat and bowed triangles, and simple arch 12

Form and Function 13

Intersecting arches 14

Shell 15

Roman arch 16

Models of Buildings:

Wrought-Iron Lattice Tower 17

Giant Catenary Arch 21

Ferris Wheel 23

About the Eiffel Tower, Gateway Arch, and High Roller 27

Giant Dome 28

Olympic Stadium 30

Neo-Futuristic Skyscraper 34

About the Riechstag Dome, 30 St Mary Axe, and Beijing National Stadium 37

High-Tech Hotel 38

Concrete Shell Performance Center 41

About the Sydney Opera House and Burj Al Arab 44

Engineering Design Challenges 44

More Assembly Tips Inside back cover

Publisher's Information Inside back cover

TIP!

At the top of each model assembly page, you will find a red bar:

>>> It shows how difficult the model's assembly will be:

easy medium hard

What Is Architectural Engineering?



Architecture is the art and science of designing buildings and spaces that humans use. Engineering is the application of science and math to the design, creation, and use of just about anything humans make. Architectural engineering refers to the engineering aspects of architecture. An architectural engineer uses engineering principles to design buildings.

Architects plan, design, and manage the construction of a building. The primary focus of an architect is to design a building to meet the needs of the users or occupants. Architectural engineers focus on the design of a building's systems including its structural systems; its heating, ventilation, and air conditioning (or HVAC for short) systems; and its plumbing, fire protection, electrical, and lighting systems. Architectural engineers use new materials and technologies, like computer modeling. They balance factors like cost, time, and quality to make decisions. Architects work with architectural engineers to make their designs become reality.

In this kit, you will learn about some of the design elements and structural components of buildings with hands-on projects.

WHAT IS DESIGN ?

Architects and engineers use the word "design" to describe what they do. Design is a sequence of steps that are used to take an idea from concept to reality. The engineering design process is iterative, meaning steps can be repeated multiple times and then improvements can be made each time, until the correct or optimal outcome is achieved.

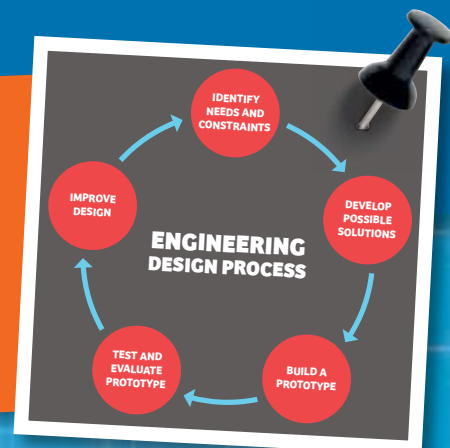

● ● ● **SQUARE**

Architects need their buildings to be structurally stable and to remain standing despite all the loads that act on them. Let's build some simple models and conduct simple experiments with them to show how connecting structural elements together in different ways can affect the strength and stability of a structure.

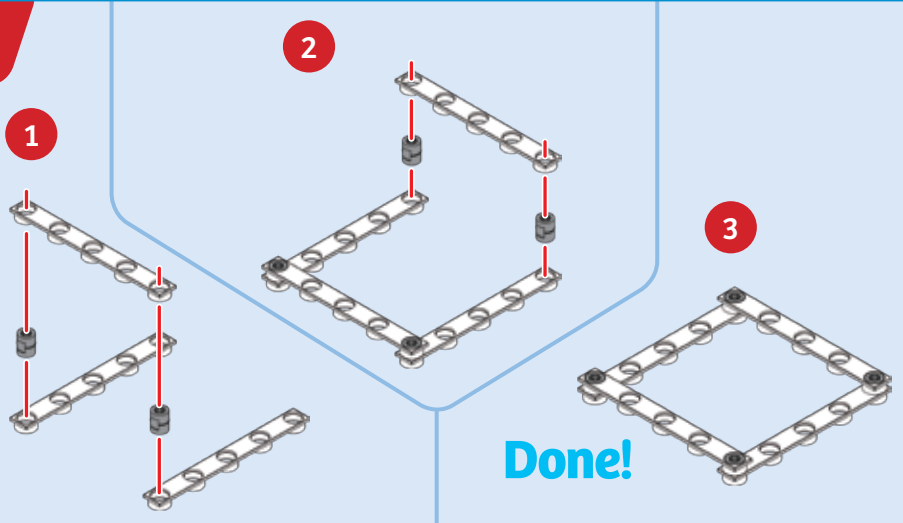

EXPERIMENT

Stability of a square

HERE'S HOW

With the square flat on a table, hold one corner of the square in one hand and try to deform it by moving the opposite corner. Does the square deform? Also try bending one corner of the square upward from the table while holding the other corner. Does it bend?

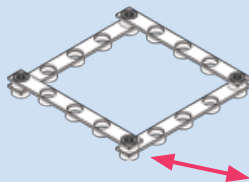

WHAT'S HAPPENING ?

When you are pushing or pulling on the corner of the square, you are applying a **force**, or **load**, to the structure. A goal of architectural engineering is to achieve the **stability** of a structure under different loads. All structures will change shape to some degree when loads act on them. In a **stable** structure, the changes in shape, or **deformations**, are small, and forces within the structure return the structure to its original shape after the load is removed.

In an **unstable** structure, the changes in shape are large and usually increase as long as the forces are applied. An unstable structure does not have the internal forces required to restore the structure to its original shape. Is the square a stable or unstable structure?

Not only is the structural shape unstable, but the flexibility of the plastic material itself makes it easy to bend.

● ● ● **BRACED SQUARE**

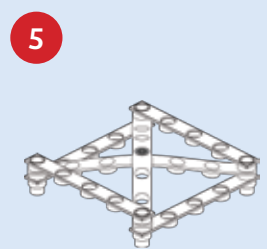
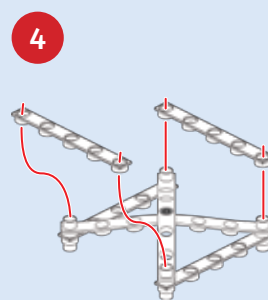
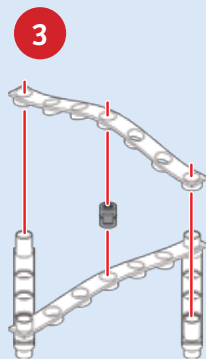
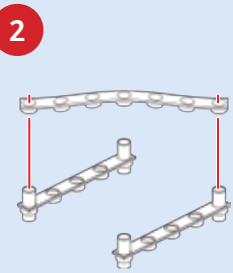
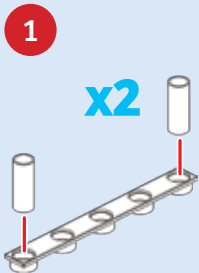

Done!

EXPERIMENT

Reinforced structures

HERE'S HOW

Repeat Experiment 1 with the braced square. How does the braced square react to the load?

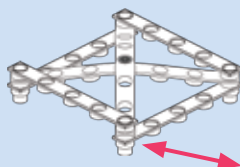

WHAT'S HAPPENING ?

By adding the two cross pieces and connecting the two corners, you made the square model into a much more stable structure. The cross pieces lock the angle of the other rods. When you push on the corner of the square, you can feel the model move a little bit. As you stop pushing on it, you can feel it return to its original shape. It's also significantly more resistant to bending. However, you used more material to achieve this. That is called a **trade-off** in engineering.

CYLINDER

Architects want to design buildings in all sorts of different shapes and sizes to meet the needs to the inhabitants and users of the spaces in them. Let's try building a simple three-dimensional volume — a cylinder. And then, we'll make it more structurally stable by adding braces to it.

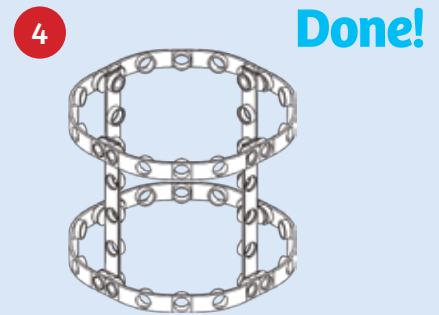
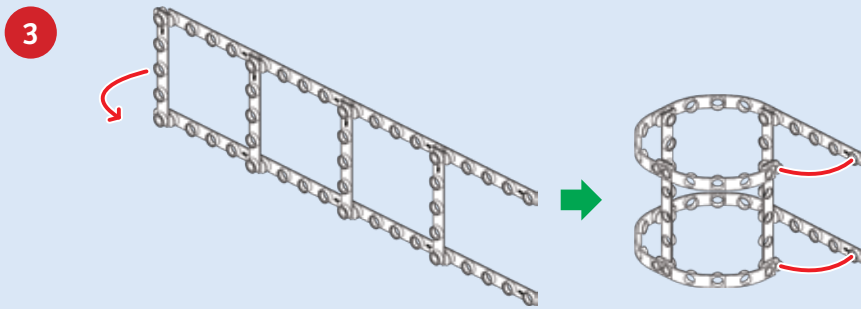
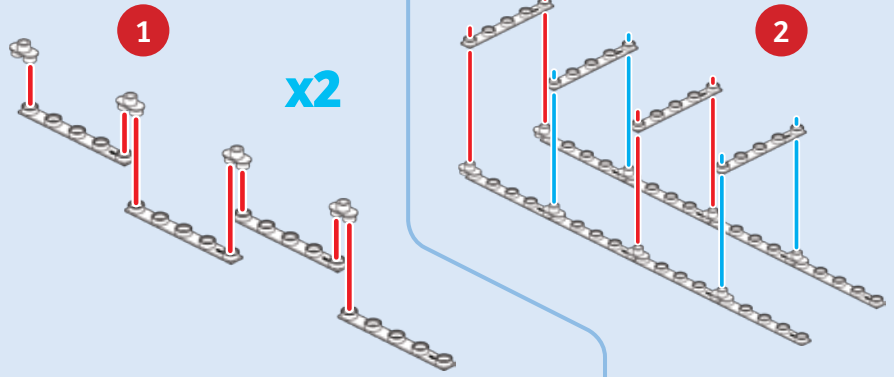

BRACED CYLINDER

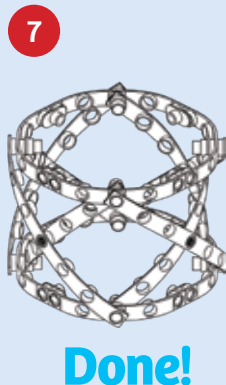
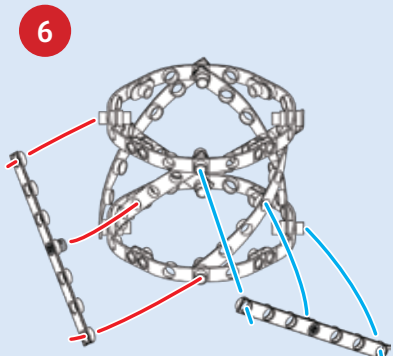
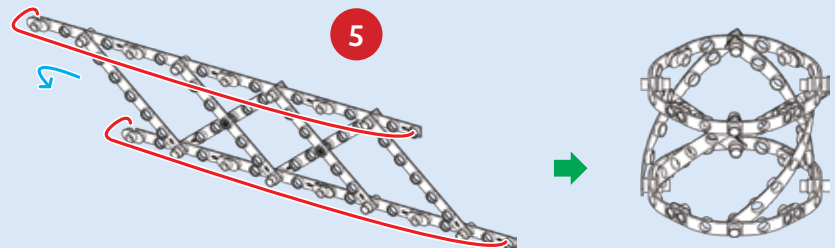
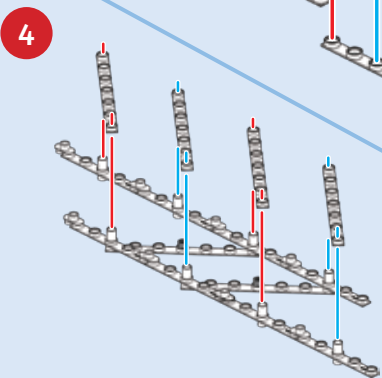
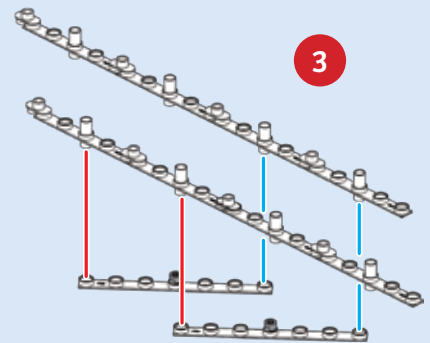
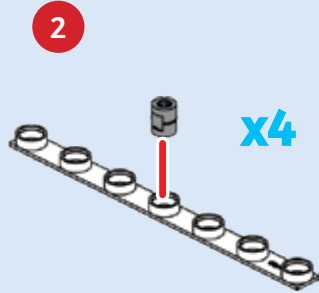
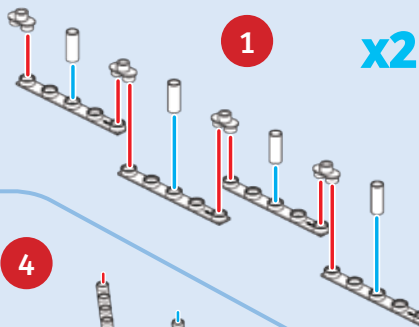

EXPERIMENT

Reinforced structures

HERE'S HOW

Build the cylinder and then the braced cylinder. Push down on each model with your hand. What do you notice?

WHAT'S HAPPENING ?

When you added the braces, you made the cylinder much more resistant to deformation. Even the flexible plastic rods become more rigid when connected like this. It's partly thanks to triangles. Continue to the next page to find out more.

FLEXED TRIANGLE

Triangles are often said to be the strongest shapes. They are rigid and stable. This is because a triangle simply cannot deform into another shape as long as its sides don't deform. Triangles are therefore the basis of most rigid structural frames. In this model, you can see how when the flexible rods are flexed and formed into a triangle, a strong shape results.

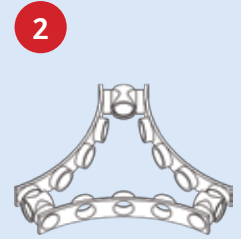
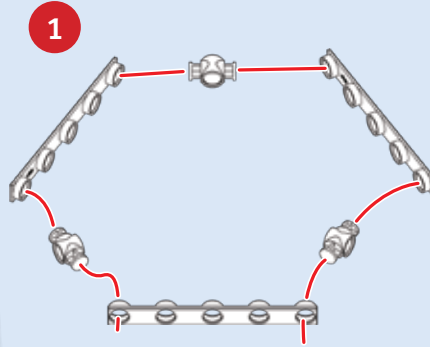

Done!

CONVEX POLYHEDRON

What happens when you combine many of these flexed triangles into one 3D shape?

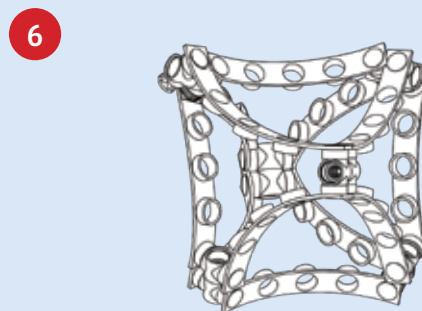
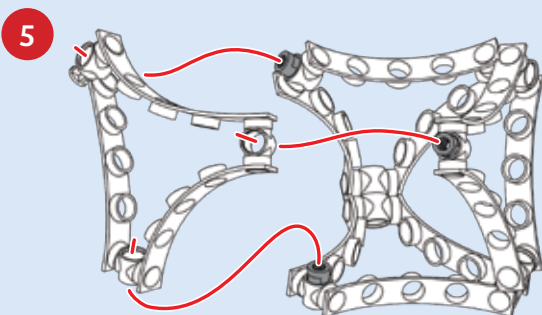
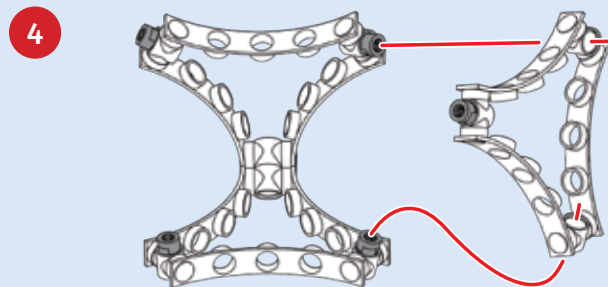
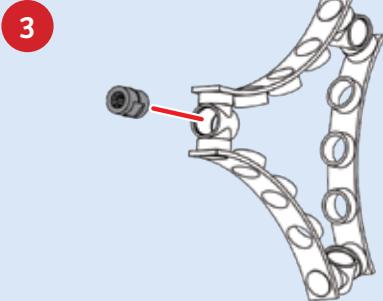
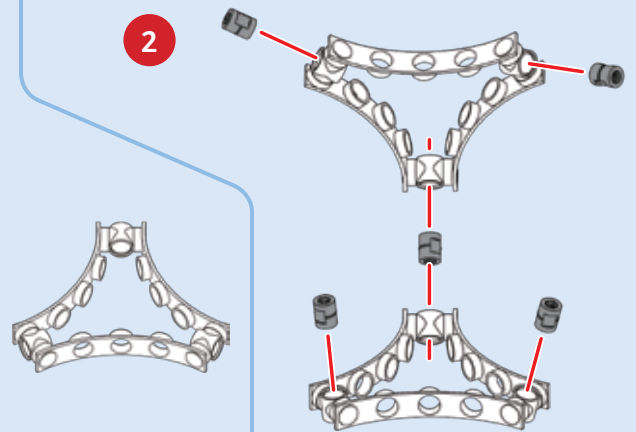
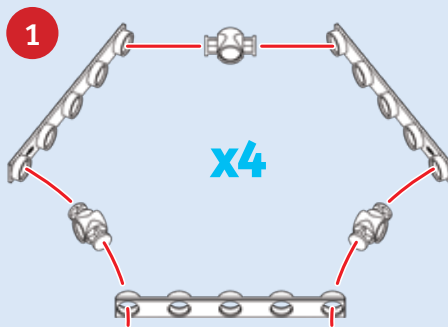

Done!

EXPERIMENT

Rigid polyhedron

HERE'S HOW

Push inward on the model with your hands. Is the model fairly rigid and stable?

WHAT'S HAPPENING?

A polyhedron is a three-dimensional shape with many sides. Here, you made a six-sided polyhedron out of the flexed triangles. Because it is made up of triangles, this shape is very rigid and hard to deform.

CHECK IT OUT



FORCES AND LOADS

A **force** is an interaction between objects. You can think of a force as a push or pull on an object that changes the motion of that object. If the object resists that motion, the object might deform — part of the object might move relative to another part of the object rather than the entire object moving. Architectural engineers must analyze the forces acting on buildings to make sure the buildings will stay standing. Forces acting on a building are called loads.

Architectural engineers often use five terms to describe how a load can affect a structure: tension, compression, shear, torsion, and bending.

Tension is any force that pulls (or stretches) an object apart.

Compression is any force that pushes in on (or squeezes) an object.

Shear is a force that causes parallel internal surfaces within an object to slide past each other.

Torsion is a force that causes the twisting of an object due to a moment.

Bending force is a force that causes an object to bend.

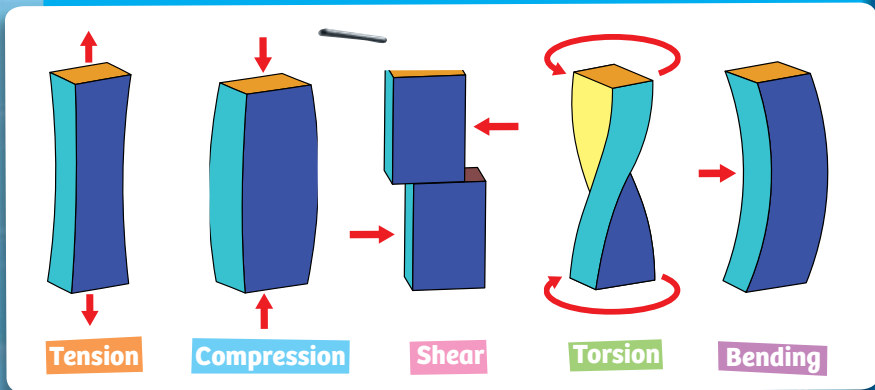

Loads Acting on a Building

Architects must design buildings to withstand many different types of loads that could pull them down or push them over. Loads can be divided into two categories: Dead loads and live loads.

Dead loads include the weight of the building itself and all the permanent things installed in the building. Gravity pulls these loads downward.

Live loads include the weight of the people, furniture, and other objects inside the building. The snow load and rain load — the weight of the snow or water on the roof — are also live loads.

Some live loads act laterally on the building, instead of pulling downward. The wind load is caused by the wind pushing on the side of the building. The groundwater and earth around the building's foundation push laterally on it. And even the load from occasional earthquakes must be considered when designing a strong, stable building.

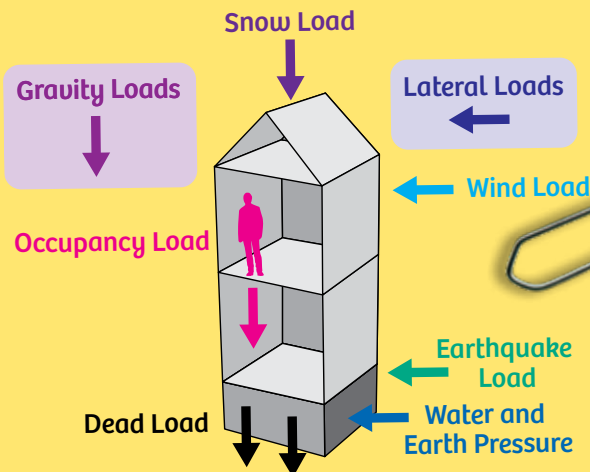

Plastic and Steel

Pull on the flexible rod from both ends. It's very strong in tension, isn't it?



Now push both ends together. It's not very rigid in compression. It buckles when you push the ends together. In terms of shear, it's pretty resilient. And when you subject it to torsion by twisting it, it twists.



Hold one end of the rod and push down on the middle. The rod bends. One side of the rod is under tension and the other side is under compression.

This is a special type of plastic that is designed to have just the right amount of flexibility for building the models in this kit. These flexible rods are used in the models to mimic steel beams in real buildings. Like plastic, steel is incredibly strong under tension but it isn't so great under compression. It will bend under too much force, but it's very hard to pull it apart from end to end.

Why aren't more buildings built with plastic rods? Steel and other metals are much more resistant to heat and less likely to degrade under normal conditions. Steel is stronger, harder, and more durable than plastic.

TRIANGLE

Now, let's investigate form. Form is a very commonly used word in architecture — it basically just means the shape and configuration of a building. The opposite of form is space. The space is the empty area defined by the forms of a building. Together, form and space make up all buildings. Let's build some forms.

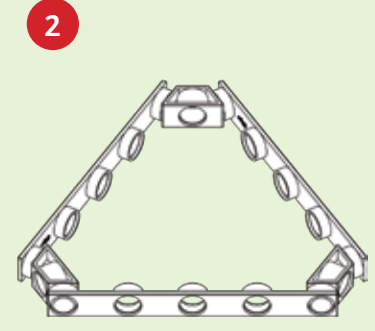
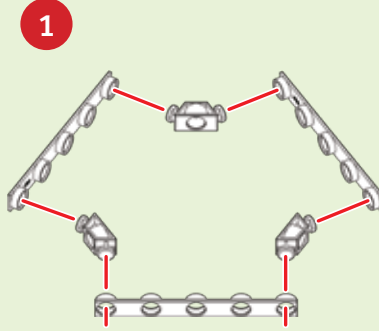

Done!

TRIANGULAR PRISM

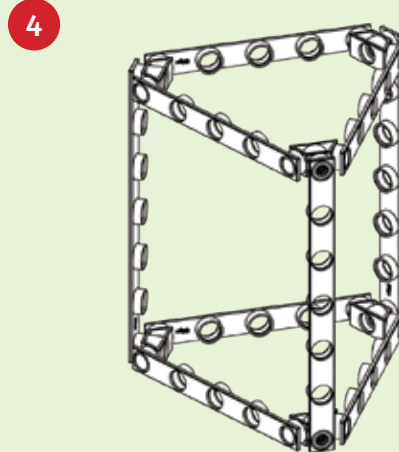
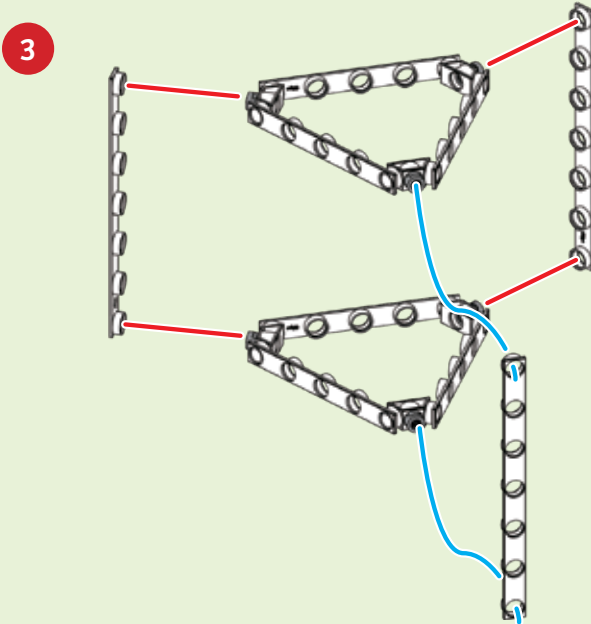
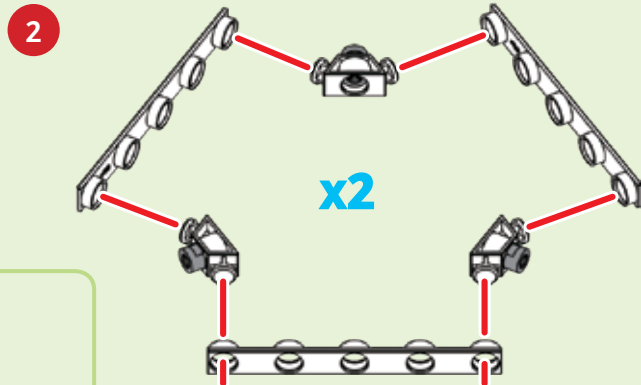
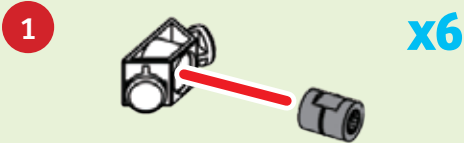

Done!

EXPERIMENT

Prisms

HERE'S HOW

Hold the top triangle in one hand and the bottom triangle in the other. Gently twist the prism by rotating the triangles in opposite directions. Try bending and compressing the prism. What do you notice?

WHAT'S HAPPENING?

You made two triangles into a prism. A prism is a 3D geometric figure whose two end faces are similar, equal, and parallel shapes, and whose sides are parallelograms — in other words, sides formed with parallel lines. The triangle prism is prone to twisting, bending, and compressing. The triangles at the ends may be stable, but the rectangles in the middle are not as strong. Nevertheless, countless buildings are built using shapes like this, and due to the strength of the materials they are made of, they are strong enough to stay standing.

SQUARE

There are lots of different types of prisms. Let's build a square prism.

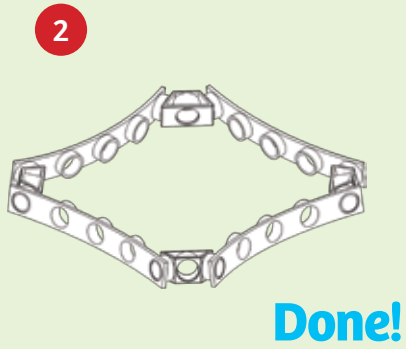
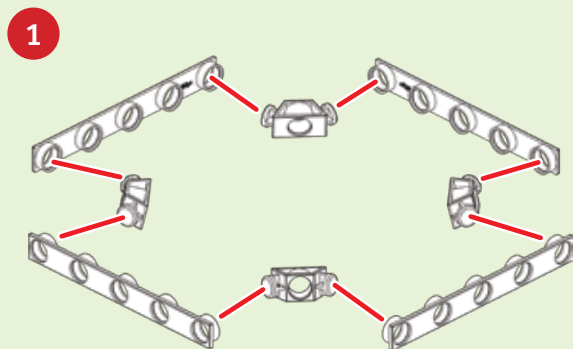

RECTANGULAR PRISM

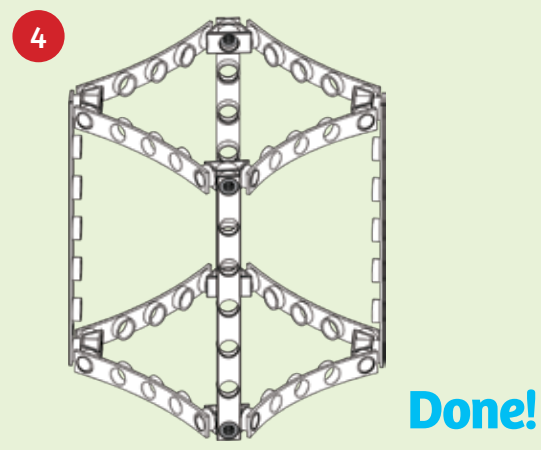
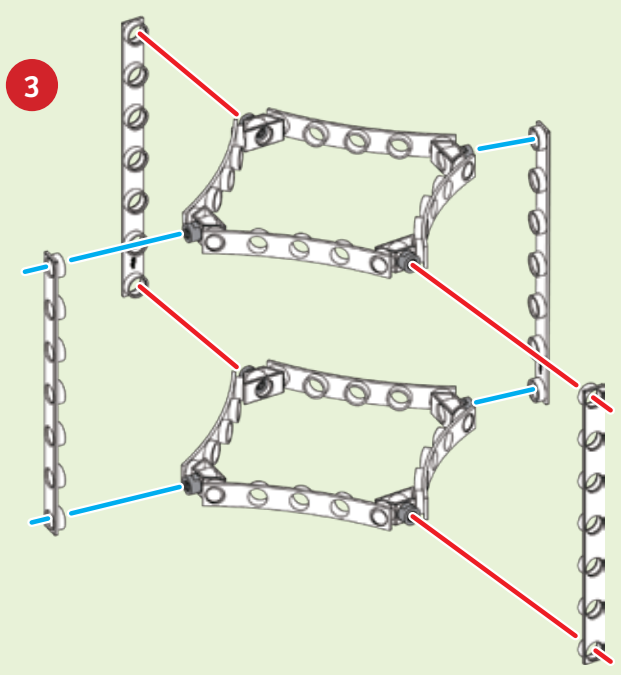
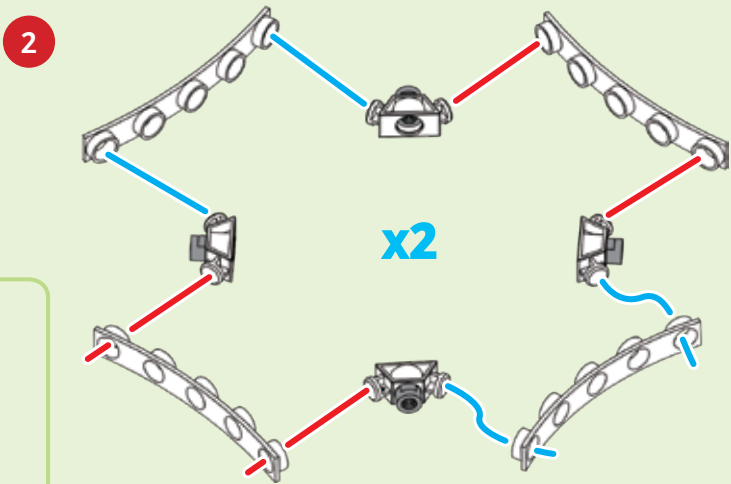
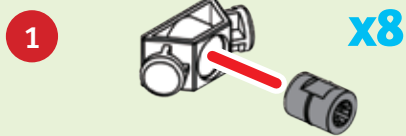

EXPERIMENT

More prisms

HERE'S HOW

Test the square prism the same way you tested the triangular prism. What do you notice? Which is more resistant to deformation?

WHAT'S HAPPENING?

There are no triangles in the square prism at all. Therefore, it can twist, bend, and deform more than the triangular prism. However, you can see that even the square prism is strong enough to stay standing on its own. By combining the 12 flexible rods into one structure, you have created a three-dimensional form with volume, or space inside. It's easy to imagine this prism shape as the basis for countless buildings.

● ● ● FLAT PENTAGON

1

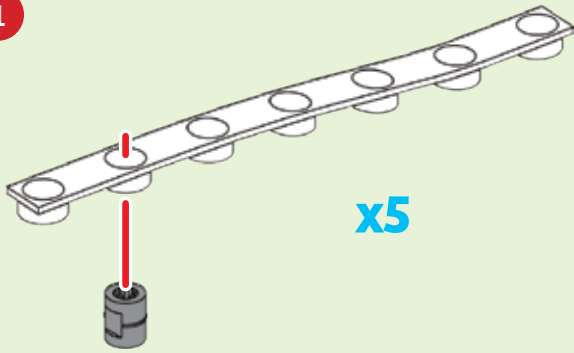

2

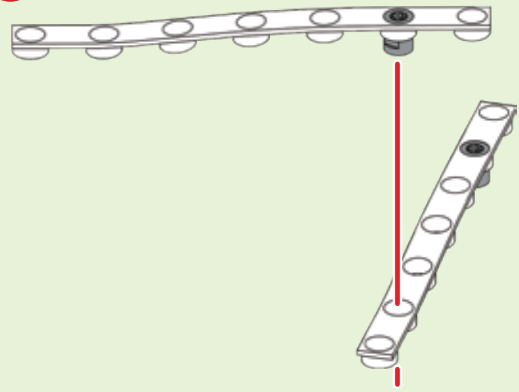

3

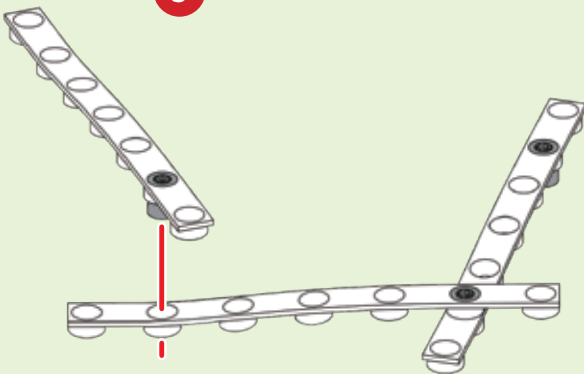

4

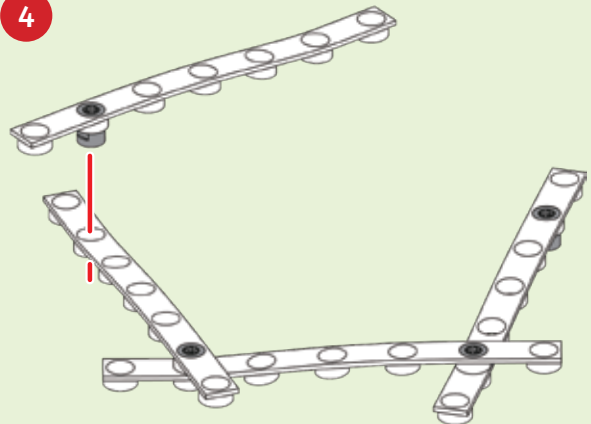

5

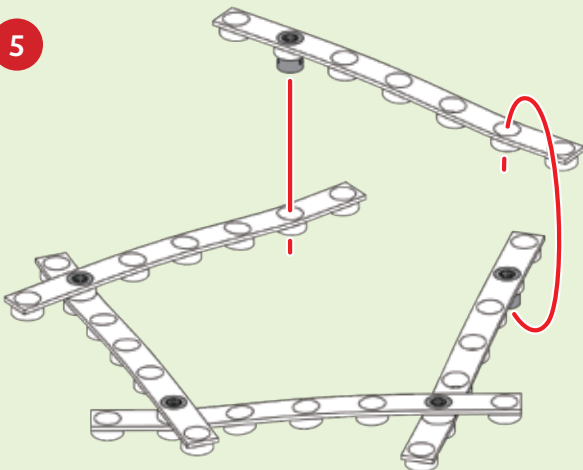

6

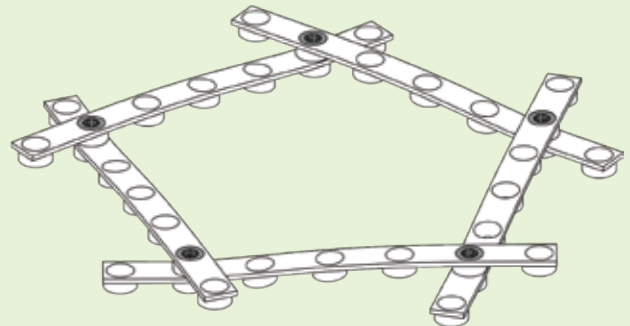

Done!

EXPERIMENT

Five lines in one plane

HERE'S HOW

Pressing down on one anchor pin of the pentagon, hold the shape by an anchor pin across from the first and pull up. What happens?

WHAT'S HAPPENING?

You made a flat pentagon. A pentagon is a shape with five sides. All five rods are in the same plane. In geometry, a plane is a flat, two-dimensional surface that extends infinitely far. Three points always define a plane.

When you hold part of the pentagon down and pull up on the other part, the pentagon bends and no longer occupies a single plane. The warped pentagon is now a curved surface. Imagine all the buildings that have curved surfaces like this!



DOME MADE OF PENTAGONS

Start with the flat pentagon from the previous page. We will now bend it to form it into a dome.

1

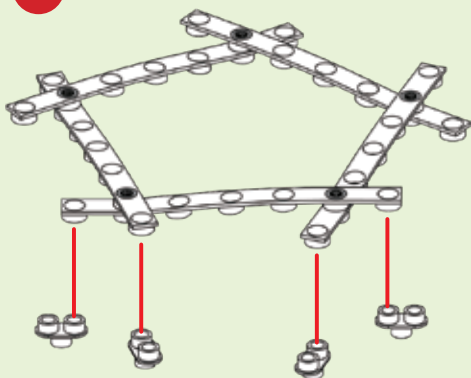

2

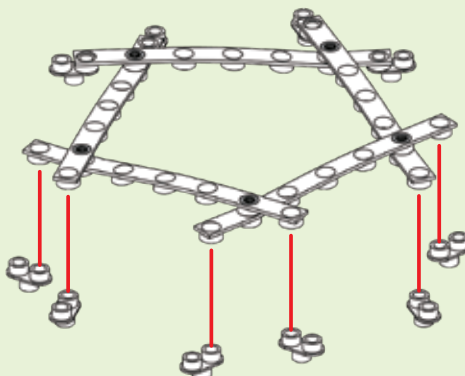

3

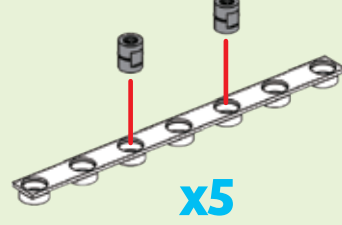

x5

4

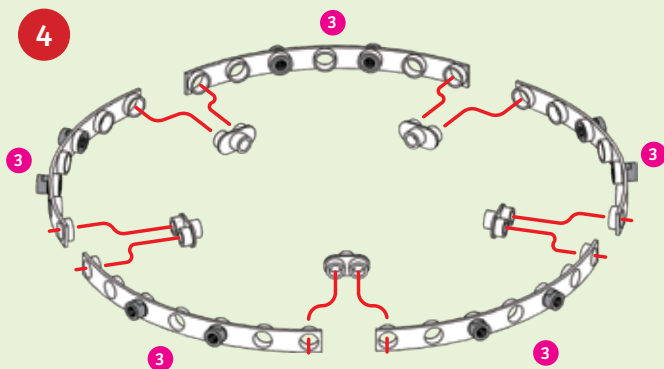

5

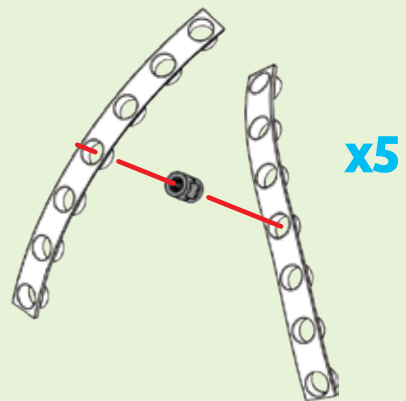

x5

6

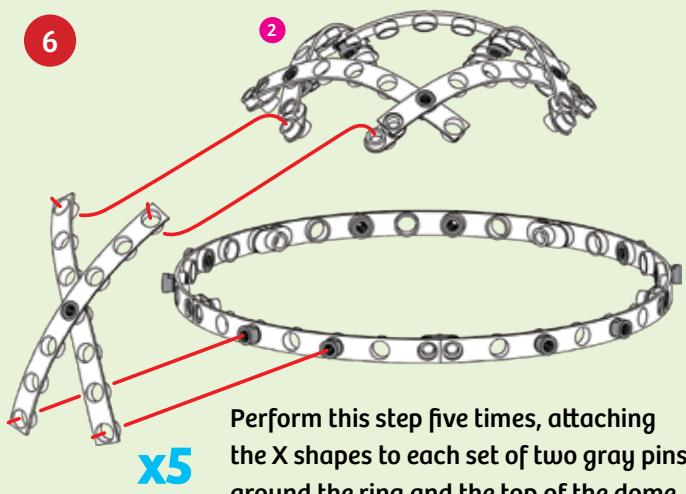

x5

Perform this step five times, attaching the X shapes to each set of two gray pins around the ring and the top of the dome.

7



Done!

EXPERIMENT

Dome of pentagons

HERE'S HOW

Place a stack of magazines, one by one, on top of the dome. How many magazines does the dome support before it starts to deform?

WHAT'S HAPPENING?

You made a dome using the flexible rods. The dome is supported by five arcs. An arc is part of the circumference of a circle or other curve. By connecting the arcs together at certain points, you have made stable triangular shapes. Can you count all the triangles in the model?

The model resembles a star dome, which is one of the first types of shelters built by humans. They were built out of thin, flexible tree trunks or branches.

● ● ● **FLAT TRIANGLE**

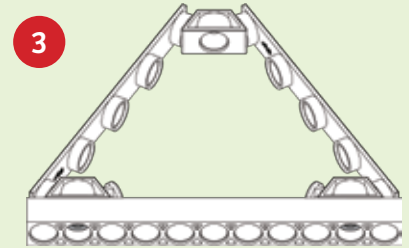
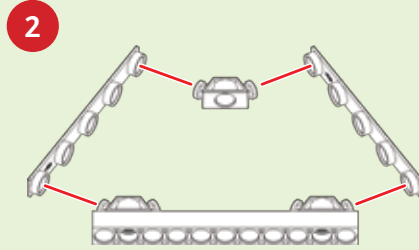
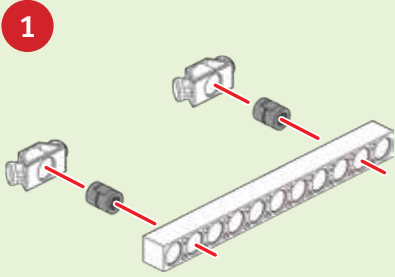

Done!

● ● ● **BOWED TRIANGLE**

An arch is a curved structure that is symmetrical on both sides and spans an opening. It often supports a load on top of it; e.g., a wall, bridge, or roof.

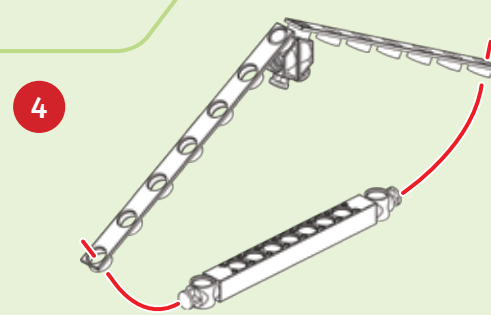
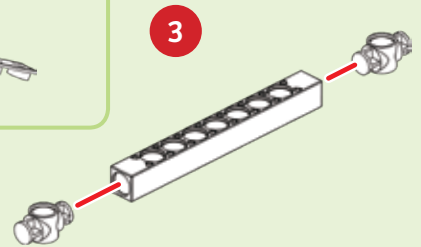
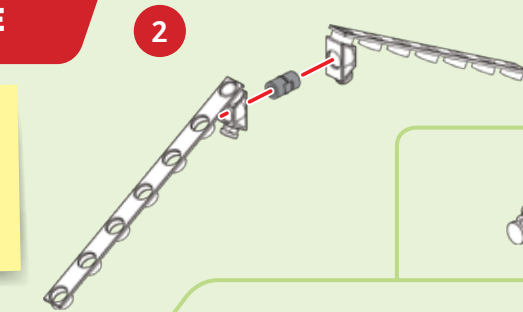
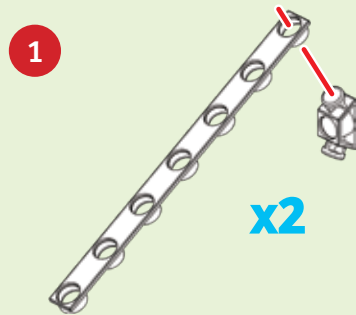

Done!

● ● ● **SIMPLE ARCH**

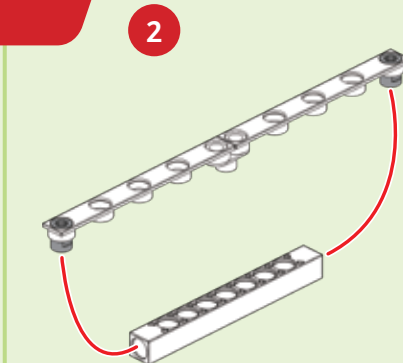
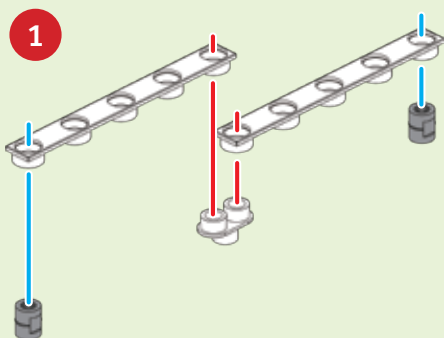

Done!

EXPERIMENT

Forces in the arch

HERE'S HOW

Build the three shapes on this page. All three use only three rods, but each forms a different shape. Push down on the top of the arches. What happens?

WHAT'S HAPPENING?

When you push down on the top of the arch, the sides of the arch bow outward. Imagine you had forces pushing downward and inward along the entire length of the arch. If the sides were prevented from being pushed outward, then the top of the arch would be prevented from being pushed downward. This is the principle behind why the arch is such a strong structural shape, and why it is used in so many buildings. The inner surface of an arch is under compression. The arch channels forces down from the top through the sides and down to the base.

CHECK IT OUT



Form and Function

Architects design buildings and spaces for people to use. From the simplest house to the most complex skyscraper, buildings must serve the needs of the people who inhabit them. In architecture, it is often said that “form follows function.” This means that the form, or shape, of a building and the spaces in and around it depends on what the building is used for. In addition to the usefulness, architects are also concerned with the durability and beauty of buildings. If a building falls down or doesn’t protect the inhabitants from the weather, it cannot fulfill its function. The beauty of a building is perhaps the hardest quality to define. The way people feel when they look at a building or occupy a space is an extremely important consideration of the architect. In this way, art is an important element of architecture. In addition, the environmental impact of buildings is a growing concern today.



Elements of Architecture

People have been designing buildings and spaces for thousands of years. Over the years, the field of architecture has developed and with it, a wealth of know-how, terminology, and technology all related to the design and construction of buildings. Just like writers must understand letters and words before they can write books, architects must understand the basic elements of architecture before they can design complex buildings. Here are some examples of the elements of architecture:

Elements of Form								Types of Roofs								
Cube	Square pyramid	Cylinder	Sphere	Hemisphere	Hexagonal prism	Cone	Half cylinder	Open gable	Shed	Saltbox	Flat	M shaped				
Types of Arches																
Round	Lancet	Segmental	Horseshoe	Shouldered	Trafal	Cameo	Tudor	Ogee	Tented	Parabolic	Moorish multifoil	Pyramid hip	Butterfly	Lean-to	Mansard	Dutch gable
Dormer	Hip and valley	Gambrel	Box gable	Clerestory												

The Materials Matter

While architects may be primarily concerned with a building’s form and function for the users, the architectural engineer’s primary concerns might center around getting the building’s systems to support its form and uses: Does the building’s structure support the weight of its inhabitants? Does the building have light, heat, electricity, and water in all the necessary places?

How do modern-day architectural engineers achieve the amazingly tall skyscrapers and fascistically shaped buildings that architects design? Largely the answer lies in the **materials** they use. Three of the most critical materials used in building today are **steel** and **concrete**.



Steel is a metal that is an alloy, or mixture, of iron and carbon. It is a common building material due to its high tensile strength and low cost.



Concrete is a composite material made of fine and coarse aggregate, like sand and gravel, bonded together with a liquid cement that hardens over time. Because of its high strength in compression and low cost, it is a common building material.



When you combine the high tensile strength of steel bars and the high compressive strength of concrete, you get another common building material called reinforced concrete that is strong in both tension and compression.

INTERSECTING ARCHES

Arches are great, but sometimes you want to enclose more space under a roof. Imagine rotating an arch around its top point to define a three-dimensional space — that's a dome!

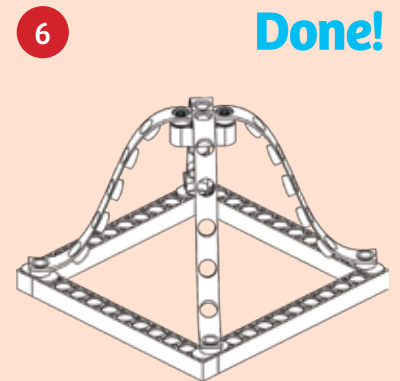
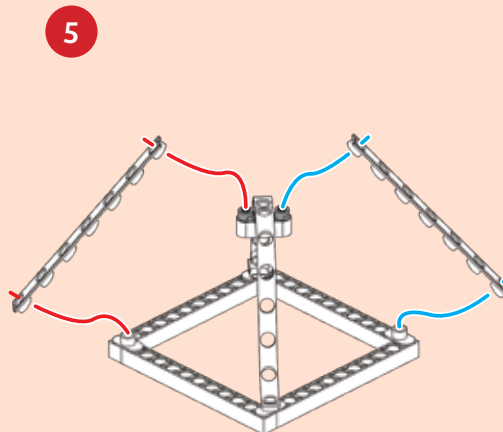
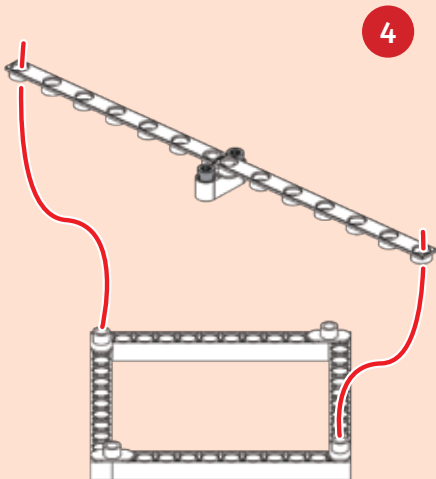
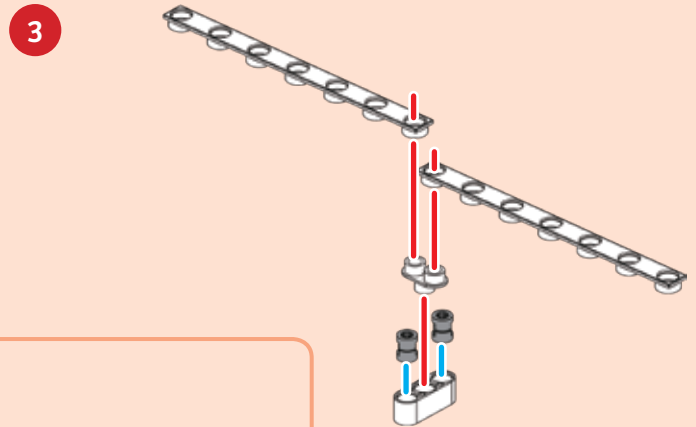
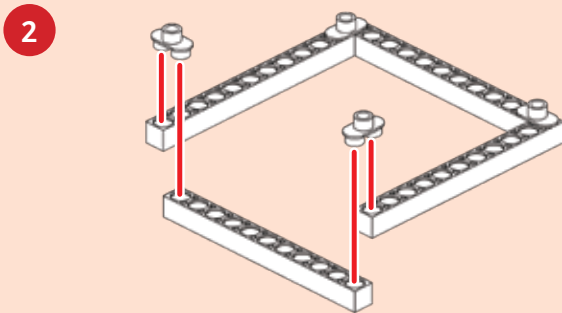
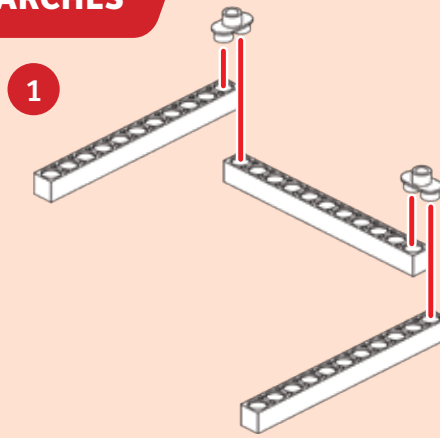
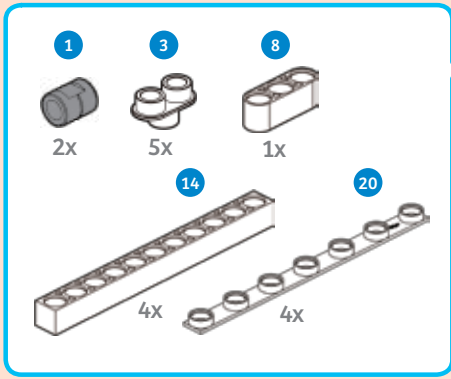

EXPERIMENT

Arches and domes

HERE'S HOW

Look at the model you built. Can you find two arches in the model? Look closely at the shape of the arches. What shape do they have?

Push down on the dome. What happens?

WHAT'S HAPPENING ?

In this experiment, you can see how a dome is like a combination of multiple arches. You built a structure with two arches in different planes. The arches are called concave arches or reverse ogee arches based on their shape.

These two arches define a three-dimensional space. This is not a common shape for a dome. You can see why when you push down on it: The dome bows inward. Ogee arches are not the strongest arches. The combination of convex and concave curves makes them rather weak structurally. They are more often used decoratively in buildings.

SHELL

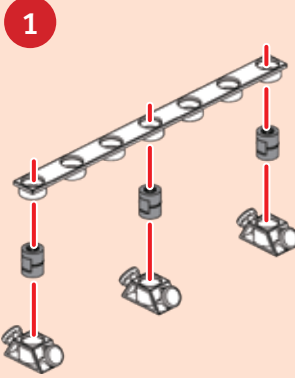
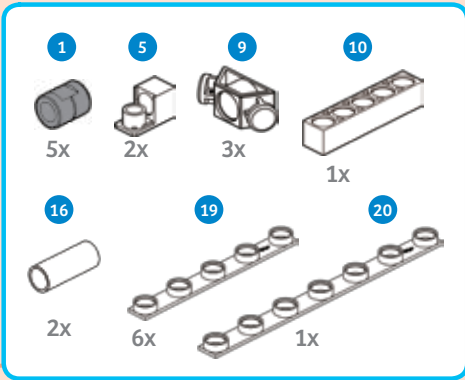

Now let's build another type of modern structural element: the shell.

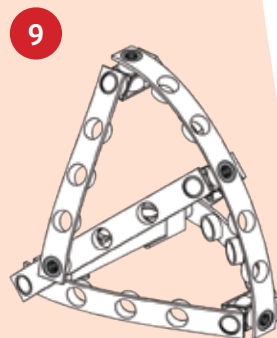
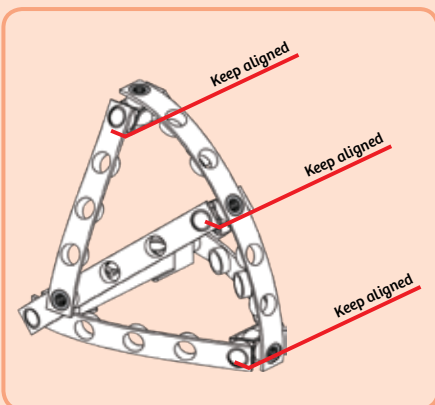
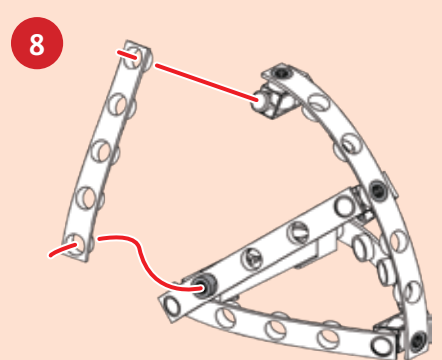
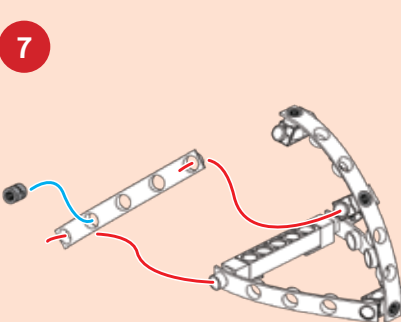
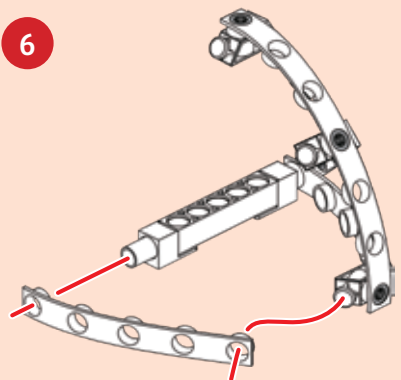
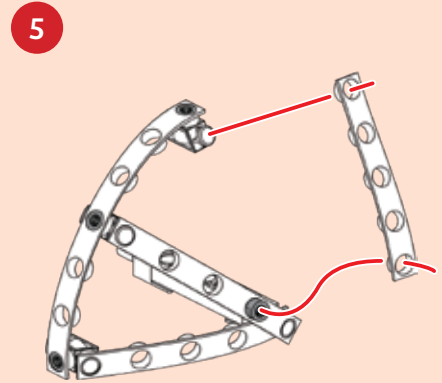
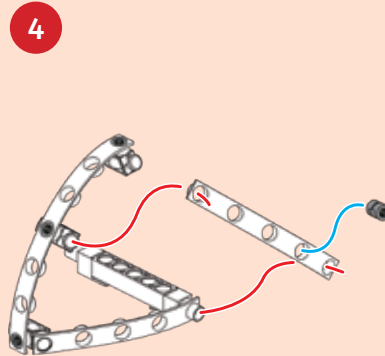
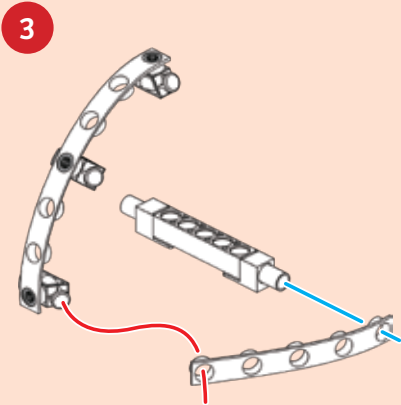
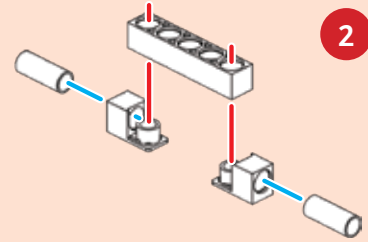

Done!

WHAT'S HAPPENING ?

Imagine a curved surface covering the outside of this model. In architecture, a **shell** is a structural element that is defined by its shape. It is a curved three-dimensional shape that is very thin in one dimension compared to the other two dimensions.

A shell is a curved **plate**. A plate is another architectural element defined by its shape. Like a shell, it is a three-dimensional shape that is very thin in one dimension compared to the others. The difference is that it is flat, not curved. The surface of the plate is in one plane.

● ● ● ROMAN ARCH

Let's build one more arch shape to investigate tension and compression.

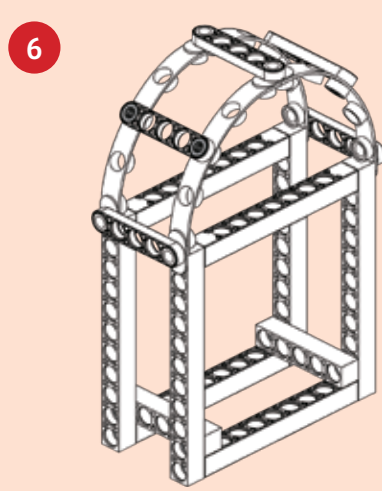
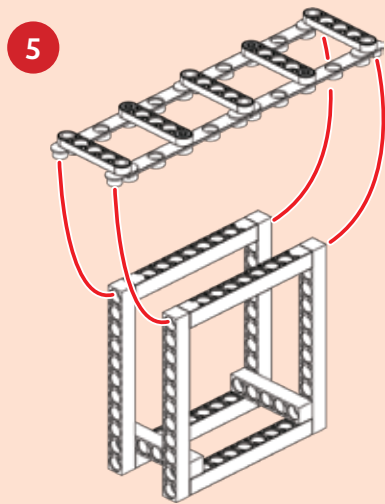
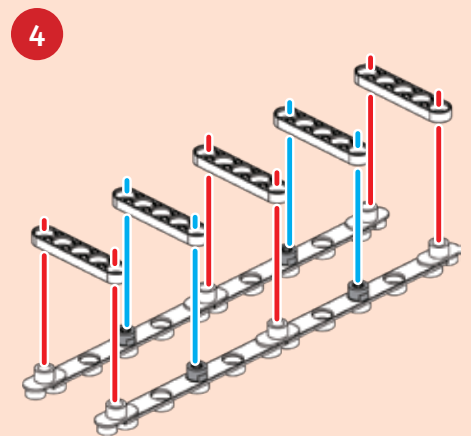
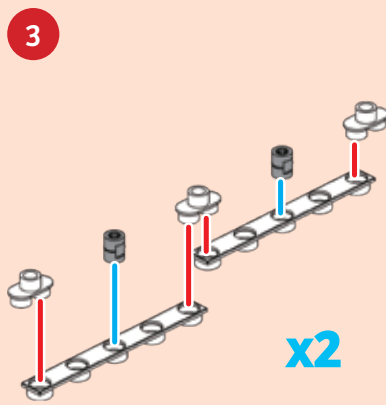
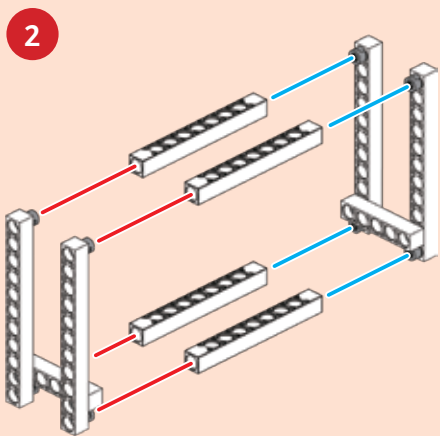
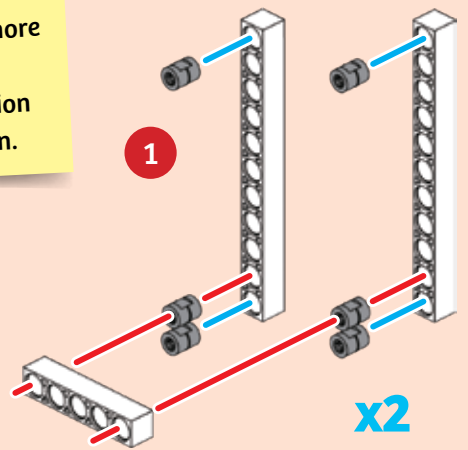
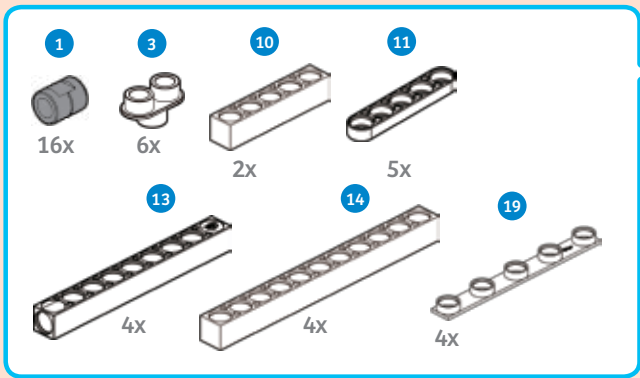

Done!

EXPERIMENT

Tension

HERE'S HOW

When you bend the top of the arch in step 5, what happens?

WHAT'S HAPPENING ?

The five 5-hole rods splay outward. They get farther apart from one another. In this way, you can see how the outer surface of the arch is being pulled apart — it is under tension. But the inside of the arch is being pushed together. It is under compression.

By the way, this classic semicircular arch shape is known as a Roman arch. It's semicircular shape makes it very strong. It was widely used in ancient Roman architecture.

Now that you've built many of the basic structural elements of architecture, let's move on to build some larger and more challenging models of buildings that use the principles and elements you have just explored, starting with this iconic tower!





WROUGHT-IRON TOWER

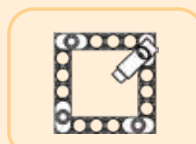
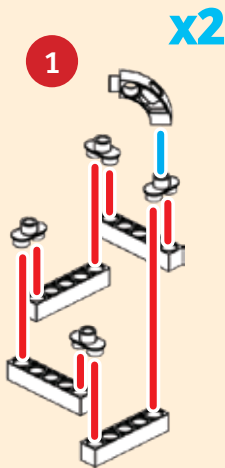
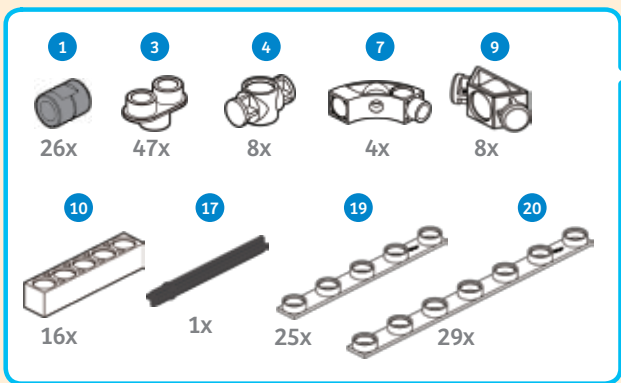

Plan

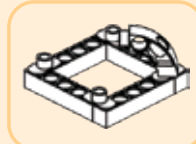

In architecture, a **plan** is a diagram of a building shown from above, looking down on the building. A plan diagram shows everything below a certain cross-section sliced horizontally through the building.

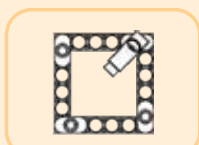
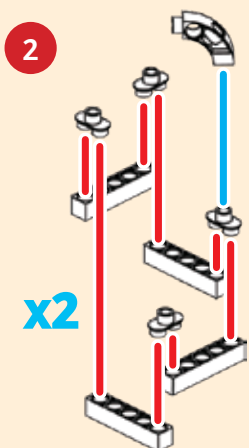

Plan

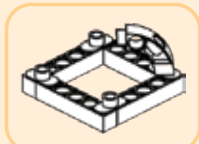

Note: Steps 1 and 2 are slightly different!

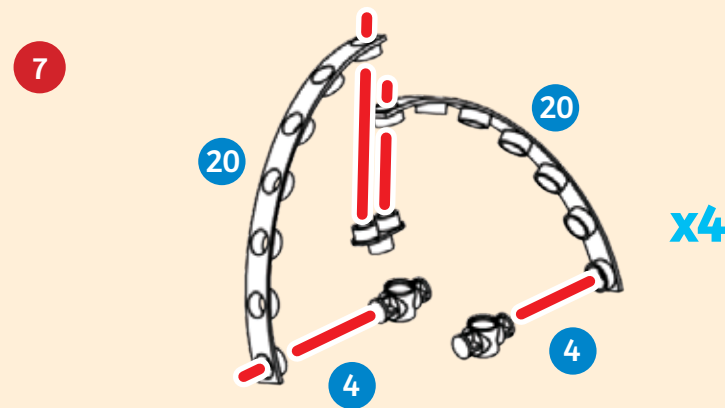
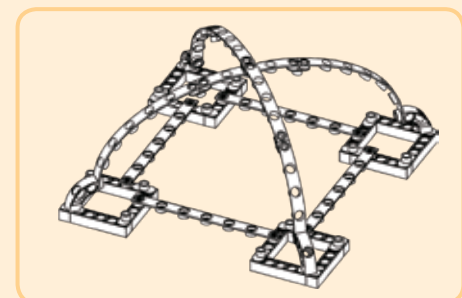
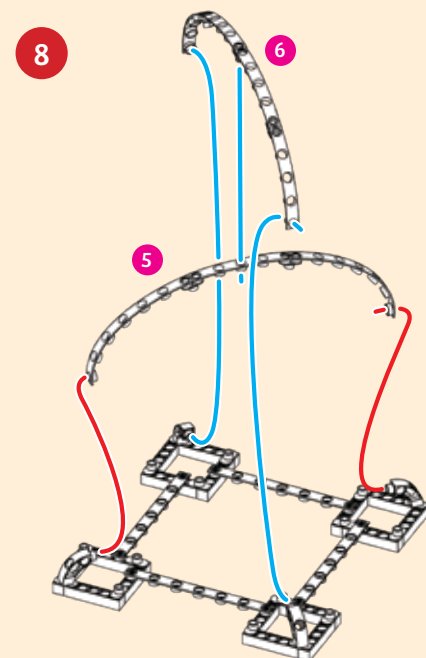
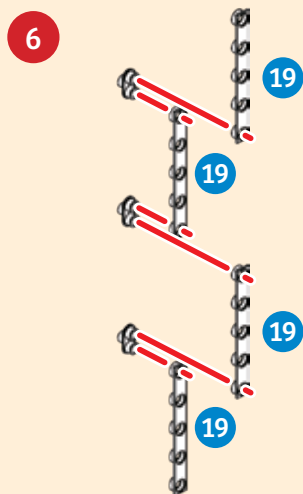
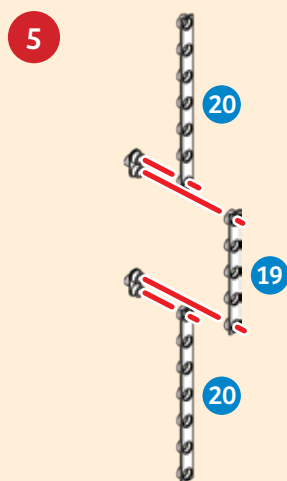
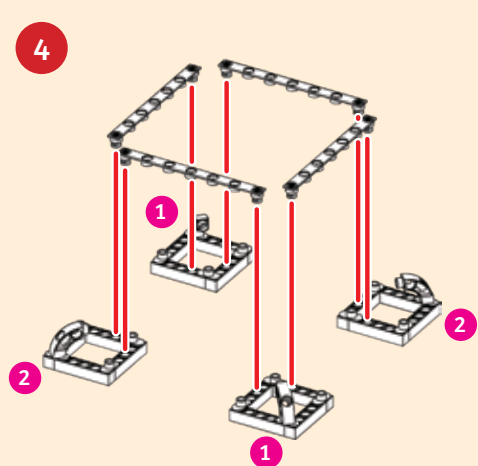
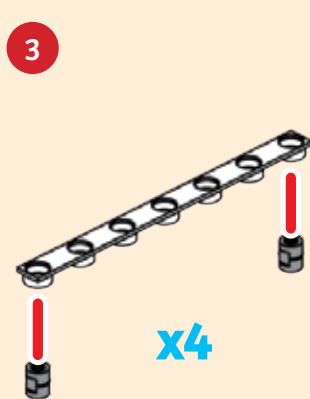

● ● ● WROUGHT-IRON TOWER

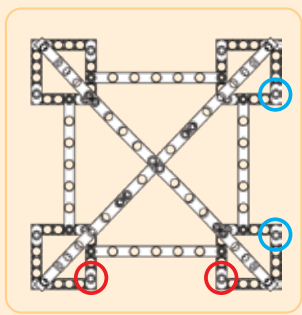
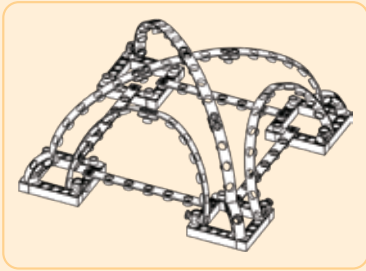
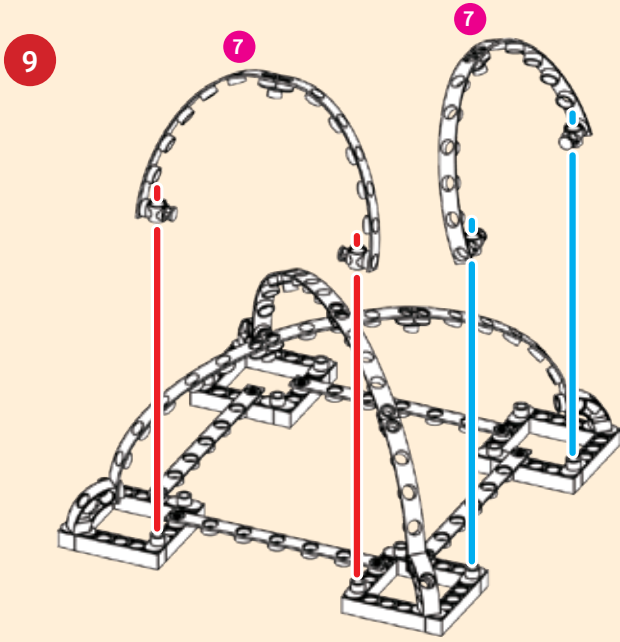

Plan

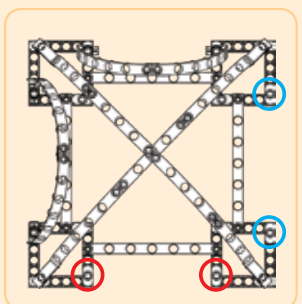
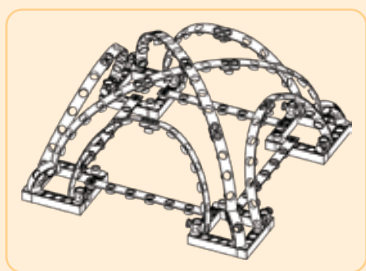
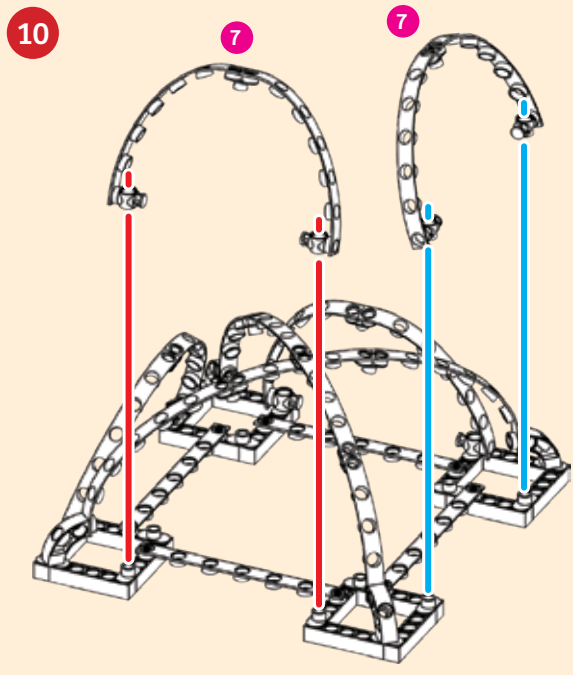

Plan

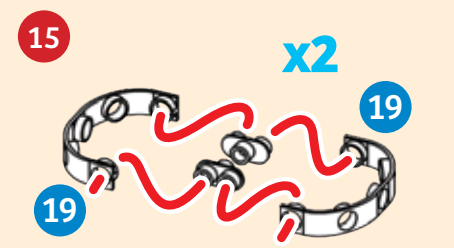
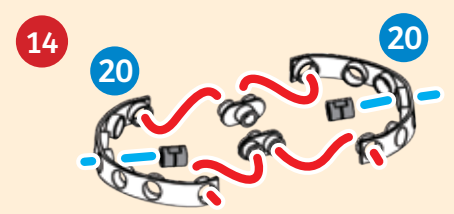
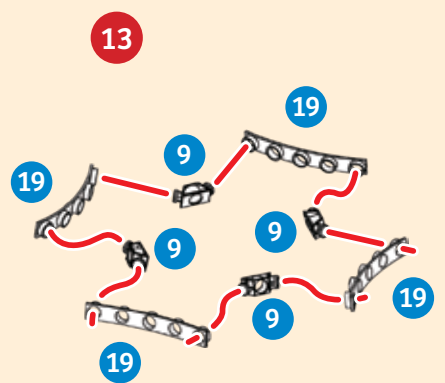
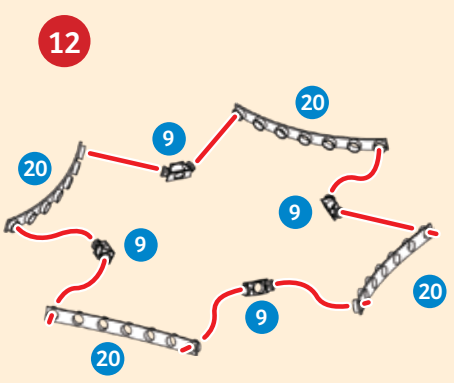
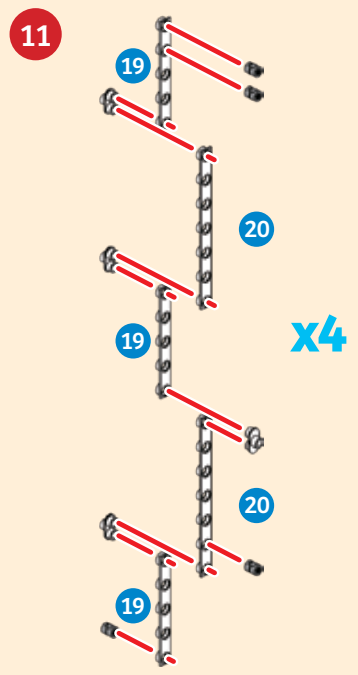

● ● ● WROUGHT-IRON TOWER

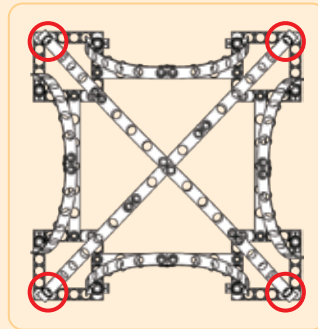
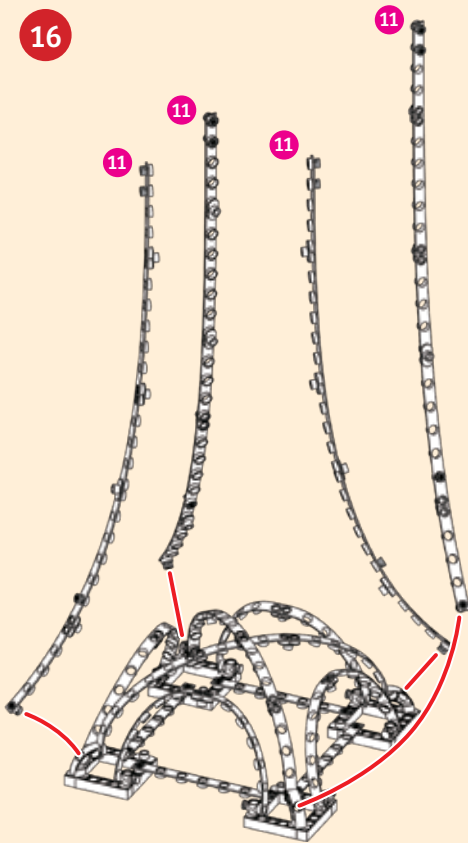

Plan

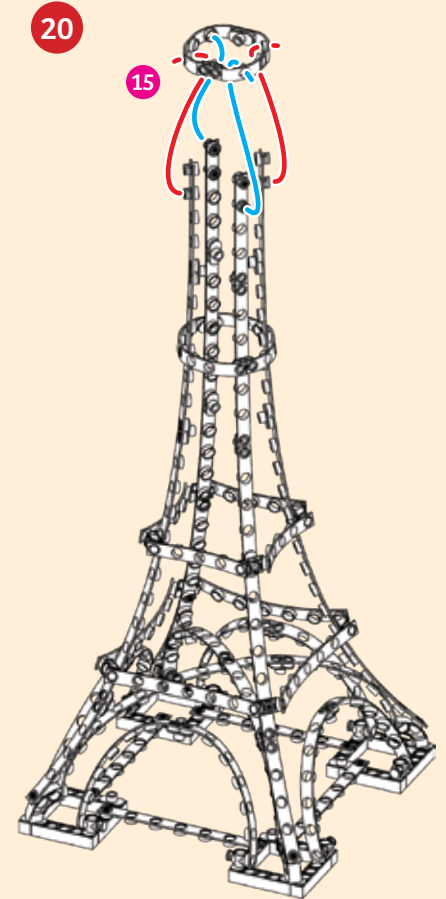
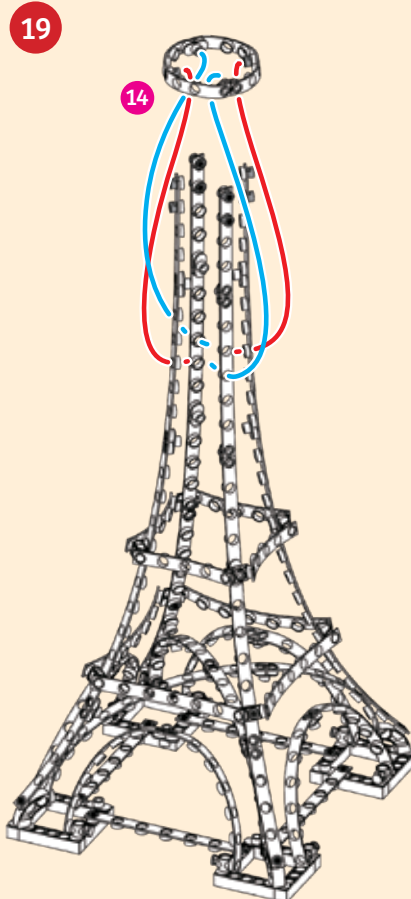
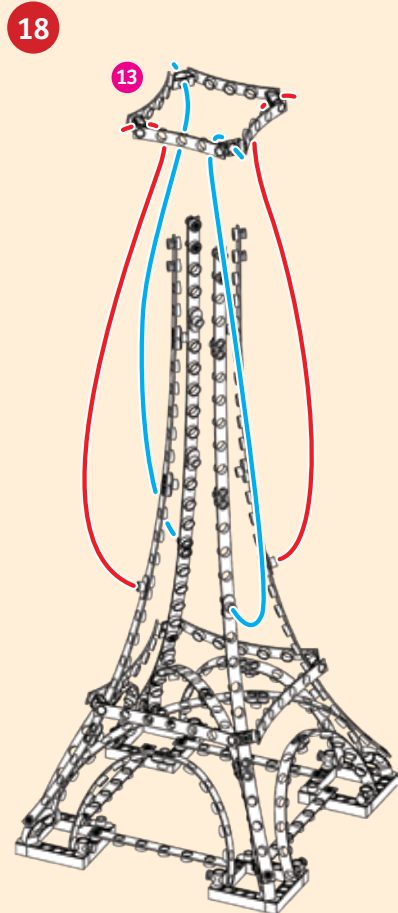
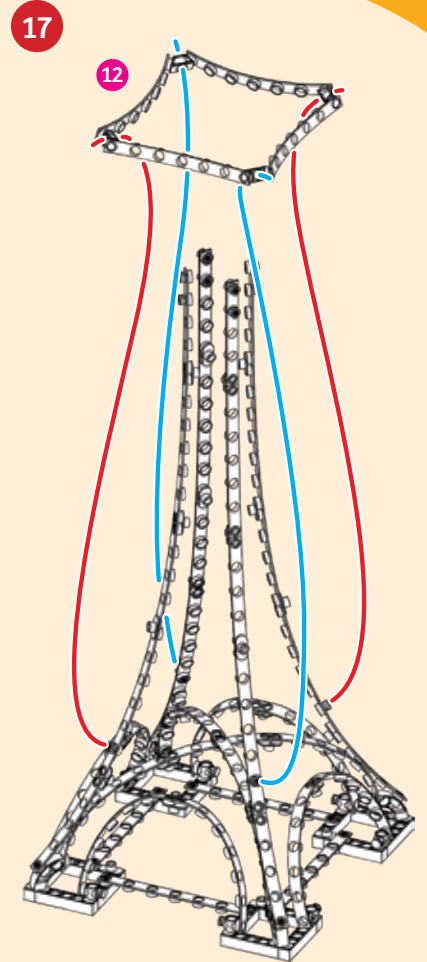
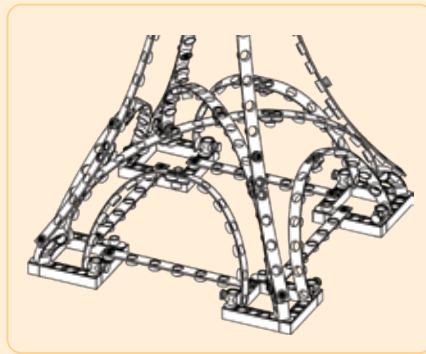



WROUGHT-IRON TOWER

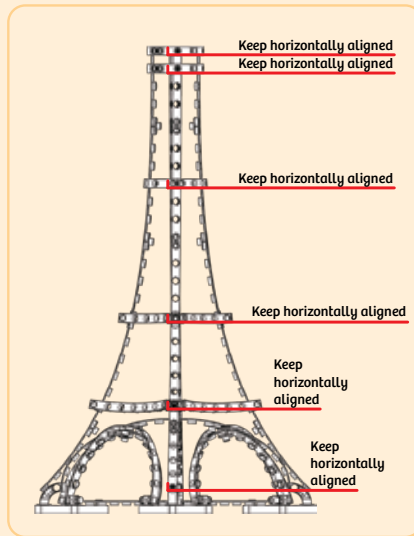
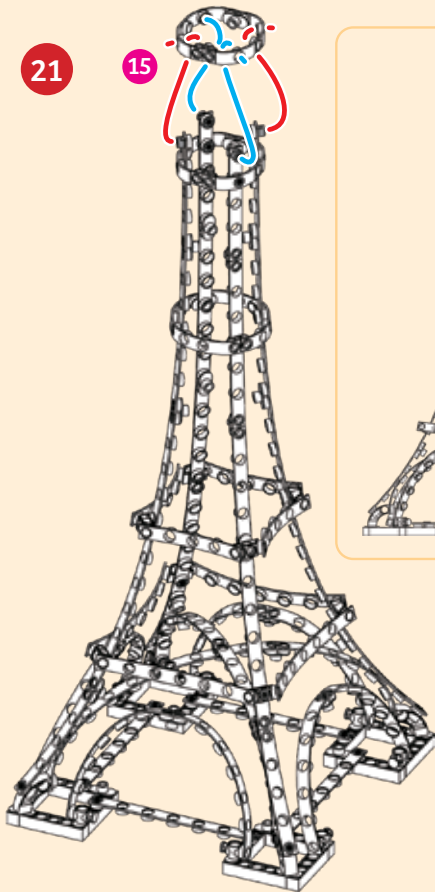

Elevation

In architecture, an elevation is a diagram of a building shown directly from the side. A plan diagram shows everything behind a certain cross-section sliced vertically through the building.

22

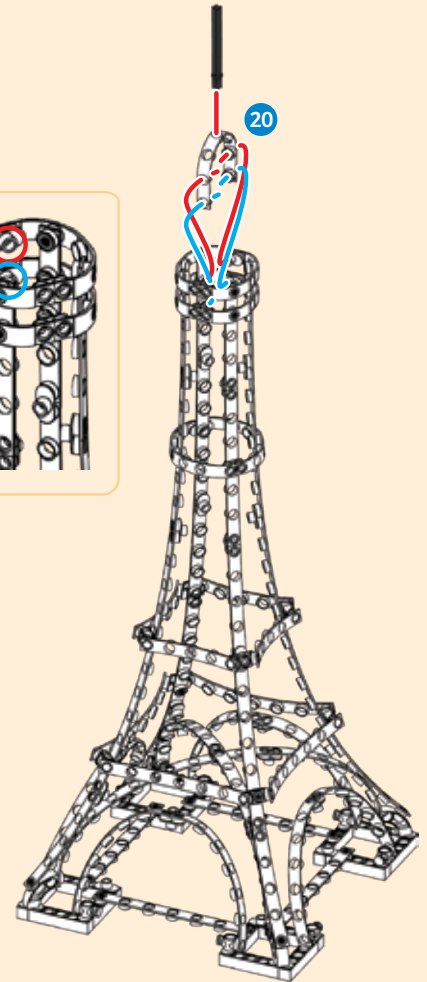
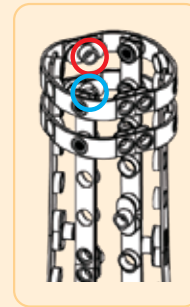

23

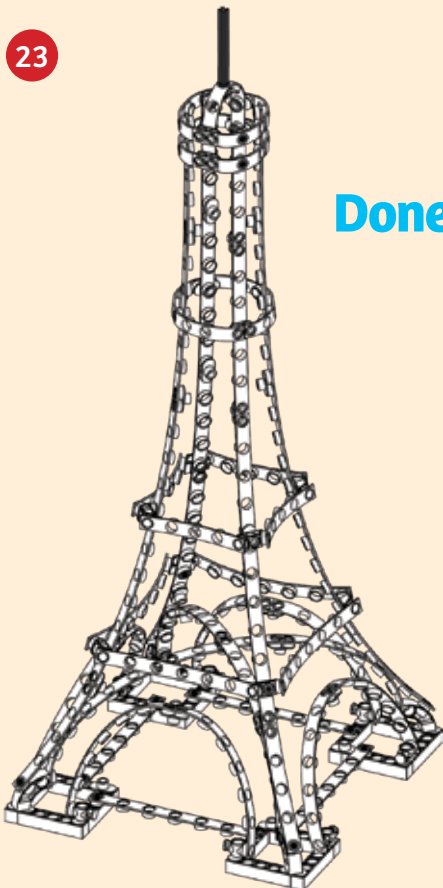

Done!

Follow the tips for model refinements on the inside back cover to finish your model.

EXPERIMENT

A tower of shapes

HERE'S HOW

Count the numbers of different shapes in the wrought-iron tower model. How many circles can you find? How many squares? How many arches?

WHAT'S HAPPENING ?

The model you built resembles the Eiffel Tower in Paris, France. Your model is made of flexible plastic rods, but the actual tower is made of iron. The flexible plastic rods help you understand how all the shapes in the tower's structure work together to hold it up and make it stable. A single flexible plastic rod could not stand up without bending and over. The same is true for the iron rods in the real Eiffel Tower. From its wide stable base to its thinner top, the iron frame of the actual Eiffel Tower has thousands of triangular shapes in trusses keeping it stable.

CATENARY ARCH

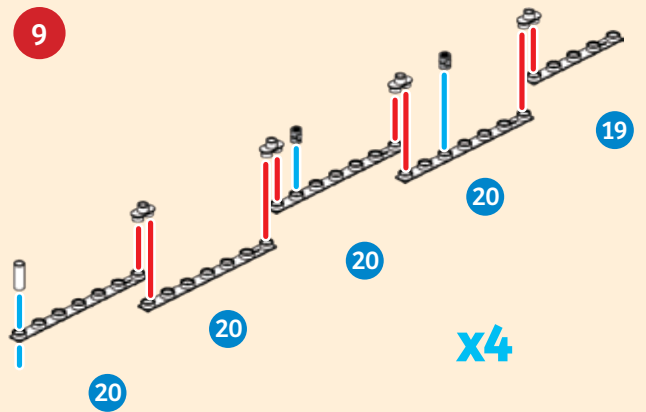
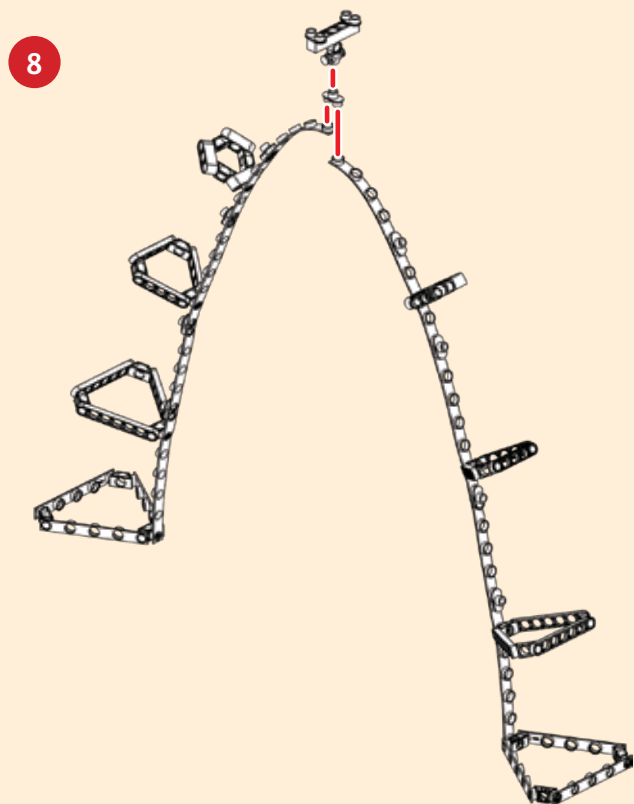
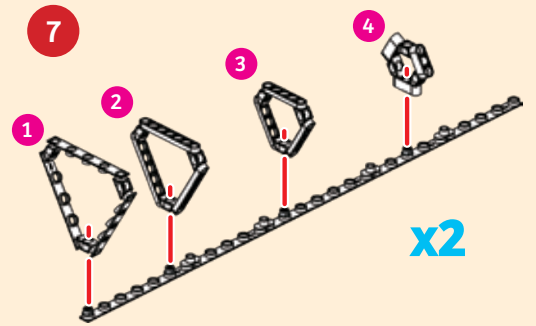
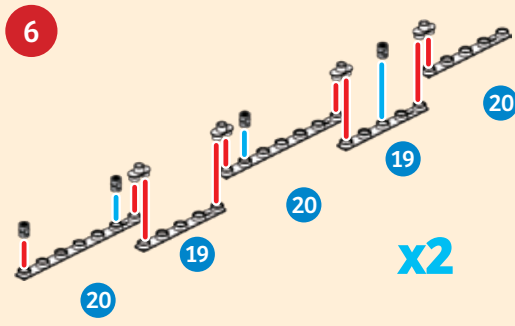
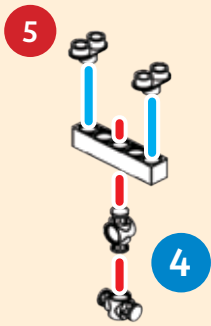
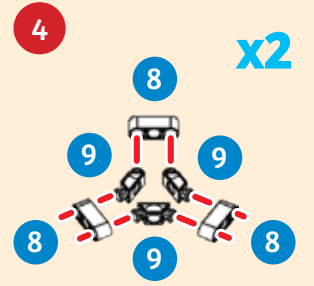
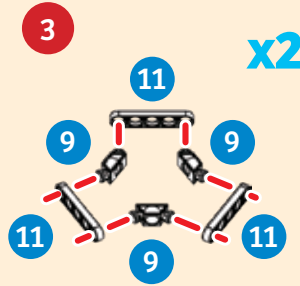
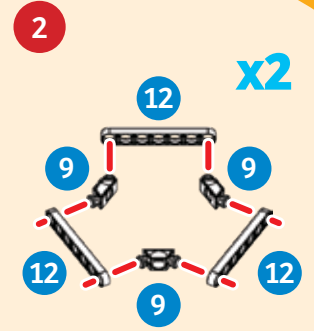
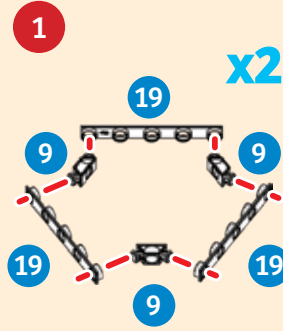
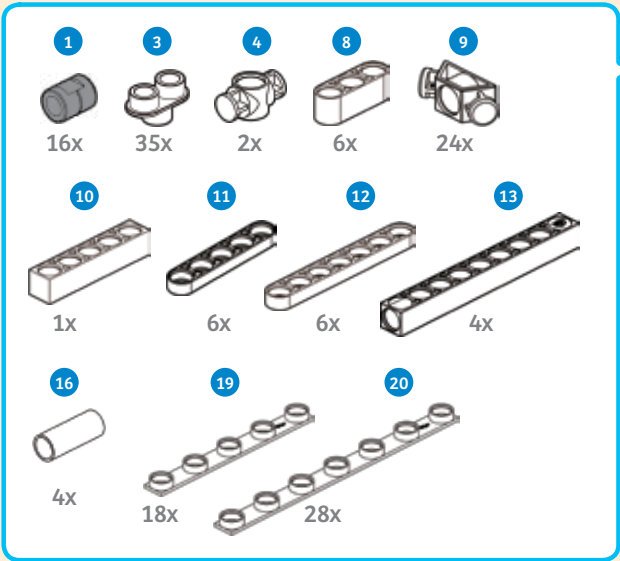

● ● ● CATENARY ARCH

10

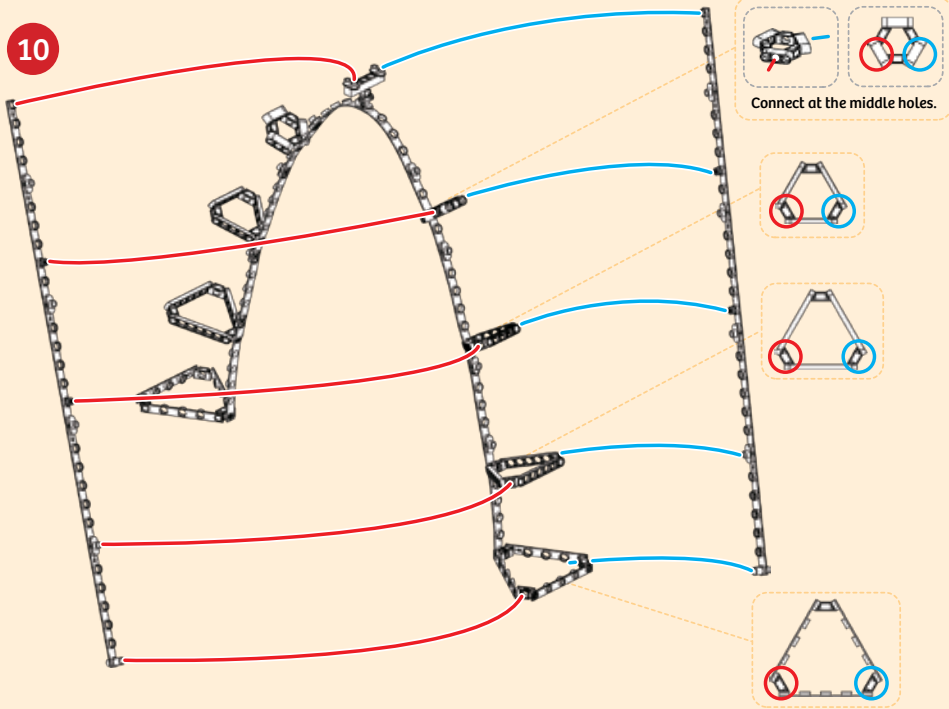

13

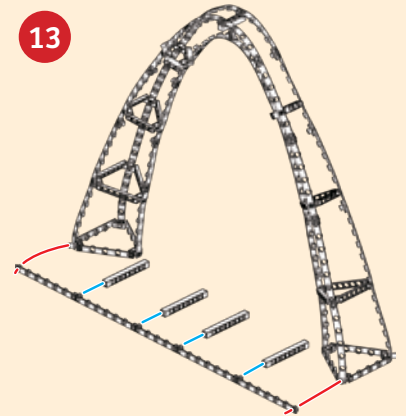

14

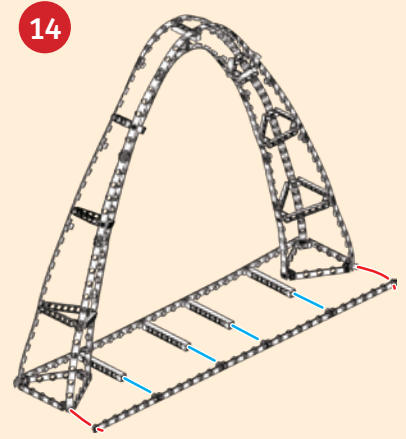

15



Done!

Adjust the rods so that the three arcs of the arch follow a smooth curve, removing spots where they are twisted, buckled, or crooked. Follow the general tips for model refinements on the inside back cover to finish your model.

11

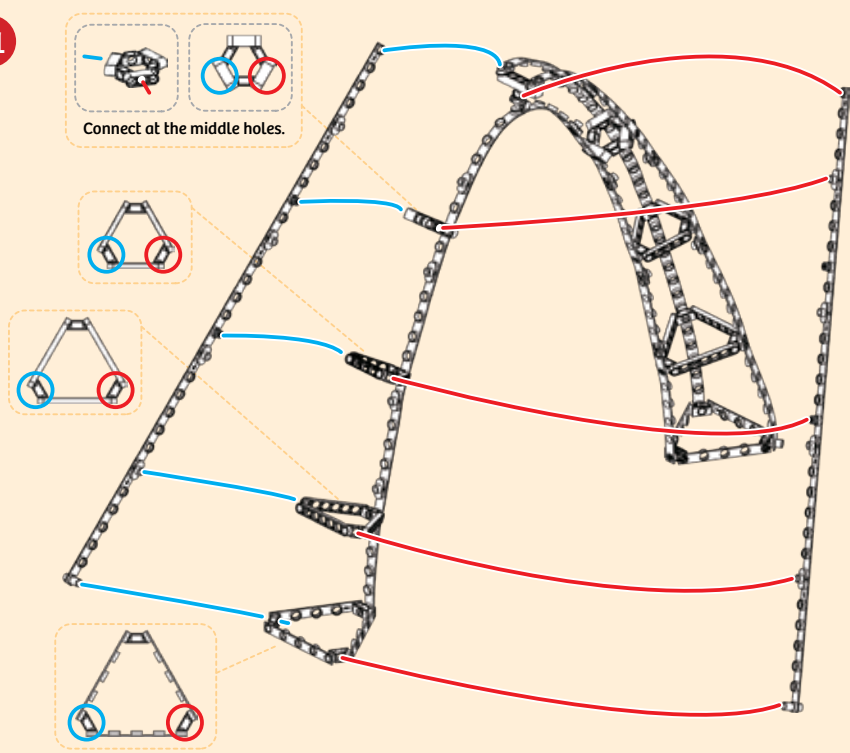

12

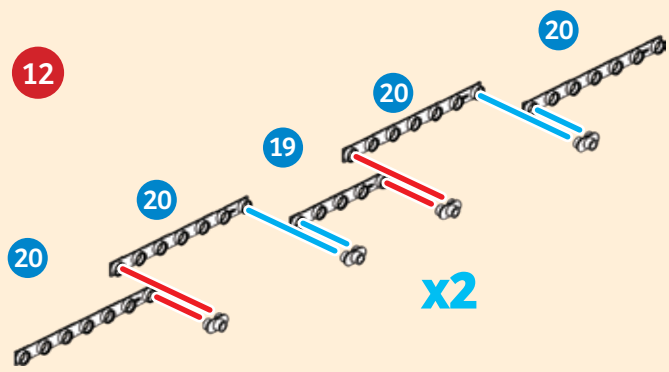

WHAT'S HAPPENING ?

You built a model that resembles the Gateway Arch in St. Louis, Missouri. Like your model, the real Gateway Arch has a triangular cross section. Without the triangular cross pieces attaching the three lengths of flexible rods, your model would not stand up.



FERRIS WHEEL

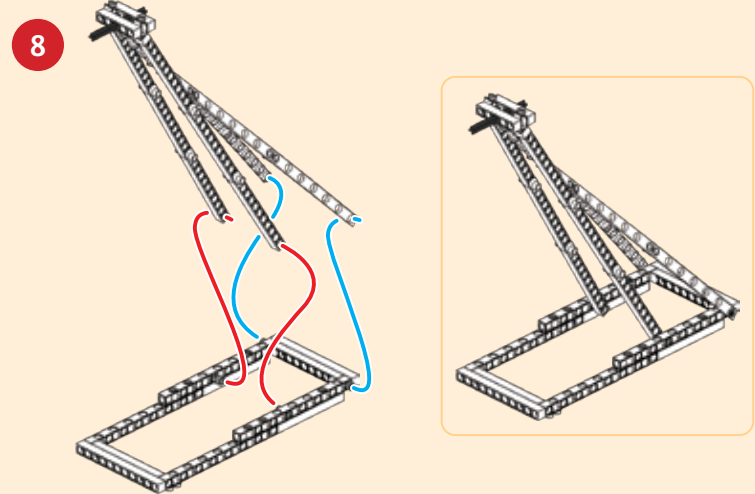
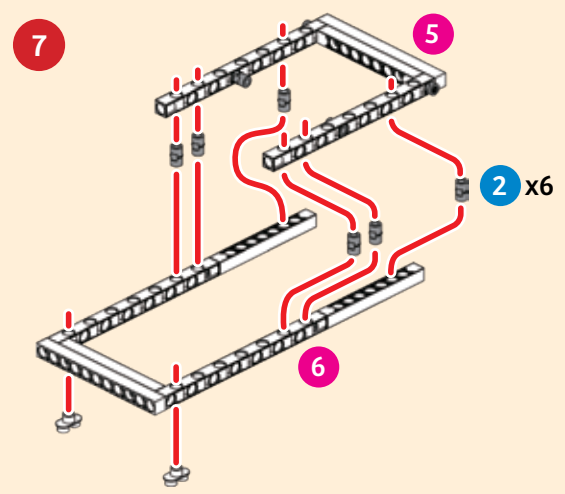
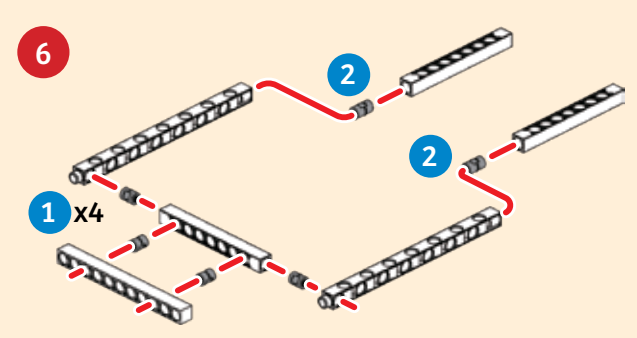
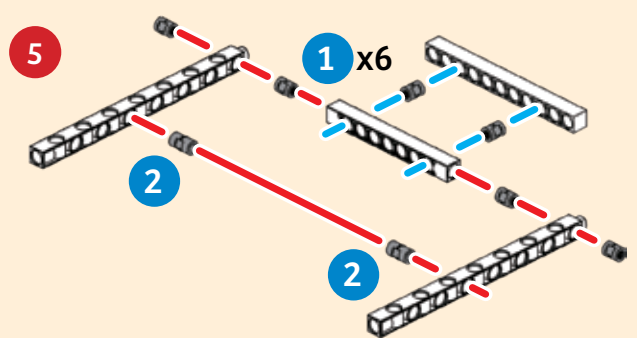
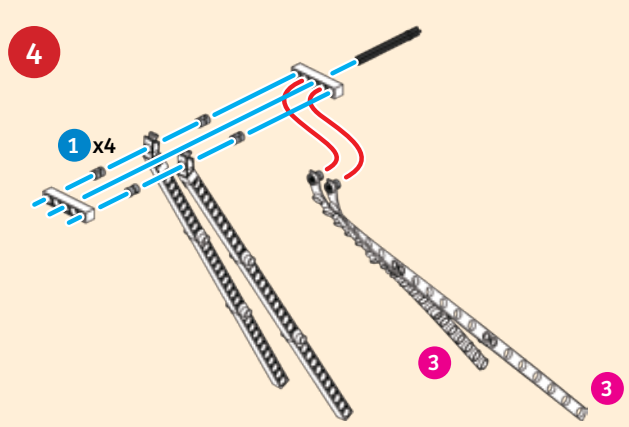
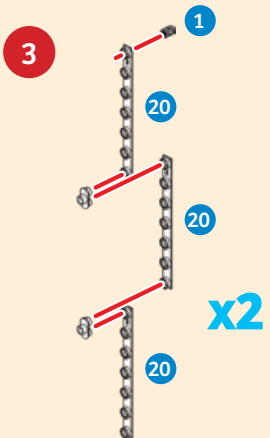
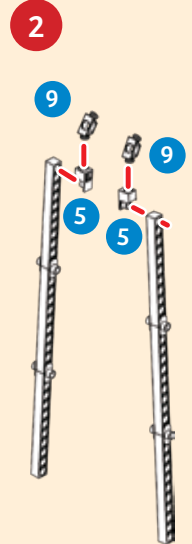
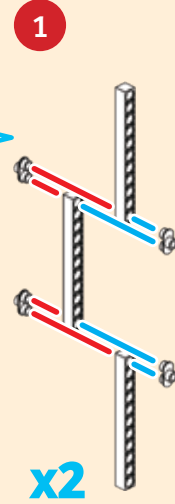
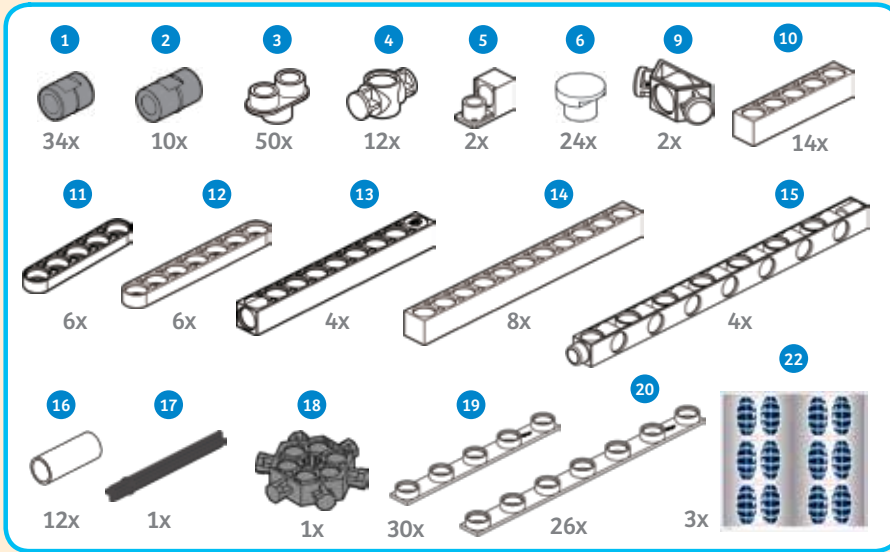

FERRIS WHEEL

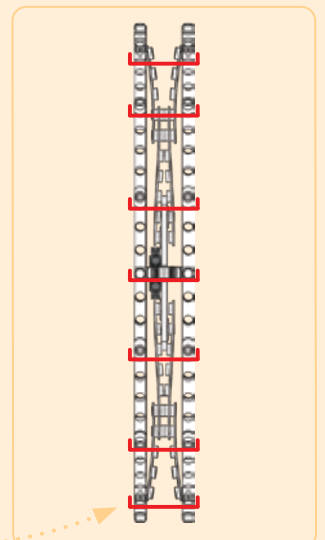
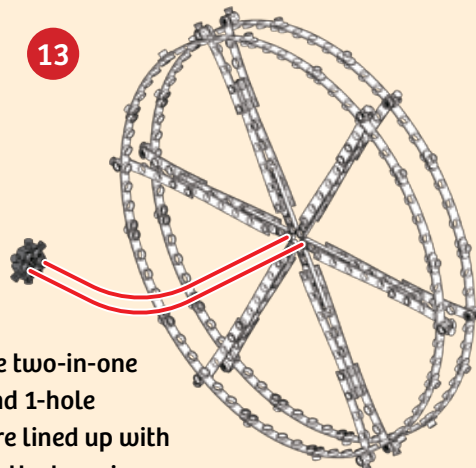
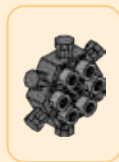
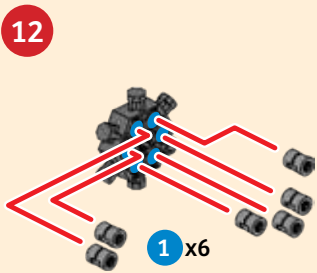
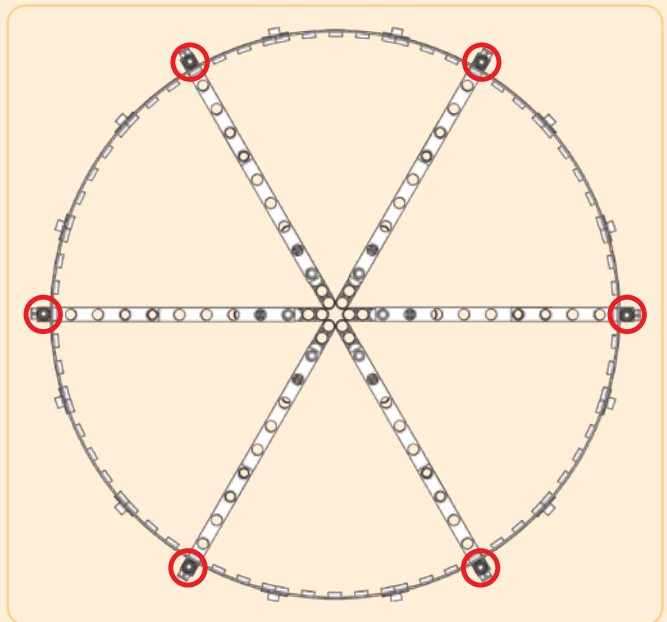
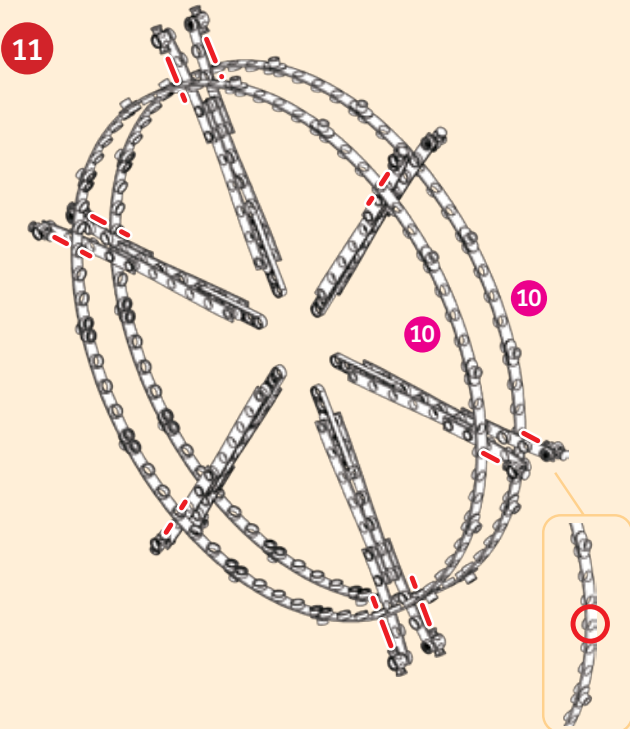
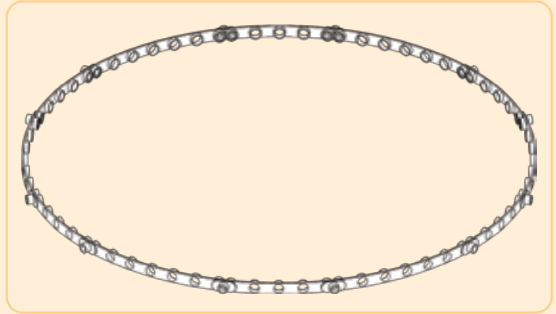
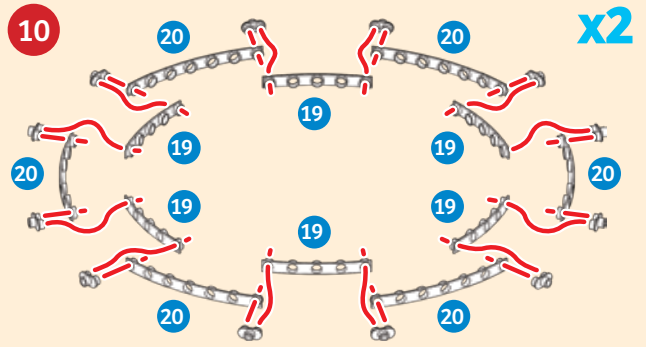
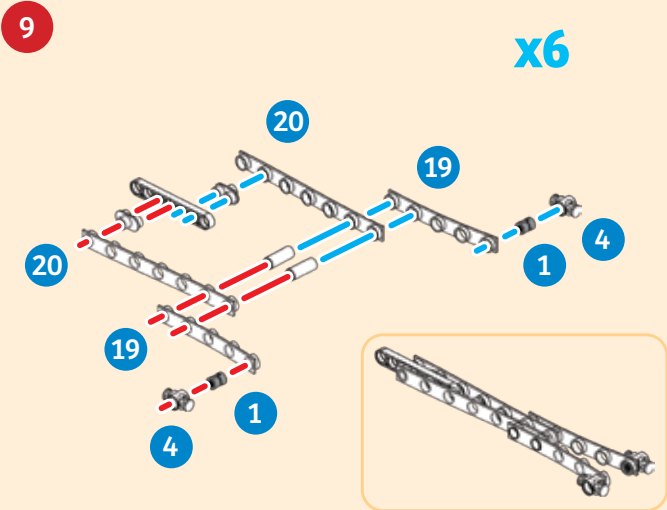

Make sure the two-in-one converters and 1-hole connectors are lined up with each other on the two rings.

FERRIS WHEEL

14

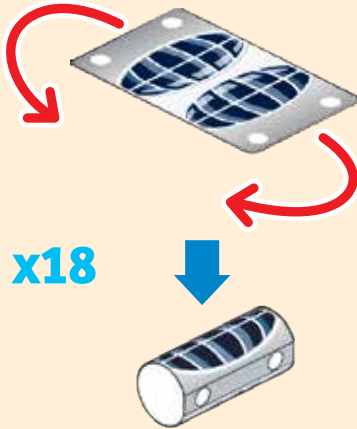

15

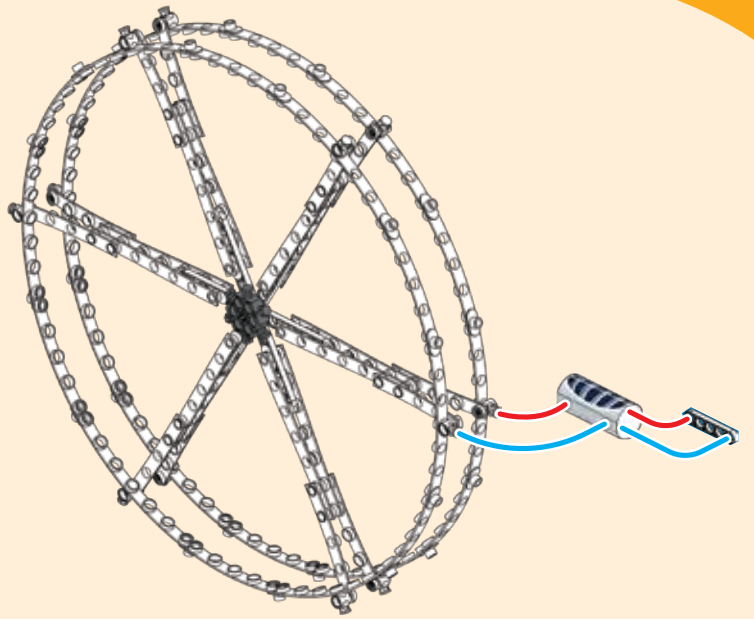

16

x6

Perform step 15 a total of six times, until six of the passenger cars are attached to the wheel at the ends of each of the six spokes.

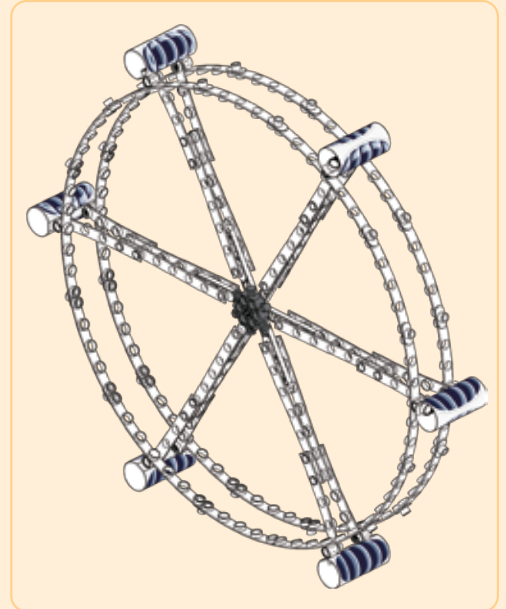
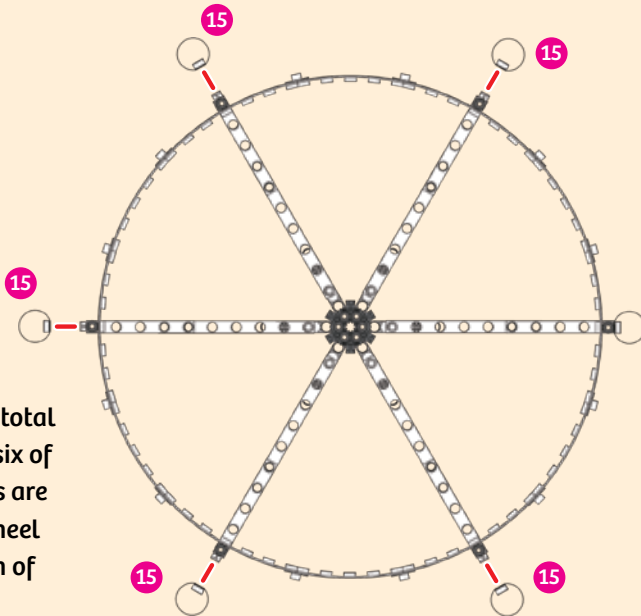

17

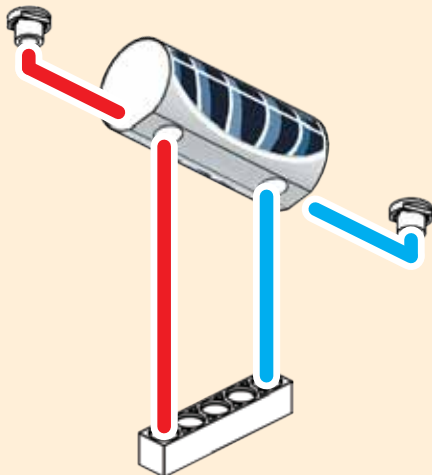

18

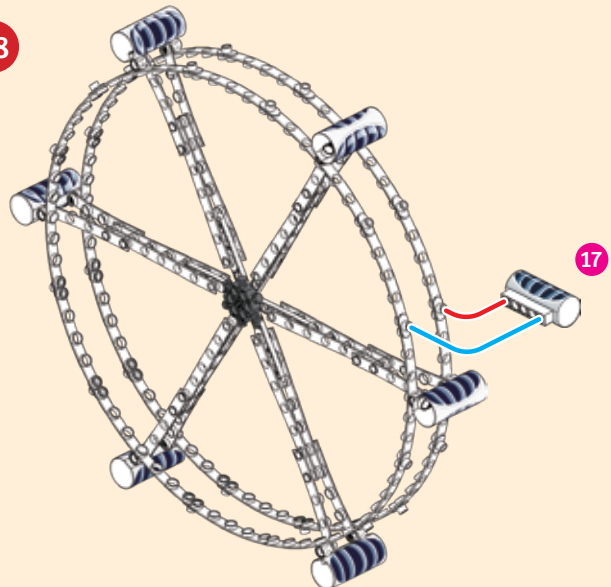

FERRIS WHEEL

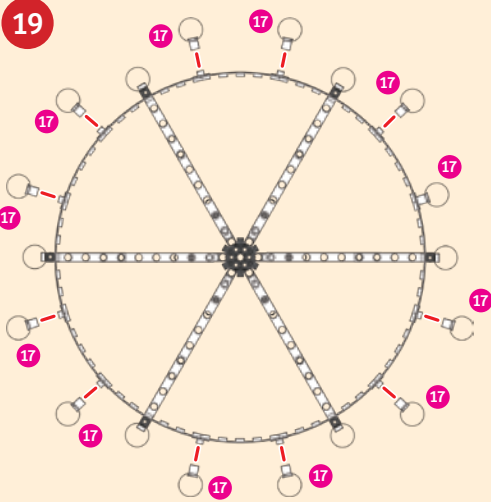

x12

Perform step 18 a total of twelve times, until a total of 18 passenger cars are attached to the wheel as shown.

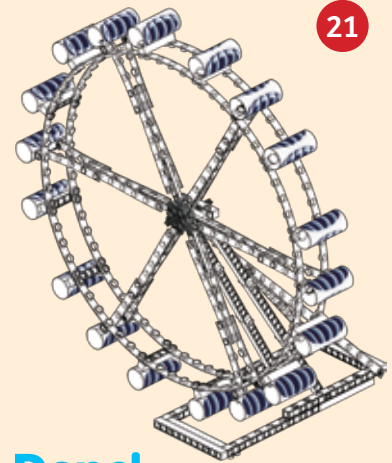
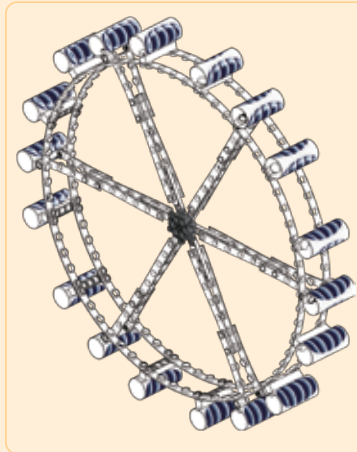

Done!

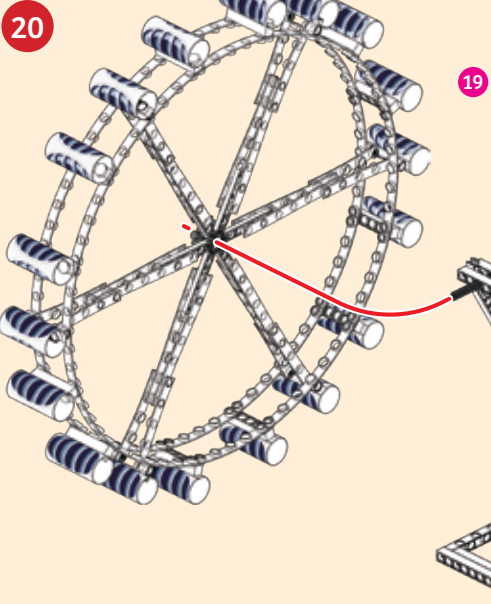
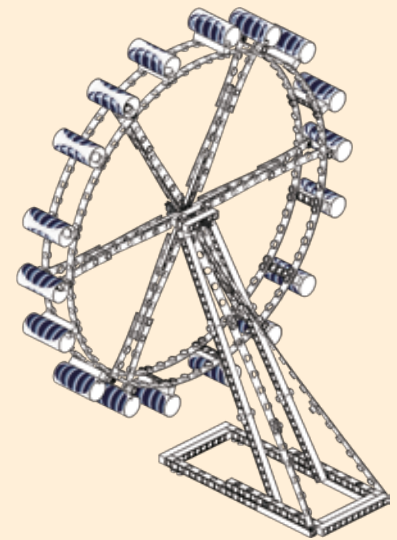

Follow the general tips for model refinements on the inside back cover to finish your model.

IMPORTANT NOTE!

If you let the assembled ferris wheel model sit for a number of days, you will notice that the wheel may distort over time. You can simply bend it back into a smooth curve again. If you rotate the model 180 degrees every few days, the distortion will be minimized.

EXPERIMENT

Ferris wheel tests

HERE'S HOW

Spin the finished Ferris wheel with your hand and observe. Does it spin all the way around? Remove the passenger cars from one half of the wheel. Spin the wheel again. What happens this time?

Remove the flexible rods that hold the base up (assembly 4). What happens?

WHAT'S HAPPENING ?

When you remove the passenger cars from half of the wheel, the wheel is no longer balanced. The side of the wheel with the cars is heavier than the other side. This causes the wheel to turn so the side with the cars is at the bottom, because its center of mass is below the pivot point at the center.

When you remove the flexible rods that are holding up the base, the base no longer stands up. You can easily see how the flexible rods are pulling the base structure in the opposite direction as the weight of the wheel when they are attached. This type of structure is called a cantilever. A **cantilever** is a rigid structural element, like a beam or plate, that is anchored at one end and protrudes out into open space where its other end is unsupported.

CHECK IT OUT



EIFFEL TOWER

Location: **Paris, France**
 Year Completed: **1889**
 Height (to Tip): **1,063 ft.**
 Material: **Wrought iron with concrete and stone based**

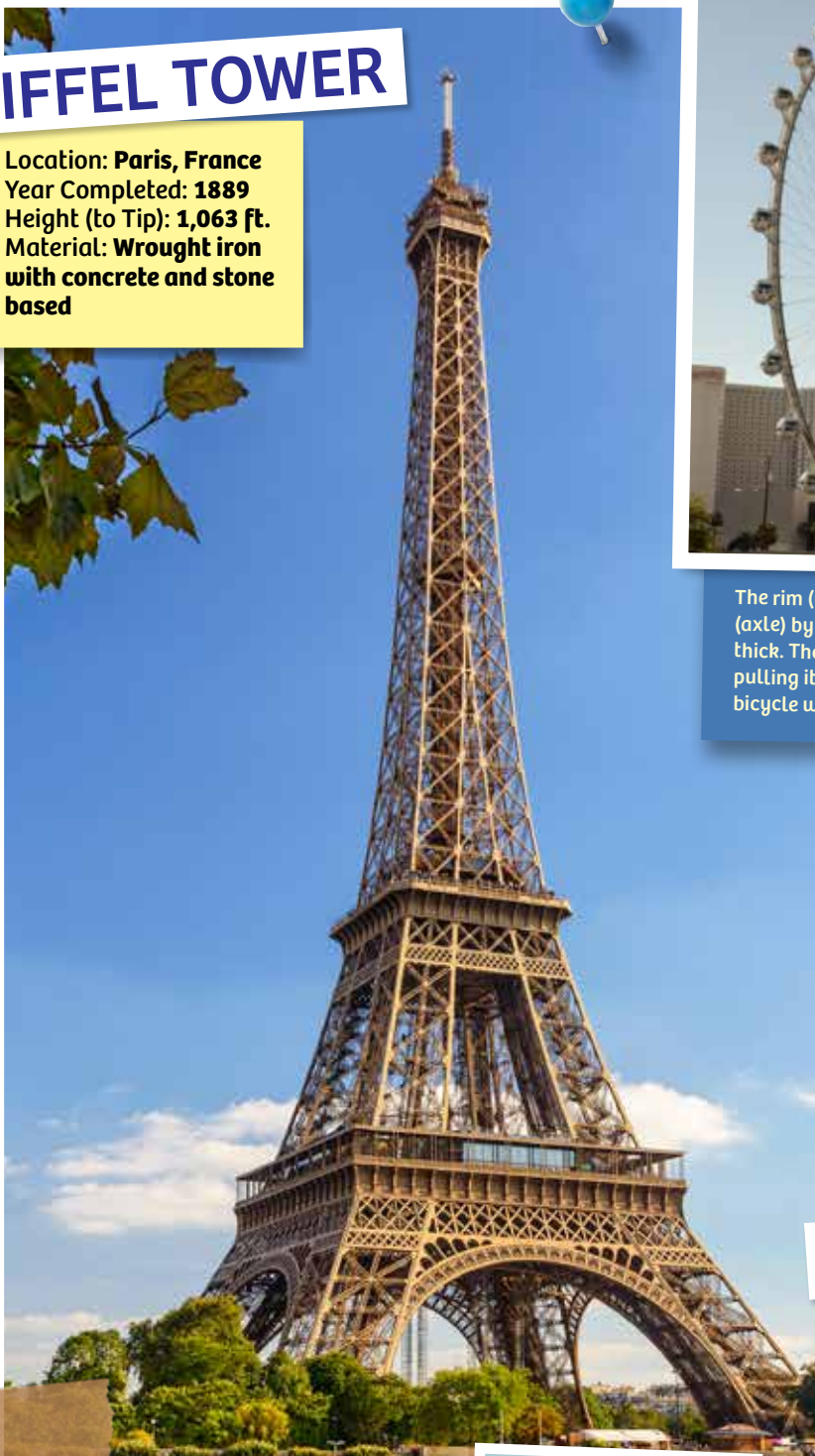

Look closely at the Eiffel tower and you will see that it has many X-shaped structures crisscrossing all over it. These are called trusses. The **truss** uses a relatively small amount of material to achieve a relatively large amount of stability. They are very efficient because they have more empty space than material (in this case, iron), and they are so strong because they make use of the inherent stability of the triangle. In the Eiffel tower, the larger trusses are even made of smaller trusses. There are over 18,000 different parts in the Eiffel tower. You can see trusses in use everywhere, including in bridges, skyscrapers, and towers.

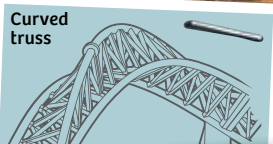

HIGH ROLLER

Location: **Las Vegas, Nevada**
 Year Completed: **2014**
 Diameter: **520 ft.**
 Height: **550 ft.**
 Material: **Steel plate and steel cables**

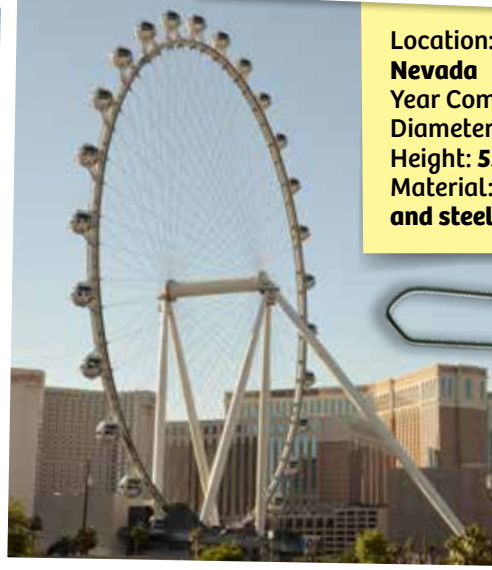

The rim (wheel) of the High Roller is connected to the hub (axle) by 112 cable spokes. The cables are three inches thick. The rim is held in place by the tension of each cable pulling it inward toward the hub. This is just like how a bicycle wheel is held together — only much bigger!



GATEWAY ARCH

Location: **St. Louis, Missouri**
 Year Completed: **1965**
 Height: **630 ft.**
 Material: **Stainless steel plates on the exterior, carbon steel plates on the interior, with reinforced concrete poured between them**

The Gateway Arch is called a weighted catenary arch because its shape matches the curve of an upside-down catenary. A **catenary** is the shape that a rope or chain makes when you hold it from both ends and let it hang down in the middle. This is the optimal shape for an arch of uniform density and thickness that needs to support only its own weight, because a catenary is the most efficient shape for channeling the force of gravity into compressive forces that pass through the arch down to the ground.

GIANT DOME

1 30x 3 50x 19 30x 20 30x

2x
Repeat steps 2–7
two times.

1

x10

2

3

4

5

6

7

8

x10

9

x2

10

GIANT DOME

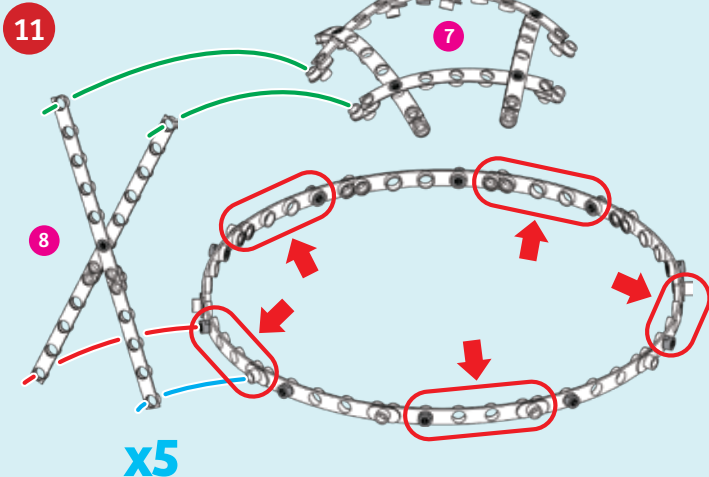

Attach five X shapes: Attach the bottom of each X shape to each alternating pair of anchor pins and two-to-one converters. Attach the top to the top pentagon.

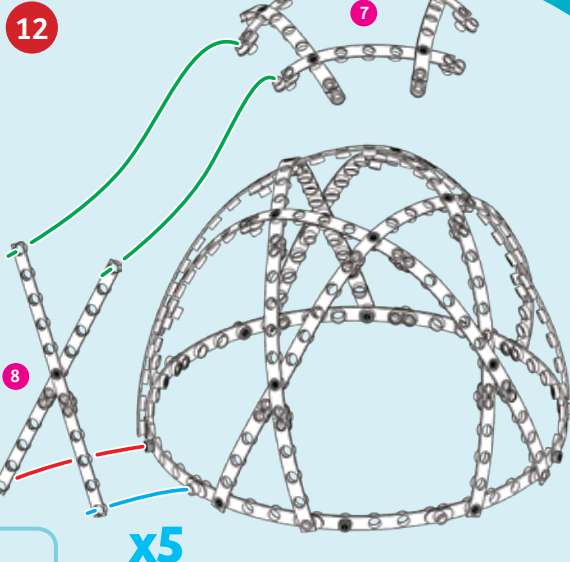
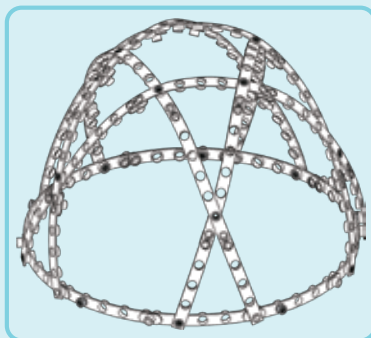

Attach the five remaining X shapes: Attach the bottom of each X shape to each alternating pair of anchor pins and two-to-one converters. Attach the top to the top pentagon.

13

Done!

Follow the general tips for model refinements on the inside back cover to finish your model.

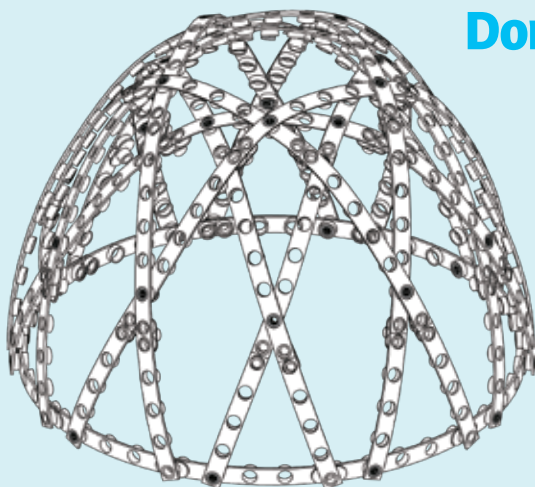

BONUS EXPERIMENT

Cover the dome structure with sheets of wet paper towels. Overlap the towels so there is at least one layer of towel covering most of the structure. You have created a surface structure to enclose the dome.

EXPERIMENT

Dome strength

HERE'S HOW

Place magazines, one at a time, on the top of the dome. How many magazines does it hold before the dome starts to deform? Compare the strength of this dome to the strength of the smaller dome you made on page 11.

WHAT'S HAPPENING ?

This dome is larger, but it also has more structural supports, than the dome on page 11. Therefore, you probably observed that this dome supports more weight than the smaller dome. However, there are many variables involved here, and it is possible that your observations differ.

OLYMPIC STADIUM

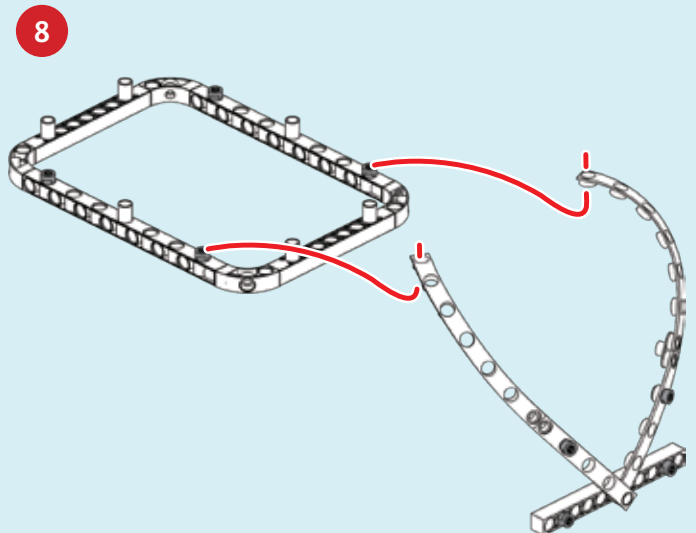
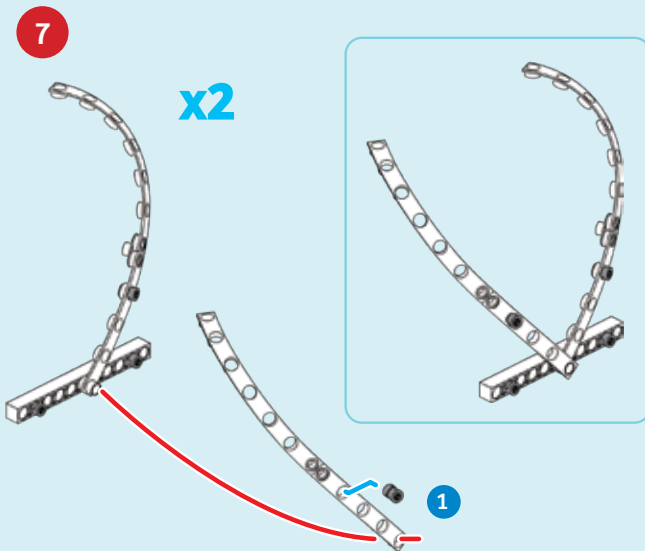
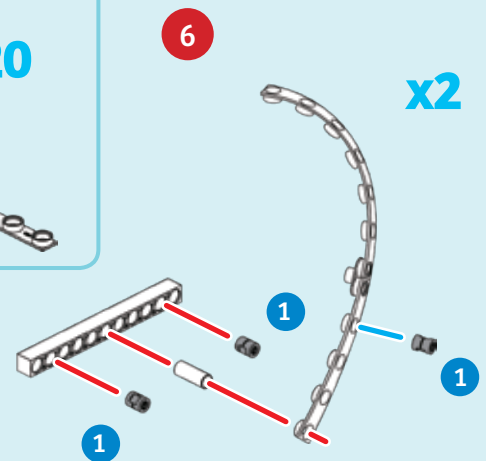
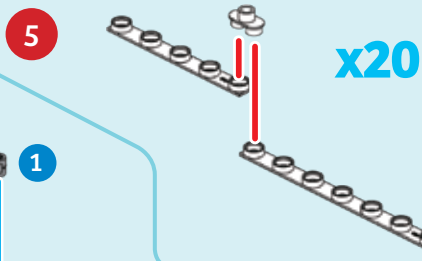
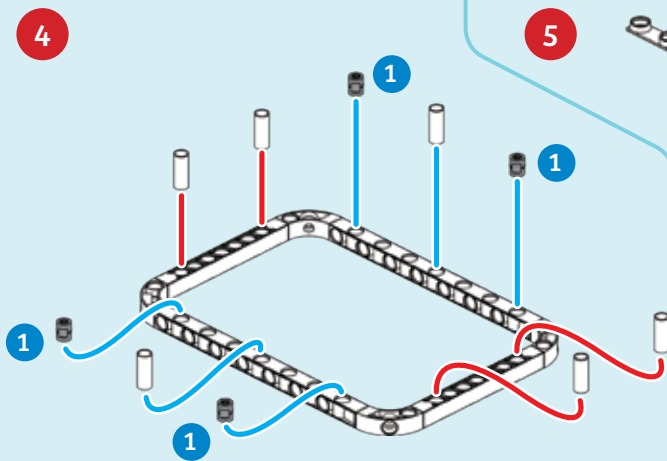
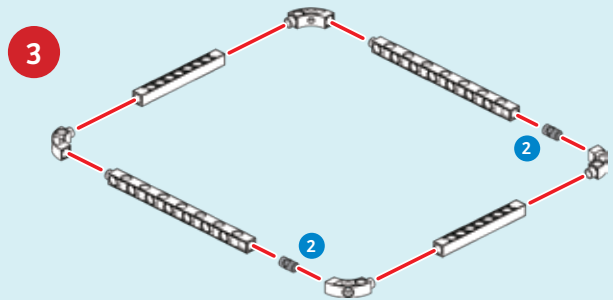
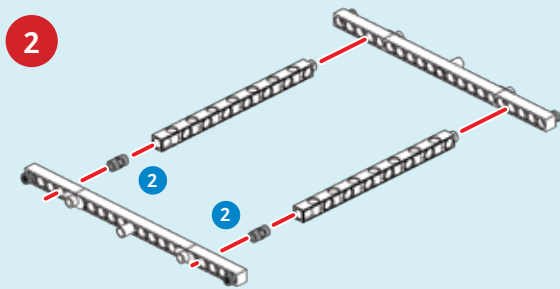
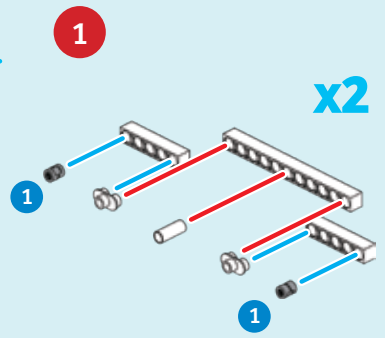
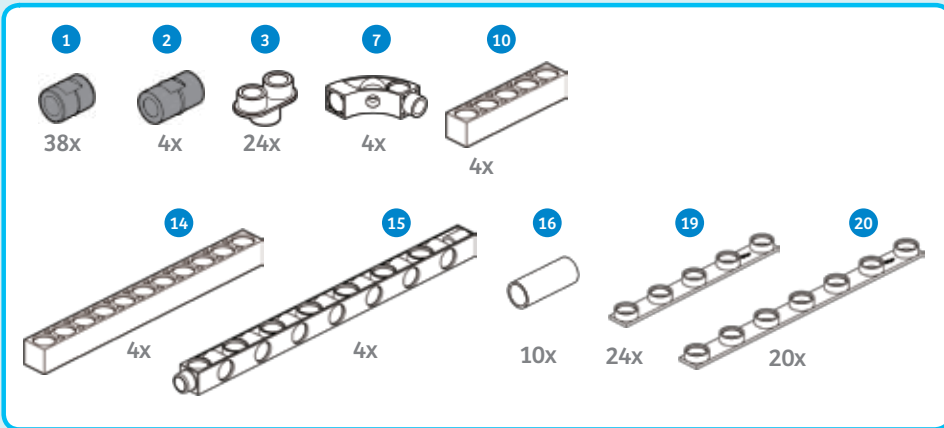

OLYMPIC STADIUM

9

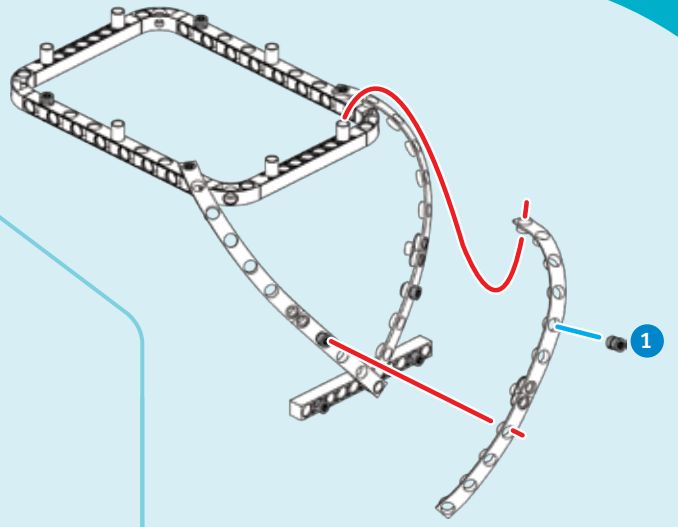

10

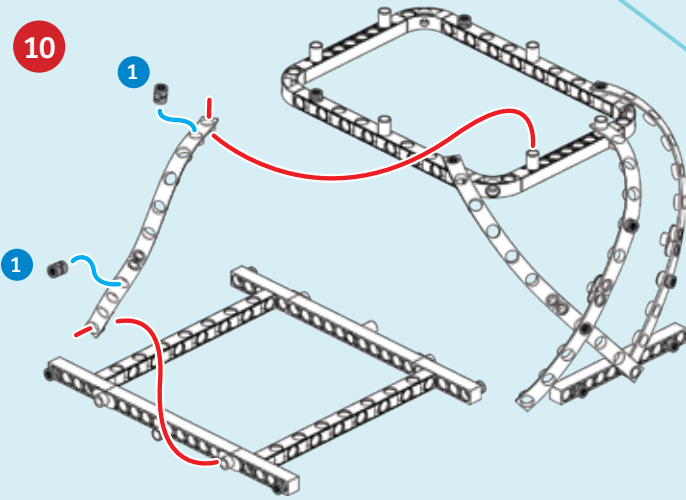

11

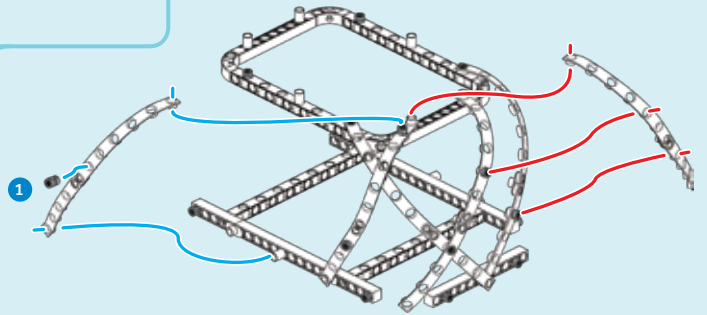

Rotate the model to work on the other end.

12

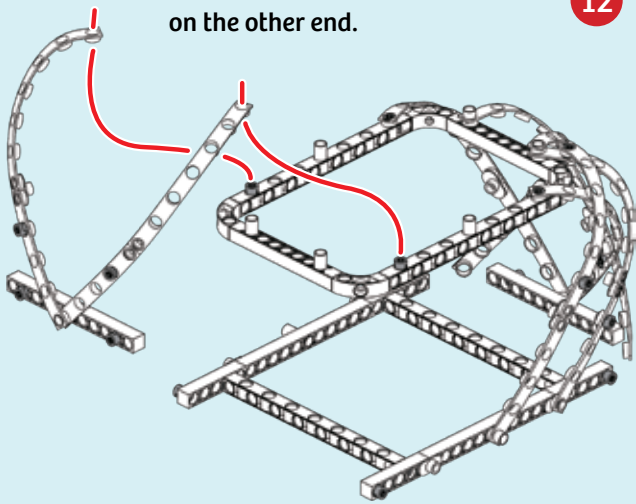

13

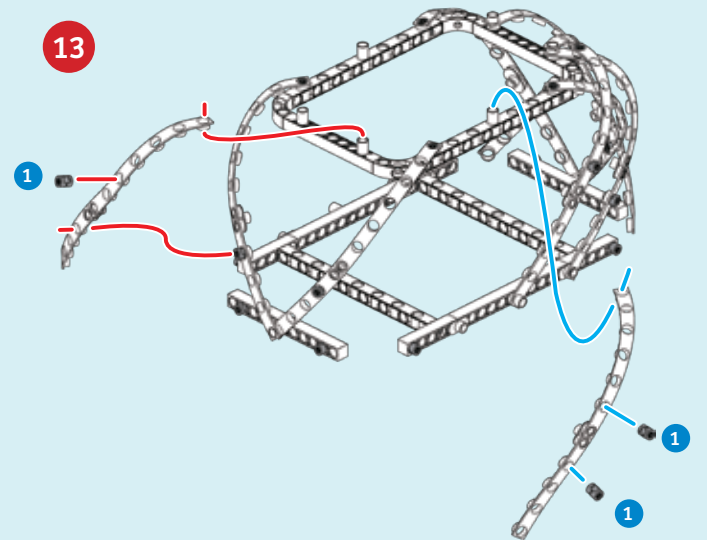

14

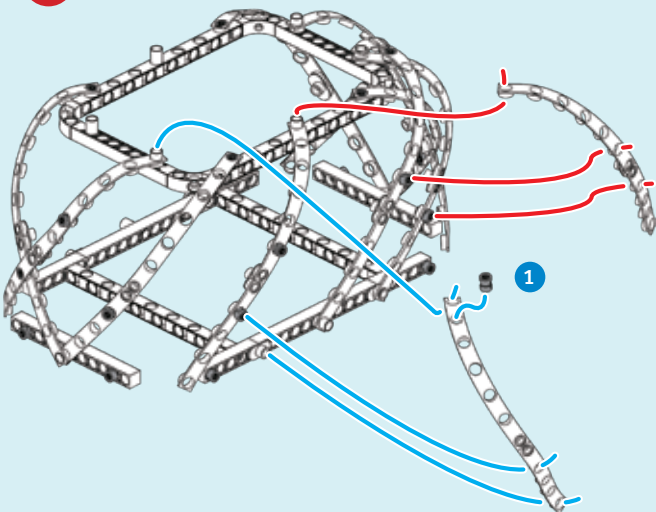

15

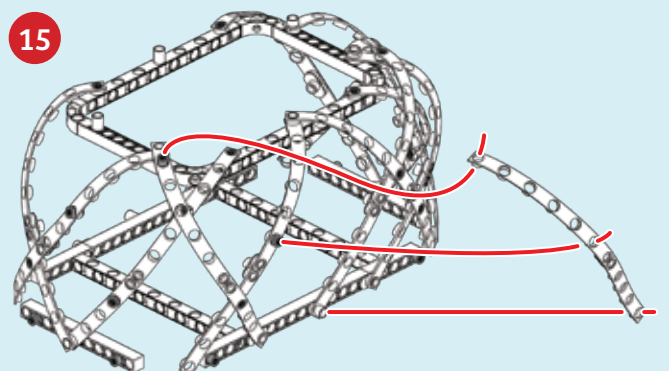

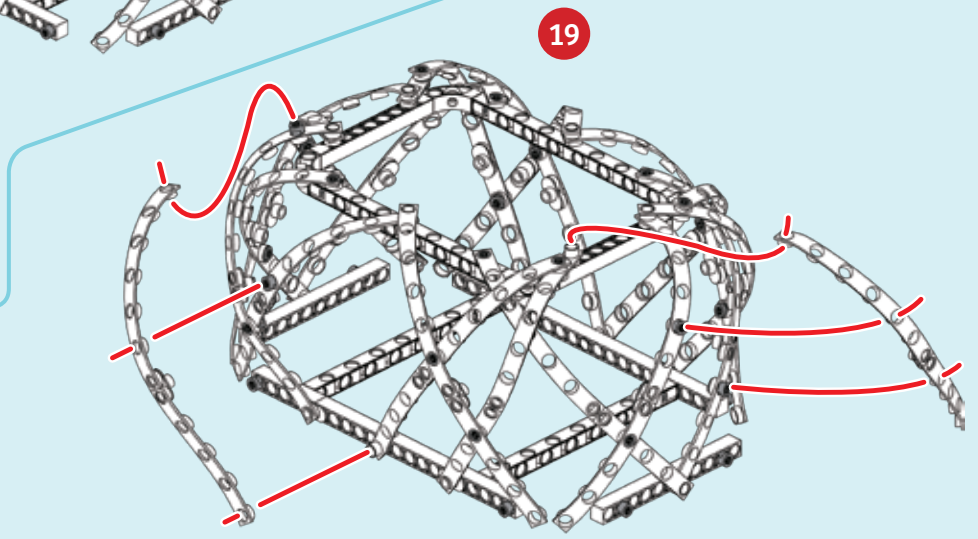
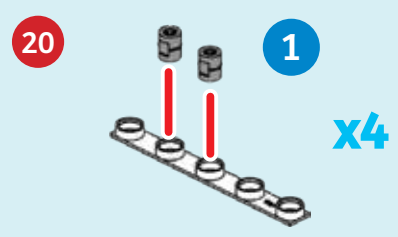
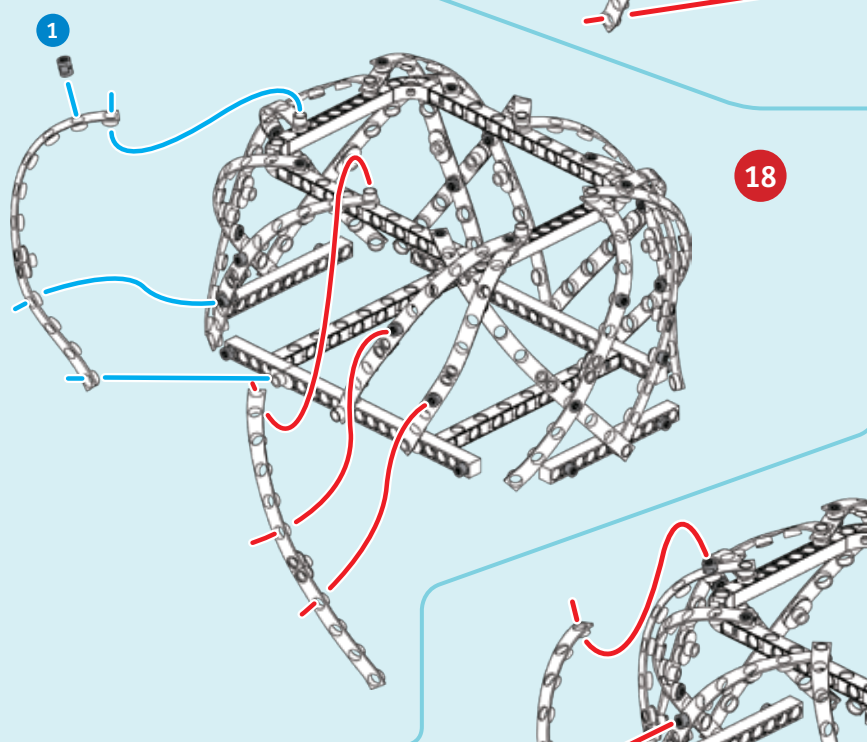
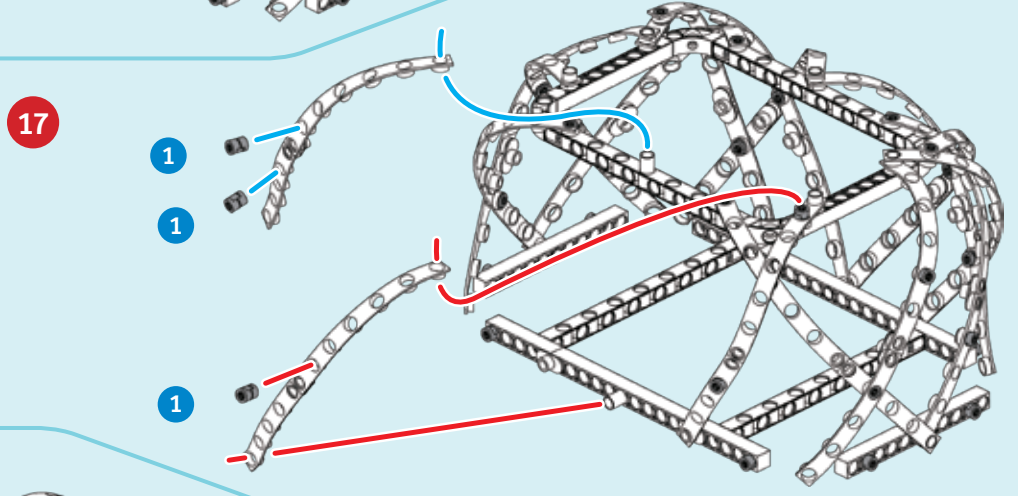
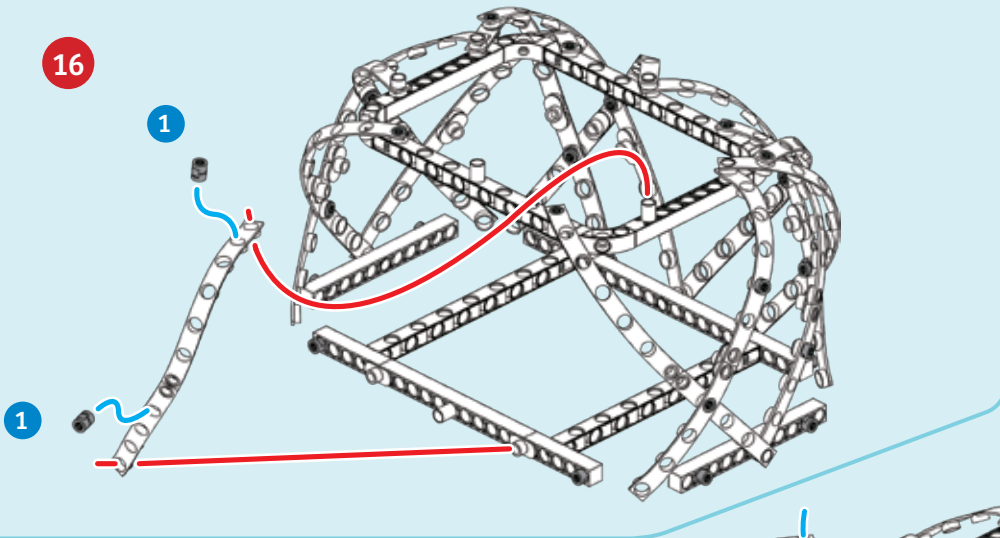

OLYMPIC STADIUM

21

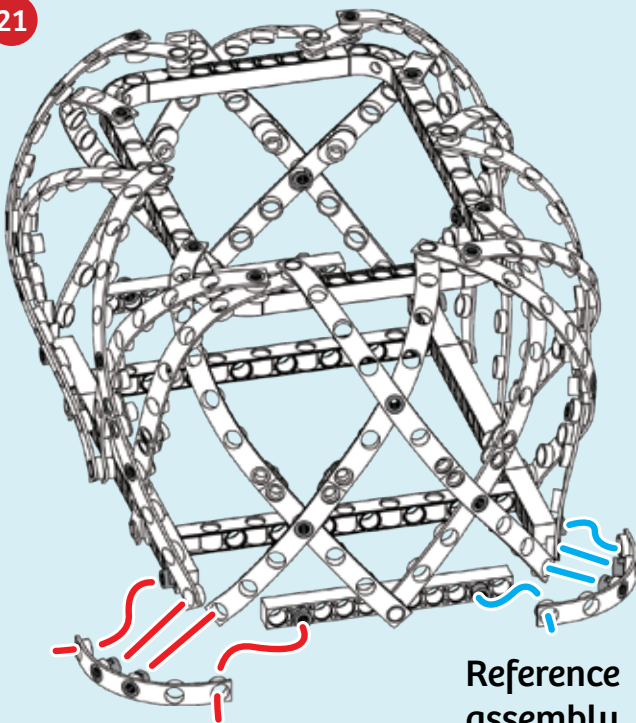

Reference assembly step **A**

Reference assembly step **B**

22

Rotate the model 180 degrees to work on the other end.

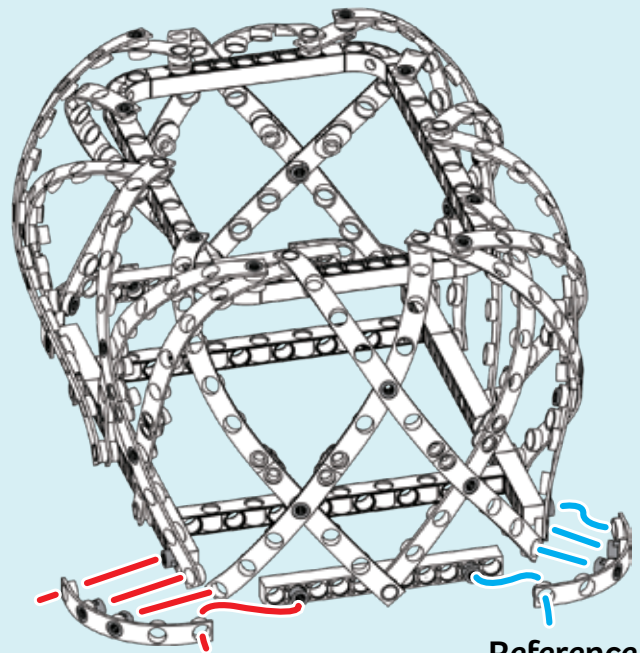

Reference assembly step **A**

Reference assembly step **B**

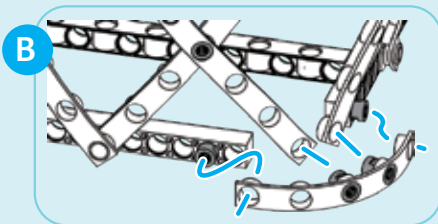
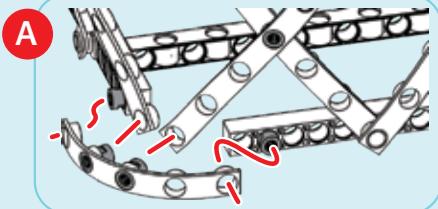

23

Done!

Follow the general tips for model refinements on the inside back cover to finish your model.

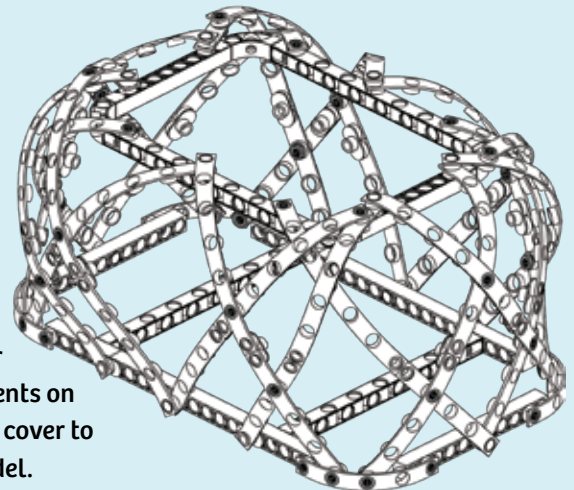

EXPERIMENT

Irregular structures

HERE'S HOW

Count the number of points at which the flexible rods connect to each other in the middle of the stadium model.

WHAT'S HAPPENING ?

The flexible rods connect together at 14 points. Each flexible rod is connected to at least one other flexible rod in the middle. This creates a truss system that turns the flexible rods into a rigid structure. The model is based on the Beijing National Stadium in China. It is nicknamed the Bird's Nest because of its irregular configuration of steel beams that resembles the intertwined twigs of a bird's nest. Complex computer modeling was required to analyze the forces acting on the irregular beams of the stadium.

● ● ● NEO-FUTURISTIC SKYSCRAPER

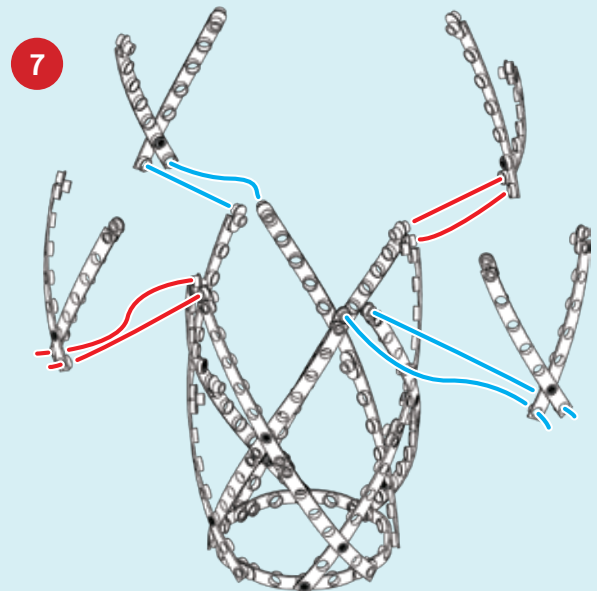
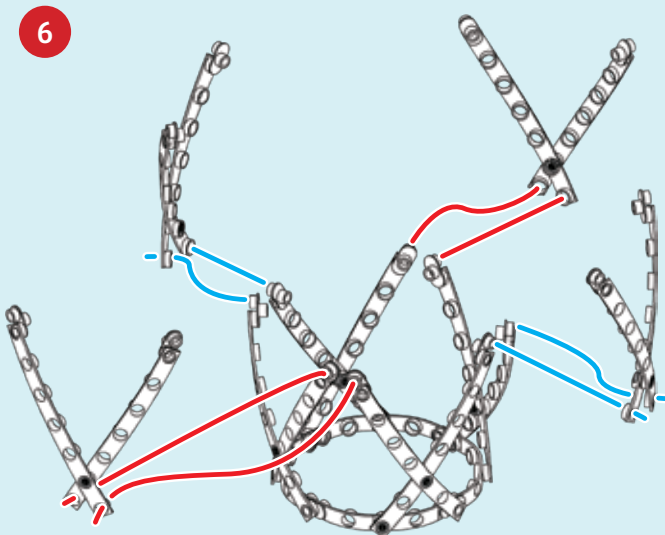
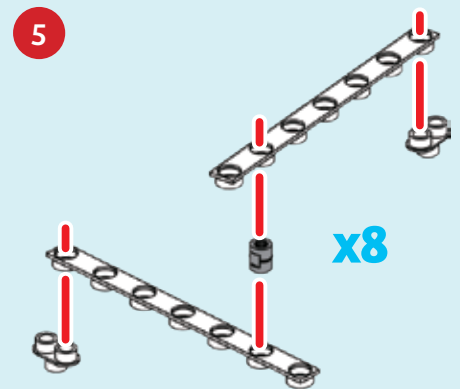
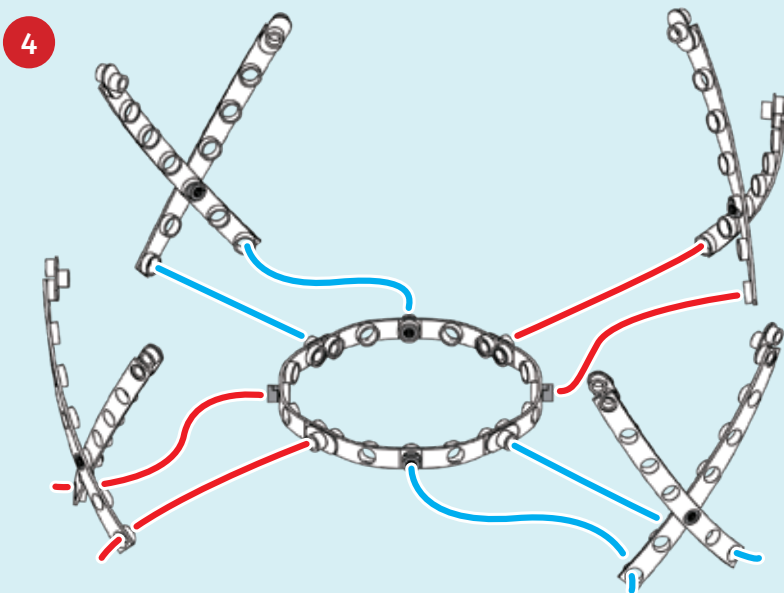
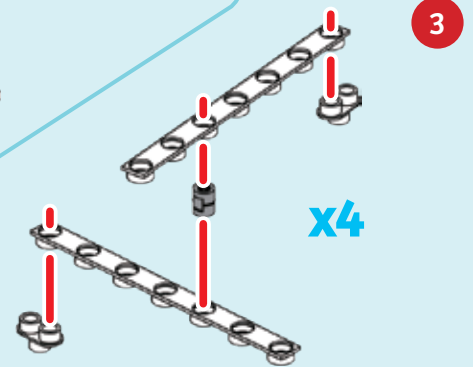
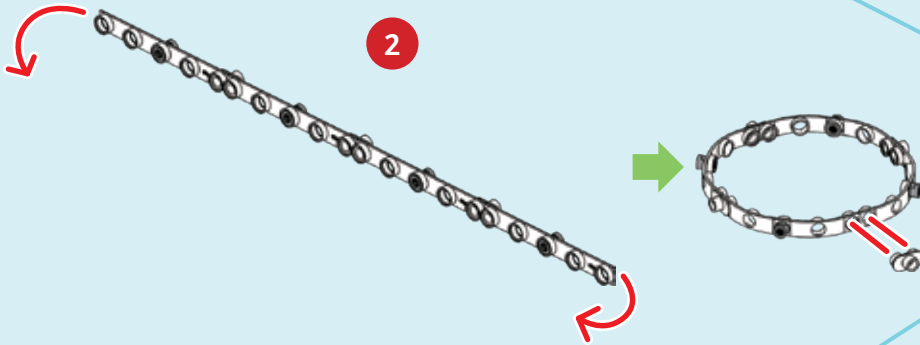
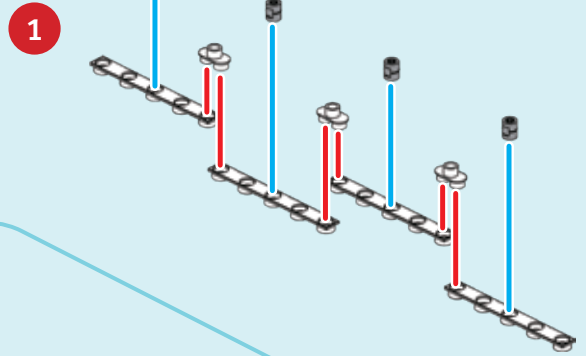
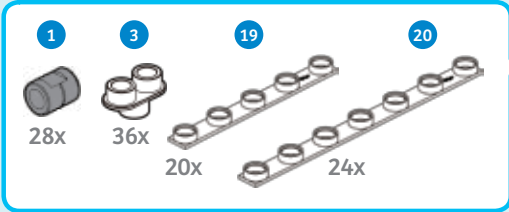

NEO-FUTURISTIC SKYSCRAPER

8

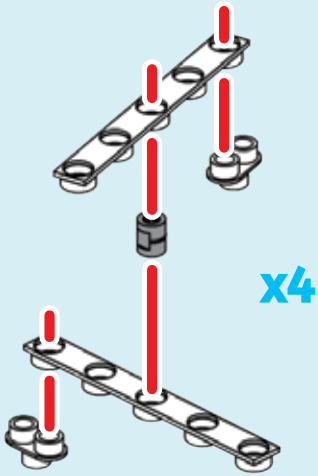

9

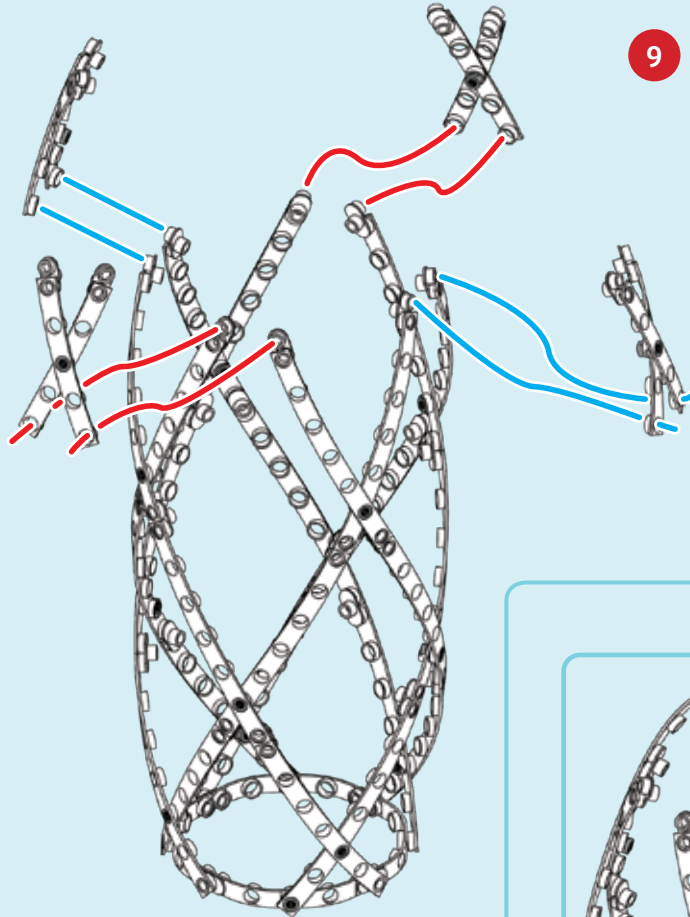

11

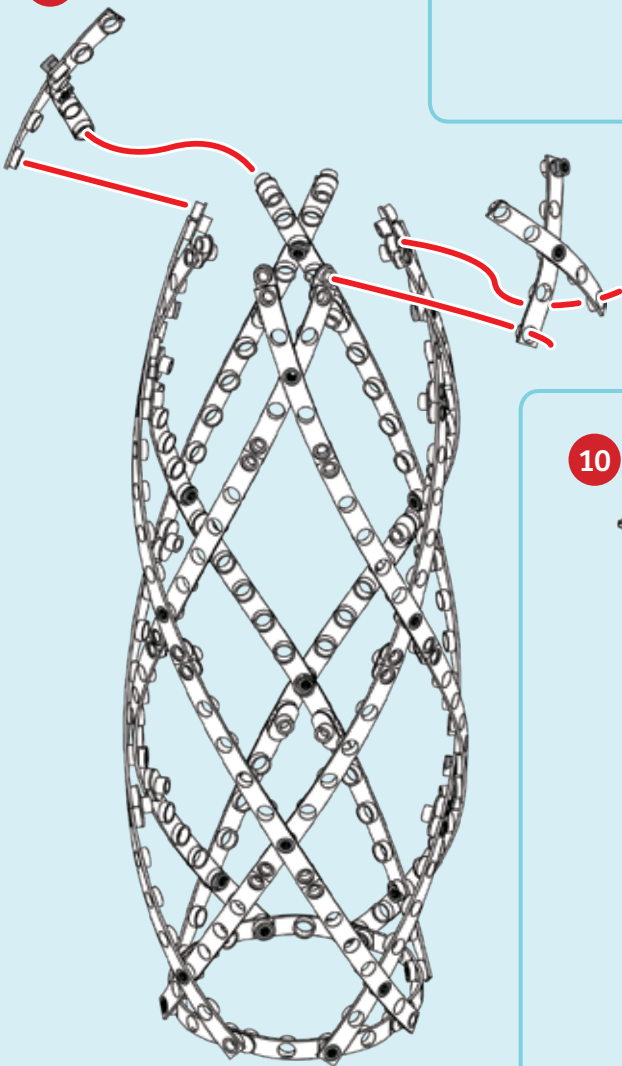

12

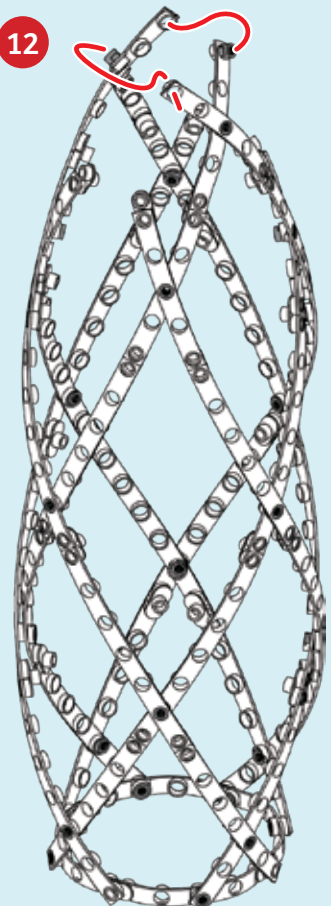

10

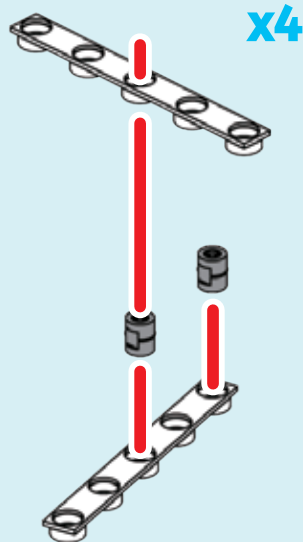

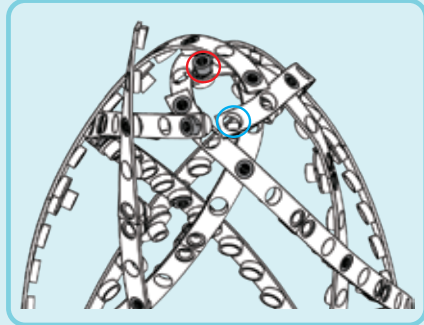
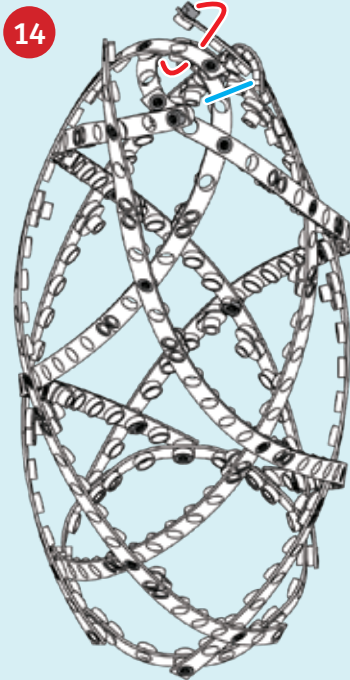
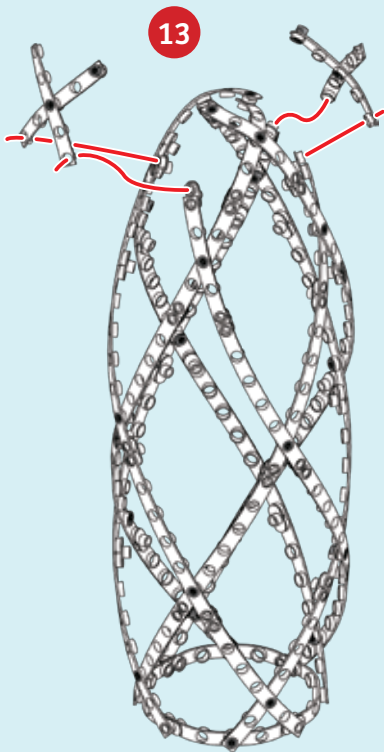

Attach the rods at the spots marked by the red and blue circles.

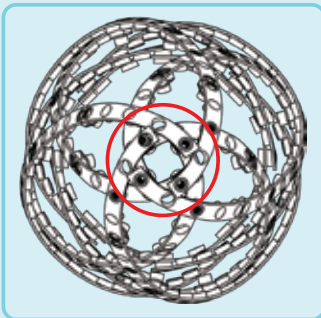

Plan

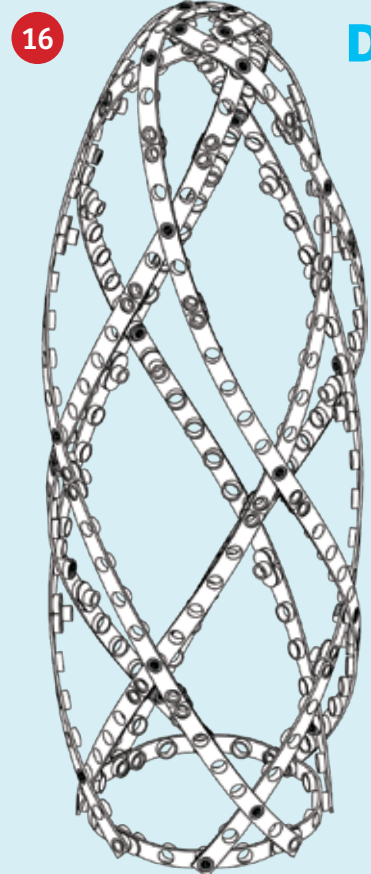

Done!

Follow the general tips for model refinements on the inside back cover to finish your model.

EXPERIMENT

Curvy skyscraper

HERE'S HOW

Starting at the circular base, follow the flexible rods up to the top of the model. How many rods are there and what is the shape of the paths they follow?

WHAT'S HAPPENING ?

There are eight strips of connected flexible rods that extend from the base up to the top of the model. Each strip curves in a spiral to the top — half in a clockwise spiral and half in a counterclockwise spiral. This model is based on a building in London, England, located at 30 St Mary Axe, nicknamed the Gherkin. The building has circular floor plans. The sixteenth floor is the largest floor; the floors get increasingly smaller as they go up and down from the sixteenth floor. This gives the building an elliptical elevation that is reminiscent of a gherkin, or a pickle.

CHECK IT OUT



REICHSTAG DOME



Location: Berlin, Germany
Year Completed: 1999
Height: 154 ft.
Material: Steel and glass dome on a stone building

The Reichstag dome sits atop the rebuilt Reichstag building, which is the home of the German parliament. The dome lets light into the main chamber. To prevent it from getting too bright and hot, there is a large solar shield that moves throughout the day to block direct sunlight from entering the dome.

Location: London, England
Year Completed: 2003
Height: 591 ft.
Material: Steel and glass

This iconic building earned the nickname the Gherkin even before it was completed. Each floor is a perfect circle of differing sizes, giving it its unique shape. The frame consists of giant steel beams crisscrossing the exterior, forming a spiral pattern.



30 ST MARY AXE

BEIJING NATIONAL STADIUM



Location: Beijing, China
Year Completed: 2008
Height: 227 ft.
Length: 1082 ft.
Material: Steel and concrete

Built for the 2008 Summer Olympics and Paralympics, this stadium can hold up to 91,000 people. It is made from over 42,000 tons of steel. To construct it, 24 huge steel columns were positioned in a ring. Then, smaller beams were welded on to connect the columns together on the sides and top, resulting in its nest-like appearance.

● ● ● HIGH-TECH HOTEL

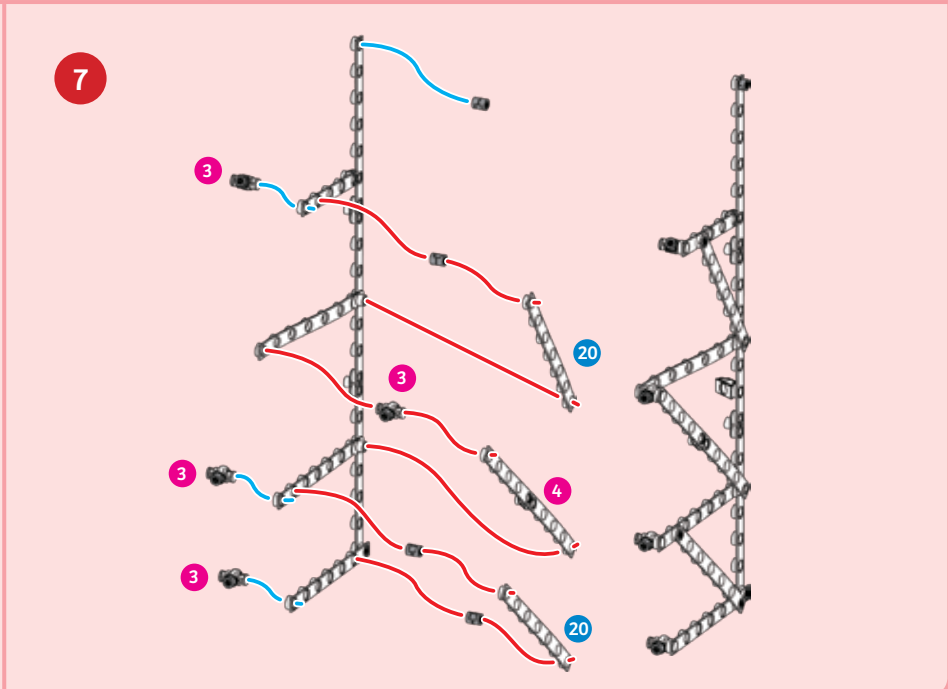
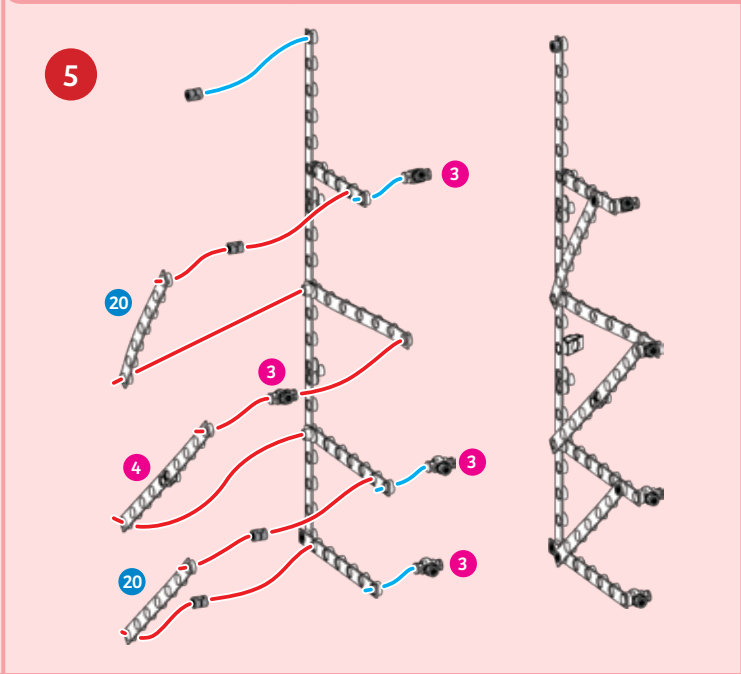
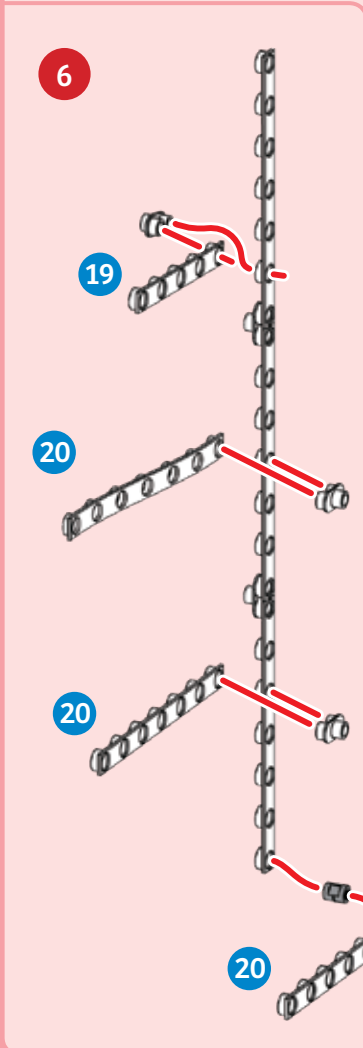
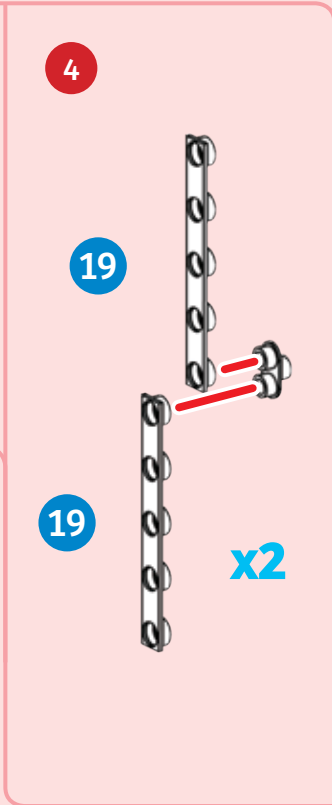
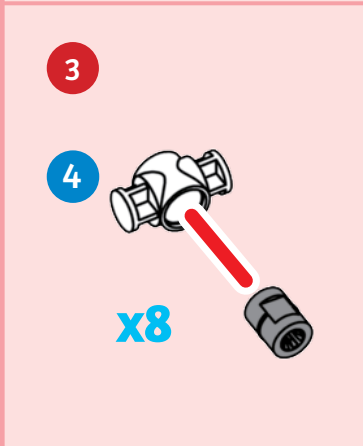
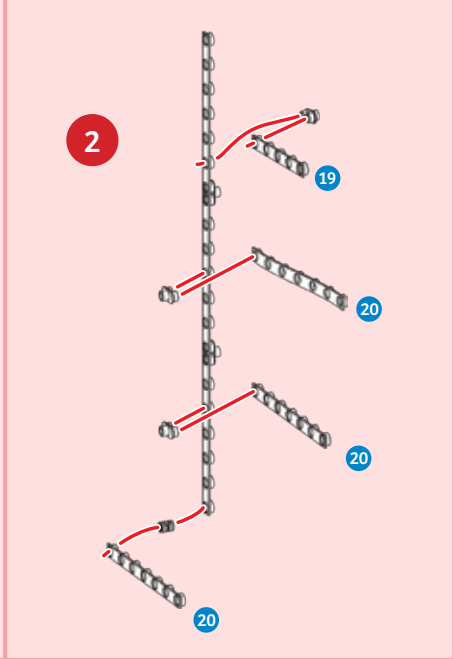
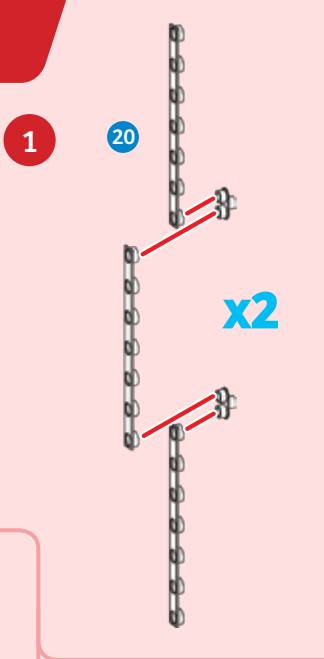
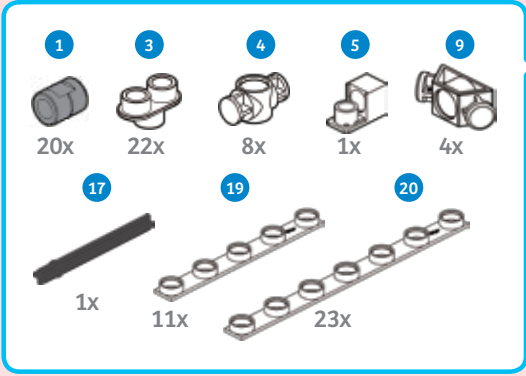

● ● ● HIGH-TECH HOTEL

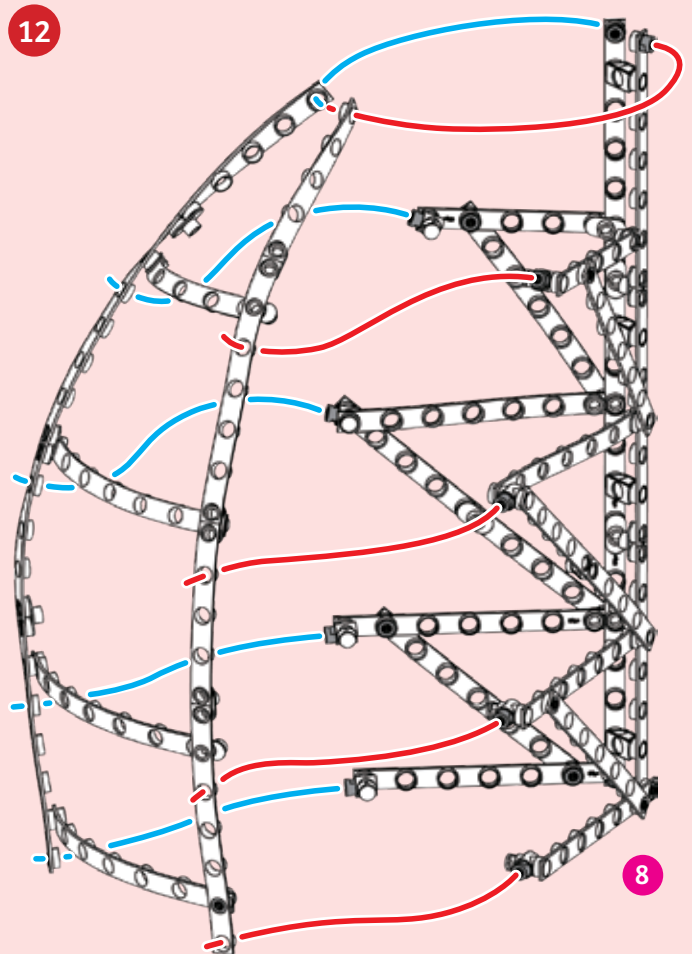
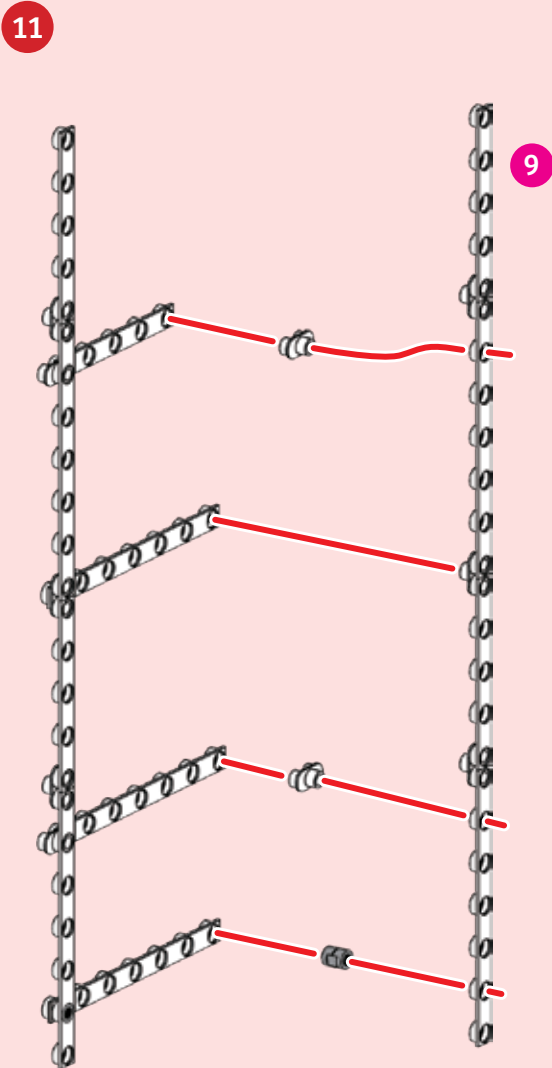
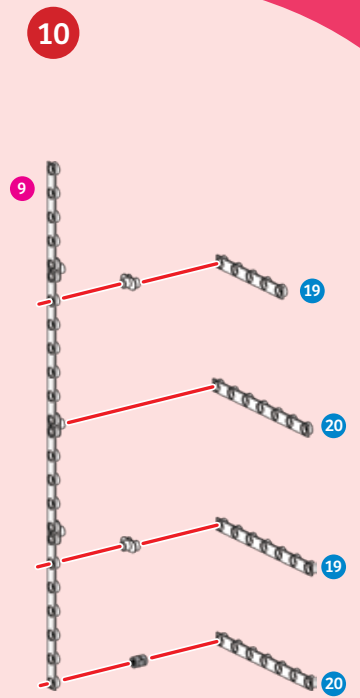
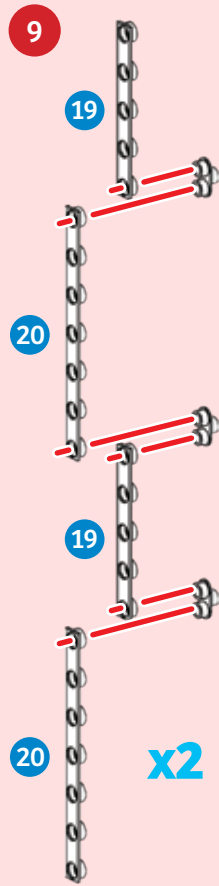
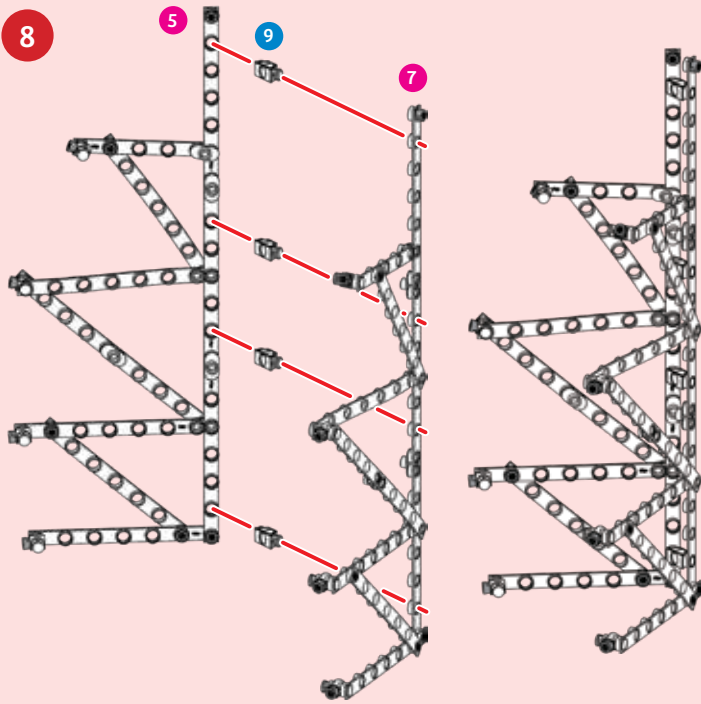

13

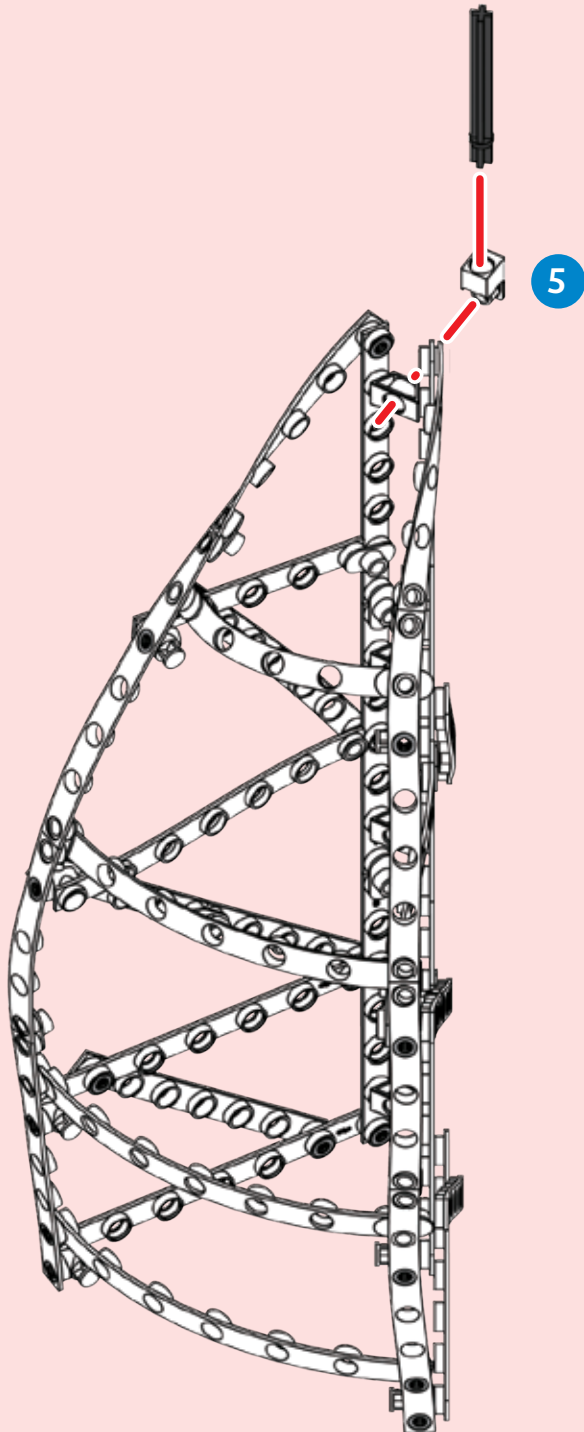

14

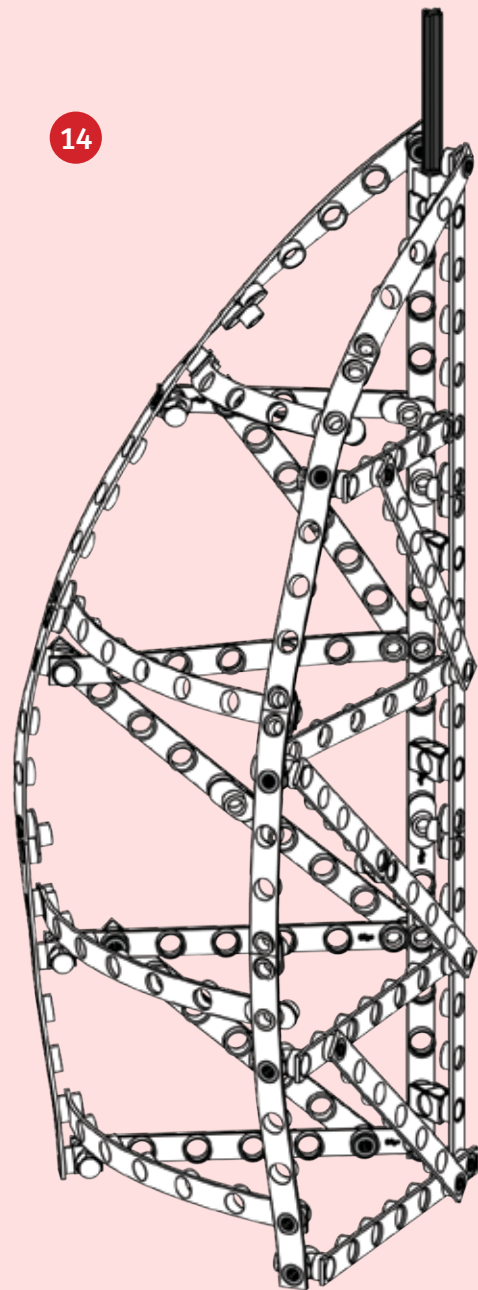

Done!

Adjust the rods so that the two arcs of the tower follow a smooth curve, removing spots where they are twisted, buckled, or crooked. Follow the general tips for model refinements on the inside back cover to finish your model.

WHAT'S HAPPENING ?

You built a model of a hotel tower in Dubai, United Arab Emirates, called Burj Al Arab, or Tower of the Arabs. It is one of the tallest hotels in the world and was designed to resemble the sail of a ship. The floor plans are like sections of a pie. A huge central mast of reinforced concrete and a steel exoskeleton support the building.



CONCRETE SHELL PERFORMANCE CENTER

1 39x
 3 12x
 9 18x
 13 2x

16 2x
 19 18x
 20 29x

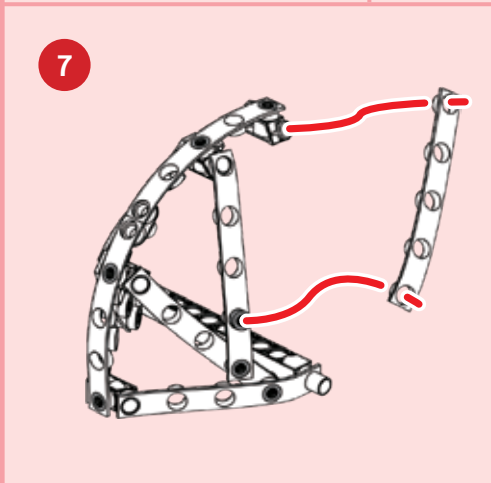
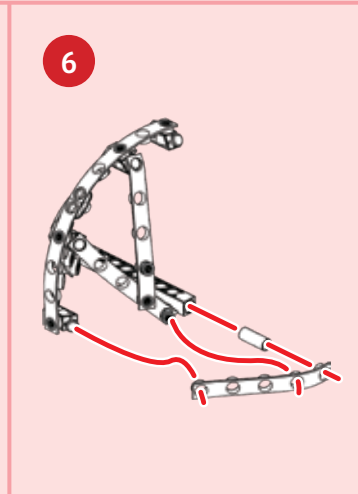
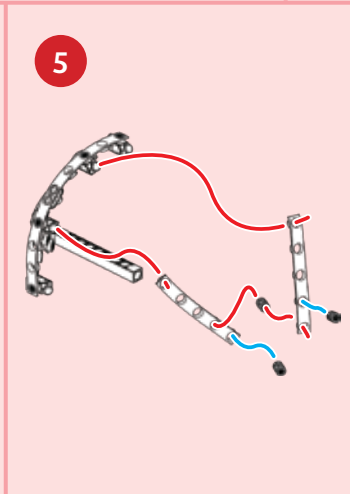
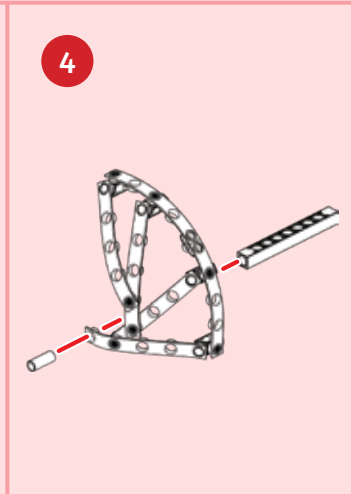
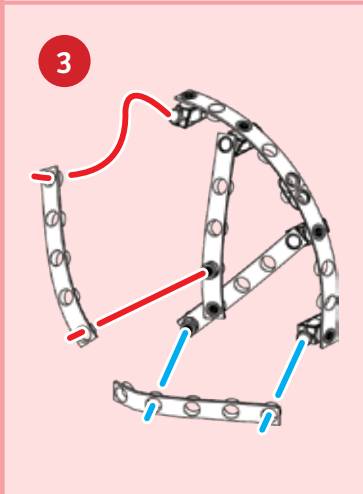
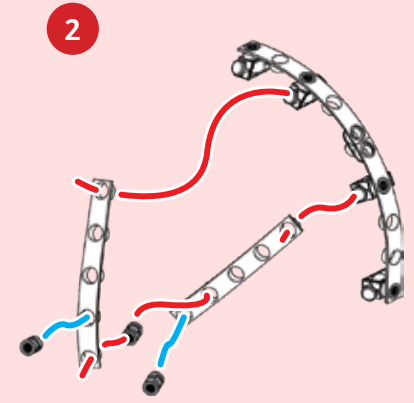
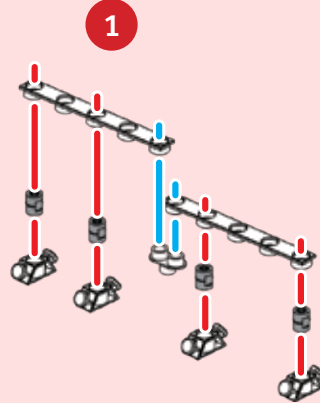

8

2x
 Repeat
 steps 8-12
 two times.

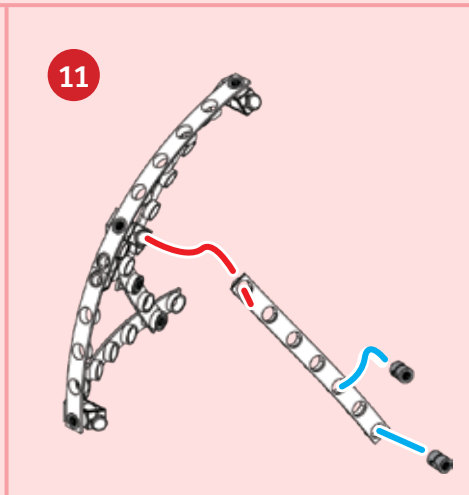
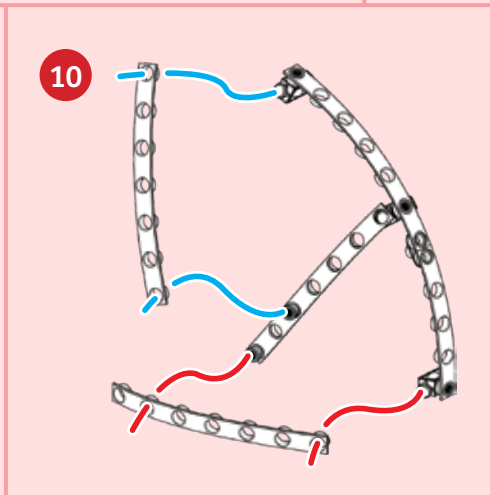
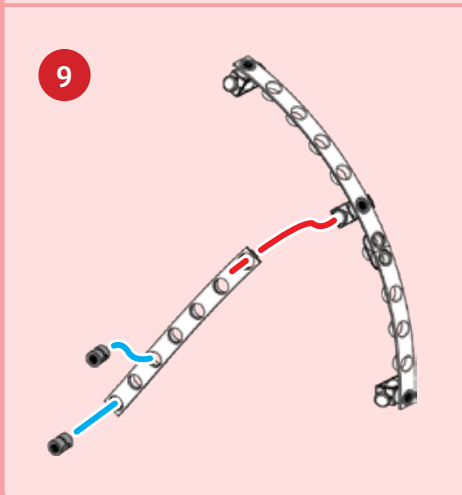



12

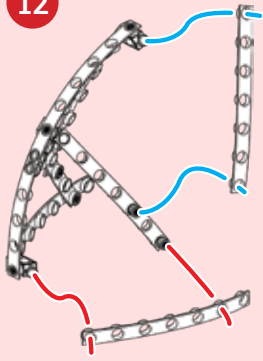

x2



13

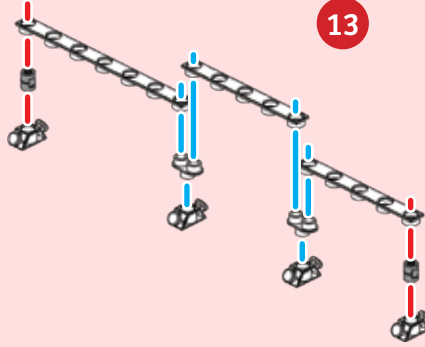

14

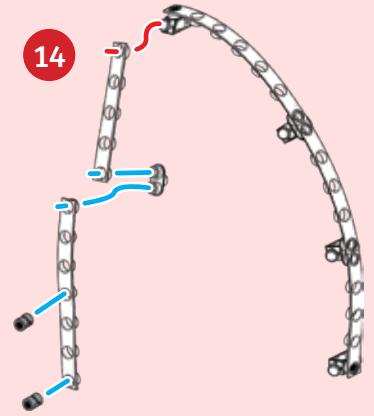

15

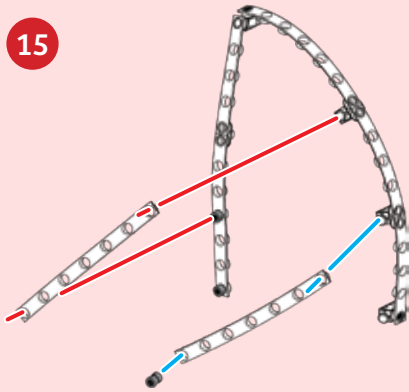

16

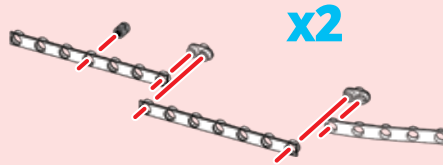

x2

17

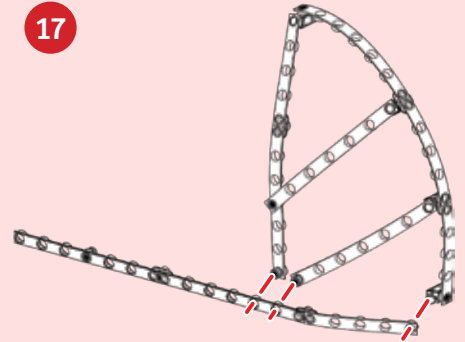

18

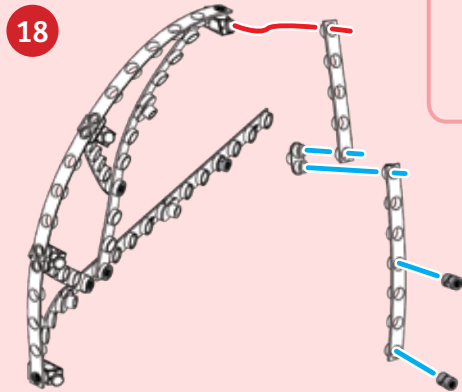

19

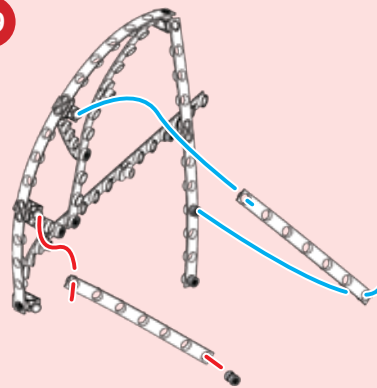

20

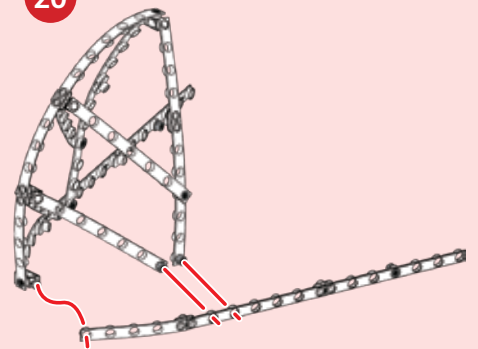

21

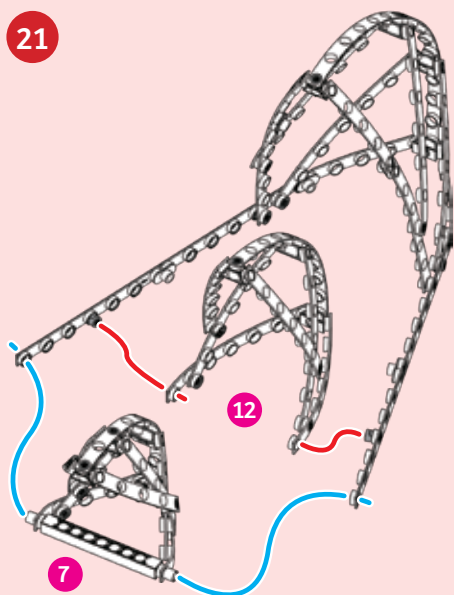

23

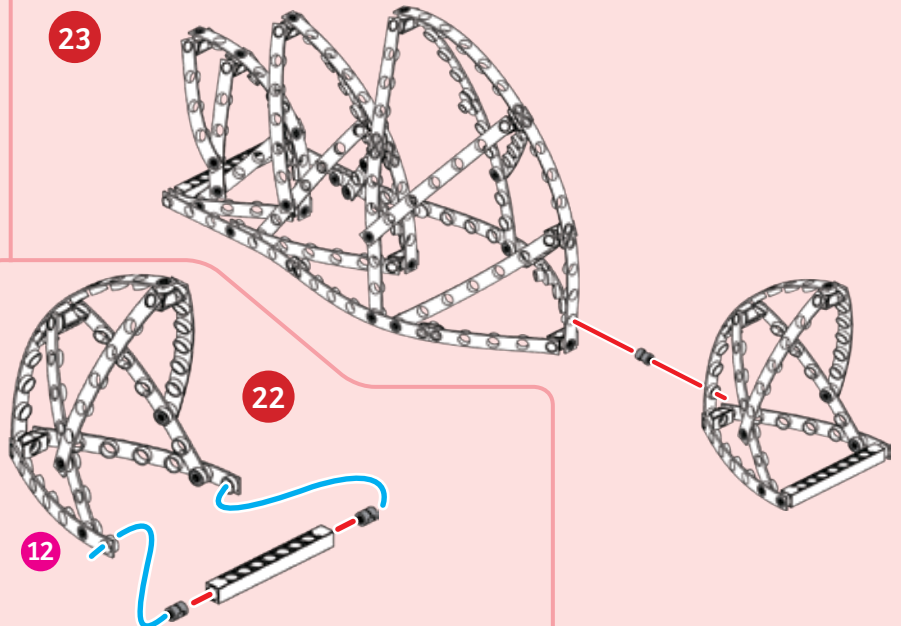



CONCRETE SHELL PERFORMANCE CENTER

24

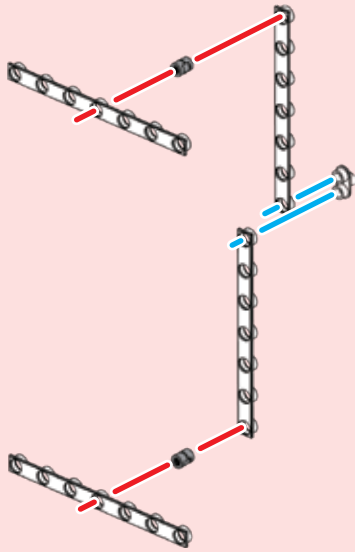

25

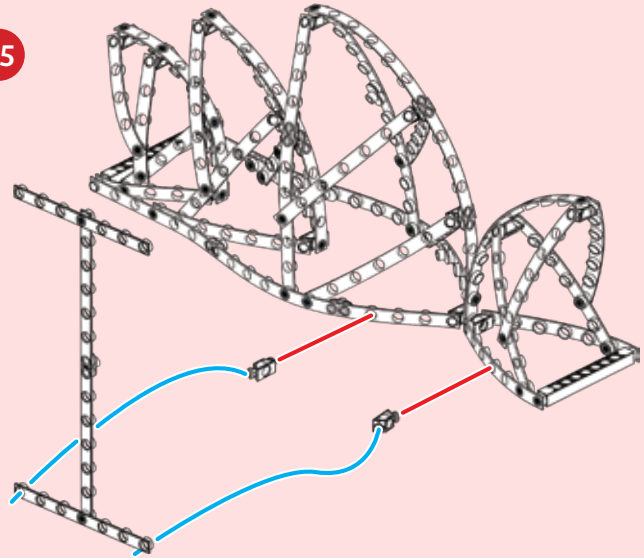

26

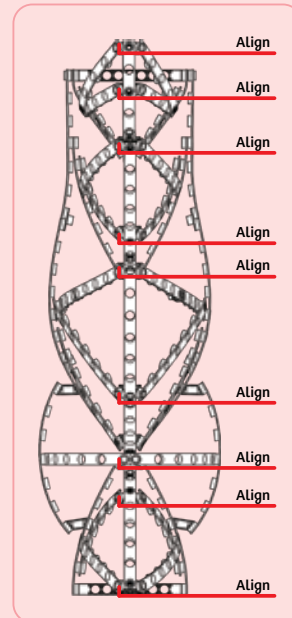
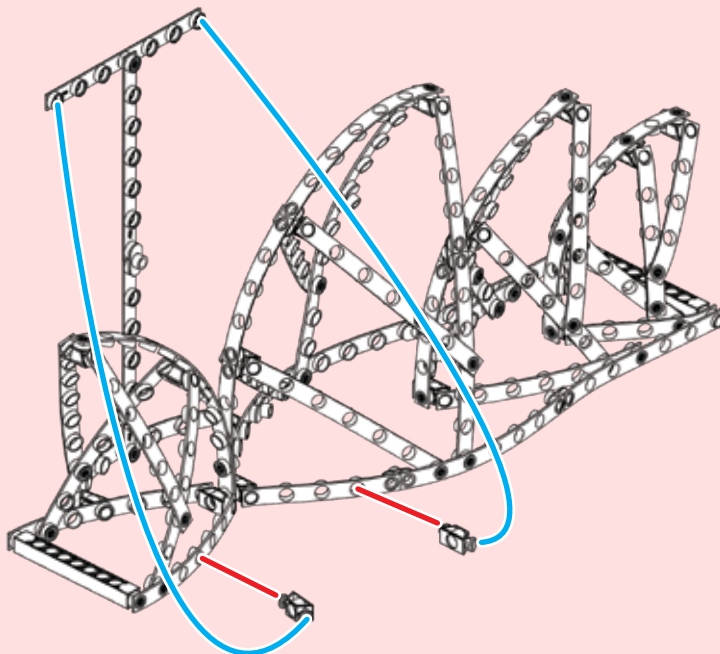

WHAT'S HAPPENING ?

You built a simple model that looks like the Sydney Opera House. Your model is made of flexible plastic rods, but the real opera house is made of cast concrete shells covered in ceramic tiles. All of the shells are sections of a perfect sphere. This regularity allowed the builders to use the same concrete molds over and over again, for each section of a shell. Your model traces the outlines of the Sydney Opera House.

27

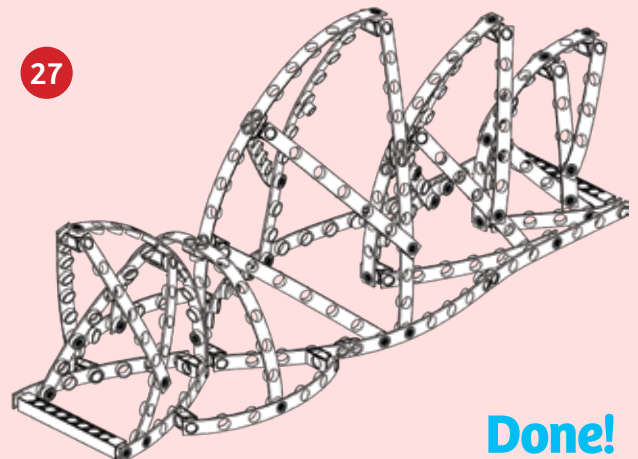

Done!

Follow the general tips for model refinements on the inside back cover to finish your model.

CHECK IT OUT



SYDNEY OPERA HOUSE



Location: Sydney, Australia
Year Completed: 1973
Height: 213 ft.
Length: 600 ft.
Material: Precast concrete shells, steel, and glass

The Sydney Opera House actually houses six different performance spaces. It is home to a theatre company, a symphony orchestra, and, of course, an opera company. It was constructed in three phases over a period of more than ten years. Each shell is a section of a perfect sphere. This regularity allowed the same concrete molds to be used again and again, saving time and cost.



BURJ AL ARAB

Location: Dubai, United Arab Emirates
Year Completed: 1999
Height: 1,053 ft.
Material: Steel, concrete, and glass

This building is one of the tallest hotels in the world. It was built on a man-made island and was designed to look like the sail of a racing sailboat. There is a helicopter landing pad on the roof, 689 feet above the ground.

BONUS EXPERIMENTS

Engineering Design Challenges

HERE'S HOW

1. Using only the materials in this kit, build the tallest tower possible. The tower must be able to remain standing on its own. You can make the challenge more difficult by adding other requirements, such as that the tower must withstand the flow of air from a hair dryer, or the shaking of the table, or must hold a certain amount of weight.

2. Using only the materials in this kit, build the largest dome possible. It must support its own weight and not collapse.

3. Using only the materials in this kit, build the longest span (bridge) possible. It must support its own weight and not fall down.

Some engineering constraints that you may need to consider in your designs include the materials available, height, weight of the structure and occupants, location, time, and the strength and stability needed to resist loads such as "earthquakes" (the shaking of the table) and "wind" (the air flow from the hair dryer).

More Assembly Tips

WARNING! Be careful when working with hot water. Do not burn yourself.

Resetting deformed flexible rods

If your flexible rods are deformed, warped, or bent after use, it is possible to straighten them out again. Simply place the pieces in hot water (120–140 °F / 50–60 °C) and wait for 15 minutes. The plastic will reset itself. You can also flatten out the pieces on a tabletop after removing them from the hot water. Don't use water hotter than 158 °F (70 °C), or the pieces will melt.

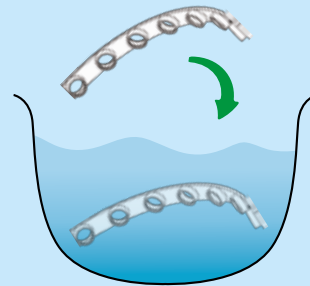

Place in hot water (120–140 °F)



Wait for 15 minutes.

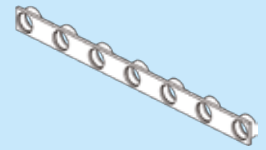

Making small refinements to perfect your models

As a final step when building the models, you can make small adjustments to the parts to align the connections and smooth out the curves in the flexible rods. The flexible rods are malleable, so you can form them somewhat with your hands to get them into exactly the right positions. Here is an example of the refinements for the wrought-iron tower model.

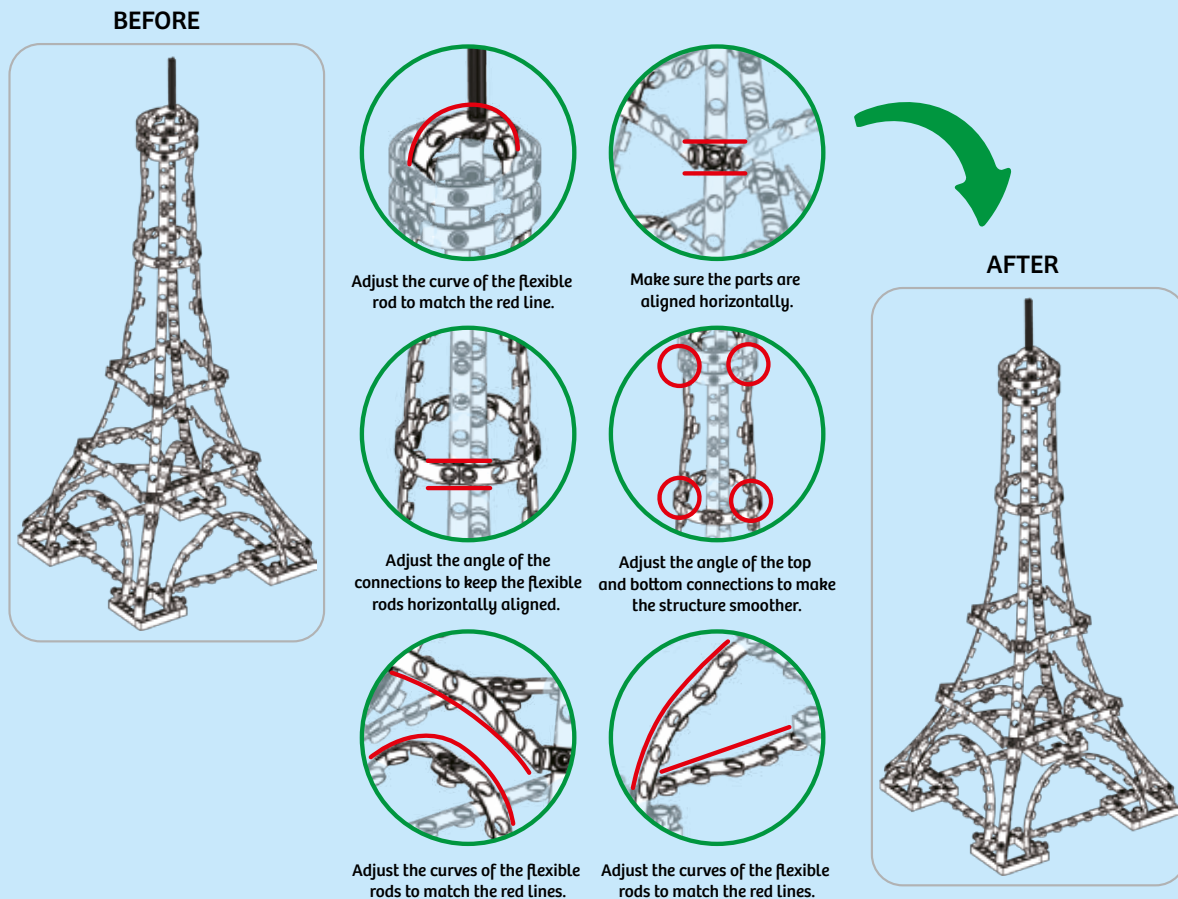

1st Edition 2019 Thames & Kosmos, LLC, Providence, RI, USA
Thames & Kosmos® is a registered trademark of Thames & Kosmos, LLC.

This work, including all its parts, is copyright protected. Any use outside the specific limits of the copyright law without the consent of the publisher is prohibited and punishable by law. This applies specifically to reproductions, translations, microfilming, and storage and processing in electronic systems and networks. We do not guarantee that all material in this work is free from copyright or other protection.

Technical product development: Genius Toy Taiwan Co., Ltd., Taichung, Taiwan, R.O.C.
Editing: Ted McGuire
Manual Layout: Mark Geary
Additional Graphics and Packaging: Dan Freitas, Ted McGuire

Manual design concept: Atelier Bea Klenk, Berlin
Manual illustrations: Genius Toy Taiwan Co., Ltd., Taichung, Taiwan, R.O.C., and Thames & Kosmos

Manual photos: Cover and packaging (city skyline) rabbit75_fot, p. 2 and p. 13 (reinforced concrete) sommersby, p. 2 and p. 27 (truss) Kadmy, p. 3 (buildings) demerzel21, p. 13 (buildings) Sailorr, p. 13 (forms) denisik11, p. 13 (arches) pelikanz, p. 13 (roofs) Vikivector, p. 13 (rebar)

peangdao, p. 13 (steel beams) terex, p. 13 (concrete) below1409, p. 27 (Eiffel Tower) scaliger, p. 27 (Gateway Arch) Gino Santa Maria, p. 27 (curved truss) labitase, p. 37 (Reichstag dome) katononia, p. 37 (30 St Mary Axe) I-Wei Huang, p. 44 (Sydney Opera House) Michael Evans, p. 44 (Burj Al Arab) Can, (all previous © Adobe Stock); p. 27 (High Roller) Roman Eugeniusz (CC BY-SA 3.0), p. 37 (Beijing National Stadium) Peter23 (CC BY-SA 3.0) (all previous Public Domain, Wikipedia);

The publisher has made every effort to locate the holders of image rights for all of the photos used. If in any individual cases any holders of image rights have not been acknowledged, they are asked to provide evidence to the publisher of their image rights so that they may be paid an image fee in line with the industry standard.

Distributed in North America by Thames & Kosmos, LLC, Providence, RI 02903
Phone: 800-587-2872; Web: www.thamesandkosmos.com

Distributed in United Kingdom by Thames & Kosmos UK LP, Cranbrook, Kent TN17 3HE
Phone: 01580 713000; Web: www.thamesandkosmos.co.uk

We reserve the right to make technical changes.

Printed in Taiwan / Imprimé en Taiwan



Kosmos Quality and Safety

More than one hundred years of expertise in publishing science experiment kits stand behind every product that bears the Kosmos name. Kosmos experiment kits are designed by an experienced team of specialists and tested with the utmost care during development and production. With regard to product safety, these experiment kits follow European and US safety standards, as well as our own refined proprietary safety guidelines. By working closely with our manufacturing partners and safety testing labs, we are able to control all stages of production. While the majority of our products are made in Germany, all of our products, regardless of origin, follow the same rigid quality standards.