

ASRock®

X3000D4-P1

User Manual

Version 1.0

Published March 2021



This device complies with Part 15 of the FCC Rules. Operation is subject to the following two conditions:

- (1) this device may not cause harmful interference, and
- (2) this device must accept any interference received, including interference that may cause undesired operation.

CALIFORNIA, USA ONLY

The Lithium battery adopted on this motherboard contains Perchlorate, a toxic substance controlled in Perchlorate Best Management Practices (BMP) regulations passed by the California Legislature. When you discard the Lithium battery in California, USA, please follow the related regulations in advance.

“Perchlorate Material-special handling may apply, see www.dtsc.ca.gov/hazardouswaste/perchlorate”

AUSTRALIA ONLY

Our goods come with guarantees that cannot be excluded under the Australian Consumer Law. You are entitled to a replacement or refund for a major failure and compensation for any other reasonably foreseeable loss or damage caused by our goods. You are also entitled to have the goods repaired or replaced if the goods fail to be of acceptable quality and the failure does not amount to a major failure. If you require assistance please call ASRock Tel : +886-2-28965588 ext.123 (Standard International call charges apply)

The terms HDMI® and HDMI High-Definition Multimedia Interface, and the HDMI logo are trademarks or registered trademarks of HDMI Licensing LLC in the United States and other countries.



Contents

Chapter 1 Introduction	1
1.1 Package Contents	1
1.2 Specifications	2
1.3 Motherboard Layout	6
1.4 Front Panel	8
1.5 Rear Panel	9
Chapter 2 Installation	10
2.1 Installing the CPU	11
2.2 Installing the CPU Fan and Heatsink	13
2.3 Installing Memory Modules (SO-DIMM)	14
2.4 Jumpers Setup	17
2.5 Onboard Headers and Connectors	18
2.6 Power Button	20
2.7 M.2 WiFi/BT Module Installation Guide	21
2.8 M.2_SSD (NGFF) Module Installation Guide (M2_1)	23
Chapter 3 Software and Utilities Operation	27
3.1 Installing Drivers	27
Chapter 4 UEFI SETUP UTILITY	28
4.1 Introduction	28
4.1.1 UEFI Menu Bar	28
4.1.2 Navigation Keys	29

4.2	Main Screen	30
4.3	OC Tweaker Screen	31
4.4	Advanced Screen	35
4.4.1	CPU Configuration	36
4.4.2	Onboard Devices Configuration	37
4.4.3	Storage Configuration	39
4.4.4	ACPI Configuration	40
4.4.5	Trusted Computing	41
4.4.6	AMD Firmware Version	43
4.5	Tools	44
4.6	Hardware Health Event Monitoring Screen	45
4.7	Security Screen	46
4.8	Boot Screen	47
4.9	Exit Screen	49

Chapter 1 Introduction

Thank you for purchasing X300D4-P1 motherboard. In this documentation, Chapter 1 and 2 contains the introduction of the motherboard and step-by-step installation guides. Chapter 3 contains the operation guide of the software and utilities. Chapter 4 contains the configuration guide of the BIOS setup.



Because the motherboard specifications and the BIOS software might be updated, the content of this documentation will be subject to change without notice.

1.1 Package Contents

- X300D4-P1 Motherboard
- X300D4-P1 Quick Installation Guide
- X300D4-P1 Support CD
- 1 x Serial ATA(SATA) Data with Power Cable (Optional)
- 1 x Screw for M.2 Socket (M2*2) (Optional)
- 1 x Screw for WiFi Module (M2*2) (Optional)

1.2 Specifications

- Platform**
- 6.7-in x 6.8-in, 17.0 cm x 17.2 cm

- CPU**
- Supports AMD AM4 Socket CPUs (Renoir, Picasso, Raven Ridge, up to 65W)
 - Supports CPU up to 65W
 - 4 Power Phase design

- Chipset**
- AMD X300

- Memory**
- Dual Channel DDR4 Memory Technology
 - 2 x DDR4 SO-DIMM Slots
 - AMD Renoir series APUs support DDR4 3200/2933/2667/2400/2133 non-ECC, un-buffered memory*
 - AMD Ryzen series CPUs (Picasso) support DDR4 2933/2667/2400/2133 non-ECC, un-buffered memory*
 - AMD Ryzen series CPUs (Raven Ridge) support DDR4 2933/2667/2400/2133 non-ECC, un-buffered memory*
 - Max. capacity of system memory: 64GB
 - 15 μ Gold Contact in SO-DIMM Slots
- * Please refer to page 15 for DDR4 SO-DIMM maximum frequency support.

- Expansion Slot**
- 1 x M.2 Socket (Key E), supports type 2230 WiFi/BT PCIe WiFi module

- Graphics**
- Integrated AMD Radeon™ Vega Series Graphics in Ryzen Series APU*
- * Actual support may vary by CPU
- DirectX 12, Pixel Shader 5.0
 - Shared memory default 2GB. Max Shared memory supports up to 16GB.
- * The Max shared memory 16GB requires 32GB system memory installed.

- Three graphics output options: D-Sub, DisplayPort 1.4 and HDMI
- Supports Triple Monitor
- Supports HDMI 1.4 with max. resolution up to 4K x 2K (4096x2160) @ 24Hz / (3840x2160) @ 30Hz
- Supports D-Sub with max. resolution up to 1920x1200 @ 60Hz
- Supports DisplayPort 1.4 with max. resolution up to 4K x 2K (4096x2304) @ 60Hz
- Supports Auto Lip Sync, Deep Color (12bpc), xvYCC and HBR (High Bit Rate Audio) with HDMI 1.4 Port (Compliant HDMI monitor is required)
- Supports HDCP 1.4 with HDMI and DisplayPort 1.4 Ports
- Supports Full HD 1080p Blu-ray (BD) playback with HDMI and DisplayPort 1.4 Ports

Audio

- Realtek ALC233 Audio Codec
- 1 x Headphone/Headset Jack
- 1 x MIC-In

LAN

- PCIE x1 Gigabit LAN 10/100/1000 Mb/s
- Realtek RTL8111GN
- Supports Wake-On-LAN
- Supports Lightning/ESD Protection
- Supports PXE

Front Panel I/O

- 1 x Power Button
- 1 x Headphone/Headset Jack
- 2 x USB 3.2 Gen1 Type-A Ports (Support ESD Protection)
- 2 x USB 3.2 Gen1 Type-C Ports (Support ESD Protection)
- 1 x Microphone Input Jack

Rear Panel I/O

- 1 x DC Jack (Compatible with the 19V power adapter)*
- * Please use 90W power adapter for 65W CPU and 65W power adapter for 35W CPU.
- 1 x Headphone Jack
 - 1 x D-Sub Port
 - 1 x HDMI Port

- 1 x DisplayPort 1.4
- 2 x USB 2.0 Ports (Support ESD Protection)
- 2 x USB 3.2 Gen1 Ports (Supports ESD Protection)
- 1 x RJ-45 LAN Port with LED (ACT/LINK LED and SPEED LED)

Storage

- 1 x SATA3 6.0 Gb/s with Power Connector , support NCQ, AHCI and Hot Plug
 - 1 x Ultra M.2 Socket, support type 2280 M.2 SATA3 6.0 Gb/s module and M.2 PCI Express module up to Gen3 x4 (32 Gb/s)*
- * Supports NVMe SSD as boot disks

Connector

- 1 x Chassis Intrusion Header
- 1 x CPU Fan Connector (4-pin)
- 1 x Mono-Out Header
- 1 x ROM Recovery Header

BIOS Feature

- AMI UEFI Legal BIOS with GUI support
- Supports "Plug and Play"
- ACPI 5.1 compliance wake up events
- Supports jumperfree
- SMBIOS 2.3 support
- DRAM Voltage adjustment

Hardware Monitor

- CPU Temperature Sensing
- CPU Fan Tachometer
- CPU Quiet Fan (Auto adjust chassis fan speed by CPU temperature)
- CPU Fan Multi-Speed Control
- CASE OPEN detection
- Voltage monitoring: +12V, +5V, +3.3V, CPU Vcore

OS

- Microsoft® Windows® 10 64-bit

Certifications

- FCC, CE
- ErP/EuP ready (ErP/EuP ready power supply is required)



Please realize that there is a certain risk involved with overclocking, including adjusting the setting in the BIOS, applying Untied Overclocking Technology, or using third-party overclocking tools. Overclocking may affect your system's stability, or even cause damage to the components and devices of your system. It should be done at your own risk and expense. We are not responsible for possible damage caused by overclocking.

1.3 Motherboard Layout

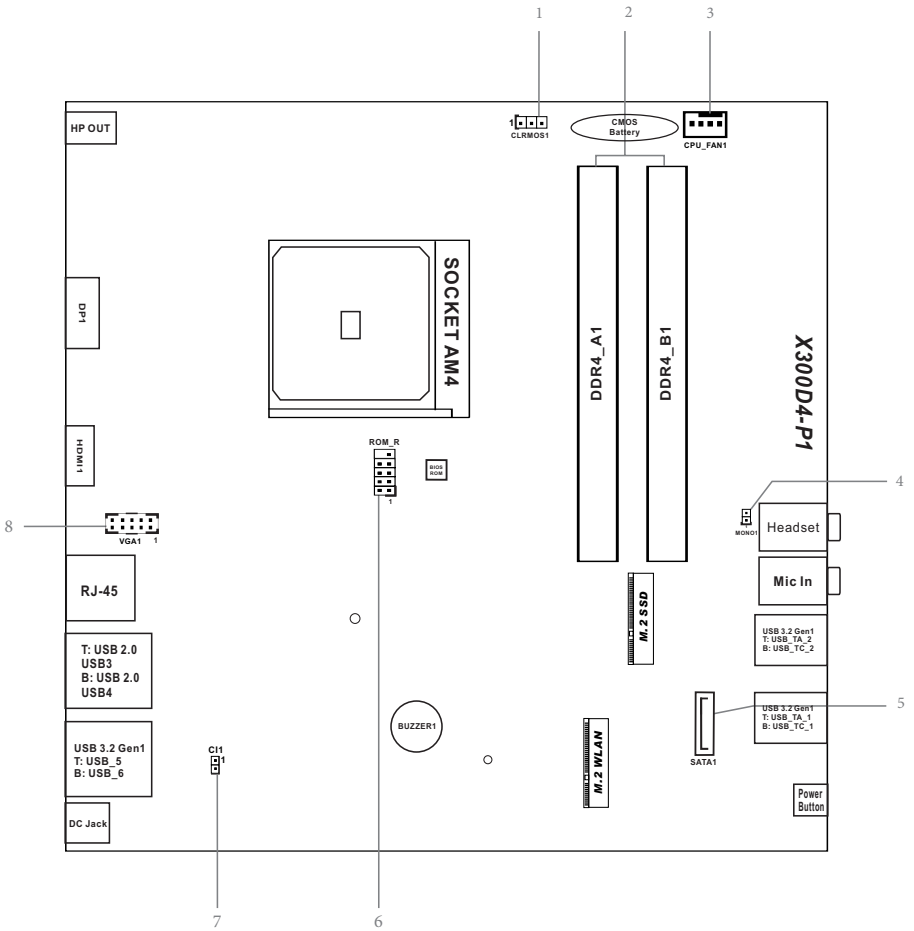

No.	Description
1	Clear CMOS Jumper (CLRMOS1)
2	2 x 260-pin DDR4 SO-DIMM Slots (DDR4_A1, DDR4_B1)
3	CPU Fan Connector (CPU_FAN1)
4	2.5W Mono Out Speaker Header (MONO1)
5	SATA3 Connector (SATA1)
6	ROM Recovery Header (ROM_R)
7	Chassis Intrusion Header (CI1)
8	VGA Header (VGA1)

1.4 Front Panel

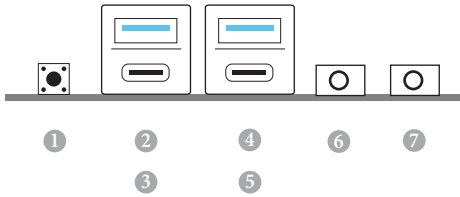

No.	Description	No.	Description
1	Power Button (SW1)	4	USB 3.2 Gen1 Type-A Port (USB_TA_2)
2	USB 3.2 Gen1 Type-A Port (USB_TA_1)	5	USB 3.2 Gen1 Type-C Port (USB_TC_2)*
3	USB 3.2 Gen1 Type-C Port (USB_TC_1)	6	Microphone Input (AUDIO1)
		7	Headphone/Headset Jack

** Please note that if your motherboard, with a AMD Flavor 2 or Picasso Athlon CPU installed, is connected to a D-Sub monitor, the USB 2.0 device on this Type-C port will be detected while the USB 3.0 device will not be detected.*

1.5 Rear Panel

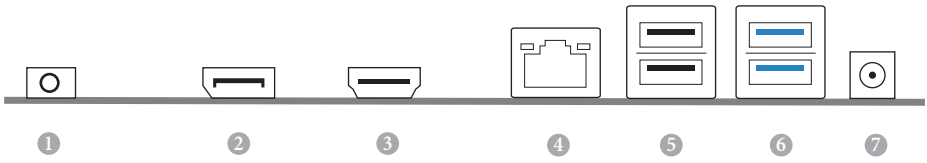

No.	Description	No.	Description
1	Headphone Jack	5	USB 2.0 Ports (USB_34)
2	Display Port	6	USB 3.2 Gen1 Ports (USB_56)
3	HDMI Port	7	DC Jack
4	LAN RJ-45 Port*		

* There are two LEDs on each LAN port. Please refer to the table below for the LAN port LED indications.

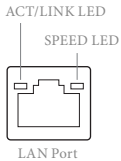

Activity / Link LED		Speed LED	
Status	Description	Status	Description
Off	No Link	Off	10Mbps connection
Blinking	Data Activity	Green	100Mbps connection
On	Link	Orange	1Gbps connection

Chapter 2 Installation

This is a Proprietary form factor motherboard. Before you install the motherboard, study the configuration of your chassis to ensure that the motherboard fits into it.

Pre-installation Precautions

Take note of the following precautions before you install motherboard components or change any motherboard settings.

- Make sure to unplug the power cord before installing or removing the motherboard components. Failure to do so may cause physical injuries and damages to motherboard components.
- In order to avoid damage from static electricity to the motherboard's components, NEVER place your motherboard directly on a carpet. Also remember to use a grounded wrist strap or touch a safety grounded object before you handle the components.
- Hold components by the edges and do not touch the ICs.
- Whenever you uninstall any components, place them on a grounded anti-static pad or in the bag that comes with the components.
- When placing screws to secure the motherboard to the chassis, please do not over-tighten the screws! Doing so may damage the motherboard.

2.1 Installing the CPU



Unplug all power cables before installing the CPU.

1

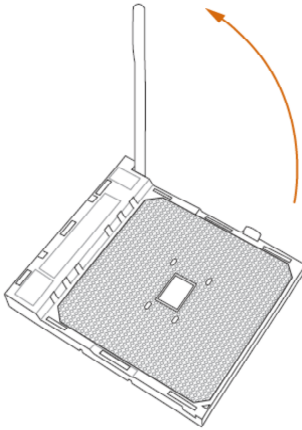

2

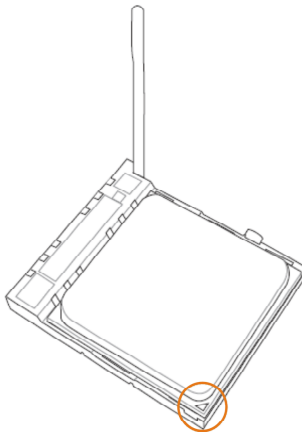

3

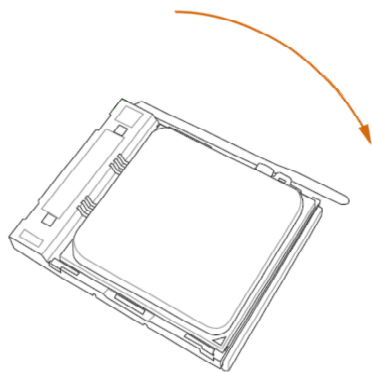

2.2 Installing the CPU Fan and Heatsink

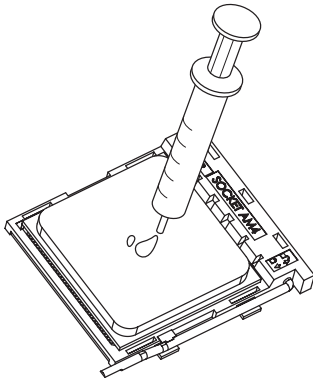
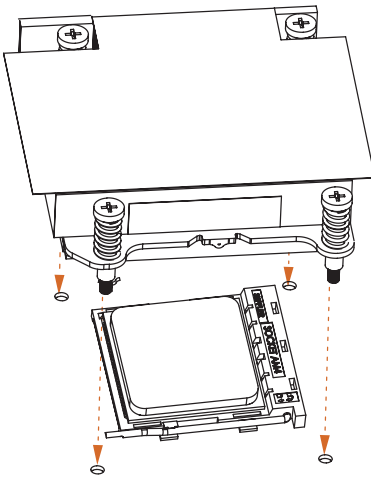
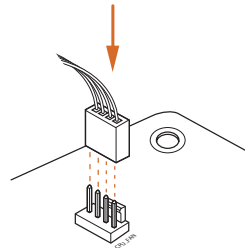
**1****2**

2.3 Installing Memory Modules (SO-DIMM)

This motherboard provides two 260-pin DDR4 (Double Data Rate 4) SO-DIMM slots.



It is not allowed to install a DDR, DDR2 or DDR3 memory module into a DDR4 slot; otherwise, this motherboard and SO-DIMM may be damaged.



The SO-DIMM only fits in one correct orientation. It will cause permanent damage to the motherboard and the SO-DIMM if you force the SO-DIMM into the slot at incorrect orientation.

1. Carefully insert the SO-DIMM memory modules into the slot at a 30-degree angle.

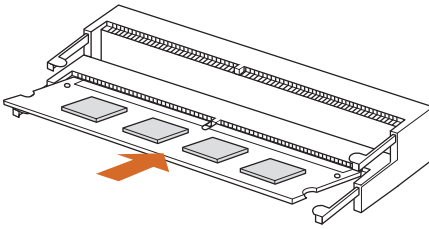

2. Push down until the modules snap into place.

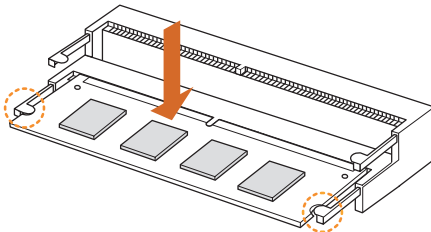

DDR4 SO-DIMM Maximum Frequency Support

Ryzen Series APUs (Renoir):

SO-DIMM Memory Slot		Frequency (Mhz)
A1	B1	
SR	-	3200
-	SR	3200
DR	-	3200
-	DR	3200
SR	SR	3200
DR	DR	3200

Ryzen Series CPUs (Picasso):

SO-DIMM Memory Slot		Frequency (Mhz)
A1	B1	
SR	-	2933
-	SR	2933
DR	-	2667
-	DR	2667
SR	SR	2933
DR	DR	2667

Ryzen Series CPUs (Raven Ridge):

SO-DIMM Memory Slot		Frequency
A1	B1	(Mhz)
SR	-	2933
-	SR	2933
DR	-	2667
-	DR	2667
SR	SR	2933
DR	DR	2667

SR: Single rank DIMM, 1Rx4 or 1Rx8 on DIMM module label

DR: Dual rank DIMM, 2Rx4 or 2Rx8 on DIMM module label

2.4 Jumpers Setup

The illustration shows how jumpers are setup. When the jumper cap is placed on the pins, the jumper is “Short”. If no jumper cap is placed on the pins, the jumper is “Open”. The illustration shows a 3-pin jumper whose pin1 and pin2 are “Short” when a jumper cap is placed on these 2 pins.

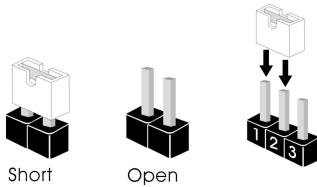

Clear CMOS Jumper
(CLRMOSE1)
(see p.6, No. 1)

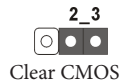

CLRMOSE1 allows you to clear the data in CMOS. To clear and reset the system parameters to default setup, please turn off the computer and unplug the power cord from the power supply. After waiting for 15 seconds, use a jumper cap to short pin2 and pin3 on CLRMOSE1 for 5 seconds. However, please do not clear the CMOS right after you update the BIOS. If you need to clear the CMOS when you just finish updating the BIOS, you must boot up the system first, and then shut it down before you do the clear-CMOS action. Please be noted that the password, date, time, and user default profile will be cleared only if the CMOS battery is removed.



1. The Clear CMOS Button has the same function as the Clear CMOS jumper.
2. If you clear the CMOS, the case open may be detected. Please adjust the BIOS option “Clear Status” to clear the record of previous chassis intrusion status.

2.5 Onboard Headers and Connectors



Onboard headers and connectors are NOT jumpers. Do NOT place jumper caps over these headers and connectors. Placing jumper caps over the headers and connectors will cause permanent damage to the motherboard.

Serial ATA3 Connector
(SATA1:
see p.6, No. 5)



This SATA3 connector supports SATA data cables for internal storage devices with up to 6.0 Gb/s data transfer rate.

CPU Fan Connectors
(4-pin CPU_FAN1)
(see p.6, No. 3)

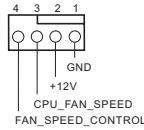

This motherboard provides a 4-Pin CPU fan (Quiet Fan) connector. If you plan to connect a 3-Pin CPU fan, please connect it to Pin 1-3.

Chassis Intrusion Header
(2-pin CI1)
(see p.6, No. 7)



This motherboard supports CASE OPEN detection feature that detects if the chassis cover has been removed. This feature requires a chassis with chassis intrusion detection design.

2.5W Audio Amp Output
Header
(2-pin MONO1)
(see p.6, No. 4)

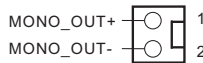

Please connect the chassis speaker to this header.

ROM Recovery
Header
(8-pin ROM_R)
(see p.6, No. 6)

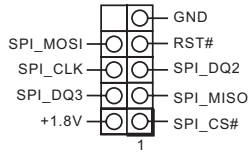

This ROM Recovery Connector allows qualified technicians to reload firmware into the SPI boot flash in case there is problem with the data.

VGA
Header
(10-pin VGA1)
(see p.6, No. 8)

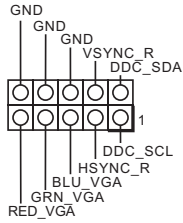

This VGA Connector provides VGA interface for your monitor.

2.6 Power Button

The motherboard has one Power Button.

Power Button
(SW1)
(see p.8, No. 1)



Power Button allows users to quickly turn on/off the system.

2.7 M.2 WiFi/BT Module Installation Guide

The M.2, also known as the Next Generation Form Factor (NGFF), is a small size and versatile card edge connector that aims to replace mPCIe and mSATA. The M.2 Socket (Key E) supports type 2230 WiFi/BT module.

* The M.2 socket does not support SATA M.2 SSDs.

Installing the WiFi/BT module

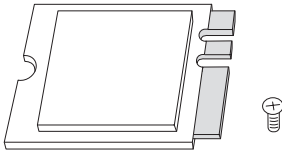

Step 1

Prepare a type 2230 WiFi/BT module and the screw.

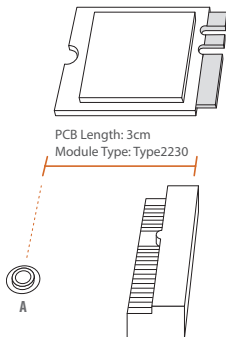

Step 2

Find the nut location to be used.

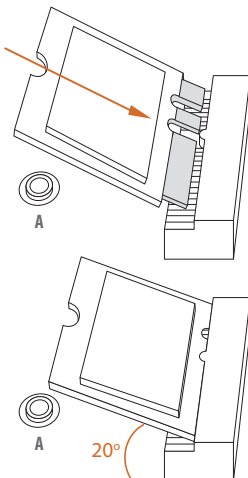

Step 3

Gently insert the WiFi/BT module into the M.2 slot. Please be aware that the module only fits in one orientation.

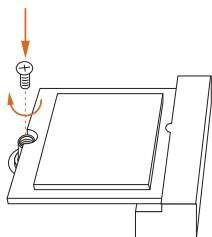

Step 4

Tighten the screw with a screwdriver to secure the module into place. Please do not overtighten the screw as this might damage the module.

2.8 M.2_SSD (NGFF) Module Installation Guide (M2_1)

The Ultra M.2, also known as the Next Generation Form Factor (NGFF), is a small size and versatile card edge connector that aims to replace mPCIe and mSATA. The Ultra M.2 Socket, support type 2280 M.2 SATA3 6.0 Gb/s module and M.2 PCI Express module up to Gen3 x4 (32 Gb/s).

Installing the M.2_SSD (NGFF) Module

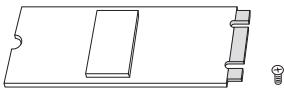

Step 1

Prepare a M.2_SSD (NGFF) module and the screw.

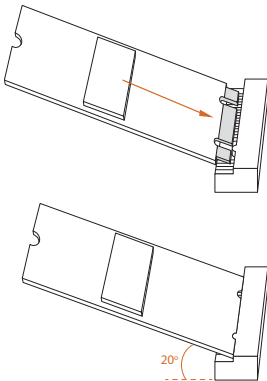

Step 2

Gently insert the M.2 (NGFF) SSD module into the M.2 slot. Please be aware that the M.2 (NGFF) SSD module only fits in one orientation.

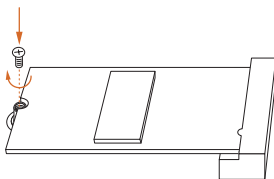

Step 3

Tighten the screw with a screwdriver to secure the module into place. Please do not overtighten the screw as this might damage the module.

M.2_SSD (NGFF) Module Support List

Vendor	Interface	P/N
ADATA	PCIe	ADATA ASX8200PNP (XPG SX8200 Pro-512GB)
ADATA	PCIe	ADATA AS40G-256GT-C XPG SPECTRIX S40G 256G Gen3 x4
ADATA	PCIe	ADATA SX8100NP-512G-C SX8100NP 512G Gen3 x4
ADATA	PCIe	ADATA ASX6000PNP-256GT-C XPG SX6000 Pro 256G Gen3 x4
ADATA	PCIe	ADATA ASX8200 Pro-256G
Apacer	PCIe	Apacer AP240GZ280-240GB
Crucial	PCIe	CRUCIAL P1 SERIES-CT1000P1SSD8-1TB
Crucial	PCIe	CRUCIAL P1-500G
Hikvision	PCIe	HIKVISION E1000N-NVMe-256G-3Y (Gen3 x2)
HP	PCIe	HP 5MS22AA#ABC EX950 512G Gen3 x4
Intel	PCIe	INTEL 660P SERIES-SSDPEKNW512G8-512G
Intel	PCIe	INTEL 760P-SSDPEKKW256G8-256GB
Intel	PCIe	INTEL SSDPEKNW020T9 665P 2TB Gen3 x4
Kingston	PCIe	KINGSTON A1000-SA1000M8/240G (Gen3 x2)
Kingston	PCIe	Kingston KC2000-250G (SKC2000M8/250G) Gen3 x4
Kingston	PCIe	Kingston KC1000 SKC1000-480GB
Patriot	PCIe	Patriot VPN100-256G (VPN100-256GM28H) Gen3 x4
Pioneer	PCIe	Pioneer APS-SE20G-256 (Gen3 x4)
Phison	PCIe	PHISON H531-190409015-1T (Gen4 x4)
PLEXTOR	PCIe	PLEXTOR PX-512M9PEGN-512GB
PLEXTOR	PCIe	PLEXTOR PX-256M8SeGN-256GB
Pioneer	PCIe	PIONEER APS-SE10G-512 (Gen3 x2)
Samsung	PCIe	Samsung MZ-V7P512-512GB (970PRO)
Samsung	PCIe	Samsung MZ-VPW1280-128GB (SM961)
Samsung	PCIe	Samsung MZ-V7E250-250GB 970EVO 250G Gen3 x4
Samsung	PCIe	Samsung MZ-V6E250-250GB (960 EVO)
Samsung	PCIe	Samsung MZ-V7S500-MZVLB500HBJQ-500G (970EVO+)
Samsung	PCIe	Samsung PM981 512G Gen3 x4
Samsung	PCIe	Samsung MZ-VLW1280-128GB (PM961)
Seagate	PCIe	Seagate FireCuda 510-1TB (ZP1000GM30011)
Seagate	PCIe	Seagate ZP2000GM30001 FireCuda 510 2TB Gen3 x4
Seagate	PCIe	Seagate ZP256CM30011 BarraCuda 510 256G Gen3 x4
Seagate	PCIe	Seagate ZP500GM30002 FireCuda 520 500G Gen4 x4
Seagate	PCIe	Seagate ZP2000GM30002 FireCuda 520 2TB Gen4 x4
Seagate	PCIe	Seagate ZP1000CM3A001 BarraCuda 510 1TB Gen3 x4
Team	PCIe	TeamTM8FP4001T-1TB Gen3 x4
Team	PCIe	Team TM8FP5001T0C110 T-FORCE-CARDEA II 1TB Gen3 x4
Team	PCIe	Team CARDEA-240GB
TOSHIBA	PCIe	TOSHIBA RD50500G00 RD500 500G Gen3 x4
TOSHIBA	PCIe	TOSHIBA THN-RC50Z5000C8 RC500 500G Gen3 x4
TOSHIBA	PCIe	TOSHIBA XG3-128GB
UMAX	PCIe	UMAX M500-HDUM500PCIE256G (Gen3 x2)
UNIC	PCIe	UNIC UNSPC256AKMM P5160 256G Gen3 x4
WD	PCIe	WD SDAPNUW-512G-1006 (SN520) (Gen3 x2)

WD	PCIe	WD WDS100T3X0C-00SJG0 (Black SN750-1TB)
WD	PCIe	WD SN500-500GB (WDS500G1B0C-00S6U0) (Gen3 x2)
ADATA	SATA	ADATA ASU650NS38-240GT-C SU650NS38 240G SATA3
ADATA	SATA	ADATA ASU800NS38-512GT-C
ADATA	SATA	ADATA-GAMING-XPG-SX930-ASX930S3-120GM-C-120G
ADATA	SATA	ADATA-ULTIMATE-SU900-ASU900SS-256GM-C-256G
Anaconda	SATA	ANACONDA-TS SERIES-TS240201803718-240G
Apacer	SATA	APACER-PANTHER-AS350-API20GAS350-1-120G
Crucial	SATA	CRUCIAL MX500 SERIES-CT500MX500SSD4-500G
Crucial	SATA	CRUCIAL-BX500-CT120BX500SSD1-120G
Crucial	SATA	CRUCIAL-MX500-CT250MX500SSD1-250G
EZLink	SATA	ezlink P51B-80-120GB
HGST	SATA	HGST-HTS721010A9E630-1TB
Hikvision	SATA	HIKVISION-C100-HS-SSD-C100-480G
Intel	SATA	INTEL-540SSERIES-SSDSCKKW240H6-240G
Intel	SATA	INTEL-545S SERIES-SSDSC2KW128G8X1-128G
Intel	SATA	INTEL-730SERIES-SSDSC2BP240G4R5-240GB
Kingston	SATA	Kingston SM2280S3G2/120G
Kingston	SATA	KINGSTON-HYPERX-FURY-RGB-SHFR200/240G-240G
Kingston	SATA	KINGSTON-HYPERX-SAVAGE-SHSS37A/240G
Kingston	SATA	KINGSTON-V300-SV300S37A-120G
KLEVV	SATA	KLEVV-NEO-N500-D240GAA-N500-240G
LITE-ON	SATA	LITE-ON-MU3-PH6-PH6-CE240-L2-240G
OCZ	SATA	OCZ-TRION100-TRN100-25SAT3-120G
OCZ	SATA	OCZ-VECTOR180-VTR180-25SAT3-120G-120G
Pioneer	SATA	PIONEER-APS-SL3N-APS-SL3N-120-120G
PLEXTOR	SATA	PLEXTOR-M6 PRO-PX-256M6PRO-256G
PLEXTOR	SATA	PLEXTOR-M6V-PX-256M6V-256G
Samsung	SATA	SAMSUNG-860EVO-MZ-76E250BW-MZ7LH250HAHQ-250G
SanDisk	SATA	SanDisk X400-SD8SN8U-128G
SanDisk	SATA	Sandisk Z400s-SD8SNAT-128G-1122
SanDisk	SATA	SANDISK-EXTREME PRO-SDSSDXPS-240G
SanDisk	SATA	SANDISK-X300-SD7SB6S-128G
Seagate	SATA	SEAGATE-FIRECUDA-LX015-ST1000LX015-1T-W/8G SSD
Seagate	SATA	SEAGATE-ST500LM021-3Y/P-500G
Tcell	SATA	TCELL-TT650-240G
Team Group	SATA	TEAM GROUP-T-FORCE-DELTA RGB-T253TR250G3C313-5V-250G
TOSHIBA	SATA	TOSHIBA-MQ02ABD100H-MLC-NAND8G+HDIT-1T
TOSHIBA	SATA	TOSHIBA-Q300 PRO-HDTS412AZSTA-128G
TOSHIBA	SATA	TOSHIBA-Q300-HDTS712AZSTA-120G
Transcend	SATA	Transcend TS256GMTS800-256GB
Transcend	SATA	TRANSCEND-SSD340K-TS128GSSD340K-128G
Transcend	SATA	TRANSCEND-SSD370S-TS128GSSD370S-128G

UMAX	SATA	UMAX-S330-HDUM330SSD240G-240G
V-Color	SATA	V-Color 240G 250g
V-Color	SATA	V-COLOR-VSS100-VSS100-240G-FO-240G
WD	SATA	WD BLUE 3D NAND WDS500G2B0B-00YS70-500G
WD	SATA	WD GREEN WDS240G1G0B-00RC30-240GB
WD	SATA	WD WDS100T1B0B-00AS40 WD BLUE PC SSD 1TB SATA3
WD	SATA	WD WDS200T2B0B-00YS70-2TB SATA3
WD	SATA	WD-BLACK-WD7500BPKX-750G
WD	SATA	WD-BLUE-WD10SPZX-00Z10T0-1T
WD	SATA	WD-BLUE-WDS250G2B0A-00SM50-250G
WD	SATA	WD-GREEN-WDS120G2G0A-00JH30-120G
WD	SATA	WD-RED-WD10JFCX-INTELLIPOWER-1T
Wyvo	SATA	WYVO-APS1-SSB240GTL4-SA-AF-240G

For the latest updates of M.2_SSD (NFGG) module support list, please visit our website for details.

Chapter 3 Software and Utilities Operation

3.1 Installing Drivers

The Support CD that comes with the motherboard contains necessary drivers and useful utilities that enhance the motherboard's features.

Running The Support CD

To begin using the support CD, insert the CD into your CD-ROM drive. The CD automatically displays the Main Menu if "AUTORUN" is enabled in your computer. If the Main Menu does not appear automatically, locate and double click on the file "ASRSETUP.EXE" in the Support CD to display the menu.

Drivers Menu

The drivers compatible to your system will be auto-detected and listed on the support CD driver page. Please click **Install All** or follow the order from top to bottom to install those required drivers. Therefore, the drivers you install can work properly.

Utilities Menu

The Utilities Menu shows the application software that the motherboard supports. Click on a specific item then follow the installation wizard to install it.

Chapter 4 UEFI SETUP UTILITY

4.1 Introduction

This section explains how to use the UEFI SETUP UTILITY to configure your system. You may run the UEFI SETUP UTILITY by pressing <F2> or right after you power on the computer, otherwise, the Power-On-Self-Test (POST) will continue with its test routines. If you wish to enter the UEFI SETUP UTILITY after POST, restart the system by pressing <Ctl> + <Alt> + <Delete>, or by pressing the reset button on the system chassis. You may also restart by turning the system off and then back on.



Because the UEFI software is constantly being updated, the following UEFI setup screens and descriptions are for reference purpose only, and they may not exactly match what you see on your screen.

4.1.1 UEFI Menu Bar

The top of the screen has a menu bar with the following selections:

Main	For setting system time/date information
OC Tweaker	For overclocking configurations
Advanced	For advanced system configurations
Tool	Useful tools
H/W Monitor	Displays current hardware status
Boot	For configuring boot settings and boot priority
Security	For security settings
Exit	Exit the current screen or the UEFI Setup Utility

4.1.2 Navigation Keys

Use <←> key or <→> key to choose among the selections on the menu bar, and use <↑> key or <↓> key to move the cursor up or down to select items, then press <Enter> to get into the sub screen. You can also use the mouse to click your required item.

Please check the following table for the descriptions of each navigation key.

Navigation Key(s)	Description
+ / -	To change option for the selected items
<Tab>	Switch to next function
<PGUP>	Go to the previous page
<PGDN>	Go to the next page
<HOME>	Go to the top of the screen
<END>	Go to the bottom of the screen
<F1>	To display the General Help Screen
<F7>	Discard changes and exit the SETUP UTILITY
<F9>	Load optimal default values for all the settings
<F10>	Save changes and exit the SETUP UTILITY
<F12>	Print screen
<ESC>	Jump to the Exit Screen or exit the current screen

4.2 Main Screen

When you enter the UEFI SETUP UTILITY, the Main screen will appear and display the system overview.

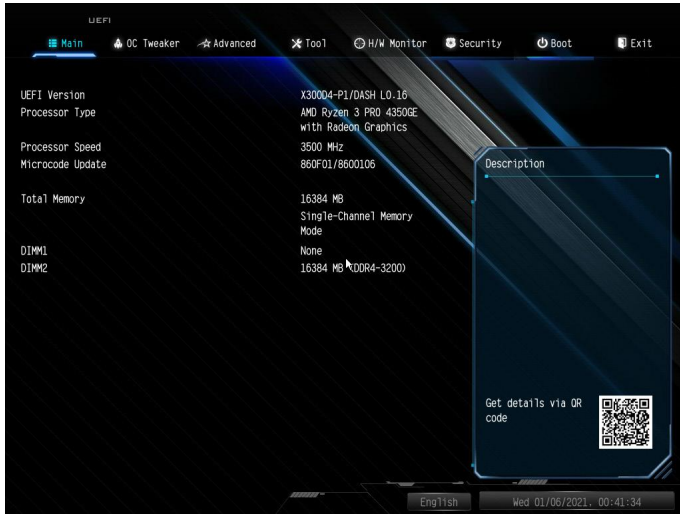

4.3 OC Tweaker Screen

In the OC Tweaker screen, you can set up overclocking features.

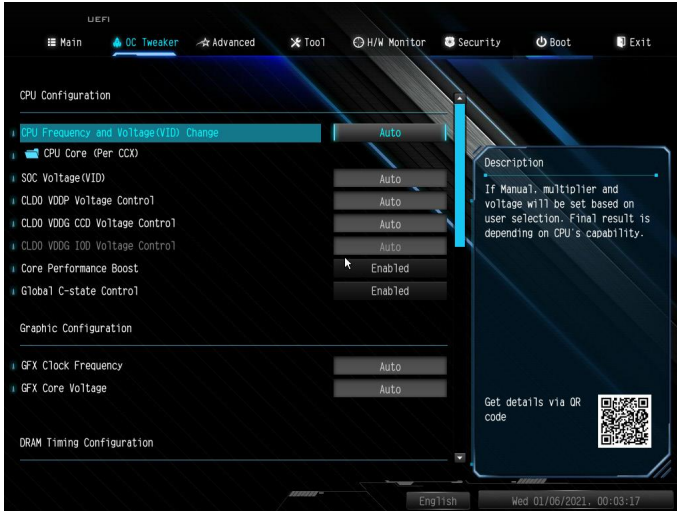

Because the UEFI software is constantly being updated, the following UEFI setup screens and descriptions are for reference purpose only, and they may not exactly match what you see on your screen.

CPU Frequency and Voltage(VID) Change

If this item is set to [Manual], the multiplier and voltage will be set based on user selection. Final result is depending on the CPU's capability.

CPU Core (Per CCX)

CPU Voltage

Specifies a custom CPU core voltage (mV), Should be combined with a custom CPU core frequency. Power saving features for idle cores (e.g. cc6 sleep) remain active.

CCD0

CCX0 Frequency (MHz)

Use this item to adjust CCX0 Frequency.

CCX1 Frequency (MHz)

Use this item to adjust CCX1 Frequency.

CCD1

CCX0 Frequency (MHz)

Use this item to adjust CCX0 Frequency.

CCX1 Frequency (MHz)

Use this item to adjust CCX1 Frequency.

SoC/Uncore OC Voltage(VID)

Specify the SoC/Uncore voltage (VDD_SOC) in mV to support memory and Infinity Fabric overclocking. VDD_SOC also determines the GPU voltage on processors with integrated graphics. "SoC/Uncore OC Mode" needs to be enabled to force this voltage.

CLD0 VDDP Voltage Control

AMD Overclocking Setup VDDP is a voltage for the DDR4 bus signaling (PHY), and it is derived from your DRAM Voltage (VDDIO_Mem). As a result, VDDP voltage in mV can approach but not exceed your DRAM Voltage.

CLD0 VDDG CCD Voltage Control

AMD Overclocking Setup VDDG CCD represents voltage for the data portion of the Infinity Fabric. It is derived from the CPU SoC/Uncore Voltage (VDD_SOC). VDDG can approach but not exceed VDD_SOC.

CLD0 VDDG IOD Voltage Control

AMD Overclocking Setup VDDG IOD represents voltage for the data portion of the Infinity Fabric. It is derived from the CPU SoC/Uncore Voltage (VDD_SOC). VDDG can approach but not exceed VDD_SOC.

Core Performance Boost

Core Performance Boost (CPB) allows you to determine whether to enable the Core Performance Boost (CPB) technology, a CPU performance-boost technology.

Global C-state Control

This option controls IO based C-state generation and DF C-states.

Graphic Configuration

GFX Clock Frequency (Only for processor with integrated graphics)

This item allows you to alter the frequency for the GFX clock frequency. After you alter the GFX Clock Frequency settings, make sure to adjust the GFX Core Voltage settings.

*The adjustable range is dependent on the CPU being installed.

GFX Core Voltage (Only for processor with integrated graphics)

This item allows you to alter the voltage for the GFX Core Voltage.

*The adjustable range is dependent on the CPU being installed.

DRAM Timing Configuration

DRAM Information

DRAM Frequency

If [Auto] is selected, the motherboard will detect the memory module(s) inserted and assign the appropriate frequency automatically. Setting DRAM Frequency can adjust DRAM Timing.

Infinity Fabric Frequency and Dividers

AMD Overclocking Setup Set Infinity Fabric frequency (FCLK). Auto: FCLK = MCLK. Manual: FCLK must be less than or equal to MCLK for best performance in most cases. Latency penalties are incurred if FCLK and MCLK are mismatched, but sufficiently high MCLK can negate or overcome this penalty.

DRAM Timing Configuration

Voltage Configuration

CPU Vcore Voltage (Offset)

Configure the voltage for the CPU Vcore (Offset).

VDDCR SOC Voltage (Offset)

Configure the voltage for the VDDCR SOC (Offset)

DRAM Voltage

Configure the voltage for the DRAM Voltage.

Performance Mode

Use this to enable or disable performance mode The default value is [Disabled].

Adapter Select

Use this to select the adapter. The default value is [120W].

SMU Common Options

XFR Enhancement

Save User Default

Type a profile name and press enter to save your settings as user default.

Load User Default

Load previously saved user defaults.

Save User UEFI Setup Profile to Disk

Save current UEFI settings as an user default profile to disk.

Load User UEFI Setup Profile to Disk

Load previously saved user defaults from the disk.

4.4 Advanced Screen

In this section, you may set the configurations for the following items: CPU Configuration, Onboard Devices Configuration, Storage Configuration, ACPI Configuration, Trusted Computing and AMD Firmware Version.

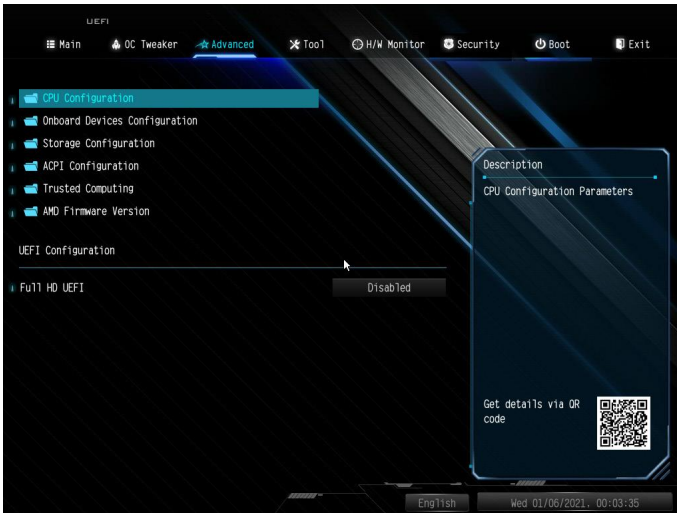

Setting wrong values in this section may cause the system to malfunction.

UEFI Configuration

Full HD UEFI

When [Auto] is selected, the resolution will be set to 1920 x 1080 if the monitor supports Full HD resolution. If the monitor does not support Full HD resolution, then the resolution will be set to 1024 x 768. When [Disable] is selected, the resolution will be set to 1024 x 768 directly.

4.4.1 CPU Configuration



PSS Support

Use this to enable or disable the generation of ACPI_PPC, _PSS, and _PCT objects.

NX Mode

Use this to enable or disable NX mode.

SVM Mode

When this is set to [Enabled], a VMM (Virtual Machine Architecture) can utilize the additional hardware capabilities provided by AMD-V. The default value is [Enabled].
Configuration options: [Enabled] and [Disabled].

SMT Mode

This item can be used to disable symmetric multithreading. To re-enable SMT, a power cycle is needed after selecting [Auto].

Warning: S3 is not supported on systems where SMT is disabled.

IOMMU

Use this to enable or disable IOMMU. The default value of this feature is [Disabled].

TPM Switch

Use this to enable or disable AMD CPU fTPM.

4.4.2 Onboard Devices Configuration



SR-IOV Support

Enable/disable the SR-IOV (Single Root IO Virtualization Support) if the system has SR-IOV capable PCIe devices.

UMA Frame buffer Size (Only for processor with integrated graphics)

This item allows you to set the size of the UMA frame buffer.

Onboard HD Audio

Enable/disable onboard HD audio. Set to Auto to enable onboard HD audio and automatically disable it when a sound card is installed.

Restore on AC/Power Loss

Select the power state after a power failure. If [Power Off] is selected, the power will remain off when the power recovers. If [Power On] is selected, the system will start to boot up when the power recovers.

WAN Device

Enable/disable the onboard WAN device.

WAN Radio

Configure the WiFi module's connectivity.

BT Control

Enable/disable the bluetooth.

Onboard LAN

Enable or disable the onboard network interface controller.

4.4.3 Storage Configuration

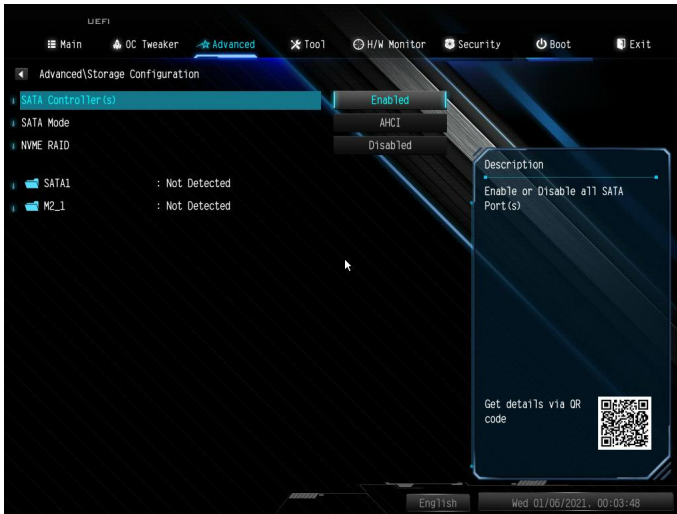

SATA Controller(s)

Enable/disable the SATA controllers.

SATA Mode

AHCI: Supports new features that improve performance.

RAID: Combine multiple disk drives into a logical unit.

NVME RAID

Enable/disable RAID mode on NVMe device.

4.4.4 ACPI Configuration

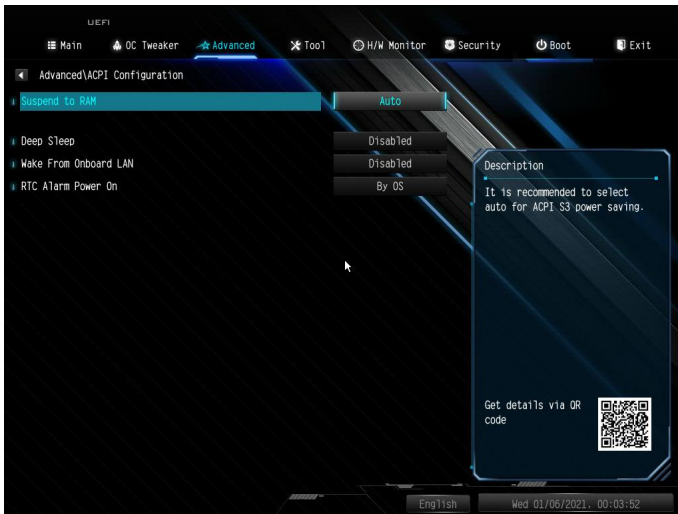

Suspend to RAM

It is recommended to select auto for ACPI S3 power saving.

Deep Sleep

Configure deep sleep mode for power saving when the computer is shut down.

Wake From Onboard LAN

Allow the system to be waked up by an onboard LAN.

RTC Alarm Power On

Allow the system to be waked up by the real time clock alarm. Set it to By OS to let it be handled by your operating system.

4.4.5 Trusted Computing

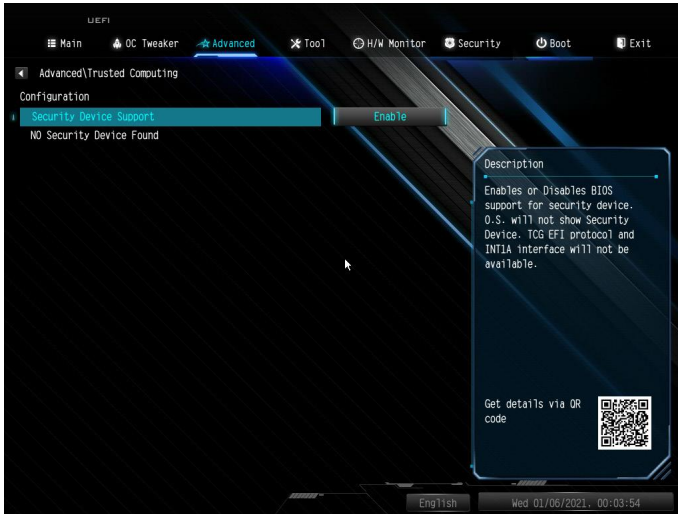

NOTE: Options vary depending on the version of your connected TPM module.

Security Device Support

Use this item to enable or disable BIOS support for security device. O.S. will not show Security Device. TCG EFI protocol and INT1A interface will not be available.

SHA-1 PCR Bank

Use this item to enable or disable SHA-1 PCR Bank.

SHA256 PCR Bank

Use this item to enable or disable SHA256 PCR Bank.

Pending Operation

Schedule an Operation for the Security Device.

NOTE: Your computer will reboot during restart in order to change State of the Device.

Platform Hierarchy

Use this item to enable or disable Platform Hierarchy.

Storage Hierarchy

Use this item to enable or disable Storage Hierarchy.

Endorsement Hierarchy

Use this item to enable or disable Endorsement Hierarchy.

TPM2.0 UEFI Spec Version

Use this item to select the TCG2 spec. version supported.

The optional settings: [TCG_1_2]; [TCG_2].

[TCG_1_2]: compatible mode for Win8/Win10.

[TCG_2]: for TCG2 newer spec. compatible mode for Win10

Physical Presence Spec version

Select this item to tell OS to support PPI spec version 1.2 or 1.3. Please note that some HCK tests might not support version 1.3.

Device Select

Use this item to select the TPM device to be supported. TPM 1.2 will restrict support to TPM 1.2 devices. TPM 2.0 will restrict support to TPM 2.0 devices. Auto will support both with the default set to TPM 2.0 devices. If TPM 2.0 devices are not found, TPM 1.2 devices will be enumerated.

4.4.6 AMD Firmware Version

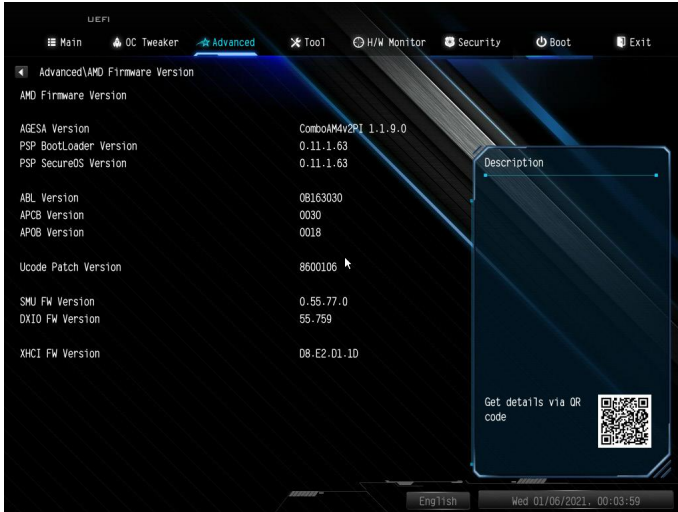

This page shows all of AMD Firmware Version.

4.5 Tools

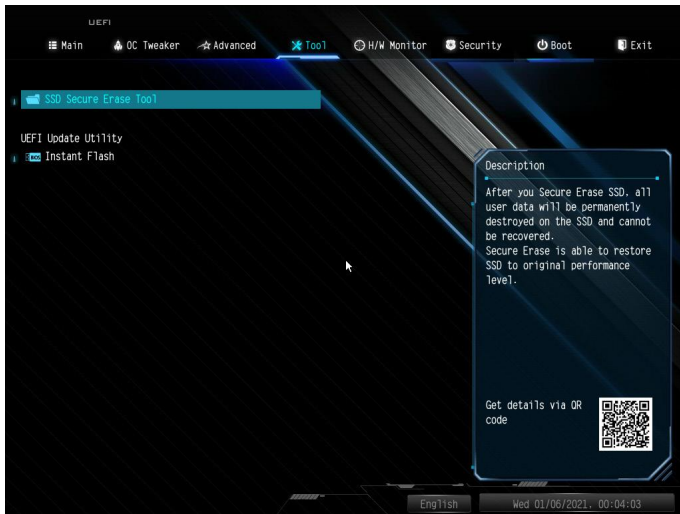

SSD Secure Erase Tool

Use this tool to securely erase SSD.

Instant Flash

Save UEFI files in your USB storage device and run Instant Flash to update your UEFI.

4.6 Hardware Health Event Monitoring Screen

This section allows you to monitor the status of the hardware on your system, including the parameters of the CPU temperature, motherboard temperature, fan speed and voltage.



CPU Fan 1 Setting

Select a fan mode for CPU Fan 1, or choose Customize to set 5 CPU temperatures and assign a respective fan speed for each temperature.

Case Open Feature

Enable or disable Case Open Feature to detect whether the chassis cover has been removed.

4.7 Security Screen

In this section you may set or change the supervisor/user password for the system. You may also clear the user password.

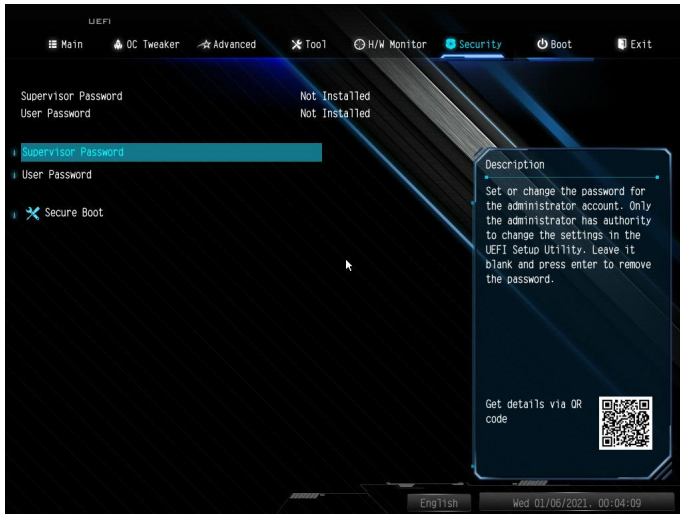

Supervisor Password

Set or change the password for the administrator account. Only the administrator has authority to change the settings in the UEFI Setup Utility. Leave it blank and press enter to remove the password.

User Password

Set or change the password for the user account. Users are unable to change the settings in the UEFI Setup Utility. Leave it blank and press enter to remove the password.

Secure Boot

Enable to support Secure Boot.

4.8 Boot Screen

This section displays the available devices on your system for you to configure the boot settings and the boot priority.

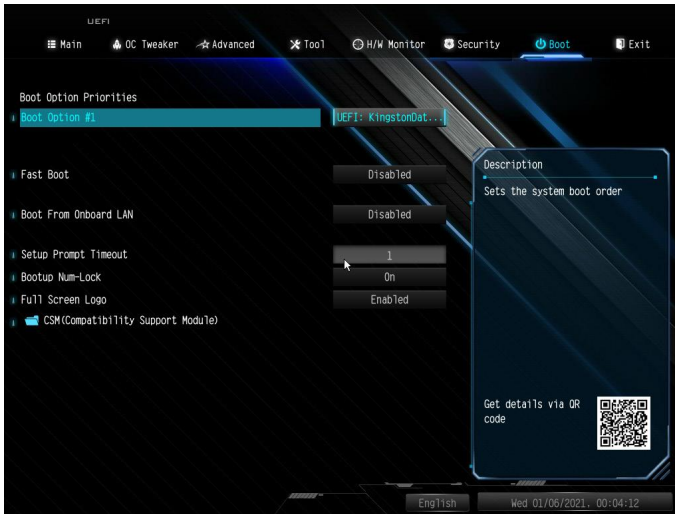

Fast Boot

Fast Boot minimizes your computer's boot time. In fast mode you may not boot from an USB storage device.

Boot From Onboard LAN

Allow the system to boot from a network instead of the local drive.

Setup Prompt Timeout

Configure the number of seconds to wait for the setup hot key.

Bootup Num-Lock

Select whether Num Lock should be turned on or off when the system boots up.

Full Screen Logo

Enable to display the boot logo or disable to show normal POST messages.

CSM (Compatibility Support Module)

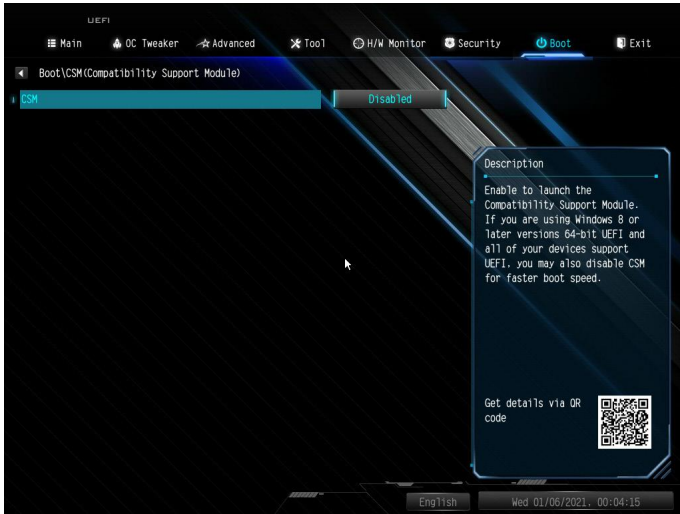

CSM

Enable to launch the Compatibility Support Module. Please do not disable unless you're running a WHCK test.

Launch PXE OpROM Policy

Select UEFI only to run those that support UEFI option ROM only. Select Legacy only to run those that support legacy option ROM only. Select Do not launch to not execute both legacy and UEFI option ROM.

Launch Storage OpROM Policy

Select UEFI only to run those that support UEFI option ROM only. Select Legacy only to run those that support legacy option ROM only. Select Do not launch to not execute both legacy and UEFI option ROM.

4.9 Exit Screen

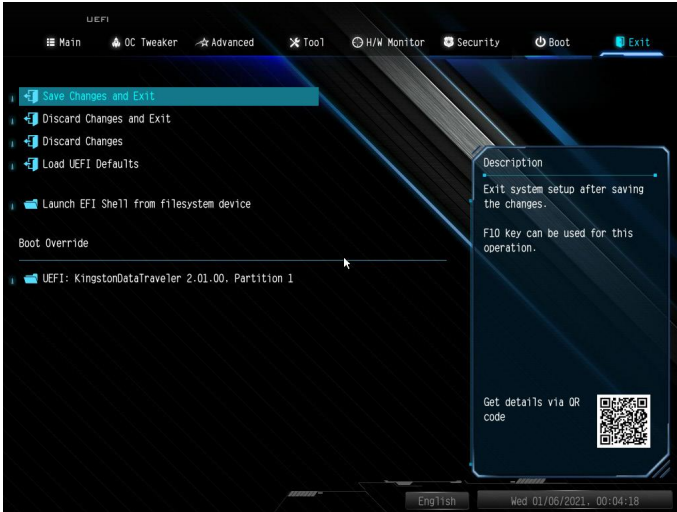

Save Changes and Exit

When you select this option the following message, “Save configuration changes and exit setup?” will pop out. Select [OK] to save changes and exit the UEFI SETUP UTILITY.

Discard Changes and Exit

When you select this option the following message, “Discard changes and exit setup?” will pop out. Select [OK] to exit the UEFI SETUP UTILITY without saving any changes.

Discard Changes

When you select this option the following message, “Discard changes?” will pop out. Select [OK] to discard all changes.

Load UEFI Defaults

Load UEFI default values for all options. The F9 key can be used for this operation.

Launch EFI Shell from filesystem device

Copy shellx64.efi to the root directory to launch EFI Shell.

DECLARATION OF CONFORMITY

Per FCC Part 2 Section 2.1077(a)



Product Name : Motherboard

Model Number : X300D4-P1

Conforms to the following specifications:

FCC Part 15, Subpart B, Unintentional Radiators

Supplementary Information:

This device complies with part 15 of the FCC Rules. Operation is subject to the following two conditions: (1) This device may not cause harmful interference, and (2) this device must accept any interference received, including interference that may cause undesired operation.

EU Declaration of Conformity

For the following equipment:

Motherboard

(Product Name)

X300D4-P1

(Model Designation / Trade Name)

EMC —Directive 2014/30/EU (from April 20th, 2016)

EN 55022:2010/AC:2011 Class B

EN 55024:2010/A1:2015

EN 55032:2012+AC:2013 Class B

EN 61000-3-3:2013

EN 61000-3-2:2014

LVD —Directive 2014/35/EU (from April 20th, 2016)

EN 60950-1 : 2011+ A2: 2013

EN 60950-1 : 2006/A12: 2011

RoHS — Directive 2011/65/EU

CE marking



(EU conformity marking)