



EMC TEST REPORT

Applicant Xiaomi Communications Co., Ltd.
FCC ID 2AFZZ119VL
Product Mobile Phone
Brand Redmi
Model 21121119VL
Report No. R2109A0821-E1
Issue Date November 8, 2021

TA Technology (Shanghai) Co., Ltd. tested the above equipment in accordance with the requirements in **FCC Code CFR47 Part15B (2020)/ ANSI C63.4 (2014)**. The test results show that the equipment tested is capable of demonstrating compliance with the requirements as documented in this report.

Wei Liu

Prepared by: Wei Liu

Guangchang Fan

Approved by: Guangchang Fan

TA Technology (Shanghai) Co., Ltd.

No.145, Jintang Rd, Tangzhen Industry Park, Pudong Shanghai, China

TEL: +86-021-50791141/2/3

FAX: +86-021-50791141/2/3-8000



Table of Contents

1	Test Laboratory.....	4
1.1	Notes of the Test Report.....	4
1.2	Test facility.....	4
1.3	Testing Location.....	4
2	General Description of Equipment under Test.....	5
2.1	Applicant and Manufacturer Information.....	5
2.2	General information.....	5
2.3	Applied Standards.....	7
2.4	Test Mode.....	8
3	Test Case Results.....	9
3.1	Radiated Emission.....	9
3.2	Conducted Emission.....	16
4	Main Test Instruments.....	20
	ANNEX A: The EUT Appearance.....	21
	ANNEX B: Test Setup Photos.....	22



Summary of measurement results

Number	Test Case	Clause in FCC Rules	Conclusion
1	Radiated Emission	FCC Part15.109, ANSI C63.4-2014	PASS
2	Conducted Emission	FCC Part15.107, ANSI C63.4-2014	PASS
Date of Testing: October 8, 2021 ~ October 17, 2021			
Date of Sample Received: September 30, 2021			
Note: All indications of Pass/Fail in this report are opinions expressed by TA Technology (Shanghai) Co., Ltd. based on interpretations and/or observations of test results. Measurement Uncertainties were not taken into account and are published for informational purposes only.			

This report only changed the Model and add LTE band 12/13/17/66 of product. There is only tested Radiated Emission except Reverse charging form original in this report. Other test values duplicated from the original report (Report No.: R2109A0819-E1).

1 Test Laboratory

1.1 Notes of the Test Report

This report shall not be reproduced in full or partial, without the written approval of **TA technology (shanghai) co., Ltd.** The results documented in this report apply only to the tested sample, under the conditions and modes of operation as described herein. Measurement Uncertainties were not taken into account and are published for informational purposes only. This report is written to support regulatory compliance of the applicable standards stated above.

1.2 Test facility

FCC (Designation number: CN1179, Test Firm Registration Number: 446626)

TA Technology (Shanghai) Co., Ltd. has been listed on the US Federal Communications Commission list of test facilities recognized to perform measurements.

A2LA (Certificate Number: 3857.01)

TA Technology (Shanghai) Co., Ltd. has been listed by American Association for Laboratory Accreditation to perform measurement.

1.3 Testing Location

Company: TA Technology (Shanghai) Co., Ltd.
Address: No.145, Jintang Rd, Tangzhen Industry Park, Pudong Shanghai, China
City: Shanghai
Post code: 201201
Country: P. R. China
Contact: Fan Guangchang
Telephone: +86-021-50791141/2/3
Fax: +86-021-50791141/2/3-8000
Website: <http://www.ta-shanghai.com>
E-mail: fanguangchang@ta-shanghai.com

2 General Description of Equipment under Test

2.1 Applicant and Manufacturer Information

Applicant	Xiaomi Communications Co., Ltd.
Applicant address	#019, 9th Floor, Building 6, 33 Xi'erqi Middle Road, Haidian District, Beijing, China, 100085
Manufacturer	Xiaomi Communications Co., Ltd.
Manufacturer address	#019, 9th Floor, Building 6, 33 Xi'erqi Middle Road, Haidian District, Beijing, China, 100085

2.2 General information

EUT Description			
Device Type	Portable Device		
Model	21121119VL		
IMEI	Original (21121119SG)	IMEI 1: 860406050015666 IMEI 2: 860406050015674	
	Variant (21121119VL)	IMEI 1: 862440050027163 IMEI 2: 862440050027171	
HW Version	P2		
SW Version	MIUI12.5		
Antenna Type	PIFA Antenna		
Frequency	Band	Tx (MHz)	Rx (MHz)
	GSM 850	824 ~ 849	869 ~ 894
	GSM 1900	1850 ~ 1910	1930 ~ 1990
	WCDMA Band II	1850 ~ 1910	1930 ~ 1990
	WCDMA Band IV	1710 ~ 1755	2110 ~ 2155
	WCDMA Band V	824 ~ 849	869 ~ 894
	LTE Band 2	1850 ~ 1910	1930 ~ 1990
	LTE Band 4	1710 ~ 1755	2110 ~ 2155
	LTE Band 5	824 ~ 849	869 ~ 894
	LTE Band 7	2500 ~ 2570	2620 ~ 2690
	LTE Band 12	699 ~ 716	729 ~ 746
	LTE Band 13	777 ~ 787	746 ~ 756
	LTE Band 17	704 ~ 716	734 ~ 746
	LTE Band 38	2570 ~ 2620	2570 ~ 2620
LTE Band 41	2535 ~ 2655	2535 ~ 2655	



	LTE Band 66	1710 ~ 1780	2110 ~ 2200
	Bluetooth	2400 ~ 2483.5	2400 ~ 2483.5
	WIFI 2.4G	2400 ~ 2483.5	2400 ~ 2483.5
	WIFI 5G(U-NII-1)	5150 ~ 5250	5150 ~ 5250
	WIFI 5G(U-NII-2A)	5250 ~ 5350	5250 ~ 5350
	WIFI 5G(U-NII-2C)	5470 ~ 5725	5470 ~ 5725
	WIFI 5G(U-NII-3)	5725 ~ 5850	5725 ~ 5850
CA band	CA_7C, CA_38C, CA_41C		
Auxiliary test equipment			
PC	PC Manufacturer: Microsoft Corporation Model: L20170076		
Phone	Manufacturer: Xiaomi Communications Co.,Ltd. Model: 21061119AG (SN : K19VF/S1WF00488)		
Note: 1. The EUT is sent from the applicant to TA and the information of the EUT is declared by the applicant.			



2.3 Applied Standards

According to the specifications of the manufacturer, it must comply with the requirements of the following standards:

Test standards

FCC Code CFR47 Part15B (2020)

ANSI C63.4 (2014)

2.4 Test Mode

Test Mode	
Mode 1:	Adapter +USB cable + Front camera On
Mode 2:	Adapter +USB cable + Rear camera On
Mode 3:	Adapter + USB cable + Mp4
Mode4:	Adapter + USB cable + Bluetooth WLAN Traffic
Mode 5:	USB Copy(EUT with PC) + USB cable + earphone
Mode 6:	Front Camera On
Mode 7:	MP4
Mode 8:	Rear camera On
Mode 9:	Bluetooth WLAN Traffic
Mode 10:	REVERSE CHARGE

During the test, the preliminary test was performed in all modes with all adapters, USB and batteries, mode 1 with Battery 1 and USB cable 2 is selected as the worst condition. The test data of the worst-case condition was recorded in this report.

3 Test Case Results

3.1 Radiated Emission

Ambient condition

Temperature	Relative humidity	Pressure
15°C~35°C	30%~60%	101.5kPa

Methods of Measurement

The EUT is placed on a non-metallic table 0.8m above the horizontal metal reference ground plane. The distance between EUT and receive antenna should be 3 meters. During the test, the EUT was operating in its typical mode. The test method is according to ANSI C63.4-2014. Sweep the whole frequency band through the range from 30MHz to the 5th harmonic of the carrier. During the test, the height of receive antenna shall be moved from 1 to 4 meters, and the antenna shall be performed under horizontal and vertical polarization. The turn table shall be rotated from 0 to 360 degrees for detecting the maximum of radiated signal level.

The data of cable loss and antenna factor has been calibrated in full testing frequency range before the testing. During the test, the EUT is worked at maximum output power.

Set the spectrum analyzer in the following:

Below 1GHz:

RBW=100 kHz / VBW=300 kHz / Sweep=AUTO

Above 1GHz:

(a) PEAK Detector: RBW=1MHz / VBW=3MHz / Sweep=AUTO

(b) AVERAGE Detector: RBW=1MHz / VBW=3MHz / Sweep=AUTO

The radiated emission was measured in the following position: EUT stand-up position (Z axis), lie-down position (X, Y axis). The worst emission was found in lie-down position (X axis) and the worst case was recorded.

During the test, EUT is connected to a laptop via a USB cable in the case of Transfer Data mode. The EUT is used as the peripheral equipment of the PC. The data is transferred from EUT to PC; PC is connected to server via a long LAN cable.

Test Setup

Below 1GHz

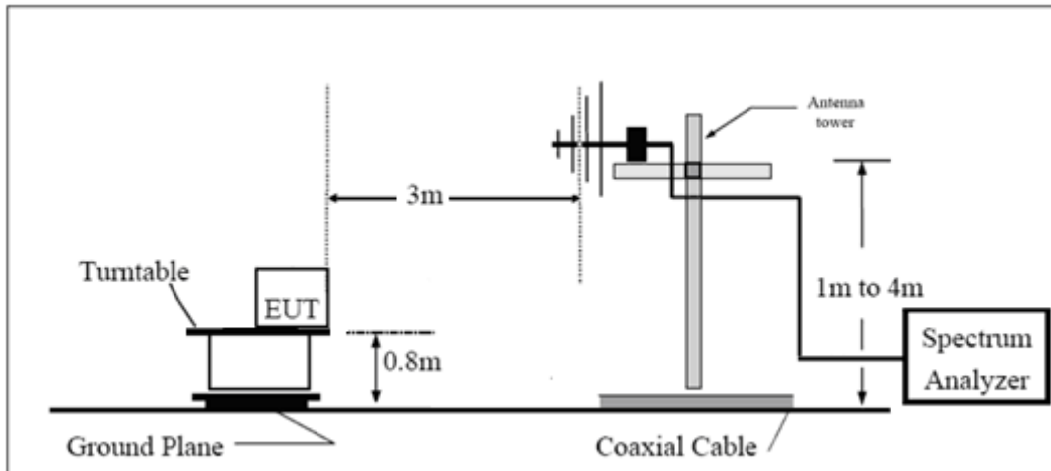

Above 1GHz

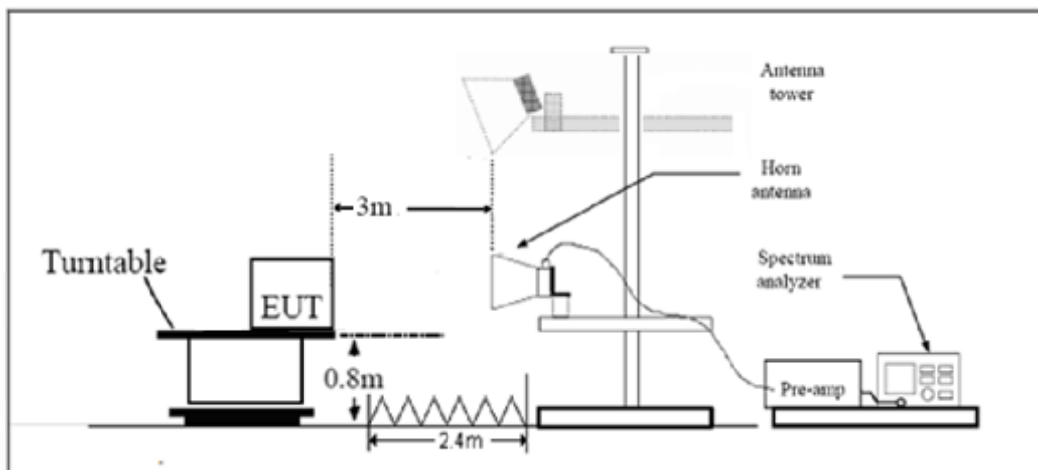

Note: Area side: 2.4mX3.6m

Antenna Tower meets ANSI C63.4 requirements for measurements above 1 GHz by keeping the antenna aimed at the EUT during the antenna's ascent/ descent along the antenna mast.

Limits**Class B**

Frequency (MHz)	Field Strength (dB μ V/m)	Detector
30 -88	40.0	Quasi-peak
88-216	43.5	Quasi-peak
216 – 960	46.0	Quasi-peak
960-1000	54.0	Quasi-peak
1000-5 th harmonic of the highest frequency or 40GHz, which is lower	54 74	Average Peak

Measurement Uncertainty

The assessed measurement uncertainty to ensure 95% confidence level for the normal distribution is with the coverage factor $k = 1.96$.

Frequency	Uncertainty
30MHz~200MHz	4.17 dB
200MHz~1000MHz	4.84 dB
1GHz~18GHz	4.35 dB
18GHz~26.5GHz	5.90 dB
26.5GHz~40GHz	5.92 dB

Test Results

Sweep the whole frequency band through the range from 30MHz to the 5th harmonic of the carrier, the Emissions in the frequency band 18GHz –40GHz is more than 20dB below the limit are not reported.

The following graphs display the maximum values of horizontal and vertical by software. For above 1GHz, Blue trace uses the peak detection, Green trace uses the average detection.

A font ($\text{Level in dB } \mu\text{V/m}$)in the test plot =(level in dB $\mu\text{V/m}$)

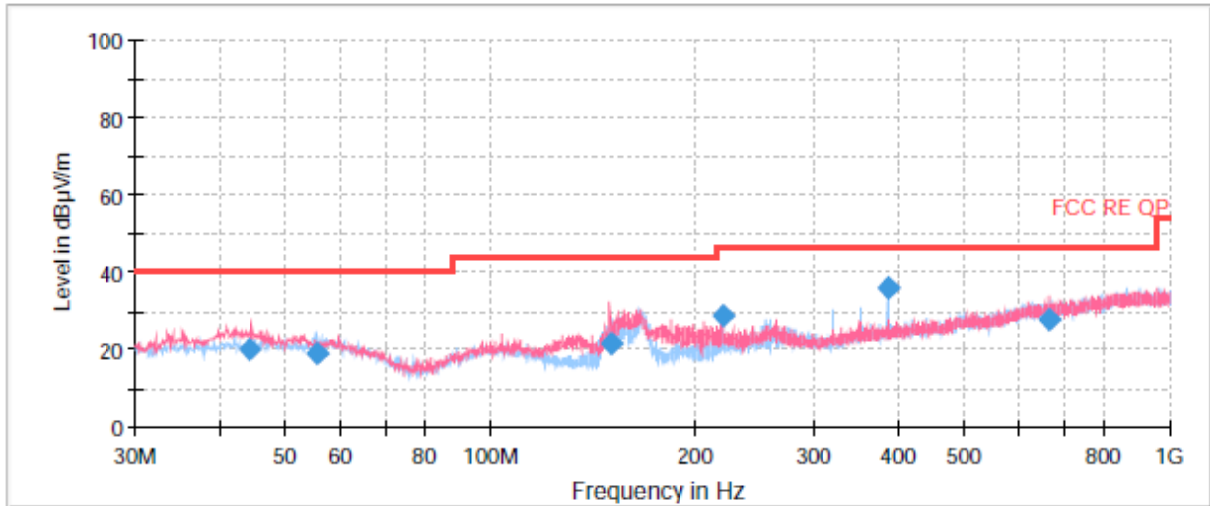

Radiated Emission from 30MHz to 1GHz

Frequency (MHz)	Quasi-Peak (dBuV/m)	Height (cm)	Polarization	Azimuth (deg)	Correct Factor (dB)	Margin (dB)	Limit (dBuV/m)
44.047250	20.06	121.0	V	94.0	14	19.94	40.00
55.461325	18.81	125.0	H	9.0	14	21.19	40.00
150.086750	21.54	100.0	V	286.0	9	21.96	43.50
219.775500	28.57	100.0	V	0.0	13	17.43	46.00
384.010000	35.65	100.0	H	0.0	17	10.35	46.00
665.127250	27.54	195.0	V	168.0	22	18.46	46.00

- Remark: 1. Correction Factor = Antenna factor + Insertion loss(cable loss+amplifier gain)
- 2. Margin = Limit – Quasi-Peak

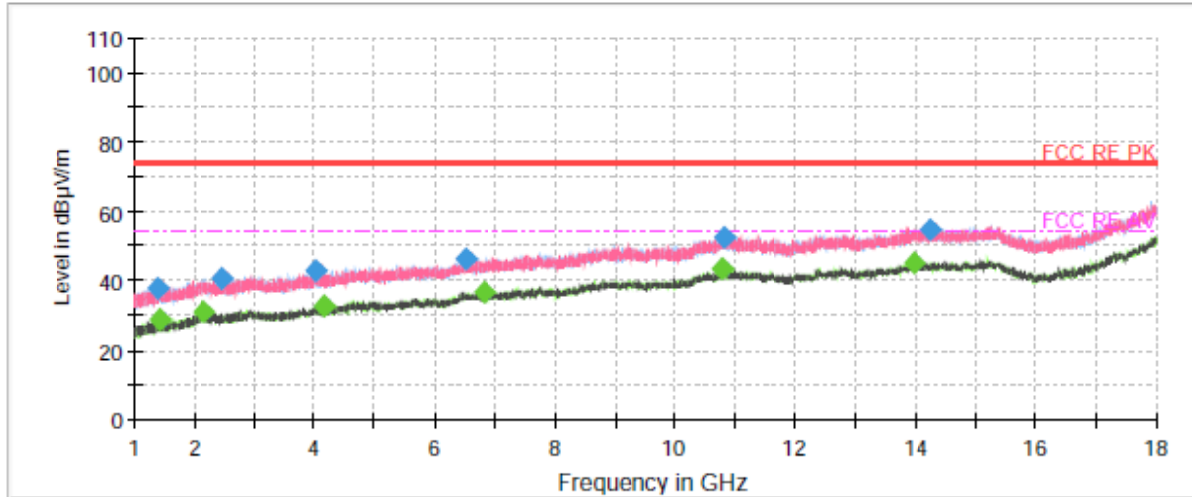

Radiated Emission from 1GHz to 18GHz

Frequency (MHz)	MaxPeak (dB µ V/m)	Average (dB µ V/m)	Limit (dB µ V/m)	Margin (dB)	Height (cm)	Pol	Azimuth (deg)	Corr. (dB/m)
1368.333333	37.91	---	74.00	36.09	200.0	V	279.0	-17
1414.800000	---	29.02	54.00	24.98	200.0	H	105.0	-17
2138.433333	---	31.02	54.00	22.98	200.0	H	65.0	-14
2460.866667	40.59	---	74.00	33.41	200.0	H	0.0	-14
4018.066667	42.67	---	74.00	31.33	100.0	V	55.0	-11
4143.866667	---	32.61	54.00	21.39	200.0	V	320.0	-11
6533.500000	46.45	---	74.00	27.55	200.0	H	5.0	-4
6841.766667	---	36.61	54.00	17.39	200.0	H	5.0	-4
10771.600000	---	43.22	54.00	10.78	100.0	V	358.0	0
10828.833333	52.68	---	74.00	21.32	100.0	H	12.0	0
13963.066667	---	45.02	54.00	8.98	100.0	H	359.0	5
14259.433333	54.67	---	74.00	19.33	100.0	H	355.0	5

Reverse charging

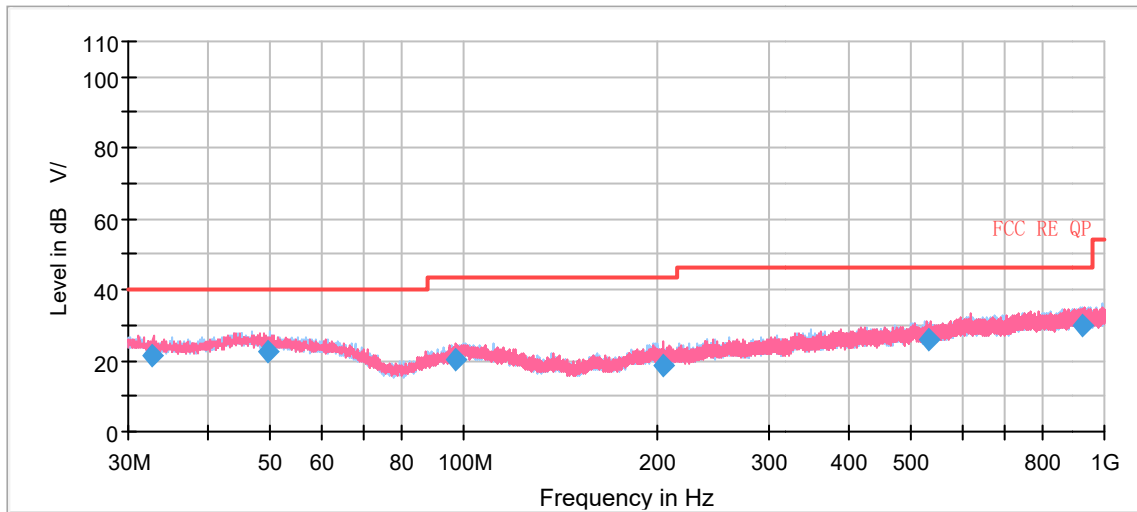

Radiated Emission from 30MHz to 1GHz

Frequency (MHz)	Quasi-Peak (dBuV/m)	Height (cm)	Polarization	Azimuth (deg)	Correct Factor (dB)	Margin (dB)	Limit (dBuV/m)
32.801107	21.55	125.0	V	190.0	0	18.45	40.00
49.539060	22.82	225.0	H	292.0	0	17.18	40.00
97.454037	20.28	125.0	V	247.0	-5	23.22	43.50
204.645500	18.81	225.0	V	310.0	-6	24.69	43.50
530.236167	25.67	184.0	V	1.0	1	20.33	46.00
926.926667	29.68	186.0	H	167.0	6	16.32	46.00

Remark: 1. Correction Factor = Antenna factor + Insertion loss(cable loss+amplifier gain)

2. Margin = Limit – Quasi-Peak

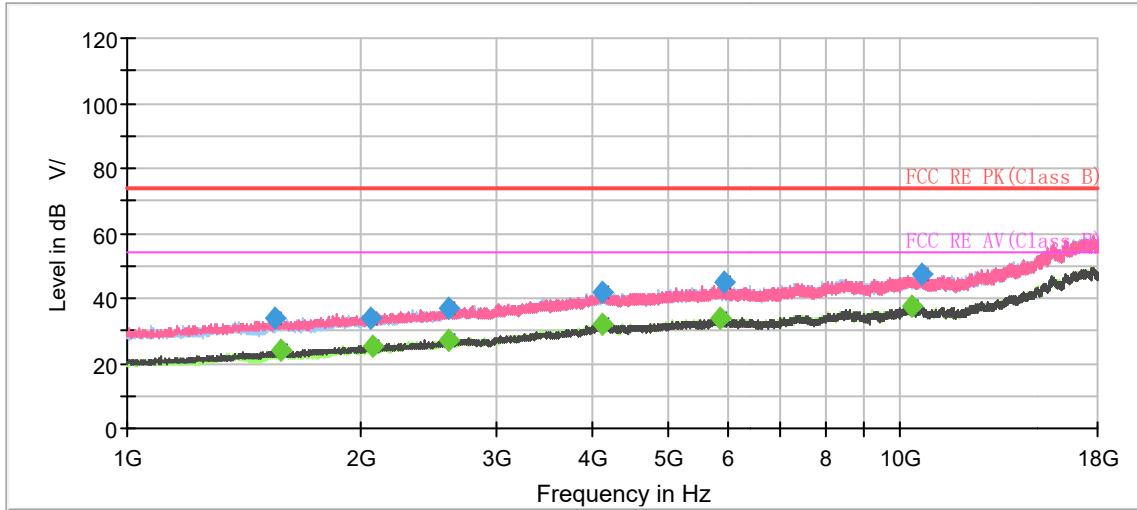

Radiated Emission from 1GHz to 18GHz

Frequency (MHz)	MaxPeak (dB μ V/m)	Average (dB μ V/m)	Limit (dB μ V/m)	Margin (dB)	Height (cm)	Pol	Azimuth (deg)	Corr. (dB/m)
1556.466667	33.97	---	74.00	40.03	100.0	H	325.0	-15
1578.566667	---	24.28	54.00	29.72	200.0	V	254.0	-15
2064.766667	34.13	---	74.00	39.87	100.0	H	0.0	-13
2078.366667	---	25.14	54.00	28.86	100.0	H	126.0	-13
2605.933333	---	27.08	54.00	26.92	100.0	V	78.0	-10
2609.900000	37.07	---	74.00	36.93	200.0	V	342.0	-10
4113.833333	41.91	---	74.00	32.09	100.0	V	78.0	-3
4118.366667	---	31.99	54.00	22.01	100.0	V	137.0	-3
5857.466667	---	33.89	54.00	20.11	100.0	V	349.0	0
5908.466667	45.07	---	74.00	28.93	200.0	H	13.0	0
10340.366667	---	37.51	54.00	16.49	200.0	V	162.0	6
10673.566667	47.57	---	74.00	26.43	200.0	V	127.0	5

3.2 Conducted Emission

Ambient condition

Temperature	Relative humidity	Pressure
15°C~35°C	30%~60%	101.5kPa

Methods of Measurement

The EUT is placed on a non-metallic table of 80cm height above the horizontal metal reference ground plane. During the test, the EUT was operating in its typical mode. The test method is according to ANSI C63.4-2014. Connect the AC power line of the EUT to the L.I.S.N. Use EMI receiver to detect the average and Quasi-peak value. RBW is set to 9 kHz, VBW is set to 30kHz. The measurement result should include both L line and N line.

During the test, EUT is connected to a laptop via a USB cable in the case of Transfer Data mode. The EUT is used as the peripheral equipment of the PC. The data is transferred from EUT to PC;

Test Setup

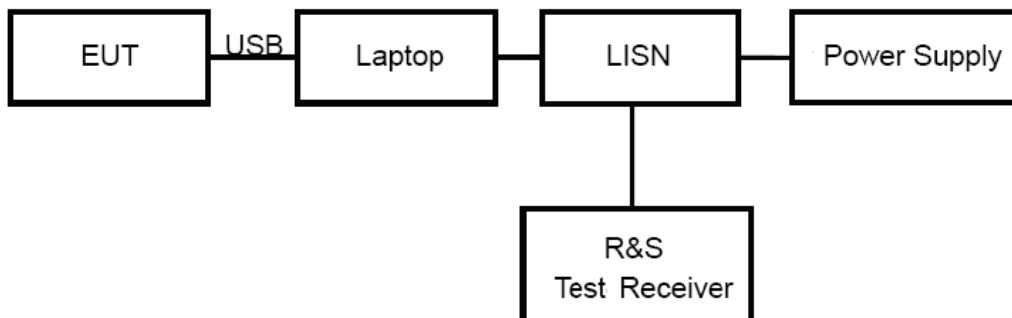

Note: Power Supply is AC Power source and it is used to change the voltage 120V/60Hz.

Limits

Frequency (MHz)	Conducted Limits(dB μ V)	
	Quasi-peak	Average
0.15 - 0.5	66 to 56 *	56 to 46 *
0.5 - 5	56	46
5 - 30	60	50

*: Decreases with the logarithm of the frequency.

Measurement Uncertainty

The assessed measurement uncertainty to ensure 95% confidence level for the normal distribution is with the coverage factor $k = 1.96$. $U = 2.57$ dB.

Test Results

Following plots, Blue trace uses the peak detection; Green trace uses the average detection.

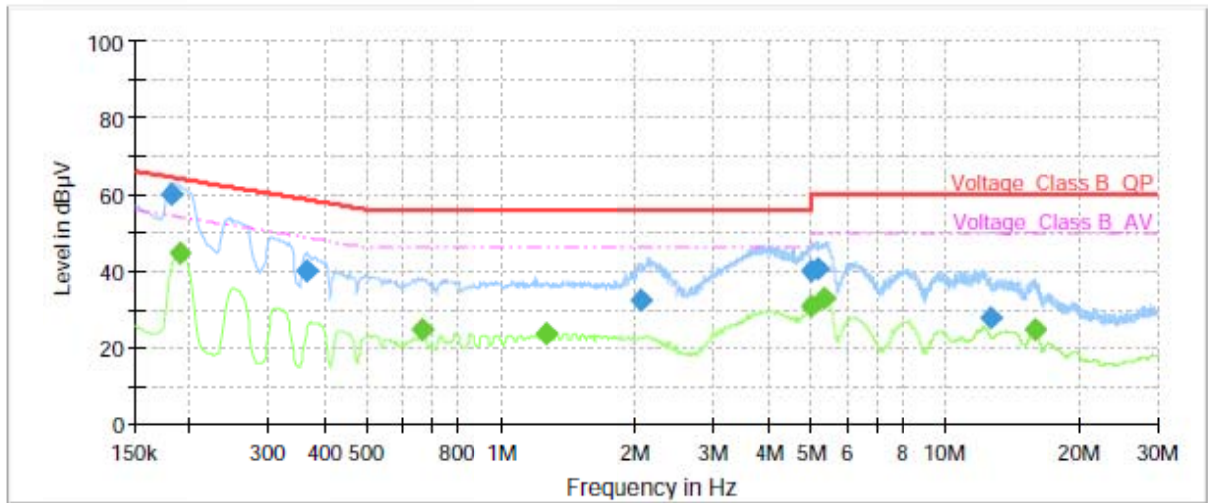

Frequency (MHz)	QuasiPeak (dBµV)	Average (dBµV)	Limit (dBµV)	Margin (dB)	Meas. Time (ms)	Bandwidth (kHz)	Line	Filter	Corr. (dB)
0.18	60.14	---	64.42	4.28	70.0	9.000	L1	ON	21
0.19	---	44.57	54.11	9.54	70.0	9.000	L1	ON	21
0.36	39.85	---	58.64	18.79	70.0	9.000	L1	ON	21
0.67	---	24.76	46.00	21.24	70.0	9.000	L1	ON	20
1.27	---	23.79	46.00	22.21	70.0	9.000	L1	ON	20
2.06	32.14	---	56.00	23.86	70.0	9.000	L1	ON	20
4.99	39.90	---	56.00	16.10	70.0	9.000	L1	ON	19
5.00	---	30.70	46.00	15.30	70.0	9.000	L1	ON	19
5.17	40.51	---	60.00	19.49	70.0	9.000	L1	ON	19
5.34	---	32.98	50.00	17.02	70.0	9.000	L1	ON	19
12.70	27.91	---	60.00	32.09	70.0	9.000	L1	ON	20
15.88	---	24.54	50.00	25.46	70.0	9.000	L1	ON	20

Remark: Correct factor=cable loss + LISN factor

L line

Conducted Emission from 150 KHz to 30 MHz

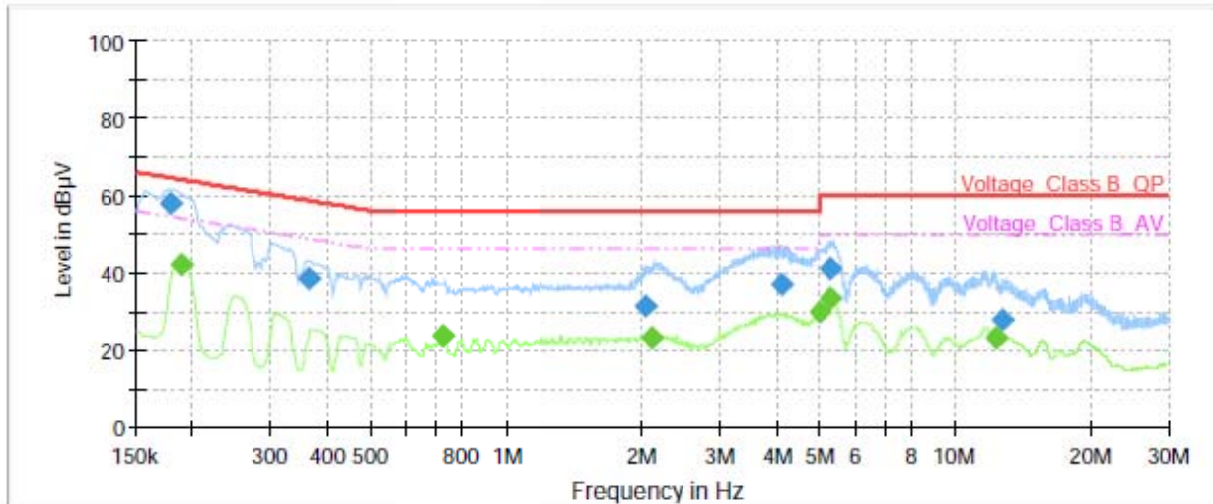

Frequency (MHz)	QuasiPeak (dBµV)	Average (dBµV)	Limit (dBµV)	Margin (dB)	Meas. Time (ms)	Bandwidth (kHz)	Line	Filter	Corr. (dB)
0.18	57.94	---	64.52	6.58	70.0	9.000	N	ON	21
0.19	---	42.26	54.11	11.85	70.0	9.000	N	ON	21
0.36	38.61	---	58.64	20.03	70.0	9.000	N	ON	21
0.72	---	23.54	46.00	22.46	70.0	9.000	N	ON	20
2.05	31.27	---	56.00	24.73	70.0	9.000	N	ON	20
2.12	---	23.32	46.00	22.68	70.0	9.000	N	ON	20
4.12	36.85	---	56.00	19.15	70.0	9.000	N	ON	19
5.00	---	29.89	46.00	16.11	70.0	9.000	N	ON	19
5.31	40.89	---	60.00	19.11	70.0	9.000	N	ON	19
5.31	---	33.21	50.00	16.79	70.0	9.000	N	ON	19
12.41	---	23.31	50.00	26.69	70.0	9.000	N	ON	20
12.76	27.62	---	60.00	32.38	70.0	9.000	N	ON	20

Remark: Correct factor=cable loss + LISN factor

N line

Conducted Emission from 150 KHz to 30 MHz

4 Main Test Instruments

Name	Manufacturer	Type	Serial Number	Calibration Date	Expiration Time
Spectrum Analyzer	R&S	FSV40	15195-01-00	2021-05-15	2022-05-14
EMI Test Receiver	R&S	ESCI	100948	2021-05-15	2022-05-14
Trilog Antenna	SCHWARZBECK	VULB 9163	391	2019-12-16	2022-12-15
Horn Antenna	R&S	HF907	102723	2020-08-11	2023-08-10
Horn Antenna	ETS-Lindgren	3160-09	00102643	2021-10-10	2024-10-09
EMI Test Receiver	R&S	ESR	101667	2021-05-16	2022-05-15
LISN	R&S	ENV216	101171	2018-12-15	2021-12-14
Bore Sight Antenna mast	ETS	2171B	00058752	/	/
Test software	EMC32	R&S	9.26.0	/	/

*****END OF REPORT *****



ANNEX A: The EUT Appearance

The EUT Appearance are submitted separately.



ANNEX B: Test Setup Photos

The Test Setup Photos are submitted separately.



ANNEX C: Product Change Description

The Product Change Description are submitted separately.