

## Systems Reference Library

### IBM 1130 Disk Monitor System Reference Manual

This publication describes Version 1 of the 1130 Disk Monitor, a combined operating and programming system. This system includes a Supervisor program, a Disk Utility program, a symbolic assembler, a FORTRAN compiler, and a subroutine library. The latter four programs operate under control of the Supervisor program to provide continuous operation.

IBM-supplied subroutine library contains routines for input input/output, conversion, and arithmetic functions.

## PREFACE

The IBM 1130 Disk Monitor System, a collective name for five distinct but interdependent programs - Supervisor, Disk Utility, assembler, FORTRAN, and subroutine library - is a powerful, combined operating and programming system.

This system should be distinguished from IBM 1130 Disk Monitor System, Version 2, which is a separate system. All references to the Monitor System made in this manual concern Version 1. Readers desiring information on Version 2 are referred to its pertinent manuals.

The programs that make up the Monitor System use advanced programming techniques, including relocatable subroutines, highly compressed formats for data and programs, and flexible input and output command structures which facilitate data conversion operations. A unique feature of the 1130 Monitor System is the "floating" boundary between the user program/data file area and the disk Working Storage area. As information is added to disk storage in the User area, the Working Storage area is decreased in size. Conversely, if a program or data file is deleted from disk storage User area, the remaining programs are packed, and the disk Working Storage area is increased in size.

The following publications may assist the user in utilizing the system:

- IBM 1130 Functional Characteristics, Form A26-5881
- IBM 1130 FORTRAN Language, Form C26-5933
- IBM 1130 Assembler Language, Form C26-5927
- IBM 1130 Subroutine Library, Form C26-5929

Throughout this publication all references to locations in storage are in hexadecimal unless otherwise noted; therefore, the subscript 16 has been omitted.

### Machine Requirements

The minimum machine features and units required for operation of the Monitor System are:

- IBM 1131 Central Processing Unit, Model 2, with a minimum of 4096 words of core storage
- IBM 1134 Paper Tape Reader and an IBM 1055 Paper Tape Punch, or an IBM 1442 Card Read Punch.

If both the 1442 Card Read Punch and 1134/1055 paper tape units are included, the 1442 Card Read Punch will be the principal I/O device. If an 1132 Printer is included, it will be the principal print device; otherwise the console printer will be the principal print device.

### Third Edition

This is a major revision of, and obsoletes, C26-3650-1 and Technical Newsletter N26-0540. This manual is updated to correspond with Version 1, Modification Level 6, of the IBM 1130 Disk Monitor System. Changes to the text are indicated by a vertical line to the left of the change; revised illustrations are denoted by a bullet (●) to the left of the caption.

Specifications contained herein are subject to change from time to time. Any such change will be reported in subsequent revisions or Technical Newsletters.

Copies of this and other IBM publications can be obtained through IBM Branch Offices. A form has been provided at the back of this publication for reader's comments. If the form has been detached, comments may be directed to IBM Nordic Laboratory, Box 962, Lidingsö 9, Sweden.

## CONTENTS

IBM 1130 DISK MONITOR SYSTEM - INTRODUCTION . . . . .	1	PAPER TAPE MONITOR SYSTEM . . . . .	45
DISK STORAGE LAYOUT . . . . .	3	DPIR Paper Tape Load Operating Procedures . . . . .	45
IBM Systems Area . . . . .	3	Procedure for Initializing Disk Monitor System	
User Storage Area . . . . .	4	from Paper Tape . . . . .	45
Working Storage Area . . . . .	5	Cold Start Operating Procedure . . . . .	46
File Protection . . . . .	5	Paper Tape Control Records . . . . .	46
SUPERVISOR PROGRAM . . . . .	7	APPENDIX A. ERROR MESSAGES . . . . .	47
Skeleton Supervisor . . . . .	7	APPENDIX B. DATA FORMATS . . . . .	57
Monitor Control Record Analyzer . . . . .	7	Disk System Format (DSF) . . . . .	57
Monitor Control Records . . . . .	7	Disk Core Image Format (DCI) . . . . .	59
Supervisor Control Records . . . . .	10	Disk Data Format (DDF) . . . . .	59
Stacked Input Arrangement . . . . .	12	Card System Format (CDS) . . . . .	59
The Loader . . . . .	12	Card Data Format (CDD) . . . . .	61
DISK UTILITY PROGRAM (DUP) . . . . .	17	Print Data Format (PRD) . . . . .	61
DUP Control Records . . . . .	17	Paper Tape System (PTS) and Paper Tape Data	
DUP Messages . . . . .	24	(PTD) Formats . . . . .	61
DUP Operating Notes . . . . .	25	APPENDIX C. DISK STORAGE UNIT CONVERSION	
ASSEMBLER . . . . .	26	FACTORS . . . . .	63
Assembler Control Records . . . . .	26	APPENDIX D. SUPERVISOR AND DUP INPUT/OUTPUT	
Origin of Source Program . . . . .	28	CHARACTER CODES . . . . .	64
Assembler Paper Tape Format . . . . .	28	APPENDIX E. 1130 SUBROUTINE LIBRARY LISTING . . . . .	65
Assembler Messages and Error Codes . . . . .	29	APPENDIX F. IN-CORE COMMUNICATIONS AREA	
Assembler Operating Procedures . . . . .	29	(COMMA) . . . . .	70
FORTRAN COMPILER . . . . .	32	APPENDIX G. LAYOUT OF LET/FLET ENTRIES . . . . .	74
FORTRAN Control Records . . . . .	32	Three-Word Entries . . . . .	74
FORTRAN Printouts . . . . .	34	Six-Word Entries . . . . .	74
//* Records at FORTRAN Execution Time . . . . .	35	APPENDIX H. IBM00 (1130 DISK MONITOR SYSTEM	
Keyboard Input of Data Records . . . . .	35.1	MAINTENANCE PROGRAM) . . . . .	75
Object Program Paper Tape Data Record Format . . . . .	35.1	System Program Maintenance . . . . .	75
FORTRAN I/O Errors . . . . .	35.1	IBM Subroutine Library Maintenance . . . . .	76
FORTRAN Programming Notes . . . . .	35.1	Operating Procedures . . . . .	77
SUBROUTINE LIBRARY . . . . .	36	Error Messages . . . . .	77
Pre-Operative Errors . . . . .	36	APPENDIX I. UTILITY ROUTINES . . . . .	78
Card Subroutine (CARD0 and CARD1) Errors . . . . .	36	Console Printer Core Dump . . . . .	78
Console Printer Subroutine (TYPE0 and WRTY0)		1132 Printer Core Dump . . . . .	78
Errors . . . . .	38	Disk Dump Routines . . . . .	79
Keyboard Subroutine (TYPE0) Functions . . . . .	38	Paper Tape Reproducing Routine . . . . .	80
Paper Tape Subroutines (PAPT) . . . . .	39	Paper Tape Utility . . . . .	81
Adding and Removing Subroutines . . . . .	39	APPENDIX J. SAMPLE PROGRAM OUTPUT . . . . .	84
SYSTEM GENERATION OPERATING PROCEDURES		APPENDIX K. GLOSSARY . . . . .	89
(CARD SYSTEM) . . . . .	40	APPENDIX L. DECIMAL AND HEXADECIMAL DISK	
Disk Pack Initialization Routine (DPIR) . . . . .	40	ADDRESSES . . . . .	93
User-Supplied Cards . . . . .	41	INDEX . . . . .	94
Procedure for Initializing Disk Monitor System			
from Cards . . . . .	43		
Cold Start Operating Procedure . . . . .	44		

## ILLUSTRATIONS

### Figures

1.	1130 Disk Monitor System . . . . .	1	11.	Disk System Format . . . . .	57
2.	Disk Storage Layout . . . . .	3	12.	Card Data Format . . . . .	62
3.	Processing Input Data Under Supervisor Control . . . . .	8	13.	Print Data Format . . . . .	62
4.	Example of Stacked Input (One Job) . . . . .	13	14.	Control Records and Data Organization (in Card Form) for Monitor Program and Subroutine Library Maintenance . . . . .	75
5.	Example of Stacked Input (Three Jobs) . . . . .	14	15.	Typeouts for 1130 Monitor System Maintenance Program . . . . .	77
6.	Layout of Object-Time Transfer Vector Area . . . . .	15	16.	PTUTL Sense Switch Options . . . . .	83
7.	Output Format from a DUMPLET Operation (LET) . . . . .	22			
8.	Output Format from a DUMPLET Operation (FLET) . . . . .	23			
9.	List Deck Format . . . . .	27			
10.	System Loader Card Sequence . . . . .	43			

### Tables

1.	Disk Storage Allocation . . . . .	3	13.	Cold Start Halt Addresses . . . . .	44
2.	Summary of Monitor Control Records . . . . .	9	A-1.	System Loader Error Codes . . . . .	47
3.	Movement of Information Using DUP Control Records . . . . .	19	A-2.	System Loader Wait Locations (Part 1) . . . . .	48
4.	Summary of DUP Control Records . . . . .	20	A-3.	System Loader Wait Locations (Part 2) . . . . .	48
5.	Restrictions on DUP Functions in Temporary Mode (JOB T) . . . . .	20	A-4.	Monitor Supervisor Error Messages . . . . .	48
6.	Summary of Assembler Control Records . . . . .	26	A-5.	Monitor Supervisor Wait Locations . . . . .	49
7.	Assembler Error Detection Codes . . . . .	29	A-6.	Loader Messages/Error Messages . . . . .	50
8.	I/O Logical Unit Designations . . . . .	32	A-7.	Assembler Error Messages . . . . .	52
9.	Summary of FORTRAN Control Records . . . . .	33	A-8.	FORTRAN Error Codes . . . . .	53
10.	DPIR Halt Addresses . . . . .	41	A-9.	DUP Error Messages . . . . .	55
11.	Load Mode Control Card Format . . . . .	41	A-10.	DUP Waits and Loops . . . . .	56
12.	REQ Card Format . . . . .	42	A-11.	FORTRAN I/O Error Codes . . . . .	56
			H-1.	IBMOO Monitor System Maintenance Error Messages . . . . .	77

The 1130 Monitor is a disk-oriented system that allows the user to assemble, compile, and/or execute individual programs or a group of programs with a minimum of operator intervention. Jobs to be performed are stacked and separated by control records that identify the operation to be performed.

The Monitor System consists of five distinct but interdependent programs (see Figure 1):

- Supervisor program
- Disk Utility Program
- Assembler program
- FORTRAN compiler
- Subroutine library

The Supervisor program provides the necessary control for the stacked-job concept. It reads and analyzes the monitor control records, and transfers control to the proper program.

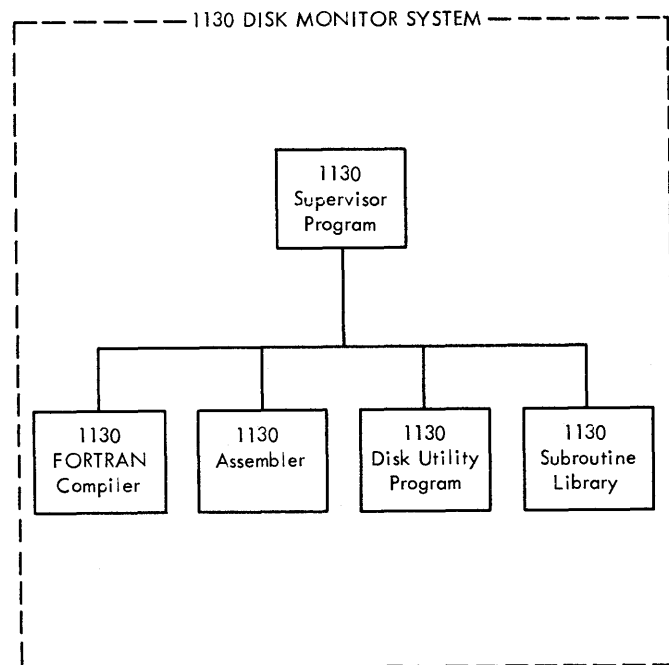

Figure 1. 1130 Disk Monitor System

The Disk Utility Program is a group of routines designed to assist the user in storing information (data and programs) on the disk, and retrieving and using the information stored.

The assembler program converts user-written symbolic-language source programs into machine-language object programs.

The FORTRAN compiler converts user-written FORTRAN-language source programs into machine-language object programs.

The subroutine library contains subroutines for data input/output, data conversion, and arithmetic functions.

The Monitor System coordinates program operations by establishing a communications area in memory which is used by the various programs that make up the Monitor System. It also guides the transfer of control between the various monitor programs and the user's programs. Operation is continuous and setup time is reduced to a minimum, thereby effecting a substantial time saving and allowing greater programming flexibility. The complete Monitor System resides on disk storage. Only those routines or programs required at any one time are transferred to core storage for execution. This feature minimizes the core storage requirements and permits segmenting of long programs.

In addition to decreasing the amount of operating time, the 1130 Disk Monitor System significantly reduces the amount of programming to be done by the user. This is made possible through the sharing of common subroutines by unrelated programs. For example, input/output or conversion operations are required by most user programs, regardless of whether the programs are written in the assembler language or in FORTRAN. IBM provides a library of subroutines as an integral part of the Monitor System.

The assembler and FORTRAN compiler facilitate development of a library of user programs. The object programs can be stored on cards or paper tape, as is customary in installations without disk storage. However, with disk storage, programs can be stored directly on disk without the necessity of designating actual storage locations, remembering or documenting the storage assignments, or updating the storage assignments and documentation as conditions change. The disk-stored programs

and data are referred to by name when called for use. The Monitor System, through the use of a table known as the Location Equivalence Table (LET), can locate any user program, subroutine, or file by a table search for the name. Stored with the name is the amount of disk storage (in disk blocks)\* required by the

program or data.

Any program that is added to the user's disk-stored programs is usually placed at the end of the other programs. If a program is deleted, the remaining programs are usually packed for effective utilization of disk storage. This packing facility is described later in this publication.

---

\*There are 16 disk blocks per sector; each disk block contains 20 data words (refer to Appendix C).

Disk Storage is divided into three logical areas: IBM Systems area, User Storage area, and Working Storage area. The contents of these three areas, described in detail in subsequent paragraphs, are shown in Figure 2. The sectors and cylinders that these areas occupy are shown in Table 1. Appendix C shows disk storage unit conversion factors.

**IBM SYSTEMS AREA**

This area contains the integral parts of the 1130 Disk Monitor System: the Supervisor program, Disk Utility Program (DUP), FORTRAN compiler, and the assembler. The FORTRAN compiler and/or the assembler can be deleted at the user's option.

Supervisor Program

This program supervises all monitor operations and performs the control and loading functions for the user programs and monitor programs (FORTRAN, Assembler, and DUP). The Supervisor is directed by monitor control records in the stacked input. Included within the Supervisor is the Skeleton Supervisor, which resides in core during monitor operation and provides the communications link between the monitor programs and the user's programs.

Table 1. Disk Storage Allocation

Use	Total Sectors	Sectors Occupied	Cylinders Occupied	Total Cylinders
Identification	1	0	0	1/8
Cold Start	1	1	0	1/8
DCOM	1	8	0	1/8
Supervisor	53	2-7, 9-55	0-6	6 5/8
DUP	72	56-127	7-15	9
FORTRAN	104	128-231	16-28	13
Assembler	40	232-271	29-33	5
CIB	24	272-295	34-36	3
LET	8	296-303	37	1
Remainder of User Area and Working Storage	1296	304-1599	38-199	162
	<u>1600</u>			<u>200</u>

Disk Utility Program (DUP)

DUP is a group of routines provided by IBM that aid the user in the day-to-day operation of his installation. By means of these routines, certain frequently required operations, such as storing, deleting, and dumping data and/or programs from disk storage, can be performed with minimum programming effort by the user.

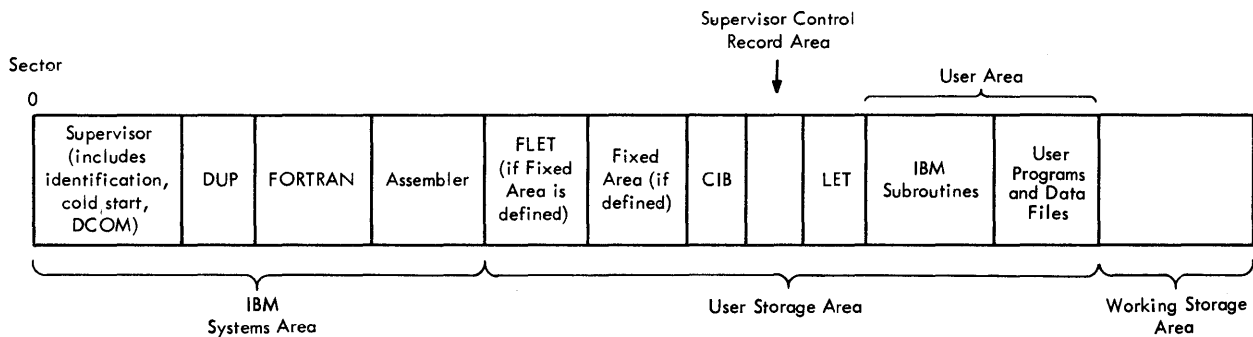

Figure 2. Disk Storage Layout

## FORTRAN Compiler

The compiler translates programs written in the FORTRAN language into machine language, and provides for calling the necessary arithmetic, functional, conversion, and input/output subroutines at execution time.

## Assembler

The assembler converts source programs written in the assembler language into machine language object programs. The conversion is one-for-one, that is, the assembler normally produces one machine language instruction for each instruction of the source program.

## USER STORAGE AREA

This area consists of the following:

- A Fixed area (optional) for storing core image programs and data. If a Fixed area is defined, there will also be a Fixed Location Equivalence Table (FLET).
- The Core Image Buffer (CIB)
- The Supervisor Control Record Area
- The Location Equivalence Table (LET)
- A User area for storing IBM-supplied subroutines, user-written programs, and data files

## Core Image Buffer (CIB)

Those parts of a core load (main program and associated subprograms) that fall below core location 4096<sub>10</sub> are put in the Core Image Buffer (CIB) as they are prepared for execution or for storing in core image format by the Loader (refer to DUP Control Records, \*STORECI). When all parts of program have been processed, either the contents of the CIB are read back into core storage by the Loader, which overlays itself in the process, or DUP is recalled from disk to core to complete the \*STORECI operation, using the CIB as source of any parts of the core load which are to reside below core location 4096<sub>10</sub>.

The CIB is also used by the Supervisor to save core locations 256<sub>10</sub>-4095<sub>10</sub> on every CALL LINK. Before each link is executed, the Loader restores any part of this area which has been included in the COMMON defined by the called link.

## Supervisor Control Record Area

This area is used by the system to store information for use by the Loader (refer to Supervisor Control Records).

## Location Equivalence Table (LET)

The Location Equivalence Table (LET) serves functionally as a "map" for the IBM subroutines, user's programs, and data files. Each subroutine, user's program, or data file that is stored on disk has at least one entry in the table. The table entry contains the name and disk block length of the subroutine, program, or data file. Each entry point in a subroutine requires a separate entry in LET. The user may print the contents of LET by using the DUP control record DUMPLET (refer to DUP Control Records).

## User Area

As each user-written program or data file is added to the User area, the space available for the Working Storage area decreases. Conversely, if a program is deleted, the Working Storage area increases by the amount of space the program formerly occupied in the User area. For example, user-written programs A, B, and C are stored on disk as follows:

CIB	LET	IBM-supplied subroutines	Program A	Program B	Program C	Working Storage Area
-----	-----	--------------------------	-----------	-----------	-----------	----------------------

If a program, D, is created, it would be stored on disk causing the Working Storage area to contract:

CIB	LET	IBM-supplied subroutines	Program A	Program B	Program C	Program D	Working Storage Area
-----	-----	--------------------------	-----------	-----------	-----------	-----------	----------------------

If Program A is now deleted, Programs B, C, and D would be moved up, maintaining a packed



condition in the User area while expanding the Working Storage area:

CIB	LET	IBM-supplied subroutines	Program B	Program C	Program D	Working Storage Area
-----	-----	--------------------------	-----------	-----------	-----------	----------------------

NOTE 1: Core Image programs and data files are always put on disk at the beginning of a sector, and remain at the beginning of a sector even after packing. Disk System format programs start at the beginning of a disk block.

NOTE 2: The Working Storage area always starts at the beginning of a sector; therefore, it might not expand or contract by the exact size of the program stored or deleted.

### IBM-Supplied Subroutine Library

The IBM-supplied subroutine library contains input/output, data conversion, arithmetic and functional, and selective dump subroutines. These subroutines are generally available for use with both the assembler and the FORTRAN compiler. Operating procedures are described in a subsequent section of this manual. Appendix E contains a complete list of all IBM-supplied subroutines.

### Flipper Routine

The subroutine library includes a Flipper routine, which is a part of the core load for those user's programs that use LOCAL (Load-on-Call) routines (refer to Supervisor Control Records). When a LOCAL routine is called, control is passed to the Flipper routine, which reads the LOCAL into core storage if it is not already in core and transfers control to it. All LOCALs in a given core load are executed from the same core storage locations; each LOCAL overlays the previous one. All LOCALs required by a program are relocated and stored by the Loader in Working Storage immediately following the last defined file, if any.

### Fixed Area

The Fixed area is an optional area that the user can define to enable him to store programs and data files at fixed disk locations. The user can define the size of the Fixed area to be a whole number of

cylinders, with a minimum of two, and he can increment (but not decrease) the size of the Fixed area by a whole number of cylinders at any time. Unlike in the User area, when a program or data file is deleted from the Fixed area no packing occurs. Thus, programs or data files in this area can be referenced by absolute sector addresses, since they will not be moved. The Fixed area, if any has been defined, requires a LET of its own, i.e., a Fixed Location Equivalence Table (FLET). The contents of FLET may also be printed by using the DUP control record DUMPLET. The Fixed area is used only for the storage of core image programs and data, and not for Disk System format programs or for working storage.

### WORKING STORAGE AREA

The Working Storage area is used for temporary storage. Most of the area is available to the user during execution of his programs. The Loader stores LOCALs (Load-on-Call routines) and SOCALs (system overlays) in this area, and it is also used extensively by the monitor programs (see Working Storage Indicator Word). For example, the assembler uses this area for temporary storage of a program during the assembly process; at the conclusion of an assembly or compilation, the object program is in the Working Storage area.

The assembler requires 32 sectors of Working Storage for possible symbol table overflow during an assembly, plus whatever additional Working Storage is required for disk output (compressed source statements in Pass 1, object program in Pass 2). Since an assembly requires at least one sector for disk output, the assembler checks for the availability of 33 sectors of Working Storage before beginning to assemble the source program. If at least 33 sectors are not available, an assembler error message is printed (refer to Appendix A), the assembly is terminated, and control is returned to the Supervisor.

During a FORTRAN compilation, FORTRAN requires the amount of Working Storage necessary to contain the compiled program.

### FILE PROTECTION

The 1130 Disk Monitor System controls file protection. All Disk I/O subroutines furnished by

IBM check the address of the sector on which they have been instructed to write to ensure that it is greater than the file protection address in COMMA (refer to Appendix F), with the exception of the Write Immediate function (described in IBM 1130 Subroutine Library, Form C26-5929). The file protection address, which is equal to the starting address of Working Storage, is updated by DUP

whenever a program is added to the User area.

Only data files which have been created in or moved into Working Storage can be written into by assembly-language programs (unless the Write Immediate function is used). FORTRAN programs may write directly into User and Fixed areas (refer to \*FILES under Supervisor Control Records).

The Supervisor program performs the control and loading functions for the Monitor System. Monitor control records, which are used to direct the sequence of jobs without operator intervention, are included in a stacked input arrangement and are processed by the Supervisor program. The Supervisor program decodes the monitor control record and calls the proper monitor program to perform the desired operation. A typical sequence of operations is listed below. The programs in parentheses would be called by the Supervisor to perform the particular operation:

1. Compilation of a FORTRAN program (FORTRAN compiler)
2. Storage of the compiled program on disk (Disk Utility Program)
3. Assembly of a symbolic program (Assembler)
4. Storage of the assembled program on disk (Disk Utility Program)
5. Execution of a disk-stored program (Loader)
6. Punching of a disk-stored program into cards (Disk Utility Program)

The Supervisor itself is a group of several distinct but closely related routines:

- Skeleton Supervisor
- Monitor Control Record Analyzer
- Loader
- Cold Start Routine

#### SKELETON SUPERVISOR

The Skeleton Supervisor provides the communications link between the monitor programs and the user's programs, i. e., it contains the necessary logic to conduct the transition from one job to another. The Skeleton Supervisor is read into core storage when the operation of the monitor is initially started by means of the Cold Start Routine (refer to Cold Start Operating Procedure), which occupies sector 1. The Disk Communications Area

(DCOM), which contains addresses and indicators necessary for the operation of the monitor, is read into core initially with the Skeleton Supervisor. The in-core communications area (referred to as COMMA) is restored from DCOM whenever a Cold Start procedure is initiated or a JOB record is encountered (refer to Monitor Control Records). When COMMA is restored there will be no usable program in Working Storage. Appendix F lists all the core locations and information contained in COMMA.

#### MONITOR CONTROL RECORD ANALYZER

This routine analyzes the monitor control records, prints out the information contained in the control record, and calls the appropriate program: Disk Utility Program, Assembler, FORTRAN compiler, or Loader.

The following three formats are used by the Monitor System to store information on disk (refer to Appendix B):

- Disk Core Image Format (DCI)
- Disk System Format (DSF)
- Disk Data Format (DDF)

#### MONITOR CONTROL RECORDS

Input to the Supervisor consists of one or more job decks, each preceded by a JOB monitor control record (see Figure 3). The character codes recognized by the Supervisor are listed in Appendix D. Although the monitor control records are described in terms of cards, these records can be entered in card image form from paper tape or the keyboard/console printer.

The JOB control record defines the starting and ending points of the job; however, the total job can consist of many subjobs. The assembler, FORTRAN compiler, Disk Utility Program, and user's programs can be called for operation by the ASM, FOR, DUP, and XEQ control records,

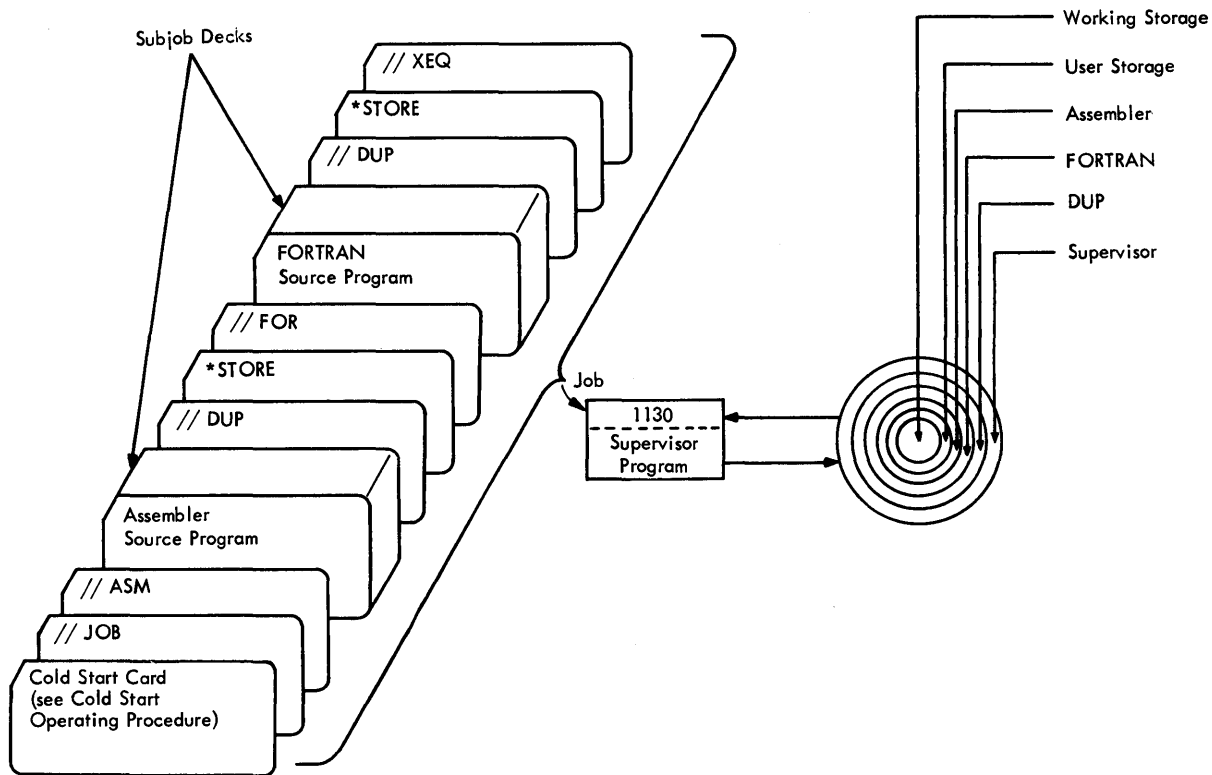

● Figure 3. Processing Input Data Under Supervisor Control

respectively. These are each considered individual subjobs. The successful completion of the total job depends on the successful completion of each individual subjob within the job. Some subjobs are not attempted if the preceding subjobs have not been successfully completed.

When a monitor control record is read, the system program required to do the subjob is read into core storage from disk storage. The program then processes input until the end of the subjob deck is reached, a new monitor control record is encountered, or an error occurs. Monitor error messages are described in Appendix A.

Every job is assumed to begin with no programs in Working Storage (see Working Storage Indicator Word).

Control can be returned to the Supervisor by manually branching to core location 0038. The

Supervisor then passes records until it encounters a monitor control record. All monitor control records have the following format:

- Columns 1-2: // (slashes, to identify monitor control record)
- 3: b (blank)
- 4-7: Pseudo-operation code (left-justified)

The following paragraphs contain a list of the codes and their operations. The monitor control records are summarized in Table 2.

NOTE: Comments are permitted in unspecified columns in all monitor control records. A "b" appearing in a column means that the column must be blank.

Table 2. Summary of Monitor Control Records

CC	1	2	3	4	5	6	7	8	9	10	11	12	13	14	15	16	17	18	19		
/	/	b	*	comments																	
/	/	b	J	O	B	T	— Disk Storage Label—														Initialize a job sequence
/	/	b	A	S	M															Read assembler into core for execution	
/	/	b	F	O	R															Read FORTRAN into core for execution	
/	/	b	P	A	U	S															Halt until START is pressed
/	/	b	T	Y	P															Change control record input from principal input unit to keyboard/console printer for succeeding monitor control records	
/	/	b	T	E	N	D															Change input mode from keyboard/console printer back to the principal unit for succeeding monitor control records
/	/	b	D	U	P															Read DUP into core for execution	
/	/	b	X	E	Q	— Program Name —		L	-Count-	Disk 0, 1, N										Read and transfer control to mainline program	

### JOB

This record causes initialization and termination of a job sequence and restores COMMA from DCOM. The format is

```
cc 1 2 3 4 5 6 7 8 9 10 11 12 13 14 15 16
   / / b J O B b T       I D E N T b
```

The letter T in column 8 indicates temporary mode. In this mode, programs or data files stored in the User area by DUP are automatically deleted at the end of the current job. DUP operations which are permitted in temporary mode are described in Table 5.

If columns 11-15 contain a disk storage identification, this identification is compared with that which is written on the first sector of the disk cartridge to determine that the desired cartridge is mounted. If the identification is not the same, the Supervisor waits for operator intervention (see Appendix A, Table A-5, Monitor Supervisor Wait Locations). The identifier must be left-justified in its field.

This record also causes a skip to channel 1 before it is printed on an 1132 Printer.

### ASM

This record causes the assembler to be read into core storage for execution. The format is

```
cc 1 2 3 4 5 6
   / / b A S M
```

The assembler control records and source statements for the program to be assembled must follow the ASM control record.

### FOR

This record causes the FORTRAN compiler to be read into core storage for execution. The format is

```
cc 1 2 3 4 5 6
   / / b F O R
```

The FORTRAN control records and source statements for the program to be compiled must follow the FOR control record.

### PAUS

This record causes a wait to allow the operator to make setup changes (see Appendix A, Table A-5, Monitor Supervisor Wait Locations). The format is

```
cc 1 2 3 4 5 6 7
   / / b P A U S
```

The monitor operation proceeds as soon as PROGRAM START is pressed.

### TYP

This record changes the control record input from the principal input unit to the keyboard/console

printer for succeeding monitor (only) control records. The format is

```
cc 1 2 3 4 5 6
   / / b T Y P
```

### TEND

This record changes the input mode from the keyboard/console printer back to the principal input unit for succeeding monitor control records. The format is

```
cc 1 2 3 4 5 6 7
   / / b T E N D
```

### DUP

This record causes the Disk Utility Program to be read into core storage for execution. The format is

```
cc 1 2 3 4 5 6
   / / b D U P
```

Control records for the Disk Utility Program must follow the DUP control record.

### XEQ

This record causes the Loader to load a specified mainline program into core storage and to transfer control to it. The format is

```
cc 1 2 3 4 5 6 7 8 9 10 11 12 13 14 15 16 17 18 19 20
   / / b X E Q b X X X X X b L Y Y Z b
```

The mainline program XXXXX must be left-justified in columns 8-12. If XXXXX is in Disk System format, the Loader converts it to Core Image format. If columns 8-12 are blank, the mainline program presently stored in Working Storage (by FORTRAN, DUP, or the assembler) is converted and read into core and executed.

A core map is printed during conversion if column 14 contains an L and the program is in Disk System format. This map includes the core loading address of the mainline program, the

names and execution addresses of all subroutines and subprograms included in the load, file allocations, if any, giving file number, sector address, and number of sectors in the file. Also, if L is specified, a core map is printed for any DSF program linked to under this execution.

Columns 16-17 must contain the count of LOCAL, NOCAL, and FILES records which follow, if any (refer to Supervisor Control Records). This count is decimal, right-justified.

DISK 0, 1, or N will be loaded with the program if column 19 contains 0, 1, or N, respectively. Any other character (including blanks) causes a special, shorter disk routine (DISKZ) to be loaded. This special version is intended for all FORTRAN programs; it is also intended for assembly-language programs which do not use the disk.

### Comments

This record provides comments in the listing. It may not immediately follow an XEQ, DUP, ASM, or FOR record. The format is

```
cc 1 2 3 4 5 - 80
   / / b * comments
```

## SUPERVISOR CONTROL RECORDS

### LOCAL

LOCAL is an acronym denoting routines specified by the user to be loaded into a LOCAL overlay area as they are called. All subroutines desired by the user to be loaded on call at execution time must be designated by LOCAL records following the XEQ monitor control record. The format is as follows:

```
cc 1
   *LOCALML1,SUB1,SUB2
```

where ML1 = name of a mainline program to be executed, and SUB1 and SUB2 are subroutines in the mainline program.

Each mainline program (in the same XEQ subjob) that calls a subroutine to be loaded on call must have its own LOCAL record. The same mainline program may have more than one LOCAL record.

For example:

```
*LOCALML1,SUB1,SUB2
*LOCALML2,SUB3,SUB4      or   *LOCALML1,SUB1,SUB2,SUB5
*LOCALML1,SUB5           *LOCALML2,SUB3,SUB4
```

If the record ends with a comma, the next record is treated as a continuation. The mainline name is not repeated in a continuation, e. g. ,

```
*LOCALML1,SUB1,SUB2,
*LOCALSUB5
```

If the mainline program is executed from Working Storage, the mainline name must be omitted by putting a comma in column 7, e. g. ,

```
*LOCAL,SUB1,SUB2
```

No embedded blanks are allowed in a LOCAL record.

### NOCAL

NOCAL is an acronym denoting routines which, although not called anywhere in the core load, are to be included in the load. Most NOCALs would probably fall into one of the following categories: (1) debugging aids such as dump and trace routines which the operator branches to manually, and (2) interrupt service routines.

All subroutines which are to be loaded but are not called at execution time must be designated by NOCAL records following the XEQ monitor control record. The format is as follows:

```
cc 1
*NOCALML1,SUB1,SUB2
```

NOCAL records are governed by the same rules and restrictions as LOCAL records.

NOTE: The user must observe the following rules in LOCAL and NOCAL records:

1. No routine can appear in a LOCAL record if it causes any of the other routines appearing in LOCAL records (for the same mainline program) to be called before the first LOCAL has returned control to the calling routine. Thus, a LOCAL cannot call another LOCAL, nor can it call a routine which causes a second LOCAL to be read into core and executed. For example, if A calls B and B calls C, and A is a LOCAL, then neither B nor C can

appear on a LOCAL record for the same mainline program.

2. If a given routine is designated a LOCAL, and the System Overlay scheme is employed, then this routine will be a LOCAL even though it might have been included in one of the System Overlays (SOCALs).
3. No program which uses LOCALs or NOCALs can be stored in Disk Core Image Format (DCI).
4. If a subroutine is designated a LOCAL, it will be loaded as a LOCAL even if it is not referenced anywhere in the core load.
5. The LOCAL information pertaining to any given XEQ record cannot exceed 640 words, counting all LOCAL names on the LOCAL records as two words and mainline program names as three words. The same rule applies to NOCAL information.
6. Only types 3, 4, 5, and 6 subroutines can appear on LOCAL and on NOCAL records (see Disk System Format, Program Types, in Appendix B).
7. All conversion tables, e. g. , EBPA, HOLTB, may not be used as LOCALs.

### FILES

File numbers specified in FORTRAN DEFINE FILE statements can be equated to:

1. names of data files in the User area or Fixed area at execution time by means of a FILES record entered after an XEQ monitor control record or
2. names of data files in the Fixed area by means of a FILES record entered after a DUP control record STORECI.

The format is as follows:

```
cc 1
*FILES(FILEN,NAMEN),(FILEM,NAMEM)
```

where FILEN and FILEM are the file numbers specified in FORTRAN DEFINE FILE statements, and NAMEN and NAMEM are names of disk storage data files which have been previously defined in a DUP control record.

No embedded blanks are allowed. If the record ends with a comma, the next record is treated as a continuation, e. g. ,

```
*FILES(FILEN,NAMEN),
*FILES(FILEM,NAMEM)
```

NOTE: The FILES information for a given XEQ record cannot exceed 640 words, counting the file numbers as one word and the file names as two words.

Any number of LOCAL, NOCAL, and FILES records can follow the XEQ monitor control record, but each type must be grouped together, e.g. ,

\*LOCAL  
\*LOCAL  
\*LOCAL  
\*NOCAL  
\*NOCAL  
\*FILES  
\*FILES

The following is not permitted:

\*LOCAL  
\*NOCAL  
\*LOCAL  
\*FILES  
\*NOCAL

#### STACKED INPUT ARRANGEMENT

Input to the Monitor System consists of control records, source programs, object programs, and data arranged logically by job.

The following points must be considered when arranging the input for any job.

1. Any number of comments records can be inserted in front of (but not immediately following) DUP, ASM, FOR, or XEQ monitor control records.
2. Any records other than monitor control records which remain after the execution of an ASM, FOR, or XEQ subjob are passed until the next monitor control record is read. After a DUP operation, records are passed until either a monitor control record or another DUP control record is read.
3. If an error is detected in an assembly, FORTRAN compilation, or during loading from Disk System format, the resulting object program or any programs that follow within the job cannot be executed. Also, if an error is detected in an assembly, FORTRAN compilation, or during a loading from Disk System format during a STORECI function, all DUP functions are bypassed until the next valid ASM, FOR, or JOB record is read.

4. If the FORTRAN compiler or the assembler encounters a monitor control record, control will be transferred to the Supervisor, i.e. , the monitor control record will be trapped. The Supervisor will correctly analyze the record after the compilation or assembly has been abandoned. DUP will not trap a monitor control record during a DUP operation (refer to DUP Control Records).

The stacked input arrangement shown in Figure 4 will compile, store, and execute both Programs A and B, providing there are no source program errors, and there is sufficient room in the Working Storage area (refer to Working Storage Area). A source program error causes the DUP STORE operation (refer to DUP Control Records) to be bypassed for that program, and all following XEQ requests preceding the next JOB record are disregarded. Thus, if the successful execution of one program depends upon the successful completion of the previous program, both programs should be considered as one job and the XEQ control records should not be separated by a JOB record.

Figure 5 shows the stacked input arrangement for three jobs which are not dependent upon each other.

Job A assembles, stores, and executes source program A. This job includes comments cards and a PAUS monitor control card to allow the operator to intervene.

Job B calls in the Disk Utility Program, and stores object program B on disk.

Job C compiles, stores, and executes FORTRAN source program C.

#### THE LOADER

The Loader has two basic functions:

1. To prepare entire core loads (Disk System format loading).
2. To bring core loads into core storage immediately before execution (Core Image format loading). This includes the restoration of COMMON, if any, between linked core loads.

These two loading processes are described after a discussion of the origin which the Loader gives a particular core load, the object-time transfer vector, and system overlays (SOCALs). Disk System format and Core Image format are described in Appendix B.



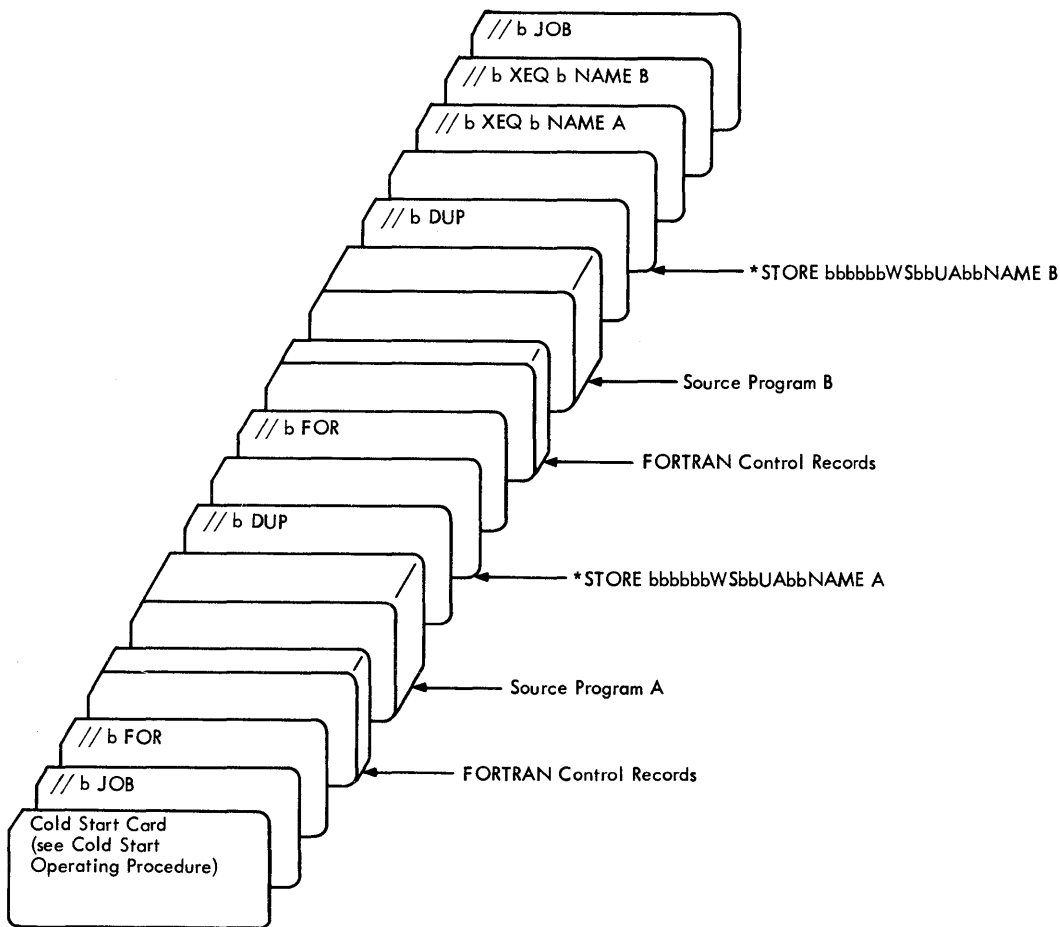

Figure 4. Example of Stacked Input (One Job)

Origins for Core Loads

The Loader origins relocatable mainlines (main programs) after the Disk I/O subroutine requested by the user on the XEQ control record. One of these disk routines is always in lower core, and no disk routine is included in any disk-stored core load. DISKZ is always used unless otherwise specified. The origins used by the Loader are shown below:

<u>Disk I/O Version</u>	<u>Main Program Origin</u> (hexadecimal) (decimal)	
DISKZ	01C2	450
DISK0	0260	608
DISK1	0370	880
DISKN	0438	1080

The origins for absolute mainlines are not controlled by the Loader; however, such mainlines must be originated above the end of the Disk I/O version used. All references in a core load to a Disk I/O subroutine must be to the same one.

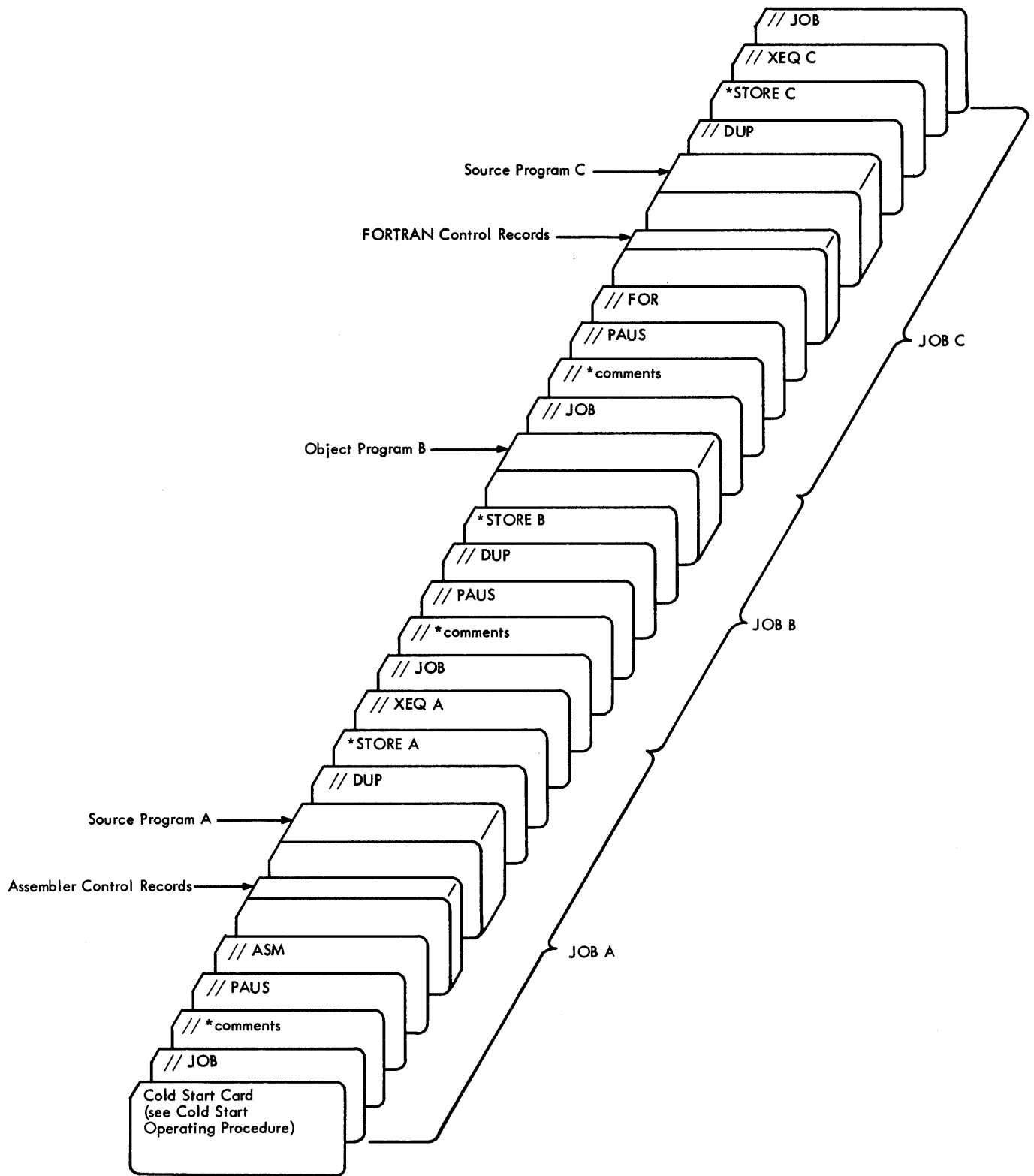

● Figure 5. Example of Stacked Input (Three Jobs)

## Object-time Transfer Vector

In order to transfer to and from subroutines at execution time, the Loader builds two separate object-time transfer vectors: the CALL TV and the LIBF TV (see Figure 6).

Each CALL TV entry is a single word containing the absolute address of a subprogram entry point; however, in the case of a LOCAL subprogram referenced by a CALL statement, the absolute address is the address of the corresponding Flipper Table entry instead of the subprogram entry point.

Each LIBF TV entry consists of three words. Word one is the link word. Words two and three contain a branch instruction to the subprogram entry point; however, in the case of a LOCAL subprogram referenced by an LIBF statement, words two and three contain a branch instruction to the corresponding Flipper Table entry instead of the subprogram entry point.

The first two LIBF TV entries are special entries, each three words long. The first entry is the Floating Accumulator (FAC). The address of the first word of FAC must be odd; therefore, if necessary, a dummy entry is made in the CALL TV to make FAC begin at an odd address. The second special entry is used by certain subroutines to indicate overflow, underflow, and divide check.

If SOCALs are used, the LIBF TV contains special entries for SOCAL subprograms referenced by LIBF statements. These entries transfer indirectly either to the referenced subprogram if the overlay containing the subprogram is presently loaded, or to the SOCAL Flipper in order to load the required overlay and transfer to the referenced subprogram (refer to System Overlays).

The CALL TV does not contain entries for SOCAL subprograms referenced by CALL statements if SOCALs are used.

## System Overlays (SOCALs)

System Overlays (SOCALs) are created for any core load with a FORTRAN mainline program if the core load will not fit into core. The Loader selects certain subroutines used in the core load and writes them into Working Storage in either two or three groups (overlays). An area in core as large as the largest overlay is reserved for these subroutines. Whenever a subroutine in one of these overlays is required during program execution, the corresponding overlay is read from the disk into the overlay area in core (if it is not already in core).

Overlays are constructed from the IBM subroutine library according to type and subtype (described in Appendix B). The user can alter this design by changing the subtypes of the library subroutines, or by specifying a subtype for his own subroutines (refer to DUP Control Records—STORE). The two levels of SOCALs are described in the following paragraphs.

SOCAL Level 1 uses the following two overlays:

1. Type 3, subtype 2 (arithmetics, e.g., FADD), and Type 4, subtype 8 (functionals, e.g., SIN).

**NOTE:** If the FORTRAN program contains a write statement to the plotter, the arithmetic and functional subroutines EADD, FADD, EMPY, FMPY, FARC, XMD, and XMDS cannot be included in the arithmetic and functional SOCAL. Instead, these routines must be in core. Due to plotter and disk interactions concerning overlap of I/O, print speeds may be less than previously achieved.

2. Type 3, subtype 3 (the non-disk FORTRAN Format subroutine SFIO, and the FORTRAN I/O subroutines, e.g., CARDZ).

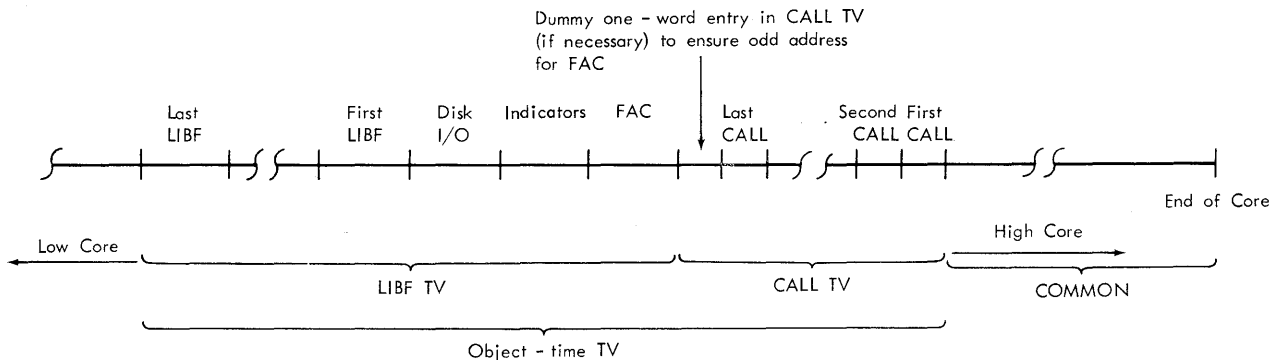

Figure 6. Layout of Object-Time Transfer Vector Area

Level 1 reduces the core requirements by an amount equal to the total size of the smaller of these overlays. Approximately 15 words of extra linkage, however, are required.

If core loads do not fit with Level 1, then Level 2, employing the following three overlays, is used:

1. Same as (1) above.
2. Same as (2) above.
3. Type 3, subtype 1 (disk FORTRAN I/O subroutines SDFND and SDFIO). In addition, this overlay includes a 320-word buffer.

Level 2 reduces the core requirements by an amount equal to the sum of the two smallest overlays, with approximately 15 words of extra linkage added.

The overlays will not contain all available subroutines of the specified types, but only those required by the core load.

Since LOCALs take priority over SOCALs, if a subroutine which would otherwise be in a SOCAL overlay is designated a LOCAL, it will appear as a LOCAL and not as part of a SOCAL.

If a core load does not fit with Level 2 overlays, core requirements may be reduced by additionally designating the following as LOCALs:

1. Subroutines not contained in any overlay.
2. Subroutines contained in the largest overlay. This reduces the SOCAL overlay area required in core.

If the core load does not fit into core even with SOCALs, an error condition is indicated. An error condition is also indicated for core loads which do not fit and which have mainline programs written in assembler language.

Programs requiring system overlays cannot be stored in Core Image format (refer to Appendix B, Disk Core Image Format).

NOTE: DISKZ and the SOCAL Flipper routine use Index Register 2 without saving or restoring it. It is, therefore, the programmer's responsibility to preserve the contents of Index Register 2 whenever a program uses subroutines that cause DISKZ to be used or subroutines that would be included in a SOCAL.

### Disk System Format Loading

A core load is built from programs stored in Disk System format in either of two cases:

1. To execute the core load immediately (called as a result of an XEQ control record or a CALL LINK). In this case control must be passed to the Core Image format loading process at the termination of the Disk System format loading process.
2. To store the core load in Disk Core Image format for future execution (called as a result of a DUP \*STORECI control record - refer to DUP Control Records). In this case, control is returned to DUP, which initiated the process.

In this type of loading, a mainline program (with its required subroutines) is converted from Disk System format to Core Image format. This includes the construction of the core image header record and the object-time transfer vector. Parts of the core load which are to reside below location 4096<sub>10</sub> are stored in the CIB; parts of the core load which are to reside above location 4095<sub>10</sub> (if any) are placed directly into core storage. LOCALs and SOCALs which are a part of the core load are also processed and written out on Working Storage (following the last data file, if any).

### Core Image Format Loading

In this loading process, the core load is read into core, except for the first sector. When loading a program immediately following its conversion from Disk System format, only the contents of the CIB are read into core (other parts of the core load are already in core). When loading a program which has previously been stored in Core Image format, both the sections above location 4095<sub>10</sub>, if any, and below 4096<sub>10</sub> are read into core. The Skeleton Supervisor is given the information necessary to enable it to read in the first sector of the core load and to move the object-time transfer vector into its location. Control is then passed to the Skeleton Supervisor, and finally to the object program.

The Disk Utility Program (DUP) is a group of routines designed to accomplish the following:

- Allocate disk storage as required by each program or data file to be stored
- Make these programs available in card or paper tape format
- Provide printed status of the User area, Fixed area, and Working Storage area.
- Perform various disk maintenance operations.

The Disk Utility Program is called into operation by a DUP monitor control record. This record may be followed by any number of DUP control records to select the routines desired. The DUP control records are described in subsequent paragraphs. The character codes recognized by DUP are listed in Appendix D.

Working Storage (WS) Indicator Word

A WS Indicator Word in COMMA (0069) contains the disk block count of the program to indicate that a valid program is in Working Storage. (There are 16 disk blocks in a sector.)

Upon completion of an assembly or compilation, the WS Indicator Word is set to the disk block count of the program left in Working Storage in Disk System format. If the user's program has put data in Working Storage, then the user must put the data disk block count into location 0069. DUP can then be called upon to store or dump this program.

When a DUP function is used to dump from the User area or the Fixed area, the WS Indicator Word is set to the disk block count of the program being moved. If the DUP function does not destroy any part of the program in Working Storage, the WS Indicator Word is not changed. It is set to zero by a store to the User area, a Cold Start, or a JOB monitor control record.

If a DUP function which involves programs is requested from Working Storage while the WS Indicator Word is zero, a FROM field error message is given and the requested function is bypassed.

DUP CONTROL RECORDS

DUP control records generally have the following format:

cc	1	2	3	4	5	6	7	8	9	10	11	12	13	14	15	16	17	18	19	20	21	22	23	24	25	26	27	28	29	30
*	Asterisk in cc 1	DUP Func- tion Name (cc 2 - 12)											"FROM" Device Symbol (cc 13 - 14)		"TO" Device Symbol (cc 17 - 18)		Program Name (cc 21 - 25)					Count Field								

All fields except Count Field are left-justified. Each DUP control record contains an asterisk (\*) in cc 1. The DUP Function Name is in cc 2 - 12. The "FROM" and "TO" symbols (cc 13 - 14 and 17 - 18, respectively) specify the I/O devices and/or disk areas from and to which data is to be transferred. The following abbreviations must be used in the FROM and TO fields:

Symbol	Meaning
PR	Principal Print Device
CD	Card Reader (if the Disk Monitor System has been loaded from paper tape, CD is equivalent to PT)
PT	Paper Tape
WS	Working Storage, Disk
UA	User area, Disk
FX	Fixed area, Disk

Program Name is one to five alphameric characters specifying the name of a mainline program or the first entry point in a subroutine.

The Count Field is in decimal, right-justified. For data files, if the source is disk, this field specifies the number of sectors; if the source is cards, this field specifies the number of cards; if the source is paper tape, this field specifies the number of records. Unspecified portions of DUP control records can be used for comments. A "b" appearing in a column indicates that the column must be blank.

In the following paragraphs, each DUP function name is accompanied by a table showing the symbol combinations that may be specified in the FROM and TO fields. The tables also show the various formats that data can be in before the operation, and the corresponding formats to which this data is converted by DUP after the operation. These formats appear in parentheses after the FROM and TO symbols, and have the following meanings:

DSF	Disk System Format
DCI	Disk Core Image Format
DDF	Disk Data Format
CDS	Card System Format
CDD	Card Data Format
PTS	Paper Tape System Format
PTD	Paper Tape Data Format
PRD	Print Data Format

These formats are shown in Appendix B. Table 3 summarizes the DUP functions that move information from one area to another; Table 4 summarizes all DUP control records; and Table 5 gives the restrictions on DUP functions when in temporary mode (JOB T).

### DUMP (Dump Program)

The DUMP routine dumps (unloads) information from the User area, Fixed area, or Working Storage area to cards, paper tape, or printer, or from the User or Fixed area to the Working Storage area. The decimal number of disk blocks dumped is specified in the corresponding LET entry or in the WS Indicator Word.

	From	To	CD (CDS)	CD (CDD)	PT (PTS)	PT (PTD)	PR (PRD)	WS (DSF)	WS (DDF)
WS (DSF)			X		X		X		
(DSF)			X		X		X	X	
UA (DDF)			X	X	X	X	X		X
(DCI)			X		X	X	X		X
FX (DCI)			X	X	X	X	X		X
(DDF)			X		X	X	X		X

The control record format is as follows:

```
cc
1 2 3 4 5 6 7 8 9 10 11 12 13 14 15 16 17 18 19 20 21 22 23 24 25 26 27 28 29 30
* DUMPb      "FROM"  "TO"  Program Name
              Symbol   Symbol  (required except for WS to PR)
```

NOTE 1: If the DUMP is from WS, and the WS Indicator is zero, a FROM field error message is given (refer to Appendix A).

NOTE 2: When the DUMP is to cards, each card is checked to see that it is blank before it is punched (refer to Appendix A).

NOTE 3: At the end of DUMP operations, all subsequent blank cards are selected into Stacker 2.

### DUMPDATA (Dump Data)

The DUMPDATA routine dumps data from the User area, Fixed area, or Working Storage area to cards, paper tape, or printer, or from the User or Fixed area to the Working Storage area. The number of sectors to dump must be specified by the count field. This number of sectors will be dumped regardless of the length of the specified data file or program.

	From	To	CD (CDD)	PT (PTD)	PR (PRD)	WS (DDF)
WS (DSF)			X	X	X	
(DDF)			X	X	X	
UA (DSF)			X	X	X	X
(DDF)			X	X	X	X
(DCI)			X	X	X	X
FX (DCI)			X	X	X	X
(DDF)			X	X	X	X

The control record format is as follows:

```
cc
1 2 3 4 5 6 7 8 9 10 11 12 13 14 15 16 17 18 19 20 21 22 23 24 25 26 27 28 29 30
* DUMPDATA b "FROM" "TO" Program Name Sector Count
              Symbol   Symbol  (required except for WS to PR) (when dumping from WS, the sector count overrides the WS Indicator)
```

NOTE 1: When the dump is to cards, each card is checked to see that it is blank before it is punched (refer to Appendix A).

NOTE 2: At the end of DUMPDATA operations, all subsequent blank cards are selected into Stacker 2.

Table 3. Movement of Information Using DUP Control Records

From To		UA			FX			WS		CD		PT		PR
		(DSF)	(DDF)	(DCI)	(DSF)	(DDF)	(DCI)	(DSF)	(DDF)	(CDD)	(CDS)	(PTD)	(PTS)	(PRD)
UA	(DSF)							DUMP**	DUMPDATA**	DUMPDATA**	DUMP**	DUMPDATA**	DUMP**	DUMP** DUMPDATA**
	(DDF)								DUMP** DUMPDATA**	DUMP** DUMPDATA**		DUMP** DUMPDATA**		DUMP** DUMPDATA**
	(DCI)								DUMP** DUMPDATA**	DUMP** DUMPDATA**		DUMP** DUMPDATA**		DUMP** DUMPDATA**
FX	(DCI)								DUMP** DUMPDATA**	DUMP** DUMPDATA**		DUMP** DUMPDATA**		DUMP** DUMPDATA**
	(DDF)								DUMP** DUMPDATA**	DUMP** DUMPDATA**		DUMP** DUMPDATA**		DUMP** DUMPDATA**
WS	(DSF)	STORE* STOREMOD		STORECI*			STORECI			DUMPDATA	DUMP	DUMPDATA	DUMP	DUMP DUMPDATA
	(DDF)		STOREDATA* STOREMOD			STOREDATA STOREMOD				DUMPDATA		DUMPDATA		DUMPDATA
CD	(CDD)		STOREDATA*			STOREDATA**			STOREDATA**					
	(CDS)	STORE*		STORECI			STORECI**	STORE**						
PT	(PTD)		STOREDATA*			STOREDATA**			STOREDATA**					
	(PTS)	STORE*		STORECI*			STORECI**	STORE**						

\*Eliminates stored information from Working Storage

\*\*Replaces current contents of Working Storage





DUP, the core image header and that portion of the program (excluding Disk I/O) that resides below core location 4096<sub>10</sub> are stored from the CIB, and that portion of the program above core location 4095<sub>10</sub>, if any, is stored from core. No COMMON area is stored, but the transfer vector is included. STORECI always requests a map from the Loader since it will not be available when the program is loaded from Core Image format.

From	To	UA (DCI)	FX (DCI)
CD (CDS)		X	X
WS (DSF)		X	X
PT (PTS)		X	X

The control record format is as follows:

cc	1	2	3	4	5	6	7	8	9	10	11	12	13	14	15	16	17	18	19	20	21	22	23	24	25	26	27	28	29	30
* STORECI								See Note 1	"FROM" Symbol		"TO" Symbol		Program Name (always re-quired)				See Note 2													

NOTE 1: Column 9 is used to specify the Disk I/O routine required by this program.

- 0 = DISK0
- 1 = DISK1
- N = DISKN
- Others = DISKZ (including blank)

NOTE 2: Count Field (cc 27-30) contains decimal count of \*FILES records that are required for program being stored. This number of records will be read before the normal STORECI function is performed.

NOTE 3: Data files named in the \*FILES record must be in the Fixed area.

NOTE 4: If the STORECI is from WS, and the WS Indicator is zero, an error message is given (refer to Appendix A).

### STOREDATA (Store Data)

The STOREDATA routine stores data from cards, Working Storage area, or paper tape to the User area, Fixed area, or Working Storage area. Each

data file starts at the beginning of the next available sector and the length is defined in whole numbers of sectors.

From	To	UA (DDF)	FX (DDF)	WS (DDF)
WS (DDF)		X	X	
CD (CDD)		X	X	X
PT (PTD)		X	X	X

The control record format is as follows:

cc	1	2	3	4	5	6	7	8	9	10	11	12	13	14	15	16	17	18	19	20	21	22	23	24	25	26	27	28	29	30
* STOREDATA												"FROM" Symbol		"TO" Symbol		Data File Name (not required for CD to WS or PT to WS)				see NOTE										

NOTE: Count Field (cc 27-30) must contain one of the following in decimal:  
Sector count if source is WS (overrides the WS Indicator), card count if source is CD, record count if source is PT.

### STOREMOD (Store Modify)

The STOREMOD routine moves data from Working Storage to the User area or Fixed area, overlaying an item specified by name in the User area or Fixed area. This permits the user to modify an item in the User or Fixed area without changing its name or relative position. If the user's program has put data in Working Storage, the user must put the data disk block count into location 0069. The length of the item in Working Storage (in disk blocks) cannot be greater than the length of the item it overlays. If the name is not found in LET/FLET, the message "D 16 DCTL, NAME FLD" is printed. If an attempt is made to STOREMOD data longer than the item already in the User or Fixed area, the function is aborted and the message "WS TOO LONG" is printed.

From	To	UA	FX
WS		X	X

The control record format is as follows:

cc	1	2	3	4	5	6	7	8	9	10	11	12	13	14	15	16	17	18	19	20	21	22	23	24	25
* STOREMOD b												WS		UA or FX		Data File Name									

## DUMPLET (Dump Location Equivalence Table)

The DUMPLET routine dumps the contents of the Location Equivalence Table (LET) to the principal printing unit (see Figure 7). If a Fixed area has been defined, the Fixed Location Equivalence Table (FLET) is printed as a separate table following LET (see Figure 8).

The control record has the following format:

```
cc
 1 2 3 4 5 6 7 8
 *DUMPLET
```

## DWADR (Disk Write Address)

The DWADR routine writes sector addresses on every sector in the Working Storage area. It restores correct disk sector addresses in the Working Storage area if they have been modified during execution of a user's program. Previous contents of the area are overlaid. Following the address word, the first two words of each sector contain D120 2663 (in hexadecimal). The next 238 words have the format Annn, where nnn is the hexadecimal address of the sector; the last 80

Line 1:	LET					
Line 2: (Entries in COMMA- base and adjusted addresses - see Appendix E)	<u>XXXX XXXX</u>	<u>XXXX XXXX</u>	<u>XXXX XXXX</u>			
	Work Storage starting sector address	Disk block address available for next User area program or data file	Number of words used by LET			
Line 3: (LET sector header words)	<u>XXXX</u>	<u>XXXX</u>	<u>XXXX</u>	<u>XXXX</u>	<u>XXXX</u>	
	Relative sector number (0-7)	0 if last sector of LET; other- wise non-zero	Reserved	Words available in this sector for more entries	Sector address of next sector (0 if last sector)	
Line 4 . . Line n	<u>XXXXXX</u>	<u>XXXX</u>	<u>XXXX</u>			
	Program name	Program size (disk blocks)	Starting address (disk blocks)	} For DSF programs		
Line 4 . . Line n	<u>XXXXXX</u>	<u>XXXX</u>	<u>XXXX</u>	<u>XXXX</u>	<u>XXXX</u>	<u>XXXX</u>
	Program name	Program size (disk blocks)	Starting address in User area (disk blocks)	Execute core address (absolute)	Program load address in core	Actual word count of core image pro- gram (includes a 60-word header)
				} For core image programs		
Line 4 . . Line n	<u>XXXXXX</u>	<u>XXXX</u>	<u>XXXX</u>	<u>0000</u>	<u>0000</u>	<u>XXXX</u>
	Data file name	Data file size (disk blocks)	Starting address in User area (disk blocks)	Reserved		Data file size (disk blocks)
				} For data files		

NOTE 1: The header words of the first sector are printed on line 3. Additional header words are printed for each following sector as required.

NOTE 2: For multi-entry subroutines, the Program Size and Starting Address fields for entry points subsequent to the first one will be blank.

NOTE 3: Program size is the disk block count of the program. This corresponds to word 3 of the actual LET entry (see Appendix G).

NOTE 4: Words 4, 5, and 6 of the printout reflect the actual LET entry words 4, 5, and 6.

NOTE 5: All numbers are in hexadecimal.

Figure 7. Output Format from a DUMPLET Operation (LET)

words are zeros. The control record has the following format:

```
cc
 1 2 3 4 5 6
 * DWADR
```

### DELETE (Delete Program or Data)

The DELETE routine deletes a specified program or data file from the User or Fixed area. The LET or FLET entry is deleted and if the program was in the User area the User area is repacked. A 1DUMMY entry is created to replace deleted FLET entries. Although no packing of the Fixed area occurs, dummy entries in FLET are packed so that two are not adjacent but are consolidated. The control record has the following format:

```
cc
 1 2 3 4 5 6 7 8 9 10 11 12 13 14 15 16 17 18 19 20 21 22 23 24 25
 * DELETE                               Name
```

### DEFINE (Define)

The DEFINE routine defines variable parameters required by the Monitor System. The following options are available:

- Define or increase the size of the Fixed area
- Delete the assembler from the system
- Delete FORTRAN from the system

If the user wishes to delete the assembler or FORTRAN, he must do so before he defines a Fixed area.

Within the Fixed area, programs can be stored at fixed disk locations. This area is initially defined as a whole number of cylinders, with a minimum of two, one of which is used for FLET, and it may be increased (but not decreased) by a whole number of cylinders at any time up to the length of Working Storage minus four cylinders. All of the specified increment is added to the Fixed Area after the initial definition. Defining or increasing the size of the Fixed area reduces disk storage available for User and Working Storage areas by the same amount.

Line 1:	FLET					
Line 2: (Entries in COMMA)	<u>XXXX XXXX</u>	<u>XXXX XXXX</u>	<u>XXXX XXXX</u>			
	Sector address of CIB	Sector address of FLET	Number of words used by FLET			
Line 3: (FLET sector header words)	<u>XXXX</u>	<u>XXXX</u>	<u>XXXX</u>	<u>XXXX</u>	<u>XXXX</u>	<u>XXXX</u>
	Relative sector number (first sector is numbered 16)	0 if last sector of FLET; otherwise non-zero	Reserved	Words available in this sector for more entries	Sector address of next sector (0 if last sector)	
Line 4 • • • Line n	FLET entries are the same as for LET except that DSF programs do not appear in the Fixed area; therefore, no three-word entries appear in FLET.					

NOTE 1: All references are in disk blocks unless otherwise indicated.

NOTE 2: The header words of the first sector are printed on line 3. Additional header words are printed for each following sector as required; there is a header for each 52 FLET entries.

NOTE 3: Program size is the disk block count of the program. This corresponds to word 3 of the actual FLET entry (see Appendix G).

NOTE 4: Words 4, 5, and 6 of the printout reflect the actual FLET entry words 4, 5, and 6.

NOTE 5: All numbers are in hexadecimal.

Figure 8. Output Format from a DUMPLET Operation (FLET)

Deleting the assembler and/or FORTRAN packs the remaining information on the disk, thus increasing disk storage available for User and Working Storage areas by the amount occupied by the deleted programs (see Figure 2).

The control record formats are as follows:

To Define the Fixed area -

```
cc
1 2 3 4 5 6 7 8 9 10 11 12 13 14 15 16 17 18 19 20 21 22 23 24 25 26 27 28 29 30
*DEFINEbFIXEDbAREA          NNNN
```

where NNNN = positive cylinder count in decimal, right-justified, specifying the initial size of Fixed area (minimum of 2 cylinders) or an increment to the Fixed area.

NOTE: The first cylinder of the first DEFINE FIXED AREA is used for FLET.

To Delete the Assembler -

```
cc
1 2 3 4 5 6 7 8 9 10 11 12 13 14 15 16 17 18 19 20 21 22
*DEFINEbVOIDbASSEMBLER
```

To Delete FORTRAN -

```
cc
1 2 3 4 5 6 7 8 9 10 11 12 13 14 15 16 17 18 19 20
*DEFINEbVOIDbFORTRAN
```

EDIT (to recall system loader)

The \*EDIT control record is used only by DUP to recall the System Loader, which initially loads the system into disk storage. The control record has the following format:

```
cc
1 2 3 4 5
*EDIT
```

NOTE: This record must not be used by the user.

### DUP MESSAGES

Each DUP control record is printed at the time it is read, thus signaling that DUP has control and

will remain in control until the next monitor control record is properly read. When a requested DUP function has been successfully completed, the following two-word exit message is printed in hexadecimal:

- Word 1: Disk block address of program or disk area that has been processed.
- Word 2: Number of disk blocks involved.

For the DUP functions listed below, these words contain the following information (all addresses and lengths are given in disk blocks):

<u>DUP Function</u>	<u>Information Printed</u>
DUMP, STORE, STORECI, STOREMOD, DELETE	Program address* and program length**
DUMPDATA, STOREDATA	Program address and decimal sectors or records specified converted to disk blocks
DUMPLET - (LET)	User area address and User area length
DUMPLET - (FLET)	Fixed area address and Fixed area length
DWADR	Working Storage address and Working Storage length
DEFINE FIXED AREA	Fixed area address and size
DEFINE VOID ASSEMBLER	Former address and size of assembler
DEFINE VOID FORTRAN	Former address and size of FORTRAN

If the above words are not printed, the DUP function was not successfully completed. If the DUP operation cannot be performed, an appropriate error message is printed at the time the DUP control record causing the error is read (see Appendix A).

---

\* If storing or dumping from Working Storage, the address of Working Storage is printed.  
 \*\*Length is the third word of LET/FLET entry (see Appendix G).

## DUP OPERATING NOTES

The use of the PROGRAM STOP key, when performing DUP operations with the 1130 Disk Monitor System, can cause the system to stop while there is disparity between LET/FLET, DCOM, and the actual disk contents. If the job is aborted at this time, the disk pack will no longer contain an operating monitor system.

DUP operations must be allowed to execute to completion. If the PROGRAM STOP key is used

(WAIT at 0005), the operation must be continued from the point at which the system stopped. Core storage must not be altered. To continue, press PROGRAM START (see DUP Waits and Loops in Appendix A).

Some DELETE functions may take several minutes since they may have to pack much of disk storage. These long DELETE and DEFINE functions must be allowed to complete their respective operations.

Control can be returned to the DUP section that reads DUP and monitor control records by manually branching to core location 0276.

## ASSEMBLER

The language for the monitor assembler is described in the publication IBM 1130 Assembler Language (Form C26-5927). Therefore, only a general description of the operation and the control records for the monitor assembler are described in this section.

The monitor assembler cannot be operated independently of the Monitor System; however, the assembler can be deleted from the Monitor System if desired.

A monitor control record with the pseudo-op ASM is used to call the assembler into operation. The assembler reads the source program, including control records, from cards or paper tape. After assembly, the object program resides in the disk Working Storage area, and can be called for execution with a monitor XEQ control record, or it can be stored in the User or Fixed area with a DUP STORE or STORECI operation or punched as a binary deck or tape with a DUP DUMP operation.

### ASSEMBLER CONTROL RECORDS

Assembler control records are used to specify assembly options and to provide input to the assembly process for certain types of source decks. Assembler control records can be either card or paper tape.

Table 6. Summary of Assembler Control Records

*TWO PASS MODE	Read source deck twice; must be specified when LIST DECK or LIST DECK E is specified, or when intermediate output fills Working Storage
*LIST	Print a listing on the principal printing device
*LIST DECK	Punch a list deck on the principal I/O device (requires TWO PASS MODE)
*LIST DECK E	Punch only error codes (cc 18-19) into source program list deck (requires TWO PASS MODE)
*PRINT SYMBOL TABLE	Print a listing of the symbol table on the principal printing device
*PUNCH SYMBOL TABLE	Punch a list deck of the symbol table on the principal I/O device
*SAVE SYMBOL TABLE	Save symbol table on disk as a System Symbol Table
*SYSTEM SYMBOL TABLE	Use System Symbol Table to initialize symbol table for this assembly
*LEVEL n	n = interrupt level number. Required for ISS subroutines
*FILE n	n = number (decimal) of sectors of Working Storage required at object time by the program being assembled
*COMMON n	n = length of COMMON in words (decimal)

All assembler control records have the following format:

Column 1: \*  
2-71: Option

If an assembler control record contains an asterisk in column 1, but the option does not agree, character for character, with its valid format, as described below, the erroneous control record is ignored in the assembly. The option is not performed; however, no error results.

Assembler control records can be written in free form, but at least one blank must separate the last character in the operation and the first character of any comments or numeric field.

Assembler control records and their meanings are listed below. A summary is contained in Table 6.

#### \*TWO PASS MODE

The source deck (or tape) must be read twice. TWO PASS MODE must be specified when:

1. The user desires a list deck to be punched (see LIST DECK and LIST DECK E).
2. One pass operation cannot be performed because intermediate output (source records) fill the Working Storage area of disk.

**\*LIST**

A printed listing is provided on the principal printing device (console printer or 1132 Printer). The format of the printed listing corresponds to that of the list deck (see Figure 9).

**\*LIST DECK**

A list deck is punched on the principal I/O device (card or paper tape). This option requires two passes (TWO PASS MODE). The list deck format is shown in Figure 9. In cards, object information is punched into columns 1-19 of the source deck in pass 2 to make the list deck. In paper tape, the list tape punched is similar to the input tape, but

with 20 frames added to the beginning of each record corresponding to card columns 1-20.

**\*LIST DECK E**

Same as LIST DECK except no object information other than errors (positions 18-19) are punched.

**\*PRINT SYMBOL TABLE**

A printed listing of the symbol table is provided on the principal printing device (console printer or 1132 Printer). Symbols are grouped five per line. Multiply-defined symbols are preceded by the letter M; symbols with absolute values in a relocatable program are preceded by the letter A. The M and A flags, however, are not counted as assembly errors.

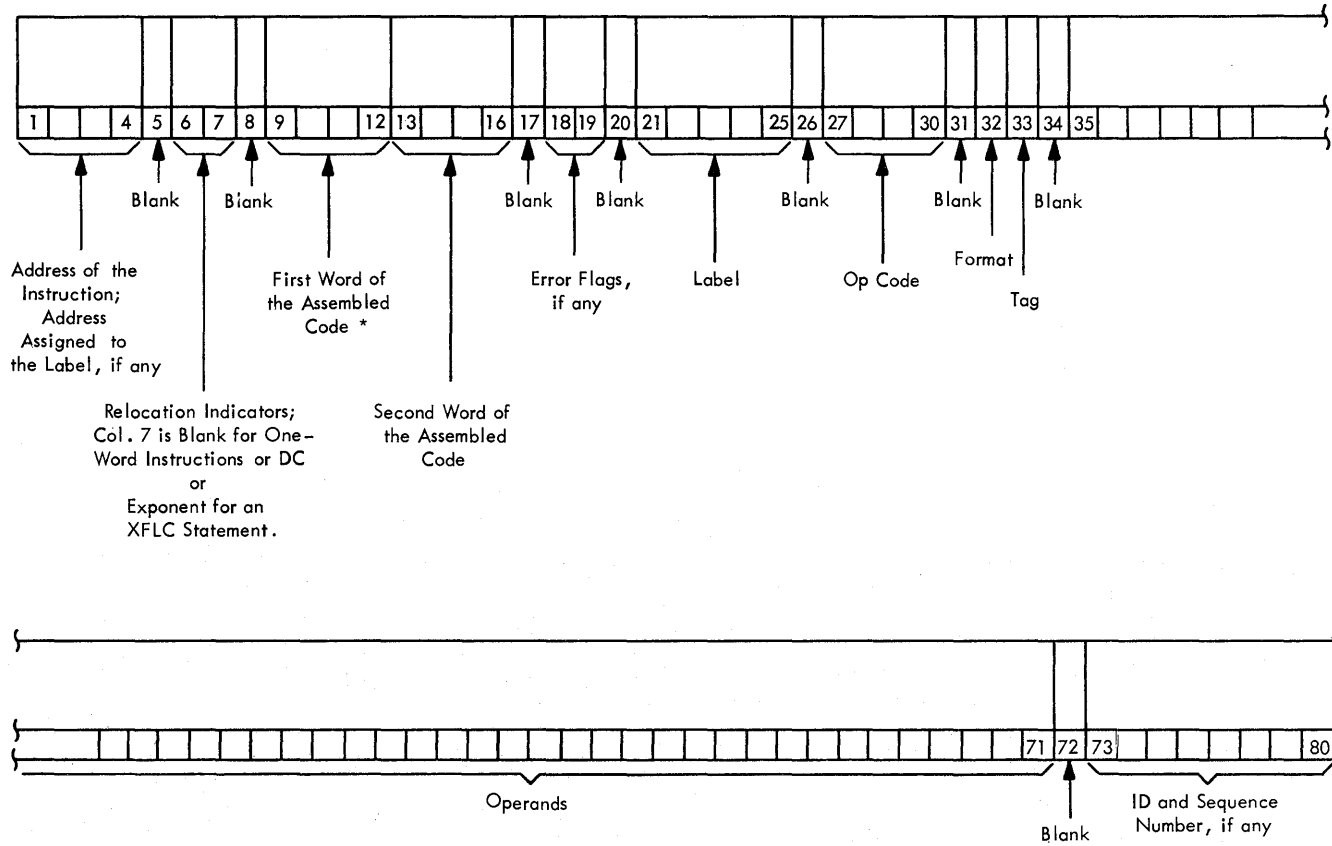

\* For EBC Statements, Col. 9-12 Contains the Number of EBC Characters  
 For BSS and BES Statements, Col. 9-12 Contains the Number of Words Reserved for the Block.

Figure 9. List Deck Format

#### \*PUNCH SYMBOL TABLE

A list deck of the symbol table is punched on the principal I/O device (card or paper tape). The record format is the same as for PRINT SYMBOL TABLE. This option may be advantageous if offline card-to-printer or paper tape-to-printer facilities are available.

#### \*SAVE SYMBOL TABLE

The symbol table generated in this assembly is saved on the disk as a System Symbol Table. The System Symbol Table is saved until the next SAVE SYMBOL TABLE control record causes a new assembly-generated symbol table to replace it. This control record is also used with the SYSTEM SYMBOL TABLE control record to add symbols to the System Symbol Table. The SAVE SYMBOL TABLE option requires this assembly to be absolute. If any assembler errors are detected, or if the symbol table exceeds the allowable size of the System Symbol Table - 100 symbols - the symbol table will not be saved as a System Symbol Table, and an assembler error message will be printed (refer to Appendix A, Assembler Error Messages).

#### \*SYSTEM SYMBOL TABLE

Before assembly begins, the System Symbol Table (previously built by a SAVE SYMBOL TABLE assembly) is copied into the symbol table generated in this assembly. This control record is used when it is desired to refer to symbols in the System Symbol Table without definition of those symbols in the source program, or together with the SAVE SYMBOL TABLE control record when it is desired to add symbols to the System Symbol Table. All symbols in the symbol table taken from the System Symbol Table will have absolute values.

#### \*LEVELbn

This control record is required for the assembly of an ISS routine. n = A decimal interrupt level number (0-5). If the device operates on two levels of interrupts (1442 Card Read Punch), two LEVEL control records are required. At least one blank must separate the word LEVEL and the interrupt level number.

#### \*FILEbn

n = Number of sectors (decimal) of the disk Working Storage area required at object time by the program being assembled. These sectors will be reserved at the beginning of Working Storage before any LOCALs or SOCIALs are stored. This control record is used only when assembling a relocatable mainline program. At least one blank must separate the word FILE and the number of sectors.

#### \*COMMONbn

n = Length of COMMON in words (decimal). This allows a COMMON area to be saved in linking from a FORTRAN mainline program to an assembly mainline and linking back to a FORTRAN mainline. At least one blank must separate the word COMMON and the decimal number.

#### ORIGIN OF SOURCE PROGRAM

The origin of a relocatable source program will always be at relative zero unless otherwise specified in the source program.

The origin of an absolute source program, if not otherwise specified, will be at the end of the disk routine DISKN (location 0438). If the program will use another disk routine, the origin may be set lower to correspond to the proper disk routine. If no disk routine is used, the origin may be set to the end of the disk routine DISKZ (refer to Origins for Core Loads).

#### ASSEMBLER PAPER TAPE FORMAT

The paper tape input to the assembler is punched on PPTC/8 tape, one frame per character. The format of the tape control records is the same as the card format. The format of the symbolic program tape records is the same as the card format except for the following:

1. The tape does not contain preceding blanks corresponding to card columns 1-20.
2. The tape does not contain blanks or data corresponding to card columns 72-80.
3. Trailing blanks need not be punched. Therefore, up to 51 characters (corresponding to card columns 21-71) can appear in the tape record.



Tape records are separated by NL (new line) characters (code DD). The delete character (code 7F) is ignored whenever it is read, but the reader stop character (RS, code 0D) causes the program reading the tape to wait and start reading again when PROGRAM START is pressed. The case shift characters (codes 0E, 6E), when required, are not considered to occupy a space in the format.

## ASSEMBLER MESSAGES AND ERROR CODES

Appendix A contains the assembler error messages printed during operation of the 1130 Monitor. If LIST DECK or LIST DECK E is specified, the error detection codes shown in Table 7 are punched in columns 18 and 19. For the first error detected in each statement the assembler stores and then punches the code in column 18; the code for a second error is stored, overlaid by any subsequent errors, and punched in column 19. Thus, if more than two errors are detected in the same statement, only the first and last are indicated.

At the end of the assembly, a message is printed indicating the total number of assembly errors detected in the source program. Since no more than two errors are flagged per statement, the error count may exceed the actual number of flags.

If symbol table overflow exceeds 32 sectors in Working Storage, an assembler error message is printed (refer to Appendix A). The maximum size of the symbol table (including overflow) and, hence, the maximum number of symbols that can be defined in a program is determined by the size of core storage as indicated below:

Type of Assembly	Size of Core Storage (words)	
	4096	8192
With Listing	3502	4867
One Pass, No Listing	3574	4940
Two Pass, No Listing	3609	4974

## ASSEMBLER OPERATING PROCEDURES

### Card Input

The source deck (including assembler control cards) can be assembled as part of a job, or it can be assembled as a separate job. In either case, the source deck must be preceded by a ASM monitor control record.

Table 7. Assembler Error Detection Codes

Flag	Cause	Assembler Action
A	Address Error Attempt made to specify displacement field, directly or indirectly, outside range of -128 to +127.	Displacement set to zero
C	Condition Code Error Character other than +, -, Z, E, C, or O detected in first operand of short branch or second operand of long BSC, BOSC, or BSI statement.	Displacement set to zero
F	Format Code Error Character other than L, I, X, or blank detected in col. 32, or L or I format specified for instruction valid only in short form.	Instruction processed as if L format were specified, unless that instruction is valid only in short form, in which case it is processed as if the X format were specified
L	Label Error Invalid symbol detected in label field.	Label ignored
M	Multiply Defined Label Error Duplicate symbol encountered in operand.	First occurrence of symbol in label field defines its value; subsequent occurrences of symbol in label field cause a multiply defined indicator to be inserted in symbol table entry (Bit 0 of first word).
O	Op Code Error Unrecognized op code  ISS, ILS, ENT, LIBR, SPR, EPR, or ABS incorrectly placed.	Statement ignored and address counter incremented by 2. Statement ignored
R	Relocation Error Expression does not have valid relocation. Non-absolute displacement specified. Absolute origin specified in relocatable program. Non-absolute operand specified in BSS or BES. Non-relocatable operand in END statement of relocatable mainline program. ENT operand non-relocatable.	Expression set to zero Displacement set to zero Origin ignored Operand assumed to be zero Card columns 9-12 left blank; entry assumed to be relative zero Statement ignored
S	Syntax Error Invalid expression (e.g., invalid symbol, adjacent operators, illegal constant) Illegal character in record.  Main program entry point not specified in END operand. Incorrect syntax in EBC statement (e.g., no delimiter in card column 35, zero character count). Invalid label in ENT or ISS operand.	Expression set to zero  If illegal character appears in expression, label, op code, format, or tag field, additional errors may be caused. Card columns 9-12 left blank; entry assumed to be relative zero Card columns 9-12 not punched; address counter incremented by 17. Statement ignored
T	Tag Error Card column 33 contains character other than blank, 0, 1, 2, or 3 in instruction statement.	Tag of zero assumed
U	Undefined Symbol Undefined symbol in expression	Expression set to absolute zero

In most cases, the source deck is passed through the 1442 Card Read Punch only once. If the assembly is part of a stacked job, the assembly proceeds without operator intervention. If the END card is the last card in the stack, when the reader goes not ready, press reader START to process the last card.

In some cases it may be necessary to assemble in the two-pass mode, that is, pass the source deck through the 1442 Card Read Punch twice. If a copy of the source deck is placed behind the original, the source deck will be read twice, and a stacked job is again possible even when in the two-pass mode.

It is important to note that when a deck is being assembled in two-pass mode, the assembler is ready to read another card as soon as Pass 1 processing of the END card is completed. Therefore, a monitor control record must not follow the END card the first time (or the first END card if the deck has been copied), or the assembler will trap this record, terminating the assembly and returning control to the Supervisor.

If the deck is not copied, the END card should be the last card. Press reader START to process the last card and complete Pass 1. The assembler will then try to begin reading cards for Pass 2, therefore the source deck (with its control cards) should be removed from the stacker and placed in the hopper. Pressing reader START will continue Pass 2 of the assembly. The card reader will go not ready when all cards but the END card have been read. Press reader START to process the END card and complete the assembly. Operation is continuous from Pass 1 to Pass 2 if the source deck is replaced behind the END card from the stacker during Pass 1.

If the \*PUNCH SYMBOL TABLE assembler control card is used, sufficient blank cards must be placed after the END card and before the next monitor control record in the stacked job. In estimating the number of blank cards required, allow one card for each five symbols used in the source deck. Unnecessary blank cards will be passed to the next monitor control record.

#### Paper Tape Input

Most of the procedures for card input are also applicable to paper tape input.

If the assembly is performed in the one-pass mode, operation is continuous, and control is returned to the Supervisor which will then pass any delete codes between the assembler and the next monitor control record. The assembler will also pass any delete codes that may occur between records of the source program.

When it is necessary to assemble in the two-pass mode, one of the following techniques may be used:

1. Have the stacked job tape contain two copies of the source program. The assembler will simply begin reading the copy after the original has been read in Pass 1.
2. Assemble outside of the stacked job tape. The job tape, or a separate strip containing an ASM monitor control record serves to bring the assembler into core. A separate source program tape (including assembler control records) should then be readied on the paper tape reader, and the assembler will read this tape and complete Pass 1. Ready the source tape again and the assembler will complete Pass 2. A stacked job tape can now be readied again on the paper tape reader, and the Supervisor will continue with the stack.
3. The assembly of a program may start in one-pass mode and then be changed to two-pass mode (see Assembler Error Messages, Appendix A). The assembler will wait, and pressing PROGRAM START continues the assembly in Pass 1 of two-pass mode. If this assembly is part of a stacked job, operator intervention is necessary to prevent the assembler from reading the monitor control record which follows the END record (applicable to card input also). When Pass 1 intermediate output may fill Working Storage, it is recommended that sufficient length of all delete codes be punched into the tape after the END statement and before the next monitor control. When the assembler is reading the delete codes following the END record, the operator should press PROGRAM STOP, and manually reposition the tape at the beginning of the source program. When the tape is positioned, press PROGRAM START to continue Pass 2 of the assembly.

When punching a list tape (\*LIST DECK or \*LIST DECK E), first create a leader in the punched tape by holding down FEED and DELETE on the punch (press DELETE before FEED and release FEED before releasing DELETE). The same procedure should be used to create a trailer

following the last record punched by the assembler.

When the paper tape reader or punch is not ready, the assembler will wait at location 0041 with  $3000_{16}$  displayed in the accumulator. Ready the punch or reader, and press PROGRAM START to continue.

## FORTRAN COMPILER

The language for the Monitor FORTRAN compiler is described in the publication IBM 1130 FORTRAN Language (Form C26-5933). Therefore, only a general description of the Monitor FORTRAN compiler operation is contained here.

The FORTRAN compiler cannot be operated independent of the Monitor System; but, if desired, the compiler can be deleted from the system.

A monitor control record having the pseudo-op FOR is used to call the FORTRAN compiler into operation. The compiler reads the source program from cards or paper tape. After compilation, the object program resides in the disk Working Storage area, and can be called for execution with a monitor XEQ control record, loaded to the User or Fixed area with a DUP STORE or STORECI operation, or punched as a binary deck or tape with a DUP DUMP operation. All FORTRAN programs are compiled in relocatable format.

For 1130 FORTRAN I/O logical unit definitions, the I/O unit numbers are permanently set as described in Table 8.

### FORTRAN CONTROL RECORDS

Before a FORTRAN program is compiled, the user can specify certain options by means of control records which must precede the source program and can be in any order. The IOCS and NAME control records can be used only in mainline programs; the others can be used in both mainline programs and subroutines.

● Table 8. I/O Logical Unit Designations

Logical Unit Number	Device	Kind of Transmission	Record Size Allowed
1	Console printer	Output only	120
2	1442 Card Read Punch	Input/output	80
3	1132 Printer	Output only	1 carriage control + 120
4	1134-1055 Paper Tape Reader/Punch	Input/output	80, plus max. of 80 case shifts for PTTC/8 code, plus NL code.
6	Keyboard	Input only	80
7	1627 Plotter	Output only	120

All FORTRAN control records have the following format:

Column 1: \* (asterisk)  
2-72: Option

FORTRAN control records can be written in free form, no comments allowed. Any unrecognizable control records are considered as comments control records.

FORTRAN control records and their meanings are listed below. A summary is contained in Table 9.

**\*IOCS (CARD, TYPEWRITER, KEYBOARD, 1132 PRINTER, PAPER TAPE, DISK, PLOTTER)**

This record is required to specify any I/O device that is to be used during execution of the program; however, only the devices required should be included. Because the \*IOCS record can appear only in the mainline program, it must include all the I/O devices used by all FORTRAN subprograms that will be called. The device names must be in parentheses with a comma between each name.

FORTRAN subprograms written in assembly language can use any I/O subroutines for any device that is not mentioned in \*IOCS and that is not on the same interrupt level as a device in \*IOCS. Otherwise, the subprograms must use FORTRAN I/O routines (CARDZ, PAPTZ, PRNTZ, WRTYZ, TYPEZ, DISKZ, PLOTX).

**\*LIST SOURCE PROGRAM**

The source program is listed as it is read in.

**\*LIST SUBPROGRAM NAMES**

The names of all subprograms (including EXTERNAL subprograms) called directly by the compiled program are listed.

**\*LIST SYMBOL TABLE**

The following items are listed:

- Variable names and their relative addresses
- Statement numbers and their relative addresses

Table 9. Summary of FORTRAN Control Records

<ul style="list-style-type: none"> <li>* NAME XXXXX</li> <li>* IOCS (CARD, TYPEWRITER, KEYBOARD, 1132 PRINTER, PAPER TAPE, DISK, PLOTTER)</li> <li>**header information to be printed on each compiler output page</li> <li>* ONE WORD INTEGERS</li> <li>* EXTENDED PRECISION</li> <li>* ARITHMETIC TRACE</li> <li>* TRANSFER TRACE</li> <li>* LIST SOURCE PROGRAM</li> <li>* LIST SUBPROGRAM NAMES</li> <li>* LIST SYMBOL TABLE</li> <li>* LIST ALL</li> </ul>	<p>(XXXXX = program name to be printed on listing)</p> <p>Delete any not used</p> <p>(Store integer variables in one word)</p> <p>(Store floating point variables and constants in 3 words instead of 2)</p> <p>(Switch 15 ON to print result of each assignment statement)</p> <p>(Switch 15 ON to print value of IF or Computed GOTO)</p> <p>(List source program as it is read in)</p> <p>(List subprograms called directly by compiled program)</p> <p>(List symbols, statement numbers, constants)</p> <p>(List source program, subprogram names, symbol table)</p>
---	--

- Statement function names and their relative addresses
- Constants and their relative addresses

not, integer constants are always contained in one word. When this control record is used, the program does not conform to the ASA Basic FORTRAN standard for data storage, and it may require modification in order to be used with other FORTRAN systems.

**\*LIST ALL**

The source program, subprogram names, and symbol table are listed. If this control record is used, the other LIST control records are not required.

**\*NAME XXXXX**

The program name represented by XXXXX is printed on the listing. XXXXX is five consecutive characters (including blanks) starting at the first non-blank column. This control record is used only on mainline programs, since subprogram names are automatically taken from the FUNCTION or SUBROUTINE statement.

**\*EXTENDED PRECISION**

Variables and real constants are stored in three words instead of two, and the compiler generates linkage to extended precision routines.

**\*\*Header Information**

The information between columns 3-72 is printed at the top of each page of compilation printout when an 1132 Printer is the principal system printer.

**\*ONE WORD INTEGERS**

Integer variables are allocated one word of storage rather than the same allocation used for real variables. Whether this control record is used or

**\*ARITHMETIC TRACE**

The compiler generates linkage to trace routines which are executed whenever a value is assigned to a variable on the left of an equal sign. If Console Entry Switch 15 is turned on at execution time and

program logic (see Optional Tracing) does not prevent tracing, the value of the assigned variable is printed as it is calculated.

#### \*TRANSFER TRACE

The compiler generates linkage to trace routines which are executed whenever an IF statement or Computed GOTO statement is encountered. If Console Entry Switch 15 is turned on at execution time and program logic (see Optional Tracing) does not prevent tracing, the value of the IF expression or the value of the Computed GOTO index is printed.

If tracing is requested, an \*IOCS control record must also be present to indicate that either typewriter or printer is needed. If both typewriter and printer are indicated in the \*IOCS record, the printer is used for tracing.

The traced value for the assignment of a variable on the left of an equal sign of an arithmetic statement is printed with one leading asterisk. For the expression of an IF statement, the traced value is printed with two leading asterisks. The traced value for the index of a Computed GOTO statement is printed with three leading asterisks.

#### Optional Tracing

The user can elect to trace only selected parts of the program by placing statements in the source program logic flow to start and stop tracing. This is done by executing a CALL to either subroutine:

CALL TSTOP (to stop tracing)  
CALL TSTRT (to start tracing)

Thus, tracing occurs only if:

- The trace control records were compiled with the source program.
- Console Entry Switch 15 is on (can be turned off at any time).
- A CALL TSTOP has not been executed, or a CALL TSTRT has been executed since the last CALL TSTOP.

#### Operating Notes - \*LIST Control Cards

A constant in a STOP or PAUSE statement is treated as a hexadecimal number. This hexadecimal number and its decimal equivalent appear in the list of constants.

Variables and constants that require more than one word of storage have the address of the word nearest the zero address of the machine. In the case of arrays, the given address refers to the addressed word of the first element. In the case of a two- or three-word integer, the integer value is contained in the addressed word. The first variable listed might not be addressed at 0000 because room may be required for generated temporary storage locations.

The relative address for variables not in COMMON would be the actual address if the program started at storage location zero. The relative address for variables in COMMON would be the actual address if the machine had 32K storage. The Loader makes any necessary adjustments. Variables in COMMON are adjusted to reside in the high-order core location of the machine being used (e.g., first COMMON variable will be loaded to 8191 on an 8K machine).

Loading begins at core location 01C2 (450 decimal). The DISKZ routine is used regardless of what disk routine is requested on the XEQ control record (refer to Origins for Core Loads).

#### FORTTRAN PRINTOUTS

#### Compilation Messages

Near the end of the compilation, core usage information and the features supported (control records used) are printed out as follows:

FEATURES SUPPORTED  
EXTENDED PRECISION  
ONE WORD INTEGERS  
TRANSFER TRACE  
ARITHMETIC TRACE  
IOCS  
CORE REQUIREMENTS FOR XXXXX  
COMMON YYYYY VARIABLES YYYYY PROGRAM YYYYY

where XXXXX is the name of the program designated in the \*NAME control record or in the SUBROUTINE or FUNCTION statement, and YYYYY is the number of words allocated for the specified parts of the program. In addition, all unreferenced statement numbers are listed unconditionally.

```

1  DIMENSION  C (10,10)
2  DIMENSION  D (5,5)
3  DIMENSION  E (6,6,,6)   (error C08)
4  DIMENSION  F (4,4)
5  DIMENSION  G (2,2)     (error C16)

```

This example will cause the following error messages to be printed.

```

C08 ERROR AT STATEMENT 00000 + 001
C16 ERROR AT STATEMENT 00000 + 002

```

### Compilation Error Messages

During compilation a check is made to determine if certain errors have occurred. If one or more of these errors have been detected the error indications are printed at the conclusion of compilation, and no object program is stored on the disk. Only one error is detected for each statement. In addition, due to the interaction of error conditions, the occurrence of some errors may prevent the detection of others until those which have been detected are corrected. With the exception of type 00 messages listed below, the error message appears in the following format:

```
C NN ERROR IN STATEMENT NUMBER XXXXX + YYY
```

NN is the error number described in Appendix A. With the exception of specification statement errors, XXXXX is the last valid statement number preceding the erroneous statement and YYY is the count of statements from XXXXX to the statement that is in error. If the erroneous statement has a valid statement number, XXXXX will be the statement in error and YYY will not be printed.

For example:

```

105  FORMAT (I5,F8.4)
110  IF (A-B) 10,30,30
      A = A+1.0
ABC  B = B-2.0           (error C01)
135  GO TO 105          (error C43)

```

This example will cause the following error messages to be printed.

```

C01 ERROR IN STATEMENT NUMBER 110 + 002
C43 ERROR IN STATEMENT NUMBER 135

```

For specification statements, XXXXX is always 00000 and YYY is the count of the number of specification statements in error. YYY is never 000, i.e., for the first error YYY is 001. Specification statements are not counted unless they contain an error. Statement numbers on specification statements and statement functions are ignored. NN is the error code.

For example:

Error indications are printed at the conclusion of compilation. If a compilation error has occurred, the message

```
OUTPUT HAS BEEN SUPPRESSED
```

is printed and no object program is punched.

If at any time during the compilation the statement string overlaps the symbol table, or vice-versa, the remainder of the compilation is bypassed and the message

```
PROGRAM LENGTH EXCEEDS CAPACITY
```

is printed.

### Type 00 Error Messages

<u>Code and Message</u>	<u>Meaning</u>
C 00 MON CALL	A Monitor call was executed (via operator intervention) during the compilation; the compilation is terminated and control is returned to the monitor.
C 00 OVER 50 DISK ERRORS AT SECTOR nnnn	The FORTRAN disk I/O routine encountered an unrecoverable disk error during compilation; nnnn is the hexadecimal address of the bad sector.
C 00 WORKING STORAGE EXCEEDED	The working storage area on disk is too small to accommodate the string area and symbol table for the program being compiled; the compilation is terminated.

The following message is printed for a normal end of compilation (with or without errors):

```
END OF COMPILATION
```





## //b RECORDS AT FORTRAN EXECUTION TIME

During FORTRAN execution time, any //b record encountered by CARDZ or PAPTZ causes a WAIT to occur; when PROGRAM START is pressed, control is returned to the monitor supervisor. The supervisor searches for the next valid monitor control record entered from the reader. Only the //b characters on the record trapped by CARDZ or PAPTZ are recognized. Any other data entered in this record is not available to other routines in the monitor system. The record is not listed. For off-line listing purposes, however, this record can contain comments (e.g. // END OF DATA).

## KEYBOARD INPUT OF DATA RECORDS

Data records of up to 80 characters can be read from the keyboard by a FORTRAN READ statement. Data values must be right-justified in their respective fields.

### Keyboard Operation

If it is desirable to key in less than 80 characters, the EOF key can be pressed to stop transmittal. Also, the ERASE FIELD or BACKSPACE key can be pressed to restart the record transmittal if an error is detected while entering data. If the keyboard appears to be locked up, press REST KB to restore the keyboard. The correct case shift must be selected before data is entered.

### Buffer Status After Keyboard Input

When the END FLD key is pressed prior to completing a full buffer load of 80 characters, blanks are inserted in the remainder of the buffer. If more data is necessary to satisfy the list items, the remaining numeric fields (I, E, or F) are stored in core as zeros and remaining alphameric fields (A or H) are stored as blanks. Processing is continuous and no errors result from the above condition.

## OBJECT PROGRAM PAPER TAPE DATA RECORD FORMAT

Data records of up to 80 EBCDIC characters in PTTC/8 code can be read or written by the FORTRAN object programs. The delete and new-line codes are recognized. Delete codes and case shifts are not included in the count of characters. If a

new-line code is encountered before the 80th character is read, the record is terminated. If the 80th character is not a new-line code, the 81st character is read and assumed to be a new-line code. A new-line code is punched at the end of each output record.

## FORTRAN I/O ERRORS

If input/output errors are detected during execution, the program stops with an error code displayed in the accumulator. The error displays and meanings are listed in Appendix A, Table A-11. If an input error is detected, zero values will be transmitted for each corresponding list element when the START key is pushed. Output errors will transmit nothing for the corresponding list elements. An exception to these general rules is the F009 error. When this error is detected, the conversion will continue as requested after the START key is depressed.

When the output field is too small to contain the number, the field is filled with asterisks and execution is continued.

The input/output routines used by FORTRAN (PAPTZ, CARDZ, PRNTZ, WRTYZ, TYPEZ) wait on any I/O device error or device not in a ready condition. When the devices are ready, press PROGRAM START to execute the I/O operation.

Error detection in functional and arithmetic subroutines is possible by the use of source program statements. Refer to "FORTRAN Machine and Program Indicator Tests" in the manual, IBM 1130 FORTRAN Language (Form C26-5933).

## FORTRAN PROGRAMMING NOTES

1. When performing synchronous transmit-receive (STR) operations in a FORTRAN program, the STR operations must be stopped before any disk I/O can be executed in the FORTRAN program. This includes FORTRAN disk READ and WRITE statements (DISKZ) and LOCAL or SOCAL conditions requiring the use of DISKZ.
2. Any time an overlapped I/O operation (such as FIND) is performed, a subsequent interrupt will occur and remove the CPU from a WAIT status if it happens to be in such a status.
3. Do not push PROGRAM STOP or IMMEDIATE STOP to try to stop FORTRAN program execution. This may result in destroying the monitor system cartridge. The recommended procedure to stop the execution during I/O operations is to cause the I/O device being used to become not ready.

## SUBROUTINE LIBRARY

The 1130 Subroutine Library consists of a group of subroutines that aid the programmer in making efficient use of the IBM 1130 Computing System. Descriptions of the subroutines and methods for programming them are contained in the publication, IBM 1130 Subroutine Library (Form C26-5929).

The following paragraphs describe the use of the IBM-supplied subroutines and discuss pre-operative errors and I/O error restarts where special handling is required.

### PREOPERATIVE ERRORS

A preoperative error is an error condition detected before an I/O operation is started. It denotes either an illegal LIBF parameter, an illegal specification in I/O area, or a device not-ready condition. This error causes a branch to location 0029 and the following conditions:

- The Instruction Address Register displays the address 002A.
- The Accumulator displays an error code represented by four hexadecimal digits.

Digit 1 identifies the ISS called:

- 1 - CARD0 or CARD1
- 2 - TYPE0 or WRTY0
- 3 - PAPT1 or PAPT1
- 5 - DISK0, DISK1, or DISKN
- 6 - PRNT1
- 7 - PLOT1

Digits 2 and 3 are not used.

Digit 4 identifies the error:

- 0 - Device not ready
- 1 - Illegal LIBF parameter or illegal specification in I/O area

- Location 0028 contains the address of the LIBF in question.

The ISS is set up to attempt initiation of the operation a second time if the LIBF is reexecuted. Therefore, since the Loader stores a wait instruction in location 0029 and an indirect branch to location 0028 in locations 002A and 002B, the

LIBF can be executed again by pressing PROGRAM START.

When a pre-operative error is encountered the operator can:

- Correct the error condition if possible and press PROGRAM START, or
- Note the contents of the Accumulator and location 0028, dump core storage, and proceed with the next job.

### CARD SUBROUTINE (CARD0 AND CARD1) ERRORS

#### Error Parameters

CARD0. There is no error parameter. If an error is detected during processing of an operation-complete interrupt, the subroutine loops internally, with interrupt level 4 on until the 1442 becomes ready, and then retries the operation.

CARD1. There is an error parameter. If an error is detected during processing of an operation-complete interrupt, the user program can elect to terminate (clear "routine busy" and the interrupt level) or to retry. A retry consists of looping internally, with interrupt level 4 on until the 1442 becomes ready, and then reinitiating the function.

#### 1442 Errors and Operator Procedures

If a 1442 error occurs, the 1442 becomes not ready until the operator has intervened. Unless the stop is caused by a stacker full (no indicator) or Chip Box indication, the 1442 card path must be cleared before proceeding. The 1442 error indicators and the position of the cards in the feed path should be used to determine which cards must be placed back in the hopper.

For the card subroutines, a retry consists of positioning the cards as indicated in the following paragraphs and reinitiating the function whenever the card reader becomes ready. The card subroutines will skip the first card, if necessary, on a read or feed operation.

Hopper Misfeed. Indicates that card 2 failed to pass properly from the hopper to the read station during the card 1 feed cycle.

Card positions after error:

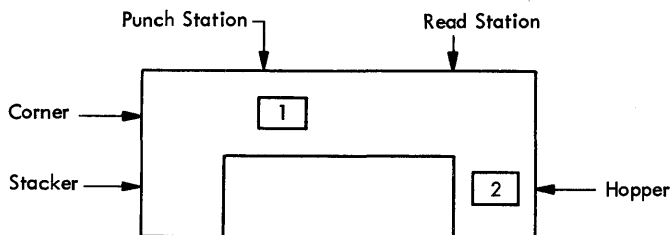

Error indicator: HOPR  
 Operator procedure: When program halts, press NPRO to eject card 1, place card 1 in hopper before card 2, and ready the 1442.

Feed Check (punch station). Indicates that card 1 is improperly positioned in the punch station at the completion of its feed cycle.

Card positions after error:

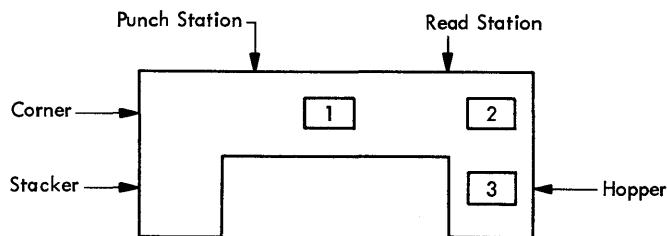

Error indicator: PUNCH STA  
 Operator procedure: When program halts, empty hopper, clear 1442 card path, place cards 1 and 2 in hopper before card 3, and ready the 1442.

Transport. Indicates that card 1 has jammed in the stacker during the feed cycle for card 2.

Card positions after error:

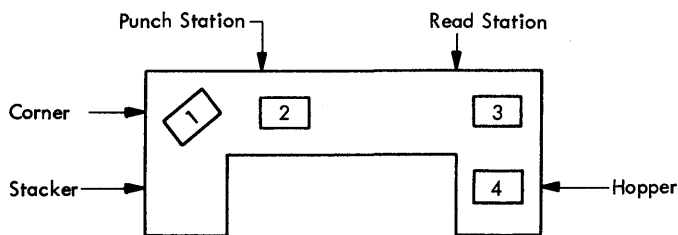

Error indicator: TRANS  
 Operator procedure: When program halts, empty hopper, clear 1442 card path, place cards 2 and 3 in hopper before card 4, and ready the 1442.

Feed Cycle. Indicates that the 1442 took an unrequested feed cycle and, therefore, cards 1, 2, and 3 are each one station farther ahead in the 1442 card path than they should be.

Card positions after error:

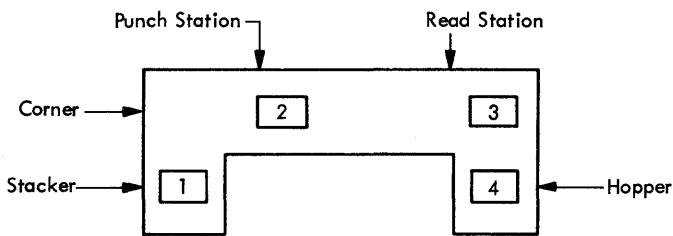

Error indicator: FEED CLU  
 Operator procedure: When program halts, empty hopper, press NPRO to eject cards 2 and 3, place cards 1, 2, and 3 in hopper before card 4, and ready the 1442.

Feed Check (read station). Indicates that card 1 failed to eject from the read station during its feed cycle.

Card positions after error:

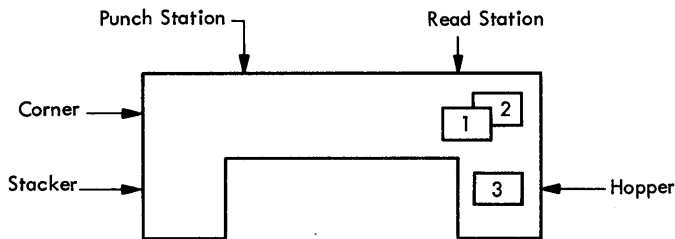

Error indicator: READ STA

Operator procedure: When program halts, empty hopper, clear 1442 card path, place cards 1 and 2 in hopper before card 3, and ready the 1442.

Read Registration. Indicates incorrect card registration or a difference between the first and second reading of a column.

Card positions after error:

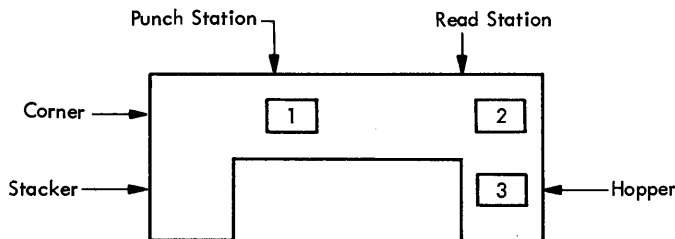

Error indicator: READ REG

Operator procedure: See Feed check (punch station). Repeated failures of this type might indicate a machine malfunction.

Punch Check. Indicates an error in output punching.

Card positions after error:

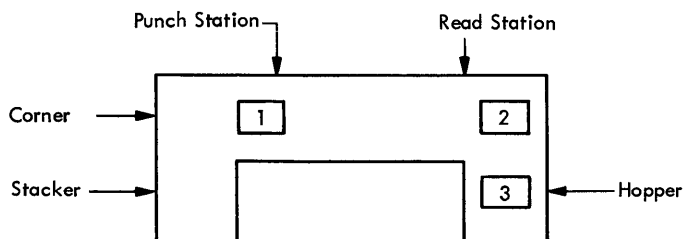

Error indicator: PUNCH

Operator procedure: When program halts, empty hopper, check card position and press NPRO to clear 1442 card path. If necessary, correct card 1 to pre-punched state. Place (corrected) card 1 and card 2 in hopper before card 3 and ready the 1442.

### CONSOLE PRINTER SUBROUTINE (TYPE0 AND WRTY0) ERRORS

If the carrier attempts to print beyond the manually positioned margins, a carrier restore (independent of the program) occurs.

Subroutine printing begins wherever the carrier is positioned as a result of the previous print operation. There is no automatic carrier return as a result of an LIBF.

If the console printer indicates a not-ready condition after printing has begun, the subroutines loop internally, with interrupt level 4 on, waiting for the console printer to become ready. Operator procedures are as follows:

1. Press IMM STOP on the console.
2. Ready the console printer.
3. Press PROGRAM START on the console.

### KEYBOARD SUBROUTINE (TYPE0) FUNCTIONS

#### Re-entry

When the Erase Field key is pressed, a character interrupt signals the interrupt response routine that the previously-entered keyboard message is in error and will be reentered. The routine prints two slashes on the console printer, restores the carrier to a new line, and prepares to replace the old message in the I/O area with the new message. The operator then enters the new message. The old message in the I/O area is not cleared. The new message overlays the previous message, character by character. If the previous message was longer than the new message, characters from the previous message remain (following the NL character which terminated the new message).

## Backspace

When the backspace key is pressed, the last graphic character entered is slashed and the address of the next character to be read is decremented by +1. If the backspace key is pressed twice consecutively, the character address is decremented by +2, but only the last graphic character is slashed. For example, assume that ABCDE has been entered and the backspace key pressed three times. The next graphic character replaces the C, but only the E is slashed. If the character F had been used for replacement the paper would show ABCDEFFF but ABFFF would be stored in the buffer.

## PAPER TAPE SUBROUTINES (PAPT)

If the reader or punch becomes not ready during an I/O operation, the subroutines exit to the user via the error parameter. The user can request the subroutine to terminate (clear device busy and interrupt level) or to loop on not-ready waiting for operator intervention (interrupt level 4 on).

The following procedure should be used to clear a paper tape not-ready condition:

1. Press IMM STOP on the console.
2. Ready the paper tape unit.
3. Press PROGRAM START on the console.

To load the paper tape reader, place the tape so that the delete characters punched in the leader are under the read starwheels. To begin reading at any point in the tape other than the leader, place the tape so that the frame (character position) preceding the character to be read is under the read starwheels. The first start reader control after tape is loaded or repositioned causes the reader to skip the character under the read starwheels and load the next character into the buffer.

## ADDING AND REMOVING SUBROUTINES

Subroutines can be added to or removed from the subroutine library as desired by the user. The DUP control record STORE adds a subroutine, and the DUP control record DELETE removes a subroutine. Each subroutine in the IBM-supplied System Deck is preceded by a DUP STORE record.

The user should not remove subroutines that are called by other subroutines left in the library (refer to Appendix E for a list of subroutines called by other subroutines).

## SYSTEM GENERATION OPERATING PROCEDURES (CARD SYSTEM)

Before the Disk Monitor System can begin operation, the user must perform the following functions:

1. Load and execute the IBM-supplied Disk Pack Initialization Routine (DPIR) to initialize the disk pack.
2. Prepare a Load Mode Control Card and System Configuration Cards, and insert these cards into the IBM-supplied System Deck.
3. Load the above deck into the disk.
4. Using the IBM-supplied Cold Start Card, load the Supervisor program into core storage from disk storage.

Each of the above procedures is described in detail in subsequent sections of this manual.

### DISK PACK INITIALIZATION ROUTINE (DPIR)

The DPIR (Disk Pack Initialization Routine) performs the following functions:

1. Clears the disk and writes disk sector addresses on all cylinders.
2. Determines which, if any, sectors are defective and writes the addresses of the cylinders containing the defective sectors on sector 0000. If sector 0000 is defective, DPIR does not write any defective cylinder table.
3. Puts an ID on the disk pack.

The 1130 Disk Routines operate effectively with up to three cylinders containing defective sectors. An attempt to read or write a defective sector that is not identified in sector 0000 results in a read or write error after the operation has been attempted 10 times.

At the completion of DPIR, an eight-word table is written on sector 0000. The first word (word 0) of the table contains the sector address 0000. Words one, two, and three contain the first sector address of any defective cylinders found (maximum of three). When there is no defective cylinder, these words contain 0658<sub>16</sub>. Word 4 is reserved. Words five, six, and seven contain a five character ID name in packed EBCDIC. Words five and six contain two characters per word, and word seven

contains an EBCDIC character in the left half of the word and an EBCDIC blank in the right half of the word.

To determine which sectors are defective, the user can dump core upon completion of execution; the defective sector table starts at location 0771.

Table 10 lists the DPIR halt addresses.

### DPIR Card Load Operating Procedures

The procedure for loading and executing the Disk Pack Initialization Routine is as follows:

1. Load the disk pack in the console cabinet, turn the File Switch on, and wait for the FILE READY light to come on.
2. Put the six-card loader, followed by the DPIR deck, in the card hopper.
3. Set the console mode switch on RUN.
4. Press IMM STOP, then RESET on the console.
5. Press START on the card reader.
6. Press PROGRAM LOAD on the console; when all cards have been read from the hopper, press START on the card reader.

After DPIR is loaded, the routine waits at 02EE and the keyboard is selected. (The keyboard Select light comes on.) Wait for the File Ready light to come on and then:

1. Enter a five-character ID (of your choice) to be written on the disk pack. If the ID is less than five characters, left-justify by following the ID with spaces. Only those characters recognized by the Supervisor should be used (see Appendix D). When the fifth character is entered, the program branches to execute. The disk surface is now cleared and the sector addresses are written. The routine waits at 03C2.
2. Set all the Console Entry switches off.
3. Press PROGRAM START. The defective sector and file protect address data is written on sector 0000. A scan of the disk is now performed to check for seek failures. If a seek or read failure occurs, the routine waits at 03EA. Other DPIR halt addresses are described in Table 10.

● Table 10. DPIR Halt Addresses

Halt Address (hex)*	Meaning	Action Required	
002E	The keyboard is not restored and an attempt is made to load DPIR. The routine loads and comes to a halt with interrupt 4 on.	Turn the console entry switches off; then press PROGRAM START on the console.	
02EE	The routine is in WAIT.		
039F	Sector 0000 is defective; the sector addresses have been written on the disk, but the table has not been written on sector 0000. (70FF loop)		
03C2	The routine is in WAIT.		
03F2	The routine has run successfully, but more than three defective sectors were found. (70FF loop)		
03F6	The routine has run successfully and no defective sectors were found. (70FF loop)		
0400	The routine has run successfully and one to three defective sectors were found. (70FF loop)		
040A	(1) The disk is not ready (70FF loop) (2) A Write Select error has occurred (70FF loop). The file ready indicator is turned off by a Write Select error.		(1) Make the disk ready and restart the program (2) Turn off the Single Disk Storage, allowing the cartridge unlock indicator to light; turn on the Single Disk Storage until the disk ready indicator lights, then resume operation. If the error persists, CE intervention is required.
0422	A seek failure or read failure occurred during a scan of the disk. (70FF loop)		

\* Displayed in Storage Address Register

USER-SUPPLIED CARDS

Before loading the Disk Monitor System programs onto the disk, the user must prepare the following cards:

1. Load Mode Control Card
2. System Configuration Deck:
  - a. SCON Card
  - b. REQ Card(s)
  - c. TERM Card

The System Loader will give error messages for

missing or invalid user-supplied cards (see Appendix A).

Load Mode Control Card

The Load Mode Control Card is used to specify an initial load or a reload. It also permits the user to specify whether the assembler and/or FORTRAN is to be loaded. At least one of these must be loaded on an initial load; then, if desired, it can be removed by using the DEFINE function of DUP. The format is shown in Table 11 (only columns 1 through

Table 11. Load Mode Control Card Format

Column	Punch	Meaning
1	12 Punch	Initial load. Monitor System programs, ILS and ISS subroutines required by the system, and functional subroutines are loaded. However, the assembler will not be loaded if column 2 contains a 0 punch, and FORTRAN will not be loaded if column 2 contains a 1 punch.
	No 12 Punch	Reload. Monitor System programs are reloaded, and the contents of the User and Fixed areas (including LET/FLET) are not changed. Only programs presently on the disk can be reloaded; if the assembler or FORTRAN were not loaded during an initial load, or have since been deleted, they cannot be reloaded.
2	0 Punch No 0 Punch	Bypass (do not load) assembler. Load assembler.
	1 Punch No 1 Punch	Bypass (do not load) FORTRAN. Load FORTRAN.
3	9 Punch	Required in all cases to identify Load Mode Control Card.

3 are used). For example, to initially load the monitor (including the assembler and FORTRAN), the Load Mode Control Card is punched with a 12 punch in column 1 and a 9 punch in column 3.

System Configuration Deck

SCON Card

The SCON Card is the deck header card. The format is as follows:

<u>Columns</u>	<u>Contents</u>
1-4	SCON

REQ Cards

REQ Cards identify devices present in system. One card should be prepared for each I/O device on the system. The System Loader uses this information for selective generation and loading of ILS sub-routines and selective loading of ISS subroutines. The format is shown in Table 12.

TERM Card

The TERM Card is the last card of the System Configuration Deck. The format is as follows:

<u>Columns</u>	<u>Contents</u>
1-4	TERM

Table 12. REQ Card Format

Device	Columns			
	1-3	10	15-16	21-22
		(ISS No.)	(Primary Interrupt Branch Address)	(Second Interrupt Branch Address)
1442 Card Read Punch	} REQ	1	08	12
Input keyboard and console printer		2	12	Blank
1134 paper tape reader or 1055 paper tape punch		3	12	Blank
Disk		4	10	Blank
1132 Printer		6	09	Blank
Plotter		7	11	Blank
NOTE: If both the console printer and the 1132 Printer are included, the 1132 Printer will be the principal printing device; if both the 1442 Card Read Punch and the 1134/1055 paper tape units are included, the 1442 Card Read Punch will be the principal I/O device.				



**PROCEDURE FOR INITIALIZING DISK MONITOR SYSTEM FROM CARDS**

1. Execute the following:
  - a. Press IMM STOP on console.
  - b. Press RESET on console.
  - c. Press NPRO on the 1442 card reader.
2. Load the following decks into hopper of the 1442 card reader (see Figure 10).
  - a. Monitor System Bootstrap, followed by IBM-supplied System Loader Deck, Part 1. Columns 73-74 contain the ID: E1.
  - b. User-supplied Load Mode Card.
  - c. IBM-supplied System Loader Deck, Part 2. Columns 73-74 contain the ID: E2.
  - d. User-supplied System Configuration Deck (SCON Card, REQ Cards, TERM Card).
  - e. Remainder of IBM-supplied System Deck.
3. Execute the following:
  - a. Ready the 1132 Printer (if the 1132 Printer is the principal print device)
  - b. Turn the File Switch on, and wait for the File Ready light on the console to go on.
  - c. Press START on the 1442 card reader.
  - d. Press RESET on console.
  - e. Press PROGRAM LOAD on console.
  - f. The system waits at 0029.

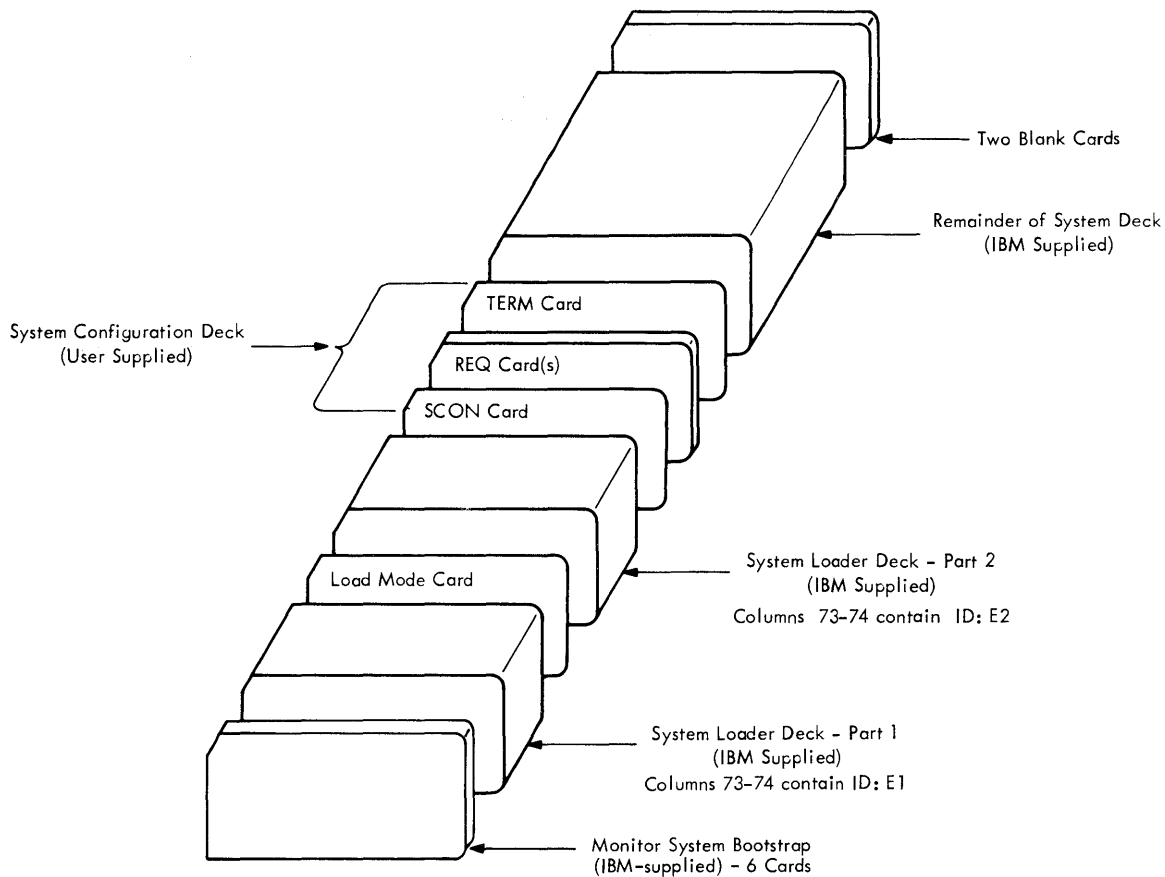

Figure 10. System Loader Card Sequence

## COLD START OPERATING PROCEDURE

The user must load the Supervisor Program into core storage from disk storage by using the IBM-supplied Cold Start Card (last card of sub-routine deck) or Cold Start paper tape record:

1. to begin operation of the Disk Monitor System after it has been loaded to the disk;
2. to return control to the Supervisor;
3. after a disk cartridge has been changed.

The procedure for executing the Cold Start Card is as follows:

1. Insert the monitor disk pack in the console cabinet.
2. Turn the File Switch on, and wait for the File Ready light on the console to go on.
3. Put the Cold Start Card into the card hopper followed by a //JOB record and another monitor control record to processed.
4. Press IMM STOP, then RESET on the console.
5. Press START on the card reader.
6. Press PROGRAM LOAD on the console.

The Cold Start record reads the Cold Start sector (0001) from disk into core location 0802. The Monitor Supervisor Program is then read into core. The first monitor control record is read under control of the Supervisor Program by the Monitor Control Record Analyzer routine.

Possible stopping locations are given in Table 13.

NOTE: A cold start cannot be used to resume an operation that has been previously terminated. After the Supervisor has been loaded into core, the following procedure may be used:

1. Press NPRO on the card reader.
2. Place program deck in the card hopper.
3. Press START on the card reader.
4. Press PROGRAM START on the console.

Table 13. Cold Start Halt Addresses

Wait Address (hex)*	Meaning
0024	The disk was not ready and the first XIO was treated as a NOP
0026	The disk was not ready and the second XIO was treated as a NOP
0034	There was a Disk Data Error
0803	Disk not ready
080A	Disk not ready
080F	Sector 000A was not read correctly
0811	Disk not ready
0816	Sector 0009 was not read correctly
081E	Disk not ready
0823	Sector 0008 was not read correctly
0839	There was a Disk Data Error

\*Displayed in Storage Address Register

All of the paper tape records needed to load the Paper Tape Monitor System to disk storage are supplied to the user by IBM. These records have the same functions as the corresponding IBM-supplied and user-written card decks. These functions are described under System Generation Operating Procedures (Card System).

The Load Mode Control record and System Configuration records are supplied by IBM to the user of the Paper Tape System. These tapes are supplied with all the possible configurations, and the user need only select the configuration for his particular use. If these tapes are not read correctly, the System Loader will give error messages (see Appendix A).

The tapes constituting the Paper Tape Monitor System are described below. The procedure for loading these tapes onto disk is described under Procedure for Initializing Disk Monitor System from Paper Tape.

<u>Tape</u>	<u>Description</u>
1	System Loader, Part 1
2	Load Mode Control Record (same function as Load Mode Control Card)
3	System Loader, Part 2
4	System Configuration Records (same function as <u>System Configuration Deck</u> )
5	Supervisor Tape (includes the Loader)
6	Disk Utility Program
7	FORTTRAN Compiler
8	Assembler
9, 10	ILS Control Records and Library Subroutines (2 parts)
11	DPIR Tape (includes core image loader)
16	Cold Start Paper Tape Record

If FORTRAN and/or the assembler are not to be loaded during an initial load, the corresponding tapes (7 and/or 8) need not be read.

During a reload of system programs, tapes 1 through 5 must be read. If DUP, FORTRAN, and/or the assembler are not to be reloaded, the corresponding tapes (6, 7, and/or 8) need not be read. The procedures for reloading DUP, FORTRAN, and the assembler are the same as the card system procedures. Tapes 9 and 10 need not be read during a reload operation.

#### DPIR PAPER TAPE LOAD OPERATING PROCEDURES

The procedure for loading and executing the DPIR (Disk Pack Initialization Routine) is as follows:

1. Insert the disk pack in the console cabinet.
2. Put the DPIR tape in the reader; position one of the delete codes that appear after the program name in the leader under the read starwheels.
3. Press IMM STOP, RESET, and PROGRAM LOAD on the console.
4. When the loader reads in and waits, position the DPIR tape.
5. Press PROGRAM START on the console.

From this point on, the operation is identical to the card load.

#### PROCEDURE FOR INITIALIZING DISK MONITOR SYSTEM FROM PAPER TAPE

To load the paper tape system onto disk, the operator must perform the following steps:

1. Ready the 1132 printer (if the 1132 printer is the principal printing device).
2. Place the System Loader, Part 1, (Tape 1) in the Paper Tape Reader. When loading tapes 1 through 10, and 16, position any one of the delete codes following the program name in the tape leader under the read starwheels.
3. Press RESET on the console.

4. Press PROGRAM LOAD on the console. Tape 1 is read into core starting at location 0.
5. When a WAIT occurs (at 05BC), place the Load Mode Control tape (Tape 2) in the Paper Tape Reader.
6. Press PROGRAM START on the console.
7. When a WAIT occurs, place the next system tape in the Paper Tape Reader.
8. Press PROGRAM START on the console.
9. Repeat steps 7 and 8 until the last system tape is read.

The System Loader determines if the complete system has been loaded. If the system has not been loaded, the System Loader WAITs for another tape to be readied by the operator until the complete system is loaded.

A WAIT at 0EA6 is a checksum error, indicating faulty tape.

#### COLD START OPERATING PROCEDURE

The procedure for executing the Cold Start paper tape record is as follows:

1. Insert the monitor disk pack into the console cabinet.
2. Turn the File Switch on, and wait for the File Ready light on the console to go on.
3. Put the Cold Start paper tape record into the reader; position any one of the delete codes following the program name in the tape leader under the read starwheels.
4. Press IMM STOP, then RESET on the console.
5. Press PROGRAM LOAD on the console.

#### PAPER TAPE CONTROL RECORDS

Paper tape control records must be punched in PTTC/8 (perforated tape transmission code). The formats are the same as the previously-described card formats. Paper tape control records must be separated by one NL (new line) control character. A control record which immediately follows paper tape data not followed by an NL code must be preceded by one NL code. Delete codes may precede or follow this NL code.

Table A-1. System Loader Error Codes

Error Code	Type of Error	Corrective Action
E1	Check-sum error.	Follow Procedure A or reload and restart.
E2	Illegal card type or blank card.	Follow Procedure A or reload and restart.
E3	Card out of sequence.	Follow Procedure A or reload and restart.
E4	ORG backward to an address lower than that established by last sector break card.	Inspect deck for card(s) missing or out of sequence. Correct deck and reload edit program.
E5	Error in Load Mode card.	Make necessary card correction and reload edit program.
E6	Disk error.	Press PROGRAM START on console to retry.
E7	Disk pack not initialized or Sector 0 data damaged.	Use DPIR program to initialize Sector 0. Initial load should follow since DPIR clears the disk.
E8*	Configuration deck missing or one of the following errors detected: a) SCON card not followed by REQ cards. b) less than 2 REQ cards present. c) more than 6 REQ cards present. d) Secondary Interrupt Branch Address (IBA) not included in ISS #1 card. e) Secondary IBA not equal to 12. f) Primary IBA not in range 8 through 12. g) ISS number missing or negative. h) ISS number 5 detected (illegal). j) ISS number greater than 7. k) TERM card missing	Make corrections and reload edit program.
E9**	File protect address (in COMMA) prohibits loading System Loader, Part 2.	No recovery unless file protect address can be lowered by deleting part of material on disk. System Loader requires temporary use of Cylinders 198 and 199.
E10**	During reload, old FORT or ASM address in COMMA is different from new FORT or ASM sector address.	If COMMA has been damaged, an initial load is required; otherwise system program deck is faulty.
E11**	Fixed area or Core Image Buffer area, as defined by COMMA, is about to be overlayed.	Same as E10.

\* Applies to initial load only.

\*\* Applies to reload only.

Procedure A:

1. Lift remaining cards from hopper and depress NPRO on 1442.
2. Place the two ejected cards (after corrections) in card hopper.
3. Replace remaining cards in card hopper.
4. Press START on 1442.
5. Press PROGRAM START on console.

Table A-2. System Loader (Part 1) Wait Locations

Address *	Explanation
.01C7	Wait after displaying E6 error
053D	Wait after displaying E1 error
06B0	Wait after displaying E3 error
0806	Wait after displaying E2 error
080B	Wait after displaying E8 error
0821	Wait after displaying E5 error
0835	Wait after displaying E9 error
0839	Wait after displaying E8 error
083D	Wait after displaying E4 error
08A4	Wait after displaying E7 error
0962	Wait after displaying E4 error
0EE6	Wait during loading of the System Loader due to incorrect check sum, e.g., a missing card or card out of sequence.

\*Displayed in Storage Address Register

Table A-3. System Loader (Part 2) Wait Locations

Address *	Explanation
0220	Wait after displaying E 10 error
022F	Wait after displaying E 10 error
0245	Wait after displaying E 11 error
025F	Wait after displaying E 1 error
027D	Wait after displaying E 3 error
05C5	Wait after displaying E 2 error
0750	Wait after displaying E 5 error
0816	Wait after displaying E 3 error
08B6	Wait after displaying E 4 error
0991	Wait after displaying E 2 error
0AD7	Wait after displaying E 6 error
0FFF	Wait after displaying END reload

\*Displayed in Storage Address Register

Table A-4. Monitor Supervisor Error Messages

Error Message	Cause of Error
M 01 PHASE NONX	Execution is not permitted for this job.
M 02 INVALID	The above listed record is an invalid Supervisor record.
M 03 NON XEQ	The currently called execution is not permitted.
M 04 CHARACTER	A character in the name listed above is not permitted.
M 05 OFLO DISK	The records listed above were too many for the disk storage allocated.
M 06 NO PROGRAM	The mainline program name listed above is not in the LET or FLET table or is not a mainline program.
M 07 NON DUP	DUP is not allowed for the subjob.
M 09 RECORD TRAP	A system program detected a Supervisor record and returned control to the Supervisor.
M 11 NOT IDENT	The cartridge identifier on the cartridge is not identical to the one on the input record. The Supervisor waits to allow the operator to rectify the difference if desired.
M 12 SEQ ERROR	LOCAL, NOCAL, and/or FILES records are intermixed (they must be grouped).
M 13 T ERROR	Column 8 in the JOB record does not contain a blank or a T. An ampersand is printed in place of the illegal character. The Supervisor waits so that the operator can (1) correct the JOB record, reload it in the reader, and press PROGRAM START on the console; or (2) press PROGRAM START on the console. In either case the JOB record is processed completely before any other processing. The job is considered non-temporary if column 8 contains a blank or a character other than a T.

●Table A-5. Monitor Supervisor Wait Locations

Address*	Explanation	Operator Action
0005	Operator pressed PROGRAM STOP on the console.	Press PROGRAM START to continue.
0029	I/O error or device not-ready condition.	Refer to <u>Subroutine Library - Preoperative Errors</u> .
00DD	Disk error.	Press PROGRAM START to retry.
07E6	<ol style="list-style-type: none"> <li>1. Pause due to PAUS control record.</li> <li>2. Identifier error in JOB control record.</li> </ol>	<ol style="list-style-type: none"> <li>1. Press PROGRAM START to continue.</li> <li>2. Correct the record, reenter it, and press PROGRAM START; or press PROGRAM START.</li> </ol>
0398	Paper tape reader not ready.	Ready paper tape reader and press PROGRAM START.
07D4	Column 8 in the JOB record does not contain a blank or a T.	Correct the record, reenter it, and press PROGRAM START; or press PROGRAM START. In either case, the current job is processed first.

\*Displayed in Storage Address Register

● Table A-6. Loader Messages/Error Messages (Part 1)

Code and Message	Explanation and Recovery Procedures
R 01 ORIGIN BELOW 1ST WORD OF MAINLINE	The Loader has been instructed to load a word into an address lower than that of the first word of the mainline program. The ORG statement which caused this situation must be removed, or the mainline program must start at a lower address.
*R 03 LOAD REQUIRES SYSTEM LOCALS, LEVEL 1	No error. The load was too long to fit into core. The Loader has made two overlays, and the program will be executed with these two groups of routines overlaying each other (refer to <u>System Overlays</u> ).
*R 04 LOAD REQUIRES SYSTEM LOCALS, LEVEL 2	No error. The load was too long to fit into core. The Loader has made three overlays, and the program will be executed with these three groups of routines overlaying one another (refer to <u>System Overlays</u> ).
R 06 FILE(S) TRUNCATED (SEE FILE MAP)	At least one defined file has been truncated either because the previously defined storage area in the User or Fixed area was inadequate or because there is inadequate Working Storage available to store the file. See Message R 12 for a possible remedy.
R 08 CORE LOAD EXCEEDS 32K	The Loader has been instructed to load a word into an address exceeding 32, 767, which is a negative number. The loading process is immediately terminated, because the Loader cannot process negative addresses. This error was probably caused by bad data, i. e., the program being loaded from the disk has been destroyed.
R 10 LIBF TV REQUIRES 82 OR MORE ENTRIES	There are at least 82 different entry points referenced in the load by LIBF statements. A possible remedy would be to subdivide the load into two or more links.
R 11 TOO MANY ENTRIES IN LOAD-TIME TV	There are more than 135 references to different entry points with CALL and/or LIBF statements in the load. A possible remedy would be to subdivide the load into two or more links.
R 12 LOCALS/SOCALS EXCEED WKNG. STORAGE	There is insufficient Working Storage remaining to accommodate the LOCAL and/or SOCIAL overlays required in the load. A possible remedy would be to create more Working Storage by deleting subroutines, subprograms, and/or data no longer required by the installation.
R 13 DEFINED FILE(S) EXCEED WKNG. STORAGE	There is insufficient Working Storage remaining to accommodate even one record of the defined file(s). See Message R 12 for a possible remedy.
**R 16 XXXXX IS NOT IN LET OR FLET	The program or data file designated in the message cannot be found in LET or FLET. A possible remedy is to store the program or data file. If the name cannot be explained otherwise, the program being loaded has probably been destroyed.
**R 17 XXXXX CANNOT BE DESIGNATED A LOCAL	The routine named in this message is either a type which cannot appear on a LOCAL record, or this routine, which is a LOCAL, has been referenced, directly or indirectly, by another LOCAL, the name of which cannot be supplied by the Loader.
**R 18 XXXXX CANNOT BE DESIGNATED A NOCAL	The routine named in the message is either a mainline, an ILS, or it has an invalid type code. In any case, it may not appear on a *NOCAL record.
**R 19 XXXXX IS NOT ON A SECTOR BOUNDARY	The area named in this message does not begin at a sector boundary, which implies that it is not a storage area but a relocatable program, and thus a possible error. Choose another area for the storage of this file.
**R 20 XXXXX COMMON EXCEEDS THAT OF ML	The length of COMMON for the routine named in this message is longer than that of the mainline program. A possible remedy is to define more COMMON for the mainline program.
**R 21 XXXXX PRECISION DIFFERENT FROM ML	The precision for the routine named in this message is incompatible with that of the mainline program. Make the precisions compatible.
**R 22 XXXXX AND ANOTHER VERSION REFERENCED	At least two different versions of the same I/O routine have been referenced, e.g., both CARDZ and CARD0 (FORTRAN utilizes the "Z" version). If a disk routine is named in the message, it is possible that the XEQ record specifies one version, e.g., DISK0, whereas the program references another, e.g., DISK1 (a blank in col. 19 of the XEQ record causes DISKZ to be chosen).
**R 23 XXXXX IS A USER AREA FILE REFERENCE	The area named in this message is in the User area; references in DEFINE FILE and DSA statements for *STORECI functions must be to the Fixed area.

\*FORTRAN mainline programs only

\*\*XXXXX = the name of the program or disk file concerned



Table A-6. Loader Messages/Error Messages (Part 2)

Code and Message	Explanation and Recovery Procedures
*R 24 XXXXX IS BOTH A LIBF AND A CALL	The routine named in this message has been either referenced improperly, i.e., CALL instead of LIBF or vice versa, or has been referenced in both CALL and LIBF statements. The only remedy is to reference the routine properly. NOTE: NOCALLs must be CALL-type routines, i.e., type 4 or 6 routines (refer to Appendix B).
*R 25 XXXXX HAS MORE THAN 14 ENTRY POINTS	This message usually indicates that the routine has been destroyed since no routine is stored with more than 14 entry points.
*R 26 XXXXX HAS AN INVALID TYPE CODE	The routine named in this message has either been designated on an XEQ record and is not a mainline program, indicating a mistake has probably been made in preparing the XEQ record, or contains a type code other than 3 (subroutine), 4 (functional), 5 (ISS), or 6 (ILS), in which case the routine has probably been destroyed. This error could also be caused by a DSA statement referencing a program which is in Disk System format, or a CALL or LIBF referencing a program in Core Image or Disk Data format.
*R 27 XXXXX LOADING HAS BEEN TERMINATED	The loading of the mainline program named in this message has been terminated as a result of the detection of the error(s) listed in the messages preceding this one.
**R 32 XXXXX CANNOT REF'CE THE LOCAL XXXXX	The routine named first in this message has referenced the routine named second, which is a LOCAL. Either the first named routine is a LOCAL or it is entered (directly or indirectly) from a LOCAL. Neither case can be allowed for it could cause a LOCAL to be overlaid by another LOCAL before the first LOCAL has been completely executed.
R 40 XXXX (HEX) = ADDITIONAL CORE REQUIRED	If the load was executed, XXXX <sub>16</sub> is the number of words by which it exceeded core storage before the Loader made it fit by creating special overlays (SOCALs); if the load was not executed, the first occurrence of the message is as described and the record indicates the number of words by which it exceeds core storage even after creating the deepest level of special overlays. A possible solution to the latter problem is to create two or more links or LOCALs.
***R 41 XXXX (HEX) TOO MANY WDS IN COMMON	The length of COMMON specified in the mainline program plus the length of the core load exceeds core storage by XXXX <sub>16</sub> words.
R 42 XXXX (HEX) IS THE EXECUTION ADDR	No error. This message follows every successful conversion from Disk System format to Core Image format provided a core map is requested.
R 43 XXXX (HEX) = ARITH/FUNC OVERLAY SIZE	No error. It has been necessary to employ the special overlays (SOCALs), and XXXX <sub>16</sub> is the length of the arithmetic/functional overlay (refer to <u>System Overlays</u> ).
R 44 XXXX (HEX) = FI/O + I/O OVERLAY SIZE	No error. It has been necessary to employ the special overlays (SOCALs), and XXXX <sub>16</sub> is the length of the FORTRAN I/O, I/O, and conversion routine overlay (refer to <u>System Overlays</u> ).
R 45 XXXX (HEX) = DISK FI/O OVERLAY SIZE	No error. It has been necessary to employ the special overlays (SOCALs), and XXXX <sub>16</sub> is the length of the Disk FORTRAN I/O overlay, including the 320-word buffer.
R 46 XXXX (HEX) = AN ILLEGAL ML LOAD ADDR	XXXX <sub>16</sub> is the address at which the loader has been requested to start loading the mainline program, but this address is lower than the highest address occupied by the version of Disk I/O requested for this load. Either make the mainline origin higher or request a shorter version of Disk.
R 47 XXXX (HEX) WORDS AVAILABLE	No error. XXXX <sub>16</sub> is the number of words of core storage not occupied by this core load. It is possible to get both this message and R41 in the same core load. See footnote to R41 for explanation.

(Concluded)

\*XXXXX = the name of the program or disk file concerned

\*\*XXXXX = the name of the program concerned

\*\*\*COMMON may not occupy any storage location lower than 896<sub>10</sub>, 1216<sub>10</sub>, 1216<sub>10</sub>, or 1536<sub>10</sub>, if DISKZ, DISK0, DISK1, or DISKN, respectively, is used.

Table A-7. Assembler Error Messages

Error Code and Error Message	Cause of Error	Corrective Action
A 01 MINIMUM W. S. NOT AVAILABLE--- ASSEMBLY TERMINATED	Less than 33 sectors of Working Storage are available at the beginning of the assembly.	Perform a DUP DELETE to expand Working Storage to a minimum of 33 sectors before attempting further assemblies.
A 02 SYMBOL TABLE OVERFLOW EXCEEDS 4 CYLINDERS	Symbol table overflow exceeds 3392 symbols (refer to <u>Assembler Messages and Error Codes</u> to compute number of symbols allowed in a program).	<ol style="list-style-type: none"> <li>1. Reduce number of symbols and reassemble.</li> <li>2. Divide program into segments and assemble each separately.</li> </ol>
A 03 DISK OUTPUT EXCEEDS W.S.	Disk output is greater than Working Storage.	<ol style="list-style-type: none"> <li>1. If error occurred during pass 1, the assembler will wait at 0AD6. When PROGRAM START is pressed, the assembly will continue in the two-pass mode. Therefore, the operator should first insure that the source statements can be read a second time without encountering the next monitor control record.</li> <li>2. If error occurred during pass 2, object output exceeds Working Storage. Perform a DUP DELETE to enlarge Working Storage.</li> </ol>
A 04 SAVE SYMBOL TABLE INHIBITED	With SAVE SYMBOL TABLE option, symbol table exceeds the allowable System Symbol Table size of 100 symbols, or at least one assembly error was detected.	Reduce number of symbols and/or correct the erroneous statements and reassemble.

Table A-8. FORTRAN Error Codes (Part 1)

Error Number*	Cause of Error
C 01	Non-numeric character in statement number.
C 02	More than five continuation cards, or continuation card out of sequence.
C 03	Syntax error in CALL LINK or CALL EXIT statement.
C 04	Undeterminable, misspelled, or incorrectly formed statement.
C 05	Statement out of sequence.
C 06	Statement following transfer statement or a STOP statement does not have statement number.
C 07	Name longer than five characters, or name not starting with an alphabetic character.
C 08	Incorrect or missing subscript within dimension information (DIMENSION, COMMON, or type).
C 09	Duplicate statement number.
C 10	Syntax error in COMMON statement.
C 11	Duplicate name in COMMON statement.
C 12	Syntax error in FUNCTION or SUBROUTINE statement.
C 13	Parameter (dummy argument) appears in COMMON statement.
C 14	Name appears twice as a parameter in SUBROUTINE or FUNCTION statement.
C 15	*IOCS control record in a subprogram.
C 16	Syntax error in DIMENSION statement.
C 17	Subprogram name in DIMENSION statement.
C 18	Name dimensioned more than once, or not dimensioned on first appearance of name.
C 19	Syntax error in REAL, INTEGER, or EXTERNAL statement.
C 20	Subprogram name in REAL or INTEGER statement.
C 21	Name in EXTERNAL which is also in a COMMON or DIMENSION statement.
C 22	IFIX or FLOAT in EXTERNAL statement.
C 23	Invalid real constant.
C 24	Invalid integer constant.
C 25	More than 15 dummy arguments, or duplicate dummy argument in statement function argument list.
C 26	Right parenthesis missing from a subscript expression.
C 27	Syntax error in FORMAT statement.
C 28	FORMAT statement without statement number.
C 29	Field width specification > 145.
C 30	In a FORMAT statement specifying E or F conversion, $w > 127$ , $d > 31$ , or $d > w$ , where $w$ is an unsigned

Table A-8. FORTRAN Error Codes (Part 2)

Error Number*	Cause of Error
C 30 Cont.	integer constant specifying the total field length of the data, and $d$ is an unsigned integer constant specifying the number of decimal places to the right of the decimal point.
C 31	Subscript error in EQUIVALENCE statement.
C 32	Subscripted variable in a statement function.
C 33	Incorrectly formed subscript expression.
C 34	Undefined variable in subscript expression.
C 35	Number of subscripts in a subscript expression does not agree with the dimension information.
C 36	Invalid arithmetic statement or variable; or, in a FUNCTION subprogram the left side of an arithmetic statement is a dummy argument (or in COMMON).
C 37	Syntax error in IF statement.
C 38	Invalid expression in IF statement.
C 39	Syntax error or invalid simple argument in CALL statement.
C 40	Invalid expression in CALL statement.
C 41	Invalid expression to the left of an equal sign in a statement function.
C 42	Invalid expression to the right of an equal sign in a statement function.
C 43	In an IF, GO TO, or DO statement a statement number is missing, invalid, incorrectly placed, or is the number of a FORMAT statement.
C 44	Syntax error in READ or WRITE statement.
C 45	*IOCS record missing with a READ or WRITE statement (mainline program only).
C 46	FORMAT statement number missing or incorrect in a READ or WRITE statement.
C 47	Syntax error in input/output list; or an invalid list element; or, in a FUNCTION subprogram, the input list element is a dummy argument or in COMMON.
C 48	Syntax error in GO TO statement.
C 49	Index of a computed GO TO is missing, invalid, or not preceded by a comma.
C 50	*TRANSFER TRACE or *ARITHMETIC TRACE control record present, with no *IOCS control record in a mainline program.
C 51	Incorrect nesting of DO statements; or the terminal statement of the associated DO statement is a GO TO, IF, RETURN, FORMAT, STOP, PAUSE, or DO statement.
C 52	More than 25 nested DO statements.
C 53	Syntax error in DO statement.
C 54	Initial value in DO statement is zero.

\*Printed at the conclusion of Compilation. Refer to "Compilation Error Messages" under FORTRAN Printouts; also see "Type 00 Error Messages" in the same section.

Table A-8. FORTRAN Error Codes (Part 3)

Error Number	Cause of Error
C 55	In a FUNCTION subprogram the index of DO is a dummy argument or in COMMON.
C 59	Syntax error in STOP statement.
C 60	Syntax error in PAUSE statement.
C 61	Integer constant in STOP or PAUSE statement is > 9999.
C 62	Last executable statement before END statement is not a STOP, GO TO, IF, CALL LINK, CALL EXIT, or RETURN statement.
C 63	Statement contains more than 15 different subscript expressions.
C 64	Statement too long to be scanned, because of compiler expansion of subscript expressions or compiler addition of generated temporary storage locations.
C 65*	All variables are undefined in an EQUIVALENCE list.
C 66*	Variable made equivalent to an element of an array, in such a manner as to cause the array to extend beyond the origin of the COMMON area.
C 67*	Two variables or array elements in COMMON are equated; or the relative locations of two variables or array elements are assigned more than once (directly or indirectly).
C 68	Syntax error in an EQUIVALENCE statement; or an illegal variable name in an EQUIVALENCE list.
C 69	Subprogram does not contain a RETURN statement, or a mainline program contains a RETURN statement.
C 70	No DEFINE FILE in a mainline program which has disk READ, WRITE, or FIND statements.
C 71	Syntax error in DEFINE FILE.
C 72	Duplicate DEFINE FILE, more than 75 DEFINE FILES, or DEFINE FILE in subprogram.
C 73	Syntax error in record number of READ, WRITE, or FIND statement.

\*The detection of a code 65, 66, or 67 error prevents any subsequent detection of any of these three errors.

Table A-9. DUP Error Messages (Part 1)

Code and Printed Message*	Description
WS TOO LONG	An attempt is made with *STOREMOD to move an item from Working Storage that is longer than the item to be overlaid in the User or Fixed Area.
D 01 NOT PRIME ENTRY	The primary name of the program in Working Storage does not match the name on the DUP control record.
D 02 INVALID TYPE	One of the following is detected: non-DSF program, mispositioned header, foreign data, or erroneous subtype.
D 03 INVALID HEADER LENGTH	Word six of the DSF header is outside the range of 3-45. The causes are similar to D 02, except for subtype.
D 05 SECONDARY ENTRY POINT NAME ALREADY IN LET IS...	The specified name is already in LET. The name must be deleted before this subprogram can be stored.
D 13 DCTL, FUNCTION	An invalid DUP function specified in columns 1-12 of the DUP control record.
D 14 DCTL, FROM FLD	Unacceptable characters are in columns 13 and 14 of the DUP control record. If Working Storage is specified in columns 13 and 14, then there is no valid program in Working Storage, i.e., the Working Storage Indicator has been set to zero, thus inhibiting the movement of programs from Working Storage.
D 15 DCTL, TO FIELD	Unacceptable characters are in columns 17 and 18 of the DUP control record.
D 16 DCTL, NAME FLD	If this is a *STORE control record, then the name is already in LET/FLET. If this is a *DUMP control record, then the name is not found in LET or FLET. If this is a *DUMP control record of Working Storage to the principal I/O, then a name is required in columns 21 through 25 of the DUP control record. If this is a *DELETE control record, then the name is not found in LET or FLET. If this is a *STOREMOD control record, then the name is not found in LET or FLET.
D 17 DCTL, COUNT	Columns 27 through 30 are blank or include alphabetic characters. The count field requires a decimal number.
D 18 DCTL, TMP MODE	This function is not allowed during the JOB T mode.
D 41 FIXED AREA PRESENT	The FORTRAN compiler and/or assembler cannot be eliminated if a Fixed area has been previously defined.
D 42 ASSEMBLER NOT IN SYSTEM	The assembler has previously been eliminated from the system.
D 43 FORTRAN NOT IN SYSTEM	The FORTRAN compiler has previously been eliminated from the system.
D 44 INCREASE VALUE IN COUNT FIELD	The count field was read as a value of zero or one. The first DEFINE requires one cylinder for FLET plus one cylinder of Fixed area. Thereafter, as little as one cylinder of additional Fixed area can be defined.
D 45 EXCEEDS WORK STORAGE	The initiation or expansion of the Fixed area is limited to the Working Storage available.
D 61 DUPCO, EXCEEDS WORK STORAGE	This function requires more Working Storage than is available.
D 62 EXCEEDS WORK STORAGE	The Working Storage area is not large enough to contain the program specified.
D 64 EXCEEDS FIXED AREA	There is insufficient room in the Fixed area for the program.
D 71 SEQUENCE OR CKSUM	The cards are out of sequence, or there was an erroneous checksum.
D 72 LOAD BLANK CARDS	More blank cards are required to complete the dump. The operator performs an NPRO and places blank cards between the two cards ejected, removes the first card, places the first card in the output stacker, places the remainder in front of the cards still in the reader hopper, and presses the reader START button.
D 82 NON FILES RECORD	The first six characters of records following *STORECI are not *FILES. The number of *FILES records is determined by the count field of DUP control record STORECI.
D 83 INVALID CHARACTER	The *FILES record following the *STORECI DUP control record has an invalid character.
D 84 EXCEEDS SECTOR ALLOCATION	Too many Files have been defined. More than two sectors are required to contain the information from the *FILES record.

\*Printed upon detection of an erroneous DUP control record.

Table A-9. DUP Error Messages (Part 2)

Code and Printed Message	Description
D 92 INVALID CI CONVERT	The Loader has inhibited the continuation of *STORECI. The specific reason has been printed by the Loader.
D 94 LET/FLET OVERFLOW	A ninth sector of LET/FLET is required for the LET/FLET entry. A deletion of a program with a LET/FLET entry of similar size is required before this program can be stored.

NOTE: DCTL means the error was detected in the DUP control record. DUPCO means the error was detected in the DUP common section.

● Table A-10. DUP Waits and Loops

Address*	Explanation	Operator Action
Loops: 70FF@0287	System check. LET/FLET, COMMA, and DCOM do not agree.	Perform an initial load of entire Monitor System (see <u>System Generation Operating Procedures</u> ).
Wait at 092C	Paper tape reader not ready	Ready paper tape reader and press PROGRAM START.
Wait at 0005	Operator pressed PROGRAM STOP on console.	Do not alter core storage. To continue, press PROGRAM START.

\*Displayed in Storage Address Register

● Table A-11. FORTRAN I/O Error Codes

Error Code*	Cause of Error
F000	No *IOCS control card appeared with the mainline program and I/O was attempted in a subroutine.
F001	1. Logical unit defined incorrectly. 2. No *IOCS control record for specified I/O device.
F002	Requested record exceeds allocated buffer size.
F003	Illegal character encountered in input record.
F004	Exponent too large or too small in input field.
F005	More than one E encountered in input field.
F006	More than one sign encountered in input field.
F007	More than one decimal point encountered in input field.
F008	1. Read of output-only device. 2. Write of input-only device.
F009	Real variable transmitted with an I format specification or integer variable transmitted with an E or F format specification.
F100	File not defined by DEFINE FILE statement.
F101	File record number too large, equal to zero, or negative.
F103	Disk FIO (SDFIO) has not been initialized.
DISKZ Errors:	
F102	Read error.
F104	Write error.
F106	Read back check error.
F108	Seek error.
F10A	Forced read error (seek or find).

\*Displayed in Accumulator

DISK SYSTEM FORMAT (DSF)

Unless otherwise instructed, DUP automatically converts programs in Card System format (CDS) to Disk System format (DSF) when storing programs to disk storage. Likewise, programs in DSF are converted to CDS when dumping from disk storage. Disk System format is shown in Figure 11; Card System format is described elsewhere in this appendix.

Program Header Format

The contents of the program header record (see Figure 11) vary with the type of routine with which it is associated. The first 12 words of the program header record for the seven types of programs are identical except for word 6, which is 9 less than the number of words in the program header record. The format of these 12 words is as follows:

<u>Word</u>	<u>Contents</u>
1	Zero
2	Checksum if source was cards; otherwise zero
3	Type, subtype, precision
4	Effective length of program, i. e., the terminal address in the program
5	Length of COMMON (words)
6	Length of program header record minus 9
7	Zero
8	Length of program, including program header record in disk blocks
9	Number of files defined
10-11	Name of entry point 1 (see Appendix G)
12	Address of entry point 1 (absolute for type 1, relative to zero otherwise)

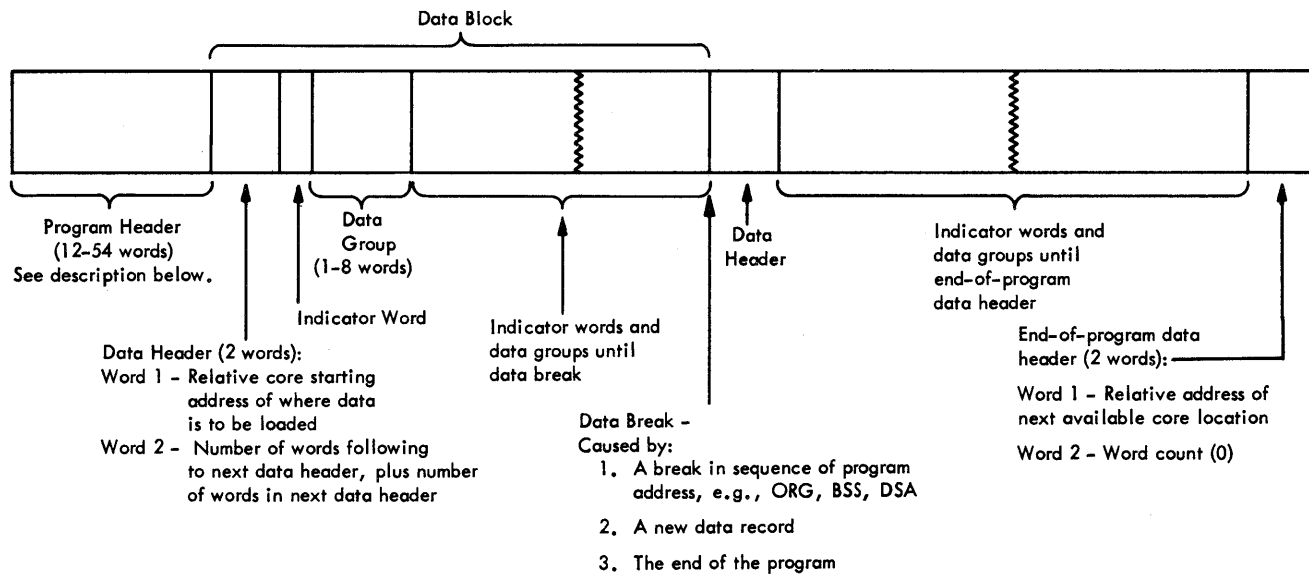

Figure 11. Disk System Format

After the first 12 words, the program header record format depends on the type of program. The header record for types 1 and 2 (absolute and relocatable mainline, respectively) consists of the first 12 words. The program types and their header record formats are shown below.

#### Program Types

Type Code	Type of Program
1	Mainline (absolute)
2	Mainline (relocatable)
3	Subroutine, not an ISS, referenced by LIBF
4	Subroutine, not an ISS, referenced by CALL
5	Interrupt service subroutine (ISS) referenced by LIBF
6	Interrupt service subroutine (ISS) referenced by CALL
7	Interrupt level subroutine (ILS)

#### Program Formats

##### Type 3, 4:

Words	Contents
13-14	Name of entry point 2 (30 bits, right-justified)
15	Address of entry point 2 (relative to zero)
17-18	Name of entry point 3 (30 bits, right-justified)
19	Address of entry point 3 (relative to zero)
20-54	Three words per entry point as above, to a maximum of 14 entry points. The header record ends at the last defined entry point; thus, it is of variable length

##### Type 5, 6:

Words	Contents
13	51 + ISS number
14	ISS number
15	Number of interrupt levels required
17	Interrupt level number associated with primary interrupt*
18	Interrupt level number associated with secondary interrupt

##### Type 7:

Words	Contents
13	Interrupt level number

\*The 1442 Card Read Punch is the only device requiring more than one interrupt level.

#### Program Subtypes

Subtypes are defined only for type 3 and 4 subroutines. When undefined, the field contains a zero.

For type 3 subroutines, subtypes are defined as follows:

Subtype	Description
0	In-core subroutines. Of the IBM subroutine library, this group includes the trace, fix, float, dump, subscript, normalize, flipper, initialization, and certain conversion subroutines
1	Disk FORTRAN I/O subroutines, SDFIO and SDFND
2	Arithmetic subroutines, e. g., FADD
3	FORTRAN Format subroutine SFIO, and FORTRAN I/O subroutines, e. g., CARDZ



For type 4 subroutines, subtypes are defined as follows:

<u>Subtype</u>	<u>Description</u>
0	All type 4 subroutines which are not subtype 8, e. g., DMTD0
8	Functional subroutines, e. g., SIN

Appendix E lists all IBM-supplied subroutines and their subtypes.

### DISK CORE IMAGE FORMAT (DCI)

A program in Disk Core Image format (DCI) is one that the Loader has converted from Disk System format (DSF). A DCI program is an entire core load, i. e., it consists of a mainline program, all subroutines referenced in the core load (except the Disk I/O routine), the object-time transfer vector, and the core image header record. The mainline program and subroutines appear as they will at execution time; however, the Loader must prepare the program for execution before it is read into core storage.

Although programs are loaded faster from DCI than from DSF, DCI programs usually occupy more disk storage because they constitute an entire core load. In addition, unlike DSF programs, the areas reserved by BSS and BES statements are a part of DCI programs unless the first statement in the mainline is a BSS or BES.

A typical DCI program is stored on disk in the User/Fixed area as follows:

Mainline Program	Subroutines (if any)	Object-time Transfer Vector	Core Image Header Record
------------------	----------------------	-----------------------------	--------------------------

The object-time transfer vector is described in the section titled The Loader. Information contained in the 60-word core image header record is used to load the DCI program into core before execution. The format is as follows:

<u>Words</u>	<u>Description</u>
1-6	Interrupt transfer vector (words 8-13 at execution time)
7	Setting for index register 3 at execution time
8	Core address (at execution time) of the subroutine ILS02
9	Number of files defined
10	Length of COMMON (in words)
11	Code for requested version of the Disk I/O subroutine (-1 = DISKZ, 0 = DISK0, 1 = DISK1, 2 = DISKN)
12	Core address (at execution time) of the entry in the LIBF TV which is associated with the Disk I/O subroutine
13	Length of the object-time transfer vector (in words)
14	Core address (at execution time) of the first word of the mainline program, exclusive of initial BSS and/or BES statements
15	Total length of mainline program, subroutines, and object-time transfer vector (in words)
16-60	Reserved

### DISK DATA FORMAT (DDF)

Disk Data format (DDF) describes information placed in the User area, Fixed area, or Working Storage area as a result of the DUP control record STOREDATA. Disk Data format consists of 320 binary words per sector; there are no headers, trailers, or indicator words.

### CARD SYSTEM FORMAT (CDS)

Card System format is in terms of words on binary cards (see Card Data Format). This is used for relocatable programs. The card ID and sequence numbers (columns 73-80) are in IBM card code.

#### Mainline Header Card

A mainline header card specifies the size of the common area and the size of the work area. It is

the first card of the mainline program. The format is as follows:

<u>Word</u>	<u>Contents</u>
1	Reserved
2	Checksum*
3	Type code (first 8 bits): 0000 0001 - absolute 0000 0010 - relocatable Precision code (last 8 bits): 0000 0001 - standard 0000 0010 - extended 0000 0000 - undefined
4	Reserved
5	Length of COMMON storage area (FORTRAN mainline program only)
6	0000 0000 0000 0011
7	Work area required (FORTRAN only)
8-54	Reserved

\*The checksum is the two's complement of the logical sum of the record count (position of the record within the deck) and the data word(s). The logical sum is obtained by summing the data word(s) and the record count arithmetically with the addition of a one each time a carry occurs out of the high-order position of the accumulator.

#### Data Cards

Data cards contain the instructions and data that constitute the assembled program. The format is as follows:

<u>Word</u>	<u>Contents</u>
1	Location (The relative load address of the first data word of the card or record. Succeeding words go into higher numbered core locations. The relocation factor must be added to this address to obtain the actual load address. For an absolute program the relocation factor is zero.)
2	Checksum
3	Type code (first 8 bits): 0000 1010 Data word count (last 8 bits)
4-9	Relocation indicators (2 bits per data word):

00 - nonrelocatable or absolute  
01 - relocatable  
10 - LIBF (one word call)  
11 - CALL (two word call)

10 Data word 1  
11-54 Data words 2 through 45

#### EOP Card

An EOP (end of program) card is the last card of each program and subroutine. The format is as follows:

<u>Word</u>	<u>Contents</u>
1	Starting location of next routine (this number is always even and is assigned by the assembler)
2	Checksum
3	Type code (first 8 bits): 0000 1111 Last 8 bits: 0000 0000
4	XEQ address, if mainline program
5-54	Reserved

#### Subroutine Header Card

A maximum of 14 entry points can be defined for each subroutine. The format of the subroutine header card is as follows:

<u>Word</u>	<u>Contents</u>
1	Reserved
2	Checksum
3	Type code (first 8 bits); 0000 0011 - to be called by a one-word call only (LIBF) 0000 0100 - to be called by a two-word call only (CALL) Precision code (last 8 bits): 0000 0000 - undefined 0000 0001 - standard 0000 0010 - extended
4-5	Reserved
6	Number of entry points times three
7-9	Reserved
10-11	Name of entry point 1
12	Relative address of entry point 1
13-51	Names and relative addresses of entry points 2 through 14
52-54	Reserved

## ISS Header Card

An ISS (interrupt service subroutine) header card for each interrupt service subroutine identifies the entry point defined by an ISS statement. Only one entry point can be defined for each subroutine. The format of the ISS header card is as follows:

<u>Word</u>	<u>Contents</u>
1	Reserved
2	Checksum
3	Type code (first 8 bits): 0000 0101 - to be called by a one-word call only (LIBF) 0000 0110 - to be called by a two-word call only (CALL) Precision code (last 8 bits): 0000 0000 - undefined 0000 0001 - standard 0000 0010 - extended
4-5	Reserved
6	Six plus number of interrupt levels required
7-9	Reserved
10-11	Subroutine name
12	Relative entry address
13	Address of ISTV (interrupt service transfer vector) is equal to 51 <sub>10</sub> plus the ISS number. *
14	ISS number (displacement in ISTV) = 1-8 <sub>10</sub>
15	Number of interrupt levels required
16	ID number for the primary interrupt level required (0-5)
17-29	ID numbers for remaining interrupt levels required (0-5)
30	Edit word (contains a 1)
31-54	Reserved

\*The ISTV table is initialized by the Loader. This table starts at location 0034. Each TV entry in this table contains the starting addresses for the corresponding ISS routine (maximum of 8 TV entries).

## ILS Header Card

An ILS (interrupt level subroutine) header card identifies the ILS routine. The format of the ILS header card is as follows:

<u>Word</u>	<u>Contents</u>
1	Reserved
2	Checksum
3	Type code (first 8 bits): 0000 0111 Reserved (last 8 bits)
4-5	Reserved
6	0000 0000 0000 0100
7-9	Reserved
10-12	Reserved
13	Interrupt level number
14-54	Reserved

## CARD DATA FORMAT (CDD)

Card Data format (CDD) is shown in Figure 12. Fifty four words can be placed on a card (1-1/3 columns per word, 4 columns for 3 words). The word numbers appear in every third column across the top of the card.

## PRINT DATA FORMAT (PRD)

Print Data format is shown in Figure 13. There are 16 four-character words per line, with a space after each word, and an additional space after each fourth word.

## PAPER TAPE SYSTEM (PTS) AND PAPER TAPE DATA (PTD) FORMATS

Paper Tape System format (PTS) is analogous to Card System format (CDS), and Paper Tape Data format (PTD) is analogous to Card Data format (CDD).

In Paper Tape format, two frames contain one binary word, which is equivalent to 16 bits per

binary word in Card Data format. In addition, a one-frame word count precedes a paper tape record. A paper tape data record contains a maximum of 54 binary words, i. e., 108 frames plus a word-count frame.

Information that would appear in columns 73-80 of a card must not appear on paper tape.

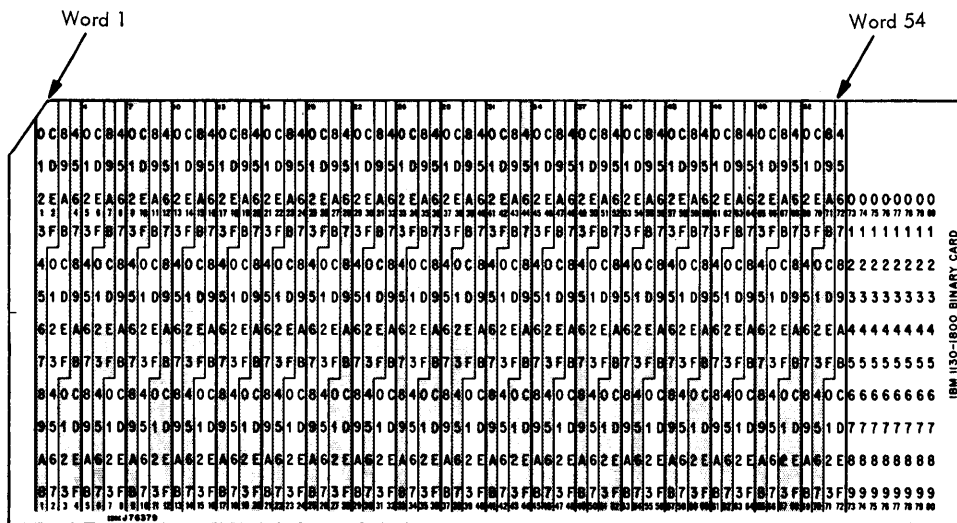

Figure 12. Card Data Format

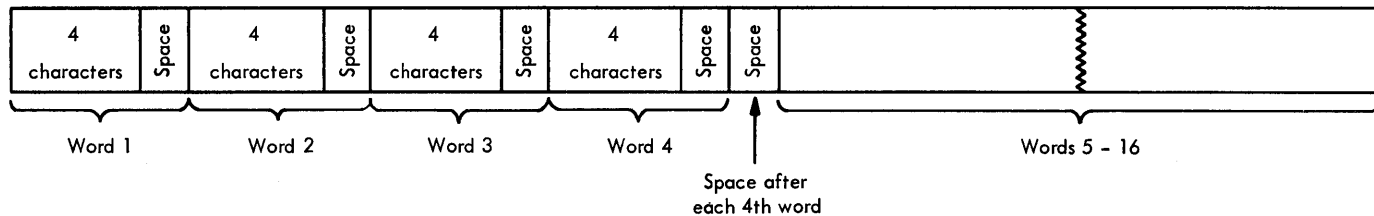

Figure 13. Print Data Format

APPENDIX C. DISK STORAGE UNIT CONVERSION FACTORS

No. Of	Per:	Word	Disk Block	Sector	Track	Cylinder	Disk
Bits		16	320	5,112	20,480	40,960	8,192,000
Data Words			20	320*	1,280	2,560	512,000
Disk Block				16	64	128	25,600
Sectors					4	8	1,600
Tracks						2	400
Cylinders							200

\*These follow the first actual word of each sector, which is used for the address.

APPENDIX D. SUPERVISOR AND DUP INPUT/OUTPUT CHARACTER CODES

Keyboard Graphic	1132 Graphic	IBM Card Code	PTTC/8 Hex (U = Upper Case) (L = Lower Case)
<u>Numeric Characters</u>			
0	0	0	1A (L)
1	1	1	01 (L)
2	2	2	02 (L)
3	3	3	13 (L)
4	4	4	04 (L)
5	5	5	15 (L)
6	6	6	16 (L)
7	7	7	07 (L)
8	8	8	08 (L)
9	9	9	19 (L)
<u>Alphabetic Characters</u>			
A	A	12-1	61 (U)
B	B	12-2	62 (U)
C	C	12-3	73 (U)
D	D	12-4	64 (U)
E	E	12-5	75 (U)
F	F	12-6	76 (U)
G	G	12-7	67 (U)
H	H	12-8	68 (U)
I	I	12-9	79 (U)
J	J	11-1	51 (U)
K	K	11-2	52 (U)
L	L	11-3	43 (U)
M	M	11-4	54 (U)
N	N	11-5	45 (U)
O	O	11-6	46 (U)
P	P	11-7	57 (U)
Q	Q	11-8	58 (U)
R	R	11-9	49 (U)
S	S	0-2	32 (U)
T	T	0-3	23 (U)
U	U	0-4	34 (U)
V	V	0-5	25 (U)
W	W	0-6	26 (U)
X	X	0-7	37 (U)
Y	Y	0-8	38 (U)
Z	Z	0-9	29 (U)

Keyboard Graphic	1132 Graphic	IBM Card Code	PTTC/8 Hex (U = Upper Case) (L = Lower Case)
<u>Special Characters</u>			
.	.	12-8-3	6B (L)
<	)	12-8-4	02 (U)
(	(	12-8-5	19 (U)
+	+	12-8-6	70 (U)
&	&	12	70 (L)
\$	\$	11-8-3	5B (L)*
*	*	11-8-4	08 (U)*
)	)	11-8-5	1A (U)
-	-	11	40 (L)
/	/	0-1	31 (L)*
,	,	0-8-3	3B (L)
%	(	0-8-4	15 (U)
#	Blank	8-3	0B (L)*
@	Blank	8-4	20 (L)*
'	'	8-5	16 (U)
=	=	8-6	01 (U)
Space	Blank	Blank	10 ( )*
c	Blank	12-2-8	A0 (U)
l	Blank	12-7-8	BB (U)
l	Blank	11-2-8	DB (U)
;	Blank	11-6-8	9B (U)
_	Blank	11-7-8	EB (U)
%	Blank	0-5-8	95 (L)
-	Blank	0-5-8	C0 (U)
>	Blank	0-6-8	8F (U)
?	Blank	0-7-8	B1 (U)
:	Blank	2-8	84 (U)
"	Blank	7-8	8B (U)

- NOTES: 1. DUP recognizes only those special characters flagged with an asterisk.  
 2. Any special characters not recognized by SUP and DUP will be corrected to an ampersand (&).

APPENDIX E. 1130 SUBROUTINE LIBRARY LISTING

Subroutines	Names	Subtype*	Other Subroutines Required
<u>Utility Calls</u>			
Selective Dump on Console Printer	DMTD0, DMTX0	0	WRTY0
Selective Dump on 1132 Printer	DMPD1, DMPX1	0	PRNT1
Dump 80 Routine	DMP80	0	None
<u>Common FORTRAN Calls</u>			
Test Data Entry Switches	DATSW	8	None
Divide Check Test	DVCHK	8	None
Functional Error Test	FCTST	8	None
Overflow Test	OVERF	8	None
Sense Light Control and Test	SLITE, SLITT	0	None
FORTRAN Trace Stop	TSTOP	8	TSET
FORTRAN Trace Start	TSTRT	8	TSET
Integer Transfer of Sign	ISIGN	8	None
<u>Extended Arith/Funct Calls</u>			
Extended Precision Hyperbolic Tangent	ETANH, ETNH	8	EEXP, ELD/ESTO, EADD, EDIV, EGETP
Extended Precision A**B Function	EAXB, EAXBX	8	EEXP, ELN, EMPY
Extended Precision Natural Logarithm	ELN, EALOG	8	XMD, EADD, EMPY, EDIV, NORM, EGETP
Extended Precision Exponential	EEXP, EXPN	8	XMD, FARC, EGETP
Extended Precision Square Root	ESQR, ESQRT	8	ELD/ESTO, EADD, EMPY, EDIV, EGETP
Extended Precision Sine-Cosine	ESIN, ESINE, ECOS, ECOSN	8	EADD, EMPY, NORM, XMD, EGETP
Extended Precision Arctangent	EATN, EATAN	8	EADD, EMPY, EDIV, XMD, EGETP, NORM
Extended Precision Absolute Value Function	EABS, EAVL	8	EGETP
<u>FORTRAN Sign Transfer Calls</u>			
Extended Precision Transfer of Sign	ESIGN	8	ESUB, ELD
Standard Precision Transfer of Sign	FSIGN	8	FSUB, FLD
<u>Standard Arith/Funct Calls</u>			
Standard Precision Hyperbolic Tangent	FTANH, FTNH	8	FEXP, FLD/FSTO, FADD, FDIV, FGETP
Standard Precision A**B Function	FAXB, FAXBX	8	FEXP, FLN, FMPY
Standard Precision Natural Logarithm	FLN, FALOG	8	FSTO, XMDS, FADD, FMPY, FDIV, NORM, FGETP
Standard Precision Exponential	FEXP, FXPN	8	XMDS, FARC, FGETP
Standard Precision Square Root	FSQR, FSQRT	8	FLD/FSTO, FADD, FMPY, FDIV, FGETP
Standard Precision Sine-Cosine	FSIN, FSINE, FCOS, FCOSN	8	FADD, FMPY, NORM, XMDS, FSTO, FGETP

\*See Disk System Format, Program Subtypes, in Appendix B.

Subroutines	Names	Subtype	Other Subroutines Required
Standard Precision Arctangent	FATN, FATAN	8	FADD, FMPY, FDIV, XMDS, FSTO, FGETP
Standard Precision Absolute Value Function	FABS, FAVL	8	FGETP
<u>Common Arith/Funct Calls</u>			
Fixed Point (Fractional) Square Root	XSQR	8	None
Integer Absolute Function	IABS	8	None
Floating Binary/EBC Decimal Conversions	FBTD (BIN. TO DEC.) FDTB (DEC. TO BIN.)	0	None
<u>Overlay Routines for LOCAL Subprograms</u>			
Long Form	FLIP0	0	DISKZ or DISK0
Short Form	FLIP1	0	DISK1 or DISKN
<u>FORTRAN Trace Routines</u>			
Extended Floating Variable Trace	SEAR, SEARX	0	ESTO, TTEST, SWRT, SIOF, SCOMP
Fixed Variable Trace	SIAR, SIARX	0	TTEST, SWRT, SIOI, SCOMP
Standard Floating IF Trace	SFIF	0	FSTO, TTEST, SWRT, SIOF, SCOMP
Extended Floating IF Trace	SEIF	0	FSTO, TTEST, SWRT, SIOF, SCOMP
Fixed IF Trace	SIIF	0	TTEST, SWRT, SIOI, SCOMP
Standard Floating Variable Trace	SFAR, SFARX	0	FSTO, TTEST, SWRT, SIOF, SCOMP
GOTO Trace	SGOTO	0	TTEST, SWRT, SIOI, SCOMP
<u>Non-Disk FORTRAN Format I/O</u>			
FORTRAN Format Routine	SFIO, SIOI, SIOAI, SIOF, SIOAF, SIOFX, SCOMP, SWRT, SRED, SIOIX	3	FLOAT, ELD/ESTO or FLD/FSTO, IFIX
<u>FORTRAN Find Routine</u>			
FORTRAN Find Routine	SDFND	1	DISKZ
<u>Disk FORTRAN I/O</u>			
FORTRAN Find Routine	SDFIO, SDRED, SDWRT, SDCOM, SDAF, SDF, SDI, SDIX, SDFX, SDAI	1	DISKZ
<u>FORTRAN Common LIBFs</u>			
FORTRAN Pause	PAUSE	2	None
FORTRAN Stop	STOP	2	None
FORTRAN Subscript Displacement Calculation	SUBSC	0	None
FORTRAN Subroutine Initialization	SUBIN	0	None
FORTRAN Trace Test and Set	TTEST, TSET	0	None
<u>FORTRAN I/O and Conversion Routines</u>			
FORTRAN Card Routine	CARDZ	3	HOLEZ
Disk I/O Routine	DISKZ	0	None
FORTRAN Paper Tape Routine	PAPTZ	3	None



Subroutines	Names	Subtype	Other Subroutines Required
FORTRAN 1132 Printer Routine	PRNTZ	3	None
FORTRAN Keyboard-Typewriter Routine	TYPEZ	3	GETAD, EBCTB, HOLEZ
FORTRAN Typewriter Routine	WRTYZ	3	GETAD, EBCTB
FORTRAN Hollerith to EBCDIC Conversion	HOLEZ	3	GETAD, EBCTB, HOLTB
FORTRAN Get Address Routine	GETAD	3	None
FORTRAN EBCDIC Table	EBCTB	3	None
FORTRAN Hollerith Table	HOLTB	3	None
<u>Extended Arith/Funct LIBFs</u>			
Extended Precision Get Parameter Subroutine	EGETP	2	ELD
Extended Precision A**I Function	EAXI, EAXIX	2	ELD/ESTO, EMPY, EDVR
Extended Precision Divide Reverse	EDVR, EDVRX	2	ELD/ESTO, EDIV
Extended Precision Float Divide	EDIV, EDIVX	2	XDD, FARC
Extended Precision Float Multiply	EMPY, EMPYX	2	XMD, FARC
Extended Precision Subtract Reverse	ESBR, ESBRX	2	EADD
Extended Add-Subtract	EADD, ESUB, EADDX, ESUBX	2	FARC, NORM
Extended Load-Store	ELD, ELDX, ESTO, ESTOX	0	None
<u>Standard Arith/Funct LIBFs</u>			
Standard Precision Get Parameter Subroutines	FGETP	2	FLD
Standard Precision A**I Function	FAXI, FAXIX	2	FLD/FSTO, FMPY, FDVR
Standard Precision Divide Reverse	FDVR, FDVRX	2	FLD/FSTO, FDIV
Standard Precision Float Divide	FDIV, FDIVX	2	FARC
Standard Precision Float Multiply	FMPY, FMPYX	2	XMDS, FARC
Standard Precision Subtract Reverse	FSBR, FSBRX	2	FADD
Standard Add-Subtract	FADD, FSUB, FADDX, FSUBX	2	NORM, FARC
Standard Load-Store	FLD, FLDX, FSTO, FSTOX	0	None
Standard Precision Fractional Multiply	XMDS	2	None
<u>Common Arith/Funct LIBFs</u>			
Fixed Point (Fractional) Double Divide	XDD	2	XMD
Fixed Point (Fractional) Double Multiply	XMD	2	None
Sign Reversal Function	SNR	2	None
Integer to Floating Point Function	FLOAT	0	NORM
Floating Point to Integer Function	IFIX	0	None
I**J Integer Function	FIXI, FIXIX	2	None

Subroutines	Names	Subtype	Other Subroutines Required
Normalize Subroutine	NORM	0	None
Floating Accumulator Range Check Subroutine	FARC	2	None
<u>Interrupt Service Subroutines</u>			
Card Input/Output (No Error Parameter)	CARD0	0	ILS00, ILS04
Card Input/Output (Error Parameter)	CARD1	0	ILS00, ILS04
One Sector Disk Input/Output	DISK0	0	ILS02
Multiple Sector Disk Input/Output	DISK1	0	ILS02
High-Speed Multiple Sector Disk Input/Output	DISKN	0	ILS02
Paper-Tape Input/Output	PAPT1	0	ILS04
Simultaneous Paper Tape Input/Output	PAPTN	0	ILS04
Plotter Output Routine	PLOT1	0	ILS03
1132 Printer Output Routine	PRNT1	0	ILS01
Keyboard/Console Printer Input/Output	TYPE0	0	HOLL, PRTY, ILS04
Console Printer Output Routine	WRTY0	0	ILS04
<u>Conversion Routines</u>			
Binary Word to 6 Decimal Characters (Card Code)	BINDC	0	None
Binary Word to 4 Hexadecimal Characters (Card Code)	BINHX	0	None
6 Decimal Characters (Card Code) to Binary Word	DCBIN	0	None
EBCDIC to Console Printer Output Code	EBPRT	0	EBPA, PRTY
Card Code to EBCDIC-EBCDIC to Card Code	HOLEB	0	EBPA, HOLL
Card Code to Console Printer Output Code	HOLPR	0	HOLL, PRTY
4 Hexadecimal Characters (Card Code) to Binary Word	HXBIN	0	None
PTTC/8 to EBCDIC-EBCDIC to PTTC/8	PAPEB	0	EBPA
PTTC/8 to Card Code-Card Code to PTTC/8	PAPHL	0	EBPA, HOLL
PTTC/8 to Console Printer Output Code	PAPPR	0	EBPA, PRTY
Card Code to EBCDIC-EBCDIC to Card Code	SPEED	0	None
EBCDIC and PTTC/8 Table	EBPA	0	None
Card Code Table	HOLL	0	None
Console Printer Output Code Table	PRTY	0	None
<u>Interrupt Level Subroutines</u>			
Interrupt Level Zero Routine	ILS00		None

Subroutines	Names	Subtype	Other Subroutines Required
Interrupt Level One Routine	ILS01		None
Interrupt Level Two Routine	ILS02		None
Interrupt Level Three Routine	ILS03		None
Interrupt Level Four Routine	ILS04		None

APPENDIX F. IN-CORE COMMUNICATIONS AREA (COMMA)

The Disk Communications Area (DCOM), sector 8 on the disk, is read into core starting in address 0028 (decimal 40). The In-Core Communications Area (COMMA), therefore, is an image of DCOM, but offset by 40 words. The first 10 words (0028-0031) include the IOCS error and interrupt error traps. The IOCS error trap entry word

(0028) is initialized to contain the version and modification level of the Disk Monitor System, and will be overlaid by a return address if an IOCS error occurs.

The core locations and contents of COMMA are shown on the following three pages.

Core Location		Comments
Dec.	Hex.	
1. 50	32	IOCS counter, incremented by 1 upon entry to every IOCS subroutine (provided an XIO is to be executed), decremented by 1 after an operation complete interrupt.
2. 51	33	Reserved.
3. 52	34	Core address (in user program) of Interrupt Level 2 subroutine (ILS02).
4. 53	35	Number of files defined.
5. 54-69	36-45	CALL LINK/CALL EXIT linkage to Skeleton Supervisor.
6. 70	46	Length of COMMON (in words).
7. 71	47	Type of Disk I/O required, e.g., -1 = DISKZ (special disk routine) 0 = DISKO 1 = DISKI 2 = DISKN
8. 72	48	Reserved.
		<u>System Addresses</u>
9. 73	49	Reserved.
10. 74	4A	Sector address of FORTRAN, zero if FORTRAN deleted.
11. 75	4B	Sector address of Assembly Program, zero if deleted.
12. 76	4C	320 <sub>10</sub> (length of 1 sector).
13. 77	4D	Sector address of first (numerically lowest) sector of Core Image Buffer (CIB). Word 1 of FLET header printed by DUMPLET.
14. 78	4E	000A (address in lower core, i.e., in the interrupt transfer vector, to which all disk interrupts branch indirectly).
15. 79	4F	Sector address of first (numerically lowest) sector of Fixed Location Equivalence Table (FLET). Word 2 of FLET header printed by DUMPLET.
16. 80	50	Sector address of first (numerically lowest) sector of Location Equivalence Table (LET).
17. 81	51	Sector address of first (numerically lowest) sector of User area.
18. 82	52	File protect sector address, otherwise used as sector address of Working Storage (base). Word 1 of LET header printed by DUMPLET. See Note 1.
19. 83	53	Same as above (adjusted). Word 2 of LET header printed by DUMPLET. See Note 1.
		<u>LET/FLET Entries</u>
20. 84	54	Total number of words used on disk by FLET. Word 3 of FLET header printed by DUMPLET.
21. 85	55	Reserved.
22. 86	56	Total number of words used on disk by LET (base). Word 5 of LET header printed by DUMPLET. See Note 1.
23. 87	57	Same as above (adjusted). Word 6 of LET header printed by DUMPLET. See Note 1.
24. 88	58	Next available disk block address in User area (base). Word 3 of LET header printed by DUMPLET. See Note 1.
25. 89	59	Same as above (adjusted). Word 4 of LET header printed by DUMPLET. See Note 1.
26. 90-91	5A-5B	Name of program (LET/FLET entry words 1 and 2).
27. 92	5C	Disk blocks used by program (LET entry word 3). Second word printed out at end of DUP function.

Core Location		Comments
Dec.	Hex.	
		<u>LET/FLET Entries (Continued)</u>
28.	93 5D	Core execution address of program (relative for relocatable programs, absolute otherwise) for word 12 of the program header record. <u>Not</u> used as word 4 of LET/FLET entry.
29.	94 5E	Core loading address of program, also used as first word on mainline program, or first word of define file table (LET/FLET entry word 5 for core image program).
30.	95 5F	Word count/disk block count of program, i.e., word count for core image programs, disk block count for data files, and address of next available core location following the program in Disk System format that is in Working Storage on the disk (LET/FLET entry word 6 for core image program data file).
		<u>Switches</u>
31.	96 60	Principal print device (odd = console printer/keyboard, even = 1132). See Note 2.
32.	97 61	Principal I/O device (odd = 1442, even = 1134/1055). See Note 2.
33.	98 62	Temporary mode if non-zero, normal if zero.
34.	99 63	Non-XEQ (disable XEQ until next // JOB record if non-zero, enable XEQ if zero). See Note 3.
35.	100 64	Non-DUP (disable DUP functions until next // JOB record is detected if non-zero, enable DUP functions if zero).
36.	101 65	System Overlays and/or LOCALs are used in program if non-zero.
37.	102 66	Disable Supervisor reading of monitor control record if non-zero, enable if zero (positive indicates monitor control record has been read under invalid conditions, negative under valid conditions).
38.	103 67	Loader return to Supervisor if zero, to address in switch itself if non-zero (after restoring DUP).
39.	104 68	Core map requested if non-zero, no map if zero.
40.	105 69	WS Indicator Word (disk block count of program in Working Storage).
		<u>Parameters for Disk IOCS</u>
41.	106 6A	Disk Arm Position
	107-108 6B-6C	Reserved
42.	109 6D	Disk File Protect Address
	110-111 6E-6F	Reserved
43.	112-114 70-72	Table of Defective Cylinders
	115-120 73-78	Reserved
		<u>Miscellaneous</u>
44.	121 79	Disk block address of program. First word printed out at end of DUP function.
45.	122-125 7A-7D	Reserved
46.	126 7E	Size of core (1000 <sub>16</sub> , 2000 <sub>16</sub> )
47.	127 7F	Absolute execution address of core load (for word 4 of LET/FLET entry).
48.	128-137 80-89	Reserved
49.	138 8A	Contents of index register 3 (points to middle of a 255-word transfer vector).
50.	139-144 8B-90	System Work Area

NOTE 1: When requested following a //JOB T control record, DUP will store information to disk and update LET on a temporary basis (only the adjusted value is altered). When the next //JOB or //JOB T control record is encountered, the adjusted value will be replaced by the base

NOTE 2: The interrupt levels associated with the I/O devices will be specified in COMMA. Since four bits are sufficient to specify any ILS number, three I/O levels may be included in each of the two words in COMMA which identify the principal I/O device and the principal print

value. Thus, all information which has been stored in the User area since the first //JOB T record will be deleted. The //JOB T function requires that both base and adjusted values be available in COMMA. The base and adjusted values will be equal except during //JOB T operation.

device (items 31 and 32, respectively). The rightmost four bits in each of these words identify the devices themselves. The layouts of these two words are as follows:

	0	1	2	3	4	5	6	7	8	9	10	11	12	13	14	15
96 <sub>10</sub>	Interrupt level of principal print device				Interrupt level of secondary print device				Reserved for future use				Principal print device indicator (0=1132, 1=console printer/keyboard)			
97 <sub>10</sub>	Interrupt level of principal I/O device				Interrupt level of column interrupt for 1442 if principal I/O device is 1134/1055; interrupt level of end-of-card interrupt for 1442 otherwise.				Interrupt level of end-of-card interrupt for 1442 if principal I/O device is 1134/1055; interrupt level of 1134/1055 otherwise.				Principal I/O device indicator (0=1134/1055, 1=1442, 2=console printer/keyboard)  Supervisor only			

Example

Word 96: 1132 + Console Printer 1400<sub>16</sub>  
 Console Printer 4001<sub>16</sub>

Word 97: 1442 0401<sub>16</sub>  
 1442 + 1134/1055 0441<sub>16</sub>  
 1134/1055 4000<sub>16</sub>

NOTE 3: Set to something other than zero or one by any part of the system that finds a non-XEQ type error, reset to one by Supervisor after

printing out a message, reset to zero by Supervisor upon sensing a //JOB record.

APPENDIX G. LAYOUT OF LET/FLET ENTRIES

THREE WORD ENTRIES (DISK SYSTEM FORMAT)

<u>Words</u>	<u>Description</u>
1-2	Name of the program, consisting of five 6-bit characters, right-justified in the 32 bits of words 1 and 2. Names of less than five characters are padded with terminal blanks. A 6-bit character is formed by truncating the leftmost two bits of the EBCDIC representation of that character. Bits 0 and 1 are zeros.
3	Disk block count of the program.

SIX-WORD ENTRIES (DISK CORE IMAGE FORMAT)

<u>Words</u>	<u>Description</u>
1-2	Same as for three-word entries, except that for core-image programs, bit 0 is one and bit 1 is zero; and for data files, both bits 0 and 1 are ones.
3	Disk block count of the program, including padding. Padding is the

<u>Words</u>	<u>Description</u>
	number of disk blocks between the end of the last program or file stored and the beginning of this program, which is a sector boundary.
4	Execution address of the program, i.e., the core location to which control is passed for execution of the program (zero for data files).
5	Loading address of the program, i.e., the core location at which the core image program is to be loaded.
6	Word count of the program, i.e., the number of words to be read from the disk when reading the information from disk to core storage.

NOTE 1: Eight sectors each are allocated for LET and FLET.

NOTE 2: The order of the entries in LET is the order in which the named items are stored in the User area.



APPENDIX H. IBM00 (1130 DISK MONITOR SYSTEM MAINTENANCE PROGRAM)

IBM00, the 1130 Disk Monitor System maintenance program, is the means by which a user updates his disk as modifications are released. The program automatically updates the monitor programs (Supervisor, Disk Utility, FORTRAN, and Assembler), provides a method of changing the IBM subroutine library, and also updates the version and modification level in the first word in DCOM. The leftmost 4 bits represent the version, and the rightmost 12 bits represent the modification level.

A card deck or paper tape containing corrections to maintain the monitor will be supplied by IBM. This includes all necessary control records. Every modification must be run to update the version and modification level even though the program affected is not on the disk.

IBM00 is stored on the disk as part of the IBM subroutine library. It is called from disk by the following control record:

```

cc
 1 2 3 4 5 6 7 8 9 10 11 12 13 14 15 16 17 18 19
// XEQ IBM 0 0 0
  
```

A zero must appear in position 19 of the XEQ record to specify DISK0.

Input to the program can be stacked with other jobs. However, when stacking modifications to the Monitor System, each patch that increases the modification level must begin with the above control record (see Figure 14).

Input to the program can be cards or paper tape. IBM00 determines the input device automatically by interrogating COMMA for the principal I/O device.

SYSTEM PROGRAM MAINTENANCE

Typical input for a system program update is as follows:

```

cc
 1 2 3 4 5 6 7 8 9 10 11 12 13 14 15 16 17 18 19
// XEQ IBM 0 0 0
Patch header record
Patch data record
.
.
Patch data record
Patch header record
Patch data record
.
.
Patch data record
Patch header record
.
.
.
  
```

} One to eight data records

} One to eight data records

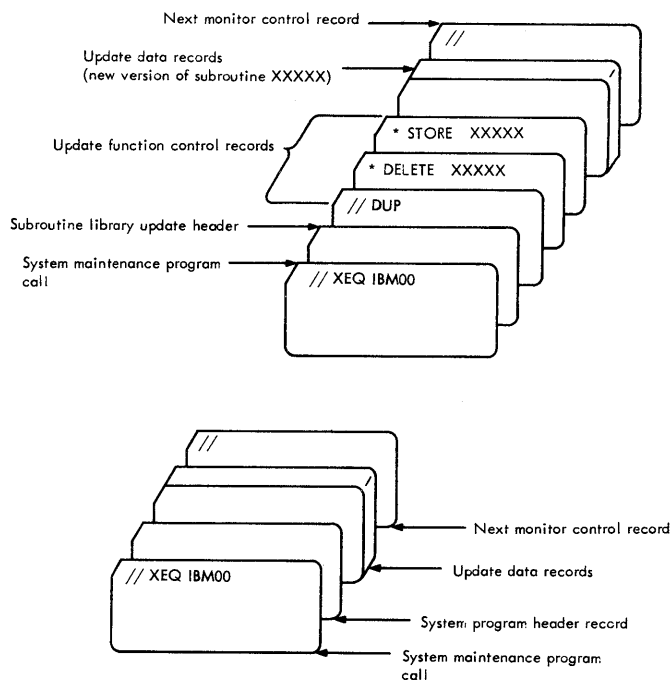

Figure 14. Control Records and Data Organization (in Card Form) for Monitor Program and Subroutine Library Maintenance

## Patch Header Record

Each sector to be changed requires a patch header record. Thus, if a patch crosses a sector, two header records are required. If FORTRAN or the assembler is being modified, a check is made to determine if that system program has been voided from the disk. If so, the modification is not made.

The format of a patch header record (in terms of card input) is as follows:

<u>Columns</u>	<u>Contents</u>
1-3	Program ID (FOR, ASM, DUP, SUP)
10-11	Monitor System Version (01-15). The patch is not made if the version number does not agree with the version number in DCOM.
15-17	Modification Level (000-999). This must be the same in every header within a patch deck. The patch is made only if the modification level number is equal to or one greater than the modification level in DCOM. Changes to the modification level must be in ascending order, increasing by one level at a time.  The user may rerun the modifications to his system by starting with modification level 001. If this is lower than the modification level in DCOM, a message is typed, followed by a wait. This notifies the user that he is processing his modifications from the beginning; upon continuing, the patch is made and the modification level is changed to 001.  The modification level in DCOM is updated after the last record of the entire change is processed.
21-23	Sector Address (absolute, decimal, sector to be modified, except for the assembler, in

## Columns

## Contents

27-29	Relative word number of first patch word (000-319).
33-35	Word count of patch (001-320).
40-41	Total records in modification (02-99). This should appear only on the first patch header record. The count is the total record count of the modification, including data records and patch header records.
78-80	Sequence number (always 001).

## Data Record

A data record (in terms of card input) is a binary data card (see Appendix B, Card System Format). One to eight data records can follow each patch header record, depending on the size of the patch. These must be numbered from 002 to 009, and must contain the proper checksum for this sequence.

The data record format is as follows:

<u>Words</u>	<u>Contents</u>
1	Location
2	Checksum
3	Type code (first 8 bits): 00001010; Word count (last 8 bits)
4-9	Relocation indicators
10-54	Data words 1 through 45
55-60	ID and sequence number

## IBM SUBROUTINE LIBRARY MAINTENANCE

Changes to the subroutine library require reloading the new subroutine. IBM00 updates the version and modification level word; the actual reload is performed by a DUP DELETE function, followed by a DUP STORE function.

Typical input for a subroutine update is as follows:

```

cc
1 2 3 4 5 6 7 8 9 10 11 12 13 14 15 16 17 18 19 20 21
// XEQ IBM 0 0 0
(Subroutine header record)
// DUP
*DELETE name
*STORE C D U A name
      or
      P T
(New version of the subroutine)

```

### Subroutine Header Record

The subroutine header record must go through IBM00 even if the subroutine being modified is not on the user's disk. This is necessary to update the version and modification level word in DCOM so that the next sequential modification level can be made.

The format of a subroutine header record (in terms of card input) is as follows:

Columns	Contents
1-3	SUB (to signify a subroutine update)
10-11	Monitor System Version (01-15)
15-17	Modification Level (000-999)

### OPERATING PROCEDURES

The card deck or paper tape supplied by IBM is to be run as a monitor job. When the control record //XEQ IBM00 is read, the version and modification level of the monitor is typed (see Figure 15, lines 1, 2, and 3). When the correct input is read, lines 1 through 6 of Figure 15 are typed.

### ERROR MESSAGES

IBM00 error messages are listed in Table H-1.

Table H-1. IBM00 Monitor System Maintenance Error Messages

Code and Message	Meaning
U01 INVALID HEADER	Program cannot recognize header record.
U02 CHECKSUM ERROR	Data record checksum error. A record might be out of sequence or there might be an invalid data record.
U03 MCR BEFORE EOJ	Monitor control record was encountered before the updating process was completed.
U04 VERSION ERROR	The version on disk does not agree with the version in header record.
U05 MOD. LEVEL ERROR	The modification level in the header record is not equal to or one greater than the modification level on disk.

NOTE 1: All of the above errors require a retry of the execution after corrective action has been taken. Following an error typeout, the program waits; pressing PROGRAM START causes an exit to the Supervisor.

NOTE 2: A user can start at modification No. 1 and add all modifications to date. A message is typed when this condition is encountered, followed by a wait. PROGRAM START must be pushed to continue. The following message will be typed: 'THE MONITOR SYSTEM IS BEING UPDATED WITH MOD. LEVEL NO. 1. PUSH PROGRAM START TO CONTINUE.'

(Line 1)	IBM00 MONITOR SYSTEM MAINTENANCE
(Line 2)	VERSION NO. IS XX
(Line 3)	PRESENT MODIFICATION LEVEL IS XXX
(Line 4)	MONITOR SYSTEM UPDATE COMPLETED
(Line 5)	VERSION NO. IS XX
(Line 6)	NEW MODIFICATION LEVEL IS XXX

Figure 15. Typeouts for 1130 Monitor System Maintenance Program

## APPENDIX I. UTILITY ROUTINES

In addition to the IBM subroutine library, the following utility programs, each complete with subroutines and loaders, are supplied to the user to enable him to perform operations external to the 1130 disk monitor system. The individual program writeups indicate whether the program is available for the card system only, the paper tape system only, or both. Where the program is applicable to both systems, operating procedures are included for card and paper tape.

The paper tape utility routine is loaded as part of the paper tape disk monitor system.

- Disk Pack Initialization Routine (DPIR). This routine is described under System Generation Operating Procedures -- Card System. The DPIR card and paper tape loading procedures are listed under the appropriate system generation procedure.
- Console Printer Core Dump
- 1132 Printer Core Dump
- Console Printer Disk Dump
- 1132 Printer Disk Dump
- Paper Tape Reproducing Routine
- Paper Tape Utility Routine (PTUTL)

### CONSOLE PRINTER CORE DUMP (CARD SYSTEM ONLY)

This routine aids the user in the debugging of programs. The programmer can dump portions of core by loading a single-card console routine which occupies the first 80 words of core. The output device is the console printer.

#### Format

This routine dumps core in hexadecimal form, starting with the word specified in the console entry switches. Dumping continues until PROGRAM STOP is pressed.

Words are dumped in four-digit hexadecimal form, with a space between each word. The first word typed is the starting address of the dump. The number of characters per line depends upon the margin settings of the console printer.

#### Operating Procedures

1. With the console Mode switch set to RUN, press IMM STOP and RESET on the console.
2. Set the console entry switches to the hexadecimal address at which dumping is to start.
3. Place the program card in the reader.
4. Press START on the 1442.
5. Press PROGRAM LOAD on the console.

Dumping continues until PROGRAM STOP is pressed. Press PROGRAM START to resume the dump.

### 1132 PRINTER CORE DUMP

This is a self-loading, four-card routine that dumps the contents of core storage in hexadecimal format on the 1132 Printer (the fourth card is blank). The routine is available in card and paper tape.

Dumping begins at hexadecimal address 00A0 and continues to the end of core. Sixteen words per line are printed, preceded by the four-digit hexadecimal address of the first word of each line.

#### Card Operating Procedure

1. Ready the 1132 printer.
2. With the console Mode switch set to RUN, press IMM STOP and RESET on the console.
3. Place the dump routine deck in the 1442 card read punch hopper.
4. Press START on the 1442.
5. Press PROGRAM LOAD on the console.

Dumping continues until the last 16 words of core are addressed and printed.

The program does not skip to the top of a new page to start, nor is page numbering or page overflow provided.

### Paper Tape Operating Procedure

1. Ready the 1132 printer.
2. Place the dump from 00A0 tape in the paper tape reader so that one of the delete codes beyond the program ID in the leader is beneath the read starwheels.
3. Press IMM STOP, RESET, and PROGRAM LOAD on the console.

The output format is the same as described for the card routine.

### DISK DUMP ROUTINES

Two routines are provided which allow the user to print out the contents of any disk sector or sectors.

- Console Printer Disk Dump
- 1132 Printer Disk Dump

These routines are available in card and paper tape.

### Format

Each sector printout (320 words) consists of 20 lines with 16 four-digit words per line, each word in hexadecimal form. Two sectors are printed on each page, each sector preceded by a two-word header. The leftmost digit of the first header word is the number of sectors remaining to be dumped; the remaining three digits show the sector address of the sector being dumped. The second header word contains the contents of the first word of the sector which is also the address of the sector.

### Operating Procedures

#### Card

1. With the console Mode switch set to RUN, press IMM STOP and RESET on the console.

2. Place the desired dump routine (console printer or 1132 printer) in the reader hopper.
3. Press START on the 1442.
4. Press PROGRAM LOAD on the console.

The program is loaded and on 8K systems WAITs at location 1C51 (console printer routine), or 1D29 (1132 printer routine). For 4K systems, the WAIT addresses will be 0C51 and 0D29.

5. Set the console entry switches as indicated below.
  - a. Enter the number of sectors to be dumped (in hexadecimal) in console entry switches 0-3. The maximum number of sectors that can be dumped at one time is 15 (switches 0-3 on); the minimum number is one (switches 0-3 off or switch 3 on).
  - b. Enter the hexadecimal address of the first sector to be dumped in console entry switches 4-15 (000 - 657). If an illegal sector address is entered, the program WAITs at location 0029. Press IMM STOP, RESET, and PROGRAM START to return the program to location 1C51 or 1D29. The correct sector address can then be entered in the console entry switches.

Note that the sector address entered in console entry switches 4-15 is a physical address, not a logical address. It is therefore possible for the data being dumped to be moved up 8, 16, or 24 sectors depending on whether the disk has one or more (maximum 3) defective cylinders. A dump of sector zero will show if there are any defective cylinders on the disk. Words one, two, and three of sector 0 contain the first sector address of any defective cylinders found. When there is no defective cylinder, these words contain /0658 (see DPIR under System Generation Operating Procedures--Card System). In the event that there are defective cylinders on the disk, it is the user's responsibility to calculate the displacement in order to locate the desired logical record.

6. Press PROGRAM START to initiate the dump.

Dumping continues until the last sector is printed, at which time the printer carriage (if the 1132 is the output device) restores to a new page and the program WAITs at location 1C51 or 1D29.

A new sector address and/or number of sectors can be entered at any time during execution by pressing IMM STOP, RESET, and PROGRAM START,

and then setting the appropriate console entry switches.

Core Image Loader Card ID. The card system console printer and 1132 printer disk dump routines are each loaded by a core image loader which comprises the first six cards of the decks. As card sequence numbers are not present on the core image loader cards, the following chart can be used to identify these cards.

		CORE IMAGE LOADER											
CARD	COLUMN	1		2		3		4		5		6	
		1	2	1	2	1	2	1	2	1	2	1	2
12								X					
11		X						X					
0		X									X		X
1		X	X					X			X		X
2													
3					X			X			X		
4								X					X
5					X						X		
6													
7		X	X										
8													
9		X											

#### Paper Tape

1. Place the desired dump routine tape (console printer or 1132 printer) in the paper tape reader so that one of the delete codes beyond the program ID in the leader is beneath the read starwheels.
2. Press IMM STOP, RESET, and PROGRAM LOAD on the console.
3. The loader (on the front of the tape) will read in and the system will WAIT.
4. Press PROGRAM START.

The disk dump program is now loaded and WAITs at location 1C51 (console printer routine), or 1D29 (1132 printer routine). Operating instructions from this point are the same as those listed in items 5 and 6 of the card operating procedures.

#### Disk Error Procedure

Detection of a disk error during a dump operation on 8K systems causes a WAIT at location 1C67 (console printer) or 1D51 (1132 printer). For 4K systems, the WAIT is at 0C67 or 0D51.

To retry the operation, set all console entry switches off and press PROGRAM START. If the retry is successful, dumping will resume at the beginning of the sector that caused the error.

If the error is to be ignored and the sector printed out, make sure that the value of the console entry switches is not zero (at least one switch on) and press PROGRAM START.

#### PAPER TAPE REPRODUCING ROUTINE

This routine, available only with the paper tape system, is a self-loading paper tape routine that reproduces paper tapes. The routine reads a character and punches it with no intermediate conversion.

#### Operation

1. Place the paper tape reproducing routine tape in the paper tape reader, positioning the tape so that one of the delete codes beyond the ID in the leader is beneath the read starwheels.
2. With the console Mode switch set to RUN, press IMM STOP, RESET, and PROGRAM LOAD on the console. The reproducing routine is read in and WAITs at location 0000.
3. Remove the reproducing routine tape and place the tape to be reproduced in the reader. Place blank tape in the tape punch unit and produce several inches of delete code leader by holding down the DELETE and FEED keys simultaneously. Be sure to release the FEED key first.
4. Press PROGRAM START to begin the tape reproducing operation. The routine continues to operate until the paper tape reader goes not-ready, indicating that there is no more tape to be read. The tape reproducing routine then WAITs at location 002C. If the paper tape punch is not-ready, the tape reproducing routine loops between 0027-002A. To restart, press IMM STOP, ready the paper tape punch, and press PROGRAM START. An unlimited number of tapes can be reproduced by this routine. Be sure to create a trailer (and leader) of delete

codes between the output tapes if the tapes are to be separated.

5. If the PROGRAM STOP key is pressed while the program is in operation, the routine WAITS at location 001D. Press PROGRAM START to continue.

## PAPER TAPE UTILITY (PTUTL)

PTUTL is a paper tape utility program that is loaded to disk during system generation and executed by the 1130 disk monitor system. It accepts input from the console printer keyboard or 1134 paper tape reader and provides printed output on the console printer and/or punched output on the 1055 paper tape punch.

Using PTUTL, the user can add FORTRAN and assembler source records and monitor control records to his programs. Records on existing tapes can also be altered or deleted. This paper tape utility program resides in the user's area on disk and is executed by a // XEQ control record.

### Operating Procedure

A paper tape containing the following records is supplied to the user to allow initial program execution.

```
// JOB
// XEQ PTUTL
// PAUS
```

To load this tape and execute the program, select the appropriate initializing procedure listed below and continue.

1. If the monitor supervisor is in core:
  - a. Place the PTUTL execute tape in the paper tape reader.
  - b. Press PROGRAM START.
2. If the monitor supervisor is not in core:
  - a. Place the cold start paper tape record in the paper tape reader.
  - b. Press IMM STOP, RESET, and PROGRAM LOAD on the console.

- c. Place the PTUTL execute tape in the paper tape reader.
  - d. Press PROGRAM START.
3. The paper tape utility program is loaded into core and then comes to a WAIT at location /0498. This wait allows the operator to ready the console printer, paper tape reader, and paper tape punch. The user should punch a leader of delete codes on the paper tape punch.

At this time, the user can select the desired program options by turning on the appropriate console entry switches (see Figure 16).

<u>Console Entry Switch On</u>	<u>Option</u>
0	Print record after reading
1	Read paper tape records from 1134
2	Accept keyboard input <sup>1</sup>
3	Punch paper tape records on 1055
14	WAIT after punching <sup>3</sup>
15	WAIT after printing <sup>2</sup>
All switches off	Exit to monitor supervisor <sup>3</sup>

### NOTES:

1. The keyboard input option uses TYPE0, therefore all features of that routine apply to PTUTL.
  - a. The input record cannot exceed 80 characters.
  - b. Pressing the backspace key cancels the last character entered.
  - c. Pressing the ERASE FIELD key cancels the entire record and allows the user to restart.
  - d. Pressing the EOF key indicates that the record is complete. The keyboard is released and the program continues.
2. Keyboard input will replace the last paper tape record read if console entry switch 2 is turned on prior to pressing PROGRAM START.
3. The test for exit is made just before an input record is read; therefore, a convenient way to branch out of PTUTL is to perform a WAIT after punching the last record desired (console entry switch 14 on). Turn off all console entry switches and press PROGRAM START. Control is returned to the monitor supervisor.

## Paper Tape Not-Ready WAITs

<u>Condition</u>	<u>Indication</u>	<u>Recovery Procedure</u>
Paper tape reader not ready	Program WAITs at location /0498 with /0005 in the Accumulator	Ready reader if additional tape is to be read. Set the console entry switches as desired and press PROGRAM START.
Paper Tape punch not ready	Program WAITs at location /0498 with /0004 in the Accumulator	Ready the paper tape punch and press PROGRAM START. To re-punch a record which was being processed when the not-ready occurred, set console entry switches 1 and 2 off (to prevent another record from being read), set switches 3 and 14 on (punch a record and WAIT), and press PROGRAM START. After the record is punched, return the console entry switches to the original configuration and press PROGRAM START.

### Example

Assume that the following records appear on a tape.

```
// JOB
//* (comments)
// ASM
// DUP
Asm. Control Records
Source Program
```

The user now desires to alter the comments record, insert a // PAUS record after the comments record, and delete the // DUP record. The procedure is as follows.

1. Load and execute PTUTL. The program will WAIT at location /0498.
2. Load the source tape in the paper tape reader and ready the paper tape punch and console printer. Remember to make a leader of delete codes on the punch.
3. Turn on console entry switches 1, 3, and 14.
4. Press PROGRAM START.
5. The // JOB record will be read, reproduced, and the program will WAIT.
6. Turn on console entry switches 0, 1, 2, 3, 14, and 15.
7. Press PROGRAM START.
8. The comments record in the source tape will be read and printed on the console printer. The program will WAIT.
9. Press PROGRAM START. The Keyboard will be selected (PROCEED light on) and the program will WAIT.
10. Enter the new comments record in the proper format.
11. Press the EOF key on the keyboard.
12. The new comments record will be punched on the tape, replacing the old record. The program will WAIT.
13. Turn off console entry switch 1. Press PROGRAM START. The keyboard will be re-selected.
14. Enter the // PAUS record from the keyboard and press EOF.
15. Turn off console entry switches 0, 2, and 15. Turn on switch 1. Leave switches 3 and 14 on.
16. Press PROGRAM START.
17. The // ASM record will be read and reproduced on the punch. The program will WAIT.
18. The next record, // DUP, is to be deleted; therefore, switches 0, 1, and 15 should be set on, all other console entry switches should be set off.
19. Press PROGRAM START.
20. The // DUP record will be read and printed but not punched. The program will WAIT.
21. Leave the sense switches at the present setting and press PROGRAM START. The next record on the input tape will be read into the I/O buffer, overlaying the // DUP record.
22. Turn on console entry switches 1 and 3, all others off.
23. Press PROGRAM START.
24. The remainder of the source tape will be read in and reproduced, record for record.
25. When the paper tape reader goes not-ready at the end of the source tape, the program will again WAIT at location /0498. Set all console entry switches off and press PROGRAM START. Control will return to the monitor supervisor.



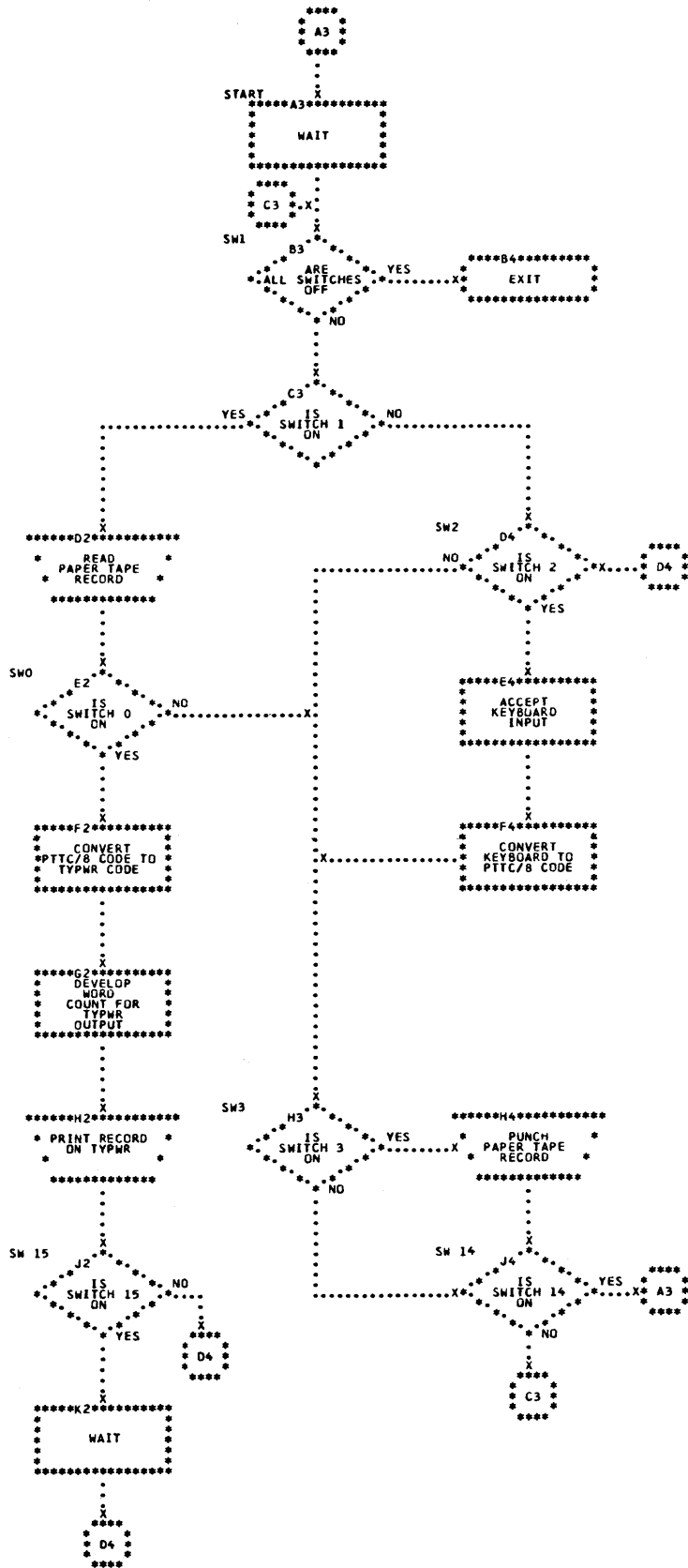

Figure 16. PTUTL Sense Switch Options

APPENDIX J. SAMPLE PROGRAM OUTPUT

// JOB  
// FOR

DKSAM001  
DKSAM002

\*\* IBM 1130 DISK MONITOR FORTRAN SAMPLE PROGRAM  
\*ONE WORD INTEGERS  
\*LIST ALL  
\*IOCS (CARD, 1132 PRINTER, DISK)  
\*NAME SAMPL

PAGE 01  
DKSAM003  
DKSAM004  
DKSAM005  
DKSAM006  
DKSAM007

	IBM 1130 DISK MONITOR FORTRAN SAMPLE PROGRAM	PAGE 02
C	IBM 1130 DISK MONITOR FORTRAN SAMPLE PROGRAM	DKSAM008
C	SIMULTANEOUS EQUATION ROUTINE	DKSAM009
	DEFINE FILE 1 (10,320,U,INXT)	DKSAM010
	DIMENSION A(10,10),X(10),B(10),Y(10)	DKSAM011
	301 FORMAT (1H1,20X15HINCOMPATIBILITY)	DKSAM012
	302 FORMAT (1H 20X41HMORE EQUATIONS THAN UNKNOWN=NO SOLUTIONS)	DKSAM013
	303 FORMAT (1H 20X46HMORE UNKNOWN THAN EQUATIONS=SEVERAL SOLUTIONS)	DKSAM014
	304 FORMAT (1H 20X15HSOLUTION MATRIX)	DKSAM015
	305 FORMAT(1H 20X8HMATRIX A)	DKSAM016
	306 FORMAT(1H 20X8HMATRIX B)	DKSAM017
	307 FORMAT (1H 20X10H A=INVERSE)	DKSAM018
	308 FORMAT(1H 20X24HDIAGONAL ELEMENT IS ZERO)	DKSAM019
	309 FORMAT (1H 20X'A=INVERSE TIMES A')	DKSAM020
	M=2	DKSAM021
	L=3	DKSAM022
	READ (M,10)	DKSAM023
	10 FORMAT(72H                    SPACE FOR TITLE	DKSAM024
	1                                )	DKSAM025
	WRITE (L,10)	DKSAM026
	12 FORMAT (6I10)	DKSAM027
	READ (M,12)M1,M2,L1,L2,N1,N2	DKSAM028
C	M1 = NO. OF ROWS OF A	DKSAM029
C	M2 = NO. OF COLS OF A	DKSAM030
C	L1 = NO. OF ROWS OF X	DKSAM031
C	L2 = NO. OF COLS OF X	DKSAM032
C	N1 = NO. OF ROWS OF B	DKSAM033
C	N2 = NO. OF COLS OF B	DKSAM034
	13 FORMAT (7F10.4)	DKSAM035
	17 FORMAT (10F10.4)	DKSAM036
	IF (N2-1)63,64,63	DKSAM037
	64 IF (L2-1)63,65,63	DKSAM038
	65 IF (L1-M2)63,66,63	DKSAM039
	66 IF (M1-N1)63,11,63	DKSAM040
	63 WRITE (L,301)	DKSAM041
	GO TO 2	DKSAM042
	11 N=M1	DKSAM043
	N=M2	DKSAM044
	IF (M1-M2) 91,14,93	DKSAM045
	91 WRITE (L,302)	DKSAM046
	GO TO 2	DKSAM047
	93 WRITE (L,303)	DKSAM048
	GO TO 2	DKSAM049
	14 WRITE (L,305)	DKSAM050
	DO 70 I=1,N	DKSAM051
	READ (M,13)(A(I,J),J=1,N)	DKSAM052
	WRITE (L,17)(A(I,J),J=1,N)	DKSAM053
	70 CONTINUE	DKSAM054
	89 FORMAT (F10.4)	DKSAM055
	WRITE (L,306)	DKSAM056
	READ (M,89)(B(I),I=1,N)	DKSAM057
	WRITE (L,89)(B(I),I=1,N)	DKSAM058
C	PRESERVE THE ORIGINAL MATRIX ON DISK	DKSAM059
	DO 19 I=1,N	DKSAM060
	19 WRITE (1'I) (A(J,I), J=1,N)	DKSAM061
C	INVERSION OF A	DKSAM062
	20 DO 120 K=1,N	DKSAM063
	D=A(K,K)	DKSAM064
	IF(D)40,200,40	DKSAM065
	40 A(K,K)=1.0	DKSAM066

```

      IBM 1130 DISK MONITOR FORTRAN SAMPLE PROGRAM
50 DO 60 J=1,N
60 A(K,J)=A(K,J)/D
   IF(K=N)80,130,130
80 IK=K+1
   DO 120 I=IK,N
   D=A(I,K)
   A(I,K)=0.0
   DO 120 J=1,N
120 A(I,J)=A(I,J)-(D*A(K,J))
C   BACK SOLUTION
130 IK=N-1
   DO 180 K=1,IK
140 I1=K+1
   DO 180 I=I1,N
   D=A(K,I)
   A(K,I)=0.0
170 DO 180 J=1,N
180 A(K,J)=A(K,J)-(D*A(I,J))
   GO TO 202
200 WRITE (L,308)
   GO TO 2
C   PRINT INVERSE
202 WRITE (L,307)
   DO 201 I=1,N
   WRITE (L,17)(A(I,J),J=1,N)
201 CONTINUE
   WRITE (L,309)
C   COMPUTE AND PRINT A=INVERSE TIMES A
   DO 123 J=1,N
C   RETRIEVE ORIGINAL BY COLUMNS
   READ (1,J) (X(M), M=1,N)
   DO 122 I=1,N
   Y(I) = 0.0
   DO 122 K = 1,N
122 Y(I) = Y(I)+A(I,K)*X(K)
123 WRITE (L,17) (Y(I), I=1,N)
   DO 21 I=1,N
   X(I)=0.0
   DO 21 K=1,N
21 X(I)=X(I)+A(I,K)*B(K)
   WRITE (L,304)
   WRITE (L,89)(X(I),I=1,N)
2 CALL EXIT
   END

```

```

PAGE 03
DKSAM067
DKSAM068
DKSAM069
DKSAM070
DKSAM071
DKSAM072
DKSAM073
DKSAM074
DKSAM075
DKSAM076
DKSAM077
DKSAM078
DKSAM079
DKSAM080
DKSAM081
DKSAM082
DKSAM083
DKSAM084
DKSAM085
DKSAM086
DKSAM087
DKSAM088
DKSAM089
DKSAM090
DKSAM091
DKSAM092
DKSAM093
DKSAM094
DKSAM095
DKSAM096
DKSAM097
DKSAM098
DKSAM099
DKSAM100
DKSAM101
DKSAM102
DKSAM103
DKSAM104
DKSAM105
DKSAM106
DKSAM107
DKSAM108
DKSAM109
DKSAM110

```

```

      IBM 1130 DISK MONITOR FORTRAN SAMPLE PROGRAM
                                     PAGE 04
VARIABLE ALLOCATIONS
A      =00CE X      =00E2 B      =00F6 Y      =010A D      =010C INXT =010E M      =010F L      =0110 M1     =0111 M2     =0112
L1     =0113 L2     =0114 N1     =0115 N2     =0116 N      =0117 I      =0118 J      =0119 K      =011A IK     =011B I1     =011C

UNREFERENCED STATEMENTS
20      50      140      170

STATEMENT ALLOCATIONS
301     =0127 302     =0134 303     =014E 304     =016A 305     =0177 306     =0180 307     =0189 308     =0193 309     =01A4 10      =01B2
12      =01D8 13      =01DB 17      =01DE 89      =01E1 64      =021C 65      =0222 66      =0228 63      =022E 11      =0234 91      =0244
93      =024A 14      =0250 70      =0289 19      =02C6 20      =02E7 40      =02FB 50      =0306 60      =030A 80      =0325 120     =0344
130     =0374 140     =037E 170     =0399 180     =039D 200     =03CF 202     =03D5 201     =03F6 122     =042D 123     =045C 21      =048C
2       =04D6

FEATURES SUPPORTED
ONE WORD INTEGERS
IOCS

CALLED SUBPROGRAMS
FADDX  FMPYX  FDIV  FLD  FLDX  FSTO  FSTOX  FSBRX  SRED  SWRT  SCOMP  SFIO  SIOFX  SIOI  SUBSC
CARDZ  PRNTZ  SDFIO  SDRED  SDWRT  SDCOM  SDFX

REAL CONSTANTS
.100000E 01=0120 .000000E 00=0122

INTEGER CONSTANTS
2=0124 3=0125 1=0126

CORE REQUIREMENTS FOR SAMPL
COMMON 0 VARIABLES 288 PROGRAM 952

END OF COMPILATION

```

// XEQ L  
FILES ALLOCATION  
1 016C 000A

DKSAM111

STORAGE ALLOCATION  
R 47 0F71 (HEX) WORDS AVAILABLE

LIBF TRANSFER-VECTOR

EBCTB	1015
HOLTB	0FDF
GETAD	0F9E
NORM	0F74
XMDS	0F58
FARC	0F36
HOLEZ	0F00
IFIX	0ED8
FLOAT	0ECE
FADDX	0E79
SDRED	06C0
FSBRX	0E50
FMPYX	0E1C
FDIV	0DCA
FSTOX	0D72
FLDX	0D8E
SDCOM	06E4
SDFX	06B2
SDWRT	070E
SIOFX	0915
SUBSC	0DA8
SIOI	0919
SCOMP	0901
SWRT	08F8
SRED	0928
FSTO	0D76
FLD	0D92
PRNTZ	0CC0
CARDZ	0C7B
SFIO	09CD
SDFIO	0713
DISKZ	00F4

SYSTEM ROUTINES

ILS02 1019

03A5 (HEX) IS THE EXECUTION ADDR.

IBM 1130 DISK MONITOR FORTRAN SAMPLE PROGRAM

MATRIX A  
4.2150 -1.2120 1.1050  
-2.1200 3.5050 -1.6320  
1.1220 -1.3130 3.9860

MATRIX B  
3.2160  
1.2470  
2.3456

A-INVERSE  
0.2915 0.0833 -0.0467  
0.1631 0.3836 0.1118  
-0.0283 0.1029 0.3008

A-INVERSE TIMES A  
0.9999 -0.0000 0.0000  
0.0000 0.9999 -0.0000  
-0.0000 0.0000 1.0000

SOLUTION MATRIX  
0.9321  
1.2654  
0.7429

```

// JOB
// ASM
*LIST
*PRINT SYMBOL TABLE

```

```

SMASM001
SMASM002
SMASM003
SMASM004

```

```

                                COMPUTE THE SQUARE ROOT OF 64
0000 0  C030          BEGIN LD      D64
0001 20 064D0063     LIBF   FLOAT   INTEGER TO FLOATING PT.
0002 30 06898640     CALL   FSQR   FLOATING PT. SQRT.
0004 20 091899C0     LIBF   IFIX   FLOATING PT. TO INTEGER
0005 0  1008          SLA      8
                                *
                                *   MASK TO BUILD EBCDIC INTEGER
                                *   RESULT AND EBCDIC BLANK IN WORD1.
0006 0  E829          OR        MASK
0007 0  D01B          STO      WORD1
                                *
                                *   CONVERT MESSAGE FROM EBCDIC
                                *   TO ROTATE/TILT CODE.
0008 20 05097663     LIBF   EBPRT
0009 0  0000          DC      0
000A 1  0023          DC      WORD1
000B 1  0015          DC      TYPE&1
000C 0  001A          DC      26
000D 20 23A17170     LIBF   TYPE0   TYPE MESSAGE
000E 0  2000          DC      /2000
000F 1  0014          DC      TYPE
0010 20 23A17170     LIBF   TYPE0   WAIT FOR TYPING COMPLETE
0011 0  0000          DC
0012 0  70FD          MDX     *-3
0013 0  6038          EXIT
                                RETURN TO MONITOR CONTROL
0014 0  000E          TYPE   DC      14
0015 0  000D          BSS    13
0022 0  8181          DC      /8181
0023 0  0000          WORD1  DC      *-#
0024 0  0018          EBC    .IS THE SQUARE ROOT OF 64.
0030 0  F040          MASK   DC      /F040
0031 0  0040          D64    DC      64
0032 0  0000          END    BEGIN

```

```

PAGE 1
SMASM006
SMASM007
SMASM008
SMASM009
SMASM010
SMASM011
SMASM012
SMASM013
SMASM014
SMASM015
SMASM016
SMASM017
SMASM018
SMASM019
SMASM020
SMASM021
SMASM022
SMASM023
SMASM024
SMASM025
SMASM026
SMASM027
SMASM028
SMASM029
SMASM030
SMASM031
SMASM032
SMASM033
SMASM034
SMASM035
SMASM036

```

SYMBOL TABLE

```

BEGIN 0000      D64  0031      MASK  0030      TYPE  0014      WORD1 0023
NO ERRORS IN ABOVE ASSEMBLY.

```

// XEQ L  
R 47 1907 (HEX) WORDS AVAILABLE

SMASMO37

CALL TRANSFER VECTOR

FSQR 020C

LIBF TRANSFER-VECTOR

FARC 066C  
XMDS 0650  
HOLL 0600  
PRTY 0580  
EBPA 0560  
FADD 04AF  
FDIV 050E  
FLD 045A  
FADDX 048B  
FMPYX 0470  
FSTO 043E  
FGETP 0424  
NORM 03FA  
TYPE0 02D2  
EBPRT 026C  
IFIX 0244  
FLOAT 01F4  
DISKZ 00F4

SYSTEM ROUTINES

ILS04 0691  
ILS02 06AD

01C2 (HEX) IS THE EXECUTION ADDR.

Program Output on Console Printer

8 IS THE SQUARE ROOT OF 64

**Absolute program:** A program which, although in Disk System format, has been written in such a way that it can be executed from only one core location.

**Assembler core load:** A core load which was built from a mainline written in Assembly Language.

**CALL routine:** A routine which must be referenced with a CALL statement. The type codes for routines in this category are 4 and 6.

**CALL TV:** The transfer vector through which CALL routines are entered at execution time. See the section on the Loader for a description of this TV.

**CIB: (the Core Image Buffer)** The buffer on which most of the first 4000 words of core are saved. Although the CIB occupies two cylinders, the last two sectors are not used. See the section on the Loader for a description of the CIB and its use.

**Cold Start Routine:** The routine which initializes the 1130 Disk System Monitor by reading down from the disk the Skeleton Supervisor.

**COMMA (the Core Communication Area):** The part of core which is reserved for the work areas and parameters which are required by the Monitor programs. In general, a parameter is found in COMMA if it is required by two or more Monitor Programs or if it is passed from one Monitor Program to another. COMMA is initialized from DCOM by the Cold Start Routine and at the beginning of each JOB.

**Control Record:** One of the records (card or paper tape) which directs the activities of the 1130 Monitor System. For example, //DUP is a Monitor control record that directs the Monitor to initialize DUP; \*DUMPLET is a DUP control record directing DUP to initialize the DUMPLET program; \*EXTENDED PRECISION is a FORTRAN control record directing the compiler to allot three words instead of two for the storage of data variables.

**Core Image format:** Sometimes abbreviated CI format. It is the format in which whole core loads are stored on the disk prior to execution.

**Core Image Header Record:** A part of a core load stored in Core Image format. It is actually the last 15 words of the format. Among these 15 words are the ITV and the setting for index register 3.

**Core Image program:** A mainline program which has been converted, along with all of its required subroutines, to CI format. In other words, it is a core load.

**Core load:** Synonymous with the term object program, which is comprised of the ITV, the object-time TV, the information contained in the Core Image Header Record, the in-core code, and all LOCALs, NOCALs, and SOCALs.

**Cylinderize:** The process of rounding a disk block/sector address up to the disk block/sector address of the next cylinder boundary.

**Data block:** A group of words consisting of a data header, data words, and Indicator Words for a routine in Disk System format. A new data block is created for every data break. (A data break occurs whenever there is an ORG, BSS, or BES statement, at the end of each record, and whenever a new sector is required to store the words comprising a routine.)

**Data break:** Sometimes referred to as a break in sequence. See "Data block" for a definition of this term.

**Data file:** An area in either the User Area or the Fixed Area in which data is stored.

**Data format:** The format in which a Data file is stored in either the User Area or the Fixed Area.

**Data group:** A group of not more than nine data words of a routine in Disk System format. In this format every such group has as its first word an associated Indicator Word. Normally a data group consists of eight data words plus its Indicator Word; but, if the data block of which the data group is a part contains a number of data words which is not a multiple of eight, then the last data group will contain less than nine data words.

**Data header:** The first pair of words in a data block for a routine in Disk System format. The first word contains the loading address of the data block, the second the total number of words contained in the data block.

**DCOM (the Disk Communications Area):** The disk sector which contains the work areas and parameters for the Monitor Programs. It is used to initialize COMMA by the Cold Start Routine and at the beginning of each JOB (see "COMMA").

**Disk block:** A 20-word segment of a disk sector. Thus, sixteen disk blocks comprise each sector. The disk block is the smallest distinguishable increment for DSF programs. Thus the Monitor System permits packing of DSF programs at smaller intervals than the hardware would otherwise allow. The disk block is also referred to elsewhere as the "disk byte".

**Disk System format:** Sometimes abbreviated DSF. It is the format in which mainlines and subroutines are stored on the disk as separate entities. It is not possible to execute a program in DSF; it must first be converted to Core Image format.

**Disk System format program:** A program which is in Disk System format. It is sometimes called a DSF program.

**Entry point:** A term which may give rise to confusion unless the reader is careful to note the context in which this term appears. Under various conditions it is used to denote (1) the symbolic address (name) of a place at which a subroutine or a Monitor Program is entered, (2) the absolute core address at which a subroutine or mainline is to be entered, and (3) the address, relative to the address of the first word of the subroutine, at which it is to be entered.

**Fixed area:** The area on disk in which core loads and data files are stored if it is desired that they always occupy the same sectors. No routines in Disk System format may be stored in this area.

**FORTTRAN core load:** A core load which was built from a mainline written in FORTTRAN.

**IBM Systems area:** That part of disk storage which is occupied by the Monitor Programs, i. e., cylinders 0-33 (sectors 0-271).

**ILS (an Interrupt Level Subroutine):** A routine which services all interrupts on a given level; i. e., it determines which device on a given level caused the interrupt and branches to a servicing routine (ISS) for processing of that interrupt. After this processing is complete, control is returned to the ILS, which turns off the interrupt.

**Indicator Word:** Tells which of the following data words should be incremented (relocated) when relocating a routine in Disk System format. It also tells which are the names in LIBF, CALL, and DSA statements. Routines which are in Disk System format all contain Indicator Words, preceding every eight data words. Each pair of bits in the Indicator Word is associated with one of the following data words, the first pair with the first data word, etc.

**Instruction address register:** Also called the I-counter. It is the register in the 1130 which contains the address of the next sequential instruction.

**In-core routine:** A part of a given core load which remains in core storage during the entire execution of the core load. ILSs are always in-core routines, whereas LOCALs and SOCALs never are.

**ISS (an Interrupt Service Subroutine):** A routine which is associated with one or more of the six levels of interrupt; i. e., CARD0, which causes interrupts on two levels, is such a routine.

**Job:** A group of tasks (subjobs) which are to be performed by the 1130 Disk Monitor System and which are interdependent; i. e., the successful execution of any given subjob (following the first one) depends upon the successful execution of at least one of those which precedes it. See the section on the Supervisor for examples.

**LET/FLET (the Location Equivalence Table for the User Area/ the Location Equivalence Table for the Fixed Area):** The table through which the disk addresses of programs and data files stored in the User Area/Fixed Area may be found. LET occupies the cylinder following the Supervisor Control Record Area. If a Fixed Area has been defined, FLET occupies cylinder 34 (sectors 272-279); otherwise, there is no FLET.



**LIBF routine.** A routine which must be referenced with an LIBF statement. The type codes for routines in this category are 3 and 5.

**LIBF TV:** The transfer vector through which LIBF routines are entered at execution time. See the section on the Loader for a description of this TV.

**Loading address:** The address at which a routine or data block is to begin. In the latter case the address is that of an absolute core location, while in the former it is either absolute or relative, depending upon whether the routine is absolute or relocatable, respectively.

**LOCAL (load-on-call routine):** That part of an object program which is not always in core. It is read from Working Storage into a special overlay area in core only when it is referenced in the object program. LOCALs, which are specified for any given execution by the User, are a means of gaining core storage at the expense of execution time. The Loader constructs the LOCALs and all linkages to and from them.

**Location assignment counter:** A counter maintained in the Assembler program for assigning addresses to the instructions it assembles.

**Modified EBCDIC code:** A six-bit code used internally by the Monitor programs. In converting from EBCDIC to Modified EBCDIC, the leftmost two bits are dropped.

**Modified Polish Notation:** The rearrangement of operators and operands (i. e., an operator and two operands) into the triple form required by the FORTRAN Compiler to generate the code necessary to perform arithmetic operations.

**Monitor Program:** One of the following parts of the 1130 Disk System Monitor: Supervisor (SUP), Disk Utility Program (DUP), Assembly Program (ASM), and FORTRAN Compiler (FOR).

**NOCAL (a load-although-not-called routine):** A routine which is to be included in an object program although it is never referenced in that program by an LIBF or CALL statement. Debugging aids such as a trace routine or a dump routine fall into this category.

**Object program:** Synonymous with the term core load.

**Object-time TV:** A collection of both the LIBF TV and the CALL TV.

**Principal I/O device:** The 1442 Card Read/Punch if one is present; the 1134 Paper Tape Reader/1055 Paper Tape Punch otherwise.

**Principal print device:** Sometimes referred to as the Principal Printer. It is the 1132 Printer if one is present; the Console Printer otherwise.

**Program header record:** A part of a routine stored in Disk System format. Its contents vary with the type of the routine with which it is associated. It contains the information necessary, along with information from LET, to identify the routine, to describe its properties, and to convert it from Disk System format to a part of a core load.

**Relocatable program:** A program which can be executed from any core location. Such a program is stored on the disk in Disk System format.

**Relocation:** The process of adding a relocation factor to address constants and to those two-word instructions whose second words are not (1) invariant quantities, (2) absolute core addresses, or (3) symbols defined as absolute core addresses. The relocation factor for any program is the absolute core address at which the first word of that program is found.

**Relocation indicator:** The second bit in a pair of bits in an Indicator Word. If the data word with which this bit is associated is not an LIBF, CALL, or DSA name, then it indicates whether or not to increment (relocate) the data word. If the relocation indicator is set to 1, the word is to be relocated.

**Sectorize:** The process of rounding a disk block address up to the disk block address of the next sector boundary.

**Skeleton supervisor:** That part of the Supervisor which is always in core (except during the execution of FORTRAN core loads) and which is, essentially, the logic necessary to process CALL

EXIT and CALL LINK statements. Together with COMMA it occupies core locations  $38_{10} - 144_{10}$ .

SOCAL (a System Overlay to be loaded-on-call): One of three overlays automatically prepared by the Loader under certain conditions when a core load is too large to fit into core storage. See the section on the Loader for an explanation.

Subroutine: Used in the 1130 Disk Monitor System interchangeably with the term subprograms, routine, and program. Any distinctions between these terms will have to be inferred from the context.

Supervisor control record area: The area in which the Supervisor Control Records are written. This area is the cylinder following the CIB. The first two sectors are reserved for \*LOCAL records, the next two for \*NOCAL records and the next two for \*FILES records. The last two sectors in this cylinder are not utilized. See the Supervisor section for the formats of these records.

The Monitor: Refers to the 1130 Disk System Monitor.

User area: The area on the disk in which all routines in Disk System format are found. Core loads

(i. e., programs in Core Image format) and Data files may also be stored in this area. All IBM-supplied routines are found here, since they are stored in Disk System format. This area begins at the cylinder following LET and occupies as many sectors as are required to store the routines and files residing there.

User programs: Are mainlines and subroutines which have been written by the user.

User storage: That part of disk storage which is neither Working Storage nor the IBM Area. It begins at cylinder 34 (sector 272), which would be the beginning of the CIB unless a Fixed Area is defined. In this case FLET would occupy cylinder 34 (sectors 272-279), the Fixed Area would begin at cylinder 35 (sector 280), and the CIB would occupy the first two cylinders following the Fixed Area, the length of which is defined by the user.

Working storage: The area on disk immediately following the last sector occupied by the User Area. This is the only one of the three major divisions of disk storage (IBM Area, User Storage, Working Storage) which does not begin at a cylinder boundary.

XR1, XR2, XR3: The acronyms for index registers 1, 2, and 3, respectively.

## APPENDIX L. DECIMAL AND HEXADECIMAL DISK ADDRESSES

SECTOR ADDRESS BASE 10	SECTOR ADDRESS BASE 16	CYLINDER ADDRESS BASE 10	CYLINDER ADDRESS BASE 16	SECTOR ADDRESS BASE 10	SECTOR ADDRESS BASE 16	CYLINDER ADDRESS BASE 10	CYLINDER ADDRESS BASE 16
+00000	0000	+00000	0000	+00800	0320	+00100	0064
+00008	0008	+00001	0001	+00808	0328	+00101	0065
+00016	0010	+00002	0002	+00816	0330	+00102	0066
+00024	0018	+00003	0003	+00824	0338	+00103	0067
+00032	0020	+00004	0004	+00832	0340	+00104	0068
+00040	0028	+00005	0005	+00840	0348	+00105	0069
+00048	0030	+00006	0006	+00848	0350	+00106	006A
+00056	0038	+00007	0007	+00856	0358	+00107	006B
+00064	0040	+00008	0008	+00864	0360	+00108	006C
+00072	0048	+00009	0009	+00872	0368	+00109	006D
+00080	0050	+00010	000A	+00880	0370	+00110	006E
+00088	0058	+00011	000B	+00888	0378	+00111	006F
+00096	0060	+00012	000C	+00896	0380	+00112	0070
+00104	0068	+00013	000D	+00904	0388	+00113	0071
+00112	0070	+00014	000E	+00912	0390	+00114	0072
+00120	0078	+00015	000F	+00920	0398	+00115	0073
+00128	0080	+00016	0010	+00928	03A0	+00116	0074
+00136	0088	+00017	0011	+00936	03A8	+00117	0075
+00144	0090	+00018	0012	+00944	03B0	+00118	0076
+00152	0098	+00019	0013	+00952	03B8	+00119	0077
+00160	00A0	+00020	0014	+00960	03C0	+00120	0078
+00168	00A8	+00021	0015	+00968	03C8	+00121	0079
+00176	00B0	+00022	0016	+00976	03D0	+00122	007A
+00184	00B8	+00023	0017	+00984	03D8	+00123	007B
+00192	00C0	+00024	0018	+00992	03E0	+00124	007C
+00200	00C8	+00025	0019	+01000	03E8	+00125	007D
+00208	00D0	+00026	001A	+01008	03F0	+00126	007E
+00216	00D8	+00027	001B	+01016	03F8	+00127	007F
+00224	00E0	+00028	001C	+01024	0400	+00128	0080
+00232	00E8	+00029	001D	+01032	0408	+00129	0081
+00240	00F0	+00030	001E	+01040	0410	+00130	0082
+00248	00F8	+00031	001F	+01048	0418	+00131	0083
+00256	0100	+00032	0020	+01056	0420	+00132	0084
+00264	0108	+00033	0021	+01064	0428	+00133	0085
+00272	0110	+00034	0022	+01072	0430	+00134	0086
+00280	0118	+00035	0023	+01080	0438	+00135	0087
+00288	0120	+00036	0024	+01088	0440	+00136	0088
+00296	0128	+00037	0025	+01096	0448	+00137	0089
+00304	0130	+00038	0026	+01104	0450	+00138	008A
+00312	0138	+00039	0027	+01112	0458	+00139	008B
+00320	0140	+00040	0028	+01120	0460	+00140	008C
+00328	0148	+00041	0029	+01128	0468	+00141	008D
+00336	0150	+00042	002A	+01136	0470	+00142	008E
+00344	0158	+00043	002B	+01144	0478	+00143	008F
+00352	0160	+00044	002C	+01152	0480	+00144	0090
+00360	0168	+00045	002D	+01160	0488	+00145	0091
+00368	0170	+00046	002E	+01168	0490	+00146	0092
+00376	0178	+00047	002F	+01176	0498	+00147	0093
+00384	0180	+00048	0030	+01184	04A0	+00148	0094
+00392	0188	+00049	0031	+01192	04A8	+00149	0095
+00400	0190	+00050	0032	+01200	04B0	+00150	0096
+00408	0198	+00051	0033	+01208	04B8	+00151	0097
+00416	01A0	+00052	0034	+01216	04C0	+00152	0098
+00424	01A8	+00053	0035	+01224	04C8	+00153	0099
+00432	01B0	+00054	0036	+01232	04D0	+00154	009A
+00440	01B8	+00055	0037	+01240	04D8	+00155	009B
+00448	01C0	+00056	0038	+01248	04E0	+00156	009C
+00456	01C8	+00057	0039	+01256	04E8	+00157	009D
+00464	01D0	+00058	003A	+01264	04F0	+00158	009E
+00472	01D8	+00059	003B	+01272	04F8	+00159	009F
+00480	01E0	+00060	003C	+01280	0500	+00160	00A0
+00488	01E8	+00061	003D	+01288	0508	+00161	00A1
+00496	01F0	+00062	003E	+01296	0510	+00162	00A2
+00504	01F8	+00063	003F	+01304	0518	+00163	00A3
+00512	0200	+00064	0040	+01312	0520	+00164	00A4
+00520	0208	+00065	0041	+01320	0528	+00165	00A5
+00528	0210	+00066	0042	+01328	0530	+00166	00A6
+00536	0218	+00067	0043	+01336	0538	+00167	00A7
+00544	0220	+00068	0044	+01344	0540	+00168	00A8
+00552	0228	+00069	0045	+01352	0548	+00169	00A9
+00560	0230	+00070	0046	+01360	0550	+00170	00AA
+00568	0238	+00071	0047	+01368	0558	+00171	00AB
+00576	0240	+00072	0048	+01376	0560	+00172	00AC
+00584	0248	+00073	0049	+01384	0568	+00173	00AD
+00592	0250	+00074	004A	+01392	0570	+00174	00AE
+00600	0258	+00075	004B	+01400	0578	+00175	00AF
+00608	0260	+00076	004C	+01408	0580	+00176	00B0
+00616	0268	+00077	004D	+01416	0588	+00177	00B1
+00624	0270	+00078	004E	+01424	0590	+00178	00B2
+00632	0278	+00079	004F	+01432	0598	+00179	00B3
+00640	0280	+00080	0050	+01440	05A0	+00180	00B4
+00648	0288	+00081	0051	+01448	05A8	+00181	00B5
+00656	0290	+00082	0052	+01456	05B0	+00182	00B6
+00664	0298	+00083	0053	+01464	05B8	+00183	00B7
+00672	02A0	+00084	0054	+01472	05C0	+00184	00B8
+00680	02A8	+00085	0055	+01480	05C8	+00185	00B9
+00688	02B0	+00086	0056	+01488	05D0	+00186	00BA
+00696	02B8	+00087	0057	+01496	05D8	+00187	00BB
+00704	02C0	+00088	0058	+01504	05E0	+00188	00BC
+00712	02C8	+00089	0059	+01512	05E8	+00189	00BD
+00720	02D0	+00090	005A	+01520	05F0	+00190	00BE
+00728	02D8	+00091	005B	+01528	05F8	+00191	00BF
+00736	02E0	+00092	005C	+01536	0600	+00192	00C0
+00744	02E8	+00093	005D	+01544	0608	+00193	00C1
+00752	02F0	+00094	005E	+01552	0610	+00194	00C2
+00760	02F8	+00095	005F	+01560	0618	+00195	00C3
+00768	0300	+00096	0060	+01568	0620	+00196	00C4
+00776	0308	+00097	0061	+01576	0628	+00197	00C5
+00784	0310	+00098	0062	+01584	0630	+00198	00C6
+00792	0318	+00099	0063	+01592	0638	+00199	00C7

## INDEX

- Adding and removing subroutines 39
- ARITHMETIC TRACE, FORTRAN control record 33
- ASM, monitor control record 9
- Assembler 26
  - control records 26
  - error detection codes 29
  - messages and error codes 29
  - operating procedures (card) 29
  - operating procedures (paper tape) 30
  - origin of source program 28
  - paper tape format 28
- Assembler control records 26
  - COMMON 28
  - FILE 28
  - LEVEL 28
  - LIST 27
  - LIST DECK 27
  - LIST DECK E 27
  - PRINT SYMBOL TABLE 27
  - PUNCH SYMBOL TABLE 28
  - SAVE SYMBOL TABLE 28
  - SYSTEM SYMBOL TABLE 28
  - TWO PASS MODE 26
- Assembler error messages (Table A-7) 52
- Card Data format (CDD) 61
- Card subroutine errors (CARD0 and CARD1) 36
- Card System format (CDS) 59
- Character codes, Supervisor and DUP I/O (Appendix D) 64
- Cold start
  - halt addresses (Table 13) 44
  - operating procedure, card 44
  - operating procedure, paper tape 46
- Cold start operating procedures (cards) 44
- Cold start operating procedures (paper tape) 46
- COMMA (In-Core Communications Area) 7
  - core locations (Appendix F) 70
- Comments, Monitor control record 10
- COMMON, assembler control record 28
- Common Arith/Funct calls (Appendix E) 66
- Common Arith/Funct LIBFs (Appendix E) 67
- Common FORTRAN calls (Appendix E) 65
- Compilation error messages 35
- Compilation messages 34
- Console Printer Core Dump 78
- Console Printer Disk Dump 79
- Console printer subroutine errors (TYPE0 and WRTY0) 38
- Control records
  - Assembler 26
  - DUP 17
  - FORTRAN 32
  - Monitor 7
  - Supervisor 10
- Conversion factors, disk storage unit 63
- Conversion routines (Appendix E) 68
- Core image buffer (CIB) 4
- Core Image format
  - format (Appendix B) 59
  - loading 16
- Data cards (Card System format) 60
- Data formats (Appendix B) 57
  - Card Data (CDD) 61
  - Card System (CDS) 59
  - Disk Core Image (DCI) 59
  - Disk Data (DDF) 59
  - Disk System (DSF) 57
  - Paper Tape Data (PTD) 61
  - Paper Tape System (PTS) 61
  - Print Data (PRD) 61
- DCOM (Disk Communications Area) 7
- DEFINE, DUP control record 23
- DELETE, DUP control record 23
- Disk Communications Area (DCOM) 7
- Disk Core Image format (DCI) 59
- Disk Data format (DDF) 59
- Disk dump routines
  - Console Printer Disk Dump 79
  - 1132 Printer Disk Dump 79
- Disk FORTRAN I/O (Appendix E) 66
- Disk Pack Initialization Routine (DPIR) 40
- Disk storage allocation (Table 1) 3
- Disk storage layout 3
- Disk storage unit conversion factors 63
- Disk system format (DSF)
  - format (Appendix B) 57
  - loading 16
- Disk Utility Program (DUP) 17
  - control records 17
  - error messages (Table A-9) 55
  - messages 24
  - operating notes 25
- DPIR card load operating procedures 40
- DPIR paper tape load operating procedures 45
- DUMP, DUP control record 18
- DUMPDATA, DUP control record 18
- DUMPLET, DUP control record 22
- DUP, monitor control record 10
- DUP control records 17
  - DEFINE 23
  - DELETE 23
  - DUMP 18
  - DUMPDATA 18
  - DUMPLET 22
  - DWADR 22
  - EDIT 24

STORE 20  
 STORECI 20  
 STOREDATA 21  
 STOREMOD 20  
 DUP error messages (Table A-9) 55  
 DUP operating notes 25  
 DUP waits and loops (Table A-10) 56  
 DWADR, DUP control record 22  
  
 EOP card (Card System format) 60  
 Error messages (Appendix A) 47  
   Assembler (Table A-7) 47  
   DUP (Table A-9) 55  
   DUP Waits and Loops (Table A-10) 56  
   FORTRAN (Table A-8) 53  
   FORTRAN I/O (Table A-11) 56  
   IBMOO 77  
   Loader (Table A-6) 50  
   Monitor Supervisor (Table A-4) 48  
   Monitor Supervisor Wait Locations (Table A-5) 49  
   System Loader (Table A-1) 47  
   System Loader Wait Locations, Part 1 (Table A-2) 48  
   System Loader Wait Locations, Part 2 (Table A-3) 48  
 Extended Arith/Funct calls (Appendix E) 65  
 Extended Arith/Funct LIBFs (Appendix E) 67  
 EXTENDED PRECISION, FORTRAN control record 33  
  
 FILE, assembler control record 28  
 File protection 5  
 FILES, supervisor control record 11  
 Fixed area 5  
 Fixed Location Equivalence Table (FLET) 5  
 FLET (Fixed Location Equivalence Table) 5  
   layout of LET/FLET entries (Appendix G) 74  
   output format (Figure 8) 23  
 Flipper routine 5  
 FOR, monitor control record 9  
 Formats (Appendix B) 57  
 FORTRAN common LIBFs (Appendix E) 66  
 FORTRAN compiler 32  
   compilation error messages 35  
   compilation messages 34  
   control records 32  
   I/O logical unit designations (Table 8) 32  
   printouts 34  
 FORTRAN control records 32  
   ARITHMETIC TRACE 33  
   EXTENDED PRECISION 33  
   IOCS 32  
   LIST ALL 33  
   LIST SOURCE PROGRAM 32  
   LIST SUBPROGRAM NAMES 32  
   LIST SYMBOL TABLE 32  
   NAME 33  
   ONE WORD INTEGERS 33  
   TRANSFER TRACE 34  
 FORTRAN error codes (Table A-8) 53  
 FORTRAN find routine (Appendix E) 66  
 FORTRAN I/O and conversion routines (Appendix E) 66  
 FORTRAN I/O errors 35.1  
 FORTRAN I/O error codes (Table A-11) 56  
 FORTRAN I/O logical unit designations 32  
 FORTRAN sign transfer calls (Appendix E) 65  
  
 FORTRAN trace routines (Appendix E) 66  
  
 Header information, FORTRAN 33  
  
 IBM systems area 3  
 IBMOO (1130 Disk Monitor System Maintenance Program) 75  
 ILS header card (Card System format) 61  
 In-Core Communications Area (COMMA) 7  
   core locations (Appendix F) 70  
 Initializing Disk Monitor System from cards 43  
 Initializing Disk Monitor System from paper tape 45  
 Interrupt level subroutines (Appendix E) 68  
 Interrupt service subroutines (Appendix E) 68  
 I/O logical unit designations, FORTRAN 32  
 IOCS, FORTRAN control record 32  
 ISS header card (Card System format) 61  
  
 JOB, monitor control record 9  
  
 Keyboard input of data records 35.1  
 Keyboard subroutine functions (TYPEO) 38  
  
 Layout of LET/FLET entries (Appendix G) 74  
 LET (Location Equivalence Table) 4  
   layout of LET/FLET entries (Appendix G) 74  
   output format (Figure 7) 22  
 LEVEL, assembler control record 28  
 LIST, assembler control record 27  
 LIST ALL, FORTRAN control record 33  
 LIST DECK, assembler control record 27  
 LIST DECK E, assembler control record 27  
 LIST SOURCE PROGRAM, FORTRAN control record 32  
 LIST SUBPROGRAM NAMES, FORTRAN control record 32  
 LIST SYMBOL TABLE, FORTRAN control record 32  
 Load Mode Control Card 41  
 Loader 12  
 Loader messages/error messages (Table A-6) 50  
 LOCAL, supervisor control record 10  
 Location Equivalence Table (LET) 4  
 Logical unit designations (FORTRAN I/O) 32  
  
 Machine requirements ii  
 Mainline header card (Card System format) 59  
 Monitor control record analyzer 7  
 Monitor control records 7  
   ASM 9  
   Comments 10  
   DUP 10  
   FOR 9  
   JOB 9  
   PAUS 9  
   TEND 10  
   TYP 9  
   XEQ 10  
 Monitor supervisor error messages (Table A-4) 48  
 Monitor supervisor wait locations (Table A-5) 49  
  
 NAME, FORTRAN control record 33  
 NOCAL, supervisor control record 11  
 Non-disk FORTRAN format I/O (Appendix E) 66  
  
 Object-time transfer vector 15  
 ONE WORD INTEGERS, FORTRAN control record 33

Operating procedures  
   cold start (cards) 44  
   cold start (paper tape) 46  
   Console Printer Core Dump 78  
   Console Printer Disk Dump (card) 79  
   Console Printer Disk Dump (paper tape) 80  
   DPIR card load 40  
   DPIR paper tape load 45  
   IBM00 77  
   initializing Disk Monitor System from cards 43  
   initializing Disk Monitor System from paper tape 45  
   Paper Tape Reproducing routine 80  
   Paper Tape Utility routine (PTUTL) 81  
   system generation (card system) 40  
   1132 Printer Core Dump 78  
   1132 Printer Disk Dump (card) 79  
   1132 Printer Disk Dump (paper tape) 80  
 Optional tracing (FORTRAN) 34  
 Origins for core loads 13  
 Overlay routines for LOCAL subprograms (Appendix E) 66  
  
 Paper tape control records 46  
 Paper Tape Data format (PTD) 61  
 Paper tape monitor system 45  
 Paper tape not-ready WAITs 82  
 Paper Tape Reproducing routine 80  
 Paper tape subroutines (PAPT) 39  
 Paper Tape System format (PTS) 61  
 Paper Tape Utility routine (PTUTL) 81  
 Patch header record (IBM00) 76  
 PAUS, monitor control record 9  
 Pre-operative errors (subroutine library) 36  
 Print Data format (PRD) 61  
 PRINT SYMBOL TABLE, assembler control record 27  
 Program header record (Disk System format) 57  
 Program subtypes 58  
 Program types 58  
 PTUTL (Paper Tape Utility routine) 81  
 PUNCH SYMBOL TABLE, assembler control record 28  
  
 REQ Cards 42  
  
 Sample program output 79  
 SAVE SYMBOL TABLE, assembler control record 28  
 SCON Card 42  
 Skeleton Supervisor 7  
 SOCALs (system overlays) 15  
 Stacked input arrangement 12  
 Standard Arith/Funct calls (Appendix E) 65  
 Standard Arith/Funct LIBFs (Appendix E) 67  
 STORE, DUP control record 20  
 STORECI, DUP control record 20  
 STOREDATA, DUP control record 21  
 STOREMOD, DUP control record 21  
  
 Subroutine header card (Card System format) 60  
 Subroutine header record (IBM00) 77  
 Subroutine library 5, 36  
   listing (Appendix E) 65  
   maintenance 76  
 Subtype codes 58  
 Supervisor and DUP I/O character codes (Appendix D) 64  
 Supervisor control record area 4  
 Supervisor control records 10  
   FILES 11  
   LOCAL 10  
   NOCAL 11  
 Supervisor program 3, 7  
 System Configuration Deck 42  
 System generation (card system) 40  
 System loader error codes (Table A-1) 47  
 System loader wait locations, Part 1 (Table A-2) 48  
 System loader wait locations, Part 2 (Table A-3) 48  
 System overlays (SOCALs) 15  
 System program maintenance (IBM00) 75  
 SYSTEM SYMBOL TABLE, assembler control record 28  
  
 TEND, monitor control record 10  
 TERM Card 42  
 TRANSFER TRACE, FORTRAN control record 34  
 Tracing (FORTRAN) 34  
 TWO PASS MODE, assembler control record 26  
 TYP, monitor control record 9  
 Type codes 58  
  
 User area 4  
 User storage area 4  
 User-supplied cards 41  
 Utility calls (Appendix E) 65  
 Utility routines (Appendix I) 78  
   Console Printer Core Dump 78  
   Console Printer Disk Dump 79  
   Disk Pack Initialization Routine (DPIR) 40  
   Paper Tape Reproducing routine 80  
   Paper Tape Utility routine 81  
   1132 Printer Core Dump 78  
   1132 Printer Disk Dump 79  
  
 Working Storage area 5  
 Working storage indicator word 17  
  
 XEQ, monitor control record 10  
  
 1130 Disk Monitor System Maintenance Program IBM00) 75  
 1130 subroutine library listing (Appendix E) 65  
 1132 Printer Core Dump 78  
 1132 Printer Disk Dump 79  
 1442 Errors and Operator Procedures (CARD0 and CARD1) 36









**IBM**

**International Business Machines Corporation**  
**Data Processing Division**  
**112 East Post Road, White Plains, N.Y. 10601**  
**[USA Only]**

**IBM World Trade Corporation**  
**821 United Nations Plaza, New York, New York 10017**  
**[International]**

# READER'S COMMENT FORM

IBM 1130 Disk Monitor System  
Reference Manual

Form C26-3750-2

- Your comments, accompanied by answers to the following questions, help us produce better publications for your use. If your answer to a question is "No" or requires qualification, please explain in the space provided below. Comments and suggestions become the property of IBM.

- |  | Yes   | No                       |
|--|---|--------------------------|
| • Does this publication meet your needs?   | <input type="checkbox"/>                              | <input type="checkbox"/> |
| • Did you find the material:   |   |                          |
| Easy to read and understand?   | <input type="checkbox"/>                              | <input type="checkbox"/> |
| Organized for convenient use?  | <input type="checkbox"/>                              | <input type="checkbox"/> |
| Complete?  | <input type="checkbox"/>                              | <input type="checkbox"/> |
| Well illustrated?  | <input type="checkbox"/>                              | <input type="checkbox"/> |
| Written for your technical level?  | <input type="checkbox"/>                              | <input type="checkbox"/> |
| • What is your occupation? _____   |   |                          |
| • How do you use this publication?   |   |                          |
| As an introduction to the subject? <input type="checkbox"/>                          | As an instructor in a class? <input type="checkbox"/> |                          |
| For advanced knowledge of the subject? <input type="checkbox"/>                      | As a student in a class? <input type="checkbox"/>     |                          |
| For information about operating procedures? <input type="checkbox"/>                 | As a reference manual? <input type="checkbox"/>       |                          |
| Other _____  |   |                          |
| • Please give specific page and line references with your comments when appropriate. |   |                          |

## COMMENTS

- Thank you for your cooperation. No postage necessary if mailed in the U.S.A.

**YOUR COMMENTS PLEASE . . .**

This SRL bulletin is one of a series which serves as reference sources for systems analysts, programmers and operators of IBM systems. Your answers to the questions on the back of this form, together with your comments, will help us produce better publications for your use. Each reply will be carefully reviewed by the persons responsible for writing and publishing this material. All comments and suggestions become the property of IBM.

Please note: Requests for copies of publications and for assistance in utilizing your IBM system should be directed to your IBM representative or to the IBM sales office serving your locality.

Fold

Fold

FIRST CLASS  
PERMIT NO. 1359  
WHITE PLAINS, N. Y.

**BUSINESS REPLY MAIL**  
NO POSTAGE NECESSARY IF MAILED IN THE UNITED STATES

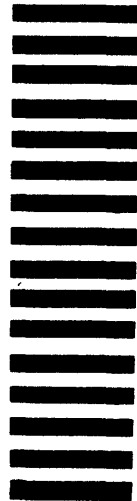

POSTAGE WILL BE PAID BY . . .

IBM Corporation  
112 East Post Road  
White Plains, N. Y. 10601

Attention: Department 813

Fold

Fold



International Business Machines Corporation  
Data Processing Division  
112 East Post Road, White Plains, N. Y. 10601  
(USA Only)

IBM World Trade Corporation  
821 United Nations Plaza, New York, New York 10017  
[International]