



contents

Introduction	7/2
For Operation in the Control Cabinet 3RW Soft Starters	
General data	7/3
3RW30 for standard applications	
Overview	7/4
Application	7/4
Selection and ordering data	7/5
Accessories	7/6
Application examples	7/7
Function	7/44
Technical specifications	7/45 - 7/54
Dimensional drawings	7/91
Schematics	7/96
3RW40 for standard applications	
Overview	7/8
Application	7/8
Selection and ordering data	7/9 - 7/11
Accessories	7/12 - 7/13
Application examples	7/14
Function	7/55
Technical specifications	7/56 - 7/69
Dimensional drawings	7/92
Schematics	7/97 - 7/98
3RW44 for high-feature applications	
Configuration	7/15
Overview	7/16
Application	7/16
Selection and ordering data	7/17 - 7/19
Sirius ES engineering software	7/20 - 7/24
Accessories	7/25 - 7/26
Application examples	7/27 - 7/29
Function	7/70
Technical specifications	7/71 - 7/90
Dimensional drawings	7/93 - 7/94
Schematics	7/99 - 7/102
Class 73/74 Enclosed Softstarter applications	
Overview	7/30
Application	7/30
Selection and ordering data	7/31 - 7/42
Factory Modifications	7/43
Dimensional drawings	7/95
Schematics	7/103

Introduction

Overview

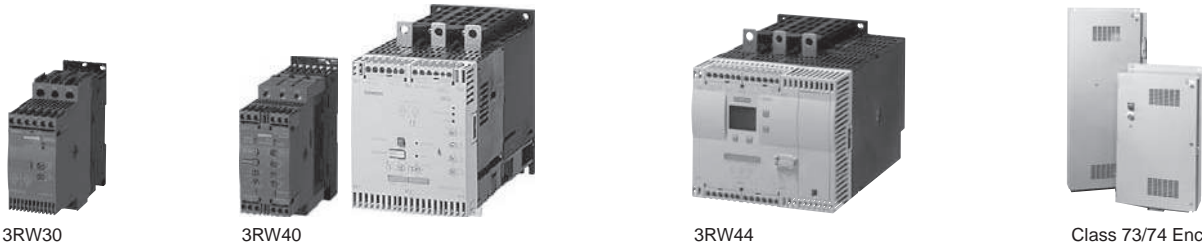

3RW30

3RW40

3RW44

Class 73/74 Enclosed

Order No. Page

For operation in the control cabinet

3RW soft starters for standard applications

	<ul style="list-style-type: none"> Application areas <ul style="list-style-type: none"> - Fans - Building/construction machines - Escalators - Air conditioning systems - Assembly lines - Operating mechanisms - Pumps - Presses - Transport systems - Fans - Compressors and coolers 		
3RW30 soft starters	<ul style="list-style-type: none"> SIRIUS 3RW30 soft starters for soft starting and smooth ramp-down of three-phase asynchronous motors Performance range of up to 75 Hp (at 460 V) 	3RW30	7/4
3RW40 soft starters	<ul style="list-style-type: none"> SIRIUS 3RW40 soft starters with the integral functions <ul style="list-style-type: none"> - Solid-state motor overload and intrinsic device protection and - Adjustable current limiting for the soft starting and stopping of three-phase asynchronous motors Performance range of up to 300 Hp (at 460 V) 	3RW40	7/8

3RW soft starters for high-feature applications

	<ul style="list-style-type: none"> Application areas <ul style="list-style-type: none"> - Pumps - Compressors - Industrial refrigerating systems - Conveying systems - Machine tools - Fans - Cooling systems - Water transport - Hydraulics - Mills 		
3RW44 soft starters	<ul style="list-style-type: none"> In addition to soft starting and soft ramp-down, the solid-state SIRIUS 3RW44 soft starters provide numerous functions for higher-level requirements Performance range <ul style="list-style-type: none"> - Up to 900 Hp (at 460 V) in inline circuit and - Up to 1600 Hp (at 460 V) in inside-delta circuit 	3RW44	7/16

For enclosed applications

Enclosures in NEMA 1, 3, 4, & 12 types UL/CSA listed	<ul style="list-style-type: none"> Complete starter includes 3RW40 or 3RW44 and CPT Performance Range of up to 600 Hp (at 460 V) Combination options include circuit breaker or fusible disconnect 	Class 73/74	7/83
	<ul style="list-style-type: none"> Application areas: <ul style="list-style-type: none"> - Compressors - Pumps - Stamping presses - Cooling towers - Molding and extruding - Chippers and debarkers - Lumber processing - Pulp & paper processing - Conveyors - Textiles - HVAC 		

3RW Soft Starters

General Data

Overview

The advantages of the SIRIUS soft starters at a glance:

- Soft starting and smooth ramp-down¹⁾
- Stepless starting
- Reduction of current peaks
- Avoidance of mains voltage fluctuations during starting
- Reduced load on the power supply network
- Reduction of the mechanical load in the operating mechanism
- Considerable space savings and reduced wiring compared with conventional starters
- Maintenance-free switching
- Very easy handling
- Fits perfectly in the SIRIUS modular system

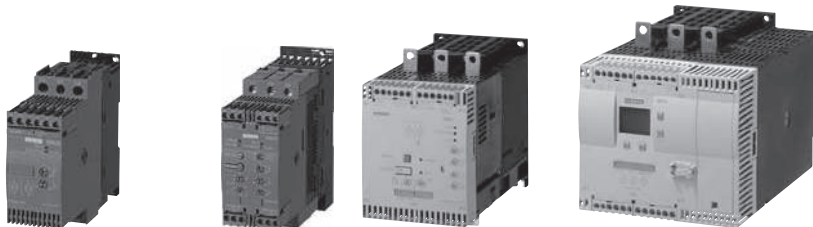

		SIRIUS 3RW30 Standard applications	SIRIUS 3RW40 Standard applications	SIRIUS 3RW44 High-Feature applications
Rated current up to 50 °C	A	3 ... 98	11 ... 385	26 ... 1076
Rated operational voltage	V	200 ... 480	200 ... 600	200 ... 690
Motor rating at 460 V				
• Inline circuit	Hp	1.5 ... 75	7.5 ... 300	15 ... 900
• Inside-delta circuit	Hp	--	--	22 ... 1600
Ambient temperature	°C	-25 ... +60	-25 ... +60	0 ... +60
Soft starting/ramp-down		✓ ¹⁾	✓	✓
Voltage ramp		✓	✓	✓
Starting/stopping voltage	%	40 ... 100	40 ... 100	20 ... 100
Starting and ramp-down time ⁷⁾	s	0 ... 20	0 ... 20	1 ... 360
Torque control		--	--	✓
Starting/stopping torque	%	--	--	20 ... 100
Torque limit	%	--	--	20 ... 200
Ramp time	s	--	--	1 ... 360
Integral bypass contact system		✓	✓	✓
Intrinsic device protection		--	✓	✓
Motor overload protection		--	✓	✓
Thermistor motor protection		--	✓ ²⁾	✓
Integrated remote RESET		--	✓ ³⁾	✓
Adjustable current limiting		--	✓	✓
Inside-delta circuit		--	--	✓
Breakaway pulse		--	--	✓
Creep speed in both directions of rotation		--	--	✓
Pump ramp-down		--	--	✓ ⁴⁾
DC braking		--	--	✓ ^{4) 5)}
Combined braking		--	--	✓ ^{4) 5)}
Motor heating		--	--	✓
Communication		--	--	With PROFIBUS DP (optional)
External display and operator module		--	--	(optional)
Operating measured value display		--	--	✓
Error logbook		--	--	✓
Event list		--	--	✓
Slave pointer function		--	--	✓
Trace function		--	--	✓ ⁶⁾
Programmable control inputs and outputs		--	--	✓
Number of parameter sets		1	1	3
Parameterization software (Soft Starter ES)		--	--	✓
Power semiconductors (thyristors)		2 controlled phases	2 controlled phases	3 controlled phases
Screw terminals		✓	✓	✓
Spring-type terminals		✓	✓	✓
UL/CSA		✓	✓	✓
CE marking		✓	✓	✓
Soft starting under heavy starting conditions		--	--	✓ ⁴⁾

Configuring support

Win-Soft Starter, Electronic Application Selector, Technical Assistance Tel.: 1-800-333-7421

✓ Function is available; -- Function is not available.

¹⁾ Only soft starting available for 3RW30.

²⁾ Optional up to size S3 (device variant).

³⁾ Available for 3RW40 2.. to 3RW40 4., optional for 3RW40 5. and 3RW40 7..

⁴⁾ Calculate soft starter and motor with size allowance where required.

⁵⁾ Not possible in inside-delta circuit.

⁶⁾ Trace function with Soft Starter ES software.

⁷⁾ Actual motor start times are load dependent.

You can find further information on the Internet at:

www.usa.siemens.com/softstarters

3RW Soft Starters

3RW30 for standard applications

Overview

The SIRIUS 3RW30 soft starters reduce the motor voltage through variable phase control and increase it in ramp-like mode from a selectable starting voltage up to mains voltage. During starting, these devices limit the torque as well as the current and prevent the shocks which arise during direct starts or wye-delta starts. In this way, mechanical loads and mains voltage dips can be reliably reduced.

Soft starting reduces the stress on the connected equipment and results in lower wear and therefore longer periods of trouble-free production. The selectable start value means that the soft starters can be adjusted individually to the requirements of the application in question and unlike wye-delta starters are not restricted to two-stage starting with fixed voltage ratios.¹⁾

The SIRIUS 3RW30 soft starters are characterized above all by their small space requirements. Integrated bypass contacts mean that minimal power loss is used at the power semiconductors (thyristors) after the motor has started up. This cuts down on heat losses, enabling a more compact design and making external bypass circuits superfluous.

Various versions of the SIRIUS 3RW30 soft starters are available:

- Standard version for fixed-speed three-phase motors, sizes S00, S0, S2 and S3, with integrated bypass contact system
- Version for fixed-speed three-phase motors in a 22.5 mm enclosure without bypass

Soft starters rated up to 75 Hp (at 460 V) for standard applications in three-phase networks are available. Extremely small sizes, low power losses and simple start-up are just three of the many advantages of this soft starter.

¹⁾ Actual motor start times are load dependent.

Application

The 3RW30 soft starters are suitable for soft starting of three-phase asynchronous motors.

Due to two-phase control, the current is kept at minimum values in all three phases throughout the entire starting time. Due to continuous voltage influencing, current and torque peaks, which are unavoidable in the case of wye-delta starters, for instance, do not occur.

Application areas

- Pumps
- Heat pumps
- Hydraulic pumps
- Presses
- Conveyors
- Roller conveyor
- Screw conveyors

3RW Soft Starters

3RW30 for standard applications

Selection and ordering data



Ambient temperature 40 °C				Ambient temperature 50 °C				Size	Order No.	List Price \$ per PU	PS*	Weight per PU approx.
Rated operational current $I_e^{1)}$	Rated power of induction motors for rated operational voltage U_e			Rated operational current $I_e^{1)}$	Rated power of induction motors for rated operational voltage U_e							
A	230 V	400 V	500 V	A	200 V	230 V	460 V	575 V				
	kW	kW	kW		hp	hp	hp	hp				
Rated operational voltage U_e 200 ... 480 V												
• With screw terminals												
3.6	0.75	1.5	--	3	0.5	0.5	1.5	--	S00		1 unit	0.580
6.5	1.5	3	--	4.8	1	1	3	--	S00	3RW30 13-1BB□4	1 unit	0.580
9	2.2	4	--	7.8	2	2	5	--	S00	3RW30 14-1BB□4	1 unit	0.580
12.5	3	5.5	--	11	3	3	7.5	--	S00	3RW30 16-1BB□4	1 unit	0.580
17.6	4	7.5	--	17	3	3	10	--	S00	3RW30 17-1BB□4	1 unit	0.580
										3RW30 18-1BB□4	1 unit	0.580
• With spring-type terminals												
3.6	0.75	1.5	--	3	0.5	0.5	1.5	--	S00		1 unit	0.580
6.5	1.5	3	--	4.8	1	1	3	--	S00	3RW30 13-2BB□4	1 unit	0.580
9	2.2	4	--	7.8	2	2	5	--	S00	3RW30 14-2BB□4	1 unit	0.580
12.5	3	5.5	--	11	3	3	7.5	--	S00	3RW30 16-2BB□4	1 unit	0.580
17.6	4	7.5	--	17	3	3	10	--	S00	3RW30 17-2BB□4	1 unit	0.580
										3RW30 18-2BB□4	1 unit	0.580
• With screw terminals												
25	5.5	11	--	23	5	5	15	--	S0		1 unit	0.690
32	7.5	15	--	29	7.5	7.5	20	--	S0	3RW30 26-1BB□4	1 unit	0.690
38	11	18.5	--	34	10	10	25	--	S0	3RW30 27-1BB□4	1 unit	0.690
										3RW30 28-1BB□4	1 unit	0.690
• With spring-type terminals												
25	5.5	11	--	23	5	5	15	--	S0		1 unit	0.690
32	7.5	15	--	29	7.5	7.5	20	--	S0	3RW30 26-2BB□4	1 unit	0.690
38	11	18.5	--	34	10	10	25	--	S0	3RW30 27-2BB□4	1 unit	0.690
										3RW30 28-2BB□4	1 unit	0.690
• With screw-type or spring-type terminals												
45	11	22	--	42	10	15	30	--	S2		1 unit	1.200
63	18.5	30	--	58	15	20	40	--	S2	3RW30 36-□BB□4	1 unit	1.200
72	22	37	--	62	20	20	40	--	S2	3RW30 37-□BB□4	1 unit	1.200
										3RW30 38-□BB□4	1 unit	1.200
• With screw-type or spring-type terminals												
80	22	45	--	73	20	25	50	--	S3		1 unit	1.710
106	30	55	--	98	30	30	75	--	S3	3RW30 46-□BB□4	1 unit	1.710
										3RW30 47-□BB□4	1 unit	1.710
Order No. supplement for connection types												
• With screw terminals												
• With spring-type terminals ²⁾												
Order No. supplement for rated control supply voltage U_s												
• 24 V AC/DC												
• 110 ... 230 V												

Soft starters for easy starting conditions and high switching frequency, rated operational voltage U_e 200 ... 400 V, rated control supply voltage U_s 24 ... 230 V AC/DC

3	0.55	1.1	--	2.6	0.5	0.5	--	--	22.5 mm			
										3RW30 03-1CB54	1 unit	0.207
										3RW30 03-2CB54	1 unit	0.188

1) Stand-alone installation.
2) Main connection from size S2: screw terminals.



Note:
Selection of the soft starter depends on the rated motor current.

The SIRIUS 3RW30 solid-state soft starters are designed for easy starting conditions. $J_{Load} < 10 \times J_{Motor}$. In the event of deviating conditions or increased switching frequency, it may be necessary to choose a larger device. Siemens recommends the use of the selection and simulation program Win-Soft Starter. For information about rated currents for ambient temperatures > 40 °C, see technical specifications (see technical information on page 7/44).

3RW Soft Starters

3RW30 for standard applications

Accessories

For soft starters		Motor starter protectors		Order No.	List Price \$ per PU	PS*	Weight per PU approx. kg
Type	Size	Size	Size				
Auxiliary terminals							
Auxiliary terminals, 3-pole							
3RW30 4.	S3			3RT19 46-4F		1 unit	0.035
Covers for soft starters							
Terminal covers for box terminals							
Additional touch protection to be fitted at the box terminals (2 units required per device)							
3RW30 3.	S2			3RT19 36-4EA2		1 unit	0.020
3RW30 4.	S3			3RT19 46-4EA2		1 unit	0.025
Terminal covers for cable lugs and busbar connections							
For complying with the phase clearances and as touch protection if box terminal is removed (2 units required per contactor)							
3RW30 4.	S3			3RT19 46-4EA1		1 unit	0.040
Link modules to motor starter protectors							
	3RW30 13,	S00	S0	3RA19 21-1A		10 units	0.028
	3RW30 14,						
	3RW30 16,			3RA19 21-1A		10 units	0.028
	3RW30 17,						
	3RW30 18						
	3RW30 26	S0	S0				
	3RW30 36	S2	S2	3RA19 31-1A		5 units	0.033
	3RW30 46,	S3	S3	3RA19 41-1A		5 units	0.072
	3RW30 47						
Operating instructions¹⁾							
For soft starters							
3RW30 1.	S00			3ZX10 12-0RW30-2DA1			
3RW30 2.	S0						
3RW30 3.	S2						
3RW30 4.	S3						

¹⁾ The operating instructions are included in the scope of supply.

Version		Functionality Functions		Order No.	List Price \$ per PU	Weight per PU approx. kg	
Covers and push-in lugs (only for 3RW30 03)							
Sealable covers							
For securing against unauthorized adjustment of setting knobs							
3RP1 902				3RP1 902		5 units	0.004
Push-in lugs							
For screw fixing							
3RP1 903				3RP1 903		10 units	0.002

3RW Soft Starters

3RW30 for standard applications

More information

Application examples for normal starting (Class 10)

Normal starting Class 10 (up to 20 s with 300 % $I_{n, motor}$).
The soft starter rating can be selected to be as high as the rating of the motor used.

Application	Conveyor belt	Roller conveyor	Compressor	Small fan	Pump	Hydraulic pump
Starting parameters						
• Voltage ramp and current limiting						
- Starting voltage	% 70	60	50	40	40	40
- Starting time	s 10	10	20	20	10	10

Note:

These tables present sample set values and device sizes. They are intended only for the purposes of information and are not binding. The set values depend on the application in question and must be optimized during start-up. Actual start times are load dependent.

The soft starter dimensions should be checked where necessary with the Win-Soft Starter software or with the help of Technical Assistance.

Configuration

The 3RW solid-state motor controllers are designed for easy starting conditions. In the event of deviating conditions or increased switching frequency, it may be necessary to choose a larger device. For accurate dimensioning, use the Win-Soft Starter selection and simulation program.

If necessary, an overload relay for heavy starting must be selected where long starting times are involved. PTC sensors are recommended.

In the motor feeder between the SIRIUS 3RW soft starter and the motor, no capacitive elements are permitted (e. g. no reactive-power compensation equipment). In addition, neither static systems for reactive-power compensation nor dynamic PFC (Power Factor Correction) must be operated in parallel during starting and ramp-down of the soft starter. This is important to prevent faults arising on the compensation equipment and/or the soft starter.

All elements of the main circuit (such as fuses, controls and overload relays) should be dimensioned for direct starting, following the local short-circuit conditions. Fuses, controls and overload relays must be ordered separately. Please observe the maximum switching frequencies specified in the technical specifications.

Note:

When induction motors are switched on, voltage drops normally appear on starters of all types (direct starters, wye-delta starters, soft starters). The infeed transformer must always be dimensioned such that the voltage dip when starting the motor remains within the permissible tolerance. If the infeed transformer is dimensioned with only a small margin, it is best for the control voltage to be supplied from a separate circuit (independently of the main voltage) in order to avoid the potential switching off of the soft starter.

Power electronics schematic circuit diagram

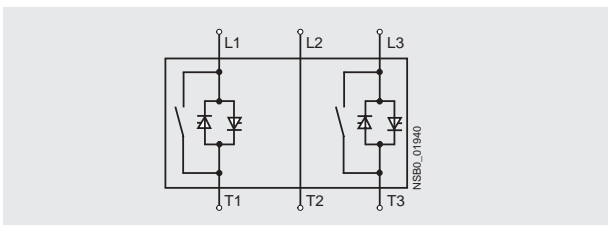

A bypass contact system is already integrated in the 3RW30 soft starter and therefore does not have to be ordered separately.

Status graphs

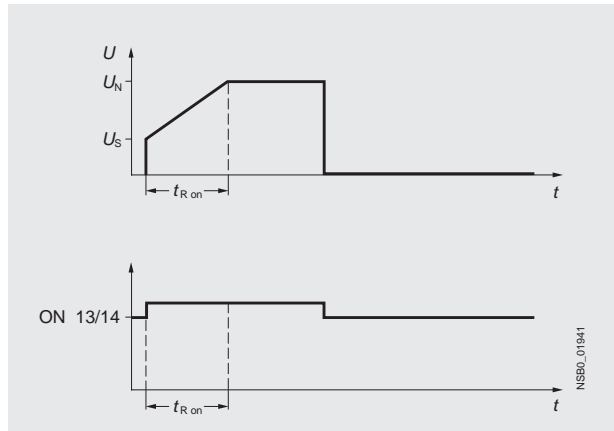

Win-Soft Starter selection and simulation program

With this software, you can simulate and select all Siemens soft starters, taking into account various parameters such as mains properties, motor and load data, and special application requirements.

The software is a valuable tool, which makes complicated, lengthy manual calculations for determining the required soft starters superfluous.

The Win-Soft Starter selection and simulation program can be downloaded from:

<http://www.siemens.de/sanftstarter> > Software

More information can be found on the Internet at:

<http://www.sea.siemens.com/softstarters>

3RW Soft Starters

3RW40 for standard applications

Overview

SIRIUS 3RW40 soft starters have all the same advantages as the 3RW30 soft starters.

The SIRIUS 3RW40 soft starters are characterized above all by their small space requirements. Integrated bypass contacts mean that minimal power is used at the power semiconductors (thyristors) after the motor has started up. This cuts down on heat losses, enabling a more compact design and making external bypass circuits superfluous.

At the same time this soft starter comes with additional integrated functions such as adjustable current limiting, motor overload and intrinsic device protection, and optional thermistor motor protection on some models.

Internal intrinsic device protection prevents the thermal overloading of the thyristors and the power section defects this can cause. As an option the thyristors can also be protected by semiconductor fuses from short-circuiting.

Thanks to integrated status monitoring and fault monitoring, this compact soft starter offers many different diagnostics options. Up to four LEDs and relay outputs permit differentiated monitoring and diagnostics of the operating mechanism by indicating the operating state as well as for example mains or phase failure, missing load, non-permissible tripping time/class setting, thermal overloading or device faults.

Soft starters rated up to 300 Hp (at 460 V) for standard applications in three-phase systems are available. Extremely small sizes, low power losses and simple start-up are just three of the many advantages of the SIRIUS 3RW40 soft starters.

"Increased safety" type of protection EEx e according to ATEX directive 94/9/EC

The 3RW40 soft starter sizes S0 to S12 are suitable for the starting of explosion-proof motors with "increased safety" type of protection EEx e.

See "Appendix" → "Standards and approvals" → "Type overview of approved devices for potentially explosive areas (ATEX explosion protection)".

Application

The SIRIUS 3RW40 solid-state soft starters are suitable for soft starting and stopping of three-phase asynchronous motors.

Due to two-phase control, the current is kept at minimum values in all three phases throughout the entire starting time and disturbing direct current components are eliminated in addition. This not only enables the two-phase starting of motors up to 300 Hp (at 460 V) but also avoids the current and torque peaks which occur e. g. with wye-delta starters.

Application areas

- Pumps
- Heat pumps
- Hydraulic pumps
- Presses
- Conveyors
- Roller conveyor
- Screw conveyors
- Escalators
- Small fans
- Centrifugal blowers
- Bow thrusters
- Stirrers
- Extruders
- Lathes
- Milling machines

3RW Soft Starters

3RW40 for standard applications

Selection and ordering data



3RW40 28-1BB14



3RW40 38-1BB14



3RW40 47-1BB14

Ambient temperature 50 °C		Rated power of induction motors for rated operational voltage U_e				Size	Order No.	List Price \$ per PU	PS*	Weight per PU approx.
Rated operational current $I_e^{(1)}$										
	200 V	230 V	460 V	575 V						
A	hp	hp	hp	hp					kg	
Rated operational voltage U_e 200 ... 480 V										
• With screw terminals										
11	3	3	7.5	--	S0	3RW40 24-1BB□4		1 unit	0.770	
23	5	5	15	--	S0	3RW40 26-1BB□4		1 unit	0.770	
29	7.5	7.5	20	--	S0	3RW40 27-1BB□4		1 unit	0.770	
34	10	10	25	--	S0	3RW40 28-1BB□4		1 unit	0.770	
• With spring-type terminals										
11	3	3	7.5	--	S0	3RW40 24-2BB□4		1 unit	0.770	
23	5	5	15	--	S0	3RW40 26-2BB□4		1 unit	0.770	
29	7.5	7.5	20	--	S0	3RW40 27-2BB□4		1 unit	0.770	
34	10	10	25	--	S0	3RW40 28-2BB□4		1 unit	0.770	
• With screw or spring-type terminals										
42	10	15	30	--	S2	3RW40 36-□BB□4		1 unit	1.350	
58	15	20	40	--	S2	3RW40 37-□BB□4		1 unit	1.350	
62	20	20	40	--	S2	3RW40 38-□BB□4		1 unit	1.350	
• With screw or spring-type terminals										
73	20	25	50	--	S3	3RW40 46-□BB□4		1 unit	1.900	
98	30	30	75	--	S3	3RW40 47-□BB□4		1 unit	1.900	
Rated operational voltage U_e 400 ... 600 V										
• With screw terminals										
11	--	--	7.5	10	S0	3RW40 24-1BB□5		1 unit	0.770	
23	--	--	15	20	S0	3RW40 26-1BB□5		1 unit	0.770	
29	--	--	20	25	S0	3RW40 27-1BB□5		1 unit	0.770	
34	--	--	25	30	S0	3RW40 28-1BB□5		1 unit	0.770	
• With spring-type terminals										
11	--	--	7.5	10	S0	3RW40 24-2BB□5		1 unit	0.770	
23	--	--	15	20	S0	3RW40 26-2BB□5		1 unit	0.770	
29	--	--	20	25	S0	3RW40 27-2BB□5		1 unit	0.770	
34	--	--	25	30	S0	3RW40 28-2BB□5		1 unit	0.770	
• With screw or spring-type terminals										
42	--	--	30	40	S2	3RW40 36-□BB□5		1 unit	1.350	
58	--	--	40	50	S2	3RW40 37-□BB□5		1 unit	1.350	
62	--	--	40	60	S2	3RW40 38-□BB□5		1 unit	1.350	
• With screw or spring-type terminals										
73	--	--	50	60	S3	3RW40 46-□BB□5		1 unit	1.900	
98	--	--	75	75	S3	3RW40 47-□BB□5		1 unit	1.900	

Order No. supplement for connection types

- With screw terminals
- With spring-type terminals²⁾

Order No. supplement for rated control supply voltage U_s

- 24 V AC/DC
- 110 ... 230 V AC/DC

¹⁾ Stand-alone installation without auxiliary fan.

²⁾ Main connection from size S2: screw terminals.

1
2

0
1

Note:

Selection of the soft starter depends on the rated motor current. The SIRIUS 3RW40 solid-state soft starters are designed for easy starting conditions. $J_{Load} < 10 \times J_{Motor}$. In the event of deviating conditions or increased switching frequency, it may be necessary to choose a larger device. Siemens recommends the use of the selection and simulation program Win-Soft Starter. For information about rated currents for ambient temperatures other than 50°C, see technical information on page 7/56

3RW Soft Starters

3RW40 for standard applications



3RW40 28-1TB04



3RW40 38-1TB04



3RW40 47-1TB04

Ambient temperature 50 °C					Size	Order No.	List Price \$ per PU	PS*	Weight per PU approx.
Rated operational current I_e ¹⁾	Rated power of induction motors for rated operational voltage U_e				A				kg
	200 V	230 V	460 V	575 V					
	hp	hp	hp	hp					
Rated operational voltage U_e 200 ... 480 V, with thermistor motor protection, rated control supply voltage U_s 24 V AC/DC									
• With screw terminals									
11	3	3	7.5	--	S0	3RW40 24-1TB04		1 unit	0.770
23	5	5	15	--	S0	3RW40 26-1TB04		1 unit	0.770
29	7.5	7.5	20	--	S0	3RW40 27-1TB04		1 unit	0.770
34	10	10	25	--	S0	3RW40 28-1TB04		1 unit	0.770
• With spring-type terminals									
11	3	3	7.5	--	S0	3RW40 24-2TB04		1 unit	0.770
23	5	5	15	--	S0	3RW40 26-2TB04		1 unit	0.770
29	7.5	7.5	20	--	S0	3RW40 27-2TB04		1 unit	0.770
34	10	10	25	--	S0	3RW40 28-2TB04		1 unit	0.770
• With screw or spring-type terminals									
42	10	15	30	--	S2	3RW40 36-□TB04		1 unit	1.350
58	15	20	40	--	S2	3RW40 37-□TB04		1 unit	1.350
62	20	20	40	--	S2	3RW40 38-□TB04		1 unit	1.350
• With screw or spring-type terminals									
73	20	25	50	--	S3	3RW40 46-□TB04		1 unit	1.900
98	30	30	75	--	S3	3RW40 47-□TB04		1 unit	1.900
Rated operational voltage U_e 400 ... 600 V, with thermistor motor protection, rated control supply voltage U_s 24 V AC/DC									
• With screw terminals									
11	--	--	7.5	10	S0	3RW40 24-1TB05		1 unit	0.770
23	--	--	15	20	S0	3RW40 26-1TB05		1 unit	0.770
29	--	--	20	25	S0	3RW40 27-1TB05		1 unit	0.770
34	--	--	25	30	S0	3RW40 28-1TB05		1 unit	0.770
• With spring-type terminals									
11	--	--	7.5	10	S0	3RW40 24-2TB05		1 unit	0.770
23	--	--	15	20	S0	3RW40 26-2TB05		1 unit	0.770
29	--	--	20	25	S0	3RW40 27-2TB05		1 unit	0.770
34	--	--	25	30	S0	3RW40 28-2TB05		1 unit	0.770
• With screw or spring-type terminals									
42	--	--	30	40	S2	3RW40 36-□TB05		1 unit	1.350
58	--	--	40	50	S2	3RW40 37-□TB05		1 unit	1.350
62	--	--	40	60	S2	3RW40 38-□TB05		1 unit	1.350
• With screw or spring-type terminals									
73	--	--	50	60	S3	3RW40 46-□TB05		1 unit	1.900
98	--	--	75	75	S3	3RW40 47-□TB05		1 unit	1.900

Order No. supplement for connection types

- With screw terminals
- With spring-type terminals²⁾

1) Stand-alone installation without auxiliary fan.
 2) Main connection from size S2: screw terminals.

1
2

Note:
 Selection of the soft starter depends on the rated motor current. The SIRIUS 3RW40 solid-state soft starters are designed for easy starting conditions. $J_{Load} < 10 \times J_{Motor}$. In the event of deviating conditions or increased switching frequency, it may be necessary to choose a larger device. Siemens recommends the use of the selection and simulation program Win-Soft Starter. For information about rated currents for ambient temperatures > 40° C, see technical information on page 7/56

3RW Soft Starters

3RW40 for standard applications



3RW40 56-6BB44



3RW40 76-6BB44

Ambient temperature 50 °C		Rated power of induction motors for rated operational voltage U_e				Size	Order No.	List Price \$ per PU	PS*	Weight per PU approx.
Rated operational current I_e ¹⁾	200 V	230 V	460 V	575 V						
	A	hp	hp	hp	hp				kg	
Rated operational voltage U_e 200 ... 460 V										
• With screw or spring-type terminals										
117	30	40	75	--	S6	3RW40 55-□BB□4		1 unit	4.900	
145	40	50	100	--		3RW40 56-□BB□4		1 unit	6.900	
• With screw or spring-type terminals										
205	60	75	150	--	S12	3RW40 73-□BB□4		1 unit	8.900	
248	75	100	200	--		3RW40 74-□BB□4		1 unit	8.900	
315	100	125	250	--		3RW40 75-□BB□4		1 unit	8.900	
385	125	150	300	--		3RW40 76-□BB□4		1 unit	8.900	
Rated operational voltage U_e 400 ... 600 V										
• With screw or spring-type terminals										
117	--	--	75	100	S6	3RW40 55-□BB□5		1 unit	4.900	
145	--	--	100	150		3RW40 56-□BB□5		1 unit	6.900	
• With screw or spring-type terminals										
205	--	--	150	200	S12	3RW40 73-□BB□5		1 unit	8.900	
248	--	--	200	250		3RW40 74-□BB□5		1 unit	8.900	
315	--	--	250	300		3RW40 75-□BB□5		1 unit	8.900	
385	--	--	300	400		3RW40 76-□BB□5		1 unit	8.900	
Order No. supplement for connection types²⁾										
• With screw terminals										
• With spring-type terminals										
Order No. supplement for the rated control supply voltage U_s³⁾										
• 115 V AC										
• 230 V AC										

1) Stand-alone installation.

2) Power connection: busbar connection.

3) Control by way of the internal 24 V DC supply and direct control by means of PLC possible.

Note:







Selection of the soft starter depends on the rated motor current.

The SIRIUS 3RW40 solid-state soft starters are designed for easy starting conditions. $J_{Load} < 10 \times J_{Motor}$. In the event of deviating conditions or increased switching frequency, it may be necessary to choose a larger device. Siemens recommends the use of the selection and simulation program Win-Soft Starter. For information about rated currents for ambient temperatures > 40 °C, see technical information on page 7/56

3RW Soft Starters

3RW40 for standard applications



Accessories

For soft starters Type	Version Size		Order No.	List Price \$ per PU	PS*	Weight per PU approx. kg
Box terminal blocks for soft starters						
For round and flat wires						
 3RW40 5.	S6	<ul style="list-style-type: none"> • Up to 70 mm² • Up to 120 mm² 	3RT19 55-4G		1 unit	0.230
3RW40 7.	S12	<ul style="list-style-type: none"> • Up to 240 mm² 	3RT19 56-4G		1 unit	0.260
			3RT19 66-4G		1 unit	0.676
Auxiliary terminals						
Auxiliary terminals, 3-pole						
3RW40 4.	S3		3RT19 46-4F		1 unit	0.035
Covers for soft starters						
Terminal covers for box terminals						
Additional touch protection to be fitted at the box terminals (2 units required per device)						
 3RW40 3.	S2		3RT19 36-4EA2		1 unit	0.020
3RW40 4.	S3		3RT19 46-4EA2		1 unit	0.025
3RW40 5.	S6		3RT19 56-4EA2		1 unit	0.030
3RW40 7.	S12		3RT19 66-4EA2		1 unit	0.040
Terminal covers for cable lugs and busbar connections						
 3RW40 4.	S3	For complying with the phase clearances and as touch protection if box terminal is removed (2 units required per contactor)	3RT19 46-4EA1		1 unit	0.040
3RW40 5.	S6		3RT19 56-4EA1		1 unit	0.070
3RW40 7.	S12		3RT19 66-4EA1		1 unit	0.130
Sealing covers						
 3RW40 2. to 3RW40 4.	S0, S2, S3		3RW49 00-0PB10		1 unit	0.005
3RW40 5. and 3RW40 7.	S6, S12		3RW49 00-0PB00		1 unit	0.010
Modules for RESET¹⁾						
Modules for remote RESET, electrical						
Operating range 0.85 ... 1.1 x U _s , power consumption 80 VA AC, 70 W DC, ON period 0.2 s ... 4 s, switching frequency 60/h						
 3RW40 5. and 3RW40 7.	S6, S12	<ul style="list-style-type: none"> • 24 ... 30 V AC/DC • 110 ... 127 V AC/DC • 220 ... 250 V AC/DC 	3RU19 00-2AB71		1 unit	0.066
			3RU19 00-2AF71		1 unit	0.067
			3RU19 00-2AM71		1 unit	0.066
Cable releases with holder for RESET						
For Ø 6.5 mm holes in the control panel; max. control panel thickness 8 mm						
 3RW40 5. and 3RW40 7.	S6, S12	<ul style="list-style-type: none"> • Length 400 mm • Length 600 mm 	3RU19 00-1B		1 unit	0.063
			3RU19 00-1C		1 unit	0.073

¹⁾ Remote RESET already integrated in the 3RW40 2. to 3RW40 4. soft starters.

3RW Soft Starters

3RW40 for standard applications

For soft starters		Motor starter protectors		Order No.	List Price \$ per PU	PS*	Weight per PU approx. kg
Type	Size	Size	Size				
Link modules to motor starter protectors							
	3RW40 24, 3RW40 26	S0	S0	3RA19 21-1A		10 units	0.028
	3RW40 36	S2	S2	3RA19 31-1A		5 units	0.033
	3RW40 46, 3RW40 47	S3	S3	3RA19 41-1A		5 units	0.072
Fans (to increase switching frequency and for device mounting in positions different from the normal position)							
	3RW40 2.	S0		3RW49 28-8VB00		1 unit	0.010
	3RW40 3., 3RW40 4.	S2, S3		3RW49 47-8VB00		1 unit	0.020
Operating instructions¹⁾							
For soft starters							
3RW40 2.	S0			3ZX10 12-0RW40-1AA1			
3RW40 3.	S2						
3RW40 4.	S3						
3RW40 5.	S6			3ZX10 12-0RW40-2DA1			
3RW40 7.	S12						

¹⁾ The operating instructions are included in the scope of supply.

They are also available on the Internet at:

www.usa.siemens.com/softstarters

Spare parts

For soft starters		Version		Order No.	List Price \$ per PU	PS*	Weight per PU approx. kg
Type	Size	Size	Rated control supply voltage U_s				
Fans							
	Fans						
	3RW40 5.-. BB3.	S6	115 V AC	3RW49 36-8VX30		1 unit	0.300
	3RW40 5.-. BB4.	S6	230 V AC	3RW49 36-8VX40		1 unit	0.300
	3RW40 7.-. BB3.	S12	115 V AC	3RW49 47-8VX30		1 unit	0.500
3RW40 7.-. BB4.	S12	230 V AC	3RW49 47-8VX40		1 unit	0.500	

3RW Soft Starters

3RW40 for standard applications

More information

Application examples for normal starting (Class 10)

Normal starting Class 10 (up to 20 s with 350 % $I_{n\ motor}$).

The soft starter rating can be selected to be as high as the rating of the motor used.

Application	Conveyor belt	Roller conveyor	Small fan	Pump	Hydraulic pump
Starting parameters					
• Voltage ramp and current limiting					
- Starting voltage	%	70	60	40	40
- Starting time	s	10	10	10	10
- Current limit value		$5 \times I_M$	$5 \times I_M$	$4 \times I_M$	$4 \times I_M$
Ramp-down time	s	5	5	0	10

Application examples for heavy starting (Class 20)

Heavy starting Class 20 (up to 40 s with 350 % $I_{n\ motor}$).

The soft starter has to be selected at least one rating class higher than the motor used.

Application	Stirrer	Centrifuge
Starting parameters		
• Voltage ramp and current limiting		
- Starting voltage	%	40
- Starting time	s	20
- Current limit value		$4 \times I_M$
Ramp-down time	s	0

Note:

These tables present sample set values and device sizes. They are intended only for the purposes of information and are not binding. The set values depend on the application in question and must be optimized during start-up. Actual start times are load dependent.

The soft starter dimensions should be checked where necessary with the Win-Soft Starter software or with the help of Technical Assistance.

3RW Soft Starters

3RW40 for standard applications

Configuration

The 3RW solid-state soft starters are designed for easy starting conditions. In the event of severe conditions or increased switching frequency, it may be necessary to choose a larger device. For accurate dimensioning, use the Win-Soft Starter selection and simulation program.

Where long starting times are involved, the integrated solid-state overload relay for heavy starting should not be disconnected. PTC sensors are recommended. This also applies for the smooth ramp-down because during the ramp-down time an additional current loading applies in contrast to free ramp-down.

In the case of high switching frequencies in S4 mode, Siemens recommends the use of PTC sensors. For corresponding device versions with integrated thermistor motor protection or separate thermistor evaluation devices see Industrial Controls catalog Chapter 11 "Function Relays, Interfaces and Converters".

In the motor feeder between the SIRIUS 3RW soft starter and the motor, no capacitive elements are permitted (e. g. no reactive-power compensation equipment, PFC capacitors). In addition, neither static systems for reactive-power compensation nor dynamic PFC (Power Factor Correction) must be operated in parallel during starting and ramp-down of the soft starter. This is important to prevent faults arising on the compensation equipment and/or the soft starter.

All elements of the main circuit (such as fuses and controls) should be dimensioned for direct starting, following the local short-circuit conditions. Fuses, controls and overload relays must be ordered separately. Please observe the maximum switching frequencies specified in the technical specifications.

Note:

When induction motors are switched on, voltage drops normally appear on starters of all types (direct starters, wye-delta starters, soft starters). The infeed transformer must always be dimensioned such that the voltage dip when starting the motor remains within the permissible tolerance. If the infeed transformer is dimensioned with only a small margin, it is best for the control voltage to be supplied from a separate circuit (independently of the main voltage) in order to avoid the potential switching off of the soft starter.

Power electronics schematic circuit diagram

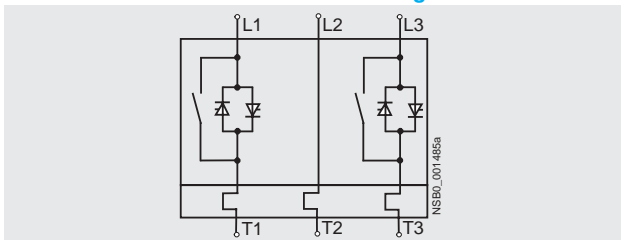

A bypass contact system and solid-state overload relay are already integrated in the 3RW40 soft starter and therefore do not have to be ordered separately.

- 1) U_n = Full Voltage
- 2) U_s = Starting (Initial) Voltage
- 3) t_{R} = Time Running
- 4) I_e = Rated operational current

Status graphs¹⁾

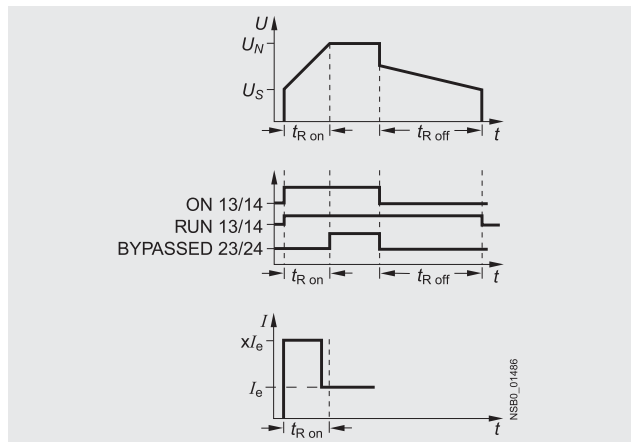

Win-Soft Starter selection and simulation program

With this software, you can simulate and select all Siemens soft starters, taking into account various parameters such as mains properties, motor and load data, and special application requirements.

The software is a valuable tool, which makes complicated, lengthy manual calculations for determining the required soft starters superfluous.

The Win-Soft Starter selection and simulation program can be downloaded from:

www.usa.siemens.com/softstarters > Software

More information can be found on the Internet at:

www.usa.siemens.com/softstarters

3RW Soft Starters

3RW44 for high-feature applications

Overview

In addition to soft starting and soft ramp-down, the solid-state SIRIUS 3RW44 soft starters provide numerous functions for higher-level requirements. They cover a performance range up to 900 Hp (at 460 V) in the inline circuit and up to 1600Hp (at 460 V) in the inside-delta circuit.

The SIRIUS 3RW44 soft starters are characterized by a compact design for space-saving and clearly arranged control cabinet layouts. For optimized motor starting and stopping the innovative SIRIUS 3RW44 soft starters are an attractive alternative with considerable savings potential compared to applications with a frequency converter. The new torque control and adjustable current limiting enable the High-Feature soft starters to be used in nearly every conceivable task. They guarantee the reliable avoidance of sudden torque applications and current peaks during motor starting and stopping. This creates savings potential when calculating the size of the switchgear and when servicing the machinery installed. Whether it's for inline circuits or inside-delta circuits – the SIRIUS 3RW44 soft starter offers savings especially in terms of size and equipment costs.

The bypass contacts already integrated in the soft starter bypass the thyristors after a motor ramp-up is detected. This results in a further reduction in the heat loss occurring during operation of the soft starter.

Combinations of various starting, operating and ramp-down possibilities ensure an optimum adaptation to the application-specific requirements. Operation and commissioning can be performed with the menu-controlled keypad and a menu-prompted, multi-line graphical display with background lighting. The optimized motor ramp-up and ramp-down can be effected quickly, easily and reliably by means of just a few settings with a previously selected language. Four-key operation and plain-text displays for each menu point guarantee full clarity at every moment of the parameterization and operation.

Applicable standards

- IEC 60947-4-2
- UL/CSA

Soft Starter ES parameterization software

Soft Starter ES software is used for the parameterization, monitoring and service diagnostics of SIRIUS 3RW44 High Feature soft starters.

Application

The SIRIUS 3RW44 solid-state soft starters are suitable for the torque-controlled soft starting and smooth ramp-down as well as braking of three-phase asynchronous motors.

Application areas, e. g.

- Pumps
- Fans
- Compressors
- Water transport
- Conveying systems and lifts
- Hydraulics
- Machine tools
- Mills
- Saws
- Crushers
- Mixers
- Centrifuges
- Industrial cooling and refrigerating systems

3RW Soft Starters

3RW44 for high-feature applications

Selection and ordering data

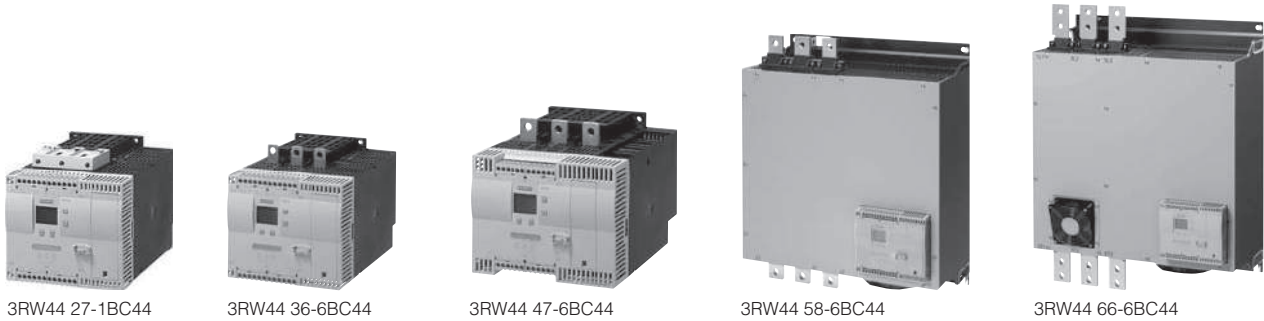

Ambient temperature 50 °C					Order No.	List Price \$ per PU	PS*	Weight per PU approx. kg
Rated operational current I_e	Rated power of induction motors for rated operational voltage U_e							
A	200 V hp	230 V hp	460 V hp	575 V hp				
Inline circuits²⁾, rated operational voltage 200 ... 460 V								
26	7.5	7.5	15	--	3RW44 22-□BC□4		1 unit	6.500
32	10	10	20	--	3RW44 23-□BC□4		1 unit	6.500
42	10	15	25	--	3RW44 24-□BC□4		1 unit	6.500
51	15	15	30	--	3RW44 25-□BC□4		1 unit	6.500
68	20	20	50	--	3RW44 26-□BC□4		1 unit	6.500
82	25	25	60	--	3RW44 27-□BC□4		1 unit	6.500
Order No. supplement for connection types								
<ul style="list-style-type: none"> • With spring-type terminals • With screw terminals 					3 1			
100	30	30	75	--	3RW44 34-□BC□4		1 unit	7.900
117	30	40	75	--	3RW44 35-□BC□4		1 unit	7.900
145	40	50	100	--	3RW44 36-□BC□4		1 unit	7.900
180	50	60	125	--	3RW44 43-□BC□4		1 unit	11.500
215	60	75	150	--	3RW44 44-□BC□4		1 unit	11.500
280	75	100	200	--	3RW44 45-□BC□4		1 unit	11.500
315	100	125	250	--	3RW44 46-□BC□4		1 unit	11.500
385	125	150	300	--	3RW44 47-□BC□4		1 unit	11.500
494	150	200	400	--	3RW44 53-□BC□4		1 unit	50.000
551	150	200	450	--	3RW44 54-□BC□4		1 unit	50.000
615	200	250	500	--	3RW44 55-□BC□4		1 unit	50.000
693	200	250	550	--	3RW44 56-□BC□4		1 unit	50.000
780	250	300	600	--	3RW44 57-□BC□4		1 unit	50.000
850	300	350	700	--	3RW44 58-□BC□4		1 unit	50.000
970	350	400	800	--	3RW44 65-□BC□4		1 unit	78.000
1076	350	400	900	--	3RW44 66-□BC□4		1 unit	78.000
Order No. supplement for connection types								
<ul style="list-style-type: none"> • With spring-type terminals • With screw terminals 					2 6			
Order No. supplement for the rated control supply voltage U_s¹⁾								
<ul style="list-style-type: none"> • 115 V AC • 230 V AC 						3 4		

Order No. supplement for connection types

- With spring-type terminals
- With screw terminals

Order No. supplement for the rated control supply voltage U_s ¹⁾

- 115 V AC
- 230 V AC

¹⁾ Control by way of the internal 24 V DC supply and direct control by means of PLC possible.

²⁾ For inside delta selection, see page 7/76.

Note:

Soft starter selection depends on the rated motor current.

The 3RW44 solid-state soft starters are designed for normal starting (Class 10). (Inertia load of the overall operating mechanism $J_{Load} < 10 \times J_{Motor}$; starting current 350 % $\times I_e$ for 20 s similar load). For any other conditions of use, the devices should be selected using the Win-Soft Starter selection and simulation program. See Technical specifications for information about rated currents for ambient temperatures > 40 °C and switching frequency.

3RW Soft Starters

3RW44 for high-feature applications

Ambient temperature 50 °C					Order No.	List Price \$ per PU	PS*	Weight per PU approx.
Rated operational current I_e	Rated power of induction motors for rated operational voltage U_e							
	200 V	230 V	460 V	575 V				
A	hp	hp	hp	hp				kg
Inline circuits²⁾, rated operational voltage 400 ... 600 V								
26	--	--	15	20	3RW44 22-□BC□5		1 unit	6.500
32	--	--	20	25	3RW44 23-□BC□5		1 unit	6.500
42	--	--	25	30	3RW44 24-□BC□5		1 unit	6.500
51	--	--	30	40	3RW44 25-□BC□5		1 unit	6.500
68	--	--	50	50	3RW44 26-□BC□5		1 unit	6.500
82	--	--	60	75	3RW44 27-□BC□5		1 unit	6.500
Order No. supplement for connection types								
<ul style="list-style-type: none"> With spring-type terminals With screw terminals 					3	1		
100	--	--	75	75	3RW44 34-□BC□5		1 unit	7.900
117	--	--	75	100	3RW44 35-□BC□5		1 unit	7.900
145	--	--	100	125	3RW44 36-□BC□5		1 unit	7.900
180	--	--	125	150	3RW44 43-□BC□5		1 unit	11.500
215	--	--	150	200	3RW44 44-□BC□5		1 unit	11.500
280	--	--	200	250	3RW44 45-□BC□5		1 unit	11.500
315	--	--	250	300	3RW44 46-□BC□5		1 unit	11.500
385	--	--	300	400	3RW44 47-□BC□5		1 unit	11.500
494	--	--	400	500	3RW44 53-□BC□5		1 unit	50.000
551	--	--	450	550	3RW44 54-□BC□5		1 unit	50.000
615	--	--	500	600	3RW44 55-□BC□5		1 unit	50.000
693	--	--	550	700	3RW44 56-□BC□5		1 unit	50.000
780	--	--	600	800	3RW44 57-□BC□5		1 unit	50.000
850	--	--	700	850	3RW44 58-□BC□5		1 unit	50.000
970	--	--	800	1000	3RW44 65-□BC□5		1 unit	78.000
1076	--	--	900	1100	3RW44 66-□BC□5		1 unit	78.000
Order No. supplement for connection types								
<ul style="list-style-type: none"> With spring-type terminals With screw terminals 					2	6		
Order No. supplement for the rated control supply voltage U_s¹⁾								
<ul style="list-style-type: none"> 115 V AC 230 V AC 						3	4	

1) Control by way of the internal 24 V DC supply and direct control by means of PLC possible.

2) For inside delta selection, see page 7/76.

Note:

Soft starter selection depends on the rated motor current.

The 3RW44 solid-state soft starters are designed for normal starting (Class 10). (Inertia load of the overall operating mechanism $J_{Load} < 10 \times J_{Motor}$; starting current 350 % $\times I_e$ for 20 s similar load). For any other conditions of use, the devices should be selected using the Win-Soft Starter selection and simulation program. See Technical specifications for information about rated currents for ambient temperatures > 40 °C and switching frequency.

3RW Soft Starters

3RW44 for high-feature applications

Ambient temperature 50 °C					Order No.	List Price \$ per PU	PS*	Weight per PU approx.
Rated operational current I_e	Rated power of induction motors for rated operational voltage U_e							
	200 V	230 V	460 V	575 V				
A	hp	hp	hp	hp				kg
Inline circuits, rated operational voltage 400 ... 690 V								
26	--	--	15	20	3RW44 22-□BC□6		1 unit	6.500
32	--	--	20	25	3RW44 23-□BC□6		1 unit	6.500
42	--	--	25	30	3RW44 24-□BC□6		1 unit	6.500
51	--	--	30	40	3RW44 25-□BC□6		1 unit	6.500
68	--	--	50	50	3RW44 26-□BC□6		1 unit	6.500
82	--	--	60	75	3RW44 27-□BC□6		1 unit	6.500
Order No. supplement for connection types								
• With spring-type terminals					3			
• With screw terminals					1			
100	--	--	75	75	3RW44 34-□BC□6		1 unit	7.900
117	--	--	75	100	3RW44 35-□BC□6		1 unit	7.900
145	--	--	100	125	3RW44 36-□BC□6		1 unit	7.900
180	--	--	125	150	3RW44 43-□BC□6		1 unit	11.500
215	--	--	150	200	3RW44 44-□BC□6		1 unit	11.500
280	--	--	200	250	3RW44 45-□BC□6		1 unit	11.500
315	--	--	250	300	3RW44 46-□BC□6		1 unit	11.500
385	--	--	300	400	3RW44 47-□BC□6		1 unit	11.500
494	--	--	400	500	3RW44 53-□BC□6		1 unit	50.000
551	--	--	450	550	3RW44 54-□BC□6		1 unit	50.000
615	--	--	500	600	3RW44 55-□BC□6		1 unit	50.000
693	--	--	550	700	3RW44 56-□BC□6		1 unit	50.000
780	--	--	600	800	3RW44 57-□BC□6		1 unit	50.000
850	--	--	700	850	3RW44 58-□BC□6		1 unit	50.000
970	--	--	800	1000	3RW44 65-□BC□6		1 unit	78.000
1076	--	--	900	1100	3RW44 66-□BC□6		1 unit	78.000
Order No. supplement for connection types								
• With spring-type terminals					2			
• With screw terminals					6			
Order No. supplement for the rated control supply voltage U_s ¹⁾								
• 115 V AC								
• 230 V AC								
								3
								4

¹⁾ Control by way of the internal 24 V DC supply and direct control by means of PLC possible.

Note:

Soft starter selection depends on the rated motor current.

The 3RW44 solid-state soft starters are designed for normal starting (Class 10). (Inertia load of the overall operating mechanism $J_{Load} < 10 \times J_{Motor}$; starting current 350 % $\times I_e$ for 20 s similar load). For any other conditions of use, the devices should be selected using the Win-Soft Starter selection and simulation program. See Technical specifications for information about rated currents for ambient temperatures > 40 °C and switching frequency.

Introduction

Overview



SIRIUS ES engineering software (E-SW)

The programs of the SIRIUS ES software family enable:

- Clearly arranged configuring of device functions and their parameters – online and offline
- Efficient diagnostics functions and display of the most important measured values
- Time savings through shorter startup times.

The SIRIUS ES programs such as Motor Starter ES, Soft Starter ES and SIMOCODE ES are available in three versions which differ in user-friendliness, scope of functions and price (for details see the descriptions of the individual products).

SIRIUS ES	Basic	Standard	Premium
Local interface on the device (system interface)	✓	✓	✓
Basic functions for parameterizing the devices			
• Parameter assignment	✓	✓	✓
• Operating	✓	✓	✓
• Diagnostics	✓	✓	✓
• Test	✓	✓	✓
Standard functionality			
• Parameterizing with the integrated graphics editor ¹⁾	--	✓	✓
• Creating typicals	--	✓	✓
• Exporting parameters	--	✓	✓
Complete functionality			
• Group functions	--	--	✓
• S7 Routing	--	--	✓
• Teleservice through MPI	--	--	✓
• STEP7 Object Manager	--	--	✓
• PROFIBUS interface	--	--	✓

¹⁾ Depending on SIRIUS ES program.

Application

In addition to device-specific parameterization, the programs of the SIRIUS ES software family also provide the following functionality in a uniform look and feel. These functions are available in many SIRIUS ES programs.

- Standards-conform printouts
The programs of the SIRIUS ES software family greatly simplify machine documentation. Parameterization printouts according to EN ISO 7200 are possible. The elements to be printed are easy to select and compile as required.
- Easy creation of parameter templates
Parameter templates can be created for devices and applications with only minimum differences in their parameters. These templates contain all the parameters which are needed for the parameterization. In addition it is possible to specify which of these parameters are fixed and which can be customized, e. g. by the startup engineer.
- Group function
For the user-friendly parameterization of numerous devices or applications of the same type, the programs of the SIRIUS ES software family offer a group function which enables the parameterization of several devices to be read out or written through PROFIBUS. In conjunction with templates it is even possible to selectively adapt the same parameters in any number of parameterizations.
- Teleservice through MPI
The premium versions of the SIRIUS ES software families support the use of MPI Teleservice (comprising the Teleservice software and various Teleservice adapters) for remote diagnostics of the devices. This facilitates diagnostics and maintenance and it shortens response times for service purposes.

Introduction

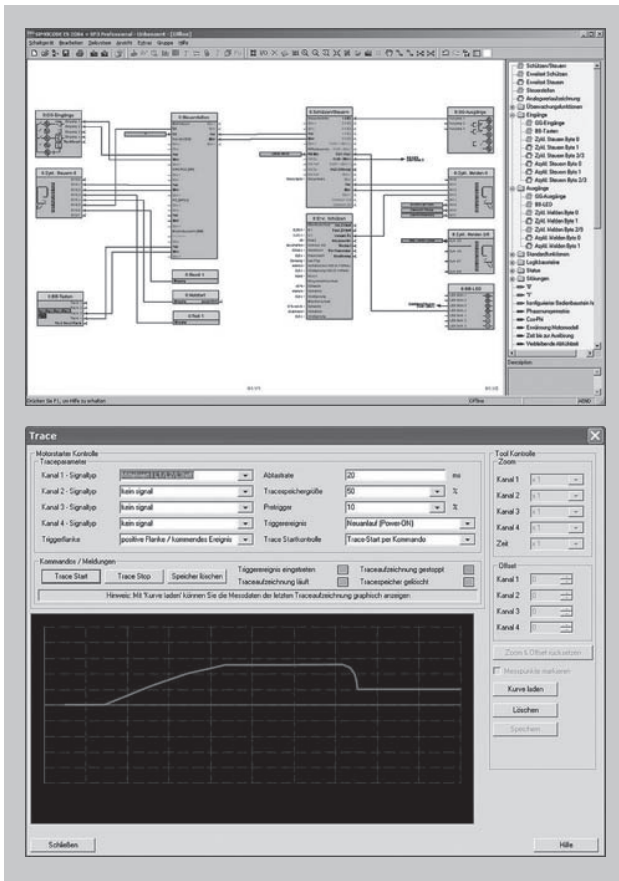

Efficient engineering and startup with graphic interfaces and diagnostics options

Types of delivery and license

The programs of the SIRIUS ES software family are available as follows:

- Floating license – the license for any one user at any one time
 - Authorizes any one user
 - Independent of the number of installations (unlike the single license which is allowed to be installed once only)
 - Only the actual use of the program has to be licensed
 - Trial license (free use of all program functions for 14 days for test and evaluation purposes, included on every product CD, available in the download file of the SIRIUS ES program in the Service&Support portal).

Following delivery versions are available in addition for the programs of the SIRIUS ES software family:

- Upgrade
 - Upgrade from an old to a new version with expanded functions, e. g. upgrade from Motor Starter ES 2006 to Motor Starter ES 2007
- Powerpack
 - Special pack for switching within the same software version to a more powerful version with more functionality, e. g. Powerpack Motor Starter ES 2007 for switching from Standard to Premium
- Software Update Service
 - To keep you up to date at all times we offer a special service which supplies you automatically with all service packs and upgrades

Soft Starter ES

Overview

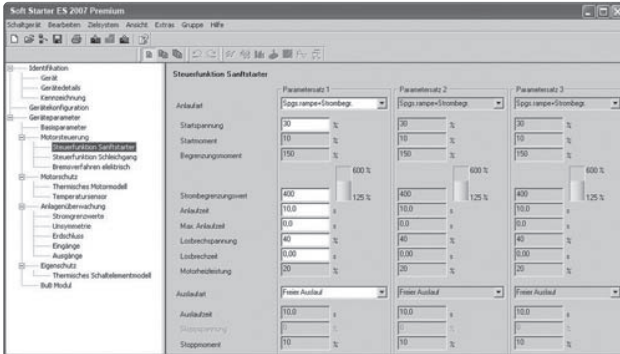

Easy and clearly arranged parameter setting of the 3RW44 soft starter with Soft Starter ES 2007

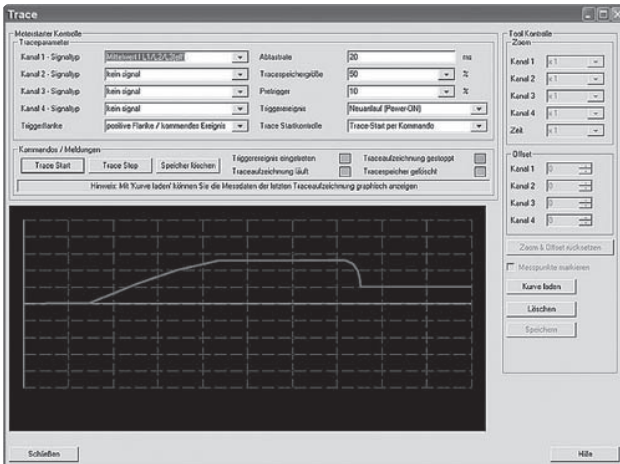

Graphic presentation of measured values with the trace function (oscilloscope function) of Soft Starter ES 2007 Standard and Premium

Soft Starter ES 2007

The Soft Starter ES software permits the quick and easy parameterization, monitoring and diagnostics of SIRIUS 3RW44 High Feature soft starters for service purposes. The device parameters can be configured directly on the PC and transferred to the soft starter through a serial cable or an optional PROFIBUS interface.

The advantages of Soft Starter ES:

- Clearly arranged configuring of device functions and their parameters – online and offline
- Effective diagnostics functions on the soft starter and display of the most important measured values
- Trace function (oscilloscope function) for recording measured values and events (in the Soft Starter ES Standard and Premium software versions).

Efficient engineering with new program versions

The Soft Starter ES software program is available in three versions which differ in their user-friendliness, scope of functions and price.

Soft starters ES	Basic	Standard	Premium
Access through the local interface on the device	✓	✓	✓
Parameter assignment	✓	✓	✓
Operating	✓	✓	✓
Diagnostics	✓	✓	✓
Creating templates	--	✓ ¹⁾	✓
Exporting parameters	--	✓	✓
Comparison functions	--	✓	✓
Standards-conform printout according to EN ISO 7200	--	✓	✓
Service data (slave pointer, statistics data)	--	✓	✓
Access through PROFIBUS	--	--	✓
Group functions	--	--	✓
Teleservice through MPI	--	--	✓
S7 Routing	--	--	✓
STEP7 Object Manager	--	--	✓

¹⁾ Templates with Service Pack 1 and higher.

More functions

- Standards-conform printouts
The software tool greatly simplifies machine documentation. Parameterization printouts according to EN ISO 7200 are possible. The elements to be printed are easy to select and compile as required.
- Easy creation of parameter templates
Parameter templates can be created for devices and applications with only minimum differences in their parameters. These templates contain all the parameters which are needed for the parameterization. In addition it is possible to specify which of these parameters are fixed and which can be adapted, e. g. by the startup engineer.
- Group function
For the user-friendly parameterization of numerous devices or applications of the same type, the programs of the SIRIUS ES software family offer a group function which enables the parameterization of several devices to be read out or written through PROFIBUS. In conjunction with typical it is even possible to selectively adapt the same parameters in any number of parameterizations.
- Teleservice through MPI
The Soft Starter ES Premium version supports the use of MPI Teleservice (comprising the Teleservice software and various Teleservice adapters) for remote diagnostics of the devices. This facilitates diagnostics and maintenance, and it shortens response times for service purposes.

Soft Starter ES

Types of delivery and license

Soft Starter ES is available as follows:

- Floating license – the license for any one user at any one time
 - Authorizes any one user
 - Independent of the number of installations (unlike the single license which is allowed to be installed once only)
 - Only the actual use of the program has to be licensed
- Trial license (free use of all program functions for 14 days for test and evaluation purposes, included on every product CD, available in the download file of the SIRIUS ES program in the Service&Support portal).

Following delivery versions are available in addition for Soft Starter ES 2007:

- Upgrade
Upgrade from an old to a new version with expanded functions, e. g. upgrade from Soft Starter ES 2006 to Soft Starter ES 2007

- Powerpack
Special pack for switching within the same software version to a more powerful version with more functionality, e. g. Powerpack Soft Starter ES 2007 for switching from Standard to Premium
- Software Update Service
To keep you up to date at all times we offer a special service which supplies you automatically with all service packs and upgrades

New licensing procedure

To make licensing easier, the three versions of Soft Starter ES are available with immediate effect with the following license:

14 day trial license for Premium functions: for test and evaluation purposes, included on every product CD, available also in the download file of the SIRIUS Soft Starter ES 2007 program at www.sea.siemens.com/softstarters.

System requirements

Soft Starter ES 2007 parameterization, start-up and diagnostics software for the SIRIUS 3RW44 soft starter	Basic/Standard	Premium
	Firmware version ≥ *E04* ¹⁾	Firmware version ≥ *E06* ²⁾
Operating system	Windows 2000 (Service Pack 3 or 4), Windows XP Professional (Service Pack 2), Windows Vista Ultimate 32/ Business 32 ³⁾	
Processor	≥ Pentium 800 MHz/≥ 1 GHz (Windows Vista)	
RAM	≥ 512 MB/≥ 1 GB (Windows Vista)	
Free space on hard disk	≥ 150 MB	
CD-ROM/DVD drive	Yes (only when installing from CD)	
Serial interface (COM)	Yes	
PC cable/parameterization cable/connection cable	Yes	
PROFIBUS communication module (optional)	--	Yes

¹⁾ SIRIUS 3RW44 with firmware version ≥ *E04*. Installed in starters delivered after December 2005.
²⁾ SIRIUS 3RW44 with firmware version ≥ *E06*. Installed in starters delivered after May 2006.
³⁾ Windows Vista Ultimate 32/ Business 32 from Soft Starter ES 2007+SP1.

Selection and ordering data

Parameterization and service software for SIRIUS 3RW44 soft starters

- Can be run under WIN 2000/WIN XP PROF/Windows Vista Ultimate 32/Business 32
- Without PC cable

Version	Order No.	List Price \$ per PU	PS*	Weight per PU approx. kg
Soft Starter ES 2007 Basic Floating license for one user E-SW, software and documentation on CD, 3 languages (German/English/French), communication through system interface • License key on USB stick, Class A, including CD	3ZS1 313-4CC10-0YA5		1 unit	0.230
Soft Starter ES 2007 Standard Floating license for one user E-SW, software and documentation on CD, 3 languages (German/English/French), communication through system interface • License key on USB stick, Class A, including CD	3ZS1 313-5CC10-0YA5		1 unit	0.230

Soft Starter ES

Version	Order No.	List Price \$ per PU	PS*	Weight per PU approx. kg
Upgrade for Soft Starter ES 2006 Floating license for one user, E-SW, software and documentation on CD, license key on USB stick, Class A, 3 languages (German/English/French), communication through the system interface	3ZS1 313-5CC10-0YE5		1 unit	0.230
Powerpack for Soft Starter ES 2007 Basic Floating license for one user, E-SW, software and documentation on CD, license key on USB stick, Class A, 3 languages (German/English/French), communication through the system interface	3ZS1 313-5CC10-0YD5		1 unit	0.230
Software Update Service For 1 year with automatic extension, assuming the current software version is in use, E-SW, software and documentation on CD, communication through the system interface	3ZS1 313-5CC10-0YL5		1 unit	0.230

Soft Starter ES 2007 Premium

Floating license for one user E-SW, software and documentation on CD, 3 languages (German/English/French), communication through system interface or PROFIBUS • License key on USB stick, Class A, including CD	3ZS1 313-6CC10-0YA5		1 unit	0.230
Upgrade for Soft Starter ES 2006 Floating license for one user, E-SW, software and documentation on CD, license key on USB stick, Class A, 3 languages (German/English/French), communication through the system interface or PROFIBUS	3ZS1 313-6CC10-0YE5		1 unit	0.230
Powerpack for Soft Starter ES 2007 Standard Floating license for one user, E-SW, software and documentation on CD, license key on USB stick, Class A, 3 languages (German/English/French), communication through the system interface or PROFIBUS	3ZS1 313-6CC10-0YD5		1 unit	0.230
Software Update Service For 1 year with automatic extension, assuming the current software version is in use, E-SW, software and documentation on CD, communication through the system interface or PROFIBUS	3ZS1 313-6CC10-0YL5		1 unit	0.230

PC cables



3UF7 940-0AA00-0

For PC/PG communication with SIRIUS 3RW44 soft starters Through the system interface, for connecting to the serial interface of the PC/PG	3UF7 940-0AA00-0		1 unit	0.150
---	-------------------------	--	--------	-------

Serial/USB







For PC/PG communication with SIRIUS 3RW44 soft starters Through the system interface, for connecting to the USB interface of the PC/PG	3UF7 946-0AA00-0		1 unit	0.150
--	-------------------------	--	--------	-------

3RW Soft Starters

3RW44 for high-feature applications



Accessories

For soft starters	Version	Order No.	List Price \$ per PU	PS*	Weight per PU approx. kg
Type					
PROFIBUS communication modules					
	<p>Modules can be plugged into the soft starters for integrating the starters in the PROFIBUS network with DPV1 slave functionality.</p> <p>On Y-link the soft starter has only DPV0 slave functionality.</p>	3RW49 00-0KC00		1 unit	0.320
PROFINET communication modules					
	<p>For 3RW44 soft starter integration in the PROFINET network, suitable for devices with firmware version E12 or higher</p>	3RW49 00-0NC00		1 unit	0.320
External display and operator modules					
	<p>For indicating and operating the functions provided by the soft starter using an externally mounted display and operator module in degree of protection IP54, N1, N12 (e. g. in the control cabinet door)</p>	3RW49 00-0AC00		1 unit	0.320
Connection cables					
	<p>From the device interface (serial) of the 3RW44 soft starter to the external display and operator module</p> <ul style="list-style-type: none"> • Length 0.5 m, flat • Length 0.5 m, round • Length 1.0 m, round • Length 2.5 m, round 	3UF7 932-0AA00-0		1 unit	0.020
		3UF7 932-0BA00-0		1 unit	0.050
		3UF7 937-0BA00-0		1 unit	0.100
		3UF7 933-0BA00-0		1 unit	0.150
Box terminal blocks for soft starters					
	<p>Box terminal blocks</p> <p>3RW44 2. Included in the scope of supply</p> <p>3RW44 3. <ul style="list-style-type: none">• Up to 70 mm²• Up to 120 mm²</p> <p>3RW44 4. <ul style="list-style-type: none">• Up to 240 mm²</p>	3RT19 55-4G		1 unit	0.230
		3RT19 56-4G		1 unit	0.260
		3RT19 66-4G		1 unit	0.676

3RW Soft Starters

3RW44 for high-feature applications

Spare parts

For soft starters	Version	Order No.	List Price \$ per PU	PS*	Weight per PU approx. kg
Covers for soft starters					
Terminal covers for box terminals					
Additional touch protection to be fitted at the box terminals (2 units required per device)					
3RW44 2. and 3RW44 3.		3RT19 56-4EA2		1 unit	0.030
3RW44 4.		3RT19 66-4EA2		1 unit	0.040
Terminal covers for cable lugs and busbar connections					
3RW44 2. and 3RW44 3.		3RT19 56-4EA1		1 unit	0.070
3RW44 4.		3RT19 66-4EA1		1 unit	0.130
 3RT19 .6-4EA1					
Operating instructions¹⁾					
For 3RW44 soft starters		3ZX10 12-0RW44-1AA1			
Fans					
 3RW49		Fans			
3RW44 2. and 3RW44 3.	115 V AC 230 V AC	3RW49 36-8VX30 3RW49 36-8VX40		1 unit 1 unit	0.300 0.300
3RW44 4.	115 V AC 230 V AC	3RW49 47-8VX30 3RW49 47-8VX40		1 unit 1 unit	0.500 0.500
3RW44 5. and 3RW44 6. ²⁾	115 V AC 230 V AC	3RW49 57-8VX30 3RW49 57-8VX40		1 unit 1 unit	0.800 0.800
3RW44 6. ³⁾	115 V AC 230 V AC	3RW49 66-8VX30 3RW49 66-8VX40		1 unit 1 unit	0.300 0.300

¹⁾ The operating instructions are included in the scope of supply.

²⁾ 3RW44 6. mounting on output side.

³⁾ For mounting on front side.

3RW Soft Starters

3RW44 for high-feature applications

More information

Application examples for normal starting (Class 10)

Normal starting Class 10 (up to 20 s with 350 % $I_{n \text{ motor}}$).

The soft starter rating can be selected to be as high as the rating of the motor used.

Application	Conveyor belt	Roller conveyor	Compressor	Small fan	Pump	Hydraulic pump
Starting parameters¹⁾						
• Voltage ramp and current limiting						
- Starting voltage	% 70	60	50	30	30	30
- Starting time	s 10	10	10	10	10	10
- Current limit value	Deactivated	Deactivated	$4 \times I_M$	$4 \times I_M$	Deactivated	Deactivated
• Torque ramp						
- Starting torque	60	50	40	20	10	10
- End torque	150	150	150	150	150	150
- Starting time	10	10	10	10	10	10
• Breakaway pulse	Deactivated (0 ms)	Deactivated (0 ms)	Deactivated (0 ms)	Deactivated (0 ms)	Deactivated (0 ms)	Deactivated (0 ms)
Ramp-down mode	Smooth ramp-down	Smooth ramp-down	Free ramp-down	Free ramp-down	Pump ramp-down	Free ramp-down

Application examples for heavy starting (Class 20)

Heavy starting Class 20 (up to 40 s with 350 % $I_{n \text{ motor}}$).

The soft starter has to be selected one rating class higher than the motor used.

Application	Mixer	Centrifuge	Milling machine
Starting parameters¹⁾			
• Voltage ramp and current limiting			
- Starting voltage	% 30	30	30
- Starting time	s 30	30	30
- Current limit value	$4 \times I_M$	$4 \times I_M$	$4 \times I_M$
• Torque ramp			
- Starting torque	30	30	30
- End torque	150	150	150
- Starting time	30	30	30
• Breakaway pulse	Deactivated (0 ms)	Deactivated (0 ms)	Deactivated (0 ms)
Ramp-down mode	Free ramp-down	Free ramp-down	Free ramp-down or DC braking

Application examples for very heavy starting (Class 30)

Very heavy starting Class 30 (up to 60 s with 350 % $I_{n \text{ motor}}$).

The soft starter has to be selected two rating classes higher than the motor used.

Application	Large fan	Mill	Crushers	Circular saw/bandsaw
Starting parameters¹⁾				
• Voltage ramp and current limiting				
- Starting voltage	% 30	50	50	30
- Starting time	s 60	60	60	60
- Current limit value	$4 \times I_M$	$4 \times I_M$	$4 \times I_M$	$4 \times I_M$
• Torque ramp				
- Starting torque	20	50	50	20
- End torque	150	150	150	150
- Starting time	60	60	60	60
• Breakaway pulse	Deactivated (0 ms)	80 %, 300 ms	80 %, 300 ms	Deactivated (0 ms)
Ramp-down mode	Free ramp-down	Free ramp-down	Free ramp-down	Free ramp-down

Note:

These tables present sample set values and device sizes. They are intended only for the purposes of information and are not binding. The set values depend on the application in question and must be optimized during start-up.

The soft starter dimensions should be checked where necessary with the Win-Soft Starter software or with the help of Technical Assistance.

¹⁾ Actual motor starting times are load dependent.

3RW Soft Starters

3RW44 for high-feature applications

Circuit concept

The SIRIUS 3RW44 soft starters can be operated in two different types of circuit.

- **Inline circuit**
The controls for isolating and protecting the motor are simply connected in series with the soft starter. The motor is connected to the soft starter with three cables.
- **Inside-delta circuit**
The wiring is similar to that of wye-delta starters. The phases of the soft starter are connected in series with the individual motor windings. The soft starter then only has to carry the phase current, amounting to about 58 % of the rated motor current (conductor current).

Comparison of the types of circuit

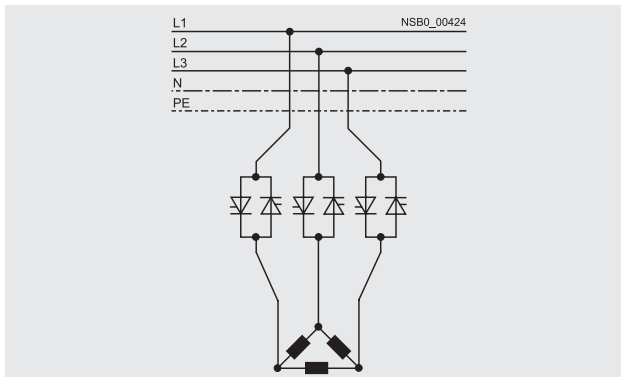

Inline circuit:
Rated current I_e corresponds to the rated motor current I_n , 3 cables to the motor

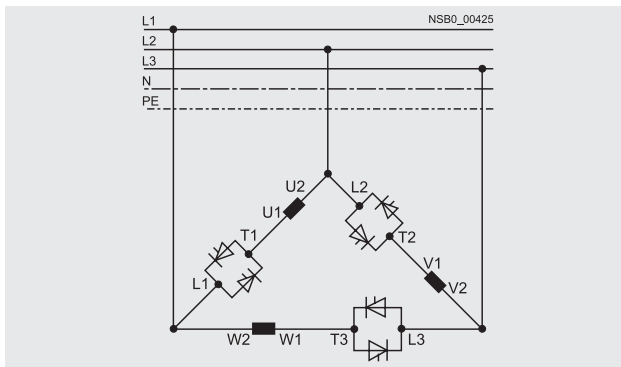

Inside-delta circuit:
Rated current I_e corresponds to approx. 58 % of the rated motor current I_n , 6 cables to the motor (as with wye-delta starters)

Which circuit?

Using the inline circuit involves the lowest wiring outlay. If the soft starter to motor connections are long, this circuit is preferable. With the inside-delta circuit there is double the wiring complexity but a smaller size of device can be used at the same rating. It is also recommended to use an isolating contactor in series with each motor winding.

Thanks to the choice of operating mode between the inline circuit and inside-delta circuit, it is always possible to select the most favorable solution.

The braking function is possible only in the inline circuit.

Configuration

The 3RW44 solid-state soft starters are designed for normal starting. In case of heavy starting or increased starting frequency, a larger device must be selected.

For long starting times it is recommended to have a PTC sensor in the motor. This also applies for the ramp-down modes smooth ramp-down, pump ramp-down and DC braking, because during the ramp-down time in these modes, an additional current load applies in contrast to free ramp-down.

In the motor feeder between the SIRIUS 3RW soft starter and the motor, no capacitive elements are permitted (e. g. no reactive-power compensation equipment). In addition, neither static systems for reactive-power compensation nor dynamic PFC (Power Factor Correction) must be operated in parallel during starting and ramp-down of the soft starter. This is important to prevent faults arising on the compensation equipment and/or the soft starter.

All elements of the main circuit (such as fuses and controls) should be dimensioned for direct starting, following the local short-circuit conditions. Fuses, controls and overload relays must be ordered separately.

A bypass contact system and solid-state overload relay are already integrated in the 3RW44 soft starter and therefore do not have to be ordered separately.

The harmonic component load for starting currents must be taken into consideration for the selection of motor starter protectors (selection of release).

Note:

When induction motors are switched on, voltage drops normally appear on starters of all types (direct starters, wye-delta starters, soft starters). The infeed transformer must always be dimensioned such that the voltage dip when starting the motor remains within the permissible tolerance. If the infeed transformer is dimensioned with only a small margin, it is best for the control voltage to be supplied from a separate circuit (independently of the main voltage) in order to avoid the potential switching off of the soft starter.

Device interface, PROFIBUS DP communication module, Soft Starter ES parameterizing and operating software

The 3RW44 electronic soft starters have a PC interface for communicating with the Soft Starter ES software or for connecting the external display and operator module. If the optional PROFIBUS communication module is used, the 3RW44 soft starter can be integrated in the PROFIBUS network and communicate using the GSD file or Soft Starter ES Premium software.

3RW Soft Starters

3RW44 for high-feature applications

System Manual for SIRIUS 3RW44

Besides containing all important information on configuring, commissioning and servicing, the manual also contains example circuits and the technical specifications for all devices. This manual can be downloaded off the internet.

Win-Soft Starter selection and simulation program

With this software, you can simulate and select all Siemens soft starters, taking into account various parameters such as mains properties, motor and load data, and special application requirements.

The software is a valuable tool, which makes complicated, lengthy manual calculations for determining the required soft starters superfluous.

The Win-Soft Starter selection and simulation program can be downloaded free of charge from:

www.usa.siemens.com/softstarters > Software

More information can be found on the Internet at:

www.usa.siemens.com/softstarters

3RW Soft Starters

Soft starters for enclosed applications

Overview

The family of 3RW40 and 3RW44 softstarters are available in stand alone enclosed control designs for smooth starting and stopping of standard NEMA design B three phase inductive motors, thus eliminating physical stresses to the system and load while minimizing starting current. These pre-engineered enclosed designs offer convenience and flexibility in and UL/CSA certified offering. Enclosed styles are available in combination and non-combination configurations through 600HP and system voltages of 200V, 230V, 480V, and 600V.

The Class 73 offers either the 3RW40 or 3RW44 in a non-combination style offering. These non-combination styles come standard with a choice of Type 1, 3R, 12, 4 NEMA rated enclosure, a control transformer, Sirius softstarter with built-in overload and bypass, line side power terminal block, and a reset pushbutton. The enclosed offering can be powerfully matched with a wide variety of factory modified options such as pushbutton control, pilot lights, metering and other control options such as isolation contactors and emergency start bypass starters. 3RW44 enclosed styles are also available with optional through the door keypad and Profibus communication.

The Class 74 offering includes all of the features of the Class 73 in a combination style design. Standard options are either a circuit breaker or fusible disconnect providing short circuit protection and soft starting in one package.

Application

The Class 73/74 product is a fully enclosed solid state reduced voltage starter designed for a wide variety of industrial applications. The enclosed softstarter offerings are ideal for new as well as existing applications where total motor controls is required.

Proper selection based on application data is made simple following these easy steps:

- Select proper RVSS by application
 - Select the 3RW40 versus the 3RW44 using the application info provided in the open section of the catalog
- Select the rating chart for normal starting or sever duty starting
 - Normal starting is rated at 350% of rated motor current IM for 10 seconds and based on starts per hour – representative of a class 20 application.
 - Severe starting is rated at 350% of rated motor current Im for 20 seconds and based on starts per hour – representative of a Class 20 application
- Select model using Motor nameplate data
 - Identify correct motor voltage column
 - Select rate current or HP row
 - Find ordering number under desired enclosure type column (e.g. NEMA 1)
 - Select appropriate system voltage
- Select factory modification on page 6/40¹⁾

Example:
3RW44, N12, CB disconnect, 460V, 200HP with a start/stop and red run light

Order No.
74MT34BFAP A1 FC

Product Nomenclature

Class 73 and 74 Enclosed Soft Starters

7
SOFT STARTERS

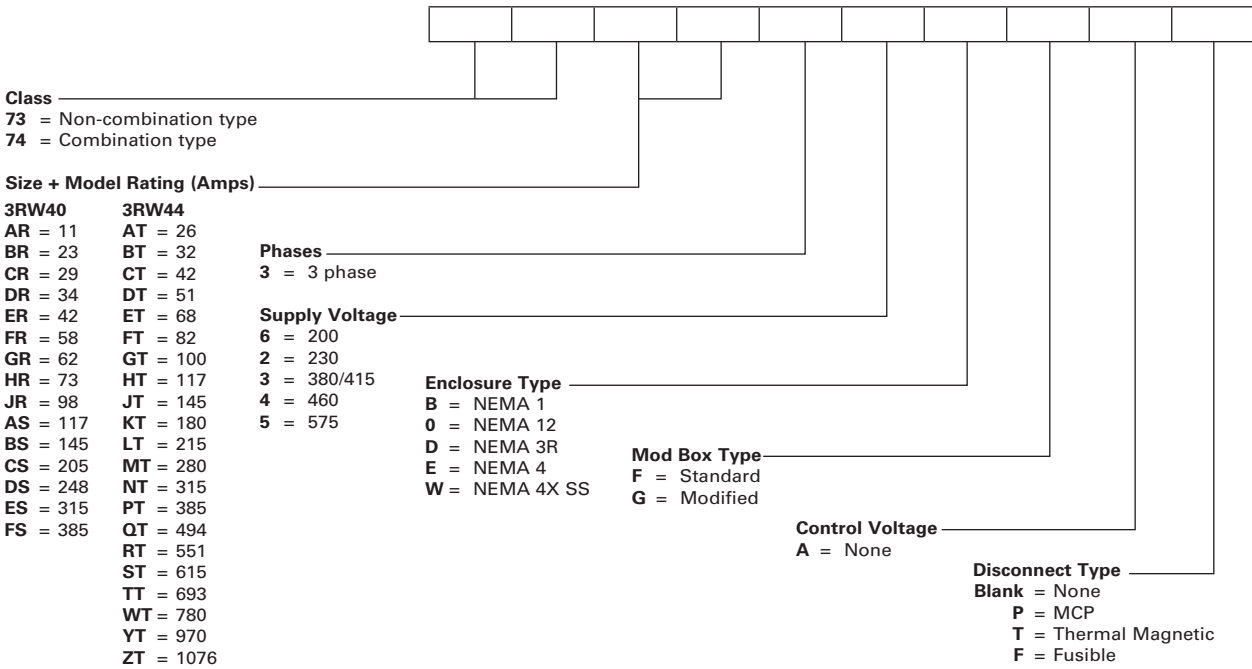

¹⁾ Some modifications will require a larger 'Modified' box than the standard box e.g. Isolation contactor, space heater, etc. See page 7/43 for instructions.

3RW Soft Starters

3RW40 Size S0-S3 Non-Combo



3RW40 Enclosed features:

- Available in NEMA 1,12,3R,4, and 4 stainless steel
- Compact size
- Built-in Bypass contactor
- Voltage ramp up and ramp down
- Current limit adjustment of 125 - 550%
- Internal overload class 10,15,or 20
- Internal self protection
- Fault monitoring
- Isolation Contactor

Ordering Information

- ▶ Enclosed devices should be ordered by the FLA of the motor.
- ▶ The 3RW40 is designed for normal starting applications.
- ▶ For factory modifications see page 7/43.
- ▶ For complete derating and application info see page 7/59
- ▶ For dimensional drawings see page 7/95.

Class 73 non-combination starters include:

- NEMA rated enclosure
- 3RW40 Sirius softstarter with built-in OL and bypass
- Control Circuit Transformer
- Line side power terminal block
- Reset button
- Isolation Contactor

Ideal applications for 3RW40 enclosed softstarters

- Fans
- Pumps
- Easy starting loads starting in less than 10 seconds

Class 73 starters are built to UL and CSA standards

3RW40 for Standard Applications

Enclosed Non-Combination (Starter Only)

Rated Operating Current	MAX HP ^①				KW	Class 10 Light Duty (350% * Ie for 10s) ^②									
	200V	230V	460V	575V		380V	OPEN Style (Starter Only)	NEMA 1	List Price \$	NEMA 3R	List Price \$	NEMA 12	List Price \$	NEMA 4	List Price \$
11	3	3	7.5	—	6	3RW4024-1BB14	73AR3_BFA		73AR3_DFA		73AR3_OFA		73AR3_EFA		73AR3_WFA
23	5	7.5	15	—	13	3RW4026-1BB14	73BR3_BFA		73BR3_DFA		73BR3_OFA		73BR3_EFA		73BR3_WFA
29	7.5	10	20	—	16	3RW4027-1BB14	73CR3_BFA		73CR3_DFA		73CR3_OFA		73CR3_EFA		73CR3_WFA
34	10	10	25	—	18	3RW4028-1BB14	73DR3_BFA		73DR3_DFA		73DR3_OFA		73DR3_EFA		73DR3_WFA
42	10	15	30	—	23	3RW4036-1BB14	73ER3_BFA		73ER3_DFA		73ER3_OFA		73ER3_EFA		73ER3_WFA
58	15	20	40	—	31	3RW4037-1BB14	73FR3_BFA		73FR3_DFA		73FR3_OFA		73FR3_EFA		73FR3_WFA
62	20	20	40	—	33	3RW4038-1BB14	73GR3_BFA		73GR3_DFA		73GR3_OFA		73GR3_EFA		73GR3_WFA
73	20	25	50	—	39	3RW4046-1BB14	73HR3_BFA		73HR3_DFA		73HR3_OFA		73HR3_EFA		73HR3_WFA
98	30	30	75	—	52	3RW4047-1BB14	73JR3_BFA		73JR3_DFA		73JR3_OFA		73JR3_EFA		73JR3_WFA
						200V	6		6		6		6		6
						230V	2		2		2		2		2
						380V	3		3		3		3		3
						460V	4		4		4		4		4

① Starter size is dependent on the nameplate Full Load Amps (FLA) rating of the motor. HPs are for reference only. Enclosed ratings are at 40°C

② Starter selection is dependent on type of application. Ie = FLA rating of motor

3RW Soft Starters

Enclosed 3RW40



3RW40 Enclosed features:

- Available in NEMA 1, 12, 3R, 4, and 4 stainless steel
- Compact size
- Built-in bypass contactor
- Voltage ramp up and ramp down
- Current limit adjustment of 125 - 550%
- Internal overload class 10, 15, or 20
- Internal self protection
- Fault monitoring

Ordering Information

- ▶ Enclosed devices should be ordered by the FLA of the motor.
- ▶ The 3RW40 is designed for normal starting applications (Class 10 applications).
- ▶ For factory modifications see page 7/43.
- ▶ For complete derating and application info see page 7/59.
- ▶ For dimensional drawings see page 7/95.

Class 73 non-combination starters include:

- NEMA rated enclosure
- 3RW40 Sirius softstarter with built-in OL and bypass
- Control circuit transformer
- Line side power terminal block
- Reset button

Ideal applications for 3RW40 enclosed softstarters:

- Fans
- Pumps
- Building/construction machines
- Presses
- Escalators
- Transport systems
- Air conditioning systems
- Ventilators
- Assembly lines

Class 73 starters are built to UL and CSA standards.

For all technical information, please consult the 2006 Industrial Controls Catalog or contact your local sales support center.

3RW40 for Standard Applications

Enclosed Non-Combination (Starter Only)

Rated Operating Current	MAX HP ^①				kW	Class 10 Light Duty (350% * Im for 10s) ^②											
	200V	230V	460V	575V		380V	OPEN Style (Starter Only)	NEMA 1	List Price \$	NEMA 3R	List Price \$	NEMA 12	List Price \$	NEMA 4	List Price \$	NEMA 4/4X Stainless Steel	List Price \$
117	30	40	75	—	56	3RW4055-6BB34	73AS3_BFA		73AS3_DFA		73AS3_OFA		73AS3_EFA		73AS3_WFA		
145	40	50	100	—	75	3RW4056-6BB34	73BS3_BFA		73BS3_DFA		73BS3_OFA		73BS3_EFA		73BS3_WFA		
205	60	75	150	—	112	3RW4073-6BB34	73CS3_BFA		73CS3_DFA		73CS3_OFA		73CS3_EFA		73CS3_WFA		
248	75	100	200	—	149	3RW4074-6BB34	73DS3_BFA		73DS3_DFA		73DS3_OFA		73DS3_EFA		73DS3_WFA		
315	100	125	250	—	186	3RW4075-6BB34	73ES3_BFA		73ES3_DFA		73ES3_OFA		73ES3_EFA		73ES3_WFA		
385	125	150	300	—	224	3RW4076-6BB34	73FS3_BFA		73FS3_DFA		73FS3_OFA		73FS3_EFA		73FS3_WFA		
						200V	6		6		6		6		6		
						230V	2		2		2		2		2		
						380V	3		3		3		3		3		
						460V	4		4		4		4		4		
117	—	—	75	100	—	3RW4055-6BB35	73AS35BFA		73AS35DFA		73AS35OFA		73AS35EFA		73AS35WFA		
145	—	—	100	150	—	3RW4056-6BB35	73BS35BFA		73BS35DFA		73BS35OFA		73BS35EFA		73BS35WFA		
205	—	—	150	200	—	3RW4073-6BB35	73CS35BFA		73CS35DFA		73CS35OFA		73CS35EFA		73CS35WFA		
248	—	—	200	250	—	3RW4074-6BB35	73DS35BFA		73DS35DFA		73DS35OFA		73DS35EFA		73DS35WFA		
315	—	—	250	300	—	3RW4075-6BB35	73ES35BFA		73ES35DFA		73ES35OFA		73ES35EFA		73ES35WFA		
385	—	—	300	400	—	3RW4076-6BB35	73FS35BFA		73FS35DFA		73FS35OFA		73FS35EFA		73FS35WFA		

Enclosed Non-Combination (Starter Only)

Rated Operating Current	MAX HP ^①				kW	Class 20 Severe Duty (350% * Ie for 20s) ^②											
	200V	230V	460V	575V		380V	OPEN Style (Starter Only)	NEMA 1	List Price \$	NEMA 3R	List Price \$	NEMA 12	List Price \$	NEMA 4	List Price \$	NEMA 4/4X Stainless Steel	List Price \$
112	30	40	75	—	56	3RW4055-6BB34	73AS3_BFA		73AS3_DFA		73AS3_OFA		73AS3_EFA		73AS3_WFA		
132	40	50	100	—	75	3RW4056-6BB34	73BS3_BFA		73BS3_DFA		73BS3_OFA		73BS3_EFA		73BS3_WFA		
185	60	60	125	—	93	3RW4073-6BB34	73CS3_BFA		73CS3_DFA		73CS3_OFA		73CS3_EFA		73CS3_WFA		
205	60	75	150	—	112	3RW4074-6BB34	73DS3_BFA		73DS3_DFA		73DS3_OFA		73DS3_EFA		73DS3_WFA		
280	75	100	200	—	149	3RW4075-6BB34	73ES3_BFA		73ES3_DFA		73ES3_OFA		73ES3_EFA		73ES3_WFA		
340	100	125	250	—	186	3RW4076-6BB34	73FS3_BFA		73FS3_DFA		73FS3_OFA		73FS3_EFA		73FS3_WFA		
						200V	6		6		6		6		6		
						230V	2		2		2		2		2		
						380V	3		3		3		3		3		
						460V	4		4		4		4		4		
112	—	—	75	75	—	3RW4055-6BB35	73AS35BFA		73AS35DFA		73AS35OFA		73AS35EFA		73AS35WFA		
132	—	—	100	125	—	3RW4056-6BB35	73BS35BFA		73BS35DFA		73BS35OFA		73BS35EFA		73BS35WFA		
185	—	—	125	150	—	3RW4073-6BB35	73CS35BFA		73CS35DFA		73CS35OFA		73CS35EFA		73CS35WFA		
205	—	—	150	200	—	3RW4074-6BB35	73DS35BFA		73DS35DFA		73DS35OFA		73DS35EFA		73DS35WFA		
280	—	—	200	250	—	3RW4075-6BB35	73ES35BFA		73ES35DFA		73ES35OFA		73ES35EFA		73ES35WFA		
340	—	—	250	300	—	3RW4076-6BB35	73FS35BFA		73FS35DFA		73FS35OFA		73FS35EFA		73FS35WFA		

① Starter size is dependent on the nameplate Full Load Amps (FLA) rating of the motor.

HPs are for reference only. Enclosed ratings are at 40°C.

② Starter selection is dependent on type of application. Im = FLA rating of motor.

3RW Soft Starters

3RW40 – Size S0-S3 Circuit Breaker



3RW40 Enclosed features:

- Available in NEMA 1, 12, 3R, 4, and 4 stainless steel
- Compact size
- Built-in Bypass contactor
- Voltage ramp up and ramp down
- Current limit adjustment of 125 - 550%
- Internal overload class 10, 15, or 20
- Internal self protection
- Fault monitoring
- Isolation Contactor

Ordering Information

- ▶ Enclosed devices should be ordered by the FLA of the motor.
- ▶ The 3RW40 is designed for normal starting applications.
- ▶ For factory modifications see page 7/43.
- ▶ For complete derating and application info see page 7/59
- ▶ For dimensional drawings see page 7/95.

Class 74 non-combination starters include:

- NEMA rated enclosure
- Circuit Breaker disconnect with shunt trip
- 3RW40 Sirius softstarter with built-in OL and bypass
- Control Circuit Transformer
- Isolation Contactor

Ideal applications for 3RW40 enclosed softstarters

- Fans
- Pumps
- Easy starting loads starting in less than 10 seconds

Class 74 starters are built to UL and CSA standards

3RW40 for Standard Applications

Enclosed Circuit Breaker Combination (Starter With Circuit Breaker Disconnect)

Rated Operating Current	MAX HP ^①				KW	Class 10 Light Duty (350% * Ie for 10s) ^②										
	200V	230V	460V	575V		380V	OPEN Style (Starter Only)	NEMA 1	List Price \$	NEMA 3R	List Price \$	NEMA 12	List Price \$	NEMA 4	List Price \$	NEMA 4/4X Stainless Steel
11	3	3	7.5	—	6	3RW4024-1BB14	74AR3_BFAP		74AR3_DFAP		74AR3_OFAP		74AR3_EFAP		74AR3_WFAP	
23	5	7.5	15	—	13	3RW4026-1BB14	74BR3_BFAP		74BR3_DFAP		74BR3_OFAP		74BR3_EFAP		74BR3_WFAP	
29	7.5	10	20	—	16	3RW4027-1BB14	74CR3_BFAP		74CR3_DFAP		74CR3_OFAP		74CR3_EFAP		74CR3_WFAP	
34	10	10	25	—	18	3RW4028-1BB14	74DR3_BFAP		74DR3_DFAP		74DR3_OFAP		74DR3_EFAP		74DR3_WFAP	
42	10	15	30	—	23	3RW4036-1BB14	74ER3_BFAP		74ER3_DFAP		74ER3_OFAP		74ER3_EFAP		74ER3_WFAP	
58	15	20	40	—	31	3RW4037-1BB14	74FR3_BFAP		74FR3_DFAP		74FR3_OFAP		74FR3_EFAP		74FR3_WFAP	
62	20	20	40	—	33	3RW4038-1BB14	74GR3_BFAP		74GR3_DFAP		74GR3_OFAP		74GR3_EFAP		74GR3_WFAP	
73	20	25	50	—	39	3RW4046-1BB14	74HR3_BFAP		74HR3_DFAP		74HR3_OFAP		74HR3_EFAP		74HR3_WFAP	
98	30	30	75	—	52	3RW4047-1BB14	74JR3_BFAP		74JR3_DFAP		74JR3_OFAP		74JR3_EFAP		74JR3_WFAP	
							200V	6		6		6		6		6
							230V	2		2		2		2		2
							380V	3		3		3		3		3
							460V	4		4		4		4		4

① Starter size is dependent on the nameplate Full Load Amps (FLA) rating of the motor. HPs are for reference only. Enclosed ratings are at 40°C

② Starter selection is dependent on type of application. Ie = FLA rating of motor

Enclosed 3RW44



3RW40 Enclosed features:

- Available in NEMA 1, 12, 3R, 4, and 4 stainless steel
- Compact size
- Built-in bypass contactor
- Voltage ramp up and ramp down
- Current limit adjustment of 125 - 550%
- Internal overload class 10, 15, or 20
- Internal self protection
- Fault monitoring

Ordering Information

- Enclosed devices should be ordered by the FLA of the motor.
- The 3RW40 is designed for normal starting applications (Class 10 applications).
- For factory modifications see page 7/43.
- For complete derating and application info see page 7/70.
- For dimensional drawings see page 7/95.

Class 74 non-combination starters include:

- NEMA rated enclosure
- Circuit breaker disconnect with shunt trip
- 3RW40 Sirius softstarter with built-in OL and bypass
- Control circuit transformer

Ideal applications for 3RW40 enclosed softstarters:

- Fans
- Pumps
- Building/construction machines
- Presses
- Escalators
- Transport systems
- Air conditioning systems
- Ventilators
- Assembly lines

Class 74 starters are built to UL and CSA standards.

For all technical information, please consult the 2006 Industrial Controls Catalog or contact your local sales support center.

3RW40 for Standard Applications

Enclosed Circuit Breaker Combination (Starter with Circuit Breaker Disconnect)

Rated Operating Current	MAX HP ^①				KW	Class 10 Light Duty (350% * I _m for 10s) ^②										
	200V	230V	460V	575V		380V	OPEN Style (Starter Only)	NEMA 1	List Price \$	NEMA 3R	List Price \$	NEMA 12	List Price \$	NEMA 4	List Price \$	NEMA 4/4X Stainless Steel
117	30	40	75	—	56	3RW4055-6BB34	74AS3_BFAP		74AS3_DFAP		74AS3_OFAP		74AS3_EFAP		74AS3_WFAP	
145	40	50	100	—	75	3RW4056-6BB34	74BS3_BFAP		74BS3_DFAP		74BS3_OFAP		74BS3_EFAP		74BS3_WFAP	
205	60	75	150	—	112	3RW4073-6BB34	74CS3_BFAP		74CS3_DFAP		74CS3_OFAP		74CS3_EFAP			
248	75	100	200	—	149	3RW4074-6BB34	74DS3_BFAP		74DS3_DFAP		74DS3_OFAP		74DS3_EFAP			
315	100	125	250	—	186	3RW4075-6BB34	74ES3_BFAP		74ES3_DFAP		74ES3_OFAP		74ES3_EFAP			
385	125	150	300	—	224	3RW4076-6BB34	74FS3_BFAP		74FS3_DFAP		74FS3_OFAP		74FS3_EFAP			
						200V	6		6		6		6		6	
						230V	2		2		2		2		2	
						380V	3		3		3		3		3	
						460V	4		4		4		4		4	
117	—	—	75	100	—	3RW4055-6BB35	74AS35BFAP		74AS35DFAP		74AS350FAP		74AS35EFAP		74AS35WFAP	
145	—	—	100	150	—	3RW4056-6BB35	74BS35BFAP		74BS35DFAP		74BS350FAP		74BS35EFAP		74BS35WFAP	
205	—	—	150	200	—	3RW4073-6BB35	74CS35BFAP		74CS35DFAP		74CS350FAP		74CS35EFAP			
248	—	—	200	250	—	3RW4074-6BB35	74DS35BFAP		74DS35DFAP		74DS350FAP		74DS35EFAP			
315	—	—	250	300	—	3RW4075-6BB35	74ES35BFAP		74ES35DFAP		74ES350FAP		74ES35EFAP			
385	—	—	300	400	—	3RW4076-6BB35	74FS35BFAP		74FS35DFAP		74FS350FAP		74FS35EFAP			

Enclosed Circuit Breaker Combination (Starter with Circuit Breaker Disconnect)

Rated Operating Current	MAX HP ^①				KW	Class 20 Severe Duty (350% * I _e for 20s) ^②										
	200V	230V	460V	575V		380V	OPEN Style (Starter Only)	NEMA 1	List Price \$	NEMA 3R	List Price \$	NEMA 12	List Price \$	NEMA 4	List Price \$	NEMA 4/4X Stainless Steel
112	30	40	75	—	56	3RW4055-6BB34	74AS3_BFAP		74AS3_DFAP		74AS3_OFAP		74AS3_EFAP		74AS3_WFAP	
132	40	50	100	—	75	3RW4056-6BB34	74BS3_BFAP		74BS3_DFAP		74BS3_OFAP		74BS3_EFAP		74BS3_WFAP	
185	60	60	125	—	93	3RW4073-6BB34	74CS3_BFAP		74CS3_DFAP		74CS3_OFAP		74CS3_EFAP			
205	60	75	150	—	112	3RW4074-6BB34	74DS3_BFAP		74DS3_DFAP		74DS3_OFAP		74DS3_EFAP			
280	75	100	200	—	149	3RW4075-6BB34	74ES3_BFAP		74ES3_DFAP		74ES3_OFAP		74ES3_EFAP			
340	100	125	250	—	186	3RW4076-6BB34	74FS3_BFAP		74FS3_DFAP		74FS3_OFAP		74FS3_EFAP			
						200V	6		6		6		6		6	
						230V	2		2		2		2		2	
						380V	3		3		3		3		3	
						460V	4		4		4		4		4	
112	—	—	75	75	—	3RW4055-6BB35	74AS35BFAP		74AS35DFAP		74AS350FAP		74AS35EFAP		74AS35WFAP	
132	—	—	100	125	—	3RW4056-6BB35	74BS35BFAP		74BS35DFAP		74BS350FAP		74BS35EFAP		74BS35WFAP	
185	—	—	125	150	—	3RW4073-6BB35	74CS35BFAP		74CS35DFAP		74CS350FAP		74CS35EFAP			
205	—	—	150	200	—	3RW4074-6BB35	74DS35BFAP		74DS35DFAP		74DS350FAP		74DS35EFAP			
280	—	—	200	250	—	3RW4075-6BB35	74ES35BFAP		74ES35DFAP		74ES350FAP		74ES35EFAP			
340	—	—	250	300	—	3RW4076-6BB35	74FS35BFAP		74FS35DFAP		74FS350FAP		74FS35EFAP			

① Starter size is dependent on the nameplate Full Load Amps (FLA) rating of the motor. HPs are for reference only. Enclosed ratings are at 40°C.

② Starter selection is dependent on type of application. I_m = FLA rating of motor.

3RW Soft Starters

3RW40 – Size S0-S3 Fusible



- 3RW40 Enclosed features:
- Available in NEMA 1, 12, 3R, 4, and 4 stainless steel
 - Compact size
 - Built-in Bypass contactor
 - Voltage ramp up and ramp down
 - Current limit adjustment of 125 - 550%
 - Internal overload class 10,15, or 20
 - Internal self protection
 - Fault monitoring
 - Isolation Contactor

Ordering Information

- ▶ Enclosed devices should be ordered by the FLA of the motor.
- ▶ The 3RW40 is designed for normal starting applications.
- ▶ For factory modifications see page 7/43.
- ▶ For complete derating and application info see page 7/59
- ▶ For dimensional drawings see page 7/95.

Ideal applications for 3RW40 enclosed softstarters

- Fans
- Pumps
- Easy starting loads starting in less than 10 seconds

Class 74 starters are built to UL and CSA standards

- Class 73 non-combination starters include:
- NEMA rated enclosure
 - Fusible Disconnect
 - 3RW40 Sirius softstarter with built-in OL and bypass
 - Control Circuit Transformer
 - Isolation Contactor

3RW40 for Standard Applications

Enclosed Fusible Combination (Starter With Fusible Disconnect)

Rated Operating Current	MAX HP ^①				KW	Class 10 Light Duty (350% * I _e for 10s) ^②										
	200V	230V	460V	575V		380V	OPEN Style (Starter Only)	NEMA 1	List Price \$	NEMA 3R	List Price \$	NEMA 12	List Price \$	NEMA 4	List Price \$	NEMA 4/4X Stainless Steel
11	3	3	7.5	—	6	3RW4024-1BB14	74AR3_BFAF		74AR3_DFAF		74AR3_OFAF		74AR3_EFAF		74AR3_WFAF	
23	5	7.5	15	—	13	3RW4026-1BB14	74BR3_BFAF		74BR3_DFAF		74BR3_OFAF		74BR3_EFAF		74BR3_WFAF	
29	7.5	10	20	—	16	3RW4027-1BB14	74CR3_BFAF		74CR3_DFAF		74CR3_OFAF		74CR3_EFAF		74CR3_WFAF	
34	10	10	25	—	18	3RW4028-1BB14	74DR3_BFAF		74DR3_DFAF		74DR3_OFAF		74DR3_EFAF		74DR3_WFAF	
42	10	15	30	—	23	3RW4036-1BB14	74ER3_BFAF		74ER3_DFAF		74ER3_OFAF		74ER3_EFAF		74ER3_WFAF	
58	15	20	40	—	31	3RW4037-1BB14	74FR3_BFAF		74FR3_DFAF		74FR3_OFAF		74FR3_EFAF		74FR3_WFAF	
62	20	20	40	—	33	3RW4038-1BB14	74GR3_BFAF		74GR3_DFAF		74GR3_OFAF		74GR3_EFAF		74GR3_WFAF	
73	20	25	50	—	39	3RW4046-1BB14	74HR3_BFAF		74HR3_DFAF		74HR3_OFAF		74HR3_EFAF		74HR3_WFAF	
98	30	30	75	—	52	3RW4047-1BB14	74JR3_BFAF		74JR3_DFAF		74JR3_OFAF		74JR3_EFAF		74JR3_WFAF	
							200V	6		6		6		6		6
							230V	2		2		2		2		2
							380V	3		3		3		3		3
							460V	4		4		4		4		4

① Starter size is dependent on the nameplate Full Load Amps (FLA) rating of the motor. HPs are for reference only. Enclosed ratings are at 40°C

② Starter selection is dependent on type of application. I_e = FLA rating of motor

Enclosed 3RW44



3RW44 Enclosed features:

- Available in NEMA 1, 12, 3R, 4, and 4 stainless steel
- Compact size
- Built-in bypass contactor
- Multiple starting/stopping techniques including torque control
- Internal overload class 5, 10, 15, 20, or 30
- Built-in graphical LCD keypad
- Internal self protection
- Fault monitoring
- 3 parameter sets
- Communication capable via opt. Profibus module
- Programmable inputs and outputs
- External keypad available

Ordering Information

- Enclosed devices should be ordered by the FLA of the motor.
- The 3RW44 is designed for normal starting applications.
- For factory modifications see page 7/43.
- For complete derating and application info see page 7/70.
- For dimensional drawings see page 7/95.

Class 73 non-combination starters include:

- NEMA rated enclosure
- 3RW44 Sirius softstarter with built-in OL and bypass
- Control circuit transformer
- Reset button

Ideal applications for 3RW44 enclosed softstarters:

- Fans
- Pumps
- Conveying systems and lifts
- Hydraulics
- Machine tools
- Mills saws
- Crushers and grinders
- Mixers
- HVAC systems

The 3RW44 severe duty rating table should be applied for high inertia applications such rock crushers, chippers, screw compressors, ect.

Class 73 starters are built to UL and CSA standards.

3RW44 For High Feature Applications

Enclosed Non-Combination (Starter Only)

Rated Operating Current	MAX HP ^①				KW	Class 10 Light Duty (350% * Im for 10s) ^②										
	200V	230V	460V	575V		380V	OPEN Style (Starter Only)	NEMA 1	List Price \$	NEMA 3R	List Price \$	NEMA 12	List Price \$	NEMA 4	List Price \$	NEMA 4/4X Stainless Steel
26	7.5	7.5	15	—	12	3RW4422-1BC34	73AT3_BFA		73AT3_DFA		73AT3_OFA		73AT3_EFA		73AT3_WFA	
32	10	10	20	—	15	3RW4423-1BC34	73BT3_BFA		73BT3_DFA		73BT3_OFA		73BT3_EFA		73BT3_WFA	
42	10	15	25	—	19	3RW4424-1BC34	73CT3_BFA		73CT3_DFA		73CT3_OFA		73CT3_EFA		73CT3_WFA	
51	15	15	30	—	22	3RW4425-1BC34	73DT3_BFA		73DT3_DFA		73DT3_OFA		73DT3_EFA		73DT3_WFA	
68	20	25	50	—	37	3RW4426-1BC34	73ET3_BFA		73ET3_DFA		73ET3_OFA		73ET3_EFA		73ET3_WFA	
82	25	30	60	—	45	3RW4427-1BC34	73FT3_BFA		73FT3_DFA		73FT3_OFA		73FT3_EFA		73FT3_WFA	
100	30	30	75	—	56	3RW4434-6BC34	73GT3_BFA		73GT3_DFA		73GT3_OFA		73GT3_EFA		73GT3_WFA	
117	30	40	75	—	56	3RW4435-6BC34	73HT3_BFA		73HT3_DFA		73HT3_OFA		73HT3_EFA		73HT3_WFA	
145	40	50	100	—	75	3RW4436-6BC34	73JT3_BFA		73JT3_DFA		73JT3_OFA		73JT3_EFA		73JT3_WFA	
180	60	60	125	—	93	3RW4443-6BC34	73KT3_BFA		73KT3_DFA		73KT3_OFA		73KT3_EFA		73KT3_WFA	
215	60	75	150	—	112	3RW4444-6BC34	73LT3_BFA		73LT3_DFA		73LT3_OFA		73LT3_EFA		73LT3_WFA	
280	75	100	200	—	149	3RW4445-6BC34	73MT3_BFA		73MT3_DFA		73MT3_OFA		73MT3_EFA		73MT3_WFA	
315	100	125	250	—	186	3RW4446-6BC34	73NT3_BFA		73NT3_DFA		73NT3_OFA		73NT3_EFA		73NT3_WFA	
385	125	150	300	—	224	3RW4447-6BC34	73PT3_BFA		73PT3_DFA		73PT3_OFA		73PT3_EFA		73PT3_WFA	
494	150	200	400	—	298	3RW4453-6BC34	73QT3_BFA		73QT3_DFA		73QT3_OFA		73QT3_EFA		73QT3_WFA	
551	150	200	450	—	336	3RW4454-6BC34	73RT3_BFA		73RT3_DFA		73RT3_OFA		73RT3_EFA		73RT3_WFA	
615	200	250	500	—	373	3RW4455-6BC34	73ST3_BFA		73ST3_DFA		73ST3_OFA		73ST3_EFA		73ST3_WFA	
693	200	250	550	—	410	3RW4456-6BC34	73TT3_BFA		73TT3_DFA		73TT3_OFA		73TT3_EFA		73TT3_WFA	
780	200	250	600	—	447	3RW4457-6BC34	73WT3_BFA		73WT3_DFA		73WT3_OFA		73WT3_EFA		73WT3_WFA	
970	350	350	800	—	597	3RW4465-6BC34	73YT3_BFA		73YT3_DFA		73YT3_OFA		73YT3_EFA		73YT3_WFA	
1076	350	400	900	—	972	3RW4466-6BC34	73ZT3_BFA		73ZT3_DFA		73ZT3_OFA		73ZT3_EFA		73ZT3_WFA	
						200V	6		6		6		6		6	
						230V	2		2		2		2		2	
						380V	3		3		3		3		3	
						460V	4		4		4		4		4	
26	—	—	15	20	—	3RW4422-1BC35	73AT35BFA		73AT35DFA		73AT35OFA		73AT35EFA		73AT35WFA	
32	—	—	20	25	—	3RW4423-1BC35	73BT35BFA		73BT35DFA		73BT35OFA		73BT35EFA		73BT35WFA	
42	—	—	25	30	—	3RW4424-1BC35	73CT35BFA		73CT35DFA		73CT35OFA		73CT35EFA		73CT35WFA	
51	—	—	30	40	—	3RW4425-1BC35	73DT35BFA		73DT35DFA		73DT35OFA		73DT35EFA		73DT35WFA	
68	—	—	50	50	—	3RW4426-1BC35	73ET35BFA		73ET35DFA		73ET35OFA		73ET35EFA		73ET35WFA	
82	—	—	60	75	—	3RW4427-1BC35	73FT35BFA		73FT35DFA		73FT35OFA		73FT35EFA		73FT35WFA	
100	—	—	75	75	—	3RW4434-6BC35	73GT35BFA		73GT35DFA		73GT35OFA		73GT35EFA		73GT35WFA	
117	—	—	75	100	—	3RW4435-6BC35	73HT35BFA		73HT35DFA		73HT35OFA		73HT35EFA		73HT35WFA	
145	—	—	100	125	—	3RW4436-6BC35	73JT35BFA		73JT35DFA		73JT35OFA		73JT35EFA		73JT35WFA	
180	—	—	125	150	—	3RW4443-6BC35	73KT35BFA		73KT35DFA		73KT35OFA		73KT35EFA		73KT35WFA	
215	—	—	150	200	—	3RW4444-6BC35	73LT35BFA		73LT35DFA		73LT35OFA		73LT35EFA		73LT35WFA	
280	—	—	200	250	—	3RW4445-6BC35	73MT35BFA		73MT35DFA		73MT35OFA		73MT35EFA		73MT35WFA	
315	—	—	250	300	—	3RW4446-6BC35	73NT35BFA		73NT35DFA		73NT35OFA		73NT35EFA		73NT35WFA	
385	—	—	300	400	—	3RW4447-6BC35	73PT35BFA		73PT35DFA		73PT35OFA		73PT35EFA		73PT35WFA	
494	—	—	400	500	—	3RW4453-6BC35	73QT35BFA		73QT35DFA		73QT35OFA		73QT35EFA		73QT35WFA	
551	—	—	450	600	—	3RW4454-6BC35	73RT35BFA		73RT35DFA		73RT35OFA		73RT35EFA		73RT35WFA	
615	—	—	500	700	—	3RW4455-6BC35	73ST35BFA		73ST35DFA		73ST35OFA		73ST35EFA		73ST35WFA	
693	—	—	550	750	—	3RW4456-6BC35	73TT35BFA		73TT35DFA		73TT35OFA		73TT35EFA		73TT35WFA	
780	—	—	600	850	—	3RW4457-6BC35	73WT35BFA		73WT35DFA		73WT35OFA		73WT35EFA		73WT35WFA	
970	—	—	800	1000	—	3RW4465-6BC35	73YT35BFA		73YT35DFA		73YT35OFA		73YT35EFA		73YT35WFA	
1076	—	—	900	1100	—	3RW4466-6BC35	73ZT35BFA		73ZT35DFA		73ZT35OFA		73ZT35EFA		73ZT35WFA	

① Starter size is dependent on the nameplate Full Load Amps (FLA) rating of the motor. HPs are for reference only. Enclosed ratings are at 40°C.

② Starter selection is dependent on type of application. Im = FLA rating of motor.

Enclosed 3RW44

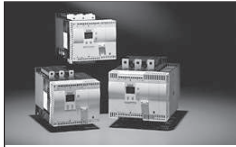

- 3RW44 Enclosed features:
- Available in NEMA 1, 12, 3R, 4, and 4 stainless steel
 - Compact size
 - Built-in bypass contactor
 - Multiple starting/stopping techniques including torque control
 - Internal overload class 10, 15, or 20
 - Built-in graphical LCD keypad
 - Internal self protection
 - Fault monitoring
 - 3 parameter sets
 - Communication capable via opt. Profibus module
 - Programmable inputs and outputs
 - External keypad available

Ordering Information

- Enclosed devices should be ordered by the FLA of the motor.
- The 3RW44 is designed for normal starting applications.
- For factory modifications see page 7/43.
- For complete derating and application info see page 7/70.
- For dimensional drawings see page 7/95.

Class 73 non-combination starters include:

- NEMA rated enclosure
- 3RW44 Sirius softstarter with built-in OL and bypass
- Control circuit transformer
- Line side power terminal block
- Reset button

Ideal applications for 3RW44 enclosed softstarters:

- Fans
- Pumps
- Conveying systems and lifts
- Hydraulics
- Machine tools
- Mills saws
- Crushers and grinders
- Mixers
- HVAC systems

The 3RW44 severe duty rating table should be applied for high inertia applications such rock crushers, chippers, screw compressors, ect.

Class 73 starters are built to UL and CSA standards.

3RW44 For High Feature Applications

Enclosed Non-Combination (Starter Only)

Rated Operating Current	MAX HP ^①				KW	Class 20 Severe Duty (350% * Im for 20s) ^②										
	200V	230V	460V	575V		380V	OPEN Style (Starter Only)	NEMA 1	List Price \$	NEMA 3R	List Price \$	NEMA 12	List Price \$	NEMA 4	List Price \$	NEMA 4/4X Stainless Steel
26	7.5	7.5	15	—	12	3RW4422-1BC34	73AT3_BFA		73AT3_DFA		73AT3_OFA		73AT3_EFA		73AT3_WFA	
32	10	10	20	—	15	3RW4423-1BC34	73BT3_BFA		73BT3_DFA		73BT3_OFA		73BT3_EFA		73BT3_WFA	
42	10	15	25	—	19	3RW4424-1BC34	73CT3_BFA		73CT3_DFA		73CT3_OFA		73CT3_EFA		73CT3_WFA	
51	15	15	30	—	22	3RW4425-1BC34	73DT3_BFA		73DT3_DFA		73DT3_OFA		73DT3_EFA		73DT3_WFA	
68	20	25	50	—	37	3RW4426-1BC34	73ET3_BFA		73ET3_DFA		73ET3_OFA		73ET3_EFA		73ET3_WFA	
82	25	30	60	—	45	3RW4427-1BC34	73FT3_BFA		73FT3_DFA		73FT3_OFA		73FT3_EFA		73FT3_WFA	
97	30	30	60	—	45	3RW4434-6BC34	73GT3_BFA		73GT3_DFA		73GT3_OFA		73GT3_EFA		73GT3_WFA	
113	30	40	75	—	56	3RW4435-6BC34	73HT3_BFA		73HT3_DFA		73HT3_OFA		73HT3_EFA		73HT3_WFA	
134	40	50	75	—	56	3RW4436-6BC34	73JT3_BFA		73JT3_DFA		73JT3_OFA		73JT3_EFA		73JT3_WFA	
175	50	60	100	—	75	3RW4443-6BC34	73KT3_BFA		73KT3_DFA		73KT3_OFA		73KT3_EFA		73KT3_WFA	
195	60	75	125	—	93	3RW4444-6BC34	73LT3_BFA		73LT3_DFA		73LT3_OFA		73LT3_EFA		73LT3_WFA	
243	75	75	150	—	112	3RW4445-6BC34	73MT3_BFA		73MT3_DFA		73MT3_OFA		73MT3_EFA		73MT3_WFA	
263	75	100	200	—	149	3RW4446-6BC34	73NT3_BFA		73NT3_DFA		73NT3_OFA		73NT3_EFA		73NT3_WFA	
326	100	125	250	—	186	3RW4447-6BC34	73PT3_BFA		73PT3_DFA		73PT3_OFA		73PT3_EFA		73PT3_WFA	
494	150	150	400	—	224	3RW4453-6BC34	73QT3_BFA		73QT3_DFA		73QT3_OFA		73QT3_EFA		73QT3_WFA	
551	150	200	450	—	298	3RW4454-6BC34	73RT3_BFA		73RT3_DFA		73RT3_OFA		73RT3_EFA		73RT3_WFA	
615	200	200	500	—	336	3RW4455-6BC34	73ST3_BFA		73ST3_DFA		73ST3_OFA		73ST3_EFA		73ST3_WFA	
634	200	250	500	—	373	3RW4456-6BC34	73TT3_BFA		73TT3_DFA		73TT3_OFA		73TT3_EFA		73TT3_WFA	
650	200	250	550	—	410	3RW4457-6BC34	73WT3_BFA		73WT3_DFA		73WT3_OFA		73WT3_EFA		73WT3_WFA	
880	300	350	700	—	522	3RW4465-6BC34	73YT3_BFA		73YT3_DFA		73YT3_OFA		73YT3_EFA		73YT3_WFA	
940	300	350	750	—	559	3RW4466-6BC34	73ZT3_BFA		73ZT3_DFA		73ZT3_OFA		73ZT3_EFA		73ZT3_WFA	
						200V	6		6		6		6		6	
						230V	2		2		2		2		2	
						380V	3		3		3		3		3	
						460V	4		4		4		4		4	
26	—	—	15	20	—	3RW4422-1BC35	73AT35BFA		73AT35DFA		73AT35OFA		73AT35EFA		73AT35WFA	
32	—	—	20	25	—	3RW4423-1BC35	73BT35BFA		73BT35DFA		73BT35OFA		73BT35EFA		73BT35WFA	
42	—	—	25	30	—	3RW4424-1BC35	73CT35BFA		73CT35DFA		73CT35OFA		73CT35EFA		73CT35WFA	
51	—	—	30	40	—	3RW4425-1BC35	73DT35BFA		73DT35DFA		73DT35OFA		73DT35EFA		73DT35WFA	
68	—	—	50	50	—	3RW4426-1BC35	73ET35BFA		73ET35DFA		73ET35OFA		73ET35EFA		73ET35WFA	
82	—	—	60	75	—	3RW4427-1BC35	73FT35BFA		73FT35DFA		73FT35OFA		73FT35EFA		73FT35WFA	
97	—	—	60	75	—	3RW4434-6BC35	73GT35BFA		73GT35DFA		73GT35OFA		73GT35EFA		73GT35WFA	
113	—	—	75	100	—	3RW4435-6BC35	73HT35BFA		73HT35DFA		73HT35OFA		73HT35EFA		73HT35WFA	
134	—	—	75	125	—	3RW4436-6BC35	73JT35BFA		73JT35DFA		73JT35OFA		73JT35EFA		73JT35WFA	
175	—	—	100	150	—	3RW4443-6BC35	73KT35BFA		73KT35DFA		73KT35OFA		73KT35EFA		73KT35WFA	
195	—	—	125	200	—	3RW4444-6BC35	73LT35BFA		73LT35DFA		73LT35OFA		73LT35EFA		73LT35WFA	
243	—	—	150	200	—	3RW4445-6BC35	73MT35BFA		73MT35DFA		73MT35OFA		73MT35EFA		73MT35WFA	
263	—	—	200	250	—	3RW4446-6BC35	73NT35BFA		73NT35DFA		73NT35OFA		73NT35EFA		73NT35WFA	
326	—	—	250	300	—	3RW4447-6BC35	73PT35BFA		73PT35DFA		73PT35OFA		73PT35EFA		73PT35WFA	
494	—	—	400	500	—	3RW4453-6BC35	73QT35BFA		73QT35DFA		73QT35OFA		73QT35EFA		73QT35WFA	
551	—	—	450	550	—	3RW4454-6BC35	73RT35BFA		73RT35DFA		73RT35OFA		73RT35EFA		73RT35WFA	
615	—	—	500	600	—	3RW4455-6BC35	73ST35BFA		73ST35DFA		73ST35OFA		73ST35EFA		73ST35WFA	
693	—	—	500	650	—	3RW4456-6BC35	73TT35BFA		73TT35DFA		73TT35OFA		73TT35EFA		73TT35WFA	
780	—	—	550	700	—	3RW4457-6BC35	73WT35BFA		73WT35DFA		73WT35OFA		73WT35EFA		73WT35WFA	
880	—	—	700	850	—	3RW4465-6BC35	73YT35BFA		73YT35DFA		73YT35OFA		73YT35EFA		73YT35WFA	
940	—	—	750	900	—	3RW4466-6BC35	73ZT35BFA		73ZT35DFA		73ZT35OFA		73ZT35EFA		73ZT35WFA	

① Starter size is dependent on the nameplate Full Load Amps (FLA) rating of the motor. HPs are for reference only. Enclosed ratings are at 40°C.

② Starter selection is dependent on type of application. Im = FLA rating of motor.

Enclosed 3RW44



3RW44 Enclosed features:

- Available in NEMA 1, 12, 3R, 4, and 4 stainless steel
- Compact size
- Built-in bypass contactor
- Multiple starting/stopping techniques including torque control
- Internal overload class 5, 10, 15, 20, or 30
- Built-in graphical LCD keypad
- Internal self protection
- Fault monitoring
- 3 parameter sets
- Communication capable via opt. Profibus module
- Programmable inputs and outputs
- External keypad available

Ordering Information

- Enclosed devices should be ordered by the FLA of the motor.
- The 3RW44 is designed for normal starting applications.
- For factory modifications see page 7/43.
- For complete derating and application info see page 7/70.
- For dimensional drawings see page 7/95.
- For stocked versions see page 7/89.

Class 74 non-combination starters include:

- NEMA rated enclosure
- 3RW44 Sirius softstarter with built-in OL and bypass
- Circuit breaker with disconnect
- Control circuit transformer
- Reset button

Ideal applications for 3RW44 enclosed softstarters:

- Fans
- Pumps
- Conveying systems and lifts
- Hydraulics
- Machine tools
- Mills saws
- Crushers and grinders
- Mixers
- HVAC systems

The 3RW44 severe duty rating table should be applied for high inertia applications such rock crushers, chippers, screw compressors, ect.

Class 74 starters are built to UL and CSA standards.

3RW44 For High Feature Applications

Enclosed Combination with Circuit Breaker Disconnect

Rated Operating Current	MAX HP ^①				KW	Class 10 Light Duty (350% * Im for 10s) ^②											
	200V	230V	460V	575V		380V	OPEN Style (Starter Only)	NEMA 1	List Price \$	NEMA 3R	List Price \$	NEMA 12	List Price \$	NEMA 4	List Price \$	NEMA 4/4X Stainless Steel	List Price \$
26	7.5	7.5	15	—	12	3RW4422-1BC34	74AT3_BFAP		74AT3_DFAP		74AT3_OFAP		74AT3_EFAP		74AT3_WFAP		
32	10	10	20	—	15	3RW4423-1BC34	74BT3_BFAP		74BT3_DFAP		74BT3_OFAP		74BT3_EFAP		74BT3_WFAP		
42	10	15	25	—	19	3RW4424-1BC34	74CT3_BFAP		74CT3_DFAP		74CT3_OFAP		74CT3_EFAP		74CT3_WFAP		
51	15	15	30	—	22	3RW4425-1BC34	74DT3_BFAP		74DT3_DFAP		74DT3_OFAP		74DT3_EFAP		74DT3_WFAP		
68	20	25	50	—	37	3RW4426-1BC34	74ET3_BFAP		74ET3_DFAP		74ET3_OFAP		74ET3_EFAP		74ET3_WFAP		
82	25	30	60	—	45	3RW4427-1BC34	74FT3_BFAP		74FT3_DFAP		74FT3_OFAP		74FT3_EFAP		74FT3_WFAP		
100	30	30	75	—	56	3RW4434-6BC34	74GT3_BFAP		74GT3_DFAP		74GT3_OFAP		74GT3_EFAP		74GT3_WFAP		
117	30	40	75	—	56	3RW4435-6BC34	74HT3_BFAP		74HT3_DFAP		74HT3_OFAP		74HT3_EFAP		74HT3_WFAP		
145	40	50	100	—	75	3RW4436-6BC34	74JT3_BFAP		74JT3_DFAP		74JT3_OFAP		74JT3_EFAP		74JT3_WFAP		
180	60	60	125	—	93	3RW4443-6BC34	74KT3_BFAP		74KT3_DFAP		74KT3_OFAP		74KT3_EFAP		74KT3_WFAP		
215	60	75	150	—	112	3RW4444-6BC34	74LT3_BFAP		74LT3_DFAP		74LT3_OFAP		74LT3_EFAP		74LT3_WFAP		
280	75	100	200	—	149	3RW4445-6BC34	74MT3_BFAP		74MT3_DFAP		74MT3_OFAP		74MT3_EFAP		74MT3_WFAP		
315	100	125	250	—	186	3RW4446-6BC34	74NT3_BFAP		74NT3_DFAP		74NT3_OFAP		74NT3_EFAP		74NT3_WFAP		
385	125	150	300	—	224	3RW4447-6BC34	74PT3_BFAP		74PT3_DFAP		74PT3_OFAP		74PT3_EFAP		74PT3_WFAP		
494	150	200	400	—	298	3RW4453-6BC34	74QT3_BFAT		74QT3_DFAT		74QT3_OFAT		74QT3_EFAT		74QT3_WFAT		
551	150	200	450	—	336	3RW4454-6BC34	74RT3_BFAT		74RT3_DFAT		74RT3_OFAT		74RT3_EFAT		74RT3_WFAT		
615	200	250	500	—	373	3RW4455-6BC34	74ST3_BFAT		74ST3_DFAT		74ST3_OFAT		74ST3_EFAT		74ST3_WFAT		
693	200	250	550	—	410	3RW4456-6BC34	74TT3_BFAT		74TT3_DFAT		74TT3_OFAT		74TT3_EFAT		74TT3_WFAT		
780	200	250	600	—	447	3RW4457-6BC34	74WT3_BFAT		74WT3_DFAT		74WT3_OFAT		74WT3_EFAT		74WT3_WFAT		
970	350	350	800	—	597	3RW4465-6BC34	74YT3_BFAT		74YT3_DFAT		74YT3_OFAT		74YT3_EFAT		74YT3_WFAT		
1076	350	400	900	—	672	3RW4466-6BC34	74ZT3_BFAT		74ZT3_DFAT		74ZT3_OFAT		74ZT3_EFAT		74ZT3_WFAT		
						200V	6		6		6		6		6		
						230V	2		2		2		2		2		
						380V	3		3		3		3		3		
						460V	4		4		4		4		4		
26	—	—	15	20	—	3RW4422-1BC35	74AT35BFAP		74AT35DFAP		74AT35OFAP		74AT35EFAP		74AT35WFAP		
32	—	—	20	25	—	3RW4423-1BC35	74BT35BFAP		74BT35DFAP		74BT35OFAP		74BT35EFAP		74BT35WFAP		
42	—	—	25	30	—	3RW4424-1BC35	74CT35BFAP		74CT35DFAP		74CT35OFAP		74CT35EFAP		74CT35WFAP		
51	—	—	30	40	—	3RW4425-1BC35	74DT35BFAP		74DT35DFAP		74DT35OFAP		74DT35EFAP		74DT35WFAP		
68	—	—	50	50	—	3RW4426-1BC35	74ET35BFAP		74ET35DFAP		74ET35OFAP		74ET35EFAP		74ET35WFAP		
82	—	—	60	75	—	3RW4427-1BC35	74FT35BFAP		74FT35DFAP		74FT35OFAP		74FT35EFAP		74FT35WFAP		
100	—	—	75	75	—	3RW4434-6BC35	74GT35BFAP		74GT35DFAP		74GT35OFAP		74GT35EFAP		74GT35WFAP		
117	—	—	75	100	—	3RW4435-6BC35	74HT35BFAP		74HT35DFAP		74HT35OFAP		74HT35EFAP		74HT35WFAP		
145	—	—	100	125	—	3RW4436-6BC35	74JT35BFAP		74JT35DFAP		74JT35OFAP		74JT35EFAP		74JT35WFAP		
180	—	—	125	150	—	3RW4443-6BC35	74KT35BFAP		74KT35DFAP		74KT35OFAP		74KT35EFAP		74KT35WFAP		
215	—	—	150	200	—	3RW4444-6BC35	74LT35BFAP		74LT35DFAP		74LT35OFAP		74LT35EFAP		74LT35WFAP		
280	—	—	200	250	—	3RW4445-6BC35	74MT35BFAP		74MT35DFAP		74MT35OFAP		74MT35EFAP		74MT35WFAP		
315	—	—	250	300	—	3RW4446-6BC35	74NT35BFAP		74NT35DFAP		74NT35OFAP		74NT35EFAP		74NT35WFAP		
385	—	—	300	400	—	3RW4447-6BC35	74PT35BFAP		74PT35DFAP		74PT35OFAP		74PT35EFAP		74PT35WFAP		
494	—	—	400	500	—	3RW4453-6BC35	74QT35BFAT		74QT35DFAT		74QT35OFAT		74QT35EFAT		74QT35WFAT		
551	—	—	450	600	—	3RW4454-6BC35	74RT35BFAT		74RT35DFAT		74RT35OFAT		74RT35EFAT		74RT35WFAT		
615	—	—	500	700	—	3RW4455-6BC35	74ST35BFAT		74ST35DFAT		74ST35OFAT		74ST35EFAT		74ST35WFAT		
693	—	—	550	750	—	3RW4456-6BC35	74TT35BFAT		74TT35DFAT		74TT35OFAT		74TT35EFAT		74TT35WFAT		
780	—	—	600	850	—	3RW4457-6BC35	74WT35BFAT		74WT35DFAT		74WT35OFAT		74WT35EFAT		74WT35WFAT		
970	—	—	800	1000	—	3RW4465-6BC35	74YT35BFAT		74YT35DFAT		74YT35OFAT		74YT35EFAT		74YT35WFAT		
1076	—	—	900	1100	—	3RW4466-6BC35	74ZT35BFAT		74ZT35DFAT		74ZT35OFAT		74ZT35EFAT		74ZT35WFAT		

① Starter size is dependent on the nameplate Full Load Amps (FLA) rating of the motor. HPs are for reference only. Enclosed ratings are at 40°C.

② Starter selection is dependent on type of application. Im = FLA rating of motor.

Enclosed 3RW44



3RW44 Enclosed features:

- Available in NEMA 1, 12, 3R, 4, and 4 stainless steel
- Compact size
- Built-in bypass contactor
- Multiple starting/stopping techniques including torque control
- Internal overload class 5, 10, 15, 20, or 30
- Built-in graphical LCD keypad
- Internal self protection
- Fault monitoring
- 3 parameter sets
- Communication capable via opt. Profibus module
- Programmable inputs and outputs
- External keypad available

Ordering Information

- Enclosed devices should be ordered by the FLA of the motor.
- The 3RW44 is designed for normal starting applications.
- For factory modifications see page 7/43.
- For complete derating and application info see page 7/70.
- For dimensional drawings see page 7/95.
- For stocked versions see page 7/89.

Class 74 non-combination starters include:

- NEMA rated enclosure
- 3RW44 Sirius softstarter with built-in OL and bypass
- Circuit breaker with disconnect
- Control circuit transformer
- Reset button

Ideal applications for 3RW44 enclosed softstarters:

- Fans
- Pumps
- Conveying systems and lifts
- Hydraulics
- Machine tools
- Mills saws
- Crushers and grinders
- Mixers
- HVAC systems

The 3RW44 severe duty rating table should be applied for high inertia applications such rock crushers, chippers, screw compressors, ect.

Class 74 starters are built to UL and CSA standards.

3RW44 For High Feature Applications

Enclosed Combination with Circuit Breaker Disconnect

Rated Operating Current	MAX HP ^①				KW	Class 20 Severe Duty (350% * Im for 20s) ^②										
	200V	230V	460V	575V		380V	OPEN Style (Starter Only)	NEMA 1	List Price \$	NEMA 3R	List Price \$	NEMA 12	List Price \$	NEMA 4	List Price \$	NEMA 4/4X Stainless Steel
26	7.5	7.5	15	—	12	3RW4422-1BC34	74AT3_BFAP	74AT3_DFAP	74AT3_OFAP	74AT3_EFAP	74AT3_WFAP					
32	10	10	20	—	15	3RW4423-1BC34	74BT3_BFAP	74BT3_DFAP	74BT3_OFAP	74BT3_EFAP	74BT3_WFAP					
42	10	15	25	—	19	3RW4424-1BC34	74CT3_BFAP	74CT3_DFAP	74CT3_OFAP	74CT3_EFAP	74CT3_WFAP					
51	15	15	30	—	22	3RW4425-1BC34	74DT3_BFAP	74DT3_DFAP	74DT3_OFAP	74DT3_EFAP	74DT3_WFAP					
68	20	25	50	—	37	3RW4426-1BC34	74ET3_BFAP	74ET3_DFAP	74ET3_OFAP	74ET3_EFAP	74ET3_WFAP					
82	25	30	60	—	45	3RW4427-1BC34	74FT3_BFAP	74FT3_DFAP	74FT3_OFAP	74FT3_EFAP	74FT3_WFAP					
97	30	30	60	—	45	3RW4434-6BC34	74GT3_BFAP	74GT3_DFAP	74GT3_OFAP	74GT3_EFAP	74GT3_WFAP					
113	30	40	75	—	56	3RW4435-6BC34	74HT3_BFAP	74HT3_DFAP	74HT3_OFAP	74HT3_EFAP	74HT3_WFAP					
134	40	50	75	—	56	3RW4436-6BC34	74JT3_BFAP	74JT3_DFAP	74JT3_OFAP	74JT3_EFAP	74JT3_WFAP					
175	50	60	100	—	75	3RW4443-6BC34	74KT3_BFAP	74KT3_DFAP	74KT3_OFAP	74KT3_EFAP	74KT3_WFAP					
195	60	75	125	—	93	3RW4444-6BC34	74LT3_BFAP	74LT3_DFAP	74LT3_OFAP	74LT3_EFAP	74LT3_WFAP					
243	75	75	150	—	112	3RW4445-6BC34	74MT3_BFAP	74MT3_DFAP	74MT3_OFAP	74MT3_EFAP	74MT3_WFAP					
263	75	100	200	—	149	3RW4446-6BC34	74NT3_BFAP	74NT3_DFAP	74NT3_OFAP	74NT3_EFAP	74NT3_WFAP					
326	100	125	250	—	186	3RW4447-6BC34	74PT3_BFAP	74PT3_DFAP	74PT3_OFAP	74PT3_EFAP	74PT3_WFAP					
494	150	150	400	—	224	3RW4453-6BC34	74QT3_BFAT	74QT3_DFAT	74QT3_OFAT	74QT3_EFAT	74QT3_WFAT					
551	150	200	450	—	298	3RW4454-6BC34	74RT3_BFAT	74RT3_DFAT	74RT3_OFAT	74RT3_EFAT	74RT3_WFAT					
615	200	200	500	—	336	3RW4455-6BC34	74ST3_BFAT	74ST3_DFAT	74ST3_OFAT	74ST3_EFAT	74ST3_WFAT					
634	200	250	500	—	373	3RW4456-6BC34	74TT3_BFAT	74TT3_DFAT	74TT3_OFAT	74TT3_EFAT	74TT3_WFAT					
650	200	250	550	—	410	3RW4457-6BC34	74WT3_BFAT	74WT3_DFAT	74WT3_OFAT	74WT3_EFAT	74WT3_WFAT					
880	300	350	700	—	522	3RW4465-6BC34	74YT3_BFAT	74YT3_DFAT	74YT3_OFAT	74YT3_EFAT	74YT3_WFAT					
940	300	350	750	—	559	3RW4466-6BC34	74ZT3_BFAT	74ZT3_DFAT	74ZT3_OFAT	74ZT3_EFAT	74ZT3_WFAT					
						200V	6		6		6		6		6	
						230V	2		2		2		2		2	
						380V	3		3		3		3		3	
						460V	4		4		4		4		4	
26	—	—	15	20	—	3RW4422-1BC35	74AT35BFAP	74AT35DFAP	74AT35OFAP	74AT35EFAP	74AT35WFAP					
32	—	—	20	25	—	3RW4423-1BC35	74BT35BFAP	74BT35DFAP	74BT35OFAP	74BT35EFAP	74BT35WFAP					
42	—	—	25	30	—	3RW4424-1BC35	74CT35BFAP	74CT35DFAP	74CT35OFAP	74CT35EFAP	74CT35WFAP					
51	—	—	30	40	—	3RW4425-1BC35	74DT35BFAP	74DT35DFAP	74DT35OFAP	74DT35EFAP	74DT35WFAP					
68	—	—	50	50	—	3RW4426-1BC35	74ET35BFAP	74ET35DFAP	74ET35OFAP	74ET35EFAP	74ET35WFAP					
82	—	—	60	75	—	3RW4427-1BC35	74FT35BFAP	74FT35DFAP	74FT35OFAP	74FT35EFAP	74FT35WFAP					
97	—	—	60	75	—	3RW4434-6BC35	74GT35BFAP	74GT35DFAP	74GT35OFAP	74GT35EFAP	74GT35WFAP					
113	—	—	75	100	—	3RW4435-6BC35	74HT35BFAP	74HT35DFAP	74HT35OFAP	74HT35EFAP	74HT35WFAP					
134	—	—	75	125	—	3RW4436-6BC35	74JT35BFAP	74JT35DFAP	74JT35OFAP	74JT35EFAP	74JT35WFAP					
175	—	—	100	150	—	3RW4443-6BC35	74KT35BFAP	74KT35DFAP	74KT35OFAP	74KT35EFAP	74KT35WFAP					
195	—	—	125	200	—	3RW4444-6BC35	74LT35BFAP	74LT35DFAP	74LT35OFAP	74LT35EFAP	74LT35WFAP					
243	—	—	150	200	—	3RW4445-6BC35	74MT35BFAP	74MT35DFAP	74MT35OFAP	74MT35EFAP	74MT35WFAP					
263	—	—	200	250	—	3RW4446-6BC35	74NT35BFAP	74NT35DFAP	74NT35OFAP	74NT35EFAP	74NT35WFAP					
326	—	—	250	300	—	3RW4447-6BC35	74PT35BFAP	74PT35DFAP	74PT35OFAP	74PT35EFAP	74PT35WFAP					
494	—	—	400	500	—	3RW4453-6BC35	74QT35BFAT	74QT35DFAT	74QT35OFAT	74QT35EFAT	74QT35WFAT					
551	—	—	450	550	—	3RW4454-6BC35	74RT35BFAT	74RT35DFAT	74RT35OFAT	74RT35EFAT	74RT35WFAT					
615	—	—	500	600	—	3RW4455-6BC35	74ST35BFAT	74ST35DFAT	74ST35OFAT	74ST35EFAT	74ST35WFAT					
693	—	—	500	650	—	3RW4456-6BC35	74TT35BFAT	74TT35DFAT	74TT35OFAT	74TT35EFAT	74TT35WFAT					
780	—	—	550	700	—	3RW4457-6BC35	74WT35BFAT	74WT35DFAT	74WT35OFAT	74WT35EFAT	74WT35WFAT					
880	—	—	700	850	—	3RW4465-6BC35	74YT35BFAT	74YT35DFAT	74YT35OFAT	74YT35EFAT	74YT35WFAT					
940	—	—	750	900	—	3RW4466-6BC35	74ZT35BFAT	74ZT35DFAT	74ZT35OFAT	74ZT35EFAT	74ZT35WFAT					

① Starter size is dependent on the nameplate Full Load Amps (FLA) rating of the motor.

HPs are for reference only. Enclosed ratings are at 40°C.

② Starter selection is dependent on type of application. Im = FLA rating of motor.

Enclosed 3RW44



3RW44 Enclosed features:

- Available in NEMA 1, 12, 3R, 4, and 4 stainless steel
- Compact size
- Built-in bypass contactor
- Multiple starting/stopping techniques including torque control
- Internal overload class 5, 10, 15, 20, or 30
- Built-in graphical LCD keypad
- Internal self protection
- Fault monitoring
- 3 parameter sets
- Communication capable via opt. Profibus module
- Programmable inputs and outputs
- External keypad available

Ordering Information

- Enclosed devices should be ordered by the FLA of the motor.
- The 3RW44 is designed for normal starting applications.
- For factory modifications see page 7/43.
- For complete derating and application info see page 7/70.
- For dimensional drawings see page 7/95.

Class 74 non-combination starters include:

- NEMA rated enclosure
- 3RW44 Sirius softstarter with built-in OL and bypass
- Fusible disconnect
- Control circuit transformer
- Reset button

Ideal applications for 3RW44 enclosed softstarters:

- Fans
- Pumps
- Conveying systems and lifts
- Hydraulics
- Machine tools
- Mills saws
- Crushers and grinders
- Mixers
- HVAC systems

The 3RW44 severe duty rating table should be applied for high inertia applications such rock crushers, chippers, screw compressors, ect.

Class 74 starters are built to UL and CSA standards.

For all technical information, please consult the 2006 Industrial Controls Catalog or contact your local sales support center.

3RW44 For High Feature Applications

Enclosed Combination with Fusible Disconnect

Rated Operating Current	MAX HP ^①				KW	Class 10 Light Duty ^② (350% * Im for 10s)										
	200V	230V	460V	575V		380V	OPEN Style (Starter Only)	NEMA 1	List Price \$	NEMA 3R	List Price \$	NEMA 12	List Price \$	NEMA 4	List Price \$	NEMA 4/4X Stainless Steel
26	7.5	7.5	15	—	12	3RW4422-1BC34	74AT3_BFAF		74AT3_DFAF		74AT3_OFAF		74AT3_EFAF		74AT3_WFAF	
32	10	10	20	—	15	3RW4423-1BC34	74BT3_BFAF		74BT3_DFAF		74BT3_OFAF		74BT3_EFAF		74BT3_WFAF	
42	10	15	25	—	19	3RW4424-1BC34	74CT3_BFAF		74CT3_DFAF		74CT3_OFAF		74CT3_EFAF		74CT3_WFAF	
51	15	15	30	—	22	3RW4425-1BC34	74DT3_BFAF		74DT3_DFAF		74DT3_OFAF		74DT3_EFAF		74DT3_WFAF	
68	20	25	50	—	37	3RW4426-1BC34	74ET3_BFAF		74ET3_DFAF		74ET3_OFAF		74ET3_EFAF		74ET3_WFAF	
82	25	30	60	—	45	3RW4427-1BC34	74FT3_BFAF		74FT3_DFAF		74FT3_OFAF		74FT3_EFAF		74FT3_WFAF	
100	30	30	75	—	56	3RW4434-6BC34	74GT3_BFAF		74GT3_DFAF		74GT3_OFAF		74GT3_EFAF		74GT3_WFAF	
117	30	40	75	—	56	3RW4435-6BC34	74HT3_BFAF		74HT3_DFAF		74HT3_OFAF		74HT3_EFAF		74HT3_WFAF	
145	40	50	100	—	75	3RW4436-6BC34	74JT3_BFAF		74JT3_DFAF		74JT3_OFAF		74JT3_EFAF		74JT3_WFAF	
180	60	60	125	—	93	3RW4443-6BC34	74KT3_BFAF		74KT3_DFAF		74KT3_OFAF		74KT3_EFAF		74KT3_WFAF	
215	60	75	150	—	112	3RW4444-6BC34	74LT3_BFAF		74LT3_DFAF		74LT3_OFAF		74LT3_EFAF		74LT3_WFAF	
280	75	100	200	—	149	3RW4445-6BC34	74MT3_BFAF		74MT3_DFAF		74MT3_OFAF		74MT3_EFAF		74MT3_WFAF	
315	100	125	250	—	186	3RW4446-6BC34	74NT3_BFAF		74NT3_DFAF		74NT3_OFAF		74NT3_EFAF		74NT3_WFAF	
385	125	150	300	—	224	3RW4447-6BC34	74PT3_BFAF		74PT3_DFAF		74PT3_OFAF		74PT3_EFAF		74PT3_WFAF	
494	150	200	400	—	298	3RW4453-6BC34	74QT3_BFAF		74QT3_DFAF		74QT3_OFAF		74QT3_EFAF		74QT3_WFAF	
551	150	200	450	—	336	3RW4454-6BC34	74RT3_BFAF		74RT3_DFAF		74RT3_OFAF		74RT3_EFAF		74RT3_WFAF	
615	200	250	500	—	373	3RW4455-6BC34	74ST3_BFAF		74ST3_DFAF		74ST3_OFAF		74ST3_EFAF		74ST3_WFAF	
693	200	250	550	—	447	3RW4456-6BC34	74TT3_BFAF		74TT3_DFAF		74TT3_OFAF		74TT3_EFAF		74TT3_WFAF	
780	200	250	600	—	447	3RW4457-6BC34	74WT3_BFAF		74WT3_DFAF		74WT3_OFAF		74WT3_EFAF		74WT3_WFAF	
						200V	6		6		6		6		6	
						230V	2		2		2		2		2	
						380V	3		3		3		3		3	
						460V	4		4		4		4		4	
26	—	—	15	20	—	3RW4422-1BC35	74AT35BFAF		74AT35DFAF		74AT35OFAF		74AT35EFAF		74AT35WFAF	
32	—	—	20	25	—	3RW4423-1BC35	74BT35BFAF		74BT35DFAF		74BT35OFAF		74BT35EFAF		74BT35WFAF	
42	—	—	25	30	—	3RW4424-1BC35	74CT35BFAF		74CT35DFAF		74CT35OFAF		74CT35EFAF		74CT35WFAF	
51	—	—	30	40	—	3RW4425-1BC35	74DT35BFAF		74DT35DFAF		74DT35OFAF		74DT35EFAF		74DT35WFAF	
68	—	—	50	50	—	3RW4426-1BC35	74ET35BFAF		74ET35DFAF		74ET35OFAF		74ET35EFAF		74ET35WFAF	
82	—	—	60	75	—	3RW4427-1BC35	74FT35BFAF		74FT35DFAF		74FT35OFAF		74FT35EFAF		74FT35WFAF	
100	—	—	75	75	—	3RW4434-6BC35	74GT35BFAF		74GT35DFAF		74GT35OFAF		74GT35EFAF		74GT35WFAF	
117	—	—	75	100	—	3RW4435-6BC35	74HT35BFAF		74HT35DFAF		74HT35OFAF		74HT35EFAF		74HT35WFAF	
145	—	—	100	125	—	3RW4436-6BC35	74JT35BFAF		74JT35DFAF		74JT35OFAF		74JT35EFAF		74JT35WFAF	
180	—	—	125	150	—	3RW4443-6BC35	74KT35BFAF		74KT35DFAF		74KT35OFAF		74KT35EFAF		74KT35WFAF	
215	—	—	150	200	—	3RW4444-6BC35	74LT35BFAF		74LT35DFAF		74LT35OFAF		74LT35EFAF		74LT35WFAF	
280	—	—	200	250	—	3RW4445-6BC35	74MT35BFAF		74MT35DFAF		74MT35OFAF		74MT35EFAF		74MT35WFAF	
315	—	—	250	300	—	3RW4446-6BC35	74NT35BFAF		74NT35DFAF		74NT35OFAF		74NT35EFAF		74NT35WFAF	
385	—	—	300	400	—	3RW4447-6BC35	74PT35BFAF		74PT35DFAF		74PT35OFAF		74PT35EFAF		74PT35WFAF	
494	—	—	400	500	—	3RW4453-6BC35	74QT35BFAF		74QT35DFAF		74QT35OFAF		74QT35EFAF		74QT35WFAF	
551	—	—	450	600	—	3RW4454-6BC35	74RT35BFAF		74RT35DFAF		74RT35OFAF		74RT35EFAF		74RT35WFAF	
615	—	—	500	700	—	3RW4455-6BC35	74ST35BFAF		74ST35DFAF		74ST35OFAF		74ST35EFAF		74ST35WFAF	
693	—	—	550	750	—	3RW4456-6BC35	74TT35BFAF		74TT35DFAF		74TT35OFAF		74TT35EFAF		74TT35WFAF	
780	—	—	600	850	—	3RW4457-6BC35	74WT35BFAF		74WT35DFAF		74WT35OFAF		74WT35EFAF		74WT35WFAF	

① Starter size is dependent on the nameplate Full Load Amps (FLA) rating of the motor. HPs are for reference only. Enclosed ratings are at 40°C.

② Starter selection is dependent on type of application. Im = FLA rating of motor.

Enclosed 3RW44



3RW44 Enclosed features:

- Available in NEMA 1, 12, 3R, 4, and 4 stainless steel
- Compact size
- Built-in bypass contactor
- Multiple starting/stopping techniques including torque control
- Internal overload class 5, 10, 15, 20, or 30
- Built-in graphical LCD keypad
- Internal self protection
- Fault monitoring
- 3 parameter sets
- Communication capable via opt. Profibus module
- Programmable inputs and outputs
- External keypad available

Ordering Information

- Enclosed devices should be ordered by the FLA of the motor.
- The 3RW44 is designed for normal starting applications.
- For factory modifications see page 7/43.
- For complete derating and application info see page 7/70.
- For dimensional drawings see page 7/95.

Class 74 non-combination starters include:

- NEMA rated enclosure
- 3RW44 Sirius softstarter with built-in OL and bypass
- Fusible disconnect
- Control circuit transformer
- Reset button

Ideal applications for 3RW44 enclosed softstarters:

- Fans
- Pumps
- Conveying systems and lifts
- Hydraulics
- Machine tools
- Mills saws
- Crushers and grinders
- Mixers
- HVAC systems

The 3RW44 severe duty rating table should be applied for high inertia applications such rock crushers, chippers, screw compressors, ect.

Class 74 starters are built to UL and CSA standards.

For all technical information, please consult the 2006 Industrial Controls Catalog or contact your local sales support center.

3RW44 For High Feature Applications
Enclosed Combination with Fusible Disconnect

Rated Operating Current	MAX HP ^①				KW	Class 20 Severe Duty (350% * Im for 20s) ^②										
	200V	230V	460V	575V		380V	OPEN Style (Starter Only)	NEMA 1	List Price \$	NEMA 3R	List Price \$	NEMA 12	List Price \$	NEMA 4	List Price \$	NEMA 4/4X Stainless Steel
26	7.5	7.5	15	—	12	3RW4422-1BC34	74AT3_BFAF		74AT3_DFAF		74AT3_OFAF		74AT3_EFAF		74AT3_WFAF	
32	10	10	20	—	15	3RW4423-1BC34	74BT3_BFAF		74BT3_DFAF		74BT3_OFAF		74BT3_EFAF		74BT3_WFAF	
42	10	15	25	—	19	3RW4424-1BC34	74CT3_BFAF		74CT3_DFAF		74CT3_OFAF		74CT3_EFAF		74CT3_WFAF	
51	15	15	30	—	22	3RW4425-1BC34	74DT3_BFAF		74DT3_DFAF		74DT3_OFAF		74DT3_EFAF		74DT3_WFAF	
68	20	25	50	—	37	3RW4426-1BC34	74ET3_BFAF		74ET3_DFAF		74ET3_OFAF		74ET3_EFAF		74ET3_WFAF	
82	25	30	60	—	45	3RW4427-1BC34	74FT3_BFAF		74FT3_DFAF		74FT3_OFAF		74FT3_EFAF		74FT3_WFAF	
97	30	30	60	—	45	3RW4434-6BC34	74GT3_BFAF		74GT3_DFAF		74GT3_OFAF		74GT3_EFAF		74GT3_WFAF	
113	30	40	75	—	56	3RW4435-6BC34	74HT3_BFAF		74HT3_DFAF		74HT3_OFAF		74HT3_EFAF		74HT3_WFAF	
134	40	50	75	—	56	3RW4436-6BC34	74JT3_BFAF		74JT3_DFAF		74JT3_OFAF		74JT3_EFAF		74JT3_WFAF	
175	50	60	100	—	75	3RW4443-6BC34	74KT3_BFAF		74KT3_DFAF		74KT3_OFAF		74KT3_EFAF		74KT3_WFAF	
195	60	75	125	—	93	3RW4444-6BC34	74LT3_BFAF		74LT3_DFAF		74LT3_OFAF		74LT3_EFAF		74LT3_WFAF	
243	75	75	150	—	112	3RW4445-6BC34	74MT3_BFAF		74MT3_DFAF		74MT3_OFAF		74MT3_EFAF		74MT3_WFAF	
263	75	100	200	—	149	3RW4446-6BC34	74NT3_BFAF		74NT3_DFAF		74NT3_OFAF		74NT3_EFAF		74NT3_WFAF	
326	100	125	250	—	186	3RW4447-6BC34	74PT3_BFAF		74PT3_DFAF		74PT3_OFAF		74PT3_EFAF		74PT3_WFAF	
494	150	150	400	—	298	3RW4453-6BC34	74QT3_BFAF		74QT3_DFAF		74QT3_OFAF		74QT3_EFAF		74QT3_WFAF	
551	150	200	450	—	336	3RW4454-6BC34	74RT3_BFAF		74RT3_DFAF		74RT3_OFAF		74RT3_EFAF		74RT3_WFAF	
615	200	200	500	—	373	3RW4455-6BC34	74ST3_BFAF		74ST3_DFAF		74ST3_OFAF		74ST3_EFAF		74ST3_WFAF	
634	200	250	500	—	373	3RW4456-6BC34	74TT3_BFAF		74TT3_DFAF		74TT3_OFAF		74TT3_EFAF		74TT3_WFAF	
650	200	250	550	—	373	3RW4457-6BC34	74WT3_BFAF		74WT3_DFAF		74WT3_OFAF		74WT3_EFAF		74WT3_WFAF	
						200V	6		6		6		6		6	
						230V	2		2		2		2		2	
						380V	3		3		3		3		3	
						460V	4		4		4		4		4	
26	—	—	15	20	—	3RW4422-1BC35	74AT35BFAF		74AT35DFAF		74AT350FAF		74AT35EFAF		74AT35WFAF	
32	—	—	20	25	—	3RW4423-1BC35	74BT35BFAF		74BT35DFAF		74BT350FAF		74BT35EFAF		74BT35WFAF	
42	—	—	25	30	—	3RW4424-1BC35	74CT35BFAF		74CT35DFAF		74CT350FAF		74CT35EFAF		74CT35WFAF	
51	—	—	30	40	—	3RW4425-1BC35	74DT35BFAF		74DT35DFAF		74DT350FAF		74DT35EFAF		74DT35WFAF	
68	—	—	50	50	—	3RW4426-1BC35	74ET35BFAF		74ET35DFAF		74ET350FAF		74ET35EFAF		74ET35WFAF	
82	—	—	60	75	—	3RW4427-1BC35	74FT35BFAF		74FT35DFAF		74FT350FAF		74FT35EFAF		74FT35WFAF	
97	—	—	60	75	—	3RW4434-6BC35	74GT35BFAF		74GT35DFAF		74GT350FAF		74GT35EFAF		74GT35WFAF	
113	—	—	75	100	—	3RW4435-6BC35	74HT35BFAF		74HT35DFAF		74HT350FAF		74HT35EFAF		74HT35WFAF	
134	—	—	75	125	—	3RW4436-6BC35	74JT35BFAF		74JT35DFAF		74JT350FAF		74JT35EFAF		74JT35WFAF	
175	—	—	100	150	—	3RW4443-6BC35	74KT35BFAF		74KT35DFAF		74KT350FAF		74KT35EFAF		74KT35WFAF	
195	—	—	125	200	—	3RW4444-6BC35	74LT35BFAF		74LT35DFAF		74LT350FAF		74LT35EFAF		74LT35WFAF	
243	—	—	150	200	—	3RW4445-6BC35	74MT35BFAF		74MT35DFAF		74MT350FAF		74MT35EFAF		74MT35WFAF	
263	—	—	200	250	—	3RW4446-6BC35	74NT35BFAF		74NT35DFAF		74NT350FAF		74NT35EFAF		74NT35WFAF	
326	—	—	250	300	—	3RW4447-6BC35	74PT35BFAF		74PT35DFAF		74PT350FAF		74PT35EFAF		74PT35WFAF	
494	—	—	400	500	—	3RW4453-6BC35	74QT35BFAF		74QT35DFAF		74QT350FAF		74QT35EFAF		74QT35WFAF	
551	—	—	450	550	—	3RW4454-6BC35	74RT35BFAF		74RT35DFAF		74RT350FAF		74RT35EFAF		74RT35WFAF	
615	—	—	500	600	—	3RW4455-6BC35	74ST35BFAF		74ST35DFAF		74ST350FAF		74ST35EFAF		74ST35WFAF	
693	—	—	550	650	—	3RW4456-6BC35	74TT35BFAF		74TT35DFAF		74TT350FAF		74TT35EFAF		74TT35WFAF	
780	—	—	600	700	—	3RW4457-6BC35	74WT35BFAF		74WT35DFAF		74WT350FAF		74WT35EFAF		74WT35WFAF	

① Starter size is dependent on the nameplate Full Load Amps (FLA) rating of the motor. HPs are for reference only. Enclosed ratings are at 40°C.

② Starter selection is dependent on type of application. Im = FLA rating of motor.

Factory Modifications

Modification Available modifications in STANDARD enclosure	3RW Version	Enclosed Style	Enclosure NEMA Type	Mod Suffix	List Price Adder \$
Push Buttons					
Start/Stop	3RW40/44	73/74	ALL	A1	
Emergency Stop	3RW40/44	73/74	ALL	ES	
Selector Switches					
Hand-Off-Auto	3RW40/44	73/74	ALL	A3	
Hand-Off-Auto w/ start pushbutton	3RW40/44	73/74	ALL	S3	
Off-On	3RW40/44	73/74	ALL	A4	
Pilot Light					
Red 'On'	3RW40/44	73/74	ALL	FA	
Green 'On'	3RW40/44	73/74	ALL	FB	
Red 'Run'	3RW40/44	73/74	ALL	FC	
Green 'Run'	3RW40/44	73/74	ALL	FD	
LED Bulb Upgrade ③	3RW40/44	73/74	ALL	FE	
Red 'Off'	3RW40/44	73/74	ALL	FJ	
Green 'Off'	3RW40/44	73/74	ALL	FK	
Amber 'Fault'	3RW40/44	73/74	ALL	FL	
White 'Control Power On'	3RW40/44	73/74	ALL	FW	
Red, 'On' Push-to-Test	3RW40/44	73/74	ALL	FS	
Green 'On' Push-to-Test	3RW40/44	73/74	ALL	FT	
Green 'Off' Push-to-Test	3RW40/44	73/74	ALL	FU	
Custom pilot light (state color and nameplate text)	3RW40/44	73/74	ALL	FZ	
Through the Door Metering					
External keypad for 3RW44	3RW44	73/74	1,12	K1	
Elapse time meter	3RW40/44	73/74	1,12 (120V)	M5	
Control Options					
Profibus Communication Module (installed-connection cable not supplied)	3RW44	73/74	ALL	P1	
Profinet Communication Module (installed-connection cable not supplied)	3RW44	73/74	ALL	P2	
Ground Lug - 1 Conductor	3RW40/44	73/74	ALL	L10	
Alarm Package (horn, light, relay & push button)	3RW40/44	73/74	1,3R,12	M7	
Electronic 8 function timing relay (.05s - 100h) 24V/100-127V supplied mounted and unwired	3RW40/44	73/74	ALL	TR	
Control Relay supplied mounted and unwired (4 pole max)	3RW40/44	73/74	ALL	R04 R22 R40	
Circuit Breaker Shunt Trip (included std in 3RW40 versions)	3RW44	74	ALL	L6	
Function identification plate w/ marking as specified	3RW40/44	73/74	ALL	N1	
Service Entrance Labeled	3RW40/44	74	ALL	N3	
Terminal Block 3 point	3RW40/44	73/74	ALL	TC3	
Terminal Block 6 point	3RW40/44	73/74	ALL	TC6	
Terminal Block 9 point	3RW40/44	73/74	ALL	TC9	
Terminal Block 12 point	3RW40/44	73/74	ALL	TC12	

Emergency HP Rated Bypass Starter	3RW Version	Class	Enclosure NEMA Type	Mod Suffix	Amp Rating (3rd character of catalog number)										
					List price Adder \$										
3RW40 new	73/74	1/12/3R/4	A12	A,B	C,D,E	FGH	J	—	—	—	—	—	—	—	—
				—	—	A	B,C	D	E,F	—	—	—	—		
	3RW44	73	1/12/3R/4	A12	A,B,C ④	D,E ④	F,G,H	J,K,L	M	N,P	Q	R,S,T,W	Y,Z ①		
					A,B,C	D,E	F,G,H	J,K,L	M	N,P	Q	R,S,T,W	Y,Z ①		

Available Modifications Requiring the MODIFIED OPTIONS Box Size (to be used with the selections ending in GA*)	3RW Version	Class	Enclosure NEMA Type	Mod Suffix	Amp Rating (3rd character of catalog number)										
					List price Adder \$										
Isolation Contactor ③	3RW40				—	—	A	B,C	D	E,F	—	—	—		
	3RW44				A,B,C	D,E	F,G,H	J,K,L	M	N,P	Q	R,S,T,W	Y,Z ①		
100 VA Extra CPT Capacity	3RW40/44	73/74	1/12/3R/4	IC											
Space Heater (120V separate control)	3RW40/44	73/74	ALL	CA											
Space Heater w/ T-stat (120V separate control)	3RW40/44	73/74	ALL	SH											
Lightning Arrestor	3RW40/44	73/74	ALL	ST											
	3RW40/44	73/74	ALL	L											

① (A) For sizes 73YT & 73ZT, mods IC & A12 are available and can have both either individually or both at the same time; (B) For sizes 74YT & 74ZT (combination w/ C/B), mods IC & A12 are only available individually (NOT both at the same time); (C) For sizes 74YT & 74ZT (combination w/ fusible disc), mods IC & A12 are NOT available individually or both.
 ② An isolation contactor is included for 3RW40 version with bypass.
 ③ An isolation contactor is standard on all 3RW40 new styles
 ④ Includes mod box price, change 8th character to G.
 ⑤ Pilot lights are transformer type as standard. For LED type bulbs, order suffix FE in addition to the standard device suffix(es). For example, to order red "ON" and green "OFF" pilot lights with LED bulbs, order FA, FK and FE.

3RW Soft Starters

3RW30 for standard applications

Overview

The SIRIUS 3RW30 soft starters reduce the motor voltage through variable phase control and increase it in ramp-like mode from a selectable starting voltage up to mains voltage. During starting, these devices limit the torque as well as the current and prevent the shocks which arise during direct starts or wye-delta starts. In this way, mechanical loads and mains voltage dips can be reliably reduced.

Soft starting reduces the stress on the connected equipment and results in lower wear and therefore longer periods of trouble-free production. The selectable start value means that the soft starters can be adjusted individually to the requirements of the application in question and unlike wye-delta starters are not restricted to two-stage starting with fixed voltage ratios.

The SIRIUS 3RW30 soft starters are characterized above all by their small space requirements. Integrated bypass contacts mean that no power loss has to be taken into the bargain at the power semiconductors (thyristors) after the motor has started up. This cuts down on heat losses, enabling a more compact design and making external bypass circuits superfluous.

Various versions of the SIRIUS 3RW30 soft starters are available:

- Standard version for fixed-speed three-phase motors, sizes S00, S0, S2 and S3, with integrated bypass contact system
- Version for fixed-speed three-phase motors in a 22.5 mm enclosure without bypass

Soft starters rated up to 75Hp (at 460 V) for standard applications in three-phase networks are available. Extremely small sizes, low power losses and simple commissioning are just three of the many advantages of this soft starter.

Function

The space required by the compact SIRIUS 3RW30 soft starter is often only about one third of that required by a contactor assembly for wye-delta starting of comparable rating. This not only saves space in the control cabinet and on the standard mounting rail but also does away completely with the wiring work needed for wye-delta starters. This is notable in particular for higher motor ratings which are only rarely available as fully wired solutions.

At the same time the number of cables from the starter to the motor is reduced from six to three. Compact dimensions, short start-up times, easy wiring and fast commissioning make themselves felt as clear-cut cost advantages.

The bypass contacts of these soft starters are protected during operation by an integrated solid-state arc quenching system. This prevents damage to the bypass contacts in the event of a fault, e. g. brief disconnection of the control voltage, mechanical shocks or life-related component defects on the coil operating mechanism or main contact spring.

The new series of devices comes with the "polarity balancing" control method, which is designed to prevent direct current components in two-phase controlled soft starters. On two-phase controlled soft starters the current resulting from superimposition of the two controlled phases flows in the uncontrolled phase. This results for physical reasons in an asymmetric distribution of the three phase currents during the motor ramp-up. This phenomenon cannot be influenced, but in most applications it is non-critical.

Controlling the power semiconductors results not only in this unbalance, however, but also in the previously mentioned direct current components which can cause severe noise generation on the motor at starting voltages of less than 50 %. The control method used for these soft starters eliminates these direct current components during the ramp-up phase and prevents the braking torque which they can cause.

It creates a motor ramp-up that is uniform in speed, torque and current rise, thus permitting a particularly gentle, two-phase starting of the motors. At the same time the acoustic quality of the starting operation comes close to the quality of a three-phase controlled soft starter. This is made possible by the on-going dynamic harmonizing and balancing of current half-waves of different polarity during the motor ramp-up. Hence the name "polarity balancing".

- Soft starting with voltage ramp; the starting voltage setting range U_s is 40 % to 100 % and the ramp time t_R can be set from 0 s to 20 s
- Integrated bypass contact system to minimize power loss
- Setting with two potentiometers
- Simple mounting and commissioning
- Mains voltages at 50/60 Hz, 200 to 480 V
- Two control voltage versions 24 V AC/DC and 110 to 230 V AC/DC
- Wide temperature range from -25 °C to +60 °C
- The built-in auxiliary contact ensures user-friendly control and possible further processing within the system ([for status graphs see page 7/54](#))

3RW Soft Starters

3RW30 for standard applications

Technical specifications

Type	3RW30 1., 3RW30 2.		3RW30 3., 3RW30 4.			
Control electronics						
Rated values	Terminal A1/A2	V	24	110 ... 230	24	110 ... 230
Rated control supply voltage		%	±20	-15/+10	±20	-15/+10
• Tolerance						
Rated control supply current		mA	< 50	6	20	< 50
• STANDBY		mA	< 100	15	< 4000	< 500
• During pick-up		mA	< 100	15	20	< 50
• ON						
Rated frequency		Hz	50/60			
• Tolerance		%	±10			
Control input						
IN			ON/OFF			
Power consumption with version		mA	Approx. 12			
• 24 V DC		mA	AC: 3/6; DC: 1.5/3			
• 110/230 V AC						
Relay outputs						
Output 1	ON	13/14	Operating indication (NO)			
Rated operational current		A	3 AC-15/AC-14 at 230 V, 1 DC-13 at 24 V			
Protection against overvoltages		A	Protection by means of varistor through contact			
Short-circuit protection			4 A gL/gG operational class; 6 A quick (fuse is not included in scope of supply)			
Operating indications						
		LEDs	DEVICE	STATE/BYPASSED/FAILURE	DEVICE	STATE/BYPASSED/FAILURE
Off			Green	Off	Green	Off
Start			Green	Green flashing	Green	Green flashing
Bypass			Green	Green	Green	Green
Error signals						
• 24 V DC:	$U < 0.75 \times U_s$ or $U > 1.25 \times U_s$		Off	Red	Off	Red
• 110 ... 230 V AC:	$U < 0.75 \times U_s$ or $U > 1.15 \times U_s$		Off	Red	Off	Red
Electrical overloading of bypass (reset by removing IN command)			Yellow	Red	--	--
Missing mains voltage, phase failure, missing load			Green	Red	Green	Red
Device fault			Red	Red	Red	Red

Type	3RW30 1. ... 3RW30 4.		Factory default
Control times and parameters			
Control times			
Closing time (with connected control voltage)	ms	< 50	
Closing time (automatic/mains contactor mode)	ms	< 300	
Mains failure bridging time			
Control supply voltage	ms	50	
Mains failure response time¹⁾			
Load circuit	ms	500	
Starting parameters			
• Starting time	s	0 ... 20	7.5
• Starting voltage	%	40 ... 100	40
Start-up detection			
		No	
Operating mode output 13/14			
Rising edge at	Start command	ON	
Falling edge at	Off command		

¹⁾ Mains failure detection only in standby state, not during operation.

3RW Soft Starters

3RW30 for standard applications

Type	3RW30 1.-.BB.4 ... 3RW30 4.-.BB.4	
Power electronics		
Rated operational voltage	V AC	200 ... 480
Tolerance	%	-15/+10
Rated frequency	Hz	50/60
Tolerance	%	±10
Uninterrupted duty at 40 °C (% of I_{θ})	%	115
Minimum load (% of I_{θ})	%	10 (at least 2 A)
Maximum cable length between soft starter and motor	m	300
Permissible installation height	m	5000 (derating from 1000, see characteristic curves); higher on request
Permissible mounting position (auxiliary fan not available)		
Permissible ambient temperature	°C	-25 ... +60; (derating from +40)
Operation	°C	-40 ... +80
Storage		
Degree of protection	IP20 for 3RW30 1. and 3RW30 2. ; IP00 for 3RW30 3. and 3RW30 4.	

Type	3RW30 13 3RW30 14 3RW30 16 3RW30 17 3RW30 18					
Power electronics						
40 °C/50 °C/60 °C						
Load rating with rated operational current I_{θ}						
• Acc. to IEC and UL/CSA ¹⁾ , for individual mounting at 40/50/60 °C, AC-53a	A	3.6/ 3.3 /3	6.5/ 6 /5.5	9/ 8 /7	12.5/ 12 /11	17.6/ 17 /14
Power loss						
• In operation after completed starting with uninterrupted rated operational current (40 °C) approx.	W	0.25	0.5	1	2	4
• During starting with 300 % I_M (40 °C)	W	6	13	20	20	29
Permissible rated motor current and starts per hour for normal starting (Class 10)						
- Rated motor current $I_M^{(2)}$, starting time 10 s	A	3.6/ 3.3 /3	6.5/ 6 /5.5	9/ 8 /7	12.5/ 12 /11	17.6/ 17 /14
- Starts per hour ³⁾	1/h	200/ 150 /70	87/ 60 /50	50	85/ 70 /60	62/ 46 /60
- Rated motor current $I_M^{(2)}$, starting time 20 s	A	3.6/ 3.3 /3	6.5/ 6 /5.5	9/ 8 /7	12.5/ 12 /11	17.6/ 17 /14
- Starts per hour ³⁾	1/h	150/ 100 /50	64/ 46 /28	35	62/ 47 /37	45/ 32 /43

¹⁾ Measurement at 60 °C according to UL/CSA not required.
²⁾ With 300 % I_M .

³⁾ For intermittent duty S4 with ON period = 30 %, $T_U = 40$ °C, stand-alone installation vertical. The quoted switching frequencies do not apply for automatic mode.

Type	3RW30 26 3RW30 27 3RW30 28			
Power electronics				
40 °C/50 °C/60 °C				
Load rating with rated operational current I_{θ}				
• Acc. to IEC and UL/CSA ¹⁾ , for individual mounting at 40/50/60 °C, AC-53a	A	25.3/ 23 /21	32.2/ 29 /26	38/ 34 /31
Power loss				
• In operation after completed starting with uninterrupted rated operational current (40 °C) approx.	W	8	13	19
• During starting with 300 % I_M (40 °C)	W	47	55	64
Permissible rated motor current and starts per hour for normal starting (Class 10)				
- Rated motor current $I_M^{(2)}$, starting time 10 s	A	25/ 23 /21	32/ 29 /26	38/ 34 /31
- Starts per hour ³⁾	1/h	23	23	19
- Rated motor current $I_M^{(2)}$, starting time 20 s	A	25/ 23 /21	32/ 29 /26	38/ 34 /31
- Starts per hour ³⁾	1/h	15	16	12

¹⁾ Measurement at 60 °C according to UL/CSA not required.
²⁾ With 300 % I_M .
³⁾ For intermittent duty S4 with ON period = 30 %, $T_U = 40$ °C, stand-alone installation vertical. The quoted switching frequencies do not apply for automatic mode.

3RW Soft Starters

3RW30 for standard applications

Type		3RW30 36	3RW30 37	3RW30 38	3RW30 46	3RW30 47
Power electronics		40 °C/50 °C/60 °C				
Load rating with rated operational current I_e						
• Acc. to IEC and UL/CSA ¹⁾ , for individual mounting at 40/50/60 °C, AC-53a						
	A	45/42/39	63/58/53	72/63/60	80/73/66	106/98/90
Power loss						
• In operation after completed starting with uninterrupted rated operational current (40 °C) approx.						
	W	6	12	15	12	21
• During starting with 300 % I_M (40 °C)						
	W	79	111	125	144	192
Permissible rated motor current and starts per hour for normal starting (Class 10)						
- Rated motor current $I_M^{(2)}$, starting time 10 s						
	A	45/42/39	63/58/53	72/63/60	80/73/66	106/98/90
- Starts per hour ³⁾						
	1/h	38	23	22	22	15
- Rated motor current $I_M^{(2)}$, starting time 20 s						
	A	45/42/39	63/58/53	72/63/60	80/73/66	106/98/90
- Starts per hour ³⁾						
	1/h	26	15	15	15	10



1) Measurement at 60 °C according to UL/CSA not required.

2) With 300 % I_M .

3) For intermittent duty S4 with ON period = 30 %, $T_U = 40$ °C, stand-alone installation vertical. The quoted switching frequencies do not apply for automatic mode.

3RW Soft Starters

3RW30 for standard applications

Soft starters	Type		3RW30 1.	3RW30 2.	3RW30 3.	3RW30 4.
Conductor cross-sections						
Screw terminals						
Front clamping point connected						
	• Solid	mm ²	2 x (1 ... 2.5); 2 x (2.5 ... 6) acc. to IEC 60947	2 x (1 ... 2.5); 2 x (2.5 ... 6) acc. to IEC 60947; max. 1 x 10	2 x (1.5 ... 16)	2 x (2.5 ... 16)
	• Finely stranded with end sleeve	mm ²	2 x (1.5 ... 2.5); 2 x (2.5 ... 6)	2 x (1 ... 2.5); 2 x (2.5 ... 6)	1 x (0.75 ... 25)	1 x (2.5 ... 35)
	• Stranded	mm ²	--	--	1 x (0.75 ... 35)	1 x (4 ... 70)
	• AWG cables - Solid - Solid or stranded - Stranded	AWG	2 x (16 ... 12) 2 x (14 ... 10) 1 x 8	2 x (16 ... 12) 2 x (14 ... 10) 1 x 8	1 x (18 ... 2) --	1 x (10 ... 2/0) --
	• Solid	mm ²	--	--	2 x (1.5 ... 16)	2 x (2.5 ... 16)
	• Finely stranded with end sleeve	mm ²	--	--	1 x (1.5 ... 25)	1 x (2.5 ... 50)
	• Stranded	mm ²	--	--	1 x (1.5 ... 35)	1 x (10 ... 70)
	• AWG cables - Solid or stranded	AWG	--	--	1 x (16 ... 2)	1 x (10 ... 2/0)
	• Solid	mm ²	--	--	2 x (1.5 ... 16)	2 x (2.5 ... 16)
	• Stranded	mm ²	--	--	2 x (1.5 ... 25)	2 x (10 ... 50)
	• Finely stranded with end sleeve	mm ²	--	--	2 x (1.5 ... 16)	2 x (2.5 ... 35)
	• AWG cables - Solid or stranded	AWG	--	--	2 x (16 ... 2)	2 x (10 ... 1/0)
	• Tightening torque	NM lb.in	2 ... 2.5 18 ... 22	2 ... 2.5 18 ... 22	4.5 40	6.5 58
	Tools		PZ 2	PZ 2	PZ 2	Allen screw 4 mm
	Degree of protection		IP20	IP20	IP20 (IP00 terminal compartment)	IP20 (IP00 terminal compartment)
Spring-type terminals						
Main conductors						
	• Solid	mm ²	1 ... 4	1 ... 10	--	--
	• Finely stranded with end sleeve	mm ²	1 ... 2.5	1 ... 6, end sleeves without plastic collar	--	--
	• AWG cables - Solid or stranded (finely stranded) - Stranded	AWG	16 ... 14 16 ... 12	16 ... 10 1 x 8	-- --	-- --
	Tools		DIN ISO 2380-1A0; 5 x 3	DIN ISO 2380-1A0; 5 x 3	--	--
	Degree of protection		IP20	IP20	--	--
Busbar connections						
Main conductors						
	• With cable lug acc. to DIN 46234 or max. 20 mm wide					
	- Stranded	mm ²	--	--	--	2 x (10 ... 70)
	- Finely stranded	mm ²	--	--	--	2 x (10 ... 50)
	• AWG cables, solid or stranded	AWG	--	--	--	2 x (7 ... 1/0)

Soft starters	Type		3RW30 1. ... 3RW30 4.			
Conductor cross-sections						
Auxiliary conductors (1 or 2 conductors can be connected):						
Screw terminals						
	• Solid	mm ²	2 x (0.5 ... 2.5)			
	• Finely stranded with end sleeve	mm ²	2 x (0.5 ... 1.5)			
	• AWG cables - Solid or stranded - Finely stranded with end sleeve	AWG	2 x (20 ... 14) 2 x (20 ... 16)			
	• Terminal screws - Tightening torque	NM lb.in	0.8 ... 1.2 7 ... 10.3			
Spring-type terminals						
	• Solid	mm ²	2 x (0.25 ... 2.5)			
	• Finely stranded with end sleeve	mm ²	2 x (0.25 ... 1.5)			
	• AWG cables, solid or stranded	AWG	2 x (24 ... 14)			

3RW Soft Starters

3RW30 for standard applications

Type		3RW30 03
Control electronics		
Rated values		
Rated control supply voltage	V	24 ... 230 AC/DC
• Tolerance	%	± 10
Rated control supply current	mA	25 ... 4
Rated frequency at AC	Hz	50/60
• Tolerance	%	± 10
Starting time	s	0.1 ... 20 (adjustable)
Starting voltage	%	40 ... 100 (adjustable)
Ramp-down time	s	0 ... 20 (adjustable)
Power electronics		
Rated operational voltage	V AC	200 ... 400
Tolerance	%	± 10
Rated frequency	Hz	50/60
Tolerance	%	± 10
Uninterrupted duty (% of I_e)	%	100
Minimum load¹⁾ (% of I_e); at 40 °C	%	9
Maximum conductor length between soft starter and motor	m	100 ²⁾
Degree of protection acc. to IEC 60529		IP20 (IP00 terminal compartment)
Permissible installation height	m	5000 (derating from 1000, see characteristic curves); higher on request
Permissible mounting position		
Permissible ambient temperature		
Operation	°C	-25 ... +60; (derating from +40)
Storage	°C	-40 ... +80
Load rating with rated operational current I_e		
• Acc. to IEC and UL/CSA ¹⁾ , for individual mounting, AC-53a		
- At 40 °C	A	3
- At 50 °C	A	2.6
- At 60 °C	A	2.2
• Acc. to IEC and UL/CSA ¹⁾ , for butt-mounting, AC-53a		
- At 40 °C	A	2.6
- At 50 °C	A	2.2
- At 60 °C	A	1.8
Power loss		
• In operation after completed starting with uninterrupted rated operational current (40 °C) approx.	W	6.5
• At utilization of max. switching frequency	W	3
Permissible starts per hour		
• For intermittent duty S4, $T_u = 40$ °C, stand-alone installation vertical	1/h	1500
• ON period = 70 %	% I_e /s	300/0.2
Conductor cross-sections		
Screw terminals (1 or 2 conductors connectable) For standard screwdriver size 2 and Pozidriv 2		
• Main conductors		
- Solid	mm ²	1 x (0.5 ... 4); 2 x (0.5 ... 2.5)
- Finely stranded with end sleeve	mm ²	1 x (0.5 ... 2.5); 2 x (0.5 ... 1.5)
- Stranded	mm ²	-
- AWG cables, solid or stranded	AWG	2 x (20 ... 14)
- Terminal screws		M3, PZ2
- Tightening torque	NM lb.in	0.8 ... 1.2 7.1 ... 8.9
• Auxiliary conductors		
- Solid	mm ²	1 x (0.5 ... 4); 2 x (0.5 ... 2.5)
- Finely stranded with end sleeve	mm ²	1 x (0.5 ... 2.5); 2 x (0.5 ... 1.5)
- AWG cables, solid or stranded	AWG	2 x (20 ... 14)
- Terminal screws		M3, PZ2
- Tightening torque	NM lb.in	0.8 ... 1.2 7 ... 8.9
Spring-type terminals		
Main and auxiliary conductors		
• Solid	mm ²	2 x (0.25 ... 1.5)
• Finely stranded with end sleeve	mm ²	2 x (0.25 ... 1)
• AWG cables, solid or stranded	mm ²	2 x (24 ... 16)

¹⁾ The rated motor current (specified on the motor's name plate) should at least amount to the specified percentage of the SIRIUS soft starter unit's rated operational current I_e .

²⁾ If this value is exceeded, problems with line capacities may arise, which can result in false firing.

3RW Soft Starters

3RW30 for standard applications

	Standard	Parameters
Electromagnetic compatibility Acc. to EN 60947-4-2		
<i>EMC interference immunity</i>		
Electrostatic discharge (ESD)	EN 61000-4-2	±4 kV contact discharge, ±8 kV air discharge
Electromagnetic RF fields	EN 61000-4-3	Frequency range: 80 ... 2000 MHz with 80 % at 1 kHz Degree of severity 3: 10 V/m
Conducted RF interference	EN 61000-4-6	Frequency range: 150 kHz ... 80 MHz with 80 % at 1 kHz Interference 10 V
RF voltages and RF currents on cables		
• Burst	EN 61000-4-4	±2 kV/5 kHz
• Surge	EN 61000-4-5	±1 kV line to line ±2 kV line to earth
<i>EMC interference emission</i>		
EMC interference field strength	EN 55011	Limit value of Class A at 30 ... 1000 MHz, limit value of Class B for 3RW30 2.; 24 V AC/DC
Radio interference voltage	EN 55011	Limit value of Class A at 0.15 ... 30 MHz, limit value of Class B for 3RW30 2.; 24 V AC/DC
<i>Radio interference suppression filters</i>		
Degree of noise suppression A (industrial applications)	Not required	
Degree of noise suppression B (applications for residential areas) Control voltage	Not available ¹⁾	
• 230 V AC/DC	Not required for 3RW30 1. and 3RW30 2.;	
• 24 V AC/DC	required for 3RW30 3. and 3RW30 4. (see Table)	

¹⁾ Degree of noise suppression B cannot be obtained through the use of filters as the strength of the electromagnetic field is not attenuated by the filter.

Soft starter type	Rated current Soft starters A	Recommended filters ¹⁾		
		Voltage range 200 ... 480 V		
		Filter type	Rated current filters A	Terminals mm ²
3RW30 36	45	4EF1512-1AA10	50	16
3RW30 37	63	4EF1512-2AA10	66	25
3RW30 38	72	4EF1512-3AA10	90	25
3RW30 46	80	4EF1512-3AA10	90	25
3RW30 47	106	4EF1512-4AA10	120	50

¹⁾ The radio interference suppression filter is used to remove the conducted interference from the main circuit. The field-related emissions comply with degree of noise suppression B. Filter selection applies under standard conditions: 10 starts per hour, start time 4 s at 300 % I_N .

Type Number	Max. Fuse Class K5, RK5, RK1	Max. Fuse Class J	Short Voltage Circuit	Voltage
<i>Standard short circuit ratings 3RW30</i>				
3RW30 13	--	15 A	5 kA	480 V
3RW30 14	--	25 A	5 kA	480 V
3RW30 16	--	36 A	5 kA	480 V
3RW30 17	--	50 A	5 kA	480 V
3RW30 18	--	60 A	5 kA	480 V
3RW30 26	100 A	100 A	5 kA	480 V
3RW30 27	125 A	125 A	5 kA	480 V
3RW30 28	125 A	125 A	5 kA	480 V
3RW30 36	175 A	175 A	10 kA	480 V
3RW30 37	250 A	250 A	10 kA	480 V
3RW30 38	250 A	250 A	10 kA	480 V
3RW30 46	--	300 A	10 kA	480 V
3RW30 47	--	350 A	10 kA	480 V
<i>High capacity short circuit ratings 3RW30</i>				
3RW30 13	--	15 A	42 kA	480 V
3RW30 14	--	25 A	42 kA	480 V
3RW30 16	--	25 A	42 kA	480 V
3RW30 17	--	25 A	42 kA	480 V
3RW30 18	--	25 A	42 kA	480 V
3RW30 26	60 A	100 A	42 kA	480 V
3RW30 27	60 A	125 A	42 kA	480 V
3RW30 28	60 A	125 A	42 kA	480 V
3RW30 36	100 A	175 A	30 kA	480 V
3RW30 37	100 A	200 A	30 kA	480 V
3RW30 38	100 A	200 A	30 kA	480 V
3RW30 46	110 A	200 A	42 kA	480 V
3RW30 47	110 A	200 A	42 kA	480 V

For solid-state motor controller, Type 3RW301: Applicable in an enclosure with minimum overall dimensions of 200 by 120 by 200 mm.
 For solid-state motor controller, Type 3RW302: Applicable in an enclosure with minimum overall dimensions of 370 by 175 by 195 mm.
 For solid-state motor controller, Type 3RW303: Applicable in an enclosure with minimum overall dimensions of 450 by 220 by 235 mm.
 For solid-state motor controller, Type 3RW304: Applicable in an enclosure with minimum overall dimensions of 450 by 220 by 235 mm.

3RW Soft Starters

3RW30 for standard applications

Fuse assignment

The type of coordination to which the motor feeder with soft starter is mounted depends on the application-specific requirements. Normally, fuseless mounting (combination of motor starter protector/circuit breaker and soft starter) is sufficient.

If type of coordination "2" is to be fulfilled, semiconductor fuses must be fitted in the motor feeder.

Fused version (line protection only)

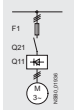

Soft starters TOC 1 Q11 Type	Rated current A	Line protection, maximum		Size	Line contactors (optional) Q21
		F1 Type	Rated current A		
Type of coordination "1"¹⁾: $I_q = 65 \text{ kA at } 480 \text{ V } 10 \%$					
3RW30 03 ²⁾	3	3NA3 805 ³⁾	20	000	3RT10 15
3RW30 13	3.6	3NA3 803-6	10	000	3RT10 15
3RW30 14	6.5	3NA3 805-6	16	000	3RT10 15
3RW30 16	9	3NA3 807-6	20	000	3RT10 16
3RW30 17	12.5	3NA3 810-6	25	000	3RT10 24
3RW30 18	17.6	3NA3 814-6	35	000	3RT10 26
3RW30 26	25	3NA3 822-6	63	00	3RT10 26
3RW30 27	32	3NA3 824-6	80	00	3RT10 34
3RW30 28	38	3NA3 824-6	80	00	3RT10 35
3RW30 36	45	3NA3 130-6	100	1	3RT10 36
3RW30 37	63	3NA3 132-6	125	1	3RT10 44
3RW30 38	72	3NA3 132-6	125	1	3RT10 45
3RW30 46	80	3NA3 136-6	160	1	3RT10 45
3RW30 47	106	3NA3 136-6	160	1	3RT10 46

¹⁾ The types of coordination are explained in more detail under "3RA1 Fuseless Load Feeders".

The type of coordination "1" refers only to soft starters in combination with the stipulated protective device (motor starter protector/circuit breaker/fuse), not to any additional components in the feeder.

²⁾ $I_q = 50 \text{ kA at } 400 \text{ V}$.

³⁾ 3NA3 805-1 (LV HRC00), 5SB2 61 (DIAZED), 5SE2 201-6 (NEOZED)

Fused version with 3NE1 SITOR fuses (semiconductor and line protection)

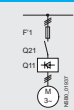

For matching fuse bases see Catalog LV 1 under "SENTRON Switching and Protection Devices for Power Distribution" —> "Switch Disconnectors", and Catalog ET B1 under "BETA Protecting" —> "SITOR Semiconductor Fuses" or go to www.siemens.com/sitor —> "Products" —> "BETA Protecting" —> "SITOR"

Soft starters TOC 2 Q11 Type	Rated current A	All-range fuses		Size	Line contactors (optional) Q21
		F1 Type	Rated current A		
Type of coordination "2"¹⁾: $I_q = 65 \text{ kA at } 480 \text{ V } 10 \%$					
3RW30 03 ²⁾	3	3NE1 813-0 ³⁾	16	000	3RT10 15
3RW30 13	3.6	3NE1 813-0	16	000	3RT10 15
3RW30 14	6.5	3NE1 813-0	16	000	3RT10 15
3RW30 16	9	3NE1 813-0	16	000	3RT10 16
3RW30 17	12.5	3NE1 813-0	16	000	3RT10 24
3RW30 18	17.6	3NE1 814-0	20	000	3RT10 26
3RW30 26	25	3NE1 803-0	35	000	3RT10 26
3RW30 27	32	3NE1 020-2	80	00	3RT10 34
3RW30 28	38	3NE1 020-2	80	00	3RT10 35
3RW30 36	45	3NE1 020-2	80	00	3RT10 36
3RW30 37	63	3NE1 820-0	80	000	3RT10 44
3RW30 38	72	3NE1 820-0	80	000	3RT10 45
3RW30 46	80	3NE1 021-0	100	00	3RT10 45
3RW30 47	106	3NE1 022-0	125	00	3RT10 46

¹⁾ The types of coordination are explained in more detail under "3RA1 Fuseless Load Feeders".

The type of coordination "2" refers only to soft starters in combination with the stipulated protective device (motor starter protector/circuit breaker/fuse), not to any additional components in the feeder.

²⁾ $I_q = 50 \text{ kA at } 400 \text{ V}$.

³⁾ No SITOR fuse required!
Alternatively: 3NA3 803 (LV HRC00), 5SB2 21 (DIAZED), 5SE2 206 (NEOZED).

TOC 1	Type of coordination "1"
TOC 2	Type of coordination "2"
The types of coordination are explained in more detail under "3RA1 Fuseless Load Feeders".	
These types of coordination are indicated in the Technical specifications by gray backgrounds.	

3RW Soft Starters

3RW30 for standard applications

Fused version with 3NE3 SITOR fuses (semiconductor protection by fuse, line and overload protection by motor starter protector; alternatively, installation with contactor and overload relay possible)

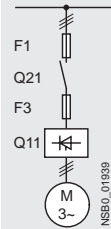
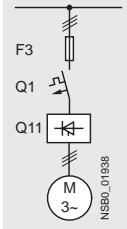

For matching fuse bases see Catalog LV 1 under "SENTRON Switching and Protection Devices for Power Distribution" → "Switch Disconnectors", and Catalog ET B1 under "BETA Protecting" → "SITOR Semiconductor Fuses" or go to www.siemens.com/sitor → "Products" → "BETA Protecting" → "SITOR"

Soft starters Toc 2 Q11 Type	Rated current A	Semiconductor fuses, minimum			Semiconductor fuses, maximum			Semiconductor fuses, minimum		
		F3 Type	Rated current A	Size	F3 Type	Rated current A	Size	F3 Type	Rated current A	Size
Type of coordination "2"¹⁾: I_q = 65 kA at 480 V 10 %										
3RW30 03 ²⁾	3	--	--	--	--	--	--	--	--	--
3RW30 13	3.6	--	--	--	--	--	--	3NE4 101	32	0
3RW30 14	6.5	--	--	--	--	--	--	3NE4 101	32	0
3RW30 16	9	--	--	--	--	--	--	3NE4 101	32	0
3RW30 17	12.5	--	--	--	--	--	--	3NE4 101	32	0
3RW30 18	17.6	--	--	--	3NE3 221	100	1	3NE4 101	32	0
3RW30 26	25	--	--	--	3NE3 221	100	1	3NE4 102	40	0
3RW30 27	32	--	--	--	3NE3 222	125	1	3NE4 118	63	0
3RW30 28	38	--	--	--	3NE3 222	125	1	3NE4 118	63	0
3RW30 36	45	--	--	--	3NE3 224	160	1	3NE4 120	80	0
3RW30 37	63	--	--	--	3NE3 225	200	1	3NE4 121	100	0
3RW30 38	72	3NE3 221	100	1	3NE3 227	250	1	--	--	--
3RW30 46	80	3NE3 222	125	1	3NE3 225	200	1	--	--	--
3RW30 47	106	3NE3 224	160	1	3NE3 231	350	1	--	--	--

Soft starters Toc 2 Q11 Type	Rated current A	Semiconductor fuses max.			Semiconductor fuses min.			Semiconductor fuses max.			Cylindrical fuses	
		F3 Type	Rated current A	Size	F3 Type	Rated current A	Size	F3 Type	Rated current A	Size	F3 Type	Rated current A
Type of coordination "2"¹⁾: I_q = 65 kA at 480 V 10 %												
3RW30 03 ²⁾	3	--	--	--	3NE8 015-1	25	00	3NE8 015-1	25	00	3NC1 010	10
3RW30 13	3.6	--	--	--	3NE8 015-1	25	00	3NE8 015-1	25	00	3NC2 220	20
3RW30 14	6.5	--	--	--	3NE8 015-1	25	00	3NE8 015-1	25	00	3NC2 220	20
3RW30 16	9	--	--	--	3NE8 015-1	25	00	3NE8 015-1	25	00	3NC2 220	20
3RW30 17	12.5	--	--	--	3NE8 015-1	25	00	3NE8 018-1	63	00	3NC2 250	50
3RW30 18	17.6	--	--	--	3NE8 003-1	35	00	3NE8 021-1	100	00	3NC2 263	63
3RW30 26	25	3NE4 117	50	0	3NE8 017-1	50	00	3NE8 021-1	100	00	3NC2 263	63
3RW30 27	32	3NE4 118	63	0	3NE8 018-1	63	00	3NE8 022-1	125	00	3NC2 280	80
3RW30 28	38	3NE4 118	63	0	3NE8 020-1	80	00	3NE8 022-1	125	00	3NC2 280	80
3RW30 36	45	3NE4 120	80	0	3NE8 020-1	80	00	3NE8 024-1	160	00	3NC2 280	80
3RW30 37	63	3NE4 121	100	0	3NE8 021-1	100	00	3NE8 024-1	160	--	--	--
3RW30 38	72	--	--	--	3NE8 022-1	125	00	3NE8 024-1	160	00	--	--
3RW30 46	80	--	--	--	3NE8 022-1	125	00	3NE8 024-1	160	00	--	--
3RW30 47	106	--	--	--	3NE8 024-1	160	00	3NE8 024-1	160	00	--	--

Soft starters Toc 2 Q11 Type	Rated current A	Line contactors (optional)		Motor starter protectors 400 V +10 %		Line protection, maximum		
		Q21	Q1 Type	Rated current A	F1 Type	Rated current A	Size	Size
Type of coordination "2"¹⁾: I_q = 65 kA at 480 V 10 %								
3RW30 03 ²⁾	3	3RT10 15	3RV10 11-1EA10	4	3NA3 805 ³⁾	20	000	
3RW30 13	3.6	3RT10 15	3RV10 21-1FA10	5	3NA3 803-6	16	000	
3RW30 14	6.5	3RT10 15	3RV10 21-1HA10	8	3NA3 805-6	16	000	
3RW30 16	9	3RT10 16	3RV10 21-1JA10	10	3NA3 807-6	20	000	
3RW30 17	12.5	3RT10 24	3RV10 21-1KA10	12.5	3NA3 810-6	25	000	
3RW30 18	17.6	3RT10 26	3RV10 21-1BA10	20	3NA3 814-6	35	000	
3RW30 26	25	3RT10 26	3RV10 31-4DA10	25	3NA3 822-6	63	00	
3RW30 27	32	3RT10 34	3RV10 31-4EA10	32	3NA3 824-6	80	00	
3RW30 28	38	3RT10 35	3RV10 31-4FA10	40	3NA3 824-6	80	00	
3RW30 36	45	3RT10 36	3RV10 31-4GA10	45	3NA3 130-6	100	1	
3RW30 37	63	3RT10 44	3RV10 41-4JA10	63	3NA3 132-6	125	1	
3RW30 38	72	3RT10 45	3RV10 41-4KA10	75	3NA3 132-6	125	1	
3RW30 46	80	3RT10 45	3RV10 41-4LA10	90	3NA3 136-6	160	1	
3RW30 47	106	3RT10 46	3RV10 41-4MA10	100	3NA3 136-6	160	1	

¹⁾ The types of coordination are explained under "3RA1 Fuseless Load Feeders". The type of coordination "2" refers only to soft starters in combination with the stipulated protective device (motor starter protector/circuit breaker/fuse), not to any additional components in the feeder.
²⁾ I_q = 50 kA at 400 V.
³⁾ 3NA3 805-1 (LV HRC00), 5SB2 61 (DIAZED).

3RW Soft Starters

3RW30 for standard applications

Characteristic curves

Permissible installation height

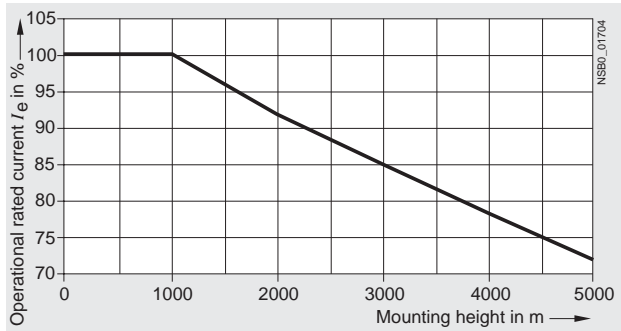

At an installation height above 2000 m, the max. permissible operational voltage is reduced to 460 V.

More information

Application examples for normal starting (Class 10)

Normal starting Class 10 (up to 20 s with 300 % $I_{n \text{ motor}}$).
 The soft starter rating can be selected to be as high as the rating of the motor used

Application	Conveyor belt	Roller conveyor	Compressor	Small fan	Pump	Hydraulic pump
Starting parameters						
• Voltage ramp and current limiting						
- Starting voltage	% 70	60	50	40	40	40
- Starting time	s 10	10	20	20	10	10

Note:
 These tables present sample set values and device sizes. They are intended only for the purposes of information and are not binding. The set values depend on the application in question and must be optimized during commissioning.
 The soft starter dimensions should be checked where necessary with the Win-Soft Starter software or with the help of Technical Assistance.

3RW Soft Starters

3RW30 for standard applications

Configuration

The 3RW solid-state motor controllers are designed for easy starting conditions. In the event of deviating conditions or increased switching frequency, it may be necessary to choose a larger device. For accurate dimensioning, use the Win-Soft Starter selection and simulation program.

If necessary, an overload relay for heavy starting must be selected where long starting times are involved. PTC sensors are recommended.

In the motor feeder between the SIRIUS 3RW soft starter and the motor, no capacitive elements are permitted (e. g. no reactive-power compensation equipment). In addition, neither static systems for reactive-power compensation nor dynamic PFC (Power Factor Correction) must be operated in parallel during starting and ramp-down of the soft starter. This is important to prevent faults arising on the compensation equipment and/or the soft starter.

All elements of the main circuit (such as fuses, controls and overload relays) should be dimensioned for direct starting, following the local short-circuit conditions. Fuses, controls and overload relays must be ordered separately. Please observe the maximum switching frequencies specified in the technical specifications.

Note:

When induction motors are switched on, voltage drops occur as a rule on starters of all types (direct starters, wye-delta starters, soft starters). The infeed transformer must always be dimensioned such that the voltage dip when starting the motor remains within the permissible tolerance. If the infeed transformer is dimensioned with only a small margin, it is best for the control voltage to be supplied from a separate circuit (independently of the main voltage) in order to avoid the potential switching off of the soft starter.

Schematic circuit diagram

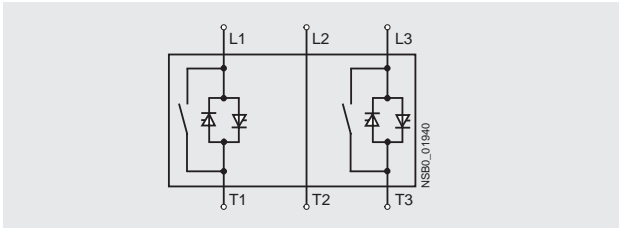

A bypass contact system is already integrated in the 3RW30 soft starter and therefore does not have to be ordered separately.

Status graphs

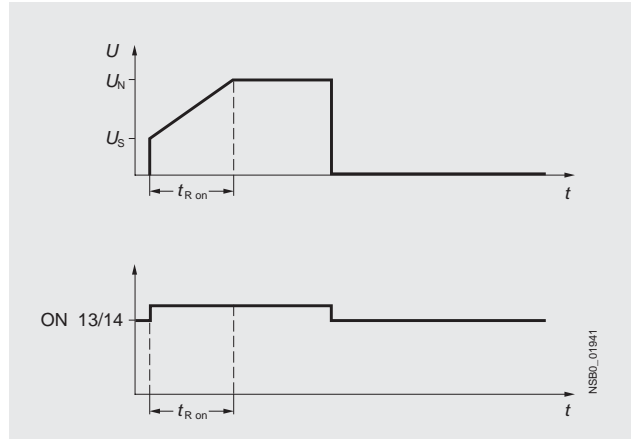

Win-Soft Starter selection and simulation program

With this software, you can simulate and select all Siemens soft starters, taking into account various parameters such as mains properties, motor and load data, and special application requirements.

The software is a valuable tool, which makes complicated, lengthy manual calculations for determining the required soft starters superfluous.

The Win-Soft Starter selection and simulation program can be downloaded from:

www.usa.siemens.com/softstarters > Software

More information can be found on the Internet at: www.usa.siemens.com/softstarters

3RW Soft Starters

3RW40 for standard applications

Overview

SIRIUS 3RW40 soft starters have all the same advantages as the 3RW30 soft starters.

The SIRIUS 3RW40 soft starters are characterized above all by their small space requirements. Integrated bypass contacts mean that no power loss has to be taken into the bargain at the power semiconductors (thyristors) after the motor has started up. This cuts down on heat losses, enabling a more compact design and making external bypass circuits superfluous.

At the same time this soft starter comes with additional integrated functions such as adjustable current limiting, motor overload and intrinsic device protection, and optional thermistor motor protection. The higher the motor rating, the more important these functions become because they make it unnecessary to purchase and install protection equipment such as overload relays.

Internal intrinsic device protection prevents the thermal overloading of the thyristors and the power section defects this can cause. As an option the thyristors can also be protected by semiconductor fuses from short-circuiting.

Thanks to integrated status monitoring and fault monitoring, this compact soft starter offers many different diagnostics options. Up to four LEDs and relay outputs permit differentiated monitoring and diagnostics of the operating mechanism by indicating the operating state as well as for example mains or phase failure, missing load, non-permissible tripping time/class setting, thermal overloading or device faults.

Soft starters rated up to 300 Hp (at 460 V) for standard applications in three-phase networks are available. Extremely small sizes, low power losses and simple start-up are just three of the many advantages of the SIRIUS 3RW40 soft starters.

"Increased safety" type of protection EEx e according to ATEX directive 94/9/EC

The 3RW40 soft starter sizes S0 to S12 are suitable for the starting of explosion-proof motors with "increased safety" type of protection EEx e.

See "Appendix" -> "Standards and approvals" -> "Type overview of approved devices for potentially explosive areas (ATEX explosion protection)".

Function

The space required by the compact SIRIUS 3RW40 soft starter is often only about one third of that required by a contactor assembly for wye-delta starting of comparable rating. This not only saves space in the control cabinet and on the standard mounting rail but also does away completely with the wiring work needed for wye-delta starters. This is notable in particular for higher motor ratings which are only rarely available as fully wired solutions.

At the same time the number of cables from the starter to the motor is reduced from six to three. Compact dimensions, short start-up times, easy wiring and fast commissioning make themselves felt as clear-cut cost advantages.

The bypass contacts of these soft starters are protected during operation by an integrated solid-state arc quenching system. This prevents damage to the bypass contacts in the event of a fault, e. g. brief disconnection of the control voltage, mechanical shocks or life-related component defects on the coil operating mechanism or main contact spring.

The starting current of particularly powerful operating mechanisms can place an unjustifiable load on the local supply system. Soft starters reduce this starting current by means of their voltage ramp. Thanks to the adjustable current limiting, the SIRIUS 3RW40 soft starter takes even more pressure off the supply system. It leaves the set start ramp during the ramp-up – the ramp gradient is fixed by the starting voltage and the ramp time – as soon as the selected current limit is reached. From this moment the voltage of the soft starter is controlled so that the current supplied to the motor remains constant. This process is ended either by completion of the motor ramp-up or by tripping by the intrinsic device protection or the motor overload protection. As the result of this function the actual motor ramp-up can well take longer than the ramp time selected on the soft starter.

Thanks to the integrated motor overload protection according to IEC 60947-4-2 there is no need of an additional overload relay on the new soft starters. The rated motor current, the setting of the overload tripping time (Class times) and the reset of the motor overload protection function can be adjusted easily and quickly. Using a 4-step rotary potentiometer it is possible to set different overload tripping times on the soft starter. In addition to Class 10, 15 and 20 it is also possible to switch off the motor overload protection if a different motor management control device is to be used for this function, e. g. with connection to PROFIBUS.

Device versions with thermistor motor protection evaluation are available up to a rating of 55 kW (at 400 V). A "Thermoclick" measuring probe can be connected directly, as can a PTC of type A. Thermal overloading of the motor, open circuits and short-circuits in the sensor circuit all result in the direct disconnection of the soft starter. And if ever the soft starter trips, various reset options are available the same as with intrinsic device protection and motor load protection: manually with the reset button, automatically or remotely through brief disconnection of the control voltage.

The new series of devices comes with the "polarity balancing" control method, which is designed to prevent direct current components in two-phase controlled soft starters. On two-phase controlled soft starters the current resulting from superimposition of the two controlled phases flows in the uncontrolled phase. This results for physical reasons in an asymmetric distribution of the three phase currents during the motor ramp-up. This phenomenon cannot be influenced, but in most applications it is non-critical.

Controlling the power semiconductors results not only in this unbalance, however, but also in the previously mentioned direct current components which can cause severe noise generation on the motor at starting voltages of less than 50 %.

The control method used for these soft starters eliminates these direct current components during the ramp-up phase and prevents the braking torque which they can cause. It creates a motor ramp-up that is uniform in speed, torque and current rise, thus permitting a particularly gentle, two-phase starting of the motors. At the same time the acoustic quality of the starting operation comes close to the quality of a three-phase controlled soft starter. This is made possible by the on-going dynamic harmonizing and balancing of current half-waves of different polarity during the motor ramp-up. Hence the name "polarity balancing".

3RW Soft Starters

3RW40 for standard applications

As an option the thyristors can also be protected by SITOR semiconductor fuses from short-circuiting so that the soft starter is still functional after a short-circuit (type of coordination 2). Three LEDs are used to indicate the operating state as well as possible errors, e. g. non-permissible tripping time (CLASS setting), mains or phase failure, missing load, thermal overloading or device faults.

- Soft starting with voltage ramp; the starting voltage setting range U_s is 40 to 100 % and the ramp time t_R can be set from 0 to 20 s.³⁾
- Smooth ramp-down with voltage ramp; the running down time t_{off} can be set between 0 s to 20 s.³⁾
- Solid-state motor overload and intrinsic device protection
- Optional thermistor motor protection (up to size S3)
- Remote reset (integrated up to size S3, optional for size S6 and larger)
- Adjustable current limiting

- Integrated bypass contact system to minimize power loss
- Setting with potentiometers
- Simple mounting and commissioning
- Integrated status monitoring and fault monitoring
- Mains voltages 50/60 Hz, 200 to 600 V
- Various control voltage versions
 - Sizes S0 to S3: 24 V AC/DC and 110 to 230 V AC/DC
 - Sizes S6 to S12: 115 V AC and 230 V AC.
 Control by way of the internal 24 V DC supply and direct control by means of PLC are possible.
- Wide temperature range from -25 to +60 °C
- Built-in auxiliary contacts ensure user-friendly control and possible further processing within the system (for status graphs see page 7/69)

Technical specifications

Type	3RW40 2.		3RW40 3., 3RW40 4.			
Control electronics						
Rated values	Terminal A1/A2	V	24 ±20	110 ... 230 -15/+10	24 ±20	110 ... 230 -15/+10
Rated control supply voltage		%				
• Tolerance						
Rated control supply current		mA	< 150	< 50	< 200	< 50
• STANDBY		mA	< 200	< 100	< 5000	< 1500
• During pick-up		mA	< 250	< 50	< 200	< 50
• ON without fan		mA	< 300	< 70	< 250	< 70
• ON with fan		mA				
Rated frequency		Hz	50/60			
• Tolerance		%	±10			
Control inputs						
IN			ON/OFF			
Rated operational current		mA	Approx. 12	3/6	Approx. 12	3/6
• AC		mA	Approx. 12	1.5/3	Approx. 12	1.5/3
• DC		mA				
Relay outputs						
Output 1	ON/RUN mode ¹⁾	13/14	Operating indication (NO)			
Output 2	BYPASSED	23/24	Bypass indication (NO)			
Output 3	OVERLOAD/FAILURE	95/96/98	Overload/error indication (NC/NO)			
Rated operational current		A	3 AC-15/AC-14 at 230 V, 1 DC-13 at 24 V			
Protection against overvoltages		A	Protection by means of varistor through contact			
Short-circuit protection			4 A gL/gG operational class; 6 A quick (fuse is not included in scope of supply)			

¹⁾ Factory default: ON mode.

Type	3RW40 5.		3RW40 7.			
Control electronics						
Rated values	Terminal A1/A2	V AC	115 -15/+10	230	115 -15/+10	230
Rated control supply voltage		%				
• Tolerance						
Rated control supply current STANDBY		mA	15		15	
Rated control supply current ON ¹⁾		mA	440	200	660	360
Rated frequency		Hz	50/60		50/60	
• Tolerance		%	±10		±10	
Control inputs						
IN			ON/OFF			
Rated operational current		mA	Approx. 10 acc. to DIN 19240			
Rated operational voltage		V DC	24 from internal supply dc+ or external DC supply (acc. to DIN 19240) through terminals and IN			
Relay outputs						
Output 1	ON/RUN mode ²⁾	13/14	Operating indication (NO)			
Output 2	BYPASSED	23/24	Bypass indication (NO)			
Output 3	OVERLOAD/FAILURE	95/96/98	Overload/error indication (NC/NO)			
Rated operational current		A	3 AC-15/AC-14 at 230 V, 1 DC-13 at 24 V			
Protection against overvoltages		A	Protection by means of varistor through contact			
Short-circuit protection			4 A gL/gG operational class; 6 A quick (fuse is not included in scope of supply)			

¹⁾ Values for the coil power consumption at +10 % U_n , 50 Hz.

²⁾ Factory default: ON mode.

³⁾ Actual motor start times are load dependent.

3RW Soft Starters

3RW40 for standard applications

Type	3RW40 2., 3RW40 3., 3RW40 4.				
Control electronics					
Operating indications	LEDs	DEVICE	STATE/BYPASSED/FAILURE	OVERLOAD	
Off		Green	Off	Off	
Start		Green	Green flashing	Off	
Bypass		Green	Green	Off	
Ramp-down		Green	Green flashing	Off	
Alarm signals					
I_e /Class setting not permissible		Green	Not relevant	Red flashing	
Start inhibited/thyristors too hot		Yellow flashing	Not relevant	Off	
Error signals					
• 24 V: $U < 0.75 \times U_s$ or $U > 1.25 \times U_s$		Off	Red	Off	
• 110 ... 230 V: $U < 0.75 \times U_s$ or $U > 1.15 \times U_s$		Off	Red	Off	
Non-permissible I_e /Class setting for edge 0 → 1 on input IN		Green	Red	Red flashing	
Motor protection shut-down (overload thermistor)		Green	Off	Red	
Thermistor defective (open circuit, short-circuit)		Green	Off	Red flickering	
Thermal overloading of the thyristors		Yellow	Red	Off	
Missing mains voltage, phase failure, missing load		Green	Red	Off	
Device fault		Red	Red	Off	
Type	3RW40 5. and 3RW40 7.				
Control electronics					
Operating indications	LEDs	DEVICE	STATE/BYPASSED	FAILURE	OVERLOAD
Off		Green	Off	Off	Off
Start		Green	Green flashing	Off	Off
Bypass		Green	Green	Off	Off
Ramp-down		Green	Green flashing	Off	Off
Alarm signals					
I_e /Class setting not permissible		Green	Not relevant	Not relevant	Red flashing
Start inhibited/thyristors too hot		Yellow flashing	Not relevant	Not relevant	Off
Error signals					
$U < 0.75 \times U_s$ or $U > 1.15 \times U_s$		Off	Off	Red	Off
Non-permissible I_e /Class setting for edge 0 → 1 on input IN		Green	Off	Red	Red flashing
Motor protection shut-down		Green	Off	Off	Red
Thermal overloading of the thyristors		Yellow	Off	Red	Off
Missing mains voltage, phase failure, missing load		Green	Off	Red	Off
Device fault		Red	Off	Red	Off

3RW Soft Starters

Type	3RW40 ..			Factory default
Protection functions				
Motor protection functions				
Trips in the event of		Thermal overloading of the motor		
Trip class to IEC 60947-4-1	Class	10/15/20		10
Phase failure sensitivity	%	> 40		
Overload warning		No		
Thermistor protection acc. to IEC 60947-8, type A/IEC 60947-5-1		Yes ¹⁾		
Reset option after tripping		Manual/automatic/remote reset ²⁾		
		(MAN/AUTO/REMOTE ²⁾)		
Recovery time	min	5		
Device protection functions				
Trips in the event of		Thermal overloading of the thyristors or bypass ³⁾		
Reset option after tripping		Manual/automatic/remote reset ²⁾		
		(MAN/AUTO/REMOTE ²⁾)		
Recovery time				
• During overloading of the thyristors	s	30		
• During overloading of the bypass	s	60		
Control times and parameters				
Control times				
Closing time (with connected control voltage)	ms	< 50		
Closing time (automatic/mains contactor mode)	ms	<300		
Recovery time (closing command in active ramp-down)	ms	100		
Mains failure bridging time				
Control supply voltage	ms	50		
Mains failure response time				
Load circuit	ms	500		
Reclosing lockout after overload trip				
Motor protection trip	min	5		
Device protection trip				
• During overloading of the thyristors	s	30		
• During overloading of the bypass	s	60		
Starting parameters				
Starting time	s	0 ... 20		7.5
Starting voltage	%	40 ... 100		40
Starting current limit		1.3 ... 5 x I _e		5 x I _e
Ramp-down parameters				
Ramp-down time	s	0 ... 20		0
Reset mode parameters (for motor/device protection shut-down)				
Manual reset	LEDs	Off		Off
Automatic reset	LEDs	Yellow		
Remote reset (REMOTE) ²⁾	LEDs	Green		
Start-up detection				
		Yes		
Operating mode output 13/14				
Rising edge at	Start command			
Falling edge at	Off command			
	Ramp-down end	ON		ON
		RUN		

¹⁾ Optional up to size S3 (device variant).

²⁾ Integrated remote reset (REMOTE) available only for 3RW40 2. to 3RW40 4.; remote reset with 3RU19 accessory module available for 3RW40 5. and 3RW40 7..

³⁾ Bypass protection up to size S3.

3RW Soft Starters

3RW40 for standard applications

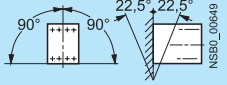
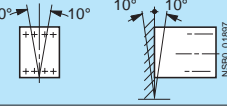
Type		3RW40 2.-..B.4, 3RW40 3.-..B.4, 3RW40 4.-..B.4	3RW40 2.-..B.5, 3RW40 3.-..B.5, 3RW40 4.-..B.5	3RW40 5.-..BB.4, 3RW40 7.-..BB.4	3RW40 5.-..BB.5, 3RW40 7.-..BB.5
Power electronics					
Rated operational voltage	V AC	200 ... 480	400 ... 600	200 ... 460	400 ... 600
Tolerance	%	-15/+10	-15/+10	-15/+10	-15/+10
Maximum blocking voltage (thyristor)	V AC	1600		1400	1800
Rated frequency	Hz	50/60			
Tolerance	%	±10			
Uninterrupted duty at 40 °C (% of I_e)	%	115			
Minimum load (% of minimum selectable rated motor current I_M)	%	20 (at least 2 A)			
Maximum cable length between soft starter and motor	m	300			
Permissible installation height	m	5000 (derating from 1000, see characteristic curves); higher on request			
Permissible mounting position					
<ul style="list-style-type: none"> With auxiliary fan (for 3RW40 2. ... 3RW40 4.) 					
<ul style="list-style-type: none"> Without auxiliary fan (for 3RW40 2. ... 3RW40 4.) 					
-- (fan integrated in the soft starter)					
Permissible ambient temperature					
Operation	°C	-25 ... +60; (derating from +40)			
Storage	°C	-40 ... +80			
Degree of protection					
IP20 for 3RW40 2.;				IP00	
IP00 for 3RW40 3. and 3RW40 4.					

Type		3RW40 24	3RW40 26	3RW40 27	3RW40 28
Power electronics					
40 °C/50 °C/60 °C					
Load rating with rated operational current I_e					
• Acc. to IEC and UL/CSA ¹⁾ , for individual mounting at 40/50/60 °C, AC-53a	A	12.5/11/10	25.3/23/21	32.2/29/26	38/34/31
Smallest adjustable rated motor current I_M					
For the motor overload protection	A	5	10	17	23
Power loss					
• In operation after completed starting with uninterrupted rated operational current (40 °C) approx.	W	2	8	13	19
• During starting with 300 % I_M (40°C)	W	17	47	55	64
Permissible rated motor current and starts per hour					
• Normal starting (Class 10)					
- Rated motor current I_M ²⁾ , starting time 3 s	A	12.5/11/10	25.3/23/21	32.2/29/26	38/34/31
- Starts per hour ³⁾	1/h	50	23	23	19
- Rated motor current I_M ²⁾⁴⁾ , starting time 4 s	A	12.5/11/10	25.3/23/21	32.2/29/26	38/34/31
- Starts per hour ³⁾	1/h	36	15	16	12
• Normal starting (Class 15)					
- Rated motor current I_M ²⁾ , starting time 4.5 s	A	11/10/9	25.3/23/21	32.2/29/26	38/34/31
- Starts per hour ³⁾	1/h	49	21	18	18
- Rated motor current I_M ²⁾⁴⁾ , starting time 6 s	A	11/10/9	25.3/23/21	32.2/29/26	38/34/31
- Starts per hour ³⁾	1/h	36	14	13	13
• Normal starting (Class 20)					
- Rated motor current I_M ²⁾ , starting time 6 s	A	10/9/8	21/19/17	27/24/21	31/28/25
- Starts per hour ³⁾	1/h	47	21	20	18
- Rated motor current I_M ²⁾⁴⁾ , starting time 8 s	A	10/9/8	21/19/17	27/24/21	31/28/25
- Starts per hour ³⁾	1/h	34	15	14	13

1) Measurement at 60 °C according to UL/CSA not required.

2) With 300 % I_M .

3) For intermittent duty S4 with ON period = 30 %, $T_u = 40$ °C, stand-alone installation vertical. The quoted switching frequencies do not apply for automatic mode.

4) Maximum adjustable rated motor current I_M , dependent on CLASS setting.

3RW Soft Starters

3RW40 for standard applications

Type		3RW40 36	3RW40 37	3RW40 38	3RW40 46	3RW40 47
Power electronics		40 °C/50 °C/60 °C				
Load rating with rated operational current I_e						
• Acc. to IEC and UL/CSA ¹⁾ , for individual mounting at 40/50/60 °C, AC-53a	A	45/42/39	63/58/53	72/63/60	80/73/66	106/98/90
Smallest adjustable rated motor current I_M						
For the motor overload protection	A	23	26	35	43	46
Power loss						
• In operation after completed starting with uninterrupted rated operational current (40 °C) approx.	W	6	12	15	12	21
• During starting with 300 % I_M (40°C)	W	79	111	125	144	192
Permissible rated motor current and starts per hour						
• Normal starting (Class 10)						
- Rated motor current $I_M^{(2)}$, starting time 3 s	A	45/42/39	63/58/53	72/63/60	80/73/66	106/98/90
- Starts per hour ³⁾	1/h	38	23	22	22	15
- Rated motor current $I_M^{(2)(4)}$, starting time 4 s	A	45/42/39	63/58/53	72/63/60	80/73/66	106/98/90
- Starts per hour ³⁾	1/h	26	15	15	15	10
• Normal starting (Class 15)						
- Rated motor current $I_M^{(2)}$, starting time 4.5 s	A	42/38/34	50/46/42	56/52/46	70/64/58	84/77/70
- Starts per hour ³⁾	1/h	30	34	34	24	23
- Rated motor current $I_M^{(2)(4)}$, starting time 6 s	A	42/38/34	50/46/42	56/52/46	70/64/58	84/77/70
- Starts per hour ³⁾	1/h	21	24	24	16	17
• Normal starting (Class 20)						
- Rated motor current $I_M^{(2)}$, starting time 6 s	A	38/34/30	46/42/38	50/46/42	64/58/52	77/70/63
- Starts per hour ³⁾	1/h	30	31	34	23	23
- Rated motor current $I_M^{(2)(4)}$, starting time 8 s	A	38/34/30	46/42/38	50/46/42	64/58/52	77/70/63
- Starts per hour ³⁾	1/h	21	22	24	16	16



1) Measurement at 60 °C according to UL/CSA not required.
 2) With 300 % I_M .
 3) For intermittent duty S4 with ON period = 30 %, $T_U = 40$ °C, stand-alone installation vertical. The quoted switching frequencies do not apply for automatic mode.
 4) Maximum adjustable rated motor current I_M , dependent on CLASS setting.

Type		3RW40 55	3RW40 56	3RW40 73	3RW40 74	3RW40 75	3RW40 76
Power electronics		40 °C/50 °C/60 °C					
Load rating with rated operational current I_e							
• Acc. to IEC and UL/CSA ¹⁾ , for individual mounting at 40/50/60 °C, AC-53a	A	134/117/100	162/145/125	230/205/180	280/248/215	356/315/280	432/385/335
Smallest adjustable rated motor current I_M							
For the motor overload protection	A	59	87	80	130	131	207
Power loss							
• In operation after completed starting with uninterrupted rated operational current (40 °C) approx.	W	60	75	75	90	125	165
• During starting with 300 % ²⁾ I_M (40°C)	W	1043	1355	2448	3257	3277	3600
Permissible rated motor current and starts per hour							
• Normal starting (Class 10)							
- Rated motor current $I_M^{(2)}$, starting time 10 s	A	134/117/100	162/145/125	230/205/180	280/248/215	356/315/280	432/385/335
- Starts per hour ³⁾	1/h	20	8	20	20	16	17
- Rated motor current $I_M^{(2)(4)}$, starting time 20 s	A	134/117/100	162/145/125	230/205/180	280/248/215	356/315/280	432/385/335
- Starts per hour ³⁾	1/h	7	1.4	9	8	5	5
• Normal starting (Class 15)							
- Rated motor current $I_M^{(2)}$, starting time 15 s	A	134/117/100	152/140/125	210/200/180	250/220/190	341/315/280	402/385/335
- Starts per hour ³⁾	1/h	11	8	11	13	11	12
- Rated motor current $I_M^{(2)(4)}$, starting time 30 s	A	134/117/100	152/140/125	210/200/180	250/220/190	341/315/280	402/385/335
- Starts per hour ³⁾	1/h	1.2	1.7	1	6	2	2
• Normal starting (Class 20)							
- Rated motor current $I_M^{(2)}$, starting time 20 s	A	124/112/100	142/132/120	200/185/168	230/205/180	311/280/250	372/340/305
- Starts per hour ³⁾	1/h	12	9	10	10	10	10
- Rated motor current $I_M^{(2)(4)}$, starting time 40 s	A	124/112/100	142/132/120	200/185/168	230/205/180	311/280/250	372/340/305
- Starts per hour ³⁾	1/h	3	3	1	5	1	1

1) Measurement at 60 °C according to UL/CSA not required.
 2) With 300 % I_M .
 3) For intermittent duty S4 with ON period = 30 %, $T_U = 40$ °C, stand-alone installation vertical. The quoted switching frequencies do not apply for automatic mode.
 4) Maximum adjustable rated motor current I_M , dependent on CLASS setting.







3RW Soft Starters

3RW40 for standard applications

Soft starters	Type		3RW40 2.	3RW40 3.	3RW40 4.
Conductor cross-sections					
Screw terminals					
Front clamping point connected					
 NSB00479	• Solid	mm ²	2 x (1.5 ... 2.5); 2 x (2.5 ... 6) acc. to IEC 60947; max. 1 x 10	2 x (1.5 ... 16)	2 x (2.5 ... 16)
	• With end sleeve	mm ²	2 x (1.5 ... 2.5); 2 x (2.5 ... 6)	1 x (0.75 ... 25)	1 x (2.5 ... 35)
	• Stranded	mm ²	--	1 x (0.75 ... 35)	1 x (4 ... 70)
	• AWG cables				
	- Solid	AWG	2 x (16 ... 12)		
Rear clamping point connected					
 NSB00480	• Solid	mm ²	--	2 x (1.5 ... 16)	2 x (2.5 ... 16)
	• With end sleeve	mm ²	--	1 x (1.5 ... 25)	1 x (2.5 ... 50)
	• Stranded	mm ²	--	1 x (1.5 ... 35)	1 x (10 ... 70)
	• AWG cables				
	- Solid or stranded	AWG	--	1 x (16 ... 2)	2 x (10 ... 1/0)
Both clamping points connected					
 NSB00481	• Solid	mm ²	--	2 x (1.5 ... 16)	2 x (2.5 ... 16)
	• With end sleeve	mm ²	--	2 x (1.5 ... 16)	2 x (2.5 ... 35)
	• Stranded	mm ²	--	2 x (1.5 ... 25)	2 x (10 ... 50)
	• AWG cables				
	- Solid or stranded	AWG	--	2 x (16 ... 2)	1 x (10 ... 2/0)
	• Tightening torque	NM lb.in	2 ... 2.5 18 ... 22	4.5 40	6.5 58
	Tools		PZ 2	PZ 2	Allen screw 4 mm
	Degree of protection		IP20	IP20 (IP00 terminal compartment)	IP20 (IP00 terminal compartment)
Spring-type terminals					
Main conductors					
	• Solid	mm ²	1 ... 10	--	
	• Finely stranded with end sleeve	mm ²	1 ... 6 end sleeves with- out plastic collar	--	
	• AWG cables				
	- Solid or stranded (finely stranded)	AWG	16 ... 10	--	
	- Stranded	AWG	1 x 8	--	
	Tools		DIN ISO 2380-1A0; 5 x 3	--	
	Degree of protection		IP20	--	
Busbar connections					
Main conductors					
	• With cable lug acc. to DIN 46234 or max. 20 mm wide				
	- Stranded	mm ²	--		2 x (10 ... 70)
	- Finely stranded	mm ²	--		2 x (10 ... 50)
	• AWG cables, solid or stranded	AWG	--		2 x (7 ... 1/0)

3RW Soft Starters

3RW40 for standard applications

Soft starters	Type		3RW40 5.	3RW40 7.
Conductor cross-sections				
Screw terminals	Main conductors			
With box terminal			3RT19 55-4G (55 kW)	3RT19 66-4G
Front clamping point connected	<ul style="list-style-type: none"> • Finely stranded with end sleeve • Finely stranded without end sleeve • Stranded • Ribbon cable conductors (number x width x thickness) • AWG cables, solid or stranded 	mm ² mm ² mm ² mm AWG	16 ... 70 16 ... 70 16 ... 70 Min. 3 x 9 x 0.8 Max. 6 x 15.5 x 0.8 6 ... 2/0	70 ... 240 70 ... 240 95 ... 300 Min. 6 x 9 x 0.8 Max. 20 x 24 x 0.5 3/0 ... 600 kcmil
				
Rear clamping point connected	<ul style="list-style-type: none"> • Finely stranded with end sleeve • Finely stranded without end sleeve • Stranded • Ribbon cable conductors (number x width x thickness) • AWG cables, solid or stranded 	mm ² mm ² mm ² mm AWG	16 ... 70 16 ... 70 16 ... 70 Min. 3 x 9 x 0.8 Max. 6 x 15.5 x 0.8 6 ... 2/0	120 ... 185 120 ... 185 120 ... 240 Min. 6 x 9 x 0.8 Max. 20 x 24 x 0.5 250 ... 500 kcmil
				
Both clamping points connected	<ul style="list-style-type: none"> • Finely stranded with end sleeve • Finely stranded without end sleeve • Stranded • Ribbon cable conductors (number x width x thickness) • AWG cables, solid or stranded • Terminal screws - Tightening torque 	mm ² mm ² mm ² mm AWG NM lb.in	Max. 1 x 50, 1 x 70 Max. 1 x 50, 1 x 70 Max. 2 x 70 Max. 2 x (6 x 15.5 x 0.8) Max. 2 x 1/0 M10 (hexagon socket, A/F4) 10 ... 12 90 ... 110	Min. 2 x 50; max. 2 x 185 Min. 2 x 50; max. 2 x 185 Max. 2 x 70; max. 2 x 240 Max. 2 x (20 x 24 x 0.5) Min. 2 x 2/0 Max. 2 x 500 kcmil M12 (hexagon socket, A/F5) 20 ... 22 180 ... 195
				
Screw terminals	Main conductors			
With box terminal			3RT19 56-4G	
Front or rear clamping point connected	<ul style="list-style-type: none"> • Finely stranded with end sleeve • Finely stranded without end sleeve • Stranded • Ribbon cable conductors (number x width x thickness) • AWG cables, solid or stranded 	mm ² mm ² mm ² mm AWG	16 ... 120 16 ... 120 16 ... 120 Min. 3 x 9 x 0.8 Max. 6 x 15.5 x 0.8 6 ... 250 kcmil	
 				
Both clamping points connected	<ul style="list-style-type: none"> • Finely stranded with end sleeve • Finely stranded without end sleeve • Stranded • Ribbon cable conductors (number x width x thickness) • AWG cables, solid or stranded 	mm ² mm ² mm ² mm AWG	Max. 1 x 95, 1 x 120 Max. 1 x 95, 1 x 120 Max. 2 x 120 Max. 2 x (10 x 15.5 x 0.8) Max. 2 x 3/0	
				
Screw terminals	Main conductors			
	<u>Without box terminal/busbar connection</u>			
	<ul style="list-style-type: none"> • Finely stranded with cable lug • Stranded with cable lug • AWG cables, solid or stranded • Connecting bar (max. width) • Terminal screws - Tightening torque 	mm ² mm ² AWG mm NM lb.in	16 ... 95 ¹⁾ 25 ... 120 ¹⁾ 4 ... 250 kcmil 17 M8 x 25 (A/F13) 10 ... 14 89 ... 124	50 ... 240 ²⁾ 70 ... 240 ²⁾ 2/0 ... 500 kcmil 25 M10 x 30 (A/F17) 14 ... 24 124 ... 210

¹⁾ When connecting cable lugs to DIN 46235, use 3RT19 56-4EA1 terminal cover for conductor cross-sections from 95 mm² to ensure phase spacing.

²⁾ When connecting cable lugs to DIN 46234, the 3RT19 66-4EA1 terminal cover must be used for cond. cross-sections of 240 mm² and more as well as DIN 46235 for cond. cross-sections of 185 mm² and more to keep the phase clearance.

Soft starters	Type		3RW40 ..
Conductor cross-sections			
Auxiliary conductors (1 or 2 conductors can be connected):			
	Screw terminals		
	<ul style="list-style-type: none"> • Solid • Finely stranded with end sleeve • AWG cables - Solid or stranded - Finely stranded with end sleeve • Terminal screws - Tightening torque 	mm ² mm ² AWG AWG NM lb.in	2 x (0.5 ... 2.5) 2 x (0.5 ... 1.5) 2 x (20 ... 14) 2 x (20 ... 16) 0.8 ... 1.2 7 ... 10.3
	Spring-type terminals		
	<ul style="list-style-type: none"> • Solid - 3RW40 2. ... 3RW40 4. - 3RW40 5., 3RW40 7. • Finely stranded with end sleeve • AWG cables, solid or stranded 	mm ² mm ² mm ² AWG	2 x (0.25 ... 2.5) 2 x (0.25 ... 1.5) 2 x (0.25 ... 1.5) 2 x (24 ... 14) for 3RW40 2. ... 3RW40 4.; 2 x (24 ... 16) for 3RW40 5. and 3RW40 7.

3RW Soft Starters

	Standard	Parameters
Electromagnetic compatibility acc. to EN 60947-4-2		
<i>EMC interference immunity</i>		
Electrostatic discharge (ESD)	EN 61000-4-2	±4 kV contact discharge, ±8 kV air discharge
Electromagnetic RF fields	EN 61000-4-3	Frequency range: 80 ... 1000 MHz with 80 % at 1 kHz Degree of severity 3: 10 V/m
Conducted RF interference	EN 61000-4-6	Frequency range: 150 kHz ... 80 MHz with 80 % at 1 kHz Interference 10 V
RF voltages and RF currents on cables		
• Burst	EN 61000-4-4	±2 kV/5 kHz
• Surge	EN 61000-4-5	±1 kV line to line ±2 kV line to earth
<i>EMC interference emission</i>		
EMC interference field strength	EN 55011	Limit value of Class A at 30 ... 1000 MHz, limit value of Class B with 3RW40 2., 24 V AC/DC
Radio interference voltage	EN 55011	Limit value of Class A at 0.15 ... 30 MHz, limit value of Class B with 3RW40 2., 24 V AC/DC
<i>Radio interference suppression filters</i>		
Degree of noise suppression A (industrial applications)	Not required	
Degree of noise suppression B (applications for residential areas)		
Control voltage		
• 110 ... 230 V AC/DC	Not available ¹⁾	
• 115/230 V AC	Not available ¹⁾	
• 24 V AC/DC	Not required for 3RW40 2.; required for 3RW40 3. and 3RW40 4. (see table)	

¹⁾ Degree of noise suppression B cannot be obtained through the use of filters as the strength of the electromagnetic field is not attenuated by the filter.

Soft starter type	Rated current Soft starters A	Recommended filters ¹⁾		
		Voltage range 200 ... 480 V		
		Filter type	Rated current filters A	Terminals mm ²
3RW40 36	45	4EF1512-1AA10	50	16
3RW40 37	63	4EF1512-2AA10	66	25
3RW40 38	72	4EF1512-3AA10	90	25
3RW40 46	80	4EF1512-3AA10	90	25
3RW40 47	106	4EF1512-4AA10	120	50

¹⁾ The radio interference suppression filter is used to remove the conducted interference from the main circuit. The field-related emissions comply with degree of noise suppression B. Filter selection applies under standard conditions: 10 starts per hour, start time 4 s at 300 % I_e.

Type Number	Max. Fuse Class K5, RK5, RK1	Max. Fuse Class J	Short Voltage Circuit	Voltage
<i>Standard short circuit ratings 3RW40</i>				
3RW40 24	50 A	60 A	5 kA	600 V
3RW40 26	100 A	100 A	5 kA	600 V
3RW40 27	125 A	125 A	5 kA	600 V
3RW40 28	125 A	125 A	5 kA	600 V
3RW40 36	175 A	175 A	10 kA	600 V
3RW40 37	250 A	250 A	10 kA	600 V
3RW40 38	250 A	250 A	10 kA	600 V
3RW40 46	450 A ¹⁾	300 A	10 kA	600 V
3RW40 47	450 A ¹⁾	350 A	10 kA	600 V

¹⁾ Special purpose fuse Type 3N81333-2 manufactured by Siemens covered in File E167357.

High capacity short circuit ratings 3RW40

3RW40 24	50 A	50 A	42 kA	600 V
3RW40 26	60 A	100 A	42 kA	600 V
3RW40 27	60 A	125 A	42 kA	600 V
3RW40 28	60 A	125 A	42 kA	600 V
3RW40 36	100 A	175 A	30 kA	600 V
3RW40 37	100 A	200 A	30 kA	600 V
3RW40 38	100 A	200 A	30 kA	600 V
3RW40 46	110 A	200 A	42 kA	600 V
3RW40 47	110 A	200 A	42 kA	600 V

For solid-state motor controller, Type 3RW402: Applicable in an enclosure with minimum overall dimensions of 370 by 190 by 190 mm.

For solid-state motor controller, Type 3RW403: Applicable in an enclosure with minimum overall dimensions of 450 by 210 by 225 mm.

For solid-state motor controller, Type 3RW404: Applicable in an enclosure with minimum overall dimensions of 450 by 220 by 235 mm.

3RW Soft Starters

3RW40 for standard applications

Circuit Breaker SCCR

TOC 1	Circuit Breakers																		
	Q11 Type	Rated current	Thermal Magnetic			Instantaneous Trip			Fuse			600 V Type	SCCR kA	Max. size A	600 V Type	SCCR kA	Max. size A		
			480 V Type	SCCR kA	Max. size A	600 V Type	SCCR kA	Max. size A	480 V Type	SCCR kA	Max. size A							600 V Type	SCCR kA
3RW40 24	11																		
3RW40 26	23																		
3RW40 27	29																		
3RW40 28	34																		
3RW40 36	42																		
3RW40 37	58																		
3RW40 38	62																		
3RW40 46	73																		
3RW40 47	98																		
3RW40 55	117	FD63B	100	150	FD63B	50	150	FXD63A	100	150	FXD63A	50	150	RK5	100	200	J	100	400
3RW40 56	145	JD63B	100	200	JD63B	50	250	FXD63A	100	250	FXD63A	50	250	RK5	100	250	J	100	500
3RW40 73	205	JD63B	100	300	JD63B	50	300	JXD63A	100	300	JXD63A	50	300	RK5	100	250			
3RW40 74	248	JD63B	100	400	JD63B	50	400	JXD63A	100	400	JXD63A	50	400	RK5	100	450			
3RW40 75	315	LD63B	100	500	LD63B	50	450	JXD63A	100	400	JXD63A	50	400	RK5	100	600			
3RW40 76	385	LD63B	100	600	LD63B	50	600	LXD63H	100	600	LXD63H	50	600	L	100	700			

Fused version (line protection only)

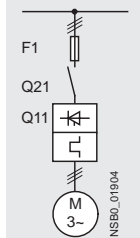

TOC 1	Soft starters		Line protection, maximum		Line contactors	
	Q11 Type	Rated current A	F1 Type	Rated current A	Size (optional) Q21	
Type of coordination "1"¹⁾: I_q = 65 kA at 600 V +5 %						
3RW40 24	12.5		3NA3 820-6	50	00	3RT10 24
3RW40 26	25		3NA3 822-6	63	00	3RT10 26
3RW40 27	32		3NA3 824-6	80	00	3RT10 34
3RW40 28	38		3NA3 824-6	80	00	3RT10 35
3RW40 36	45		3NA3 130-6	100	1	3RT10 36
3RW40 37	63		3NA3 132-6	125	1	3RT10 44
3RW40 38	72		3NA3 132-6	125	1	3RT10 45
3RW40 46	80		3NA3 136-6	160	1	3RT10 45
3RW40 47	106		3NA3 136-6	160	1	3RT10 46
3RW40 55	134		3NA3 244-6	250	2	3RT10 55-6A.36
3RW40 56	162		3NA3 244-6	250	2	3RT10 56-6A.36
3RW40 73	230		2 x 3NA3 354-6	2 x 355	3	3RT10 65-6A.36
3RW40 74	280		2 x 3NA3 354-6	2 x 355	3	3RT10 66-6A.36
3RW40 75	356		2 x 3NA3 365-6	2 x 500	3	3RT10 75-6A.36
3RW40 76	432		2 x 3NA3 365-6	2 x 500	3	3RT10 76-6A.36

¹⁾ The types of coordination are explained under "3RA1 Fuseless Load Feeders". The type of coordination "1" refers only to soft starters in combination with the stipulated protective device (motor starter protector/circuit breaker/fuse), not to any additional components in the feeder.

3RW Soft Starters

3RW40 for standard applications

Fused version with 3NE1 SITOR fuses (semiconductor and line protection)

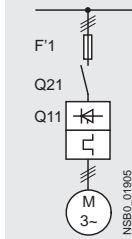

For matching fuse bases see Catalog LV 1 under "SENTRON Switching and Protection Devices for Power Distribution" → "Switch Disconnectors", and Catalog ET B1 under "BETA Protecting" → "SITOR Semiconductor Fuses" or go to www.siemens.com/sitor → "Products" → "BETA Protecting" → "SITOR"

Soft starters ToC 2	Rated current	All-range fuses			Line contactors (optional)	
		F'1 Type	Rated current A	Size	Q21	
Q11 Type	A	F'1 Type	A		Q21	
Type of coordination "2"¹⁾: $I_q = 65 \text{ kA at } 600 \text{ V } +5 \%$						
3RW40 24	12.5	3NE1 814-0	20	000	3RT10 24	
3RW40 26	25	3NE1 803-0	35	000	3RT10 26	
3RW40 27	32	3NE1 020-2	80	00	3RT10 34	
3RW40 28	38	3NE1 020-2	80	00	3RT10 35	
3RW40 36	45	3NE1 020-2	80	00	3RT10 36	
3RW40 37	63	3NE1 820-0	80	000	3RT10 44	
3RW40 38	72	3NE1 820-0	80	000	3RT10 45	
3RW40 46	80	3NE1 021-0	100	00	3RT10 45	
3RW40 47	106	3NE1 022-0	125	00	3RT10 46	
3RW40 55	134	3NE1 227-2	250	1	3RT10 55-6A.36	
3RW40 56	162	3NE1 227-2	250	1	3RT10 56-6A.36	
3RW40 73	230	3NE1 331-2	350	2	3RT10 65-6A.36	
3RW40 74	280	3NE1 333-2	450	2	3RT10 66-6A.36	
3RW40 75	356	3NE1 334-2	500	2	3RT10 75-6A.36	
3RW40 76	432	3NE1 435-2	560	3	3RT10 76-6A.36	

¹⁾ The types of coordination are explained in more detail under "3RA1 Fuseless Load Feeders".
The type of coordination "2" refers only to soft starters in combination with the stipulated protective device (circuit breaker/fuse), not to any additional components in the feeder.

ToC 1 Type of coordination "1"

ToC 2 Type of coordination "2"

The types of coordination are explained in more detail under "3RA1 Fuseless Load Feeders".

These types of coordination are indicated in the Technical specifications by gray backgrounds.

3RW Soft Starters

3RW40 for standard applications

Fused version with 3NE3 SITOR fuses (semiconductor protection by fuse, line and overload protection by motor starter protector; alternatively, installation with contactor and overload relay possible)

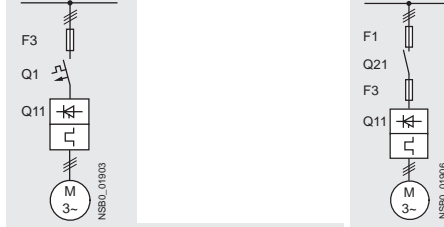

For matching fuse bases see Catalog LV 1 under "SENTRON Switching and Protection Devices for Power Distribution" -> "Switch Disconnectors", and Catalog ET B1 under "BETA Protecting" -> "SITOR Semiconductor Fuses" or go to www.siemens.com/sitor -> "Products" -> "BETA Protecting" -> "SITOR"

Soft starters Q11 Type	Rated current A	Semiconductor fuses, minimum			Semiconductor fuses, maximum			Semiconductor fuses, minimum		
		F3 Type	Rated current A	Size	F3 Type	Rated current A	Size	F3 Type	Rated current A	Size

Type of coordination "2" ¹⁾ : I _q = 65 kA at 600 V +5 %										
3RW40 24	12.5	--	--	--	--	--	--	3NE4 101	32	0
3RW40 26	25	--	--	--	3NE3 221	100	1	3NE4 102	40	0
3RW40 27	32	--	--	--	3NE3 224	160	1	3NE4 118	63	0
3RW40 28	38	--	--	--	3NE3 224	160	1	3NE4 118	63	0
3RW40 36	45	--	--	--	3NE3 224	160	1	3NE4 120	80	0
3RW40 37	63	--	--	--	3NE3 225	200	1	3NE4 121	100	0
3RW40 38	72	3NE3 221	100	1	3NE3 227	250	1	--	--	--
3RW40 46	80	3NE3 222	125	1	3NE3 225	200	1	--	--	--
3RW40 47	106	3NE3 224	160	1	3NE3 231	350	1	--	--	--
3RW40 55	134	3NE3 227	250	1	3NE3 335	560	2	--	--	--
3RW40 56	162	3NE3 227	250	1	3NE3 335	560	2	--	--	--
3RW40 73	230	3NE3 232-0B	400	1	3NE3 333	450	2	--	--	--
3RW40 74	280	3NE3 233	450	1	3NE3 336	630	2	--	--	--
3RW40 75	356	3NE3 335	560	2	3NE3 336	630	2	--	--	--
3RW40 76	432	3NE3 337-8	710	2	3NE3 340-8	900	2	--	--	--

Soft starters Q11 Type	Rated current A	Semiconductor fuses max.			Semiconductor fuses min.			Semiconductor fuses max.			Cylindrical fuses	
		F3 Type	Rated current A	Size	F3 Type	Rated current A	Size	F3 Type	Rated current A	Size	F3 Type	Rated current A

Type of coordination "2" ¹⁾ : I _q = 65 kA at 600 V +5 %												
3RW40 24	12.5	3NE4 117	50	0	3NE8 015-1	25	00	3NE8 017-1	50	00	3NC2 240	40
3RW40 26	25	3NE4 117	50	0	3NE8 017-1	50	00	3NE8 021-1	100	00	3NC2 263	63
3RW40 27	32	3NE4 118	63	0	3NE8 018-1	63	00	3NE8 022-1	125	00	3NC2 280	80
3RW40 28	38	3NE4 118	63	0	3NE8 020-1	80	00	3NE8 024-1	160	00	3NC2 280	80
3RW40 36	45	3NE4 120	80	0	3NE8 020-1	80	00	3NE8 024-1	160	00	3NC2 280	80
3RW40 37	63	3NE4 121	100	0	3NE8 021-1	100	00	3NE8 024-1	160	00	--	--
3RW40 38	72	--	--	--	3NE8 022-1	125	00	3NE8 024-1	160	00	--	--
3RW40 46	80	--	--	--	3NE8 022-1	125	00	3NE8 024-1	160	00	--	--
3RW40 47	106	--	--	--	3NE8 024-1	160	00	3NE8 024-1	160	00	--	--
3RW40 55	134	--	--	--	--	--	--	--	--	--	--	--
3RW40 56	162	--	--	--	--	--	--	--	--	--	--	--
3RW40 73	230	--	--	--	--	--	--	--	--	--	--	--
3RW40 74	280	--	--	--	--	--	--	--	--	--	--	--
3RW40 75	356	--	--	--	--	--	--	--	--	--	--	--
3RW40 76	432	--	--	--	--	--	--	--	--	--	--	--

Soft starters Q11 Type	Rated current A	Line contactors (optional) Q21	Motor starter protectors/circuit breakers				Line protection, maximum		
			400 V +10 % Q1 Type	Rated current A	575 V +10 % Q1 Type	Rated current A	F1 Type	Rated current A	Size

Type of coordination "2" ¹⁾ : I _q = 65 kA at 600 V +5 %										
3RW40 24	12.5	3RT10 24	3RV1 021-4KA10	55	--	--	--	3NA3 820-6	50	00
3RW40 26	25	3RT10 26	3RV1 021-4DA10	55	--	--	--	3NA3 822-6	63	00
3RW40 27	32	3RT10 34	3RV1 031-4EA10	55	--	--	--	3NA3 824-6	80	00
3RW40 28	38	3RT10 35	3RV1 031-4FA10	55	--	--	--	3NA3 824-6	80	00
3RW40 36	45	3RT10 36	3RV1 031-4GA10	20	--	--	--	3NA3 130-6	100	1
3RW40 37	63	3RT10 44	3RV1 041-4JA10	20	--	--	--	3NA3 132-6	125	1
3RW40 38	72	3RT10 45	3RV1 041-4KA10	20	--	--	--	3NA3 132-6	125	1
3RW40 46	80	3RT10 45	3RV1 041-4LA10	11	--	--	--	3NA3 136-6	160	1
3RW40 47	106	3RT10 46	3RV1 041-4MA10	11	--	--	--	3NA3 136-6	160	1
3RW40 55	134	3RT10 55-6A.36	3VL3 720	200	3VL3 720	200	3NA3 244-6	250	2	
3RW40 56	162	3RT10 56-6A.36	3VL3 720	200	3VL3 720	200	3NA3 244-6	250	2	
3RW40 73	230	3RT10 65-6A.36	3VL4 731	315	3VL5 731	315	2 x 3NA3 354-6	2 x 355	3	
3RW40 74	280	3RT10 66-6A.36	3VL4 731	315	3VL5 731	315	2 x 3NA3 354-6	2 x 355	3	
3RW40 75	356	3RT10 75-6A.36	3VL4 740	400	3VL5 740	400	2 x 3NA3 365-6	2 x 500	3	
3RW40 76	432	3RT10 76-6A.36	3VL5 750	500	3VL5 750	500	2 x 3NA3 365-6	2 x 500	3	

¹⁾ The types of coordination are explained under "3RA1 Fuseless Load Feeders". The type of coordination "2" refers only to soft starters in combination

with the stipulated protective device (motor starter protector/circuit breaker/fuse), not to any additional components in the feeder.

3RW Soft Starters

3RW40 for standard applications

Characteristic curves

Motor protection tripping characteristics for 3RW40 (with symmetry)

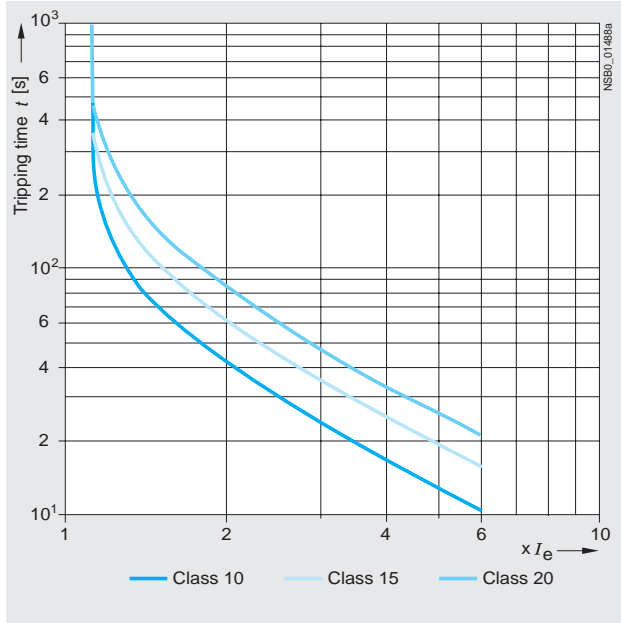

Motor protection tripping characteristics for 3RW40 (with asymmetry)

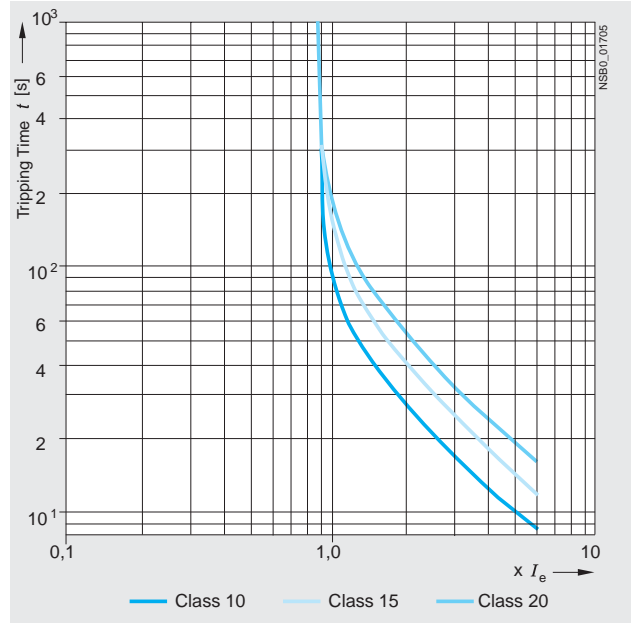

Permissible installation height



At an installation height above 2000 m, the max. permissible operational voltage is reduced to 460 V.

3RW Soft Starters

3RW40 for standard applications

More information

Application examples for normal starting (Class 10)

Normal starting Class 10 (up to 20 s with 350 % $I_{n, motor}$).

The soft starter rating can be selected to be as high as the rating of the motor used.

Application	Conveyor belt	Roller conveyor	Small fan	Pump	Hydraulic pump
Starting parameters					
• Voltage ramp and current limiting					
- Starting voltage	%	70	60	40	40
- Starting time	s	10	10	10	10
- Current limit value		$5 \times I_M$	$5 \times I_M$	$4 \times I_M$	$4 \times I_M$
Ramp-down time	s	5	5	0	10

Application examples for heavy starting (Class 20)

Heavy starting Class 20 (up to 40 s with 350 % $I_{n, motor}$).

The soft starter has to be selected at least one performance class higher than the motor used.

Application	Stirrer	Compressor	Centrifuge
Starting parameters			
• Voltage ramp and current limiting			
- Starting voltage	%	40	50
- Starting time	s	20	10
- Current limit value		$4 \times I_M$	$4 \times I_M$
Ramp-down time		0	0

Note:

These tables present sample set values and device sizes. They are intended only for the purposes of information and are not binding. The set values depend on the application in question and must be optimized during commissioning.

The soft starter dimensions should be checked where necessary with the Win-Soft Starter software or with the help of Technical Assistance.

3RW Soft Starters

3RW40 for standard applications

Configuration

The 3RW solid-state soft starters are designed for easy starting conditions. In the event of deviating conditions or increased switching frequency, it may be necessary to choose a larger device. For accurate dimensioning, use the Win-Soft Starter selection and simulation program.

Where long starting times are involved, the integrated solid-state overload relay for heavy starting should not be disconnected. PTC sensors are recommended. This also applies for the smooth ramp-down because during the ramp-down time an additional current loading applies in contrast to free ramp-down.

In the case of high switching frequencies in S4 mode, Siemens recommends the use of PTC sensors. For corresponding device versions with integrated thermistor motor protection or separate thermistor evaluation devices see Catalog LV 1.

In the motor feeder between the SIRIUS 3RW soft starter and the motor, no capacitive elements are permitted (e. g. no reactive-power compensation equipment). In addition, neither static systems for reactive-power compensation nor dynamic PFC (Power Factor Correction) must be operated in parallel during starting and ramp-down of the soft starter. This is important to prevent faults arising on the compensation equipment and/or the soft starter.

All elements of the main circuit (such as fuses and controls) should be dimensioned for direct starting, following the local short-circuit conditions. Fuses, controls and overload relays must be ordered separately. Please observe the maximum switching frequencies specified in the technical specifications.

Note:

When induction motors are switched on, voltage drops occur as a rule on starters of all types (direct starters, wye-delta starters, soft starters). The infeed transformer must always be dimensioned such that the voltage dip when starting the motor remains within the permissible tolerance. If the infeed transformer is dimensioned with only a small margin, it is best for the control voltage to be supplied from a separate circuit (independently of the main voltage) in order to avoid the potential switching off of the soft starter.

Schematic circuit diagram

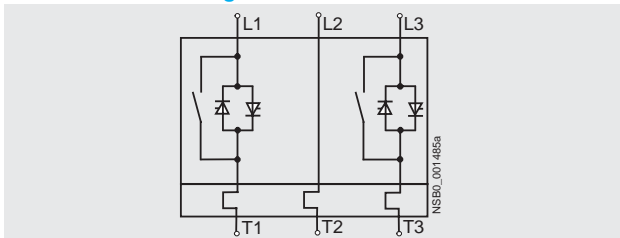

A bypass contact system and solid-state overload relay are already integrated in the 3RW40 soft starter and therefore do not have to be ordered separately.

Status graphs

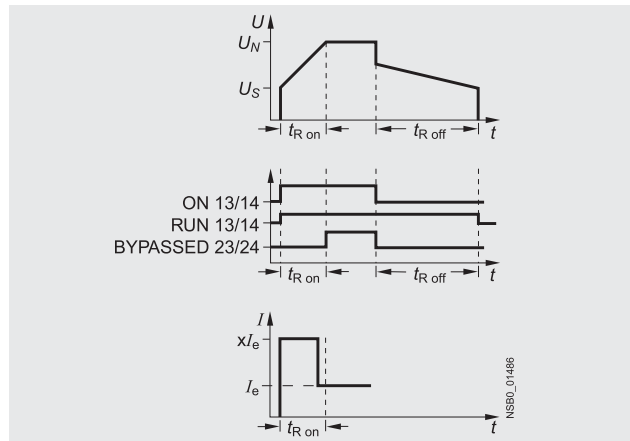

Win-Soft Starter selection and simulation program

With this software, you can simulate and select all Siemens soft starters, taking into account various parameters such as mains properties, motor and load data, and special application requirements.

The software is a valuable tool, which makes complicated, lengthy manual calculations for determining the required soft starters superfluous.

The Win-Soft Starter selection and simulation program can be downloaded from:

www.usa.siemens.com > Software

More information can be found on the Internet at:

www.usa.siemens.com.

3RW Soft Starters

3RW44 for high-feature applications

Overview

In addition to soft starting and soft ramp-down, the solid-state SIRIUS 3RW44 soft starters provide numerous functions for higher-level requirements. They cover a performance range up to 900 Hp (at 460 V) in the inline circuit and up to 1600 Hp (at 460 V) in the inside-delta circuit.

The SIRIUS 3RW44 soft starters are characterized by a compact design for space-saving and clearly arranged control cabinet layouts. For optimized motor starting and stopping the innovative SIRIUS 3RW44 soft starters are an attractive alternative with considerable savings potential compared to applications with a frequency converter. The new torque control and adjustable current limiting enable the High-Feature soft starters to be used in nearly every conceivable task. They reliably mitigate the sudden torque applications and current peaks during motor starting and stopping. This creates savings potential when calculating the size of the controlgear and when servicing the machinery installed. Be it for inline circuits or inside-delta circuits – the SIRIUS 3RW44 soft starter offers savings especially in terms of size and equipment costs.

The bypass contacts already integrated in the soft starter bypass the thyristors after a motor ramp-up is detected. This results in a further great reduction in the heat loss occurring during operation of the soft starter at rated value.

Combinations of various starting, operating and ramp-down possibilities ensure an optimum adaptation to the application-specific requirements. Operation and commissioning can be performed with the menu-controlled keypad and a menu-prompted, multi-line graphic display with background lighting. The optimized motor ramp-up and ramp-down can be effected quickly, easily and reliably by means of just a few settings with a previously selected language. Four-key operation and plain-text displays for each menu point guarantee full clarity at every moment of the parameterization and operation.

Applicable standards

- IEC 60947-4-2
- UL/CSA

Soft Starter ES parameterization software

Soft Starter ES software is used for the parameterization, monitoring and service diagnostics of SIRIUS 3RW44 High Feature soft starters.

See Catalog LV 1, Chapter 12 "Planning and Configuration with SIRIUS".

Function

Equipped with modern, ergonomic user prompting the SIRIUS 3RW44 soft starters can be commissioned quickly and easily using a keypad and a menu-prompted, multi-line graphic display with background lighting. The optimized motor ramp-up and ramp-down can be effected quickly, easily and reliably by means of just a few settings with a selectable language. Four-key operation and plain-text displays for each menu point guarantee full clarity at every moment of the parameterization and operation. During operation and when control voltage is applied, the display field continuously presents measured values and operating values as well as warnings and fault messages. An external display and operator module can be connected by means of a connection cable to the soft starter, thus enabling active indications and the like to be read directly from the control cabinet door.

The SIRIUS 3RW44 soft starters are equipped with optimum functionality. An integral bypass contact system reduces the power loss of the soft starter during operation. This reliably prevents heating of the switchgear environment. The SIRIUS 3RW44 soft starters have internal intrinsic device protection. This prevents thermal overloading of the power section's thyristors, e. g. due to unacceptably high closing operations.

Wiring outlay for installing an additional motor overload relay is no longer needed as the SIRIUS 3RW44 soft starters perform this function too. In addition they offer adjustable trip classes and a thermistor motor protection function. As an option the thyristors can also be protected by SITOR semiconductor fuses from short-circuiting so that the soft starter is still functional after a short-circuit (type of coordination 2). And even inrush current peaks are reliably avoided thanks to adjustable current limiting.

As a further option the SIRIUS 3RW44 soft starters can be upgraded with a PROFIBUS DP module. Thanks to their communication capability and their programmable control inputs and relay outputs the SIRIUS 3RW44 soft starters can be very easily and quickly integrated in higher-level controllers.

In addition a creep speed function is available for positioning and setting jobs. With this function the motor can be controlled in both directions of rotation with reduced torque and an adjustable, low speed.

On the other hand the SIRIUS 3RW44 soft starters offer a new, combined DC braking function for the fast stopping of driving loads.

Highlights

- Soft starting with breakaway pulse, torque control or voltage ramp, adjustable torque or current limiting as well as any combination of these, depending on load type
- Integrated bypass contact system to minimize power loss
- Various setting options for the starting parameters such as starting torque, starting voltage, ramp-up and ramp-down time, and much more in three separate parameter sets
- Start-up detection
- Inside-delta circuit for savings in terms of size and equipment costs
- Various ramp-down modes selectable: free ramp-down, torque-controlled pump ramp-down, combined DC braking
- Solid-state motor overload and intrinsic device protection
- Thermistor motor protection
- Keypad with a menu-prompted, multi-line graphic display with background lighting
- Interface for communication with the PC for more accurate setting of the parameters as well as for control and monitoring
- Simple adaptation to the motor feeder
- Simple mounting and commissioning
- Display of operating states and fault messages
- Connection to PROFIBUS with optional PROFIBUS DP module
- External display and operator module
- Mains voltages from 200 to 690 V, 50 to 60 Hz
- Applicable up to 60 °C (derating from 40 °C)

3RW Soft Starters

3RW44 for high-feature applications

Type		3RW44 ...BC.4	3RW44 ...BC.5	3RW44 ...BC.6
Power electronics				
Rated operational voltage for inline circuit	V AC	200 ... 460	400 ... 600	400 ... 690
Tolerance	%	-15/+10	-15/+10	-15/+10
Maximum blocking voltage (thyristor)	V AC	1400	1800	1800
Rated operational voltage for inside-delta circuit	V AC	200 ... 460	400 ... 600	400 ... 600
Tolerance	%	-15/+10	-15/+10	-15/+10
Rated frequency	Hz	50 ... 60		
Tolerance	%	±10		
Uninterrupted duty at 40 °C (% of I_e)	%	115		
Minimum load (% of set motor current I_M)	%	8		
Maximum cable length between soft starter and motor	m	500 ¹⁾		
Permissible installation height	m	5000 (derating from 1000, see characteristic curves); higher on request		
Permissible mounting position				
Installation type		Stand-alone installation ① ≥ 5 mm (≥ 0.2 in) ② ≥ 75 mm (≥ 3 in) ③ ≥ 100 mm (≥ 4 in)		
Permissible ambient temperature				
Operation	°C	0 ... +60; (derating from +40)		
Storage	°C	-25 ... +80		
Degree of protection		IP00		

1) At the project configuration stage, it is important to make allowance for the voltage drop on the motor cable up to the motor connection. If necessary,

higher values for the rated operational voltage or current must be calculated accordingly for the soft starter.

Type		3RW44 22	3RW44 23	3RW44 24	3RW44 25	3RW44 26	3RW44 27
Power electronics							
40 °C/50 °C/60 °C							
Load rating with rated operational current I_e							
• Acc. to IEC and UL/CSA ¹⁾ , for individual mounting at 40/50/60 °C, AC-53a	A	29/26/23	36/33/29	47/42/37	57/51/45	77/68/59	93/82/72
Smallest adjustable rated motor current I_M	A	5	7	9	11	15	18
For the motor overload protection							
Power loss							
• In operation after completed starting with uninterrupted rated operational current (40 °C) approx.	W	8	10	32	36	45	55
• During starting with 300 % I _M (40 °C)	W	400	470	600	725	940	1160
Permissible rated motor current and starts per hour							
• Normal starting (Class 5)							
- Rated motor current I _M ²⁾ , starting time 5 s	A	29/26/23	36/33/29	47/42/37	57/51/45	77/68/59	93/82/72
- Starts per hour ³⁾	1/h	41	34	41	42	43	44
- Rated motor current I _M ²⁾⁴⁾ , starting time 10 s	A	29/26/23	36/33/29	47/42/37	57/51/45	77/68/59	93/82/72
- Starts per hour ³⁾	1/h	20	15	20	20	20	20
• Normal starting (Class 10)							
- Rated motor current I _M ²⁾ , starting time 10 s	A	29/26/23	36/33/29	47/42/37	57/51/45	77/68/59	93/82/72
- Starts per hour ³⁾	1/h	20	15	20	20	20	20
- Rated motor current I _M ²⁾⁴⁾ , starting time 20 s	A	29/26/23	36/33/29	47/42/37	57/51/45	77/68/59	93/82/72
- Starts per hour ³⁾	1/h	10	6	10	10	8	8
• Normal starting (Class 15)							
- Rated motor current I _M ²⁾ , starting time 15 s	A	29/26/23	36/33/29	47/42/37	57/51/45	77/68/59	93/82/72
- Starts per hour ³⁾	1/h	13	9	13	13	13	13
- Rated motor current I _M ²⁾⁴⁾ , starting time 30 s	A	29/26/23	36/33/29	47/42/37	57/51/45	77/68/59	93/82/72
- Starts per hour ³⁾	1/h	6	4	6	6	6	6
• Normal starting (Class 20)							
- Rated motor current I _M ²⁾ , starting time 20 s	A	29/26/23	36/33/29	47/42/37	57/51/45	73/66/59	88/80/72
- Starts per hour ³⁾	1/h	10	6	10	10	10	10
- Rated motor current I _M ²⁾⁴⁾ , starting time 30 s	A	29/26/23	36/33/29	47/42/37	57/51/45	73/66/59	88/80/72
- Starts per hour ³⁾	1/h	4	2	4	5	1.8	0.8
• For very heavy starting (Class 30)							
- Rated motor current I _M ²⁾ , starting time 30 s	A	29/26/23	36/33/29	44/42/37	57/51/45	65/60/54	77/70/63
- Starts per hour ³⁾	1/h	6	4	6	6	6	6
- Rated motor current I _M ²⁾³⁾ , starting time 60 s	A	29/26/23	36/33/29	44/42/37	57/51/45	65/60/54	77/70/63
- Starts per hour ³⁾	1/h	1.8	0.8	3.3	1.5	2	1

1) Measurement at 60 °C according to UL/CSA not required.

2) With 300 % I_M.

3) For intermittent duty S4 with ON period = 30 %, T₀ = 40 °C, stand-alone installation vertical. The quoted switching frequencies do not apply for automatic mode.

4) Maximum adjustable rated motor current I_M, dependent on CLASS setting.

3RW Soft Starters

3RW44 for high-feature applications

Type		3RW44 34	3RW44 35	3RW44 36
Power electronics		40 °C/50 °C/60 °C		
Load rating with rated operational current I_e				
<ul style="list-style-type: none"> • Acc. to IEC and UL/CSA¹⁾, for individual mounting at 40/50/60 °C, AC-53a 	A	113/100/88	134/117/100	162/145/125
Smallest adjustable rated motor current I_M				
For the motor overload protection	A	22	26	32
Power loss				
<ul style="list-style-type: none"> • In operation after completed starting with uninterrupted rated operational current (40 °C) approx. • During starting with 300 % I_M (40 °C) 	W	64	76	95
	W	1350	1700	2460
Permissible rated motor current and starts per hour				
• Normal starting (Class 5)				
- Rated motor current $I_M^{(2)}$, starting time 5 s	A	113/100/88	134/117/100	162/145/125
- Starts per hour ³⁾	1/h	41	39	41
- Rated motor current $I_M^{(2)(4)}$, starting time 10 s	A	113/100/88	134/117/100	162/145/125
- Starts per hour ³⁾	1/h	20	15	20
• Normal starting (Class 10)				
- Rated motor current $I_M^{(2)}$, starting time 10 s	A	113/100/88	134/117/100	162/145/125
- Starts per hour ³⁾	1/h	20	15	20
- Rated motor current $I_M^{(2)(4)}$, starting time 20 s	A	113/100/88	134/117/100	162/145/125
- Starts per hour ³⁾	1/h	9	6	7
• Normal starting (Class 15)				
- Rated motor current $I_M^{(2)}$, starting time 15 s	A	113/100/88	134/117/100	162/145/125
- Starts per hour ³⁾	1/h	13	9	12
- Rated motor current $I_M^{(2)(4)}$, starting time 30 s	A	113/100/88	134/117/100	162/145/125
- Starts per hour ³⁾	1/h	6	6	1
• Normal starting (Class 20)				
- Rated motor current $I_M^{(2)}$, starting time 20 s	A	106/97/88	125/113/100	147/134/122
- Starts per hour ³⁾	1/h	9	9	10
- Rated motor current $I_M^{(2)(4)}$, starting time 30 s	A	106/97/88	125/113/100	147/134/122
- Starts per hour ³⁾	1/h	1.5	2	1
• For very heavy starting (Class 30)				
- Rated motor current $I_M^{(2)}$, starting time 30 s	A	91/84/76	110/100/90	120/110/100
- Starts per hour ³⁾	1/h	6	6	6
- Rated motor current $I_M^{(2)(4)}$, starting time 60 s	A	91/84/76	110/100/90	120/110/100
- Starts per hour ³⁾	1/h	2	2	2

1) Measurement at 60 °C according to UL/CSA not required.

2) With 300 % I_M .

3) For intermittent duty S4 with ON period = 30 %, $T_u = 40$ °C, stand-alone installation vertical. The quoted switching frequencies do not apply for automatic mode.

4) Maximum adjustable rated motor current I_M , dependent on CLASS setting.

3RW Soft Starters

3RW44 for high-feature applications

Type		3RW44 43	3RW44 44	3RW44 45	3RW44 46	3RW44 47
Power electronics						
40 °C/50 °C/60 °C						
Load rating with rated operational current I_e • Acc. to IEC and UL/CSA ¹⁾ , for individual mounting at 40/50/60 °C, AC-53a	A	203/180/156	250/215/185	313/280/250	356/315/280	432/385/335
Smallest adjustable rated motor current I_M For the motor overload protection	A	40	50	62	71	86
Power loss						
• In operation after completed starting with uninterrupted rated operational current (40 °C) approx.	W	89	110	145	174	232
• During starting with 300 % I_M (40 °C)	W	3350	4000	4470	5350	5860
Permissible rated motor current and starts per hour						
• Normal starting (Class 5)						
- Rated motor current $I_M^{(2)}$, starting time 5 s	A	203/180/156	250/215/185	313/280/250	356/315/280	432/385/335
- Starts per hour ³⁾	1/h	41	41	41	41	39
- Rated motor current $I_M^{(2,4)}$, starting time 10 s	A	203/180/156	250/215/185	313/280/250	356/315/280	432/385/335
- Starts per hour ³⁾	1/h	20	20	19	17	16
• Normal starting (Class 10)						
- Rated motor current $I_M^{(2)}$, starting time 10 s	A	203/180/156	250/215/185	313/280/250	356/315/280	432/385/335
- Starts per hour ³⁾	1/h	20	20	19	17	16
- Rated motor current $I_M^{(2,4)}$, starting time 20 s	A	203/180/156	250/215/185	313/280/250	356/315/280	432/385/335
- Starts per hour ³⁾	1/h	9	10	6	4	5
• Normal starting (Class 15)						
- Rated motor current $I_M^{(2)}$, starting time 15 s	A	203/180/156	240/215/185	313/280/250	325/295/265	402/385/335
- Starts per hour ³⁾	1/h	13	13	10	13	11
- Rated motor current $I_M^{(2,4)}$, starting time 30 s	A	203/180/156	240/215/185	313/280/250	325/295/265	402/385/335
- Starts per hour ³⁾	1/h	3	6	1	2	1
• Normal starting (Class 20)						
- Rated motor current $I_M^{(2)}$, starting time 20 s	A	195/175/155	215/195/180	275/243/221	285/263/240	356/326/295
- Starts per hour ³⁾	1/h	10	10	10	10	10
- Rated motor current $I_M^{(2,4)}$, starting time 30 s	A	195/175/155	215/195/180	275/243/221	285/263/240	356/326/295
- Starts per hour ³⁾	1/h	1	5	1	3	1
• For very heavy starting (Class 30)						
- Rated motor current $I_M^{(2)}$, starting time 30 s	A	162/148/134	180/165/150	220/201/182	240/223/202	285/260/235
- Starts per hour ³⁾	1/h	6	6	6	6	6
- Rated motor current $I_M^{(2,4)}$, starting time 60 s	A	162/148/134	180/165/150	220/201/182	240/223/202	285/260/235
- Starts per hour ³⁾	1/h	3	3	3	2	1

¹⁾ Measurement at 60 °C according to UL/CSA not required.

²⁾ With 300 % I_M .

³⁾ For intermittent duty S4 with ON period = 30 %, $T_u = 40$ °C, stand-alone installation vertical. The quoted switching frequencies do not apply for automatic mode.

⁴⁾ Maximum adjustable rated motor current I_M , dependent on CLASS setting.

3RW Soft Starters

3RW44 for high-feature applications

Type		3RW44 53	3RW44 54	3RW44 55	3RW44 56	3RW44 57	3RW44 58
Power electronics		40 °C/50 °C/60 °C					
Load rating with rated operational current I_e							
• Acc. to IEC and UL/CSA ¹⁾ , for individual mounting at 40/50/60 °C, AC-53a	A	551/494/438	615/551/489	693/615/551	780/693/615	880/780/693	970/850/760
Smallest adjustable rated motor current I_M	A	110	123	138	156	176	194
For the motor overload protection							
Power loss							
• In operation after completed starting with uninterrupted rated operational current (40 °C) approx.	W	159	186	220	214	250	270
• During starting with 300 % I_M (40 °C)	W	7020	8100	9500	11100	13100	15000
Permissible rated motor current and starts per hour							
• Normal starting (Class 5)							
- Rated motor current $I_M^{(2)}$, starting time 5 s	A	551/494/438	615/551/489	693/615/551	780/693/615	880/780/693	970/850/760
- Starts per hour ³⁾	1/h	41	41	37	33	22	17
- Rated motor current $I_M^{(2/4)}$, starting time 10 s	A	551/494/438	615/551/489	693/615/551	780/693/615	880/780/693	970/850/760
- Starts per hour ³⁾	1/h	20	20	16	13	8	5
• Normal starting (Class 10)							
- Rated motor current $I_M^{(2)}$, starting time 10 s	A	551/494/438	615/551/489	693/615/551	780/693/615	880/780/693	970/850/760
- Starts per hour ³⁾	1/h	20	20	16	13	8	5
- Rated motor current $I_M^{(2/4)}$, starting time 20 s	A	551/494/438	615/551/489	693/615/551	780/693/615	880/780/693	970/850/760
- Starts per hour ³⁾	1/h	10	9	6	4	0.3	0.3
• Normal starting (Class 15)							
- Rated motor current $I_M^{(2)}$, starting time 15 s	A	551/494/438	615/551/489	666/615/551	723/693/615	780/710/650	821/755/693
- Starts per hour ³⁾	1/h	13	13	11	9	8	8
- Rated motor current $I_M^{(2/4)}$, starting time 30 s	A	551/494/438	615/551/489	666/615/551	723/693/615	780/710/650	821/755/693
- Starts per hour ³⁾	1/h	6	4	3	1	0.4	0.5
• Normal starting (Class 20)							
- Rated motor current $I_M^{(2)}$, starting time 20 s	A	551/494/438	591/551/489	633/615/551	670/634/576	710/650/590	740/685/630
- Starts per hour ³⁾	1/h	10	10	7	8	8	9
- Rated motor current $I_M^{(2/4)}$, starting time 30 s	A	551/494/438	591/551/489	633/615/551	670/634/576	710/650/590	740/685/630
- Starts per hour ³⁾	1/h	4	2	1	1	0.4	1
• For very heavy starting (Class 30)							
- Rated motor current $I_M^{(2)}$, starting time 30 s	A	500/480/438	525/489/455	551/520/480	575/540/490	600/550/500	630/580/530
- Starts per hour ³⁾	1/h	6	6	6	6	6	6
- Rated motor current $I_M^{(2/4)}$, starting time 60 s	A	500/480/438	525/489/455	551/520/480	575/540/490	600/550/500	630/580/530
- Starts per hour ³⁾	1/h	2	1	1	1	1.5	1

¹⁾ Measurement at 60 °C according to UL/CSA not required.

²⁾ With 300 % I_M .

³⁾ For intermittent duty S4 with ON period = 30 %, $T_U = 40$ °C, stand-alone installation vertical. The quoted switching frequencies do not apply for automatic mode.

⁴⁾ Maximum adjustable rated motor current I_M , dependent on CLASS setting.

3RW Soft Starters

3RW44 for high-feature applications

Type		3RW44 65	3RW44 66
Power electronics		40 °C/50 °C/60 °C	
Load rating with rated operational current I_e			
• Acc. to IEC and UL/CSA ¹⁾ , for individual mounting at 40/50/60 °C, AC-53a	A	1076/970/880	1214/1076/970
Smallest adjustable rated motor current I_M			
For the motor overload protection	A	215	242
Power loss			
• In operation after completed starting with uninterrupted rated operational current (40 °C) approx.	W	510	630
• During starting with 300 % I_M (40 °C)	W	15000	17500
Permissible rated motor current and starts per hour			
• Normal starting (Class 5)			
- Rated motor current $I_M^{(2)}$, starting time 5 s	A	1076/970/880	1214/1076/970
- Starts per hour ³⁾	1/h	30	20
- Rated motor current $I_M^{(2)(4)}$, starting time 10 s	A	1076/970/880	1214/1076/970
- Starts per hour ³⁾	1/h	10	6
• Normal starting (Class 10)			
- Rated motor current $I_M^{(2)}$, starting time 10 s	A	1076/970/880	1214/1076/970
- Starts per hour ³⁾	1/h	11	6
- Rated motor current $I_M^{(2)(4)}$, starting time 20 s	A	1076/970/880	1214/1076/970
- Starts per hour ³⁾	1/h	3	0.5
• Normal starting (Class 15)			
- Rated motor current $I_M^{(2)}$, starting time 15 s	A	1020/950/850	1090/1000/920
- Starts per hour ³⁾	1/h	7	5
- Rated motor current $I_M^{(2)(4)}$, starting time 30 s	A	1020/950/850	1090/1000/920
- Starts per hour ³⁾	1/h	1	1
• Normal starting (Class 20)			
- Rated motor current $I_M^{(2)}$, starting time 20 s	A	970/880/810	1030/940/860
- Starts per hour ³⁾	1/h	7	5
- Rated motor current $I_M^{(2)(4)}$, starting time 30 s	A	970/880/810	1030/940/860
- Starts per hour ³⁾	1/h	1	1
• For very heavy starting (Class 30)			
- Rated motor current $I_M^{(2)}$, starting time 30 s	A	880/810/740	920/850/780
- Starts per hour ³⁾	1/h	6	6
- Rated motor current $I_M^{(2)(4)}$, starting time 60 s	A	880/810/740	920/850/780
- Starts per hour ³⁾	1/h	1	1

1) Measurement at 60 °C according to UL/CSA not required.

2) With 300 % I_M .

3) For intermittent duty S4 with ON period = 30 %, $T_u = 40$ °C, stand-alone installation vertical. The quoted switching frequencies do not apply for automatic mode.

4) Maximum adjustable rated motor current I_M , dependent on CLASS setting.

3RW Soft Starters

3RW44 for high-feature applications



3RW44 27-1BC44



3RW44 36-6BC44



3RW44 47-6BC44

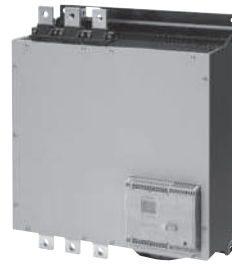

3RW44 58-6BC44



3RW44 66-6BC44

Ambient temperature 40 °C					Ambient temperature 50 °C					DT	Order No.	List Price \$ per PU	PU (UNIT, SET, M)	PS*	PG	Weight per PU approx. kg	
Rated operational current $I_e^{1)}$	Rated power of induction motors for rated operational voltage U_e					Rated operational current I_e	Rated power of induction motors for rated operational voltage U_e										
A	230 V	400 V	500 V	690 V	1000 V	A	200 V	230 V	460 V	575 V							
	kW	kW	kW	kW	kW		hp	hp	hp	hp							
Inside-delta circuits, rated operational voltage 200 ... 460 V²⁾																	
50	15	22	--	--	--	45	10	15	30	--	▶	3RW44 22-□BC□4		1	1 unit	131	6.500
62	18.5	30	--	--	--	55	15	20	40	--	▶	3RW44 23-□BC□4		1	1 unit	131	6.500
81	22	45	--	--	--	73	20	25	50	--	▶	3RW44 24-□BC□4		1	1 unit	131	6.500
99	30	55	--	--	--	88	25	30	60	--	▶	3RW44 25-□BC□4		1	1 unit	131	6.500
133	37	75	--	--	--	118	30	40	75	--	▶	3RW44 26-□BC□4		1	1 unit	131	6.500
161	45	90	--	--	--	142	40	50	100	--	▶	3RW44 27-□BC□4		1	1 unit	131	6.500
Order No. supplement for connection types																	
<ul style="list-style-type: none"> • With spring-type terminals • With screw terminals 																	
196	55	110	--	--	--	173	50	60	125	--	B	3RW44 34-□BC□4		1	1 unit	131	7.900
232	75	132	--	--	--	203	60	75	150	--	B	3RW44 35-□BC□4		1	1 unit	131	7.900
281	90	160	--	--	--	251	75	100	200	--	B	3RW44 36-□BC□4		1	1 unit	131	7.900
352	110	200	--	--	--	312	100	125	250	--	B	3RW44 43-□BC□4		1	1 unit	131	11.500
433	132	250	--	--	--	372	125	150	300	--	B	3RW44 44-□BC□4		1	1 unit	131	11.500
542	160	315	--	--	--	485	150	200	400	--	B	3RW44 45-□BC□4		1	1 unit	131	11.500
617	200	355	--	--	--	546	150	200	450	--	B	3RW44 46-□BC□4		1	1 unit	131	11.500
748	250	400	--	--	--	667	200	250	600	--	B	3RW44 47-□BC□4		1	1 unit	131	11.500
954	315	560	--	--	--	856	300	350	750	--	C	3RW44 53-□BC□4		1	1 unit	131	50.000
1065	355	630	--	--	--	954	350	400	850	--	C	3RW44 54-□BC□4		1	1 unit	131	50.000
1200	400	710	--	--	--	1065	350	450	950	--	C	3RW44 55-□BC□4		1	1 unit	131	50.000
1351	450	800	--	--	--	1200	450	500	1050	--	C	3RW44 56-□BC□4		1	1 unit	131	50.000
1524	500	900	--	--	--	1351	450	600	1200	--	C	3RW44 57-□BC□4		1	1 unit	131	50.000
1680	560	1000	--	--	--	1472	550	650	1300	--	C	3RW44 58-□BC□4		1	1 unit	131	50.000
1864	630	1100	--	--	--	1680	650	750	1500	--	C	3RW44 65-□BC□4		1	1 unit	131	78.000
2103	710	1200	--	--	--	1864	700	850	1700	--	C	3RW44 66-□BC□4		1	1 unit	131	78.000
Order No. supplement for connection types																	
<ul style="list-style-type: none"> • With spring-type terminals • With screw terminals 																	
Order No. supplement for the rated control supply voltage $U_s^{3)}$																	
<ul style="list-style-type: none"> • 115 V AC • 230 V AC 																	

Order No. supplement for connection types

- With spring-type terminals
- With screw terminals

Order No. supplement for the rated control supply voltage $U_s^{3)}$

- 115 V AC
- 230 V AC

¹⁾ In the selection table, the unit rated current I_e refers to the induction motor's rated operational current in the inside-delta circuit. The actual current of the device is approx. 58 % of this value.

²⁾ 3RW44 2 ... 3RW44 4. soft starters with screw terminals: delivery times ▶ (preferred type),

³⁾ Control by way of the internal 24 V DC supply and direct control by means of PLC possible.

Note:

Soft starter selection depends on the rated motor current.

The 3RW44 solid-state soft starters are designed for normal starting (Class 10). (Inertia load of the overall operating mechanism $J_{Load} < 10 \times J_{Motor}$; starting current 350 % $\times I_e$ for 20 s similar load). For any other conditions of use, the devices should be selected using the Win-Soft Starter selection and simulation program. See Technical specifications for information about rated currents for ambient temperatures > 40 °C and switching frequency.

3RW Soft Starters

3RW44 for high-feature applications

Ambient temperature 40 °C						Ambient temperature 50 °C					DT	Order No.	List Price \$ per PU	PU (UNIT, SET, M)	PS*	PG	Weight per PU approx.	
Rated operational current $I_e^{1)}$	Rated power of induction motors for rated operational voltage U_e					Rated operational current I_e	Rated power of induction motors for rated operational voltage U_e											
A	230 V	400 V	500 V	690 V	1000 V	A	200 V	230 V	460 V	575 V								kg
	kW	kW	kW	kW	kW		hp	hp	hp	hp								
Inside-delta circuits, rated operational voltage 400 ... 600 V²⁾																		
50	--	22	30	--	--	45	--	--	30	40	A	3RW44 22-□BC□5		1	1 unit	131	6.500	
62	--	30	37	--	--	55	--	--	40	50	A	3RW44 23-□BC□5		1	1 unit	131	6.500	
81	--	45	45	--	--	73	--	--	50	60	A	3RW44 24-□BC□5		1	1 unit	131	6.500	
99	--	55	55	--	--	88	--	--	60	75	A	3RW44 25-□BC□5		1	1 unit	131	6.500	
133	--	75	90	--	--	118	--	--	75	100	A	3RW44 26-□BC□5		1	1 unit	131	6.500	
161	--	90	110	--	--	142	--	--	100	125	A	3RW44 27-□BC□5		1	1 unit	131	6.500	
Order No. supplement for connection types																		
<ul style="list-style-type: none"> • With spring-type terminals • With screw terminals 																		
196	--	110	132	--	--	173	--	--	125	150	B	3RW44 34-□BC□5		1	1 unit	131	7.900	
232	--	132	160	--	--	203	--	--	150	200	B	3RW44 35-□BC□5		1	1 unit	131	7.900	
281	--	160	200	--	--	251	--	--	200	250	B	3RW44 36-□BC□5		1	1 unit	131	7.900	
352	--	200	250	--	--	312	--	--	250	300	B	3RW44 43-□BC□5		1	1 unit	131	11.500	
433	--	250	315	--	--	372	--	--	300	350	B	3RW44 44-□BC□5		1	1 unit	131	11.500	
542	--	315	355	--	--	485	--	--	400	500	B	3RW44 45-□BC□5		1	1 unit	131	11.500	
617	--	355	450	--	--	546	--	--	450	600	B	3RW44 46-□BC□5		1	1 unit	131	11.500	
748	--	400	500	--	--	667	--	--	600	750	B	3RW44 47-□BC□5		1	1 unit	131	11.500	
954	--	560	630	--	--	856	--	--	750	950	C	3RW44 53-□BC□5		1	1 unit	131	50.000	
1065	--	630	710	--	--	954	--	--	850	1050	C	3RW44 54-□BC□5		1	1 unit	131	50.000	
1200	--	710	800	--	--	1065	--	--	950	1200	C	3RW44 55-□BC□5		1	1 unit	131	50.000	
1351	--	800	900	--	--	1200	--	--	1050	1350	C	3RW44 56-□BC□5		1	1 unit	131	50.000	
1524	--	900	1000	--	--	1351	--	--	1200	1500	C	3RW44 57-□BC□5		1	1 unit	131	50.000	
1680	--	1000	1200	--	--	1472	--	--	1300	1650	C	3RW44 58-□BC□5		1	1 unit	131	50.000	
1864	--	1100	1350	--	--	1680	--	--	1500	1900	C	3RW44 65-□BC□5		1	1 unit	131	78.000	
2103	--	1200	1500	--	--	1864	--	--	1700	2100	C	3RW44 66-□BC□5		1	1 unit	131	78.000	

Order No. supplement for connection types

- With spring-type terminals
- With screw terminals

Order No. supplement for the rated control supply voltage $U_s^{3)}$

- 115 V AC
- 230 V AC

¹⁾ In the selection table, the unit rated current I_e refers to the induction motor's rated operational current in the inside-delta circuit. The actual current of the device is approx. 58 % of this value.

²⁾ Soft starter with screw terminals:
 3RW44 2. ... 3RW44 4. Delivery time A
 3RW44 5. ... 3RW44 6. Delivery time B.

³⁾ Control by way of the internal 24 V DC supply and direct control by means of PLC possible.

Note:

Soft starter selection depends on the rated motor current.

The 3RW44 solid-state soft starters are designed for normal starting (Class 10). (Inertia load of the overall operating mechanism $J_{Load} < 10 \times J_{Motor}$; starting current 350 % $\times I_e$ for 20 s similar load). For any other conditions of use, the devices should be selected using the Win-Soft Starter selection and simulation program. See Technical specifications for information about rated currents for ambient temperatures > 40 °C and switching frequency.

3RW Soft Starters

3RW44 for high-feature applications

Technical specifications

Type	Terminal		3RW44 ...-BC3.	3RW44 ...-BC4.
Control electronics				
Rated values				
Rated control supply voltage	A1/A2/PE	V	115 AC	230 AC
• Tolerance		%	-15/+10	-15/+10
Rated control supply current STANDBY		mA	30	20
Rated control supply current ON				
• 3RW44 2.		mA	300	170
• 3RW44 3.		mA	500	250
• 3RW44 4.		mA	750	400
• 3RW44 5.		mA	450	200
• 3RW44 6.		mA	650	300
Maximum current (pickup bypass)				
• 3RW44 2.		mA	1000	500
• 3RW44 3.		mA	2500	1250
• 3RW44 4.		mA	6000	3000
• 3RW44 5.		mA	4500	2500
• 3RW44 6.		mA	4500	2500
Rated frequency		Hz	50 ... 60	50 ... 60
• Tolerance		%	±10	±10

Type	Terminal		3RW44 ..	Factory default
Control electronics				
Control inputs				
Input 1	IN1			Start motor right parameter set 1
Input 2	IN2			No action
Input 3	IN3			No action
Input 4	IN4			Trip reset
Supply	L+/L-			
• Rated operational current	L+	mA	Approx. 10 per input to DIN 19240	
• Rated operational voltage	L-		Internal voltage: 24 V DC from internal supply through terminal L+ to IN1 ... IN4. Maximum load at L+ approx. 55 mA	
			External voltage: DC external voltage (acc. to DIN 19240) through terminals L- and IN1 ... IN4 (min. 12 V DC, max. 30 V DC)	
Thermistor motor protection input				
Input	T1/T2		PTC type A or Thermoclick	Deactivated
Relay outputs (floating auxiliary contacts)				
Output 1	13/14			ON period
Output 2	23/24			No action
Output 3	33/34			No action
Output 4	95/96/98			Group fault
Switching capacity of the relay outputs (auxiliary contacts)				
230 V/AC-15		A	3 at 240 V	
24 V/DC-13		A	1 at 24 V	
Protection against overvoltages			Protection by means of varistor through relay contact	
Short-circuit protection			4 A gL/gG operational class; 6 A quick (fuse is not included in scope of supply)	
Protection functions				
Motor protection functions				
Trips in the event of			Thermal overloading of the motor	
Trip class acc. to IEC 60947-4-1		Class	5/10/15/20/30	10
Phase failure sensitivity		%	>40	
Overload warning			Yes	
Reset and recovery			Manual/Automatic	Manual
Reset option after tripping			Manual/Automatic	Manual
Recovery time		min.	1 ... 30	1
Device protection functions				
Trips in the event of			Thermal overloading of the thyristors	
Reset option after tripping			Manual/Automatic	Manual
Recovery time		min.	0.5	
Bypass protection functions				
Trips in the event of			Thermal overloading of the bypass contacts	
Reset option after tripping			Manual	
Recovery time		min.	1	

3RW Soft Starters

3RW44 for high-feature applications

Type	3RW44..		Factory default
Control times and parameters			
Control times			
Closing time (with connected control voltage)	ms	<50	
Closing time (automatic mode)	ms	<4000	
Recovery time (closing command in active ramp-down)	ms	<100	
Mains failure bridging time			
Control supply voltage	ms	100	
Mains failure response time			
Load circuit	ms	100	
Reclosing lockout after overload trip			
Motor protection trip	min.	1 ... 30	1
Device protection trip	s	30	
Setting options for starting			
Voltage ramp for starting voltage	%	20 ... 100	30
Torque control for starting torque	%	10 ... 100	10
Torque control for limit torque	%	20 ... 200	150
Starting time	s	0 ... 360 ³⁾	20
Maximum starting time	s	1 ... 1000	Deactivated
Current limit value	%	125 ... 550 ¹⁾	450
Breakaway voltage	%	40 ... 100	80
Breakaway time	s	0 ... 2	Deactivated
Motor heat output	%	1 ... 100	20
Creep mode Left/Right running			
Speed factor as function of rated speed ($n = n_{rated}/factor$)		3 ... 21	7
Creep torque ²⁾	%	20 ... 100	50
Setting options for ramp-down			
Torque control for stopping torque	%	10 ... 100	10
Ramp-down time	s	0 ... 360 ³⁾	10
Dynamic braking torque	%	20 ... 100	50
DC braking torque	%	20 ... 100	50
Operating indications			
		Test voltage	
		Test mains phases	
		Ready to start	
		Start active	
		Motor running	
		Ramp-down active	
		Emergency start active	
Warnings/error signals			
		Mains voltage missing	
		Leading-edge phase error	
		Phase failure	
		• L1	
		• L2	
		• L3	
		Missing load phase	
		• T1	
		• T2	
		• T3	
		Failure	
		• Contact element 1 (thyristor)	
		• Contact element 2 (thyristor)	
		• Contact element 3 (thyristor)	
		Flash memory faulty	
		Supply voltage	
		• Below 75 %	
		• Below 85 %	
		• Over 110 %	
		Current unbalance exceeded	
		Thermal motor model overload	
		Prewarning limit exceeded	
		• Motor heating	
		• Time-related trip reserve	
		Bypass element defective	
		Mains voltage too high	
		Device not named	
		Wrong naming version	
		Current measuring range exceeded	
		Bypass element protection disconnection	
		Power section	
		• Overheated	
		• Overheating	

¹⁾ Max. current limit value for 3RW44 53 ... 3RW44 57: 500 % and for 3RW44 58 ... 3RW44 66: 450 %.

²⁾ Reference variable depends on the motor used but is always smaller than the rated torque of the motor.

³⁾ Actual motor start times are load dependent.

3RW Soft Starters







3RW44 for high-feature applications

Type	3RW44 ..	Factory default
Control times and parameters		
Warnings/error signals (continued)		
	Temperature sensor <ul style="list-style-type: none"> • Overload • Open circuit • Short-circuit Ground fault <ul style="list-style-type: none"> • Detected Connection abort in manual operating mode Max. number of starts exceeded I_g limit value overshoot/undershoot Heat sink sensor <ul style="list-style-type: none"> • Open circuit • Short-circuit Quick-stop active Switching block defective I_g /class setting not permissible No external start-up parameters received PAA fault	
Control inputs Input 1 Input 2 Input 3 Input 4 Parameterizing options for control inputs 1 ... 4	No action Local manual mode Emergency start Creep speed Quick-stop Trip reset Motor right parameter set 1 Motor left parameter set 1 ¹⁾ Motor right parameter set 2 Motor left parameter set 2 ¹⁾ Motor right parameter set 3 Motor left parameter set 3 ¹⁾	Motor right parameter set 1 No action No action Trip reset
Relay outputs Output 1 Output 2 Output 3 Output 4 Parameterizing options for relay outputs 1 ... 3	No action PAA output 1 PAA output 2 Input 1 Input 2 Input 3 Input 4 Starting Operation/Bypass Ramp-down ON period Command motor on DC braking contactor Group warning Group fault Bus fault Device fault Power on Ready to start	ON period No action No action Group fault
Motor temperature sensor	Deactivated Thermoclick PTC type A	

¹⁾ Parameter motor left possible only in conjunction with creep mode.

3RW Soft Starters

3RW44 for high-feature applications

Type		3RW44 2.	3RW44 3.	3RW44 4.	3RW44 5. 3RW44 6.
Conductor cross-sections					
Screw terminals	Main conductors				
With box terminal			3RT19 55-4G (55 kW)	3RT19 66-4G	--
Front clamping point connected	<ul style="list-style-type: none"> Finely stranded with end sleeve Finely stranded without end sleeve Solid Stranded Ribbon cable conductors (number x width x thickness) AWG cables, solid or stranded 	mm ² 2.5 ... 35 mm ² 4 ... 50 mm ² 2.5 ... 16 mm ² 4 ... 70 mm 6 x 9 x 0.8 AWG 10 ... 2/0	16 ... 70 16 ... 70 -- 16 ... 70 Min. 3 x 9 x 0.8 Max. 6 x 15.5 x 0.8 6 ... 2/0	70 ... 240 70 ... 240 -- 95 ... 300 Min. 6 x 9 x 0.8 Max. 20 x 24 x 0.5 3/0 ... 600 kcmil	--
					
Rear clamping point connected	<ul style="list-style-type: none"> Finely stranded with end sleeve Finely stranded without end sleeve Solid Stranded Ribbon cable conductors (number x width x thickness) AWG cables, solid or stranded 	mm ² 2.5 ... 50 mm ² 10 ... 50 mm ² 2.5 ... 16 mm ² 10 ... 70 mm 6 x 9 x 0.8 AWG 10 ... 2/0	16 ... 70 16 ... 70 -- 16 ... 70 Min. 3 x 9 x 0.8 Max. 6 x 15.5 x 0.8 6 ... 2/0	120 ... 185 120 ... 185 -- 120 ... 240 Min. 6 x 9 x 0.8 Max. 20 x 24 x 0.5 250 ... 500 kcmil	--
					
Both clamping points connected	<ul style="list-style-type: none"> Finely stranded with end sleeve Finely stranded without end sleeve Solid Stranded Ribbon cable conductors (number x width x thickness) AWG cables, solid or stranded Terminal screws - Tightening torque 	mm ² 2 x (2.5 ... 35) mm ² 2 x (4 ... 35) mm ² 2 x (2.5 ... 16) mm ² 2 x (4 ... 50) mm 2 x (6 x 9 x 0.8) AWG 2 x (10 ... 1/0) M6 (hexagon socket, A/F4) 4 ... 6 36 ... 53 NM lb.in	Max. 1 x 50, 1 x 70 Max. 1 x 50, 1 x 70 -- Max. 2 x 70 Max. 2 x (6 x 15.5 x 0.8) Max. 2 x 1/0 M10 (hexagon socket, A/F4) 10 ... 12 90 ... 110	Min. 2 x 50 Max. 2 x 185 Min. 2 x 50 Max. 2 x 185 -- Max. 2 x 70 Max. 2 x 240 Max. 2 x (20 x 24 x 0.5) Min. 2 x 2/0 Max. 2 x 500 kcmil M12 (hexagon socket, A/F4) 20 ... 22 180 ... 195	--
					
Screw terminals	Main conductors				
With box terminal		--	3RT19 56-4G	--	--
Front or rear clamping point connected	<ul style="list-style-type: none"> Finely stranded with end sleeve Finely stranded without end sleeve Stranded Ribbon cable conductors (number x width x thickness) AWG cables, solid or stranded 	mm ² -- mm ² -- mm ² -- mm -- AWG --	16 ... 120 16 ... 120 16 ... 120 Min. 3 x 9 x 0.8 Max. 6 x 15.5 x 0.8 6 ... 250 kcmil	--	--
					
Both clamping points connected	<ul style="list-style-type: none"> Finely stranded with end sleeve Finely stranded without end sleeve Stranded Ribbon cable conductors (number x width x thickness) AWG cables, solid or stranded 	mm ² -- mm ² -- mm ² -- mm -- AWG --	Max. 1 x 95, 1 x 120 Max. 1 x 95, 1 x 120 Max. 2 x 120 Max. 2 x (10 x 15.5 x 0.8) Max. 2 x 3/0	--	--
					
Screw terminals	Main conductors				
	<u>Without box terminal/busbar connection</u>				
	<ul style="list-style-type: none"> Finely stranded with cable lug Stranded with cable lug AWG cables, solid or stranded Connecting bar (max. width) Terminal screws - Tightening torque 	mm ² -- mm ² -- AWG -- mm -- -- NM -- lb.in --	16 ... 95 ¹⁾ 25 ... 120 ¹⁾ 4 ... 250 kcmil 17 M8 x 25 (A/F13) 10 ... 14 89 ... 124	50 ... 240 ²⁾ 70 ... 240 ²⁾ 2/0 ... 500 kcmil 25 M10 x 30 (A/F17) 14 ... 24 124 ... 210	50 ... 240 ²⁾ 70 ... 240 ²⁾ 2/0 ... 500 kcmil 60 M12 x 40 20 ... 35 177 ... 310

¹⁾ When connecting cable lugs to DIN 46235, use 3RT19 56-4EA1 terminal cover for conductor cross-sections from 95 mm² to ensure phase spacing.
²⁾ When connecting cable lugs to DIN 46234, the 3RT19 66-4EA1 terminal cover must be used for conductor cross-sections of 240 mm² and more as well as DIN 46235 for conductor cross-sections of 185 mm² and more to keep the phase clearance.

3RW Soft Starters

3RW44 for high-feature applications

Soft starters	Type	3RW44..	
Conductor cross-sections			
Auxiliary conductors (1 or 2 conductors can be connected):			
Screw terminals			
• Solid	mm ²	2 x (0.5 ... 2.5)	
• Finely stranded with end sleeve	mm ²	2 x (0.5 ... 1.5)	
• AWG cables			
- Solid or stranded	AWG	2 x (20 ... 14)	
- Finely stranded with end sleeve	AWG	2 x (20 ... 16)	
• Terminal screws			
- Tightening torque	NM lb.in	0.8 ... 1.2 7 ... 10.3	
Spring-type terminals			
• Solid	mm ²	2 x (0.25 ... 1.5)	
• Finely stranded with end sleeve	mm ²	2 x (0.25 ... 1.5)	
• AWG cables, solid or stranded	AWG	2 x (24 ... 16)	
		Standard	Parameters
Electromagnetic compatibility acc. to EN 60947-4-2			
EMC interference immunity			
Electrostatic discharge (ESD)	EN 61000-4-2	±4 kV contact discharge, ±8 kV air discharge	
Electromagnetic RF fields	EN 61000-4-3	Frequency range: 80 ... 1000 MHz with 80 % at 1 kHz Degree of severity 3, 10 V/m	
Conducted RF interference	EN 61000-4-6	Frequency range: 150 kHz ... 80 MHz with 80 % at 1 kHz Interference 10 V	
RF voltages and RF currents on cables			
• Burst	EN 61000-4-4	±2 kV/5 kHz	
• Surge	EN 61000-4-5	±1 kV line to line ±2 kV line to ground	
EMC interference emission			
EMC interference field strength	EN 55011	Limit value of Class A at 30 ... 1000 MHz	
Radio interference voltage	EN 55011	Limit value of Class A at 0.15 ... 30 MHz	
Is an RI suppression filter necessary?			
Degree of noise suppression A (industrial applications)		No	

3RW Soft Starters

Circuit Breaker SCCR

Soft starters ToC 1	Rated current	Circuit Brakers																	
		Thermal Magnetic						Instantaneous Trip						Fuse					
Q11 Type		480 V Type	SCCR kA	Max. size A	600 V Type	SCCR kA	Max. size A	480 V Type	SCCR kA	Max. size A	600 V Type	SCCR kA	Max. size A	600 V Type	SCCR kA	Max. size A	600 V Type	SCCR kA	Max. size A
3RW44 22	11	ED63B, HEG3G	100	40				ED63A, HEM3M	100	40	ED63A, HEM3M	50	40	RK5	100	50	J	100	100
3RW44 23	23	ED63B, HEG3G	100	50				ED63A, HEM3M	100	50	ED63A, HEM3M	50	50	RK5	100	60	J	100	120
3RW44 24	29	ED63B, HEG3G	100	70				ED63A, HEM3M	100	100	ED63A, HEM3M	50	50	RK5	100	80	J	100	160
3RW44 25	29	ED63B, HEG3G	100	70				ED63A, HEM3M	100	50	ED63A, HEM3M	50	50	RK5	100	80			
3RW44 26	29	ED63B, HEG3G	100	100				ED63A, HEM3M	100	100	ED63A, HEM3M	50	100	RK5	100	125	J	100	250
3RW44 27	34	ED63B, HEG3G, FD63B	100	150				ED63A, HEM3M	100	100	ED63A, HEM3M	50	125	RK5	100	150	J	100	300
3RW44 34	42	FD63B	100	150	FD63B	50	150	ED63A, HEM3M	100	125	FXD63A	50	150	RK5	100	200	J	100	400
3RW44 35	58	FD63B	100	150	FD63B	50	150	FXD63A	100	150	FXD63A	50	150	RK5	100	200	J	100	400
3RW44 36	62	JD63B	100	200	JD63B	50	250	FXD63A	100	250	FXD63A	50	250	RK5	100	250	J	100	500
3RW44 43	73	JD63B	100	300	JD63B	50	250	FXD63A	100	250	JXD63A	50	300	RK5	100	300	J	100	600
3RW44 44	98	JD63B	100	300	JD63B	50	300	JXD63A	100	300	JXD63A	50	300	RK5	100	350			
3RW44 45	98	JD63B	100	400	JD63B	50	400	JXD63A	100	400	JXD63A	50	400	RK5	100	450			
3RW44 46	98	LD63B	100	500	LD63B	50	450	LXD63H	100	400	JXD63A	50	400	RK5	100	600			
3RW44 47	98	LD63B	100	600	LD63B	50	600	LXD63H	100	600	LXD63H	50	600	L	100	700			
3RW44 53	117	HMD6	65	800/800	HMD6	50	800/800							L	100	1000			
3RW44 54	145	HND6	100	1200/900	HND6	50	1200/900							L	100	1000			
3RW44 55	145	HND6	100	1200/900	HND6	50	1200/900							L	100	1000			
3RW44 56	145	HND6	100	1200/1000	HND6	50	1200/1000							L	100	1000			
3RW44 57	145	HND6	100	1200/1000	HND6	50	1200/1000							L	100	1000			
3RW44 58	145	CND6	65	1200	CND6	65	1200												
3RW44 65	205	CND6	42	1600	CND6	42	1600												
3RW44 66	248	CND6	42	1600	CND6	42	1600												

Specified Type

ED63A
FXD63A
JXD63A
ED63B
FD63B
JD63B
HND6

Others permitted

HED63A, HHED63A or CED63A
HFXD63A or CFD63A
HJXD63A or CJD63A
HED63B, HHED63B or CED63B
HFD63B, HHFD63B or CFD63B
HJ63B, HHJD63B or CJD63B
HNXD6 or CND6

3RW Soft Starters

3RW44 for high-feature applications

Inline circuit fused version with 3NE1 SITOR all-range fuse (semiconductor and line protection)

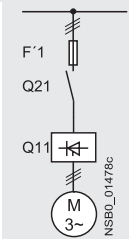

For matching fuse bases see Catalog LV 1 under "SETRON Switching and Protection Devices for Power Distribution" → "Switch Disconnectors", and Catalog ET B1 under "BETA Protecting" → "SITOR Semiconductor Fuses" or go to www.siemens.com/sitor → "Products" → "BETA Protecting" → "SITOR"

Soft starters Q11 Type	Rated current A	All-range fuses			Line contactors up to 400 V (optional) Q21 Type	Braking contactors ¹⁾²⁾ (for example circuit see page 7/70) Q91 Type Q92 Type		
		F'1 Type	Rated current A	Voltage V		Size		
Type of coordination "2"ⁿ³⁾; I_q = 65 kA								
3RW44 22	29	3NE1 020-2	80	690 +5 %	00	3RT10 34	3RT15 26	--
3RW44 23	36	3NE1 020-2	80	690 +5 %	00	3RT10 35	3RT15 26	--
3RW44 24	47	3NE1 021-2	100	690 +5 %	00	3RT10 36	3RT15 35	--
3RW44 25	57	3NE1 022-2	125	690 +5 %	00	3RT10 44	3RT15 35	--
3RW44 26	77	3NE1 022-2	125	690 +5 %	00	3RT10 45	3RT10 24	3RT10 35
3RW44 27	93	3NE1 024-2	160	690 +5 %	1	3RT10 46	3RT10 25	3RT10 36
3RW44 34	113	3NE1 225-2	200	690 +5 %	1	3RT10 54	3RT10 34	3RT10 44
3RW44 35	134	3NE1 227-2	250	690 +5 %	1	3RT10 55	3RT10 36	3RT10 45
3RW44 36	162	3NE1 227-2	250	690 +5 %	1	3RT10 56	3RT10 44	3RT10 45
3RW44 43	203	3NE1 230-2	315	600 +10 %	1	3RT10 64	3RT10 44	3RT10 54
3RW44 44	250	3NE1 331-2	350	460 +10 %	2	3RT10 65	3RT10 44	3RT10 55
3RW44 45	313	3NE1 333-2	450	690 +5 %	2	3RT10 75	3RT10 54	3RT10 56
3RW44 46	356	3NE1 334-2	500	690 +5 %	2	3RT10 75	3RT10 54	3RT10 56
3RW44 47	432	3NE1 435-2	560	690 +5 %	3	3RT10 76	3RT10 55	3RT10 64
3RW44 53	551	2 x 3NE1 334-2	500	690 +10 %	2	3TF68	3RT10 64	3RT10 66
3RW44 54	615	2 x 3NE1 334-2	500	690 +10 %	2	3TF68	3RT10 64	3RT10 75
3RW44 55	693	2 x 3NE1 334-2	500	690 +10 %	2	3TF69	3RT10 65	3RT10 75
3RW44 56	780	2 x 3NE1 435-2	560	690 +10 %	3	3TF69	3RT10 65	3RT10 75
3RW44 57	880	2 x 3NE1 435-2	560	690 +10 %	3		3RT10 75	3RT10 76
3RW44 58	970	2 x 3NE1 435-2	560	690 +10 %	3		3RT10 75	3RT10 76
3RW44 65	1076	3 x 3NE1 334-2	500	690 +10 %	2		3RT10 75	3TF68
3RW44 66	1214	3 x 3NE1 435-2	560	690 +10 %	3		3RT10 76	3TF68

1) If the ramp-down function "Combined braking" is selected, no braking contactor is required.
If the ramp-down function "DC braking" is selected, a braking contactor must be used in addition (see table for type).
For applications with large centrifugal masses ($J_{Load} > J_{Motor}$) we recommend the function "DC braking".

2) Additional auxiliary relay K4:
LZX:RT4A4T30
(3RW44 soft starter with rated control supply voltage 230 V AC),
LZX:RT4A4S15
(3RW44 soft starter with rated control supply voltage 115 V AC).

3) The type of coordination "2" refers only to soft starters in combination with the stipulated protective device (motor starter protector/circuit breaker/fuse), not to any additional components in the feeder.
[The types of coordination are explained under "3RA1 Fuseless Load Feeders".](#)

3RW Soft Starters

3RW44 for high-feature applications

Inline circuit fused version with 3NE or 3NC SITOR semiconductor fuse

(semiconductor protection by fuse, line and overload protection by motor starter protector/circuit breaker)

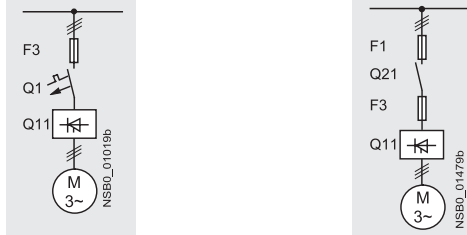

For matching fuse bases see Catalog LV 1 under "SENTRON Switching and Protection Devices for Power Distribution" → "Switch Disconnectors", and Catalog ET B1 under "BETA Protecting" → "SITOR Semiconductor Fuses" or go to www.siemens.com/sitor → "Products" → "BETA Protecting" → "SITOR"

Soft starters Q11 Type	Rated current A	Semiconductor fuses, minimum			Semiconductor fuses, maximum			Semiconductor fuses (cylinder)		
		690 V +10 % F3 Type	Rated current A	Size	690 V +10 % F3 Type	Rated current A	Size	F3 Type	Rated current A	Size
Type of coordination "2"³⁾: I_q = 65 kA										
3RW44 22	29	3NE4 120	80	0	3NE4 121	100	0	3NC2 280	80	22 x 58
3RW44 23	36	3NE4 121	100	0	3NE4 121	100	0	3NC2 200	100	22 x 58
3RW44 24	47	3NE4 121	100	0	3NE4 122	125	0	3NC2 200	100	22 x 58
3RW44 25	57	3NE4 122	125	0	3NE4 124	160	0			
3RW44 26	77	3NE4 124	160	0	3NE4 124	160	0			
3RW44 27	93	3NE3 224	160	1	3NE3 332-0B	400	2			
3RW44 34	113	3NE3 225	200	1	3NE3 335	560	2			
3RW44 35	134	3NE3 225	200	1	3NE3 335	560	2			
3RW44 36	162	3NE3 227	250	1	3NE3 333	450	2			
3RW44 43	203	3NE3 230-0B	315	1	3NE3 333	450	2			
3RW44 44	250	3NE3 230-0B	315	1	3NE3 333	450	2			
3RW44 45	313	3NE3 233	450	1	3NE3 336	630	2			
3RW44 46	356	3NE3 333	450	2	3NE3 336	630	2			
3RW44 47	432	3NE3 335	560	2	3NE3 338-8	800	2			
3RW44 53	551	2 x 3NE3 335	560	2	3 x 3NE3 334-0B	500	2			
3RW44 54	615	2 x 3NE3 335	560	2	3 x 3NE3 334-0B	500	2			
3RW44 55	693	2 x 3NE3 335	560	2	3 x 3NE3 334-0B	500	2			
3RW44 56	780	2 x 3NE3 336	630	2	2 x 3NE3 340-8	900	2			
3RW44 57	880	2 x 3NE3 336	630	2	2 x 3NE3 340-8	900	2			
3RW44 58	970	2 x 3NE3 336	630	2	2 x 3NE3 340-8	900	2			
3RW44 65	1076	2 x 3NE3 340-8	900	2	3 x 3NE3 338-8	800	2			
3RW44 66	1214	2 x 3NE3 340-8	900	2	3 x 3NE3 338-8	800	2			

Soft starters Q11 Type	Rated current A	Line contactors (optional) Q21 Type	Braking contactors ¹⁾²⁾ (for example circuit see page 7/64)		Motor starter protectors/ circuit breakers		Line protection, maximum			
			Q91 Type	Q92 Type	440 V +10 % Q1 Type	Rated current A	690 V +5 % F1 Type	Rated current A	Size	
Type of coordination "2"³⁾: I_q = 65 kA										
3RW44 22	29	3RT10 34	3RT15 26	--	3RV10 41-4HA10	50		3NA3 820-6	50	00
3RW44 23	36	3RT10 35	3RT15 26	--	3RV10 41-4JA10	63		3NA3 822-6	63	00
3RW44 24	47	3RT10 36	3RT15 35	--	3RV10 41-4KA10	75		3NA3 824-6	80	00
3RW44 25	57	3RT10 44	3RT15 35	--	3RV10 41-4LA10	90		3NA3 830-6	100	00
3RW44 26	77	3RT10 45	3RT10 24	3RT10 35	3RV10 41-4MA10	100		3NA3 132-6	125	1
3RW44 27	93	3RT10 46	3RT10 25	3RT10 36	3RV10 41-4MA10	100		3NA3 136-6	160	1
3RW44 34	113	3RT10 54	3RT10 34	3RT10 44	3VL17 16	160		3NA3 244-6	250	2
3RW44 35	134	3RT10 55	3RT10 36	3RT10 45	3VL17 16	160		3NA3 244-6	250	2
3RW44 36	162	3RT10 56	3RT10 44	3RT10 45	3VL37 25	250		3NA3 365-6	500	3
3RW44 43	203	3RT10 64	3RT10 44	3RT10 54	3VL47 31	315		2 x 3NA3 354-6	2 x 355	3
3RW44 44	250	3RT10 65	3RT10 44	3RT10 55	3VL47 31	315		2 x 3NA3 354-6	2 x 355	3
3RW44 45	313	3RT10 75	3RT10 54	3RT10 56	3VL47 40	400		2 x 3NA3 365-6	2 x 500	3
3RW44 46	356	3RT10 75	3RT10 54	3RT10 56	3VL47 40	400		2 x 3NA3 365-6	2 x 500	3
3RW44 47	432	3RT10 76	3RT10 55	3RT10 64	3VL57 50	500		2 x 3NA3 365-6	2 x 500	3
3RW44 53	551	3TF68	3RT10 64	3RT10 66	3VL67 80	800		2 x 3NA3 365-6	2 x 500	3
3RW44 54	615	3TF68	3RT10 64	3RT10 75	3VL67 80	800		2 x 3NA3 365-6	2 x 500	3
3RW44 55	693	3TF69	3RT10 65	3RT10 75	3VL67 80	800		2 x 3NA3 365-6	2 x 500	3
3RW44 56	780	3TF69	3RT10 65	3RT10 75	3VL77 10	1000		2 x 3NA3 365-6	2 x 500	3
3RW44 57	880		3RT10 75	3RT10 76	3VL77 10	1000		2 x 3NA3 365-6	2 x 500	3
3RW44 58	970		3RT10 75	3RT10 76	3VL77 12	1250		3 x 3NA3 365-6	3 x 500	3
3RW44 65	1076		3RT10 75	3TF68	3VL77 12	1250		3 x 3NA3 365-6	3 x 500	3
3RW44 66	1214		3RT10 76	3TF68	3VL77 12	1250		3 x 3NA3 365-6	3 x 500	3

1) If the ramp-down function "Combined braking" is selected, no braking contactor is required. If the ramp-down function "DC braking" is selected, a braking contactor must be used in addition (see table for type). For applications with large centrifugal masses ($J_{Load} > J_{Motor}$) we recommend the function "DC braking".

2) Additional auxiliary relay K4:
LZX:RT4A4T30
(3RW44 soft starter with rated control supply voltage 230 V AC),
LZX:RT4A4S15
(3RW44 soft starter with rated control supply voltage 115 V AC).

3) The type of coordination "2" refers only to soft starters in combination with the stipulated protective device (motor starter protector/circuit breaker/fuse), not to any additional components in the feeder. The types of coordination are explained under "3RA1 Fuseless Load Feeders".

3RW Soft Starters

3RW44 for high-feature applications

Inside-delta circuit fused version with 3NE or 3NC SITOR fuses
 (semiconductor protection by fuse, lead and overload protection by motor starter protector/circuit breaker)

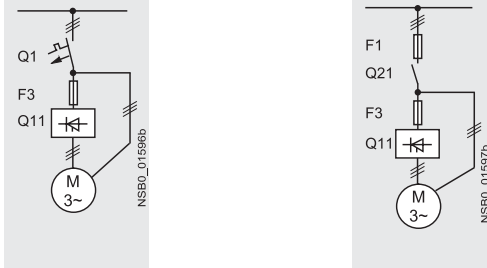

For matching fuse bases see Catalog LV 1 under "SENTRON Switching and Protection Devices for Power Distribution" → "Switch Disconnectors", and Catalog ET B1 under "BETA Protecting" → "SITOR Semiconductor Fuses" or go to www.siemens.com/sitor → "Products" → "BETA Protecting" → "SITOR"

Soft starters Q11 Type	Rated current A	Semiconductor fuses, minimum			Semiconductor fuses, maximum			Semiconductor fuses (cylinder)		
		F3 Type	Rated current A	Size	F3 Type	Rated current A	Size	F3 Type	Rated current A	Size
Type of coordination "2"¹⁾										
3RW44 22	50	3NE4 120	80	0	3NE4 121	100	0	3NC2 280	80	22 x 58
3RW44 23	62	3NE4 121	100	0	3NE4 121	100	0	3NC2 200	100	22 x 58
3RW44 24	81	3NE4 121	100	0	3NE4 122	125	0	3NC2 200	100	22 x 58
3RW44 25	99	3NE4 122	125	0	3NE4 124	160	0			
3RW44 26	133	3NE4 124	160	0	3NE4 124	160	0			
3RW44 27	161	3NE3 224	160	1	3NE3 332-0B	400	2			
3RW44 34	196	3NE3 225	200	1	3NE3 335	560	2			
3RW44 35	232	3NE3 225	200	1	3NE3 335	560	2			
3RW44 36	281	3NE3 227	250	1	3NE3 333	450	2			
3RW44 43	352	3NE3 230-0B	315	1	3NE3 333	450	2			
3RW44 44	433	3NE3 230-0B	315	1	3NE3 333	450	2			
3RW44 45	542	3NE3 233	450	1	3NE3 336	630	2			
3RW44 46	617	3NE3 333	450	2	3NE3 336	630	2			
3RW44 47	748	3NE3 335	560	2	3NE3 338-8	800	2			
3RW44 53	954	2 x 3NE3 335	560	2	3 x 3NE3 334-0B	500	2			
3RW44 54	1065	2 x 3NE3 335	560	2	3 x 3NE3 334-0B	500	2			
3RW44 55	1200	2 x 3NE3 335	560	2	3 x 3NE3 334-0B	500	2			
3RW44 56	1351	2 x 3NE3 336	630	2	2 x 3NE3 340-8	900	2			
3RW44 57	1524	2 x 3NE3 336	630	2	3 x 3NE3 340-8	900	2			
3RW44 58	1680	2 x 3NE3 336	630	2	3 x 3NE3 340-8	900	2			
3RW44 65	1864	2 x 3NE3 340-8	900	2	3 x 3NE3 338-8	800	2			
3RW44 66	2103	2 x 3NE3 340-8	900	2	3 x 3NE3 338-8	800	2			

Soft starters Q11 Type	Rated current A	Line contactors up to 400 V (optional)		Motor starter protectors/circuit breakers		Line protection, maximum		
		Q21 Type	Q1 Type	Rated current A	Rated current A	Rated current A	Size	
Type of coordination "2"¹⁾								
3RW44 22	50	3RT10 36-1AP04	3RV10 42-4KA10	75	3NA3 824-6	80		00
3RW44 23	62	3RT10 44-1AP04	3RV10 42-4LA10	90	3NA3 830-6	100		00
3RW44 24	81	3RT10 46-1AP04	3RV10 42-4MA10	100	3NA3 132-6	125		1
3RW44 25	99	3RT10 54-1AP36	3VL27 16	160	3NA3 136-6	160		1
3RW44 26	133	3RT10 55-6AP36	3VL27 16	160	3NA3 240-6	200		2
3RW44 27	161	3RT10 56-6AP36	3VL37 20	200	3NA3 244-6	250		2
3RW44 34	196	3RT10 64-6AP36	3VL37 25	250	3NA3 360-6	400		3
3RW44 35	232	3RT10 65-6AP36	3VL47 31	315	3NA3 360-6	400		3
3RW44 36	281	3RT10 66-6AP36	3VL47 40	400	2 x 3NA3 360-6	2 x 400		3
3RW44 43	352	3RT10 75-6AP36	3VL47 40	400	2 x 3NA3 365-6	2 x 500		3
3RW44 44	433	3RT10 76-6AP36	3VL57 50	500	2 x 3NA3 365-6	2 x 500		3
3RW44 45	542	3TF68 44-0CM7	3VL57 63	800	3 x 3NA3 365-6	3 x 500		3
3RW44 46	617	3TF68 44-0CM7	3VL67 80	800	3 x 3NA3 365-6	3 x 500		3
3RW44 47	748	3TF69	3VL67 80	800	3 x 3NA3 365-6	3 x 500		3
3RW44 53	954		3VL77 10	1000	3 x 3NA3 365-6	3 x 500		3
3RW44 54	1065		3VL77 12	1250	3 x 3NA3 365-6	3 x 500		3
3RW44 55	1200		3VL87 16	1600	3 x 3NA3 365-6	3 x 500		3
3RW44 56	1351		3VL87 16	1600	3 x 3NA3 372	3 x 630		3
3RW44 57	1524		3VL87 16	1600	3 x 3NA3 372	3 x 630		3
3RW44 58	1680		3WL12 20	2000	2 x 3NA3 480	2 x 1000		4
3RW44 65	1864		3WL12 25	2500	2 x 3NA3 482	2 x 1250		4
3RW44 66	2103		3WL12 25	2500	2 x 3NA3 482	2 x 1250		4

¹⁾ The type of coordination "2" refers only to soft starters in combination with the stipulated protective device (motor starter protector/circuit breaker/fuse), not to any additional components in the feeder.

The types of coordination are explained under "3RA1 Fuseless Load Feeders".

3RW Soft Starters

3RW44 for high-feature applications

Characteristic curves

Motor protection tripping characteristics for 3RW44 (with symmetry)

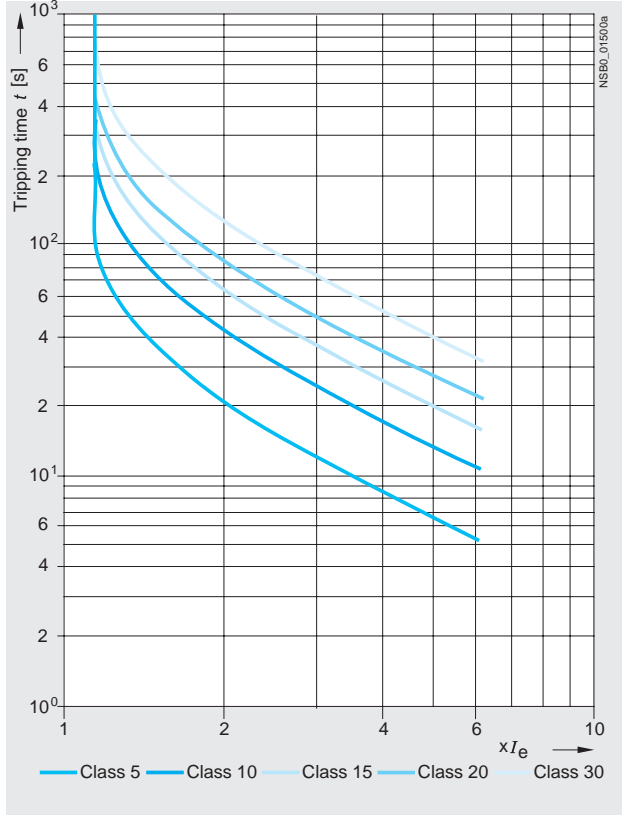

Motor protection tripping characteristics for 3RW44 (with asymmetry)

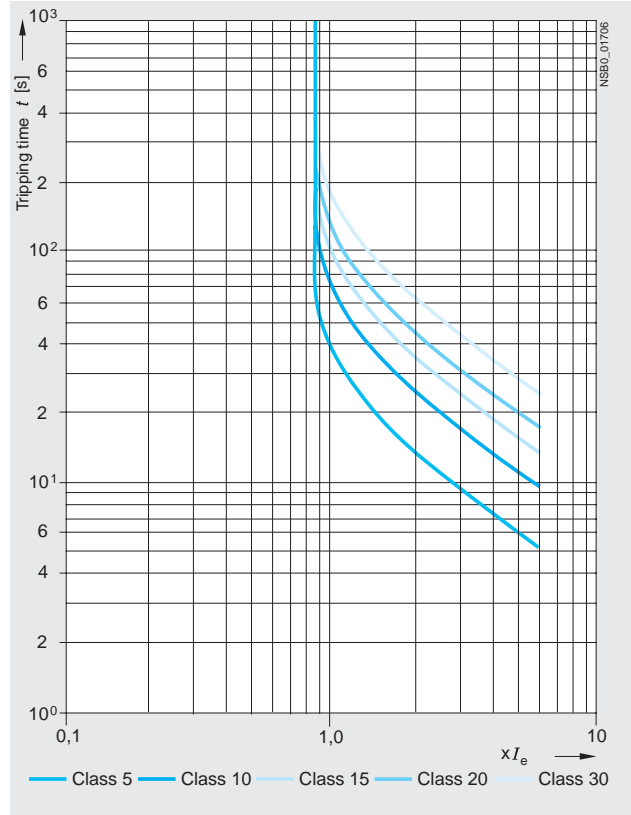

Permissible installation height

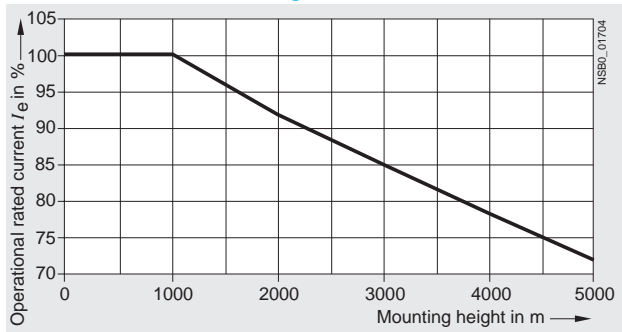

At an installation height above 2000 m, the max. permissible operational voltage is reduced to 460 V.

3RW Soft Starters

3RW44 for high-feature applications

More information

Application examples for normal starting (Class 10)

Normal starting Class 10 (up to 20 s with 350 % $I_{n \text{ motor}}$).

The soft starter rating can be selected to be as high as the rating of the motor used

Application	Conveyor belt	Roller conveyor	Compressor	Small fan	Pump	Hydraulic pump
Starting parameters						
• Voltage ramp and current limiting						
- Starting voltage	%	70	60	50	30	30
- Starting time	s	10	10	10	10	10
- Current limit value		Deactivated	Deactivated	$4 \times I_M$	$4 \times I_M$	Deactivated
• Torque ramp						
- Starting torque		60	50	40	20	10
- End torque		150	150	150	150	150
- Starting time		10	10	10	10	10
• Breakaway pulse						
		Deactivated (0 ms)	Deactivated (0 ms)	Deactivated (0 ms)	Deactivated (0 ms)	Deactivated (0 ms)
Ramp-down mode						
		Smooth ramp-down	Smooth ramp-down	Free ramp-down	Free ramp-down	Pump ramp-down
						Free ramp-down

Application examples for heavy starting (Class 20)

Heavy starting Class 20 (up to 40 s with 350 % $I_{n \text{ motor}}$).

The soft starter has to be selected one performance class higher than the motor used

Application	Stirrer	Centrifuge	Milling machine
Starting parameters			
• Voltage ramp and current limiting			
- Starting voltage	%	30	30
- Starting time	s	30	30
- Current limit value		$4 \times I_M$	$4 \times I_M$
• Torque ramp			
- Starting torque		30	30
- End torque		150	150
- Starting time		30	30
• Breakaway pulse			
		Deactivated (0 ms)	Deactivated (0 ms)
Ramp-down mode			
		Free ramp-down	Free ramp-down or DC braking

Application examples for very heavy starting (Class 30)

Very heavy starting Class 30 (up to 60 s with 350 % $I_{n \text{ motor}}$).

The soft starter has to be selected two performance classes higher than the motor used

Application	Large fan	Mill	Crusher	Circular saw/bandsaw
Starting parameters				
• Voltage ramp and current limiting				
- Starting voltage	%	30	50	30
- Starting time	s	60	60	60
- Current limit value		$4 \times I_M$	$4 \times I_M$	$4 \times I_M$
• Torque ramp				
- Starting torque		20	50	20
- End torque		150	150	150
- Starting time		60	60	60
• Breakaway pulse				
		Deactivated (0 ms)	80 %, 300 ms	Deactivated (0 ms)
Ramp-down mode				
		Free ramp-down	Free ramp-down	Free ramp-down

Note:

These tables present sample set values and device sizes. They are intended only for the purposes of information and are not binding. The set values depend on the application in question and must be optimized during commissioning. The soft starter dimensions should be checked where necessary with the Win-Soft Starter software or with the help of Technical Assistance.

3RW Soft Starters

Circuit concept

The SIRIUS 3RW44 soft starters can be operated in two different types of circuit.

- **Inline circuit**
The controls for isolating and protecting the motor are simply connected in series with the soft starter. The motor is connected to the soft starter with three cables.
- **Inside-delta circuit**
The wiring is similar to that of wye-delta starters. The phases of the soft starter are connected in series with the individual motor windings. The soft starter then only has to carry the phase current, amounting to about 58 % of the rated motor current (conductor current).

Comparison of the types of circuit

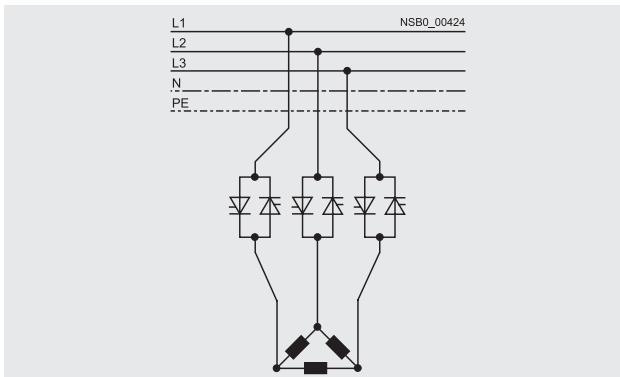

Inline circuit:
Rated current I_g corresponds to the rated motor current I_n , 3 cables to the motor

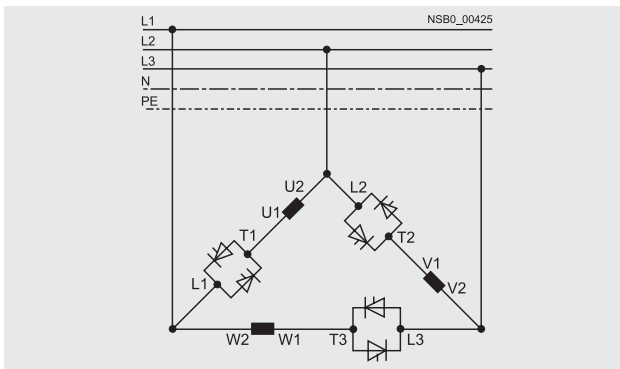

Inside-delta circuit:
Rated current I_g corresponds to approx. 58 % of the rated motor current I_n , 6 cables to the motor (as with wye-delta starters)

Which circuit?

Using the inline circuit involves the lowest wiring outlay. If the soft starter to motor connections are long, this circuit is preferable.

With the inside-delta circuit there is double the wiring complexity but a smaller size of device can be used at the same rating.

Thanks to the choice of operating mode between the inline circuit and inside-delta circuit, it is always possible to select the most favorable solution.

The braking function is possible only in the inline circuit.

Configuration

The 3RW44 solid-state soft starters are designed for normal starting. In case of heavy starting or increased starting frequency, a larger device must be selected.

For long starting times it is recommended to have a PTC sensor in the motor. This also applies for the ramp-down modes smooth ramp-down, pump ramp-down and DC braking, because during the ramp-down time in these modes, an additional current load applies in contrast to free ramp-down.

In the motor feeder between the SIRIUS 3RW soft starter and the motor, no capacitive elements are permitted (e. g. no reactive-power compensation equipment). In addition, neither static systems for reactive-power compensation nor dynamic PFC (Power Factor Correction) must be operated in parallel during starting and ramp-down of the soft starter. This is important to prevent faults arising on the compensation equipment and/or the soft starter.

All elements of the main circuit (such as fuses and controls) should be dimensioned for direct starting, following the local short-circuit conditions. Fuses, controls and overload relays must be ordered separately.

A bypass contact system and solid-state overload relay are already integrated in the 3RW44 soft starter and therefore do not have to be ordered separately.

The harmonic component load for starting currents must be taken into consideration for the selection of motor starter protectors (selection of release).

Note:

When induction motors are switched on, voltage drops occur as a rule on starters of all types (direct starters, wye-delta starters, soft starters). The infeed transformer must always be dimensioned such that the voltage dip when starting the motor remains within the permissible tolerance. If the infeed transformer is dimensioned with only a small margin, it is best for the control voltage to be supplied from a separate circuit (independently of the main voltage) in order to avoid the potential switching off of the soft starter.

Device interface, PROFIBUS DP communication module, Soft Starter ES parameterizing and operating software

The 3RW44 electronic soft starters have a PC interface for communicating with the Soft Starter ES software or for connecting the external display and operator module. If the optional PROFIBUS communication module is used, the 3RW44 soft starter can be integrated in the PROFIBUS network and communicate using the GSD file or Soft Starter ES Premium software.

The Soft Starter ES parameterizing and operating software can be downloaded from www.usa.siemens.com > Software with a 14-day trial license.

More information about Soft Starter ES can be found in Chapter 12 of Catalog LV 1.

3RW Soft Starters

3RW44 for high-feature applications

Manual for SIRIUS 3RW44

Besides containing all important information on configuring, commissioning and servicing, the manual also contains example circuits and the technical specifications for all devices.

Win-Soft Starter selection and simulation program

With this software, you can simulate and select all Siemens soft starters, taking into account various parameters such as mains properties, motor and load data, and special application requirements.

The software is a valuable tool, which makes complicated, lengthy manual calculations for determining the required soft starters superfluous.

The Win-Soft Starter selection and simulation program can be downloaded from: www.usa.siemens.com > Software

More information can be found on the Internet at: www.usa.siemens.com

3RW Soft Starters

Project Planning aids

Dimensional drawings

3RW30 for standard applications

3RW30 1. ... 3RW30 4.

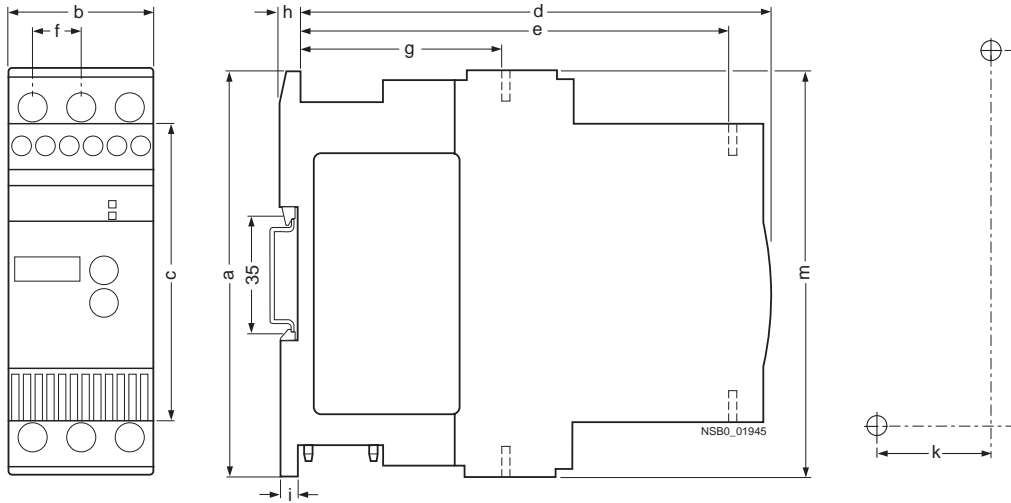

Type/Dimension (mm)	a	b	c	d	e	f	g	h	i	k	l	m
3RW30 1.-1.	95	45	62	146	126	14.4	63	5	6.5	35	85	95
3RW30 1.-2.	95	45	62	146	126	14.4	63	5	6.5	35	85	117.2
3RW30 2.-1.	125	45	92	146	126	14.4	63	5	6.5	35	115	125
3RW30 2.-2.	125	45	92	146	126	14.4	63	5	6.5	35	115	150
3RW30 3.	160	55	110	163	140	18	63	5	6.5	30	150	144
3RW30 4.	170	70	110	181	158	22.5	85	5	10	60	160	160

Clearances to grounded parts (mm)	Lateral	Top	Bottom	Fixing screws	Tightening torques (Nm)
3RW30 1.	5	60	40	M4	1
3RW30 2.	5	60	40	M4	1
3RW30 3.	30	60	40	M4	1
3RW30 4.	30	60	40	M4	2

3RW30 03-1. (screw terminals)

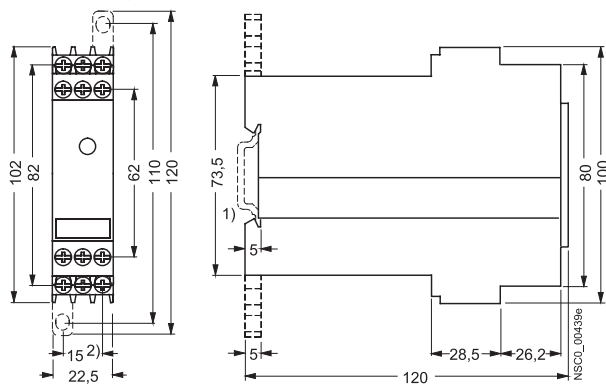

3RW30 03-2. (spring-type terminals)

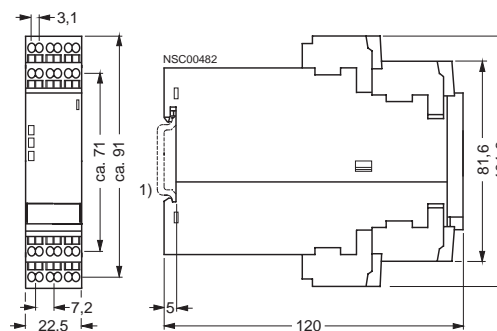

1) For mounting onto standard mounting rail TH 35 according to EN 60715.

2) Dimension for screw fixing.
Screw fixing with two 3RP1 903 push-in lugs per 3RW30 03 device.

3RW Soft Starters

Project Planning aids

3RW40 for standard applications

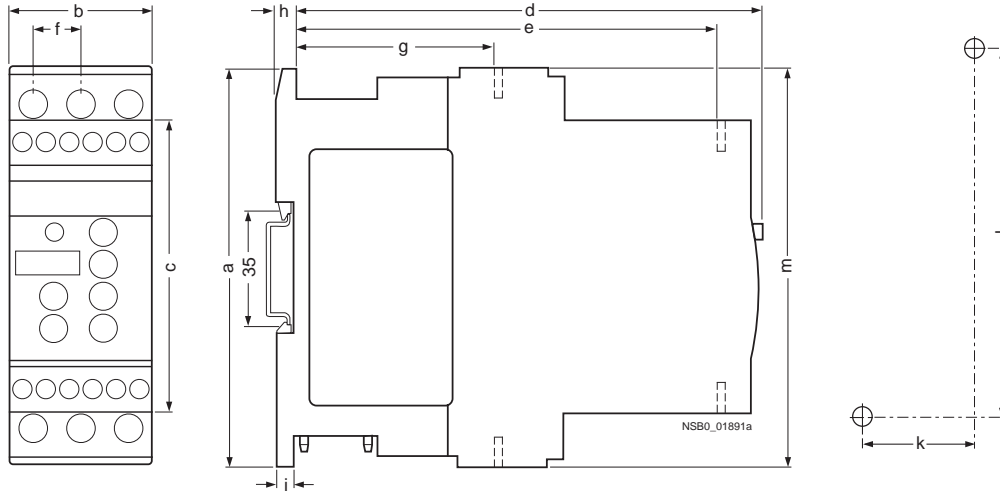

Type/Dimension (mm)	a	b	c	d	e	f	g	h	i	k	l	m
3RW40 2.-1.	125	45	92	149	126	14.4	63	5	6.5	35	115	125
3RW40 2.-2.	125	45	92	149	126	14.4	63	5	6.5	35	115	150
3RW40 3.	170	55	110	165	140	18	63	5	6.5	30	150	144
3RW40 4.	170	70	110	183	158	22.5	85	5	10	60	160	160

Clearances to grounded parts (mm)	Lateral	Top	Bottom	Fixing screws	Tightening torques (Nm)
3RW40 2.	5	60	40	M4	1
3RW40 3.	30	60	40	M4	1
3RW40 4.	30	60	40	M4	2

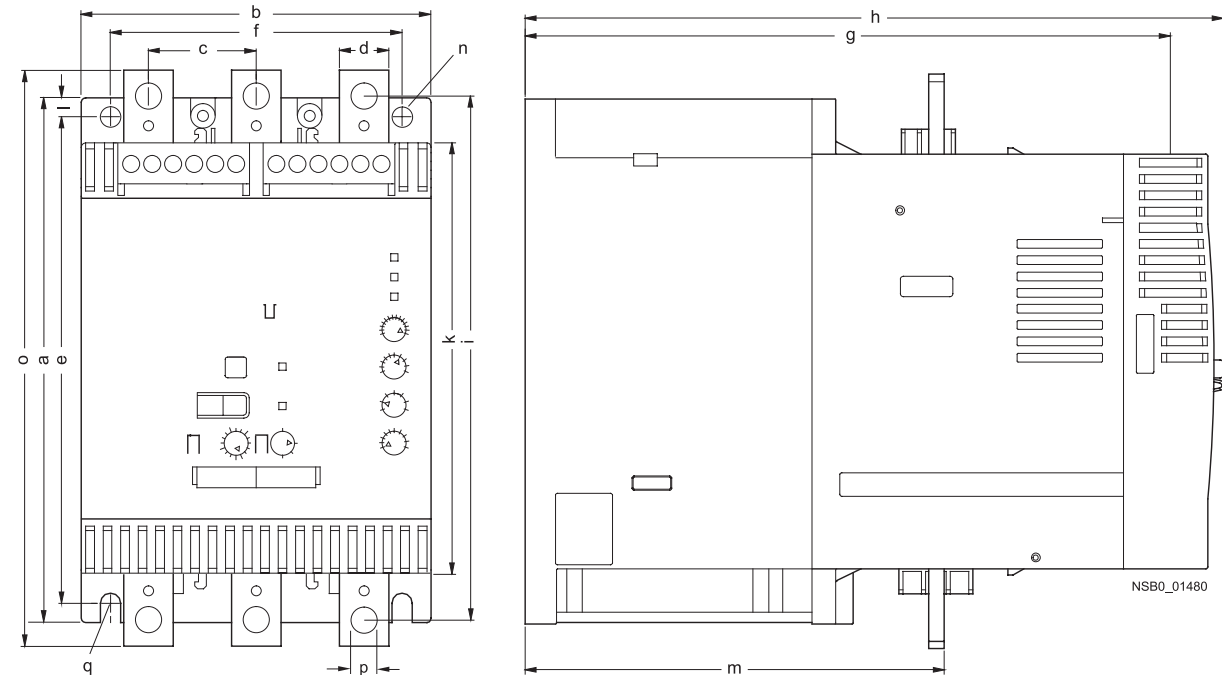

Type/Dimension (mm)	a	b	c	d	e	f	g	h	i	k	l	m	n	o	p	q
3RW40 5.	180	120	37	17	167	100	223	250	180	148	6.5	153	7	198	9	M6, 10 Nm
3RW40 7.	210	160	48	25	190	140	240	278	205	166	10	166	9	230	11	M8, 15 Nm

3RW Soft Starters

Project Planning aids

3RW44 2., 3RW44 3. and 3RW44 4. for High-Feature applications

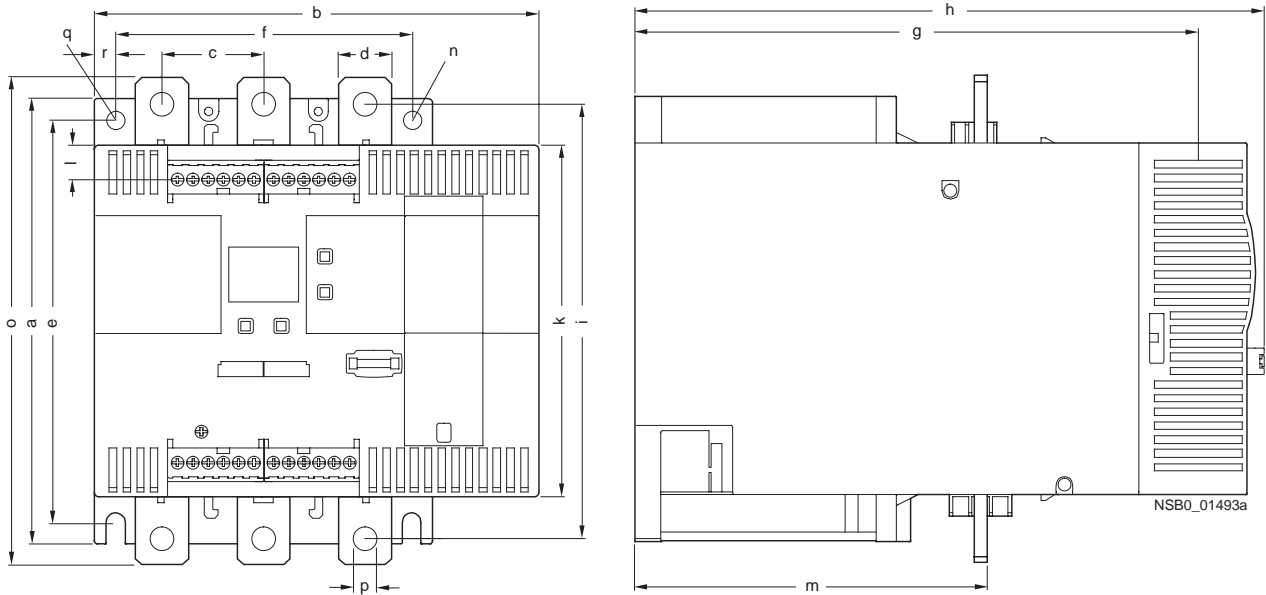

Type/Dimension (mm)	a	b	c	d	e	f	g	h	i	k	l	m	n	o	p	q	r
3RW44 2.	180	170	37	11	167	100	240	270	174	148	7.5	153	7	184	6.6	M6, 10 Nm	10
3RW44 3.	180	170	37	17	167	100	240	270	174	148	7.5	153	7	198	9	M6, 10 Nm	10
3RW44 4.	210	210	48	25	190	140	269	298	205	166	16	166	9	230	11	M8, 15 Nm	10

3RW Soft Starters

Project Planning aids

3RW44 5. and 3RW44 6. for High-Feature applications

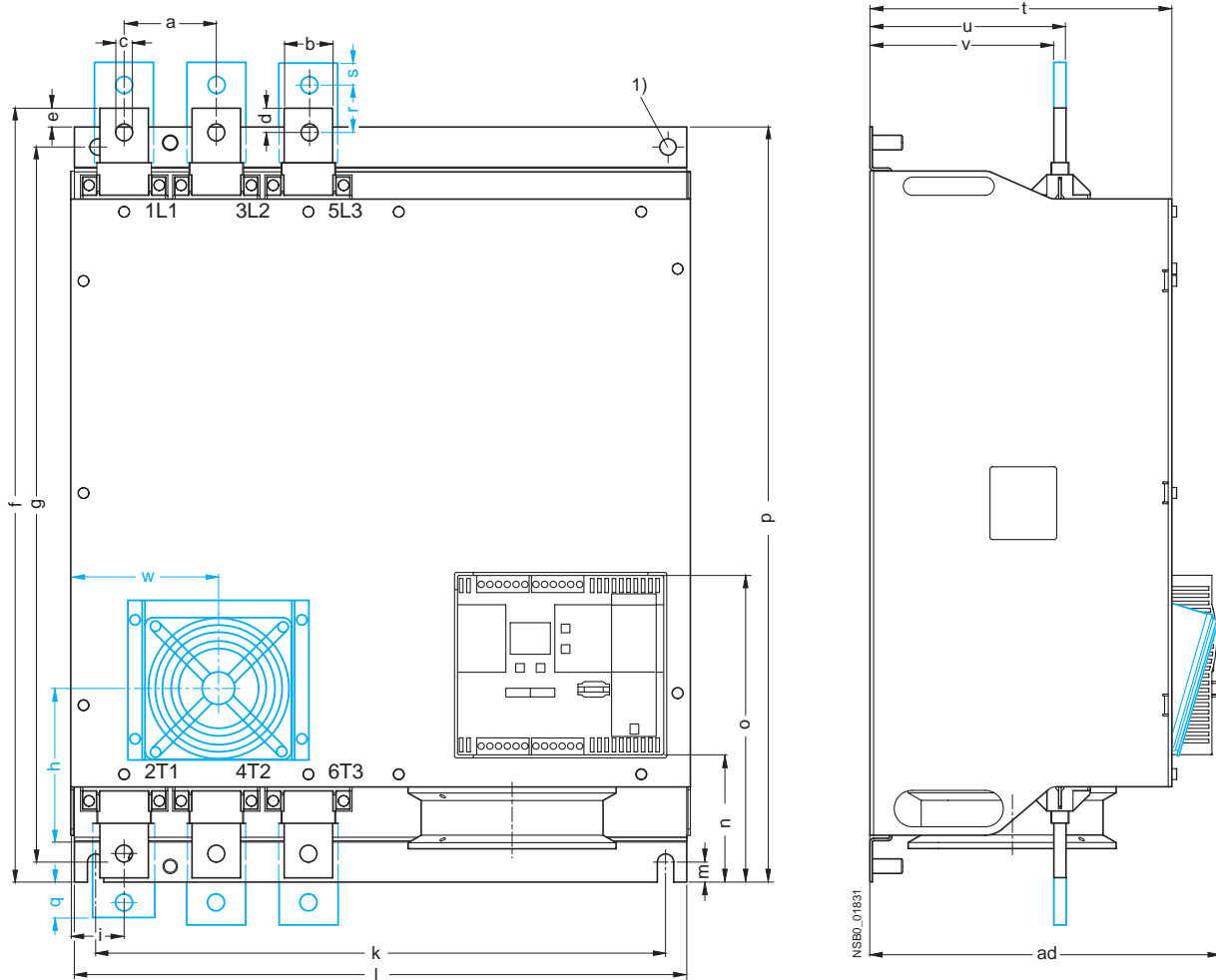

1) For M12 screw, tightening torque max. 35 Nm (310 lb.in).

Type/Dimension (mm)	a	b	c	d	e	f	g	h	i	k	l	m
3RW44 5.	76	40	14	20	15.5	638.5	590	--	44	470	510	16.5
3RW44 6.	85	50	14	--	--	667	660	160	37.5	535	576	16.5

Type/Dimension (mm)	n	o	p	q	r	s	t	u	v	W	ad
3RW44 5.	105	253	623	--	--	--	249	162	152	--	290
3RW44 6.	103	251	693	43.5	40	20	249	162	151.4	123	290

3RW49 00-0AC00 external display and operator module

Installation cutout for 3RW49 00-0AC00 external display and operator module

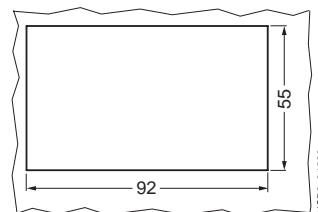
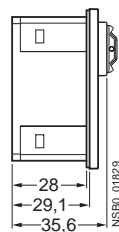
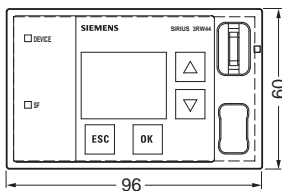

Class 73, 74

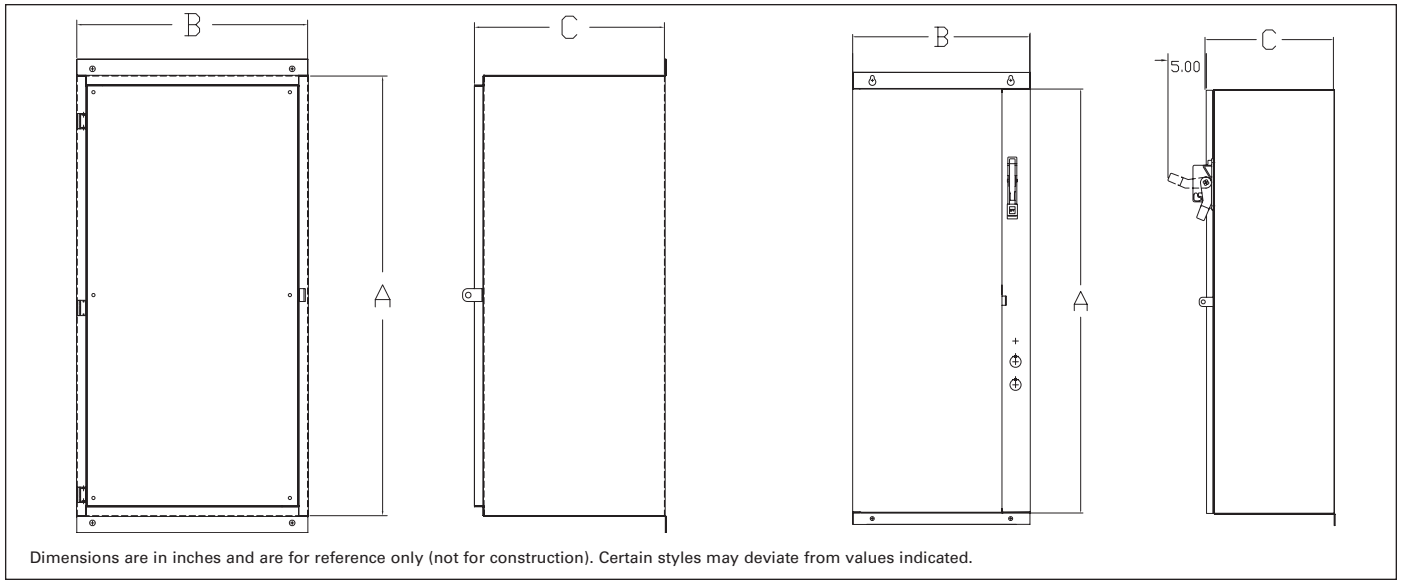

Non-Combination Class 73

N1, N3R, N12, N4 Standard Enclosure

	Amps	A	B	C
3RW40new	11 - 73	25	18	13
	98	36	23	10
3RW40	117-145	36	18	15
	205-315	36	22	20
	385	54	36	20
3RW44	26 - 68	26	12.5	15
	82 - 117	36	18	15
	145 - 215	36	22	20
	280 - 385	54	36	20
	494 - 780	90	40	20
	970 - 1076	90	50	20

N4X Stainless Steel Standard Enclosure

	Amps	A	B	C
3RW40new	11- 98	55	29	11
3RW40	117	36	18	15
	145 - 205A	36	22	20
	248 - 385	54	36	20
3RW44	26 - 51	26	12.5	15
	68 - 82	36	18	15
	100 - 117	36	22	20
	145 - 385	54	36	20

N1, N3R, N12, N4 Modified Enclosure

	Amps	A	B	C
3RW40	117-385	56	36	20
3RW44	26-51	36	22	20
	68-385	54	36	20

N4X Stainless Steel Modified Enclosure

	Amps	A	B	C
3RW40	117-385	54	36	20
3RW44	26-51	36	22	20
	68-385	54	36	20

Combination Type Class 74

N1, N3R, N12, N4 Standard Enclosure

	Amps	A	B	C
3RW40new	11 - 73	36	20	11
	98	46	20	10
3RW40	117	50	25	20
	145 - 205	66	25	20
	248 - 315	90	30	20
	385	90	40	20
3RW44	26 - 68	36	23	15
	82 - 117	50	25	20
	145 - 215	66	25	20
	280	90	30	20
	315 - 384	90	40	20
	494	90	40	20
	551 - 780	90	40 [Ⓞ]	20
	970 - 1076	90	50	20

N1, N12 Fusible

	Amps	A	B	C
3RW44	494-780	90	50	20

N4X Stainless Steel Standard Enclosure

	Amps	A	B	C
3RW40new	11- 98	55	29	11
3RW40	117 - 145	54	36	20
	205 - 300	90	40	20
3RW44	26 - 42	36	23	15
	51 - 100	50	25	20
	117 - 145	54	36	20
	180 - 385	90	40	20

N1, N3R, N12, N4 Modified Enclosure

	Amps	A	B	C
3RW40	117 - 248	76	30	20
	315	90	30	20
	385	90	40	20
3RW44	26 - 215	76	30	20
	280	90	30	20
	315 - 385	90	40	20

N4X Stainless Steel Modified Enclosure

	Amps	A	B	C
3RW40	117-145	76	30	20
3RW44	26-145	76	30	20

Ⓞ Add 4" for N4.

3RW Soft Starters

Project Planning aids

Schematics

3RW30 .. connection examples for control circuit

Control using switches

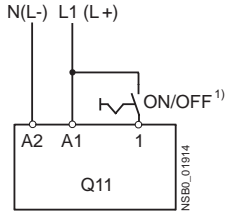

Automatic mode

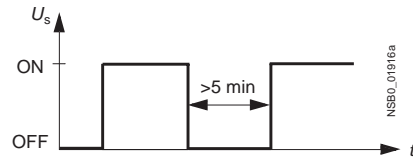
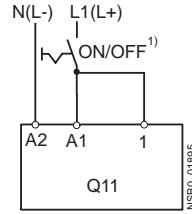

Control by pushbutton

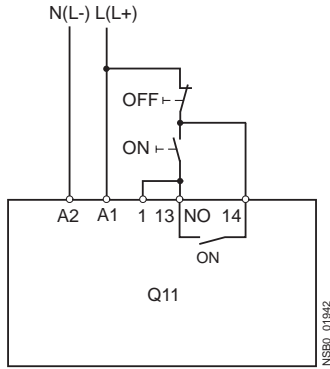

Control of a main contactor

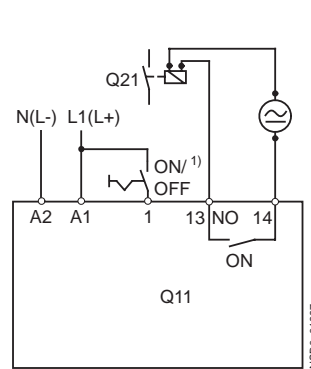

3RW30 connection examples for main circuit²⁾

3RW30 – 3-phase motor with 3NA/3NE fuse

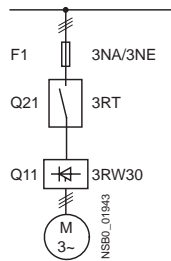

3RV motor starter protector

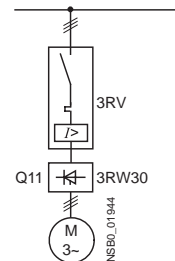

1) Caution: Risk of restarting!

When operating with a switch (ON/OFF) a new, automatic restart will take place automatically if the start command is still active at terminal 1.

2) As an alternative, the motor feeder can also be installed as a fuseless or as a fused version. For fuse and switching device coordination, see "Technical specifications".

The wiring diagrams are provided only as examples.

3RW Soft Starters

Project Planning aids

3RW40 2. ... 3RW40 4. connection examples for control circuit

Control using switches

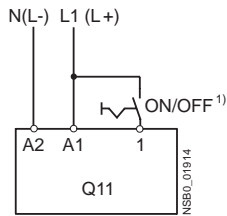

Automatic mode

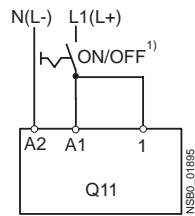

Control with remote reset

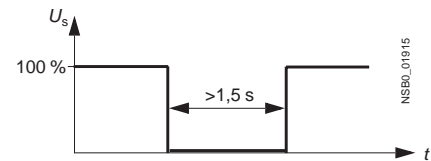
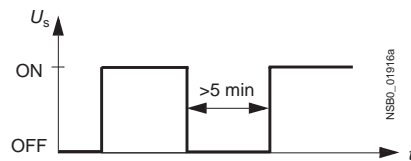
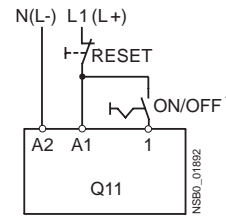

Control of 3RW40 2. ... 3RW40 4. by pushbutton

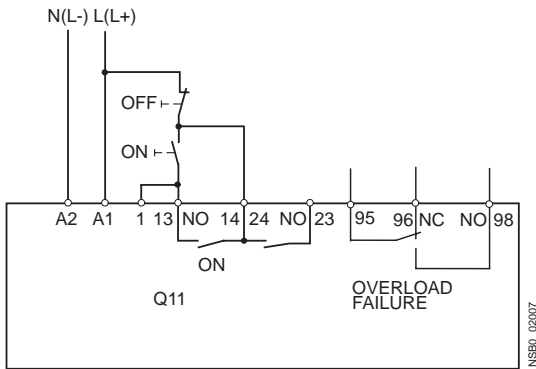

Control of a main contactor

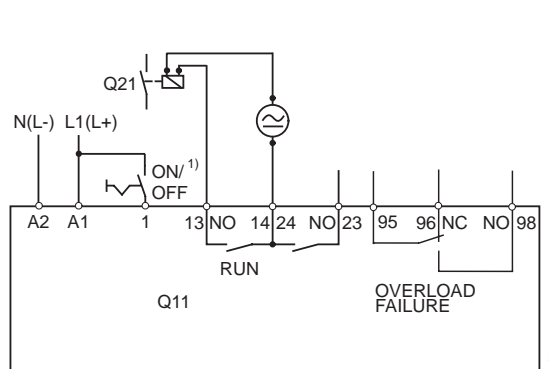

Connection example of 3RW40 2. ... 3RW40 4. for PTC sensors (thermistor motor protection)

Thermoclick

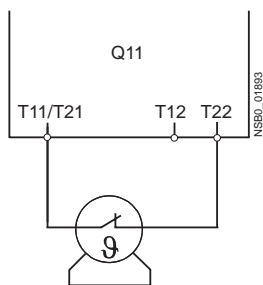

PTC type A

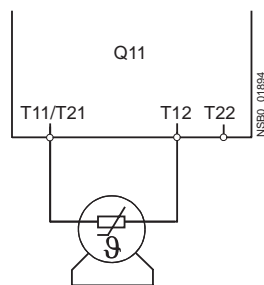

¹) Caution: Risk of restarting!

When operating with a switch (ON/OFF) a new, automatic restart will take place automatically if the start command is still active at terminal 1.

3RW Soft Starters

Project Planning aids

3RW40 5. and 3RW40 7. connection examples for control circuit

Control by switch using internal 24 V DC supply

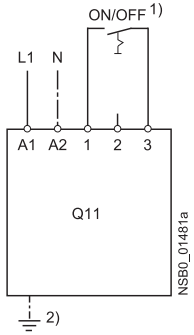

external power supply

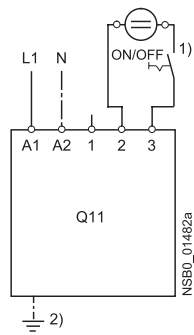

Control by pushbutton

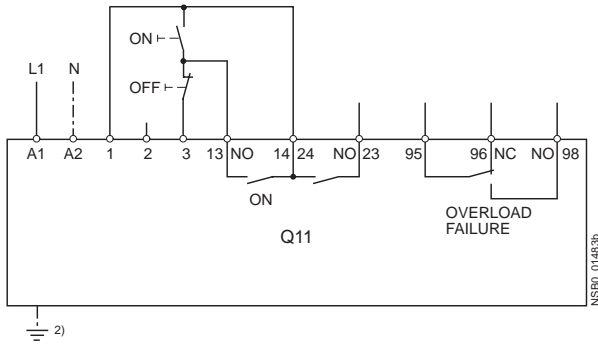

Control of a main contactor

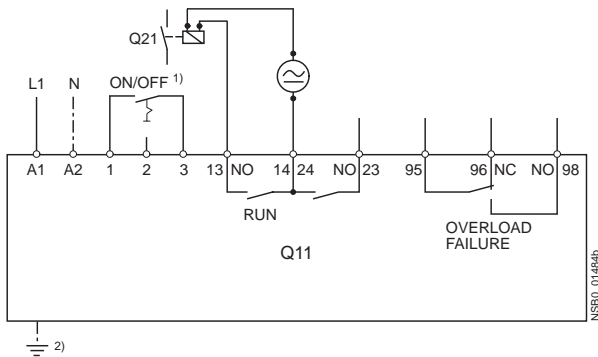

3RW40 connection examples for main circuit³⁾

3RW40 – 3-phase motor with 3NA/3NE fuse

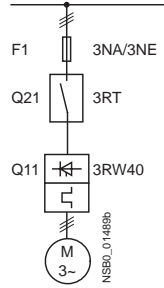

3RV motor starter protector/ 3VL circuit breaker

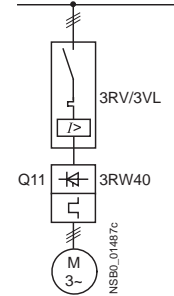

¹⁾ **Caution: Risk of restarting!**

When operating with a switch (ON/OFF) a new, automatic restart will take place automatically if the start command is still active at terminal 3.

²⁾ Grounding necessary for fan connection to 3RW40 5...

³⁾ As an alternative, the motor feeder can also be installed as a fuseless or as a fused version. [For fuse and switching device coordination, see "Technical specifications"](#).

The wiring diagrams are provided only as examples.

3RW Soft Starters

Project Planning aids

3RW44 connection examples for main and control circuits

Main circuit

Possibility 1a:
Inline circuit with motor starter protector and SITOR fuse
(semiconductor protection only)

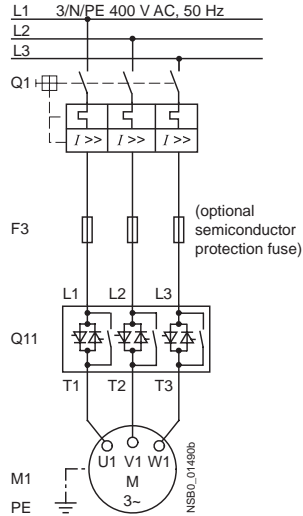

Control circuit

Possibility 1:
Control by pushbutton

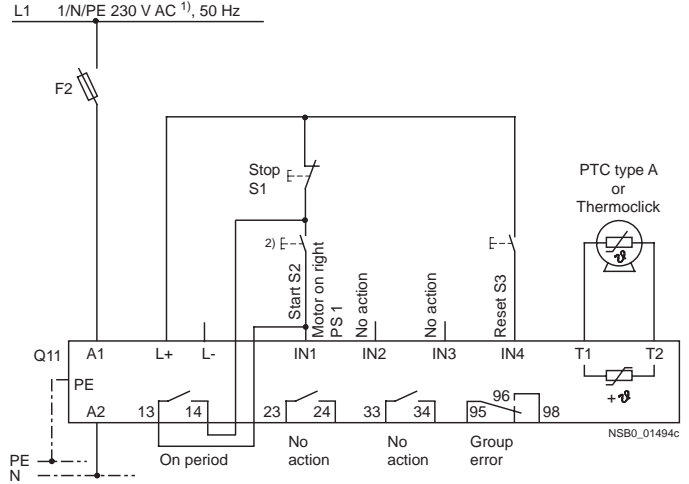

Main circuit

Possibility 1b:
Inline circuit with all-range
protection
(line and semiconductor protection)

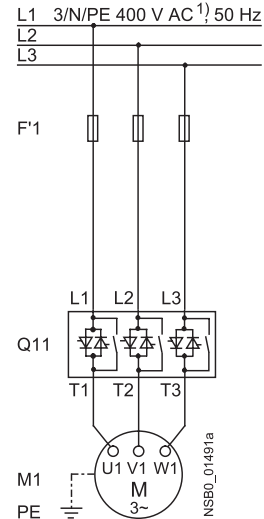

Possibility 1c:
Inline circuit with line and
SITOR fuse
(semiconductor protection only)

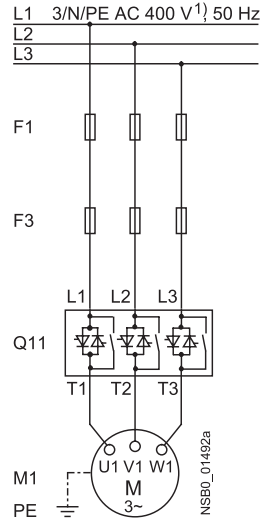

1) Permissible values for main and control voltage, see "Technical specifications".

2) **Caution: Risk of restarting!**

Because the output is parameterized to "Motor ON", the start command is automatically active after the reset command and a new, automatic restart will take place. This applies especially in case of motor protection tripping. For safety reasons we recommend connecting the group error output (terminals 95/96) in series with the output parameterized to "Motor ON".

3RW Soft Starters

Project Planning aids

Main circuit

Possibility 2:
Inline circuit with main contactor

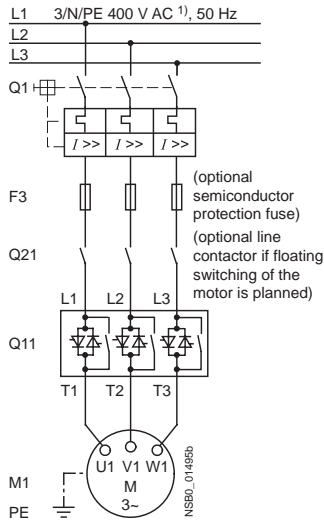

Control circuit

Possibility 2:
Control of a main contactor and control by means of PLC

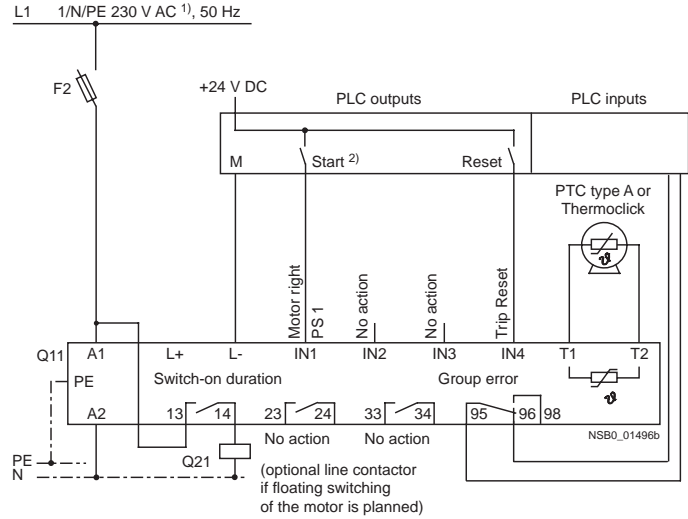

1) Permissible values for main and control voltage, see "Technical specifications".

2) **Caution: Risk of restarting!**

The start command (e. g. from the PLC) must be reset prior to a reset command because a new, automatic restart will take place automatically if a start command is active after the reset command. This applies especially in case of motor protection tripping. For safety reasons we recommend incorporating the group error output (terminals 95 and 96) in the controller.

3RW Soft Starters

Project Planning aids

Main circuit

Possibility 3a:
 Inline circuit with ramp-down function DC braking³⁾
 (for device types 3RW44 22 to 3RW44 25)

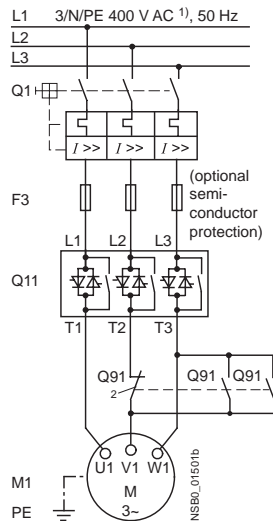

Control circuit

Possibility 3a:
 Control of the DC braking contactor³⁾

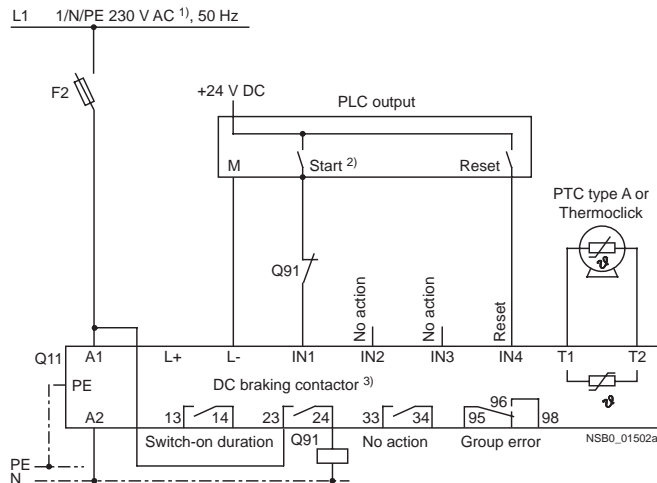

Main circuit

Possibility 3b:
 Inline circuit with ramp-down function DC braking³⁾
 (for device types 3RW44 26 to 3RW44 47)

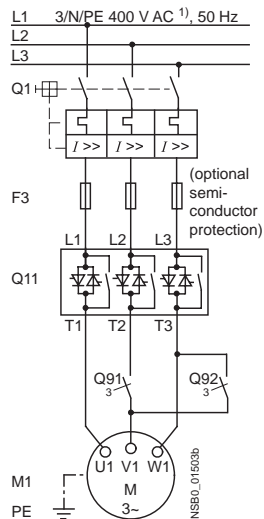

Control circuit

Possibility 3b:
 Control of the DC braking contactor³⁾

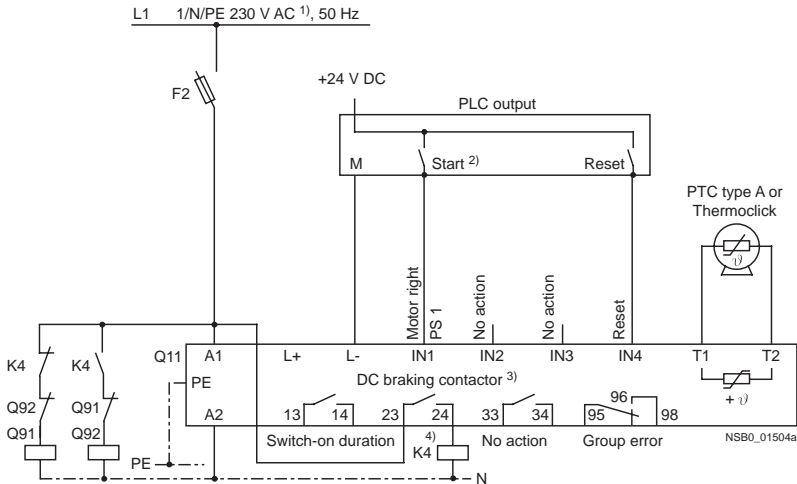

¹⁾ Permissible values for main and control voltage, see "Technical specifications".

²⁾ **Caution: Risk of restarting!**

The start command (e. g. from the PLC) must be reset prior to a reset command because a new, automatic restart will take place automatically if a start command is active after the reset command. This applies especially in case of motor protection tripping. For safety reasons we recommend incorporating the group error output (terminals 95 and 96) in the controller.

³⁾ If the ramp-down function "Combined braking" is selected, no braking contactor is required.

If the ramp-down function "DC braking" is selected, a braking contactor must be used in addition. For type see "Fuse Assignment (Inline Circuit)" on pages 7/47 to 7/49.

For applications with large centrifugal masses ($J_{Load} > J_{Motor}$) we recommend the function "DC braking".

The output 2 must be switched over to "DC braking contactor".

⁴⁾ Auxiliary relay K4, e. g.:

LZX:RT4A4T30 (230 V AC rated control supply voltage),
 LZX:RT4A4S15 (115 V AC rated control supply voltage).

3RW Soft Starters

Project Planning aids

Main circuit

Possibility 4a:
Inside-delta circuit

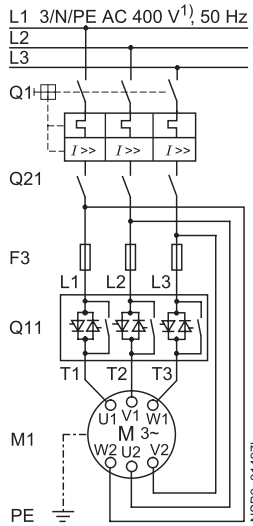

Possibility 4b:
Change of direction of rotation for
inside-delta circuit

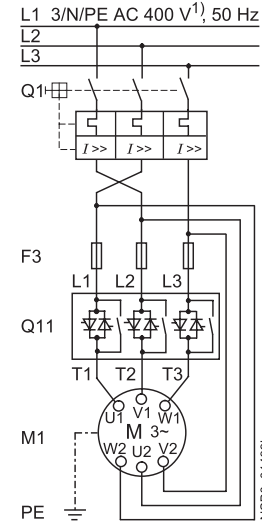

Control circuit

Possibility 4:
Control by means of PLC

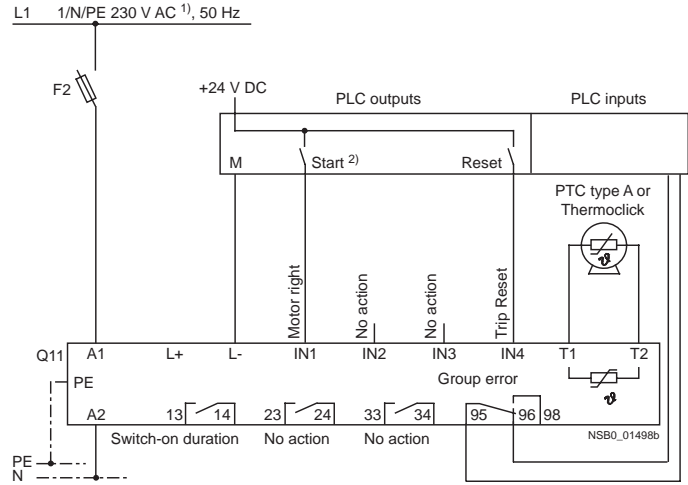

1) Permissible values for main and control voltage, see "Technical specifications".

2) **Caution: Risk of restarting!**

The start command (e. g. from the PLC) must be reset prior to a reset command because a new, automatic restart will take place automatically if a start command is active after the reset command. This applies especially in case of motor protection tripping. For safety reasons we recommend incorporating the group error output (terminals 95 and 96) in the controller.

Class 73, 74

