

# SCON

## SCON Controller

Operation Manual Fourteenth Edition



***IAI America, Inc.***



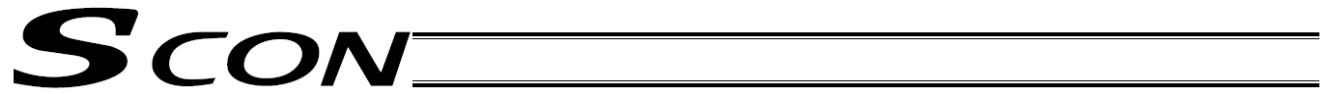

## Please Read Before Use

Thank you for purchasing our product.

This Operation Manual explains the handling methods, structure and maintenance of this product, among others, providing the information you need to know to use the product safely.

Before using the product, be sure to read this manual and fully understand the contents explained herein to ensure safe use of the product.

The CD that comes with the product contains operation manuals for IAI products.

When using the product, refer to the necessary portions of the applicable operation manual by printing them out or displaying them on a PC.

After reading the Operation Manual, keep it in a convenient place so that whoever is handling this product can reference it quickly when necessary.

### [Important]

- This Operation Manual is original.
- The product cannot be operated in any way unless expressly specified in this Operation Manual. IAI shall assume no responsibility for the outcome of any operation not specified herein.
- Information contained in this Operation Manual is subject to change without notice for the purpose of product improvement.
- If you have any question or comment regarding the content of this manual, please contact the IAI sales office near you.
- Using or copying all or part of this Operation Manual without permission is prohibited.
- The company names, names of products and trademarks of each company shown in the sentences are registered trademarks.



### 1. PC Software and Teaching Pendant Models

New functions have been added to the entire SCON controller series.

To support these new features, the communication protocol has been changed to the general Modbus (Modbus-compliant) mode. As a result, the existing PC software programs and teaching pendants compatible with RCS/E-Con controllers can no longer be used.

If you are using this controller, use a compatible PC software program and/or teaching pendant selected from the following models.

	Model	Remarks
PC software (with RS232C communication cable)	RCM-101-MW	All are compatible with existing RCS/E-Con controllers.
PC software (with USB communication cable)	RCM-101-USB	
Teaching pendant	CON-T	
Teaching pendant	RCM-T	
Simple teaching pendant	RCM-E	
Data setting unit	RCM-P	
Touch panel display	RCM-PM-01	Cannot be connected to conventional RCS controller

### 2. Recommendation for Backing up Latest Data

This product uses nonvolatile memory to store the position table and parameters. Normally the memory will retain the stored data even after the power is disconnected. However, the data may be lost if the nonvolatile memory becomes faulty.

(We strongly recommend that the latest position table and parameter data be backed up so that the data can be restored quickly in the event of power failure, or when the controller must be replaced for a given reason.)

The data can be backed up using the following methods:

- [1] Save to a CD or FD from the PC software.
- [2] Hand write the position table and parameter table on paper.

### 3. Using a Rotary Actuator of Multi-rotation Specification

Rotary actuators available in the multi-rotation specification allow the user to select the multi-rotation mode or limited-rotation mode using a parameter.

For the parameter setting, refer to 3.2.5, "Linear/Rotary Control" under 3, "Parameter Settings" in Appendix. When using a rotary actuator of multi-rotation specification, the user should take note of the following points:

- [1] Rotational axes of absolute specification do not support the index mode. Accordingly, these axes cannot perform multi-rotation operations.
- [2] In solenoid valve mode 2 [3-point type]: PIO pattern 5 (parameter No. 25), rotary operations cannot be performed by means of relative coordinate specification.

Applicable models

Actuator	RS-30/60
	RCS2-RT6/RT6R/RT7/RT7R
	RCS2-RTC8L/RTC8HL/RTC10L/RTC12L

## Precautions

Please use rotary actuators of multi-rotation specification within the range where the following formula is satisfied. Moreover, the maximum rotation angle is  $\pm 9999$  [deg]<sup>(NOTE1)</sup> (maximum software stroke limit).

$$\pm 2^{23} \geq \frac{\text{Maximum rotation angle [deg]}}{\text{Unit Travel Distance [deg/pulse]}}$$

- Maximum rotation angle: Set the usage conditions (maximum -9999 to 9999 [deg]).

Note 1 :The following models can not be rotated up to  $\pm 9999.99$  [deg].

deceleration ratio	Maximum rotation angle [deg]	corresponding model
1/24	$\pm 7679.99$	RCS2-RTC8、RCS2-RTC10
1/30	$\pm 6143.99$	RCS2-RTC12
1/50	$\pm 3685$	RS-30、RS-60
1/100	$\pm 1842$	

- Unit movement: The amount of movement per command pulse.

Example) In case RCS2-RTC8L-I-12-24(deceleration ratio : 1/24) is operated maximum rotation angle 6000 [deg].

$$\pm 2^{23} \geq \frac{\text{Maximum rotation angle [deg]}}{\text{Unit Travel Distance [deg/pulse]}}$$

$$\pm 2^{23} \geq \text{Maximum rotation angle [deg]} \times \frac{\text{No. of Encoder Pluses [pulse/rev]}}{360[\text{deg/rev}] \times \text{Rotary Axis deceleration Ratio}}$$

$$\pm 2^{23} \geq 6000 \times \frac{16384}{360 \times \frac{1}{24}}$$

$$\pm 2^{23} \geq 6553600$$

Therefore, the actuator can be operated in this case.

- About zone function change

Applicable application version: From V001E

In zone signal settings, it is now valid to specify plus side zone setting smaller than minus side zone setting.

Up to V001D: Zone signals are not output in the case of plus side zone setting  $\leq$  minus side zone setting only.

From V001E: Zone signals are not output in the case of plus side zone setting = minus side zone setting only.

With this arrangement, zone output is enabled even if the zone single ON range spans over 0° in the index mode of rotary actuators.

An example is shown below.

[In index mode of rotary actuators]

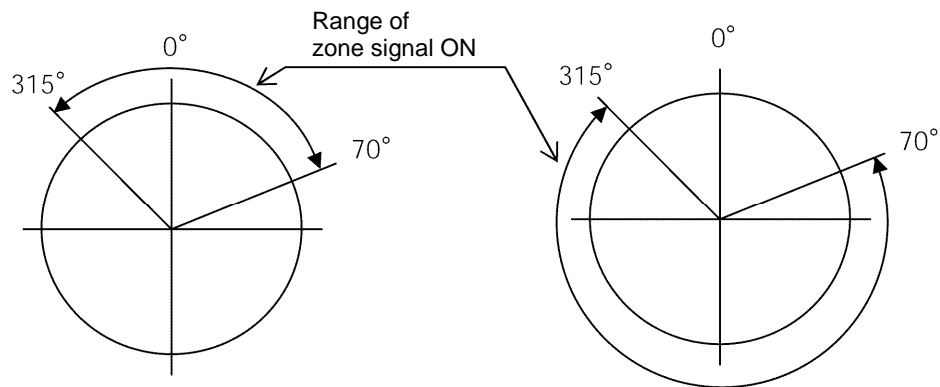

Setting value  
 Plus side zone setting: 70°  
 Minus side zone setting: 315°

Setting value  
 Plus side zone setting: 315°  
 Minus side zone setting: 70°

[In case of translation axis]

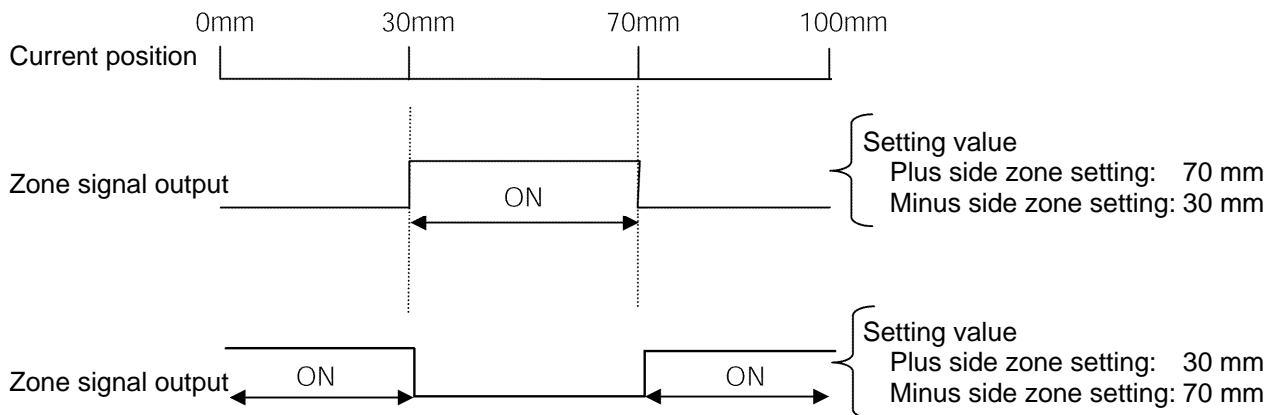







## Table of Contents

Safety Guide .....	Pre-1
Chapter 1 Introduction .....	1
1. Overview .....	1
1.1 Introduction.....	1
1.2 SCON Functions .....	1
1.3 How to Read the Model Specification .....	4
1.4 System Configuration .....	5
1.5 Procedure from Unpacking to Test Operation and Adjustment .....	6
1.6 Warranty Period and Scope of Warranty.....	8
2. Specifications .....	9
2.1 Basic Specifications.....	9
2.2 Name and Function of Each Part .....	10
2.3 External Dimensions .....	21
3. Installation and Wiring.....	23
3.1 Installation Environment.....	23
3.2 Heat Radiation and Installation .....	23
3.3 Noise Elimination Measures and Grounding.....	24
3.4 Wiring the Power Supply .....	26
3.5 Connecting the Actuator .....	28
3.6 Connecting the PIO Cable (I/O) .....	29
3.7 External Input/Output Specifications .....	30
3.8 Connecting the Emergency Stop Input (Wiring to the System I/O Connector) .....	32
3.9 Connecting the Regenerative Unit (RB).....	48
3.10 Connecting the Brake Box (RCB-110-RA13-0) .....	50
Chapter 2 Positioner Mode .....	52
1. I/O Signal Control and Signal Functions .....	52
1.1 PIO Patterns and Signal Assignments .....	52
1.2 Connecting the I/O Cable .....	61
1.3 Details of I/O Signal Functions.....	67
2. Data Entry .....	77
2.1 Description of Position Table .....	77
2.2 Explanation of Modes.....	84
2.3 Power-saving Modes at Standby Positions .....	94
3. Operation .....	96
3.1 How to Start.....	96
3.2 How Return Operation.....	107
3.3 Positioning Mode (Back and Forth Movement between Two Points).....	109
3.4 Push & Hold Mode .....	111
3.5 Speed Change during Movement.....	114
3.6 Operation at Different Acceleration and Deceleration Settings.....	116
3.7 Pause .....	118
3.8 Zone Signal Output .....	120
3.9 Incremental Moves .....	123

3.10	Jogging/Teaching Using PIO .....	129
3.11	Operations in Solenoid Valve Mode 1 [7-point Type].....	131
3.12	Operations in Solenoid Valve Mode 2 [3-point Type].....	135
<b>Chapter 3 Pulse-train Input Mode .....</b>		<b>142</b>
1.	Overview .....	142
1.1	Features .....	142
1.2	Standard Accessories.....	143
1.3	Options .....	143
2.	Wiring.....	147
2.1	External Connection Diagram .....	147
2.2	Command Pulse-train Input Specifications .....	148
2.3	Feedback Pulse Output Part .....	149
3.	I/O Signal Control and Signal Functions .....	150
3.1	Input Signals.....	150
3.2	Output Signals.....	156
4.	How to Switch to the Pulse-train Control Mode.....	161
5.	Parameters .....	162
5.1	Parameter Settings Required for Operation.....	162
5.2	Effective Parameters in the Pulse-train Mode.....	166
* Appendix .....		169
1.	Actuator Specification List.....	169
2.	Battery Backup Function.....	174
2.1	Absolute-encoder Backup Battery.....	175
3.	Parameter Settings .....	177
3.1	Parameter Table .....	177
3.2	Detail Explanation of Parameters.....	179
4.	PC/Teaching Pendant Connection Method in Multi-axis Configurations .....	202
4.1	Connection Example .....	202
4.2	Name and Function of Each Part of the SIO Converter.....	203
4.3	Address Switch.....	205
4.4	Connection Cables.....	205
4.5	Detail Connection Diagram .....	206
5.	Troubleshooting .....	207
5.1	Action to Be Taken upon Occurrence of Problem .....	207
5.2	Alarm Level Classification .....	208
5.3	Alarm Description Output Using PIO.....	209
5.4	Alarm Description and Cause/Action .....	211
5.5	Messages Displayed during Operation Using the Teaching Pendant.....	220
5.6	Specific Problems.....	222
6.	Basic Example of Positioning Sequence .....	224
	Recording of Parameters .....	227
<b>Change History .....</b>		<b>229</b>

## Safety Guide

This "Safety Guide" is intended to ensure the correct use of this product and prevent dangers and property damage. Be sure to read this section before using your product.

### Regulations and Standards Governing Industrial Robots

Safety measures on mechanical devices are generally classified into four categories under the International Industrial Standard ISO/DIS 12100, "Safety of machinery," as follows:

- Safety measures
  - Inherent safety design
  - Protective guards --- Safety fence, etc.
  - Additional safety measures --- Emergency stop device, etc.
  - Information on use --- Danger sign, warnings, operation manual

Based on this classification, various standards are established in a hierarchical manner under the International Standards ISO/IEC. The safety standards that apply to industrial robots are as follows:

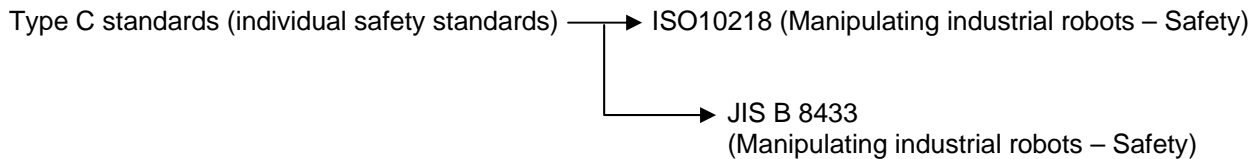

Also, Japanese laws regulate the safety of industrial robots, as follows:

Industrial Safety and Health Law Article 59

Workers engaged in dangerous or harmful operations must receive special education.

Ordinance on Industrial Safety and Health

Article 36 --- Operations requiring special education

- No. 31 (Teaching, etc.) --- Teaching and other similar work involving industrial robots (exceptions apply)
- No. 32 (Inspection, etc.) --- Inspection, repair, adjustment and similar work involving industrial robots (exceptions apply)

Article 150 --- Measures to be taken by the user of an industrial robot

## Requirements for Industrial Robots under Ordinance on Industrial Safety and Health

Work area	Work condition	Cutoff of drive source	Measure	Article
Outside movement range	During automatic operation	Not cut off	Signs for starting operation	Article 104
			Installation of railings, enclosures, etc.	Article 150-4
Inside movement range	During teaching, etc.	Cut off (including stopping of operation)	Sign, etc., indicating that work is in progress	Article 150-3
			Preparation of work rules	Article 150-3
		Not cut off	Measures to enable immediate stopping of operation	Article 150-3
			Sign, etc., indicating that work is in progress	Article 150-3
			Provision of special education	Article 36-31
	During inspection, etc.	Cut off	To be performed after stopping the operation	Article 150-5
			Sign, etc., indicating that work is in progress	Article 150-5
		Not cut off (when inspection, etc., must be performed during operation)	Preparation of work rules	Article 150-5
			Measures to enable immediate stopping of operation	Article 150-5
			Sign, etc., indicating that work is in progress	Article 150-5
Provision of special education (excluding cleaning and lubrication)	Article 36-32			
		Checkup, etc., before commencement of work	Article 151	

## Applicable Modes of IAI's Industrial Robot

Machines meeting the following conditions are not classified as industrial robots according to Notice of Ministry of Labor No. 51 and Notice of Ministry of Labor/Labor Standards Office Director (Ki-Hatsu No. 340):

- (1) Single-axis robot with a motor wattage of 80 W or less
- (2) Combined multi-axis robot whose X, Y and Z-axes are 300 mm or shorter and whose rotating part, if any, has the maximum movement range of within 300 mm<sup>3</sup> including the tip of the rotating part
- (3) Multi-joint robot whose movable radius and Z-axis are within 300 mm

Among the products featured in our catalogs, the following models are classified as industrial robots:

1. Single-axis ROBO Cylinders  
RCS2/RCS2CR-SS8□ whose stroke exceeds 300 mm
2. Single-axis robots  
The following models whose stroke exceeds 300 mm and whose motor capacity also exceeds 80 W:  
ISA/ISPA, ISDA/ISPDA, ISWA/ISPWA, IF, FS, NS
3. Linear servo actuators  
All models whose stroke exceeds 300 mm
4. Cartesian robots  
Any robot that uses at least one axis corresponding to one of the models specified in 1 to 3
5. IX SCARA robots  
All models whose arm length exceeds 300 mm  
(All models excluding IX-NNN1205/1505/1805/2515, NNW2515 and NNC1205/1505/1805/2515)

## Notes on Safety of Our Products

Common items you should note when performing each task on any IAI robot are explained below.

No.	Task	Note
1	Model selection	<ul style="list-style-type: none"> <li>● This product is not planned or designed for uses requiring high degrees of safety. Accordingly, it cannot be used to sustain or support life and must not be used in the following applications:               <ul style="list-style-type: none"> <li>[1]Medical devices relating to maintenance, management, etc., of life or health</li> <li>[2]Mechanisms or mechanical devices (vehicles, railway facilities, aircraft facilities, etc.) intended to move or transport people</li> <li>[3]Important safety parts in mechanical devices (safety devices, etc.)</li> </ul> </li> <li>● Do not use this product in the following environments:               <ul style="list-style-type: none"> <li>[1]Place subject to flammable gases, ignitable objects, flammables, explosives, etc.</li> <li>[2]Place that may be exposed to radiation</li> <li>[3]Place where the surrounding air temperature or relative humidity exceeds the specified range</li> <li>[4]Place subject to direct sunlight or radiated heat from large heat sources</li> <li>[5]Place subject to sudden temperature shift and condensation</li> <li>[6]Place subject to corrosive gases (sulfuric acid, hydrochloric acid, etc.)</li> <li>[7]Place subject to excessive dust, salt or iron powder</li> <li>[8]Place where the product receives direct vibration or impact</li> </ul> </li> <li>● Do not use this product outside the specified ranges. Doing so may significantly shorten the life of the product or result in product failure or facility stoppage.</li> </ul>
2	Transportation	<ul style="list-style-type: none"> <li>● When transporting the product, exercise due caution not to bump or drop the product.</li> <li>● Use appropriate means for transportation.</li> <li>● Do not step on the package.</li> <li>● Do not place on the package any heavy article that may deform the package.</li> <li>● When using a crane of 1 ton or more in capacity, make sure the crane operators are qualified to operate cranes and perform slinging work.</li> <li>● When using a crane, etc., never hoist articles exceeding the rated load of the crane, etc.</li> <li>● Use hoisting equipment suitable for the article to be hoisted. Calculate the load needed to cut off the hoisting equipment and other loads incidental to equipment operation by considering a safety factor. Also check the hoisting equipment for damage.</li> <li>● Do not climb onto the article while it is being hoisted.</li> <li>● Do not keep the article hoisted for an extended period of time.</li> <li>● Do not stand under the hoisted article.</li> </ul>
3	Storage/preservation	<ul style="list-style-type: none"> <li>● The storage/preservation environment should conform to the installation environment. Among others, be careful not to cause condensation.</li> </ul>
4	Installation/startup	<p>(1) Installing the robot, controller, etc.</p> <ul style="list-style-type: none"> <li>● Be sure to firmly secure and affix the product (including its work part). If the product tips over, drops, malfunctions, etc., damage or injury may result.</li> <li>● Do not step on the product or place any article on top. The product may tip over or the article may drop, resulting in injury, product damage, loss of/drop in product performance, shorter life, etc.</li> <li>● If the product is used in any of the following places, provide sufficient shielding measures:               <ul style="list-style-type: none"> <li>[1]Place subject to electrical noise</li> <li>[2]Place subject to a strong electric or magnetic field</li> <li>[3]Place where power lines or drive lines are wired nearby</li> <li>[4]Place subject to splashed water, oil or chemicals</li> </ul> </li> </ul>





No.	Task	Note
4	Installation/ startup	<p>(2) Wiring the cables</p> <ul style="list-style-type: none"> <li>● Use IAI's genuine cables to connect the actuator and controller or connect a teaching tool, etc.</li> <li>● Do not damage, forcibly bend, pull, loop round an object or pinch the cables or place heavy articles on top. Current leak or poor electrical continuity may occur, resulting in fire, electric shock or malfunction.</li> <li>● Wire the product correctly after turning off the power.</li> <li>● When wiring a DC power supply (+24 V), pay attention to the positive and negative polarities. Connecting the wires in wrong polarities may result in fire, product failure or malfunction.</li> <li>● Securely connect the cables and connectors so that they will not be disconnected or come loose. Failing to do so may result in fire, electric shock or product malfunction.</li> <li>● Do not cut and reconnect the cables of the product to extend or shorten the cables. Doing so may result in fire or product malfunction.</li> </ul> <p>(3) Grounding</p> <ul style="list-style-type: none"> <li>● Be sure to provide class D (former class 3) grounding for the controller. Grounding is required to prevent electric shock and electrostatic charges, improve noise resistance and suppress unnecessary electromagnetic radiation.</li> </ul> <p>(4) Safety measures</p> <ul style="list-style-type: none"> <li>● Implement safety measures (such as installing safety fences, etc.) to prevent entry into the movement range of the robot when the product is moving or can be moved. Contacting the moving robot may result in death or serious injury.</li> <li>● Be sure to provide an emergency stop circuit so that the product can be stopped immediately in case of emergency during operation.</li> <li>● Implement safety measures so that the product cannot be started only by turning on the power. If the product starts suddenly, injury or product damage may result.</li> <li>● Implement safety measures so that the product will not start upon cancellation of an emergency stop or recovery of power following a power outage. Failure to do so may result in injury, equipment damage, etc.</li> <li>● Put up a sign saying "WORK IN PROGRESS. DO NOT TURN ON POWER," etc., during installation, adjustment, etc. If the power is accidentally turned on, electric shock or injury may result.</li> <li>● Implement measures to prevent the work part, etc., from dropping due to a power outage or emergency stop.</li> <li>● Ensure safety by wearing protective gloves, protective goggles and/or safety shoes, as necessary.</li> <li>● Do not insert fingers and objects into openings in the product. Doing so may result in injury, electric shock, product damage, fire, etc.</li> <li>● When releasing the brake of the vertically installed actuator, be careful not to let the actuator drop due to its dead weight, causing pinched hands or damaged work part, etc.</li> </ul>
5	Teaching	<ul style="list-style-type: none"> <li>● Whenever possible, perform teaching from outside the safety fences. If teaching must be performed inside the safety fences, prepare "work rules" and make sure the operator understands the procedures thoroughly.</li> <li>● When working inside the safety fences, the operator should carry a handy emergency stop switch so that the operation can be stopped any time when an abnormality occurs.</li> <li>● When working inside the safety fences, appoint a safety watcher in addition to the operator so that the operation can be stopped any time when an abnormality occurs. The safety watcher must also make sure the switches are not operated inadvertently by a third party.</li> <li>● Put up a sign saying "WORK IN PROGRESS" in a conspicuous location.</li> </ul>

No.	Task	Note
5	Teaching	<ul style="list-style-type: none"> <li>● When releasing the brake of the vertically installed actuator, be careful not to let the actuator drop due to its dead weight, causing pinched hands or damaged load, etc.</li> <li>* Safety fences --- Indicate the movement range if safety fences are not provided.</li> </ul>
6	Confirmation operation	<ul style="list-style-type: none"> <li>● After teaching or programming, carry out step-by-step confirmation operation before switching to automatic operation.</li> <li>● When carrying out confirmation operation inside the safety fences, follow the specified work procedure just like during teaching.</li> <li>● When confirming the program operation, use the safety speed. Failure to do so may result in an unexpected movement due to programming errors, etc., causing injury.</li> <li>● Do not touch the terminal blocks and various setting switches while the power is supplied. Touching these parts may result in electric shock or malfunction.</li> </ul>
7	Automatic operation	<ul style="list-style-type: none"> <li>● Before commencing automatic operation, make sure no one is inside the safety fences.</li> <li>● Before commencing automatic operation, make sure all related peripherals are ready to operate in the auto mode and no abnormalities are displayed or indicated.</li> <li>● Be sure to start automatic operation from outside the safety fences.</li> <li>● If the product generated abnormal heat, smoke, odor or noise, stop the product immediately and turn off the power switch. Failure to do so may result in fire or product damage.</li> <li>● If a power outage occurred, turn off the power switch. Otherwise, the product may move suddenly when the power is restored, resulting in injury or product damage.</li> </ul>
8	Maintenance/inspection	<ul style="list-style-type: none"> <li>● Whenever possible, work from outside the safety fences. If work must be performed inside the safety fences, prepare "work rules" and make sure the operator understands the procedures thoroughly.</li> <li>● When working inside the safety fences, turn off the power switch, as a rule.</li> <li>● When working inside the safety fences, the operator should carry a handy emergency stop switch so that the operation can be stopped any time when an abnormality occurs.</li> <li>● When working inside the safety fences, appoint a safety watcher in addition to the operator so that the operation can be stopped any time when an abnormality occurs. The safety watcher must also make sure the switches are not operated inadvertently by a third party.</li> <li>● Put up a sign saying "WORK IN PROGRESS" in a conspicuous location.</li> <li>● Use appropriate grease for the guides and ball screws by checking the operation manual for each model.</li> <li>● Do not perform a withstand voltage test. Conducting this test may result in product damage.</li> <li>● When releasing the brake of the vertically installed actuator, be careful not to let the actuator drop due to its dead weight, causing pinched hands or damaged work part, etc.</li> <li>* Safety fences --- Indicate the movement range if safety fences are not provided.</li> </ul>
9	Modification	<ul style="list-style-type: none"> <li>● The customer must not modify or disassemble/assemble the product or use maintenance parts not specified in the manual without first consulting IAI.</li> <li>● Any damage or loss resulting from the above actions will be excluded from the scope of warranty.</li> </ul>
10	Disposal	<ul style="list-style-type: none"> <li>● When the product becomes no longer usable or necessary, dispose of it properly as an industrial waste.</li> <li>● When disposing of the product, do not throw it into fire. The product may explode or generate toxic gases.</li> </ul>



## Indication of Cautionary Information

The operation manual for each model denotes safety precautions under “Danger,” “Warning,” “Caution” and “Note,” as specified below.

Level	Degree of danger/loss	Symbol
Danger	Failure to observe the instruction will result in an imminent danger leading to death or serious injury.	 <b>Danger</b>
Warning	Failure to observe the instruction may result in death or serious injury.	 <b>Warning</b>
Caution	Failure to observe the instruction may result in injury or property damage.	 <b>Caution</b>
Note	The user should take heed of this information to ensure the proper use of the product, although failure to do so will not result in injury.	 <b>Note</b>

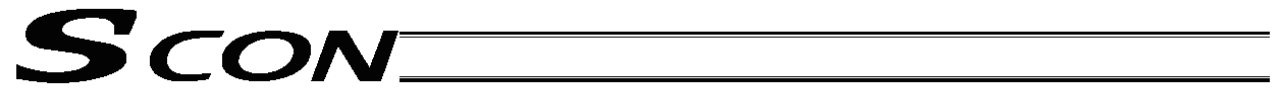

## CE Marking

If a compliance with the CE Marking is required, please follow Overseas Standards Compliance Manual (ME0287) that is provided separately.

## Chapter 1 Introduction

### 1. Overview

#### 1.1 Introduction

Thank you for purchasing the SCON controller.

Please read this manual carefully to handle the controller with due care while ensuring the correct operation of the controller.

Keep this manual with you so that you can reference the applicable sections whenever necessary.

Should you encounter any trouble when actually starting up your system, also refer to the manuals for the teaching pendant, PC software and other components included in your system, in addition to this manual.

This manual does not cover all possible operations other than normal operations, or unexpected events such as complex signal changes resulting from use of critical timings. Accordingly, you should consider items not specifically explained in this manual as “prohibited.”

\* We have made every effort to ensure precision of the information provided in this manual. Should you find an error, however, or if you have any comment, please contact IAI.

Keep this manual in a convenient place so it can be referenced readily when necessary.

#### 1.2 SCON Functions

The SCON is a single-axis AC servo controller capable of controlling actuators in the positioner mode or the pulse-train input mode.

The functions of SCON are as follows:

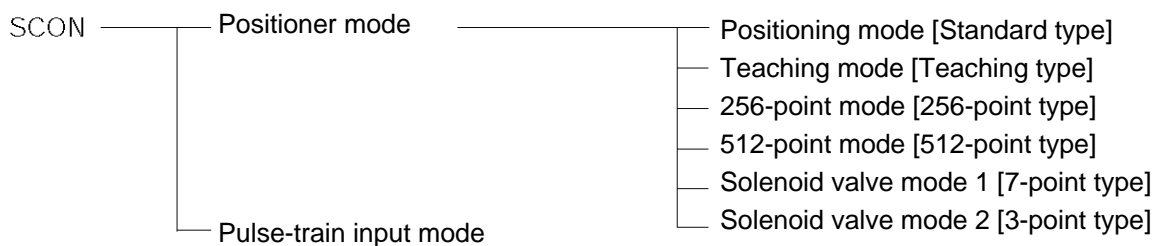

The positioner mode and the pulse-train input mode cannot be used at the same time. Switching of modes uses the piano switch located on the front face of the controller.

## 1.2.1 Features of the Positioner Mode

In the positioner mode, one of five PIO patterns is selected using a parameter.

The number of positioning points and input/output functions vary depending on the PIO pattern selected.

The table below lists the parameter settings and corresponding PIO patterns, as well as the features of each PIO pattern.

Parameter setting	Features of PIO pattern
0	Positioning mode [Standard type] 64 positioning points are supported. Available output functions include the moving output and zone output.
1	Teaching mode [Teaching type] 64 positioning points are supported. Normal positioning operation can be performed, along with jogging via I/O operation and writing of the current position to the position table. The MODE input signal is used to switch between the normal positioning operation mode and the teaching mode. The zone output (set by parameters) and brake forced-release input accessible in the standard type are not available in this type.
2	256-point mode [256-point type] The moving output and zone output (set by parameters) accessible in the standard type are not available in this type.
3	512-point mode [512-point type] The moving output and zone output (set by parameters/position data) accessible in the standard type are not available in this type.
4	Solenoid valve mode 1 [7-point type] Seven positioning points are supported. Direct command inputs and position complete outputs are provided separately for different target positions to simulate air-cylinder control. The moving output accessible in the standard type is not available in this type.
5	Solenoid valve mode 2 [3-point type] Three positioning points are supported. The function of position complete output signals is different from how these signals function in the 7-point type. The "position detection" function, which operates just like an auto-switch of an air cylinder, is also available. <u>Take note that incremental positioning commands are not supported in this mode.</u>

## 1.2.2 Features of the Pulse-train Input Mode

- **Dedicated home return signal**  
Home return operation is supported in this mode.  
When this function is used, home return can be performed automatically without having to program a complex sequence or use an external sensor, etc.
- **Brake control function**  
The electromagnetic brake power is supplied to the controller from a power supply different from the main power. Since the controller controls the brake, there is no need to program a separate sequence. Also, the electromagnetic brake can be released freely after the main power has been cut off.
- **Torque limiting function**  
The torque can be limited (a desired limit can be set by a parameter) using an external signal. When the torque reaches the specified level, a signal will be output. This function permits push & hold operation, press-fit operation, etc.
- **Feed-forward control function**  
With this function, response can be improved in certain situations such as when the load inertia ratio is high. Increasing the parameter value will reduce the deviation (difference between the position command and the position feedback), thereby improving response.
- **Position-command primary filter function**  
Soft start and stop can be achieved even when the actuator is operated in the command-pulse input mode where acceleration and deceleration are not considered.
- **Feedback function**  
Position detection data is output using pulse trains (differential).  
The current actuator position can be read in real time from the host controller.

## 1.3 How to Read the Model Specification

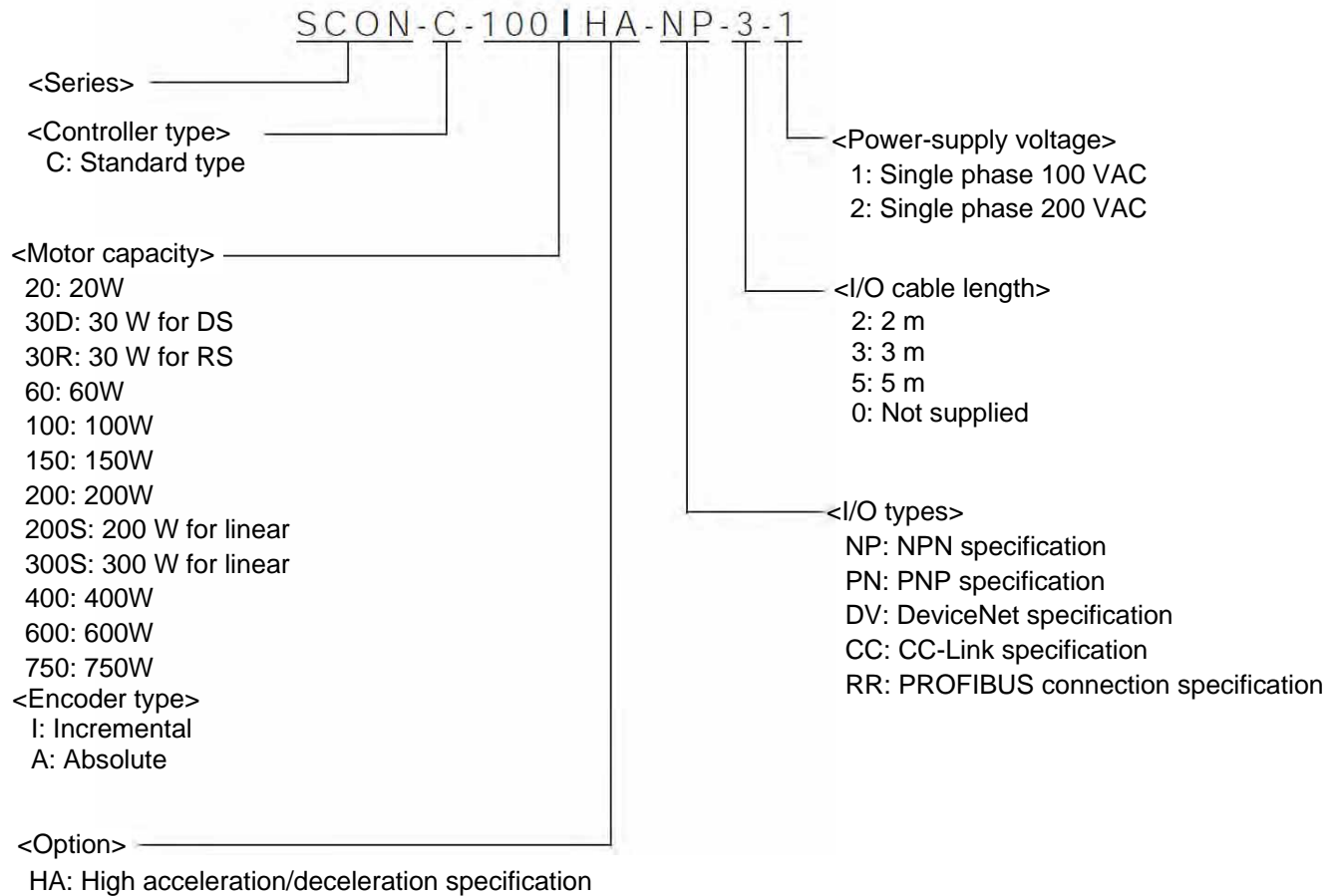

## 1.4 System Configuration

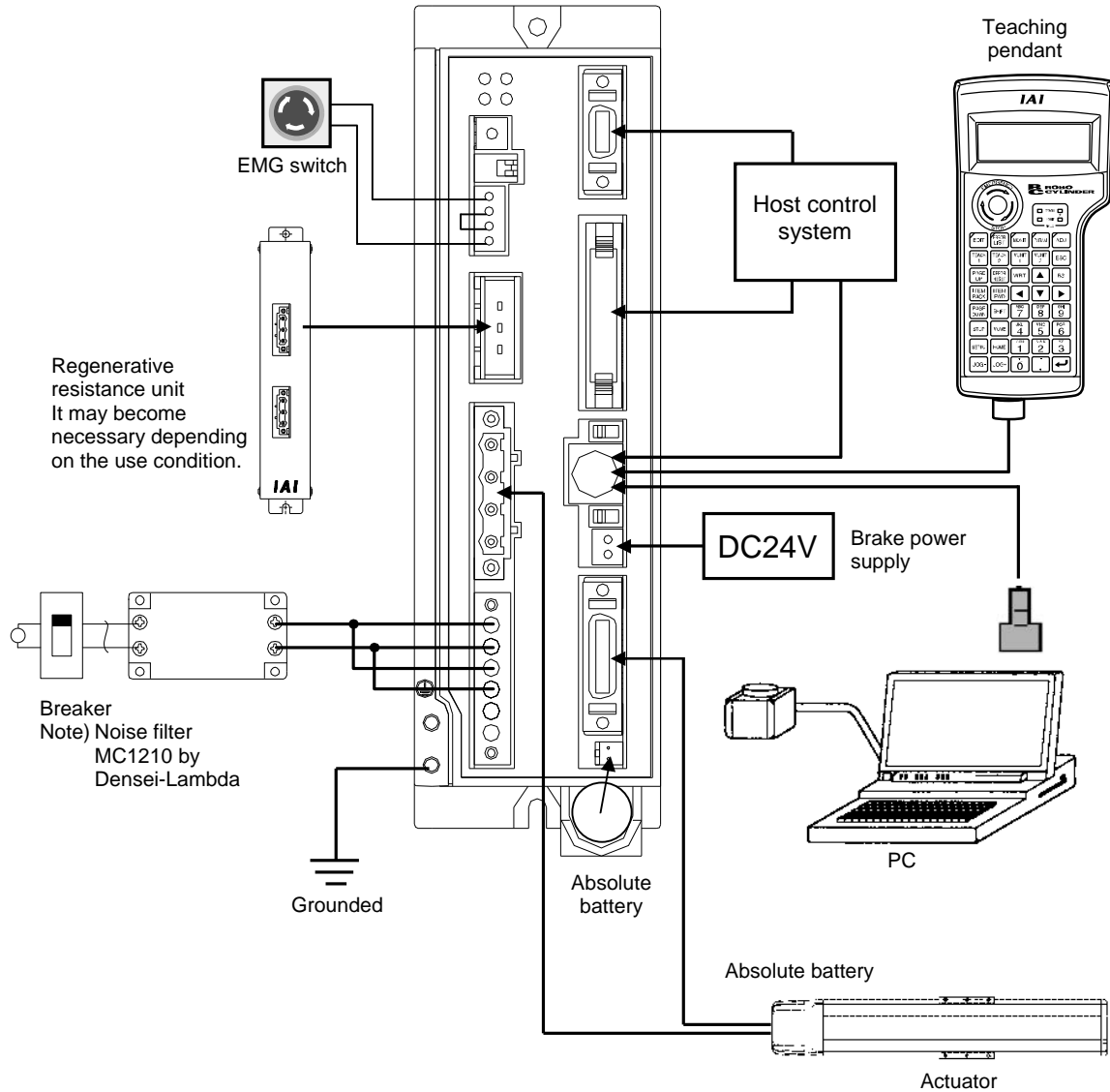

**⚠ Caution:** The customer must provide a noise filter. A noise filter is always required at the minimum, even when your system need not conform to the EC Directives. Also add clamp filters, etc., if necessary.

## 1.5 Procedure from Unpacking to Test Operation and Adjustment

If you are using this product for the first time, carry out each step by referring to the procedure below to ensure that all necessary items are checked and all wires are connected correctly. The procedure below covers the flow from unpacking to trial operation using a PC or teaching pendant.

### (1) Check the content in the package

If you found any missing part or part specified for a different model, please contact your dealer.

\* Check that the model specification pasted on the controller and the model specification of the delivered actuator match.

- Controller SCON-\* - ...
- Motor cable
- Encoder cable
- I/O flat cable
- Pulse-train control connector plug: 10114-3000PE (Sumitomo 3M)
- Pulse-train control connector housing: 10314-52F0-008 (Sumitomo 3M)
- Actuator
- System I/O shorting connector
- Power connector
- Brake connector

### Options

- Pulse converter AK-04, JM-08
- Teaching pendant COM-T RCM-T RCM-E RCM-P
- PC software RCM-101-MW, RCM-101-USB
- Regenerative unit
- Touch panel display RCM-PM-01 (supported from system software version V0015)

### (2) Installation

- [1] Affix the actuator.
- [2] Install the controller.

### (3) Wiring/connection

- Connect the motor cable and encoder cable.
- Wire the AC power supply.
- Connect the grounding wire to ground.
- Wire the emergency stop circuit.
- Connect the I/O flat cable (wiring with the host PLC and 24-V I/O power supply).
- Connect the 24-V brake power supply (only if the actuator is equipped with a brake).
- Connect the regenerative unit(s). The need for regenerative unit will vary depending on the use condition.

### (4) Turn on the power and check for alarms

- [1] If the SCON is to be used in the positioner mode, set piano switch 1 to the OFF position (right side).
- [2] Connect the PC or teaching pendant, and then set the AUTO/MANU switch to the MANU position.
- [3] Input the 24-V I/O power.
- [4] If the actuator is equipped with a brake, turn on the 24-V power supply for the brake.
- [5] Input the AC power (control power, drive power).

If an emergency stop is actuated, the EMG LED indicator will illuminate in red.

If an alarm generates, the ALM LED indicator will illuminate in orange. Check the nature of the alarm using the PC or teaching pendant and remove the cause by referring to Appendix 5, "Troubleshooting."



## (5) Set parameters

- Before the 24-V I/O power supply is connected, PIO power monitor can be disabled temporarily by changing the applicable parameter setting.

Parameter No. 74, "PIO power monitor": 0 (Enable) → 1 (Disable)

Note) After the 24-V I/O power supply has been connected, be sure to reset parameter No. 74 to "0" to enable PIO power monitor.

- If the host PLC or other host controller is not yet wired and the servo-on signal cannot be input, the servo-on input can be disabled temporarily by changing the applicable parameter setting.

Parameter No. 21, "Servo-on input": 0 (Enable) → 1 (Disable)

Note) After the host PLC, etc., has been wired, be sure to reset parameter No. 21 to "0" to enable the servo-on input.

Change the safety speed, if necessary.

The factory-set safety speed is "100 mm/sec." (If the maximum speed is less than 100 mm/sec, the safety speed conforms to the maximum speed.)

- Select a desired PIO pattern using the applicable parameter.

Parameter No. 25, "PIO pattern selection": 0 to 5

When a parameter has been changed, the new setting will become effective once the power is reconnected or software is reset.

## (6) Check the servo-on status

When the servo turns on, the SV LED indicator will illuminate in green. (In the MANU teaching mode, the servo will not turn on even when the servo-on signal is input after the AC power has been turned on.)

If the servo-on input is disabled by the parameter and the controller is in the AUTO mode, the servo will turn on automatically after the controller has started.

## (7) Operate with the PC or teaching pendant

While the servo is on, perform the operation check specified below. For details on the operating method, refer to the operation manual for your PC software or teaching pendant.

[1] Use the PC or teaching pendant to set a target position in the "Position" field of the position table.

[2] Perform home return.

[3] Move the actuator to the specified position.

## (8) Check the actuation of the emergency stop circuit

While the actuator is operating, press the emergency stop button to confirm that an emergency stop will be actuated.

 **Caution:** When the teaching pendant is disconnected, an emergency stop is actuated momentarily. The emergency stop will be cancelled immediately thereafter, but the actuator and other equipment that are operating when the teaching pendant is disconnected will stop. Therefore, do not disconnect the teaching pendant when an actuator or any other equipment is operating. Also pay attention to the design of the emergency stop circuit that includes the emergency stop switch on the teaching pendant.

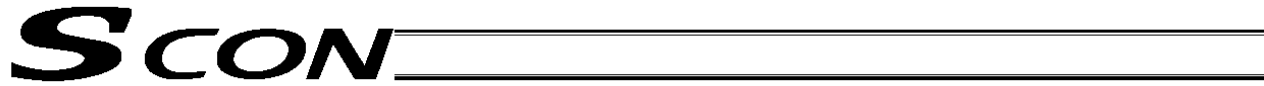

## 1.6 Warranty Period and Scope of Warranty

The SCON controller you have purchased passed IAI's shipping inspection implemented under the strictest standards. The unit is covered by the following warranty:

### 1. Warranty Period

The warranty period shall be one of the following periods, whichever ends first:

- 18 months after shipment from our factory
- 12 months after delivery to a specified location

### 2. Scope of Warranty

The scope of warranty shall cover our products delivered at cost. If an obvious manufacturing defect is found during the above period under an appropriate condition of use, IAI will repair the defect free of charge. Note, however, that the following items are excluded from the scope of warranty.

- Aging such as natural discoloration of coating
- Wear of a consumable part due to use
- Noise or other sensory deviation that doesn't affect the mechanical function
- Defect caused by inappropriate handling or use by the user
- Defect caused by inappropriate or erroneous maintenance/inspection
- Defect caused by use of a part other than IAI's genuine part
- Defect caused by an alteration or other change not approved by IAI or its agent
- Defect caused by an act of God, accident, fire, etc.

The warranty covers only the product as it has been delivered and shall not cover any losses arising in connection with the delivered product. The defective product must be brought to our factory for repair.

Please read carefully the above conditions of warranty.

## 2. Specifications

### 2.1 Basic Specifications

Item	Less than 400 W	400 W or more	
Applicable motor capacity	20 W to 399 W	400 W to 750 W	
Power-supply voltage	Single-phase 100 to 115 VAC ± 10% Single-phase 200 to 230 VAC ± 10%	Single-phase 200 to 230 VAC ± 10%	
Rush current <sup>*1</sup>	100 VAC 200 VAC	20 A (control), 70 A (drive) 20 A (control), 80 A (drive)	
Leak current <sup>*2</sup>	3.0 mA (Primary side when noise filter is connected to the power supply line)		
Heat output	30 W to 58 W		
Power supply frequency	50/60 Hz		
PIO interface power supply <sup>*3</sup>	24 VDC ± 10% (Externally supplied)		
Solenoid brake power supply (in case of actuators equipped with brake)	24 VDC ± 10% 1 A (peak value) (Externally supplied)		
Resistance against temporary electric power failure	10 ms (50 Hz), 8 ms (60 Hz)		
Motor control method	Sine wave PWM vector current control		
Supported encoders	Incremental serial encoder Absolute serial encoder ABZ (UVW) parallel encoder		
Operation mode	Positioner mode/pulser-train control mode (Operation mode is switched with the DIP switch.)		
Positioner mode	Number of positions	512 points (maximum)	
	Inputs/outputs	16 dedicated input points / 16 dedicated output points	
Pulse-train mode	Input pulse frequency	Differential pulse	MAX. 500 kpps
		Open-collector pulse	MAX. 200 kpps (Pulse converter AK-04 is required.)
	Feedback pulse frequency	The maximum speed with differential pulse is 500 kpps (up to 109 kpps can be output linearly following the speed of actuators).	
	Command pulse multiplier (electronic gear: A/B)	A, B = 1 to 4096 (Parameter settings) $\frac{1}{50} < \frac{A}{B} < \frac{50}{1}$	
	Dedicated I/O (PIO)	8 input points / 12 output points	
Serial communication interface	RS485: 1 channel (conforming to Modbus protocol RTU/ASCII) Speed: 9.6 kpps to 230.4 kpps Control via serial communication is possible with the positioner mode.		
I/O (PIO) cable length	10 m or less		
Communication cable length	Total cable length shall be 100 m or less (RS485). Length in case of Fieldbus specifications (CC-Link, DeviceNet, PROFIBUS) depends on each Fieldbus specification.		
Data input method	Teaching pendant, PC software		
Protective functions	Overvoltage, motor overcurrent, motor overload, driver temperature error, encoder error, etc.		
Air cooling method	Natural cooling	Forced cooling	
Withstand voltage	Between primary and secondary: 1500 VAC, 1 minute Between primary and FG: 1500 VAC, 1 minute		
Insulation resistance	Between secondary and FG: 500 VDC 100 MΩ or more		
Environment	Surrounding air temperature	0°C to 40°C	
	Surrounding humidity	85%RH or less (no condensation)	
	Surrounding environment	(See the installation environment section.)	
	Storage ambient temperature	-10°C to 65°C	
	Storage ambient humidity	90%RH or less (no condensation)	
	Vibration resistance	XYZ directions, 10 to 57 Hz, one side width 0.035 mm (continuous), 0.075 mm (intermittent) 57 to 150 Hz 4.9 m/s <sup>2</sup> (continuous), 9.8 m/s <sup>2</sup> (ongoing)	
Protection class	IP20		
Weight	Approximately 800 g (approximately 25 g more in case of absolute specifications)	Approximately 1100 g (approximately 25 g more in case of absolute specifications)	
External dimension	58 (W) x 194 (H) x 121 (D) (Installation pitch: 184)	72 (W) x 194 (H) x 121 (D) (Installation pitch: 184)	

\*1 Rush current flows approximately 20 ms after turning the power supply on (guideline at 40°C).

\*2 Leak power supply changes depending on the capacity of connected motor, cable length, and surrounding environment. If protection against leak current is installed, measure leak current at installation location of leak current breaker.

\*3 Power supply for I/O signals is not necessary if the controller is operated using field network (CC-Link, DeviceNet, PROFIBUS), gateway unit, or SIO converter, without using PIO. In this case, set "1" (disabled) for parameter No. 74 (PIO power supply monitoring).

⚠ Caution: Position data, parameters, etc. are written in EEPROM. The number of writings is limited to approximately 100,000 times.

## 2.2 Name and Function of Each Part

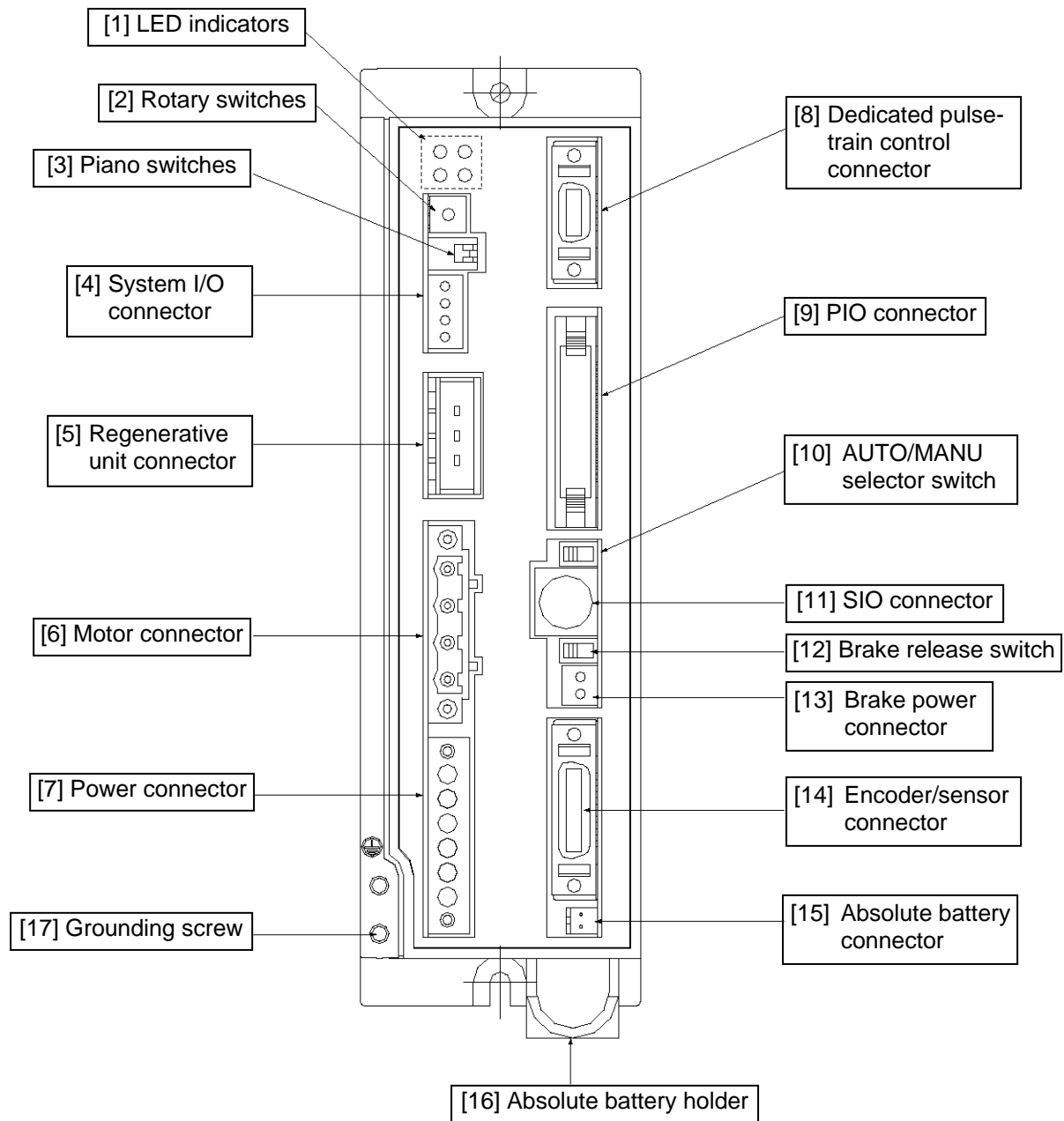

[1] LED indicators

These LEDs indicate the condition of the controller.

Name	Color	Description
PWR	Green	This LED illuminates when the system has become ready (after the power has been input and the CPU has started normally).
SV	Green	This LED illuminates when the servo has turned on.
ALM	Orange	This LED illuminates while an alarm is present.
EMG	Red	This LED illuminates while an emergency stop is actuated.

[2] Rotary switches

These switches are used to set the controller address.

If two or more controllers are linked via serial communication, set a unique address for each controller.

\* The address set by the switches will become effective after the power is reconnected or software is reset.

[3] Piano switches

These switches are used to set the various modes of the controller system.

Name	Description
1	Operation mode selector switch OFF: Positioner mode, ON: Pulse-train control mode * The mode set by the switch will become effective after the power is reconnected.
2	Reserved by the system. (This switch must be set to "OFF.")

 **Caution:** When controlling the SCON controller via serial communication, always set the controller in the "positioner mode" (piano switch 1: OFF).  
If it happens to be in the "pulse-train mode" by mistake, the SCON controller may operate erratically because it is operated according to the "pulse-train mode" parameters.

[4] System I/O connector

This connector is used to connect the emergency stop switch, etc.

Connector (controller side): MC1.5/4-G-3.5 (Phoenix Contact)

Connector (plug-in side): FMC1.5/4-ST-3.5 (Phoenix Contact)

Applicable cable diameter: 0.2 to 1.3 mm<sup>2</sup> (AWG24 to 16)

Pin No.	Signal name	Description
1	S1	Emergency-stop switch contact output for teaching pendant
2	S2	Emergency-stop switch contact output for teaching pendant
3	EMG+	24-V output for emergency stop
4	EMG-	Emergency stop input

[5] Regenerative unit connector

This connector is used to connect an external regenerative resistance unit. The need for regenerative unit will vary depending on the use condition.

[6] Motor connector

This connector is used to connect the motor power cable of the actuator.

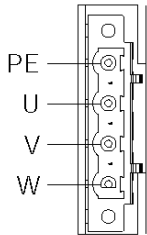

Motor connector specifications

Item	Overview		Description
Connector (cable side)	GIC2.5/4-STF-7.52		4-pin, 2-piece connector by Phoenix Contact
Connector name	M1 to 2		Motor connector
Cable size	0.75 mm <sup>2</sup> (AWG18 or equivalent)		Supplied with the actuator
Connected unit	Actuator		
Terminal assignments	1		PE Protective grounding wire
	2	Out	U Motor drive phase U
	3	Out	V Motor drive phase V
	4	Out	W Motor drive phase W

[7] Power connector

This power connector accepts a 100/200-VAC single-phase power supply. The pins are divided into control power inputs and motor power inputs.

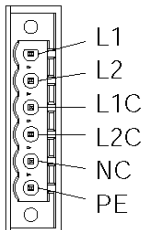

Item	Specification		Remarks
Connector (cable side)	6-pin, 2-piece connector		MSTB2.5/6-STF-5.08 connector by Phoenix Contact
Applicable cable size	Control power: 0.75 mm <sup>2</sup> (AMG18)		Recommended stripped wire length: 7 mm
	Motor power: 2 mm <sup>2</sup> (AMG14)		
Terminal assignments	Pin No.	Signal name	
	1	L1	Motor power AC input
	2	L2	Motor power AC input
	3	L1C	Control power AC input
	4	L2C	Control power AC input
	5	NC	Not connected
	6	PE	Grounding terminal

Signal names are indicated on the mating connector.

[8] Dedicated pulse-train input mode connector

This connector is used when the controller is to be operated in the pulse-train input mode. Do not connect it if the controller is to be operated in the positioner mode.

[9] PIO connector

This connector is used to connect to the host controller (PLC, etc.) via the PIO (parallel input/output) cable. It consists of a 40-pin flat connector and constitutes a DIO group of 16 inputs and 16 outputs.

[10] AUTO/MANU switch

The operating mode using the teaching pendant/PC (software) connected to the SIO connector, and PIO input, will change as follows in accordance with the setting of this switch.  
Prohibition/permission of PIO activation is specified using the PC software/teaching pendant.

MANU	PIO activation inhibited (teaching mode 1 or teaching mode 2)	All operations are possible using the PC software/teaching pendant. PIO inputs are not accepted.
	PIO activation permitted (monitor mode 1 or monitor mode 2)	Only monitoring operations are possible using the PC software/teaching pendant. PIO inputs are accepted.
AUTO	Only monitoring operations are possible using the PC software/teaching pendant. PIO inputs are accepted.	

\* The emergency stop switch on the teaching pendant is enabled when the switch is connected, regardless of the AUTO/MANU mode. Take note that although an emergency stop is actuated momentarily when the teaching pendant or SIO cable is removed, this does not indicate an error condition.  
Therefore, the actuator and other equipment that are currently operating will stop.  
Do not disconnect the teaching pendant or SIO communication cable while an actuator or any other equipment is operating.

[11] SIO connector

This connector is used to connect the dedicated communication cable for teaching pendant/PC. It is also used when two or more controllers are linked via serial communication.

[12] Brake release switch

This switch forcibly releases the electromagnetic brake of an actuator with brake.

RLS: Power is supplied to the brake to forcibly release the brake.

NOM: The controller controls ON/OFF of the brake. This setting should be used in normal conditions of use.

\* A 24-VDC power supply must be connected to drive the brake.

Even if the controller power is not turned on, you can still move the slider or rod manually by turning on the 24-VDC power supply for driving the brake and then forcibly releasing the brake.

[13] Brake power connector

This connector supplies the 24-VDC brake power. If an actuator with brake is connected, 24 VDC must be supplied externally.

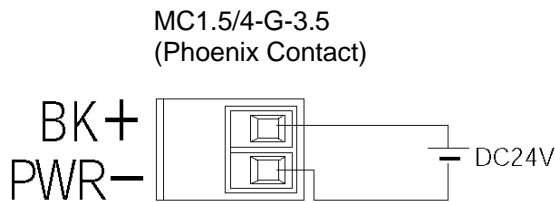

\* Turn on the 24-VDC brake power before turning on the SCON controller power.

[14] Encoder/sensor connector

This connector is used to connect the encoder/sensor cables of the actuator.

With the SCON, encoder voltage is adjusted using a parameter (one of four levels is set in accordance with the encoder type and cable length).

14 Encoder sensor cable  
 Cable model: CB-X1-PA \*\*\*

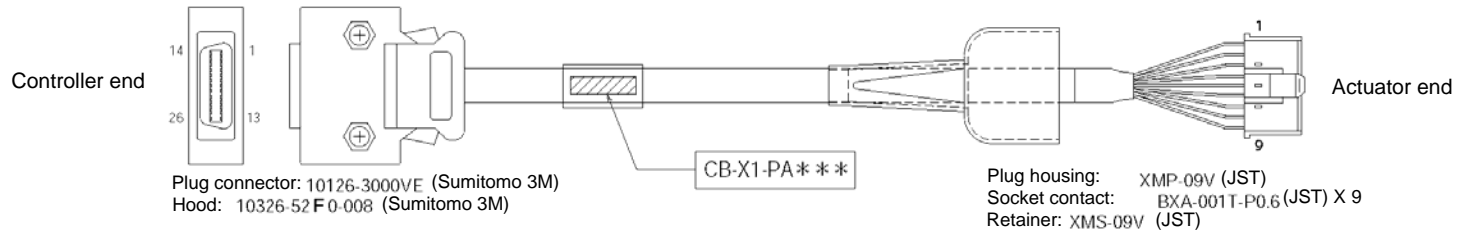

Wiring diagram

10126-3000VE

Wire	Color	Signal	No.
—	—	—	10
—	—	—	11
—	E24V	—	12
—	0V	—	13
—	LS	—	26
—	CLEEP	—	25
—	OT	—	24
—	RSV	—	23
—	—	—	9
—	—	—	18
—	—	—	19
AWG26 (soldered)	—	A+	1
AWG26 (soldered)	—	A-	2
AWG26 (soldered)	—	B+	3
AWG26 (soldered)	—	B-	4
AWG26 (soldered)	—	Z+	5
AWG26 (soldered)	—	Z-	6
Orange	SRD+	7	
Green	SRD-	8	
Purple	BAT+	14	
Gray	BAT-	15	
Red	VCC	16	
Black	GND	17	
Blue	BKR-	20	
Yellow	BKR+	21	
—	—	—	22

XMP-09V

No.	Signal	Color	Wire
1	BAT+	Purple	AWG26 (pressure-welded)
2	BAT-	Gray	
3	SD	Orange	
4	SD	Green	
5	VCC	Red	
6	GND	Black	
7	FG	Drain	
8	BK-	Blue	
9	BK+	Yellow	

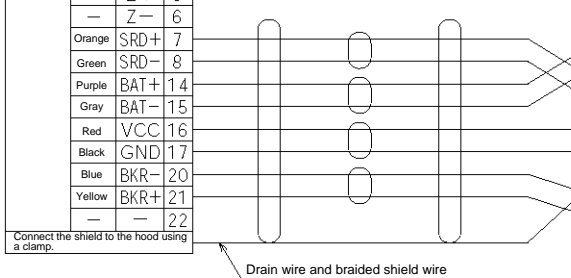

Connect the shield to the hood using a clamp.

Drain wire and braided shield wire



Cable model: CB-X1-PLA \*\*\*

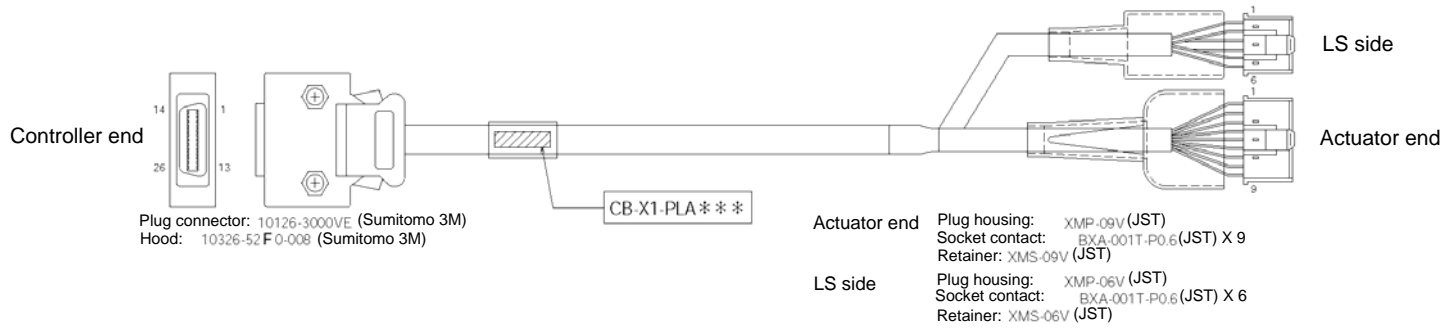

**Wiring diagram**

10126-3000VE

Wire	Color	Signal	No.
—	—	—	10
—	—	—	11
White/Blue	E24V	12	
White/Yellow	0V	13	
White/Red	LS	26	
White/Black	CLEEP	25	
White/Purple	OT	24	
White/Gray	RSV	23	
—	—	—	9
—	—	—	18
—	—	—	19
—	A+	1	
—	A-	2	
—	B+	3	
—	B-	4	
—	Z+	5	
—	Z-	6	
Orange	SRD+	7	
Green	SRD-	8	
Purple	BAT+	14	
Gray	BAT-	15	
Red	VCC	16	
Black	GND	17	
Blue	BKR-	20	
Yellow	BKR+	21	
—	—	—	22

AWG26 (soldered)

Connect the shield to the hood using a clamp.

Drain wire and braided shield wire

XMP-06V

No.	Signal	Color	Wire
1	E24V	White/Blue	AWG26 (pressure-welded)
2	0V	White/Yellow	
3	LS	White/Red	
4	CLEEP	White/Black	
5	OT	White/Purple	
6	RSV	White/Gray	

XMP-09V

No.	Signal	Color	Wire
1	BAT+	Purple	AWG26 (pressure-welded)
2	BAT-	Gray	
3	SD	Orange	
4	SD	Green	
5	VCC	Red	
6	GND	Black	
7	FG	Drain	
8	BK-	Blue	
9	BK+	Yellow	

16 Cable model: CB-X2-PA \*\*\*

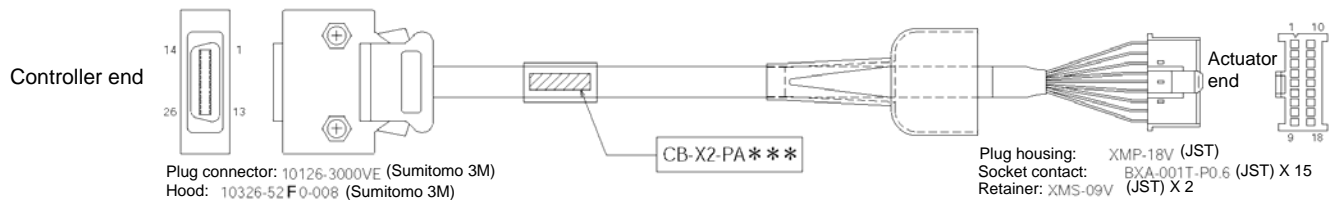

Wiring diagram

10126-3000VE

Wire	Color	Signal	No.
—	—	—	10
—	—	—	11
—	E 24V		12
—	0V		13
—	LS		26
—	CLEEP		25
—	OT		24
—	RSV		23
—	—	—	9
—	—	—	18
—	—	—	19
White/Blue	A +		1
White/Yellow	A -		2
White/Red	B +		3
White/Black	B -		4
White/Purple	Z +		5
White/Gray	Z -		6
Orange	SRD +		7
Green	SRD -		8
Purple	BAT +		14
Gray	BAT -		15
Red	VCC		16
Black	GND		17
Blue	BKR -		20
Yellow	BKR +		21
—	—	—	22

AWG26 (soldered)

XMP-18V

No.	Signal	Color	Wire
1	A	White/Blue	AWG26 (pressure-welded)
2	A	White/Yellow	
3	B	White/Red	
4	B	White/Black	
5	Z	White/Purple	
6	Z	White/Gray	
7	—	—	
8	—	—	
9	FG	Drain	
10	SD	Orange	
11	SD	Green	
12	BAT +	Purple	
13	BAT -	Gray	
14	VCC	Red	
15	GND	Black	
16	—	—	
17	BK -	Blue	
18	BK +	Yellow	

AWG26 (pressure-welded)

Connect the shield to the hood using a clamp.

Drain wire and braided shield wire

Cable model: CB-X2-PLA \*\*\*

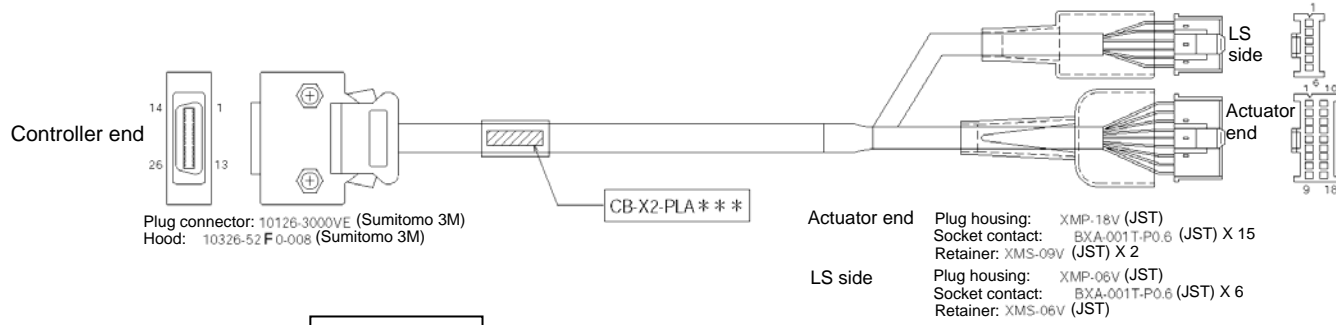

Wiring diagram

10126-3000VE

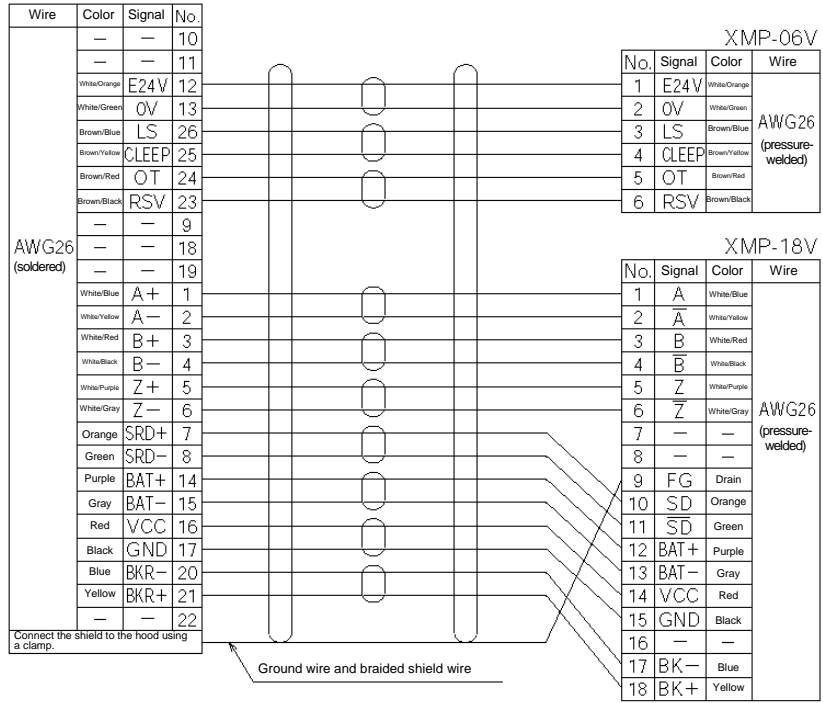

18 Cable model: CB-RCS2-PA \*\*\*

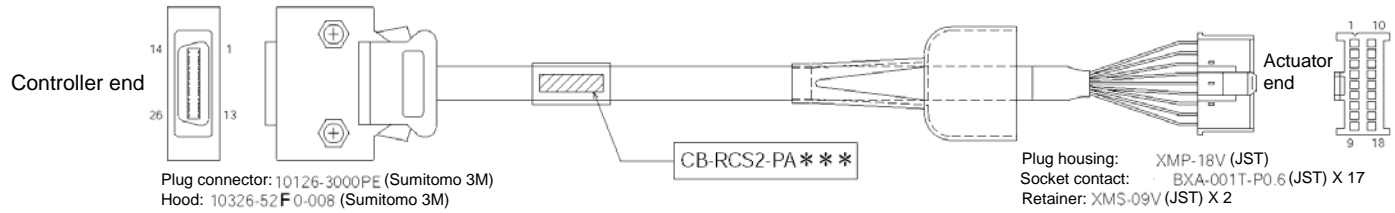

**Wiring diagram**

10126-3000PE

Wire	Color	Signal	No.
—	—	—	10
—	—	—	11
—	—	E24V	12
White/Green	—	0V	13
Brown/White	—	LS	26
—	—	CLEEP	25
—	—	OT	24
—	—	RSV	23
—	—	—	9
—	—	—	18
—	—	—	19
Pink	—	A+	1
Purple	—	A-	2
White	—	B+	3
Blue/Red	—	B-	4
Orange/White	—	Z+	5
Green/White	—	Z-	6
Blue	—	SRD+	7
Orange	—	SRD-	8
Black	—	BAT+	14
Yellow	—	BAT-	15
Green	—	VCC	16
Brown	—	GND	17
Gray	—	BKR-	20
Red	—	BKR+	21
—	—	—	22

AWG26  
(soldered)

XMP-18V

No.	Signal	Color	Wire
1	A	Pink	AWG26 (pressure-welded)
2	A	Purple	
3	B	White	
4	B	Blue/Red	
5	Z	Orange/White	
6	Z	Green/White	
7	LS+	Brown/White	
8	—	—	
9	FG	Drain	
10	SD	Blue	
11	SD	Orange	
12	BAT+	Black	
13	BAT-	Yellow	
14	VCC	Green	
15	GND	Brown	
16	LS-	Gray/White	
17	BK-	Gray	
18	BK+	Red	

Connect the shield to the hood using a clamp.

Drain wire and braided shield wire

Cable model: CB-RCS2-PLA \*\*\*

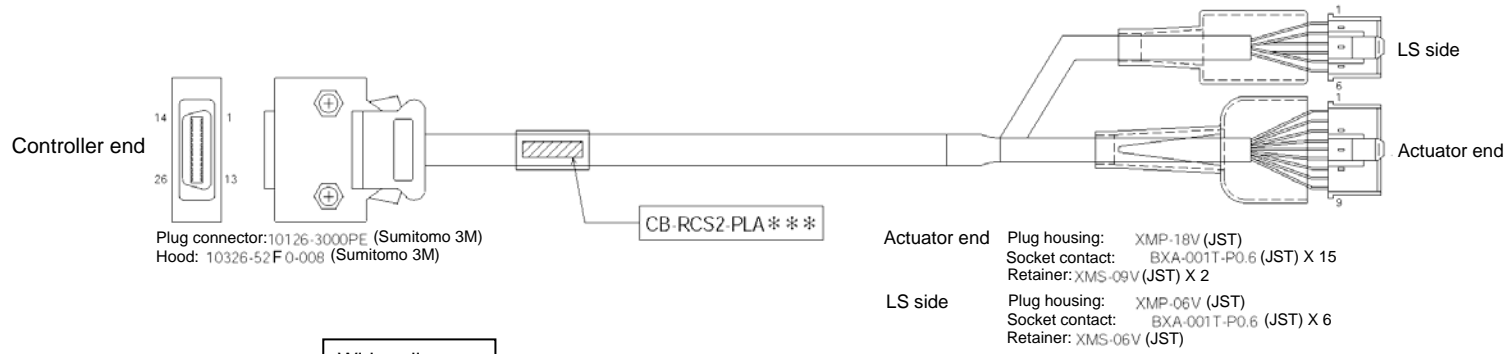

**Wiring diagram**

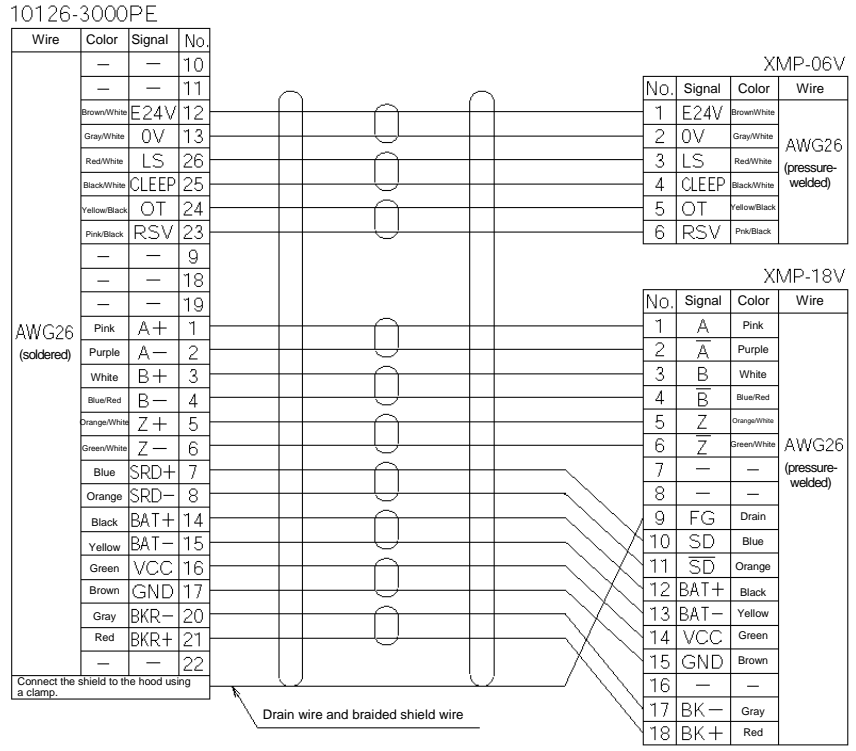

- [15] Absolute battery connector  
This connector is used to connect the absolute-encoder backup battery (required when the controller is of absolute encoder specification).
- [16] Absolute battery holder  
This battery holder is used to install the absolute-encoder backup battery.
- [17] Grounding screw  
This screw is used to implement protective grounding. It is connected inside the controller to the PE terminal in the power connector. Use this terminal if protective grounding based on a 2-piece connector is not feasible due to conflict with the safety standard or for any other reason.

Item	Description
Cable size	2.0 to 5.5 mm <sup>2</sup> or larger
Grounding method	Class D grounding

## 2.3 External Dimensions

External dimensions of models with a power output of less than 400 W

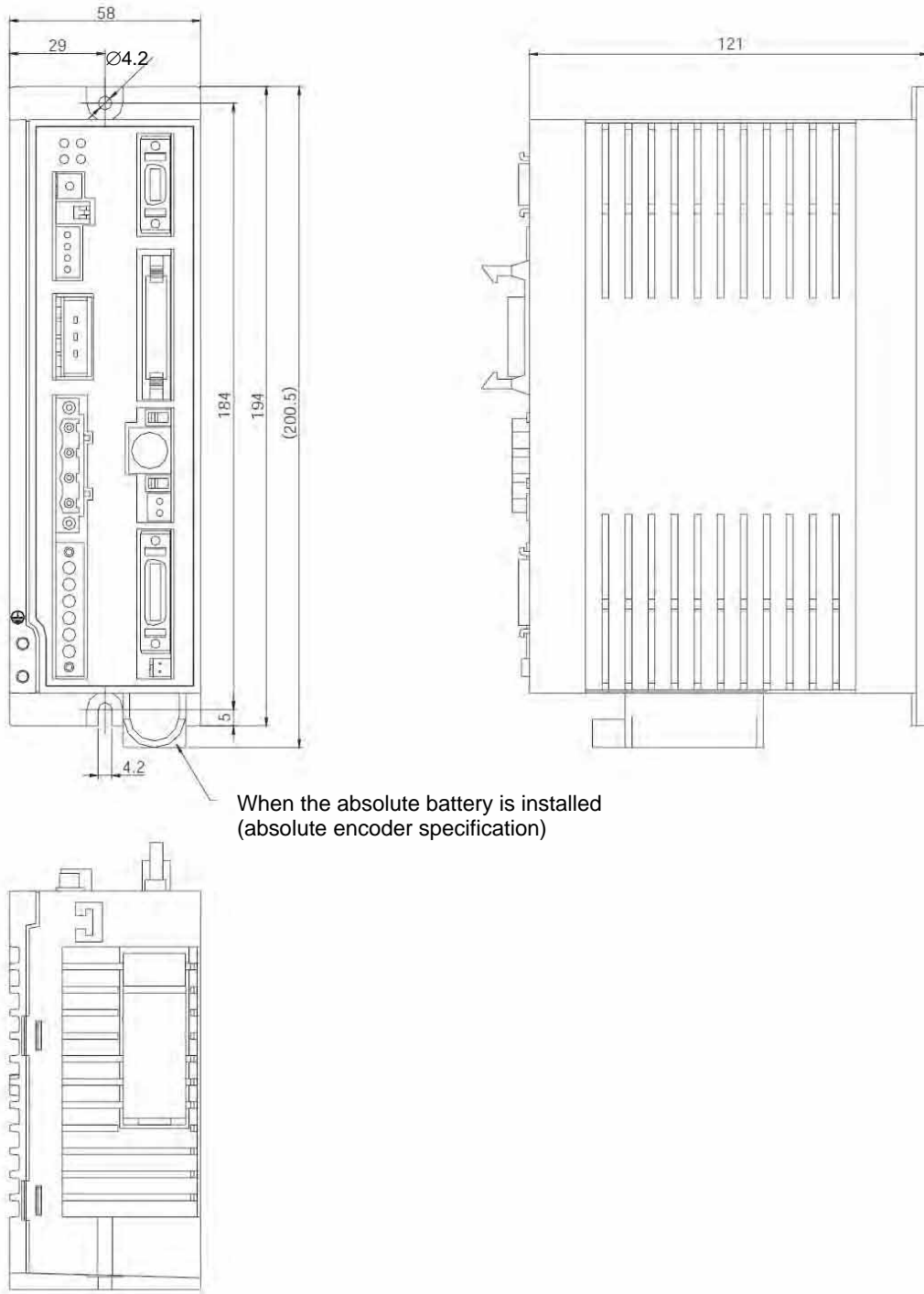

External dimensions of models with a power output of 400 W or more

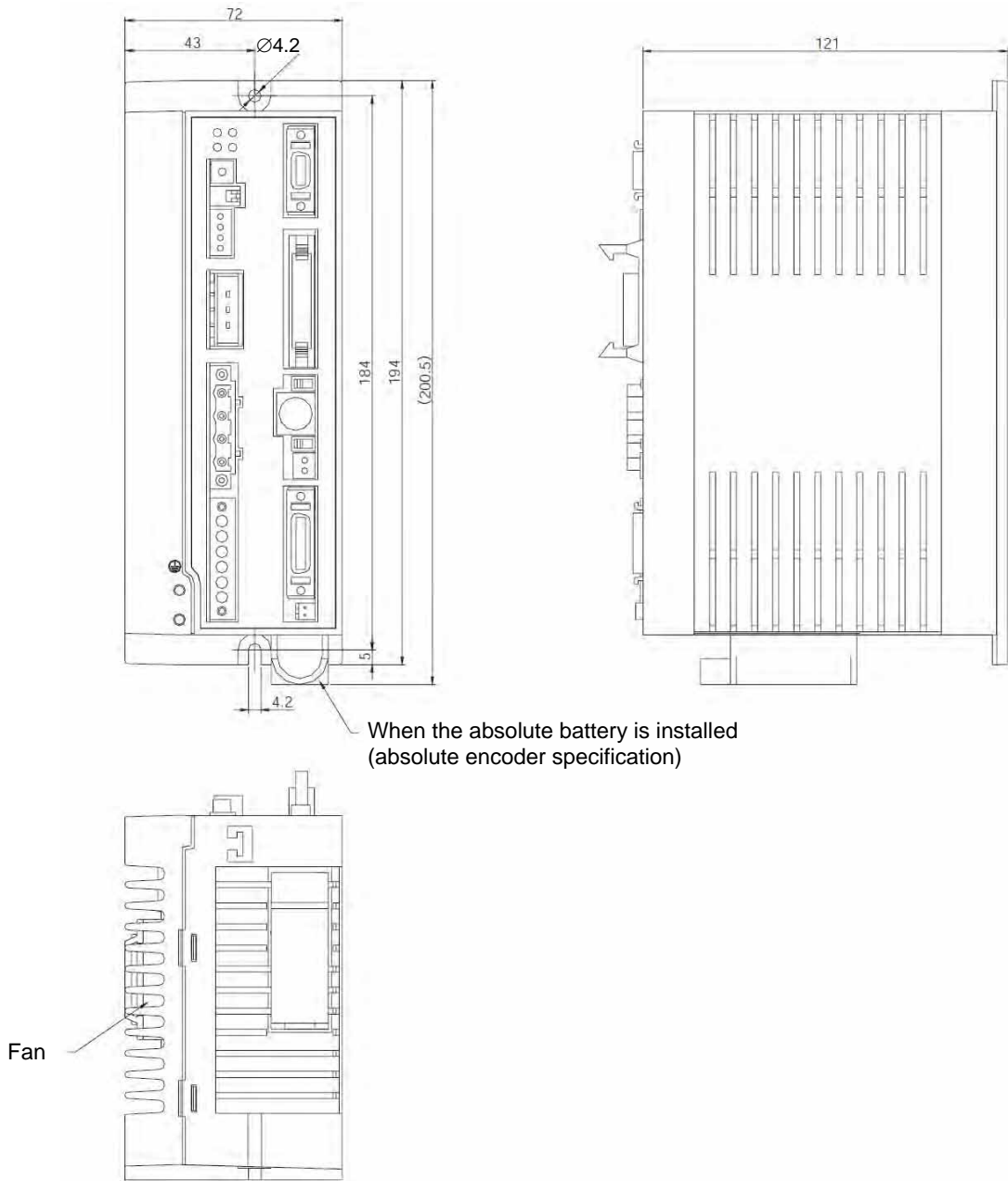



## 3. Installation and Wiring

### 3.1 Installation Environment

- (1) When installing and wiring the controller, do not block the ventilation holes for cooling. (Insufficient ventilation may not only prevent the controller from demonstrating its design performance fully, but it may also cause a breakdown.)
- (2) Prevent foreign matter from entering the controller through the ventilation holes. This controller is not dustproof or splashproof (against water or oil), so avoid using the controller in a place subject to large amounts of dust, oil mist or splashes of cutting fluid.
- (3) Keep the controller from direct sunlight or irradiated heat from large heat sources such as heat treatment furnaces.
- (4) Use the controller in an environment of 0 to 40°C in surrounding air temperature and 85% or below in humidity (non-condensing), where the surrounding air is free from corrosive or flammable gases.
- (5) Use the controller in an environment where it does not receive external vibration or impact.
- (6) Prevent electrical noise from entering the controller or connected cables.

### 3.2 Heat Radiation and Installation

Design the control panel size, controller layout and cooling method so that the temperatures around the controller will always be kept to 40°C or below.

Mount the controller on a wall vertically as shown below. This controller implements cooling by means of forced ventilation (air is blown out from the top). When installing the controller, observe the aforementioned direction and provide a minimum clearance of 100 mm above and 50 mm below the controller, and 30 mm from an adjacent controller.

If you are installing multiple controllers side by side, provide a fan on top of the controllers to agitate the airflows as an effective way to keep the surrounding air temperatures constant.

Provide a minimum clearance of 150 mm between the front face of the controller and the wall (cover).

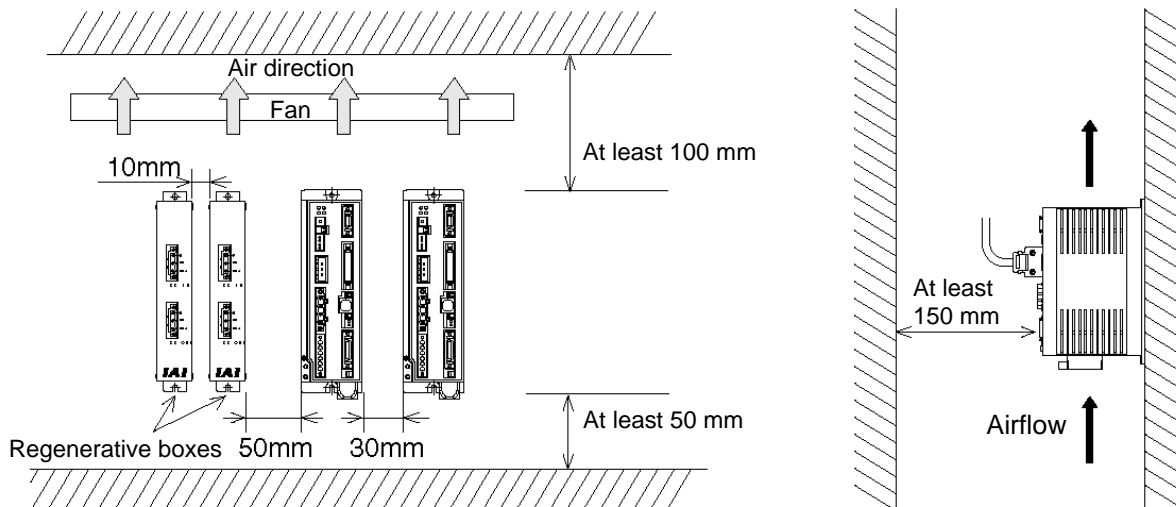

If multiple controllers are linked with the controllers arranged vertically, make sure the exhaust air from a given controller is not sucked into the controller above it.

Provide a clearance of approx. 50 mm between a controller and a regenerative box, or 10 mm between regenerative boxes.

## 3.3 Noise Elimination Measures and Grounding

The following explains the noise elimination measures that should be taken when using this controller.

### (1) Wiring and power connection

- [1] Provide dedicated class-D grounding (former class-3 grounding: Grounding resistance 100  $\Omega$  or less) using a grounding wire with a size of 1.6 mm<sup>2</sup> or larger.

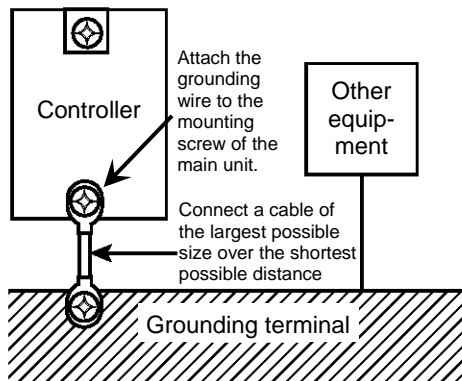

Class-D grounding  
(Former class-3 grounding:  
Grounding resistance 100  $\Omega$  or less)

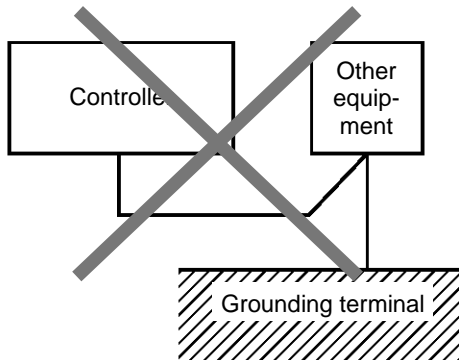

Ground the grounding wire for each controller:  
do not share with or connect to other equipment.

### [2] Cautions on wiring method

Separate the controller wiring from high-power lines of motive power circuits, etc. (Do not tie them together or place in the same cable duct.)

If the supplied motor or encoder cable is to be extended, consult IAI's Engineering Service Section or Sales Engineering Section.

### (2) Noise sources and elimination

Noise generates from many sources, but the most common sources of noise you should consider when designing a system are solenoid valves, magnet switches and relays. Noise generation from these components can be prevented by the method explained below.

- [1] AC solenoid valves, magnet switches, relays

Method --- Mount a noise killer in parallel with the coil.

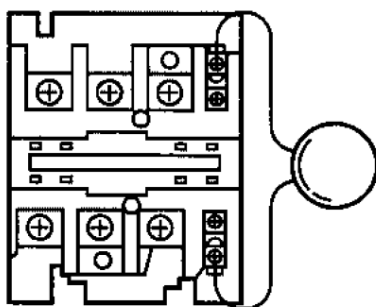

← Noise killer  
Connect to each coil over the shortest possible wiring distance.  
When a surge absorber is installed on the terminal block, etc., its noise elimination effect will decrease if the distance from the coil is long.

[2] DC solenoid valve/magnet switch relay

Action --- Install a diode in parallel with the coil or use valve/relay with built-in diode.

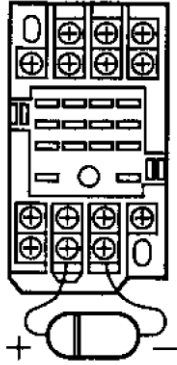

In a DC circuit, connecting a diode in reverse polarities may damage the diode, internal controller parts, or DC power supply. Exercise due caution when connecting a diode.

## 3.4 Wiring the Power Supply

### 3.4.1 Connecting the Power Cable

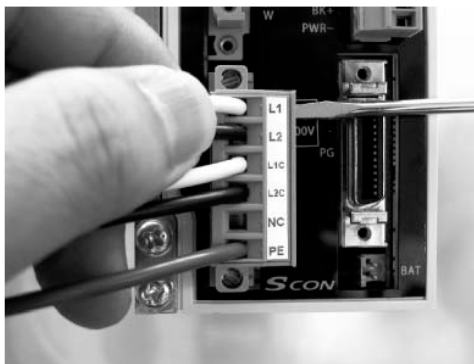

As shown to the left, insert the stripped end of the cable into the connector and screw in the cable using a screwdriver.

Recommended cable diameter

Motor power (L1, L2): 2 mm (AWG14)

Control power (L1C, L2C): 0.75 mm (AWG18)

Recommended stripped wire length: 7 mm



As shown to the left, tighten the screws to secure the connector.

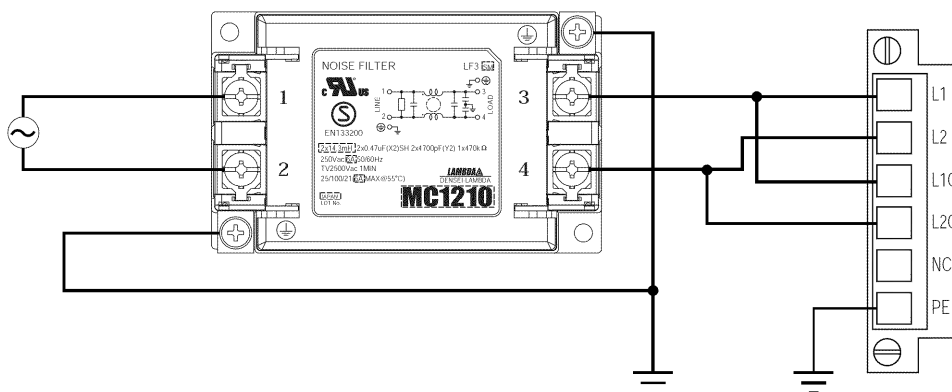

**⚠ Caution:** Always install a noise filter.

Recommended noise filter: MC1210 by Densai-Lambda

The power-supply voltage of the controller (100 or 200 V) has been set prior to the shipment.

## 3.4.2 Power-supply Capacities and Heat Output

Rated power-supply capacity = Motor power-supply capacity + Control power-supply capacity

Maximum momentary power-supply capacity = Maximum momentary motor power-supply capacity + Control power-supply capacity

Actuator motor wattage	Motor power-supply capacity [VA]	Maximum momentary motor power-supply capacity [VA]	Control power-supply capacity [VA]	Rated power-supply capacity [VA]	Maximum momentary power-supply capacity [VA]	Heat output [W]
20	26	78	48	74	126	30
30 (Excluding RS)	46	138		94	186	31
60 (Excluding RS)	138	414		186	462	33
RS	138	414		186	462	33
100	234	702		282	750	35
150	328	984		376	1032	37
200	421	1263		469	1311	38
200L	469	1407		517	1455	38
300L	662	1986		710	2034	40
400L	920	2760		968	2808	45
400	796	2388		844	2436	48
600	1164	2328		1212	2376	56
750	1521	3042		1569	3090	58

RS: Rotational axis

200L: 200-W linear actuator

300L: 300-W linear actuator

400L: 400-W linear actuator

## 3.4.3 Selecting a Breaker

Follow the guidance below when selecting a breaker.

- Current 3 times more than the rated current flows in the controller during acceleration/deceleration. Select a breaker that does not trip when this current is conducted. If a trip occurs, select a breaker with rated current one rank higher.
- Select a breaker that does not trip due to rush current. (Refer to operation characteristic curves described in catalogues by manufacturers.)
- Select a breaker with rated breaking current values that can break without fails even if short-circuit current is conducted.
- Rated breaking current > short-circuit current = primary side power supply capacity / power supply voltage  
Select a circuit breaker with rated current with sufficient margin.

Rated breaker current > (Rated motor power-supply capacity [VA] + Control power-supply capacity [VA]) / AC input voltage

Moreover, leak current breakers must be selected with specific purposes such as protection against fire, protection of humans and so on. Furthermore, leak current shall be measured at the location where a leak current breaker is installed. Please use a leak current breaker supporting higher harmonics.

## 3.5 Connecting the Actuator

### 3.5.1 Connecting the Motor Cable (MOT1, 2)



Connect the motor cable of the actuator to the motor connector on the front face of the controller.

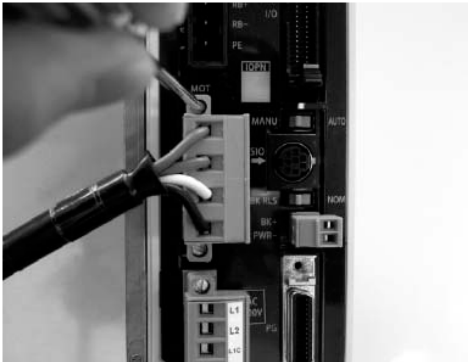

Use a screwdriver to tighten the screws at the top and bottom of the connector to secure the connector.

### 3.5.2 Connecting the Encoder Cable (PG1, PG2)



Connect the encoder cable of the actuator to the encoder connector on the front face of the controller.

Note) If the controller is of absolute specification, disconnect the absolute battery connector before connecting the encoder cable.

## 3.6 Connecting the PIO Cable (I/O)

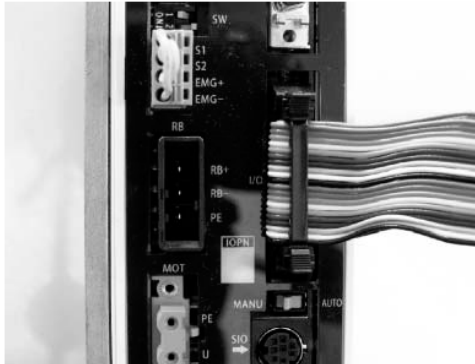

Connect the supplied flat cable. Connect the opposite end of the cable (no connector) to an appropriate peripheral (host PLC, etc.).

I/O flat cable (supplied) Model: CB-PAC-PIO□□□□

\* □□□ indicates the cable length (L). A cable length of up to 30 m is supported.

Example: 080 = 8 m

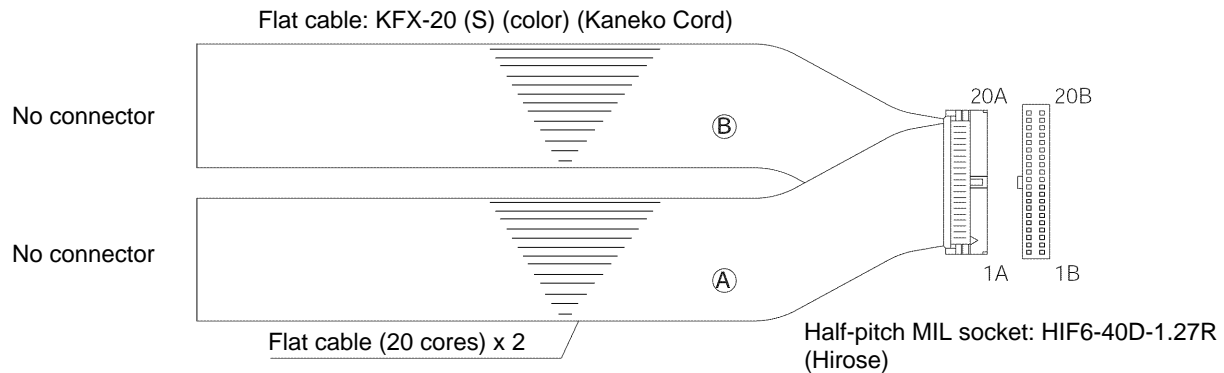

HIF6-40D-1.27R

No.	Signal	Color	Wire	No.	Signal	Color	Wire
1A	24V	Brown-1	Flat cable [A] (pressure-welded)	1B	OUT0	Brown-3	Flat cable [B] (pressure-welded)
2A	24V	Red-1		2B	OUT1	Red-3	
3A	—	Orange-1		3B	OUT2	Orange-3	
4A	—	Yellow-1		4B	OUT3	Yellow-3	
5A	IN0	Green-1		5B	OUT4	Green-3	
6A	IN1	Blue-1		6B	OUT5	Blue-3	
7A	IN2	Purple-1		7B	OUT6	Purple-3	
8A	IN3	Gray-1		8B	OUT7	Gray-3	
9A	IN4	White-1		9B	OUT8	White-3	
10A	IN5	Black-1		10B	OUT9	Black-3	
11A	IN6	Brown-2		11B	OUT10	Brown-4	
12A	IN7	Red-2		12B	OUT11	Red-4	
13A	IN8	Orange-2		13B	OUT12	Orange-4	
14A	IN9	Yellow-2		14B	OUT13	Yellow-4	
15A	IN10	Green-2		15B	OUT14	Green-4	
16A	IN11	Blue-2		16B	OUT15	Blue-4	
17A	IN12	Purple-2		17B	—	Purple-4	
18A	IN13	Gray-2		18B	—	Gray-4	
19A	IN14	White-2		19B	0 V	White-4	
20A	IN15	Black-2		20B	0 V	Black-4	

## 3.7 External Input/Output Specifications

The standard interface specification of the controller is NPN, but the PNP specification is also available as an option.

To prevent confusion during wiring, the NPN and PNP specifications use the same power line configuration. Accordingly, there is no need to reverse the power signal assignments for a PNP controller.

### 3.7.1 External Input Specifications

Item	Specification
Number of input points	16 points
Input voltage	24 VDC $\pm$ 10%
Input current	4 mA/point
ON/OFF voltage	ON voltage: Min. 18 VDC (3.5 mA) OFF voltage: Max. 6 VDC (1 mA)
Insulation method	Photocoupler

Internal circuit configuration  
[NPN specification]

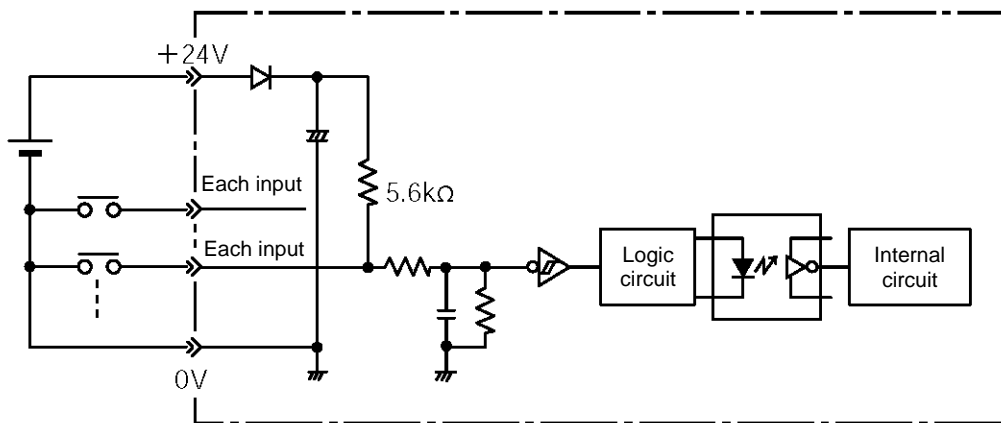

[PNP specification]

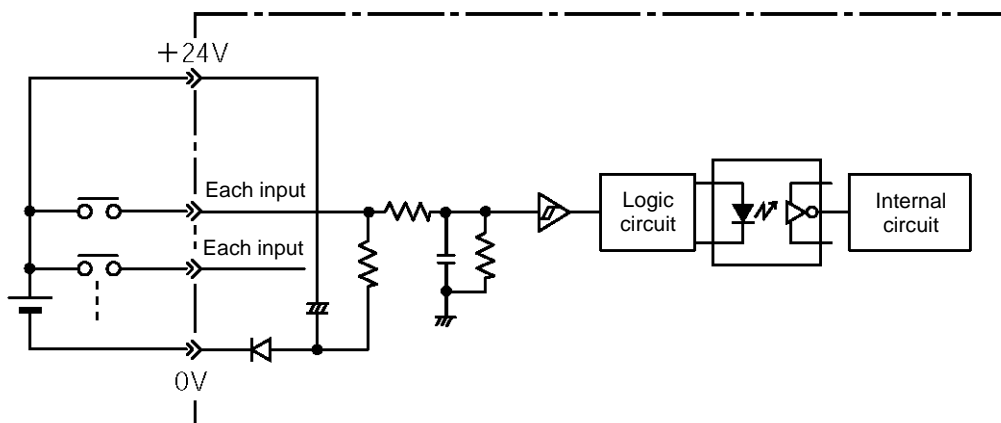



## 3.7.2 External Output Specifications

Item	Specification
Number of output points	16 points
Rated load voltage	24 VDC
Maximum current	100 mA/point 400 mA/8 points
Insulation method	Photocoupler

Internal circuit configuration  
[NPN specification]

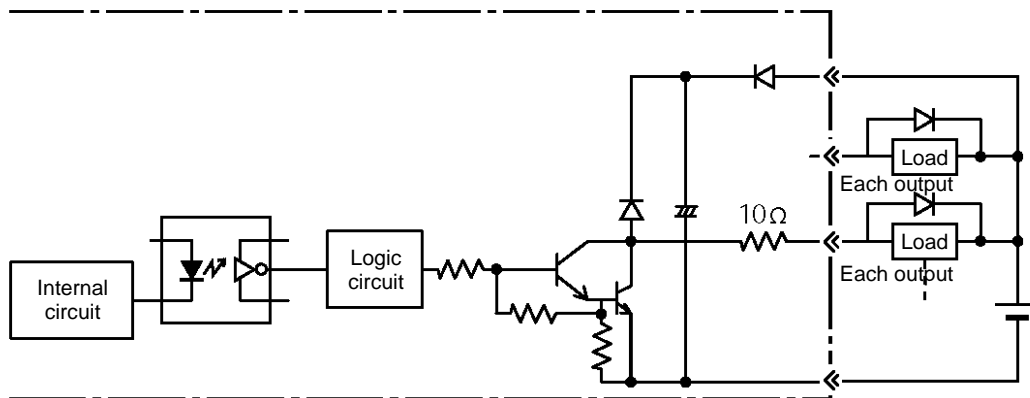

[PNP specification]

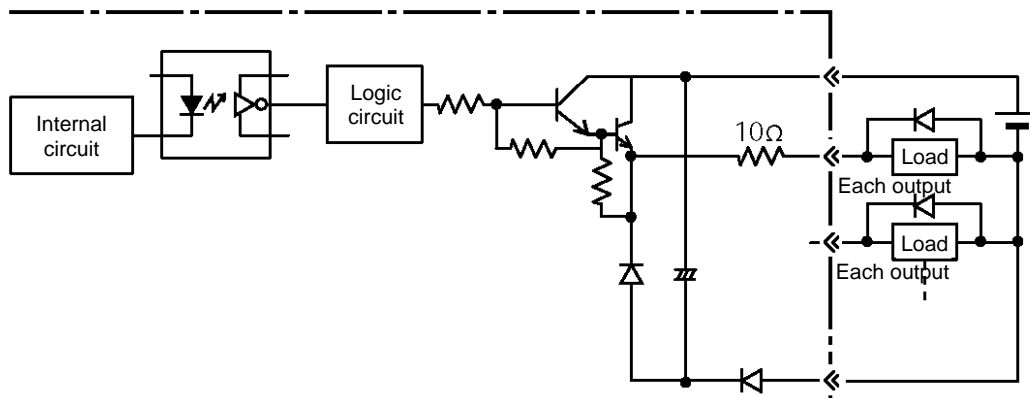

## 3.8 Connecting the Emergency Stop Input (Wiring to the System I/O Connector)



As shown to the left, insert the stripped end of the cable while pressing down the spring using a screwdriver.  
Applicable cable diameter: 0.2 to 1.3 mm (AWG24 to 16)  
Recommended stripped wire length: 10 mm

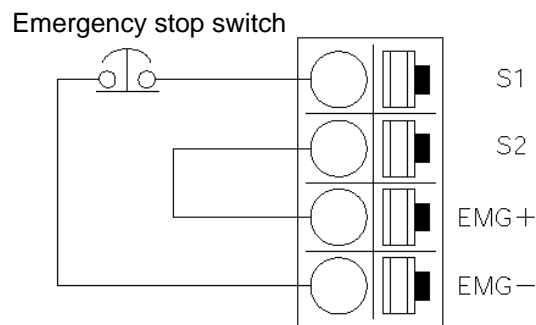

**Emergency stop circuit when multiple controllers are linked**

Internal drive-source cutoff specification (Connections when the entire system requires a level of safety conforming to safety category B)  
 Connect an emergency-stop status relay contact for each controller. Make sure to install a surge-absorbing element for the external relay.  
 S1, S2 contact specification: 30 VDC/0.5 A

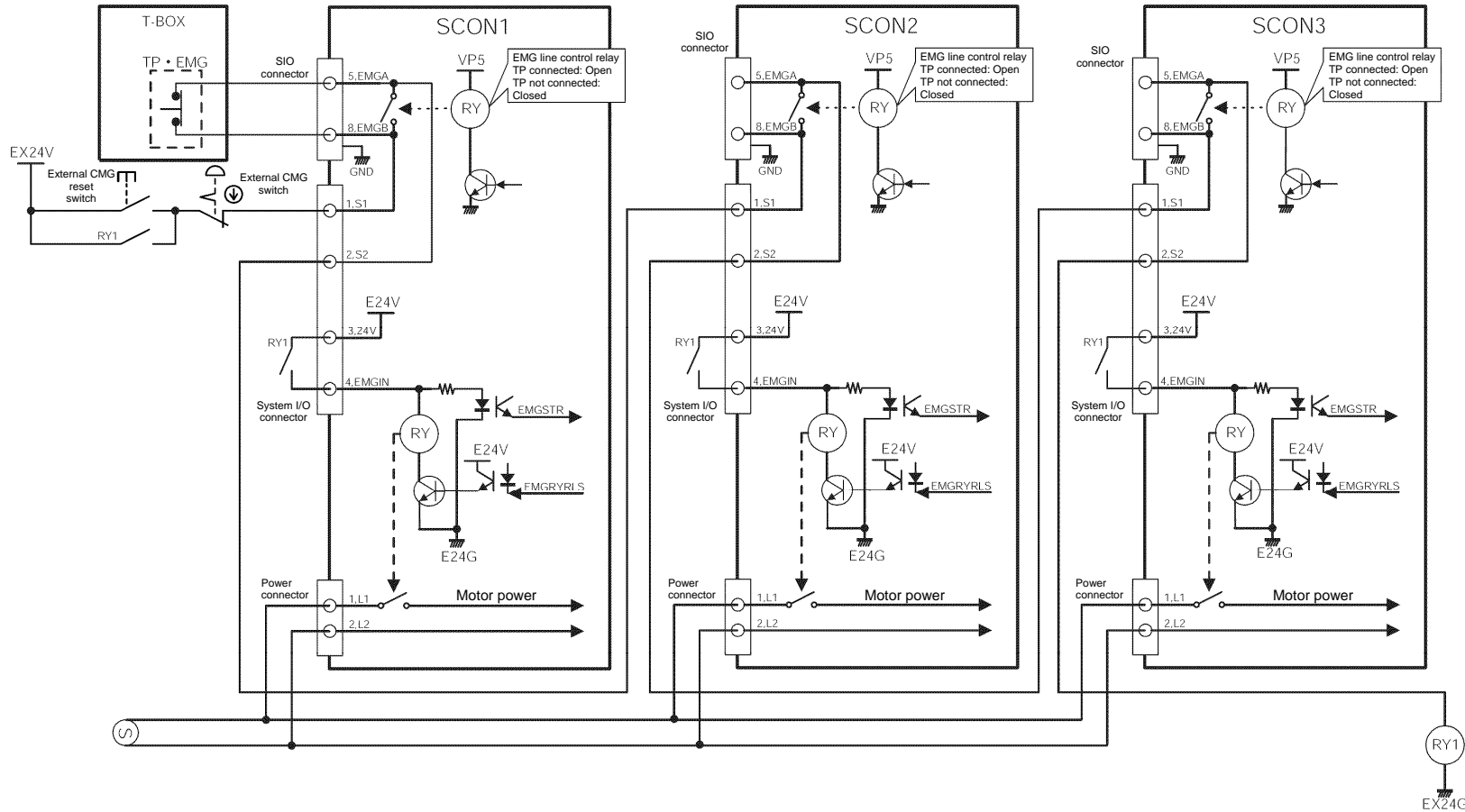

**⚠ Caution:** When the teaching pendant is disconnected, an emergency stop is actuated momentarily. The emergency stop will be cancelled immediately thereafter, but the actuator and other equipment that are operating when the teaching pendant is disconnected will stop. Therefore, do not disconnect the teaching pendant when an actuator or any other equipment is operating. Also pay attention to the design of the emergency stop circuit that includes the emergency stop switch on the teaching pendant.

**SCON**\_\_\_\_\_

- On Support of Safety Categories

[1] System configuration

When constructing a system supporting safety categories, use teaching pendant "CON-TG" and TP adapter "RCB-LB-TG."

It is possible to support categories from B to 4 by changing connection of the system I/O connector.

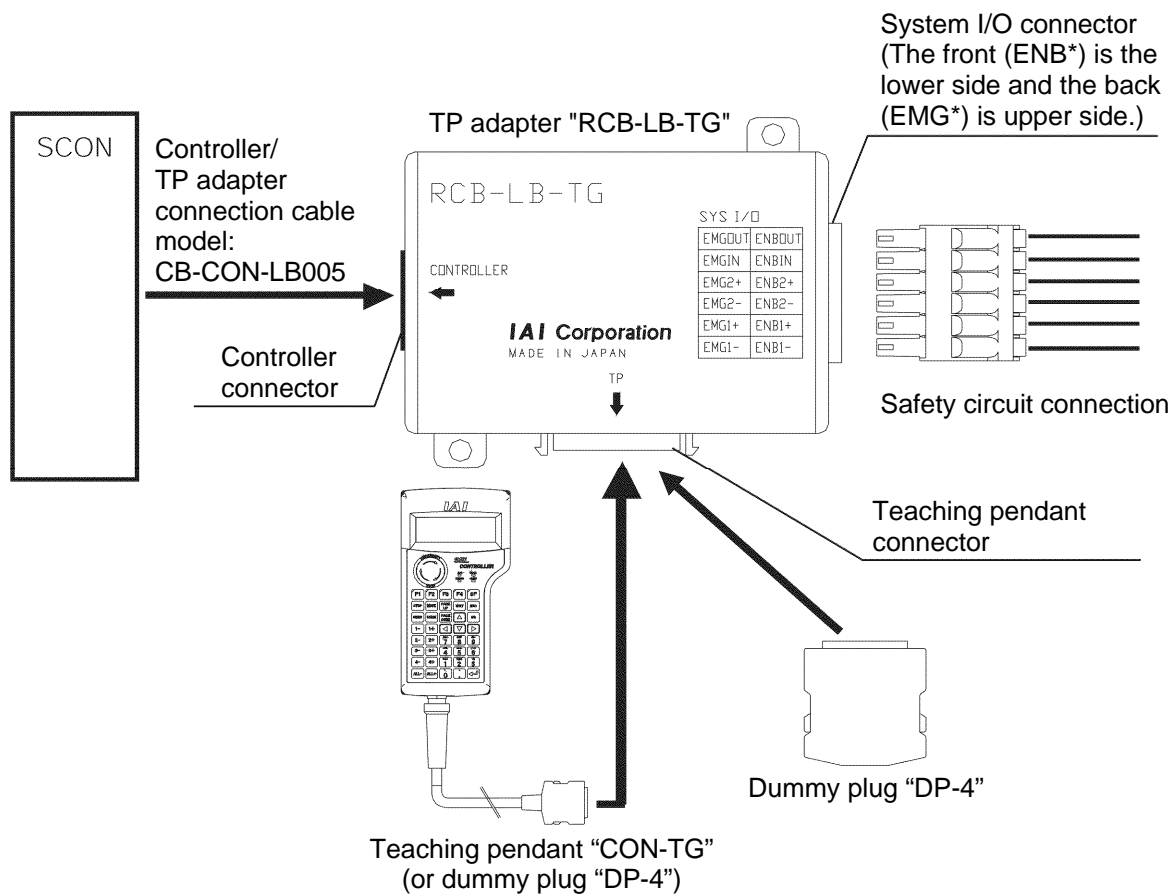

## [2] Wiring and setting of safety circuit

### [1] Power supply

If a safety circuit is configured using safety relays and contactors of 24 V specifications, it is recommended to use a separate power supply from the power supply for controllers of 24 V specifications (ACON, PCON etc.). It can be configured using the common power supply between the two, but breakage may occur when falsely wired.

### [2] System I/O connector specification

- Connector used: MCDN1.5/6-G1-3.5P26THR (PHOENIX CONTACT)
- Cable side connector (accessory: initial wiring already conducted \*):  
FMC1.5/6-ST-3.5 (PHOENIX CONTACT)  
Supported wire thickness: AWG24-16, recommended stripped wire length: 7 mm

	Pin No.	Signal name	Explanation
Upper side (EMG side)	1	EMG1-	Emergency stop contact 1 (30 VDC or less, 100 mA or less)
	2	EMG1+	
	3	EMG2-	Emergency stop contact 2 (30 VDC or less, 100 mA or less)
	4	EMG2+	
	5	EMGIN	Emergency stop detection input
	6	EMGOUT	24 V power supply output for emergency stop detection input
Lower side (ENB side)	7	ENB1-	Enable contact 1 (30 VDC or less, 100 mA or less)
	8	ENB1+	
	9	ENB2-	Enable contact 2 (30 VDC or less, 100 mA or less)
	10	ENB2+	
	11	ENBIN	Enable detection input
	12	ENBOUT	24 V power supply output for enable detection input

\* Connectors on the cable side are attached under conditions where initial wiring has been conducted. In order to support each category, remove the initial wiring and wire your safety circuit.

- Upper side (EMG) connector

- Lower side (ENB) connector

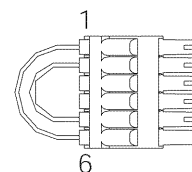
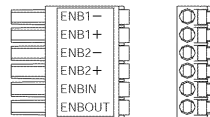
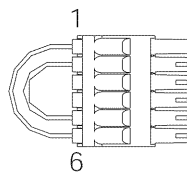
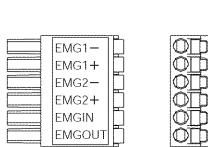

Wiring	Color	Signal	No.
AWG24	Yellow	EMG1-	1
	Yellow	EMG1+	2
	—	EMG2-	3
	—	EMG2+	4
	Yellow	EMGIN	5
	Yellow	EMGOUT	6

Wiring	Color	Signal	No.
AWG24	Yellow	ENB1-	1
	Yellow	ENB1+	2
	—	ENB2-	3
	—	ENB2+	4
	Yellow	ENBIN	5
	Yellow	ENBOUT	6

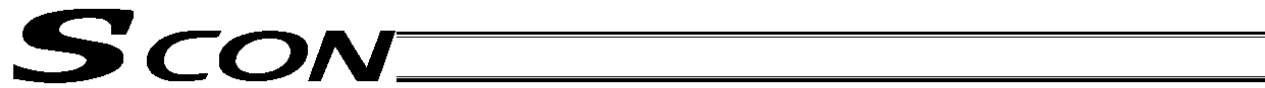

[3] Connection of dummy plug

If you operate a controller in the AUTO mode, connect a dummy plug (DP-4) to the TP connector.

\* Make sure to use "DP-4" as the dummy plug. If "DP-3" is used, the connector does not operate normally.

[4] Enable function

If you are using the enable function, set it to Enable using the controller parameter.

Parameter No. 42      Enable function

0: Enable

1: Disable [Default setting at shipment]

[3] Examples of safety circuits

[1] In case of category 1

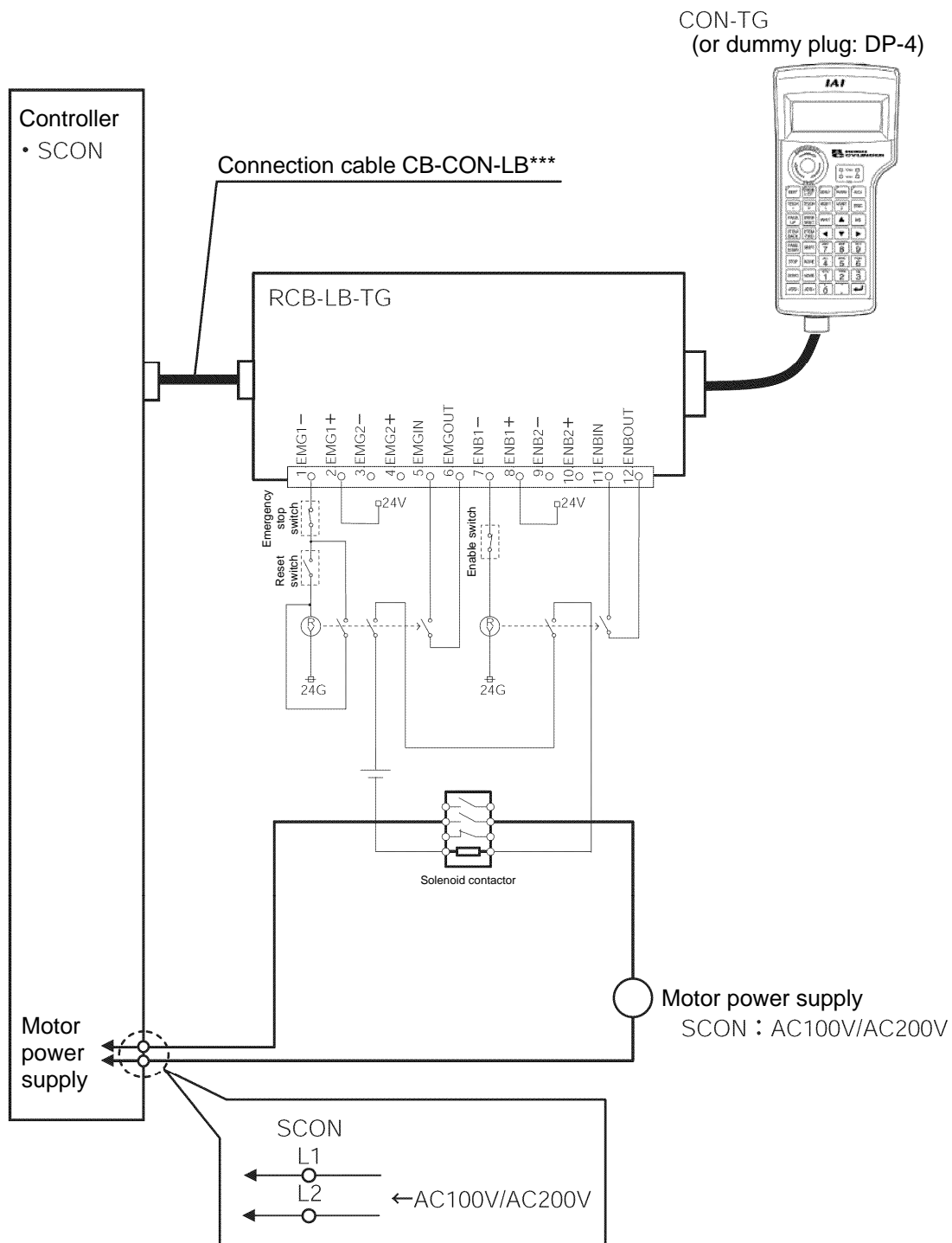



- Detailed category 1 circuit example

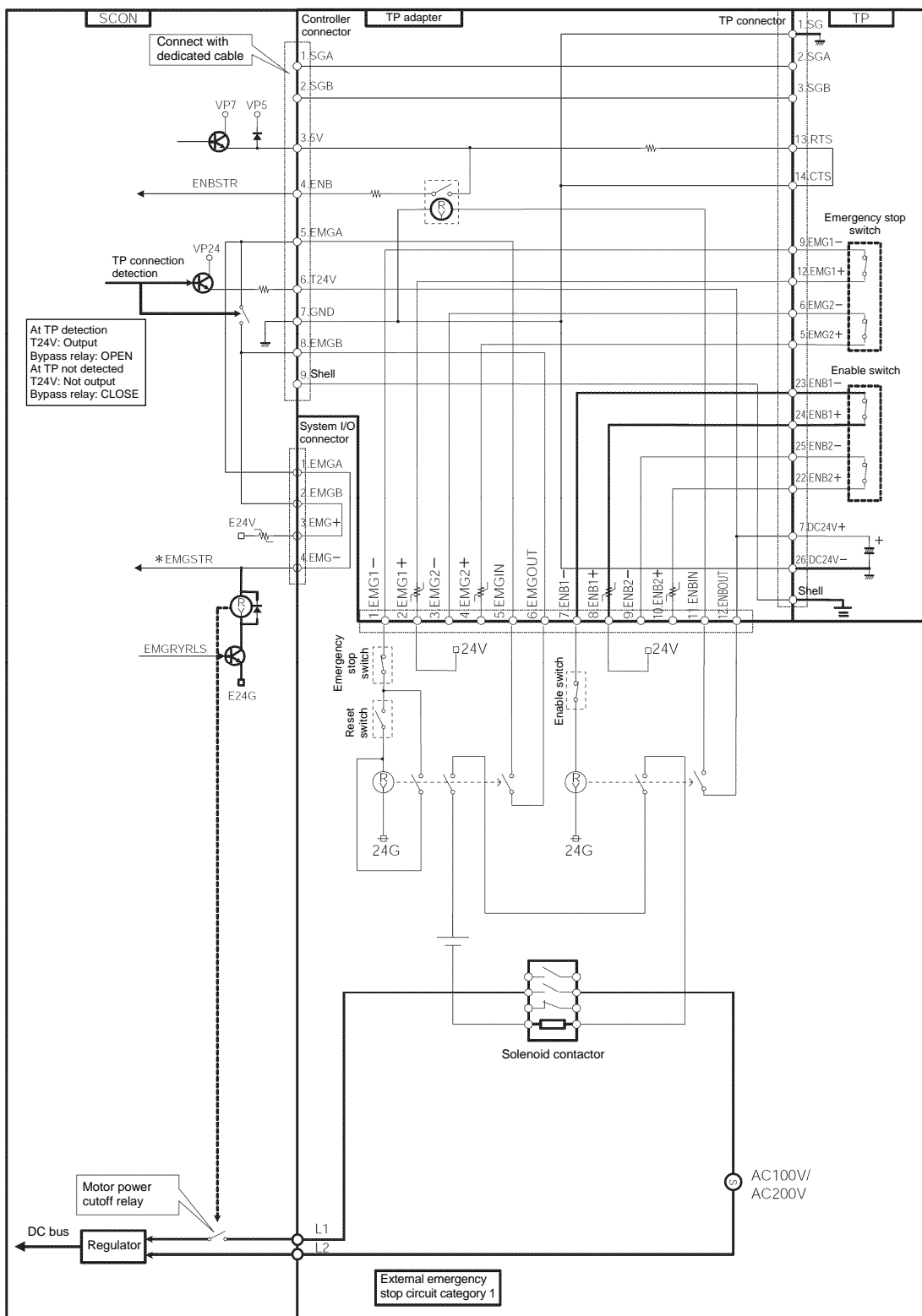

[2] In case of category 2

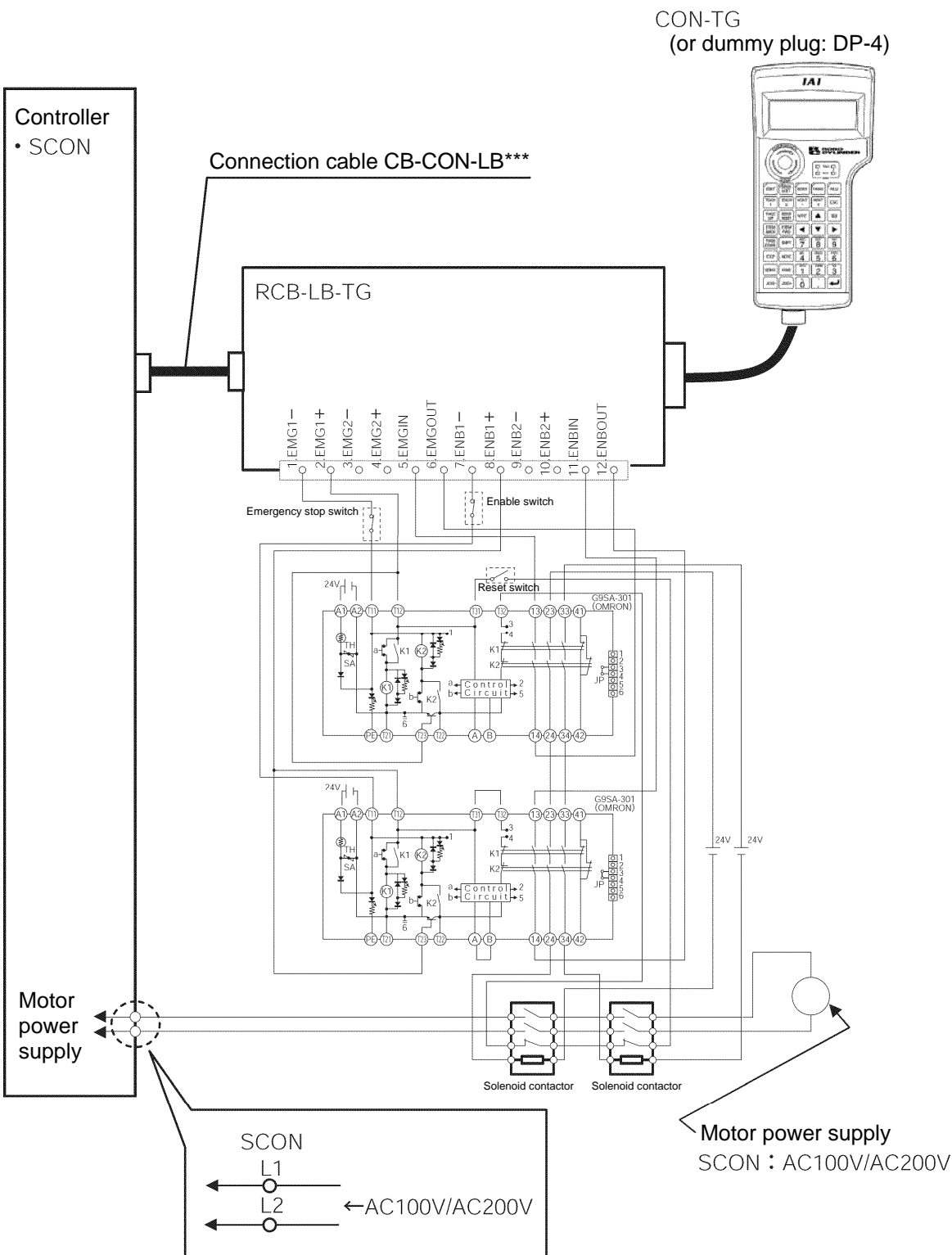

- Detailed category 2 circuit example

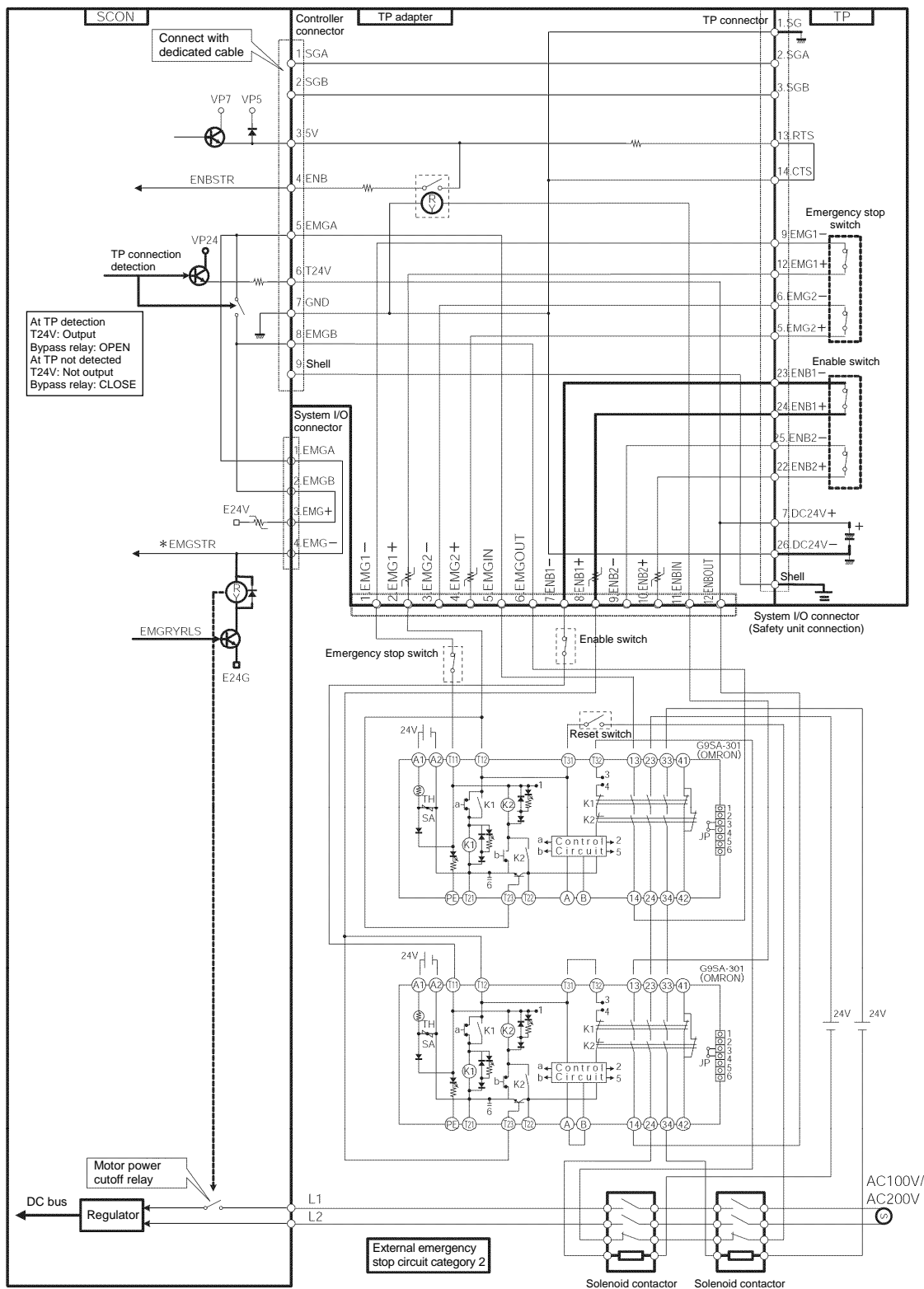

[3] In case of category 3 or 4

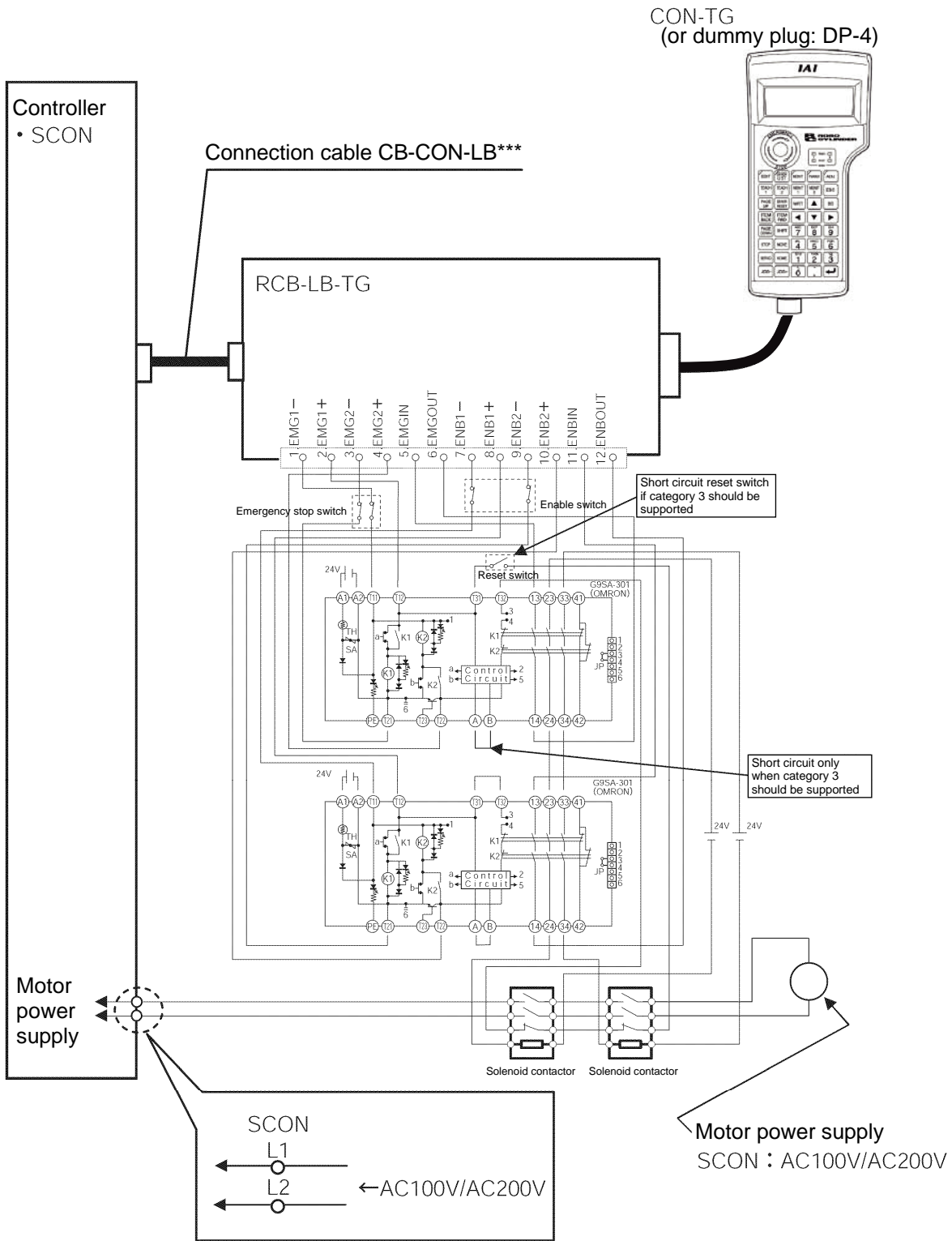

• Detailed category 3/4 circuit example

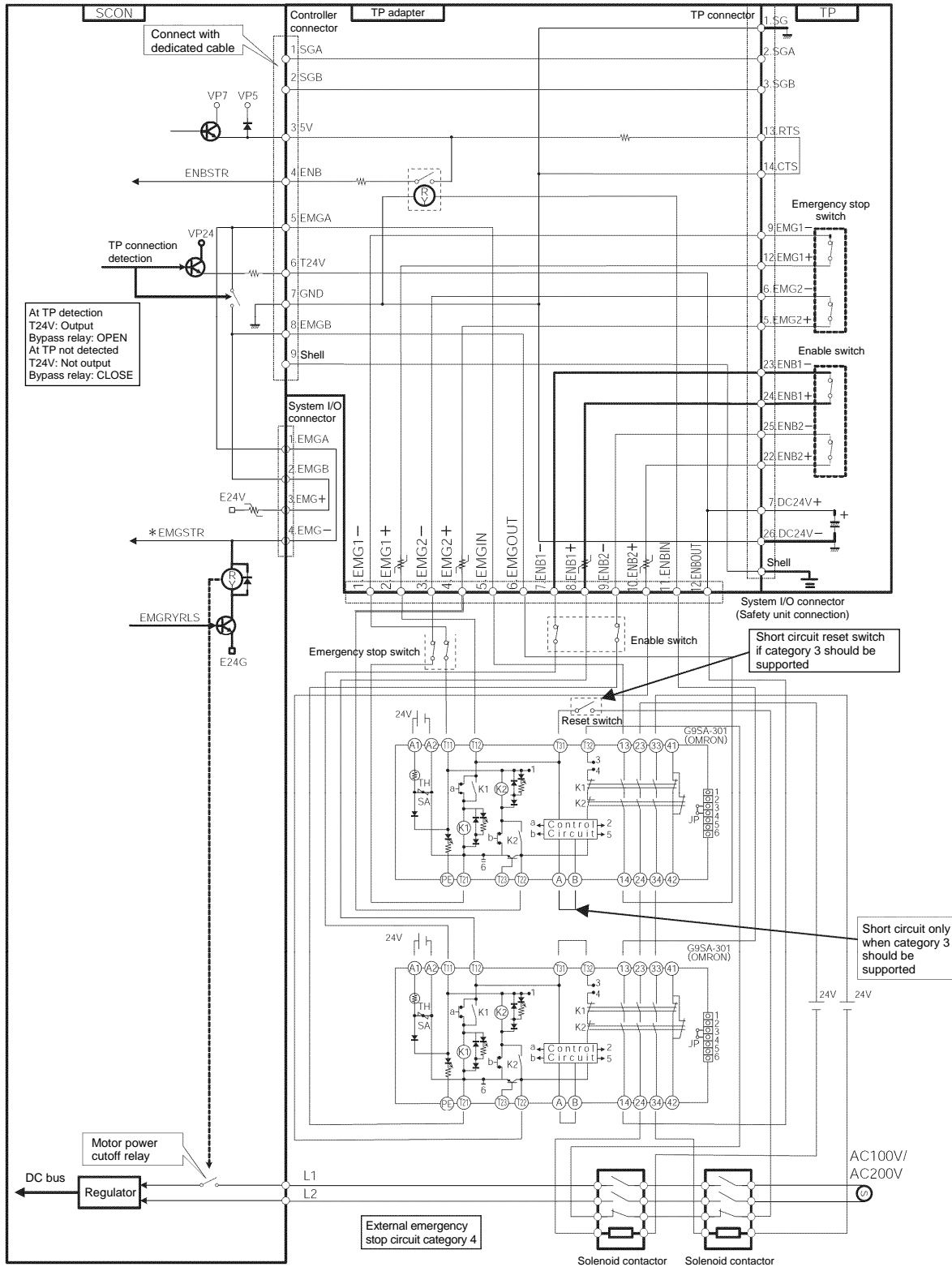

[4] Appendix

[1] TP adapter external dimensions

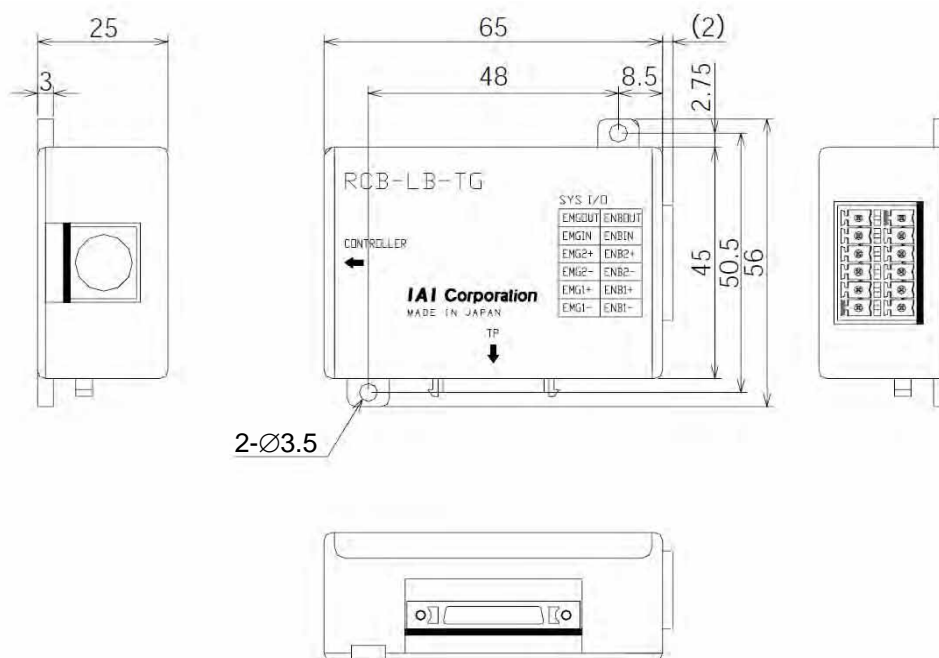

[2] Connection cable

• Controller/TP adapter connection cable

Use this cable to connect the controller and TP adapter (RCB-LB-TG).

Model: CB-CON-LB005 (standard cable length: 0.5 m)

Maximum cable length: 2.0 m

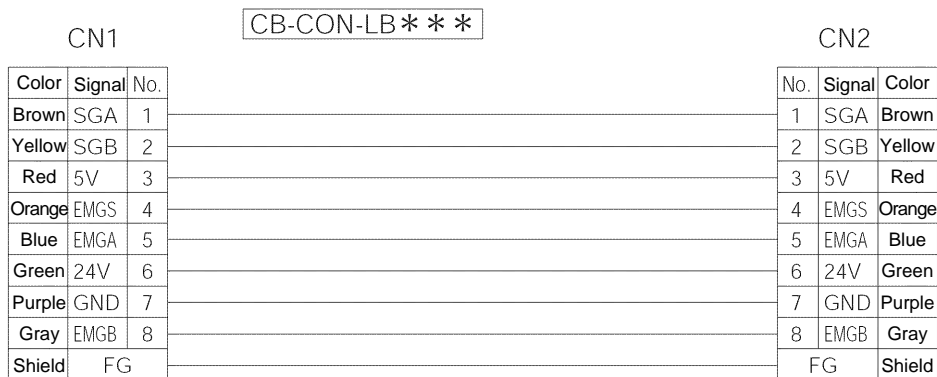
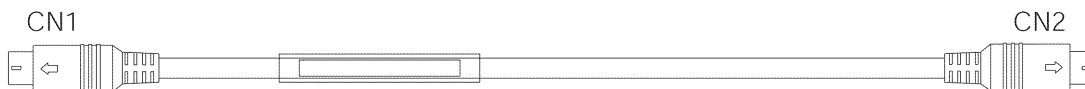

8-pin MIN DIN connector (mold casting)  
 Contact: MD-SP2240 (JST) x 8  
 Metal shell: MD-PS8T (JST)  
 Housing A: MD-PI8A (JST)  
 Housing B: MD-PI8B (JST)  
 Cover: MD-PCC8T (JST)

8-pin MIN DIN connector (mold casting)  
 Contact: MD-SP2240 (JST) x 8  
 Metal shell: MD-PS8T (JST)  
 Housing A: MD-PI8A (JST)  
 Housing B: MD-PI8B (JST)  
 Cover: MD-PCC8T (JST)

### [3] Dummy plug

Connect a dummy plug to the teaching pendant connecting connector.

Make sure to connect a dummy plug if the AUTO mode is specified.

Model: DP-4

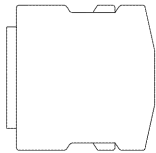

Plug : TX20A-26PH1-D2P1-D1E (JAE)

Signal	No.
GND	1
EMGS	2
VCC	3
DTR	4
EMGOUT2	5
EMGIN2	6
NC	7
RSVCC	8
EMGIN1	9
NC	10
NC	11
EMGOUT1	12
RTS	13
CTS (GND)	14
TXD	15
RXD	16
DSR	17
NC	18
NC	19
RSVTBX1	20
RSVTBX2	21
ENBVCC2	22
ENBTBX1	23
ENBVCC1	24
ENBTBX2	25
GND	26

Short-circuit processing

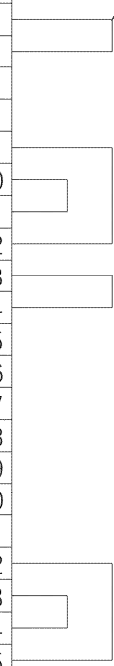

## Connecting the Pulse-train Control Cable



Use the pulse-train control cable when the controller is operated in the pulse-train input mode. It should not be connected when the controller is operated in the positioner mode. The pulse-train control cable is optional. (Normally the controller comes only with a plug and a shell.)

## Connecting the Brake Power Input (for Actuator with Brake)

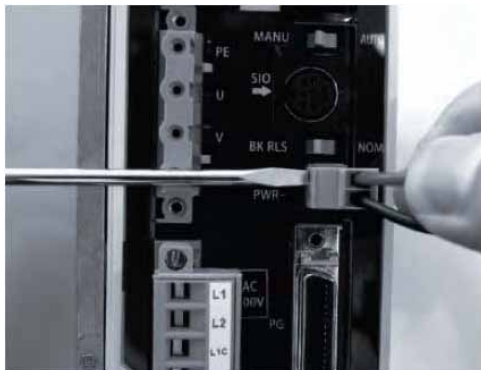

As shown to the left, insert the stripped end of the cable into the connector and screw in the cable using a screwdriver. Applicable cable: 0.75 to 1.25 mm Recommended stripped wire length: 7 mm

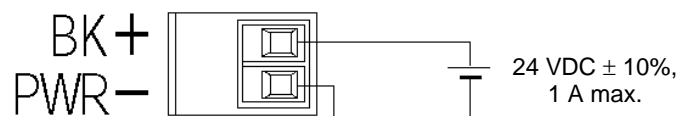



## Connecting the Teaching Pendant/PC Software (TP) (Optional)



If the teaching pendant/PC software cable is used, connect it to the teaching connector on the controller.

Set the AUTO/MANU selector switch to the MANU position (right side).

**⚠ Caution:** When the teaching pendant is disconnected, an emergency stop is actuated momentarily. The emergency stop will be cancelled immediately thereafter, but the actuator and other equipment that are operating when the teaching pendant is disconnected will stop. Therefore, do not disconnect the teaching pendant when an actuator or any other equipment is operating. Also pay attention to the design of the emergency stop circuit that includes the emergency stop switch on the teaching pendant.

## 3.9 Connecting the Regenerative Unit (RB)

Regenerative energy produced when the actuator decelerates to a stop or moves downward in vertical installation is absorbed by means of the capacitor or resistor provided in the controller. If the produced regenerative energy cannot be fully absorbed by the controller, an overheat error (error code: OCA) will generate. If this is the case, connect one or more regenerative resistance units externally.

### 3.9.1 Number of Units to Be Connected

Guideline for number of units to be connected

Motor wattage		Number of regenerative resistance units to be connected
Horizontal installation	Vertical installation	
~ 100 W	~ 100 W	Not required
~ 400 W, 200 S, 300 S	~ 400 W, 200 S, 300 S	1
~ 750 W	~ 750 W	2

- \* The above are reference values when the actuator is moved back and forth at an operation duty of 50% based on the rated acceleration/deceleration, rated load and 1000-mm stroke.
- \* If the operating duty exceeds 50%, the applicable number of regenerative units shown in the table above must be increased.

The maximum number of external regenerative resistance units that can be connected is as follows:

Less than 400 W --- 2 units

400 W or more --- 4 units

(Never connect external regenerative resistance units more than the limits shown above, as it may result in system failures.)

### 3.9.2 Connection Method

The figure below illustrates how one regenerative unit, and multiple units, should be connected, respectively. When connecting one regenerative unit, connect the unit using cable [1] explained in 3.9.3. When connecting two or more regenerative units, connect the controller with the first regenerative unit using cable [1], and connect the adjacent regenerative units using cable [2].

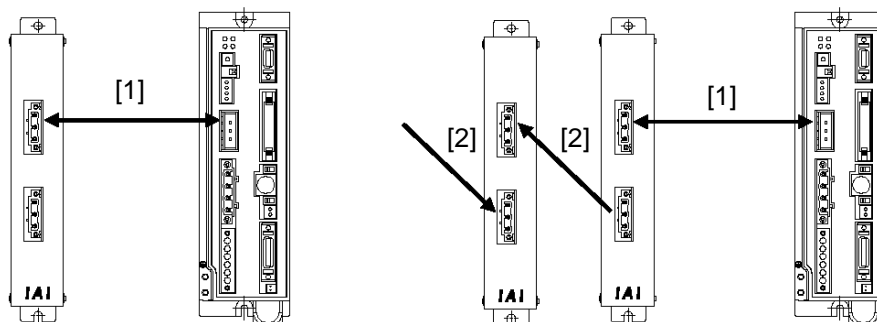

### 3.9.3 Connection Cables

The cable used to connect the controller to a regenerative resistance unit is different from the corresponding cable used on conventional controllers (the connectors are not compatible). To connect a regenerative resistance unit to the controller, cable [1] specified below is required.

[1] Regenerative resistance connection cable for SCON (CB-SC-REU\*\*\*)

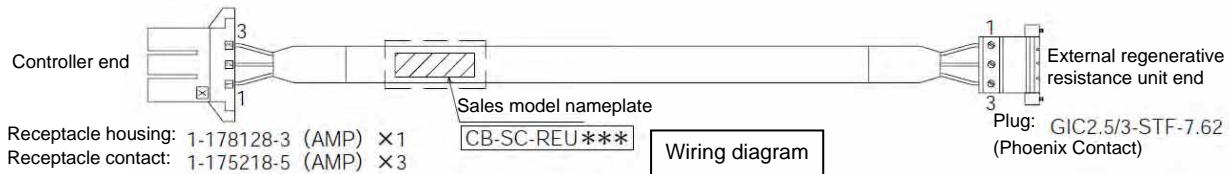

1-178128-3				GIC2.5/3-STF-7.62			
Wire	Color	Signal	No.	No.	Signal	Color	Wire
1sq	Light blue	RB+	1	1	RB+	Light blue	1sq
	Brown	RB-	2	2	RB-	Brown	
	Green/Yellow	PE	3	3	PE	Green/Yellow	

[2] Regenerative resistance connection cable for conventional controllers (X-SEL, E-Con) (CB-ST-REU\*\*\*)

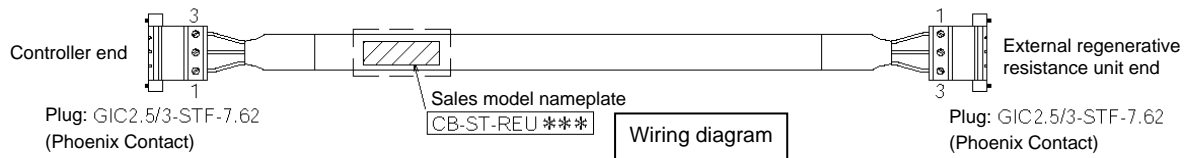

GIC2.5/3-STF-7.62				GIC2.5/3-STF-7.62			
Wire	Color	Signal	No.	No.	Signal	Color	Wire
1sq	Light blue	RB+	1	1	RB+	Light blue	1sq
	Brown	RB-	2	2	RB-	Brown	
	Green/Yellow	PE	3	3	PE	Green/Yellow	

## 3.10 Connecting the Brake Box (RCB-110-RA13-0)

One brake box can support 2 actuators.

### 3.10.1 Installation Standard

Actuator to be used: RCS2-RA13R with brake

### 3.10.2 Specification

Item	Specification
Dimension of main unit	162 x 94 x 65.5 mm
Power supply voltage, current	24 VDC $\pm$ 10% 1 A
Connection cable (sold separately)	Encoder cable (model specification CB-RCS2-PLA□□□), where □□□ indicates cable length

### 3.10.3 External Dimensions

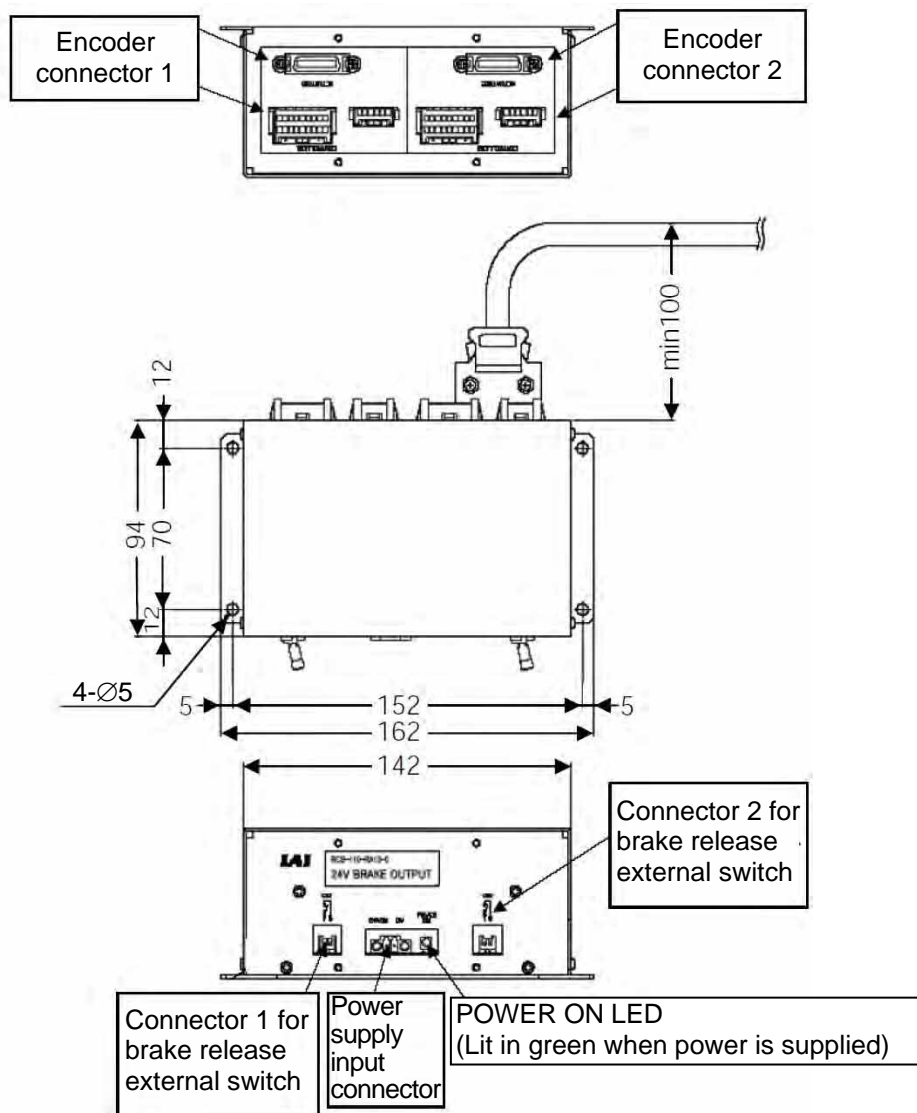

### 3.10.4 24 V Power Supply Connector

Connector on cable side	MC1.5 / 2-STF-3.5 (Phoenix Contact)		
Conforming cable	AWG28 to 16		
Terminal assignment	1	0 V	Power supply ground for brake excitation
	2	24 VIN	+24 V power supply for brake excitation

\* It is necessary to supply +24 V to the brake power supply connector of the controller as well.

### 3.10.5 Brake Release External Switch Connectors 1 and 2

Connection destination device	Break release switch		
Connector on cable side	XAP-02V-1 (Contact BXA-001T-P0.6) (JST)		
Switch rating	30 VDC, minimum current 1.5 mA		
Terminal assignment	1	BKMRL	Brake release switch input
	2	COM	Brake release switch input power supply output

\* If the connector pins 1 and 2 are short circuited, the brake is forcefully released.

### 3.10.6 Connection

Input +24 V power supply to the 24 V power supply connector of the external brake connection box.

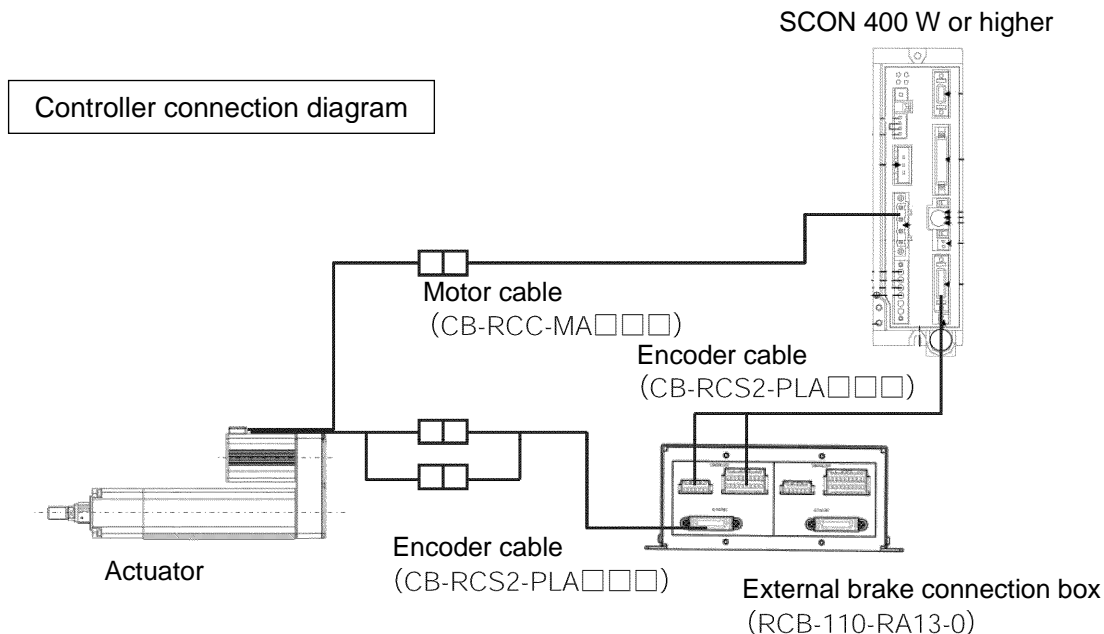

## Chapter 2 Positioner Mode

### 1. I/O Signal Control and Signal Functions

#### 1.1 PIO Patterns and Signal Assignments

This controller provides six PIO pattern types to meet the needs of various applications. To select a desired type, set a corresponding value from 0 to 5 in parameter No. 25 (PIO pattern selection). The features of each PIO pattern are explained below:

Parameter No. 25 setting	Feature of PIO pattern
0	Positioning mode [Standard type] A basic type supporting 64 positioning points and two zone outputs. * How to set zone boundaries within which to output a zone signal: Zone boundaries are set using parameter Nos. 1 and 2 for one zone output, and in the position table for another zone output.
1	Teaching mode [Teaching type] In this type, 64 positioning points and one zone output (boundaries are set in the position table) are supported. In addition to the normal positioning mode, the user can also select the teaching mode in which the actuator can be jogged via I/Os and the current actuator position can be written to a specified position. (Note) Positions can be rewritten by approximately 100,000 times.
2	256-point mode [256-point type] The number of positioning points is increased to 256, so only one zone output is available (boundaries are set in the position table).
3	512-point mode [512-point type] The number of positioning points is increased to 512, so no zone output is available.
4	Solenoid valve mode 1 [7-point type] The number of positioning points is limited to seven, but separate direct command inputs and position complete outputs are provided. PLC ladder sequence circuits can be designed easily.
5	Solenoid valve mode 2 [3-point type] Use of the controller as an air cylinder is assumed in this type. The function of position complete output signals is different from how these signals function in the 7-point type. These signals not only indicate that the position specified by each move command "has been reached," but the also function as a limit switch. This means that the signals will turn ON even when the actuator is moved by hand. <u>Take note that incremental positioning commands are not supported in this mode.</u>

Quick reference table for functions available under each PIO pattern (○: Available, x: Not available)

No. 25	Number of positioning points	Zone output Boundaries set by parameters (ZONE1)	Zone output Boundaries set in the position table (PZONE)	Brake release input signal (BKRL)	Moving output signal (MOVE)
0	64 points	○	○	○	○
1	64 points	x	○	x	○
2	256 points	x	○	○	x
3	512 points	x	x	○	x
4	7 points	○	○	○	x
5	3 points	○	○	○	x

## 1.1.1 Explanation of Signal Names

The following explains the signal names, and gives a function overview of each signal.

In the explanation of operation timings provided in a later section, each signal is referenced by its self-explanatory name for clarity. If necessary, however, such as when marker tubes are inserted as a termination of the flat cable, use the signal abbreviations.

- PIO pattern = 0 Positioning mode [Standard type]

Category	Signal name	Signal abbreviation	Function overview
Input	Command position number	PC1	The target position number is input. A command position number must be specified by 6 ms before the start signal (CSTR) turns ON.
		PC2	
		PC4	
		PC8	
		PC16	
		PC32	
	Brake release	BKRL	This signal is used on an actuator equipped with a brake to forcibly release the brake.
	Operating mode	RMDO	This signal switches the operating mode between AUTO and MANU. (ON: MANU, OFF: AUTO)
Home return	HOME	Home return operation is started at a rise edge of this signal.	
Pause	*STP	ON: Actuator can be moved, OFF: Actuator decelerates to a stop	
Start	CSTR	The actuator will start moving at a rise edge of this signal.	
Alarm reset	RES	An alarm is reset at a rise edge of this signal.	
Servo ON	SON	The servo remains ON while this signal is ON. The servo remains OFF while this signal is OFF.	
Output	Completed position number	PM1	The relevant position number is output when positioning has completed. The signal will turn OFF when the next start signal is received. It is used by the PLC to check if the commanded position has definitively been reached, and also to provide a position interlock, etc.
		PM2	
		PM4	
		PM8	
		PM16	
		PM32	
	Moving	MOVE	This signal will remain ON while the actuator is moving, and OFF while the actuator is standing still. Used to check the operation or determine if the load was missed in push & hold operation.
	Zone 1	ZONE1	This signal becomes effective after home return. It will turn ON when the current actuator position enters the range set by the parameters and remain ON until the actuator exits the range.
	Position zone	PZONE	This signal becomes effective after a position movement command is input. It will turn ON when the current actuator position enters the range specified in the position table and remain ON until the actuator exits the range.
	Operating mode status	RMDS	A signal indicating the operating mode of AUTO or MANU is output.
	Home return completion	HEND	This signal is OFF immediately after the power is input, and turns ON when home return has completed.
Position complete	PEND	This signal turns ON when the actuator has moved to the target position and entered the positioning band. It is used to determine if the positioning has completed.	
Servo-on status	SV	This signal is always output once the servo is turned ON and the controller is ready to operate.	
Emergency stop status	*EMGS	When this signal is OFF, it means that an emergency stop is being actuated.	
Alarm	*ALM	This signal remains ON in normal conditions of use and turns OFF when an alarm generates.	
Battery alarm	*BALM	This signal is ON when the absolute battery voltage is normal or an incremental encoder is used.	



● PIO pattern = 1 Teaching mode [Teaching type]

Category	Signal name	Signal abbreviation	Function overview
Input	Command position number	PC1	The target position number is input. A command position number must be specified by 6 ms before the start signal (CSTR) turns ON.
		PC2	
		PC4	
		PC8	
		PC16	
		PC32	
	Operation mode	MODE	Mode selection (ON: Teaching mode, OFF: Normal mode)
	Jog/inching switching	JISL	OFF: Jog, ON: Inching
	+jog/inching movement	JOG+	The actuator will start jogging or inching in the positive direction at an ON edge of this signal.
	-jog/inching movement	JOG-	The actuator will start jogging or inching in the negative direction at an ON edge of this signal.
	Operating mode	RMOD	This signal switches the operating mode between AUTO and MANU. (ON: MANU, OFF: AUTO)
	Home return	HOME	Home return operation is started at a rise edge of this signal.
	Pause	*STP	ON: Actuator can be moved, OFF: Actuator decelerates to a stop
Start	CSTR	The actuator will start moving at a rise edge of this signal.	
Current-position write	PWRT	When this signal has remained ON for 20 msec or longer, the current position will be stored under the position number selected by PC1 to PC32.	
Alarm reset	RES	An alarm is reset at a rise edge of this signal.	
Servo ON	SON	The servo remains ON while this signal is ON. The servo remains OFF while this signal is OFF.	
Output	Completed position number	PM1	The relevant position number is output when positioning has completed. The signal will turn OFF when the next start signal is received. It is used by the PLC to check if the commanded position has definitively been reached, and also to provide a position interlock, etc.
		PM2	
		PM4	
		PM8	
		PM16	
		PM32	
	Moving	MOVE	This signal will remain ON while the actuator is moving, and OFF while the actuator is standing still. Used to check the operation or determine if the load was missed in push & hold operation.
	Mode status	MODES	This signal is ON when the controller is in the teaching mode, and OFF when the controller is in the normal mode.
	Position zone	PZONE	This signal becomes effective after a position movement command is input. It will turn ON when the current actuator position enters the range specified in the position table and remain ON until the actuator exits the range.
	Operating mode status	RMDS	A signal indicating the operating mode of AUTO or MANU is output.
	Home return completion	HEND	This signal is OFF immediately after the power is input, and turns ON when home return has completed.
	Position complete	PEND	This signal turns ON when the actuator has moved to the target position and entered the positioning band. It is used to determine if the positioning has completed.
	Write completion	WEND	This signal is output upon completion of writing to the nonvolatile memory in response to a current-position write command (PWRT).
Servo-on status	SV	This signal is always output once the servo is turned ON and the controller is ready to operate.	
Emergency stop status	*EMGS	OFF: Emergency stop has been actuated	
Alarm	*ALM	This signal remains ON in normal conditions of use and turns OFF when an alarm generates.	
Battery alarm	*BALM	This signal is ON when the absolute battery voltage is normal or an incremental encoder is used.	

● PIO pattern = 2 256-point mode [256-point type]

Category	Signal name	Signal abbreviation	Function overview
Input	Command position number	PC1	The target position number is input. A command position number must be specified by 6 ms before the start signal (CSTR) turns ON.
		PC2	
		PC4	
		PC8	
		PC16	
		PC32	
		PC64	
		PC128	
	Brake release	BKRL	This signal is used on an actuator equipped with a brake to forcibly release the brake.
	Operating mode	RMOD	This signal switches the operating mode between AUTO and MANU. (ON: MANU, OFF: AUTO)
Home return	HOME	Home return operation is started at a rise edge of this signal.	
Pause	*STP	ON: Actuator can be moved, OFF: Actuator decelerates to a stop	
Start	CSTR	The actuator will start moving at a rise edge of this signal.	
Alarm reset	RES	An alarm is reset at a rise edge of this signal.	
Servo ON	SON	The servo remains ON while this signal is ON. The servo remains OFF while this signal is OFF.	
Output	Completed position number	PM1	The relevant position number is output when positioning has completed. The signal will turn OFF when the next start signal is received. It is used by the PLC to check if the commanded position has definitively been reached, and also to provide a position interlock, etc.
		PM2	
		PM4	
		PM8	
		PM16	
		PM32	
		PM64	
		PM128	
	Position zone	PZONE	This signal becomes effective after a position movement command is input. It will turn ON when the current actuator position enters the range specified in the position table and remain ON until the actuator exits the range.
	Operating mode status	RMDS	A signal indicating the operating mode of AUTO or MANU is output.
	Home return completion	HEND	This signal is OFF immediately after the power is input, and turns ON when home return has completed.
	Position complete	PEND	This signal turns ON when the actuator has moved to the target position and entered the positioning band. It is used to determine if the positioning has completed.
	Servo-on status	SV	This signal is always output once the servo is turned ON and the controller is ready to operate.
Emergency stop status	*EMGS	OFF: Emergency stop has been actuated	
Alarm	*ALM	This signal remains ON in normal conditions of use and turns OFF when an alarm generates.	
Battery alarm	*BALM	This signal is ON when the absolute battery voltage is normal or an incremental encoder is used.	

● PIO pattern = 3 512-point mode [512-point type]

Category	Signal name	Signal abbreviation	Function overview
Input	Command position number	PC1	The target position number is input. A command position number must be specified by 6 ms before the start signal (CSTR) turns ON.
		PC2	
		PC4	
		PC8	
		PC16	
		PC32	
		PC64	
		PC128	
	PC256		
	Brake release	BKRL	This signal is used on an actuator equipped with a brake to forcibly release the brake.
	Operating mode	RMOD	This signal switches the operating mode between AUTO and MANU. (ON: MANU, OFF: AUTO)
	Home return	HOME	Home return operation is started at a rise edge of this signal.
	Pause	*STP	ON: Actuator can be moved, OFF: Actuator decelerates to a stop
Start	CSTR	The actuator will start moving at a rise edge of this signal.	
Alarm reset	RES	An alarm is reset at a rise edge of this signal.	
Servo ON	SON	The servo remains ON while this signal is ON. The servo remains OFF while this signal is OFF.	
Output	Completed position number	PM1	The relevant position number is output when positioning has completed. The signal will turn OFF when the next start signal is received. It is used by the PLC to check if the commanded position has definitively been reached, and also to provide a position interlock, etc.
		PM2	
		PM4	
		PM8	
		PM16	
		PM32	
		PM64	
		PM128	
	PC256		
	Operating mode status	RMDS	A signal indicating the operating mode of AUTO or MANU is output.
	Home return completion	HEND	This signal is OFF immediately after the power is input, and turns ON when home return has completed.
	Position complete	PEND	This signal turns ON when the actuator has moved to the target position and entered the positioning band. It is used to determine if the positioning has completed.
	Servo-on status	SV	This signal is always output once the servo is turned ON and the controller is ready to operate.
Emergency stop status	*EMGS	OFF: Emergency stop has been actuated	
Alarm	*ALM	This signal remains ON in normal conditions of use and turns OFF when an alarm generates.	
Battery alarm	*BALM	This signal is ON when the absolute battery voltage is normal or an incremental encoder is used.	

● PIO pattern = 4 Solenoid valve mode 1 [7-point type]

Category	Signal name	Signal abbreviation	Function overview
Input	Position No. 0 move	ST0	The actuator starts moving to position No. 0 when this signal turns ON.
	Position No. 1 move	ST1	The actuator starts moving to position No. 1 when this signal turns ON.
	Position No. 2 move	ST2	The actuator starts moving to position No. 2 when this signal turns ON.
	Position No. 3 move	ST3	The actuator starts moving to position No. 3 when this signal turns ON.
	Position No. 4 move	ST4	The actuator starts moving to position No. 4 when this signal turns ON.
	Position No. 5 move	ST5	The actuator starts moving to position No. 5 when this signal turns ON.
	Position No. 6 move	ST6	The actuator starts moving to position No. 6 when this signal turns ON.
	Brake release	BKRL	This signal is used on an actuator equipped with a brake to forcibly release the brake.
	Operating mode	RMOD	This signal switches the operating mode between AUTO and MANU. (ON: MANU, OFF: AUTO)
	Home return	HOME	Home return operation is started at a rise edge of this signal.
	Pause	*STP	ON: Actuator can be moved, OFF: Actuator decelerates to a stop
	Alarm reset	RES	An alarm is reset at a rise edge of this signal.
	Servo ON	SON	The servo remains ON while this signal is ON. The servo remains OFF while this signal is OFF.
Output	Position No. 0 complete	PE0	This signal will turn ON when the actuator completes moving to position No. 0.
	Position No. 1 complete	PE1	This signal will turn ON when the actuator completes moving to position No. 1.
	Position No. 2 complete	PE2	This signal will turn ON when the actuator completes moving to position No. 2.
	Position No. 3 complete	PE3	This signal will turn ON when the actuator completes moving to position No. 3.
	Position No. 4 complete	PE4	This signal will turn ON when the actuator completes moving to position No. 4.
	Position No. 5 complete	PE5	This signal will turn ON when the actuator completes moving to position No. 5.
	Position No. 6 complete	PE6	This signal will turn ON when the actuator completes moving to position No. 6.
	Zone 1	ZONE1	This signal becomes effective after home return. It will turn ON when the current actuator position enters the range set by the parameters and remain ON until the actuator exits the range.
	Position zone	PZONE	This signal becomes effective when the current actuator position is in the range specified in the position table, while a position movement command is input.
	Operating mode status	RMDS	A signal indicating the operating mode of AUTO or MANU is output.
	Home return completion	HEND	This signal is OFF immediately after the power is input, and turns ON when home return has completed.
	Position complete	PEND	This signal turns ON when the actuator has moved to the target position and entered the positioning band. It is used to determine if the positioning has completed.
	Servo-on status	SV	This signal is always output once the servo is turned ON and the controller is ready to operate.
	Emergency stop status	*EMGS	OFF: Emergency stop has been actuated
	Alarm	*ALM	This signal remains ON in normal conditions of use and turns OFF when an alarm generates.
Battery alarm	*BALM	This signal is ON when the absolute battery voltage is normal or an incremental encoder is used.	

● PIO pattern = 5 Solenoid valve mode 2 [3-point type]

Category	Signal name	Signal abbreviation	Function overview
Input	Rear end move command	ST0	The actuator will move toward the rear end while this signal remains at ON level.
	Front end move command	ST1	The actuator will move toward the front end while this signal remains at ON level.
	Intermediate point move command	ST2	The actuator will move toward the intermediate point while this signal remains at ON level.
	Brake release	BKRL	This signal is used on an actuator equipped with a brake to forcibly release the brake.
	Operating mode	RMOD	This signal switches the operating mode between AUTO and MANU. (ON: MANU, OFF: AUTO)
	Alarm reset	RES	An alarm is reset at a rise edge of this signal.
	Servo ON	SON	The servo remains ON while this signal is ON. The servo remains OFF while this signal is OFF.
Output	Rear end position detected	LS0	This signal will remain ON while the rear end is recognized. (This signal is not output in the push & hold mode.)
	Front end position detected	LS1	This signal will remain ON while the front end is recognized. (This signal is not output in the push & hold mode.)
	Intermediate position detected	LS2	This signal will remain ON while the intermediate point is recognized. (This signal is not output in the push & hold mode.)
	Zone 1	ZONE1	This signal becomes effective after home return. It will turn ON when the current actuator position enters the range set by the parameters and remain ON until the actuator exits the range.
	Position zone	PZONE	This signal becomes effective when the current actuator position is in the range specified in the position table, while a position movement command is input.
	Operating mode status	RMDS	A signal indicating the operating mode of AUTO or MANU is output.
	Home return completion	HEND	This signal is OFF immediately after the power is input, and turns ON when home return has completed.
	Servo-on status	SV	This signal is always output once the servo is turned ON and the controller is ready to operate.
	Emergency stop status	*EMGS	OFF: Emergency stop has been actuated
	Alarm	*ALM	This signal remains ON in normal conditions of use and turns OFF when an alarm generates.
	Battery alarm	*BALM	This signal is ON when the absolute battery voltage is normal or an incremental encoder is used.

Take note that incremental position commands are not supported in solenoid valve mode 2 [3-point type].

## 1.1.2 Signal Assignment Table for Respective PIO Patterns

When creating a PLC sequence or wiring signals, assign each pin correctly by referring to the assignment table below.

When "1 [Teaching type]" is selected, the meaning of each pin number will vary depending on the mode. Accordingly, also pay due attention to the mode switch timings.

Pin No.	Category	Wire color	Parameter No. 25 setting						
			0	1	2	3	4	5	
1A	+24V	Upper stage	P24						
2A		Brown - 1							
3A		Red - 1	(Not used)						
4A		Orange - 1	(Not used)						
5A	Input	Yellow - 1							
6A		Green - 1	PC1	PC1	PC1	PC1	ST0	ST0	
7A		Blue - 1	PC2	PC2	PC2	PC2	ST1	ST1	
8A		Purple - 1	PC4	PC4	PC4	PC4	ST2	ST2	
9A		Gray - 1	PC8	PC8	PC8	PC8	ST3	-	
10A		White - 1	PC16	PC16	PC16	PC16	ST4	-	
11A		Black - 1	PC32	PC32	PC32	PC32	ST5	-	
12A		Brown - 2	-	MODE	PC64	PC64	ST6	-	
13A		Red - 2	-	JISE	PC128	PC128	-	-	
14A		Orange - 2	-	JOG+	-	PC256	-	-	
15A		Yellow - 2	BKRL	JOG-	BKRL	BKRL	BKRL	BKRL	
16A		Green - 2	RMOD						
17A		Blue - 2	HOME						-
18A		Purple - 2	*STP						-
19A	Gray - 2	CSTR	CSTR/PWRT	CSTR	CSTR	-	-		
20A	White - 2	RES							
	Black - 2	SON							
1B	Output	Lower stage							
2B		Brown - 3	PM1	PM1	PM1	PM1	PE0	LS0	
3B		Red - 3	PM2	PM2	PM2	PM2	PE1	LS1	
4B		Orange - 3	PM4	PM4	PM4	PM4	PE2	LS2	
5B		Yellow - 3	PM8	PM8	PM8	PM8	PE3	-	
6B		Green - 3	PM16	PM16	PM16	PM16	PE4	-	
7B		Blue - 3	PM32	PM32	PM32	PM32	PE5	-	
8B		Purple - 3	MOVE	MOVE	PM64	PM64	PE6	-	
9B		Gray - 3	ZONE1	MODES	PM128	PM128	ZONE1	ZONE1	
10B		White - 3	PZONE	PZONE	PZONE	PM256	PZONE	PZONE	
11B		Black - 3	RMDS						
12B		Brown - 4	HEND						
13B		Red - 4	PEND	PEND/WND	PEND	PEND	PEND	-	
14B		Orange - 4	SV						
15B	Yellow - 4	*EMGS							
16B	Green - 4	*ALM							
17B	Blue - 4	*BALM							
18B	Purple - 4	(Not used)							
19B	Gray - 4	(Not used)							
20B	0V	White - 4	N						
		Black - 4							

- Caution:
- [1] The signals indicated by \* in the table (\*ALM, \*STP, \*EMGS and \*BALM) are based on the negative logic, meaning that they remain ON in normal conditions of use.
  - [2] Do not connect pins denoted by "Not used" (orange-1, yellow-1, purple-4, gray-4), but insulate them instead.
  - [3] The NPN and PNP specifications use the same power line configuration, so there is no need to reverse the power signal assignments for a PNP controller.

## 1.2 Connecting the I/O Cable

- PIO pattern 0 Positioning mode [Standard type]

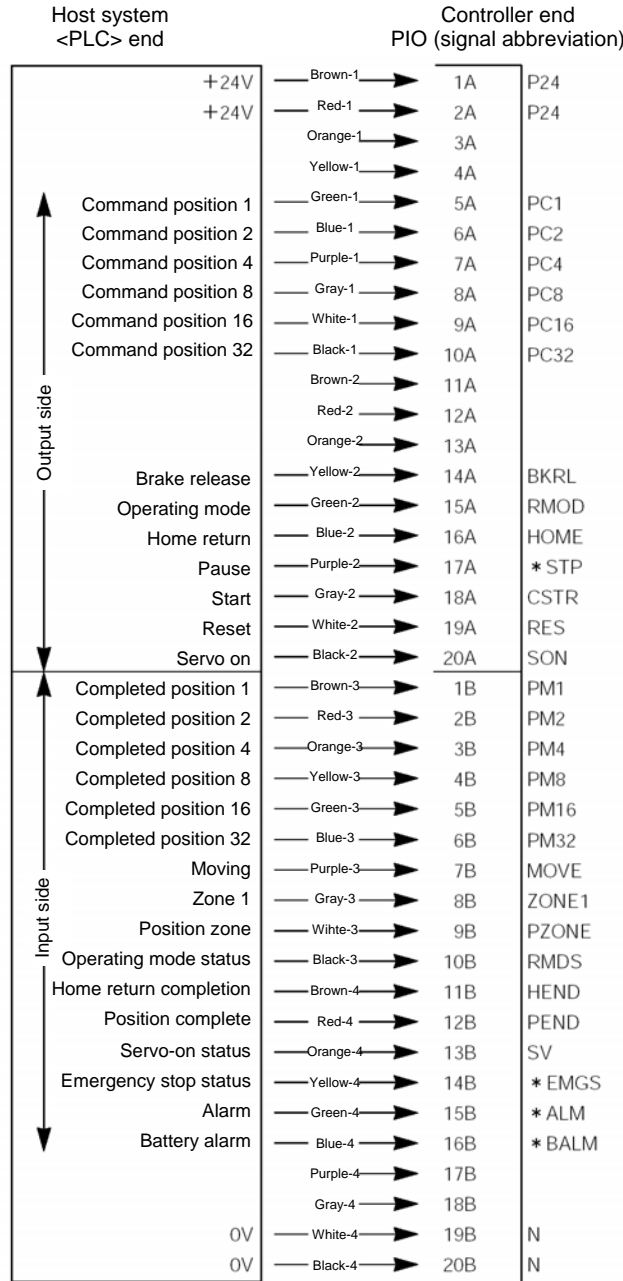

(Note) \*STP, \*ALM, \*EMGS and \*BALM are negative-logic signals.

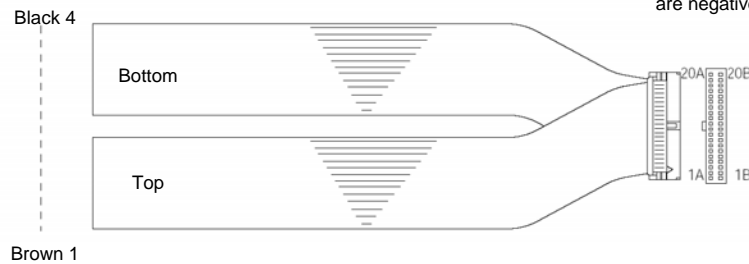

● PIO pattern 1 Teaching mode [Teaching type]

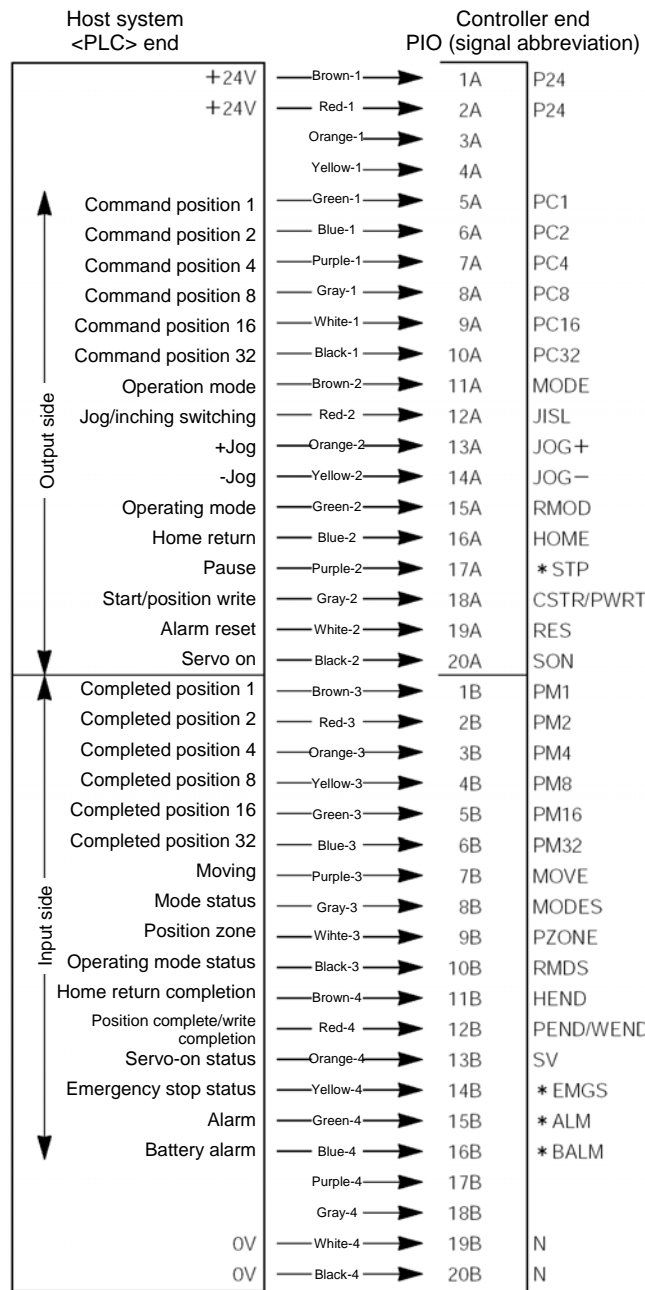

(Note) \*STP, \*ALM, \*EMGS and \*BALM are negative-logic signals.

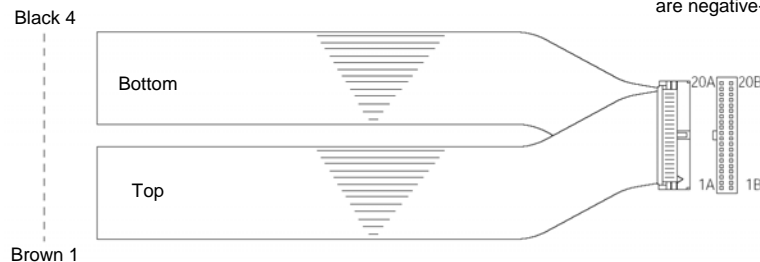



● PIO pattern 2 256-point mode [256-point type]

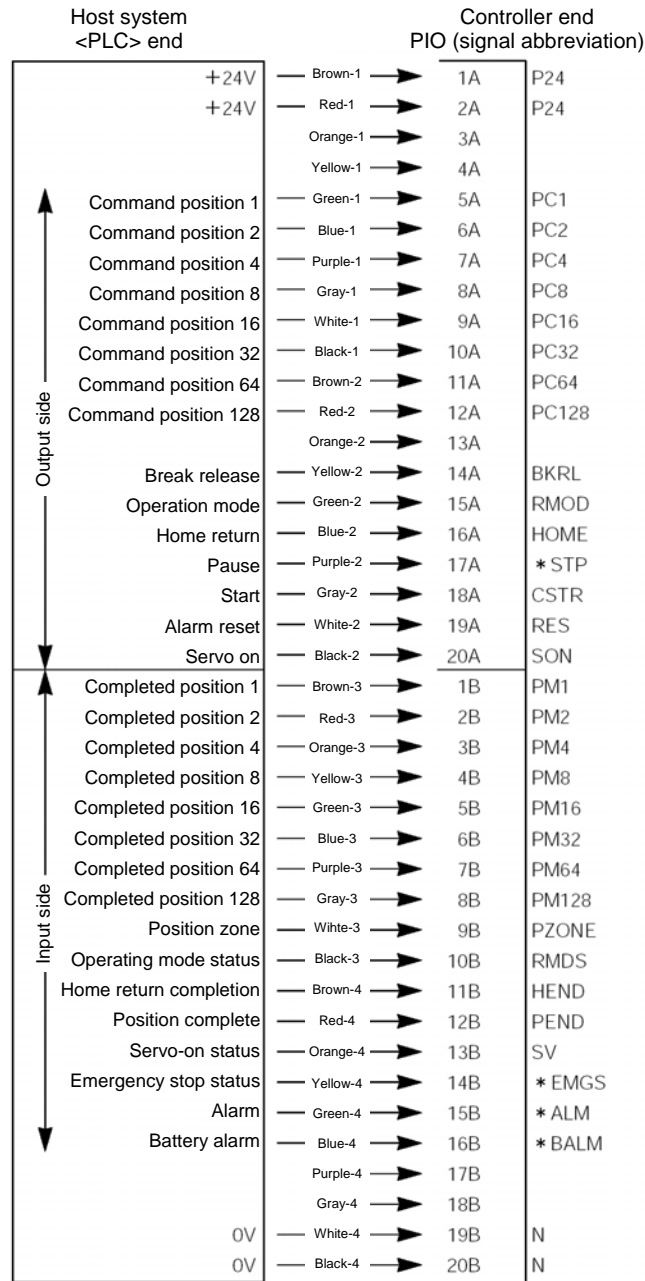

(Note) \*STP, \*ALM, \*EMGS and \*BALM are negative-logic signals.



● PIO pattern 3 512-point mode [512-point type]

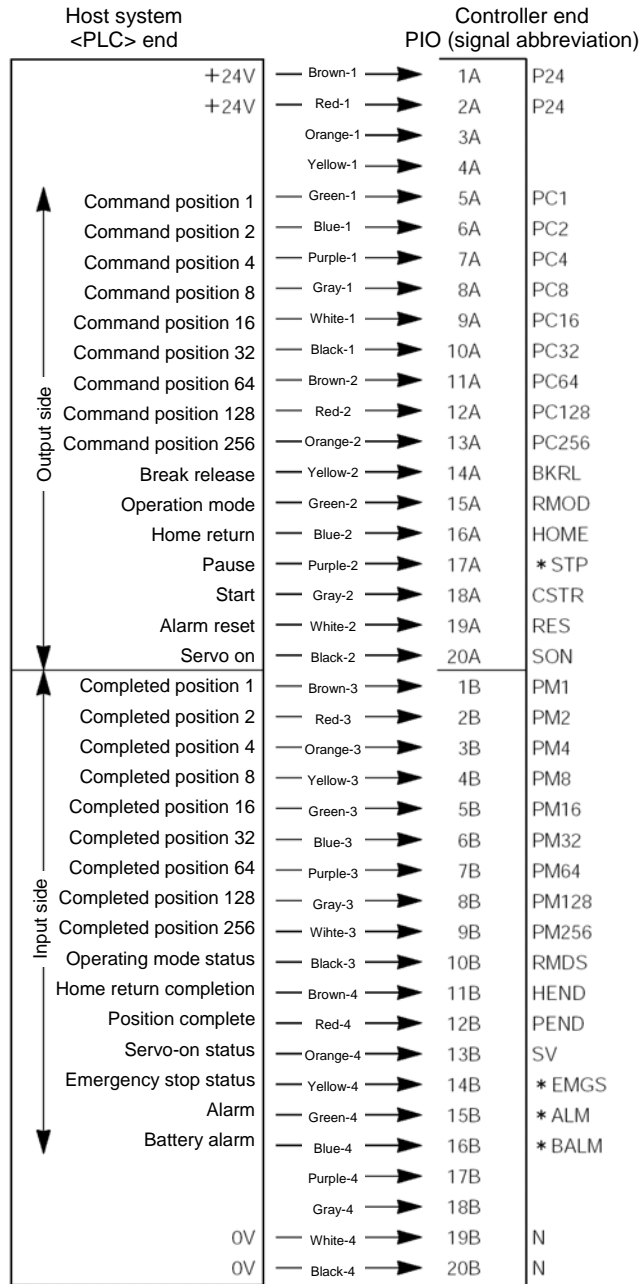

(Note) \*STP, \*ALM, \*EMGS and \*BALM are negative-logic signals.

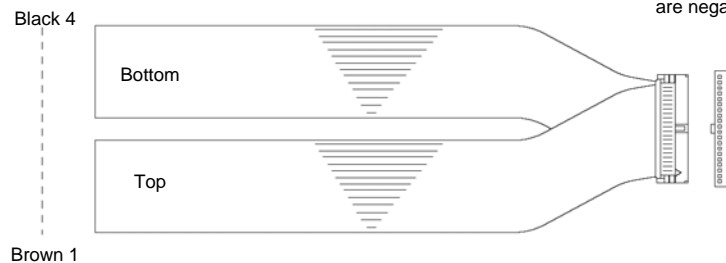

● PIO pattern 4 Solenoid valve mode 1 [7-point type]

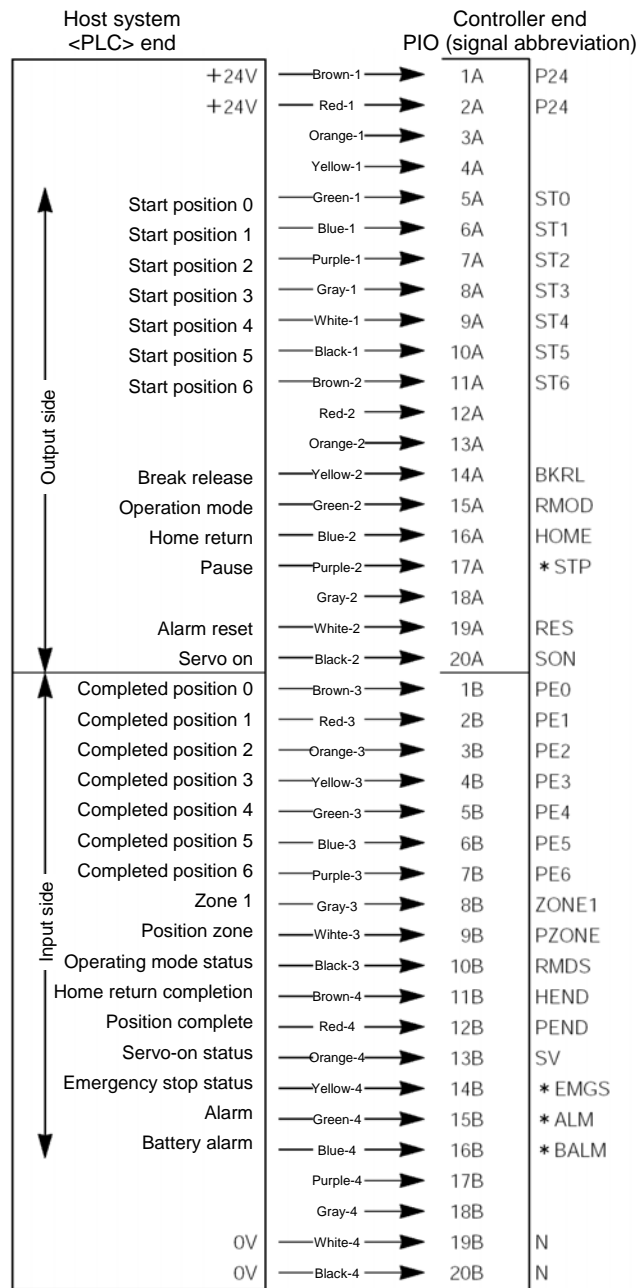

(Note) \*STP, \*ALM, \*EMGS and \*BALM are negative-logic signals.

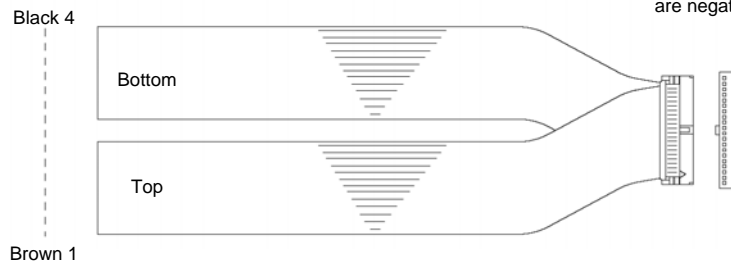

• PIO pattern 5 Solenoid valve mode 2 [3-point type]

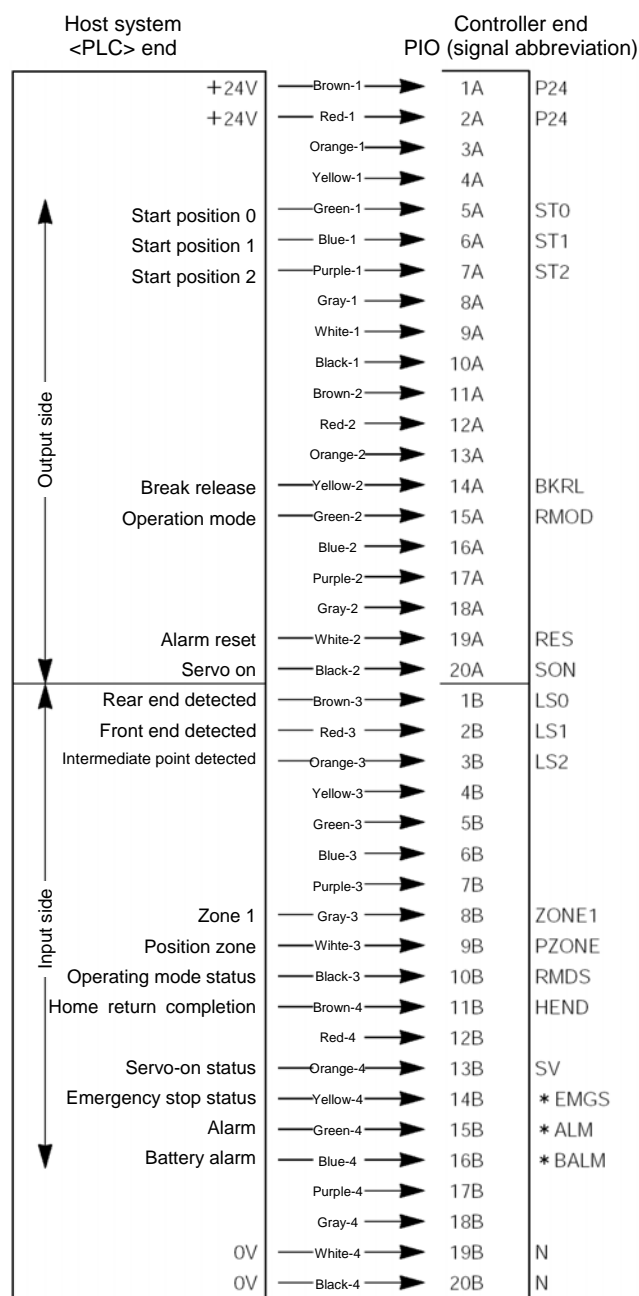

(Note) \*STP, \*ALM, \*EMGS and \*BALM are negative-logic signals.



## 1.3 Details of I/O Signal Functions

An input time constant is provided for the input signals of this controller, in order to prevent malfunction due to chattering, noise, etc.

Except for certain signals, switching of each input signal will be effected when the signal has been received continuously for at least 6 msec. For example, when an input is switched from OFF to ON, the controller will only recognize that the input signal is ON after 6 msec. The same applies to switching of input signals from ON to OFF (Fig. 1).

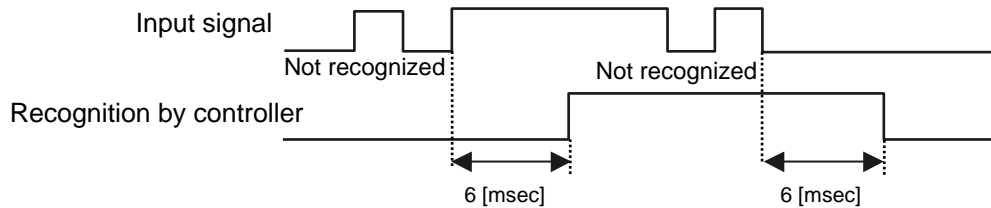

Fig. 1 Recognition of Input Signal

### 1.3.1. Details of Each Input Signal

#### ■ Command position number (PC1 to PC256)

When a movement command is effected upon OFF → ON of the start signal, the nine-bit binary code consisting of signals PC1 to PC256 will be read as the command position number.

In the standard or teaching type, six bits of PC1 through PC32 are used. In the 256-point type, eight bits of PC1 to PC128 are used. In the 512-point type, nine bits of PC1 through PC256 are used.

The weight of each bit is as follows:  $2^0$  for PC1,  $2^1$  for PC2,  $2^2$  for PC4, ..., and  $2^8$  for PC256. A desired position number between 0 and 511 (maximum) can be specified.

#### ■ Brake forced-release signal (BKRL)

This signal forcibly releases the brake of an actuator equipped with an electromagnetic brake. If this signal turns ON while the 24-V brake power is supplied to the controller externally and the servo is off, the electromagnetic brake will be forcibly released.

This signal is disabled when the actuator is not equipped with electromagnetic brake, 24-V brake power is not supplied externally, servo is on, or brake release switch on the controller is set to the RLS position.

#### ■ Operating mode (RMOD)

This signal is used to switch the operating mode of the controller.

Turning OFF this signal will switch the operating mode to "AUTO," while turning it ON will switch the mode to "MANU."

The RMOD signal is enabled when the "AUTO/MANU selector switch" on the front face of the controller is set to "AUTO."

For details on the operating modes, refer to 3, "Operation."

## ■ Home return (HOME)

The controller will start home return operation upon detection of an OFF → ON edge of this signal. When the home return is complete, the HEND signal will be output. The HOME signal can be input as many times as required.

(Note) Even if home return is not performed after the power has been input, the actuator will automatically perform home return and then move to the target position. Therefore, this signal need not be used at all time.

The actuator will move to the home position if “0.00 mm” is set in the position data table. However, this signal is useful when the position data table has no available fields or when the controller is used in the teaching mode.

## ■ Pause (\*STP)

When this signal turns OFF while the actuator is moving, the actuator will decelerate to a stop.

The remaining movement is retained and will be resumed when the signal is turned ON again.

If you wish to cancel the move command itself while this signal is OFF, turn the RES signal ON while this signal is OFF to cancel the remaining travel distance.

The \*STP signal can be used for the following purposes:

- [1] Provide a low-level safety measure to stop the axis while the servo is ON, such as a sensor that detects a person approaching the system
- [2] Prevent contact with other equipment
- [3] Perform positioning based on sensor or LS detection

(Note) If the \*STP signal is turned OFF while the actuator is performing home return, the home return operation will be put on hold. Once the signal turns ON, the home return operation will be resumed from the point where the actuator contacts a mechanical end.

## ■ Start (CSTR)

Upon detecting an OFF → ON edge of this signal, the controller will read the target point number (PC1 to PC256) and execute positioning operation to the corresponding target position.

Before executing this command, the target position, speed, acceleration and other operation data must be set in the position table using the PC software or teaching pendant.

If a start command is issued when home return operation has not been performed yet (the HEND output signal is OFF), the controller will automatically perform home return operation before positioning to the target position.

## ■ Alarm reset (RES)

This signal provides two functions.

- [1] Reset the alarm output signal (\*ALM) that turned OFF due to an alarm

If an alarm has generated, turn ON this signal after confirming the nature of the alarm.

The controller will reset the alarm upon detection of a rise edge of the RES signal.

(Note) Certain alarms cannot be reset by the RES signal. For details, refer to Appendix 5, “Troubleshooting.”

- [2] Cancel the remaining movement when the pause signal is OFF

This function is used when the remaining movement must be cancelled to allow for incremental moves (movements at a constant increment) from the position where the actuator stopped following a sensor detection.

## ■ Servo ON (SON)

The servo remains ON while this signal is ON.

Use this signal based on the default setting (the factory setting is “0: Enable”) if servo ON/OFF control must be performed by the PLC as part of the operation of the safety circuit covering the entire system.

Whether this signal is enabled or disabled is defined by parameter No. 21, “Servo ON input.” If the SON signal is used, set this parameter to “0: [Enable].” If it is not used, set the parameter to “1: [Disable].”

(Note) If the SON signal is turned OFF during movement in case of error, the actuator will decelerate to a stop at the emergency-stop torque and then the servo will turn OFF.

At this time, the function selected by a parameter (dynamic brake, electromagnetic brake, or deviation counter clear) is performed.

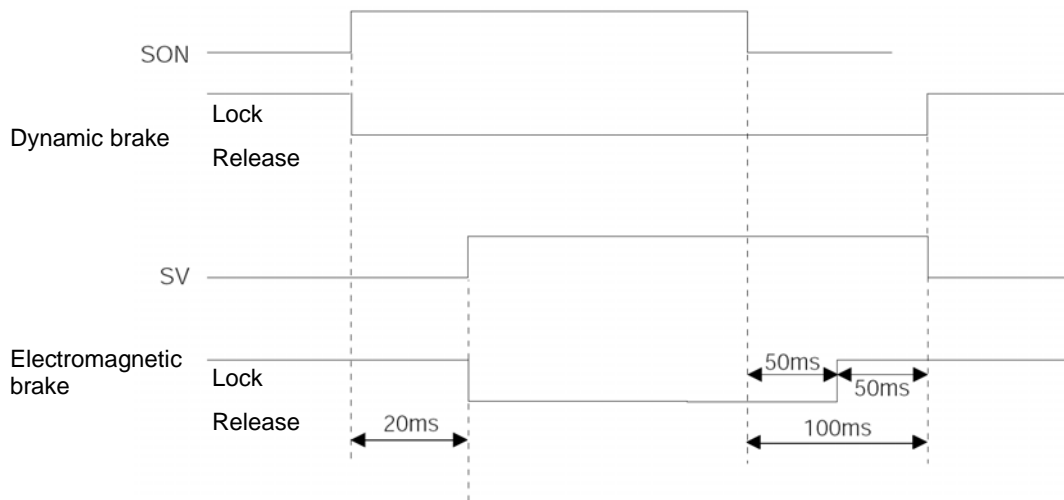

## ■ Operation mode (MODE)

This signal is enabled when parameter No. 25, “PIO pattern selection” is set to [1] (when the teaching mode [teaching type] is selected).

When this signal is turned ON, the normal operation mode will switch to the teaching mode.

(Note) For the controller to switch modes, all of the JOG+, JOG-, PWRT and CSTR signals must be OFF and the actuator must be stopped (except when the actuator is pushing the load).

Once the modes have been switched, the MODES output signal turns ON.

The PLC should be programmed in such a way that it will confirm that the MODES output signal is ON before accepting any PWRT operation command.

To switch the controller back to the normal operation mode, turn this signal OFF.

The PLC should be programmed in such a way that it will confirm that the MODES output signal is OFF before accepting any operation command in the normal operation mode.

(Note) The controller will not return to the normal operation mode unless the PWRT input signal is OFF.

## ■ Jog/inching switching signal (JISL)

When the jog/inching switching signal (JISL) is OFF, the functions of the JOG+ and JOG- signals are switched to those pertaining to jog operation. When the JISL signal is ON, the functions of the above signals are switched to those relating to inching operation.

If the JISL signal is turned ON (switched to inching) while the actuator is jogging, the actuator will decelerate to a stop and enter the inching mode.

When the JISL signal is turned OFF (switched to jogging) while the actuator is inching, the actuator will complete the movement and then enter the jogging mode.

## ■ Jog (JOG+, JOG-)

These signals function in two modes, which are toggled according to the input (ON/OFF) of the jog/inching switching signal (JISL).

[1] Jog mode: The jog/inching switching signal (JISL) is OFF

The actuator jogs while a jog signal is ON, and will decelerate to a stop when the signal is turned OFF. The JOG+ signal causes the actuator to jog forward, while the JOG- signal causes the actuator to jog backward.

If the JOG+ and JOG- signals turn ON simultaneously, the actuator will decelerate to a stop.

The travel speed corresponds to the value set in parameter No. 26, "PIO jog speed."

[2] Inching mode: Jog/inching switching signal (JISL) is ON

Once a jog signal turns ON, the actuator will travel for the specified inching distance.

The JOG+ signal causes the actuator to inch forward, while the JOG- signal causes the actuator to inch backward.

The distance traveled as a result of a single inching movement (= inching distance) corresponds to the value set in parameter No. 36, "PIO inching distance."

These signals are accepted regardless of whether the actuator is stopped or moving. The total number of times the JOG+ and JOG- signals have been input determines the final stopping position.

The travel speed corresponds to the value set in parameter No. 26, "PIO jog speed."

If a jog signal is turned ON during normal operation, the actuator will continue with its normal operation (the jog signal will be ignored).

(Note) Until home return is completed, the software stroke limits are ineffective and therefore the actuator may crash into a mechanical end. Exercise due caution.

## ■ Current-position write (PWRT)

This signal is enabled when the aforementioned MODES output signal is ON.

If this signal remains ON for 20 msec or more, the controller will read a position number consisting of the binary code specified by PC1 to PC32 that are currently detected, and write the current position data as a target position in the position data table under the corresponding position number.

If data other than the target position (speed, acceleration/deceleration, positioning band, etc.) are yet to be defined, the default parameter settings will be written.

When the writing completes successfully, the WEND output signal will turn ON.

Configure the system in such a way that the PLC will turn OFF the PWRT signal when WEND turns ON. The controller will turn OFF WEND once the PWRT signal turns OFF. If the PWRT signal is turned OFF before the WEND signal turns ON, the WEND signal will not turn ON.

(Note) An alarm will generate if a write command is issued when home return has not been performed yet or while the actuator is moving.

- Required condition when the servo is on:

This signal is enabled when both the JOG+ and JOG- input signals are OFF, HEND output signal is ON, and MOVE output signal is OFF.

- Required condition when the servo is off:

This signal is enabled as long as the HEND output signal is ON. However, whether the actuator is being moved by hand or stopped cannot be distinguished. Therefore, this signal should be input after physically checking the actuator operation to confirm that the actuator is stopped.



■ Start position number (ST0 to ST6) Solenoid valve mode 1 [7-point type]

These signals are effective when "4" is set in parameter No. 25 (= when the air-cylinder type is selected).

Upon detection of an OFF → ON rise edge or ON level of this signal, the actuator will move to the target position set in the corresponding position data.

Before executing this command, the target position, speed and other operation data must be set in the position table using a PC/teaching pendant.

If two or more ON signals are detected at the same time, priority will be given to the position command of the smallest number among all detected commands. (Example: If ON signals of ST0 and ST1 are detected at the same time, the actuator will start moving to position 0.)

Although commands are executed upon detection of ON signal edge, priority is given to the command that was specified the earliest. In other words, a signal input will not be accepted while the actuator is moving. Even if a different position signal is turned ON while the actuator is moving, the actuator will not commence moving to the new position even after reaching the target position.

Correspondence table of input signals and command positions

Input signal	Command position
ST0	Position No. 0
ST1	Position No. 1
ST2	Position No. 2
ST3	Position No. 3
ST4	Position No. 4
ST5	Position No. 5
ST6	Position No. 6

If a movement command is issued when the first home return is not yet completed after the power was input, home return will be performed automatically to establish the coordinates first, after which the actuator will move to the target position.

■ Movement to each position (ST0, ST1, ST2) Solenoid valve mode 2 [3-point type]

Since the number of positioning points is limited to three, the actuator can be controlled just like an air cylinder. While this signal is ON, the actuator will move toward the target position.

If the signal turns OFF while the actuator is moving, the actuator will decelerate to a stop.

Before executing this command, enter a target position in the "Position" field for position No. 0, 1 or 2 in the position table.

Input signal	Target position	Remarks
ST0	Rear end	The target position is defined in the "Position" field for position No. 0.
ST1	Front end	The target position is defined in the "Position" field for position No. 1.
ST2	Intermediate point	The target position is defined in the "Position" field for position No. 2.

## 1.3.2 Details of Each Output Signal

### ■ Completed position number (PM1 to PM256)

These signals can be used to check the completed position number when the PEND signal turns ON.

The signals are output as a binary code.

Immediately after the power is input, all of the PM1 to PM256 signals are OFF.

In the standard or teaching type, six bits of PM1 through PM32 are used. In the 256-point type, eight bits of PM1 through PM128 are used. In the 512-point type, nine bits of PM1 through PM256 are used.

All of these signals are OFF also when the actuator is moving.

As described above, this signal is output only when positioning is completed.

(Note) All of these signals will turn OFF when the servo is turned OFF or an emergency stop is actuated. They will return to the ON status when the servo is turned ON again, provided that the current position is inside the positioning band with respect to the target position. If the current position is outside the band the signals will remain OFF.

When the power is input, the PEND signal will turn ON. These signals are all OFF, this condition is the same as one achieved after positioning to position "0" is completed.

Check the position of position "0" after the movement command has completed.

If an alarm is present, the corresponding alarm code (abbreviated form) consisting of four bits from PM1 to PM8 will be output.

The meanings of these signals vary between the normal condition and the alarm condition, so be careful not to use them wrongly in the sequence.

### ■ Moving (MOVE)

This signal is output while the servo is ON and the actuator is moving (also during home return, push & hold operation or jogging).

Use the MOVE signal together with the PEND signal to allow the PLC to determine the actuator status.

The MOVE signal will turn OFF after positioning or home return is completed or a judgment is made during push & hold operation that the load is being contacted.

### ■ Zone (ZONE1)

This signal will remain ON while the current actuator position is inside the zone specified by parameters No. 1, "Zone 1+ [ZONM]" and No. 2, "Zone 1- [ZONL]," or OFF while the actuator is outside the above zone. This signal is always effective once home return has been completed and is not affected by the servo status or presence of an alarm.

(Note 1) This signal becomes effective only after the coordinate system has been established following a completion of home return. It will not be output immediately after the power is turned on.

As long as home return has been completed, this signal is enabled even when the servo is off or while an emergency stop is actuated.

(Note 2) The zone functions have been changed due to version upgrade. Refer to the precautions at the outset.

### ■ Position zone signal (PZONE)

This signal will turn ON when the current actuator position enters the area between the zone boundaries set in the position table. After the current position movement command is completed, the signal will remain effective until the next position movement command is received.

(Note) The zone functions have been changed due to version upgrade. Refer to the precautions at the outset.

## ■ Operating mode status (RMDS)

The internal operating mode of the controller is output based on the AUTO/MANU selector switch on the controller and the RMOD signal received by the input port. If the selector switch is set to "AUTO" and the RMOD signal is OFF (AUTO), the controller is in the AUTO (OFF) mode. If the selector switch is set to "MANU" and/or the RMOD signal is ON (MANU), the controller is in the MANU (ON) mode.

If the RMOD input is disabled by parameter No. 41, the MODE switch status will be output by this signal.

## ■ Home return completion (HEND)

This signal is OFF immediately after the power is input, and turns ON in either of the following two conditions:

[1] This signal turns ON when home return operation has completed with respect to the first move command issued with the start signal.

[2] Home return operation has completed following an input of the home return signal.

Once turned ON, the HEND signal will not turn OFF unless the input power supply is cut off, a soft reset is executed, or the home return signal is input again.

The HEND signal can be used for the following purposes:

[1] Check prior to establishing the home if movement toward the home direction is permitted, in cases where an obstacle is located in the direction of the home

[2] Use as a condition for writing the current position in the teaching mode

[3] Use as a condition for enabling the zone output signal

## ■ Position complete (PEND)

This signal indicates that the target position was reached and positioning has completed.

Use this signal together with the MOVE signal to allow the PLC to determine the positioning status.

When the controller becomes ready after the power was input and the servo has turned ON, this signal will turn ON if the position deviation is within the in-position range.

Then, when a move command is issued by turning ON the start signal, the PEND signal will turn OFF.

Once the start signal turns OFF, the PEND signal will turn ON again when the deviation from the target position falls within the positioning band.

Once turned ON, the PEND signal will not turn OFF even when the position subsequently exceed the positioning band.

(Note) If the start signal remains ON, the PEND signal will not turn OFF even when the deviation from the target position falls within the positioning band: it will turn ON when the start signal turns OFF.

Even when the motor is stopped, the PEND signal will remain OFF if the pause signal is input or the servo is OFF.

## ■ Ready (SV)

This is a monitor signal indicating that the servo is ON and the motor is ready.

The ON/OFF state of this signal is synchronized with the lit/unlit state of the "SV" LED on the front face of the controller enclosure.

Use this signal as a condition for starting a movement command on the PLC side.

For the signal timings after the power is input, refer to 3.1, "How to Start."

■ Emergency stop status (\*EMGS)

This signal remains ON in a normal condition, and will turn OFF if the emergency stop switch is pressed. Program the PLC so that it will monitor this signal and implement appropriate safety measures for the entire system if the signal turns OFF.

■ Alarm (\*ALM)

This signal remains ON while the controller is operating properly, and turns OFF when an alarm has generated. Provide an appropriate safety measure for the entire system by allowing the PLC to monitor the OFF status of this signal.

For details of alarms, refer to Appendix 5, "Troubleshooting."

■ Absolute-battery voltage low warning signal (\*BALM)

This signal remains ON while the absolute battery voltage is normal when controller is of absolute specification, or when the controller is of incremental specification. It will turn OFF once the absolute battery voltage drops to 3.1 V. If the voltage drops further to 2.5 V, an alarm will generate and the controller will no longer be able to retain position information.

As long as the aforementioned alarm is not present, the controller still retains position information and thus operations can be performed properly even when this signal is OFF.

■ Mode status (MODES)

The MODES signal will turn ON when the teaching mode is enabled upon selection of the teaching mode via the operation mode input signal (MODE signal ON).

Thereafter, the MODES signal will remain ON until the MODE signal turns OFF.

Configure the system in such a way that the PLC will start teaching operation after confirming that the MODES signal has turned ON.

This signal is enabled only when the PIO pattern is "teaching type."

■ Write completion (WEND)

The WEND signal is OFF immediately after the controller has switched to the teaching mode. It will turn ON when the writing of position data in response to the current-position write signal is completed.

When the current-position write signal turns OFF, this signal will also turn OFF.

Configure the system in such a way that the PLC will acknowledge completion of writing when the WEND signal turns OFF.

This signal is enabled only when the PIO pattern is "teaching type" and the actuator is currently operating in the teaching mode.

■ Current position number signal (PE0 to PE6) Solenoid valve mode 1 [7-point type]

When the PIO pattern is "4" (air-cylinder type), upon completion of positioning the position number (0 to 6) specified in the applicable move command will be output separately. If push & hold operation is specified, the corresponding PE signal will turn ON upon detection of successful push & hold operation. However, the corresponding PE signal will also turn ON even after the load has been missed, so it is not recommended to specify push & hold operation when missing of the load must be detected.

Simple alarm-code output function is not provided for these signals. If an alarm generates, only the \*ALM signal will turn OFF. Check the details of the alarm code by connecting the PC software or teaching pendant.

Correspondence table of output signals and positions completed

Output signal	Position completed
PE0	Position No. 0
PE1	Position No. 1
PE2	Position No. 2
PE3	Position No. 3
PE4	Position No. 4
PE5	Position No. 5
PE6	Position No. 6

Note) These signals turn OFF when the servo is turned OFF or an emergency stop is actuated. They will return to the ON status when the servo is turned ON again, provided that the current position is inside the positioning band with respect to the target position. If the current position is outside the band, the signals will remain OFF.

(Reference) Output Signal Changes in Each Mode

Mode classification	MOVE	PEND	SV	HEND	PM1 ~
Actuator is stopped with the servo ON after the power was input	OFF	ON	ON	OFF	OFF
Home return is in progress following an input of the home return signal	ON	OFF	ON	OFF	OFF
Home return has completed following an input of the home return signal	OFF	ON	ON	ON	OFF
Actuator is moving in the positioning/push & hold mode	ON	OFF	ON	ON	OFF
Actuator is paused in the positioning/push & hold mode	OFF	OFF	ON	ON	OFF
Positioning has completed in the positioning mode	OFF	ON	ON	ON	ON
Actuator has stopped after contacting the load in the push & hold mode	OFF	ON	ON	ON	ON
Actuator has stopped after missing the load (no load) in the push & hold mode	OFF	OFF	ON	ON	ON
Actuator is stopped with the servo ON in the teaching mode	OFF	/	ON	ON	/
Actuator is jogging in the teaching mode	ON		ON	ON	
Actuator is being moved by hand with the servo OFF in the teaching mode	OFF		OFF	ON	
Servo is OFF after home return	OFF	OFF	OFF	ON	OFF
Emergency stop has been actuated after home return	OFF	OFF	OFF	ON	

(Note) Determine whether the actuator has stopped after contacting the load or missing the load from the signal statuses of MOVE, PEND and PM1 to 8.

■ Position detection output at each position (LS0, LS1, LS2) Solenoid valve mode 2 [3-point type]

These signals have the same meanings as the LS signals of an air cylinder. Each signal will turn ON when the current position enters the positioning band of the target position.

(Note) Even if the servo turns off or an emergency stop is actuated while the actuator is stopped at the target position, the signal will remain ON as long as the actuator is inside the positioning band.

Output signal	Position detected	Remarks
LS0	Rear end	The detection position is defined in the "Position" and "Positioning band" fields for position No. 0.
LS1	Front end	The detection position is defined in the "Position" and "Positioning band" fields for position No. 1.
LS2	Intermediate point	The detection position is defined in the "Position" and "Positioning band" fields for position No. 2.

### 1.3.3 Feedback Output Signal Details of Each Output Signal

Position detection data is output by pulse trains (differential mode).

The current position can be read in real time from the host controller.

\* The controller has been shipped with the feedback pulse output disabled.

To use the feedback pulse output, set user parameter No. 68 to 0 (Enable).

(Note) For details, refer to 2.3, 3.2.8 and 5.2 in Chapter 3, "Pulse Train Input Mode."

## 2. Data Entry

To move the actuator to a specified position, a target position must be entered in the "Position" field.

A target position can be specified in the absolute mode where a distance from the home is entered, or in the incremental mode where a relative travel from the current position is entered.

Once a target position is entered, all other fields will be automatically populated with their default values set by the applicable parameters.

The default values vary depending on the characteristics of the actuator.

### 2.1 Description of Position Table

The position table is explained using an example on the PC software screen.

(The items displayed on the teaching pendant are different.)

No.	Position [mm]	Speed [mm/s]	Acceleration [G]	Deceleration [G]	Push [%]	Threshold [%]	Positioning band [mm]
0	5.00	300.00	0.30	0.30	0	0	0.10
1	380.00	300.00	0.30	0.10	0	0	0.10
2	200.00	300.00	0.30	0.10	0	0	0.10

Zone+ [mm]	Zone- [mm]	Acceleration/ deceleration mode	Incremental	Command mode	Standstill mode	Comment
0.00	100.00	0	0	0		
300.00	400.00	0	0	0		
150.00	250.00	0	0	0		

(1) No.

- Indicate the position data number.

(2) Position

- Enter the target position to move the actuator to, in [mm].  
 Absolute mode: Enter the target position to move the actuator to, using the distance from the home.  
 Incremental mode: Enter the target position to move the actuator to, using the distance from the current position. A negative value can also be entered (a negative value indicates a distance in the negative direction of displayed coordinates).

No.	Position	
0	30	Absolute mode 30 mm from the home
1	$\equiv$ 10	Incremental mode +10 mm from the current position
2	$\equiv$ -10	Incremental mode -10 mm from the current position
3	100	Absolute mode 100mm from the home

On the teaching pendant RCM-T, these signs indicate that the data was entered in the relative coordinate specification mode.

(3) Speed

- Enter the speed at which the actuator will be moved, in [mm/sec].  
 The default value varies depending on the actuator type.

(4) Acceleration/deceleration

- Enter the acceleration/deceleration at which to move the actuator, in [G].  
 Basically, the acceleration and deceleration should be inside the rated acceleration/deceleration range specified in the catalog.  
 The input range is greater than the rated range in the catalog to accommodate situations where you want to “reduce the tact time when the load mass is significantly smaller than the rated load capacity.”  
 If vibration of the load causes problem during acceleration/deceleration, decrease the set value.

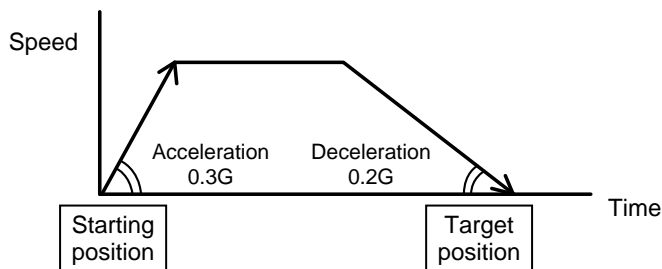

Increasing the set value makes the acceleration/deceleration quicker while decreasing the value makes it more gradual.

**Caution:** Refer to the attached list of supported actuator specifications and set appropriate speed and acceleration/deceleration so that the actuator will not receive excessive impact or vibration under the applicable installation condition and for the load of the specific shape. Increasing the speed and acceleration/deceleration may significantly impact the actuator depending on the load mass, and the actuator characteristics also vary from one model to another. Contact IAI for the maximum limits that can be entered in your specific application.



(5) Push

- Select either the positioning mode or push & hold mode.  
The default setting is "0."  
0: Positioning mode (= normal operation)  
Other than 0: Push & hold mode [%]
- If the push & hold mode is selected, enter the current-limiting value to be applied to limit the AC servo motor current during push & hold operation.

Caution: Take note that if the push force is too small, a false detection may occur during push & hold operation due to sliding resistance, etc.

(6) Threshold

- This field is not used for this controller.  
The factory setting is "0."

(7) Positioning band

- The meaning of this field varies between "positioning operation" and "push & hold operation."  
"Positioning operation":  
This field defines how much before the target position the completion signal will turn ON.  
Increasing the positioning band allows the next operation in the sequence to be started early, and consequently the tact time can be reduced. Set an optimal value by checking the overall balance of the system.

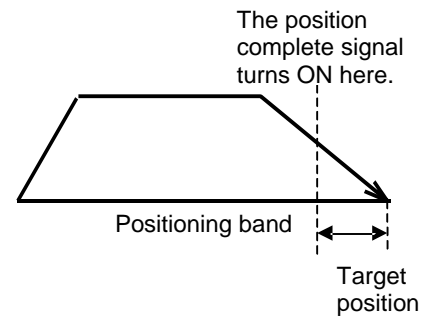

"Push & hold operation"

This field defines the maximum push distance after reaching the target position in push & hold operation.  
Consider possible mechanical variation of the load and set an appropriate positioning band that will prevent the positioning from completing before the load is contacted.

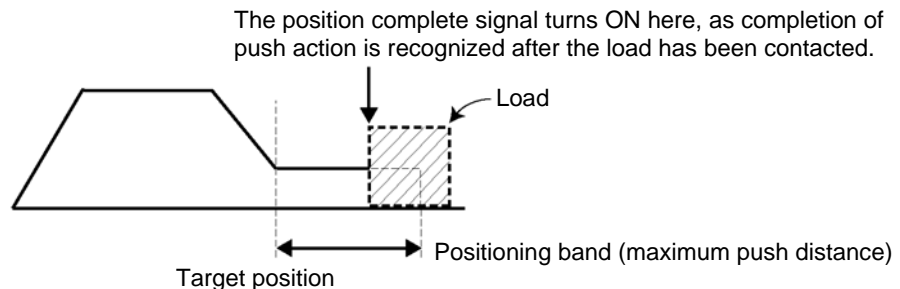

(8) Zone +/-

- This field defines the zone in which PZONE (zone output signal) will turn ON during operations in PIO pattern 0, 1, 2, 4 or 5. To add flexibility, a different zone can now be set for each target position. [Setting example]

No.	Position [mm]	Zone+ [mm]	Zone- [mm]
0	5.00	100.00	0.00
1	380.00	400.00	300.00
2	200.00	250.00	150.00

Movement command to position No. 0

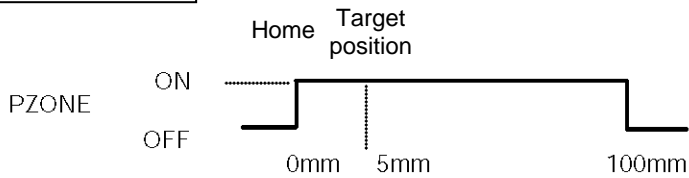

Movement command to position No. 1

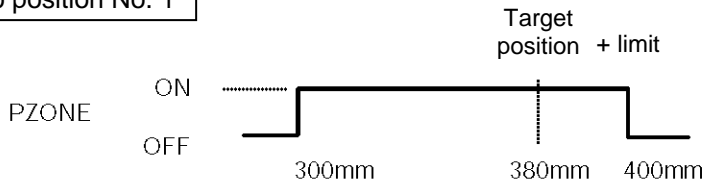

Movement command to position No. 2

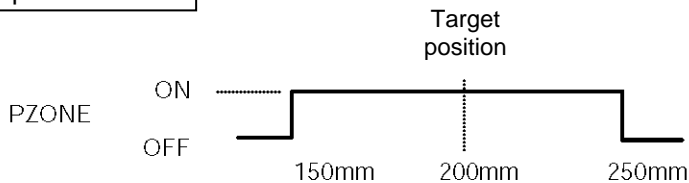

\* The zone functions have been changed due to version upgrade. Refer to the precautions at the outset.

(9) Acceleration/deceleration mode

- This field defines the acceleration/deceleration pattern. The factory setting is "0."  
 0: Trapezoid pattern  
 1: S-motion  
 2: Primary delay filter

Trapezoid pattern

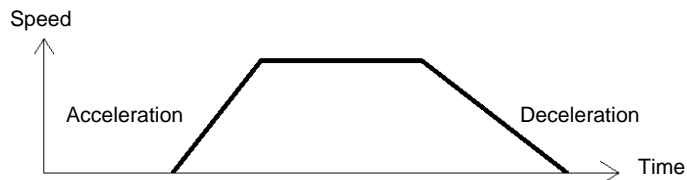

\* Set desired acceleration and deceleration in the "Acceleration" and "Deceleration" fields of the position table.

## S-motion

During acceleration, the actuator operates along an acceleration curve that gradually rises until a certain point, and then increases sharply.

Use this mode if you wish to set high acceleration/deceleration to meet the required tact time, while still allowing the actuator to accelerate gradually immediately after it starts moving and immediately before stopping.

Note, however, that this setting is not reflected in jogging or inching using a PC or teaching pendant.

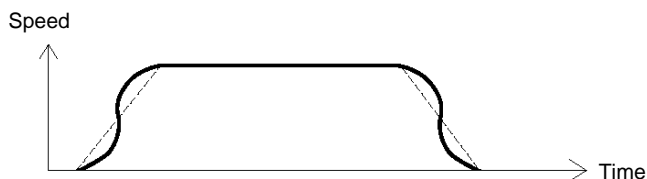

- \* Set a desired S-motion level in parameter No. 56, "S-motion ratio setting." The setting unit is %, while the setting range is 0 to 100. (The graph above assumes an S-motion ratio of 100%.) The S-motion function is disabled when "0" is set.

- ⚠ Caution:
- [1] Even if you issue a position command or high-value command with specified S-motion acceleration/deceleration in order to change moving speed while the actuator is operating, trapezoid control, rather than S-motion acceleration/deceleration control, is performed. Make sure to issue a command when the actuator is stopped.
  - [2] S-motion acceleration/deceleration is disabled in the index mode of the rotary actuator. Trapezoid control is performed even if S-motion acceleration/deceleration control is specified.
  - [3] If acceleration or deceleration time exceeding 2 seconds is set, do not command S-motion acceleration/deceleration control. Normal operation cannot be performed.
  - [4] Do not suspend the operation during acceleration or deceleration. The speed changes (accelerates), which may be dangerous.

## Primary delay filter

The actuator operates along acceleration/deceleration curves that are more gradual than those of linear acceleration/deceleration (trapezoid pattern).

Use this mode in situations where you wish to prevent the load from receiving micro-vibration during acceleration or deceleration.

Note, however, that this setting is not reflected in jogging or inching using a PC or teaching pendant.

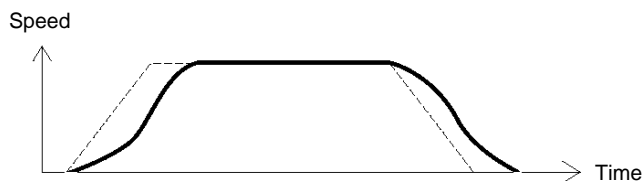

- \* Set a desired primary delay in parameter No. 55, "Position-command primary filter time constant." The setting unit is 0.1 msec, while the setting range is 0.0 to 100.0. The primary delay filter is disabled when "0" is set.

- (10) Incremental command
  - This field defines whether the position is specified in the absolute mode or incremental mode.  
The factory setting is "0."  
0: Absolute mode  
1: Incremental mode

**Warning:** On the solenoid valve mode 2 [3-point type], make sure the position is specified in the absolute mode. If it is specified in the incremental mode, the position data error (OA2) will generate.

- (11) Command mode
  - This field is not used for this controller.  
The factory setting is "0."
- (12) Standstill mode
  - Set a desired power-saving mode to be applied while the actuator stands by after completion of positioning. To save energy when the actuator stands by for a long period of time, this controller provides a mode in which to reduce the power consumption while the actuator is at standstill.  
The factory setting is "0" (disabled).  
0: Power-saving mode is disabled  
1: Automatic servo-off mode, with the delay time defined by parameter No. 36  
2: Automatic servo-off mode, with the delay time defined by parameter No. 37  
3: Automatic servo-off mode, with the delay time defined by parameter No. 38

Automatic servo-off mode

After positioning is completed, the servo will turn off automatically upon elapse of a specified time.

(Power is not consumed because holding current does not flow.)

When the next movement command is received from the PLC, the servo will turn on and the actuator will start moving.

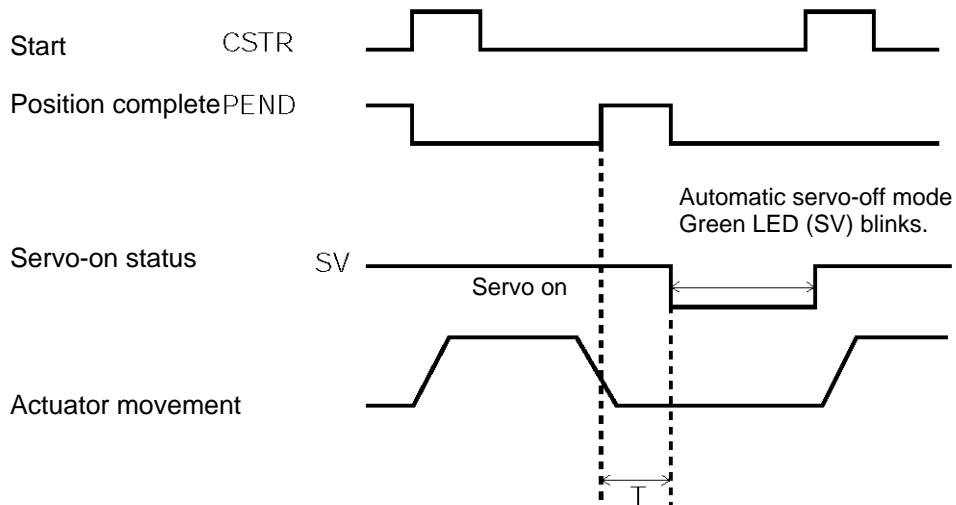

T: Delay time (seconds) after positioning is completed until the servo turns off

When the setting is 1: T corresponds to the value set in parameter No. 36.  
When the setting is 2: T corresponds to the value set in parameter No. 37.  
When the setting is 3: T corresponds to the value set in parameter No. 38.

 **Warning:** If the next move command is an incremental command (constant pitch feed), never use the automatic servo-off mode.  
The current position may shift slightly when the servo turns off and then on again.

 **Caution:**

- In push & hold operation, the automatic servo-off mode is disabled if push & hold operation has completed successfully. This mode is enabled if the actuator has missed the load. As a basic rule of thumb, do not use the automatic servo-off mode in push & hold operation.
- If the MANU teaching mode, the automatic servo-off mode is disabled.

## 2.2 Explanation of Modes

### 2.2.1 Positioning Mode Push = 0

The actuator moves to the target position set in the “Position” field of the position table.

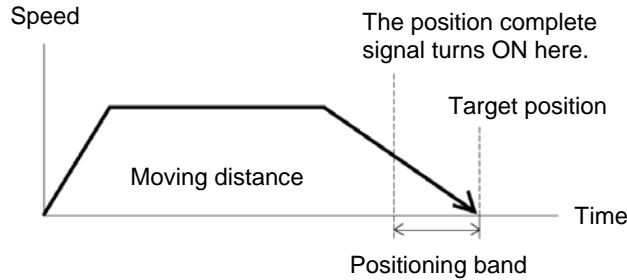

### 2.2.2 Push & Hold Mode Push = Other than 0

(1) Load was contacted successfully

Upon reaching the target position set in the “Position” field of the position table, the actuator moves at the push speed for the distance set in the “Positioning band” field.

If the actuator contacts the load while moving and the controller recognizes that “push action has completed,” the position complete signal will turn ON.

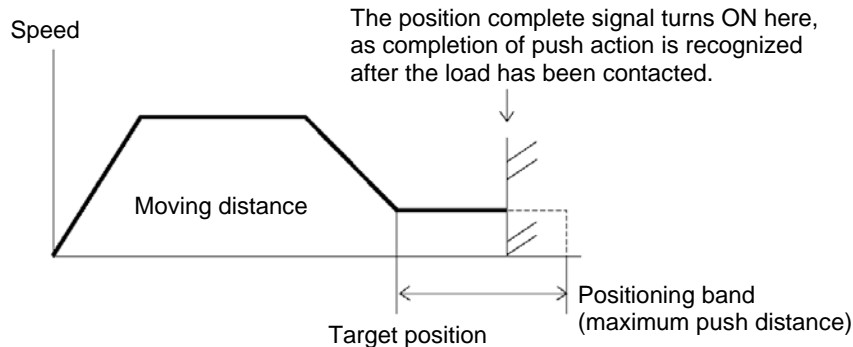

- The push speed is set by parameter No. 34.  
The factory setting varies with each actuator in accordance with the actuator’s characteristics.  
Set an appropriate speed by considering the material and shape of the load, among others.  
Since the maximum speed is 20 mm/s, operate the actuator at a speed not exceeding this value.
- Set a positioning band slightly longer than the last position, in order to absorb possible mechanical variation of the load.
- “Completion of push action” is determined based on a combination of the current-limiting value set in the “Push” field of the position table and the push completion judgment time set by parameter No. 6.  
Set an appropriate condition by considering the material and shape of the load, among others.  
For details, refer to Appendix 3, “Parameter Settings.”

<b>Warning</b>	<ul style="list-style-type: none"> <li>• If the actuator contacts the load before reaching the target position, an overload or deviation overflow alarm will generate. Pay due attention to the relationship of the target position and the load position.</li> <li>• The actuator continues to push the load at the push force at standstill determined by the current-limiting value. Since the actuator is not inactive, exercise due caution when handling the machine in this condition.</li> </ul>
----------------	--

(2) Load was not contacted (missed)

If the actuator does not still contact the load after having moved the distance specified in the “Positioning band” field, the position complete signal will not turn ON.

Therefore, include timeout check processing in the sequence circuit on the PLC side.

- It is recommended that a zone signal be also used as a “simple ruler” to supplement the judgment of missed load.

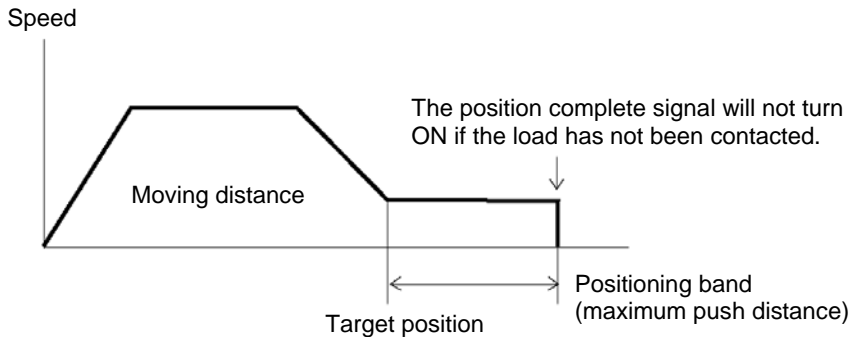

(3) Load moves during push & hold operation

[1] Load moves in the pushed direction

If the load moves in the pushed direction after completion of push action, the actuator will chase the load within the positioning band.

If the current drops to below the current-limiting value set in the “Push” field of the position table while the actuator is moving, the position complete signal will turn OFF. The position complete signal will turn ON when the current-limiting value increases to the specified level again.

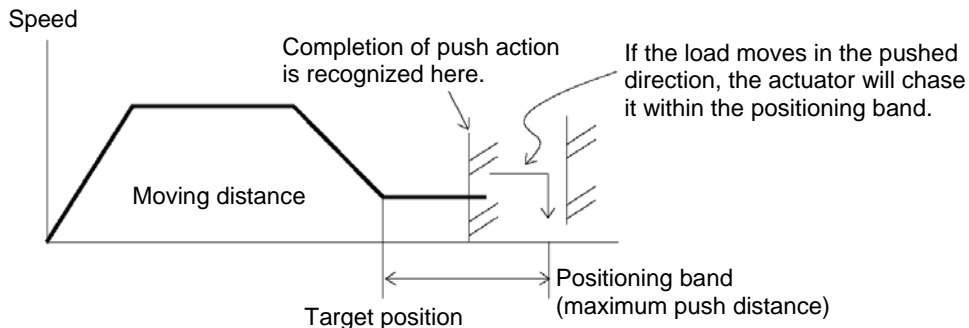

[2] Load moves in the opposite direction

(Actuator is pushed back by the strong reactive force of the load)

If the actuator is pushed back after completion of push action because the reactive force of the load is greater than the thrust force of the actuator, the actuator will be pushed back until its push force balances out with the reactive force of the load.

The position complete signal will remain ON.

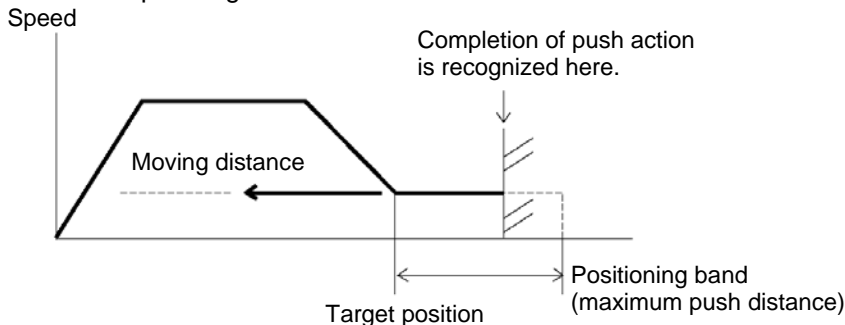

(Note) If the actuator is pushed back to the target position, an “out of push & hold operation range” alarm will generate.

#### (4) Positioning band was entered with a wrong sign

Take note that if a value with a wrong sign is set in the "Positioning band" field of the position table, the operation will deviate by a distance corresponding to "positioning band x 2," as shown below.

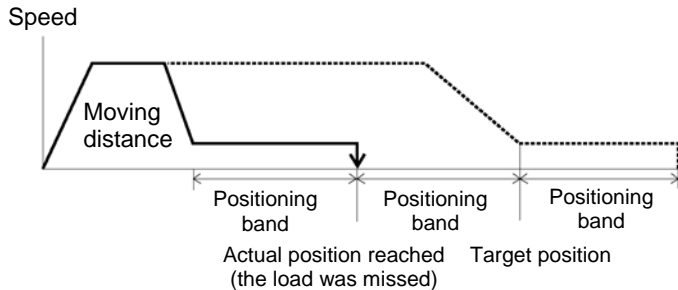

### 2.2.3 Speed Change during Movement

Speed control involving multiple speed levels is possible in a single operation. The actuator speed can be decreased or increased at a certain point during movement. However, the position at which to implement each speed change must be set.

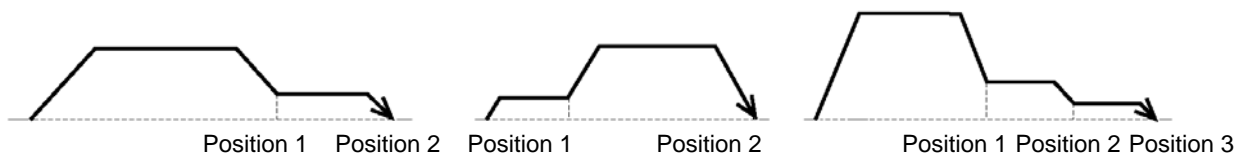

### 2.2.4 Operation at Different Acceleration and Deceleration Settings

If the load is a CCD camera or other precision equipment, the deceleration curb at stop must be made as gradual as possible.

To accommodate these sensitive applications, the position table has separate fields for "acceleration" and "deceleration."

For example, you can set the deceleration differently from the acceleration, such as setting 0.3 G (rated acceleration) in "Acceleration" and 0.1 G in "Deceleration."

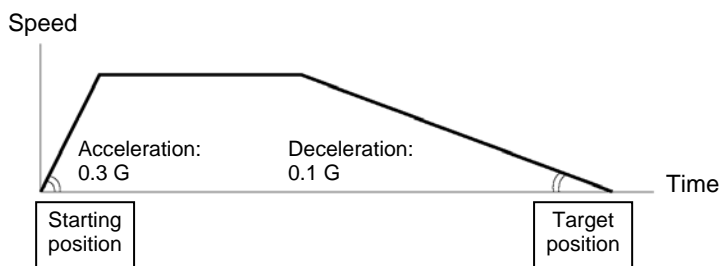

**⚠ Caution:** Basically, the acceleration and deceleration should be inside the rated acceleration/deceleration range specified in the catalog. The input range is greater than the rated range in the catalog, but this is only to accommodate situations where you want to "reduce the tact time when the load mass is significantly smaller than the rated load capacity." If you want to use acceleration/deceleration settings greater than the rating, consult IAI beforehand because it may affect the life of the actuator.



## 2.2.5 Pause

The actuator can be paused during movement using an external input signal (\*STP). The pause signal uses the contact b logic (always ON) to ensure safety. Turning the \*STP signal OFF causes the actuator to decelerate to a stop. When \*STP is turned ON subsequently, the actuator will resume the remaining movement.

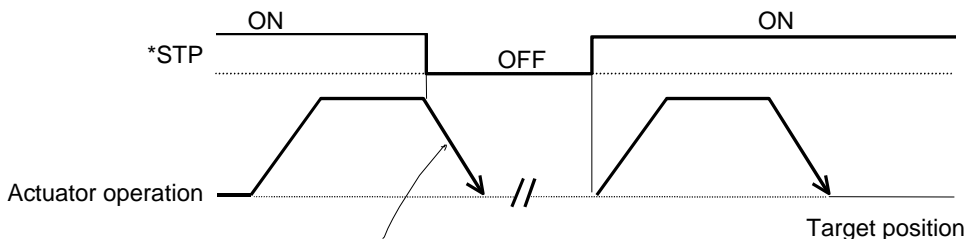

(Note) The deceleration corresponds to the value set in the “Deceleration” field for the current position number in the position table.

## 2.2.6 Zone Signal Output

The zone output is suitable for the following applications, because a signal can be output when the actuator enters a specified zone during movement:

- [1] Issue a trigger signal to surrounding equipment to reduce the tact time
- [2] Prevent contact with surrounding equipment
- [3] Use as a “simple ruler” in push & hold operation

A different method is used for the zone output signal, and for the position zone output signal, to set the zone within which the signal will turn ON.

- Zone output signal (ZONE1)  
Set the signal ON zone using parameters.  
Parameter No. 1 = Zone+, Parameter No. 2 = Zone-

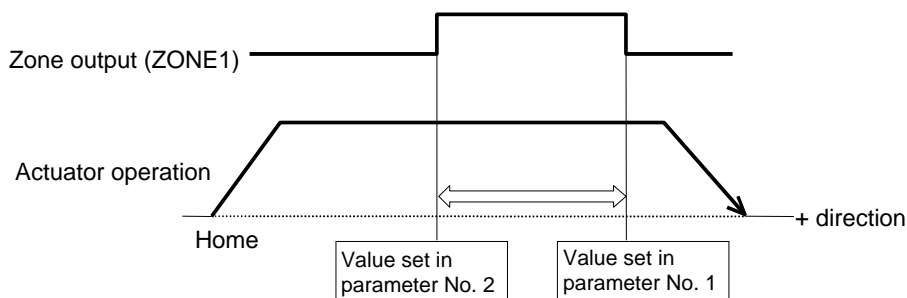

## ■ Position zone output signal (PZONE)

Set the signal ON zone using the "Zone-" and "Zone+" fields of the position table

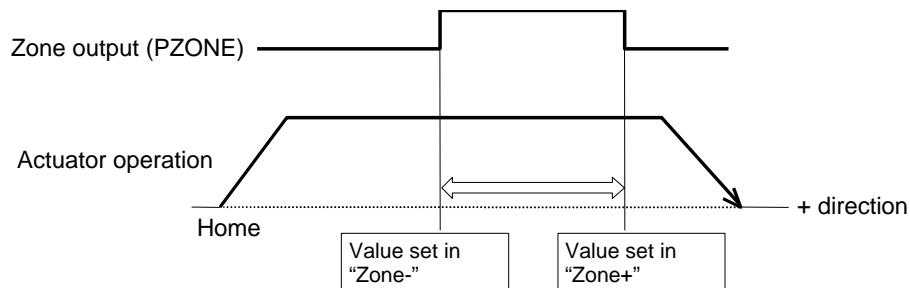

\* The zone functions have been changed due to version upgrade. Refer to the precautions at the outset.

## 2.2.7 Home Return

After the power is turned on, home return must be performed to establish the home position.

The method of home return varies depending on the PIO pattern.

- When a dedicated input is used [PIO pattern ≠ 5]  
Home return is performed using the home return (HOME) input.  
The actuator will return home regardless of whether or not home return has been completed once before.  
When home return is completed, the home return complete (HEND) output signal will turn ON.
- When a dedicated input is not used [PIO pattern = 5]  
When a rear end move command is input while home return is not yet completed, the actuator will perform home return first and then move to the rear end.

★ For details, refer to 3.2, "How to Execute Home Return."

## 2.2.8 Overview of Teaching Mode [Teaching Type]

Depending on your system, it may be desirable to be able to use a touch panel, etc., to perform jogging operation or write the current position to the "Position" field of the position table, without using a PC or teaching pendant.

The teaching type is provided to support these applications.

The features of the teaching type are summarized below:

- [1] The actuator can be jogged using I/O signals input from the PLC.  
 Continuous jog feed or inching feed can be selected by the manual switching signal to facilitate fine position adjustment.  
 \* This function is effective regardless of the ON/OFF state of the operation mode input (MODE) signal.
- [2] The current position can be written to the "Position" field of the position table using I/O signals input from the PLC.  
 \* This function is effective only when the operation mode input (MODE) signal is ON.

(Note) The number of I/O points is limited, so some I/O ports are used in both the teaching type and the normal positioning type. Remember this when creating a sequence circuit for the PLC.

Operation mode input (MODE) * Signal for switching to the teaching mode	ON (teaching mode)	OFF (positioning mode)
Current operation mode output (MODES) * Monitor output indicating the internal mode of the controller	ON (teaching mode)	OFF (positioning mode)
Meaning of I/O connector pin 18A	Current-position write input (PWRT)	Start input (CSTR)
Meaning of I/O connector pin 12B	Write completion output (WEND)	Position complete output (PEND)

 **Warning:** Jog commands are effective even before home return is completed, but the soft stroke checks are not performed prior to home return. Accordingly, the actuator may move all the way to the mechanical end if the jog command (JOG+/JOG-) signal remains ON. Exercise caution not to let the actuator hit the mechanical end.

## 2.2.9 Overview of Solenoid Valve mode 1 [7-point Type]

The number of positioning points is kept small, or specifically to seven or less. This type assumes simple applications where the PLC ladder sequence only requires a simple circuit configuration.

I/O signals provide separate command inputs and movement complete outputs for respective position numbers. Accordingly, the signal pattern is different from the one in the 64-point positioning type (PIO pattern = 0).

Example) The differences are explained by using an example of moving the actuator to the target position for position No. 5.

### [1] Solenoid valve mode 1 [7-point type]

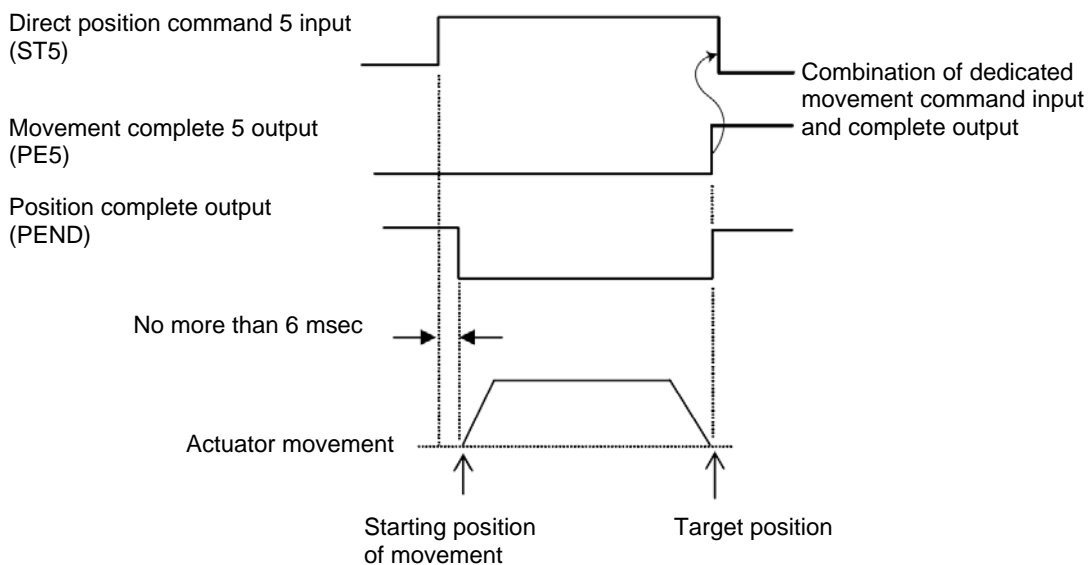

\* In the Positioning mode [64-point type], a position command input (binary) signal and a start input signal must be turned ON at staggered timings to initiate movement (refer to the next page). In this type, however, there is only one input signal that needs to be turned ON.

### ■ Explanation of I/O signals

Signal name	Category	Function explanation
Direct position command 0 (ST0)	Input	Movement command to the target position for position No. 0
Direct position command 1 (ST1)		Movement command to the target position for position No. 1
Direct position command 2 (ST2)		Movement command to the target position for position No. 2
Direct position command 3 (ST3)		Movement command to the target position for position No. 3
Direct position command 4 (ST4)		Movement command to the target position for position No. 4
Direct position command 5 (ST5)		Movement command to the target position for position No. 5
Direct position command 6 (ST6)		Movement command to the target position for position No. 6
Movement complete 0 (PE0)	Output	Indicates that the actuator reached the target position for position No. 0.
Movement complete 1 (PE1)		Indicates that the actuator reached the target position for position No. 1.
Movement complete 2 (PE2)		Indicates that the actuator reached the target position for position No. 2.
Movement complete 3 (PE3)		Indicates that the actuator reached the target position for position No. 3.
Movement complete 4 (PE4)		Indicates that the actuator reached the target position for position No. 4.
Movement complete 5 (PE5)		Indicates that the actuator reached the target position for position No. 5.
Movement complete 6 (PE6)		Indicates that the actuator reached the target position for position No. 6.

[2] Positioning mode [64-point type]

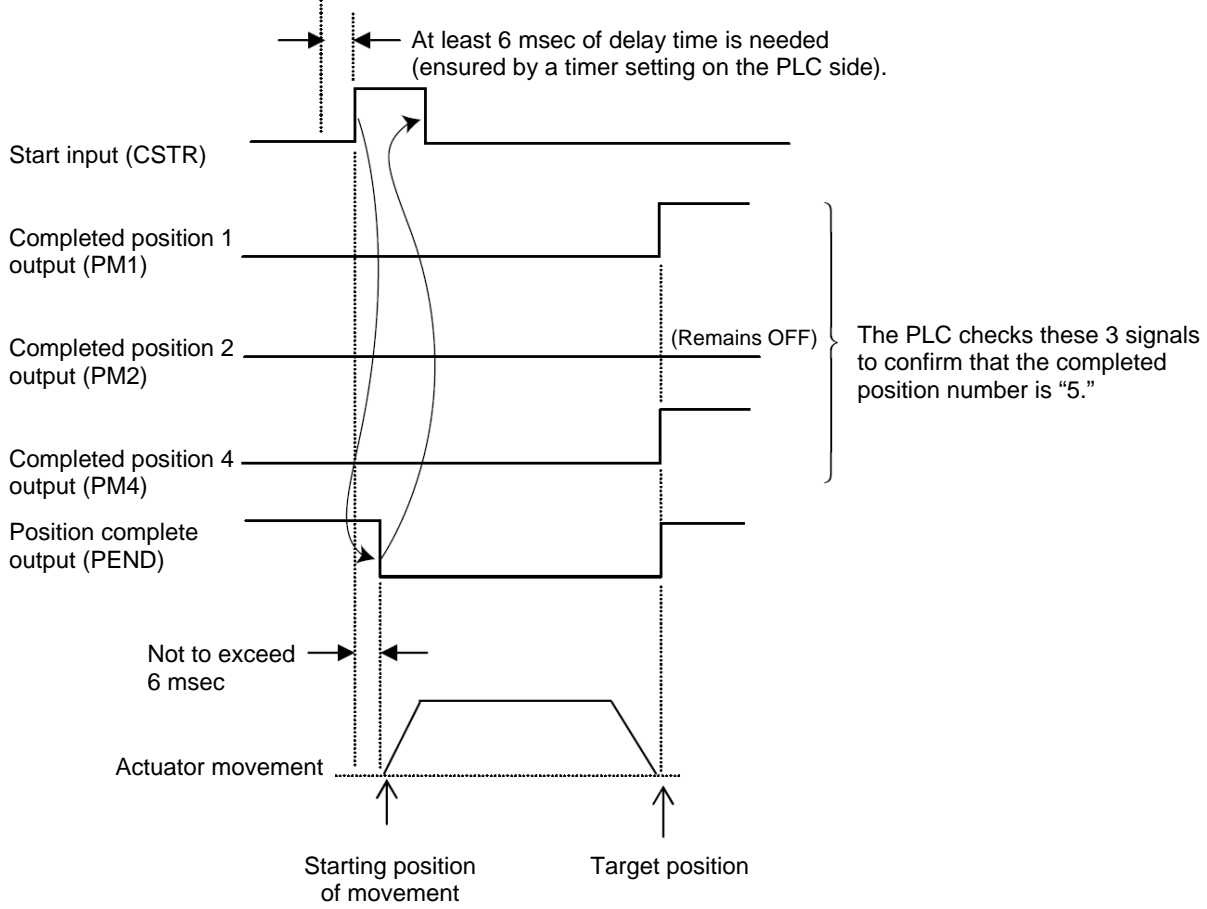
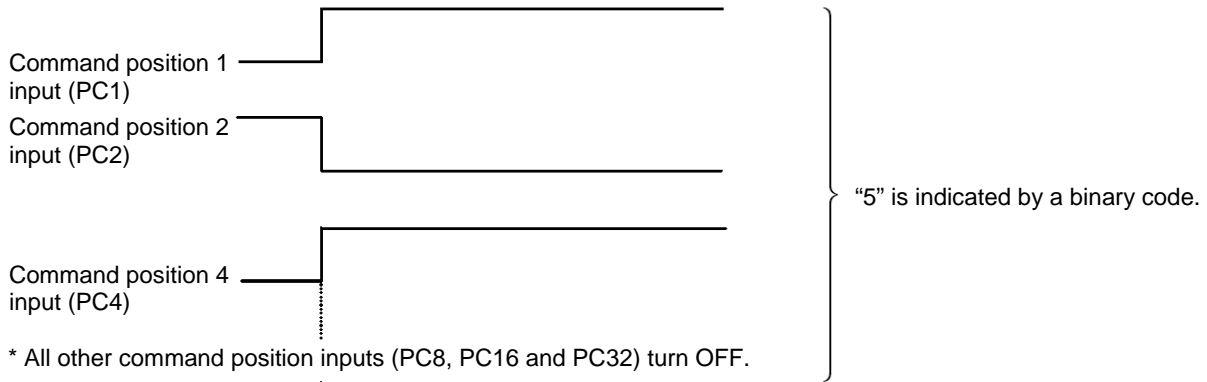

## 2.2.10 Overview of Solenoid Valve Mode 2 [3-point Type]

This type provides a control method adjusted to that of an air cylinder by assuming that the controller is used as an air cylinder.

The key differences between this controller and an air cylinder are summarized in the table below. Program appropriate controls by referring to this table.

Take note that incremental position commands are not supported in solenoid valve mode 2 [3-point type].

Item	Air cylinder	SCON								
Drive method	Air pressure supplied via electromagnetic valve control	Ball-screw or timing-belt drive using an AC servo motor, or linear-motor drive								
Target position setting	Mechanical stopper (including shock absorber)	<p>Desired coordinates are entered in the [Position] field of the position table. Coordinates can be entered from the PC/teaching pendant using the keyboard/keys, or the actuator can be moved to the desired position to read the achieved coordinates directly. Example) 400-mm stroke</p> <table border="1" style="margin-left: 20px;"> <thead> <tr> <th>Position No.</th> <th>Position</th> </tr> </thead> <tbody> <tr> <td>0</td> <td>5 (mm) Rear end</td> </tr> <tr> <td>1</td> <td>400 (mm) Front end</td> </tr> <tr> <td>2</td> <td>200 (mm) Intermediate point</td> </tr> </tbody> </table>	Position No.	Position	0	5 (mm) Rear end	1	400 (mm) Front end	2	200 (mm) Intermediate point
Position No.	Position									
0	5 (mm) Rear end									
1	400 (mm) Front end									
2	200 (mm) Intermediate point									
Target position detection	An external detection sensor, such as a reed switch, is installed.	Determined based on the internal coordinates provided by the position information from the position detector (encoder). Accordingly, external detection sensor is not required.								
Speed setting	Adjusted by a speed controller.	A desired feed speed is entered in the [Speed] field of the position table (unit: mm/sec). Note that the rated speed is automatically set as the initial value.								
Acceleration/ deceleration setting	Determined in accordance with the load, supplied air volume, as well as the performance of the speed controller and electromagnetic valve.	<p>Desired acceleration/deceleration are entered in the [Acceleration] and [Deceleration] fields of the position table (minimum setting unit: 0.01 G). Reference: 1 G = Gravitational acceleration Note that the rated acceleration/deceleration is automatically set as the initial value. Since the acceleration/deceleration can be set in fine steps, a gradual acceleration/deceleration curve can be programmed.</p> <div style="text-align: center;"> </div> <p>Setting a larger value makes the curve steeper, while setting a smaller value makes the curb more gradual.</p>								

Item	Air cylinder	SCON
Position check upon power ON	Determined by an external detection sensor, such as a reed switch.	<p>Immediately after the power is turned on, the controller cannot identify the current position because the mechanical coordinates have been lost. Accordingly, a rear end command must always be executed after the power is turned on, to establish the coordinates. The actuator will perform home-return operation first, and then move to the rear end.</p> <p>[1] The actuator moves at the home return speed toward the mechanical end on the motor side.            [2] The actuator contacts the mechanical end and turns back, and then stops temporarily at the home position.            [3] The actuator moves to the rear end at the speed set in the [Speed] field of the position table.            (Note) Pay attention not to allow any obstacle in the travel path of the actuator during home return.</p>

The relationship of each movement command input/position detected and corresponding position number is shown below.

The input/output signals are given easy-to-identify names by following the naming convention of air-cylinder switches.

However, the target position is determined by the value set in the [Position] field for each position number. Therefore, changing the magnitude relationships of settings under position Nos. 0, 1 and 2 will change the meanings of input/output signals.

For this reason, it is recommended that you always use the signals under their names defined in this manual, unless doing so presents problem, so that the signals have the same meanings at all time.

Input signal	Output signal	Target position
Rear end move (ST0)	Rear end detected (LS0)	Value set in the [Position] field for position No. 0 Example) 5 mm
Front end move (ST1)	Front end detected (LS1)	Value set in the [Position] field for position No. 1 Example) 390 mm
Intermediate point move (ST2)	Intermediate point detected (LS2)	Value set in the [Position] field for position No. 2 Example) 200 mm

● Positioning relationship on the ROBO Cylinder

An example of a slider type with a stroke of 400 mm is explained.

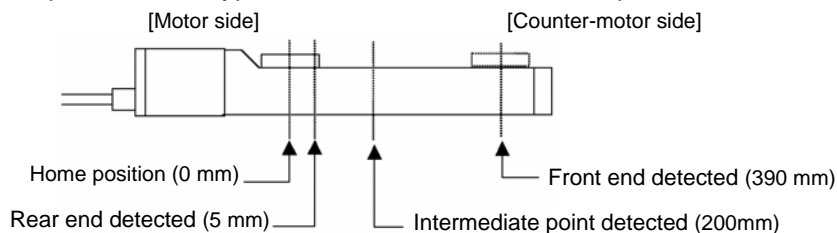

● Position table (Enter in the fields indicated in bold)

No.	Position [mm]	Speed [mm/s]	Acceleration [G]	Deceleration [G]	Push [%]	Positioning band [mm]
0	<b>5.00</b>	500.00	0.30	0.30	0	0.10
1	<b>390.00</b>	500.00	0.30	0.30	0	0.10
2	<b>200.00</b>	500.00	0.30	0.30	0	0.10

## 2.3 Power-saving Modes at Standby Positions

To save energy when the actuator stands by for a long period of time, this controller provides a mode in which to reduce the power consumption while the actuator is at standstill.

Use this mode after confirming that it will not present problems to any part of your system.

The actuator stands by after completing the home return operation effected by the HOME input signal

In this condition, you can select the power-saving mode using parameter No. 53 (Default standstill mode).  
(This setting is not affected by the value in the "Standstill mode" field of the position table.)

The actuator stands by after completing the positioning to the target position set in the "Position" field for the applicable position number

In this condition, you can select the power-saving mode based on the value in the "Standstill mode" field of the position table.

(This setting is not affected by the value of parameter No. 53.)

Meanings of values set in the "Standstill mode" field of the position table and in parameter No. 53

	Setting
All power-saving modes are disabled. (The actuator is completely stopped.)	0
Automatic servo-off mode. The delay time is defined by parameter No. 36.	1
Automatic servo-off mode. The delay time is defined by parameter No. 37.	2
Automatic servo-off mode. The delay time is defined by parameter No. 38.	3

### ■ Automatic servo-off mode

After positioning is completed, the servo will turn off automatically upon elapse of a specified time.

(Since no holding current flows, power consumption will decrease.)

When the next movement command is received from the PLC, the servo will turn on and the actuator will start moving.

\* Since the servo turns off once, some position deviation may occur. Do not use this function at standby positions where position deviation will cause problem.

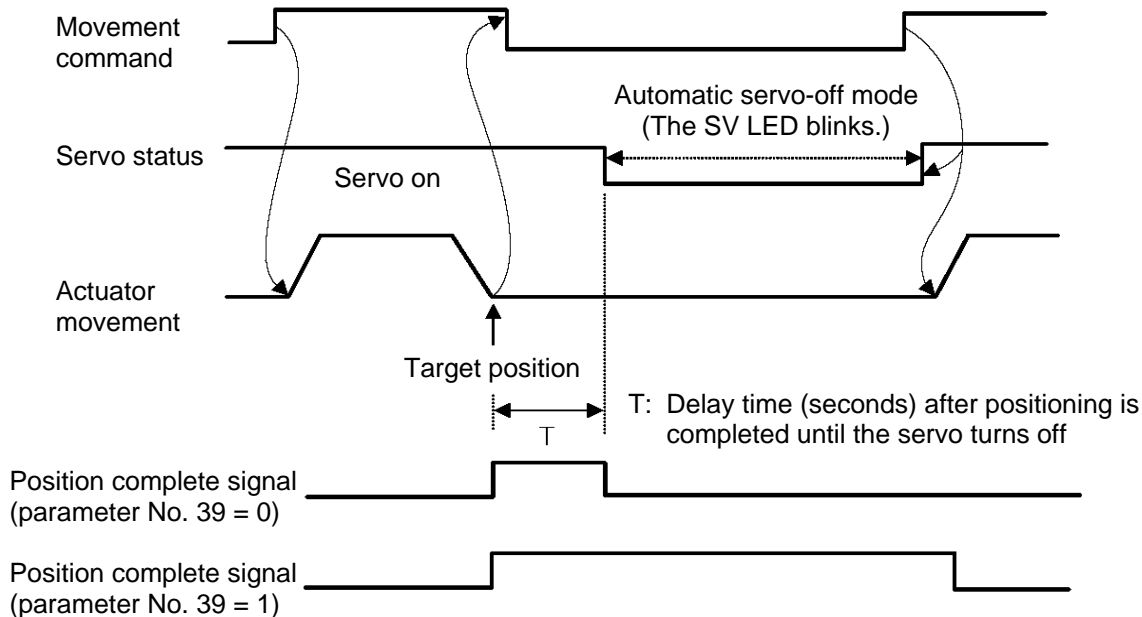

(Note) The automatic servo-off function is disabled in the MANU teaching mode.



When the PIO pattern is 0, 1, 2, 3 or 4, the servo will turn off and therefore the position complete signal (PEND), completed position number signals (PM1 to PM256) and movement complete signals at respective positions (PE0 to PE6) will turn OFF.

However, you can keep the complete signals ON using a parameter in situations where the PLC sequence circuit is designed in such a way that problems will occur if the complete signals turn OFF. (Position complete INP)

Setting of parameter No. 39 (Output mode of position complete signal)	<p>[1] PIO pattern = 0 to 3 Position complete (PEND) signal status, completed position number (PM1 to PM256) signal status</p> <p>[2] PIO pattern = 4 Position complete (PEND) signal status, movement complete (PE0 to PE6) signal status</p>
0 [PEND]	The signal will turn OFF unconditionally when the servo turns off. Even when the next movement command is issued and the servo turns on again, the actuator has already started moving to the next target position, so the signal still remains OFF.
1 [INP]	Even when the servo is off, the signal turns ON if the current position is within the range set by the "Positioning band" field of the position table, with respect to the target position, and turns OFF if the current position is outside this range.

(Note) The factory setting is "0 [PEND]."

**Warning:** If the next movement command is specified in the incremental mode (based on constant pitch feed), never use the automatic servo-off mode. The current position may deviate slightly as the servo turns off and then on again.

**Caution:** In push & hold operation, the automatic servo-off mode is disabled if push & hold operation has completed successfully. This mode is enabled if the actuator has missed the load. As a basic rule of thumb, do not use the automatic servo-off mode in push & hold operation.

## 3. Operation

### 3.1 How to Start

#### 3.1.1 Incremental Specification

##### ■ Procedure after initial startup until actuator adjustment

- [1] Connect the motor relay cable to the MOT connector and encoder relay connector to the PG connector.
- [2] Connect the supplied flat cable to the PIO connector (for connection between the host PLC and I/O unit).
- [3] Reset the emergency stop or enable the supply of motor drive power.
- [4] Supply the 24-VDC I/O power (1A/2A pins (+24 V) and 19B/20B pins (0 V) in the PIO connector).
- [5] If the actuator is equipped with a brake, turn on the 24-V power supply for the brake.
- [6] Supply the control power and motor power simultaneously (from the same power supply).
  - \* The controller has started properly if the monitor LED [PWR] on the front panel illuminates. If [ALM] illuminates in orange, an alarm has generated. In this case, connect a PC or teaching pendant to check the nature of the alarm and then remove the cause of the alarm by referring to Appendix 5, "Troubleshooting."
- [7] Set the minimum set of required parameters initially.

Set the mode selector switch on the front panel to the "MANU" side.  
On the PC or teaching pendant, set the MANU operation mode to "Teaching mode: Enable safety speed].  
Change the necessary parameters in this condition.  
(Example) • Use a PIO pattern other than "Standard type" → Parameter No. 25 (PIO pattern selection)  
• Reduce the safety jog speed → Parameter No. 35 (Safety speed)
- [7] Turn on the servo.

Turn on the servo using the "servo ON function" of the PC software or teaching pendant.  
If the actuator enters a servo lock mode and the monitor LED [SV] on the front panel illuminates in green, the controller is functioning properly.
- ★ If the ALM lamp illuminates, an error is present. Refer to the alarm list.
- [9] Check the operation of the safety circuit.

Confirm that the emergency stop circuit (or motor drive-power cutoff circuit) operates properly.
- [10] Perform home return.
  - Overview of operation on the teaching pendant
    - On the CON-T, select "\*\*EDIT," 4, "Teaching/Play Screen," and 1, "Jog Screen." Press the **HOME** key.
    - On the RCM-T, select the "Edit/Teach" screen, bring the cursor to "\*\*Home" in the sub display area, and then press the Return key.
    - On the RCM-E, select the "Teach/Play" screen, scroll until "\*\*Home Return" is displayed, and then press the Return key.

 **Caution:** When the teaching pendant is disconnected, an emergency stop is actuated momentarily. The emergency stop will be cancelled immediately thereafter, but the actuator and other equipment that are operating when the teaching pendant is disconnected will stop. Therefore, do not disconnect the teaching pendant when an actuator or any other equipment is operating. Also pay attention to the design of the emergency stop circuit that includes the emergency stop switch on the teaching pendant.

- [11] Set a target position in the "Position" field of the position table.  
 Set a target position in the "Position" field of each position table.  
 Determine a desired target position by fine-adjusting the load and hand via jogging or inching.  
 Also adjust the servo gain, if necessary.
- \* Once a target position has been set, other fields (speed, acceleration/deceleration, positioning band, etc.) will be automatically populated by their default values. Set optimal values for the speed, acceleration/deceleration, positioning band, etc.
  - \* For safety reasons, it is recommended that the safety speed be enabled during the initial movement. To move the actuator at the actual speed set in the "Speed" field of the position table, change the MANU operation mode to [Teaching mode: Disable safety speed].

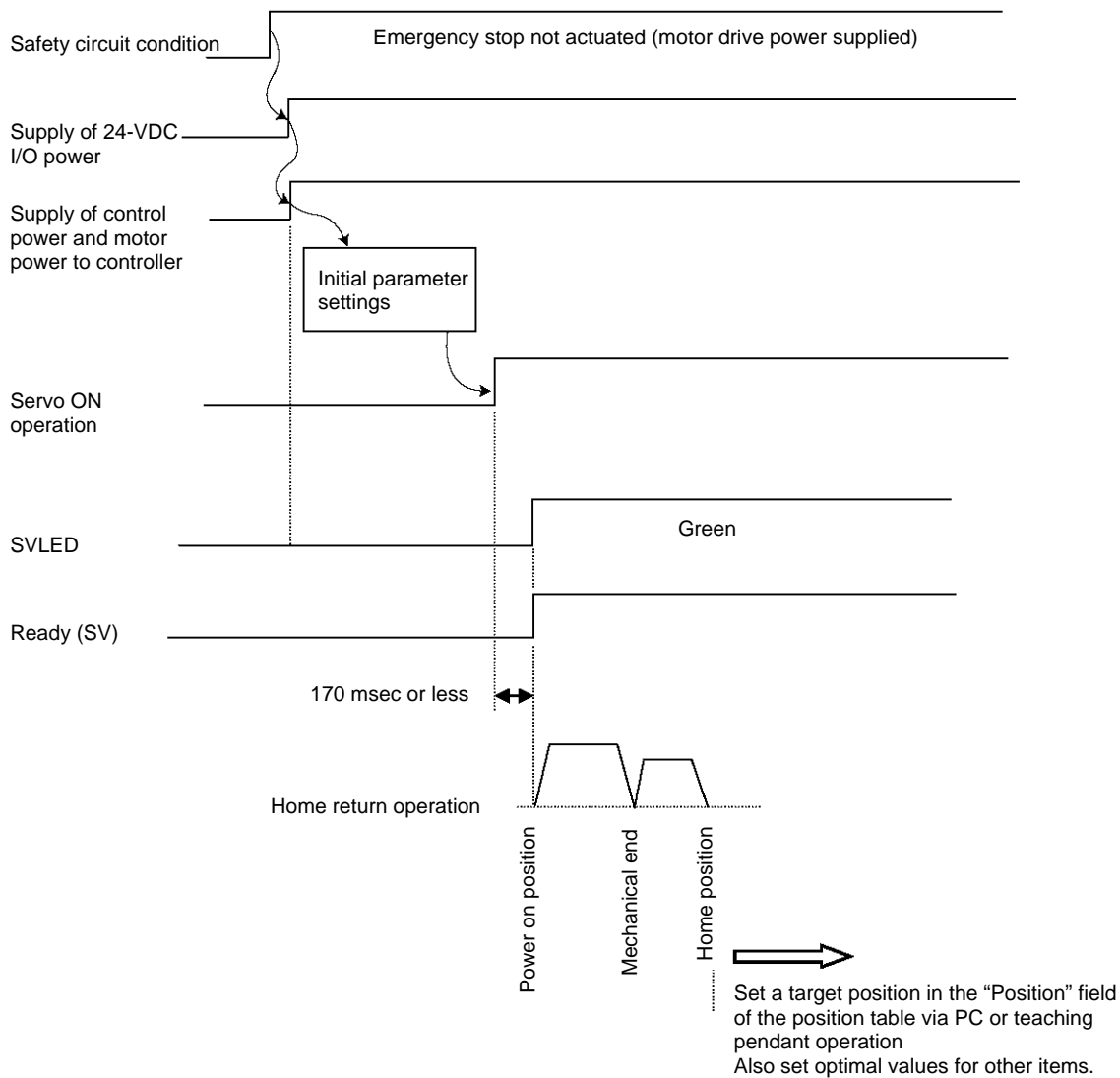

## 3.1.2 Absolute Specification (Absolute Reset)

- [1] On absolute reset from PC software or teaching pendant
- [1] Connect the motor cable and encoder cable to the controller.
- [2] Connect the host PLC to the PIO connector using the supplied flat cable.
- [3] If two or more controller axes are linked, set the address of each controller using the axis setting switches. For details, refer to Appendix 4, "PC/Teaching Pendant Connection Method in Multi-axis Configurations."
- [4] Connect the battery connector.
- [5] Supply 24 V for PIO from the flat cable.
- [6] If the actuator is equipped with a brake, turn on the 24-V power supply for the brake.
- [7] Supply the control power and motor power simultaneously (from the same power supply).
  - ★ The alarm output signal (\*ALM) turns OFF, an alarm code "0EE" or "0EF" generates, the PIO alarm output signals (PM8 to PM1) become "1101," and the ALM lamp illuminates. Also, the message "Absolute encoder (2)" appears on the PC/teaching pendant.
- [8] Connect a PC or teaching pendant to set the minimum parameters required.
  - Parameter No. 25, "PIO pattern selection"
  - If the air-cylinder type is selected, also set parameter No. 27, "Move command type."For details, refer to Appendix 3, "Parameter Settings."
- [9] Reset the alarm.
  - Operation using the teaching pendant
    - On the CON-T, pres the **ERROR RESET** key.
    - If you are using the RCM-T or RCM-E, press the BEGIN/END key.
  - Operation using the PC software
    - Select position data in the main screen, and then click the **Alarm** button.
    - ★ The message "Absolute encoder error (2)" disappears.
      - The alarm output signal (\*ALM) turns ON, while the alarm code output signals (PM8 to PM1) turn OFF.
      - (Note) The "0EE" and "0EF" alarms cannot be reset via PIO.
- [10] Turn the servo ON.

Use the "Servo ON function" of the PC software or teaching pendant to turn the servo ON. If the servo has been turned ON successfully, the actuator should enter a servo lock mode and the SV LED on the front face of the controller should illuminate in green.

  - ★ If the ALM lamp illuminates, an error is present. Refer to the alarm list.
- [11] Perform home return.
  - Overview of operation using the teaching pendant
    - On the CON-T, select "\*\*EDIT," 4, "Teaching/Play Screen," and 1, "Jog Screen." Press the **HOME** key.
    - If you are using the RCM-T, select the "Edit/Teach" screen, bring the cursor to "\*\*Home" in the sub display area, and then press the Return key.
    - If you are using the RCM-E, select the "Teach/Play" screen, scroll until "\*\*Home Return" is displayed, and then press the Return key.

- Overview of operation using the PC software  
Select position data in the main screen, and then click the **Home** button.

For details, refer to the operation manual for your teaching pendant or the PC software.

- Using a PLC command  
Refer to Chapter 2, 1.1.2, "Signal Assignment Table for Respective PIO Patterns" to perform the necessary signal processing corresponding to the PIO pattern currently selected.

Issue a command after confirming that the position complete signal (PEND) is ON.

If home return cannot be executed, check if the STP and SON signals are ON, if the safety circuit has been reset, and if any error message is displayed, among others.

Once the home return is completed, the home position will be established and stored as position data. This position data will be retained by a battery even after the power is cut off, so home return will not be needed after the power is reconnected.

- [12] Set desired data for the target position, speed, acceleration/deceleration, positioning band, etc., in the position table.  
For the method to set these data, refer to the operation manual for the teaching pendant or PC software.

The controller is now ready to perform automatic operation with the PLC.

 **Caution:** When the teaching pendant is disconnected, an emergency stop is actuated momentarily. The emergency stop will be cancelled immediately thereafter, but the actuator and other equipment that are operating when the teaching pendant is disconnected will stop. Therefore, do not disconnect the teaching pendant when an actuator or any other equipment is operating.

## Startup Timing Chart

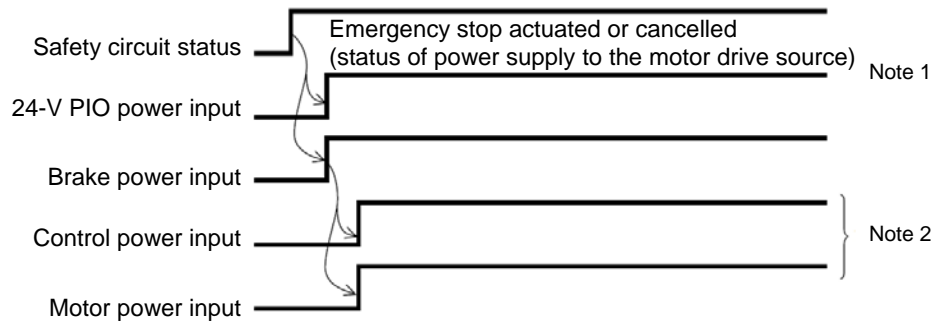

### Alarm reset

- CON-T: Press the ERROR RESET key.
- RCM-T/E: Press the BEGIN/END key.
- PC software: Click the **Alarm** button.

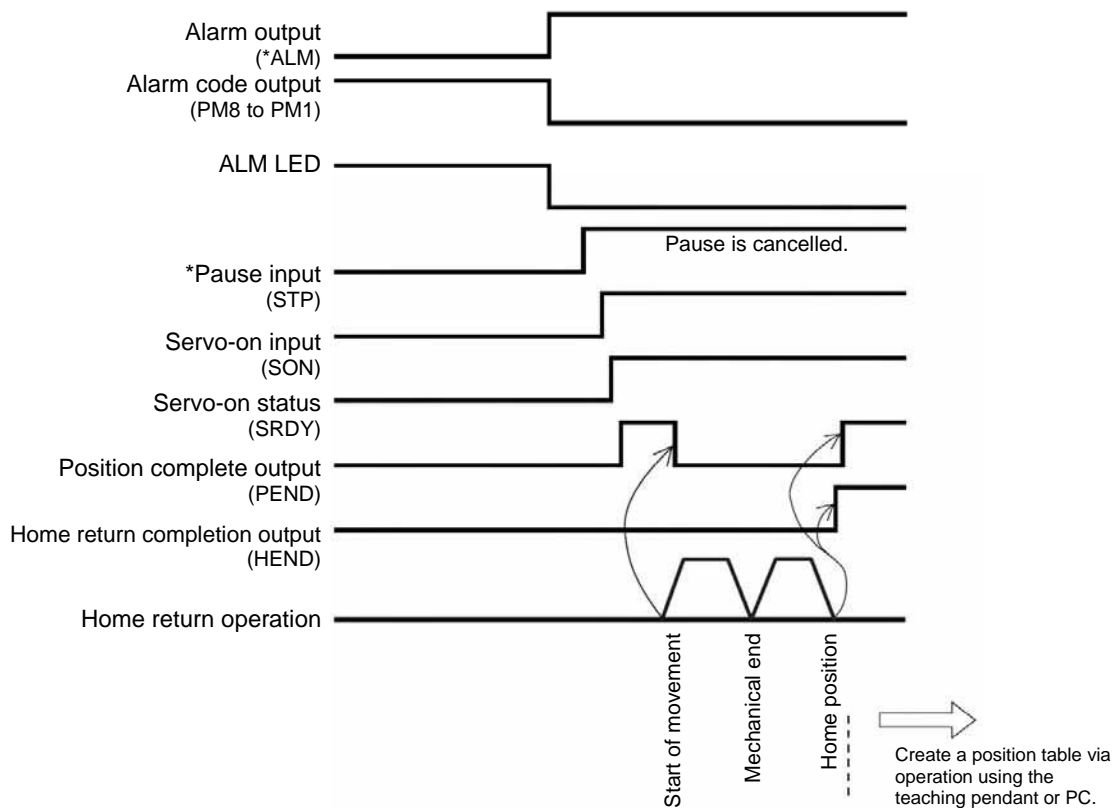

Note 1) Always input the 24-V PIO power (and the 24-V brake power if the actuator is equipped with a brake) before the control power and motor power.

Note 2) Supply the control power and motor power simultaneously from the same power supply.

[2] On absolute reset from PIO (supported from version V001E)

It is possible to use PIO to perform absolute reset.

Execute the following steps [1] to [3] in order to perform absolute reset.

[1] Shift the controller to a status where absolute reset is possible.

[1] Check that the SV signal is OFF.

[2] Turn the SON signal OFF for 100 ms or longer.

(Turn the SV and SON signals OFF and continue this status for 100 ms or longer.)

[3] Turn the HOME signal (STO signal in case of PIO pattern 5) from OFF to ON (ON edge).

[2] Cancel errors related to absolute.

[1] In the status of [1], turn the RES signal from OFF to ON (ON edge).

[2] Check that the \*ALM signal is turned ON (controller's alarm \* is cancelled).

\* If the cause of an error is not removed, an alarm will be present again (XALM signal OFF).

[3] Turn the HOME (STO signal in case of PIO pattern 5) and RES signals OFF.

[3] Perform absolute reset.

[1] Turn the SON signal ON.

[2] Wait until the SV signal turns ON.

[3] Turn the HOME signal (STO signal in case of PIO pattern 5) ON (ON edge). The home return operation is started.

[4] When the HEND signal is turned ON (completion of home return), absolute reset is completed.

The following diagram shows the timing chart of absolute reset from PIO.

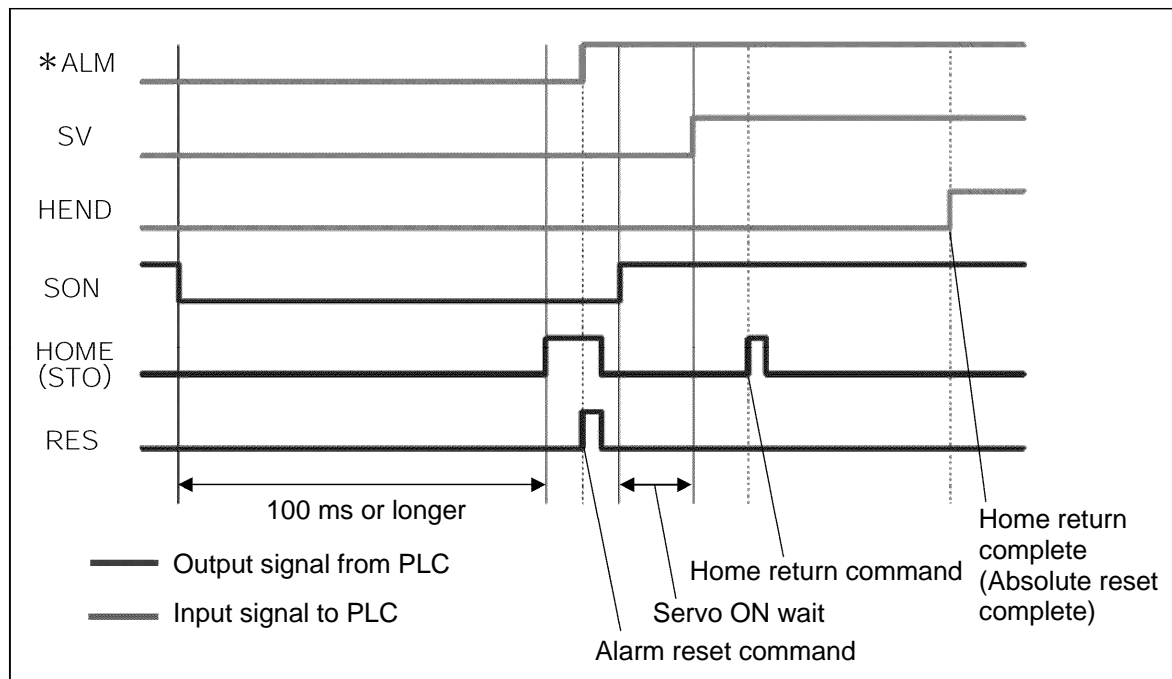

### 3.1.3 Normal Operation Procedure

Normally, the operation procedure follows the steps below:

- [1] Cancel the emergency stop or enable the motor drive power supply.
- [2] Supply the 24-VDC I/O power.
- [3] If the actuator is equipped with a brake, turn on the 24-V power supply for the brake.
- [4] Supply the control power and motor power to the controller.
  - \* The controller has started properly if the monitor LED [PWR] on the front panel illuminates.  
If [ALM] illuminates in red, an alarm has generated.  
In this case, connect a PC or teaching pendant to check the nature of the alarm and then remove the cause of the alarm by referring to Appendix 5, "Troubleshooting."
- [5] Set the mode selector switch on the front panel of the controller to the "AUTO" side.
- [6] Input the servo-on signal and pause signal from the PLC.
- [7] If the controller is of incremental specification, input the home return signal from the PLC to perform home return operation.
- [8] Start automatic operation.

 Caution: When operating the controller using I/O signals exchanged with the PLC, be sure to set the mode selector switch on the front panel to the "AUTO" side.



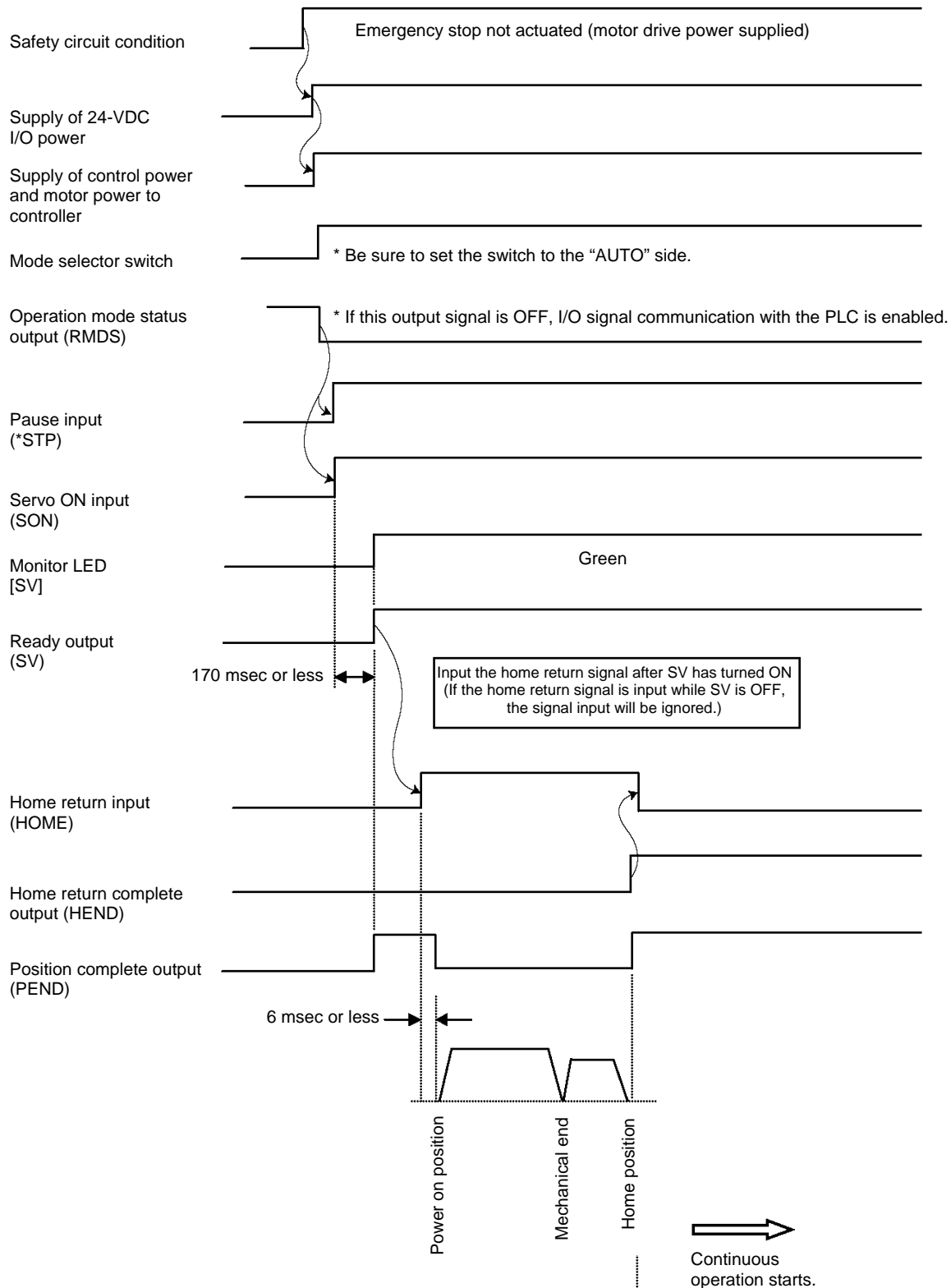

## 3.1.4 Position Table and Parameter Settings Required for Operation

### ■ Startup adjustment

Immediately after the system has been started, the moving speed can be reduced by the methods specified below to ensure safety of operators and prevent damage to jigs, etc.

Change the applicable parameters, if necessary.

→ For details on the setting-change operations, refer to the operation manual for your PC software/teaching pendant.

#### Safety speed during manual feed

To move the actuator using the PC/teaching pendant, set the mode selector switch on the front panel of the controller to the "MANU" side.

For safety reasons, it is recommended that the actuator be moved at the safety speed during manual feed. To do this, change the MANU operation mode to [Teaching mode: Enable safety speed] on the PC/teaching pendant.

The safety speed is defined by parameter No. 35. Change the parameter value, if necessary.

Take note that the maximum speed is limited to 250 mm/s or below.

The factory setting is "100 mm/s" or below.

#### Speed override for movement commands from the PLC

You can lower the feed speed to be applied when the actuator is moved by the movement commands output from the PLC.

To lower the speed to below the level set in the "Speed" field of the position table, you can use parameter No. 46 to override the "Speed" field.

Actual moving speed = [Speed set in the position table] x [Value of parameter No. 46] ÷ 100

Example) Value in the "Speed" field of the position table 500 (mm/s)

Value of parameter No. 46 20 (%)

Under the above settings, the actual moving speed becomes 100 mm/s.

The minimum setting unit is "1%," while the input range is "1 to 100 %." The factory setting is "100 %."

## ■ Full-scale operation

This product provides energy-saving modes to reduce power consumption in situations where the actuator remains standstill for a long period at a standby position.

You can also select the status of position complete signal to be applied if the servo turns off or “position deviation” occurs while the actuator is standing still after completing positioning.

Use these functions after confirming that they will not present problems to any part of your system.

Saving energy when the actuator stands by after completing the home return operation effected by the HOME input signal

Applicable to PIO pattern = 0 to 4

In this condition, you can select the automatic servo-off mode using parameter No. 53 (Default standstill mode). (This setting is not affected by the value in the “Standstill mode” field of the position table.)

Saving energy when the actuator stands by for a long time at the target position

Common to all PIO patterns

In this condition, you can select the automatic servo-off mode based on the value in the “Standstill mode” field of the position table.

(This setting is not affected by the value of parameter No. 53.)

→ For details, refer to 2.3, “Power-saving Modes at Standby Positions” and Appendix 3.2.2, “Parameters Relating to Actuator Operating Characteristics.”

Output mode of complete signal

Applicable to PIO pattern = 0 to 4

You can select the status of position complete signal to be applied if the servo turns off or “position deviation” occurs while the actuator is standing still after completing positioning.

This setting uses parameter No. 39. Consider the characteristics of the control you need and select an appropriate mode.

→ For details, refer to Appendix 3.2.3, “Parameters Relating to the External Interface.”

(Note) If the home is not yet established immediately after the power has been turned on, directly inputting the command position signal and start signal without inputting the home return signal (HOME) first will cause the actuator to perform home return operation and then move to the target position. However, it is recommended that the PLC sequence circuit use the home return signal (HOME) to prevent errors.

[1] PIO pattern = 0 to 3

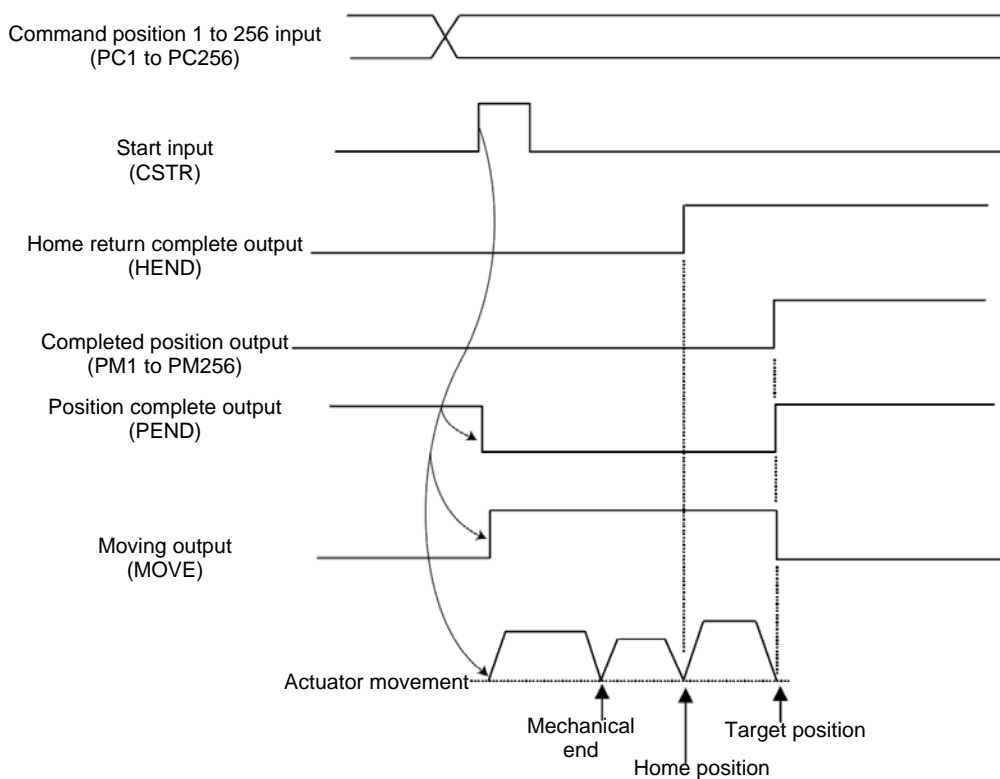

[2] PIO pattern = 4

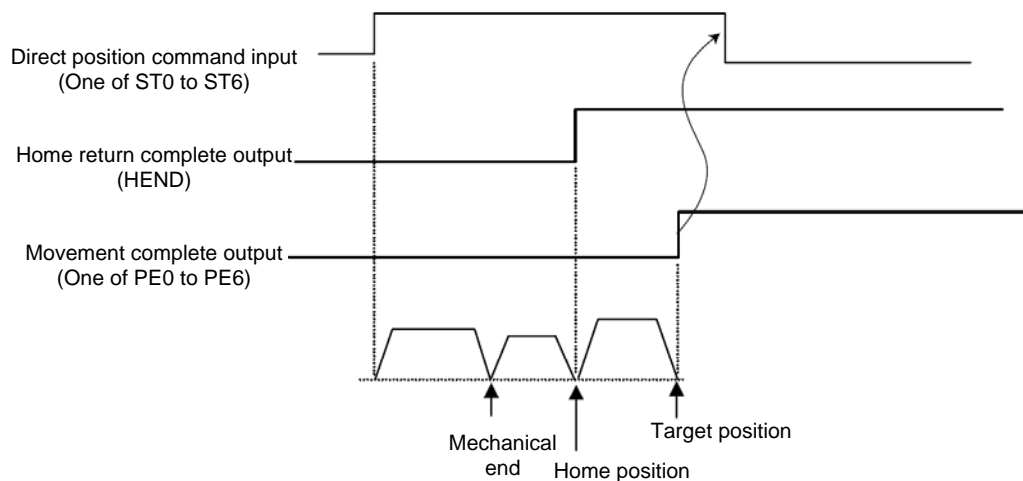

## 3.2 How Return Operation

### 3.2.1 Method Using the HOME Input Signal (PIO Pattern = 0 to 4)

Since the home return signal (HOME) is provided in PIO patterns 0 to 4, perform home return using this signal.

- When the home return signal (HOME) turns ON, the actuator starts moving toward the mechanical end on the home side. Once the mechanical end is contacted, the actuator reverses its direction and moves, and then stops at the home position.
- At the start of movement, the position complete output (PEND) turns OFF while the moving output (MOVE) turns ON.
- When the actuator stops at the home position, the position complete output (PEND) and home return complete output (HEND) turn ON. On the other hand, the moving output (MOVE) turns OFF.
- On the PLC side, turn OFF the home return signal (HOME) after the home return complete output (HEND) has turned ON.

With an absolute type controller, home return operation is not a requirement because the home return completion output (HEND) will turn ON after the power is input to the controller.

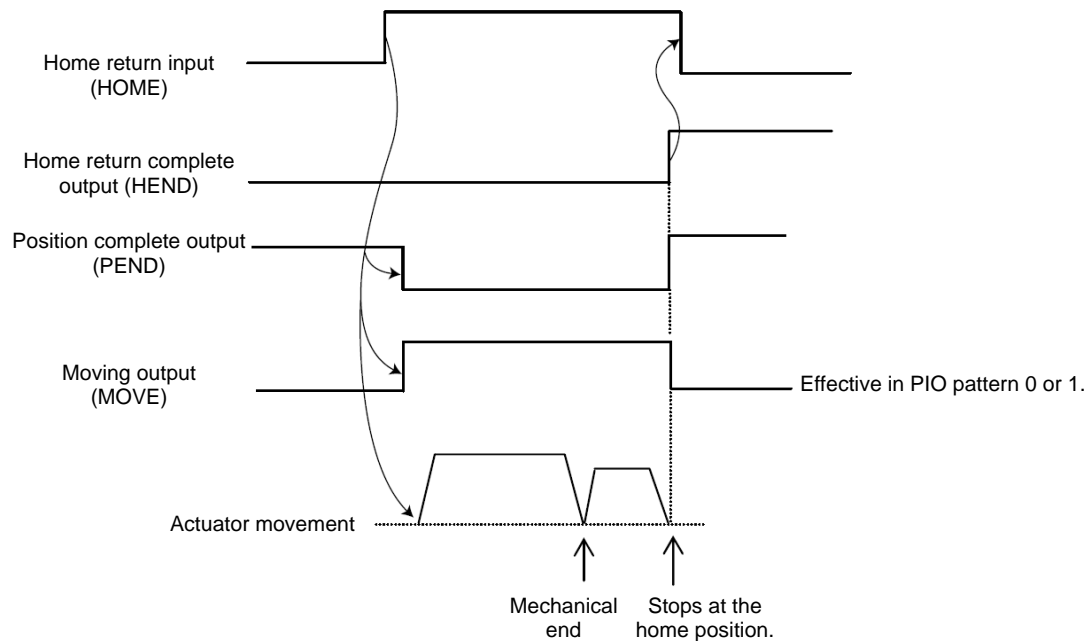

- ⚠ Caution:** When performing home return, pay attention to the following:
- [1] Confirm that no obstacle is present in the home return direction.
  - [2] If any obstacle is present in the home return direction, review the PLC sequence circuit and change the circuit so that home return will be executed only when there is no obstacle.

## 3.2.2 Method Used When No HOME Input Signal Is Available (PIO Pattern = 5)

Since no home return signal (HOME) is available in PIO pattern 5, input the rear end move command (ST0) first to perform home return.

- When the rear end movement command (ST0) turns ON, the actuator starts moving toward the mechanical end on the home side. Once the mechanical end is contacted, the actuator reverses its direction and moves to the home position, stops temporarily at the home position, and then moves to the rear end.
- Once the home position is reached, the home return complete output (HEND) turns ON. With an absolute type controller, home return operation is not a requirement because the home return completion output (HEND) will turn ON after the power is input to the controller.

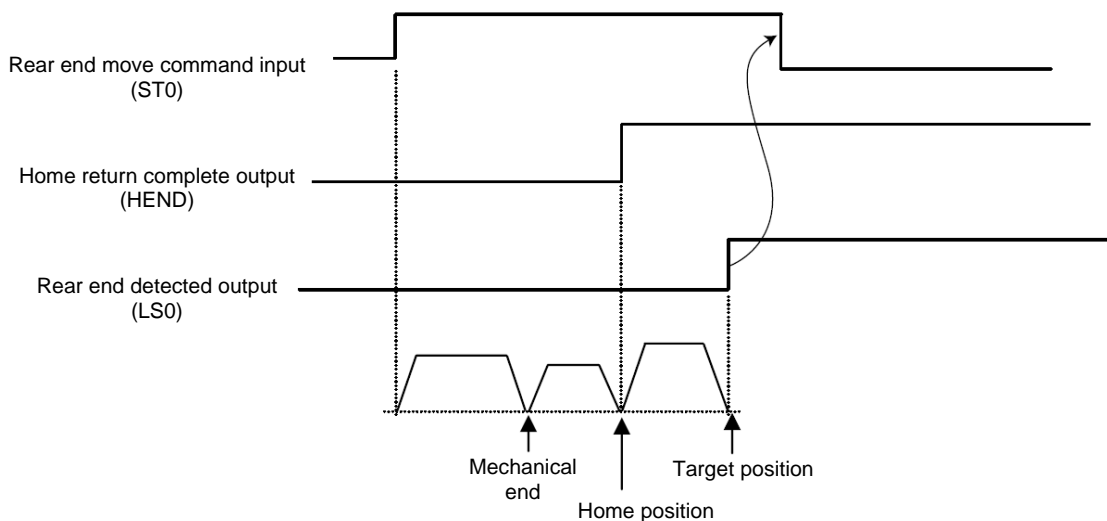

- ⚠ Caution:** When performing home return, pay attention to the following:
- [1] Confirm that no obstacle is present in the rear end direction.
  - [2] If any obstacle is present in the rear end direction, move the actuator toward the front end and remove the obstacle. Issuance of the front end move command is permitted for this reason. In this case, the actuator moves forward at the home return speed and when the actuator reaches the mechanical end, the front end position complete output (LS1) turns ON.
  - [3] Do not input the intermediate point move command (even if the command is input, it will be ignored).

### 3.3 Positioning Mode (Back and Forth Movement between Two Points)

Example of use in operation) The actuator moves back and forth between two positions. The position 250 mm from the home is set as position 1, and the position 100 mm from the home is set as position 2. The travel speed to position 1 is set as 200 mm/sec, and to position 2 is set as 100 mm/sec.

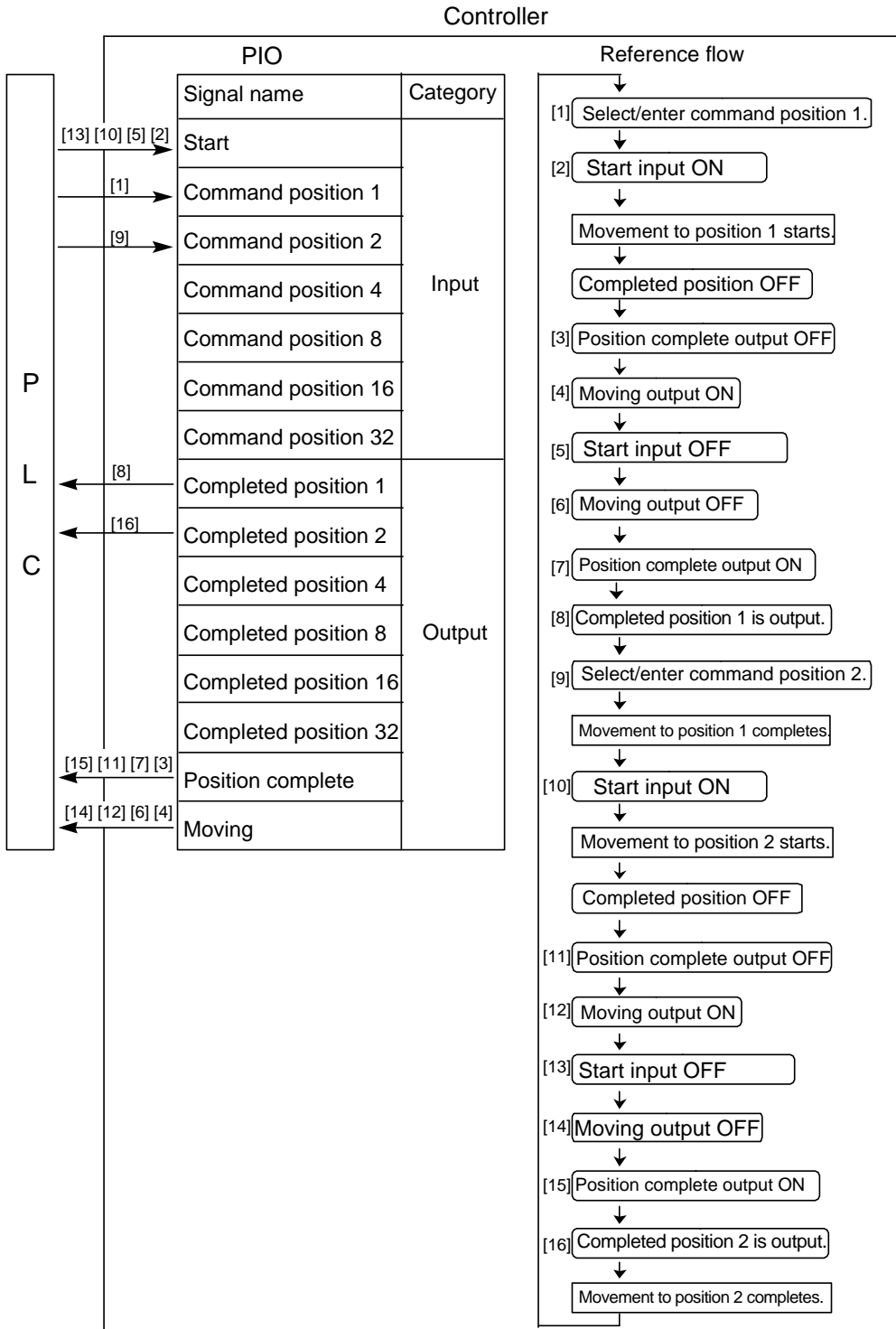

Position table (Field(s) within thick line must be entered.)

No.	Position [mm]	Speed [mm/s]	Acceleration [G]	Deceleration [G]	Push [%]	Positioning band [mm]
0	*	*	*	*	*	*
1	250.00	200.00	0.30	0.30	0	0.10
2	100.00	100.00	0.30	0.30	0	0.10
:						

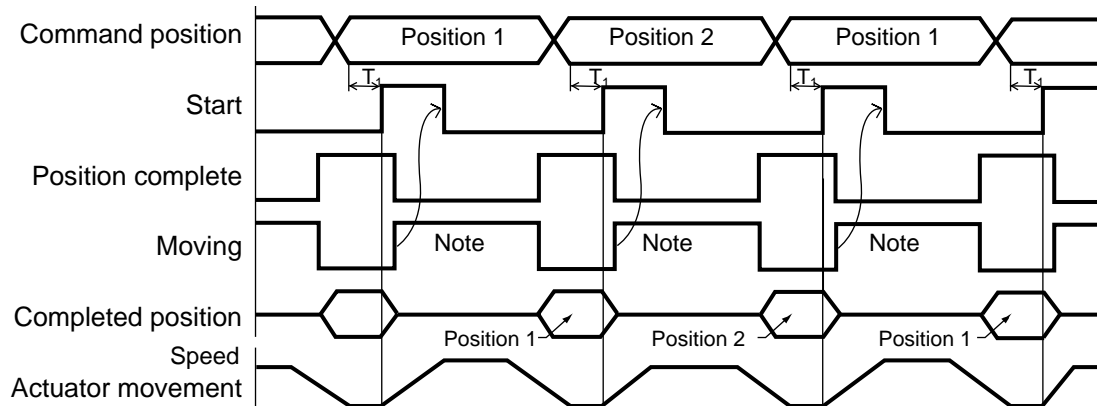

T1: 6 msec or more; time after selecting/entering a command position until the start input turns ON (The scan time of the host controller must be considered.)

Each command position must be input after the position complete output has turned ON for the movement to the previous position.

- Caution:
- When the start signal turns ON, the position complete output will turn OFF and the moving output will turn ON.
  - Always turn OFF the start signal after confirming that the start signal is currently ON and the position complete output has turned OFF.
  - If the start input remains ON as shown below, the position complete output will not turn ON even when the actuator movement is completed.

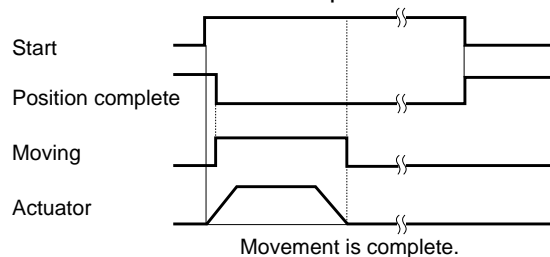

- If a move command specifying the same position is issued, the position complete output will turn OFF but the moving output will not turn ON.
- The moving output will turn OFF at the same time the position complete output turns ON, even when the actuator is moving. Therefore, although increasing the positioning band in the position data will cause the moving output to turn OFF the moment the position complete output turns ON, the actuator may still be moving when this happens.
- When the actuator reaches a soft limit after a series of incremental moves, the actuator will stop at the soft limit position and the position complete signal will be output.



## 3.4 Push & Hold Mode

Example of use in operation) The actuator is caused to move back and forth in the push & hold mode and positioning mode. The position 280 mm from the home is set as position 1, and the position 40 mm from the home is set as position 2.

Movement to position 1 is performed in the push & hold mode (the actuator is caused to contact the load and push it in the counter-motor direction). The maximum push amount at position 1 is set as 15 mm, and the current-limiting value during the push & hold operation by the stepper motor is set as 50%. Movement to position 2 is performed in the positioning mode. The travel speed to position 1 is set as 200 mm/sec, and that to position 2 is set as 100 mm/sec.

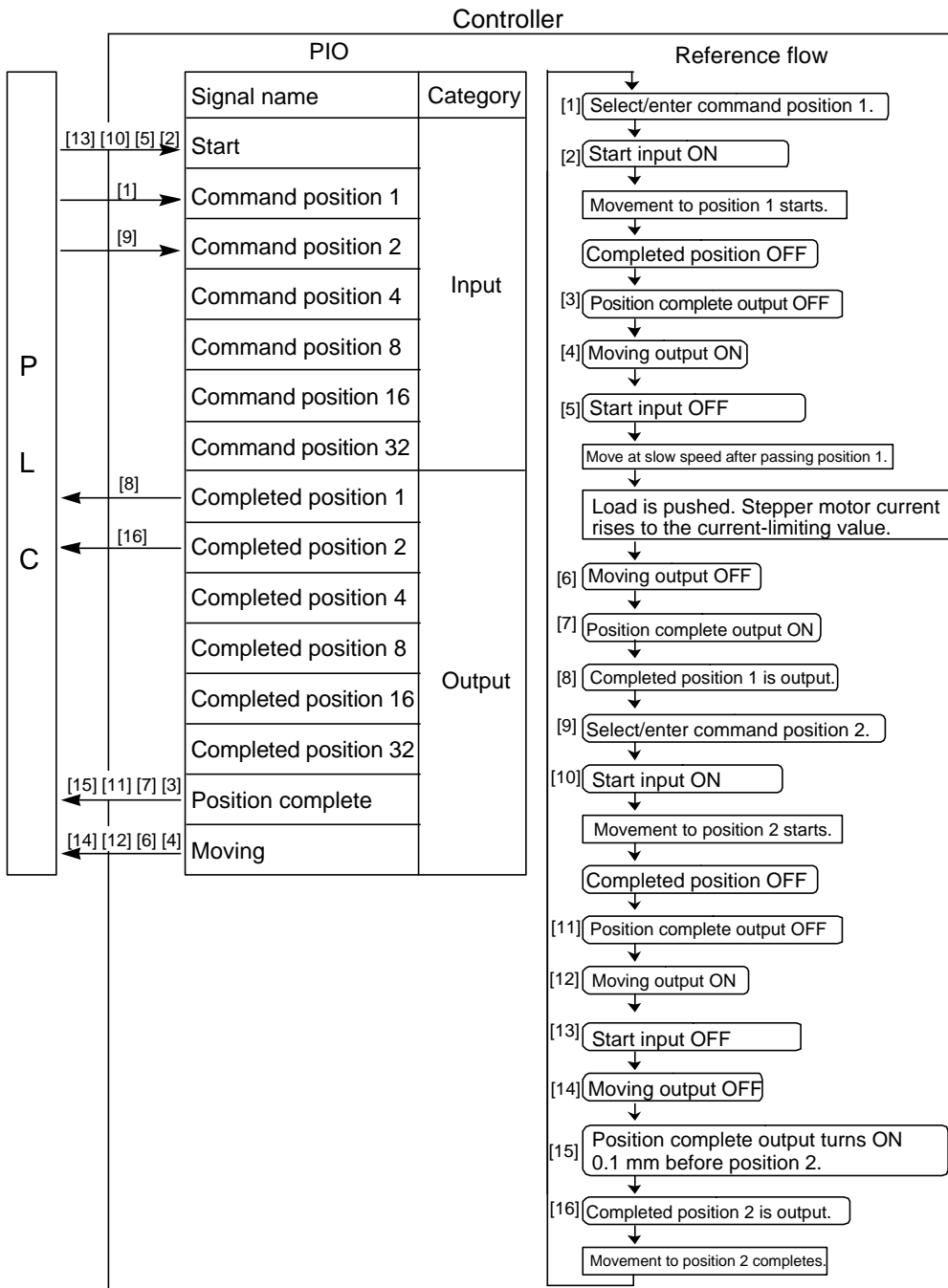

Position table (Field(s) within thick line must be entered.)

No.	Position [mm]	Speed [mm/s]	Acceleration [G]	Deceleration [G]	Push [%]	Positioning band [mm]
0	*	*	*	*	*	*
1	280.00	200.00	0.30	0.30	50	15.00
2	40.00	100.00	0.30	0.30	<b>0</b>	0.10
:						

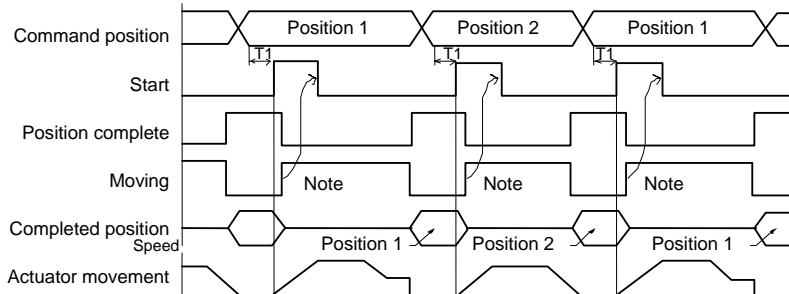

T1: 6 msec or more; time after selecting/entering a command position until the start input turns ON  
(The scan time of the host controller must be considered.)

Each command position must be input after the position complete output has turned ON for the movement to the previous position.

● Conditions for determining completion of push & hold operation

Push & hold operation is deemed to have completed upon elapse of the time set by parameter No. 6 (Push completion judgment time) after the motor current reached the current-limiting value set in the "Push" field of the position table.

Set an appropriate value by considering the material and shape of the load, and so on.

The minimum setting unit is "1 msec," while the maximum value is "9999 msec." The factory setting is "255 msec."

(Note) The chart below explains how completion of push & hold operation is determined if the load shifted during the judgment and the current has changed as a result, based on a judgment time of 255 msec.

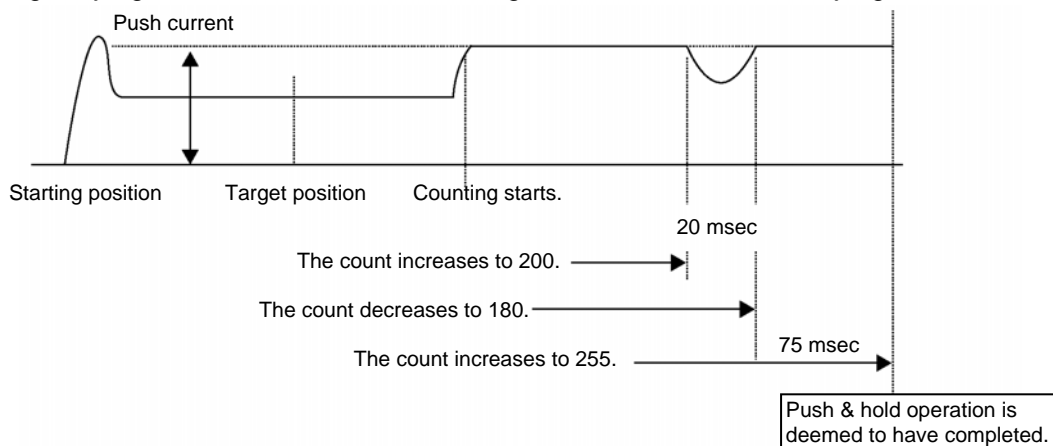

If the motor current remains at or above the push current for 200 msec and then drops below this level for 20 msec, the count will decrease by 20. When the push current is reached again thereafter, counting will start from 180. If the motor current remains at or above the push current for 75 msec, the count will increase to 255 and thus push & hold operation will be deemed to have completed.

In total, 295 msec was required for the judgment.

## 3.4.1 Return Action after Push & Hold by Relative Coordinate Specification

- Positioning mode

The reference position is the target position for the position number used in the applicable push & hold operation. In the aforementioned example, the actuator moves to the 240-mm position if position No. 2 is set to -40 mm in the incremental mode ( $280 - 40 = 240$  mm).

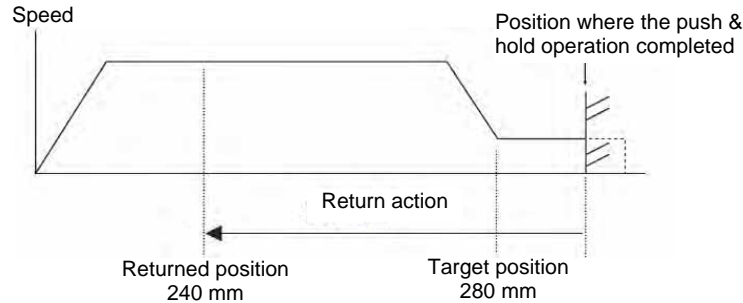

- Push & hold mode

The reference position is the position where the push & hold operation completed.

In the aforementioned example, the actuator moves to the 250.34-mm position if position No. 2 is set to -40 mm in the incremental mode and the push & hold operation completed at 290.34 mm ( $290.34 - 40 = 250.34$  mm).

(Note) In this case, the controller determines that the actuator has missed the load and thus does not turn ON the position complete signal.

It is therefore recommended that the zone output signal be used to determine completion of push & hold operation on the PLC side.

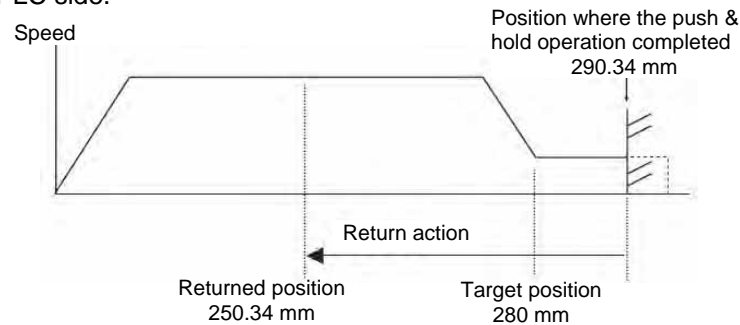

**Caution:** When the start signal turns ON, the position complete output will turn OFF and the moving output will turn ON.

Always turn OFF the start signal after confirming that the start signal is currently ON and the position complete output has turned OFF.

If the actuator has missed the load, the position complete output will not turn ON as shown below. The completed position will be output and the moving output will turn OFF.

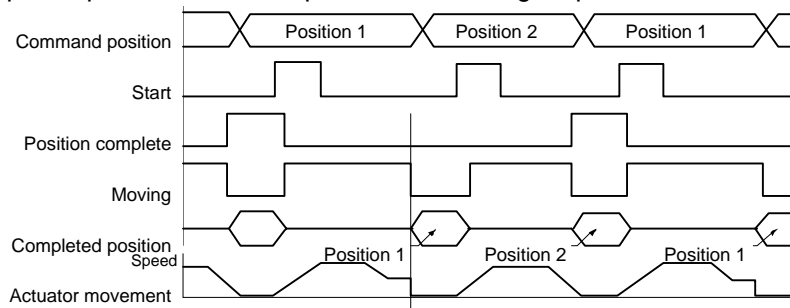

If the actuator has missed the load, the position complete output will not turn ON.

## 3.5 Speed Change during Movement

Example of use in operation) The actuator speed is reduced at a certain point during movement. The position 150 mm from the home is set as position 1, and the position 200 mm from the home is set as position 2. The actuator is initially located between the home and position 1. The actuator is moved to position 2 being the target position, at a travel speed of 200 mm/sec to position 1 and that of 100 mm/sec from position 1 to position 2.

Method) In this example, the actuator is caused to move to position 1 and to position 2 successively. Before the actuator is stopped at position 1, command position 2 must be selected/entered and the start signal must be input. To do this, set a wide positioning band at position 1 and cause the start signal for movement to position 2 to be input immediately after the completion signal for movement to position 1 is output. (Command position 2 should be entered while the actuator is moving to position 1.)

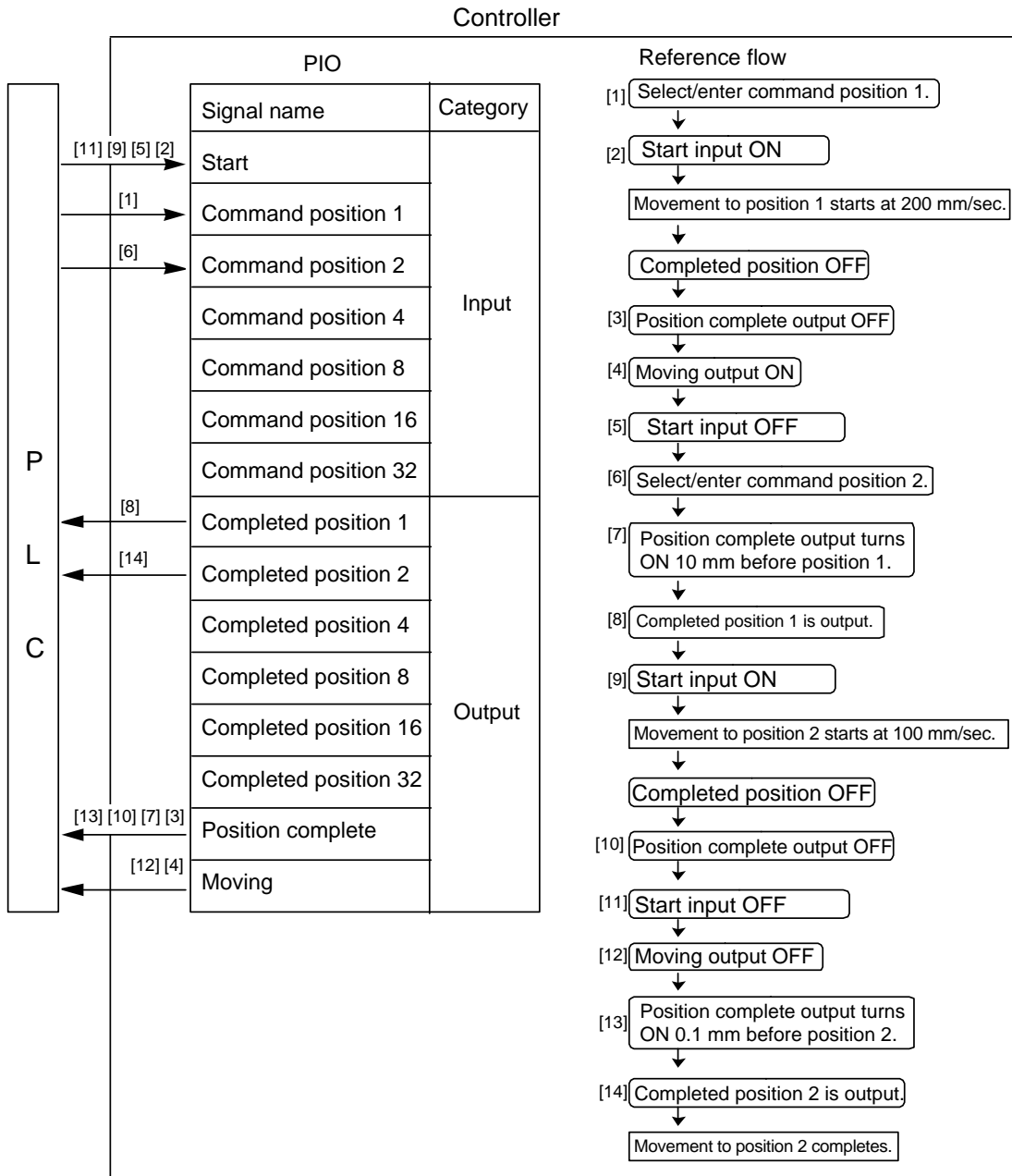

Position table (Field(s) within thick line must be entered.)

No.	Position [mm]	Speed [mm/s]	Acceleration [G]	Deceleration [G]	Push [%]	Positioning band [mm]
0	*	*	*	*	*	*
1	150.00	200.00	0.30	0.30	0	10.00
2	200.00	100.00	0.30	0.30	0	0.10
:						

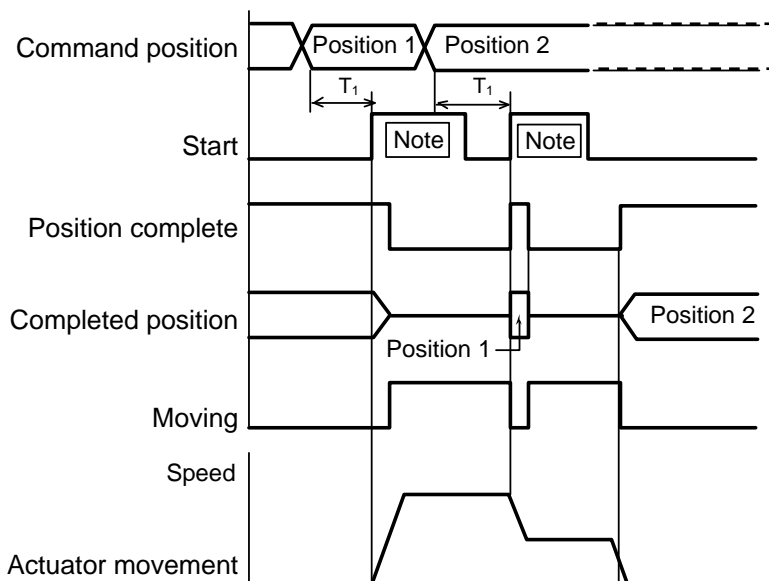

T1: 6 msec or more; time after selecting/entering a command position until the start input turns ON (The scan time of the host controller must be considered.)

Caution: When the start signal turns ON, the position complete output will turn OFF and the moving output will turn ON.  
Always turn OFF the start signal after confirming that the start signal is currently ON and the position complete output has turned OFF.

## 3.6 Operation at Different Acceleration and Deceleration Settings

Example of use in operation) Positioning is performed to the position 150 mm from the home (position 1) at a speed of 200 mm/sec.

The acceleration is 0.3 G and the deceleration is 0.1 G.

Method) Set 0.3 [G] in the "Acceleration" field and 0.1 [G] in the "Deceleration" field of the position table.

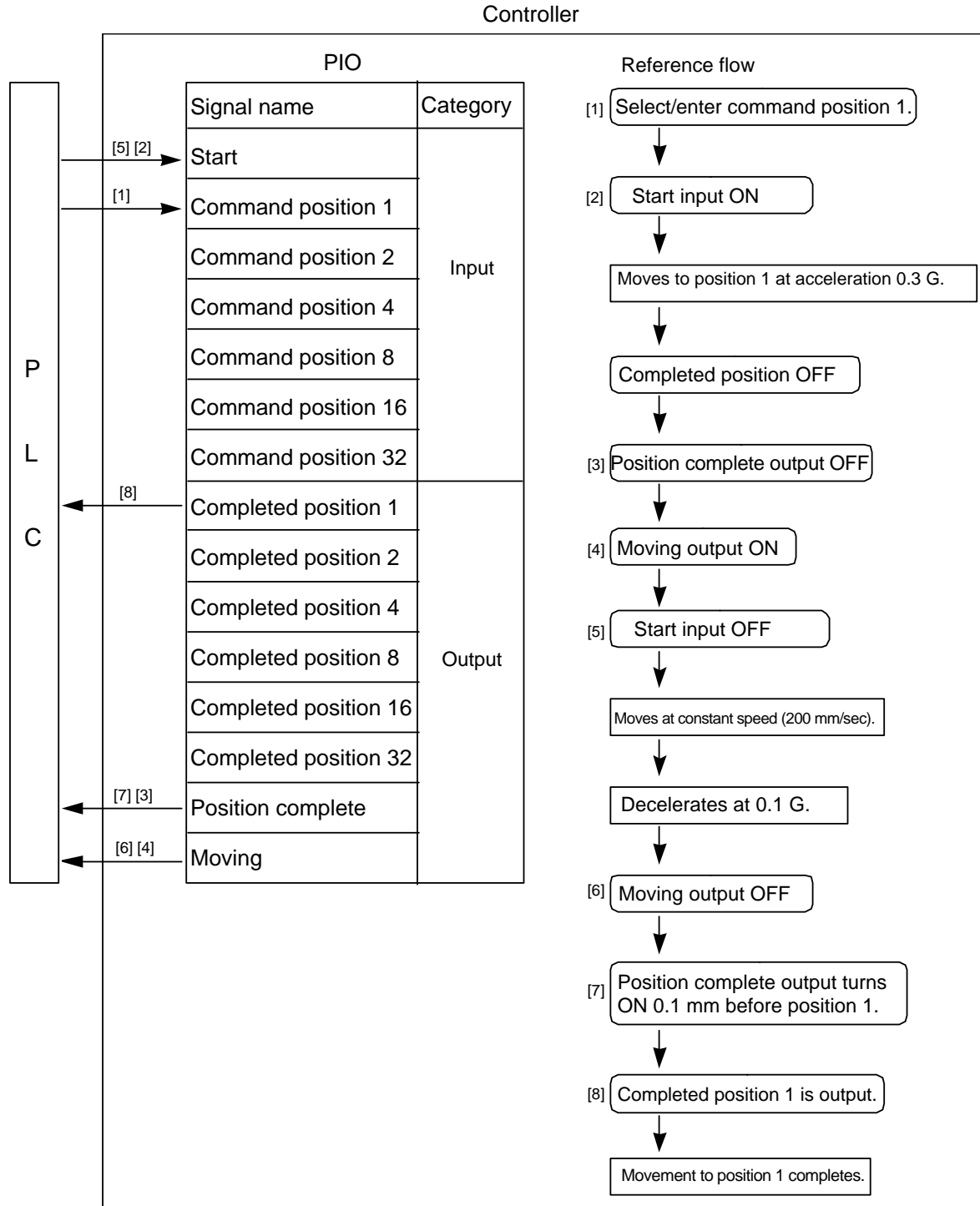

Position table (Field(s) within thick line must be entered.)

No.	Position [mm]	Speed [mm/s]	Acceleration [G]	Deceleration [G]	Push [%]	Positioning band [mm]
0	*	*	*	*	*	*
1	150.00	200.00	0.30	0.10	0	0.10
:						

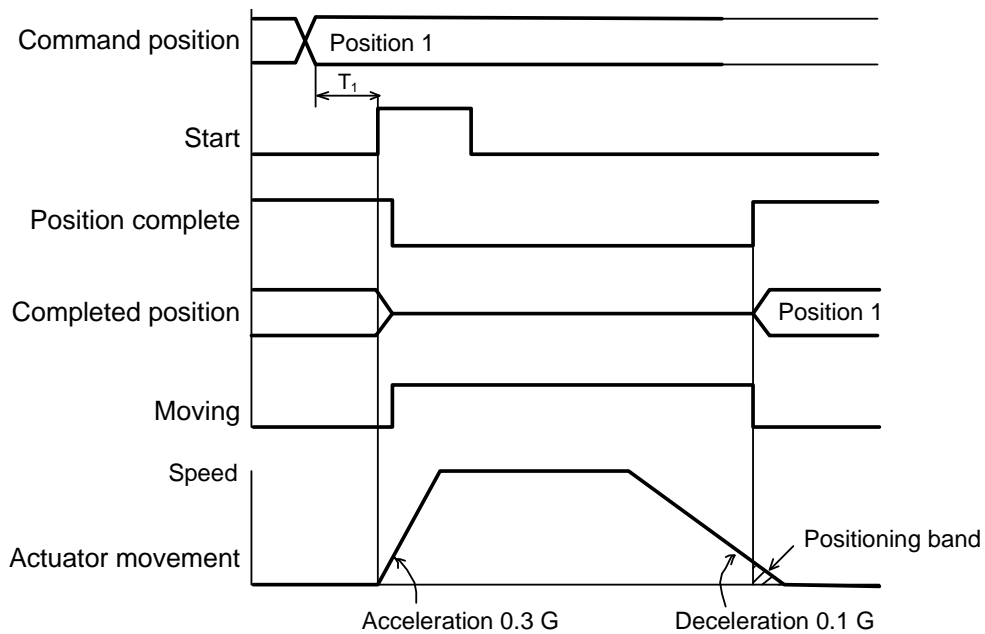

T1: 6 msec or more; time after selecting/entering a command position until the start input turns ON (The scan time of the host controller must be considered.)

**Caution:** When the start signal turns ON, the position complete output will turn OFF and the moving output will turn ON. Always turn OFF the start signal after confirming that the start signal is currently ON and the position complete output has turned OFF. If the start input remains ON as shown below, the position complete output will not turn ON even when the actuator movement is completed.

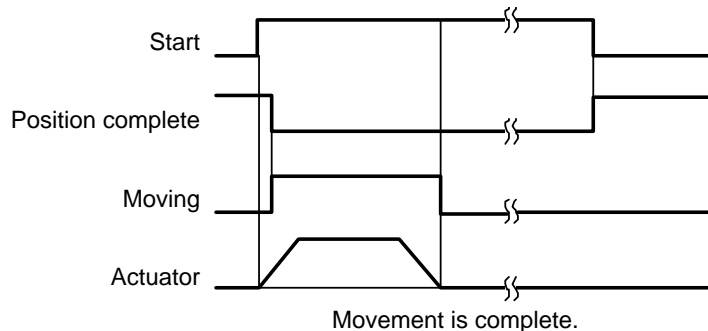

## 3.7 Pause

Example of use in operation) Pause the actuator during movement. [Effective in PIO pattern = 0 to 4]  
 Method) Use the pause input.

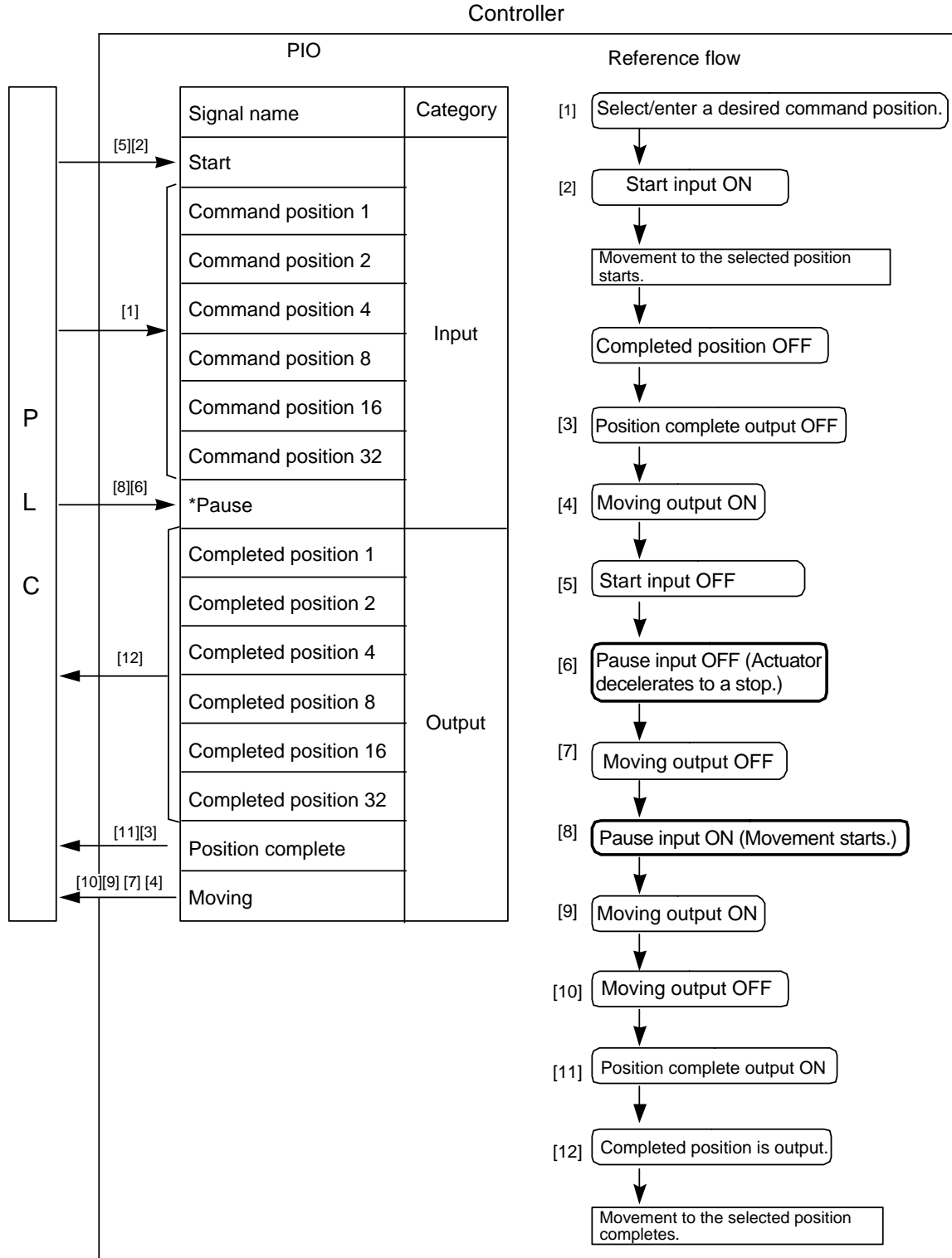



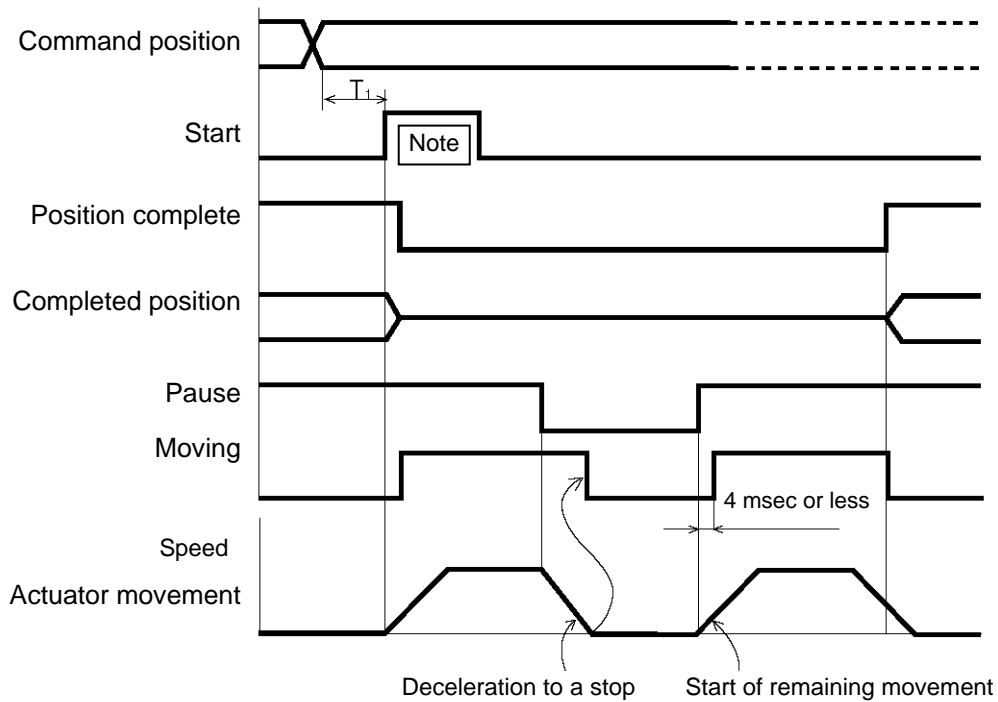

T1: 6 msec or more; time after selecting/entering a command position until the start input turns ON  
(The scan time of the host controller must be considered.)

**Caution:** When the start signal turns ON, the position complete output will turn OFF and the moving output will turn ON.  
Always turn OFF the start signal after confirming that the start signal is currently ON and the position complete output has turned OFF.

The remaining movement can be cancelled by turning ON the reset input during pause.  
(The controller will detect a rise of the reset signal and cancel the remaining movement.)

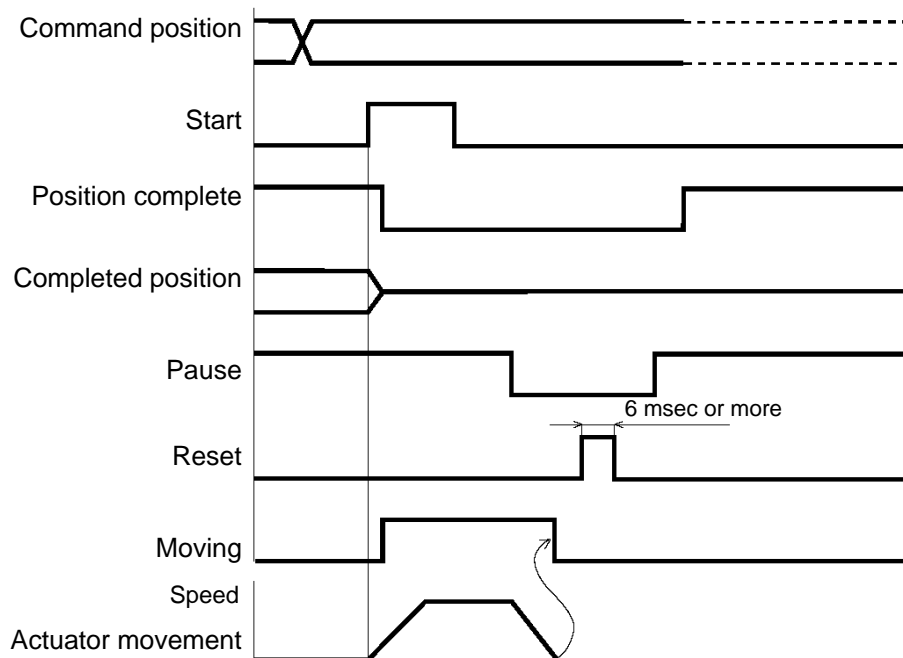

## 3.8 Zone Signal Output

Two types of zone output signals are available: zone output (ZONE1) and position zone output (PZONE). The boundaries defining the signal ON range are set differently for each zone output.

[1] Zone output (ZONE1) --- Set by parameter No. 1/No. 2.

[2] Position zone output (PZONE) --- Set in the “Zone boundary-“ and “Zone boundary+“ fields of the position table.

Whether these signals are available or not varies depending on the PIO pattern, as shown below.

○: Available / x: Not available

Signal classification	PIO pattern					
	0	1	2	3	4	5
Zone output (ZONE1)	○	x	x	x	○	○
Position zone output (PZONE)	○	○	○	x	○	○

Example of use in operation) Move the actuator from the home to the 150-mm position (position 1) and output a zone signal once the actuator enters the range between 40 mm and 120 mm.

Method) • Zone output (ZONE1)

The zone within which this signal turns ON is set by the Zone 1+ and Zone 1- parameters.

Parameter No. 1	Zone 1+	120 (mm)
Parameter No. 2	Zone 1-	40 (mm)

• Position zone output (PZONE)

The signal ON range is set in the “Zone+“ and “Zone-“ fields of the position table.

No.	Position [mm]	Zone+ [mm]	Zone- [mm]
0	*	*	*
1	150.00	120.00	40.00

\* The zone functions have been changed due to version upgrade. Refer to the precautions at the outset.

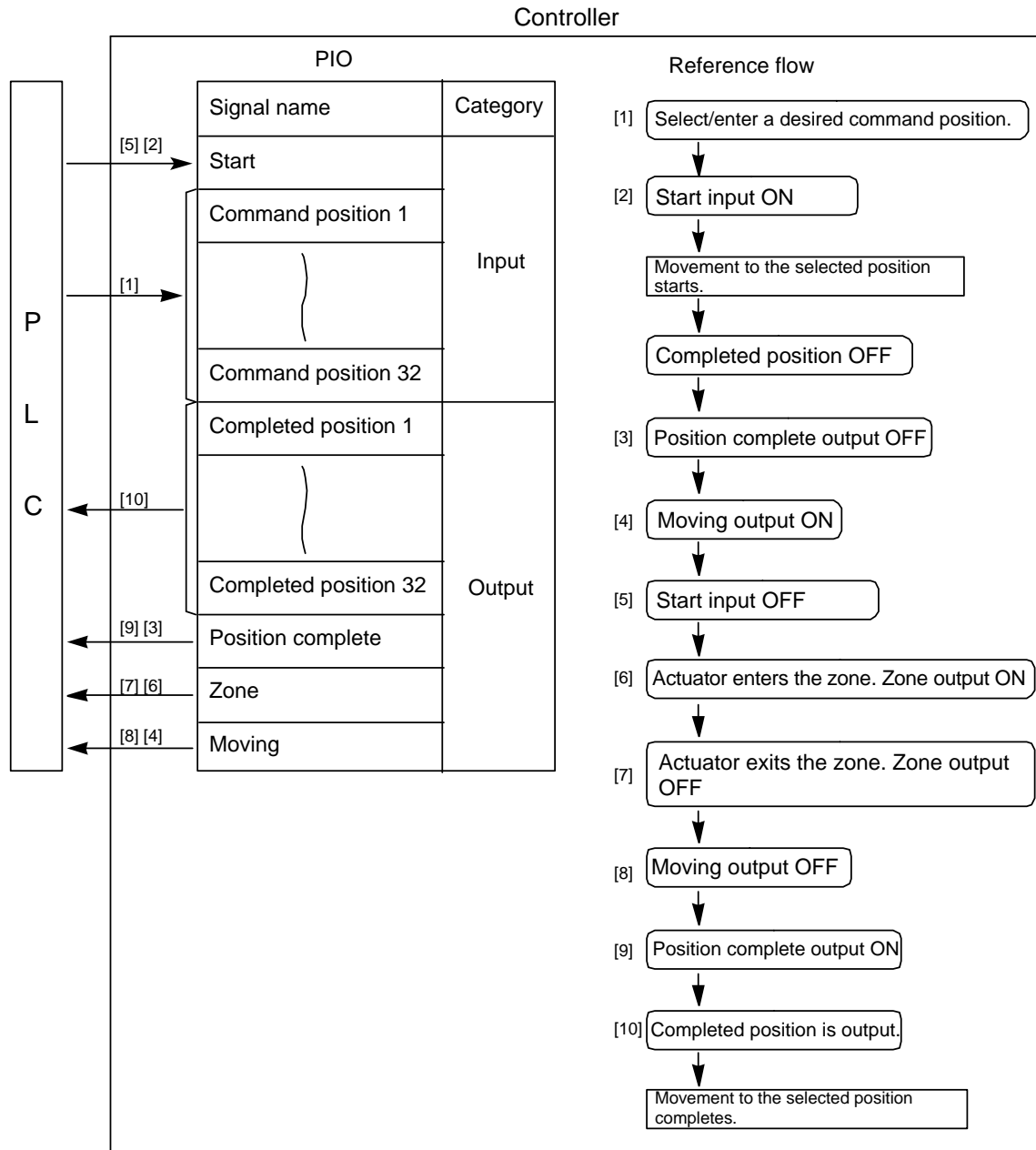

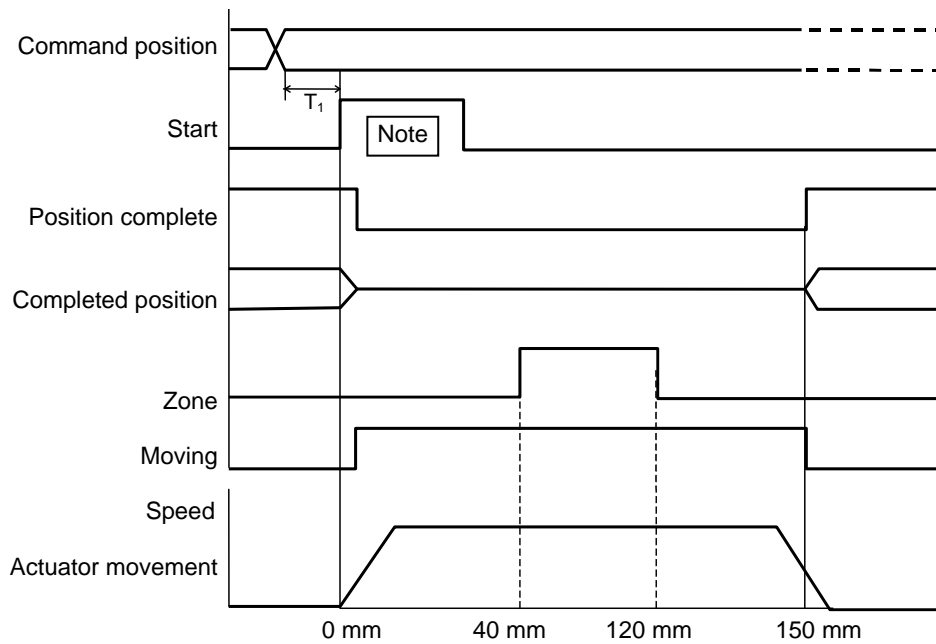

T1: 6 msec or more; time after selecting/entering a command position until the start input turns ON (The scan time of the host controller must be considered.)

Caution: When the start signal turns ON, the position complete output will turn OFF and the moving output will turn ON.  
Always turn OFF the start signal after confirming that the start signal is currently ON and the position complete output has turned OFF.

Example of other zone output)

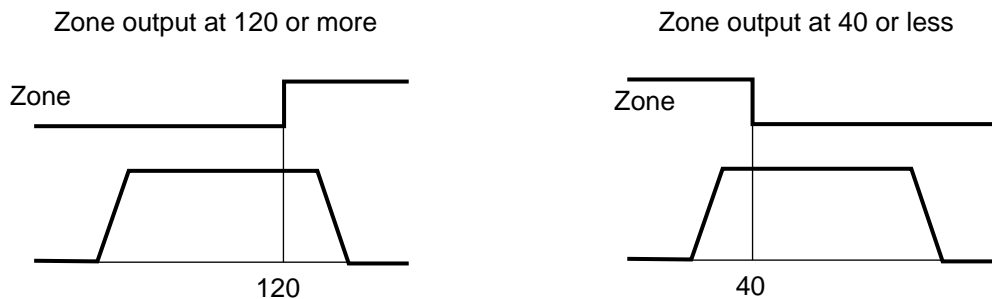

Zone1+	Maximum stroke length
Zone1-	120

Zone1+	40
Zone1-	0

\* The zone functions have been changed due to version upgrade. Refer to the precautions at the outset.

## 3.9 Incremental Moves

Example of use in operation) Move the actuator from the home to the 30-mm position by issuing an absolute position command (position No. 1), and thereafter move the actuator continuously at a 10-mm pitch until the final position of 200 mm is reached. (Pitch feed command: Position No. 2)

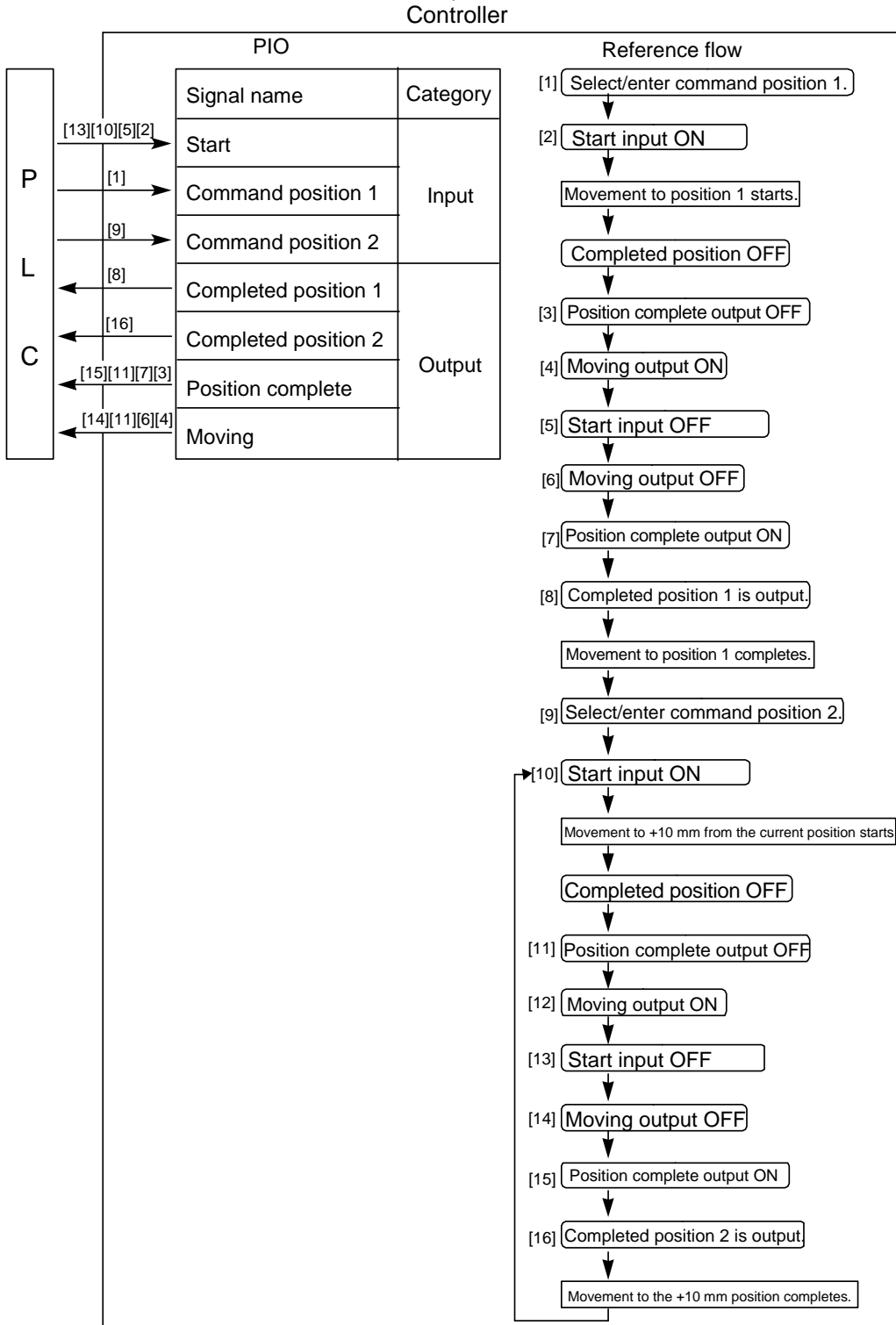

Position table (Field(s) within thick line must be entered.)

No.	Position [mm]	Speed [mm/ss]	Positioning band [mm]	Zone + [mm]	Zone - [mm]	Incremental
<b>0</b>	*	*	*	*	*	*
<b>1</b>	30.00	100.00	0.10	<b>0</b>	<b>0</b>	<b>0</b>
<b>2</b>	10.00	20.00	0.10	190.50	29.50	1
⋮						

Incremental feed

\* On the RCM-T teaching pendant, this symbol indicates that the applicable position is specified in relative coordinates.

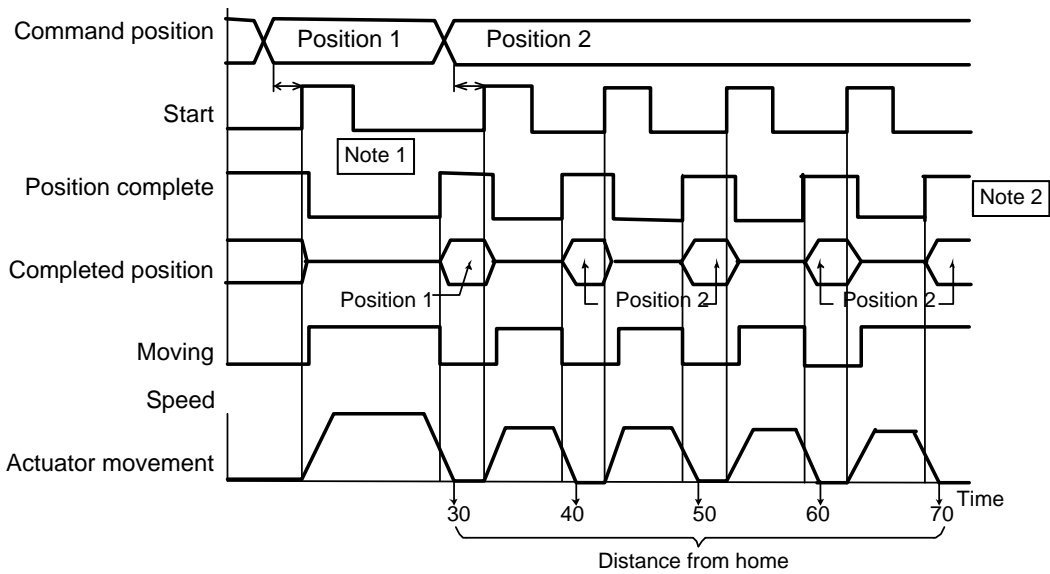

T1: 6 msec or more; time after selecting/entering a command position until the start input turns ON (The scan time of the host controller must be considered.)

**Caution 1:** When the start signal turns ON, the position complete output will turn OFF and the moving output will turn ON. Always turn OFF the start signal after confirming that the start signal is currently ON and the position complete output has turned OFF. If the start input remains ON as shown below, the position complete output will not turn ON even when the actuator movement is completed.

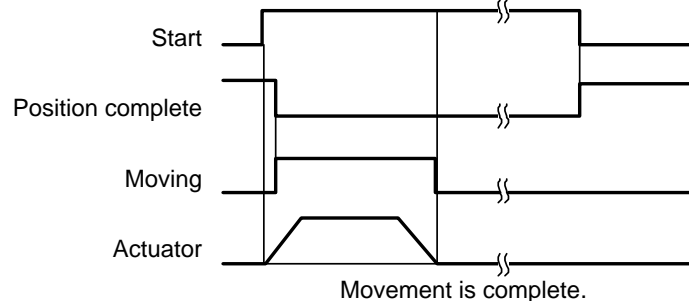

**Caution 2:** When a soft limit is reached as a result of repeated incremental moves, the actuator will stop at that position and the position complete signal will be output.

## 3.9.1 Judgment Method of End Position

Although completion judgment is based on the applicable count managed by the PLC, the zone output signal can be used additionally to double-check the completion of movement.

Program the PLC so that the ON/OFF status of the zone output signal is checked when positioning is completed, and if the signal is OFF, the applicable position will be determined as the last load position.

If the count in the PLC does not match the zone output signal status, signal timings may not be synchronized.

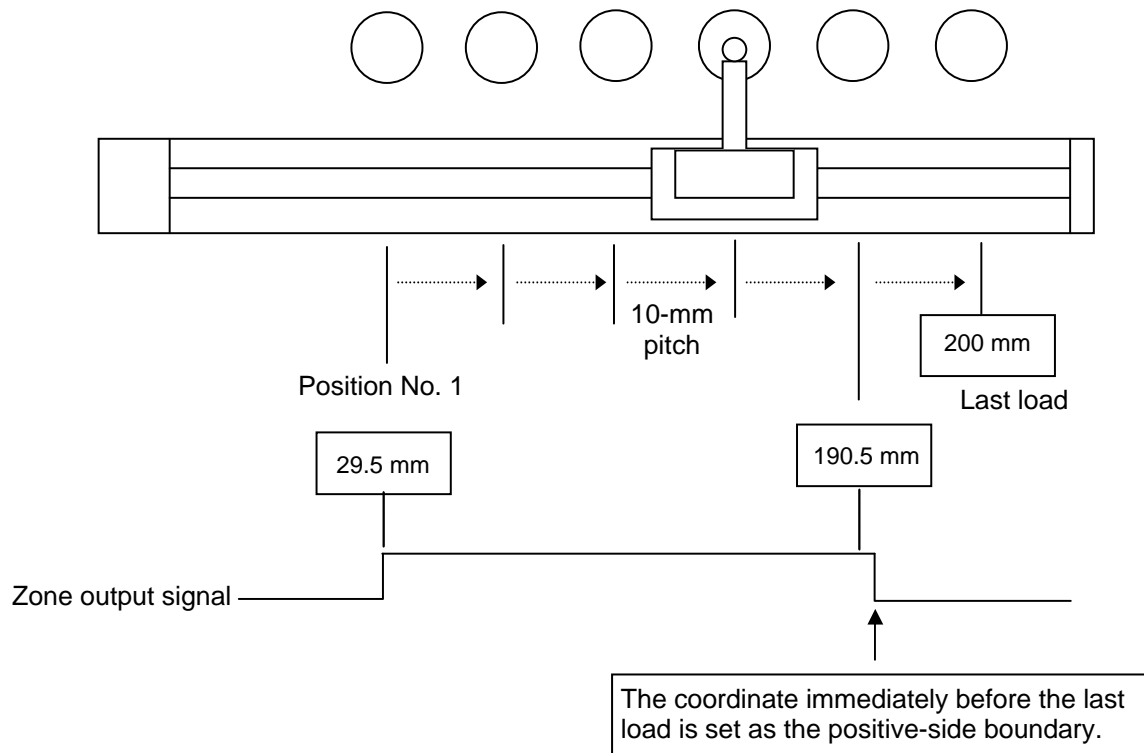

## 3.9.2 Notes on Incremental Mode

### (1) Positioning mode

If any incremental position number is selected and input and then a start signal is input while positioning is in progress, the actuator will move to the position corresponding to the target position of the initial command plus the incremental distance.

(If the incremental distance is a negative value, the actuator will move to the position corresponding to the target position minus the incremental distance.)

Example) If the start signal for movement to position 2 is input while the actuator is moving to position 1, the actuator will move to the position 215 mm from the home.

Position table (Field(s) within thick line must be entered.)

No.	Position [mm]	Speed [mm/ss]	Positioning band [mm]	Push [%]	Incremental
0	*	*	*	*	*
1	200.00	100.00	0.10	0	0
2	15.00	20.00	0.10	0	1
⋮					

Incremental feed

\* On the RCM-T teaching pendant, this symbol indicates that the applicable position is specified in relative coordinates.

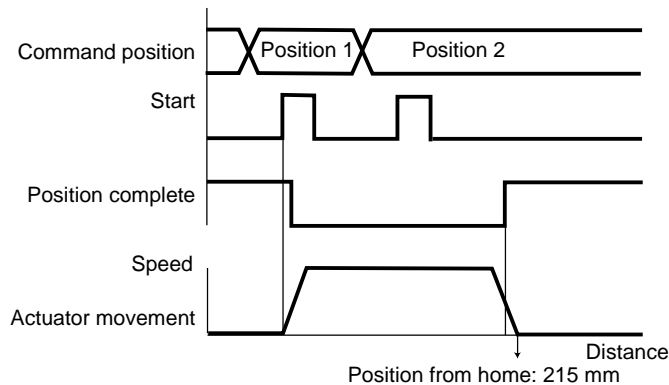

If the start signal for movement to an incremental position number is input multiple times during positioning, the actuator will move to the position corresponding to the initial position plus the “increment x number of times the signal was input.”

Example) If the start signal for movement to position 2 is input twice while the actuator is moving to position 1, the actuator will move to the position 230 mm from the home.

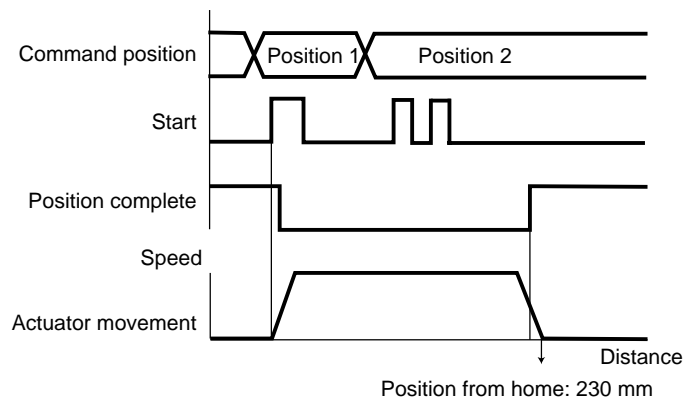



(2) Push & hold mode

The following explains how the actuator will move if an incremental position number is selected and input and then a start signal is input while the actuator is moving in the push & hold mode.

● Positioning operation using the incremental position number

Example) If a position 2 command is input followed by a start signal while the actuator is moving to position 1, the actuator will move to the position corresponding to the target position of the position 1 command plus the incremental distance.

If the position table is set as follows, the actuator will move to the 215-mm position.

Position table (Field(s) within thick line must be entered.)

No.	Position [mm]	Speed [mm/ss]	Positioning band [mm]	Push [%]	Incremental
0	*	*	*	*	*
1	200.00	100.00	30.00	50	0
2	15.00	20.00	0.10	0	1
⋮					

Incremental feed

\* On the RCM-T teaching pendant, this symbol indicates that the applicable position is specified in relative coordinates.

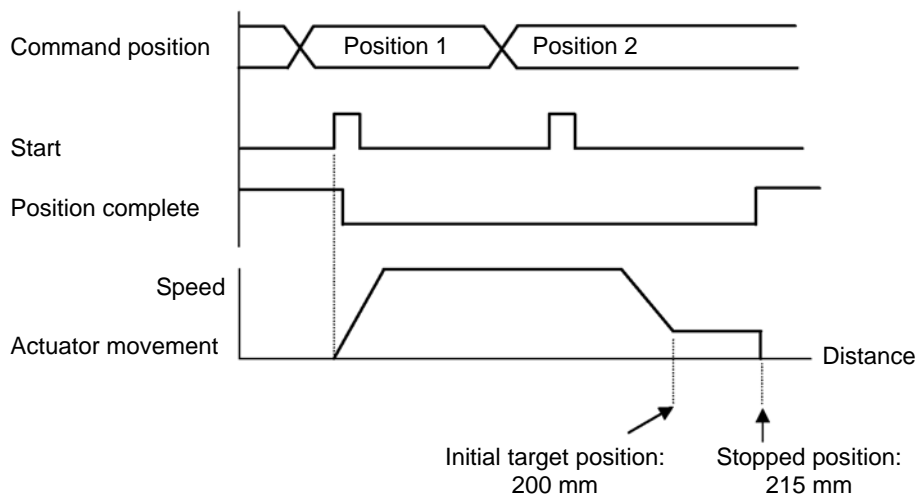

- Push & hold operation using the incremental position number

Example) If a position 2 command is input followed by a start signal while the actuator is moving to position 1, a new target position will be set by adding the incremental distance to the current position where the start input was received. Since the target position is indeterminable, never use this method.

Position table (Field(s) within thick line must be entered.)

No.	Position [mm]	Speed [mm/ss]	Positioning band [mm]	Push [%]	Incremental
0	*	*	*	*	*
1	200.00	100.00	30.00	50	0
2	15.00	20.00	60.00	50	1
⋮					

Incremental feed

\* On the RCM-T teaching pendant, this symbol indicates that the applicable position is specified in relative coordinates.

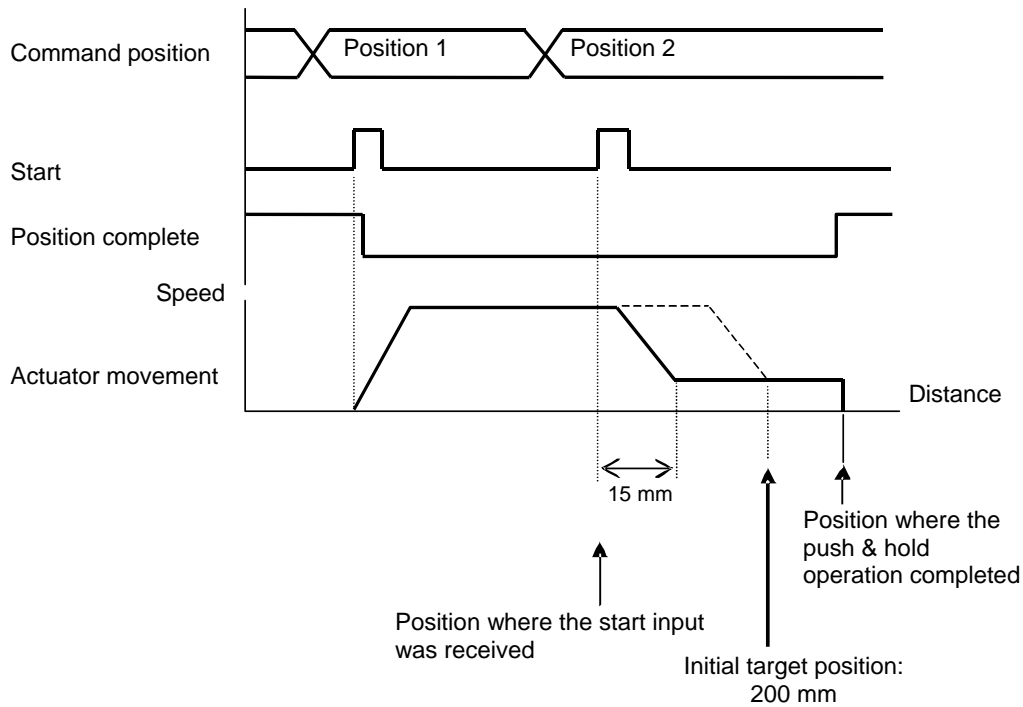

## 3.10 Jogging/Teaching Using PIO

If the teaching type is selected, you can jog the actuator via operation from the PLC.

You can also write the current actuator position to the "Position" field of the position table under a specified position number via operation from the PLC.

If the actuator position is written to a blank "Position" field where no position has yet been defined, the positioning band and other fields will be automatically populated by their default values set in the applicable parameters.

Example of use in operation) Move the actuator to the target position by inputting a jog command from the PLC and write the achieved position to position No. 1.

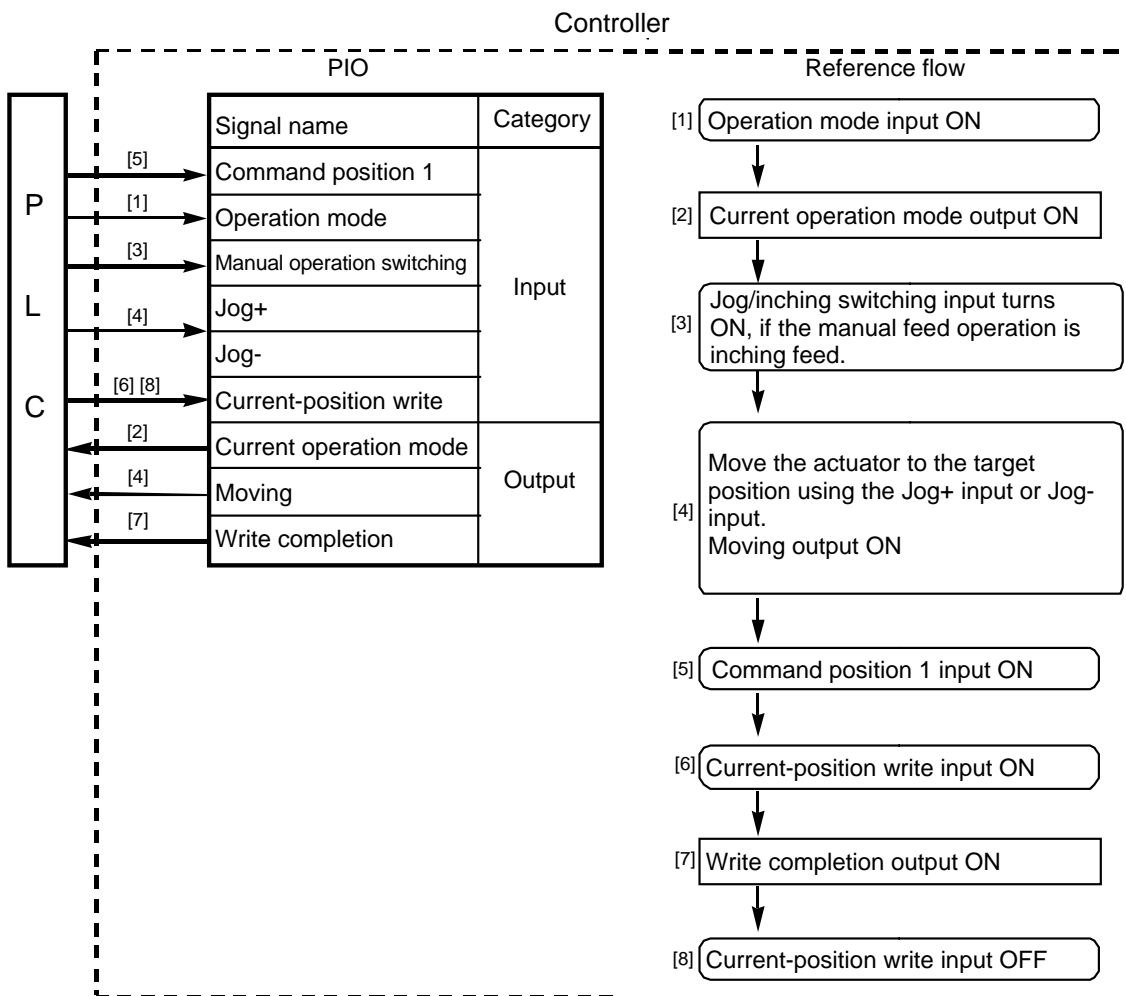

## Jogging/teaching timing

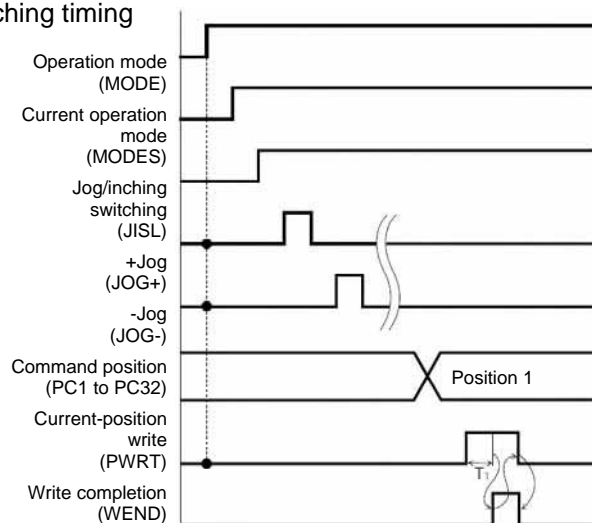

T1: 40 msec or more; time after the current-position write input is turned ON until writing of the current position is completed. If an alarm generate, the writing time may become longer due to alarm registration.

- When the operation mode (MODE) input is turned ON, the mode status (MODES) output will turn ON and the teaching mode permitting PIO teaching will become effective. Once the controller switches to the teaching mode, the start (CSRT) signal will change to the current-position write (PWRT) signal, while the position complete (PEND) signal will change to the write complete (WEND) signal. The teaching mode will not become effective unless the operation mode (MODE) input is turned ON while the actuator is stopped.
  - To confirm that the teaching mode is effective, check if the current operation mode (MODES) output is ON.
  - If the Jog+ input or Jog- input turns ON, the actuator will turn ON. Turning both inputs OFF will stop the actuator. While the actuator is moving, the moving (MOVE) signal turns ON. If both the JOG+ move input and JOG- move input turn ON simultaneously, however, the actuator will stop. In this case, turn OFF both signals and then resume the jogging operation.
  - The manual operation switching (JISL) input is ON during inching and OFF during jogging. The inching distance is set by parameter No. 48, while the jog speed is set by parameter No. 26.
  - If the current-position write (PWRT) input has remained ON for 20 msec or longer, the current actuator position will be written to the selected command position number. When writing is completed, the write complete (WEND) output will turn ON. When the current-position write (PWRT) input is subsequently turned OFF, the write complete (WEND) output will turn OFF.
- (Note) If the current-position write (PWRT) signal turns OFF before the write complete (WEND) signal turns ON, the write complete (WEND) signal will not turn ON. Always turn the current-position write (PWRT) signal OFF after confirming that the write complete (WEND) signal has turned ON.

If a signal to be written is input from the PLC while the position table screen is open on the PC or teaching pendant, the position data display will not be refreshed. Perform one of the following operations to check the retrieved position data:

PC ----- Click the  button.

Teaching pendant --- Open the user adjustment screen and enter "4" as the adjustment number to reset the software.

## 3.11 Operations in Solenoid Valve Mode 1 [7-point Type]

Separate movement command inputs are provided for the target positions for position Nos. 0 to 6, so simply turn ON the input signal corresponding to the position you wish to move the actuator to, and the actuator will start moving.

Example of use in operation) Move the actuator to position No. 0 (5 mm), position No. 1 (200 mm) and position No. 2 (390 mm) in sequence.

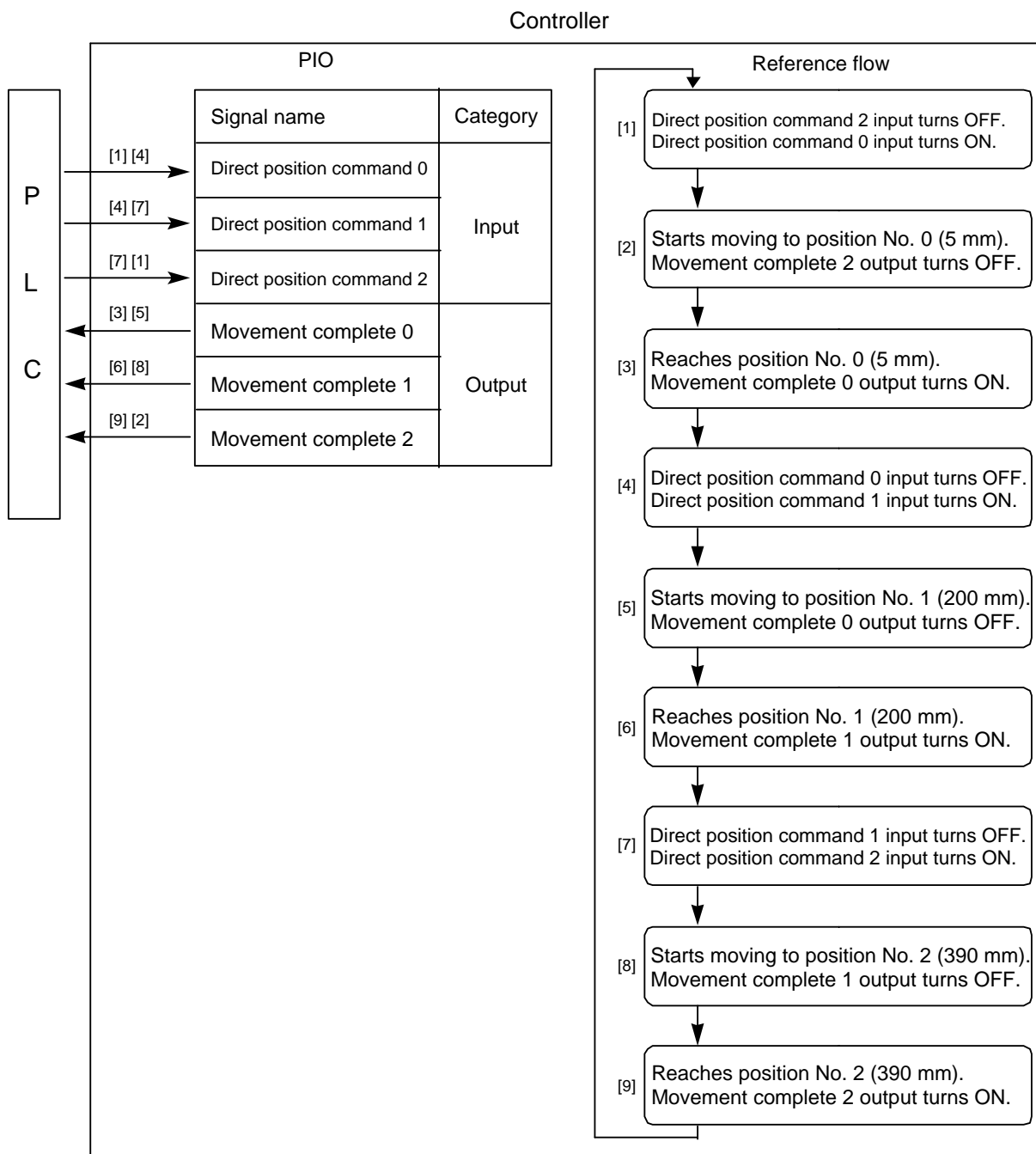

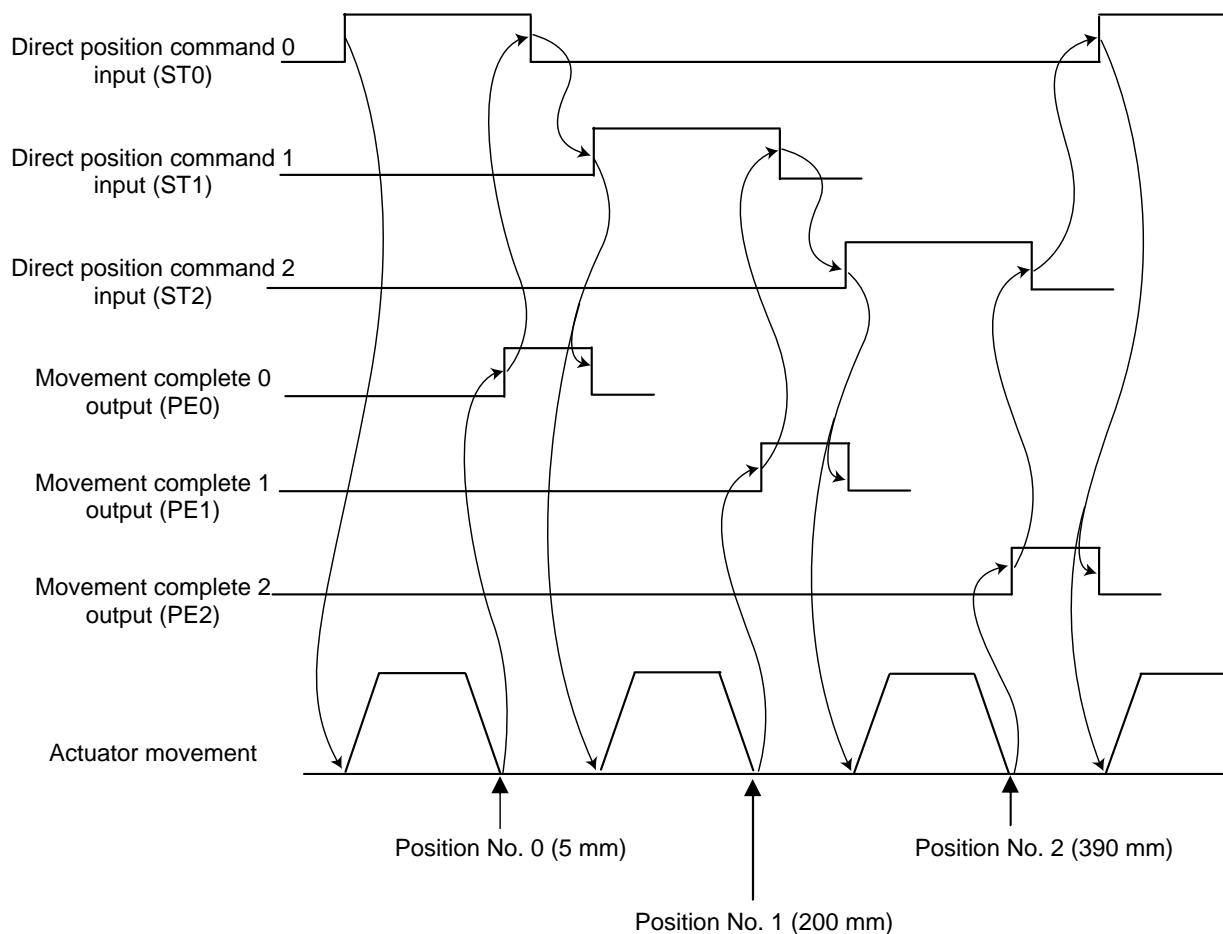

**⚠ Caution:** Movement commands are executed based on the rise edge, so input each signal continuously for 6 msec or more.  
 If two or more movement commands are input simultaneously, they will be executed according to the following priorities:  
 The priorities follow the command numbers in ascending order: [1] Direct position command 0, [2] Direct position command 1, ..., [7] Direct position command 6.  
 The sequence circuit on the PLC side must ensure only one command is input at a time.

- The movement command input operates in two modes.  
You can select the operation condition of the movement command input (ST0 to ST6) in parameter No. 27. The factory setting is "0: [Level mode]."

Description of the movement command input	Setting
Level mode: The actuator starts moving when the input signal turns ON. When the signal turns OFF during the movement, the actuator will decelerate to a stop and complete its operation.	0
Edge mode: The actuator starts moving when the rise edge of the input signal is detected. The actuator will not stop even when the signal turns OFF during the movement, until the target position is reached.	1

### [Level mode]

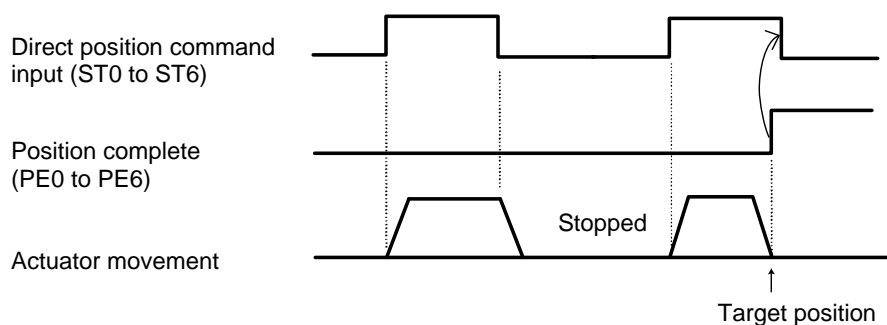

(Note) Turn OFF the movement command input after confirming that the target position has been reached.

### [Edge mode]

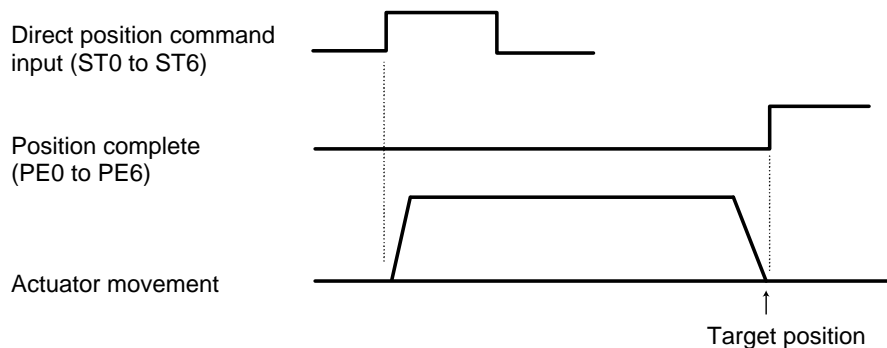

- Handling of the pause (\*STP) signal

This is a negative-logic signal, so it must remain ON while the actuator is moving.

If the pause signal turns OFF while the actuator is moving, the actuator will decelerate to a stop.

The actuator will start moving when the signal turns ON again.

Use this signal as an interlock that actuates when an operator entry prohibition sensor or contact prevention sensor is activated.

If the pause signal is not to be used, set parameter No. 15 (Pause input disable selection) to "1," and the actuator will move even when this signal is OFF.

(Note) When the "edge mode" is selected as the movement command type, you can change the target position while the actuator is stopped with this signal turned OFF, as follows:

- [1] Input a reset signal (RES) for 6 msec or more to cancel the remaining travel.

Next, turn ON the pause signal, and then input a movement command specifying the new target position.

(Example) Turn OFF the pause signal while the actuator is moving under direct position command 1.

The actuator decelerates to a stop.

→ Turn OFF direct position command 1, and turn ON the reset signal for 6 msec or more.

→ Turn ON the pause signal again, and input direct position command 2.

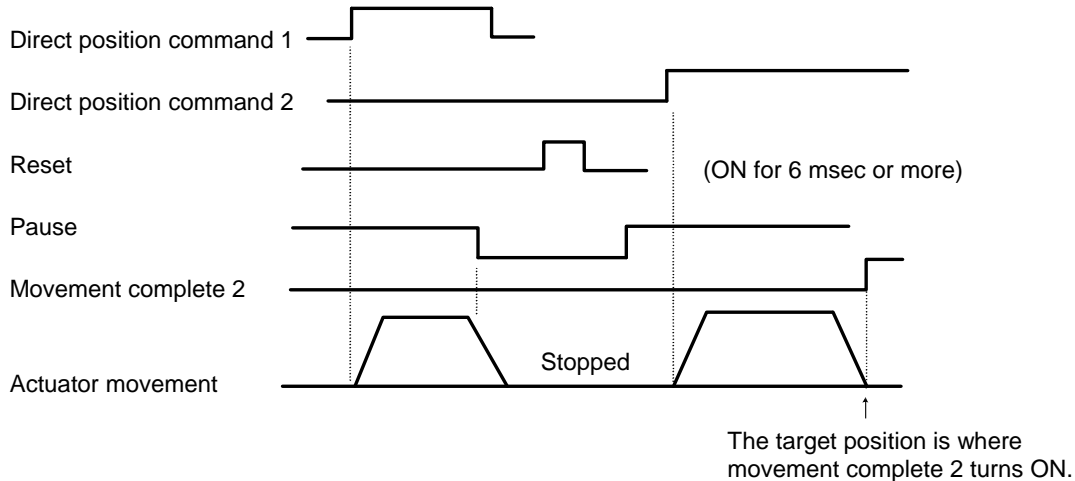

- [2] After inputting a movement command specifying the new target position, turn ON the pause input.

(Example) Turn OFF the pause signal while the actuator is moving under direct position command 1.

The actuator decelerates to a stop.

→ Turn OFF direct position command 1, and turn ON direct position command 2.

→ Turn ON the pause signal again. The front end is recognized as the new target position.

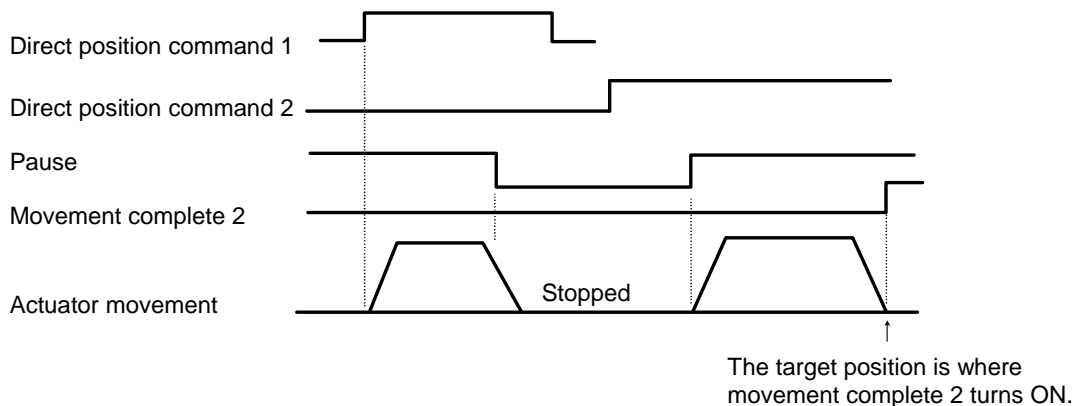



## 3.12 Operations in Solenoid Valve Mode 2 [3-point Type]

After the power has been turned on, input the rear end move command first to complete home return, and then perform continuous operation.

Example of use in operation) How to move the actuator from the rear end to the front end is explained. Although the actuator does not stop at the intermediate point, you can increase the positioning band and use the intermediate point detected output signal (LS2) as a quasi zone output signal.

Example of position table

No.	Position [mm]	Speed [mm/s]	Acceleration [G]	Deceleration [G]	Push [%]	Positioning band [mm]	Remarks
0	5.00	300.00	0.30	0.30	0	0.10	Rear end
1	380.00	300.00	0.30	0.30	0	0.10	Front end
2	200.00	300.00	0.30	0.30	0	50.00	Intermediate point

Operation timings

**PLC processing 1:** Turn OFF the rear end move command signal (ST0) and intermediate point move command signal (ST2), and turn ON the front end move command signal (ST1).

**Operation:**

- [1] The actuator starts moving toward the front end.
- [2] When the current position passes 5.1 mm, the rear end detected output (LS0) turns OFF.
- [3] When the current position reaches 150 mm, the intermediate point detected output (LS2) turns ON. Once 250 mm is passed, LS2 turns OFF.

**PLC processing 2:** If necessary, use the intermediate point detected output (LS2) as a trigger signal with respect to surrounding equipment.

- [4] When the current position reaches 379.9 mm, the front end detected output (LS1) turns ON.

- [5] When the current position reaches 380 mm, the actuator stops.

**PLC processing 3:** Once the front end detected output (LS1) turns ON, the sequence processing at the front end is executed. Upon completion of the sequence processing, the front end move command signal (ST1) turns OFF.

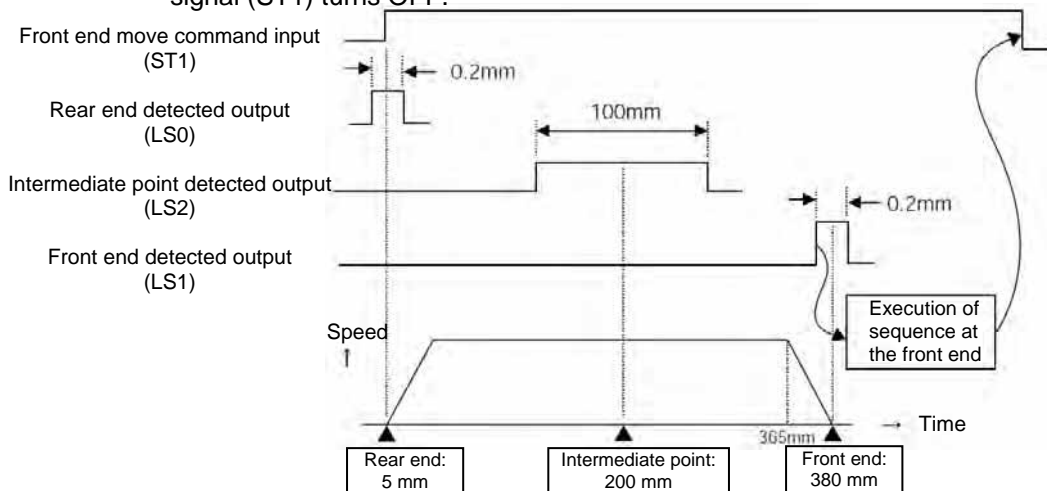

**⚠ Caution:** Provide a ladder sequence circuit where only one move command signal turns ON at a time. If two or more signals are input at the same time, the signals will be processed in the following priorities: Priorities: [1] Rear end, [2] Front end, [3] Intermediate point

Take note that incremental position commands are not supported in solenoid valve mode 2 [3-point type].

- Meaning of position detected output signals (LS0, LS1, LS2)

These signals are handled in the same manner as limit switches (LSs), and turn ON when the following conditions are met:

- [1] The home return complete output signal (HEND) is ON.
- [2] The current position is within the positioning band from each target position in the positive or negative direction.

Accordingly, these signals turn ON not only when the actuator is moving under a move command, but also when the actuator is moved by hand with the servo turned off.

In a case where none of these signals (LS0, LS1, LS2) is ON when an emergency stop was actuated while the actuator was moving, if LS0, LS1 or LS2 must be ON as a condition for resuming actuator operation from the PLC, move the actuator to any target position.

⚠ Caution: This signal will turn OFF when an open phase-A/B/Z detection alarm generates.

- Notes on positioning band setting

The positioning band setting defines the range within which the position detected output signal turns ON. Condition for the position detected output signal to turn ON = Target position  $\pm$  (Positioning band)

With any normal move command, once the position detected output signal turns ON the sequence processing will be executed and the move command input signal will turn OFF.

Take note that if the positioning band is wide and the move command input signal turns OFF quickly, the actuator may not reach the target position.

(Example) When the feed speed is 300 mm/s and deceleration is 0.3 G, the deceleration distance becomes approx. 15 mm.

If the positioning band is set to 30 mm, the position detected output signal will turn ON before the actuator starts decelerating.

In this case, promptly turning OFF the move command input signal on the PLC will cause the controller to initiate the deceleration stop processing.

Depending on the timing, therefore, the actuator may stop before the target position.

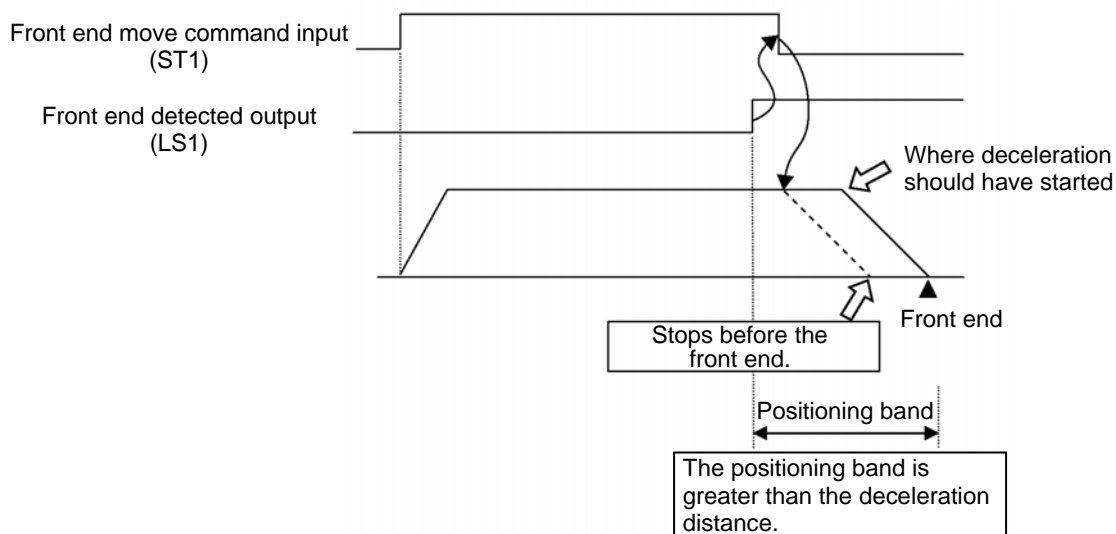

- Speed change during movement

If the load is made of soft material or is a bottle or otherwise topples easily due to its shape, one of the following two methods can be used to prevent the load from receiving vibration or impact when it stops:

- [1] Reduce the deceleration to make the deceleration curve gradual.
- [2] Initially move the actuator at the rated speed, and reduce the feed speed immediately before the target position.

Method [2], where the feed speed is reduced, is explained below.

(Example) Move the actuator from the rear end to the front end by using the intermediate point as a dummy point, where the feed speed is set to 300 mm/s until the intermediate point and then reduced to 20 mm/s after passing the intermediate point.

Example of position table

No.	Position [mm]	Speed [mm/s]	Acceleration [G]	Deceleration [G]	Push [%]	Positioning band [mm]	Remarks
0	5.00	300.00	0.30	0.30	0	0.10	Rear end
1	380.00	20.00	0.30	0.30	0	0.10	Front end
2	300.00	300.00	0.30	0.30	0	30.00	Intermediate point

Operation timings

**PLC processing 1:** Turn OFF the rear end move command signal (ST0) and intermediate point move command signal (ST2), and turn ON the front end move command signal (ST1).

**Operation:** [1] The actuator starts moving toward the intermediate point.  
[2] When the current position reaches 270 mm, the intermediate point detected output (LS2) turns ON.

**PLC processing 2:** Turn OFF the intermediate point move command signal (ST2) and turn ON the front end move command signal (ST1).  
[3] The actuator decelerates from 300 mm/s to 20 mm/s and stops at the front end.

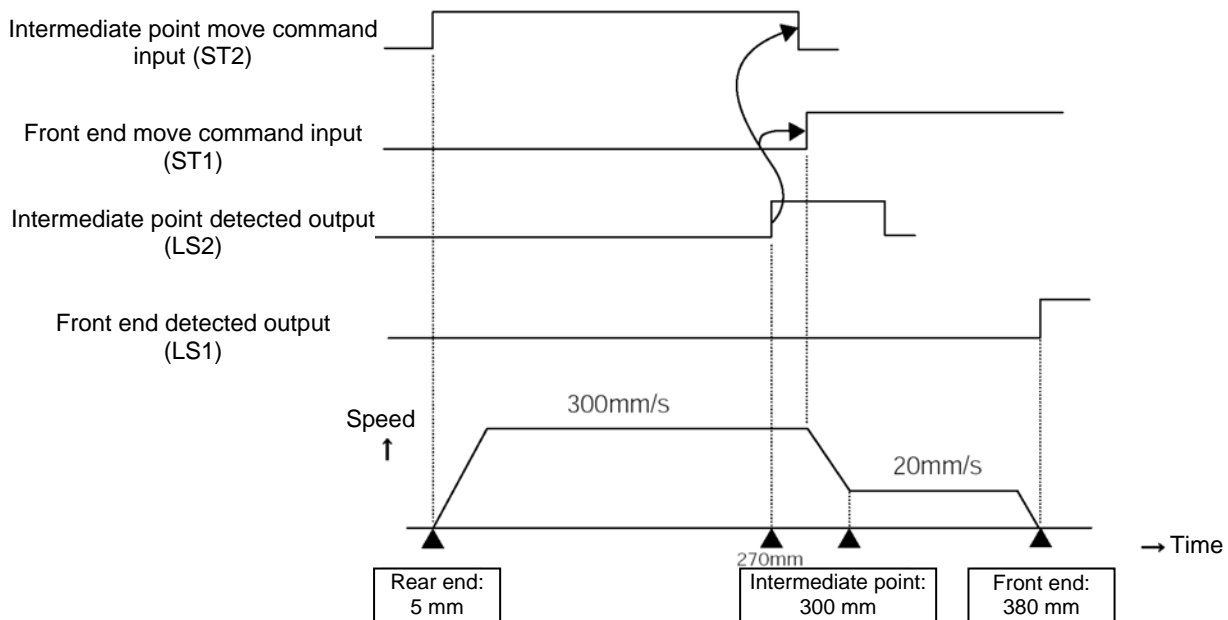

**Caution:** By setting a wide positioning band for the intermediate point, smooth speed change can be implemented without requiring the actuator to stop temporarily at the intermediate point.

● Pause during movement

Since move commands are based on level mode, the actuator continues to move while a move command is ON. Once the move command turns OFF, the actuator will decelerate to a stop and complete the operation. Therefore, turn OFF the move command if the actuator must be stopped temporarily as a low-degree safety measure.

(Example) Temporarily stop the actuator while it is moving to the front end.

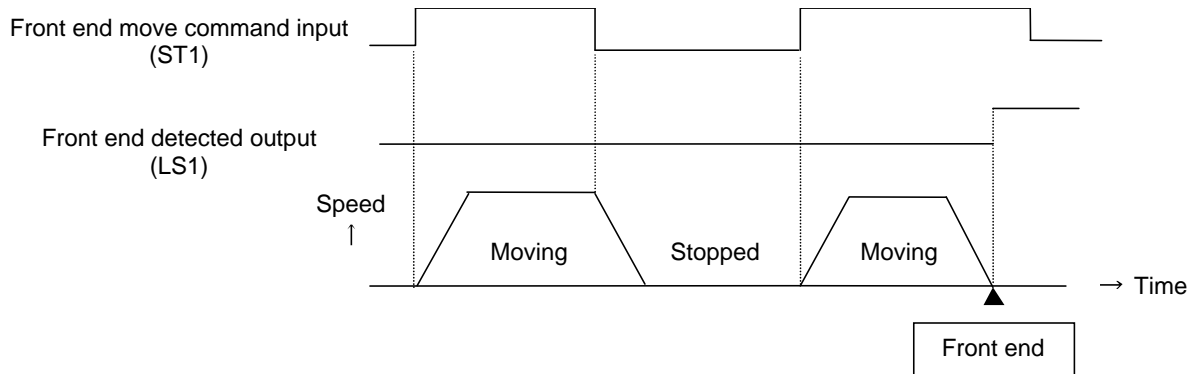

● Emergency return operation

The following explains what to do when an emergency situation occurred while the actuator was moving and you want to return the actuator to the standby position (rear end).

(Example) Return the actuator to the standby position (rear end) following an emergency situation occurring while the actuator was moving to the front end.

Operation timings

**PLC processing 1:** Turn ON the rear end move command signal (ST0) upon occurrence of the emergency situation, and then turn OFF the front end move command signal (ST1).

**Operation:**

- [1] The actuator starts decelerating upon turning OFF of the front end move command signal (ST1), and stops.
- [2] The actuator reverses its direction and starts moving toward the rear end.
- [3] When the rear end is reached, the rear end position complete output (PE0) turns ON.

**PLC processing 2:** Turn OFF the rear end move command signal (ST0).

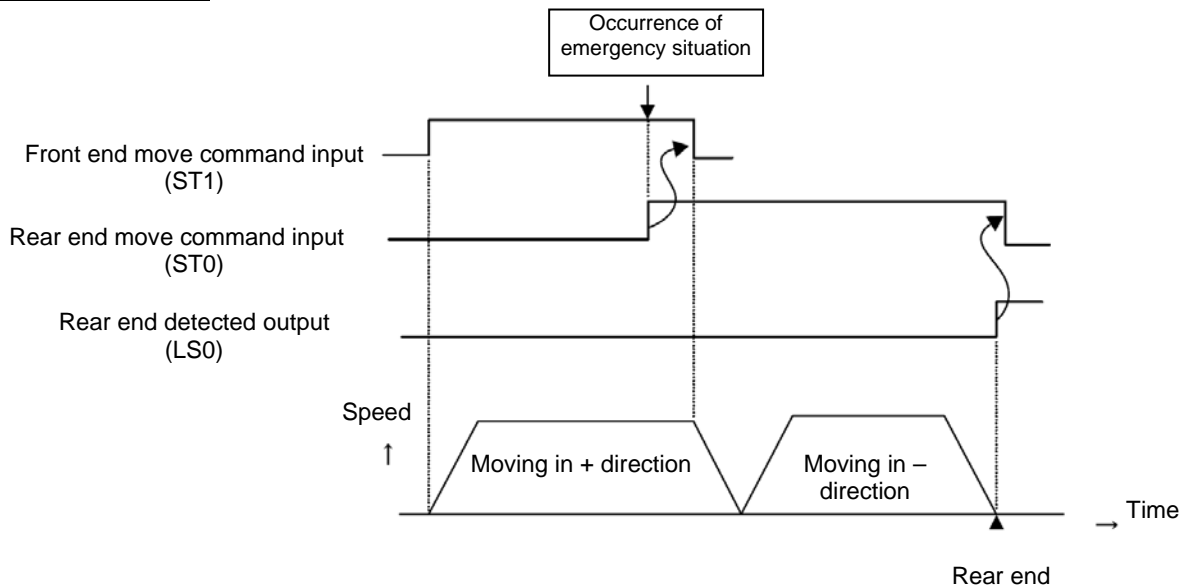

- Push & hold operation

The following limitations apply in solenoid valve mode 2 [3-point type]:

- The position complete signal (PEND) is not available.
- In push & hold operation, the rear end position detected (LS0), front end position detected (LS1) and intermediate position detected (LS2) signals turn ON only when the actuator has reached a point within the positioning band (parameter No. 10) with respect to the target position. Accordingly, these signals cannot be used to notify completion of push & hold operation.

This means that push & hold operation must follow a procedure different from the one used in other PIO pattern operations.

Specifically, use the following procedure when performing push & hold operation in solenoid valve mode 2 [3-point type]:

[Basics of push & hold operation]

- [1] Enter the current-limiting value in the "Push" field corresponding to the front end (position No. 1) to define that the front end command specifies push & hold operation.
- [2] In the "Positioning band" field, enter the maximum distance (relative distance) to be traveled in push & hold operation, calculated from the front end position.  
(Consider the position error associated with the installation of the load, or the amount of decompression if the load is made of elastic material.)
- [3] If there is a possibility that the equipment may miss the load, use the zone output signal to determine whether the load was missed. To do so, in the "Zone+" and "Zone-" fields enter values defining the zone within which the push & hold operation is deemed to have completed successfully.
- [4] Change the value in parameter No. 6 (Push completion judgment time), if necessary.
- [5] Change the value in parameter No. 34 (Push speed), if necessary.  
(These parameters have been set at the factory to values appropriate for the applicable actuator model.)  
\* For the parameter details, refer to Chapter 6, "Parameter Settings."

(Example) An example is given where push & hold operation is performed using a rod-type actuator with a 200-mm stroke based on a current-limiting value of 40%, maximum travel distance in push & hold operation of 20 mm, and successful push completion zone of 180 mm to 185 mm. Enter 160 mm, 40%, 30 mm, 185 mm and 180 mm in the "Position" field, "Push" field, "Positioning band" field, "Zone+" field and "Zone-" field, respectively, in the position table under No. 1.

Example of position table

No.	Position [mm]	Push [%]	Positioning band [mm]	Zone+ [mm]	Zone- [mm]	Comment
0	5.00	0	0.10	100.00	4.90	Rear end (standby position)
1	160.00	40	30.00	185.00	180.00	Front end
2	*	*	*	*	*	Intermediate point

## Operation timings

**PLC processing 1:** [1] The PLC turns OFF the rear end move command signal (ST0) and intermediate point move command signal (ST2), and turns ON the front end move command signal (ST1).  
[2] The PLC sets in the timer the period after a move command is issued until push & hold operation is completed, to enable monitoring with the timer.

**Operation 1:** The actuator starts moving and upon reaching the front end (160 mm), it decelerates to the push speed. The actuator continues to move at this speed until stopping upon contacting the load.  
If the actuator has stopped at a position between 180 mm and 185 mm, the zone output (PZONE) turns ON.

**PLC processing 2:** After an elapse of the monitor timer period specifying the time until positioning operation is completed, the PLC checks the ZONE output (PZONE).  
If the zone output signal is ON, indicating that the operation has completed successfully, the PLC executes sequence processing in the “condition where the load is being pushed.”  
Once the sequence processing is completed, the PLC turns OFF the front end move command signal (ST1) and turns ON the rear end move command signal (ST0).

**Operation 2:** As soon as the actuator starts moving toward the rear end, the zone signal turns OFF. The zone signal turns ON again when the actuator reaches the 100-mm position. When the rear end position is reached thereafter, the rear end position detected signal (LS0) turns ON.

**PLC processing 3:** If you wish to shorten the tact time by issuing a command to the peripheral equipment while the actuator is returning to the rear end, the zone output signal can be utilized as a trigger signal.

\* If the front end detected signal (LS1) turns ON but the zone output signal does not turn ON, the actuator should be deemed to have “missed” the load. If neither the front end detected signal (LS1) nor zone output signal turns ON, it should be deemed that the “load is set at a wrong position.”

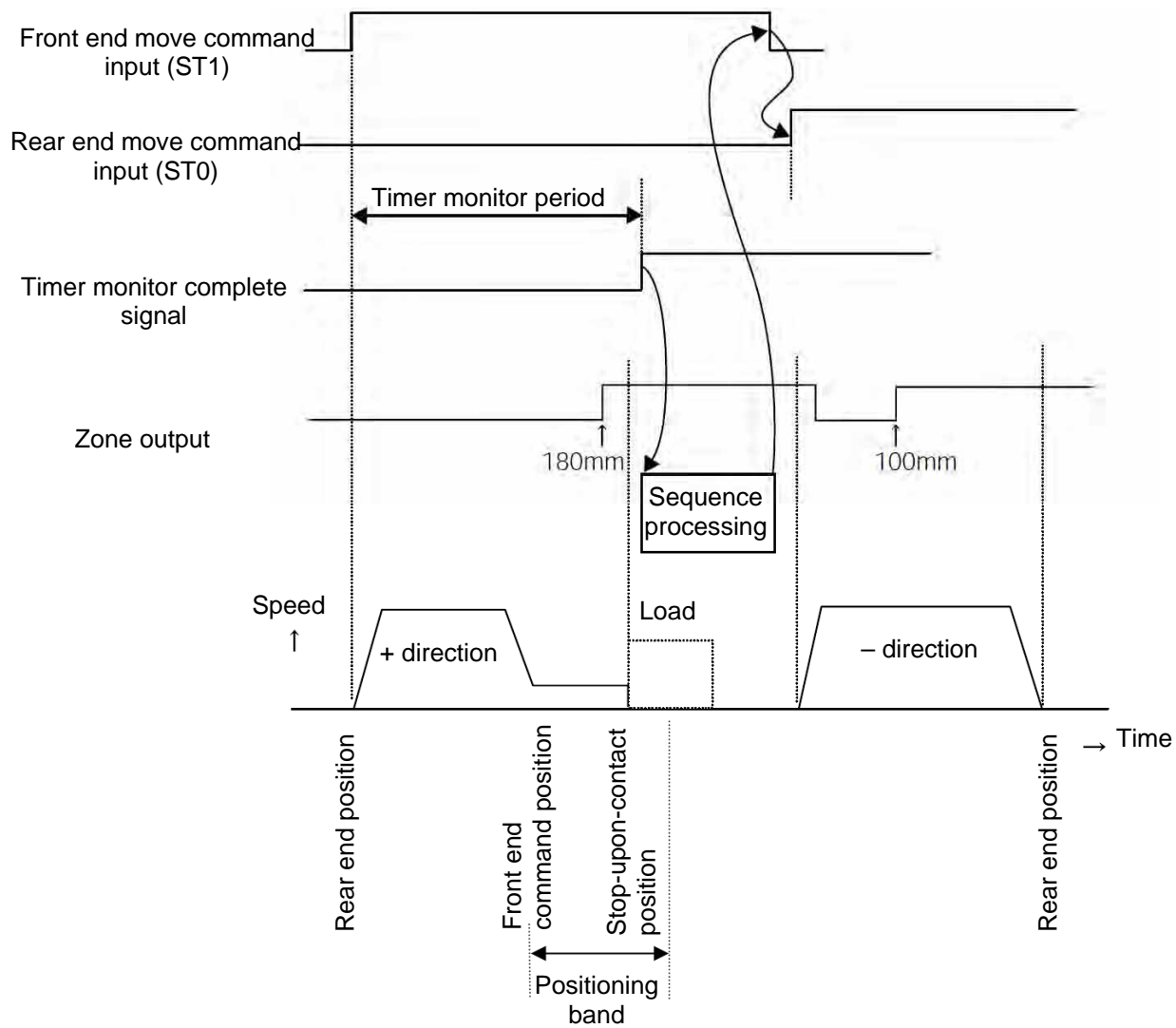

## Chapter 3 Pulse-train Input Mode

### 1. Overview

In this mode, the actuator can be controlled using the positioning control function (pulse-train input) of the host controller (PLC).

#### 1.1 Features

- **Dedicated home return signal**  
IAI's original stroke-end push type home return operation is supported in this mode.  
When this function is used, home return can be performed automatically without having to program a complex sequence or use an external sensor, etc.
- **Brake control function**  
The electromagnetic brake power is supplied to the controller from a power supply different from the main power. Since the controller controls the brake, there is no need to program a separate sequence. Also, the electromagnetic brake can be released freely after the main power has been cut off.
- **Torque limiting function**  
The torque can be limited (a desired limit can be set by a parameter) using an external signal. When the torque reaches the specified level, a signal will be output. This function permits push & hold operation, press-fit operation, etc.
- **Feed-forward control function**  
With this function, response can be improved in certain situations such as when the load inertia ratio is high. Increasing the parameter value will reduce the deviation (difference between the position command and the position feedback), thereby improving response.
- **Position-command primary filter function**  
Soft start and stop can be achieved even when the actuator is operated in the command-pulse input mode where acceleration and deceleration are not considered.
- **Feedback function**  
Position detection data is output using pulse trains (differential).  
The current actuator position can be read in real time from the host controller.  
\* The controller is shipped with the feedback pulse output disabled. To use the feedback function, set user parameter No. 68 to "0 (Enable)."

 **Caution:** In the pulse train input mode, actuators of absolute specifications also operate as if actuators of incremental specifications.



## 1.2 Standard Accessories

### (1) Pulse-train control service connector

Description: Plug (10114-3000PE by Sumitomo 3M)  
Shell (10314-52F0-008 by Sumitomo 3M)

## 1.3 Options

### 1.3.1 Pulse Converter (AK-04)

Model: AK-04

Description: Pulse converter + Input/output e-CON connector

Use this converter when the host controller outputs open-collector pulses.

This converter is used to convert open-collector command pulses output from the host controller, to differential pulses. Converting open-collector pulses to differential pulses has the effect of improving noise resistance.

The converter outputs two phases of differential pulses corresponding to those of the line driver 26C31.

It comes with an e-CON input/output connector that makes field wiring easy.

#### Basic specifications

- Input power supply: 24 VDC  $\pm$  10% (50 mA max.)
- Input pulse: Open-collector (collector power supply: 12 mA max.)
- Input frequency: 200 kHz max.
- Output pulse: Corresponding to 26C31 differential output (10 mA max.)
- External dimensions: Refer to the figure below (cable connector not included).
- Weight: 10 g max. (cable connector not included)
- Accessory: Input/output e-CON connector 37104-3122-000L by 3M
- Applicable wire: AWG24 to 26, 0.14 to 0.3 mm (max.) {EMBED Equation 3}  
Final outer diameter:  $\varnothing$ 1.0 to 1.2 mm

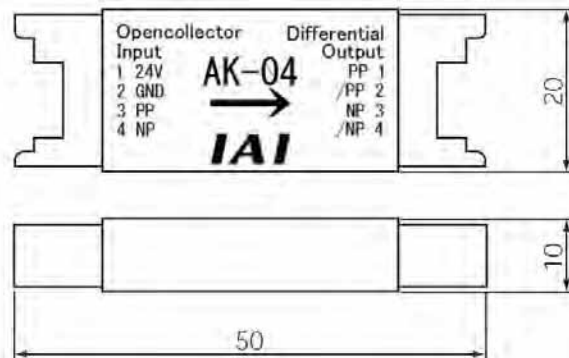

- Caution:
- Minimize the wiring distance between the host controller and the AK-04.
  - The input/output connector of the AK-04 can be installed in either direction. Be sure to connect the correct side.
  - Exercise caution as the surface temperature of the AK-04 will rise during operation ( $\Delta T \cong 30^{\circ}\text{C}$ ).
  - When using the AK-04, make sure the converter will not receive any excessive external force.

On installation of AK-04

- [1] Use AK-04 in environment where surrounding air temperature is 0 to 40°C.
- [2] The temperature of AK-04 increases by approximately 30°C during operation. Do not install multiple AK-04 converters closely or store them within ducts. Moreover, do not set them near other heating elements.
- [3] When you use several AK-04 converters, lay them out separated for 10 mm or more.

A recommended installation example is shown below.

- Make the cable length between the host controller and pulse converter as short as possible.

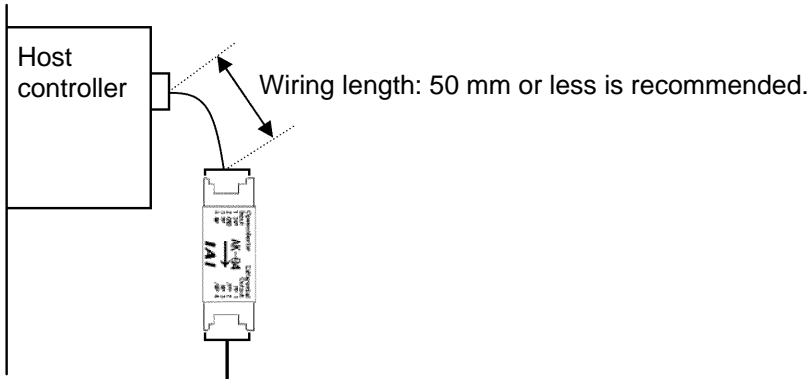

- Keep pulse converters separated for 10 mm or more from each other.

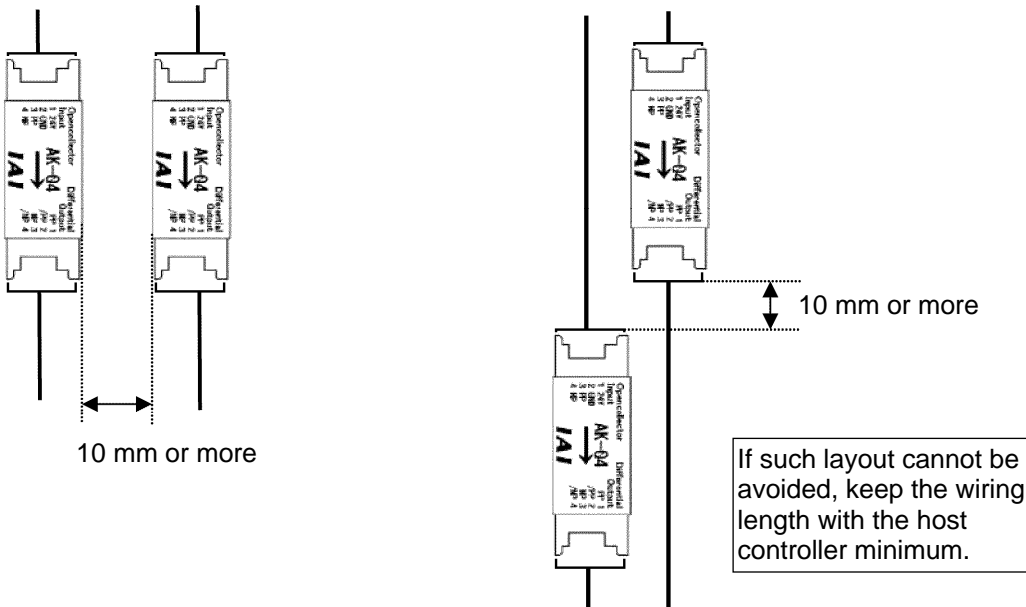

## 1.3.2 Pulse Converter (JM-08)

Model: JM-08

Description: Pulse converter + Input/output e-CON connector

This converter converts differential pulses (operation system compliant to RS-422) to open-collector pulses. It is possible to use feedback pulse output to operate other devices of open collector pulse train inputs. However, cautions must be paid to input frequency specifications of input devices.

### Basic specifications

- Input power supply: 24 VDC  $\pm$  10% (50 mA max.)
  - Differential input: 2 phases (differential signal compliant to RS-422, maximum 10 mA/phase)
  - Input frequency: 500 kHz max.
  - Output: 2 phases (24 VDC open-collector pulse, collector current: maximum 25 mA/phase)
  - Weight: 10 g max. (cable connector not included)
  - Accessory: e-CON connector on the plug side  
37104-3122-000FL made by 3M: 2 units attached
- Applicable wire: AWG24 to 26, 0.14 to 0.3 mm (max.) {EMBED Equation 3}  
Final outer diameter:  $\varnothing$ 1.0 to 1.2 mm

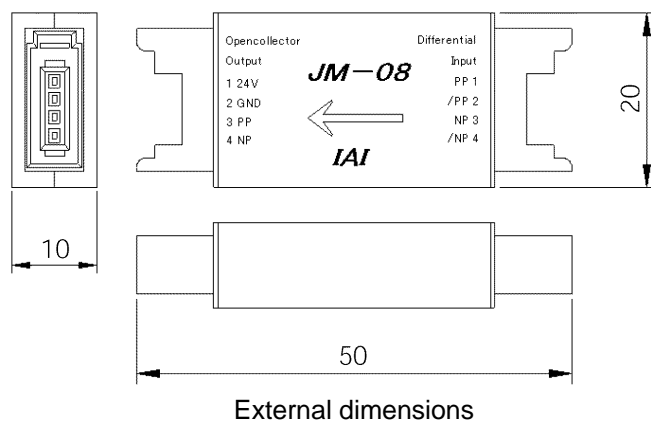

## 1.3.3 Pulse-train Control Service Cable

Model: CB-SC-PIOS□□□

\* Enter the cable length in □□□. Lengths up to 10 m can be specified. Example) 020 = 2 m  
 (The maximum cable length is 2 m if the AK-04 is used to convert open-collector pulses.)

Description: Plug + Shell + Shielded cable

Use this cable to connect pulse-train control signals to the host equipment.

The cable does not have a connector on the host equipment end.

The customer should connect the cable to the host equipment by processing the host equipment end of the cable in accordance with the equipment to be connected.

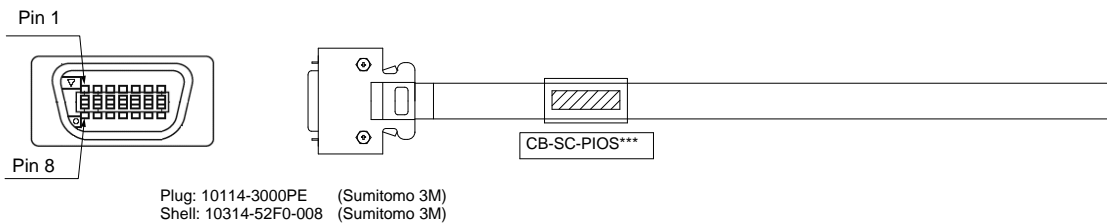

Wire	Color	Symbol	Signal name	No.
0.2 sq., soldered	Black	—	—	1
	White/Black	—		2
	Red	PP	Pulse-train input	3
	White/Red	/PP		4
	Green	NP		5
	White/Green	/NP		6
	Yellow	AFB	+A	7
	White/Yellow	/AFB	-A	8
	Brown	BFB	+B	9
	White/Brown	/BFB	-B	10
	Blue	ZFB	+Z	11
	White/Blue	/ZFB	-Z	12
	Gray	GND	Line-driver output line for feedback pulse output	13
	White/Gray	GND		14

Connect the shield to the hood using a clamp.

Shield

Host equipment end

## 2. Wiring

### 2.1 External Connection Diagram

A wiring example in the pulse control mode is shown below.

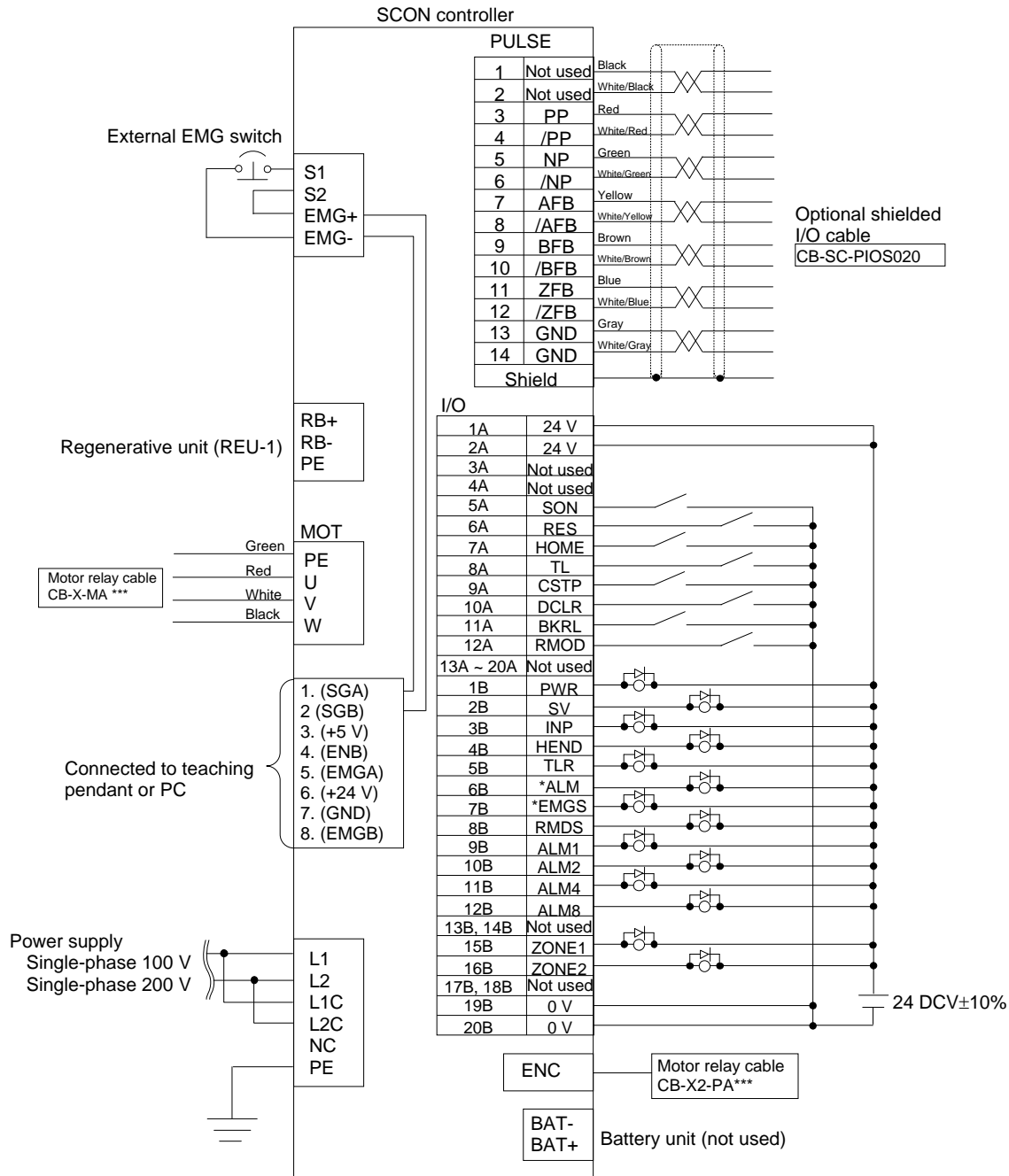

**Caution:** To operate the actuator by allowing the controller to communicate with the PLC via I/O signals, be sure to tilt the mode selector switch on the front panel of the controller to the "AUTO" position.

## 2.2 Command Pulse-train Input Specifications

[Differential line-driver input]

Applicable line driver: 26C31 or equivalent

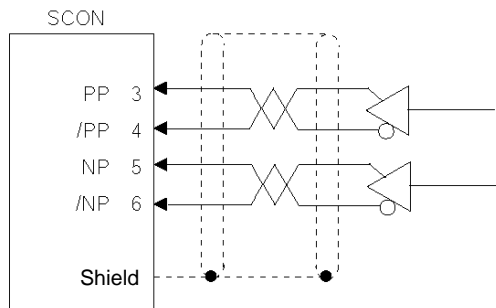

[Open-collector input]

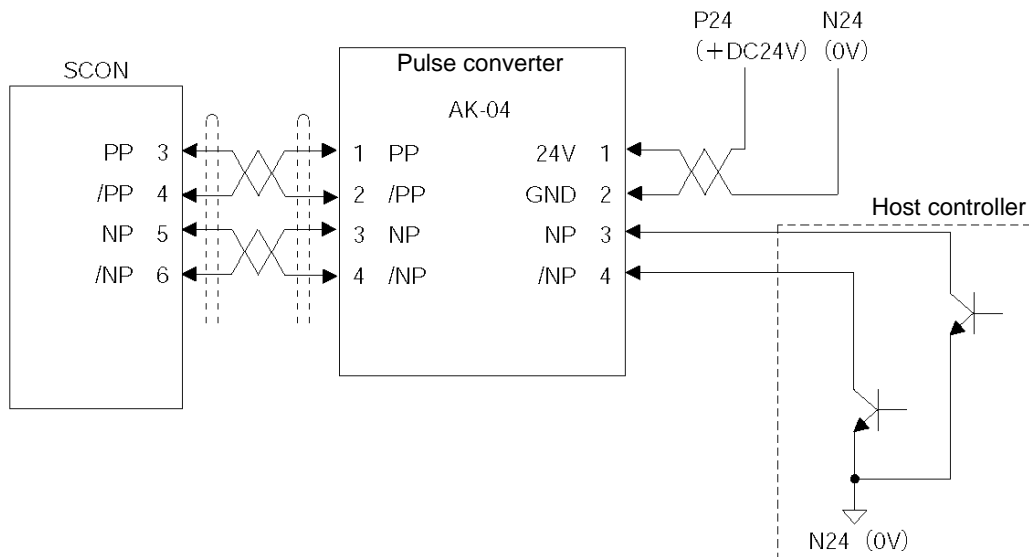

- Caution:
- Use a host controller conforming to the figure shown above.
  - If environmental noise is anticipated, use a host controller of differential line-driver output specification. If the host controller is of open-collector specification, use the pulse converter AK-04. For details on the pulser converter AK-04, refer to "Pulse converter (Model: AK-04)" in 1.3, "Options."

## 2.3 Feedback Pulse Output Part

Applicable line receiver: 26C32 or equivalent

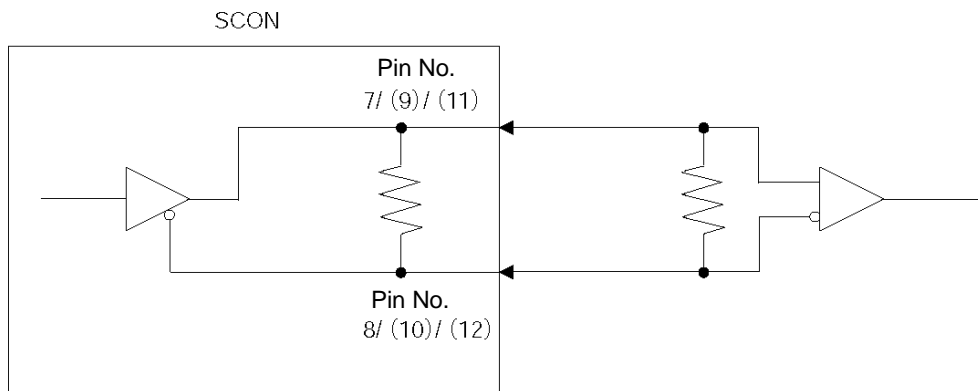

**Caution:** The range in which feedback pulses can be output linearly in accordance with the actuator speed is 0 to 109 kpps. Therefore, use feedback pulses in this range in applications where positions must be read accurately while the actuator is moving, such as when performing closed-loop control or displaying positions during movement. If 109 kpps is exceeded, the pulses corresponding to the traveled distance will still be output. If position data need not follow the speed accurately, such as when checking positions achieved by positioning operations, feedback pulses beyond the above range, but not exceeding 500 kpps, can be used without problem.

## 3. I/O Signal Control and Signal Functions

**⚠ Caution:** To operate the actuator by allowing the controller to communicate with the PLC via I/O signals, be sure to tilt the mode selector switch on the front panel of the controller to the "AUTO" position.

### 3.1 Input Signals

The input signals of this controller incorporate an input time constant to prevent malfunction due to chattering, noise, etc.

(The external forced stop signal (CSTP) and command pulse-train input (PP•/PP, NP•/NP) are excluded.)

Accordingly, each input signal should remain ON for at least 6 ms before the signal is recognized.

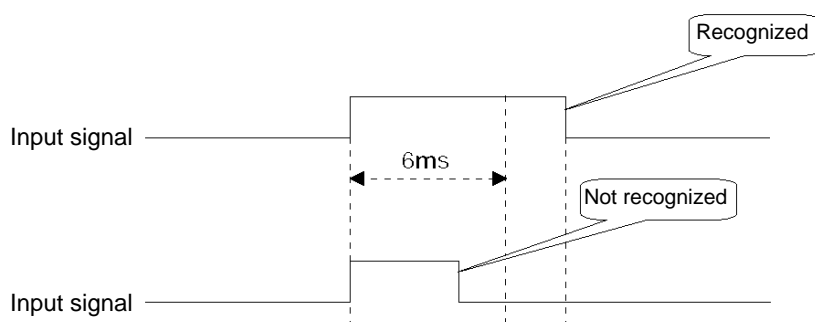

#### 3.1.1 Servo-on Signal (SON)

This signal puts the actuator's servo motor in a ready state.

- The actuator can operate while the SON signal is ON.

While this signal is OFF, the actuator cannot be operated even when the controller power is supplied.

If this signal turns OFF while the actuator is operating, the actuator will decelerate to a stop at the forced stop torque. After the actuator has stopped, the servo will turn off and the motor will enter a free-run state.

At this time, the function selected by the applicable parameter (dynamic brake, electromagnetic brake or deviation counter clearing) is implemented.

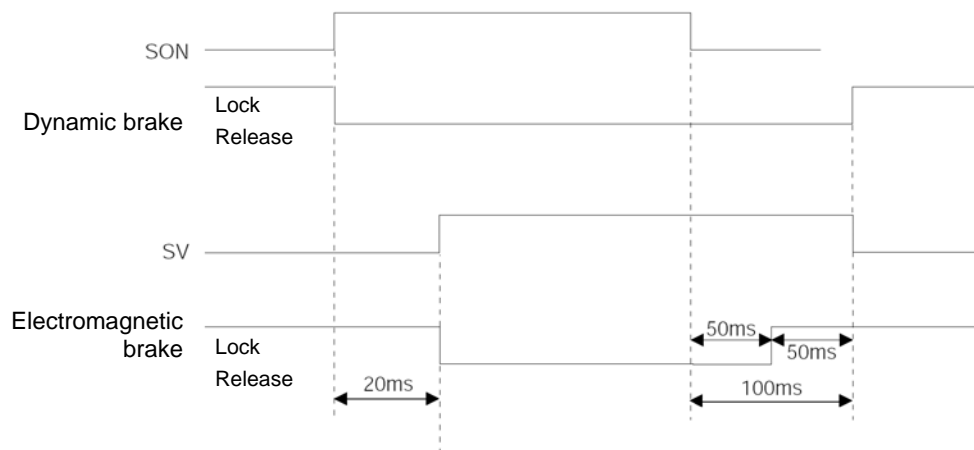



- Servo-off status
  1. Once the actuator stops, no holding torque will be supplied.
  2. The pulse-train input, HOME (home return signal), TL (torque-limiting selection signal) and CSTP (external forced stop signal) are all ignored.
  3. The output signals SV (ready signal), HEND (home return completion signal) and TLR (torque limiting signal) are all cleared (turned OFF).
  4. INP (position complete signal)
    - If the AUTO/MANU switch is set to "AUTO," the INP signal (position complete signal) is OFF when the servo is OFF.
    - If the AUTO/MANU switch is set to "MANU," the INP signal (position complete signal) is ON when the servo is OFF and the actuator is inside the band set in parameter No. 10, "Default positioning band."
- ★ Related parameter
  - The SON signal can be disabled (so that the servo always remains on) using parameter No. 21.
  - When the SON signal is disabled, the servo will turn on automatically once the controller power is input.

### 3.1.2 Reset Signal (RES)

This signal resets the alarms detected by the controller.

#### Function

Alarms detected by the controller can be reset when the RES signal is turned ON.

- Caution:
- If a cold-start level error generates, turning the RES signal ON while the SON (servo-on) signal is OFF will clear the error display. However, the alarm will generate again once the SON signal is turned ON again.
  - Identify the cause of the alarm and remove the cause, before restarting the controller.

### 3.1.3 Home Return Signal (HOME)

This command signal is used to implement automatic home return.

When the HOME signal is turned ON, the command will be processed at the leading edge (ON edge) of the signal and the actuator will perform home return operation automatically.

Once the home return is completed, the HEND (home return completion) output signal will turn ON.

Program a sequence so that the home will be set ("0" will be entered) in the current value register of the host controller (PLC) using the current-value preset function, etc., when the HOME signal turns ON.

\* This signal is always enabled while the servo is ON.

\* Even after home return has been completed once, the actuator will perform home return again every time the HOME signal is turned ON.

Caution:

- The HOME signal is given priority over any pulse-train command. Even when the actuator is moving with a pulse-train command, it will start home return once the HOME signal is turned ON.
- The HOME signal is processed only at the leading edge (ON edge) of the signal.
- If the SON signal is turned OFF or an alarm is detected during home return, the home return operation will stop. If the servo is turned OFF, the home return command will be cancelled even when the HOME signal remains ON. To perform home return again, therefore, turn the HOME signal OFF and then turn it ON again.
- The actuator can be operated without using this function. If this function is not used, however, management of position data will solely be dependent on the host controller. In this case, take the necessary measures to prevent an over-stroke, such as not sending pulse commands with travel distances exceeding the effective stroke or providing external limit switches, etc., to forcibly stop the actuator upon reaching the stroke ends.

## 3.1.4 Torque-limiting Selection Signal (TL)

This signal limits the motor torque.

### Function

The actuator thrust (motor torque) can be limited by the torque set in parameter No. 57, "Torque-limiting value" while this signal is ON.

While the TL signal is ON, the TLR (torque limiting) output signal will turn ON once the torque limit is reached. The TL signal is disabled during home return and while the actuator is forcibly stopped.

Caution:

- Do not turn OFF the TL signal while the TLR signal is ON.
- An excessive deviation (accumulated pulses) may generate while torque is being limited (the TL signal is ON) (for example, the actuator may receive a load just like it receives a push force in push & hold operation and therefore become no longer operable). If the TL signal is turned OFF in this condition, actuator control will start at the maximum torque the moment the signal changes, thus causing the actuator to move suddenly or run uncontrollably. After the TL signal has turned ON (upon completion of push & hold operation, etc.), always move the actuator in the opposite direction and confirm that the TLR signal turns OFF. If moving the actuator in the opposite direction is difficult, turn off the servo.

### ★ Related parameter

The TL signal can be disabled using parameter No. 61.  
If the TL signal is not used, disabled the signal.

## 3.1.5 Forced Stop Signal (CSTP)

This signal is used to forcibly stop the actuator.

### Function

Input the CSTP signal continuously for 10 ms or longer. When the CSTP signal is accepted, the actuator will decelerate at the emergency stop torque and then the servo will turn OFF. At this time, the function (dynamic brake, electromagnetic brake or deviation counter clearing) set by the actuator parameter for forced stop input (0: Enable/1: Disable) will be implemented.

For the servo-off status and relevant processing, refer to 3.1.1, "Servo-on Signal (SON)."

### ★ Related parameter

The forced stop signal (CSTP) can be disabled using parameter No. 67.

## 3.1.6 Deviation-counter Clear Signal (DCLR)

This signal is used to clear the deviation counter.

### Function

If a deviation generates while the TL signal is ON, this signal can be used to clear the deviation.

Caution: The actuator will operate if a pulse train is input while the DCLR signal is ON. If DCLR is used, turn this signal ON only when the deviation counter is cleared.

### ★ Related parameter

The deviation counter clear signal (DCLR) can be disabled using parameter No. 60.

## 3.1.7 Brake Forced-release Signal (BKRL)

As long as the controller is receiving the 24-V brake power externally for the controlled actuator equipped with an electromagnetic brake, turning this signal ON while the servo is off will forcibly release the electromagnetic brake.

Caution: If the actuator is used in a vertical application, exercise caution when using this signal, because turning off the servo while the brake release signal is ON will cause the actuator to drop.

## 3.1.8 Operating Mode (RMOD)

This signal is used to switch the operation mode between AUTO and MANU.

### Function

This signal switches the internal operating modes of the controller while the MODE switch on the controller is set to AUTO.

Turning this signal OFF will switch the controller to the AUTO mode, while turning it ON will switch the controller to the MANU mode.

If the MODE switch is set to MANU, the internal mode of the controller will remain MANU regardless of the state of this signal.

Caution: Once the operating mode switches to MANU, PIO activation will be inhibited. If a tool is connected, however, the PIO activation permission/inhibition setting and safety speed enable/disable setting will follow the selections made for the tool.  
In the AUTO mode, the settings selected for the tool are disabled.  
If PIO activation is permitted (monitor mode) in the AUTO mode or MANU mode, actuator operation commands and parameter write commands from the tool are inhibited (limited by the tool).

★ The operating mode signal (RMOD) can be disabled using parameter No. 41.

## 3.1.9 Command Pulse Input

Pulses up to 200 kpps in the open-collector mode, or up to 500 kpps in the differential line-driver mode, can be input.

Available command pulses include the 90° phase-difference (phase-A/B x4) signal, pulse train + forward/reverse signal and forward pulse/reverse pulse, and either the positive logic or negative logic can be selected as the input pattern for each pulse signal.

**Caution:**

- The directions in which the actuator moves upon receiving forward and reverse pulses conform to the pulse count direction set in parameter No. 62.
- As for the forward/reverse directions, pay attention to the host controller setting or PP•/PP and NP•/NP connection.
- Set the actuator acceleration/deceleration on the host controller side.
- The actuator acceleration/deceleration should not exceed the rated acceleration/deceleration of the applicable actuator. (The rated acceleration/deceleration of each actuator is specified in the actuator's catalog.)
- \* The rotating direction of the motor is defined so that the counterclockwise direction as viewed from the end of the load shaft represents the forward direction.

★ Related parameter

Six command pulse patterns can be set in the command-pulse input mode.

Command pulse-train pattern		Input terminal	Forward	Reverse
Negative logic	Forward pulse train	PP • /PP		
	Reverse pulse train	NP • /NP		
	A forward pulse train indicates motor revolutions in the forward direction, while a reverse pulse train indicates motor revolutions in the negative direction.			
	Pulse train	PP • /PP		
	Sign	NP • /NP	Low	High
	Command pulses indicate motor revolutions, while a command sign indicates a rotating direction.			
	Phase-A/B pulse train	PP • /PP		
	NP • /NP			
Phase-A/B x4 pulses with a 90° phase difference indicate motor revolutions and a rotating direction.				
Positive logic	Forward pulse train	PP • /PP		
	Reverse pulse train	NP • /NP		
	Pulse train	PP • /PP		
	Sign	NP • /NP	High	Low
	Phase-A/B pulse train	PP • /PP		
	NP • /NP			

## 3.2 Output Signals

### 3.2.1 System Ready Signal (PWR)

After the main power has been input, this signal will turn ON once the SCON enters a ready state.

#### Function

The signal will turn ON once the SCON enters a ready state after the main power has been input and the controller has been initialized successfully, regardless of the servo status or whether an alarm is present, etc. Even if an alarm is present, this signal is ON as long as the SCON is ready.

This signal is synchronized with the illumination of the PWR LED (green) on the front face of the controller.

### 3.2.2 Servo-on Status Signal (SV)

This signal is output when the servo is ON.

#### Function

When the SON (servo-on) signal turns ON, the servo will turn on and the controller will become ready (pulse-train inputs can be accepted) (pulse-train inputs can be accepted = pulse mode). The SV signal turns ON in this condition.

It will turn OFF when the servo is turned off due to a SON signal OFF.

This signal is synchronized with the illumination of the SV LED (green) on the front face of the controller.

### 3.2.3 Position Complete Signal (INP)

This signal will turn ON when the deviation (accumulated pulses) on the deviation counter enters the in-positioning band, and remain ON while the deviation is inside this range.

#### Function

When the servo is ON, this signal turns ON when the accumulated pulses on the deviation counter are within the number of pulses set in parameter No. 10, "Default positioning band."

This signal is OFF while the servo is off.

- Caution:
- This signal will turn ON when the servo turns on (because positioning is executed at the current position where the servo turns on).
  - Since this signal turns ON only based on the deviation (accumulated pulses), setting an excessively large value in the position control parameter for the positioning band will cause the signal to turn ON while the actuator is still operating at slow speed (i.e., positioning is not yet completed) as long as the current actuator position is inside the in-position band.

## 3.2.4 Home Return Completion Signal (HEND)

This signal will turn ON when home return is completed and the coordinate system is established.

### Function

This signal will turn ON when the home return initiated by the applicable signal, teaching pendant or PC software is completed.

The signal will turn OFF once the servo turns off. After the servo is turned off, perform home return again.

- Caution:
- The software stroke limits set by the actuator parameters remain effective only while this signal is ON.
  - Although the actuator can be operated without using this function, if this function is not used the necessary measures must be taken such as not sending pulse commands with travel distances exceeding the effective stroke or providing external limit switches to forcibly stop the actuator upon reaching the stroke ends.

## 3.2.5 Torque Limiting Signal (TLR)

This signal will turn ON when the torque reaches the limit while torque is being limited.

### Function

This signal will turn ON when the actuator thrust (motor torque) reaches the torque limit set by the torque limit parameter while the TL (Torque-limiting selection) signal is ON.

This signal will turn OFF when the motor torque lowers.

- Caution:
- Even if the TL signal is turned ON, the TLR signal will not turn ON unless the actuator torque reaches the specified torque.
  - Do not turn the TL signal OFF while this signal is ON.  
(For details, refer to “Caution” in 3.1.4, “Torque-limiting Selection Signal (TL).”)

## 3.2.6 Alarm Signal (\*ALM)

This signal will turn OFF when the SCON's protective circuit (function) detects an error.

### Function

This signal will turn OFF when any of the controller's protective circuits (functions) actuates upon detecting an alarm and the base cutoff function is executed.

Once the cause of the alarm has been removed, this signal can be turned ON by turning the RES (reset) signal ON. (This does not apply to cold-start level alarms.)

When an alarm is detected, the ALM LED on the front face of the controller will illuminate. This LED remains unlit in a normal state.

Caution:

- If a cold-start level error generates, turning the RES signal ON while the servo-on (SON) signal is OFF will clear the error display. However, the alarm will generate again once the SON signal is turned ON again.
- Alarm codes can be checked using the teaching pendant or PC software. The controller can store up to 16 past alarms, with each alarm shown with the time of occurrence, to let you identify which alarm occurred when.

### Controller alarm list (PC software)

Data type	Code	Message	Adrs	Detail	Time
detected last	OD9	Software stroke limit over error	----	0001	0:17:58
History 1					
History 2					
History 3					
History 4					
History 5					
History 6					
History 7					
History 8					
History 9					
History 10					
History 11					
History 12					
History 13					
History 14					



### 3.2.7 Alarm Code Output Signals (ALM1, ALM2, ALM4, ALM8)

When an alarm generates, the alarm information is output using the ALM1 to 8 ports so that the nature of the alarm can also be recognized on the PLC side.

For details, refer to 5.3, "Alarm Description Output Using PIO" in Appendix.

### 3.2.8 Zone (ZONE1, ZONE2)

The ZONE1 signal turns ON when the current actuator position is inside the range specified by "Parameter No. 1: Zone 1+" and "Parameter No. 2: Zone 1-," and OFF when outside this range. This signal is always effective after a home return has completed, and not affected by the servo status or alarm status. (The ZONE2 signal turns ON/OFF according to "Parameter No. 23: Zone 2+" and "Parameter No. 24: Zone 2-.")

(Note 1) This signal becomes effective after the coordinate system is established following a home return. Turning on the power is not enough to output this signal. Once a home return is complete, this signal remains effective even when the servo is OFF or during an emergency stop.

(Note 2) The zone function is changed through a version upgrade. Refer to the cautions in the beginning of this manual.

Example of operation/use) Output a zone signal inside the zone of 40 to 120 mm as the actuator moves from its home to the 150-mm position (position 1).

Method) • Zone output (ZONE1)  
Set the ON zone by the parameters for zone 1+/zone 1-.

Parameter No. 1	Zone 1+	120 (mm)
Parameter No. 2	Zone 1-	40 (mm)

## 3.2.9 Feedback-pulse Output Signals (AFB•/AFB, BFB•/BFB, ZFB•/ZFB, GND)

Data of detected positions are output using differential pulses.

### Function

Data of detected positions are output using differential pulses (phases A, B and Z). The host controller can read the current actuator position in real time using a counter function, etc.

### ★ Related parameter

The resolution of output pulses is determined based on the electronic gear ratio of input pulses set by the applicable position control parameters, where the resolution of output pulses is the same as that of command pulses.

A desired feedback-pulse output pattern can be set using the user parameter for feedback pulse pattern.

These pulse signals can be disabled using user parameter No. 68, "Enable/disable feedback pulses."

Set this parameter to "Disable" if the feedback pulses are not used.

Caution:

- If these signals are to be read by the host controller to set a closed loop, set a logically consistent sequence to implement the applicable processing.
- If the actuator encoder is not a serial encoder, the phase-Z signal is output directly.  
If the actuator uses a serial encoder, the phase-Z pulse is output within a mechanical-angle range of  $\pm 0.5^\circ$  from the zero (home) position. Based on the communication cycle with the encoder, this precision can be assured when the motor speed is 100 rpm or below.

## 3.2.10 Emergency Stop Status (\*EMGS)

The status is ON under normal conditions, but is turned OFF if the emergency stop switch is pressed.

Monitor the OFF status of this signal on the PLC side and take appropriate safety measures for the entire device.

## 4. How to Switch to the Pulse-train Control Mode

Change the position of the piano switch located on the front panel of the controller.

Front panel

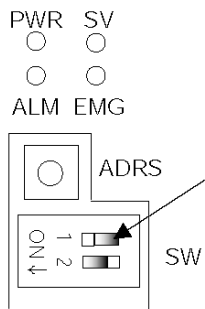

- [1] Set SW1 to the ON position (tilt the switch to the left) when the power is still off.
- [2] Turn on the power.

Piano switches

Name	Description
1	Operation mode selector switch OFF: Positioner mode, ON: Pulse-train mode * The setting will become effective after the power is reconnected.
2	Used by the manufacturer for adjustment purposes. Keep the switch in the OFF position.

**⚠ Caution:** To operate the actuator by allowing the controller to communicate with the PLC via pulse trains, be sure to tilt the mode selector switch on the front panel of the controller to the "AUTO" position.

## 5. Parameters

### 5.1 Parameter Settings Required for Operation

Parameters can be set or changed using the teaching pendant or PC software.

After a parameter has been changed, the new setting will become effective once a “software reset” is performed using the teaching pendant or PC software or the power is reconnected.

#### 5.1.1 Basic Settings

The parameters that must be set before the actuator can be operated are explained below.

(The following parameters are all you need to set, if the actuator performs only positioning operation.)

##### (1) Electronic gear

User parameter Nos. 65/66, “Electronic gear numerator/denominator”

Name	Symbol	Unit	Input range	Default setting (reference)
Electronic gear numerator	CNUM	-	1 to 4096	2048
Electronic gear denominator	CDEN	-	1 to 4096	125

These parameters are used to determine the unit travel distance of the actuator per each command pulse-train input pulse.

Unit travel distance for linear axis = Minimum travel unit (1, 0.1, 0.01 mm, etc.) per pulse

Unit travel distance for rotational axis = Minimum travel unit (1, 0.1, 0.01 deg, etc.) per pulse

##### ■ Electronic-gear calculation formula

###### Linear axis

$$\frac{\text{Electronic gear numerator (CNUM)}}{\text{Electronic gear denominator (CDEN)}} = \frac{\text{Number of encoder pulses (pulses/rev)}}{\text{Ball screw lead (mm/rev)}} \times \text{Unit travel distance (mm/pulse)}$$

###### Rotational axis

$$\frac{\text{Electronic gear numerator (CNUM)}}{\text{Electronic gear denominator (CDEN)}} = \frac{\text{Number of encoder pulses (pulses/rev)}}{360 \text{ (deg/rev)} \times \text{Gear ratio of rotational axis}} \times \text{Unit travel distance (deg/pulse)}$$

##### Reference

The actuator speed is calculated by the formula below:

$$\text{Speed} = \text{Unit travel distance} \times \text{Input pulse frequency (Hz)}$$

Take note that setting the unit travel distance too small may prevent the actuator from reaching the maximum speed in certain conditions.

The number of encoder pulses varies depending on the actuator type.

Actuator type	Number of encoder pulses (pulses/rev)
RCS-SS (R)/RCS-SM (R)/RCS-RA55/RCS-F55 ISP (D) (A)/IS (D) (A)/IS (P) A/IF/FS/SS/NS (excluding NS-S***-I) RS-60/RS-30 DS-SA4/5/6 [T1] RCS2-SA4 (C) (D) (R) RCS2-SA5 (C) (D) (R) /RCS2-SA6 (C) (D) (R) RCS2-A4R/RCS2-A5R/RCS2-A6R/RCS2-SA7 (C) RCS2-SS7C/RCS2-SS7R/RCS2-SS8C/RCS2-SS8R RCS2-RA5C/RCS2-RA5R/RCS2-F5D RCS2-RA4C (D) (R) /RCS2-RA13R RCS2-G20/RCS2-RT6/RCS2-RT6R/RCS2-RT7R RCS-G20/RCS2-GR8/RCS3 RCS2-RTC8L/RCS2-RTC8HL/RCS2-RTC10L/RCS2-RTC12L	16384
RCS-RB7530/RCS-RB7535/RCS2-RA7AD/RCS-RA7BD	3072
RCS-G20/RCS-R10/RCS-R20/RCS-R30	4096
S6S (linear)	48000
S8S/S8H (linear)	60000
S10S/S10H (linear)	90000
H8S/H8H/L15S/N10S/N15S/N15H (linear)	50000
M19S/N19S (linear)	72000
W21S (linear)	45000
NS-S***-I	2400

With actuators of belt-drive type, the ball screw lead is assumed as follows in the calculation.

Actuator type	Lead (mm)	
IF	35	
FS	HM	40
	Other than HM	25

The gear ratios of rotational axes and ROBO Rotaries are as follows.

Actuator type	Gear ratio
RS-60	1/50 or
RS-30	1/100
RCS-R10/ RCS2-RT6	1/18
RCS-R20/ RCS2-RT6R	
RCS-R30/RCS2-RT7R	1/4
RCS-G20/RCS2-GR8	1/5
RCS2-RTC8L/RCS2-RTC8HL/RCS2-RTC10L	1/15 or 1/24
RCS2-RTC12L	1/18 or 1/30

In calculating the electronic gear ratio, the ROBO Gripper RCS-G20 is assumed as a "linear axis."

Follow the rules below to use an appropriate ball screw lead for the RCS-G20:

- When commands from the host controller specify values for one finger: 12.5 mm
- When commands from the host controller specify total values of both fingers: 25 mm

With linear actuators, calculations are performed by assuming the lead as one of the following lengths as applicable.

Actuator type	Gear ratio
S6S	48
S8S/S8H	60
S10S/S10H	90
H8S/H8H/L15S/N10S/N15S/N15H	50
M19S/N19S	72
W21S	45

# SCON

## ■ Calculation example

To set the unit travel distance to 0.01 (1/100) (mm) for an actuator with a ball screw lead of 10 (mm), equipped with an encoder of 16,384 (pulses/rev).

$$\frac{\text{Electronic gear numerator (CNUM)}}{\text{Electronic gear denominator (CDEN)}} = \frac{\text{Number of encoder pulses (pulses/rev)}}{\text{Ball screw lead (mm/rev)}} \times \text{Unit travel distance (mm/pulse)}$$

$$= \frac{16384}{10} \times \frac{1}{100} = \frac{2048}{125}$$

The electronic gear numerator (CNUM) is calculated as 2,048, while the electronic gear denominator (CDEN) is calculated as 125. Based on these settings, the travel distance per each command pulse-train input pulse becomes 0.01 (mm).

### Caution:

- The fraction has to be completely reduced so both the electric gear numerator (CNUM) and electric gear denominator (CDEN) can be 4096 or less and make them to be integral numbers. (Do not stop reducing the fraction on the way.)
- CNUM and CDEN on the line axis have to satisfy the following relative formulas.

$$2^{31} \geq \frac{\text{Stroke Length [mm]}}{\text{Ball Screw Lead Length [mm/rev]}} \times \text{No. of Encoder Pluses [pulse]} \times \text{CNUM}$$

$$2^{31} \geq \frac{\text{Stroke Length [mm]}}{\text{Ball Screw Lead Length [mm/rev]}} \times \text{No. of Encoder Pluses [pulse]} \times \text{CDEM}$$

- Use rotary actuators of multi-rotation specification within the range where the following formula is satisfied. Moreover, the maximum rotation angle is  $\pm 9999$  <sup>(note1)</sup> deg (maximum software stroke limit).

$$\pm 2^{23} \geq \frac{\text{Maximum rotation angle [deg]}}{\text{Unit Travel Distance [deg/pulse]}}$$

Maximum rotation angle : Set the usage conditions (MAX. -9999 to 9999deg)

Note 1 : The following models can not be rotated up to  $\pm 9999.99$  [deg].

deceleration ratio	Maximum rotation angle [deg]	corresponding model
1/24	$\pm 7679.99$	RCS2-RTC8、RCS2-RTC10
1/30	$\pm 6143.99$	RCS2-RTC12
1/50	$\pm 3685$	RS-30、RS-60
1/100	$\pm 1842$	

Unit Travel Distance : Travel distance per command pulse

- Do not set the minimum movement unit out of the encoder resolution ability. If this setting is conducted, the actuator would not start moving until enough command pulse is stored in the encoder resolution error.

$$\text{Encoder resolution for line axis [mm/pulse]} = \frac{\text{Ball Screw Lead Length [mm/rev]}}{\text{No. of Encoder Pluses [pulse/rev]}}$$

$$\text{Encoder resolution for rotational axis [deg/pulse]} = \frac{360[\text{deg/rev}] \times \text{Rotary Axis Reduction Ratio}}{\text{No. of Encoder Pluses [pulse/rev]}}$$

- Pay attention not to exceed the specification limit when setting the velocity, acceleration and deceleration.

## (2) Command pulse mode

User parameter No. 63, "Command-pulse input mode"

Name	Symbol	Unit	Input range	Default setting (reference)
Command-pulse input mode	CPMD	-	0 to 2	1

Set a desired pulse-train input pattern for command pulse input (PP•/PP, NP•/NP).

\* Whether to apply the positive logic or negative logic is set in accordance with (3), "Input polarity in the command pulse mode."

Command pulse-train pattern		Input terminal	Forward	Reverse	
Negative logic	Forward pulse train	PP • /PP			2
	Reverse pulse train	NP • /NP			
	A forward pulse train indicates motor revolutions in the forward direction, while a reverse pulse train indicates motor revolutions in the negative direction.				
	Pulse train	PP • /PP			1
	Sign	NP • /NP	Low	High	
	Command pulses indicate motor revolutions, while a command sign indicates a rotating direction.				
	Phase-A/B pulse train	PP • /PP			0
	NP • /NP				
Phase-A/B x4 pulses with a 90° phase difference indicate motor revolutions and a rotating direction.					
Positive logic	Forward pulse train	PP • /PP			2
	Reverse pulse train	NP • /NP			
	Pulse train	PP • /PP			1
	Sign	NP • /NP	High	Low	
	Phase-A/B pulse train	PP • /PP			0
	NP • /NP				

## (3) Input polarity in the command pulse mode

User parameter No. 64, "Command-pulse input mode polarity"

Name	Symbol	Unit	Input range	Default setting (reference)
Command-pulse input mode polarity	POLE	-	0 to 1	0

Setting

Positive logic: 0

Negative logic: 1

## 5.2 Effective Parameters in the Pulse-train Mode

Parameters can be set or changed using the teaching pendant or PC software.

After a parameter has been changed, the new setting will become effective once a “software reset” is performed using the teaching pendant or PC software or the power is reconnected.

### 5.2.1 Applied Settings

#### (1) Torque limit

No.	Name	Symbol	Unit	Input range	Default setting
57	Torque limit	TQLM	%	0 to 70	70

Set a desired torque limit used in the torque-limit input signal (TL), which is an external input signal.

Set a desired torque as a percentage of the rated thrust representing 100% (the rated thrust is specified in the catalog).

When the external torque-limit input signal (TL) turns ON, torque will be limited according to the setting.

Once the torque current reaches a level corresponding to the specified torque limit, the torque limiting signal (TLR) will be output as an external output signal.

#### (2) Clearing the deviation during servo off or alarm stop

No.	Name	Symbol	Unit	Input range	Default setting
58	Clearing the deviation during servo off or alarm stop	FSTP	-	0 to 1	1

You can select whether to enable or disable the function to clear the deviation when the servo is off or the actuator is stopped due to an alarm.

Setting 0: Disable

Setting 1: Enable

#### (3) Error monitor during torque limiting

No.	Name	Symbol	Unit	Input range	Default setting
59	Deviation error monitor during torque limiting	FSTP	-	0 to 1	0

You can select whether to enable or disable the function to monitor deviation while torque is being limited (the TL signal is ON).

By enabling this function, you can have the controller output an error upon generation, while torque is being limited, of a deviation equal to or exceeding the value set by the applicable parameter.

Setting 0: Disable

Setting 1: Enable

#### (4) Deviation-counter clearing input

No.	Name	Symbol	Unit	Input range	Default setting
60	Deviation-counter clearing input	FPIO	-	0 to 1	0

You can select whether to enable or disable the function to clear the generated deviation while torque is being limited (the TL signal is ON).

Disable this function in conditions where torque must be limited during movement (push & hold operation is not performed).

Setting 0: Enable

Setting 1: Disable



## (5) Torque-limit command input

No.	Name	Symbol	Unit	Input range	Default setting
61	Torque-limit command input	FPIO	-	0 to 1	0

You can select whether to enable or disable the torque-limiting signal (TL signal).

Setting 0: Enable

Setting 1: Disable

## (6) Pulse count direction

No.	Name	Symbol	Unit	Input range	Default setting
62	Pulse count direction	CPR	-	0 to 1	Set individually.

You can set the direction in which the motor turns upon receiving a command pulse.

Setting 0: Forward

Setting 1: Reverse

## (7) Forced stop input

No.	Name	Symbol	Unit	Input range	Default setting
67	Forced stop input	FPIO	-	0 to 1	0

You can select whether to enable or disable the forced-stop input signal (CSTP signal).

Setting 0: Enable

Setting 1: Disable

## (8) Feedback pulse output

No.	Name	Symbol	Unit	Input range	Default setting
68	Feedback pulse output	FPIO	-	<b>0 to 1</b>	<b>1</b>

You can select whether to enable or disable the feedback pulse output.

Setting 0: Enable

Setting 1: Disable

## (9) Position Command Primary Filter Time Constant

No.	Name	Symbol	Unit	Input range	Default setting
55	Position Command Primary Filter Time Constant	PLPF	msec	0.0 ~ 100.0	0.0

The actuator can be accelerated/decelerated along a S-motion curve by setting this parameter accordingly.

If a command pulse-train input is given at a specified frequency, the actuator accelerates/decelerates slowly from the set time constant.

The actuator moves by the number of pulses specified by the command.

By setting this parameter, smooth actuator acceleration/deceleration can be ensured even when the host controller has no acceleration/deceleration function or the command pulse frequency changes rapidly.

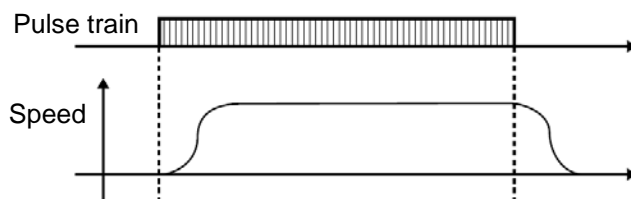

## (9) Feedback pulse pattern

No.	Name	Symbol	Unit	Input range	Default setting
69	Feedback pulse pattern	FBPT	-	0 to 2	0

You can set a desired pattern in which to output feedback pulses.

Command pulse-train pattern		Input terminal	Forward	Reverse	Setting
Negative logic	Forward pulse train	AFB $\blacktriangle$ /AFB			2
	Reverse pulse train	BFB $\blacktriangle$ /BFB			
	A forward pulse train indicates motor revolutions in the forward direction, while a reverse pulse train indicates motor revolutions in the negative direction.				
	Pulse train	AFB $\blacktriangle$ /AFB			1
	Sign	BFB $\blacktriangle$ /BFB	Low	High	
	Command pulses indicate motor revolutions, while a command sign indicates a rotating direction.				
Phase-A/B pulse train	AFB $\blacktriangle$ /AFB			0	
	BFB $\blacktriangle$ /BFB				
Phase-A/B x4 pulses with a 90° phase difference indicate motor revolutions and a rotating direction.					
Positive logic	Forward pulse train	AFB $\blacktriangle$ /AFB			2
	Reverse pulse train	BFB $\blacktriangle$ /BFB			
	Pulse train	AFB $\blacktriangle$ /AFB			1
	Sign	BFB $\blacktriangle$ /BFB	High	Low	
	Phase-A/B pulse train	AFB $\blacktriangle$ /AFB			0
BFB $\blacktriangle$ /BFB					
ZFB $\blacktriangle$ /ZFB		<p>If the actuator encoder is not a serial encoder, the phase-Z signal is output directly.</p> <p>If the actuator uses a serial encoder, the phase-Z pulse is output within a mechanical-angle range of <math>\pm 0.5^\circ</math> from the zero (home) position. Based on the communication cycle with the encoder, this precision can be assured when the motor speed is 100 rpm or below.</p> <p>* The actuator is using a serial encoder if the number of encoder pulses is 16,384 (pulses/rev).</p>			

## (10) Feedback-pulse pattern polarity

No.	Name	Symbol	Unit	Input range	Default setting
70	Feedback-pulse pattern polarity	FBPT	-	0 to 1	0

You can set a desired polarity to be applied to the feedback pulse pattern.

Setting 0: Positive logic

Setting 1: Negative logic

\* Appendix

## 1. Actuator Specification List

	Model	Stroke (mm), maximum speed (mm/sec) *1																Loading capacity *2		Rated acceleration	
																		Horizontal	Vertical	Horizontal	Vertical
		50	100	150	200	250	300	350	400	450	500	550	600	700	800	900	1000	1100	1200	(kg)	(kg)
(Slider type) $\sim \sim \sim \sim$	RCS2-SA4C-□-20-10-□□□	665																4	1	0.3	0.3
	RCS2-SA4C-□-20-5-□□□	330																6	2.5	0.3	0.3
	RCS2-SA4C-□-20-2.5-□□□	165																8	4.5	0.2	0.2
	RCS2-SA5C-□-20-12-□□□	800																4	1	0.3	0.3
	RCS2-SA5C-□-20-6-□□□	400																8	2	0.3	0.3
	RCS2-SA5C-□-20-3-□□□	200																12	4	0.2	0.2
	RCS2-SA6C-□-30-12-□□□	800																6	1.5	0.3	0.3
	RCS2-SA6C-□-30-6-□□□	400																12	3	0.3	0.3
	RCS2-SA6C-□-30-3-□□□	200																18	6	0.2	0.2
	RCS2-SA7C-□-60-16-□□□	800																12	3	0.3	0.3
	RCS2-SA7C-□-60-8-□□□	400																25	6	0.3	0.3
	RCS2-SA7C-□-60-4-□□□	200																40	12	0.2	0.2
	RCS2-SS7C-□-60-12-□□□	600																15	4	0.3	0.3
	RCS2-SS7C-□-60-6-□□□	300																30	8	0.3	0.3
	RCS2-SS8C-□-100-20-□□□	1000																20	4	0.3	0.3
RCS2-SS8C-□-100-10-□□□	500																40	8	0.3	0.3	
RCS2-SS8C-□-150-20-□□□	1000																30	6	0.3	0.3	
RCS2-SS8C-□-150-10-□□□	500																60	12	0.3	0.3	
(Rod type) $\sim \sim \sim \sim$	RCS2-RA4C-□-20-12-□□□	600																3	1	0.3	0.3
	RCS2-RA4C-□-20-6-□□□	300																6	2	0.3	0.3
	RCS2-RA4C-□-20-3-□□□	150																12	4	0.2	0.2
	RCS2-RA4C-□-30-12-□□□	600																4	1.5	0.3	0.3
	RCS2-RA4C-□-30-6-□□□	300																9	3	0.3	0.3
	RCS2-RA4C-□-30-3-□□□	150																18	6.5	0.2	0.2
	RCS2-RA5C-□-60-16-□□□	800																12	2	0.3	0.3
	RCS2-RA5C-□-60-8-□□□	400																25	5	0.3	0.3
	RCS2-RA5C-□-60-4-□□□	200																50	11.5	0.2	0.2
	RCS2-RA5C-□-100-16-□□□	800																15	3.5	0.3	0.3
	RCS2-RA5C-□-100-8-□□□	400																30	9	0.3	0.3
	RCS2-RA5C-□-100-4-□□□	200																60	18	0.2	0.2
	RCS2-RA7AD-I-60-12-□□□	600																10	2.5	0.15	0.15
	RCS2-RA7AD-I-60-6-□□□	300																20	7	0.1	0.1
	RCS2-RA7AD-I-60-3-□□□	150																40	15	0.05	0.05
	RCS2-RA7AD-I-100-12-□□□	600																15	5.5	0.2	0.2
	RCS2-RA7AD-I-100-6-□□□	300																30	12.5	0.1	0.1
	RCS2-RA7BD-I-100-16-□□□	800																10	3.5	0.25	0.25
	RCS2-RA7BD-I-100-8-□□□	400																22	9	0.17	0.17
	RCS2-RA7BD-I-100-4-□□□	200																40	19.5	0.1	0.1
RCS2-RA7BD-I-150-16-□□□	800																15	6.5	0.3	0.3	
RCS2-RA7BD-I-150-8-□□□	400																35	14.5	0.2	0.2	
(Arm/flat type) $\sim \sim \sim \sim$	RCS2-A4R-□-20-10-□□□	330																-	2.5	-	0.2
	RCS2-A4R-□-20-5-□□□	165																-	4.5	-	0.2
	RCS2-A5R-□-30-12-□□□	400																-	2	-	0.2
	RCS2-A5R-□-30-6-□□□	200																-	4	-	0.2
	RCS2-A6R-□-30-12-□□□	400																-	3	-	0.2
	RCS2-A6R-□-30-6-□□□	200																-	6	-	0.2
	RCS2-F5D-□-60-16-□□□	800																-	2	-	0.3
	RCS2-F5D-□-60-8-□□□	400																-	5	-	0.3
	RCS2-F5D-□-60-4-□□□	200																-	11.5	-	0.2
	RCS2-F5D-□-100-16-□□□	800																-	3.5	-	0.3
RCS2-F5D-□-100-8-□□□	400																-	9	-	0.3	
RCS2-F5D-□-100-4-□□□	200																-	18	-	0.2	

\*1: The figure in the elongated circle indicates the maximum speed for each stroke.

\*2: The loading capacity is calculated by assuming actuator operation at the rated acceleration.

	Model	Stroke (mm), maximum speed (mm/sec) *1																				Loading capacity *2		Rated acceleration	
																						Horizontal	Vertical	Horizontal	Vertical
		50	100	150	200	250	300	350	400	450	500	550	600	700	800	900	1000	1100	1200	(kg)	(kg)	(G)	(G)		
RCS2CR (Rotary type)	RCS2-RT5-I-60-18-300	500/sec																				-	-	-	-
	RCS2-RT6R-I-60-18-300	500/sec																				-	-	-	-
	RCS2-RT7R-I-60-4-300	500/sec																				-	-	-	-
(Slider type) RCS2CR	RCS2CR-SA4C-□-20-10-□□□	665																				4	1	0.3	0.3
	RCS2CR-SA4C-□-20-5-□□□	330																				6	2.5	0.3	0.3
	RCS2CR-SA4C-□-20-2.5-□□□	165																				8	4.5	0.2	0.2
	RCS2CR-SA5C-□-20-12-□□□	800																				4	1	0.3	0.3
	RCS2CR-SA5C-□-20-6-□□□	400																				8	2	0.3	0.3
	RCS2CR-SA5C-□-20-3-□□□	200																				12	4	0.2	0.2
	RCS2CR-SA6C-□-30-12-□□□	800																				6	1.5	0.3	0.3
	RCS2CR-SA6C-□-30-6-□□□	400																				12	3	0.3	0.3
	RCS2CR-SA6C-□-30-3-□□□	200																				18	6	0.2	0.2
	RCS2CR-SA7C-□-60-16-□□□	600																				12	3	0.3	0.3
	RCS2CR-SA7C-□-60-8-□□□	400																				25	6	0.3	0.3
	RCS2CR-SA7C-□-60-4-□□□	200																				40	12	0.2	0.2
	RCS2CR-SS7C-□-60-12-□□□	600																				15	4	0.3	0.3
	RCS2CR-SS7C-□-60-6-□□□	300																				30	8	0.3	0.3
	RCS2CR-SS8C-□-100-20-□□□	1000																				20	4	0.3	0.3
	RCS2CR-SS8C-□-100-10-□□□	500																				40	8	0.3	0.3
	RCS2CR-SS8C-□-150-20-□□□	1000																				30	6	0.3	0.3
	RCS2CR-SS8C-□-150-10-□□□	500																				60	12	0.3	0.3
RCS2W (Dustproof/dust- proof type)	RCS2W-RA4□-□-30-12-□□□	600																				4	1.5	0.3	0.3
	RCS2W-RA4□-□-30-6-□□□	300																				9	3	0.3	0.3
	RCS2W-RA4□-□-30-3-□□□	150																				18	6.5	0.2	0.2

\*1: The figure in the elongated circle indicates the maximum speed for each stroke.  
 \*2: The loading capacity is calculated by assuming actuator operation at the rated acceleration.

	Model	Stroke (mm), maximum speed (mm/sec) *1														Loading capacity *2		Rated acceleration						
		50	100	150	200	250	300	350	400	450	500	550	600	700	800	900	1000	Horizontal	Vertical	Horizontal	Vertical			
																(kg)	(kg)	(G)	(G)					
(Slider type) スライド	RCS-SS-□-60-H-□□□	600											470			15	4	0.3	0.2					
	RCS-SS-□-60-M-□□□	300											230			30	8							
	RCS-SM-□-100-H-□□□	1000											960 765 625 515			20	4							
	RCS-SM-□-100-M-□□□	500											480 380 310 255			40	8							
	RCS-SM-□-150-H-□□□	1000											960 765 625 515			30	6							
	RCS-SM-□-150-M-□□□	500											480 380 310 255			60	12							
	RCS-SSR-□-60-H-□□□	600											470			15	4							
	RCS-SSR-□-60-M-□□□	300											230			30	8							
	RCS-SMR-□-100-H-□□□	1000											960 765 625 515			20	4							
	RCS-SMR-□-100-M-□□□	500											480 380 310 255			40	8							
	RCS-SMR-□-150-H-□□□	1000											960 765 625 515			30	6							
RCS-SMR-□-150-M-□□□	500											480 380 310 255			60	12								
(Rod type) ロッド	RCS-RA55-□-60-H-□□□	800		755																12	2	0.3	0.2	
	RCS-RA55-□-60-M-□□□	400		377																25	5			
	RCS-RA55-□-60-L-□□□	200		188																50	11.5	0.2		
	RCS-RA55-□-100-H-□□□	800		755																15	3.5	0.3		
	RCS-RA55-□-100-M-□□□	400		377																30	9			
	RCS-RA55-□-100-L-□□□	200		188																60	18	0.2		
	RCS-RA55R-□-60-H-□□□	800		755																12	2	0.3		
	RCS-RA55R-□-60-M-□□□	400		377																25	5			
	RCS-RA55R-□-60-L-□□□	200		188																50	11.5	0.2		
	RCS-RB7530-I-60-H-□□□	600		505																10	2.5	0.15		0.15
	RCS-RB7530-I-60-M-□□□	300		250																20	7	0.1		0.1
	RCS-RB7530-I-60-L-□□□	150		125																40	15.5	0.05		0.05
	RCS-RB7530-I-100-H-□□□	600		505																15	5.5	0.2		0.2
	RCS-RB7530-I-100-M-□□□	300		250																30	12.5	0.1		0.1
	RCS-RB7535-I-100-H-□□□	800																		10	3.5	0.25		0.25
	RCS-RB7535-I-100-M-□□□	400																		22	9	0.17		0.17
	RCS-RB7535-I-100-L-□□□	200																		40	19.5	0.1		0.1
	RCS-RB7535-I-150-H-□□□	800																		15	6.5	0.3		0.3
RCS-RB7535-I-150-M-□□□	400																		35	14.5	0.2	0.2		
(Flat type) フラット	RCS-F55-□-60-H-□□□	800														-	2	0.3	0.2					
	RCS-F55-□-60-M-□□□	400															5							
	RCS-F55-□-60-L-□□□	200															11.5			0.2				
	RCS-F55-□-100-H-□□□	800															3.5			0.3				
	RCS-F55-□-100-M-□□□	400															9							
	RCS-F55-□-100-L-□□□	200															18			0.2				

\*1: The figure in the elongated circle indicates the maximum speed for each stroke.  
 \*2: The loading capacity is calculated by assuming actuator operation at the rated acceleration.

	Model	Stroke (mm), maximum speed (mm/sec) *1																		Loading capacity *2		Rated acceleration		
		50	100	150	200	250	300	350	400	450	500	550	600	700	800	900	1000	Horizontal	Vertical	Horizontal	Vertical			
																				(kg)	(kg)	(G)	(G)	
DS	DS-SA4-□-20-10-□□□	665																		4	1	0.3	0.3	
	DS-SA4-□-20-5-□□□	330																		5	2.5			
	DS-SA4-□-20-2.5-□□□	165																		5	4.5	0.2	0.2	
	DS-SA5-□-20-12-□□□	800																		4	1	0.3	0.3	
	DS-SA5-□-20-6-□□□	400																		8	2			
	DS-SA5-□-20-3-□□□	200																		8	4	0.2	0.2	
	DS-SA6-□-30-12-□□□	800																		6	1.5	0.3	0.3	
	DS-SA6-□-30-6-□□□	400																		12	3			
	DS-SA6-□-30-3-□□□	200																		12	6	0.2	0.2	
	DS-A4-□-20-10-□□□	330																		-	2.5	-	0.2	
	DS-A4-□-20-5-□□□	165																		-	4.5			
	DS-A5-□-20-12-□□□	400																		-	2			
	DS-A5-□-20-6-□□□	200																		-	4			
	DS-A6-□-30-12-□□□	400																		-	3			
DS-A6-□-30-6-□□□	200																		-	6				
		100	200	300	400	500	600	700	800	900	1000	1100	1200	1300	1400	1500	2000							
SS	SS-S-□-60-12-□□□	600																		15	4	0.3	0.3	
	SS-S-□-60-6-□□□	300																		30	8			
	SS-M-□-100-20-□□□	1000																		20	4			
	SS-M-□-100-10-□□□	500																		40	8			
	SS-M-□-150-20-□□□	1000																		30	6			
	SS-M-□-150-10-□□□	500																		60	12			
ISA ISPA	ISA (ISPA)-SXM-□-60-16-□□□	800																		12	3	0.3	0.3	
	ISA (ISPA)-SXM-□-60-8-□□□	400																		25	6			
	ISA (ISPA)-SXM-□-60-4-□□□	200																		50	14	0.15	0.15	
	ISA (ISPA)-SYM-□-60-16-□□□	800																		12	3	0.3	0.3	
	ISA (ISPA)-SYM-□-60-8-□□□	400																		25	6			
	ISA (ISPA)-SYM-□-60-4-□□□	200																		50	14	0.15	0.15	
	ISA (ISPA)-SZM-□-60-8-□□□	400																		-	6	-	0.3	
	ISA (ISPA)-SZM-□-60-4-□□□	200																		-	14	-	0.15	
	ISA (ISPA)-MXM-□-100-20-□□□	1000																		20	5	0.3	0.3	
	ISA (ISPA)-MXM-□-100-10-□□□	500																		40	9			
	ISA (ISPA)-MXM-□-100-5-□□□	250																		80	19	0.15	0.15	
	ISA (ISPA)-MXM-□-200-30-□□□	1500																		25	6	0.3	0.3	
	ISA (ISPA)-MXM-□-200-20-□□□	1000																		40	9			
	ISA (ISPA)-MXM-□-200-10-□□□	500																		80	19			
	ISA (ISPA)-MXMX-□-200-30-□□□	1500																		25	-			
	ISA (ISPA)-MXMX-□-200-20-□□□	1000																		40	-			
	ISA (ISPA)-MYM-□-100-20-□□□	1000																		20	5			
	ISA (ISPA)-MYM-□-100-10-□□□	500																		40	9	0.3	0.3	
	ISA (ISPA)-MYM-□-100-5-□□□	250																		80	19			
	ISA (ISPA)-MYM-□-200-30-□□□	1500																		25	6	0.3	0.3	
	ISA (ISPA)-MYM-□-200-20-□□□	1000																		40	9			
	ISA (ISPA)-MYM-□-200-10-□□□	500																		80	19			
ISA (ISPA)-MZM-□-100-10-□□□	500																		-	9				
ISA (ISPA)-MZM-□-100-5-□□□	250																		-	19	0.15			0.15
ISA (ISPA)-MZM-□-200-10-□□□	500																		-	19	-			0.3

\*1: The figure in the elongated circle indicates the maximum speed for each stroke.  
 \*2: The loading capacity is calculated by assuming actuator operation at the rated acceleration.

	Model	Stroke (mm), maximum speed (mm/sec) *1														Loading capacity *2		Rated acceleration	
																Horizontal	Vertical	Horizontal	Vertical
		100~500	600	700	800	900	1000	1100	1200	1300	1400	1500	1600	1700~2000	2100~2500	3000	(kg)	(kg)	(G)
ISA ISPA	ISA (ISPA)-LXM-□-200-40-□□□	1000														40	9	0.3	0.3
	ISA (ISPA)-LXM-□-200-20-□□□	500														80	19		
	ISA (ISPA)-LXM-□-400-40-□□□	2000														40	9		
	ISA (ISPA)-LXM-□-400-20-□□□	1000														80	19		
	ISA (ISPA)-LXMX-□-200-20-□□□															40	—	0.3	—
	ISA (ISPA)-LXMX-□-400-40-□□□															40	—		
	ISA (ISPA)-LXMX-□-400-20-□□□															80	—		
	ISA (ISPA)-LXUWX-□-200-20-□□□															40	—		
	ISA (ISPA)-LXUWX-□-400-40-□□□															40	—	0.3	—
	ISA (ISPA)-LXUWX-□-400-20-□□□															80	—		
	ISA (ISPA)-LYM-□-200-20-□□□	1000														40	9		
	ISA (ISPA)-LYM-□-200-10-□□□	500														80	19		
	ISA (ISPA)-LYM-□-400-40-□□□	2000														40	9	0.3	0.3
	ISA (ISPA)-LYM-□-400-20-□□□	1000														80	19		
ISA (ISPA)-LZM-□-200-10-□□□	500														—	19			
ISA (ISPA)-LZM-□-400-10-□□□	500														—	39			
ISP	ISP-WXM-□-600-40-□□□	2000														60	14	0.3	—
	ISP-WXM-□-600-20-□□□	1000														120	29		
	ISP-WXM-□-600-10-□□□	500														150	60		
	ISP-WXM-□-750-40-□□□	2000														75	18	0.3	—
	ISP-WXM-□-750-20-□□□	1000														150	37		
	ISP-WXMX-□-600-40-□□□															60	—		
	ISP-WXMX-□-600-20-□□□															120	—	—	—
	ISP-WXMX-□-750-40-□□□															75	—		
	ISP-WXMX-□-750-20-□□□															150	—		
ISD	ISD-S-□-60-16-□□□	800 780														12	3	0.3	0.3
	ISD-S-□-60-8-□□□	400 380														25	6		
	ISD-S-□-60-4-□□□	200 190														50	14		
	ISD-M-□-100-20-□□□	1000														20	5	0.3	0.3
	ISD-M-□-100-10-□□□	500														40	9		
	ISD-M-□-100-5-□□□	250														80	19		
	ISD-M-□-200-20-□□□	1000														40	9	0.3	0.3
	ISD-M-□-200-10-□□□	500														80	19		
	ISD-MX-□-200-20-□□□	1000														40	—		
	ISD-L-□-200-20-□□□	1000														40	9	0.3	0.3
	ISD-L-□-200-10-□□□	500														80	19		
	ISD-L-□-400-20-□□□	1000														80	19		
	ISD-LX-□-200-20-□□□															40	—	0.3	—
	ISD-LX-□-400-20-□□□															80	—		
IF	IF-SA□□-□-60-□□□	1750														5	—	0.3	—
	IF-SA□□-□-100-□□□	1750														10	—		
	IF-MA□□-□-200-□□□	1750														20	—		
	IF-MA□□-□-400-□□□	1750														40	—		
FS	FS-11NM-□-60-□□□	1250														2	—	0.3	—
	FS-12NM-□-60-□□□	1250														5~9	—		
	FS-11NM-□-100-□□□	1250														3	—		
	FS-12NM-□-100-□□□	1250														9~15	—		
	FS-11WM-□-100-□□□	1250														3	—		
	FS-12WM-□-100-□□□	1250														9~15	—		
	FS-11WM-□-200-□□□	1250														6	—		
	FS-12WM-□-200-□□□	1250														18~30	—		
	FS-11LM-□-400-□□□	1250														15	—		
	FS-12LM-□-400-□□□	1250														28~60	—		
	FS-11HM-□-400-□□□	2000														10	—		
	FS-12HM-□-400-□□□	2000														20~40	—		

\*1: The figure in the elongated circle indicates the maximum speed for each stroke.  
 \*2: The loading capacity is calculated by assuming actuator operation at the rated acceleration.

## 2. Battery Backup Function

The SCON controller uses the following battery:

- Absolute-encoder backup battery

This battery is used to retain the rotation data of the absolute encoder, so that the motor rotation data will be retained, and thus can be updated, after the controller power has been cut off. Each controller to which an absolute type actuator is connected is shipped with this backup battery.

The details are explained on the following pages.



## 2.1 Absolute-encoder Backup Battery

If the SCON controller is to drive/control an absolute type actuator, an absolute-encoder backup battery must be installed in the controller.

An absolute encoder is designed to retain rotation data and detect rotations using the power supplied from the absolute-encoder backup battery, even when the controller's control power is not supplied. This allows the controller to resume positioning control immediately after the controller power is restored, without performing home return.

### <Backup Time>

The recommended replacement interval for the absolute-encoder backup battery is two years. This may be a little misleading. It means that if the battery is left at a surrounding air temperature of 40°C, it will retain the stored data for two years. In normal operating conditions, the battery can retain data for a longer period. As a guide, the battery will last for around four years if the controller is used at an ambient temperature of 40°C with the controller powered up 50% of the time.

### <Battery Replacement>

To replace the absolute-encoder backup battery, unplug the battery connector at the bottom of the controller and replace the battery in the battery holder.

It is recommended that the battery be replaced regularly in accordance with the frequency/duration of usage.

The battery must be replaced as soon as the controller's battery voltage monitor function generates a battery voltage low alarm.

After an alarm is detected, a battery error will occur in approx. 10 days at an ambient temperature of 20°C if the power is supplied to the controller continuously. Once a battery error occurs, operations can no longer be performed unless the battery is replaced and an absolute reset is performed.

If the controller is not operated, the above period should be reduced to 70% at 20°C or to 60% at 40°C.

The controller is designed so that the data will not be lost for at least 15 minutes without a battery if the controller is not detecting a battery error. Remember to complete the battery replacement within 15 minutes (i.e., the controller should not be without a battery for more than 15 minutes).

The absolute-encoder backup battery is replaced differently depending on whether a battery error has generated or not. If an error has not been detected, only the battery needs to be replaced and an absolute reset is not required. If an error has been detected, an absolute reset will be required.

The table below lists the absolute-encoder backup specifications.

List of absolute-encoder backup functions

Battery model	AB-5 (by IAI)	
Battery voltage	3.6 V	
Current capacity	2000 mAH	
Detection voltage for battery voltage low alarm	(Typical) 3.1 V, 3.0 V to 3.2 V	
Detection voltage for battery voltage low error	(Typical) 2.5 V, 2.3 V to 2.7 V	
Time after alarm detection until error detection (reference)	10 days if the controller is operated continuously at 20°C, or 7 days if no power is supplied 10 days if the controller is operated continuously at 40°C, or 2.5 days if no power is supplied	
Minimum data retention voltage	2.7 V min. (Varies depending on the encoder characteristics.)	
Time after alarm detection until data loss (reference)	With an absolute encoder, absolute reset must always be performed once an error has been detected.	
Data assurance limit during battery replacement	15 minutes (Maximum time during which data can be retained without any battery in the battery holder)	Data is retained by the super capacitor in the absolute brake unit.
Reference battery replacement interval	Temperature 40°C, power supplied 0% of the time	2 years
	Temperature 40°C, power supplied 50% of the time	4 years

## 3. Parameter Settings

### 3.1 Parameter Table

The parameters are classified into the following seven types based on what they are for:

- Category:
- a: Parameter relating to the actuator stroke range
  - b: Parameter relating to the actuator operating characteristics
  - c: Parameter relating to the external interface
  - d: Servo gain adjustment
  - e: Linear/rotary control parameter
  - f: Other parameter
  - g: Parameter relating to the pulse-train mode

No.	Category	Name	Unit	Default factory setting	Positioner mode parameter	Pulse-train mode parameter	Remarks
1	a	Zone 1+	mm	Effective actuator length	○		
2	a	Zone 1-	mm	Effective actuator length	○		
3	a	Soft limit+	mm	Effective actuator length	○	○	
4	a	Soft limit-	mm	Effective actuator length	○	○	
5	a	Home return direction [0: Reverse / 1: Forward]	-	(In accordance with the specification at the time of order)	○	○	
6	b	Push & hold stop judgment period	msec	255	○		
7	d	Servo gain number	-	Set individually in accordance with the actuator characteristics.	○	○	
8	b	Default speed	mm/sec	Set individually in accordance with the actuator characteristics.	○		
9	b	Default acceleration/deceleration	G	Set individually in accordance with the actuator characteristics.	○		
10	b	Default positioning band (in-position)	mm	0.10	○	○	
13	b	Current-limiting value during home return	%	Set individually in accordance with the actuator characteristics.	○	○	
14	b	Dynamic brake [0: Disable / 1: Enable]	-	1 [Enable]	○	○	
15	c	Pause input disable selection [0: Enable / 1: Disable]	-	0 [Enable]	○		
16	c	SIO communication speed	bps	38400	○		
17	c	Minimum delay time for slave transmitter activation	msec	5	○		
18	b	Home-sensor input polarity	-	(In accordance with the specification at the time of order)	○	○	
19	b	Overrun-sensor input polarity	-	(In accordance with the specification at the time of order)	○	○	
20	b	Creep-sensor input polarity	-	(In accordance with the specification at the time of order)	○	○	
21	c	Servo ON input disable selection [0: Enable / 1: Disable]	-	0 [Enable]	○	○	
22	a	Home return offset	mm	Set individually in accordance with the actuator characteristics.	○	○	
23	a	Zone 2+	mm	Effective actuator length	○		
24	a	Zone 2-	mm	Effective actuator length	○		
25	c	PIO pattern selection	-	0 [Standard type]	○		
26	b	PIO jog speed	mm/sec	100	○		
27	c	Movement command type [0: Level / 1: Edge]	-	0 [Level]	○		
31	d	Speed loop proportional gain	-	Set individually in accordance with the actuator characteristics.	○	○	
32	d	Speed loop integral gain	-	Set individually in accordance with the actuator characteristics.	○	○	
33	d	Torque filter time constant	-	Set individually in accordance with the actuator characteristics.	○	○	
34	b	Push speed	mm/sec	Set individually in accordance with the actuator characteristics.	○		
35	b	Safety speed	mm/sec	100	○	○	
36	b	Automatic servo-off delay time 1	sec	0	○		
37	b	Automatic servo-off delay time 2	sec	0	○		
38	b	Automatic servo-off delay time 3	sec	0	○		
39	c	Output mode of position complete signal [0: PEND / 1: INP]	-	0 [PEND]	○		*1
40	c	Home-return input disable selection [0: Enable / 1: Disable]	-	0 [Enable]	○	○	
41	c	Operating-mode input disable selection [0: Enable / 1: Disable]	-	0 [Enable]	○	○	

\*1 In the pulse-train mode, INP is automatically selected. (Cannot be selected)

No.	Category	Name	Unit	Default factory setting	Positioner mode parameter	Pulse-train mode parameter	Remarks
42	b	Enable function [0: Enable / 1: Disable]	-	1 [Disable]	○	○	
45	c	Silent interval multiplier	time	0 [Do not apply multiplier]	○		
46	b	Speed override	%	100	○		
47	b	PIO jog speed 2	mm/sec	100	○		
48	b	PIO inching distance	mm	0.1	○		
49	b	PIO inching distance 2	mm	0.1	○		
50	b	Load output judgment time	msec	255	○		
52	b	Default acceleration/deceleration mode	-	0 [Trapezoid]	○	○	
53	b	Default standstill mode	-	0	○		
54	d	Current-control band number	-	Set individually in accordance with the actuator characteristics.	○	○	
55	b	Position-command primary filter time constant	msec	0	○	○	
56	b	S-motion ratio setting	%	0	○		
57	g	Torque-limiting value [%]	%	70		○	
58	g	Deviation clear at servo OFF & alarm stop [0: Disable / 1: Enable]	-	1		○	
59	g	Deviation error monitor during torque limiting [0: Disable / 1: Enable]	-	0		○	
60	g	Deviation counter clear input [0: Enable / 1: Disable]	-	0		○	
61	g	Torque limit command input [0: Enable / 1: Disable]	-	0		○	
62	g	Pulse count direction [0: Forward / 1: Reverse]	-	Set individually in accordance with the actuator characteristics.		○	
63	g	Command pulse input mode	-	1		○	
64	g	Command-pulse input mode polarity [0: Positive / 1: Negative]	-	0		○	
65	g	Electronic gear numerator	-	2048		○	
66	g	Electronic gear denominator	-	125		○	
67	g	Forced stop input [0: Enable / 1: Disable]	-	0		○	
68	g	Feedback pulse output [0: Enable / 1: Disable]	-	1		○	
69	g	Feedback pulse pattern	-	0		○	
70	g	Feedback pulse pattern polarity [0: Positive / 1: Negative]	-	0		○	
71	d	Feed-forward gain	-	0	○	○	
72	f	Timer period for emergency-stop relay fusing monitor	msec	3000	○	○	
73	f	Encoder voltage level	-	(In accordance with the specification at the time of order)	○	○	
74	f	PIO power monitor [0: Enable / 1: Disable]	-	0 [Enable]	○	○	
75	f	Electromagnetic-brake power monitor [0: Disable / 1: Enable]	-	Set individually in accordance with the actuator characteristics.	○	○	
76	f	Belt-breaking sensor input polarity	-	Set individually in accordance with the actuator characteristics.	○	○	
77	b	Ball screw lead	mm	Set individually in accordance with the actuator characteristics.	○	○	
78	e	Axis operation type	-	Set individually in accordance with the actuator characteristics.	○		
79	e	Rotational axis mode selection	-	Set individually in accordance with the actuator characteristics.	○		
80	e	Rotational axis shortcut selection	-	0	○		
88	a	Software limit margin	mm	Set individually in accordance with the actuator characteristics.	○	○	
89	b	Allowable time of exceeding torque allowing continuous push & hold	sec	Set individually in accordance with the actuator characteristics.	○	○	
91	b	Current limit value at stopping due to missed push & hold	-	0 [Current limit value during movement]	○	○	
139	a	Home preset	mm	Set individually in accordance with the actuator characteristics.	○	○	

(Note) The numbers are displayed in the PC software, but not on the teaching pendant. Skipped numbers are not used and therefore omitted.

The classification codes are provided for the sake of convenience and are not displayed either in the PC software or on the teaching pendant.

(Note) For the pulse-train mode parameters corresponding to Nos. 57 to 70, refer to 5.2, "Effective Parameters in the Pulse-train Mode." For all other parameters, refer to 3.2, "Detail Explanation of Parameters" on the following pages in this Appendix.

 **Caution:** When controlling the SCON controller via serial communication, always set the controller in the "positioner mode" (piano switch 1: OFF). If it happens to be in the "pulse-train mode" by mistake, the SCON controller may operate erratically because it is operated according to the "pulse-train mode" parameters.

## 3.2 Detail Explanation of Parameters

If a parameter has been changed, always restart the controller using a software reset command or by reconnecting the power.

### 3.2.1 Parameters Relating to the Actuator Stroke Range

- **Soft limit**

Set the soft limit in the positive direction in parameter No. 3, and that in the negative direction in parameter No. 4. The factory setting for the soft limits conforms to the effective actuator length. Change the settings, as necessary, to prevent crash with an obstacle or when the actuator must be stroked slightly beyond its effective length. A wrong soft limit setting will cause the actuator to crash into the mechanical end, so exercise due caution. The minimum setting unit is "0.01 [mm]."

(Note) To change a soft limit, set a value corresponding to 0.3 mm outside of the effective range.

Example) Set the effective range to between 0 mm and 80 mm  
 Parameter No. 3 (positive side) 80.3  
 Parameter No. 4 (negative side) -0.3

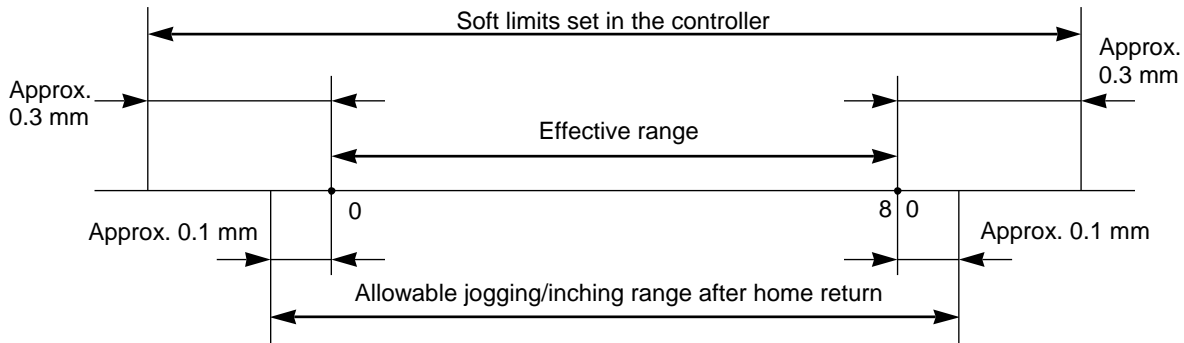

- **Software limit margin (No. 88 SWLM)**

If the actuator exceeds the soft limit, a "software limit over error" occurs. By setting parameter No. 88, it is possible to disable detection of setting value errors from the soft limit to parameter No. 88. The minimum setting range is 0.01 mm.

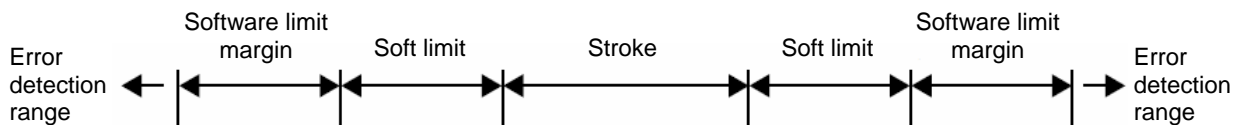

- Zone boundary

You can set the zone in which a zone output signal (ZONE1 or ZONE2) turns ON when the PIO pattern is set to 0 (positioning mode [standard type]), 4 (solenoid valve mode [7-point type]) or 5 (solenoid valve mode 2 [3-point type]) and the pulse-train input mode is selected.

Each signal turns ON when the current position is inside the range defined by the set boundaries on negative side and positive side.

For ZONE1, set the boundary on positive side in parameter No. 1 and boundary on negative side in parameter No. 2.

For ZONE2, set the boundary on positive side in parameter No. 23 and boundary on negative side in parameter No. 24.

The minimum setting unit is "0.01 [mm]."

Example) To turn ON the ZONE1 signal when the actuator with a 300-mm stroke enters the section of 100 to 200 mm, set 200.00 in parameter No. 1 (Zone boundary+) and 100.00 in parameter No. 2 (Zone boundary-).

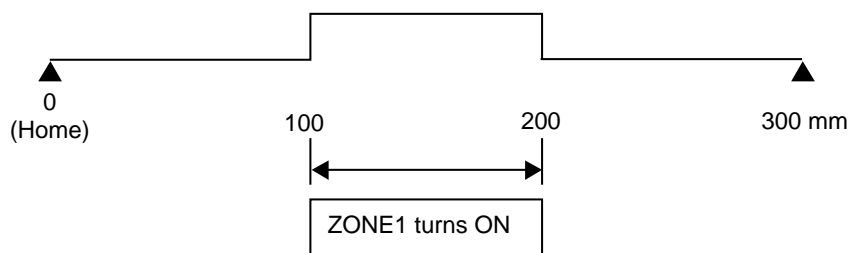

(Note 1) The zone functions have been changed due to version upgrade. Refer to the precautions at the outset.

- Home return direction

Unless specified by the user, the home return direction is set to the motor direction at the factory.

Should a need arise to change the home direction after the actuator has been assembled into your system, reverse the setting in parameter No. 5 between "0" and "1."

If necessary, also change the home return offset, soft limit and excited-phase signal detection direction parameters.

**⚠ Caution:** With rod-type actuators (excluding the RCP2-RA3C, 4C and 6C), the factory-set home direction cannot be reversed by changing the above parameter.

● Home Return Offset, ● Home Preset

For both the home return offset (No. 22) and home preset (No. 139), an optimal value has been set to ensure a constant distance from the mechanical end to the home.

The minimum setting unit is "0.01 [mm]."

Adjust these parameters in the following conditions:

- [1] Want to align the actuator home and the system's mechanical home after the actuator has been assembled into the system
- [2] Want to set a new home after reversing the factory-set home direction
- [3] Want to eliminate a slight deviation generated after replacing the actuator

[Adjustment]

- [1] If your actuator is of incremental specification, adjust only the home return offset and set the home preset to "0."
- [2] If your actuator is of absolute specification, adjust both the home return offset and home preset.  
Set appropriate values so that the following relationships will be achieved:  
 $0 < (\text{Home return offset} + \text{Home preset}) < \text{Lead}$   
 (Note) For the home preset, you can only set a multiple of the lead or "0."

[Example]

Lead: 4 mm, Home return offset: 10 mm, Home preset: -8 mm

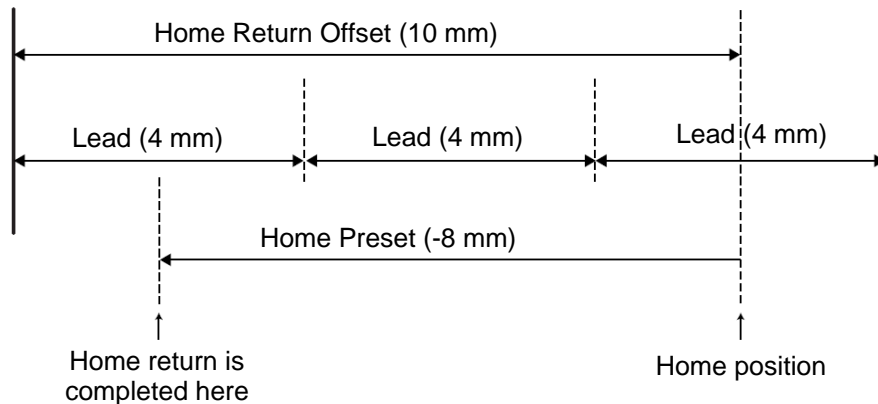

⚠ Caution: If the home return offset has been changed, the soft limit parameters must also be adjusted accordingly.

: Notes on absolute encoder  
 If the home offset is set to a value close to an integer multiple of the phase-Z-to-phase-Z distance (lead) (including a case where the home return offset is set to "0"), the actuator will enter a servo lock mode at the phase-Z point when an absolute reset is performed, in which case the coordinates may become offset by the phase-Z-to-phase-Z distance (lead).  
 For the above reason, never set a home offset close to an integer multiple of the phase-Z-to-phase-Z distance (lead).  
 (Ensure a sufficient allowance with respect to the servo amplitude.)

## 3.2.2 Parameters Relating to the Actuator Operating Characteristics

- PIO jog speed

When the selected PIO pattern is “1” (teaching mode [teaching type]), this parameter defines the jog speed to be applied when jog input commands are received from the PLC.

The factory setting is “100 [mm/sec].”

Set an appropriate value in parameter No. 26 in accordance with the purpose of use.

The maximum speed is limited to “250 [mm/sec].”

(Note) Parameter No. 47 (PIO jog speed 2) is not used for this controller.

- PIO inching distance

When the selected PIO pattern is “1” (teaching mode [teaching type]), this parameter defines the inching distance to be applied when inching input commands are received from the PLC.

The factory setting is “0.1 [mm].”

Set an appropriate value in parameter No. 48 in accordance with the purpose of use.

The maximum limit is limited to “1 [mm].”

(Note) Parameter No. 49 (PIO inching distance 2) is not used for this controller.

- Default speed

The factory setting is the rated speed of the actuator.

When a target position is set in an unregistered position table, the setting in this parameter will be used as the speed data for the applicable position number.

To reduce the default speed from the rated speed, change the setting in parameter No. 8.

- Default acceleration/deceleration

The factory setting is the rated acceleration/deceleration of the actuator.

This value is treated as the acceleration/deceleration data corresponding to the applicable position number when a target position has been written to the unregistered position table.

To reduce the default acceleration/deceleration from the rated acceleration/deceleration, change the setting in parameter No. 9.

- Default positioning band (in-position)

The factory setting is “0.10 [mm].”

This value is treated as the positioning band data corresponding to the applicable position number when a target position has been written to the unregistered position table.

Increasing the default positioning band will allow the position complete signal to be output early. Change the setting in parameter No. 10, as necessary.



- Default acceleration/deceleration mode

This value is treated as the data in the “Acceleration/deceleration mode” field corresponding to the applicable position number when a target position has been written to the unregistered position table.

The factory setting is “0 [Trapezoid].”

To change the default acceleration/deceleration pattern, set an applicable value in parameter No. 52 as shown below.

	Setting
Trapezoid pattern	0
S-motion	1
Primary delay filter	2

- Current-limiting value during home return

The factory setting conforms to the standard specification of the actuator.

Increasing this setting will increase the home return torque.

This setting need not be changed in normal conditions of use. However, if an increased slide resistance causes the home return to complete before the correct position depending on the affixing method, load condition or other factor when the actuator is used in a vertical application, the value set in parameter No. 13 must be increased.

Please contact IAI.

- Speed override

Use this parameter when moving the actuator at a slower speed to prevent danger when the system is initially started for test operation.

When move commands are issued from the PLC, the moving speed set in the “Speed” field of the position table can be overridden by the value set by parameter No. 46.

Actual moving speed = [Speed set in the position table] x [Value of parameter No. 46] ÷ 100

Example) Value in the “Speed” field of the position table 500 (mm/s)

Value of parameter No. 46 20 (%)

Under the above settings, the actual moving speed becomes 100 mm/s.

The minimum setting unit is “1 [%],” while the input range is “1 to 100 [%].” The factory setting is “100 [%].”

(Note) This parameter is ignored for move commands from the PC and teaching pendant.

- Safety speed

This parameter defines the feed speed to be applied during manual operation.

The factory setting is “100 [mm/sec].”

To change this speed, set an optimal value in parameter No. 35.

Take note that the maximum speed is limited to “250 [mm/s]” and that you should set a speed not exceeding this value.

● Automatic servo-off delay time

This parameter defines the delay time after the positioning is completed until the servo turns off automatically, when the “Standstill mode” field of the position table is set to “1,” “2” or “3” (automatic servo-off control enabled) or parameter No. 53 (Default standstill mode) is set to “1,” “2” or “3”(automatic servo-off control enabled).

Meaning of settings: 1: T becomes the value set by parameter No. 36.  
 2: T becomes the value set by parameter No. 37.  
 3: T becomes the value set by parameter No. 38.

The factory setting is “0 [sec].”

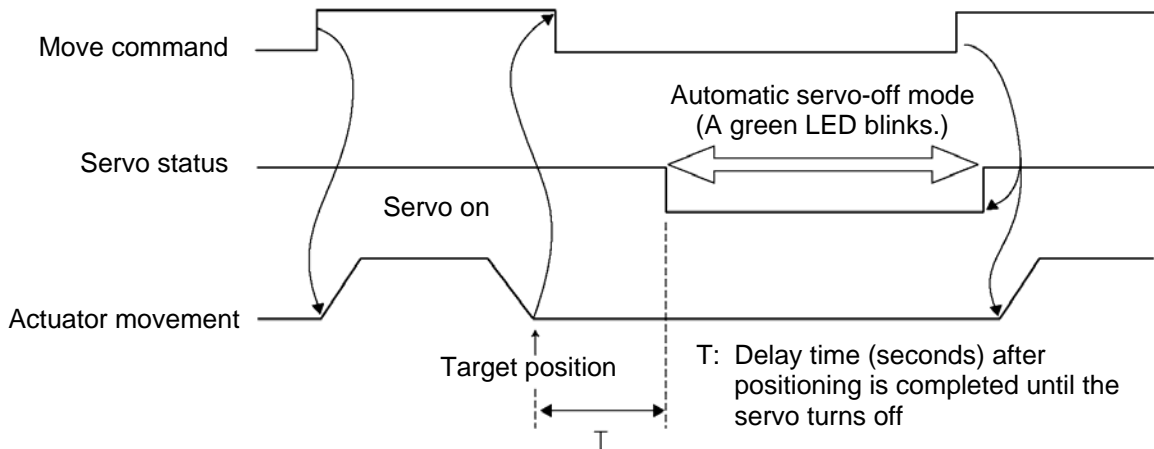

● Default standstill mode

- [1] If the PIO pattern is 0, 1, 2, 3 or 4, the automatic servo-off mode can be selected to save current consumption when the actuator is standing by for a long time after completing the home return effected by the HOME input signal.
- [2] If the PIO pattern is 5, this value is treated as the setting in the “Standstill mode” field corresponding to the applicable position number when a target position has been written to the unregistered position table.

A value of “1,” “2” or “3” must be set in parameter No. 53 in order to enable the automatic servo-off function. The factory setting is “0 [Disable].”

	Setting
All power-saving modes are disabled.	0
Automatic servo-off mode. The delay time is defined by parameter No. 36.	1
Automatic servo-off mode. The delay time is defined by parameter No. 37.	2
Automatic servo-off mode. The delay time is defined by parameter No. 38.	3

**Automatic servo-off mode**

After positioning is completed, the servo will turn off automatically upon elapse of a specified time. (Since no holding current flows, power consumption will decrease.)

When the next movement command is received from the PLC, the servo will turn on and the actuator will start moving.

Refer to the above timing chart.

● Push speed

This parameter defines the push speed to be applied after the actuator reaches the target position in push & hold operation.

Before the shipment, this parameter has been set to the default value selected in accordance with the characteristics of the actuator.

Set an appropriate speed in parameter No. 34 by considering the material and shape of the load, and so on. Take note that maximum speed is limited to “20 [mm/sec]” even on high-speed types and that you should use the actuator at push speeds not exceeding this level.

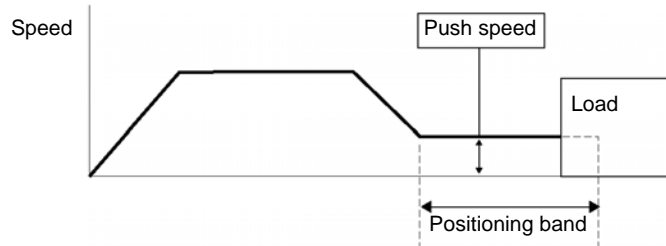

⚠ Caution: It is recommended that you set the push speed to 5 [mm/s] or above to minimize the negative effect of push force variation.

● Push completion judgment time

This parameter is used as a condition for determining that the load was contacted and the push & hold operation has completed.

As for the specific method of judgment, the push & hold operation is deemed to have completed if the current-limiting value set in the position table has been retained for the time set by parameter No. 6.

Set an optimal time matching the current-limiting value, by considering the material and shape of the load, and so on.

The minimum setting unit is “1 [msec],” while the maximum value is “9999 [msec].” The factory setting is “255 [msec].”

(Note) The chart below explains how completion of push & hold operation is determined if the load shifted during the judgment and the current has changed as a result, based on a judgment time of 255 msec.

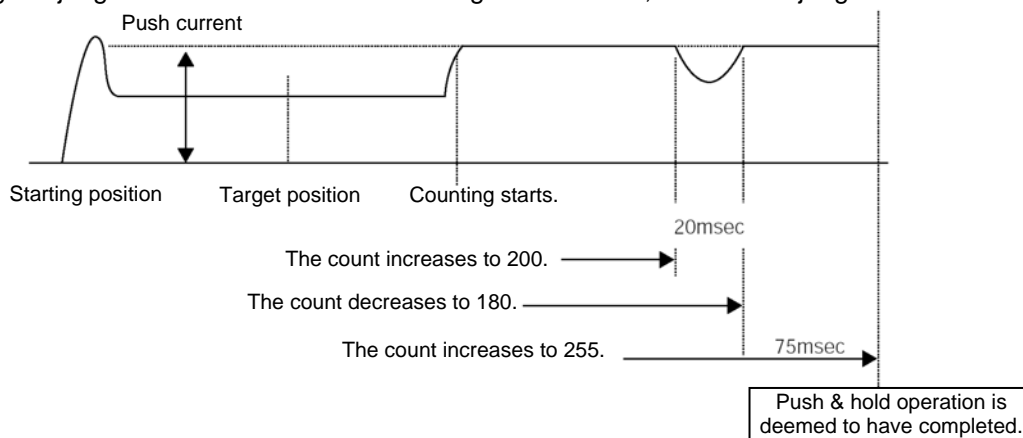

If the motor current remains at or above the push current for 200 msec and then drops below this level for 20 msec, the count will decrease by 20. When the push current is reached again thereafter, counting will start from 180. If the motor current remains at or above the push current for 75 msec, the count will increase to 255 and thus push & hold operation will be deemed to have completed.

In total, 295 msec was required for the judgment.

- Allowable time of exceeding torque allowing continuous push & hold

When push & hold operation is continuously performed, a code "OC4" alarm is generated when the time set with this parameter is exceeded, thereby excessive push & hold can be prevented.

This parameter is applied to actuators that allow push & hold setting exceeding 70%.

\* As of April 2009, the target actuators are RCS2-RA13R.

Parameter No. 89	Description
0	Do not judge
1 to 300 sec	Allowable time of continuous push & hold (Target actuator: Limited to RCS2-RA13R)

- Current limit value at stopping due to missed push & hold

Define the restricted current value at stopping due to missed push & hold.

Parameter No. 91	Description
0	Current limit value during movement (2.8 to 4 times depending on actuator characteristics)
1	Current limit value at push & hold

- Enable function

Whether to enable or disable the deadman switch function on an ANSI-type teaching pendant is defined by parameter No. 42.

\* An ANSI-type teaching pendant will be developed in the future.

	Setting
Enable (Use)	0
Disable (Do not use)	1

The factory setting is "1 [Disable]."

- Polarity of home check sensor input

The home check sensor is not included in the standard specification, but it can be installed as an option.

Normally this parameter need not be changed, but if the customer wishes to change the mode after the shipment, change the value of Parameter No. 18.

Definition of settings: 0 (Standard specification without home check sensor)

1 (Use the home check sensor based on contact-a sensor polarity)

2 (Use the home check sensor based on contact-b sensor polarity)

- **Overrun-sensor input polarity**

The overtravel detection sensor is not included in the standard specification, but it can be installed as an option. This parameter is set properly prior to the shipment according to the customer's specification and thus normally it need not be changed, but if the customer wishes to change the mode after the shipment, change the value of parameter No. 19.

Definition of settings: 0 (Standard specification without sensor)

1 (Use the overtravel detection sensor based on contact-a sensor polarity)

2 (Use the overtravel detection sensor based on contact-b sensor polarity)

- **Creep-sensor input polarity**

The travel speed of home return is normally set to a low level, or 20 mm/s to be specific.

Therefore, an actuator with a long stroke will take a longer time to complete home return if the actuator was away from the home when the power was cut off.

To save time in this situation, an optional creep sensor is available.

The actuator moves at the creep speed (100 mm/s or below) until a creep sensor signal is detected, upon which the actuator will decelerate to the home return speed (20 mm/s).

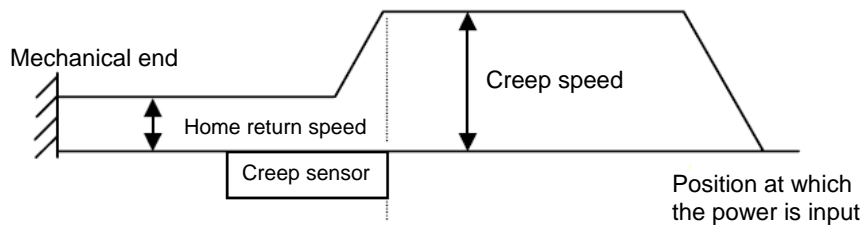

The actuator starts to decelerate upon detection of a creep sensor signal.

This parameter is set properly prior to the shipment according to the customer's specification and thus normally it need not be changed, but if the customer wishes to change the mode after the shipment, change the value of parameter No. 20.

Definition of settings: 0 (Standard specification without sensor)

1 (Creep sensor used based on contact-a sensor polarity)

2 (Creep sensor used based on contact-b sensor polarity)

- **Dynamic brake**

This parameter defines whether the dynamic brake is enabled or disabled while the actuator is at standstill.

The factory setting is "1 (Enable)."

Normally this parameter need not be changed, but there are situations where the actuator with a short ball screw lead does not move smoothly, such as when the actuator is moved by hand with the servo turned off.

In these situations, changing the value of parameter No. 14 to "0 (Disable)" will release the dynamic brake and allow the actuator to move more smoothly.

**Caution:** Before returning to normal operation, be sure to reset this parameter to "1 (Enable)."

● Position-command primary filter time constant

Parameter No. 55 defines the delay to be applied when “1 [Primary delay filter]” is set in the “Acceleration/deceleration mode” field of the position table.

The setting unit is 0.1 mm, while the setting range is 0.0 to 100.00.

The factory setting is “0” [msec].

\* The primary delay filter is disabled when “0” is set.

The greater the value set in this parameter, the longer the delay becomes.

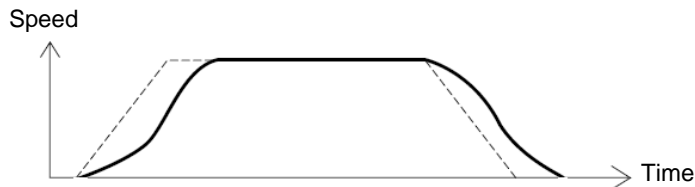

● S-motion ratio setting

Parameter No. 56 defines the S-motion level to be applied when “1 [S-motion]” is set in the “Acceleration/deceleration mode” field of the position table.

The setting unit is %, while the setting range is 0 to 100.

Set to 0% at shipment (S-motion is disabled).

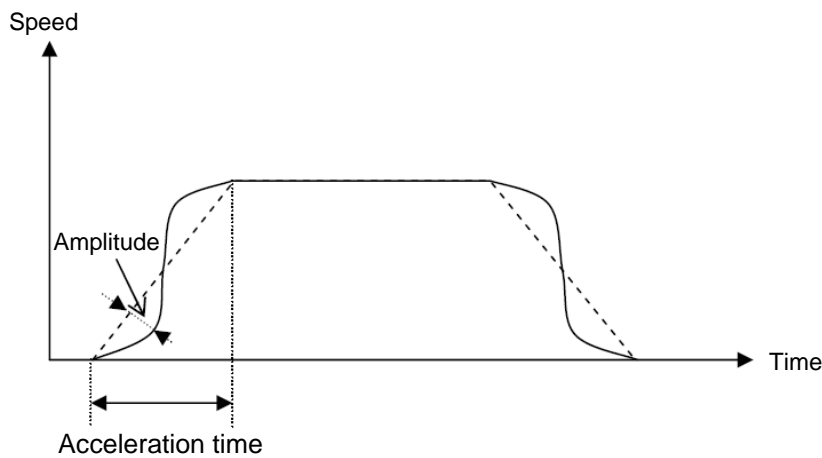

S-motion has a sine waveform whose single cycle is acceleration time.

Specify the degree of amplitude with parameter No. 56.

Setting of parameter No. 56 [%]	Degree of amplitude
0 [setting at shipment]	No S-motion (dotted line in the figure below)
100	Amplitude of sine wave x 1 (2-dot dashed line in the figure below)
50	Amplitude of sine wave x 0.5 (1-dot dashed line in the figure below)
10	Amplitude of sine wave x 0.1 (solid line in the figure below)

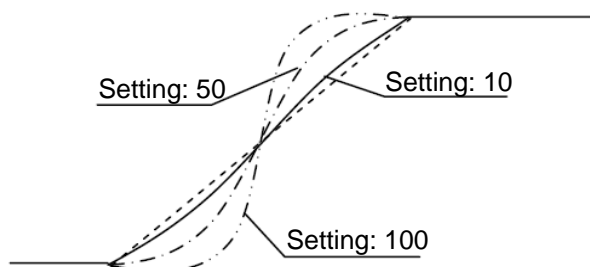

- ⚠ Caution:
- [1] Even if you issue a position command or high-value command with specified S-motion acceleration/deceleration in order to change moving speed while the actuator is operating, trapezoid control, rather than S-motion acceleration/deceleration control, is performed. Make sure to issue a command when the actuator is stopped.
  - [2] S-motion acceleration/deceleration is disabled in the index mode of the rotary actuator. Trapezoid control is performed even if S-motion acceleration/deceleration control is specified.
  - [3] If acceleration or deceleration time exceeding 2 seconds is set, do not command S-motion acceleration/deceleration control. Normal operation cannot be performed.
  - [4] Do not suspend the operation during acceleration or deceleration. The speed changes (accelerates), which may be dangerous.

- Load-output judgment time

Parameter No. 50 (Load output judgment time) is not used with this controller.

- Ball screw lead

Parameter No. 77 defines the ball screw lead.

The controller is shipped from the factory with an optimal value set in this parameter according to the characteristics of the applicable actuator.

\* Do not change the setting.

### 3.2.3 Parameters Relating to the External Interface

- PIO pattern selection

Select the PIO operation pattern in parameter No. 25.

This setting forms the basis of operation, so be sure to set this parameter at the beginning.

The factory setting is “0.”

Parameter No. 25 setting	Feature of PIO pattern
0	<p>Positioning mode [Standard type]            A basic type supporting 64 positioning points and two zone outputs.            * How to set zone boundaries within which to output a zone signal:            Zone boundaries are set using parameter Nos. 1 and 2 for one zone output, and in the position table for another zone output.</p>
1	<p>Teaching mode [Teaching type]            In this type, 64 positioning points and one zone output (boundaries are set in the position table) are supported.            In addition to the normal positioning mode, the user can also select the teaching mode in which the actuator can be jogged via commands from a PLC and the current actuator position can be written to a specified position.            (Note 1) Jog commands from a PLC are also accepted in the positioning mode.            (Note 2) Positions can be rewritten by approximately 100,000 times.</p>
2	<p>256-point mode [256-point type]            The number of positioning points is increased to 256, so only one zone output is available (boundaries are set in the position table).</p>
3	<p>512-point mode [512-point type]            The number of positioning points is increased to 512, so no zone output is available.</p>
4	<p>Solenoid valve mode 1 [7-point type]            The number of positioning points is limited to seven to offer separate direct command inputs and movement complete outputs for respective positions.            PLC ladder sequence circuits can be designed easily.</p>
5	<p>Solenoid valve mode 2 [3-point type]            Use of the controller as an air cylinder is assumed in this type.            Movement complete output signals function differently in this type, compared to the 7-point type.            Specifically, the signal functions not only to “indicate movement complete,” but also to “detect a position” in the same manner as auto-switches of an air cylinder.            Take note that incremental position commands are not supported in this mode.</p>



● Movement command type

This parameter defines the operating condition for move command inputs (ST0 to ST6) when the PIO pattern is “solenoid valve mode 1 [7-point type]” or “solenoid valve mode 2 [3-point type].”

The factory setting is “0 [Level mode].”

Description of the movement command input	Setting
<b>Level mode:</b> The actuator starts moving when the input signal turns ON. When the signal turns OFF during the movement, the actuator will decelerate to a stop and complete its operation.	0
<b>Edge mode:</b> The actuator starts moving when the rise edge of the input signal is detected. The actuator will not stop even when the signal turns OFF during the movement, until the target position is reached.	1

[Level mode]

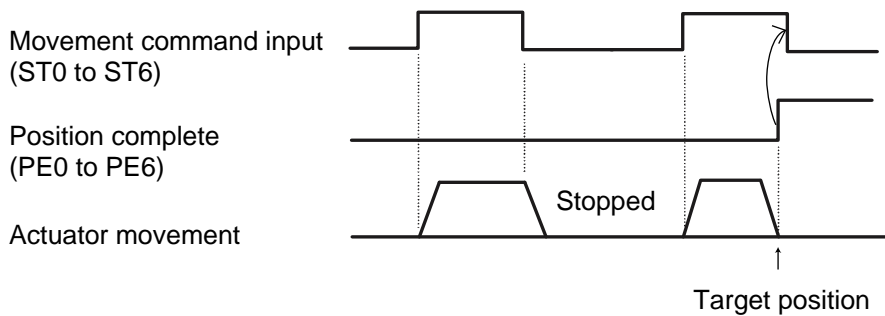

(Note) Turn OFF the movement command input after confirming that the target position has been reached.

[Edge mode]

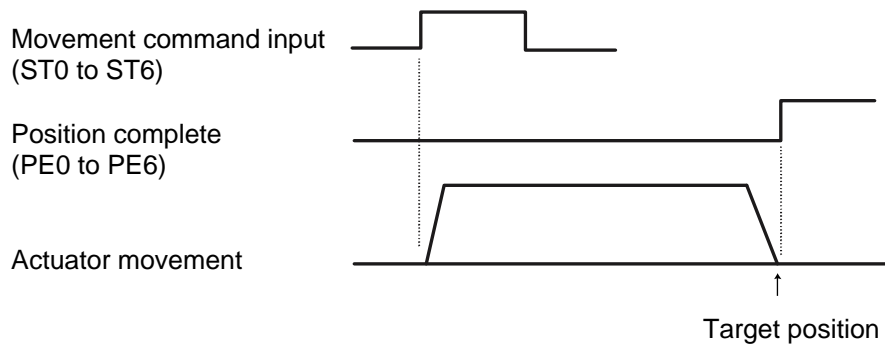

- Pause input disable selection

Parameter No. 15 defines whether the pause input signal is disabled or enabled.

	Setting
Enable (use)	0
Disable (do not use)	1

The factory setting is "0 [Enable]."

- Servo ON input disable selection

Parameter No. 21 defines whether the servo ON input signal is disabled or enabled.

	Setting
Enable (use)	0
Disable (do not use)	1

The factory setting is "0 [Enable]."

- Home-return input disable selection

Parameter No. 40 defines whether the home-return input signal is disabled or enabled.

	Setting
Enable (use)	0
Disable (do not use)	1

The factory setting is "0 [Enable]."

- Operating-mode input disable selection

Parameter No. 41 defines whether the operating-mode input signal is disabled or enabled.

	Setting
Enable (use)	0
Disable (do not use)	1

The factory setting is "0 [Enable]."

- Output mode of position complete signal

This parameter is effective when any PIO pattern other than “5” (solenoid valve mode 2 [3-point type]) is selected.

It defines the status of completed position number signals [PM1 to PM256], movement complete signals at respective positions [PE0 to PE6] and position complete signal [PEND] to be applied if the servo turns off or “position deviation” occurs while the actuator is standing still after completing positioning.

The following two conditions can be considered:

- [1] The position has deviated, due to external force and while the servo was on, beyond the value set in the “Positioning band” field of the position table.
- [2] The position has deviated, due to external force and while the servo was off, beyond the value set in the “Positioning band” field of the position table.

This parameter is provided to permit flexible specification of how the “position complete status” is monitored in accordance with the characteristics of the system or sequence circuit on the PLC side.

The ON/OFF status of each position complete signal is controlled as follows in accordance with the setting of parameter No. 39.

Setting of parameter No. 39	Definition of completed position number signals [PM1 to PM256], movement complete signals at respective positions [PE0 to PE6] and position complete signal [PEND]
0 [PEND]	[1] The servo is on The signal remains ON even after the current position has exited the range set by the “Positioning band” field of the position table, with respect to the target position. [2] The servo is off The signal is OFF unconditionally regardless of the current position.
1 [INP]	Regardless of the servo on/off status, the signal turns ON if the current position is within the range set by the “Positioning band” field of the position table, with respect to the target position, and turns OFF if the current position is outside this range. * In this mode, the applicable signals are used as limit switches.

The factory setting is “0 [PEND].”

\* In the pulse-train mode, the INP mode is selected automatically when the mode selector switch is set to “AUTO.” In this case, each applicable signal is OFF when the servo is OFF.

If the mode selector switch is set to “MANU,” each applicable signal turns ON even when the servo is OFF, as long as the actuator position is within the range specified by parameter No. 10, “Default positioning band.”

- SIO communication speed

This parameter is used for controllers of serial communication type.

Set the communication speed to be used when the control is performed via serial communication using the PLC's communication module.

Set an appropriate value in parameter No. 16 in accordance with the specification of the communication module. One of 9600, 19200, 38400, 115200 and 230400 bps can be selected as the communication speed.

The factory setting is "38400 [bps]."

- Minimum delay time for slave transmitter activation

This parameter is used for controllers of serial communication type.

This parameter defines the minimum delay until the controller's transmitter will be activated after completion of command reception, when serial communication is performed using the PLC's communication module.

The factory setting is "5 [msec]," but other necessary delay time must be set in parameter No. 17 if the specification of the communication module exceeds 5 msec.

- Silent interval multiplier

It is applied to controllers of RS485 serial communication type.

If specified, this parameter defines the multiplier to be applied to the silent interval time for delimiter judgment in the RTU mode.

The default setting is the communication time corresponding to 3.5 characters in accordance with the Modbus specification.

This setting need not be changed for normal operations performed with a PC or teaching pendant.

If the scan time of the PLC is not optimal and the character transmission interval exceeds the silent interval, the silent interval time can be extended using parameter No. 45.

The minimum setting unit is "1 [time]," while the input range is "0 to 10." If "0" is set, no multiplier is applied.

### 3.2.4 Servo Gain Adjustment

Before the shipment, the servo has been adjusted in accordance with the standard specification of the actuator. Accordingly, the servo settings need not be changed in normal conditions.

Nonetheless, the parameters relating to servo adjustment are made accessible by the customer so that speedy actions can be taken in situations where vibration or noise occurs due to the affixing method of the actuator, load condition, or the like.

In particular, custom types (having a longer ball screw lead or stroke than standard types) are more vulnerable to vibration and noise due to external conditions.

In these circumstances, the following parameters must be changed. Contact IAI for details.

- Servo gain number

Parameter No.	Unit	Input range	Default
7	---	0 to 31	5

This parameter determines the response when a position control loop is used.

Increasing the set value improves the tracking performance with respect to the position command.

However, increasing the parameter value excessively increases the chances of overshooting.

If the set value is small, the tracking performance with respect to the position command drops and positioning takes a longer time.

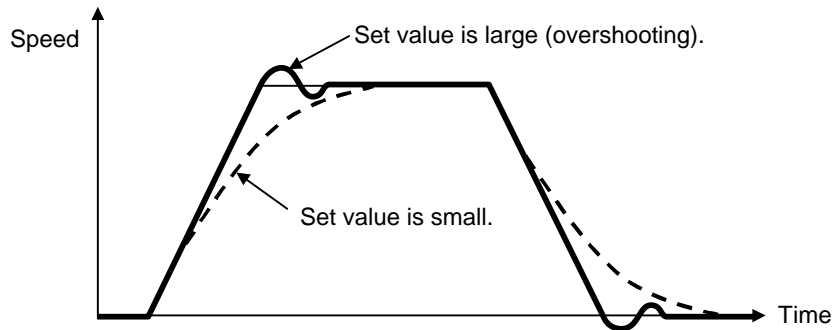

- Speed loop proportional gain

Parameter No.	Unit	Input range	Default
31	---	1 to 27661	Set individually in accordance with the actuator characteristics.

This parameter determines the response when a speed control loop is used.

Increasing the set value improves the tracking performance with respect to the speed command (i.e., servo rigidity increases).

The greater the load inertia, the larger this parameter value should be.

However, increasing the parameter value excessively makes the actuator more vulnerable to overshooting or shaking, leading to mechanical vibration.

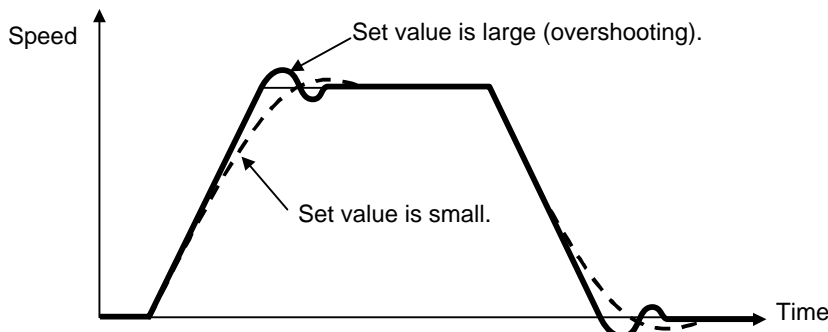

● Speed loop integral gain

Parameter No.	Unit	Input range	Default
32	---	1 to 217270	Set individually in accordance with the actuator characteristics.

This parameter determines the level of response with respect to a speed control loop. Decreasing the setting results in lower response to the speed command and decreases the reactive force upon load change. If the setting is too low, compliance with the position command drops and the positioning time increases as a result.

Increasing the setting too much increases the tendency of the actuator to overshoot or oscillate, resulting in increased mechanical vibration.

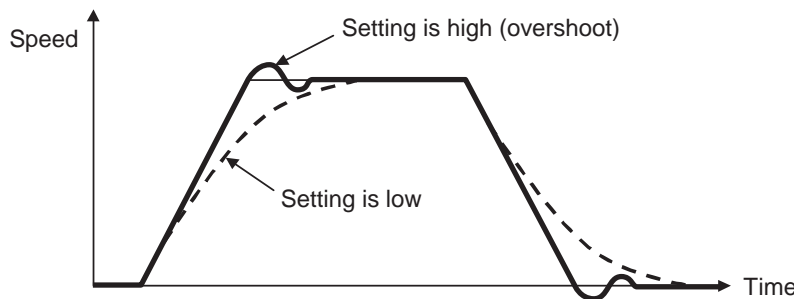

● Torque filter time constant

Parameter No.	Unit	Input range	Default
33	---	1 to 2500	Set individually in accordance with the actuator characteristics.

This parameter determines the filter time constant for torque commands.

If the resonance frequency of the machine is smaller than the response frequency of the servo loop, the motor vibrates.

This mechanical resonance can be suppressed by increasing the value set in this parameter.

However, increasing the parameter value excessively may reduce the stability of control.

● Current-control band number

Parameter No.	Unit	Input range	Default
54	---	0 to 7	Set individually in accordance with the actuator characteristics.

This parameter sets the control band for PI current control.

Normally this parameter need not be changed, so the customer is advised not to change the setting.

If the parameter is changed carelessly, control safety may be adversely affected and a very dangerous situation may result.

However, changing this parameter may be effective in certain situations, such as when the actuator generates resonance noise that can be suppressed by changing this parameter.

Even in this case, the customer is advised to consult IAI and change the parameter according to the instruction given.

- Feed-forward gain

Parameter No.	Unit	Input range	Default
71	---	0 to 100	Set individually in accordance with the actuator characteristics.

This parameter sets the level of feed-forward gain to be applied to position control.

Use this parameter to improve the response of the position control system.

Use this parameter if you wish to improve the response of your system having low mechanical rigidity or whose mechanical configuration is subject to a high load inertia ratio.

As a guide, set a value between 10 and 50. Increasing the value set in this parameter will reduce the deviation and therefore improve the response.

Take note, however, that setting a larger value may result in vibration or noise.

## 3.2.5 Linear/Rotary Control

- Axis operation type  
Parameter No. 78 defines the type of the actuator used.

Connected actuator	Setting	Remarks
Linear axis	0	Actuator other than rotational axis
Rotational axis	1	Rotational axis (RS-30/60, RCS2-RT6/RT6R/R17/RT7R)

- Rotational axis mode selection  
Parameter No. 79 defines the mode of the rotational axis  
If the axis operation type (parameter No. 78) is set to “rotational axis,” selecting the index mode will fix the current value to a range of 0 to 359.99. When the index mode is selected, shortcut control is enabled.  
Definition of settings: 0 (Normal mode)  
1 (Index mode)

- The index mode cannot be specified for actuators of absolute specification.

(Note) With the rotational axes RS-30 and 60, the factory setting is “1” (index mode). With the rotational axes RCS2-RT6, RT6R, RT7 and RT7R, the factory setting is “0” (normal mode).

Caution: Push & hold operation is not possible in the index mode. Even if data is entered in the “Push” field of the position data, the data will be ignored and normal movement will be performed.  
The positioning band will conform to the default positioning band.



● Rotational axis shortcut selection

Parameter No. 80 defines the shortcut selection for the rotational axis.

Shortcut refers to moving the actuator in the rotation direction with fewer movement with respect to the next positioning operation.

	Setting
Disable	0
Enable	1

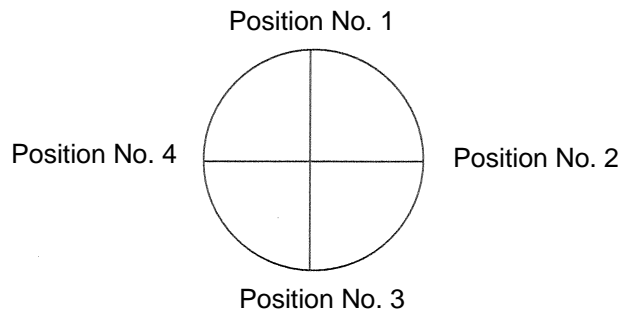

Position

Position No.	Position data
1	0
2	90
3	180
4	270

With position data, 1° equals 1 mm.

When the actuator is moved to positions 1, 2, 3 and 4 in this order, the operation varies depending on whether or not shortcut is selected, as illustrated below.

**When shortcut is not selected**

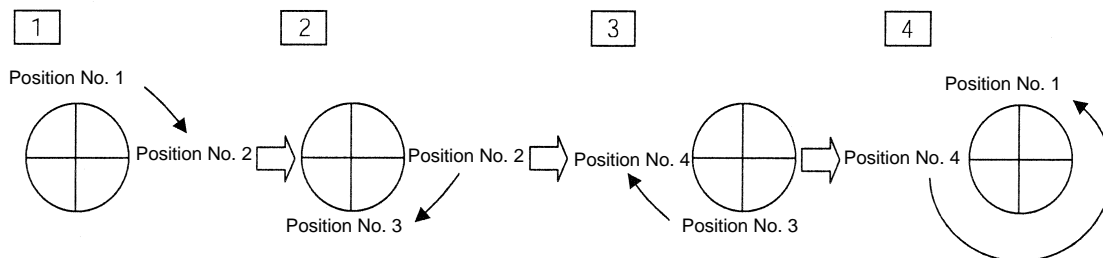

**When shortcut is selected**

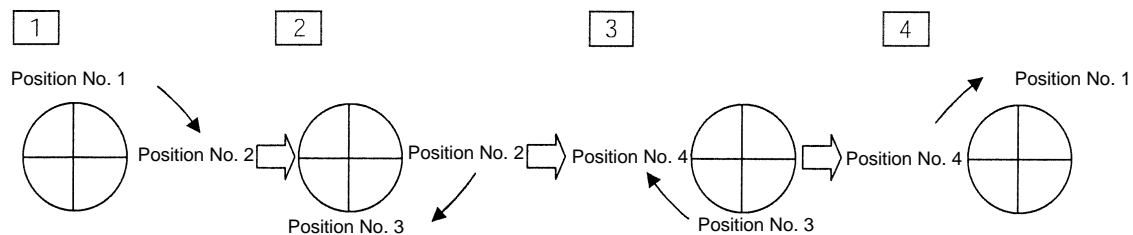

A table summarizing “Axis operation type,” “Rotational axis mode selection,” “Rotational axis shortcut selection,” “Supported encoder type” “Current position range,” “Absolute position command range,” “Incremental position command range,” “Software limit+” and “Software limit-” is shown on the next page.

Axis operation type	Rotational axis mode selection	Rotational axis shortcut selection	Supported encoder type		Current position range	Absolute position command range	Incremental position command range	Soft limit+	Soft limit-	Screw lead
			ABS	INC						
0 Linear movement	Disable	Disable	○	○	-9999.99 to 9999.99 (Note 1)	-0.15 to 9999.99 (Note 1)	-9999.30 to 9999.30 (Note 1)	Enable	Enable	Enable
Rotational axis	0 Normal mode	Disable	○	○	-9999.99° to 9999.99° (Note 1)	-0.15° to 9999.99° (Note 1)	-9999.30° to 9999.30° (Note 1)	Enable	Enable	Enable
	1 Index mode	0 Disable	x Not supported	○	0° to +359.99°	0° to +359.99°	-360.00° to +360.00°	Disable	Disable	Gear ratio is converted to lead.
1 Enable										

(Note 1) The maximum value that can be set in the parameter. The actual operation range is defined by the positive and negative values set in parameter Nos. 3 and 4, respectively, and varies according to the actuator characteristics.

\* Points to note when the axis operation type is set to "1" (rotational axis) and the rotational axis mode selection is set to "1" (index mode)

- [1] The soft limits are set to 0° (soft limit-) and +355.99° (soft limit +) in the controller when the controller is started. Accordingly, the values set in the applicable parameters will be ignored. No soft limit error will generate.
- [2] Incremental position commands are not performed in shortcut operation, even when the shortcut selection is set to "Enable" (1).
- [3] Push & hold operation is not supported. If push & hold operation is set by position data, the data will be executed as normal rotary movement. In this case, the positioning band parameter will revert to the default positioning band.
- [4] In jogging or inching, the maximum number of rotations per command becomes 1 (within 360°).
- [5] The motor rotation pulse may become 0.01° or greater depending on the specified gear ratio (screw lead) and encoder pulse count. In this case, an error generates between the target position and the position at which the positioning has completed.

 Caution: [1] The index mode cannot be set for actuators of absolute specification.  
[2] Incremental position commands are not supported in PIO pattern 5 (solenoid valve mode 2 [3-point type]).

## 3.2.6 Others

- **Timer period for emergency-stop relay fusing monitor**

The controller has a built-in emergency stop relay for cutting off the motor drive power, so fusing of this relay is detected.

If the motor AC power is not cut off after elapse of the timer period set by this parameter following the cutoff of the driver power, the controller will recognize that the relay has been fused and generate an alarm.

Normally this parameter need not be changed. If you have installed an additional drive-power cutoff relay, etc., with a timer and are using the relay with a timer period longer than the factory setting, however, the value of parameter No. 72 should be changed accordingly.

The factory setting is “3,000” [msec]. If a value between 0 and 9 is set, fusing of the relay will not be detected.

- **Encoder voltage level**

To stabilize encoder detection signals, this parameter sets the voltage supplied to the encoder circuit to one of four levels in accordance with the encoder type and the length of the encoder relay cable.

Normally this parameter need not be changed. If you have changed the length of the encoder relay cable supplied with the controller, however, the value of parameter No. 73 must be changed accordingly.

If you wish to change this parameter, always consult IAI in advance. (If set inappropriately, this parameter may cause problems such as an encoder failure.)

- **PIO power monitor [0: Enable /1: Disable]**

A power monitor function is provided to prevent burning of the I/O board or breakdown of parts caused by an abnormal voltage of the 24-V PIO power supply.

Although it is recommended to enable this function, it can be disabled in certain situations such as when making adjustments during trial operation.

To disable the function, set parameter No. 74 to “1 [Disable].”

The factory setting is “0 [Enable].”

\* If a fieldbus module (such as a CC-Link or DeviceNet module) is installed, the controller will not perform PIO power monitor regardless of the setting of this parameter.

- **Electromagnetic-brake power monitor [0: Disable /1: Enable]**

A power monitor function is provided to prevent actuator malfunction or breakdown of parts caused by an abnormal voltage of the 24-V brake power supply when an actuator with brake is used.

Normally this parameter need not be changed because it has been set properly prior to the shipment in accordance with the actuator, i.e., whether or not the actuator is equipped with a brake. If you have changed the original actuator specification, however, change the value of parameter No. 75 accordingly.

The factory setting is “0 [Disable]” if the actuator has no brake, and “1 [Enable]” if the actuator is equipped with a brake.

- **Belt-breaking sensor input characteristics**

This parameter sets the input characteristics of the belt-breaking sensor on the ultra-high thrust RCS2-RA13R. The factory setting is “Contact B.”

Parameter No.		Setting
76	Not used	0
	Contact A	1
	Contact B	2

## 4. PC/Teaching Pendant Connection Method in Multi-axis Configurations

This section explains the method to permanently connect a PC/teaching pendant in configurations consisting of multiple axes, so that the PC/teaching pendant connector need not be removed/inserted each time. The connector is connected to a SIO converter, and the SIO converter sends/receives data to/from each controller via RS485 serial communication.

The basic specifications are as follow:

- [1] Maximum number of connected axes: 16
- [2] Maximum length of serial communication cable: 100 m or less
- [3] Terminal resistor: 220 Ω (Be sure to install a terminal resistor for the last axis to prevent the effect of radiating noise.)

### 4.1 Connection Example

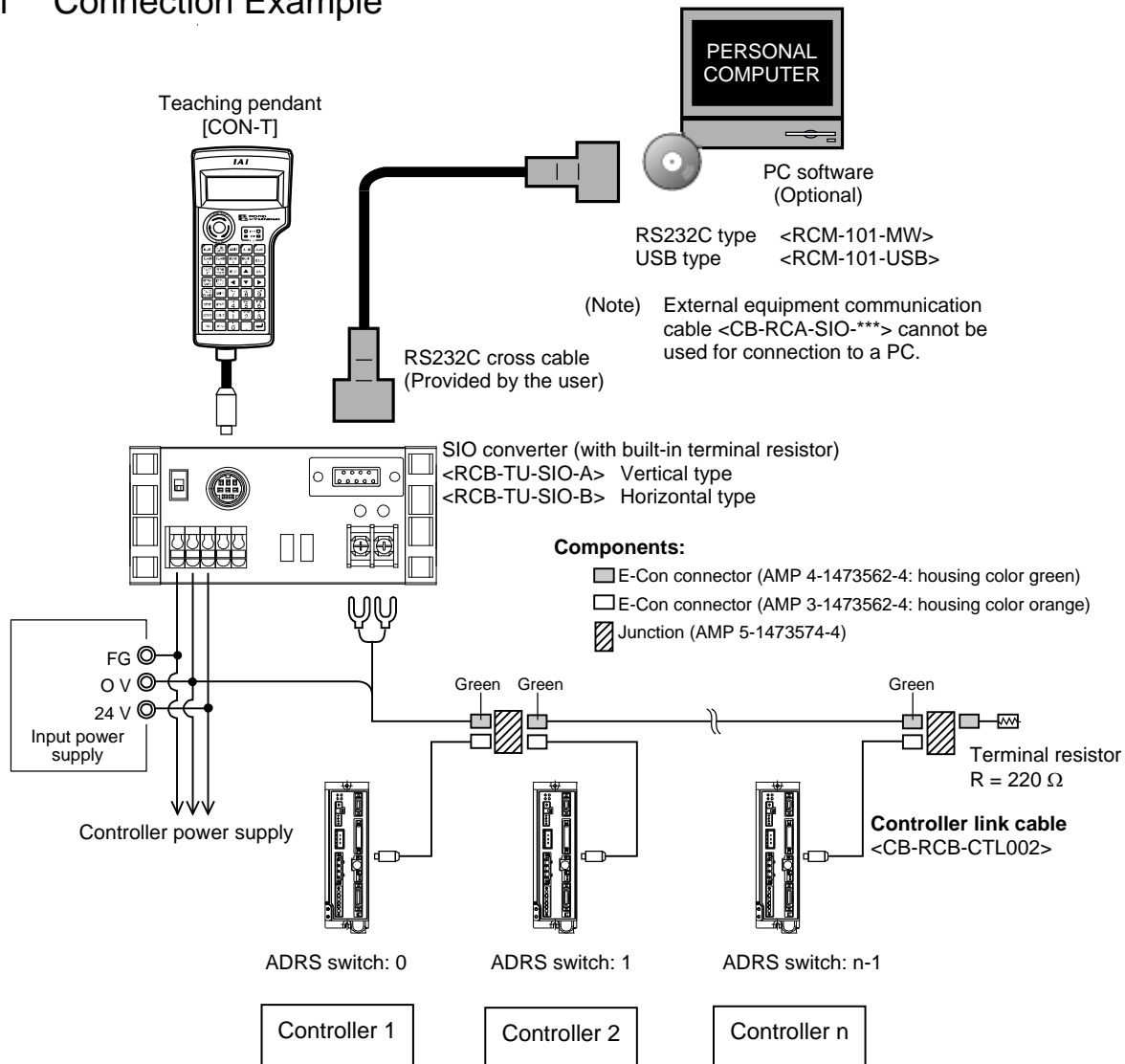

**Caution:** Do not connect the teaching pendant and PC at the same time. If both are connected at the same time, a communication error (message level) will occur.

## 4.2 Name and Function of Each Part of the SIO Converter

This is a converter unit conforming to RS485/232C.

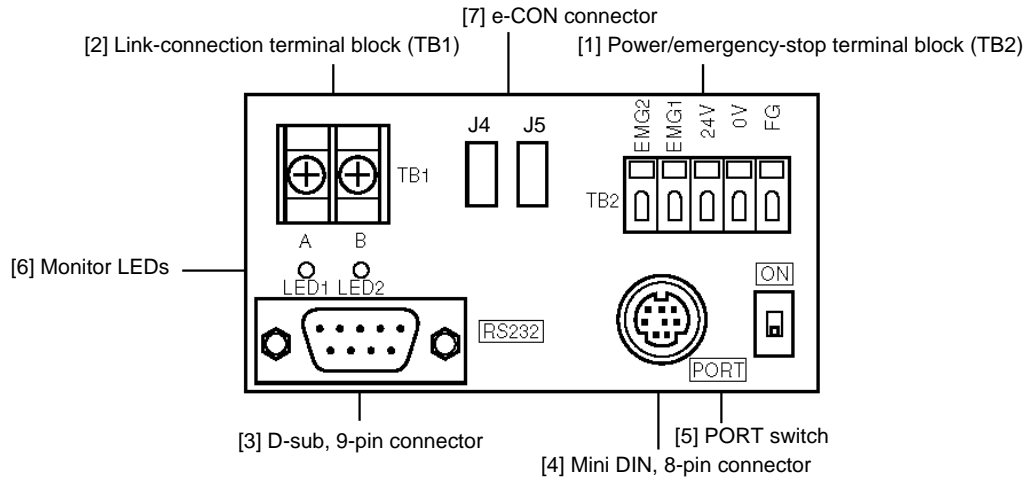

### [1] Power/emergency-stop terminal block (TB2)

EMG1, EMG2	Provide a contact output for the emergency-stop switch on the teaching pendant. EMG1 and EMG2 connect to the emergency-stop switch on the teaching pendant when the PORT switch is ON, or are shorted when the PORT switch is OFF. These terminals comprise an interlock with a safety circuit provided by the user.
24V	Positive side of the 24-V power supply (power supply for the teaching pendant and conversion circuit)
0V	Negative side of the 24-V power supply
FG	FG of the 24-V power supply

(Note) 0V connects to pin 7 (GND) in the controller's communication connector.

- Connection method

Use a connection cable satisfying the following specifications:

Item	Specification
Applicable wire size	Single wire: $\varnothing 0.8$ to 1.2 mm / Stranded: AWG size 20 to 18 (end is soldered)
Stripped wire length	10 mm

Used for continuity check Insert a flathead screwdriver with a bit size of approx. 2.6 mm.

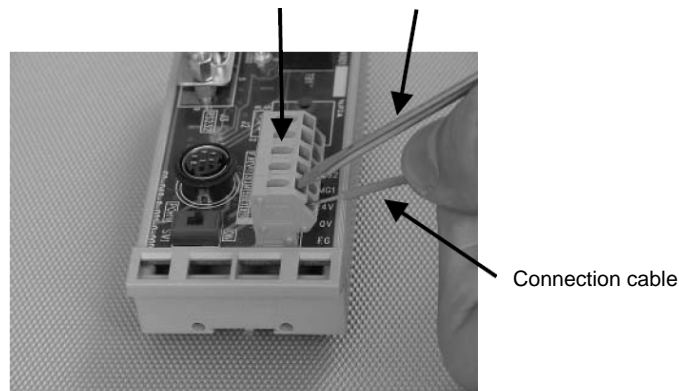

- [2] Link-connection terminal block (TB1)  
A connection port for linking the controller.  
"A" on the left side connects to pin 1 (SGA) in the controller's communication connector.  
"B" on the right side connects to pin 2 (SGB) in the controller's communication connector.  
(Note) Be sure to use twisted pair wires for the above two connections (SGA/SGB).
- [3] D-sub, 9-pin connector  
A connection port with the PC.
- [4] Mini DIN, 8-pin connector  
A connection port with the teaching pendant.
- [5] PORT switch  
A switch for enabling/disabling the teaching pendant.  
Set the switch to ON when a teaching pendant is used, or OFF when teaching pendant is not used.
- [6] Monitor LEDs  
LED1 --- Lit when the controller is transmitting  
LED2 --- Lit when the RS232 is transmitting
- [7] e-con connector  
This connector port is used to connect a controller by means of an e-con connector.

## 4.3 Address Switch

Set an address (0 to 15) as a hexadecimal (0 to F) using the ADRS switch on the front panel of each controller to define the slave number for the controller.

Assign "0" to the controller nearest the host, and then assign 1, 2, 3, ..., E and F to the remaining controllers in the direction of moving away from the host.

After all addresses have been set, reconnect the power.

Caution: After the setting, be sure to confirm that the addresses are not duplicated.

Adjust the arrow to a desired position using a flathead screwdriver.

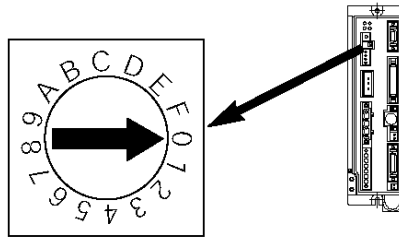

## 4.4 Connection Cables

- Controller link cable  
Model: CB-RCB-CTL002

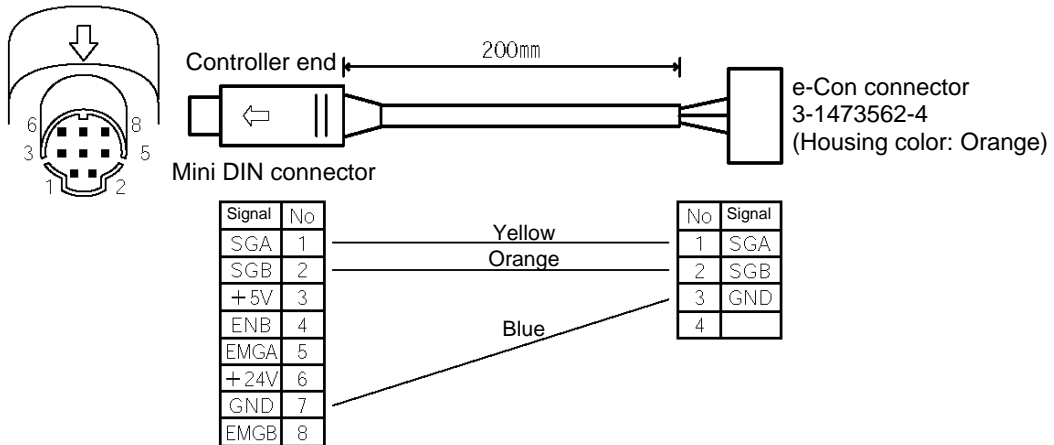

(Reference) Connection diagram for RS232C cross cable

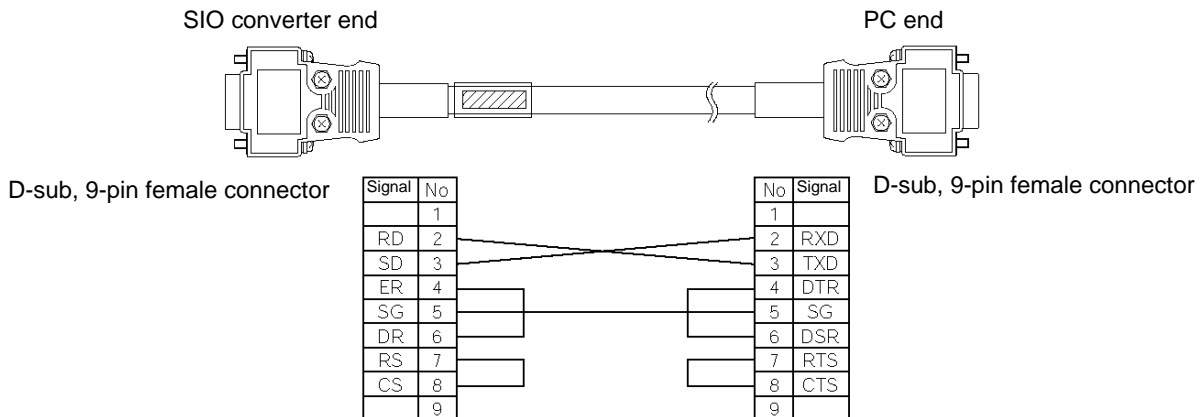

## 4.5 Detail Connection Diagram

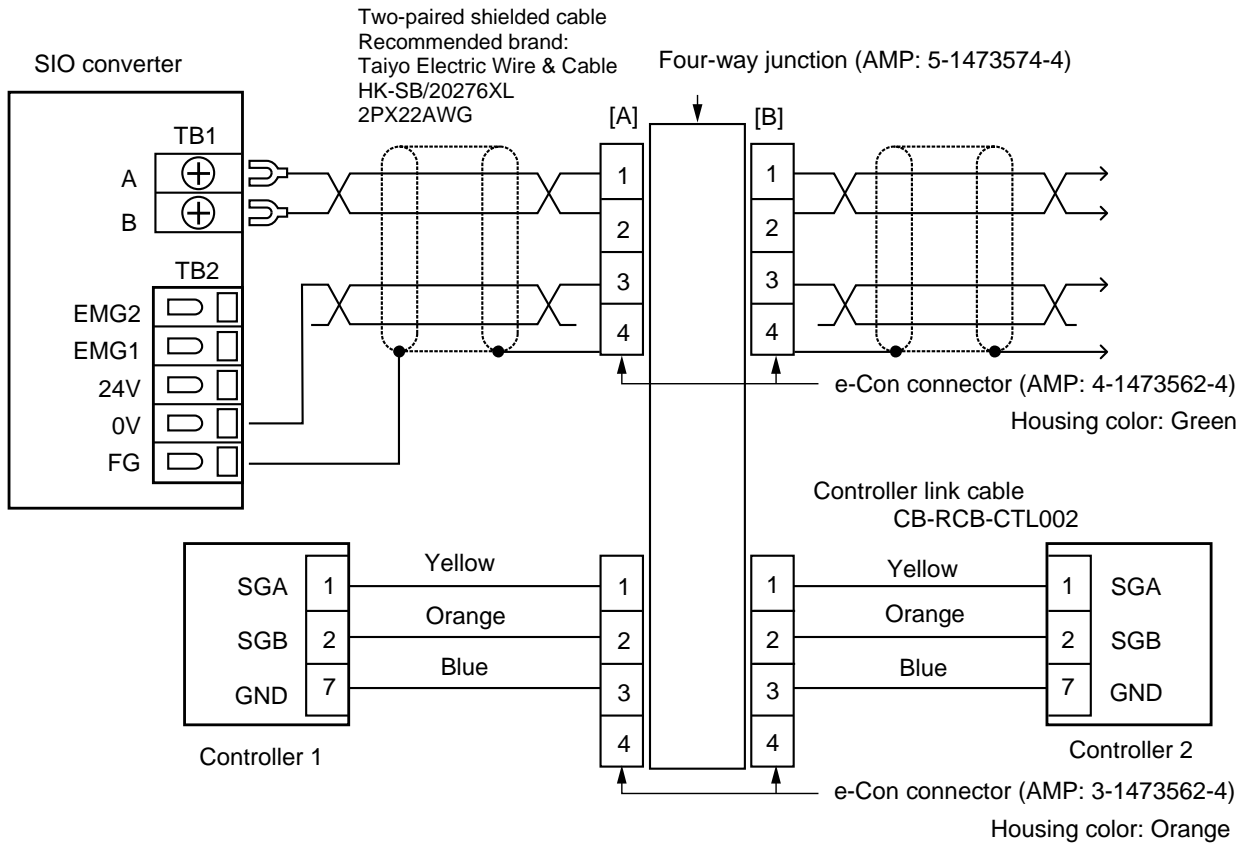

(Note) The user must provide the two-paired shielded cable.  
If cables other than the recommended brands are connected to [A] and [B], use those with a cable-sheath outer diameter of 1.35 to 1.60 mm.

### Accessories (Optional):

- [1] Controller link cable CB-RCB-CTL002 (connector on both ends), length 200 mm
- [2] Four-way junction, made by AMP: 5-1473574-4
- [3] e-Con connector, made by AMP: 4-1473562-4 (green)
- [4] Terminal resistor 220  $\Omega$  (with e-Con connector)

Of the above, [2], [3] and [4] are provided for the same number as the controller link cables. Therefore, not all units are needed when multiple axes are used.



## 5. Troubleshooting

### 5.1 Action to Be Taken upon Occurrence of Problem

Upon occurrence of a problem, take an appropriate action according to the procedure below in order to ensure speedy recovery and prevent recurrence of the problem.

- a. Check the status indicator LEDs.
  - SV (green) ----- The servo is ON.
  - ALM (orange) --- An alarm is present or the motor drive power is cut off.
  - EMG (red) ----- An emergency stop is actuated.
- b. Check for error in the host controller.
- c. Check the voltage of the main power supply (control power, motor power).
- d. Check the voltage of the 24-VDC power supply for input/output signals as well as the 24-VDC power supply for brake (if the actuator is equipped with a brake).
- e. Check for alarm.
  - Confirm the details of error on the PC or teaching pendant.
- f. Check the cables for connection error, disconnection or pinching.
  - Before performing a continuity check, turn off the power (to prevent a runaway actuator) and disconnect the cables (to prevent accidental power connection due to a sneak current path).
- g. Check the I/O signals.
- h. Check the noise elimination measures (grounding, installation of surge killer, etc.).
- i. Review the events leading to the occurrence of problem, as well as the operating condition at the time of occurrence.
- j. Check the serial numbers of the controller and actuator.
- k. Analyze the cause.
- l. Take action.

Please check items a through j before contacting IAI.

(Note 2) \* The ALM output is a negative-logic signal.

After the power is turned on, this signal remains ON while the controller is normal. It remains OFF while the power is cut off.

It cannot be used as a contact-b interlock when the power is cut off.

## 5.2 Alarm Level Classification

Alarms are classified into two levels based on the corresponding symptoms.

Alarm level	ALM lamp	*ALM signal	What happens when alarm generates	How to reset
Operation cancellation	Lit	Output	The actuator decelerates to a stop and then the servo turns OFF.	Alarm reset using an I/O, PC or teaching pendant
Cold start	Lit	Output	The actuator decelerates to a stop and then the servo turns OFF.	Software reset using a PC or teaching pendant or reconnection of power

**Caution:** Reset each alarm after identifying and removing the cause of the alarm. If the cause of the alarm cannot be removed or the alarm still persists after the cause has been removed, contact IAI. If the same error occurs again after resetting the alarm, it means that the cause of the alarm still remains.

## 5.3 Alarm Description Output Using PIO

In PIO patterns 0 to 3 corresponding to the positioner mode (64 to 512-point positioning types), alarm information can be output using the ports for completed position output signals (four bits of PM1 to PM8) so that when an alarm occurs, the nature of the alarm can also be identified on the PLC side.

Program the PLC so that whether a given output is a completed position number or alarm can be identified based on the status of the alarm output signal (\*ALM).

In the pulse-train input mode, alarm information can be output using the ports for alarm code output signals (ALM1, ALM2, ALM4 and ALM8) so that when an alarm occurs, the nature of the alarm can be identified on the PLC side.

Bit assignment table for alarm description (● = OFF, ○ = ON)

Positioner mode, PIO = 0 to 3					Description: Code number in ( )
*ALM	PM8	PM4	PM2	PM1	
Pulse-train input mode					
*ALM	ALM8	ALM4	ALM2	ALM1	
○	x	x	x	x	Normal
●	●	●	○	●	Software reset during servo ON (090) Position number error during teaching (091) PWRT signal detected during movement (092) PWRT signal detected before completion of home return (093)
●	●	●	○	○	Move command during servo OFF (080) Absolute position move command before completion of home return (083) Move command during home return (084) Position number error during movement (085) Position command data error (0A3) Deceleration command error (0A7)
●	●	○	●	●	PCB mismatch error (0F4)
●	●	○	○	●	Parameter data error (0A1) Position data error (0A2) Unsupported motor/encoder types (0A8)
●	●	○	○	○	Phase Z position error (0B5) Magnetic pole not confirmed (0B7) Home sensor not detected (0BA) Home return timeout (0BE) Creep sensor not detected (0BF)
●	○	●	●	●	Excessive actual speed (0C0) Overrun detected (0C2)
●	○	●	●	○	Electromagnetic brake not released (0A5) Dynamic brake not released (0A6) Overcurrent (0C8) Overheating (0CA) Current-sensor offset adjustment error (0CB) Emergency stop relay fused (0CD) Control power-supply voltage low (0CE) 24-V I/O power-supply error (0CF)

Positioner mode, PIO = 0 to 3					Description: Code number in ( )
*ALM	PM8	PM4	PM2	PM1	
Pulse-train input mode					
*ALM	ALM8	ALM4	ALM2	ALM1	
●	○	●	○	○	Command counter overflow (0A4) Mismatching electric angle (0B4) Deviation over-flow (0D8) Software stroke limit exceeded (0D9) Feedback pulse error (0DA) Out of push & hold operation range error (0DC)
●	○	○	●	●	Exceeded allowable time of exceeding torque allowing continuous push & hold (0C4) Motor power-supply voltage excessive (0D2) Motor power-supply voltage low (0D3) Belt-breaking sensor detected (0D7) Overload (0E0) Driver logic error (0F0)
●	○	○	●	○	Encoder send error (0E4) Encoder receive error (0E5) Encoder count error (0E6) Open phase A/B/Z (0E7) Absolute encoder error detected 2 (0EE) Absolute encoder error detected 3 (0EF)
●	○	○	○	●	CPU error (0FA) FPGA error (0FB)
●	○	○	○	○	Nonvolatile memory write verification error (0F5) Nonvolatile memory write timeout (0F6) Damaged nonvolatile memory data (0F8)

## 5.4 Alarm Description and Cause/Action

### (1) Operation-cancellation level alarms

Code	Error name	Cause/Action
080	Move command during servo off	Cause: A move command was issued by numerical specification when the servo was off. Action: Issue a command after confirming that the servo is on (SV or PEND is "1").
083	Numerical command before completion of home return	Cause: An absolute position command was issued by numerical specification before home return was completed. (This does not present a problem in the position number specification mode.) Action: Issue a move command by numerical specification after completing the home return operation and confirming that the complete signal (HEND) has turned ON.
084	Move command during home return	Cause: A move command was issued by numerical specification when home return was still in progress. Action: Issue a move command by numerical specification after completing the home return operation and confirming that the complete signal (HEND) has turned ON.
085	Position number error during movement	Cause: A position number not yet registered in the position table was specified in the position number specification mode. Action: Check the position table again.
090	Soft reset during servo on	Cause: A soft reset command was received when the servo was on. Action: Send a soft reset command to the controller after confirming that the servo is off (SV is "0").
091	Position number error during teaching	Cause: An out-of-range position number was specified during teaching. Action: Check the position number.

Code	Error name	Cause/Action
092	PWRT signal detected during movement	<p>Cause: The current-position write signal (PWRT) was input in the teaching mode while the actuator was jogging.</p> <p>Action: Input the PWRT signal after confirming that the jog button is not pressed and the actuator is stopped (MOVE output signal is OFF).</p>
093	PWRT signal detected before completion of home return	<p>Cause: The current-position write signal (PWRT) was input in the teaching mode when home return was not yet completed.</p> <p>Action: Input the HOME signal first to perform home return, and then input the PWRT signal after confirming that home return has completed (HEND output signal is ON).</p>
0A1	Parameter data error	<p>Supported version: Up to V001A</p> <p>Refer to the cold start level code "0A1" for the detailed information.</p>
0A2	Position data error	<p>Cause: [1] A move command was input when no target position was set in the "Position" field.            [2] The target position in the "Position" field exceeds a soft limit setting.            [3] An incremental target position was specified in the "Position" field in the solenoid valve mode 2 [3-point type].</p> <p>Action: [1] Set a target position first.            [2] Change the target position to a value inside the soft limit setting.            [3] Specify an absolute target position.</p>
0A3	Position command data error	<p>Cause: The speed or acceleration/deceleration specified by the numerical command exceeds the maximum value that can be set.</p> <p>Action: Change the applicable setting to an appropriate value.</p>
0A4	Command counter overflow	<p>Cause: The number of input command pulses exceeded the range of -134217728 to +134217728 (H'F8000000 to H'07FFFFFFF).</p> <p>Action: Raise the electronic gear ratio to increase the unit travel distance.</p>
0A5	Electromagnetic brake not released	<p>Cause: The brake cannot be released when an electromagnetic brake is equipped.</p> <p>Action: Check the 24-V electromagnetic-brake power supply.</p>
0A7	Deceleration command error	<p>If a position command is issued while the actuator is moving where the target position corresponding to the position number is located near a soft limit and the deceleration is also set low, the actuator may move past the soft limit.</p> <div style="text-align: center;"> </div> <p>Cause: When the speed was changed during movement, the next move command was not issued quick enough.</p> <p>Action: Quicken the speed change timing so that the actuator will not overshoot the soft limit.</p>

Code	Error name	Cause/Action
0B5	Phase Z position error	The position where phase Z was detected at home return was outside the specified range. Cause: Encoder failure Action: Please contact IAI.
0BA	Home sensor not detected	This error indicates that the actuator equipped with the home check sensor has not yet successfully completed the home return operation. Cause: [1] The load contacted any surrounding equipment or structure during home return. [2] The slide resistance of the actuator is high in some location. [3] The home check sensor is not properly installed, faulty or open. Action: If the load is not contacting any surrounding equipment or structure, [2] or [3] is suspected. Please contact IAI.
0BE	Home return timeout	Cause: Home return does not complete after elapse of the time set by the applicable manufacturer's parameter following the start of home return operation. (This error does not occur in normal operations.) Action: The controller and actuator combination is wrong, among others. Please contact IAI.
0BF	Creep sensor not detected	This error indicates during home return operation using a creep sensor a home-sensor detection signal was output or mechanical end was reached before a creep sensor signal was detected (or the actuator cannot move due to an excessive load). Cause: [1] Signal is not detected because the creep sensor is not installed in an appropriate position. [2] The cable is disconnected or the connector is not plugged in properly. [3] The load is receiving an external force. Action: [1] Readjust the sensor installation position. [2] Perform continuity check to see if the cable is disconnected. Also check if the connector is plugged in properly. [3] Review the mechanisms around the load and prevent the load from receiving any strong external force. If the cause cannot be specified, contact IAI.
0C0	Excessive actual speed	Cause: The motor speed exceeded the maximum level set by the applicable manufacturer's parameter. Although this error does not occur in normal operations, it may occur if the load decreased before a servo error was detected and the actuator moved quickly as a result, which can be caused by various reasons including the following: [1] The slide resistance of the actuator is high in some location. [2] The load increased due to momentary application of external force. Action: Check the assembly condition of mechanical parts for any abnormality. If the actuator itself is suspected as the cause, please contact IAI.

Code	Error name	Cause/Action
0C2	Overrun sensor signal detected	<p>This error indicates that a signal from the OT sensor installed at a mechanical end was detected.</p> <p>Cause: [1] The actuator was moved by hand or received an external force while the servo was off (normal detection).            [2] The actuator was jogged in a condition where the home coordinates were not yet established and thus the soft stroke check did not function correctly (normal detection).            [3] The home position achieved by home return is not correct, or in the case of an absolute type controller the coordinates have shifted due to an inappropriate absolute reset position.            [4] The sensor characteristics do not match the setting of sensor parameter No. 19, or the sensor is wired wrongly.            [5] The controller and actuator combination is wrong, or the soft limit or screw lead set in the controller is not appropriate.</p> <p>Action: If [1] or [2] is suspected, move the actuator in the opposite direction by hand.            If this error occurred inside the effective stroke range, [3], [4] or [5] is a likely cause. Check the home position, parameter setting, wiring, etc. If the cause cannot be specified, contact IAI.</p>
0CF	24-V I/O power error	<p>Cause: The 24-V PIO power supply is abnormal.</p> <p>Action: Turn on the 24-V PIO power first, and then turn on the controller power.</p>
0D2	Motor power-supply voltage excessive	<p>Supported version: Up to V001A</p> <p>Please refer to the cold start level code "0D2" for the detailed information.</p>
0D3	Motor power-supply voltage low	<p>Supported version: Up to V001A</p> <p>Please refer to the cold start level code "0D3" for the detailed information.</p>
0D8	Deviation overflow	<p>The position deviation counter has overflowed.</p> <p>Cause: [1] The speed dropped while the actuator was moving due to the effect of an external force, etc.            [2] The excited-phase detection operation following the power on is unstable.            [3] The power-supply voltage dropped.</p> <p>Action: [1] Check the loading condition, such as whether the load is contacting with any surrounding object or if the brake is released, and remove the cause of the problem found.            [2] Since an overload condition is suspected, review the load weight. Reconnect the power, and then perform home return.            [3] Check the power-supply voltage.</p>
0D9	Software stroke limit exceeded	<p>Cause: After completion of home return, the current actuator position is outside the software stroke limits.</p> <p>Action: Move the actuator to a position inside the software stroke limits.</p>
0DA	Feedback pulse error	<p>Cause: The feedback pulse data could no be output within the specified cycle.</p> <p>Action: Implement noise elimination measures.</p>
0DC	Out of push & hold operation range error	<p>This error occurs when the actuator was pushed back to the target position due to an excessive push force after completion of push &amp; hold operation.</p> <p>Review the entire system.</p>
0F5	Nonvolatile memory write verification error	<p>Supported version: Up to V001A</p> <p>Please refer to the cold start level code "0F5" for the detailed information.</p>



(2) Cold-start level alarms

Code	Error name	Cause/Action
0A1	Parameter data error	Supported version: V001B~ Cause: The input range of parameter range data is not appropriate. (Example) This error occurs when the magnitude relationship of a pair of range parameters is inappropriate, such as when the value of soft limit- is mistakenly set to 300 mm when the value of soft limit+ is 200.3 mm. Action: Change the parameters to appropriate values.
0A6	Dynamic brake not released	Cause: The dynamic brake cannot be released when the servo is ON, due to noise, electrostatic, etc. Action: Implement measures to eliminate noise or electrostatic.
0A8	Unsupported motor/encoder types	Cause: Motor types and/or encoder types set for the parameter are not supported. Action: Contact IAI if the problem persists even after turning the power supply off and then on again.
0B4	Mismatching electric angle	Cause: The position deviation counter overflowed. Action: Check if loads interfere with peripheral objects, the brake is released, and other load conditions. Deviation overflow may occur before fixing of electric angle (at phase Z non-detection). In this case, motor/encode cables may have output errors: check connection of the cables.
0B7	Magnetic pole not confirmed	This controller detects the magnetic-pole phase when the servo is turned on for the first time after turning on the power. This error indicates that the magnetic-pole phase cannot be detected after a specified period. Cause: [1] The connector of the motor relay cable is loose or its circuit is open. [2] If the actuator is equipped with a brake, the brake cannot be released. [3] The motor load increased due to application of external force. [4] The sliding distance of the actuator itself is high. Action: [1] Check the wiring condition of the motor relay cable. [2] Check the wiring condition of the brake cable, and also turn on/off the brake release switch to check if "click" sound is heard. [3] Check the assembly condition of mechanical parts for any abnormality. [4] If the load weight is normal, cut off the power and move the actuator by hand to check the sliding resistance. If the actuator itself is suspected as the cause, contact IAI.
0C4	Exceeded allowable time of exceeding torque allowing continuous push & hold	Cause: The continuous push & hold time exceeded the time set for parameter No. 89. Action: Check the sequence again.
0C8	Overcurrent	Cause: The output current in the power-supply circuit became abnormally high. This error should not occur in normal conditions of use. If it occurs, insulation of the motor coil may have deteriorated. Action: Measure the resistance among motor wire phases U, V and W, as well as the insulation with respect to ground. to check if insulation has deteriorated. Contact IAI before performing the above measurement.

Code	Error name	Cause/Action
0CA	Overheating	This error indicates that the temperature around the power transistor in the controller is excessively high (95°C or above). Cause: [1] The surrounding air temperature is high. [2] A faulty part inside the controller. Action: [1] Lower the surrounding air temperature. [2] Add one or more regenerative boxes.
0CB	Current-sensor offset adjustment error	When the controller is started, the condition of the current detection sensor in the controller is checked during the initialization processing. This error indicates that this sensor was found abnormal. Cause: [1] The current detection sensor or any of its surrounding parts is faulty. [2] Inappropriate offset adjustment Action: The board must be replaced or the offset must be adjusted. Contact IAI.
0CD	Emergency stop relay fused	Cause: The emergency stop relay in the controller is fused. Action: The relay or controller must be replaced. Contact IAI.
0CE	Control power-supply voltage low	Cause: [1] The AC power-supply voltage is low. [2] A faulty part inside the controller. Action: Check the input power-supply voltage. If the voltage is normal, please contact IAI.
0D2	Motor power-supply voltage excessive	Supported version: V001B~ Cause: [1] The input power-supply voltage of the motor is high. [2] Faulty component in the controller Action: Check the input power-supply voltage of the motor. If the voltage is normal, please contact IAI.
0D3	Motor power-supply voltage low	Supported version: V001B~ Cause: [1] The motor input voltage is low. [2] Faulty component in the controller Action: Check the power-supply input voltage of the motor. If the voltage is normal, please contact IAI.
0D7	Belt-breaking sensor detected	Cause: The belt of the ultra-high thrust RCS2-RA13R was broken. Action: Contact IAI to arrange for belt replacement.
0E0	Overload	Cause: [1] The load increased due to application of external force. [2] If the actuator is equipped with a brake, the brake cannot be released. [3] The sliding resistance of the actuator is large in some areas. Action: [1] Check the load and its surrounding area. If the load is receiving an abnormal external force, make the necessary correction to remove the external force. [2] Turn on the brake release switch to see if the brake is released. If the brake is not released, the brake itself may be faulty, cable may be disconnected, or there may be a faulty brake circuit component in the controller, among others. [3] If the load can be moved by hand, move the load to check if the sliding resistance increases at a given point. If [2] or [3] is suspected, contact IAI.  Caution: Be sure to remove the cause of the error before resuming the operation. If the power was cut off, wait for at least 30 minutes before turning on the power to prevent the motor coil from burning.

Code	Error name	Cause/Action
0E4	Encoder send error	<p>When the encoder is of serial data communication type, the controller exchanges position data with the encoder via serial communication. This error indicates that the encoder could not successfully receive data sent by the controller.</p> <p>Cause: [1] Data turned garbage due to noise.            [2] The communication IC installed on the encoder board is faulty.            [3] The communication IC installed on the controller board is faulty.</p> <p>Action: [1] Cut off the power to all peripherals and operate the controller and actuator only. If the error no longer occurs, noise may have triggered the error.            If [2] or [3] is the case, the encoder or controller must be replaced.            If the cause cannot be specified, contact IAI.</p>
0E5	Encoder receive error	<p>When the encoder is of serial data communication type, the controller exchanges position data with the encoder via serial communication. This error indicates that the encoder did not return correct data in response to a request from the controller.</p> <p>Cause: [1] The encoder relay cable or supplied actuator cable is disconnected or its connector is not plugged in correctly.            [2] Data turned garbage due to noise.            [3] The communication IC installed on the encoder board is faulty.            [4] The communication IC installed on the controller board is faulty.</p> <p>Action: [1] Check the connector for open circuit or examine its connection condition. (Conduct continuity check by referring to the explanation of the encoder sensor cable in 2.2, "Name and Function of Each Part" of Chapter 1.)            [2] Cut off the power to all peripherals and operate the controller and actuator only. If the error no longer occurs, noise may have triggered the error.            If [3] or [4] is the case, the encoder or controller must be replaced.            If the cause cannot be specified, contact IAI.</p>
0E6	Encoder count error	<p>When the encoder is of serial data communication type, this error indicates that the ASIC board installed in the encoder cannot detect position information correctly.</p> <p>Cause: [1] Foreign matter is deposited on the code wheel.            [2] The position relationship of the code wheel and photo-sensor changed due to misalignment caused by application of excessive external force, etc.            [3] Faulty encoder board component</p> <p>Action: It is necessary to clean the code wheel (by air blow), readjust its installation position, or replace the motor unit or actuator.            In any case, contact IAI.</p>
0E7	Open phase A/B/Z	<p>When the encoder is not of serial data communication type, this error indicates that encoder signals cannot be detected correctly.</p> <p>Cause: [1] The encoder relay cable or supplied actuator cable is disconnected or its connector is not plugged in properly.            [2] The encoder itself is faulty.</p> <p>Action: [1] Check the connector for open circuit or examine its connection condition. (Conduct continuity check by referring to the explanation of the applicable accessory cable in 2.5.)            If the cables are normal, a faulty encoder is suspected. Contact IAI.</p>

Code	Error name	Cause/Action
0EE	Absolute encoder error detected 2	This error indicates that the ASIC board installed in the absolute encoder cannot detect position information correctly. Cause: [1] The voltage of the absolute-encoder backup battery is low. [2] The encoder cable is disconnected. Action: [1] Check the PIO battery alarm output. If the output is OFF, replace the absolute-encoder backup battery. [2] Connect the encoder cable. Whichever action is taken under [1] or [2], an absolute reset must be performed.
0EF	Absolute encoder error detected 3	This error indicates that the ASIC board installed in the absolute encoder cannot detect position information correctly. (Absolute encoder overspeed error) Example of cause: In the case of an absolute actuator installed vertically, the actuator dropped suddenly because the brake was released when the power was cut off, and the acceleration exceeded the allowable limit as a result. (This condition should not occur in normal conditions of use, but it may happen if an external force is applied to the load from above.)
0F0	Driver logic error	Cause: Possible causes include overload, unmatched parameter (motor type), noise, and faulty controller. Action: Contact IAI.
0F4	Unmatched PCB	This controller uses a different motor drive circuit depending on the motor capacity, and thus adopts a different printed circuit board (PCB) appropriate for each motor capacity. For this reason, whether the motor type set by the applicable manufacturer's parameter matches the board is checked in the initialization process after startup. This error indicates that the two do not match. Cause: The parameter was not entered correctly or the correct board was not assembled. Action: Should this error occur, please contact IAI.
0F5	Nonvolatile memory write verification error	Supported version: V001B~ When data has been written to the nonvolatile memory, the written data is read again to check (verify) if it matches the original data. This error indicates that the two data do not match. Cause: [1] Faulty nonvolatile memory [2] The memory has been rewritten more than 100,000 times. (The nominal rewrite limit of the nonvolatile memory is around 100,000 times.) Action: If the alarm generates again after reconnecting the power, please contact IAI.
0F6	Nonvolatile memory write timeout	This error indicates that response is not received within the specified time after data was written to the nonvolatile memory. Cause: [1] Faulty nonvolatile memory [2] The memory has been rewritten more than 100,000 times. (The nominal rewrite limit of the nonvolatile memory is around 100,000 times.) Action: If the alarm generates again after reconnecting the power, please contact IAI.
0F8	Damaged nonvolatile memory	Abnormal data was detected during the nonvolatile memory check after starting. Cause: [1] Faulty nonvolatile memory [2] The memory has been rewritten more than 100,000 times. (The nominal rewrite limit of the nonvolatile memory is around 100,000 times.) Action: If the alarm generates again after reconnecting the power, please contact IAI.

Code	Error name	Cause/Action
0FA	CPU error	<p>The CPU is not operating properly.</p> <p>Cause: [1] Faulty CPU [2] Malfunction due to noise</p> <p>Action: If the alarm generates again after reconnecting the power, please contact IAI.</p>
0FB	FPGA error	<p>The FPGA is not operating normally.</p> <p>Cause: [1] Malfunction due to the effect of noise, etc. [2] The FPGA itself is faulty. [3] Faulty circuit component around the FPGA [4] Inappropriate board installation in the controller</p> <p>Action: Reconnect the power. If the error occurs again, check for presence of noise. If a spare controller is available, replace the problem controller with the spare controller. A recurring error with the spare controller suggests presence of noise. If the cause cannot be identified, contact IAI.</p>

## 5.5 Messages Displayed during Operation Using the Teaching Pendant

This section explains the warning messages that may be displayed during operation using the teaching pendant.

Code	Message name	Description
112	Invalid data	An inappropriate value was entered in a parameter. (Example) 9601 was entered as the serial communication speed by mistake. Enter an appropriate value again.
113 114	Value too small Value too large	The entered value is smaller than the setting range. The entered value is larger than the setting range. Refer to the actuator specifications or parameter table and enter an appropriate value again.
115	Home return non-completion	The current position was written when home return was not yet completed. Execute home return again.
117	No movement data	Target position is not set under the selected position number. Enter the target position first.
11E	Paired data mismatch	The values indicating the magnitude relationship of a pair of data are inappropriate. (Example) The same value was entered in both the parameters for + and – soft limits. Enter appropriate values again.
11F	Absolute position too small	The minimum movement toward the target position is determined by the lead length of the drive system and resolution of the encoder. This message indicates that the entered target value is smaller than the minimum movement. (Example) If the lead length is 20 mm, the encoder's resolution is 800 pulses and accordingly the minimum movement becomes $20 \div 800 = 0.025$ mm/pulse. In this case, this message will be displayed if 0.02 mm is entered as the target position.
121	Push & hold search end over	The final position in push & hold operation exceeds the soft limit. This has no negative effect if the actuator contacts the load. If the actuator misses the load, however, the soft limit will be reached and thus this message is displayed as a warning. Change either the target position or positioning band.
122	Multiple axes connected at assignment	Address was assigned when multiple axes were connected. Assign each address only when one axis is connected.
180 181 182 183	Address change OK Controller initialization OK Home change all clear I/O function changed	These messages are displayed to confirm operation. (They don't indicate an operation error or other abnormality.)
202	Emergency stop	This message indicates that an emergency stop has been actuated.
20A	Servo OFF during operation	This message indicates that the servo ON signal (SON) was turned OFF by the PLC while the actuator was moving, and that the servo turned OFF and the movement was disabled as a result.

Code	Message name	Description
20C	CSTR-ON during operation	This message indicates that a movement command signal was turned ON by the PLC while the actuator was moving, and that duplicate movement commands occurred as a result.
20E	Soft limit over	This message indicates that a soft limit was reached.
221	Write prohibited in monitor mode	This message indicates that an attempt was made to write data to the position table or any parameter in the monitor mode.
223	Operation prohibited in monitor mode	This message indicates that an attempt was made to move the actuator in the monitor mode.
301 302 304 305 306 308 30A 30B	Overrun error (M) Framing error (M) SCIR-QUE OV (M) SCIS-QUE OV (M) R-BF OV Response timeout (M) Packet R-QUE OV Packet S-QUE OV	<p>These messages indicate an error in the serial communication with the controller.</p> <p>Cause: [1] Garbage data due to the effect of noise [2] Duplicate slave numbers when multiple controllers are controlled by serial communication</p> <p>Action: [1] Adjust the wiring in a manner eliminating the effect of noise and review the installation of equipment, etc. [2] Change the slave numbers to avoid duplication.</p> <p>If the message is still displayed after taking the above actions, please contact IAI.</p>
307	Memory command refused	This message indicates that the command was refused in the serial communication with the controller.
309	Write address error	<p>This message indicates that an indeterminate WRITE address error occurred in the serial communication with the controller.</p> <p>These conditions do not occur in normal operation. Should they occur, record the entire error list before cutting off the power for use in the cause investigation.</p> <p>Also contact IAI.</p>
30C	No connected axis	<p>This message indicates that no controller address is recognized.</p> <p>Cause: [1] The controller is not operating properly. [2] Only the supplied communication cable (SGA/SGB) is disconnected. [3] If a SIO converter is used, 24V is supplied to the converter but the link cable is not connected. [4] The ADRS switch settings are duplicated by mistake when multiple controllers are linked.</p> <p>Action: [1] Check if the RDY lamp on the controller is lit. If the lamp is not lit, the controller is faulty. [2] If a spare teaching pendant is available, replace the current pendant with the spare unit, or with a PC, and see if the message disappears. [3] Supply power after connecting the link cable between the converter and controller. [4] Make sure the ADRS switch settings are not duplicated.</p> <p>If the message is still displayed after taking the above actions, please contact IAI.</p>

## 5.6 Specific Problems

- I/O signals cannot be exchanged with the PLC.  
Cause: [1] The 24-V I/O power supply is connected in reverse.  
(In this case, the input circuits are not affected, but the output circuits will be damaged.)  
[2] If the problem is with an output circuit, a circuit component may have been damaged due to a large load that caused the current flowing into the circuit to exceed the maximum current.  
[3] Contact failure in the connector or relay terminal block on the PLC end.  
[4] Contact failure between the female pins in the flat cable connector and the male pins on the controller due to expanded female pins.  
Action: Check the connection condition of the power supply and connector, as well as the load on the output side.  
If the cause is identified as [1] or [2], the controller must be replaced. If there is a possibility of [4], the flat cable must be replaced. Please contact IAI.

 Warning: When performing a continuity check of the flat cable, pay due attention not to expand the female pins in the connector. It may cause contact failure and disable normal operation of the controller.

- The ALM lamp illuminates when the power is input.  
(An alarm is present.)  
\* An alarm is present. Connect the PC or teaching pendant, check the nature of the alarm, and remove the cause.
- The EMG lamp illuminates when the power is turned on.  
(This condition indicates that an emergency stop is actuated.)  
[1] Check if the emergency stop switch on the operation panel is depressed.  
[2] Check if pin 4 (EMG-) of the system I/O connector is unconnected.  
(Refer to 2.2, "Name and Function of Each Part.")
- The SV lamp does not illuminate when the servo ON signal is input after the power was input.  
(The servo does not turn ON.)  
Cause: [1] Contact failure of the flat cable  
[2] The operation mode status is "MANU."  
[3] Faulty controller  
Check the servo ON signal (SON) on the I/O monitor screen of the PC or teaching pendant.  
If the signal is input, probably the controller is faulty. Please contact IAI.



- Home return ends in the middle in a vertical application.  
Cause: [1] The load exceeds the rating.  
[2] The ball screw is receiving torsional stress due to the affixing method of the actuator, tightening of bolts only on one side, etc.  
[3] The slide resistance of the actuator itself is large.  
Action: [1] If [1] is the cause, reduce the load.  
[2] Loosen the fixing bolts and check if the slider moves smoothly.  
If the slider moves smoothly, review the affixing method and bolt tightening condition.  
[3] If the slide resistance of the actuator itself is large, please contact IAI.
- The actuator overshoots when decelerated to a stop.  
Cause: The load inertia is high due to an inappropriate balance of load and deceleration.  
Action: Decrease the acceleration/deceleration setting.
- The home and target positions sometimes shift.  
Cause: [1] The encoder waveform is disturbed by the effect of noise.  
[2] In the case of a rod-type actuator, the non-rotation precision increased due to application of rotating moment to the rod.  
Action: [1] Check if the grounding is implemented correctly. Also check for any equipment being a potential noise source.  
[2] The actuator may have to be replaced in some cases. Please contact IAI.
- The actuator moves only a half of, or twice as much as, the specified movement.  
Cause: [1] The combination of controller and actuator is wrong.  
The lead length of the ball screw varies depending on the actuator type, so a wrong combination will cause the movement and speed to change.  
[2] Factory setting error at IAI  
Action: [1] If multiple actuators of different types must be used, confirm using the identification labels, etc., that the correct actuator is connected to the controller.  
[2] Please contact IAI.
- The SV lamp blinks.  
The automatic servo-off mode is active. (This is not an error or fault.)

## 6. Basic Example of Positioning Sequence

The following example illustrates a basic sequence that can be used to create a positioning sequence for your SCON controller. The items shown with a shaded background indicate PIO signals of the SCON controller.

Note: This basic sequence cannot be used in solenoid valve mode 2 (3-point type).

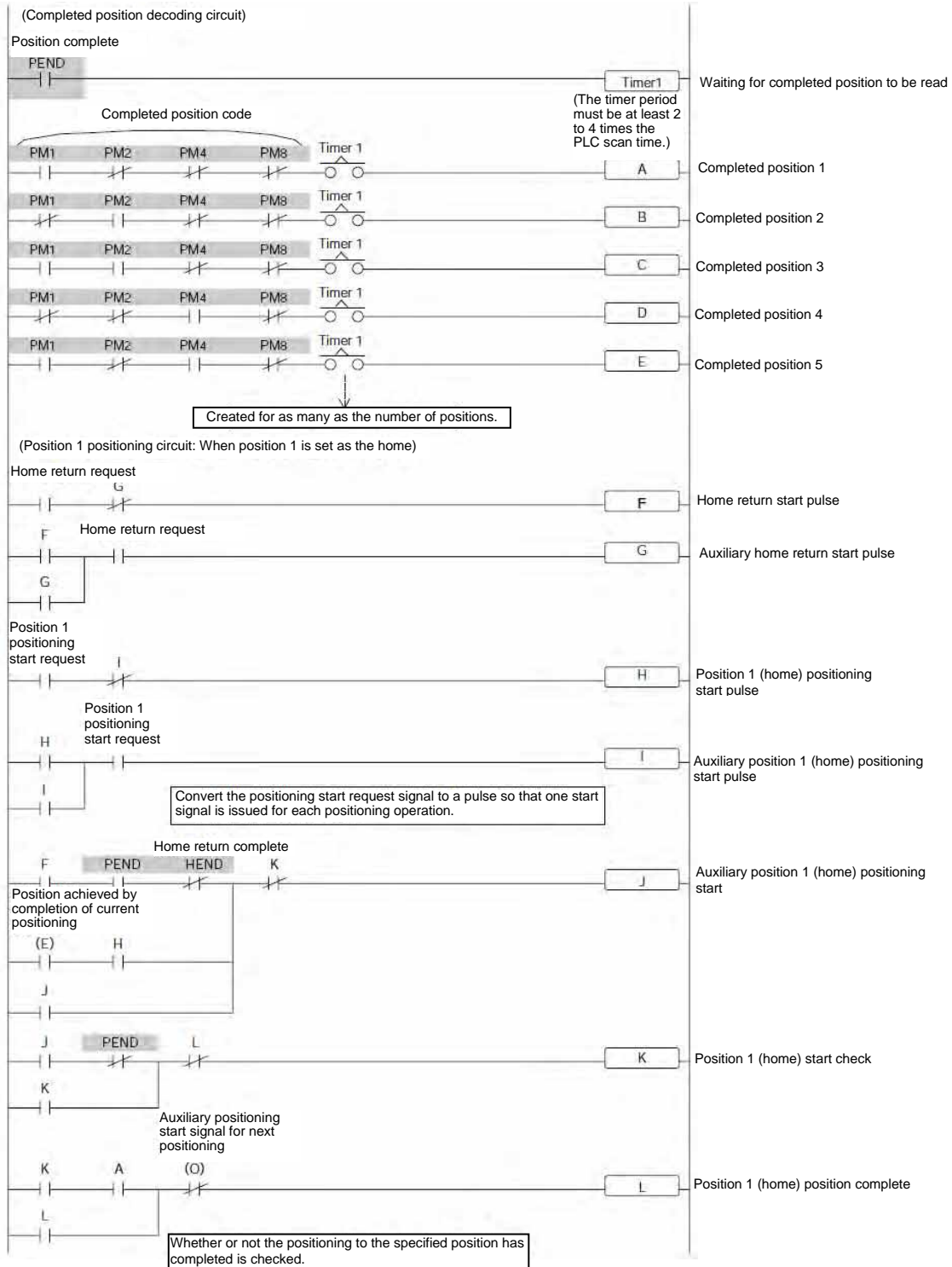

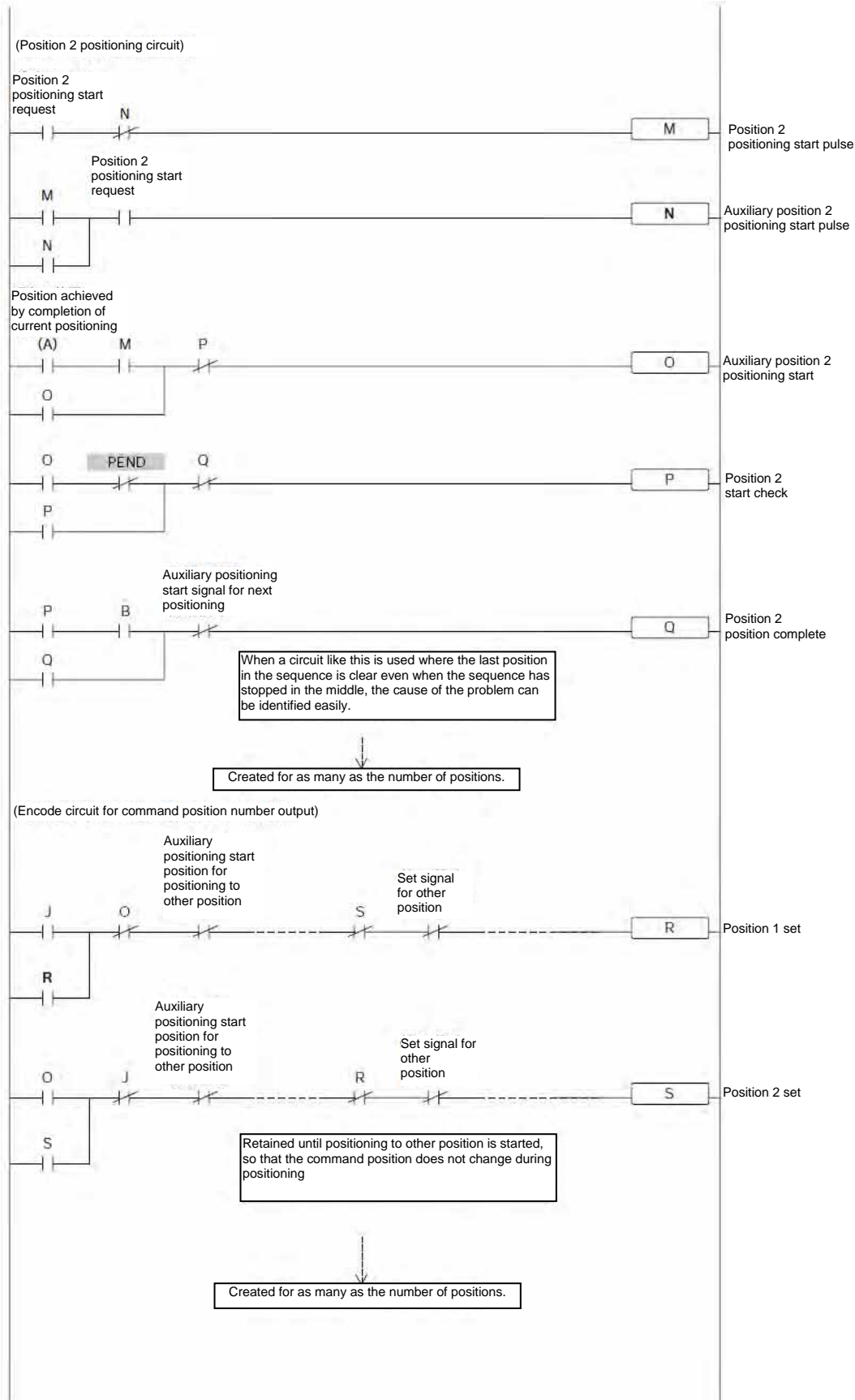

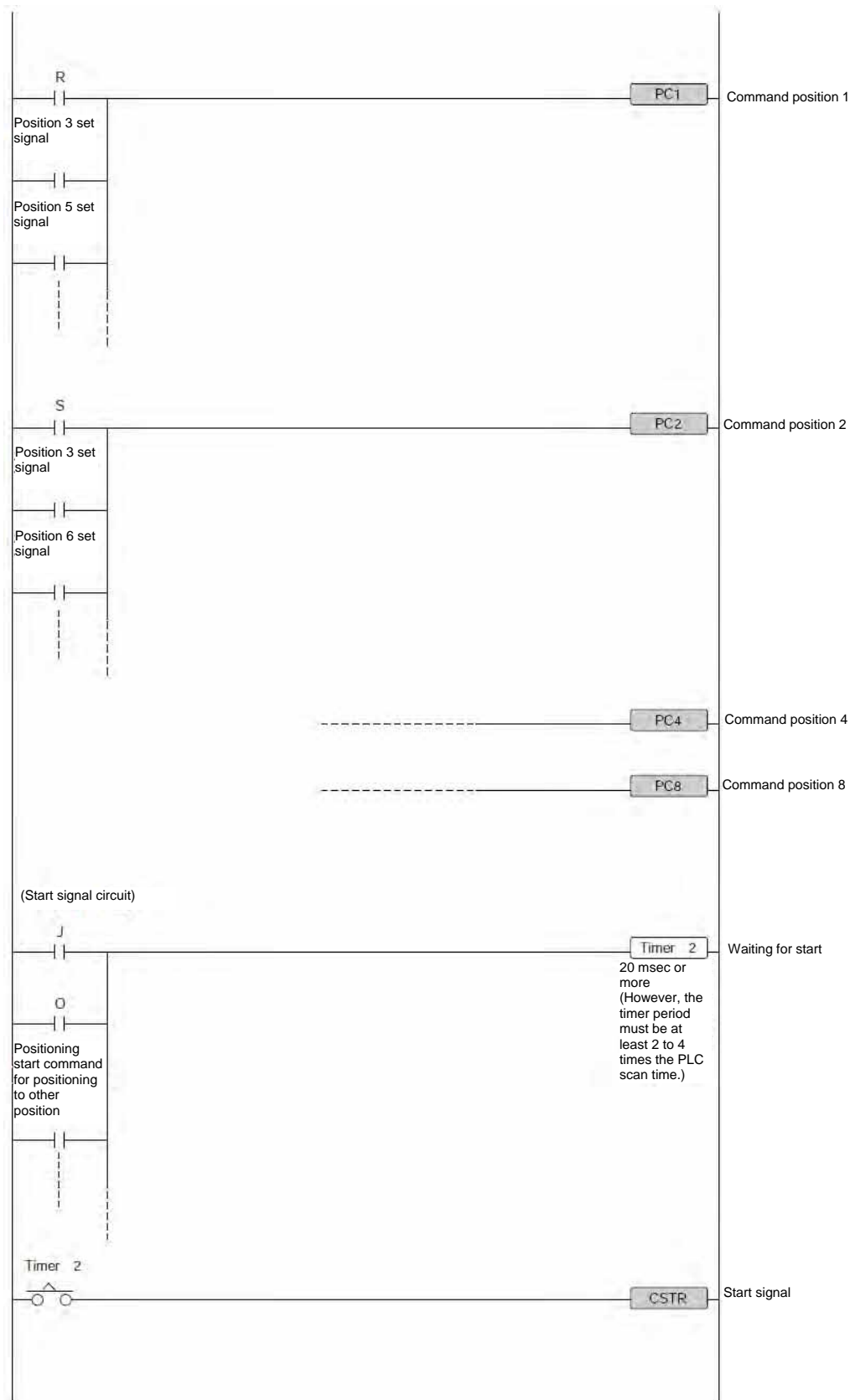

## Recording of Parameters

Recorded date: \_\_\_\_\_

No.	Category	Name	Unit	Recorded data
1	a	Zone 1+	mm	
2	a	Zone 1-	mm	
3	a	Soft limit+	mm	
4	a	Soft limit-	mm	
5	a	Home return direction [0: Reverse / 1: Forward]	-	
6	b	Push & hold stop judgment period	msec	
7	d	Servo gain number	-	
8	b	Default speed	mm/sec	
9	b	Default acceleration/deceleration	G	
10	b	Default positioning band (in-position)	mm	
13	b	Current-limiting value during home return	%	
14	b	Dynamic brake [0: Disable / 1: Enable]	-	
15	c	Pause input disable selection [0: Enable / 1: Disable]	-	
16	c	SIO communication speed	bps	
17	c	Minimum delay time for slave transmitter activation	msec	
18	b	Home-sensor input polarity	-	
19	b	Overrun-sensor input polarity	-	
20	b	Creep-sensor input polarity	-	
21	c	Servo ON input disable selection [0: Enable / 1: Disable]	-	
22	a	Home return offset	mm	
23	a	Zone 2+	mm	
24	a	Zone 2-	mm	
25	c	PIO pattern selection	-	
26	b	PIO jog speed	mm/sec	
27	c	Movement command type [0: Level / 1: Edge]	-	
31	d	Speed loop proportional gain	-	
32	d	Speed loop integral gain	-	
33	d	Torque filter time constant	-	
34	b	Push speed	mm/sec	
35	b	Safety speed	mm/sec	
36	b	Automatic servo-off delay time 1	sec	
37	b	Automatic servo-off delay time 2	sec	
38	b	Automatic servo-off delay time 3	sec	
39	c	Output mode of position complete signal [0: PEND / 1: INP]	-	
40	c	Home-return input disable selection [0: Enable / 1: Disable]	-	
41	c	Operating-mode input disable selection [0: Enable / 1: Disable]	-	
42	b	Enable function [0: Enable / 1: Disable]	-	
45	c	Silent interval multiplier	time	
46	b	Speed override	%	
47	b	PIO jog speed 2	mm/sec	
48	b	PIO inching distance	mm	
49	b	PIO inching distance 2	mm	
50	b	Load output judgment time	msec	
52	b	Default acceleration/deceleration mode	-	
53	b	Default standstill mode	-	

No.	Category	Name	Unit	Recorded data
54	d	Current-control band number	-	
55	b	Position-command primary filter time constant	msec	
56	b	S-motion ratio setting	%	
57	g	Torque-limiting value [%]	%	
58	g	Deviation clear at servo OFF & alarm stop [0: Disable / 1: Enable]	-	
59	g	Deviation error monitor during torque limiting [0: Disable / 1: Enable]	-	
60	g	Deviation counter clear input [0: Enable / 1: Disable]	-	
61	g	Torque limit command input [0: Enable / 1: Disable]	-	
62	g	Pulse count direction [0: Forward / 1: Reverse]	-	
63	g	Command pulse input mode	-	
64	g	Command-pulse input mode polarity [0: Positive / Negative]	-	
65	g	Electronic gear numerator	-	
66	g	Electronic gear denominator	-	
67	g	Forced stop input [0: Enable / 1: Disable]	-	
68	g	Feedback pulse output [0: Enable / 1: Disable]	-	
69	g	Feedback pulse pattern	-	
70	g	Feedback pulse pattern polarity [0: Positive / Negative]	-	
71	d	Feed-forward gain	-	
72	f	Timer period for emergency-stop relay fusing monitor	msec	
73	f	Encoder voltage level	-	
74	f	PIO power monitor [0: Enable / 1: Disable]	-	
75	f	Electromagnetic-brake power monitor [0: Disable / 1: Enable]	-	
76	f	Belt-breaking sensor input polarity	-	
77	b	Ball screw lead	mm	
78	e	Axis operation type	-	
79	e	Rotational axis mode selection	-	
80	e	Rotational axis shortcut selection	-	
88	a	Software limit margin	mm	
89	b	Allowable time of exceeding torque allowing continuous push & hold	sec	
91	b	Current limit value at stopping due to missed push & hold	-	

## Change History

Revision Date	Description of Revision
	First edition
October 2006	Second edition
October 2006	Third edition
March 2007	Fourth edition
July 2007	Fifth edition
June 2009	Sixth edition
October 2009	Seventh edition <ul style="list-style-type: none"> <li>• P48: Changed the acceleration/deceleration used as a condition for determining the number of regenerative resistors to be connected, from 0.3 G to the rated acceleration.</li> <li>• P76: Changed the text by stating that feedback pulses can also be used in the positioner mode.</li> <li>• P146: Specified pulse connector pin numbers.</li> <li>• P147, 159, 180: Added a zone function under the pulse train mode (Version 0025 and later).</li> <li>• P214: Added remedial actions for error codes 0CF and 0D8 and made corrections.</li> <li>• P165: Put back the set value of user parameter No. 63.</li> </ul>
November 2009	Eighth edition <ul style="list-style-type: none"> <li>• P163: Added an encoder pulse count for NS-S***-I (2400 p/r).</li> </ul>
June 2010	Ninth edition <ul style="list-style-type: none"> <li>• Added "Please Read Before Use" on the first page after the cover.</li> <li>• Deleted "Precautions on Safety" before the table of contents and added "Safety Guide" on the first page after the table of contents.</li> <li>• Added "Change History" on the last page.</li> <li>• Updated the back cover. (Changed the addresses of the head office and sales offices, specified the 24-hour service of Eight, etc.)</li> </ul>
August 2010	Tenth edition <ul style="list-style-type: none"> <li>• P163: Added models (RCS3, hollow rotary).</li> <li>• P178, P181: Added parameter No. 139.</li> </ul>
September 2010	Eleventh edition <ul style="list-style-type: none"> <li>• Added the caution about S-shaped acceleration/deceleration function.</li> </ul>
January 2011	Twelfth edition <ul style="list-style-type: none"> <li>• Correction made in "Speed loop integral gain" in P.196</li> </ul>
April 2011	Thirteenth edition <ul style="list-style-type: none"> <li>• Swapped over the page for CE Marking</li> </ul>

---

---

MEMO

---

---





---

---

MEMO

---

---





## ***IAI Corporation***

Head Office: 577-1 Obane Shimizu-KU Shizuoka City Shizuoka 424-0103, Japan  
TEL +81-54-364-5105 FAX +81-54-364-2589  
website: [www.iai-robot.co.jp/](http://www.iai-robot.co.jp/)

Technical Support available in USA, Europe and China

## ***IAI America, Inc.***

Head Office: 2690 W. 237th Street, Torrance, CA 90505  
TEL (310) 891-6015 FAX (310) 891-0815  
Chicago Office: 110 East State Parkway, Schaumburg, IL 60173  
TEL (847) 908-1400 FAX (847) 908-1399  
Atlanta Office: 1220 Kennestone Circle, Suite 108, Marietta, GA 30066  
TEL (678) 354-9470 FAX (678) 354-9471  
website: [www.intelligentactuator.com](http://www.intelligentactuator.com)

## ***IAI Industrieroboter GmbH***

Ober der Röth 4, D-65824 Schwalbach am Taunus, Germany  
TEL 06196-88950 FAX 06196-889524

## ***IAI (Shanghai) Co., Ltd.***

SHANGHAI JIAHUA BUSINESS CENTER A8-303, 808, Hongqiao Rd. Shanghai 200030, China  
TEL 021-6448-4753 FAX 021-6448-3992  
website: [www.iai-robot.com](http://www.iai-robot.com)