



**Innovative And Future-Proof.  
Our Program For Efficient  
Pneumatics Solutions**

**AVENTICS™ Pneumatics Solutions**

Cylinders and drives, valves and valve systems, air supply management.



# A pneumatics program that opens up a world of opportunities

## 06 Cylinders and Accessories

- 06 Piston rod cylinders
- 11 Rodless cylinders
- 14 Cylinder accessories
- 15 Cylinder sensors

## 20 Valves and Valve Systems

- 22 Directional control valves
- 27 Valve systems
- 30 ISO valves
- 34 Fieldbus
- 38 Proportional pressure control valves

## 42 Air Supply Management

- 44 Air preparation units

- 46 Pressure and flow sensors
- 48 Flow and check valves
- 48 Pneumatic connection technologies

## 50 Vacuum Technology

- 50 Non-contact transport system
- 50 Vacuum generators
- 50 Vacuum cups and vacuum accessories

## 51 Machine Safety

## 52 Customer-specific Solutions

## 53 Industrial Internet of Things

## 54 Pneumatics Shop and Engineering Tools

## Our package leaves no gaps in the system

In good hands right from the start: superior product quality, an extensive product portfolio, solution expertise, and target-oriented, long-term support – as an Emerson customer, you can take advantage of everything you need for a future-proof pneumatic solution. What we offer:

- Best-in-class products and components
- Expertise in pneumatics: systems know-how and experience in the industry
- Comprehensive automation solutions with pneumatics

Successful collaboration with you is a major building block for our innovation. Each new project and daily practical experience add to our industry expertise and provide crucial inspiration. Functional integration, component reduction, and alternative material management are just some of the current trends on the path to optimized productivity. Thanks to the targeted use of new technologies and materials, as well as the integration of electronic elements, we continually optimize the function and features of our products and solutions. All for your benefit – you can be sure of that.



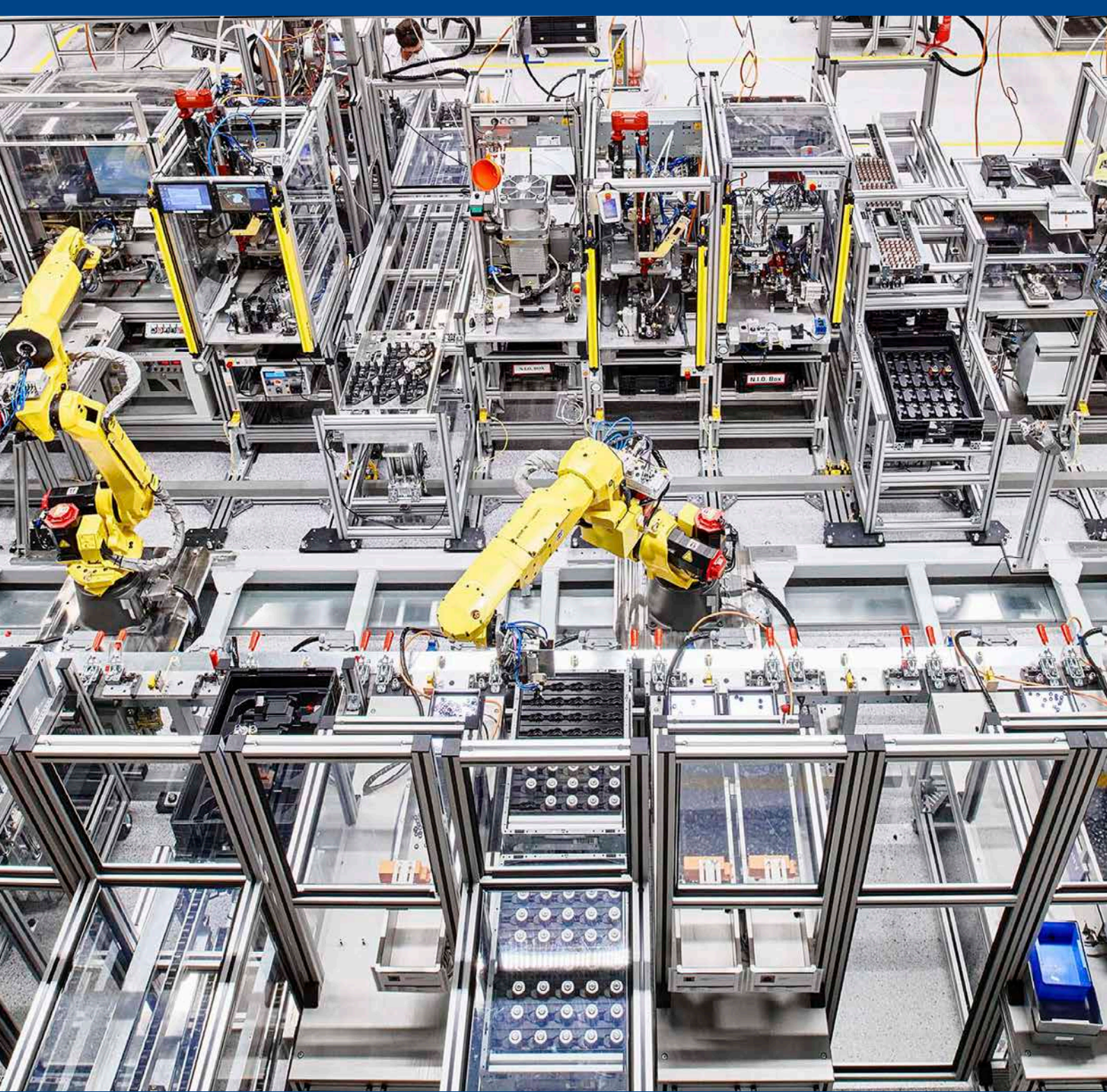

The products in our portfolio play a major role in automation technology and have been well-received in virtually all industries. We would like to make your automation tasks more efficient with our program.

## With everything you need – all perfectly matched



At Emerson, we know that in the end it's all about your satisfaction. About solutions that work safely and efficiently for your needs and reliably accomplish your automation tasks. Long-lasting and maintenance-free. Our products, components, and systems are designed for just that. And that's what we work towards every day.

### **Pneumatic solutions tailored to the application**

It's the perfect interaction of products and components that makes an application successful. Of course, using individual AVENTICS products and components also ensures proven quality for your machines and systems. But our mission doesn't stop there. We know that maximum efficiency requires all elements of a system to work together in perfect harmony. This is why we offer you solutions, not just products; efficiency, not just functionality. Let's talk about it – take advantage of our expertise in pneumatics for your application tasks!

Emerson across the line: a pneumatic application generally consists of compressed air supply, compressed air control, and actuators. For all areas, Emerson offers a comprehensive range of equally innovative and proven products that optimally complement each other in line with our product philosophy. Everything works together perfectly – down to the last fitting.





## Actuators: movements with precision and power – cylinders and drives for every application

Whether in extremely tight spaces, in especially tough conditions, or tasks with high hygienic demands – when it comes to our cylinders and drives, there are no unsuitable or unusual environments. Our products have mastered their roles and perform well in every application, whether for fast cycles and sensitive movements, the heaviest of loads, or finely metered forces.

## Mini and round cylinders

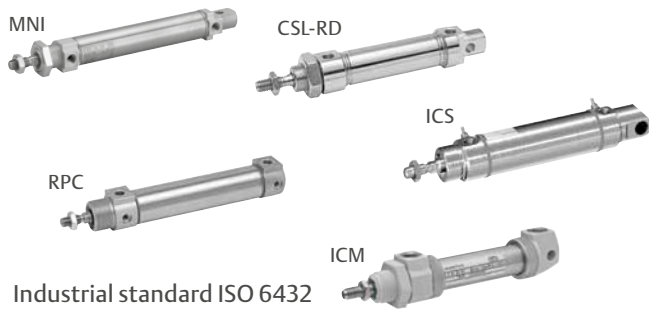

Industrial standard ISO 6432  
Page 8

## Short-stroke and compact cylinders



Industrial standard ISO 21287 / ISO 15524 / NFE 49004  
Page 9

## Profile and tie rod cylinders

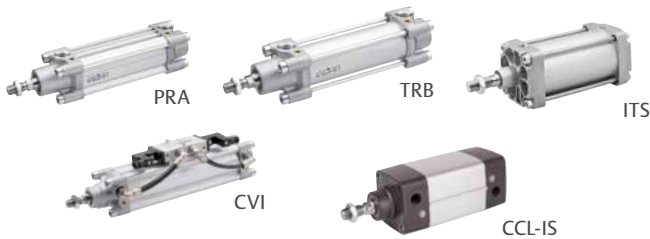

Industrial standard ISO 15552  
Page 10

## Rodless cylinders

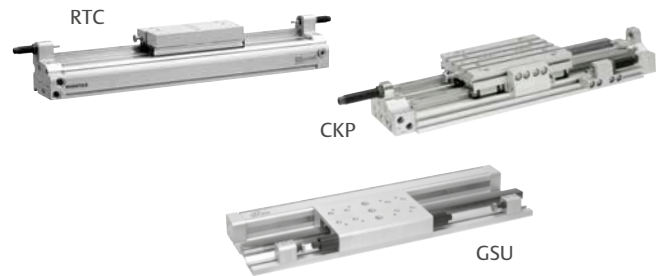

Page 11

## Mini slides, guided cylinders, and rotary actuators



Page 12

## Bellows and specialty cylinders



Page 13

## Accessories



Pages 14 – 15



## Mini and round cylinders

### Series MNI (ISO 6432)

Our standard cylinder series for universal application in mechanical engineering. It is available in many variants and is characterized by extreme durability and a long service life.



MNI

### Series ICM (ISO 6432)

Series ICM cylinders are corrosion-resistant and durable. The cylinder is standardized according to ISO 6432 but is also available in a more compact length. The cylinder tube and piston rod are made of stainless steel, while the cover is made of high-quality polymer.



ICM

### Series CSL-RD (ISO 6432)

The stainless steel series CSL-RD is available in an ISO version, a short version, and in hygienic design. The cylinders do not have any gaps, feature a low surface roughness, and work with food-grade lubricants and seals. Also available with cushioning adjusted at the factory.



CSL-RD

### Series RPC

The series RPC is the big brother to the MNI and also offers a short variant. The cylinders are easy to clean and are suitable for packaging applications in the food industry thanks to food-grade lubricants.

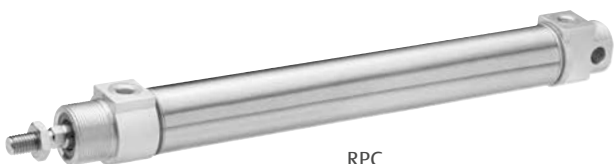

RPC

### Series ICS-D2

Cylinder series in hygienic design. Stainless steel, smooth surfaces, form-fit seals, and cushioning screws ensure optimal cleaning conditions.



ICS-D2



## Short-stroke and compact cylinders

### Series CCI (ISO 21287)

The series CCI is ideal for increased cycle time and moving mass requirements. It has a compact, easy-to-clean design with integrated sensor slots on all sides, and offers a wide range of variants and equipment details, e.g. an ATEX version or US version.



CCI, non-rotating

### Series CCL-IC (ISO 21287)

The series CCL-IC cylinders, with their compact and hygienic design, can be used in a wide range of applications. Their smooth surface together with their materials, such as anodized aluminum, stainless steel, and NSF-H1 lubricants, make the cylinders ideal for demanding requirements such as those in the food and beverage industry.



CCL-IC

### Series KPZ (NFE 49 004)

Series KPZ compact cylinders can be used for a wide range of applications thanks to their dimensions based on the established standard NFE 49 004. Also available in an ATEX version.



KPZ

### Series SSI (ISO 15524)

The SSI short-stroke cylinders, which meet ISO standard 15524, feature a particularly short design and are up to 30% lighter than comparable cylinders thanks to material and component optimization. The 4 and 6 mm slots on all sides provide maximum flexibility for sensor installation.



SSI

### Series KHZ

Series KHZ cylinders feature an extremely compact design and are available from a piston diameter of 8 mm. They are ideal for installation in even the tightest of spaces and can be assembled anywhere, easily and securely.



KHZ

## Cushioning Adjustment Tool CAT – making precise cushioning adjustment easy

Until now, optimum end cushioning adjustment required experience, a certain sensitivity, and sometimes patience. Today, you can count on the reliable support of sensor electronics. The adjustment of end cushioning is easy and quick, ensuring the correct settings are applied. Once the sensor is fixed on the cylinder and switched on, all functions can be read from the large LED display and cushioning adjustment can be made with precision. In addition, the optional AVENTICS app provides visual information about piston speed and cushioning characteristics.



# Profile and tie rod cylinders

## Series PRA (ISO 15552)

PRA cylinders are based on a compact aluminum profile with integrated 4 and 6 mm sensor slots for simple, space-saving installation of sensor technology.



PRA with modular scraper (optional)

## Series TRB (ISO 15552)

TRB cylinders with a classic design featuring smooth tubing and tie rods offer an impressive load capacity and adaptability to existing processes.



TRB

## Series ITS (ISO 15552)

ITS cylinders are used for moving masses up to several tons. As standard, they are equipped with a configurable scraper module from the modular sealing system.



ITS with modular scraper (integrated)

## Series CCL-IS (ISO 15552)

This cylinder in clean design is produced specifically for packaging applications in the food industry. It is characterized by practical sensor mountings and its hygienic design that combines simple cleaning with low maintenance.



CCL-IS

## Series CVI (ISO 15552)

Cylinder valve units can also be configured online with the ISO cylinder series PRA and TRB, and five freely combinable valve series.



CVI

## How to find the perfect cylinder for your application

Simply enter the key performance parameters for your new application to get an overview of all possible cylinders. Additional filters and comparison analyses narrow down your results. After you have made a selection, you are forwarded to the directly linked configuration program.

- Application data input: stroke, mass load, time, load movement direction and pitch angle, cycles per hour, optional additional detailed data – intuitive navigation with help information.
- As a result, all possible cylinder series are listed with the key basic data and additional comparison values – weight, speed, air consumption, etc.
- The selection can be refined according to the desired specifications via the comprehensive filter menu.

Product series	Drive	Cushioning	Guide	Weight (kg)	Air Consumption (l/cycle)
PRA	32	1-Elastic	500 Plain InternalBushings	0.72	1.05
PRA	32	1-Elastic	L01 Plain LinearGuide	0.72	1.08
PRA	32	2-Pneumatic	500 Plain InternalBushings	0.72	1.00
PRA	32	2-Pneumatic	L01 Plain LinearGuide	0.72	1.00
TRB	32	1-Elastic	500 Plain InternalBushings	0.70	1.05
TRB	32	1-Elastic	L01 Plain LinearGuide	0.70	1.08
TRB	32	2-Pneumatic	500 Plain InternalBushings	0.70	1.00
TRB	32	2-Pneumatic	L01 Plain LinearGuide	0.70	1.00

# Rodless cylinders and guided slide units

The unique oval piston shape and one-piece slide/piston unit enables higher loads and torques, and highly compact designs. Users achieve the same performance with far more compact cylinders, which cuts down on weight and costs.

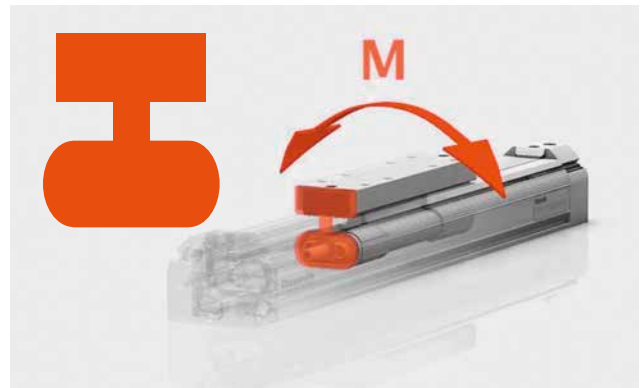

## Series RTC

RTC offers four variants with different strengths for movement and positioning as well as a wide range of speeds. They are available as a basic version and slide bearing, compact guide, and heavy-duty versions for large loads.



RTC-BV



RTC-CG



RTC-SB



RTC-HD

## Series CKP

CKP is particularly suitable for applications requiring the movement of heavy loads. It provides sturdy, ultra-precise guiding with excellent repeatability.



CKP

## Series GSU

With its flat design, this high-performance guided slide unit is the ideal basis for many handling systems. Stroke length and stroke position can be variably adjusted over the entire length – individually from both sides.



GSU



For further information on these or any other AVENTICS product, visit [Emerson.com/AVENTICS](https://www.emerson.com/AVENTICS)



# Mini slides, guided cylinders, and rotary actuators

## Series MSC

MSC provides maximum rigidity for high torques and loads. Versatile configuration options make the mini slide a truly universal handling component, ensuring great flexibility in machine design.



## Series MSN

MSN offers precise guidance without play in a slim package. A wide variety of attachment and air supply and exhaust options allows for application in virtually any position and location.



## Series GPC

The robust design is particularly reliable and absorbs high torques and transverse forces. The E and ST variants offer users a particularly cost-efficient handling solution.



## Series RCM rotary compact module

RCM rotary compact modules can be mounted directly on mini slides. Different cushioning types, air ducts, and intermediate positions are available. Fine-adjustment of the end positions.

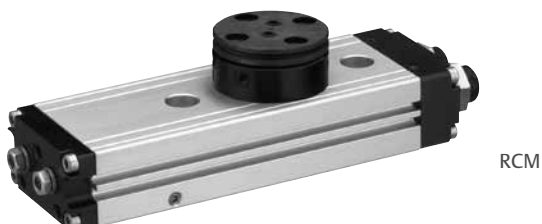

## Series TRR rotary cylinder

The series TRR can realize angles of rotation up to 360° and torques up to 110 Nm, and offers adjustable pneumatic cushioning.



## Special cylinders

### Series SWN screw-in cylinders

Thanks to their integrated thread, SWN cylinders are compact and easy to mount without accessories in their working environment.



SWN

### Series RDC rolling diaphragm cylinders

RDC cylinders can be operated at low pressures. This allows for precise force control in finely tuned systems.



RDC

## Bellows actuators

### Series BCP, BCC, BRB, BCR

Our range offers four series for different areas of application. All bellows actuators enable high forces in the tightest of spaces and are virtually wear and maintenance-free. They are available in many sizes, with different versions and rubber qualities, in single, double, or triple bellows variants.

BCC



BCP



BCR



BRB



For further information on these or any other AVENTICS product, visit [Emerson.com/AVENTICS](https://www.emerson.com/aventics)





## Modular scraper system

The modular scraper system enables individual adaptation to the requirements of the respective application. This means maximum flexibility, optimal scraping, higher performance, and lower costs for maintenance and downtime. Standard for the series ITS cylinder and optional for PRA/TRB and CCL-IS cylinders.

Each of the cylinder series features five scraper modules. They are available separately with fully installed seals, bushings, and metal scrapers, and can be exchanged at any time, quickly and easily, without dismantling the cylinder.

## Mounting accessories

### Series CM1 cylinder mountings



### Series CM2 piston rod mountings



### Series CG1 guide units



### Series CB1 sensor mountings



## Locking units

### LU1 – LU5 locking units

With eccentric movements, the units hold the piston rod in any position. Mounting to the cylinder is realized via a flange.

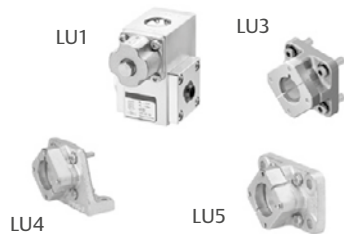

### Series HU1 holding unit

The series HU1 holds piston rods using spring force. A corresponding adapter is used for attachment to the cylinder. Holding cartridges can be exchanged in case of wear.



### Series LU6 locking unit

The LU6 is a mechanical holding unit/dynamic brake for piston rods in pneumatic cylinders according to ISO 15552 or comparable round bars. This unit is certified to be used in accordance with ISO 13849.



## Cylinder sensors

### Series ST4/ST4-2P

These series offer high tech in the tightest of spaces and are ideal for pneumatic actuators in small handling. The ST4-2P sensor with two switching points also permits the measurement of any two switching points in a range of 50 mm.



### Series ST6

The ST6 is our universal sensor for the 6 mm slot. Established in automation technology as a standard sensor, it is space-saving and can be mounted on all round cylinders, tie rod cylinders, and profile cylinders via sensor mounting.



### Series SM6/SM6-AL

Series SM6 and SM6-AL sensors enable high-resolution, permanent distance measurement and are ideal for continual detection of piston movements in pneumatic cylinders within the maximum measurement range of 1,007 mm. Thanks to an intuitive teach pad, a 4-color LED display, and IO-Link communication, the SM6-AL is also easy to start up in next to no time.

















### Series SC4

The SC4 is suitable for applications with pneumatic cylinders with a C-slot. Its short housing and connection line rotated by 90° make it ideal for use in tight spaces and with short-stroke cylinders. Thanks to a short, exact switching range, the SC4 is also a perfect fit for the AVENTICS series UPG gripper.



For further information on these or any other AVENTICS product, visit [Emerson.com/AVENTICS](https://www.emerson.com/AVENTICS)



Cylinder			
Series	Picture	Piston diameter	Max. stroke
SWN		6 – 16 mm	15 mm
ICM ISO 6432		8 – 32 mm	400 mm
MNI ISO 6432		10 – 25 mm	1,300 mm
CSL-RD ISO 6432		16 – 25 mm	1,300 mm
RPC		32 – 63 mm	1,200 mm
ICS ISO 6431		32 – 100 mm	1,600 mm
CCI ISO 21287		16 – 100 mm	500 mm
SSI ISO 15524		12 – 100 mm	150 mm
KHZ		8 – 100 mm	100 mm
KPZ NFE 49 004		16 – 100 mm	500 mm
CCL-IC ISO 21287		16 – 100 mm	500 mm
CCL-IS ISO 15552		25 – 125 mm	2,800 mm
PRA/TRB ISO 15552		32 – 125 mm	2,800 mm
ITS ISO 15552		160 – 320 mm	2,700 mm
CVI ISO 15552		32 – 125 mm	2,800 mm



## Special features and benefits

- Miniature single-acting cylinder
- Simple mounting by using the continuous thread

- Lightweight design
- Food- and beverage-compatible materials (NSF-H1 grease, stainless steel, water-repellent POM covers)

- Robust and space-saving design
- Characterized by extreme durability and a long service life

- Stainless steel cylinder with a hygienic design
- Certified according to Regulation (EC) No 1935/2004 on materials and articles intended to come into contact with food
- Ideally suited for the F&B splash zone

- Compact and space-saving design
- Corrosion-resistant materials: tube and piston rod made of stainless steel and covers made of anodized aluminum

- Stainless steel cylinder with a hygienic design
- Fully stainless steel cylinder for harsh environments
- Certified according to Regulation (EC) No 1935/2004 on materials and articles intended to come into contact with food

- Simple sensor assembly along the complete cylinder length thanks to a continuous aluminum profile
- Excellent flexibility thanks to hollow piston rod, multi-position, tandem, integrated holding or braking unit

- Shortest and most compact cylinder
- Non-magnetic versions with a clean design

- Clean profile
- For applications requiring a very short/narrow cylinder

- Excellent flexibility thanks to hollow piston rod, multi-position, integrated holding unit
- Simple sensor assembly along the complete cylinder length thanks to a continuous aluminum profile

- Compact clean design with anodized surfaces
- Lubricants (NSF-H1) are approved for food applications

- Easy-to-clean anodized surfaces
- Lubricants (NSF-H1) are approved for food applications

- Widest range of variants and accessories
- With the optional modular scraper system, you can service the cylinder in less than 5 minutes without removing the cylinder

- Heavy-duty applications; up to five tons can be moved by a single cylinder
- Allows the simple and cost-effective automation of extremely powerful applications
- The modular sealing system enables tailor-made solutions for specific applications that function efficiently and minimize maintenance efforts

- Ready-to-install cylinder valve unit with PRA/TRB cylinder and one of five different spool valves.
- Typical applications: open/close functions such as flap controls and spool applications

## Cylinder/handling technology

Series	Picture	Diameter	Max. stroke
RTC		RTC-BV = 16 – 80 mm RTC-SB = 25 – 50 mm RTC-CG = 16 – 40 mm RTC-HD = 16 – 63 mm	RTC-BV = 100 – 9,900 mm RTC-SB = 100 – 9,900 mm RTC-CG = 200 – 2,000 mm RTC-HD = 200 – 4,300 mm
CKP		16 – 32 mm	100 – 3,700 mm
GSU		16 – 25 mm	200 – 1,000 mm
BCP		90 – 640 mm	
BCC		80 – 435 mm	
BCR		442 – 950 mm	
BRB		60 – 173 mm	
MSN		6 – 16 mm	5 – 30 mm
MSC		8 – 25 mm	10 – 200 mm
TWC		2x10 – 2x32 mm	100 mm
GPC		GPC-BV = 10 – 100 mm GPC-E = 12 – 20 mm	GPC-BV = 10 – 200 mm GPC-E = 25 – 150 mm
RCM		6 – 25 mm	Angle of rotation 90 – 180°
TRR		32 – 100 mm	Angle of rotation 90 – 360°
RDC		52.5 – 115 mm	95 mm

## Special features

- Comprehensive range with many variants and options enables configurations that are individually tailored to the application
- Easy-2-Combine interface

- High load capacity with two linear guides, clearance-free
- Easy-2-Combine interface

- High load capacity with optimized height
- Easy-2-Combine interface

- Bellows cylinder with permanently crimped connecting plates

- Bellows cylinder with removable mounting parts

- Bellows cylinder with bead-ring connecting parts

- Lightweight and easy to assemble
- Nearly constant force output over the stroke range

- High torque and load absorption with maximum stability
- Narrow design

- High torque and load absorption with maximum stability
- Compact design
- Easy-2-Combine interface

- High force with low space requirements
- Torsion protection with double piston rods

- Two guide rods with high side load capacity and high precision
- Cost-effective solution

- A combination of an opposed pneumatic double piston drive (rack/pinion) and a precise rotary flange guided without play
- Easy-2-Combine interface

- Rack-and-pinion gears with double piston
- Optionally with adjustable angle of rotation

- Cylinder with extraordinary low friction for precise force control



## Valve technology: Precise drive and control

Valves and valve systems play a key role in pneumatic solutions. And that's why no compromises are made here – only the best for our customers. Innovation and quality from Emerson. With precise commands, our valves and valve systems control the pneumatic components in all automation processes. We have the right program for you – best in class.

## Directional control valves

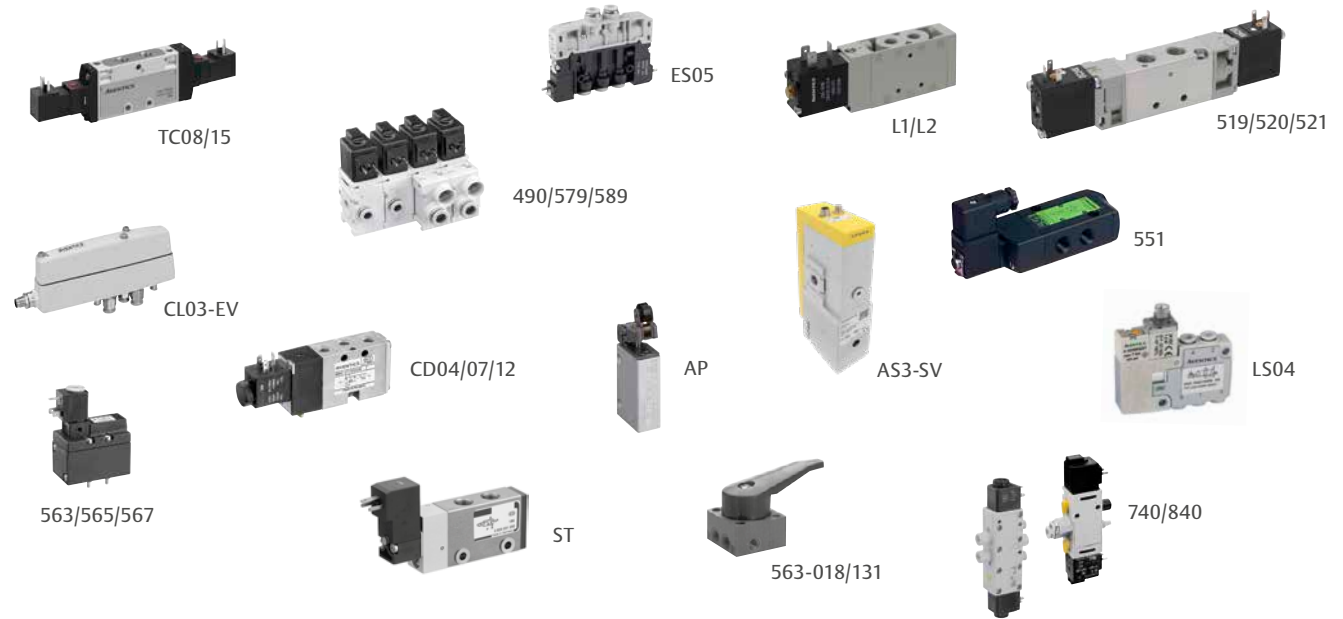

Pages 23 – 26

## Valve systems



Pages 27 – 29

## ISO valves

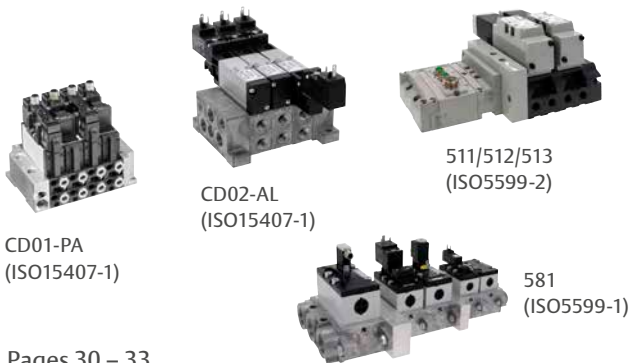

Pages 30 – 33

## Fieldbus and IO solutions



Pages 34 – 37

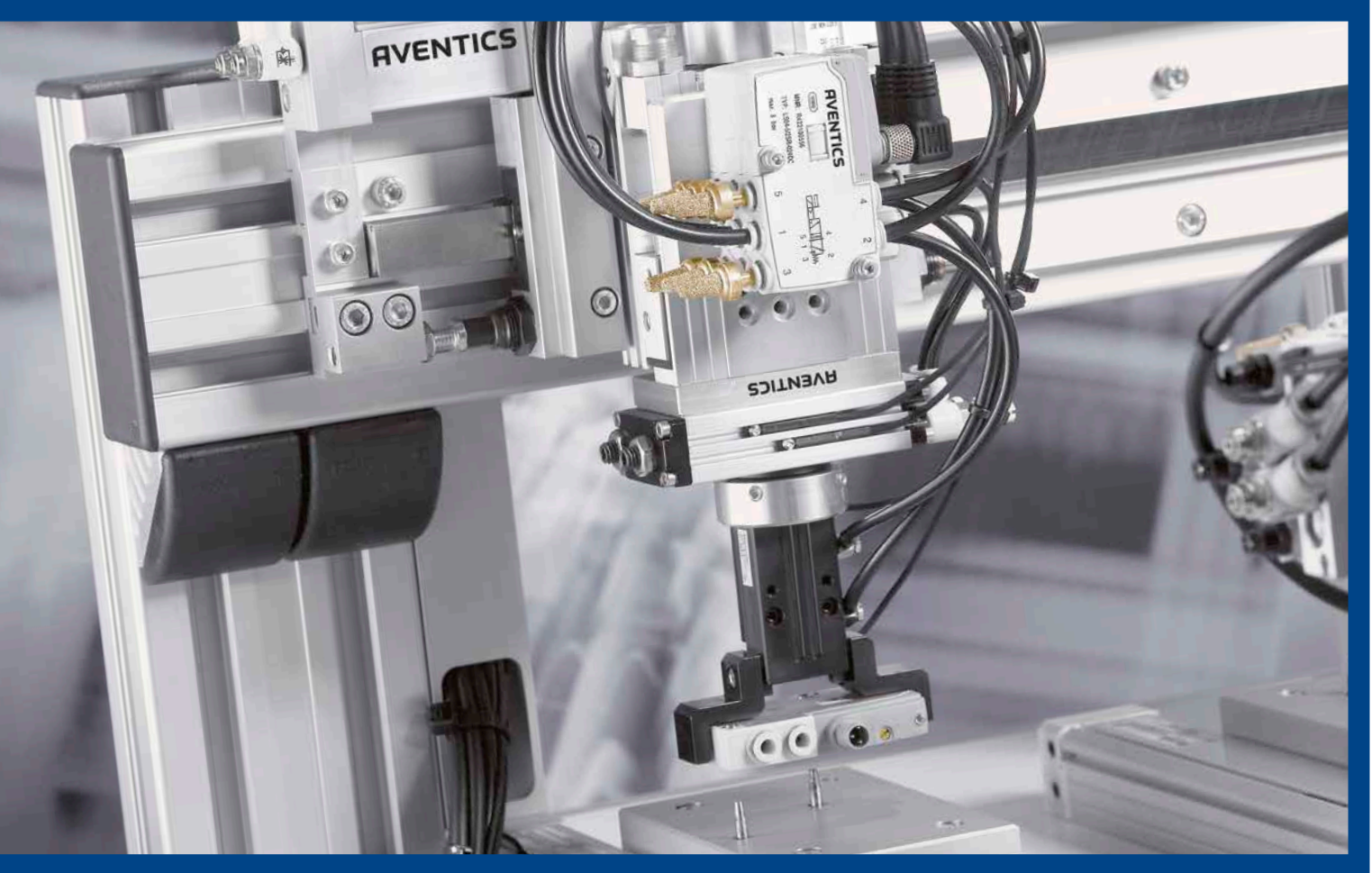

## Directional control valves for different tasks: as single valves or valve system assemblies

### Ideal for decentralized applications

For applications indoors or outdoors, in extreme cold or heat, for delicate work or tasks demanding enormous power – our range of directional valves has the right valve solutions for every situation. From the Clean Line valve for wash-down applications in the food industry, to the special valve for use in furnaces in the aluminum industry – the single valves with flow rate performances from a minimum of 50 to a tremendous 13,620 l/min are tailored to a broad spectrum of applications with their specific characteristics.

# Directional control valves

## Series CD

The Series CD is available in three sizes from 900 to 4,100 l/min as electrically, pneumatically, and mechanically and manually operated valves. They consist of various spool valves with an extremely durable die-cast zinc housing. Their electrical, pneumatic, or mechanical actuating controls (roller, lever, pedal, or plunger) make the Series CD ideal for applications in harsh environments.

Pneumatically operated

Electrically operated

Manually operated

CD04



CD07



CD12



## Series TC

The Series TC08/TC15 includes a wide range of spool valves with housings made of high-performance polymers with robust and flexible metal inserts. They are designed for flow rate performances from 800 to 1,500 l/min. These directional valves are easy to assemble, making them ideal for applications requiring the highest efficiency in limited spaces.

Electrically operated

Pneumatically operated

TC08



TC15



## Series 519/520/521

The Series 519/520/521 is a range of solenoid air-operated or pneumatically controlled mini-spool valves from 175 to 1,050 l/min that are ideal for piloting pneumatic cylinders. The valves have a machined aluminum body and high-quality, heat- and moisture-resistant coils, and are suitable for high ambient temperatures and harsh environments. They can be mounted on joinable subbases for manifold applications.

Pneumatically operated

Electrically operated

519



520



521



## Series L1/L2

The Series L1/L2 spool-and-sleeve valves offer high speed and high flow capacity from 1,000 to 1,700 l/min in a compact design. They are available either with solenoid pilot, air pilot, or hand lever actuation for inline mounting or on manifolds from 2 to 12 stations.



L1



L2

## Directional control valves

### Series LS04

The Series LS04 are lightweight spool valves and save space with their polyamide housing. The valves are suitable for direct mounting onto moving machines and system parts.



### Series 490/579/589

The Series 490/579/589 featuring poppet valve technology have a robust polymer housing that can be mounted individually or as a block. They cover a large range of voltages and feature fast connections for pneumatic tubing.



### Series 740/840

The Series 740/840 feature directional control with soft, abrasion-free diaphragm technology. The simple, reliable, and robust design is suitable for all air qualities and ensures high repeatability and unsurpassed service life. Due to its excellent resilience, the corrosion-resistant polyamide housing is also suitable for dusty and wet environments.



### Series AP

The Series AP offers a wide range of poppet valves with aluminum housing. With many actuation control versions available (roller, lever, pedal, push-button, or plunger) the Series AP is the universal solution for automation systems and panel installation.



### Series ST

The Series ST offers a comprehensive range of spool valves with hardened stainless steel housing. The metal sealing system ensures their extended service life independent of the air quality. Their electrical, pneumatic, or mechanical actuating controls (roller, lever, push-button, or plunger) make the Series ST ideal for demanding industry applications and panel installation.



### Series 563/565/567

The Series 563/565/567 poppet valves have an aluminum housing and are suitable for assembly on single or manifold subbases, offering flow rate performances of up to 13,620 l/min with a working pressure of up to 30 bar. The 3/2 directional valves can be operated both electrically and pneumatically.



### Series AS3-SV

The Series AS3-SV are 3/2 safety exhaust valves with integrated electronic safety relays that can achieve category 4 safety-relevant control while realizing the maximum performance level "e" (PLe) according to ISO 13849-1.



### Series SV01/SV03/SV05

The Series SV01/03/05 double valves are redundant 3/2 and 5/2 valves for external monitoring that are designed to meet the needs and requirements of safe air supply and exhaust 3/2 valve and safe cylinder return 5/2 valves applications for machinery with pneumatic controls according to the requirements of ISO 13849-1-2 for safety functions.





## Directional control valves

Series	Picture	Max. flow	Piloting	Benefits
CD04 CD07 CD12		900 l/min 1,200 l/min 4,100 l/min	Mechanic/manual/ pneumatic/electric	Robust, reliable, ATEX (CD07)
TC08 TC15		800 l/min, 1,500 l/min	Pneumatic/electric	Small size, 2x3/2, valve system version
519 520 521		175 l/min, 600 l/min, 1,050 l/min	Pneumatic/electric	Small size
L1 L2		985 l/min, 1,674 l/min	Pneumatic/electric, manual lever (L2)	Spool-and-sleeve, robust, base plates, accessories
LS04-AF		200 l/min	Electric	Very small size 2x3/2 version
490		100 l/min	Pneumatic/electric	Cost-efficient, common supply
579 589		750 l/min	Pneumatic/electric	Cost-efficient, common supply with joinable version

## Directional control valves

Series	Picture	Max. flow	Piloting	Benefits
740		1,100 l/min	Electric	Robust, base plate assembly, throttles
840		200 l/min	Electric	Robust, base plate assembly, throttles
AP		550 l/min	Mechanic, manual	Large portfolio
ST		280 l/min	Pneumatic, electric	Stainless steel, metal sealed
563-018 563-131		300 l/min, 1,100 l/min	Manual	Robust
563 565 567		1,350 l/min, 4,240 l/min, 13,620 l/min	Pneumatic, electric	Robust 567: high flow
ES05		610 l/min	Electric	2x3/2 version, collected pilot exhaust, valve system version
CL03-EV		700 l/min	Electric	Hygienic design, IP69K, valve system version
551 553		860 l/min 3,000 l/min	Mechanic, manual Pneumatic, electric	Special versions such as stainless steel, brass, ATEX

# Valve systems

## Series AV03/AV05

The Series AV03/AV05 provide a reliable basis for both compact handling systems and complex automation solutions. The Series AV03/AV05 offer intelligent solutions for machine safety that significantly reduce the effort required for creating a safe design. With the integration of the fieldbus and I/O-modules of the Series AES, all requirements for decentralized control are also available. The Series AV03/AV05 is easy to configure, easy to use, and easy to extend as well as future-proof thanks to the option of IIoT integration.



AV03



AV03/AV05



AV05

## Series 501/502/503

The Series 500 valve platform, with advanced connectivity in addition to the multipole up to G3 or 580, is a state-of-the-art electronic system with integrated graphic display and IO module capability. Series 501 (11 mm) offers high flow of 400 l/min and a panel mount solution for cabinet mounting as well as zone safety or ATEX option.

Series 502 (18 mm) and 503 (26 mm) can be used on ISO 15407-2 base plates but also offer a flow up to 1,400l/min in combination with a flow-optimized base plate. All products in this range offer a large number of sandwich accessories such as speed controls, sandwich shut-offs, or pressure regulators.



502/503

501 with panel mount



## Series ES05

The Series ES05 is ideal for standard pneumatic applications. Its simplicity and modularity make it especially well suited to applications that require quick changes or extensions. Due to its modular system consisting of a limited number of components and the one-tool concept, the ES05 is also easy to assemble in-house.



ES05



## Series CL03

The clean line Series CL03 is the ideal valve system for pneumatic solutions in the food industry – clean design, utmost configuration flexibility, module extension possible at any time, and the highest protection from water. The synthetic material is resistant to cleaning agents and aggressive chemicals, enabling applications in wet areas, even under harsh conditions. The valve system offers outstanding flexibility with the option to generate up to 32 different pressure stages in a single system.



CL03

## Valve systems

### Series HF02-LG

HF02-LG offers a compact design with high flow of up to 1,400 l/min. Individual base plates offer flexibility as well as the connectivity with el. multipole, fieldbus connection, or adaptation to AV05.

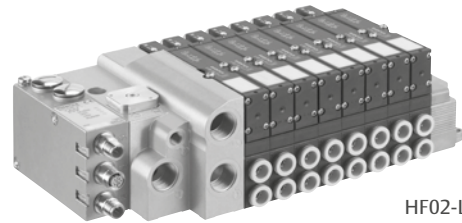

HF02-LG

### Series 2035

The Series 2035 valves, which allow advanced connectivity in addition to multipole up to G3 or 580, are state-of-the-art electronic systems with integrated graphic display and IO module capability.

This series has an excellent ratio of size/flow. Despite a width of only 42 mm, this valve allows a flow of 3,820 l/min. The 2035 range offers a large number of sandwich accessories such as flow reducers or pressure regulators.



2035

### Series TC08/TC15











The Series TC08/TC15 includes a wide range of spool valves with housings made of high-performance polymers with robust and flexible metal inserts. They are designed for flow rate performances from 800 to 1500 l/min. These directional valves are easy to assemble, making them ideal for applications requiring the highest efficiency in limited spaces.



TC08

TC15

## Valve systems

Series	Picture	Max. flow	Versions	Benefits
AV03		300 l/min	Multipole, fieldbus, single wire, bottom ported	IIoT ready Small, lightweight Optimized for safety-related circuits
AV05		700 l/min	Multipole, fieldbus, single wire, bottom ported	IIoT ready Small, light-weight, optimized for safety-related circuits
501		400 l/min	Multipole, fieldbus, cabinet mounting	Metal body and base plate, ATEX option, and panel mount
502		650 l/min	Multipole, fieldbus, single wire M12x1	Metal body and base plate, ISO and high-flow base plate, spool-and-sleeve, ATEX option
503		1,400 l/min	Multipole, fieldbus, single wire M12x1	Metal body and base plate, ISO and high-flow base plate, spool-and-sleeve
ES05		610 l/min	Multipole, fieldbus, single wire, inline valve	Modular, easy to mount
CL03		700 l/min 1,100 l/min	Multipole, fieldbus, inline valve	IP69k, hygienic design, high flow, up to 32 pressure zones
HF02-LG		1,400 l/min	Multipole, fieldbus	High flow, 2x3/2 version, can be combined with AV
2035		3,500 l/min	Multipole, fieldbus	High flow, spool-and-sleeve
TC08		800 l/min	Pneumatic, electric, single wire, inline valve	Compact valve system, inline version
TC15		1,500 l/min	Pneumatic, electric, single wire, inline valve	Compact valve system, inline version

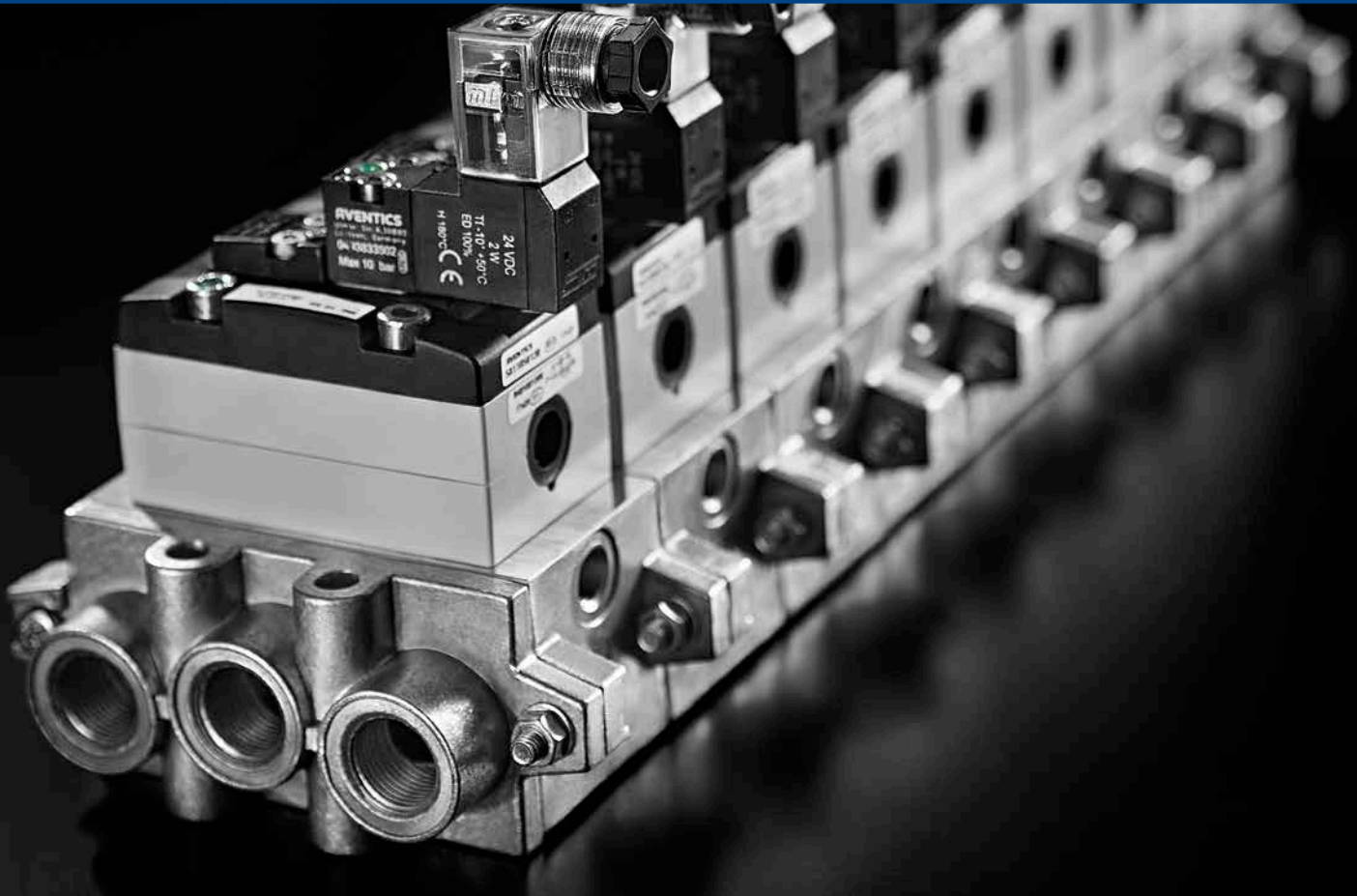

## Directional control valves complying with ISO standards for universal applications

Our ISO-standardized valve solutions have long been important pneumatic components in the automotive industry and for machine builders. They ensure reliability, speed, and efficiency – all reasons why they are also used in the timber, printing, and paper industries, as well as heavy industry.

# ISO valve systems

## Series CD02-AL

Series CD02-AL complies with the ISO standard 15407-1 with a size of 18 mm and flow up to 450 l/min. The robust valve series offers the full range of valve functions as well as various control voltage and connection types. The joinable base plate system can be combined with 26 mm base plates.

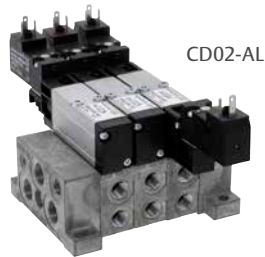

## Series CD01-PA

Series CD01-PA complies with the ISO standard 15407-1 with a size of 26 mm and flow up to 1,010 l/min. The robust valve series offers the full range of valve functions as well as various control voltage and connection types. 16 bar versions are also available. The valve can be easily inverted to an ISO plug-in valve with contact bridges. The joinable base plate system can be combined with 18 mm base plates.

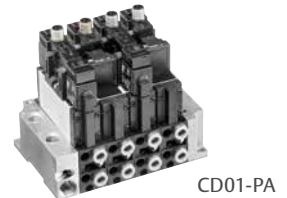

## Series 502 / 503

In addition to the broad product range of Series 502 and 503, this valve family offers a plug-in base plate system that complies with ISO 15407-2. Alongside the pneumatic portfolio, the electronic Series G3 and 580 offer connectivity to all relevant fieldbus protocols, IO functionality, and distributed flexibility.



## Series 581

The Series 581 single valves according to ISO 5599-1 are available in sizes 1 – 4. The extensive range of valve functions, electrical connectivity, and pneumatically controlled versions meet the demands of many different applications. With its small dimensions and reliable robust sleeve design together with a wide range of accessories, the Series 581 is the all-in-one solution for standardized demands.



## Series 511/512/513

ISO 5599-2 Series 511/512/513 allow the control of a flow up to 5,200 l/min. The robust spool-and-sleeve technology makes for sturdy products even in rough environment. Together with the option of direct action pilot, constant and fast shifting times are benchmark. Alongside the pneumatic portfolio, the electronic Series G3 offers connectivity to all relevant fieldbus protocols, IO functionality with integrated graphic display, and distributed flexibility.



For further information on these or any other AVENTICS product, visit [Emerson.com/AVENTICS](https://www.emerson.com/AVENTICS)



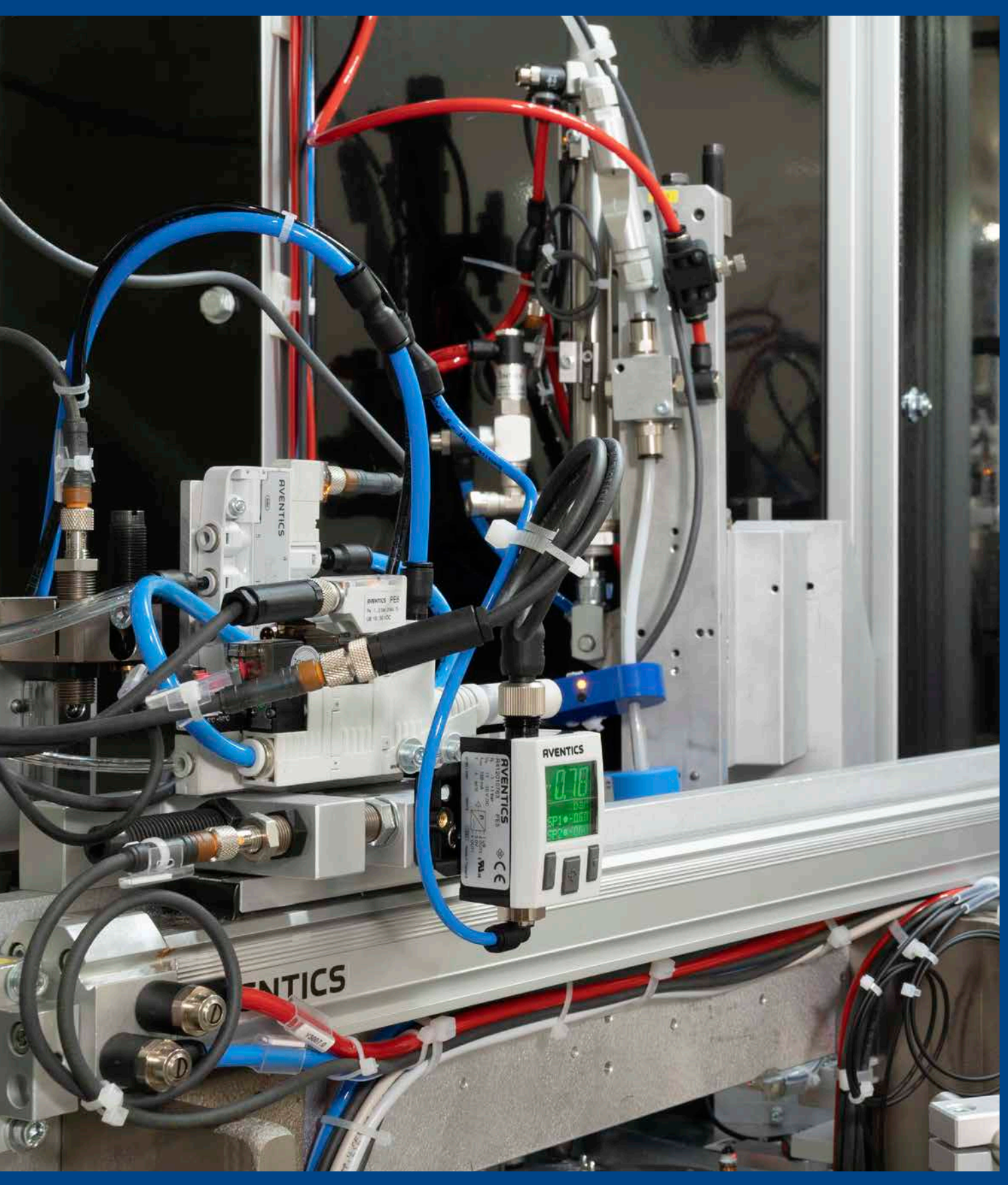



## ISO valve systems

Series	Picture	Standard	Max. flow	Versions	Benefits
CD02-AL		ISO 15407-1 (18 mm)	450 l/min	Single wire – Form C Single wire – M12x1 pneumatic	2x3/2 function, various voltages
CD01-PA		ISO 15407-1 (26 mm)	1,050 l/min	Single wire – Form C Single wire – M12x1 pneumatic	2x3/2 function, various voltages, 16 bar version
502 - ISO		ISO 15407-2 (18 mm)	650 l/min	Multipole, fieldbus, single wire – M12x1	Various fieldbus protocols via G3 and 580
503 - ISO		ISO 15407-2 (26 mm)	1,000 l/min	Multipole, fieldbus, single wire – M12x1	Various fieldbus protocols via G3 and 580
581		ISO 5599-1 (43 mm, 56 mm, 72 mm, 86 mm)	ISO1: 1,400 l/min ISO2: 2,700 l/min ISO3: 4,800 l/min ISO4: 6,000 l/min	Pneumatic, elec- tric, single wire – Form A, BI, C, M12x1	Integrated throttles Small dimensions 16 bar
511		ISO 5599-2 (43 mm)	1,280 l/min	Multipole, fieldbus, via G3	Direct actuation version, spool- and-sleeve
512		ISO 5599-2 (56 mm)	2,860 l/min	Multipole, fieldbus, via G3	Direct actuation version, spool- and-sleeve
513		ISO 5599-2 (76 mm)	5,220 l/min	Multipole, fieldbus, via G3	Direct actuation version, spool- and-sleeve

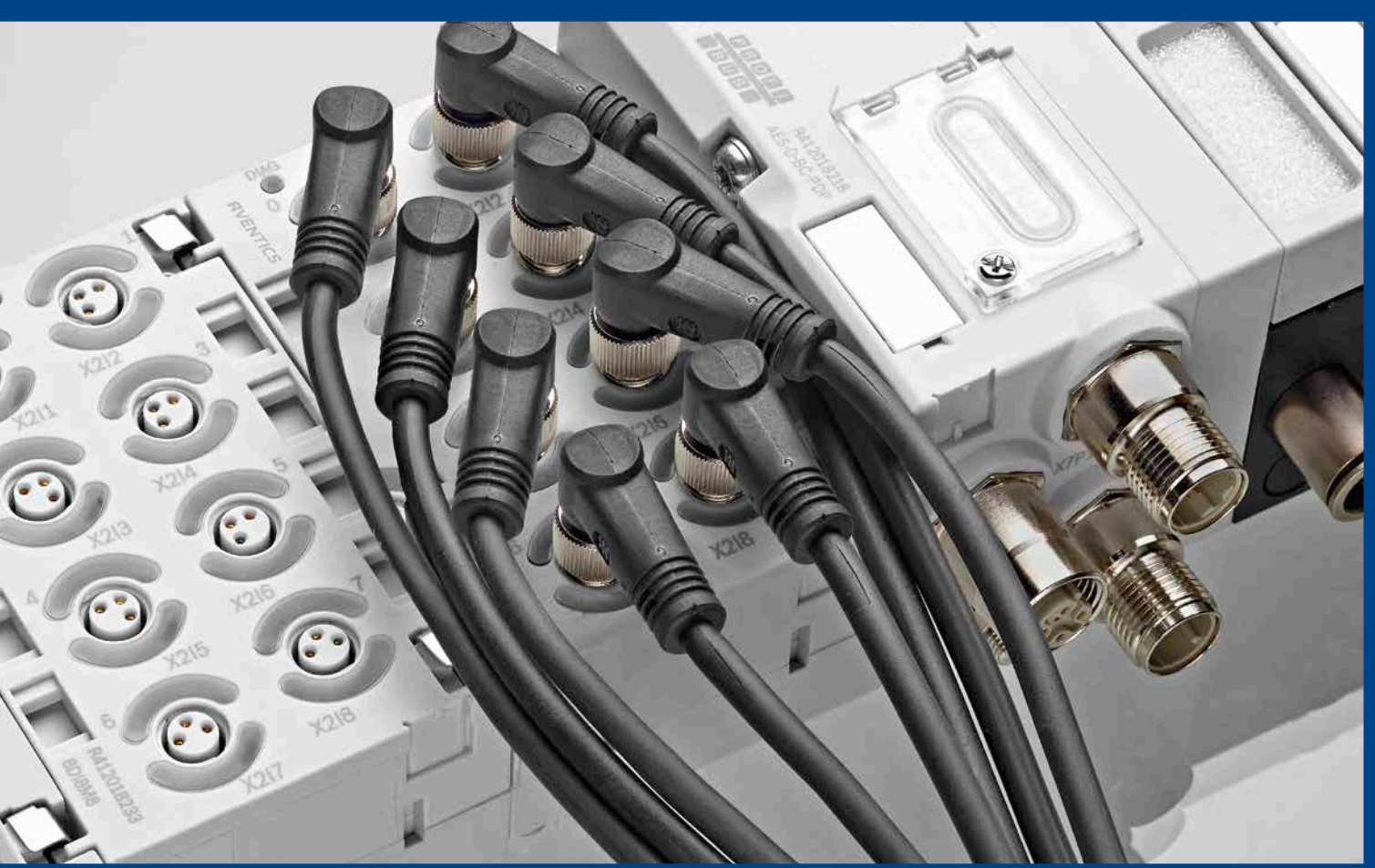

## Communication is everything!

Using our fieldbus connections, valve systems can be directly integrated into the control structure of your machine. No matter whether the valve system will be controlled only by fieldbus or used as a decentral control center with centralized or distributed IO-functionality, Emerson has a solution for every situation with the AVENTICS electronic portfolio.

Highlights	AES	G3	580
Number of valve coils	128	Up to 128	Up to 128
Max. possible I/O modules	10	16	-
Protection class	IP65	IP65	IP65
I/O functionality	Digital, analog, pn. pressure signal	Digital, analog, temperature	-
Connection options	M8x1, M12x1, D-SUB, spring clamp	M8x1, M12x1, spring clamp	-



# Fieldbus

## Series AES

The Series AES fieldbus connection can be integrated into all AVENTICS fieldbus-compatible valve systems or can also be configured as a stand-alone solution. AES connects your AVENTICS valve system to all relevant fieldbus protocols and offers the integration of I/O-modules and enables optimized decentralized wiring of sensors. The fast internal backplane and integrated IIoT functionality enables a future-proof solution.



AES

## Series G3

Series G3 are industrial communication fieldbus electronic solutions with a large number of fieldbus protocols and IO module types with integrated graphic display for easy identification, setup, and diagnostics. Robust construction with sturdy metal thread.

Series G3 also offers a distributed system so the complete machine can be covered by one single fieldbus node.



G3

## Series 580

Series 580 is a pure industrial communication fieldbus electronic solution with integrated graphic display for easy identification, setup, and diagnostics.

The large number of fieldbus protocols as well as IO-Link or Delta V CHARM version makes the solution compact, lean, and efficient.







580

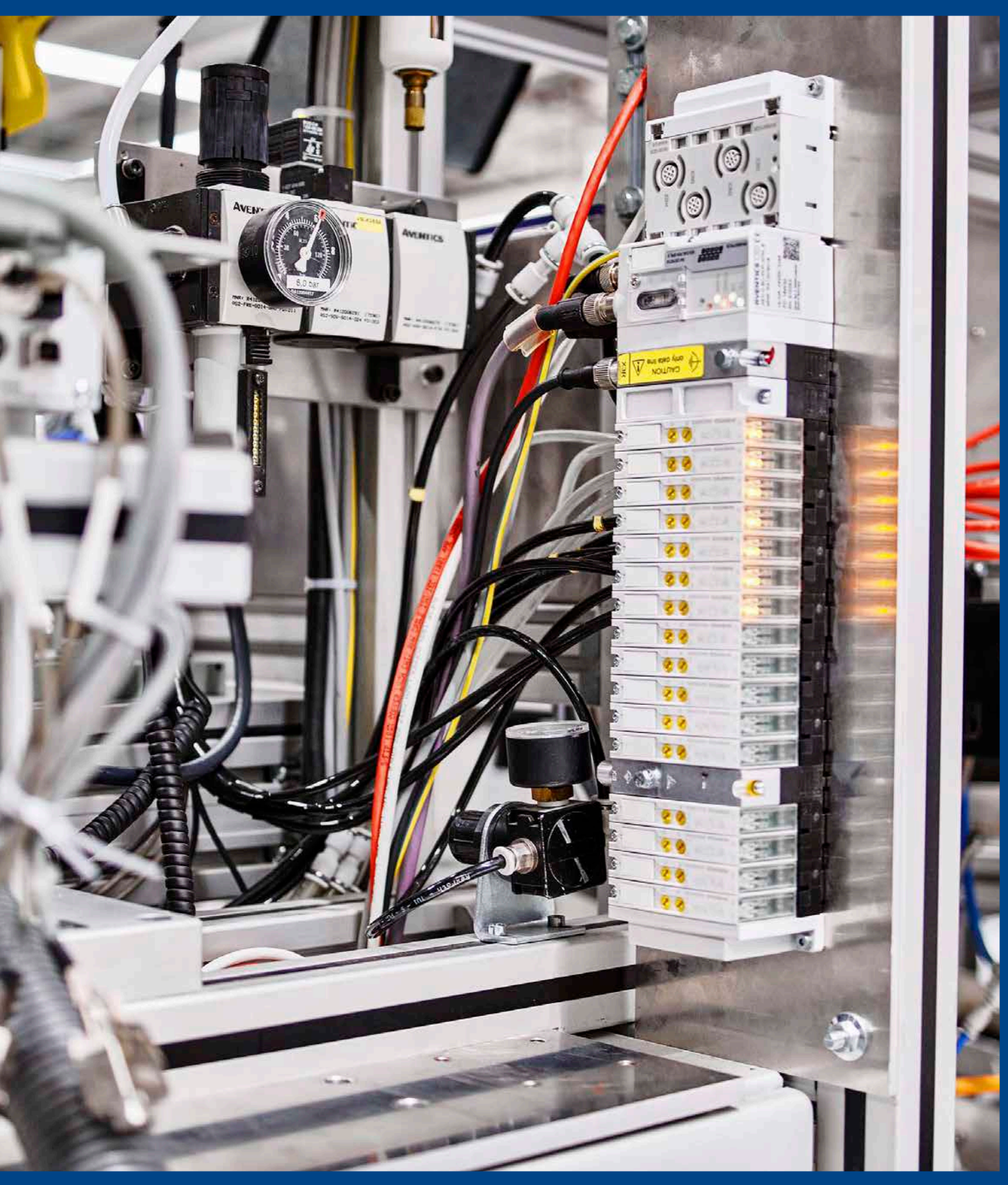

For further information on these or any other AVENTICS product, visit [Emerson.com/AVENTICS](https://Emerson.com/AVENTICS)





Fieldbus					
Series	Picture	Protocols	IO functions	Structure	Benefits
AES		Profibus, CANopen, DeviceNet, Profinet, EtherCAT, Ethernet IP, Powerlink	Digital IN/OUT, analog IN/OUT, pressure sensor, closed loop controller	Central	Small, lightweight, parameter handling via PLC, IIoT integrated Fast backplane
G3		Profibus, CANopen, DeviceNet, Profinet, EtherCAT, Ethernet IP, Powerlink, Modbus TCP	Digital IN/OUT, analogue IN/OUT Temperature, intrinsically safe IN	Central, distributed	Display, ARM, IO-Link master, wireless web server, parameter handling via web server
580		Profibus, CANopen, DeviceNet, Profinet, EtherCAT, Ethernet IP, Powerlink, Modbus TCP, IO-Link, Delta V		Central, direct	Display, web server

Electronic series	AES	G3	580	CL03-BDC	IO-Link integrated
Valve system series					
AV03/AV05	✓				✓ (Type A/B)
ES05	✓				✓ (Type B)
501/502/503		✓	✓		
511/512/513		✓			
HF02	✓				
2035		✓	✓		
CL03				✓	
Protocols					
Profibus	✓	✓	✓	✓	
CANopen	✓	✓	✓	✓	
DeviceNet	✓	✓	✓	✓	
Profinet IO	✓	✓	✓	✓	
EtherCAT	✓	✓	✓	✓	
EtherNET IP	✓	✓ (DLR)	✓ (DLR)	✓	
Powerlink	✓	✓	✓		
Modbus TCP		✓	✓		
CC-Link IE Field		✓			
IO-Link			✓ (Type A/B)		
Delta V CHARM			✓		



## Maximize the efficiency of your machines through precise control of pressure and flow of liquids and gases

### Proportional pressure control valves

Emerson's extensive range of AVENTICS proportional pressure control valves provide optimal control of pressure within many machines and processes worldwide. Pilot, directly or indirectly controlled devices provide precise control of highly dynamic pressure variations, with the ability to compensate for variations within the control chain. With over 30 years of experience with proportional technology, Emerson's digitally operated devices offer low energy consumption, short response times, and adjustable parameters to ensure the challenging demands of your specific application are met. Small footprints, fieldbus and Ethernet TCP/IP connectivity, and a broad range of connection options support IIoT applications and ensure easy installation into your machine or process design. Supporting data acquisition software helps streamline your development process by identifying application-specific problems earlier.

## Proportional pressure control valves

### Series 614, Sentronic Plus

Sentronic PLUS is a digitally operated pressure regulator valve. This valve accurately adjusts pressure, flow, force, speed, and linear or angular positions. All orifices have the same diameter for short response times whether increasing or exhausting pressure. The valve components are designed to provide control at an extremely low hysteresis. Sentronic PLUS regulates pressure from vacuum up to 50 bar and can be used in potentially explosive atmospheres according to ATEX Directive 2014/34/EC. With the Data Acquisition Software (DaS), it is now possible to optimally adjust the valve's control parameters to a specific application. The scope function allows you to log and read out the system's response in real time.



### Series 616, Sentronic HD

Sentronic HD is a highly accurate three-way proportional valve with digital control and a broad range of diagnostic functions. It is supplied with DaS HD software, which can be used with a PC for optimal calibration of the valve. Sentronic HD regulates pressure from vacuum up to 10 bar. Command signal, feedback signal, and control parameters can be viewed in real time and adjusted as required for any application. Sentronic HD can be configured for dual-loop control of process variables such as flow, force, speed, RPM, and temperature.



### Series ED02

The extremely compact yet powerful ED02 offers perfect control solutions in a variety of applications. Reliable, dynamic, and cost-effective. On top of that, it is easy to stack. ED02 regulates pressure from vacuum up to 10 bar.



ED02

### Series ED07/ED12

ED07 and ED12 are E/P valves for highly dynamic control. They can realize high air flow rates and offer particularly dynamic control characteristics thanks to proportional valves for pressurization and exhaust that can be controlled separately. ED07/ED12 regulate pressure ranges from vacuum up to 20 bar.



ED07

## Proportional flow control valves

### Series 202

The range of PreciFlow valves and PosiFlow valves are suitable for a wide range of media: neutral gases, oxygen liquid, vacuum. Different materials are available, e.g. brass, stainless steel, etc. A wide flow range and different sizes are also available. Precise, quick-acting, and robust valve. The control D, a stand-alone PID control device, can be used for actuation. The valve series are ideal for precise control of flow rates in medical equipment and analytical instrumentation.



202 PosiFlow

### Series 630

The Piezotronic valve with proportional control is a high-tech solution designed in particular for applications requiring extremely low power consumption. It is suitable for use with battery-operated equipment or in potentially explosive areas. Due to its long service life of 1 billion cycles, it is also integrated in measuring systems such as medical equipment and gas analyzers. It can even be powered by solar cells. Moreover, the Piezotronic valve's light weight makes it especially attractive for portable equipment.



630

### Series 607

607

Flowtronic D is a digitally operated flow controller up to 2,000 Nl/min. The Flowtronic D consists of a fast, direct-operated 2-port proportional valve that operates independent of the inlet pressure and a control unit that contains all of the control electronics and sensors. The Flowtronic D offers precise flow adjustment and is very responsive to outside influences. The digital control electronics and a USB interface allow the controller to be adapted to different applications. The FlowCom PC software provides easy start-up.



### Series E290 Motor

Motorized proportional valve with integrated control electronics. Valve regulates variable flow proportional to the control signal. The valve can be used in an open control loop to control air or neutral gases, fluid, or steam. Isolation between motorized actuator and valve body -> protection against fluid. E290 can be used for a pressure range from vacuum up to 10 bar. Special design to eliminate water hammer.



E290 Motor

## Proportional pressure control valves

Series	Picture	Flow (Nl/min)	Pressure range, bar	Function	Construction	Dynamic applications	Precision applications	Customization	Explosion-proof
608/609 Sentronic D		470 – 1,300 l/min	-1 to 12	3/3	Direct controlled	■	▲	■	No
614 Sentronic PLUS		55 – 5,600 l/min	-1 to 50	3/3	Direct controlled	■	■	■	Yes
615 Servotronic Digital		1,700 l/min	-1 to 50	3/3	Direct controlled	■	▲	■	No
616 Sentronic HD		1,200 l/min	-1 to 10	3/3 (2x2/2)	Pilot controlled	▲	■	■	No
617 Sentronic LP		13 – 5,200 l/min	0 to 10	3/3 (2x2/2)	Pilot controlled	▲	▲	■	No
ED02		120 l/min	-1 to 10	3/3 (2x2/2)	Direct controlled	■	▲	●	No
ED05		1,000 l/min	0 to 10	3/3	Direct controlled	■	▲	●	No
ED07/ED12		1,300 – 2,600 l/min	-1 to 20	3/3 (2x2/2)	Direct controlled	■	■	●	No
EV03/AV03-EP		600 l/min	0 to 10	3/3 (2x2/2)	Pilot controlled	▲	▲	▲	No
EV12/18		6,500 – 16,500 l/min	0 to 10	3/3 (2x2/2)	Pilot controlled	▲	▲	▲	No



## Proportional flow control valves

Series	Picture	Flow (Nl/min)	Function	Medium	Construction	Dynamic applications	Precision applications	Customization
202 Preciflow		0.08 – 200 l/min	2/2	Neutral gas	Direct controlled	■	■	■
202 Posiflow		0 – 2,200 l/min	2/2	Neutral gas/water/oil	Direct or pilot controlled	▲	▲	▲
630		0.086 – 0.12 l/min	2/2	Neutral gas	Direct controlled	■	■	●
E290		0 – 80,000 l/min	2/2	Neutral gas/water/steam	Pilot controlled	●	●	●
E290 Motor		0 – 6,480 l/min	2/2	Neutral gas/water/steam	Motorized	●	●	●
607		5 – 2,000 l/min	2/2	Neutral gas	Direct controlled	▲	▲	■

■ Ideal ▲ Suitable ● Requires vendor support



## We provide the power you need – with precisely prepared compressed air available at all times

The demands on our pneumatic solutions are high – there's no room for error. Our air supply management solutions provide the best possible air conditions. Tailored to the application, right on target, finely filtered, and well oiled. Our program: from air preparation units to tubing, everything is perfectly matched.



# Compressed air preparation

## Air preparation units

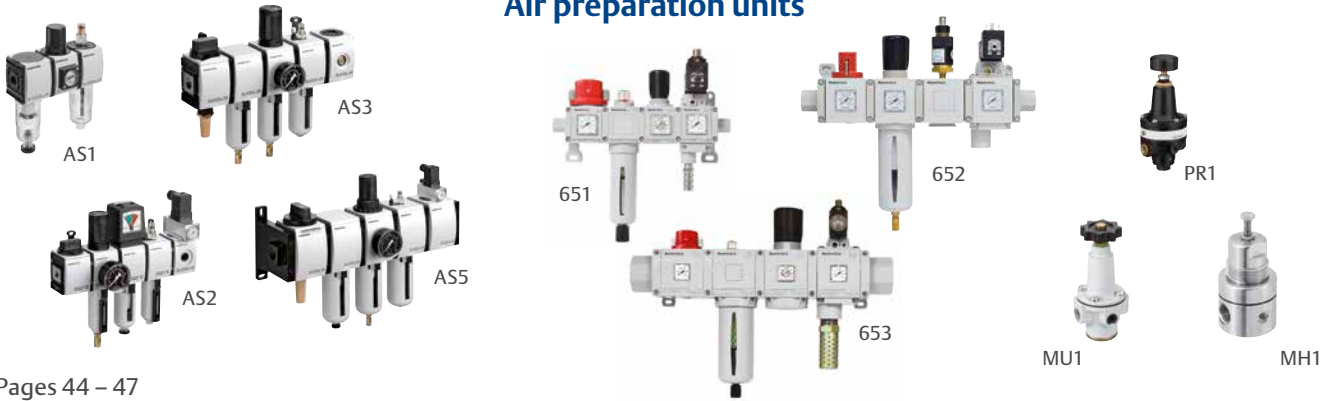

Pages 44 – 47

## Pressure gauges



Page 45

## Sensors



Page 46

# Assembly material

## Push-in fittings



Page 48

## Fittings with tube nuts, couplings, silencers, and other products



Page 48

## Plastic tubing



Page 48

# Flow and check valves

## Flow and check valves, throttle valves, non-return valves, other valves



Pages 48 – 49

# Air preparation units

## Series 651, 652, 653 aluminum air preparation, product range overview

This product line offers you complete, customizable compressed air preparation technology. It includes an option to combine every component in the series to achieve the desired function, making it possible to adjust the components precisely to the application requirements.

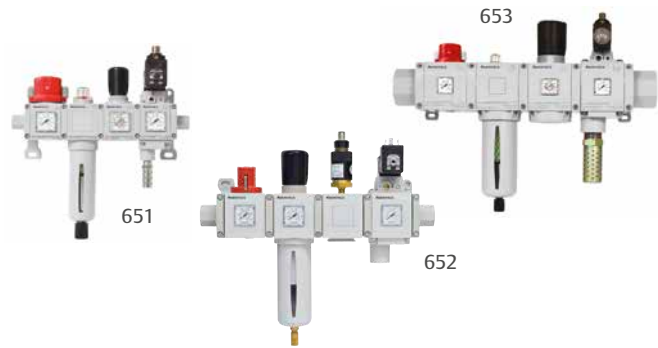

## Broad range of products and accessories make selection easy

The AVENTICS 651, 652, 653 ranges of air preparation equipment include particulate and coalescing filters, regulators, filter regulators, lubricators (FRL), shut-off valves, and a variety of accessories and assembly kits. The range is one of the most comprehensive offerings of air preparation products available from one supplier.

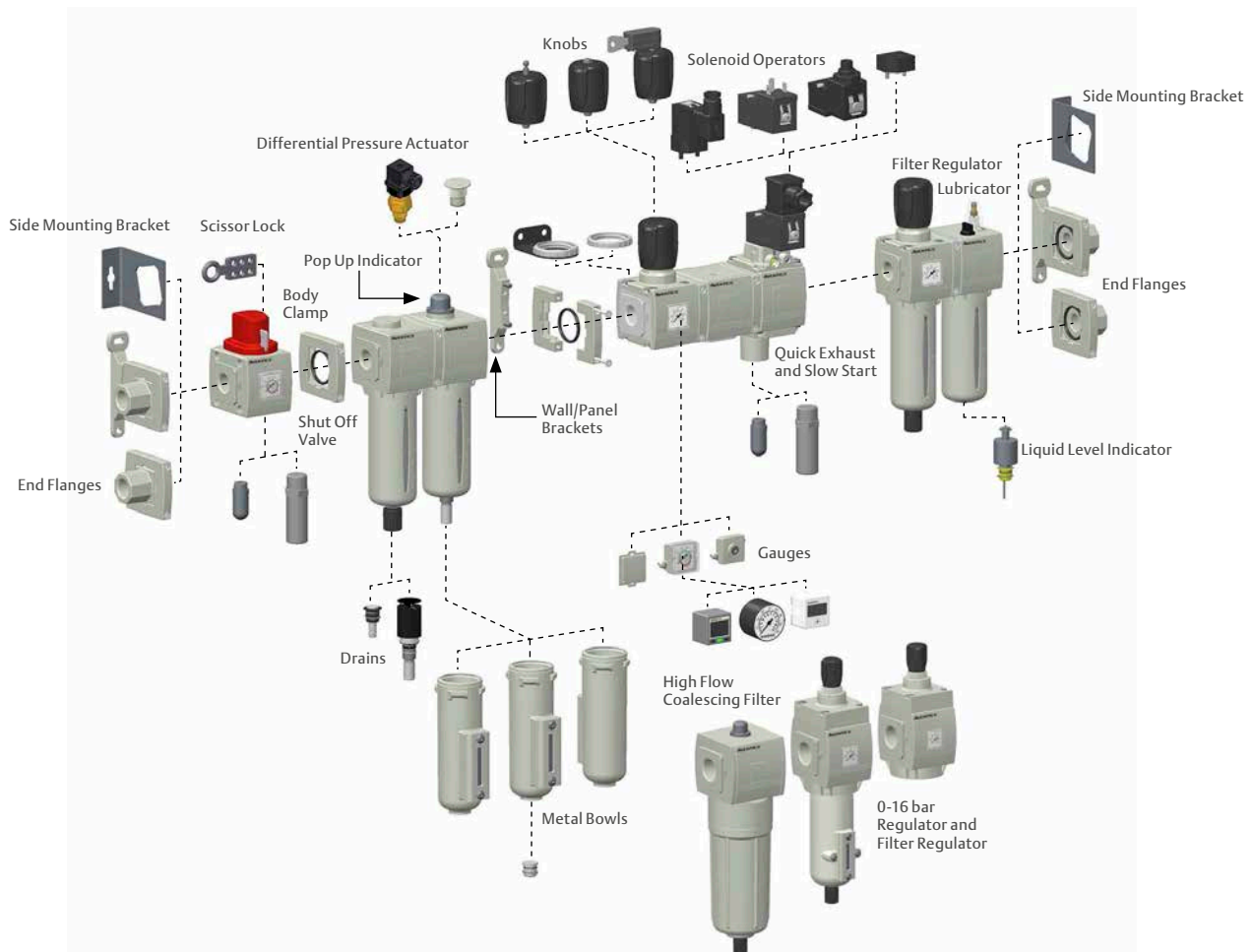

# Air preparation units

## Smart functions of the Series AS

The modular versatility of the Series AS makes it perfect for universal application. With four size variants, they cover the entire operating range up to a flow of 14,500 l/min and enable not only the standard functions of filtering, regulating, and lubricating but also the integration of all specifically required functions.



### Online Configurator

- All functions are part of the online configurator
- Easy integration in FRL with all accessories

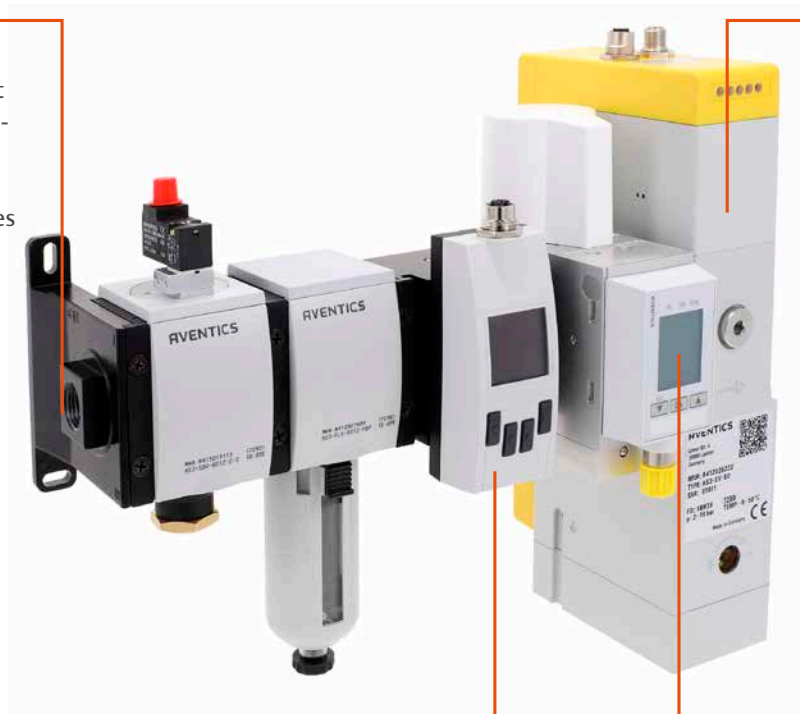

### AS3-SV – Safety valve

- Safe exhaust and protection against unexpected start-up
- High exhaust flow
- Internal monitoring with detailed failure diagnosis and display for the customer
- Safety component, up to Category 4, PLe
- Integrated adjustable soft-start function
- Modular integration in AS3 air preparation units

### AF2 - Flow sensor

- Air flow sensor with smart functions
- Analog, IO-Link, or EtherNET connection
- Available in three sizes
- Integrated analysis
- Very compact design
- Allows for flow sensing technology to be integrated into FRL

### EV12/EV18 – E/P pressure regulator

- High air flow
- Precise pressure control
- For highly dynamic applications
- Allows for proportional technology to be integrated into FRL
- Available in two sizes
- Analog or IO-Link connection

# Air preparation units

## Series MH1 air preparation units

Series MH1 air preparation units are designed for use in food production and primary packaging. In a stainless steel version, optionally available with a protective cap in the hygienic design variant, the products are resistant to corrosion, cleaning agents, and disinfectants. The materials comply with Regulation (EC) No. 1935/2004. The seals are made of FDA-certified material with NSF H1 grease. Every component also complies with NACES MR0175 and ISO standard 15156.



## MU1

MU1 series components are always the perfect choice for applications in tough environments where large dimensions, thread connections, or flow rates are required. The largest connection G2 (2") enables a compressed air flow rate of up to 50,000 l/min and provides reliable filtration, regulation, and lubrication.

MU1 series components are also designed to meet the demands of harsh environments thanks to very robust construction.



## PR1

The precision pressure regulators in the PR1 series are ideal for applications that demand fast responses to the slightest fluctuation in compressed air. They can be adjusted precisely and are a good alternative to electronic pressure regulators.

PR1 regulators are used to achieve extremely accurate pressure control of the output pressure, independent of the pilot pressure and the flow rate. They offer high performance and absolute flexibility, combined with guaranteed reliability.



# Sensors

## AF2 flow sensors

Series AF2 flow sensors monitor air consumption in pneumatic systems, enabling rapid action to be taken in the event that leaks are detected. AF2 helps to optimize energy consumption, prevent machine downtime, and cut costs. The AF2 determines not only the flow but also the current pressure and temperature in the feed line, enabling advanced diagnosis of the system operating parameters. The data is forwarded to the control either via standard switch or analog outputs, or through IO-Link. Data can also be communicated directly via the EtherNET interface using OPC UA or MQTT.



## Series PM1 pressure sensor

With Series PM electromechanical pressure switches, switching points are set manually. The adjustment screw can be fixed easily and securely. The switching point is continuously adjustable, even during operation.



## Series PE pressure sensor

The electronic pressure sensors in the Series PE can be used in virtually all applications and are easy to integrate into existing compressed air preparation systems. They feature a high degree of switching precision and repeatability with optimal operating comfort.



## Air preparation units

Series	Picture	Max. flow	Housing material	Connections	Filter porosity	Optional certification
AS1		1,000 l/min	Polyamide	G1/4	0.01 – 5 µm	ATEX
AS2		2,700 l/min	Polyamide	G1/4 – G3/8	0.01 – 40 µm	ATEX
AS3		5,200 l/min	Polyamide	G3/8 – G1/2	0.01 – 40 µm	ATEX
AS5		14,500 l/min	Polyamide	G3/4 – G1	0.01 – 40 µm	ATEX
651		2,060 l/min	Aluminum	G1/8 – G1/4 (available in NPT/RC)	0.01 – 40 µm	ATEX CUT-R
652		7,000 l/min	Aluminum	G1/4 – G3/8 – G1/2 (available in NPT/RC)	0.01 – 40 µm	ATEX CUT-R
653		11,500 l/min	Aluminum	G1/2 – G3/4 – G1 (available in NPT/RC)	0.01 – 40 µm	ATEX CUT-R
MH1		325 – 2,000 l/min	Stainless steel	G1/4 – G1/2	0.01 – 5 µm	

## Flow and check valves

### Series CC check-choke valves

Series CC check-choke valves are designed for nominal flows from 60 to 5,600 l/min. The different versions are available with a push-in fitting or internal thread.



### Series CH throttle valves

Series CH throttle valves can be used for nominal flows up to 4,100 l/min. The series features special versions with integrated silencer and screw-in variants.



### Series NR non-return valves

Thanks to an array of connection options, the NR non-return valves can be screwed in separately and are also suitable for direct installation in piping.



### Series QR1 non return, ball, and shut-off valves

Designed for safety-relevant processes, the valves enable automatic blocking of the air supply to immediately stop the working stroke.

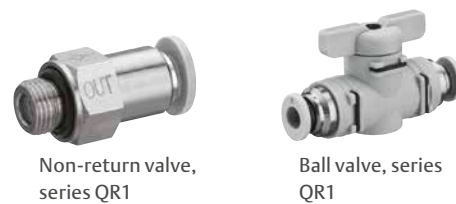

## Pneumatic connection technologies, plastic tubing

### Series QR push-in fittings

The push-in connectors with easy, secure mounting are available in many versions: for tubing diameters from 3 to 16 mm, as well as in plastic, metal, and stainless steel variants. Our QR program offers the right solution for every application and industry.





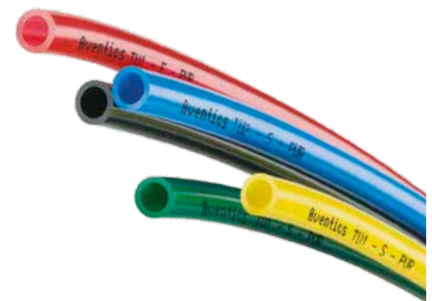





### Series TU plastic tubing











For further information on these or any other AVENTICS product, visit [Emerson.com/AVENTICS](http://Emerson.com/AVENTICS)





Flow and check valves			
Series	Designation	Picture	Qn
CC02	Check-choke valves		50 – 1,960 l/min
CC04	Check-choke valves		85 – 2,100 l/min
CC01	Check-choke valves		110 – 8,830 l/min
CH01	Throttle valves		38 – 2,800 l/min
CH02	Throttle valves		200 – 4,100 l/min
NR01	Non-return valves		40 – 7,950 l/min
NR02	Non-return valves with release		300 – 5,800 l/min
QR1	Non-return valves		280 – 2,000 l/min
QR1	Ball valve and shut-off valve		500 – 2,600 l/min

Fittings and plastic tubing			
Series	Designation	Picture	Connections
QR1-S mini	Push-in fittings		Ø 3 – 6 M3 – G1/8
QR1-S standard	Push-in fittings		Ø 4 – 16 M5 – G1/2
QR2-S standard	Push-in fittings		Ø 4 – 16 M5 – G1/2
QR2-C stainless steel	Push-in fittings		Ø 4 – 12 M5 – G3/8
TU1	Plastic tubing, polyethylene		Ø 4 – 16
TU1-S	Plastic tubing, polyethylene		Ø 4 – 22
TU1	Plastic tubing, polyethylene		Ø 3 – 16
TU2	Duo plastic tubing, polyurethane		Ø 4 – 10

## Mechanical grippers

### Mechanical grippers for high gripping forces

One series, seven sizes, countless possibilities – finding the right gripper solution is easy with the new Series UPG. The universal parallel grippers (UPG) cover performance needs for virtually any standard application in automation technology.



## Non-contact transport system

### NCT non-contact transport system

The unique, gentle NCT gripper technology is available in two material versions. NCT-AL (aluminum) is suitable for all standard applications. NCT-PK (PEEK) grippers are designed for special requirements in the food, semiconductor, and solar industries and enable direct contact with foods or silicon.



## Vacuum cups and vacuum accessories

### Vacuum cups

Whether angle joints, flow valves, vacuum filters, spring-loaded plungers, the right fitting, or the entire range of vacuum cups – along with vacuum ejectors, our program offers everything required for a vacuum-based pneumatic solution.



## Vacuum ejectors

### Series EBS

The Series ESB features inline ejectors with axial compressed air and vacuum connections for direct installation in the vacuum line as well as compact ejectors with several integrated functions: vacuum generation, pilot valves, filters, switches, and silencers.



## Vacuum ejectors

### Series EMS

Enormous suction capacity with maximum efficiency – the multistage ejectors with multiple Venturi nozzles connected in series offer a very high suction capacity, making it possible to handle workpieces with difficult-to-seal surfaces.



### Series ECD

From Basic, Smart, Intelligent, to Large: series ECD ejectors are available in four modular versions with functions, sizes, and features that can be selected as needed.

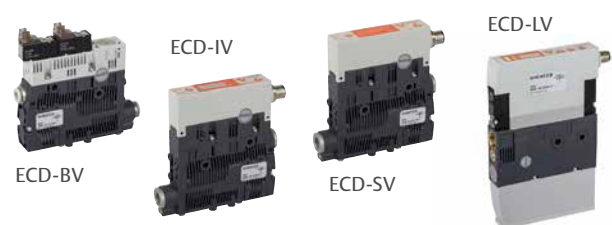

For further information on these or any other AVENTICS product, visit [Emerson.com/AVENTICS](http://Emerson.com/AVENTICS)



# Machine safety

## Stay on the safe side with Emerson

Safety first. We advise on all matters of machine safety for pneumatic controls and offer comprehensive service to help you develop and achieve a sound safety concept. We supply the right products and the required documentation.

### Certified products and integrated solutions

- Products include documentation with reliability ratings
- Comprehensive advice on site
- Pneumatic components in certified quality
- Free access to switching examples
- Compliant machine equipment
- Proven expertise



### Regulations and specifications dictate the design of safe machines

The regulations relevant to machine construction set a uniform level of safety for accident prevention as well as safety and health requirements for engineering. Pneumatics offers a wide range of technical safeguards. This includes restricted, secure speeds, reduced pressure and force, de-energizing through exhaust, ensuring secure movement directions, or stopping or blocking a movement.



### Example: Series LU6

Static locking or dynamic braking

- Prevents dangerous movements
- Secure hold in upper end position through clamping and one-sided pressurization
- Stops a dangerous movement (emergency stop/emergency off)



Locking unit, series LU6,  
max. holding force 12,000 N

### Towards safe machinery: Risk assessment

The legal specifications for designing and operating machines require a risk assessment. This process serves to determine the type and quality of protective measures to be taken and safety equipment to be implemented:

#### Risk analysis:

Determine the machine limits, identify and estimate risks

#### Risk evaluation:

Check and estimate design, technical, and instructive machine safety measures

#### Risk mitigation:

Realization of all safety functions

## Saving the best for last! Tailored entirely to the customer

Looking for something customized to your needs? You've come to the right place. Customer-specific solutions have always been an Emerson specialty. If there's a suitable solution for your task, we'll find it. Not because we're driven by ambition at any price, but out of conviction.

### System technology – ready-to-install pneumatic solutions

Our system engineers mainly focus on the planning, configuration, and assembly of control panels, control cabinets, or handling systems. They turn your task into an optimized ready-to-install modular solution – including compressed air preparation, valve technology, electrical control, and all accessory parts.

- Ready-to-install cylinder valve units
- Modified valve systems and air preparation units
- Configured control cabinets and panels
- Pneumatic handling systems

Save time and costs: from planning, design, and documentation, to logistics and assembly, to delivery and reliable commissioning, we do it all for you.

### Specific product development

Our product development experts create specific product adaptations and special solutions just for you. Their tasks range from simple modification of existing products to completely new designs and product solutions for your application.

- Modification of standard components
- Integrating various functions in a single product
- Product development with additional specifications
- Integration of electrical system and pneumatics

From highly complex projects with functional integration to careful, yet effective, adjustments, the tailored components offer clear added benefits for your application.



# Immediately integrate an Internet of Things Solution

## Start Your IIoT Journey

Everyone talks about the Industrial Internet of Things or IIoT – but there are often problems in implementation. You can start your journey quickly and easily with the SPA. By digitalizing the pneumatic environment, the SPA provides you with options to directly experience the benefits and potential of IIoT applications on your own machine. If you are already familiar with IIoT and want have all the available analysis capabilities, the SPM is the right choice for you.

## The Smart Pneumatics Analyzer (SPA) analyzes and visualizes pneumatic installations and systems



Emerson's AVENTICS Smart Pneumatics Analyzer (SPA) provides analysis of pneumatic systems and installation at a glance. The integrated IIoT Edge Gateway Smart Pneumatics Monitor (SPM) continually records the respective operating states. All of the sensor data from the pneumatic maintenance unit is digitized and turned into information using mathematical algorithms. These algorithms have been developed based on decades of expertise in product engineering and application. The obtained information is then recorded and shown live in a dashboard. The SPA thus gives you more insight into the overall pneumatic system and opens up the world of IIoT-relevant applications, such as preventive maintenance and energy optimization.

- Visualization of live and historical data
- Demo mode with random data for demonstrations without air
- CSV Excel export of all sensor data
- Leakage detection by pressure drop test
- Electrically operated valve controllable via dashboard
- Time synchronization
- Visual comparison of consumption data from various measurement intervals

## The Smart Pneumatics Monitor (SPM) offers advanced analytics

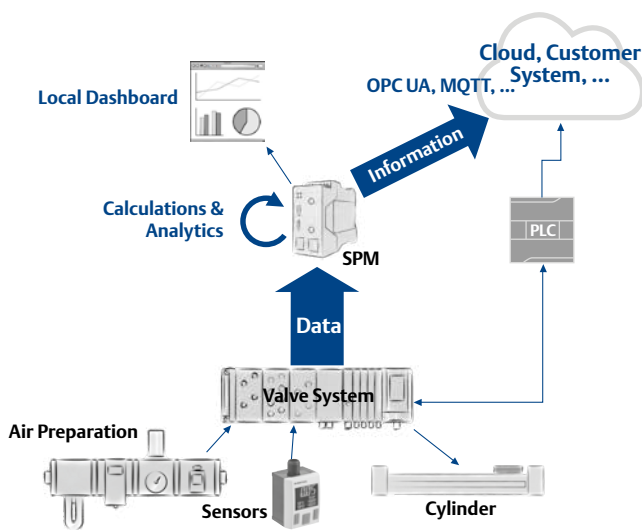

Want to check the state of wear? Need information on energy efficiency? The new Smart Pneumatics Monitor will provide you with reliable answers. It sends status messages to defined employees and parent IT systems without detouring via the machine controller. This minimizes the risk of machine downtime and substantially lowers operating costs.

- PLC agnostic
- No change to PLC sequence required
- Works on greenfield and brownfield applications
- Can change dataflow without stopping the machine
- Predefined analytics by design
- Easy data configuration with Node-RED
- Edge computing for advanced analytics and calculations
- Supports open IIoT protocols such as OPC UA or MQTT
- Flexible information aggregation to upper systems such as clouds or customer systems
- Local dashboard

## Pneumatics Shop.

### Online shopping with Emerson means:

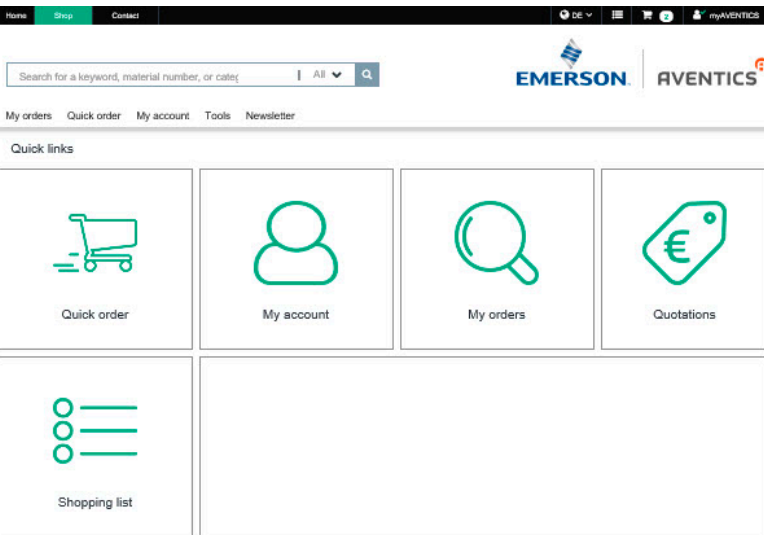

- Find products fast with intelligent search and filter functions
- Spare parts and accessories available for every product in the shop
- Transparent pricing based on general list prices
- Track your orders online, including the delivery date, status, and invoice
- Offers can be transformed into orders online
- Register with your e-mail address and password in a single step to place your order
- Upload and download all order documents
- Keep track of interesting items in shopping lists
- Optional express shipping and transparent freight cost calculation without a small-order surcharge
- Electronic payment methods (debit or credit card)
- Complete technical documentation and CAD data available
- Innovative shop design and intuitive navigation for computers, tablets, and smartphones

---

### Focused on you – myAVENTICS

myAVENTICS gives you a compact overview of current and completed orders in the AVENTICS Shop, as well as the option to upload your order. Place a repeat order with a simple click.

- Track the status of your delivery
- Quotation overview: Accept offers and add them to your cart
- Manage your user and SAP accounts
- All service information is now stored in one place
- Access to additional individual information

## The homepage for non-stop service

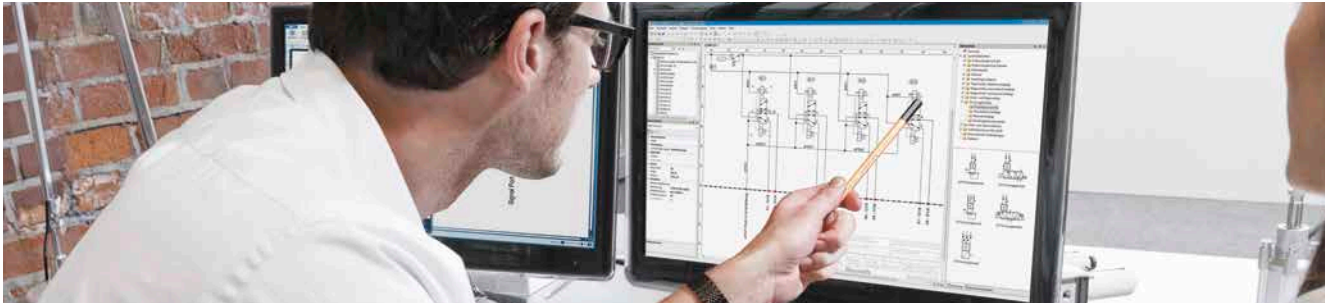

AVENTICS' Engineering Tools bundle the entire pneumatics range and comprehensive expertise at one convenient location – [www.engineering-tools.com](http://www.engineering-tools.com)

### CAD



Objects can be issued here directly as a CAD file in various formats, as a PDF file, or for further configuration in our customers' software.

### Configurators



To create customized products matching their individual requirements, customers can set their parameters in the configuration program, which then presents a product tailored to their specifications.

### Calculation programs



With transparent calculations, our customers can determine the size or durability needed for their products and can even keep an eye on energy consumption.

### Circuit diagram software



With the Scheme Editor, our customers can quickly and easily create circuit diagrams that are based on their components and linked to your catalog selection.

### Cross Reference Tool



This tool shows our customers the right alternatives to competitor products from within the AVENTICS catalog.

### CylinderFinder



This free online tool helps our customers find the right cylinder for their application with just a few clicks.

### Sales Partner Portal



The Sales Partner Portal establishes a direct connection between AVENTICS and our sales partners and speeds up communication. It also contains a great deal of valuable information.

### Smart shopping for pneumatics professionals



In the new Online Shop, you can easily, quickly, and securely order your pneumatics products – [www.pneumatics-shop.com](http://www.pneumatics-shop.com)

Your advantages:





- Intelligent search and filter functions
- Spare parts and accessories available for every product
- Track your orders online
- Transparent pricing

Simply register with your e-mail address and password, and order directly.

**Efficient pneumatic solutions, our program:  
cylinders and drives, valves and valve systems,  
air supply management, proportional pressure  
control valves**



Visit us: [www.Emerson.com/aventics](http://www.Emerson.com/aventics)  
Your local contact: [Emerson.com/contactus](http://Emerson.com/contactus)

-  [Emerson.com](http://Emerson.com)
-  [Facebook.com/EmersonAutomationSolutions](https://Facebook.com/EmersonAutomationSolutions)
-  [LinkedIn.com/company/Emerson-Automation-Solutions](https://LinkedIn.com/company/Emerson-Automation-Solutions)
-  [Twitter.com/EMR\\_Automation](https://Twitter.com/EMR_Automation)



The Emerson logo is a trademark and service mark of Emerson Electric Co. AVENTICS is a registered trademark of one of the Emerson family of companies. All other trademarks are the property of their respective owners. © 2020 Emerson Electric Co. All rights reserved. BR000050ENUS-01\_04-20



**CONSIDER IT SOLVED™**