

CHANGING PERSPECTIVES

Combined Connectivity Solutions
2017

LINDY CONTACT & DELIVERY INFORMATION

OPENING AN ACCOUNT

You can open a LINDY account by phone, fax or email, or through the Dealer Registration section of our website. Simply complete our new customer form and order today using Visa, MasterCard, Maestro, American Express and PayPal, or on a cleared funds basis. Credit accounts are also available subject to our acceptance.

NO SMALL ORDER SURCHARGES

NO CREDIT CARD SURCHARGES



ORDERING FROM LINDY

Order by phone, fax, email or through our website. Orders are despatched same day! (Subject to stock availability and time of order).

TECHNICAL SUPPORT

At LINDY we believe that the highest level of technical support should be available FREE of charge. Our Technical Hotline connects you to highly trained technicians for pre and post sales support.

HOW TO FIND US

We are located on Teesside Industrial Estate, off the A19, close to Thornaby-on-Tees. If travelling from the South, take the A1(M) North and leave at Exit 49 [A168] to join the A19. If travelling from the North, take the A1(M) South and leave at Exit 60 towards the A689 Teesside. Follow signs for the A19.

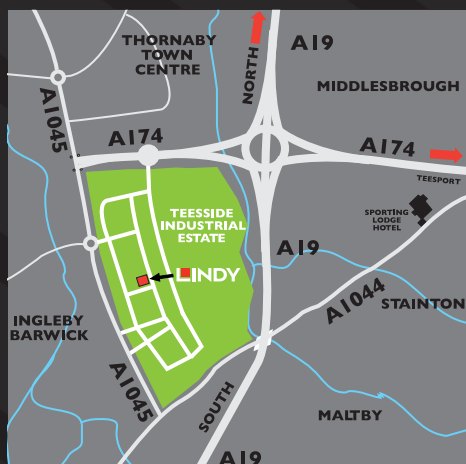

LINDY Electronics Ltd
Sadler Forster Way, Teesside Industrial Estate,
Thornaby, Stockton-on-Tees, TS17 9JY, England



UNITED KINGDOM

Open 9am-6pm, Monday-Friday

Sales

Tel: 01642 754000 Fax: 01642 765274
Email: postmaster@lindy.co.uk

Technical Support (9am - 4.45pm)

Tel: 01642 754040
Email: technical@lindy.co.uk

General Enquiries

Telephone: 01642 754000
Fax: 01642 754027
Email: postmaster@lindy.co.uk

Account Enquiries

Telephone: 01642 754035
Fax: 01642 754031
Email: accounts@lindy.co.uk

Deliveries

Standard next day delivery to all mainland UK destinations (excludes Scottish Highlands & Islands) is FREE if your order is over £125 (excluding VAT). Timed deliveries are also available for more urgent requirements. Please refer to our website for delivery costs or contact the Sales Team for further information.

For destinations other than the UK mainland please contact the Technical Sales Team for delivery options.

lindy.co.uk



REPUBLIC OF IRELAND

Open 8am-4pm, Monday - Friday

Sales

Tel: +44 1642 754020
Fax: +44 1642 754029
Email: postmaster@lindy.com

Technical Support (9am - 4.45pm)

Tel: +44 1642 754040
Email: technical@lindy.co.uk

Deliveries

Courier delivery will usually be made within three to five working days of dispatch. Please refer to the current price list for delivery costs. Orders received and accepted before 3.00pm will be despatched on the same working day, subject to stock availability.

lindy.ie

See our website for full Terms & Conditions

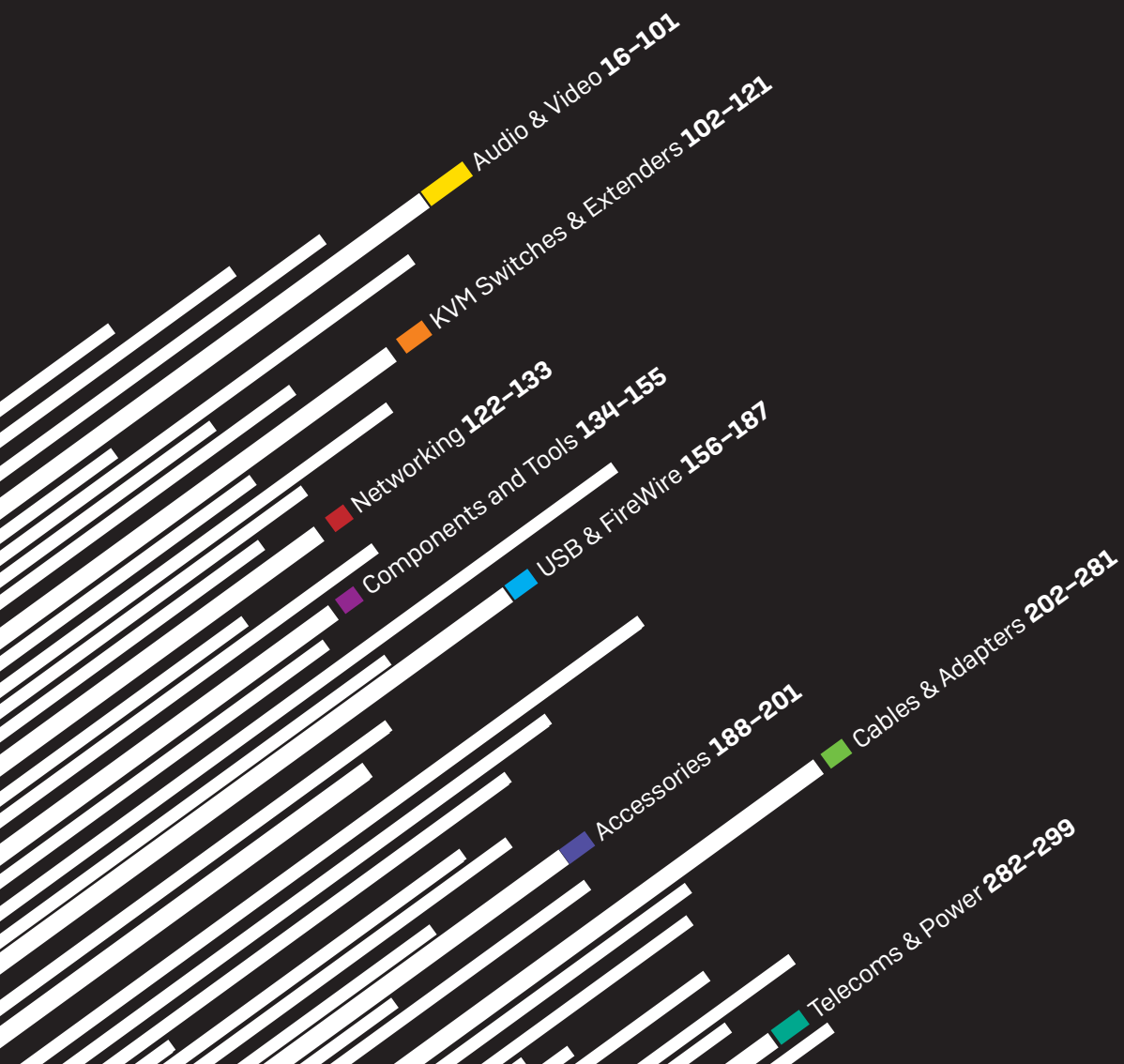

Audio & Video **16-101**

KVM Switches & Extenders **102-121**

Networking **122-133**

Components and Tools **134-155**

USB & FireWire **156-187**

Accessories **188-201**

Cables & Adapters **202-281**

Telecoms & Power **282-299**

DEAR BUSINESS PARTNERS AND CUSTOMERS

For over eight and a half decades, the LINDY brand has been synonymous with quality connection products. Our years of experience in both the IT and AV sectors has provided us with unique insights into the ways in which complicated systems are deployed and how the individual components and devices connect and interact with each other. Our wide portfolio of products allows us to support these complex installations with a range of combined connectivity solutions that work seamlessly together to create bespoke and effective systems.

As the LINDY brand continues to expand globally we look outwards to the market to make sure our solutions meet the needs of the customer. However it is equally important to reflect our family values and to promise the same outstanding quality of service and level of technical expertise that has brought us to where we are today. We care about creating long-lasting relationships to help our business partners design amazing connectivity solutions worldwide.





**International Management Board.
One Business. Four Families.**

(left to right)
Sheau Chen
Jürgen Lindenberg
Peter Lindenberg
Darren Casey
Tony Jamieson



CONTACT US

UNITED KINGDOM



Sufri Weithers
sufri.weithers@lindy.co.uk

LINDY Electronics Ltd.
Sadler Forster Way
Teesside Industrial Estate,
Thornaby
Stockton-on-Tees TS17 9JY
T: +44 1642 754000
F: +44 1642 765274
postmaster@lindy.co.uk

GERMANY



Matthias Starke
matthias.starke@lindy.de

LINDY-Elektronik GmbH
Markircher Str. 20
68229 Mannheim
T: +49621470050
F: +4962147005990
info@lindy.de

**INTERNATIONAL
& REPUBLIC
OF IRELAND**



Esteban Chaparro
esteban.chaparro@lindy.com

LINDY International Ltd.
Sadler Forster Way
Teesside Industrial Estate,
Thornaby
Stockton-on-Tees TS17 9JY
T: +44 1642 754020
F: +44 1642 754029
postmaster@lindy.com

ITALY



Gianfranco Alberio
gianfranco.alberio@lindy.it

LINDY Italia S.r.l.
Via Varesina, 126/b
22079 - Villa Guardia [CO]
T: +39 31 48 40 11
F: +39 31 48 06 52
info@lindy.it
Supporto Tecnico:
tech@lindy.it

FRANCE



Claude Kruger
claude.kruger@lindy.fr

LINDY France
13 Rue Desaix,
67450 Mundolsheim
Services client:
T: +33 825 825111
F: +33 3 88 20 5774
Services administratifs:
T: +33 (0) 3 88 20 04 66
france@lindy.fr

PORTUGAL



Dhiren C Asher
lider@lidertronica.com

Lidertrónica, Lda
Av. Mouzinho de Albuquerque,
48 Cv
1170-265 Lisboa
T: +351 21 816 1050
lider@lidertronica.com

SWITZERLAND



Marc-André Ansermoz
marc-andre.ansermoz@lindy.ch

LINDY-Elektronik AG
Florenz-Strasse 9
4023 Basel
T: +41 61 335 9700
F: +41 61 335 9709
info@lindy.ch

SOUTH AFRICA



Erika van Robbroeck
erikavr@linkqage.co.za

Linkqage
30 Gold Street, Northgate
Estate,
Brooklyn, Cape Town,
7405, South Africa
T: +27215144800
F: +27215111433
support@linkqage.co.za

AUSTRALIA



Tony Jamieson
tony.jamieson@lindy.com.au

Australia
LINDY Australia Pty Ltd
Unit 2, 43-49 Sandgate Road
Albion Qld 4010
T: +61 7 3262 9033
F: +61 7 3262 9055
info@lindy.com.au

China

LINDY
No. 979, Yinxian Dadao,
Xia Ying Duan
Yinzhou District, Ningbo 315100
T: +86 574 86995613
F: +86 574 86995610
info@lindy-china.cn

LINDY Taiwan

LINDY Asia Inc.
16F-6, No.75, Sec.1
Hsin Tai Wu Rd,
Shijr District, New Taipei
CityT: +886 2 8698 1141
F: +886 2 8698 1143
sales@lindy.com.tw

Japan

LINDY Sales Inc.
2-14-#203,
Asahi Jinbocho Plaza,
Kanda-Jinbocho,
Chiyoda-ku,
Tokyo, 101-0051
T: +81-3-6272-9860
F: +81-3-6369-3883
support@lindy.co.jp

LINDY Austria

T: +43 3179 23200
F: +43 3179 232001
info@lindy.at

USA

**LINDY Computer Connection
Technology Inc.,**
26469 Nick Davis Road, Suite B
Athens, AL 35613
T: +1 256 771-0660
F: +1 256 771-0460
usa@lindy-usa.com

CONNECTION TECHNOLOGY

High bandwidth, high quality signal transmission solutions have always been one of our greatest strengths. Our huge choice of cables not only cover standard connection types and lengths, but also feature a comprehensive selection of long range solutions for transmitting both analogue and digital signals over incredible distances that far exceed standard specifications.

We pride ourselves on the quality of LINDY cables & adapters and customers value their reliability and performance too. However, any copper based cable can reach its physical limits, especially with regards to high bandwidth digital AV signals. For extreme distances, LINDY repeaters, Cat.6 and Fibre Optic Extenders, and HDBaseT devices provide a variety of solutions that meet a whole host of customers' installation requirements.



BEST AVAILABILITY

Hundreds of different cable types in a variety of lengths ready to be dispatched. 24 hour delivery thanks to a worldwide logistics network with three centres in the UK, Germany and China.

IN BULK & INDIVIDUAL

Delivery from just one product to large quantity orders. From simple USB cables to high performance HDMI distribution products. Standard orders, special make solutions and projects.

Using superior materials and construction, our copper based Super Long Distance cable range is designed to transmit digital AV signals over distances greater than 10m. 360 degree shielding, solid metal connectors with 24K gold plated connectors ensure loss-free, reliable transmission.

SUPER LONG DISTANCE

FO LONG DISTANCE CONNECTIONS

Over 50 different extenders and repeaters make it possible to send digital AV signals, including HDMI, DVI and DisplayPort over incredible distances. Up to 300m using Cat.6 copper cable and up to 20km using fibre optic (FO) technology.



MODULAR MATRIX TECHNOLOGY

Modular Matrix is a uniquely powerful suite of products that provide AV integrators with an extremely versatile and effective means of converting, switching and distributing audio and video signals.

With Modular Matrix, installers benefit from an all-in-one solution that can be customised, scaled and configured according to their specific requirements. The basic units are made up of 8x8, 16x16 and 32x32 chassis. Each chassis can be equipped with interchangeable modular input and output boards, each with eight video ports.

Users can choose multiple HDMI, DVI, VGA and HDBaseT input boards and multiple HDMI, DVI and HDBaseT output boards. Any of the inputs can be combined with any of the outputs to create incredibly powerful and fully flexible matrix distribution installations. And, with powerful extender technology built in, UHD 4Kx2K@30Hz display signals can be sent over distances of up to 100m.

VGA
DVI
HDMI
HDBaseT

MANY POSSIBILITIES
4 input modules each with 8 ports for up to 32 input ports. Input modules available for HDMI, DVI, VGA and HDBaseT.



VARIATIONS 8, 16, 24 or 32 inputs to 8, 16, 24 or 32 outputs as a matrix switch. Source to end device distance is scalable via the use of HDBaseT modules.

SIGNAL CONVERSION

Simultaneous signal conversion of dozens of analogue or digital input signals to digital outputs in any combination and in real time.

24/7

RELIABILITY

24/7 operation. Modular redundant power supplies. If the main power supply fails an alarm occurs and the second power supply takes over.



HDBaseT™ TECHNOLOGY

Using a single cable to transfer uncompressed digital image and sound signals coupled with control and return signals over long distances is not a simple task. Especially since the UHD multimedia content needs to be maintained without any quality loss. Our HDBaseT solutions are designed to reliably meet these demands. The range encompasses complete transmitter & receiver kits to individual matrix extenders, splitters and compatible receivers.

We believe that HDBaseT 5Play will be one of the most important connectivity standards in the future. For AV distribution in both consumer and professional segments, the quality of the cabling is essential. Cat.6 and Cat.7 installation cables are required to achieve the maximum bandwidth and distance. We offer individual components and complete solutions for HDBaseT installations.



A SINGLE CABLE ...

... can transmit the 5Play standard signal which includes UltraHD Digital Video/Audio, 100Base-T Ethernet, up to 100W power over HDBaseT, RS232, IR control signals and USB 2.0 signals.

HDBaseT

When using cost-effective, dedicated Cat.X cables, HDBaseT is the technology for transmitting uncompressed signals up to 100m.

DIVERSITY

From 5 full equipped transmitter and receiver sets, to 15 individual components with the High Performance class. Whether for 1:1, 1:n, or n:n connections.

COM- BINE

Combine the HDBaseT technology with more than 400 additional components, such as splitters and matrix switches, as well as RJ-45 installation cables up to 100m in length.



FIBRE OPTIC TECHNOLOGY

To reach the greatest possible transmission distances, fibre optic technology becomes a necessary requirement. LINDY hybrid cables and fibre optic extenders are highly recommended to achieve the highest performance over maximum distances.

These products provide an ideal transfer medium in the digital signage market, medical, military and government environments. This technology is used because it is particularly resistant to electromagnetic interference and also has the benefit of being easy to install and use providing a simple, cost effective and flexible solution.

20 KILOMETRES

is the maximum distance with our cable connected fiber optic solutions.



20 GIGABITS per second can be achieved with our fibre optic cables.

300

... configurable solutions consisting of FO extenders and patch cables, including MPO versions, and of course in different lengths with high stock availability.

SPECIAL ORDER

Customized products as well as individual project support for any desired cable length according to your individual specifications.





USB TECHNOLOGY

A new era of USB connectivity has begun with USB 3.1 SuperSpeed+. This new standard is already being supported by all modern operating systems. The reasons: faster data transmission, power delivery, video transmission and backwards compatibility. Together with the new Type-C connector, USB 3.1 is an indispensable interface for meeting modern requirements and challenges in the home and professional markets.

Every USB application is different and has different data transfer requirements. Our wide range of USB extender technologies allows for efficient expansion and distribution of USB signals. By properly selecting and combining the individual elements, USB signals can be transmitted over very long distances from source to destination device. In industrial applications extenders and hubs with metal housings provide the increased sturdiness and reliability required in harsh environments.



FASTER

USB 3.1 SuperSpeed+

With data rates of up to 10Gbps, approximately 20 times faster than USB 2.0 and 1.2 times faster than FireWire. A 4K UltraHD movie can be transferred in 30 seconds.

DIVERSE

15

15 cable and adapter types for USB 3.1 Type-C.
20 Type-C adapters, hubs and enclosures.
A variety of USB Type C display adapters for connecting monitors with VGA, DVI, HDMI, DisplayPort and HDMI 2.0.

RANGE

1.5 Metres

with direct cable connection for USB 3.1 Gen2.

30 Metres

with the cascadable copper based repeater system for USB 3.1 Gen1.

400 Metres

with Optical Extender technology for USB 3.1 Gen1.



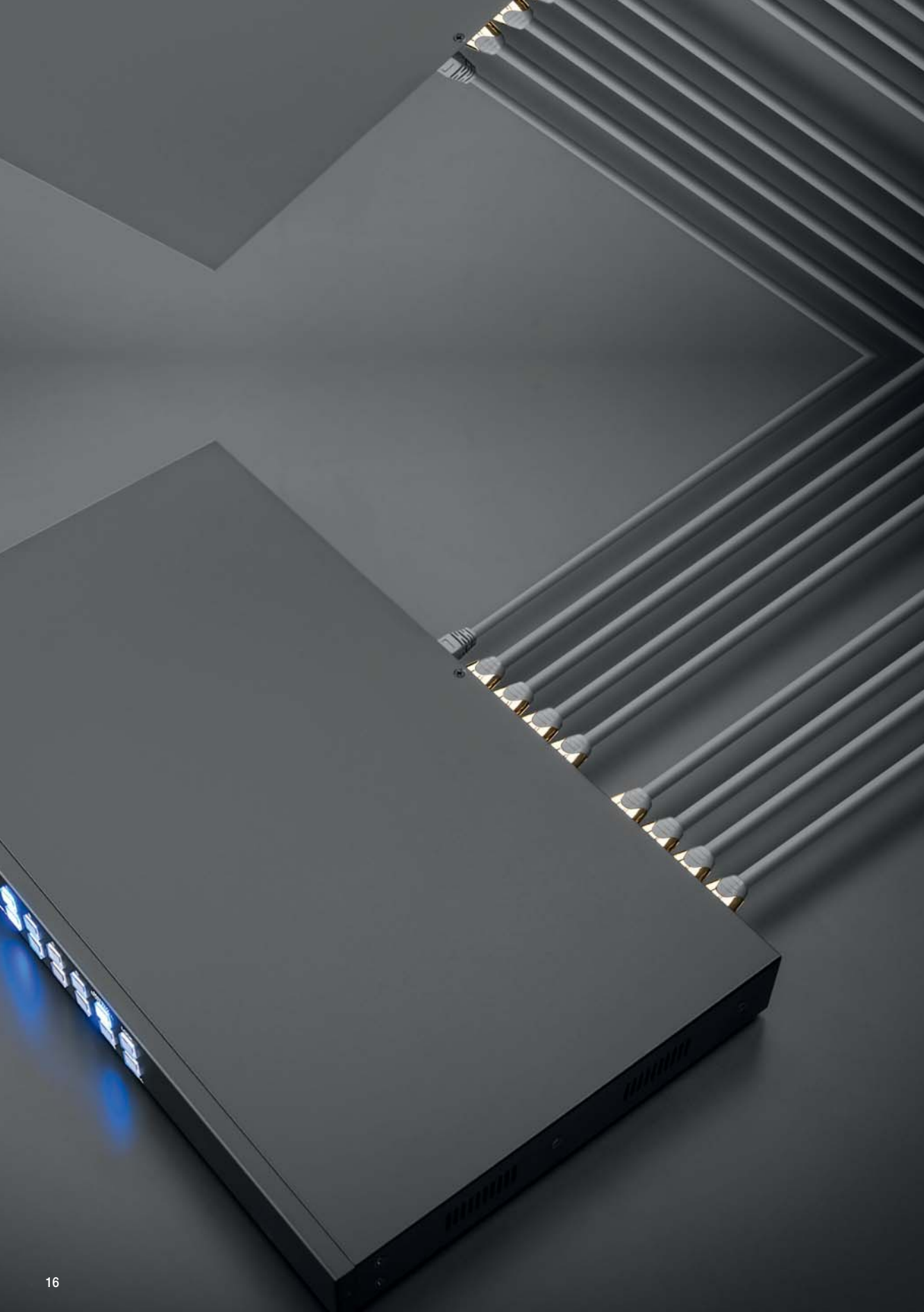

AUDIO & VIDEO CLARITY

Headphones	20
Bluetooth Audio, DACs, Switches & Splitters	25
AV Converters & Adapters	29
Video Splitters, Switches & Distribution	35
AV Faceplates	90
Mains Conditioners	93
Projector Servers	94
Display Brackets & Stands	95

HEADPHONES FOR ALL OCCASIONS

On-ear, over-ear and in-ear. Cabled or wireless. Whether it's portable earphones for use with your smartphone or noise cancelling over ears for travelling. Rock, hip-hop, classical or blues: whichever music style you favour, the right headphones guarantee audio integrity. LINDY provides four types of headphones to choose from. In ear headphones are small and practical to handle, on-ear and over-ear are significantly larger, but offer better comfort, isolation and a clearer sound. The Active Noise Cancelling technology and Bluetooth models provide a solution against disturbing external ambient noise. The multi award winning LINDY BNX-60 holds up to 12 hours of battery life and can be recharged via micro USB. Additionally, the BNX-60 features a built-in microphone to make calls via the hands free function.





1

BNX-60 Wireless

Noise Cancelling Headphones

→ Page 20, 73 136

2

NC-40 Noise Cancelling

Headphones

→ Page 21, 20 425

3

HF-20 Lightweight

Headphones

→ Page 24, 20 257

4

Mini Splitter

& Headphone Amplifier

→ Page 22, 35 507

5

Audio Converters

Digital to Analogue

→ starting Page 26, 70 408

BNX-60

Award winning headphones with aptX® technology

LINDY multiple award winning BNX-60 wireless noise cancelling headphones have been developed to deliver superb quality Hi-Fi sound using advanced aptX® technology.

The BNX-60s provide you with the flexibility to use them in a number of different ways: wireless and noise cancelling functionality at the same time, with wireless or noise cancelling separately, or in passive mode with no active features enabled. The BNX-60s feature a built in battery, which can be recharged under 3 hours to provide up to 30 hours of use.

**BEST
SELLER**

40mm high output drivers with neodymium magnets

Built-in battery charges via USB

Integrated microphone for hands free calling

On-ear controls allow your phone to remain out of sight

Volume control

Lightweight design for optimum comfort

Supplied with an audio cable for use with aircraft in-flight entertainment, Hi-Fi equipment etc.

Bluetooth 4.1 with aptX® technology allows wire-free crystal clear audio with a range of up to 15m

Selectable active noise cancellation removes up to 85% of external noise



NC-40 Noise Cancelling Headphones

- High output 40mm drivers for superb sound quality
- 16dB of active noise reduction
- Closed back, circumaural over ear design
- Soft cushioned earpads for comfortable use over long periods
- Neat, folding design for portability
- Frequency range: 20Hz – 23kHz
- Supplied with carry bag, in-flight adapter, 6.3mm adapter and AAA battery

SUNDAY Mirror
STAR BUY!
Rated 10 out of 10

WHAT HI-FI?
SOUND AND VISION
★★★★★

LINDY Noise Cancelling Headphones March 2010

Computer active
GREAT PICK
★★★★★

May 2014



**BEST
SELLER**



NC-40 Noise Cancelling Headphones

20425

CROMO NCX-100 Noise Cancelling Headphones

Multi award winning active noise cancelling headphones

- 40mm high output drivers with neodymium magnets
- Active noise cancellation using 4 microphones to remove up to 95% of external noise
- Auto power off in noise cancelling and bass modes
- Bypass circuitry allows passive use without batteries
- Frequency response: 20Hz – 20kHz
- Up to 20 hours battery life
- Requires two AAA batteries (not included)

Hi-Fi Choice
RECOMMENDED

August 2014

HOME CINEMA Choice
RECOMMENDED

October 2014

avforums
BEST BUY AWARD

August 2014



Audio cable with built-in microphone, in-flight and 6.3mm stereo jack adapters



Rigid carry case

CROMO NCX-100 Noise Cancelling Headphones

20258

NC-60 Active Noise Cancelling Headphones

Featuring inverse phase active technology which 'cancels out' background noise and high quality protein leather ear pads, the NC-60s reduce external noise by up to 85% resulting in a more enjoyable audio experience. The 40mm driver units provide superior sound performance whilst the soft, cushioned earpads are comfortable to wear for long periods. Perfect for on a long flight, train journey, in the car or just to use at home.

For added convenience the NC-60 ear pieces can be rotated so that the headphones can be stored flat in the included durable vinyl carry case, saving you precious space in your hand luggage whilst keeping the NC-60 protected. In addition to the flexible 1.5m audio cable, adapters for connecting to dual plug in-flight entertainment systems and your Hi-Fi are included.

- Active Noise Cancellation technology delivers up to 85% reduction of ambient noise
- 40mm high output drivers with neodymium magnets for smooth, solid bass and clear, sparkling treble
- Frequency response: 20Hz – 20kHz
- Features a fully adjustable headband and soft cushioned earpads for your comfort
- Closed back design eliminates sound leakage
- Folds flat for convenient storage
- Supplied with tough carry case, 1.5m audio cable, batteries, 6.3mm and in-flight adapters



NC-60 On-Ear Headphones

20424

Headphone Splitters



Splitter Adapter



Splitter Cable



Splitter Cable with Volume Control

Mini Headphone Splitter & Amp

Share & improve the sound from your portable devices

- Compact, portable dual headphone splitter with amplification circuit
- Built-in rechargeable battery provides up to 12 hours of use
- Includes 3.5mm audio and USB A to Micro-B charging cables



Mini Headphone Splitter & Amp

35507

Splitter Adapter	35530
Splitter Cable	35627
Splitter Cable with Volume Control	35517

Premium Hi-Fi Headphones

Award winning, audiophile headphones

Our Premium Hi-Fi headphones have been developed to deliver superb audio quality with a wide sound stage and exceptionally accurate detail. The HF-100s are the closed back variant designed to limit audio leakage - ideal for recording applications. The HF-110s are an open backed design that feature a 'vented' earpiece which improves bass response and provides an open, spacious sound stage.

- Exceptionally accurate acoustic performance for the most natural sound
- High quality 42mm drivers with neodymium magnets and copper clad aluminium wire (CCAW) voice coils provide increased sensitivity for accurate mid and high tone reproduction as well as a powerful, defined bass
- Frequency Response: 10Hz - 26kHz
- Includes 3m detachable cable, spare ear pads, carry case and 3.5mm to 6.3mm jack adapter
- Optional 1.5m detachable cable also available separately



LINDY HF-100 Headphones
September 2011



HF-100, January 2012



HF-110, July 2014



HF-100 Premium Hi-Fi Closed Back Headphones	20378
HF-110 Premium Hi-Fi Open Back Headphones	20375
Optional 1.5m Audio Cable	35510

HF-40 Hi-Fi Studio Headphones

High quality, closed back headphones specially designed for Hi-Fi and studio use

- High output 40mm neodymium drivers deliver superb clarity
- Frequency response: 10Hz – 22kHz
- Soft, protein leather ear pads for maximum comfort
- Elasticated headband provides a secure fit
- Removable 1.2m cable with 3.5mm Stereo Jack
- Supplied with a handy carry bag



HF-40 Hi-Fi Studio Headphones

20256

HEADPHONES

HF-20 Lightweight Stereo Headphones

Superb sound quality for your smartphone, iPod or MP3 player

- High output 30mm neodymium drivers provide superb clarity and excellent bass response
- On-ear design with breathable protein leather ear pads for maximum comfort and excellent sound isolation
- Frequency response: 10Hz - 20kHz
- 1.2m cable with 3.5mm Stereo Jack

**BEST
SELLER**



August 2012

HF-20 Lightweight Stereo Headphones

20257

CROMO IEM-75 Dual Driver Earphones

Luxury earphones with superior sound quality

- Superior dual driver earphones with high quality, accurate sound
- Dual driver design incorporates 15mm and 7mm drivers into a single earpiece
- Supplied with a handy carry pouch and with 3 exchangeable ear tips
- Frequency Response: 8Hz - 20kHz
- Cable length: 1.2m
- Connector: 3.5mm stereo jack plug (gold plated)



Carry case

CROMO IEM-75 Dual Driver Earphones

20381

IEM-50X Hi-Fi Earphones

Featuring Dynamic Bass Tuning

- High fidelity extended response 6.5mm dynamic drivers
- Dynamic Bass Tuning Control allows you to adjust low frequencies to your preference
- Frequency response: 8Hz - 20kHz
- 1.2m tangle free cable with gold plated jack
- In-line microphone with single button control
- Supplied with two sets of S/M/L eartips and a handy carry case



IEM-50X Hi-Fi Earphones

20396

BTS-360 Bluetooth Speaker

Immersive 360° audio and enhanced bass

- High quality, stylish 360° surround sound speaker with bass reflex chamber
- Uses Bluetooth 3.0 with NFC for simple pairing
- Built-in rechargeable battery provides up to 18 hours continuous use; charges via USB Micro-B cable
- 3.5mm stereo female audio socket for auxiliary input



))) **NFC**)))



High Fidelity 3" driver with bass tube



Tap-to-pair with NFC for instant Bluetooth audio



BTS-360 Bluetooth Speaker

73146

BTA-30 Bluetooth Audio Receiver

NFC for easy pairing

- Built in microphone for hands free speakerphone function
- Simple Bluetooth or NFC pairing
- Built-in rechargeable battery provides up to 10 hours continuous use
- 3.5mm stereo female audio socket for audio output
- Recharging via USB Micro-B cable

))) **NFC**)))



BTA-30 Bluetooth Audio Receiver

20407

USB Portable Wireless Audio System

Neat little device for transmitting audio

- Wirelessly transmits stereo audio signals from a computer to powered speakers, headphones or an amplifier
- Portable, battery powered receiver with a typical 10m range (up to 45m line of sight)
- Supplied with battery and power supply
- Compatible with Windows XP/Vista/7/8, Mac OS 10 & Linux



WIN **MAC OS** **LINUX**

USB Portable Wireless Audio System

20519

LDAC Pro USB DAC & Headphone Amp

Ultimate DAC for home cinema and audio enthusiasts

This professional DAC can cater for even the most demanding applications. Featuring bit perfect Asynchronous USB 2.0 with a highly accurate PLL and low jitter reduction clock system, the LDAC-Pro provides a superb digital audio listening experience.

- Provides audiophile sound quality up to 24bit/192kHz
- Sampling Rate Conversion (SRC) for all digital inputs to 44.1/48/88.2/96/176.4/192kHz output
- Accepts 2 channel digital audio and works with any LPCM stream with Dolby Digital or DTS disabled
- HDMI, optical, coaxial and USB 2.0 (USB Audio Class 2) digital audio interfaces
- Phono, XLR, line-in and headphone analogue audio interfaces
- Headphone amplifier, with high quality TI TPA6120A2 chipset
- XMOS Asynchronous USB chipset
- HDMI pass through, supports resolutions to Full HD 1080p 60Hz including 1080p 3D



WIN | MAC OS

LDAC Pro USB DAC & Headphone Amp

70410

TOSLINK Optical DAC with Dolby Digital Decoder

Ideal for digital recording and computer audio systems

- Optical digital audio signal input and conversion into analogue audio signal L/R output
- LPCM audio sampling rates from 32 to 96kHz (32, 44.1, 48, 88.2 and 96kHz)
- Dolby Digital audio sampling rates of 32, 44.1 and 48kHz
- Dolby Digital audio down-mixing to 2-channel audio
- Powered by USB, cable included



TOSLINK Optical DAC with Dolby Digital Decoder

70471

SPDIF DACs

Two versions available for converting digital to analogue or analogue to digital

- Part No 70408 converts TOSLINK or coaxial SPDIF signals to analogue stereo phono
- Part No 70409 converts analogue stereo phono to TOSLINK or coax SPDIF signals
- Optical and coaxial cables can both be connected at the same time; a switch control determines which signal is active



BEST SELLER

SPDIF Digital to Analogue Stereo Audio Converter

70408

Analogue Stereo Audio to SPDIF Digital Converter

70409

SPDIF DAC Combo

Compact DAC converts digital coax and optical to analogue audio

- TOSLINK and digital coax (Phono) inputs
- Output Ports: 1 x 3.5mm & 2 x Phono
- Optical and coaxial cables can both be connected at the same time; a switch control determines which signal is active
- Supports sampling rates up to 192kHz



SPDIF Digital to Analogue Stereo Audio Converter Combo

70469

SPDIF DAC Pro with Headphone Amp

Converts digital coaxial or optical to analogue stereo audio via a 3.5mm socket

- Can convert either digital optical or coaxial SPDIF signals to an analogue stereo 3.5mm output
- Integrated headphone amp
- Allows higher sampling rates up to 192kHz, for clearer audio output
- Optical and coaxial cables can be connected at the same time



SPDIF DAC Pro with Headphone Amp

70467

SPDIF DAC Pro with Phono Outputs

Converts digital coax or optical to analogue stereo audio via two phono outs

- Both optical and coaxial cables can be connected at the same time
- Switch control for selecting either optical or coaxial
- Supports higher sampling rates up to 192kHz, for clearer audio output



SPDIF DAC Pro with Phono Outputs

70468

2 Way TOSLINK Optical / Digital Coaxial Converter

Converts SPDIF digital coax to optical and vice versa

- Switch control for selecting coaxial or optical input
- Can output coaxial and optical signals at the same time



TOSLINK Optical / Digital Coaxial Converter

70411

2 Way Automatic TOSLINK Switch

Connect two digital optical TOSLINK sources to a single optical TOSLINK input

- Automatically switches to the active optical port
- Supports long distance cable lengths of 5m and above depending on the quality of the optical cable
- For best performance, we recommend LINDY Gold TOSLINK cables, see page 267



2 Way Automatic TOSLINK Switch

70405

2 Way TOSLINK Switch

Connects two TOSLINK sources to one TOSLINK input

- Switch control for selecting devices
- Supports cable distances of up to 5m on input and output ports
- For best performance, we recommend LINDY Gold TOSLINK cables



2 Way TOSLINK Switch

70406

4 Way TOSLINK Switch

Allows you to connect four TOSLINK sources to one TOSLINK input

- Remote control operation
- Supports cable distances of up to 5m on input and output ports
- For best performance, we recommend LINDY Gold TOSLINK cables



4 Way TOSLINK Switch

70416

2 Way TOSLINK Splitter

Connects one TOSLINK source to two devices

- Supports cable distances of up to 5m on input and output ports
- For best performance, we recommend LINDY Gold TOSLINK cables



2 Way TOSLINK Splitter

70407

4 Way TOSLINK Splitter

Allows you to connect one TOSLINK source to four devices

- Supports cable distances of up to 5m on input and output ports
- For best performance, we recommend LINDY Gold TOSLINK cables



4 Way TOSLINK Splitter

70403



2 Port Bi-Directional Phono Switch

- Allows you to connect two phono sources to a receiver and then switch between them
- Alternatively you can use the switch to connect and switch one audio source to two receivers
- Push button for switching
- No external power required



2 Port Bi-Directional Phono Switch

70402

Lip Sync Corrector

- Ideal for adjusting audio signals that are distributed over long distances through multiple devices to ensure audio and video signals are in sync
- Manually adjustable audio delay from 0 – 300ms (8 preset settings)



Lip Sync Corrector

70449

HDMI ARC Audio Extractor DAC

- Extracts the HDMI audio signal from a HDTV's ARC connection and converts it to a line level analogue stereo output
- Supports HDMI audio sampling rates up to 192kHz



HDMI ARC Audio Extractor DAC

38092

HDMI 4K ARC Extractor with HDMI Pass-Through & CEC Emulation

- Extracts stereo or multi-channel audio from HDMI ARC signals
- HDMI audio pass-through support
- CEC emulation for control of AV source equipment from the display's remote
- Low power design allows - can be powered by the HDMI interface or USB
- Supports up to Ultra HD 4K 3840 x 2160p 30Hz, including 1080p 3D



HDMI 4K ARC Extractor, HDMI Pass-Through & CEC Emulation

38068

4K HDMI Audio Extractor with MHL & ARC

- Extracts analogue and digital audio from HDMI & MHL signals
- Supports resolutions up to Ultra HD 4K 3840 x 2160p 30Hz, including 1080p 3D
- Supports MHL 2.0 input via passive cable up to Full HD 1080p 60Hz
- ARC (Audio Return Channel) extraction via TOSLINK

**BEST
SELLER**



4K HDMI Audio Extractor with MHL & ARC

38097

DVI & VGA to HDMI Converters

- Perfect for using older PCs and AV equipment with HDMI displays
- DVI-D and VGA versions available
- Supports resolutions up to Full HD 1080p 60Hz



VGA & Audio to HDMI



VGA & Audio to HDMI, Cable Version



DVI & Audio to HDMI

DVI & Audio to HDMI Converter

38164

VGA & Audio to HDMI Converter

38165

VGA & Audio to HDMI Converter, Cable Version

38183

AV CONVERTERS

HDMI to VGA Converters

HDMI Male to
VGA Female

**BEST
SELLER**



HDMI Male to VGA Female, 0.1m 38191

Mini HDMI Male to
VGA Female



Mini HDMI Male to VGA Female, 0.1m 38192

Micro HDMI Male to
VGA Female



Micro HDMI Male to VGA Female, 0.1m 38193

HDMI Male to
VGA Female & Audio



HDMI Male to
VGA Female & Audio, 0.1m 38185

Mini HDMI Male to
VGA Female & Audio



Mini HDMI Male to
VGA Female & Audio, 0.1m 38186

Micro HDMI Male to
VGA Female & Audio



Micro HDMI Male to
VGA Female & Audio, 0.1m 38187

HDMI Male to
VGA Female Dongle



HDMI Male to VGA Female Dongle 38194

**VGA to DVI-D
Converter Cable**

- Powered via a USB Type A connection



VGA Male to DVI-D Female, 0.1m 38184

HDMI Converters

HDMI to Composite/S-Video
& Stereo Audio



HDMI to Composite /S-Video &
Stereo Audio Converter 32597

HDMI to CVBS/S-Video
& Stereo Audio



HDMI to CVBS/S-Video &
Stereo Audio Converter 38093

HDMI Male to
DisplayPort 4K
Female



HDMI to DisplayPort 4K Adapter 38146

DisplayPort Male to
HDMI Female, Passive



DP Male to HDMI Female 41005

DisplayPort Male to
4K HDMI Female,
Passive



DP Male to HDMI Female, Passive 41718

DisplayPort 1.2 Male to
4K HDMI Female, Active



DP 1.2 Male to HDMI Female, Active 41068

**BEST
SELLER**

NEW

HDMI Converters

Mini DisplayPort Male to HDMI Female, Passive



**BEST
SELLER**

Mini DisplayPort Male to HDMI Female 41014

Mini DisplayPort 1.2 Male to 4K HDMI Female, Passive



Mini DP Male to HDMI Female, 0.15m 41719

Mini DisplayPort 1.2 Male to 4K HDMI Female, Active

NEW



Mini DisplayPort 1.2 Male to 4K HDMI Female 41069

Mini DisplayPort Male to 4K HDMI / VGA Female, Active

NEW



Mini DisplayPort Male to 4K HDMI / VGA Female 41070

Mini DisplayPort & USB to HDMI, Active

- Connects a Mini DisplayPort Mac to an HDTV
- Built-in external USB audio adapter to allow audio playback over HDMI

Mini DisplayPort & USB to HDMI Adapter	Length	Part No.
	0.70m	41026



Mini DisplayPort Male to 4K HDMI/DVI/DisplayPort, Active



Mini DisplayPort Male to 4K HDMI/DVI/DisplayPort Female Adapter	Length	Part No.
	0.20m	41039

Mini DisplayPort to 4K HDMI/DVI/VGA, Active

- Connect your Macbook to an HDTV, monitor or projector



Mini DisplayPort to 4K HDMI/DVI/VGA Adapter	Length	Part No.
	0.20m	41035

Download the latest
PRICE LIST
from our website 

HDMI Converters

MHL Male to HDMI Female



MHL Male to HDMI Female 41561

MHL 3.0 Male to 4K HDMI Female



MHL 3.0 Male to 4K HDMI Female 41563

SlimPort Male to HDMI Female



SlimPort to HDMI Active Adapter 41571

3G SDI to HDMI



3G SDI to HDMI Converter 38098

3G SDI to HDMI Converters

- 3G SDI to HDMI and HDMI to 3G SDI versions available
- A built-in 3.5mm stereo audio output allows you to enjoy synchronised analogue audio and digital video
- Use in conjunction with each other to create an extender capable of distances up to 100m using low cost coaxial cable
- Supports resolutions up to Full HD 1080p 60Hz



HDMI to 3G SDI



3G SDI to HDMI

3G SDI to HDMI Converter 38198

HDMI to 3G SDI Converter 38199

3G SDI to DVI Converters

- 3G SDI to DVI-D and DVI-D to 3G SDI versions available
- A built-in 3.5mm stereo audio output allows you to enjoy synchronised analogue audio and digital video
- Use in conjunction with each other to create an extender capable of distances up to 100m using low cost coaxial cable
- Supports resolutions up to Full HD 1080p 60Hz



DVI-D to 3G SDI



3G SDI to DVI-D

3G SDI to DVI-D Converter 38196

DVI-D to 3G SDI Converter 38197

4 Port 3G SDI Splitter

- Splits a 3G-SDI signal to 4 3G-SDI Displays
- Backwards compatible with SDI and HD-SDI formats
- Supports resolutions up to 1920 x 1080@60Hz
- Robust industrial metal housing

NEW



4 Port 3G SDI Splitter

38085

USB 3.1 Type C to Video Converter Adapters

LINDY USB 3.1 Type C to Video Adapter Converters allow you to quickly add external video capabilities to devices featuring the USB 3.1 Type C port with support for DisplayPort Alternate Mode.

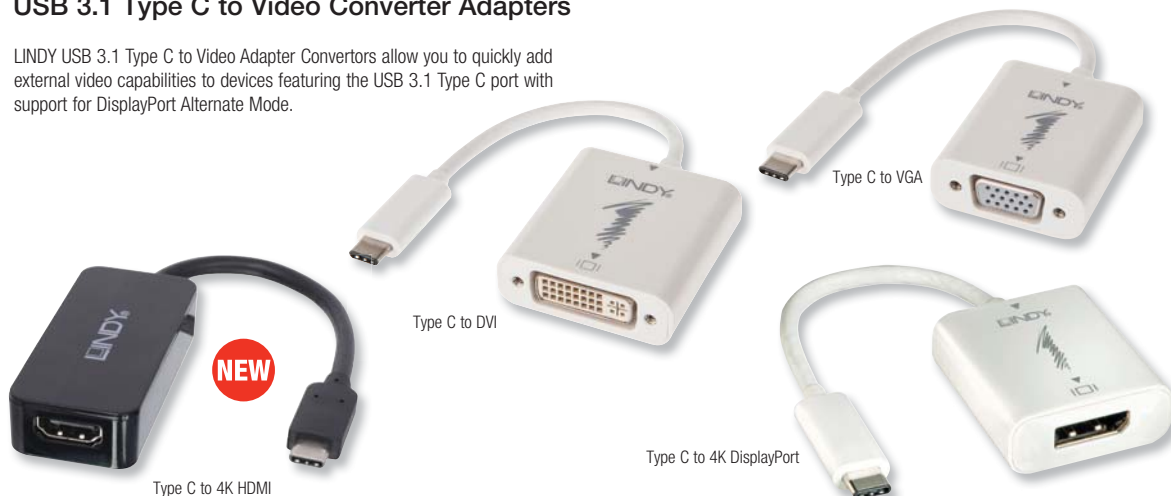

USB 3.1 Type C to VGA Adapter Converter,	43190
USB 3.1 Type C to DVI-D Adapter Converter	43191
USB 3.1 Type C to 4K HDMI Adapter Converter	43197
USB 3.1 Type C to 4K DisplayPort Converter Adapter	43193

USB 3.1 Type C to Video Converters with USB Power Delivery

The LINDY USB 3.1 Type-C to VGA Adapter Converter allows you to quickly add external video capabilities to devices featuring the USB 3.1 Type-C port with support for DisplayPort Alternate Mode. USB Power delivery of up to 60W (20V 3A maximum) allows you to power your compatible notebook or Ultrabook via its USB Type C port whilst simultaneously using it as a video output.



USB 3.1 Type C to VGA Adapter Converter with Power Delivery	43194
USB 3.1 Type C to VGA & USB Adapter Converter with Power Delivery	43230
USB 3.1 Type C to DVI-D Adapter Converter with Power Delivery	43195
USB 3.1 Type C to HDMI Adapter Converter with Power Delivery	43196
USB 3.1 Type C to 4K HDMI Adapter Converter with Power Delivery	43178
USB 3.1 Type C to 4K HDMI & VGA Adapter Converter with Power Delivery	43179
USB 3.1 Type C to 4K HDMI & USB Adapter Converter with Power Delivery	43198

VIDEO CONVERTERS

DVI, VGA & Composite Video Converters



DVI-D Male to VGA Female



DVI-D to VGA / RGB / Component Video



VGA Male to DVI-D Female



SCART to Component Video



VGA to Composite / S-Video



Composite / S-Video to VGA



Composite / S-Video to Component



VGA & Audio to Composite Video

NEW

DVI-D Male to VGA Female Converter	38189
DVI-D to VGA / RGB / Component Video Converter	32562
VGA Male to DVI-D Female Converter	38184
VGA to Composite / S-Video Converter	32566
Composite / S-Video to VGA Converter	32629
SCART to Component Video Converter	38102
Composite / S-Video to Component Video Converter	32625
VGA & Audio to Composite Video	32544

**FOR OUR FULL RANGE OF
AV CABLES AND ADAPTERS
SEE PAGES
237-265**



3 Port HDMI Switch

Connect up to three HDMI devices to a single HDMI port on a TV or projector

- Infrared remote control for easy switching (battery included)
- IR sensor with 1.2m cable for optimal positioning
- Supports up to Full HD 1080p 60Hz, including 1080p 3D

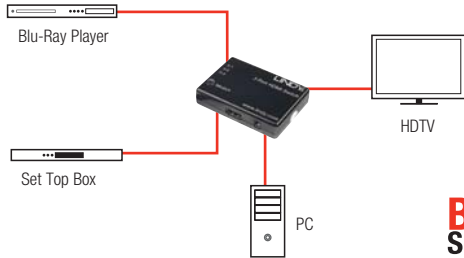

**BEST
SELLER**

3 Port HDMI Switch

38033

2 Port HDMI & VGA to VGA & Audio Switch

Connect an HDMI and VGA source to a single VGA display and speakers

- Easily switch between sources using the supplied cable remote control
- Supports cable lengths of up to 50m using LINDY Gold VGA cables (see page 250)
- Supports up to Full HD 1080p 60Hz, including 1080p 3D



2 Port HDMI & VGA to VGA & Audio Switch

38029

2 Port Bi-Directional 4K HDMI Switch

Versatile HDMI switching device

- Two modes of operation:
- Connect two sources to a single display and switch between sources
- Connect two displays to a single source and switch output to either display
- Supports up to Ultra HD 4K 3840 x 2160 30Hz, including 1080p 3D



Dual Modes

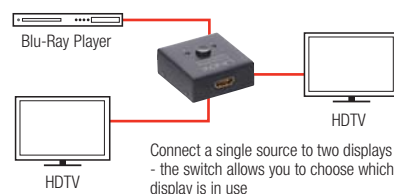
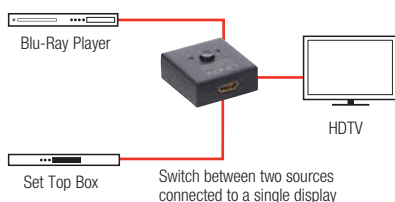

2 Port Bi-Directional 4K HDMI Switch

38036

HDMI SWITCHES & SPLITTERS

4 Port 4K UHD Picture in Picture HDMI Switch

This Ultra HD HDMI Switch offers maximum convenience when you need to connect multiple UHD HDMI sources to a UHD display. It features 4 HDMI input source ports and 1 HDMI output display port. Each of the 4 sources can be directed to the UHD display using the supplied remote control.

- Connect up to 4 UHD HDMI devices to 1 UHD display or projector
- HDCP 1.4 and HDMI 1.4a compliant
- Supports resolutions up to 4K 30Hz & 1080p 60Hz including 1080p 3D and 10.2G / 300MHz
- Supports PiP (Picture in Picture), 1 main picture, 3 sub pictures

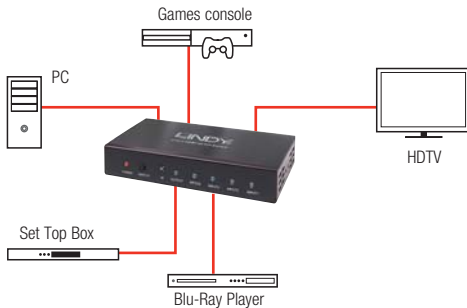

Picture in Picture
Input selected under channel 1 will be displayed full screen, with the inputs selected under channels 2 - 4 shown across the bottom of the screen

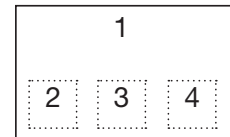

4 Port 4K UHD Picture in Picture HDMI Switch

38151

2 Port 4K HDMI Splitter Compact

- Supports resolutions up to 4K2K@30Hz including 1080p 3D
- Supports 7.1 channel of LPCM, Dolby TrueHD and DTS-HD Master Audio digital audio signals
- HDCP 1.4 compliant
- Supports cable distances up to 20m (10m in, 10m out)



2 Port 4K HDMI Splitter Compact

38157

FOR HDMI CABLES
SEE PAGES
237-241

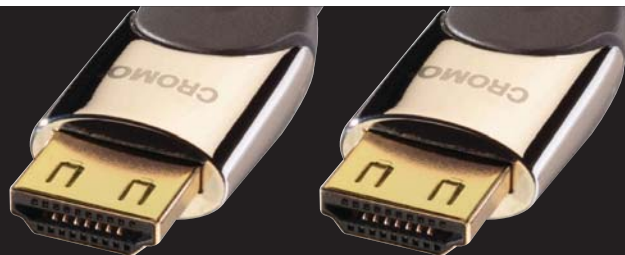

HDMI 2.0 4K UHD Splitters

- Supports resolutions up to 4K 60Hz 8 bit 4:2:0
- Supports 7.1 channels, LPCM, Dolby TrueHD and DTS-HD Master Audio digital audio signals
- Ideal for digital signage, presentations and demonstrations
- HDCP 2.2 compliant
- Maximum bandwidth: 10.2Gbps / 300MHz
- Available with 2, 4, 8 or 16 ports

**BEST
SELLER**



2 Port HDMI 2.0 4K UHD Splitter	38220
4 Port HDMI 2.0 4K UHD Splitter	38221
8 Port HDMI 2.0 4K UHD Splitter	38222
16 Port HDMI 2.0 4K UHD Splitter	38062

HDMI 2.0 UHD 18G 4K Splitters

- Supports resolutions up to 4K 60Hz 8 bit 4:4:4
- Supports 7.1 channels, LPCM, Dolby TrueHD and DTS-HD Master Audio digital audio signals
- Ideal for digital signage, presentations and demonstrations
- Support for High Dynamic Range (HDR10)
- HDCP 2.2 compliant
- Maximum bandwidth: 18Gbps / 600MHz

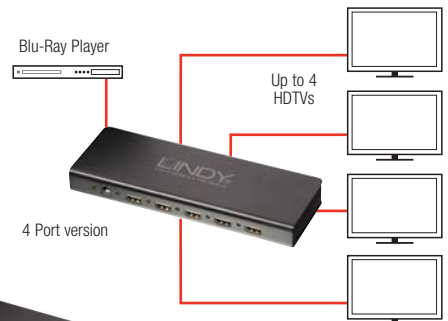

2 Port HDMI 2.0 4K UHD 18G Splitter	38240
4 Port HDMI 2.0 4K UHD 18G Splitter	38241
8 Port HDMI 2.0 4K UHD 18G Splitter	38242

HDMI MATRIX SWITCHES

4 x 2 & 4 x 4 4K HDMI UHD True Matrix

- Supports resolutions up to Ultra HD 4K 3840 x 2160 30Hz including 1080p 3D
- HDCP 1.4 support
- Each of the sources can be directed to any of the displays using the supplied remote control or RS-232 (4 x 4 version only)
- Maximum bandwidth: 10.2Gbps / 300MHz
- EDID management via DIP switches

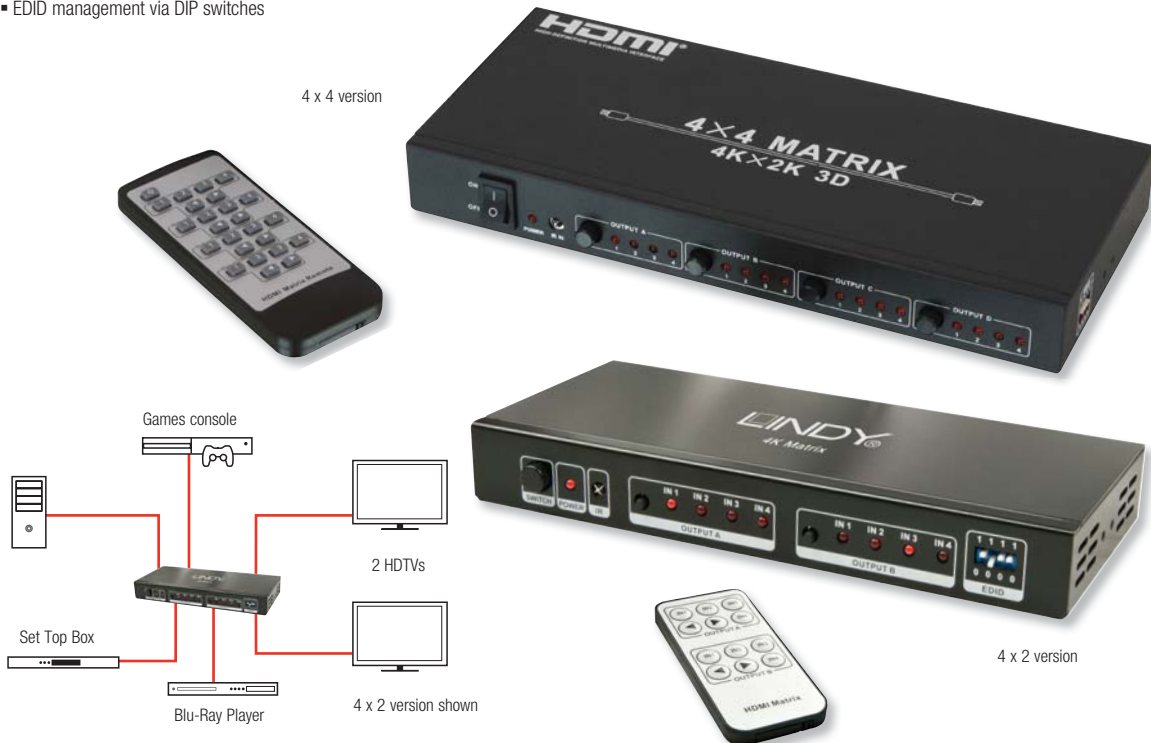

4 x 2 4K HDMI UHD True Matrix	38049
4 x 4 4K HDMI UHD True Matrix	38152

8 x 8 4K HDMI UHD True Matrix

Connect up to 8 HDMI source devices to 8 HDTV displays or projectors

- Supports resolutions up to 4K 60Hz 8 bit 4:2:0
- HDCP 1.4 support and HDMI 2.0 compliant
- Each of the connected sources can be directed to any of the displays using the supplied remote control
- Switching via push button, IR remote, RS-232 and TCP/IP
- Maximum bandwidth: 10.2Gbps / 300MHz
- Supplied with 19" rack mounting brackets

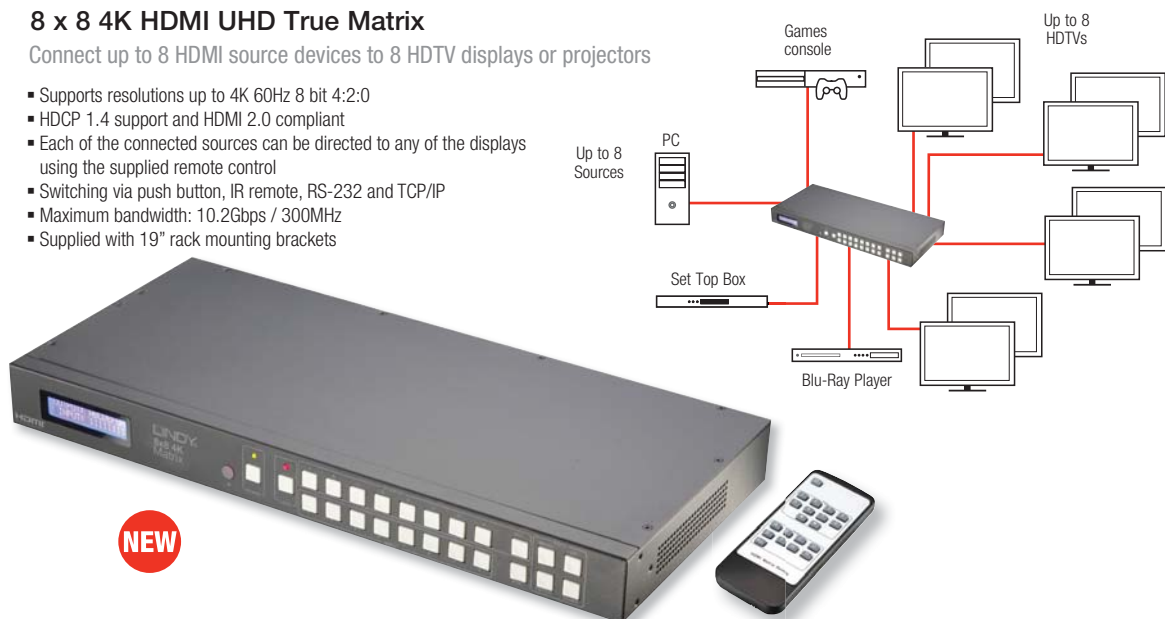

8 x 8 4K HDMI UHD True Matrix	38153
-------------------------------	-------

Modular Matrix System

Versatile system allows you to create a matrix with up to 32 inputs and 32 outputs

The LINDY Modular Matrix is designed to allow you to create a matrix with multiple input and output ports. 8 x 8, 16 x 16 and 32 x 32 versions are available. The input ports can be a choice of 4K HDMI, DVI or VGA while the output ports can be 4K HDMI, DVI or C6 HDBaseT. Any of the inputs can be combined with any of the outputs to create a UHD 4Kx2K@30Hz display over distances of up to 100m.

The modular design provides the ultimate in flexibility for audio and video distribution as a matrix, convertor or an extender in retail product demonstration, training and public display applications in education, pubs etc. The modules slide easily in and out.



8x8 Port Modular Matrix

- Allows you to create a matrix with up to 8 input and 8 output ports
- Convert and matrix switch up to 4K signals
- Control via front panel, remote, display or via web GUI/IP

38252



16x16 Port Modular Matrix

- Allows you to create a matrix with up to 16 input and 16 output ports
- Convert and matrix switch up to 4K signals
- Control via front panel, remote, display or via web GUI/IP

38251



32x32 Port Modular Matrix

- Allows you to create a matrix with up to 32 input and 32 output ports
- Convert and matrix switch up to 4K signals
- Control via front panel, remote, display or via web GUI/IP

38250

Input Modular Boards



8 Port 4K HDMI Input Module

- HDMI 1.4 compatible, 2160p 30

38253



8 Port DVI-D Input Module

- DVI-D Single Link up to 1920x1200

38255



8 Port VGA Input Module

- VGA up to 1920x1200
- 3.5mm stereo inputs

38257



8 Port HDBaseT Input Module

- HDBaseT up to 4K30 with support for PoH and Ethernet

38258



Output Modular Boards



8 Port 4K HDMI Output Module

- HDMI 1.4 compatible, 2160p 30

38254

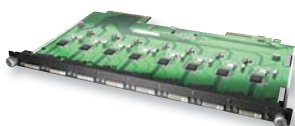

8 Port DVI-D Output Module

- DVI-D Single Link up to 1920x1200

38256



8 Port HDBaseT Output Module

- HDBaseT up to 4K30 with support for PoH and Ethernet

38259



LONG DISTANCE CONNECTIONS

High performance super long distance cable solutions from LINDY provide reliable, lossless high speed digital distribution of audio and video data. Digital audio and video signal performance is becoming sharper, clearer and more flexible – but not simpler. High performance IT, digital signage and AV distribution solutions must be able to transmit huge amounts of data at high speeds to provide the highest resolutions and audio performance with up to eight channels. State of the art technologies such as 3D and 4K also need significantly more bandwidth. Additionally, data transfer must include HDMI control commands and copy protection (HDCP).

The quality of LINDY cables goes far beyond these market requirements. However, even high quality standard copper HDMI, DVI or DisplayPort cables soon reach their performance limits over longer distances. This scenario occurs in professional environments, e.g. in conference and training rooms when using large wall displays or ceiling mounted projectors.

Therefore, it is not sufficient to simply use a longer cable for transmitting the high resolution and bandwidth intensive content. Our goal when designing our Super Long Distance cable range was to ensure excellent and loss-free signal transmission regardless of length. To provide this performance, LINDY Super Long Distance cables are equipped with large conductors and full metal connectors with 360° shielding to protect against electromagnetic interference.



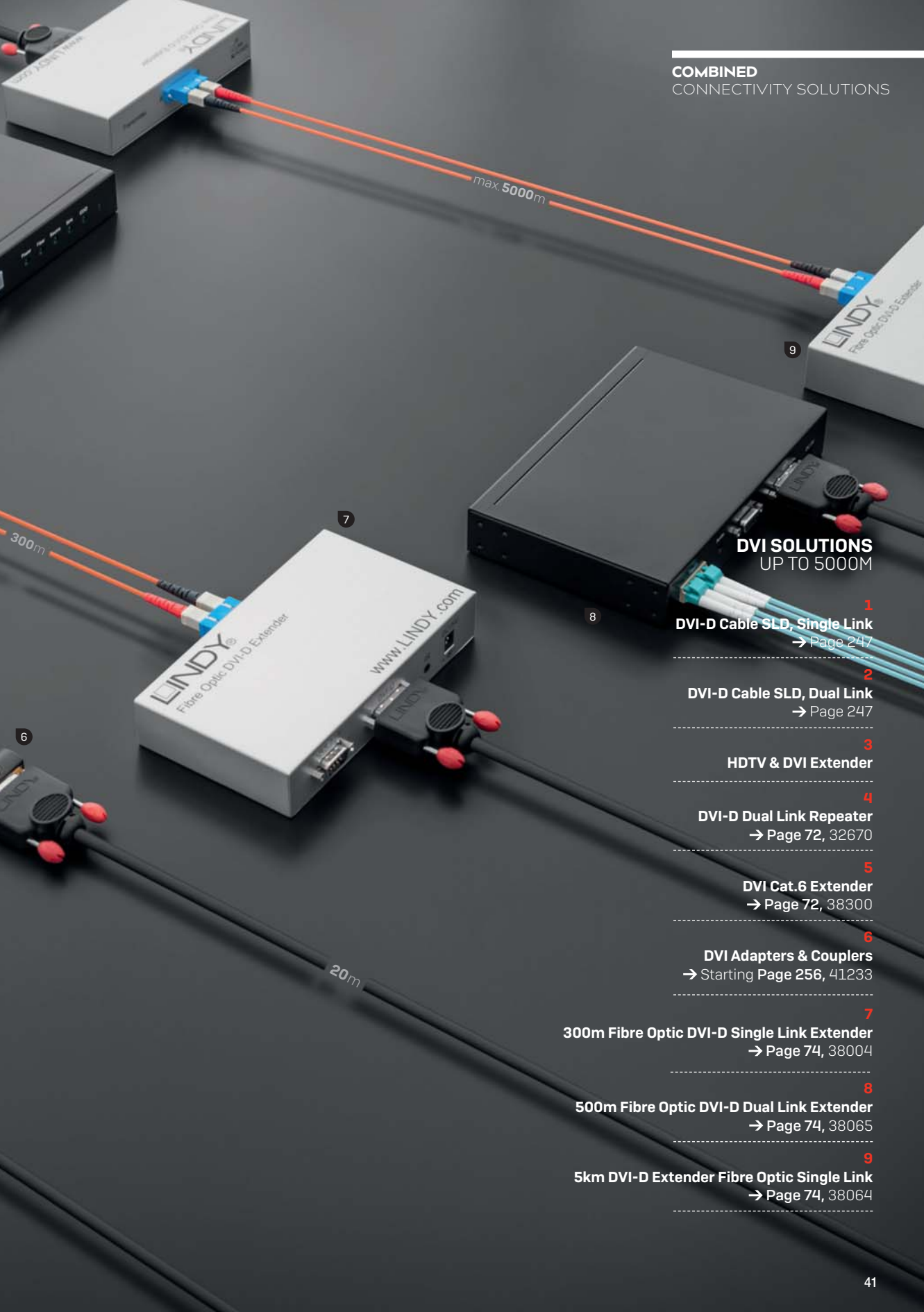

**DVI SOLUTIONS
UP TO 5000M**

- 1**
DVI-D Cable SLD, Single Link
→ Page 247

- 2**
DVI-D Cable SLD, Dual Link
→ Page 247

- 3**
HDTV & DVI Extender

- 4**
DVI-D Dual Link Repeater
→ Page 72, 32670

- 5**
DVI Cat.6 Extender
→ Page 72, 38300

- 6**
DVI Adapters & Couplers
→ Starting Page 256, 41233

- 7**
300m Fibre Optic DVI-D Single Link Extender
→ Page 74, 38004

- 8**
500m Fibre Optic DVI-D Dual Link Extender
→ Page 74, 38065

- 9**
5km DVI-D Extender Fibre Optic Single Link
→ Page 74, 38064

DISTANCE EXTENSION

To guarantee reliable operation in event management, fixed installation AV and digital signage applications, cables must meet very high requirements. LINDY Super Long Distance cable solutions can be used up to a maximum length of 20m. For longer distances, HDMI and DVI extenders or repeaters can be used. Extenders are inserted into a transmission link in order to extend the maximum bridging distance. They usually comprise two components: the transmitter and receiver. They are connected to each other by means of copper cables (for connections typically under 100m) or fibre optic cables (for even longer distances). These are different to repeaters which merely boost an existing AV data signal and act as a simple line repeater. ▶



HDMI SOLUTIONS
UP TO 3000M

1

High Speed HDMI Cable

length: 0.3–20 m

→ starting page 238

2

High Speed Active HDMI Cable

length: 10m–30m

→ starting page 239

3

HDMI Cat.6 Extender

Full HD

→ starting page 46

4

HDMI Repeater/Extender

for HDTV Signals, up to 4K30Hz

→ Page 46, 38015

5

HDMI & IR Cat.6 Extender

Full HD

→ starting page 47

6

HDMI Repeater/Extender

for HDTV Signals, up to 4K30Hz

→ Page 46, 38015

7

HDMI Coupler

Supports HDCP

→ Page 257, 41656

8

100m HDMI 4K Extender

with HDBaseT Technology

→ Page 52, 38119

9

100m HDMI Extender Premium

Power over HDBaseT

→ Page 52, 38115

10

300m Fiber Optic HDMI Extender

Supports 4K Resolutions up to 60Hz

→ Page 61, 38170

INTELLIGENT FIBRE OPTIC CONNECTIONS

When you need to bridge larger distances, more sophisticated optical technology is needed. We recommend using LINDY hybrid cables or fibre optic extenders. They offer very high performance with data speeds of almost 20 Gigabits per second over maximum distances. This technology represents an ideal transmission method for the large distances required, e.g., for digital signage. This technology is used in medical, military and official environments mainly due to its resistance to interferences. Video data signals, which require the highest available bandwidth, are sent over fibre optic cables. These cables are fully resistant to electromagnetic interference. They can therefore be installed next to other high current cables without problem.

LINDY has minimised the fibre optic to HDMI conversion electronics so they fit inside the HDMI connector. At the same time all signals are transmitted via a single duplex cable. The HDMI signals are converted into optical light pulses by the sender and converted back to HDMI signals by the receiver. Flexible solutions which can quickly be replaced with variable cable lengths are now becoming more and more important. Fibre optic cables are the most sensitive part of such an HDMI extender solution. For this reason, an additional benefit lies in being able to replace the fibre optics easily and cost effectively. The new 4K UHD sender and receiver pair is a solution allowing for flexible use of fibre optic connection technology.



DISPLAYPORT SOLUTIONS
UP TO 200M

1
DisplayPort Cable, 4K
length: 0.5-20m
→ starting page **243**

2
DisplayPort Repeater
4K@60Hz / 4K@30Hz
→ Page **77, 38413**

3
200m Fibre Optic DisplayPort Extender
4K@60 Hz
→ Page **77, 38403**

4
MPO to MPO Multi-mode Fibre Optic Cable
length: 10-200m
→ starting Page **211**



4K HDMI Repeater / Extender

- Connects two HDMI cables together to allow longer transmission distances
- Supports the following resolutions and distances:
 - 4K 3840x2160p60, 35m: 15m In / 20m Out (4:2:0 8 bit per channel)
 - 4K 3840x2160p30, 35m: 15m In / 20m Out (4:4:4 8 bit per channel)
 - 1080p60/1080p 3D, 50m: 20m In / 30m Out (4:4:4 8 bit per channel)
- HDCP 2.2 compliant
- We recommend you use this repeater with LINDY Gold HDMI cables, see page 238
- Powered from the HDMI interface, no external power required



**BEST
SELLER**



4K HDMI Repeater / Extender

38015

30m Dual CAT5e/6 HDMI Extender

- Supports resolutions up to Full HD 1080p 60Hz
- Transmits HDMI video and audio signals up to 30m over two CAT5e/6 cables (not included, see page 212)
- HDCP pass-through

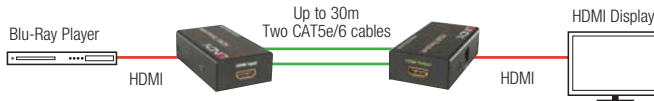

30m Dual CAT5e/6 HDMI Extender

38023

50m CAT6 HDMI Extender

- Extends HDMI 1.4 & IR Signals up to 50m using a single Cat.6 cable
- Supports resolutions up to Full HD 1080p, including 3D
- Features a loop-through HDMI output on the Transmitter for local monitoring
- Supports power over Cat.6, only a single power supply is required

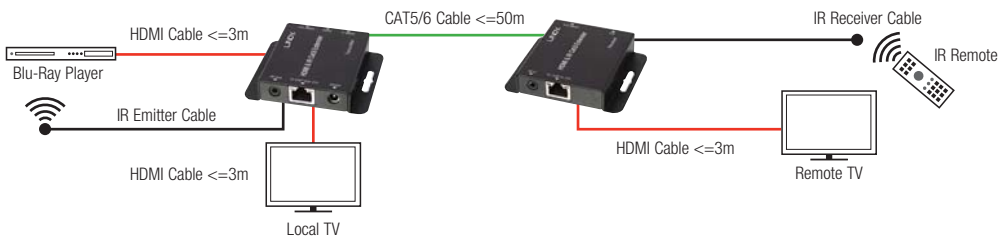

50m CAT6 HDMI & IR Extender

38144

80m CAT6 HDMI & IR Extender Premium

- Allows HDMI and IR signals to be sent up to 80m using low cost CAT6 cable (not included)
- Supports resolutions up to Full HD 1080p 60Hz including 1080p 3D
- Supports multi-channel High Definition Digital Audio, including Dolby Digital True HD and DTS-HD
- Bi-Directional IR support at 20 - 60KHz
- Supports PoC (Power over Cable) which allows the remote unit to be operated without a power supply

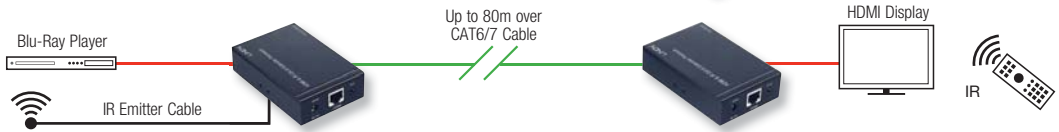

80m CAT6 HDMI & IR Extender Premium

38009

150m Cascadeable HDMI CAT6 Extender

The LINDY Cascadeable HDMI CAT6 Extender allows you to transmit an HDMI video signal to a series of remote displays/projectors up to a distance of up to 150m between each Transmitter and Receiver/Repeater using high quality Cat.5e/6 solid core cables. The Cascadeable HDMI CAT6 Extender is sold in the form of individual Transmitter and Receiver units, providing the ultimate in flexibility at the point of installation and the ability to easily expand the installation at a later date.

- Flexible digital signage extension solution - Transmitter & Receiver Units sold separately
- Extend an HDMI source to up to 100 HDMI Displays
- Supports resolutions up to 1920x1080p, including HDCP protected content
- Supports distances of up to 150m between each unit

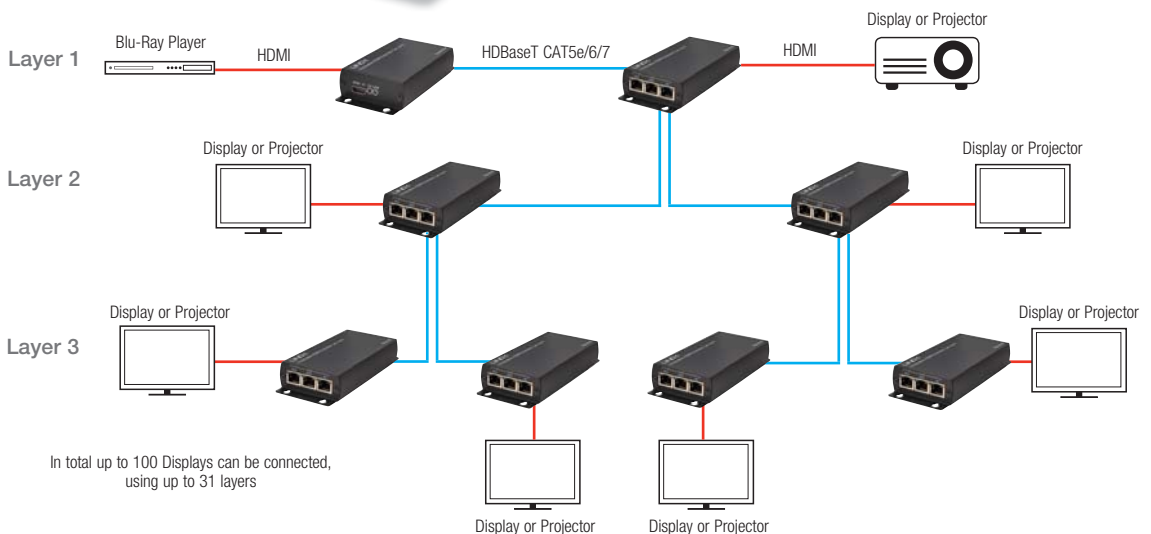

150m Cascadeable HDMI CAT6 Extender, Transmitter Unit

38140

150m Cascadeable HDMI CAT6 Extender, Receiver/Repeater Unit

38141

HDMI DISTRIBUTION

CAT6 HDMI Distribution System

Modular solution for extending & distributing HDMI signals

The LINDY CAT6 HDMI Distribution System is a range of modular products that work in combination to transmit uncompressed high definition video and audio over long distances using affordable CAT6 network cable. The range consists of a Receiver, Transmitter, Receiver/Extender and an 8 Port Splitter. The System supports video signals up to Full HD 1080p 60Hz, including 1080p 3D, at distances of up to 40m, as well as multi-channel digital audio.

Typical Installation Examples

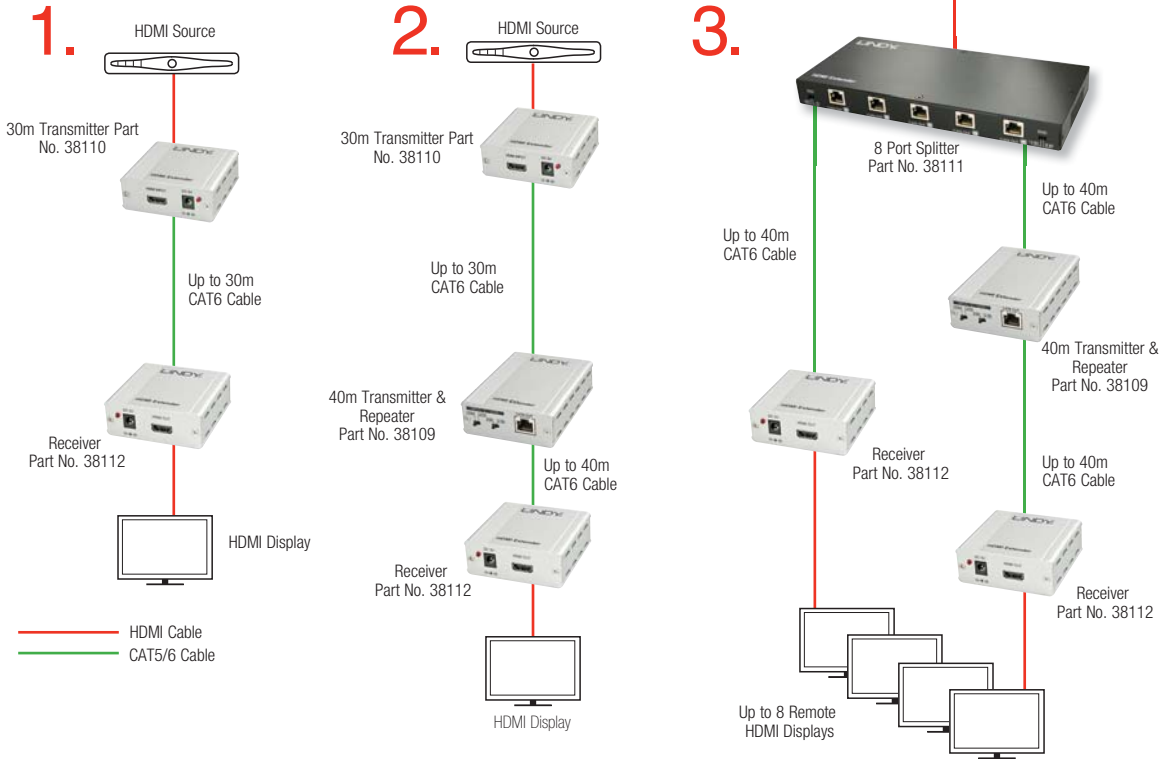

30m CAT6 HDMI Transmitter

- Input: HDMI
- Output: RJ-45, CAT6



30m CAT6 HDMI Transmitter

38110

40m CAT6 8 Port HDMI Splitter

- Input: HDMI
- Output: 8 x RJ-45, CAT6



40m CAT6 8 Port HDMI Splitter

38111

40m CAT6 HDMI Transmitter & Repeater

- Can be used as a 40m Transmitter connected to a Receiver, or as a 40m Repeater connected between a Transmitter and a Receiver
- Input: RJ-45, CAT6 or HDMI
- Output: RJ-45, CAT6



40m CAT6 HDMI Transmitter & Repeater

38109

40m CAT6 HDMI Receiver

- Input: RJ-45, CAT6
- Output: HDMI



40m CAT6 HDMI Receiver

38112

HDMI & IR CAT6 Extender 4 x 4 Matrix, 50m

The LINDY HDMI & IR CAT6 Extender 4 x 4 Matrix supports the transmission of high definition video (resolutions up to Full HD 1080p 60Hz and 1920 x 1200@60Hz, including 1080p 3D), multi-channel digital audio and control via push button, IR, RS-232 and TCP/IP from four high definition sources to four remote displays over a single CAT5e/6 cable of up to 50m for each output. Each of the 4 outputs is also simultaneously mirrored on local HDMI output ports, perfect for monitoring outputs or for the creation of a secondary local zone.

It supports high resolution digital audio formats such as LPCM 7.1 CH, Dolby TrueHD, Dolby Digital Plus and DTS-HD Master Audio as well as 3D content that can be displayed when connecting a 3DTV and 3D source.

- Extend and distribute 4 HDMI sources up to 50m to 4 HDMI displays
- Each output features simultaneous output to HDMI (local) & CAT6 (remote)
- Supports resolutions up to Full HD 1080p 60Hz including 1080p 3D
- Features support for bi-directional IR signals (20 - 60kHz)
- Controlled via IR Remote, Push Button, RS-232 or TCP/IP



This flexible feature rich product has been designed to be used in a number of different applications, such as:

- Domestic HDMI Matrix system
- Video/TV wall display and control
- Security surveillance and control
- Commercial advertising, display and control
- University Lecture hall display and control
- Retail Sales and demonstration

Demo' Kit Available

If you're a LINDY Credit Account Holder, you can try this for yourself for FREE! (subject to our approval). Please e-mail postmaster@lindy.co.uk for details.

Typical Installation Example

- HDMI Cable
- CAT5/6 Cable
- RS-232 Cable

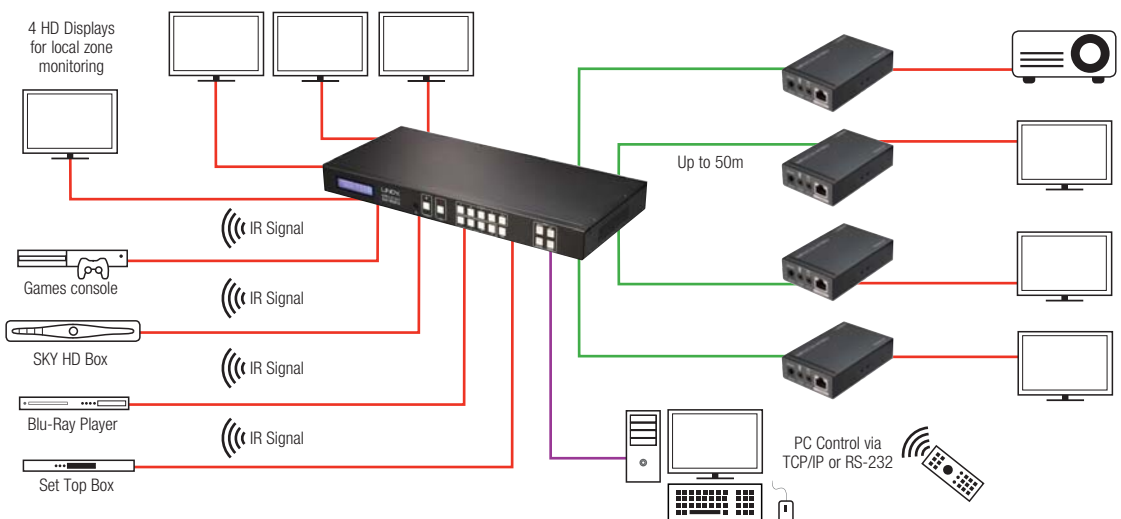



HDMI VIA HDBaseT™ 100METRES VIA CAT. 6

As modern source devices deliver image signals with maximum quality and colour depth, digital signage applications must also use the same high definition quality. The distribution of these signals needs to meet more and more varied requirements for distance and bandwidth. What if you wish to distribute these digital signals and content to multiple displays over as large as possible distances? HDBaseT is a transmission standard that makes professional, high resolution and high performance solutions possible. LINDY's HDBaseT technology based solutions meets these requirements to perfection. They can split an HDMI signal over 1:1 or 4/8 displays (HDMI 1:4 or 1:8 splitter).

Using an easy to install network cable and an HDBaseT receiver, these signals can be sent to multiple displays, each at a distance of up to 100m. This splitter/extender solution supports 4K30, full HD resolutions and is also able to send 3D signals. Infrared remote control signals and LAN signals are also supported, e.g. to control connected systems remotely. LINDY's HDBaseT devices are compatible with HDBaseT projectors and devices made by all popular manufacturers.

1
HDMI HDBaseT Extender
with 4 Port Splitter
→ Page 53, 38116
with 8 Port Splitter
→ Page 53, 38117

2
HDMI BaseT RECEIVER
HDMI UHD 4K@60Hz
→ Page 53, 38118

3
IPOWER CONTROL
with Sensors
→ Page 132, 32672



2

3

HDMI DISTRIBUTION

C6 70m HDMI Extender

- Extends HDMI & IR signals up to 70m via its HDBaseT connection
- Supports resolutions up to Ultra HD 4K 60Hz including Full HD 1080p 3D
- Power over HDBaseT allows a single power supply to power the Transmitter and Receiver
- Bi-directional IR control of AV display and source equipment

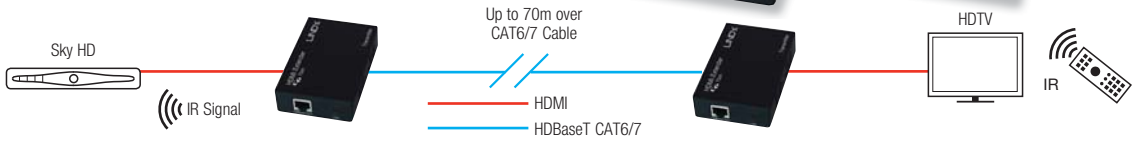

NEW

70m C6 HDMI Extender Premium

38139

C6 HDMI 100m Extender

- Allows high-resolution digital video, including 3D signals to be sent between devices at distances of up to 100m using low cost CAT6/7 cable
- Extends uncompressed HDMI or DVI-D signals up to 100m via its HDBaseT connection
- Supports HDTV resolutions up to Ultra HD 4K 3840x2160p 60Hz 4:2:0 8 bit including 1080p 3D
- Supports LPCM, DTS Digital, DTS HD, Dolby Digital & Dolby True HD audio
- Allows the remote control of equipment via CEC or IR extension up to 100m
- An integrated Ethernet hub also allows you to conveniently connect network equipment over the same single CAT 5e/6/7 cable

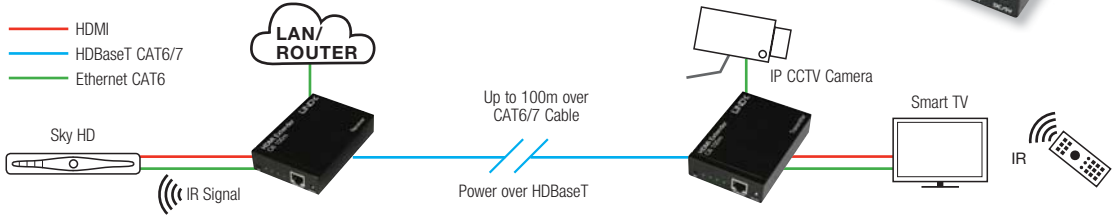

BEST SELLER

C6 HDMI 100m Extender

38119

C6 100m HDMI Extender Premium

- Extends uncompressed HDMI or DVI-D signals up to 100m via HDBaseT
- Supports HDTV resolutions up to Ultra HD 4K 3840x2160p 60Hz 4:2:0 8 bit
- Full HD 1080p 60Hz support including 1080p 3D
- Receiver unit is powered over CAT6/7 from the Transmitter (Power over HDBaseT)
- Supports LPCM, DTS Digital, DTS HD, Dolby Digital & Dolby True HD audio
- Supports hardware RS-232 link function and Infrared remote signal
- Integrated 3 port 10/100 Ethernet hubs in both the transmitter and receiver units

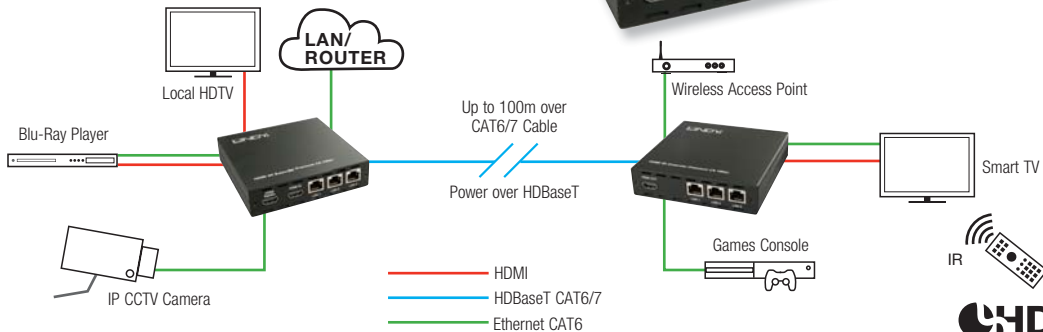

HDBT™

C6 100m HDMI Extender Premium

38115

C6 4 & 8 Port HDMI 100m Splitter Extenders

Extend an uncompressed HDMI/DVI signal to 4 or 8 displays at distances of up to 100m



- Must be used in conjunction with our 100m Receivers (38118) or Wall Plate Receivers (38114)
- Allows remote control of equipment via IR Emitter (included with Extender units)
- Connect using CAT6/7 RJ-45 cable (see page 212)
- Integrated 2 port 10/100 Ethernet hubs in both the splitter extender and receiver units
- HDBaseT technology allows uncompressed Ultra HD 4K 3840 x 2160 30Hz including Full HD 1080p 3D, as well as digital video, audio, 100BaseT Ethernet, power over cable etc. through a single LAN cable

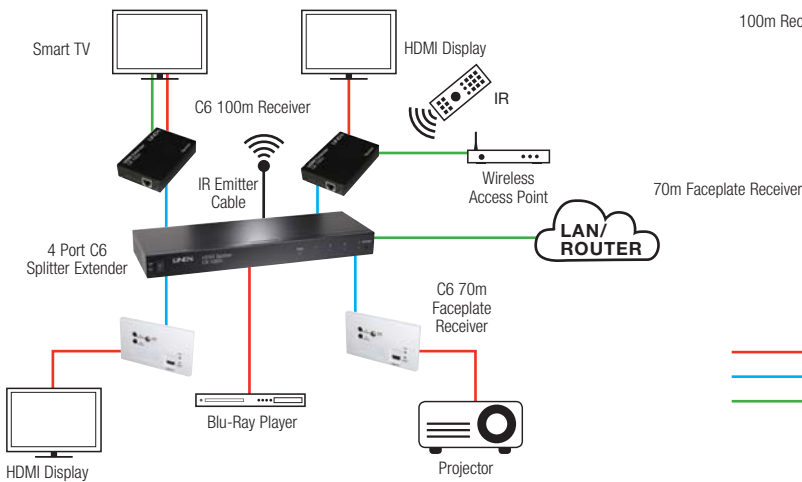

100m Receiver



70m Faceplate Receiver

- HDMI Cable
- HDBaseT CAT6/7
- Ethernet CAT6



4 Port HDMI C6 Splitter Extender	38116
8 Port HDMI C6 Splitter Extender	38117
HDMI C6 100m Receiver	38118
HDMI C6 70m Faceplate Receiver	38114

FOR CAT5E/6 CABLES
SEE PAGES
212-214

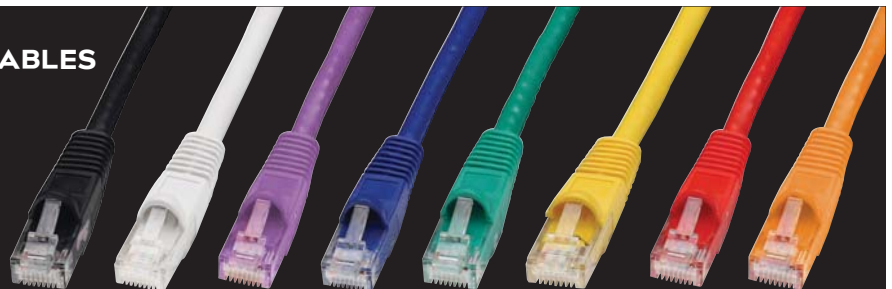

1
HDMI 4x4 Matrix Switch
with HDBaseT
→ Page 57, 38216

2
HDMI Receiver
with HDBaseT
→ Page 57, 38218

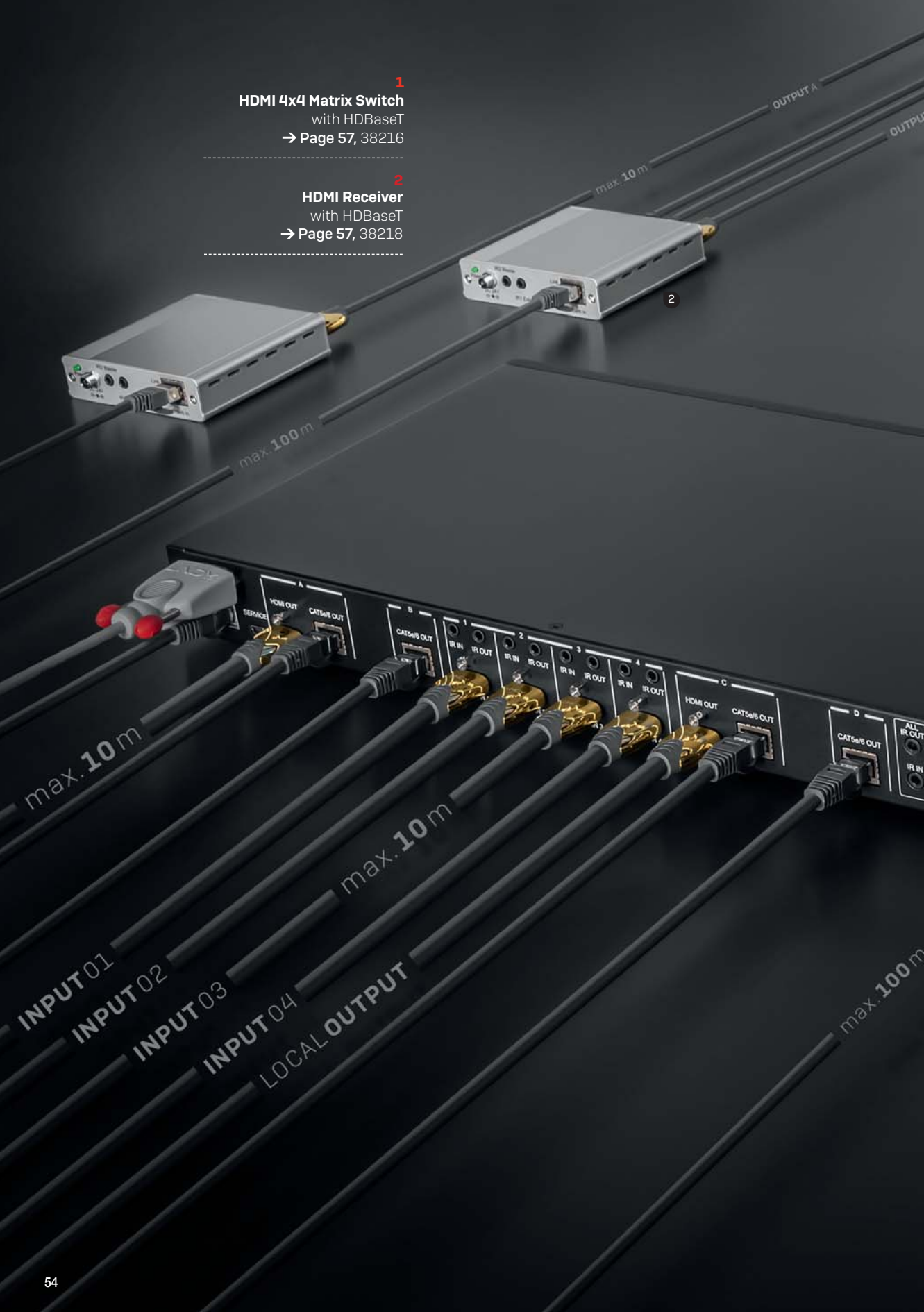



HDBaseT MATRIX FLEXIBLE SWITCHING

Modern digital signal distribution installations need flexible and scalable solutions which can transmit signals over ever greater distances. Such systems must meet bandwidth and resolution requirements and also send maximum quality audio and video signals to displays using a variety of different transmission methods. Installations in company buildings and commercial environments require large signal ranges and the use of network cable infrastructure.

The LINDY C6 HDMI 4x4 Matrix Switch sends high quality AV signals with resolutions up to 1920 x 1200 @60Hz including 1080p with 3D and multi-channel audio data from four HD source devices to four HDBaseT outputs. The switch is configured and controlled via RS-232, over IP or telnet.

The system comprises a matrix device unit and receivers (available separately). Long distance connections can be implemented at each output via a single Cat.5e cable (up to 80m) or a Cat 6/7 cable (up to 100m). Two of the outputs offer local HDMI connections for monitoring purposes.

The system supports high resolution digital audio formats such as LPCM 7.1, Dolby TrueHD, Dolby Digital Plus or DTS-HD Master Audio. Power over HDBaseT (PoH) support means that PoH compatible HDBaseT receivers no longer need their own power supply, but can be supplied with power from the network cable.

Thanks to the LAN connection, the Ethernet system can be extended to network enabled signal sources, such as Smart TV sets, to allow them to connect to the internet. This setup allows the network infrastructure in the existing building to be used.

C6 HDMI 100m Transmitter with HDBaseT

This HDBaseT Transmitter is to be used with HDBaseT equipped projectors, displays and wall plates and is perfect for home cinema or professional AV installations, capable of extending Ultra HD 4K 3840x2160p 60Hz 4:2:0 8 bit, including 3D, at distances of up to 100m using a single CAT6/7 cable. An integrated Ethernet hub also allows you to conveniently connect PC/Mac, NAS, Wireless Access Points and other network equipment over the same single CAT5e/6/7 cable.

- Extends an uncompressed HDMI/DVI signal up to 100m
- For use with HDBaseT equipped projectors, displays and wall plates
- Supports LPCM, DTS Digital, DTS HD, Dolby Digital & Dolby True HD audio through a single LAN cable

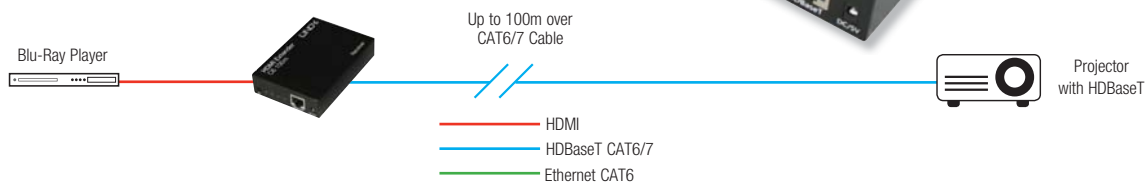

C6 HDMI 100m Transmitter with HDBaseT

38019

Free UK DELIVERY on all orders over **£125** (ex VAT.)
Some exceptions apply, see delivery terms & conditions on our website



Visit our website **WEBSITE** for the latest prices & special offers

C6 100m HDBaseT HDMI/VGA Switching 100m Extender Transmitter

Using HDBaseT(TM) Technology the LINDY C6 HDMI & VGA Switching Extender Transmitter allows you to send HDMI or VGA with Analogue Audio, Ethernet, RS-232, and IR signals up to 100m using a single high quality CAT6/7 RJ-45 cable to an HDBaseT Receiver or Display/Projector with integrated HDBaseT technology.

Switching between the HDMI and VGA inputs is quick and easy and can be completed by push button, IR remote control, RS-232 command or auto-switching, perfect for integration in to a meeting room, classroom or control centre.

- Extend HDMI/VGA, IR, Ethernet & RS-232 over a single CAT6/7 Cable when used with a compatible HDBaseT display or Receiver
- Integrated HDMI/VGA switch with manual or auto switching
- Video scaling for using legacy equipment in High Definition installations
- Includes HDBaseT PoE functionality to remotely power compatible receivers (sold separately)

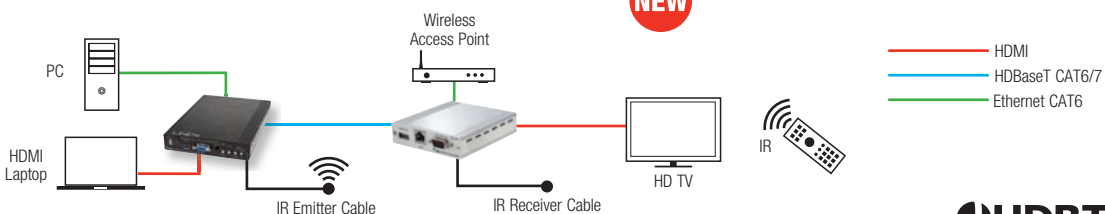

HDBaseT C6 HDMI/VGA Switching Extender Transmitter, 100m

38215

C6 HDMI Receiver Premium with HDBaseT, 100m

38218

C6 HDMI 4 x 4 Matrix Premium with HDBaseT, 100m

The C6 HDMI 4 x 4 Matrix Premium supports the transmission of high definition video (resolutions up to Full HD 1080p including Full HD 1080p 3D***), multi-channel digital audio and control via IR, RS-232 or Web GUI/Telnet IP from four high definition sources to four HDBaseT outputs. Long distance connections are made over a single CAT5e (up to 80m) or CAT6/7 cable (up to 100m) for each output. Outputs A and C have additional mirrored HDMI outputs.

It supports high resolution digital audio formats such as LPCM 7.1 CH, Dolby TrueHD, Dolby Digital Plus and DTS-HD Master Audio as well as 3D video content. Power over HDBaseT (PoH) support means compatible receivers do not need their own separate power supplies for greater flexibility in installations whilst the LAN serving function allows devices such as Smart TVs to be connected to the network/internet.

- Distribute 4 HDMI Inputs up to 100m* to 4 HDMI displays
- Extend HDMI, IR**, Ethernet & RS-232 over a single CAT5e/6/7 Cable
- Supports resolutions up to Full HD 1080p including Full HD 1080p 3D***
- Controllable via IR, RS-232, Telnet IP & Web GUI
- Supports LPCM, DTS Digital, DTS HD, Dolby Digital & Dolby True HD audio

C6 HDMI Receiver Premium with HDBaseT, 100m

- For use C6 HDMI 4 x 4 Matrix Extender Premium
- Includes Power over HDBaseT (PoH) functionality for remote powering via C6 HDMI 4 x 4 Matrix Extender Premium

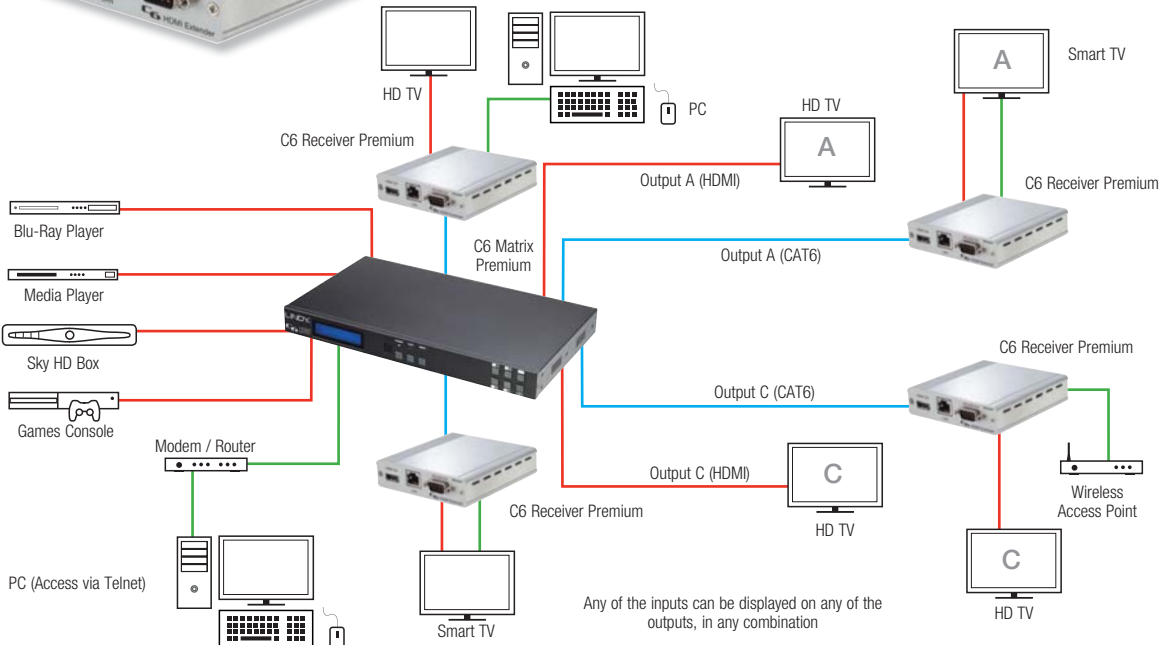

* CAT5e Maximum distance 80m, CAT6/7 100m

** IR Functionality is only available using No. 38218 C6 HDMI Receiver Premium and No. 38114 C6 HDMI Faceplate Receiver

*** 1080p 3D can only be supported using the TV EDID setting, with a 3D equipped display connected to Output A

- HDMI Cable
- HDBaseT CAT6 (up to 100m)
- Ethernet CAT6 (up to 100m)

HDMI 2.0 EXTENDER NEW HORIZONS



The development time and release intervals of new AV products has been getting shorter and shorter. Standardization bodies have been releasing new standards that define how higher resolutions, colour depths and technical refinements for 3D and HDCP are implemented. These new specifications greatly affect maximum cable distance and transmission requirements. Current displays and devices which use these new standards and requirements must continue to function reliably over extended distances from the source device.

The C6 HDMI 2.0 Extender is designed to transmit uncompressed HDMI 2.0 signals up to 100m using HDBaseT 2.0 technology. It supports HDMI resolutions up to 4K @60Hz with increased colour depth of up to 12 bits per colour channel. The transmitter and receiver is connected via a dedicated Cat.6 RJ-45 cable. Additional USB 2.0, RS-232, 10/100Base-T Fast Ethernet and IR remote control signals are also transmitted bi-directionally. This allows complete KVM workstations to be extended up to 100m from the computer with the highest resolutions, colour depth and according to the latest standards.

100m C6 HDMI 2.0 & USB KVM Extender

- Extends HDMI 2.0 compatible signals up to 100m using HDBaseT 2.0 Technology
- Supports resolutions up to Ultra HD 4K 3840x2160p 60Hz 4:2:0 8 bit including 1080p 3D
- Use a single cable to extend HDMI, USB, RS-232, IR, Ethernet and Audio Signals
- Integrated Power over HDBaseT functionality, requires only a single power supply
- HDCP 1.4/2.2 pass-through

NEW

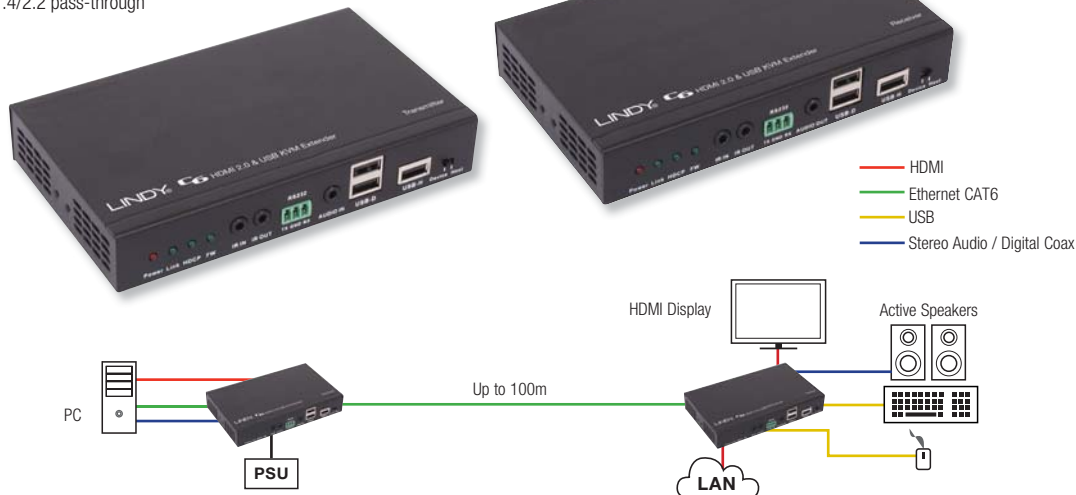

100m C6 HDMI 2.0 & USB KVM Extender

38209

C6 HDMI 2.0 Extender Pro with HDBaseT Technology, 100m

Using HDBaseT 2.0 technology the LINDY C6 HDMI 2.0 Extender Pro system allows you to send HDMI (up to 4K 60Hz), USB, Ethernet, RS-232, digital & analogue audio and IR signals up to 100m using a single high quality CAT6/CAT7 RJ-45 cable. For added convenience and to enable discreet installation of the Receiver unit, the Extender supports PoH (Power over HDBaseT) allowing a single power supply to be used with the Transmitter to power both units. For best results and especially longer distances, we recommend using solid core/structured cabling.

- Consists of a transmitter and receiver unit (each sold separately)
- Extends HDMI 2.0 compatible signals up to 100m using HDBaseT 2.0 technology
- Supports resolutions up to Ultra HD 4K 3840x2160p 60Hz 4:2:0 8 bit including 1080p 3D
- HDCP 1.4/2.2 pass-through
- Use a single cable to extend HDMI, USB, RS-232, IR, Ethernet and audio signals
- Integrated Power over HDBaseT (PoH) functionality requires only a single power supply

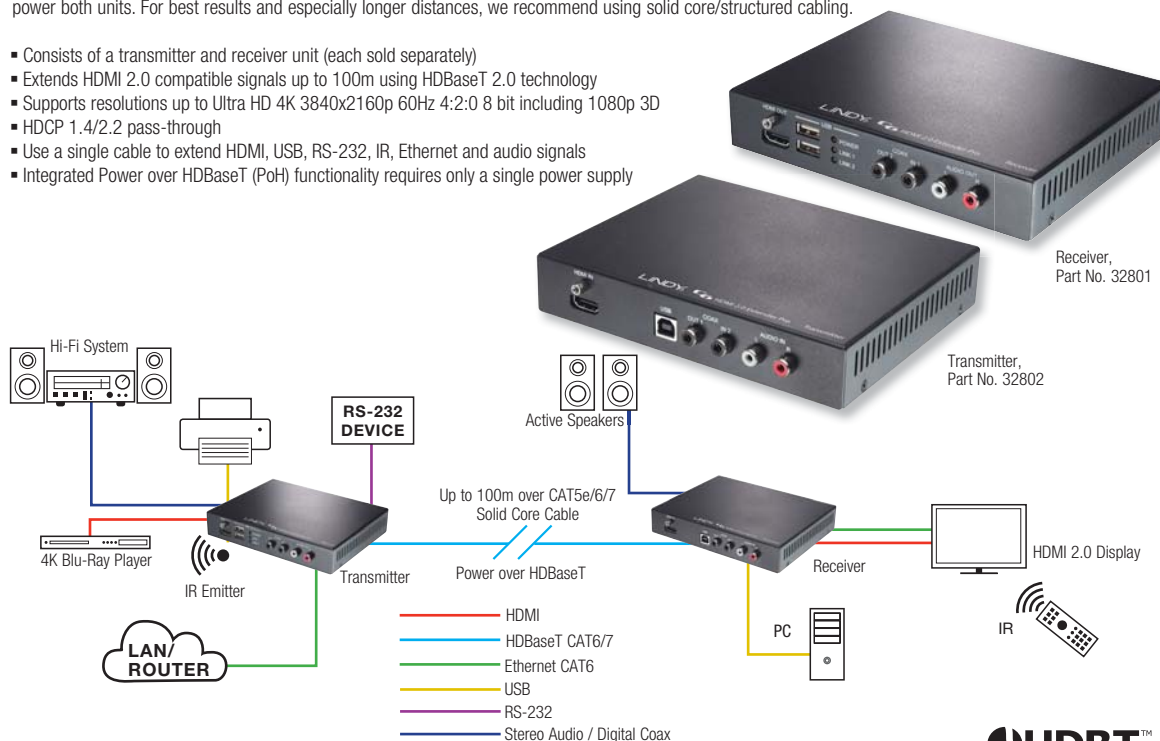

C6 HDMI 2.0 4K Extender Pro, Transmitter 100m

38202

C6 HDMI 2.0 4K Extender Pro, Receiver 100m

38201

FIBRE OPTIC 4K HDMI EXTENDER AT THE SPEED OF LIGHT

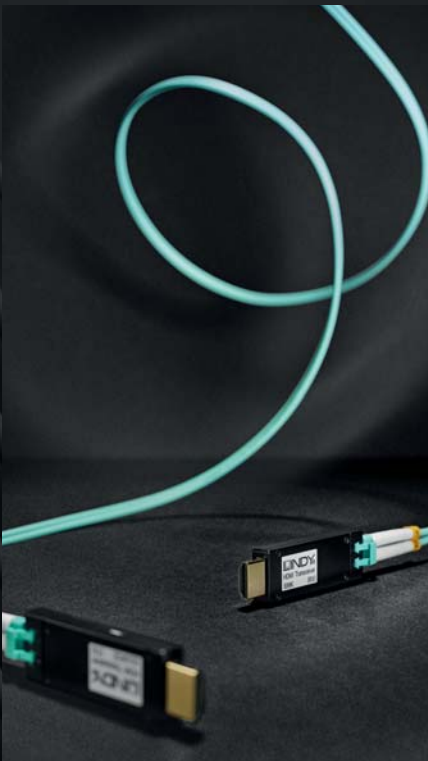

1080p, 1080p120, 2160p30, 1080p3D, 2K, and now 4K: The requirements for bandwidth and speed of a signal transmission increases with each new HDMI version. With 4K@60Hz, a colour sampling ratio of 4:4:4 at 12 bits per colour channel, the bandwidth increases to 21.6 Gbits per second. Given these requirements, a conventional (copper based) extender system will quickly reach its limits.

The fibre optic based extender systems were specially designed for such scenarios. They take advantage of the higher bandwidth, the much better transmission characteristics and the significantly lower susceptibility to interference of optical media compared to copper based transmission paths.

In contrast to copper cables, fibre optic cables work reliably even when surrounded by electromagnetic interference. Thus, with the right systems and high quality, low attenuation OM3 fibres, you can easily bridge distances of over 300m, or even of up to 5000m when using single-mode fibres.

300m Fibre Optic 4K HDMI Extender

- Extends HDMI signals, including Ultra HD 4K 3840x2160p 60Hz 4:2:0 8 bit including Full HD 1080p 3D at distances of up to 300m using a single fibre optic cable
- Requires a LC Duplex OM3 50/125µm cable (see page 211)
- Supports HDMI signals including 3D, HDCP, CEC, DDC/EDID and audio
- HDCP compatible

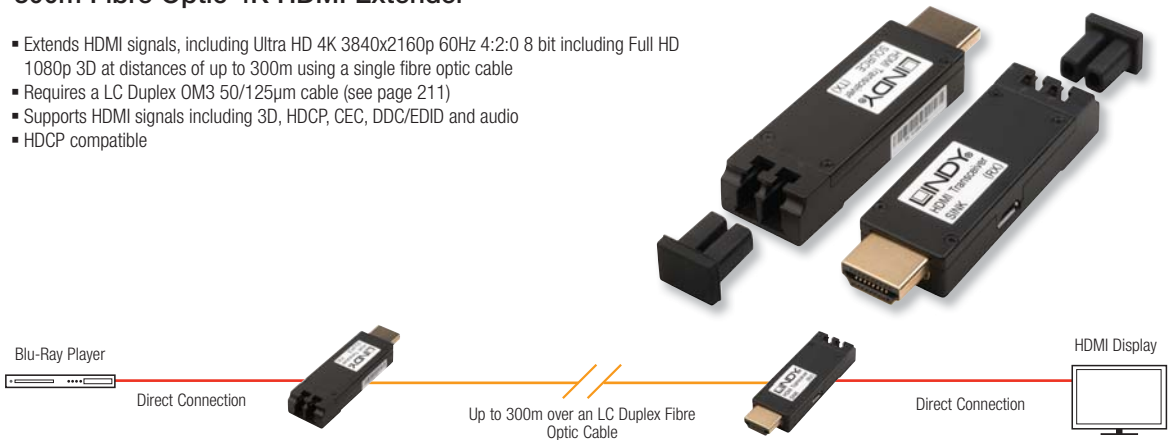

300m Fibre Optic 4K HDMI Extender

38170

300m Fibre Optic 4K HDMI Extender

- Extends Ultra HD 4K 3840x2160p 60Hz 4:2:0 8 bit, including Full HD 1080p 3D, up to 300m using a single SC duplex multimode fibre optic cable, see page 210
- HDCP compatible
- Infrared Remote Control Kit (sold separately)

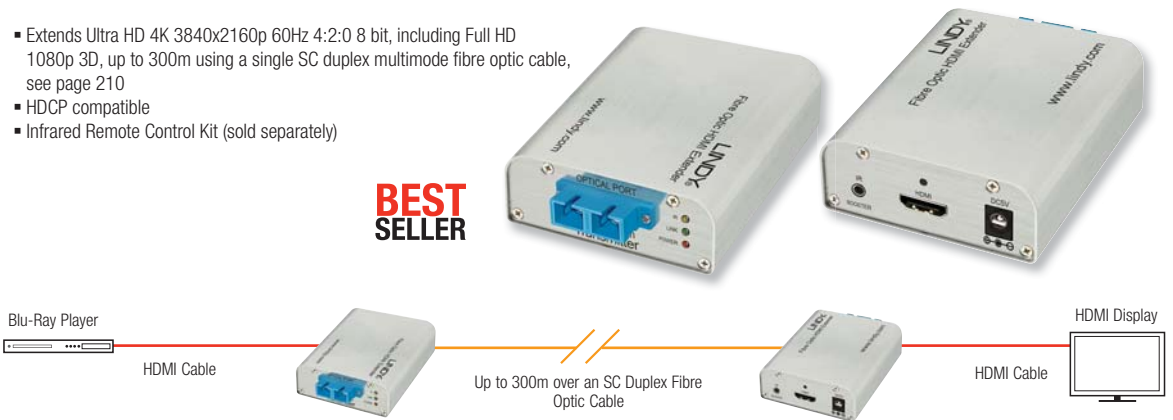

300m Fibre Optic 4K HDMI Extender

38003

Infrared Remote Control Kit

38006

3km Fibre Optic 4K HDMI Extender

Sends ultra high definition 4K up to 3km

- Extends Ultra HD 4K 3840x2160p 60Hz 4:2:0 8 bit, including Full HD 1080p 3D, up to 3km using a single LC duplex fibre optic cable, see page 210
- HDCP compatible (up to 700m)
- Infrared Remote Control Kit (sold separately)

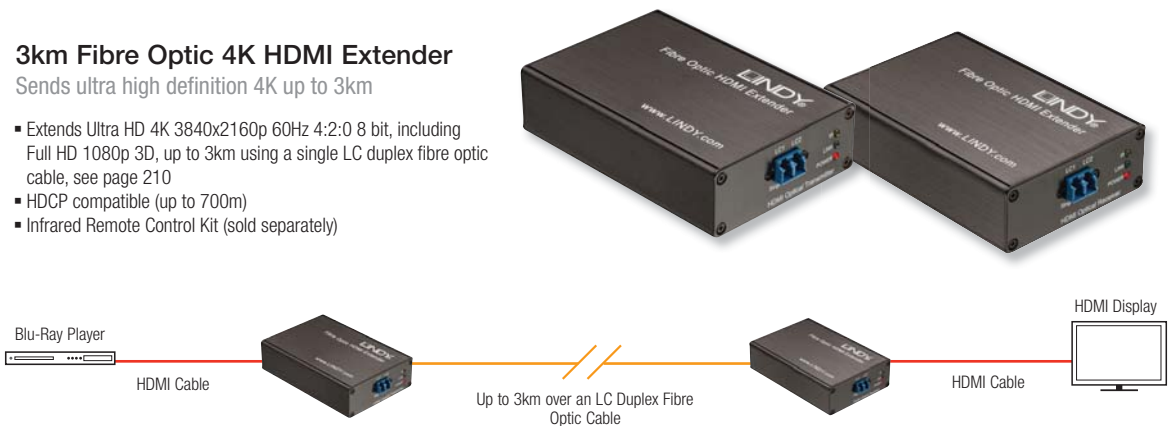

3km Fibre Optic 4K HDMI Extender

38063

Infrared Remote Control Kit

38006

HDMI OVER IP MAXIMUM DISTANCES

Modern video signal transmissions are putting ever greater demands on transmission technology. Often there is the need to distribute signals and content for digital display in unicast or multicast applications to one or more displays. A cost efficient solution is needed to transmit AV signals to multiple locations with exceptional image reproduction. These kinds of extender and signal products should be IP based in order to be able to make use of existing network structures.

The IP based HDMI transmission systems from LINDY can be used to distribute AV signals in Full HD quality to displays placed in various locations whether these be flat screens, projectors or mobile devices. One receiver is needed for each display.

The products are configured over the network in a simple, uncomplicated way. In contrast to digital signage solutions, with media players on each individual display, these systems offer low costs as well as the advantage of simultaneous, real-time transmission of content on all display devices.





1
100m HDMI over IP Extender
Full HD 1080p
→ Page 64, 38126

2
HDMI Cable
length: 0.3–30m
→ starting page 237

3
Cat.5/6/7 Cable
length: 0.3–100m
→ starting page 212

FIBRE OPTIC EXTENDERS, HDMI OVER IP

200m MPO Fibre Optic 4K HDMI 2.0 Extender

- Supports HDMI 2.0 up to Ultra HD 4K 3840 x 2160 60Hz including Full HD 1080p 3D
- Support for HDR (High Dynamic Range) video
- Requires a single MPO fibre cable of up to 200m
- Maximum bandwidth: 18Gbps / 600MHz
- Supports High Dynamic Range HDR10
- HDCP pass-through

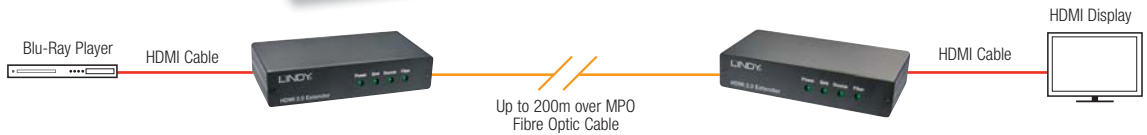

200m MPO Fibre Optic 4K HDMI 2.0 Extender

38204

100m HDMI over Gigabit Ethernet IP Extender

NEW



Designed to distribute HD video signals over long distances the HDMI over IP Extender is a cost effective solution for digital signage, presentation and demonstration applications. The HDMI over IP Extender is capable of broadcasting 1080p Full HD over a standard gigabit network, in 1 to 1, 1 to many and many to many configurations. Using up to 3 layers of active network equipment to distribute signals the HDMI over IP Extender is ideal for distributing video content throughout large buildings such as schools, hotels, hospitals, shops, shopping centres and business premises.

The HDMI over IP Extender is sold with Transmitter and Receiver units included with additional Receivers available separately providing the ultimate in flexibility at the point of installation and the ability to easily expand the installation at a later date. In addition the Transmitter and Receiver units can be directly connected using a CAT6 cable of up to 100m, to create a low cost 100m HDMI and IR Extender.

- Extend HDMI signals over a Gigabit Ethernet Network or 100m using a single CAT6 Cable
- Supports 1 to 1, 1 to Many and Many to Many configurations via Gigabit Ethernet
- Designed for digital signage, presentations and demonstrations
- Supports resolutions up to 1080p with 8 bit colour and HDCP

1 to Many over a Gigabit Network:



1 to 1 over CAT6:



100m HDMI over Gigabit Ethernet IP Extender

38126

Additional Receiver Module

38129

HDMI over Gigabit Ethernet Extender System

- Extends Full HD 1080p 60Hz via 1000Base-T Gigabit Ethernet or a single RJ-45 cable (up to 100m, not included)
- Also extends USB, RS-232 and IR remote control signals - can be used as a KVM extender for remote control of a PC
- Supports transmission through network switches and other devices such as Fibre Optic Media Converters for longer distances
- Supports infrared signals to the HDMI source – you can control the remote HDMI source (BD/DVD player) using its own remote control
- Transmitter and Receiver units sold separately - you can purchase the relevant quantities according to your requirements

— HDMI Cable
— Ethernet Cable
— USB Cable

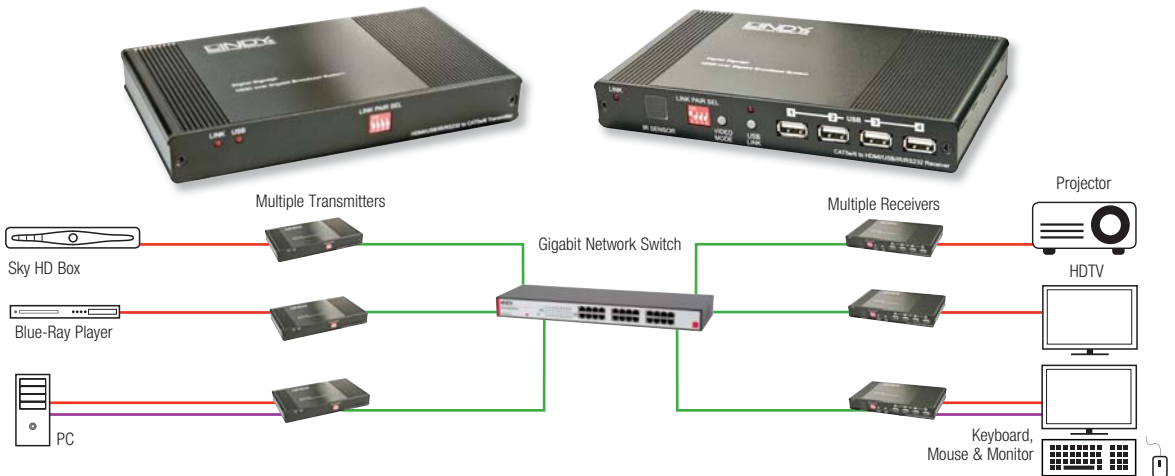

*Please Note: Only asynchronous USB devices such as keyboard and mouse are supported, mass storage, pen drives, printers and webcams cannot be supported

HDMI over Gigabit Ethernet Extender System Transmitter

38066

HDMI over Gigabit Ethernet Extender System Receiver

38067

HDMI over Gigabit IP Video Wall Extender

- Allows you to distribute HDMI via RJ-45 cable up to 100m or through an Ethernet network to multiple displays
- Converts the HDMI signal to IP broadcast signals allowing network devices to be used to distribute the signals
- Supports 1-to-1 (Unicast), 1-to-many (Multicast), many-to-many (Multicast) modes
- Video Wall mode supports screen arrays from 1 x 2, 2 x 2 to 8 x 8
- Ability to cascade up to 3 layers of network switches
- Features Video Tearing & Display Bezel correction
- Supports resolutions up to Full HD 1080p 60Hz
- Transmitter and Receiver units sold separately

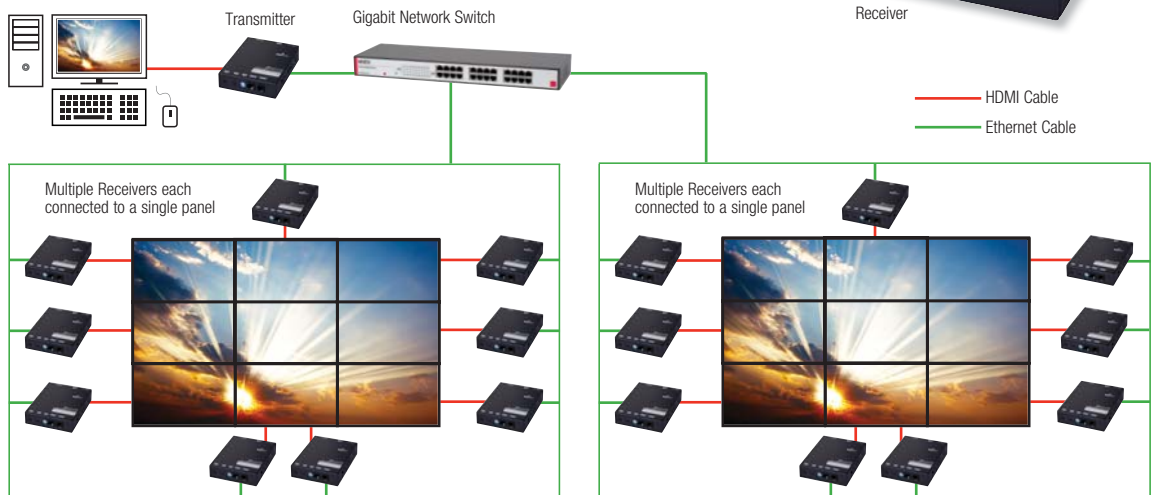

HDMI over Gigabit IP Video Wall Extender, Transmitter Unit

38132

HDMI over Gigabit IP Video Wall Extender, Receiver Unit

38133

VIDEO WALL MATRIX

1 SWITCH - 3 SOLUTIONS

A video wall fitted with HDMI panels needs a flexible and reliable solution for diverse applications. It should be possible to control multiple inputs from different source devices and switch them according to the needed requirement. The outputs need to support functions such as video wall, video matrix or dual-mode operation with simple installation and intuitive management control.

The LINDY HDMI 2x2 Video Wall Matrix Controller provides optimal convenience for bringing together different HDMI sources and outputting in three different modes: Video Wall, Matrix or Dual. In these modes, 4 HDMI inputs can be switched to 4 HDMI outputs. Operation can be controlled with the supplied remote control, the front control panel or the (supplied) controller software via RS-232 or Ethernet. The ideal, flexible solution for digital signage applications, restaurants, schools and colleges, monitoring environments or TV/radio broadcasting buildings.



1

1
HDMI Video Wall Matrix
with integrated scaler
→ Page 68, 38131

2

HDMI Cable
length: 0.3–30m
→ starting Page 237

4 x 4 Seamless HDMI Matrix with Video Wall Scaling

Pro grade video wall with 3 display modes

- Allows 4 HDMI inputs to be displayed in 3 different modes across 4 displays:
 - Video Wall Mode – Display an HDMI source across a 2 x 2 video wall
 - Matrix Mode – Display any HDMI source on any HDMI display
 - Dual Mode – Display 2 sources on a single HDMI display
- Bezel correction to assist screen blending
- Provides seamless switching between HDMI sources
- Controlled via on-panel controls, IR remote, RS-232 and Telnet
- Supports input resolutions up to Full HD 1080p 60Hz
- Memory function to store 4 user determined configurations



Output Mode Examples

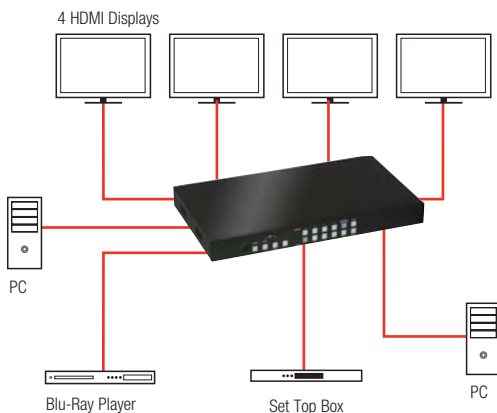

Video Wall

Displays a single user definable HDMI source across a 2 x 2 video wall

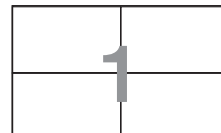

Video Matrix

Displays any HDMI source on any HDMI display



Dual Output

Displays two HDMI sources on a single output. Outputs are grouped as follows: Dual A (outputs A & B) and Dual B (outputs C & D)



4 x 4 Seamless HDMI Matrix with Video Wall Scaling

38131

HDMI 1:4 Video Wall Controller Scaler

The LINDY HDMI Video Wall Controller Scaler allows an HDMI input source to be freely arranged on 4 displays (TV or monitor) and or cascaded (via Output D) using multiple units to extend the HDMI signal to even larger arrays. Each output can be adjusted for bezel correction, contrast, brightness, saturation and hue so that you can optimise the appearance of your video wall.



- Scale a single HDMI input across 4 displays (2 x 2, 4 x 1, 1 x 4)
- Larger video walls (up to 15 x 15) can be created by cascading additional Scalers
- Bezel correction and picture adjustment
- Supports input resolutions up to Full HD 1080p 60Hz

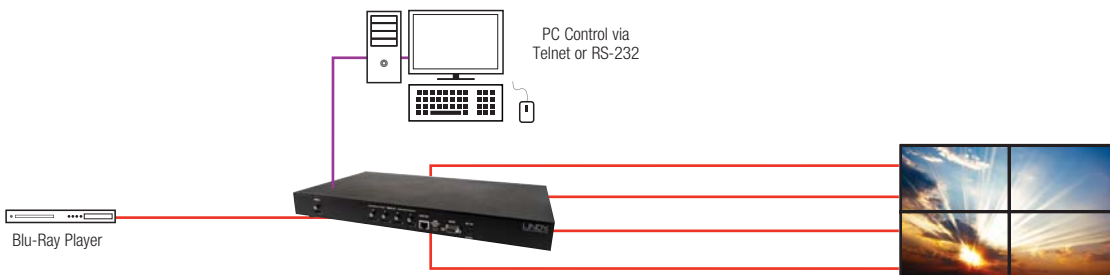

The Scaler, or multiple Scalers in larger installations, can be controlled by a simple control application or via RS-232 and Telnet using the commands listed in the user manual, making it simple to integrate within your installation.

HDMI 1:4 Video Wall Controller Scaler

38134

4K UHD HDMI 1:4 Video Wall Controller Scaler

The LINDY 4K HDMI Video Wall Controller Scaler allows a Ultra HD 4K input source to be freely arranged on 4 displays (TV or monitor) in a variety of arrangements (2 x 2, 4 x 1, 1 x 4). Larger video walls (up to 15 x 15) can be created using a HDMI splitter and multiple Scalers.

Each output can be adjusted for bezel correction, contrast, brightness, saturation and hue so that you can optimise the appearance of your video wall.

- Scale a single HDMI input across 4 displays (2 x 2, 4 x 1, 1 x 4)
- Larger video walls (up to 15 x 15) can be created by using additional Scalers combined with HDMI splitters
- Bezel correction and picture adjustment
- Supports Input resolutions of up to Ultra HD 4K 4096 x 2160 30Hz

This flexible feature rich product has been designed to be used in a number of different applications, such as:

- Public/Retail Advertisement
- Digital Presentation
- Broadcasting & Control
- Surveillance & Control
- University Lecture hall display and control
- Conference & Meeting Room



The Scaler, or multiple Scalers in larger installations, can be controlled by a simple control application or via RS-232 and Telnet using the commands listed in the user manual, making it simple to integrate within your installation.

4K UHD HDMI 1:4 Video Wall Controller Scaler

38135

4 Port Seamless HDMI Video Processor Switch with PiP

Picture-in-Picture, multi-window and overlay modes

- Allows 4 inputs to be displayed in 3 different modes on a single display
 - Picture in Picture (PiP)
 - Multi-Window
 - Overlay (Chromakey)
- Seamless switching between HDMI sources
- Independent audio channel election
- Supports resolutions up to Full HD 1080p 60Hz
- Controlled via on-panel controls, IR remote, RS-232, Telnet and web GUI

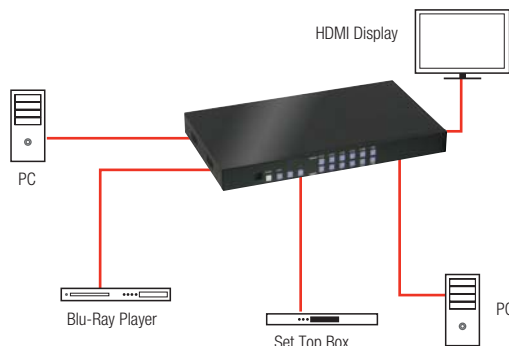

Output Mode Examples

Single Channel

A single input is displayed



All Channels

All inputs are displayed in a 2 x 2 grid



Picture in Picture

Input selected under channel 1 will be displayed full screen, with the inputs selected under channels 2 - 4 shown across the bottom of the screen



4 Port HDMI Video Processor Switch with PiP

38130

DVI SWITCHES & SPLITTERS

4 Port DVI & Audio Switch

Remote control digital multimedia switch

- Supports resolutions up to 1920 x 1200 60Hz
- Allows up to 4 DVI equipped devices to be connected to one display
- Also supports stereo audio signals via five 3.5mm sockets (20cm audio cables included)

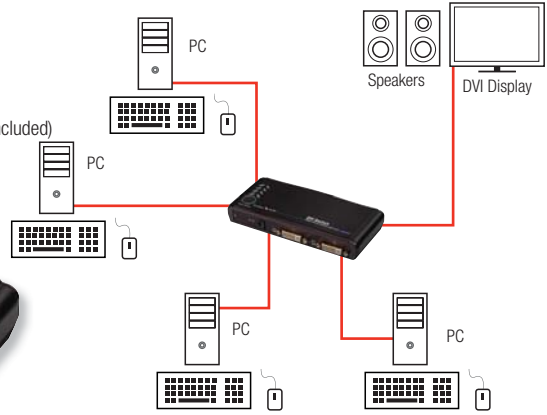

4 Port DVI & Audio Switch

38032

DVI Splitter Cables

Allows a computer, or other DVI equipped device, to output its signal to two separate displays

DVI-I Male to DVI-D Female + VGA Female

- Designed for short range desktop installations of up to 10m; for longer distances we recommend you use our powered DVI-D video splitter boxes
- Available in beige and black
- Length: 0.2m



DVI-I Male to DVI-D Female + VGA Female, Beige, 0.2m

41048

DVI-I Male to DVI-D Female + VGA Female, Black, 0.2m

41218

DVI-I Female to DVI-D Male + VGA Male

- Allows VGA and DVI-D signals to be sent to a display equipped with both DVI and VGA inputs
- Length: 0.25m



CABLE GURU
FIND THE CABLE YOU NEED
Try it now on our
WEBSITE

DVI-I Female to DVI-D Male + VGA Male, 0.25m

41008

DVI-D Single Link Splitters

Sends DVI digital signals to multiple monitors

- 2, 4 and 8 port models available
- Supports resolutions up to 1920 x 1200 60Hz
- Daisy chain support for adding extra monitors
- Video bandwidth: 165MHz

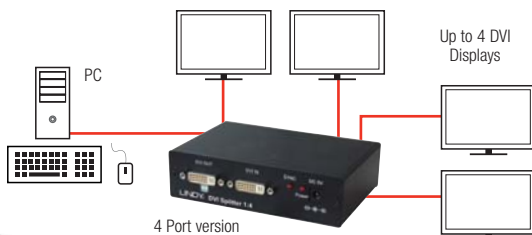

2 Port DVI-D Splitter	32447
4 Port DVI-D Splitter	32446
8 Port DVI-D Splitter	38108

Download the latest
PRICE LIST
 from our website



Visit our website
WEBSITE
 for the latest prices
 & special offers



DVI-D Dual Link Splitters

Dual Link support for higher resolutions

- 2 & 4 port versions available
- Supports resolutions up to DVI-D Dual Link 2560 x 1600 60Hz
- Video bandwidth: 225MHz

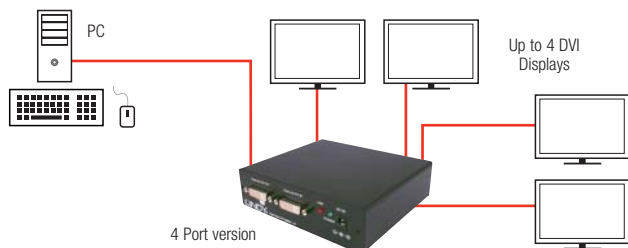

2 Port DVI-D Dual Link Video Splitter	38107
4 Port DVI-D Dual Link Video Splitter	38104

DVI MATRIX SWITCH & EXTENDERS

8 x 8 DVI Matrix Switch

Connects up to 8 DVI devices to 8 displays or projectors

- Each input can be sent to any of the 8 connected display devices
- Infrared remote control for switching between devices and displays
- Supports cable runs of up to 20m (10m in, 10m out)
- RS-232 port for external control
- Supplied with 19" rack mount brackets

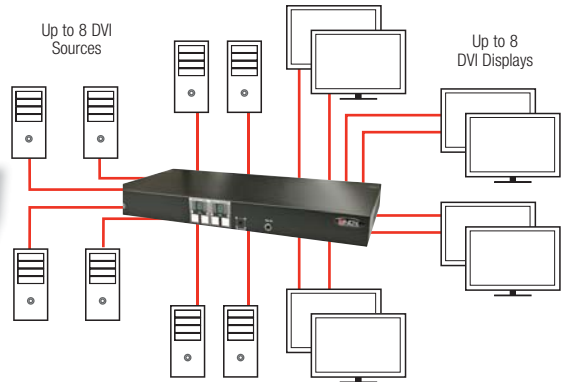

8 x 8 DVI Matrix Switch

38089

45m DVI-D Dual Link Repeater

- When used in conjunction with our Super Long Distance DVI Cables (see page 252) it allows connections of up to 25m from the source and up to 20m to the display
- Supports DVI-D Dual Link resolutions up to 2560 x 1600



45m DVI-D Dual Link Repeater

32670

30m & 70m CAT6 DVI-D Single Link Extenders

Affordable solution using low cost Ethernet cables

- Transmitter and receiver which connect to your device's DVI ports
- 32599 supports the following transmission distances and resolutions:
 - 15m @ 1920 x 1200 or 1080p using CAT6a (S/FTP) cable
 - 20m @ 1280 x 1024 using CAT6 UTP or S/FTP cable
 - 30m @ 1024 x 768 using CAT6a (S/FTP) cable
- 38300 supports the following transmission distances and resolutions (using CAT6 UTP cable):
 - 50m @ 1920 x 1200 or 1080p
 - 65m @ 1024 x 768
 - 70m @ 800 x 600
- HDCP encrypted content is not supported

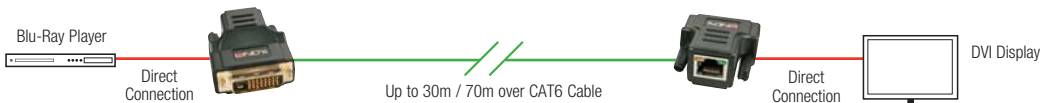

30m CAT6 DVI-D Single Link Extender

32599

70m CAT6 DVI-D Single Link Extender

38300

500m Fibre Optic DVI-D Single Link Extender

- Supports resolutions up to Full HD 1920 x 1200p 60Hz
- Uses two standard LC duplex or four LC simplex multimode (50/125µm) cables, up to 500m (not included, see pages 210-211)
- Auto & Self learning EDID transmission
- Connects directly to the source and display

NEW

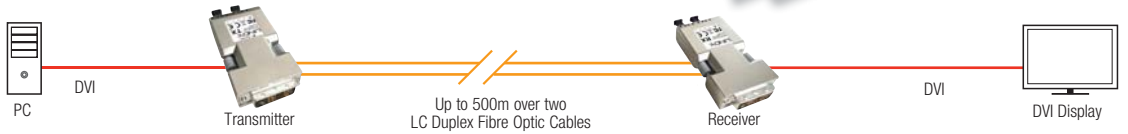

500m Fibre Optic DVI-D Single Link Extender

38301

1500m Fibre Optic DVI-D Single Link Extender

- Supports resolutions up to Full HD 1920 x 1200p 60Hz
- Uses standard LC duplex multimode (50/125µm) up to 500m or LC duplex single mode (9/125µm) up to 1500m fibre optic cable (not included, see pages 210-211)
- Auto & Self learning EDID transmission
- Connects directly to the source and display

BEST SELLER

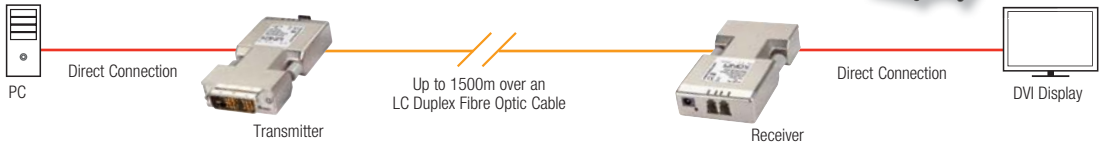

1500m Fibre Optic DVI-D Single Link Extender

38113

500m Fibre Optic DVI-D Dual Link Extender

- Supports dual link resolutions up to Full HD 2560 x 1600p 60Hz
- Uses standard MPO multimode (50/125µm) cables with method A termination, up to 500m (not included, see page 211)
- Auto & Self learning EDID transmission
- Connects directly to the source and display

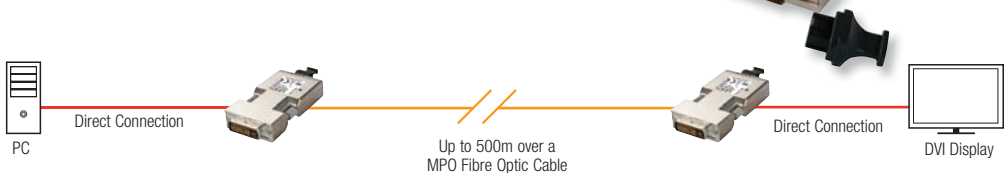

500m Fibre Optic DVI-D Dual Link Extender

38106

FIBRE OPTIC DVI EXTENDERS

300m Fibre Optic DVI-D Single Link Extender

- Supports resolutions up to Full HD 1920 x 1200p
- IR remote control support using our infrared kit (sold separately)
- RS-232 port for extending control signals
- Uses standard SC duplex multimode (50/125µm) fibre optic cable up to 300m (not included, see page 211)
- HDCP compliant

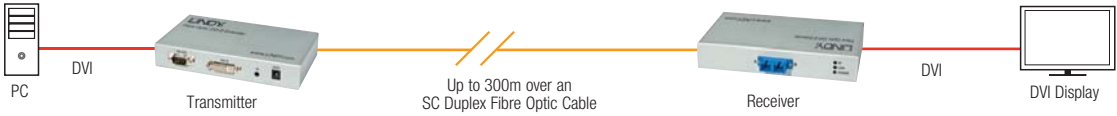

300m Fibre Optic DVI-D Single Link Extender

38004

Infrared Remote Control Kit

38006

5km Fibre Optic DVI-D Single Link Extender

- Supports resolutions up to Full HD 1920 x 1200p
- IR remote control support using our infrared kit (sold separately)
- RS-232 port for extending remote control signals
- Uses standard SC duplex single mode (9/125µm) fibre optic cable up to 5km (not included, see page 210)

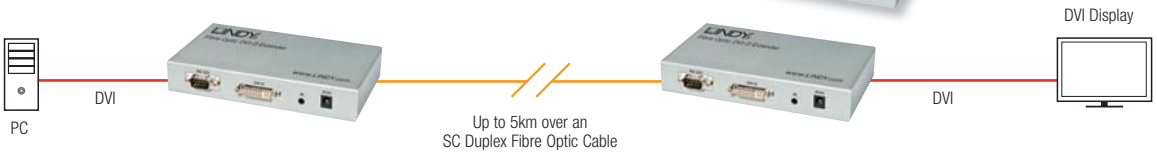

5km Fibre Optic DVI-D Single Link Extender

38064

Infrared Remote Control Kit

38006

500m Fibre Optic DVI-D Dual Link Extender

- Supports dual link resolutions up to Full HD 2560 x 1600p
- Auto & Self learning EDID transmission
- RS-232 port for extending control signals
- Uses standard LC duplex multimode (50/125µm) fibre optic cable (not included, see page 211)
- HDCP compliant

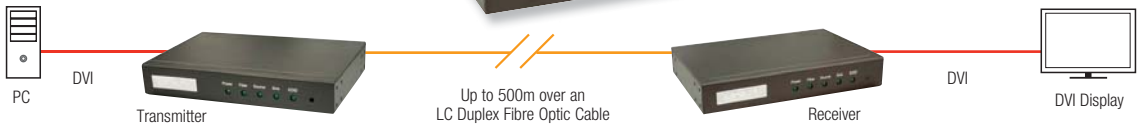

500m Fibre Optic DVI-D Dual Link Extender

38065

2 Port DisplayPort MST Hub

- Expand or duplicate your DisplayPort signal over 2 DisplayPort monitors
- Supports 4K2K@60Hz, 1080p@30Hz and 3D resolutions
- Extend your display - use a secondary screen to view additional information while working on your main screen
- Mirror your display - you can mirror your source information to view the same data across two screens
- Supports one dual mode input and two dual mode outputs
- Supports audio up to PCM 7.1
- Compliant with DP version 1.2a

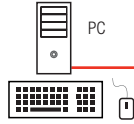

NEW



Two DisplayPort displays can be used in expanded or duplicated modes

2 Port DisplayPort MST Hub

38402

2 Port DisplayPort to HDMI Splitter with Expander View

- Split your DP signal over 2 HDMI monitors
- Alternatively expand a signal over two monitors
- Extend your display - use a secondary screen to view additional information while working on your main screen
- Compatible with DP 1.2, MST, AMD Eyefinity, NVIDIA Surround or Intel Collage mode

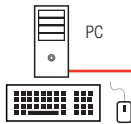

Two HDMI displays can be used in expanded or duplicated modes

Duplicated

Displays the source mirrored across 2 displays



Expanded

Displays the source expanded across 2 displays



2 Port DisplayPort to 2 Port HDMI Splitter with Expander View

38409

Mini DisplayPort to 2 x DVI-D MST Hub



NEW

- Expand or duplicate your Mini DisplayPort signal over 2 DVI monitors
- Supports up to 3840x1200 or 1920x1200 in splitter mode
- Open applications on separate displays or expanded across two monitors
- Compatible with DisplayPort 1.2, MST, AMD Eyefinity, NVIDIA Surround and Intel Collage mode



Two DVI displays can be used in expanded or duplicated modes

Mini DisplayPort to 2 x DVI-D MST Hub

41731

Mini DisplayPort to 2 x HDMI MST Hub



NEW

- Expand or duplicate your Mini DisplayPort signal over 2 HDMI monitors
- Supports up to 3840x1200 or 1920x1200 in splitter mode
- Open applications on separate displays or expanded across two monitors
- Compatible with DisplayPort 1.2, MST, AMD Eyefinity, NVIDIA Surround and Intel Collage mode



Two HDMI displays can be used in expanded or duplicated modes

Mini DisplayPort to 2 x HDMI MST Hub

41732

DISPLAYPORT VIDEO WALL & SWITCH

4K DisplayPort to 4 x HDMI Video Wall Processor

- Allows a single DisplayPort input to be displayed in 4 different modes across 4 HDMI displays: Video Wall, Duplicate, Extended and Expander / Eyefinity
- Supports DP input resolutions up to 3840 x 2160 @ 60Hz
- Supports DisplayPort MST and SST modes
- Supports HDMI resolutions up to
 - Ultra HD 3840 x 2160 30Hz – 2 Outputs
 - Full HD 1080p 60Hz – 4 Outputs
- Displays 1 & 2 can be combined to make one Ultra HD 3840 2 2160 60Hz Display
- Supports extended and duplicated desktop modes



Output Mode Examples

Video Wall

Displays a single source across a 2 x 2 video wall



Duplicated

Displays the source mirrored across 2 banks of 2 displays



Extended

Displays an extended desktop across 2 banks of 2 displays

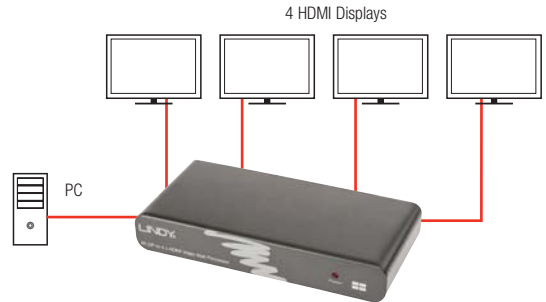

Expanded / Eyefinity

Displays the source expanded across 4 displays



4K DisplayPort to 4 x HDMI Video Wall Processor

38418

2 Port 4K DisplayPort Switch

- Switch between two DisplayPort 1.2 compatible signals with a simple button push
- Supports Ultra HD 4K 60Hz, multi-channel digital audio, DPCP and HDCP
- Supports resolutions up to Ultra HD 4K 3840 x 2160
- Supports Dual Mode DisplayPort
- Multi-channel High Definition Digital Audio, including Dolby Digital True HD and DTS-HD compatible

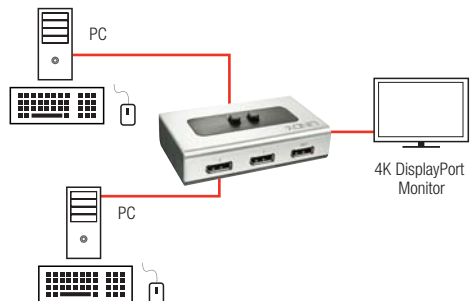

2 Port 4K DisplayPort Switch

38411

40m DisplayPort 1.2 Repeater

Allows DisplayPort signals to be transmitted at distances of up to 40m

- Supports resolutions up to Ultra HD 4K 3840x2160p 60Hz
- Max. lengths: 4K @ 60Hz up to 10m, 1600p 60Hz up to 40m
- Supports DP++/Dual Mode, DPCP and Audio over DP

NEW



40m DisplayPort 1.2 Repeater

38413

17.5m 4K DisplayPort 1.2 Repeater / Extender

- Supports resolutions up to Ultra HD 4K 3840x2160p 60Hz
- Max. lengths: 4K @ 60Hz up to 17.5m, 1600p 60Hz up to 30m
- Supports MST, DPCP and Audio over DP

NEW



17.5m 4K DisplayPort 1.2 Repeater / Extender

38412

200m Fibre Optic 4K DisplayPort 1.4 Extender

Sends DisplayPort signals up to 200m using a single fibre optic cable

- Transmits ultra high resolution DisplayPort signals up to 200m via MPO fibre optic cable
- Uses standard MPO multimode (50/125µm) cables with method A termination, up to 200m (not included, see page 211)
- Supports DisplayPort 1.4 signals with audio & DisplayPort Content Protection – DPCP
- Supports resolutions up to Ultra HD 4K 3840 x 2160p 60Hz, HBR3 & MST

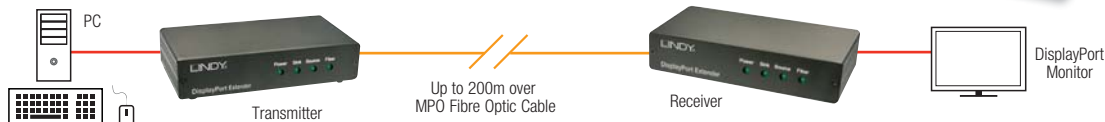

200m Fibre Optic 4K DisplayPort 1.4 Extender

38403

**FOR FIBRE OPTIC
PATCH CABLES**
SEE PAGES
210-211



VGA SWITCHES

2 Port VGA Auto Switch

- Allows you to connect 2 VGA sources to 1 VGA display and then switch between them using a front panel button, cable remote control or auto scan system
- Supports cable lengths of up to 50m using LINDY Gold VGA cables, please see page 250

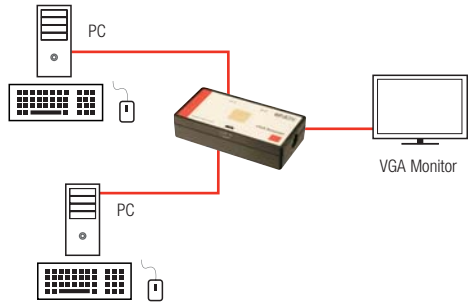

2 Port VGA Auto Switch

32585

2 Port VGA & Audio Switch

- Switch video and audio from two sources to one monitor and speakers
- Supports cable lengths of up to 50m using LINDY Gold VGA cables, please see page 250
- Remote control with 1.4m cable for convenient operation



2 Port VGA & Audio Switch

32586

4 Port VGA & Audio Switch

- Supports resolutions up to 2048 x 1536
- Switch video and stereo audio from four sources to one monitor and set of speakers
- Push button switching with optional 2m remote control cable available (see table below)
- Supports cable lengths of up to 50m using LINDY Gold VGA cables, see page 250

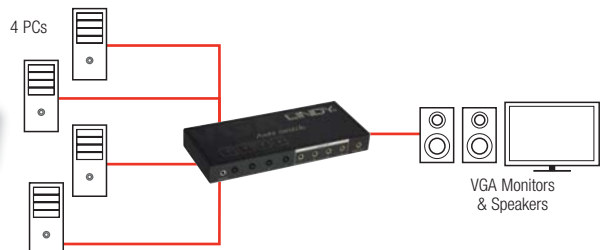

4 Port VGA & Audio Switch

32647

2m Remote Control Cable

32646

FOR VGA CABLES
SEE PAGES
250-251

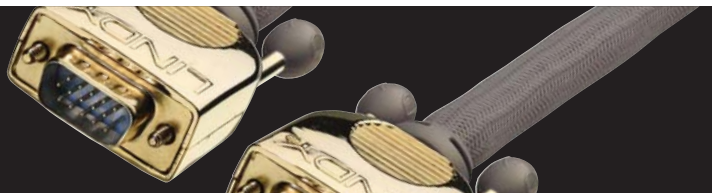

2 Port Internal VGA Video Splitter

Installs into a back-plate slot in your PC case

- High resolution support (up to 2048 x 1536)
- Transmission distance of up to 75m
- VGA card and internal power connection cables included

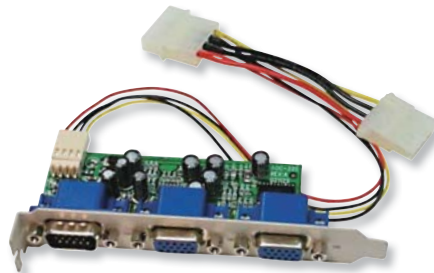

2 Port Internal VGA Video Splitter

32407

2 Port VGA Splitter Cable

Low cost alternative to an electronic VGA splitter

- Allows a computer or other VGA equipped device to output its signal to two separate displays
- Gold plated connectors
- Length: 0.18m



2 Port VGA Splitter Cable, 0.18m

41214

2 Port VGA Splitter

Duplicate and amplify your PC's video signals for transmission to two monitors

- Provides a simultaneous display on all connected monitors
- Maximum Resolution: 1920 x 1080
- Cascadeable - up to 3 units may be daisy chained for additional displays
- USB power cable included



2 Port VGA Splitter

32356

2 Port VGA Splitter Lite

Duplicate a PC's video output to two monitors

- Provides a simultaneous display on all connected monitors
- Enhances video signals for long distance broadcasting (up to 50m when using LINDY Gold VGA cables, see page 250)
- Maximum Resolution: 2048 x 1536
- Cascadeable - up to 5 units may be daisy chained for additional displays



2 Port VGA Splitter Lite

32073

Free UK DELIVERY  **on all orders over £125 (ex VAT).**
Some exceptions apply, see delivery terms & conditions on our website

Download the latest
PRICE LIST
from our website



VGA SPLITTERS & EXTENDERS

VGA Splitter Pro

Effective solution for distributing multiple video signals over long distances

- Duplicates the VGA video signal from your PC to 2, 4 or 8 monitors
- Provides a simultaneous display on all connected monitors
- Maximum cable distances (using LINDY Gold cables, page 238):
 - 5m (source to splitter) • 50m (splitter to display)
- Maximum Resolution: 2048 x 1536
- Cascadeable - several units may be daisy chained for additional displays

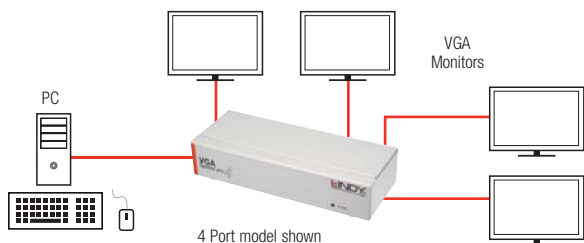

BEST SELLER

2 Port VGA Splitter Pro	32569
4 Port VGA Splitter Pro	32572
8 Port VGA Splitter Pro	32573

VGA & Audio Matrix

Versatile device for switching and splitting video and audio signals

- 2 and 4 port models available
- Each input can be sent to any of the connected displays
- Maximum Resolution: 2048 x 1536
- Infrared remote control for switching between devices and displays
- Supports cable runs of up to 65m (5m in, 60m out)

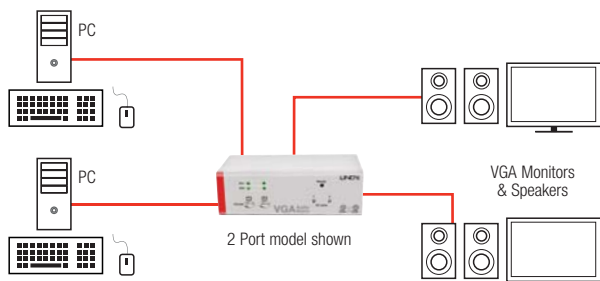

2 Port VGA & Audio Matrix	32577
4 Port VGA & Audio Matrix	32578

50m CAT5e/6 VGA Extender

- Can support the following transmission distances and resolutions:
 - 50m @ 800 x 600
 - 30m @ 1024 x 768
- Uses CAT5e or higher cable



50m CAT5e/6 VGA Extender	37571
--------------------------	-------

300m CAT5e/6 VGA Extender

- Consists of local transmitter and remote receiver units
- Supplied with a 1.2m VGA cable for connecting your PC
- Transmitter VGA pass through port for local monitor
- Supports the following distances and resolutions:
 - 300m @ 640 x 480
 - 200m @ 800 x 600
 - 100m @ 1280 x 1024
 - 50m @ 2048 x 1536

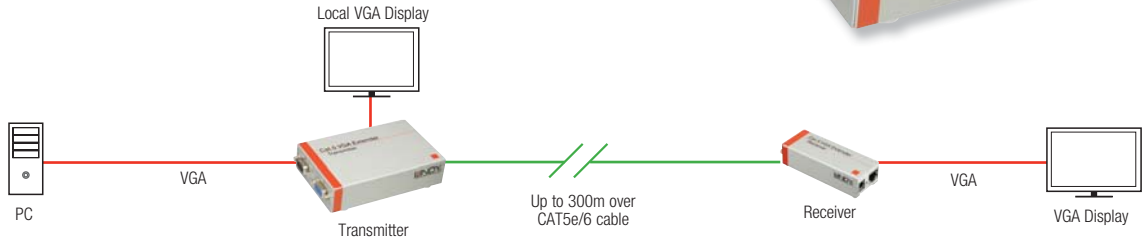

300m CAT5e/6 VGA Extender

32537

300m CAT5e/6 VGA & Audio Extender

- Consists of transmitter and remote receiver units
- Supports resolutions up to Full HD 1920 x 1200p 60Hz
- Supports the following distances and resolutions:
 - 100m @ 1920 x 1200 / 1080p
 - 200m @ 1280 x 1024 / 720p
 - 300m @ 1024 x 768
- Built in Gain and Skew controls
- Mono audio signal support (left and right channels are combined)

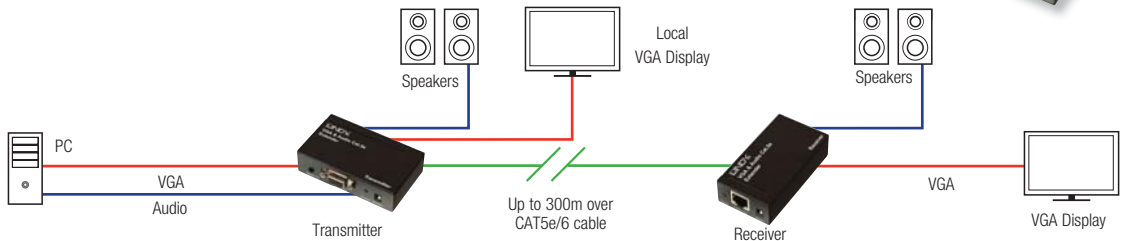

300m CAT5e/6 VGA & Audio Extender

32540

VGA Skew Compensator for CAT5 VGA Extenders

- Adjust RGB channels and eliminate colour drift when extending VGA signals over CAT5 cable
- Pass-through power connection



VGA Skew Compensator for CAT5 VGA Extenders

32766

CONFERENCE ROOMS

EFFECTIVE MANAGEMENT

In the modern business environment, meetings and conferences are unthinkable without notebooks or other mobile devices. Everyone has something to contribute and needs access to video projectors, large image displays or electronic whiteboards. Depending on the number of data sources or output devices to be integrated, the visualization of content with increasingly higher resolution AV signals can become a major challenge.

LINDY offers powerful and complete AV and KVM connectivity solutions. If the environment needs to be equipped with state-of-the-art conference technology, or if existing installations have to be retrofitted, LINDY can help. Our connectivity solutions bring high definition content to conference rooms.





- 1**
Conference Table Connection Unit
Multi AV to HDMI Presentation Switch
→ Page 85, 38 271

- 2**
HDMI Switch
→ starting Page 35

- 3**
HDMI & IR Cat.6 Extender
1080p 3D
→ Page 47, 38 009

- 4**
8 Port Desktop Switch
10/100/1000 GIGABIT
→ Page 124, 25 045

- 5**
HDMI Cable
length: 0.3–30m
→ starting Page 237

- 6**
Cat.5/6/7 Cable
length: 0.3–100m
→ starting Page 212

750m Fibre Optic VGA & Audio Extender

- Supports resolutions up to Full HD 1920 x 1200p
- Extends VGA & stereo audio signals
- Transmitter features a VGA pass-through port for local monitoring
- Uses two standard LC duplex or four LC simplex multimode (50/125µm) cables, up to 750m (not included, see pages 210-211)

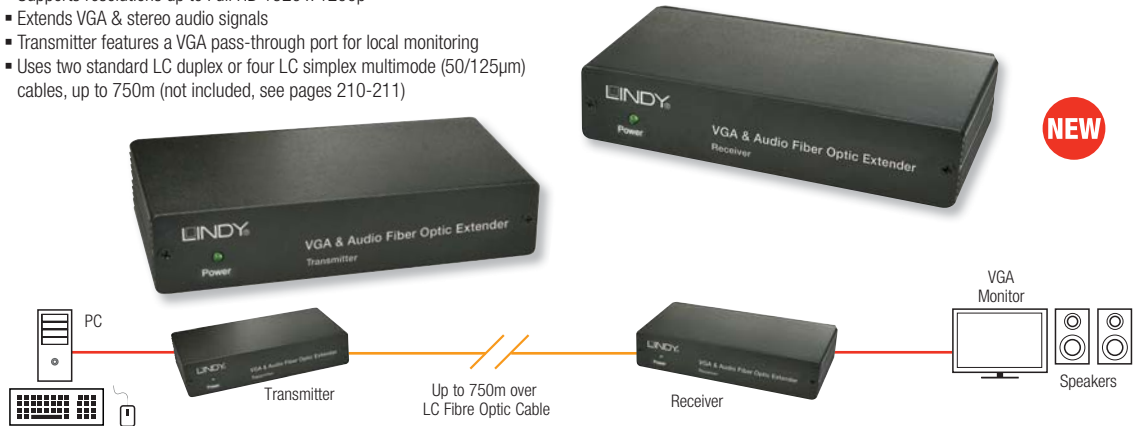

750m VGA & Audio Fibre Optic Extender

32541

8 Port Upscaling AV Conversion Switch

Featuring 8 AV inputs which can be converted and scaled to resolutions up to Full HD 1080p this AV Conversion Switch is an ideal addition to any meeting or conference room, lecture hall or auditorium. Any of the available inputs (3 x HDMI, 3 x VGA & Audio, Component Video & Audio and Composite Video & Audio) can be simultaneously shown across display equipment connected to each of the outputs (2 x HDMI and VGA). These three outputs provide compatibility with both current and legacy AV displays and can be combined with LINDY HDMI or VGA extenders to reach remotely located displays.

- Converts and scales 8 AV Inputs to resolutions up to Full HD 1080p
- Accepts HDMI, VGA, Component & Composite video signals
- Simultaneous video output via VGA and 2 x HDMI
- Can embed analogue audio to HDMI video signals
- Controlled by IR, OSD, RS-232, Telnet and Web GUI (IP/Ethernet)

- HDMI
- VGA
- Composite Video cable
- Composite Video cable
- RS-232
- Stereo Audio / Digital Coax

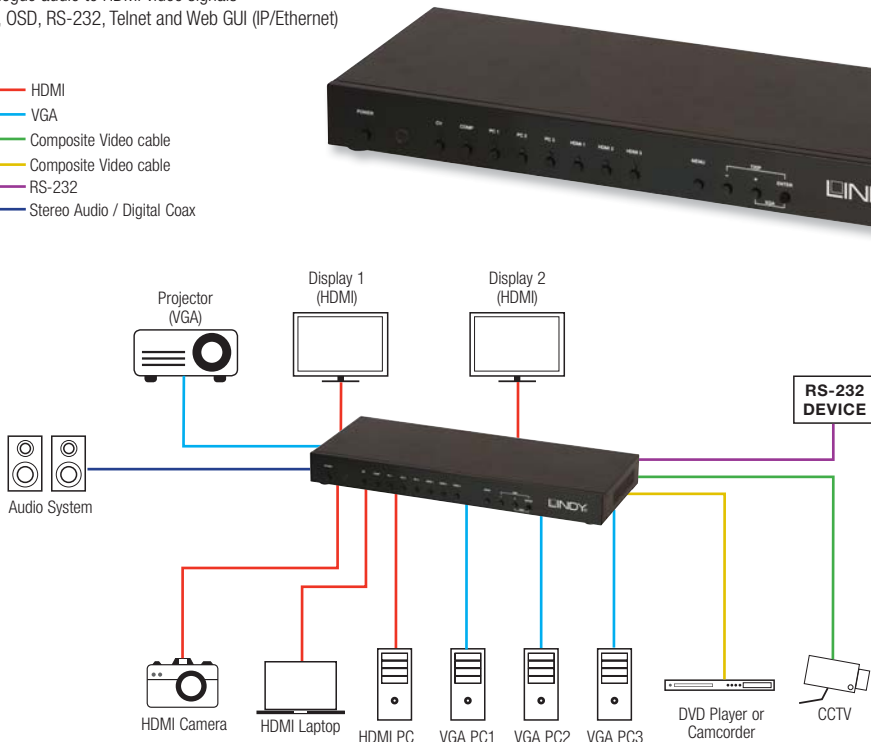

8 Port Upscaling AV Conversion Switch

38273

Multi AV to HDMI Conference Table Connection Unit

The LINDY Conference Table Connection Unit allows you to conveniently share content from a variety of devices to an HDMI display, such as a projector, using just a single cable. Each of the connected devices is instantly converted and scaled to an HDMI signal, with the unit automatically switching to use the most recently active device, making it ideal for use in class rooms, meeting/conference rooms and auditoriums. For added convenience, the unit also features an Ethernet pass through port and a USB charging (5V 1.5A) port, handy for use in the absence of WiFi or for powering mobile devices. When the unit is not in use the integrated protection panel can be pulled over the connectors hiding them from sight and protecting them from dust.

In addition to the options given by the ports featured, it is also possible to connect devices with different interfaces, such as DisplayPort, DVI, MHL and Slimport, using our range of AV converters. The Connection Unit can be used in conjunction with our range of long length HDMI cables and HDMI Extenders to reach even the most awkwardly located display or projector.

- Solution for integrating multiple devices in to meeting/conference/class room or auditorium
- Concealed, in-desk design helps reduce cable clutter
- Convert multiple analogue & digital inputs to a HDMI output
- Features VGA & Audio, Composite Video, Mini DisplayPort and HDMI AV inputs

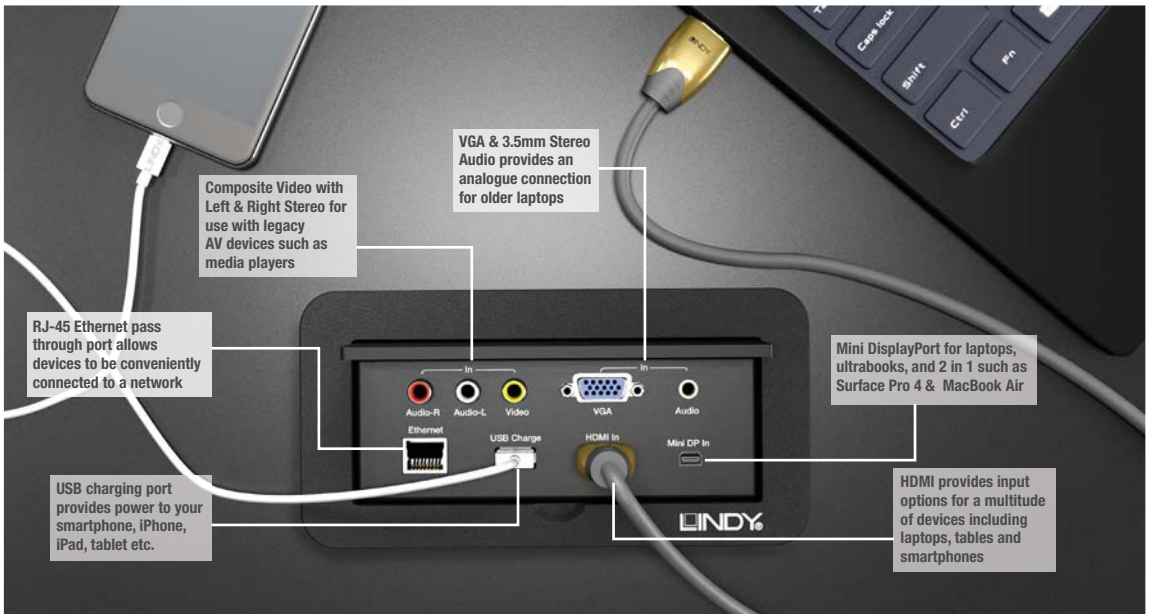

Multi AV to HDMI Conference Table Connection Unit

38271

Multi AV Input to HDMI Desktop Presentation Switch

- Solution for integrating multiple devices in to meeting/conference/class room or auditorium
- Convert multiple analogue & digital inputs to a HDMI output
- Features VGA & Audio, Composite Video, Mini DisplayPort and HDMI AV inputs
- USB charging and Ethernet pass-through ports



Multi AV Input to HDMI Desktop Presentation Switch

38270

EDID/DDC EMULATORS, HDMI SURGE PROTECTOR

EDID Emulator/Adapter for 4K HDMI 2.0 Displays

- Standalone solution, does not require an Emulator Programmer
- Supports resolutions up to Ultra HD 4K 60Hz including HDCP 1.4 pass-through
- Built in cloning/EDID Learning functionality



EDID Emulator/Adapter for 4K HDMI 2.0 Displays 32113

EDID/DDC Emulator Programmer for VGA/DVI & HDMI Displays

- Clones EDID/DDC data from VGA/DVI/HDMI displays (using VGA/DVI/HDMI Adapters, see below)
- Writes cloned EDID/DDC data to LINDY EDID/DDC Adapters (Part No's 32101, 32102 & 32103, see below)



EDID/DDC Emulator Programmer for VGA/DVI & HDMI Displays 32100

EDID/DDC Adapter for VGA, DVI & HDMI Displays

- Continuously emulates EDID/DDC information
- Uses cloned data or, when this is not available, the stored preset EDID data



DVI



HDMI



VGA

EDID/DDC Adapter for VGA Displays	32101
EDID/DDC Adapter for DVI Displays	32102
EDID/DDC Adapter for HDMI Displays	32103

EDID/DDC Emulators

- Designed for KVM switches and digital signage systems that require EDID/DDC signals to be continuously provided without interruption
- HDCP not supported



VGA



HDMI



DVI

HDMI EDID/DDC Emulator	32108
VGA EDID/DDC Emulator	32107
DVI-I EDID/DDC Emulator	32106

In-Line HDMI Surge Protector

- Protects an HDMI device against anti-static discharge, lightning surge and electrical transient bursts
- Supports all HDMI resolutions and specifications up to Ultra HD 4K 3840 x 2160 60Hz
- HDMI Female in / HDMI Female out
- Supports HEC & HDCP
- No PSU required



In-Line HDMI Surge Protector

73312

VGA/Component Video to DVI-I Scaler

- Converts VGA signals to DVI-I (digital & analogue RGB)
- A supplied adapter cable allows you to convert and upscale component video signals (YPbPr or YCbCr)
- Supplied with the following cables:
 - 1m VGA Male to 3 x Phono Male adapter cable
 - 1.2m VGA Male to Male cable
 - 1.9m DVI-I Male to DVI-I Male

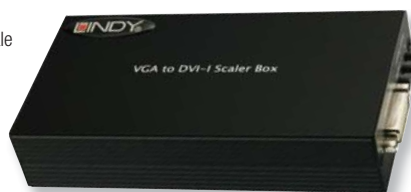

Rear

VGA/Component Video to DVI-D Scaler

32563

VGA to HDMI Upscaler, 1080p

- Can convert analogue audio to digital (TOSLINK) & digital (TOSLINK) to analogue
- Supports PC resolutions up to 1920 x 1200 (WUXGA) & HDTV resolutions up to Full HD 1080p 60Hz

**BEST
SELLER**



VGA to HDMI Upscaler, 1080p

38099

4K HDMI Upscaling Adapter

- Designed to integrate a non-4K source into a 4K installation
- Supported resolutions:
 - Input: Full HD 1080p 60Hz / Output: Ultra HD 4K 4096 / 3840 x 2160 60Hz
 - Input: 480p - 720p / Output: Full HD 1080p 60Hz
- Low power design, with optional external USB power



4K HDMI Upscaling Adapter

38069

SCART to HDMI Upscaler, 720p

- HDCP 1.1 & DVI 1.0 compliant
- Compatible with RGB and composite video capable source devices
- Supports NTSC and PAL systems



SCART to HDMI Upscaler, 720p

38101

SCART to HDMI Upscaler, 1080p

- Allows a SCART device to be connected to an HDMI input
- Automatic lip sync (audio delay) ensures audio / video synchronisation
- HDCP and DVI compliant



SCART to HDMI Upscaler, 1080p

38103

Mini HDMI Pattern Generator 3D

- Capable of outputting a wide range of test patterns, screen resolutions and refresh rates



Mini HDMI Pattern Generator 3D

32645



FOR CABLE TESTERS
SEE PAGE
154

CAT5e/6 AV Extenders

- Choose from Composite Video or S-Video versions
- Both versions support video and stereo audio signals
- Distances of up to 600m can be achieved using CAT5e/6 cable



Composite Video



S-Video

* Maximum transmission distances will depend on the application and the type of twisted pair cable used. These products are designed for use with a single network cable between the transmitter and receiver.

CAT5e/6 Composite Video + Stereo Audio Extender

32535

CAT5e/6 S-Video + Stereo Audio Extender

32523

150m CAT5e SPDIF Digital Audio Extender

- Inputs: Coaxial (SPDIF) & Optical (TOSLINK), USB Mini-B (power only)
- Outputs: Coaxial (SPDIF) & Optical (TOSLINK)



150m CAT5e SPDIF Digital Audio Extender

70466

100m Stereo Audio CAT6 Extender

- Extends analogue stereo audio signals up to 100m using CAT6 UTP cable
- Compact design allows discreet installation
- Passive extension solution, does not require external power



100m Stereo Audio CAT6 Extender

70460

2m IR Repeater Cable

- Extends an IR Signal by 2m
- Ideal for use with concealed AV equipment
- Simple plug & play installation
- Powered by your AV equipment's USB port
- Supported IR Frequency: 38 – 56kHz

NEW

IR Repeater Cable

38086



Infrared over HDMI Extender Kit

- Allows control of up to 4 devices via Infrared*
- Control devices from up to 30m
- An Injector and a Splitter simply connect to each end of a standard HDMI cable
- Supported IR Frequency: 20 – 60kHz

* Please Note: 1 x IR Emitter included, additional IR Emitters are required to operate extra devices.



Infrared over HDMI Extender Kit

38017

Additional Infrared Emitter

38016

250m CAT5e/6 Infrared Extender

- Uses CAT5e/6 cable to make the long distance connection, see pages 212-213 for our range
- Transmitter features IR in and 2 x IR out
- Receiver features 3 x IR out
- Supported IR Frequency: 20 – 60kHz

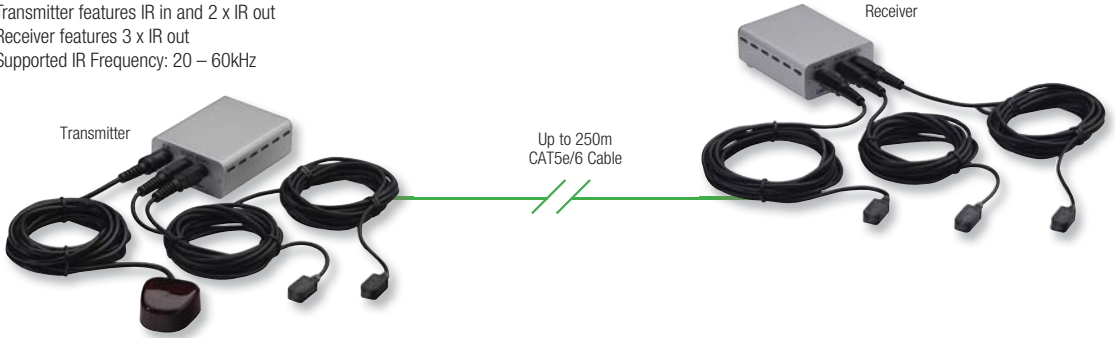

250m CAT5e/6 Infrared Extender

38007

450m Infrared over CAT5 Extender Kit

- Control up to 4 devices via Infrared* at distances of up to 450m
- Injector and Splitter connect to each end of a network cable
- Supplied with one IR Emitter
- Supported IR Frequency: 20 – 60kHz

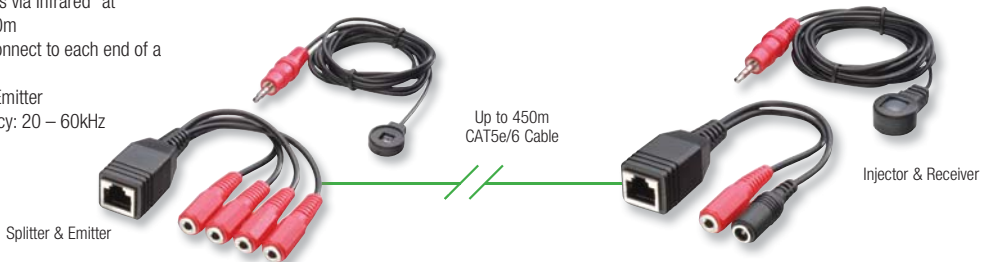

*Please Note: 1 x IR Emitter included, additional IR Emitters required to operate extra devices.

450m Infrared over CAT5 Extender Kit

38018

Additional IR Emitter

38016

Wireless IR Extender

- Wirelessly extends IR signals up to 100m (line of sight), 30m indoor (distances vary depending on building construction)
- Compact design allows discreet installation, supplied with IR Receiver and Emitter cables
- Powered via AV equipment's USB Port or USB power supply (not included - see table below)
- Supported IR Frequencies 20 – 60kHz

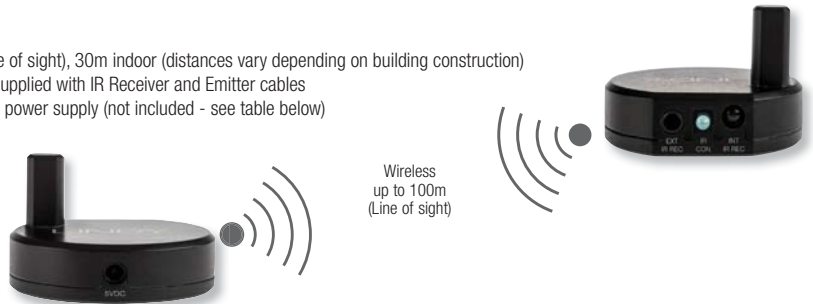

Wireless IR Extender

38105

2 Port USB Multi Country Charger / PSU

73355

Free UK DELIVERY  on all orders over **£125 (ex VAT.)**

Some exceptions apply, see delivery terms & conditions on our website

Visit our website **WEBSITE** for the latest prices & special offers



AV FACEPLATES

VGA & Audio Faceplates



- Faceplate front connectors:
 - 15 Way VGA Female
 - 3.5mm Stereo Audio Socket
- 60211 and 60212 feature rear screw terminals
- 60225 features right angled VGA Female and 3.5mm stereo Female rear connections

VGA & Audio Faceplate, Screw Terminals Rear, Plastic	60212
VGA & Audio Faceplate, Screw Terminals Rear, Metal	60211
VGA & Audio Faceplate, Right Angled Rear, Plastic	60225

Multimedia Faceplate

- Suitable for VGA, audio installations and whiteboards
- Faceplate front connectors:
 - 15 Way VGA Female
 - 3 x Phono Female
 - USB Type A Female
 - 3.5mm Stereo Audio Socket
- Rear connectors: screw terminals



Multimedia Faceplate, Plastic	60221
Multimedia Faceplate, Metal	60222

AV Faceplate with Built-in Cables

Integrated solution for AV installers

- Built-in cables:
 - 2 x VGA Male
 - 3 x Phono
 - 3.5mm Stereo Audio Jack
 - 3m USB cable for connecting to a whiteboard
- Supplied on a surface mount back box
- Double Faceplate assembly which provides the following computer connections:
 - 2 x VGA Female
 - 3 x Phono Female (red, white & yellow)
 - USB Type B Female
 - 3.5mm Stereo Audio Socket



	5m	10m	15m	20m
AV Faceplate with Built-in Cables (USB cable length: 3m)	60255	60256	60257	60258

Multi AV Faceplate, Plastic

- Installation ready Multi AV faceplate with 10cm trailing leads
- Single gang, plastic wall plate design – fits a standard mains back box
- Connectors: HDMI, VGA, USB, Audio
- Faceplate size: 86mm x 86mm



NEW

Multi AV Faceplate, Plastic	60220
-----------------------------	-------

Premium DVI & HDMI Faceplate

Stylish brushed steel finish

- Right angled connector for easy cable routing
- HDMI connector feature a holding post



Back View

Premium DVI-I & HDMI Faceplate	60525
--------------------------------	-------

Snap In Faceplates

- Designed for use with the modular snap-in blocks, see opposite page
- Supplied with fixing screws
- May be surface or flush mounted



2 x Snap In



4 x Snap In

Single Faceplate for 2 x Snap In Blocks	60541
Double Faceplate for 4 x Snap In Blocks	60542

Modular AV Faceplates

Allows you to create a customised faceplate according to your requirements

This faceplate system allows you to create your own custom Faceplates using a combination of snap-in blocks and keystone modules.

- Keystones simply clip into the bare snap-in blocks
- Snap-in blocks fit into our single or double modular AV faceplates
- Requires a pattress box (see page opposite)

Snap-in Blocks



2 x Phono Female to Female



3 x Phono Female to Female



DVI-I Female to Female



VGA Connector Shape



Snap-in Blanking Plate



Double Faceplate with Keystones and Snap-in Blocks installed



SC Duplex Multimode Coupler



ST Duplex Multimode Coupler



Keystone Snap-in Blocks

Snap-in Blocks

2 x Phono Female to Female	60563
3 x Phono Female to Female	60533
VGA Female to Female	60480
Right Angled VGA Male to Female	60513
Right Angled DisplayPort Female to Female	60556
DVI-I Female to Female	60574
SC Fibre Optic Duplex Multimode Coupler	60706
ST Fibre Optic Duplex Multimode Coupler	60707
Snap-in Block for 1 Keystone, Pack of 4	60551
Snap-in Block for 2 Keystones, Pack of 4	60552
Snap-in Blanking Plates, Pack of 2	60540
VGA Connector Shape	60527



VGA Female to Female



Right Angled VGA Male to Female



Right Angled DisplayPort Female to Female

Modular AV Faceplate Keystones



HDMI Female to Female



HDMI Female to Female, 90 Degree



3.5mm Stereo



USB Type A to A, Reversible



USB Type A to B



USB Type A to A, 90 Degree



USB 3.0 Type A to A



USB 3.0 Type A to A, 90 Degree



CAT5e RJ-45 Coupler



LC Duplex Multimode Coupler



Keystone Blanking Plate



F-Type Keystone



3.5mm Stereo 90 Degree



Coax to F-Type



BNC



Banana Connector

Keystones

HDMI Female to Female	60526
HDMI Female to Female, 90 Degree	60490
3.5mm Stereo Female to Female, Pack of 2	60528
USB Type A Female to A Female, Reversible	60583
USB Type A Female to B Female	60555
USB Type A Female to A Female, 90 Degree	60491
USB 3.0 Type A Female to A Female	60753
USB 3.0 Type A Female to A Female, 90 Degree	60492
CAT5e RJ-45 Coupler	60742
LC Duplex Multimode Coupler	60703
Keystone Blanking Plates, Pack of 5	60745
F-Type Keystone, Pack of 2	60559
3.5mm Stereo Female to Female, 90 Degree	60493
Coax Female to F-Type Female, Pack of 2	60522
BNC Keystone Female to Female, Pack of 2	60562
Banana Connector, Pack of 2	60564

AV FACEPLATES

CAT5e/6 Modular AV Extender Faceplate System

A neat and affordable solution for distributing a range of audio and video signals

Modular AV Faceplate shown with four Extenders installed

- Each pack consists of local and remote modules which 'snap-in' to double or single faceplates (face plates and back boxes available separately)
- Supports distances of up to 300m (VGA supports up to 50m)
- Requires a patchbox with a minimum depth of 44mm (see page 90)



Keystones

S-Video & Phono Stereo Audio	60536
Phono Stereo Audio	60534
Composite Video & Phono Stereo	60535
VGA	60538

Brush Faceplates

- Dimensions:
 - Single 86 x 86mm
 - Double 146 x 86mm
- Available with white or black brushes



Single Gang Brush Plate, Black Brushes	60237
Double Gang Brush Plate, Black Brushes	60238
Single Gang Brush Plate, White Brushes	60235
Double Gang Brush Plate, White Brushes	60236

CAT5e/6 Faceplates

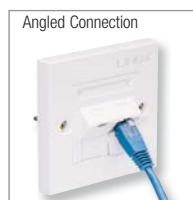

CAT5e Faceplates

Single Faceplate with 1 x RJ-45 Flat Socket	60585
Single Faceplate with 2 x RJ-45 Flat Socket	60586
Double Faceplate with 4 x RJ-45 Flat Socket	60587
Single Faceplate with 1 x RJ-45 Angled Socket	60568
Single Faceplate with 2 x RJ-45 Angled Socket	60569
Double Faceplate with 4 x RJ-45 Angled Socket	60570

CAT6 Faceplates

Single Faceplate with 1 x RJ-45 Flat Socket	60565
Single Faceplate with 2 x RJ-45 Flat Socket	60566
Double Faceplate with 4 x RJ-45 Flat Socket	60567
Single Faceplate with 1 x RJ-45 Angled Socket	60571
Single Faceplate with 2 x RJ-45 Angled Socket	60572
Double Faceplate with 4 x RJ-45 Angled Socket	60573

Pattress Boxes

Single
Pattress Box



Double
Pattress Box



Pattress Box, Single, depth 32mm, 1 pack	73088
Pattress Box, Single, depth 32mm, 10 pack	73188
Pattress Box, Single, depth 44mm, 1 pack	73114
Pattress Box, Single, depth 44mm, 10 pack	73187
Pattress Box, Double, depth 32mm, 1 pack	73089
Pattress Box, Double, depth 32mm, 10 pack	73316
Pattress Box, Double, depth 44mm, 1 pack	73115
Pattress Box, Double, depth 44mm, 5 pack	73315

6 Way AV Surge Protector with RFI Rejection System

- Ideal for use with all audio visual equipment including LCD, LED and Plasma HDTVs, music systems, home cinema systems, games consoles and computers
- Surge protection circuitry protects your equipment from surges and spikes
- Radio Frequency Interference (RFI) rejection system helps keep your sounds and images free from interference
- Provides 6 UK mains sockets via a 2m mains lead

**BEST
SELLER**



6 Way AV Surge Protector, 2m

30088

6 Way Mains Conditioner

Surge protector and mains conditioner for Hi-Fi and home cinema

The LINDY 6 Way Mains Conditioner Power Strip contains a powerful mains conditioner and radio frequency interference filter specially designed to help reduce the mains interference which can adversely affect video and audio performance in Hi-Fi and home cinema installations.

- Provides improved clarity from your audio devices
- Allows for cleaner, sharper picture quality from your video devices
- Features 6 sockets - perfect for your Hi-Fi and home cinema installations
- Surge protection to protect your valuable equipment
- 2m cable length

MAINS CONDITIONER

Mains conditioners aid in the reduction of mains borne radio frequency interference and so help to enhance the sound and/or picture quality

FILTER STATUS TEST

Mains conditioners do not have any indicating lights on during normal use as this can affect the performance. So we have a test button for your piece of mind. Pressing the green button briefly illuminates a green status light, indicating the Mains Conditioner filter is operational, has not been damaged or seriously degraded and all layers of protection are intact

SCREENED MAINS LEAD

Prevents the mains lead from acting as an aerial and so injecting interference into your system



THERMAL PROTECTION

Internal thermal fusing prevents the circuit from dangerous overheating in the event of a worse case surge/spike scenario

GAS TUBE PROTECTION - Gas discharge tube technology is used to satisfy the latest safety requirements for surge protectors

SURGE PROTECTION

Three channel protection - absorbing mains surges and spikes which can cause permanent damage to your valuable equipment

6 Way AV Mains Conditioner, 2m

30089

WIRELESS PROJECTOR SERVERS

WLAN 11n HDMI & VGA Projector Server

Connect to an HDMI or VGA projector over Wi-Fi

- Allows up to 32 users to simultaneously connect to a projector or monitor via a wired or wireless LAN
- Supports real-time transmission of presentations, video and audio streaming etc.
- Supports split screen mode allowing four users to simultaneously display content in a quad arrangement
- USB port used for "Plug and Show" setup of USB dongles

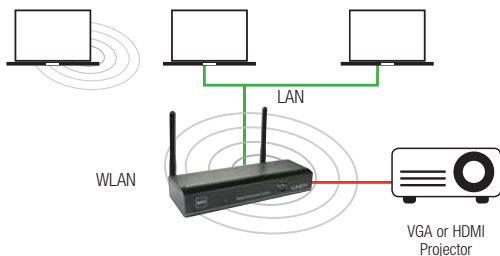

WIN | MAC OS

WLAN 11n HDMI & VGA Projector Server

32701

WLAN 11n VGA Extender & Projector Server with Audio

Connect to a VGA projector via a wired or wireless LAN

- Ideal for PowerPoint and other presentation applications
- Split screen mode is also supported allowing 4 users to simultaneously display their screens
- Supports audio and MPEG 1,2 & 4 video

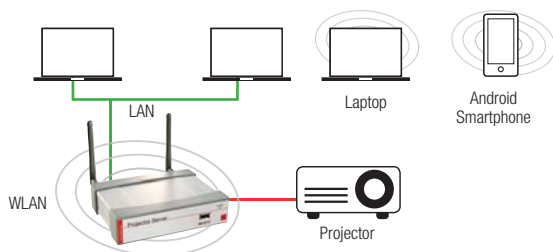

WIN | MAC OS

WLAN 11n VGA Extender & Projector Server with Audio

32700

Download the latest
PRICE LIST
from our website



Visit our website
WEBSITE
for the latest prices
& special offers

Wall Bracket (Up to 20kg), Black

- Mount your display 20mm from the wall
- Supplied with wall fixing bolts and display mounting screws
- VESA mount: 75/100mm

Supports
up to
20kg



Wall Bracket (up to 20kg), Black

40870

Adjustable Wall Bracket (Up to 15kg), Black

- Mount your display 70mm from the wall
- Pivot and tilt action
- VESA mount: 50/75/100mm
- Supplied with wall fixing bolts and display mounting screws

Supports
up to
15kg

**BEST
SELLER**



Adjustable Wall Bracket (up to 15kg), Black

40875

Detachable Wall Bracket (Up to 15kg), Black

- Wall bracket with removable mount
- Mount your display 80mm from the wall
- Rotatable by 360 degrees
- VESA mount: 75/100mm
- Supplied with wall fixing bolts and display mounting screws

Supports
up to
15kg



Detachable Wall Bracket (up to 15kg), Black

40876

Wall Bracket, (Up to 36kg), Black

- Mount your display 12mm from the wall
- Supplied with fixing bolts and display mounting screws
- VESA mount: 50/75/100/100 x 200/200 x 200mm

Supports
up to
36kg



Wall Bracket (Up to 36.6kg), Black

40871

Multi-Joint Wall Bracket, Black

- Left, right, tilt and rotary adjustment
- Arm with 3 joints extends up to 410mm
- VESA mount: 75/100mm
- Supplied with wall fixing bolts, display mounting screws and hex key wrench



Supports
up to
10kg

Multi-Joint Wall Bracket (Up to 10kg), Black

40765

Easy Mount Wall Bracket (Up to 8kg), Black

- Left, right, tilt and rotary adjustment
- VESA mount: 75/100mm
- Supplied with wall fixing bolts, display mounting screws and hex key wrench



Supports
up to
8kg

Easy Mount Wall Bracket (Up to 8kg), Black

40727

Adjustable Wall Bracket (Up to 15kg), Black

- Left, right, tilt and rotary adjustment
- VESA mount: 75/100mm
- Supplied with wall fixing bolts, display mounting screws and hex key wrench

Supports
up to
15kg



Adjustable Wall Bracket (Up to 15kg), Black

40721

Adjustable Wall Bracket (Up to 20kg), Silver

- Left, right, tilt and rotary adjustment
- Torque control for each adjustment setting
- VESA mount: 75/100mm
- Supplied with wall fixing bolts, display mounting screws and spanner

Supports
up to
20kg

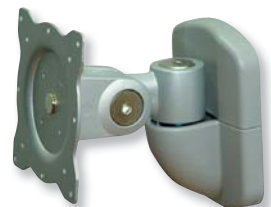

Adjustable Wall Bracket (Up to 20kg), Silver

40766

DISPLAY BRACKETS

Adjustable Wall Bracket, Black

- Adjustable distance from wall to display: 92 to 390mm
- VESA mount: up to 400 x 400mm
- Supplied with wall fixing bolts and display mounting screws

Supports
up to
35kg



Adjustable Wall Bracket (up to 35kg), Black

40877

Plasma & LCD Wall Bracket, Black

- Recommended for screens up to 40"
- Mount your display 20mm from the wall
- VESA mount: up to 400 x 200mm
- Supplied with wall fixing bolts and display mounting screws
- Bracket dimensions:
586 x 369mm (WxH)

Supports
up to
40kg



Plasma & LCD Wall Bracket (Up to 40kg), Black

40872

Plasma & LCD Wall Bracket, Black

- Recommended for screens up to 50"
- VESA mount: up to 600 x 400mm
- Mount your display 20mm from the wall
- Supplied with wall fixing bolts and display mounting screws
- Bracket dimensions:
756 x 450mm (WxH)

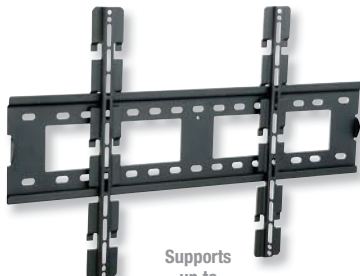

Supports
up to
60kg

Plasma & LCD Wall Bracket (Up to 60kg), Black

40873

Slimline Plasma & LCD Wall Bracket, Black

- Compatible with displays with mounting screw hole distances of up to 800mm high and 600mm wide
- Allows your display to be mounted just 54mm from the wall
- Supplied with all fixtures and fittings

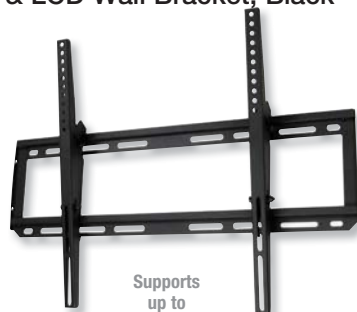

Supports
up to
70kg

Slimline Plasma & LCD Wall Bracket (Up to 70kg), Black

40874

Free UK DELIVERY  on all orders over **£125** (ex VAT.)

Some exceptions apply, see delivery terms & conditions on our website

Visit our website **WEBSITE** for the latest prices & special offers



Plasma & LCD Ceiling Brackets, Black

- Universal fit, supports most plasma and LCD displays weighing up to 50kg
- Telescopic design allows the screen to be mounted from 670 to 1070mm from the ceiling
- Compatible with displays with mounting screw hole distances of up to 800mm high and 450mm wide
- Supplied with all fixtures and fittings

Single Plasma & LCD TV
Ceiling Bracket, Black



Double Plasma & LCD TV
Ceiling Bracket, Black



Supports
up to
50kg
per side

Single Plasma & LCD TV Ceiling Bracket (Up to 50kg), Black

40843

Double Plasma & LCD TV Ceiling Bracket (Up to 50kg per side), Black

40844

Custom Projector Brackets

This collection of poles and brackets is part of the LINDY Wall Mount Projector System, a range designed to allow users to create customised configurations for mounting their projector. Simply use either a small or large pole in conjunction with a LINDY projector bracket and then attach a projector to either a ceiling or a wall.

Short Projector Pole

- For use with either the LINDY Box Type Projector Bracket (40848) or the X-Type Projector Bracket (40849) (below)
- Hollow pole to allow cable management
- Adjustable from 31cm to 41cm
- Includes wall fixing screws/bolts
- Brackets not included



Supports up to **11.5kg**

Short Projector Pole (Up to 11.5kg)

40847

Long Projector Pole

- For use with either the LINDY Box Type Projector Bracket (40848) or the X-Type Projector Bracket (40849) (below)
- Hollow pole to allow cable management
- Adjustable from 73cm to 123cm
- Includes wall fixing screws/bolts
- Brackets not included



Supports up to **11.5kg**

Long Projector Pole (Up to 11.5kg)

40846

Box Type Projector Bracket (Up to 11.5kg)

- For use with a LINDY Short Projector Pole (40847) or Long Mount Projector Pole (40846) (see above)
- Dimensions:
 - Width: 180mm - 280mm
 - Height: 50mm - 120mm
- Depth: 250mm
- Pole not included



Supports up to **11.5kg**

Box Type Projector Bracket (Up to 11.5kg)

40848

X-Type Projector Bracket (Up to 11.5kg)

- For use with a LINDY Short Projector Pole (40847) or Long Projector Pole (40846) (see above)
- Maximum dimensions: 390mm to outer radius
- Pole not included



Supports up to **11.5kg**

X-Type Projector Bracket (Up to 11.5kg)

40849

Under Cabinet LCD Mount, Silver

- Folds under your kitchen cabinet
- VESA mount: 75/100mm
- Fits most LCD flat panel TV's from 13" to 15"
- Includes all fitting fixtures and instructions



Supports up to **5kg**

Under Cabinet LCD Mount (Up to 5kg), Silver

40713

Universal Ceiling Mounted Bracket

- Rotating mount assembly for projectors or LCD/TFT displays
- Adjustable length: from 745mm to 1145mm
- Fully adjustable projector mount arms
- Supplied with fixing screws, cable ties and an Allen key



BEST SELLER



Supports up to **11.5kg**

Universal Ceiling Mounted Bracket (Up to 11.5kg)

40720

MODULAR DESKTOP MOUNTING SYSTEM - SILVER

The LINDY Modular Desktop Mounting System is a selection of poles, arms and brackets that, when used together, can create customised configurations for mounting laptops, tablets and LCD displays. First choose a suitable pole then add additional segments to meet your needs. Silver and black range available

Silver Desk Poles

450mm & 700mm lengths of Desk Clamp & Grommet poles

- Attaches to a range of brackets and arms from our Silver Modular Desktop Mounting System range (sold separately, see below)
- Desk Clamp Poles offer a sturdy, adjustable C-Clamp for mounting the pole to a desk (30mm to 100mm thickness)
- Desk Grommet Poles sit neatly into a free desk grommet hole
- Robust, lightweight metal construction with a durable, powder coated silver finish

450mm Desk Grommet Clamp Pole



700mm Desk Clamp Pole



450mm Silver Desk Clamp Pole	40692
700mm Silver Desk Clamp Pole	40693
450mm Silver Desk Grommet Clamp Pole	40962
700mm Silver Desk Grommet Clamp Pole	40963

Silver LCD Bracket

- For use with a 450mm pole or 700mm pole (not included, see above)
- VESA mount: 75/100mm

Supports up to **10kg**



Silver Adjustable LCD Arm

- For use with a 450mm pole or 700mm pole (not included, see above)
- VESA mount: 75/100mm

Supports up to **10kg**



Silver LCD Bracket (Up to 10kg) 40695

Silver Adjustable LCD Arm (Up to 10kg) 40696

Silver Dual Back to Back LCD Bracket

- For use with a 450mm pole or 700mm pole (not included, see above)
- Allows two screens to be mounted back to back - ideal for use on two facing desks
- Rotate, pivot and tilt action
- VESA mount: 75/100mm



Supports up to **6kg** per side

Silver Dual Back to Back Bracket (Up to 6kg per side) 40694

Silver Dual Adjustable LCD Arms

- For use with a 450mm pole or 700mm pole (not included, see above)
- VESA mount: 75/100mm

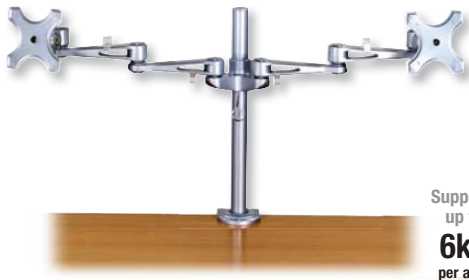

Supports up to **6kg** per arm

Silver Laptop Arm

- Extends outwards up to 609mm
- For use with a 450mm pole or 700mm pole (not included, see above)
- Aluminium vented platform helps keep your laptop cool
- Retractable holder for external keyboard
- Platform dimensions: 287 x 287mm
- Arm has built in cable management

Supports up to **8kg**



Silver Dual Adjustable LCD Arms (Up to 6kg per arm) 40697

Silver Laptop Arm (Up to 8kg) 40699

MODULAR DESKTOP MOUNTING SYSTEM - BLACK

Black Desk Poles

400mm & 700mm lengths of Desk Clamp & Grommet poles

- Attaches to a range of brackets and arms from our Black Modular Desktop Mounting System range (sold separately, see below)
- Desk Clamp Poles offer a sturdy, adjustable C-Clamp for mounting the pole to a desk (7mm to 750mm thickness)
- Desk Grommet Poles sit neatly into a free desk grommet hole
- Robust, lightweight metal construction with a durable, powder black finish

400mm Black Desk Clamp Pole	40952
700mm Black Desk Clamp Pole	40950
400mm Black Desk Grommet Clamp Pole	40953
700mm Black Desk Grommet Clamp Pole	40951



Black LCD Bracket

- For use with a 400mm pole or 700mm pole (not included, see above)
- VESA mount: 75/100mm



Supports
up to
6kg

Black LCD Bracket (Up to 6kg)

40955

Black Laptop Arm

- Extends outwards up to 526mm
- For use with a 400mm pole or 700mm pole (not included, see above)
- Platform dimensions: 300 x 270mm



Supports
up to
6kg

Black Laptop Arm (Up to 6kg)

40954

Black Adjustable LCD Arm

- For use with a 400mm pole or 700mm pole (not included, see above)
- VESA mount: 50/75/100mm

Supports
up to
6kg



Black Adjustable LCD Arm (Up to 6kg)

40958

Black Dual Adjustable LCD Arms

- For use with a 400mm pole or 700mm pole (not included, see above)
- VESA mount: 50/75/100mm

Supports
up to
6kg
per arm



Black Dual Adjustable LCD Arms (Up to 6kg per arm)

40959

Black Dual Back to Back LCD Bracket

- For use with a 400mm pole or 700mm pole (not included, see above)
- Allows two screens to be mounted back to back - ideal for use on two facing desks
- Rotate, pivot and tilt action
- VESA mount: 50/75/100mm

Supports
up to
6kg
per side



Black Dual Back to Back Bracket (Up to 6kg per side)

40960

Black Dual Curved Arm LCD Bracket

- For use with a 400mm pole or 700mm pole (not included, see above)
- VESA mount: 50/75/100mm

Supports
up to
6kg
per arm



Black Dual Curved Arm Bracket (Up to 6kg per arm)

40957

Black Triple Curved Arm LCD Bracket

- For use with a 400mm pole or 700mm pole (not included, see above)
- VESA mount: 50/75/100mm

Supports
up to
6kg
per arm



Black Triple Curved Arm Bracket (Up to 6kg per arm)

40956

DESK CLAMP MONITOR BRACKETS

Desk Clamp Monitor Brackets with Poles

Our Desktop LCD arms are an 'all in one box' solution for raising multiple monitors to a comfortable and convenient viewing angle whilst at the same time freeing up essential desk space. They're supplied ready to go with all brackets and clamps included.

Installation couldn't be easier as there's no drilling or wall mounting required. Instead, a pole is clamped into place on your desktop edge. It's secured using sturdy thumb screws. The LCD arms can slide up and down the pole for optimum viewing height. The brackets and arms have a multitude of adjustment options for a perfect installation.

Manufactured using tough and stylish powder coated light weight aluminium, they're available in four different models for use with a variety of screen configurations.



Single LCD Monitor Bracket With Pole & Desk Clamp

- Supports a maximum weight of 10kg
- VESA mount: 75/100mm
- Designed with an easy mount option for attaching the monitors to the bracket
- Robust, lightweight metal pole with aluminium powder coated bracket



Supports
up to
10kg

**BEST
SELLER**

NEW

Single LCD Monitor Arm With Pole & Desk Clamp

- Supports a maximum weight of 10kg
- VESA mount: 75/100mm
- Designed with an easy mount option for attaching the monitors to the bracket
- Robust, lightweight metal pole with aluminium powder coated bracket



Supports
up to
10kg

**BEST
SELLER**

NEW

Single LCD Monitor Bracket With Pole And Desk Clamp 40964

Single LCD Monitor Arm With Pole And Desk Clamp 40965

Double LCD Monitor Arm With Pole & Desk Clamp

- Supports a maximum weight of 10kg per arm
- VESA mount: 75/100mm
- Designed with an easy mount option for attaching the monitors to the bracket
- Robust, lightweight metal pole with aluminium powder coated bracket



Supports
up to
10kg
per arm

NEW

Quad LCD Monitor Arm With Pole & Desk Clamp

- Supports a maximum weight of 10kg per arm
- VESA mount: 75/100mm
- Easy mount option for attaching the monitors to the bracket
- Robust, lightweight metal pole with aluminium powder coated bracket



Supports
up to
10kg
per arm

NEW

Double LCD Monitor Arm With Pole And Desk Clamp 40966

Quad LCD Monitor Arm With Pole And Desk Clamp 40967

Mobile Display Trolley, Silver

- Compatible with displays with mounting screw hole distances of up to 800mm high and 450mm wide
- Adjustable shelf for DVD player, video conferencing equipment etc.
- Height adjustable to a maximum 1120mm
- Adjustable design to tilt screens up to 15°

Display Trolley Shelf

- Add more storage space to your mobile plasma & LCD trolley with an extra shelf



Please note this shelf is only for use with Part No. 40736



Mobile Display Trolley (Up to 50kg)

40736

Display Trolley Shelf

40737

Mobile Display Trolley Lite, Black

- Maximum mounting dimensions of up to 600x400mm
- Locking wheels
- Adjustable height: from 100cm to 160cm from the ground (measured to the centre of the display bracket)



Supports
up to
35kg

Display Trolley Lite (Up to 35kg)

40762

Video Conferencing Bracket for LINDY Display Trolleys, Silver

- For use with the LINDY Mobile Display Trolley (above) and Mobile Display Trolley Lite (left)
- Adds an additional shelf above the screen to allow the placement of a video conference unit or to store devices out of reach
- Includes a pole, bracket and shelf
- Pole and bracket height are adjustable



Supports
up to
5kg

Video Conferencing Bracket for LINDY Trolleys (Up to 5kg)

40761

Mobile 2 x 2 Display Trolley Stand for Video Wall, Black

This sturdy trolley allows you to securely mount a Plasma, LCD or LED display to a mobile stand for easy transportation. It's four omni-directional, locking wheels make it ideal for schools, colleges and business where shared resources need to be moved and safely secured for viewing in different rooms. It consists of two heavy gauge steel uprights and four individual brackets that are capable of holding screens up to 56kg in weight. The design also allows TV displays to be tilted downwards up to 0.5°.

- Universal fit, supports most Plasma, LED and LCD displays weighing up to 56kg
- Supports 2 x 2 configuration (4 screens)
- Compatible with displays with mounting screws up to 800 x 400mm
- Each bracket can be moved horizontally or vertically depending on the screen size

Supports
up to
56kg
per screen



Mobile 2 x 2 Display Trolley Stand for Video Wall (Up to 56kg)

40735

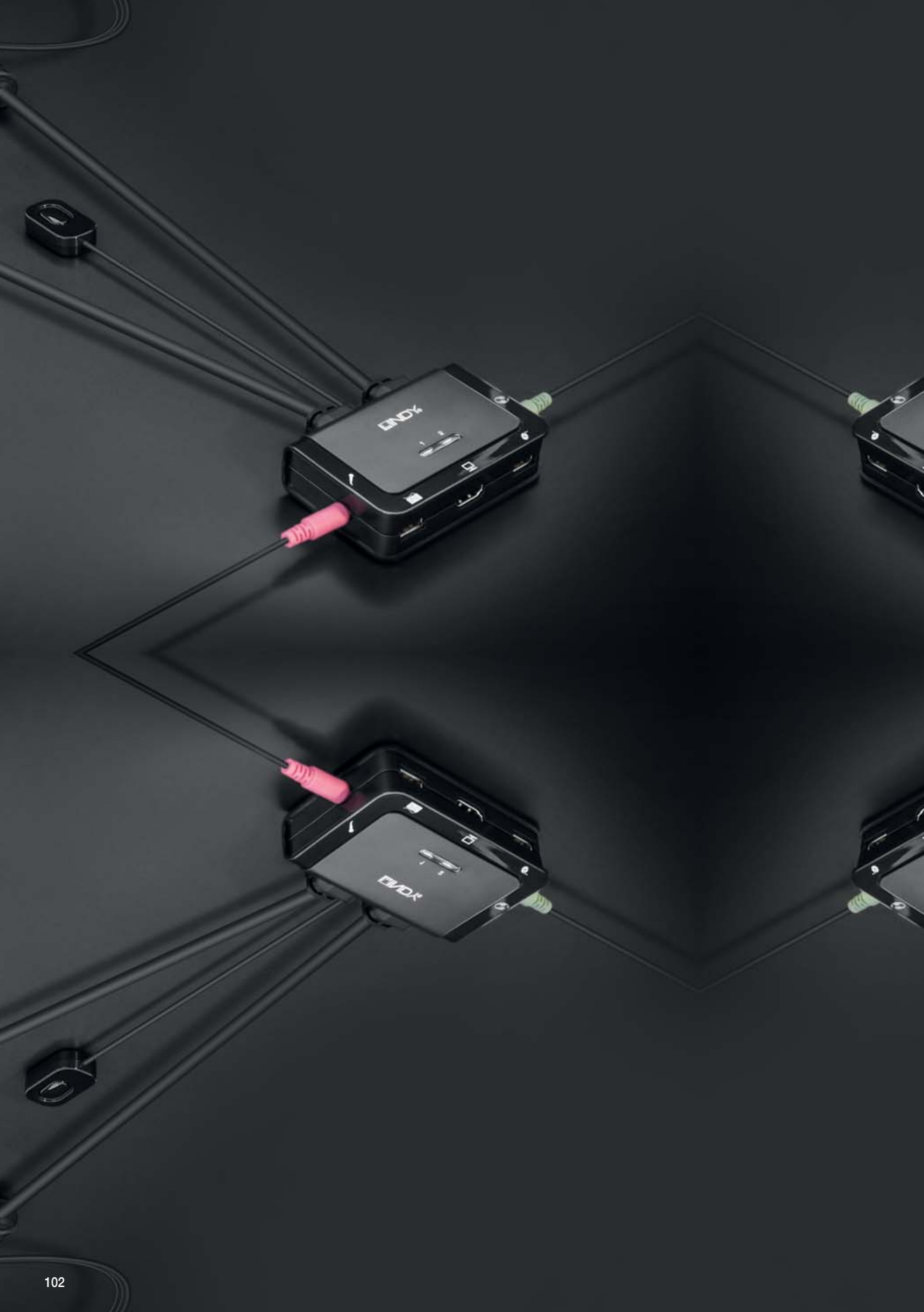

ENDX

ENDX

KVM SWITCHES & EXTENDERS DISTRIBUTION

Desktop KVM Switches	106
Rackmount KVM Switches	111
LCD KVM Terminals	115
KVM Extenders	116
Multipoint Server Clients	121



DESKTOP KVM SWITCHING INTELLIGENT CONTROL

Professional KVM switches for intelligent, convenient and reliable working with multiple workstations. Shared use of peripherals using integrated hubs saves procurement costs for additional devices. When working with multiple computers at a single workstation, the requirement is for a professional easy to use solution in the server room, office or home. This requirement can be met in different ways. In the simplest of cases, the operator can work with multiple mice, keyboards and monitors next to each other. However, this soon becomes very inefficient, does not save space and is impractical. There are various ways of countering this problem: A monitor switch is perhaps the most well known, which renders at least one of the monitors unnecessary. Anyone who has ever tried this out would have quickly realised that often the wrong mouse and keyboard is used and very little desk space is saved because of the requirement to use multiple keyboards and mice.

The elegant solution from LINDY for this entire problem is called a KVM switch - a device which can switch the monitor, mouse and keyboard and, optionally, other USB and audio devices. LINDY provides such KVM switches in different standards from basic to professional with 2 to 32 ports and with various monitor interfaces. Desktop KVM switches usually have 2 or 4 ports. KVM switches for server rooms can have up to 32 ports and are frequently cascadable for larger integrations.

With a KVM switch, the very first decisions are determined by the display interface and the number of connected computers. To connect to the PCs, KVM cables with all of the four connections (video, USB, audio, microphone) are used. The KVM switch does not convert the video interfaces. All of the connected computers must have a matching video output (e.g. HDMI) or are able to be adapted using a suitable converter/adaptor.

The next question concerns which optional peripherals to connect. Simple KVM switches often support only mouse and keyboard connections, usually via USB. However, other USB peripherals, such as a printer are supported by more advanced models. One of the extra options consists of extending the USB functionality by connecting a USB hub. KVM switches with this option allow the common switchover of all of the devices connected to the hub, such as card readers, memory sticks, webcams, printers and much more. Professional models with separate USB device and mouse/keyboard ports allow devices to be excluded from the switching as required, or even to be switched separately. For high quality KVM switches, audio devices are also supported which can also be excluded from switching.

The headset or loudspeakers can remain connected to the same PC even if the KVM signals are briefly switched to a different machine e.g. during a video conference.

1
Desktop HDMI KVM Switch

USB 2.0 & Audio
→ Page 107, 42340

2
Video Adapter

Mini-DisplayPort to HDMI
→ Page 255, 41014

3
Adapter DVI-D / HDMI

HDTV & HDCP compatible
→ Page 257, 41228

4
Headset with microphone

and volume control
→ See our website



1

4

2 Port USB Cable Keyboard & Mouse Switch

- Affordable solution for controlling two PCs using one keyboard, mouse and two monitors
- Also supports switching via keyboard hotkeys and mouse buttons
- Cable length: 1.1m

BEST SELLER



Allows you to scroll between screens to switch control

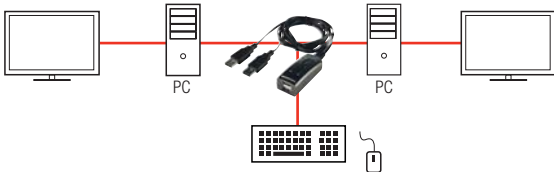

WIN | MAC OS | LINUX

2 Port USB Cable Keyboard & Mouse Switch

32165

2 Port KVM Switch Micro, USB & VGA

- Allows control of 2 USB / VGA equipped computers using just one keyboard, mouse and monitor
- Switch between computers via keyboard hotkeys
- Cable length: 1.2m

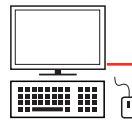

Ready to go
Built-in KVM cables!

WIN | MAC OS | LINUX

2 Port KVM Switch Micro, USB & VGA

32816

2 Port KVM Switch Compact VGA, USB & Audio

- Supports USB keyboards, mice and VGA monitors
- Windows KVM Switcher software allows you to customise hotkey commands
- Supports push button switching for Mac and PC use, hotkey and software switching for Windows PC users
- Connect additional USB peripherals using a USB hub, not included
- Cable length: 1.4m



Ready to go
Built-in KVM cables!

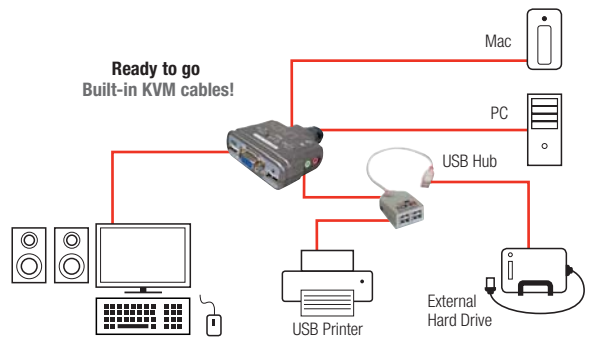

WIN | MAC OS | LINUX

2 Port KVM Switch Compact VGA, USB & Audio

32797

Download the latest
PRICE LIST
from our website



Visit our website
WEBSITE
for the latest prices
& special offers

KVM Switch Compact USB 2.0 Audio

Provides essential interfaces for modern peripherals

Switch via push button, software or keyboard. 3.5mm audio ports to connect headphones, speakers and a microphone. Connect additional USB 2.0 peripherals using a USB hub (not included).

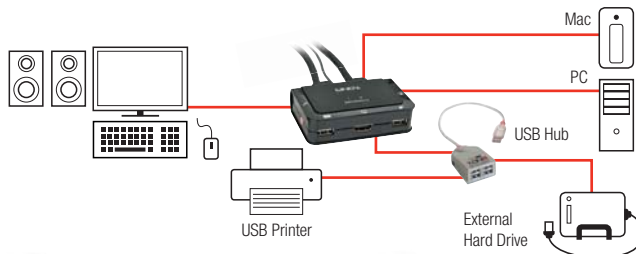

Ready to go
Built-in KVM cables!



DVI-D KVM Switch Compact
USB 2.0 Audio 2 port



HDMI KVM Switch Compact
USB 2.0 Audio 2 port



DisplayPort Switch Compact
USB 2.0 Audio 2 port

- KVM Switch for digital LCDs and USB 2.0 sharing
- For DVI-D resolutions up to 1920 x 1200
- HDCP support
- Switches DVI, USB mouse and keyboard, USB 2.0 devices, stereo speakers and mic

- For HDMI resolutions up to Ultra HD 4K 60Hz, including 1080p 3D
- Switches HDMI, USB mouse and keyboard, USB 2.0 devices, stereo speakers and mic
- Supports PCs, Macs, consoles with HDMI and 3D

- For DisplayPort resolutions up to Ultra HD 4K 30Hz
- Switches DisplayPort, USB mouse and keyboard, USB 2.0 devices, stereo speakers and mic

WIN **MAC OS** **LINUX**

42341

42340

42343

4 Port KVM Switch, HDMI, USB 2.0 & Audio

- Allows control of 4 computers using a single keyboard, mouse and monitor set
- Supports HDMI signals up to Full HD 1080p, including 1080p 3D and audio support for digital audio signals - suitable for PCs, consoles and Blu-Ray Players
- 3.5mm audio ports allow you to connect headphones or speakers and a microphone
- Additional USB accessories can be attached using a USB Hub (not included)
- Switches via push buttons or the supplied infrared remote control



Ready to go
Includes KVM cables!

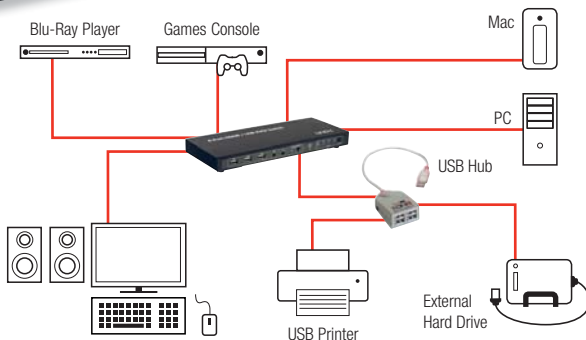

WIN **MAC OS** **LINUX**

4 Port KVM Switch, HDMI, USB 2.0 & Audio

32811

KVM SWITCHES MULTITASKING



The increasing demand for higher resolutions and better image quality leads to rising requirements for the peripherals used for transmission. Often, it is not about implementing a simple transmission between one source and one display device, but switching between multiple transmission paths and several displays. This means switches, need to meet increasing requirements in terms of bandwidth and range.

LINDY KVM switches, in all forms and applications, have proven their worth over decades and thousands of installations whether you want to switch between two computers via VGA, or connect a modern 4K graphics workstation. Options include a simple KVM switch for two computers that require installation in close proximity to the work space or having the signals transmitted across long distances between switch and computer. LINDY has many years of experience in each of these fields of application.

Dual Head DVI-I KVM Switch Pro

Control up to 4 dual head video equipped PCs and share USB 2.0 devices

- Control up to 4 computers and share USB 2.0 devices via a built-in 2 port hub
- Single Link and Dual Link, 2 and 4 port versions available
- True Transparent USB (TTU) - supports all widely used mice & keyboards
- Three methods of switching between computers: front panel push button, keyboard hotkeys and auto scan
- Supports DVI-I analogue and digital dual link resolutions:
 - Digital Dual Link resolutions of up to 2560 x 1600
 - Analogue VGA resolutions of up to 2048 x 1536
- Compatible with all major operating systems

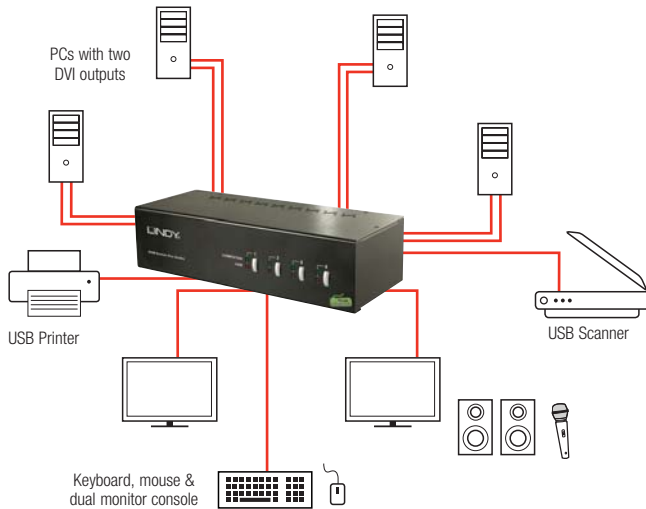

WIN **MAC OS** **LINUX**

2 Port Dual Head, Single Link DVI-I KVM Switch Pro with TTU	39300
2 Port Dual Head, Dual Link DVI-I KVM Switch Pro with TTU	39302
4 Port Dual Head, Single Link DVI-I KVM Switch Pro with TTU	39301
4 Port Dual Head, Dual Link DVI-I KVM Switch Pro with TTU	39335

8 Port KVM Switch PRO USB 2.0 Audio DVI-I Single-Link



- 8 Port KVM Switch with USB hub and audio support
- Supports DVI-D Signals up to 1920 x 1200
- Built in two port USB 2.0 hub
- Plug & Play installation - no special software required
- Advanced compatibility - supports all widely used mice
- 19" rackmount brackets and screws included
- Connection cables not included, requires DVI, USB and Audio cables
- Compatible with all major operating systems

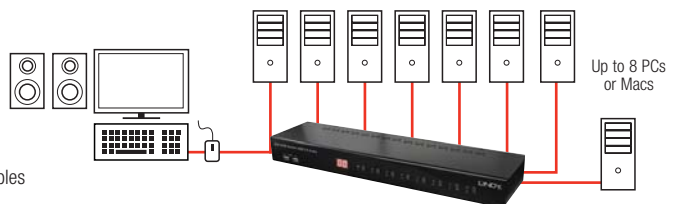

WIN **MAC OS** **LINUX**

8 Port KVM Switch PRO USB 2.0 Audio DVI-I Single-Link	39317
---	-------

DESKTOP KVM SWITCHES

KVM Switch Pro USB 2.0

High quality, stylish desktop KVM Switches



2 port version



4 port version



39332



39328



39331,
39333

Features of all models

- Available with VGA, DVI Single Link, Dual Link and DisplayPort connections
- Built-in 2 port USB 2.0 hub for sharing peripherals between the connected computers
- Full audio support with connections for stereo speakers and a microphone
- Allows independent switching of KVM, USB and audio ports
- Supports auto-scan, hotkey and push button switching
- Tough metal housing with rear mounted connectors for a tidy installation

VGA Version:

- Features VGA display connections and USB keyboard/mouse ports
- Supports display resolutions of up to 2048 x 1536

DisplayPort Version:

- Features DisplayPort connections and USB keyboard/mouse ports
- True Transparent USB (TTU) - supports all widely used mice & keyboards
- Supports display resolutions of up to 2560 x 1600 60Hz and Ultra HD 4K 30Hz

DVI Version:

- Single Link and Dual Link versions available
- Features DVI-I display connections and USB keyboard/mouse ports
- TTU versions support all widely used mice & keyboards
- Supports the following DVI-D display resolutions
- Up to 1920 x 1200 (DVI Single Link models)
- Up to 2560 x 1600 (DVI Dual Link models)
- Supports VGA resolutions of up to 2048 x 1536

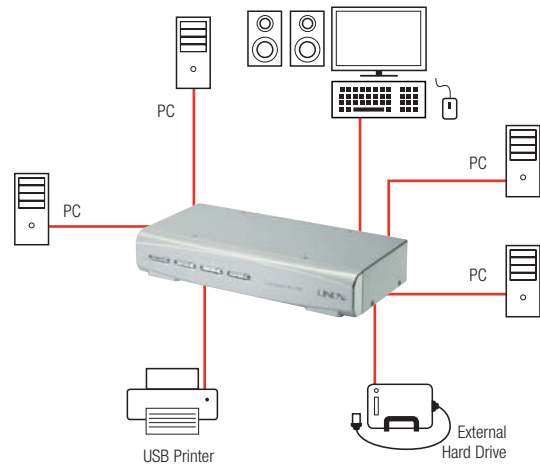

Ready to go
Includes KVM cables!

WIN | MAC OS | LINUX

4 Port KVM Switch Pro USB 2.0, VGA	32321
4 Port KVM Switch Pro USB 2.0, DisplayPort with TTU	39328
4 Port KVM Switch Pro USB 2.0, DVI Single Link with TTU	39331
2 Port KVM Switch Pro USB 2.0, DVI Dual Link with TTU	39332
4 Port KVM Switch Pro USB 2.0, DVI Dual Link with TTU	39333

Combo 8 & 16 Port KVM Switches

Professional KVM Switch with optional IP access module

- Supports USB & VGA and PS/2 & VGA equipped computers
- Supports remote access via optional Slot-in KVM over IP module
- On-Screen Display (OSD) for easy display and configuration
- Supports display resolutions up to 2048 x 1536
- Requires dedicated KVM cables (see below)
- Supplied with 19" rackmount brackets

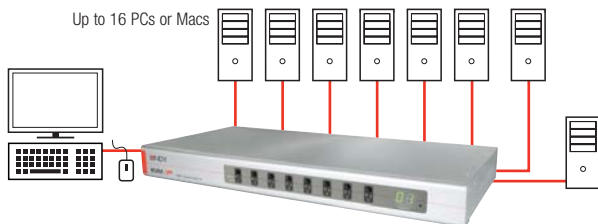

Optional KVM over IP Extender Module

WIN **MAC OS** **LINUX**

Combo 8 Port KVM Switch	39523
Combo 16 Port KVM Switch	39524
KVM over IP Extender Module	39636

	1m	2m	3m
USB & VGA KVM Cable for Combo 8/16	33770	33771	33772
USB, PS/2 & VGA Cable for Combo 8/16	-	33774	-



	1m	2m	3m	5m
Combined KVM Cable for Classic 16	32510	32506	32507	32508

**BEST
SELLER**



Optional USB to PS/2 Converter Cable	42866
--------------------------------------	-------

Download the latest
PRICE LIST
 from our website



**Free UK
 DELIVERY** 
 on all orders over **£125** (ex VAT.)
 Some exceptions apply, see delivery terms & conditions on our website

RACKMOUNT KVM SWITCHES

KVM Switch CAT-32 IP Combo

Multi-format switch that allows computers to be connected at up to 100m with optional IP access



- Uses CAT5e/6 structured cabling to provide the long distance connections to the computers via dedicated computer modules (see below)
- An optional KVM over IP module allows the connected computers to be accessed on the LAN or via the internet
- Provides local and remote BIOS level access
- Supports resolutions up to 1920 x 1200 at the local console and 1280 x 1024 at the remote console
- Supplied with 19" rackmount brackets, 20cm daisy chain cable and 1m firmware update cable
- Compatible with all commonly used operating systems

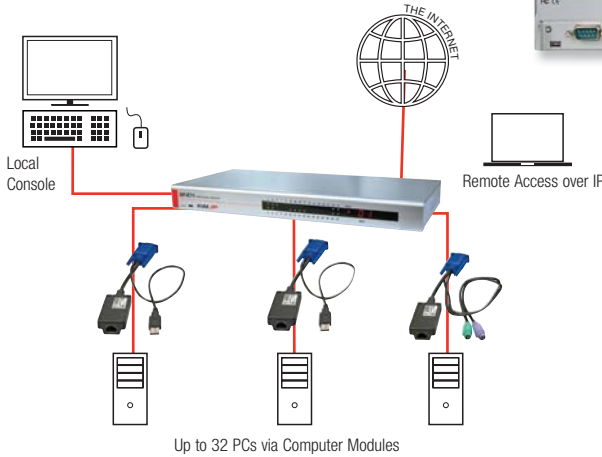

Rear showing IP module installed

Computer Modules

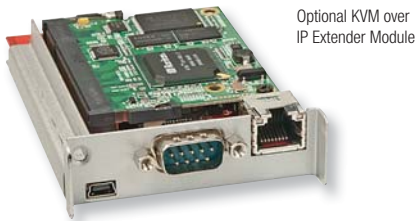
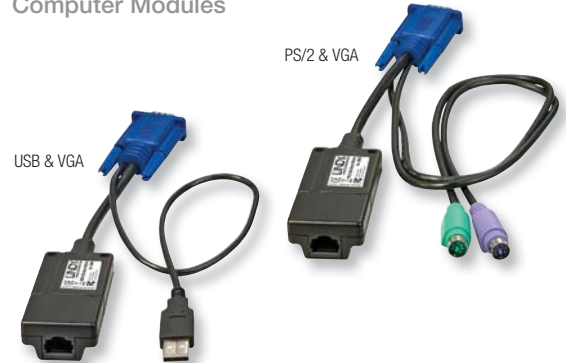

Optional KVM over IP Extender Module

WIN | MAC OS | LINUX

KVM Switch CAT-32 IP Combo	39631
KVM over IP Extender Module	39636
1m Daisy Chain Cable (Male to Female)	39637

PS/2 & VGA Computer Module	39633
USB & VGA Computer Module	39634

**FOR
CAT5E/6
CABLES
SEE PAGES
212-213**

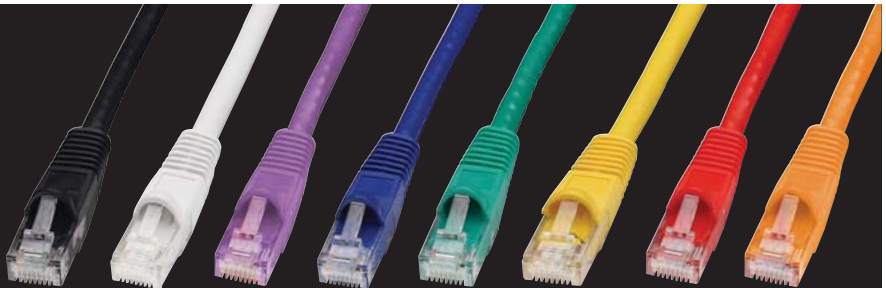

SC5 & SC5-IP 16 Port KVM Switches

Multi-format, dual console KVM switch with computer connection distances of up to 50m and console control up to 300m

- Supports up to 16 PC, SUN, Mac, RS/6000, Alpha and SGI computers at distances of up to 50m using Computer Access Modules (see below)
- Single user dual console support allows the connected computers to be controlled either locally or at distances of up to 300m using an additional CAT5/5e User Station
- SC5-IP version also allows remote access from almost anywhere in the world via IP access.
- Provides local and remote BIOS level access
- Local user keyboard, video and mouse console can be connected via USB and VGA ports
- Supports display resolutions up to 1600 x 1200
- Stereo audio support when using compatible CAM modules
- 19" 1U rack mountable (brackets included)
- Compatible with all common operating systems: DOS, Windows, Linux, Unix, SUN, Mac OS and NetWare



Rear

3 YEAR GUARANTEE

WIN | MAC OS | LINUX

KVM Switch SC5, 16 Port	32365
KVM Switch SC5-IP, 16 Port	32369

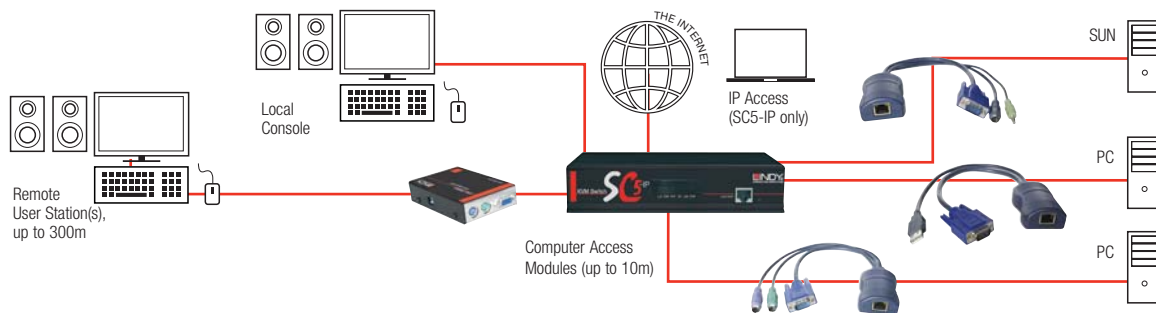

User Stations



PS/2 & VGA version shown

CAM Modules



PS/2 & VGA (up to 200m)	32357
PS/2 & VGA with Audio Support (up to 200m)	32359
PS/2 & VGA with Audio Support (up to 300m)	32358
USB & VGA (up to 200m)	39357
USB & VGA with Audio Support (up to 300m)	39356

PS/2 & VGA	39351
PS/2 & VGA with Audio Support	39353
USB & VGA	39352
USB & VGA with Audio Support	39354
SUN (Mini-DIN) & VGA with Audio Support	39355

RACKMOUNT KVM SWITCHES

MC5 & MC5-IP 24 Port KVM Switches

Multi-format, single user dual console KVM switch that allows computers to be connected at distances of up to 50m and console control up to 300m



MC5-IP rear

- Advanced switches that use CAT5/5e structured cabling to link computers and KVM consoles
- Computer Access Modules (CAM) are used to make the connections to the computers at up to 50m
- Remote 'User Stations' are used to connect the operators at up to 300m
- MC5-IP variant allows up to four users to share access via the internet
- Supports four simultaneous users
- Supports resolutions up to 1900 x 1440
- 19" 1U rack mountable (brackets included)
- Compatible with all common operating systems: Windows, Linux, Unix, SUN, Mac OS, and NetWare

3 YEAR GUARANTEE

WIN | MAC OS | LINUX

KVM Switch MC5, 24 Port	32367
KVM Switch MC5-IP, 24 Port	32368

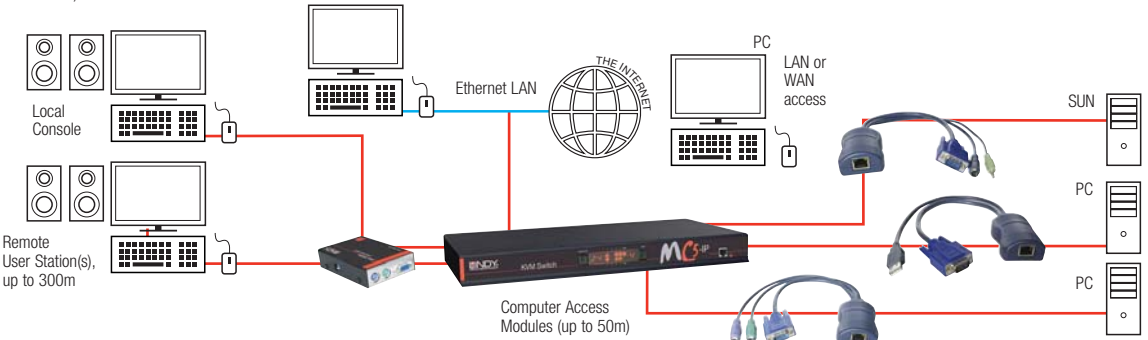

User Stations



PS/2 & VGA version shown

CAM Modules

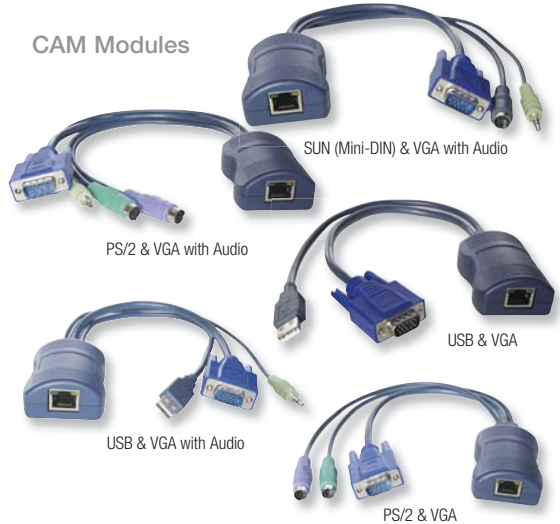

PS/2 & VGA (up to 200m)	32357
PS/2 & VGA with Audio Support (up to 200m)	32359
PS/2 & VGA with Audio Support (up to 300m)	32358
USB & VGA (up to 200m)	39357
USB & VGA with Audio Support (up to 300m)	39356

PS/2 & VGA	39351
PS/2 & VGA with Audio Support	39353
USB & VGA	39352
USB & VGA with Audio Support	39354
SUN (Mini-DIN) & VGA with Audio Support	39355

Quad View KVM Switch Pro, DVI, USB & Audio

NEW

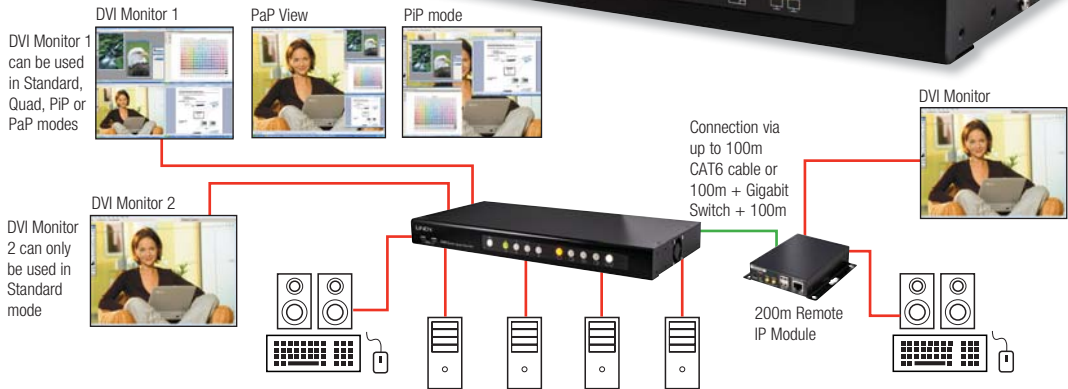

The LINDY Quad View KVM Switch Pro simultaneously displays video signals from four digital or analogue sources on a single screen as well as giving individual Keyboard & Mouse control over connected computers. In addition a second display can be connected (Full Screen Mode only!), so that you can directly control or work on one of the computers without having to disrupt the monitoring of the other connected computers. An optional Remote IP Module is available which allows you to create a Remote Console, giving you full remote control over the connected computers at distances of up to 100m (200m via Gigabit Ethernet Switch).

In addition to its video capabilities the Quad View Pro features a USB hub and support for analogue audio for each input. These ports can be automatically switched along with video input, or if required switched independently.

- Simultaneously control 4 computers from a single workstation
- Supports Quad View, PiP, PaP and Full Screen Modes
- Supports DVI-I, USB keyboard & mouse and audio signals
- Dual Video Output allows 2 local displays to be connected
- A Remote IP Module (sold separately) can be added to create a Remote Console

Quad View KVM Switch Pro, DVI, USB & Audio	32327
Optional 200m Remote IP Module	32328

LCD KVM Terminals

Available with 15" or 17" TFT screens

- Optional 8, 16 and 32 Port KVM Switch modules available (see below)
- Optional IP Access Module available (see below)
- Fits into a standard 19" 1U rack space and slides in and out for use
- Can be used with USB or PS/2 and VGA equipped computers / KVM switches (see page 270 for compatible KVM cables)
- Optional KVM switch and computer access modules are available - the switch and modules share the same features as our CAT-32 IP Combo products, see page 112
- 15" model supports resolutions up to 1024 x 768; 17" models support up to 1280 x 1024
- Key locking mechanism with 2 keys



17" model allows the screen and keyboard to be slid out independently.

15" LCD KVM Terminal	21603
17" LCD KVM Terminal - Dual Rail	21615
8 Port KVM Switch Upgrade Module	39530
Combo 8C 8 Port KVM Switch Upgrade Module	39525
16 Port KVM Switch Upgrade Module	39531
32 Port KVM Switch Upgrade Module	39635

19" KVM Console Basic with 17" LCD

Value for money 1U high keyboard, touchpad and 17" LCD screen

- 17" TFT LCD monitor supporting VGA resolutions of up to 1280 x 1024
- Fits into a standard 19" 1U rack space and slides in and out for use
- UK keyboard, numeric keypad and touchpad
- PS/2* and USB Combo design for wider support of KVM Switches
- Key locking mechanism with 2 keys



19" KVM Console Basic with 17" LCD

21733

300m CAT5 KVM Extender Combo

Versatile extender with USB, PS/2 & VGA KVM support

- Extends PS/2, USB & VGA signals up to 300m over a single CAT5, or higher, cable
- Consists of a transmitter and a receiver unit
- Supports PS/2 and USB keyboard and mouse signals in any combination
- Transmitter and receiver units with built-in KVM switch for local and remote operation
- High resolution support: up to 1600 x 1200 / 1680 x 1050 @ 300m
- Power supply and two USB, PS/2 & VGA Combo KVM cables included
- Compatible with all major operating systems

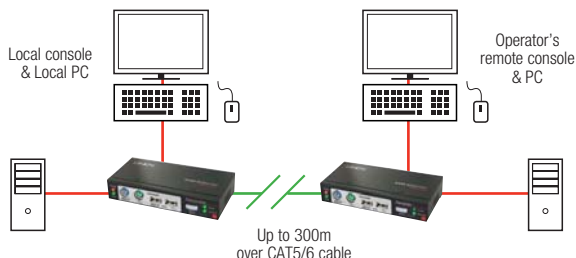

300m CAT5 KVM Extender Combo

39378

200m KVM Extender with Dual Head VGA, USB & Audio

Send two VGA, keyboard, mouse & audio signals up to 200m

- Extends dual head VGA video with a local output
- Supports distances of up to 200m between local and remote units
- Uses affordable network cables CAT5/5e/6 to connect devices (see page 212)
- Allows you to connect two VGA monitors, USB keyboard & mouse as well as stereo speakers to the local transmitter and remote receiver unit
- Supports VGA signals with resolutions up to 1600 x 1200 or 1920 x 1080
- Power supplies, KVM cable and VGA cable included

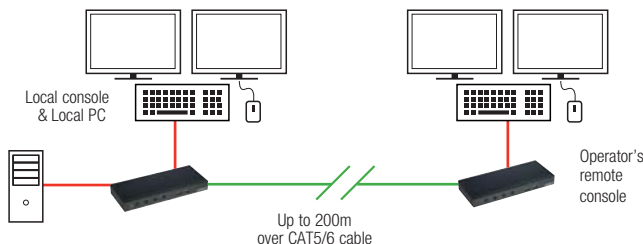

Ready to go
Includes KVM cables!

200m KVM Extender with Dual VGA, USB & Audio

39396

130m CAT6 DVI-D & USB KVM Extender

Ideal for use with USB touchscreens

- Extends DVI-D video and USB keyboard and mouse signals up to 130m over a single CAT6 cable
- Supports USB touchscreens and similar HID devices
- Supports DVI-D 1920 x 1200 and HDMI up to 1080p (without audio or HDCP)
- Includes DVI-D to HDMI adapter cable & USB connection cables



Ready to go
Includes KVM cables!

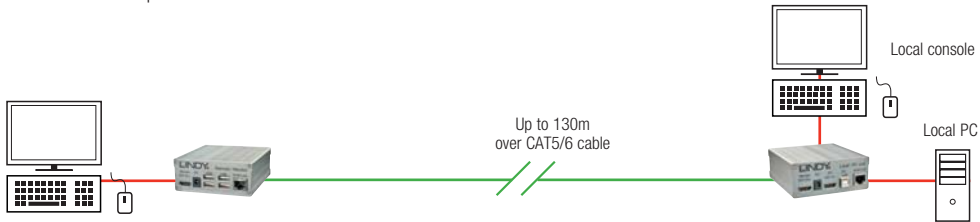

130m CAT6 DVI-D & USB KVM Extender

39221

130m CAT6 DVI-D & USB 2.0 KVM Extender for Mass Storage

Extends connections to your PC, USB hard drives and other devices

- Extends DVI-D video and USB keyboard and mouse signals up to 130m over a single CAT6 cable
- Supports USB 2.0 mass storage devices and other USB devices such as printers etc.
- Supports DVI-D up to 1920 x 1200 and HDMI up to 1080p (without audio or HDCP)
- Includes DVI-D to HDMI adapter cable & USB connection cables



Ready to go
Includes KVM cables!

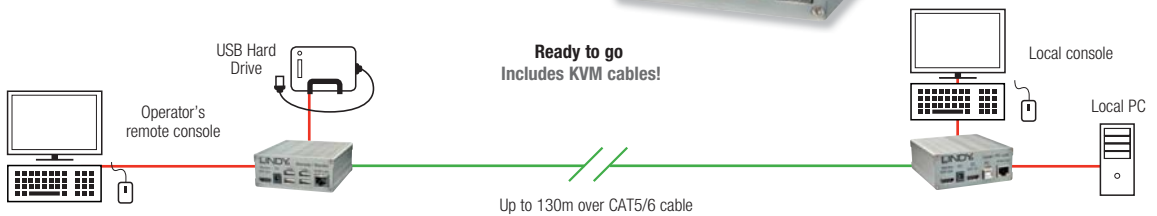

130m CAT6 DVI-D & USB KVM Extender for Mass Storage

39222

50m CAT6 KVM Extender Classic with HDMI, USB & Audio

- Provides remote operation of a PC using CAT6 cable at distances of up to 50m
- Supports Full HD 1080p / 1920 x 1200 including 3D and HDCP
- Supports USB keyboard and mouse signals
- Analogue audio support via a 3.5mm jack
- Allows a local console connection at the transmitter end

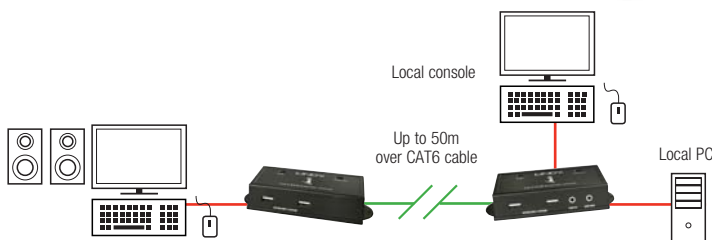

50m CAT6 KVM Extender Classic with HDMI, USB & Audio

39371

100m C6 HDMI 2.0 & USB KVM Extender

- Extends HDMI 2.0 compatible signals up to 100m using HDBaseT 2.0 Technology
- Supports resolutions up to Ultra HD 4096/3840x2160p60 including 1080p 3D
- Use a single cable to extend HDMI, USB, RS-232, IR, Ethernet and Audio Signals
- Integrated Power over HDBaseT functionality, requires only a single power supply

NEW

- HDBaseT CAT6
- HDMI
- USB
- Stereo Audio / Digital Coax

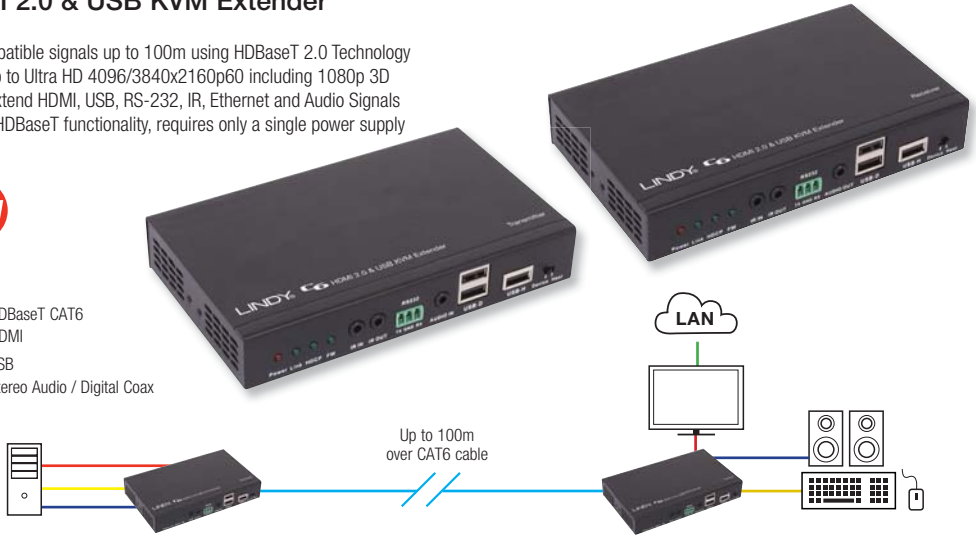

100m C6 HDMI 2.0 & USB KVM Extender

38209

**FOR OUR C6 HDMI
EXTENDER RANGE
SEE PAGES
50-59**



150m CAT6 KVM Extender with Dual Head HDMI, USB, Audio, IR & RS-232

- Supports dual head HDMI 1.4 1080p60 with HDCP as well as DVI-D up to 1920x1200, RS-232 Full Duplex, IR signals and analogue stereo audio
- Features copy functions for monitor EDID as well as keyboard and mouse models
- Plug and Play – no software to install
- Includes power supplies, USB, RS-232 and IR receiver and transmitter cables

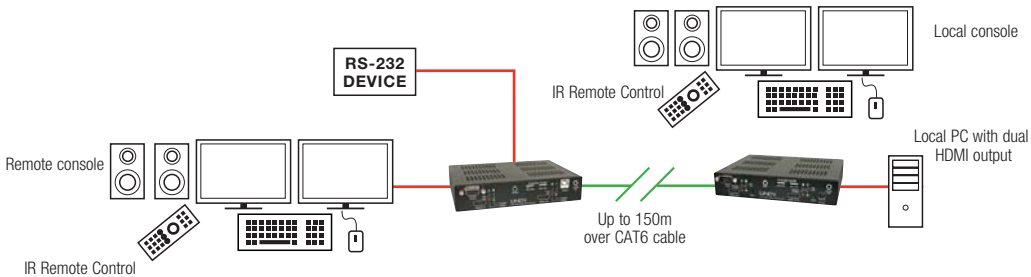

150m CAT6 KVM Extender with Dual Head HDMI, USB, Audio, IR & RS-232

39372

KVM Gigabit Console Adapters

Extend HDMI, DVI and Audio and USB signals over a Gigabit Network

- Extend HDMI, DVI, Audio and USB signals over a Gigabit network
- HDMI and DVI and Audio versions available
- KVM Console over Gigabit Ethernet with USB keyboard and mouse
- Supports resolutions up to 1080p (including video playback)
- Supports up to 4 remote computers
- Features 2 USB Ports for connecting keyboard, mouse, mass storage and printers
- Supported operating systems Windows XP/Vista/7 32bit and 64bit

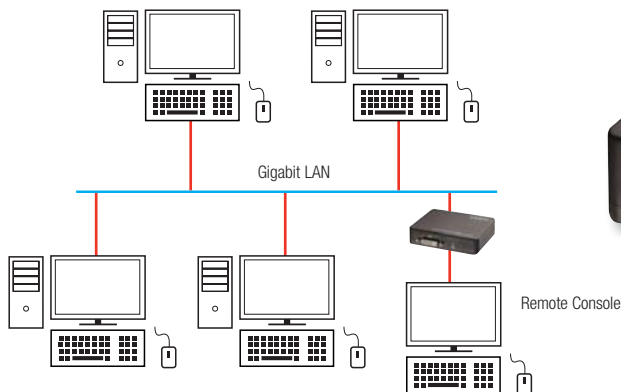

HDMI version



DVI & Audio version

WIN

KVM Gigabit Console Adapter HDMI

38082

KVM Gigabit Console Adapter DVI-D & Audio

38083

**FOR FIBRE OPTIC
PATCH CABLES**
SEE PAGES
210-211



100m CAT5 PS/2 Keyboard & Mouse Extender

- Extends PS/2 signals up to 100m using CAT5 or higher cable
- Transmitter unit features two short PS/2 cables for connecting to your computer's keyboard and mouse ports



WIN

100m CAT5 PS/2 Keyboard and Mouse Extender

32685

300m USB Keyboard and Mouse Extender

- Consists of a transmitter and receiver unit which are connected by long length CAT5e/6 cables



WIN MAC OS LINUX

100m CAT5 PS/2 Keyboard and Mouse Extender

32686

250m CAT5 RS-232 Extender

- Extends the distance between RS-232 compliant devices up to 250 metres
- Simply connect via a single CAT5 cable (not included)



250m CAT5 RS-232 Extender

32158

1.2km CAT5 RS-232 Extender

- Extends the distance between RS-232 compliant devices up to 1.2km
- Simply connect via a single CAT5 cable (not included)



1.2km CAT5 RS-232 Extender

42720

2km CAT5 RS-232 Serial Extender

- Unique solution for connecting a serial equipped PC or Mac to any RS-232 serial equipment over distances of up to 2000m using low cost CAT5e/6 network cable
- Hardware solution, no software required
- Ideal for use with EPOS, process control, lab equipment, digital signage etc.
- Aluminium transmitter and receiver modules



2km RS-232 Serial Extender over CAT5

32156

70m USB to RS-232 Serial Extender over CAT5

- Unique solution for connecting a modern USB equipped PC or Mac to any RS-232 serial equipment over distances of up to 70m using low cost CAT5e/6 network cable
- Ideal for use with EPOS, process control, lab equipment, digital signage etc.
- Consists of transmitter and receiver modules
- Bus-powered - no external power supply required for local or remote units



70m USB to RS-232 Serial Extender over CAT5

32157

2km USB to RS-232 Serial Extender over CAT5

- Unique solution for connecting a modern USB equipped PC or Mac to any RS-232 serial equipment over distances of up to 2000m using low cost CAT5e/6 network cable
- Local Transmitter is USB Bus Powered
- Ideal for use with EPOS, process control, lab equipment, digital signage etc.
- Aluminium transmitter and receiver modules



2km USB to RS-232 Serial Extender over CAT5

32155

User Clients for MultiPoint Server

Affordable and reliable workstations designed to work in combination with Windows Multipoint Server

- Cost effective solution for classrooms, call centres and offices
- Consumes 95% less power than a standard PC
- USB and LAN versions available
- VGA monitor port (supports up to 1600 x 1200)
- USB ports for keyboard, mouse and other peripherals
- USB based model is ideal for single room installation such as in a classroom
- LAN version is designed for distribution around multiple rooms (connection via a network switch is required)
- Microphone and stereo speaker sockets
- Can be placed flat, vertically or fixed to the VESA mounting points on a monitor

Demo' Kit Available

If you're a LINDY Credit Account Holder, you can try this for yourself for FREE! (subject to our approval). Please e-mail postmaster@lindy.co.uk for details.

LAN version

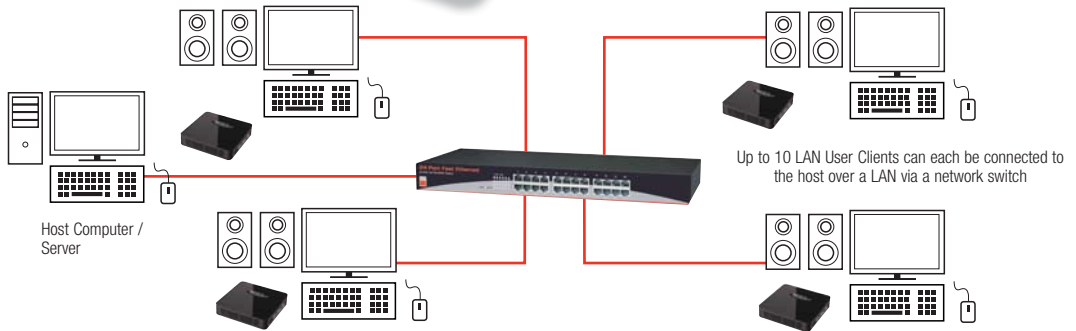

USB version

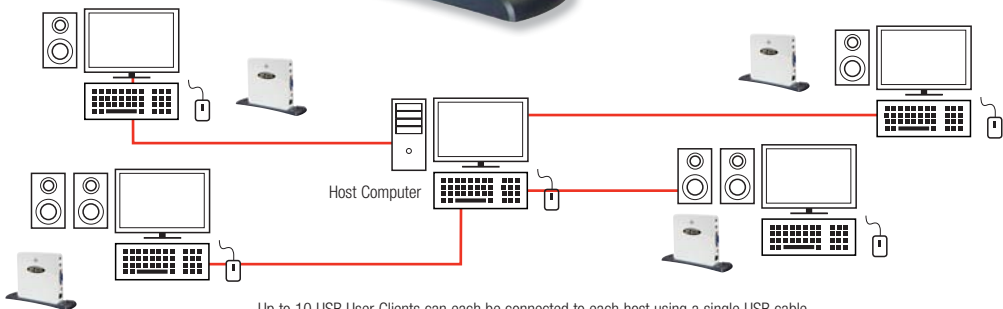



NETWORKING IT INFRASTRUCTURE

Network Switches	124
Power Over Ethernet, IP Cameras	124
Ethernet Adapters	126
Port Blockers & Serial Over IP	127
Fibre Optic Converters	128
Power Distribution	129
Cabinet Accessories	130
Power Control & Management	132

8 Port Gigabit Desktop Switch

Brings Gigabit networking to your desktop

- Compact size with tough metal case
- Provides 8 x 10/100/1000 Gigabit Ethernet ports
- Dimensions: 130 x 97 x 25mm



8 Port Gigabit Desktop Switch

25045

24 Port 10/100 Fast Ethernet Rackmount Switch

Suitable for mounting in a 19" rack

- Auto MDI/MDI-X on all ports
- 10/100Mbps Auto-Negotiation on all ports
- Full/Half-duplex operation
- Packet Buffer: 160KB
- Mac Addresses: 8K, self learning
- 19" 1U rackmount brackets included



24 Port 10/100 Fast Ethernet Switch

25009

8 Port PoE Midspan

Add Power over Ethernet support to your network

- Converts standard 100-240V AC power into low voltage DC that can be run over CAT5, or higher, Ethernet cable
- For use with up to 8 IEEE 802.3af compliant PoE devices such as wireless access points and IP cameras
- Outputs 48V DC at 15.4W (max.) on each port
- 8 'data' input ports and 8 'data & power' output ports
- 19" 1U rackmount brackets included



8 Port PoE Midspan

25058

PoE Accessories

PoE Splitter

- Allows a non PoE device to be connected to a PoE installation
- Ideal for use with our PoE Switch or PoE Injector (below)
- Supports devices with a supply voltage of 5V, 9V or 12V DC
- Operating distance: up to 40m



PoE Splitter

PoE Injector



PoE Injector

- Outputs 48V DC at 15.4W (max.) on each port
- Allows a PoE device to be connected to a non PoE switch
- Can also be used in conjunction with our PoE Splitter (above)
- Operating distance: up to 90m

Passive PoE Kit

- Low cost kit for running data and power over a single cable
- Consists of an injector and splitter unit
- Supports devices with a supply voltage up to 24V DC
- Max current 800mA



Passive PoE Kit

PoE Splitter

25053

PoE Injector

25052

Passive PoE Kit

34025

Power Over Ethernet (PoE) Tester

- Quickly test an RJ-45 port for Power over Ethernet
- Tests for IEEE 802.3af/at PoE voltage
- Mid-span, End-span and 4-pair LED identification
- Compact Plug and Play design



Power Over Ethernet (PoE) Tester 60197

10/100 Parallel Print Server

- Supports: IPX/SPX, NetBEUI, TCP/IP, AppleTalk, DHCP, SNMP
- Compatible with Windows 98/ME/2000/XP/Vista/7/8, NetWare & UNIX, Mac OS 10 & above



WIN MAC OS

1 Port 10/100 Parallel Print Server 42374

IP Cameras

- MPEG4, MJPEG Video Compression
- 10/100Base-T Fast Ethernet connection
- Event-triggered, scheduled and manual recording, with motion detection windows
- Images may be uploaded via FTP and Email
- Compatible with Windows 98SE/ME/2000/XP/Vista/7



WIN

IP Camera 42442

Portable Wi-Fi Router, SD Card & Pen Drive Reader

- Easily access memory card and USB flash drive files from any iOS or Android device
- Connect to iOS and Android mobile devices via Wi-Fi
- Share and transfer stored media with up to 3 people at the same time
- Also acts as a wireless router, access point or repeater
- Compact design, ideal for travel use
- Built in re-chargeable battery



IOS ANDROID

Portable Wi-Fi Router, SD Card & Pen Drive Reader 52063

USB 2.0 Dual Band 802.11ac Wireless LAN Adapter

- Dual data transfer: 2.4Gbps - 150Mbps / 5Ghz - 433Mbps
- Backwards compatible with 802 a/b/g/n
- Compatible with Windows XP/7/8 32/64bit/10



WIN

USB 2.0 Dual Band 802.11ac Wireless LAN Adapter 52054

10m External WLAN Antenna Cable

- For use with external WLAN antennas
- Connectors: 1 x RP-SMA, 1 x N-Type
- 50 Ohm cable



10m External WLAN Antenna Cable 35586

USB 2.0 Fast Ethernet Adapter

- Available with Type A and Micro B connections
- For desktops, notebooks, netbooks, ultrabooks and tablets
- Compatible with 2000/XP/Vista/7/8/10, Mac OS X & Linux



WIN **MAC OS** **LINUX**

USB 2.0 Fast Ethernet Adapter, Type A	42945
USB 2.0 Fast Ethernet Adapter, Micro-B	42948

USB 3.1 Gigabit Ethernet Adapter

- Easily connect your USB computer to a Gigabit network
- SuperSpeed USB 3.1 Gen1 5Gbps, backwards compatible with USB 3.0, 2.0 and USB 1.1
- LED for connection and data transmission
- Compatible with Windows XP/Vista/7/8/10, Mac OS X 10.8 & Linux



WIN **MAC OS** **LINUX**

USB 3.1 Gigabit Ethernet Adapter	43188
----------------------------------	-------

USB 3.1 Type C Gigabit Ethernet Adapter

- USB 3.1 Gen 1 / USB 3.0 SuperSpeed up to 5Gbps
- Compatible with Windows XP, Vista, 7, 8, 8.1, 10, Mac OS X & Linux



WIN **MAC OS** **LINUX**

USB 3.1 Type C Gigabit Ethernet Adapter	43164
---	-------

USB 3.1 Type C to Gigabit Ethernet Adapter & 3 Port Type A Hub

- Provides three USB 3.1 Type A ports and a Gigabit Ethernet interface
- Supports USB 3.1 SuperSpeed 5Gbps data transfer rates
- Compatible with Windows XP, Vista, 7, 8, 8.1, 10, Mac OS X & Linux



WIN **MAC OS** **LINUX**

USB 3.1 Type C to Gigabit Adapter & 3 Port Type A Hub	43177
---	-------

Gigabit Ethernet Card, PCIe

- Compatibility: Windows 2003/2008 XP/Vista/7/8/10/Server, Microsoft NDIS2, NDIS5
- Standard & Low Profile backplates included



WIN

Gigabit Ethernet Card, PCIe	51192
-----------------------------	-------

Gigabit Ethernet Card, PCI

- Compatibility: Win 98SE/ME/NT/2000/XP/Server 2003/Vista/7/8/10, Netware 5.x, Netware ODI for DOS, Linux, Unix
- 10/100/1000Mbps
- Standard & Low Profile backplates included



WIN **MAC OS** **LINUX**

Gigabit Ethernet Card, PCI	51221
----------------------------	-------

USB 3.1 Gen1 & Gigabit Ethernet Card 4 Port, PCIe

- Features 3 x USB Type A Female and 1 x RJ-45
- Compatibility: Windows Vista 7/8/8.1/10
- Standard & Low Profile backplates included



USB 3.1 Gen1 & Gigabit LAN Card 4 Port, PCIe	51049
--	-------

Gigabit Ethernet Adapter, ExpressCard/34

- Compatibility: Windows 2000/XP/2003 Server/Vista/7/8/10



WIN

Gigabit Ethernet Adapter, ExpressCard/34	51512
--	-------

RJ-45 Port Blockers

- Available in packs of 10 with a key or 20 without a key
- Quick and easy to use
- Block physical access to RJ-45 Network ports

**BEST
SELLER**



	Colour Code	Part No.
RJ-45 Port Blocker (10 locks & 1 key)	Black	40470
	Green	40472
	Orange	40480
	Yellow	40482

	Colour Code	Part No.
Additional Lock Pack (20 locks without key)	Black	40471
	Green	40473
	Orange	40481
	Yellow	40483

LC Security Locks

Physically locks Fibre Optic LC connectors into ports

- Available as a pack of 10 locks with 1 key or a pack of 20 locks and no key



10 x LC Security Locks with 1 Key	40475
20 x LC Security Locks without Key	40476

Serial over IP Servers

Connect and share 1, 2 or 4 serial devices on your network

- Supports RS-232, RS-422 & RS-485 serial devices
- RJ-45 10/100 network connection
- Configuration via IP Server Management Mode for Windows, web browser or Telnet
- Compatible with Windows 98/ME/2000/XP/Vista/7 and 8

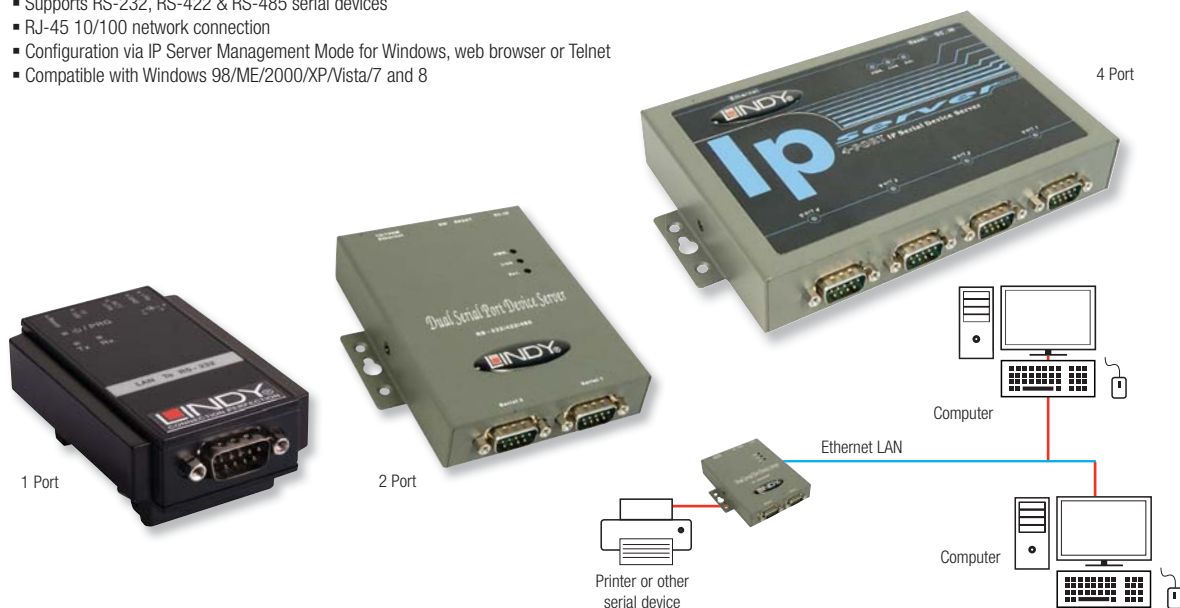

1 Port Serial over IP Server	42721
2 Port Serial over IP Server	25104
4 Port Serial over IP Server	25105

Fast Ethernet Fibre Optic Converters

Extend your Fast Ethernet network up to 2km

These Fast Ethernet Fibre Optic Converters allow you to extend your Fast Ethernet network over incredible distances using fibre optic cable. They are ideal for high speed interconnections of up to 200Mbps (Full-duplex) between buildings and floors.

Features of all versions

- 100Base-FX (fibre) to 10/100Base-TX (copper)
- Standards: IEEE 802.3, 802.3u, 802.3x
- Network data transfer rate: 200Mbps (Full-duplex)
- Auto MDI-X support for RJ-45 port connection
- Fibre Type: Multi-mode
- Maximum fibre cable distance: 2km

Fast Ethernet Fibre Optic Converter, Multi-mode, LC Duplex



Fast Ethernet Fibre Optic Converter, Multi-mode, LC 25115

Fast Ethernet Fibre Optic Converter, Multi-mode, SC Duplex



Fast Ethernet Fibre Optic Converter, Multi-mode, SC 25110

Fast Ethernet Fibre Optic Converter, Multi-mode, ST Duplex



Fast Ethernet Fibre Optic Converter, Multi-mode, ST 25111

Gigabit Ethernet Fibre Optic Converters

Extend your Gigabit Ethernet network up to 550m

Our Gigabit Ethernet Fibre Optic Converters allow you to convert and extend the distance of your Gigabit Ethernet network by up to 550m over fibre optic cable. They're ideal for high speed interconnections up to 2000Mbps (Full-duplex) between buildings and floors.

- Part No. 25112: 1000Base-T (copper) to 1000Base-SX (fibre)
- Part No. 25116: 1000Base-T (copper) to 1000Base-LX (fibre)
- Standards: IEEE 802.3ab, 802.3z
- Network data transfer rate: 2000Mbps (Full-duplex)
- Auto MDI/MDI-X support for RJ-45 port connection
- Fibre Type: Multi-mode
- Maximum fibre cable distance: 550m

Gigabit Ethernet Fibre Optic Converter, Multi-mode, LC Duplex



Gigabit Fibre Optic Converter, Multi-mode, LC 25116

Gigabit Ethernet Fibre Optic Converter, Multi-mode, SC Duplex



Gigabit Fibre Optic Converter, Multi-mode, SC 25112

Power Distribution Units

Convenient power inside your 19" enclosure

Features of all models

- Integral On/Off rocker switch
- BS5733 approved
- Cable length: 3m



Choose from UK mains plug, IEC male plug or Commando plug (vertical models only) versions



Horizontal Mount PDU with UK Mains Sockets



- UK Mains plug models: 13A fused
- Max. power for UK plug version 3250W (total not to exceed 13A)
- Max. power for IEC plug version 2500W (total not to exceed 10A)

1U, 6 Way, UK Mains Plug with Surge Protection

1U, 4 Way, UK Mains Plug	73562
1U, 4 Way, IEC Male Plug	73563
1U, 6 Way, UK Mains Plug	73560
1U, 6 Way, IEC Male Plug	73561
1U, 6 Way, UK Mains Plug with Surge Protection	73564

Horizontal Mount PDU with IEC Mains Sockets

- For models equipped with IEC Male plugs
- The total load should not exceed 10A



1U 8 Way IEC

1U, 8 Way, UK Mains Plug	29990	1U, 8 Way, IEC Male Plug	29993
1U, 10 Way, UK Mains Plug	29991	1U, 10 Way, IEC Male Plug	29994
1U, 12 Way, UK Mains Plug	29992	1U, 12 Way, IEC Male Plug	29995

Vertical Mount PDU

- UK Mains plug models: 13A fused
- For models equipped with IEC Male plugs, the total load should not exceed 10A
- Angled sockets for a tidier installation



Vertical 8 Way PDU

6 x UK Mains Sockets, UK Mains Plug	29980
8 x UK Mains Sockets, UK Mains Plug	29981
10 x UK Mains Sockets, UK Mains Plug	29982
12 x UK Mains Sockets, UK Mains Plug	29983
6 x UK Mains Sockets, IEC Male Plug	29984
8 x UK Mains Sockets, IEC Male Plug	29985
10 x UK Mains Sockets, IEC Male Plug	29986
12 x UK Mains Sockets, IEC Male Plug	29987
6 x UK Mains Sockets, Commando Plug	29996
8 x UK Mains Sockets, Commando Plug	29997
10 x UK Mains Sockets, Commando Plug	29998
12 x UK Mains Sockets, Commando Plug	29999
6 x IEC C19, 16 x IEC C13 Sockets, Commando Plug	29989

1U Rackmount Fan Tray

Keep your equipment cool and efficient

- 2 x fans for effective cooling
- Supplied with UK mains cable
- Colour: Black



1U Rackmount Fan Tray

27505

Screws & Washers

**BEST
SELLER**



4 x Cage Nuts, Screws & Washers (4 pcs of each)	66034
---	-------

50 x Cage Nuts, Screws & Washers (50 pcs of each)	66033
---	-------

Telescopic Shelves

- Fixed between the front and back 19" mounting angles
- Ventilated design
- Supports a maximum weight of 40kg



Telescopic Shelf, 472 x 330mm (WxD)	27285
-------------------------------------	-------

Telescopic Shelf, 472 x 530mm (WxD)	27286
-------------------------------------	-------

Telescopic Shelf, 472 x 730mm (WxD)	27287
-------------------------------------	-------

Adjustable Depth Direct Mount Shelf

- Fixed between the front and back 19" mounting angles to support heavier weights
- Supports loads of up to 80kg when closed, 60kg when open
- Depth adjustable: 530mm to 1005mm
- Fixing screws included



1U Adjustable Shelf, 445 x 530-1005mm (WxD)	27594
---	-------

Cantilever Shelves

- Vented shelf, ideal for small equipment and accessories that are not designed for rackmounting
- For use with 19" rackmount enclosures (fastens between the front 19" mounting angles)
- Supports up to 20kg
- Fixing screws, cage nuts and washers not included (see above)



2U version

1U 19" Cantilever Shelf, 200mm Depth	27380
--------------------------------------	-------

1U 19" Cantilever Shelf, 300mm Depth	27381
--------------------------------------	-------

2U 19" Cantilever Shelf, 400mm Depth	27382
--------------------------------------	-------

Cable Management



1U Brush Panel

**BEST
SELLER**



2U, 5 Hoops

1U Cable Management Panel with 4 Vertical Hoops	20715
---	-------

1U Cable Management Panel with 9 Vertical Hoops	20718
---	-------

2U Cable Management Panel with 5 Vertical Hoops	20719
---	-------

1U Brush Panel	20716
----------------	-------

Blank Panels

Fill in unused spaces

- Improves appearance and hides unsightly cables
- For use with 19" enclosures
- Fixing screws required (see above)

2U Blank Panel

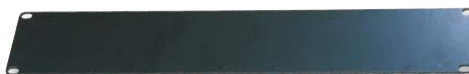

1U Blank Panel	70505
----------------	-------

3U Blank Panel	70507
----------------	-------

4U Blank Panel	70508
----------------	-------

19" CAT5e & 6 Patch Panels

Available with up to 48 ports

- High quality angled terminal block contacts
- Accepts 22-26 AWG solid core wire
- Dual type terminal blocks
- Dual standard labelling (T568A/T568B colour coding standards)
- Cable tie mounts and cable ties supplied

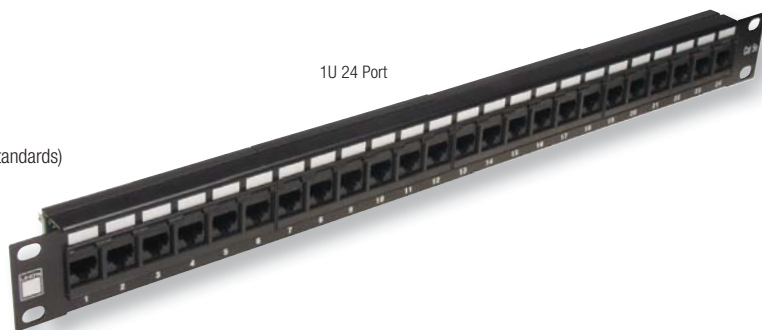

RJ-45 Patch Panels	CAT5e	CAT6	CAT6A
1U 16 Port	20755	12751	-
1U 24 Port	20756	12752	-
1U 48 Port	-	25889	-
2U 32 Port	20757	12753	-
2U 48 Port	20758	12754	-

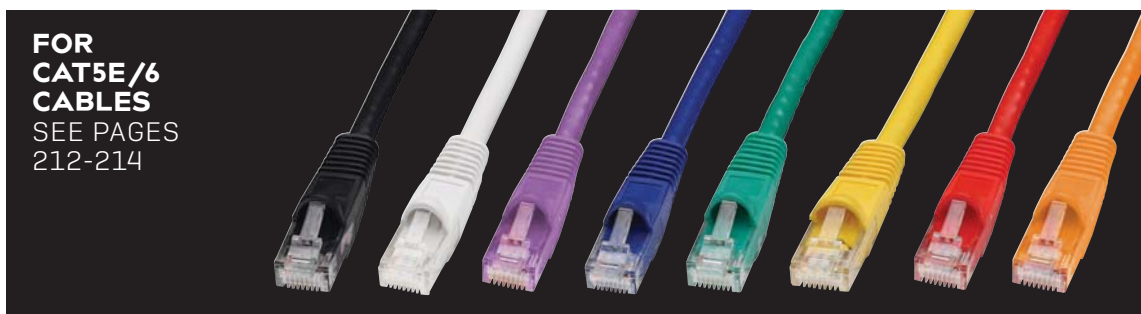

CAT6 Locking Keystone Coupler

- Securely lock RJ-45 cables into their ports
- For use with our range of keystone patch panels
- Pack of 10

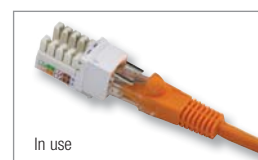

CAT6 Locking Keystone Coupler, 10 Pack

60755

RJ-45 Dust Cover, 10 Pack

- Protects unused ports from dust, copper strands and other foreign objects



RJ-45 Dust Cover, 10 Pack

60756

1000Base-T LAN Surge Protector

- Plugs into a standard RJ-45 port of each device you wish to protect
- Supports up to 10/100/1000Mbps
- Performance protection line to line: 1000V
- Connectors: RJ-45 Male to RJ-45 Female



1000Base-T LAN Surge Protector

60198

IPower Control Modules

Advanced power management over IP

- Control power to your devices over LAN/WAN or the internet
- Quick and easy to install and use with a simple browser interface
- Supports DHCP or manual IP address allocation
- Network connection: RJ-45 10Base-T Ethernet port



IPower Control IEC

- 1 In 1 Out: 1 x IEC C14 (230V AC); 1 x IEC C13 (10A max.)
- Supplied with a 1m IEC extension mains cable
- Longer IEC extension cables are available (see table to the right)

IPower Control IEC	32672
2m IEC C14 to C13 Extension Cable	30331
3m IEC C14 to C13 Extension Cable	30327
5m IEC C14 to C13 Extension Cable	30333

IPower Control 8

- 1 In 8 Out: 1 IEC C20 (230V AC); 8 x IEC C14
- Total switching power: 13A using a UK 3 Pin Plug; 16A using 'Commando' to IEC C19 power cables (not included)
- Mains cables included:
 - Input: 1 x UK 3 Pin Plug to IEC C19 Female, 2m
 - Output: 8 x IEC C14 Male to IEC C13 Female, 2m
- Ports for optional temperature sensor, RS-232 control, smoke detectors, door contacts etc.
- 19" 1U rackmount design
- Optional Temperature Sensor available (below)



IPower Control 8	32652
Optional Temperature Sensor, 2m	32648

IPower Switch Classic

- Remote management switch for 8 or 16 devices
- True RMS current meter for real time monitoring of power consumption
- Sends email and SNMP warnings when overloads occur
- Switched power (per port): max. 2400W (10A @240V)
- Switched power (total): max. 3120W (13A@240V) or 3840W (16A@240V) using optional 'Commando' to IEC C19 power cables
- Mains cable included: 2m IEC C19 to UK Mains Plug
- 8 socket version is a 19" 1U rackmount design
- 16 socket version is a vertical 28U rackmount design of 125cm in height



**BEST
SELLER**

IPower Switch Classic 8	32657
IPower Switch Classic 16	32658
2m IEC C14 to C13 Extension Cable	30331
3m IEC C14 to C13 Extension Cable	30327
5m IEC C14 to C13 Extension Cable	30333

IPower Control 12

Remotely control the power of up to 12 devices with individual energy measurement of each connected device

- User friendly web browser interface allows easy access and configuration
- 2 In 12 Out: 2 x IEC C20 (230V AC); 12 x IEC C14
- Measures the throughput power of 12 individual devices
- Total switched power for one single port: max 2400W (10A@240V)
- Total switched power for all ports: Max 3120W (13A@240V)
- Mains cables included:
 - Input: 2 x UK 3 Pin Plug to IEC C19 Female, 2m
 - Output: 12 x IEC C14 Male to IEC C13 Female, 2m
- Ports for optional temperature sensor, RS-232 control and smoke detectors
- 1U rackmount design



IPower Control 12	32690
Optional Temperature Sensor, 2m	32649

IPower Control 12 (2 x 6)

Remotely control the power of up to 12 devices with energy measurement of two banks of six devices

- User friendly web browser interface allows easy access and configuration
- 2 In 12 Out: 2 x IEC C20 (230V AC); 12 x IEC C14
- Measures the throughput power of each bank of six devices
- Total switched power for one single port: max 2400W (10A@240V)
- Total switched power for all ports: Max 3120W (13A@240V)
- Mains cables included:
 - Input: 2 x UK 3 Pin Plug to IEC C19 Female, 2m
 - Output: 12 x IEC C14 Male to IEC C13 Female, 2m
- Ports for optional temperature sensor, RS-232 control and smoke detectors
- 1U rackmount design



IPower Control 12 (2 x 6)

32660

Optional Temperature Sensor, 2m

32649

4 Port DIN Rail Mounted IPower Switch

- Controllable through a browser interface, manually or by RS-232
- Integrated DHCP client
- Switching current for a single 10A channel (total 16A)
- One sensor input for either temperature or humidity
- 4 switched power ports
- Timed start function



4 Port DIN Rail Mounted IPower Switch

32650

GSM Power Socket

Control power to everyday products using SMS messaging

- Uses a PAYG or contract GSM SIM card
- Includes external temperature sensor
- Automatically sends an SMS when the power fails



GSM Power Socket

32665

Free UK DELIVERY  on all orders over £125 (ex VAT.)

Some exceptions apply, see delivery terms & conditions on our website

Visit our website **WEBSITE** for the latest prices & special offers



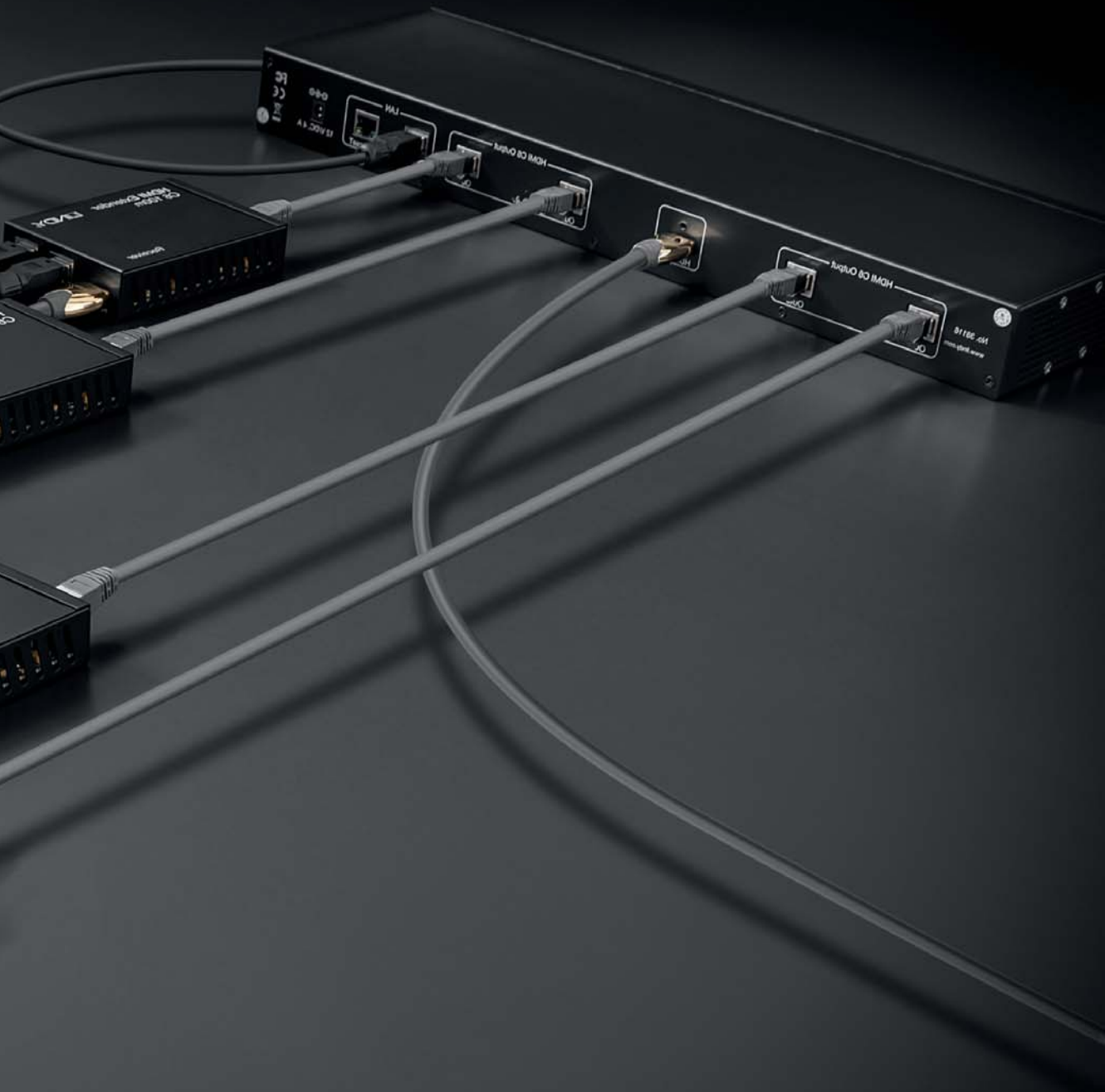

COMPONENTS & TOOLS UPGRADE

Add-on Cards	136
Drive Enclosures	142
Drive Docking & Cloning Stations	143
Caddies	145
Raid Back Plane Systems	146
Drive Accessories, Rail & Brackets	147
Tools, Tool Kits & Testers	148

Serial Cards

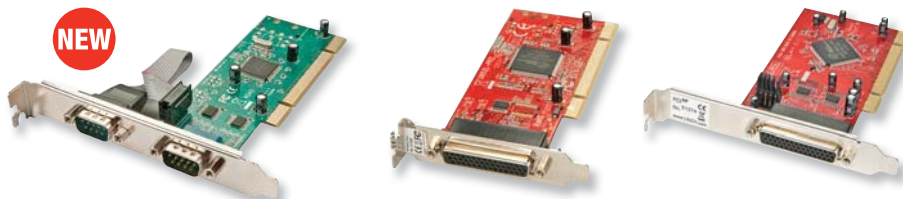

Description	2 x RS-232, PCI	2 x RS-232, PCI	4 x RS-232, PCI
Ports	2 x 9 Way D Male	2 x 9 Way D Male*	4 x 9 Way D Male*
Form Factor	Standard	Low Profile	Standard & Low Profile
Compatibility	XP/Vista/7/8.1/10 Server 2003 & 2008, Linux	XP/Vista/7/10 Server 2003, Linux	XP/Vista/7/10 Server 2003 & 2008
	51241	51326	51274 * via breakout cable



Description	1 x RS-232, PCIe x1	2 x RS-232, PCIe x1	2 x RS-232, PCIe x1
Ports	1 x 9 Way D Male	2 x 9 Way D Male	2 x 9 Way D Male
Form Factor	Standard	2 x Low Profile	Standard
Compatibility	XP/Vista/7/8/8.1/10 Server 2003 & 2008, Linux	XP/Vista/7/8/8.1/10 Server 2003, Linux	XP/Vista/7/8/8.1/10 Server 2003 & 2008, Linux
	51186	51245	51187 * via breakout cable



Description	4 x RS-232, PCIe x1	2 x RS-232, CardBus	1 x RS-232, ExpressCard	2 x RS-422/485, PCI
Ports	4 x 9 Way D Male*	2 x 9 Way D Male*	1 x 9 Way D Male	2 x 9 Way D Male*
Form Factor	Standard	CardBus	ExpressCard/34	Standard & Low Profile
Compatibility	XP/Vista/7/8/8.1/10 Server 2003 & 2008, Linux	XP/Vista/7/8/8.1 Server 2003, Linux	XP/Vista/7 Server 2003 & 2008, Linux	XP/Vista/7/10 Server 2003 & 2008, Linux
	51189	51334	51530	51215 * via breakout cable

Parallel Cards

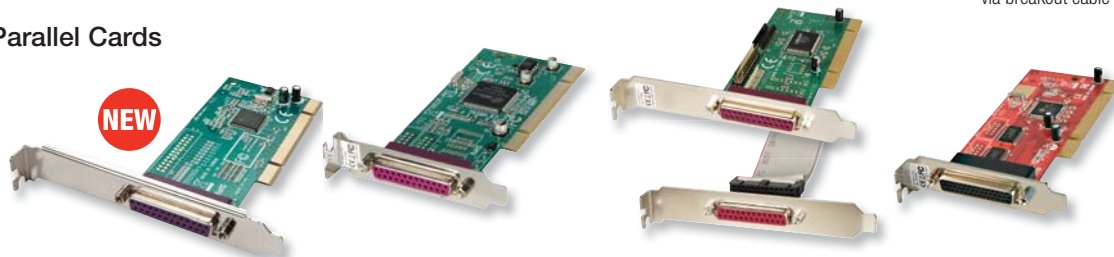

Description	1 x Parallel, PCI	1 x Parallel, PCI	2 x Parallel, PCI	2 x Parallel, PCI
Ports	1 x 25 Way D Female	1 x 25 Way D Female	2 x 25 Way D Female	2 x 25 Way D Female*
Form Factor	Standard	Low Profile	2 x Standard	Low Profile
Compatibility	XP/Vista/7/8/8.1/10 Server 2003 & 2008, Linux	XP/Vista/7/10 Server 2003, Linux	XP/Vista/7/10 Server 2003 & 2008, Linux	XP/Vista/7 Server 2003 & 2008, Linux
	51243	51325	51296	51318 * via breakout cable

Parallel Cards



Description	1 x Parallel, ExpressCard/34	1 x Parallel, PCIe x1
Ports	1 x 25 Way D Female*	1 x 25 Way D Female
Form Factor	ExpressCard/34	Standard
Compatibility	XP/Vista/7/8 Server 2003 & 2008, Linux	XP/Vista/7/8/8.1/10 Server 2003, Linux
	51535	51185

* via breakout cable

Parallel Cards, Serial & Parallel Combo Cards

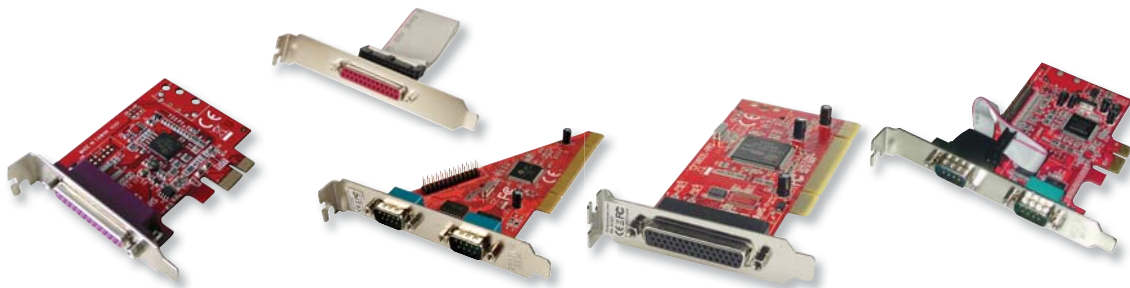

Description	1 x Parallel, PCIe x1	2 x RS-232, 1 x Parallel, PCI	2 x RS-232, 1 x Parallel, PCI	2 x RS-232, 1 x Parallel, PCIe x1
Ports	1 x 25 Way D Female	2 x 9 Way D Male 1 x 25 Way D Female	2 x 9 Way D Male* 1 x 25 Way D Female*	2 x 9 Way D Male 1 x 25 Way D Female
Form Factor	Low Profile	2 x Standard	Low Profile	2 x Standard
Compatibility	XP/Vista/7/10 Server 2003 & 2008, Linux	XP/Vista/7/8/8.1/10 Linux	XP/Vista/7/10 Server 2003, Linux	XP/Vista/7/8/8.1/10 Server 2003, Linux
	51246	51237	51327	51188

* via breakout cable

Controller Cards



Description	2 x SATA, PCI	4 x SATA, PCI	4 x SATA II, PCI
Ports	2 x SATA (1.5Gbps)	4 x SATA (1.5Gbps)	4 x SATA (3Gbps)
Form Factor	Standard & Low Profile	Standard & Low Profile	Standard & Low Profile
Features	RAID 0 & 1	RAID 0,1 & 0+1	RAID 0,1, 0+1, 5 & JBOD
Compatibility	XP/Vista/7/8 Server 2003 & 2008	XP/Vista/7/8.1	XP/Vista/7/8/8.1/10 Server 2003 & 2008, Linux
	51150	51151	51131

Controller Cards

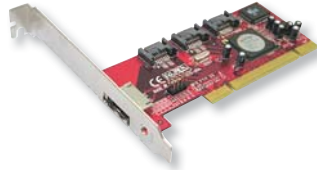
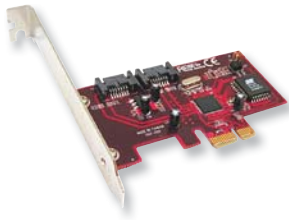

Description	2 x SATA II, PCIe x1	4 x SATA II, PCI	4 x eSATA II, PCIe x8
Ports	2 x SATA (3Gbps)	3 x SATA (3Gbps) & 1 x eSATA (3Gbps)	4 x eSATA (3Gbps)
Form Factor	Standard & Low Profile	Standard & Low Profile	Standard
Features	RAID 0, 1, 0+1, 5 & JBOD	RAID 0,1, 0+1, 5 & JBOD	RAID 0,1, 0+1, 5 & JBOD
Compatibility	XP/Vista/7/8/8.1/10 Server 2003 & 2008, Linux, OS X	XP/Vista/7/8/8.1/10 Server 2003 & 2008, Linux	XP/Vista/7/8/8.1/10 Server 2003, Linux, OS X
	51139	51136	51133

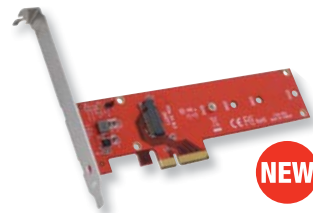
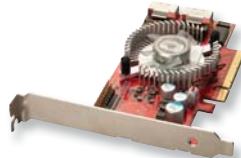

Description	8 x SAS/SATA III, PCIe x8	8 x SATA III Multilane, PCIe x8	M.2 SSD, PCIe x4
Ports	2 x SFF-8088	2 x SFF-8087 (6Gbps)	M.2 NGFF Type 22110-D5-M
Form Factor	Standard & Low Profile	Standard & Low Profile	Standard & Low Profile
Compatibility	XP/Vista/7/8/8.1/10/Server 2008	XP/Vista/7/8/8.1/10, Linux	Windows 7/8/10 Server 2008/2012, Linux, OS X
	51138	51137	51132

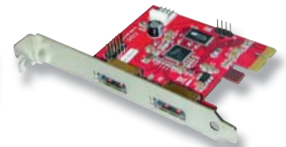

Description	1 x eSATA II, ExpressCard	2 x eSATA II, ExpressCard	2 x eSATA III, ExpressCard	2 x eSATAp, PCIe x1
Ports	1 x eSATA (3Gbps)	2 x eSATA (3Gbps)	2 x eSATA (6Gbps)	2 x eSATAp (3Gbps) / USB 2.0 (480Mbps)
Form Factor	ExpressCard/34	ExpressCard/34	Standard & Low Profile	Standard
Compatibility	XP/Vista/7 Server 2003 & 2008	XP/Vista/7 Server 2003 & 2008, OS X	XP/Vista/7/8 Server 2003 & 2008	XP/Vista/7/8/8.1/10 Server 2003 & 2008, Linux, OS X
	51525	51520	51545	51165

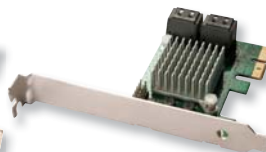
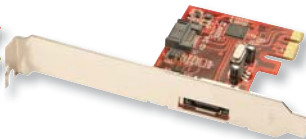
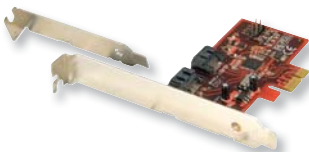

Description	2 x SATA III, PCIe x1	1+1 x SATA III, PCIe x1	4 x SATA III, PCIe x2	2 x eSATA III, PCIe x1
Ports	2 x SATA (6Gbps)	1 x eSATA, 1 x SATA (shared) (6Gbps)	4 x SATA (6Gbps)	2 x eSATA (6Gbps)
Form Factor	Standard & Low Profile	Standard & Low Profile	Standard & Low Profile	Standard & Low Profile
Compatibility	XP/Vista/7/8/8.1/10 Server 2003 & 2008	XP/Vista/7/8/8.1/10 Server 2003 & 2008	XP/Vista/7/8/8.1/10 Server 2003 & 2008, OS X, Linux	XP/Vista/7/8/8.1/10 Server 2003 & 2008
	51403	51402	51163	51400

Network Cards



Description	Gigabit Fibre SFP, PCIe x1	Gigabit Ethernet, PCIe x1	Gigabit Ethernet, ExpressCard
Ports	1 x Fibre SFP	1 x RJ-45 Female	1 x RJ-45 Female
Form Factor	Standard & Low Profile	Standard & Low Profile	ExpressCard/34
Compatibility	XP/2003/Vista/7/8/10 OS X, Linux	XP/Vista/7/8/8.1/10 Server 2008	XP/Vista/7/8/8.1 OS X 10.5 & above
	51219	51192	51512

IDE / SATA Converters & Adapters



Part No. 51020

Part No. 51025

Part No. 51027

Part No. 51024

Description	SATA Converter for IDE Drives	IDE Converter for SATA Drives	SATA Adapter for Motherboard IDE Slot
Ports	40 Way IDC Female to SATA Male	40 Way IDC Male (Controller) to SATA Male (Drive)	40 Way IDC Female (Controller) to 2 x SATA Female; 4 Pin Power
Form Factor	On IDE drive	On SATA drive	On Motherboard IDE port
Compatibility	Silicon Image	JMicron	JMicron
	51020	51025	51024

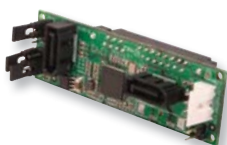

Description	2 Port 6 Gbps Hardware RAID Adapter for PC/Server	SAS / SATA 6Gbps Multilane Bracket Adapter for Drive Enclosures
Ports	2 x 7 Pin SATA Female 1 x 22 Pin SATA Male	SFF-8088 to 4 x SATA
Form Factor	-	SCSI-I (50 Way Centronics) Form Factor
	51017	70552

USB 2.0 Cards

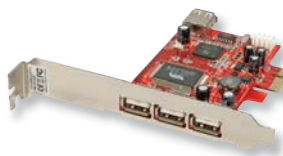

Description	2 + 2 Port USB 2.0, PCI	4 + 1 Port USB 2.0, PCI	3 + 1 Port USB 2.0, PCIe x1	2 Port USB 2.0, CardBus
Ports	2 x Type A Female; 1 x USB Header (internal)	4 x Type A Female; 1 x Type A Female (internal)	3 x Type A Female; 1 x Type A Female (internal)	2 x Type A Female
Form Factor	Standard & Low Profile	Standard	Standard & Low Profile	CardBus
Compatibility	XP/Vista/7/8/10 Server 2003 & 2008	XP/Vista/7/10 Server 2003 & 2008, OS X	XP/Vista/7/8/10 Server 2003 & 2008	XP/Vista/7/8 Server 2003 & 2008, OS X
	51058	51064	51120	51340

USB & FIREWIRE CARDS

USB 3.0 Cards

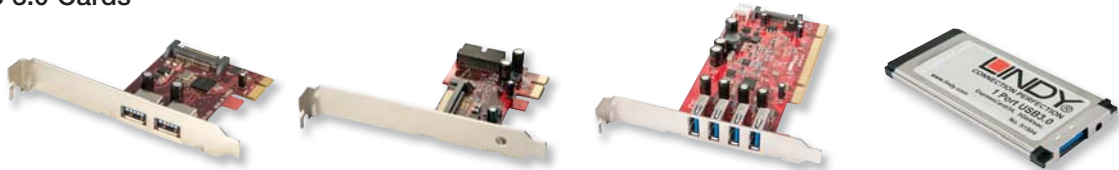

Description	2 Port USB 3.0, PCIe x1	2 Port USB 3.0, PCIe x1	4 Port USB 3.0, PCI	1 Port USB 3.0, ExpressCard/34
Ports	2 x Type A USB 3.0 Female; SATA Internal Power	1 x 19 Pin USB 3.0 Header (internal); 15 Way SATA Power	4 x Type A USB 3.0 Female; SATA & 3.5" Internal Power	1 x Type A USB 3.0 Female
Form Factor	Standard & Low Profile	Standard & Low Profile	Standard & Low Profile	-
Compatibility	XP/Vista/7/8	XP/Vista/7/8/10 Linux	XP/Vista/7/8/10, Linux	Win 7/8/8.1
	51119	51124	51048	51504



Description	2 Port USB 3.0, PCIe x1	3 + 1 Port USB 3.0, PCIe x1	6+1 Port USB 3.0 Card, PCIe x1
Ports	2 x Type A USB 3.0 Female 5.25" Int. Power Connector	3 x Type A USB 3.0 Female 1 x Type A USB 3.0 Female (int) SATA Power	6 x Type A USB 3.0 Female; 1 x Type A USB 3.0 (internal) SATA Power
Form Factor	Standard	Standard & Low Profile	Standard & Low Profile
Compatibility	Win 2000/XP/Vista/7/8/10 Server 2003 & 2008, Linux	Win XP/Vista/7/10, Linux	All OS supporting USB 3.0
	51118	51121	51067

USB 3.1 Cards



Description	2 Port USB 3.1, PCIe x4	2 Port USB 3.1, PCIe x4	2 Port USB 3.1, Gigabit Ethernet, PCIe x1
Ports	2 x USB 3.1 Type C	1 x USB 3.1 Type C, 1 x USB 3.1 Type A	3 x USB 3.1 Type A, 1 x RJ-45 Female
Form Factor	Standard & Low Profile	Standard	Standard & Low Profile
Compatibility	Vista/7/8/8.1/Server 2003/2008/2012	Supported OS: Windows 10, 8.1, 8, 7, Vista (32bit /64bit)	Supported OS (32bit /64bit): Windows Vista, 7 / 8 / 8.1 / 10
	51054	51056	51049

FireWire Cards



Description	2 Port FireWire 400, PCIe x1	2 Port FireWire 800, 1 Port FireWire 400, PCIe x1	2 Port FireWire 800, 1 Port FireWire 400, ExpressCard
Ports	2 x 6 Pin; 4 Pin Power (internal)	2 x 9 Pin, 1 x 6 Pin; 4 Pin Power (internal)	2 x 9 Pin, 1 x 6 Pin; Power Jack for optional PSU
Form Factor	Standard & Low Profile	Standard	ExpressCard/34
Compatibility	XP/Vista/7/8/10 Server 2003 & 2008, OS X	XP/Vista/7/8/10 Linux, OS X	XP/Vista/7/8, OS X
	51180	51182	51499

FireWire Cards



Description	3 + 1 Port FireWire 400, PCI	2 Port FireWire 400, ExpressCard
Ports	3 x 6 Pin; 1 x 6 Pin (internal shared)	2 x 6 Pin; Power Jack for optional PSU
Form Factor	Standard	ExpressCard/34
Compatibility	XP/Vista/7/10 Server 2003 & 2008, OS X	XP/Vista/7/Server 2003 & 2008, OS X
	51088	51500

USB & FireWire Combo Card



Description	4 Port USB 2.0, 2 Port FireWire 400, PCI
USB Ports	2 x Type A; 2 x Type A (internal)
FireWire Ports	1 x 6 Pin, 1 x 4 Pin
Form Factor	Standard
Features	Includes VideoStudio for PC
Compatibility	XP/Vista/7/10/Server 2003 & 2008
	51095

CABLE GURU

FIND THE CABLE YOU NEED

Try it now on our

WEBSITE

Adapter Cards

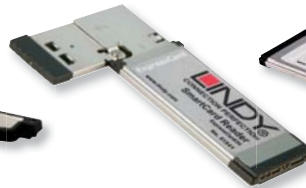

Description	Card Reader, PCMCIA	Compact Flash Card Reader, PCMCIA	Smart Card Reader, ExpressCard/34	CardBus to ExpressCard/34 Adapter
Card Support	SD, SD HC XD, MMC, Memory Stick & many more	Compact Flash	ISO7816 compatible Smart Cards	CardBus (32 Bit) - Type I/II (FireWire cards not supported)
Form Factor	16 Bit PCMCIA	16 Bit PCMCIA	ExpressCard/34 or 54	ExpressCard/34
Compatibility	XP/Vista/7 Server 2003 & 2008	XP/Vista/7/ Server 2003 & 2008	XP/Vista/7/8, OS X	XP/Vista/7, OS X
	70924	70952	51541	51355

mPCIe to USB 2.0 Converter

- Allows USB 2.0 devices, including flash storage or wireless adapters, to be added to a laptop via an internal mPCIe slot
- Full size mPCIe module adapter
- 52 pin mPCIe to USB 2.0 Type A Female
- Transparent to the operating system - No driver installation required
- Includes fastening screws M2x3 for full and half size securing holes
- Compatible with all modern OS supporting USB 2.0



mPCIe to USB 2.0 Converter

51181

2.5" SATA Enclosure, USB 2.0

- For 2.5" SATA 1.5Gbps and 3Gbps drives up to 9.5mm in height
- Supplied with a dual USB 2.0 A to Micro-B data & power cable
- Not suitable for use with SSDs requiring 3.3V



WIN | MAC OS | LINUX

2.5" SATA Enclosure, USB 2.0

42673

2.5" SATA Enclosure, One Push Backup, USB 2.0

- For 2.5" SATA 1.5Gbps and 3Gbps drives up to 9.5mm in height
- One Push Backup function for easy data storage
- Supplied with a dual USB 2.0 A to Mini-B data & power cable



**BEST
SELLER**

WIN | MAC OS | LINUX

2.5" SATA Enclosure, One Push Backup, USB 2.0

42671

2.5" SATA Enclosure, USB 3.1 Type A

- For 2.5" SATA 1.5Gbps and 3Gbps drives up to 9.5mm in height
- With integrated USB 3.1 Type A cable

NEW



WIN | MAC OS | LINUX

2.5" SATA Enclosure, USB 3.1

43240

2.5" SATA Drive Enclosure, USB 3.1 Type A with 3 Port Hub

- For 2.5" SATA 1.5Gbps, 3Gbps and 6Gbps drives up to 9.5mm height
- Integrated 3 port USB 3.1 hub (3 x USB Type A Female)
- USB port for the USB Battery Charging Standard BC 1.2 (max. 1.5A)
- Supplied with a USB Type A to Micro-B cable



NEW

2.5" SATA Drive Enclosure, USB 3.1 with 3 Port Hub

43199

3.5" SATA Drive Enclosure, USB 2.0

- For use with 3.5" SATA 1.5Gbps and 3Gbps drives of up to 3TB
- Power supply and connection cables included



WIN | MAC OS | LINUX

3.5" SATA Enclosure, USB 2.0

42901

2.5" SATA Drive Enclosure, USB 3.1 Type C

- USB 3.1 Gen 2 SuperSpeed+ interface - 10Gbps, backwards compatible with USB3.0 / 2.0 / 1.1
- Supports 2.5" HDD and SSDs up to 9.5mm in Height
- Supports SATA 6Gbps, 3Gbps and 1.5Gbps

NEW



2.5" SATA drive Enclosure, USB 3.1 Type C

43184

USB 3.1 Type C mSATA SSD Enclosure

- USB 3.1 Gen 2 SuperSpeed+ interface - 10Gbps, backwards compatible with USB 3.0 / 2.0 / 1.1
- Supports SATA 6Gbps, 3Gbps and 1.5Gbps

NEW

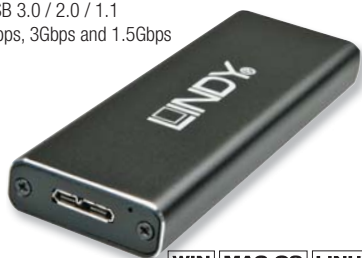

WIN | MAC OS | LINUX

USB 3.1 Type C mSATA SSD Enclosure

43186

USB 3.0 M.2 SSD Enclosure

- USB 3.1 Gen 2 SuperSpeed+ interface - 10Gbps, backwards compatible with USB 3.0 / 2.0 / 1.1
- Supports SATA 6Gbps, 3Gbps and 1.5Gbps

NEW



WIN | MAC OS | LINUX

mSATA SSD Enclosure, USB 3.0

43187

USB 3.1 Ultra Slim Optical Drive Housing - 9.5mm

- External USB Enclosure for Optical Drives
- SATA / SSD storage disk support via adapter (No. 20974, see page 146)
- Supports USB 3.1 Gen 1 Connection Speeds - 5Gbps
- Aluminium Alloy Case



NEW

USB 3.1 Ultra Slim Optical Drive Housing - 9.5mm

42714

Blu-Ray / DVD / CD Enclosure, USB 3.0

SuperSpeed connection for your optical drive

- Supplied with an IDE / SATA drive converter
- Includes 0.8m USB 3.0 cable



WIN | MAC OS | LINUX

Blu-Ray / DVD / CD Enclosure, USB 3.0

43138

1U Rackmount Enclosure for Two Half Height DLT Drives

- Features two slots suitable for half height internal 5.25" DLT drives
- 3 fans at rear
- Internal connectors 2 x 68 Way SCSI
- External connectors: 2 x 68 Way SCSI
- Rackmount brackets, power cable and installation screws included



1U Enclosure for 2 DLT Drives

20811

SAS / SATA Multilane Quad Drive RAID System

- Supports four SATA 1.5Gbps or 3Gbps HDDs up to 2TB each
- SAS / SATA Multilane SFF-8470 interface supports transfer rates up to 12Gbps (4 x 3 Gbps)
- Supports all RAID levels for 4 HDDs depending on host controller
- Built-in USB printer server, UPnP Server



WIN | MAC OS | LINUX

SAS / SATA Multilane Quad RAID System

42827

USB 3.0 Docking & Cloning Station For 2.5" & 3.5" Drives

Ideal for technicians and IT departments



NEW

- Standalone cloning functionality, no computer required
- Full bitwise cloning including MBR and EISA partitions
- Dual Bay design accepts either 2.5" or 3.5" SATA disk drives
- USB 3.0 SuperSpeed 5Gbps Interface - Compatible with USB 3.0 equipped PCs and Macs

USB 3.0 Docking & Cloning Station For 2.5" & 3.5" Drives

43113

DRIVE DOCKING STATIONS EASILY CLONE HARD DRIVES



For IT technicians in schools, colleges and workplaces, the ability to easily clone hard drives is an essential requirement when PCs are being upgraded or transferred between users.

LINDY Drive Cloning Stations are a simple and quick solution for connecting and cloning internal hard drives. Available with USB and eSATA connections they can be used with 2.5" and 3.5" drives for maximum convenience.

USB 2.0 & eSATA Drive Docking Station

- Quickly connect and disconnect different drives without the hassle of installing them into external housings or opening up a computer case
- Accepts 2.5" or 3.5" SATA disk drives (accepts one drive at a time)
- Supplied with 1m USB & eSATA cables



WIN | MAC OS | LINUX

USB 2.0 & eSATA Hard Drive Docking Station

42789

USB 2.0 & eSATA Drive Cloning Station

- Clones drives without connecting to a PC
- Cloning function allows a bit by bit drive cloning (including operating system and partitions)
- Supports 2.5" and 3.5" SATA hard drives
- Supplied with 1m USB and eSATA cables



WIN | MAC OS | LINUX

USB 2.0 & eSATA Hard Drive Cloning Station

42797

Micro SATA to 2.5" SATA Adapter Case

- Converts Micro SATA drives to 2.5" SATA form factor
- For 1.8 inch HDDs/SSDs with Micro SATA connector
- Incorporates a 5V DC to 3.3V DC voltage regulator
- 10mm high 2.5 inch aluminium alloy case
- 7 Pin Data + 15 Pin Power (SATA port) to 7 Pin Data + 9 Pin Power (Device) connector



Micro SATA to 2.5" SATA Adapter Case

20932

mSATA to 2.5" IDE SSD Drive, 7mm

- Converts mSATA to 2.5" IDE form factor
- Includes 7mm high 2.5" drive metal frame
- Latch type mSATA connection



mSATA to 2.5" IDE SSD Drive, 7mm

20937

mSATA SSD to 2.5" SATA Caddy

- Converts mSATA SSD to a 2.5" drive form factor
- Internal 52 pin mSATA Female connector
- External 22 pin SATA Male connector
- The caddy has the same dimensions as a 2.5" drive with a 7mm height

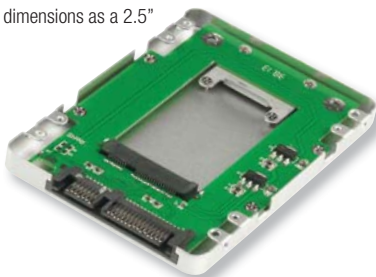

mSATA SSD to 2.5" SATA Drive Caddy

20933

M.2 SSD to 2.5" SATA Caddy

- Converts M.2 (NGFF) SSD to SATA 22 pin form factor
- Supports 2280, 2260, 2242, 2230 M.2 form factors
- The caddy has the same dimensions as a 2.5" drive with a 7mm height

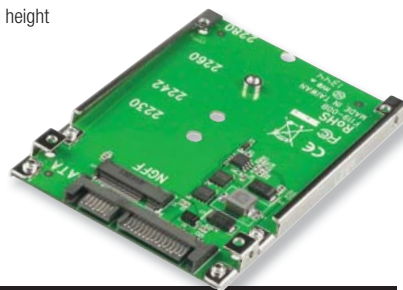

M.2 SSD to 2.5" SATA Caddy

20934

mSATA & M.2 SSD to 2.5" SATA Caddy

- Converts mSATA and M.2 (NGFF) SSD into a 2.5" drive form factor
- Supports 2280, 2260, 2242, 2230 M.2 form factors
- Internal 52 pin mSATA Female connector and an M.2.B Key slot
- External 22 pin SATA Male connector
- The caddy has the same dimensions as a 2.5" drive with a 9.5mm height



mSATA & M.2 SSD to 2.5" SATA Caddy

20939

Ultra Slim ODD Caddies for HDD & SSD

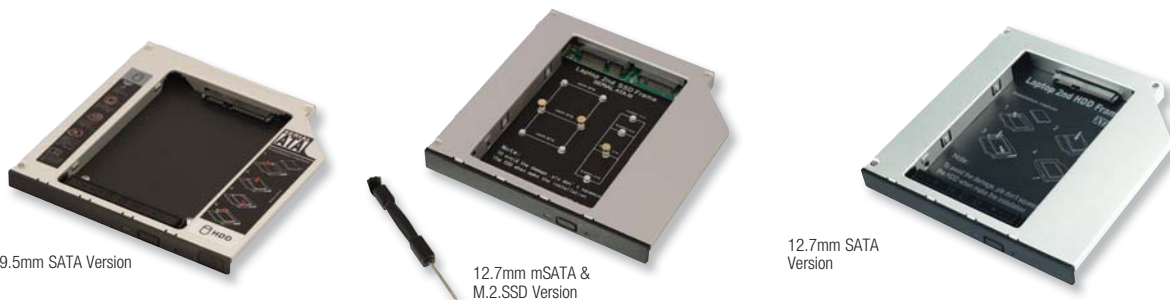

- Allows you to install a hard drive in your notebook using the optical drive bay
- Designed to fit most standard CD/DVD/Optical Drive bays
- Two SATA hard drive versions available to support 9.5mm or 12.5mm drive heights (SATA versions do not support 3.3V SSDs)
- mSATA & M.2.SSD version also available (supports 12.7mm drive heights)
- Laptop Interface: Slim SATA 13 Pin connector (ODD)
- Supplied with screwdriver for installation
- Dimensions (WxDxH):
 - 9.5mm version: 29 x 128 x 9.5mm (No. 20974)
 - 12.7mm versions: 29 x 128 x 12.7mm (No. 20963 & No. 20929)

Ultra Slim ODD Caddy for 2.5" SATA HDD (9.5mm)	20974
Ultra Slim ODD Caddy for 2.5" SATA HDD (12.7mm)	20963
Ultra Slim ODD Caddy for 2.5" mSATA & M.2.SSD (12.7mm)	20929

Back Plane System for four 2.5" SAS / SATA Drives

Add four 2.5" HDDs to a single 5.25" bay

- Supports drives up to 12.5mm in height
- Fits into a standard 5.25" drive bay
- Supports hot swap function
- Supplied with caddies for each drive
- External connectors : 8 x SATA 7 Pin (primary & secondary data channels); 15 Way SATA Power
- Dimensions (WxDxH): 146 x 173 x 41mm



Back Plane System for 4 x 2.5" SAS / SATA Drives	21981
--	-------

SAS / SATA Back Plane Modules

For servers, PCs and external storage systems

- SAS and SATA III versions available
- Fits into a 5.25" expansion bay and supports 3.5" drives
- SAS / SATA version 1.5Gbps and 3Gbps drive support
- SATA III version: 6Gbps drive support
- Hot plug support
- Lockable drive eject handle with automatic drive release system



Drive mounts into the module without the need for a caddy



SATA III Back Plane Module	21978
SAS / SATA Back Plane Module	21970

3.5" HDD Wallets

- Features two compartments - one for the drive and one for a cable or paperwork etc.



3.5" Hard Drive Wallet

40684

HDD Rails

Install 2.5" drives into a 3.5" bay or 3.5" drives into a 5.25" bay

- Hard disk drive installation kit, short bracket only
- Includes left and right rails and screws

2.5" to 3.5" Rail



2.5" HDD to 3.5" Rail

40588

Universal 3.5" HDD to 5.25" Rail

40545

Universal 3.5" HDD to 5.25" Bay



Universal 3.5" HDD to 5.25" Bay

40526

PC Case Security Screws

- 4 security screws and 1 key



PC Case Security Screws

40258

HDD Storage Case

- Anti-static protection
- Foam padding to provide protection from vibration/shock
- Includes stickers for labelling



3.5" HDD Storage Case, Grey

40682

3.5" HDD Storage Case, Blue

40686

Universal 2.5" HDD to 3.5" Bay

- IDE & SATA versions
- Includes drive bracket and data & power adapter cable

SATA version shown

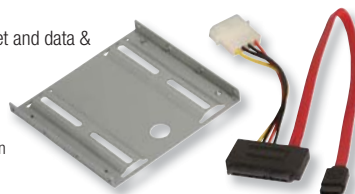

Universal 2.5" HDD to 3.5" Bay, IDE

40528

Universal 2.5" HDD to 3.5" Bay, SATA

40527

Universal 5.25" Bay

Mount Slim & Super Slim ODD & HDD drives in a standard 5.25" bay

- For the installation of either:
 - 2 x 5.25" Slim ODD
 - 1 x 5.25" Slim/Super Slim ODD & 1 x 3.5" HDD
 - 1 x 5.25" Slim/Super Slim ODD & 1 x 2.5" HDD/SSD



Universal 5.25" Bay

40513

500W ATX Power Supply

- Input: 230V AC 5A 50~60Hz
- 12cm cooling fan (automatically regulated)
- Features the following connectors:
 - 1 x 24 pin (20+4), 1 x 4 pin (P4 CPU) ATX motherboard
 - 3 x SATA power (with 3.3V core)
 - 2 x 5.25" Molex type HDD/DVD power
 - 1 x 3.5" type floppy drive power



500W ATX PSU

73263

RJ-45 Crimp Tool

- Crimp tool for 8 Way RJ-45 type connectors
- Integrated cable cutter & stripper



RJ-45 Crimp Tool

43208

Professional Combo Crimp Tool

- For use with RJ-11, RJ-12, RJ-45 and DEC crimp plugs
- Integrated cable cutter & stripper



Professional Combo Crimp Tool

43216

RJ-12/RJ-11/RJ-10/BT Plug Crimp Tool

- Crimp tool for RJ-12, RJ-11, RJ-10 or BT crimp plugs
- Integrated cable cutter & stripper



RJ-12/11/10/BT Crimp Tool

40197

Professional IDC Punchdown Tool

- Built in Hook & Unlocking Blades
- Works with CAT3, CAT5, CAT5e & CAT6 shielded and non-shielded cable



Professional IDC Punchdown Tool

43211

7 Piece Folding Screwdriver Set

- Chromium-vanadium steel (CR-V) which is lightweight and strong
- Includes 4 x Flathead - 2mm, 3mm, 5mm, 6mm & 3 x Philips - PH1, PH2, PH3



NEW

7 Piece Folding Screwdriver Set

43037

7 Piece Colour Coded Folding Ball End Hex Set

- Double Sided Folding Tool with Painted Screwdrivers for easy identification
- Chromium-vanadium steel (CR-V) which is lightweight and strong
- Includes 1.5mm, 2mm, 2.5mm, 3mm, 4mm, 5mm and 6mm Hex keys
- Ball End joints allow the hex key to be inserted at an angle to the socket
- Size: 74 x 30 x 21mm (WxHxD)



NEW

7 Piece Colour Coded Folding Ball End Hex Set

43036

9 Piece Colour Coded Hex Key Set

- Folding holder for quick and easy access
- Colour Coded for easy identification
- S2 Grade steel for exceptional strength
- Includes 1.5mm, 2mm, 2.5mm, 3mm, 4mm, 5mm, 6mm, 8mm, 10mm Hex Keys



NEW

9 Piece Colour Coded Hex Key Set

43038

7 Piece Colour Coded Long Ball End Hex Key Set

- Folding holder for quick and easy access
- Colour Coded S2 Grade steel for exceptional strength and easy identification
- Chamfered Ball End and extra long shaft
- Includes 1.5mm, 2mm, 2.5mm, 3mm, 4mm, 5mm, 6mm Hex Keys



NEW

7 Piece Colour Coded Long Ball End Hex Key Set

43039

40 Piece Colour Coded Precision Screwdriver & Torx Set

- Ideal for precision work that requires various screwdriver types
- Supplied with 40 Colour Coded Screwdriver bits for easy identification
- S2 grade steel bits including Philips, Pozidriv, Flathead, Hex, Torx and Tamper Hex & Torx
- Metal case for storage and complete protection



40 Piece Colour Coded Precision Screwdriver & Torx Set

43035

Professional Torx Set

- 6 x Tamper proof Torx drivers:
 - T7H, T8H, T9H, T10H, T15H, T20H
- Supplied in a compact carry case



Professional Torx Set

43026

Precision Torx Set

- 5 x Torx drivers: T6, T7, T8, T9, T10
- Supplied in a compact carry case



BEST SELLER

Precision Torx Set

43012

Professional Screwdriver Set

- 3 x Philips drivers:
 - PH00, PH0, PH1
- 4 x Flathead drivers:
 - 1.6mm, 2mm, 2.4mm, 3mm
- Supplied in a compact carry case



Professional Screwdriver Set

43025

Precision Screwdriver Set

- 3 x Philips drivers:
 - PH00, PH0, PH1
- 3 x Flathead drivers:
 - 1.4mm, 1.8mm, 2.4mm
- Supplied in a compact carry case



BEST SELLER

Precision Screwdriver Set

43011

Network Tool Kit Pro

- Combo crimp tool with integral cable cutter/stripper for RJ series crimp connectors
- Co-axial cable stripper
- LAN cable tester with a passive module for remote testing of pre-installed cables
- 12 x RJ-45 crimp plugs
- 12 x coloured boots
- Supplied in a carry case



Network Tool Kit Pro

43048

Cable & Satellite TV Installers Tool Kit

- Compression crimp tool
- Cable cutting tool
- Co-axial cable stripper
- 8 x F-Type compression plugs supplied (additional packs of 10 also available)
- Supplied in a tough and lightweight carry case



BEST SELLER

Cable and Satellite TV Installers Tool Kit

43055

Pack of 10 F-Type Compression Plugs

43056

17 Piece Smartphone & Tablet Repair Screwdriver Set

- Ideal for working on various smartphones and tablets including Apple (iPhone, iPad), HTC, LG, Motorola, Samsung and Sony
- Can also be used with a wide range of everyday computer hardware and smaller gadgets as well as Xbox, PlayStation and Nintendo Wii consoles
- 12 precision bits for the removal of common smartphone screws
- Includes Pentalobe, Torx and Y (Tri wing) bits
- Rubberised driver handle for extra grip and control
- Touchscreen sucker tool for screen removal



17 Piece Smartphone & Tablet Repair Screwdriver Set

43004

13 Piece Bit Set with L Handle

- Includes an assortment of screwdriver bits for working on many common mobile devices, computers and home electronics
- Rubber coated L-Handle offers extra leverage and helps when working in tight spaces
- 3 x Philips drivers: PH0, PH1, PH2, PH3
- 4 x Flathead drivers: 2mm, 4mm, 5mm, 6mm
- 4 x Pozidrive drivers: PZ0, PZ1, PZ2, PZ3
- Supplied in a compact carry case



13 Piece Bit Set with L Handle

43030

25 Piece Socket and Bit Set with Ratchet Handle

- For general repairs, DIY, maintaining electrical and electronic equipment
- Compact, steel ratchet for working in tight areas
- 6 x Chrome Vanadium 1/4" sockets: 7mm, 8mm, 9mm, 10mm, 11mm, 12mm
- 3 x Philips drivers: PH0, PH1, PH2
- 4 x Flathead drivers: 2mm, 4mm, 5mm, 6mm
- 3 x Pozidrive drivers: PZ0, PZ1, PZ2
- 6 x Torx drivers: T6, T7, T8, T9, T10, T15
- Supplied in a carry case with belt clip



25 Piece Socket and Bit Set with Ratchet Handle

43031

12 Piece Precision Screwdriver Set

- 3 x Philips drivers: PH000, PH00, PH0
- 3 x Flathead drivers: 1.5mm, 2mm, 2.5mm
- 6 x Torx drivers: T5, T6, T7, T8, T9, T10
- Supplied in a neat carry wallet



12 Piece Precision Screwdriver Set

43021

30 Piece Precision Screwdriver Set

- 4 x Philips drivers: PH000, PH00, PH0, PH1
- 2 x Pozidriv drivers: PZ0, PZ1
- 7 x Flathead drivers: 1mm, 1.5mm, 2mm, 2.5mm, 3mm, 3.5mm, 4mm
- 8 x Hex drivers: 0.7mm, 0.9mm, 1.3mm, 1.5mm, 2mm, 2.5mm, 3mm, 4mm
- 9 x Torx drivers: T4, T5, T6, T7, T8, T9, T10, T15, T20
- Supplied in a handy carry case



30 Piece Precision Screwdriver Set

43020

Precision Service Kit

- 3 x Philips drivers: PH00, PH0, PH1
- 3 x Flathead drivers: 2mm, 2.4mm, 3mm
- 4.5" Thin Cutting Edge Side Cutters
- 4.5" Long Nose Pliers
- 5.5" Long Nose Pliers with 45° angle
- 5.5" Flat Nose Assembly Pliers
- 5.5" Needle Nose Pliers
- Supplied in a handy carry case



Precision Service Kit

43016

Compact Service Kit

- 2 x Philips drivers: PH0, PH1
- 2 x Flathead drivers: 3mm, 5mm
- 2 x Nut drivers: 5mm, 7mm
- Driver with T10 + T15 Torx bit
- IC Extractor
- Tweezers
- 3 claw pick-up tool
- Spare parts tube
- Supplied in a handy carry case



Compact Service Kit

43041

Light Duty Cable Tacker

NEW



- Compatible with 4mm to 8mm Round and 2.5mm to 6.3mm Flat Cables
- Suitable for a wide range of electrical installation tasks
- Used with staples 43083 and 43084
- Supplied with 100 cable staples

Light Duty Cable Tacker for Round and Flat Cable

43081

Heavy Duty Cable Tacker

NEW



- Compatible with 8mm to 12.5mm Round Cables and 4mm to 7mm Flat Cables
- Suitable for a wide range of electrical installation tasks
- Used with staples 43805, 43806, and 43807
- Supplied with 200 cable staples

Heavy Duty Cable Tacker for Round and Flat Cable

43082

Light Duty Staples

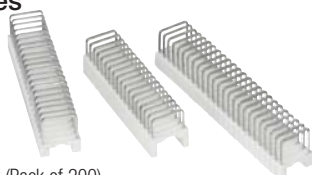

Staples for Light Duty Tacker (Pack of 200)

- For 4-6mm Round & 2.5-4mm Flat Cable 43083
- For 6-8mm Round & 4.5-6.3mm Flat Cable 43084

Heavy Duty Staples



Staples for Heavy Duty Tacker (Pack of 200)

- For 8-9mm Round & 4-7mm Flat Cable 43085
- For 9.5-11mm Round Cable 43086
- For 11.5-12.5mm Round Cable 43087

TOOL KITS & TORCHES

34 Piece Premium Tool Kit

Ideal for field service engineers

Designed for computer engineers and network technicians, this high quality 34 piece tool kit features a wide selection of essential tools. The kit is supplied in a robust vinyl hard case which features both a handle and shoulder strap for easy carrying.

Soldering Equipment

- 30W Soldering iron
- Solder
- De-soldering pump
- Soldering iron stand

Screwdrivers

- 3 x Flathead - 2mm, 2.4mm, 3.0mm
- 3 x Philips - PH0, PH00, PH1
- Flathead (Chrome Vanadium):
3.2mm x 75mm, 5mm x 75mm
- Philips (Chrome Vanadium):
3mm x 75mm PH0, 5mm x 75mm PH1,
6mm x 100mm PH2
- Neon mains tester screwdriver

Pliers & Spanners

- 8" Wire stripper pliers
- 5" Side cutter pliers
- 5.5" Long nose pliers
- 6" Combination pliers
- 8" RJ-45 crimping tool
- 8 Piece mini combination spanner set (5, 5.5, 6, 7, 8, 9, 10, 11mm)

Miscellaneous

- Anti-static wrist strap with crocodile clip
- 2 Piece alignment tool set (2-in-1)
- Storage box with 6 compartments for storing small components, screws etc.
- IC Extractor • Utility knife
- Vinyl carry-case with handle and shoulder strap
- Case dimensions: 350 x 300 x 110mm (WxDxH)
- Weight (including tools): 3.3kg



34 Piece Premium Tool Kit

43042

Magnetic Project Mat

Helps prevent the loss of screws, clips and other small metal parts

- Organise small parts while you repair a device
- Dry erase surface for making notes (pen included)
- Safe for hard drives and other electronics



Magnetic Project Mat

40166

Super-Bright LED Torches

Ideal for use in the car, home or office

- 28 Super-Bright LEDs with an expected life of 100,000 hours
- Tough, weatherproof, aluminium alloy design
- Available in silver or black
- Requires 3 x AAA batteries (not included, see table below)



**BEST
SELLER**

Super-Bright LED Torch, Silver

43072

Super-Bright LED Torch, Black

43071

300lm CREE LED Zoom Torch

- Pocket sized twist zoom torch
- Uses the industry leading high output 300 Lumen XR-E LED from specialist LED manufacturer, Cree
- 100,000 hours LED life
- Black, aluminium alloy casing (IP54 rated, dust and weather proof) - ideal for indoor or outdoor use
- Requires 3 x AAA batteries



300lm CREE LED Zoom Torch

43074

Anti-Static Service Kit

For safe handling of electronic components

- Anti-static mat with two storage pockets
- Mat size: 600 x 650mm
- 3.5m ground cord with crocodile clip
- 1.5m coiled wrist strap cord
- Elasticated wrist strap connects to the mat via a coiled cord

**BEST
SELLER**



Anti-Static Service Kit

43080

Anti-Static Earth Bonding Plugs

The LINDY Anti-Static Earth Bonding Plugs offers protection against ESD damage to expensive components. Used in combination with an Anti-Static wrist strap or Anti-Static mat (sold separately) this provides a convenient, static control workstation for service engineers and technicians. ESD can destroy sensitive electronic components, wipe data from media or even start fires.

- 5 versions available with a variety of connections including stud, post and banana socket
- Metal Earth Pin
- 1 Megohm Resistor
- Plastic Neutral and Live pins
- Ideal for grounding operators and their equipment

**BEST
SELLER**

NEW



1 x 10mm Stud

1 x 10mm Stud, 2 x 4mm Banana Sockets

3 x 10mm Stud

2 x M5 Posts

UK Anti-Static Earth Bonding Plug

1 x 10mm Stud	40175
3 x 10mm Studs	40168
1 x 10mm Stud, 2 x 4mm Banana Sockets	40169
2 x 10mm Studs, 1 x M5 Post	40173
2 x M5 Posts	40174

Anti-Static Wrist Strap

**BEST
SELLER**



Anti-Static Wrist Strap

40165

Anti-Static Bags

- Available in two sizes
 - 150 x 200mm
 - 255 x 300mm

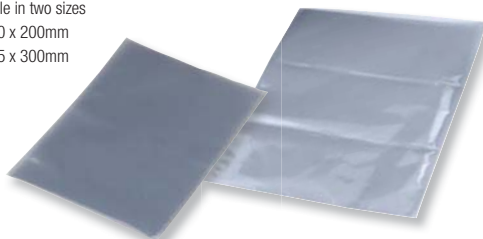

Anti-Static Bags, 150 x 200mm, Pack of 50	00241
Anti-Static Bags, 255 x 300mm, Pack of 50	00242

4-in-1 Crimp & Cable Tester Tool

The crimping, cutting, stripping and testing solution

- Convenient, hand held cable tester and crimp tool
- Integrated cable stripper and cutter
- Can be used with RJ-45, RJ-12, RJ-11, RJ-10 crimping plugs
- Suitable for use with CAT5, CAT5e, CAT6 and CAT7 cables
- Detachable cable tester
- Includes batteries and carry pouch



4-in-1 Crimp & Cable Tester Tool

43206

ATX Power Supply Tester

Compact and easy to use PSU tester with LCD screen

- Accurate voltage indicator (+/- 0.1V) tests:
 - +12V1 / +5V / +3.3V / +5V / 5V Standby / +12V2 / -12V
- Connections:
 - 20 Pin ATX PSU / 24 Pin ATX PSU
 - 4P / 6P / 8P
- 5.25" type power / 3.5" type power / SATA power



ATX Power Supply Tester

43058

Multi-Function Cable Tester

Tests and analyses a comprehensive range of connector types and commonly used cables

- Checks open, shorted, crossed, miswired and continuity problems
- Supports 18 types of cables (See below for more details)
- USB connection allows up to 100 test results to be uploaded to a PC
- Low voltage indicator
- Requires 9V PP3 battery (Part No. 84859)

The following cables are supported

- IDC 40 Pin ▪ IDC 34 Pin ▪ SATA ▪ F-Type
- BNC ▪ RJ-11/RJ-12 ▪ RJ-45/48 ▪ 6 Pin FireWire
- 4 Pin FireWire ▪ USB A to B
- 15 Way Male & Female ▪ 9 Way Male & Female
- RCA Phono ▪ DVI Male to Male ▪ HDMI



Multi-Function Cable Tester

43019

Multi Function Cable Tester Pro

Test and analyse a wide range of connector types and cables including USB 3.0

- Advanced cable tester ideal for use in computer workshops and repair centres
- Checks open, shorted, crossed, miswired and continuity problems
- USB connection allows up to 100 test results to be uploaded to a PC
- Low battery indicator
- Includes robust carry case and USB connection cables

The following cables are supported

- IDC 40 Pin ▪ IDC 40 extension HD15 Male ▪ HD15 Female
- Audio 3.5mm ▪ RJ-11 ▪ RJ-45 ▪ eSATAp 5V ▪ SATA 7 pin
- USB 2.0 Type A ▪ USB 2.0 Type B ▪ USB 2.0 Type Micro-A
- USB 2.0 Type Micro-B ▪ USB 2.0 Type Mini-B ▪ USB 3.0 Type A
- USB 3.0 Type B ▪ USB 3.0 Type Micro-B ▪ HDMI ▪ Mini HDMI
- Micro HDMI ▪ DisplayPort



Multi Function Cable Tester Pro

43069

Power Over Ethernet (PoE) Tester

- Quickly tests an RJ-45 port for Power over Ethernet
- Tests for IEEE 802.3af/at PoE voltage
- Mid-span, End-span and 4-pair LED identification

NEW



Power Over Ethernet (PoE) Tester

60197

LAN Cable Tester for RJ-45, RJ-11 & RJ-12

- Quickly tests network cables for wiring continuity, open, shorts and mis-wires
- Separate remote tester for pre-installed cables
- Status LED for each individual wire
- Complete with soft carry case

BEST
SELLER

NEW

LAN Network Cable Tester for RJ-45, RJ-11 & RJ-12

43008

Tester for HDMI Cables

- Auto/manual scan modes
- Passive module included for remote testing of pre-installed cables
- Separate status LED for each wire/function
- Requires 9V PP3 battery (Part No. 84859, see table below)

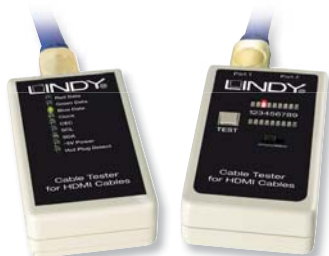

Tester for HDMI Cables

43062

Digital Multimeter

- Complete with two probes
- Battery included

Tests

- DC/AC Voltage
- DC/AC Current
- Resistance
- Diode Test
- Audible Continuity
- hFE Transistor (NPN & PNP)



Digital Multimeter

43028

USB Power Meter

- Measures current and voltage output from any USB port
- Pass through data support at USB 2.0 480Mbps allows you to measure the power demands of a USB device

NEW



USB Power Meter

43010

USB Power Meter, Quick Charge Support

43032

Digital Multimeter

- Measurement functions: Voltage, Current, Resistance, Diode and PNP/NPN hFE Transistor Tester
- Complete with two probes and 9V battery



Digital Multimeter

43027

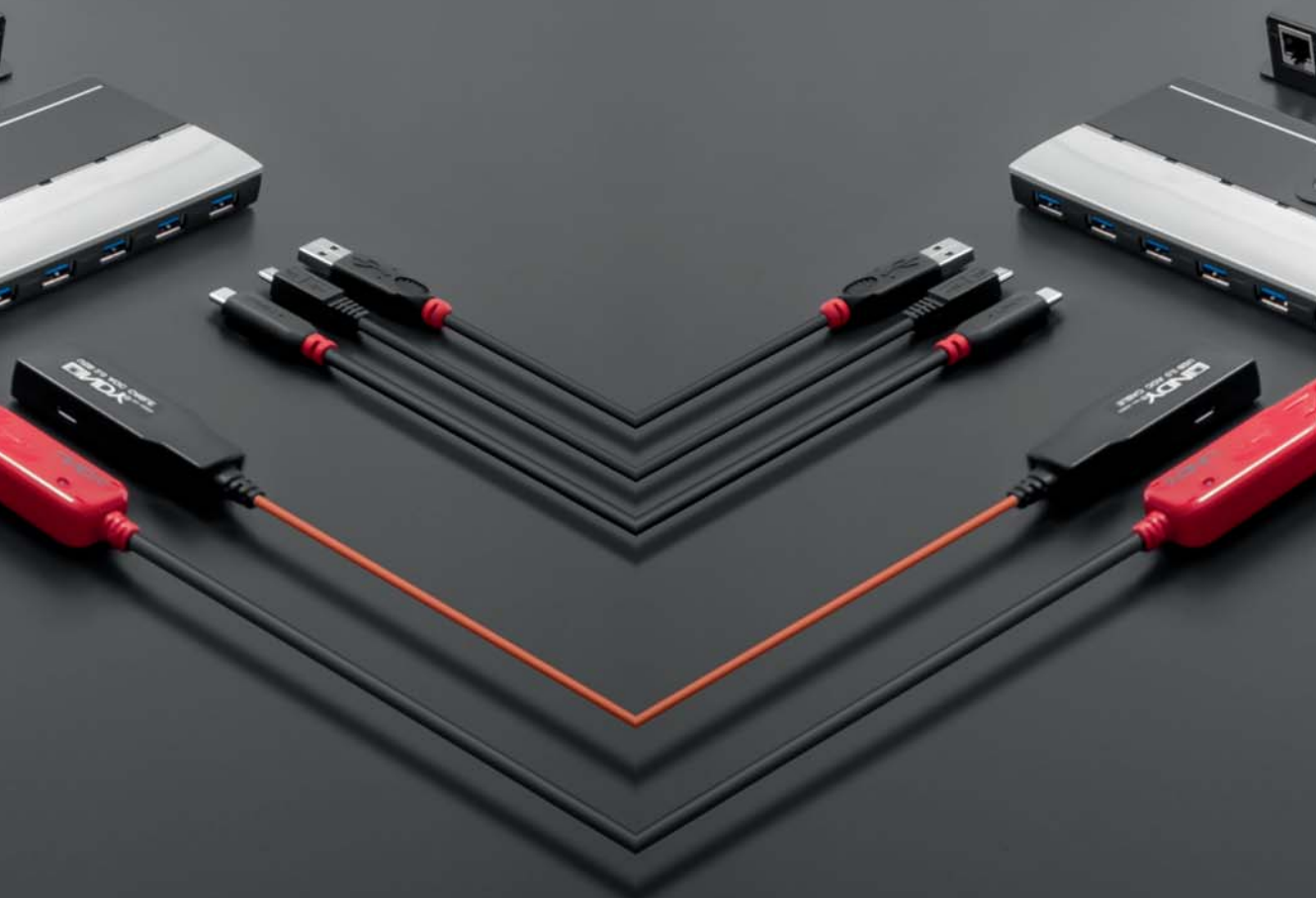

USB & FIREWIRE EXPANSION

USB Hubs, Switches & Sharers	160
USB Docking Stations	165
USB Card Readers	166
USB Converters & Adapters	167
USB Input Devices	174
USB Transfer & KM Sharing	175
USB Chargers	176
USB Extension	178
FireWire Extension & Hubs	187

- 1
USB 2.0 Adapter
Type-C Female / A Male
→ Page 229, 41898

- 2
USB 3.1 Type-C
HDMI / USB Type A / PD Adapter
→ Page 172, 43198

- 3
USB 3.1 Type-C DVI-D
with PD Adapter
→ Page 172, 43195

- 4
USB 3.1 / 3.0 Fibre Optic
400 m Extender
→ Page 186, 42707

- 5
USB 3.1 Type-C 4K HDMI
with PD Adapter
→ Page 172, 43178

- 6
USB 3.1 Type-C
3 Port Hub with PD
→ Page 160, 43090

- 7
USB 3.1 Type-C 4K HDMI & VGA
Dual Display Adapter
→ Page 172, 43179

- 8
Thunderbolt 3 to Dual DP
Adapter
→ Check our website

- 9
USB 3.1 Type-C
4 Port Hub
→ Check our website

- 10
USB 3.1 Cable
& Adapter Cable
→ starting Page 228



CONNECTOR OF THE FUTURE USB 3.1 SUPERSPEED+

The USB 2.0 standard is an integral component of almost every modern PC, laptop and peripheral. USB is used in an ever increasing range of applications. Technological advances and the resulting bandwidth requirements of modern applications - especially the ever faster USB sticks and external hard disks, both with steadily growing data capacity, have placed ever greater demands on the interface. Looking further into the future, it becomes clear that not only faster storage media, but also developments such as 4K TVs, HDTV DVB receivers or entertainment electronics such as smartphones will require a faster interface. The charging of mobile and operating stationary devices via USB is becoming increasingly important in mobile life. Not forgetting video streaming from mobile sources to output devices at the highest resolutions.

All of these requirements and developments show we need a faster, better standard with more bandwidth and a better power supply for the devices. The LINDY product portfolio has been developed in accordance with the industry standard USB 3.1 SuperSpeed+ as a next generation solution for current and future USB applications. It meets the highest quality requirements to connect bandwidth hungry devices reliably and safely.

LINDY USB 3.1 solutions are suitable for daily mobile use, in the business environment, and are sufficiently robust for industrial applications. This new standard also has a new connector type, the universal USB Type-C plug. Only Type-C makes it possible to use all specifications of the new standard in its entirety. The compact, reversible connector provides a single port for data up to 10Gbps, power for up to 100 watts, and AV signal transmission.

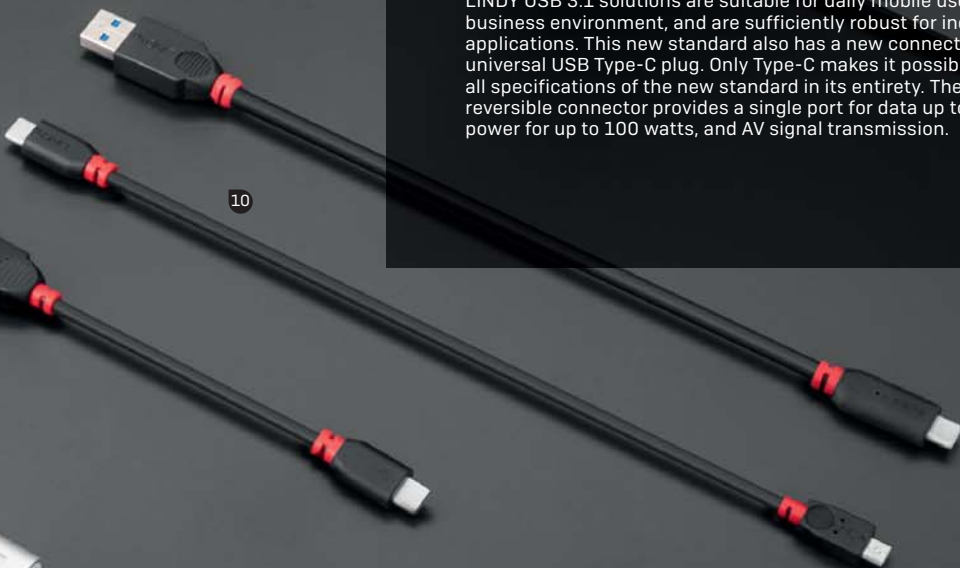

4 Port USB 2.0 Smart Hub

- Bus or self-powered; available with or without power supply
- Cable length: 50cm

**BEST
SELLER**



WIN | MAC OS | LINUX

4 Port USB 2.0 Smart Hub (without Power Supply)	42998
4 Port USB 2.0 Smart Hub Pro (with 5V 2A Power Supply)	42999
Optional 5V 3A Power Supply	73824

7 Port USB 2.0 Hub with Sliding Port Cover

- Integrated 30cm USB cable
- Sliding cover to protect ports from dust
- 5V 2A power supply included



WIN | MAC OS | LINUX

7 Port USB 2.0 Hub with Sliding Port Cover	42786
--	-------

4 Port USB 2.0 Cable Hub, Mini-B

- Adds 4 USB 2.0 ports to your PC, but unlike standard USB hubs the ports are not fixed into a housing
- No longer are you limited by the gap between ports when connecting USB accessories to your computer
- 3 Type A connections and 1 Mini-B
- Length: 35cm



WIN | MAC OS | LINUX

4 Port USB 2.0 Cable Hub, Mini-B	42836
----------------------------------	-------

4 Port USB 2.0 Cable Hub, Micro-B

- Adds 4 USB 2.0 ports to your PC, but unlike standard USB hubs the ports are not fixed into a housing
- No longer are you limited by the gap between ports when connecting USB accessories to your computer
- 3 Type A connections and 1 Micro-B
- Length: 35cm



WIN | MAC OS | LINUX

4 Port USB 2.0 Cable Hub, Micro-B	42704
-----------------------------------	-------

4 Port USB 2.0 Mini Hub

- Bus-powered operation
- Supplied with a 60cm USB Type A to Mini-B cable
- Dimensions: 40 x 40 x 12mm (WxDxH)



**BEST
SELLER**

WIN | MAC OS | LINUX

4 Port USB 2.0 Mini Hub	42742
-------------------------	-------

3 Port USB 3.1 Hub with Power Delivery

- Connects 3 Type A USB 3.1/3.0 Peripherals to a Type C Port
- Supports SuperSpeed data rates of up to 5Gbps
- Features a USB Type C Female port for Power Delivery input up to 60W (20V 3A) - ideal for charging a notebook



WIN | MAC OS | LINUX

3 Port USB 3.1 Hub with Power Delivery	43090
--	-------

3 Port USB OTG Hub & Card Reader

- Easily add additional Ports to your mobile device:
- Integrated cable for direct connection to Smartphones/Tablets
- 3 x USB Type A Female for connecting accessories
- SD and Micro-SD slots supporting SDXC, SDHC and SD formats



3 Port USB OTG Hub & Card Reader

42626

4 Port USB 3.1 Gen 1 Desktop Hubs

Choose Type A or Type C computer connection

- 4 port USB 3.1 Gen 1 hub backwards compatible with USB 3.0/2.0/1.1
- Standard version without power supply; Pro includes a power supply
- Supports USB 3.1 SuperSpeed transfer rates of up to 5Gbps
- One port serves as a charging port delivering 5V 1.2A (PSU required)
- Supplied with a 0.5m USB 3.1 cable



WIN **MAC OS** **LINUX**

4 Port USB 3.1 Desktop Hub Type A PC Connection	43147
4 Port USB 3.1 Desktop Hub Type A PC Connection Pro (with PSU)	43148
4 Port USB 3.1 Desktop Hub Type C PC Connection	43168
4 Port USB 3.1 Desktop Hub Type C PC Connection Pro (with PSU)	43169

Industrial 7 Port USB 2.0 Metal Hub

- Shielded metal construction
- Integrated brackets for mounting
- 5V 3A power supply included
- Dimensions: 165 x 48 x 24mm (WxDxH)

**BEST
SELLER**



WIN **MAC OS** **LINUX**

Industrial 7 Port USB 2.0 Metal Hub

42794

Industrial 7 Port USB 3.0 Metal Hub

- Shielded metal construction
- Integrated brackets for mounting
- 16V 2A power supply included
- Dimensions: 185 x 75 x 20mm (WxDxH)



WIN **MAC OS** **LINUX**

Industrial 7 Port USB 3.0 Metal Hub

43128

3 Port USB 3.0 Hub & Gigabit Ethernet Adapter

- Provides three USB 3.0 ports and a Gigabit Ethernet interface
- Up to 5Gbps transfer rates compatible with USB 2.0/1.1
- For USB Battery Charging at 1.5A and for USB devices with high power consumption, an additional power supply is required



WIN **MAC OS** **LINUX**

3 Port USB 3.0 Hub & Gigabit Ethernet Adapter

43176

Optional 5V 2A Power Supply

73846

USB 3.1 Type C to Gigabit Ethernet Adapter & 3 Port Type A Hub

- Provides three USB 3.1 Type A ports and a Gigabit Ethernet interface
- Supports USB 3.1 SuperSpeed 5Gbps data transfer rates
- Compatible with Windows XP, Vista, 7, 8, 8.1, 10, Mac OS X & Linux



NEW

WIN **MAC OS** **LINUX**

USB 3.1 Type C to Gigabit Adapter & 3 Port Type A Hub

43177

DOCKING STATIONS

MOBILE WORKING

For flexible, mobile working in the office, on the road, or at home our LINDY USB 3.0 Notebook Docking Station can help with all your connection needs. All peripherals are connected to the notebook via its own USB 3.0 cable. With high bandwidth 5 Gbps provided by USB 3.0, the Notebook Docking Station makes simultaneous peripheral operation very easy. Two monitors with extended desktop are supported as is Gigabit LAN connectivity or printer, scanner, card reader, mouse, keyboard, external hard drive, audio devices such as headsets, microphones, speakers, cameras, and much more.

You can also use cloning stations to clone and backup local hard drives with minimal hassle. Thanks to the DisplayLink technology, the graphics interfaces feature HDMI up to 4K Ultra HD 3840 x 2160 and DVI up to 1920 x 1200; the docking station can even handle the old VGA standard up to 2048 x 1152 via a DVI-I adapter. A wide range of peripherals is accessible via a single cable connection. When your work at the office is done, simply power down the notebook, unplug and take off.





1
USB 3.1 Docking Station
4K HDMI/DVI
→ Page 165, 43183

2
USB 2.0 Card Readers
Choice available
→ Page 166

3
USB 2.0 10m Active Extender
4 Port Hub
→ Page 180, 42630

4
USB 3.0 Enclosure
for SATA 2.5"
→ Check our website

5
Qi Wireless Charger
for Smartphones
→ Page 299, 73324

USB HUBS & SWITCHES

4 Port USB 3.1 Gen 1 Hub with On/Off Ports

- On / Off switch on each port allows you to manage power consumption of the connected devices
- SuperSpeed transfer rates up to 5Gbps, backwards compatible with USB 3.0 / 2.0 / 1.1
- Bus powered with DC socket for external power supply (not included)
- Supplied with a 50cm USB Type A to Micro-B cable



WIN | MAC OS | LINUX

4 Port USB 3.1 Gen 1 Hub with On/Off Ports	43167
Optional 5V 2.6A Power Supply	73824

4 Port USB 2.0 Sharing Hub

Shares up to 4 USB 2.0 devices between 2 computers

- Bus-powered with external 5V 2A power supply included
- A Type A to B USB cable is required for each computer (see page 220)

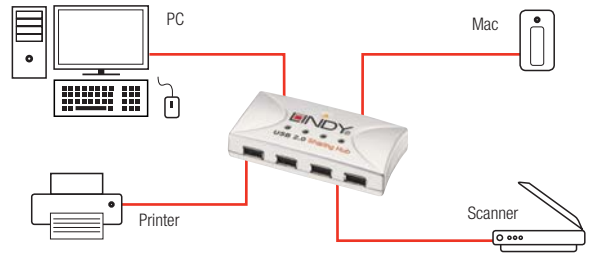

WIN | MAC OS

4 Port USB 2.0 Sharing Hub	42887
----------------------------	-------

2 and 4 Port USB Switches

Allows up to 4 computers to share one USB device

- Ideal for USB printer, scanner and storage sharing
- USB 2.0 and USB 3.0 versions available
- Push button switching, Part No. 43149 also supports hotkey switching (PC only)
- Can be combined with a USB hub to share multiple devices
- A Type A to B USB cable (not included) is required for each computer (see page 220)



2 Port USB 3.0



4 Port USB 3.0



2 Port USB 3.0
with Hotkey Switching



2 Port USB 2.0



4 Port USB 2.0

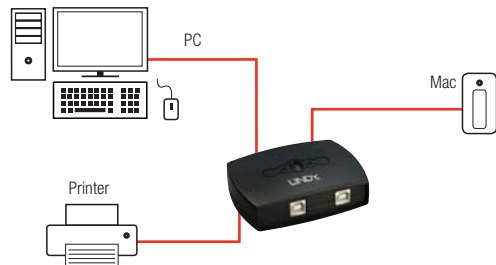

WIN | MAC OS | LINUX

2 Port USB 3.0 Switch	43141
4 Port USB 3.0 Switch	43144
2 Port USB 3.0 Switch with Hotkey Switching	43149

WIN | MAC OS | LINUX

2 Port USB 2.0 Switch	42795
4 Port USB 2.0 Switch	42784

USB 2.0 Docking Station DVI-I

Connect a monitor and USB peripherals to a notebook using one cable

- Supports resolutions up to 1920 x 1200 including 1080p
- Supports Extended and Mirrored desktops
- 4 Port USB 2.0 Hub
- Audio In/Out
- Fast Ethernet Port (RJ-45 10/100Mbps)
- Compatible with Windows 2000/XP/Vista/7/8/10 and Mac OS X 10.4.3 and above



WIN | MAC OS

USB 2.0 Docking Station, DVI-I

42620

USB 3.0 Docking Station HDMI & DVI-I

Easily connect peripherals to a notebook via a single USB 3.0 connection

- HDMI or DVI connections allow you to use a monitor or HDMI TV as a display
- Supports resolutions up to Full HD 1080p (HDMI) and 1920 x 1200 (DVI)
- Built-in 2 Port USB 3.0 Hub and 4 Port USB 2.0 Hub
- 10/100/1000 RJ-45 Gigabit Ethernet port
- Audio Input/Output
- Compatible with Windows Vista/7/8/10



WIN

USB 3.0 Docking Station HDMI & DVI-I

43180

USB 3.0 Notebook Docking Station HDMI/VGA/ Gigabit Ethernet

Compact solution with VGA, HDMI and Gigabit LAN connections via one simple USB connection

- Connect external peripherals to your notebook or Ultrabook via USB 3.0
- HDMI output port supports resolutions up to Full HD 1080p with support for HDCP
- VGA output port supports resolutions up to 2048 x 1152
- SuperSpeed USB 3.0 port
- 10/100/1000Mbps RJ-45 Gigabit Ethernet port
- USB bus powered via built-in USB 3.0 cable
- Compatible with Windows 7/8.1/10 and Mac OS 10.9 and above



WIN | MAC OS | LINUX

USB 3.0 Notebook Docking Station HDMI/VGA/Ethernet

43181

USB 3.1 Docking Station VGA

1080p, Fast Ethernet and USB 2.0 via your computer's USB 3.1 / 3.0 port

- Perfect for Notebooks and Ultrabooks
- Provides VGA, Ethernet 10/100 BASE-T and a USB 2.0 port from a single USB 3.0 port
- Supports resolutions up to Full HD 1080p
- Requires a PC with an Intel i series 3rd Generation or higher CPU, or an AMD CPU with an integrated USB 3.0 controller
- Compatible with Windows 7, 8 and 10



WIN

USB 3.1 Docking Station VGA

43182

USB 3.1 Notebook Mini Docking Station HDMI 4K & DVI

- Single cable docking station solution for Windows, Mac OS X & Android devices
- Supports resolutions up to Ultra HD 4K 30Hz or 2 x 1920 x 1200 60Hz
- Dual Video Interface supports HDMI & DVI-I displays
- Supports primary, mirrored and extended desktop display modes
- Features a 4 Port USB 3.1 Gen 1 Hub, Gigabit LAN and 3.5mm stereo analogue audio connection
- Two front facing USB support USB Battery Charging v1.2, so mobile devices can be connected and charged at up to 5V 1.5A.



NEW

USB 3.1 Notebook Mini Docking Station HDMI 4K & DVI

43183

USB CARD READERS

USB 2.0 Multi Card Reader Pro

- Reads most card memory formats and mobile phone SIM cards
- Supplied with SIM editor software for Windows PCs
- Supports Smart Media (SM), Compact Flash (CF), MultiMediaCard (MMC), Secure Digital (SD), SDHC, Micro Drive (MD), Memory Stick (MS) & more



WIN | MAC OS

USB 2.0 Multi Card Reader Pro

42982

USB 2.0 43-in-1 Card Reader

- Supports most popular card formats including: M2, MicroSD, TF, Memory Stick, SD, Mini SD, SDHC, MMC, RS MMC & more



**BEST
SELLER**

WIN | MAC OS

USB 2.0 43-in-1 Card Reader

42788

USB 3.0 Multi-Card Reader

- 0.5m USB Type A to Micro-B cable included
- Supports cards including: Compact Flash (CF), CF UDMA, SDXC, Memory Stick, SD, Mini SD, Micro SD, TransFlash, xD



WIN | MAC OS

USB 3.0 Multi-Card Reader

43150

USB 3.0 SD/MicroSD Card Reader

- Reads / writes SDXC, SDHC, SD and Mini SD (with adapter) cards



WIN | MAC OS | LINUX

USB 3.0 SD / MicroSD Card Reader

43151

USB 3.1 Type C SD & microSD Card Reader

- Supports UHS-I Ultra High Speed Class 1 SDXC speeds



WIN | MAC OS | LINUX

USB 3.1 Type C SD & microSD Card Reader

43185

USB 3.1 Multi-Card Reader UHS-II

- Supports cards including CompactFlash, MS, SD, Micro-SD, UHS-I and UHS-II SD
- 0.5m USB Type A to Micro-B cable included



WIN | MAC OS | LINUX

USB 3.1 Multi-Card Reader UHS-II

43163

USB Smart Card Reader

- Supports PC smart card industry standard PC/SC 1.0, PC/SC 2.0
- Supports asynchronous cards: protocols T0, T1
- Supports synchronous cards: 2-wire, 3-wire, I2C Memory Cards: SLE4418/28, SLE4432/42, AT88sc1608/153, AT24c128/256, ST M14C16/M14C04
- Supports 1.8V/3V/5V cards

**BEST
SELLER**



MAC OS | WIN

USB Smart Card Reader

42768

USB to Serial RS-232 Converter

- Supports most standard serial RS-232 devices
- Connectors: 9 or 25 Way D Male to USB A Male
- Prolific chipset
- Length: 1.5m

**BEST
SELLER**

9 Way D Male



25 Way D Male



WIN **MAC OS**

USB to Serial RS-232 Converter, 25 Way D Male

42812

USB to Serial RS-232 Converter, 9 Way D Male

42855

USB to 2 / 4 Port Serial RS-232 Converter Lite

- Supports standard serial devices
- 2 and 4 port versions
- Moschip chipset
- Connectors: USB A Male to 2/4 x 9 Way D Serial Male

**BEST
SELLER**



4 Port version shown

WIN **MAC OS** **LINUX**

2 Port USB to 9 Way Serial Converter Lite

42689

4 Port USB to 9 Way Serial Converter Lite

42690

USB to 2 & 4 Port Serial RS-232 Converters

- Supports most standard serial RS-232 devices
- FTDI chipset
- Connectors: 2 or 4 x 9 Way D Male



4 Port



2 Port



8 Port

WIN **MAC OS**

USB to 2 Port Serial RS-232 Converter

42889

USB to 4 Port Serial RS-232 Converter

42858

USB to 8 Port Serial RS-232 Converter

42894

USB to Serial RS-232 Converter with COM Retention

- COM Port Retention feature allows COM port settings to be stored within the adapter, so there's no need for any software reconfiguration if the adapter is plugged into a different USB port on the same computer
- FTDI chipset
- Connectors: 9 Way D Male to USB A Male
- Length: 1.1m



WIN **MAC OS** **LINUX**

USB to RS-232 Converter with COM Retention

42686

USB 2.0 to Serial RS-422 Converter

- Connectors: 9 Way D Male to USB A Male
- FTDI chipset
- Length: 1m



WIN | MAC OS

USB to Serial RS-422 Converter

42844

USB 2.0 to Serial RS-485 Converter

- Connectors: 9 Way D Male to USB A Female
- FTDI chipset
- Length: 1m



WIN | MAC OS

USB to Serial RS-485 Converter

42845

USB to 2 Port Serial RS-422/RS-485 Converter

- Provides two separate RS-422/RS-485 ports (2 x 9 Way D Male)
- Ideal for connecting EPOS and industrial control equipment to the latest generation desktop PCs and notebooks
- FTDI chipset
- Integrated 60cm USB cable with Type A connector

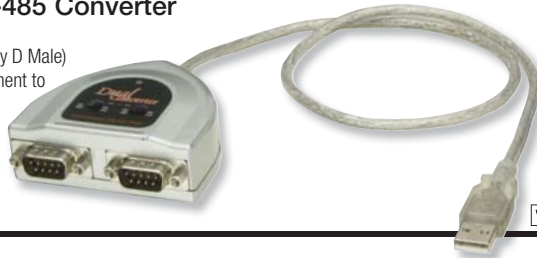

WIN | MAC OS | LINUX

USB to 2 Port Serial RS-422/RS-485 Converter

42859

2 Port Industrial USB to Serial RS-232 Converter

- Supports standard RS-232 serial devices
- FTDI chipset
- Connectors: USB Mini-B Female to 2 x 9 Way D Serial Male, supplied with 80cm USB A/Mini-B Cable



WIN | MAC OS | LINUX

2 Port Industrial USB to Serial RS-232 Converter

42734

USB to 25 Way Parallel Printer Port Converter

- Connectors: USB Type A Male to 25 Way D Female
- Prolific chipset
- Cable length: 1.5m
- Connects to a parallel cable from your printer
- Supports parallel printer connections only

**BEST
SELLER**



WIN

USB to 25 Way Parallel Converter Cable

42882

USB to 36 Way Parallel Converter

- Connectors: USB Type A Male to 36 Way Centronics Male
- Prolific chipset
- Cable length: 1.5m



WIN

USB to 36 Way Parallel Converter Cable

42864

USB to 9 Way Serial RS-232 and 25 Way Parallel Adapter

- Connectors: USB A Male to 9 Way D Male & 25 Way D Female
- Moschip chipset
- Cable length: 0.7m
- USB port adapter which supports all standard serial and parallel devices



WIN | MAC OS

USB to Serial and Parallel Adapter

42838

USB 2.0 & eSATA Drive Docking Station

- Quickly connect and disconnect different drives without the hassle of installing them into external housings or opening up a computer case
- Accepts 2.5" or 3.5" SATA disk drives (accepts one drive at a time)
- Supplied with 1m USB & eSATA cables



WIN | MAC OS | LINUX

USB 2.0 & eSATA Hard Drive Docking Station

42789

USB 2.0 & eSATA Drive Cloning Station

- Clones drives without connecting to a PC
- Cloning function allows a bit by bit drive cloning (including operating system and partitions)
- Supports 2.5" and 3.5" SATA hard drives
- Supplied with 1m USB and eSATA cables



WIN | MAC OS | LINUX

USB 2.0 & eSATA Hard Drive Cloning Station

42797

USB 3.0 Docking & Cloning Station For 2.5" & 3.5" Drives

Ideal for technicians and IT departments

- Standalone cloning functionality, no computer required
- Full bitwise cloning including MBR and EISA partitions
- Dual Bay design accepts either 2.5" or 3.5" SATA disk drives
- USB 3.0 SuperSpeed 5Gbps Interface - Compatible with USB 3.0 equipped PCs and Macs



USB 3.0 Docking & Cloning Station For 2.5" & 3.5" Drives

43113

USB 2.0 to SATA & IDE Adapter

- Ideal for computer technicians who need to quickly connect and disconnect drives for testing and data transfer
- Can be used with 2.5" & 3.5" hard drives and 5.25" CD/DVD drives
- Power supply and connection cables included



WIN | MAC OS

USB 2.0 to SATA & IDE Adapter

42868

USB 3.1 to SATA 6Gbps Adapter, Type C

- USB 3.1 Gen2 SuperSpeed+ up to 10Gbps (backwards compatible with USB 3.0, 2.0 and 1.1)
- Features the USB Type C connector
- Suitable for 2.5" and 3.5" SATA III HDDs/SSDs* and 5.25" ODD drives
- Compliant to SATA 3.2 Specification (1.5Gbps, 3Gbps and 6Gbps)



NEW

USB 3.1 to SATA 6Gbps Adapter, Type C

43189

USB 3.0 to SATA 6Gbps Adapter

- Back up, restore and transfer data from your SATA 6Gbps hard drive using SuperSpeed USB 3.0 5Gbps transfer speeds
- SATA 1.5/3/6Gbps compatible
- Suitable for 2.5" and 3.5" SATA 6Gbps HDDs/SSDs and 5.25" ODD drives
- Power supply included



WIN | MAC OS | LINUX

USB 3.0 to SATA 6Gbps Adapter

43119

USB 2.0 Fast Ethernet Adapter

- Available with Type A and Micro B connections
- For desktops, notebooks, netbooks, ultrabooks and tablets



WIN | MAC OS | LINUX

USB 2.0 Fast Ethernet Adapter, Type A

42945

USB 2.0 Fast Ethernet Adapter, Micro-B

42948

USB 3.1 Gigabit Ethernet Adapter

- Easily connect your USB computer to a Gigabit network
- SuperSpeed USB 3.1 Gen1 5Gbps, backwards compatible with USB 3.0, 2.0 and USB 1.1
- LED for connection and data transmission
- Compatible with Windows XP/Vista/7/8/10, Mac OS X 10.8 & Linux



WIN | MAC OS | LINUX

USB 3.1 Gigabit Ethernet Adapter

43188

USB 3.1 Type C Gigabit Ethernet Adapter

- USB 3.1 Gen 1 / USB 3.0 SuperSpeed up to 5Gbps
- Compatible with Windows XP, Vista, 7, 8, 8.1, 10, Mac OS X & Linux



WIN | MAC OS | LINUX

USB 3.1 Type C Gigabit Ethernet Adapter

43164

Free UK DELIVERY  on all orders over **£125** (ex VAT.)
Some exceptions apply, see delivery terms & conditions on our website

USB 2.0 Nano Bluetooth Dongle

- Bluetooth version 4.0 Low Energy
- Range: up to 15m
- BlueSoleil (VT 7.0) software included

BEST SELLER



WIN

USB 2.0 Nano Bluetooth Dongle

52214

USB 2.0 to VGA Adapter

- Supports screen resolutions up to Full HD 1080p
- Supplied with a 1m USB A to Mini-B cable
- Compatible with Windows 7/8/8.1/10, OS X and Android 5.0+

**BEST
SELLER**



WIN | MAC OS

USB 2.0 to VGA Adapter

42744

USB 2.0 to DVI Adapter

- Supports resolutions up to 1920 x 1200 (DVI) 2048 x 1152 (VGA)
- Supplied with a 1m USB A to Mini-B cable
- Compatible with Windows 7/8/8.1/10, OS X and Android 5.0+



WIN | MAC OS

USB 2.0 to DVI-I Adapter

42728

USB 3.0 to VGA Adapter Lite

- Supports resolutions up to Full HD 1080p
- Requires an Intel i5/i7 (or higher) processor
- Compatible with Windows 7/8/10

**BEST
SELLER**



WIN

USB 3.0 to VGA Adapter Lite

43172

USB 3.0 to HDMI Adapter

- Supports resolutions up to Full HD 1080p and 1920 x 1200
- HDMI v1.3 3D compliant
- Supplied with a USB A to Micro-B cable
- Compatible with Windows 7/8/8.1/10, OS X and Android 5.0+



WIN | MAC OS

USB 3.0 to 4K HDMI Adapter

43173

USB 3.0 to 4K DisplayPort Adapter

- Compliant with USB 3.0 specification; supports resolutions up to Ultra HD 4K 3840 x 2160p 30Hz, including 1080p
- Bus Powered - supplied with a 50cm USB 3.0 cable (no external power supply required)
- Can be used as a primary, mirrored or extended desktop
- Compatible with Windows 7/8/8.1/10, OS X and Android 5.0+



WIN

USB 3.0 to 4K DisplayPort Adapter

43174

USB 3.0 to 4K HDMI Adapter

- Compliant with USB 3.0 specification; supports resolutions up to Ultra HD 4K 3840 x 2160p 30Hz, including 1080p
- HDMI v1.3 & 3D compliant with HDCP support
- Supports Multi-channel 5.1, LPCM 32, 44.1 & 48KHz, 16bit Audio
- Bus Powered - supplied with a 50cm USB 3.0 cable (no external power supply required)
- Can be used as a primary, mirrored or extended desktop
- Compatible with Windows 7/8/8.1/10, OS X and Android 5.0+



WIN | MAC OS | LINUX

USB 3.0 to 4K HDMI Adapter

43175

USB VIDEO ADAPTERS & CONVERTERS

USB 3.1 Type C to Video Converter Adapters

LINDY USB 3.1 Type C to Video Adapter Converters allow you to quickly add external video capabilities to devices featuring the USB 3.1 Type C port with support for DisplayPort Alternate Mode.

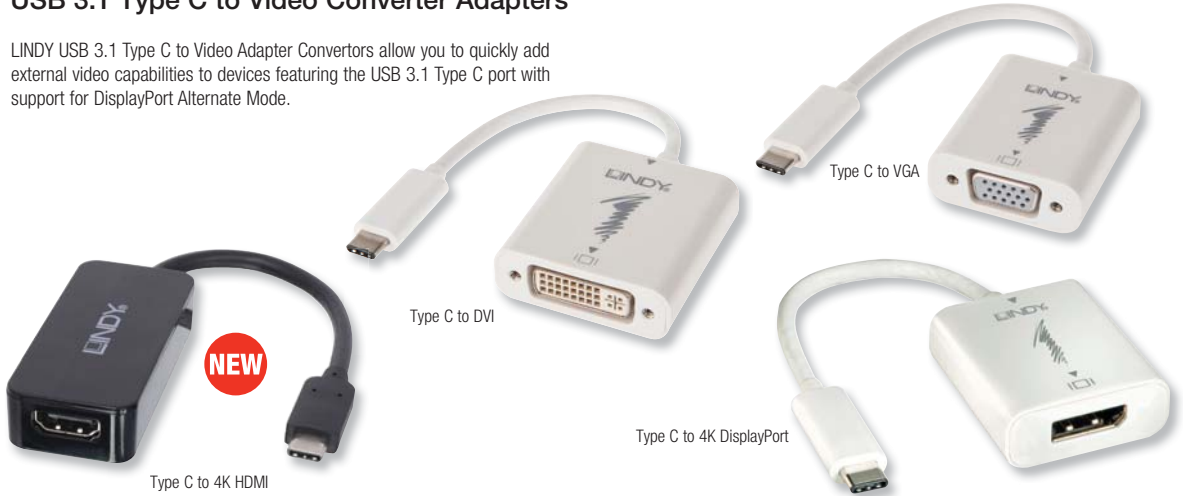

USB 3.1 Type C to VGA Adapter Converter,	43190
USB 3.1 Type C to DVI-D Adapter Converter	43191
USB 3.1 Type C to 4K HDMI Adapter Converter	43197
USB 3.1 Type C to 4K DisplayPort Converter Adapter	43193

USB 3.1 Type C to Video Converters with USB Power Delivery

The LINDY USB 3.1 Type-C to VGA Adapter Converter allows you to quickly add external video capabilities to devices featuring the USB 3.1 Type-C port with support for DisplayPort Alternate Mode. USB Power delivery of up to 60W (20V 3A maximum) allows you to power your compatible notebook or Ultrabook via it's USB Type C port whilst simultaneously using it as a video output.



USB 3.1 Type C to VGA Adapter Converter with Power Delivery	43194
USB 3.1 Type C to VGA & USB Adapter Converter with Power Delivery	43230
USB 3.1 Type C to DVI-D Adapter Converter with Power Delivery	43195
USB 3.1 Type C to HDMI Adapter Converter with Power Delivery	43196
USB 3.1 Type C to 4K HDMI Adapter Converter with Power Delivery	43178
USB 3.1 Type C to 4K HDMI & VGA Adapter Converter with Power Delivery	43179
USB 3.1 Type C to 4K HDMI & USB Adapter Converter with Power Delivery	43198

USB 2.0 Video & Audio Grabber

- Connect a camcorder or VCR to a PC to transfer video and audio for editing, storage etc.
- High speed USB 2.0 support for superior performance
- Compact size - ideal for use with notebook and desktop PCs
- Compatible with Windows 2000, XP, Vista & 7 (32/64bit)

BEST SELLER



USB 2.0 Video & Audio Grabber

42886

USB 2.0 Audio Grabber

- Transfer your old music collection to your PC or Mac using your existing Tape Deck, turntable or other analogue source device
- Includes Audacity software for Windows
- Samples up to 48KHz 16 Bit



WIN | MAC OS | LINUX

USB 2.0 Audio Grabber

42715

USB 2.0 Audio Adapter

- Plug & Play sound for your notebook or desktop
- Supplied with 1m USB extension cable
- 2 x 3.5mm Jack Sockets for headphone/speaker and microphone
- Volume, microphone mute and headphone/speaker mute buttons

BEST SELLER



WIN | MAC OS

USB 2.0 Audio Adapter

42961

USB Audio Cables



USB to MIDI Cable

USB Guitar Cable

USB XLR Microphone Cable

- XLR, 1/4" Jack and MIDI versions available
- Ideal for use with Garageband and other audio software

WIN | MAC OS

USB XLR Microphone Cable, 5m

6105

USB Guitar Cable, 5m

6104

USB to MIDI Cable, 2m

6100

CABLE GURU
FIND THE CABLE YOU NEED

Try it now on our **WEBSITE**

USB Portable Wireless Audio System

- Wirelessly transmits stereo audio signals from a computer to powered speakers, headphones or an amplifier
- Portable, battery powered receiver with a typical 10m range (up to 45m line of sight)
- Supplied with battery and power supply



WIN | MAC OS | LINUX

USB Portable Wireless Audio System

20519

LDAC Pro USB DAC & Headphone Amp

This professional DAC can cater for even the most demanding applications. Featuring bit perfect Asynchronous USB 2.0 with a highly accurate PLL and low jitter reduction clock system, the LDAC-Pro provides a superb digital audio listening experience.

- Provides audiophile sound quality up to 24bit/192KHz
- Sampling Rate Conversion (SRC) for all digital inputs to 44.1/48/88.2/96/176.4/192KHz output
- Accepts 2 channel digital audio and works with any LPCM stream with Dolby Digital or DTS disabled
- HDMI, Optical, Coaxial and USB 2.0 (USB Audio Class 2) digital audio interfaces
- Phono, XLR, Line-In and Headphone analogue audio interfaces
- Headphone amplifier, with high quality TI TPA6120A2 chipset
- XMOS Asynchronous USB chipset



WIN | MAC OS

LDAC Pro USB DAC & Headphone Amp

70410

USB Optical Mouse

- 800dpi optical sensor
- 1.4m USB cable



WIN | MAC OS | LINUX

USB Optical Mouse

20571

Wireless Gyro Mouse

- Allows mouse control using 3D gestures in the air
- Also functions as a standard wireless optical mouse



WIN | MAC OS | LINUX

Wireless Gyro Mouse

20579

USB Two Piece VoIP Phone

- Ideal for Skype
- Integrated 1.3m USB cable
- Can be desk or wall mounted



**BEST
SELLER**

WIN

USB Two Piece VoIP Phone

42779

USB Wireless Gyro Presenter

- Incorporates a 2.4GHz 3D Wireless Mouse
- Laser Free - for safety & easy travel
- Up to 30m range
- Requires two AAA batteries (included)



WIN | MAC OS | LINUX | ANDROID

USB Wireless Gyro Presenter

32819

USB Floppy Drive

- For use with 3.5" 1.44MB floppy disks



WIN | MAC OS | LINUX

USB Floppy Drive

42790

USB Notebook Light

- Long lasting LED design
- Flexible neck for easy positioning



WIN | MAC OS

USB Notebook Light

42772

USB & Flash Drive Combination Lock

- 3 digit user definable combination
- Prevents unauthorised access to devices and files
- Can also be used as a more traditional padlock



USB Flash Drive not included

USB Combination Lock

40449

USB to PS/2 Converter

- Connects your PS/2 keyboard and mouse to a USB port



**BEST
SELLER**

WIN | MAC OS

USB to PS/2 Converter Cable

42866

USB 2.0 Transfer & KM Sharing Cable

- Allows you to easily transfer data between two computers, laptops or different operating systems
- Control two computers using a single keyboard and mouse
- USB 2.0 480Mbps bi-directional file & data transfer
- Length: 1.8m
- Compatible with Windows 2000/XP/Vista/7/8/10, Mac OS X 10.6 and above, iOS 3.2 and above and Android 2.1 and above



WIN | MAC OS | LINUX | ANDROID

USB 2.0 Transfer & KM Sharing Cable

42614

USB 3.0 Transfer & KM Sharing Cable

- KVM control of two PCs through a single USB 3.0 cable
- Turns laptop displays, desktop monitors or tablet screens into a 2nd display
- Maximum resolution: 2048 x 1152
- Seamless file transfer and clipboard sharing up to 5Gbps between two computers, laptops or different operating systems
- Touchscreen support
- Length: 1.5m
- Compatible with Windows XP/7/8/8.1/10



WIN | MAC OS

USB 3.0 Transfer & KM Sharing Cable

42624

Android OS Mirroring & KM Sharing Cable

- Android OS Mirroring on a Windows PC
- Keyboard, Mouse and data sharing from a Windows PC to Android smartphone or tablet
- Charges your Android Smartphone or Tablet whilst in use
- Compatible with Windows XP/Vista/7/8
- For OS Mirroring: Android 4.0 (Ice Cream Sandwich) or higher
- For KM Sharing: Android 2.3 (Gingerbread) or higher
- Length: 1.2m



ANDROID | WIN

Android OS Mirroring & KM Sharing Cable

42613

USB CHARGERS & POWER ADAPTERS

USB Car Chargers

- Choose from single, two and three port versions
- Smart IC design for Rapid Charging

NEW



BEST SELLER

1 Port USB Car Charger, 1.2A Output	73318
2 Port Smart USB Car Charger 4.8A Output	73319

3-in-1 Micro-B USB Charging Kit

- USB mains plug, car charger and cable kit to charge and power your Micro-B USB devices
- Both chargers feature a USB Type A Female socket
- Ideal for use with Amazon Kindles, smartphones and other Micro-B devices
- Supplied with a USB Type A to Micro-B cable



3-in-1 Micro-B USB Charging Kit	73357
---------------------------------	-------

Folding USB UK Mains Charger

- Compact, portable folding design fits neatly into a laptop bag
- Charges and powers a USB device
- Features a USB Type A Female Socket for connecting your iPod, MP3 Player, Smartphone etc
- Input: AC 100-240V / 50-60HZ
- Output: 5V DC, 2.1A

BEST SELLER



Folding USB UK Mains Charger	73376
------------------------------	-------

2 Port USB & Mains Plug Travel Adapter

- All-in-one design features UK, Euro and USA & Australian plug types
- Replace multiple travel adapters with one compact unit
- Each different plug type slides out of the unit and locks into place
- Two USB ports for powering smartphones and other USB devices
- Input: 110-240V AC, 50-60Hz
- Output: 5V DC, 2.1A (max 1A per port)

BEST SELLER



2 Port USB & Mains Plug Travel Adapter	73110
--	-------

2 Gang Switched Single Pole Socket with 2 USB Charger Ports

- 2 x UK 3 Pin Switched Sockets
- 2 x USB Ports (Total 2.1A output)
- Includes, self-setting overheat protection and output stabilising
- Will charge any device that normally charges by a standard USB port

NEW



2 Gang Socket with 2 x USB Charger Ports	73081
--	-------

QuickCharge 2.0 USB Power Adapter

Quick Charge 2.0 is designed to interoperate with existing USB charging solutions. To achieve full charging speeds, a Quick Charge 2.0 enabled device must be paired with a Quick Charge 2.0 certified adapter. The LINDY QC 2.0 Travel adapter allows QC 2.0 compatible devices to charge at up to 75% faster than non QC 2.0 adapters.

- Output:
 - 5V DC 1.8A / 9W
 - 9V DC 1.8A / 16.2W
 - 12V DC 1.35A / 16.2W
- Over current, over voltage and short circuit protection
- Includes adapters for use in UK, Europe, USA and Australia



QuickCharge 2.0 USB Power Adapter

73107

4 Port Smart USB Travel Charger, 24W, QuickCharge 3.0 Compatible

The 4 Port Smart USB Travel Charger allows you to charge up to 4 USB devices at the same time. Smart IC support recognises devices intelligently and automatically adjust charging power. The unit is also Quick Charge 3.0 compatible, which is 38% percent more efficient than Quick Charge 2.0.

- 3 x USB Type A Ports with Smart IC function – 5V up to 2.4A
- Single QuickCharge 3.0 compatible port – 5V, 9V, 12V
- Over current, over voltage and short circuit protection
- Includes 4 adapters for use in UK, Europe, US & Australia



4 Port Smart USB Travel Charger, 24W

73313

2 Port USB Travel Charger

- Perfect for use with iPods, iPads, MP3 Players, PDAs, mobile phones etc.
- Input: 100-240V AC, 50-60Hz
- Output: 5V DC, 1A per port (2.1A total)
- Includes 4 adapters for use in UK, Europe, US & Australia



2 Port USB Travel Charger

73355

USB UK Mains Chargers

- For use with iPods, MP3 Players, PDAs, mobile phones etc.
- Input: 100-240V AC, 50-60Hz
- Output: 5V DC, 1A per port (2.1A total)



4 Port USB UK Mains Charger, White

73353

4 Port USB UK Mains Charger, Black

73354

4 Port USB Mains Charger, 4 x 1A

- Features 4 individually switched USB Type A Female sockets for connecting your devices
- Built in surge protection
- Input: 100-240V AC, 50-60Hz
- Output: 5V DC, 1A per port



4 Port USB Mains Charger, 4 x 1A

73384

Visit our website
WEBSITE
 for the latest prices
 & special offers

USB 2.0 ACTIVE EXTENSION SYSTEM PRO

The USB 2.0 Active Extension System Pro is a range of products which can be combined together to extend and distribute USB 2.0 signals over incredibly long distances.

The Extension system Pro range consists of 8m, 12m and 30m extension cables and hubs. See below for a typical installation example.

- USB 2.0 and USB 1.1 compatible
- Supports transfer speeds of up to 480Mbps
- Cables are USB bus powered; the hub versions include a multi-country power supply
- Locking connectors for a secure installation.

Installation Example

Start with an 8m Active Extension Cable Pro. You can then use up to additional segments made up of 8m or 12m Extension Kits to extend the distance further. Or, if you need additional USB ports or want to connect a bus powered USB device requiring more than 100mA bus power, you can use the 8m or 12m 4 Port Extension Hub kit as the final extension segment.

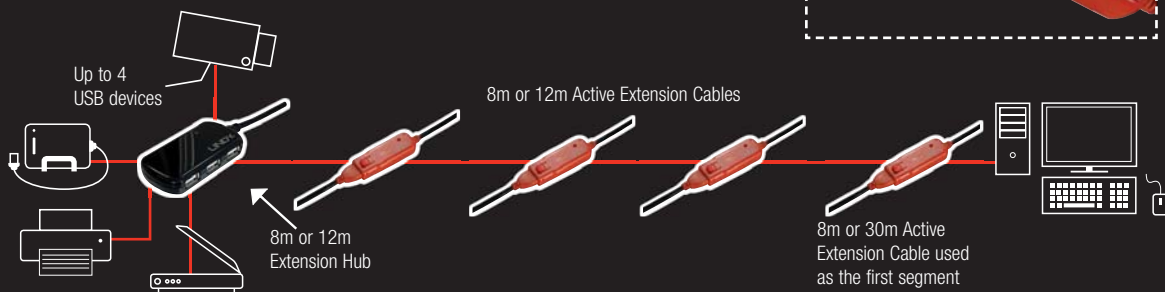

PRODUCTS IN USE

8m & 30m USB 2.0 Active Extension Cable Pro

- Connects directly to your computer's USB 2.0 port
- Can be used as the starting segment in a long distance USB Active Extension System Pro installation
- Connectors: USB Type A Male to USB Type A Female



8m USB 2.0 Active Extension Cable Pro
30m USB 2.0 Active Extension Cable Pro

42780
42923

12m USB 2.0 Active Extension Cable Pro

- Can be used as the middle and final segments in a long distance USB Active Extension System Pro installation
- Latching connector for a secure installation
- Can not be connected directly to a computer's USB port
- Connectors: USB Type A Male to USB Type A Female



12m USB 2.0 Active Extension Cable Pro

42782

8m USB 2.0 Active Extension Pro 4 Port Hub

- Can be directly connected to a computer's USB 2.0 port
- Can also be connected as the final segment in a long distance USB Active Extension System Pro installation
- Connectors: USB Type A Male to 4 x USB Type A Female



8m USB 2.0 Active Extension Pro 4 Port Hub

42781

12m USB 2.0 Active Extension Pro 4 Port Hub

- Can be used as the final segment in a long distance USB Active Extension System Pro installation
- Can not be connected to a computer's USB port as the first segment
- Connectors: USB Type A Male to 4 x USB Type A Female



12m USB 2.0 Active Extension Pro 4 Port Hub

42783

USB 3.0 ACTIVE EXTENSION SYSTEM PRO

The LINDY USB 3.0 Active Extension System Pro is a range of products which can be combined together to extend and distribute USB 3.0 signals over long distances of either 18m, 28m or 38m.

The system consists of 8m and 10m extension cables and a 10m hub.

- Supports SuperSpeed transfer rates of to 5Gbps
- Plug & Play - no special software installation required
- Backwards compatible with both USB 2.0 and USB 1.1 devices
- Compatible with USB 3.0 equipped computers
- 2 year warranty

Installation Example

Always start with this 8m USB 3.0 Active Extension Cable Pro. You can then use up to 3 additional 10m USB 3.0 Active Extension Cables to extend your device further up to 18, 28 or 38m. Or, if you wish to add extra USB ports or to connect a bus powered USB device, use a 10m USB 3.0 Active Extension Pro 4 Port Hub as the final segment.

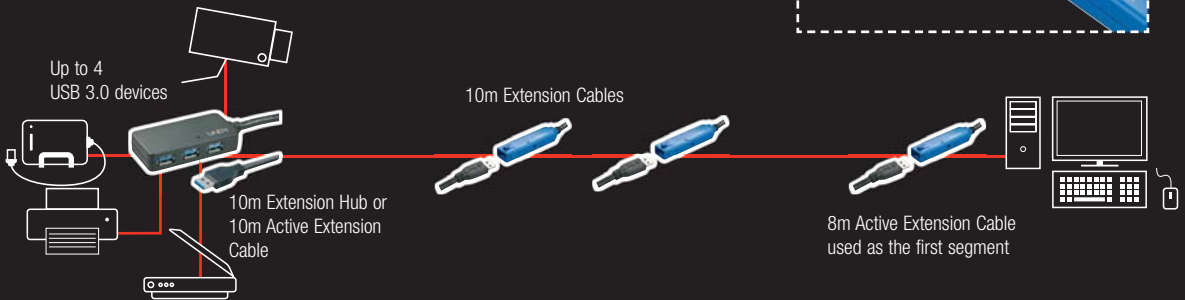

PRODUCTS IN USE

8m USB 3.0 Active Extension Cable Pro

- Connects directly to your computer's USB 3.0 port
- Can be used as a stand-alone 8m extension cable or as part of a long distance USB 3.0 Active Extension System Pro with 43157 and 43159
- Connectors: Type A USB Male to Type A USB Female



8m USB 3.0 Active Extension Cable Pro

43158

10m USB 3.0 Active Extension Cable Pro

- Can be used as either the middle or final segment in a long distance USB 3.0 Active Extension System Pro
- Connect up to 3 cables to 43158 to extend your USB 3.0 Active Extension System up to 18, 28 or 38m
- Connectors: Type A USB Male to Type A USB Female



10m USB 3.0 Active Extension Cable Pro

43157

10m USB 3.0 Active Extension Cable Pro 4 Port Hub

- Should be used as the final segment in a long distance USB 3.0 Active Extension System
- Must be connected to either 43158 or 43157
- Connectors: Type A USB Male to 4 x Type A USB Female
- Supplied with a multi country 5V DC 3.5A PSU



10m USB 3.0 Active Extension Pro 4 Port Hub

43159

USB ACTIVE EXTENSION CABLES

5m USB 2.0 Panel Mount Active Extension Cable

- 5 metre USB 2.0 Active Extension Repeater cable
- Plug & Play - no special software installation required
- Connectors: Type A USB Male to Panel Mount Type A USB Female
- For even greater distances of up to 25m simply connect up to 5 cables in series

5m USB 2.0 Panel Mount Active Extension Cable 42830



5m USB 2.0 Slimline Active Extension Cable

- Slimline design allows the active electronics to be fitted into a standard USB connector - an advantage over other active USB cables that use special, bulky connectors
- For lengths of up to 25m you can connect up to 5 of these cables in series
- Connectors: Type A USB Male to Type A USB Female

**BEST
SELLER**



5m USB 2.0 Slimline Active Extension Cable 42817

20m USB 2.0 Active Extension Cable

- Supports transfer rates up to 480Mbps
- Two extensions can be connected together to reach 40m
- Connectors: Type A USB Male to Type A USB Female

**BEST
SELLER**



20m USB 2.0 Active Extension Cable 42631

10m USB 2.0 Active Extension 4 Port Hub

- Extends the length of up to four USB devices by 10m
- Bus powered from the computer or self powered using an additional power supply (not included)

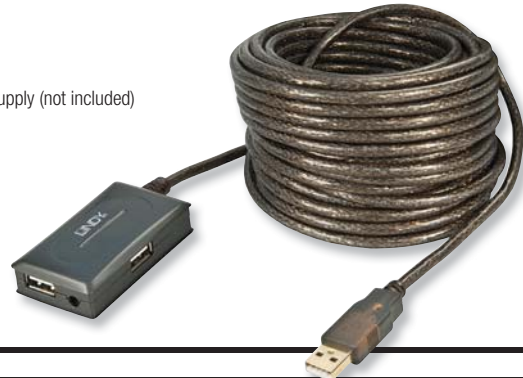

10m USB 2.0 Active Extension 4 Port Hub 42630

Optional Multi-Country Power Supply 73820

USB 3.0 Active Extension Cables 5m and 10m versions available

- Connectors: Type A USB Male to Type A USB Female
- USB 3.0/2.0 & 1.1 compatible
- 10m and 15m version features a connection for attaching a power supply (not included)

5m version



**BEST
SELLER**



10m version

5m USB 3.0 Active Extension Cable 43155

10m USB 3.0 Active Extension Cable 43156

Optional Multi Country Power Supply for 10m 73824

50m CAT5 USB Extender

- Extends a USB port by up to 50m using CAT5/5e/6 cable
- Ideal for use with keyboards, mice, printers, card readers etc.
- USB 1.1 compliant
- Powered by the USB bus from the computer – an optional power supply is available for use with high current USB devices

**BEST
SELLER**

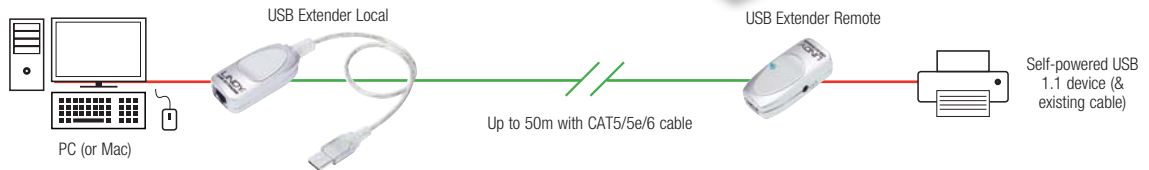

50m CAT5 USB Extender

42805

Optional Power Supply

73824

50m CAT5 USB Extender Premium

- Extends a USB port by up to 50m using CAT5/5e/6 cable
- Features an advanced chipset design which makes it suitable for use with USB 1.1 multimedia devices such as webcams and whiteboards
- USB 1.1 compliant
- USB bus powered - no extra power supply is required

**BEST
SELLER**



50m CAT5 USB Extender Premium

42801

50m CAT5 USB Extender with 4 Port USB 1.1 Hub

- Extends a USB port by up to 50m using CAT5/5e/6 cable
- Remote unit features a 4 port USB 1.1 hub
- Powered by the USB bus from the computer – an optional power supply is available for use with high current USB devices

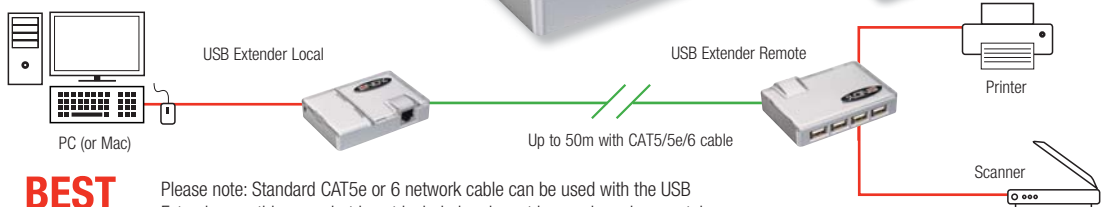

**BEST
SELLER**

Please note: Standard CAT5e or 6 network cable can be used with the USB Extenders on this page, but is not included and must be purchased separately. Please see page 212 for our range.

50m CAT5 USB Extender with 4 Port USB 1.1 Hub

42802

USB EXTENDER RANGE FOR LONG DISTANCE

ACTIVE EXTENSIONS

To connect a USB device, e.g. a printer or external hard drive to a computer over long distances. LINDY Active extenders use built-in electronics to amplify the USB signal and transmit it up to a distance of 50 metres. They can be used in a variety of applications.

CAT.5 EXTENDER

To connect a touch board to a PC at a distance of 50m. USB Extender 42693 bridges 50m using a Cat.5 cable.

Control systems or test benches in industrial applications often need to be controlled and monitored from computers placed at distances of up to 100 metres. Extender reliability has top priority here. Failures could lead to production downtime thereby leading to high costs or distorting the result of tests - for example, on the life cycles of a motor. The premium models No. 42700 and 42695 meet these requirements. They transmit data over long distances and have been designed for conditions typical in industrial environments. The metal housing protects against interference radiation. The extenders have 2 power supplies for both the transmitter and receiver.

OPTICAL EXTENDER

To manage large volumes of data from a server placed 100m away. USB 3.1/3.0 active optical cable, 42696 can transmit data volumes far greater than USB 2.0 – up to a maximum of 5Gbps.

To provide remote control and maintenance of a video wall placed 200m away from a server. Electromagnetic fields in the environment make it necessary to protect data transmissions from interference radiation. For these long distances, the USB 2.0 Fibre Optic Extender, 42703 is the perfect solution. It sends the data via Fibre Optic cables at distances of up to 200m. Unlike copper cables, Fibre Optic cables are not susceptible to magnetic interference.

To monitor industrial manufacturing processes using industrial CCTV cameras at distances of up to 400m. The LINDY USB 3.1/3.0 Fibre Optic Extender 42707 provides access to multiple cameras at different distances, up to a maximum of 400m. It provides support for the new USB 3.0 vision standard making it especially suited to systems with video support.

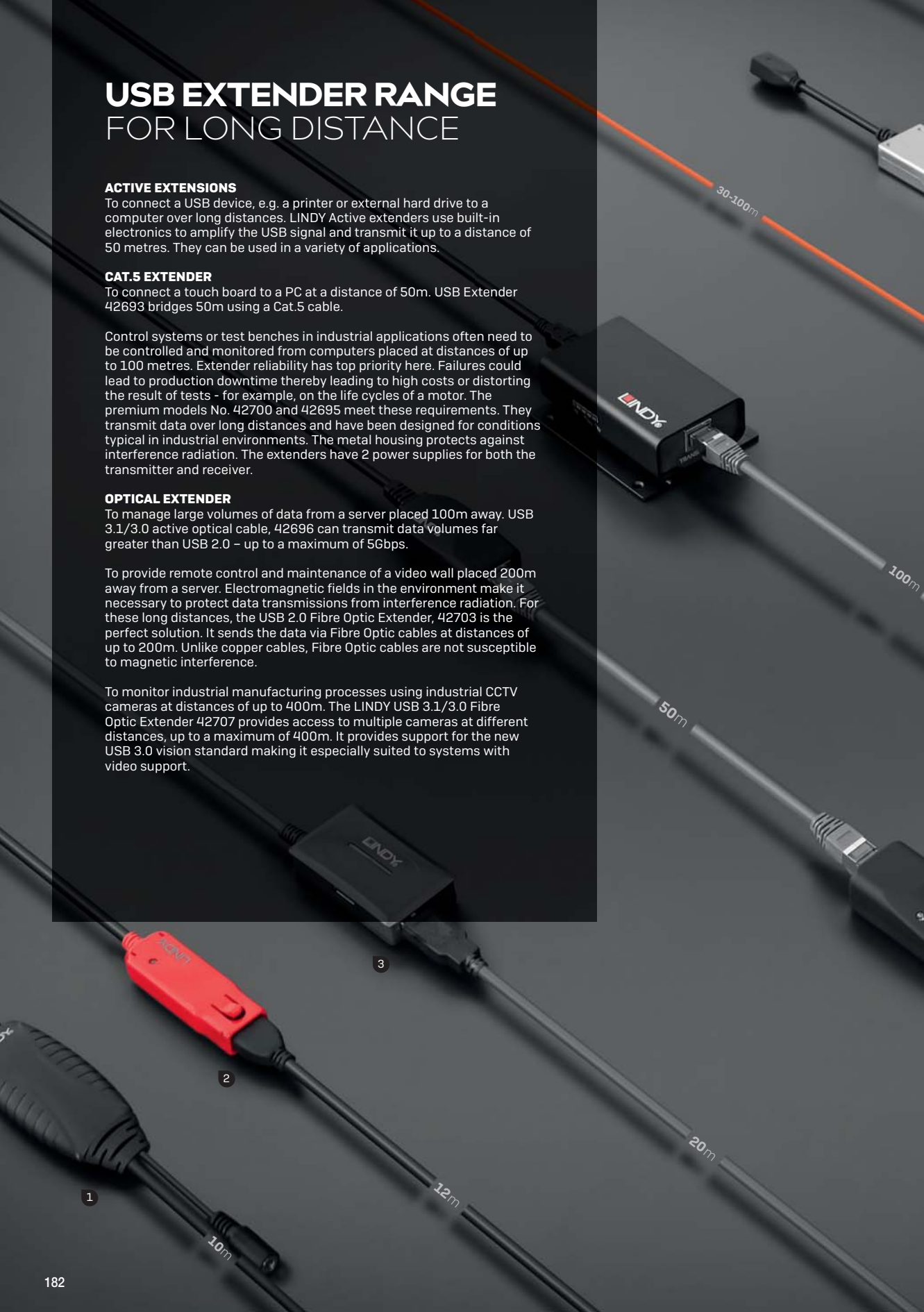



1
10m USB 3.0 Extension Cable
Active Extension
→ Page 180, 43156

2
12m USB 2.0 Extension Cable
Active Extension
→ Page 178, 42782

3
10m USB 2.0 Active Extender Hub
4 Port Hub
→ Page 180, 42630

4
50m USB 2.0 Cat.5 Extender
1 Port
→ Page 181

5
100m USB 2.0 Cat.5 Extender
4 Port Hub
→ Page 185, 42700

6
USB 3.1 / 3.0 Fibre Optic Cable
length: 30-100m
→ Check our website

7
200m USB 2.0 Fibre Optic Extender
LC Multimode
→ Check our website

8
400m USB 3.1 Fibre Optic Extender
USB 3.1/3.0
→ Page 186, 42707

50m CAT5 STP USB 2.0 Extender

- Extends a single USB port up to 50m using low cost UTP / STP CAT5/5e/6 network cable (not included)
- USB 2.0 compliant; supports USB 2.0 High Speed and USB 1.1 Full Speed / Low Speed
- Can be used with shielded cables making it ideal for use in commercial and industrial installations
- Supports USB hubs for connecting multiple devices
- USB bus powered from the computer or the supplied multi-country power supply



BEST SELLER

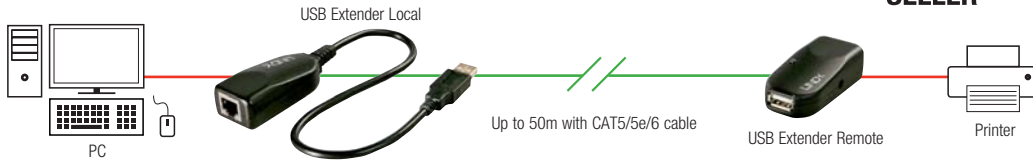

50m CAT5 STP USB 2.0 Extender

42693

100m CAT5 UTP USB 2.0 Extender Lite

- Locate your High Speed USB 2.0 peripherals up to 100m away from your computer and connect them using low cost UTP CAT5/5e/6 network cable (not included, see page 212)
- Can support USB hubs for connecting multiple devices
- USB 2.0 compliant; supports USB 2.0 High Speed and USB 1.1 Full Speed / Low Speed
- USB bus powered from the computer or the supplied multi-country power supply
- Compatible with USB equipped PCs and Macs



BEST SELLER

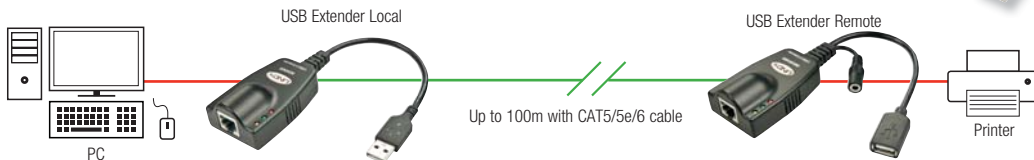

100m CAT5 UTP USB 2.0 Extender Lite

42694

50m USB 2.0 4 Port CAT.5/6 Extender With Power Over CAT.5/6

- Extends a USB 2.0 port up to 50m using low cost CAT5/5e/6 network cable (not included)
- Power over CAT5/6 requires a single power supply to be connected to local unit only
- Supports USB 2.0 High Speed and USB 1.1 Full Speed / Low Speed
- Plug & Play installation – compatible with all operating Systems with USB support



NEW

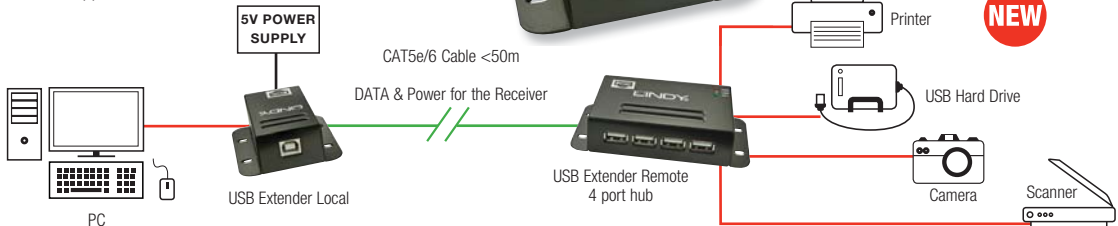

50m USB 2.0 4 Port CAT.5/6 Extender with Power Over CAT.5/6

42681

100m USB 2.0 CAT5 Extender Pro with 4 Port Hub

- Extends the distance of 4 USB 2.0 peripherals by up to 100m
- Supports USB 2.0 High Speed (480Mbps) and USB 1.1 Full Speed/Low Speed
- Connect devices using standard UTP / STP CAT5/5e/6 or higher network cables (not included, see page 212)
- Robust aluminium housing with mounting points

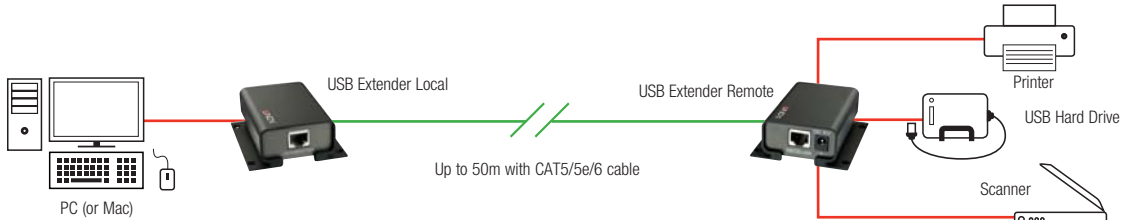

100m USB 2.0 CAT5 Extender Pro with 4 Port Hub

42700

100m CAT5 USB 2.0 Switching Extender with 7 Port USB 2.0 Hub

- Integrated 2 port switch allows peripherals to be shared between 2 PCs
- Allows you to extend multiple USB devices up to 100m using low cost CAT5/5e/6/7 network cable (not included)
- Supports USB 2.0 High Speed (480Mbps) & USB 1.1 Full Speed/Low Speed
- Includes a 3 port USB hub on the transmitter and a 7 port USB hub on the receiver

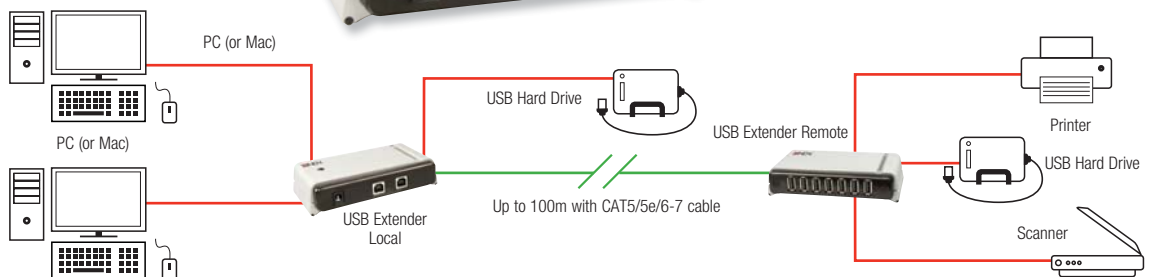

100m CAT5 USB 2.0 Switching Extender, 7 Port Hub

42695

300m USB CAT5 Keyboard and Mouse Extender

- Consists of a transmitter and receiver unit which are connected by long length CAT5e/6 cables (not included, see page 212)

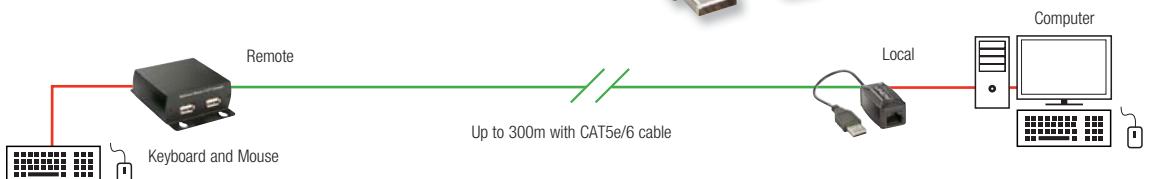

300m USB Keyboard and Mouse Extender

32686

Fibre Optic USB 3.0 Extender, 400m

- Extends USB 3.1 Gen 1 (5Gbps) / USB 3.0 connections up to a maximum length of 400m
- Uses standard LC multimode duplex fibre optic cable (not included, see page 211) to make the long distance connection
- Fibre optic technology makes this product immune to EMI making it ideal for use in industrial installations
- Supports all major operating systems with USB 3.1 Gen 1 or USB 3.0
- Note: this product is not backwards compatible with USB 2.0/1.1/1.0

Ideal for remote desktop links, industrial control, surveillance and external storage applications the extender gives long distance access to many devices.

Below are examples of the achievable distances using the different grades of fibre:

- 62.5/125µm OM1: 100m
- 50/125µm OM2: 200m
- 50/125µm OM3: 400m



Fibre Optic USB 3.0 Extender, 400m

42707

4 Port USB 2.0 over Gigabit IP Server

- Share USB storage devices, printers, webcams etc over a Gigabit network
- Four High Speed USB 2.0 ports
- RJ-45 10/100/1000 Network Connection
- Windows application for easy management of devices
- Network protocol: TCP / IP

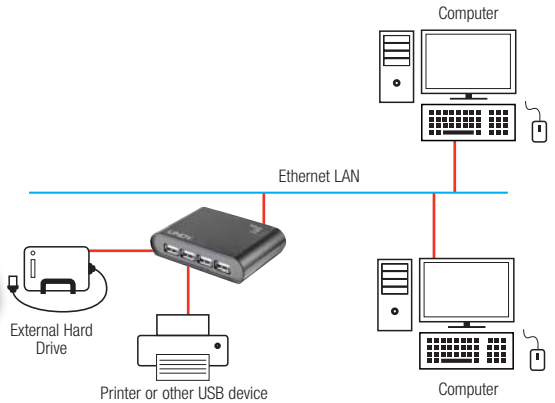

WIN

4 Port USB 2.0 over Gigabit IP Server

42633

CAT5 USB to RS-232 Serial Extender

70m and 2km versions available

- Ideal for use with EPOS, process control, lab equipment, digital signage etc.
- Consists of transmitter and receiver modules
- Low cost CAT5e/6 cable (not included) is used to make the long distance connection
- Bus-powered - no external power supply required for local and remote units



NEW



70m CAT5 USB to RS-232 Serial Extender

32157

2km CAT5 USB to RS-232 Serial Extender

32155

FireWire Active Extension Cable

4.5m and 10m versions available

- Extends the cable length between FireWire devices over distances greater than the IEEE 1394a specified limit of 4.5m
- Cables can be daisy chained together to a maximum 50m
- Supports IEEE 1394a devices at speeds of up to 400Mbps



4.5m FireWire Active Extension Cable	32908
10m FireWire Active Extension Cable	32958

FireWire 800 Active Extension Cable

Extend the length of your FireWire 800 device by 5 or 10m

- FireWire Repeater Cable for extending the cable length between FireWire devices over distances greater than the IEEE 1394b specified limit of 4.5m
- Cables can be daisy chained together to a maximum 50m
- Supports IEEE 1394b devices at speeds of up to 800Mbps
- Ideal for use with DV Camcorders, FireWire printers, scanners, digital



5m FireWire 800 Active Extension Cable	32918
10m FireWire 800 Active Extension Cable	32957

75m CAT5e/6 FireWire Extender

- Extends FireWire peripheral devices up to 75m via CAT5e/6 cable
- Local unit connects to your computer and is bus powered; the remote unit connects to your device and is powered using the included power supply
- Both units feature 9 Pin FireWire 800 connectors; two adapter cables are provided for use with 6 Pin FireWire 400 ports

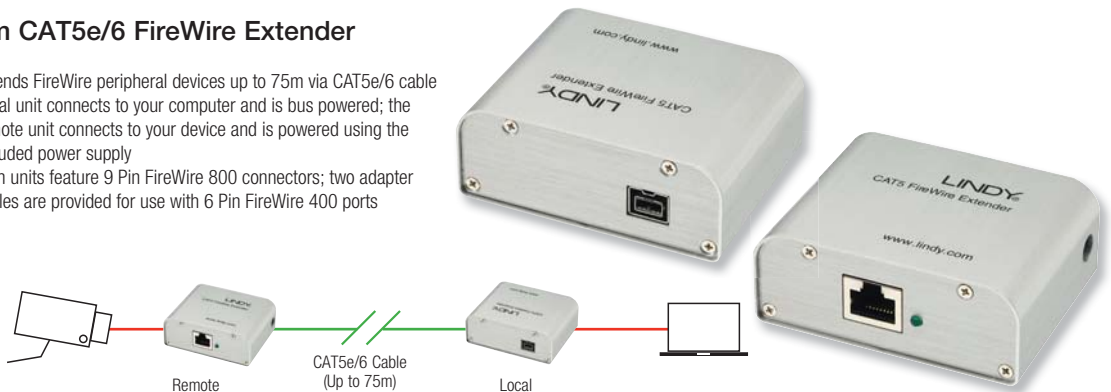

75m CAT5e/6 FireWire Extender

32917

6 Port FireWire Repeater Hub

- Features 6 ports: one for connecting to a computer, five for connecting to your devices
- Supports data transfer rates of up to 400Mbps
- Supplied with 1.8m FireWire cable



6 Port FireWire Repeater Hub

32916

3 Port FireWire 800 Repeater Hub

- Features 3 ports: one for connecting to a computer, two for connecting to your devices
- Supports speeds of up to 800Mbps
- Supports transfer distances of up to 4.5m
- 1m FireWire 800 9 Pin Beta cable included



3 Port FireWire 800 Repeater Hub

32911

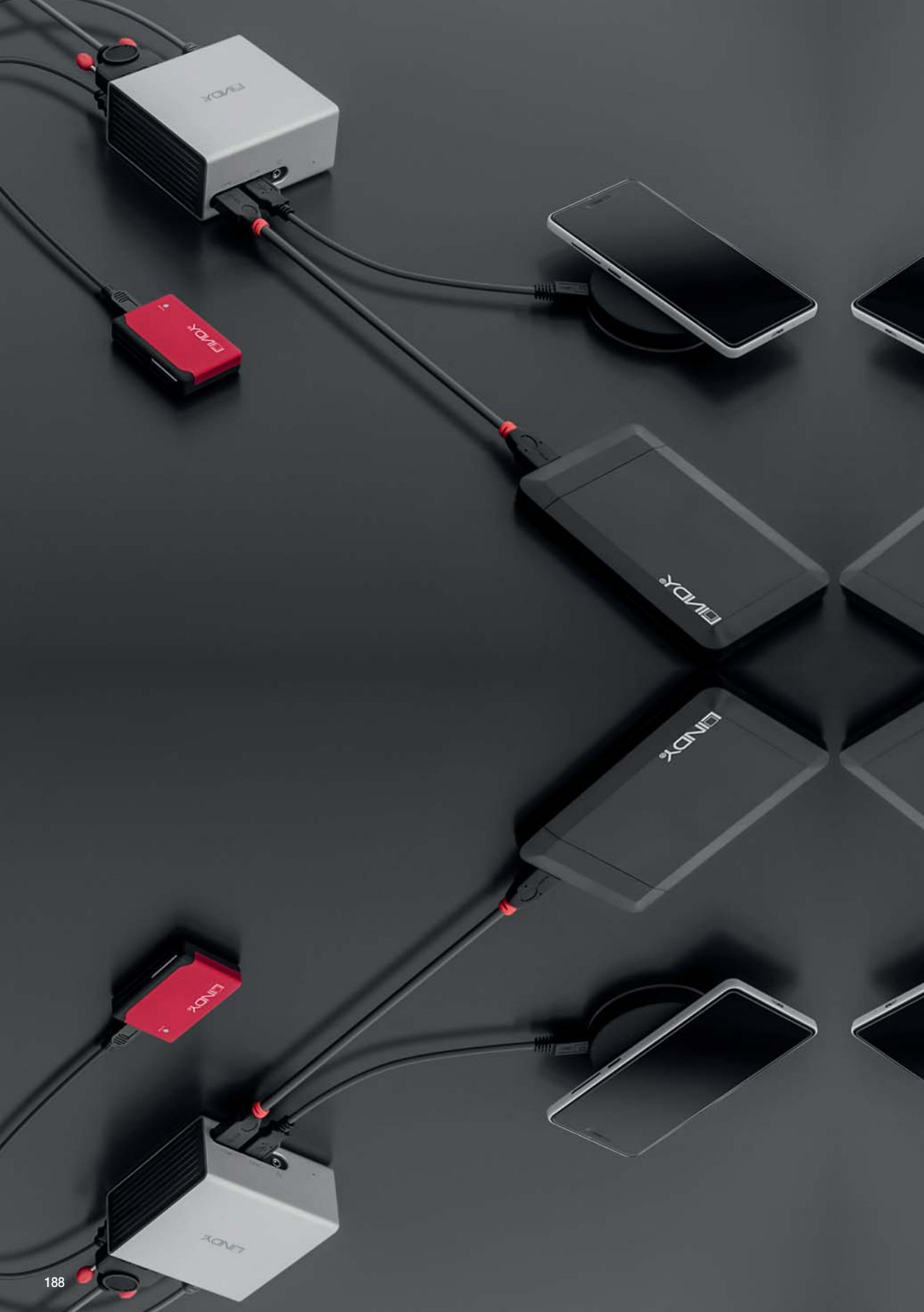

ACCESSORIES EQUIPMENT

Input devices	190
Wi-Fi Router & Portable Accessories	191
Tablet & Smartphone Accessories	193
PC & Tablet Mounts & Stands	196
Security Cables, Port Blockers & Accessories	197
Cleaning Products, Torches	201

USB Optical Mouse

- 800dpi optical sensor
- 1.4m USB cable



WIN | MAC OS | LINUX

USB Optical Mouse

20571

Wireless Gyro Mouse

- Allows mouse control using 3D gestures in the air
- Also functions as a standard wireless optical mouse



WIN | MAC OS | LINUX

Wireless Gyro Mouse

20579

Keyboard and mice accessories

- Helps prevent RSI (Repetitive Strain Injury)
- High quality, micro-fibre fabric covering



Gel Keyboard Wrist Rest



Mouse Pad with Gel Wrist Rest

XXL Professional Mouse Pad



Mouse Holder

In use example.
Mouse not included.

Gel Keyboard Wrist Rest	40213
Mouse Pad with Gel Wrist Rest	40216
Mouse Holder	40171
XXL Professional Mouse Pad	40211

CCD Barcode Scanner

- PS/2 and USB versions available
- Integrated 2m cable
- Continuous or trigger activated
- Reads all common barcodes



PS/2 version



USB version

WIN | MAC OS

CCD Barcode Scanner, PS/2 Version (PC)	20772
CCD Barcode Scanner, USB Version (PC & Mac)	20789

USB Laser Barcode Scanner Classic

- Can be used in hand-held or hands-free mode
- Read speed up to 100 scans per second
- Cable length 2m



WIN | MAC OS

USB Laser Barcode Scanner Classic

20779

2D & 1D Barcode Scanner, USB

- Reads 2D and 1D barcodes
- Scans mobile phone screens - ideal for scanning QR code boarding passes, tickets etc.
- CMOS sensor, 1280 x 960 pixels
- Auto scan function
- Omni-directional reading



NEW

2D & 1D Barcode Scanner, USB

20770

Portable Wi-Fi Router, SD Card & Pen Drive Reader

- Easily access memory card and USB flash drive files from any iOS or Android device
- Connect to iOS and Android mobile devices via Wi-Fi
- Share and transfer stored media with up to 3 people at the same time
- Also acts as a wireless router, access point or repeater
- Built in re-chargeable battery



Android or Apple device



ANDROID

Portable Wi-Fi Router, SD Card & Pen Drive Reader

52063

Retractable Cables

USB, network and audio versions available

**BEST
SELLER**



Type A to Micro-B USB



CAT5 UTP



3.5mm Jack to 3.5mm Jack



Type A to Mini-B USB

Length Part No.

Type A USB Male to Type Mini-B Male	0.8m	31618
Type A USB Male to Micro-B Male	0.8m	31619
CAT5 RJ-45 UTP Male to Male with RJ-12 Adapters	2m	44995
3.5mm Stereo Jack Male to 3.5mm Stereo Jack Male Cable	1.1m	35445

USB 360° Adapter

Swivel and rotate action allows you connect devices without obstructing adjacent ports.

- Type A Male to Female
- Supports USB 2.0 and USB 1.1 devices



USB 360° Adapter, Type A Male to Type A Female

70339

USB Charging Adapter for iPad

- Charge your iPad from your PC or older Mac
- Compatible with Apple iPads, iPods and iPhones



USB Charging Adapter for iPad

73336

USB Notebook Light

- Long lasting LED design
- Flexible neck for easy positioning



USB Notebook Light

42772

CABLE GURU

FIND THE CABLE YOU NEED

Try it now on our

WEBSITE

16 PORT CHARGING STATION TAKE CHARGE IN THE CLASSROOM



The LINDY 16 port USB charging Station allows you to charge up to 16 tablets, phones or other mobile devices at the same time. Each port can provide 5v 2.1A to satisfy the most hungry power devices.

In addition to charging, you can also sync your devices using the maker's configurator software. The unit can also be rack mounted with the included brackets. When rack mounted the dividers can be assembled and stood on the top of the unit. When freestanding, the dividers can be attached to the side of the station for a sturdy setup.

This product is perfect for use in schools, libraries, hotels, restaurants or any location that uses multiple tablets on a daily basis.

16 Port Charging Station

USB Charging Station allows IT Co-ordinators to easily charge and sync multiple tablets



Can be used with iPads, iPhones, Android tablets, smartphones or any device that charges via USB.



Different coloured LEDs indicate charging status: slow charge, fast charge & fully charged.



A separate LED display shows the charging rate of the selected port. Provides up to 2.1A on each port for super fast charging of all devices.



Integrated cable tidies allow each USB charger cable to be neatly routed from front to back.



Versatile installation options: the divider module can be separated from the USB station which can then be rack mounted using the supplied kit.

- Charges and syncs up to 16 tablets, smartphones or other mobile devices at the same time
- Each port can provide 5v 2.1A to satisfy the most hungry power devices
- Sync using your device manufacturer's software
- Can be rack mounted using the included brackets
- 16 Type A USB Ports
- LED status showing current charge for each port

16 Port Charging Station

73399

10 Tablet Charging/Sync Station

Ideal for schools, colleges and universities

- Securely charge up to 10 tablets
- Syncs iPads while they are charging
- Daisy chain up to 3 units to sync up to 30 tablets at the same time
- Stackable option - built in bracket allows stations to be placed on top of each other and locked in place
- Slide-in lockable door
- Built-in surge protection
- USB output: DC 5V/2.1A (max) per port
- Maximum tablet size 18 x 240 x 200mm (WxDxH)
- Dimensions: 310 x 350 x 340mm (WxDxH)

Please note: charging cables not included, see pages 220 to 229 and page 236 for our range

View showing door locked



10 Tablet Charging/Sync Station

73397

10 Port USB Charging Station for Tablets & Smartphones

- 10 x USB Type A Ports with up to 2.4A charging per port
- 11 Adjustable separators allows different tablet/mobile phone sizes
- Smart charging function adjusts the charge current
- Protects against overvoltage, overloading and short circuits



Please note: charging cables not included

**BEST
SELLER**

10 Port USB Charging Station for Tablets & Smartphones

73309

iPad & Tablet Tripod Stand

- Perfect for schools, universities, business environments etc
- Height adjusts from 75cm to 157cm
- Bracket can swivel and rotate 360 degrees and tilt 180 degrees
- Accommodate most 7" to 10" tablets
- Includes a carry bag



iPad & Tablet Tripod Stand

40734

Portable Stand for iPad & Tablet PC

- Ideal for watching movies and video, surfing the web, viewing photographs as well as reading and typing
- 2 viewing positions, upright for video, picture and web viewing and laid down for a comfortable typing position
- Includes a carry pouch for easy transportation



October 2012



August 2012



Portable Stand for iPad & Tablet PC

54003

Silicone Tablet & Smartphone Stand

- For Tablets & Smartphones with screens up to 11" and 1cm deep
- Black and white versions available



Silicone Tablet & Smartphone Stand, Black

54005

Silicone Tablet & Smartphone Stand, White

54006

Capacitive Touchscreen Stylus

- For use with any capacitive touchscreen device
- Retractable tip



**BEST
SELLER**

Capacitive Touchscreen Stylus

40255

Wireless Charging Adapters

- For use with our Wireless Charging Pad (73324)
- Install underneath the standard battery cover
- Compatible with all Qi Wireless compatible chargers
- Maximum Power Output:
 - 73386: 5V DC 500mA
 - 73387: 5V DC 600mA
 - 73361: 5V DC 600mA
 - 73388: 5V DC 500mA
 - 73389: 5V DC 600mA
 - 73325: 5V DC 500mA



S3 version



S5 version



S4 version



Note 2 version



Note 3 version



Note 4 version

For Galaxy S3	73386
For Galaxy S4	73387
For Galaxy S5	73361
For Galaxy Note 2	73388
For Galaxy Note 3	73389
For Galaxy Note 4	73325

Qi Wireless Charger

- For use with the latest smartphones, watches, and tablets that are fitted with a LINDY Wireless Charging Adapter or feature integrated Qi Wireless charging
- Fully compatible with the Qi wireless charging standard
- Uses induction charging technology for convenient charging
- Simply place the device on top of the pad to charge
- Includes 1m USB A to Micro-B cable
- Maximum Power Output: 5VDC 1A



Qi Wireless Charger	73324
---------------------	-------

Smartphone Desktop Dock

Versions for use with Samsung Galaxy S4, S5, HTC One M7, One M8 and Nexus 5

- A convenient and safe way to charge or sync your smartphone
- High quality, soft touch rubberised plastic
- Built in surge protection
- Includes USB cable



Galaxy S4 version



Galaxy S5 version



HTC One M7 version



HTC One M8 version



Nexus 5 version

For Samsung Galaxy S4	73395
For Samsung Galaxy S5	73321
For HTC One M7	73396
For HTC One M8	73322
For Nexus 5	73398

In-Car Headrest iPad & Tablet Holder

- 2 viewing positions, portrait mode for picture and web viewing and landscape mode for video viewing
- Easy to install and remove, no tools required
- 360° rotation and 30° angle adjustment
- Supports devices from 105mm up to 200mm in width



Tablet Fridge / Wall Mount

- Extra strong magnets for attaching to a fridge or other metal surface
- Also includes holes for hanging on a wall
- Supports landscape or portrait orientation
- Maximum tablet height: 26cm



In-Car Headrest iPad & Tablet Holder

54004

Tablet Fridge / Wall Mount

40698

Under Desk Keyboard & Mouse Shelf

Easy to install, fully adjustable shelf with wrist rest

- Slide out mouse rest can be fitted to the left or right
- Includes all fixing screws & fitting instructions
- Suitable for keyboards up to 600 x 230mm (WxD)



Mobile CPU Stand

- Make light work of moving your PC
- For use with computers up to 255mm wide
- Heavy duty plastic construction



Supports
up to
30kg

Under Desk Keyboard & Mouse Shelf

40711

Mobile CPU Stand, Black

40286

Under Desk PC Holders

Fixed and sliding versions available

- Sliding Holder has 360° swivelling action and can be pulled from under the desk up to 140mm
- Includes all fixing screws
- Suitable for computers measuring: (WxDxH) 160-220 x 450 x 340-490mm approx
- Suitable for any 25mm thick work surface

Supports
up to
30kg

Fixed Under Desk
version shown

**BEST
SELLER**



Locking Under Desk PC Holder

Neatly secure your PC under your desk

- Simply attach to the underside of your desk or workbench
- A secure locking design means only those with a key can remove the computer from the bracket
- With 360° swivelling action
- Includes all fixing screws
- Holds a maximum weight of 20kgs
- Suitable for any work surface with a thickness of 15mm and above
- Suitable for computers measuring: (WxDxH) 120-230 x 320-530 x 370-570mm approx

Supports
up to
20kg



Fixed Under Desk PC Holder

40283

Sliding Under Desk PC Holder

40284

Locking Under Desk PC Holder

40288

Security Kit for iPad

Versatile, rotating stand with security cable

- Compatible with iPad 1, iPad 2, iPad and iPad with retina display
- Supplied with a high quality 2m security cable & lock and two barrel lock keys
- Ideal for use in schools, shops or trade shows and mobile kiosks
- Cutaways for rear camera, speaker, slide switch and volume button
- Built in rotating handle/stand



Security Kit for iPad

40730

Universal Tablet Security Lock

Portable protection for a range of Tablets

- Adjustable angle and length to fit a wide range of tablets with 9 to 11" screens
- Ideal for use in commercial and educational set ups
- Use in combination with any barrel-style security slot cables

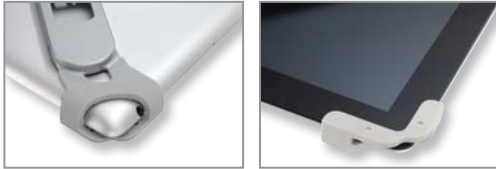

Universal Tablet Security Lock

20943

Notebook Security Cables

Available with barrel, key or combination locks

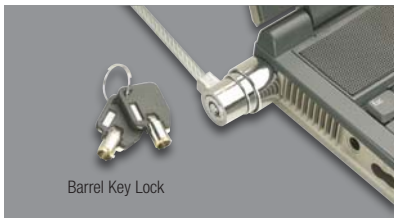

Barrel Key Lock



Combination Lock

**BEST
SELLER**

- Protects your laptop or other computer accessories which have a suitable security slot fitted, e.g. TFTs, projectors etc.

- Plastic covered steel cable
- Length: 1.6m

Barrel Key Lock Security Cable

20945

Combination Lock Security Cable

20903

Peripheral and Notebook Security Cable, Barrel Lock

- Designed for laptop, PCs Macs and other devices that use the Kensington style slot
- Secures your expensive devices using the lock ring
- 1.8m plastic covered steel cable, 4mm diameter



NEW

Peripheral and Notebook Security Cable, Barrel Lock

20912

Twin Lock Security Cable

Secures two devices at the same time

- Features a pair of barrel keylocks for securing two devices e.g. a laptop and a TFT screen
- Attaches to the security slots found on most notebooks and many other devices
- Plastic covered steel cable
- Supplied with 3 keys
- Length: 1.7m



**BEST
SELLER**

Twin Lock Security Cable

20946

Security Slot Locking Bolt

Secure your notebook or TFT monitor

- Inserts into the security slot found on most notebook computers and TFTs
- Passing a security cable or lock through the bolt fastens it into place
- Supports cables/locks with a maximum diameter of 5mm



Security Slot Locking Bolt

20909

Coiled Notebook Security Cable

Key operated barrel lock design

- Easily attaches to a security slot found on most notebooks, desktops, LCD monitors etc
- Supplied with 2 keys
- Plastic covered coiled steel cable
- Length: Coiled 12cm Uncoiled 1.8m



Coiled Notebook Security Cable

20977

USB Security Cable, Combination Lock

- 4 wheel combination lock design with push button operated lock release
- Attaches to the USB Type A port, ideal for devices without a Kensington Style Slot
- Plastic covered heavy duty steel cable with 4.5mm diameter
- Length: 1.7m



NEW

USB Security Cable, Combination Lock

20983

Computer Security Kit

Fast and easy installation with no tools required

- Heavy duty steel-coated cable
- 3 permanent, self-adhesive mounting plates, and a padlock with 2 keys
- Length: 2m



Computer Security Kit

20275

Monitor, Keyboard & Mouse Security Bracket

Replaces a PC's standard blanking plate

- One bracket can secure several devices at the same time
- Moulded connectors on the end of each cable prevent the devices from being taken away from the PC
- Maximum cable diameter: 7mm

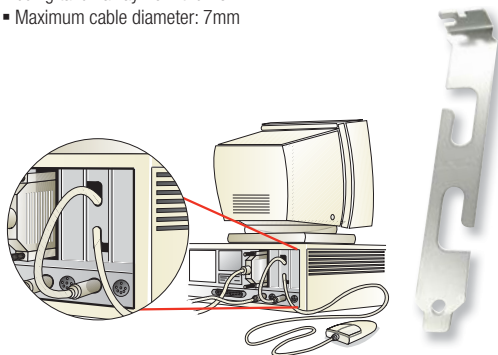

Monitor, Keyboard & Mouse Security Bracket

40167

USB Port Blocker

Simple and effective tool for blocking a USB port

- Prevent users from connecting pen drives, smartphones, MP3 players and other devices to a computer to copy data, introduce viruses etc.
- 5 colour coded versions available: Pink, Green, Blue, Orange & White
- Includes 4 locks and 1 key (additional lock packs available)
- Each key only works with a lock of the same colour



**BEST
SELLER**

	Colour Code	Part No.
USB Port Blocker (4 locks & 1 key)	Pink	40450
	Green	40451
	Blue	40452
	Orange	40453
	White	40454

	Colour Code	Part No.
Additional Lock Pack (10 locks without key)	Pink	40460
	Green	40461
	Blue	40462
	Orange	40463
	White	40464

RJ-45 Port Blockers

Prevent unauthorised access to RJ-45 ports

- Available in packs of 10 with a key or 20 without a key
- Quick and easy to use
- Block physical access to RJ-45 Network ports



**BEST
SELLER**

	Colour Code	Part No.
RJ-45 Port Blocker (10 locks & 1 key)	Black	40470
	Green	40472
	Orange	40480
	Yellow	40482

	Colour Code	Part No.
Additional Lock Pack (20 locks without key)	Black	40471
	Green	40473
	Orange	40481
	Yellow	40483

LC Security Locks

Physically locks Fibre Optic LC connectors into ports

- Available as a pack of 10 locks with 1 key or a pack of 20 locks and no key



10 x LC Security Locks with 1 Key	40475
20 x LC Security Locks without Key	40476

SD Port Blockers

Prevent people interfering with SD Ports connections

- Physically blocks access to SD card slots
- Quick and easy to use
- Available as a pack of 4 locks with 1 key or a pack of 10 locks and no key



4 x SD Port Blockers with 1 Key	40478
10 x SD Port Blockers without Key	40479

**Free UK
DELIVERY**  **on all orders over £125 (ex VAT.)**
Some exceptions apply, see delivery terms & conditions on our website

Visit our website
WEBSITE
for the latest prices
& special offers



Lightning Cable Protector Kit

The LINDY Lightning Cable Protector Kit provides a solution to common problems with Lightning cables, including damaged cable, broken connections, and cable pulling away from the connector. The protector provides a tough and rugged shell for your existing cable by using a two piece design with a silicone centre. The kit comes with a USB Type A and Lightning protector, this provides maximum protection for the cable as both ends are fully protected.

- Protect your Lightning cables from deterioration
- Quick and Easy to Install
- Supplied with Both USB Type A and Lightning protectors



**BEST
SELLER**



NEW

Lightning Cable Protector Kit	Colour	Part No.
	Pink	31387
	Green	31388
	Blue	31389
	White	31385

Mini DP / Thunderbolt Port Blockers

With the LINDY Mini DisplayPort & Thunderbolt Port Blocker, you can quickly block open ports and easily prevent users from connecting cables, devices or inserting foreign objects without permission.

To use, simply attach a blocker to the magnetic key and plug it into the port. Hold the blocker in place and pull away the Key. To remove, simply insert the Key back on to the blocker and pull it away. Easy!

- Physically blocks access to a Mini DisplayPort or Thunderbolt port
- Quick and easy to use
- Consists of 4 locks and 1 key
- Also available in packs of 10 (without key)



NEW

Port Blocker Key with 4x Mini DP / Thunderbolt Port Blockers	40457
Pack of 10 Mini DP / Thunderbolt Port Blockers (without key)	40456

USB Type C / Thunderbolt 3 Port Blockers

With this neat little device, system administrators can physically prevent users from connecting Pen Drives, Mobile Phones and other USB Mass Storage Devices to their computers to copy data and introduce viruses.

To use, simply attach a blocker to the magnetic key and plug it into the port. Hold the blocker in place and pull away the Key. To remove, simply insert the Key back on to the blocker and pull it away.

- Physically blocks access to a USB Type C / Thunderbolt 3 port
- Quick and easy to use
- Consists of 4 locks and 1 key
- Also available in packs of 10 (without key)



NEW

Port Blocker Key with 4x USB Type C / Thunderbolt 3 Port Blockers	40459
Pack of 10 Mini DP / Thunderbolt 3 Port Blockers (without key)	40458

USB & Flash Drive Combination Lock

Multi-function USB lock

- 3 digit user definable combination
- Prevents unauthorised access to devices and files
- Can also be used as a traditional padlock



USB Flash Drive not included

USB Combination Lock

40449

LCD & Plasma Screen Cleaners

Small and large screen versions

- Specially formulated cleaning solution reduces static electricity which can attract dust
- Soft, micro-fibre cleaning pad
- Can also be used to clean CDs and DVDs
- Cleaning fluid is neatly stored in the pad handle
- Small version is ideal for screens up to 20"; large kit is designed for larger LCD and Plasma displays over 20"
- Large kit also includes a soft brush for cleaning keyboards and other devices
- Cleaning solution does not contain IPA (isopropyl alcohol) or other harmful additives



Large Screen Cleaning Kit



Small Screen Cleaning Kit



Small Screen Cleaning Kit	40445
Large Screen Cleaning Kit with Brush	40446

Cleaning Tissues

- 25 dry cleaning tissues



Cleaning Tissues, Pack of 25 40416

Microfibre Screen Cleaning Cloth

- Two sided - a long fibre side removes dust; a short side cleans smudge and finger marks
- Dimensions: 150 x 180mm



Microfibre Screen Cleaning Cloth 40448

Multi-format DVD/CD Lens Cleaner

- Compatible with PCs, Macs, games consoles and CD, LD, VCD and DVD players



Multi-format DVD/CD Lens Cleaner 40424

Super-Bright LED Torches

Ideal for use in the car, home or office

- 28 Super-Bright LEDs with an expected life of 100,000 hours
- Tough, weatherproof, aluminium alloy design
- Available in silver or black
- Requires 3 x AAA batteries (not included, see table below)



BEST SELLER

Super-Bright LED Torch, Silver	43072
Super-Bright LED Torch, Black	43071

300lm CREE LED Zoom Torch

- Pocket sized twist zoom torch
- Uses the industry leading high output 300 Lumen XR-E LED from specialist LED manufacturer, Cree
- 100,000 hours LED life
- Black, aluminium alloy casing (IP54 rated, dust and weather proof) - ideal for indoor or outdoor use
- Requires 3 x AAA batteries



300lm CREE LED Zoom Torch	43074
---------------------------	-------

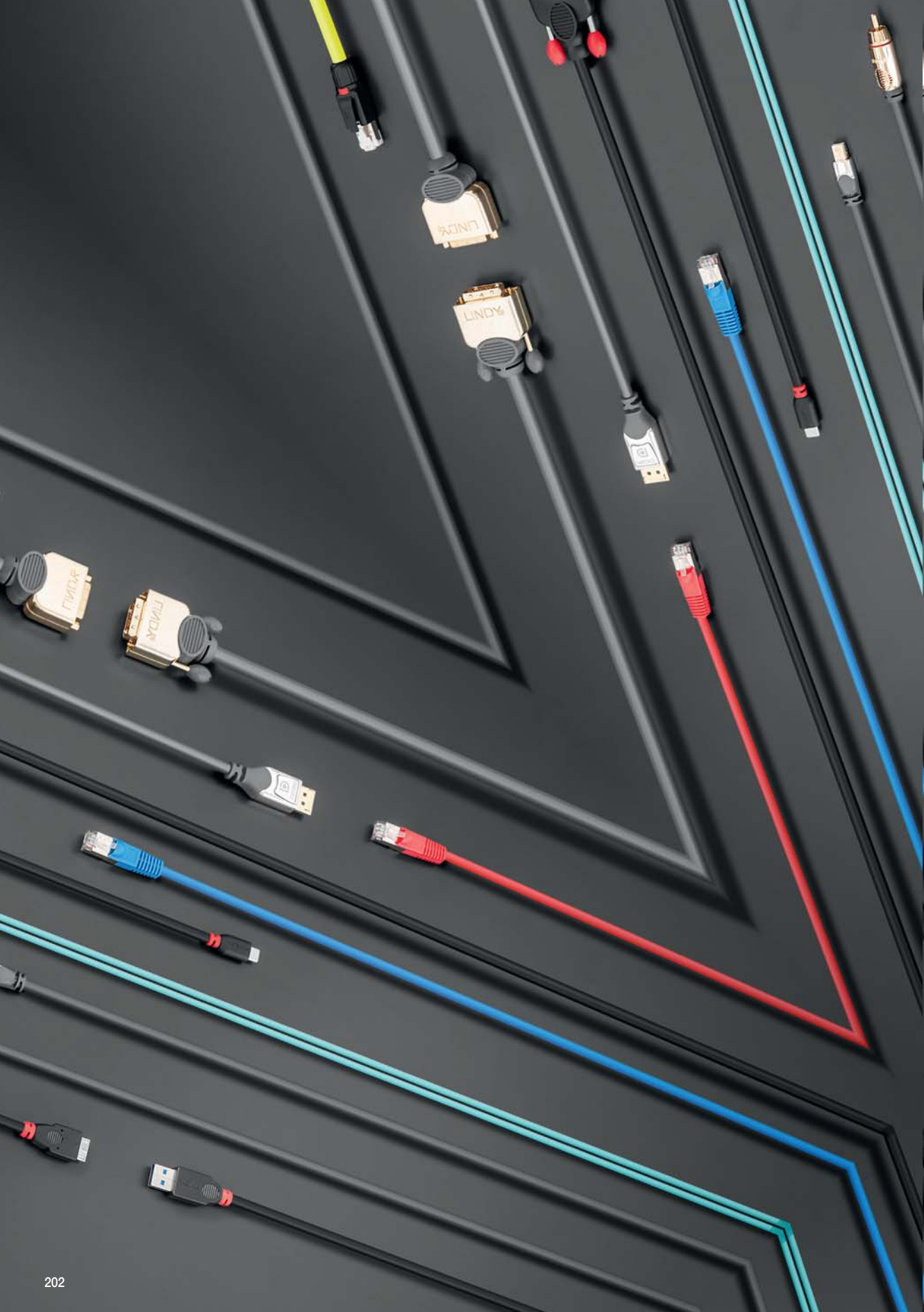

CABLES & ADAPTERS CONNECTIVITY

Fibre Optic Cables	210
Network Cabling	212
Twisted Pair Cabling	215
Port Doublers & Line Adapters	218
Bulk Cable, Connectors & Adapters	219
USB Cables & Adapters	220
FireWire Cables & Adapters	236
HDMI Cables	237
DisplayPort & Mini DisplayPort Cables	242
Thunderbolt Cables	246
DVI Cables	246
VGA Cables	250
Video Splitter Cables	252
AV Adapter Cables	253
Aerial, TV & AV Cables	258
Audio Cables	260
Portable Device Cables & Adapters	262
AV Adapters	265
Music Cables	266
Bulk AV Cables and Faceplates	267
KVM Cables	270
Serial & Parallel Cables	271
SATA, SAS, IDE & SCSI Cables	273
Internal Adapters, Cables Ties & Accessories	278

LINDY CABLE LEXICON FOR PERFECT CONNECTIONS

IN ORDER TO MEET THE CONSTANTLY GROWING REQUIREMENTS OF DATA TRANSMISSION RATES AND SIGNAL QUALITY IN WIRED CONNECTIONS, HIGHER QUALITY CABLES ARE NEEDED THAT ARE ABLE TO TRANSMIT HIGH FREQUENCY DATA SIGNALS RELIABLY AND EASILY.

In these times of wireless technologies such as WiFi, Bluetooth, LTE, etc. - the days of wired data transmissions are far from numbered. On the contrary, this technology is now able to show its true strengths for the first time. In terms of speed, security and reliability, this traditional data transmission technology is still without equal. One question that often comes up concerns what requirements a cable must meet in professional environments.

As data volumes increase continuously, the transmission media chosen must be as future-proof as possible.

The fact that many cables can work with today's resolutions and data speeds does not mean that there are no differences between them. Such differences only become apparent when transmission data speeds get ever faster which is when the more basic cable designs will get left behind.

Before installing hundreds of metres of cabling in network and/or A/V environments, you should be aware what criteria a cable needs to meet to ensure long lasting operation. The quality requirements of a cable increase in proportion to the distance covered, and the volume of data transmitted.

The following text describes specifically which criteria are responsible for quality and what you need to consider when planning larger data transmission distances with copper cables.

CORE CROSS SECTION

An indicator of the electrical conductor resistance of a cable core is firstly, the conductive material - which has its own material specific resistance (usually copper), and secondly the cross section of the core (the surface area of the front face visible when precisely cutting through the cable core in a radial direction). This is inversely proportional to the conductor resistance. The bigger the cross section, the thicker the core and the smaller the resistance and thus also the smaller the signal damping effect. Technically speaking, the core cross section is measured in mm^2 . Generally, the AWG (American Wire Gauge) measure is often used.

The following rule holds: the smaller the AWG measure, the thicker the core. The length of the cable is another characteristic which can affect conductor resistance. It is proportional to the resistance, ergo: the shorter the cable, the less is its signal damping effect. For this reason, choose as short a data cable as possible.



SHIELDING

Sophisticated cable shielding protects data signals from electromagnetic interference. It helps with electromagnetic compatibility (EMC) and reduces interdependencies on other cables and devices. Electromagnetic problems can be present in the signal path inductively or capacitively in poorly shielded cables or cables which do not have any shielding at all. They can diminish the quality of the usable data signal in a lasting way. The problems as described arise to a varying degree depending on how transmission cables are installed inside a building (e.g. in cable ducts along longer paths in parallel to high current or other high frequency cables near radiation-emitting devices, etc.). In extreme cases, a total breakdown of the image or visible artefacts on a monitor screen may arise with AV cables in the form of pixel noise. In network cables, it may bring about a massive breakdown in data transmission speeds. Close attention should therefore be paid to cable shielding. A good rule of thumb is as follows: The better the shielding, the better the signal transmission. This can be illustrated clearly using network cables as an example. The new naming system designates cables based on the schema [A]A/BCC, where A marks the overall shielding (**U** - Unshielded, **S** - Braided Shielding, **F** - Foiled or **SF** - Braided Shielding, Foil); B is the pair shielding (**U** - Unshielded, **S** - Braided Shielding, **F** - Foiled), and C is the cable type (**TP** - Twisted Pair).

UNSHIELDED CABLES

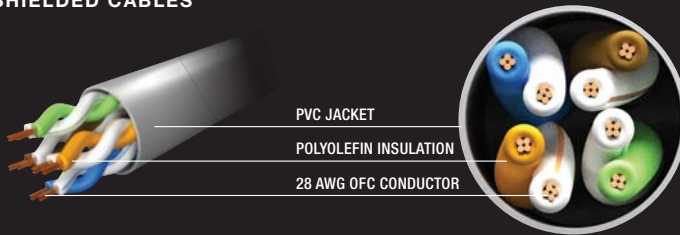

Cables without shielding, e.g. network cables are designated as U/UTP - Unshielded Unshielded Twisted Pair (formerly: UTP). These cables must not be installed next to power cables and not laid parallel to them at less than a few centimetres in distance over lengths in excess of ten metres. On these cables, the twisted pairs with plastic insulation are surrounded by a plastic jacket.

SINGLE SHIELDED CABLES



The following cables have good shielding sufficient in most uses. They bear the designation S/UTP (Braided Unshielded Twisted Pair), F/UTP (Foiled Unshielded, Twisted Pair, formerly: FTP) or SF/UTP (Braided Foiled Unshielded Twisted Pair). Alongside the exterior outer plastic jacket between the twisted cable pairs, there is also a protective copper braiding or an aluminium film, or both.

DOUBLE SHIELDED CABLES



The following cables offer good protection: they bear the designation: PIMF (Pairs in Metal Film) based on EN 50173 FTP (Foiled Twisted Pair), are actually called U/FTP (Unshielded, Foiled Twisted Pair). Unlike S/UTP (Shielded, Unshielded Twisted Pair) the cable does not have an outer overall shielding. Instead, the pairs are shielded. The cable is a little stiffer and less flexible as a result.

The best protection against faults are offered by double-shielded network cables termed S/FTP (Braided Foiled Twisted Pair). In these cables, all pairs have individual shielding using copper braiding or film. These cables feature an additional layer of metal protection between the core pairs and the outer protective jacket. This makes double-shielded pairs very good for use in harsh industrial applications where interference issues are often unavoidable, and also when bridging long distances.

CONNECTORS AND CONTACTS

Plug connectors are important components which establish the physical contact between cables and network cards, switches, routers and, in AV applications, between cables and source and destination devices. They must be of high quality, installed properly and have a precise finish to reliably ensure electrical connections without significant signal-damping contact resistances. Moreover, kink protection is vital too to prevent core fractures and damage to the cable jacket. The contacts themselves should be gold, silver or nickel plated as a means of ensuring good contact quality in an environment which is at risk of corrosion.

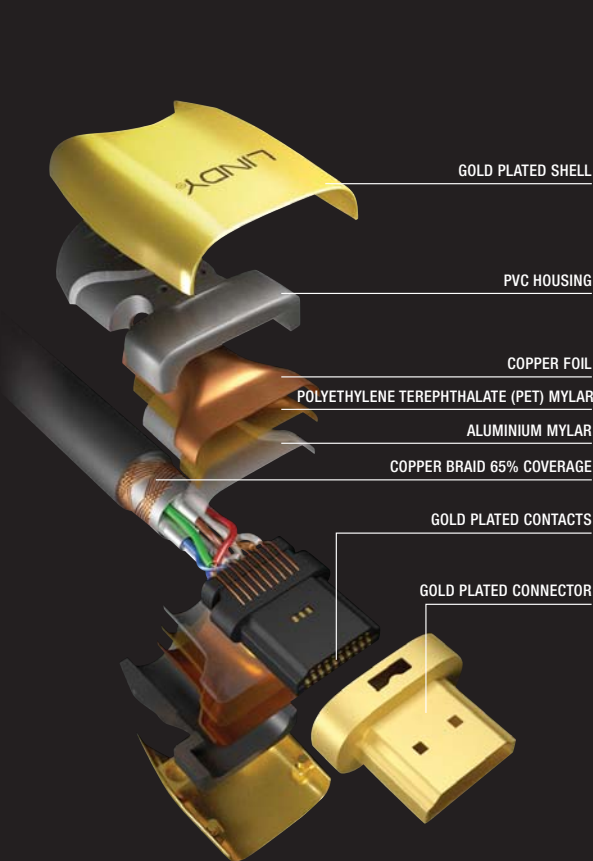

PROTOCOL VERSIONS AND FUNCTIONALITY

In the past with respect to data signals, the large number of transmission protocol versions (e.g. HDMI 1.2, 1.4 or 2.0 or DP 1.2 or 1.3 etc.) were a source of great confusion. Ever higher versions of the transmission protocols require ever greater bandwidth and high-frequency support from cables. For example, for the largest possible resolution for HDMI 1.0 (1080p) cables at 60Hz and a colour depth of 8 Bit/channel just under 4.5Gbit/s is transmitted. With HDMI 1.3 at 1440p, in excess of 8Gbit/s is transmitted. A 4K resolution (under HDMI 2.0) needs a data speed of approx. 17Gbit/s. The increase in colour depths and colour sampling rates play their part too. Exactly the same situation can be found in DisplayPort applications as well as network and USB cables for transmitting the latest protocol versions, such as 10GBase-T and USB 3.1. Data cables need to be able to satisfy this increasing hunger for bandwidth now and in the future. LINDY cables are able to do this with their high precision production processes and the use of high quality materials.

MATERIALS

Usable bandwidth, potential throughput and a cable's service life are ultimately a product of the materials and how they are finished. In terms of physical science, each two-wire cable connection represents a passive low-pass filter (RC member) with series resistance along the cores and electrical capacity between the cores. The smaller the capacity and resistance, the higher the maximum transmissible frequency. The insulating material and pair twisting is responsible for the minimising of the electrical capacity. The resistance is determined by the conductor material. Since copper - of all the chemical elements with the exception of silver - has the highest specific electrical conductivity (in other words, the smallest specific resistance), it should not be combined with other metals to achieve as low as possible resistance of the individual cores in the interests of high frequency resistance. Ultra-pure oxygen free copper (OFC) with a purity greater than 99.99% is also very corrosion resistant. Thanks to its fine grained crystalline structure it is very resistant to fracture caused by material fatigue. Especially for flexible (stranded) cables constantly in motion, this is crucial for a long cable life.

ROHS AND REACH COMPLIANT

All LINDY cables also comply with RoHS (more precisely: RoHS-II-) guidelines and the REACH directive as you would expect. These EU chemicals regulations restrict (in the case of RoHS) certain materials in electronic products, or restrict or prohibit the use of non-listed chemicals for any products through REACH. Cables must comply with this regulatory framework as the materials and substances which are the subject of these regulations are harmful to health and the environment.

HALOGEN FREE CABLES

Halogen-free (Low Smoke free of Halogen, LS0H or Low Smoke Zero Halogen) cables have become increasingly prevalent in public buildings, especially in the network cable area. These cables do not contain chlorine or other halogens such as fluorine or bromine so that no poisonous gases are released if there is a fire. In these cables, the materials used for the jacket and insulation are polymers and are 100% hydrocarbon based. They do not give off any poisonous or corrosive gases when burned. LINDY offers a wide range of halogen free network cables in various colours and configurations.

FIBRE OPTIC CABLES

The domain of fibre optic cables begins where copper cables - in spite of their quality and performance - reach their limits. This completely different kind of signal transmission is not affected by electromagnetic issues. For this reason, there is absolutely no need to shield fibre optic cables. However, transmission quality is critically dependent on the ultra-precise production of the actual fibres. These fibres consist of a core and a jacket. Insertion loss is the important measure of the transmission properties of a fibre optic cable

In assuring and verifying high-precision production, LINDY Fibre Optic Cables are tested and their insertion losses are measured individually. The resulting measurement report is enclosed with every single LINDY cable.

INSERTION LOSS CHARACTERISTICS OF FIBRE OPTICS

The refractive index profile - on modern fibres, this is always given as the smooth transition between the refractive index of the fibre core and jacket, the so called gradient index; on older fibres it sometimes defined as a stepped transition, the so-called, step-index profile. Gradient index fibres have considerably less damping than step-index fibres.

The ratio between the diameter of the core and that of the jacket is usually $0\mu\text{m}/125\mu\text{m}$ on multi-mode fibres which can be used up to a few 100m in distance; and $m/125\mu\text{m}$ on single-mode fibres which can bridge distances up to a few dozen kilometres.

The so-called bandwidth length product of the cable, on which basis fibre optic cables are classified into the categories OM1-OM4 for multi-mode and OS1 or OS2 for single-mode fibres. These are colour-coded:

- OM1 and OM2: orange
- OM3: aqua blue
- OM4: violet
- Single-mode: yellow

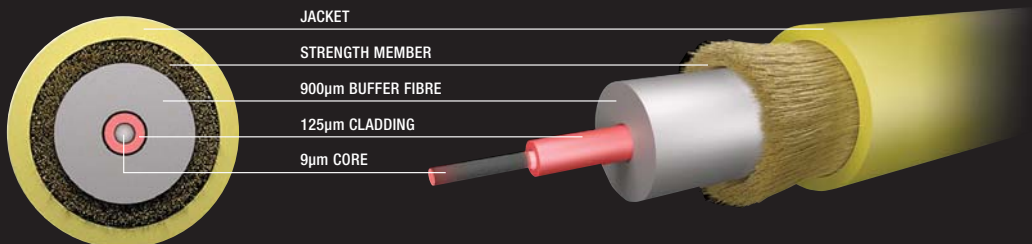



QUICK REFERENCE CONNECTOR GUIDE

D Type Connectors

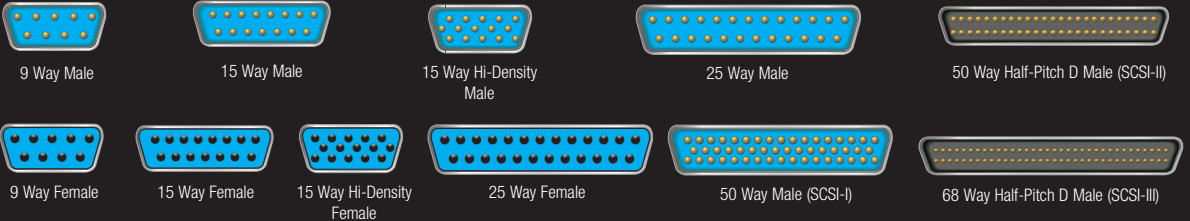

Centronics Connectors

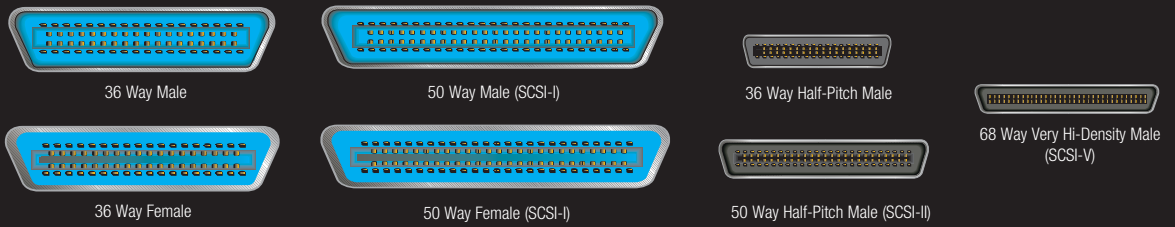

DIN Connectors



SATA & SAS Connectors



IDC Connectors

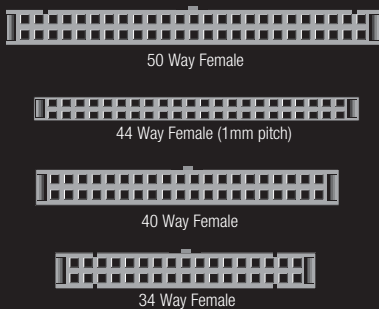

Network Connectors

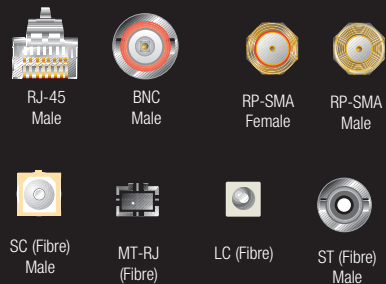



All our standard cables and adapters
come with a minimum 10 year warranty!

10 YEAR
GUARANTEE

Match up the connector end views and identify the connector you require!

Audio & Video Connectors



SCART Male



DisplayPort Male



HDMI Male



DVI-I Female



DVI-A Male



15 Way Hi-Density
Male (VGA)



Mini DisplayPort/
Thunderbolt Male



Mini DVI Male



HDMI Female



DVI-D Female



DVI-I Dual Link Male



15 Way Hi-Density
Female (VGA)



Sun Sparc Male



Mini HDMI Male



DVI-D Single Link Male



Micro HDMI Male

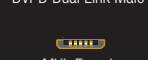

DVI-D Dual Link Male



DVI-I Single Link Male



Micro HDMI Female



MHL Female



TOSLINK



Mini Optical



Phono Male



3.5mm Stereo
Jack Male



3.5mm Stereo
Jack Female



4 Pin Mini
Male (S-Video)



4 Pin Mini
Female (S-Video)



BNC Male



COAX Male



F Type Male



0.25" (6.3mm)
Mono Jack Male



XLR Female

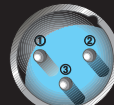

XLR Male



5 Pin
DIN Male (MIDI)



5 Pin
DIN Female (MIDI)

Power Connectors



IEC C14 Plug



IEC C13 Socket



IEC C13 'Hot' Socket



IEC C19 Socket



IEC C5 'Cloverleaf' Socket



IEC C7 'Figure 8'
Socket



4 Way 3.5" Female



LP4 Male



LP4 Female

USB & Apple Connectors



USB 1.1/2.0
Type A Male



USB 1.1/2.0
Type A Female



USB 1.1/2.0
Type B Male



USB 1.1/2.0
Mini-B Male



USB 1.1/2.0
Mini-A Male



USB 1.1/2.0
Micro-A Male



USB 1.1/2.0
Micro-B Male



USB 3.0
Type A Male



USB 3.0
Type B Male



USB 3.0
Micro-B Male



USB Type C



Apple Lightning



Apple Dock

FireWire Connectors



4 Pin Male



FireWire 800
9 Pin Biingual



FireWire 800
9 Pin Beta



6 Pin Male

Fibre Optic Patch Cables

- Recommended for connections between fibre patch panels, switches, media converters and routers, etc.
- High quality ceramic connectors ensure low signal loss and maximum reliability
- Full-duplex SC and LC single-mode and ST, SC and LC multi-mode types are available

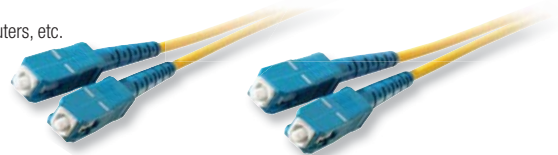

SC to SC Duplex Single-mode Cables

Fibre Type	1m	2m	3m	5m	10m	15m	20m	25m	30m
OS1, 9/125µm	46693	46694	46695	46696	46697	46698	46699	46714	46715

LC to SC Duplex Single-mode Cables



Fibre Type	1m	2m	3m	5m	10m	15m	20m	25m	30m
OS1, 9/125µm	46700	46701	46702	46703	46704	46705	46706	46716	46717

LC to LC Duplex Single-mode Cables

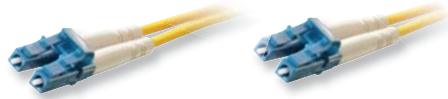

Fibre Type	1m	2m	3m	5m	10m	15m	20m	25m	30m
OS1, 9/125µm	46707	46708	46709	46710	46711	46712	46713	46718	46719

ST to SC Duplex Multi-mode Cables



Fibre Type	1m	2m	3m	5m	10m	15m	20m	25m	30m
50/125µm, OM2	46654	46655	46656	46657	46658	46659	46660	46661	46662
62.5/125µm, OM1	46663	46664	46665	46666	46667	46668	46669	46670	46671

ST to ST Duplex Multi-mode Cables



Fibre Type	1m	2m	3m	5m	10m	15m	20m	25m	30m
50/125µm, OM2	46636	46637	46638	46639	46640	46641	46642	46643	46644
62.5/125µm, OM1	46645	46646	46647	46648	46649	46650	46651	46652	46653

LC to ST Duplex Multi-mode Cables



Fibre Type	1m	2m	3m	5m	10m	15m	20m	25m	30m
50/125µm, OM2	46576	46577	46578	46579	46580	46581	46582	46583	46584
62.5/125µm, OM1	46585	46586	46587	46588	46589	46590	46591	46592	46593

Fibre Optic Couplers & Adapters



Coupler	Fibre Type	Ferrule	Housing	Mounting	Part No.
ST to ST, Simplex	Multi-mode	Ceramic	Metal	3/8" 'D' Hole	70455
SC to SC, Duplex	Multi-mode	Metal	Plastic	Snap-in	70464
LC to LC, Duplex	Multi-mode	Metal	Plastic	Snap-in	70487

LC to LC Duplex Multi-mode Cables

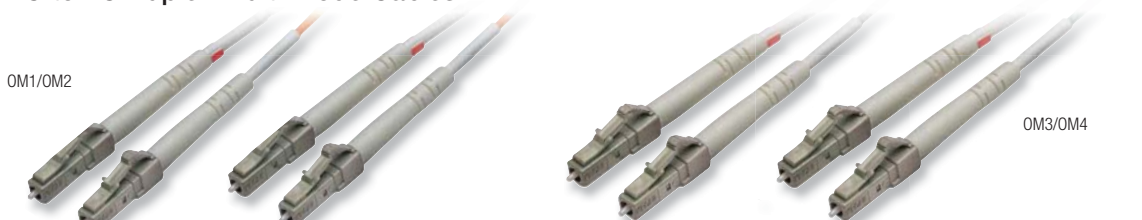

OM1/OM2 OM3/OM4

Fibre Type	1m	2m	3m	5m	10m	15m	20m	25m	30m	50m	75m	100m	150m	200m	250m	300m
50/125µm OM2	46552	46553	46554	46555	46556	46557	46558	46559	46560	46561	46562	46563	46764	46765	46766	46767
50/125µm OM3	46679	46680	46681	46682	46683	46684	46685	46722	46723	46753	46754	46755	46756	46757	46758	46759
50/125µm OM4	46735	46736	46737	46738	46739	46740	46741	46742	46743	-	-	-	-	-	-	-
62.5/125µm OM1	46564	46565	46566	46567	46568	46569	46570	46571	46572	46573	46574	46575	-	-	-	-

LC to SC Duplex Multi-mode Cables

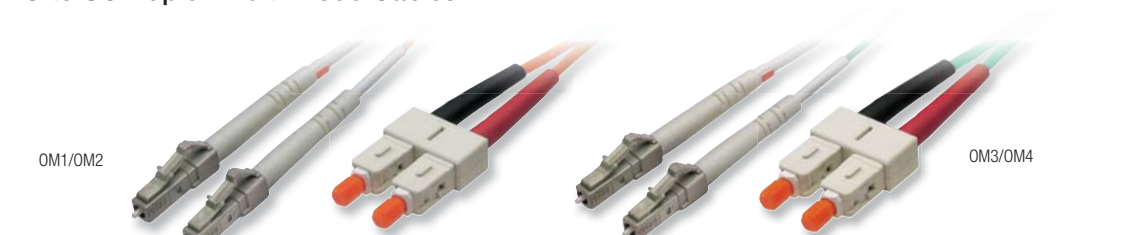

OM1/OM2 OM3/OM4

Fibre Type	1m	2m	3m	5m	10m	15m	20m	25m	30m
50/125µm OM2	46594	46595	46596	46597	46598	46599	46600	46601	46602
50/125µm OM3	46686	46687	46688	46689	46690	46691	46692	46724	46725
50/125µm OM4	46744	46745	46746	46747	46748	46749	46750	46751	46752
62.5/125µm OM1	46603	46604	46605	46606	46607	46608	46609	46610	46611

SC to SC Duplex Multi-mode Cables

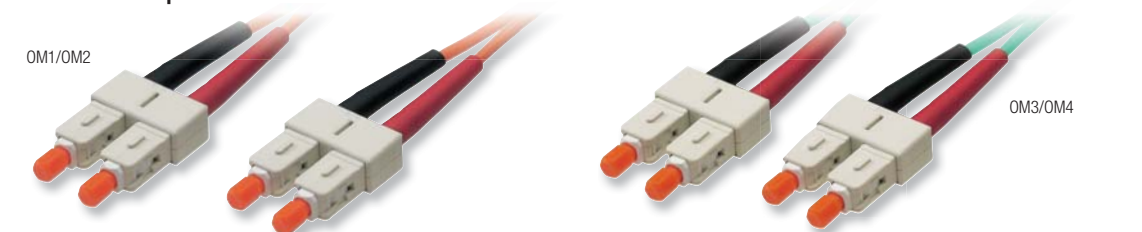

OM1/OM2 OM3/OM4

Fibre Type	1m	2m	3m	5m	10m	15m	20m	25m	30m	50m	100m	150m	200m	250m	300m
50/125µm OM2	46612	46613	46614	46615	46616	46617	46618	46619	46620	46621	46622	46623	46624	46625	46626
50/125µm OM3	46672	46673	46674	46675	46676	46677	46678	46720	46721	-	-	-	-	-	-
50/125µm OM4	46726	46727	46728	46729	46730	46731	46732	46733	46734	-	-	-	-	-	-
62.5/125µm OM1	46627	46628	46629	46630	46631	46632	46633	46634	46635	-	-	-	-	-	-

MPO to MPO Multi-mode Cables

- Method A cable type
- Fitted with MTP® connectors that feature improved optical and mechanical performance compared to generic MPO connectors.



NEW

Fibre Type	10m	20m	30m	50m	100m	150m	200m
50/125µm OM3	46980	46981	46982	46983	46984	46985	46986

Patch Cables

Colour code your network

- Choose from the following types:
 - CAT6 U/UTP • CAT6 S/STP • CAT6a S/STP
 - CAT5e U/UTP • CAT5e F/UTP
- Available in Unshielded Twisted-Pair (U/UTP) and Braided Shielded Twisted-Pair (S/STP) - the extra shielding protects against Electromagnetic Interference (EMI) and Radio Frequency Interference (RFI)

**BEST
SELLER**

CAT6 U/UTP Stranded Core Cable



Colour	0.3m	0.5m	1m	1.5m	2m	3m	5m	7.5m	10m	15m	20m	30m
Grey	48000	48001	48002	48014	48003	48004	48005	48006	48007	48008	48009	48010
Yellow	48060	48061	48062	-	48063	48064	48065	48066	45837	45838	45839	45840
Blue	48015	48016	48017	-	48018	48019	48020	45791	45792	48023	48024	45795
Red	45800	45801	48032	-	48033	48034	48035	45806	45807	48038	48039	45810
Green	48045	45816	48047	-	48048	48049	48050	48051	48052	45823	48054	48055
Orange	48105	48106	48107	-	48108	45173	48110	48111	45176	45177	48114	48115
Purple	48120	48121	48122	-	48123	48124	48125	45186	48127	45188	45189	48130
Black	48075	48076	48077	-	48078	48079	48080	48081	48082	48083	48084	48085
White	48090	48091	48092	-	48093	48094	48095	48096	48097	48098	48099	48100

CAT6 U/UTP LS0H Stranded Core Cable

Colour	0.3m	0.5m	1m	2m	3m	5m	7.5m	10m	15m	20m	30m
Grey	44175	44176	44177	44178	44179	44180	44181	44182	44183	44184	44185

CAT6 U/UTP Solid Core Cable

Colour	10m	20m	30m	40m	50m	75m	100m
Grey	44460	44461	44462	44463	44464	44465	44466

CAT6 U/UTP Flat Gigabit Stranded Core Cable

- Low profile flat design

Colour	0.3m	1m	2m	3m	5m	10m
Grey	47490	47491	47492	47493	47494	47495

CAT6 F/UTP Stranded Core Cable

Colour	0.3m	0.5m	1m	2m	3m	5m	7.5m	10m
Grey	47250	47251	47252	47253	47254	47255	47256	47257



CAT6 S/FTP PiMF Stranded Core Cable

Colour	0.3m	0.5m	1m	1.5m	2m	3m	5m	7.5m	10m	15m	20m	30m
Grey	47700	47701	47702	47703	47704	47705	47706	47707	47708	47709	47710	47711



CAT6 U/UTP Locking Stranded Core Cable

The LINDY Locking Patch Cable is the ideal Layer 1 security tool. With its unique locking feature, you can prevent the cables being accidentally disconnected. Ideal for public areas, in shops, hospitals and more, once the cables is locked it stays locked till you release them using a key. The key is sold separately (see below, Part No. 45086)



Colour	0.3m	0.5m	1m	2m	3m	5m	7.5m	10m	15m	20m	30m
Grey	45075	45076	45077	45078	45079	45080	45081	45082	45083	45084	45085

Key for CAT6 Locking Cable

- Only for use with out CAT6 Locking cables (above)
- Allows you to securely lock cables into a network port



Key for CAT6 Locking Cable

45086

CROMO CAT6 S/FTP Snagless Cable

From our CROMO range of high quality cables

- High quality full CAT6 S/FTP Patch Cable with moulded boots and unique connector latch protection
- Snagless strain relief prevents damage to the RJ-45 latch during installation and removal
- Gold plated contacts



Colour	0.3m	0.5m	1m	2m	3m	5m	7.5m	10m
Anthracite	47210	47211	47212	47213	47214	47215	47216	47217

CAT6a S/FTP LS0H Stranded Core Cable



Colour	0.3m	0.5m	1m	2m	3m	5m	7.5m	10m	15m	20m	30m
Grey	45350	45351	45352	45353	45354	45355	45356	45357	45358	45359	45360

CAT5e U/UTP Stranded Core Cable

**BEST
SELLER**

NEW



Colour	0.3m	0.5m	1m	2m	3m	5m	7.5m	10m	15m	20m	30m	40m	50m	60m	70m	80m	90m	100m
Grey	48285	48286	48287	45963	45964	45965	45966	48292	45968	48294	48295	48296	48297	48298	48299	48300	45976	48302

CAT6/5e U/UTP Solid Core Cable

- Ideal for CATx AV Extender use
- the solid core design reduces skew problems that are common when using stranded cable



Colour & Type	10m	15m	25m	50m	75m	100m
Grey, CAT5e	44480	44481	44483	-	44489	-

Retractable CAT5 U/UTP Cable

- RJ-45 connectors with RJ-12 adapters for modem use
- Maximum length: 2m



Retractable U/UTP Cable with RJ-12 Adapters, 2m	44995
---	-------

CAT7 S/FTP LS0H Stranded Core Cable



Colour	0.3m	0.5m	1m	1.5m	2m	3m	5m	7.5m	10m	15m	20m	30m	
Grey		47260	47261	47262	47263	47264	47265	47266	47267	47268	47269	47270	47271

Right Angled RJ-45 UTP Adapters

- Available in 'up' and 'down' configurations
- RJ-45 male to RJ-45 Female
- CAT5e/6, 10/100/1000Base-T compatible



71150



71151

Right Angled RJ-45 UTP Adapter 'Up'	71150
Right Angled RJ-45 UTP Adapter 'Down'	71151

RJ-45 Crossover Adapter

- Converts a standard patch cable into a crossover cable
- CAT5e, Shielded or Unshielded
- 10/100/1000Base-T



RJ-45 Crossover Adapter	60194
-------------------------	-------

RJ-45 InLine Couplers

- Connects your network cables together



**BEST
SELLER**

UTP CAT5e Line Coupler	34007
UTP CAT6 Line Coupler	34009

Bulk Network Cable, Easy Pull Box

- Easy Pull Box for convenient installation

NEW



Bulk Network Cable	Length	Colour	Part No.
CAT6 U/UTP Solid Core, LSOH	305m	Grey	12975
CAT6 S/FTP Stranded Core	305m	Grey	12974

External CAT5e Bulk Cable, Easy Pull Box

- Designed for exterior use but can also be used indoors
- Easy Pull Box for convenient installation

NEW



External Bulk Network Cable	Length	Colour	Part No.
CAT5e U/UTP Solid Core	305m	Black	12967

RJ-45 Strain Relief Boots

- Pre-assembly boots must be used before crimping the RJ-45 connector onto the cable
- Fits cable diameters up to 6mm
- Pack of 10



Colour	Red	Green	Blue	Black	White	Beige
Part No.	62350	62351	62352	62353	62354	62355

Unshielded RJ-45 Connector

- CAT6 Crimp including boot
- Crimp Type
- For use with stranded core cable



Unshielded RJ-45 Connector, Pack of 10 62431

Serial/RJ-45 Modular Adapters

RJ-45 Female to 25 Way D Male



RJ-45 Female to 9 Way D Male	70246
RJ-45 Female to 9 Way D Female	70247
RJ-45 Female to 25 Way D Male	70244
RJ-45 Female to 25 Way D Female	70245

Bulk Network Cable, Reel

- Choose from CAT5 or CAT5e U/UTP stranded core and CAT6 S/FTP stranded core
- Supplied on a reel



Bulk Network Cable	Length	Colour	Part No.
CAT5 U/UTP Stranded Core	100m	Grey	12032
CAT5e U/UTP Stranded Core	305m	Grey	12930
	305m	Blue	12932
CAT6 S/FTP Stranded Core	100m	Grey	12973

RJ-45 Connectors

- Suitable for use with our stranded core bulk cables



RJ-45 Connectors	Qty	Part No.
Unshielded Standard, Crimp Type	10	62400
Unshielded CAT5e, Crimp Type	10	60406
Unshielded CAT6, Crimp Type	10	62430
Shielded CAT6, Crimp Type	10	62435

IDC Termination Blocks



CAT5e IDC Termination Block, Unshielded (joins solid core UTP cable)	34008
CAT6 IDC Termination Block, Unshielded (joins solid core UTP cable)	34010

CAT5e/6 Faceplates

- Flat and angled versions available
- Unshielded
- High quality angled terminal block contacts
- Accepts 22-26 AWG solid core wire
- Dual type terminal blocks
- Dual standard labelling (T568A/T568B colour coding standards)
- Shuttered sockets to protect against dust
- Easy attach ID labels with protective cover
- Screws supplied



Angled versions



Angled Connection



1 x RJ-45



2 x RJ-45



4 x RJ-45

CAT5e Flat Faceplates

Single Faceplate, 1 x RJ-45 Flat Socket	60585
Single Faceplate, 2 x RJ-45 Flat Socket	60586
Double Faceplate, 4 x RJ-45 Flat Socket	60587

Pattress Boxes



CAT5e Angled Faceplates

Single Faceplate, 1 x RJ-45 Angled Socket	60568
Single Faceplate, 2 x RJ-45 Angled Socket	60569
Double Faceplate, 4 x RJ-45 Angled Socket	60570

CAT6 Flat Faceplates

Single Faceplate, 1 x RJ-45 Flat Socket	60565
Single Faceplate, 2 x RJ-45 Flat Socket	60566
Double Faceplate, 4 x RJ-45 Flat Socket	60567

Pattress Box, Single, depth 32mm, 1 pack	73088
Pattress Box, Single, depth 32mm, 10 pack	73188
Pattress Box, Single, depth 44mm, 1 pack	73114
Pattress Box, Single, depth 44mm, 10 pack	73187
Pattress Box, Double, depth 32mm, 1 pack	73089
Pattress Box, Double, depth 32mm, 10 pack	73316
Pattress Box, Double, depth 44mm, 1 pack	73115
Pattress Box, Double, depth 44mm, 5 pack	73315

CAT6 Angled Faceplates

Single Faceplate, 1 x RJ-45 Angled Socket	60571
Single Faceplate, 2 x RJ-45 Angled Socket	60572
Double Faceplate, 4 x RJ-45 Angled Socket	60573

Download the latest
PRICE LIST
from our website



Visit our website
WEBSITE
for the latest prices
& special offers

Brush Faceplates

- Dimensions:
 - Single 86 x 86mm
 - Double 146 x 86mm
- Available with white or black brushes



Single Gang Brush Plate, Black Brushes	60237
Double Gang Brush Plate, Black Brushes	60238
Single Gang Brush Plate, White Brushes	60235
Double Gang Brush Plate, White Brushes	60236

CAT6 Surface Mount Wall Boxes



Single RJ-45 Surface Mount Wall Box, Unshielded	60575
Double RJ-45 Surface Mount Wall Box, Unshielded	60576

Toolless CAT5e In-line Coupler

- Toolless push down connectors
- For use with 22-26 AWG Unshielded cable
- Can also be used with 110 and Krone punch down tools



Toolless CAT5e In-line Coupler	60174
--------------------------------	-------

Toolless CAT6 Surface Mount Box

- RJ-45 to toolless push down connector
- For use with 22-26 AWG CAT6 cable
- Can also be used with 110 and Krone punch down tools
- Unshielded

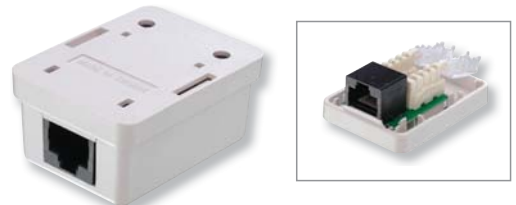

Toolless CAT6 Surface Mount Box	60175
---------------------------------	-------

Toolless CAT6 Keystone Jack

- RJ-45 to toolless push down connector
- For use with 22-26 AWG CAT6 cable
- Can also be used with 110 and Krone punch down tools
- Unshielded



Toolless CAT6 Keystone Jack	60368
-----------------------------	-------

Toolless Gigabit Coupler

- For use with CAT5e/6 cable
- Connector A: RJ-45 Socket
- Connector B: IDC with easy pushdown
- Supports 10/100/1000Base-T Ethernet
- Unshielded



Toolless Gigabit Coupler	60181
--------------------------	-------

Port Doublers

- Connect two devices to one port of a structured cabling system
- Existing installations can be easily expanded allowing additional computers/telephones to be added temporarily or permanently
- Ideal for installations where additional cables cannot be installed easily



**BEST
SELLER**

2 x Voice or Token Ring devices to 1 Port

Port Doublers (sold as single units - not pairs)

	Unshielded	Shielded
1 x 10/100Base-T device & 1 x Voice or Token Ring Device to 1 Port	34023	34013
2 x Voice or Token Ring devices to 1 Port	34024	-
2 x 10/100Base-TX devices to 1 Port	34006	-

RJ-45 Analogue Telephone Line Port Multiplier

- Connect 4 RJ-45 connections to 1 unshielded port of a structured cabling system
- For analogue telephone lines only (not VoIP or LAN connections)
- Allows existing installations to be quickly expanded
- Must be used in pairs by connecting one to a patch panel and the other to a wall outlet
- Please note: sold as single units, not pairs



RJ-45 Analogue Telephone Line Port Multiplier

34015

RJ-45 Analogue Telephone Line 'Y' Adapter

2 and 4 port versions available

- Allows multiple parallel telephones at different locations to be connected to the same line enabling them to all ring simultaneously etc.
- Existing installations can be easily expanded allowing additional computers/telephones to be added temporarily or permanently



2 Port 'Y' Adapter



4 Port 'Y' Adapter

'Y' Adapter - Bridges all pairs (sold as single units - not pairs)

	Unshielded	Shielded
Connects 2 telecoms devices in parallel	34001	34011
Connects 4 telecoms devices in parallel	34016	-

Telephone Line Adapters

These adapters allow telephones with BT connectors to be used in a structured cabling system with RJ-45 connectors. Three versions are available:

Full Master

Includes surge protector and a capacitor to generate a ring.

PABX Master

Includes capacitor to generate ring, surge protection is not required as this is already provided by most PABX systems.

Secondary

Used for secondary extensions or on a PABX system when the equipment connected has it's own ring detection circuit and a capacitor is not required. Many modems have this.

**BEST
SELLER**



RJ-45 Male to BT Female Full Master, 0.25m	75140
RJ-45 Male to BT Female PABX Master, 0.25m	75141
RJ-45 Male to BT Female Secondary, 0.25m	75142

Premium Phono Cable, 100m Reel

Make your own high quality AV cable

- 75 Ohm Pure Crystal Oxygen Free Copper (PC-OFC) coaxial conductor
- OFC braid with Aluminium Mylar foil wrap
- Supplied on a 100m reel
- Colour: Blue



Premium Phono Cable, 100m Reel

37573

Bulk VGA Cable, 100m Reel

- 3 x 75Ω 28 AWG individually shielded coaxial cores (RGB) and 8 x 24 AWG cores, double overall shield
- Supplied on a 100m reel
- Colour: Blue

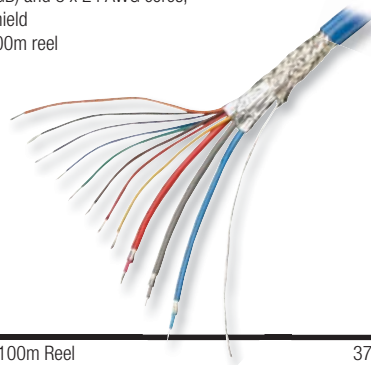

Bulk VGA Cable, 100m Reel

37244

Interface Cable, 100m Reel

- 6 Core spirally wrapped with AL/polyester foil and drain wire, 7/0.16mm (26 AWG), 5.0mm O.D.
- 9 Core spirally wrapped with AL/polyester foil and drain wire, 7/0.16mm (26 AWG), 6.0mm O.D.
- Colour: Black

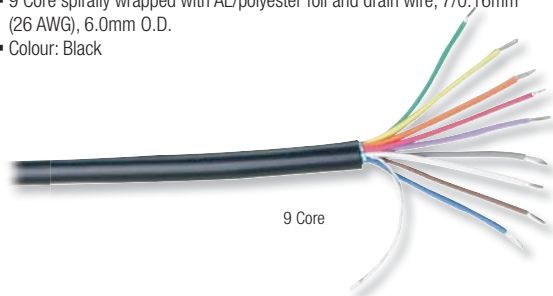

9 Core

6 Core Screened Multi-core Cable, 100m Reel

12011

9 Core Screened Multi-core Cable, 100m Reel

12019

Mini DIN Connector



6 Pin Mini DIN Male, Pack of 10

62026

PhoneNet/MacNet Connectors



RJ-11
Male



RJ-11/RJ-12
Line Coupler

RJ-11 Male, 4 Pin, Crimp type, Pack of 10

62201

RJ-11/RJ-12 Line Coupler (Female/Female), 6 Way, Pack of 1

70171

RJ-10 Line Coupler (Female/Female), 4 Way, Pack of 1

70251

RJ-11 Telephone Cable, 100m Reel

- 4 Way, for use with "MacNet/PhoneNet" compatible networks
- Colour: Grey



RJ-11 Bulk Cable, 4 Way, 100m Reel

12108

CABLE GURU
FIND THE CABLE YOU NEED



Try it now on our
WEBSITE

FOR TOOLS & TOOL KITS
SEE PAGES
148-155



USB 2.0 Cables

LINDY high quality USB 2.0 Cables comply fully with the USB 2.0 specification allowing data transfer speeds up to 480Mbps. Ideal for use with printers, scanners, external storage and all other USB 1.1 and USB 2.0 peripherals

USB Type A to B

**BEST
SELLER**



Colour	0.2m	0.5m	1m	2m	3m	5m	7.5m	10m
Grey	31649	41921	41922	41923	41924	31647	-	-
Black	41740	41741	41742	41743	41744	41745	31848	31841
Transparent	31703	31693	31694	41753	41754	31697	-	-

USB Type A Male to Type A Female Extension

**BEST
SELLER**



Colour	0.2m	0.5m	1m	2m	3m	5m
Grey	41760	41761	41762	41763	41764	41765
Black	41770	31851	41772	41773	41774	41775
Transparent	-	31850	-	31700	-	31702

USB Type A Male to A Male



Colour	0.2m	0.5m	1m	2m	3m	5m	7.5m	10m
Grey	41930	41931	41932	41933	31641	31642	-	-
Black	-	-	-	-	-	-	31710	31711

USB 2.0 Cables, Box of 50

- Super value bulk packs contains 50 of our high quality USB 2.0 Type A to Type B cables

USB 2.0 Cables, Box of 50,
Type A USB Male to Type B USB Male

Length	Part No.
1m	41737
2m	41738
3m	41739



NEW

USB 2.0 Type A to B Active Cable

- Plug & Play - no special software installation required
- Connectors: Type A USB Male to Type B USB Male
- Ideal for direct device connection

USB 2.0 Active Cable - Type A to B

Length	Part No.
10m	42761
15m	42762
20m	42763



NEW

USB 2.0 Cables

USB Type A to Mini-B

NEW

BEST SELLER



Colour	0.2m	0.5m	1m	2m	3m	5m	7.5m	10m
Transparent	41780	31683	31684	41783	31686	41785	-	-
Black	41790	41791	41792	41773	41794		31888	31889

USB Type A to Micro-B

Type A Male to Micro-B Male, Black

NEW



Length	Part No.
0.2m	41800
0.5m	41801
1m	41802
2m	31665
3m	41804
5m	41805

USB Type Mini-B to Micro-B

Type Mini-B Female to Micro-B Male, Black



Length	Part No.
0.1m	70392

USB Type A to Right Angled Mini-B

Type A Male to Mini-B Mini B Male Right Angled, Black



Length	Part No.
0.5m	31970
1m	31971
2m	31972

BEST SELLER

USB Type A to Right Angled Micro-B

Type A Male to Micro-B Male Right Angled, Black



Length	Part No.
0.5m	31975
1m	31976
2m	31977

USB Type B Extension Cable, 2m

- Allows a notebook to be connected to a separate wall plate rather than directly to the whiteboard
- USB 2.0 Type B Male to Type B Female
- Bracket for securing to a wall plate

USB Type B Extension Cable, 2m 31669

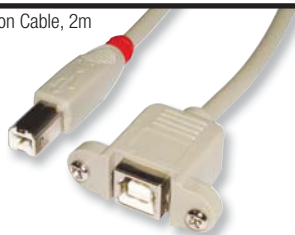

USB Power Only Extension Cable

- Length: 0.15m
- USB Type A Male to Type A Female
- Provides power only, no data support

0.15m USB Power Only Extension Cable 70386

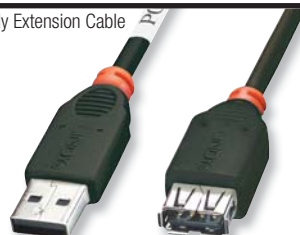

USB CABLES

Easy Fit Reversible USB 2.0 Cables

Easily insert a USB cable without looking at the connector

Featuring a reversible USB Type A connector and ultra-thin cable this handy cable can be inserted into your computer or charger either way around.

Reversible Type A USB Male to Type Mini-B, Easy Fit	Length	Part No.
	0.5m	31175
	2m	31177
	3m	31178



Reversible Type A USB Male to Type Micro-B, Easy Fit	Length	Part No.
	0.5m	31195
	2m	31197
	3m	31198

Flat, Reversible USB 2.0 Type A to Micro-B Cables

Available in a range of vibrant colours with a reversible USB Type A connector

- Ideal for use with smartphones and tablets
- Soft touch rubber TPE coating provides a stylish finish and maximum flexibility
- Reversible Type A connector can be inserted into a computer or charger either way around

Colour	0.5m	1m	2m
Orange	30895	30896	30897
Pink	30900	30901	30902
Yellow	30905	30906	30907
White	30910	30911	30912
Green	30915	30916	30917
Blue	30920	30921	30922

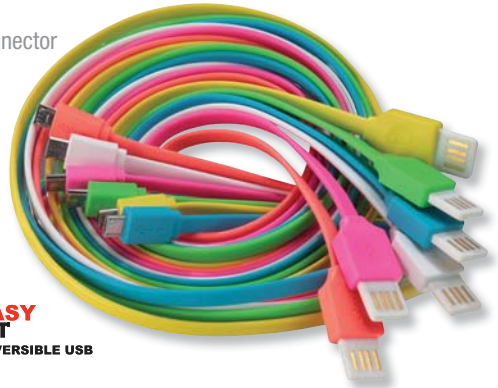

Coiled USB 2.0 Cables

- Extends from 0.2m to 2m
- Transparent

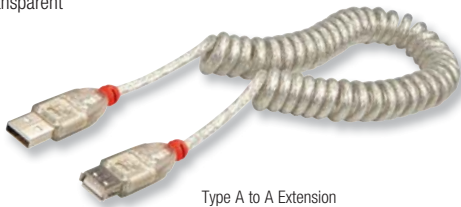

Type A to A Extension

Coiled USB 2.0 Type A to A Female Cable, 0.2m to 2m	31927
Coiled USB 2.0 Type A to Mini-B Cable, 0.2m to 2m	31925
Coiled USB 2.0 Type A to Micro-B Cable, 0.2m to 2m	31926

Dual Reversible USB 2.0 Cable, Type A to Micro-B

- Quickly connect your mobile device without looking
- Reversible USB Type A and Reversible Micro B connector
- Up-rated wire gauge delivers up to 2.4A of power allowing your device to charge quicker
- USB 2.0 High Speed compatible with data transfer up to 480Mbit/sec

Dual Reversible USB 2.0 Cable, Type A to Micro-B	Length	Part No.
	0.5m	31466
	1m	31467
	2m	31468



NEW

FOR COLOURED LIGHTNING CABLES
SEE PAGE 262

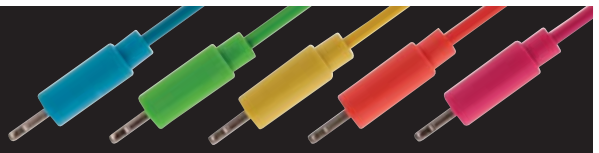

SuperSpeed USB 3.0 Cables

Our USB 3.0 cables use high quality construction for a better quality, more durable design - ideal for industrial and commercial installations.

USB 3.0 Type A Male to B Male



Colour	0.5m	1m	2m	3m	5m
Blue	31915	31916	31917	31918	31919
Black	31460	41811	41812	41813	41814

USB 3.0 Type A Male to A Male

**BEST
SELLER**



Colour	0.5m	1m	2m	3m	5m
Blue	31900	41851	41852	31903	31904
Black	31980	31981	31982	41823	41824

USB Type A Male to Type A Female Extension



NEW

Colour	0.5m	1m	2m	3m
Blue	31908	31909	31910	31911
Black	41830	41831	41832	41833
Anthracite	41860	41861	41862	41863

USB 3.0 Type A Male to Micro-B Male



NEW

Colour	0.5m	1m	2m	3m
Blue	31890	41866	41867	41868
Black	41835	41836	41837	41838

CROMO CABLE EYE CATCHER



We live in a time where form and function are growing together. PCs, notebooks, media devices and home cinema equipment match the futuristic style of the interior design. In times like these even cables have to fit in seamlessly.

Our CROMO Cables make your home cinema shine in a completely new light and give your equipment a timeless touch. They are made using the finest materials and have a stylish design: glossy chrome plugs meet cables in velvety anthracite.

CROMO Cables turn any modern audio and video installation into an eye catcher. All CROMO cables are backed by a 10 year warranty.

CROMO USB 2.0 Cables

Advanced High Speed cable with gold plated contacts

- Robust and stylish design featuring fully moulded connectors with chrome detail and gold plated contacts - ideal for use in AV and domestic installations
- Supports the highest USB 2.0 data transfer speeds of up to 480Mbps
- Upgraded copper conductors for better power delivery
- Double shielded construction

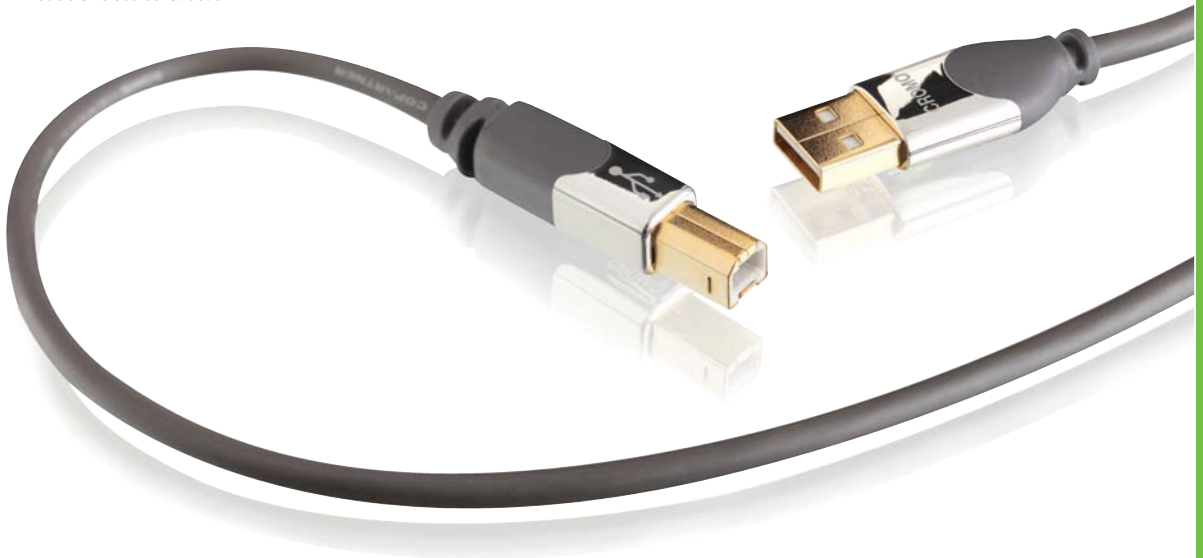

CROMO USB 2.0 Type A to B

CROMO Type A Male to B Male	Length	Part No.
	0.5m	41580
	1m	41581
	2m	41582
	3m	41583
	5m	41584
	7.5m	41585

**BEST
SELLER**

CROMO USB 2.0 Type A to Mini-B

CROMO Type A Male to Mini-B Male	Length	Part No.
	0.5m	41587
	1m	41588
	2m	41589
	3m	41590
	5m	41591
	7.5m	41592

CROMO USB 2.0 Type A to Micro-B

CROMO Type A Male to Micro-B Male	Length	Part No.
	0.5m	41593
	1m	41594
	2m	41595
	3m	41596
	5m	41597

CROMO Slim USB 2.0 Type A to Micro-B

- Slim, ultra flexible design - ideal for use with smartphones and tablets

CROMO Slim Cable Type A Male to Micro-B Male	Length	Part No.
	1m	41690
	2m	41691



CROMO SuperSpeed USB 3.0 Cables

- Fully USB 3.0 compliant, capable of data transfer rates of up to 5Gbps and complete with copper conductors, double shielding and gold plated contacts
- High grade components, with precision finishing

CROMO USB 3.0 Type A to B

CROMO Type A Male to B Male	Length	Part No.
	0.5m	41610
	1m	41611
	2m	41612
	3m	41613
	5m	41614



CROMO USB 3.0 Type A to Type A

CROMO Type A Male to A Male	Length	Part No.
	0.5m	41600
	1m	41601
	2m	41602
	3m	41603
	5m	41604



CROMO USB 3.0 Type A to Type Micro-B

CROMO Type A Male to Micro-B Male	Length	Part No.
	0.5m	41617
	1m	41618
	2m	41619
	3m	41620



Fibre Optic USB 3.0 Cable

The LINDY USB 3.0 Active Optical Cable supports far longer distances than standard copper cables, with lengths of up to 100m available, whilst retaining SuperSpeed transfer rates of up to 5Gbps. A more light and flexible construction makes this cable simple to install with cable trays and through conduit, whilst low RFI/EMI ensures that the cable can be installed in the most sensitive of environments.

- USB 3.0 Active Optical Cable (AOC), compliant with SuperSpeed USB electrical specifications
- Plug and Play installation, no software required
- Low RFI/EMI for sensitive environments
- Powered by the included 5V external power supply

Please Note: This product is not backwards compatible with USB 2.0/1.1/1.0, unless used with the USB 2.0 Adapter, Part No. 42682, see right

Fibre Optic USB 3.0 Type A Male to A Female	Length	Part No.
	30m	42683
	50m	42684
	70m	42685
	100m	42696

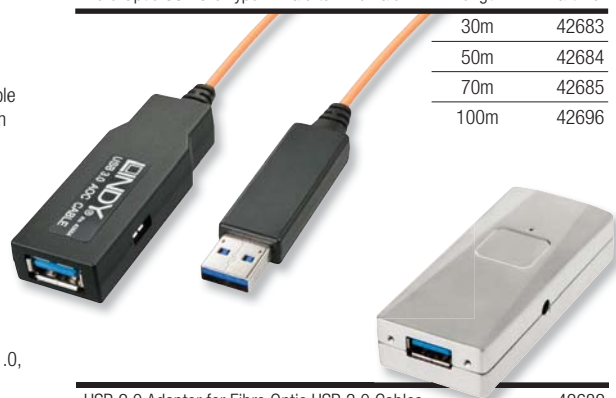

USB 2.0 Adapter for Fibre Optic USB 3.0 Cables 42682

50m Hybrid Fibre Optic USB 3.1 Cable

The LINDY USB 3.1 Gen 1/3.0 Hybrid Cable extends a USB port by 50m whilst retaining SuperSpeed transfer rates of up to 5Gbps. A more light and flexible construction makes this cable simple to install with cable trays and through conduit, whilst low RFI/EMI ensures that the cable can be installed in the most sensitive of environments.

For added convenience the Hybrid cable is bus powered and is supplied with a USB Micro-B cable which can be attached to a second USB port should additional power be required.

- USB 3.0 Hybrid Active Optical Cable (AOC), compliant with SuperSpeed USB specifications
- Plug and Play installation, no software required
- Low RFI/EMI for sensitive environments
- Supports all USB compatible operating systems

50m Hybrid Fibre Optic USB 3.1 Cable 42701



USB On-The-Go Cables

USB 2.0 OTG Micro-B to Type A Female

OTG Micro-B Male to Type A Female	Length	Part No.
	0.5m	31935
	1m	31936

USB 2.0 OTG 90° Micro-B to Type A Female

OTG 90° Micro-B Male to Type A Female	Length	Part No.
	0.15m	31934

USB 2.0 OTG Micro-B to Mini-B

OTG Micro-B Male to Mini-B Male	Length	Part No.
	0.5m	31717
	1m	31718
	2m	31719

**BEST
SELLER**

USB 2.0 OTG Micro-B to Micro-B

OTG Micro-B Male to Micro-B Male	Length	Part No.
	0.5m	31758
	1m	31759
	2m	31760

USB 2.0 OTG Micro-A to Type A Female

OTG Micro-A Male to Type A Female	Length	Part No.
	0.5m	31945
	1m	31956

USB 2.0 OTG 90° Micro-A to Type A Female

OTG Type Micro-A Male to Type A Female	Length	Part No.
	0.5m	31947

USB 2.0 OTG Micro-A to Mini-B

OTG Type Micro-A Male to Mini-B Male	Length	Part No.
	0.5m	31957
	1m	31958

USB 2.0 OTG Mini-A to Micro-B

OTG Type Mini-A Male to Micro-B Male	Length	Part No.
	0.5m	31805
	1m	31806
	2m	31807

USB 2.0 OTG Mini-A to Mini-B

OTG Mini-A Male to Mini-B Male	Length	Part No.
	0.5m	31632

USB 3.0 OTG Micro-B to Type A

USB 3.0 OTG Micro-B Male to Type A Female	Length	Part No.
	0.5m	31613

USB 3.0 OTG Micro-B to Type A Male (Charging) & Type A Female



USB 3.0 OTG Type Micro-B to Type A Male (Charging) & Type A Female

31612

USB 3.1 Type C Cables & Adapters

USB 3.1 Gen 2 Type C Male to Type C Male with Power Delivery

- USB 3.1 Type C Male to USB Type C Male, seamless connectors with gold plated contacts
- USB 3.1 SuperSpeed+/Gen 2 Cable for data transfer rates of up to 10Gbps
- 100W Power Delivery, supports 5/9/15/20V up to 5A (100W) max
- Supports DisplayPort Alternate Mode

USB 3.1 Cable Type C Male to Type C Male	Length	Part No.
	0.5m	41900
	1m	41901
	1.5m	41902

USB 3.1 Gen 2 Type C Male to Type A Male with Power Delivery

- USB 3.1 Type C Male to USB Type A Male, seamless connector with gold plated contacts
- USB 3.1 SuperSpeed+/Gen 2 Cable for data transfer rates of up to 10Gbps
- 100W Power Delivery, 5/9/15/20V up to 5A (100W) max

USB 3.1 Cable Type C Male to Type A Male	Length	Part No.
	0.5m	41910
	1m	41911
	1.5m	41912

USB 3.1 Gen 2 Type C Male to Type C Male

- USB 3.1 Type C Male to USB Type C Male connectors with gold plated contacts
- USB 3.1 SuperSpeed+/Gen 2 Cable for data transfer rates of up to 10Gbps
- Supports power up to 15W, 5V at up to 3A
- Supports DisplayPort Alternate Mode

USB 3.1 Cable Type C Male to Type C Male	Length	Part No.
	0.5m	41905
	1m	41906
	1.5m	41907

USB 3.1 Gen 2 Type C Male to Type A Male

- USB 3.1 Type C Male to USB Type A Male connector with gold plated contacts
- USB 3.1 SuperSpeed+/Gen 2 Cable for data transfer rates of up to 10Gbps
- Supports power up to 15W, 5V at up to 3A

USB 3.1 Cable Type C Male to Type A Male	Length	Part No.
	0.5m	41875
	1m	41876
	1.5m	41877

USB 3.1 Gen 1 Type C Male to Type A Female

- Connect legacy USB Type A peripherals to Type C equipped devices
- USB 3.1 SuperSpeed Gen 1 Cable for data transfer rates of up to 5Gbps

USB 3.1 Cable Type C Male to Type A Female	Length	Part No.
	0.2m	41895

USB 3.1 Gen 1 Type C Male to Type A Female Adapter

- Connect legacy USB Type A peripherals to Type C equipped devices
- USB 3.1 SuperSpeed Gen 1 Cable for data transfer rates of up to 5Gbps



USB 3.1 Gen 1 Type C Male to Type A Female Adapter	41899
--	-------

Features of USB 3.1

DATA

Transfer large files with 2x the speed of USB 3.0

- USB 2.0: **High Speed** up to 480Mbps
- USB 3.1 Gen 1: **SuperSpeed** up to 5Gbps
- USB 3.1 Gen 2: **SuperSpeed+** up to 10Gbps

POWER

Enhanced Power delivery with PD Mode

Power Delivery (PD) Mode:

- Supports up to 100W
- 5/9/15/20V up to 5A (100W) max

Non Power Delivery:

- Supports up to 15W
- 5V at up to 3A Max

USB 2.0 Type C Cables & Adapters

USB 2.0 Type C Male to Type C Male

- USB 2.0 Type C Male to USB Type C Male, with gold plated contacts
- USB 2.0 High Speed Cable for data transfer rates of up to 480Mbps
- Supports power up to 10W, 5V at up to 2A

USB 2.0 Cable Type C Male to Type C Male	Length	Part No.
	0.5m	41870
	1m	41871
	2m	41872
	3m	41873

USB 2.0 Type C Male to Type A Male

- USB 2.0 Type C Male to USB Type A Male, with gold plated contacts
- USB 2.0 High Speed Cable for data transfer rates of up to 480Mbps
- Supports power up to 10W, 5V at up to 2A

USB 2.0 Cable Type C Male to Type A Male	Length	Part No.
	0.5m	41885
	1m	41886
	2m	41887
	3m	41888

USB 2.0 Type C Male to Micro-B Male

- USB 2.0 Type C Male to USB Type C Male, with gold plated contacts
- USB 2.0 High Speed Cable for data transfer rates of up to 480Mbps
- Supports power up to 10W, 5V at up to 2A

USB 2.0 Cable Type C Male to Type Micro-B Male	Length	Part No.
	0.5m	41890
	1m	41891
	1.5m	41892

USB 2.0 Type C Male to Type A Female

- Connect legacy USB Type A peripherals to Type C equipped devices
- USB 2.0 High Speed Cable for data transfer rates of up to 480Mbps

USB 2.0 Cable Type C Male to Type A Female	Length	Part No.
	0.2m	41897

USB 2.0 Type C Male to Type Micro-B Female Adapter

- Convert USB Type Micro-B Cables and Power Supplies for use with Type C equipped devices
- USB 2.0 High Speed Cable for data transfer rates of up to 480Mbps



USB 2.0 Type C Male to Type Micro-B Female Adapter 41896

USB 2.0 Type A Male to Type C Female Adapter

- Convert an existing USB Type A port into a USB Type C port
- USB 2.0 High Speed Cable for data transfer rates of up to 480Mbps



USB 2.0 Type A Male to Type C Female Adapter 41898

ALT MODE

Simultaneous 4K Video and Data transfer

Currently used for Video

DisplayPort Alternate Mode:

- Supports resolutions up to Ultra HD 4K 3840 x 2160
- Simultaneous 4K Video & 5Gbps Data
- Simultaneous 1080p Video x 2 & 5Gbps Data

REVERSIBLE

Completely reversible USB

USB 3.1 is completely reversible making it easier than ever to connect to devices faster on the go. No more plugging in the wrong way and possibly causing damage to the USB port or the device.

Retractable USB 2.0 Cables

- Ideal for use when travelling
- Extends to approximately 80cm



Type A to Micro-B Male

**BEST
SELLER**

USB 2.0 Type A Male to Micro-B Male, 0.8m	31619
USB 2.0 Type A Male to Mini-B Male, 0.8m	31618

USB 2.0 Dual Power Cable

- Can be used to connect a PC to a bus-powered external USB device which has power consumption requirements greater than 500mA (e.g. hard drive enclosures)
- Features two USB Type A connectors: one for data and power, and one for power only; the cable terminates in a Mini-B connector for connecting to the device

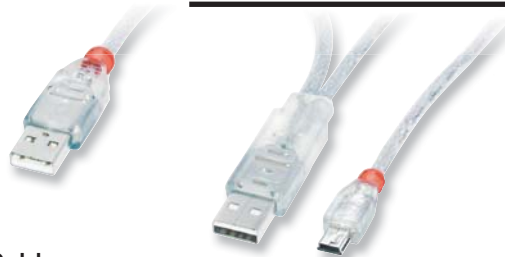

2 x Type A Male (20cm apart) to Mini-B Male	Length	Part No.
	0.5m	31779
	1m	31784
	2m	31785

Switched USB Power Extension Cable

The LINDY Switched USB Power Extension Cable allows you to switch off USB DC powered devices that do not have a power switch built in. Simply switching the 5V line enables even the most basic of devices to be power cycled saving wear and tear on your connector and socket.

- Add a switch to devices that do not already have the ability to be turned off
- Male and Female Type A USB connectors
- Ideal for DIY computers like the raspberry Pi and BBC Micro Bit
- Supports a maximum power rating of 5V 1.5A

NEW



Switched USB Power Extension Cable	Length	Part No.
	0.5m	70241
	1m	70242
	2m	70243

USB 360° Adapter

- Swivel and rotate action allows you to connect to devices without obstructing adjacent USB ports
- Supports USB 2.0 and USB 1.1 devices



Type A Male to Female

USB 360° Adapter, Type A Male to A Female	70339
---	-------

USB 3.0 Dual Power Cable

- Suitable for use with bus powered USB devices with power consumption requirements of up to 1.4A such as hard drive enclosures
- USB SuperSpeed interface for data transfer rates of up to 5Gbps

Type	Length	Part No.
2 x Type A Male to A Female	0.5m	31112
	1m	31113
2 x Type A Male to Micro-B Male	0.5m	31115
	1m	31116



USB 2.0 Adapters



Type A Female to Type B Female



Type A Male to Type B Female



Type B Female to Mini-B Male



90° Up Type A Male to Type A Female



90° Mini-B Male to Mini-B Female



90° Mini-B Female to Micro-B Male



Mini-B Female to Micro-B Male



Micro-B Female to Mini-B Male



90° Down Type A Male to Type A Female



Type A Male to Type A Male



Type A Female to Type A Female



Type B Female to Micro-B Male



USB 2.0 OTG Micro-B Male to Type A Female



Type A Male to Micro-B Female

Type A Female to Type B Female	71228
Type A Male to Type A Male	71229
Type A Female to Type A Female	71230
Type A Male to Type B Female	71231
Type A Male to Micro-B Female	71236
Type B Female to Mini-B Male	71232
Type B Female to Micro-B Male	71233
Mini-B Female to Micro-B Male	71234
Micro-B Female to Mini-B Male	71235
90° Down Type A Male to Type A Female	71220
90° Up Type A Male to Type A Female	71221
90° Mini-B Male to Mini-B Female	71223
90° Mini-B Female to Micro-B Male	71224
USB 2.0 OTG Micro-B Male to Type A Female	31933

USB 3.0 Adapters



90° Down Type A Male to Type A Female



90° Up Type A Male to Type A Female



Type A Female to Type B Male



Type A Male to Type A Male



Type B Female to Type B Male



Type A Male to Type B Female



Type A Male to Micro-B Male



Type B Female to Micro-B Male



Type A Female to Micro-B Male



Type A Female to Type A Female



Type A Female to Type B Female

Type A Male to Type B Female	71270
Type A Male to Micro-B Male	71271
Type A Male to Type A Male	71272
Type B Female to Type B Male	71273
Type A Female to Type B Male	71274
Type A Female to Micro-B Male	71275
Type A Female to Type A Female	71276
Type A Female to Type B Female	71277
Type B Female to Micro-B Male	71278
90° Down Type A Male to Type A Female	71260
90° Up Type A Male to Type A Female	71261

USB to DC Cables

- Use a 5V USB port to power external drives or peripherals
- USB Type A connector to DC jack
- Length: 1.5m



Part No. 70265

USB to 0.7mm Inner / 2.3mm Outer	70265
USB to 0.7mm Inner / 2.35mm Outer	70264
USB to 1.35mm Inner / 3.5mm Outer	70266
USB to 2.5mm Inner / 5.5mm Outer	70267
USB to 2.1mm Inner / 5.5mm Outer	70268
USB to 1.7mm Inner / 4.8mm Outer	70269
USB to 1.1mm Inner / 3.5mm Outer	73340
USB to 0.6mm Inner / 2mm Outer	73344

Android OS Mirroring & KM Sharing Cable

- Android OS Mirroring on a Windows PC
- Keyboard & Mouse sharing from a Windows PC to Android smartphone or tablet
- Data Transfer between PC & Smartphone or Tablet
- Charges your Android Smartphone or Tablet whilst in use
- Specifications:
 - Compatible with Windows XP/Vista/7/8
 - For OS Mirroring: Android 4.0 (Ice Cream Sandwich) or higher
 - For KM Sharing: Android 2.3 (Gingerbread) or higher
 - Length: 1.2m



WIN **ANDROID**

Android OS Mirroring & KM Sharing Cable

42613

USB 2.0 Transfer & KM Sharing Cable

- Allows you to easily transfer data between two computers, laptops or different operating systems
- Control two computers using a single keyboard and mouse
- USB 2.0 480Mbps bi-directional file & data transfer
- 1.8m cable
- Compatible with Windows 2000/XP/Vista/7/8/10, Mac OS X 10.6 and above, iOS 3.2 and above and Android 2.1 and above



WIN **MAC OS** **LINUX** **ANDROID**

USB 2.0 Transfer & KM Sharing Cable

42614

USB 3.0 Transfer & KM Sharing Cable

- KVM control of two PCs through a single USB 3.0 cable
- Turns laptop displays, desktop monitors or tablet screens into a 2nd display
- Maximum Resolutions: 2048 x 1152
- Seamless file transfer and clipboard sharing up to 5Gbps between two computers, laptops or different operating systems
- Create an 'extended desktop' set up using the display of another computer
- Touchscreen support
- Compatible with Windows XP/7/8/8.1/10



WIN **MAC OS**

USB 3.0 Transfer & KM Sharing Cable

42624

5m USB 2.0 Panel Mount Active Extension Cable

- 5 metre USB 2.0 Active Extension Repeater cable
- Plug & Play - no special software installation required
- Connectors: Type A USB Male to Panel Mount Type A USB Female
- For even greater distances of up to 25m simply connect up to 5 cables in series

5m USB 2.0 Panel Mount Active Extension Cable

42830

NEW



5m USB 2.0 Slimline Active Extension Cable

- Slimline design allows the active electronics to be fitted into a standard USB connector - an advantage over other active USB cables that use special, bulky connectors
- For lengths of up to 25m you can connect up to 5 of these cables in series
- Connectors: Type A USB Male to Type A USB Female

**BEST
SELLER**



5m USB 2.0 Slimline Active Extension Cable

42817

20m USB 2.0 Active Extension Cable

- Supports transfer rates up to 480Mbps
- Two extensions can be connected together to reach 40m
- Connectors: Type A USB Male to Type A USB Female



20m USB 2.0 Active Extension Cable

42631

10m USB 2.0 Active Extension 4 Port Hub

- Extends the length of up to four USB devices by 10m
- Bus powered from the computer or self powered using an additional power supply (not included)

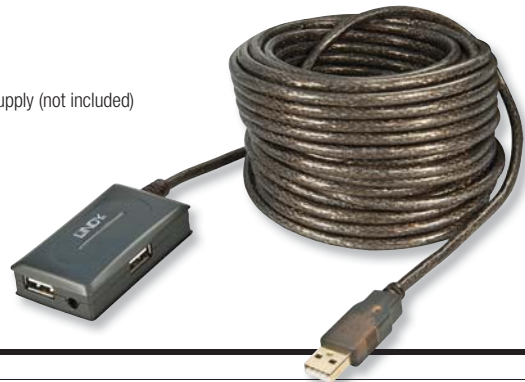

10m USB 2.0 Active Extension 4 Port Hub

42630

Optional Multi-Country Power Supply

73824

USB 3.0 Active Extension Cables 5m and 10m versions available

- Connectors: Type A USB Male to Type A USB Female
- USB 3.0/2.0 & 1.1 compatible
- 10m and 15m version features a connection for attaching a power supply (not included)

5m version



10m version



5m USB 3.0 Active Extension Cable

43155

10m USB 3.0 Active Extension Cable

43156

Optional Multi Country Power Supply for 10m

73824

USB 2.0 ACTIVE EXTENSION SYSTEM PRO

The USB 2.0 Active Extension System Pro is a range of products which can be combined together to extend and distribute USB 2.0 signals over incredibly long distances.

The Extension system Pro range consists of 8m, 12m and 30m extension cables and hubs. See below for a typical installation example.

- USB 2.0 and USB 1.1 compatible
- Supports transfer speeds of up to 480Mbps
- Cables are USB bus powered; the hub versions include a multi-country power supply
- Locking connectors for a secure installation.

Installation Example

Start with an 8m Active Extension Cable Pro. You can then use up to additional segments made up of 8m or 12m Extension Kits to extend the distance up to 60m. Or, if you need additional USB ports or want to connect a bus powered USB device requiring more than 100mA bus power, you can use the 8m or 12m 4 Port Extension Hub kit as the final extension segment.

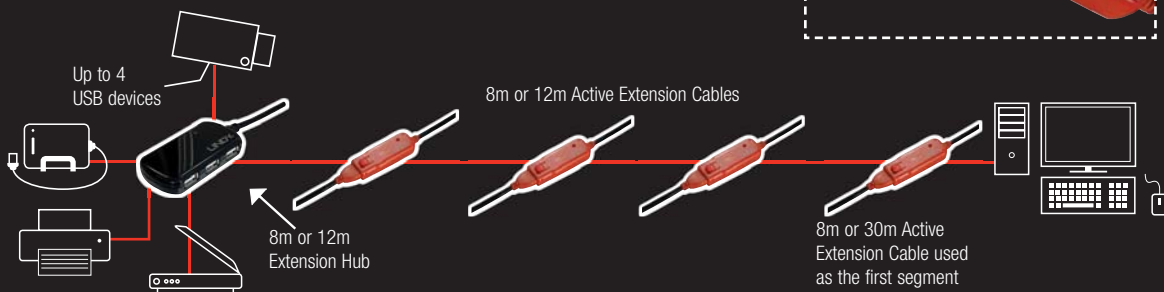

PRODUCTS IN USE

8m & 30m USB 2.0 Active Extension Cable Pro

- Connects directly to your computer's USB 2.0 port
- Can be used as the starting segment in a long distance USB Active Extension System Pro installation
- Connectors: USB Type A Male to USB Type A Female



8m USB 2.0 Active Extension Cable Pro	42780
30m USB 2.0 Active Extension Cable Pro	42923

12m USB 2.0 Active Extension Cable Pro

- Can be used as the middle and final segments in a long distance USB Active Extension System Pro installation
- Latching connector for a secure installation
- Can not be connected directly to a computer's USB port
- Connectors: USB Type A Male to USB Type A Female



12m USB 2.0 Active Extension Cable Pro	42782
--	-------

8m USB 2.0 Active Extension Pro 4 Port Hub

- Can be directly connected to a computer's USB 2.0 port
- Can also be connected as the final segment in a long distance USB Active Extension System Pro installation
- Connectors: USB Type A Male to 4 x USB Type A Female



8m USB 2.0 Active Extension Pro 4 Port Hub	42781
--	-------

12m USB 2.0 Active Extension Pro 4 Port Hub

- Can be used as the final segment in a long distance USB Active Extension System Pro installation
- Can not be connected to a computer's USB port as the first segment
- Connectors: USB Type A Male to 4 x USB Type A Female



12m USB 2.0 Active Extension Pro 4 Port Hub	42783
---	-------

USB 3.0 ACTIVE EXTENSION SYSTEM PRO

The LINDY USB 3.0 Active Extension System Pro is a range of products which can be combined together to extend and distribute USB 3.0 signals over long distances of either 18m, 28m or 38m.

The system consists of 8m and 10m extension cables and a 10m hub.

- Supports SuperSpeed transfer rates of to 5Gbps
- Plug & Play - no special software installation required
- Backwards compatible with both USB 2.0 and USB 1.1 devices
- Compatible with USB 3.0 equipped computers
- 2 year warranty

Installation Example

Always start with this 8m USB 3.0 Active Extension Cable Pro. You can then use up to 3 additional 10m USB 3.0 Active Extension Cables to extend your device further up to 18, 28 or 38m. Or, if you wish to add extra USB ports or to connect a bus powered USB device, use a 10m USB 3.0 Active Extension Pro 4 Port Hub as the final segment.

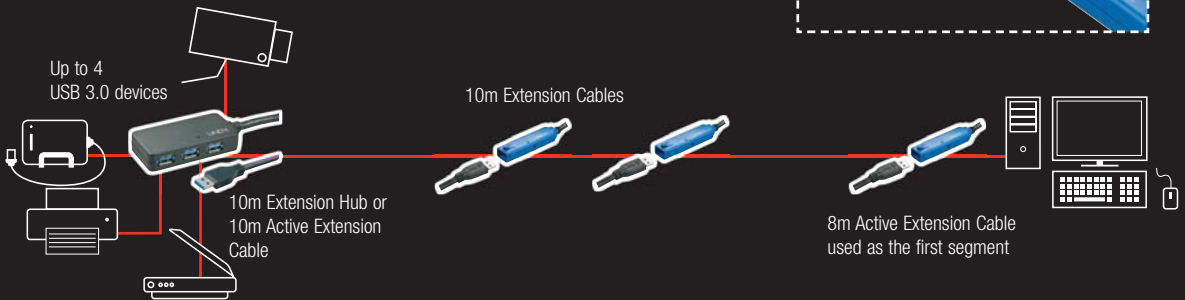

PRODUCTS IN USE

8m USB 3.0 Active Extension Cable Pro

- Connects directly to your computer's USB 3.0 port
- Can be used as a stand-alone 8m extension cable or as part of a long distance USB 3.0 Active Extension System Pro with 43157 and 43159
- Connectors: Type A USB Male to Type A USB Female



8m USB 3.0 Active Extension Cable Pro

43158

10m USB 3.0 Active Extension Cable Pro

- Can be used as either the middle or final segment in a long distance USB 3.0 Active Extension System Pro
- Connect up to 3 cables to 43158 to extend your USB 3.0 Active Extension System up to 18, 28 or 38m
- Connectors: Type A USB Male to Type A USB Female



10m USB 3.0 Active Extension Cable Pro

43157

10m USB 3.0 Active Extension Cable Pro 4 Port Hub

- Should be used as the final segment in a long distance USB 3.0 Active Extension System
- Must be connected to either 43158 or 43157
- Connectors: Type A USB Male to 4 x Type A USB Female
- Supplied with a multi country 5V DC 3.5A PSU



10m USB 3.0 Active Extension Pro 4 Port Hub

43159

FireWire 400 Cables

FireWire 6 Pin Male to 6 Pin Male

6 Pin FireWire Male to
6 Pin FireWire Male, Transparent

Length	Part No.
0.3m	30859
1m	30860
2m	30861
3m	30862
4.5m	30863
7.5m	30864
10m	30865
15m	30866
20m	30867
25m	30868



FireWire 800 Cables

FireWire 9 Pin Male to 9 Pin Male

9 Pin FireWire 800 Beta Male to
9 Pin FireWire 800 Beta Male, Transparent

Length	Part No.
0.3m	30754
1m	30755
2m	30756
3m	30757
4.5m	30758
7.5m	30759
10m	30760
25m	30746



FireWire 4 Pin Male to 4 Pin Male

4 Pin FireWire Male to
4 Pin FireWire Male, Transparent

Length	Part No.
3m	30882
4.5m	30883
7.5m	30884
10m	30885
15m	30886
20m	30887
25m	30888



FireWire 6 Pin Male to 9 Pin Male

6 Pin FireWire Male to
9 Pin FireWire 800 Bilingual Male, Transparent

Length	Part No.
0.3m	30764
1m	30765
2m	30766
3m	30767
4.5m	30768
7.5m	30769
10m	30770
15m	30771
20m	30772
25m	30773



FireWire 4 Pin Male to 6 Pin Male

4 Pin FireWire Male to
6 Pin FireWire Male Transparent

Length	Part No.
0.3m	30869
1m	30870
3m	30872
4.5m	30873
7.5m	30874
10m	30875
15m	30876
20m	30877



FireWire 4 Pin Male to 9 Pin Male

4 Pin FireWire Male to
9 Pin FireWire 800 Bilingual Male, Transparent

Length	Part No.
0.3m	30784
1m	30785
2m	30786
4.5m	30788
7.5m	30789
15m	30791
20m	30792

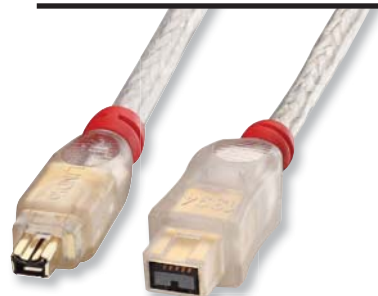

FireWire Adapter

6 Pin to 9 Pin



CROMO Friction Locking HDMI Cables

Secure connection to prevent accidental removal

LINDY CROMO Friction Locking HDMI cables feature a unique connector design which locks into any standard HDMI socket to help prevent the cable from being easily removed. Ideal for use in home cinema and other AV installations where a secure connection is paramount.

	Length	Part No.
CROMO Friction Locking High Speed HDMI Cable	0.3m	41439
	0.5m	41440
	1m	41441
	2m	41442
	3m	41443
	5m	41444
CROMO Friction Locking Standard HDMI Cable	7.5m	41445
	10m	41446
	15m	41447
	20m	41448

- 24K gold plated contacts with chrome plated connector hoods, fully shielded flexible cable and additional strain relief
- HDMI 2.0 compliant
- Supports resolutions up to Ultra HD 4K (3840 x 2160) 60Hz including 1080p 3D
- Full support for HEC, ARC and CEC compliant devices
- HDR (High Dynamic Range) capable
- High Speed lengths up to 5m (Standard available in 7.5m to 20m lengths)



HDMI™

CROMO HDMI to Mini HDMI Cable

CROMO High Speed HDMI to Mini HDMI Cable	Length	Part No.
	0.5m	41435
	1m	41436
	2m	41437

HDMI™

CROMO HDMI to Micro HDMI Cable

CROMO High Speed HDMI to Micro HDMI Cable	Length	Part No.
	0.5m	41420
	1m	41421
	2m	41422

HDMI™

CROMO Slim High Speed HDMI Cables

Advanced, ultra flexible and light cable for connecting your HDMI devices

This super thin and flexible HDMI cable has been specially designed for connection to devices in confined spaces or with restricted access to the HDMI ports.

- 3m and 5m versions feature built-in active electronics to amplify the signal for long distance transmission
- 24K gold plated contacts with chrome plated connector hoods, fully shielded flexible cable and additional strain relief
- Supports resolutions up to Ultra HD 4K (3840 x 2160) 60Hz including 1080p 3D
- Full support for HEC, ARC and CEC compliant devices
- HDR (High Dynamic Range) capable
- Supports HDCP 2.2



CROMO Slim HDMI to HDMI Cable

CROMO Slim High Speed HDMI Cable	Length	Part No.
	0.3m	41669
	0.5m	41670
	1m	41671
	2m	41672
	3m	41675
	4.5m	41676

Passive version shown

HDMI™

CROMO Slim HDMI to Micro HDMI Cable

CROMO Slim HDMI to Micro HDMI Cable	Length	Part No.
	0.5m	41680
	1m	41681
	2m	41682
	3m	41678
	5m	41679

Active version shown

HDMI™

HDMI CABLES

Gold HDMI Cables

Superb quality cable for the latest HDMI devices



Our Gold HDMI cables features cutting edge design and construction to provide the highest quality, most reliable HDTV connection available. This 'future proof' cable incorporates the latest HDMI technology. HEC, ARC and 3D compliant, it supports resolutions up to an amazing Ultra HD 4K (3840 x 2160) 60Hz.

The triple shielded, low attenuation cable provides superb clarity, definition and detail, even over longer transmission distances, whilst the 24K gold plated connectors allow for excellent, consistent signal transfer.

- HDMI 2.0 compliant
- Supports resolutions up to Ultra HD 4K (3840 x 2160) 60Hz including 1080p 3D
- Full support for HEC, ARC and CEC compliant devices
- Audio Return Channel supports bi-directional audio
- HDR (High Dynamic Range) capable
- Supports all HDMI audio formats including 5.1, 7.1, 8.1 and 13.1 channel high definition digital audio
- High Speed lengths available up to 5m (Standard from 7.5m to 20m)

	Length	Part No.
Gold High Speed HDMI Cable	0.5m	37850
	1m	37851
	2m	37852
	3m	37853
	5m	37854
Gold Standard HDMI Cable	7.5m	37855
	10m	37856
	15m	37857
	20m	37858



Premium HDMI Cables

High quality cable for home cinema

	Length	Part No.
Premium High Speed HDMI Cable	0.3m	41109
	0.5m	41110
	1m	41111
	2m	41112
	3m	41113
	5m	41114
Premium Standard HDMI Cable	7.5m	41115
	10m	41116
	15m	41117
	20m	41118

- 24K gold plated contacts
- Supports resolutions up to Ultra HD 4K (3840 x 2160) 60Hz including 1080p 3D
- Supports ARC and CEC compliant devices
- HDR (High Dynamic Range) capable
- Compact connector size - ideal for use with recessed HDMI sockets
- High Speed lengths available up to 5m (Standard from 7.5m to 20m)

Premium High Speed HDMI Extension Cable	Length	Part No.
	0.5m	41313
	1m	41314
	2m	41315
	3m	41316
	5m	41317

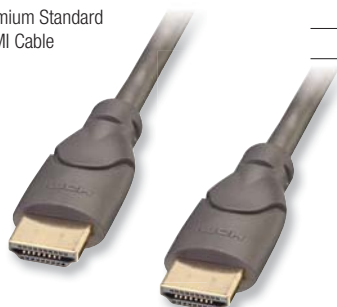

**BEST
SELLER**



HDMI Cables

- Supports resolutions up to 1080p and higher

HDMI Cables	Length	Part No.
	0.5m	41394
	1m	41395
	2m	41396
	3m	41397
	5m	41398

**BEST
SELLER**

White HDMI Cables

- Supports display resolutions up to 1080p and higher
- Gold plated connectors

White High Speed HDMI Cable	Length	Part No.
	0.5m	41410
	1m	41411
	2m	41412
	3m	41413
	4.5m	41414

Long Distance Active High Speed HDMI Cables

- 24K gold plated contacts, fully shielded cable with strain relief
- Supports resolutions up to Ultra HD 4K (3840 x 2160) 60Hz 4:2:0 8bit including 1080p 3D
- HDMI 2.0 compliant
- HDR10 (High Dynamic Range) compatible

Long Distance Active High Speed HDMI Cable	Length	Part No.
	15m	41052
	20m	41053
	25m	41054
	30m	41055

Active 4K HDMI 2.0 Cable

- 24K gold plated contacts
- Active electronics amplify the HDMI signal for long distance transmission
- Supports resolutions up to Ultra HD 4K (3840 x 2160) 60Hz 4:4:4 8bit including
- 1080p 3D Supports Dolby® True HD, DTS-HD Master Audio up to 32 audio channels
- Full support for HEC, ARC and CEC compliant devices
- HDR10 (High Dynamic Range) compatible
- Supports HDMI 2.0b, 18G bandwidth & HDCP 2.2

Active HDMI 2.0 4K Male to Male Cable	Length	Part No.
	10m	41345
	15m	41346

NEW

HDMI Power Injector Cable

The HDMI interface was not designed to power external devices, but rather to supply sufficient power to complete the initial handshake, HDCP authentication and EDID exchange. Whilst many source devices provide more than the specified 55mA to perform these functions, they do not always provide enough additional power to allow the operation of external HDMI accessories.

Connecting the HDMI Power Injector Cable allows you to provide additional power to such devices, by positioning the cable inline between the HDMI source and the HDMI Accessory and then connecting the USB cable to a USB port on your HDMI Source or to an external USB power supply (not included).

- HDMI A Male & USB Type A Male to HDMI A Female
- Adds additional current to the 5V output of a HDMI port
- USB Type A Male provides additional power via external USB port or USB PSU
- Length: HDMI cable 12cm, USB Cable 50cm

HDMI Power Injector Cable	Part No.
	41080

Fibre Optic Hybrid 4K HDMI 1.4 Cables

- Extend HDMI signals over long distances without degradation or compression
- Supports up to 10.2 Gbps of bandwidth
- Supports resolutions up to 3840x2160p 60 Hz 4:2:0 8bit, including 1080p 3D
- HDCP and CEC pass-through
- Slim-line fibre optic and copper hybrid cable

NEW

Fibre Optic Hybrid HDMI 1.4 Cables	Length	Part No.
	20m	38175
	30m	38176
	50m	38178

Fibre Optic Hybrid 4K HDMI 2.0 Cables

- Extend HDMI 2.0 signals over long distances without degradation or compression
- Supports up to 18 Gbps of bandwidth
- Supports resolutions up to 3840x2160p 60 Hz 4:4:4 8bit
- HDR (High Dynamic Range) Compatible
- HDCP and CEC pass-through
- Slim-line fibre optic and copper hybrid cable

NEW

Fibre Optic Hybrid 4K HDMI 2.0 Cables	Length	Part No.
	20m	38275
	30m	38276
	40m	38277
	50m	38278

High Speed HDMI to Micro HDMI Cables

Connect the latest mobile phones, digital camera and camcorders to an HDMI display

- HDMI 2.0 compliant,
- Supports resolutions up to Ultra HD 4K (3840 x 2160) 60Hz including 1080p 3D
- Gold plated connectors

High Speed HDMI to Micro HDMI Cable	Length	Part No.
	0.5m	41350
	1m	41351
	2m	41353
	3m	41354

HDMI™

High Speed HDMI to Mini HDMI Cables

Allows Mini HDMI devices to be connected to standard HDMI ports

- HDMI 2.0 compliant
- Supports resolutions up to Ultra HD 4K (3840 x 2160) 60Hz including 1080p 3D
- Gold plated connectors

High Speed HDMI to Mini HDMI Cable	Length	Part No.
	0.5m	41030
	1m	41031
	2m	41032
	3m	41033

HDMI™

MHL to HDMI Cables

Show content stored on your smartphone on a MHL compatible HDTV

- MHL connector: USB 2.0 Micro-B Male
- HDMI connector: HDMI 19 pin Type A male
- Supports resolutions up to Full HD 1080p
- Please check your portable device and TV supports MHL technology before ordering

MHL to HDMI Cable	Length	Part No.
	1m	41566
	2m	41567

HDMI™

HDMI to DVI-D Cables

- Supports high-bandwidth, uncompressed digital video

HDMI Male to DVI-D Male	Length	Part No.
	0.5m	36580
	1m	36581
	2m	36582
	3m	36583
	5m	36584
	10m	36585

CABLE GURU

FIND THE CABLE YOU NEED

Try it now on our

WEBSITE



Gold HDMI to DVI-D Cables

- 24K gold plated connectors with 360° EMC shielding
- Low attenuation cable for long distance performance

HDMI Male to DVI-D Male Gold Plated Connectors, Metal Hoods	Length	Part No.
	0.5m	37180
	1m	37181
	2m	37182
	3m	37183
	5m	37184
	7.5m	37187
	10m	37185
	15m	37186

25 YEAR
GUARANTEE

Mini HDMI to DVI-D Cables

- Allows you to connect devices with Mini HDMI connections to DVI-D equipped displays

Mini HDMI Male to DVI-D Male	Length	Part No.
	1m	41176
	2m	41177

HDMI to DisplayPort Cables

- Allows you to connect PCs and laptops with HDMI connections to DisplayPort monitors
- Supports video-mirroring and extended desktop

HDMI Male to DisplayPort Male	Length	Part No.
	1m	41485
	2m	41486
	3m	41487
	3m	41487
	5m	41488

HDMI to VGA Cables

- Ideal for connecting HDMI equipment to older VGA displays and projectors
- Supports resolutions up to 1080p / 1920 x 1200

HDMI Male to VGA Male & USB Type A Male (Power)	Length	Part No.
	1m	41455
	2m	41456
	3m	41457
	5m	41458

DISPLAYPORT CABLES

Gold DisplayPort Cables

Advanced, digital audio/video cable for the next generation of computer devices

- Features cutting edge design to provide a high quality connection
- Triple shielded, low attenuation cable
- 24K gold plated connector pins for a consistent signal transfer
- DisplayPort 1.2
- Full support for high definition video, multi-channel digital audio, DPCP and HDCP
- Supports resolutions up to Ultra HD 4K 3840x2160 60Hz, including stereoscopic 3D
- DisplayPort compliance certified
- Supports up to 18Gbits and up to 4:4:4 chroma subsampling

Gold DisplayPort Cable, Male to Male

25 YEAR GUARANTEE



Length	Part No.
0.5m	37800
1m	37801
2m	37802
3m	37803
5m	37804
7.5m	37805
10m	37806
15m	37807
20m	37808

CROMO DisplayPort Cables

Advanced, high quality cable with gold plated contacts

- Fully shielded cable design
- Stylish chrome plated connector hoods
- DisplayPort 1.2
- Full support for high definition video, multi-channel digital audio and DPCP
- Supports resolutions up to Ultra HD 4K 3840x2160 60Hz, including stereoscopic 3D
- Supports 8 channel, uncompressed 24bit audio
- DisplayPort compliance certified

CROMO DisplayPort, Male to Male

CROMO DisplayPort Cable, Male to Male

BEST SELLER



Length	Part No.
0.5m	41530
1m	41531
2m	41532
3m	41533
5m	41534

CROMO Mini DisplayPort, Male to Male

CROMO Mini DisplayPort Cable, Mini Male to Mini Male

Length	Part No.
0.5m	41540
1m	41541
2m	41542
3m	41543
5m	41544



CROMO DisplayPort to Mini DisplayPort

CROMO DisplayPort Cable, Male to Mini Male

Length	Part No.
0.5m	41550
1m	41551
2m	41552
3m	41553
5m	41554



FOR DISPLAYPORT SWITCHES, SPLITTERS & EXTENDERS
SEE PAGES 75-77



DisplayPort Cables

High quality cable for the next generation of monitors

- DisplayPort 1.1a HD 1080p compatible
- Full support for high definition video and multi-channel digital audio
- 24K gold plated connectors
- Supports HDTV resolutions up to 1080p and 2560 x 1600
- 8 channel, uncompressed 24 bit audio support
- DisplayPort compliance certified

DisplayPort Male to Female Extension

DisplayPort Cable Male to Female	Length	Part No.
	1m	41623
	2m	41624
	3m	41625

Basic DisplayPort Cable

- Low cost, value for money connection cable for basic home and office use

DisplayPort Cable Male to Male	Length	Part No.
	1m	41991
	2m	41636
	3m	41993
	5m	41638

Active DisplayPort to HDMI Cables

- Supports video-mirroring and extended desktop
- DisplayPort 1.1 and HDMI 1.3 compliant
- Supports resolutions up to Ultra HD 4K (3840 x 2160) 30Hz including 1080p 3D (0.5m to 2m lengths); 3m & 5m lengths support up to 1080p
- Audio support when the connected PC supports audio over DisplayPort

DisplayPort Male to HDMI Male	Length	Part No.
	0.5m	41715
	1m	41716
	2m	41717
	3m	41703
	5m	41704

Active DisplayPort to VGA Cables

- Supports video-mirroring and extended desktop modes
- DisplayPort 1.1a compliant
- Supports resolutions up to 2048 x 1536

DisplayPort Male to Male

DisplayPort Cable Male to Male	Length	Part No.
	0.5m	41980
	1m	41981
	2m	41982
	3m	41632
	5m	41633
	7.5m	41324
	10m	41325
	15m	41326
	20m	41327

DisplayPort Extension Cable (No Pin 20)

- For use with cables that have pin 20 connected and cause power feedback to graphics cards

DisplayPort Cable Male to Female	Length	Part No.
	0.2m	41627

DisplayPort to DVI-D Cables

- Supports video-mirroring and extended desktop modes
- DisplayPort 1.1 and DVI 1.1 compliant
- Supports resolutions up to 1920 x 1200 and 1080p

DisplayPort Male to DVI-D Male	Length	Part No.
	1m	41490
	2m	41491
	3m	41492
	5m	41493

DisplayPort Male to VGA Male	Length	Part No.
	1m	41941
	2m	41471
	3m	41472
	5m	41473

MINI DISPLAYPORT CABLES

Mini DisplayPort Cable

- Full support for high definition video, multi-channel digital audio
- Supports resolutions up to 2560 x 1600 and 1080p
- 24K gold plated connector pins
- Supports 8 channel, uncompressed 24bit audio

Mini DisplayPort Male to Mini DisplayPort Male, White	Length	Part No.
	1.5m	41065



1.5m Mini DisplayPort Extension Cable

- Compliant with DisplayPort 1.1 specification for 1.62 and 2.7Gbps
- Up to 2560 x 1600 resolution

Mini DisplayPort Male to Mini DisplayPort Female	Length	Part No.
	1.5m	41036

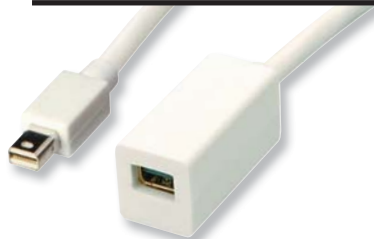

Mini DisplayPort to DisplayPort Cables

- DisplayPort 1.1a HD 1080p compatible
- 24K gold plated contacts
- Supports resolutions up to 2560 x 1600 and 1080p
- Supports 8 channel, uncompressed 24 bit audio

Mini DP Male to DP Male Cable, White

Mini DisplayPort Male to DisplayPort Male, White	Length	Part No.
	1m	41056
	2m	41057
	3m	41058
	5m	41059



**BEST
SELLER**

Mini DP Male to DP Male Cable, Black

Mini DisplayPort Male to DisplayPort Male, Black	Length	Part No.
	1m	41645
	2m	41646
	3m	41647
	5m	41648



Mini DP Male to DP Female Cable, White

Mini DisplayPort Male to DisplayPort Female, White	Length	Part No.
	1.5m	41045



Active Mini DisplayPort to 4K HDMI Cables

- Supports video-mirroring & extended desktop modes
- Supports up to Ultra HD 4K (3840 x 2160) 30Hz including 1080p 3D

Mini DisplayPort Male to 4K HDMI Male	Length	Part No.
	0.5m	41720
	1m	41721
	2m	41722
	3m	41666
	5m	41667



**BEST
SELLER**

**Free UK
DELIVERY**  **on all orders over £125 (ex VAT.)**

Some exceptions apply, see delivery terms & conditions on our website

Download the latest
PRICE LIST
from our website



Mini DisplayPort to DVI-D Cables

- Supports Video-Mirroring & Extended desktop modes
- Supports Mini DisplayPort supports resolutions up to 1920 x 1200

Mini DP Male to DVI-D Male Cable, White

Mini DisplayPort Male to DVI-D Male, White	Length	Part No.
	0.5m	41955
	1m	41495
	2m	41496
	3m	41497
	5m	41959

Mini DP Male to DVI-D Male Cable, White

Mini DisplayPort Male to DVI-D Male, Black	Length	Part No.
	0.5m	41950
	1m	41695
	2m	41696
	3m	41697
	5m	41954

Passive Mini DisplayPort to VGA Cables

- Supports Video-Mirroring & Extended desktop modes
- Mini DisplayPort supports resolutions up to 1920 x 1200p 60Hz

Passive Mini DP Male to VGA Male Cable, White

Passive Mini DP Male to VGA Male Cable, White	Length	Part No.
	0.5m	41965
	1m	41966
	2m	41967

NEW

Passive Mini DP Male to VGA Male Cable, Black

Passive Mini DP Male to VGA Male Cable, Black	Length	Part No.
	0.5m	41960
	1m	41961
	2m	41962

NEW



CABLE GURU
FIND THE CABLE YOU NEED
Try it now on our
WEBSITE

Active Mini DP to VGA Male Cable, White

Active Mini DP to VGA Male Cable, White	Length	Part No.
	3m	41968
	5m	41969

NEW

Active Mini DP Male to VGA Male Cable, Black

Active Mini DP Male to VGA Male Cable, Black	Length	Part No.
	3m	41963
	5m	41964

NEW

Thunderbolt Cables

- Thunderbolt Generation 1 & 2 compatible
- Combines Data, Video, Audio and Power in one cable
- Supports 4K video and DisplayPort 1.2
- Bandwidth: 20Gbps bi-directional (10Gbps each line)

Thunderbolt 20 Pin Male to
Thunderbolt 20 Pin Male

Length	Part No.
0.5m	41710
1m	41711
2m	41712
3m	41713



Gold DVI-D Cables

25 YEAR
GUARANTEE

- 24K gold plated connectors with 360° EMC shielding
- Low attenuation cable for longer distances
- Supports DVI resolutions of up to 2560 x 1600 and HDTV resolutions up to 1080p

Gold DVI-D Dual Link Extension Cables

DVI-D Dual Link Male to DVI-D Dual Link Female
Gold Plated Connectors, Metal Hoods

Length	Part No.
2m	37150
3m	37151
3m	37152
7.5m	37153



Gold DVI-D Dual Link Cables

DVI-D Dual Link Male to DVI-D Dual Link Male
Gold Plated Connectors, Metal Hoods

Length	Part No.
0.5m	37140
1m	37141
2m	37142
3m	37143
5m	37144
7.5m	37145
10m	37146



Gold DVI-D Super Long Distance Cables

- Low attenuation cable for longer distances
- Single Link versions support up to 1920 x 1200 / 1080p
- Dual Link versions support up to 2560 x 1600 / 1080p

Gold DVI-D Single Link Super Long Distance Cables

DVI-D Single Link Male to DVI-D Single Link Male
Super Long Distance, Gold Plated Connectors,
Metal Hoods

Length	Part No.
10m	37160
15m	37161
20m	37162
25m	37163



Gold DVI-D Dual Link Super Long Distance Cables

DVI-D Dual Link Male to DVI-D Dual Link Male
Super Long Distance, Gold Plated Connectors,
Metal Hoods

Length	Part No.
10m	37155
15m	37156
20m	37157
25m	37158



Premium DVI-D Dual Link Cables

DVI-D Dual Link Cables

DVI-D Dual Link Male to
DVI-D Dual Link Male, Moulded

Length	Part No.
0.5m	41238
1m	41239
2m	41240
3m	41241
5m	41242
7.5m	41244
10m	41243

**BEST
SELLER**



DVI-D Dual Link Extension Cables

DVI-D Dual Link Male to
DVI-D Dual Link Female, Moulded

Length	Part No.
0.5m	41127
1m	41128
2m	41245
3m	41246
5m	41247
7.5m	41249
10m	41248



DVI-I Dual Link Super Long Distance Cables

DVI-I Dual Link Male to
DVI-I Dual Link Male, Moulded

Length	Part No.
10m	41275
15m	41276
20m	41277

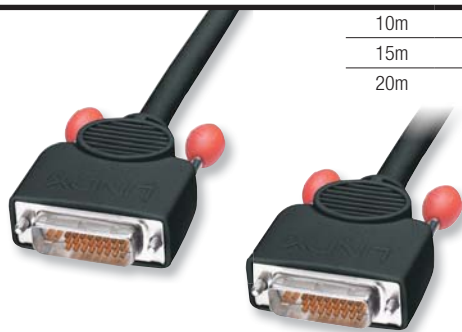

Download the latest
PRICE LIST
from our website



Premium DVI-D Single Link Super Long Distance Cables

- RF-BLOK connector for improved shielding and reliability

**BEST
SELLER**

DVI-D Super Long Distance Cables

DVI-D Single Link Male to
DVI-D Single Link Male, Moulded

Length	Part No.
10m	41260
15m	41261
20m	41262
25m	41263



DVI-D Super Long Distance Extension Cables

DVI-D Single Link Male to
DVI-D Single Link Female, Moulded

Length	Part No.
10m	41265
15m	41266
20m	41267



Value DVI Cables

Value DVI-D Single Link Cables

DVI-D Single Link Male to
DVI-D Single Link Male, Moulded

Length	Part No.
1m	36605
2m	36606
3m	36607
5m	36608
10m	36609



Value DVI-D Dual Link Cables

DVI-D Dual Link Male to
DVI-D Dual Link Male, Moulded

Length	Part No.
0.5m	36610
1m	36611
2m	36612
3m	36613
5m	36614

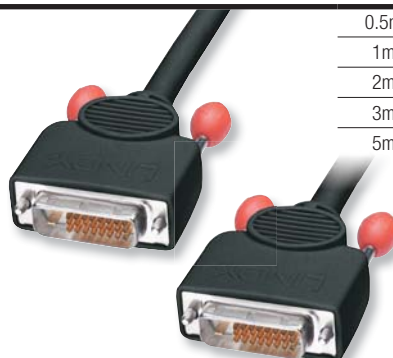

FOR DVI EXTENDERS
SEE PAGES
72-74



Fibre Optic DVI Cables

Our Fibre Optic Hybrid DVI-D cables are the perfect solution for easily extending DVI digital signals over incredible distances. Fibre-optic technology allows transmission distances that far exceed the maximum supported by standard copper only cables.

- Extend DVI digital signals over incredible distances compared to standard copper only cables
- Supports resolutions of up to 1920 x 1200 and 1080p

DVI-D Male to DVI-D Male

Length Part No.

20m	38370
30m	38371
40m	38372
50m	38373
60m	38374
70m	38375
80m	38376
90m	38377
100m	38378

2 YEAR
GUARANTEE



DVI-D (with USB) to DisplayPort Active Adapter Cable

- Converts a DVI-D signal into a DisplayPort Signal
- Supports resolutions up to 1920x1200p 60Hz
- Plug & Play - simple to install and use
- Low power, can be powered by DVI-D or USB

NEW

DVI-D (with USB) to DP Active Adapter Cable, Black	Length	Part No.
	0.5m	41975
	1m	41976
	2m	41977
	3m	41978
	5m	41979

DVI-D (with USB) to Mini DisplayPort Active Adapter Cable

NEW

DVI-D (with USB) to Mini DP Active Adapter Cable, Black	Length	Part No.
	0.5m	41995
	1m	41996
	2m	41997
	3m	41998
	5m	41999

DVI-I to VGA Cables

These cables are useful when you want to connect two VGA monitors to a computer equipped with VGA and DVI-I ports. Simply connect the first monitor to the VGA port and the second, using one of these cables, to the DVI port.

DVI-A Male to VGA Female Adapter Cable (PC with a DVI-I output to a monitor with a built-in VGA cable)

DVI-A Male to VGA Female	Length	Part No.
	1m	41155
	2m	41156
	3m	41157
	5m	41158

DVI-A Male to VGA Male Adapter Cable (PC with a DVI-I output to a VGA monitor)

DVI-A Male to VGA Male	Length	Part No.
	1m	41195
	2m	41196
	3m	41197
	5m	41198

DVI-D to VGA Cable

- Converts DVI-D signals to a VGA signal
- Supports resolutions up to 1080p / 1920x1200
- Powered via the DVI port (USB A connector for additional power when needed)

NEW

DVI-D to VGA Cable	Length	Part No.
	1m	41430
	2m	41431
	3m	41432
	5m	41433

Gold VGA Cables

Our highest quality VGA cable for professional and long distance installations

25 YEAR
GUARANTEE

BEST
SELLER

Our Gold VGA cables have been designed for users who demand maximum reliability and the best possible performance. No compromises have been made in design or construction to ensure that these cables provide superb picture quality at the highest resolutions, even over very long distances.

Available in lengths of up to 50m and backed by a 25 year warranty, they're the perfect choice for home cinema, presentation, CAD, DTP and AV installations.

Gold VGA Cables

15 Way VGA Male to
15 Way VGA Male, Gold Plated Metal



Length	Part No.
0.5m	37831
1m	37832
2m	37820
3m	37821
5m	37822
7.5m	37819
10m	37823
15m	37824
20m	37825
30m	37826
40m	37827
50m	37828
75m	37829
100m	37830

Gold VGA Extension Cables

15 Way VGA Male to
15 Way VGA Female, Gold Plated Metal



Length	Part No.
0.5m*	37728
1m	37834
2m	37835
3m	37836
5m	37837
7.5m	37846
10m*	37733
15m	37839
20m*	37735
30m	37841
40m	37842
50m*	37738
75m	37844
100m	37845

* The cables marked with an asterisk are blue in colour, not anthracite

Premium VGA Cables

Super quality cable for high resolutions & long distances

- Heavily shielded coaxial RGB cable
- Ferrite core at each end to reduce interference

Premium VGA Cables

15 Way VGA Male to 15 Way VGA Male,
Moulded



Length	Part No.
0.25m	36370
0.5m	36371
1m	36372
2m	36373
3m	36374
5m	36375
7.5m	36376
10m	36377
15m	36378
20m	36379
30m	36380
40m	36381
50m	36382

BEST
SELLER

Premium VGA Extension Cables

15 Way VGA Male to
15 Way VGA Female, Moulded



Length	Part No.
0.25m	36390
0.5m	36391
1m	36392
2m	36393
3m	36394
5m	36395
7.5m	36396
10m	36397
15m	36398
20m	36399

BEST
SELLER

Standard VGA Cables

Standard VGA Cables

15 Way VGA Male to 15 Way VGA Male, Moulded

Length	Part No.
1.5m	31013
2m	31014
5m	31015



**BEST
SELLER**

Standard VGA Extension Cables

15 Way VGA Male to 15 Way VGA Female, Moulded

Length	Part No.
1.5m	31030
2m	31031
5m	31032



Premium VGA Cable with Integrated Audio

VGA and stereo audio combined in a single heavily shielded coaxial cable

- Audio break-out cable length: 50cm
- Ferrite core at each end to reduce interference for the best picture quality
- Fully moulded
- DDC (Display Data Channel) compatible

15 Way VGA Male & 3.5mm Jack to 15 Way VGA Male & 3.5mm Jack

Length	Part No.
1m	37298
2m	37299
3m	37300
5m	37301
7.5m	37302
10m	37303
15m	37304



VGA & Audio to HDMI Cables

Converts and combines analogue VGA and audio to HDMI in a single cable

- Input resolution matches output resolution, no scaling
- USB bus powered
- Audio support via 3.5mm stereo jack
- Supports resolutions up to 1680 x 1050 & 1080p
- HDMI 1.2a and DVI 1.0 compliant

VGA Male + 3.5mm Stereo Male + USB Type A Male to HDMI Male

Length	Part No.
1m	41705
2m	41706
3m	41707
5m	41708



VIDEO SPLITTER CABLES

Video Splitter Cables

VGA Splitter Cable

- Allows a computer or other VGA equipped device to output its signal to two separate displays

**BEST
SELLER**



Length Part No.

VGA Male to 2 x VGA Female

0.18m 41214

DMS 59 to 2 x DVI-I Splitter Cable

- Allows a computer with a DMS 59 connector to output its signal to two separate DVI equipped displays



Length Part No.

DMS 59 Male to 2 x DVI-I Female

0.16m 41009

DMS 59 to 2 x VGA Splitter Cable

- Allows a computer with a DMS 59 connector to output its signal to two separate VGA equipped displays



Length Part No.

DMS 59 Male to 2 x VGA Female

0.16m 41010

DVI-I to DVI-D Male + VGA Splitter Cable

- Dual Link
- Allows VGA and DVI-D signals to be sent to a display equipped with both DVI and VGA inputs



Colour Length Part No.

DVI-I Dual Link Female to DVI-D Male + VGA Male

Beige 0.25m 41008

Black 0.25m 41204

DVI-I to DVI-D Female + VGA Splitter Cable

- Allows computers that support simultaneous digital and analogue video output via their DVI-I output ports to be connected to two separate monitors



Colour Length Part No.

DVI-I Male to DVI-D Single Link Female + VGA Female

Beige 0.2m 41048

Black 0.2m 41218

HDMI to VGA Converters

HDMI Male to
VGA Female



**BEST
SELLER**

HDMI Male to VGA Female, 0.1m 38191

Mini HDMI Male to
VGA Female



Mini HDMI Male to VGA Female, 0.1m 38192

Micro HDMI Male to
VGA Female



Micro HDMI Male to VGA Female, 0.1m 38193

HDMI Male to
VGA Female & Audio



**BEST
SELLER**

HDMI Male to
VGA Female & Audio, 0.1m 38185

Mini HDMI Male to
VGA Female & Audio



Mini HDMI Male to
VGA Female & Audio, 0.1m 38186

Micro HDMI Male to
VGA Female & Audio



Micro HDMI Male to
VGA Female & Audio, 0.1m 38187

HDMI Male to
VGA Female Dongle



HDMI Male to VGA Female Dongle 38194

**VGA to DVI-D
Converter Cable**

- Powered via a USB Type A connection



VGA Male to DVI-D Female, 0.1m 38184

DVI & VGA Adapter Cables

DVI-A Male to
VGA Female



DVI-A Male to VGA Female, 0.2m 41222

DVI-A Female to
VGA Male



DVI-A Female to VGA Male, 0.2m 41223

DVI-D Female to
HDMI Male



DVI-D Female to HDMI Male, 0.2m 41227

DVI-D Male to VGA Female
Active Adapter



**BEST
SELLER**

DVI-D Male to VGA Female, 0.1m 38189

DVI-D Female & USB Type B
to M1-DA Male



DVI-I Female & USB Type B to
M1-DA Male, 0.2m 41229

VGA Male to 5 x BNC Male



	Length	Part No.
VGA Male to	1.8m	31562
5 x BNC Male	3m	33203

DISPLAYPORT ADAPTER CABLES

DVI-D to DisplayPort Converter Adapter



DVI-D to DisplayPort Converter Adapter

38145

Mini DVI Male to HDMI Female



Mini DVI Male to HDMI Female, 0.2m

41001

DisplayPort Adapter Cables

DisplayPort Male to HDMI Female, Passive



DP Male to HDMI Female, 0.15m

41005

DisplayPort Male to VGA Female, Active



DP Male to VGA Female, 0.15m

41006

DisplayPort Male to DVI-D Female, Passive



DP Male to VGA Female, 0.15m

41004

DisplayPort 1.2 Male to 4K HDMI Female, Passive



DP Male to HDMI Female Passive 0.15m

41718

DisplayPort 1.2 Male to 4K HDMI Female, Active



DP Male to HDMI Active Female 0.15m

41068

DisplayPort Male to Mini DisplayPort Female



DP Male to Mini DP Female, 0.15m

41060

DisplayPort 1.2 to HDMI, VGA & DVI-D Active Adapter



DisplayPort 1.2 to HDMI, VGA & DVI-D Active Adapter

41028

DisplayPort Male to Mini DisplayPort Female Adapter



DisplayPort Male to Mini DisplayPort Female Adapter

41089

DisplayPort to DVI-D Active Adapter Cable, Black



DisplayPort to DVI-D Active Adapter Cable, Black

41734

Thunderbolt 3 to Dual DisplayPort 1.2 Adapter

- Connect two independent DisplayPort monitors to a single Thunderbolt 3 port
- Supports resolutions up to Ultra HD 4K 60Hz on 2 monitors or Ultra HD 5K 60Hz on a single monitor
- Thunderbolt 3 and DisplayPort 1.2 compliant
- Plug & Play, bus powered solution



Thunderbolt 3 to Dual DisplayPort 1.2 Converter Adapter

43901

Mini DisplayPort Adapter Cables

- Connect a VGA, DVI or HDMI display to a Mini DisplayPort device

Mini DisplayPort Male to VGA Female, Active



Mini DisplayPort Male to VGA Female	Length	Part No.
	0.20m	41015

Mini DisplayPort Male to DVI-D Female, Passive



Mini DisplayPort Male to DVI-D Female	Length	Part No.
	0.20m	41013

Mini DisplayPort Male to DVI-D Female, Active



Mini DisplayPort Male to DVI-D Female	Length	Part No.
	0.20m	41733

Mini DisplayPort to DVI-D Dual Link, Active



Mini DisplayPort to DVI-D Dual Link	Length	Part No.
	0.60m	41038

Mini DisplayPort Male to HDMI Female, Passive



Mini DisplayPort Male to HDMI Female	Length	Part No.
	0.20m	41014

Mini DisplayPort 1.2 Male to 4K HDMI Female, Passive



Mini DisplayPort 1.2 Male to 4K HDMI Female	Length	Part No.
	0.15m	41719

Mini DisplayPort 1.2 Male to 4K HDMI Female, Active



Mini DisplayPort Male to 4K HDMI Female	Length	Part No.
	0.15m	41069

Mini DisplayPort Male to 4K HDMI / VGA Female, Active



Mini DisplayPort Male to 4K HDMI / VGA Female	Length	Part No.
	0.15m	41070

Mini DisplayPort to 4K HDMI/DVI/VGA, Active



Mini DisplayPort to 4K HDMI/DVI/VGA Adapter	Length	Part No.
	0.20m	41035

Mini DisplayPort to 4K HDMI/DVI/DisplayPort, Active



Mini DisplayPort Male to 4K HDMI/DVI/DisplayPort Female	Length	Part No.
	0.20m	41039

Mini DisplayPort Male & USB Type A Male to HDMI Female, Active

- Connects a Mini DisplayPort Mac to an HDTV
- Built-in external USB audio adapter to allow audio playback over HDMI



Mini DP Male & USB Type A Male to HDMI Female	Length	Part No.
	0.70m	41026

DISPLAYPORT & DVI ADAPTERS

Mini DisplayPort Adapters

Mini DisplayPort Male to DisplayPort Female Adapter



Mini DisplayPort Male to DisplayPort Female Adapter 41077

Panel Mount DisplayPort Coupler

- Connect two DisplayPort cables together



DisplayPort Coupler 41044

DisplayPort Coupler

- Connects two DisplayPort cables together



DisplayPort Coupler 41020

DVI Adapters and Couplers

- Easily connect two cables together

DVI-I Coupler



BEST SELLER

DVI-I Female to DVI-I Female Coupler 41233

DVI-D Male to DVI-I Female



BEST SELLER

DVI-D Male to DVI-I Female Adapter 41098

DVI-I Male to DVI-I Female



DVI-I Male to DVI-I Female Adapter 41099

DVI-D Single Link Female to HDMI Male



DVI-D Female to HDMI Male Adapter 41217

DVI-A Male to VGA Female



DVI-A Male to VGA Female Adapter 71244

DVI-D Male to DVI-I Female, Hot Plug Support



DVI-D Male to DVI-I Female Adapter with 1K Resistor for Hot Plug Support 41082

90 Degree DVI Adapters & Couplers

- Ideal for use with a wall plate or in trunking to achieve right angled bends by joining two cables together

90° DVI-I Female to DVI-I Female Coupler

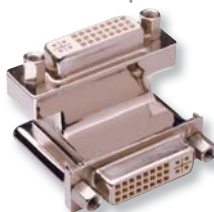

90° DVI-I Female to DVI-I Female Coupler 60516

90° DVI-I Female to DVI-I Male Adapter

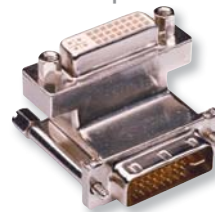

90° DVI-I Female to DVI-I Male 60514

90° Up DVI-I Male to DVI-I Female Adapter



90° Up DVI-I Male to DVI-I Female 41253

90° Down DVI-I Female to DVI-I Female Coupler



90° Down DVI-I Female to DVI-I Female Coupler 41251

90° Down DVI-I Male to DVI-I Female Adapter



90° Down DVI-I Male to DVI-I Female 41252

HDMI Adapters & Couplers

HDMI Female to
HDMI Male CEC Less



HDMI Female to
HDMI Female



NEW



HDMI Male to
Female 360°

Mini HDMI Female to
HDMI Male



Micro HDMI Female to
HDMI Male



HDMI Female to
DVI-D Male



90° HDMI Adapters

- Allows easier access to awkwardly placed HDMI ports
- Gold plated connectors

90° Up
HDMI Male to
HDMI Female



90° Down
HDMI Male to
HDMI Female



90° Right HDMI Male to
HDMI Female



90° Left HDMI Male to
HDMI Female



NEW

HDMI Female to Male Coupler CEC Less	41232
HDMI Female to Female Coupler	41656
HDMI Male to Female 360° Adapter	41096
Mini HDMI Female to HDMI Male Adapter	41236
Micro HDMI Female to HDMI Male Adapter	41083
HDMI Female to DVI-D Male Adapter	41228

90° Up HDMI Male to HDMI Female Adapter	41086
90° Right HDMI Male to HDMI Female Adapter	41657
90° Left HDMI Male to HDMI Female Adapter	41658
90° Down HDMI Male to HDMI Female Adapter	41085

CROMO HDMI Adapters & Couplers

Stylish and robust range of adapters with all metal housings and gold plated connectors

- Allows easier access to awkwardly placed HDMI ports
- Gold plated connectors

CROMO 90° Down
HDMI Male to
HDMI Female



CROMO 90° Up
HDMI Male to
HDMI Female



CROMO 90° Right
HDMI Male to HDMI
Female



CROMO 90° Down HDMI Adapter 41505

CROMO 90° Up HDMI Adapter 41506

CROMO 90° Right HDMI Adapter 41507

CROMO 90° Left HDMI
Male to HDMI Female



CROMO HDMI
Female to Female
Coupler



CROMO HDMI
Female to Micro
HDMI Male Adapter



CROMO 90° Left HDMI Adapter 41508

CROMO HDMI Coupler 41509

CROMO HDMI to Micro HDMI Adapter 41510

VGA ADAPTERS, SCART & RF CABLES

VGA Adapters & Couplers

VGA Couplers



VGA Male to VGA Male Coupler 70092
VGA Female to VGA Female Coupler 70094

VGA Male to VGA Female Adapter



VGA Male to VGA Female Adapter 70093

VGA Female to VGA Female Coupler



VGA Female to VGA Female Coupler 71242

VGA Male to VGA Male Coupler



VGA Male to VGA Male Coupler 71240

VGA Male to VGA Female Coupler



VGA male to VGA female Coupler 71241

VGA Male to DVI-A Female Adapter



VGA Male to DVI-A Female Adapter 71245

90° VGA Female to VGA Male 'Up' Adapter

- Ideal for use with a wall plate
- Cable direction is 'up' when fitted to a VGA port (depending on the orientation of the port)



90° VGA Female to Male 'Up' Adapter 70318

90° VGA Female to VGA Male 'Down' Adapter

- Ideal for use with a wall plate
- Cable direction is 'down' when fitted to a VGA port (depending on the orientation of the port)



90° VGA Female to Male 'Down' Adapter 70387

Premium SCART Adapter

- Connects Composite or S-video and stereo audio to SCART
- Gold plated connectors



Premium SCART Adapter 37568

Visit our website

WEBSITE

for the latest prices & special offers

SCART Lead

High quality cable with gold plated connectors

SCART Male to SCART Male, All pins wired

Length	Part No.
2m	35561
3m	35562
5m	35563
10m	35564

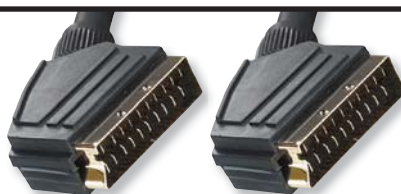

TV UHF Coax RF Cable

Ideal for use with Freeview boxes and TVs

Male to Male Coax Cable

Length	Part No.
1m	35615
2m	35616
3m	35617
5m	35618



Premium Aerial, Satellite & Cable TV Cables

These high quality cables can replace and upgrade the low cost cables used in most TV installations. Robust, gold plated connectors and 75 Ohm double screened OFC coaxial copper conductors provide optimal signal transfer and reduced interference for a more clear, consistent image.

Premium Coax Cable

Premium Male to Male Coax Cable	Length	Part No.
	0.5m	37770
	1m	37771
	2m	37772
	3m	37773
	5m	37774
	10m	37775
	15m	37776
	20m	37777

Premium Coax Extension Cable

Premium Male to Female Coax Extension Cable	Length	Part No.
	0.5m	37780
	1m	37781
	2m	37782
	3m	37783
	5m	37784
	10m	37785
	15m	37786
	20m	37787

Premium F-Type Cable

Premium Male to Male F-Type Satellite Aerial Cable	Length	Part No.
	0.5m	37790
	1m	37791
	2m	37792
	3m	37793
	5m	37794
	10m	37795
	15m	37996
	20m	37797

CABLE GURU

FIND THE CABLE YOU NEED



Try it now on our **WEBSITE**

Composite Video + Stereo Audio Cable

3 x Phono Male to 3 x Phono Male, Moulded, Gold Plated Connectors

	Length	Part No.
	1m	35690
	2m	35691
	3m	35692
	5m	35693
	7.5m	35694
	10m	35544
	15m	35696
	20m	35546

White AV Cables

Component Video (RGB) / Composite Video & Stereo Audio Cable

3 x Phono Male to 3 x Phono Male, Moulded, Gold Plated Connectors

	Length	Part No.
	1m	37630

Phono Cables

Audio connection cable, ideal for use with Hi-Fi and home cinema equipment etc.

2 x Phono Male to 2 x Phono Male,
Moulded, Gold Plated Connectors

Length	Part No.
1m	35660
2m	35661
3m	35662
5m	35663
7.5m	35477
10m	35474
15m	35665
20m	35666

NEW

2 x Phono Male to 2 x Phono Female Extension
Cable, Moulded, Gold Plated Connectors

Length	Part No.
1m	35670
2m	35671
3m	35672
5m	35673
10m	35674
15m	35675
20m	35676

NEW

3.5mm Stereo Jack Male to 2 x Phono Female,
Moulded, Gold Plated Connectors

Length	Part No.
0.25m	35488

3.5mm Stereo Jack Male to 2 x Phono Male,
Moulded, Gold Plated Connectors

Length	Part No.
1m	35490
2m	35681
3m	35682
5m	35683
7.5m	35684
10m	35685
15m	35686
20m	35496

NEW

3.5mm Stereo Socket to 2 x Phono Male,
Moulded, Gold Plated Connectors

Length	Part No.
0.25m	35487

**BEST
SELLER**

Audio Cables

3.5mm Stereo Jack Male to
3.5mm Stereo Jack Male, Moulded
Gold Plated Connectors

Length	Part No.
0.25m	35450
1m	35641
2m	35452
3m	35643
5m	35644
7.5m	35456
10m	35646
15m	35647
20m	35648

**BEST
SELLER**

Audio Extension Cables

3.5mm Stereo Jack Male to
3.5mm Stereo Socket Female,
Moulded, Gold Plated Connectors

Length	Part No.
0.25m	35650
1m	35651
2m	35652
3m	35653
5m	35654
7.5m	35466
10m	35465

NEW

Retractable Audio Cable

Handy, portable stereo audio lead



3.5mm Stereo Jack Male to 3.5mm Stereo Jack Male Cable

Length	Part No.
1.1m	35445

CROMO Audio Cables

- High quality, ultra flexible cable construction
- Gold plated connectors

CROMO 3.5mm Stereo Jack Male to 3.5mm Stereo Jack Male

Length	Part No.
0.5m	35300
1m	35301
2m	35302
3m	35303
5m	35304



CROMO 3.5mm Stereo Jack Male to 3.5mm Stereo Jack Female Extension Cable

Length	Part No.
0.5m	35290
1m	35291
2m	35292
3m	35293
5m	35294



TOSLINK Cables

TOSLINK Male to TOSLINK Male
Protective shell, outer diameter 2.2mm
Moulded connectors fitted on both ends

Length	Part No.
0.5m	35210
1m	35211
2m	35212
5m	35214
10m	35215
20m	35217



**BEST
SELLER**

TOSLINK to Mini Optical Cables

TOSLINK Male to Mini Optical Male
Protective shell, outer diameter 4mm
Moulded connectors fitted on both ends

Length	Part No.
0.5m	35220
1m	35221
2m	35222
5m	35224



Gold TOSLINK SPDIF Digital Optical Cables

High quality optical digital interconnect

- Designed for home theatre and AV installations
- High grade fibre optic core with bronze ferrule for the clearest, most accurate digital audio transmission
- Ultra flexible triple layer protective jacket for advanced protection
- Sturdy, gold plated metal connector body for added strength

Gold TOSLINK Male to Male SPDIF Digital Optical Cable

Length	Part No.
0.5m	37880
1m	37881
2m	37882
3m	37883
5m	37884
7.5m	37885
10m	37886
15m	37887
20m	37888
30m	37889
40m	37890
50m	37891



Component Video & Stereo Audio Cable for Nintendo Wii

- Premium shielded cable design
- Ferrite core for reduced electromagnetic interference
- Length: 1.8m



PORTABLE DEVICE CABLES & ADAPTERS

MHL to HDMI Active Adapters

- Show audio & video from your MHL equipped smartphone or digital camera on an HDTV
- USB Micro-B charging port
- Cable length: 15cm



MHL to HDMI Active Adapter, 15cm 41561
MHL 3.0 to 4K HDMI Active Adapter, 15cm 41563

SlimPort to HDMI Active Adapter

- Show audio & video from a mobile device on a HDTV
- SlimPort/MyDP to HDMI Female
- USB 2.0 Micro B charging port
- Length: 15cm



SlimPort to HDMI Active Adapter, 15cm 41571

iPhone to PC Audio Adapter Cable

- Use your 3.5mm iPhone headset and microphone with your PC
- Works with iPhone & iPod headsets



iPhone to PC Audio Cable, 12cm 35522

Microphone Cable for iPhone

- Add a microphone to your iPhone headphones
- Volume control key and Answer/Reject button
- Compatible with iPhone and iPad



iPhone Microphone Cable, 85cm 35521

Headset to PC Cable

- Allows you to connect your headset to a PC
- 3.5mm Stereo Socket Female to 2 x 3.5mm Stereo Jack Male



Headset to PC Cable, 6cm 35508

Headset to Smartphone Cable

- Allows you to connect your headset to a smartphone
- Not for use with Apple headsets



Headset to Smartphone Cable, 6cm 35509

Earphone & Mic Headset to iPhone, iPod & HTC Cable

- Connect your headset to an iPhone, iPod or HTC device



Headset to iPhone, iPod & HTC Cable, 6cm 35523

Headphone Splitter Cable with Volume Control

- 3.5mm Stereo Jack Male to 2 x 3.5mm Stereo Female



3.5mm Stereo Jack Headphone Splitter Cable, 27cm 35517

Flat Reversible USB to Lightning Coloured Cables

Available in a range of vibrant colours

- Reversible USB Type A connector fits in to USB ports either way around
- Flat TPE cable construction for increased flexibility, portability and durability
- Apple MFi Licensed product, Made for iPod, iPhone & iPad
- Length: 1m



Flat Reversible USB to Lightning Cables

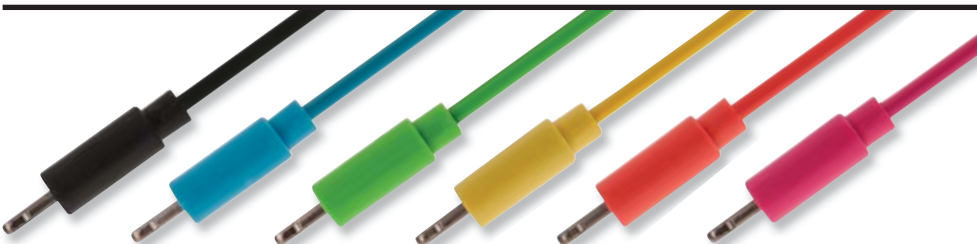

Colour	Part No.
Black	31390
Blue	31391
Green	31392
Yellow	31393
Orange	31394
Pink	31395

USB to Lightning Cable

Charge, Sync or Transfer Data

- Easily transfer and exchange music, video, pictures and more between your PC or Mac and your iPhone, iPad or iPod
- Ideal for use with iTunes
- Apple certified for use with iPhones, iPods and iPads with a Lightning interface



USB to Lightning Cable

Length

Part No.

0.5m	31349
1m	31350
2m	31352
3m	31353

Lightning Cable Protector Kit

The LINDY Lightning Cable Protector Kit provides a solution to common problems with Lightning cables, including damaged cable, broken connections, and cable pulling away from the connector. The protector provides a tough and rugged shell for your existing cable by using a two piece design with a silicone centre. The kit comes with a USB Type A and Lightning protector, this provides maximum protection for the cable as both ends are fully protected.

- Protect your Lightning cables from deterioration
- Quick and Easy to Install
- Supplied with Both USB Type A and Lightning protectors

Lightning Cable Protector Kit

Colour Part No.

Pink	31387
Green	31388
Blue	31389
White	31385



NEW

1m CROMO USB to Lightning Cable

- Apple certified for use with iPhones, iPods and iPads with a Lightning interface
- Ultra slim design



1m CROMO USB to Lightning Cable

41575

1m USB to Lightning & Micro-B Sync / Charger Combo Cable

- Charge and sync your Apple or Micro-B device using one handy cable
- Apple certified for use with iPhones, iPods and iPads with a Lightning interface



1m USB to Lightning / Micro-B Combo Cable

31345

Retractable USB to Lightning Cable

- Extends up to 1m
- Apple certified for use with iPhones, iPods and iPads with a Lightning interface



1m Retractable USB to Lightning Cable

31620

1m USB Dock Connector Cable for iPhone, iPad & iPod

- Compatible with: iPod Classic, iPod Nano iPod touch, iPhone & iPad
- Length: 1m (approx)



1m USB Dock Connector Cable

31351

USB Charging / Sync Adapter Cable for iPad



- Charge your iPad from your PC or Mac
- Switch for moving from Charge to Sync mode
- Length: 1.2m

USB Charging / Sync Adapter Cable for iPad, 1.2m 73335

Guitar Cable for iPhone & iPad

- Designed for use with guitar recording and amp simulation apps
- 3.5mm Stereo Jack Male to 3.5mm & 6.3mm Stereo Socket Female
- Length: 0.5m



Guitar Cable for iPhone & iPad, 0.5m 35519

USB Micro-B to Lightning Adapter

- Use your existing Micro-B USB cables and power supplies with Apple Lightning equipped devices



USB Micro-B to Lightning Adapter 41076

USB Micro-B 5 to 11 pin Adapter

- Allows you to use a standard HDMI to USB-Micro 5 pin adapter with Galaxy S3, S4, Note 2 and other USB Micro-B 11 pin equipped devices



USB Micro-B 5 to 11 pin Adapter 41570

Audio Splitter Cable



3.5mm Stereo Jack Male to 2 x 3.5mm Stereo Socket Female, Moulded, 0.6m 35627

CABLE GURU

FIND THE CABLE YOU NEED

Try it now on our

WEBSITE



Stereo Jack Adapters

BEST SELLER



3.5mm Stereo Male to 6.3mm Stereo Female



Right Angled 3.5mm Stereo Male to 3.5mm Stereo Female



6.3mm Stereo Male to 3.5mm Stereo Female



Right Angled 6.3mm Stereo Male to 6.3mm Stereo Female



Right Angled 6.3mm Stereo Male to 6.3mm Stereo Female



3.5mm Stereo Male to 2 x 3.5mm Stereo Female



3.5mm Stereo Female to Female Coupler

3.5mm Stereo Female to 3.5mm Stereo Female	35535
3.5mm Stereo Male to 6.3mm Stereo Female	35531
3.5mm Stereo Male to 2 x 3.5mm Stereo Female	35530
6.3mm Stereo Male to 3.5mm Stereo Female	35620
Right Angled 6.3mm Stereo Male to 3.5mm Stereo Female	35605
Right Angled 6.3mm Stereo Male to 6.3mm Stereo Female	35606
Right Angled 3.5mm Stereo Male to 3.5mm Stereo Female	35505

AV Adapter Cable

- Adapter cable for use with AV cable in combination with a PC sound card and graphics card with video output
- 3 x Phono Female to 1 x 3.5mm Stereo Jack Male & 1 x Phono Male
- Gold plated connectors



	Length	Part No.
3x Phono Female to 3.5mm Stereo Jack Male & Phono Male	0.2m	35538

360 Degree Right Angled TOSLINK Adapter

- Rotate and swivel your cable to almost any angle



360 Degree Right Angled TOSLINK Adapter	70421
---	-------

S-Video Coupler

- 4 Pin Female to 4 Pin Female
- Can be used as a coupler or gender changer
- Nickel plated connectors



S-Video Coupler	37648
-----------------	-------

Mini Optical Coupler

- Connects two Mini Optical cables together



Mini Optical Coupler	70415
----------------------	-------

13mm Ferrite Core

- Removes unwanted noise and hum from audio connections
- Clip on design



13mm Ferrite Core	70170
-------------------	-------

Camcorder AV Adapter Cable

This adapter cable can be used with Notebooks, Camcorders and other devices which feature a 4 segment 3.5mm combined video & stereo audio socket.

BEST SELLER

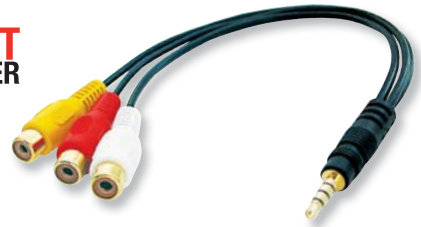

	Length	Part No.
4 Segment 3.5mm Stereo Jack Male to 3 x Phono Female	0.25m	35539

Phono Adapters & Couplers



6.3mm Mono Male to Phono Female



6.3mm Stereo Male to 2 x Phono Female



3.5mm Stereo Male to 2 x Phono Female



BNC Female to Phono Male



Right Angled Phono Adapter (Pack of 2, Red & Black)



BNC Male to Phono Female

3.5mm Stereo Male to 2 x Phono Female	35511
6.3mm Stereo Male to 2 x Phono Female	35512
6.3mm Mono Male to Phono Female	35514
BNC Female to Phono Male, Pack of 3	35536
BNC Male to Phono Female, Pack of 3	35537
Phono Female to Female Coupler	37574
Right Angled Phono Adapter (Pack of 2, Red & Black)	35587

Guitar Leads

- Heavy duty metal jack plugs with gold plated inner conductor tips
- Professional grade 6mm cable with Oxygen Free Copper conductor and flexible steel spring cable relief

Straight Jack to Straight Jack

Guitar Lead ¼" Straight Jack to ¼" Straight Jack, Black

Length	Part No.
0.5m	6020
1m	6021
2m	6022
3m	6023
6m	6026
10m	6029



Straight Jack to Right Angled Jack

Guitar Lead, ¼" Straight Jack to ¼" Right Angled Jack, Black

Length	Part No.
0.5m	6030
1m	6031
2m	6032
3m	6033
6m	6036
10m	6039



Guitar Lead, ¼" Straight Jack to ¼" Straight Jack, Red

Length	Part No.
0.5m	6010
1m	6011
2m	6012
3m	6013
6m	6016
10m	6019

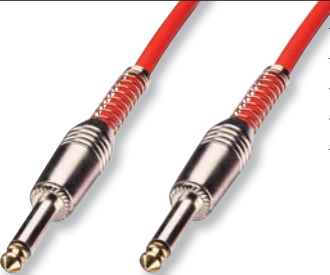

Guitar Lead, ¼" Straight Jack to ¼" Right Angled Jack, Red

Length	Part No.
0.5m	6000
1m	6001
2m	6002
3m	6003
6m	6006
10m	6009



**BEST
SELLER**

XLR Cable

- For use with microphones and other devices with XLR connections
- Heavy duty metal jack plugs with rubber strain relief
- Professional grade, flexible 7mm diameter, balanced cable with twin Oxygen Free Copper conductors

XLR Cable, Male to Female, Black

Length	Part No.
1.5m	6052
3m	6053
6m	6056
10m	6059



XLR Cable, Male to Female, Red

Length	Part No.
3m	6043
6m	6046
10m	6049



MIDI Cable

5 Pin DIN Male to 5 Pin DIN Male MIDI Cable

Length	Part No.
2m	31511



CABLE GURU

FIND THE CABLE YOU NEED

Try it now on our

WEBSITE



Superior Speaker Cable, 100m Reel

- Highly durable, transparent PVC insulated twin speaker cable with oxygen free copper for a superior, crystal clear sound
- Supplied on a 100m reel



Superior Speaker Cable, 2 x 1.5mm, 100m Reel

35498

Superior Speaker Cable, 2 x 2.5mm, 100m Reel

35499

High Flex Speaker Cable, 100m Reel

- Highly flexible 'rubberized' speaker cable
- Black cable with red and black cores for polarity identification
- Can withstand sub zero temperatures
- Supplied on a 100m reel



High Flex Speaker Cable, 100m Reel

35391

Banana Plugs & Spade Connectors

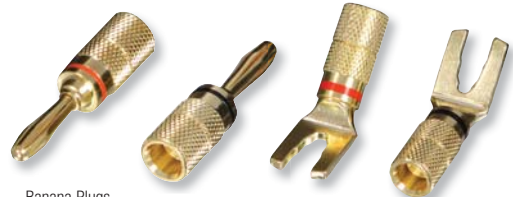

Banana Plugs

Spade Connectors

Banana Plugs, Pack of 2

71140

Banana Plugs, Pack of 10

71141

Spade Connectors, Pack of 2

71143

Spade Connectors, Pack of 10

71144

Expandable Braided Sleeving, 10m

- Lightweight, self-fitting, flexible sleeving that provides protection for bundles of cables up to a diameter of 38mm
- Length: 10m



Expandable Braided Sleeving, 10m

40287

Gold Phono Cable, 100m Reel

- 75 Ohm Pure Crystal Oxygen Free Copper (PC-OFC) coaxial conductor
- OFC braid with Aluminium Mylar foil wrap provides improved shielding
- Supplied on a 100m reel



Gold Phono Cable, 100m Reel

37573

Compression F-Type Plugs

- Pack of 10 compression F-Type plugs
- For use with PF100 Co-Axial cable
- Minimum cable diameter: 6.3mm



Compression F-Type Plugs, Pack of 10

43056

**FOR TOOLS &
TOOL KITS**
SEE PAGES
148-155



3.5mm Stereo Jack Male with Solder Contacts

- 3 solder contact points
- Maximum cable diameter: 5mm



3.5mm Stereo Jack Male with Solder Contacts

61050

Make your own HDMI cables!

Use our DIY HDMI Cable Tool Kit in conjunction with the LINDY HDMI Connectors and bulk HDMI Cable to create HDMI cables to lengths of up to 10m with 1080p and 12 bit colour depth support.

DIY HDMI Cable Kit

- Crimp Tool
- HDMI Cable Tester with 9V battery
- 10 HDMI Connectors with Wire Guide
- 5 Wire Compression Guides
- Supplied in a plastic carry case



DIY HDMI Cable Kit

43063

100m Bulk HDMI Cable

- Raw unterminated HDMI Cable
- Full 19-wire HDMI 24 AWG Copper Cable
- Triple shielded
- Supplied on a 100m reel



HDMI Connector

- HDMI type A connector with cable guide
- High gloss silver metal finish



100m Bulk HDMI Cable

43068

HDMI Connector

43066

High Quality Tri-Coax Bulk VGA Cable, 100m Reel

- 3 x 75Ω 28 AWG individually shielded coaxial cores (RGB) and 8 x 24 AWG cores, double overall shield
- Supplied on a 100m reel
- Colour: Blue

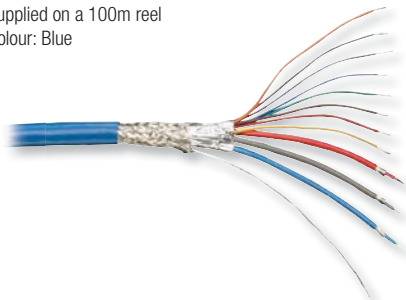

VGA Snap-in Block

- Designed for use with Modular AV Faceplates (page 91), Gold VGA Cables and LINDY Holding Posts & Nuts (see below)
- See our website for full details of how to assemble a VGA faceplate



High Quality Tri-Coax VGA Cable, 100m Reel

37244

VGA Connector Snap-in Block, Pack of 4

60527

VGA Solder Buckets, 10 pack

- 15 Way Hi-Density Female
- Can be combined with Part No's 60527 and 66025/6 to build your own VGA wall plate



VGA Holding Posts & Nuts

- Available in packs of 10 or 50
- See our website for full details on how to assemble the LINDY VGA faceplate



VGA Solder Buckets, Pack of 10

60297

VGA Holding Posts & Nuts, Pack of 10

66026

VGA Holding Posts & Nuts, Pack of 50

66025

Premium DVI & HDMI Faceplate

Stylish brushed steel finish

- Right angled connector for easy cable routing
- HDMI connector feature a holding post

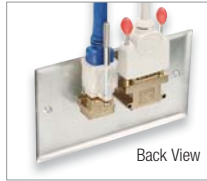

Premium DVI-I & HDMI Faceplate

60525

Pattress Boxes



Single Pattress Box



Double Pattress Box

Pattress Box, Single, depth 32mm, 1 pack	73088
Pattress Box, Single, depth 32mm, 10 pack	73188
Pattress Box, Single, depth 44mm, 1 pack	73114
Pattress Box, Single, depth 44mm, 10 pack	73187
Pattress Box, Double, depth 32mm, 1 pack	73089
Pattress Box, Double, depth 32mm, 10 pack	73316
Pattress Box, Double, depth 44mm, 1 pack	73115
Pattress Box, Double, depth 44mm, 5 pack	73315

VGA & Audio Faceplates

- Faceplate front connectors:
 - 15 Way VGA Female
 - 3.5mm Stereo Audio Socket
- 60211 and 60212 feature rear screw terminals
- 60225 features right angled VGA Female and 3.5mm stereo Female rear connections



VGA & Audio Faceplate, Screw Terminals Rear, Plastic	60212
VGA & Audio Faceplate, Screw Terminals Rear, Metal	60211
VGA & Audio Faceplate, Right Angled Rear, Plastic	60225

Multimedia Faceplates

- Suitable for VGA, audio installations and whiteboards
- Faceplate front connectors:
 - 15 Way VGA Female
 - 3 x Phono Female
 - USB Type A Female
 - 3.5mm Stereo Audio Socket
- Rear connectors: screw terminals



Multimedia Faceplate, Plastic	60221
Multimedia Faceplate, Metal	60222

AV Faceplate with Built-in Cables

Integrated solution for AV installers

- Built-in cables:
 - 2 x VGA Male
 - 3 x Phono
 - 3.5mm Stereo Audio Jack
 - 3m USB cable for connecting to a whiteboard
- Supplied on a surface mount back box
- Double Faceplate assembly which provides the following computer connections:
 - 2 x VGA Female
 - 3 x Phono Female (red, white & yellow)
 - USB Type B Female
 - 3.5mm Stereo Audio Socket



	Length	Part No.
AV Faceplate with Built-in Cables	5m	60255
(USB cable length: 3m)	10m	60256
	15m	60257
	20m	60258

Multi AV Faceplate, Plastic

- Installation ready Multi AV faceplate with 10cm trailing leads
- Single gang, plastic wall plate design – fits a standard mains back box
- Connectors: HDMI, VGA, USB, Audio
- Faceplate size: 86mm x 86mm

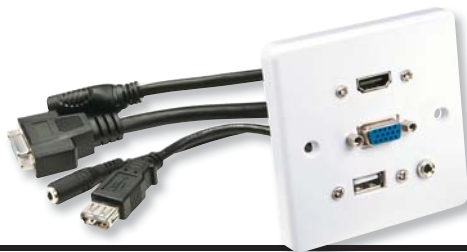

Multi AV Faceplate, Plastic

60220

3-in-1 KVM Cables

For general keyboard, monitor & mouse extension



	Length	Part No.
2 x PS/2 Female/Male & 15 Way VGA Female/Male, Moulded	2m	33732
	3m	33733

For KVM switches with Female VGA & PS/2 connectors



	Length	Part No.
2 x PS/2 Male & 15 Way VGA Male/Male, Moulded	2m	33712
	5m	33714

**BEST
SELLER**

For KVM switches with Male VGA & Female PS/2 connectors



	Length	Part No.
2 x PS/2 Male/Male & 15 Way VGA Female/Male, Moulded	2m	33752
	3m	33753
	5m	33754

For KVM switches and PCs with VGA & USB connectors



	Length	Part No.
VGA Male to VGA Male & USB Type A Male, Moulded	1m	33770
	2m	33771
	3m	33772

For LINDY P16/PXT & U-Series KVM Switches (PS/2)



	Length	Part No.
2 x PS/2 Male/Male & 15 Way VGA Male/Male, Moulded	1m	32510
	3m	32507
	5m	32508

For LINDY U-Series KVM Switches (USB)



	Length	Part No.
15 Way VGA Male/Male & USB Type A Male, Moulded	2m	33531
	3m	33532
	5m	33533
'U' Series USB to PS/2 Adapter	-	70510

For LINDY 8 & 16 Port PS/2 KVM Combo Switches

	Length	Part No.
VGA Male to VGA Male & USB Type A Male & 2 x PS/2 Male	2m	33774



RS-232 Serial Cables

25 Way D Male to 25 Way D Female, Moulded
All pins connected (straight through)

Length	Part No.
2m	31374
10m	31380



9 Way D Male to 9 Way D Female, Moulded
All pins connected (straight through)

Length	Part No.
2m	31519
3m	31520
5m	31525
10m	31522



**BEST
SELLER**

Serial Null Modem Cables

9 WAY D Male to 9 Way D Female, Moulded	Length	Part No.
	2m	31573



8 Pin Mini DIN Male to 9 Way D Female, Moulded	Length	Part No.
	2m	30249

- Mac to PC (for legacy / older Macs)



8 Pin Mini DIN Male to 8 Pin Mini DIN Male, Moulded	Length	Part No.
	2m	31531
	5m	31534

- Mac to PC (for legacy / older Macs)



CABLE GURU

FIND THE CABLE YOU NEED

Try it now on our

WEBSITE



Serial Back Plate Adapters



10 Way IDC Female to 9 Way D Male 1:1 wiring	33135
10 Way IDC Female to 9 Way D Male x wiring	33136

EPP/ECP Parallel Printer Cable

25 Way D Male to
36 Way Centronics Male, Moulded

Length	Part No.
2m	30304



Parallel Printer Cables

25 Way D Male to
36 Way Centronics Male, Moulded

Length	Part No.
2m	31304
3m	31306
5m	31308

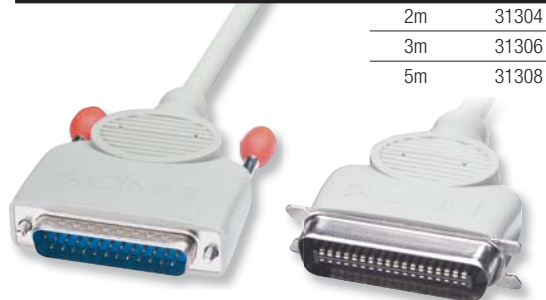

PS/2, SERIAL CABLES & GENDER CHANGERS

PC Serial Printer Cable

9 Way D Female to 25 Way D Male, Moulded	Length	Part No.
	2m	30293



Apple Serial Printer Cables

Standard LocalTalk Printer Cable

8 Pin Mini DIN Male to 8 Pin Mini DIN Male, Moulded	Length	Part No.
	2m	31531
	5m	31534



PS/2 Keyboard or Mouse Cable

PS/2 Male to Male, Moulded	Length	Part No.
	3m	33267



DIY Printer Cable

8 Pin Mini DIN Male (Moulded) to open end	Length	Part No.
	2m	38008

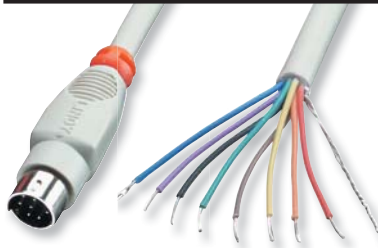

PS/2 Keyboard or Mouse Extension Cable

PS/2 Male to Female, Moulded	Length	Part No.
	2m	33461
	5m	33463
	15m	33466



Mac Serial Port Extension Cable

8 Pin Mini DIN Male to 8 Pin Mini DIN Female, Moulded	Length	Part No.
	5m	33051



PS/2 'Y'-Adapter Cable

PS/2 Male to 2 x PS/2 Female, Moulded	Length	Part No.
	0.1m	30365



Gender Changers & Port Savers

25 Way D Male to Male



Connector A	Connector B	Part No.
9 Way D Male	9 Way D Male	70071
9 Way D Female	9 Way D Female	70072
15 Way HD Male	15 Way HD Male	70092
15 Way HD Male	15 Way HD Female	70093
15 Way HD Female	15 Way HD Female	70094

Visit our website
WEBSITE
 for the latest prices
 & special offers

SATA Cable

- Available with straight and right angled plugs

SATA 7 Pin to SATA 7 Pin	Length	Part No.
	0.2m	33369
	0.5m	33370
	0.7m	33371
	1m	33372

**BEST
SELLER**

SATA 7 Pin to Right Angled SATA 7 Pin	Length	Part No.
	0.2m	33441
	0.5m	33443

SATA Extension Cable

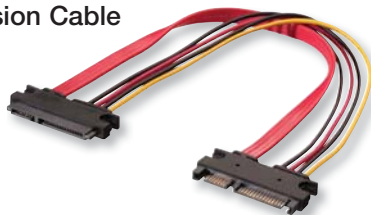

SATA 22 Pin Male to SATA 22 Pin Female	Length	Part No.
	0.3m	33291

SATA Data & Power Cables

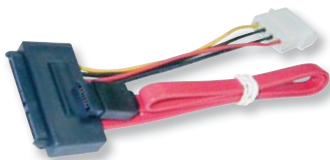

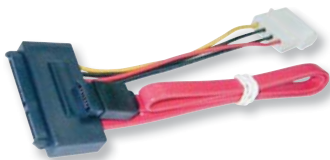
SATA 7 Pin Female Data + LP4 Male Power to SATA 22 Pin Female SFF-8482	Length	Part No.
	0.3m	33364
	0.5m	33365
	0.7m	33366

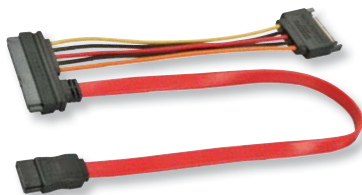

SATA 7 Pin Data + SATA 15 Pin Power to SATA 22 Pin SFF-8482	Length	Part No.
	0.3m	33383
	0.5m	33384

Latching SATA Cable

- Latch type SATA plugs which lock into place when used with compatible latching controller or device ports
- Can also be used with standard non-latching SATA ports
- Available with straight, right angled and low profile plugs

SATA 7 Pin to SATA 7 Pin, Latching	Length	Part No.
	0.2m	33449
	0.5m	33450
	0.7m	33451
	1m	33452

SATA 7 Pin to Right Angled SATA 7 Pin, Latching	Length	Part No.
	0.5m	33456
	0.7m	33457
	1m	33458

SATA 7 Pin to SATA 7 Pin, Low Profile, Latching	Length	Part No.
	0.2m	33559
	0.5m	33560
	1m	33562

Slimline SATA Cable

SATA 7 Pin Data + LP4 Male Power to SATA 7 Pin Female Data+ 6 Pin Female Slimline SATA Power

SATA 7 Pin Data + LP4 Male Power to SATA 7 Pin Female Data+ 6 Pin Female Slimline SATA Power	Length	Part No.
	0.3m	33607
	0.5m	33608
	1m	33609

SATA Power Adapter Cable

- 4 Way 3.5" Male to 15 Pin SATA Power Female

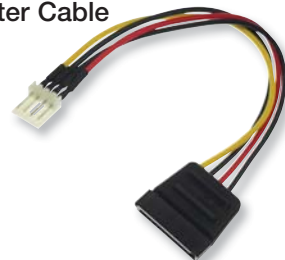

SATA Power Adapter Cable	Length	Part No.
	0.15m	33297

eSATAp Cables

eSATAp to eSATA, 5V & 12V

- Connects an eSATAp device to an eSATA controller
- Can connect to 2.5" or 3.5" drives as it provides both 5V and 12V DC power

eSATAp to eSATAp (5V & 12V)	Length	Part No.
	1m	33683
	2m	33684

eSATAp & USB Cables

eSATAp to eSATA & USB Mini-B Male, 5V only

- Connects an external eSATA device to an eSATAp controller
- USB connection can power the external device and can also transfer data

eSATAp to eSATA 7 Pin & USB Mini-B	Length	Part No.
	1m	33690

Micro SATA Extension Cable

- For use with 1.8" form factor hard drives and solid state drives (SSD)

Micro SATA (Data & Power) Male to Female	Length	Part No.
	0.5m	33672

SATA Male to Male Gender Changer

- Can be used as a gender changer or port extender



SATA Male to Male Gender Changer 33483

SATA 90 Degree Male to Female, L-Adapter

- Latched 90° SATA 7 Pin Male, SATA 7 Pin Female
- Can be used with standard non-latching ports



SATA 90 Degree Down Male to Female, L-Adapter 33484

2.5" SATA Adapter for mSATA SSD

- Install an mSATA SSD into a 2.5" SATA adapter frame
- Fits in to standard 2.5" enclosures



2.5" SATA Adapter for mSATA SSD 20972

2.5" Latching SATA Adapter for mSATA SSD

- Latching mSATA connector
- Install an mSATA SSD in a 2.5" SATA adapter into a 9.5mm or 7mm frame

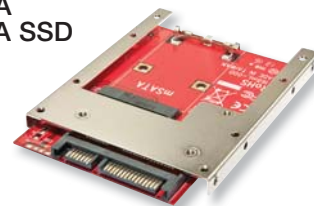

2.5" Latching SATA Adapter for mSATA SSD 20959

FOR DRIVE ENCLOSURES
SEE PAGES
142-143



eSATAp to eSATA, USB Mini-B & 5V DC Mini Jack, 5V only

eSATAp to eSATA 7 Pin, USB Mini-B & 1.3mm 5V DC Power Jack	Length	Part No.
	0.5m	33654
	1m	33655

Micro SATA to SATA Data & Power Adapters

Part. No 33500

- Allows a Micro SATA equipped hard disk equipped to be used in a SATA backplane or drive housing
- Micro SATA 16 Pin Female (Data & Power) to SATA 22 Pin Male (Data & Power)
- Two versions: 33500 supports 5V DC devices only; 33502 supports 3.3V or 5V DC



Part. No 33502

Micro SATA to SATA Data & Power 5V only	33500
Micro SATA to SATA Data & Power 3.3V & 5V	33502

Mini SAS Internal Cables

Mini SAS SFF-8087 to SFF-8087

SFF-8087 to SFF-8087	Length	Part No.
	0.5m	33495
	1m	33496



SAS / SATA Multilane SFF-8484 to Mini SAS SFF-8087

SFF-8484 to SFF-8087	Length	Part No.
	1m	33536



Mini SAS SFF-8087 (Host) to 4 x SATA (Target)

- Allows you to connect a Mini SAS controller to 4 SATA hard drives
- Features latching SATA connectors for a secure installation

SFF-8087 (Host) to 4 x 7 Way Latching SATA Male (Target)	Length	Part No.
	1m	33506

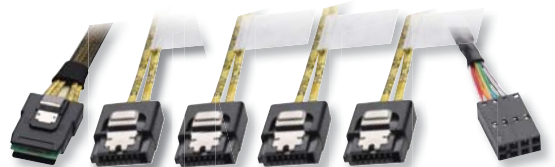

SATA / SAS Internal Cables

2 x SATA (Host) to SAS SFF-8482 + LP4 Power (Target)

- Latching SATA connectors
- Supports primary and secondary data channels

2 x 7 Way Latching SATA to SAS SFF-8482 + LP4 Power Male	Length	Part No.
	1m	33541



SAS / SATA Multilane SFF-8484 (Host) to 4 x SATA (Target)

- Connects an SFF-8484 host controller to 4 SATA hard drives
- Available with latching SATA connectors for a secure installation

SFF-8484 (Host) to 4 x 7 Way SATA (Target)	Length	Part No.
	0.5m	33330
	1m	33331



SATA / SAS Internal Cables

SAS / SATA Multilane SFF-8484 (Host) to 4 x SAS SFF-8482 + LP4 Power (Target)

- Connects an SFF-8484 host controller to 4 SAS / SATA hard drives
- Features LP4 type power supply connectors for drive power

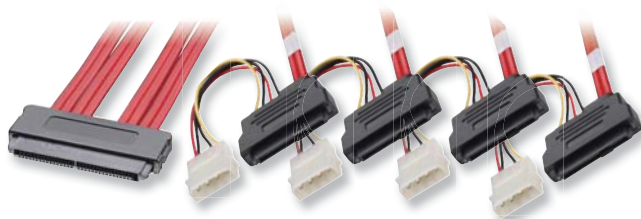

	Length	Part No.
SFF-8484 (Host) to 4 x SAS SFF-8482 + LP4 Power Male (Target)	0.5m	33490
	1m	33491

SAS/SATA Multilane x4 Infiniband External Cables

- For use with SAS/SATA HBAs (Host Board Adapters) and external drive housings
- SAS (Serial Attached SCSI) and SATA 3Gbps compliant
- Full duplex communication; up to 3Gb each direction/channel
- Available with thumbscrew and ejector style connectors

SFF-8470 (Thumbscrew) to SFF-8470 (Thumbscrew)

SFF-8470 Thumbscrew to SFF-8470 Thumbscrew	Length	Part No.
	0.5m	33227
	1m	33226
	2m	33225
	3m	33224



SFF-8470 (Latch Type) to 4 x eSATA

SFF-8470 Latch Type to 4 x eSATA Male	Length	Part No.
	1m	33855
	2m	33856



SFF-8470 (Thumbscrew) to Mini SAS SFF-8088

SFF-8470 Thumbscrew to 26 Way Mini SAS SFF-8088	Length	Part No.
	0.5m	33630
	1m	33631
	2m	33632
	3m	33633



Mini SAS SFF-8088 to Mini SAS SFF-8088

26 Way Mini SAS SFF-8088 to 26 Way Mini SAS SFF-8088	Length	Part No.
	0.5m	33640
	1m	33641
	2m	33642
	3m	33643
	5m	33644

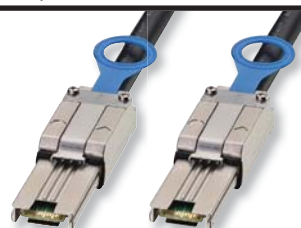

FOR ADD-ON CARDS
SEE PAGES 136-141

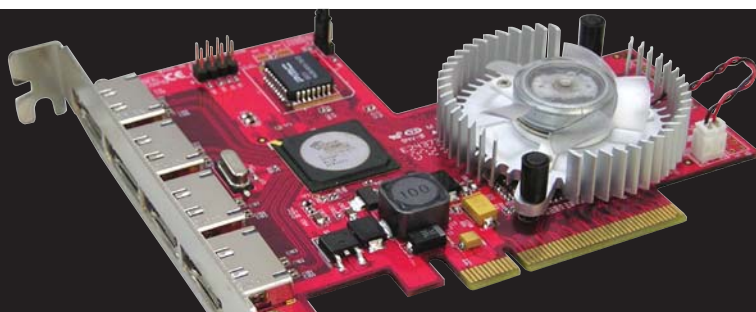

3.5" Ultra ATA 133 HDD Round Cable

- Allows air to circulate better inside the PC, keeping it cooler and helping to extend the life of components

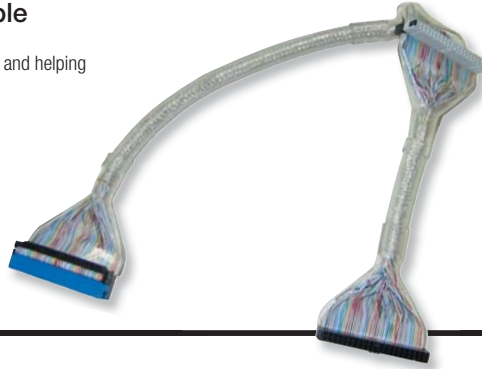

80 Way Ribbon Cable,
3 x 40 Way IDC Female

Length	Part No.
0.45m	33173
0.6m	33174

2.5" IDE HDD Cable

- 44 Way IDC Female to 44 Way IDC Female



2.5" IDE HDD Cable, 0.6m

33032

3.5" to 2.5" IDE Hard Disk Drive Adapter

- 40 Way IDC Male & LP4 Power Male to 44 Way IDC Female

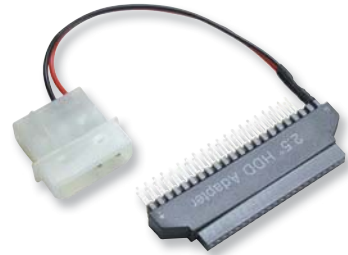

3.5" to 2.5" IDE Hard Disk Drive Adapter

70189

Download the latest
PRICE LIST
from our website



Visit our website
WEBSITE
for the latest prices
& special offers



SCSI-II Cables with Half-Pitch D Connectors

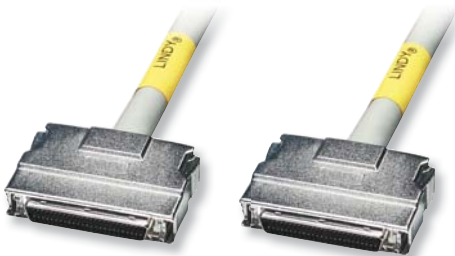

	Length	Part No.
50 Way Half-Pitch D Male (Clip) to	0.9m	30602
50 Way Half-Pitch D Male (Clip), Metal	1.8m	30603

Internal Ultra320 Round Cables

- Allows air to circulate better inside the PC, keeping it cooler and helping to extend the life of components



	Length	Part No.
4 x 68 Way Half-Pitch D Male	0.75m	33177

SCSI-V Cables Screw Type to Screw Type (Ultra160 LVD Compliant)

Very High Density Male to Very High Density Male

68 Way Very High Density Male (Screw) to 68 Way Very High Density Male (Screw), Moulded	Length	Part No.
	1m	30720
	2m	30721



Very High Density Male to Half-Pitch D Male

68 Way Very High Density Male (Screw) to 68 Way Half-Pitch D Male (Screw), Moulded	Length	Part No.
	1m	30732

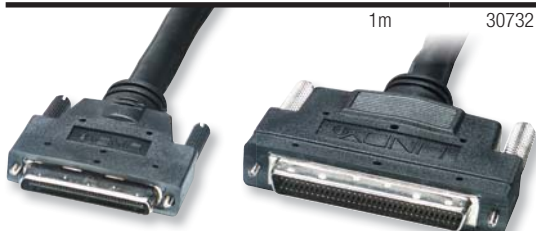

SCSI-II Adapter

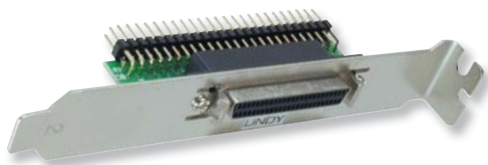

50 Way IDC Male to 50 Way Half-Pitch D Female Internal to External Adapter (w/ Back Plate)	70184
---	-------

Internal Terminator



- Internal LVD/SE Terminator, HPD68 Female Single Ended (SE)/Low Voltage Differential (LVD) autosensing
- Up to 320MBps compatible
- Size: 51 x 16 x 11mm

Internal SCSI Terminator U2W/U3W/Ultra160/Ultra320 LVD/SE	70447
--	-------

Serial Back Plates



10 Way IDC Female to 9 Way D Male 1:1 wiring	33135
10 Way IDC Female to 9 Way D Male x wiring	33136

CABLE GURU

FIND THE CABLE YOU NEED

Try it now on our

WEBSITE

USB Back Plates



Type A USB
Female to Type B
USB Female

Type A USB Female to Male



4 x Type A USB Female to
2 x 10 Way Header

2 x Type A USB Female to
5 Way Header

2 x Type A USB Female to 2 x 5 Way Header Female	33147
4 x Type A USB Female to 2 x 10 Way Header Female	33167
Type A USB Female to Type A USB Male	33123
Type A USB Female to Type B USB Female	31659

SATA & eSATA Back Plates



eSATA to Latching SATA

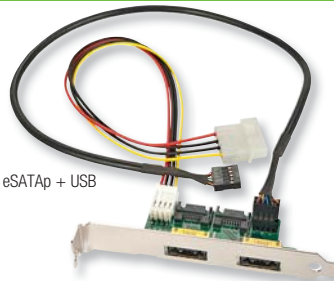

2 x eSATAp + USB



2 x eSATA Female to 2 x SATA



eSATAp + USB



2 x eSATA to 2 x Latching SATA

	Length	Part No.
2 x eSATA Female to 2 x SATA	0.25m	33235
2 x eSATA to 2 x Latching SATA	0.35m	33316
eSATA to Latching SATA	0.35m	33317
eSATAp + USB (5V & 12V support)	-	70534
2 x eSATAp + USB (5V & 12V support)	-	70539

SATA Power Adapter Cables



SATA Power to
3 x SATA Power

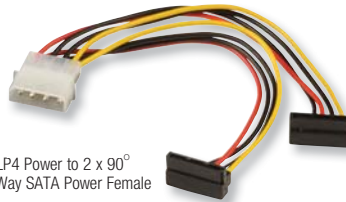

LP4 Power to 2 x 90°
15 Way SATA Power Female



LP4 Power to
SATA & LP4 Power



LP4 Power to 90°
15 Way SATA Power Female



SATA Power Male to
2 x LP4 Power

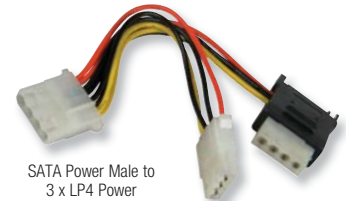

SATA Power Male to
3 x LP4 Power



15 Way SATA Power Male to
3.5" SATA Power Female



15 Way SATA Power Male to
LP4 Power Adapter (non cable)



LP4 to 15 Way
SATA Power



15 Way SATA Power Male to
4 Way ATX Male

	Length	Part No.
15 Way SATA Power Male to 3 x 15 Way SATA Power Female	0.15m	33278
15 Way SATA Power Male to 3.5" Power Female	0.15m	33285
LP4 Power Male to 15 Way SATA Power Female	0.15m	33298
15 Way SATA Power Male to 2 x LP4 Power Female	0.15m	33288
15 Way SATA Power Male to 3 x LP4 Power Female	0.15m	33277
15 Way SATA Power Male to LP4 Power Female Adapter (non cable)	-	70390
LP4 Power Male to 2 x 15 Way SATA Power Female	0.15m	33299
LP4 Power Male to 15 Way SATA Power Female & LP4 Power Female	0.15m	33289
LP4 Power Female to 90° 15 Way SATA Power Female	0.15m	33615
LP4 Power Female to 2 x 90° 15 Way SATA Power Female	0.15m	33616

USB 3.0 Motherboard Header Adapter

- Connects to an available USB Header on your motherboard to create two SuperSpeed USB Type A Female ports
- IDC 19 Pin USB 3.0 Header
- 2 x USB 3.0 Type A Female



USB 3.0 Motherboard Header Adapter 33472

ATX P4 Motherboard Power Extension Cable

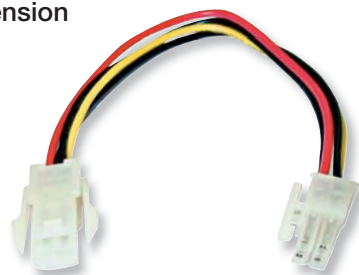

	Length	Part No.
4 Way ATX Male to 4 Way ATX Female	0.3m	33130

Power Adapters



Part No. 33002



Part No. 33126



Part No. 33279

	Length	Part No.
LP4 Power Male to 3.5" Power Female	0.15m	33002
LP4 Power Male to 2 x LP4 Power Female	0.25m	33126
LP4 Power Male to 4 Way ATX Male	0.15m	33279

PCIe & EPS12V Power Adapter Cables



6 Way PCIe Female to 8 Way PCIe Male



2 x SATA 15 Way Male to 6 Way PCIe Male



2 x SATA 15 Way Male to 8 Way PCIe Male

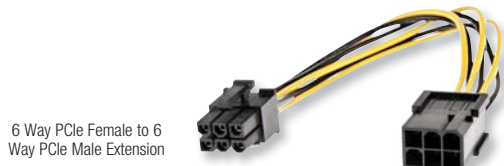

6 Way PCIe Female to 6 Way PCIe Male Extension

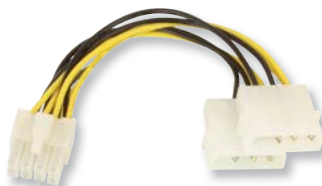

2 x LP4 Power Male to 8 Way ATX Male

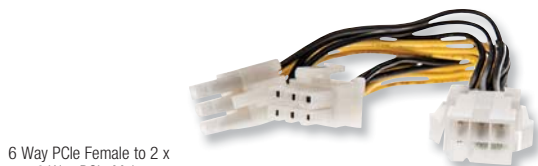

6 Way PCIe Female to 2 x 6 Way PCIe Male

	Length	Part No.
6 Way PCIe Female to 8 Way PCIe Male	0.15m	33858
2 x SATA 15 Way Male to 6 Way PCIe Male	0.15m	33859
2 x SATA 15 Way Male to 8 Way PCIe Male	0.15m	33860
6 Way PCIe Female to 6 Way PCIe Male Extension	0.20m	33861
2 x LP4 Power Male to 8 Way ATX Male	0.15m	33862
6 Way PCIe Female to 2 x 6 Way PCIe Male	0.15m	33863

Standard Cable Ties

- Available in a range of different sizes
- Pack contents: 100 pieces
- Nylon



Standard Cable Tie, 101mm x 2.5mm	40784
Standard Cable Tie, 150mm x 3.6mm	40785
Standard Cable Tie, 200mm x 4.8mm	40786

Self Adhesive Cable Clips

- Pack contents: 10 pieces
- Supports cables up to 8mm in diameter
- Dimensions: 35 x 25mm

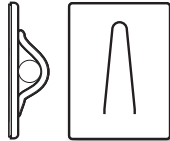

Self Adhesive Cable Clips, Pack of 10	40780
---------------------------------------	-------

Hook & Loop Cable Ties

- Ideal for rack and patch panels
- Will not pinch or abrade delicate cables
- Colour: black
- Pack contents: 10 pieces



	Length	Part No.
Hook & Loop Cable Ties, black	20cm	40791
	30cm	40795

Cable Bridging

- Helps prevent tripping over loose cables
- Ribbed base grips almost any surface
- Single channel can accommodate cables up to 16 x 8mm (WxH)
- Narrow channel can accommodate up to 30 x 10mm (WxH)
- Allows wheeled traffic to pass over with minimum interference

	Length	Colour	Part No.
Narrow Channel	3m	Black	40396
	1m	Black	40578
Wide Channel	3m	Black	40397
	1m	Grey	40579
Wide Channel	3m	Grey	40398



Black,
Narrow Channel

Grey,
Wide Channel

Hook & Loop Cable Tie Roll, 5m

Perfect solution for managing and arranging cables

- Continuous roll length: 5m
- Width: 13mm
- Colour: Black
- Material: Nylon
- Consistent closure strength
- Low-profile design for neat cable management



Hook & Loop Cable Tie Roll, 5m	40571
--------------------------------	-------

Hook And Loop Self Adhesive Tape, 5m

- High Quality Multi-purpose Self Adhesive Roll
- Width: 13mm
- Colour: Black
- Ideal for management of small electronics devices
- Supplied with 5m of Hook and 5m of Loop Tape

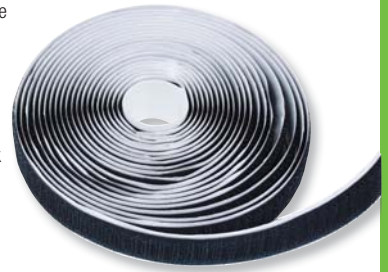

NEW

Hook And Loop Self Adhesive Tape, Black, 20mm x 5m	40583
--	-------

Free UK DELIVERY  on all orders over **£125** (ex VAT.)

Some exceptions apply, see delivery terms & conditions on our website

Cable Grip, 6 Pack

- Ideal for use with peripheral cables from your camera, printer, monitor etc
- Strong, adhesive base sticks securely to almost any surface
- Each pack contains 2 x white, 2 x brown and 2 x black
- Pack contents: 6 pieces



Cable Grip, 6 Pack	40799
--------------------	-------

TELECOMS & POWER ELECTRICITY

Telephone Cables & Adapters	284
Fax/Modem Cables, VoIP Accessories	285
Mains Conditioners	287
Power Cables	288
Extension Leads, Power Strips, Surge Protectors	293
Power Adapters & Converters	295
USB Power	296
Power Adapters, Supplies & Accessories	297
Smartphone Power	299

TELEPHONE CABLES & ADAPTERS

Telephone Extension Cables

- For UK BT style plug and socket



	Length	Part No.
Telephone Extension Cable	5m	35064
	10m	35066

ADSL Microfilter

- Allows connection of a telephone and ADSL modem to one telephone socket
- Ideal for use with 'wires only' ADSL service



ADSL Microfilter	75111
------------------	-------

VDSL2 Microfilter Faceplate

- Replaces an NTE5 Telephone Master Socket front cover to provide a VDSL2 and standard Telephone sockets
- Ideal for use with 'wires only' VDSL services
- Backwards compatible with ADSL



VDSL2 Microfilter Faceplate	75114
-----------------------------	-------

Download the latest
PRICE LIST
from our website



Telephone Socket Doubler & Tripler



Telephone Socket Doubler	75028
Telephone Socket Tripler	75027

Telephone Cable Tangle Eliminator

- For use with telephones that have modular handsets

**BEST
SELLER**



Telephone Cable Tangle Eliminator	75004
-----------------------------------	-------

USA to UK Telephone Adapter

- Connects any USA/RJ-11 telephone cable to any standard UK wall jack



USA to UK Telephone Adapter	75021
-----------------------------	-------

Handset Cable

- Replacement handset cord for telephones with modular connectors
- Length: 30cm (extends to approximately 1.1m)



Telephone Handset Cable, White	35079
Telephone Handset Cable, Black	35076

UK/USA Double Telephone Adapter

- Allows the use of US equipment on the UK telephone system
- Additional BT Female socket allows a UK telephone to be connected at the same time



UK/USA Double Telephone Adapter	75020
---------------------------------	-------

Fax/Modem Cables

Fax/Modem to BT Telephone Wall Socket

	Length	Part No.
	2m	35033
RJ-11 Male (4 Way) to BT Telephone Male Straight-through wiring	3m	35034
	5m	35035
	10m	35036
	2m	35055
RJ-11 Male (4 Way) to BT Telephone Male Crossed-over wiring	5m	35057

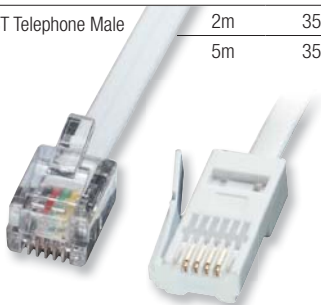

6 Way RJ-12 Cable

	Length	Part No.
	2m	34223
RJ-12 Male (6 Way) to RJ-12 Male (6 Way) Straight-through wiring	3m	34224
	5m	34225
	10m	34226
	15m	34227
	20m	34228

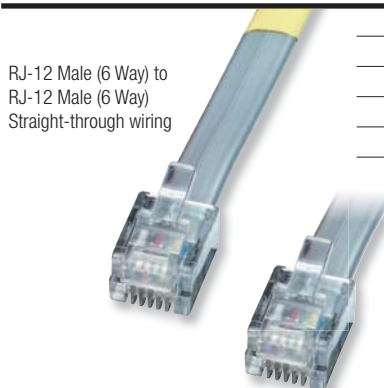

Retractable UTP Cable with RJ-12 Adapters

2-in-1 network/modem cable

- CAT5 UTP cable
- RJ-45 Male to RJ-45 Male
- Includes two docking RJ-12 adapters for modem use
- Maximum length: 2m



Retractable UTP Cable with RJ-12 Adapters 44995

RJ-11 to RJ-45 Cable

High quality ADSL/Broadband/Modem Cable

	Length	Part No.
	1m	34233
RJ-11 Male to RJ-45 Male Straight-through wiring	2m	34234
	3m	34235
	5m	34236
	10m	34237



**BEST
SELLER**

USB Two Piece VoIP Phone

- Contemporary design - perfect for home or office use
- Fully integrates with Skype, MSN and Yahoo! Messenger
- Auto launches Skype when the handset is picked up
- Can be desk or wall mounted



**BEST
SELLER**

USB Two Piece VoIP Phone 42779

Stereo Headset with Microphone



- Adjustable headband with foam ear pads
- Adjustable omni-directional condenser microphone
- Connectors: 2 x Stereo Jack Male
- Cable length: 1.8m

Stereo Headset with Microphone 20398

MAINS CONDITIONER SIGNAL PROTECTION



When multiple electronic devices are in use there may be an increase in electrical and radio interference in signals to AV displays and Hi-Fi systems. Mains conditioners filter out mains borne electrical and radio interference to ensure the highest quality of audio and visual signals are being sent to your AV display or Hi-Fi installation.

Mains Conditioners from LINDY are fitted with a powerful radio frequency interference filter designed to help reduce the mains interference, alongside a screened mains lead that stops the mains lead acting as an aerial, to provide the best possible image quality and improve clarity from your audio devices.

6 Way Mains Conditioner

Surge protector and mains conditioner for Hi-Fi and home cinema

The LINDY 6 Way Mains Conditioner Power Strip contains a powerful mains conditioner and radio frequency interference filter specially designed to help reduce the mains interference which can adversely affect video and audio performance in Hi-Fi and home cinema installations.

- Provides improved clarity from your audio devices
- Allows for cleaner, sharper picture quality from your video devices
- Features 6 sockets - perfect for your Hi-Fi and home cinema installations
- Surge protection to protect your valuable equipment
- 2m cable length

MAINS CONDITIONER

Mains conditioners aid in the reduction of mains borne radio frequency interference and so help to enhance the sound and/or picture quality

FILTER STATUS TEST

Mains conditioners do not have any indicating lights on during normal use as this can affect the performance. So we have a test button for your piece of mind. Pressing the green button briefly illuminates a green status light, indicating the Mains Conditioner filter is operational, has not been damaged or seriously degraded and all layers of protection are intact

SCREENED MAINS LEAD

Prevents the mains lead from acting as an aerial and so injecting interference into your system

THERMAL PROTECTION

Internal thermal fusing prevents the circuit from dangerous overheating in the event of a worse case surge/spike scenario



GAS TUBE PROTECTION - Gas discharge tube technology is used to satisfy the latest safety requirements for surge protectors

SURGE PROTECTION

Three channel protection - absorbing mains surges and spikes which can cause permanent damage to your valuable equipment

6 Way AV Mains Conditioner, 2m

30089

6 Way AV Surge Protector with RFI Rejection System

- Ideal for use with all audio visual equipment including LCD, LED and Plasma HDTVs, music systems, home cinema systems, games consoles and computers
- Surge protection circuitry protects your equipment from surges and spikes
- Radio Frequency Interference (RFI) rejection system helps keep your sounds and images free from interference
- Provides 6 UK mains sockets via a 2m mains lead

**BEST
SELLER**



6 Way AV Surge Protector, 2m

30088

GSM Power Socket

- Control power to everyday products using SMS messaging
- Uses a PAYG or contract GSM SIM card
- Includes external temperature sensor
- Automatically sends an SMS when the power fails



GSM Power Socket

32665

POWER CABLES

UK 3 Pin Mains Leads

UK Plug to IEC C13 Socket

- Approved to BS 1363/A
- 5A fuse fitted
- Colour: Black

UK Plug to Right Angled IEC C13 Female

UK Plug to Right Angled IEC C13 Female, 5A	Length	Part No.
	1m	30446
	2m	30447
	3m	30448



NEW

UK Plug to IEC C15 'Hot Condition' Female

UK Plug to IEC C15 Female, 13A	Length	Part No.
	2m	30458



NEW

UK Plug to IEC C19 Female

UK Plug to IEC C19 Female, 13A	Length	Part No.
	2m	30459



IEC C14 Male to Locking IEC C13 Female

IEC C14 Male to Locking IEC C13 Female	Length	Part No.
	2m	30259



UK Plug to IEC C13 Female, 5A	Length	Part No.
-------------------------------	--------	----------



	0.2m	30430
	0.7m	30431
	1m	30432
	2m	30142
	3m	30434
	5m	30435
	7.5m	30436
	10m	30437
	15m	30438
	20m	30439

BEST SELLER

NEW

UK Plug to IEC C7 'Figure 8' Female

UK Plug to IEC C7 Fig. 8 Female, 3A	Length	Part No.
	1m	30443
	2m	30444
	3m	30397



UK Plug to Right Angled IEC C7 Female

UK Plug to Right Angled IEC C7 Female, 3A	Length	Part No.
	0.5m	30454
	1m	30455
	2m	30045
	3m	30457



NEW

UK Plug to IEC C5 'Cloverleaf' Female

UK Plug to IEC C5 Cloverleaf Female, 5A	Length	Part No.
	1m	30460
	2m	30404
	3m	30461



NEW

BEST SELLER

Free UK DELIVERY  on all orders over £125 (ex VAT.)

Some exceptions apply, see delivery terms & conditions on our website

Locking IEC Cables

UK Plug to Locking IEC C13 Female

- Protects from accidental or deliberate disconnection

UK Plug to Locking IEC C13 Female, 5A	Length	Part No.
	2m	30138



Schuko Plug to Locking IEC C13 Female

- Protects from accidental or deliberate disconnection

Schuko Plug to Locking IEC C13 Female, 5A	Length	Part No.
	2m	30134



IEC Extension Leads

IEC C14 Male to IEC C13 Female, Black

IEC C14 Male to IEC C13 Female, Black	Length	Part No.
	0.5m	30320
	1m	30321
	2m	30331
	3m	30327
	5m	30333



IEC C14 Male to IEC C13 Female, Blue

IEC C14 Male to IEC C13 Female, Blue	Length	Part No.
	0.5m	30470
	1m	30471
	2m	30472

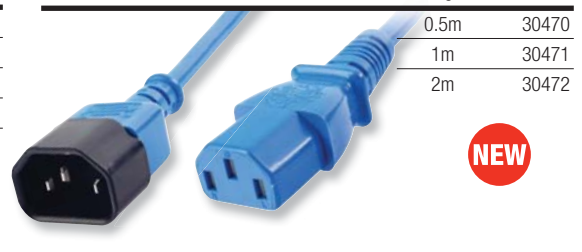

IEC C14 Male to IEC C13 Female, Orange

IEC C14 Male to IEC C13 Female, Orange	Length	Part No.
	0.5m	30514
	2m	30475

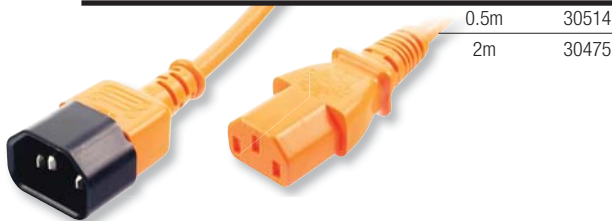

IEC C14 Male to IEC C13 Female, Red

IEC C14 Male to IEC C13 Female, Red	Length	Part No.
	0.5m	30517
	1m	30477
	2m	30478



IEC Adapters



Right Angled IEC Adapter, Up	73091
Right Angled IEC Adapter, Down	73092

'Cloverleaf' Male to IEC C13 Female



'Fig. 8' Male to IEC C13 Female

'Fig. 8' Female to IEC C14 Male



'Cloverleaf' Female to IEC C14 Male

IEC C6 'Cloverleaf' Male to IEC C13 Female	30450
IEC C8 'Figure 8' Male to IEC C13 Female	30451
IEC C8 'Figure 8' Female to IEC C14 Male	30452
IEC C5 'Cloverleaf' Female to IEC C14 Male	30453

POWER CABLES

IEC Extension Leads

IEC C14 Male to IEC C15 'Hot Condition' Female

- IEC C15 connectors are rated at 120 degrees for use with devices with a higher operating temperature

IEC C14 Male to IEC C15 'Hot Condition' Female	Length	Part No.
	2m	30314

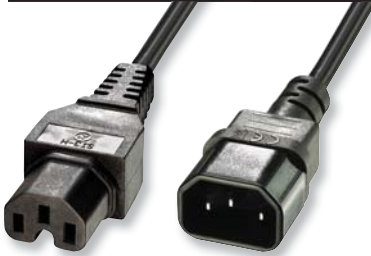

NEW

**BEST
SELLER**

IEC C14 Male to IEC C7 'Figure 8' Female

IEC C14 Male to IEC C7 Female	Length	Part No.
	1m	30311
	2m	30312



NEW

IEC C14 Male to IEC C5 'Cloverleaf' Female

IEC C14 Male to IEC C5 Female	Length	Part No.
	1m	30340
	2m	30341
	3m	30342
	5m	30343



NEW

IEC C20 Male to IEC C19 Female

IEC C20 Male to IEC C19 Female	Length	Part No.
	2.5m	30361



NEW

'Y-Type' Dual Power Cables

IEC C14 Male to 2 x IEC C13 Female

IEC C14 Male to 2 x IEC C13 Female	Length	Part No.
	1m	30389
	2m	30039
	2.5m	30388



NEW

IEC C14 Male to 2 x IEC C7 Female

IEC C14 Male to 2 x IEC C7 Female	Length	Part No.
	2.5m	30368



NEW

IEC C14 Male to 2 x IEC C5 Female

IEC C14 Male to 2 x IEC C5 Female	Length	Part No.
	2.5m	30370



NEW

CABLE GURU

FIND THE CABLE YOU NEED

Try it now on our

WEBSITE

'Y-Type' Dual Power Cables

- Double-ended cable powers two devices
- Saves on mains sockets

**BEST
SELLER**

UK Plug to 2 x IEC C13 Female

UK Plug to 2 x IEC C13 Female, 13A	Length	Part No.
	2.5m	30371

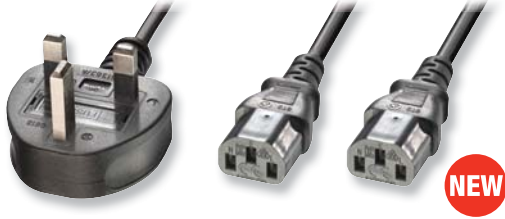

UK Plug to IEC C7 Female & C13 Female

UK Plug to IEC C7 & IEC C13 Sockets, 5A	Length	Part No.
	2.5m	30426



UK Plug to 2 x IEC C7 Female

UK Plug to 2 x IEC C7 Female, 5A	Length	Part No.
	2.5m	30372



UK Plug to IEC C5 Female & C7 Female

UK Plug to IEC C5 & IEC C13 Female, 5A	Length	Part No.
	2.5m	30427



UK Plug to IEC C5 Female & C13 Female

UK Plug to IEC C5 & IEC C13 Female, 5A	Length	Part No.
	2.5m	30374



UK Plug to 2 x IEC C5 Female

UK Plug to 2 x IEC C5 Female, 5A	Length	Part No.
	2.5m	30381



Schuko Plug to 2 x IEC C13 Female

Schuko Plug to 2 x IEC C13 Female	Length	Part No.
	1.9m	30049



Visit our website
WEBSITE
for the latest prices
& special offers



Other Mains Leads

Schuko Plug to IEC C13 Female

Schuko Plug to IEC C13 Female	Length	Part No.
	2m	30335
	3m	30336

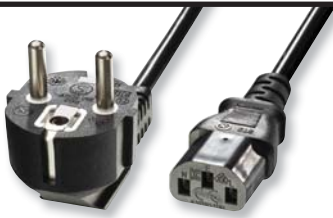

NEW

US 3 Pin Plug to IEC C13 Female

US 3 Pin Plug to IEC C13 Female	Length	Part No.
	2m	30338



Schuko Plug to IEC C5 'Cloverleaf' Female

Schuko Plug to IEC C5 Female	Length	Part No.
	2m	30449

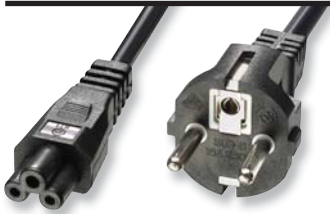

NEW

US 2 Pin Plug to IEC C7 'Figure 8' Female

US 2 Pin Plug to IEC C7 Female	Length	Part No.
	2m	30034

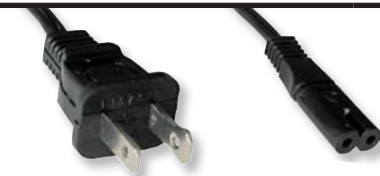

Schuko Plug to IEC C19 Female

Schuko Plug to IEC C19 Female	Length	Part No.
	2m	30347



European Plug to IEC C7 'Figure 8' Female

European Plug to IEC C7 Female	Length	Part No.
	2m	30466
	3m	30422



US 3 Pin Plug to IEC 'Cloverleaf' C5 Female

US 3 Pin Plug to IEC C5 Female	Length	Part No.
	2m	30462



NEW

16A Commando Plug to 16A IEC C19 Female

16A Commando Plug to 16A IEC C19 Female	Length	Part No.
	3m	30109



Folding UK Plug to Fig. 8 Power Lead

- Ideal for travelling
- 3A fuse fitted



**BEST
SELLER**

Folding UK Plug to Fig. 8 Mains Lead, 3A	Length	Part No.
	1.8m	73377

Download the latest
PRICE LIST
 from our website 

UK 3 Pin Mains Extension Leads

For those hard to reach places

- 3 core white flex
- 13A extension socket complies to BS 1363/A and plug to BS 1363



UK 3 Pin Mains Extension Leads	Length	Part No.
	5m	33311
	10m	33312

Individually Switched UK Mains Power Strips

4 and 6 Way individually switched mains power strips



- Eco friendly individually switched designs
- Green power "ON" indicators for each socket
- Fitted with a 13A fuse
- Can be floor or wall mounted
- Maximum load: 13 Amps, 250V, 3000W
- Complies with BS 1363/A
- Cable length: 2m

4 Way Individually Switched Power Strip, 2m	73036
6 Way Individually Switched Power Strip, 2m	73037

4 Way Power Strip, Black

Additional sockets for mains powered devices

- Stylish black design with 2m cable
- Maximum load: 13 Amps, 250V, 3000W
- Complies with BS 1363/A



4 Way Power Strip, Black, 2m	73026
------------------------------	-------

UK Mains Extension Lead, White, 0.2m

- The short solution that allows you to plug multiple bulky transformers in to a 4 way strip
- Fitted with 13 Amp plug and fuse
- Cable length: 0.2m

NEW

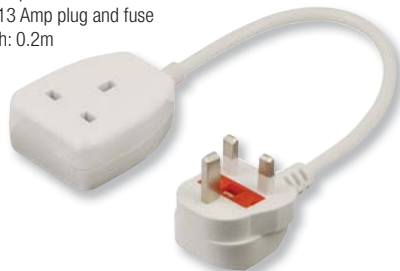

UK Mains Extension Lead, White, 0.20m	30135
---------------------------------------	-------

4 & 6 Way Power Strips

Extra sockets for your mains powered devices

- Choose from 4 or 6 way versions with either 2m or 5m cables
- Maximum load: 13 Amps, 250V, 3000W
- Complies with BS 1363

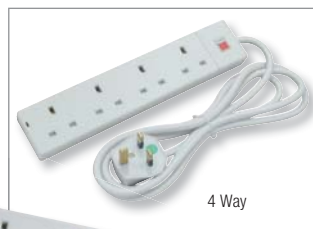

BEST SELLER

	Length	Part No.
4 Way Power Strip	2m	70145
	5m	73073
6 Way Power Strip	2m	30145
	5m	73074

4 & 6 Way Surge Protectors

- 4 and 6 way versions
- 6 way version also provides in line surge protection for your fax/modem via 2 standard BT sockets (3m BT style telephone cable included)
- Maximum load: 13 Amps, 250V, 3000W
- Can be floor or wall mounted

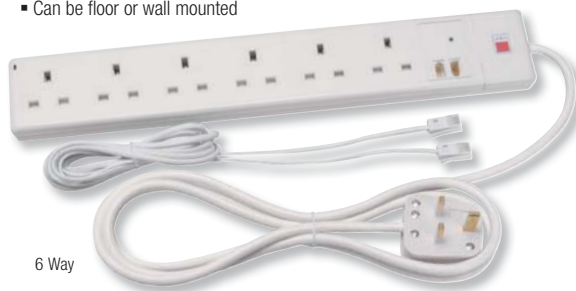

4 Way Surge Protector, 2m	73076
6 Way Surge Protector, Fax/Modem Protection, 2m	30147
6 Way Surge Protector, Fax/Modem Protection, 5m	30143

10 Way Vertical Surge Protector

Unique, space-saving power extension with surge protection

- Suitable for use with audio, video and computer equipment
- Vertical design for a tidier, safer installation
- Built-in surge protector
- Surge protection and power indicators
- Maximum load: 13 Amps, 250V, 3000W
- 2m cable with cable tidy in the base of the unit



10 Way Surge Protector, 2m

73077

8 Way Surge Protector with 2 USB Ports

Ideal for computer, AV & IT installations

- 8 way extension strip
- 2 x USB ports (2.1A each); Port 1 is specially optimized for use with Apple products
- Vertical design for a tidier, safer installation
- Built in Surge Protection



8 Way Surge Protector with 2 USB Ports

73080

2 Gang Switched Single Pole Socket with 2 USB Charger Ports

NEW



- 2 x UK 3 Pin Switched Sockets
- 2 x USB Ports (Total 2.1A output)
- Includes, self-setting overheat protection and output stabilising
- Will charge any device that normally charges by a standard USB port

2 Gang Socket with 2 x USB Charger Ports

73081

Energy Saving Power Meter

- For use with domestic equipment only
- Built in LCD Data display
- Shows mains voltage, current consumption and costs of running connected equipment
- Overload power setting alarm
- UK 3 Pin plug to socket
- 2 x LR44 batteries included



Energy Saving Power Meter

73121

Raspberry Pi Controller Board with 2 RF Sockets

- Allows Raspberry Pi users to control their power sockets from a range of up to 30m
- Short range radio transmitter
- Up to 16 individual control commands can be used
- Experimental board and ideal learning tool



Raspberry Pi Controller with 2 RF Sockets

84001

Mains Power Adapters & Converters

Important Note: All of these devices are designed to change the shape of the plug. They **DO NOT** change the voltage! Before use, please ensure your electrical equipment complies with the voltage of the country you are in.

UK to Euro Adapter

- Allows UK equipment to be used in European Schuko sockets



UK to Euro Adapter

73099

UK to USA / Australia Adapter

- Allows UK equipment to be used in US, Australian, Chinese and South American sockets

BEST SELLER



UK to USA / Australia Adapter

73067

Euro to UK Converter, 5A Fused

- Converts a CEE7 Euro plug to a UK 3 pin plug

BEST SELLER



Euro Plug to UK Converter, 5A

73094

Free UK DELIVERY  on all orders over **£125** (ex VAT.)

Some exceptions apply, see delivery terms & conditions on our website

Earthed Schuko to UK Converter, 13A Fused

- Converts a CEE7 earthed plug to a UK 3 pin plug

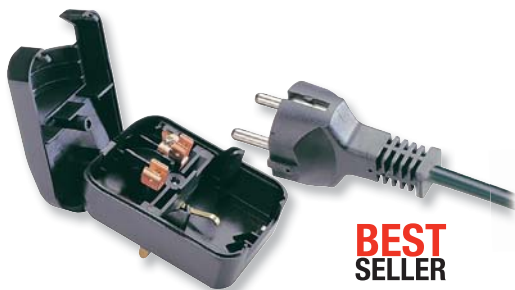

BEST SELLER

Earthed Schuko to UK Converter, 13A

73096

Euro Transformer to UK Converter, Rear Socket, 3A Fused

- Converts a euro transformer to a UK 3 pin plug



Euro Transformer to UK Converter, Rear Socket, 3A

73070

Permanent Euro Transformer to UK Converter, 3A Fused

- Permanently converts a euro transformer to a UK 3 pin plug



Permanent Euro Transformer to UK Converter, 3A

73072

Euro Transformer to UK Converter, Base Socket, 3A Fused

- Converts a euro transformer to a UK 3 pin plug



Euro Transformer to UK Converter, Base Socket, 3A

73098

QuickCharge 2.0 USB Power Adapter

Quick Charge 2.0 is designed to interoperate with existing USB charging solutions. To achieve full charging speeds, a Quick Charge 2.0 enabled device must be paired with a Quick Charge 2.0 certified adapter. The LINDY QC 2.0 Travel adapter allows QC 2.0 compatible devices to charge at up to 75% faster than non QC 2.0 adapters.

- Output:
 - 5V DC 1.8A / 9W
 - 9V DC 1.8A / 16.2W
 - 12V DC 1.35A / 16.2W
- Over current, over voltage and short circuit protection
- Includes adapters for use in UK, Europe, USA and Australia



QuickCharge 2.0 USB Power Adapter

73107

4 Port Smart USB Travel Charger, 24W, QuickCharge 3.0 Compatible

The 4 Port Smart USB Travel Charger allows you to charge up to 4 USB devices at the same time. Smart IC support recognises devices intelligently and automatically adjust charging power. The unit is also Quick Charge 3.0 compatible, which is 38% percent more efficient than Quick Charge 2.0.

- 3 x USB Type A Ports with Smart IC function – 5V up to 2.4A
- Single QuickCharge 3.0 compatible port – 5V, 9V, 12V
- Over current, over voltage and short circuit protection
- Includes 4 adapters for use in UK, Europe, US & Australia



NEW

5A / 25W 4 Port USB Travel Charger

73313

2 Port USB Travel Charger

- Perfect for use with iPods, iPads, MP3 Players, PDAs, mobile phones etc.
- Input: 100-240V AC, 50-60Hz
- Output: 5V DC, 1A per port (2.1A total)
- Includes 4 adapters for use in UK, Europe, US & Australia



2 Port USB Travel Charger

73355

USB UK Mains Chargers

- For use with iPods, MP3 Players, PDAs, mobile phones etc.
- Input: 100-240V AC, 50-60Hz
- Output: 5V DC, 1A per port (2.1A total)



4 Port USB UK Mains Charger, White

73353

4 Port USB UK Mains Charger, Black

73354

4 Port USB Mains Charger, 4 x 1A

- Features 4 individually switched USB Type A Female sockets for connecting your devices
- Built in surge protection
- Input: 100-240V AC, 50-60Hz
- Output: 5V DC, 1A per port



4 Port USB Mains Charger, 4 x 1A

73384

2 Port USB & Mains Plug Travel Adapter

- All-in-one design features UK, Euro and USA/Australia plug types
- Each different plug type slides out of the unit and locks into place
- Two USB ports for powering smartphones and other USB devices
- Input: 110-240V AC, 50-60Hz
- Output: 5V DC, 2.1A (max 1A per port)



**BEST
SELLER**

2 Port USB & Mains Plug Travel Adapter

73110

Folding USB UK Mains Charger

- Compact, portable folding design fits neatly into a laptop bag
- Features a USB Type A Female Socket for connecting your iPod, MP3 Player, Smartphone etc
- Input: AC 100-240V / 50-60HZ
- Output: 5V DC, 2.1A

**BEST
SELLER**



Folding USB UK Mains Charger

73376

3-in-1 Micro-B USB Charging Kit

- USB mains plug, car charger and cable kit to charge and power your Micro-B USB devices
- Both chargers feature a USB Type A socket for connecting your devices
- Ideal for use with Amazon Kindles, smartphones and other Micro-B devices
- Supplied with a USB Type A to Micro-B cable



3-in-1 Micro-B USB Charging Kit

73357

USB Car Chargers

- Choose from single, two and three port versions
- Smart IC design for Rapid Charging
- 3 port version is QuickCharge 2.0 compatible

**BEST
SELLER**



NEW

1 Port USB Car Charger, 1.2A Output

73318

2 Port Smart USB Car Charger 4.8A Output

73319

Multi Country Switching Power Adapters

These travel adapters can be used in:

- Europe • UK, Hong Kong, Singapore
- United States, Canada, Taiwan, Japan, China
- Australia, New Zealand



24V Multi Country Switching Power Adapters

24V Multi Country
Switching Power
Adapter

DC Output	Amps	DC Plug Size	Part No.
24V	1.25A	2.1/5.5mm	73825

5V Multi Country Switching Power Adapters

	DC Output	Amps	DC Plug Size	Part No.
5V Multi Country Switching Power Adapter	5V	2.6A	2.5/5.5mm	73820
	5V	3A	2.5/5.5mm	73813
	5V	2A	1.7/4.75mm	73846
	5V	3A	1.35/3.5mm	73824
	5V	1.2A	1.35/3.5mm	73845
	5V	2.6A	2.1/5.5mm	73829

9V Multi Country Switching Power Adapters

	DC Output	Amps	DC Plug Size	Part No.
9V Multi Country Switching Power Adapter	9V	0.5A	2.5/5.5mm	73800
	9V	0.5A	2.1/5.5mm	73840
	9V	2A	2.1/5.5mm	73847

12V Multi Country Switching Power Adapters

NEW

	DC Output	Amps	DC Plug Size	Part No.
12V Multi Country Switching Power Adapter	12V	1.25A	2.5/5.5mm	73807
	12V	2.6A	2.1/5.5mm	73806

DC ADAPTER ACCESSORIES, IN LINE SWITCH

Screw Terminal to DC Jack, Pack of 10

- Allows you to connect bare wire to a barrel jack connector
- Provides two screw terminals for simple and secure installation
- Male and Female 2.1 Inner / 5.5mm Outer DC Barrel Size
- Supplied in a Pack of 5 Male and 5 Female Adapters
- Ideal for CCTV, LEDs, PCBs, Motors and more



NEW

Screw Terminal to DC Jack, Pack of 10

70215

DC Power Supply Extension Cable

- Fully Moulded, High Quality 24AWG Conductors
- 5.5mm outer
- Available with 2.1mm or 2.5mm inner tip

NEW

DC PSU Ext. Cable 2.1mm Inner/ 5.5mm Outer	Length	Part No.
	0.3m	70320
	0.5m	70321
	1m	70322
	2m	70323
	3m	70324
	5m	70325

0.15m DC Jack Power Supply Converter Cable

The LINDY DC Jack Power Supply Converter Cable is designed to change your existing DC jack from 2.1mm to a 2.5mm inner tip, or vice versa, whilst the outer remains 5.5mm.

- Ideal for adapting an existing DC Barrel
- Reuse old power supplies with new equipment



NEW

2.1mm to 2.5mm inner tip, 5.5mm outer	70216
2.5mm to 2.1mm inner tip, 5.5mm outer	70217

DC PSU Ext. Cable 2.5mm Inner/ 5.5mm Outer	Length	Part No.
	0.3m	70326
	0.5m	70327
	1m	70328
	2m	70329
	3m	70330
	5m	70331

NEW

0.15m Switched DC Power Extension Cable

This clever inline switched DC power cable allows you to switch off DC powered devices that do not have a power switch built in.

- 0.15m cable with male and female DC connectors
- 1.35mm inner / 3.5mm outer diameter DC jack
- Supports a maximum power rating of 5V 1.5A



NEW

1.35mm inner / 3.5mm outer

0.15m Switched DC Ext. Cable, 1.35mm inner, 3.5mm outer

70211

IEC C8/C7 (Fig 8) In-Line Switch

The LINDY IEC C8/C7 in-line switch is ideal for any appliance that requires rebooting but the only option is to remove the cable then re-insert it. Some models of the slim line PS3, PS4 and SKY TV boxes with a C7 (Figure 8) cable do not have an off switch and are constantly in stand-by.

- IEC C8 (Female) to IEC C7 (Male) connectors (Figure 8)
- Rated at 240V 2.5A
- Features an integral on / off switch
- Colour: Black



IEC C8/C7 (Fig 8) In-Line Switch

70214

PSU for LINDY 2.5" HDD Housings

- For optional use with LINDY 2.5" External Drive Housing (Part No 42671)
- DC round plug: 1.35mm inner / 3.5mm outer
- Input: 200-240V AC
- Output: 5V DC, 2.6A



Power Adapter for LINDY 2.5" Drive Housings

70229

Wireless Charging Adapters

- For use with our Wireless Charging Pad (73324)
- Install underneath the standard battery cover
- Compatible with all Qi Wireless compatible chargers
- Maximum Power Output:
 - 73386: 5V DC 500mA
 - 73387: 5V DC 600mA
 - 73361: 5V DC 600mA
 - 73388: 5V DC 500mA
 - 73389: 5V DC 600mA
 - 73325: 5V DC 500mA



For Galaxy S3	73386
For Galaxy S4	73387
For Galaxy S5	73361
For Galaxy Note 2	73388
For Galaxy Note 3	73389
For Galaxy Note 4	73325

Qi Wireless Charger

- For use with devices fitted with a LINDY Wireless Charging Adapter or feature integrated Qi Wireless charging
- Fully compatible with the Qi wireless charging standard
- Simply place the device on top of the pad to charge
- Includes 1m USB A to Micro-B cable
- Maximum Power Output: 5V DC 1A



Qi Wireless Charger

73324

Smartphone Desktop Dock

Versions for use with Samsung Galaxy S4, S5, HTC One M7, One M8 and Nexus 5

- A convenient and safe way to charge or sync your smartphone
- High quality, soft touch rubberised plastic
- Built in surge protection
- Includes USB cable



For Samsung Galaxy S4	73395
For Samsung Galaxy S5	73321
For HTC One M7	73396
For HTC One M8	73322
For Nexus 5	73398

INDEX

- A**
AC Adapters195-197
Active HDMI Cables239
Adapter Cards142
Add On Cards137
ADSL Microfilters284
Aerial Cable265
Android OS Mirroring & KM Sharing Cable238
Antenna Cable125, 259
Anti-Static Bags153
Anti-Static Service Kit153
Anti-Static Wrist Strap153
ATX Power Supply147
ATX Power Supply Tester154
Audio Cables260-261, 266
Audio Extenders84
Audio Extractor29
Audio Splitter28
Audio Switch28
AV Adapters257
AV Converters44, 48
AV Extenders85
AV Faceplates90-93
AV Mains Conditioners93
- B**
Back Plane Systems146
Barcode Scanners190
Bluetooth Audio Receiver25
Bluetooth Headphones20
Bluetooth Speaker25
Brush Faceplates90
Bulk AV Cables267-268
Bulk Cable219, 267-268
Bulk Network Cable215
- C**
C6 HDMI System46-59
Cabinet Accessories129-131
Cabinet Shelves130
Cable Analyser154
Cable Bridging281
Cable Grips281
Cable Testers154-155
Cable Ties281
Camera123
Card Readers123
CAT5/6 USB Extenders181-185
CAT5/6 DVI Extenders72
CAT5/6 HDMI Extenders46-59
CAT5/6 KVM Extenders117-118
CAT5/6 VGA Extenders81
CAT5/6/7 Cable212-214
CAT5e HDMI Distribution System57
CAT5e/6 Faceplates216
CAT6 HDMI Distribution System57
CAT6 Surface Mount Boxes217
CD/DVD Lens Cleaner201
Cleaners & Cleaning Cloths201
Cloning Stations145
Coiled USB Cables222
Coloured USB 2.0 Cables222
Coloured Lightning Cables262
Commando Cables292
Computer Stands & Holders196
Connector Guide208-209
Controller Cards137-138
Crimp Tools148
CROMO Audio Cables261
CROMO CAT6 S/FTP Cable213
CROMO DisplayPort Cables242
CROMO Headphones & Earphones21, 24
CROMO HDMI Adapters & Couplers257
CROMO HDMI Cables237
CROMO USB Cables225-226
CROMO USB to Lightning Cable263
- D**
DACs26-27
Desktop KVM Switches106-110
Display Brackets95-96
Display Trolleys101
DisplayPort Adapter Cables254-255
DisplayPort Cables242-245
DisplayPort Converters30-31
DisplayPort Extender77
DisplayPort Switch76
DisplayPort to HDMI Splitter75
DIY HDMI Cable Kit268
DLT Enclosures143
Drive Adapters145
Drive Caddies145-146
Drive Docking Stations145
Drive Enclosures / Housings142-143
Drive Rails & Brackets147
DVD Lens Cleaner201
DVI Adapters & Couplers256
DVI Cables245-249
DVI Extenders72
DVI Matrix Switch72
DVI Repeater72
DVI Splitters70-71
DVI Super Long Distance Cables246-247
DVI Switches70
DVI to HDMI Cables252
DVI to VGA Adapters249
- E**
Earphones24
Eco Friendly Power293-294
EDID/DDC Emulators86
eSata Backplates279
eSATA Cables274
Ethernet Cable212-214
Euro Power Cables292
Extension Strips293-294
External Floppy Drive174
- F**
Fan Tray130
Fax/Modem Cables285
Fibre Optic Cables210-211
Fibre Optic Converters128
Fibre Optic DVI Cable248
Fibre Optic DVI Extenders73-74
Fibre Optic HDMI Cable240
Fibre Optic HDMI Extender61-64
Fibre Optic KVM Extenders119
Fibre Optic USB 3.0 Cable226
Fibre Optic USB Extenders186
FireWire Adapters236
FireWire Cables236
FireWire Cards140-141
FireWire Extension187
FireWire Repeater Hubs187
Friction Locking HDMI Cables237
Fridge Mount for Tablets196
FTP Cable213-214
F-Type Cable259
- G**
Gel Wrist Rests190
Gold DisplayPort Cables242
Gold DVI Cables246
Gold HDMI Cables238
Gold Toslink Cable261
Gold VGA Cables250
GSM Power Socket287
Guitar Leads266
- H**
Hard Drive Rails147
HDBaseT Products56-59
HDMI Adapters & Couplers257
HDMI Audio Extractor29
HDMI Cables237-241
HDMI Converters30-32
HDMI Distribution48-59
HDMI Extenders46-47, 52-53, 56-64
HDMI Matrix Switches38-39, 48
HDMI over IP64-65
HDMI Power Injector Cable239
HDMI Projector Server94
HDMI Splitters37
HDMI Surge Protector86
HDMI Switches34-36
HDMI to DisplayPort Cables241
HDMI to DVI Cables241
HDMI to VGA Cables241
HDMI to VGA Converters253
HDMI Video Processor76
Headphone Amp22, 26-27
Headphone Splitter22
Headphones20-24
Headset285
- I**
I/O Cards136-137
IDC Punchdown Tools148
IDC Termination Blocks215
IDE / SATA Converters139
IDE Cables277
IEC Cables288-292
In-Car Headrest Tablet Holder196
Infrared Extenders88-89
Interface Cable219
Internal Adapters280
iPod / iPad / iPhone Cables & Adapters262-264
iPower Control132-133
- K**
Keyboard & Mouse Extender120
Keyboard & Mouse Shelf196
Keyboards & Accessories190-191
KVM Cables270
KVM Extenders117-120
KVM Cables270
KVM over IP111-114
KVM Switches106-115
KVM Terminals115-116
- L**
LAN Cable210-214
LAN Surge Protector131
Laptop Docking Stations165
Laptop Security Cables197-198
LC Security Locks127
LCD Brackets95-96
Lightning Cables268-269
Lip Sync Corrector29
Locking HDMI Cable237
Locking IEC Cables289
LSOH Network Cable213
- M**
Magnetic Project Mat152
Mains Conditioners93
Mains Leads288-291
MHL to HDMI Active Adapter262
MHL to HDMI Cables240
Mice & Accessories190-191
Micro HDMI Cables237, 240-241
Microphone Cable266
MIDI Cable266
Mini DisplayPort Adapter Cables255
Mini DisplayPort Adapters256
Mini DisplayPort Cables242-245
Mini DVI Adapter Cables254
Mini HDMI Cables237, 240-241
Mini SAS Cables275
Modular Desktop Mounting System98-99
Modular Faceplates90-91
Modular Matrix System39
Mouse Pads190
Multi Country Switching Power Adapters297
Multimeters155
Musical Instrument Cables266
- N**
NAS Storage143
Network Cable212-219
Network Cards139
Network Couplers217
Network Faceplates217
Network Switches124
Noise Cancelling Headphones21-22
Notebook Arm98-99
Notebook Docking Stations165
Notebook Security Cables197
- P**
Parallel Cables271
Parallel Cards136-137
Patch Cables212-217
Patch Panels131
PC Cards136-141
PC Security Cables197-198
PC Stands & Holders196
PCIe Power Adapter Cables280

PhoneNet/MacNet Connectors.....	219	Stereo Jack Adapters.....	264	USB WLAN Adapters.....	170
Phono Cable.....	260	STP Cable.....	213	User Clients for MultiPoint Server.....	121
Port Blockers.....	127	Stylus.....	194	UTP Cable.....	212-215
Port Doublers.....	218	Super Long Distance DVI Cables.....	246-247	V	
Power Adapters & Converters.....	295	Surge Protectors.....	293-294	VDSL Microfilter.....	284
Power Cables.....	288-292	S-Video Cable.....	259	VGA Adapters & Couplers.....	258
Power Control.....	132-133	T		VGA Cables.....	250-251
Power Distribution Units.....	129	Tablet Charging Stations.....	193-194	VGA Extenders.....	81-84
Power Extension.....	293	Tablet Mounts.....	194	VGA Matrix.....	80
Power over Ethernet (PoE).....	125	Tablet Security Cables.....	197-198	VGA Projector Server.....	94
Power over IP.....	132-133	Tablet Stands.....	194	VGA Splitter.....	79-80
Power Strips.....	287, 293-294	Telephone Cables & Adapters.....	284	VGA Switch.....	78-79
Power Supplies.....	147, 297-299	Testers.....	154-155	VGA to HDMI Cables.....	251
Power Supply Tester.....	154	Thunderbolt Cables.....	246	Video Converters.....	29
Projector Brackets.....	97	Tools & Tool Kits.....	148-152	Video Scalers.....	87
Projector Servers.....	94	Torches.....	152	Video Splitter Cables.....	252
PS/2 Cables.....	272	TOSLINK Cables.....	261	Video Wall Solutions.....	68-69
PS/2 Extender.....	120	TOSLINK Extender.....	186	VoIP Phone.....	174
Punchdown Tools.....	148	TOSLINK Splitter.....	28	W	
Q		TOSLINK Switch.....	28	Wall Brackets.....	95-96
Qi Wireless Charger.....	195	Travel Adapters (Power).....	296-297	Wi-Fi Adapters.....	125
R		U		Wi-Fi Router.....	125
Rackmount Fan Tray.....	130	UHF Coax Cable.....	258	Wireless Adapter.....	125
Rackmount KVM Switches.....	111-114	Upscalers.....	87	Wireless Audio.....	25-26
RAID Systems.....	144	US Power Cables.....	292	Wireless Charging Adapters.....	195
RAID Controllers.....	137-138	USB 2.0 & USB 3.0 Adapters.....	231	Wireless Gyro Mouse.....	190
Remote Controlled Power Sockets.....	287, 294	USB 2.0 Active Extension System.....	178	Wireless Headphones.....	20
Remote Power Switching.....	132-133	USB 3.0 Active Extension System.....	179	Wireless IR Extender.....	89
Retractable Cables.....	191, 230	USB 3.1 Cables & Adapters.....	228-229	Wireless Presenter.....	174
Reversible USB 2.0 Cables.....	222	USB 3.1 Video Converters.....	33	Wireless Projector Server.....	94
RJ-11 Cable.....	219, 285	USB 360 Adapter.....	191	Wireless Speaker.....	25
RJ-12 Cable.....	285	USB Active Extension Cables.....	180	WLAN Antenna Cable.....	125
RJ-45 Adapters.....	218	USB Audio Adapters & Cables.....	173	X	
RJ-45 Connectors.....	215	USB Bluetooth Dongle.....	170	XLR Cable.....	266
RJ-45 Couplers.....	219	USB Cables.....	220-230		
RJ-45 Line Adapters.....	218	USB Card Readers.....	166		
RJ-45 Port Blocker.....	127	USB Cards.....	139-140		
RJ-45 Strain Relief Boots.....	215	USB Charging Adapter for iPads.....	191		
RJ-45 to Modular Serial Adapters.....	215	USB DAC.....	26		
RS-232 Cards.....	136-137	USB Docking Stations.....	165, 169		
RS-232 Extenders.....	120	USB Dual Power Cables.....	230		
RS-232 Serial Cables.....	271	USB Extension.....	178-186		
S		USB Extension Cables.....	221, 230, 233-235		
SAS Cables.....	275-276	USB Floppy Drive.....	174		
SATA / IDE Converters.....	139	USB Gadgets.....	175		
SATA Backplates.....	279	USB Hubs.....	160-164		
SATA Cables.....	273-277	USB Keyboard & Mouse Extender.....	120		
SATA Power Adapter Cables.....	279	USB Mains Chargers.....	176		
Satellite TV Cable.....	259	USB Network Adapters.....	171		
SCART Adapters.....	258	USB Notebook Light.....	174		
SCART Cable.....	258	USB On-The-Go Cables.....	227		
Schuko Cables.....	289, 291-292	USB Port Blockers.....	199		
Screen Cleaners.....	201	USB Power.....	296		
Screwdrivers.....	149-151	USB Power Meter.....	155		
SCSI Cables.....	277-278	USB Power Supplies.....	176-177		
SDI Converters.....	32	USB Switches.....	164		
Security Cables.....	197-198	USB to DC Cables.....	232		
Security Kits for iPads & Tablets.....	197	USB to DisplayPort Adapter.....	171		
Serial Cables.....	271	USB to DVI Adapter.....	171		
Serial Cards.....	136-137	USB to HDMI Adapter.....	171		
Serial Extenders.....	120	USB to IDE Adapter.....	169		
Serial over IP.....	127	USB to Lightning Cables.....	262		
Shelves.....	130	USB to Parallel Converters.....	168		
Skew Compensators.....	86	USB to PS/2 Converters.....	175		
Slim HDMI Cables.....	237	USB to SATA Adapters.....	169		
SlimPort to HDMI Active Adapter.....	262	USB to Serial Converters.....	167-168		
Smartphone & Tablet Chargers.....	176-177	USB to SSD Housing.....	170		
Smartphone & Tablet Repair Kit.....	150	USB to VGA Adapters.....	171		
Smartphone Desktop Docks.....	195	USB Transfer & KM Sharing Cables.....	175		
Socket Set.....	150	USB Travel Adapters.....	176-177		
SPDIF Cables.....	261	USB Type C Cables.....	228-229		
Speaker Cable.....	267	USB Video Adapters.....	171-172		
Stereo Headset.....	285	USB VoIP Phone.....	174		

BEST SELLERS

LOOK OUT FOR THE LOGO
IN THE CATALOGUE

**BEST
SELLER**



BNX-60
Headphones
→ Page 20, 73136



HDMI Male
to VGA Female
→ Page 30, 38191



100m C6 HDMI Extender
with HDBaseT
→ Page 52, 38119



300m Fibre Optic
4k HDMI Extender
→ Page 61, 38003



Computer Technician
Screwdriver Set
→ Page 149, 43011



USB to Serial Adapter
9 Way (RS-232)
→ Page 167, 42855



5m USB 2.0 Slimline
Active Extension Cable
→ Page 180, 42817



100m Cat 5 USB 2.0
Extender
→ Page 184, 42694



Under Desk
PC Holder
→ Page 196, 40283



USB 2.0 Cable Pro
Active Extension
→ Page 234, 42780



Premium HDMI Cable
with Ethernet
→ Page 238, 41116



CROMO DisplayPort
Male to Male
→ Page 242

A LINDY RETROSPECTIVE

85 YEARS IN THE MAKING

In 2017 we celebrate our 85th anniversary.

The LINDY group was founded by Kurt Lindenberg in Germany, 1932. Originally the company sold petrol lamps and early electrical appliances. LINDY UK was formed in 1987 by Gerry Casey in partnership with Kurt's son, Klaus Lindenberg.

Today, we are a group of independent multinational companies all working together within the LINDY brand. We pride ourselves on delivering high performance solutions and outstanding customer service for over 85 years.

Thank you from everyone at LINDY for your continued support. We look forward to creating further connections with you in the future.

A LINDY RETROSPECTIVE
85 YEARS IN THE MAKING

85
1932-2017
years
85TH ANNIVERSARY



NEW PRODUCTS

LOOK OUT FOR THE LOGO
IN THE CATALOGUE



NC-60
Headphones
→ Page 22, 20424



USB 3.1 Converters
with Power Delivery
→ Page 33



HDMI UHD Splitters
18G 4K
→ Page 37



CAT.6 HDMI
Cascadable Extender
→ Page 47



Conference Table Unit
Multi AV to HDMI
→ Page 85, 38271

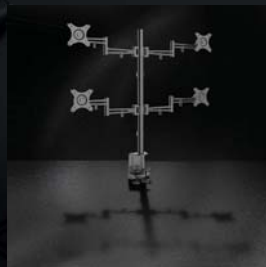

Monitor Brackets
With Pole and Desk Clamp
→ Page 100



Folding Screwdriver
Tool Set
→ Page 148



10 Port Charging Station
Tablets and Smartphones
→ Page 194, 73309



Lightning Cable
Protector Kit
→ Page 200



HDMI Cables
Active 4K
→ Page 239



Fibre Optic HDMI Cables
HDMI 2.0
→ Page 240



4 Port USB Travel Charger
3.0 Compatible
→ Page 296, 73313

ORDER ON THE LINDY WEBSITE

Secure shopping all day, everyday.



www.lindy.co.uk



www.lindy.ie

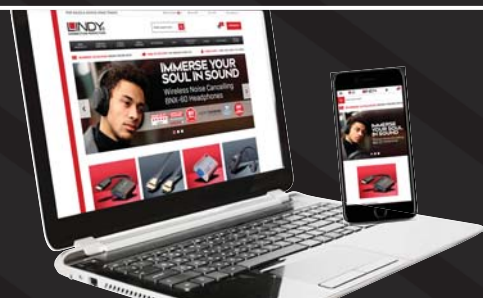

- Fast, secure and easy to use
- Responsive, mobile friendly design
- Advanced search and product filtering functions
- Technical Support forum
- Live Chat feature
- LINDY Blog - for product news and reviews

CHECK OUT OUR REVIEWS!

We partner with the independent review site, Trustpilot, to collect reviews from our customers. All reviews can be viewed at www.trustpilot.co.uk.



@LINDYUK



Facebook.com/LINDY.UK.Official

THE LINDY CABLE GURU

FIND THE CABLE YOU NEED

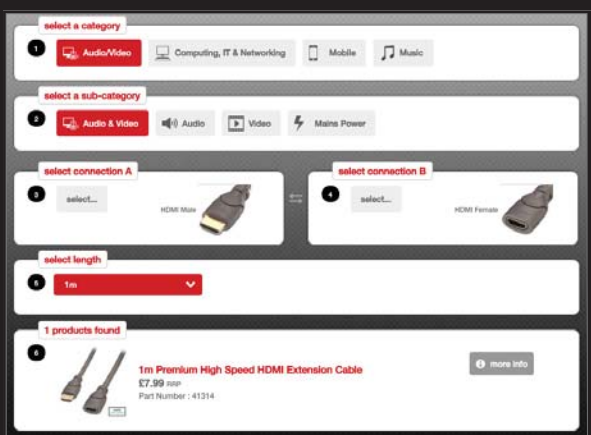

- The interactive cable selector available on our website
- Simple step by step guide for choosing the right cable
- In just a few effortless steps be directed to the cable you need

UNITED KINGDOM

LINDY Electronics Ltd.
Sadler Forster Way

Teesside,

Tel: **01642 754000**

Sales Fax: **01642 765274**

General Fax: 01642 754027

E-Mail: postmaster@lindy.co.uk

REPUBLIC OF IRELAND

LINDY International Ltd.

Sadler Forster Way

Teesside Industrial Estate

Thornaby, Stockton-on-Tees

England, TS17 9JY

Tel: +44 1642 754020

Fax: +44 1642 754029

E-mail: postmaster@lindy.com