



MARCONI
INSTRUMENTATION

*A Technical Information Bulletin
Issued Quarterly by
Marconi Instruments Limited, St. Albans, England*

IN THIS ISSUE

COMMUNICATION	page 157
A FREQUENCY MODULATED LINE OSCILLATOR TYPE TF 1060/3	„ 159
MEASURING THE RESPONSE OF U.H.F. TELEVISION TRANSMITTERS	„ 163
TRANSISTORIZED M.F./H.F. A.M. SIGNAL GENERATOR TYPE TF 2002	„ 168
A SIGNAL GENERATOR FOR AIRBORNE NAVIGATION AIDS TYPE TF 801D/5M1	„ 177
A NEW QUALITY CONTROL TOOL, TYPE OE 1280B	„ 182

ELECTRONIC INSTRUMENTS FOR TELECOMMUNICATIONS AND INDUSTRY

MARCONI INSTRUMENTATION

Issued with

the compliments of

MARCONI INSTRUMENTS
LIMITED

ST. ALBANS

ENGLAND

EDITORS

P. M. RATCLIFFE, A.M.I.E.E.

and

J. R. HAYWARD, A.M.I.E.R.E.

Communication

AS OCTOBER APPROACHES, the Olympic Games at Tokyo become a centre of world interest. Of all the contests in the Games it is probably the Marathon that best typifies the spirit of the occasion, not only because of the athletic effort involved but also because of the tradition behind it. The event this race commemorates, as every schoolboy is supposed to know, is the Greek victory at the battle of Marathon in 490 B.C., the news of which was brought to Athens by a legendary Greek runner. Nearly twenty-five centuries later this rather strenuous and time-consuming method of transmitting the result of a military engagement over a line-of-sight distance by a human carrier has been superseded by a u.h.f. carrier modulated by a speech waveform or code.

Communication by code was, of course, widely used long before the development of radio or even line transmission, and particularly so for maritime use. To warn of the approach of the Spanish Armada in 1588 a strictly low-capacity circuit comprising a network of beacons was established over southern England. At sea, the Royal Navy, after centuries of rather limited flag signalling, was issued with a comprehensive signal book in the 1770's; but the traditionally favourite signal—'Engage the enemy more closely' nailed to the mast-head—long remained the only one they claimed to understand. At the beginning of the 19th century the naval base at Plymouth was linked to the Admiralty in London, 200 miles away, by a series of semaphore relay stations by which messages could be transmitted and acknowledged in as little as three minutes.

Even by this time a practical system of electric telegraphy had been devised by a Scotsman named Marshall, and in the 1830's more convenient systems were developed, such as Wheatstone's telegraph which was used for railway signalling. But it was not until Samuel Morse introduced his code and made the historic transmission from New York to Baltimore in 1844 that the widespread use of electric telegraphy was inaugurated. The military advantages of this new method of communication were quickly appreciated and it proved its effectiveness in the Crimean War and the American Civil War.

The electric telegraph was not seriously challenged until 1901 when Marconi made his famous transmission by radio across the Atlantic. This dramatically demonstrated that wireless telegraphy had potentialities far greater than was held possible by the informed opinion of the day and laid the foundations for the modern radio industry.

Subsequent early radio development tended to show that frequencies we now classify as m.f. were suitable for medium range working, and that the way to better long-distance radio communication was by the use of longer wavelengths, which soon raised the problem of modulation bandwidth. One way of reducing the bandwidth, it was thought, was to use frequency modulation rather than amplitude modulation since the bandwidth of an f.m. signal would be no greater than the deviation employed. This fallacy was finally exposed by Carson in 1922, about the same time that the Marconi Company again altered the course of radio progress by demonstrating the practicability of beamed h.f. signals for inter-continental communication. The wide new spectrum thus opened up eased the bandwidth problem at least for some years. Today a.m. is still popular for h.f. communication but such is the overcrowding in this band that single sideband modulation and bandwidth

The copyright of all articles is strictly reserved but the material may be reprinted without permission providing definite acknowledgement is made to Marconi Instruments Limited

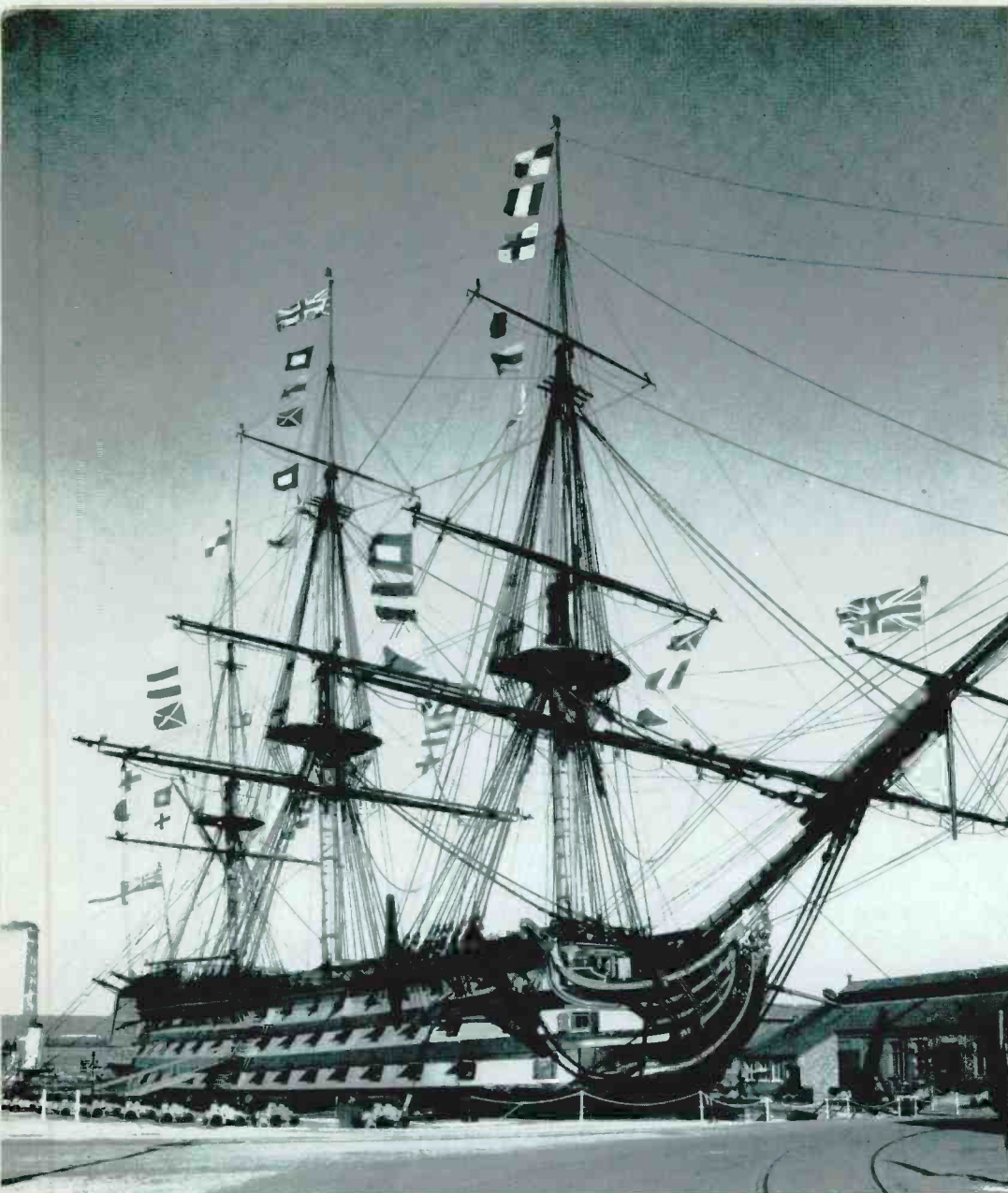

Nelson's flagship HMS Victory in dry dock at Portsmouth flying its famous signal 'England expects that every man will do his duty' in commemoration of the naval victory of Trafalgar on 21st October, 1805

compression systems are becoming increasingly common. F.M. is too extravagant in bandwidth to be used in the m.f. and h.f. bands, although narrow-deviation frequency shift keying and photo-telegraph systems are permitted.

The v.h.f., u.h.f. and s.h.f. bands provide greater scope for wide-band modulation and here it is often profitable to buy signal-to-noise ratio at the expense of bandwidth by using wide-band f.m. Except when used for tropospheric scatter links these bands have only a short range so that overcrowding can be avoided by allocating the same channel frequencies to geographically separated circuits. Although v.h.f. systems have for many years handled most of the wide-band traffic, the increasing demand for high-capacity multi-channel telephone and telegraph circuits, wide-band television, high-speed data and radar information channels has led to the main national and international trunk routes being equipped with wide-band radio relay systems in the u.h.f. and s.h.f. bands. Although f.m. is the more usual type of modulation, a.m. is often used at v.h.f. for telephony

circuits and aircraft navigation aids and for handling the extremely wide bandwidth of television signals. Indirect f.m. has application in telemetry circuits, for example, where thousands of data samples per second can be transmitted by sampling techniques employing various types of pulse modulated sub-carriers which, in turn, are used to frequency modulate a single u.h.f. carrier.

As manufacturers of telecommunications measuring equipment we are responsible for providing the means of keeping communications circuits at maximum efficiency. Each of the four instruments in this journal has been designed for this purpose in four different types of system.

Wide-band f.m. circuits are catered for by the U.H.F. Signal Generator type TF 1060/3, an f.m. version of the well-known a.m. generator TF 1060. A simplified approach to testing V.O.R. and I.L.S. aircraft navigation aids is described in the article on the special A.M. Signal Generator type TF 801D/5M1. The expansion of television broadcasting into the u.h.f. bands has brought about the introduction of the U.H.F. Converter for use with the TF 2360 Television Transmitter Sideband Analyser in providing a frequency swept signal for dynamic testing of transmitter response. Finally, the major new Signal Generator type TF 2002 provides a familiar type of test signal in a new way—its high-grade a.m. output covering the m.f. and h.f. bands is produced from an all-transistorized circuit. It thus leads the field in this important class of generators, and keeps the name of Marconi in the fore-front of the h.f. communication band which, despite rapid progress in other bands, still plays an indispensable part in the business of carrying the information of the world.

J.R.H.

MARCONI
INSTRUMENTS

A Frequency Modulated Line Oscillator

TYPE TF 1060/3

by
P. M. RATCLIFFE,
A.M.I.E.E.

There are several methods of producing frequency modulation, and the one selected depends on the nature of the r.f. oscillator to be modulated. Reverse biased diodes form suitable modulating elements, and have made possible the frequency modulation of coaxial line oscillators. For this particular application the requirements of such a diode are considered together with the manner in which it can be coupled to the tuned circuit. The performance of a frequency modulated signal generator, covering the range 470 to 960 Mc/s is given.

SINCE THE EARLY nineteen-forties this company has been manufacturing frequency modulated signal generators. These currently in production are the F.M. Signal Generators Type TF 995A¹ series, the Type TF 1066B² series, and the V.H.F. Signal Generator Type TF 1064B³ series. Together they have a frequency cover which extends from 1.5 to 555 Mc/s. These three series of instruments utilize different systems to frequency modulate the r.f. oscillator. In the TF 995A series the familiar reactance valve is used as the modulator, but due to the inherent limitations of the device the required frequency range can only be realized by multiplication and beat frequency techniques. The TF 1066B and TF 1064B series use the more fundamental magnetic reactor as the modulating element in which the core permeability of an inductor connected across the resonant circuit of an oscillator, is varied in sympathy with the

modulating signal. By this means direct modulation can be achieved up to a frequency of 555 Mc/s. Both of these methods are practical where the basic r.f. oscillator is a lumped tuned circuit, and the modulating element can be physically connected across that tuned circuit; but when it becomes a distributed line neither of these systems is applicable.

At microwave frequencies where klystrons are preferred for low power generation, producing frequency modulation is relatively simple as they are frequency sensitive to voltage variations on the reflector. By applying a suitable signal directly to this electrode the oscillator is modulated, and very wide deviations are possible provided the incidental amplitude variations can be tolerated.

Above about 500 Mc/s, and below the microwave range, the usual circuit configuration for a wide range



Prototype model of TF 1060/3 being subjected to the mechanical bump test. Here the frequency deviation of the output signal is being monitored with a Carrier Deviation Meter type TF 791 D

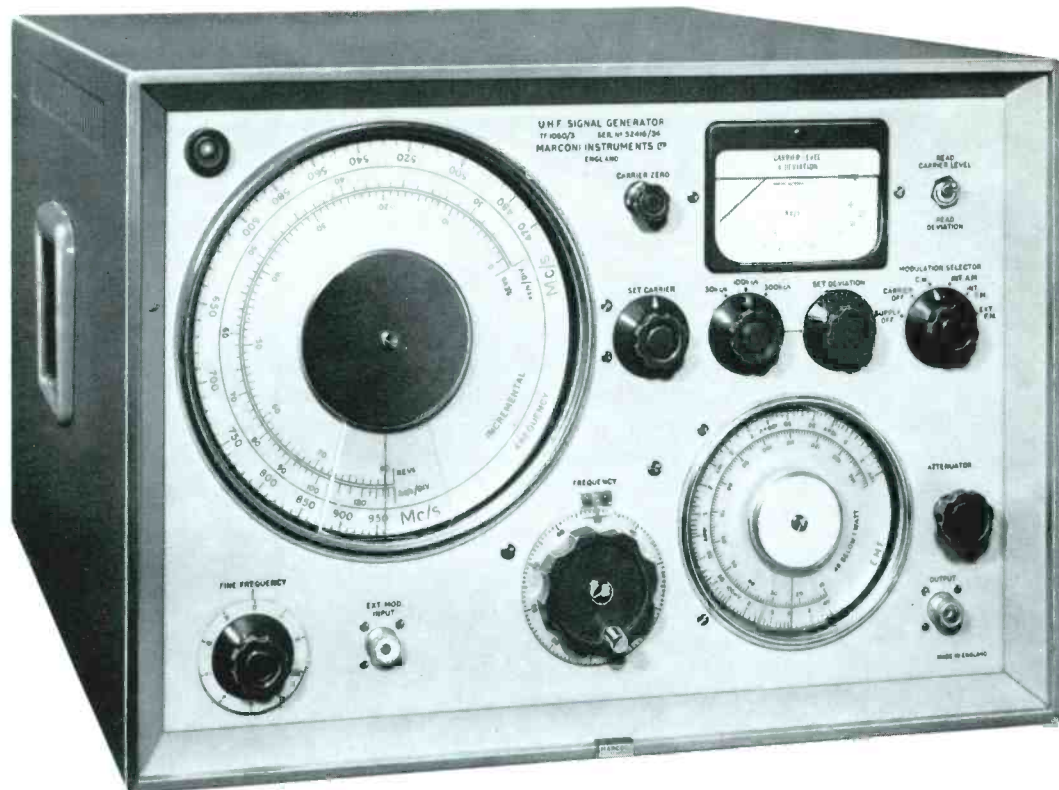

The U.H.F. Signal Generator Type TF 1060/3, covering the frequency range 470 to 960 Mc/s, has provision for both internal and external frequency modulation

oscillator is the disk-seal triode valve mounted in a coaxial line which forms the resonant circuit. The U.H.F. Signal Generator TF 1060 is an example of such a generator. This particular instrument covers the frequency range from 450 to 1,250 Mc/s, and has facilities for amplitude and pulse modulation only. Another version, designated TF 1060/3, covering the range from 470 to 960 Mc/s has now been produced with provision for both internal and external frequency modulation. This additional facility has become possible mainly owing to the availability of high frequency reverse biased diodes which can be used as the modulating element for a line oscillator. Their use in this application is not of course, confined to this particular form of r.f. circuit⁴, as they are also used on the highest r.f. range of the V.H.F. Signal Generator Type TF 1064B series. The problems involved however, are somewhat more complex than at these lower frequencies due to the inadequate value of Q-factor that can be realized.

Reverse Biased Diode

Silicon junction diodes have a barrier capacitance, the value of which, for a given diode, depends upon the reverse bias applied. This relationship between the capacitance and the bias voltage is of the form:

$$C = K(V_b + V_c)^{-n}$$

where C is the junction capacitance
 V_b is the reverse bias voltage
 V_c is the contact potential and lies between 0.5 and 0.7 V,
 and n is the voltage sensitivity.

The value assigned to n is dependent upon the method of fabrication, and is approximately $\frac{1}{3}$ for graded junctions and $\frac{1}{2}$ for abrupt junctions. Since there is a maximum voltage than can be applied to a diode to ensure that breakdown does not occur, it follows that a greater capacitance swing can be obtained with an abrupt junction which was the reason why this type was selected for this particular application.

To operate the diode as a frequency modulator it must be coupled to the r.f. oscillator resonant circuit, which in the u.h.f. band presents a major problem due to the relative Q-factors of the tuned circuit and diode. An equivalent circuit of the junction, under reverse bias conditions, is shown in Fig. 1(a) where the barrier resistance is commonly in the order of tens of megohms. So, at high frequencies the circuit reduces to that of

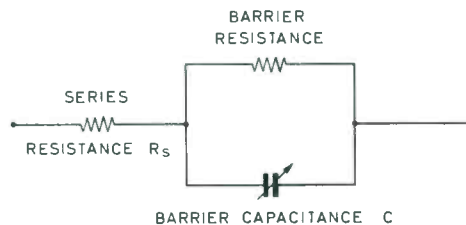

Fig. 1(a). Equivalent circuit of diode under reverse bias conditions

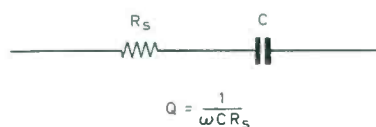

Fig. 1(b). High frequency equivalent circuit of diode

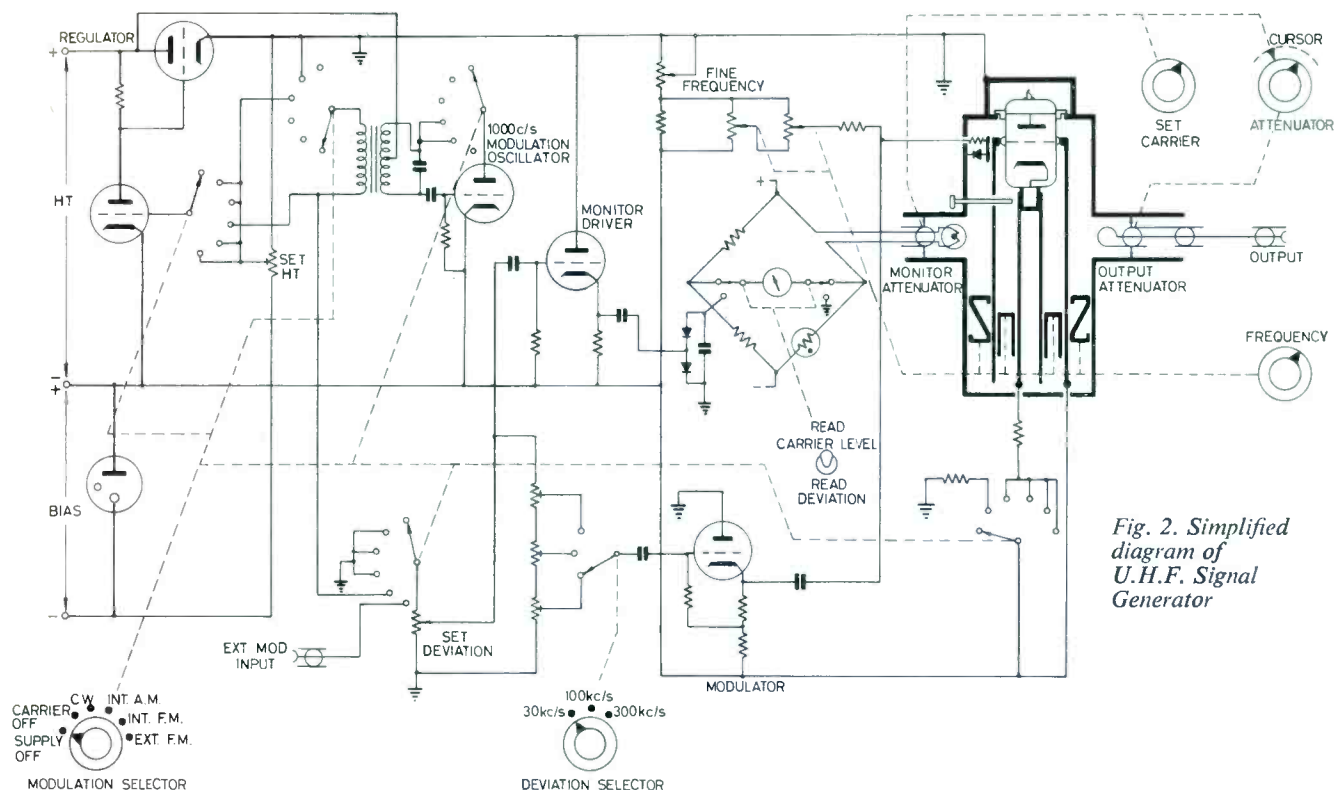

Fig. 2. Simplified diagram of U.H.F. Signal Generator

Fig. 1(b) where the series resistance R_s is due to the bulk resistance of the semiconductor material and leads, therefore the Q-factor of this component is given by $Q = 1/\omega CR_s$, and will at a given frequency depend upon the value of C and hence the applied reverse bias. At 1,000 Mc/s Q-factors, with minimum capacitance, in the order of 10 to 40 can be obtained, but this would have a severe damping effect if coupled too closely into the tuned circuit where the normal loaded Q is the order of 100 to 150. Also if the diode is in a strong r.f. field it would dissipate an excessive amount of energy causing overheating with a probability of damage occurring.

Coupling to the Oscillator

In the oscillator considered here the main r.f. tuned circuit consists of a length of short-circuited coaxial line between anode and grid of the valve, with the anode at earth potential. So that the low Q-factor of the diode does not unduly damp this circuit, it is mounted in series with a small air spaced capacitor and the combination connected between the anode and grid of the oscillator. This configuration has the advantage that the diode can be mounted external to the cavity, as the anode is earthed, and will not be subjected to the intense r.f. field which exists within the cavity. Although this improves the Q-factor of the modulating element to an acceptable value, it reduces the available capacitance swing, and the final value of the air spaced capacitor is a compromise between suitable Q-factor and capacitance variation.

It is desirable in any signal generator that the degree of modulation produced should be independent of the r.f. frequency. To accomplish this with a frequency modulated system it is necessary to vary the sensitivity of

the modulating element as the r.f. frequency is varied, with lowest sensitivity being required at the highest r.f. frequency. This is easily achieved with reverse bias diodes by changing the applied d.c. voltage in sympathy with the r.f. frequency. Thus, maximum bias is applied at the high frequency end giving minimum capacitance and maximum Q-factor, and then reduced to a suitable value at the low frequency to give an identical sensitivity. Frequency modulation is produced by superimposing on the d.c. bias an alternating signal which for a given deviation will be constant in amplitude at all frequencies. The minimum value of bias must be such that it exceeds the peak value of the a.c. signal so that the diode is not driven into the conducting region on the positive excursions of the modulating signal.

Compared with the capacitance of the tuned circuit the additional capacitance of the modulating element is insignificant as is demonstrated by the small change in frequency that occurs when it is added. Adding further diodes in the same manner will only give a small increase in the total circuit capacitance, but the overall swing available will be proportional to the number of diodes used. In this manner the sensitivity can be increased by the addition of further capacitors across the tuned circuit, and in this instrument two diodes are used.

In the simplified diagram, Fig. 2, is shown the method of mounting the modulating element in close proximity to the oscillator valve with the air spaced capacitor within the cavity, and the diode connected to earth outside. The housings for the diodes and associated r.f. filters are shown in Fig. 3, mounted on the side of the line oscillator on the left side of the photograph.

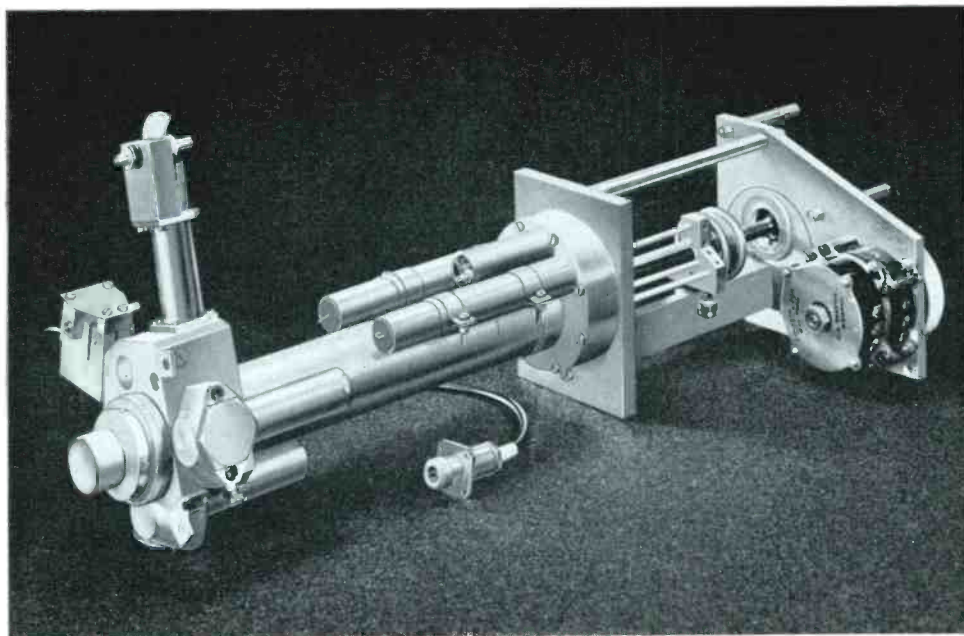

*Fig. 3
Coaxial line oscillator and
drive assembly. The reverse
biased diodes and filters are
housed in the blocks adjacent
to the valve screening cap*

Performance

The degree of frequency modulation obtainable with this system depends upon many factors such as the number of diodes used, how closely they are coupled to the r.f. circuit and the amplitude of modulating signal applied. Although the full potentialities have not been completely investigated it appears that it is capable of producing several megacycles of deviation, but in this instrument, which covers broadcast and communication bands, the maximum deviation has been purposely limited to 300 kc/s. For narrow band working a 30 kc/s range is also included which for ease of operation requires the same input signal level, but not the same level applied to the modulating element. As the d.c. tracking system ensures constant sensitivity over the frequency range, the deviation is monitored by displaying the amplitude of the applied signal on a meter.

As stated previously, the capacitance of the diode is inversely proportional to the square root of the applied voltage. Inevitably when an a.c. signal is applied to

vary the diode capacitance distortion will be produced. At a given carrier frequency this distortion will be proportional to the amplitude of the applied signal and thus will increase with increase in deviation. As the tracking system maintains constant sensitivity there will be a greater swing of capacitance at the low r.f. frequencies for a given deviation, so the distortion will be greatest at the low end of the bands.

Basically the diodes are broad-band devices, and the frequency range of the modulating signal is only limited by the response of the external circuits such as the filters and the monitor. External modulation can be used over the frequency band from 30 c/s to 120 kc/s, and there is an internal 1 kc/s oscillator. In common with all our frequency modulated generators the incidental modulation due to hum and noise has been kept low and does not exceed 100 c/s deviation. Due to the rigid mechanical construction that is necessary in a coaxial line oscillator it also exhibits a remarkable freedom from microphony.

REFERENCES

- HILL, J. C.: 'An F.M./A.M. Signal Generator for Mobile V.H.F. Equipment' *Marconi Instrumentation*, September 1958, 6, p. 187.
- DEICHEN, J. H.: 'A Wide Deviation Signal Generator type TF 1066B/6' *Ibid.*, September 1963, 9, p. 69.
- DEICHEN, J. H.: 'V.H.F. Signal Generators Type TF 1064B/5, -/6, -/7, and -/8', *Ibid.*, June 1962, 8, p. 132.
- ARSEM, C.: 'Wideband F.M. with Capacitance Diodes', *Electronics*, December 4th 1959, 32, p. 112.

ABRIDGED SPECIFICATION

Frequency

RANGE: 470 to 960 Mc/s in one band.

ACCURACY: $\pm 1\%$.

STABILITY: After 2 hours' warm up the drift is less than $\cdot 003\%$ in a 10 minute period.

R.F. Output

LEVEL: Continuously variable from $1\cdot 0\mu\text{V}$ to at least $0\cdot 5\text{V}$ source e.m.f. The maximum available output rises with frequency to give not less than $1\cdot 0\text{V}$ at 960 Mc/s.

ACCURACY: $\pm 2\text{dB}$.

SOURCE IMPEDANCE: 50Ω ; v.s.w.r. better than 1.5:1 or using the 10 dB pad TM 5554 better than 1.2:1.

Frequency Modulation

INTERNAL: Modulation frequency 1 kc/s. Deviation variable to 300 kc/s maximum in 3 ranges of 0 to 30 kc/s, 0 to 100 kc/s and 0 to 300 kc/s.

EXTERNAL: Modulation frequency range 30 c/s to 120 kc/s Input requirements 2.5 volts across $5\text{k}\Omega$.

DEVIATION ACCURACY: $\pm 15\%$ f.s.d. up to 600 Mc/s and $\pm 12\%$ of f.s.d. above 600 Mc/s at 1 kc/s modulation frequency. Using correction chart supplied, accuracy at all carrier frequencies is within $\pm 7\%$ of f.s.d. Over external modulation frequency range 30 c/s to 120 kc/s is within 0.5 dB of accuracy at 1 kc/s.

MODULATION DISTORTION:

Not greater than 2% on 0 to 30 kc/s range.
Not greater than 5% on 0 to 100 kc/s range.

Not greater than 15% on 0 to 300 kc/s range.

RESIDUAL F.M.: The frequency modulation due to hum and noise is less than 100 c/s deviation.

Amplitude Modulation

INTERNAL: Modulation frequency 1 kc/s at a nominal 30% depth.

RESIDUAL A.M.: The a.m. due to hum and noise is better than 46 dB below 30% modulation depth.

MARCONI
INSTRUMENTS

MEASURING THE RESPONSE OF U.H.F. TELEVISION TRANSMITTERS

by
R. J. LUDBROOK,
B.Sc., Graduate I.E.E.

The TF 2360 Television Transmitter Sideband Analyser was described fully in the March 1963 issue of Instrumentation, with only a brief account of the associated U.H.F. Converter TM 6936, for extending the range to cover bands IV and V. A more detailed account of the converter is now given, describing the method used and the factors upon which the accuracy of measurement depends.

THE INCREASE of television broadcasting in u.h.f. Bands IV and V brings a requirement for test equipment to operate in that region. One important measurement to be made on television transmitters is that of the frequency response over the sidebands. Fig. 1 shows the ideal frequency characteristic on a 625 line system using a 7 Mc/s channel width to C.C.I.R. recommendations.

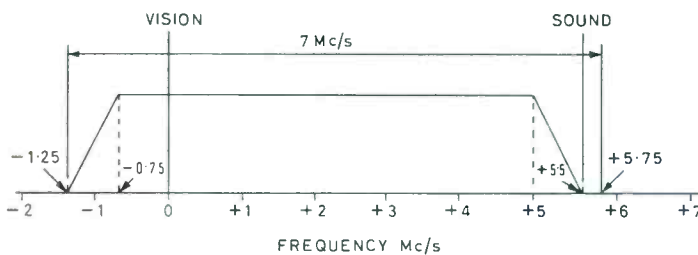

Fig. 1. Ideal characteristic, 625-line vision transmitter using 7 Mc/s channel width

In order to measure the frequency response to the specification laid down for the transmitter a method is used based on the standard technique of modulating the transmitter with a signal whose amplitude and frequency are known and measuring the resulting r.f. output from the transmitter, relating the sideband amplitude at any given modulating frequency with the amplitude of the modulating input. While it is possible to use a point by point method, recording the sideband amplitudes for various modulating frequencies, the accuracy obtained is likely to be inadequate; this is because of the difficulty of monitoring the modulating signal accurately over a wide range of video frequencies and of obtaining constant sensitivity in the receiver used for measuring each sideband frequency over the band. In addition, the time taken for the measurement is considerable especially when it has to be repeated after every adjustment. The use of sweep frequency techniques can overcome these disadvantages and an instrument making use of these techniques and specially designed for measuring the frequency response of television transmitters in Bands I and III is the Television Transmitter Sideband Analyser type TF 2360¹. For measurements in Bands IV and V the U.H.F. Converter TM 6936 is available for use with

the TF 2360. The purpose of the present article is to give a fuller account of the way in which the measurement at u.h.f. is achieved.

Principles of Operation

Since the Television Transmitter Sideband Analyser type TF 2360 has already been described in detail it is sufficient here to state that it is capable of measuring the frequency response of any television transmitter operating in Bands I and III by applying a modulating video signal which sweeps up to at least 7 Mc/s on either side of the carrier, or up to 20 Mc/s asymmetrically, analysing the resulting sidebands and presenting a detected response showing both upper and lower sidebands, in correct relationship to the carrier, on an oscilloscope. The modulation may be composite with blanking and synchronising components of the required amplitudes. The design is such as to allow for conversion to u.h.f. without alteration to the main instrument.

In order to make a measurement on a U.H.F. transmitter which has a carrier between 470 and 890 Mc/s a frequency converter is required which will give an output

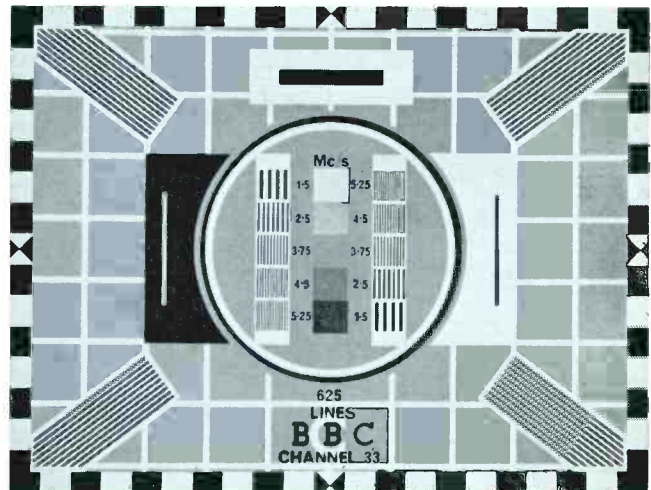

Test card 'C', used in the morning television trade test transmissions of BBC-2

frequency somewhere within the range of the basic instrument, without detracting from the accuracy of measurement. Sensitivity is also important in order to keep the noise level of the picture on the oscilloscope to a low level, and for this reason the output frequency of the converter was chosen to be 50 Mc/s as this is the frequency at which the TF 2360 has maximum sensitivity and a low input v.s.w.r. Without altering the main instrument in any way there are two ways of producing the 50 Mc/s signal at the required level. One is to use a low level mixer and then to use a broad band amplifier centred on 50 Mc/s to increase the amplitude of the converted signal before application to the TF 2360. The other is to convert at a high level and feed the output directly without an intervening amplifier. Both methods require the mixer itself to be wide band so that it will accept the widest video bandwidth likely at carrier frequencies from 470 to 890 Mc/s with negligible variation in response over this bandwidth. The second method is considered to have the most advantages, as there are less components which reduces the cost and maintenance, and there are no circuits apart from the mixer to contribute towards the frequency response. Also since there are no tuned circuits, the output frequency is not necessarily fixed at 50 Mc/s; for instance if the TF 2360 should be used on a 45 Mc/s transmitter on the same site as a u.h.f. transmitter the tuning may be left at 45 Mc/s. The possible disadvantage is that the signal to noise ratio on the final display may not be as good under the worst conditions, i.e. with low r.f. input and low percentage modulation, although even under these conditions the display is satisfactory and the accuracy of measurement is not affected.

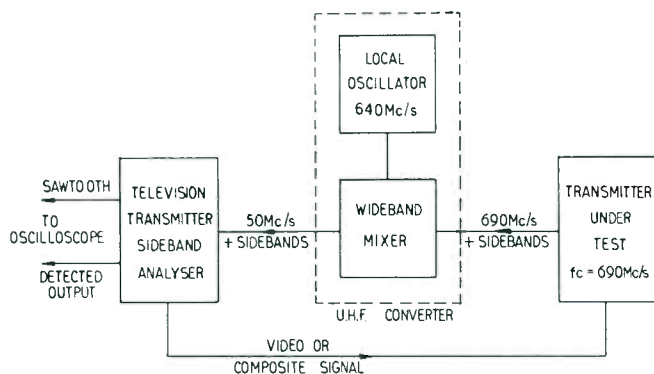
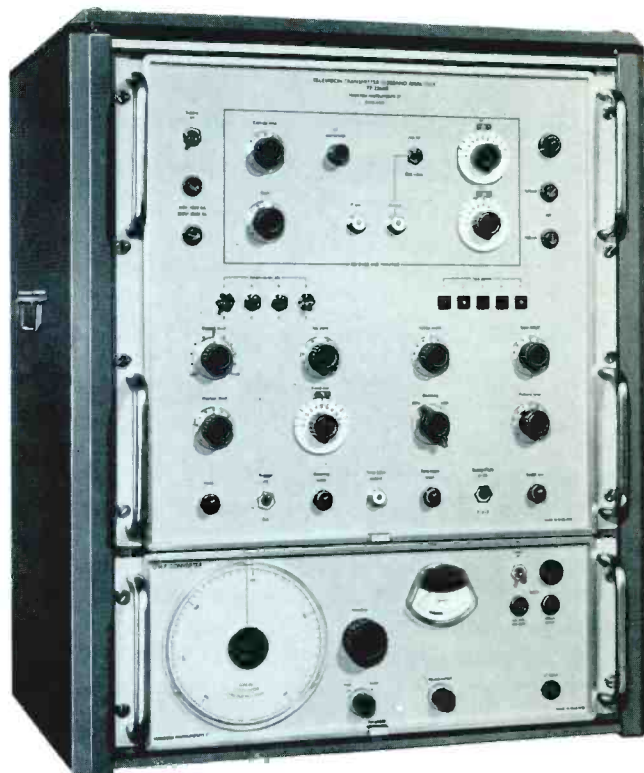

Fig. 2. Arrangement of U.H.F. Converter type TM 6936 and Television Transmitter Sideband Analyser type TF 2360 for measuring Band IV and V transmitter response. For a transmitter frequency of 690 Mc/s the Converter is operated at 640 Mc/s and the Sideband Analyser at 50 Mc/s

For these reasons the second method is used and the block diagram of Fig. 2 shows the configuration when the complete equipment is in use.

The local oscillator operates from 420 to 850 Mc/s so that the complete coverage is obtained with the oscillator tuned below the signal, although over much of the band the oscillator could be tuned above the signal, the effect being to reverse the polarity of the display.



Rack-mounted assembly of Television Transmitter Sideband Analyser type TF 2360 with U.H.F. Converter type TM 6936

Requirements of Mixer and Oscillator

Although the configuration used is basically simple there are several requirements which must be met by both mixer and local oscillator which are peculiar to this particular application. The mixer must satisfy the following conditions:

- Flat frequency response within 0.25 dB over at least a 10 Mc/s band.
- Low conversion loss.
- Input v.s.w.r. less than 1.1 : 1.
- Ability to accept high level input signals.
- Low noise.

In order to obtain the required flat response it is desirable that there are no tuned circuits, either r.f. or i.f., and in any case because of the wide frequency range any form of r.f. tuning would be inconvenient. A silicon mixer diode is therefore incorporated in a broadband circuit.

The conversion loss must be as low as possible since although there is ample power available from the transmitter there is a limit to the power which can be applied to the mixer, hence the need to accept high level signals up to about 30 mW peak sync level. Typical figures for conversion loss are 10-12 dB over the whole band. Although the diode current necessary to achieve the high input level is higher than usual, the noise level is low compared to that in the overall system. To prevent any additional loss of signal there is no d.c. return in the mixer itself, the d.c. path being provided by the input of the TF 2360 via the interconnecting lead.

Since the diode impedance contributes towards the input impedance of the mixer it is impracticable to achieve an input v.s.w.r. of less than 1.1:1 with any certainty but, by careful matching of the input circuits, a figure of less than 1.4:1 over the whole band is achieved. To obtain the desired figure of 1.1:1 a 9 dB attenuator is supplied for connection to the input. This raises the level of the applied input to between 10 and 250 mW at peak sync level, a figure of 100 mW peak sync giving a satisfactory signal to noise ratio on the display at all video levels.

The requirements for the local oscillator are as follows:

- (a) Frequency range of 420 to 850 Mc/s to give 50 Mc/s output from mixer.
- (b) Output of the order of 200 mW.
- (c) Good frequency stability.
- (d) Low incidental f.m. and microphony.

The need for good frequency stability will be understood when it is considered that the final i.f. bandwidth in the receiver of the TF 2360 is 40 kc/s at the 3 dB points and, to obtain a static display, the local oscillator must stay tuned within this pass band up to its maximum frequency of 850 Mc/s. A crystal controlled oscillator would provide the complete answer to this, but would suffer from lack of versatility; the variable frequency oscillator finally adopted is sufficiently stable so that slight peaking of the fine tuning controls on the TF 2360 from time to time is all that is necessary. To obtain the required frequency range and power output the oscillator is of the butterfly type, but built in concentric form using a disk-seal triode, in which both inductance and capacitance are varied together. The sturdy construction gives an adequate heat sink which helps to maintain

the frequency stability and also to keep microphony to a low level. Spurious f.m. is an important factor since, if this is present to any extent, there is a variation in output from the receiver in the TF 2360 if the tuning does not coincide with the peak of the i.f. response; this is because the frequency excursions cause the output level to follow the curve of the i.f. response. Since spurious f.m. is most likely to occur at mains frequency

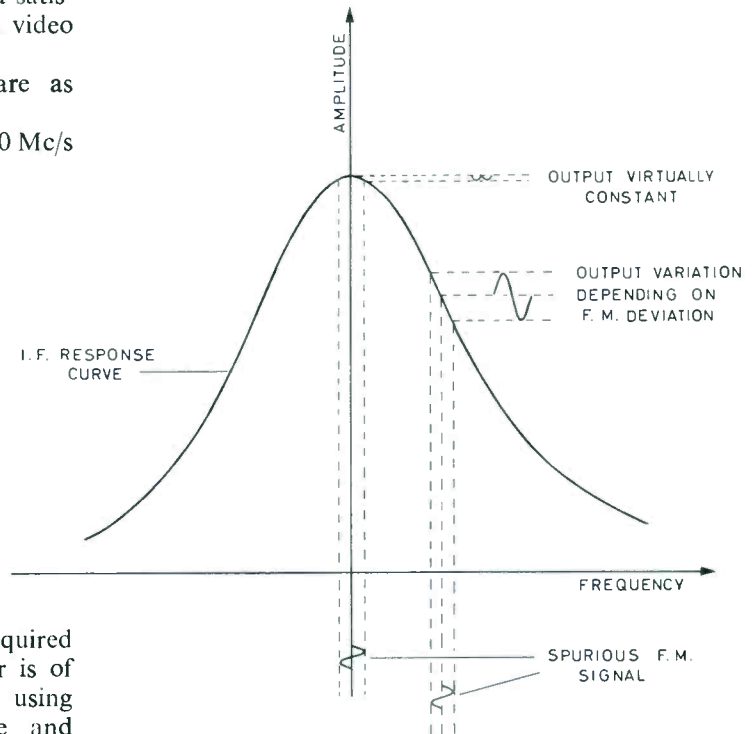

Fig. 3. Effect of local oscillator or signal f.m. upon output of receiver at different tuning points



U.H.F. Converter type TM 6936



Televising 'Impromptu' an unscripted comedy show, seen on the BBC-2 Television Service

(by courtesy of BBC)

due to modulation from the oscillator heater and also that the display is locked to mains frequency, the effect is that of a mains ripple superimposed upon the display which changes phase as the tuning is varied on either side of the peak and disappears when exactly in tune, as shown in Fig. 3. In this design the f.m. content is kept well below 1 kc/s at all frequencies by using d.c. stabilized supplies for both h.t. and heater.

Effect of v.s.w.r. on Accuracy

Since the amplitude of the display obtained depends on the voltage present at the mixer input any fluctuations over the band due to standing waves will be reproduced on the display. The amplitude of the fluctuations depends on the degree of mismatch and the number of fluctuations on the length of cable used. It may be shown that the number of voltage maxima on an unmatched cable at a given frequency is

$$n = 2x/\lambda, \text{ where } x \text{ is the length of the cable and } \lambda \text{ the wavelength in metres}$$

This may be extended to $\frac{n}{f} = \frac{2x}{v} = N$, where N is the

number of maxima per Mc/s, and v is the velocity of propagation along the cable $\approx 200 \times 10^6$ metres/sec, i.e. the number of maxima over a given frequency band is independent of the frequency in use.

Since we are only interested in a 10 Mc/s bandwidth, for there to be a ripple on the response at a frequency of 1 Mc/s, the cable would have to be 100 metres long and for one maximum per 10 Mc/s the cable would have to be 10 metres long. Although in practice it is unlikely that such long cables would be used, these examples illustrate the possibility of altering the response with different lengths of cable in the presence of a mismatch.

Using a shorter length of cable, any such mismatch would show the variation as a portion of that between maximum and minimum and would give the effect of a tilt on the response, the amount of tilt depending on the degree of mismatch and the phase depending on the exact length of cable.

At first sight this would appear to be a very stringent requirement considering that the response is to be flat to within 0.25 dB and this could be produced by a v.s.w.r. of 1.05:1 on the cable. However, to see all the variation due to the mismatch the cable would have to be at least 10 metres long, whereas with a more normal length of 3 metres the proportion of the total variation would be approximately 0.05 dB. Thus with a cable of this length and a v.s.w.r. of 1.1:1 the error would be approximately 0.1 dB. The situation is further improved since the utmost accuracy is likely to be required over only 5 Mc/s bandwidth and, therefore, the v.s.w.r. could be greater than 1.2:1 without any noticeable effect and this is confirmed in practice.

As previously stated a 9 dB attenuator is supplied for connection to the mixer input to ensure that the input v.s.w.r. is better than 1.1:1 at all frequencies. For measurements on small signals it is possible to use the mixer without the 9 dB attenuator, e.g. for measuring the modulation response of signal generators. In this case the v.s.w.r. can reach 1.4:1 at the ends of the frequency range although over most of the range from 550 to 800 Mc/s it is of the order of 1.2:1 or better and the error is therefore still very small. In practice it appears that with the worst v.s.w.r. available the error is less than 0.5 dB over a 10 Mc/s band.

Having achieved a good match at the mixer input it is equally important that the cable and connectors should conform to the same standard. In case of doubt the use of

a variable length coaxial line, otherwise known as a line stretcher, may be used while observing the display to see if any change takes place.

Effect of R.F. Input Power on Accuracy

Excessive input power will cause overloading of the mixer, shown as a flattening of the response. This is easily determined by inserting additional attenuation in the input circuit and noting if there is any change in shape. The maximum recommended input is 250 mW at peak sync level, this power being applied to the 9 dB attenuator attached to the mixer input. A satisfactory input power for operation is of the order of 100mW at peak sync level.

Operation

The instrument is exceptionally easy to use. Assuming that the Television Transmitter Sideband Analyser type TF 2360 has already been set up to accept a frequency of 50 Mc/s all that is necessary is to tune the U.H.F. Converter to 50 Mc/s below the carrier frequency in use, adjust the crystal current control to give a standard meter indication and then to finally adjust the tuning until a display appears on the oscilloscope. It is easier to peak the display using the fine tuning controls on the TF 2360 because of the better discrimination obtained.

Measurements carried out on the complete equipment and tests made on transmitters show that it is quite possible to measure a transmitter response to better than 0.5 dB overall, providing the above precautions are taken. The advantages over a point by point method are

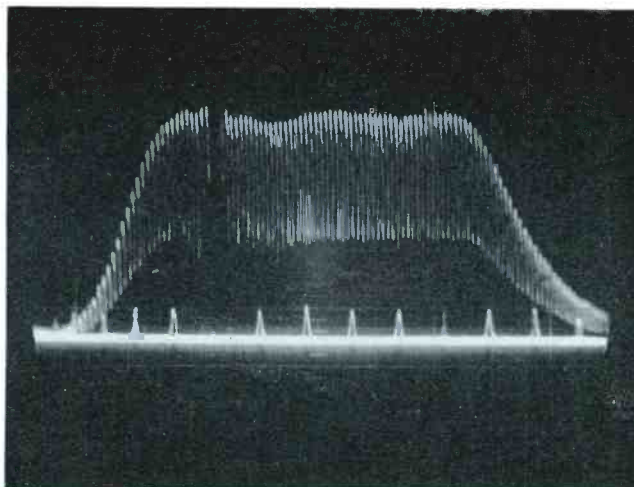

Typical display obtained on u.h.f. transmitter at a carrier frequency of 620 Mc/s. Input power to U.H.F. Converter 60 mW peak sync, local oscillator tuned to 570 Mc/s. Upper sideband is on the right of the display.

obvious and the ready availability of the response shape gives confidence in the quality of the transmitted signal. The equipment is of course also highly suitable for measuring the overall response of signal generators which can accept wide band video modulation.

REFERENCE

1. Ludbrook, R. J.: 'Television Transmitter Sideband Analyser type TF 2360' *Marconi Instrumentation*, March 1963, 9, p. 13.

ABRIDGED SPECIFICATION

R.F. Input Frequency Range

470 to 900 Mc/s, assuming 50 Mc/s output from Converter.

Dial calibrated in local oscillator frequency.

with 9 dB pad, TM 5554/4.

Input Impedance

50 Ω .

Frequency Response

Flat to within 0.5 dB over any 10 Mc/s sweep range from 470 to 900 Mc/s in conjunction with TF 2360.

Local Oscillator Frequency Range

420 Mc/s to 850 Mc/s.

Input V.S.W.R.

Better than 1.4:1, or better than 1.1:1

NEW COMMERCIAL MANAGER

MR. JOHN BRODRICK has been appointed Commercial Manager of Marconi Instruments Limited. He is responsible for Marconi Instruments' home and export sales and service, publicity and market research.

Mr. Brodrick was previously with Mullard Limited, where he had special responsibilities for market promotion and headed the Market Research Department within Mullard's Marketing Services Division. From 1954 to 1960 Mr. Brodrick headed the Economic Intelligence Department of the English Electric Company, and prior to that worked for Lazard Brothers & Co. Ltd., the merchant bankers.

Mr. Brodrick is 38 years old, married with two children, and holds the B.Sc.(Econ.) degree of London University. He has served on committees of the Federation of British Industries, B.V.A., V.A.S.C.A. and R.E.C.M.F., and writes and lectures on industrial marketing subjects.



TRANSISTORIZED

M.F./H.F. A.M. Signal Generator . TYPE TF 2002

by
J. M. PARKYN

This is an entirely new fully transistorized signal generator giving a high quality a.m. output in the carrier range 10 kc/s to 72 Mc/s. Its salient features include exceptionally high discrimination tuning with low drift, low leakage and spurious modulation. The instrument is rugged yet compact in design, weighing only 50 lbs, and includes many unique features ensuring ease of operation and the best performance through its wide range of operating frequencies. TF 2002 is the first fully transistorized wideband general purpose signal generator of its kind.

IN THE PAST few years there has been in the Marconi Instruments catalogue a steady displacement of instruments using thermionic valves by new designs using all or mostly semiconductors. TF 2002 is the first fully transistorized signal generator which is being introduced via this journal. However, in keeping with the statements made in the introduction to our 1963-64 Catalogue, the mere use of semiconductor active elements is not considered in itself a merit: it is the advance in performance which is the criterion.

After extensive investigation, the advantages of transistors in signal generator design have been exploited to include advanced techniques of both circuit and mechanical design ensuring the best in performance. It will be seen from the description to follow that a number of new systems and techniques, which have become possible and practicable by the use of transistors, have been employed to give a considerable advance in performance over previous designs.

Tuning System and Range Changing

The heart of any signal generator is in the carrier oscillator. Upon this section of the instrument depend such vital performance factors as frequency stability, both thermal and mechanical, and discrimination. Carrier sources in wide-band signal generators can be divided into three main classes:

- (i) Multi-range oscillators for use as fundamental frequency sources,
- (ii) single range oscillators for use in multiplier type generators, and
- (iii) crystal oscillators for driving multipliers, dividers and adders in synthesizers.

TF 2002 employs a special form of multi-range band switching where a completely separate oscillatory circuit



A 100% modulated r.f. output signal from the generator being viewed on the Oscilloscope type TF 2200

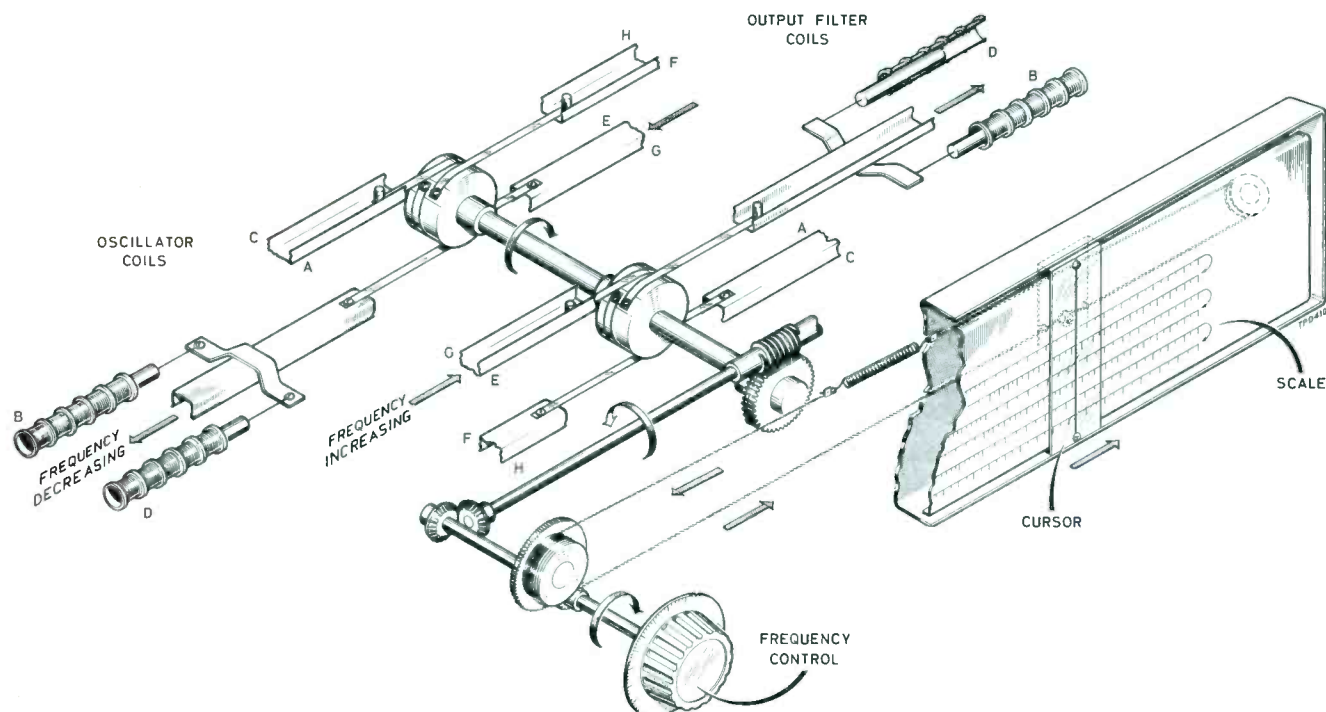

Fig. 1. Tuning drive system

is used for each band. This system eliminates (i) the compromise value of the continuously variable tuning element—normally a ganged capacitor—which must suit the entire frequency cover of the generator, (ii) the use of r.f. contacts operating in the path of the tuned circuit circulating currents. Each oscillator is fitted with a separate L-C tuned circuit and its own transistor(s). Range changing is effected by supply switching using ordinary wafer switches to actuate the appropriate oscillator unit. A further wafer on the range change switch selects the low level oscillator output and feeds this signal via a $50\ \Omega$ matched feeder to a common amplifier and other circuit units to be described later. Separate switched $100\ \Omega$ continuously tuned π output filters are used after the common wide-band amplifiers to maintain a low level of carrier distortion.

With its eight ranges TF 2002 contains 16 complete tuned circuits. Permeability tuning has been used throughout to provide two major advantages. First, since the physical size of variable inductors of widely different electrical values can be the same, the system allows a free choice of L-C ratio and hence circuit impedance; it has thus been possible to ensure a correct match to the transistor impedances without the use of the usual techniques of high tapping ratios with their attendant problems. Second, the microphony of permeability tuning systems is generally lower than capacitively tuned systems; this is because air spaced capacitors have a certain area of unsupported vane which is free to vibrate whereas the permeability tuning system used here provides full support for the tuning cores through a three point bearing spring.

Frequency Stability

High grade coils and tuning capacitors have been used in the oscillators to keep the temperature coefficient of frequency down to about $50 \times 10^{-6}/^{\circ}\text{C}$ which is a typical figure for good quality signal generators. However, the oscillator units work with high efficiency at about a 1mW level also the total power—15 watts—and consequent heating of the whole generator is small so that the instruments exhibit very low frequency drift rates. These can be expressed in two ways, either (i) after the usual four hour warm-up period at constant ambient temperature the drift rate drops to about $2\ \text{c/s} + 3.5 \times 10^{-6}/15\ \text{min}$ or (ii) only half an hour after switch-on the maximum drift rate is $25\ \text{c/s} + 50 \times 10^{-6}/15\ \text{min}$ which is a typical figure reached by valve instruments after four to six hours.

The Frequency Scale

The tuning drive system has been designed to provide a particular user advantage whilst also meeting certain internal layout and assembly requirements. The basic system is shown diagrammatically in Fig. 1. Each tuning core derives the required $1\frac{1}{2}$ inches of linear movement from a tape attached to a drum. Alternate ranges are coupled to tapes wound in opposite ways around a common, central drum. The frequency of successive ranges thus alternately increases and decreases with one direction of rotation of the rotary tuning components. This drive system allows the hand-calibrated near logarithmic tuning scales to be displayed in a continuous zig-zag pattern as shown on page 170, with scales running alternately left to right and right to

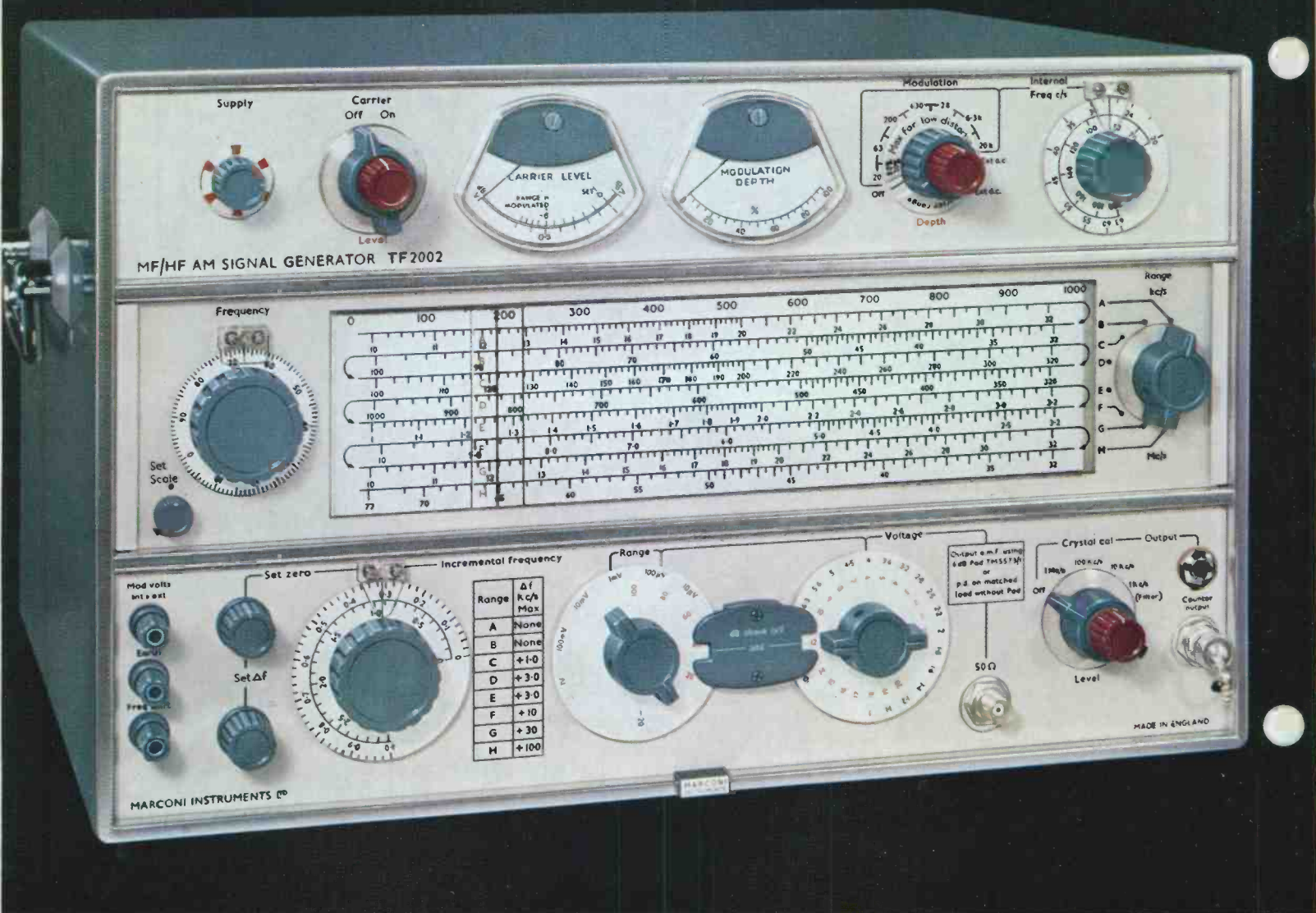

The Marconi Instruments Transistorized M.F./H.F. A.M. Signal Generator type TF 2002

left, which cuts out much of the tedium usually associated with tuning about the band change frequencies. The system also provides symmetrical layout of the oscillator and output filter modules with a cancellation of any bending moment on the central precision drive drum.

R.F. Screening

Having outlined some of the advantages of using permeability tuning it would be relevant at this stage to describe the screening system since in the m.f./h.f. range the tuning coils are generally the major source of leakage field from signal generators. Considered in general terms the operation of permeability tuning relies upon the use of a long thin coil, i.e. very high l/d ratio, where the flux linkage of the ends is poor; therefore the inductance, without the core engaged, is lower than a better proportioned coil. It is the core which changes the flux pattern to increase greatly the flux linkage to make

L_{max}/L_{min} ratios of well over 10 possible. It could be said, therefore, that permeability tuning relies upon poor flux linkage and may as a result encourage leakage fields from an instrument using this system, certainly in comparison with, say, toroidal coils. TF 2002 employs no less than six screening layers plus the outer case to give an overall result some 40 dB better than other generators operating in the same frequency range.

Complete Electrical System

The influence of signal generator performance requirements upon the choice of carrier oscillator design, with particular reference to improvements possible using semiconductors, has already been discussed, and the oscillator design used has been described. It is now appropriate to give an overall description of the circuitry which includes 57 transistors and 24 other semiconductors arranged to provide a wider degree of

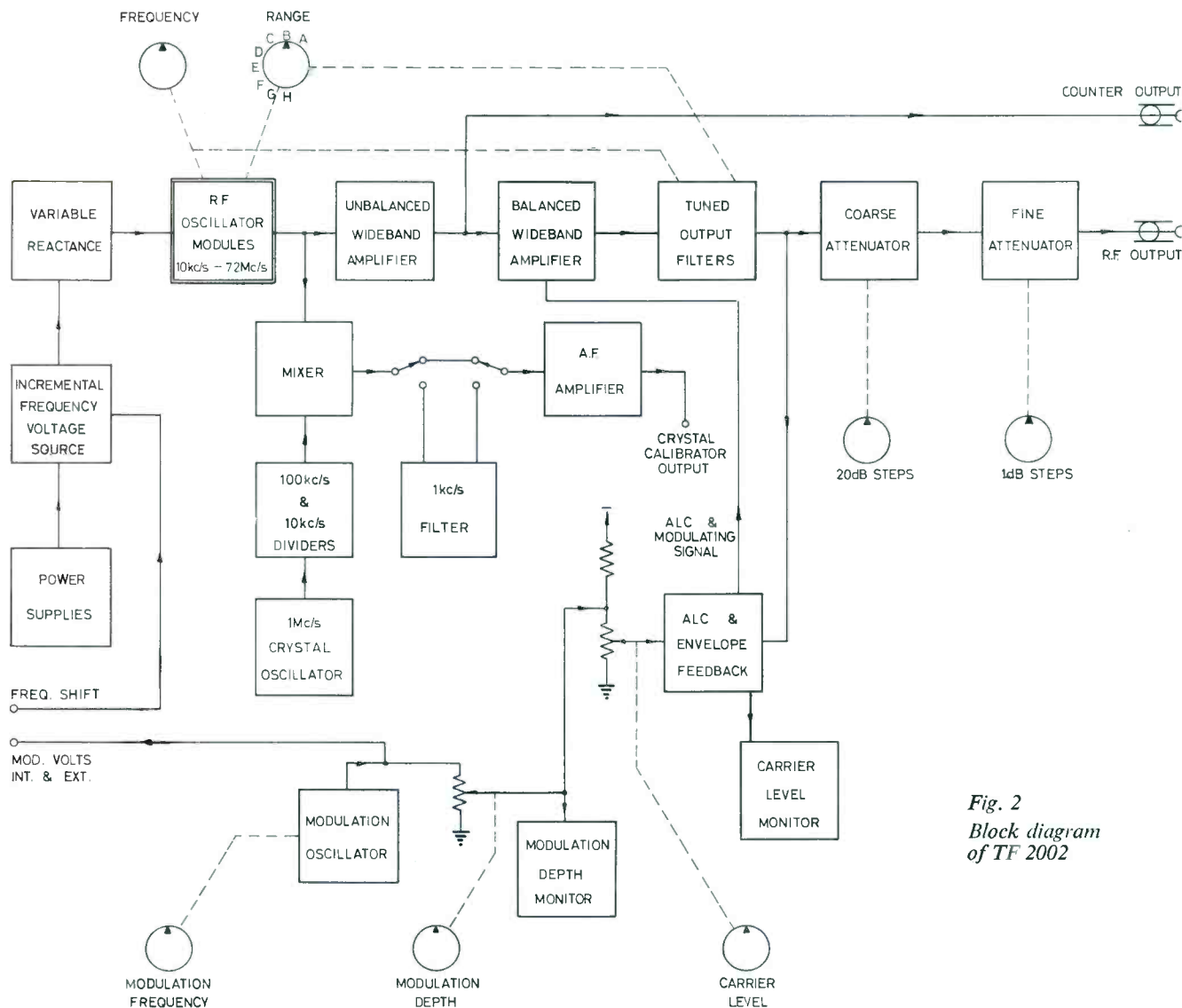

Fig. 2
Block diagram
of TF 2002

automatic control and operational facilities than has been practical when using valves with their larger size and power requirements. First, the path of the carrier signal through to the modulated r.f. output socket will be shown, followed by an outline of the various ancillary systems, with the aid of the block diagram Fig. 2.

The low level distortion output from the active oscillator module is fed to an unbalanced wide-band amplifier and also to the crystal calibrator mixer. From this amplifier an output is taken to the front panel for driving an external frequency counter when required. The main output from this amplifier drives a three stage balanced wide-band modulated amplifier whose output is fed via the range change switch to the appropriate continuously tunable π output filter. The carrier monitor and envelope feedback system is tapped off at the filter output where the fully modulated signal is fed through the two attenuators.

Push-pull operation of the power amplifier gives three advantages. Firstly it allows a balanced modulator to be used where the audio feed is at a neutral r.f. point and no decoupling is necessary. This reduces modulation phase shift at this point and also ensures a level response over the full audio bandwidth. Secondly there is cancellation of even carrier harmonics so that the output filters can have a wider bandwidth since they are only required to filter out the 3rd and higher harmonics. This is a further aid to modulation bandwidth. Thirdly, the push-pull system is a method of providing a high level of output with relatively small transistors.

Modulation System

Amplitude modulating voltages can be derived either from the internal audio oscillator or from an external source. The low distortion Wien bridge internal modulation oscillator is continuously variable through a

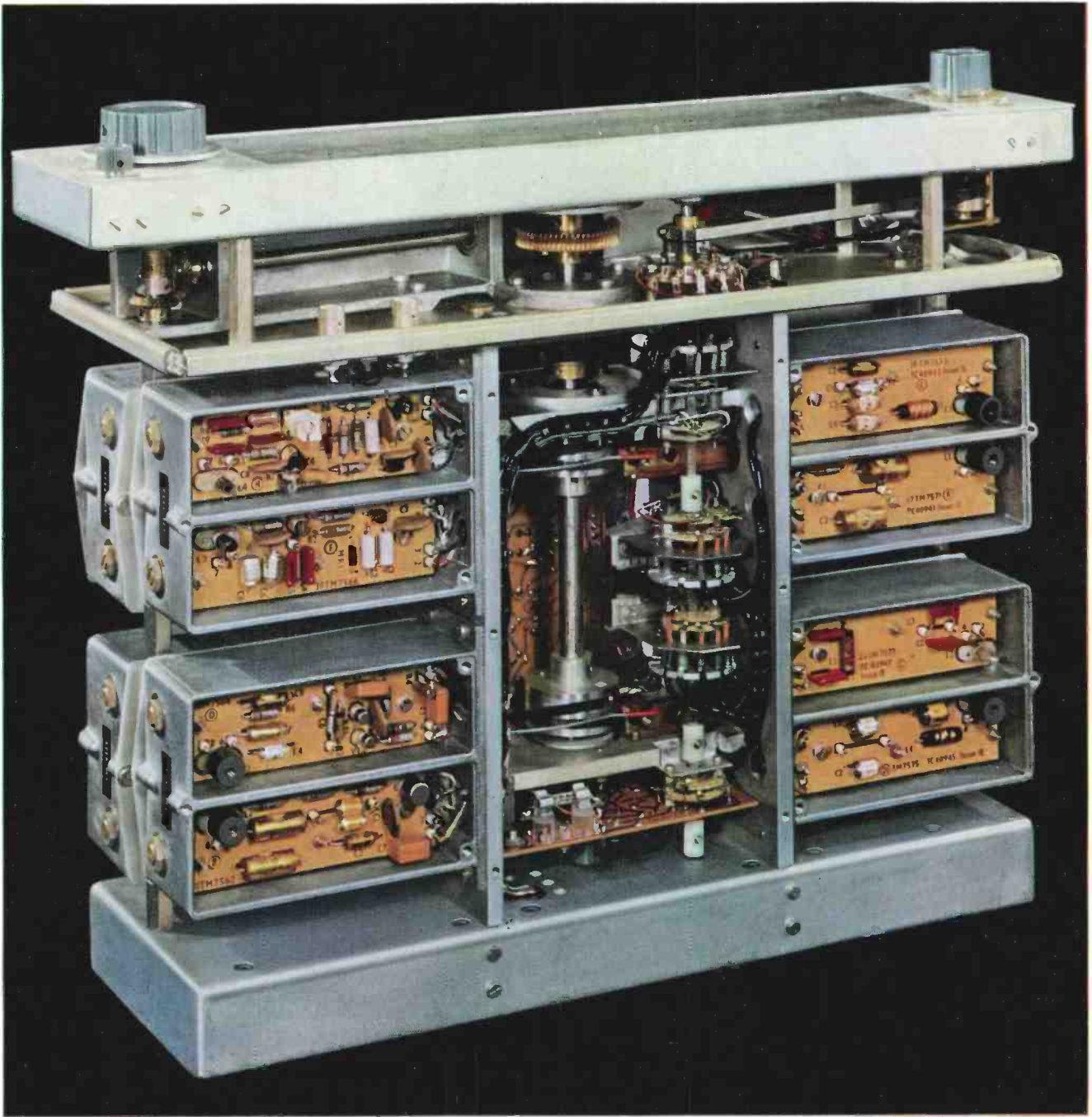

Bottom view of r.f. unit with covers removed shows the central tuning drive shaft with oscillator boards on the left and output filter boards on the right

frequency range of 20 c/s to 20 kc/s in six half-decade ranges. Efficient level stabilization is provided by a peak detector and zener diode reference voltage driving a pair of point contact diodes connected so that their slope resistance, controlled by the detector, forms part of a negative feedback loop. Whilst the internal modulation oscillator is in use a constant level audio signal of about 1 V is available at the external modulation terminals which may be used as a synchronizing signal for an

oscilloscope. This can be particularly useful as it is often difficult to obtain a stable oscilloscope trace of a modulated r.f. signal particularly at low modulation depth. The external modulation bandwidth is d.c. to 20 kc/s, subject to the usual limitation caused by the r.f. output tuned circuit bandwidth. To provide a clear indication of the necessary restriction for low distortion modulation the range selector for the internal modulation oscillator has a cutout on the skirt of the knob to show

the lowest carrier frequency range which is appropriate to 30% and 80% modulation depth for each range of audio frequencies.

It will be seen from the block diagram that the modulation depth control and monitor precede the carrier level control. With a fixed direct voltage across the carrier level control the modulation meter can then express dc/ac ratios which are independent of the setting of the carrier level. A large degree of envelope feedback can ensure that the modulation follows very closely the input signal so that a measure of the applied audio/d.c. ratio is an accurate measure of modulation depth. Because of this, the modulation monitor indicates the modulation depth independently of the setting of the carrier level.

The d.c. coupled modulation signal is routed through the automatic level control unit which includes modulation amplifiers. The amplified signal modulates the emitter the penultimate push-pull r.f. amplifiers. Where the modulators precede the output stages it is usual to operate the output stages in class A or B. But because of the characteristics of transistor amplifiers it is possible to use class C operation with advantage. Fig. 3 shows how the action of the class C output stage is to deepen the modulation whilst introducing very little distortion. In fact the need for only some 50% depth at the actual modulators, to be deepened to 100% at the output stages, gives so much less distortion at the modulators that the overall distortion of the complete system is better than could be expected from more usual systems. At higher carrier frequencies capacitive breakthrough can introduce distortion in the troughs of the modulation envelope but with this system the h.f. defect is minimized because the cut-off condition in the troughs is the combined loss of the modulators and output stages in cascade.

Envelope Feedback

The combined envelope feedback and automatic level control system is an area where considerable investigation has provided improved methods of dealing with the common problems of such a system. In common with any negative feedback arrangement, loop phase shift and the resultant spurious oscillation is a hazard in an envelope feedback system but it is generally aggravated because the a.m. detector, which must be included, is notorious for audio phase shift due to the carrier filter capacitor. The modulator can cause similar phase shift due to its r.f. bypass capacitor. The detector in TF 2002, which also acts as a carrier monitor, employs an average diode circuit with a time constant of substantially less than 75 nsec. As already mentioned the modulator is a balanced system and thus avoids audio phase shift because r.f. bypassing is unnecessary. The average monitor bridge has another advantage. As discussed in a previous article¹ a peak detector can cause significant carrier distortion and intermodulation in

two signal generator tests due to the heavy peak currents drawn. On the other hand, an average full wave detector has a nearly linear input impedance and is much less prone to cause carrier distortion. Two-signal-generator tests using two of these generators allow direct connection with both set at 0.25 V at 30 Mc/s when intermodulation is more than 60 dB down.

Another problem with envelope feedback is non-linearity of the detector. The feedback only produces low distortion by comparison of the audio input signal with the audio output of the detector. The feedback will therefore ensure a near perfect audio output from the detector. Any non-linearity of the detector will be impressed on to the envelope in reverse sign so that the output of the detector can be a perfect sine wave. A special detector system has been incorporated to overcome

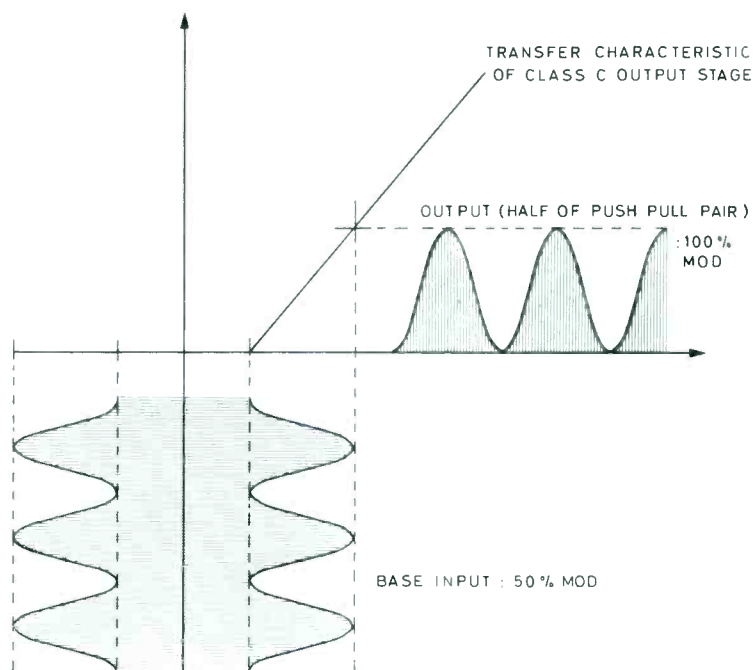

Fig. 3. Modulation deepening process

detector non-linearity. However, there is a resultant component from the detector which has a high temperature coefficient though the detector efficiency is maintained more constant by the use of bias. To cancel this component a similar bridge is used in opposition by use of a lattice interconnection, see Fig. 4. A further advantage gained by the use of two bridges in a comparison arrangement is that the small remaining detector distortion at low levels is offset by a similar distortion experienced by the incoming modulating signal.

Returning to a description of the feedback loop; it is at the bridge interconnection point that the feedback or servo loop is closed. At this point a comparison is made between the 'instruction signal'—modulating voltage—and the 'sampling signal'—detector output. The difference output is d.c. coupled to the modulation amplifier.

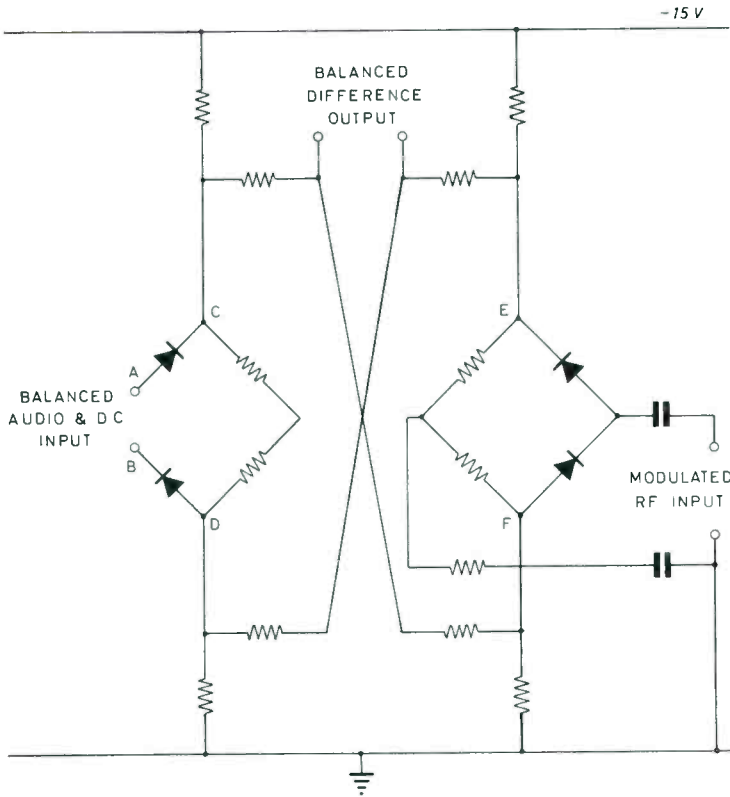

Fig. 4. Comparison detector

The detector system described does involve some extra complications in circuitry but these are justified by the advantages gained in low distortion. Largely due to the low distortion detector in a system of some 40 dB of feedback, under 1% envelope distortion is obtained to nearly 100% modulation depth over a large part of the carrier range. One complication the detector system causes is the need for a d.c. coupled unbal-to-bal modulation input amplifier but this is accomplished with inherent temperature stability, by using only three transistors. Another complication is the double star resistance network needed to connect the carrier level meter so that it reads the actual carrier level (not the instruction signal) and includes the temperature compensating action of the two bridges. The star connection feeds the meter with the algebraic sum of the error and instruction signal, i.e. the actual carrier signal—see Fig. 5.

Crystal Calibrator

Owing to high efficiency and small size of transistors, it is feasible to include a comprehensive crystal calibrator providing over 20,000 check points. A 1 Mc/s crystal drives a 10 nsec pulse generator whose output is fed to a mixer to beat with a pure signal from the carrier oscillator. This combination provides a correctly tailored spectrum and eliminates ambiguity which can occur when distortion of the signal to be measured causes beats at

the 1/3 and 2/3 Mc/s points etc. Two temperature stable dividers can be switched on in turn to feed 100 kc/s and 10 kc/s pulses into the mixer providing 10 kc/s check points up to 72 Mc/s. Identification of any check point is quite simply accomplished by first locating the nearest 1 Mc/s check point below the required frequency by using the main tuning dial calibration, and subsequently counting up the 100 kc/s and then the 10 kc/s pips until the frequency is advanced to the correct point. As an additional facility a 1 kc/s audio notch filter provides a null point 1 kc/s each side of every 10 kc/s check point thus giving an accurate measure of 1 kc/s increments in carrier frequency.

Incremental Frequency Measurement

Above 100 kc/s each oscillator unit is fitted with a separate voltage controlled reactor which can produce a frequency shift between 1 kc/s and 100 kc/s depending on the carrier frequency. Capacitive reactors are used since they require the minimum tracking to maintain a constant shift in any one band. This occurs because a permeability tuned system has a fixed tuning capacitor for each band; therefore a capacitive reactor produces a constant fractional change in capacitance anywhere on the band, resulting in a fixed fractional change in frequency. A tracking system to maintain a constant absolute frequency change is required to reduce the drive voltage to the reactor inversely with the frequency settings of the main tuning element. For the lower frequency bands where a large capacitive swing is required a transistor is operated as a capacitive reactor, and for the higher bands reverse biased diodes are fitted.

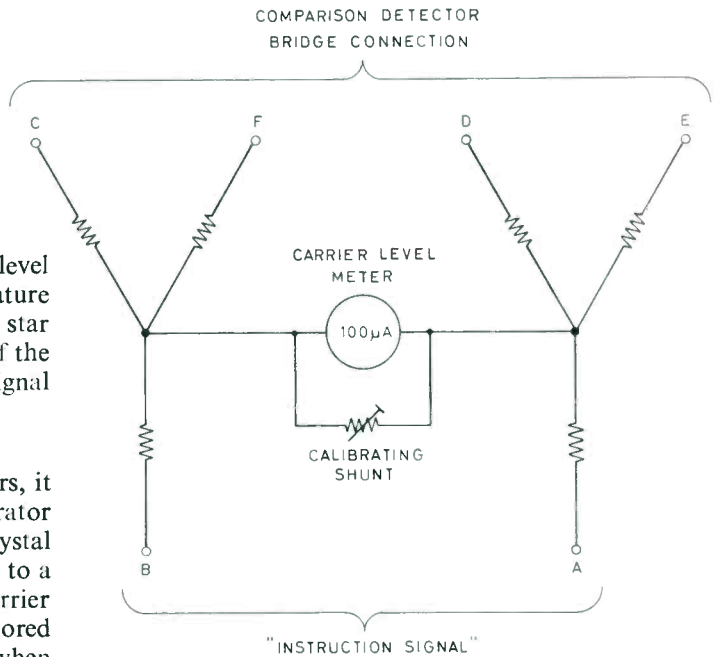

Fig. 5. Double star carrier meter connections

A potentiometer network in the incremental frequency voltage control unit is arranged so that both ends of a calibrated incremental scale can be adjusted against the crystal calibrator. This provides accurate interpolation between crystal check points so that the incremental frequency control not only provides considerable scale expansion but also provides a readout of high absolute accuracy. This facility can be advantageous in the adjustment of crystal controlled receivers where the channel spacing is small and the i.f. pass band must have an accurate absolute setting to give the required channelling accuracy. Carrier frequency stability is sufficient to measure down to 100 c/s bandwidth at up to 30 Mc/s. This measurement uses over $\frac{1}{2}$ inch of scale length which is equivalent to a total scale expansion of $2\frac{1}{2}$ miles.

Although the internal drive system for the reactors offers only a d.c. coupled incremental facility the filtering into the r.f. box has an audio bandwidth of d.c. to 4 kc/s up to 1 Mc/s carriers and d.c. to 20 kc/s above 1 Mc/s. Therefore the terminal on the front panel which gives access to the reactor circuits can also be used to provide remote fine frequency control or lock, phase lock, or external f.m. or sweep.

Output Level and Attenuation

The importance of tuning precision, frequency stability and discrimination has already been stressed. However, as a signal generator is essentially a device for simulating a transmission, it is also called upon to provide accurately the required amplitude of e.m.f. which may or may not be modulated. Therefore the level monitoring and adjusting mechanism in a signal generator provides this other basic feature.

There are four controls which adjust the output level. Two concentric controls near the carrier level meter provide (i) an on/off carrier facility by switching the supplies to the oscillators to guarantee a complete shut-off of signal, and (ii) a continuous adjustment through at least 10 dB range which is shown on the carrier meter. In the centre of the bottom section of the front panel, step attenuators provide six 20 dB steps and twenty 1 dB steps. This system allows a 10 dB range of continuously variable adjustment to be used with the modulation depth maintained constant, or the level can be adjusted down to $0.1 \mu\text{V}$ in 1 dB steps and the carrier level control used for interpolation between 1 dB steps. The output level calibrations are in terms of e.m.f. or on load p.d. The output level figures apply to the e.m.f. (50Ω source) when a 6 dB pad provided is in use. Without the pad the calibration refers to p.d. (50Ω load).

Both coarse and fine attenuators use a system of cam driven microswitches to bring into circuit one or more of a series of π section attenuator pads. The loss of the pads has been chosen to keep the number of resistors to a minimum and the coding of the cams is arranged to use the correct combination to produce 1 dB steps in one unit and 20 dB steps in the other. Although 10 dB steps provide a simple decade readout in dB's the complication of providing two half decade scales used

alternately for the voltage calibration led to the choice of decade steps in voltage i.e. 20 dB steps. This system, however, leads to the display of, say, +54 dB above $1 \mu\text{V}$ as $40 + 14$ dB, but the voltage scale is thereby greatly clarified.

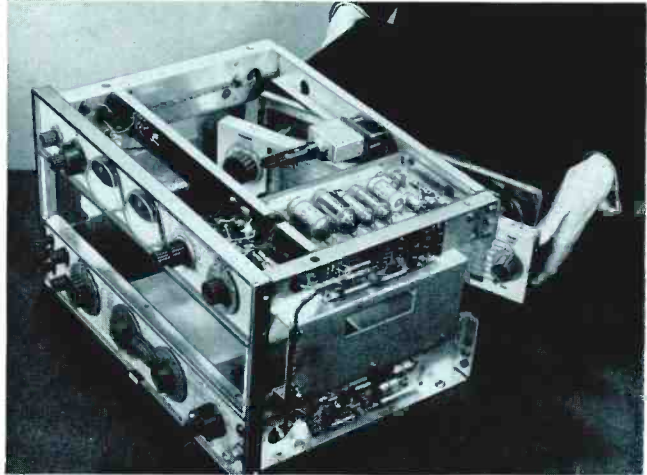

For servicing purposes the r.f. unit can be easily removed without interrupting the operation of the generator

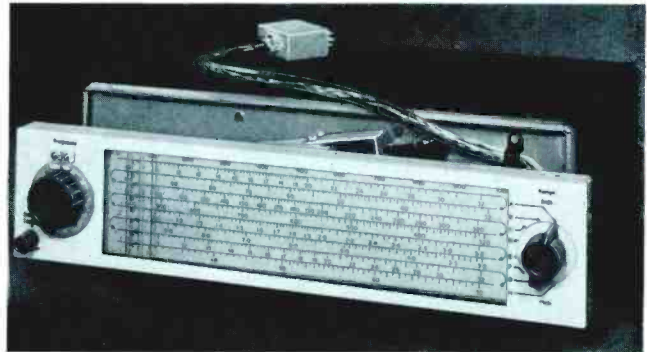

The r.f. unit, showing the near-logarithmic tuning scales running alternately left and right

Mechanical Design

A photograph of the front panel, page 170, shows that the controls have been grouped and positioned with a consideration of human engineering. The full-view main tuning scale allows quick location of the required tuning point. A partially covered scale viewed through a window can necessitate some searching except in some special cases where a single linear scale is used and the location of hidden calibrations can be anticipated. Dual concentric controls have been used extensively to combine switched and fine adjustment of the same function. This saves space and permits closer grouping of associated control.

REFERENCE

1. PARKYN, J. M.: 'Standard Signal Generator Type TF 144H', *Marconi Instrumentation*, December 1960, 7, p. 229.

ABRIDGED SPECIFICATION

TYPE TF 2002

Frequency

RANGE:

10 kc/s to 72 Mc/s, in 8 bands:—

10— 32 kc/s 1 — 3.2 Mc/s
 32— 100 kc/s 3.2—10 Mc/s
 100— 320 kc/s 10 —32 Mc/s
 320—1,000 kc/s 32 —72 Mc/s

MECHANICAL TUNING DISCRIMINATION:

The frequency scales are near logarithmic and a 1,000 division linear logging scale is provided.

CALIBRATION ACCURACY: $\pm 1\%$.

ELECTRICAL FINE TUNING:

Operative above 100 kc/s only.

Adjustable up to maxima of:—

+ 1.0 kc/s for 100—320 kc/s band
 + 3.0 kc/s for 320—1,000 kc/s band
 + 3.0 kc/s for 1—3.2 Mc/s band
 + 10.0 kc/s for 3.2—10 Mc/s band
 + 30.0 kc/s for 10—32 Mc/s band
 + 100 kc/s for 32—72 Mc/s band

Scales marked 1.0 and 3.0 full scale with $\times 1$, $\times 10$, or $\times 100$ multipliers.

INCREMENTAL FREQUENCY ACCURACY:

$\pm 5\%$ of full scale when standardized at full scale against internal crystal calibrator.

DISCRIMINATION: Better than 0.03%.

CRYSTAL CALIBRATOR:

Check points at 1 Mc/s, 100 kc/s and 10 kc/s intervals.

Accuracy: 0.01%.

Check points at ± 1 kc/s about these points.

Accuracy: ± 10 c/s.

R.F. Output

LEVEL:

10 kc/s—32 Mc/s.

Max. 2 V e.m.f. with up to 100% modulation.

32 Mc/s—72 Mc/s.

Max. 2 V e.m.f. c.w. or 1 V e.m.f. with up to 100% modulation.

Variable down to 0.1 μ V at all frequencies.

ATTENUATORS:

Six 20 dB steps

Twenty 1 dB steps

10 dB continuously variable on meter.

External 6 dB pad, TM 5573/1.

IMPEDANCE:

Effectively 50 Ω at all level settings.

V.S.W.R. 1.15:1 below 200mV with or without 6dB pad TM 5573/1.

CARRIER HARMONICS: Less than 3% individual harmonics at maximum output level.

LEAKAGE: Allows measurement on sensitive ferrite aerial receivers to be made close to the signal generator.

COUNTER OUTPUT: Suitable for use with Counter type TF 1417/2 and Converter type TF 2400, e.g. 10 mV into 50 Ω .

Amplitude Modulation

DEPTH: Continuously variable up to 100%

MONITOR: Reads equivalent average modulation and is not dependent on carrier level reference.

ACCURACY:

5% modulation provided maximum usable modulation frequencies shown in table is not exceeded at the lower carrier frequencies.

ENVELOPE DISTORTION:

Less than 1½% distortion factor using modulating frequency of 400 c/s for modulation depths up to 80% at carrier frequencies between 100 kc/s and 32 Mc/s. The maximum usable modulation frequencies for other distortion limits over the whole carrier range are shown in the table.

INTERNAL OSCILLATOR:

Continuously variable 20 c/s to 20 kc/s in 6 ranges.

Accuracy: $\pm 10\%$

Output: Fixed sync signal available at MOD. terminal:

approx. 1 V from 10 k Ω at 1% distortion.

EXTERNAL A.C.: 20 c/s to 20 kc/s: Accuracy of modulation depth and frequency limitations as table.

Input: 1 V r.m.s. into 1 k Ω for 100% a.m.

EXTERNAL D.C.: Carrier level control by external variable resistor, by keying or by voltage of up to —4.5 V peak.

SPURIOUS F.M. OR A.M.: Less than 100 c/s + 10 p.p.m. of carrier freq. for 30% a.m. up to 1 kc/s mod. frequency.

SPURIOUS F.M. ON C.W.: Less than 3 c/s ± 1 p.p.m. of carrier frequency using mains operation.

SPURIOUS A.M. ON C.W.: —70 dB relative to 30% modulation.

Special Modulation Facilities:

May be used for manual or automatic frequency control, frequency modulation, phase modulation or sweeping.

Operation above 100 kc/s only.

Will provide with an applied voltage up to —10 V d.c. frequency excursions to at least the limits shown in the table under electrical fine tuning. Between 100 kc/s and 1 Mc/s up to $\times 10$ the tabulated sweep widths are obtainable with voltages up to —15 V.

MODULATION FREQUENCY RANGE:

D.C. to 4 kc/s for carriers below 1 Mc/s.
 D.C. to 20 kc/s above 1 Mc/s.

Carrier Frequency	Distortion Factor and Modulation Depth		
	3%	5%	
	Up to 80%	Up to 30%	Up to 80%
10 — 32 kc/s	63 c/s	200 c/s	100 c/s
32 — 100 kc/s	63 c/s	200 c/s	100 c/s
100 — 320 kc/s	1 kc/s	3.5 kc/s	1.5 kc/s
320 — 1,000 kc/s	1 kc/s	3.5 kc/s	2 kc/s
1 — 3.2 Mc/s	6.3 kc/s	20 kc/s	20 kc/s
3.2 — 10 Mc/s	10 kc/s	20 kc/s	20 kc/s
10 — 32 Mc/s	10 kc/s	20 kc/s	20 kc/s
32 — 72 Mc/s	20 kc/s	20 kc/s	20 kc/s
	up to 30%		

MARCONI
INSTRUMENTS

A SIGNAL GENERATOR *for Airborne Navigation Aids* . TYPE TF 801D/5M1

by
J. F. GOLDING

A version of the TF 801D series of signal generators, specially adapted for use with V.O.R. and I.L.S. navigation aid equipments, is now available. This instrument, the TF 801D/5M1, is suitable for a number of tests that have hitherto required an equivalent number of specialized signal generators.

THE V.O.R. AND I.L.S. navigation aid systems have been universally adopted by the International Civil Aviation Organisation (I.C.A.O.); so it naturally follows that there is a demand for suitable test gear. This, like the operational equipment, is of a highly specialized nature, with the result that the currently available test gear is expensive and produced by a very limited number of manufacturers.

As the airborne equipment used in these systems primarily consists of special receivers, signal generators play an essential part in its maintenance. Altogether, there are five separate but complementary receiving systems, which must be set up to a high standard of accuracy. Furthermore, the complete system has been evolved by collecting together navigation aids that were developed independently. These two factors have given rise to the manufacture of a number of specialized signal generators, each of which is suitable for testing only part of the overall system. The advantages of a single signal generator for the complete system will be discussed later in this article.

It is not within the scope of this article to describe the overall functioning of the operational equipment, which is adequately dealt with elsewhere¹. The special requirements of the signal generators, however, are most easily explained as part of a brief consideration of the nature and functions of the receiving equipment used.

There are two main systems; viz, V.O.R. (V.H.F. Omnidirectional Range) and I.L.S. (Instrument Landing

System). V.O.R. is a bearing indicator and is used in conjunction with pulsed distance-measuring equipment (D.M.E.) to give position-fixing information at long range. I.L.S., which should be regarded as an instrument approach system only, provides the short-range information required when the aircraft is approaching the airfield with the intention of landing.

V.O.R. Bearing Indicator

The V.O.R. bearing indicator shows the position of the aircraft in terms of a bearing on a beacon of known position. This bearing is expressed in degrees relative to the meridian passing through the beacon.

The indication is obtained from the phase comparison of two 30 c/s modulation signals which are superimposed on the same v.h.f. carrier. One of these is a reference signal and the other indicates the bearing by its phase relative to the reference. Although the two modulations are derived from the same source in the transmitter, they are clearly identifiable from each other, because the reference signal takes the form of a 9.96 kc/s sub-carrier which is frequency modulated at 30 c/s to a deviation of 480 c/s. The bearing indicator signal is applied as direct amplitude modulation on the v.h.f. carrier.

In the receiver, the two modulations are separated by means of filters, and the 30 c/s reference signal is obtained by demodulating the 9.96 kc/s sub-carrier. The two 30 c/s signals are then fed to a phase comparator, which drives the visual bearing indicator.

Highly accurate radio-navigation equipment becomes increasingly important as faster aircraft come into service. The VC10 pictured here is one of the latest types of long range jet airliners



(By courtesy of British Aircraft Corporation)

V.O.R. operates in the band 112 to 118 Mc/s, with channel spacing of 100 kc/s, giving 60 channels over the band.

The special requirements of the signal generator to be used for setting up the V.O.R. receiver and the bearing indicator are:

- (1) It must cover the frequency band 112 to 118 Mc/s with adequate tuning discrimination to select the appropriate 100 kc/s channel.
- (2) The phase shift between the applied modulating waveform and the modulation envelope must not exceed 0.1° over the a.f. range 30 c/s to 10 kc/s.
- (3) It must be possible to modulate the carrier to a depth of 90% without distortion.

For test and alignment purposes, a special modulator is used in conjunction with the signal generator to produce a final output which can be adjusted to simulate a received V.O.R. signal on any desired bearing.

I.L.S. Equipment

I.L.S. is more correctly an instrument approach system; for the ultimate landing must be made visually. It comprises three separate aids: the localizer, which indicates to the pilot his azimuth position relative to an ideal approach path; the glide-slope indicator, which performs a similar function in the vertical plane; and the distance markers, which give an indication of distance from the end of the runway.

Localizer

The localizer beacon transmits a composite signal which is modulated with a 90 c/s waveform and a 150 c/s waveform.

The aerial arrangement is such that, as the approaching aircraft deviates to one side of the ideal path, the 90 c/s modulation becomes stronger than the 150 c/s, and, as it deviates to the other side, the reverse happens. When the aircraft is flying the ideal course, the depths of the 150 c/s and 90 c/s modulations are equal at 20% to 40%. The peak modulation depth at the instant when the 90 c/s and the 150 c/s waveforms are additive may be as high as 80%.

The localizer receiver compares the depths of the two modulations, and produces an output which is proportional to their difference. This is applied to a centre-zero indicator, which is calibrated in degrees off course.

The localizer system operates over the frequency range 108 to 112 Mc/s; so the same aerial and receiver are normally used for the V.O.R. and I.L.S. Localizer. The equipment is, of course, never called upon to perform both functions at the same time. Like the V.O.R., the channel spacing for the I.L.S. localizer is 100 kc/s, giving 40 channels over the band.

Requirements for a signal generator to test the localizer receiver are similar to those for V.O.R. except that the very close phase tolerance is not required. It is very important, however, that the modulation response of the generator shall be the same for 90 c/s and 150 c/s; but, as these two frequencies are so close, this is not a very stringent requirement. The instrument must also be able



Setting up I.L.S. equipment in the Marconi test room at London Airport. The crystal oscillator output of the TF 801D/5M1 modulated to 90% by the R-C Oscillator type TF 1101 provides a test signal for a 75 Mc/s marker receiver

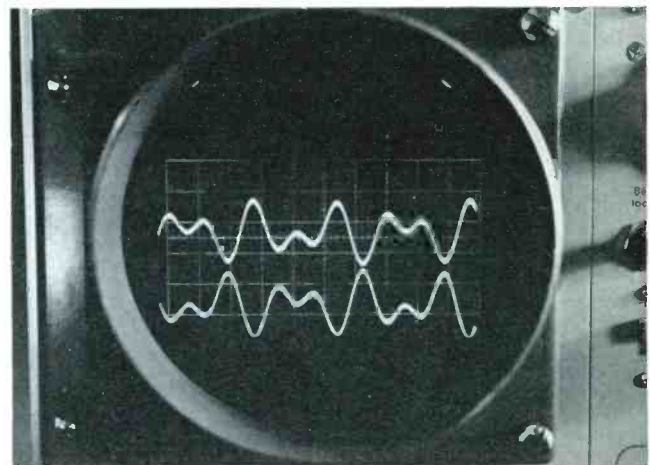

Oscillograms of test signal for an I.L.S. localizer receiver. The lower trace shows the two-tone input modulating signal to the TF 801D/5M1 and the upper trace the resultant demodulated output from the receiver

to handle modulation depths of up to 90% without distortion.

Glide-Slope Indicator

So far as the airborne equipment is concerned, the glide-slope indicator is similar in its action to the localiser. The received signal again comprises a carrier with two modulations; one at 90 c/s and the other at 150 c/s. When the aircraft is on the correct glide slope, the modulation depths are equal for the two frequencies; if the aircraft is too high, the 90 c/s modulation is of greater depth than the 150 c/s modulation; and, when it is too low, the reverse applies.

The glide-slope system operates at u.h.f. in the band 328.6 to 335.4 Mc/s. Its r.f. equipment is, therefore, somewhat different from that used for the localizer or the V.O.R., and a separate receiver is used.

Signal generator requirements are exactly similar to those for the localizer except that the carrier is in the u.h.f. band instead of the v.h.f.

V.H.F. Position Markers

These markers provide positional checks during an I.L.S. approach. The beacons radiate at a frequency of $75 \text{ Mc/s} \pm 0.02\%$. Horizontal polarization is used, and the aërials are so positioned as to operate with the narrow lobe of the radiation pattern in the direction of the approach. The aircraft thus receives a signal only when passing directly over a line extended through the aerial at right angles to the approach path.

Two beacons are used: an outer beacon located at approximately four nautical miles from the reference point at the end of the runway, and an inner beacon at between 3000 and 6000 feet from the reference point. To distinguish the beacons from each other, the 75 Mc/s carrier of the outer beacon is modulated with a 400 c/s note and that of the inner beacon is modulated at 1,300 c/s. Modulation depths up to 90% are used. As the aircraft passes over a beacon, the demodulated note can be heard in a loudspeaker, and an appropriately coloured warning lamp lights up.

For testing the distance-marker receiver, the signal generator must produce an r.f. output at 75 Mc/s with

an accuracy of the order of ten times better than that of the marker beacon; so crystal control is virtually a necessity. The generator must also be capable of accepting modulation depths of up to 90% without distortion at 400 c/s and 1,300 c/s.

G.C.A. Receiver

The G.C.A. receiver is not strictly part of the V.O.R. or I.L.S. systems, but, as it operates over the frequency band 118 to 139.5 Mc/s, it is convenient to regard it as part of the v.h.f. navigation aid system from the point of view of testing and setting up. The initial letters stand for Ground Controlled Approach, and the receiver is simply the airborne terminal of a voice communicating link with the ground station. Ground radar tracks the aircraft and the pilot is given instructions over this link.

For testing this receiver any of the TF 801D series of v.h.f. a.m. generators would be suitable except the 60Ω version—TF 801D/4M1.

THE SIGNAL GENERATOR

At present it is general practice to use the separate specialized signal generators for each part of the airborne installation, as these cover the complete test requirements mentioned earlier in this article. These instruments, together with their power units and the



Marconi Instruments
A.M. Signal Generator type TF 801D/5M1

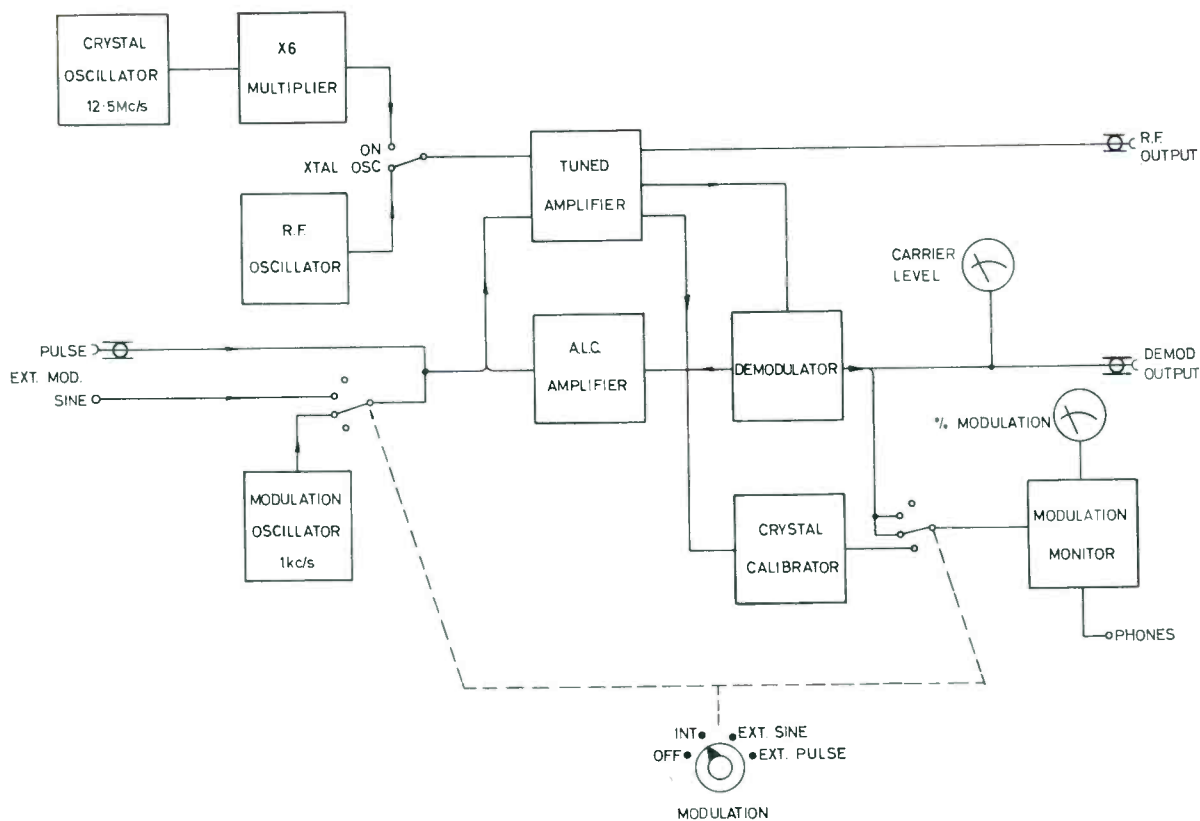

Fig. 1. Block diagram of TF 801D/5M1

modulators amount to a formidable array of test gear, which is often rack mounted, so that it is necessary to bring the receiver to the test gear in every case; and *in situ* tests are virtually impossible.

There is a strong case for the use of a single signal generator that can be used for normal routine testing. Such an instrument is smaller and considerably more portable than an assembly of separate signal generators, even though separate external modulators have to be used. Servicing receivers close to, if not actually inside, the aircraft then becomes feasible. Although the special narrow-range signal generators permit very precise measurements with great discrimination, a quite acceptable order of accuracy can be obtained by the use of a rather more versatile wider range instrument providing sufficient care is exercised when using it. The cost of the single signal generator is also very much lower; and this is extremely important to the smaller operator, with only a small number of aircraft, who wishes to do his own servicing.

In order to meet the special requirements of navigation-aid servicing, the TF 801D/5M1 has three special features not present on the other instruments in the TF 801D series.

1. For measurements on the V.O.R. bearing indicator, the modulator circuit of the signal generator has been modified so that there is less than 0.1° phase shift between the modulation envelope and the input signal over the range 30 c/s to 10 kc/s.

2. In order to accommodate the V.O.R. bearing indicator, the I.L.S. localizer, and the G.C.A. receiver all on one band, the frequency cover of band D (which is normally 110 to 260 Mc/s) has been modified to be 70 to 150 Mc/s.
3. For precise alignment of the 75 Mc/s marker receiver, the variable oscillator of the signal generator can be replaced electrically by a crystal-controlled oscillator operating at $75 \text{ Mc/s} \pm 300 \text{ c/s}$. This oscillator feeds the internal amplifier of the signal generator so that the normal modulation and monitoring facilities are unaffected; and the final output is drawn via the piston attenuator in the usual way.

Modulation Phase Shift

In order to achieve the desired low phase shift at 30 c/s, the low-frequency response of the modulation circuit has been extended to about 2 c/s at the -3 dB point, thus overcoming the phase shift which is in the standard version of the TF 801D.

To provide facilities for monitoring the modulation phase shift, the output from the level-monitor diode is connected to a BNC socket mounted on the front panel. The demodulated waveform at this socket can be compared with the modulation input waveform, and the phase shift measured. A counter technique for measuring very small phase shifts is described in an earlier issue of *Marconi Instrumentation*².

Special Frequency Range

The new 70 to 150 Mc/s frequency band is obtained by increasing the tuning inductance on band D. This is done by fitting larger tuning inductors to both the variable oscillator and the r.f. amplifier. Although the approximate 2:1 frequency-cover ratio is maintained, the total cover of the band is reduced from 150 Mc/s to 80 Mc/s. Calibration marks at 1 Mc/s intervals are, therefore, possible, giving adequate discrimination for selection of the desired channel on the V.O.R., I.L.S., or G.C.A. receiver.

The available output from the new band D is rather more than that of the unmodified instrument. It is possible to obtain 90% modulation over the whole of the band with the NORMAL/HIGH switch in the NORMAL position and the attenuator set to the maximum-output position. This may be necessary when setting up the I.L.S. localizer receiver.

Crystal Oscillator

The built-in crystal oscillator is the only one of the three special features that requires a different operating

technique from the standard version of the signal generator.

For setting up the distance-marker receiver, the variable oscillator of the signal generator is switched off, and a fixed-frequency crystal oscillator is switched on in its place. This is achieved by operation of a toggle switch on the front panel. As the r.f. amplifier remains in use, however, it is necessary to set the band-selector switch to C or D and adjust the tuning for 75 Mc/s. The tuning may be peaked finally by either the main tuning control or the PEAK CARRIER control.

Fig. 1 shows the electrical arrangement. The fixed oscillator comprises a 12.5 Mc/s crystal in a tuned-anode tuned-grid circuit feeding a frequency trebler and doubler in cascade, giving a final frequency of 75 Mc/s.

REFERENCES

1. HANSFORD, R. F.: 'Radio aids to civil aviation', (Heywood, 1960).
2. SPENCER, A. J.: 'Measurement of phase angle using a counter', *Marconi Instrumentation*, September 1963, 9, p. 60.

SPECIFICATION

The specification of the TF 801D/5M1 differs from that of the standard version only in the following respects:

Carrier Frequency

Range D: 70 to 150 Mc/s.
Range E: 260 to 400 Mc/s.
Crystal-controlled output: 75 Mc/s
 ± 300 c/s.

Modulation

With external modulation the phase angle between the modulation envelope and the input waveform is not greater than 0.1° over the frequency range 30 c/s to 10 kc/s.

EXPORT EXPANSION

A SIGN of increasing sales of instruments abroad is the appointment at Marconi Instruments Ltd. of three Export Regional Managers. They are responsible to Mr. I. G. Gardner, Export Manager.

Between them, Mr. B. E. Morris, Mr. J. H. Buying and Mr. F. R. Creasey are in charge of sales, through agents and associated companies, in 165 territories throughout the world. They will be assisted by sales engineers, and are already personally acquainted with many of the countries for which they are responsible, having visited them on behalf of M.I. during the past few years.

Briefly, Mr Buying's territories are Australasia, Near East, India and Ceylon, Africa, Central and South

America. Mr. Creasey's areas are Far East, Middle East and Eastern Europe, while Mr. Morris is responsible for North America and Western Europe, including Scandinavia.

Off to Australia

The sales of Marconi instruments in Australia have reached a record level. It is a happy co-incidence that Mr. P. Crumpler, a well-known executive of the Export Department, has decided to take up residence in Australia and has joined our agents, Amalgamated Wireless (Australasia) Limited, to assist them to promote sales still further in this important market.

BINDER REMINDER

A NEAT BINDER to contain copies of Volumes 8 and 9 of *Marconi Instrumentation* has now been made available so that readers and librarians may keep copies of the Bulletin in a convenient form for reference. It is bound in red 'Rexine' and copies can be inserted without punching and opened flat. These binders are available at a cost of 12s. each, post free. To simplify the transaction please send remittance when ordering.

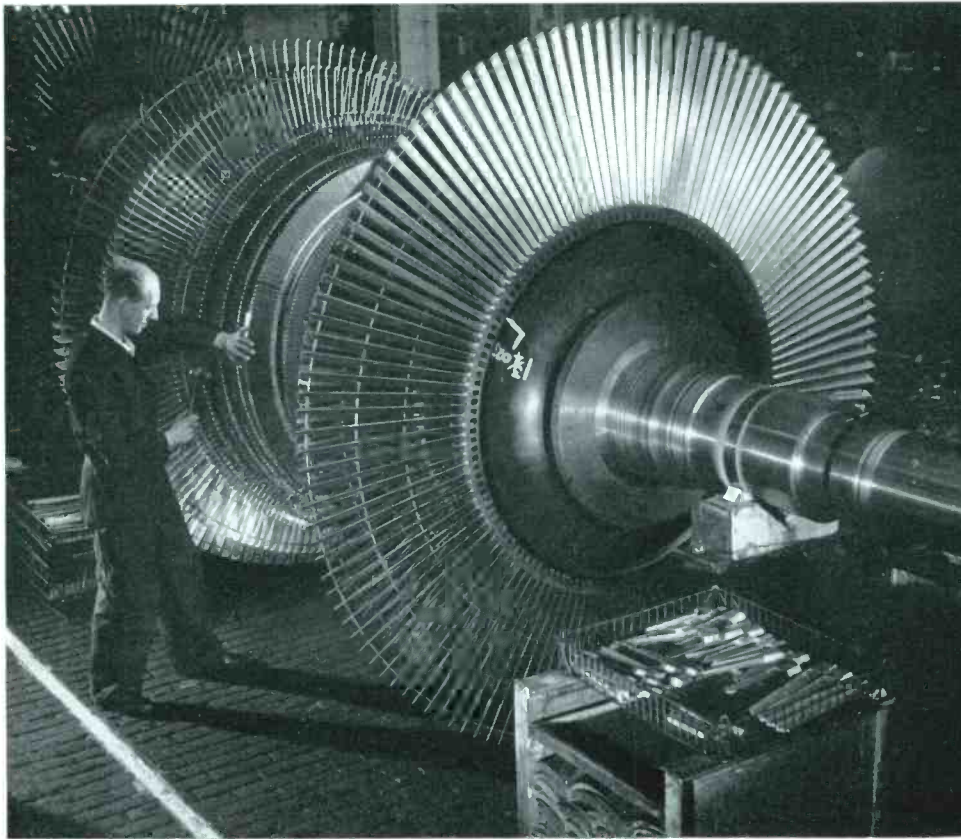

The close examination of blades for steam turbines built by English Electric is now done with Marconi Instruments' Image Amplifier. This picture shows the low-pressure shaft of a 60 MW steam turbine being fitted with shrouding

A New Quality Control Tool . . . TYPE OE 1280B

The basic system used in the M.I. Industrial Image Amplifier

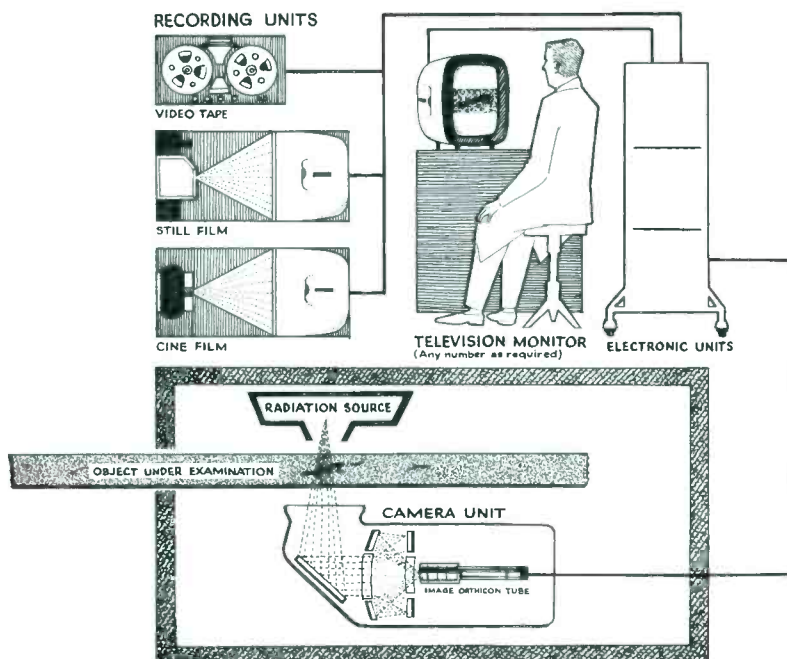

ALREADY WELL-KNOWN in medical circles for the high degree of accuracy and convenience it has brought to both diagnosis and treatment, the Marconi Instruments' twelve-inch Image Amplifier is now available in an industrial version. Among the first of the production models to be installed was one in the Willans Works of the English Electric Company Limited at Rugby, where it is materially assisting the production of steam turbine blades of consistently high quality.

The Image Amplifier is a high-definition, closed-circuit television system designed for direct viewing of a fluorescent image produced by the passage of X-rays through the specimen under examination. The image is displayed on one or more 17-inch television monitor screens.

The English Electric installation is being used to examine the adhesion of the Stellite erosion shields which are brazed, by induction heating, on to the leading edges of low-pressure, reaction turbine blades. Each blade, ranging in length from 3 to 36 inches, is placed on a variable speed, remotely controlled trolley which passes between the X-ray source and the television tubehead, a complete detailed examination taking less than five minutes a blade. Maximum thickness of steel that can be examined visually, using a 250 kV source at 10 milliamperes, is 1½ inches.

Summaries of Articles appearing in this issue

RESUME D'ARTICLES PUBLIES DANS LE PRESENT NUMERO

GENERATEUR DE SIGNAUX A ULTRA-HAUTES FREQUENCES TF 1060/3

Il existe plusieurs moyens pour obtenir la modulation de fréquence. Celui choisi ici dépend de la nature de l'oscillateur haute fréquence à moduler. Des diodes à polarisation inverse constituent d'excellents organes de modulation et ce sont elles qui ont rendu possible la fréquence de modulation des oscillateurs à ligne coaxiale. Les conditions nécessaires pour réaliser une diode de ce genre sont étudiées, ainsi que la méthode de couplage à un circuit accordé. On indique également les résultats obtenus avec un générateur de signaux modulés en fréquence dans la gamme de 470 à 960 MHz.

Page 159

CONVERTISSEUR A ULTRA-HAUTES FREQUENCES TM 6936

L'analyseur de bande latérale de télévision TF 2360 a été décrit en détail dans le numéro de Mars 1963 de INSTRUMENTATION mais dans lequel il n'était que très brièvement fait allusion au convertisseur à ultra-haute fréquence TM 6936, destiné à lui être adjoint afin que sa gamme de fonctionnement puisse inclure les bandes IV et V. Il en est donc donné ici une description plus détaillée, y compris la méthode utilisée et les facteurs dont dépendent la précision des mesures.

Page 163

GENERATEUR DE SIGNAUX MOYENNE ET HAUTE FREQUENCE MODULES EN AMPLITUDE

Le TF 2002 est un générateur de signaux complètement transistorisé et de réalisation complètement nouvelle. Il assure la production de signaux haute-fréquence, modulés en amplitude, de qualité très élevée. Ses caractéristiques les plus importantes sont une grande sélectivité de l'accord, une dérive et des pertes très faibles, ainsi qu'une modulation parasite extrêmement réduite. Cet appareil de mesure, en dépit de son faible volume, est de construction très robuste, ne pèse que 23 kg et comprend des caractéristiques uniques en leur genre assurant une maniabilité exceptionnelle et les meilleurs résultats possibles dans sa large bande de fréquences de fonctionnement.

En fait, le TF 2002 est le premier générateur de signaux et à multiples usages qui soit transistorisé et qui fonctionne dans une large bande.

Page 168

GENERATEUR DE SIGNAUX MODULES EN FREQUENCE, TF 801D/5M1

Cet appareil est une version de la série des générateurs de signaux TF 801D, réalisés pour être utilisés en liaison avec les indicateurs de direction V.O.R. et les dispositifs d'atterrissage sans visibilité. Il est livrable sous le no. de référence TF 801D/5M1 et particulièrement indiqué pour certains essais qui nécessitaient jusqu'à présent un nombre égal de générateurs de signaux spécialement conçus à ces fins.

Page 177

ZUSAMMENFASSUNG DER IN DIESER NUMMER ERSCHEINENDEN BEITRÄGE

UHF MESSENDER TF 1060/3

Frequenzmodulierte Signale können auf verschiedene Weise erzeugt werden, wobei die gewählte Methode von der Art des zu modulierenden Hochfrequenzoszillators abhängt. Dioden mit Sperrspannung sind geeignete Modulationsmittel und ermöglichen eine Modulation von Oszillatoren mit koaxialen Topfkreisen. Die an eine Diode für diese besondere Anwendung zu stellenden Anforderungen werden im Zusammenhang mit der Art der Ankopplung an die Schwingungsbildung behandelt. Die Leistungswerte eines frequenzmodulierten Meßsenders für einen Frequenzbereich von 470 bis 960 MHz werden angegeben.

Seite 159

UHF FREQUENZUMSETZER TM 6936

In der Ausgabe März 1963 der Zeitschrift INSTRUMENTATION wurde der Fernseh-Seitenbandanalysator TF 2360 näher beschrieben, wobei jedoch der zugehörige UHF Frequenzumsetzer TM 6936 zur Bereichserweiterung auf die Fernsehbander IV und V nur kurz erwähnt wurde. In diesem Aufsatz wird der Frequenzumsetzer genauer behandelt, wobei die benutzte Methode und die Faktoren, welche die Genauigkeit der Messung beeinflussen, beschrieben werden.

Seite 163

MW UND KW MESSENDER TF 2002 MIT AMPLITUDENMODULATION

Das Gerät TF 2002 ist ein vollkommen neuer und volltransistorisierter Meßsender mit Amplitudenmodulation hoher Qualität für Trägerfrequenzen im Bereich von 10 kHz bis 72 MHz. Seine hervorstechendsten Eigenschaften umfassen u.a.: Hohe Einstellungsgenauigkeit und geringe Frequenzabwanderung, geringe Streustrahlung und niedrige Störmodulation. Das Gerät ist trotz seiner raumsparenden Bauweise für rauhe Behandlung geeignet und wiegt nur 23 kg. Es vereinigt in sich viele einzigartige Vorzüge, welche eine einfache Bedienung und beste Leistungsfähigkeit über das breite Frequenzband ermöglichen. Das Gerät TF 2002 ist der erste volltransistorisierte Vielzweck-Meßsender dieser Bauart mit einem großen Frequenzbereich.

Seite 168

MESSENDER TF 801D/5M1 MIT AMPLITUDENMODULATION

Eine besonders auf VOR- und ILS-Navigationseinrichtungen zugeschnittene Ausführung der Meßsender-Baureihe TF 801D ist jetzt lieferbar. Dieses Gerät, die Ausführung TF 801D/5M1, eignet sich für eine Anzahl Messungen, die bisher eine entsprechende Zahl von Spezial-Meßsendern erforderten.

Seite 177

SOMMARIO DEGLI ARTICOLI PUBBLICATI IN QUESTO NUMERO**GENERATORE DI SEGNALI IN UHF TF 1060/3**

Svariati sono i metodi in grado di produrre modulazione di frequenza, e quello prescelto dipende dalla natura dell'oscillatore a radiofrequenza da modularsi. Diodi con polarizzazione inversa costituiscono elementi modulatori idonei, ed hanno reso possibile la modulazione di frequenza di oscillatori a linea coassiale. Si considerano i requisiti che un tale diodo deve possedere per questa applicazione particolare, come pure la maniera nella quale il diodo stesso può essere accoppiato al circuito accordato. Si forniscono dati sulle prestazioni di un generatore di segnali con modulazione di frequenza che copre il campo da 470 a 960 MHz. Pagina 159

CONVERTITORE PER UHF TM 6936

L'esauriente descrizione dell'analizzatore delle bande laterali per trasmettitori televisivi TF 2360 apparsa nel fascicolo di Instrumentation di marzo 1963 conteneva soltanto un breve accenno al convertitore per UHF TM 6936, un accessorio che ne estende il campo di frequenze sì da coprire le bande IV e V. Si dà ora un ragguaglio più particolareggiato del convertitore, descrivendo il metodo usato ed i fattori dai quali dipende la precisione delle misure. Pagina 163

GENERATORE DI SEGNALI AD OL, OM ED OC, CON MODULAZIONE DI AMPIEZZA, TF 2002

Il TF 2002 è un generatore di segnali totalmente nuovo ed interamente transistorizzato, fornente segnali di uscita di alta qualità, modulati in ampiezza, con valori della portante compresi fra 10 kHz e 72 MHz. Fra le sue caratteristiche precipue si annoverano un dispositivo di accordo con risoluzione eccezionalmente elevata, una lieve deriva di frequenza ed un basso livello di irradiazioni parassite e modulazione spuria. Lo strumento è robusto pur nella sua costruzione compatta, con un peso di soli 23 kg., ed include molti particolari accorgimenti che assicurano una manovra agevole e le migliori prestazioni entro tutto il vasto campo di frequenze di lavoro. Il TF 2002 è il primo generatore di segnali del suo genere, cioè interamente transistorizzato, a gamma estesa, per impieghi di carattere generale. Pagina 168

GENERATORE DI SEGNALI CON MODULAZIONE DI AMPIEZZA TF 801D/5M1

E' ora disponibile un modello di generatore di segnali della serie TF 801D, specialmente adattato per l'impiego con apparecchiature di assistenza alla navigazione V.O.R. (radiofari omnidirezionali ad onde ultracorte) ed I.L.S. (impianti di atterraggio strumentale). Questo strumento, denominato TF 801D/5M1, è atto all'esecuzione di un buon numero di prove, per ciascuna delle quali si rendeva necessario finora un apposito generatore di segnali specializzato. Pagina 177

RESUMENES DE ARTICULOS QUE APARECEN EN ESTE NUMERO**GENERADOR DE SEÑAL EN UHF, TF 1060/3**

Existen varios métodos de producir modulación de frecuencia, y el que se elija dependerá del oscilador de r.f. que se vaya a modular. Los diodos con polarización inversa son elementos modulados adecuados, y han hecho posible la modulación en frecuencia de osciladores a línea coaxial. Para esta aplicación especial, se consideran necesarios estos diodos. Se explica el modo de acoplarlos al circuito sintonizado, y el funcionamiento del generador de señal, en frecuencia modulada, con margen de 470 a 960 MHz. Pagina 159

CONVERTIDOR EN UHF, TF 6936

El analizador de bandas laterales de transmisores de televisión, se describía con gran detalle en el número de marzo 1963 de INSTRUMENTATION. También se hacía allí una breve referencia del convertidor en UHF, TM 6936 para ampliar su margen a las bandas IV y V. Se detalla ahora el convertidor con más extensión, describiendo el método empleado y los factores de los que depende la precisión de las medidas. Pagina 163

GENERADOR DE SEÑAL EN MF/HF Y AM, TF 2002

El TF 2002 es un nuevo generador de señal, completamente transistorizado, que produce salidas en a.m. de alta calidad, en el margen de la portadora, de 10 kHz, a 72 MHz. Entre sus características más importantes están: sintonización de alta discriminación, baja desviación y dispersión de portadora, y modulación espúrea mínimas. El aparato, de construcción robusta, es compacto—pesa sólo 23 kgs.—y posee muchas características excepcionales, que aseguran un fácil manejo, así como un funcionamiento óptimo en todo su amplio margen de frecuencias. El TF 2002 es el primer generador de señal en banda ancha, de uso general, completamente transistorizado. Pagina 168

GENERADOR DE SEÑAL EN AM, TF 801D/5M1

Existe ya una versión de la serie TF 801D de generadores de señal, especialmente adaptados para su empleo con los equipos de ayuda a la navegación ILS y VOR. Con el TF 801D/5M1 se pueden efectuar gran número de pruebas, que hasta aquí exigían el empleo de generadores de señal especializados, y en mayor número. Pagina 177

MARCONI INSTRUMENTS
111 Cedar Lane
Englewood, N.J.

BULK RATE
U.S. POSTAGE
PAID
Englewood, N.J.
Permit No. 313

SIGNAL GENERATORS

NOISE GENERATORS

OSCILLATORS

SWEEP GENERATORS

OSCILLOSCOPES

PULSE GENERATORS

MODULATION METERS

DISTORTION ANALYSERS

SPECTRUM ANALYSERS

FREQUENCY COUNTERS
AND METERS

POWER METERS

VOLTMETERS

IMPEDANCE BRIDGES,
DIELECTRIC AND Q METERS

MOISTURE METERS

IMAGE AMPLIFIERS FOR
INDUSTRIAL AND MEDICAL
X-RAY EQUIPMENT

Mr. A. Brody, Dir. of Eng.
KCOP Television, Inc.
915 La Brea Ave.
Hollywood 38, Calif.

Return Requested

MARCONI INSTRUMENTS LIMITED

Head Office, Works and Export Department

ST. ALBANS · HERTFORDSHIRE · ENGLAND

Telephone: St. Albans 59292 Telex: 23350 Telegrams: Measurtest, St. Albans, Telex

SALES AND SERVICE OFFICES

*London and
the South*

ENGLISH ELECTRIC HOUSE, STRAND, LONDON, W.C.2
Telephone: Covent Garden 1234 Telex: 22572

Midland (East)

ST. ALBANS, HERTFORDSHIRE

Telephone: St. Albans 59292 Telex: 23350

Midland (West)

40 WHITELADIES ROAD, BRISTOL 8

Telephone: Bristol 39639

Northern

23/25 STATION SQUARE, HARROGATE

Telephone: Harrogate 67454 (2 lines) Telex: 5723

Service Division

HEDLEA WORKS, HEDLEY ROAD, ST. ALBANS

Telephone: St. Albans 50731 (4 lines) Ansafone

U.S.A.

ENGLISH ELECTRIC CORPORATION
MARCONI INSTRUMENTS DIVISION
111 CEDAR LANE, ENGLEWOOD, NEW JERSEY
Telephone: LOwell 7-0607

FEDERAL REPUBLIC OF GERMANY

MARCONI MESSTECHNIK G.m.b.H.
WOLFRATSHAUSER STRASSE 243, MÜNCHEN-SOLLN
Telephone: 797321 Telex: 524642

ASSOCIATED COMPANIES AND DISTRIBUTORS THROUGHOUT THE WORLD