

ROBOT CONTROLLER

RC180

Rev.15

EM135C2505F

ROBOT CONTROLLER RC180 Rev.15

ROBOT CONTROLLER

RC180

Rev.15

Copyright © 2006-2013 SEIKO EPSON CORPORATION. All rights reserved.

FOREWORD

Thank you for purchasing our robot products.

This manual contains the information necessary for the correct use of the robot controller.

Please carefully read this manual and other related manuals before installing the robot system.

Keep this manual handy for easy access at all times.

WARRANTY

The robot system and its optional parts are shipped to our customers only after being subjected to the strictest quality controls, tests, and inspections to certify its compliance with our high performance standards.

Product malfunctions resulting from normal handling or operation will be repaired free of charge during the normal warranty period. (Please ask your Regional Sales Office for warranty period information.)

However, customers will be charged for repairs in the following cases (even if they occur during the warranty period):

1. Damage or malfunction caused by improper use which is not described in the manual, or careless use.
2. Malfunctions caused by customers' unauthorized disassembly.
3. Damage due to improper adjustments or unauthorized repair attempts.
4. Damage caused by natural disasters such as earthquake, flood, etc.

Warnings, Cautions, Usage:

1. If the robot system associated equipment is used outside of the usage conditions and product specifications described in the manuals, this warranty is void.
2. If you do not follow the WARNINGS and CAUTIONS in this manual, we cannot be responsible for any malfunction or accident, even if the result is injury or death.
3. We cannot foresee all possible dangers and consequences. Therefore, this manual cannot warn the user of all possible hazards.

TRADEMARKS

Microsoft, Windows, and Windows logo are either registered trademarks or trademarks of Microsoft Corporation in the United States and/or other countries. Other brand and product names are trademarks or registered trademarks of the respective holders.

TRADEMARK NOTATION IN THIS MANUAL

Microsoft® Windows® XP Operating system

Microsoft® Windows® Vista Operating system

Microsoft® Windows® 7 Operating system

Throughout this manual, Windows XP, Windows Vista and Windows 7 refer to above respective operating systems. In some cases, Windows refers generically to Windows XP, Windows Vista and Windows 7.

NOTICE

No part of this manual may be copied or reproduced without authorization.

The contents of this manual are subject to change without notice.

Please notify us if you should find any errors in this manual or if you have any comments regarding its contents.

INQUIRIES

Contact the following service center for robot repairs, inspections or adjustments.

If service center information is not indicated below, please contact the supplier office for your region.

Please prepare the following items before you contact us.

- Your controller model and its serial number
- Your manipulator model and its serial number
- Software and its version in your robot system
- A description of the problem

SERVICE CENTER

--

MANUFACTURER

SEIKO EPSON CORPORATION

Toyoshina Plant
Industrial Solutions Division
6925 Toyoshina Tazawa,
Azumino-shi, Nagano, 399-8285
JAPAN
TEL : +81-(0)263-72-1530
FAX : +81-(0)263-72-1495

SUPPLIERS

North & South America **EPSON AMERICA, INC.**

Factory Automation/Robotics
18300 Central Avenue
Carson, CA 90746
USA
TEL : +1-562-290-5900
FAX : +1-562-290-5999
E-MAIL : info@robots.epson.com

Europe

EPSON DEUTSCHLAND GmbH

Factory Automation Division
Otto-Hahn-Str.4
D-40670 Meerbusch
Germany
TEL : +49-(0)-2159-538-1391
FAX : +49-(0)-2159-538-3170
E-MAIL : robot.infos@epson.de

China

EPSON China Co., Ltd

Factory Automation Division
7F, Jinbao Building No. 89 Jinbao Street
Dongcheng District, Beijing,
China, 100005
TEL : +86-(0)-10-8522-1199
FAX : +86-(0)-10-8522-1120

Taiwan

EPSON Taiwan Technology & Trading Ltd.

Factory Automation Division
14F, No.7, Song Ren Road, Taipei 110
Taiwan, ROC
TEL : +886-(0)-2-8786-6688
FAX : +886-(0)-2-8786-6677

Southeast Asia
India

EPSON Singapore Pte Ltd.
Factory Automation System
1 HarbourFrontPlace, #03-02
HarbourFront Tower one, Singapore
098633
TEL : +65-(0)-6586-5696
FAX : +65-(0)-6271-3182

Korea

EPSON Korea Co, Ltd.
Marketing Team(Robot Business)
27F DaeSung D-Polis A, 606
Seobusaet-gil, Geumcheon-gu, Seoul, 153-803
Korea
TEL : +82-(0)-2-3420-6692
FAX : +82-(0)-2-558-4271

Japan

EPSON SALES JAPAN CORPORATION
Factory Automation Systems Department
Nishi-Shinjuku Mitsui Bldg.6-24-1
Nishishinjuku. Shinjuku-ku. Tokyo. 160-8324
JAPAN
TEL : +81-(0)3-5321-4161

Before Reading This Manual

NOTE



Do not connect the followings to the TP/OP port of RC180. Connecting to the followings may result in malfunction of the device since the pin assignments are different.

OPTIONAL DEVICE dummy plug

Operation Pendant OP500

Operator Pendant OP500RC

Jog Pad JP500

Teaching Pendant TP-3**

NOTE



For RC180, be sure to install the EPSON RC+5.0 to the development PC first, then connect the development PC and RC180 with the USB cable.

If RC180 and the development PC are connected without installing the EPSON RC+5.0 to the development PC, [Add New Hardware Wizard] appears. If this wizard appears, click the <Cancel> button.

NOTE



Concerning the security support for the network connection:

The network connecting function (Ethernet) on our products assumes the use in the local network such as the factory LAN network. Do not connect to the external network such as Internet.

In addition, please take security measure such as for the virus from the network connection by installing the antivirus software.

NOTE



Security support for the USB memory:

Make sure the USB memory is not infected with virus when connecting to the Controller.

NOTE



Every data of the Controller is stored to the Compact Flash inside the Controller. When you execute the commands listed below, data is written to the Compact Flash. Frequent data writing to the Compact Flash may shorten the Compact Flash life. It is recommended to use the following commands only when it is necessary.

- Renew the Point files (SavePoints)
- Change the Robot parameters (Base, Local, LocalClr, CalPIs, Calib, Hofs, ArmSet, ArmClr, HomeSet, HomeClr, Hordr, MCOder, Weight, JRange, Range, XYLim, TLSet, TLClr, Arm, Tool, Inertia, EcpSet, EcpClr, Box, BoxClr, Plane, PlaneClr)

Safety

1. Safety	3
2. Conventions	3
3. Safety Precautions	4

Setup & Operation

1. Specifications	9
1.1 System Example	9
1.2 Standard Specifications	10
1.3 Outer Dimensions	12
2. Part Names and Functions	13
2.1 Part Names	13
2.2 Functions	14
2.3 LED and Seven-segment LED	17
2.3.1 LED and Seven-segment Display	17
2.3.2 Particular Status Display	18
2.4 Safety Features.....	18
3. Installation	21
3.1 Unpacking	21
3.2 Environmental Requirements.....	21
3.2.1 Environment.....	21
3.2.2 Installation.....	22
3.2.3 Install inside the Cabinet.....	24
3.3 Power Supply.....	25
3.3.1 Specifications.....	25
3.3.2 AC Power Cable	26
3.4 Cable Connection	26
3.4.1 Typical Cable Connection	27
3.4.2 Connecting Manipulator to Controller.....	30
3.5 Noise Countermeasures	32
4. Operation Mode (TEACH/AUTO)	33
4.1 Overview.....	33
4.2 Switch Operation Mode.....	33
4.3 Program Mode (AUTO).....	34
4.3.1 What is Program Mode (AUTO)?	34

4.3.2	Setup from EPSON RC+5.0	34
4.3.3	Setup from Teach Pendant.....	34
4.4	Auto Mode (AUTO).....	35
4.4.1	What is Auto mode (AUTO)?	35
4.4.2	Setup from EPSON RC+ 5.0	35
4.4.3	Setup from Control Device	36
5. Development PC Connection Port		37
5.1	About Development PC Connection Port	37
5.2	Precaution	38
5.3	Software Setup and Connection Check.....	38
5.4	Disconnection of Development PC and Controller	39
6. Memory Port		40
6.1	What is Controller Status Storage Function?.....	40
6.2	Before Using Controller Status Storage Function.....	40
6.2.1	Precautions	40
6.2.2	Adoptable USB Memory	40
6.3	Controller Status Storage Function	41
6.3.1	Controller Status Storage with Trigger Button	41
6.3.2	Controller Status Storage with Teach Pendant (Option).....	41
6.3.3	Load Data with EPSON RC+ 5.0.....	42
6.3.4	Transfer with E-mail.....	43
6.4	Details of Data.....	44
7. LAN (Ethernet Communication) Port		45
7.1	About LAN (Ethernet Communication) Port.....	45
7.2	IP Address.....	46
7.3	Changing Controller IP Address	46
7.4	Connection of Development PC and Controller with Ethernet	48
7.5	Disconnection of Development PC and Controller with Ethernet	49
8. TP/OP Port		50
8.1	What is TP/OP Port?	50
8.2	Teach Pendant Connection	51
8.3	Operator Panel Connection	51
9. EMERGENCY		52
9.1	Safety Door Switch and Latch Release Switch.....	53
9.1.1	Safety Door Switch	53

9.1.2	Latch Release Switch.....	54
9.1.3	Checking Latch Release Switch Operation	54
9.2	Emergency Stop Switch Connection.....	55
9.2.1	Emergency Stop Switch	55
9.2.2	Checking Emergency Stop Switch Operation	55
9.2.3	Recovery from Emergency Stop	55
9.3	Pin Assignments	56
9.4	Circuit Diagrams	57
9.4.1	Example 1: External emergency stop switch typical application	57
9.4.2	Example 2: External safety relay typical application	58
10.	I/O Connector	59
10.1	Input Circuit.....	59
10.2	Output Circuit.....	61
10.3	Pin Assignment.....	63
11.	I/O Remote Set Up	64
11.1	I/O Signal Description	65
11.1.1	Remote Input Signals	65
11.1.2	Remote Output Signals	67
11.2	Timing Specifications	69
11.2.1	Design Notes for Remote Input Signals.....	69
11.2.2	Timing Diagram for Operation Execution Sequence.....	69
11.2.3	Timing Diagram for Program Execution Sequence	69
11.2.4	Timing Diagram for Safety Door Input Sequence	70
11.2.5	Timing Diagram for Emergency Stop Sequence	70
12.	Option Units	71
12.1	What are Option Units?.....	71
12.2	Expansion I/O Board.....	71
12.2.1	About Expansion I/O Board	71
12.2.2	Board Configuration (Expansion I/O).....	71
12.2.3	Confirmation with EPSON RC+5.0	72
12.2.4	Input Circuit	72
12.2.5	Output Circuit	74
12.2.6	Pin Assignments.....	76
12.3	Fieldbus I/O Board	78
12.3.1	Overview of Fieldbus I/O	78

12.3.2	Response Speed of Fieldbus I/O	78
12.3.3	Fieldbus I/O Board Configuration.....	79
12.3.4	DeviceNet	80
12.3.5	PROFIBUS-DP	84
12.3.6	CC-Link.....	88
12.3.7	EtherNet/IP	98
12.3.8	PROFINET.....	102
12.3.9	Operation (DeviceNet, PROFIBUS-DP, EtherNet/IP)	106
12.4	RS-232C Board	108
12.4.1	About RS-232C Board	108
12.4.2	Board Setup (RS-232C).....	108
12.4.3	Verify with EPSON RC+5.0 (RS-232C)	109
12.4.4	RS-232C Software Communication Setup (RS-232C).....	110
12.4.5	Communication Cable (RS-232C)	110

Maintenance

1. Safety Precautions on Maintenance	113
1.1 Safety Precautions	113
1.2 Lockout / Tagout.....	114
2. Regular Maintenance Inspection	115
2.1 Schedule for Maintenance Inspection	115
2.2 Inspection Point.....	116
2.2.1 Inspection While the Controller is Turned OFF.....	116
2.2.2 Inspection While the Controller is Turned ON	116
3. Controller Structure	117
3.1 Location of Parts	117
3.2 Diagram of Cable Connections.....	119
3.3 Connector Pin Assignment.....	122
3.3.1 M/C Power Connector	122
3.3.2 M/C Signal Connector	123
4. Backup and Restore	124
4.1 What is Backup Controller?	124
4.2 Backup Data Types	124
4.3 Backup	125
4.3.1 Backup from EPSON RC+5.0.....	125
4.3.2 Backup from the Teach Pendant (Option)	126

4.4	Restore	128
4.4.1	Restore from EPSON RC+5.0.....	128
4.4.2	Restore from Teach Pendant (Option).....	129
5. Firmware Update		132
5.1	Updating Firmware.....	132
5.2	Firmware Upgrading Procedure	132
5.3	Controller Recovery	135
5.4	Firmware Initialization Procedure.....	136
6. Maintenance Parts Replacement Procedures		138
6.1	Fan and Fan Filter.....	139
6.1.1	Cleaning and Replacing Fan Filter.....	139
6.1.2	Replacing Fan Unit.....	140
6.1.3	Cleaning and Replacing Fan Filter of Option Unit	142
6.2	Battery	143
6.3	Motor Driver	145
6.3.1	Part Names	145
6.3.2	Replacing Motor Driver (Axis from 1 to 4)	145
6.3.3	Replacing Motor Driver (Axis 5 and 6)	150
6.4	CPU Board Unit	152
6.5	CF (Compact Flash).....	155
6.6	Fuse.....	156
6.7	Option Unit.....	158
6.7.1	Remove Option Unit 1	158
6.7.2	Mount Option Unit 1	159
6.7.3	Remove Option Unit 2.....	159
6.7.4	Mount Option Unit 2	161
6.7.5	Remove Option Unit 1, 2.....	162
6.7.6	Mount Option Unit 1, 2	163
6.7.7	Replacing Adding Option Board.....	164
7. Verifying Manipulator Operation		165
8. Trouble Shooting		166
8.1	Error Code table.....	166
8.2	Cannot Connect the Development PC and the Controller using the USB cable	232
8.2.1	Confirmation Using Windows Device Manager	232

8.2.2 When recognized under “Other devices”
in Windows Device Manager 235

9. Maintenance Parts List 236

Safety

This section contains information for safety of the Robot System.

1. Safety



Installation and transportation of robots and robotic equipment shall be performed by qualified personnel and should conform to all national and local codes.

Please read this manual and other related manuals before installing the robot system or before connecting cables. Keep this manual in a handy location for easy access at all times.

Read the Safety chapter in *EPSON RC+ 5.0 User's Guide* and confirm *Safety-related requirements*.

2. Conventions

Important safety considerations are indicated throughout the manual by the following symbols. Be sure to read the descriptions shown with each symbol.

 WARNING	This symbol indicates that a danger of possible serious injury or death exists if the associated instructions are not followed properly.
 WARNING	This symbol indicates that a danger of possible harm to people caused by electric shock exists if the associated instructions are not followed properly.
 CAUTION	This symbol indicates that a danger of possible harm to people or physical damage to equipment and facilities exists if the associated instructions are not followed properly.

3. Safety Precautions

Only trained personnel should design and install the robot system.

Trained personnel are defined as those who have taken robot system training class held by the manufacturer, dealer, or local representative company, or those who understand the manuals thoroughly and have the same knowledge and skill level as those who have completed the training courses.

The following items are safety precautions for qualified design or installation personnel:

 WARNING	<ul style="list-style-type: none"> ■ Personnel who design and/or construct the robot system with this product must read the Safety chapter in User's Guide to understand the safety requirements before designing and/or constructing the robot system. Designing and/or constructing the robot system without understanding the safety requirements is extremely hazardous, may result in serious bodily injury and/or severe equipment damage to the robot system, and may cause serious safety problems. ■ The Manipulator and the Controller must be used within the environmental conditions described in their respective manuals. This product has been designed and manufactured strictly for use in a normal indoor environment. Using the product in an environment that exceeds the specified environmental conditions may not only shorten the life cycle of the product but may also cause serious safety problems. ■ The robot system must be used within the installation requirements described in the manuals. Using the robot system outside of the installation requirements may not only shorten the life cycle of the product but also cause serious safety problems. ■ The interlock of the Safety Door must be functioning when the robot system is operated. Do not operate the system under the condition that the switch cannot be turned ON/OFF. (I.E. the condition where the switch is disabled) (Example: Tape is put around the switch to hold it closed.) Operating the robot system when the switch is not functioning properly is extremely hazardous and may cause serious safety problems as the Safety Door input cannot fulfill its intended function. ■ Connect input signal wires for Emergency Stop and Safety Door to the EMERGENCY connector so that the Emergency Stop switch in the Operator Panel or Teach Pendant connected to the TP/OP port always functions. (Refer to the typical application diagram in Setup & Operation 9.4 Circuit Diagrams.)
--	---

The following items are safety precautions for qualified design or installation personnel: (cont.)

 <p>WARNING</p>	<ul style="list-style-type: none"> ■ Do not open the cover(s) of the Controller except while maintaining it. Opening the cover(s) of the Controller is extremely hazardous and may result in electric shock even when its main power is OFF because of the high voltage charge inside the Controller. ■ Make sure that the power to the Controller is turned OFF before connecting or disconnecting any cables. Connecting or disconnecting any cables with the power ON is extremely hazardous and may result in electric shock and/or malfunction of the Controller. ■ Be sure to connect the cables properly. Do not allow unnecessary strain on the cables. (Do not put heavy objects on the cables. Do not bend or pull the cables forcibly.) The unnecessary strain on the cables may result in damage to the cables, disconnection, and/or contact failure. Damaged cables, disconnection, or a contact failure is extremely hazardous and may result in electric shock and/or improper function of the system. ■ When connecting the plug to fit the outlet in your factory, make sure that it is done by qualified personnel. When connecting the plug, be sure to connect the earth wire of the AC power cable colored green/yellow on the Controller to the earth terminal of the factory power supply. The equipment must be grounded properly at all times to avoid the risk of electric shock. Always use a power plug and receptacle. Never connect the Controller directly to the factory power supply. (Field wiring)
--	--

 <p>CAUTION</p>	<ul style="list-style-type: none"> ■ The serial number of the Manipulator that should be connected is indicated on the Connection Check Label on the Controller. Connect the Controller and the Manipulator correctly. Improper connection between the Controller and the Manipulator may cause improper function of the robot system and also safety problems. ■ When using remote I/O, always make sure of the following. Using the robot system under unsatisfactory conditions may cause malfunction of the system and/or safety problems. <ul style="list-style-type: none"> - Assign remote functions to inputs/outputs correctly and wire correctly when setting up remote I/O signals. - Make sure that the functions correspond to the correct input/output signals before turning ON the system. - When verifying the robot system operation, prepare for failures with initial settings or wiring. If the Manipulator functions unusually by the failures with initial settings or wiring, press the Emergency Stop switch immediately to stop the Manipulator.
--	--

The following items are safety precautions for qualified operator personnel:

 <p>WARNING</p>	<ul style="list-style-type: none">■ The interlock of the Safety Door must be functioning when the robot system is operated. Do not operate the system under the condition that the switch cannot be turned ON/OFF. (I.E. the condition where the switch is disabled) (Example: Tape is put around the switch to hold it closed.) Operating the robot system when the switch is not functioning properly is extremely hazardous and may cause serious safety problems as the Safety Door input cannot fulfill its intended function.
--	---

 <p>WARNING</p>	<ul style="list-style-type: none">■ Do not open the cover(s) of the Controller except while maintaining it. Opening the cover(s) of the Controller is extremely hazardous and may result in electric shock even when its main power is OFF because of the high voltage charge inside the Controller.
--	--

Setup & Operation

This section contains information for setup and operation of the Robot Controller.

1. Specifications

1.1 System Example

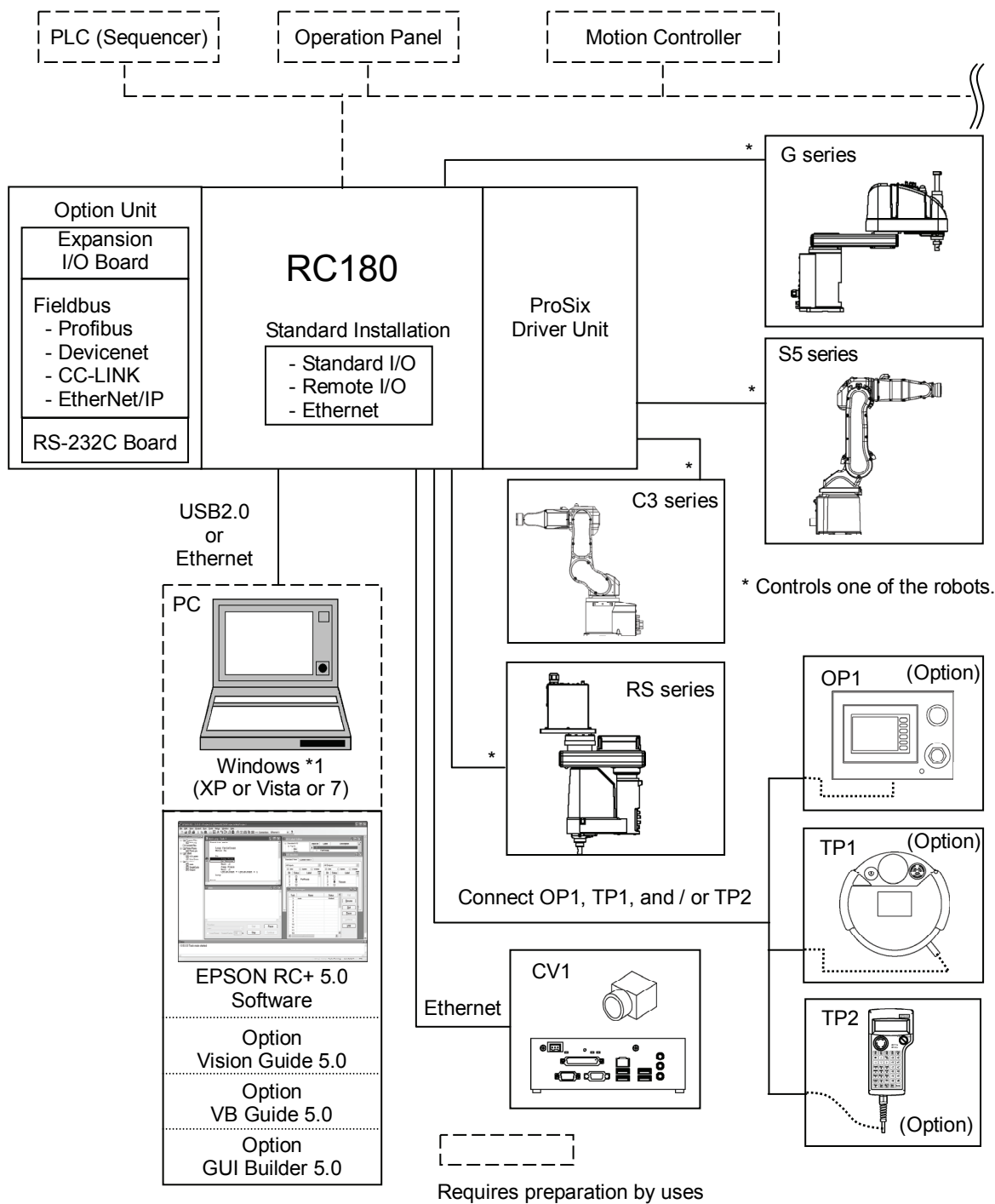

*1 EPSON RC+ 5.0 supports the following OS.
 Windows XP Professional Service Pack 3 (EPSON RC+ 5.0 Ver.5.2.0 SP3 or after is required.)
 Windows Vista Business Service Pack 2 (EPSON RC+ 5.0 Ver.5.3.1 or after is required.)
 Windows 7 Professional (EPSON RC+ 5.0 Ver.5.3.4 or after is required.)

1.2 Standard Specifications

Item	Specification		
Model	Robot Controller RC180 (UL specification: RC180-UL)		
CPU	32 bits Ultra Low Voltage Processor		
Controllable axes	Up to six (6) connectable AC servo motors		
Robot manipulator control	Programming language and Robot control software	EPSON RC+ 5.0 (a multi-tasking robot language)	
	Joint Control	Up to six (6) joints Simultaneous control Software AC servo control	
	Speed Control	PTP motion : Programmable in the range of 1 to 100% CP motion : Programmable (Actual value to be manually entered.)	
	Acceleration/ deceleration control	PTP motion : Programmable in the range of 1 to 100%; Automatic CP motion : Programmable (Actual value to be manually entered.)	
Positioning control	PTP (Point-To-Point control) CP (Continuous Path control)		
Memory capacity	Maximum Object Size : 4 MB Point data area : 1000 points (per file) Backup variable area : Max. 100 KB (Includes the memory area for the management table.) Approx. 1000 variables (Depends on the size of array variables.)		
Teaching method	Remote Direct MDI (Manual Data Input)		
External input/output signals (standard)	Standard I/O	Input : 24 Output : 16	Including 8 inputs, 8 outputs with remote function assigned Assignment change allowed
Communication interface (standard)	Ethernet	1 channel	
Options (Max. 4 slots)	I/O	Input : 32 per board Output : 32 per board	Addition of 4 boards allowed
	Communication interface	RS-232C : 4ch per board	Addition of 2 boards allowed
		Fieldbus I/O : 1ch per board PROFINET PROFIBUS-DP DeviceNet CC-Link EtherNet/IP	Addition of 1 board allowed

Item	Specification		
Safety features	<ul style="list-style-type: none"> - Emergency stop switch - Safety door input - Low power mode - Dynamic brake - Encoder cable disconnection error detection - Motor overload detection - Irregular motor torque (out-of-control Manipulator) detection - Motor speed error detection - Positioning overflow - servo error - detection - Speed overflow - servo error - detection - CPU irregularity detection - Memory check-sum error detection - Overheat detection at the Motor Driver Module - Relay welding detection - Over-voltage detection - AC power supply voltage reduction detection - Temperature error detection - Fan error detection 		
Power Source	AC 200 V to AC 240 V Single phase 50/60 Hz		
Maximum Power Consumption	2.5 kVA (Depending on the Manipulator model)		
Insulation Resistance	100 MΩ or more		
Rated Ambient Temperature	5 to 40 deg.C		
Rated Relative Humidity	20% to 80% (with no condensation)		
Weight *1	For SCARA robot *2	9.0 kg	Base unit without option
	For Six-axis robot *3	10.5 kg	Base unit + ProSix Driver Unit
	Option unit	1.0 kg	Incase of installing 2 option boards

*1 Weight of the unit is indicated on the Controller itself.

Make sure to check the weight before units transfer or relocation and prevent throwing out your back at holding the unit.

Also, make sure to keep your hands, fingers, and feet safe from being caught or serious injury.

*2 Including RS series.

*3 Including C3 series, S5 series.

1.3 Outer Dimensions

Dimension of RC180-UL is the same as RC180.

Base Unit (Four-axis robot construction)

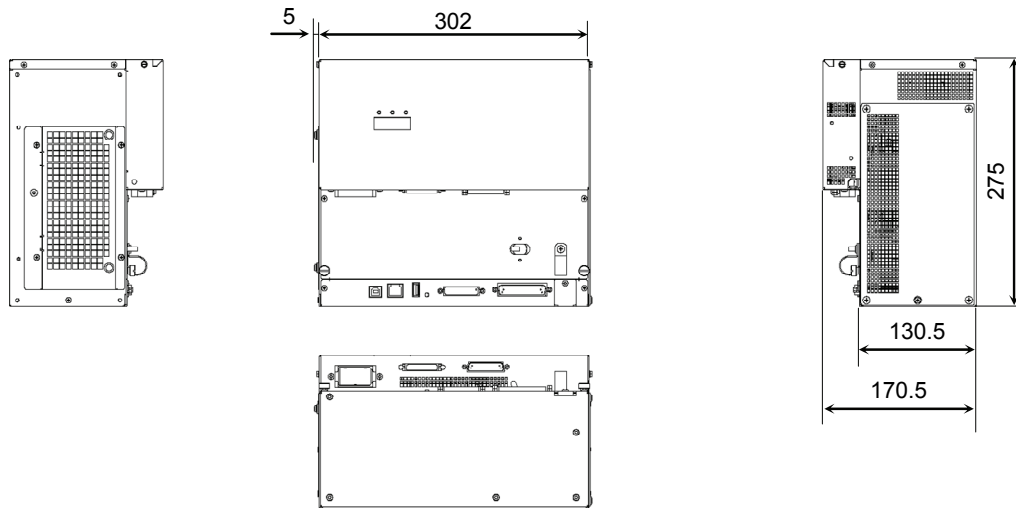

Base Unit + ProSix Driver Unit (Six-axis robot construction)

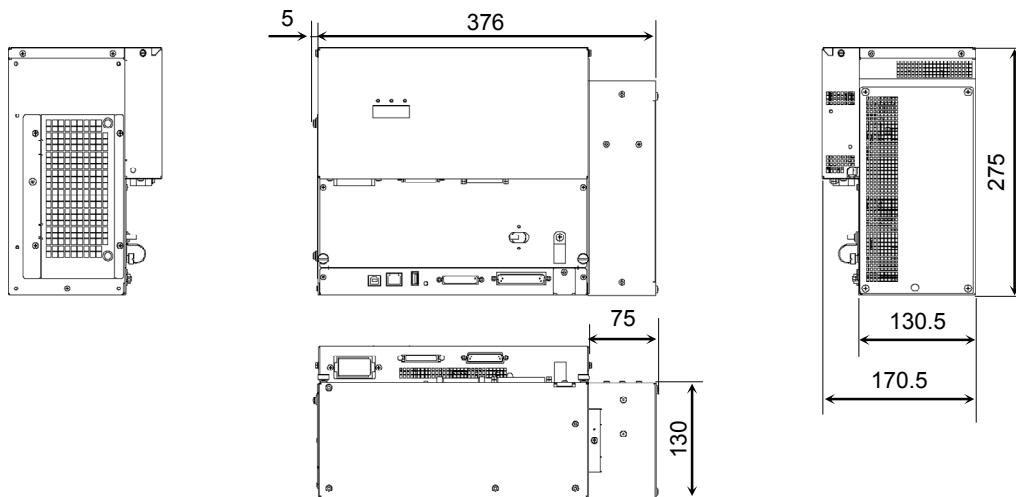

RC180: Base Unit + Option Unit

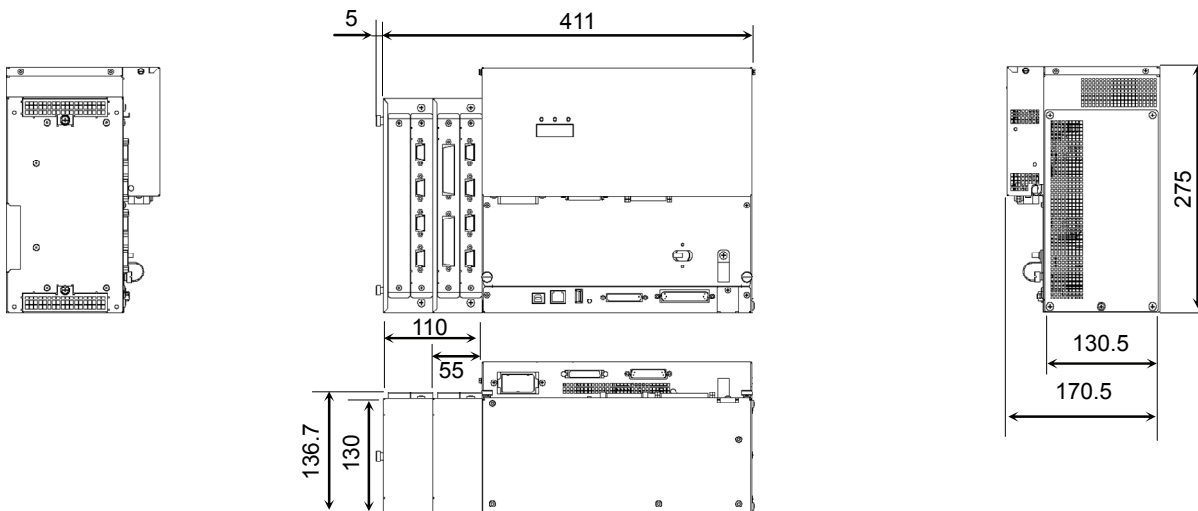

2. Part Names and Functions

2.1 Part Names

RC180

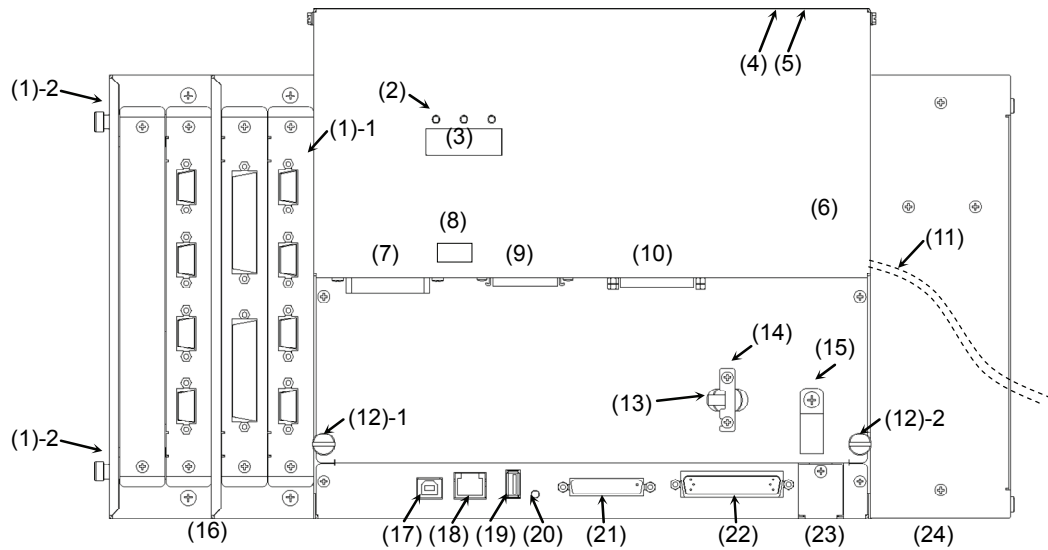

RC180-UL

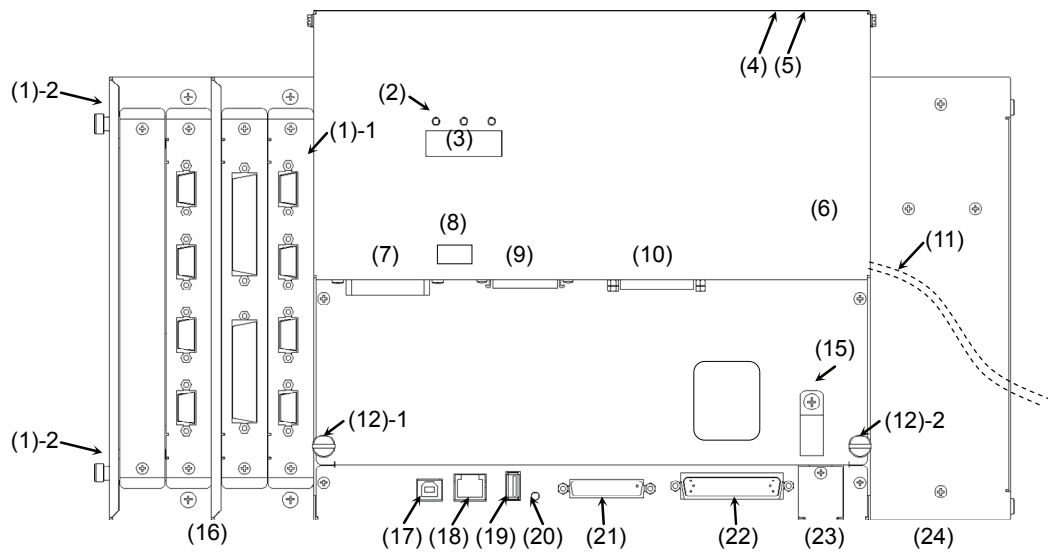

2.2 Functions

(1) -1 Fan Filter (Without Option Unit)

A protective filter is installed in front of the fan to filter out dust.

Check the condition of the filter regularly and clean it when necessary. A dirty filter may result in malfunction of the robot system due to temperature rise of the Controller.

For inspection, cleaning, and replacement, refer to the *Maintenance 6.1 Fan and Fan Filter*.

(1) -2 Fan Filter (With Option Unit)

A protective filter is installed in front of the fan to filter out dust.

Check the condition of the filter regularly and clean it when necessary. A dirty filter may result in malfunction of the robot system due to temperature rise of the Controller.

For inspection, cleaning, and replacement, refer to the *Maintenance 6.1 Fan and Fan Filter*.

(2) LED

The LED indicates current operation mode (TEACH, AUTO, or PROGRAM mode).

For details, refer to *Setup & Operation 2.3 LED and Seven-segment LED*.

(3) Seven-segment LED

Four-digit seven-segment LED displays the line number and the status of the controller (error number, warning number, status of Emergency Stop and Safety Door).

For details, refer to *Setup & Operation 2.3 LED and Seven-segment LED*.

(4) Signature label (top panel)

The serial number of the Controller and other information are shown.

(5) MT label (top panel)

The label indicates the specification number for the customized Manipulator and is attached only to the customized Manipulator. If your Manipulator indicates this label, it may require a specific maintenance procedure. In this case, make sure to contact your dealer before performing any maintenance procedures.

(6) Controller Number label

The serial number of the Controller is indicated.

(7) M/C POWER connector

A connector for the Manipulator power source.

Connect the dedicated power cable attached to the Manipulator.

(8) Connection Check label

The details of the Manipulator to be connected are recorded on the label as shown in the right. The label indicates the Manipulator model and Manipulator serial number.

MANIPULATOR	
G6-551S	00002

(9) M/C SIGNAL connector

This connector is used for signals such as the Manipulator's motor encoders, the origin sensor signals, etc. Connect the Manipulator's dedicated signal cable.

(10) EMERGENCY connector

This connector is used for input/output from/to Emergency Stop and Safety Door switches. For details, refer to the *Setup & Operation 9. EMERGENCY*.

(11) AC IN

The cable for AC 200V power input.

For details, refer to *Setup & Operation 3.3.2 AC Power Cable*.

(12) Thumb Head screw

This is two of the four screws used to attach the front cover of the Controller. Use these screws to pull out the Motor Driver module and CPU board unit.

NOTE



- A spacer is attached to the thumb head screw on Controllers S/N01001 or later.

Do not remove the spacer.

Installing the front cover using a thumb head screw without a spacer may result in a cable being stuck and/or malfunction of the Controller.

- Installing the front cover using other screws may result in cable being stuck and/or malfunction of the Controller.

(13) POWER switch

Turns ON or OFF the Controller.

* This is not available for RC180-UL. For details, refer to the *Setup & Operation 3.3.2 AC Power Cable, For RC180-UL*.

(14) Power Switch metal hasp

To lock the power switch in the OFF position, set the power switch to the OFF position and mount the metal hasp. Lock the power off for maintenance or repair of the robot system.

* This is not available for RC180-UL. For details, refer to the *Setup & Operation 3.3.2 AC Power Cable, For RC180-UL*.

(15) Cable Clamp

This can be used to secure the M/C Signal Cable and the EMERGENCY cable if necessary.

(16) Option Unit

Option boards such as expansion I/O board, Fieldbus I/O board, RS-232C board can be installed. Two slots per unit are available. Up to two units (four slots) are supported.

For details, refer to *Setup & Operation 12. Option Unit*.

(17) Development PC connection port

This port connects the Controller and the Development PC using a USB cable.

Do not connect other devices except the Development PC.

For details, refer to *Setup & Operation 5. Development PC Connection Port*.

(18) LAN (Ethernet communication) port

This port connects the Controller and the Development PC using an Ethernet cable. 100BASE-TX / 10BASE-T communication are available.

For details, refer to *Setup & Operation 7. LAN (Ethernet communication) Port*.

(19) Memory port

This port connects the common USB memory for Controller status storage function. Do not connect other USB devices except the USB memory.

For details, refer to *Setup & Operation 6. Memory Port*.

(20) Trigger Switch

This switch is for Controller status storage function using the USB memory.

For details, refer to *Setup & Operation 6. Memory Port*.

(21) TP/OP port

Connects Teach Pendant TP1 (Option) TP2 (Option), Operator Panel OP1 (Option), and TP/OP bypass plug.

For details, refer to *Setup & Operation 8. TP/OP Port*.

NOTE



Do not connect the following to the TP/OP port of RC180. Connecting to the followings may result in malfunction of the device since the pin assignments are different.

OPTIONAL DEVICE dummy plug

Operation Pendant OP500

Operator Pendant OP500RC

Jog Pad JP500

Teaching Pendant TP-3**

(22) I/O connector

This connector is used for input/output device. There are 24 inputs and 16 outputs.

For details, refer to *Setup & Operation 10. I/O Connector*.

(23) Battery

This is a lithium battery for data backup.

For replacement, refer to *Maintenance 6.2 Battery*.

(24) ProSix Driver Unit

This unit is used for C3 series and S5 series manipulators.

Motor driver for two axes is installed.

2.3 LED and Seven-segment LED

2.3.1 LED and Seven-segment Display

Three LEDs and a four-digit seven-segment LED display are located on the front panel of the Controller.

LED : LED (TEACH, AUTO, PROGRAM) turns ON according to the current operation mode (TEACH, Auto, Program).

Seven-segment : Indicates the line number and Controller status (error number, warning number, Emergency Stop or Safeguard status).

From turning ON the Controller to completing startup

LED : All three LEDs blink.









Seven-segment : All four LED digits turn OFF the lights.

After Controller Startup

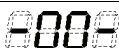
LED : LED (TEACH, AUTO, PROGRAM) turns ON according to the current operation mode (TEACH, Auto, Program).

Seven-segment : Display changes according to the Controller status.

When several Controller statuses occurred at one time, the status indicated earlier on the following table is displayed. For an example, when both Emergency Stop and Safeguard statuses occurred at one time,  is displayed.

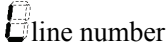
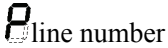
Controller status	Display of seven-segment		
Execute Controller status storage function to the USB memory	Displays  and  repeatedly.		
Complete Controller status storage to USB memory	Displays  (for 2 seconds)		
Failure of Controller status storage to USB memory	Displays  (for 2 seconds)		
Error	Displays four-digit error number (1.6 sec) and  (0.4 sec) repeatedly.		*1
Warning	Displays four-digit warning number (1.6 sec) and  (0.4 sec) repeatedly.		*1
Emergency Stop		Blink	
Safety Door		Blink	
READY		Blink	
START	 line number	Blink	*2
PAUSE	 line number	Blink	*2

*1 For error numbers and warning numbers, refer to *Maintenance 8.1 Error Code Table*.





*2 In initial status, execution line of task number 1 is displayed in three-digit.

Use Ton statement to change the displayed task number.

For details, refer to *EPSON RC+ 5.0 SPEL+ Language Reference*, or *Online Help*.

2.3.2 Particular Status Display

When particular status occurs, seven-segment displays the followings.

Seven-segment	Controller status
	Controller startup failure
	Controller startup failure
	Controller in Recovery mode Refer to <i>Maintenance 4. Backup and Restore.</i>
	AC power supply drop is detected and software shut down.
	Software shut down is specified from the EPSON RC+ 5.0 (software) or the Teach Pendant (option).

2.4 Safety Features

The robot control system supports safety features described below. However, the user is recommended to strictly follow the proper usage of the robot system by thoroughly reading the attached manuals before using the system. Failure to read and understand the proper usage of the safety functions is highly dangerous.

Among the following safety features, the Emergency Stop Switch and Safety Door Input are particularly important. Make sure that these and other features function properly before operating the robot system.

For details, refer to the *Setup & Operation 9. EMERGENCY.*

Emergency Stop Switch

The EMERGENCY connector on the Controller has expansion Emergency Stop input terminals used for connecting the Emergency Stop switches.

Pressing any Emergency Stop switch can shut off the motor power immediately and the robot system will enter the Emergency Stop condition.

Safety Door Input:

In order to activate this feature, make sure that the Safety Door Input switch is connected to the EMERGENCY connector at the Controller.

When the safety door is opened, normally the Manipulator immediately stops the current operation, and the status of Manipulator power is operation-prohibited until the safety door is closed and the latched condition is released. In order to execute the Manipulator operation while the safety door is open, you must change the mode selector key switch on the Teach Pendant to the “Teach” mode. Manipulator operation is available only when the enable switch is on. In this case, the Manipulator is operated in low power status.

Low Power Mode

The motor power is reduced in this mode.

Executing a power status change instruction will change to the restricted (low power) status regardless of conditions of the safety door or operation mode. The restricted (low power) status ensures the safety of the operator and reduces the possibility of peripheral equipment destruction or damage caused by careless operation.

Dynamic Brake

The dynamic brake circuit includes relays that short the motor armatures. The dynamic brake circuit is activated when there is an Emergency Stop input or when any of the following errors is detected: encoder cable disconnection, motor overload, irregular motor torque, motor speed error, servo error (positioning or speed overflow), irregular CPU, memory check-sum error and overheat condition inside the Motor Driver Module.

Encoder Cable Disconnection Error Detection

The dynamic brake circuit is activated when the Motor Encoder Signal cable is disconnected.

Motor Overload Detection

The dynamic brake circuit is activated when the system detects that the load on the motor has exceeded its capacity.

Irregular Motor Torque (out-of-control manipulator) Detection

The dynamic brake circuit is activated when irregularity with motor torque (motor output) is detected (in which case the Manipulator is out of control).

Motor Speed Error Detection

The dynamic brake circuit is activated when the system detects that the motor is running at incorrect speed.

Positioning Overflow –Servo Error- Detection

The dynamic brake circuit is activated when the system detects that the difference between the Manipulator's actual position and commanded position exceeds the margin of error allowed.

Speed Overflow –Servo Error- Detection

The dynamic brake circuit is activated when the Manipulator's actual speed is detected to mark an overflow (the actual speed is outside the nominal range) error.

CPU Irregularity Detection

Irregularity of CPU that controls the motor is detected by the watchdog timer. The system CPU and the motor controlling CPU inside the Controller are also designed to constantly check each other for any discrepancies. If a discrepancy is detected, the dynamic brake circuit is activated.

Memory Check-sum Error Detection

The dynamic brake circuit is activated when a memory check-sum error is detected.

Overheat Detection at the Motor Driver Module

The dynamic brake circuit is activated when the temperature of the power device inside the Motor Driver module is above the nominal limit.

Relay Deposition Detection

The dynamic brake circuit is activated when relay deposition or junction error is detected.

Over-Voltage Detection

The dynamic brake circuit is activated when the voltage of the Controller is above the normal limit.

AC Power Supply Voltage Drop Detection

The dynamic brake circuit is activated when the drop of the power supply voltage is detected.

Temperature Anomaly Detection

The temperature anomaly is detected.

Fan Malfunction Detection

Malfunction of the fan rotation speed is detected.

3. Installation

3.1 Unpacking

TP/OP bypass plug	1 unit
Controller mounting metal hasp	1 set
EMERGENCY port connector	1 set

3.2 Environmental Requirements



- The Manipulator and the Controller must be used within the environmental conditions described in their manuals. This product has been designed and manufactured strictly for use in a normal indoor environment. Using the product in the environment that exceeds the conditions may not only shorten the life cycle of the product but also cause serious safety problems.

3.2.1 Environment

In order to optimize the robot system's performance for safety, the Controller must be placed in an environment that satisfies the following conditions:

- The Controller is not designed for clean-room specification. If it must be installed in a clean room, be sure to install it in a proper enclosure with adequate ventilation and cooling.
- Install Controller in a location that allows easy connection / disconnection of cables.

Item	Condition
Ambient temperature	5 to 40 deg.C (with minimal variation)
Ambient relative humidity	20% to 80% (with no condensation)
First transient burst noise	2 kV or less (Power supply wire) 1 kV or less (Signal wire)
Electrostatic noise	4 kV or less
Base table	Use a base table that is at least 100 mm off the floor. Placing the Controller directly on the floor could allow dust penetration leading to malfunction.

If the Controller must be used in an environment that does not fulfill the conditions mentioned above, take adequate countermeasures. For example, the Controller may be enclosed in a cabinet with adequate ventilation and cooling.

- Install indoors only.
- Place in a well-ventilated area.
- Keep away from direct sunlight and radiation heat.
- Keep away from dust, oily mist, oil, salinity, metal powder or other contaminants.
- Keep away from water.
- Keep away from shocks or vibrations.
- Keep away from sources of electronic noise
- Prevent the occurrence of strong electric or magnetic field.

3.2.2 Installation

- Mount the Controller mounting screws with 80 to 110 Ncm torque.
- Install the controller on a flat surface such as wall, floor, and controller box in the direction shown from (A) to (D).

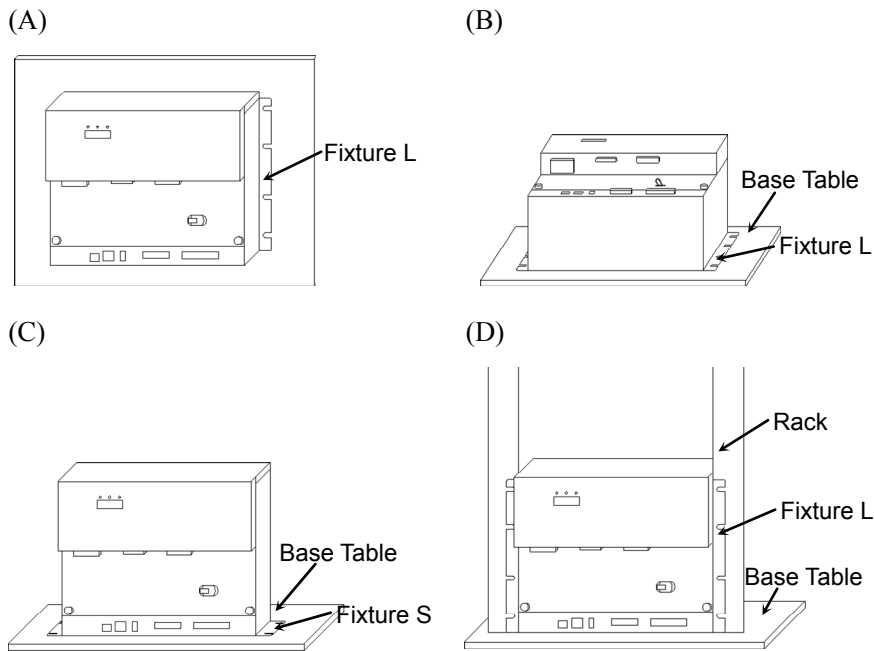

There are two types of fixtures. Mount the fixture to the Controller with the four attached screws.

Fixture L: Used in (A), (B), and (D)

Fixture S: Used in I



The length from the edge of fixture L differs by the side. Refer to the following figure and mount the side with shorter distance from the edge to the screw hole on the Upper side.

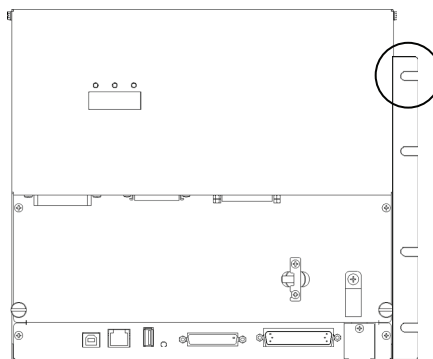

For Controller installation to the Controller box or the base table, process screw hole drilling as follows.

When mounting direction is (A) or (B)

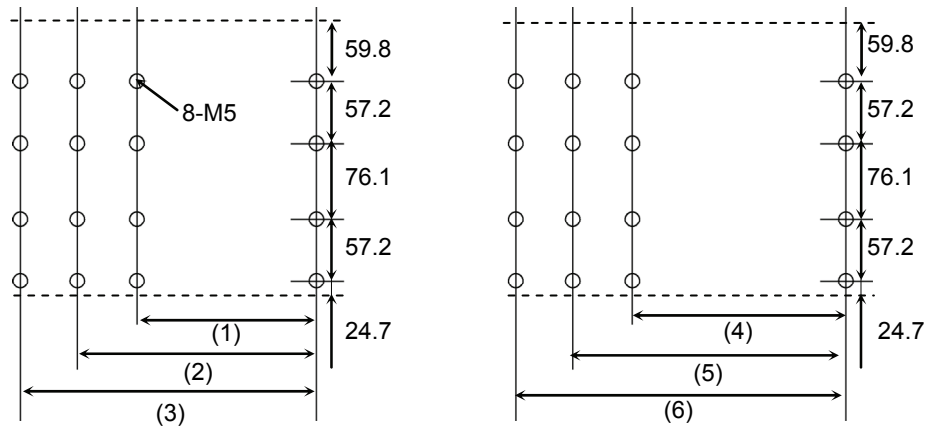

When mounting direction is (C) : Fixture S

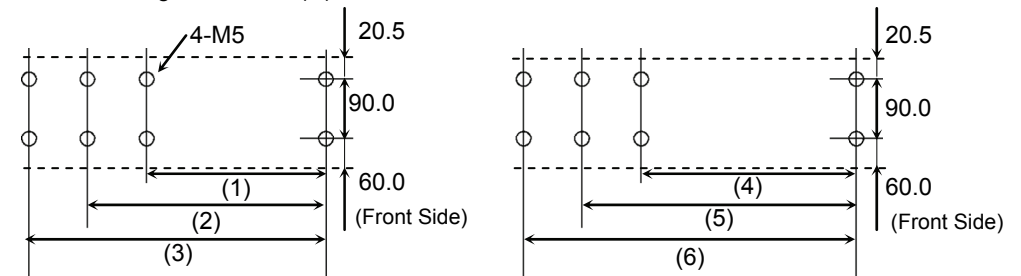

No screw hole processing is required for mounting direction (D).
Secure it to the rack with screws and nuts.

	Controller Only	Controller + ProSix Driver Unit
No Option Unit	(1) 323 mm	(4) 398 mm
Option Unit × 1	(2) 378 mm	(5) 453 mm
Option Unit × 2	(3) 433 mm	(6) 508 mm

- Ensure the draft around the in/out and also install the Controller by keeping the distance as follows to prevent the nose influence from other equipments such as large contactor and relay.

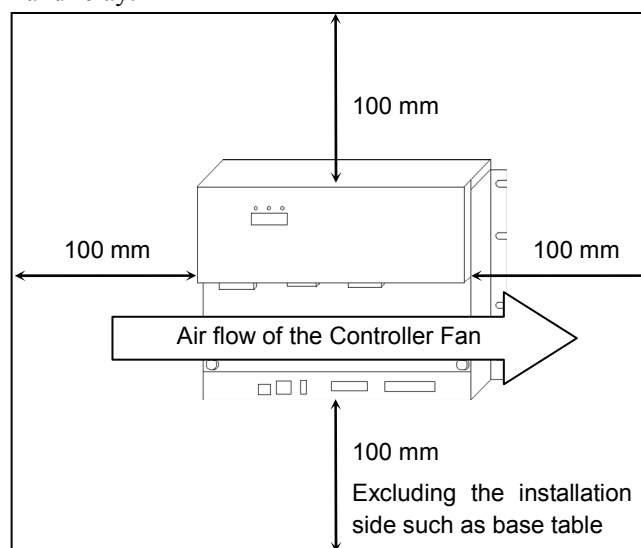

- Hot air with higher temperature than the ambient temperature (about 10 deg.C) comes out from the Controller.
Make sure that heat sensitive devices are not placed near the outlet.

3.2.3 Install inside a Cabinet

When installing the Controller inside a Cabinet, make sure to satisfy the condition indicated in 3.2.1 *Environment*, 3.2.2 *Installation* and also the following conditions.

- The distance from the mounting surface and the inside of the door must be 220 mm or more (190 mm when using the option I/O connector).

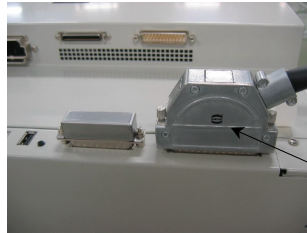
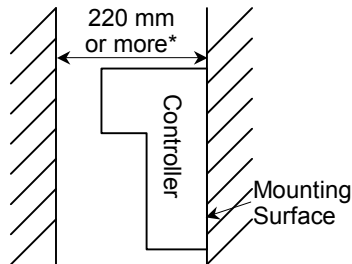

I/O Connector (Option)
Product No: R12B040710

* When using the I/O connector (option), 190 mm or more

- Set the temperature inside the Controller box to 40 deg.C or less by referring the cooling method in the following example.

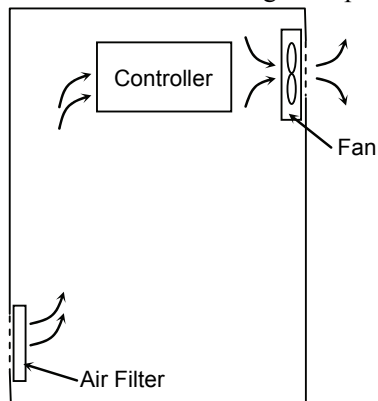

3.3 Power Supply

3.3.1 Specifications

Ensure that the available power meets following specifications.

Item	Specification
Voltage	AC 200 V to AC 240 V
Phase	Single phase
Frequency	50/60 Hz
Momentary Power Interrupt	10 msec. Or less
Power Consumption	Max. 2.5 kVA Actual consumption depends on the model, motion, and load of the Manipulator. Rated consumption $= (150 \text{ W} + \text{total Manipulator rated consumption}) / 0.6$ The rated consumption for G10 and G20 is 2.5 kVA. Refer to Manipulator manual for Manipulator rated consumption.
Peak Current	When power is turned ON : approximately 150 A (2 msec.) When motor is ON :approximately 60 A (5 msec.)
Leakage Current	Max. 3.5 mA
Ground Resistance	100 Ω or less

Install an earth leakage circuit breaker or a circuit breaker in the AC power cable line at 15 A or less rated electric current. Both should be a two-pole disconnect type. If you install an earth leakage circuit breaker, make sure to use an inverter type that does not operate by induction of a 10 kHz or more leakage current. If you install a circuit breaker, please select one that will handle the above mentioned “peak current”.

The power receptacle shall be installed near the equipment and shall be easily accessible.

3.3.2 AC Power Cable

 WARNING	<ul style="list-style-type: none"> Make sure that cable manufacturing and connection are done by a qualified personal. When proceeding, be sure to connect the earth wire of the AC power cable colored green/yellow on the Controller to the earth terminal of the factory power supply. The equipment must be grounded properly at all times to avoid the risk of electric shock. Always use a power plug and receptacle for power connecting cable. Never connect the Controller directly to the factory power supply. (Field wiring)
--	---

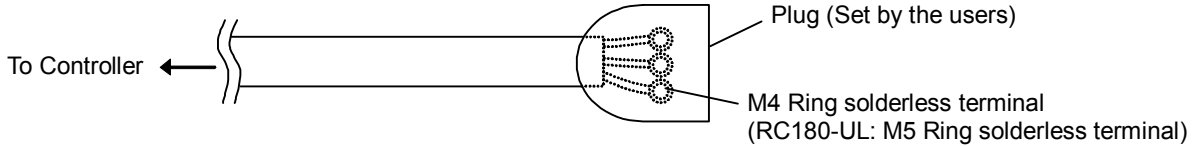

The AC plug in not attached to the AC power cable delivered at shipment. Refer to the wire connection specification and attach a proper plug to the cable that is suitable for the factory power supply. (A plug is prepared as option.)

Cable Wire Connection Specification

Purpose	Color
AC power wire (2 cables)	Black
Ground wire	Green / Yellow

Cable length: 3 mm (Standard)

For RC180-UL

 WARNING	<ul style="list-style-type: none"> Branch Circuit protection (Rated current: 15 A or less) shall be installed in the external AC power supplying side in accordance with the National Electrical Code. A disconnecting means shall be installed in accordance with the National Electrical Code and provide the ability for lockout and tagout.
--	--

3.4 Cable Connection

 WARNING	<ul style="list-style-type: none"> Make sure that the power to the Controller is turned OFF and the power plug is disconnected before connecting or disconnecting any cables. Connecting or disconnecting any cables with the power ON is extremely hazardous and may result in electric shock and malfunction of the Controller. Be sure to connect the cables properly. Do not allow unnecessary strain on the cables. (Do not put heavy objects on the cables. Do not bend or pull the cables forcibly.) The unnecessary strain on the cables may result in damage to the cables, disconnection, and/or contact failure. Damaged cables, disconnection, or contact failure is extremely hazardous and may result in electric shock and/or improper function of the system.
--	---

 CAUTION	<ul style="list-style-type: none"> The serial number of the Manipulator that should be connected is indicated on the Connection Check Label on the Controller. Connect the Controller and the Manipulator correctly. Improper connection between the Controller and the Manipulator may cause not only improper function of the robot system but also safety problems. Before connecting the connector, make sure that the pins are not bent. Connecting with the pins bent may damage the connector and result in malfunction of the robot system.
--	---

3.4.1 Typical Cable Connection

- Disconnectable connector
- Cable attached at delivery
- - - - Cable prepared by users

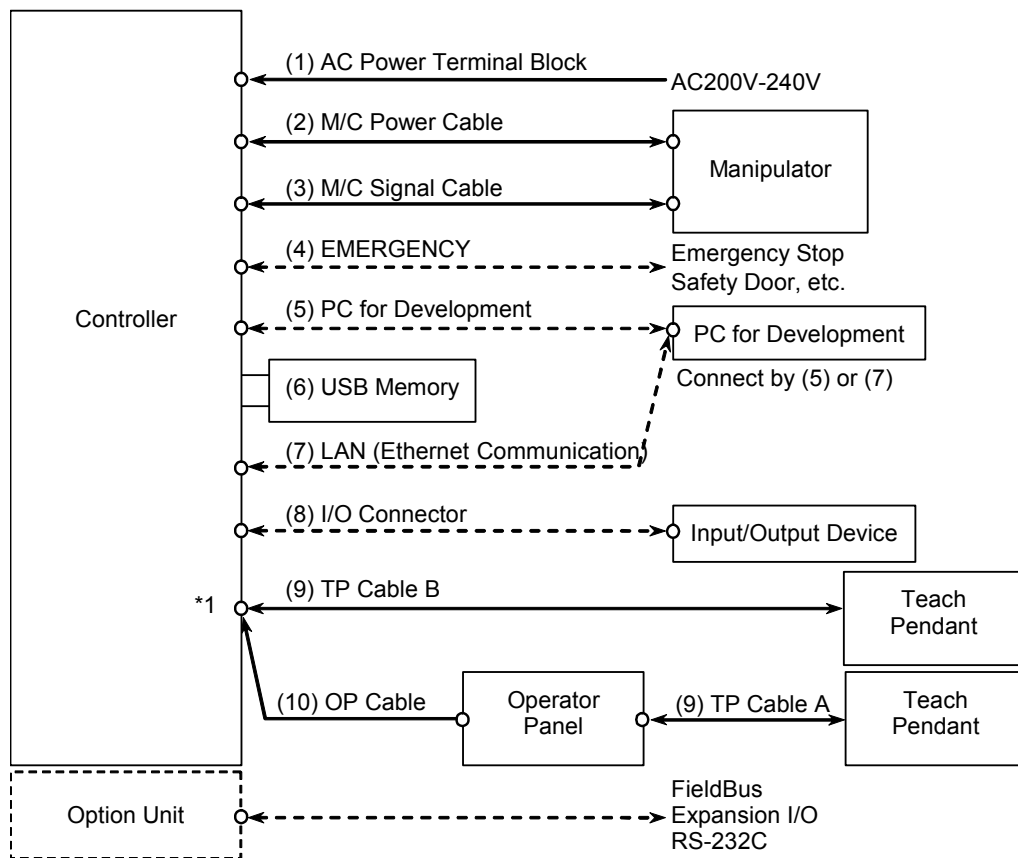

*1 For this connection, only one of the connectors (9) TP cable B or (10) OP cable is connectable to the TP/OP port.

For details of connection of Operator Panel or Teach Pendant to the TP/OP port, refer to *Setup & Operation 8.1 What is TP/OP Port?*

(1) AC Power terminal block

Terminal block for AC 200V power input to the Controller.

(2) M/C Power cable

The cable with 50-pin connector on the Controller side.

Connect the POWER connector on the Manipulator and the M/C POWER connector on the Controller. Insert the connectors until you hear a “click”.

(3) M/C Signal cable

The cable with 50-pin connector on the Controller side.

Connect the signal cable to the SIGNAL connector on the Manipulator and the M/C SIGNAL connector on the Controller.

(4) EMERGENCY

The EMERGENCY connector has inputs to connect the Emergency Stop switch and the Safety Door switch. For safety reasons, connect proper switches for these input devices.

For details, refer to the *Setup & Operation 9. EMERGENCY*.

(5) PC for development

Connect the PC for development.

For details, refer to the *Setup & Operation 5. Development PC Port*.

(6) USB memory

Connect the USB memory.

For details, refer to the *Setup & Operation 6. Memory Port*.

(7) LAN (EtherNet Communication)

Connect the EtherNet cable.

For details, refer to the *Setup & Operation 7. LAN (Ethernet Communication) Port*.

(8) I/O connector

This connector is used for input/output devices of the user.

When there are input/output devices, use this connector.

There are I/O cable (option) and terminal block (option) for the I/O connector.

For details, refer to the *Setup & Operation 10. I/O Connector*.

(9) TP cable

Connect the option Teach Pendant.

There are two types of connector shapes for the Teach Pendant.

TP cable A : Circular connector

TP cable B : D-sub 25pin

For details, refer to the *Setup & Operation 8.TP/OP Port*.

(10) OP cable

Connect the option Operator Panel.

For details, refer to the *Setup & Operation 8.TP/OP Port*.

3.4.2 Connecting Manipulator to Controller

Connect the Manipulator to the Controller by using the Power cable and the Signal cable.

 WARNING	<ul style="list-style-type: none"> Make sure that the power to the Controller is turned OFF before connecting or disconnecting any cables. Connecting or disconnecting any cables with the power ON is extremely hazardous and may result in electric shock and malfunction of the Controller. Be sure to connect the cables properly. Do not allow unnecessary strain on the cables. (Do not put heavy objects on the cables. Do not bend or pull the cables forcibly.) The unnecessary strain on the cables may result in damage to the cables, disconnection, and/or contact failure. Damaged cables, disconnection, or contact failure is extremely hazardous and may result in electric shock and/or improper function of the system.
--	--

 CAUTION	<ul style="list-style-type: none"> The serial number of the Manipulator that should be connected is indicated on the Connection Check Label on the Controller. Connect the Controller and the Manipulator correctly. Improper connection between the Controller and the Manipulator may cause not only improper function of the robot system but also safety problems. When connecting the Manipulator to the Controller, make sure that the serial numbers on each equipment match. Improper connection between the Manipulator and Controller may not only cause improper function of the robot system but also serious safety problems. The connection method varies with the Controller used. For details on the connection, refer to the Controller manual. If the SCARA Manipulator is connected to the Controller for the 6-axis Manipulator, it may result in malfunction of the Manipulator.
--	---

The configuration data for the Manipulator and Manipulator model are stored in the Controller. Therefore the Controller should be connected to the Manipulator whose serial number is specified in the Connection Check label attached on the front of the Controller.

NOTE  The Manipulator's serial number is indicated on the signature label on the back of the Manipulator.

G series

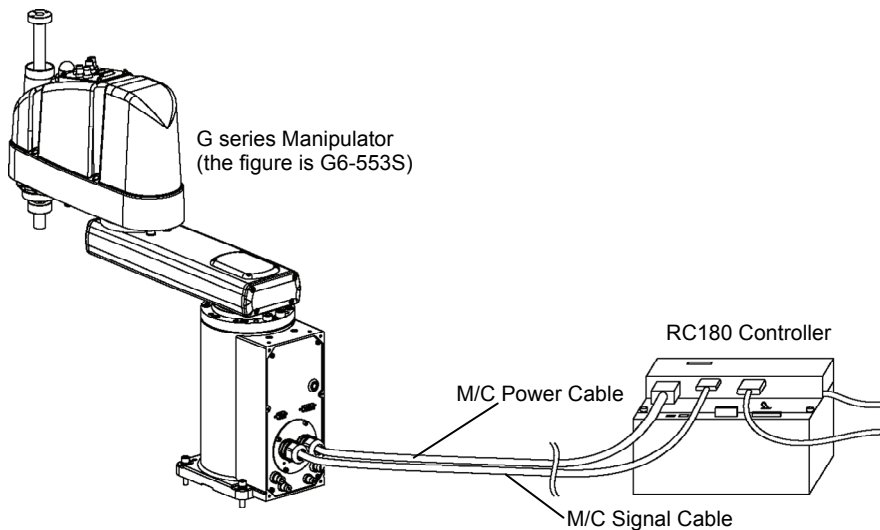

RS series

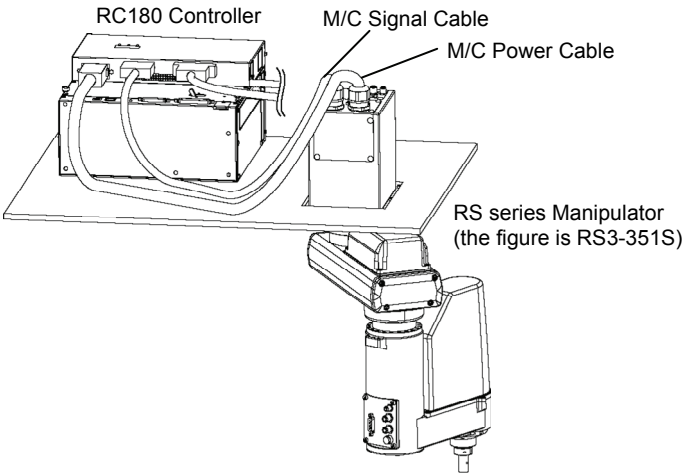

C3 series and

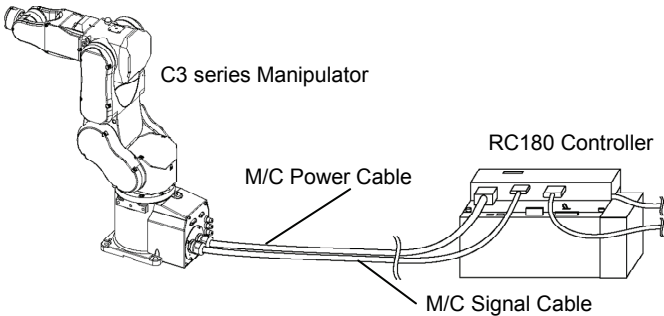

S5 series

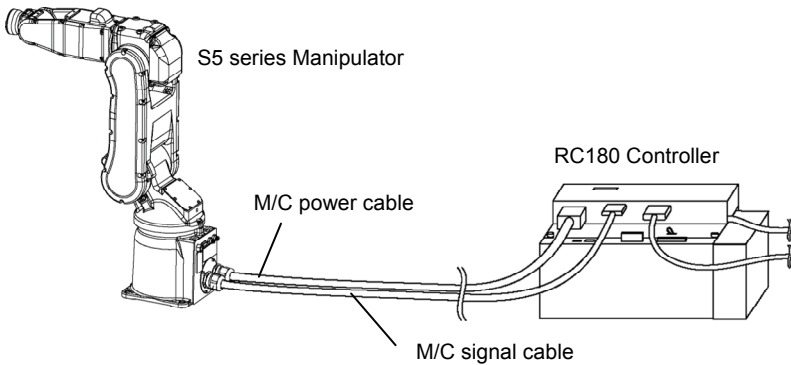

3.5 Noise Countermeasures

To minimize electrical noise conditions, the following items must be observed in the system's cable wiring:

To minimize electrical noise condition, be sure of followings for wiring.

- The earth wire of the power supply should be grounded. (Ground resistance: 100 Ω or less) It is important to ground the frame of Controller not only for prevention from electric shock, but also for reducing the influence of electric noise around the Controller. Therefore, be sure to connect the earth wire (yellow/green) of the Controller's power cable to the ground terminal of the factory power supply. For details about the plug and AC power cable, refer to the *Setup & Operation 3.3 Power Supply*.
- Do not tap power from a power line that connects to any equipment which may cause noise.
- When you tap power for the Controller and the single-phase AC motor from the same power line, change the phase of one or the other. Ensure that they will not be the same phase.
- Use a twisted pair motor power line.
- Do not run AC power lines and DC power lines in the same wiring duct, and separate them by at least 200 mm. For example, separate the AC motor power line and the Controller power line by at least 200 mm from the sensor or valve I/O lines; and do not bundle both sets of wiring with the same cable tie. If more than one duct/cable must cross each other, they should cross perpendicularly. The preferable example is shown in the right figure.
- Wire as short as possible to the I/O connector and EMERGENCY connector. Use a shielded cable and clamp the shield to the attached connector interior. Make sure to keep away from the peripheral noise source as far as possible.
- Make sure that the induction elements used to connect to the Controller's I/O (such as relays and solenoid valves) have surge suppressors. If an induction element without a surge suppressor is used, make sure to connect a rectifying diode located at the induction element in parallel with it. In selecting a rectifying diode, make sure that it can handle the voltage and current incurred by the induction load.
- To start and change revolutions of the conveyer's (or the like's) AC motor (ex: an induction motor or three-phase induction motor) regularly or abruptly, make sure to install a spark suppressor between the wires. The spark suppressor is more effective when placed closer to the motor.
- As they are easily influenced by static electricity or the noise from power source, keep cable such as USB, Ethernet, RS-232C, or fieldbus away from peripheral noise sources.

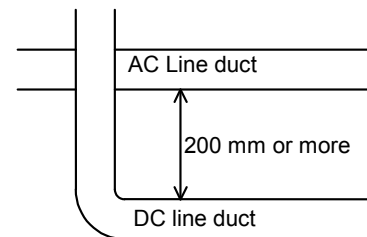

4. Operation Mode (TEACH/AUTO)

4.1 Overview

The Robot system has two operation modes TEACH mode and AUTO mode.

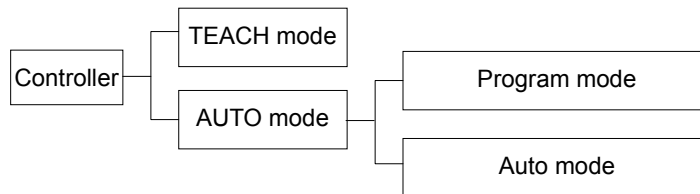

TEACH mode This mode enables point data teaching and checking close to the Robot using the Teach Pendant.
In this mode the Robot operates in Low power status.

AUTO mode This mode enables automatic operation (program execution) of the Robot system for the manufacturing operation, and also programming, debug, adjustment, and maintenance of the Robot system.
This mode cannot operate the Robots or run programs with the Safety Door open.

4.2 Switch Operation Mode

Change the operation mode using the mode selector key switch on the Teach Pendant.

TEACH mode Turn the mode selector key switch to “Teach” for TEACH mode.
Switching to TEACH mode pauses the program if it was running.
The operating Robot stops by Quick Pause.

AUTO mode Turn the mode selector key switch to “Auto” and turn on the latch release input signal for AUTO mode.

4.3 Program Mode (AUTO)

4.3.1 What is Program Mode (AUTO)?

Program mode is for programming, debug, adjustment, and maintenance of the Robot system.

Procedures for switching to the Program mode are the followings.

A : Set the start mode of the EPSON RC+ 5.0 to “Program” and start the Controller connection. (Refer to 4.3.2 *Setup from EPSON RC+ 5.0.*)

B : Select the “Program mode” from the Teach Pendant main menu.

(Refer to 4.3.3 *Setup from Teach Pendant.*)

NOTE



When EPSON RC+ 5.0 is used for switching to Program mode, the Teach Pendant cannot switch modes. Also, when the Teach Pendant is used for switching to Program mode, EPSON RC+ 5.0 cannot switch modes.

4.3.2 Setup from EPSON RC+ 5.0

Switch the mode to Program mode from the EPSON RC+ 5.0.

- (1) Select EPSON RC+ 5.0 menu-[Setup]-[Configuration] to display the [Preference] dialog.

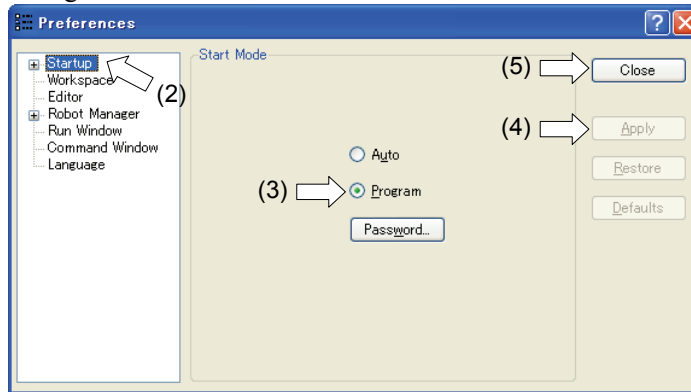

- (2) Select [Startup].
- (3) Select [Start mode]-<Program> button.
- (4) Click the <Apply> button.
- (5) Click the <Close> button.

4.3.3 Setup from Teach Pendant

Switch the mode to Program mode from the Teach Pendant.

(Only TP1. TP2 does not support this function.)

- (1) Press the <F4> key on the Print window to display the Main menu window.
- (2) Select the “Program mode ...” by the <↑↓> key.
- (3) Press the <OK> key.

4.4 Auto Mode (AUTO)

4.4.1 What is Auto mode (AUTO)?

Auto mode (AUTO) is for automatic operation of the Robot system.

Procedures for switching to the Auto mode (AUTO) are the followings.

A :Set the start mode of the EPSON RC+ 5.0 to “Auto” and start the EPSON RC+ 5.0.

(Refer to 4.4.2 Setup from EPSON RC+ 5.0.)

B : Offline the EPSON RC+ 5.0.

NOTE



Execute and stop the program from the control device specified by the EPSON RC+ 5.0.
(Refer to 4.4.3 Setup Control Device.)

4.4.2 Setup from EPSON RC+ 5.0

Switch the mode to Auto mode (AUTO) from the EPSON RC+ 5.0.

(1) Select EPSON RC+ 5.0 menu-[Setup]-[Preference] to display the [Preference] dialog.

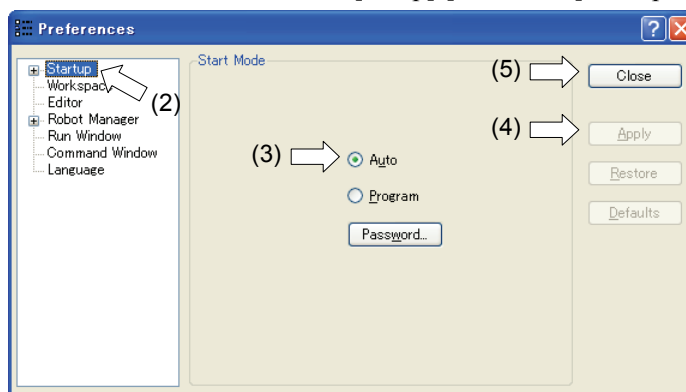

- (2) Select [Startup].
- (3) Select [Start Mode]-<Auto> button.
- (4) Click the <Apply> button.
- (5) Click the <Close> button.

4.4.3 Setup from Control Device

Set the control device from EPSON RC+ 5.0.

- (1) Select EPSON RC+ 5.0 menu-[Setup]-[Controller] to display the [Setup Controller] dialog.

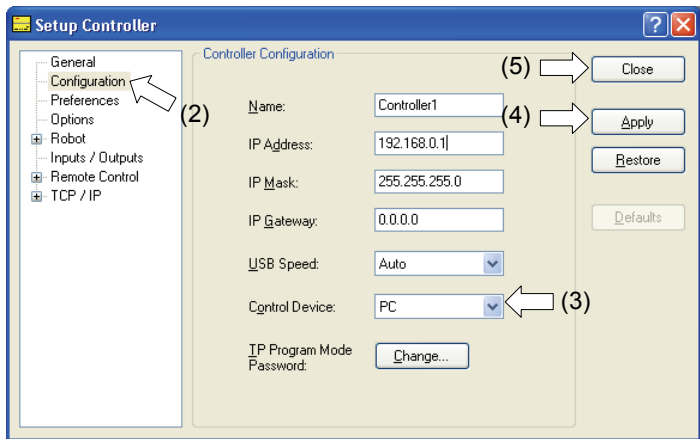

- (2) Select [Configuration].
- (3) Select [Setup Controller]-[Control Device] to select the control device from the following three types.
 - PC
 - Remote (I/O)
 - OP (Option: Operator Panel)
- (4) Click the <Apply> button.
- (5) Click the <Close> button.

5. Development PC Connection Port

Development PC connection USB port (USB B series connector)

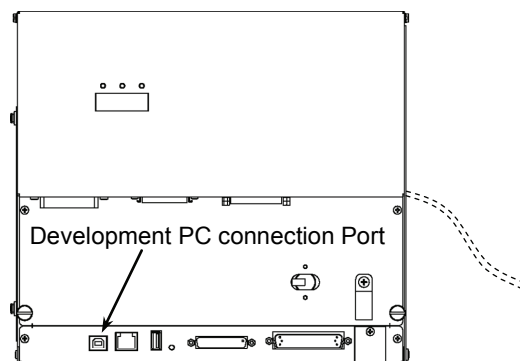

NOTE



For other details of development PC and Controller connection, refer to *EPSON RC+ 5.0 User's Guide 5.12.1 PC to Controller Communications Command*.

NOTE



For RC180, be sure to install the EPSON RC+ 5.0 to the development PC first, then connect the development PC and RC180 with the USB cable.

If RC180 and the development PC are connected without installing the EPSON RC+ 5.0 to the development PC, [Add New Hardware Wizard] appears. If this wizard appears, click the <Cancel> button.

5.1 About Development PC Connection Port

The development PC connection port supports the following USB types.

- USB2.0 HighSpeed/FullSpeed (Speed auto selection, or FullSpeed mode)
- USB1.1 FullSpeed

Interface Standard : USB specification Ver.2.0 compliant
(USB Ver.1.1 upward compatible)

Connect the Controller and development PC by a USB cable to develop the robot system or set the Controller configuration with the EPSON RC+ 5.0 software installed in the development PC.

Development PC connection port supports hot plug feature. Cables insert and remove from the development PC and the Controller is available when the power is ON.

However, stop occurs when USB cable is removed from the Controller or the development PC during connection.

5.2 Precaution

When connecting the development PC and the Controller, make sure of the following:

- Connect the development PC and the Controller with a 5 m or less USB cable.
Do not use the USB hub or extension cable.
- Make sure that no other devices except the development PC are used for development PC connection port.
- Use a PC and USB cable that supports USB2.0 HighSpeed mode to operate in USB2.0 HighSpeed mode.
- Do not pull or bend the cable strongly.
- Do not allow unnecessary strain on the cable.
- When the development PC and the Controller are connected, do not insert or remove other USB devices from the development PC. Connection with the Controller may be lost.

5.3 Software Setup and Connection Check

Connection of the development PC and the Controller is indicated.

- (1) Make sure that software EPSON RC+ 5.0 (Ver.5.2 or later) is installed to the Controller connected to the development PC. (Install the software when it is not installed.)
- (2) Connect the development PC and the Controller using a USB cable.
- (3) Turn ON the Controller.
- (4) Start EPSON RC+ 5.0.
- (5) Select the EPSON RC+ 5.0 menu-[Setup]-[PC to Controller Communications] to display the [PC to Controller Communications] dialog.

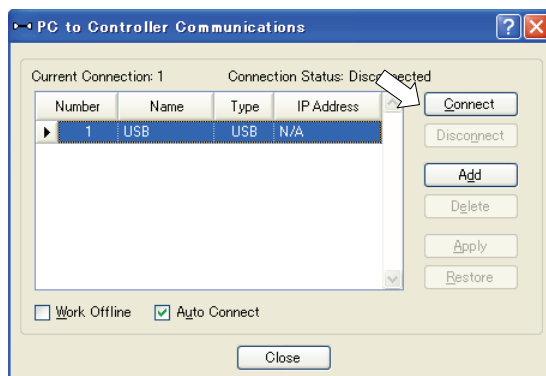

- (6) Select "No.1 USB" and click the <Connect> button.

- (7) After the development PC and the Controller connection has completed, “Connected” is displayed at [Connection status]. Make sure that “Connected” is displayed and click the <Close> button to close the [PC to Controller Communications] dialog.

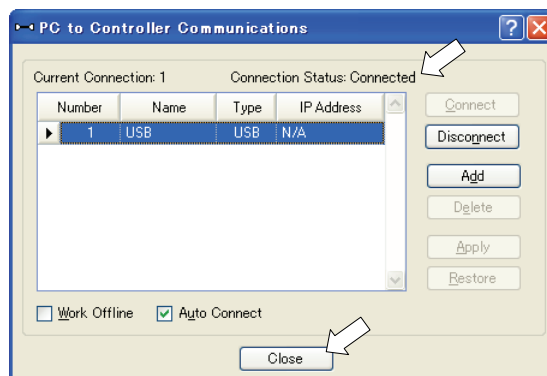

The connection between the development PC and the Controller is completed. Now the robot system can be used from EPSON RC+ 5.0.

5.4 Disconnection of Development PC and Controller

Disconnection of the development PC and the Controller communication.

- (1) Select the EPSON RC+ 5.0 menu-[Setup]-[PC to Controller Communications] to display the [PC to Controller Communications] dialog.
- (2) Click the <Disconnect> button.
Communication between the Controller and the development PC is disconnected and the USB cable can be removed.



If the USB cable is removed when the Controller and the development PC are connected, the Robot will stop. Be sure to click the <Disconnect> button in the [PC to Controller Communications] dialog before USB cable is removed.

6. Memory Port

Connect a commercial USB memory to the Controller memory port for following functions. (Only TP1. TP2 does not support this function.)

- Function for Controller status storage to the USB memory.
 - Transfer Programs and various data.
- Option TP1 Teach Pendant is required. For programs and various data transfer using TP1, refer to manual *RC180 Option Teach Pendant TP1*.

6.1 What is Controller Status Storage Function?

This function saves various kinds of Controller data with one push to the USB memory. Data saved in USB memory is loaded to EPSON RC+ 5.0 to get the status of the Controller and the program simply and accurately.

The saved data can also be used for restoring the Controller. For details, refer to *Maintenance 4.4 Restore*.

6.2 Before Using Controller Status Storage Function

6.2.1 Precautions



- Controller status storage function is available at any time and in any Controller status after starting the Controller. However, operations from the console including stop and pause are not available while executing this function. Also, this function influences the robot cycle time and the communication with EPSON RC+ 5.0. Other than only when it is necessary, do not execute this function when operating the robot.

- Make sure that the USB port is used only for USB memory even though the port on the Controller is a universal USB port.
- Insert the USB memory directly into the Controller memory port. Connection with cables or hubs between the Controller and the USB memory is not assured.
- Make sure that the USB memory is inserted or removed slowly.
- Do not edit the saved files with an editor. Operation of the robot system after data restoration to the Controller is not assured.

6.2.2 Adoptable USB Memory

Use USB memory that meets following conditions.

- USB2.0 supported
 - Without security function
- USB memory with password input function cannot be used.
- No installation of a driver or software is necessary for Windows XP or Windows Vista.

6.3 Controller Status Storage Function

6.3.1 Controller Status Storage with Trigger Button



CAUTION

- Controller status storage function is available at any time and in any Controller status after starting the Controller.
However, operations from the console including stop and pause are not available while executing this function.
Also, this function influences the robot cycle time and the communication with EPSON RC+ 5.0. Other than only when it is necessary, do not execute this function when operating the robot.

Use this procedure to save the status of the Controller to USB memory.

- (1) Insert the USB memory into the memory port.
- (2) Wait approximately 10 seconds for USB memory recognition.
- (3) Press the trigger button on the Controller.

The seven-segment displays and repeatedly during the data transfer. Wait until the display returns back to the former display. (Transfer time differs depending on the amount of data, such as the project size.)

- (4) When the storage has been completed, is displayed on the seven-segment for two seconds.

When the storage has failed, is displayed on the seven-segment for two seconds.

- (5) Remove the USB memory from the Controller.

NOTE



USB memory with LED is recommended to check the status changes in procedure (2).

NOTE



When storage is executed during Motor ON status, it may fail to store the status. Use another USB memory or execute the storage during Motor OFF status.

6.3.2 Controller Status Storage with Teach Pendant (Option)

Use this procedure to save the status of the Controller to the USB memory.

- (1) Insert the USB memory into the Controller.
- (2) In the [Main Menu] screen, move the cursor to [Controller States...], and press the <OK> key. The following screen appears.

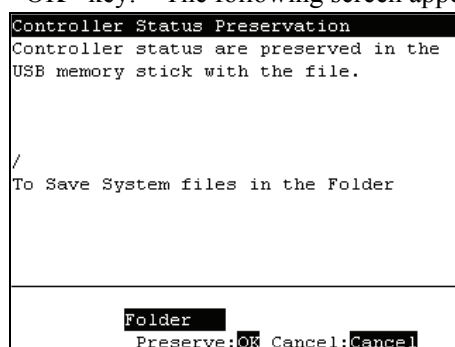

- (3) Select a folder to save the data.
The root directory is selected by default.
- (4) Press the <OK> key to save the status.

6.3.3 Load Data with EPSON RC+ 5.0

The following shows the procedure to read the data stored in the USB memory by EPSON RC+ 5.0 and display the Controller status.

- (1) Insert the USB memory into the PC with EPSON RC+ 5.0.
- (2) Make use that the following folder is indicated in the USB memory.
 S_ serial number_data status was saved
 → Exmapple: S_12345_200608074410
- (3) Copy the folder confirmed in procedure (2) to the “\EpsonRC50\Status” folder.
- (4) Select the EPSON RC+ 5.0 menu-[Tools]-[Controller] to display the [Controller Tools] dialog.

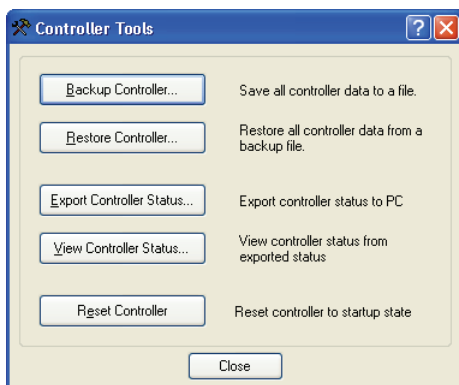

- (5) Click the <Export Controller Status...> button.
- (6) [Browse For Folder] dialog appears. Select the folder copied in procedure (3) and click the <OK> button.

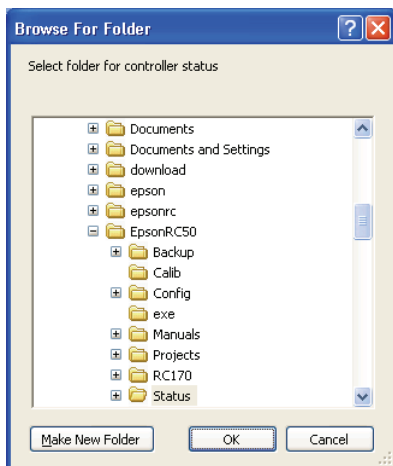

- (7) [Controller Status Viewer] dialog appears to confirm the Controller status.
 For details, refer to *View Controller Status* in *EPSON RC+ 5.0 User's Guide 5.11.7 Controller Command (Tools Menu)*.

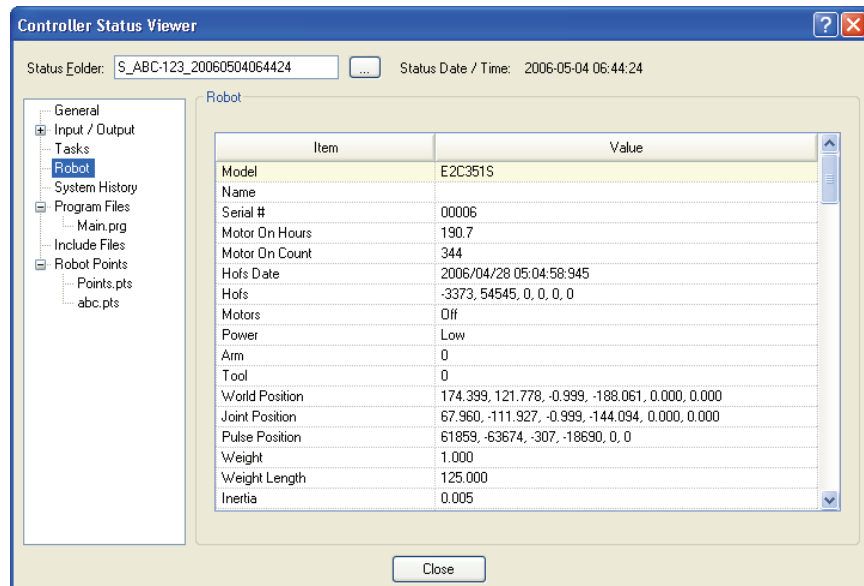

6.3.4 Transfer with E-mail

Follow this procedure to transfer the data by e-mail that was saved to the USB memory.

- (1) Insert the USB memory to a PC that supports sending of e-mail.
- (2) Make sure that the USB memory has following folders.
 S_serial number_data status was saved
 → Example: S_12345_200608074410
- (3) Send all the folders by e-mail.



Delete files that do not relate to the project before transfer.

This function is used to send the data to the system director and EPSON from the end users for problem analysis.

6.4 Details of Data

The following data files are created by the Controller status storage function.

File Name	Outline	
Backup.txt	Information file for restore	File with information for Controller restore.
CurrentMnp01.PRM	Robot parameter	Saves information such as ToolSet.
CurrentStatus.txt	Save status	Saves program and I/O status.
ErrorHistory.csv	Error history	
InitFileSrc.txt	Initial setting	Saves various settings of the Controller.
MCSys01.MCD	Robot setting	Saves information of connected robot.
SrcmcStat.txt	Hardware information	Saves installation information of hardware.
ProjectName.obj	OBJ file	Result of project build. Prg file is not included.
GlobalPreserves.dat *1	Global Preserve variables	Saves values of Global Preserve variables.
MCSRAM.bin MCSYSTEMIO.bin MCTABLE.bin MDATA.bin SERVOSRAM.bin VXDWORK.bin	Inner information of Robot operation	
All files related to project except ProjectName.obj *2	Project	When [Include project files when status exported] check box is checked in EPSON RC+ 5.0 menu-[Setup]-[Setup Controller]-[Preference], the project file is stored. Includes program files.

1 When the Controller firmware version is Ver.1.0..*, GlobalPreserves.dat is not stored.

*2 Storage of "All files related to project except ProjectName.obj" can be specified by a setting.

7. LAN (Ethernet Communication) Port

- NOTE  - Refer to *EPSON RC+ 5.0 User's Guide 5.12.1 PC to Controller Communications Command (Setup Menu)* for other details for the development PC and Controller connection.
- For Ethernet (TCP/IP) communication with robot application software, refer to *EPSON RC+ 5.0 Online Help* or *User's Guide 12. TCP/IP Communications*.
 - Refer to *Vision Guide 5.0* manual for other details of connection of the Controller and CV1.
 - This port is not used for EtherNet/IP. Use the port for fieldbusI/O board. For other details, refer to *Setup & Operation 12.3.7 EtherNet/IP*.

7.1 About the LAN (Ethernet Communication) Port

Ethernet communication port supports 100BASE-TX / 10 BASE-T.

This port is used for three different purposes.

Connection with development PC

LAN (Ethernet communication) port is used for connection of the Controller and the development PC.

Equivalent operation is available to connect between the Controller and the development PC with the development PC connection port.

(Refer to *Setup & Operation 5. Development PC Connection Port*)

Connection with other Controller or PC

The LAN (Ethernet communication) port can be used as an Ethernet (TCP/IP) communication port to communicate between multiple controllers from robot application software.

Connection with CV1

The LAN (Ethernet communication) port is used for connection of the Controller and CV1.

7.2 IP Address

Set the proper IP address or subnet mask depending on the Controller and development PC configuration to use the LAN port.

Do not input a random value for the IP address of the network configured TCP/IP. This is the only address that specifies the computer using an Internet connection.

The IP address is assigned from the company or organization that has control of IP address.

Use an address from the following Internet private environment such as P2P or line. Make sure that the address is not redundantly assigned inside the closed network.

Private Address List

10.0.0.1	to	10.255.255.254
172.16.0.1	to	172.31.255.254
192.168.0.1	to	192.168.255.254

The following is the configuration of the controller at delivery.

IP Address : 192.168.0.1
 IP Mask : 255.255.255.0
 IP Gateway : 0.0.0.0

7.3 Changing Controller IP Address

In this section, the procedure to change the Controller IP address when connecting Controller development PC connection port and the development PC by the USB cable is indicated.

- (1) For connection between the development PC and the Controller, refer to *Setup & Operation 5.3 Connection of Development PC and Controller*.
- (2) Select the EPSON RC+ 5.0 menu-[Setup]-[Controller] to display the [Setup Controller] dialog.

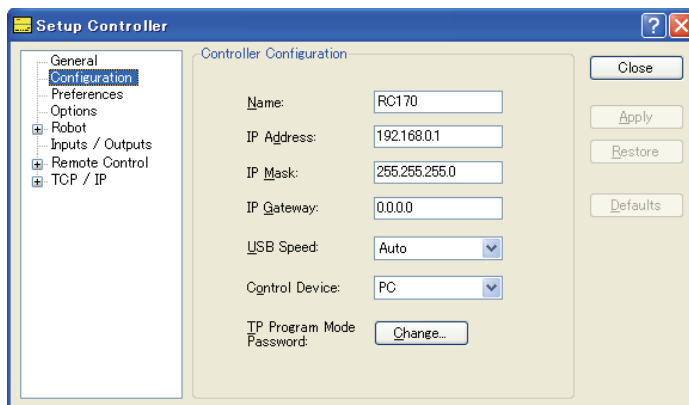

- (3) Enter the proper IP address and subnet mask and click the <Apply> button.

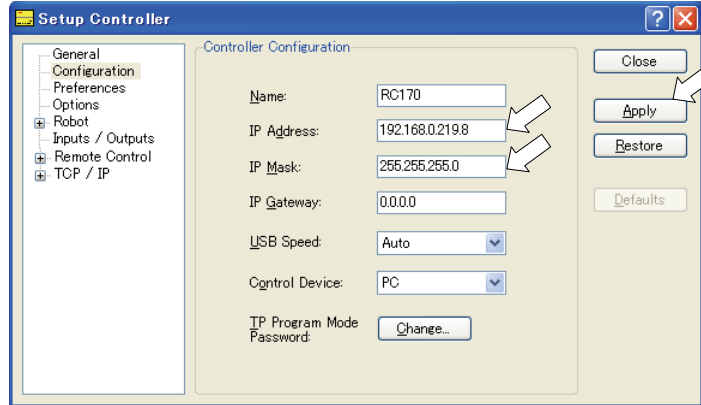

- (4) Click the <Close> button. The Controller reboots automatically.

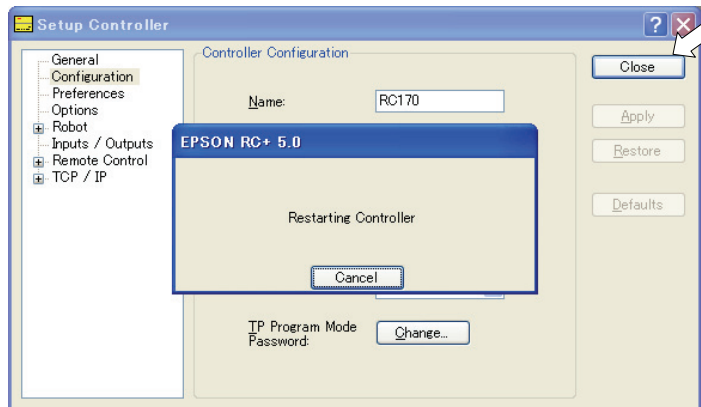

IP address configuration is completed and the Controller reboot dialog disappears.

- (5) Connect the Ethernet cable to the Controller LAN port.



When the Controller and the development PC are connected via the Ethernet, the Controller IP address can also be changed. However, Controller and the development PC do not connect automatically after rebooting the Controller at Ethernet connection.

7.4 Connection of Development PC and Controller with Ethernet

Connection between the development PC and the Controller is shown below.

- (1) Connect the development PC and the Controller. (Set the IP address in the same subnet before hand.)
- (2) Turn on the Controller.
- (3) Start EPSON RC+ 5.0.
- (4) Display the [PC-Controller Connection] dialog from [Setup] in EPSON RC+ 5.0 menu.
- (5) Click the <Add> button.

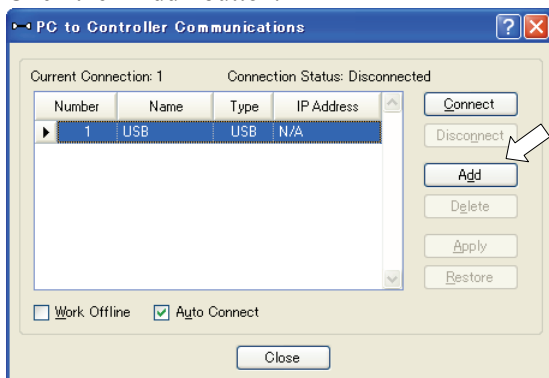

- (6) Connection “No.2” is added. Set the following and click the <Apply> button.
 Name : Valid value to identify the controller to connect
 IP Address : IP address for Controller to connect

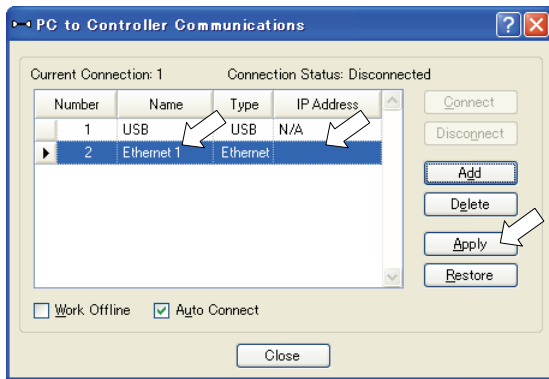

- (7) [Name] and [IP Address] specified in procedure (6) is displayed.

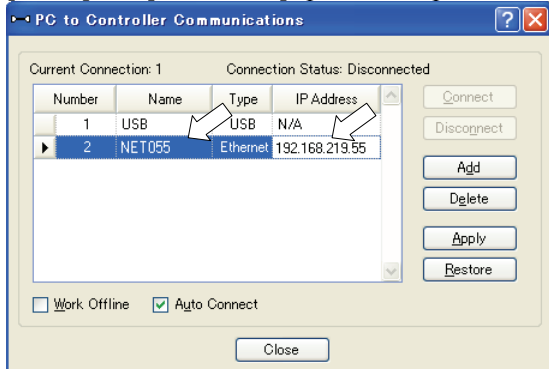

- (8) Make sure that “No.2” is selected, and click the <Connect> button.

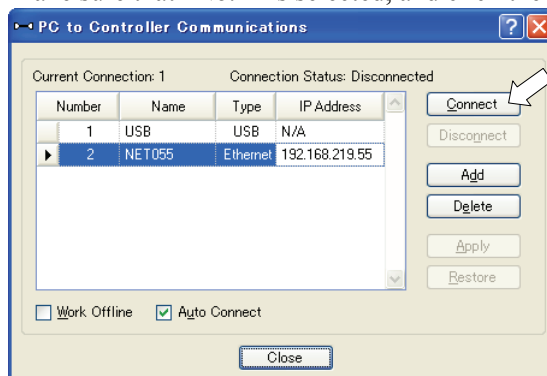

- (9) After the development PC and Controller connection is completed, “Connected” is displayed in the [Connection status:]. Make sure that “Connected” is displayed and click the <Close> button to close the [PC to Controller Communications] dialog.

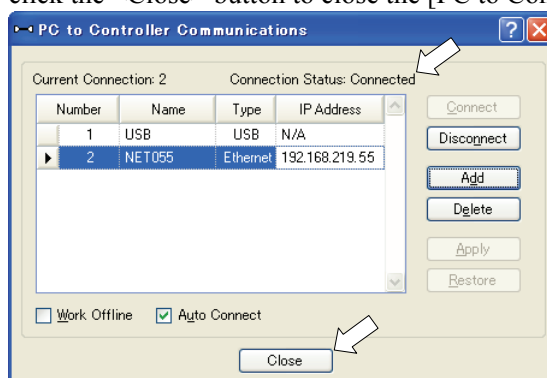

Connection between the development PC and the Controller is complete. Now the robot system can be used via an Ethernet connection from EPSON RC+ 5.0.

7.5 Disconnection of Development PC and Controller with Ethernet

Disconnection of the development PC and the Controller is shown below.

- (1) Display [PC-Controller Connection] dialog from [Setup] in EPSON RC+ 5.0 menu.
- (2) Click the <Disconnect> button.

Communication between the Controller and the development PC is disconnected and the Ethernet cable can be removed.



NOTE If the Ethernet cable is removed when the Controller and the development PC is connected, Emergency Stop occurs and the Robot stops. Be sure to click the <Disconnect> button in the [PC to Controller Communications] dialog before the Ethernet cable is removed.

8. TP/OP Port

8.1 What is the TP/OP Port?

The TP/OP port connects the Teach Pendant and / or the Operator Panel to the Controller.



When nothing is connected to the TP/OP port, Emergency Stop status occurs in the Controller. When the Teach Pendant or the Operator Panel is not connected, connect the TP/OP bypass plug.

Typical cable connection (TP1 is only B.)

A: Only using Teach Pendant (TP Cable A)

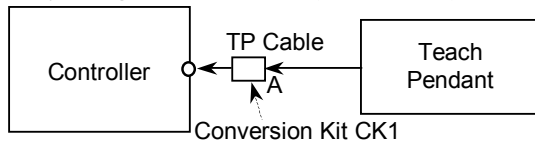

B: Only using Teach Pendant (TP Cable B)

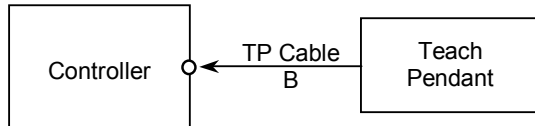

C: Only using Operator Panel

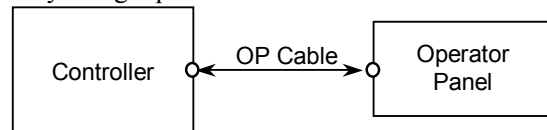

D: Using Teach Pendant and Operator Panel

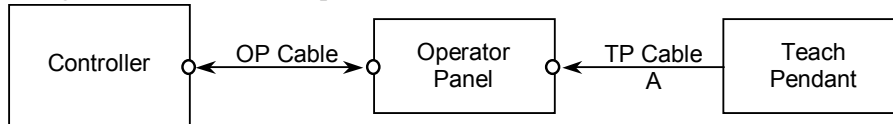

The cable connectors used in connection A, D and connection B are different.

TP Cable A: Circular connector used to connect to the Operator Panel.
(Direct connection is available with conversion kit CK1.)

TP Cable B: D-sub connector to connect directly to the Controller.



When the Teach Pendant with Operator Panel cable is inserted to the TP port of the Operator Panel, both Operator Panel and Teach Pendant are available.
(Connection D)



Do not connect the following devices to the TP/OP port of RC180. Connecting these devices may result in malfunction of the device since the pin assignments are different.

- OPTIONAL DEVICE dummy plug
- Operation Pendant OP500
- Operator Pendant OP500RC
- Jog Pad JP500
- Teaching Pendant TP-3**

8.2 Teach Pendant Connection

A cable for connection to the RC180 Controller is attached to the Teach Pendant. Connect this cable connector to the TP/OP port.

Communication is set automatically. Enable the Teach Pendant by one of the following procedures.

- Insert the Teach Pendant connector to the Controller and turn ON the Controller.
- Insert the Teach Pendant connector while the Controller is turned ON.

NOTE



Teach Pendant connection and disconnection from the Controller are allowed when the Controller power is ON.

NOTE



When the Teach Pendant connector is removed from the Controller with the mode selector key switch of the Teach Pendant in the “Teach” position, the operation mode will remain in the TEACH mode. The operation mode cannot be switched to AUTO mode. Be sure to remove the Teach Pendant after switching the operation mode to “Auto” mode.

For details, refer to manual

RC180 Option Teach Pendant TP1.

RC90/RC180 Option Teach Pendant TP2.

8.3 Operator Panel Connection

A cable for connection to the RC180 Controller is attached to the Operator Panel OP1. Connect this cable connector to the TP/OP port.

Communication is set automatically. Enable the Operator Panel as follows.

- Insert the Operator Panel cable connector to the Controller and turn ON the Controller.

NOTE



Make sure that the Controller is turned OFF when inserting or removing the Operator Panel.

For details, refer to manual *RC180 Option Operator Panel OP1.*

9. EMERGENCY

NOTE  The details of safety requirements for this section are described in *EPSON RC+ 5.0 2. Safety*. Please refer to them to keep the robot system safe.

Connect a safeguard switch or Emergency Stop switch to the Controller EMERGENCY connector for safety.

When nothing is connected to the EMERGENCY connector, the Controller does not operate normally.

 WARNING	<ul style="list-style-type: none">■ Before connecting the connector, make sure that the pins are not bent. Connecting with the pins bent may damage the connector and result in malfunction of the robot system.
--	--

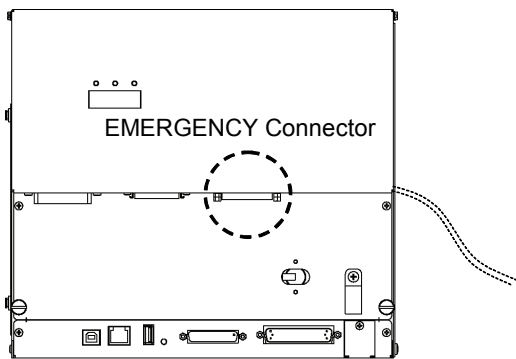

9.1 Safety Door Switch and Latch Release Switch

The EMERGENCY connector has input terminals for the Safety Door switch and the Emergency Stop switch. Be sure to use these input terminals to keep the system safe.

Connector	Standard
EMERGENCY connector (Controller side)	D-sub 25 male pin Mounting style #4 - 40

* The E-STOP BOX, connector cable, terminal block, and connector kit are offered as options.

9.1.1 Safety Door Switch

 WARNING	<ul style="list-style-type: none"> ■ The interlock of the Safety Door must be functioning when the robot system is operated. Do not operate the system under the condition that the switch cannot be turned ON/OFF (e.g. The tape is put around the switch.). Operating the robot system when the switch is not functioning properly is extremely hazardous and may cause serious safety problems as the Safety Door input cannot fulfill its intended function.
---	---

In order to maintain a safe working zone, a safeguard must be erected around the Manipulator. The safeguard must have an interlock switch at the entrance to the working zone. The Safety Door that is described in this manual is one of the safeguards and an interlock of the Safety Door is called a Safety Door switch. Connect the Safety Door switch to the Safety Door input terminal on the EMERGENCY connector.

The Safety Door switch has safety features such as temporary hold-up of the program or the operation-prohibited status that are activated whenever the Safety Door is opened.

Observe the followings in designing the Safety Door switch and the Safety Door.

- For the Safety Door switch, select a switch that opens as the Safety Door opens, and not by the spring of the switch itself.
- The signal from the Safety Door (Safety Door input) is designed to input to two redundant signals. If the signals at the two inputs differ by two seconds or more, the system recognizes it to be a critical error. Therefore, make sure that the Safety Door switch has two separate redundant circuits and that each connects to the specified pins at the EMERGENCY connector on the Controller.
- The Safety Door must be designed and installed so that it does not close accidentally.

9.1.2 Latch Release Switch

The controller software latches these conditions:

- The safety door is open.
- The operation mode is set to “TEACH”.

The EMERGENCY connector has an input terminal for a latch release switch that cancels the latched conditions.

Open : The latch release switch latches conditions that the safety door is open or the operation mode is “TEACH”.

Closed : The latch release switch releases the latched conditions.



When the latched TEACH mode is released while the safety door is open, the status of Manipulator power is operation-prohibited because the safety door is open at that time. To execute a Manipulator operation, close the safety door again, and then close the latch release input.

9.1.3 Checking Latch Release Switch Operation

After connecting the safety door switch and latch release switch to the EMERGENCY connector, be sure to check the switch operation for safety by following the procedures described below before operating the Manipulator.

- (1) Turn ON the Controller while the safety door is open in order to boot the controller software.
- (2) Make sure that “Safety” is displayed on the main window status bar.
- (3) Close the safety door, and turn ON the switch connecting to the latch release input. Make sure that the “Safety” is dimmed on the status bar.

The information that the safety door is open can be latched by software based on the latch release input condition.

Open : The latch release switch latches the condition that the safety door is open. To cancel the condition, close the safety door, and then close the safety door latch release input.

Closed : The latch release switch does not latch the condition that the safety door is open.



The latch release input also functions to acknowledge the change of to TEACH mode. In order to change the latched condition of TEACH mode, turn the mode selector key switch on the Teach Pendant to “Auto”. Then, close the latch release input.

9.2 Emergency Stop Switch Connection

9.2.1 Emergency Stop Switch

If it is desired to add an external Emergency Stop switch(es) in addition to the Emergency Stop on the Teach Pendant and Operator Panel, be sure to connect such Emergency Stop switch(es) to the Emergency Stop input terminal on the EMERGENCY connector.

The Emergency Stop switch connected must comply with the following:

- It must be a push button switch that is “normally closed”.
- A button that does not automatically return or resume.
- The button must be mushroom-shaped and red.
- The button must have a double contact that is “normally closed”.



NOTE



The signal from the Emergency Stop switch is designed to use two redundant circuits. If the signals at the two circuits differ by two seconds or more, the system recognizes it as a critical error. Therefore, make sure that the Emergency Stop switch has double contacts and that each circuit connects to the specified pins on the EMERGENCY connector at the Controller. Refer to the *Setup & Operation 5.5 Circuit Diagrams*.

9.2.2 Checking Emergency Stop Switch Operation

Once the Emergency Stop switch is connected to the EMERGENCY connector, continue the following procedure to make sure that the switch functions properly. For the safety of the operator, the Manipulator must not be powered ON until the following test is completed.

- (1) Turn ON the Controller to boot the controller software while pressing the Emergency Stop switch.
- (2) Make sure that the seven-segment LED on the Controller displays .
- (3) Make sure that “E.Stop” is displayed on the status bar on the main window.
- (4) Release the Emergency Stop Switch.
- (5) Execute the RESET command.
- (6) Make sure that  LED is turned OFF and that “E-Stop” is dimmed on the main window status bar.

9.2.3 Recovery from Emergency Stop

To recover from the emergency stop condition, follow the procedure of safety check as required by the system.

After safety check, the operations below are required to recover from the emergency stop condition.

- Release the Emergency Stop Switch
- Execute the RESET command

9.3 Pin Assignments

The EMERGENCY connector pin assignments are as follows:

Pin No.	Signal	Function	Pin No.	Signal	Function
1	ESW11	Emergency Stop switch contact (1) ^{*3}	14	ESW21	Emergency Stop switch contact (2) ^{*3}
2	ESW12	Emergency Stop switch contact (1) ^{*3}	15	ESW22	Emergency Stop switch contact (2) ^{*3}
3	ESTOP1+	Emergency Stop circuit 1 (+)	16	ESTOP2+	Emergency Stop circuit 2 (+)
4	ESTOP1-	Emergency Stop circuit 1 (-)	17	ESTOP2-	Emergency Stop circuit 2 (-)
5	NC	^{*1}	18	SDLATCH1	Safety Door Latch Release
6	NC	^{*1}	19	SDLATCH2	Safety Door Latch Release
7	SD11	Safety Door input (1) ^{*2}	20	SD21	Safety Door input (2) ^{*2}
8	SD12	Safety Door input (1) ^{*2}	21	SD22	Safety Door input (2) ^{*2}
9	24V	+24V output	22	24V	+24V output
10	24V	+24V output	23	24V	+24V output
11	24VGND	+24V GND output	24	24VGND	+24V GND output
12	24VGND	+24V GND output	25	24VGND	+24V GND output
13	NC				

*1 Do not connect anything to these pins.

*2 A critical error occurs if the input values from the Safety Door 1 and Safety Door 2 are different for two or more seconds. They must be connected to the same switch with two sets of contacts.

*3 A critical error occurs if the input values from the Emergency Stop switch contact 1 and Emergency Stop switch contact 2 are different for two or more seconds. They must be connected the same switch with two sets of contacts.

Emergency Stop switch output rated load	+30 V 0.3 A or under	1-2, 14-15 pin
Emergency Stop rated input voltage range	+24 V $\pm 10\%$	3-4, 16-17 pin
Emergency Stop rated input current	47.5 mA /+24 V input	
Safety Door rated input voltage range	+24 V $\pm 10\%$	7-8, 20-21 pin
Safety Door rated input current	10 mA/+24 V input	
Latch Release rated input voltage range	+24 V $\pm 10\%$	18-19 pin
Latch Release rated input current	10 mA/+24 V input	

NOTE  The total electrical resistance of the Emergency Stop switches and their circuit should be 1 Ω or less.

9.4 Circuit Diagrams

9.4.1 Example 1: External emergency stop switch typical application

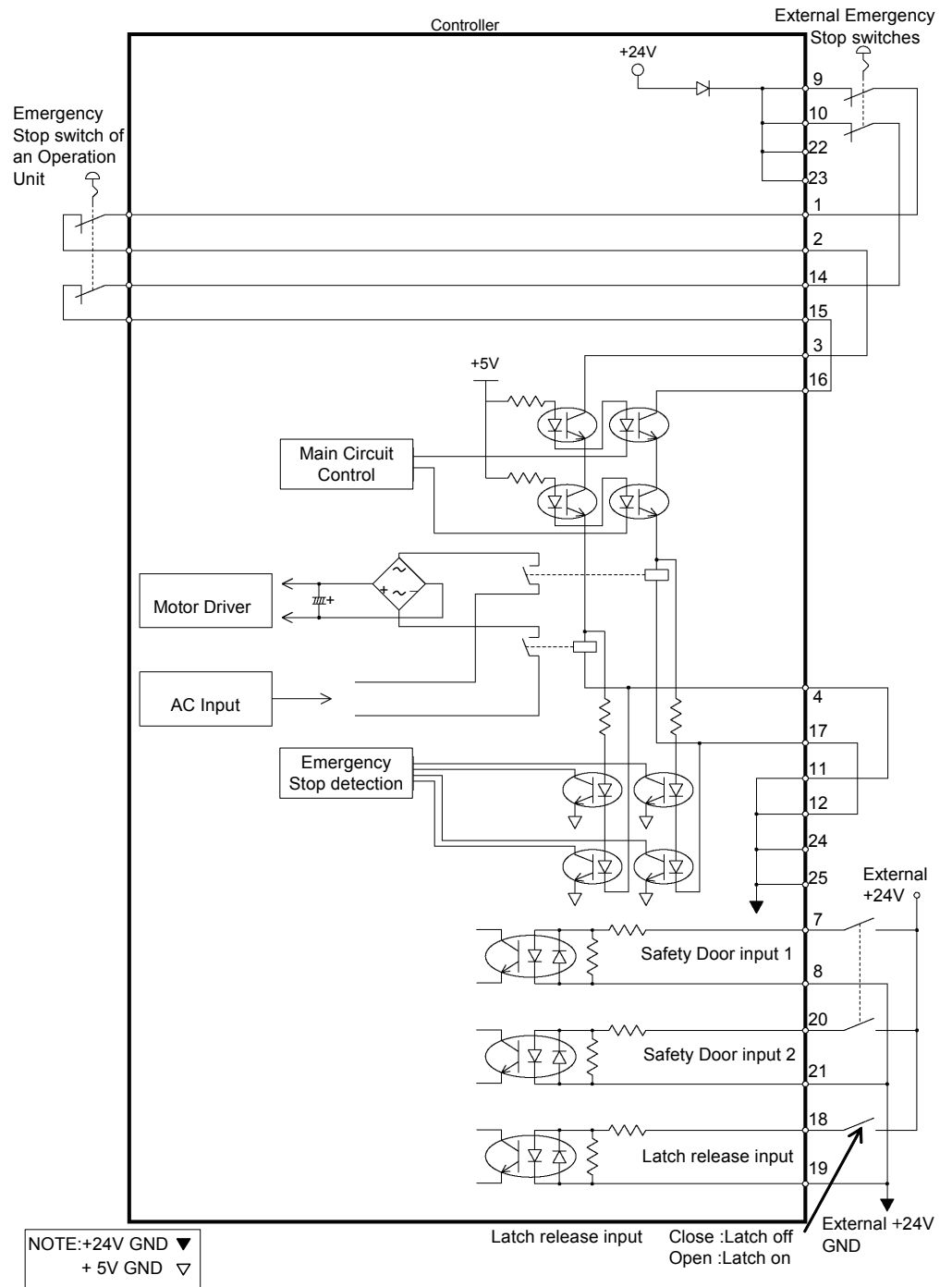

9.4.2 Example 2: External safety relay typical application

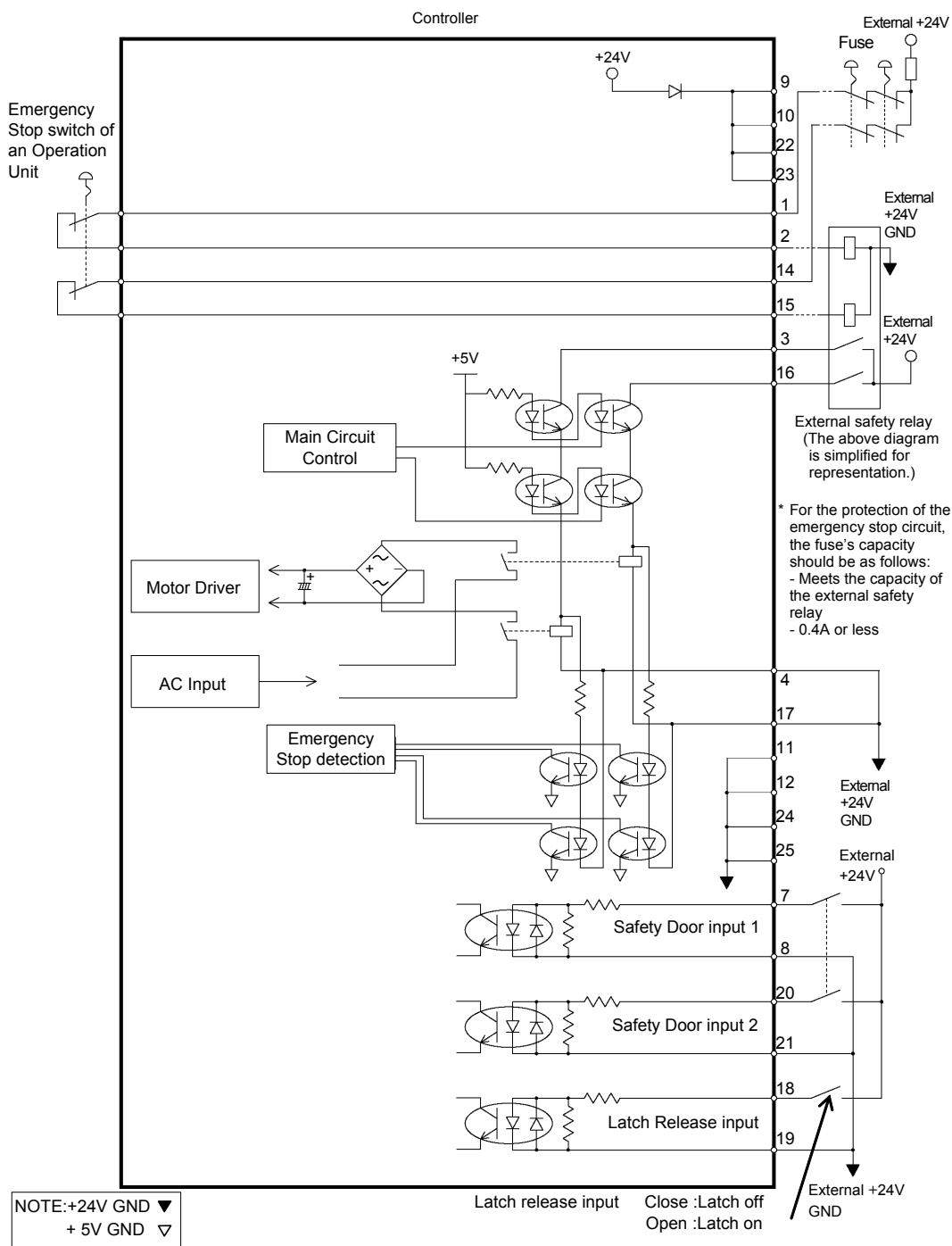

10. I/O Connector

The I/O connector is for connecting your input/output equipment to the system.

	Pins	Bit number
Input	24	0 to 23
Output	16	0 to 15

Refer to Setup & Operation 12.2. Expansion I/O board.

For cable wiring, refer to the *Setup & Operation 3.5 Noise Countermeasures* in order to prevent noise.

Remote function is initially assigned to both input and output from 0 to 7. For further details, refer to *11. I/O Remote Settings*.

10.1 Input Circuit

Input Voltage Range	: +12 to 24 V \pm 10%
ON Voltage	: +10.8 V (min.)
OFF Voltage	: +5 V (max.)
Input Current	: 10 mA (TYP) at +24 V input

Two types of wiring are available for use with the two-way photo coupler in the input circuit.

Typical Input Circuit Application 1

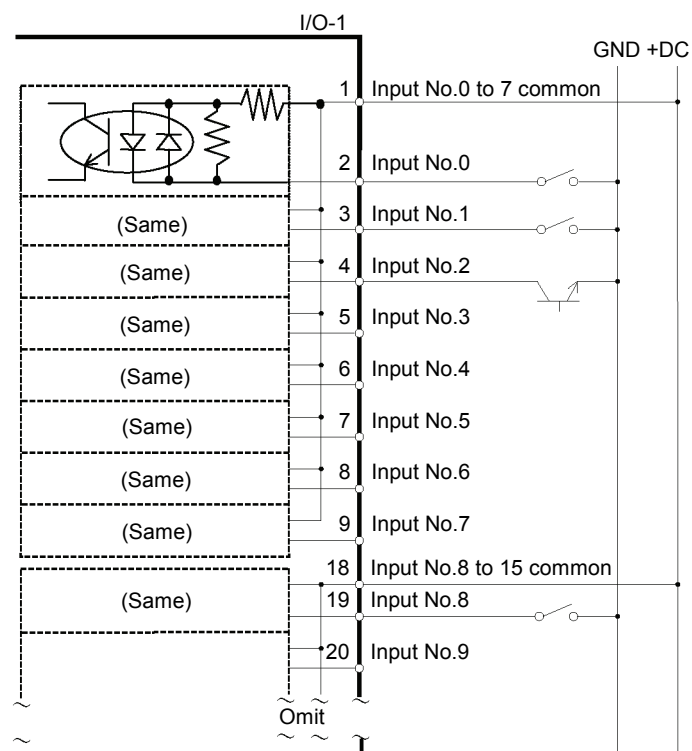

Typical Input Circuit Application 2

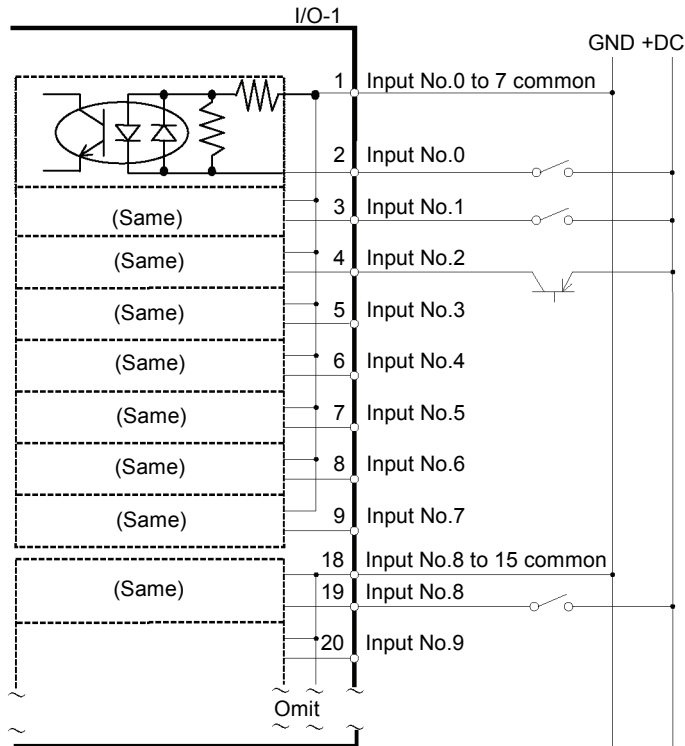

10.2 Output Circuit

Rated Output Voltage : +12 V to 24 V \pm 10%
 Maximum Output Current : TYP 100 mA/1 output
 Output Driver : PhotoMOS Relay
 On-State Resistance (average) : 23.5 Ω or less

Two types of wiring are available for use with the nonpolar photoMOS relay in the output circuit.

Typical Output Circuit Application 1

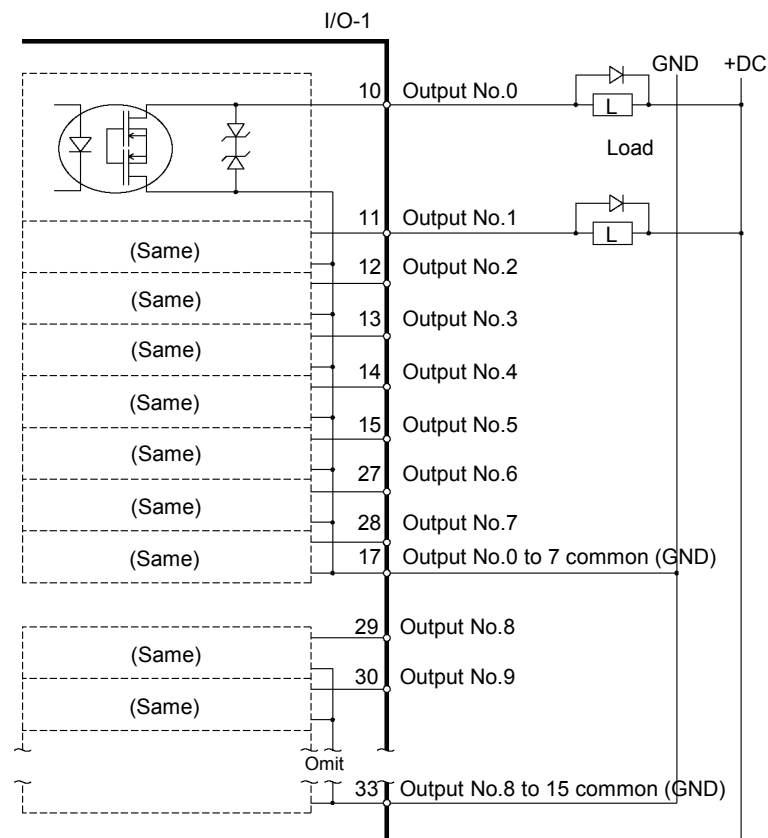

Typical Output Circuit Application 2

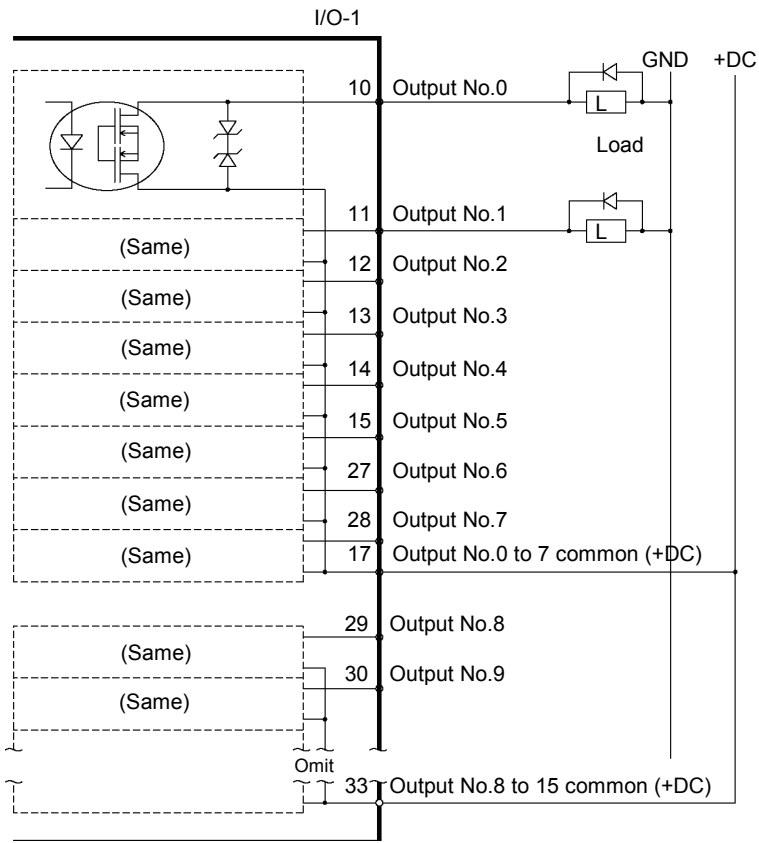

10.3 Pin Assignments

Pin No.	Signal Name	Pin No.	Signal Name	Pin No.	Signal Name
1	Input common No. 0 to 7	18	Input common No. 8 to 15	34	Input common No. 16 to 23
2	Input No. 0 (Start)	19	Input No. 8	35	Input No. 16
3	Input No. 1 (SelProg1)	20	Input No. 9	36	Input No. 17
4	Input No. 2 (SelProg2)	21	Input No. 10	37	Input No. 18
5	Input No. 3 (SelProg4)	22	Input No. 11	38	Input No. 19
6	Input No. 4 (Stop)	23	Input No. 12	39	Input No. 20
7	Input No. 5 (Pause)	24	Input No. 13	40	Input No. 21
8	Input No. 6 (Continue)	25	Input No. 14	41	Input No. 22
9	Input No. 7 (Reset)	26	Input No. 15	42	Input No. 23
10	Output No. 0 (Ready)	27	Output No. 6 (SError)	43	Output No.11
11	Output No. 1 (Running)	28	Output No. 7 (Warning)	44	Output No.12
12	Output No. 2 (Paused)	29	Output No. 8	45	Output No.13
13	Output No. 3 (Error)	30	Output No. 9	46	Output No.14
14	Output No. 4 (EstopOn)	31	Output No.10	47	Output No.15
15	Output No. 5 (SafeguardOn)	32	NC	48	NC
16	NC	33	Output common No. 8 to 15	49	NC
17	Output common No. 0 to 7			50	NC

Remote function inside () in the table above is initially assigned to both input and output from 0 to 7. For further details, refer to 11. I/O Remote Settings.

Connector	Standard
I/O Connector (Controller side)	D-sub 50 male pin Mounting style #4 - 40

* The I/O connector, I/O connector cable, terminal block, and I/O connector kit are offered as options.

11. I/O Remote Settings

This section describes the functions and timings of input and output signals.

The remote functions may be assigned to your standard I/O board(s), expansion I/O board(s), or fieldbus I/O board(s) to enhance robot system control - either from an operational unit of your choice or a sequencer.

Remote function is initially assigned to both input and output from 0 to 7.

To accept external remote inputs, assign the remote function and the control device is remote. For further details, refer to the section, *Remote Control Software Configuration* in *EPSON RC+ 5.0 User's Guide 10. Remote Control*.

The user defines the I/O number that a remote function is assigned to using software configuration. For further details, refer to the section, *Remote Control Software Configuration* in *EPSON RC+ 5.0 User's Guide 10. Remote Control*.

For details about I/O cable connection, refer to sections on *Setup & Operation 10. I/O Connector* and *12.2. Expansion I/O Board (Option)* and *12.3 Fieldbus I/O Board (Option)*.

For details about communication with external equipment, refer to *EPSON RC+ 5.0 User's Guide 10. Remote Control*.

 CAUTION	<ul style="list-style-type: none"> ■ When using remote I/O, always make sure of the following. Using the robot system under unsatisfactory conditions may cause malfunction of the system and/or safety problems. <ul style="list-style-type: none"> - Assign remote functions to inputs/outputs correctly and wire correctly when setting up remote I/O signals. - Make sure that the functions correspond to the correct input/output signals before turning ON the system. - When verifying the robot system operation, prepare for failures with initial settings or wiring. If the Manipulator functions unusually by the failures with initial settings or wiring, press the Emergency Stop switch immediately to stop the Manipulator.
--	--

NOTE

Remote function is available when virtual I/O is enabled.

NOTE

When you set up a remote I/O signal, please either keep a written record of the settings or store the data in a file for later reference.

NOTE

When you set up a fieldbus I/O signal to the remote function, response depends on the baud rate of the fieldbus. For details of fieldbus response, refer to *Setup & Operation 12.3.2 Response Speed of Fieldbus I/O*.

11.1 I/O Signal Description

Remote function is initially assigned to both input and output from 0 to 7.

To change the function assignment from the initial setting, use EPSON RC+ 5.0.

To use all signals, you will need to add Expansion I/O or Fieldbus I/O board(s).

11.1.1 Remote Input Signals

Remote inputs are used to control the Manipulators and start programs. Certain conditions must be met before inputs are enabled, as shown in the table below.

To accept external remote inputs, assign the remote function and set remote to the control device. When external remote input is available, “AutoMode output” turns ON.

Except “SelProg”, the signals execute each function when the signal starts in input acceptance condition. The function executes automatically. Therefore, no special programming is needed.

NOTE



When an error occurs, you must execute a “Reset” to clear the error condition before any other remote input commands can be executed. Use the “Error output” and “Reset input” to monitor the error status and clear error conditions from the remote device.

Name	Initial	Description	Input Acceptance Condition (*1)
Start	0	Execute function selected at SelProg. (*2)	Ready output ON Error output OFF EStopOn output OFF SafeguardOn output OFF Pause input OFF Stop input OFF
SelProg1 SelProg2 SelProg4	1 2 3	Specify the executing Main function number. (*2)	
Stop	4	All tasks and commands are stopped.	
Pause	5	All tasks are paused. (*3)	Running output ON
Continue	6	Continue the paused task.	Paused output ON Pause input OFF Stop input OFF
Reset	7	Reset emergency stop and error. (*4)	Ready output ON
SetMotorOn	NA	Turn ON robot motors. (*5)	Ready output ON EStopOn output OFF SafeguardOn output OFF SetMotorOff input OFF
SetMotorOff	NA	Turn OFF robot motors.	Ready output ON
Home	NA	Move the Robot Arm to the home position defined by the user.	Ready output ON Error output OFF EStopOn output OFF SafeguardOn output OFF MotorsOn output ON Pause input OFF Stop input OFF

Name	Initial	Description	Input Acceptance Condition (*1)
ForcePowerLow (*6)	NA	Stops all tasks and commands. Sets the motor power at Low. The status is Low power mode while the input is ON even executing Power High command.	Any time This input is acceptable even AutoMode output is OFF.

(*1) “AutoMode output” ON is omitted from the table. This is an input acceptance condition for all functions.

(*2) “Start input” executes Function specified by the “SelProg1, 2, 4, and 3” bits.

Function	SelProg1	SelProg2	SelProg4
Main	0	0	0
Main1	1	0	0
Main2	0	1	0
Main3	1	1	0
Main4	0	0	1
Main5	1	0	1
Main6	0	1	1
Main7	1	1	1

0=OFF, 1=ON

(*3) “NoPause task” and “NoEmgAbort task” do not pause.

For details, refer to EPSON RC+ 5.0 *Online Help* or *Pause* in *SPEL+ Language Reference*.

(*4) Turns OFF the I/O output and initializes the robot parameter.

For details, refer to EPSON RC+ 5.0 *Online Help* or *Reset* in *SPEL+ Language Reference*.

(*5) Initializes the robot parameter.

For details, refer to EPSON RC+ 5.0 *Online Help* or *Motor* in *SPEL+ Language Reference*.

(*6) This is for the experienced. Make sure that you fully understand the input specification before using. When the input changes from ON to OFF, all tasks and commands will stop.

It is supported by EPSON RC+ 5.0 Ver.5.4 and Firmware Ver. 1.10.*.*.

11.1.2 Remote Output Signals

Remote outputs provide status for the Manipulator and Controller.

Remote outputs provide the assigned function using with any control device. The outputs execute automatically. Therefore, no special programming is needed.

Name	Initial	Description
Ready	0	Turns ON when the controller startup completes and no task is running.
Running	1	Turns ON when task is running. However, turns OFF when "Paused output" is OFF.
Paused	2	Turns ON when pause task exists.
Error	3	Turns ON when an error occurs. Use "Reset input" to recover from the error.
EStopOn	4	Turns ON at Emergency Stop.
SafeguardOn	5	Turns ON when the safeguard is open.
SError	6	Turns ON when critical error occurs. When a critical error occurs, "Reset input" does not function. Reboot the controller to recover.
Warnig	7	Turns ON when warning occurs. The task runs as normal with the warning. However, be sure to eliminate the cause of the warning as soon as possible.
MotorsOn	NA	Turns ON when the motor is ON.
AtHome	NA	Turns ON when the robot is in the home position.
CurrProg1 CurrProg2 CurrProg4	NA	Indicates the running or the last main function number (*1)
AutoMode	NA	Turns ON in remote input acceptable status. (*2)
TeachMode	NA	Turns ON in TEACH mode.
ErrorCode1 . . . ErrorCode8192	NA	Indicates the error number.
InsideBox1 . . . InsideBox15	NA	Turns ON when the robot is in the approach check area. For details, refer to EPSON RC+ 5.0 <i>Online Help</i> or <i>Box</i> in <i>SPEL+ Language Reference</i> .
InsidePlane1 . . . InsidePlane15	NA	Turns ON when the robot is in the approach check plane. For details, refer to EPSON RC+ 5.0 <i>Online Help</i> or <i>Plane</i> in <i>SPEL+ Language Reference</i> .
Power High (*4)	NA	Turns ON when the power status is High.

(*1) Outputs the current or the last function number of CurrProg1, CurrProg2, or CurrProg4.

Function	CurrProg1	CurrProg2	CurrProg4
Main	0	0	0
Main1	1	0	0
Main2	0	1	0
Main3	1	1	0
Main4	0	0	1
Main5	1	0	1
Main6	0	1	1
Main7	1	1	1

0=OFF, 1=ON

(*2) Remote function is available in the followings conditions.

- The setting is Auto mode and the control device is remote.
- The setting is Program mode and Remote I/O is enabled.

(*3) It is supported by EPSON RC+ 5.0 Ver.5.4 and Firmware Ver. 1.10.*.*.

11.2 Timing Specifications

11.2.1 Design Notes for Remote Input Signals

The following charts indicate the timing sequences for the primary operations of the Controller.

The indicated time lapses (time durations) should be referred to only as reference values since the actual timing values vary depending on the number of tasks running, as well as CPU speed of the Controller. Check carefully and refer to the following charts for the timing interrelation when you enter an input signal.

During system design, make sure that you actuate only one remote input operation at a time, otherwise an error will occur.

The pulse width of an input signal must be 25 or more milliseconds to be detected.

[Unit: msec]

11.2.2 Timing Diagram for Operation Execution Sequence

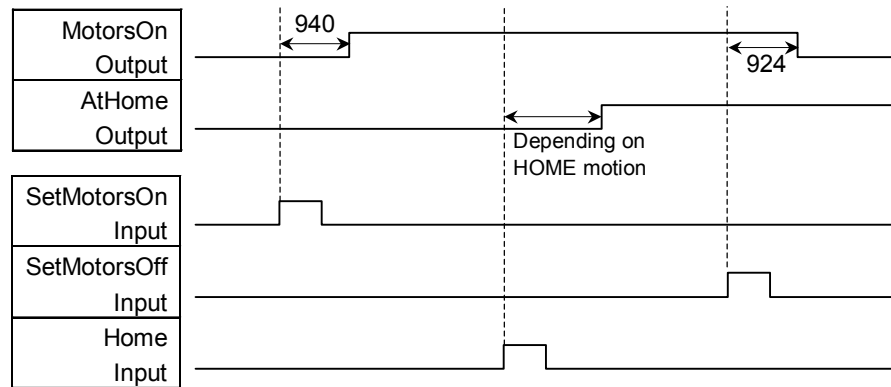

11.2.3 Timing Diagram for Program Execution Sequence

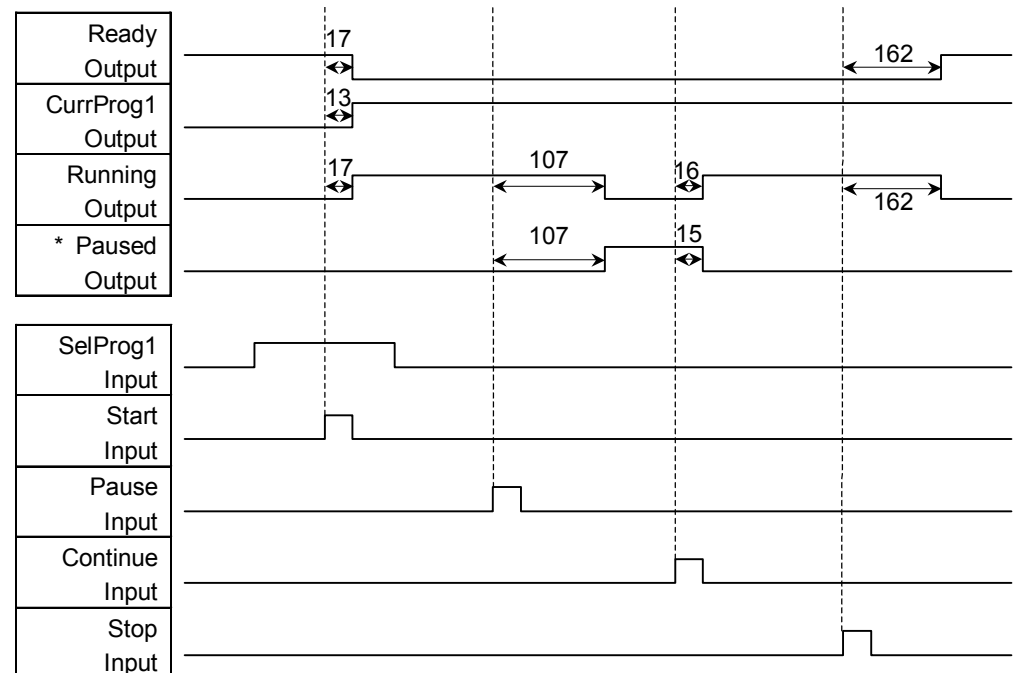

* The duration varies depending on the Quick Pause (QP) setting and the program's operating status at the time of Pause input

11.2.4 Timing Diagram for Safety Door Input Sequence

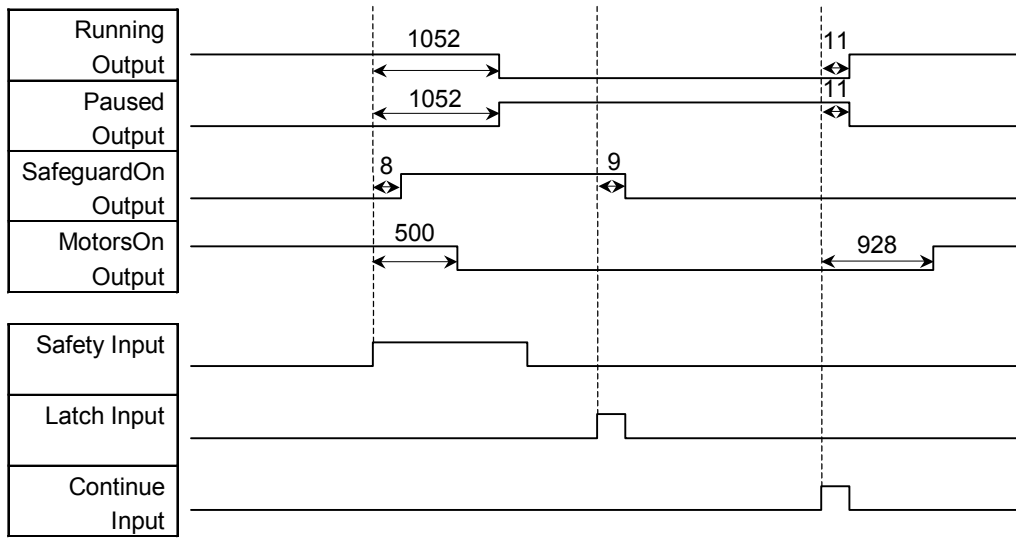

11.2.5 Timing Diagram for Emergency Stop Sequence

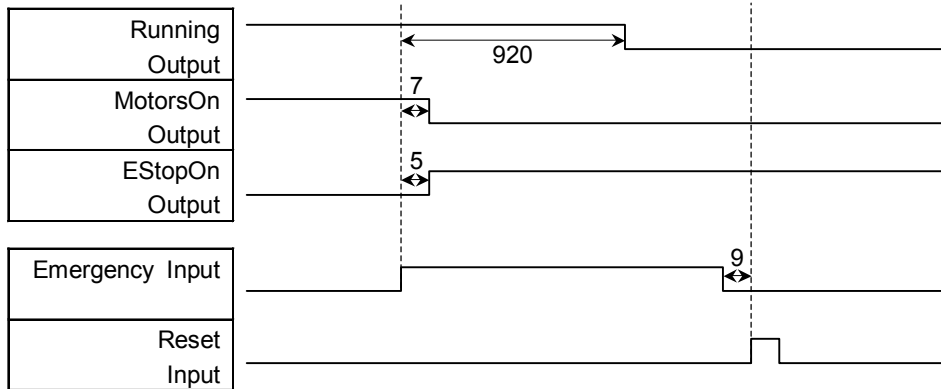

12. Option Units

12.1 What are Option Units?

The option units contain option boards for RC180.

Up to two units can be installed on one Controller. Up to four option boards can be installed.

The types of the option boards are as follows.

- 12.2 Expansion I/O Board
- 12.3 Fieldbus I/O Board
- 12.4 RS-232C Board

12.2 Expansion I/O Board

12.2.1 About Expansion I/O Board

Install an option unit in the Controller when extra inputs or outputs are desired.

Each additional expansion I/O board provides 32 inputs and 32 outputs.

CN1: 16 inputs / 16 outputs

CN2: 16 inputs / 16 outputs

The number of I/Os that can be expanded is maximum 4 boards and 128 inputs and outputs.

The input and output bit numbers are assigned as follows. (Bit number is assigned from CN1.)

Input Bit #	Output Bit #	Applicable Hardware
0 to 23	0 to 15	STANDARD I/O
64 to 95	64 to 95	The 1 st Expansion I/O board
96 to 127	96 to 127	The 2 nd Expansion I/O board
128 to 159	128 to 159	The 3 rd Expansion I/O board
160 to 191	160 to 191	The 4 th Expansion I/O board

12.2.2 Board Configuration (Expansion I/O)

Board Appearance

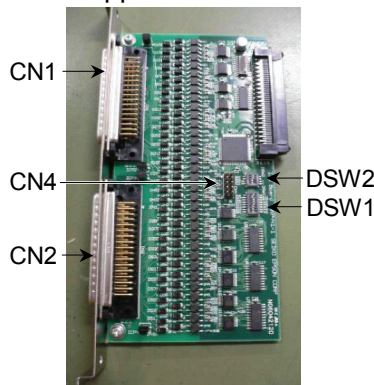

Switch and Jumper Configuration

Setup the DSW1 and DSW2. CN4 is all open.

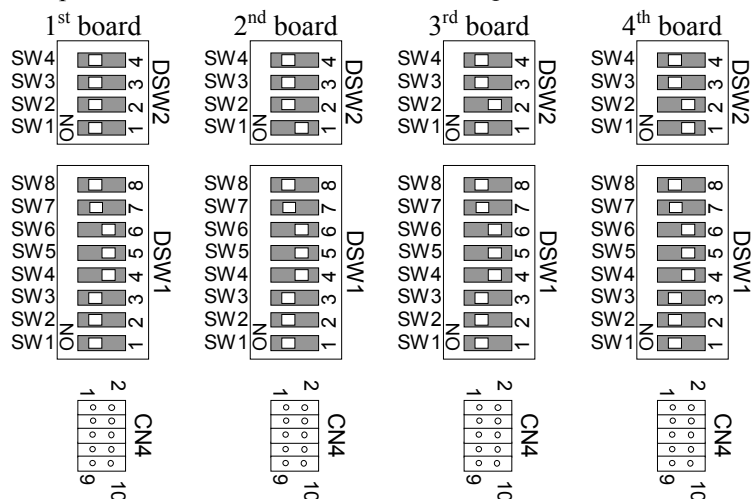

12.2.3 Confirmation of Operation Using EPSON RC+ 5.0

When an expansion I/O board is mounted to the option unit, the Controller software automatically identifies the expansion I/O board. Therefore, no software configuration is needed.

Correct identification can be confirmed from EPSON RC+ 5.0.

- (1) Select the EPSON RC+ 5.0 menu-[Setup]-[Controller] to display the [Setup Controller] dialog.
- (2) Select the [Inputs / Outputs].

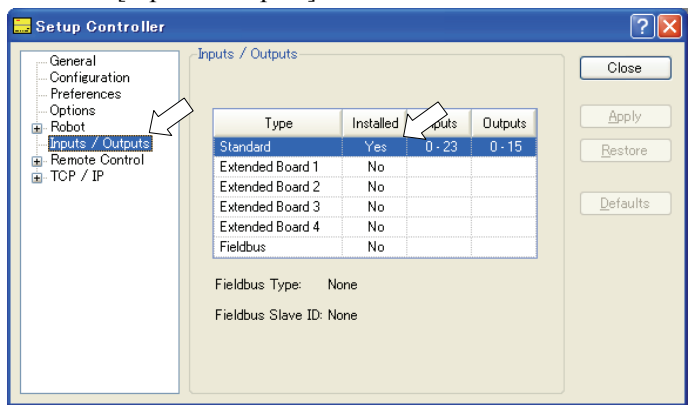

- (3) Make sure that “Yes” is displayed in the Installed column.
The expansion I/O board is identified by the Controller software. Corresponding Input and Output is available.

12.2.4 Input Circuit

- Input Voltage Range : + 12 V to 24 V ±10%
- ON Voltage : + 10.8 V (Min.)
- OFF Voltage : + 5 V (Max.)
- Input Current : 10 mA (TYP) at + 24 V input

Two types of wiring are available for use with the two-way photo coupler in the input circuit.

Protected Expansion I/O Board
 Typical Input Circuit Application 1

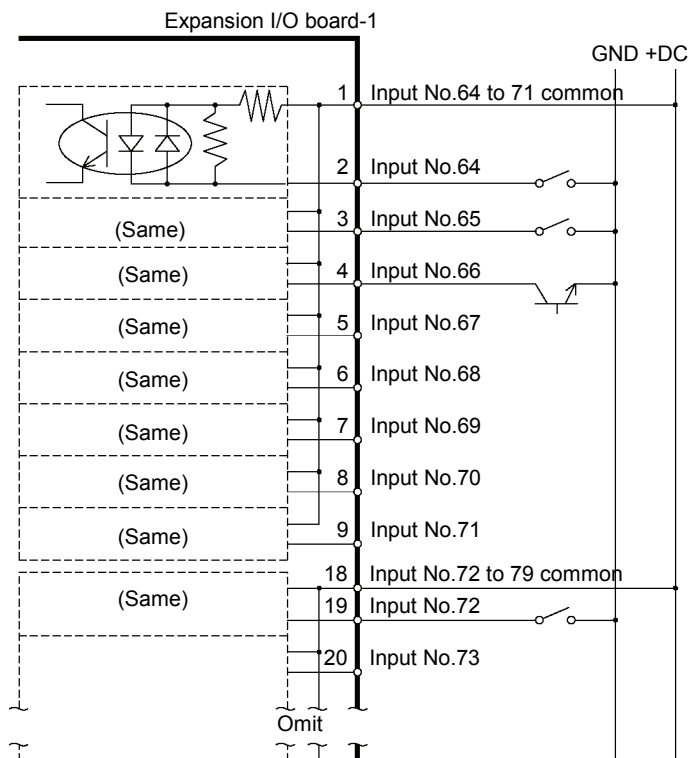

Protected Expansion I/O Board
 Typical Input Circuit Application 2

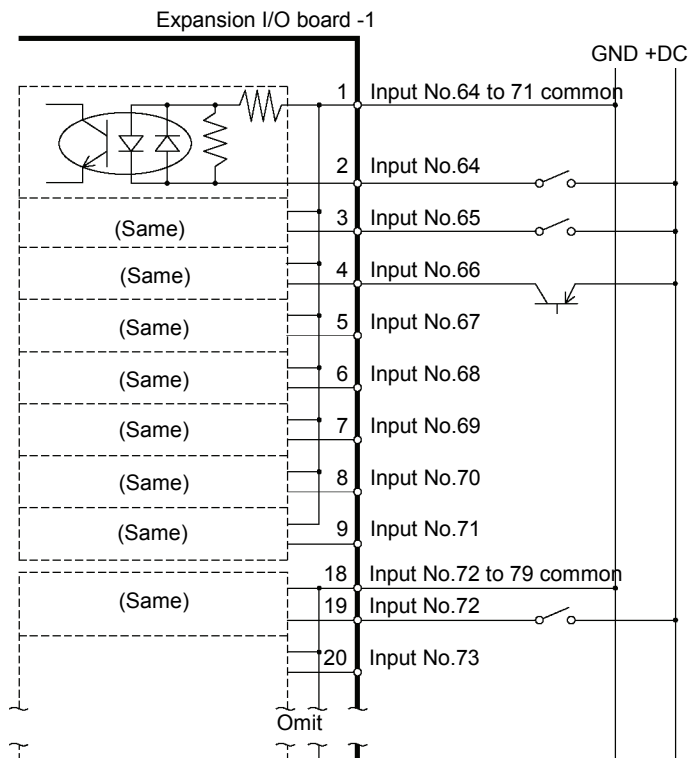

12.2.5 Output Circuit

- Rated Output Voltage : +12 V to 24 V ±10%
- Maximum Output Current : TYP 100 mA/1 output
- Output Driver : PhotoMOS Relay
- On-State Resistance (average) : 23.5 Ω or less

Two types of wiring are available for use with the nonpolar photoMOS relay in the output circuit.

Protected Expansion I/O Board

Typical Output Circuit Application 1

Expansion I/O-1

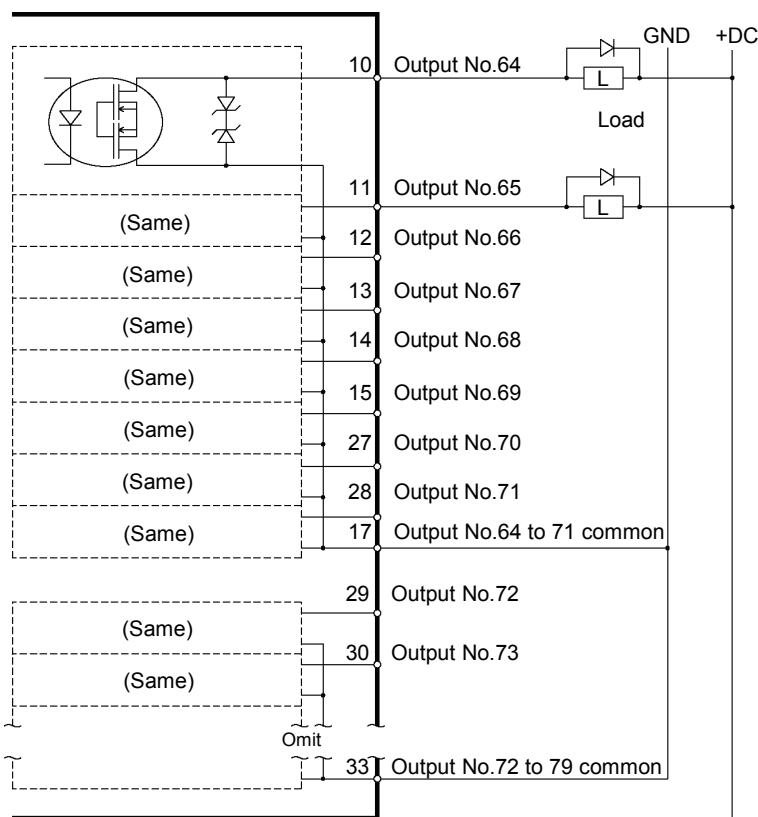

Protected Expansion I/O Board
Typical Output Circuit Application 2
Expansion I/O-1

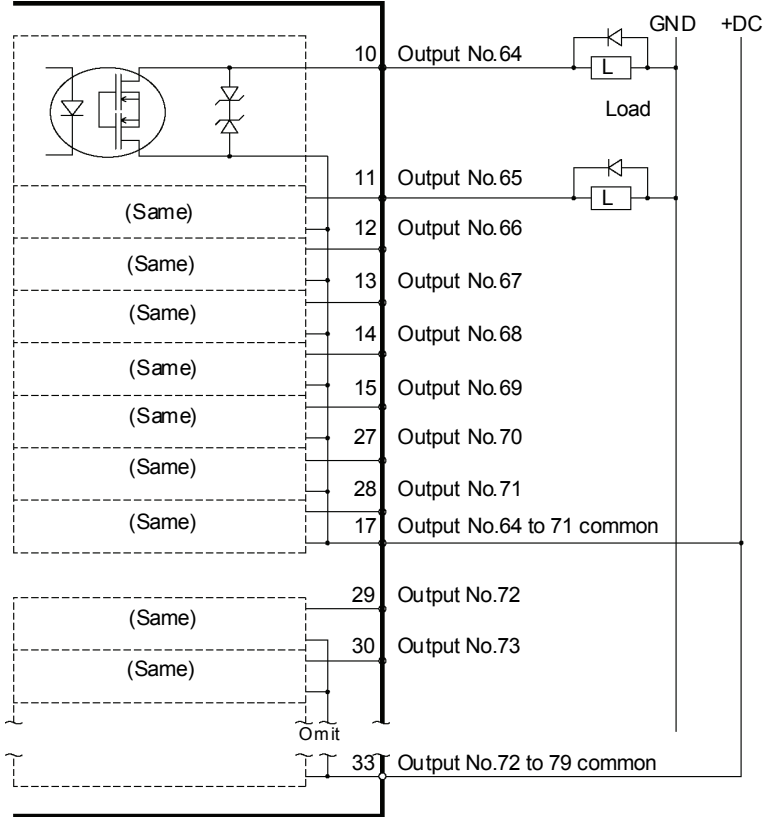

12.2.6 Pin Assignments

Pin Assignment table of the 1st Expansion I/O board.

Connector 1 Pin Assignments

Pin No.	Signal Name	Pin No.	Signal Name	Pin No.	Signal Name
1	Input common No.64 to 71	18	Input common No.72 to 79	34	NC
2	Input No.64	19	Input No.72	35	NC
3	Input No.65	20	Input No.73	36	NC
4	Input No.66	21	Input No.74	37	NC
5	Input No.67	22	Input No.75	38	NC
6	Input No.68	23	Input No.76	39	NC
7	Input No.69	24	Input No.77	40	NC
8	Input No.70	25	Input No.78	41	NC
9	Input No.71	26	Input No.79	42	NC
10	Output No.64	27	Output No.70	43	Output No.75
11	Output No.65	28	Output No.71	44	Output No.76
12	Output No.66	29	Output No.72	45	Output No.77
13	Output No.67	30	Output No.73	46	Output No.78
14	Output No.68	31	Output No.74	47	Output No.79
15	Output No.69	32	NC	48	NC
16	NC	33	Output common No.72 to 79	49	NC
17	Output common No.64 to 71			50	NC

Connector	Standard
I/O Connector (Controller side)	D-sub 50 male pin Mounting style #4 - 40

* The I/O connector, I/O connector cable, terminal block, and I/O connector kit are offered as options.

Connector 2 Pin Assignments

Pin No.	Signal Name	Pin No.	Signal Name	Pin No.	Signal Name
1	Input common No.80 to 87	18	Input common No.88 to 95	34	NC
2	Input No.80	19	Input No.88	35	NC
3	Input No.81	20	Input No.89	36	NC
4	Input No.82	21	Input No.90	37	NC
5	Input No.83	22	Input No.91	38	NC
6	Input No.84	23	Input No.92	39	NC
7	Input No.85	24	Input No.93	40	NC
8	Input No.86	25	Input No.94	41	NC
9	Input No.87	26	Input No.95	42	NC
10	Output No.80	27	Output No.86	43	Output No.91
11	Output No.81	28	Output No.87	44	Output No.92
12	Output No.82	29	Output No.88	45	Output No.93
13	Output No.83	30	Output No.89	46	Output No.94
14	Output No.84	31	Output No.90	47	Output No.95
15	Output No.85	32	NC	48	NC
16	NC	33	Output common No.88 to 95	49	NC
17	Output common No.80 to 87			50	NC

Connector	Standard
I/O Connector (Controller side)	D-sub 50 male pin Mounting style #4 - 40

* The I/O connector, I/O connector cable, terminal block, and I/O connector kit are offered as options.

12.3 Fieldbus I/O Board

12.3.1 Overview of Fieldbus I/O

The Fieldbus I/O option is an option to add fieldbus slave function (DeviceNet, PROFIBUS-DP, PROFINET, CC-Link, EtherNet/IP) to the robot Controller.

A fieldbus is a standard of signal communications between field devices operating in a factory (sensor, actuator, robot controller, etc.) and controller (PLC or robot controller) using serial communications. Compared to signal communications using analog signals, a fieldbus has the following features:

- Access to signals from multiple devices and multiple data from each device using one cable.
- Precise signal transmission since there is no need for A/D conversion and D/A conversion.
- Less wiring costs, including signal relay board costs and installation area due to several dozen (or a hundred) devices connected on one fieldbus.
- More flexible modification and expansion of a system because multiple devices are simply added to one fieldbus without additional wiring.
- Slave devices can transmit self-diagnostics information.

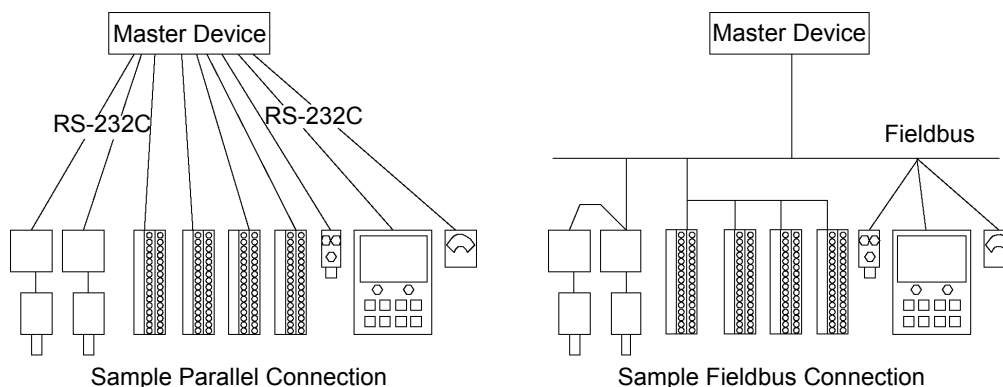

Fieldbus slave function can be added to the RC180 Controller. For each fieldbus on the controller, there is one board installed. You cannot use more than one fieldbus type on the same controller.

For master device transmission, up to 256 inputs and 256 outputs are available with Fieldbus I/O.



Response times for Fieldbus I/O can vary and depend on several factors, including baud rate, scan rate, number and types of devices, number of SPEL+ tasks, etc.

12.3.2 Response Speed of Fieldbus I/O

Fieldbus I/O communicates the I/O status using serial communication. I/O status exchange lag occurs according to the serial communication speed. This exchange lag is also influenced by scan cycle, amount and type of the device, and existence of communication error.

In the RC180 Controller, status of the Fieldbus I/O is updated approximately every 30 mS. Although the fieldbus communication speed is fast, response is not available for pulses less than or equal to 30 mS.

12.3.3 Fieldbus I/O Board Configuration

The Fieldbus I/O board is configured as follows at shipment.

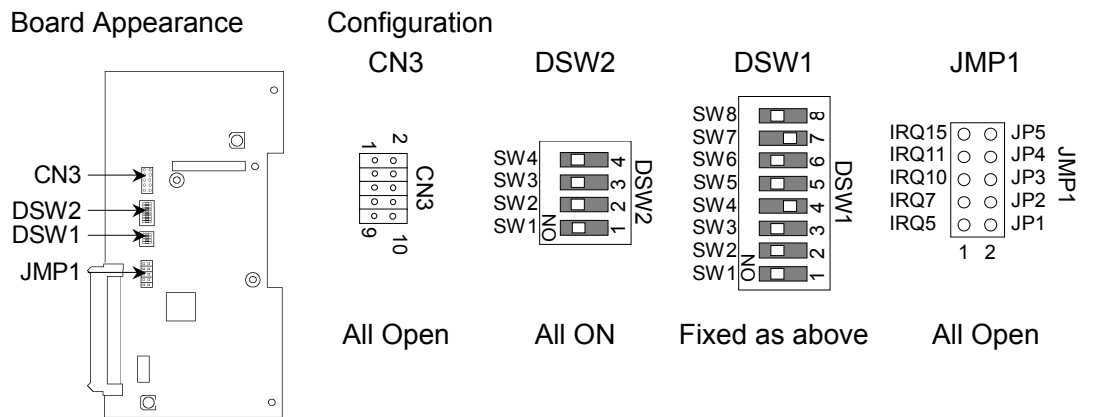

12.3.4 DeviceNet

 WARNING	<ul style="list-style-type: none"> ■ Make sure that the power is turned OFF before installing/removing any boards or connecting/disconnecting any cables. Installing/removing any boards or connecting/disconnecting any cables with the power ON is extremely hazardous and may result in electric shock and/or malfunction of equipment.
--	---

 CAUTION	<ul style="list-style-type: none"> ■ Pay attention to the followings in order to prevent the the DeviceNet connector from coming off. <ol style="list-style-type: none"> 1. Use the connectors attached to the board. 2. Insert the connectors all the way seated. 3. Fix the cables at proper positions in order not to put a load on the connectors.
--	---

Overview of DeviceNet

DeviceNet is a fieldbus network that provides easy interconnection between control devices (PLC, PC, sensor, actuator, etc.). DeviceNet was developed by Allen-Bradley as an open communication standard to connect various field devices (sensor, actuator, robot controller, etc.). Because of the open communication standard, DeviceNet users can easily construct a multi-vendor system with various devices developed around the world.

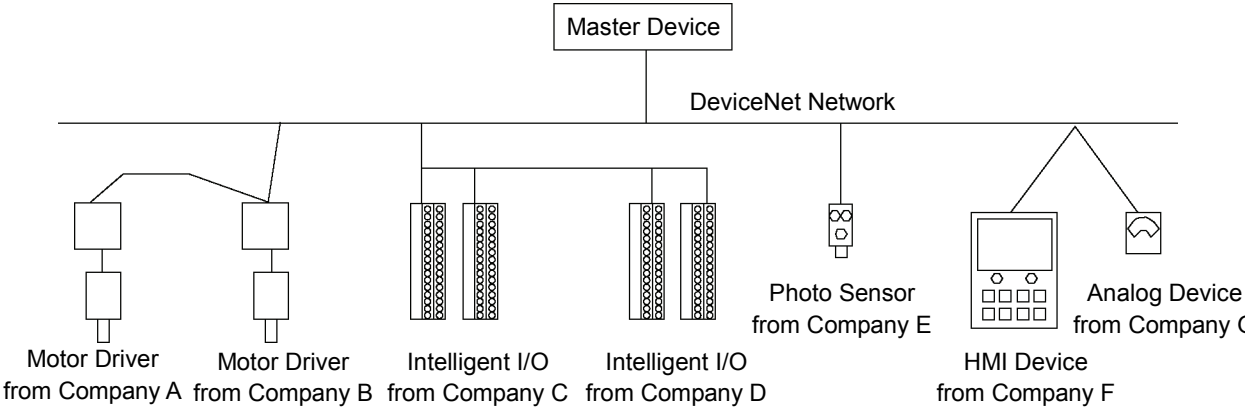

DeviceNet Communication Specifications

Item	Specification			
Name	DeviceNet board			
Code	R12B040706			
Supported Connection	I/O messaging connection (Polling), Explicit message connection DeviceNet communication protocol			
Baud Rates	125 K / 250 K / 500 K (bps)			
Transfer Distance	Baud Rates	Max. Network Length	Drop Length	Total Drop Line Length
	500 K (bps)	100 m	6 m or under	39 m or under
	250 K (bps)	250 m *	6 m or under	78 m or under
	125 K (bps)	500 m *	6 m or under	156 m or under
Cable	5-wire cable dedicated to DeviceNet (2 wires for signal, 2 wires for power supply, 1 shield wire)			
Communications Power Supply Voltage	24 V DC (supplied from a connector)			
Communication Power Supply Current Consumption	Maximum 30 mA			
Mode	Slave			
Interface	1 DeviceNet port			
Connection type	Polling			
Explicit message connection	Supported			
Input data size	256 bits (32 bytes)			
Output data size	256 bits (32 bytes)			

* When thin cable is used for trunk line, the maximum network length is 100 m.

DeviceNet Appearance

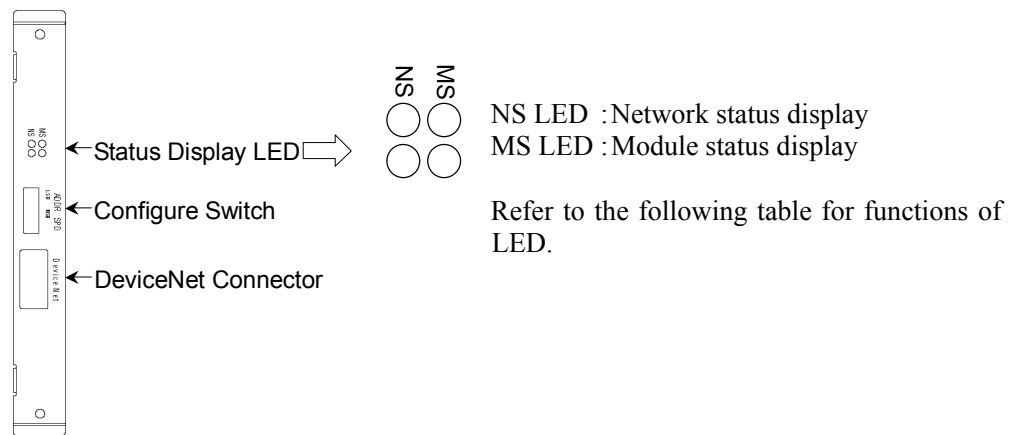

LED Description of DeviceNet

LED status represents the status of the fieldbus board.

LED status		NS	MS
OFF		Communication power supply OFF Disconnected	Device power supply OFF
GRN	ON	Link OK Online connected	Device operating
	Blinking	Online disconnected	Data size error
RED	ON	Link error	Critical error
	Blinking	Communication time out	Error

Board Installation of DeviceNet

Set the baud rates between the MAC address of the device and the master by setting the DeviceNet board configure switch.

- (1) Set the MAC address for DeviceNet board by setting the configure switch. Make sure that the MAC address is different from the other devices in the network. Refer to the following table for the configuration.

MAC address	Switch					
	sw3 (MSB)	sw4	sw5	sw6	sw7	sw8 (LSB)
0	OFF	OFF	OFF	OFF	OFF	OFF
1	OFF	OFF	OFF	OFF	OFF	ON
2	OFF	OFF	OFF	OFF	ON	OFF
3	OFF	OFF	OFF	OFF	ON	ON
⋮	OFF	OFF	OFF	OFF	OFF	OFF
62	ON	ON	ON	ON	ON	OFF
63 (at shipment)	ON	ON	ON	ON	ON	ON

- (2) Set the DeviceNet baud rate. Check the master configuration and set the same baud rate. Refer to the following table for configuration settings.

Baud Rate	Switch	
	sw1	sw2
125 K	OFF	OFF
250 K	OFF	ON
500 K	ON	OFF
Configuration prohibited	ON	ON

Wiring (DeviceNet)

The DeviceNet connector is a 5 pin open connector. Use the connector attached to the board for wiring.

Terminal name for each pin

Terminal No	Terminal Name
1	V-
2	CAN L
3	SHELD
4	CAN H
5	V+



Prepare the cable for DeviceNet sold in the market as a communication cable. Install terminating resistors at both ends of the network.

DeviceNet Confirmation with EPSON RC+ 5.0

When the DeviceNet board is installed to the Controller, it is recognized automatically. Confirm whether EPSON RC+ 5.0 has recognized the DeviceNet board using the following procedure.

- (1) Select EPSON RC+ 5.0 menu-[Setup]-[Controller] to display the [Setup Controller] dialog.

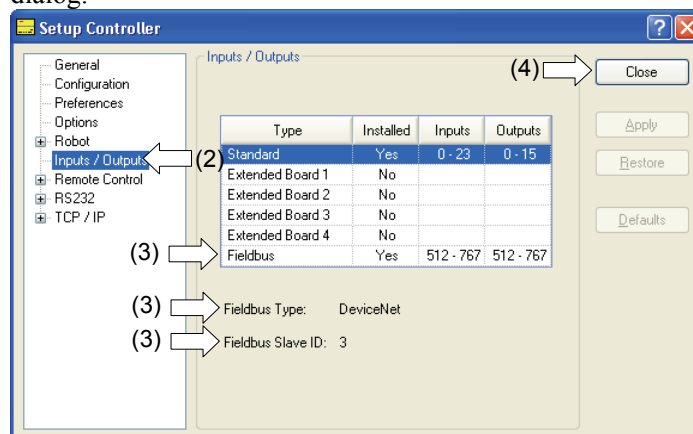

- (2) Select [Inputs / Outputs].
- (3) Make sure that the following are displayed.
 - Fieldbus-Installed : Yes
 - Fieldbus Type : DeviceNet
 - Fieldbus Slave ID : (MAC address depending on the setting)
- (4) Click the <Close> button.

Operation

For details, refer to 12.3.9 Operation.

Electronic Information File (EDS file)

An EDS file is supplied for DeviceNet network configuration. The file is located in the following folder in the Manual Update CD that is attached to the Robot Controller.

\EpsonRC50\Fieldbus\DeviceNet

12.3.5 PROFIBUS-DP

	<p>■ Make sure that the power is turned OFF before installing/removing any boards or connecting/disconnecting any cables. Installing/removing any boards or connecting/disconnecting any cables with the power ON is extremely hazardous and may result in electric shock and/or malfunction of equipment.</p>
---	--

Overview of PROFIBUS-DP

PROFIBUS DP is one of the fieldbus networks that provide easy interconnection between control devices (PLC, PC, sensor, actuator, etc.). PROFIBUS DP was developed as an open communication standard to connect various field devices (sensor, actuator, robot controller, etc.). Because of the open communication standard, PROFIBUS DP can easily construct multi-vendor system with various devices developed around the world.

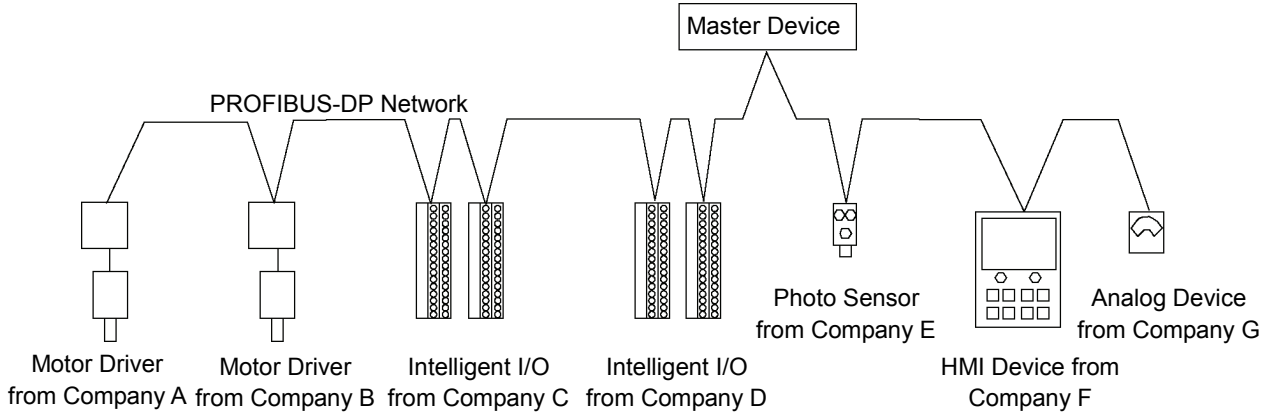

PROFIBUS DP Specifications

Item	Specification	
Name	PROFIBUS-DP board	
Code	R12B040707	
Connection Method	Hybrid (token passing procedure and master-slave communication)	
Baud Rates (bps)	9.6 K, 19.2 K, 45.45K, 93.75 K, 187.5 K, 500 K, 1.5 M, 3 M, 6 M, 12 M	
Transfer Distance	Baud Rates	Cable Length
	12 M (bps)	100 m
	6 M (bps)	100 m
	3 M (bps)	100 m
	1.5 M (bps)	200 m
	500 K (bps)	400 m
	187.5 K (bps)	1000 m
	93.75 K (bps)	1200 m
	45.45 K (bps)	1200 m
19.2 K (bps)	1200 m	
9.6 K (bps)	1200 m	
Maximum Stations	126 (including master unit and repeater)	
Data Length / Frame	244 bytes	
Cable	2-wire cable dedicated to PROFIBUS (2 wires for signal)	
Modes	Slave	
Interface	1 PROFIBUS-DP port (EN 50170)	
Output Current Capacity	Maximum 150 mA	
Input Data Size	256 bits (32 bytes)	
Output Data Size	256 bits (32 bytes)	

Appearance of PROFIBUS-DP

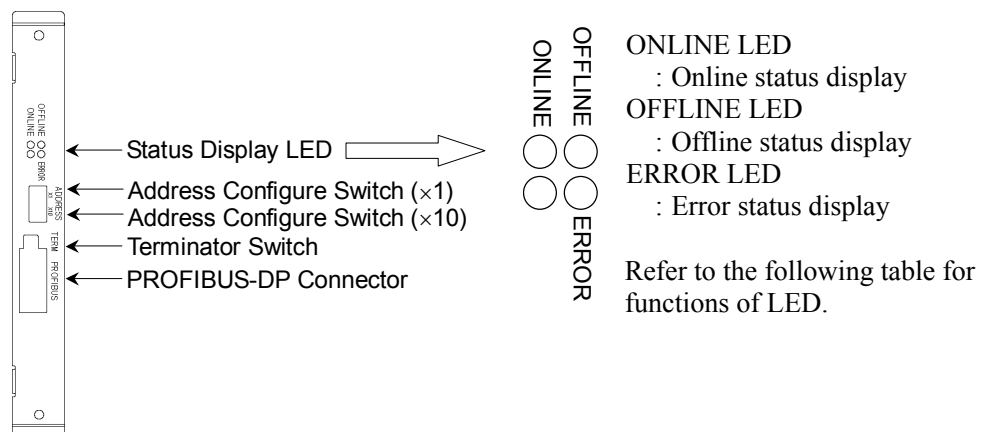

LED Description of PROFIBUS-DP

LED status represents the status of the fieldbus board.

LED status	ONLINE GRN	OFFLINE RED	ERROR RED
OFF	Offline	Online	Normal operation
ON	Online Data exchangeable	Offline Data unexchangeable	–
1 Hz blinking	–	–	Initialization error (Mismatch with network configuration)
2 Hz blinking	–	–	Initialization error (Mismatch with user parameter)
4 Hz blinking	–	–	Initialization error (Module initialization error)

Board Installation of PROFIBUS-DP

Set the node address of the device using the address configuration switch of the PROFIBUS-DP board. Set network termination ON or OFF with the terminator switch.

- Set the node address of the PROFIBUS-DP board using the address configuration switch. Make sure that the node address is different from the other devices in the network. Switch on the “×10” side for tens digit address configuration. Switch on the “×1” side for units digit address configuration.



Generally, a node address from 0 to 125 is available for the PROFIBUS-DP device, however, this Controller supports node addresses from 0 to 99.

Generally, node addresses are recommended to be configured as shown in the table.

Node address	Device Name
0	Service unit such as PG/PC
1	Operation panel such as HMI
2	Master station
3-99 (-125)	DP slave station

- Turn network termination ON or OFF using the terminator switch.

Wiring (PROFIBUS-DP)

PROFIBUS-DP connector is standard D-sub 9 pins connector.

Terminal name for each pin

Terminal No	Terminal Name
Case	Shield
1	NC
2	NC
3	B line
4	RTS
5	GND BUS
6	+5V BUS
7	NC
8	A line
9	NC



Prepare the cable for PROFIBUS-DP sold in the market as a communication cable. Install terminating resistors at both ends of the network.

A terminating resistor is installed in the PROFIBUS-DP board. Turn the terminating resistor ON or OFF using the terminator switch on the front panel.

PROFIBUS-DP Confirmation with EPSON RC+ 5.0

When a PROFIBUS-DP board is installed to the Controller, it is recognized automatically. Confirm whether EPSON RC+ 5.0 has recognized the PROFIBUS-DP board using the following procedure.

- (1) Select EPSON RC+ 5.0 menu-[Setup]-[Controller] to display the [Setup Controller] dialog.

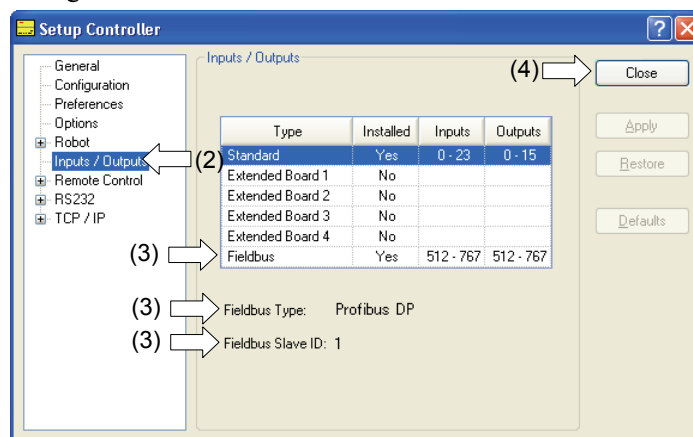

- (2) Select [Inputs / Outputs].
- (3) Make sure that the following are displayed.

Fieldbus-Installed	: Yes
Fieldbus Type	: PROFIBUS DP
Fieldbus Slave ID	: (depends on the address configure switch)
- (4) Click the <Close> button.

Operation

For details, refer to *12.3.9 Operation*.

Electronic Information File (GSD file)

A GSD file (EPSN0A4C.gsd) is supplied for PROFIBUS-DP network configuration. The file is located in the following folder in the Manual Update CD that is attached to the Robot Controller.

\EpsonRC50\Fieldbus\PROFIBUS

12.3.6 CC-Link

 WARNING	<ul style="list-style-type: none"> ■ Make sure that the power is turned OFF before installing/removing any boards or connecting/disconnecting any cables. Installing/removing any boards or connecting/disconnecting any cables with the power ON is extremely hazardous and may result in electric shock and/or malfunction of equipment.
--	---

 CAUTION	<ul style="list-style-type: none"> ■ Pay attention to the followings in order to prevent the CC-Link connector from coming off. <ol style="list-style-type: none"> 1. Use the connectors attached to the board. 2. Insert the connectors all the way seated. 3. Fix the cables at proper positions in order not to put a load on the connectors.
--	---

Overview of CC-Link

CC-Link is one of fieldbus networks that provide easy interconnection between control devices (PLC, PC, sensor, actuator, etc.).

CC-Link was developed as an open communication standard to connect various field devices (sensor, actuator, robot controller, etc.). Because of the open communication standard, CC-Link can easily construct multi-vendor system with various devices developed around the world.

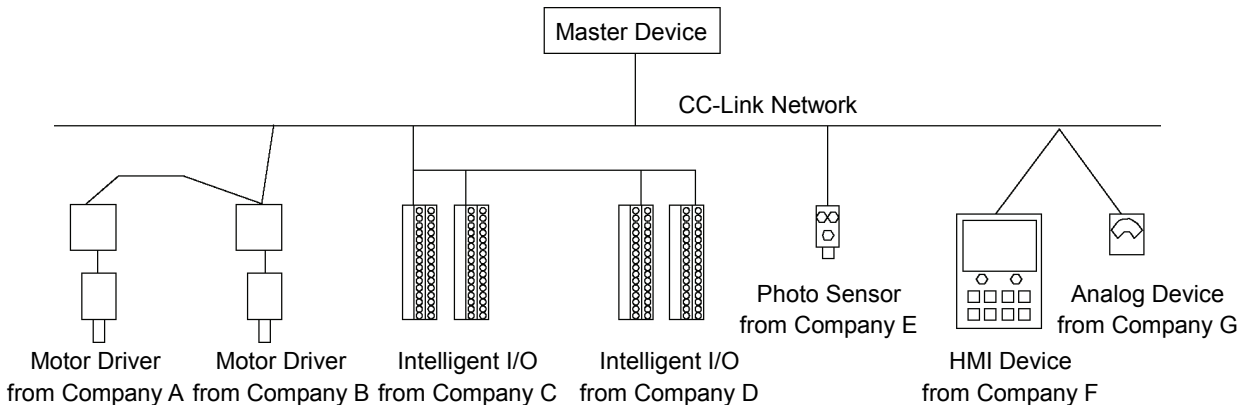

CC-Link Specifications

Item	Specification	
Name	CC-Link board	
Code	R12B040708	
Connection Method	Broadcast polling	
Baud Rates (bps)	156 K, 625 K, 2.5 M, 5 M, 10 M	
Transfer Distance	Baud Rates	Cable Length
	10 M (bps)	100 m
	5 M (bps)	160 m
	2.5 M (bps)	400 m
	625 K (bps)	900 m
156 K (bps)	1200 m	
Maximum Device Volume	64 units	
Cable	Dedicated cable supporting CC-Link Ver.1.10	
Modes	Slave	
Interface	1 CC-Link V1 port	
Occupied stations	3 station fixed	
Input Data Size	256 bits (96 bits + 10 words)*	
Output Data Size	256 bits (96 bits + 10 words)*	

* 16 bits of each system inputs and outputs are reserved. Open data size for user is as follows.
 Inputs/Outputs: 80 bits + 10 words

Appearance of CC-Link

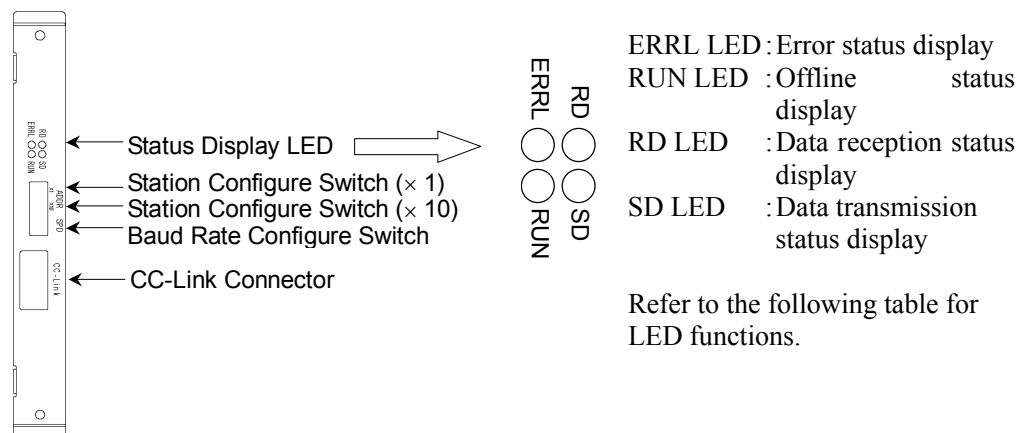

LED Description of CC-Link

LED status represents the status of the fieldbus I/O board.

LED status	ERRL RED	RUN GRN	RD GRN	SD GRN
OFF	Normal operation Device power supply OFF	Offline Device power supply OFF	No data reception Device power supply OFF	No data transmission Device power supply OFF
ON	CRC error: station Address error Baud rate configuration error	Normal operation	Data reception	Data transmission
Blinking	—	—	—	—

Board Configuration (CC-Link)

Configuration of the device station is available with the station configure switch on the

CC-Link board.

Baud rate configuration is available with baud rate configure switch on the CC-Link board.

- (1) Set the station of the CC-Link board with the station configuration switch.
 Make sure that the station does not duplicate with the other devices inside the network at configuration.
 Switches on the ×10 side are for tens place address value configuration. Switches on the ×1 side are for units digit address value configuration. Stations from 1 to 62 are available. CC-Link board occupies three stations. Assign the configured stations +3 stations to the next node.
- (2) Set the CC-Link baud rate. Check the master configuration and set the same baud rate. Refer to the following table for configuration.

Baud Rate	Switch
156 K	0
625 K	1
2.5 M	2
5 M	3
10 M	4
Configuration prohibited	5-9

Wiring (CC-Link)

The CC-Link connector is a 5 pin open connector. Use the connector attached to the board for wiring.

Terminal name for each pin

Terminal No	Terminal Name
1	DA
2	DB
3	DG
4	SLD
5	FG

Connect the CC-Link master module and the CC-Link board as follows.

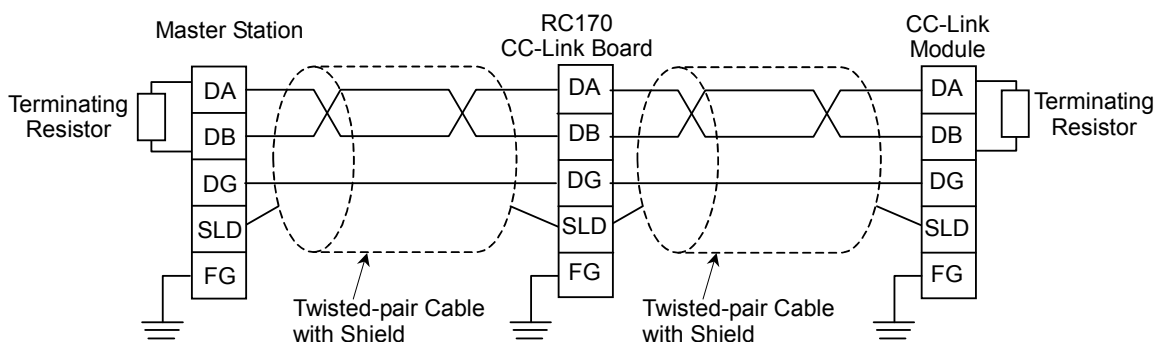

Prepare the cable for CC-Link Ver.1.10 sold in the market as a communication cable.



Install terminating resistors at both end of the network.

Use the terminating resistor attached to the CC-Link master station.

Make sure to disconnect the connectors only after turning OFF the power supply of the specific station.

Connect the shield wire for CC-Link to the “SLD” of each unit and ground the both end via the “FG.”

CC-Link Confirmation with EPSON RC+ 5.0



Confirmation with EPSON RC+5.0 should be done while connecting to the PLC.

Following error occurs when the PLC is not running or not connected.

Error: 7101 Communication error occur during transform

When CC-Link board is installed to the Controller, it is recognized automatically. Confirm whether EPSON RC+ 5.0 has recognized the CC-Link board using the following procedure.

- (1) Select EPSON RC+ 5.0 menu-[Setup]-[Controller] to display the [Setup Controller] dialog.

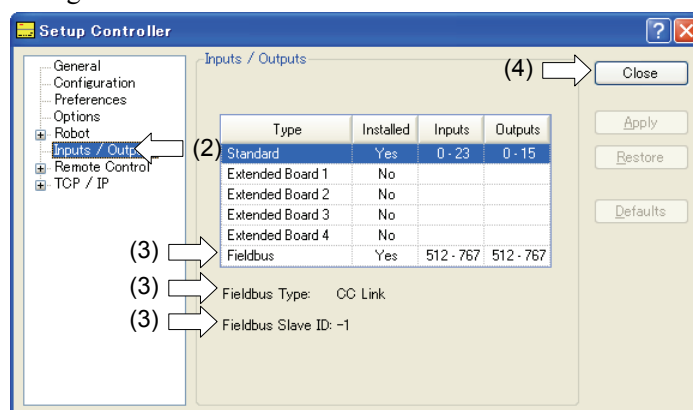

- (2) Select [Inputs / Outputs].
- (3) Make sure that the following are displayed.
 Fieldbus-Installed : Yes
 Fieldbus Type : CC Link
- (4) Click the <Close> button.



For CC-Link, station address cannot be confirmed. “-1” is displayed.

Operation (CC-Link)

When CC-Link is installed, some operation differs from the other Fieldbus I/O options. This section indicates how to operate.

Remote Input

Remote input (RX) and remote output (RY) indicates ON/OFF information. Remote data is bit data and the FROM/TO command is executed per 16 bits (1 word).

“n” in the following tables is address configured as a master station with the station configure. This is calculated by the following expression.

$$n = (\text{Station} - 1) \times 2$$

Result of the calculation is in decimal number. Substitute the result to “n” after converting to hexadecimal number.

(Example)

When CC-Link board station is 1

Remote Input RXn0 to RX(n+5)F → RX00 to RX5F

Remote Output RYn0 to RY(n+5)F → RY00 to RY5F

When CC-Link board station is 4

Remote Input RXn0 to RX(n+5)F → RX60 to RXAF

Remote Output RYn0 to RY(n+5)F → RY60 to RYAF

Remote Input List (3 stations occupied, Default configuration *1)

Signal direction : Remote device station (CC-Link board) → Master station (PLC)

Bits indicated as “NA” are left for user. Use these free for SPEL+ program.

Address	Signal Name		Controller Bit No
RXn0	Ready	*1	512
RXn1	Start	*1	513
RXn2	Pause	*1	514
RXn3	Error	*1	515
RXn4	EStopOn	*1	516
RXn5	SafeguardOn	*1	517
RXn6	SError	*1	518
RXn7	Waning	*1	519
RXn8	MotorOn	*1	520
RXn9	Home	*1	521
RXnA	CurrProg1	*1	522
RXnB	CurrProg2	*1	523
RXnC	CurrProg4	*1	524
RXnD	AutoMode	*1	525
RXnE	TeachMode	*1	526
RXnF	ErrorCode1	*1	527
RX(n+1)0	ErrorCode2	*1	528
RX(n+1)1	ErrorCode4	*1	529
RX(n+1)2	ErrorCode8	*1	530
RX(n+1)3	ErrorCode16	*1	531
RX(n+1)4	ErrorCode32	*1	532
RX(n+1)5	ErrorCode64	*1	533
RX(n+1)6	ErrorCode128	*1	534
RX(n+1)7	ErrorCode256	*1	535
RX(n+1)8	ErrorCode512	*1	536
RX(n+1)9	ErrorCode1024	*1	537
RX(n+1)A	ErrorCode2048	*1	538
RX(n+1)B	ErrorCode4096	*1	539
RX(n+1)C	ErrorCode8192	*1	540
RX(n+1)D	NA		541
RX(n+1)E	NA		542
RX(n+1)F	NA		543
RX(n+2)0	NA		544
:	:		
RX(n+4)F	NA		591
RX(n+5)0	System reservation		592
RX(n+5)1	System reservation		593
RX(n+5)2	System reservation		594
RX(n+5)3	System reservation		595
RX(n+5)4	System reservation		596
RX(n+5)5	System reservation		597
RX(n+5)6	System reservation		598
RX(n+5)7	System reservation		599
RX(n+5)8	Initial data processing request flag	*2	600
RX(n+5)9	Initial data configuration complete flag	*2	601
RX(n+5)A	Error status flag	*2	602
RX(n+5)B	Remote Ready	*2	603
RX(n+5)C	System reservation		604
RX(n+5)D	System reservation		605
RX(n+5)E	System reservation		606
RX(n+5)F	System reservation		607

*1 I/O assignment can be changed or invalid (NA). For details, refer to *EPSON RC+ 5.0 User's Guide 10. Remote Control*.

*2 For details, refer to the *CC-Link flag operation* section.

Remote Output List (3 stations occupied, Default configuration *1)

Signal direction : Master station (PLC) → Remote device station (CC-Link board)

Bits indicated as “NA” are left for user. Use these free for SPEL+ program.

Address	Signal Name		Controller Bit No
RYn0	Start	*1	512
RYn1	SelProg1	*1	513
RYn2	SelProg2	*1	514
RYn3	SelProg4	*1	515
RYn4	Stop	*1	516
RYn5	Pause	*1	517
RYn6	Continue	*1	518
RYn7	Reset	*1	519
RYn8	SetMotorOn	*1	520
RYn9	SetMotorOff	*1	521
RYnA	Home	*1	522
RYnB	NA		523
RYnC	NA		524
RYnD	NA		525
RYnE	NA		526
RYnF	NA		527
RY(n+1)0	NA		528
:	:		
RY(n+4)F	NA		591
RY(n+5)0	System reservation		592
RY(n+5)1	System reservation		593
RY(n+5)2	System reservation		594
RY(n+5)3	System reservation		595
RY(n+5)4	System reservation		596
RY(n+5)5	System reservation		597
RY(n+5)6	System reservation		598
RY(n+5)7	System reservation		599
RY(n+5)8	Initial data processing complete flag	*2	600
RY(n+5)9	Initial data configuration request flag	*2	601
RY(n+5)A	Error reset request flag	*2	602
RY(n+5)B	System reservation		603
RY(n+5)C	System reservation		604
RY(n+5)D	System reservation		605
RY(n+5)E	System reservation		606
RY(n+5)F	System reservation		607

*1 I/O assignment can be changed or invalid (NA). For details, refer to *EPSON RC+ 5.0 User's Guide 10. Remote Control*.

*2 For details, refer to the *CC-Link flag operation* section.

Remote Register

Remote register (RW_r, RW_w) is numeric value

“m” indicated in the following tables are master station address configured with station configure. This is calculated by the following expression.

$$m = (\text{Station} - 1) \times 4$$

Result of the calculation is in decimal number. Substitute the result to “m” after converting to hexadecimal number.

(Example)

When the CC-Link board is 1

Remote Register RW_{rm} to RW_{rm}+B → RW_r0 to RW_rB

Remote Register RW_{wm} to RW_{wm}+B → RW_w0 to RW_wB

When the CC-Link board is 4

Remote Register RW_{rm} to RW_{rm}+B → RW_rC to RW_r17

Remote Register RW_{wm} to RW_{wm}+B → RW_wC to RW_w17

Remote Register List (3 stations occupied, Default configuration *1)

Signal direction : Remote device station (CC-Link board) → Master station (PLC)

Bits indicated as “NA” are left for user. Use these free for SPEL+ program.

Address	Signal Name	Controller Word No	Controller Bit No
RW _{rm}	NA	38	608 to 623
:	:		
RW _{rm} +9	NA	47	752 to 767
RW _{rm} +A	System reservation	-	-
RW _{rm} +B	System reservation	-	-

Signal direction : Master station (PLC) → Remote device station (CC-Link board)

Bits indicated as “NA” are left for user. Use these free for SPEL+ program.

Address	Signal Name	Controller Word No	Controller Bit No
RW _{wm}	NA	38	608 to 623
:	:		
RW _{wm} +9	NA	47	752 to 767
RW _{wm} +A	System reservation	-	-
RW _{wm} +B	System reservation	-	-

CC-Link Flag Operation

Flag operation of the remote output is describes in this section.

Initial Request Process after Power Supply

Initial request process is executed from the remote device station (CC-Link board).

After turning ON the Controller, the initial data processing request flag [RX(n+5)8] will be ON by completing the CC-Link board initialization. Set the initial data processing complete flag [RY(n+5)8] ON.

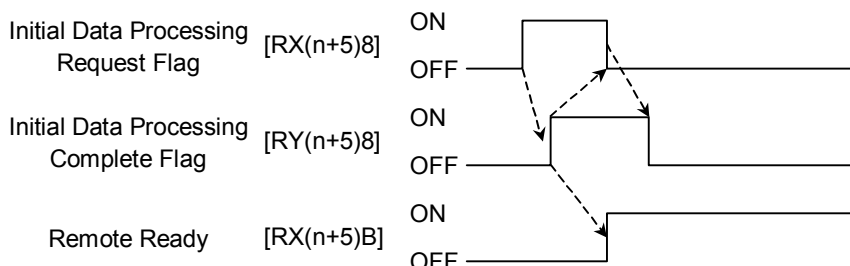

Initial Processing Request from the Master (PLC)

This is an initial configure request for the CC-Link board. No processing is required for no initial data.

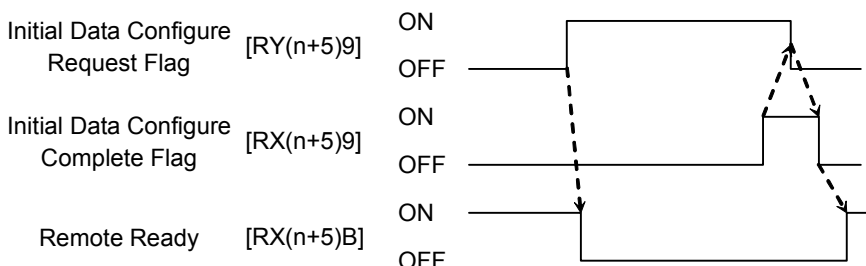

Error Flag, Error Reset Process

Error status flag [RX(n+5)A] turns ON at master error or configure error.

When error reset request flag [RY(n+5)A] turns ON at error occurrence, [RX(n+5)A] turns OFF at status that enables error status clear.

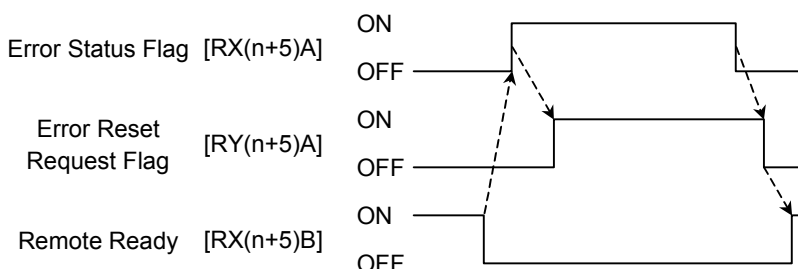

NOTE

When CC-Link error occurs (when error status flag is ON), the Controller status changes to the error status. Reset the error status of the Controller after the error reset process indicated above is completed.

When an error occurred at the Robot or the program, the error flag indicated above does not turn ON.

Electronic Information File (CSP file)

A CSP file is supplied for CC-Link network configuration. The file is located in the following folder in the Manual Update CD that is attached to the Robot Controller.

`\EpsonRC50\Fieldbus\CCLink`

12.3.7 EtherNet/IP

	<p>■ Make sure that the power is turned OFF before installing/removing any boards or connecting/disconnecting any cables. Installing/removing any boards or connecting/disconnecting any cables with the power ON is extremely hazardous and may result in electric shock and/or malfunction of equipment.</p>
---	--

Overview of EtherNet/IP

EtherNet/IP is a fieldbus network that provides easy interconnection between control devices (PLC, PC, sensor, actuator, etc.).

EtherNet/IP was developed by Allen-Bradley as an open communication standard to connect various field devices (sensor, actuator, robot controller, etc.). Because of the open communication standard, EtherNet/IP users can easily construct a multi-vendor system with various devices developed around the world.

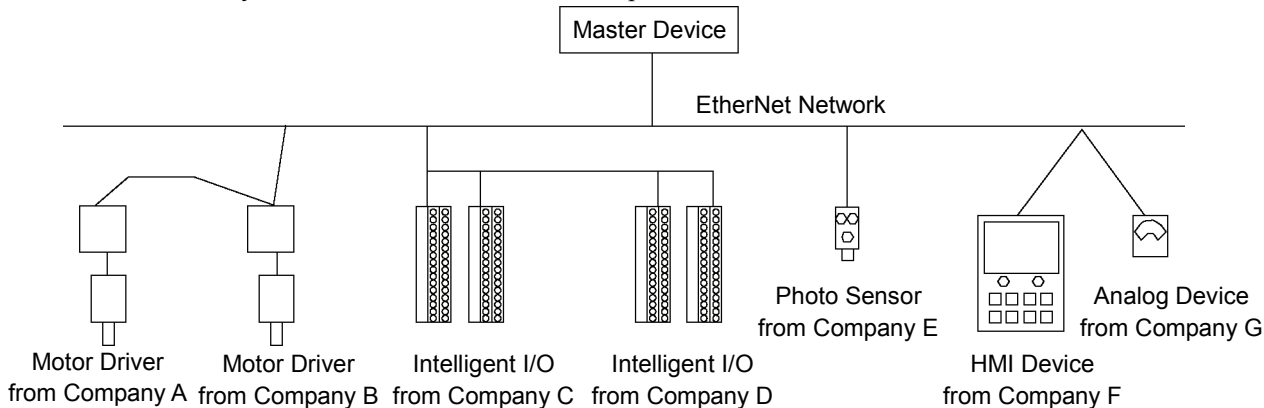

EtherNet/IP Communication Specifications

Item	Specification
Name	EtherNet/IP board
Code	R12B040719
Supported Connection	I/O messaging connection (Cyclic), Explicit message connection EtherNet/IP communication protocol
Baud Rates	10 M, 100 M (bps)
Transfer Distance	Standard Ethernet protocol
Cable	Standard Ethernet protocol
Mode	Slave
Interface	1 EtherNet/IP port
Connection type	Cyclic
Explicit message connection	Supported
Input data size	256 bits (32 bytes)
Output data size	256 bits (32 bytes)

EtherNet/IP Appearance

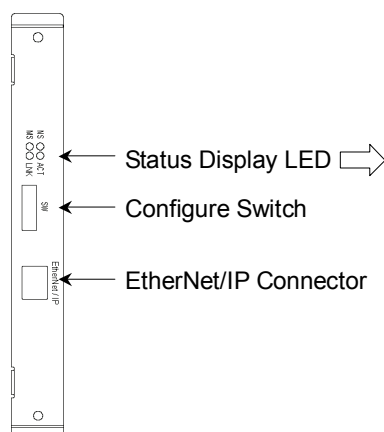

- MS LED : Module status display
- NS LED : Network status display
- LNK LED : Link status display
- ACT LED : Communication packet reception or transmission status display

Refer to the following table for functions of LEDs.

LED Description of EtherNet/IP

LED status		MS	NS
OFF		Power supply OFF	Power supply OFF or IP address not configured
GRN	ON	Master connected (executing)	Online operating
	Blinking	Master connected (idling)	Waiting master connection
RED	ON	Non-recoverable error	Wrong IP address (duplication)
	Blinking	Non-recoverable error	Connection time out
GRN/RED alternate		Self-diagnosing	Self-diagnosing

LED status		LNK	ACT
OFF		No link	No communication packet reception or transmission
ON		Linking	Communication packet reception or transmission

Board Installation of EtherNet/IP

Set all EtherNet/IP board configure switches OFF. If all EtherNet/IP board configure switches are not OFF, reset error occurs.

All the EtherNet/IP communication configurations are set by the development software (EPSON RC+ 5.0).

Wiring (EtherNet/IP)

Use a standard Ethernet connector for wiring to the board.

 CAUTION	<ul style="list-style-type: none"> ■ You can use the general Ethernet hub or Ethernet switch for the EtherNet/IP. However, be sure to use a product complying with the industrial standards or noise resistant Ethernet cable (STP cable). If you use an office use product or UTP cable, it may cause communication errors and may not offer the proper performance.
--------------------	--

EtherNet/IP Confirmation and Configuration with EPSON RC+ 5.0

When EtherNet/IP board is installed to the Controller, it is recognized automatically. Confirm whether the EPSON RC+ 5.0 has recognized the EtherNet/IP board by the following procedure.

- (1) Select EPSON RC+ 5.0 menu-[Setup]-[Controller] to display the [Setup Controller] dialog.

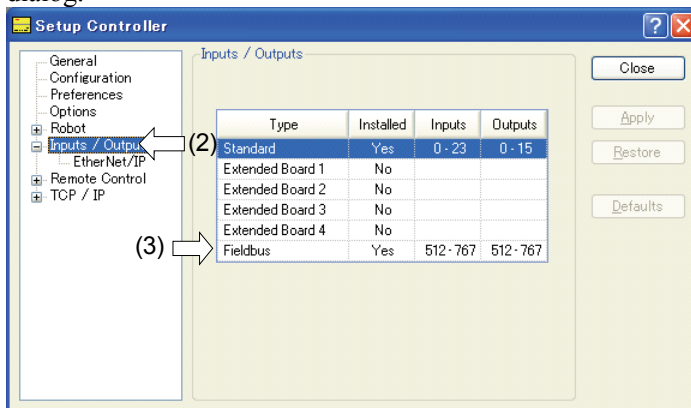

- (2) Select the [Inputs / Outputs].
- (3) Make sure that following is displayed.

Fieldbus-Installed : Yes

- (4) Click the “+” displayed on the left of [Input / Output] and select the [General].

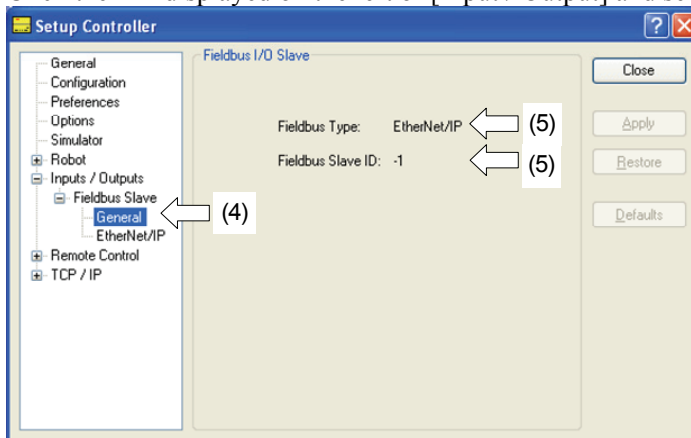

- (5) Make sure that following are displayed.

Fieldbus type : EtherNet/IP

Fieldbus station ID : -1 (Fixed)

- (6) Click the “+” displayed on the left of [Input / Output] and select the [EtherNet/IP].

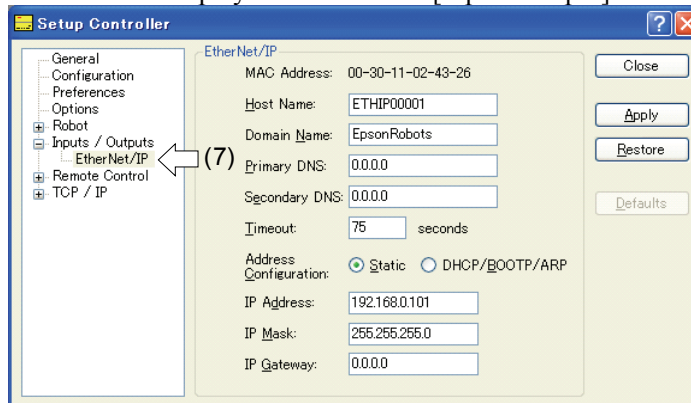

- (7) Set each item to the specific value to connect the Ethernet network.
For information about the setting values, contact your network administrator.
Address Configuration is set to “DHCP/BOOTP/ARP” at shipment.
- (8) When the configuration is completed, click the <Apply> button to apply the setting.
- (9) Click the <Close> button.



When Address Configuration is set to “DHCP/BOOTP/ARP”, the Controller waits for DHCP/BOOTP/ARP sever response for 30 seconds at Controller startup. When DHCP/BOOTP/ARP does not response within a time, the Controller stops the request to the DHCP/BOOTP/ARP server and waits ARP.

Operation

For details, refer to *12.3.9 Operation*.

Electronic Information File (EDS file)

An EDS file is supplied for EtherNet/IP network configuration. The file is located in the following folder in the Manual Update CD that is attached to the Robot Controller.

\EpsonRC50\Fieldbus\EtherNet/IP

12.3.8 PROFINET

	<p>■ Make sure that the power is turned OFF before installing/removing any boards or connecting/disconnecting any cables. Installing/removing any boards or connecting/disconnecting any cables with the power ON is extremely hazardous and may result in electric shock and/or malfunction of equipment.</p>
---	--

Overview of PROFINET

PROFINET is a fieldbus network using industrial Ethernet. PROFINET was developed as an open communication standard to connect various field devices (sensor, actuator, robot controller, etc.). Because of the open communication standard, PROFIBUS DP can easily construct multi-vendor system with various devices developed around the world.

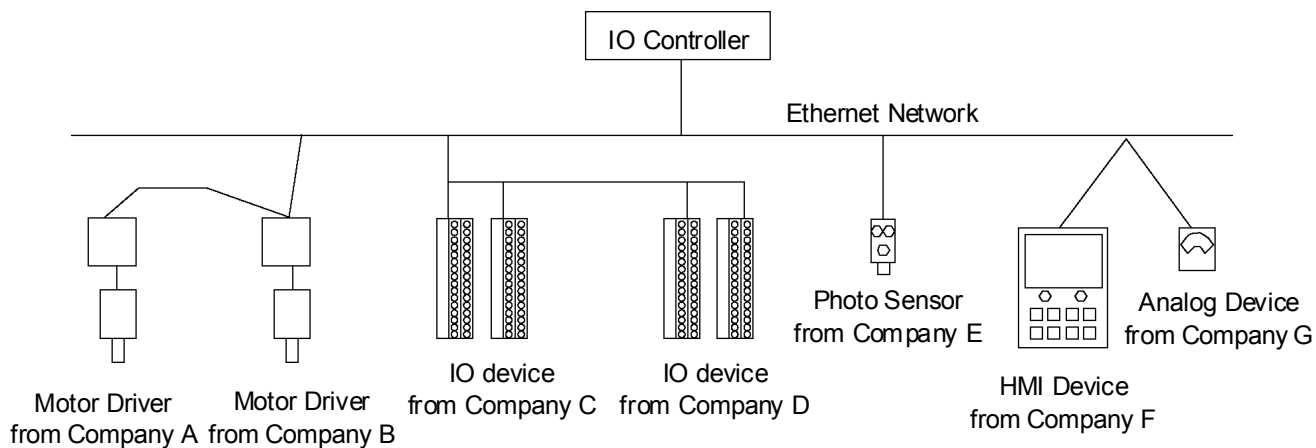

PROFINET Specifications

Item	Specification
Name	PROFINET board
Code	R12B040707
Connection Method	RT (Real-Time)
Protocol	PROFINET IO
Device type	IO device
Baud Rates (bps)	100 M bps, full duplex
Maximum segment length	100 m
Cable	RJ45 with connector 100BASE-TX (Cat5)
Cycle time	2 msec
Interface	RJ45 port × 1
Input Data Size	256 bits (32 bytes)
Output Data Size	256 bits (32 bytes)

PROFINET Appearance

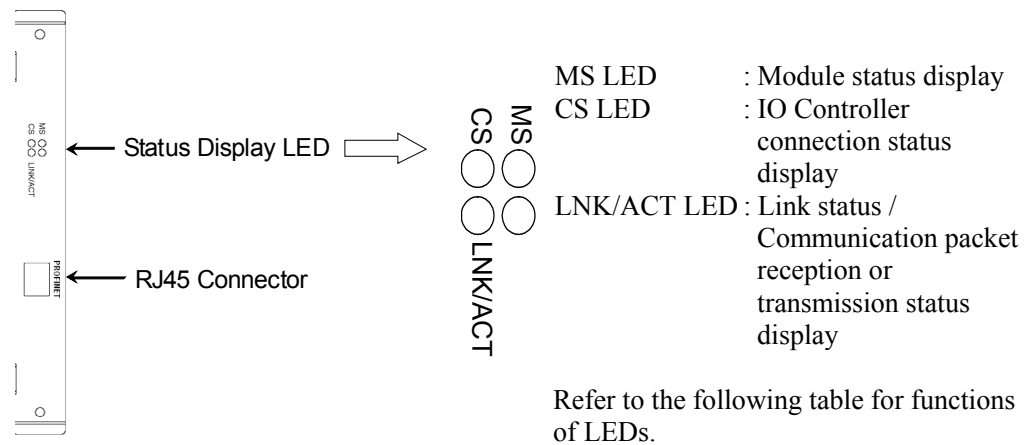

LED Description of PROFINET

LED status represents the status of the fieldbus board.

LED status		MS	CS	LNK/ACT
OFF		Power OFF or Device is being initialized	Offline	No link or Power OFF
GRN	ON	Normal operation	Offline IO controller is in RUN	Linking
	Blinking	-	-	Receiving/transmitting communication packet
	Blinking once	Evaluating	Offline / IO controller is in STOP	-
RED	Blinking	Blinking once	-	-
		Blinking 3 times	No station name has been set or No IP address has been set	-
		Blinking 4 times	Internal error	-

Board Configuration (PROFINET)

PROFINET settings such as the communication setting are all configured by the development software (EPSON RC+ 5.0). You don't need to configure anything about PROFINET board.

Wiring (PROFINET)

PROFINET connector is RJ45 connector.

Use cable 100 BASE-TX (STP type).

 CAUTION	<ul style="list-style-type: none"> Be sure to use cables and connectors complying with the industrial standards or noise resistant Ethernet cable (STP cable). If you use an office use product or UTP cable, it may cause communication errors and may not offer the proper performance.
---	--

PROFINET Confirmation with EPSON RC+ 5.0

When PROFINET board is installed in the controller, it is recognized automatically. Confirm that EPSON RC+ 5.0 has recognized the board in the following procedure.

- (1) Select EPSON RC+ 5.0 menu-[Setup]-[Controller] to display the [Setup Controller] dialog.

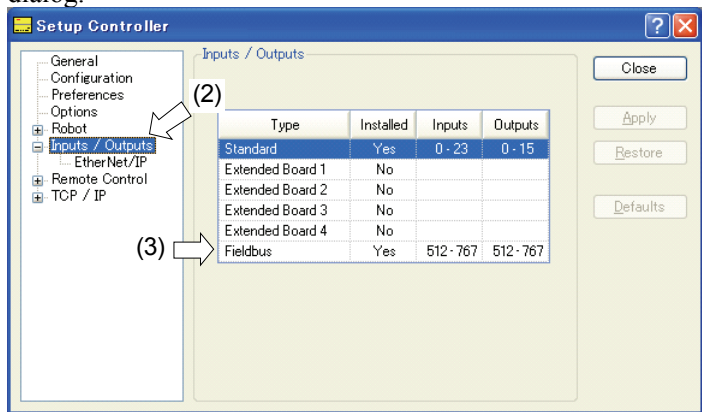

- (2) Select the [Inputs / Outputs].
- (3) Make sure that following is displayed.
Fieldbus : Yes

- (4) Click the “+” displayed on the left of [Input / Output] and select the [General].

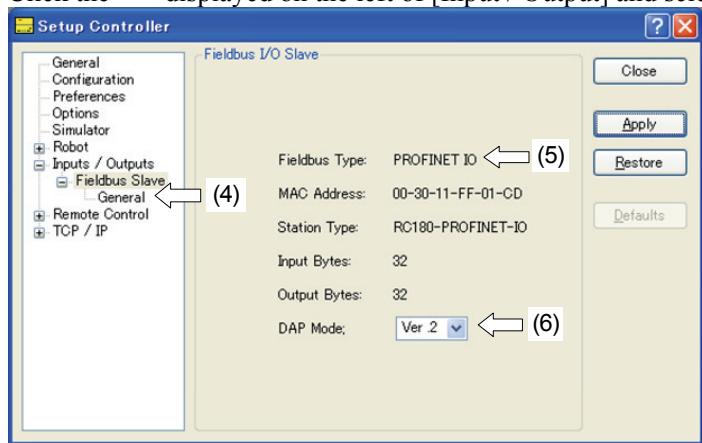

- (5) Make sure that following is displayed.
Fieldbus Type : PROFINET IO

- (6) Set the [MAC Address] according to the PROFINET IO controller that uses the DAP mode.

Usually, select DAP Ver.2. DAP Ver.1 is available for the obsolete PROFINET IO controller.

NOTE

The PROFINET option does not have the alert function that is an optional function in DAP Ver.2.

- (7) When the configuration is completed, click the <Apply> button and apply the settings.
- (8) Click the <Close> button.

Operation

For details, refer to *12.3.9 Operation*.

Electronic Information File (GSDML file)

A GSDML file is supplied for PROFINET network configuration. The file is located in the following folder in the Manual Update CD that is attached to the Robot Controller.

\EpsonRC50\Fieldbus\PROFINET

12.3.9 Operation (DeviceNet, PROFIBUS-DP, EtherNet/IP, PROFINET)

This section indicates how to use the Fieldbus I/O option after it has been installed.
For details of CC-Link, also refer to *12.3.5 CC-Link – Operation (CC-Link)*.

SPEL+ Fieldbus I/O Commands

All the commands for the Fieldbus I/O are the same as the standard I/O.

Bit numbers differ from standard I/O. There is no restriction for command use.

Typical I/O commands are listed in the following table.

For command details, refer to EPSON RC+ 5.0 *Online Help* or *SPEL+ Language Reference*.

Command	Function
In	Returns the status of the specified 8 bits input port.
InW	Returns the status of the specified 16 bits input port.
Off	Turns Off the specified output.
On	Turns On the specified output.
Out	Simultaneously sets 8 output bits.
OutW	Simultaneously sets 16 output bits.
Sw	Returns the specified input port status.
Wait	Waits until the specified input condition.

NOTE



Response times for Fieldbus I/O can vary and depend on several factors, including baud rate, scan rate, number and types of devices, communication error, etc.

Outputs Off by Emergency Stop and Reset Instruction

You can configure the controller system so that all outputs including the fieldbus outputs will be turned off when the emergency stop occurs and when a Reset instruction is executed.

For details of the configuration, refer to *[Setup]-[Controller]-[Preference]* in *EPSON RC+ 5.0 User's Guide 5.12.2 Controller command (Setup Menu)*.

NOTE



A command that was issued just before an emergency stop can be executed after the emergency stop condition is cleared. If the outputs from the fieldbus involve risk, check the [Outputs off during Emergency Stop] box to remove all power to output devices when an emergency stop occurs.

Remote I/O Configuration

You can configure the controller system so that all I/O including the fieldbus will be set to remote function.

I/O setup for Fieldbus I/O is the default configuration.

NOTE



Setup for the Remote I/O can be changed by signal. Configuration with bits of standard I/O, expansion I/O and Fieldbus I/O is available.

Input Signal	Bit No.
Start	512
Pause	513
Reset	514
SelProg1	515
SelProg2	516
SelProg4	517
Stop	518
Continue	519
MotorOn	520
MotorOff	521
Home	522

Output Signal	Bit No.	Output Signal	Bit No.
Ready	512	InsideBox1	NA
Start	513	InsideBox2	NA
Pause	514	InsideBox3	NA
Error	515	InsideBox4	NA
EStopOn	516	InsideBox5	NA
SafeguardOn	517	InsideBox6	NA
SError	518	InsideBox7	NA
Waning	519	InsideBox8	NA
MotorOn	520	InsideBox9	NA
Home	521	InsideBox10	NA
CurrProg1	522	InsideBox11	NA
CurrProg2	523	InsideBox12	NA
CurrProg4	524	InsideBox13	NA
AutoMode	525	InsideBox14	NA
TeachMode	526	InsideBox15	NA
ErrorCode1	527	InsidePlane1	NA
ErrorCode2	528	InsidePlane2	NA
ErrorCode4	529	InsidePlane3	NA
ErrorCode8	530	InsidePlane4	NA
ErrorCode16	531	InsidePlane5	NA
ErrorCode32	532	InsidePlane6	NA
ErrorCode64	533	InsidePlane7	NA
ErrorCode128	534	InsidePlane8	NA
ErrorCode256	535	InsidePlane9	NA
ErrorCode512	536	InsidePlane10	NA
ErrorCode1024	537	InsidePlane11	NA
ErrorCode2048	538	InsidePlane12	NA
ErrorCode4096	539	InsidePlane13	NA
ErrorCode8192	540	InsidePlane14	NA
		InsidePlane15	NA

Explicit Message Connection (for DeviceNet, EtherNet/IP)

Issuing an Explicit message from DeviceNet / EtherNet/IP master unit to the RC180 controller acquires and configures the DeviceNet / EtherNet/IP I/O area.

Supported function and Class ID configurations are as follows:

When using Assembly Object Class (Class ID = 4)

Function	Class ID	Instance	Service Code
Input acquisition	4 (04h)	100 (64h)	14 (0Eh)
Output configuration	4 (04h)	150 (96h)	16 (10h)
Output acquisition	4 (04h)	150 (96h)	14 (0Eh)

When using I/O Data Mapping Object Class (Class ID = 160, 161)

Function	Class ID	Instance	Service Code
Input acquisition	160 (A0h)	01 (01h)	14 (0Eh)
Output configuration	161 (A1h)	01 (01h)	16 (10h)
Output acquisition	161 (A1h)	01 (01h)	14 (0Eh)

Command response

It can acquire 32 bytes input/output data.

12.4 RS-232C Board**12.4.1 About the RS-232C Board**

A standard RS-232C port is not available with the Controller. An RS-232C option board must be added.

Mount the RS-232C board in the option unit to communicate with external equipment with RS-232C.

The RS-232C option accepts four ports expansion per board. A maximum of two boards, eight ports expansion is available for RS-232C board.

Port numbers are assigned as follows.

Port No.	Supported hardware
#1 to #4	First RS-232C board
#5 to #8	Second RS-232C board

12.4.2 Board Setup (RS-232C)

Board Appearance

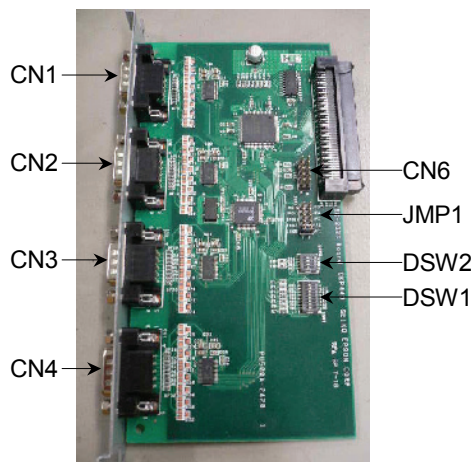

Switch and Jumper Configuration

Set DSW1, DSW2 and JMP1.

CN6 is all open.

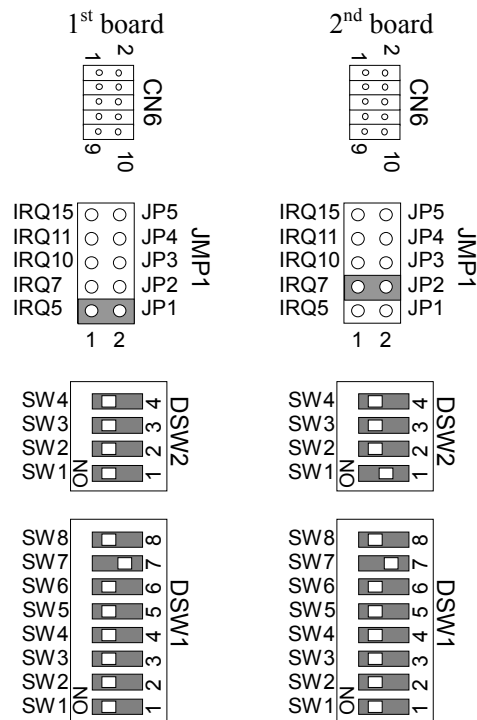

12.4.3 Verify with EPSON RC+ 5.0 (RS-232C)

When an RS-232C board is mounted in as option unit, the Controller software automatically identifies the RS-232C board. Therefore, no software configuration is needed. Correct identification can be confirmed from EPSON RC+ 5.0.

- (1) Select the EPSON RC+ 5.0 menu-[Setup]-[Controller] to display the [Setup Controller] dialog.
- (2) Select the [RS-232C].

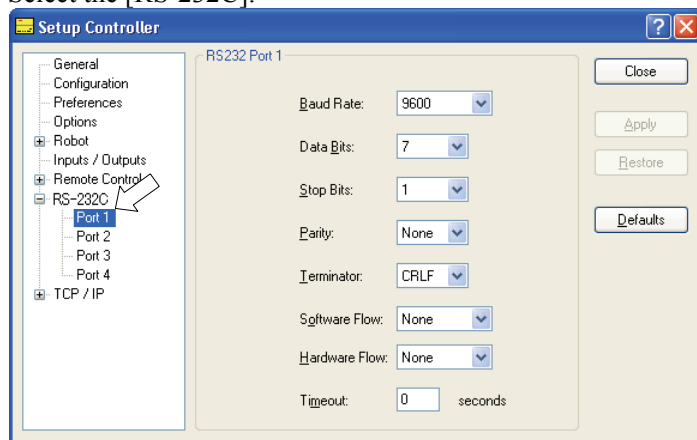

If no RS-232C board is identified, RS-232C will not be displayed. If RS-232C is displayed, then the Controller software identified the RS-232C board. Communication with external equipment is available.

12.4.4 RS-232C Software Communication Setup (RS-232C)

Available communication settings are as follows.

Item	Specification
Baud Rates	110, 300, 600, 1200, 2400, 4800, 9600, 14400, 19200, 38400, 57600, 115200
Data bit length	7, 8
Stop bit length	1, 2
Parity	Odd, even, NA
Terminator	CR, LF, CRLF

Refer to *EPSON RC+ 5.0 Online Help* or *11. RS-232C Communications* for RS-232C communication from the Robot application.

12.4.5 Communication Cable (RS-232C)

Prepare a communication cable as described in this section.

Connector	Standard
RS-232C Connector (Controller side)	D-sub 9 male pin Mounting style #4 - 40

NOTE

Use twisted pair cable for shielded wire.
Clamp the shield to the hood for noise prevention.

Pin assign of the RS-232C connector is as follows.

Pin No	Signal	Function	Signal Direction
1	DCD	Data carrier detect	Input
2	RXD	Receive data	Input
3	TXD	Send data	Output
4	DTR	Terminal ready	Output
5	GND	Signal ground	-
6	DSR	Data set ready	Input
7	RTS	Request to send	Output
8	CTS	Clear to send	Input
9	RI	Ring indicator	Input

Maintenance

This section contains maintenance procedures for the Robot Controller.

1. Safety Precautions on Maintenance

1.1 Safety Precautions

 <p>WARNING</p>	<ul style="list-style-type: none"> ■ Only authorized personnel who have taken the safety training should be allowed to execute teaching or calibration of the robot system. The safety training is the program for industrial robot operator that follows the laws and regulations of each nation. The personnel who have taken the safety training acquire knowledge of industrial robots (operations, teaching, etc.). The personnel who have completed the robot system-training class held by the manufacturer, dealer, or locally-incorporated company are allowed to maintain the robot system. ■ Only authorized personnel who have taken the safety training should be allowed to maintain the robot system. The safety training is the program for industrial robot operator that follows the laws and regulations of each nation. The personnel who have taken the safety training acquire knowledge of industrial robots (operations, teaching, etc.), knowledge of inspections, and knowledge of related rules/regulations. The personnel who have completed the robot system-training and maintenance-training classes held by the manufacturer, dealer, or locally-incorporated company are allowed to maintain the robot system. Make sure to use only dedicated/specified maintenance parts especially for the optional boards or any other parts in the Controller to be replaced. Using non-specified parts may cause serious damage to the robot system and/or serious safety problems. ■ Do not remove any parts that are not covered in this manual. Follow the maintenance procedure strictly as described in this manual. Do not proceed using any methods other than described in this manual when you do replace a part or maintain the equipment. Improper removal of parts or improper maintenance may cause not only improper function of the robot system but also serious safety problems.
--	---

 <p>WARNING</p>	<ul style="list-style-type: none"> ■ Before performing any maintenance procedure, always make sure that the main power of the Controller is turned OFF, unplug the power supply, and that the high voltage charged area is completely discharged. Performing any maintenance procedure while the main power is ON or the high voltage charged area isn't discharged completely is extremely hazardous and may result in electric shock and/or cause serious safety problems.
--	---

 CAUTION	<ul style="list-style-type: none"> ■ Do not touch the Motor Driver modules, Switching Power Supply, and Regeneration Module directly in the Controller. The metal resistance of these can become very hot and may result in a burn. If you maintain them, examine the surface temperatures and wear protective gloves if necessary. ■ Do not shock, shake, or drop any parts during maintenance. When the parts related with data are shocked physically, they may be damaged and may also cause data loss during data loading/saving. ■ Do not lose the screws removed at maintenance. When the screw is dropped into the Controller, be sure to take it out. Leaving the screw in the Controller may cause short circuit and may result in equipment damage to the parts and/or robot system. ■ Make sure that the power rating (wattage) of a new Motor Driver module is correct. Using a Motor Driver module with improper power rating (wattage) in the Controller may cause improper function of the robot system and errors. ■ The serial number of the Manipulator that should be connected is indicated on the Connection Check Label on the Controller. Connect the Controller and the Manipulator correctly. Improper connection between the Controller and the Manipulator may cause not only improper function of the robot system but also serious safety problems.
--	--

NOTE  Before performing maintenance on the Controller, all the data must be copied as a backup. The details of data backup/restore are described in the *Maintenance 4. Backup and Restore*.

1.2 Lockout / Tagout

Lockout / tagout is a method to prevent any one from turning ON the robot system by mistake while someone else is within the safeguarded area for maintenance or repair. When performing maintenance and repair, lockout and tagout using the following procedure.

- (1) Turn OFF the POWER switch.
- (2) Secure the POWER switch mounting metal hasp in the POWER switch OFF position with screws.

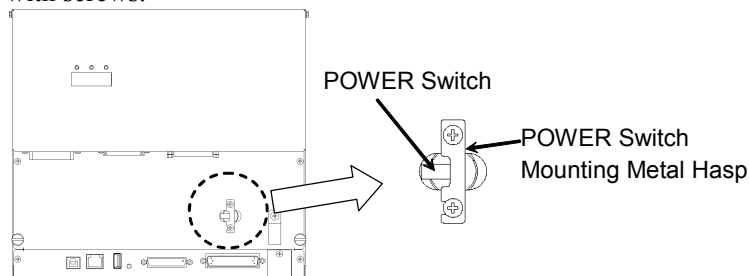

- (3) Unplug the power supply plug of the Controller from the power supply socket.
- (4) Attach a note to the POWER switch or the power supply plug to prevent any one from turning ON the robot system by mistake.

RC180-UL:

For maintenance and repair, make sure to lockout and tagout the external disconnecting means.

2. Regular Maintenance Inspection

Performing regular maintenance inspection properly is essential for preventing trouble and maintaining safety. This chapter describes the schedules for maintenance inspection and procedures.

Be sure to perform the maintenance inspections in accordance with the schedules.

2.1 Schedule for Maintenance Inspection

Inspection points are divided into five stages: daily, monthly, quarterly, biannual, and annual. Inspection points are added at every stage.

If the robot system is operated for 250 hours or more per month, inspection points must be added every 250 hours, 750 hours, 1500 hours, and 3000 hours operation.

	Inspection Point				
	Daily inspection	Monthly inspection	Quarterly inspection	Biannual inspection	Annual inspection
1 month (250 h)	Inspect every day	✓			
2 months (500 h)		✓			
3 months (750 h)		✓	✓		
4 months (1000 h)		✓			
5 months (1250 h)		✓			
6 months (1500 h)		✓	✓	✓	
7 months (1750 h)		✓			
8 months (2000 h)		✓			
9 months (2250 h)		✓	✓		
10 months (2500 h)		✓			
11 months (2750 h)		✓			
12 months (3000 h)		✓	✓	✓	✓
13 months (3250 h)		✓			
⋮	⋮	⋮	⋮	⋮	⋮

2.2 Inspection Point

2.2.1 Inspection While the Controller is Turned OFF

Inspection Point	Inspection Location	Daily	Monthly	Quarterly	Biannual	Annual
Visually check for external defects. Clean up if necessary.	External appearance of Controller	✓	✓	✓	✓	✓
Clean the fan filter	Fan filter on the side of the Controller		✓	✓	✓	✓
Battery	Front side	Ever 5 years				

2.2.2 Inspection While the Controller is Turned ON

Inspection Point	Inspection Location	Daily	Monthly	Quarterly	Biannual	Annual
Check whether unusual sound or vibration is occurring.	Entire Controller	✓	✓	✓	✓	✓
Make a backup of data.	Project and system data	Whenever data is changed.				

3. Controller Structure

3.1 Location of Parts

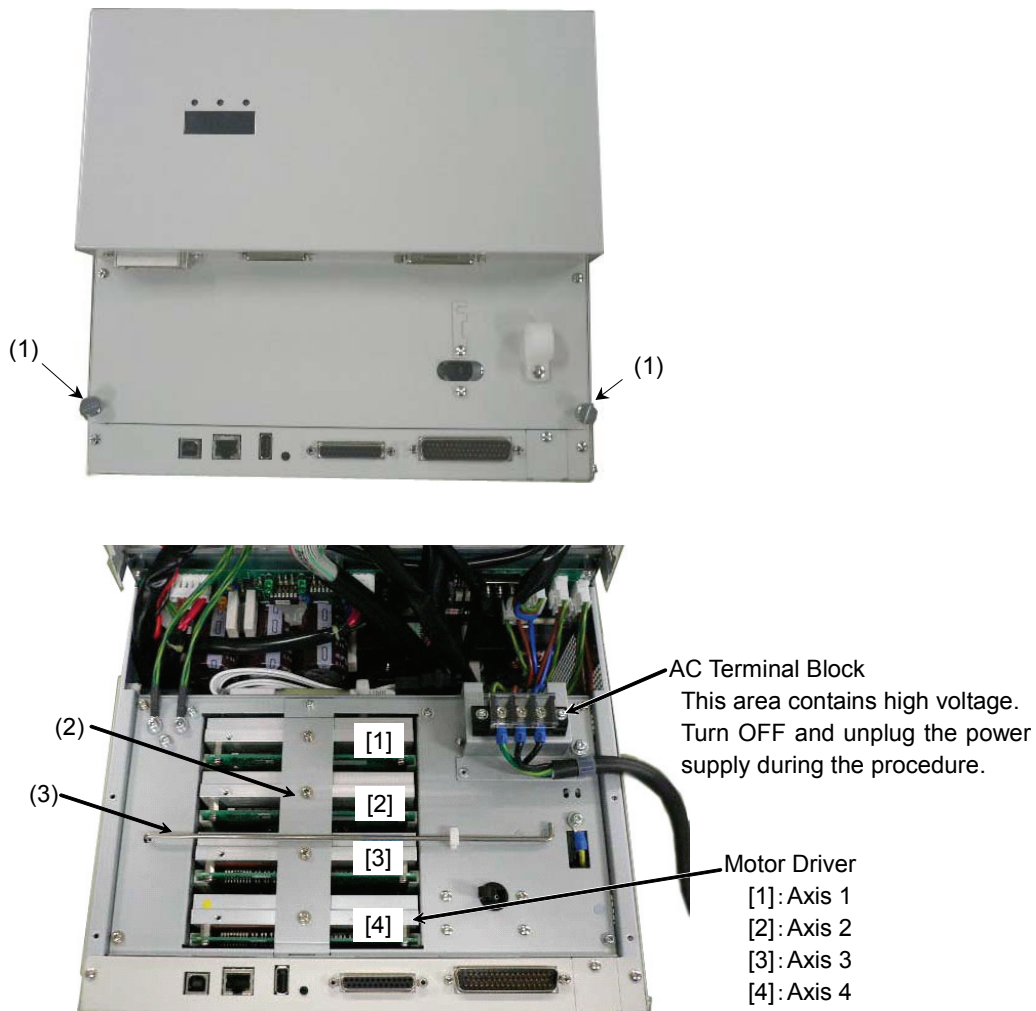

(1) Thumb Head screws

These are two of the four screws used to mount the front cover of the Controller. These screws are also used to pull out the Motor Driver module and CPU board unit.

(2) Motor Driver Mounting Bracket

This is a bracket is used to secure the four motor drives. Make sure that each Motor Driver is connected properly and then mount the bracket. Improper connection may cause not only improper function of the robot system but also safety problems.

(3) Front Side Supporting Bar

This supporting bar is used to hold the front cover open. Make sure that the supporting bar is in the proper position.

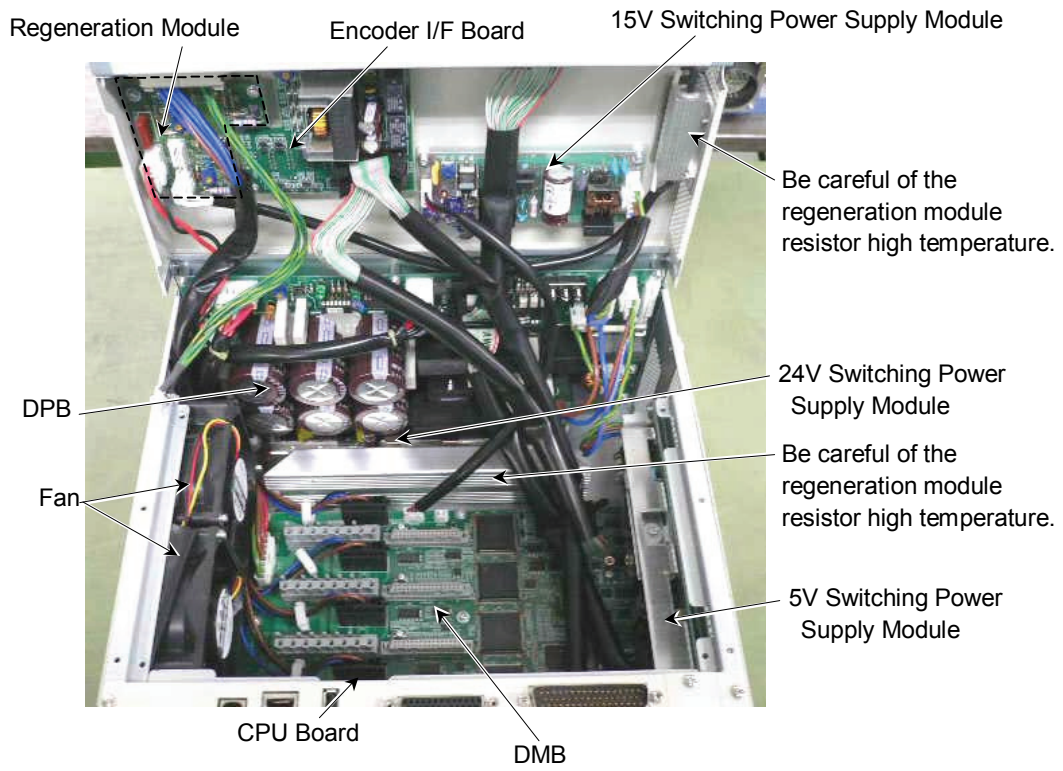

3.2 Diagram of Cable Connections

For the electrical connections of the Controller, refer to the following diagram.

RC180

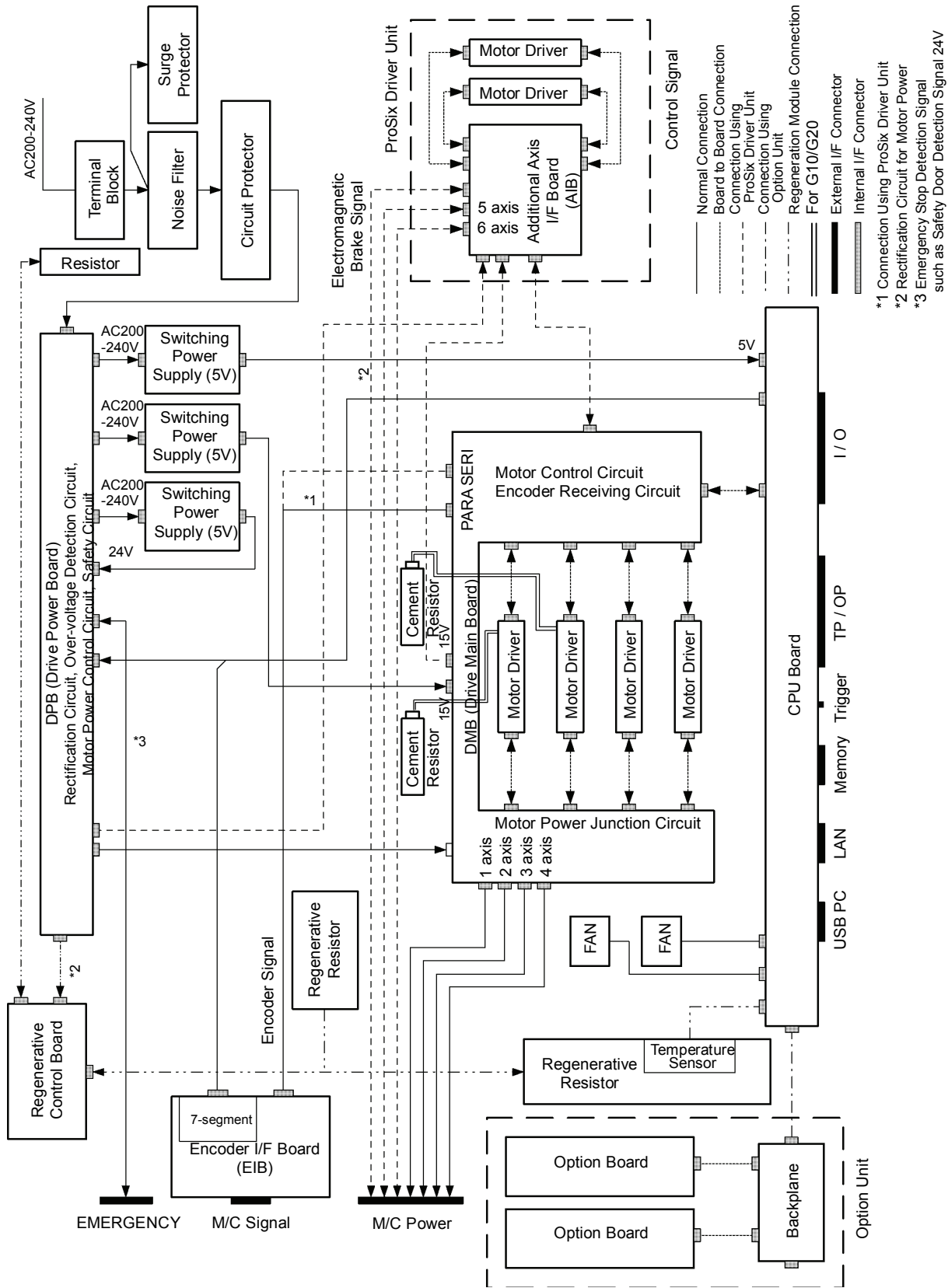

Cable Layout Drawing







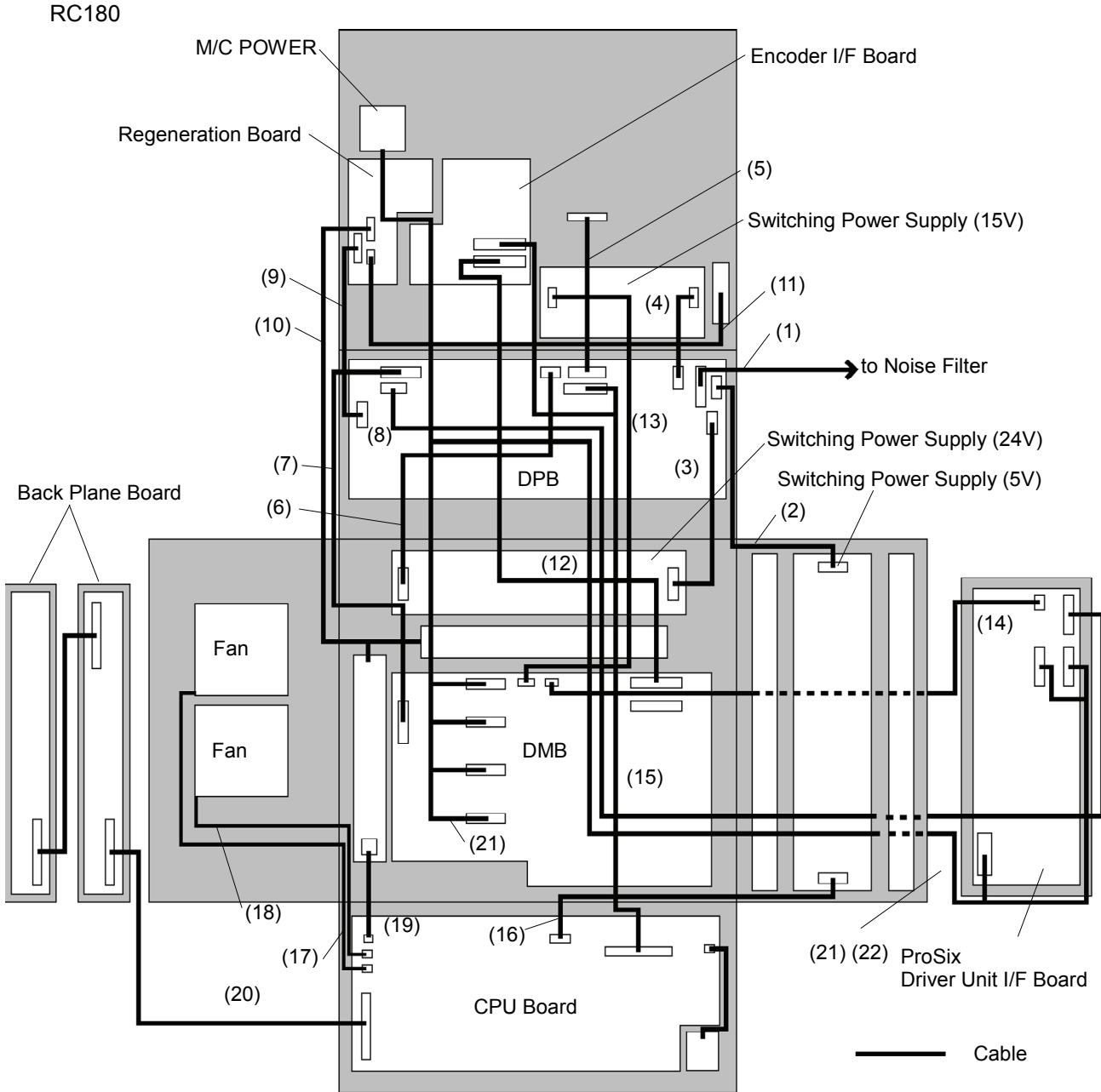











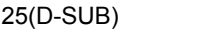



For cable connections inside the Controller, refer to the following figure.

This diagram is a simplified development view inside the Controller.

The numbers indicated such as (1), (2), (3) correspond to the following cable list.



RC180 Cable List

Cable No.	Connection	Connector Pin Quantity	Wire Quantity	Connector Pin Quantity	Connection	Note
(1)	DPB	8 	6	–	Noise Filter	
(2)	DPB	5 	3	5 	Switching Power Supply (5V)	
(3)	DPB	5 	3	5 	Switching Power Supply (24V)	
(4)	DPB	5 	3	5 	Switching Power Supply (15V)	
(5)	DPB	26	26<F>	25(D-SUB)	EMERGENCY	
(6)	DPB	4 	4	8 	Switching Power Supply (24V)	
(7)	DPB	8 	6	8 	DMB	
(8)	DPB	5 	3	5 	ProSix Driver Unit I/F Board	*1
(9)	DPB	5 	2	5 	Regeneration Board	
(10)	Regeneration Board	4 	2	–	Regeneration Resistance	
(11)	Regeneration Board	3 	2	–	Resistance	
(12)	DMB	34	34<F>	34	Encoder I/F Board	
(13)	DMB	4 	4	4 	Switching Power Supply (15V)	
(14)	DMB	2 	2	2 	ProSix Driver Unit I/F Board	*1
(15)	CPU Board	50	34<F> 16<F>	34 16	DPB Encoder I/F Board	
(16)	CPU Board	4 	4	4 	Switching Power Supply (5V)	
(17)	CPU Board	3	3	–	Fan	
(18)	CPU Board	3	3	–	Fan	
(19)	CPU Board	2	2	–	Temperature Sensor	
(20)	CPU Board	80	80<F>	80	Back Plane Board	*3
(21)	M/C POWER	50	16	4,4,4,4	DMB	
(22)	M/C POWER	50	16 14	4,4,4,4 4,4,8	DMB ProSix Driver Unit I/F Board	*1

<F> Flat cable

*1 When connected to ProSix Driver unit

*3 When connected to Option unit

3.3 Connector Pin Assignment

Pin assignments differ depending on the manipulator type.

The following tables show the pin assignments for the M/C power connector and M/C signal connector for E2 series and PS series. For EMERGENCY and TP/OP connectors, refer to *Setup & Operation*.

3.3.1 M/C Power Connector

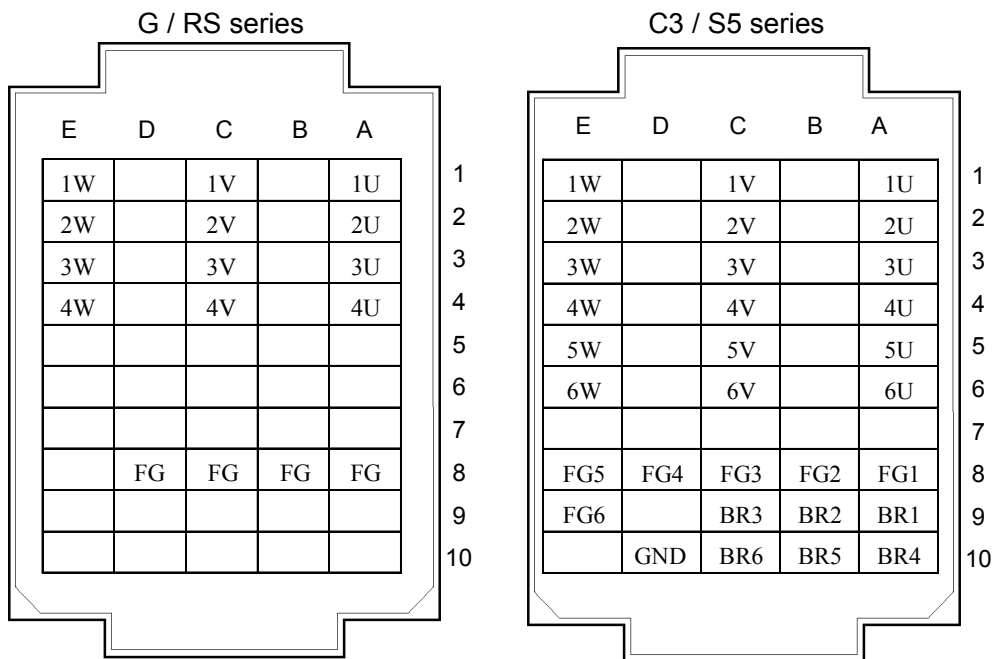

3.3.2 M/C Signal Connector

	G / RS	C3 / S5		G / RS	C3 / S5
1	-	-	26	ENC_GND	ENC_GND
2	1S+	1S+	27	1S-	1S-
3	2S+	2S+	28	2S-	2S-
4	3S+	3S+	29	3S-	3S-
5	ENC_5V	ENC_5V	30	-	EMC_PWR
6	ENC_GND	ENC_GND	31	-	ENC_GND
7	4S+	4S+	32	4S-	4S-
8	-	5S+	33	-	5S-
9	-	6S+	34	-	6S-
10	ENC_5V	ENC_5V	35	-	ENC_5V
11	ENC_GND	ENC_GND	36	-	ENC_GND
12	-	-	37	-	-
13	-	-	38	-	-
14	-	-	39	-	-
15	ENC_5V	ENC_5V	40	-	-
16	ENC_GND	ENC_GND	41	-	-
17	-	-	42	-	-
18	-	-	43	-	-
19	-	-	44	-	-
20	ENC_5V	ENC_5V	45	-	-
21	-	-	46	-	-
22	MPOWER	MPOWER	47	-	-
23	EMB_J3	-	48	-	-
24	-	-	49	24V	24V
25	-	24VGND	50	24VGND	24VGND

4. Backup and Restore

4.1 What is the Backup Controller Function?

The controller configuration set by EPSON RC+ 5.0 can be stored with the “Backup Controller” function.

The Controller settings can be restored easily using the data previously stored with “Backup Controller” after a configuration mistake or Controller problem.

Be sure to execute “Backup Controller” before changing the Controller setup, before maintenance, or after teaching.

For some problems, backup may not be available before maintenance has to be performed. Be sure to backup the data after making changes, before problems occur.



“Controller Status Storage” is one of the RC180 functions. It saves the Controller setup data the same as with “Backup Controller,” and additional data such as the Controller status.

These data can be used as the backup data at restoring.

The methods for “Controller Status Storage” are as follows:

- A : “Controller status storage to USB memory”
For details, refer to *Setup & Operation 6. Memory Port*.
- B : “Export Controller Status function” in EPSON RC+ 5.0.
For details, refer to *EPSON RC+ 5.0 User’s Guide 5.9.9 Import Command (Project Menu)*.

4.2 Backup Data Types

The table below shows the files created with “Backup Controller”.

File Name	Overview	
Backup.txt	Information file for restore	File including information for restoring the Controller.
CurrentMnp01.PRM	Robot parameters	Stores information such as TlSet.
InitFileSrc.txt	Initial configuration	Stores various Controller parameters.
MCSys01.MCD	Robot configuration	Stores connected Robot information.
All the files related to Project *	Project related	All the project files transferred to the Controller. Includes program files when EPSON RC+ 5.0 is configured to transfer source code to the Controller.
GlobalPreserves.dat *	Global Preserve variables	Saves values of Global Preserve variables.

* If the version of the Controller firmware is Ver.1.0.*.*, project related data and GlobalPreserves.dat are not stored.

4.3 Backup

Backup the Controller status from the Teach Pendant (Option) or EPSON RC+ 5.0.

4.3.1 Backup from EPSON RC+ 5.0

- (1) Select EPSON RC+ 5.0 menu-[Tools]-[Controller] to display the [Controller Tools] dialog.

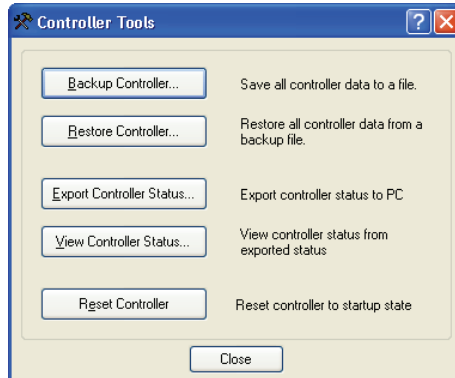

- (2) Click the <Backup Controller...> button to display the [Browse For Folder] dialog.

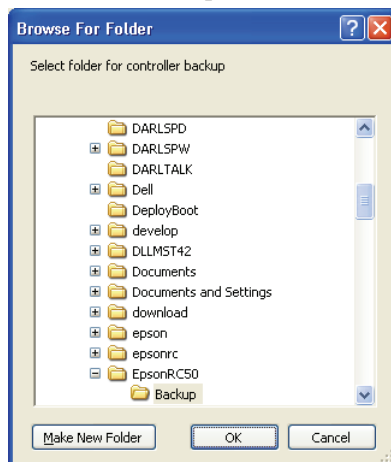

- (3) Specify the folder to save the backup data. Create a new folder if desired.
- (4) Click the <OK> button. A folder is created in the specified folder containing the backup data with a name in the following format.
B_ serial number_date status was saved
→ Example: B_12345_200608074410
- (5) The following message appears when backup is completed.

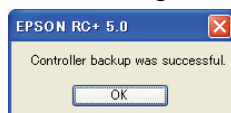

- (6) Click the <OK> button to complete the backup.



- Do not edit the backup files. Otherwise, operation of the robot system after data restoration to the Controller is not assured.

4.3.2 Backup from the Teach Pendant TP1 (Option)

Backs up system files in the Controller to USB memory. (Only TP1. TP2 does not support this function.)

- (1) Insert the USB memory into the Controller.
- (2) In the [Programming] screen, move the cursor to [System Backup...], and press the <OK> key. The following screen appears.

Enter the file name.

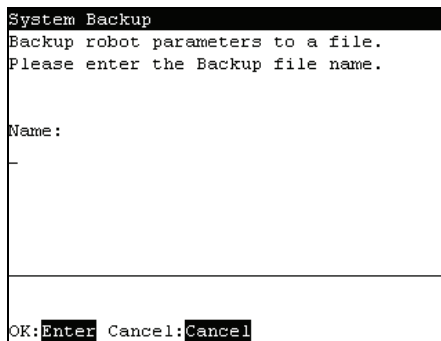

- (3) Press the <Enter> key. The following screen appears.

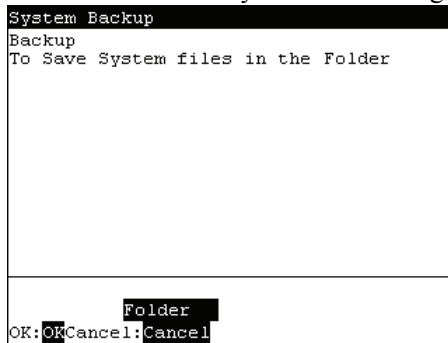

<OK> When the <OK> key is pressed without specifying a folder, the backup files are stored in a subfolder of the USB memory root folder.

- (4) Press the <F2> key. The following screen appears.

Specify the folder to save the backup data.

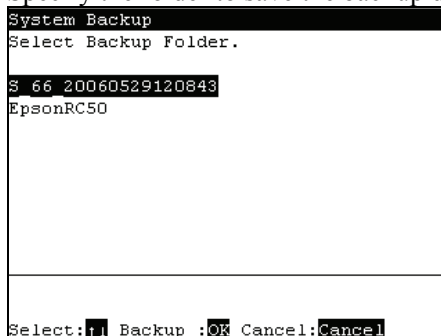

- (5) Press the <OK> key. The following screen appears.

```
System Backup
Backup
To Save System files in the Folder

Folder
OK:OKCancel:Cancel
```

- (6) Press the <OK> key to execute the system backup.

When a file of the same name already exists, the following screen appears.

```
System Backup
SYS
file already exist.
Overwrite?

Yes No
Cancel:Cancel
```

- <F1> Overwrites the file.
<F2> Moves to the [Programming] screen.

- (7) After execution has completed, the following screen appears.

```
System Backup

Backup completed successfully.

OK:OK
```



CAUTION

- Do not edit the backup files. Otherwise, operation of the robot system after data restoration to the Controller is not assured.

4.4 Restore

Restore the Controller status from the Teach Pendant (Option) or EPSON RC+ 5.0.

4.4.1 Restore from EPSON RC+ 5.0

 CAUTION	<ul style="list-style-type: none"> ■ Make sure that the data used for restore was saved previously for same Controller. ■ Do not edit the backup files. Otherwise, operation of the robot system after data restoration to the Controller is not assured.
---	---

- (1) Select the EPSON RC+ 5.0 menu-[Tools]-[Controller] to display the [Controller Tools] dialog.

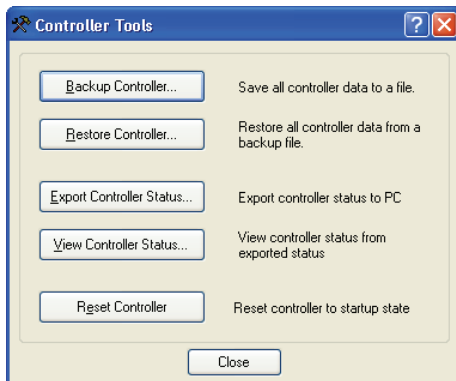

- (2) Click the <Restore Controller...> button to display the [Browse For Folder] dialog.

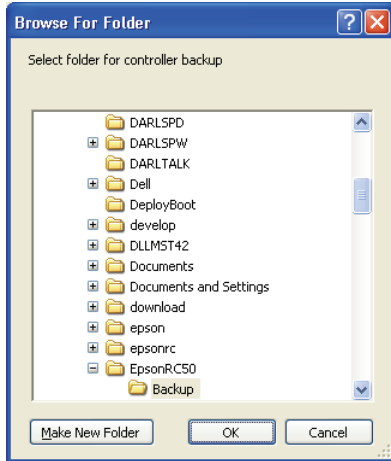

- (3) Specify the folder that contains the backup data. Backup data folders are named using the following format:

B_serial number_date status was saved
 → Example: B_12345_200608074410



Data saved with the Controller status storage function can also be specified for restore. Specify the following folder.

S_serial number_data status was saved
 → Example: S_12345_200608074410

- (4) Click the <OK> button to display the dialog to select the restore data.

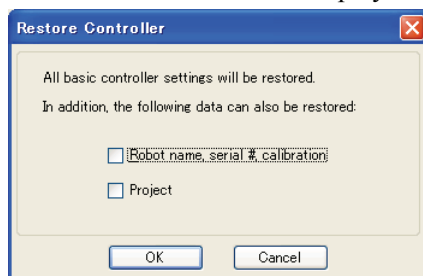

Robot name, serial #, calibration

This checkbox allows you to restore the robot name, robot serial number, Hof's data, and CalPI's data. Make sure that the correct Hof's data is restored. If the wrong Hof's data is restored, the robot may move to wrong positions.

The default setting is unchecked.

Project

This checkbox allows you to restore the files related to projects.

The default is unchecked.

When a project is restored, the values of Global Preserve variables are loaded.

For details about Global Preserve variable backup, refer to *EPSON RC+ 5.0 User's Guide 5.10.10 Display Variables Command (Run Menu)*.



If the version of the Controller firmware is Ver.1.0.*.*, or the version of EPSON RC+ 5.0 Ver.5.0.*, this dialog does not appear. Robot name, serial number, and calibration data is always restored.

The project is not restored.

- (5) Click the <OK> button to restore the system information.



Restore the system configuration saved using Backup Controller only for the same system.

When different system information is restored, the following warning message appears.

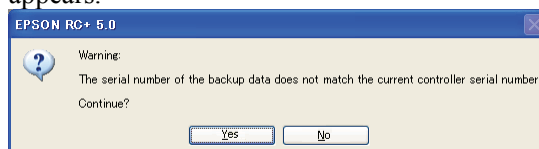

Click the <No> button (do not restore data) except for special situations such as controller replacement.

4.4.2 Restore from Teach Pendant TP1 (Option)



CAUTION

- Make sure that the data used for restore was saved previously for same Controller.
- Do not edit the backup files. Otherwise, operation of the robot system after data restoration to the Controller is not assured.

Restores system files backed up in USB memory to the Controller. (Only TP1. TP2 does not support this function.)

- (1) Insert the USB memory into the Controller.
- (2) In the [Program Mode] screen, move the cursor to [7 System Restore...], and press the <OK> key.

- (3) The following screen appears.

```
System Restore
All basic controller settings will be
restored.
In addition, the following data can also
be restored:

Robot name, serial #, calibration
Project

Select : f1  -- OK:OK Cancel :Cancel
```

When you restore the robot name, serial number, and the calibration data with the basic Controller settings, move the cursor to [Robot name, serial #, calibration] and press the <-> key.

When you restore the project with the basic Controller settings, move the cursor to [Project] and press the <-> key.

- (4) Press the <OK> key
 (5) The following screen appears. Press the <OK> key.

```
System Restore
Restore robot parameters from a file.
Please press the OK key to select
the configuration.

OK:OK Cancel:Cancel
```

- (6) The following screen appears. Move the cursor to the desired folder.
 Press the <Enter> key.

```
System Restore
Select Backup files.

RC170
B_00000_20060711125450
B_00000_20060530144013
B_00000_20060711125512
B_00000_20060912094421

Select: f1 Restore:OK Down:ENTER
```

- (7) The following screen appears. Press the <F1> key to start the restore.

```
System Restore
/B_00000_20060912094421
Ready to restore system files.
Continue?

Yes No Cancel:Cancel
```

When the Controller serial number does not match the serial number of the selected Controller setting data, the following screen appears. To continue, press the <F1> key.

```
System Restore
Warning:
The serial number of the backup data
does not match the current controller
serial number.
Continue?

Yes No Cancel:Cancel
```

When the Controller system software version does not match the version of the selected Controller setting data, the following screen appears. To continue, press the <F1> key.

```
System Restore
Warning:
The version number of the backup data
does not match the current controller
version.
Continue?

Yes No Cancel:Cancel
```

- (8) After execution is completed, the following screen appears.

Press the <OK> key and the Controller reboots.

```
System Restore

Restore completed successfully.

OK:OK
```

5. Firmware Update

This chapter describes the firmware upgrade procedure and data file initialization when firmware or Robot configuration errors cause Controller startup or operation failure.

5.1 Updating Firmware

Firmware (software stored in non-volatile memory) and data files necessary to control the Controller and the Robot are preinstalled in the Controller. Controller configuration set from EPSON RC+ 5.0 is always saved in the Controller.

Controller firmware is supplied by CD-ROM as needed. Please contact us for information.

You must use a PC running EPSON RC+ 5.0 connected to a Controller with USB to update the Controller firmware. Firmware cannot be updated with an Ethernet connection.

5.2 Firmware Upgrade Procedure

The firmware upgrade procedure is described as follows:

- (1) Connect the development PC and the Controller with a USB cable (the firmware cannot be changed with an Ethernet connection).
- (2) Turn ON the Controller. (Do not start the development software EPSON RC+ 5.0 until the firmware upgrade is completed.)
- (3) Insert the “firmware CD-ROM” in the development PC CD-ROM drive.
- (4) Execute “Ctrlsetup.exe”. The following dialog appears.
- (5) Select the <Upgrade> option button and click the <Next> button.

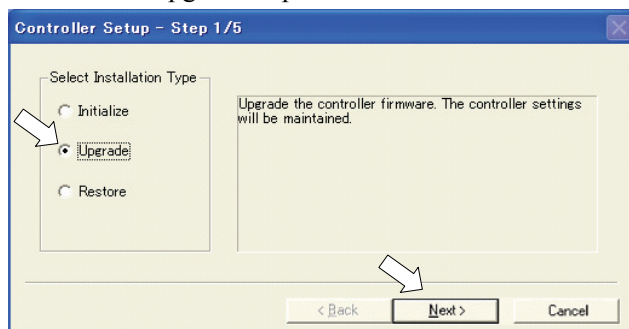

- (6) Make sure that the development PC is connected to the Controller with a USB cable and Click the <Next> button.

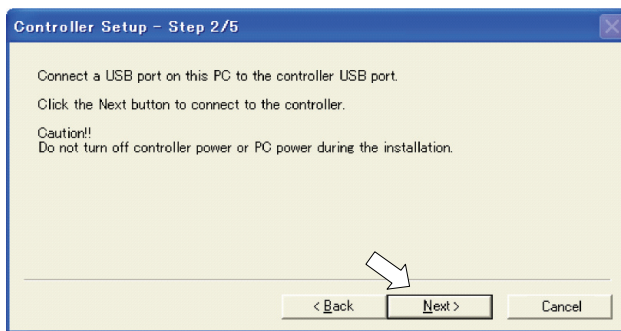

- (7) Check the current firmware version and the new firmware version and click the <Install> button.

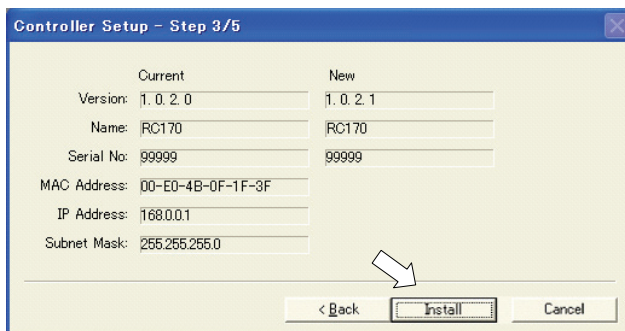

NOTE

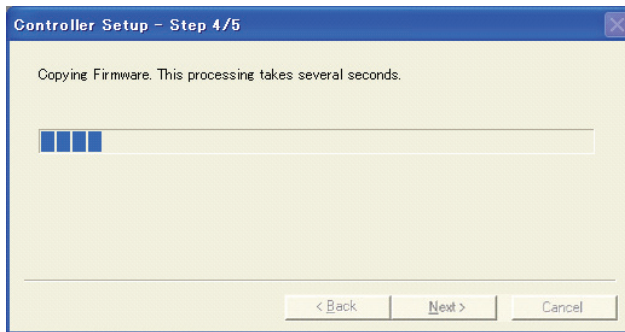

- (8) The firmware upgrade starts. It takes several minutes to complete. Do not unplug the USB cable during transfer or turn OFF the Controller or the development PC.

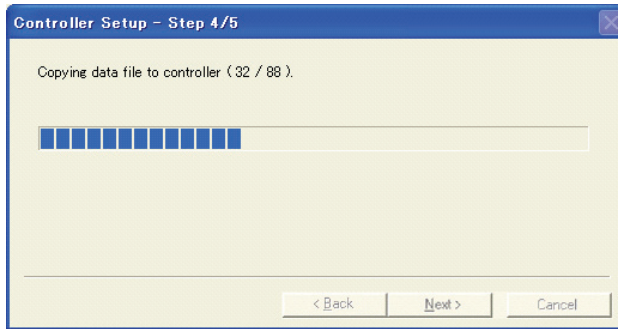

(9) Continuous data file transfer starts.

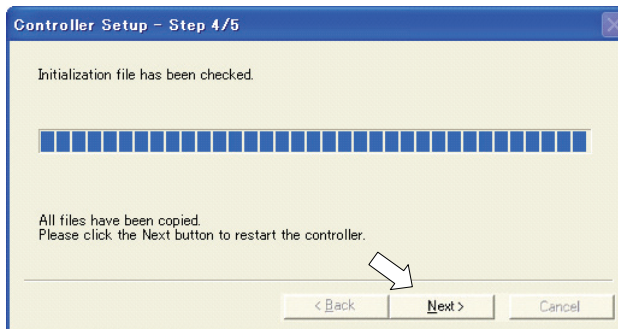

(10) The following dialog appears when transfer has completed. Click the <Next> button to reboot the Controller.



(11) The following dialog appears after the Controller reboot. Click the <Finish> button.

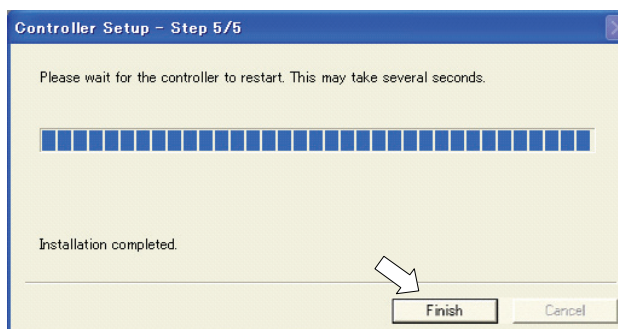

The firmware upgrade is complete.

5.3 Controller Recovery

If the Controller becomes inoperable, use the procedures described in this section to recover.

NOTE



Controller Backup is recommended for easy recovery of the Controller operation. For details of Controller Backup, refer to *Maintenance 4. Backup and Restore*.

The following two conditions describe the Controller error status after turning on the Controller.

Condition A The Controller automatically changes to Recovery mode and the seven-segment LED blinks **8888**. You are able to communicate with the development PC though the Controller does not operate properly.

Condition B The Controller seven-segment LED does not blink.
Cannot communicate with the Controller using the development PC.

Countermeasure for the error status is as follows.

Condition A Follow the Firmware Initialization Procedure in section 5.4 to initialize the firmware.

Condition B Execute the following steps:

- (1) Turn OFF the Controller.
- (2) Push the trigger button located on the front side of the Controller and while holding the button in, turn ON the Controller. Continue to hold in the trigger button for 30 seconds. This will cause the Controller to start in Recovery mode.
- (3) Make sure that the seven-segment LED blinks **8888**.
- (4) Follow the procedure in *5.4 Firmware Initialization Procedure* from step (3) to initialize the firmware.

5.4 Firmware Initialization Procedure

The firmware initialization procedure described in this section.

- (1) Connect the development PC to the Controller with a USB cable (the firmware cannot be changed with an Ethernet connection).
- (2) Turn ON the Controller. Do not start the development software EPSON RC+ 5.0 until firmware initialization is complete.
- (3) Insert the “firmware CD-ROM” in the development PC CD-ROM drive.
- (4) Execute “Ctrlsetup.exe”.
- (5) Select the <Initialize> option button and click the <Next> button.

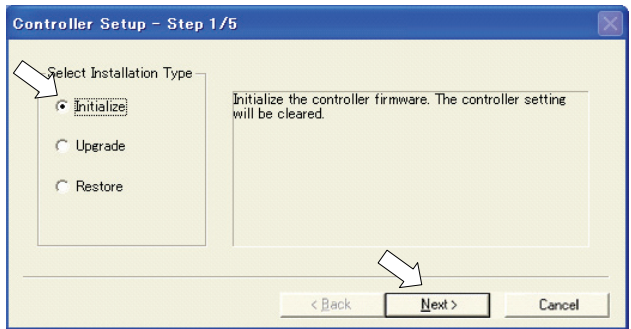

- (6) Make sure that the development PC is connected to the Controller with a USB cable and Click the <Next> button.

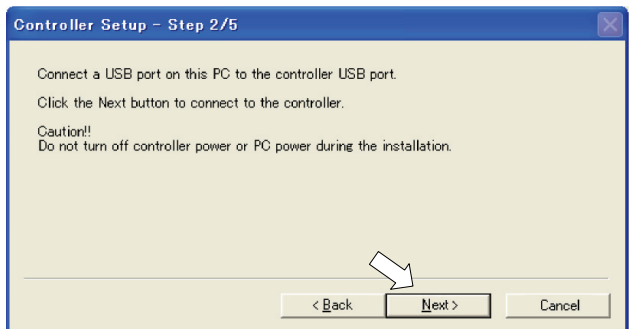

- (7) Check the version information and click the <Install> button.

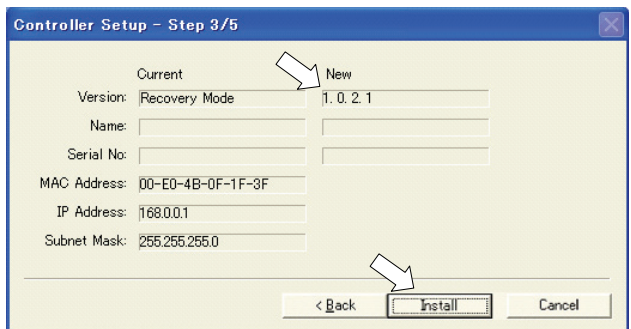

- (8) Firmware and data file transfer starts. It takes several minutes to complete.



Do not unplug the USB cable during transfer or turn OFF the Controller or the development PC.

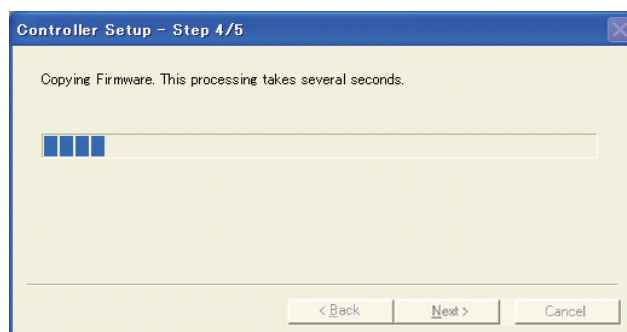

- (9) The following dialog appears when transfer is completed. Click the <Next> button to reboot the Controller.

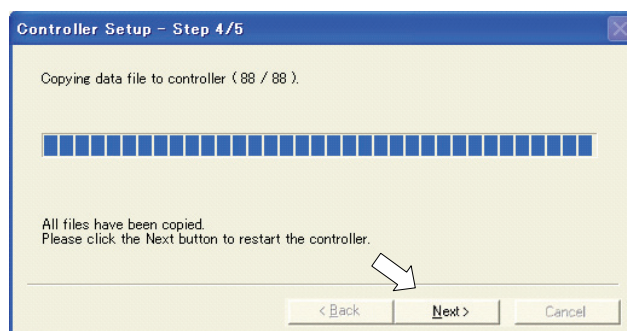

- (10) The following dialog appears after the Controller reboot. Click the <Finish> button.

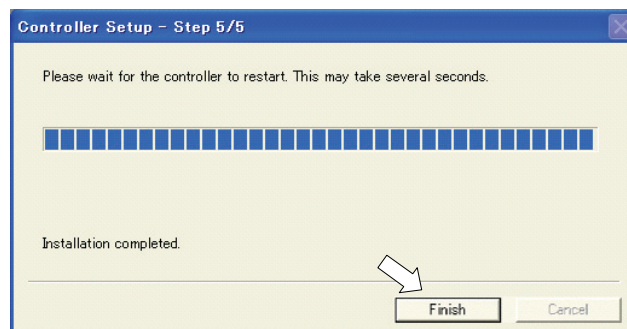

The firmware upgrade is completed.

Start EPSON RC+ 5.0 and restore the Controller settings.

For details of restoring the operating system, refer to *Maintenance 4. Backup and Restore*.

6. Maintenance Parts Replacement Procedures

 <p>WARNING</p>	<ul style="list-style-type: none">■ Before performing any maintenance procedure, always make sure that the main power of the Controller is turned OFF and that the high voltage charged area is completely discharged. Performing any maintenance procedure while the main power is ON or the high voltage charged area is not discharged completely is extremely hazardous and may result in electric shock and/or cause serious safety problems.■ When opening or closing the front side, make sure that the 200 V power supply for the Controller is OFF. Performing procedure to the power supply terminal block inside the Controller while the power supply is ON is extremely hazardous and may result in electric shock and/or cause serious safety problems.
--	--

NOTE



- Be careful not to damage cables. Be sure not to drop any screws into the Controller.
- A spacer is used with each thumb head screw on controllers with serial number 01001 or later. Do not remove the spacer. Installing the front cover using a thumb head screw without a spacer may result in a cable being damaged and/or malfunction of the Controller.
- Installing the front cover using the wrong screws may result in a cable being damaged and/or malfunction of the Controller.

6.1 Fan and Fan Filter

Inspect the fan filter periodically and clean it when needed. The temperature inside the Controller may get too high and the Controller may not operate properly if the filter is not kept clean.

For the inspection schedule of the fan filter, refer to *Maintenance 2. Regular Maintenance Inspection*.

6.1.1 Cleaning and Replacing the Fan Filter

Fan Filter Remove

- (1) Turn OFF the Controller.
- (2) Pull out the two plastic fasteners indicated in the photo.

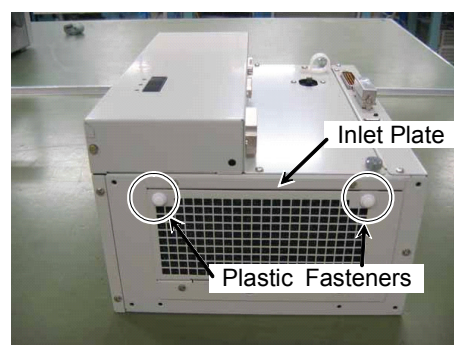

- (3) Remove the fan filter.
Vacuum off the dust when cleaning the filter.

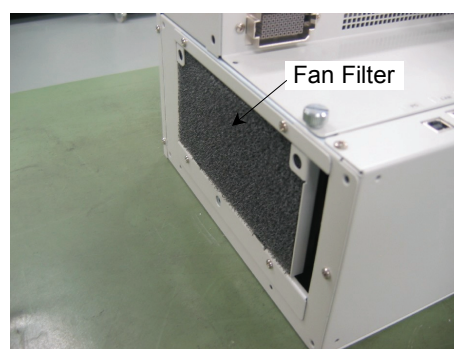

Fan Filter Mount

- (1) Mount the fan filter.
- (2) Insert the two flared parts of the inlet plate into the opening of the Controller in the direction shown by arrow (a).
- (3) Push the two plastic fasteners in the direction shown by arrow (b) until they make a clicking sound to secure the inlet plate.
Make sure that the plate is mounted properly.
- (4) Plug in the power connector. Turn ON the Controller and make sure that the Controller starts properly without any vibration or abnormal noise.

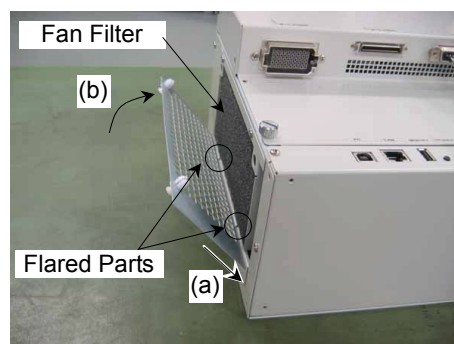

6.1.2 Replacing the Fan Unit

Fan Unit
Remove

- (1) Turn OFF the Controller.

Remove the Option Units if they are mounted.

Refer : *Procedure (1) to (4) in Maintenance 6.7.1 Remove Option Unit 1*
Maintenance 6.7.5 Remove Option Unit 1, 2

- (2) Pull out the two plastic fasteners and remove the inlet plate.

- (3) Remove the four screws on the fan unit.

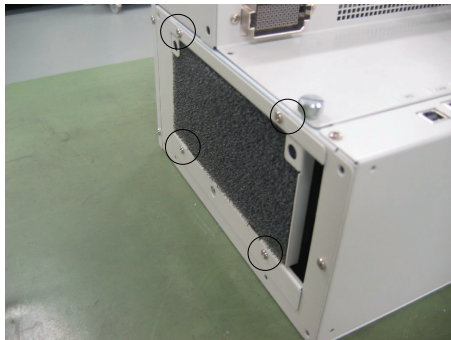

- (4) Remove the fan unit.



The fan cable is connected to the fan unit. Be sure to remove it slowly.

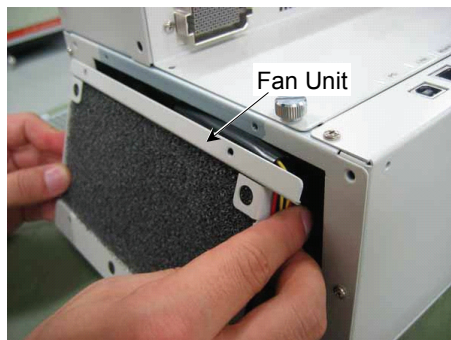

- (5) Pull out the two fan cable connectors from the CPU board to the direction shown by the arrow.

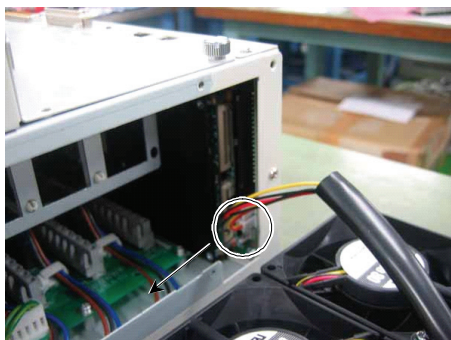

- (6) Remove the fan filter from the fan unit.



When the Option Unit is mounted, the fan filter is not used.

Fan Unit
Mount

- (1) Mount a new fan filter in the fan unit.

NOTE



When an Option Unit is mounted, no fan filter is necessary.

- (2) Connect the two fan cable connectors to the CPU board.

Refer : *Maintenance 3.2 Diagram of Cable Connections - Cable Layout Drawing*

- (3) Hold down the fan cable protection tube as shown in the photo and install the fan unit to the Controller.

NOTE



Be sure to keep the Controller cable from being trapped between the DPB and the fan.

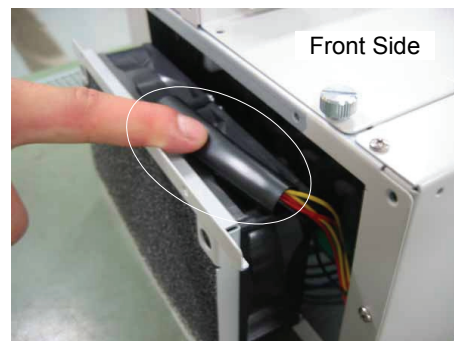

- (4) Secure the fan unit to the main chassis with four screws.

- (5) Mount the Option units if they were mounted before.

Refer : *Maintenance 6.7.2 Mount Option Unit 1.*

- (6) Insert the two flared parts of the inlet plate into the opening of the Controller in the direction shown by arrow (a).

- (7) Push in the two plastic fasteners in the direction shown by arrow (b) until they make a clicking sound to mount the inlet plate.

Make sure that the plate is mounted properly.

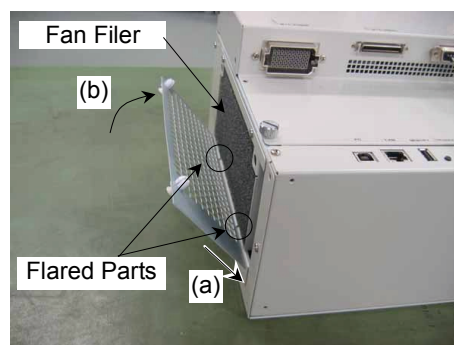

- (8) Plug in the power connector. Turn ON the Controller and make sure that the Controller starts properly without any vibration or abnormal noise.

6.1.3 Cleaning and Replacing the Option Unit Fan Filter

Option Unit
Fan Filter
Remove

- (1) Turn OFF the Controller.
- (2) Remove the mounting screw for each fan filter located on the top and the bottom of the Option Unit.



NOTE Two fan filters are mounted on the Option Unit. Be sure to replace both at the same time.

Clean the fan filter when it is necessary.

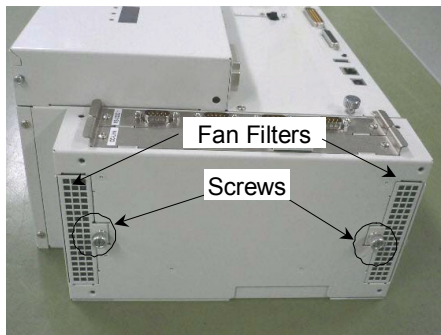

Option Unit
Fan Filter
Mount

- (1) Insert the fan filters into the Option Unit and secure each of them with a screw.
- (2) Plug in the power connector. Turn ON the Controller and make sure that the Controller starts properly without any vibration or abnormal noise.

6.2 Battery

 CAUTION	<ul style="list-style-type: none"> ■ Use meticulous care when handling the lithium battery. Improper handling of the lithium battery as mentioned below is extremely hazardous, may result in heat generation, leakage, explosion, or inflammation, and may cause serious safety problems. <ul style="list-style-type: none"> • Battery Charge • Disassembly • Incorrect Installation • Exposing to Fire • Forced Discharge • Deformation by Pressure • Short-circuit (Polarity; Positive/Negative) • Heating (85°C or more) • Soldering the terminal of the lithium battery directly ■ Be sure to use the battery supplied as maintenance part from EPSON (Refer to 9. Maintenance Parts List). ■ When disposing of the battery, consult with the professional disposal services or comply with the local regulation. Spent battery or not, make sure the battery terminal is insulated. If the terminal contacts with the other metals, it may short and result in heat generation, leakage, explosion, or inflammation.
--	---

NOTE  Before starting battery replacement, turn on the controller for approximately one minute. Perform the replacement within 10 minutes to prevent data loss.

Battery Removal

- (1) Backup the Controller data.
Refer to *Maintenance 4. Backup and Restore*.
- (2) Turn OFF the Controller.
- (3) Remove the screw for the battery mounting plate.



- (4) Pull out the battery assembly.

NOTE  The lithium battery cable is connected to the main chassis. Be sure to remove it slowly.

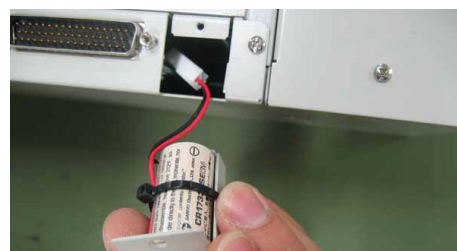

- (5) Disconnect the relay connector.

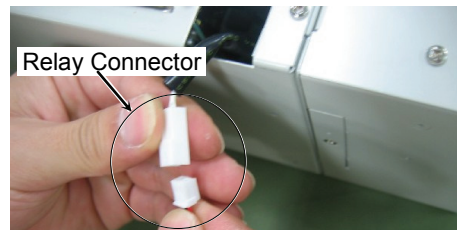

- (6) Cut the cable tie to remove the lithium battery.

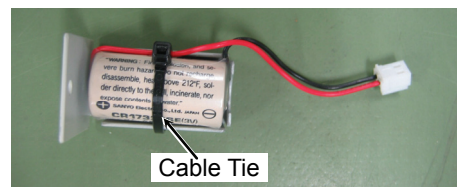

**Battery
Installation**

- (1) Place a new lithium battery in position and secure it with the attached cable tie.

Position the cable tie as show in the photo.

If it is difficult to insert the lithium battery to the Controller, adjust the cable tie position.

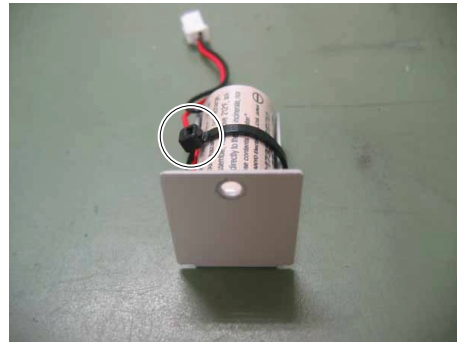

- (2) Connect the relay connector.
- (3) Insert the lithium battery assembly into the Controller.

NOTE



Be sure to prevent the cable and the connector from being trapped.

Push the relay connector to the left when inserting the lithium battery. If the connector is behind the lithium battery, the lithium battery may not be inserted.

- (4) Mount the plate to the Controller with a screw.
- (5) Plug in the power connector. Turn ON the Controller and make sure that the Controller starts properly without any vibration or abnormal noise.

6.3 Motor Driver

6.3.1 Part Names

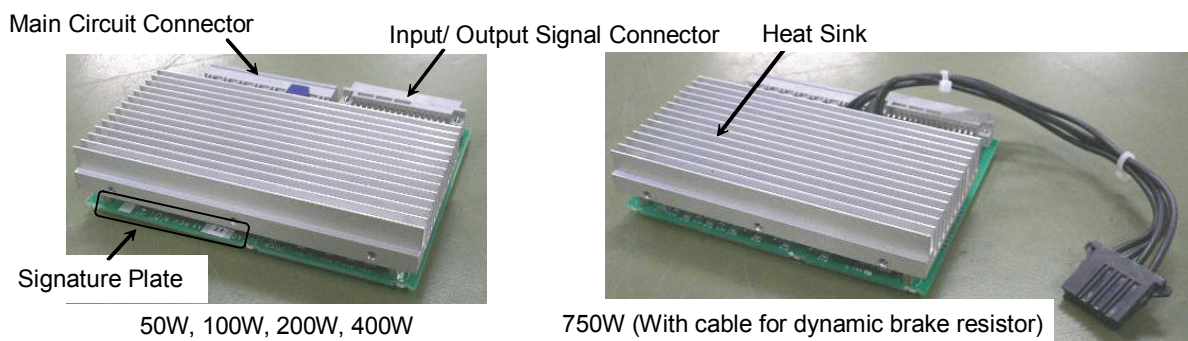

The wattage of the motor driver can be determined by the type code indicated on the signature plate. The wattage of the installed motor driver corresponds with the wattage of the driving motor.

Type	Wattage
JUSP-SU021A*	50 W
JUSP-SU028A*	100 W
JUSP-SU065A*	200 W
JUSP-SU085A*	400 W
JUSP-SU169A*	750 W

* The asterisk indicates one alphanumeric character.

6.3.2 Replacing the Motor Driver (Axis 1 to 4)



WARNING

- Be sure to record the type and the power rating (wattage) setting of the current Motor Driver to set the correct power rating (wattage) when replacing the Motor Driver.

Using a Motor Driver with improper power rating (wattage) in the Controller will cause improper function of the robot system.

Motor Driver
(Axis 1 to 4)
Remove

- (1) Turn OFF the Controller and unplug the power connector.
- (2) Disconnect the following cables from the front side of the Controller.
 - M/C Power Cable
 - M/C Signal Cable
 - EMERGENCY Cable

NOTE

- (3) Remove the four screws shown in the photo.

The thumb head screws are used to pull out the Motor Driver.

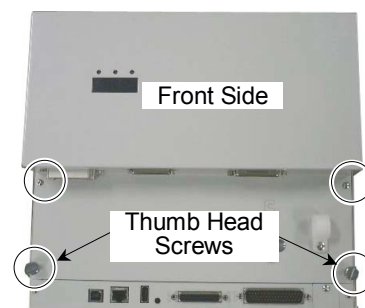

(4) Loosen the two screws on the side of the front side.

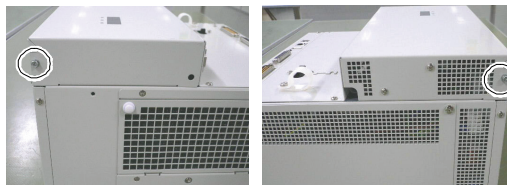

(5) Open the front cover and hold it open.

Motor Driver
 1: Axis 1
 2: Axis 2
 3: Axis 3
 4: Axis 4

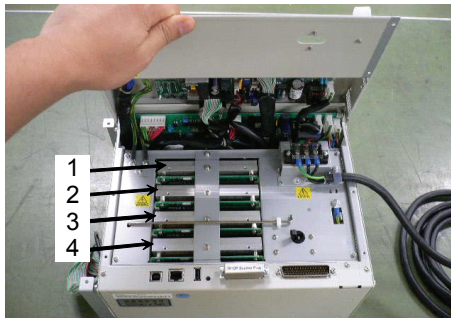

(6) Open the clamp for the front cover support bar.

NOTE Push the latch A shown in the photo first and then open the clamp.

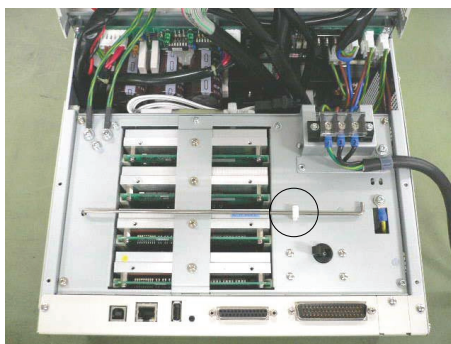
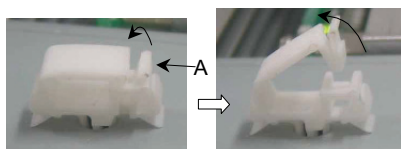

(7) Insert the top of the support bar into the support hole as shown without moving the base point.

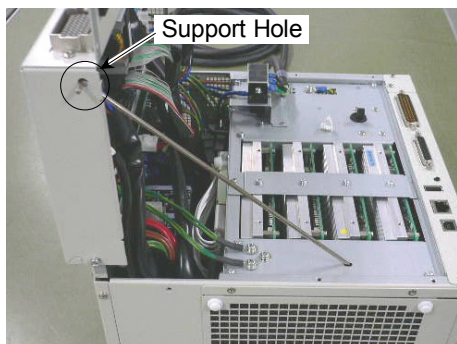
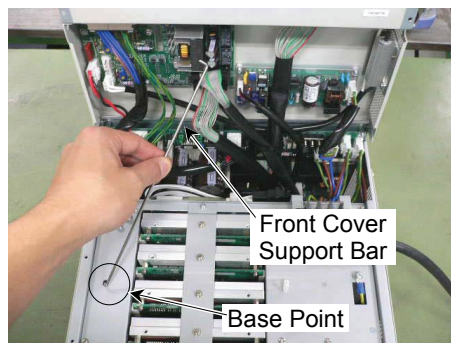

- (8) Remove the five screws from the Motor Driver mounting bracket.

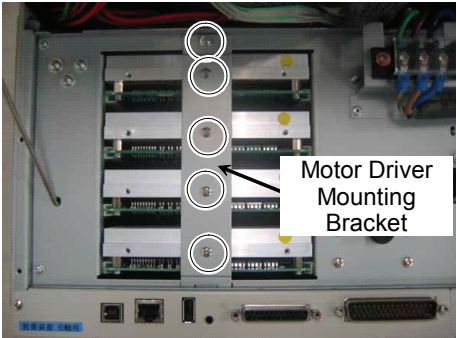

Connected to the G10 or G20 series manipulator
 Refer to Remove step (9) and remove the connector.

Connected to the G1, G3, G6, RS, C3 or S5 series manipulator
 Go on to Remove step (10).

- (9) When replacing the first or the second motor driver, compress both ends of the connector connected to the driver to pull out the connector.
 (Remove the connector connected to the replacing motor driver.)

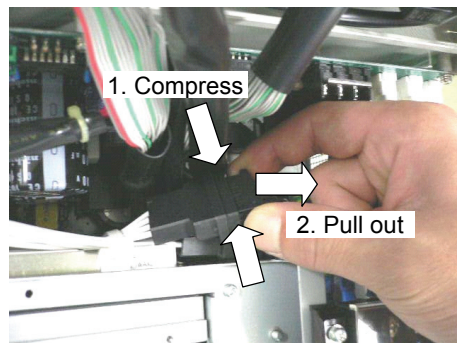
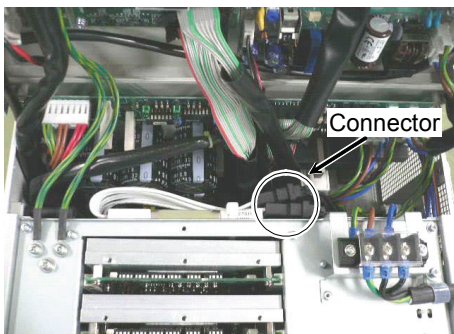

- (10) Secure the two thumb head screws removed in step (3) to the Motor Driver heat sink.

Pull out the Motor Driver by pulling the two thumb head screws together evenly.



When using the G10 or G20 series manipulator, a cable and a connector are connected to the first and the second motor driver.
 When removing the motor driver, make sure to keep the connector from being stuck.

 CAUTION	<ul style="list-style-type: none"> Be careful not to cut your fingers. The Motor Driver connector may be connected tightly. The connector may be disconnected suddenly by a strong pull and may cause your fingers to be cut by the Motor Driver heat sink.
-------------	---

Motor Driver
(Axis 1 to 4)
Mount

Connected to the G10 or G20 series manipulator
Start from Mount step (1).
Connected to the G1, G3, G6, RS, C3 or S5 series manipulator
Start from Mount step (3).

- (1) When replacing the first or the second motor driver, insert the connector connected to the motor driver carefully along the guide rail through the rear side of the intermediate plate

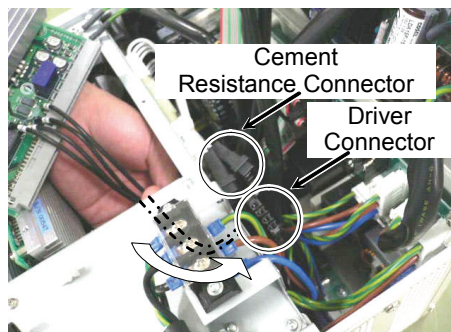

- (2) Connect the connector connected to the replacing first or second motor driver to the cement resistance connector.

NOTE

There are two cement resistance connectors. The connector for the motor driver can be connected to either one of them. Connect to the resistance connector in the easier position.

- (3) Insert the Motor Driver along the guide rails until the surface height differences of the Motor Driver comes to 5 mm or less.
- (4) Push the Motor Driver securely into the two Motor Driver connectors.

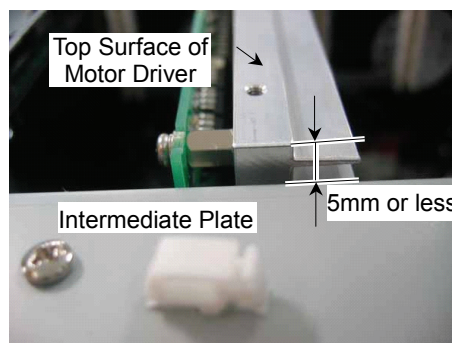

- (5) Secure the Motor Driver mounting bracket with five screws.
- (6) Hold the front cover and put the front cover support bar back to the normal position.
- (7) Secure the front cover support bar with the clamp.

NOTE

Push latch A as shown in the photo first and open up the clamp.

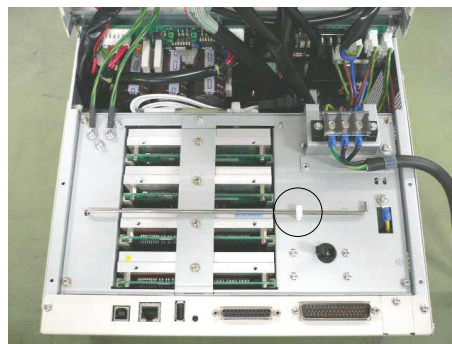
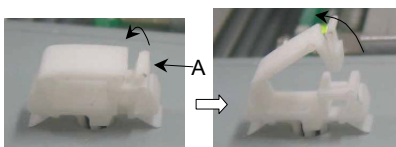

- (8) Secure the two screws on the side of the front cover.
- (9) Close the front cover and secure it with four screws.

NOTE

Make sure to keep cables from becoming trapped or damaged.

- (10) Connect the following cables if they were previously connected to the front of the Controller.
 - M/C Power Cable
 - M/C Signal Cable
 - EMERGENCY Cable
- (11) Plug in the power connector. Turn ON the Controller and make sure that the Controller starts properly without any vibration or abnormal noise.

6.3.3 Replacing the Motor Driver (Axis 5 and 6)

Motor Driver
(Axis 5 and 6)
Remove

- (1) Turn OFF the Controller and unplug the power connector.
- (2) Open the front cover.
Refer : *Maintenance 6.3.2 Replacing Motor Driver (Axis 1 to 4)*
Removing procedure from (2) to (7)

- (3) Remove the four screws shown to remove the top cover of the ProSix Driver Unit.

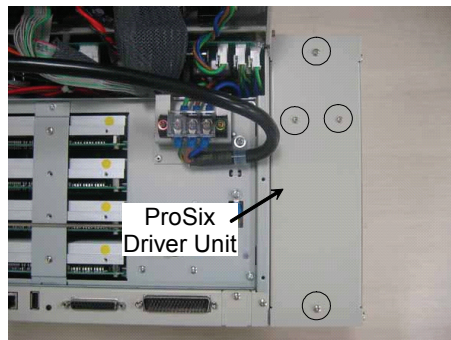

- (4) Remove two screws to remove the Motor Driver mounting bracket.

Motor Driver
5: Axis 5
6: Axis 6

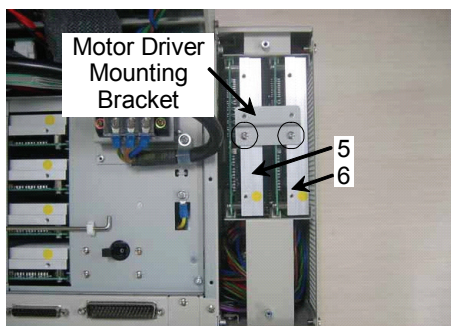

- (5) Secure the two thumb head screws removed in step (2) to the Motor Driver heat sink as shown.

- (6) Pull out the Motor Driver by pulling the two thumb head screws together evenly.



■ Be careful not to cut your fingers.
The Motor Driver connector may be connected tightly. The connector may be disconnected suddenly by a strong pull and may cause your finger to be cut by the Motor Driver heat sink.

Motor Driver
(Axis 5 and 6)
Mount

- (1) Insert the Motor Driver along the guide rails until the surface height differences of the Motor Driver comes to 5 mm or less.
- (2) Push the Motor Driver securely into the two Motor Driver connectors.

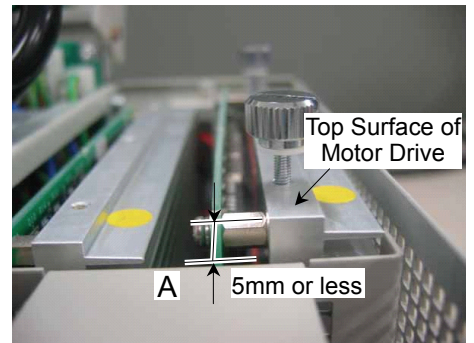

- (3) Secure the Motor Driver mounting bracket with two screws.
- (4) Secure the top cover of the ProSix Driver Unit with four screws.
- (5) Close the front side.
Refer : *Maintenance 6.3.2 Replacing Motor Driver (Axis 1 to 4)*
Mounting procedure from (5) to (9)
- (6) Plug in the power connector. Turn ON the Controller and make sure that the Controller starts properly without any vibration or abnormal noise.

6.4 CPU Board Unit

NOTE  The controller differs by the using manipulator. Different procedures are instructed for each controller as follows. Follow the corresponding procedure.

- Connected to the C3 or S5 series manipulator
- Connected to the G or RS series manipulator

Remove the Option Units if they are mounted.

Refer : *Maintenance 6.7.1 Remove Option Unit 1*

Maintenance 6.7.5 Remove Option Unit 1, 2

CPU Board Unit Remove (1) Turn OFF the Controller and unplug the power connector.

(2) Disconnect the cables connected to the CPU board.
 USB PC LAN USB memory TP/OP I/O

(3) Remove four screws on the front cover and three screws on the backside shown in the photo.

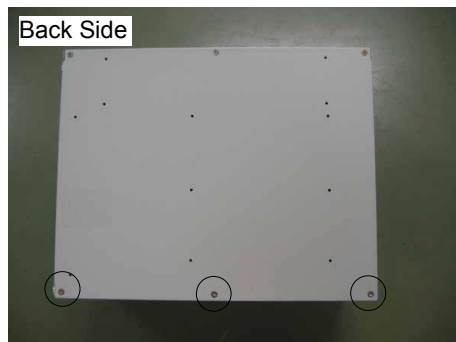
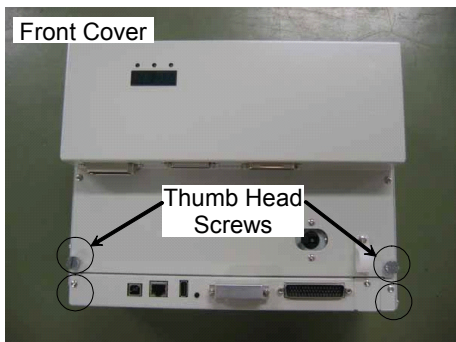

Connected to the C3 or S5 series manipulator
 Perform steps (4) to (6) to remove the ProSix Driver Unit.

Connected to the G or RS series manipulator
 Go on to step (7).

(4) Remove the screw on the top and bottom to remove the two covers.



- (5) Remove two screws on each cover.



- (6) Slide the ProSix Driver Unit approximately 20 mm in direction (A) and then slowly slide it approximately 10 mm in direction (B).



NOTE The ProSix Driver Unit cable is connected to the main chassis. Be sure to remove it slowly.

The DMB of the ProSix Driver Unit is connected to the board connector.

Be sure to slide the ProSix Driver Unit straight out in direction (A) as shown.

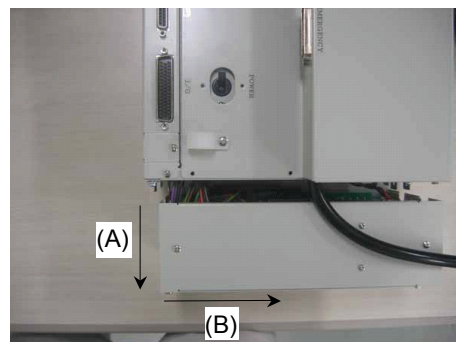

- (7) Remove the screws on both sides of the CPU board unit.

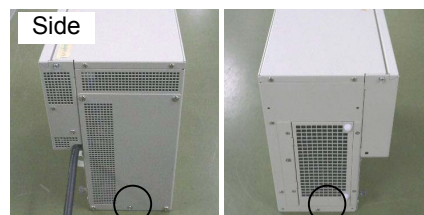

- (8) Install the two thumb head screws removed in step (3) in the CPU board unit.

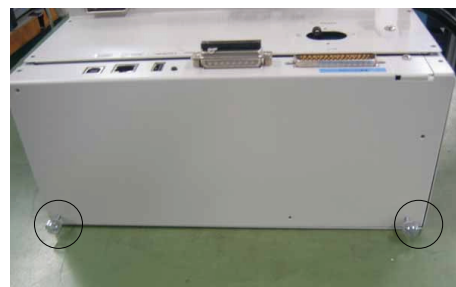

- (9) Hold the thumb head screws and pull the CPU board unit straight out.



NOTE The CPU board unit cable is connected to the main chassis. Be sure to remove slowly.

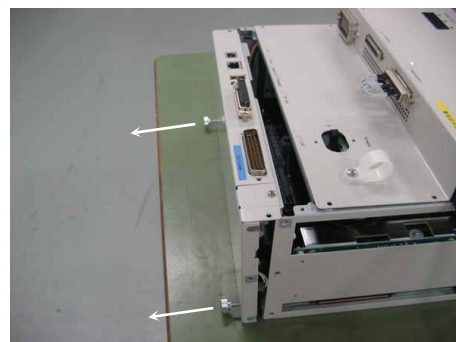

- (10) Disconnect the four connectors connected to the CPU board.

Refer : *Maintenance 3.2 Diagram of Cable Connections - Cable Layout Drawing*

CPU Board Unit Mount (1) Connect the four CPU board connectors.
 Refer : *Maintenance 3.2 Diagram of Cable Connections - Cable Layout Drawing*

(2) Carefully insert the CPU board unit by pushing it straight in.



NOTE Make sure that connector CN2 of the CPU Board and the DMB connector (CPU IF) are connected when inserting the Unit.

Be sure to keep the cable from being trapped or damaged.

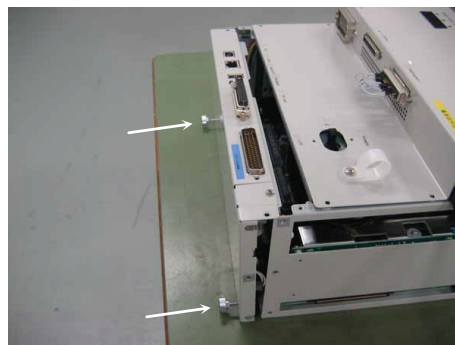

(3) Mount the screw on each side of the CPU board.

Connected to the C3 or S5 series manipulator
 Perform steps (4) to (6) to secure the ProSix Driver Unit.

Connected to the G or RS series manipulator
 Move on to step (7).

(4) Insert the ProSix Driver Unit into the position.



NOTE Refer to the photo and be sure to position the mounting bracket properly as shown.

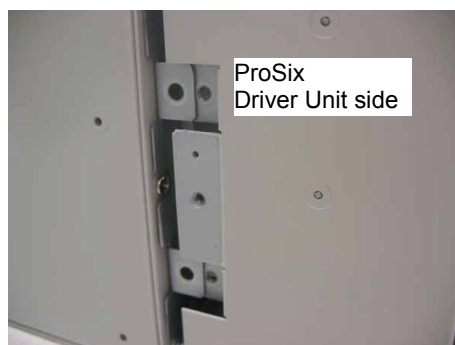

(5) Secure the ProSix Driver Unit with two screws on the top and bottom.

(6) Secure the two covers with a screw of the top and bottom.

(7) Secure each cover with the screws.
 (Front cover : 4 screws, Backside : 3 screws)

(8) Connect the following cables to the CPU board.
 USB PC LAN USB memory TP/OP I/O

(9) Plug in the power connector. Turn ON the Controller and make sure that the Controller starts properly without any vibration or abnormal noise.

6.5 CF (Compact Flash)

- CF Remove
- (1) Turn OFF the Controller and unplug the power connector.
 - (2) Remove the CPU board unit.
Refer : *Maintenance 6.4 CPU Board Unit*
 - (3) Pull out the CF in the direction shown by the arrow.

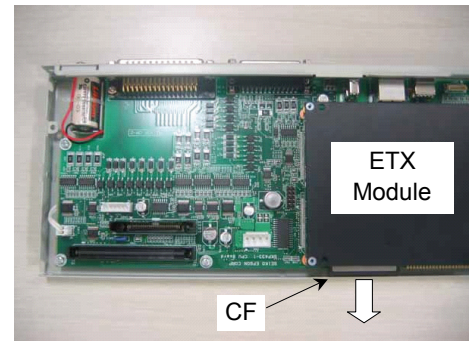

- CF Mount
- NOTE
-  Insert the CF until the CF is approximately 3 mm out from the ETX module.
- (1) Insert the new CF along the guide rail.
Refer : *Maintenance 6.4 CPU Board Unit*
 - (2) Mount the CPU board unit.
Refer : *Maintenance 6.4 CPU Board Unit*
 - (3) Plug in the power connector. Turn ON the Controller and make sure that the Controller starts properly without any vibration or abnormal noise.

6.6 Fuse

NOTE
 The fuse is not used for RC180-UL.

Fuse Remove

- (1) Turn OFF the Controller and unplug the power connector.
- (2) Remove the Option Unit when it is mounted.
 Refer : *Maintenance 6.7.2 Remove Option Unit 1*
Maintenance 6.7.5 Remove Option Unit 1, 2
- (3) Remove the fan unit
 Refer : *Maintenance 6.1.2 Replacing Fan Unit*
- (4) Remove the Motor Drive Module.
 Refer : *Maintenance 6.3.2 Replacing Motor Driver (Axis 1 to4)*
- (5) Remove four screws on the intermediate plate as shown.

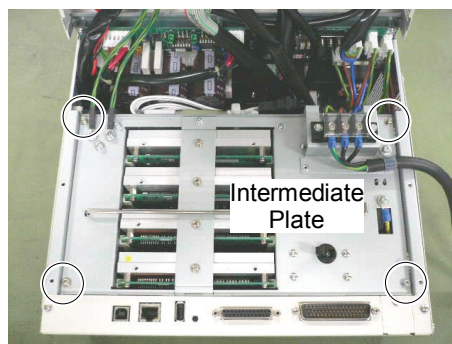

- (6) Remove the FG mounting screws (G/RS: 2 screws, C3/S5: 3 screws) and remove the plate.

NOTE
 Be sure to remove the intermediate plate slowly.
 The cables are connected to the main chassis.

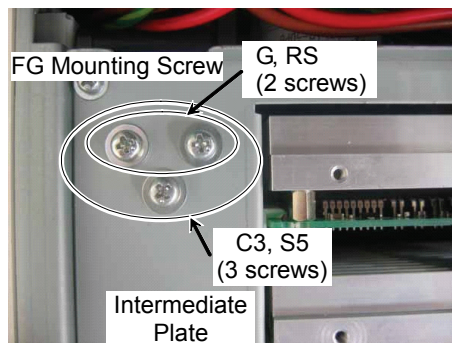

WARNING

- Before disconnecting the DPB cable connector, always make sure that the power supply of the Controller is unplugged. Performing this procedure while the power supply is connected is extremely hazardous and may result in electric shock and/or cause serious safety problems.

- (7) Pull out the DPB cable connector (CN1) and remove the intermediate plate.

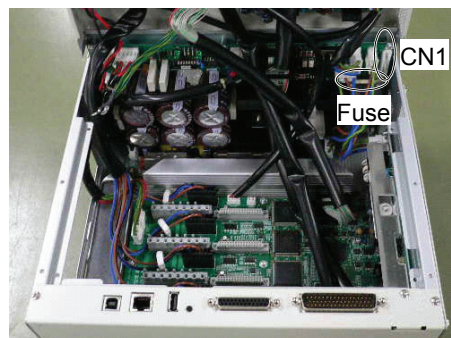

NOTE

- (8) Pull out the fuse in direction of the arrow. Pull the wires to the side to allow clearance for pulling out the fuse.

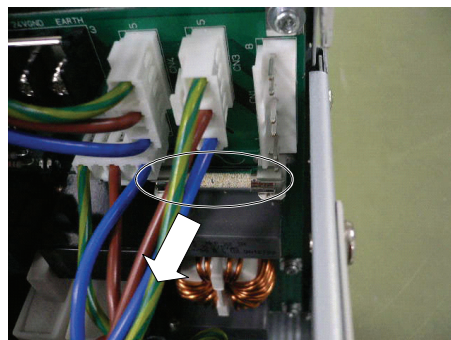

Fuse Mount

- (1) Hold the intermediate plate to connect the DPB cable connector (CN1).
- (2) Mount the intermediate plate to the Controller and secure the four mounting screws and the FG mounting screws (G / RS: 2 screws, C3 / S5: 3 screws) removed in steps (5) and (6).

NOTE

Be sure to keep the cable from being trapped or damaged.

- (3) Mount the Motor Driver Module.
Refer : *Maintenance 6.3.2 Replacing Motor*
- (4) Mount the fan unit.
Refer : *Maintenance 6.1.2 Replacing Fan Unit*
- (5) Mount the Option Unit when it was installed.
Refer : *Maintenance 6.7.2 Mount Option Unit 1*
Maintenance 6.7.6 Mount Option Unit 1, 2
- (6) Plug in the power connector. Turn ON the Controller and make sure that the Controller starts properly without any vibration or abnormal noise.

6.7 Option Unit

This section contains instructions for removing and installing the two Option Units. Option Unit 1 and Option Unit 2 are shown in the following figure.

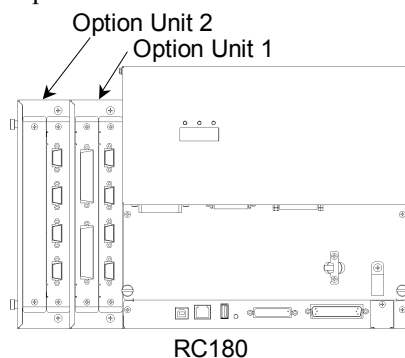

6.7.1 Remove Option Unit 1

- (1) Turn OFF the Controller and unplug the power connector.
- (2) Disconnect the cables connected to the Option Unit board.
- (3) Remove two screws on the backside and remove the cover.



- (4) Pull out the flat cable connector connected on the backside.

NOTE

Compress both ends of the connector to pull out the connector.

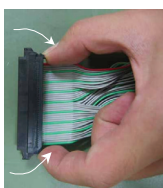

- (5) Remove the screws (two screws each on front side and backside) and remove Option Unit 1 in the direction shown by the arrow.



6.7.2 Mount Option Unit 1

- (1) Secure Option Unit 1 with two screws each on front side and backside.
- (2) Connect the flat cable connector to the backside of Option Unit 1.

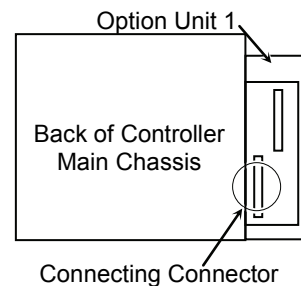

- (3) Secure the backside cover to Option Unit 1 with two screws. Orient the cover so that there is no gap when mounted.
- (4) Plug in the power connector. Turn ON the Controller and make sure that the Controller starts properly without any vibration or abnormal noise.

6.7.3 Remove Option Unit 2

- (1) Turn OFF the Controller and unplug the power connector.
- (2) Disconnect the cables connected to the Option Unit board.
- (3) Remove two screws on each unit from the backside of Option Units 1 and 2 to remove the covers.



- (4) Pull out the flat cable connector connected on the backside of Option Units 1 and 2.

NOTE

Compress both ends of the connector to pull out the connector.

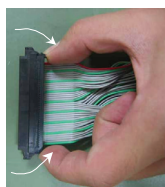

- (5) Secure a backside cover to Option Unit 1 with two screws.
Orient the cover so that there is no gap when mounted.

NOTE  Be sure to keep the cable from being trapped or damaged.



- (6) Remove two screws each on the front side and backside and remove Option Unit 2 in the direction shown by the arrow.

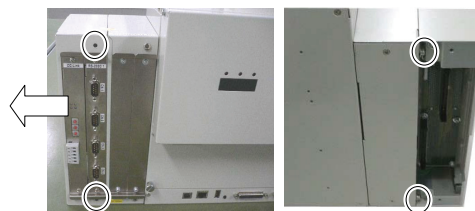

When replacing Option Unit 2.
The removal procedure is complete.

When Option Unit 2 is not used.
Perform steps (7) to (9).

- (7) Remove four screws and remove the Option Unit mounting bracket from the Option Unit 1.

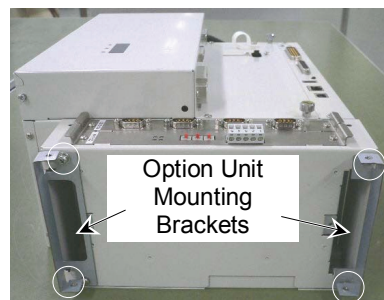

- (8) Remove the Option Unit 2 filter units (two places).
Refer : *Maintenance 6.1.3 Cleaning and Replacing Fan Filter*

- (9) Mount the fan filters (two places) to Option Unit 1.

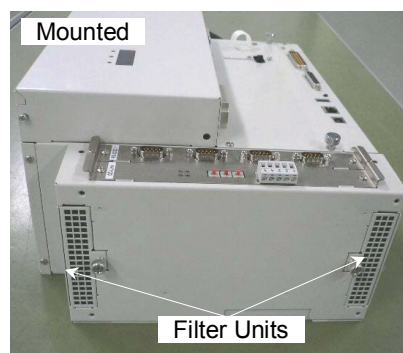

6.7.4 Mount Option Unit 2

When adding Option Unit 2

Perform steps (1) to (8).

When replacing Option Unit 2

Perform steps (3) to (7).

- (1) Remove the fan filters (two places) of Option Unit 1 and mount Option Unit 2.
Refer : *Maintenance 6.1.3 Cleaning and Replacing Fan Filter*

- (2) Secure the Option Unit mounting brackets to Option Unit 1 with four screws.

NOTE



The shape of the mounting bracket for the top (DPB) and bottom (CPU board) side are different. Be sure to mount them properly.

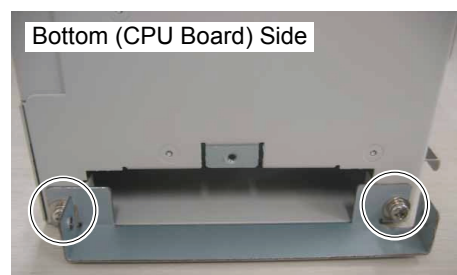
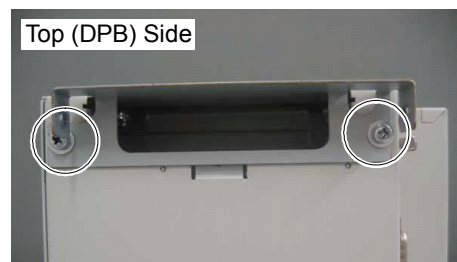

- (3) Secure Option Unit 2 with two screws each on front and backside.
- (4) Remove two screws to remove the backside cover of the Option Unit 1.
- (5) Connect the flat cable connectors (two places) to the backside of Option Units 1 and 2.

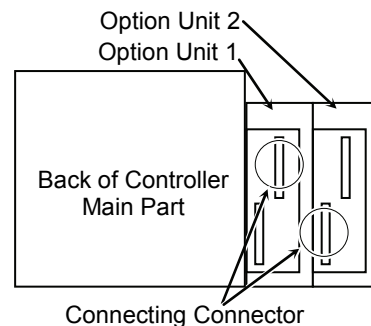

- (6) Secure the covers to the backside of Option Units 1 and 2 with two screws for each.
Orient the cover so that there is no gap when mounted.



- (7) Plug in the power connector. Turn ON the Controller and make sure that the Controller starts properly without any vibration or abnormal noise.

6.7.5 Remove Option Units 1 & 2

- (1) Turn OFF the Controller and unplug the power connector.
- (2) Disconnect the cables connected to the Option Unit boards.
- (3) Remove two screws from the backside of Option Unit 1 to remove the cover.



- (4) Pull out the flat cable connector connected on the backside.

NOTE

Compress both ends of the connector to pull out the connector.

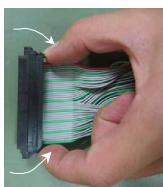

- (5) Remove the screws (two screws each on front side and backside) and remove Option Units 1 and 2 in direction shown by the arrow.



6.7.6 Mount Option Units 1 & 2

- (1) Secure Option Units 1 and 2 with two screws each on front and backside.
- (2) Connect the flat cable connector to the backside of Option Unit 1.

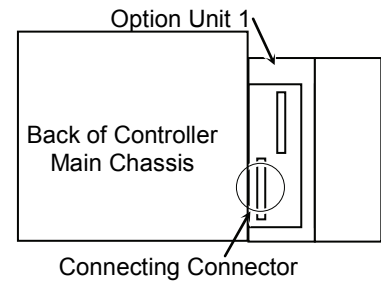

- (3) Secure the backside covers of Option Unit 1 with two screws for each.
- (4) Plug in the power connector. Turn ON the Controller and make sure that the Controller starts properly without any vibration or abnormal noise.

6.7.7 Replacing or Adding an Option Board

Remove

- (1) Turn OFF the Controller and unplug the power connector.
- (2) Disconnect the cables connected to the Option Unit board.
- (3) Remove two screws and pull out the Option board.



Mount

- (1) Configure the Option board switches.
Refer : *Maintenance 12. Option Unit*
- (2) Insert an Option board into the Option Unit along the guide rail and secure with two screws.
- (3) Connect the cables to the Option board.
- (4) Plug in the power connector. Turn ON the Controller and make sure that the Controller starts properly without any vibration or abnormal noise.

Add

- (1) Turn OFF the Controller and unplug the power connector.
- (2) Remove two screws to remove the cover.





- (3) Insert an Option board into the Option Unit along the guide rail and secure with two screws.
- (4) Plug in the power connector. Turn ON the Controller and make sure that the Controller starts properly.

7. Verifying Robot System Operation



When maintenance has been performed for either the Manipulator or the Controller, including replacing any parts in those units, items must be checked according to the procedures in this section to ensure proper operation.

- (1) Connect all the necessary cables for the system.

 WARNING	<ul style="list-style-type: none"> ■ When verifying the robot system operation, prepare for failures with initial settings or wiring. If the Manipulator operates abnormally because of incorrect initial settings or wiring, press the Emergency Stop switch immediately to stop the Manipulator. <p>Verify the robot system operation in the restricted mode (low speeds and low power) status. Verifying the robot system operation at high speeds may damage the robot system and/or cause serious safety problems as the Manipulator cannot stop operating immediately in case of abnormal operation of the Manipulator.</p>
---	--

 CAUTION	<ul style="list-style-type: none"> ■ The serial number of the Manipulator that should be connected is indicated on the Connection Check Label on the Controller. Connect the Controller and the Manipulator correctly. Improper connection between the Controller and the Manipulator may cause not only improper function of the robot system but also serious safety problems.
---	---

- (2) Turn ON the Controller. The Controller will boot up. During this process, watch and monitor the LED status as described in the following list:

		From power-on to boot	While running	
LED	All blink		LED for current operation mode (TEACH, AUTO, PROGRAM) turns ON.	
7 segment	All lights out			READY (Normal)
				Emergency Stop
				Safeguard
			Four digits	Error

For details of the display, refer to *Maintenance 2.3 LED and Seven-segment LED*.
 For error number, refer to *Maintenance 8.1 Error Code Table*.

- (3) Execute MOTOR ON and check the following:
 - No error is displayed.
 - There is servo excitation and the Manipulator operates normally.
- (4) Execute various motion commands (such as JUMP, etc.). The Manipulator must operate accordingly and normally without vibration or unusual sounds.

8. Troubleshooting

8.1 Error Code Table

There are 18 types of errors as follows.

Events	Simulator	Points
Warnings	Interpreter	Fieldbus
Controller Main	Parser	Vision
Operator Panel	Motor control	GUI Builder
Teach Pendant	Servo	Hardware
PC	Vision Calibration	EPSON RC+

Events

No.	Message	Remedy	Note 1	Note 2
1	Controller control program started.			
2	Termination due to low voltage of the power supply.			
3	Controller control program has completed.	Stores this log when the controller is rebooted from EPSON RC+ or TP1.		
4	Preserve variables save area has been cleaned.			
5	Function Main started.			
6	Function Main started. Later same logs are skipped.	Skip the log "Function Main started." to prevent system history space run out.		
7	Serial number has been saved.			
8	System backup has been executed.			
9	System restore has been executed.			
10	Robot parameters have been initialized.			
11	Offset pulse value between the encoder origin and the home sensor (HOFS) is changed. Additional data is J1 value.		J1 value after change	J1 value before change
12	Offset pulse value between the encoder origin and the home sensor (HOFS) is changed. Additional data is J2 value.		J2 value after change	J2 value before change
13	Offset pulse value between the encoder origin and the home sensor (HOFS) is changed. Additional data is J3 value.		J3 value after change	J3 value before change
14	Offset pulse value between the encoder origin and the home sensor (HOFS) is changed. Additional data is J4 value.		J4 value after change	J4 value before change
15	Offset pulse value between the encoder origin and the home sensor (HOFS) is changed. Additional data is J5 value.		J5 value after change	J5 value before change
16	Offset pulse value between the encoder origin and the home sensor (HOFS) is changed. Additional data is J6 value.		J6 value after change	J6 value before change
17	Move to the message saving mode.			
18	Conversion of Robot Parameter file has been executed.			
20	Enable setting in Teach mode has been saved.			
21	Enable setting in Teach mode has been changed.			
100	Device connected to Controller.			
101	Console device has changed.		21:PC 22:Remote 23:OP1	

No.	Message	Remedy	Note 1	Note 2
102	Display device has changed.			
103	Working mode has changed.			
110	Controller firmware has been installed.		1:Setup 2:Initialize 3:Upgrade 4:Recover	
111	IP address has been restored.	May store this log when the controller firmware is installed.		
120	PC connected to the Controller.		1:Ethernet 2:USB	
121	TP connected to the Controller.			
122	OP connected to the Controller.			
123	PC disconnected from the Controller.			
124	TP disconnected from the Controller.			
125	OP disconnected from the Controller.			
126	Working mode changed to AUTO.			
127	Working mode changed to Program.			
128	Working mode changed to Teach.			
129	Remote Ethernet connected to the Controller.			
130	Remote Ethernet disconnected from the Controller.			
131	Remote RS232 connected to the Controller.			
132	Remote RS232 disconnected from the Controller.		LogoutStatus 0:Nomal 1:Abnormal (Timeout)	

Warnings

No.	Message	Remedy	Note 1	Note 2
501	Trace history is active.	Effects system performance if trace history is active.		
502	Memory has been initialized.	When this error occurs, the value of the Global Preserve variable will be initialized. Replace the CPU board battery. Replace the CPU board.		
505	Reboot the controller.			
511	Battery voltage of the CPU board backup is lower than the allowed voltage. Replace the CPU board battery.	Replace the CPU board battery immediately. Keep the power to the controller ON as far as possible until you replace the battery.	Current value	Boundary value
512	5V input voltage for the CPU board is lower than the allowed voltage.	If normal voltage is not generated by a 5V power supply alone, replace the power supply.	Current value	Boundary value
513	24 V input voltage for the motor brake, encoder and fan is lower than the specified voltage.	If normal voltage is not generated by a 24V power supply alone, replace the power supply.	Current value	Boundary value
514	Internal temperature of the Controller is higher than the allowed temperature.	Stop the controller as soon as possible and check whether the ambient temperature of the controller is not high. Check whether the filter is not clogged up.	Current value	Boundary value
515	Rotating speed of the controller fan is below the allowed speed. (FAN1)	Check whether the filter is not clogged up. If the warning is not cleared after the controller is rebooted, replace the fan.	Current value	Boundary value
516	Rotating speed of the controller fan is below the allowed speed. (FAN2)	Check whether the filter is not clogged up. If the warning is not cleared after the controller is rebooted, replace the fan.	Current value	Boundary value
517	Internal temperature of the Controller is higher than the allowed temperature.			
598	Robot stopped due to a collision detection. Move in a different direction to avoid the collision.			
599	Jogging attempted near singularity point.			
700	Motor driver type does not match the current robot model. Check the robot model. Replace the motor driver.	Check the robot model.		
736	Encoder has been reset. Reboot the controller.	Reboot the controller.		
737	Low voltage from the encoder battery. Replace the battery with the controller ON.	Replace the battery for the robot with the controller ON.		
752	Servo alarm D.			

Controller Main

No.	Message	Remedy	Note 1	Note 2
1001	Operation Failure. Command parameter is invalid.			
1002	Requested data cannot be accessed. The data is not set up or the range is invalid.	Check whether the target I/O, variables, and tasks exist.		
1003	The password is invalid	Enter the correct password.		
1004	Cannot execute with unsupported version.	Use the correct version file.		
1005	Cannot execute with invalid serial number.	Use the backup data for the same controller to restore the controller configuration.		
1006	Cannot execute with invalid Robot model.	Use the backup data for the same controller to restore the controller configuration.		
1007	Cannot execute with invalid Controller.	Controller connected with PC is not supported. Connect with a regular controller.		
1008	Initialization failure. Failed to initialize TP.			
1009	OP is not supported by the connected controller.			
1020	Cannot execute in recovery mode.	Boot the controller as normal.		
1021	Cannot execute due to controller initialization failure.	Restore the controller configuration.		
1022	Cannot execute without the project being open.	Open a project.		
1023	Cannot execute while the project is open.	Rebuild the project.		
1024	Cannot activate from remote.	Enable the remote input.		
1025	Execution in Teach mode is prohibited.	Change to the AUTO mode.		
1026	Cannot execute in Teach mode except from TP.	Change to the AUTO mode.		
1027	Cannot execute in Auto mode.	Change to the Program mode.		
1028	Cannot execute in Auto mode except from the main console.	Change to the Program mode.		
1029	Cannot execute from OP.	Enable the OP input.		
1030	Does not allow Operation mode to be changed.	Change to the Auto mode with a console in the Program mode.		
1031	Cannot execute while tasks are executing.	Stop the task and then execute.		
1032	Cannot execute while the maximum number of tasks are executing.	Stop the task and then execute.		
1033	Cannot execute during asynchronous motion command.	Execute after the motion ends.		
1034	Asynchronous command stopped during operation.	The asynchronous command already stopped when the controller received a stop command.		
1035	Cannot execute in Remote enable except from the Remote.			
1036	Cannot execute in OP enable except from the OP.			

Maintenance 8. Trouble Shooting

No.	Message	Remedy	Note 1	Note 2
1037	Cannot execute in Remote Ethernet enable except from the Remote Ethernet.			
1040	Cannot execute in Remote RS232C enable except from the Remote RS232C.			
1041	Cannot execute during Emergency Stop status.	Cancel the Emergency Stop status.		
1042	Cannot execute while the safeguard is open.	Close the safeguard.		
1043	Cannot execute during error condition.	Cancel the error condition.		
1044	Cannot execute when the remote pause input is ON.	Change the remote pause input to OFF.		
1045	Input waiting condition is the only available condition to input.	The controller received an input while it was not in the Input waiting condition.		
1046	Cannot execute during file transfer.	Execute after the file transmission.		
1047	Cannot cancel the command executed from other devices.	Cancel the motion command from the device the command was issued from.		
1048	Cannot execute after after low voltage was detected.			
1049	Other devices are in program mode.			
1050	Password is too long.			
1051	Export Controller Status failed.			
1052	Export Controller Status busy.			
1100	File failure. Cannot access the file.			
1102	File failure. Read and write failure of the registry			
1103	File is not found.	Check whether the file exists.		
1104	Project file was not found.	Rebuild the project.		
1105	Object file was not found.	Rebuild the project.		
1106	Point files were not found.	Rebuild the project.		
1107	The program is using a feature that is not supported by the current controller firmware version.			
1108	One or more source files are updated. Please build the project.	Rebuild the project.		
1109	Not enough storage capacity.	Increase free space of the USB memory.		
1110	File is not found.			
1120	File failure. Setting file is corrupt.	Restore the controller configuration.		
1121	File failure. Project file is corrupt.	Rebuild the project.		
1122	File failure. Point file is corrupt.	Rebuild the project.		
1123	File failure. I/O label file is corrupt.	Rebuild the project.		
1124	File failure. User error file is corrupt.	Rebuild the project.		
1125	File failure. Error message file is corrupt.			
1126	File failure. Software option information is corrupt.			
1127	File failure. Vision file is corrupt.	Rebuild the project.		
1128	File failure. Backup information file is corrupt.			
1130	Error message failure. No item is found in the error history.			

No.	Message	Remedy	Note 1	Note 2
1131	Cannot access the USB memory.	Insert the USB memory properly. When this error still occurs after the USB memory is inserted properly, the memory may be unrecognizable to controller. Insert another memory to check the operation.		
1132	File failure. Failed to copy the file.			
1133	File failure. Failed to delete the file.			
1135	File failure. The name of Playback is invalid.			
1140	File failure. Failed to open the object file.			
1141	File failure. Failed to open the project file.			
1142	File failure. Failed to read the project file.			
1143	File failure. Failed to open the condition save file.			
1144	File failure. Failed to write the condition save file.			
1150	File failure. Error history is invalid.			
1151	File failure. Failed to map the error history.			
1152	File failure. Failed to open the error history file.			
1153	File failure. Failed to write the error history file.			
1155	File failure. Failed to open the settings file.	Restore the controller configuration.		
1156	File failure. Failed to save the settings file.	Restore the controller configuration.		
1157	File failure. Failed to read the settings file.	Restore the controller configuration.		
1158	File failure. Failed to write the settings file.	Restore the controller configuration.		
1160	MCD failure. Failed to open the MCD file.	Restore the controller configuration.		
1161	MCD failure. Failed to read the MCD file.	Restore the controller configuration.		
1162	MCD failure. Failed to write the MCD file.	Restore the controller configuration.		
1163	MCD failure. Failed to save the MCD file.	Restore the controller configuration.		
1165	MPD failure. Failed to open the MPD file.			
1166	MPD failure. Failed to read the MPD file.			
1167	MPD failure. Failed to write the MPD file.			
1168	MPD failure. Failed to save the MPD file.			
1170	MPL failure. Failed to open the MPL file.			
1171	MPL failure. Failed to read the MPL file.			

Maintenance 8. Trouble Shooting

No.	Message	Remedy	Note 1	Note 2
1172	MPL failure. Failed to write the MPL file.			
1173	MPL failure. Failed to save the MPL file.			
1175	MAL failure. Failed to open the MAL file.			
1176	MAL failure. Failed to read the MAL file.			
1177	MAL failure. Failed to write the MAL file.			
1178	MAL failure. Failed to save the MAL file.			
1180	MTR failure. Failed to create the MTR file.			
1181	PRM failure. Failed to replace the PRM file.			
1185	File failure. Failed to open the backup information file.			
1186	File failure. Failed to read the backup information file.			
1187	File failure. Failed to write the backup information file.			
1188	File failure. Failed to save the backup information file.			
1189	The backup data was created by an old version.	Cannot restore the controller configuration in the specified procedure for using old backup data. Check the backup data.		
1190	The backup data was created by a newer version.			
1191	There is no project in the backup data.			
1200	Compile failure. Check the compile message.	This error occurs during compilation from TP. Correct where the error occurred.		
1201	Link failure. Check the link message.	This error occurs during compilation from TP. Correct where the error occurred.		
1500	Communication error.			
1501	Command did not complete in time.	Execute the command again after a while. Check the connection between the PC and controller.		
1502	Communication disconnection between PC and Controller. Re-establish communication.	Check the connection between the PC and controller.		
1503	Disconnection while executing a task.			
1510	Out of IP Address range.			
1521	Vision communication. Failed to initialize Ethernet.			
1522	Vision communication. Failed to terminate Ethernet.			
1523	Vision communication. Failed to create the socket handle.			
1524	Vision communication. Failed to connect.			

No.	Message	Remedy	Note 1	Note 2
1526	Vision communication. Failed to send to the server.	Check the connection of the camera and controller.		
1527	Vision communication. Failed to read from the server.	Check the connection of the camera and controller.		
1528	Vision communication. Failed to set option.			
1529	Vision communication. Ethernet has not been initialized yet.			
1530	Vision communication. Connection is not completed.	Check the connection of the camera and controller.		
1531	Vision communication. All sockets are used.			
1532	Vision communication. Send timeout.	Check the connection of the camera and controller.		
1533	Vision communication. Read timeout.	Check the connection of the camera and controller.		
1534	Vision communication. Communication error.	Check the connection of the camera and controller.		
1550	Communication failure. Ethernet initialization error.			
1551	Communication failure. USB initialization error.			
1552	Communication failure. Controller internal communication error.			
1553	Communication failure. Invalid data is detected.			
1555	Ethernet transmission error.	Check the connection between the PC and controller.		
1556	Ethernet reception error.	Check the connection between the PC and controller.		
1557	USB transmission error.	Check the connection between the PC and controller.		
1558	USB reception error.	Check the connection between the PC and controller.		
1559	Communication failure. Failed to allocate memory.			
1580	Parser communication error.			
1581	Parser communication failure. Timeout error occurred during communication with parser.			
1582	Parser communication failure. Parser transmission error.			
1583	Parser communication failure. Parser initialization error.			
1584	Parser communication failure. Connection error.			
1585	Parser communication failure. Parameter is invalid.			
1586	Parser communication failure. Busy.			
1587	Parser communication failure. Invalid data is detected.			
1901	Unsupported. Unsupported command was attempted.			
1902	Unsupported. Unsupported parameter was specified.			

Maintenance 8. Trouble Shooting

No.	Message	Remedy	Note 1	Note 2
1903	System error.			

Operator Panel

No.	Message	Remedy	Note 1	Note 2
1600	Initialization failure. Failed to initialize OP.			
1603	Timeout error occurred during communication with OP.	Check whether the cable is firmly connected. Replace the cable.		
1604	Parity error occurred during communication with OP.	Check whether the cable is firmly connected. Replace the cable.		
1605	Framing error occurred during communication with OP.	Check whether the cable is firmly connected. Replace the cable.		
1606	Overrun error occurred during communication with OP.	Check whether the cable is firmly connected. Replace the cable.		
1607	Checksum error occurred during communication with OP.	Check whether the cable is firmly connected. Replace the cable.		
1608	Retry error occurred during communication with OP.	Check whether the cable is firmly connected. Replace the cable.		
1609	OP cannot be connected.	Upgrade the controller software. Upgrade the OP firmware.		

Teach Pendant

No.	Message	Remedy	Note 1	Note 2
1700	Initialization failure. Failed to initialize TP.			
1701	Initialization failure. Failed to initialize TP.			
1702	Initialization failure. Failed to initialize TP.			
1703	File failure. Failed to read the screen data file.			
1704	Failed to read the setting file.			
1706	Failed to open the TP port.			
1708	Failed to read the key table for TP.			
1709	Failed to change the language.			
1710	Failed to make the screen.			

PC

No.	Message	Remedy	Note 1	Note 2
1800	The controller is already connected to a PC.	Only one PC can be connected to the controller.		
1802	The command was attempted without being connected to a controller.			
1803	Failed to read or write the file on the PC.			
1804	Initialization failure. Failed to allocate memory on the PC.			
1805	Connection failure. Check the controller startup and connection of the communication cable.			
1806	Timeout during connection via Ethernet.			
1807	Timeout during connection via USB.			
1808	USB driver is not installed.	Failed to install EPSON RC+ 5.0. Install EPSON RC+ 5.0 again.		
1851	Unsupported. Unsupported command was attempted.			
1852	System error. Uncommon error.			

Simulator

No.	Message	Remedy	Note 1	Note 2
1861	Initialization failure. Failed to initialize SimulatorMNG.			
1862	Initialization failure. Failed to initialize WBProxy.			
1863	The parameter is invalid.			
1864	Initialization failure. Virtual controller does not exist.	Installation of EPSON RC+ 5.0 was failed. Reinstall EPSON RC+ 5.0.		
1865	Initialization failure. Failed to start virtual controller.	Try again after a while.		
1866	Termination failure. Failed to terminate virtual controller.			
1867	Cannot execute because it is not dry run mode.			
1868	Initialization failure. Directory cannot be found.			
1869	Initialization failure. File cannot be found.			
1870	Pallet failure. Number of point is beyond the maximum value.			
1871	Connection failure. Virtual controller version is old.			
1872	Connection failure. Files for simulator that used real controller cannot be found.			
1873	Connection failure. Files for simulator that used virtual controller cannot be found.	Register the virtual controller again in the connection setting.		
1874	Virtual Controller cannot be added.	Installation of EPSON RC+ 5.0 was failed. Reinstall EPSON RC+ 5.0.		
1875	Simulator Object failure. Cannot register data of the simulator object.			
1876	Simulator Object failure. Cannot register data of the simulator object.			
1877	Simulator Object failure. Cannot remove data of the simulator object.			
1878	Simulator Object failure. Cannot update data of the simulator object.			
1879	Other virtual controllers are starting.	Start another EPSON RC+5.0 and check if it connects with the virtual controller.		
1880	Cannot execute during controller reset.			

No.	Message	Remedy	Note 1	Note 2
7750	Initialization failure.	Reboot RC+.		
7751	Failed to save the objects.	Reboot RC+.		
7752	Failed to load the objects.	Reboot RC+.		
7753	Failed to mapping of memory.	Reboot RC+.		
7754	The virtual controller already exists.	Name of the virtual controller may be duplicated. Check the virtual controller name.		
7755	Failed to create the virtual controller connection information.	Reboot RC+.		
7756	The copy source of the virtual controller does not exist.	Check the virtual controller name.		
7757	The copy destination of the virtual controller already exists.	Name of the virtual controller may be duplicated. Check the virtual controller name.		
7758	Failed to copy the virtual controller connection information.	Reboot RC+.		
7759	Failed to delete the virtual controller connection information.	Reboot RC+.		
7760	Failed to delete the controller connection information.	Reboot RC+.		
7761	Failed to rename the controller connection information.	Check the virtual controller name.		
7762	The rename source of the virtual controller does not exist.	Check the virtual controller name.		
7763	The rename destination of the virtual controller already exists.	Check the virtual controller name.		
7764	Invalid Robot number.	Reboot RC+.		
7765	Failed to read the Robot definition file.	Check whether the definition file exists.		
7766	Failed to copy the layout objects.	Reboot RC+		
7767	Failed to cut the layout objects.	Reboot RC+		
7768	Failed to paste the layout objects.	Reboot RC+		
7769	Failed to remove the Robot.	Reboot RC+		
7770	Cannot execute with unsupported version.	Update RC+ to the latest version		

Interpreter

No.	Message	Remedy	Note 1	Note 2
2000	Unsupported. Unsupported command was attempted.	Rebuild the project.		
2001	Unsupported. Unsupported motion command was attempted.	Rebuild the project.		
2002	Unsupported. Unsupported conveyer command was attempted.	Rebuild the project.		
2003	Unsupported. Unsupported Function argument was specified.	Rebuild the project.		
2004	Unsupported. Unsupported Function return value was specified.	Rebuild the project.		
2005	Unsupported. Unsupported condition was specified.	Rebuild the project.		
2006	Unsupported. Unsupported I/O command was specified.	Rebuild the project.		
2007	Unsupported condition was specified.			
2008	Unsupported. Unknown error number.			
2009	Unsupported. Invalid Task number.			
2010	Object file error. Build the project. Out of internal code range.	Rebuild the project.		
2011	Object file error. Build the project. Function argument error.	Rebuild the project.		
2012	Object file error. Build the project. Command argument error.	Rebuild the project.		
2013	Object file error. Build the project. Cannot process the code.	Rebuild the project.		
2014	Object file error. Build the project. Cannot process the variable type code.	Rebuild the project.		
2015	Object file error. Build the project. Cannot process the string type code.	Rebuild the project.		
2016	Object file error. Build the project. Cannot process the variable category code.	Rebuild the project.		
2017	Object file error. Build the project. Cannot process because of improper code.	Rebuild the project.		
2018	Object file error. Build the project. Failed to calculate the variable size.	Rebuild the project.		
2019	Object file error. Cannot process the variable wait. Build the project.	Rebuild the project.		
2020	Stack table number exceeded. Function call or local variable is out of range.	Check whether no function is called infinitely. Reduce the Call function depth.		
2021	Stack area size exceeded. Stack error. Function call or local variable is out of range.	If using many local variables, especially String type, replace them to global variables.		

Maintenance 8. Trouble Shooting

No.	Message	Remedy	Note 1	Note 2
2022	Stack failure. Required data not found on the stack.	Rebuild the project.		
2023	Stack failure. Unexpected tag found on the stack.	Rebuild the project.		
2030	System failure. Drive unit quantity is beyond the maximum count.	Restore the controller configuration.		
2031	System failure. Robot number is beyond the maximum count.	Restore the controller configuration.		
2032	System failure. Task number compliance error.	Rebuild the project.		
2033	System failure. Too many errors.	Remedy the errors occurring frequently.		
2040	Thread failure. Failed to create the thread.			
2041	Thread failure. Thread creation timeout.			
2042	Thread failure. Thread termination timeout.			
2043	Thread failure. Thread termination timeout.			
2044	Thread failure. Daemon process timeout.			
2045	Thread failure. Task continuance wait timeout.			
2046	Thread failure. Task stop wait timeout.			
2047	Thread failure. Task startup wait timeout.			
2050	Object file operation failure. Object file size is beyond the allowable size.	Rebuild the project.		
2051	Object file operation failure. Cannot delete the object file during execution.	Reboot the controller.		
2052	Object file operation failure. Cannot allocate the memory for the object file.	Reboot the controller.		
2053	Object file update. Updating the object file.	Perform the same processing after a while. Rebuild the project.		
2054	Object file operation failure. Synchronize the project. Function ID failure.	Synchronize the files of the project. Rebuild the project.		
2055	Object file operation failure. Synchronize the project. Local variable ID failure.	Synchronize the files of the project. Rebuild the project.		
2056	Object file operation failure. Synchronize the project. Global variable ID failure.	Synchronize the files of the project. Rebuild the project.		
2057	Object file operation failure. Synchronize the project. Global Preserve variable ID failure.	Synchronize the files of the project. Rebuild the project.		
2058	Object file operation failure. Failed to calculate the variable size.	Synchronize the files of the project. Rebuild the project.		

No.	Message	Remedy	Note 1	Note 2
2059	Exceed the global variable area. Cannot assign the Global variable area.	Reduce the number of Global variables to be used.		
2070	SRAM failure. SRAM is not mapped.	Replace the CPU board.		
2071	SRAM failure. Cannot delete when Global Preserve variable is in use.	Perform the same processing after a while. Rebuild the project.		
2072	Exceed the backup variable area. Cannot assign the Global Preserve variable area.	Reduce the number of Global Preserve variables to be used.	Maximum size	The size you attempted to use
2073	SRAM failure. Failed to clear the Global Preserve variable area.	Rebuild the project.		
2074	SRAM failure. Failed to clean up the Global Preserve variable save area.	Reboot the controller.		
2100	Initialization failure. Failed to open the initialization file.	Restore the controller configuration.		
2101	Initialization failure. Duplicated initialization.			
2102	Initialization failure. Failed to initialize MNG.			
2103	Initialization failure. Failed to create an event.			
2104	Initialization failure. Failed to setup a priority.			
2105	Initialization failure. Failed to setup the stack size.			
2106	Initialization failure. Failed to setup an interrupt process.			
2107	Initialization failure. Failed to start an interrupt process.			
2108	Initialization failure. Failed to stop an interrupt process.			
2109	Initialization failure. Failed to terminate MNG.	Reboot the controller.		
2110	Initialization failure. Failed to allocate memory.	Reboot the controller.		
2111	Initialization failure. Failed to initialize motion.	Restore the controller configuration.		
2112	Initialization failure. Failed to terminate motion.	Reboot the controller.		
2113	Initialization failure. Failed to map SRAM.	Replace the CPU board.		
2114	Initialization failure. Failed to register SRAM.	Replace the CPU board.		
2115	Initialization failure. Fieldbus board is beyond the maximum count.			
2116	Initialization failure. Failed to initialize fieldbus.			
2117	Initialization failure. Failed to terminate fieldbus.			

Maintenance 8. Trouble Shooting

No.	Message	Remedy	Note 1	Note 2
2118	Initialization failure. Failed to open motion.	Restore the controller configuration.		
2119	Initialization failure. Failed to initialize conveyor tracking.	Make sure the settings of conveyor and encoder are correct.		
2120	Initialization failure. Failed to allocate the system area.	Reboot the controller.		
2121	Initialization failure. Failed to allocate the object file area.	Reboot the controller.		
2122	Initialization failure. Failed to allocate the robot area.	Reboot the controller.		
2123	Initialization failure. Failed to create event.	Reboot the controller.		
2124	Initialization failure. Failed to create the simulator data file.			
2130	MCD failure. Failed to open the MCD file.	Restore the controller configuration.		
2131	MCD failure. Failed to map the MCD file.	Restore the controller configuration.		
2132	PRM failure. PRM file cannot be found.	Restore the controller configuration.		
2133	PRM failure. Failed to map the PRM file.	Restore the controller configuration.		
2134	PRM failure. PRM file contents error.	Restore the controller configuration.		
2135	PRM failure. Failed to convert the PRM file.			
2136	PRM failure. Failed to convert the PRM file.			
2137	PRM failure. Failed to convert the PRM file.			
2150	Operation failure. Task number cannot be found.			
2151	Operation failure. Executing the task.			
2152	Operation failure. Object code size failure.			
2153	Operation failure. Jog parameter failure.			
2154	Operation failure. Executing jog.			
2155	Operation failure. Cannot execute the jog function.			
2156	Operation failure. Jog data is not configured.			
2157	Operation failure. Failed to change the jog parameter.			
2158	Operation failure. Failed to allocate the area for the break point.			
2159	Operation failure. Break point number is beyond the allowable setup count.			
2160	Operation failure. Failed to allocate the function ID.			
2161	Operation failure. Failed to allocate the local variable address.			

No.	Message	Remedy	Note 1	Note 2
2162	Operation failure. Not enough buffer to store the local variable.			
2163	Operation failure. Value change is available only when the task is halted.			
2164	Operation failure. Failed to allocate the global variable address.			
2165	Operation failure. Not enough buffer to store the global variable.			
2166	Operation failure. Failed to obtain the Global Preserve variable address.			
2167	Operation failure. Not enough buffer to store the Global Preserve variable.			
2168	Operation failure. SRAM is not mapped.			
2169	Operation failure. Cannot clear the Global Preserve variable when loading the object file.			
2170	Operation failure. Not enough buffer to store the string.			
2171	Operation failure. Cannot start the task after low voltage was detected.			
2172	Operation failure. Duplicated remote I/O configuration.			
2173	Remote setup error. Cannot assign non-existing input number to remote function.			
2174	Remote setup error. Cannot assign non-existing output number to remote function.			
2175	Operation failure. Remote function is not configured.			
2176	Operation failure. Event wait error.			
2177	Operation failure. System backup failed.			
2178	Operation failure. System restore failed.			
2179	Remote setup error. Cannot assign same input number to some remote functions.			
2180	Remote setup error. Cannot assign same output number to some remote functions.			
2190	Cannot calculate because it was queue data.	Check the program.		
2192	Cannot execute AbortMotion because robot task is already finished.			
2193	Cannot execute Recover without motion because AbortMotion was not executed.	Execute AbortMotion in advance to execute Recover WithoutMove.		
2194	Conveyor setting error.	Make sure the settings of conveyor and encoder are correct.		
2195	Conveyor setting error.	Make sure the settings of conveyor and encoder are correct.		

Maintenance 8. Trouble Shooting

No.	Message	Remedy	Note 1	Note 2
2196	Conveyor number is out of range.	Make sure the settings of conveyor and encoder are correct.		
2200	Robot in use. Cannot execute the motion command when other tasks are using the robot.	The motion command for the robot cannot be simultaneously executed from more than one task. Review the program.		
2201	Robot does not exist.	Check whether the robot setting is performed properly. Restore the controller configuration.		
2202	Motion control module status failure. Unknown error was returned.			
2203	Cannot clear local number '0'.	The Local number 0 cannot be cleared. Review the program.		
2204	Cannot clear an arm while in use.	The Arm cannot be cleared while it is in use. Check whether the Arm is not used.	The Arm number you attempted to clear	
2205	Cannot clear arm number '0'.	The Arm number 0 cannot be cleared. Review the program.		
2206	Cannot clear a tool while in use.	The Tool cannot be cleared while it is in use. Check whether the Tool is not used.	The Tool number you attempted to clear	
2207	Cannot clear tool number '0'.	The Tool number 0 cannot be cleared. Review the program.		
2208	Cannot clear ECP '0'.	The ECP number 0 cannot be cleared. Review the program.		
2209	Cannot clear an ECP while in use.	The ECP cannot be cleared while it is in use. Check whether the ECP is not used.	The ECP number you attempted to clear	
2210	Cannot specify '0' as the local number.	The command processing the Local cannot specify the Local number 0. Review the program.		
2216	Box number is out of range.			
2217	Box number is not defined.			
2218	Plane number is out of range.			
2219	Plane number is not defined.			
2220	PRM failure. No PRM file data is found.	Reboot the controller. Restore the controller configuration.		
2221	PRM failure. Failed to flash the PRM file.	Reboot the controller. Restore the controller configuration.		
2222	Local number is not defined.	Check the Local setting. Review the program.	The specified Local number	
2223	Local number is out of range.	Available Local number is from 1 to 15. Review the program.	The specified Local number	
2224	Unsupported. MCOFS is not defined			
2225	CalPIs is not defined.	Check the CalPIs setting.		

No.	Message	Remedy	Note 1	Note 2
2226	Arm number is out of range.	Available Arm number is from 0 to 3. Depending on commands, the Arm number 0 is not available. Review the program.	The specified Arm number	
2227	Arm number is not defined.	Check the Arm setting. Review the program.	The specified Arm number	
2228	Pulse for the home position is not defined.	Check the HomeSet setting.		
2229	Tool number is out of range.	Available Tool number is from 0 to 3. Depending on commands, the Tool number 0 is not available. Review the program.	The specified Tool number	
2230	Tool number is not defined.	Check the Tool setting. Review the program.	The specified Tool number	
2231	ECP number is out of range.	Available Tool number is from 0 to 15. Depending on commands, the Tool number 0 is not available. Review the program.	The specified ECP number	
2232	ECP number is not defined.	Check the ECP setting. Review the program.	The specified ECP number	
2233	Axis to reset the encoder was not specified.	Be sure to specify the axis for encoder reset.		
2234	Cannot reset the encoder with motor in the on state.	Turn the motor power OFF before reset.		
2235	XYLIM is not defined.	Check the XYLim setting. Review the program.		
2236	PRM failure. Failed to set up the PRM file contents to the motion control status module.	Reboot the controller. Restore the controller configuration.		
2240	Array subscript is out of user defined range. Cannot access or update beyond array bounds.	Check the array subscript. Review the program.	The dimensions exceeding the definition	The specified subscript
2241	Dimensions of array do not match the declaration.	Check the array's dimensions. Review the program.		
2242	Zero '0' was used as a divisor.	Review the program.		
2243	Variable overflow. Specified variable was beyond the maximum allowed value.	Check the variable type and calculation result. Review the program.		
2244	Variable underflow. Specified variable was below the minimum allowed value.	Check the variable type and calculation result. Review the program.		
2245	Cannot execute this command with a floating point number.	This command cannot be executed for Real or Double type. Review the program.		
2246	Cannot calculate the specified value using the Tan function.	Check the specified value. Review the program.	The specified value	
2247	Specified array subscript is less than '0'.	Check the specified value. Review the program.	The specified value	
2248	Array failure. Redim can only be executed for an array variable.	You attempted to redimension the variable that is not array. Rebuild the project.		
2249	Array failure. Cannot specify Preserve for other than a single dimension array.	Other than a single dimension array was specified as Preserve for Redim. Rebuild the project.		

No.	Message	Remedy	Note 1	Note 2
2250	Array failure. Failed to calculate the size of the variable area.	Rebuild the project.		
2251	Cannot allocate enough memory for Redim statement.	Reduce the number of subscripts to be specified for Redim. Perform Redim modestly.		
2252	Cannot allocate enough memory for ByRef.	Reduce the number of array's subscripts to be seen by ByRef.		
2253	Cannot compare characters with values.	Check whether the string type and the numeric data type are not compared. Review the program.		
2254	Specified data is beyond the array bounds. Cannot refer or update beyond the array bounds.	Check the number of array's subscripts and data. Review the program.	The number of array subscripts	The number of data to be referred or updated
2255	Variable overflow or underflow. Specified variable is out of value range.	The value that exceeds the range of Double type is specified. Review the program.		
2256	Specified array subscript is beyond the maximum allowed range.	Reduce the number of subscripts to be specified. For available subscripts, see the online help.		
2260	Task number is out of the available range.	For available task number, see the online help. Review the program.	The specified task number	
2261	Specified task number does not exist.	Review the program.	The specified task number	
2262	Robot number is out of the available range.	The available Robot number is 1. Review the program.	The specified robot number	
2263	Output number is out of the available range. The Port No. or the Device No. is out of the available range.	For available output number, see the online help. Review the program.	The specified output number	
2264	Command argument is out of the available range. Check the validation. Added data 1: Passed value. Added data 2: argument order.	For available range of argument, see the online help. Review the program.	The specified value	What number argument?
2265	Joint number is out of the available range.	Available Joint number is from 1 to 6. Review the program.	The specified joint number	
2266	Wait time is out of available range.	Available wait time is from 0 to 2147483. Review the program.	The specified wait time	
2267	Timer number is out of available range.	Available timer number is from 0 to 15. Review the program.	The specified timer number	
2268	Trap number is out of available range.	Available trap number is from 1 to 4. Review the program.	The specified trap number	
2269	Language ID is out of available range.	For available language ID, see the online help. Review the program.	The specified language ID	
2270	Specified D parameter value at the parallel process is out of available range.	Available D parameter value is from 0 to 100. Review the program.	The specified D parameter value	
2271	Arch number is out of available range.	Available arch number is from 0 to 7. Review the program.	The specified arch number	
2272	Device No. is out of available range.	The specified number representing a control device or display device is out of available range. For available device number, see the online help. Review the program.	The specified device number	

No.	Message	Remedy	Note 1	Note 2
2273	Output data is out of available range.	Available output data value is from 0 to 255. Review the program.	Output data	What number byte data is out of range?
2274	Asin argument is out of available range. Range is from -1 to 1.	Review the program.		
2275	Acos argument is out of available range. Range is from -1 to 1.	Review the program.		
2276	Sqr argument is out of available range.	Review the program.		
2277	Randomize argument is out of available range.	Review the program.		
2278	Sin, Cos, Tan argument is out of available range.	Review the program.		
2280	Timeout period set by the TMOOut statement expired before the wait condition was completed in the WAIT statement.	Investigate the cause of timeout. Check whether the set timeout period is proper.	Timeout period	
2281	Timeout period set by TMOOut statement in WaitSig statement or SyncLock statement expired.	Investigate the cause of timeout. Check whether the set timeout period is proper.	Signal number	Timeout period
2282	Timeout period set by TMOOut statement in WaitNet statement expired.	Investigate the cause of timeout. Check whether the set timeout period is proper.	Port number	Timeout period
2283	Timeout. Timeout at display device setting.	Reboot the controller.		
2290	Cannot execute a motion command.	Cannot execute the motion command after using the user function in the motion command. Review the program.		
2291	Cannot execute the OnErr command.	Cannot execute OnErr in the motion command when using user function in the motion command. Review the program.		
2292	Cannot execute an I/O command while the safeguard is open. Need Forced.			
2293	Cannot execute an I/O command during emergency stop condition. Need Forced.			
2294	Cannot execute an I/O command when an error has been detected. Need Forced.			
2295	Cannot execute this command from a NoEmgAbort Task.			
2296	One or more source files are updated. Please build the project.	Rebuild the project.		
2297	Cannot execute an I/O command in TEACH mode without the Forced parameter.	-		
2298	Cannot continue execution in Trap SGClose process.	You cannot execute Cont and Recover statements with processing task of Trap SGClose.		
2299	Cannot execute this command. Need the setting.	Enable the [enable the advance taskcontrol commands] from RC+ to execute the command.		

Maintenance 8. Trouble Shooting

No.	Message	Remedy	Note 1	Note 2
2300	Robot in use. Cannot execute the motion command when other task is using the robot.	The motion command for the robot cannot be simultaneously executed from more than one task. Review the program.	Task number that is using the robot	
2301	Cannot execute the motion command when the Enable Switch is OFF.			
2302	Cannot execute a Call statement in a Trap Call process.	Another function cannot be called from the function called by Trap Call. Review the program.		
2303	Cannot execute a Call statement in a parallel process.	Review the program.		
2304	Cannot execute an Xqt statement in a parallel process.	Review the program.		
2305	Cannot execute a Call statement from the command window.			
2306	Cannot execute an Xqt statement from the task started by Trap Xqt.	Review the program.		
2307	Cannot execute this command while tasks are executing.	Check whether all tasks are completed.		
2308	Cannot turn on the motor because of a critical error.	Find the previously occurring error in the error history and resolve its cause. Then, reboot the controller.		
2309	Cannot execute a motion command while the safeguard is open.	Check the safeguard status.		
2310	Cannot execute a motion command while waiting for continue.	Execute the Continue or Stop and then execute the motion command.		
2311	Cannot execute a motion command during the continue process.	Wait until the Continue is complete and then execute the motion command.		
2312	Cannot execute a task during emergency stop condition.	Check the emergency stop status.		
2313	Cannot continue execution immediately after closing the safeguard.	Wait 1.5 seconds after the safeguard is open, and then execute the Continue.		
2314	Cannot continue execution while the safeguard is open.	Check the safeguard status.		
2315	Duplicate execution continue.	Wait until the Continue is completed.		
2316	Cannot continue execution after an error has been detected.	Check the error status.		
2317	Cannot execute the task when an error has been detected.	Reset the error by Reset and then execute the task.		
2318	Cannot execute a motion command when an error has been detected.			
2319	Cannot execute a I/O command during emergency stop condition.			
2320	Function failure. Argument type does not match.	Rebuild the project.		
2321	Function failure. Return value does not match to the function.	Rebuild the project.		
2322	Function failure. ByRef type does not match.	Rebuild the project.		
2323	Function failure. Failed to process the ByRef parameter.	Rebuild the project.		

No.	Message	Remedy	Note 1	Note 2
2324	Function failure. Dimension of the ByRef parameter does not match.	Rebuild the project.		
2325	Function failure. Cannot use ByRef in an Xqt statement.	Rebuild the project.		
2326	Cannot execute a Dll Call statement from the command window.	-		
2327	Failed to execute a Dll Call.	-		
2328	Cannot execute the task before connect with RC+.	You need to connect with RC+ before executing the task.		
2329	Cannot execute a Eval statement in a Trap Call process.	Check the program.		
2330	Trap failure. Cannot use the argument in Trap Call or Xqt statement.	Check the program.		
2331	Trap failure. Failed to process Trap Goto statement.	Rebuild the project.		
2332	Trap failure. Failed to process Trap Goto statement.	Rebuild the project.		
2333	Trap failure. Trap is already in process.	Rebuild the project.		
2334	Cannot execute a Eval statement in a Trap Finsh and Trap Abort process.	Check the program.		
2335	Cannot continue execution and Reset Error in TEACH mode.	Check the program.		
2336	Cannot use Here statement with a parallel process.	Go Here :Z(0) ! D10; MemOn(1) ! is not executable. Change the program to: P999 = Here Go P999 Here :Z(0) ! D10; MemOn(1) !		
2337	Cannot execute except from the event handler function of GUI Builder	Check the program.		
2340	Value allocated in InBCD function is an invalid BCD value.	Review the program.	Tens digit	Units digit
2341	Specified value in the OpBCD statement is an invalid BCD value.	Review the program.	The specified value	
2342	Cannot change the status for output bit configured as remote output.	Check the remote I/O setting.	I/O number	1: bit, 2: byte, 3: word
2343	Output time for asynchronous output commanded by On or Off statement is out of the available range.	Review the program.	The specified time	
2344	I/O input/output bit number. is out of available range or the board is not installed.	Review the program. Check whether the expansion I/O board and Fieldbus I/O board are correctly detected.	Bit number	
2345	I/O input/output byte number is out of available range or the board is not installed.	Review the program. Check whether the expansion I/O board and Fieldbus I/O board are correctly detected.	Byte number	
2346	I/O input/output word No. is out of available range or the board is not installed.	Review the program. Check whether the expansion I/O board and Fieldbus I/O board are correctly detected.	Word number	
2347	Memory I/O bit number is out of available range.	Review the program.	Bit number	

Maintenance 8. Trouble Shooting

No.	Message	Remedy	Note 1	Note 2
2348	Memory I/O byte number is out of available range.	Review the program.	Byte number	
2349	Memory I/O word number is out of available range.	Review the program.	Word number	
2350	Command allowed only when virtual I/O mode is active.	The command can be executed only for virtual I/O mode.		
2351	Cannot change the status for CC-Link system area.			
2352	Remote setup error. Cannot assign CC-Link system area to remote function.			
2360	File failure. Failed to open the configuration file.	Restore the controller configuration.		
2361	File failure. Failed to close the configuration file.	Restore the controller configuration.		
2362	File failure. Failed to open the key of the configuration file.	Restore the controller configuration.		
2363	File failure. Failed to obtain the string from the configuration file.	Restore the controller configuration.		
2364	File failure. Failed to write in the configuration file.	Restore the controller configuration.		
2365	File failure. Failed to update the configuration file.	Restore the controller configuration.		
2370	The string combination exceeds the maximum string length.	The maximum string length is 255. Review the program.	Combined string length	
2371	String length is out of range.	The maximum string length is 255. Review the program.	The specified length	
2372	Invalid character is specified after the ampersand in the Val function.	Review the program.		
2373	Illegal string specified for the Val function.	Review the program.		
2374	String Failure. Invalid character code in the string.	Review the program.		
2380	Cannot use ' 0 ' for Step value in For...Next.	Check the Step value.		
2381	Relation between For...Next and GoSub is invalid. Going in or out of a For...Next using a Goto statement.	Review the program.		
2382	Cannot execute Return while executing OnErr.	Review the program.		
2383	Return was used without GoSub. Review the program.	Review the program.		
2384	Case or Send was used without Select. Review the program.	Review the program.		
2385	Cannot execute EResume while executing GoSub.	Review the program.		
2386	EResume was used without OnErr. Review the program.	Review the program.		
2400	Curve failure. Failed to open the Curve file.	Reboot the controller. Create a Curve file again.		
2401	Curve failure. Failed to allocate the header data of the curve file.	Reboot the controller. Create a Curve file again.		

No.	Message	Remedy	Note 1	Note 2
2402	Curve failure. Failed to write the curve file.	Reboot the controller. Create a Curve file again.		
2403	Curve failure. Failed to open the curve file.	Reboot the controller. Create a Curve file again.		
2404	Curve failure. Failed to update the curve file.	Reboot the controller. Create a Curve file again.		
2405	Curve failure. Failed to read the curve file.	Reboot the controller. Create a Curve file again.		
2406	Curve failure. Curve file is corrupt.	Reboot the controller. Create a Curve file again.		
2407	Curve failure. Specified a file other than the curve file.	Reboot the controller. Create a Curve file again.		
2408	Curve failure. Version of the curve file is invalid.	Reboot the controller. Create a Curve file again.		
2409	Curve failure. Robot number in the curve file is invalid.	Reboot the controller. Create a Curve file again.		
2410	Curve failure. Cannot allocate enough memory for the CVMove statement.	Reboot the controller.		
2411	Specified point data in the Curve statement is beyond the maximum count.	The maximum number of points specified in the Curve statement is 200. Review the program.		
2412	Specified number of output commands in the Curve statement is beyond the maximum count.	The maximum number of output commands specified in the Curve statement is 16. Review the program.		
2413	Curve failure. Specified internal code is beyond the allowable size in Curve statement.	Reboot the controller.		
2414	Specified continue point data P(:) is beyond the maximum count.	The maximum number of points specified continuously is 200. Review the program.	Start point	End point
2415	Curve failure. Cannot create the curve file.	Reboot the controller. Create a Curve file again.		
2416	Curve file does not exist.	Check whether the specified Curve file name is correct.		
2417	Curve failure. Output command is specified before the point data.	Check whether no output command is specified before the point data.		
2418	Curve file name is too long.	Check whether the specified Curve file name is correct. The maximum string length of the file name is 32.		
2419	Curve failure. Curve file path is too long.	Check whether the specified Curve file name is correct.		
2420	Curve file name is invalid.			
2430	Error message failure. Error message file does not exist.	Reboot the controller.		
2431	Error message failure. Failed to open the error message file.	Reboot the controller.		
2432	Error message failure. Failed to obtain the header data of the error message file.	Reboot the controller.		
2433	Error message failure. Error message file is corrupted.	Reboot the controller.		
2434	Error message failure. Specified a file other than the error message file.	Reboot the controller.		

Maintenance 8. Trouble Shooting

No.	Message	Remedy	Note 1	Note 2
2435	Error message failure. Version of the error message file is invalid.	Reboot the controller.		
2440	File Error. File number is used.	Check the file number.		
2441	File Error. Failed to open the file.	Make sure the file exists and you specified the file correctly.		
2442	File Error. The file is not open.	Open the file in advance.		
2443	File Error. The file number is being used by another task.	Check the program.		
2444	File Error. Failed to close the file.			
2445	File Error. File seek failed.			
2446	File Error. All file numbers are being used.			
2447	File Error. No read permission.	Use ROpen or UOpen that has read access to the file.		
2448	File Error. No write permission.	Use WOpen or UOpen that has write access to the file.		
2449	File Error. No binary permission.	Use BOpen that has binary access to the file.		
2450	File Error. Failed to access the file.			
2451	File Error. Failed to write the file.			
2452	File Error. Failed to read the file.			
2453	File Error. Cannot execute the commnad for current disk.	The specified command is not available in the current disk (ChDisk).		
2454	File Error. Invalid disk.			
2455	File Error. Invalid drive.			
2456	File Error. Invalid folder.			
2460	Database Error. The database number is already being used.			
2461	Database Error. The database is not open.			
2462	Database Error. The database number is being used by another task.			
2470	Windows Communication Error. Invalid status.			
2471	Windows Communication Error. Invalid answer.			
2472	Windows Communication Error. Already initialized.			
2473	Windows Communication Error. Busy.			
2474	Windows Communication Error. No request.			
2475	Windows Communication Error. Data buffer overflow.			

No.	Message	Remedy	Note 1	Note 2
2476	Windows Communication Error. Failed to wait for event.			
2477	Windows Communication Error. Invalid folder.	Make sure the specified folder is correct.		
2478	Windows Communication Error. Invalid error code.			
2500	Specified event condition for Wait is beyond the maximum count.	The maximum number of event conditions is 8. Review the program.		
2501	Specified bit number in the Ctr function was not setup with a CTRreset statement.	Review the program.	The specified bit number	
2502	Task number is beyond the maximum count to execute.	The available number of the tasks that can be executed simultaneously is 16. Review the program.		
2503	Cannot execute Xqt when the specified task number is already executing.	Review the program.	The specified task number	
2504	Task failure. Specified manipulator is already executing a parallel process.	Rebuild the project.		
2505	Not enough data for Input statement variable assignment.	Check the content of communication data. Review the program.		
2506	Specified variable for the Input statement is beyond the maximum count.	For OP, only one variable can be specified. For other devices, up to 32 variables can be specified.		
2507	All counters are in use and cannot setup a new counter with CTRreset.	The available number of the counters that can be set simultaneously is 16. Review the program.		
2508	OnErr failure. Failed to process the OnErr statement.	Rebuild the project.		
2509	OnErr failure. Failed to process the OnErr statement.	Rebuild the project.		
2510	Specified I/O label is not defined.	The specified I/O label is not registered. Check the I/O label file.		
2511	SyncUnlock statement is used without executing a previous SyncLock statement. Review the program.	Review the program.	Signal number	
2512	SyncLock statement was already executed.	The SyncLock statement cannot be executed for the second time in a row. Review the program.	Signal number	
2513	Specified point label is not defined.	The specified point label is not registered. Check the point file.		
2514	Failed to obtain the motor on time of the robot.	Reboot the controller.		
2515	Failed to configure the date or the time.	Check whether a date and time is set correctly.		
2516	Failed to obtain the debug data or to initialize.	Reboot the controller.		
2517	Failed to convert into date or time.	Check the time set on the controller. Reboot the controller.		
2518	Larger number was specified for the start point data than the end point data.	Specify a larger number for the end point data than that for the start point data.	Start point	End point
2519	Specified the format for FmtStr\$ can not understand.	Check the format.		

No.	Message	Remedy	Note 1	Note 2
2520	Point file name is too long.	Check whether the specified point file name is correct. The maximum string length of the file name is 32.		
2521	Point failure. Point file path is too long.	Check whether the specified point file name is correct.		
2522	Point file name is invalid.			
2523	The continue process was already executed.			
2524	Cannot execute Xqt when the specified trap number is already executing.			
2525	Password is invalid.	Check whether a password is set correctly.		
2526	No wait terms.			
2527	Too many variables used for global variable wait.			
2528	The variables cannot use global variable wait.			
2529	Cannot use Byref if the variables used for global variable wait.			
2530	Too many point files.			
2531	The point file is used by another robot.			
2532	Cannot calculate the point position because there is undefined data.			
2533	Error on INP or OUTP.			
2534	No main function to start on Restart statement.	Without executing main function, Restart is called.		
2535	Does not allow Enable setting in Teach mode to be changed.			
2536	Failed to change Enable setting in Teach mode.			
2539	Password is invalid.	Check whether a password is set correctly.		
2900	Failed to open as server to the Ethernet port.	Check whether the Ethernet port is set properly. Check whether the Ethernet cable is connected properly.		
2901	Failed to open as client to the Ethernet port.	Check whether the Ethernet port is set properly. Check whether the Ethernet cable is connected properly.		
2902	Failed to read from the Ethernet port.	Check whether the port of communication recipient is not close.		
2904	Invalid IP Address was specified.			
2905	Ethernet failure. No specification of Server/Client.			
2906	Ethernet port was not configured.	Check whether the Ethernet port is set properly.	Port number	
2907	Ethernet port was already in use by another task.	A single port cannot be used by more than one task.	Port number	
2908	Cannot change the port parameters while the Ethernet port is open.	The port parameters cannot be changed while the port is open.	Port number	
2909	Ethernet port is not open.	To use the Ethernet port, execute the OpenNet statement.	Port number	
2910	Timeout reading from an Ethernet port.	Check the communication.	Timeout value	
2911	Failed to read from an Ethernet port.	Check the communication.		

No.	Message	Remedy	Note 1	Note 2
2912	Ethernet port was already open by another task.	A single port cannot be used by more than one task.	Port number	
2913	Failed to write to the Ethernet port.	Check whether the Ethernet port is set properly. Check whether the Ethernet cable is connected properly.	Port number	
2914	Ethernet port connection was not completed.	Check whether the port of communication recipient is open.	Port number	
2915	Data received from the Ethernet port is beyond the limit of one line.	The maximum length of a line is 255 bytes.	The number of bytes in a received line	
2920	RS-232C failure. RS-232C port process error.	Check whether the RS-232C board is correctly detected.		
2921	RS-232C failure. Uncommon error. RS-232C port read process error.			
2926	The RS-232C port hardware is not installed.	Check whether the RS-232C board is correctly detected.	Port number	
2927	RS-232C port is already open by another task.	A single port cannot be used by more than one task.	Port number	
2928	Cannot change the port parameters while the RS-232C port is open.	The port parameters cannot be changed while the port is open.	Port number	
2929	RS-232C port is not open.	To use the RS-232C port, execute the OpenCom statement.	Port number	
2930	Timeout reading from the RS-232C port.	Check the communication.	Timeout value	
2931	Failed to read from the RS-232C port.	Check the communication.		
2932	RS-232C port is already open by another task.	A single port cannot be used by more than one task.	Port number	
2933	Failed to write to the RS-232C port.	Check the communication.	Port number	
2934	RS-232C port connection not completed.			
2935	Data received from the RS-232C port is beyond the limit of one line.	The maximum length of a line is 255 bytes.	The number of bytes in a received line	
2937	Cannot execute while Remote RS-232C are using.			
2950	Daemon failure. Failed to create the daemon thread.			
2951	Daemon failure. Timeout while creating the daemon thread.			
2952	TEACH/AUTO switching key input signal failure was detected.	Set the TP key switch to TEACH or AUTO properly. Check whether the TP is connected properly.		
2953	ENABLE key input signal failure was detected.	Check whether the TP is connected properly.		
2954	Relay weld was detected.	Overcurrent probably occurred due to short-circuit failure. Investigate the cause of the problem and take necessary measures and then replace the DPB.		
2955	Temperature of regeneration resistor was higher than the specified temperature.	Check whether the filter is not clogged up and the fan does not stop. If there is no problem on the filter and fan, replace the regenerative module.		
2970	MNG failure. Area allocate error.			
2971	MNG failure. Real time check error.			

Maintenance 8. Trouble Shooting

No.	Message	Remedy	Note 1	Note 2
2972	MNG failure. Standard priority error.			
2973	MNG failure. Boost priority error.			
2974	MNG failure. Down priority error.			
2975	MNG failure. Event wait error.			
2976	MNG failure. Map close error.			
2977	MNG failure. Area free error.			
2978	MNG failure. AddIOMem error.			
2979	MNG failure. AddInPort error.			
2980	MNG failure. AddOutPort error.			
2981	MNG failure. AddInMemPort error.			
2982	MNG failure. AddOutMemPort error.			
2983	MNG failure. IntervalOutBit error.			
2984	MNG failure. CtrReset error.			
2997	Collision was detected.			
2998	AbortMotion attempted when robot was not moving	See Help for AbortMotion.		
2999	AbortMotion attempted when robot was moving	See Help for AbortMotion.		

Parser

No.	Message	Remedy	Note 1	Note 2
3000	OBJ file size is large. TP1 may not be able to build this project.			
3050	Main function is not defined.	Declare a Main function.		
3051	Function does not exist.	Declare an unresolved function.		
3052	Variable does not exist.	Declare an unresolved variable.		
3100	Syntax error.	Correct the syntax error.		
3101	Parameter count error.	The number of parameters is excess or deficiency. Correct the parameters.		
3102	File name length is beyond the maximum allowed.	Shorten the file name.		
3103	Duplicate function definition.	Change the function name.		
3104	Duplicate variable definition ' ** '.	Change the variable name.		
3105	Global and Global Preserve variables cannot be defined inside a function block.	Declare the Global and Global Preserve variables outside the function block.		
3106	An undefined function was specified.	Specify a valid function name.		
3107	Both While and Until for Do...Loop was specified.	The While/Until statement is specified for both Do statement and Loop statement. Delete either While/Until statement.		
3108	Specified line number or label ' ** ' does not exist.	Set the line label.		
3109	Overflow error.	The direct numerical specification overflows. Reduce the numeric value.		
3110	An undefined variable was specified ' ** '.	There is an undefined variable. Declare the variable.		
3111	Specified variable is not an array variable.	Specify the array variable.		
3112	Cannot change the dimensions of the array variable.			
3114	Specified Next variable does not match the specified For variable.	Correct the variable name.		
3115	Cannot use a point expression in the first argument.	Specify a single point for the point flag setting. Do not specify a point expression.		
3116	Array number of dimensions does not match the declaration.	Check the number of array dimensions.		
3117	File cannot be found.			
3118	Corresponding EndIf cannot be found.	The number of EndIf statements is not enough. Add the EndIf.		
3119	Corresponding Loop cannot be found.	The number of Loop statements is not enough. Add the Loop.		
3120	Corresponding Next cannot be found.	The number of Next statements is not enough. Add the Next.		
3121	Corresponding Send cannot be found.	The number of Send statements is not enough. Add the Send.		
3123	On/Off statements are beyond the maximum count.	An upper limit is set on the number of On/Off statements. Check the upper limit and correct the program.		
3124	Point number is beyond the maximum count.	An upper limit is set on the available number of points. Check the upper limit and correct the program.		

No.	Message	Remedy	Note 1	Note 2
3125	Corresponding If cannot be found.	The number of EndIf statements is too many. Delete the unnecessary EndIf.		
3126	Corresponding Do cannot be found.	The number of Loop statements is too many. Delete the unnecessary Loop.		
3127	Corresponding Select cannot be found.	The number of Send statements is too many. Delete the unnecessary Send.		
3128	Corresponding For cannot be found.	The number of Next statements is too many. Delete the unnecessary Next.		
3129	'_' cannot be used as the first character of an identifier.	Change the first character of the identifier to an alphabetic character.		
3130	Cannot specify Rot parameter.			
3131	Cannot specify Ecp parameter.			
3132	Cannot specify Arch parameter.			
3133	Cannot specify LimZ parameter.			
3134	Cannot specify Sense parameter.			
3135	Invalid parameter is specified.			
3136	Cannot use #include.			
3137	Cannot specify the array variable subscript.	The array variable subscript cannot be specified.		
3138	ByRef was not specified on Function declaration.			
3139	Cannot execute the Xqt statement for a function that needs a ByRef parameter.	The Xqt statement cannot be executed for a function needing a ByRef parameter. Delete the ByRef parameter.		
3140	Cannot execute the Redim statement for a ByRef variable.			
3141	OBJ file is corrupt.			
3142	OBJ file size is beyond the available size after compiling.	The compilation result exceeds the limit value. Divide the program.		
3143	Ident length is beyond the available size.			
3144	'**' already used for a function name.			
3145	'**' already used for a Global Preserve variable.			
3146	'**' already used for a Global variable.			
3147	'**' already used for a Module variable.			
3148	'**' already used for a Local variable.			
3149	'**' already used for a I/O label.			
3150	'**' already used for a User Error label.			
3151	Cannot use a function parameter.	Argument cannot be specified for the function that is executed by the Trap statement.		
3152	Over elements value.			
3153	Parameter type mismatch.			
3154	'**' is not Input Bit label.			
3155	'**' is not Input Byte label.			
3156	'**' is not Input Word label.			

No.	Message	Remedy	Note 1	Note 2
3157	'**' is not Output Bit label.			
3158	'**' is not Output Byte label.			
3159	'**' is not Output Word label.			
3160	'**' is not Memory Bit label.			
3161	'**' is not Memory Byte label.			
3162	'**' is not Memory Word label.			
3163	Too many function arguments.			
3164	Cannot compare Boolean value.			
3165	Cannot use Boolean value in the expression.			
3166	Cannot compare between Boolean and expression.			
3167	Cannot store Boolean value to the numeric variable.			
3168	Cannot store numeric value to the Boolean variable.			
3169	Undefined I/O label was specified.			
3170	Invalid condition expression was specified.			
3171	Cannot compare between numeric value and string.			
3172	Cannot use keyword for the variable name.			
3172	'**' already used for a line label.			
3173	Duplicate line number or label (**).			
3175	Undefined Point label was specified.			
3176	An undefined variable was specified.			
3177	'**' already used for a Point label.			
3178	Cannot use the result number.			
3179	String literal is beyond the available length.			
3180	Cannot change a calibration property value with the VSet command.			
3181	Array variable should be used with ByRef.			
3182	Subscription was not specified.			
3187	Invalid Point flag value was specified.			
3188	Call command cannot be used in parallel processing.			
3189	Local variables cannot be used with the Wait command.			
3190	Array variables cannot be used with the Wait command.			
3191	Real variables cannot be used with the Wait command.			
3192	String variables cannot be used with the Wait command.			
3194	Cannot use Boolean value for the timeout value.			
3196	Fend is not there.			
3197	Numeric variable name cannot use '\$'.			
3198	String variable should has '\$'.			
3199	Invalid object is specified.			
3200	Value is missing.			

Maintenance 8. Trouble Shooting

No.	Message	Remedy	Note 1	Note 2
3201	Expected ', '.			
3202	Expected '('.			
3203	Expected ') '.			
3204	Identifier is missing.			
3205	Point is not specified.			
3206	Event condition expression is missing.			
3207	Formula is missing.			
3208	String formula is missing.			
3209	Point formula is missing.			
3210	Line label was not specified.			
3211	Variable was not specified.			
3212	Corresponding Fend cannot be found.			
3213	Expected ' : '.			
3214	True/False was not specified.			
3215	On/Off was not specified.			
3216	High/Low was not specified.			
3217	Input bit label was not specified.			
3218	Input byte label was not specified.			
3219	Input word label was not specified.			
3220	Output bit label was not specified.			
3221	Output byte label was not specified.			
3222	Output word label was not specified.			
3223	Memory bit label was not specified.			
3224	Memory byte label was not specified.			
3225	Memory word label was not specified.			
3226	User error label was not specified.			
3227	Function name was not specified.			
3228	Variable type was not specified.			
3229	Invalid Trap statement parameter. Use Goto, Call, or Xqt.			
3230	Expected For/Do/Function.			
3231	Above/Below was not specified.			
3232	Righty/lefty was not specified.			
3233	NoFlip/Flip was specified.			
3234	Port number was not specified.			
3235	String type variable was not specified.			
3236	RS-232C port number was not specified.			
3237	Network communication port number was not specified.			
3238	Communication speed was not specified.			
3239	Data bit number was not specified.			
3240	Stop bit number was not specified.			
3241	Parity was not specified.			
3242	Terminator was not specified.			
3243	Hardware flow was not specified.			
3244	Software flow was not specified.			

No.	Message	Remedy	Note 1	Note 2
3245	None was not specified.			
3246	Parameter ' O ' or ' C ' was not specified.			
3247	NumAxes parameter was not specified.			
3248	J4Flag value (0-1) was not specified.			
3249	J6Flag value (0-127) was not specified.			
3250	Array variable was not specified.			
3251	String Array variable was not specified.			
3252	Device ID was not specified.			
3253	I/O type was not specified.			
3254	I/O bit width was not specified.			
3255	ByRef was not specified.	Although the ByRef is specified in the function declaration, no ByRef is specified for calling.		
3256	Variable type was not specified.			
3257	Condition expression does not return Boolean value.			
3258	RS232C port number was not specified.			
3259	Network communication port number was not specified.			
3260	Language ID was not specified.			
3261	Expected '!.			
3262	Vision Sequence Name was not specified.			
3263	Vision Sequence Name or Calibration Name was not specified.			
3264	Vision Property Name or Result Name was not specified.			
3265	Vision Property Name, Result Name or Object Name was not specified.			
3266	Vision Calibration Property Name was not specified.			
3267	Task type was not specified.			
3268	Form name was not specified.			
3269	Property Name or Control Name was not specified.			
3270	Property Name was not specified.			
3271	BackColorMode was not specified.			
3272	BorderStyle was not specified.			
3273	DropDownStyle was not specified.			
3274	EventTaskType was not specified.			
3275	ImageAlign was not specified.			
3276	IOType was not specified.			
3277	FormBorderStyle was not specified.			
3278	ScrollBars was not specified.			
3279	SizeMode was not specified.			
3280	StartPosition was not specified.			

Maintenance 8. Trouble Shooting

No.	Message	Remedy	Note 1	Note 2
3281	TextAlign was not specified.			
3282	TextAlign was not specified.			
3283	TextAlign was not specified.			
3284	WindowState was not specified.			
3285	J1FLAG was not specified.			
3286	J2FLAG was not specified.			
3289	areaID was not specified.			
3300	External definition symbol was included. (Not in use)			
3301	Version of linked OBJ file does not match.	Not all project files are compiled in the same version. Perform the rebuild.		
3302	Linked OBJ file does not match the compiled I/O label.	The project configuration has been changed. Perform the rebuild.		
3303	Linked OBJ file does not match the compiled user error label.	The project configuration has been changed. Perform the rebuild.		
3304	Linked OBJ file does not match the compiled compile option.	The project configuration has been changed. Perform the rebuild.		
3305	Linked OBJ file does not match the compiled link option.	The project configuration has been changed. Perform the rebuild.		
3306	Linked OBJ file does not match the compiled SPEL option.	The project configuration has been changed. Perform the rebuild.		
3307	Duplicate function.	The same function name is used for more than one file.		
3308	Duplicate global preserve variable.	The same global preserve variable name is used for more than one file.		
3309	Duplicate global variable.	The same global variable name is used for more than one file.		
3310	Duplicate module variable.	The same module variable name is used for more than one file.		
3311	File cannot be found.			
3312	OBJ file is corrupt.			
3313	The specified file name includes character(s) that cannot be used.			
3314	Cannot open the file.	The file is used for other application. Quit the other application.		
3315	'**' is already used for the function name.			
3316	'**' is already used for the global preserve variable.			
3317	'**' is already used for the global variable.			
3318	'**' is already used for the module variable.			
3319	Dimension of the array variable does not match the declaration.			
3320	Return value type of the function does not match the declaration.			
3321	'**' is already used with function name.			

No.	Message	Remedy	Note 1	Note 2
3322	' ** ' is already used with Global Preserve name.			
3323	' ** ' is already used with Global name.			
3324	' ** 'is already used with Module name.			
3325	' ** ' is already used with Local name.			
3326	The number of parameters does not match the declaration.			
3327	ByRef was not specified on Function declaration on parameter **.			
3328	ByRef was not specified on parameter **.			
3329	Parameter ** type mismatch.			
3330	Linked OBJ file does not match the compiled Vision Project.			
3331	OBJ file size is beyond the available size after linking.	The OBJ file size exceeds the limit value. Reduce the program.		
3332	Variable '%s' is redefined.	Variable '%s' is redefined with the different variable type. Review the definition.		
3333	Linked OBJ file does not match the compiled GUI Builder Project.			
3334	The number of variable which is using Wait command are beyond the maximum allowed.			
3335	Call cannot use in the parallel processing.			
3336	Variable was redefined.			
3405	DialogResult was not specified.			
3406	MsgBox_Type was not specified.			
3408	Single array variable was not specified.			
3409	Point list was not specified.			
3411	EdgeType was not specified.			
3414	Point was not specified.			
3415	Reference was not specified.			
3500	Duplicate macro in #define statement.	Another macro with the same name has been defined. Change the macro name.		
3501	Macro name was not specified.			
3502	Include file name cannot be found.			
3503	Specified include file is not in the project.	The include file that is not registered in the project configuration is specified. Add the include file to the project configuration.		
3504	Parameter of the macro function does not match to the declared.			
3505	Macro has a circular reference.	The macro has a circular reference. Correct the circular reference.		
3506	#define, #ifdef, #ifndef, #else, #endif, #undef and variable declaration statements are only valid in an include file.			

Maintenance 8. Trouble Shooting

No.	Message	Remedy	Note 1	Note 2
3507	Over #ifdef or #ifndef nesting level.	Reduce the nesting level to under the limited value.		
3508	Cannot find corresponding #ifdef or #ifndef.			
3509	No #endif found for #ifdef or #ifndef.			
3510	Cannot obtain the macro buffer.			
3550	Parameter for the macro function was not specified.	The macro declared as a macro function is called without argument.		
3601	Parameter type is mismatch for the external function '%s'. Confirm all place which are using this function, in this file.			
3602	The specified motion command cannot use LJM parameter.			
3603	InReal function cannot use with Wait statement.			
3800	Compile process aborted.			
3801	Link process aborted.			
3802	Compile process aborted. Compile errors reached the maximum count.			
3803	Link process aborted. Link errors reached the maximum count.			
3804	Specified command cannot be executed from the Command window.			
3805	Specified command can only be executed from the Command window.			
3806	Specified function cannot be executed from the Command window.			
3808	Specified parameter cannot be used with the current version.			
3809	Module variable cannot be used from the Command window.			
3810	The number of point file is beyond the limit.	There are too many point files. Reduce some point files that are registered to project.		
3811	The number of points is beyond the limit.	There are too many points defined by registered point files. Reduce some points.		
3850	File not found.			
3900	Uncommon error. Cannot obtain the internal communication buffer.			
3901	Buffer size is not enough.			
3910	Undefined command was specified.			
3911	Cannot enter the file name in the file name buffer.			
3912	Cannot obtain the internal buffer.			
3913	Cannot set priority.			
3914	Invalid ICode.			
3915	Invalid ICode.			
3916	Invalid ICode.			
3917	Invalid ICode.			

No.	Message	Remedy	Note 1	Note 2
3918	Invalid ICode.			
3919	Invalid ICode.			
3920	Invalid ICode.			
3921	Invalid ICode.			

Motor Control

No.	Message	Remedy	Note 1	Note 2
4001	Arm reached the limit of motion range.	Check the point to move, current point, and Range setting.		
4002	Specified value is out of allowable range.	Review the setting parameters.		The parameter causing the error
4003	Motion device driver failure. Communication error within the motion control module.	Reboot the controller. Initialize the controller firmware. Replace the controller.		
4004	Motion device driver failure. Event waiting error within the motion control module.	Reboot the controller. Initialize the controller firmware. Replace the controller.		
4005	Current point position is above the specified LimZ value.	Lower the Z axis. Increase the specified LimZ value.		
4006	Target point position is above the specified LimZ value.	Lower the Z coordinate position of the target point. Increase the specified LimZ value.		
4007	Coordinates conversion error. The end/mid point is out of the motion area. Jogging to the out of the motion area.	Check whether the coordinate out of the motion range is not specified.		
4008	Current point position or specified LimZ value is out of motion range.	Change the specified LimZ value.		
4009	Motion device driver failure. Timeout error within motion control module.	Reboot the controller. Initialize the controller firmware. Replace the controller.		
4010	Specified Local coordinate was not defined.	Define the Local coordinate system.		Local number
4011	Arm reached the limit of XY motion range specified by XYLim statement.	Check the area limited by the XYLim statement.		
4013	Motion control module internal calculation error.			
4016	SFree statement was attempted for prohibited joint(s).	Due to robot mechanistic limitation, setting some joint(s) to servo free status is prohibited. Check the robot specifications.		
4018	Communication error within the motion control module. Check sum error.	Reboot the controller. Initialize the controller firmware. Replace the controller.		
4021	Point positions used to define the Local are too close.	Set the distance between points more than 1 μ m.		
4022	Point coordinate data used to define the Local is invalid.	Match the coordinate data for the points to be specified.		
4023	Cannot execute when the motor is in the off state.	Turn the motor power ON and then execute.		
4024	Cannot complete the arm positioning using the current Fine specification.	Check whether the robot does not generate vibration or all parts and screws are secured firmly. Increase the Fine setting value.		
4025	Cannot execute a motion command during emergency stop condition.	Clear the emergency stop condition and execute the motion command.		
4026	Communication error within the motion control module. Servo I/F failure.	Reboot the controller. Initialize the controller firmware. Replace the controller.		

No.	Message	Remedy	Note 1	Note 2
4028	Communication error within the motion control module. Device driver status failure.	Reboot the controller. Initialize the controller firmware. Replace the controller.		
4030	Buffer for the average torque calculation has overflowed. Shorten the time interval from Atclr to Atrq.	Shorten the time interval from Atclr to Atrq less than about two minutes.		
4031	Cannot execute a motion command when the motor is in the off state.	Turn the motor power ON and then execute the motion command.		
4032	Cannot execute a motion command when one or more joints are in SFree state.	Set all joints to the SLock state and execute the motion command.		
4034	Specified command is not supported for this manipulator model.	Use the Jump3 and Jump3CP statements.		
4035	Only the tool orientation was attempted to be changed by the CP statement.	Set a move distance between points. Use the ROT modifier, SpeedR statement, and AccelR statement.		
4036	Rotation speed of tool orientation by the CP statement is too fast.	Decrease the setting values for the SpeedS and AccelS statements. Use the ROT modifier, SpeedR statement, and AccelR statement.		
4037	The point attribute of the current and target point positions differ for executing a CP control command.	Match the point attribute.		
4038	Two point positions are too close to execute the Arc statement.	Set the distance between points more than 1 μ m.		
4039	Three point positions specified by the Arc statement are on a straight line.	Use the Move statement.		
4041	Motion command was attempted to the prohibited area at the backside of the robot.	Check the robot motion range.		
4042	Motion device driver failure. Cannot detect the circular format interruption.	Reboot the controller. Initialize the controller firmware. Replace the controller.		
4043	Specified command is not supported for this manipulator model or this joint type.			
4044	Curve failure. Specified curve form is not supported.	Create a Curve file again with the Curve statement.		
4045	Curve failure. Specified mode is not supported.	Specify the Curve mode properly. Create a Curve file again with the Curve statement.		
4046	Curve failure. Specified coordinate number is out of the allowable range.	The number of the available coordinate axes is 2, 3, 4, and 6. Create a Curve file again with the Curve statement.		
4047	Curve failure. Point data was not specified.	Create a Curve file again with the Curve statement.		
4048	Curve failure. Parallel process was specified before the point designation.	Create a Curve file again with the Curve statement.		
4049	Curve failure. Number of parallel processes is out of the allowable range.	Create a Curve file again with the Curve statement.		
4050	Curve failure. Number of points is out of the allowable range.	The number of available point numbers differs according to the curve form. Check the number of points again.		

Maintenance 8. Trouble Shooting

No.	Message	Remedy	Note 1	Note 2
4051	Curve failure. Local attribute and the point attribute of all specified points do not match.	Match the local and point flag for all the specified points.		
4052	Curve failure. Not enough memory to format the curve file.			
4053	Curve failure. Failed to format the curve file.	Review the point data. Check whether adjacent two points do not overlap on the specified point line.		
4054	Curve failure. Curve file error	The Curve file is broken. Create a Curve file again with the Curve statement.		
4055	Curve failure. No distance for curve file movement.	Review the point data.		
4056	Curve failure. Point positions for the Curve statement are too close.	Set the distance between two points adjacent to the specified point more than 0.001 mm.		
4059	Executed encoder reset command while the motor is in the on state.	Turn the motor power OFF.		
4060	Executed an invalid command while the motor is in the on state.	Turn the motor power OFF.		
4061	Specified parameter is in use.	You attempted to clear the currently specified Arm and Tool. Select other Arm and Tool and execute.		
4062	Orientation variation is over 360 degrees.	You attempted to rotate the joint #J6 more than 360 degrees with a CP motion command.		
4063	Orientation variation of adjacent point is over 90 degrees.	On the specified point line by the Curve statement, set the orientation variation of U, V, and W coordinate values between two adjacent points to under 90 degrees.		
4064	Cannot execute the orientation correction automatically.	On the specified point line, a curve cannot be created by automatic orientation correction. Change the specified point line so that the joint #J6 orientation variation decreases.		
4065	Attempt to revolve J6 one rotation with the same orientation in CP statement.	You attempted to rotate the joint #J6 more than 360 degrees with a CP motion command. You attempted to revolve the joint 6 one rotation with the same as motion start orientation. Change the target point so that the joint #J6 revolves less than one rotation.		
4066	Motion command was attempted in the prohibited area depended on joint combination.	You attempted to move the joints to the robot's interference limited area.		
4068	ROT modifier parameter was specified for the CP motion command without orientation rotation.	Delete the ROT from the CP motion command.		
4069	Specified ECP without selecting ECP in CP statement.	Specify a valid ECP.		
4070	Specified ECP number does not match the ECP number used in curve file creation.	Specify a valid ECP.		

No.	Message	Remedy	Note 1	Note 2
4071	Attempted motion command during electronic brake lock condition.			
4072	Initialization failure. Hardware monitor was not initialized.			
4074	Motor type does not match the current robot setting.	Check whether the specified robot model is connected.		
4075	ECP Option is not active.	Enable the ECP option.		
4076	Point positions used to define the Plane are too close.	Set the distance between points more than 1 μ m.		
4077	Point coordinate data used to define the Plane is invalid.	Match the coordinate data for the points to be specified.		
4080	Cannot execute when the Enable Switch is OFF.	Turn the Enable Switch ON and then execute.		
4085	Failed to change to specified location.			
4086	Cannot execute because it is not dry run mode.			
4099	Servo error was detected during operation.			
4100	Communication error in motion control module. Cannot calculate the current point or pulse.	Reboot the controller. Initialize the controller firmware. Replace the controller.		
4101	Communication error in the motion control module. Cannot calculate the current point or pulse.	Reboot the controller. Initialize the controller firmware. Replace the controller.		
4103	Initialization failure. Motion control module initialization error.	Reboot the controller. Initialize the controller firmware. Replace the controller.		
4105	EMERGENCY connector connection failure.			
4106	Drive unit failure.			
4150	Redundant input signal failure of the emergency stop.	The input status of the redundant emergency stop input continuously differs for more than two seconds. Check whether no disconnection, earth fault, or short-circuit of the emergency stop input signal exists. Then reboot the controller.		
4151	Redundant input signal failure of the safeguard.	The input status of the redundant emergency stop input continuously differs for more than two seconds. Check whether no disconnection, earth fault, or short-circuit of the emergency stop input signal exists. Then reboot the controller.		
4152	Relay welding error of the main circuit.	A relay welding error was detected due to power system over current. Replace the controller. Replace the robot.		
4153	Redundant input signal failure of the enable switch.	The input status of the redundant enable signal differs continuously for more than two seconds. Check the TP connector connection. Replace the TP. Replace the controller.		

Maintenance 8. Trouble Shooting

No.	Message	Remedy	Note 1	Note 2
4154	Temperature of regeneration resistor was higher than the specified temperature.			
4180	Manipulator initialization failure. Specified manipulator was is not found.			
4181	Manipulator initialization failure. Specified manipulator was in use by another task.			
4182	Manipulator initialization failure. Manipulator name is too long.			
4183	Manipulator initialization failure. Manipulator data version error.			
4184	Manipulator initialization failure. Duplication of single axis joint is assigned.			
4185	Manipulator initialization failure. Specified axis is in use by the other manipulator.			
4186	Manipulator initialization failure. Necessary hardware resource is not defined.			
4187	Manipulator initialization failure. Communication error with the module : VSRCMNPk.			
4188	Manipulator initialization failure. Joint angle interference matrix is invalid.			
4189	Manipulator initialization failure. Communication error with the module : VSRCMC.			
4191	Manipulator initialization failure. Physical-logical pulse transformation matrix is invalid.			
4192	Manipulator initialization failure. Communication error with the servo module.			
4210	RAS circuit detected the servo system malfunction. Reboot the controller. Measure the noise. Replace the controller.			
4211	Servo CPU internal RAM failure. Reboot the controller. Measure the noise. Replace the DMB.			
4212	RAM for the main and servo CPU communication failure. Reboot the controller. Measure the noise. Replace the DMB.			
4213	Servo CPU internal RAM failure. Reboot the controller. Measure the noise. Replace the DMB.			
4214	Initialization communication of main CPU and servo CPU failure. Reboot the Controller. Measure the noise. Replace DMB.			

No.	Message	Remedy	Note 1	Note 2
4215	Initialization communication of the main and servo CPU failure. Reboot the controller. Noise measure. Replace the DMB.			
4216	Communication of the main and servo CPU failure. Reboot the controller. Measure the noise. Replace the DMB.			
4217	Communication of the main and servo CPU failure. Reboot the controller. Measure the noise. Replace the DMB.			
4218	Servo long time command overrun.			
4219	Servo long time command check sum error.			
4220	System watchdog timer detected the failure. Reboot the controller. Measure the noise. Replace the DMB.			
4221	Drive unit check failure.			
4222	RAM failure of the servo CPU. Reboot the controller. Measure the noise. Replace the DMB.			
4223	Failure of duplicate circuit of the emergency stop or the safeguard. Check the wiring.			
4224	Low voltage of the main circuit power supply is detected. Check the power supply voltage. Reboot the controller.			
4225	Control relay contact of the main circuit power supply is welded. Replace the DPB.			
4230	Servo real time status failure. Check sum error.	A data checksum error was detected in the controller. Check the short-circuit and improper connection of the peripheral equipment wiring. (Emergency, D-I/O, and Expansion I/O connectors) Replace the controller.		
4232	Servo real time status failure. Free running counter error with the servo.	A free running counter error was detected in the controller. Check the short-circuit and improper connection of the peripheral equipment wiring. (Emergency, D-I/O, and Expansion I/O connectors) Replace the controller.		
4233	Servo real time status failure. Communication error with the servo CPU.	A communication error was detected in the controller. Check the short-circuit and improper connection of the peripheral equipment wiring. (Emergency, D-I/O, and Expansion I/O connectors) Replace the controller.		
4240	Irregular motion control interruption was detected. Interruption duplicate.	A interruption error was detected in the controller. Check the short-circuit and improper connection of the peripheral equipment wiring. (Emergency, D-I/O, and Expansion I/O connectors) Replace the controller.		

Maintenance 8. Trouble Shooting

No.	Message	Remedy	Note 1	Note 2
4241	Over speed during low power mode was detected.	The robot over speed was detected during low power mode. Check the robot mechanism. (Smoothness, backlash, non-smooth motion, loose belt tension, brake) Check whether the robot does not interfere with peripheral equipment. (Collision, contact) Replace the motor driver. Replace the motor. (Motor and encoder failure) Check the short-circuit and improper connection of the peripheral equipment wiring. (Emergency, D-I/O, and Expansion I/O connectors)		
4242	Improper acceleration reference was generated.	You attempted to operate the robot with the acceleration reference exceeding the specified value. For a CP motion, decrease the AccelS value.		
4243	Improper speed reference is generated in the high power mode.	The robot over speed was detected during high power mode. Check the robot mechanism. (Smoothness, backlash, non-smooth motion, loose belt tension, brake) Check whether the robot does not interfere with peripheral equipment. (Collision, contact) Replace the motor driver. Replace the motor. (Motor and encoder failure) Check the short-circuit and improper connection of the peripheral equipment wiring. (Emergency, D-I/O, and Expansion I/O connectors)		
4250	Arm reached the limit of motion range during the operation.	Check whether a CP motion trajectory is within the motion range.		
4251	Arm reached the limit of XY motion range specified by XYLim during the operation.	Check the XYLim setting.		
4252	Coordinate conversion error occurred during the operation.	Check whether a CP motion trajectory is within the motion range.		
4267	Attempt to exceed the J4Flag attribute without indication.	You attempted to exceed the J4Flag attribute during motion without the J4Flag indication. Change the J4Flag for the target point.		
4268	Attempt to exceed the J6Flag attribute without indication.	You attempted to exceed the J6Flag attribute during motion without the J6Flag indication. Change the J6Flag for the target point.		
4269	Attempt to exceed the particular wrist orientation attribute without indication.	You attempted to exceed the particular wrist orientation attribute during motion without the Wrist indication. Change the Wrist attribute for the target point. Change the target point to avoid a particular wrist orientation.		

No.	Message	Remedy	Note 1	Note 2
4270	Attempt to exceed the particular arm orientation attribute without indication.	You attempted to exceed the particular hand orientation attribute during motion without the Hand indication. Change the Hand attribute for the target point. Change the target point to avoid a particular hand orientation.		
4271	Attempt to exceed the particular elbow orientation attribute without indication.	You attempted to exceed the particular elbow orientation attribute during motion without the Elbow indication. Change the Elbow attribute for the target point. Change the target point to avoid a particular elbow orientation.		
4272	Specified point flag is invalid.	For a CP motion command, the arm form at the target point is different from the point flag specified with the target point. Change the point flag for the target point.		
4273	J6Flag switched during the lift motion in conveyer tracking	Adjust the Tool orientation so that J6Flag will not switch		
4274	Manipulator motion did not match to J6Flag of the target point	For a CP motion command, the manipulator reached to the target point with J6Flag which differs from the one specified for the target point. Change J6Flag for the target point.		
4275	Manipulator motion did not match to J4Flag of the target point	For a CP motion command, the manipulator reached to the target point with J4Flag which differs from the one specified for the target point. Change J4Flag for the target point.		
4276	Manipulator motion did not match to ArmFlag of the target point	For a CP motion command, the manipulator reached to the target point with ArmFlag which differs from the one specified for the target point. Change ArmFlag for the target point.		
4277	Manipulator motion did not match to ElbowFlag of the target point	For a CP motion command, the manipulator reached to the target point with ElbowFlag which differs from the one specified for the target point. Change ElbowFlag for the target point.		
4278	Manipulator motion did not match to WristFlag of the target point	For a CP motion command, the manipulator reached to the target point with WristFlag which differs from the one specified for the target point. Change WristFlag for the target point.		

Servo

No.	Message	Remedy	Note 1	Note 2
5000	Servo control gate array failure. Check the DMB.	Check the short-circuit and improper connection of the peripheral equipment wiring. (Emergency and I/O connectors) Replace the DMB. Replace the additional axis unit.		
5001	Disconnection of the parallel encoder signal. Check the signal cable connection or the robot internal wiring.	Check the M/C cable signal. Check the robot signal wiring. (Missing pin, disconnection, short-circuit) Replace the motor. Replace the DMB. Check the connector connection in the controller. (Loosening, connecting to the serial encoder terminal on the DMB) Check the model setting. Check the peripheral equipment wiring. (Emergency and I/O)		
5002	Motor driver is not installed. Install the motor driver. Check the DMB or the motor driver.	Check whether the motor driver is mounted. Check the model setting and hardware setting. Replace the motor driver. Replace the DMB.		
5003	Initialization communication failure of incremental encoder. Check the signal cable connection and the robot setting.	Check the model setting. Replace the motor. Replace the DMB.		
5004	Initialization failure of absolute encoder. Check the signal cable connection or the robot setting.	Check the model setting. Replace the motor. Replace the DMB.		
5005	Encoder division setting failure. Check the robot setting.	Check the model setting.		
5006	Data failure during absolute encoder initialization. Check the signal cable connection, the controller, or the motor.	Replace the motor. Replace the DMB. Check the noise countermeasures.		
5007	Absolute encoder multi-turn is beyond the maximum range. Reset the encoder.	Reset the encoder. Replace the motor.		
5008	Position is out of the range. Reset the encoder.	Reset the encoder. Replace the DMB. Replace the motor.		
5009	No response from the serial encoder. Check the signal cable connection, the motor, the DMB, or the encoder IF board.	Check the model setting. (Improperly setting of the parallel encoder model) Check the signal cable connection. Replace the DMB and encoder I/F board.		
5010	Serial encoder initialization failure. Reboot the controller. Check the motor, the DMB, or the encoder IF board.	Check the robot configuration. Check the signal cable connection. Replace the DMB and encoder I/F board.		

No.	Message	Remedy	Note 1	Note 2
5011	Serial encoder communication failure. Reboot the controller. Check the motor, the DMB, or the encoder I/F board.	Check the robot configuration. Check the signal cable connection. Replace the DMB and encoder I/F board.		
5012	Servo CPU watchdog timer failure. Reboot the controller. Check the motor or the DMB.	Replace the DMB. Check the noise countermeasures.		
5013	Current control circuit WDT failure. Reboot the controller. Check the controller.	Check the power cable connection. Check the 15V power supply and cable connection. Replace the DMB. Check the noise countermeasures.		
5015	Encoder is reset. Reboot the controller.	Reboot the controller.		
5016	Power supply failure of the absolute encoder. Replace the battery. Check the robot internal wiring.	Reset the encoder. Check the signal cable connection.		
5017	Backup data failure of the absolute encoder. Reset the encoder.	Reset the encoder. Check the signal cable connection.		
5018	Absolute encoder battery alarm.	Replace the battery. Check the signal cable connection.		
5019	Position failure of the absolute encoder. Reset the encoder. Replace the motor.	Reset the encoder. Replace the motor.		
5020	Speed is too high at controller power ON. Stop the robot and reboot the controller.	Reboot the controller.		
5021	Absolute encoder overheat.	Lower the motion duty. Wait until the temperature of the encoder decreases.		
5022	R/D transducer failure. Check the resolver board.	Check the noise countermeasure. Replace the resolver board.		
5023	G sensor communication failure. Check the control board.	Check the M/C signal cable. Check the robot signal wiring (for pin falling, disconnection, short). Check the noise countermeasure. Replace the control board. Replace the DMB board.		
5024	G sensor data failure. Check the control board.	Replace the control board.		
5025	Resolver mixing failure. Reset the encoder.	Reset the resolver. Replace the resolver board.		
5026	Resolver signal disconnection. Check the motor and resolver board.	Check the robot signal wiring. Replace the resolver board.		
5027	S-DSP communication failure. Check-sum error, Free-run counter error	Reboot the controller. Replace the DMB. Check the noise countermeasure.		
5028	Current data failure. Data update stopped. Parity error.	Reboot the controller. Replace the DMB. Check the noise countermeasure.		
5029	D-DSP communication failure. Check-sum error, Free-run counter error	Reboot the controller. Replace the DMB. Check the noise countermeasure.		
5032	Servo alarm A.			

No.	Message	Remedy	Note 1	Note 2
5040	Motor torque output failure in high power state. Check the power cable connection, the robot, the driver or the motor.	Specify the Weight/Inertia setting. Check the load. Check the robot. (Smoothness, backlash, non-smooth motion, loose belt tension, brake) Check the interference with the peripheral equipment. (Collision, contact) Check the model setting. Check the power cable connection. Check the robot power wiring. (Missing pin, disconnection, short-circuit) Check the power supply voltage. (Low power supply voltage) Replace the motor driver. Replace the DMB. Replace the motor.		
5041	Motor torque output failure in low power state. Check the power cable connection, robot, brake, driver, or motor.	Check the robot. (Smoothness, backlash, non-smooth motion, loose belt tension, brake) Check the interference with the peripheral equipment. (Collision, contact) Check the model setting. Check the power cable connection. Check the robot power wiring. (Missing pin, disconnection, short-circuit) Check the power supply voltage. (Low power supply voltage) Replace the motor driver. Replace the DMB. Replace the motor.		
5042	Position error overflow in high power state. Check the power cable connection, the robot, the driver and the motor.	Specify the Weight/Inertia setting. Check the load. Check the robot. (Smoothness, backlash, non-smooth motion, loose belt tension, brake) Check the interference with the peripheral equipment. (Collision, contact) Check the model setting. Check the power cable connection. Check the robot power wiring. (Missing pin, disconnection, short-circuit) Check the power supply voltage. (Low power supply voltage) Replace the motor driver. Replace the DMB. Replace the motor.		

No.	Message	Remedy	Note 1	Note 2
5043	Position error overflow in low power state. Check the power cable connection, robot, brake, driver, or motor.	<p>Check the robot. (Smoothness, backlash, non-smooth motion, loose belt tension, brake)</p> <p>Check the interference with the peripheral equipment. (Collision, contact)</p> <p>Check the model setting.</p> <p>Check the power cable connection.</p> <p>Check the robot power wiring. (Missing pin, disconnection, short-circuit)</p> <p>Check the power supply voltage. (Low power supply voltage)</p> <p>Replace the motor driver.</p> <p>Replace the DMB.</p> <p>Replace the motor.</p>		
5044	Speed error overflow in high power state. Check the power cable connection, robot, brake, driver, or motor.	<p>Specify the Weight/Inertia setting.</p> <p>Check the load.</p> <p>Check the robot. (Smoothness, backlash, non-smooth motion, loose belt tension, brake)</p> <p>Check the interference with the peripheral equipment. (Collision, contact)</p> <p>Check the model setting.</p> <p>Check the power cable connection.</p> <p>Check the robot power wiring. (Missing pin, disconnection, short-circuit)</p> <p>Check the power supply voltage. (Low power supply voltage)</p> <p>Replace the motor driver.</p> <p>Replace the DMB.</p> <p>Replace the motor.</p>		
5045	Speed error overflow in low power state. Check the power cable connection, robot, brake, drive, or motor.	<p>Check the robot. (Smoothness, backlash, non-smooth motion, loose belt tension, brake)</p> <p>Check the interference with the peripheral equipment. (Collision, contact)</p> <p>Check the model setting.</p> <p>Check the power cable connection.</p> <p>Check the robot power wiring. (Missing pin, disconnection, short-circuit)</p> <p>Check the power supply voltage. (Low power supply voltage)</p> <p>Replace the motor driver.</p> <p>Replace the DMB.</p> <p>Replace the motor.</p>		

No.	Message	Remedy	Note 1	Note 2
5046	Over speed in high power state. Reduce SpeedS. Check the signal cable connection, robot, brake, driver or motor.	Reduce SpeedS of the CP motion. Change the orientation of the CP motion. Specify the Weight/Inertia setting. Check the load. Check the robot. (Smoothness, backlash, non-smooth motion, loose belt tension, brake) Check the interference with the peripheral equipment. (Collision, contact) Check the model setting. Check the power cable connection. Check the robot power wiring. (Missing pin, disconnection, short-circuit) Check the power supply voltage. (Low power supply voltage) Replace the motor driver. Replace the DMB. Replace the motor.		
5047	Over speed in low power state. Check the signal cable connection, robot, brake, driver, or motor.	Check the motion in high power state. Check the robot. (Smoothness, backlash, non-smooth motion, loose belt tension, brake) Check the interference with the peripheral equipment. (Collision, contact) Check the model setting. Check the power cable connection. Check the robot power wiring. (Missing pin, disconnection, short-circuit) Check the power supply voltage. (Low power supply voltage) Replace the motor driver. Replace the DMB. Replace the motor.		
5048	Over voltage of the main power circuit. Check the main power voltage or the regeneration module.	Specify the Weight/Inertia setting. Check the load. Check the robot. (Smoothness, backlash, non-smooth motion, loose belt tension, brake) Check the interference with the peripheral equipment. (Collision, contact) Check the model setting. Check the power cable connection. Check the robot power wiring. (Missing pin, disconnection, short-circuit) Check the power supply voltage. (Low power supply voltage) Replace the motor driver. Replace the DMB. Replace the motor.		
5049	Over current of the motor driver. Check the power cable connection or the robot internal wiring.	Check the short-circuit and earth fault of the power line. Replace the motor driver. Replace the DMB.		

No.	Message	Remedy	Note 1	Note 2
5050	Over speed during torque control. Check the work motion speed range.	Check the motion speed during torque control.		
5051	15V PWM drive power supply failure. Reboot the controller. Replace the 15V power supply.	Check the 15V power supply and cable connection. Replace the motor driver. Replace the DMB.		
5054	Overload of the motor. Decrease the motion duty and the Accel.	Lower the motion duty. Check the Weight/Inertia setting. Check the robot. (Backlash, large load, loose belt tension, brake)		
5055	Overload of the motor. Decrease the operation duty and the Accel.	Lower the motion duty. Check the Weight/Inertia setting. Check the robot. (Backlash, large load, loose belt tension, brake)		
5056	G sensor output failure. Check the control board.	Check the noise countermeasures. Replace the control board.		
5072	Servo alarm B.			
5080	Motor is overloaded. Decrease the duty and the Accel.	Lower the motion duty. Check the Weight/Inertia setting. Check the robot. (Backlash, large load, loose belt tension, brake)		
5098	High temperature of the encoder. Decrease the duty. Check the reduction gear unit of the robot.	Wait until the temperature of the encoder decreases. Lower the motion duty. Check the Weight/Inertia setting. Check the robot. (Backlash, large load, loose belt tension, brake)		
5099	High temperature of the motor driver . Clean the controller fan filter. Check the ambient temperature. Decrease the duty.	Clean the cooling fan filter. Lower the motion duty. Check the Weight/Inertia setting. Lower the ambient temperature.		
5112	Servo alarm C.			

Vision Calibration

No.	Message	Remedy	Note 1	Note 2
6001	Calibration number is out of range.			
6002	Calibration data is not defined.			
6003	Camera mounting direction is out of range.			
6004	2-point measurement flag is out of range.			
6005	There is an invalid data in the pose data.			
6006	Calibration failure: Invalid data prevents calculation.			
6007	Coordinate conversion: Invalid data prevent calculation.			
6009	Calibration file name is not correct.			
6010	Calibration file does not exist.			
6012	Failed to load the calibration file.			
6013	Failed to write into the calibration file.			
6014	Specify continuous 9 data for the Pixel coordinate.			
6015	Specify continuous 18 data for the Pixel coordinate.			
6016	Specify continuous 9 data for the Robot coordinate.			
6017	Specify continuous 18 data for the Robot coordinate.			
6018	Specify continuous 9 data and 1 reference point for the Robot coordinate.			
6019	Specify continuous 9 data and 2 reference points for the Robot coordinate.			

Points

No.	Message	Remedy	Note 1	Note 2
7003	The specified robot cannot be found.			
7004	Duplicate allocation of the point data area.			
7006	Specified point number cannot be found. Specify a valid point number.	Check the specified point number.		
7007	Specified point number was not defined. Specify a teach point number.	Check whether point data is registered in the specified point. Perform the teaching.		
7010	Cannot allocate the memory area for the pallet definition.			
7011	Cannot free the memory area for the pallet definition.			
7012	Specified pallet number cannot be found. Specify a valid pallet number.	Check the pallet number.		
7013	Specified pallet is not defined. Specify a defined pallet or define the pallet.	Check whether the specified pallet is defined by the Pallet statement. Declare the pallet.		
7014	Specified division number is beyond the pallet division number definition. Specify a valid division.	Check the specified division number.		
7015	Specified coordinate axis number does not exist.			
7016	Specified arm orientation number does not exist.			
7017	Cannot allocate the required memory.			
7018	Specified point label cannot be found. Specify a valid point label.	Check the specified point label.		
7019	Parameter setup in the initialization file is invalid.			
7021	Duplicate point label. Specified label name is already registered. Change the label name.	Change the point label.		
7022	Specified local coordinate system is not defined. Specify a valid local coordinate system number.	Check the specified local number. Define the Local coordinate system.		
7023	Specified string is not in the correct format.			
7024	Point data memory area for the specified robot is not allocated.			
7026	Cannot open the point file. Specify a valid point file name.	Check the point file name. Check whether the point file specified for the project exists.		
7027	Cannot read the point data from the point file.	Create the point file again.		
7028	Point area is allocated beyond the available point number.			
7029	Specified point file name is not correct. Specify a valid point file name.	Check the file extension.		

Maintenance 8. Trouble Shooting

No.	Message	Remedy	Note 1	Note 2
7030	Specified point label is beyond the maximum length. Specify a valid point label.	Change the point label.		
7031	Description for the specified point is beyond the maximum length. Specify a valid description.	Change the comment.		
7032	Point file is corrupted. Check sum error.	Create the point file again.		
7033	Specified point file cannot be found. Specify a valid point file name.			
7034	Cannot save the point file.			
7035	Cannot save the point file.			
7036	Cannot save the point file.			
7037	Cannot save the point file.			
7038	Cannot save the point file.			
7039	Cannot save the point file.			
7040	The point label is not correct. Specify a valid point point label.			
7041	The point label is not correct. Specify a valid point point label.			

Fieldbus

No.	Message	Remedy	Note 1	Note 2
7101	Communication error occur during transform.	The module is broken or the controller software is damaged. Restore the controller firmware. (If Code 1 is 1, 2, 3, 4, or 10)		
		A communication data error was detected during communication. The communication cable has a problem. Check the communication cable and its related units. (If Code 1 is 11 or 12)		
		The module is broken or the controller software is damaged. Restore the controller firmware. (If Code 1 is 13, 14, or 15)		
		The PLC is not running or not connected. Check the PLC, the communication cable, and peripherals. (If Code 1 is 22 when the CC-Link board is used.)		
7103	Timeout error occurs during transform.	The module is broken or the controller software is damaged. Restore the controller firmware. (If Code 1 is 1, 2, or 3)		
		A communication data error was detected during communication. The communication cable has a problem. Check the communication cable and its related units. (If Code 1 is 4)		

Vision

No.	Message	Remedy	Note 1	Note 2
7300	Vision Communication. Server mode not supported.			
7302	Vision Communication. Failed to read from the camera.	Check the connection with the camera.		
7303	Vision Communication. Read data overflow.			
7304	Vision Communication. Failed to open the Ethernet port.			
7305	Vision Communication. Invalid IP address of camera.	Rebuild the project. Check the camera configuration.		
7306	Vision Communication. No specification of Server/Client.			
7307	Vision Communication. Failed to send to the camera.	Check the connection with the camera.		
7308	Vision Communication. Camera version is old.			
7321	Vision Communication. Camera setting has not been set.	Rebuild the project. Check the camera configuration.		
7322	Vision Communication. Read timeout.			
7323	Vision Communication. Read invalid data.	Check the connection with the camera.		
7324	Vision Communication. Failed to send to the camera.	Check the connection with the camera.		
7325	Vision Communication. Connection is not completed.	Check the connection with the camera.		
7326	Vision Communication. Read data is too long.			
7327	Vision Communication. Undefined vision sequence.			
7328	Vision Communication. Camera setting has not been set.	Rebuild the project. Check the camera configuration.		
7329	Vision Communication. Vis file is not found.	Rebuild the project. Check the camera configuration.		
7330	Vision Communication. Failed to allocate memory.			
7341	Vision Communication. Out of max camera number.			
7342	Vision Communication. Invalid camera number.			
7343	Vision Communication. VSet parameter is too long.			
7344	Vision Communication: Too many parameters for VGet.			
7345	Vision Communication. Not enough data for VGet statement variable assignment.			
7346	Vision Communication. Cannot execute a Vision statement from the command window.			
7500	Smart camera. Out of memory.			
7501	Smart camera. Project does not exist.			
7502	Smart camera. Project has not been set.			

No.	Message	Remedy	Note 1	Note 2
7503	Smart camera. Vision property or result not supported.			
7504	Smart camera. Cannot open project file.			
7505	Undefined vision sequence.			
7506	Undefined vision object.			
7507	Smart camera. Critical error.			
7508	Smart camera. Invalid command.			
7509	Invalid vision property value.			
7510	Invalid vision property.			
7511	Vision model not trained.			
7512	Undefined vision calibration.			
7513	Vision model object not Self.			
7514	Invalid vision result.			
7515	Vision object not found.			
7516	No vision calibration.			
7517	Incomplete vision calibration.			
7518	Smart camera. Cannot connect with camera.			
7819	Smart camera. Communication error.			

GUI Builder

No.	Message	Remedy	Note 1	Note 2
7600	Cannot execute a GUI Builder statement from the command window.	GUI Builder commands are only available in the program.		
7602	GSet parameter is too long.	-		
7603	Too many parameters for GGet.	-		
7604	Not enough data for GGet statement variable assignment.	-		
7610	The event task cannot be executed. System in pause state and EventTaskType is Normal.	Specify NoEmgAbort for EventTaskType.		
7611	The event task cannot be executed. Safeguard is open and EventTaskType is Normal.	Specify NoEmgAbort for EventTaskType.		
7612	The event task cannot be executed. Estop is active and EventTaskType is not NoEmgAbort.	Specify NoEmgAbort for EventTaskType.		
7613	The event task cannot be executed. System in error state and EventTaskType is not NoEmgAbort.	Specify NoEmgAbort for EventTaskType.		
7650	Invalid property.	-		
7651	Invalid form.	-		
7652	Invalid control.	-		
7653	The specified form is already open.	-		
7654	Event function does not exist.	Create the event function.		
7655	The item does not exist.			
7656	Invalid property value.			

Hardware

No.	Message	Remedy	Note 1	Note 2
9001	Emergency stop circuit failure was detected. Disconnection or other failure was found in one of the redundant inputs.	Check whether no disconnection, earth fault, or short-circuit of the emergency stop input signal exists. Then reboot the controller.		
9002	Safeguard circuit failure was detected. Disconnection or other failure was found in one of the redundant inputs.	Check whether no disconnection, earth fault, or short-circuit of the safeguard input signal exists. Then reboot the controller.		
9011	Battery voltage of the CPU board backup is lower than the specified voltage. Replace the CPU board battery.			
9012	5V input voltage for CPU board is lower than the specified voltage.			
9013	24 V input voltage for the motor brake, encoder and fan is lower than the specified voltage.			
9014	Internal temperature of the Controller is higher than the specified temperature.	Stop the controller as soon as possible and check whether the ambient temperature of the controller is not high. Check whether the filter is not clogged up.	Current value	Boundary value
9015	Rotating speed of the controller fan is below the allowed speed. (FAN1)	Check whether the filter is not clogged up. If the warning is not cleared after the controller is rebooted, replace the fan.	Current value	Boundary value
9016	Rotating speed of the controller fan is below the allowed speed. (FAN2)	Check whether the filter is not clogged up. If the warning is not cleared after the controller is rebooted, replace the fan.	Current value	Boundary value
9017	Internal temperature of the Controller is higher than the specified temperature.			
9100	Initialization failure. Failed to allocate memory.	Reboot the controller.		
9101	Message queue has become full.			
9233	The Fieldbus I/O driver is in an abnormal state.	The module is broken or the controller software is damaged. Restore the controller firmware.		
9234	Fieldbus I/O driver initialization failure.	The module is broken or the controller software is damaged. Restore the controller firmware.		
9610	RAS circuit detected a servo system malfunction. Reboot the controller. Check for noise. Replace the controller.	Check the noise countermeasures. Replace the DMB.		
9611	Servo CPU internal RAM failure. Reboot the controller. Check for noise. Replace the DMB.	Check the noise countermeasures. Replace the DMB.		
9612	RAM for the main and servo CPU communication failure. Reboot the controller. Check for noise. Replace the DMB.	Check the noise countermeasures. Replace the DMB.		
9613	Servo CPU internal RAM failure. Reboot the controller. Check for noise. Replace the DMB.	Check the noise countermeasures. Replace the DMB.		
9614	Initialization communication of main CPU and servo CPU failure. Reboot the Controller. Check for noise. Replace DMB.	Check the noise countermeasures. Replace the DMB.		

Maintenance 8. Trouble Shooting

No.	Message	Remedy	Note 1	Note 2
9615	Initialization communication of the main and servo CPU failure. Reboot the controller. Check for noise. Replace the DMB.	Check the noise countermeasures. Replace the DMB.		
9616	Communication of the main and servo CPU failure. Reboot the controller. Check for noise. Replace the DMB.	Check the noise countermeasures. Replace the DMB.		
9617	Communication of the main and servo CPU failure. Reboot the controller. Check for noise. Replace the DMB.	Check the noise countermeasures. Replace the DMB.		
9618	Servo long time command overrun.	Check the noise countermeasures. Replace the DMB.		
9619	Servo long time command check sum error.	Check the noise countermeasures. Replace the DMB.		
9620	System watchdog timer detected a failure. Reboot the controller. Check for noise. Replace the DMB.	Check the noise countermeasures. Replace the DMB.		
9621	Drive unit check failure.	Check the noise countermeasures. Replace the DMB.		
9622	RAM failure of the servo CPU. Reboot the controller. Check for noise. Replace the DMB.	Check the noise countermeasures. Replace the DMB.		
9623	Failure of the redundant circuitry for the emergency stop or the safeguard. Check the wiring.	Check the noise countermeasures. Replace the DMB.		
9624	Low voltage of the main circuit power supply was detected. Check the power supply voltage. Reboot the controller.	Check the noise countermeasures. Replace the DMB.		
9625	Control relay contact of the main circuit power supply is welded closed. Replace the DPB.	Replace the DMB.		
9630	Servo real time status failure. Check sum error.	Reboot the controller. Replace the DMB. Check the noise countermeasures.		
9632	Servo real time status failure. Servo free running counter error	Reboot the controller. Replace the DMB. Check the noise countermeasures.		
9633	Servo real time status failure. Servo CPU communication error.	Reboot the controller. Replace the DMB. Check the noise countermeasures.		
9640	Irregular motion control interruption was detected. Interruption duplicate.	Reboot the controller. Replace the DMB. Check the noise countermeasures.		
9700	Servo control gate array failure. Check the DMB.	Check the short-circuit and improper connection of the peripheral equipment wiring. (Emergency and I/O connectors) Replace the DMB. Replace the additional axis unit.		

No.	Message	Remedy	Note 1	Note 2
9701	Disconnection of the parallel encoder signal. Check the signal cable connection or the robot internal wiring.	Check the M/C cable signal. Check the robot signal wiring. (Missing pin, disconnection, short-circuit) Replace the motor. (Encoder failure) Replace the DMB. (Detection circuit failure) Check the connector connection in the controller. (Loosening, connecting to the serial encoder terminal on the DMB) Check the model setting. (Improperly setting of the parallel encoder) Check the peripheral equipment wiring. (Emergency and I/O)		
9702	Motor driver is not installed. Install the motor driver. Check the DMB or the motor driver.	Check whether the motor driver is mounted. Check the model setting and hardware setting. Replace the motor driver. Replace the DMB.		
9703	Initialization communication failure of incremental encoder. Check the signal cable connection and the robot setting.	Check the model setting. Replace the motor. (Encoder failure) Replace the DMB.		
9704	Initialization failure of absolute encoder. Check the signal cable connection or the robot setting.	Check the model setting. Replace the motor. (Encoder failure) Replace the DMB.		
9705	Encoder division setting failure. Check the robot setting.	Check the model setting.		
9706	Data failure at the absolute encoder initialization. Check the signal cable connection, the controller, or the motor.	Replace the motor. (Encoder failure) Replace the DMB. Check the noise countermeasures.		
9707	Absolute encoder multi-turn is beyond the maximum range. Reset the encoder.	Reset the encoder. Replace the motor. (Encoder failure)		
9708	Position is out of the range. Reset the encoder.	Reset the encoder. Replace the DMB. Replace the motor. (Encoder failure)		
9709	No response from the serial encoder. Check the signal cable connection, the motor, the DMB, or the encoder IF board.	Check the model setting. (Improperly setting of the parallel encoder model) Check the signal cable connection. Replace the DMB and encoder I/F board.		
9710	Serial encoder initialization failure. Reboot the controller. Check the motor, the DMB, or the encoder IF board.	Check the robot configuration. Check the signal cable. Replace the DMB and encoder I/F board.		
9711	Serial encoder communication failure. Reboot the controller. Check the motor, the DMB, or the encoder IF board.	Check the robot configuration. Check the signal cable. Replace the DMB and encoder I/F board.		
9712	Servo CPU watchdog timer failure. Reboot the controller. Check the motor or the DMB.	Replace the DMB. Check the noise countermeasures.		
9713	Current control circuit WDT failure. Reboot the controller. Check the controller.	Check the power cable connection. Check the 15V power supply and cable connection. Replace the DMB. Check the noise countermeasures.		
9715	Encoder is reset. Reboot the controller.	Reboot the controller.		
9716	Power supply failure of the absolute encoder. Replace the battery to a new one. Check the robot internal wiring.	Reset the encoder. Check the signal cable connection.		
9717	Backup data failure of the absolute encoder. Reset the encoder.	Reset the encoder. Check the signal cable connection.		

Maintenance 8. Trouble Shooting

No.	Message	Remedy	Note 1	Note 2
9718	Absolute encoder battery alarm.	Replace the battery. Check the signal cable connection.		
9719	Position failure of the absolute encoder. Reset the encoder. Replace the motor.	Reset the encoder. Replace the motor. (Encoder failure)		
9720	Speed is too high at controller power ON. Stop the robot and reboot the controller.	Reboot the controller.		
9721	Absolute encoder over heat.	Lower the motion duty. Wait until the temperature of the encoder decreases.		
9722	R/D transducer failure. Check the resolver board.	Check the noise countermeasure. Replace the resolver board.		
9723	G sensor communication failure. Check the control board.	Check the M/C signal cable. Check the robot signal wiring (for pin falling, disconnection, short). Check the noise countermeasure. Replace the control board. Replace the DMB board.		
9724	G sensor data failure. Check the control board.	Replace the control board.		
9725	Resolver mixing failure. Reset the encoder.	Reset the resolver. Replace the resolver board.		
9726	Resolver signal disconnection. Check the motor and resolver board.	Check the robot signal wiring. Replace the resolver board.		
9727	S-DSP communication failure. Check-sum error, Free-run counter error	Reboot the controller. Replace the DMB. Check the noise countermeasure.		
9728	Current data failure. Data update stopped. Parity error.	Reboot the controller. Replace the DMB. Check the noise countermeasure.		
9729	D-DSP communication failure. Check-sum error, Free-run counter error	Reboot the controller. Replace the DMB. Check the noise countermeasure.		
9732	Servo alarm A.			

EPSON RC+

No.	Message	Remedy	Note 1	Note 2
7713	Option not enabled.			
7714	File not found.			
10000	Command aborted by user			
10001	Command timeout.			
10002	Bad point file line syntax			
10003	Project could not be built.			
10004	Cannot initialize Spel class instance.			
10005	Cannot initialize parser.			
10006	Cannot initialize wbproxy.			
10007	Project does not exist.			
10008	No project specified.			
10009	Cannot open file.			
10010	Cannot create file.			
10011	File not found			
10012	Option not enabled			
10013	Cannot execute LoadPoints with Robot Manager open.			
10014	Project cannot be locked. It is being used by another session.			
10015	Project could not be synchronized.			
10016	Drive not ready			
10017	Invalid IP address			
10018	Invalid IP mask			
10019	Invalid IP gateway			
10020	IP address or gateway cannot be the subnet address			
10021	IP address or gateway cannot be the broadcast address			
10022	Invalid DNS address			
10023	Commands cannot be executed because the project build is not complete.			
10024	Invalid task name.			
10025	Trial runtime expired.			
10100	Command already in cycle.			
10101	Command aborted by user.			

8.2 Cannot Connect the Development PC and the Controller using the USB cable

 CAUTION	<ul style="list-style-type: none"> Do not connect the USB cable to a PC or a Controller without installing Program Development Software EPSON RC+ 5.0 to the PC. You must install EPSON RC+ 5.0 to control the Controller. If the USB cable is connected to a PC or a Controller without installing Program Development Software EPSON RC+ 5.0, the [Add New Hardware] wizard appears. Click the <Cancel> button to close the [Add New Hardware] wizard.
---	---

If the following error message appears when connecting the development PC and Controller with the USB cable and connecting the Controller to EPSON RC+ 5.0, Windows may not recognize the Controller properly. Refer to 8.2.1 *Confirmation Using Windows Device Manager* to check the connection of the Controller.

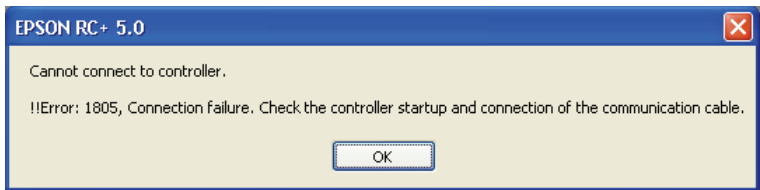

8.2.1 Confirmation Using Windows Device Manager

- Make sure that the development PC and the Controller is connected to the USB cable.



When checking the Controller connection using the Windows device manager, the development PC and the Controller must be connected with the USB cable.

- Click Windows-[Control Panel]-<Performance and Maintenance>.

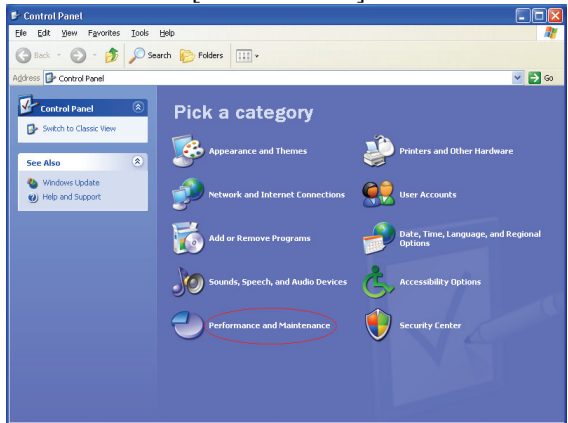

- (3) The [Performance and Maintenance] dialog appears.
Click the <System> icon.

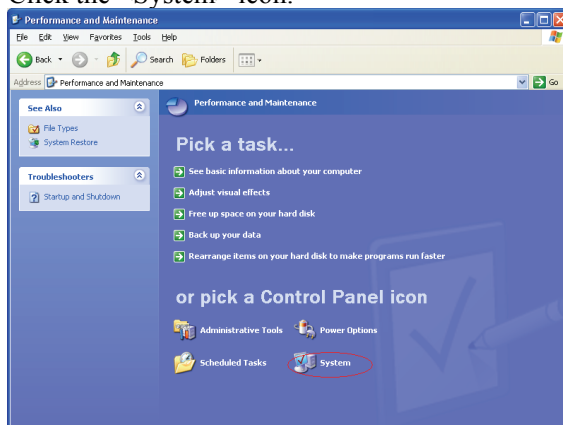

- (4) The [System Properties] dialog appears.
Select the [Hardware] tab and click the <Device Manager> button.

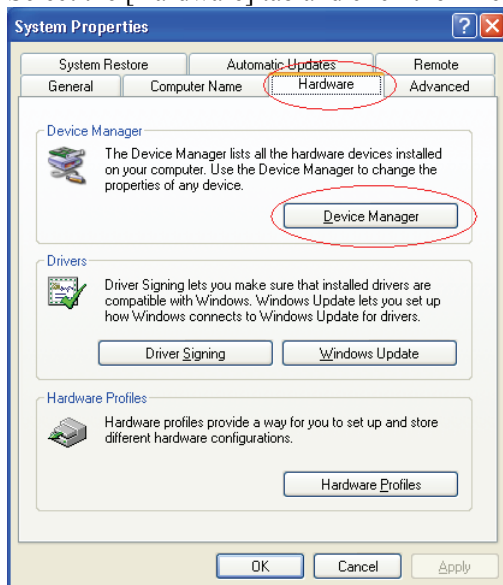

- (5) The [Device Manager] dialog appears.
Click <Universal Serial Bus controllers> and make sure that "EPSON Robot Controller RC170 (or RC180)" is registered.

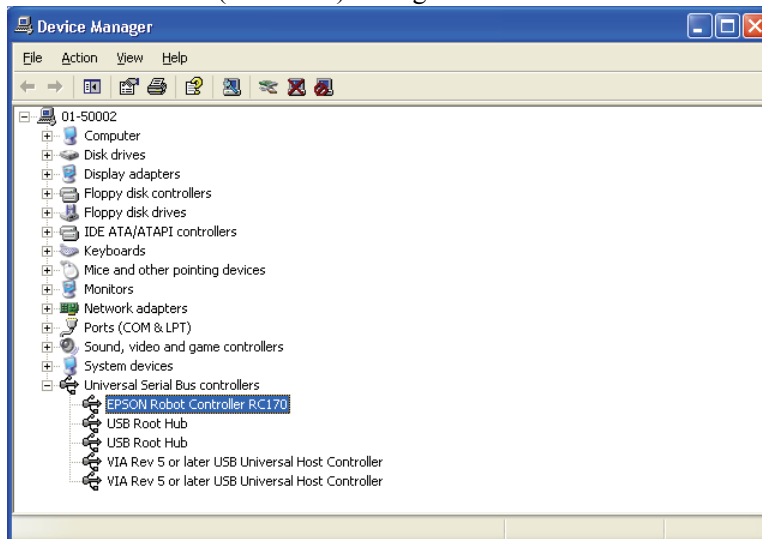

NOTE



When “EPSON Robot Controller RC170 (or RC180)” is registered and located under “Universal Serial Bus controllers” in step (5), the development PC and the Controller connect properly.

If the following error message appears, please contact EPSON.

“Cannot connect to controller.

!! Error: 1805, Connection failure, check the controller startup and connection of the communication cable.”

If “EPSON Robot Controller RC170 (or RC180)” is not located under “Universal Serial Bus controllers” but located under “Other devices” in step (5), refer to 8.2.2 *When recognized under “Other devices” in Windows Device Manager.*

8.2.2 When recognized under “Other devices” in Windows Device Manager

If “EPSON Robot Controller RC170 (or RC180)” is recognized under “Other devices” in the Windows device manager as shown in the following dialog, delete “EPSON Robot Controller RC170 (or RC180)” from the device manager and connect the USB cable again to correct the problem.

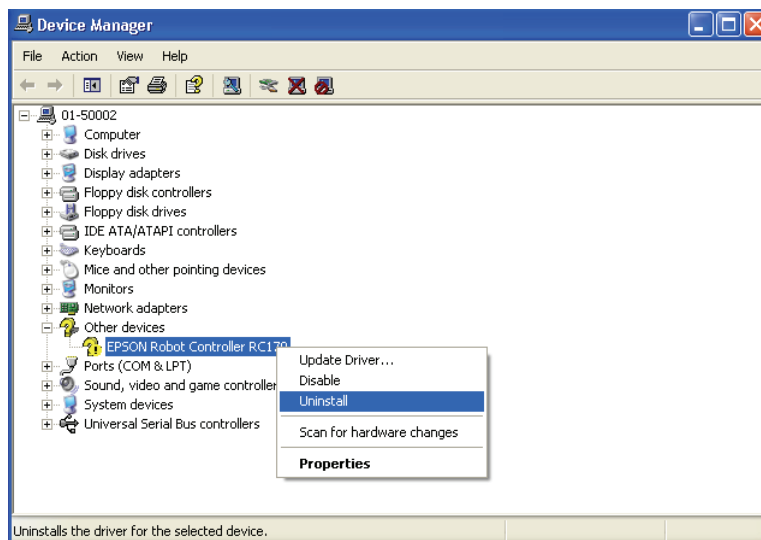

- (1) Select and right click “EPSON Robot Controller RC170 (or RC180)” in the [Device Manager] dialog.
- (2) Select [Uninstall].
- (3) The [Confirm Device Removal] dialog appears.
Click the <OK> button.



- (4) Remove the USB cable and connect the USB cable again. The following message appears at the right bottom of the Windows screen.



- (5) When the Controller is installed automatically and the following message appears, the communication is available.



NOTE



If the problem is not corrected, please contact EPSON.

9. Maintenance Parts List

Part Name		Code	Note
Fan Unit		R13B060501	
Fan Filter	For Base Unit	R13B060502	
	For Option Unit	R13B060503	2 unit per set
Battery		R13B060003	Banding band CR17335SE (FDK)
Motor Driver	50 W	R13B070101	
	100 W	R13B070102	
	200 W	R13B070103	
	400 W	R13B070104	
	750 W	R13B070105	
Fuse		R13B060401	For DPB
CPU Unit	S/N: 10000 or below	R13B040004	
	S/N: 10001 or later	R13B040009	
CF (Compact Flash)	S/N: 10000 or below	R13B110601	
	S/N: 10001 or later	R13B110608	
TP/OP Bypass Plug		R13B060705	
Controller Mounting Metal Hasp	S	R13B071302	
	L	R13B071303	
Expansion I/O Board		R12B040301	Option
RS-232C Board		R12B040705	Option
DeviceNet Board		R12B040706	Option
PROFIBUS-DP Board		R12B040707	Option
CC-Link Board		R12B040708	Option
EtherNet/IP Board		R12B040719	Option
PROFINET board		R12B040728	Option