

GE ZONELINE[®]

Packaged Terminal Air Conditioners



GE APPLIANCES

Zoneline[®]

**ARCHITECTS & ENGINEERS
DATA MANUAL
AZ45/AZ65 SERIES**

QUICK REFERENCE



AZ45 and AZ65 series control panel

Full Specs on pages 51-52

.....
All units require power connection kit.
.....

Power connection kit determines
resistance heat output
.....

AZ45 SERIES COOLING WITH ELECTRIC HEAT

MODEL NUMBER	VOLTAGE	COOLING (BTUH)	EER	WATTS
AZ45E07DAB	208	7,000	13.4	520
	230	7,200	13.4	535
AZ45E09DAB	208	9,600	12.1	790
	230	9,700	12.1	800
AZ45E12DAB	208	11,800	11.8	1,000
	230	11,900	11.8	1,010
AZ45E15DAB	208	14,800	10.5	1,405
	230	14,900	10.5	1,415

AZ45 SERIES COOLING WITH ELECTRIC HEAT CORROSION TREATED MODELS

MODEL NUMBER	VOLTAGE	COOLING (BTUH)	EER	WATTS
AZ45E07DAC	208	7,000	13.4	520
	230	7,200	13.4	535
AZ45E09DAC	208	9,300	11.8	790
	230	9,400	11.8	795
AZ45E12DAC	208	11,600	11.5	1,005
	230	11,800	11.5	1,020
AZ45E15DAC	208	14,500	10.5	1,380
	230	14,600	10.5	1,390
AZ45E07EAC	265	7,300	13.4	540
AZ45E09EAC	265	9,500	11.6	815
AZ45E12EAC	265	11,800	11.7	1,005
AZ45E15EAC	265	14,900	10.7	1,390

DRY AIR 25*

AZ45 SERIES COOLING WITH ELECTRIC HEAT

MODEL NUMBER	VOLTAGE	COOLING (BTUH)	EER	WATTS
AZ45E07DAP	208	6,500	12.8	520
	230	6,900	12.8	535
AZ45E09DAP	208	9,500	12.1	765
	230	9,400	12.1	775
AZ45E12DAP	208	11,000	11.5	960
	230	11,200	11.5	970
AZ45E09EAP	265	9,500	12.1	780
AZ45E12EAP	265	11,000	11.0	995

*Dry Air models are corrosion treated

AZ45 SERIES COOLING WITH ELECTRIC HEAT MAKEUP AIR

MODEL NUMBER	VOLTAGE	COOLING (BTUH)	EER	WATTS
AZ45E09DAM	208	9,100	11.5	790
	230	9,200	11.5	800
AZ45E12DAM	208	11,500	11.4	1,005
	230	11,600	11.4	1,010



QUICK REFERENCE

AZ65 SERIES HEAT PUMP WITH BACKUP ELECTRIC HEAT

MODEL NUMBER	VOLTAGE	COOLING (BTUH)	EER	COOLING WATTS	HEATING (BTUH)	COP	HEATING WATTS
AZ65H07DAB	208	6,900	13.0	530	6,100	4.0	440
	230	7,100	13.0	545	6,200	4.0	450
AZ65H09DAB	208	9,600	12.2	785	8,000	3.7	630
	230	9,700	12.2	795	8,100	3.7	645
AZ65H12DAB	208	11,900	11.9	1,000	10,400	3.6	840
	230	12,100	11.9	1,015	10,500	3.6	850
AZ65H15DAB	208	14,200	10.6	1,335	13,300	3.3	1,180
	230	14,400	10.6	1,355	13,400	3.3	1,190

AZ65 SERIES HEAT PUMP WITH BACKUP ELECTRIC HEAT CORROSION TREATED MODELS

MODEL NUMBER	VOLTAGE	COOLING (BTUH)	EER	COOLING WATTS	HEATING (BTUH)	COP	HEATING WATTS
AZ65H07DAC	208	7,000	13.0	535	6,100	4.0	445
	230	7,100	13.0	545	6,200	4.0	450
AZ65H09DAC	208	9,600	12.2	785	8,000	3.7	630
	230	9,700	12.2	795	8,100	3.7	645
AZ65H12DAC	208	11,800	11.7	1,005	10,300	3.6	815
	230	11,900	11.7	1,015	10,400	3.6	845
AZ65H15DAC	208	14,200	10.4	1,360	13,300	3.3	1,180
	230	14,500	10.4	1,390	13,500	3.3	1,195
AZ65H07EAC	265	7,000	12.8	545	6,200	3.9	460
AZ65H09EAC	265	9,500	11.7	810	8,100	3.6	655
AZ65H12EAC	265	11,900	11.6	1,025	10,500	3.6	875
AZ65H15EAC	265	14,500	10.6	1,365	13,500	3.3	1,195

AZ65 SERIES HEAT PUMP WITH BACKUP ELECTRIC HEAT ICR (INTERNAL CONDENSATE REMOVAL)

MODEL NUMBER	VOLTAGE	COOLING (BTUH)	EER	COOLING WATTS	HEATING (BTUH)	COP	HEATING WATTS
AZ65H07DAD	208	6,900	13.0	530	6,000	4.0	530
	230	7,000	13.0	535	6,200	4.0	535
AZ65H09DAD	208	9,500	12.0	790	8,000	3.6	790
	230	9,600	12.0	800	8,200	3.6	800
AZ65H12DAD	208	11,600	11.5	1,005	10,200	3.5	1,005
	230	11,800	11.5	1,020	10,400	3.5	1,020
AZ65H15DAD	208	14,100	10.3	1,360	13,400	3.2	1,360
	230	14,300	10.3	1,385	13,500	3.2	1,385
AZ65H07EAD	265	7,000	12.8	545	6,200	3.9	545
AZ65H09EAD	265	9,500	11.7	810	8,100	3.5	810
AZ65H12EAD	265	11,900	11.7	1,015	10,300	3.4	1,015
AZ65H15EAD	265	14,300	10.4	1,375	13,500	3.2	1,375

AZ65 SERIES COOLING WITH ELECTRIC HEAT MAKEUP AIR

MODEL NUMBER	VOLTAGE	COOLING (BTUH)	EER	COOLING WATTS	HEATING (BTUH)	COP	HEATING WATTS
AZ65H07DAM	208	6,600	12.0	550	6,000	3.6	480
	230	6,700	12.0	555	6,100	3.6	485
AZ65H09DAM	208	9,100	11.5	790	8,000	3.5	655
	230	9,200	11.5	800	8,100	3.5	670
AZ65H12DAM	208	11,400	11.2	1,010	10,300	3.5	840
	230	11,500	11.2	1,020	10,400	3.5	860

HEATER WATTAGE AND POWER CONNECTION KITS

Power connection kits are required on all Zoneline chassis. (See chart.)

The correct kit for the installation is determined by the voltage and amperage of the electrical circuit and the means of connecting the unit to the building wiring. If the unit is to be plugged into a receptacle, a line cord kit would be used; if the unit is to be permanently connected, a direct connector or a permanent connection kit would be used.

Note: 265-volt cord set units must be installed in compliance with National Electrical Code.

	230/208-Volt					
	Line-Cord-Connected (P) and Direct-Connected Units (D)					
BTUH size	7,000/9,000			12,000/15,000		
Power connection kit	RAK315P & RAK315D	RAK320P & RAK320D	RAK330P & RAK330D	RAK315P & RAK315D	RAK320P & RAK320D	RAK330P & RAK330D
Total watts	2,410/1,990	3,420/2,830	4,830/3,990*	2,430/2,020	3,450/2,860	4,860/4,020*
Heater watts	2,400/1,960	3,400/2,780	4,800/3,930*	2,400/1,960	3,400/2,780	4,800/3,930*
Heater BTUH	8,100/6,600	11,600/9,400	16,300/13,400*	8,100/6,600	11,600/9,400	16,300/13,400*
Total Amps	10.5/9.6	14.9/13.6	21.0/19.2	10.6/9.7	15.1/13.8	21.2/19.3
Min. circuit Amps	15	20	25	15	20	25
Recommended protective device	15 amp time-delay fuse or breaker	20 amp time-delay fuse or breaker	30 amp time-delay fuse or breaker	15 amp time-delay fuse or breaker	20 amp time-delay fuse or breaker	30 amp time-delay fuse or breaker

	265-Volt					
	Permanent (P, Cord Set) and Direct-Connected Units (D)					
BTUH size	7,000/9,000			12,000/15,000		
Power connection kit	RAK515P & RAK515D	RAK520P & RAK520D	RAK530P & RAK530D	RAK515P & RAK515D	RAK520P & RAK520D	RAK530P & RAK530D
Total watts	2,440	3,450	4,850*	2,460	3,470	4,870*
Heater watts	2,400	3,400	4,800*	2,400	3,400	4,800*
Heater BTUH	8,100	11,600	16,300*	8,100	11,600	16,300*
Total amps	9.1	12.9	18.1	9.3	13.1	18.4
Min. circuit Amps	15	20	25	15	20	25
Recommended protective device	15 amp time-delay fuse or breaker	20 amp time-delay fuse or breaker	25 amp time-delay fuse or breaker	15 amp time-delay fuse or breaker	20 amp time-delay fuse or breaker	25 amp time-delay fuse or breaker

Each line cord kit has an integral Leakage Current Detection and Interruption (LCDI) device as required by National Electrical Code (NEC) and Underwriters Laboratories (UL) for units manufactured after August 1, 2004.

POWER CONNECTION KIT

Required on all models. See specification sheet for heater KW and branch circuit ampacity.

Receptacles/Sub-bases



Tandem
230/208V 15 Amp
NEMA6-15R



Perpendicular
230/208V 20 Amp
NEMA6-20R



Large tandem
230/208V 30 Amp
NEMA6-30R



265V 15 amp
NEMA7-15R;
receptacle used on
265V sub-base



265V 20 amp
NEMA7-20R;
receptacle used on
265V sub-base



265V 30 amp
NEMA7-30R;
receptacle used on
265V sub-base

ESSENTIAL ELEMENTS ORDERING OVERVIEW

230/208-volt line-cord connected units — order line cord kit.

230/208-volt sub-base connected units — order sub-base (includes power connection kit) and junction box for chassis (if hard wired).

265-volt units — order sub-base and power connection kit separately.

ZONELINE CHASSIS NOMENCLATURE

The Zoneline chassis is identified by a model number defining the type of unit, cooling capacity, electrical information and optional features included on the unit. When specifying or ordering the Zoneline chassis, the use of this nomenclature will assure receiving the correct unit.

EXAMPLE

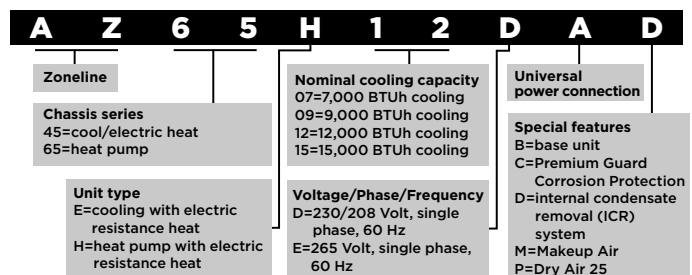

*Wattage reduced with low-speed fan.

Specifications subject to change.

TABLE OF CONTENTS

Mini Specs AZ45 and AZ65 Series	2-3
Mini Specs Power Connection Kits & Nomenclature	4
Table of Contents.....	5
Introduction.....	6
The Zonline® System	7

FEATURES & BENEFITS

Features Table	8
Makeup Air	9
Dry Air 25	10
Features and Benefits	11-13
Auxiliary Control Settings	14-15
Central Desk Control.....	16
Remote Thermostat Control	17-19
Heat Pumps and Energy Savings.....	20
Reverse Cycle Defrost	21

INSTALLATION & DIMENSIONS

Application Comments	22
Case Dimensions	23-24
Wall Case/Sub-Base Installation	24-35
Condensate Disposal Systems.....	36-38
Ducted Installations	39-42
Exterior Grilles.....	42-43

PRODUCT DATA

Power Connection Kits	43-45
Normal Yearly Operating Data	46
Wiring Diagram/Schematics	47

PRODUCT SPECIFICATIONS

Suggested Bid Form Specifications	48-49
Zonline Chassis Nomenclature/Receptacles/Sub-Bases.....	50
Specifications.....	51-52
Complete Accessory List.....	53
Sizing and Capacity Considerations.....	54
General Installation Suggestions.....	55-56
Warranty	56
Notes.....	57-58
Alphabetical Index	59

IMPORTANT NOTICE

Equipment used as a primary source for heating or cooling is an integral part of the building in which it is installed. Proper application is essential for satisfactory performance over a wide range of operating conditions. It is strongly recommended that a professional engineer determine proper application. If the unit is a replacement unit, its specifications and performance may differ from those of the unit it is replacing. For that reason, we again strongly recommend that a professional engineer determine proper application.

INTRODUCTION

This manual is designed for use in design and selection of zoned comfort control systems utilizing GE Appliances Zoneline Packaged Terminal Air Conditioners (PTAC) and Packaged Terminal heat Pumps (PTHP). It provides product, performance and application information to our customers as well as architects and engineers.

GE Appliances Zoneline PTACs and PTHPs are self-contained units designed for through-the-wall installations in hotels, motels, apartments, hospitals, nursing homes, add-on rooms and many other installations.

Zoneline units provide individual room or zone control in both cooling and heating operation. There is a model for practically every application, ranging from 7,000 to 14,900 BTUH in cooling capacity and from 6,200 to 13,500 BTUH heating capacity in heat pump operation. *See pages 43, 44 and 50 for resistance heaters available.*

The Zoneline lineup consists of the AZ45 series with electric resistance heat and the AZ65 series heat pump. The AZ65 series heat pump features reverse-cycle defrost and simultaneous supplemental resistance heat, when needed, to maintain room comfort.

STANDARD FEATURES:

- Two independent DC fan motors with indoor cross-flow blower for quieter operation
- Digital Controls
 - White LED Display
 - Auto Dimming Display (no control cover)
 - Easy Temperature Selection
 - Touch Pad Controls
- Universal Heaters
- Composite Material Base Pan
- “Smart Fan” Fan Cycle/Continuous Control
- Supplemental Resistance Heat on Heat Pumps
- Reverse Cycle Defrost
- Quick Heat Recovery
- Quick Connect Remote Thermostat Interface
- Electronic Temperature Limiting
- Freeze Sentinel
- Heat Sentinel
- Infinitely Adjustable Vent Door
- Indoor Coil Frost Control
- Random Restart
- Central Desk Control Interface
- Transfer Fan Interface

OPTIONAL FEATURES:

- Corrosion Protection
- Make up Air Module
- Dry Air (AZ45 series only)
- Internal Condensate Removal (AZ65 series only)

NOTE: *Dry Air 25 models include all the standard features of the AZ45 Series plus standard corrosion protection*

ADVANTAGES OF THE ZONELINE SYSTEM:

- Flexible Application
 - May be installed from flush to finished floor, to 3" from the ceiling
 - 7,000 to 15,000 nominal BTUH units in same physical size
 - AZ45 and AZ65 series may be ducted to condition more than one room
 - Class 2 remote thermostat control option
 - Compatible with 2-wire CDC or many Energy Management Systems
- Economical Installation
 - Replacement units fit existing 42"-wide by 16"-high wall cases
 - No ductwork necessary
 - No mechanical equipment rooms or pipes required for heating/cooling units
- Quiet Operation
 - Large indoor cross-flow blower
 - Sound deadening mastic on SMC bulkhead
 - DC fan motors with isolation grommets
- Energy-Saving Operation
 - Units in unoccupied areas may be turned off
 - Designed for efficient cooling operation
 - EERs from 10.4 to 13.4
 - Efficient heat pump units - COPs from 3.3 to 4.0
 - Reverse Cycle heat pump operation
- Ease of Maintenance
 - Access with common 5/16" nut driver
 - Unit design for ease of maintenance
 - Upfront lift-out interchangeable filters
 - Slide-out chassis for easy access for cleaning or if service is required

The AZ65 series heat pumps utilize the unique GE Appliances heat pump logic and operation to ensure a comfortable room. The logic used by the units is the same logic used by central system heat pumps to provide greater savings.

THE ZONELINE® SYSTEM

The typical Zoneline® installation consists of the wall case (or sleeve), chassis, power cord and exterior grille. Some installations may use a sub-base for support of the unit or for ease of electrical connections. Each of the components should be the standard products offered by GE Appliances, or, in the case of the exterior grille, approved by GE Appliances Applications Engineering. Use of components not specifically designed or approved for use with the Zoneline unit can result in unsatisfactory operation and can be the cause of failure not covered by the warranty.

COMPONENTS OF THE ZONELINE SYSTEM TYPICAL INSTALLATION

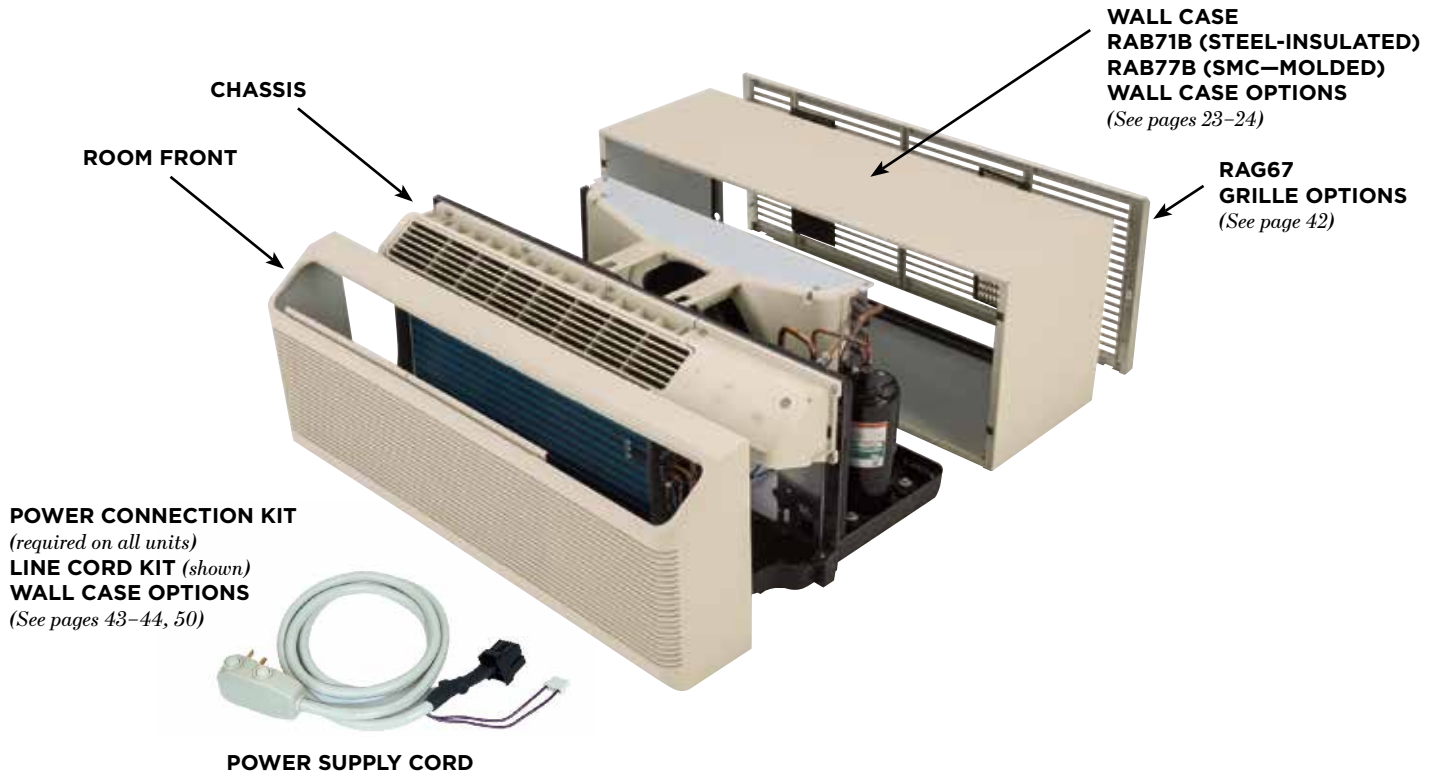

OPTIONAL ACCESSORIES OF THE ZONELINE SYSTEM

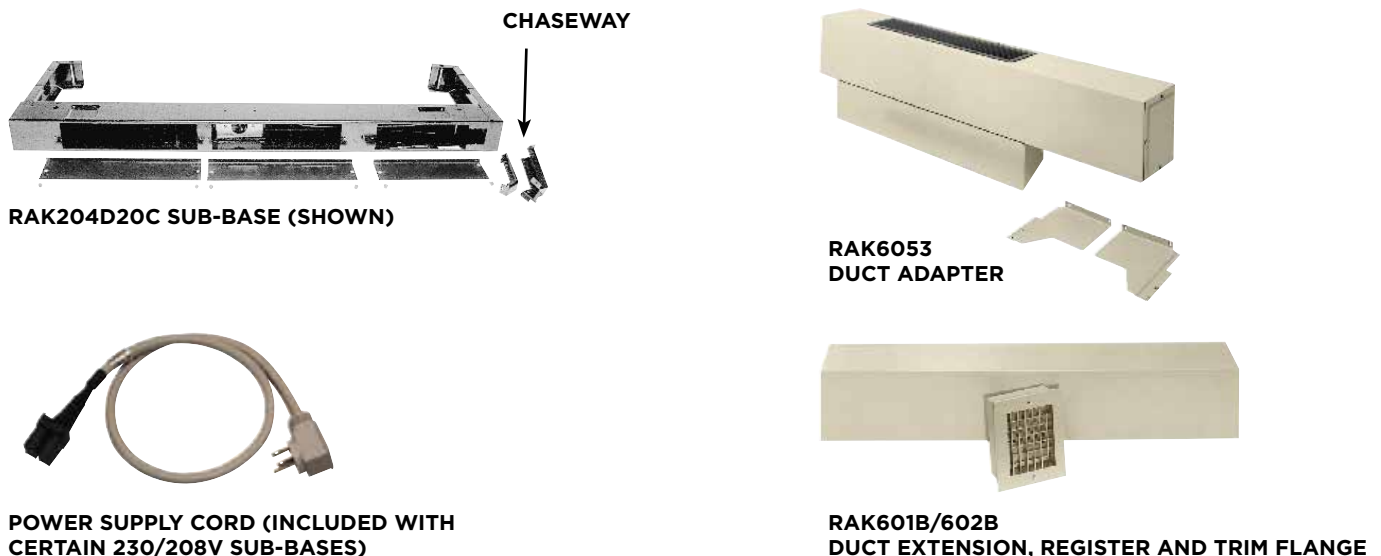

See pages 24–25 and 33 for information on electrical sub-bases and chaseway.
 See pages 39–41 for information on ducted installations.

ZONELINE FEATURES

	RESISTANCE HEAT		HEAT PUMP
	AZ45 SERIES	AZ45 DRY AIR 25	AZ65 SERIES
Cooling EER range (230 Volts/265 Volts)	10.5 - 13.4	11.0 - 12.8	10.3 - 13.0
Heating COP range (230 Volts/265 Volts)	N/A	N/A	3.2 - 4.0
Refrigerant type	R-410A	R-410A	R-410A
Cross-flow (tangential) blower	Standard	Standard	Standard
Enhanced dehumidification	Optional	Standard	—
Sound deadening mastic	Standard	Standard	Standard
Composite (non rustable) basepan	Standard	Standard	Standard
Heat pump with resistance heat back-up	—	—	Standard
Heat pump with supplemental resistance heat (Boost heat)	—	—	Selectable
Staged heating	—	—	3-Stage***
Universal heaters—UPC**	Standard	Standard	Standard
Touch-pad controls with white LEDs	Standard	Standard	Standard
Auto dimming display	Standard	Standard	Standard
Auxiliary control features	Standard	Standard	Standard
Electric resistance heat lock-out (above 46°F)	—	—	Standard
Automatic emergency heat	Standard	Standard	Standard
Heat pump defrost system	—	—	Reverse cycle
Quick heat recovery	—	—	Standard
Separate indoor & outdoor motors — permanently lubricated	DC	DC	DC
2-speed outdoor fan	Standard	Standard	Standard
Indoor fan speed settings	Hi/Low	Hi/Low	Hi/Low
“SmartFan” fan cycle control	Standard	Standard	Standard
Auto power recovery	Standard	Standard	Standard
Automatic compressor restart delay	Standard	Standard	Standard
Freeze Sentinel (41°F)	Standard	Standard	Standard
Heat Sentinel (85°F)	Standard	Standard	Standard
Automatic indoor frost control	Standard	Standard	Standard
Temperature limiting	Electronic 7-step	Electronic 7-step	Electronic 7-step
Remote thermostat compatibility	Standard	Standard	Standard
Central Desk Control compatibility	Standard	Standard	Standard
2-position discharge grille 45°/65°	Standard	Standard	Standard
Upfront filter (interchangeable)	Standard	Standard	Standard
Manual air vent control	Standard	Standard	Standard
Transfer fan connections	Standard	Standard	Standard
Ducted installation (non makeup air module)	—	Optional	Optional
Corrosion-treated chassis*	Optional	Standard	Optional
Internal condensate removal (ICR)*	—	—	Optional
Makeup air module*	Optional	—	Optional

*Not for use in corrosive environments

**UPC—Universal Power Cord Connection (see pages 43–44 and 50).

***Two-stage heating if using remote thermostat

*Corrosion treatment is standard on all 265V models

265-volt units must be connected in a manner to meet National Electrical Code and all local codes.

GE ZONELINE® WITH MAKEUP AIR

Recent code changes have dramatically changed the method and requirements for providing fresh air to the guest rooms. Before, fresh air was typically provided from a rooftop system pumping air into the hallways and then under the entry door into the room. Now, those systems must utilize individual ducts (and fire dampers) to each individual room.

As an alternative to an individually ducted rooftop system, the Zoneline has been converted to provide makeup air for those projects looking for alternatives.

The GE Zoneline with Makeup Air PTAC utilizes the trusted and reliable GE Zoneline packaged terminal air conditioner with an additional dehumidification system to deliver makeup air directly to each individual room.

The main system provides the standard individual room zone control in both cooling and heating applications. The makeup air module is a secondary sealed system that delivers 35 CFM of continuous makeup air and dehumidifies the air when outdoor humidity levels rise above 55% relative humidity.

The GE Zoneline® with Makeup Air PTAC is designed to fit into our standard 42" x 16" sleeve and is primarily intended for those new construction applications where in-room makeup air is needed.

AGENCY LISTING

Both the Makeup Air Module & Zoneline system are approved by UL, CEC, NRCAN & AHRI and comply with ASHRAE 90.1-2013 minimum efficiency requirements for PTACs.

FEATURES

- Delivers 35 CFM of outdoor air anytime the unit is plugged into the power source (even if unit is turned off).
- Dehumidifies outdoor air to $\leq 55\%$ for maintaining room comfort and relative humidity.
- Dehumidifies at a rate of 6 pints/24 hours.
- Modular design for improved serviceability.
- Factory installed and tested.
- GE Zoneline warranty.

Each unit also has all the leading features of the base Zoneline unit – composite base pan, mastic sound barrier, white auto dimming LED controls (eliminates the control door cover) and many others.

The GE Zoneline with Makeup Air is also covered by the same warranty as all other Zoneline models.



THE MAKEUP AIR MODULE COMES INSTALLED IN SELECT ZONELINE PTAC UNITS.

DESIGN CONSIDERATIONS

- To avoid bringing salt/corrosive air into the living space, Makeup Air systems are not recommended for installation within 2 miles of coastal areas.
- The Makeup Air Module will increase room load requirements for both heating and cooling.
 - Consult with your architect or engineer to ensure proper sizing of the PTAC/PTHP unit to accommodate this additional load.
 - Due to the additional heating and cooling load, energy costs of the room will increase with the use of makeup air.
 - Because makeup air increases room BTU load requirements and requires additional PTAC cooling or heating, the building's electrical needs may be impacted.
- It is strongly recommended to install makeup air models with wall thermostats.
- With the additional dehumidification of outside air, additional condensate will be generated and therefore an internal or external piped drain line is recommended.
- With the additional pathway/opening for outside air, additional consideration should be used for areas with high exterior noise (traffic, airports, etc.) to not unintentionally bring that noise into the room and disturb the guest.
- It is the architects'/engineers'/contractors'/customers' responsibility to verify all state and local codes to ensure product meets local code requirements.

NOTE: Ducted installations (page 39) and auxiliary controls duct mode (page 15) NOT available with Dry Air 25 models.

THE ZONELINE AZ45 AND AZ65 SERIES have changes suggested by customers and enhancements from GE Appliances Engineering to make product improvements and meet the changing environment.

- Quieter Operation
- Ease of access—fewer screws and number of parts
- Make up air module
- Cross-flow blower across the product line for quieter operation

See the “Features and Benefits” section for in-depth explanation of these changes and the industry-leading features of GE Appliances Zoneline retained from previous series.

DRY AIR 25

THE ZONELINE AZ45 SERIES INCLUDES “DRY AIR 25” MODELS, WHICH REMOVE 20-35% MORE MOISTURE THAN OTHER ZONELINE MODELS*.



DRY AIR 25 MODELS COOLING WITH RESISTANCE HEAT

- Removes 20-35% more moisture than standard Zoneline models*
- Dry Air is a separate sealed refrigerant system
 - No mechanical parts
 - No special maintenance required
- Helps maintain lower relative humidity in rooms
- Maintains comfort at slightly higher room temperatures
 - Reduces operating costs
 - Provides comfort without overcooling
- Corrosion treatment is standard
- Excellent choice for humid climates
- Available in 7,000, 9,000 and 12,000 BTU sizes

The Dry Air 25 system, a heat pipe, is a hermetically sealed heat transfer surface installed in a “saddlebag” configuration around the indoor (evaporator) coil of the Zoneline unit. This coil arrangement will transfer heat from the front coil of the saddlebag to the rear coil without power consumption.

This assembly uses R-410A as the refrigerant and is not connected to the regular Zoneline refrigerant circuit.

As warm, humid air is pulled through the front (pre-cool) section of the heat pipe, the heat removed from the air is absorbed by the refrigerant, causing the refrigerant to change to a gas and flow to the rear (re-heat) section of the heat pipe. The air leaving the pre-cool section of the heat pipe is cooler and at a higher relative humidity level than the room air. The pre-cooled air is further cooled as it passes through the evaporator, consequently allowing the evaporator coil to remove more moisture.

When the cold air from the evaporator comes in contact with the re-heat section of the heat pipe, the heat that was removed by the pre-cool section is added back to the air and the refrigerant in the heat pipe condenses and flows back to the pre-cool (front) section. The air discharged into the room by this process is much drier, creating a more comfortable room condition.

The Dry Air 25 models center around GE Appliance’s heat pipe technology. This technology enables Dry Air 25 to remove 20-35% more moisture from the air than other leading manufacturers’ packaged terminal air conditioners. This helps maintain room comfort at a higher room temperature, reducing operating costs.

The Dry Air 25 keeps a room cool and dry, and this is the most important benefit when it comes to the occupant of the room—hotel guests, apartment residents, students. In a hot, humid climate, getting away from the humidity is just as important as getting away from the heat, and the Dry Air 25 is the perfect solution. The dehumidification of the Dry Air 25 has been verified by the same AHRI test conditions under which standard units are rated.

*Varies when comparing dehumidification rates of the 700/9,000/12,000 BTU BASF models to their Dry Air model counterparts.

FEATURES BENEFITS

STANDARD PHYSICAL DIMENSIONS

GE Appliances has maintained the same wall case dimensions since 1961—42" wide x 16" high x 13-3/4" deep—making replacement of older units easy.

WEATHER RESISTANT SYSTEM SEAL

Per AHRI, the air infiltration rate shall not exceed 19.3 CFM at the perimeter of the wall sleeve where it normally projects through the wall.

With superior design and premium materials, a properly installed Zoneline unit in an undistorted case keeps air leakage to a minimum (5 CFM).

COMPOSITE BASE PAN

The base pan is made of SMC and comes standard on all models. Since the base pan is exposed to the elements and is a water bearing device, this composite (non-metal) base pan eliminates the concern or problem of rusting metal base pans.

HEATER SIZES TO MEET ROOM REQUIREMENTS

All units are equipped with a universal heater—the resistance heat output is determined by power connection kit.

230/208 Volt Units

15 AMP Circuits—2.4/1.96 KW—RAK315P and RAK315D
20 AMP Circuits—3.4/2.78 KW—RAK320P and RAK320D
30 AMP Circuits—4.8/3.93 KW—RAK330P and RAK330D

265 Volts Units

15 AMP Circuits—2.4 KW—RAK515D
20 AMP Circuits—3.4 KW—RAK520D
30 AMP Circuits—4.8 KW—RAK530D

UNIT CONTROLS

AZ45 and AZ65 Series—touch pad controls with large, white LED readout with auto dimming feature, eliminates the need for the control cover.

HIGHLY FEATURED MICROPROCESSOR CONTROLS

Microprocessor controls are programmed to interface with the temperature sensors to maximize comfort conditions for the room occupant and provide outstanding performance features.

Thermistors are used to sense small changes in temperature to give excellent room control and allow the microprocessor to monitor and react to changing conditions.

ELECTRIC RESISTANCE HEAT LOCK-OUT

To maximize the savings of the heat pump operation, the Zoneline® heat pumps do not utilize the resistance heater when the outdoor temperature is above 46°F (and below 85°F) during normal operation. However, the resistance heat is still used in the quick heat recovery feature.

AUTOMATIC EMERGENCY HEAT

Automatically uses electric resistance heat if the heat pump output is not sufficient to maintain selected room temperature.

REVERSE-CYCLE HEAT PUMP DEFROST SYSTEM

- Standard on all Zoneline AZ65 Series heat pumps
- Enables heat pump to operate at lower temperatures when other systems switch to more expensive electric resistance heat.

See pages 20–21 for discussion of heat pump operation and defrost systems.

HIGH-TEMPERATURE HEAT PUMP OPERATION PROTECTION

- Automatically protects the compressor if heat pump is operated with high outdoor temperatures.
- Power to the outdoor fan is turned off if the indoor coil gets too hot during heat pump operation to prevent damage to the compressor.

QUICK HEAT RECOVERY—HEAT PUMP UNITS

When the unit operation is changed from STOP or COOL to HEAT, the electric resistance heaters are used to warm the room to the thermostat set point for the first cycle. This provides faster room temperature increase for greater guest comfort.

FAN MOTORS—PERMANENTLY LUBRICATED

- All units have two fan motors for quiet operation and maximum operating efficiency.
- Motors are permanently lubricated to reduce maintenance and totally enclosed to keep dirt and water out of the motor windings.

OUTDOOR FAN

The unit automatically selects the most efficient speed for the outdoor fan. The operating sound level is lower when the outdoor fan can operate in low speed, yet there are situations where it must operate in high speed. The unit changes the fan speed automatically.

INDOOR FAN SPEED SELECTIONS—HIGH/LOW

Unit may be operated in HIGH HEAT, LOW HEAT, HIGH COOL or LOW COOL. The unit also provides the option of selecting either HIGH or LOW speed for Fan-Only operation.

FAN-CYCLE SWITCH—“SMARTFAN”

- Unique “SmartFan” allows the unit to operate the indoor fan continuously in cooling operation and in cycle mode for heating, to provide better guest comfort. Smart Fan provides air circulation in summer for its help in cooling and eliminates complaint of cold-air draft during the heating season.

FEATURES AND BENEFITS (CONTINUED)

- Eliminates the need for changing fan-cycle switch seasonally.
- “SmartFan” settings are controlled via the auxiliary control setting push button.

COMPRESSOR RANDOM RESTART

In the event of a power failure, all compressors attempting to restart immediately when power is restored can result in a power surge that can cause another power interruption.

The microprocessors in the Zoneline units have a random restart logic system that prevents all units from starting at the same time.

ROTARY COMPRESSOR

Provides smoother operation for quiet, dependable service. GE Appliances has used rotary compressors since 1961.

COMPRESSOR RESTART DELAY

Zoneline units are designed to provide a minimum of three minutes of compressor-off time to allow refrigerant pressures to equalize before restarting to prevent compressor damage.

Zoneline units are also designed to provide a minimum of three minutes of compressor-run time to prevent room occupant disturbance due to short-cycling of the air conditioner.

FREEZE SENTINEL

- Detects low room temperature and turns on heater to help protect against damage caused by freezing room temperatures.
- The electric heater turns on at 41°F and warms the room up to 46°F and shuts off.
- Freeze Sentinel may be turned off via the auxiliary control.

HEAT SENTINEL

The property owner may choose to activate the Heat Sentinel feature on the Zoneline unit. If the Heat Sentinel is activated and room temperature reaches 85°F (even when the unit is in the “OFF” mode), the unit will automatically start the air conditioning operation and will shut off when the room temperature reaches 80°F. This will help dehumidify the air and lower high temperatures so the guest will not be entering an extremely hot room.

INDOOR COIL FROST CONTROL

Prevents indoor coil from freezing and causing complaints due to lack of cooling. Frost can form on the indoor coil when the unit is operated in cooling when outdoor temperatures are low. The unit automatically shuts the compressor off (and keeps the indoor fan running) until the indoor coil temperature warms to the point where frosting will no longer occur.

TRANSFER FAN INTERFACE

A 24 VAC connector is available (RAKCDC) to operate a relay to control a fan mounted in a wall to move conditioned air into another space. The electrical power for the operation of the transfer fan itself is not provided by the Zoneline unit. Transfer fans and their controlling relays, power and wiring are field supplied.

ELECTRONIC TEMPERATURE LIMITING

Seven independent programmable heating temperature limits and seven independent programmable cooling temperature limits

HEATING TEMPERATURE LIMITS							HIGHEST HEAT
65	70	72	74	76	78	80	85

LOWEST COOL	COOLING TEMPERATURE LIMITS						
60	64	66	68	70	72	74	76

Limits can be adjusted via the auxiliary control settings. To help you with energy conservation, GE Zoneline units are shipped with truncated temperature limiting preset to 66° minimum cooling and 78° maximum heating.

TEMPERATURE DISPLAY

The GE Zoneline AZ45 and AZ65 temperature display can be adjusted to display the temperature settings in either Fahrenheit, or Celsius. The unit is preset from the factory to read in Fahrenheit, but can be changed to display Celsius via the auxiliary control setting.

REMOTE CONTROL CAPABILITY WITH WALL-MOUNTED THERMOSTAT

See pages 17–19.

CENTRAL DESK CONTROL CAPABILITY

See page 16.

REVERSIBLE INDOOR AIR LOUVERS

- Allows air to be directed into room at 45° or 65° angle (from horizontal) to provide better air distribution.
- Angle is changed by removing room front and screws holding louver in place on the chassis, and rotating the louver section 180° and reinstalling.



UP-FRONT AIR FILTERS

Two interchangeable up-front filters, easy to remove and reinstall, may be cleaned without opening or removing the room front.

Clean filters by brushing, vacuuming or back-flushing under faucet or shower head.

CONCEALED MANUAL VENT CONTROL

An open ventilation door on GE Appliances Zoneline® packaged terminal air conditioners and heat pumps allows outside air to enter the room through a screen-covered opening in the weather barrier that separates the indoor and outdoor sections of the unit.

A concealed lever, located along the left side of the unit under the front cover, is used to open and close the vent door.

NOTE: *Two shipping screws must be removed from the vent door before use.*

The manual vent door has infinite adjustability with the slide rod and wing nut to meet everyone's needs. Simply tighten the wing nut at the desired opening level. Positive vent door closure and tightening of the wing nut prevents accidental opening and unwanted air infiltration.

VENT CFM*—HIGH FAN

SIZE	AZ45 SERIES	AZ65 SERIES
7,000	33 CFM	38 CFM
9,000	38 CFM	40 CFM
12,000	42 CFM	45 CFM
15,000	47 CFM	44 CFM

*CFM using additional RAKVENT kit.

Outside ambient air entering the room through this screened vent opening is not conditioned. This unconditioned air becomes mixed with the conditioned air that is circulated by the indoor fan. This air mixture generates an additional heat load/heat loss that causes the unit to run longer and may translate into higher operating costs.

For each CFM of air to enter the room, an equal amount of air must be removed through exhaust fans in the bathroom or rooftops. Greater amounts of air will be introduced (from chart shown above) depending on the size of the exhaust fan.

Zoneline vent openings are not intended to be the source of make-up air for building ventilation systems since the vent is not continuously conditioned or powered by separate fans.

See page 9 for more information on Makeup Air.

CORROSION PROTECTION (OPTIONAL)

AZ45 and AZ65 Series units may be ordered with special protection to better withstand damage from salt air and salt water in seacoast or other corrosive areas.

Corrosion protection is standard on the Dry Air and 265V models.

Makeup Air module units and heat pump units with ICR are not available with corrosion protection and should not be installed in seacoast or other corrosive environments.

Units installed in corrosive areas should use the RAB77B wall sleeve and be examined/cleaned more frequently than normal installations.

INTERNAL CONDENSATE REMOVAL (ICR)

See page 36 for a discussion of the internal AZ65 Series heat pumps.

DRY AIR 25

Moisture removal is an important function of an air conditioner. People are more comfortable at higher temperatures when the humidity level is relatively low. Air conditioners operate with less energy consumption when the room temperatures are set higher.

The GE Zoneline AZ45 Series with the Dry Air 25 heat pipe application removes 20–35% (varies by model) more moisture than the standard AZ45 Series unit.

Customers who are using the Dry Air 25 report a fresher-smelling room as a result of the lower humidity levels, as well as lower operating costs.

AUXILIARY CONTROL—AUX SET BUTTON

The auxiliary control push button is located behind the room cabinet, below the control panel. The auxiliary controls come preset to the modes most desired by customers. However, the owner is responsible for ensuring the auxiliary controls are set to the desired function. There are 9 different modes that can be set using the auxiliary set button.

TO CHANGE MODES:

- Press the STOP button.
- Press AUX SET (“AU” appears on the display).
- Press the MODE button on the control pad until the first digit in the display shows the number corresponding to the mode you are choosing and the correct HEAT/COOL LED is lit.
- Press the “+” or “-” buttons to change the mode setting selection (second digit in the display).
- Press the MODE button to move to the next feature or the AUX SET button to exit the set up process.

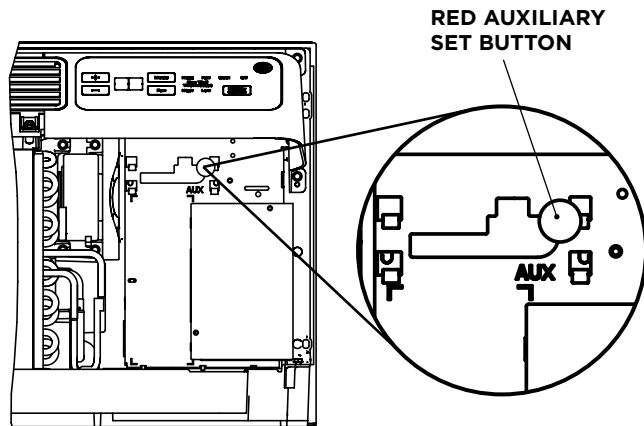

AUXILIARY CONTROL SETTINGS

Mode 1—Smart Fan—Cooling/Heating
The default setting for Mode 1 is as follows:
Cooling: Continuous (ON)
Heating: Cycle (OFF)

*Note: In cyclic Cooling Mode, the indoor fan will activate occasionally to verify air temperature in the room. In cyclic Heating Mode, the fan will continue to operate for 45 seconds after the heating function has stopped in order to increase unit efficiency.

Mode 2—Fahrenheit/Celsius
The default setting for Mode 2 is Fahrenheit.
This feature allows the individual to switch the temperature units between Fahrenheit and Celsius on the display.

Press the - pad to select Celsius or the + pad to select Fahrenheit. The individual will see a F for Fahrenheit or a C for Celsius in the second digit of the display based on the selection.

Press “AUX SET”																				
First Digit	Second Digit																			
Press “Mode”	Press + / -																			
Smart Fan HEAT COOL	- Cycle / - Continue																			
Temperature Display	/																			
Sentinel HEAT COOL	- Off / - On																			
Constant Fan																				
Temperature Limit HEAT COOL		<table border="0"> <thead> <tr> <th>COOL</th> <th>HEAT</th> </tr> </thead> <tbody> <tr><td>0: 60F-85F</td><td>0: 60F-65F</td></tr> <tr><td>1: 64F-85F</td><td>1: 60F-70F</td></tr> <tr><td>2: 66F-85F</td><td>2: 60F-72F</td></tr> <tr><td>3: 68F-85F</td><td>3: 60F-74F</td></tr> <tr><td>4: 70F-85F</td><td>4: 60F-76F</td></tr> <tr><td>5: 72F-85F</td><td>5: 60F-78F</td></tr> <tr><td>6: 74F-85F</td><td>6: 60F-80F</td></tr> <tr><td>7: 76F-85F</td><td>7: 60F-85F</td></tr> </tbody> </table>	COOL	HEAT	0: 60F-85F	0: 60F-65F	1: 64F-85F	1: 60F-70F	2: 66F-85F	2: 60F-72F	3: 68F-85F	3: 60F-74F	4: 70F-85F	4: 60F-76F	5: 72F-85F	5: 60F-78F	6: 74F-85F	6: 60F-80F	7: 76F-85F	7: 60F-85F
COOL	HEAT																			
0: 60F-85F	0: 60F-65F																			
1: 64F-85F	1: 60F-70F																			
2: 66F-85F	2: 60F-72F																			
3: 68F-85F	3: 60F-74F																			
4: 70F-85F	4: 60F-76F																			
5: 72F-85F	5: 60F-78F																			
6: 74F-85F	6: 60F-80F																			
7: 76F-85F	7: 60F-85F																			
Class 2 Mode																				
Duct Mode (non-dry air models)	- Off / - On																			
All Electric Heat Mode (AZ65 Only)																				
Boost Heat (AZ65 Only)																				
Press “SET”																				
First Digit	Second Digit																			
Press “Mode”	Press + / -																			
 HEAT COOL	Smart Fan Cool - Cycle* Smart Fan Cool - Continue																			
Press “Mode”	Press + / -																			
 HEAT COOL	Smart Fan Heat - Cycle* Smart Fan Heat - Continue																			
Press “Mode”	Press + / -																			
	Fahrenheit Celcius																			

AUXILIARY CONTROL SETTINGS (CONTINUED)

Mode 3—Freeze Sentinel/Heat Sentinel

The default settings for Mode 3 are: Heat Sentinel is OFF. Freeze Sentinel is ON. When Freeze Sentinel is activated, it automatically provides heat without user interface. This helps to prevent plumbing damage by turning the heater and indoor fan ON at 41°F and OFF at 46°F.

When Heat Sentinel is activated, it automatically provides cooling without user interface. This helps to prevent an excessively hot room by turning the air conditioner ON at 85°F and OFF at 80°F.

NOTE: *These functions are active whenever the unit is plugged in, even if the unit is in the STOP position.*

Mode 4—Constant ON fan

The default setting for Mode 4 is OFF.

NOTE: *Constant fan “on” runs the indoor fan continuously at high speed—even if the unit is turned off.*

Mode 5—Temperature limiting

The default setting for Mode 5 is as follows:

Cool: 2 (66°F to 85°F) Heat: 5 (60°F to 78°F)

Temperature limits—Cool Temperature limits—Heat

0 = 60°F to 85°F	0 = 60°F to 65°F
1 = 64°F to 85°F	1 = 60°F to 70°F
2 = 66°F to 85°F	2 = 60°F to 72°F
3 = 68°F to 85°F	3 = 60°F to 74°F
4 = 70°F to 85°F	4 = 60°F to 76°F
5 = 72°F to 85°F	5 = 60°F to 78°F
6 = 74°F to 85°F	6 = 60°F to 80°F
7 = 76°F to 85°F	7 = 60°F to 85°F

Mode 6—Remote thermostat – Class 2

The default setting for Mode 6 is OFF. Setting this mode to ON will allow the unit to operate with a Class 2 Remote Control Wall Thermostat.

Mode 7—Duct mode

The default setting for Mode 7 is OFF. This setting is used when the unit is installed using a duct adapter kit. If the unit is ducted, the Duct Mode needs to be set to ON. This increases the fan speed to ensure proper circulation.

NOTE: *Heater wattages are reduced in duct mode (see page 39).*

NOTE: *This function is disabled on Dry Air 25 models.*



































Mode 8—All-electric heat (AZ65 only)

The default setting for Mode 8 is OFF. This electric heat option functions only on the AZ65 model. When this option is ON, heat pump operation is locked out, causing the unit to provide only electric resistance heat.

Mode 9—Heat boost (AZ65 only)

The default setting for Mode 9 is OFF. The Heat Boost option works with remote thermostat operation and unit control operation. This setting is used to provide supplementary heat to the heat pump operation by adding 1,000 watts of electric resistance heat in conditions where the heat pump only operation is not sufficient to maintain a consistent, comfortable room temperature.

NOTE: *Boost heat will not operate below 25°F outdoor ambient conditions or above 85°F ambient conditions. In those cases, boost heat will be replaced by all electric heat.*

Press “Mode”  	Press + / –  Freeze Sentinel – Off  Freeze Sentinel – On
Press “Mode”  	Press + / –  Heat Sentinel – Off  Heat Sentinel – On
Press “Mode”  	Press + / –  Constant Fan – Off  Constant Fan – On
Press “Mode”  	Press + / –  Temperature Limit Cool 0: 60F-85F 1: 64F-85F 2: 66F-85F 3: 68F-85F 4: 70F-85F 5: 72F-85F 6: 74F-85F 7: 76F-85F
Press “Mode”  	Press + / –  Temperature Limit Heat 0: 60F-65F 1: 60F-70F 2: 60F-72F 3: 60F-74F 4: 60F-76F 5: 60F-78F 6: 60F-80F 7: 60F-85F
Press “Mode”  	Press + / –  Class 2 Mode – Off  Class 2 Mode – On
Press “Mode”  	Press + / –  Duct Mode – Off  Duct Mode – On
Press “Mode”  	Press + / –  ALL Electric Mode – Off  ALL Electric Mode – On
Press “Mode”  	Press + / –  Boost Heat – Off  Boost Heat – On

CENTRAL DESK CONTROL

Some installations may want to govern the ability of the unit to operate from a control device remote to the unit or even remote to the room in which the unit is located. The general term given to systems such as this is Central Desk Control (CDC). The most common installation of this type of system is a switch mounted at the registration desk and, upon guest check-in, a button is pushed or a switch is moved to allow the air conditioner to operate. Likewise, when the guest checks out, the device is put into the “OFF” position so the unit will not operate while the room is vacant.

It is not necessary that the controlling device be located at a central desk to employ a device that will control the unit operation. For instance, in some resort areas, devices are connected to sliding glass doors and opening the door causes a contact to close, turning the air conditioner off. This prevents energy being wasted by operating the air conditioner when warm, humid air is entering the room. Some systems operate by motion sensors or heat-sensing detectors mounted in the room. These types of systems determine occupant presence in the room and allow the unit to operate; if no one is in the room the device signals the air conditioner to turn off.

There is a wide variety of devices available, each with its own benefits and constraints. While GE Appliances does not offer components that are external to the unit for a Central Desk Control system, GE Appliances Zoneline units are compatible with most CDC and energy management systems.

All GE Zoneline AZ45 and AZ65 Series units are compatible with simple on/off 2-wire Central Desk Control (CDC) systems. Consult with the provider of the energy management system to be sure it is compatible with GE Zoneline units.

All GE Zoneline units have a port available and offer accessory (RAKCDC) to provide an CDC interface to most of the energy management systems.

Control power to the switch (24 VAC) is provided by the GE Zoneline unit.

IMPORTANT CDC COMMENTS (ALL SERIES APPLICABLE)

1. When the switching device closes the circuit of the CDC conductors, the unit operation stops.
2. Do not use a common bus (at the unit or at the switch panel) in the wiring. Both wires comprising the circuit must connect to the unit connectors and to the controlling switch. Running one wire from one unit to another unit is common busing and may damage internal components or cause erratic operation of the system.
3. A 24-volt transformer is contained within the Zoneline unit. No external voltage may be applied to the unit through the CDC terminals. (Voltage on the CDC conductors is 24 volts AC.)

4. When the remote switch is closed, the unit cannot be operated in the fan, cool or heat modes. Recommended wire size must be followed as a minimum requirement.

WIRE SIZE #AWG	MAXIMUM ALLOWABLE LENGTH
#22	600 Ft.
#20	900 Ft.
#18	1,500 Ft.
#16	2,000 Ft.

Freeze Sentinel and Heat Sentinel remain operational when the unit is connected to a CDC system. Even if the unit is turned “OFF” at the central location, if the sensor at the unit detects the low or high limit temperature, the unit will automatically turn on until it reaches the preset shutdown temperature (46°F heating, 80°F cooling).

Connecting the Zoneline unit to a CDC system does not eliminate the ability to connect the unit to a remote thermostat. Once the circuit is “opened,” and control of the unit removed from the CDC system, the selected controls—either the unit-mounted control or the remote thermostat—govern the operation of the unit.

Please see page 55 for installation recommendations for the Central Desk Control wiring.

CDC TERMINAL LOCATION AND TYPICAL WIRING

See page 19 for location of CDC terminals on unit.

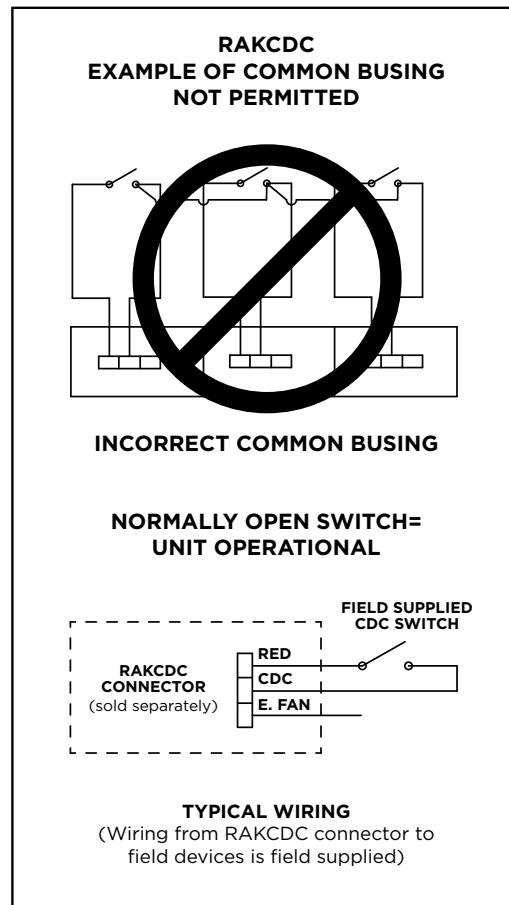

REMOTE THERMOSTAT CONTROL

In many installations, control of the operation of the unit at a location remote from the unit itself is desired. A unit mounted high in the wall or over a door, for instance, where the unit-mounted controls are inaccessible, can be connected to a wall-mounted thermostat. Other installations may use remote thermostat control for design or performance enhancement. The unit is connected to the thermostat by low-voltage wiring which permits the operation of the unit to be selected and the temperature sensed at the thermostat.

Important Notes: Remote thermostat wiring should not be run through the wall case. Thermostat wiring should exit the wall below the unit and enter the unit between room cabinet and chassis. Wire molding may be used to hide thermostat wiring. If a sub-base is used, the thermostat wiring may be concealed by the sub-base. Thermostat wiring should not be run parallel to line voltage wires since induced current may cause erratic operation.

All Zonline® AZ45 and AZ65 Series units are adaptable to Class 2 remote low-voltage thermostats. The only additional field-supplied components are the remote thermostat and wiring necessary to connect it.

The controls on the unit are not functional when the remote control function is used.

CONTROL PANEL



USE WALL THERMOSTAT —will illuminate whenever any button on the unit controls is pressed if the unit is set up to be controlled by a remote wall thermostat. The LED will dim down after a few

seconds and then turn off after a few minutes as to not disturb the guest in a dark room.

RESISTANCE HEAT MODELS

The Zonline AZ45 series resistance heat units may be connected to a single-stage thermostat designed for use with cooling with electric heat systems. GE Appliances offers three thermostats compatible with the AZ45 Series unit.



RAK164D2
Digital thermostat requiring five connection wires.



RAK164P2
Digital programmable thermostat requiring five connection wires.



RAK164F2
Digital thermostat with two fan speeds—requiring six connection wires.

The remote thermostat-Class 2 option (Mode 6 in the auxiliary control setting) must be turned ON to enable remote thermostat control. Refer to installation instructions packaged with the chassis.

Please see page 55 for installation recommendations for the remote thermostat wiring. Compatibility of other thermostats considered for use with GE Appliances Zonline units is the responsibility of the customer.

The control voltage on the remote control conductors is 24-volts AC. The AC voltage may not be compatible with some solid-state thermostats.

If using a 1-fan speed remote thermostat, the fan speed for the AZ45 Series in remote thermostat operation is selected by the connection of the fan wire from the thermostat to either the HIGH or LOW wire on the remote thermostat connector. See the sketch of the connector below for the color of the HIGH and LOW fan-speed wire. Operating the unit in low fan speed reduces the operating sound level of the unit.

Freeze Sentinel and Heat Sentinel remain operational if the unit is connected to a remote thermostat. The unit may be connected to a Central Desk Control (CDC) system and controlled with a remote thermostat when the CDC system has the unit in operation. *See page 16 for additional information on the CDC system.*

Unit temperature-limiting settings are not functional when unit is connected to a remote thermostat.

NOTE: *The low voltage transformer which powers the remote thermostat (and other controls) is “self-recovering” from potential wiring shorts. Should you lose low voltage control power (to the thermostat and the display panel on the unit), remove power to the unit, check the thermostat wiring for shorts, correct the issue and reapply power to the unit.*

NOTE: *With the new AZ45 and AZ65 Series, thermostat twinning is allowed, where more than one unit may be connected to a single remote thermostat. In order to accomplish this, ONLY ONE POWER SOURCE (24VAC – R TERMINAL WIRE) CAN BE CONNECTED TO THE THERMOSTAT. All other thermostat wires of the additional unit should be connected as directed.*

THERMOSTAT WIRING DIAGRAM

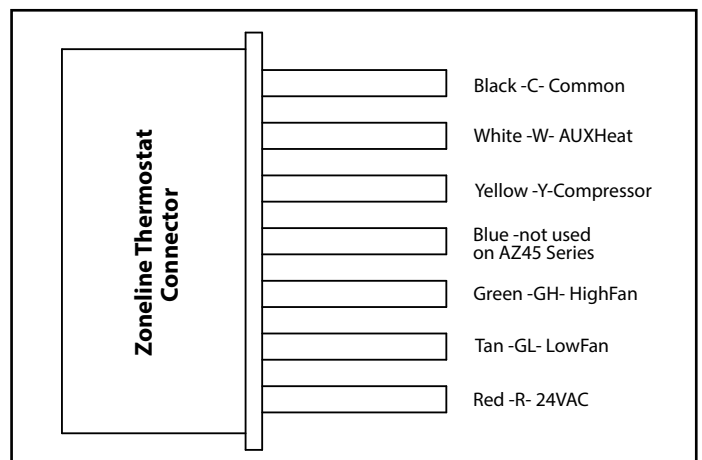

REMOTE THERMOSTAT CONTROL (CONTINUED)

HEAT PUMP MODELS

The Zoneline AZ65 Series heat pump units may be connected to a single-stage cooling/two-stage heating thermostat designed for use with heat pump systems. GE Appliances offers three thermostats compatible with the AZ65 Series units:



RAK148D2
Digital thermostat requiring six connection wires.



RAK148P2
Digital programmable thermostat requiring six connection wires.



RAK148F2
Digital thermostat with two fan speeds—requiring seven connection wires.

Please see page 55 for installation recommendations for the remote thermostat wiring. Compatibility of other thermostats considered for use with the GE Appliances Zoneline unit is the responsibility of the customer.

The control voltage on the remote control conductors is 24 VAC.

The Class 2 remote thermostat option (Mode 6 in the auxiliary control setting) must be turned ON to enable remote thermostat control. Refer to installation instructions packaged with the chassis.

If using a 1-fan speed remote thermostat, the fan speed for the AZ65 Series in remote thermostat operation is selected by the connection of the fan wire from the thermostat to either the HIGH or LOW wire on the remote thermostat connector. See the sketch of the unit connector for the color of the HIGH and LOW fan speed wire. Operating the unit in low fan speed reduces the operating sound level of the unit.

UNIT/REMOTE THERMOSTAT CONTROL

FEATURE	HEAT PUMP	ELECTRIC HEAT
Indoor frost control	Yes	Yes
Freeze Sentinel	Yes	Yes
Heat Sentinel	Yes	Yes
Electronic temperature limiting	Determined by remote thermostat	Determined by remote thermostat
Switch to resistance heat based on indoor temperature	Determined by remote thermostat	N/A
Switch to resistance heat based on outdoor temperature	Yes	N/A
Reverse cycle defrost	Yes	N/A
Partial resistance heat with heat pump	When heat boost option turned on	N/A
Resistance heat lockout	Yes	N/A
“Smart Fan” fan cycle	Fan ON/AUTO set on remote thermostat	Fan ON/AUTO set on remote thermostat
Central Desk Control	Yes	Yes

When connected to a remote thermostat, indoor air-temperature sensing is shifted from the unit to the remote thermostat. For this reason, the units will operate slightly differently when connected to a remote thermostat. The above chart shows the unit operation when connected to a remote thermostat.

NOTE: *The low voltage transformer which powers the remote thermostat (and other controls) is “self-recovering” from potential wiring shorts. Should you lose low voltage control power (to the thermostat and the display panel on the unit), remove power to the unit, check the thermostat wiring for shorts, correct the issue and reapply power to the unit.*

NOTE: *With the new AZ45 and AZ65 Series, thermostat twinning is allowed, where more than one unit may be connected to a single remote thermostat. In order to accomplish this, ONLY ONE POWER SOURCE (24VAC – R TERMINAL WIRE) CAN BE CONNECTED TO THE THERMOSTAT. All other thermostat wires of the additional unit should be connected as directed.*

THERMOSTAT WIRING DIAGRAM

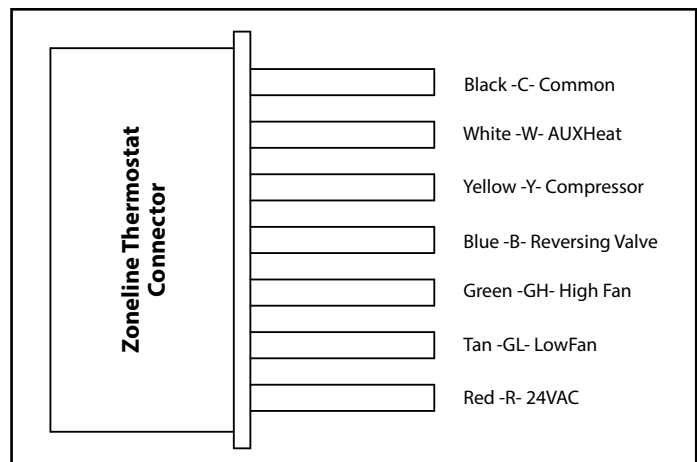

REMOTE THERMOSTAT CONTROL SELECTION CHART FOR ZONELINE® PACKAGED TERMINAL UNITS

ZONELINE SERIES	THERMOSTAT MODEL	TYPE	FUNCTION	LOW-VOLTAGE CONDUCTORS
AZ45	RAK164D2	Digital	Single Stage Cooling and Heating	5
	RAK164P2	Digital Programmable		5
	RAK164F2	Digital—Two Speed Fan		6
AZ65	RAK148D2	Digital	Single Stage Cooling and Two Stage Heating	6
	RAK148P2	Digital Programmable		6
	RAK148F2	Digital—Two Speed Fan		7

Thermostat wire size—up to 60 feet AWG20—up to 66 feet AWG17

FOR REMOTE THERMOSTAT OPERATION FOLLOW THE STEPS BELOW*:

1. Turn on the unit and ensure it is working properly BEFORE proceeding.
2. Unplug the unit or disconnect power and remove the room cover.
3. Connect the thermostat wiring per the appropriate diagram/colors for your model.
4. Plug the unit back in or reconnect power.
5. With the unit in the "off" mode, press the Aux Set button once. The letters AU will appear in the display.
6. Press the mode button until the number "6" appears in the left hand digit.
7. Press the + button once so the top half of the right hand digit is lit.
8. Press the Aux Set button to exit the setup function.
9. Replace the room cover.

**Thermostat wiring connector is shipped with each unit – located in basepan area below control box.*

See pages 14–15 for full instructions on using the Auxiliary Controls Feature.

AUXILIARY CONNECTOR DIAGRAM

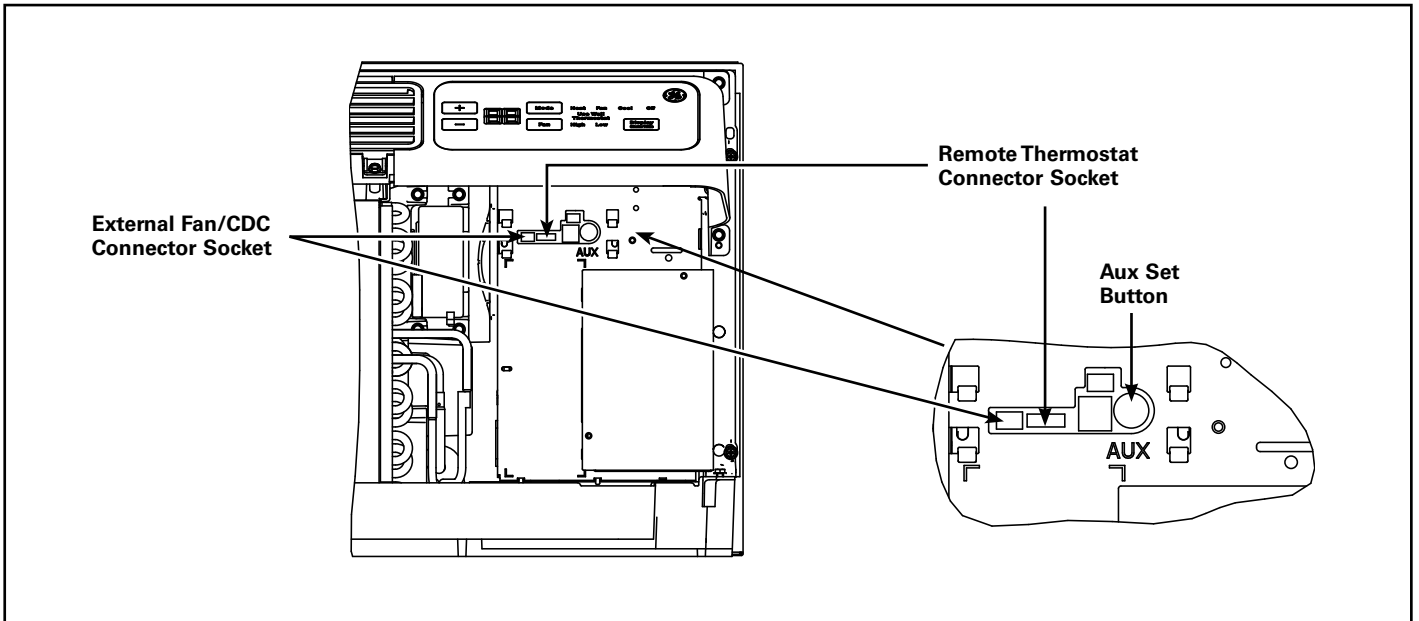

HEAT PUMPS ENERGY SAVINGS

Heat pumps save energy and cost less to operate than units with electric resistance heaters as the only heat source. Just as the EER (Energy Efficiency Ratio) of an air conditioner is an indication of the efficiency of the unit, COP (Coefficient of Performance) is the indication of the efficiency of the heat pump. This relative efficiency of a heat pump compares the unit to electric resistance heat. If a unit has a COP of 3.0, it means the unit will produce three times as much heat at rating conditions for the same electrical input wattage used for electric resistance heat.

GE Zoneline heat pumps are designed to provide cost-efficient heat pump operation while monitoring room conditions to maintain comfort.

The Zoneline AZ65 series employs extensive software and logic that monitors and reacts to both outdoor and indoor temperatures to determine the heat source. This increases energy savings by operating longer in the heat pump mode.

Just as in air conditioning operation, the compressor is used in heat pump operation. The difference is that in heat pump operation, the hot refrigerant gas is directed to the indoor coil rather than to the outdoor coil. With the indoor fan, room air circulates over the indoor coil, gains heat from the coil and distributes it into the room.

At some point as the outdoor temperature falls, the heat pump cannot extract as much heat from the outdoor air to maintain the temperature of the room. For this reason, all packaged terminal heat pumps also have electric resistance heaters as backup to heat pump operation.

The point where Packaged Terminal Heat Pumps cease heat pump operation and change to the more expensive resistance heat (to maintain room temperature) is called the “switchover point.” It is important to compare the switchover point of the various manufacturers since it may occur at higher outdoor temperatures with other brands where savings from the GE Zoneline heat pump operation could still be realized.

Zoneline AZ65 series heat pump units, with their extensive software and features, react to the indoor and outdoor temperatures to determine the best heat source to provide comfortable room conditions for the guest AND energy savings.

BALANCE POINT

An important consideration in the selection of a heat pump unit is the “balance point” of the installation—the point at which the heat pump is unable to produce enough heat to compensate for the heat loss of the room or area being heated.

Virtually every room is unique—with different insulation, different sizes and types of windows, different types of construction and different directional exposures. All these variables, as well as geographical location, must be considered in order to determine the balance point. For these reasons, a professional engineer should be engaged to calculate the heat loss of the space and specify the heat pump unit required.

HEAT PUMP OPERATION—ZONELINE AZ65 SERIES

Heat sources: Heat pump, heat pump with partial electric resistance heat, or electric resistance heat.

Zoneline heat pumps employ a highly featured microprocessor control system interfaced with thermistors to accurately measure indoor air temperature, outdoor air temperature, indoor coil temperature and outdoor coil temperature. This system allows the microprocessor to precisely and predictably react to changing conditions in order to provide a very advanced packaged terminal heat pump operating system.

Zoneline heat pumps are designed to help ensure a comfortable room. When “HEAT” is selected, the unit will determine if the room air is warm enough to satisfy the thermostat setting. If the temperature at the unit sensor is below the desired temperature, the electric resistance heater will be utilized to warm the room to the point where the thermostat is satisfied. This feature is designed to allow the temperature of an unoccupied room to be maintained at an energy-saving level without inconveniencing the room occupant. Once the thermostat has been satisfied, the resistance heater will turn off and the heat pump will operate (as shown below in the Heat Source Logic chart) when the thermostat calls for heat again.

ZONELINE HEAT PUMP HEAT SOURCE LOGIC

The chart below indicates the standard heating source of the Zoneline AZ65 Series heat pump unit under various indoor and outdoor conditions. The unit is designed to provide heat pump savings without sacrificing room comfort.

ROOM TEMPERATURE VS. THERMOSTAT SET POINT	ABOVE 46°F*	BETWEEN 46°F AND 25°F	BELOW 25°F
Less Than 2.9°F Below	Heat Pump	Heat Pump*	Full Resistance Heat
2.9°F to 4.0°F Below	Heat Pump	Heat Pump + Supplemental Heater**	Full Resistance Heat
More than 4.0°F Below	Heat Pump	Full Resistance Heat	Full Resistance Heat

* At OD temperatures above 46°F, the electric heaters are locked out.

At OD temperatures above 85°F, heat pump operation is locked out.

**Simultaneous supplemental heater: 1.0 KW @ 230 V & 265V; 0.8 KW @ 208V

The Quick Heat Recovery feature is not affected by the Heat Source Logic shown in the prior chart.

For more information about the Quick Heat Recovery feature, see page 11.

The full heat output of the resistance heater is dependent upon circuit amperage and the power connection kit used. *See pages 4, 43–44 and 50 for information on power connection kits and available heater capacities.*

An option is provided in the auxiliary controls (Mode 8) to allow the unit to operate only in resistance heat. The use of this option significantly increases the cost for heating.

BOOST HEAT

The Zoneline AZ65 series offers a Boost Heat option feature that utilizes partial supplemental resistance heat at the same time as the heat pump operation. The boost heat feature changes stage one heating (heat pump) to be heat pump with partial resistance heat. Stage two heating stays as full resistance heat. This applies to both unit control and remote thermostat control.

NOTE: *Heat Pump and full resistance heat shall never be on at the same time.*

HEAT PUMP DEFROST

Zoneline heat pumps utilize a reverse-cycle, demand-defrost system to extend heat pump operation and increase savings from extended operation. The microprocessor determines the need for defrosting from criteria based on continuous compressor running time, outdoor air temperature and outdoor coil temperature. When defrosting is required, the unit reverses the flow of refrigerant to direct the hot gas into the outdoor coil to melt the frost buildup.

Before and after the reverse-cycle defrost, the unit shuts off the compressor to allow the refrigerant pressures to equalize throughout the system. During these periods of pressure equalization, the full resistance heat capacity of the unit is activated to help ensure room comfort conditions during the defrost cycle. The unit remains in the defrost cycle for a minimum of three minutes and up to a maximum of nine minutes. The defrost cycle terminates when the outdoor coil reaches a temperature of 68°F or the maximum time has been reached.

HEAT PUMP CONDENSATE

Zoneline AZ65 Series heat pumps may be ordered with a factory-installed Internal Condensate Removal (ICR) system to minimize the amount of condensate water draining from the unit during heat pump operation. The ICR system has proven to be an effective means of minimizing the amount of heat pump condensate dripping from the unit. However, if the requirements of a particular installation will allow no dripping of condensate water from the wall case, the installation of an internal or external drain system is recommended. *See pages 36–38 for more information on heat pump condensate.*

Units with an ICR system may not be installed in seacoast or other corrosive environments.

APPLICATION COMMENTS

It is important that any air conditioning system be properly sized and applied in order to achieve the desired temperature and humidity levels in the space to be conditioned. Zoneline units are designed primarily to provide heating and cooling with the additional benefit that during operation in the cooling mode, the units also remove some moisture from the conditioned space. The following are some brief application comments on undersizing, oversizing, heating, wall coverings, and air infiltration: all are important in the proper matching of the heating/air conditioning system to the building structure.

UNDERSIZING

Cooling: If an air conditioner is undersized (cooling capacity is less than required for a specific application), the unit will typically not be able to cool the space down to the desired temperature (thermostat set point), nor be able to remove enough moisture from the air. The result could be a warm and humid or warm and dry conditioned space.

Heating: Undersizing can result in not being able to maintain the desired temperature level within the conditioned space.

OVERSIZING

Cooling: If an air conditioner is oversized (cooling capacity is greater than required for the specific application), the unit will typically cool the space down to the desired temperature (thermostat set point) too quickly. Since dehumidification only takes place when the compressor is operating in the cooling mode, typical result in a hot/humid climate could be a cool but excessively humid space.

Wall Covering: Use of non-permeable wall coverings (some paints, some wallpapers, and other types of coverings) which severely restricts passage of air or water vapor can cause a severe moisture problem. Typical results could be staining of room surfaces, wall damage, as well as mold and mildew growth in hot/humid climates.

Air Infiltration: Excessive air infiltration can magnify problems associated with undersizing or oversizing of an air conditioner unit and can be the root cause of insufficient cooling, dehumidification or heating problems. Some sources of air infiltration include vents, gaps around windows and doors, and improperly sealed floor, ceiling and wall joints.

Recommendation: For the above reasons it is strongly recommended that a professional engineer be retained to match the size of the Zoneline unit with the building structure.

AIR DISTRIBUTION

Zoneline packaged terminal air conditioners and heat pumps discharge air from the top of the unit through reversible two-position discharge louvers. Unit discharge

louvers are reversed by removing the room cabinet from the unit, removing four screws that hold the louver section in place; removing the louver section and rotating it end for end, reinstalling the louver section with the four screws, and reinstalling the room cabinet on the unit. The unit is shipped from the factory with the discharge louvers at an angle of 45° off horizontal. In the alternate position, the louvers will be at an angle of 65° off horizontal.

All room cabinets return air through the front of the unit.

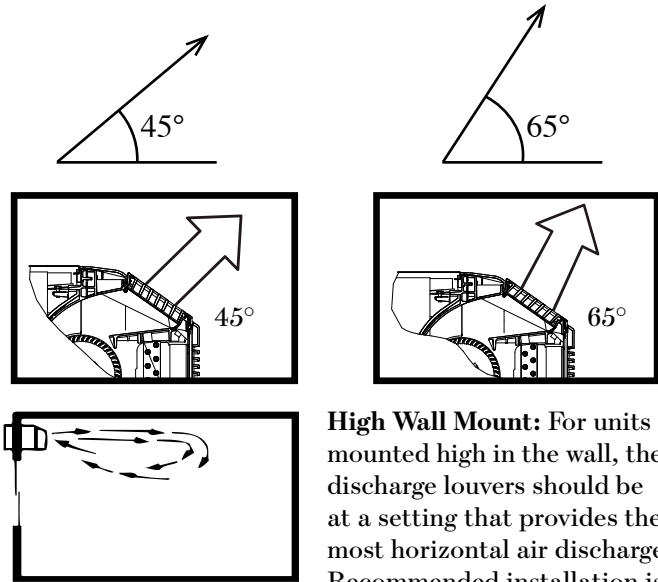

High Wall Mount: For units mounted high in the wall, the discharge louvers should be at a setting that provides the most horizontal air discharge. Recommended installation is at least 3" below the ceiling. In installations where units are close to the ceiling, the greatest horizontal discharge angle can be obtained by removing the discharge grille from the room cabinet. For best room control, a remote wall thermostat is recommended.

Supply Air Throw: One Zoneline unit should not be required to do a job obviously requiring two or more units. Units should be located around large rooms according to calculated loads or in such fashion as to achieve balanced air distribution in all parts of the room. The single unit in the "Incorrect" illustration below obviously cannot condition the entire room. Add a second unit as shown in the "Correct" illustration.

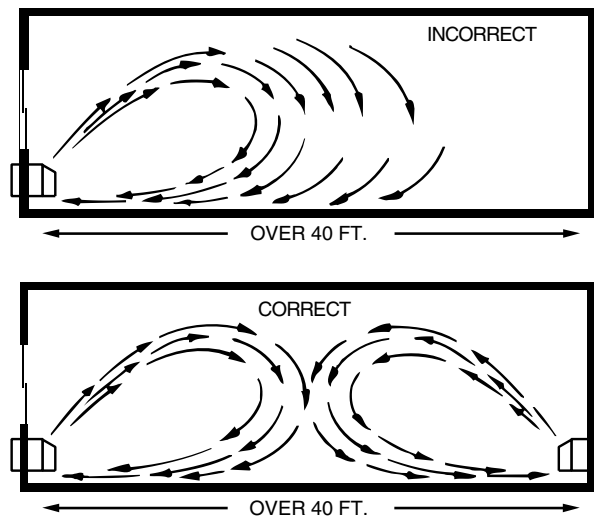

WALL CASE DIMENSIONS

**ADDITIONAL
WALL CASE DEPTHS**
RAB7116B - 16"
RAB7124B - 24"

RAB71* WALL CASE

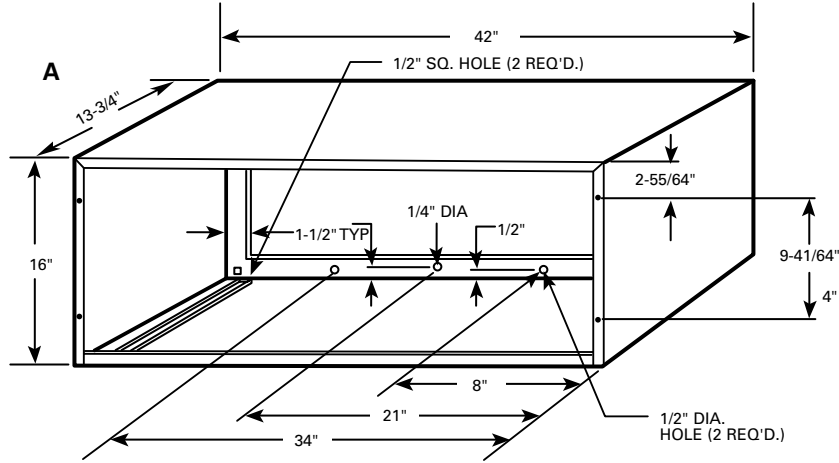

WALL OPENING
16-1/4" MIN. x 42-1/4" MIN.

RAB77* WALL CASE

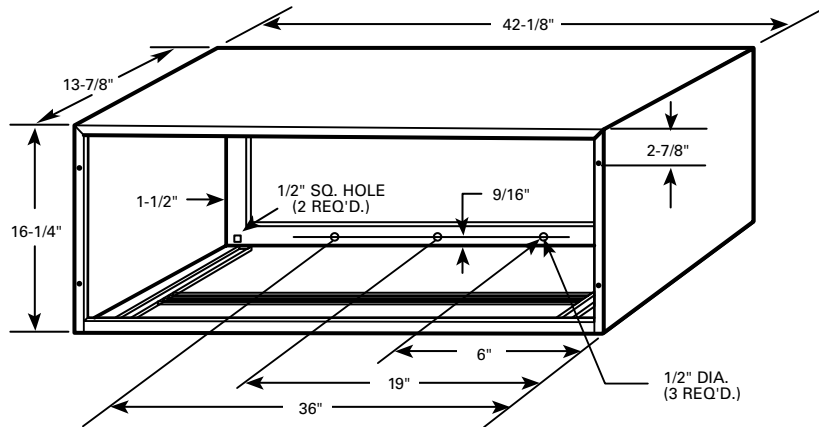

WALL OPENING
16-1/2" MIN. x 42-3/8" MIN.

WALL CASE WITH CHASSIS INSTALLED

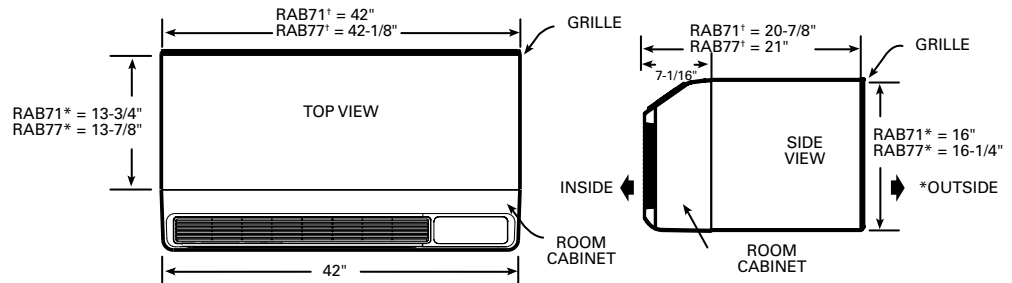

WALL CASE WITH SUB-BASE

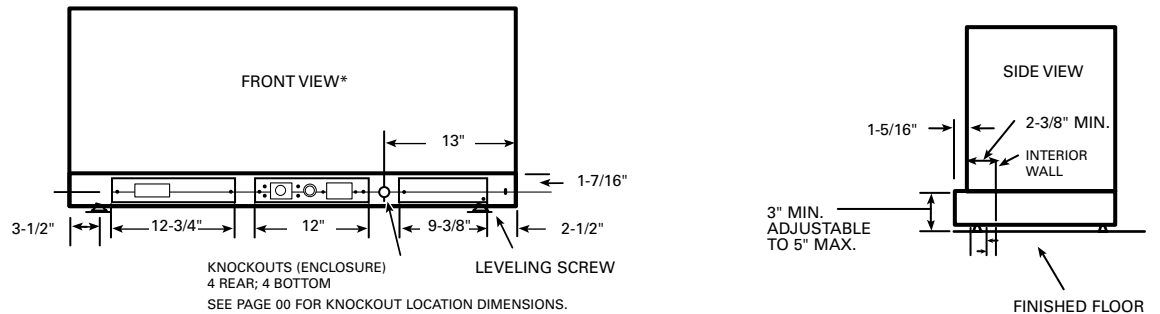

*SHOWN WITH ACCESS COVERS REMOVED.
†WORKS FOR ALL RAB71 OR RAB77 SERIES WALL CASE
NOTE: CAUTION - REMOVE KNOCKOUTS FROM INSIDE OUT.

Installation instructions packed with wall case. See page 27 for additional information concerning outdoor weather panel and case stiffener.

WALL CASE

A choice of wall cases is available for Zoneline® units.

RAB71B — This insulated case is constructed of heavy-gauge galvanized steel and finished with a baked-enamel finish for protection and appearance. Design of the case provides for support of the chassis and free draining of any water entering the wall case. A petroleum microcrystalline wax is applied at critical points of fabrication to seal against moisture. The dimensions of the RAB71B wall case are 42" wide by 16" high by 13-3/4" deep, the same dimensions as the original wall case for GE Zoneline units built in 1961. The RAB71B wall case is also available in depths other than the standard depth. It is available on special order as: **RAB7116B – 16" deep; RAB7124B – 24" deep.** All these special-order deep wall cases are insulated and have sheet-metal dividers, or splitters, to prevent the recirculation of condenser discharge air.

RAB77B — This non-insulated wall case is molded from fiberglass-reinforced polyester compound. This sheet-molded compound (SMC) wall case offers outstanding strength, durability, color retention, water integrity and corrosion resistance. The dimensions of the RAB77B wall case are 42-1/8" wide by 16-1/4" high by 13-7/8" deep.

- Both wall cases are of universal design, accepting all Zoneline chassis of current design as well as all GE Appliances Zoneline chassis produced since 1961.
- Drain holes are provided in the rear of all wall cases to permit excessive cooling condensate water, heat pump condensate or precipitation entering the wall case to drain freely. A drain kit may be connected to the wall case to control any water draining from the wall case. See pages 37–38 for information on **RAD10 Drain Kit.**

WALL CASE INSTALLATION DATA

GENERAL

Generally, Zoneline® units are installed 3" to 5" above the floor (flush to finished floor installation is possible) as near to the center of the room as possible; underneath a window or a glass panel is typical. Normal installation of the wall case allows installation flexibility; from flush with the finished interior wall to a minimum of 1/4" of the wall case extending beyond the finished exterior of the building. Special consideration must be given to installations where the wall case does not extend a minimum of 1/4" beyond the finished exterior wall. See pages 32–33 for information on this type of installation. The unit may be installed high in the wall and these installations usually require a remote thermostat and are discussed on pages 17–19.

Regardless of the installation, there are several things to consider when selecting a location for installing the unit. For instance, drapery location could interfere with air discharge, and placement of furniture may have an impact on the performance of the unit. The following information

is intended to minimize installation problems and assure you of trouble-free installation.

Refer to page 28 for required wall opening dimensions. Minimum recommended interior and exterior case projections for standard wall thicknesses are shown in the drawings in this manual. The case may be installed flush with the finished indoor wall. Special attention must be paid to room-side case projection when the unit is installed in a ducted application as shown on pages 40–41.

In walls thicker than 13-1/2" for line-cord-connected units and 11-1/8" for sub-base installations, it may be necessary to install a field-fabricated case extension or use one of the special-order RAB71 deep wall cases. Such extensions must be carefully flashed and sealed both to the wall case and to the wall to ensure water integrity. This is necessary to ensure that any water entering the wall case, either from operation of the unit or from other sources, such as rain storms or from washing the exterior of the building, will drain from the case without the possibility of capillary action drawing the water into either the room or the wall cavity. In an installation where the case is recessed less than 3" from the outside surface, flashing and sealing may be all the modification necessary. In such an installation, the sides and top of the wall opening must be waterproof to prevent moisture from seeping into and damaging the walls. See pages 32–33 for suggested detail. Since the installation of a case extension requires a considerable amount of attention, we recommend using one of the deep wall cases if the standard case is not of sufficient depth.

Mounting an outdoor grille or louver section to the building face may cause a space between the outdoor coil and the louver section. Air splitters, aligned with the ends of the outdoor coil, must be installed between the outdoor coil inlet and outlet air streams. Gaps between the outdoor coil and the louver section may allow condenser air recirculation and affect the operation of the unit. See page 43 for requirements for custom louvers.

The wall case should be level from side to side and from level to 1/4 bubble tilt to the outdoors. The condensate disposal system in the unit is designed to dissipate the condensate water generated during cooling operation in accordance with AHRI standards and actually uses this water for maximum unit efficiency. A level unit will also ensure proper drainage from the RAD10 drain kit to a building internal drain and proper performance of the Internal Condensate Removal (ICR) system optional on heat pump units.

SUB-BASE

The sub-base is an optional accessory for the Zoneline unit. It is discussed with the wall case information since deciding whether or not to use a sub-base in the installation is a factor in the location of the wall opening. National Electrical Code® (NEC) requires that air conditioning units connected to voltages in excess of 250 volts be "permanently connected." There are also some installations where units connected to voltage

sources under 250 volts may also need to be “permanently connected.” If you are in doubt about the requirements for a particular installation, consult Article 440 of the NEC or the local electrical inspector. These requirements are designed to protect personal safety and should be strictly followed. Although NEC is cited here as a reference, all electrical wiring and installations must conform to any and all local electrical codes and regulations.

“Permanent connection” generally means wiring to the unit must be contained in an enclosed “chaseway,” where access to the wiring connections is more restrictive than a normal line cord plugged into a receptacle. NEC requirements may be met by using flexible or rigid conduit to contain the wiring between the unit and a junction box that contains the wiring connections. The conduit is connected to the unit and to the junction box with connectors to hold the conduit in place. The junction box may be located in the floor or the wall of the structure, but only approved connectors may be used outside the unit or the junction box. The sub-base is UL® listed as a junction box for permanent connection of a Zoneline unit.

Using a sub-base in an installation requiring permanent connection provides a convenient, consistent location for unit wiring to be connected to building wiring. The use of a sub-base is not required, but the convenience and the improved aesthetics it offers make the use of a sub-base a viable means of permanent connection.

RAK204U — The RAK204U Series of sub-base provides a design that fits the site needs and is available for use with Zoneline PTAC/PTHP units. The RAK204U will most likely be used for support of the wall case and unit. The RAK204U is the same physically as the other sub-bases except there is no receptacle installed. Receptacles and wiring can be field installed and, by using the RAK205CW chaseway and the RAK4002C junction box, perform the same function as any of the other sub-base kits by selecting the correct receptacle and installing it in the interior mounting plate inside the RAK204U.

230/208-volt receptacles can also be mounted in the cover plate for easy access when direct-connect wiring is not required. 265-volt units are to be “Permanently (or Direct) Connected” and the external receptacle (when wiring is not enclosed in a chaseway) does not meet this requirement. A knockout for a fuseholder or a disconnect is also provided in the cover plate.

The 230/208-volt sub-bases include a short, sub-base power connection kit. Since sub-base connected units are not considered to be line-cord connected, a Leakage Current Detection Interrupter or Arc Fault Current Interrupter device is not necessary.

RAK204DI5C 208/230-volt 15-amp receptacle. Receptacle is NEMA6-20R with 18" of #12AWG wires attached to the receptacle. Short power connection kit included. Chaseway included.

RAK204D20C 208/230-volt 20-amp receptacle. Receptacle is NEMA6-20R with 18" of #12AWG wires attached to the receptacle. Short power connection kit included. Chaseway included.

RAK204D30C 208/230 volt 30-amp receptacle. Receptacle is NEMA6-30R with 18" of #12AWG wires attached to the receptacle. Short power connection kit included. Chaseway included.

The junction box (RAK4002C for AZ45 and AZ65 Series units) that mounts on the chassis of 230/208-volt sub-base connected units must be purchased separately. The RAK4002C junction box is included with RAK3150, RAK320D, RAK330D, RAK315SP, RAK320SP and RAK330SP.

SUB-BASES FOR THE 265-VOLT UNITS:

RAK204E15 265-volt 15-amp receptacle. Receptacle is NEMA7-15R with 18" of #12AWG wires attached to the receptacle. Chaseway included.

RAK204E20 265-volt 20-amp receptacle. Receptacle is NEMA7-20R with 18" of #12AWG wires attached to the receptacle. Chaseway included.

RAK204E30 265-volt 30-amp receptacle. Receptacle is NEMA7-30R with 18" of #12AWG wires attached to the receptacle. Chaseway included.

The junction box for 265-volt units is shipped with the chassis since all 265-volt units are to be “permanently (or direct) connected.”

The power connection kit is not included.

There are separate internal compartments to permit separation of low-voltage (Class 2) connections from line-voltage connections as required by National Electrical Code (NEC). Conduit containing building wiring enters the sub-base through knockouts located in the rear or bottom of the sub-base and is not accessible when the wall case is installed.

The sub-base attaches to the RAB71B wall case with two clips (field-assembled) that are screwed into field-drilled holes in the bottom front flange of the wall case. It attaches to the RAB77B wall case with clips that fit over molded ribs without requiring the use of screws into the wall case. (See page 35 for illustration.) Since the sub-base extends under the wall case, clearance from the inner edge of the wall case to the finished wall must be 2-3/8" or greater. The sub-base has four leveling legs and adjustable side channels to enable the area under the wall case to be enclosed. Clearance from the bottom edge of the wall case to the finished floor must be between 3" and 5".

The sub-base may be used as support for the chassis and wall case in installations where the wall is of insufficient thickness to provide secure mounting of the wall case.

(continued)

SUB-BASE (CONT)

For new construction, early planning with the architect is necessary. Unit location, electrical connection locations and wall openings of the proper dimensions are essential to avoid the necessity of rework, fillers, framing, moving electrical outlets and other expensive modifications.

For existing construction, it is important that carpentry, masonry and electrical work be performed by competent, qualified personnel. Since installations in existing construction may involve removal of building material from the structure, locating the wall case must be done correctly.

ARCHITECTURAL WINDOW/ LOUVER INSTALLATION

Many installations utilize an architectural window/louver combination to enhance the exterior appearance of the building. The exterior grille for the air conditioner is built as an integral part of the window frame. An internal drain system is highly recommended for these installations (see page 38). When this type of installation is made, there must be provision in the grille work for condensate water to drain to the exterior (including the overflow relief drain holes) and not be routed back into the interior of the building or into the wall cavity. Failure to allow for the drainage of condensate water can cause extensive damage to structural components.

The problems associated with the lack of condensate drain consideration often show up shortly after the air conditioners are turned on in a new building. New buildings that have been virtually wide-open during construction have a significant amount of moisture in the air and in the building components that the air conditioners start removing as they operate.

The free area in the louver section must also comply with the requirements shown on page 43.

The wall case should be anchored to the architectural window/louver section to reduce air infiltration and excessive vibration of the chassis and wall case during unit operation. Field-fabricated and -installed case angles are the recommended method of securing the wall case to the window/louver framework.

WINDOW, CURTAIN AND PANEL WALL CONSTRUCTION

With this type of construction, provision for support of the unit, other than by the wall itself, is often required. Such support may be in the form of wood or metallic material of the proper thickness to maintain a level case. This additional support should be located both near the wall and at the front of the wall case. Sub-base (RAK204 Series) with four leveling legs provides an excellent support for the unit in this type of installation. (See page 30 for details of this type of installation.)

In existing construction, common practice is to remove a pane of glass, metal, wood, or other construction material and build a frame around the wall case. Similar filler panel material may be installed around the case for appearance and weather seal.

MASONRY WALL CONSTRUCTION

The wall case should be installed during construction and lintels must be used to support the blocks above the wall case. The wall case will not support the concrete block. The installation instructions show how the wall case must be secured to the masonry and caulked. Do not remove the cardboard stiffener supplied with the wall case until ready to install the chassis. (See page 31 for details of installation in masonry wall).

For existing masonry construction, wall openings must be made by removing concrete blocks to achieve the proper-size opening. Consult the builder, architect or owner to determine the necessity for lintels to support the block above the wall case.

Anchor bolts are normally required to secure the case to the wall and shims may be required to prevent distortion of the wall case when securing the wall case to the wall. Field-supplied case angles can be used to position and secure the wall case to the wall and to cover oversized wall openings.

BRICK, FRAME, STUCCO AND SHINGLE CONSTRUCTION

For new construction, the opening for the wall case should be framed and the wall case inserted into the opening during construction. Lintels must be used when the building material is heavy and is not self-supporting (such as brick). The wall case will fit an opening of six courses of standard brick or five courses of jumbo brick. Wall framing in this type construction is normally on 16" centers and the wall case will fit a framed opening spanning three 16" O.C. 2" x 4" stud spaces.

For existing construction, the indoor and outdoor wall will need to be cut out, allowing for clearances of 1/8" on all sides of the wall case. Work should begin on the inside wall. Cut the correct dimensions and mark (using drill holes) the outside wall from each corner of the inside cutout. Studding that interferes with the opening must be removed and a suitable frame constructed to secure the wall case and provide adequate support for case and chassis.

As shipped, the RAB71B Series or RAB77B is ready for installation.

PREPARATION OF THE WALL CASE FOR ALL TYPES OF CONSTRUCTION

Do not remove the stiffener from inside the wall case or the weather closure panel from the outside face of the wall case until the outdoor grille and chassis are ready to be installed.

1. Position the wall case into the wall. The room-side edge of the RAB71B or RAB77B wall case should be at least flush with the finished wall for line-cord installations and permanent-connection installations when no sub-base is used, and should project into the room at least 2-3/8" when a sub-base is used. The outside edge of the wall case should extend at least 1/4" beyond the outside wall. This is necessary for proper caulking, to prevent sealing the drain holes in the rear flange of the wall case, and to facilitate the installation of an accessory drain, if used. If the minimum exterior dimensions are not met, refer to pages 32–33.

The wall case should be level from side to side and from level to 1/4 bubble tilt to the outdoors. The condensate disposal system in the unit is designed to dissipate the condensate water generated during cooling operation in accordance with AHRI standards and actually uses this water for maximum unit efficiency. A level unit will also ensure proper drainage from the RAD10 drain kit to a building internal drain and proper performance of the Internal Condensate Removal (ICR) system optional on heat pump units.

2. The wall case should be secured to the wall at both sides. Use a minimum of two screws or other fastening device on each side. (See Figure 2 on page 28.) Mark the wall case on each side 2" from the bottom and 2" from the top at a point where basic wall structure is located. Drill wall case and use fasteners appropriate for wall construction. All holes for fasteners in the side of the wall case must be at least 2" up from the bottom of the wall case. Never locate screws or put other holes in the bottom of the wall case. The only exception is when an RAD10 drain kit is installed to connect to an internal drain system. (See page 37 for RAD10 drain kit information.)

If the wall opening is greater than the case dimensions, spacers must be used on the sides between the wall case and the wall support structure to prevent distorting the wall case.

3. Caulk or gasket the entire opening on the outside between the wall case and exterior wall surface (four sides) to provide total water and air seal.
4. Caulk or gasket room-side opening between wall case and interior wall surface (four sides). Openings beneath or around the wall case can allow outdoor air to leak into the room, resulting in increased operating costs and improper room temperature control.

Care should be taken in location of electrical supply entry in relationship to wall sleeve to assure access to receptacle or junction box once unit is installed.

- Refer to page 45 for maximum power cord length.
- Permanently connected units close to finished floor must allow for conduit clearance.

CASE ANGLES

In some installations, such as curtain walls, window walls, or where the structural material of the wall is insufficient to support or fasten wall case, case angles may be used. Case angles are pieces of steel or other material of similar structural strength that are formed to a 90° angle, with holes to fasten the case angle to the wall case and to the structural component of the wall surrounding the wall case.

The following describes the procedure when field-fabricated and -installed case angles are applied.

1. Position case angles around top and sides of wall case at the desired location. Position case angles vertically on each side of wall case to provide a level installation.
2. Mark wall case through holes in case angles. The lowest hole on the sides of the wall case must be a minimum of 2" above the bottom of the case.
3. For **RAB71B** wall case, drill 5/32" diameter holes at locations marked on wall case in Step 2, and assemble angles to wall case using #10 x 1/2" self-tapping screws. For **RAB77B** wall case, follow the same procedure except use a #10 x 1/2" bolt, washer and nut to attach case angles to case. Install screws or bolts from inside wall case.
4. Do not drill any holes in bottom of wall case. Do not distort wall case.
5. Do not use case angles for a lintel.

FRAMING FOR WALL CASE

Brick Veneer and Frame Construction

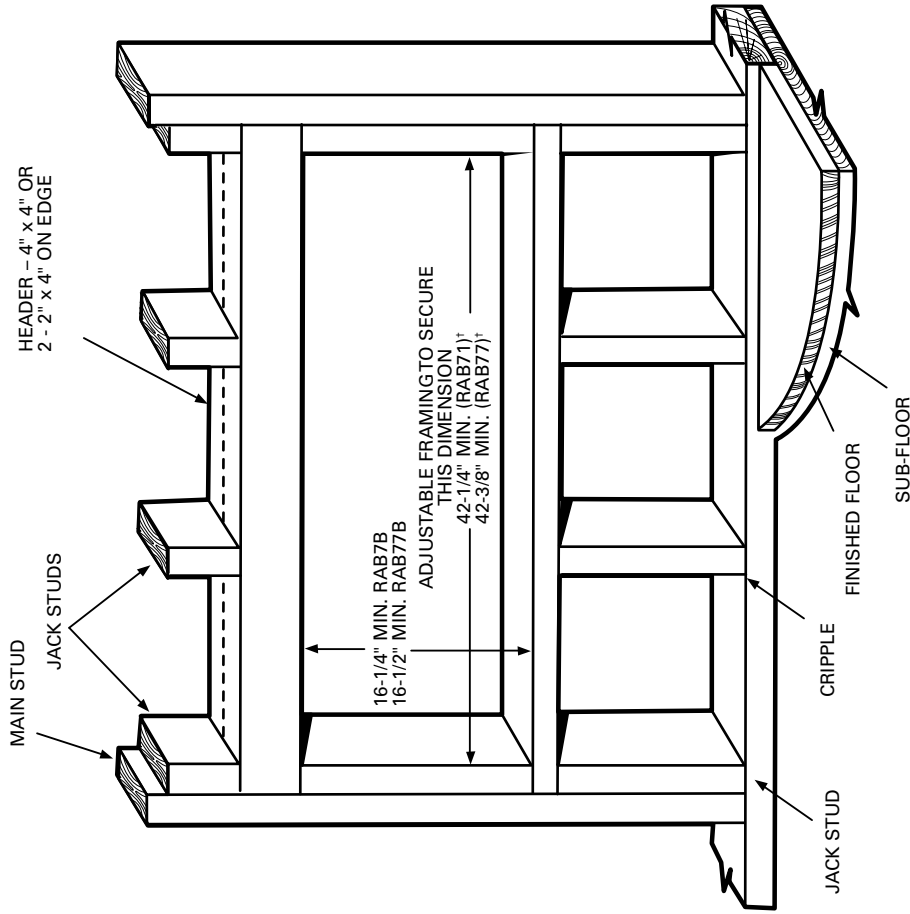

*WORKS FOR ALL RAB71 OR RAB77 SERIES WALL CASE

Figure 1

FASTENING WALL CASE

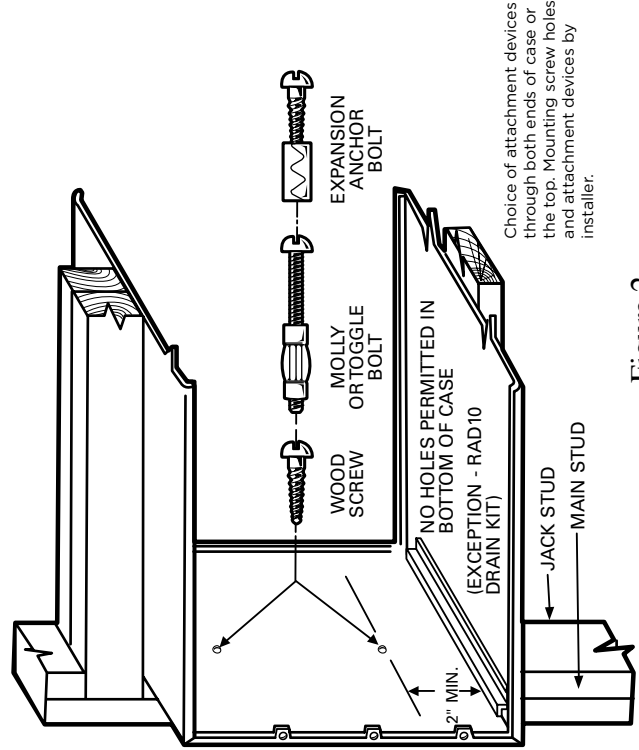
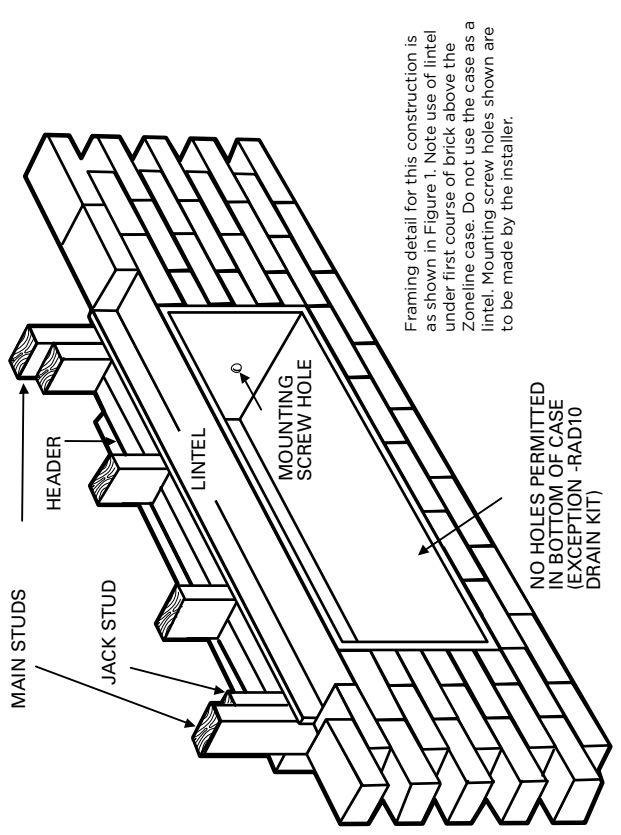
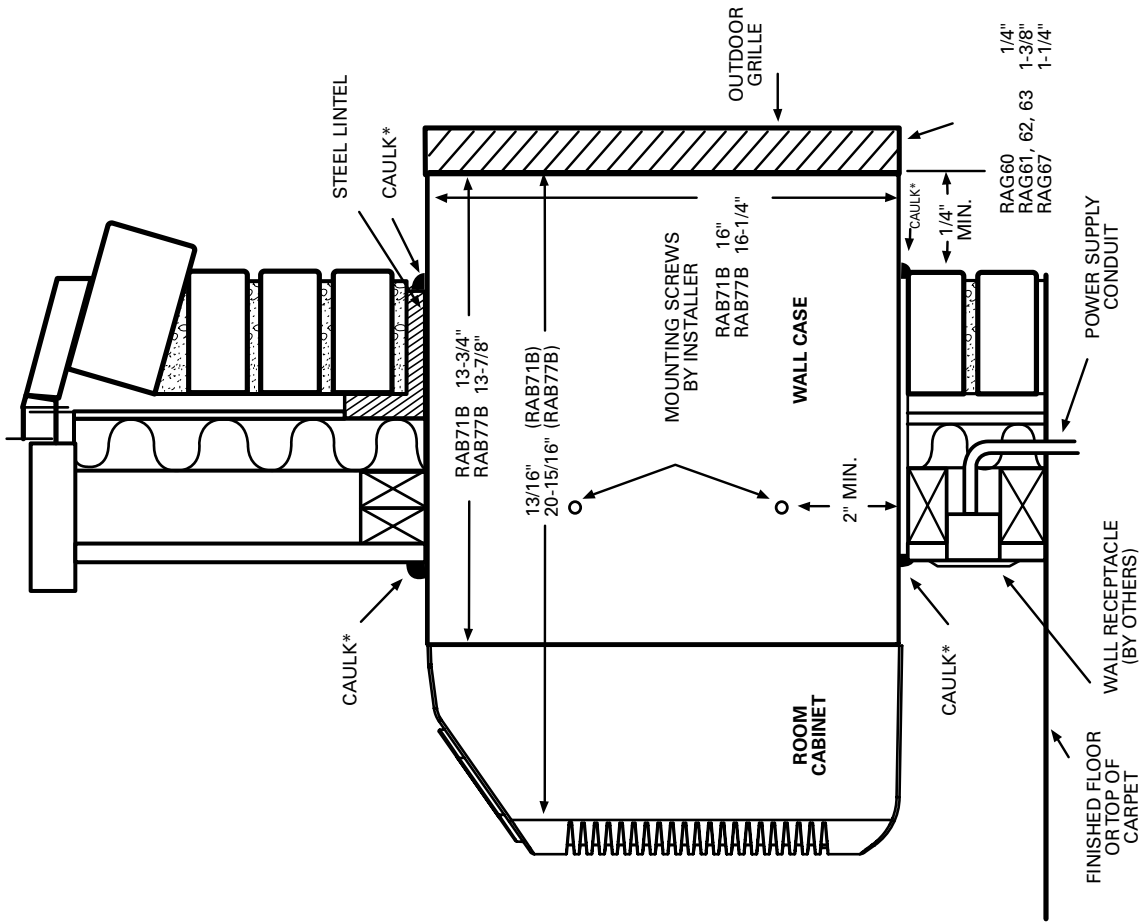

Figure 2

WALL SECTION - DETAILED SIDE VIEW

Frame and Brick Veneer Installation

CORD-SET CONNECTED



*Caulk around perimeter of wall case all four sides where it joins the building - Interior and Exterior.

SUB-BASE CONNECTED

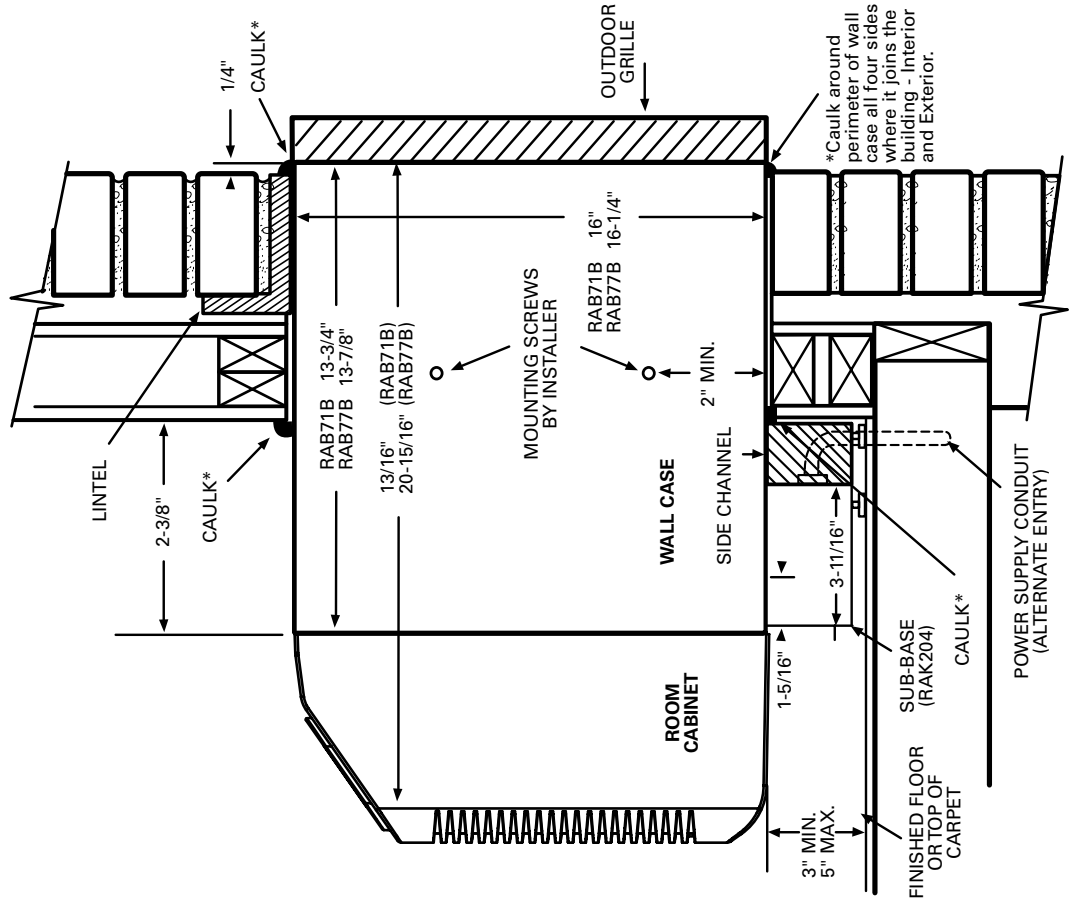

*Caulk around perimeter of wall case all four sides where it joins the building - Interior and Exterior.

WALL SECTION - DETAILED SIDE VIEW

Window, 2" curtain or panel wall installation with rag rear grille extended beyond outer wall surface

CORD-SET CONNECTED

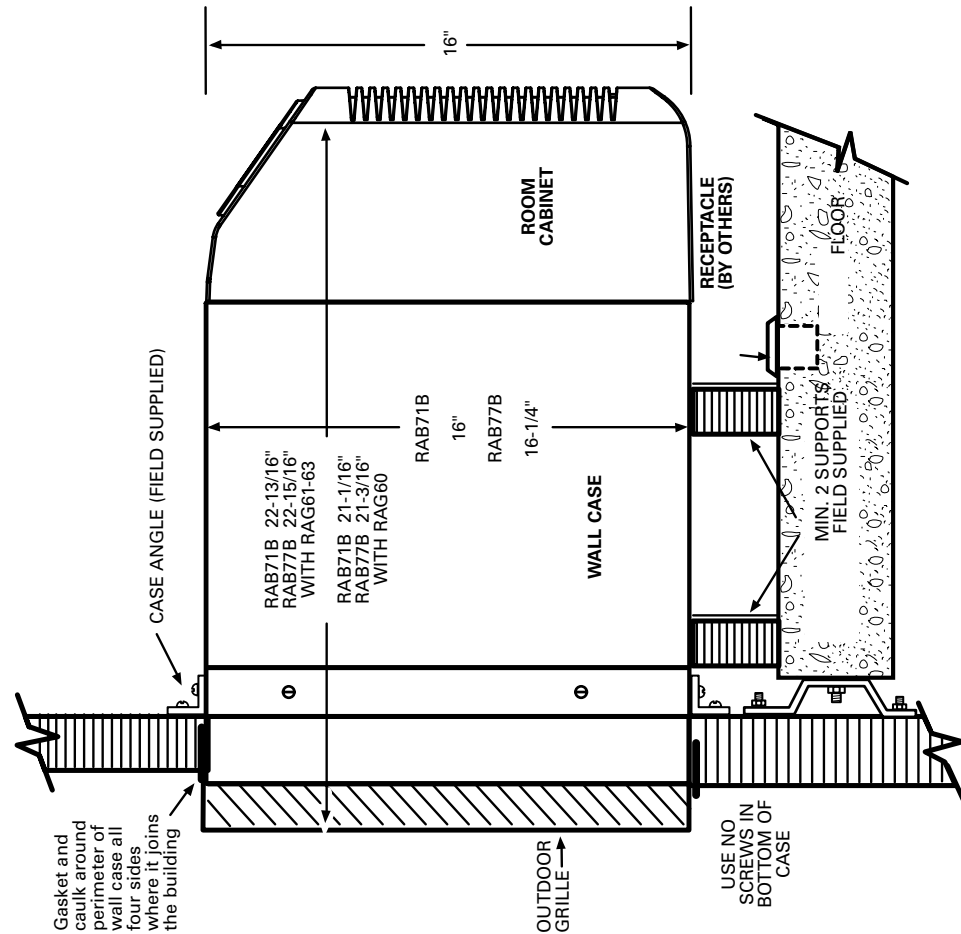

SUB-BASE CONNECTED

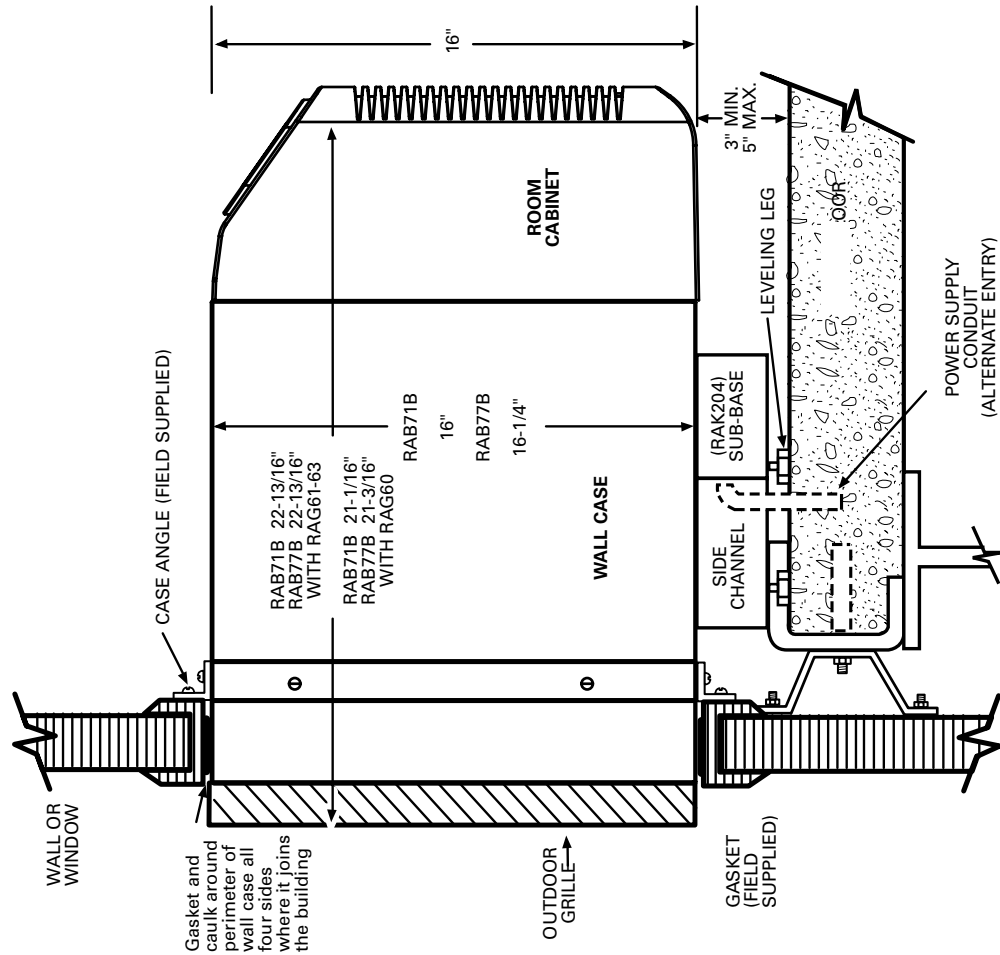

WALL CASE INSTALLATION - CORD-SET CONNECTED

Example: block and veneer - dimensional data and comments are also applicable to other types of construction

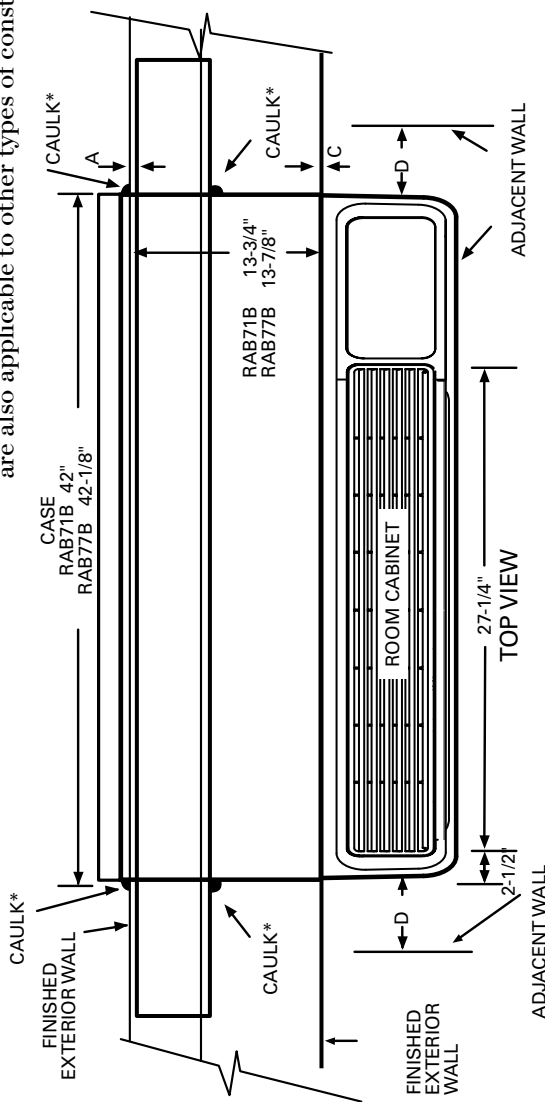

*Caulk around perimeter of wall case all four sides where it joins the building - Interior and Exterior.

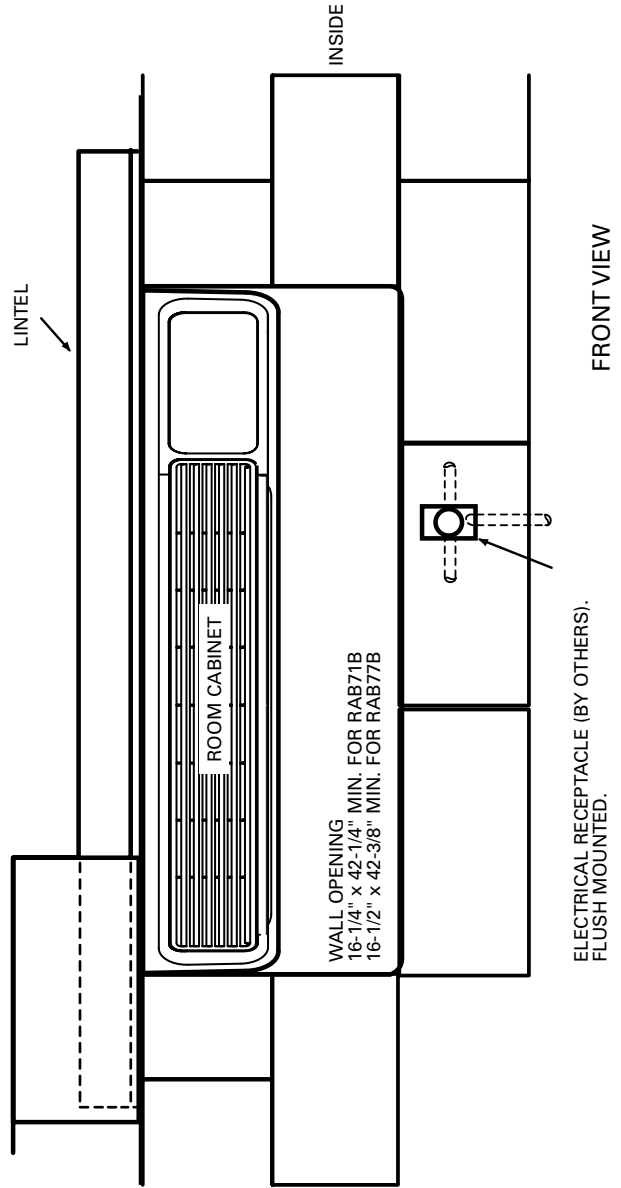

Dimension	Manufacturer Required Minimum Installation Clearance
A	1/4" (See note 1)
B	Allow For Electrical Wiring 0" Min. (See page 00)
C	0" Minimum
D	0" Minimum 2" Recommended See pages 00-00 for ducted application.
E	3" Minimum

NOTE:
1. FOR OUTSIDE FLUSH MOUNTING SEE PAGE 35 FOR DRAIN INSTALLATION.

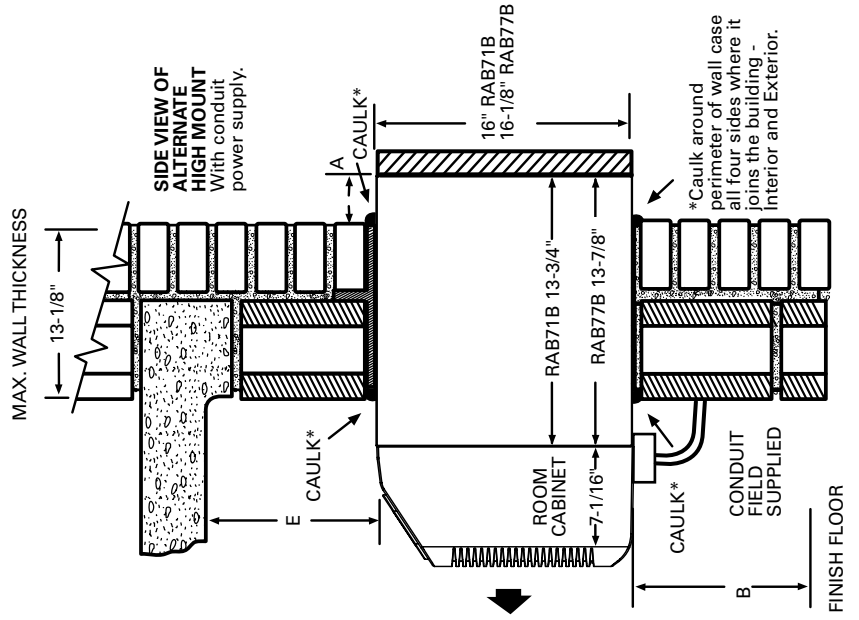

SIDE VIEW OF ALTERNATE HIGH MOUNT With conduit power supply.

See page 45 for line cord length.

METAL CASE EXTENSION FOR WALLS DEEPER THAN 13-1/8" (11-1/8" WITH SUB-BASE)

Field fabricated – GE Appliances recommends the use of one of the deeper RAB71+ wall cases offered as special order items.

GE Zoneliner® units can be installed in walls of greater depth than the wall case. Where the case recession is less than 3" and where it is possible to waterproof the exposed sides and top of the opening, the suggested procedure is to apply a flashing to the bottom of the wall case as shown on page 33. Where waterproofing is questionable or not possible, or for installations in walls of greater depth, the following is a suggested application procedure. It involves the field fabrication of a case extension. **Since the wall case is a water-bearing container, the extension likewise must also be water-bearing and the connection between the two must be watertight. The case extension must contain splitters to prevent recirculation of the outdoor air circuit.**

1. The case extension is field fabricated. The extension depth "D" should allow for a minimum outdoor projection of 1/4". This allows for room cabinet clearance to the finished wall and ample surfaces to apply sealant or caulking for a tight weather seal between the completed wall case/extension assembly and the wall opening. It is recommended that the extension be painted and corner and lap joints be additionally sealed with a quality-grade sealant.

2. The wall case and extension should be connected prior to installation in the wall opening. A quality-grade sealant should be applied to all four (4) butting flanges. Use bolts and nuts or oversized self-tapping screws (driven from the wall case to the extension) to attach the two assemblies. Clean all drain holes of excess sealant. The assembly must be free draining.

3. Install flashing, using a quality-grade sealant between the flashing and wall as shown in section A-A below.

4. Install the wall case/extension assembly following procedures described for a standard installation. See diagrams below. The assembly should be sealed or caulked to the wall around all four sides both outdoors and indoors.

NOTE: The wall case/extension assembly should be level.

5. Suggested materials for case extension and flashing should be non-ferrous metals. Minimal acceptable material: Galvanized G-90 painted.

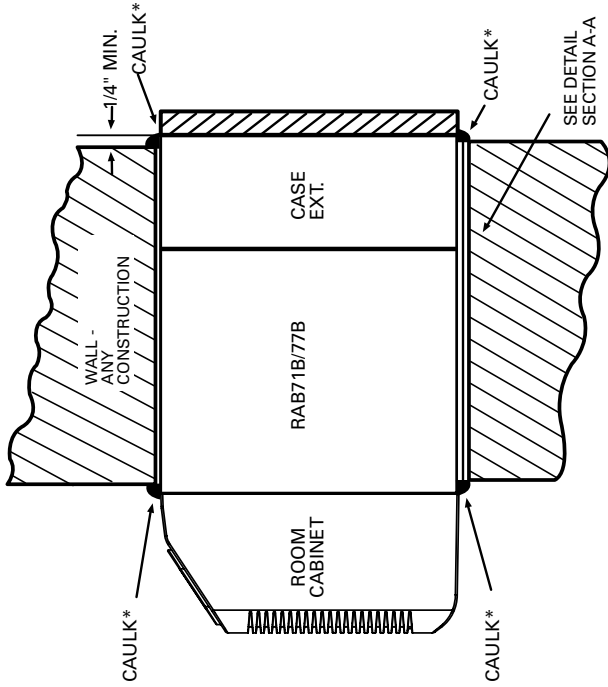

*Caulk around perimeter of wall case all four sides where it joins the building - Interior and Exterior.

SECTION A-A
BASEPAN/FLANGE DESIGN
SHOWING SEALANT LOCATIONS.

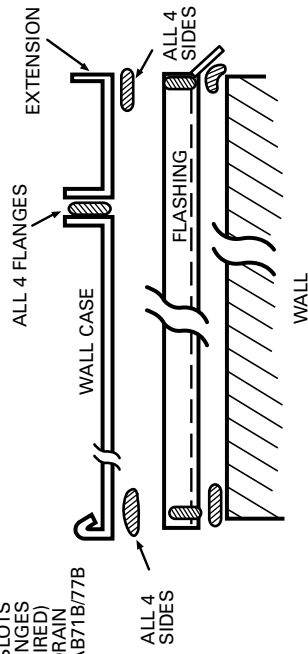

*WORKS FOR ALL RAB71 OR RAB77 SERIES WALL CASE

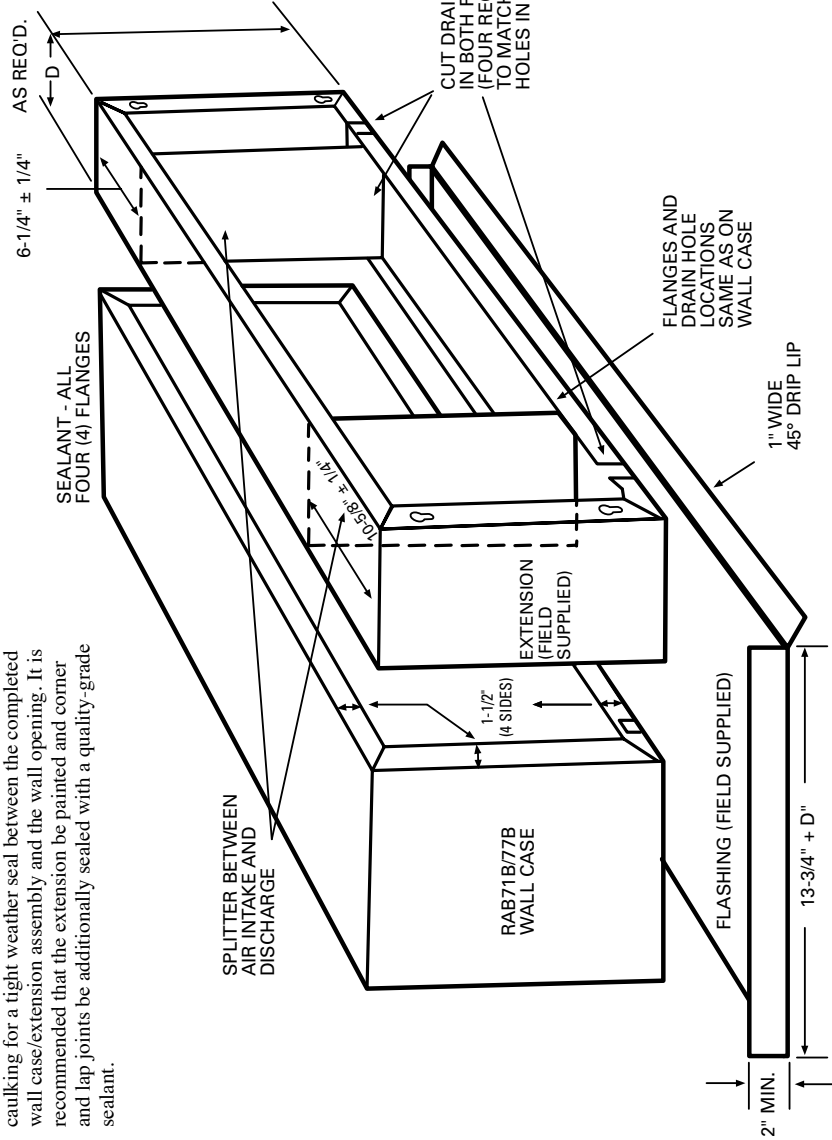

ALTERNATE - CASE RECESSION LESS THAN 3" WITH SIDES AND TOP OF WALL OPENING WATERPROOF, FLASHING ON BOTTOM ONLY

For an installation that will provide better protection against water infiltration, GE Appliances recommends the use of one of the deeper RAB71B Series wall cases offered as special-order items.
(See page 23.)

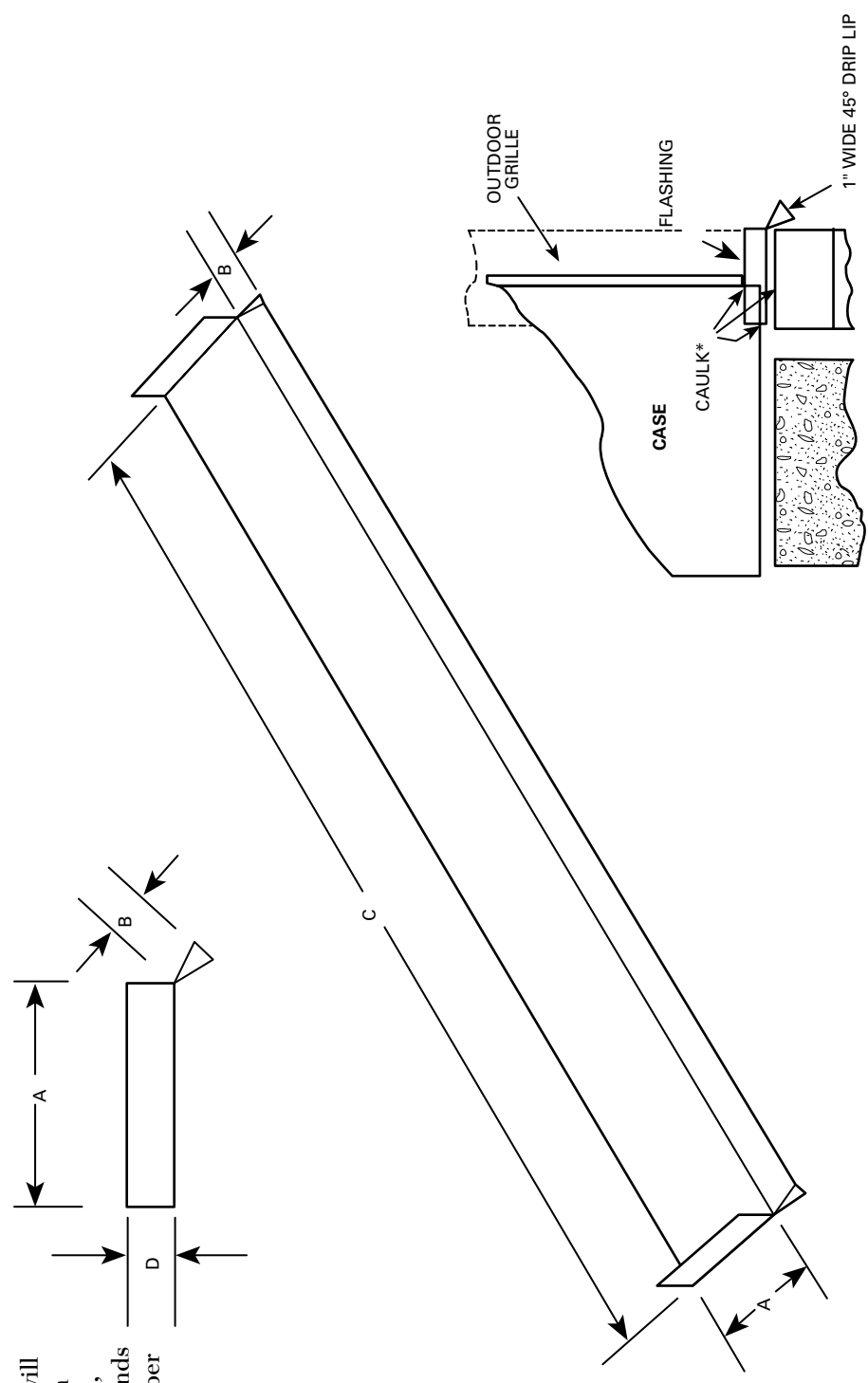

- DIMENSIONS:**
- A. DISTANCE FROM GRILLE OR CASE TO OUTSIDE SURFACE OF WALL PLUS 2" TO 4" (TO INSERT UNDER CASE).
 - B. 1" DRIP LIP (MINIMUM)
 - C. 42" PLUS - SUFFICIENT TO FIT SNUGGLY UNDER AND UP AROUND THE CASE.
 - D. 2" MINIMUM
- (CAUTION: WHEN CAULKING, DO NOT BLOCK DRAIN HOLES IN CASE OR GRILLE.)
IF GRILLE IS TO BE MOUNTED TO WALL SURFACE "A" SPLITTERS MUST BE USED. (SEE PAGE 00.)

*Caulk around perimeter of wall case all four sides where it joins the building - Interior and Exterior.

RA871B/77B WALL CASE INSTALLATION - RAK204 SERIES SUB-BASE CONNECTED

Example: frame and brick veneer - dimensional data and comments

are also applicable to other types of construction

Dimension	Manufacturer Required Minimum Installation Clearance
A	1/4" (See note 1)
B	3" Min. (5" MAX.)
C	2-3/8" Minimum
D	0" Minimum 2" Recommended See pages 39-41 for ducted application.

NOTE:
1. FOR OUTSIDE FLUSH MOUNTING SEE PAGE 32 FOR FLASHING INSTALLATION.

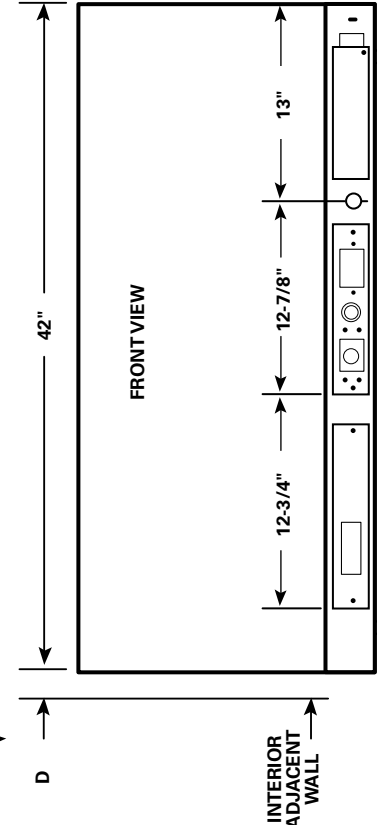
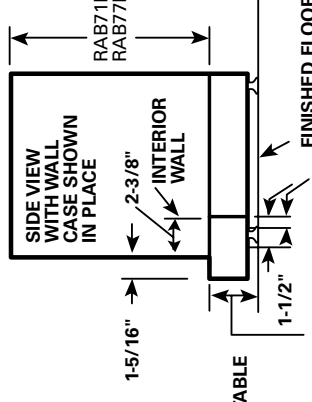
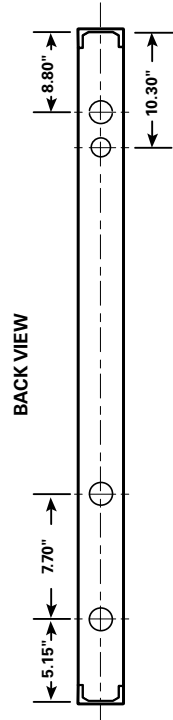
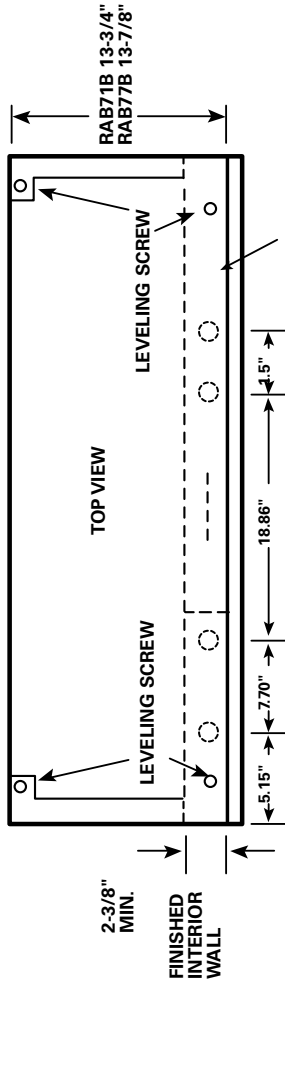

KNOCKOUTS (ENCLOSURE) 4 REAR; 4 BOTTOM

KNOCKOUT SIZE
LARGE 1-1/8" DIA.
SMALL 7/8" DIA.

*SHOWN WITH ACCESS COVERS REMOVED.
NOTE: CAUTION - REMOVE KNOCKOUTS FROM INSIDE OUT.

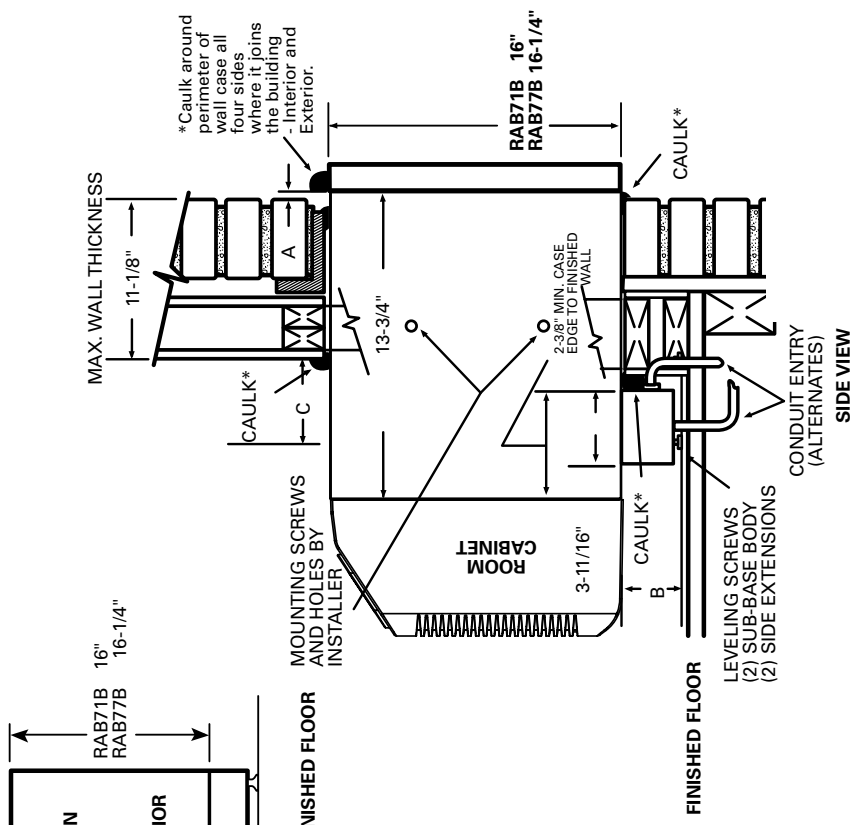

*Caulk around perimeter of wall case all four sides where it joins the building - interior and exterior.

RECOMMEND 2" TO INTERIOR ADJACENT WALL BOTH SIDES.

SEE NOTE LEFT SIDE

CONDUIT ENTRY (ALTERNATES)

RAK204 SERIES SUB-BASE INSTALLATION AND ELECTRICAL DATA

RAK71B/77B Wall Case

CHASEWAY OPTION
(Shown Without Chassis and Wall Case for Installation Location Only.)

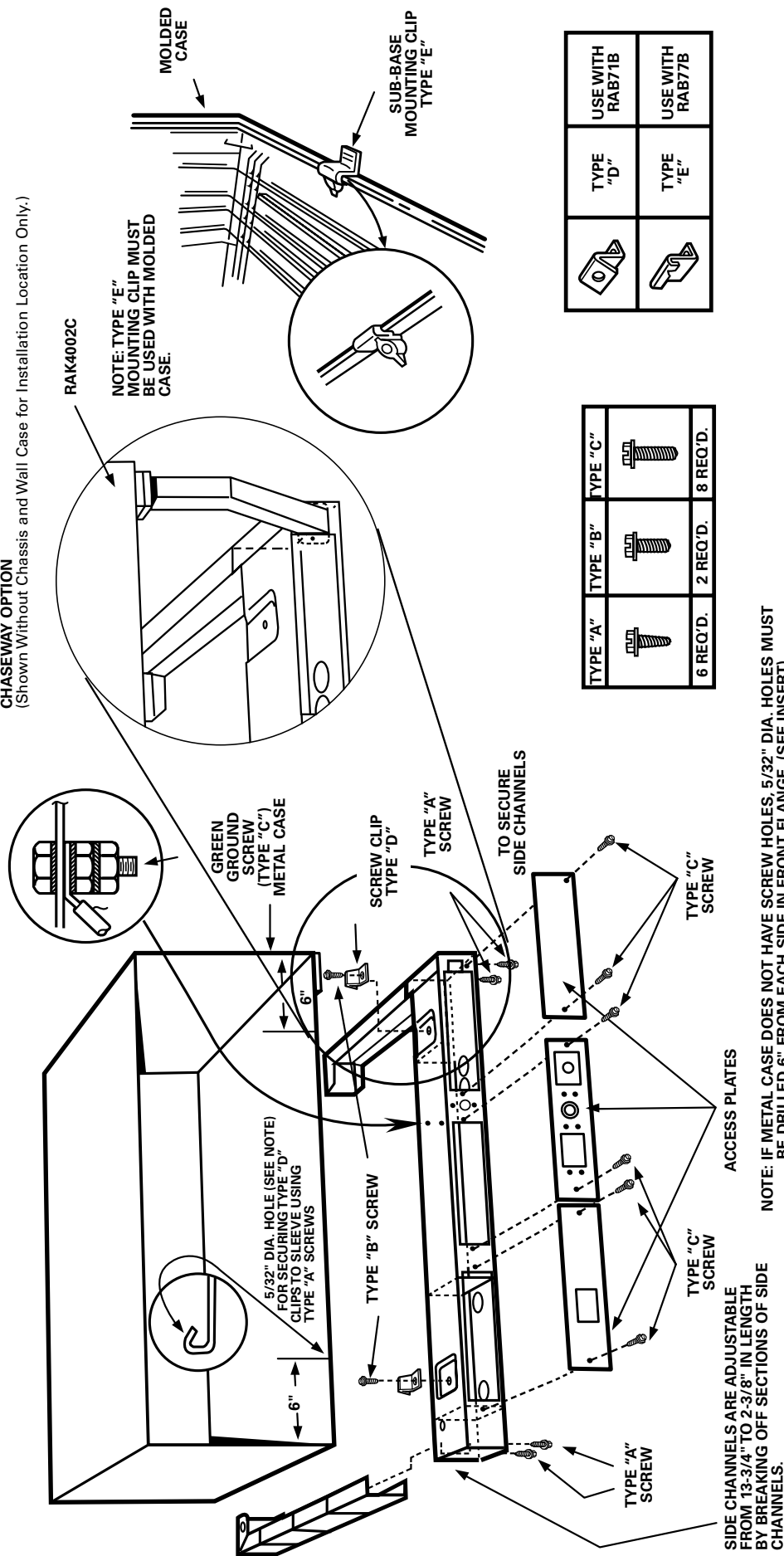

Electrical wiring may enter the sub-base through any of the knockout holes provided in the sub-base. Knockout holes in the sub-base access plate may accommodate a receptacle, which allows the use of a power cord (if permitted by code for the particular installation). A knockout for a circuit breaker, fuseholder or a disconnect is also provided. See page 25 for description of electrical contents of these sub-bases.

CONDENSATE DISPOSAL SYSTEMS

COOLING CONDENSATE

Air conditioners produce condensate water as a result of lowering the humidity of the area being conditioned. When the indoor coil temperature is below the dew point, moisture in the air condenses into water droplets on the indoor coil. This water drains to a pan located under the indoor coil and is routed through the weather barrier or bulkhead (the partition separating the indoor and outdoor sides of the unit) to the base pan on the outdoor side. It is then picked up and dispersed against the outdoor coil - which is hot when the unit is in the air conditioning mode - where it is evaporated into the atmosphere by contact with the hot outdoor coil. This evaporation process also helps lower the temperature of the outdoor coil and improves the operating efficiency of the unit.

SLINGER RING SYSTEMS

Packaged terminal units employ various means of dispersing the condensate water. One of the most popular, and most effective, means is by the use of a “slinger ring.” A slinger ring is a ring around the circumference of the outdoor fan. The design of the unit positions the slinger ring very close to the bottom of the base pan so water in the base pan is lifted by the rotating ring. Water picked up by the slinger ring will be dispersed into the air stream and deposited on the hot outdoor coil where it evaporates.

All Zoneline® Series packaged terminal air conditioners and packaged terminal heat pumps utilize a slinger ring for cooling condensate disposal.

CERTIFICATION TEST REQUIREMENTS

AHRI (Air Conditioning, Heating & Refrigerating Institute) requires that all certified packaged terminal air conditioners and packaged terminal heat pumps pass a cooling condensate disposal test. One stipulation of the AHRI test is that under standard rating conditions “the equipment shall be started with its condensate collection pan filled to the overflowing point.” In order to pass the AHRI Condensate Disposal Test the unit must operate continuously for four hours without condensed water dripping, running, or blowing off the unit during the test or after the unit has been turned off.

Under extremely high outdoor humidity conditions or extreme operating conditions, such as exceptionally high air infiltration (a door or window left open while the unit is running, for instance) it is possible for any air conditioner to be unable to dissipate all the cooling condensate generated.

All Zoneline Series packaged terminal air conditioners and packaged terminal heat pumps meet the condensate disposal requirements of AHRI standards 310/380.

HEAT PUMP CONDENSATE

During the operation of a unit in the heat pump, or “reverse cycle,” mode, the outdoor coil becomes the cold coil and the indoor coil becomes the hot coil due to reversing the flow of the refrigerant. When the temperature of the outdoor coil is below the dew point, condensation will form on the outdoor coil just as it does on the indoor coil during cooling operation. Since the dew point is humidity and temperature-related, there may be more condensate on days when the relative humidity is high.

HEAT PUMP CONDENSATE DISPOSAL

Since the outdoor coil is cold during heat pump operation, the condensate water cannot be deposited on the outdoor coil because the water would cause frost to form on the coil. This frost would block the airflow through the coil. Rather than allow this problem to occur, heat pump units must dispose of the condensate in another manner. The most widely used method of disposing of heat pump condensate is with a temperature-activated drain valve.



TEMPERATURE-ACTIVATED DRAIN VALVE

This is a device mounted in the base pan of a heat pump unit with a bellows that expands on temperature rise and contracts with temperature drop. A shaft with a rubber plug on the end is connected to the bellows. When the outdoor temperature remains above a certain temperature, the bellows is expanded and the plug fits tightly into a hole in the bottom, or base pan, of the unit. When the plug is blocking the hole, as it should be during cooling operation, the condensate water is contained in the base pan. At temperatures when heating is required, the bellows contracts, the rubber plug is retracted from the hole and the heat pump condensate water is allowed to drain into the wall case. The valve is fully open at approximately 45°F.

DRAIN KITS

Although the Zoneline units are designed to dissipate most of the condensate generated during normal cooling operation, there may be times when abnormal operating conditions cause more condensate than the unit can dissipate. Heat pumps also generate condensate that the unit may not be designed to dissipate. For these reasons, if condensate dripping from the wall case is objectionable, an internal or external drain system should be installed. See pages 37–38 for information covering the drain systems and the RAD10 kit available to connect to the wall case.

INTERNAL CONDENSATE REMOVAL (ICR) SYSTEM

GE has developed an Internal Condensate Removal (ICR) system for packaged terminal heat pumps. This system has been offered as an option on Zoneline packaged terminal Heat Pumps since 1982, and thousands of them are in use. During heat pump operation, the ICR system utilizes a small pump to lift the water from the base pan and pump it into a collector tray positioned above the indoor coil. The water drains from the collector tray and drips onto the warm indoor coil where it is evaporated into the room atmosphere. If an excess amount of water is pumped to the indoor side, it is routed back to the outdoor portion of the base pan.



The ICR system has proven to be an effective means of minimizing the amount of heat pump condensate dripping from the unit. However, if the restrictions of a particular installation will allow absolutely no drippage of condensate water from the wall case, the installation of an internal or external drain system is recommended.

Units with ICR may not be installed in seacoast or other corrosive environment applications.

WALL CASE WITH RADIO DRAIN KIT

External Drain. See page 38 for internal drain.

SCREWS

"A" METAL	"B" PLASTIC
	

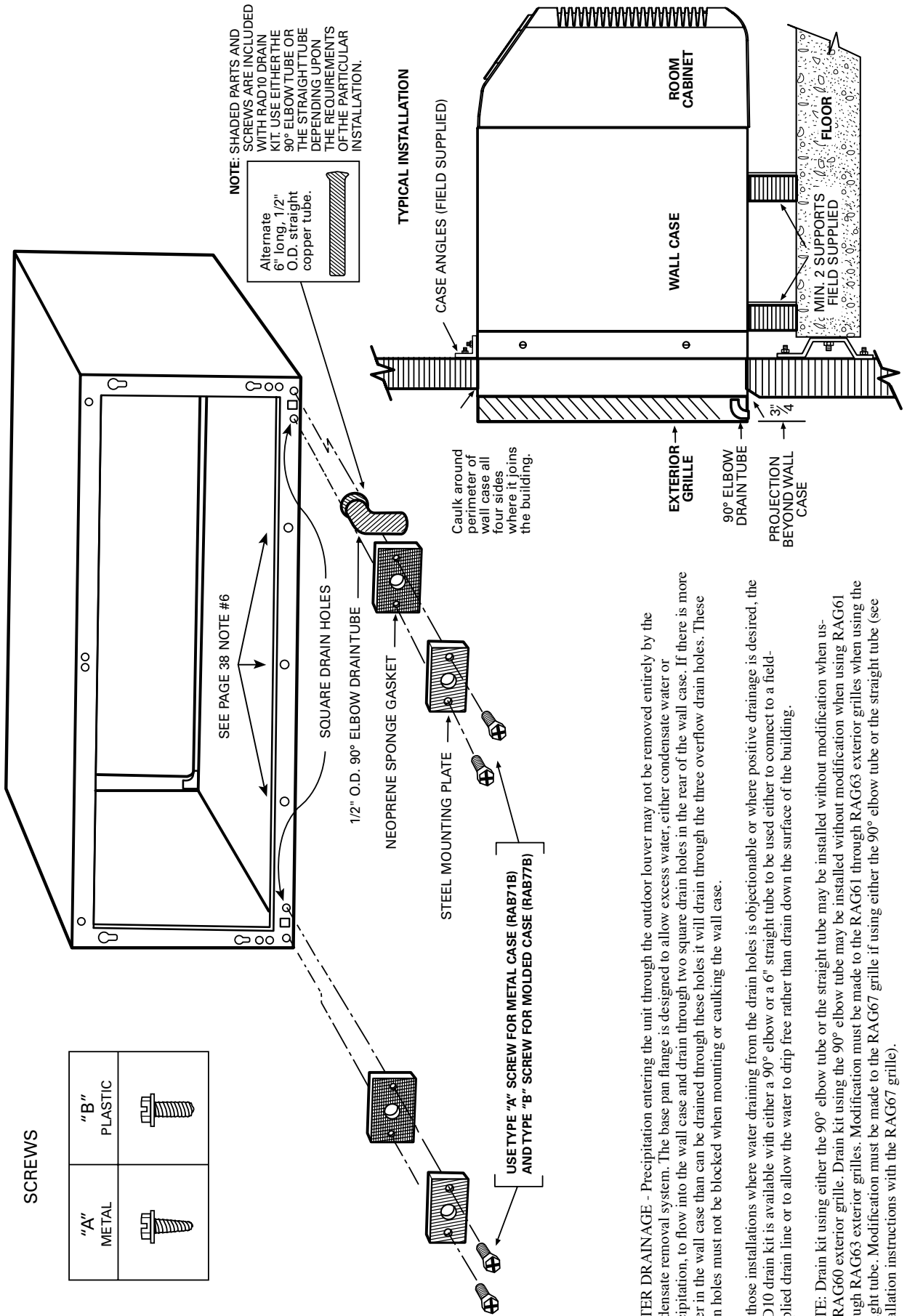

WATER DRAINAGE - Precipitation entering the unit through the outdoor louver may not be removed entirely by the condensate removal system. The base pan flange is designed to allow excess water, either condensate water or precipitation, to flow into the wall case and drain through two square drain holes in the rear of the wall case. If there is more water in the wall case than can be drained through these holes it will drain through the three overflow drain holes. These drain holes must not be blocked when mounting or caulking the wall case.

For those installations where water draining from the drain holes is objectionable or where positive drainage is desired, the RAD10 drain kit is available with either a 90° elbow or a 6" straight tube to be used either to connect to a field-supplied drain line or to allow the water to drip free rather than drain down the surface of the building.

NOTE: Drain kit using either the 90° elbow tube or the straight tube may be installed without modification when using RAG60 exterior grille. Drain kit using the 90° elbow tube may be installed without modification when using RAG61 through RAG63 exterior grilles. Modification must be made to the RAG61 through RAG63 exterior grilles when using the straight tube. Modification must be made to the RAG67 grille if using either the 90° elbow tube or the straight tube (see installation instructions with the RAG67 grille).

WALL CASE WITH RADIO DRAIN KIT

Internal Drain. See page 00 for external drain.

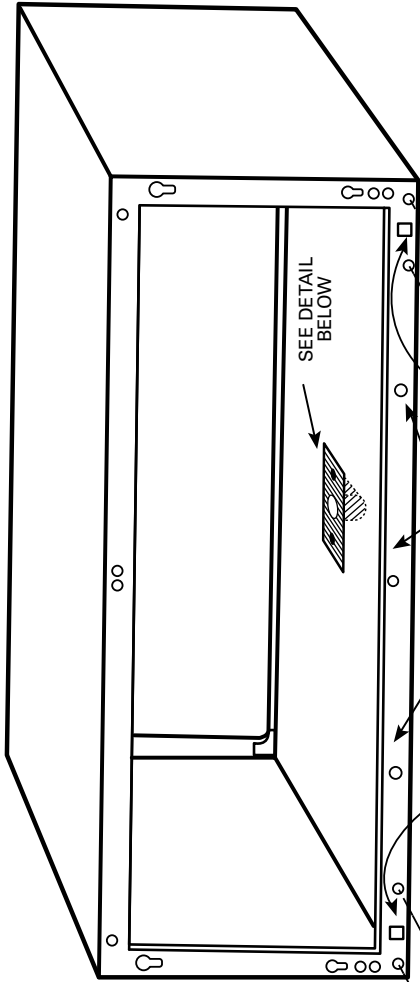

NOTE: SHADED PARTS AND SCREWS INCLUDED WITH RAD10 DRAIN KIT. THE 90° ELBOW TUBE IS RECOMMENDED FOR INTERNAL DRAIN INSTALLATION.

SCREWS

"A" METAL	"B" PLASTIC

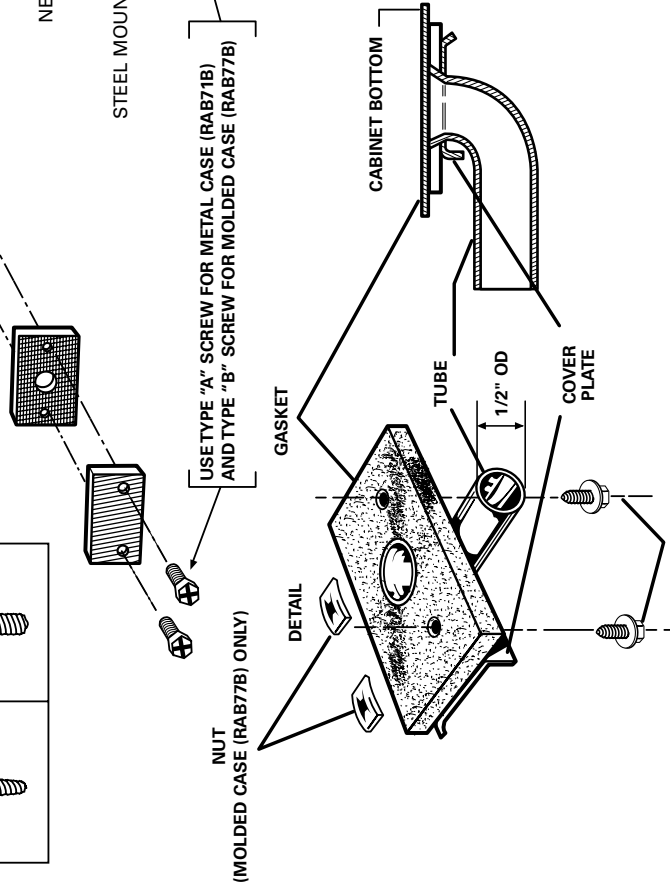

USE TYPE "A" SCREWS FOR BOTH RAB71B AND RAB77B

1. The RAD10 drain kit is installed in the bottom of the wall case when it is desired to drain condensate to an internal drain system in the building.
2. The drain kit is mounted on the bottom of the wall case prior to installation of the case in the wall. It may be located anywhere on the room-side portion except for sub-base installations. For these the drain should be at least 3" from the indoor edge of the case so as to adequately clear the sub-base.
3. A template is furnished with the kit for locating the necessary three holes in the case bottom — two to provide a securing means and one to provide a drain hole for the 1/2" OD tubing (see details at left).
4. A tube or hose 1/2" I.D. (obtained locally) must be installed on the drain tube and connected to the internal drain system in the building.
5. With the RAD10 the two square drain holes in the bottom outer flange of the wall case are sealed by the gaskets and mounting plates shown above.
6. Two 1/2" diameter holes located 1/4" above the case bottom in the bottom outer flange provide overflow drainage to the outdoors when wind-driven rain enters the chassis.

NOTE: If using RAD10 internal drain kit with an integral window louver system special attention should be paid to:

- Allowance for drainage from overflow drain holes in rear flange of wall case.
- Alternative methods for sealing square drain holes (and associated screw holes) in rear corners of the wall case. The RAD10 drain kit will interfere with the seal and fit of the case to the inside face of the integral window louver system/.
- Sealing of wall case to the building structure (see wall case installation instructions) and integral window louver system to prevent the elements from entering the structure.

DUCTED INSTALLATIONS

AZ45 AND AZ65 SERIES ZONELINE® UNITS MAY BE USED IN DUCTED INSTALLATIONS.

With a ducted installation it is possible to condition the air in two areas that have a common wall separating them. A special adapter mounts on the wall case and a transition piece directs the air from the unit into the adapter duct. Instructions for mounting the adapter to the wall case are included with the duct adapter. The adapter contains a grille that allows air from the unit to be discharged into the primary room and the adapter connects to a duct extension that allows the air to flow to the adjoining room. Ducting a unit may allow a single unit to be used rather than a separate unit in each room, providing a means of reducing initial equipment cost. The duct may extend a total of 15 feet (with a field-fabricated insulated duct extension) in one direction, either to the right or to the left of the unit. A baffle or damper installed in the discharge duct of the adapter is provided from the factory to provide approximately 70% air discharge into the primary room (room in which the unit is installed) and 30% into the secondary (adjacent) room. Completely removing the discharge damper will result in approximately 80% air discharge into the primary room and 20% into the secondary room.

The installation of the wall case and sub-base, if used, is the same for units being ducted as for free-standing units. The duct adapter support bracket overlaps the wall case by 1" and the bracket and mounting screws add approximately 3/8" (3/16" on each side) to the width of the wall case. If less than 1" of the wall case projects into the room it will be necessary to allow for the additional width in the opening for the wall case. The duct adapter mounting brackets should be mounted prior to installing the case in the wall.

Refer to pages 40–41 for drawings of ducted installations.

Prior to the installation of the transition from the room cabinet to the adapter, it will be necessary to remove the discharge grille from the room cabinet. Instructions for this modification are included with the duct adapter.

NEW DUCTED INSTALLATIONS

COMPONENTS

Duct Adapter RAK6053 — The duct adapter is secured to each side of the wall case and requires the drilling of mounting holes in the wall case during installation. A template for the hole location is in the installation instructions. By securing the duct adapter to the wall case, the chassis retains the slide-out feature for servicing after the transition piece is removed.



DUCT ADAPTER RAK6053

Duct Extension RAK601B — This kit contains a 44"-long insulated duct, a register mounting collar, and an air supply register. It can be secured to the duct adapter at either end of the adapter. This duct may be cut at any

dimension and used in two applications, providing the sum of the two duct lengths necessary does not exceed the 44" length. Even in single applications, **the mounting flange must be cut off one end of the duct to accept the collar and supply register.**



DUCT EXTENSION, MOUNTING COLLAR AND REGISTER RAK601B

Mounting Collar and Supply Register RAK602B — Are components included in the duct extension kit RAK601B. They may be ordered separately for installations where two duct extensions are made from one RAK601B.

DUCTED APPLICATION CONSIDERATIONS

When designing a ducted application, some application considerations to be made include:

1. Do not exceed the 15-foot-length maximum for the duct extension. Field-supplied duct extension must be completely insulated with minimum of 1/2" insulation.
2. The duct must be a straight run. Turns or bends in the duct extension create air pressure drops that the unit is not designed to overcome.
3. Turn the "Duct Mode" on in the auxiliary control settings (Mode 7). This increases the fan speed to ensure proper circulation.
4. Minimum recommended clearance between the unit and the adjacent wall is 2".
5. Provisions for return air must be made to allow air circulation from secondary room. Doors in both secondary and primary rooms may be undercut or a return grille may be installed through a common wall.
6. When calculating the heat gain/heat loss, take both areas into consideration.
7. Duct adapters are not for use on Dry Air 25 models.
8. Heater wattages are reduced in duct mode (see chart below).

DUCT MODE - HEATER WATTS OUTPUT
(265V AND 230/208V)

FAN SPEED	POWER CORD CONNECTION KIT		
	30 AMP	20 AMP	15 AMP
High	3800/3100	3400/2780	2400/1960
Low	2400/1960	2400/1960	2400/1960

(Text continues on page 42.)

DUCTED APPLICATION AZ45/AZ65 SERIES)

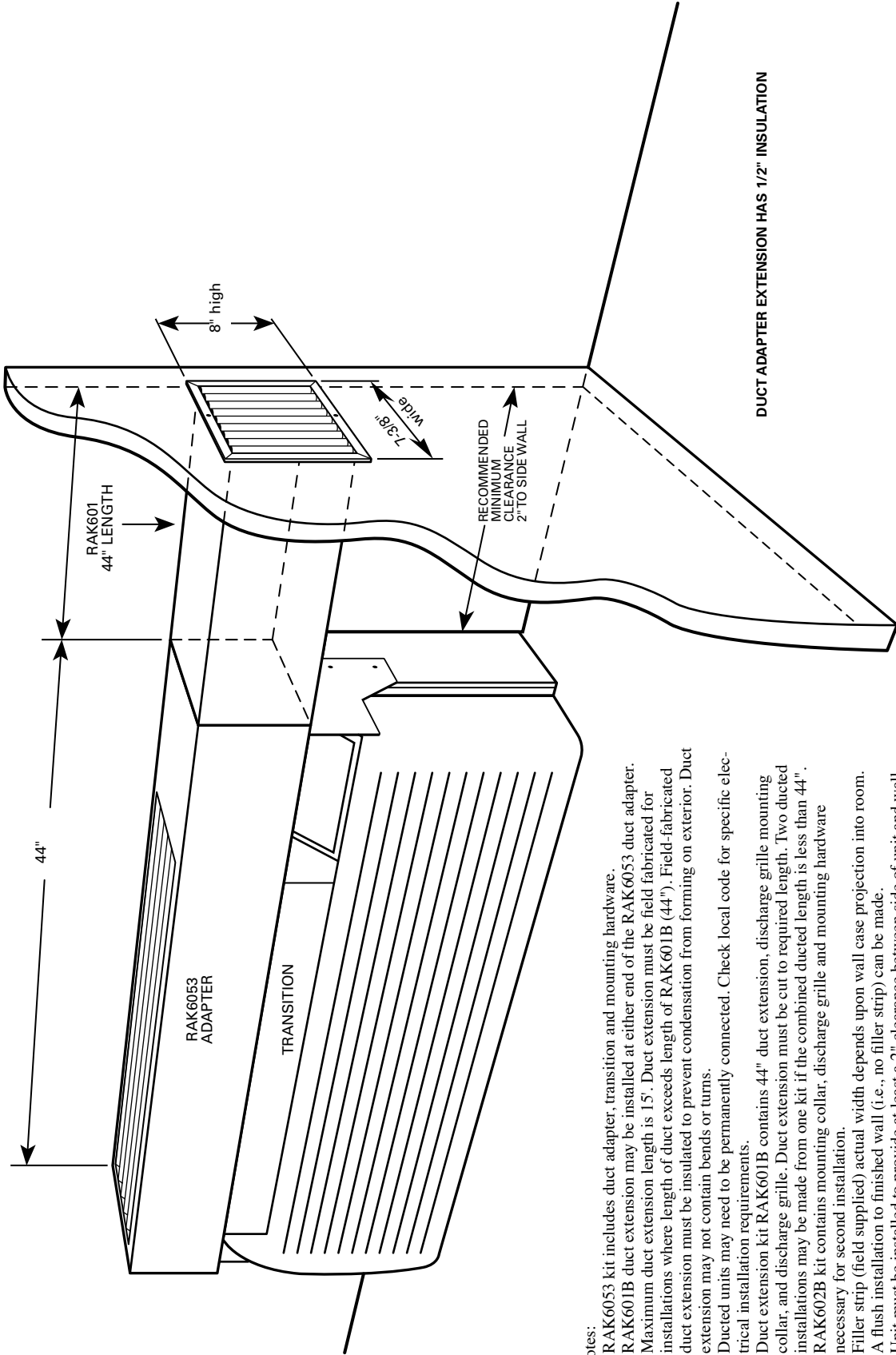

- Notes:
1. RAK6053 kit includes duct adapter, transition and mounting hardware.
 2. RAK601B duct extension may be installed at either end of the RAK6053 duct adapter. Maximum duct extension length is 15'. Duct extension must be field fabricated for installations where length of duct exceeds length of RAK601B (44"). Field-fabricated duct extension must be insulated to prevent condensation from forming on exterior. Duct extension may not contain bends or turns.
 3. Ducted units may need to be permanently connected. Check local code for specific electrical installation requirements.
 4. Duct extension kit RAK601B contains 44" duct extension, discharge grille mounting collar, and discharge grille. Duct extension must be cut to required length. Two ducted installations may be made from one kit if the combined ducted length is less than 44". RAK602B kit contains mounting collar, discharge grille and mounting hardware necessary for second installation.
 5. Filler strip (field supplied) actual width depends upon wall case projection into room. A flush installation to finished wall (i.e., no filler strip) can be made.
 6. Unit must be installed to provide at least a 2" clearance between side of unit and wall.
 7. Provisions for return air must be made in order to allow air circulation from secondary room. Doors in both secondary and primary rooms may be undercut or a return grille may be installed through common wall.
 8. For replacement of previous-design units, see pages 39, 42 and 55-56.

DUCTED DETAILED SIDE VIEWS - AZ45/AZ65 SERIES

See page 40 for all notes

Line Cord Installation

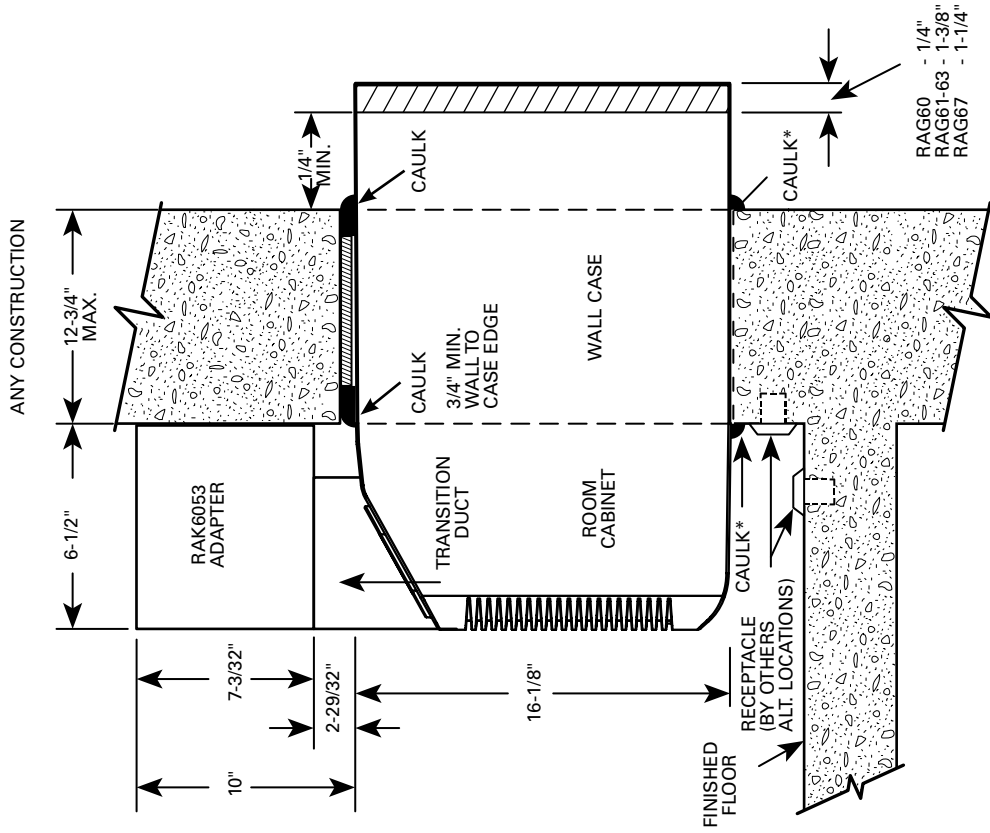

*Caulk around perimeter of wall case all four sides where it joins the building - Interior and Exterior.

Sub-Base Installation

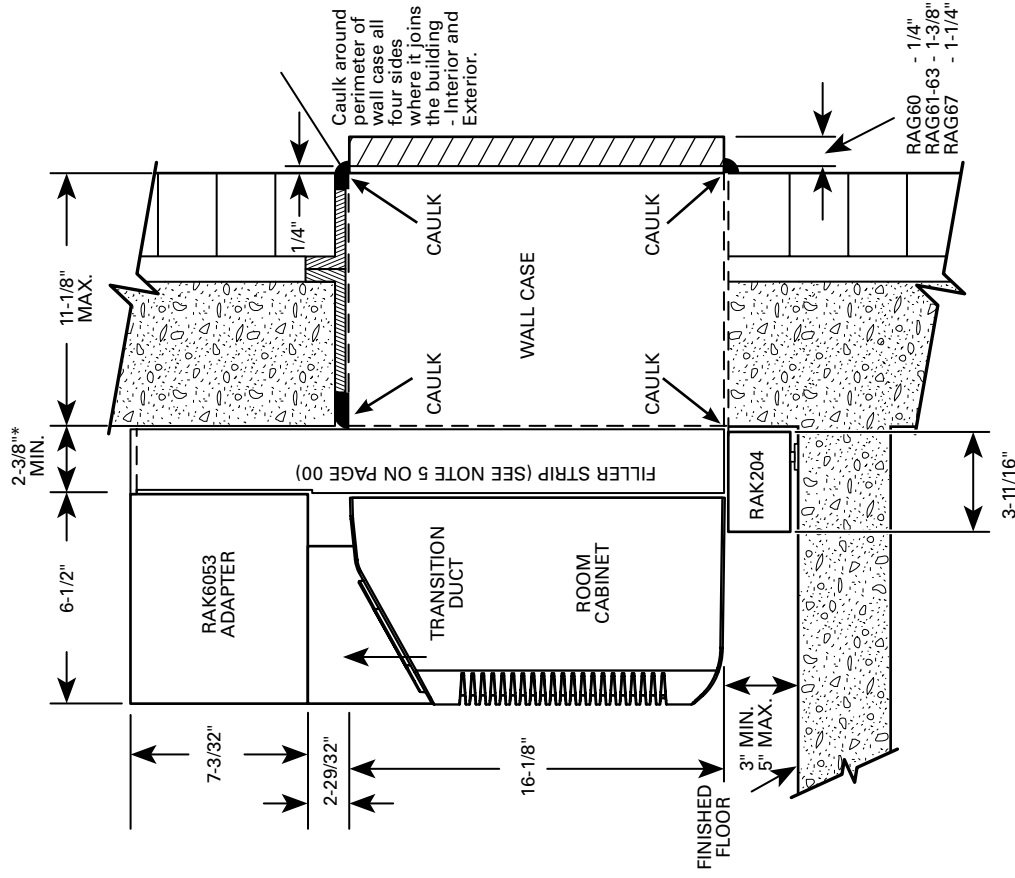

*2-3/8" min. when installed with RAK204.

REPLACEMENTS OF EXISTING DUCTED UNITS

The design of the Zonline chassis has changed over the years to provide better performance and appearance, therefore, some of the components used in ducted applications have changed. Select the proper components from the information below. The best procedure in determining the correct kit is to measure the existing duct extension cross section.

Existing Duct Extension cross-section measurements:
8-3/8" H x 6-1/2" W (used prior to 1988)

Duct Adapter RAK7013 — This duct adapter will allow the replacement of a new chassis (AZ45 or AZ65 Series unit) into an existing ducted application. This adapter will align properly with the duct extension and will eliminate the need to modify the wall opening. In order to minimize replacement costs, some of the components of the old duct adapter must be removed and used in the new installation. Consult the Installation Instructions of the RAK7013 before removing and discarding the old duct adapter. (See notes on pages 55–56.)

Existing Duct Extension Cross-Section Measurements:
7-3/32" H x 6 -1/2" W

Duct Transition RAK7023 — This transition duct will allow the replacement of a previous Zonline chassis with a new AZ45/AZ65 series. (See notes on pages 55–56.)

EXTERIOR GRILLES

Four styles of outdoor grilles are available for exterior treatments. The standard stamped aluminum grille (RAG60), the molded architectural louvered exterior grilles (RAG61-63) and the extruded aluminum architectural louvered grille (RAG67). All grilles include air deflectors (RAK40) and gaskets to prevent condenser air recirculation.

RAG60 Outdoor Grille — The standard exterior grille is made of durable aluminum to protect chassis components and prevent air recirculation.

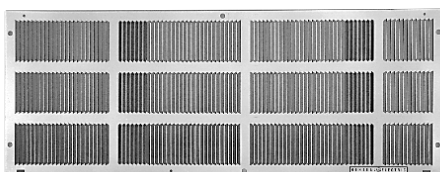

**RAG60
OUTDOOR
GRILLE**

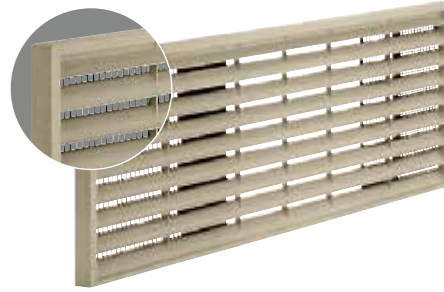

**RAG61
OUTDOOR
GRILLE**

RAG61, 62, 63 Architectural Grille — One-piece optional molded grille and frame assembly provides improved appearance, protection and weatherability. Molded of durable polycarbonate, the surfaces of the grille have a colorfast, slightly textured finish which blends well with most types of wall surfaces. The grilles can be painted in the field to match the building for improved aesthetics.

Colors: RAG61 — Beige
RAG62 — Maple
RAG63 — Dark brown

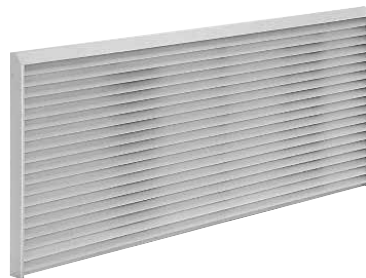

RAG67

RAG67 Extruded Aluminum Grille — The RAG67 is made from extruded anodized aluminum for use where an aluminum architectural grille is preferred. The RAG67 comes in a clear finish and may be special ordered from GE Appliances in other colors. Minimum order quantities may be required. Contact your GE Appliances salesperson for details.

All grilles are installed and secured to the wall case from the inside. Keyhole slots in the rear flange of the case allow the grille to be placed in position before securing it firmly to the wall case.

Replacement of existing units: If an existing grille is not replaced, capacity and efficiency will be reduced and the unit may fail to operate properly or fail prematurely. If the existing grill is from 1992 to present and has deflectors, the RAK40 is not needed. A deflector kit, RAK40, must be used with grilles that were not designed for current AZ Series GE Appliances' Zonline® units. The RAK40 contains air deflectors and gaskets that mount to the chassis to direct the hot exhaust air away from the air intake to allow the unit to function properly. If RAK40 deflectors are used on the chassis, all old deflectors on the exterior grille must be removed. All grilles used with GE Appliances' Zonline units must comply with requirements of Exterior Architectural Treatments and Special Outdoor Grilles (See page 43).

EXTERIOR ARCHITECTURAL TREATMENTS AND SPECIAL OUTDOOR GRILLES

The architectural design of a building may dictate the use of special or oversized louvers for aesthetic reasons. Louvers other than standard Zonline® exterior grilles may be used on the Zonline unit, however, these special louvers, or any special exterior architectural treatments of the building facade that may restrict the free circulation of condenser airflow, should be referred to GE Appliances Application Engineering for evaluation and approval. The following guidelines should be followed in selecting a louver:

- The louver must have a minimum of 65% free area.** ASHRAE defines "free area" as the minimum area of the opening in an air inlet or outlet through which air can pass. Percent (%) free area equals the X dimension divided by the Y dimension.
- The louver should be attached to the wall case in a manner that will prevent recirculation of condenser discharge air into the air inlet. If the louver is not attached directly to the wall case, a field-supplied splitter or gasket is required between the chassis and the louver to prevent recirculation.

It is important that the above criteria be followed since a louver that is too restrictive or allows recirculation will reduce the unit's capacity and efficiency, increase

the electrical current draw, cause intermittent operation due to the compressor overload protector shutting the compressor off, and cause failure of the compressor overload protector and shorten compressor life. Using the unit with a grille that is too restrictive or allows recirculation may constitute improper installation and will void the unit's warranty.

A scale drawing of the louver section should be sent to GE Appliances Application Engineering. To assure the proper performance of the Zonline unit and comply with Underwriters Laboratories® requirements, it may be necessary to send a sample louver section (at least 16" x 42") to an independent lab to be tested with the Zonline unit.

Sample Calculations

Free Area (%) = $\frac{X}{Y} \times 100$ $x = 1"$ $y = 1.5"$

F.A. % = $\frac{1}{1.5} \times 100 = 66.7\%$

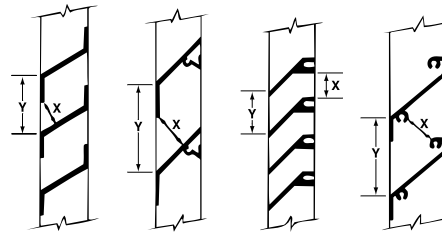

POWER CONNECTION FOR AZ45 AND AZ65 SERIES ZONELINE UNITS

All AZ45 and AZ65 Series Zonline units are equipped with universal heaters allowing chassis installation flexibility. The Zonline units are connected to the building power supply by a unique power connection kit. By utilizing a separate universal power connection kit, each unit is capable of providing various outputs of electric resistance heat to more closely meet the heating requirements of the particular room, thereby increasing the installation flexibility of the particular chassis. This power connection kit is the only means of supplying power to the Zonline chassis. The appropriate kit is determined by the voltage, the means of electrical connection, either line-cord connected or permanently connected, and the desired resistance heat output that may be supported by the branch circuit.

230/208 VOLT LINE CORD CONNECTED UNITS

Line Cord Kits consist of a self-aligning four-pin molded connector that plugs into a mating connector on the Zonline chassis and insulated line cord with an electrical plug on the end.



FOUR PIN CONNECTOR AND 20 AMP PERSONALITY PLUG

The configuration of the electrical plug conforms to Nation Electrical Code (NEC) standards for the circuit amperage, and the configuration of the extra personality plug determines the heater wattage and current requirements when it is plugged into the Zonline chassis. If the four pin connector does not have a personality plug (or the plug is not connected) the unit identifies it as a 15 amp circuit.

The power connection kit is selected by the amperage of the circuit where it will be installed. Each line cord kit has an integral Leakage Current Detection Interrupter (LCDI) or Arc Fault Current Interrupter (AFCI) device as required by the NEC and Underwriters Laboratory (UL) for line-cord connected air conditioners manufactured on or after August 1, 2004. The line-cord power connection kits are shown in the table below.

230/208 VOLT	7,000/9,000			12,000/15,000		
LINE CORD KIT	RAK315P	RAK320P	RAK330P	RAK315P	RAK320P	RAK330P
Total Watts	2,410/1,990	3,420/2,830	4,830/3,990	2,430/2,020	3,450/2,860	4,860/4,020
Heater Watts	2,400/1,960	3,400/2,780	4,800/3,930 *	2,400/1,960	3,400/2,780	4,800/3,930 *
Heater BTU	8,100/6,600	11,600/9,400	16,300/13,400	8,100/6,600	11,600/9,400	16,300/13,400
Total Amps	10.5/9.6	14.9/13.6	21.0/19.2	10.6/9.7	15.1/13.8	21.2/19.3
Min Circuit Amps	15	20	25	15	20	25
Recommended Protective Device	15 amp time-delay fuse or breaker	20 amp time-delay fuse or breaker	30 amp time-delay fuse or breaker	15 amp time-delay fuse or breaker	20 amp time-delay fuse or breaker	30 amp time-delay fuse or breaker

Total watts and total amps include electric heat and fan motor
 * 30-amp heater wattage is reduced in low fan operation.

Specifications subject to change.

POWER CONNECTION FOR AZ45 AND AZ65 SERIES ZONELINE UNITS (CONTINUED)

230/208 VOLT PERMANENTLY CONNECTED UNITS

Permanently connected units do not require the LCDI or AFCI device. Permanent connection is usually made through the use of a sub-base. Each 230/208 volt sub-base consists of a sub-base with appropriate receptacle for minimum circuit amperage, a chaseway to route power connector from the sub-base to the chassis, wiring to connect the sub-base to building wiring and a short line cord with a self-aligning four-pin connector to connect to the chassis and plug into the receptacle in the sub-base. Permanent, or direct-wired, installation of a 230/208 volt unit requires a junction box kit, RAK4002C, which attaches to the chassis to form an enclosed junction box.

The short sub-base line cord may not be used without the sub-base.

For AZ45 and AZ65 Series 230/208-volt units where a permanent installation using flexible conduit is desired,

the RAK4002C forms an enclosed junction box on the chassis. The RAK4002C has a hole to allow a 1/2" trade size electrical conduit and a square knockout for the chaseway to be connected to the junction box. For direct connection, purchase and install the appropriate universal power supply kit (also referred to as the direct connection kit below) that matches the ampacity of the building circuit connected to the unit. This four-pin connector with three 7"-long conductor wires is used for direct connections to the building wiring inside a direct-connect junction box. These wires are then connected to the building wiring by field-supplied connectors.



230/208 VOLT	7,000/9,000			12,000/15,000		
SUB BASE	RAK204D15C	RAK204D20C	RAK204D30C	RAK204D15C	RAK204D20C	RAK204D30C
DIRECT CONNECT KIT	RAK315D	RAK320D	RAK330D	RAK315D	RAK320D	RAK330D
Total watts	2,410 / 1,990	3,420 / 2,830	4,830 / 3,990	2,430 / 2,020	3,450 / 2,860	4,860 / 4,020
Heater watts	2,400 / 1,960	3,400 / 2,780	4,800 / 3,930 *	2,400 / 1,960	3,400 / 2,780	4,800 / 3,930 *
Heater btu	8,100 / 6,600	11,600 / 9,400	16,300 / 13,400	8,100 / 6,600	11,600 / 9,400	16,300 / 13,400
Total Amps	10.5 / 9.6	14.9 / 13.6	21.0 / 19.2	10.6/9.7	15.1/13.8	21.2/19.3
Min circuit Amps	15	20	25	15	20	25
Recommended protective device	15 amp time-delay fuse or breaker	20 amp time-delay fuse or breaker	30 amp time-delay fuse or breaker	15 amp time-delay fuse or breaker	20 amp time-delay fuse or breaker	30 amp time-delay fuse or breaker

Total watts and total amps include electric heat and fan motor
 230/208 Volt sub base includes non LCDI short power cord
 *30-Amp heater wattage is reduced in low fan operation.

265 OR 277 VOLT UNIT INSTALLATION – PERMANENTLY CONNECTED UNITS

NEC (Article 440.60) requires permanent connection for units connected to power sources over 250 volts; therefore these units must be permanently connected (direct-wired) with field-supplied connectors. Units connected using a sub-base meet the requirement for permanent connection since all wiring is internal wiring between the sub-base and the chassis and it is enclosed.

Since 265-volt units may not be line-cord connected, an LCDI device is not required.

265 VOLT	7,000/9,000			12,000/15,000		
SUB BASE	RAK204E15	RAK204E20	RAK204E30	RAK204E15	RAK204E20	RAK204E30
DIRECT CONNECT KIT	RAK515D	RAK520D	RAK530D	RAK515D	RAK520D	RAK530D
SHORT LINE CORD KIT	RAK515P	RAK520P	RAK530P	RAK515P	RAK520P	RAK530P
Total Watts	2440	3450	4850	2460	3470	4870
Heater Watts	2400	3400	4800 *	2400	3400	4800 *
Heater BTU	8100	11600	16300	8100	11600	16300
Total Amps	9.1	12.9	18.1	9.3	13.1	18.4
Min Circuit Amps	15	20	25	15	20	25
Recommended protective device	15 amp time-delay fuse or breaker	20 amp time-delay fuse or breaker	25 amp time-delay fuse or breaker	15 amp time-delay fuse or breaker	20 amp time-delay fuse or breaker	25 amp time-delay fuse or breaker

Total watts and total amps include electric heat and fan motor
 Each 265 volt sub base kit consists of a sub base with appropriate receptacle for minimum circuit amperage, a chaseway to route the power connector from the sub base to the chassis junction box and wiring to connect the receptacle to the building wiring.
 265 volt sub base DOES NOT include short power cord
 * 30-amp heater wattage is reduced in low fan operation.

The 265-volt power connection kit must be ordered separately. All wiring must conform to local electrical regulations and codes.

**ELECTRICAL WIRING INFORMATION
- AZ45/AZ65 SERIES**

All Zonelines are single-phase 60-hertz units.

For all installations, the feeder, sub-feeder, branch circuit and electrical protective devices and selection must conform to the National Electrical Code (NEC) and to local codes.

Maximum connected load in amperes, including demands for the electric heater and the fan motor, are shown on pages 43–44. Branch circuit ampacity and electrical protective device sizing are shown on pages 43–44 for 230/208-volt and for 265-volt units.

More than one unit per branch circuit is not recommended. When in doubt, consult the NEC. All wiring, including installation of receptacle, must conform to local electrical regulations and codes.

**REPLACEMENT OF
EXISTING CHASSIS**

230/208 VOLT AND 265 VOLT UNITS

There have been changes to NEC and improvements and modifications to the Zoneline® chassis and sub-bases since the unit was first introduced. Some of these changes require alterations to be made when replacing an older unit with a new chassis.

LINE CORD CONNECTED UNITS

The plug configuration of new line-cord connected units complies with the current NEC standards. Older installations may have wall receptacles that conformed to NEC standards at the time the building was constructed and may not match the configuration of the plug on the new line cord. The recommended solution is to change the wall receptacle to conform to current standard plug configuration. See chart on this page for current receptacle configuration.



**TYPICAL LINE CORD
POWER CONNECTION KIT
RAK320P SHOWN**

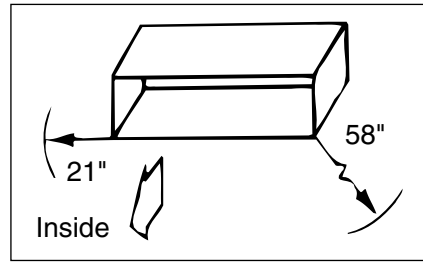

RECEPTACLE

TYPE	MFG	PART NO	CONFIGURATION
15 AMP Tandem NEMA6-15R	Hubbell P&S	5661 5671	
20 AMP Perpendicular NEMA6-20R	Hubbell P&S	5461 5871	
30 AMP Large Tandem NEMA6-30R	Hubbell P&S	9330 3801	

**PERMANENTLY CONNECTED UNITS
WITH SUB BASE**

If the existing unit is connected to a sub-base, the installation of the new unit may involve modifying the existing installation slightly. It is recommended these modifications be made by a qualified electrician.

If more assistance is needed, contact the Zoneline Application Engineer.

NORMAL YEARLY OPERATING DATA

(Cooling Hours based on 75°F indoor temperature with air conditioner sized to meet the design conditions.)

LOCATION	ASHRAE HEATING DEGREE DAYS	ESTIMATED COOLING Hours
ALABAMA		
Birmingham	2,551	1,390
Huntsville	3,070	1,340
Mobile	1,560	1,640
Montgomery	2,291	1,580
ARIZONA		
Flagstaff	7,152	310
Phoenix	1,765	2,280
Tucson	1,800	1,920
Yuma	974	2,520
ARKANSAS		
Fort Smith	3,292	1,410
Little Rock	3,219	1,330
CALIFORNIA		
Bakersfield	2,122	1,530
Fresno	2,611	1,210
Los Angeles	2,061	310
Sacramento	2,502	1,030
San Diego	1,458	390
San Francisco	3,015	110
COLORADO		
Colorado Springs	6,423	520
Denver	6,283	550
Grand Junction	5,641	910
CONNECTICUT		
Hartford	6,235	480
DISTRICT OF COLUMBIA		
Washington	4,224	1,010
DELAWARE		
Wilmington	4,930	770
FLORIDA		
Jacksonville	1,239	1,690
Miami	214	2,850
Orlando	766	1,930
Tallahassee	1,485	1,500
Tampa	683	2,350
GEORGIA		
Atlanta	2,961	1,130
Augusta	2,397	1,400
Macon	2,136	1,440
Savannah	1,819	1,510
IDAHO		
Boise	5,809	670
Lewiston	5,542	600
Pocatello	7,033	570
ILLINOIS		
Chicago	6,155	780
Moline	6,408	760
Springfield	5,429	890
INDIANA		
Evansville	4,435	1,090
Fort Wayne	6,205	710
Indianapolis	5,699	820
South Bend	6,439	600
IOWA		
Burlington	6,114	730
Des Moines	6,588	710
Sioux City	6,951	770
KANSAS		
Dodge City	4,986	1,020
Goodland	6,141	800
Topeka	5,182	880
Wichita	4,620	1,070

LOCATION	ASHRAE HEATING DEGREE DAYS	ESTIMATED COOLING Hours
KENTUCKY		
Lexington	4,683	830
Louisville	4,660	1,130
LOUISIANA		
Alexandria	1,921	1,670
Baton Rouge	1,560	1,860
New Orleans	1,385	1,790
Shreveport	2,184	1,470
MAINE		
Portland	7,511	290
MARYLAND		
Baltimore	4,654	850
MASSACHUSETTS		
Boston	5,634	500
MICHIGAN		
Detroit	6,293	590
Flint	7,377	440
Grand Rapids	6,894	530
MINNESOTA		
Duluth	10,000	200
Minneapolis	8,382	550
MISSISSIPPI		
Jackson	2,239	1,560
MISSOURI		
Columbia	5,046	960
Kansas City	4,711	1,210
Springfield	4,900	970
St. Louis	4,900	1,080
MONTANA		
Billings	7,049	520
Glasgow	8,996	410
Great Falls	7,750	420
Missoula	8,125	350
NEBRASKA		
Grand Island	6,530	770
Omaha	6,612	750
NEVADA		
Ely	7,733	500
Las Vegas	2,709	1,980
Reno	6,332	520
NEW JERSEY		
Newark	4,589	710
NEW MEXICO		
Albuquerque	4,348	1,040
Clayton	5,158	720
Silver City	3,705	1,260
NEW YORK		
Albany	6,875	480
Binghamton	7,286	310
Buffalo	7,062	450
New York	4,811	790
Rochester	6,748	470
Syracuse	6,756	500
NORTH CAROLINA		
Asheville	4,042	690
Charlotte	3,191	1,230
Raleigh	3,393	1,070
Winston-Salem	3,595	960
NORTH DAKOTA		
Bismarck	8,851	510
Fargo	9,226	490
Williston	9,243	580

LOCATION	ASHRAE Heating Degree Days	Estimated Cooling Hours
OHIO		
Cincinnati	5,265	840
Cleveland	6,351	610
Columbus	5,660	810
Dayton	5,622	740
Toledo	6,494	590
OKLAHOMA		
Oklahoma City	3,725	1,200
Tulsa	3,860	1,410
OREGON		
Medford	5,008	620
Pendleton	5,127	590
Portland	4,635	270
PENNSYLVANIA		
Harrisburg	5,251	730
Philadelphia	5,144	810
Pittsburgh	5,987	590
Scranton	6,254	440
Williamsport	5,934	600
RHODE ISLAND		
Providence	5,954	470
SOUTH CAROLINA		
Charleston	2,033	1,390
Columbia	2,484	1,440
Greenville	2,980	1,120
SOUTH DAKOTA		
Rapid City	7,345	580
Sioux Falls	7,839	610
TENNESSEE		
Chattanooga	3,254	1,180
Knoxville	3,494	1,070
Memphis	3,232	1,320
Nashville	3,578	1,220
TEXAS		
Corpus Christi	914	2,380
Dallas	2,363	1,900
El Paso	2,700	1,580
Houston	1,396	1,850
Lubbock	3,578	1,310
San Antonio	1,546	1,920
UTAH		
Milford	6,497	910
Salt Lake City	6,052	830
VERMONT		
Burlington	8,269	130
VIRGINIA		
Norfolk	3,421	1,010
Richmond	3,865	1,020
Roanoke	4,150	870
WASHINGTON		
Seattle	5,145	180
Spokane	6,655	430
Yakima	5,941	530
WEST VIRGINIA		
Charleston	4,476	860
Huntington	4,446	820
WISCONSIN		
Madison	7,863	530
Milwaukee	7,635	450
WYOMING		
Casper	7,410	600
Cheyenne	7,381	420
Sheridan	7,680	530

FORMULA FOR CALCULATING OPERATING COSTS USING ABOVE DATA:

$$\text{Heating*} = \frac{\text{Heat Loss KW} \times \text{Heating Degree Days} \times \text{“C”} \times \text{Cost Per KWH}}{\text{Outdoor Design Temperature Difference}} = \text{Operating Cost}$$

*The above formula is for electric resistance heating only. Power consumption using the Zoneline® heat pumps should be adjusted by Seasonal Performance Factor (SPF).

The local power supplier should be consulted for recommended value of “C.” This factor will vary between 17 and 24.

$$\text{Cooling} = \frac{\text{Calculated Heat Gain (BTUH)}}{\text{Installed unit capacity (BTUH)}} \times \frac{\text{Unit Cooling Watts}}{1,000 \text{ Watts/KW}} \times \text{Cooling Hours} \times \text{Cost per KWH} = \text{Operating Cost}$$

TYPICAL AZ45/AZ65 SERIES WIRING DIAGRAM

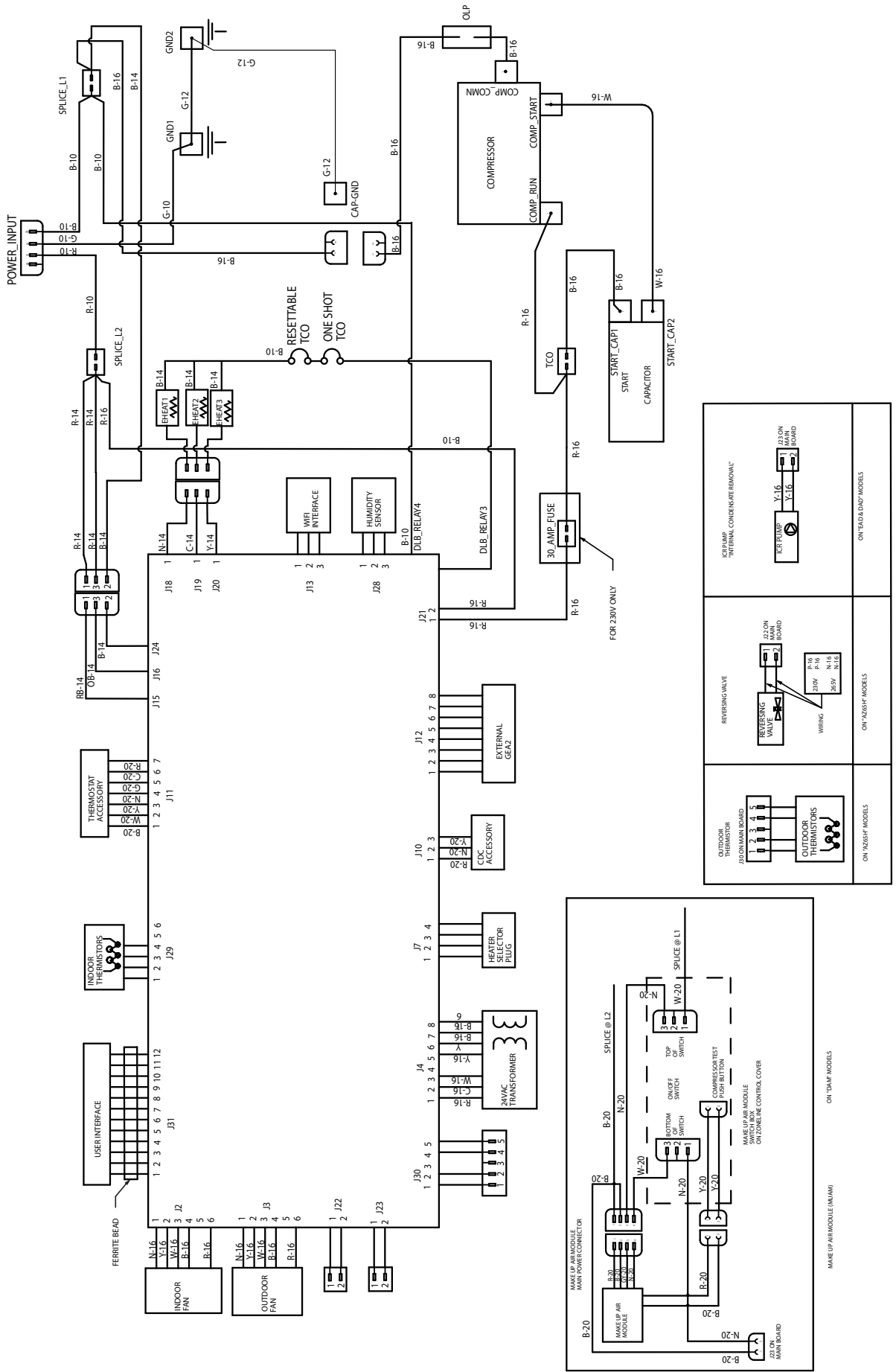

SUGGESTED BID FORM SPECIFICATIONS

The following are suggested specifications for the Zoneline® AZ45 Series Packaged Terminal Air Conditioner and the AZ65 Series Packaged Terminal Heat Pump.

The contractor will furnish packaged terminal air conditioners of the sizes and capacities shown on the schedule and in the specifications. The units shall be located as shown on the drawings and each shall consist of a chassis, room cabinet, wall case, sub-base if specified, and outdoor grille.

Units shall be listed by UL, and AHRI and eUL certified as to capacity and efficiency and shall be GE Appliances Zoneline® models or equal. Unit dimensions shall not exceed 42-1/8" wide and 16-1/4" high with room cabinet in place.

Units shall be designed to operate on (208) (230) (265) volts, 60 Hz, single-phase power.

Chassis. The air conditioner chassis shall be the standard product of the manufacturer and shall be shipped in protective cartons to prevent damage. Cartons shall be appropriately marked at the factory with wording sufficient to warn handlers against improper stacking, up-ending, rolling or dropping. The chassis shall be the slide-in type, ready to operate after installation.

Each shall consist of the following sections and components:

- Each unit shall have a matching, easily removable, textured finish, wrap-around room cabinet molded of high-impact Polystyrene to resist corrosion and damage. The room cabinet shall have slide-out washable filters accessible without requiring removal of room cabinet from chassis;
- Hermetically sealed refrigerant system with external vibration isolated rotary-type compressor, condenser and evaporator coils and capillary refrigerant control. Airflow system consisting of one permanently lubricated variable-speed fan motor for the outdoor fan and a separate permanently lubricated variable-speed fan motor for the indoor fan. Outdoor fan shall be multi-blade axial-flow design made of non-corrosive material. Indoor fan shall be of a design to optimize airflow and operating sound. All motors on the exterior side of the weather barrier shall be of an enclosed design to reduce the effects of moisture and corrosion;
- Line-cord connected units shall require a line-cord power connection kit with integral Leakage Current Detection Interruption device or (Arc Fault Current Interrupter) as required by National Electrical Code® (NEC) and Underwriters' Laboratories. The unit shall have a universal resistance heater with output determined by connection to the power source with the appropriate power connection kit to provide specified heat output;
- A fan-cycle option to permit continuous fan operation or fan cycle operation, independently selectable for heating and cooling operation;
- Fan-only operation in either high or low fan speed selectable by room occupant;
- A positive cooling condensate disposal system which meets the test requirements of applicable AHRI Standard 310 (for packaged terminal air conditioners)

and 380 (for packaged terminal heat pumps) (80°F dry bulb, 75°F wet bulb, 80% relative humidity);

- Condenser and evaporator coils to be constructed of copper tubing and aluminum plate fins designed to achieve EER and COP rating of the unit;
- Indoor and outdoor airflows that match the capacity of the coils for efficient heat transfer. Water blow-off shall not occur on the indoor coil;
- Adjustable indoor discharge air louvers that provide a 45° off horizontal air pattern with an alternate position to provide a 65° off horizontal air pattern;
- Easily accessible controls for selection of unit operation and thermostat setting.
- Controls shall automatically dim to not disturb the guest.
- Positive-closing, manually controlled, multi-position fresh-air vent capable of providing selection anywhere from fully open to fully closed. Vent door is to be secured for shipping;
- Integrated circuit and software to sense and control room temperature;
- Electronic temperature limiting with seven independent heating and cooling settings to limit maximum and minimum temperatures.
- Freeze Sentinel to automatically activate the electric resistance heater and fan motor to warm and circulate indoor air to help prevent damage due to freezing temperatures. Freeze Sentinel shall operate as long as unit is connected to a powered electrical circuit and unit shall provide ability for owner to defeat the Freeze Sentinel operation;
- Heat Sentinel to automatically activate air conditioner operation as long as unit is connected to a powered electrical circuit (even if the unit is in the off mode) when the room temperature warms to 85°F and turns air conditioner operation off when the room temperature cools to 80°F, if selected by owner;
- Compatible with two-wire Central Desk Control systems;
- Remote thermostat compatibility with Class 2 remote thermostat;
- Connections to interface with a transfer fan to move air into another room;

Unit shall have means of electrical connection listed by Underwriters' Laboratories and compatible with the unit's required voltage and ampacity in conformance with National Electrical Code and local codes.

Additional specifications for GE Appliances Zoneline AZ65 Series Packaged Terminal Heat Pumps:

Heat pump units shall provide operation that will either: A) automatically phase in electric resistance heat, if outdoor temperature is below 46°F, if heat pump alone is unable to maintain room temperature; or B) use partial electric resistance heat simultaneous with heat pump operation any time the outdoor temperature is below 46°F. Selection of A or B operation is made by means of a selector concealed from room occupant. In either A or B operation, the unit will switch to full resistance heat if room temperature continues to decline or the outdoor temperature falls below 25°F. If the outdoor temperature is above 46°F (and below 86°F), unit will lock out electric resistance heat and operate on heat pump only.

Heat pump unit shall include reverse cycle defrost that automatically begins a defrost cycle when hardware and software determines the criteria for defrosting has been met. Defrosting shall be accomplished by systematically ceasing heat pump operation, pausing to allow internal refrigerant pressures to equalize, and then operating the compressor with the flow of refrigerant reversed to allow the hot gas to flow through the outdoor coil, melting the accumulated frost. The unit shall automatically resume heat pump operation, after pausing to allow refrigerant pressures to equalize, at conclusion of defrost cycle.

The unit shall be equipped with a temperature-activated drain valve to allow water generated in heat pump operation and defrost cycles to drain into the wall case.

The unit shall have a switch concealed from room occupant to allow heat pump operation to be overridden and heat provided by electric resistance heat regardless of outdoor temperature.

In the event of compressor failure during heat pump operation, unit shall automatically switch to electric resistance heat to maintain selected room temperature regardless of outdoor temperatures.

Specifications for optional Internal Condensate Removal (ICR) system for AZ65 Series heat pump units.

The unit shall have a factory-installed Internal Condensate Removal (ICR) system to permit unit to automatically dispose of heat-pump-generated condensate water with no overflow to outdoors during heating under outdoor ambient of 55°F dry bulb, 90% relative humidity; indoor ambient 70°F dry bulb, 52% relative humidity, for four hours of continuous run time.

WALL CASES AND GRILLES (NEEDED FOR NEW INSTALLATIONS.)

(Alternate specification for steel wall case)

Wall Case. The wall case shall be constructed of heavy-gauge, insulated, zinc-coated phosphated steel with a protective baked-on enamel finish. Bottom critical points of the steel wall case shall be coated with petroleum microcrystalline wax for added corrosion protection and shall meet ASTM B-117, 1,800-hour hot air aerated salt spray test.

(Alternate specification for molded wall case)

Wall Case. The wall case shall be constructed of a non-corroding fiberglass-reinforced polyester compound.

Cases shall be installed through exterior walls where shown on the plans and shall be installed per manufacturer's installation instructions. In no instance shall fasteners be used through the bottom in order to retain the water integrity of the bottom of the wall case.

Outside weather panels shipped with the cases shall remain in place until the outdoor grille and chassis are installed, at which time they are to be removed and discarded by the installer.

Outside Grille. Each unit shall be equipped with a standard exterior grille that has been designed to allow unit operation in high ambient conditions. Grilles shall be of material and design specified.

Special grilles or customer louver sections to be supplied

by others will conform to a minimum of 65% free area (as calculated by Ashrae) to allow for proper unit operation and shall be submitted to the PTAC/PTHP manufacturer, if requested, for feasibility and airflow characteristics.

SPECIFICATIONS FOR SUB-BASE (IF REQUIRED)

Sub-Base. Each unit shall have a field-installed UL-listed electrical sub-base. The sub-base shall be attached to the lower inside flange of the wall case prior to installation in the exterior wall. It shall include adjustable screws at the bottom corners to permit exact leveling of the wall case. The sub-base shall have a factory-installed receptacle to allow unit line cord to plug into mating receptacle and shall have a chaseway to contain and conceal the line cord. The sub-base shall have side panels adjustable from a minimum of 2-3/8" to a maximum of 13-3/4" to enclose the area under the wall case.

Weather Resistance. Complete unit including outside louver shall be submitted to an independent agency for weather-resistance tests.

Air-infiltration test to be conducted in accordance with AHRI 310/380 and in such a facility for leakage air flow measurements described in ANSI/ASHRAE I6 and 58. With indoor static pressure maintained at 0.1" in H₂O below the outdoor static pressure, the allowable air infiltration shall not exceed 19.3 ft.³/min.

Water-infiltration test to be conducted in accordance with ASTM E331-86 with static air pressure differential of 10.0 lb./ft² (1.93" H₂O) equivalent to 63 mph wind, 5.0 gal./ft² (8" rain/ft²/hr.) for 15 minutes and there shall be no leakage into the room.

Approvals. Units shall be certified under the AHRI and cUL certification program and listed by UL.

Service. Submit complete information with bid covering service availability to whom service on units will be assigned, along with complete address and phone number, including phone number of emergency service personnel.

Start-Up, Adjust, Demonstrate. Contractor shall be responsible for the initial starting of units, adjustments thereto, etc., to place the units in required operating condition. Contractor shall demonstrate to the owner or his representative the operation of units for both summer and winter functions.

Warranty. The warranty shall be a full one-year parts and labor on the entire unit, plus an additional full four years parts and labor for the sealed refrigerating system, including service call for diagnosis and transportation to and from service shop (if necessary) at no charge to the customer. The warranty shall also include a limited second-through-fifth-year parts-only warranty for fan motors, switches, thermostat, heater, heater protectors, compressor overload, solenoids, circuit boards, auxiliary controls, thermistors, frost controls, ICR pump, capacitors, varistors and indoor blower bearing.

Installation Responsibility. Units shall be installed according to the manufacturer's recommendations and the manufacturer shall not be responsible for unit failure as a result of improper installation, or unit performance when installed with accessories not approved by the manufacturer.

ZONELINE® CHASSIS NOMENCLATURE

The Zoneline chassis is identified by a model number defining the type of unit, cooling capacity, electrical information and optional features included on the unit. When specifying or ordering the Zoneline chassis, use of this nomenclature will assure receiving the correct unit.

EXAMPLE

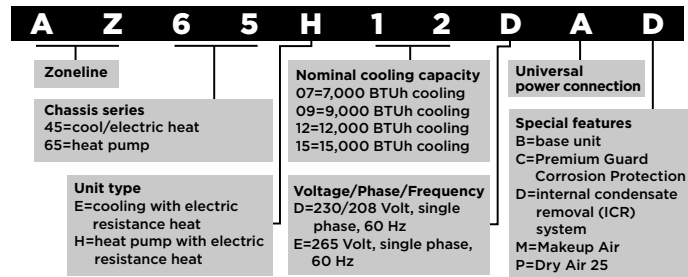

RECEPTACLES/SUB-BASES



TANDEM
230/208V 15 Amp
NEMA6-15R



PERPENDICULAR
230/208V 20 Amp
NEMA6-20R



LARGE TANDEM
230/208V 30 Amp
NEMA6-30R



265V 15 AMP
NEMA7-15R



265V 20 AMP
NEMA7-20R;



265V 30 AMP
NEMA7-30R;

SUB-BASES

	RAK204U	RAK204D15C	RAK204D20C	RAK204D30C	RAK204E15	RAK204E20	RAK204E30
Voltage	N/A	230/208	230/208	230/208	265	265	265
Amps	N/A	15	20	30	15	20	30
Receptacle	N/A	NEMA6-20R	NEMA6-20R	NEMA6-30R	NEMA7-15R	NEMA7-20R	NEMA7-30R

POWER CONNECTION KITS ARE REQUIRED ON ALL ZONELINE CHASSIS (SEE CHART BELOW).

The correct kit for the installation is determined by the voltage and amperage of the electrical circuit and the means of connecting the unit to the building wiring.

Zoneline connection kits now come with “personality plugs.” The black connector carries the power to the unit, but the extra wiring and connector attached to the plug determine the wattage of the heater to be engaged (which should match the breaker feeding the unit). Kits without a personality connector (or if connector is not plugged in) will provide the 15 amp heater values described below. The two-wire connector is for a 20 amp circuit and the four-wire connector is for the 30 amp circuit.

If the unit is to be plugged into a receptacle, a line-cord kit would be used; if the unit is to be permanently connected, a permanent-connection kit would be used. 265 volt cord set units must be installed in compliance with National Electrical Code®.

POWER CONNECTION KITS

Required on all models. See specification sheet for heater KW and branch circuit ampacity.



230/208 VOLT LINE-CORD CONNECTION KIT

DIRECT CONNECT KIT

230/208 VOLT	CORD-CONNECTED (P) & DIRECT-CONNECT UNITS (D)					
	7,000/9,000			12,000/15,000		
POWER CONNECTION KIT	RAK315P & RAK315D	RAK320P & RAK320D	RAK330P & RAK330D *	RAK315P & RAK315D	RAK320P & RAK320D	RAK330P & RAK330D *
Total Watts	2,410/1,990	3,420/2,830	4,830/3,990	2,430/2,020	3,450/2,860	4,860/4,020
Heater Watts	2,400/1,960	3,400/2,780	4,800/3,930	2,400/1,960	3,400/2,780	4,800/3,930
Heater BTU	8,100/6,600	11,600/9,400	16,300/13,400	8,100/6,600	11,600/9,400	16,300/13,400
Total Amps	10.5/9.6	14.9/13.6	21.0/19.2	10.6/9.7	15.1/13.8	21.2/19.3
Min Circuit Amps	15	20	25	15	20	25
Recommended Protective Device	15 amp time-delay fuse or breaker	20 amp time-delay fuse or breaker	30 amp time-delay fuse or breaker	15 amp time-delay fuse or breaker	20 amp time-delay fuse or breaker	30 amp time-delay fuse or breaker

265 VOLT	CORD-CONNECTED (P) & DIRECT-CONNECT UNITS (D)					
	7,000/9,000			12,000/15,000		
POWER CONNECTION KIT	RAK515P / RAK515D	RAK520P / RAK520D	RAK530P / RAK530D *	RAK515P / RAK515D	RAK520P / RAK520D	RAK530P / RAK530D *
Total Watts	2,440	3,450	4,850	2,460	3,470	4,870
Heater Watts	2,400	3,400	4,800	2,400	3,400	4,800
Heater BTU	8,100	11,600	16,300	8,100	11,600	16,300
Total Amps	9.1	12.9	18.1	9.3	13.1	18.4
Min Circuit Amps	15	20	25	15	20	25
Recommended Protective Device	15 amp time-delay fuse or breaker	20 amp time-delay fuse or breaker	25 amp time-delay fuse or breaker	15 amp time-delay fuse or breaker	20 amp time-delay fuse or breaker	25 amp time-delay fuse or breaker

Total watts and total amps include electric heat and fan motor(s)
RAK515P, RAK520P and RAK530P are only to be used with a sub-base
* 30-amp heater wattage is reduced in low fan operation.

AZ45 SERIES SPECIFICATIONS

AZ45 series (typical) cooling with electric heat				
230/208V Models	AZ45E07DAB	AZ45E09DAB	AZ45E12DAB	AZ45E15DAB
Cooling BTUH	7,200/7,000	9,700/9,600	11,900/11,800	14,900/14,800
EER (BTU/Watt)	13.4/13.4	12.1/12.1	11.8/11.8	10.5/10.5
Dehumidification Pts/Hr	1.7	2.7	3.5	4.6
Refrigerant type	R-410A	R-410A	R-410A	R-410A
CFM, indoor fan high	409	409	449	449
CFM, indoor fan low	250	280	270	300
Vent CFM (full open)	33	38	42	47
Power factor	96%	98%	98%	97%
Sensible heat ratio @ 230 volts	70%	64%	60%	63%
Cooling Watts	535/520	800/790	1,010/1,000	1,415/1,405
Cooling Amperes, F.L.	2.5/2.6	3.6/3.9	4.7/5.0	6.4/6.8
Amperes, L.R.	13.5	21.0	29.5	31.5
Weight (Net/Ship)	90/100	103/113	106/116	106/116

AZ45 series cooling with electric heat (Premium Guard Corrosion Protection)									
230/208V Models	AZ45E07DAC	AZ45E09DAC	AZ45E12DAC	AZ45E15DAC	265V Models	AZ45E07EAC	AZ45E09EAC	AZ45E12EAC	AZ45E15EAC
Cooling BTUH	7,200/7,000	9,400/9,300	11,800/11,600	14,600/14,500	Cooling BTUH	7,300	9,500	11,800	14,900
EER (BTU/Watt)	13.4/13.4	11.8/11.8	11.5/11.5	10.5/10.5	EER (BTU/Watt)	13.4	11.6	11.7	10.7
Dehumidification Pts/Hr	1.6	2.7	3.5	4.6	Dehumidification Pts/Hr	1.7	2.7	3.5	4.6
Refrigerant type	R-410A	R-410A	R-410A	R-410A	Refrigerant type	R-410A	R-410A	R-410A	R-410A
CFM, indoor fan high	409	409	449	449	CFM, indoor fan high	409	409	449	449
CFM, indoor fan low	250	280	270	300	CFM, indoor fan low	250	280	270	300
Vent CFM (full open)	33	38	42	47	Vent CFM (full open)	33	38	42	47
Power factor	96%	98%	98%	97%	Power factor	95%	94%	97%	98%
Sensible heat ratio @ 230 volts	74%	64%	60%	63%	Sensible heat ratio @ 265 volts	72%	67%	61%	59%
Cooling Watts	535/520	795/790	1,020/1,005	1,390/1,380	Cooling Watts	540	815	1,005	1,390
Cooling Amperes, F.L.	2.5/2.6	3.5/3.9	4.5/4.9	6.3/6.7	Cooling Amperes, F.L.	2.2	3.3	4.0	5.4
Amperes, L.R.	13.5	21	29.5	31.5	Amperes, L.R.	11.7	16.5	23.5	26.0
Weight (Net/Ship)	90/100	103/113	106/116	106/116	Weight (Net/Ship)	95/105	103/113	106/116	107/117

AZ45 series cooling with electric heat (Dry Air 25)						
230/208V Models	AZ45E07DAP	AZ45E09DAP	AZ45E12DAP	265V Models	AZ45E09EAP	AZ45E12EAP
Cooling BTUH	6,900/6,800	9,400/9,300	11,200/11,100	Cooling BTUH	9,500	11,000
EER (BTU/Watt)	12.8/12.8	12.1/12.1	11.5/11.5	EER (BTU/Watt)	12.1	11.0
Dehumidification Pts/Hr	2.3	3.4	4.2	Dehumidification Pts/Hr	3.5	4.2
Refrigerant Type	R-410A	R-410A	R-410A	Refrigerant type	R-410A	R-410A
CFM, indoor fan high	320	370	360	CFM, indoor fan high	370	360
CFM, indoor fan low	230	280	270	CFM, indoor fan low	280	270
Vent CFM (full open)	40.0	44.0	44	Vent CFM (full open)	44	44
Power factor	96%	97%	98%	Power factor	93%	97%
Sensible heat ratio @ 230 volts	61%	58%	54%	Sensible heat ratio @ 265 volts	58%	54%
Cooling Watts	535/530	775/765	970/960	Cooling Watts	780	995
Cooling Amperes, F.L.	2.5/2.7	3.5/3.8	4.4/4.7	Cooling Amperes, F.L.	3.2	3.9
Amperes, L.R.	13.5	21.0	29.5	Heating Amperes	16.5	23.5
Weight (Net/Ship)	96/106	109/119	112/122	Weight (Net/Ship)	109/119	112/122

AZ45 series cooling with electric heat (makeup air)		
230/208V Models	AZ45E09DAM	AZ45E12DAM
Cooling BTUH	9,200/9,100	11,600/11,500
EER (BTU/Watt)	11.5/11.5	11.4/11.4
Dehumidification Pts/Hr	1.8	3.2
Refrigerant type	R-410A	R-410A
CFM, indoor fan high	409	449
CFM, indoor fan low	280	270
Vent CFM (full open/)	35	35
Power factor	98%	98%
Sensible heat ratio @ 230 volts	78%	69%
Cooling Watts	800/790	1,010/1,005
Cooling Amperes, F.L.	4.8/5.1	5.8/6.1
Amperes, L.R.	21.0	29.5
Weight (Net/Ship)	122/132	125/135

AZ65 SERIES SPECIFICATIONS

AZ65 (typical) series heat pump with backup electric heat (Premium Guard Corrosion Protection)					265V Models					
230/208V Models	AZ65H07DAC	AZ65H09DAC	AZ65H12DAC	AZ65H15DAC	AZ65H07EAC	AZ65H09EAC	AZ65H12EAC	AZ65H15EAC		
Cooling BTUH	7,100/7,000	9,700/9,600	11,900/11,800	14,500/14,200	7,000	9,500	11,900	14,500		
EER (BTU/Watt)	13.0/13.0	12.2/12.2	11.7/11.7	10.4/10.4	12.8	11.7	11.6	10.6		
Dehumidification Pts/Hr	1.6	2.6	3.7	4.8	1.5	2.5	3.7	4.8		
Refrigerant type	R-410A	R-410A	R-410A	R-410A	R-410A	R-410A	R-410A	R-410A		
CFM, indoor fan high	409	409	449	449	409	409	449	449		
CFM, indoor fan low	250	300	300	290	250	300	300	290		
Vent CFM (full open)	38	40	45	44	38	40	45	44		
Power factor	96%	98%	98%	97%	95%	94%	97%	98%		
Sensible heat ratio @ 230 volts	73%	68%	62%	60%	77%	68%	62%	60%		
Cooling Watts	545/535	795/785	1,015/1,005	1,390/1,360	545	810	1,025	1,365		
Cooling Amperes, F.L.	2.5/2.7	3.6/3.9	4.5/4.9	6.2/6.7	2.2	3.3	4.0	5.3		
Amperes, L.R.	13.5	21.0	29.5	31.5	11.7	16.5	23.5	26.0		
Reverse cycle heat BTUH	6,200/6,100	8,100/8,000	10,400/10,300	13,500/13,300	6,200	8,100	10,500	13,500		
Coefficient of Performance	4.0/4.0	3.7/3.7	3.6/3.6	3.3/3.3	3.9	3.6	3.6	3.3		
Heating Watts	450/445	645/630	845/815	1,195/1,180	460	655	875	1,195		
Heating Amperes	2.1/2.2	2.9/3.1	3.8/4.0	5.4/5.7	1.9	2.8	3.5	4.6		
Weight (Net/Ship)	98/108	106/116	104/114	108/118	98/108	104/114	104/114	109/119		

AZ65 series heat pump with backup electric heat (Internal Condensate Removal)					265V Models					
230/208V Models	AZ65H07DAD	AZ65H09DAD	AZ65H12DAD	AZ65H15DAD	AZ65H07EAD	AZ65H09EAD	AZ65H12EAD	AZ65H15EAD		
Cooling BTUH	7,000/6,900	9,600/9,500	11,800/11,600	14,300/14,100	7,000	9,500	11,900	14,300		
EER (BTU/Watt)	13.0/13.0	12.0/12.0	11.5/11.5	10.3/10.3	12.8	11.7	11.7	10.4		
Dehumidification Pts/Hr	1.6	2.6	3.7	4.8	1.5	2.5	3.7	4.8		
Refrigerant type	R-410A	R-410A	R-410A	R-410A	R-410A	R-410A	R-410A	R-410A		
CFM, indoor fan high	409	409	449	449	409	409	449	449		
CFM, indoor fan low	250	300	300	290	250	300	300	290		
Vent CFM (full open)	38.0	40.0	45.0	44.0	38	40	45	44		
Power factor	96%	98%	98%	97%	95%	94%	97%	98%		
Sensible heat ratio @ 230 volts	73%	68%	62%	60%	77%	68%	62%	60%		
Cooling Watts	535/530	800/790	1,020/1,005	1,385/1,360	545	810	1,015	1,375		
Cooling Amperes, F.L.	2.5/2.7	3.6/3.9	4.6/4.9	6.1/6.6	2.2	3.3	4.0	5.3		
Amperes, L.R.	13.5	21.0	29.5	31.5	11.7	16.5	23.5	26.0		
Reverse cycle heat BTUH	6,200/6,000	8,200/8,000	10,400/10,200	13,500/13,400	6,200	8,100	10,500	13,500		
Coefficient of Performance	4.0/4.0	3.6/3.6	3.5/3.5	3.2/3.2	3.9	3.5	3.4	3.2		
Heating Watts	450/435	665/650	870/850	1,235/1,225	460	670	885	1,235		
Heating Amperes	2.1/2.2	3.0/3.2	3.8/4.1	5.3/5.6	1.9	2.8	3.5	4.6		
Weight (Net/Ship)	100/110	108/118	106/116	110/120	98/108	104/114	104/114	111/121		

AZ65 series heat pump with backup electric heat				
230/208V Models	AZ65H07DAB	AZ65H09DAB	AZ65H12DAB	AZ65H15DAB
Cooling BTUH	7,100/6,900	9,700/9,600	12,100/11,900	14,400/14,200
EER (BTU/Watt)	13.0/13.0	12.2/12.2	11.9/11.9	10.6/10.6
Dehumidification Pts/Hr	1.7	2.6	3.7	4.8
Refrigerant type	R-410A	R-410A	R-410A	R-410A
CFM, indoor fan high	409	409	449	449
CFM, indoor fan low	250	300	300	290
Vent CFM (full open)	38	40	45	44
Power factor	96%	98%	98%	97%
Sensible heat ratio @ 230 volts	79%	68%	62%	60%
Cooling Watts	545/530	795/785	1,015/1,000	1,355/1,335
Cooling Amperes, F.L.	2.5/2.7	3.6/3.8	4.5/4.9	6.1/6.5
Amperes, L.R.	13.5	21.0	29.5	31.5
Reverse cycle heat BTUH	6,200/6,100	8,100/8,000	10,500/10,400	13,400/13,300
Coefficient of Performance	4.0/4.0	3.7/3.7	3.6/3.6	3.3/3.3
Heating Watts	450/440	645/630	850/840	1,190/1,180
Heating Amperes	2.1/2.2	3.0/3.2	3.8/4.0	5.2/5.6
Weight (Net/Ship)	98/108	104/114	104/114	107/117

AZ65 series heat pump with backup electric heat (makeup air)			
230/208V Models	AZ65H07DAM	AZ65H09DAM	AZ65H12DAM
Cooling BTUH	6,700/6,600	9,200/9,100	11,500/11,400
EER (BTU/Watt)	12.0/12.0	11.5/11.5	11.2/11.2
Dehumidification Pts/Hr	0.5	1.6	2.8
Refrigerant type	R-410A	R-410A	R-410A
CFM, indoor fan high	409	409	449
CFM, indoor fan low	250	300	300
Vent CFM (full open)	35	35	35
Power factor	98%	98%	98%
Sensible heat ratio @ 230 volts	90%	80%	72%
Cooling Watts	555/550	800/790	1,020/1,010
Cooling Amperes, F.L.	3.8/3.9	4.8/5.1	5.9/6.3
Amperes, L.R.	13.5	21.0	29.5
Reverse cycle heat BTUH	6,100/6,000	8,100/8,000	10,400/10,300
Coefficient of Performance	3.6/3.5	3.5/3.5	3.5/3.5
Heating Watts	485/480	670/655	860/840
Heating Amperes	3.4/3.6	4.3/4.5	5.2/5.4
Weight (Net/Ship)	117/127	123/133	123/133

ACCESSORY LIST

KIT NUMBER	DESCRIPTION	FOR ADDITIONAL INFORMATION REFER TO PAGE
RAA64	Spare Filters for AZ45 and AZ65 (one pair per box)	12
RAB71B	Steel Wall Case - 13-3/4" deep	23
RAB7116B	Steel Wall Case - 16" deep	23
RAB7124B	Steel Wall Case - 24" deep	23
RAB77B	Molded SMC Wall Case	23
RAD10	Interior/Exterior Drain kit	37-38
RAG60	Stamped Aluminum Exterior Grille	42
RAG61	Architectural Exterior Grille, Beige Molded High-Impact Plastic	42
RAG62	Architectural Exterior Grille, Maple Molded High-Impact Plastic	42
RAG63	Architectural Exterior Grille, Dark Brown Chocolate Molded High-Impact Plastic	42
RAG67	Aluminum Architectural Grille (Custom Colors Available by Special Order)	42
RAK40	Condenser Air Deflector Kit	42
RAK148D2	Wall Thermostat For Heat Pump Models - Electronic Digital	18
RAK148P2	Wall Thermostat For Heat Pump Models - Electronic Digital Programmable	18
RAK148F2	Heat Pump digital 2 fan speed remote thermostat	18
RAK164D2	Wall Thermostat For Resistance Heat Models - Electronic Digital	17
RAK164P2	Wall Thermostat For Resistance Heat Models - Electronic Digital Programmable	17
RAK164F2	Cooling with electric heat 2 fan speed digital remote thermostat	17
RAK204D15C	Sub-Base - 208/230-volt with NEMA 6-20R 15/20 Amp Receptacle - Power Cord and Chaseway included	25
RAK204D20C	Sub-Base - 208/230-volt with NEMA 6-20R 15/20 Amp Receptacle - Power Cord and Chaseway included	25
RAK204D30C	Sub-Base - 208/230-volt with NEMA 6-30R 30 Amp Receptacle -Power Cord and Chaseway included	25
RAK204E15	Sub-Base - 265-volt with NEMA 7-15R 15 Amp Receptacle - Chaseway included	25
RAK204E20	Sub-Base - 265-volt with NEMA 7-20R 20 Amp Receptacle - Chaseway included	25
RAK204E30	Sub-Base - 265-volt with NEMA 7-30R 30 Amp Receptacle - Chaseway included	25
RAK204U	Sub-Base - non-electrical - Chaseway not included	25
RAK205CW	Chaseway for Sub-Base	25
RAK315P	Power Cord - AZ45/AZ65 - 15-Amp 230/208 V - 2.40/1.96 kW heat	43
RAK320P	Universal Power Cord - AZ45/AZ65 - 20-Amp 230/208V - 3.4/2.78 kW heat	43
RAK330P	Universal Power Cord - AZ45/AZ65 - 30-Amp 230/208V - 4.8/3.93 kW heat	43
RAK315SP	230/208V Universal power supply, short, 15 amp for 45 & 65 only	25
RAK320SP	230/208V Universal power supply, short, 20 amp for 45 & 65 only	25
RAK330SP	230/208V Universal power supply, short, 30 amp for 45 & 65 only	25
RAK4002C	Direct-Connect Junction Box - 230/208-volt units AZ45/AZ65	44
RAK315D	208//230V Direct Connection Kit, 15 AMP for AZ45/AZ65 - 2.4/1.96 kW heat	44
RAK320D	208//230V Direct Connection Kit, 20 AMP for AZ45/AZ65 - 3.4/2.78 kW heat	44
RAK330D	208//230V Direct Connection Kit, 30 AMP for AZ45/AZ65 - 4.8/3.93 kW heat	44
RAK515D	Direct Connect Kit - 265V - 15 Amp - Use w/RAK204E15 Sub-Base - 2.40 kW heat	44
RAK520D	Direct Connect Kit - 265V - 20 Amp - Use w/RAK204E20 Sub-Base - 3.40 kW heat	44
RAK530D	Direct Connect Kit - 265V - 30 Amp - Use w/RAK204E30 Sub-Base - 4.80 kW heat	44
RAK515P	265V Short Power Connection Kit - Non LCD1, 15 AMP 2.40 kW heat	44
RAK520P	265V Short Power Connection Kit - Non LCD1, 20 AMP 3.40 kW heat	44
RAK530P	265V Short Power Connection Kit - Non LCD1, 30 AMP 4.8 kW heat	44
RAK601B	Duct Extension - Insulated - 44" long - includes Register and Trim Flange	39
RAK602B	Register and Trim Flange (Included with RAK601B)	39
RAK6053	Duct Adapter for New Installation with AZ45/AZ65 Series	39
RAK7013	Duct Adapter for replacement of existing duct system with 8-3/8" x 6-1/2" Duct	42
RAK7023	Duct Transition for replacement of existing duct system with 7-3/32" x 6-1/2" Duct	42
RAKCDC	CDC Wiring Connector for 45 & 65	16, 19
RAKVENT	Manifold Kit added for fresh air intake through the vent door (non-Makeup Air models)	13

SIZING AND CAPACITY CONSIDERATIONS

COOLING

Room air conditioner sizing is all about matching the room size to the air conditioner size. Since air conditioners remove both heat and humidity from the air, a unit that is too large, will cool the room before it has a chance to remove the humidity. The result will be a room that's not very comfortable – cool, but feeling damp and clammy. Most musty odors in rooms are due to excess humidity. Using a smaller-capacity unit or using Dry Air 25 units will provide better dehumidification. The largest factor in causing mold and mildew in the room is excess moisture. A smaller unit running longer or a Dry Air 25 model can remove more moisture. Mold behind wall coverings that do not allow water vapor to pass through—vinyl wallpaper or oil-based paints, for example—is not a problem of excessive moisture in the room, but rather is caused by moisture trapped in the walls.

Since larger capacity units typically are louder, oversized air conditioners also create guest complaints due to the noise and short cycling.

HEATING

Using a resistance heater larger than required—using a 4.8 kW heater when a 3.4 kW heater would suffice, for example—may not cost any more in electrical consumption since the larger heater will operate, for less time. The “demand charge” portion of the utility bill—which is based on the highest electrical load for a period of time—may be a significant portion of the utility bill. Some customers have reported the demand charge actually being more than the usage charge. In a 100-room property it would be possible for the demand of the 4.8 kW heater versus a 3.4 kW heater to be 140 kW more than the demand charge if the lower wattage heaters were used. Working with the utility companies to understand their method of billing and taking advantage of any rebates they may offer can reduce the utility bill.

A heat load analysis should be performed to determine the heating and cooling load required for the space in question. How much heat is coming into the space that the air conditioner must remove and how much heat is lost during the winter months that must be replaced. The heat load analysis takes many factors into play, including cubic footage of space, location and construction type/materials. Getting the right size means getting the comfort and the energy efficiency right.

KEY TERMS

Capacity - The capacity of an air conditioner is measured by the amount of cooling it can do when running continuously. The total capacity is the sum of the latent capacity (ability to remove moisture from the air) and sensible capacity (ability to reduce the dry-bulb temperature). Each of these capacities is rated in BTUs per hour (Btu/h).

Air conditioner capacity is rated per AHRI 310/380 conditions at 95°F drybulb and 75°F wetbulb outside with an inside temperature of 80°F drybulb and 67°F wetbulb.

LATENT SYSTEM CAPACITY

The total capacity of an air conditioner is made up of the sensible capacity (the output of the unit used to remove heat from the air in the area being conditioned) and the latent capacity (the output of the unit used to dehumidify the air in the area being conditioned). For humid climates and applications, the sensible/latent capacity split of the unit should be considered.

The latent system capacity is 1.00 minus the sensible capacity. (If the sensible capacity is listed at 74% the latent capacity is 26%. This means that 74% of the capacity of the unit is used to remove heat from the air and 26% is used to remove moisture from the air at standard test conditions.)

Latent Cooling Load - The net amount of moisture added to the inside air by plants, people, cooking, infiltration, and any other moisture source. The amount of moisture in the air can be calculated from a combination of dry-bulb and wet-bulb temperature measurements.

Sensible Cooling Load - The heat gain of the home due to conduction, solar radiation, infiltration, appliances, people, and pets. Burning a light bulb, for example, adds only sensible load to the house. This sensible load raises the dry-bulb temperature.

Dry-bulb Temperature - The temperature measured by a standard thermometer.

Wet-bulb Temperature - When a wet wick is placed over a standard thermometer and air is blown across the surface, the water evaporates and cools the thermometer below the dry-bulb temperature. This cooler temperature (called the wet-bulb temperature) depends on how much moisture is in the air.

EER - The Energy Efficiency Ratio is the efficiency of the air conditioner. It is capacity in BTUs per hour divided by the electrical input in watts.

GENERAL INSTALLATION SUGGESTIONS

Many times poor or non-existent caulking around the exterior of the wall case results in air infiltration, causing the unit to run excessively. One way to check for air infiltration is to look under and around the unit to the outdoors. If you can see light, there is air infiltration. The first floor of a building is where this problem most frequently occurs since caulking the bottom of the wall case may require lying outside in the dirt while working. This has been the cause of many complaints about the “short cycling” of the unit.

Curtains, furniture or other obstructions interfering with the discharge air circulation will make the unit cycle/turn off too soon since the cooled (or heated) discharge air is pulled back into the unit. This results in a room that is not adequately heated or cooled.

Blocking the discharge air on the unit during the heating operation can result in the unit overheating or shutting off prematurely. In some cases it is recommended that a “tent card” be used advising room occupants not to put anything on the unit.

ELECTRICAL WIRING INSTALLATION

Do not allow the installer to drill a hole in the wall case to run the electrical wiring. If this is done, the wiring will have to be run between the chassis and the edge of the wall case so it can be connected to the unit wiring on the room side of the wall case. When the chassis is removed for servicing or cleaning, the insulation on the wires can be cut and can create a safety hazard.

If the electrical connection on a 230-volt or 208-volt installation is to be made by the line cord plugged into a wall-mounted receptacle, the receptacle should be located in the wall under the case or close to the side of the wall case. This installation makes a much neater appearance than a line cord running a foot or more across the floor. The electrician may want to place the receptacle as far from the unit as possible to save a few feet of wiring without considering how the installation may appear.

CENTRAL DESK CONTROL AND REMOTE THERMOSTAT WIRING

Do not allow the installer to drill a hole in the wall case to run Central Desk Control (CDC) wiring or remote thermostat wiring to the unit terminals. CDC and remote thermostat wiring is classified as low-voltage wiring and does not have to be run in conduit unless required by local code. CDC and remote thermostat wiring should be run in the walls and exit the wall under the wall case about 2" from the right-hand side. The base pan is designed with a clearance for the line cord and the low-voltage wiring can also be run to the chassis in this area. Wire molding can be used to hold the wiring close to the bottom of the wall case.

If a sub-base is used, the wiring can be run through the sub-base, entering the rear and exiting through one of the front panels. When the room cabinet is in place, the CDC or remote thermostat wiring is usually not visible to someone standing or sitting in the room.

Do not run the low-voltage wiring in conduits with line-voltage wiring or near uninsulated line-voltage wiring since induced current can interrupt the low-voltage controls.

Consult the electrical inspector early in the project, especially if the power to the air conditioner is to be 265 volts, to understand what is required to comply with local electrical codes.

WALL CASE/EXTERIOR GRILLE

When making an installation where the exterior grille is flush with the exterior wall, or part of a custom window/louver section, make sure the installer caulks the wall case to the exterior wall, especially the bottom of the case. Many times the air conditioners are run during construction and the building is not closed. This can result in excessive humidity from the warm humid air entering the building, or from the “drying out” of the building materials. Many problems have been caused by condensate water or rainwater running back into the building where proper caulking has not been done.

EXTERIOR GRILLES

When replacing an older unit, the existing outdoor grille may need to be changed or modified. Outdoor airflow patterns have changed and this may dictate the need for outdoor grille replacement or modification.

If using an existing non-GE exterior grille, special attention must be paid to ensuring the air deflectors are in the proper locations on the exterior grille. Otherwise they should be removed and replaced with new RAK40 deflectors on the back of the chassis.

NOTE: *Heater wattages are reduced in duct mode (see page 39).*

DUCTED INSTALLATION COMMENTS

Anytime a duct extension is used, it is required to go into the auxiliary controls and turn on the duct mode feature. This will boost the fan speeds to allow for proper air circulation for ducted applications.

NOTE: *Heater wattages are reduced in duct mode (see page 39).*

NEW INSTALLATIONS

The GE Zoneline® AZ45 and AZ65 Series are approved for ducted installation using the GE Duct Adapter model RAK6053 and the GE Duct Extension RAK601B. A field-fabricated duct extension with the same interior measurements as the RAK601B may be used with the RAK6053 duct adapter. GE does not allow ducting in more than one direction.

The use of a duct adapter other than the RAK6053 is not approved by GE Appliances and may cause problems such as inadequate airflow to the secondary room or the unit shutting off on one of the overload devices.

Failure to allow for adequate air return from the secondary room is often the cause of less than satisfactory performance of a ducted installation.

REPLACEMENT INSTALLATIONS

GE offers duct adapters to allow for easy replacements of previous-design chassis in ducted installations where a GE duct adapter was used in the original installation. A duct adapter is available that will align with the duct extension when GE-built components were used in the original installation.

The duct adaptor/extension used from the early 1960s until late 1987 was **8-3/8" high by 6-1/2" wide**. If the chassis to be replaced uses this size duct, use the duct adapter model RAK7013 with the new product to match up to the existing duct extension. This means the duct extension will not have to be changed.

However, to keep the cost of the replacement to a minimum there are components that will need to be taken off the existing installation and reused on the RAK7013 duct adapter. Therefore, save all parts from the existing setup until after the installation is complete. It is important that those parts not be discarded until the new installation is complete.

If the existing duct dimensions are **7-3/32" high by 6-1/2" wide**, the RAK7023 transition piece is required to install an AZ45 or AZ65 Series unit in the ducted installation.

There were a number of Zoneline units installed in ducted installations that did not use a GE duct adapter. The easiest way to determine if the existing duct adapter is a GE duct adapter is to compare the duct adapter dimensions to the dimensions above. If the dimensions are different from the dimensions above or if the duct adapter is not made of sheet metal, it is not a GE duct adapter. In such installations, GE recommends the removal of the old duct adapter and duct extension and the installation of a RAK6053 duct adapter and a RAK601B duct extension. Zoneline units installed in installations not using GE duct adapters and an extension with the same cross-section dimensions as the duct adapter may not be covered by the warranty.

ZONELINE WARRANTY

FOR THE PERIOD OF	GE APPLIANCES WILL REPLACE
ONE YEAR <i>From the date of the original purchase</i>	Any part of the air conditioner which fails due to a defect in materials or workmanship. During this limited one-year warranty , GE will provide, free of charge , all labor and related service costs to replace the defective part.
FIVE YEARS <i>From the date of the original purchase</i>	Sealed Refrigerating System , if any part of the Makeup Air Module or Sealed Refrigerating System (the compressor, condenser, evaporator, and all connecting tubing) should fail due to a defect in materials or workmanship. During this limited five-year warranty , GE will provide, free of charge , all labor and related service costs to replace the defective part.
SECOND THROUGH FIFTH YEAR <i>From the date of the original purchase</i>	Fan Motors, Switches, Thermostat, Heater, Heater Protectors, Compressor Overload, Solenoids, Circuit Boards, Auxiliary Controls, Thermistors, Freeze Sentinel, Frost Controls, ICR Pump, Capacitors, Varistors and Indoor Blower Bearing , if any of these parts should fail due to a defect in materials or workmanship. During this additional four-year limited warranty , the customer will be responsible for any labor and related service costs.

*See written warranty for details

ALPHABETICAL INDEX

Accessory List	53
Application Comments	22
Auxiliary Control Settings	14–15
Case Dimensions	23–24
Central Desk Control	16
Condensate Disposal Systems	36–38
Ducted Installations	39–42
Dry Air 25	10
Exterior Grilles	42–43
Features and Benefits	11–13
Features Table	8
General Installation Suggestions	55–56
Heat Pumps and Energy Savings	20–21
Introduction to Zoneline Units	6
Makeup Air	9
Mini Specs AZ45 Series	2
Mini Specs AZ65 Series	3
Nomenclature	4, 50
Normal Yearly Operating Data	46
Power Connection Kits	43–45, 50
Remote Thermostat Control	17–19
Reverse Cycle Defrost	21
Sizing and Capacity Considerations	54
Specifications	51–52
Suggested Bid Form Specifications	48–49
Table of Contents	5
Wall Case/Sub-Base Installation	24–35
Warranty	56
Wiring Diagram/Schematics	47
Zoneline System	7

Colors may vary slightly due to printing process.



Beige



Maple

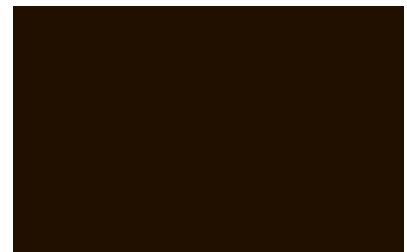

Dark Brown



GE APPLIANCES

GE is a trademark of the General Electric Company.
Manufactured under trademark license.

Appliance Park
Louisville, KY 40225
zonline.com | 888.231.2548
Pub. No. 20-S0046 PC84434