

**DIESEL GENERATOR
MMG330DI4 • MMG480DI4**

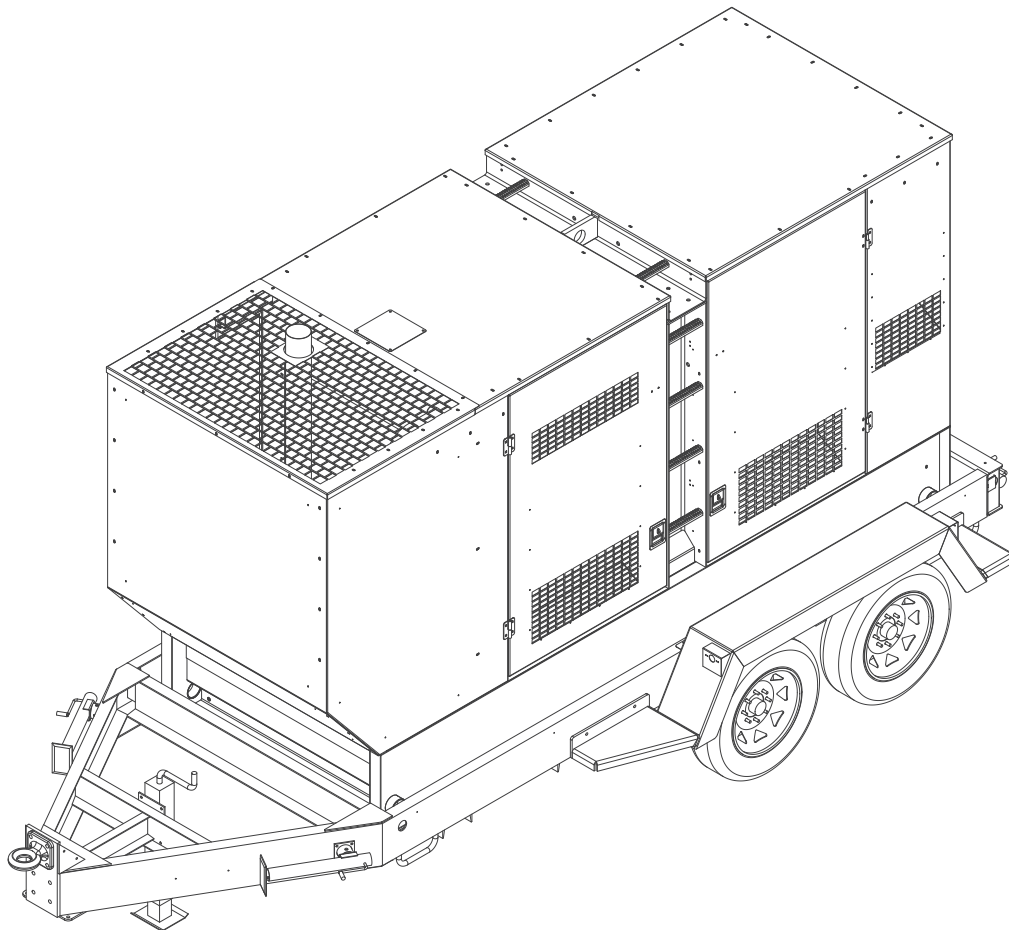

OPERATING MANUAL

⚠ WARNING

CALIFORNIA PROPOSITION 65 WARNING: Diesel engine exhaust and some of its constituents are known to the state of California to cause cancer, birth defects, and other reproductive harm. (000004)

⚠ WARNING

CALIFORNIA PROPOSITION 65 WARNING: This product contains or emits chemicals known to the state of California to cause cancer, birth defects, and other reproductive harm. (000005)

⚠ WARNING

ENVIRONMENTAL HAZARD: Always recycle batteries at an official recycling center in accordance with all local laws and regulations. Failure to do so could result in environmental damage, death or serious injury. (000228)

Introduction

This manual provides information and procedures to safely operate and maintain the Generac Mobile Products unit. For your own safety and protection from physical injury, carefully read, understand, and observe the safety instructions described in this manual. Keep a copy of this manual with the unit at all times. Additional copies are available from Generac Mobile Products, or can be found at www.generacmobile.com. *The information contained in this manual was based on machines in production at the time of publication. Generac Mobile Products reserves the right to change any portion of this information without notice.*

Read all of the manuals included with the unit. Each manual details specific information regarding items such as setup, use and service requirements. An engine operator's manual provides detailed operation and maintenance procedures for the engine. Additional copies of the engine operator's manual are available from the engine manufacturer.

DO NOT MODIFY or use this equipment for any application other than for which it was designed.

Only a trained and licensed electrician should perform wiring and connections to unit. Wiring must be in compliance with National Electrical Code (NEC), state and local regulations, as well as Occupational Safety and Health Administration (OSHA) guidelines.

GENERAC MOBILE PRODUCTS LLC

215 Power Drive • Berlin, WI 54923

U.S.A.

Phone: 920-361-4442

FAX: 920-361-4416

Toll Free: 1-800-926-9768

www.generacmobile.com

For technical or parts QUESTIONS, please contact the Generac Mobile Products Technical Service team at 1-800-926-9768. Please have your serial number available.

To ORDER SERVICE PARTS, please contact the dealer from which you purchased the unit, or call Generac Mobile Products to locate a dealer in your area.

Engine Make: _____

Engine Serial Number: _____

Engine Model Number: _____

Generator Make: _____

Generator Model Number: _____

Generator Serial Number: _____

Unit Model Number: _____

Unit Serial Number: _____

This Page Intentionally Left Blank

Table of Contents

Section 1 - Safety

Safety Notes	1
Operating Safety.....	1
Engine Safety	2
Service Safety	2
Towing Safety.....	2
Reporting Trailer Safety Defects	3
Safety Symbol Summary	4

Section 2 - General Information

Specifications	5
Unit Dimensions	7
Unit Serial Number Locations	8
Component Locations (MMG330 Shown)	9
Control Panel - MMG330DI4	10
Control Panel - MMG480DI4	11
Power Zone™ Controller	12
Controller Features and Functions	12
Operator Screens	12
Alarm Mute	12
Auto/Manual Mode	12
Navigation Buttons	13
Control Power Switch	13
Engine Start.....	13
Engine Stop/Reset.....	13
Operator Screens	13
Home Screen.....	13
Engine Screen	14
Generator Screen	14
Voltage Adjust Screen	15
Maintenance Screens	15
Generator Summary	16
Engine Tab	16
Generator Tab	16
Alarms Tab	17
Input/Output Tab.....	18
Status Tab	19
Generator Monitoring.....	19
Generator Screen	19
Generator Tab - Maintenance Screens	20
Engine Monitoring.....	20
Engine Operator Screen.....	20
Engine Tab - maintenance Screens	20
Diesel Exhaust Filter Monitoring.....	21
Power Zone™ Controller Information Displays, Functions, And Reset	22
Belt Tension.....	22
Changing Output Voltage	22
Control Panel Receptacles	24
Derating for Altitude	24
Remote Start Terminal Block.....	24

Section 3 - Operation

Pre-Start Checklist.....	25
Manual Starting of the Generator	25
Automatically Starting The Generator	26

Accessing the Configuration Menu	27
“Auto” (Remote) Starting of the Generator	27
Generator Output Connection Lugs.....	27
Fine Voltage Adjustment	28
Voltage Regulation	29
Main Circuit Breaker	29
Exhaust Filter Cleaning Operations.....	30
Transfer Switch.....	30
Auto Exercise Timer	31
Schedule Tab	32
Set the Controller Clock.....	32
Set the Schedule	32
Set the Unit to Auto Mode	33
Shutting Down the Generator	33
Emergency Stop Switch	34
Disable Automatic (Auto) Exhaust Filter Cleaning.....	34
Force a Manual Exhaust Filter Cleaning	34
Enable Exhaust Filter Cleaning	34
Power Zone™ Controller Information Displays, Functions, And Reset.....	35
Towing The Trailer.....	35
Lifting The Generator.....	35
Section 4 - Maintenance	
Emissions Information	37
Daily Walk Around Inspection.....	37
Engine And Generator Maintenance	37
Engine Break-In Requirements	39
Resetting The Maintenance Alarms	39
Exhaust Filter Service Requirements	40
Checking Generator Drive Plate Torque	40
Jack Maintenance.....	40
Side-wind models	40
Top-wind models	41
Trailer Wheel Bearings	41
Section 5 - Troubleshooting	
Section 6 - Wiring Diagrams	
AC Wiring - MMG330DI4.....	45
AC Wiring - MMG480DI4.....	46
AC Wiring - 4 Position Voltage Selector Switch Option (MMG330DI4 only)	47
AC Wiring Diagrams for Optional Equipment	48
DC Wiring Diagram.....	49
DC Wiring Diagrams for Optional Equipment.....	50
Wiring Block Diagram - Dedicated 12 Lead Generators Option	51
Trailer Wiring Diagram.....	52
Wiring Harness - Electric Brake Option	53
Section 7 - Options & Accessories	
Generator Cam Lock Connections Option.....	55
Auxiliary Fuel Tank Option	56
Fuel Transfer Pump Option	57
Viscous Fan Clutch Option	57

Section 1 - Safety

SAFETY NOTES



This is the safety alert symbol. It is used to alert you to potential personal injury hazards. Obey all safety messages that follow this symbol to avoid possible injury or death.

This manual contains DANGERS, WARNINGS, CAUTIONS, NOTICES and NOTES which must be followed to prevent the possibility of improper service, damage to the equipment, personal injury or death. The following formatting options will apply when calling the readers attention to the DANGERS, WARNINGS, CAUTIONS, NOTICES and NOTES.

▲ DANGER

INDICATES A HAZARDOUS SITUATION WHICH, IF NOT AVOIDED, WILL RESULT IN DEATH OR SERIOUS INJURY.

▲ WARNING

Indicates a hazardous situation which, if not avoided, could result in death or serious injury.

▲ CAUTION

Indicates a hazardous situation which, if not avoided, could result in minor or moderate injury.

NOTICE

Indicates a hazardous situation which, if not avoided, could result in property or equipment damage.

Note: Notes contain additional information important to a procedure and will be found within the regular text body of this manual.

OPERATING SAFETY



Before using the unit, be sure you read and understand all of the instructions. This equipment was designed for specific applications; **DO NOT** modify or use this equipment for any application other than which it was designed for. Equipment operated improperly or by untrained personnel can be dangerous. Read the operating instructions and familiarize yourself with the location and proper use of all instruments and controls. Inexperienced operators should receive instruction from someone familiar with the equipment before being allowed to operate or set up the unit. The following points should be practiced at all times:

- The area immediately surrounding the unit should be dry, clean, and free of debris.
- Position and operate the unit on a firm, level surface.
- **DO NOT** start a unit in need of repair.
- If the unit is equipped with a frame grounding stud, follow any local, state, and National Electrical Code (NEC) guidelines when connecting.
- **DO NOT** operate the unit on a combustible surface.
- **DO NOT** operate a unit while tired, distracted, or under the influence of drugs or alcohol.
- Keep all body parts, clothing and other loose items away from moving parts.

ENGINE SAFETY



Internal combustion engines present special hazards during operation and fueling. Failure to follow the safety guidelines described below could result in severe injury or death. Read and follow all safety warnings described in the engine operator's manual. A copy of this manual was supplied with the unit when it was shipped from the factory.

- **DO NOT** run engine indoors or in an area with poor ventilation. Engine exhaust contains carbon monoxide, a deadly, odorless and colorless gas which, if inhaled, can cause nausea, fainting or death. Make sure engine exhaust cannot seep into closed rooms or ventilation equipment.
- **DO NOT** touch or lean against hot exhaust pipes or engine components.
- **DO NOT** clean air filter with gasoline or other types of low flash point solvents.
- **DO NOT** operate the unit without a functional exhaust system.
- Prolonged exposure to sound levels in excess of 85 dB(A) can cause permanent hearing loss. Wear hearing protection when working around a running engine.
- Batteries contain sulfuric acid which can cause severe injury or death. Sulfuric acid can cause eye damage, burn flesh or eat holes in clothing. Protective eye wear and clothing are necessary when working on or around the battery. Always disconnect the negative (-) battery cable from the corresponding terminal before performing any service on the engine or other components.

SERVICE SAFETY



All service work must be performed by qualified personnel who are familiar with the equipment. Only a qualified electrician should troubleshoot or repair electrical problems occurring in this equipment. Follow the safety guidelines described below to prevent hazardous situations which could result in severe injury or death.

- **DO NOT** wash the unit with high pressure hoses, power washers, or steam cleaners. Water may collect in the unit, causing damage to electrical parts.
- **ALWAYS** use extreme caution when servicing this unit in damp conditions. Do not service the unit if your skin or clothing is wet. Do not allow water to collect around the base of the unit.
- Replace all missing and hard to read decals. Decals provide important operating instructions and warn of dangers and hazards.

TOWING SAFETY



Towing a trailer requires care. Both the trailer and vehicle must be in good condition and securely fastened to each other to reduce the possibility of an accident. Some states require that large trailers be registered and licensed. Contact your local Department of Transportation office to check on license requirements for your particular unit.

- Verify the hitch and coupling on the towing vehicle are rated equal to, or greater than, the trailer's Gross Vehicle Weight Rating (GVWR).
- Check trailer tires for wear and proper inflation.
- **DO NOT** tow trailer using defective parts. Inspect the hitch and coupling for wear or damage.
- Verify the trailer hitch and the coupling are compatible. Make sure the coupling is securely fastened to the vehicle.
- Verify directional and brake lights on the trailer are connected and working properly.
- Verify wheel lug nuts are present and tightened to the specified torque.
- Maximum recommended speed for highway towing is 45 mph (72 km/h). Recommended off-road towing speed is 10 mph (16 km/h) or less, depending on terrain.

- When towing, maintain extra space between vehicles and avoid soft shoulders, curbs and sudden lane changes. Practice turning, stopping and backing up in an area away from heavy traffic prior to transporting the unit.
- Wipe the coupler clean and apply fresh grease each time the trailer is towed to eliminate squeaking.

REPORTING TRAILER SAFETY DEFECTS

If you believe your trailer has a defect which could cause a crash or could cause injury or death, you should immediately inform the National Highway Traffic Safety Administration (NHTSA) in addition to notifying Generac Mobile Products LLC.

If NHTSA receives similar complaints, it may open an investigation; and if it finds that a safety defect exists in a group of vehicles, it may order a recall and remedy campaign. However, NHTSA cannot become involved in an individual problem between you, your dealer, or Generac Mobile Products LLC.























To contact NHTSA, you may either call the Auto Safety Hotline toll-free at 1-888-327-4236 (TTY:1-800-424-9153), go to <http://www.safercar.gov>; or write to:

Administrator
NHTSA
1200 New Jersey Avenue S.E.
Washington, DC 20590

You can also obtain other information about motor vehicle safety from <http://www.safercar.gov>.

SAFETY SYMBOL SUMMARY

The safety and operating decals affixed to the unit provide important instructions and warn of dangers and hazards. Replace any missing or hard-to-read decals and use care when washing or cleaning the unit. Decal placement and part numbers can be found in the online parts manual at www.generacmobile.com. Below is a summary of the intended meanings for the symbols used on the decals.

 Safety alert symbol; used to alert you to potential hazards.	 Asphyxiation hazard; operate in well ventilated area.	 Belt/entanglement hazard; keep body parts clear of this area.
 Hot surface(s) nearby.	 Burn/scald hazard; pressurized steam.	 Never change phase switch position while engine is running.
 Dangerous voltage may be present.	 Anchor/tie down point.	 Do not remove guard.
 Check diesel fuel fill level.	 Disconnect battery before servicing.	 Fire/explosion hazard; keep open flames away from unit.
 Read and understand the operator's manual before operating.	 Unit electrical ground.	 Lift here only.
 Stop engine.	 Isolate generator to prevent electrocution hazard.	 Never change switch position while engine is running.
 Battery is disconnected.	 Automatic Start.	 Fan hazard; keep body parts clear of this area.
 Engine running.	 Force Exhaust Regeneration.	

01879

Figure 1-1. Decal Safety Symbol Summary

Section 2 - General Information

SPECIFICATIONS

GENERAC MODEL	MMG330DI4	MMG330DI4 Super Start
Engine		
Make/Brand.....	John Deere	John Deere
Model	PE609HFG95.....	PE609HFG95
Horsepower - prime hp (kW)	396 (295).....	396 (295)
Horsepower - standby hp (kW)	440 (328).....	440 (328)
Operating Speed rpm	1800	1800
Displacement in³ (L)	549 (9.0).....	549 (9.0)
Cylinders - qty	6	6
Fuel Consumption - 100% prime gph (Lph)	18.7 (70.8).....	18.7 (70.8)
Battery Type.....	Group 31	Group 31
Battery Voltage (Quantity per Unit)	12V (2)	12V (2)
Battery Rating	1000 CCA.....	1000 CCA
Generator		
Make/Brand.....	Marathon Electric	Marathon Electric
Model	432PSL6210	433PSL6220
Type, Insulation.....	Brushless, H.....	Brushless, H
Generator Set (Engine/Generator)		
3Ø - Standby kW (kVA)	290 (363).....	294 (367)
Amps - 3Ø Standby 480V (208V) A	437 (1008).....	441 (1019)
3Ø - Prime kW (kVA)	263 (329).....	263 (329)
Amps - 3Ø Prime 480V (208V) A	396 (913).....	396 (913)
1Ø - Standby kW (kVA)	N/A	N/A
Amps - 1Ø Standby - 240V A	N/A	N/A
1Ø - Prime kW (kVA)	N/A	N/A
Amps - 1Ø Prime - 240V A	N/A	N/A
Frequency Hz	60	60
Power Factor.....	0.8 (3Ø).....	0.8 (3Ø)
Weights		
Dry Weight, Skid Mounted lbs (kg)	9447 (4285).....	10007 (4539)
Operating Weight, Skid Mounted lbs (kg)	12907 (5854).....	13467 (6109)
Dry Weight, Trailer Mounted lbs (kg)	12320 (5588).....	12880 (5842)
Operating Weight, Trailer Mounted lbs (kg)	15780 (7158).....	16340 (7412)
Capacities		
Fuel Tank Volume gal (L)	459 (1738).....	459 (1738)
Usable Fuel Volume gal (L)	423 (1601).....	423 (1601)
Coolant (incl. engine) qt (L)	75.0 (70.9).....	75.0 (70.9)
Maximum Run Time hrs	23	23
AC Distribution		
Circuit Breaker Size	1200	1200
Voltage Selection	Link/Reconnect Board.....	Link/Reconnect Board
Voltage Regulation.....	+/- 1%.....	+/-1%
Voltages Available 1Ø	N/A	N/A
Voltages Available 3Ø	208, 480	208, 480
Trailer		
Number of Axles.....	2	2
Capacity - Axle Rating lbs (kg)	8000 (3629).....	8000 (3629)
Tire Size in	17.5	17.5
Brakes.....	Electric	Electric
Hitch - Standard	3" Ring	3" Ring
Maximum Tire Pressure psi	125	125

Specifications are subject to change without notice.

General Information

GENERAC MODEL	MMG480DI4
Engine	
Make/Brand.....	John Deere
Model	RG6135HFG95
Horsepower - prime hp (kW)	571 (426)
Horsepower - standby hp (kW)	634 (472)
Operating Speed rpm	1800
Displacement in³ (L)	824 (13.5)
Cylinders - qty	6
Fuel Consumption - 100% prime gph (Lph)	28.4 (107.6)
Battery Type	Group 31
Battery Voltage (Quantity per Unit)	24V (2-12V)
Battery Rating	1000 CCA
Generator	
Make/Brand.....	Marathon Electric
Model	433PSL6220
Type, Insulation.....	Brushless, H
Generator Set (Engine/Generator)	
3Ø - Standby kW (kVA)	419 (524)
Amps - 3Ø Standby 480V (208V) A	630 (1454)
3Ø - Prime kW (kVA)	379 (474)
Amps - 3Ø Prime 480V (208V) A	570 (1316)
1Ø - Standby kW (kVA)	N/A
Amps - 1Ø Standby - 240V A	N/A
1Ø - Prime kW (kVA)	N/A
Amps - 1Ø Prime - 240V A	N/A
Frequency Hz	60
Power Factor.....	0.8 (3Ø)
Weights	
Dry Weight, Skid Mounted lbs (kg)	12690 (5756)
Operating Weight, Skid Mounted lbs (kg)	17130 (7770)
Dry Weight, Trailer Mounted lbs (kg)	15940 (7230)
Operating Weight, Trailer Mounted lbs (kg)	20380 (9244)
Capacities	
Fuel Tank Volume gal (L)	616 (2332)
Usable Fuel Volume gal (L)	573 (2169)
Coolant (incl. engine) qt (L)	95.5 (90.4)
Maximum Run Time hrs	20
AC Distribution	
Circuit Breaker Size	1600
Voltage Selection	Link/Reconnect Board
Voltage Regulation	+/-1%
Voltages Available 1Ø	N/A
Voltages Available 3Ø	208, 480
Trailer	
Number of Axles.....	3
Capacity - Axle Rating lbs (kg)	8000 (3629)
Tire Size in	17.5
Brakes.....	Electric
Hitch - Standard	3" Ring
Maximum Tire Pressure psi	125

Specifications are subject to change without notice.

Unit Dimensions

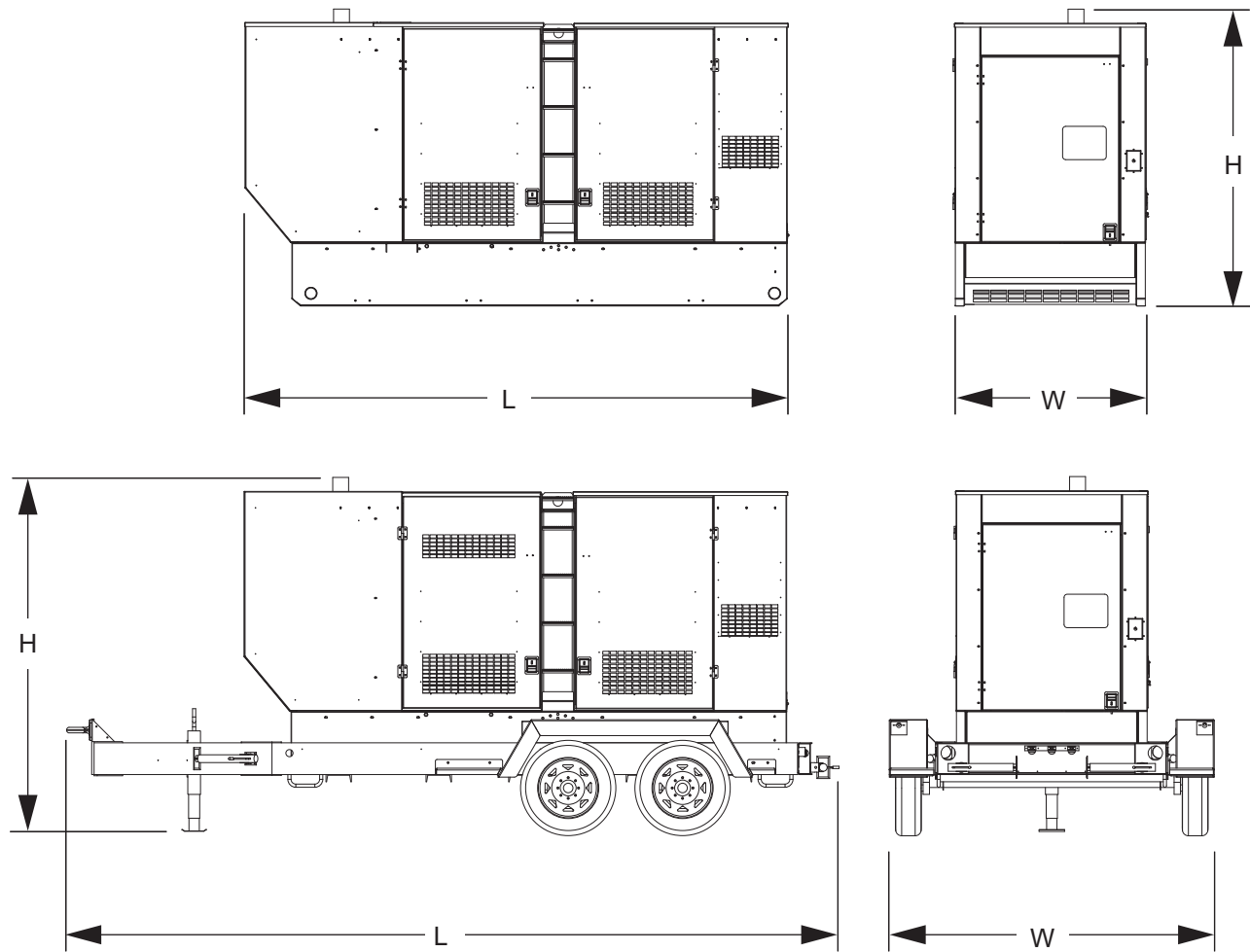

Figure 2-1. Unit Dimensions

		L	W	H
MGG330	Skid Mounted	171 in (4.35 m)	60 in (1.52 m)	90 in (2.29 m)
	Trailer Mounted	230 in (5.84 m)	102 in (2.59 m)	110 in (2.79 m)
MGG480	Skid Mounted	175 in (4.45 m)	60 in (1.52 m)	96 in (2.44 m)
	Trailer Mounted	250 in (6.35 m)	102 in (2.59 m)	116 in (2.95 m)

Specifications are subject to change without notice.

UNIT SERIAL NUMBER LOCATIONS

See **Figure 2-2** to locate the unit ID tag and Vehicle Identification Number (VIN) tag on the unit. Important information, such as the unit serial number, model number, VIN and tire loading information are found on these tags. Record the information from these tags so it is available if the tags are lost or damaged. When ordering parts or requesting assistance, you may be asked to provide this information.

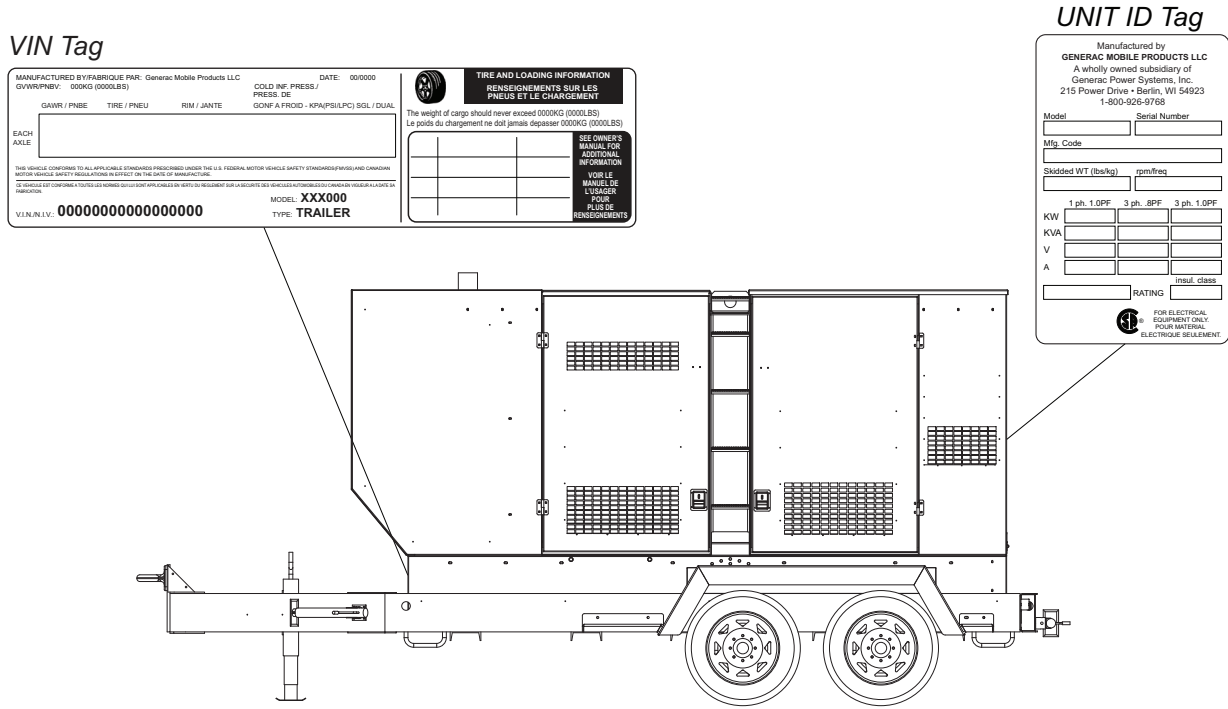
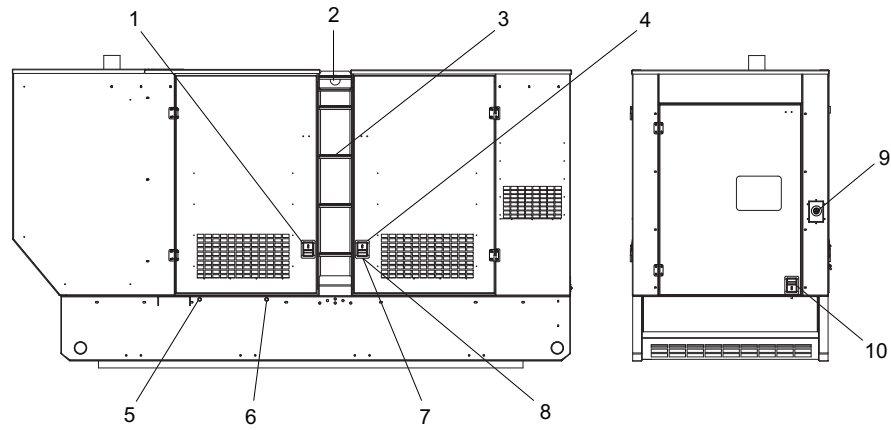

Figure 2-2. Serial Number Locations

COMPONENT LOCATIONS (MMG330 SHOWN)



*MMG480 control panel is accessible from the rear side of the unit.

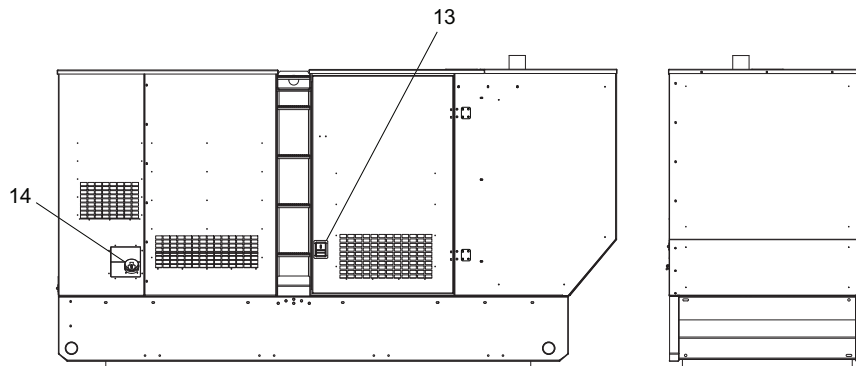
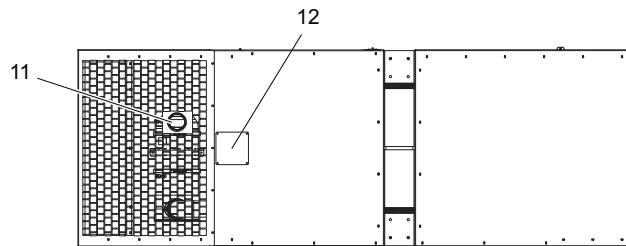

Figure 2-3. Component Locations

- | | |
|------------------------|---------------------------|
| 1. Engine access | 8. Reconnect board access |
| 2. Central lift point | 9. Emergency stop |
| 3. Ladder | 10. Control panel access |
| 4. Generator Access | 11. Engine exhaust |
| 5. Radiator drain port | 12. Radiator access panel |
| 6. Oil drain port | 13. Engine service access |
| 7. Engine battery | 14. Fuel fill |

CONTROL PANEL - MMG330DI4

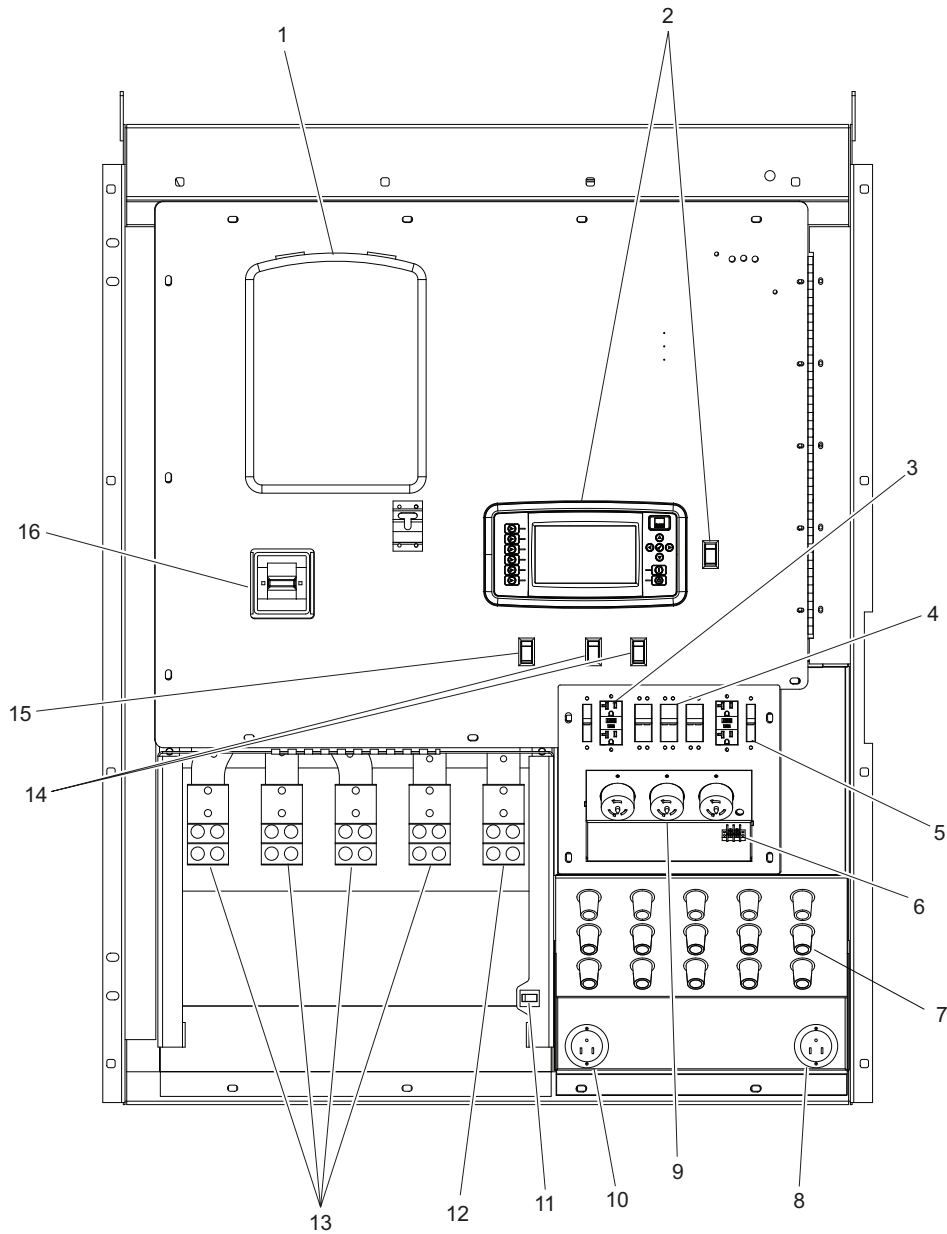

Figure 2-4. Control Panel Component Locations

- | | |
|--|---|
| 1. Document holder | 9. 120/240V twist-lock receptacles (3) |
| 2. Power Zone™ controller | 10. Connection for engine block heater (optional) |
| 3. 120V GFCI duplex receptacles (2) | 11. Door safety switch |
| 4. 50A circuit breakers (3) | 12. Output ground connection |
| 5. 20A circuit breakers (2) | 13. Connection terminal lugs |
| 6. Remote start terminal block | 14. Auxiliary light switches (optional) |
| 7. Optional cam lock connectors (15) | 15. Diesel exhaust filter cleaning switch |
| 8. Connection for battery charger (optional) | 16. Main circuit breaker for connection lugs |

CONTROL PANEL - MMG480DI4

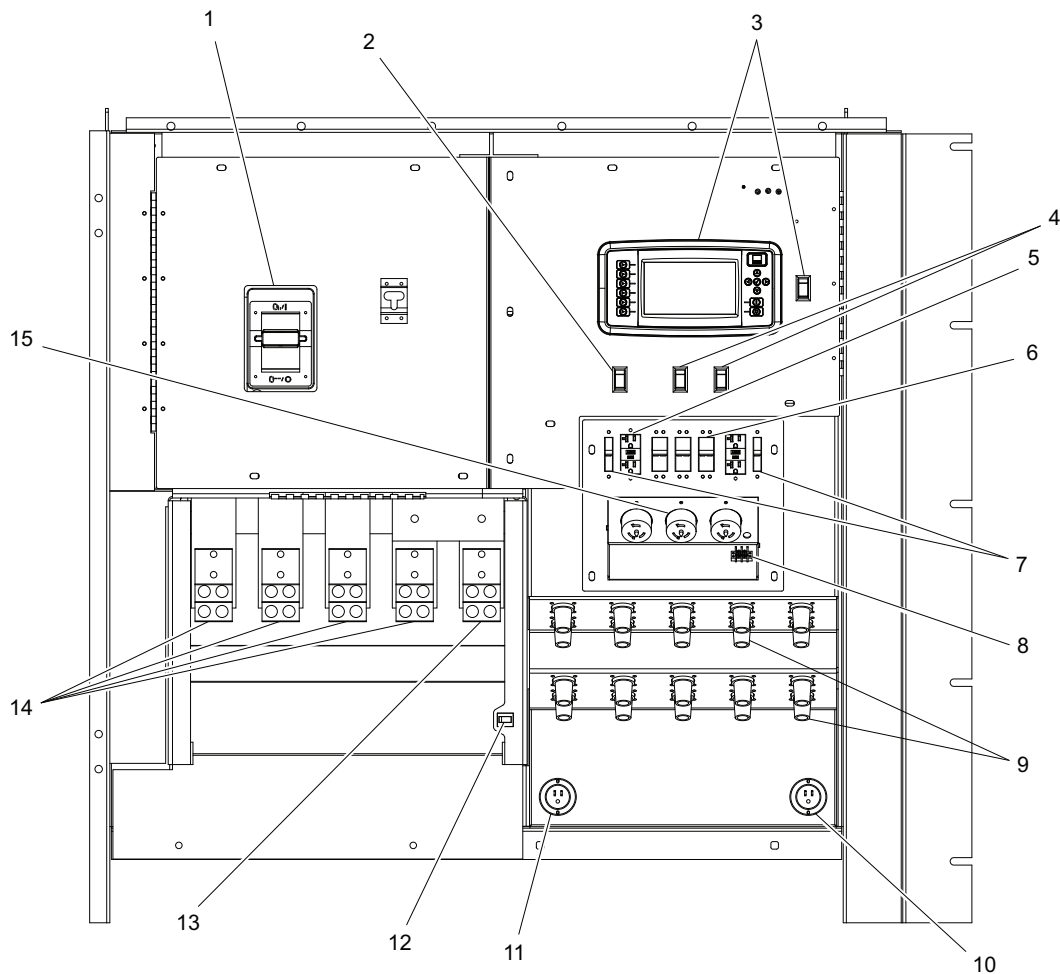

Figure 2-5. Control Panel Component Locations

- | | |
|---|---|
| 1. Main circuit breaker for connection lugs | 9. Cam lock connectors (20) (optional) |
| 2. Diesel exhaust filter cleaning switch | 10. Connection for battery charger (optional) |
| 3. Power Zone™ controller | 11. Connection for engine block heater (optional) |
| 4. Auxiliary light switches (optional) | 12. Door safety switch |
| 5. 120V gfcı duplex receptacles (2) | 13. Output ground connection |
| 6. 50A circuit breakers (3) | 14. Connection terminal lugs |
| 7. 20A circuit breakers (2) | 15. 120/240V twist-lock receptacles (3) |
| 8. Remote start terminal block | |

POWER ZONE™ CONTROLLER

The Power Zone™ controller is an auto start controller that monitors the unit and indicates operational status and fault conditions. The controller can be programmed to automatically start or stop on based time schedule, fault condition, or load demand.

The controller constantly monitors vital generator and engine functions for a number of pre-programmed alarm and fault conditions. When a fault condition occurs, the engine can be shut down automatically and the main display will show the fault that caused the shut down; to resume operation, the fault condition must be resolved.

This controller also records a history of unit performance which may be viewed at any time and will not be lost when the controller is powered down.

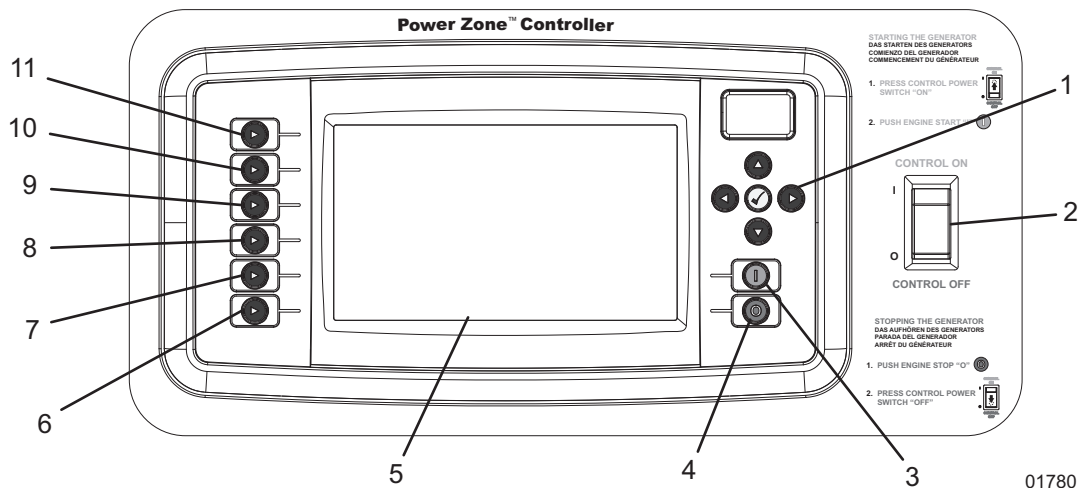

Figure 2-6. Power Zone™ Controller Layout

- | | |
|-------------------------------|-------------------|
| 1. Navigation buttons | 7. Alarm mute |
| 2. Control power switch | 8. Voltage adjust |
| 3. Engine start (manual mode) | 9. Generator |
| 4. Engine stop/reset | 10. Engine |
| 5. Main display | 11. Home |
| 6. Auto/manual mode | |

CONTROLLER FEATURES AND FUNCTIONS

Operator Screens

See [Operator Screens](#) for more information.



Alarm Mute

The Alarm Mute button silences the audible alarm. Additional action will be required to fully disable the active alarm.



Auto/Manual Mode

The Auto/Manual mode button is used to change the startup and shutdown modes of the unit. When pressed once, the unit enters "Manual Mode" and when pressed and held for five seconds, the unit enters "Auto Mode". If in "Auto Mode", pressing once will return the unit to "Manual Mode".



Navigation Buttons

These buttons are used to navigate and interact with the Power Zone™ controller screens. Pressing any directional arrow (“▲”, “▶”, “▼”, “◀”) while on any of the operator screens will open the maintenance screens, and navigate the tabs and pages within the maintenance screens. The Enter “✓” button is used to select menus, confirm alarms, and confirm altered settings.

Control Power Switch

Use this switch to start up and shut down the Power Zone™ controller. This switch should not be turned off when the unit is running.

Engine Start

Pressing the Engine Start “I” button while the controller is in “Manual Mode” will start the unit, provided there are no shutdown errors, and the engine satisfies the start status. If the controller is in “Auto Mode”, the engine start button has no effect.

Engine Stop/Reset

Pressing the Engine Stop/Reset “O” button will shut down the unit and put the controller into Stop Mode, whether in “Manual Mode” or “Auto Mode”.

▲ CAUTION

In case of an emergency, always press the “EMERGENCY STOP” switch located on the side of the unit to stop the engine immediately. The Engine Stop/Reset “O” button may delay the engine shutdown if stop faults exist.

NOTICE

To prevent damage to the generator and connected equipment, remove all loads from the generator by opening all circuit breakers (turn to “OFF/O”) before pressing the Engine Stop/Reset “O” button.

OPERATOR SCREENS

The operator screens display the most relevant and critical information an operator will need to properly configure and utilize a unit. From these four screens the operator can access engine, generator and power transmission information necessary to operate the unit under normal conditions.

Home Screen

The Home screen is the default screen of the controller and will display after the controller is powered up and the unit management software is loaded. It displays a live readout of the kW meter, percent of load used (gauge), selected phase, volts and amps being produced by the generator, and the fuel level with time until empty. The controller will automatically return to this screen from any other screen after a period of inactivity.

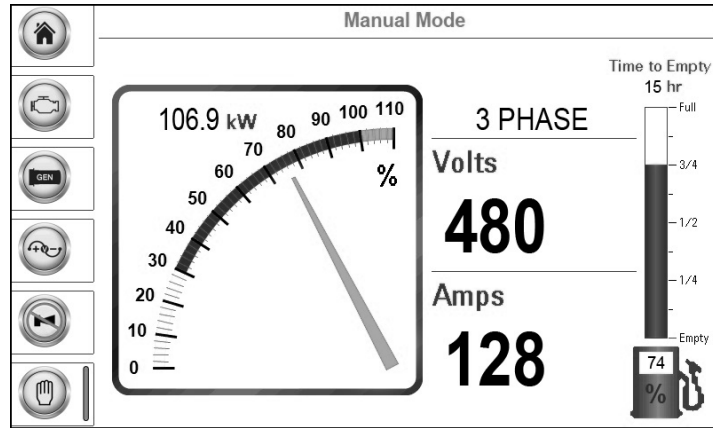

Figure 2-7. Home Screen

Engine Screen

The Engine screen displays the oil pressure, coolant temperature and battery voltage on three main gauges. Below the gauges is an hour gauge displaying the total run time on the engine. This screen also displays maintenance alarm status with the time remaining (black text) or the time past (red text) of scheduled maintenance tasks.

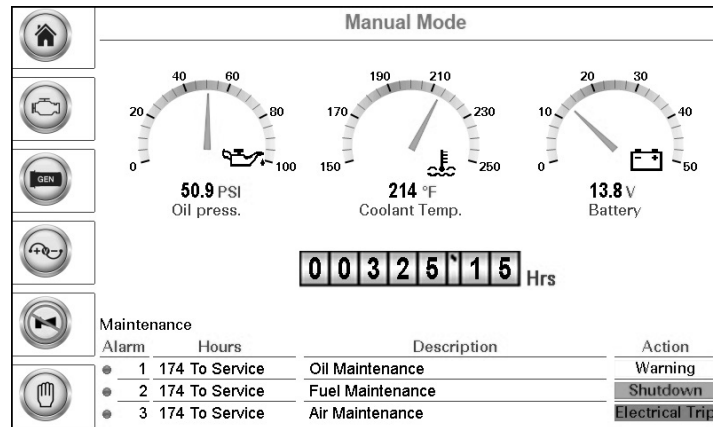

Figure 2-8. Engine Screen

Generator Screen

The Generator screen displays the average voltage frequency, volts and amps from the generator, as well as line-to-line voltage, and individual line-to-neutral voltage, amperage and power (kW). This screen also displays the generator winding configuration set by the voltage selector switch in the lower right corner.

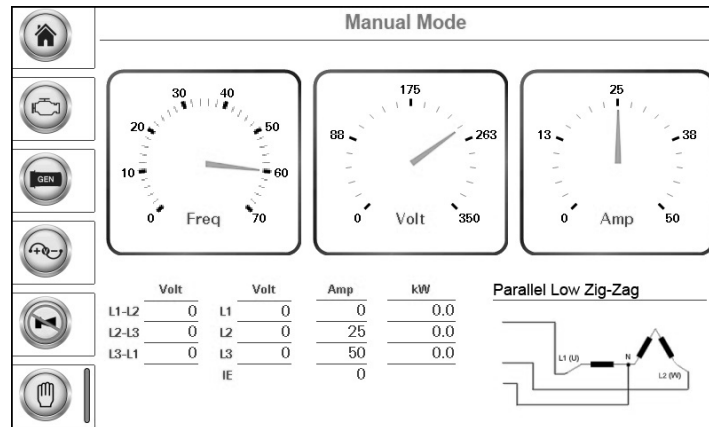

Figure 2-9. Generator Screen

Voltage Adjust Screen

The Voltage Adjust screen displays the line-to-neutral and line-to-line voltage averages. The operator can electronically adjust the voltage within limits to prevent under-voltage or over-voltage conditions using the on-screen instructions. This feature replaces a traditional potentiometer. See [Power Zone™ Controller Information Displays, Functions, And Reset](#) for more information.

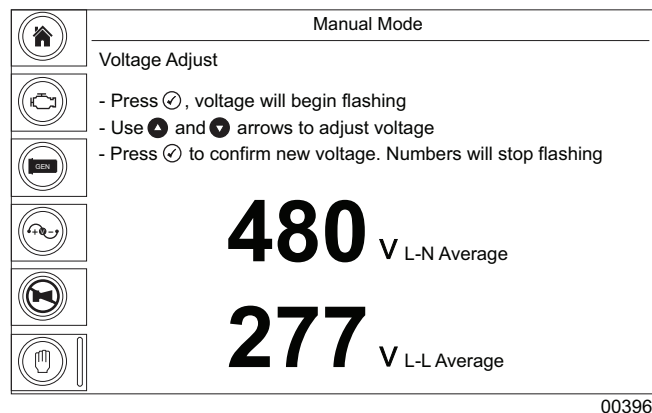

Figure 2-10. Voltage Adjust Screen

MAINTENANCE SCREENS

All of the data inputs from the engine, generator, alarms, inputs/outputs connected to the Power Zone™ controller, schedule and Power Zone™ controller status are visible on the maintenance screens.

The information displayed on the maintenance screens can be used to identify, diagnose and troubleshoot unit shutdown conditions and poor unit performance. The maintenance screens can be accessed from any Operator screen by pressing any directional arrow ("▲", "▶", "▼", "◀").

Generator Summary

The Generator Summary can be found at the top of all maintenance screens and provides an overview of the system.

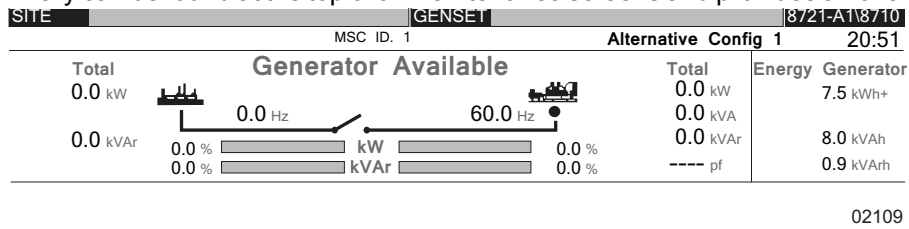

Figure 2-11. Generator Summary Screen

The bottom of the screens have a list of available tabs, with the currently displayed tab highlighted in blue. To the left of the tabs, the current/available pages are displayed. Whenever a new tab is selected, the current page will always be page 1.

Engine Tab

The “Engine” tab contains maintenance and instrumentation data gathered from the engine itself.

The content may change, depending upon the selected engine and the features supported by the engine.

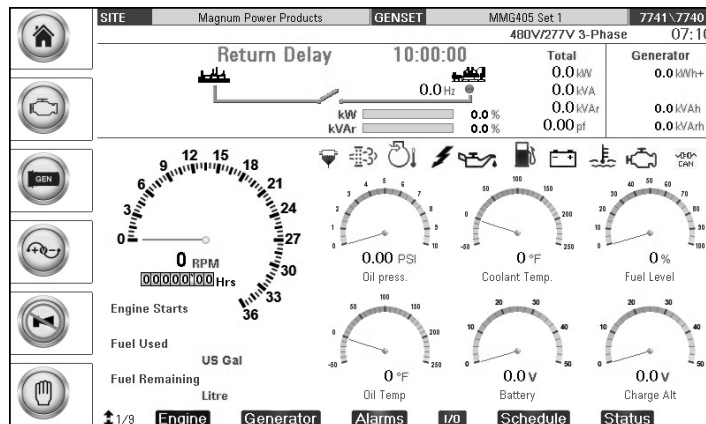

Figure 2-12. Engine Tab Screen

Generator Tab

The “Generator” tab contains maintenance and instrumentation data gathered from the generator and electrical sensing components within the unit.

The content may change, depending upon the selected generator and the features supported by the generator.

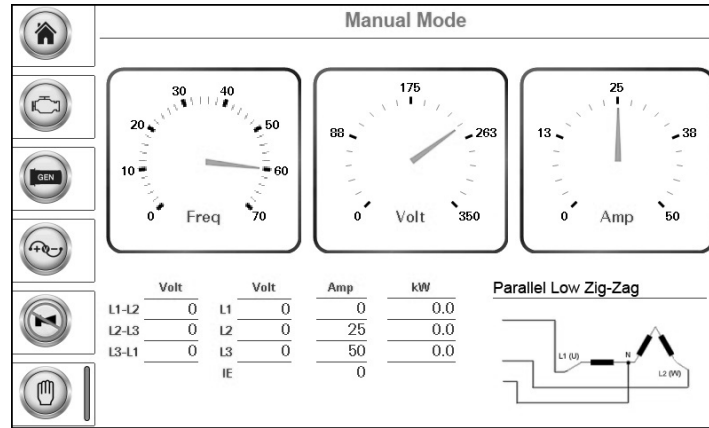

Figure 2-13. Generator Tab Screen

Alarms Tab

The “Alarms” tab displays warnings, electrical trip and shutdown alarms, and engine Diagnostic Trouble Codes (DTC) that are occurring or have occurred previously. The first page on the “Alarms” tab displays the alarms that are currently active. They are organized by alarm type.

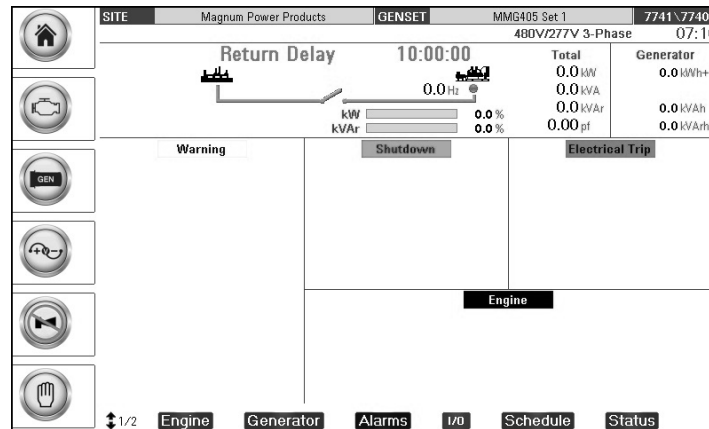

Figure 2-14. Alarms Tab Screen

Alarm Level	Color - Background/Text	Graphic
Warning	Yellow/Black	Warning
Electrical Trip	Purple/Black	Electrical Trip
Shutdown	Red/Black	Shutdown
ECU Code	Blue/White	Engine

The second page of the “Alarms” tab shows the event log with a list of events, including normal operation events and alarm notifications, with the most recent events at the top of the list. All indexed events include the date and time of the event, hours of runtime on the engine when it occurred, along with the event name or alarm type and details.

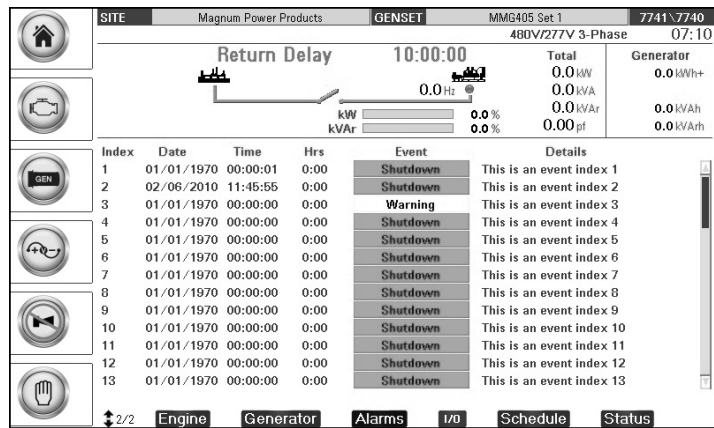

Figure 2-15. Alarms Tab Screen - Second Page

To scroll down within the event log, press the Enter “✓” button. The scroll bar will change to blue, signifying it is active. Press the “▲” or “▼” buttons to scroll up or down in the event log. When finished, press the Enter “✓” button again.

Input/Output Tab

The Input/Output (“I/O”) tab shows a list of digital inputs and outputs connected to the controller, whether they are active, and the current state of the input.

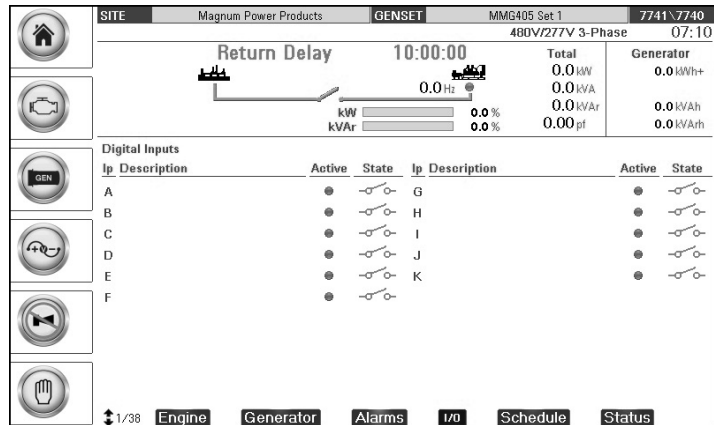

Figure 2-16. Input/Output Tab Screen

Status Tab

The “Status” tab contains the status and configuration of the controller, firmware and data connections.

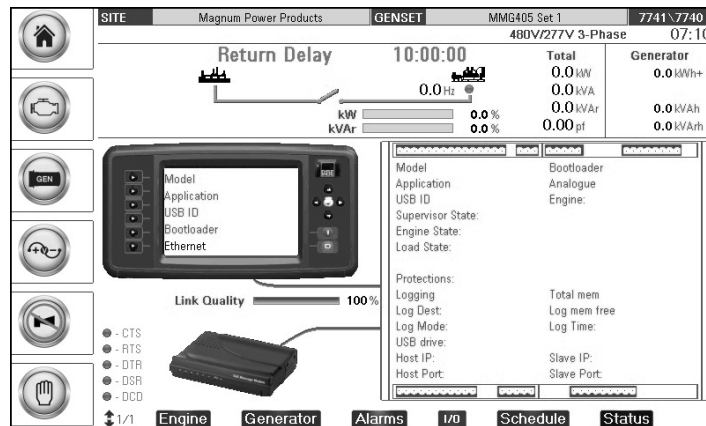

Figure 2-17. Status Tab Screen

GENERATOR MONITORING

Generator information is displayed on both the Generator screen and “Generator” tab within the maintenance screens.

Generator Screen

The Generator screen displays the average voltage frequency, volts and amps from the generator, as well as line-to-line voltage, and individual line-to-neutral voltage, amperage and power (kW). This screen also displays the voltage selector switch current setting.

When loading the generator, it is important to observe the amperage to determine the load balance on each line of the generator. Minor load imbalances, usually ten percent or less, will not cause problems. Every effort should be made to distribute the load equally between all lines.

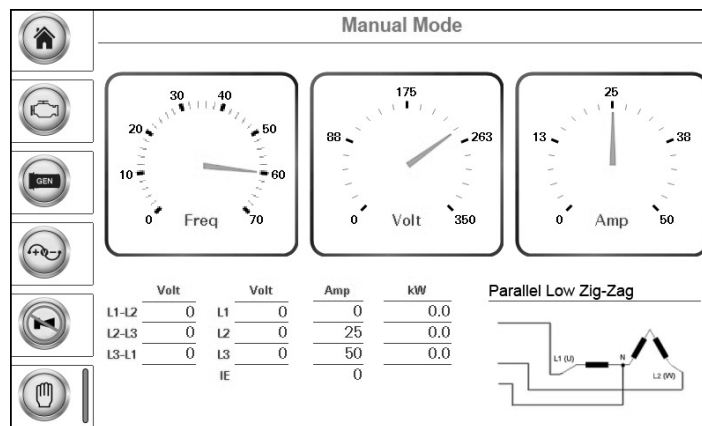

Figure 2-18. Generator Screen

- **Freq:** Displays the output frequency in Hertz (Hz). Normal operating frequency is 60 Hz.
- **Volts:** Displays the nominal voltage in Volts (V).
- **Amps:** Displays the AC output amperage produced by the generator in Amps (A).

Additional information can be found on the electric power table at the bottom left side of the screen. This provides an overview of all three lines and average voltage and amperage readouts.

Generator Tab - Maintenance Screens

Additional generator information can be viewed on the maintenance screens by pressing the left or right arrow and highlighting the “Generator” tab. See [Maintenance Screens](#) for more information.

ENGINE MONITORING

Engine information is displayed on both the Engine screen and “Engine” tab within the maintenance screens.

Engine Operator Screen

The Engine Operator screen displays the oil pressure, coolant temperature and battery voltage from the engine on the three main gauges. Total run time is displayed below the three main gauges on the hour meter and the maintenance configuration status at the bottom of the screen.

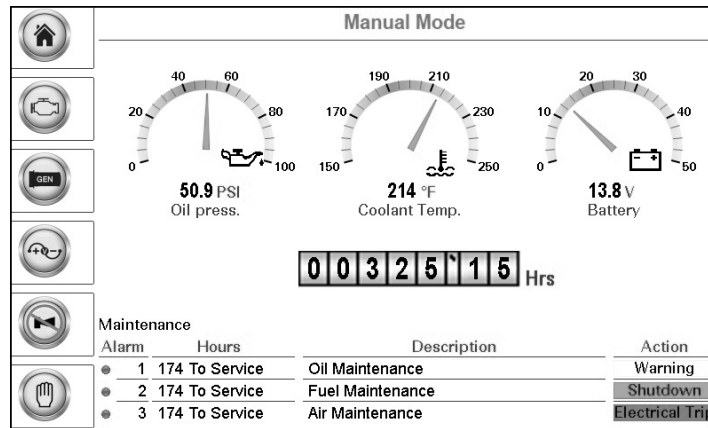

Figure 2-19. Engine Operator Screen

The maintenance configuration status displays upcoming maintenance procedures in black text, and past due maintenance in red text. A description of the maintenance procedure and the action will take place when the timer trips the alarm.

If the measured value is outside the range of a gauge, the needle will not be displayed. The digital value below the gauge will still show the measured value.

- **Oil Press:** Displays engine oil pressure. Current coolant temperature is displayed directly below the gauge at all times. The gauge registers oil pressure between 0-100 psi (10-689 kPa). Normal operating pressure is between 35-80 psi (241-552 kPa).
- **Coolant Temp:** Displays engine coolant temperature. Current coolant temperature is displayed directly below the gauge at all times. The gauge displays coolant temperature between 150°-250°F (66°-121°C). Normal operating temperature of the unit is between 180°-200°F (82°-93°C) with an average ambient air temperature of 70°F (21°C).
- **Battery:** Displays engine battery voltage. Current battery voltage is displayed directly below the gauge at all times. The gauge displays battery voltage between 0-50V. A normal reading is 12-14V on 12 volt systems and 24-26V on 24 volt systems (with the engine running).

Engine Tab - maintenance Screens

Additional engine information can be viewed on the maintenance screens by pressing the left or right arrow and highlighting the “Engine” tab. See [Maintenance Screens](#) for more information.

DIESEL EXHAUST FILTER MONITORING

This unit is equipped with a Diesel Particulate Filter (DPF) to meet current EPA emissions standards. This section gives an explanation of the indicators that are displayed on the “DPF Status” screen on the Power Zone™ controller. Diesel particulate filter information can be found on the “Engine” tab within the maintenance screens.

To access the DPF Status page, press any direction arrow (“▲”, “▶”, “▼”, “◀”) to enter the maintenance screens, and then press the “▼” directional arrow on the “Engine” tab to toggle through pages until the “DPF Status” page appears. There are four areas on the “DPF Status” screen that communicate various information to the operator. The areas and indicators that appear in those areas are explained here:

- HEST Lamp (High Exhaust System Temperature):** This area will display the Regeneration Underway indicator above the words “HEST Lamp - Solid” when the unit is in the process of diesel exhaust filter regeneration. During the regeneration process, the exhaust temperature will be very high.

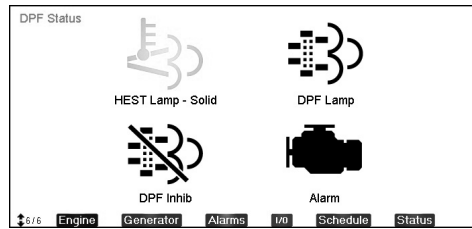

Figure 2-20. Regeneration Underway Indicator

- DPF Lamp:** This area will display the Regeneration indicator above the words “DPF Lamp - Solid” when auto exhaust filter cleaning is enabled. When the unit is being operated with auto exhaust filter cleaning disabled, the indicator will begin to flash above the words “DPF Lamp -Flashing” if the soot load level goes above 80%.

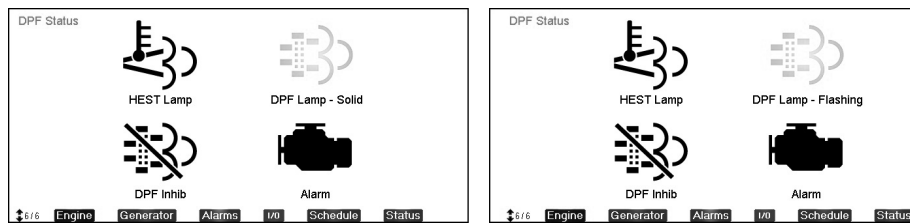

Figure 2-21. Regeneration Indicator

- DPF Inhib:** This area will display the Disabled Regeneration indicator above the words “DPF Inhib - Solid” when auto exhaust filter cleaning is disabled.

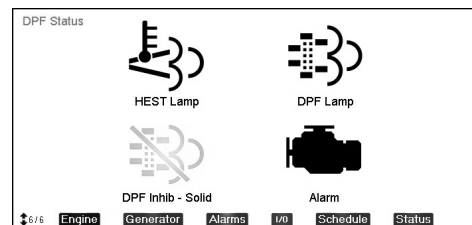

Figure 2-22. Disabled Regeneration Indicator

- **Alarm:** This area will display the Engine Alarm indicator above the words “Alarm - Solid” when an alarm condition occurs. This area displays different text, depending upon which alarm condition occurs.

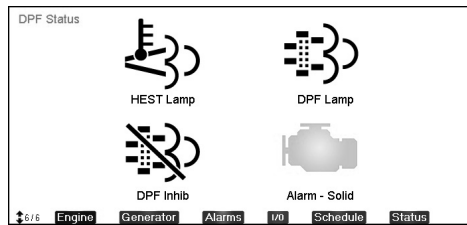

Figure 2-23. Engine Alarm Indicator

For more information on the operation of auto exhaust filter regeneration and service regeneration, see [Exhaust Filter Cleaning Operations](#).

POWER ZONE™ CONTROLLER INFORMATION DISPLAYS, FUNCTIONS, AND RESET

The Power Zone™ controller constantly monitors vital generator and engine functions for a number of operation, alarm and fault conditions. When a fault condition occurs, the engine will shut down automatically and the main display will show the fault that has caused the shutdown. To resume operation, the fault condition must be resolved. To reset the controller and resume operation, press the Enter “✓” button.

BELT TENSION

John Deere engines use manual and automatic belt tensioners. Adjust the belt using the manual tensioner according to the manufacturer’s specifications. The automatic tensioner cannot be adjusted or repaired and is designed to maintain proper tension over the life of the belt. Units with the automatic belt tensioner must be inspected according to the manufacturer’s specifications.

CHANGING OUTPUT VOLTAGE

The output voltage can be changed by moving the shorting (link) board in the generator reconnect box. The reconnect box is located on top of the generator. Before attempting to change the output voltage, shut the generator down and make sure that the main circuit breaker and the control power switch are “OFF/O”.

⚠ DANGER

**NEVER ATTEMPT TO CHANGE THE VOLTAGE WHILE THE ENGINE IS RUNNING.
LETHAL VOLTAGE MAY BE PRESENT AT THE CONNECTION LUGS ON THE SHORT-
ING (LINK) BOARD.**

To receive 480/277 3Ø voltage at the connection lugs, the shorting (link) board must be attached in the lower position as shown in the illustration. For 208/120 3Ø voltage, the shorting (link) board must be in the upper position as shown in the illustration. If the board needs to be changed from one setting to the other, remove all of the 1/2” nuts that hold the shorting (link) board down and move it to the new position. Replace all of the hardware and tighten it to 25 ft-lbs (583 Nm) of torque.

Reinstall the reconnect box door and start the generator by following the [Pre-Start Checklist](#).

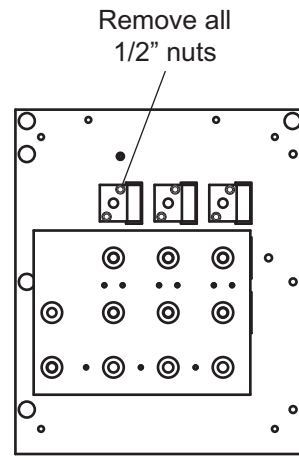
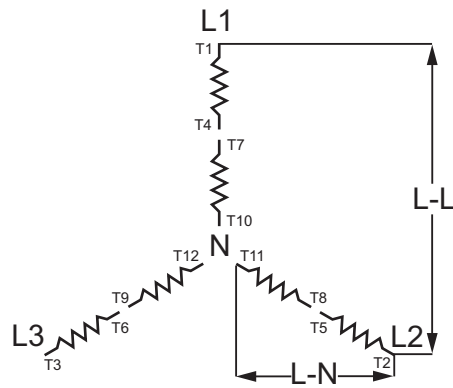

Link Board Attached in 480 Volt 3Ø Position

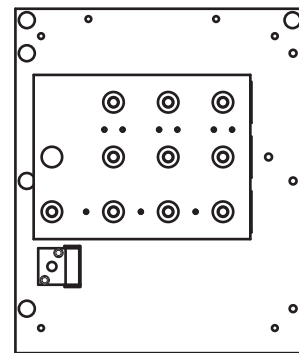
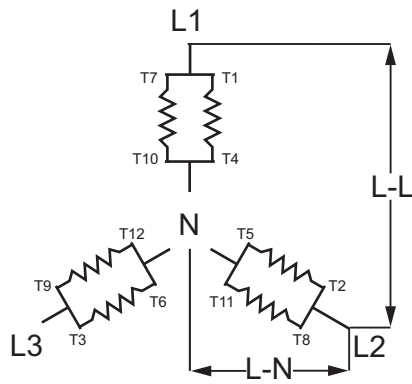

Link Board Attached in 208 Volt 3Ø Position

Figure 2-24. Link Board

CONTROL PANEL RECEPTACLES

The generator is equipped with five receptacles. The large receptacles are 120/240VAC twist-lock receptacles rated at 50A each. The smaller receptacles are 120VAC duplex receptacles rated at 20A each with Ground Fault Circuit Interrupt (GFCI) protection. These receptacles are not routed through the main circuit breaker. Each receptacle has its own circuit breaker, located directly above or next to the receptacle. Each breaker is sized to the maximum rating of the corresponding receptacle.

NOTICE

Power to the receptacles is available any time the generator is running, **EVEN IF THE MAIN CIRCUIT BREAKER IS "OFF/O," VERIFY ANY EQUIPMENT CONNECTED TO THE RECEPTACLES IS TURNED OFF BEFORE TURNING THE BREAKERS ON.** Verify the voltage selector switch is in the proper position and the output voltage is correct for the equipment connected to the receptacles. Improper voltage may cause equipment damage or malfunction.

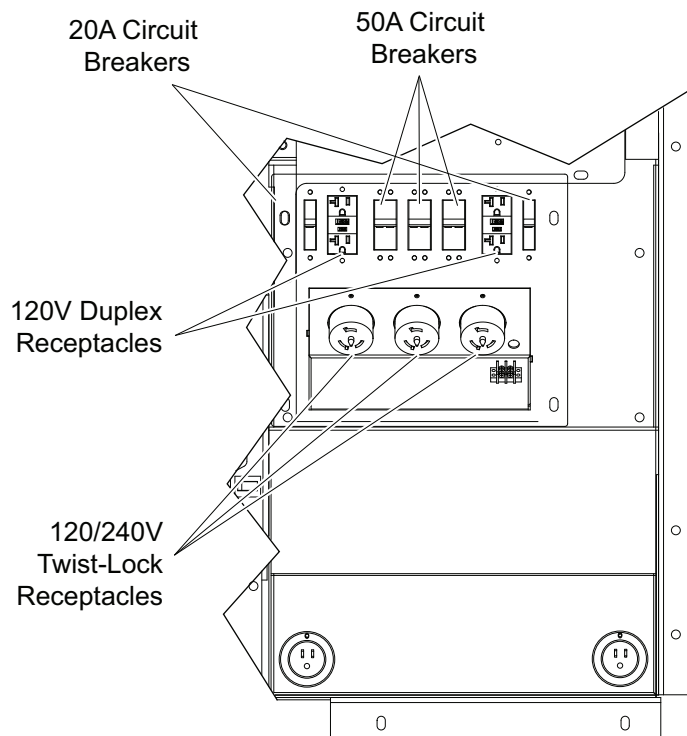

Figure 2-25. Control Panel Receptacles

DERATING FOR ALTITUDE

All units are subject to derating for altitude and temperature; this will reduce the available power for operating tools and accessories connected to the receptacles. Typical reductions in performance are 2-4% for every 1000 ft. (305 m) of elevation and 1% per 10°F (5.6°C) increase in ambient air temperature over 72°F (22°C).

REMOTE START TERMINAL BLOCK

The remote start terminal block provides a connection for installation of a remote start switch which will allow the unit to be started by a remote dry-contact closure switch. For location of the remote start terminal block, see [Control Panel - MMG330D14](#).

Before entering Auto mode, verify that the contacts on any remote switch linked to the unit are **OPEN**. If the contacts on a remote switch are closed, the engine will crank and start when Auto mode is entered. Attach the switch leads to the two unused terminals on the unit's remote start terminal block. For additional information, see ["Auto" \(Remote\) Starting of the Generator](#).

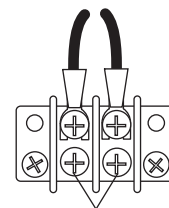

Remote Start Switch Terminals

Figure 2-26. Remote Start Terminal Block

Section 3 - Operation

PRE-START CHECKLIST

Before starting the generator, carefully read the pre-start checklist. Make sure that all of the items are checked before trying to start the generator. This check list applies to both manual and remote starting of the generator.

- Read and understand **ALL** safety sections at the beginning of this manual.
- Make sure the control power switch is “CONTROL OFF/O”.
- Make sure the circuit breakers are “OFF/O”.
- Verify the generator is properly grounded. Installation should be in compliance with National Electrical Code (NEC), as well as any state and local codes or regulations.
- Check all electrical connections at the connection lugs and cam lock receptacles (if equipped). Are they wired correctly? Are they tight?
- Verify link board and voltage selector switch are both set to the desired voltage.
- Is the voltage selector switch (if equipped) locked?
- Is the generator sitting level?
- Thoroughly check for water inside the unit, on, or near the generator. Dry the unit before starting.
- Check oil, coolant and fuel levels and engine battery connections.
- Check engine fan belt tension and condition.
- Check engine fan belt guard.
- Check engine exhaust system for loose or rusted components.
- Check radiator and surrounding shroud for debris.
- Are any generator covers loose or missing?
- Are all preventive maintenance procedures up to date?
- Verify the battery disconnect switch is on, if equipped.

MANUAL STARTING OF THE GENERATOR

All generators equipped with the Power Zone™ controller will initially start up in “Manual Mode”. This allows the operator to start the generator as soon as the controller is powered up. Use the following procedure to start the generator in “Manual Mode”:

1. Move the control power switch to “CONTROL ON/I”.

⚠ DANGER

CARBON MONOXIDE: USING A GENERATOR INDOORS CAN KILL YOU IN MINUTES.

2. The main display will show the prestart diagnosis and the controller will load the unit management software.

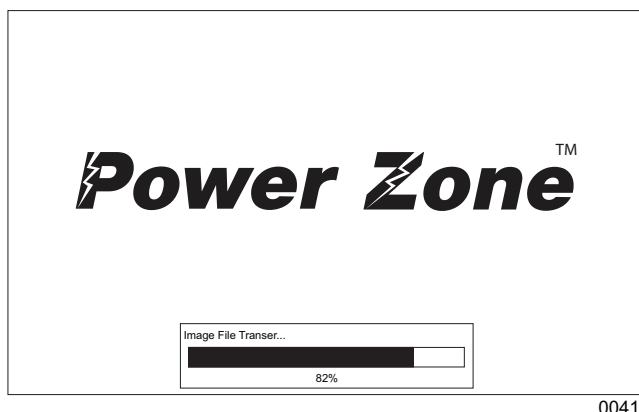

Figure 3-1. Startup Screen

- When the software is loaded, the Home screen will be displayed and the controller will be in “Manual Mode” as indicated at the top of the screen.

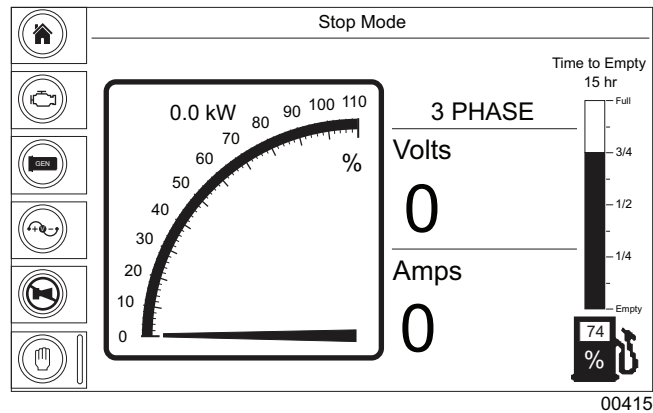

Figure 3-2. Home Screen

Note: The controller can be started from any screen when it is in “Manual Mode.”

- Press the green Engine Start “I” button on the controller. The controller will initiate the startup procedure and start the engine, provided there are no engine faults preventing the unit from starting.

Note: It may take a few seconds for the engine to run smoothly and reach its governed operating speed. During this time, the display will show a voltage different from that set with the voltage selector switch.

- If the engine does not start after the first cranking attempt, the engine will pause for 15 seconds to allow the starter to cool. The main display will show “Manual Mode - Crank Rest.” The engine will make two more attempts to start for a total of three crank cycles.
- Should the engine not start and run within three starting cycles, the main display will show the “Fail to Start” alarm. The starting sequence may be repeated after the starter has had a minimum of two minutes to cool. Press the Enter “✓” button to clear the alarm and reset the controller.

Note: The engine controller may skip the preheat engine steps on some larger models.

- Once the engine starts, it will immediately begin speeding up to a constant 1800 rpm. The engine may hunt or change speeds until operating speed is reached. After a few minutes of operation, the engine will be warmed up and the operator screens will show engine and generator operating parameters.
- Check the generator for excessive noise or vibration and any coolant, oil, or fuel leaks before applying loads.
- Verify the AC output voltage is correct. The output voltage can be fine adjusted by using the [Voltage Adjust Screen](#).
- Verify the frequency (Hz) is correct on the Generator screen. With no loads connected to the generator, the frequency should read approximately 60 Hz, depending on the type of engine governing used.
- If all wiring connections have been made correctly, switch the main circuit breaker to “ON/I” and add loads attached to the receptacles by switching the respective circuit breaker to “ON/I”. You will notice a slight change in engine sound when a load is applied to the unit.

AUTOMATICALLY STARTING THE GENERATOR

The Power Zone™ controller is capable of starting and stopping the unit automatically, based on a programmable schedule.

Generators installed in a standby application should be exercised regularly to maintain operating condition and to ensure responsiveness in an emergency situation. Use the following procedures to operate the generator in “Auto Mode”:

Accessing the Configuration Menu

1. With the unit stopped, navigate to the maintenance screens by pressing any directional arrow (“▲”, “▶”, “▼”, “◀”) from any of the operator screens.
2. While on any maintenance screen, press the Enter “✓” button and the Engine Stop/Reset “O” button simultaneously. The controller will display the Configuration menu.
3. To save changes and exit the Configuration menu, press and hold the Enter “✓” button for five seconds. To cancel changes and return to the maintenance screen, press and hold the Engine Stop/Reset “O” button for five seconds.

“AUTO” (REMOTE) STARTING OF THE GENERATOR

“Auto Mode” is used when the generator is started from a location other than the control panel by using a transfer switch. “AUTO” (remote start) is the normal setting when the generator is being used as a standby power supply. Before putting the generator in the “AUTO” mode, review the [Pre-Start Checklist](#) and [Manual Starting of the Generator](#). Also follow all safety warnings and information on isolating the generator with a transfer switch if the unit is to be used as a standby power supply. See [Pre-Start Checklist](#), then continue with the steps described below:

1. Perform a manual start of the generator at least once to verify that the engine is operating correctly.
2. Check the remote start circuit by removing the wires from the remote start terminal block. Press the Auto/Manual Mode button. The main display should show the “AUTO” icon. Attach a jumper wire (minimum 16 gauge) across the two terminals on the remote start terminal block. This applies a ground to the Power Zone™ Controller to close the starting circuit contacts. The engine should crank, start and run.
3. Remove the jumper wire from the remote start terminal block and the engine will stop. Reconnect any necessary wires from the remote start switch (transfer switch) to the remote start terminal block.
4. Verify the unit is in “Auto Mode.” The main display should show “Auto Mode” at the top of the screen.
5. Close the main circuit breaker (set to “ON/I”).
6. Secure the generator by closing and locking all access doors.
7. The generator is now ready for remote starting.

GENERATOR OUTPUT CONNECTION LUGS

The generator is equipped with connection lugs, located behind the lug box door on the lower portion of the control box. The lugs provide connection points for attachment of external loads to the generator. A large decal on the inside of the connection lug door details the proper connections for selected voltages.

▲ WARNING

Only a trained and licensed electrician should perform wiring and connections to unit. Failure to follow proper installation requirements could result in death, serious injury, and damage to equipment or property. (000155)

▲ WARNING

Before any connections are made to the generator, verify the main circuit breaker and control power switch are “OFF/O” and the negative (-) battery cable is disconnected. Potentially lethal voltages may be present at generator connection lugs.

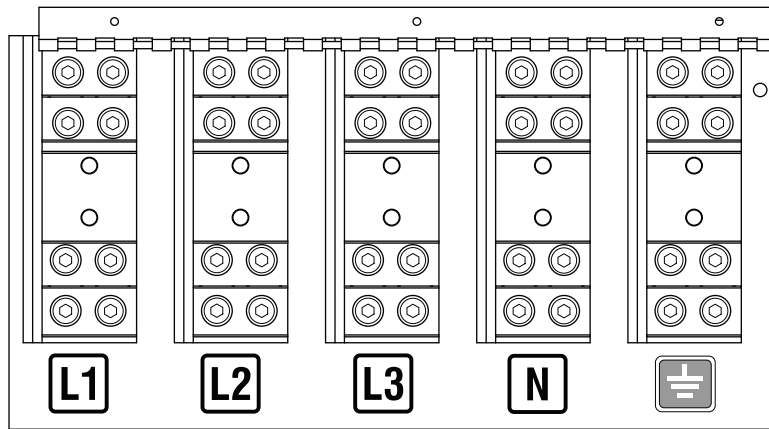

RUN CABLES THROUGH SLOT

Figure 3-3. Connection Lugs

⚠ DANGER

IMPROPER OR INCORRECT CONNECTIONS TO A BUILDING'S ELECTRICAL SYSTEM CAN CAUSE POTENTIALLY LETHAL VOLTAGES TO BACKFEED INTO UTILITY LINES. THIS MAY RESULT IN INJURY OR ELECTROCUTION TO UTILITY WORKERS NEARBY. VERIFY THE GENERATOR IS SUPPLYING POWER TO AN ISOLATED OBJECT OR BUILDING THAT IS NOT CONNECTED TO ANY UTILITY LINES.

Connections to the lugs should be made by running the power cables up through the slot in the bottom of the box. Use a hex-wrench to tighten the cable connections. The connection lug door is equipped with safety interlock switches that will trip the main circuit breaker and disable the voltage regulator if the door is opened while the unit is operating.

⚠ WARNING

Never attempt to disable or modify the lug door safety switches. Equipment damage, personal injury or death may result.

A ground connection is located next to the connection lugs. The unit **MUST HAVE** this ground lug connected to ground for proper operating safety. The generator neutral is bonded to ground when it is shipped from the factory. The bonding plate will need to be removed when the generator is used as a standby power source. **INSTALLATION SHOULD BE IN COMPLIANCE WITH NATIONAL ELECTRICAL CODE (NEC), AS WELL AS ANY STATE AND LOCAL CODES OR REGULATIONS.**

FINE VOLTAGE ADJUSTMENT

Adjustment of the output voltage from the generator is necessary to provide the correct voltage to the end of the power line. Voltage adjustment can be carried out at any time on the "Voltage Adjust" screen.

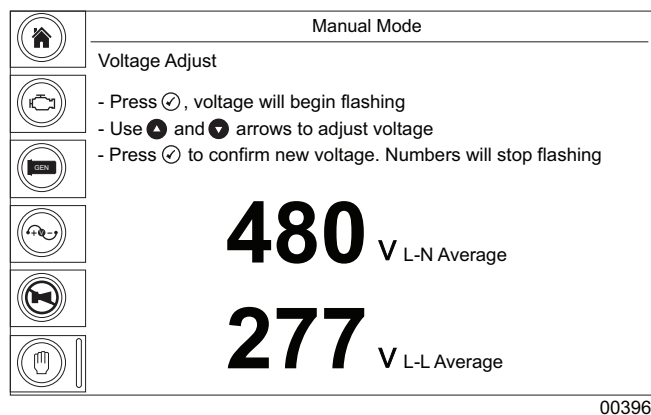

Figure 3-4. Fine Voltage Adjustment

1. With the unit running, press the “Voltage Adjust” screen button.
2. Press the Enter “✓” button. The voltages displayed will begin to flash.
3. Use the up and down directional arrows “▲”, “▼” to adjust the voltage.

Press the Enter “✓” button to confirm the new voltage. The voltages displayed will stop flashing.

VOLTAGE REGULATION

The electronic voltage regulator controls generator output by regulating the current into the exciter field. The regulator has six screwdriver adjustable potentiometers that may be adjusted for U/F dip, under frequency protection (U/F), droop, stability, voltage, and trim. The voltage regulator is adjusted before shipment from the factory. Contact Generac Mobile Products LLC for additional information before attempting to adjust the voltage regulator.

Note: For units equipped with a Marathon DVR2000E+ digital voltage regulator, see the Marathon operating manual provided with the unit.

MAIN CIRCUIT BREAKER

The main circuit breaker is located on the main control panel. When the breaker is “OFF/O”, power is interrupted between the customer connection lugs and the generator. Once the connections have been made to the connection lugs and the generator has been started and allowed to reach normal operating temperature, the breaker may be switched to “ON/I”. Use the breaker handle extension supplied with this unit to apply additional leverage to the switch.

The main circuit breaker will be tripped, disconnecting power to the connection lugs if any of the following items occur while the unit is running:

- Overload of the generator circuits to the connection lugs (208/120V only)
- The door covering the connection lugs is opened
- If the emergency stop switch is activated
- If the door to the reconnect box (shorting board) is removed

Verify problems that cause the main circuit breaker to trip are corrected before returning the switch to “ON/I”.

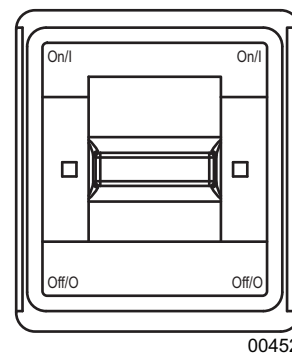

Figure 3-5. Main Circuit Breaker

▲ WARNING

The main circuit breaker interrupts power to the connection lugs only. The receptacles have power even if the main circuit breaker is “OFF/O”. To disconnect power to the receptacles, use the individual circuit breakers located near each receptacle.

EXHAUST FILTER CLEANING OPERATIONS

When enabled, the exhaust filter system goes through an automatic cleaning process known as regeneration. Under normal circumstances, regeneration occurs without interruption of unit operation and with minimal operator involvement. In the event there are conditions requiring the operation of the unit with auto exhaust filter cleaning disabled, the operator may be required to perform procedures to enable or disable the auto exhaust filter cleaning. The operator may also be required to perform a manual regeneration. The following procedures describe how to perform these functions.

▲ WARNING

The area above and surrounding the exhaust system during an auto or manual exhaust filter cleaning should be clear of any people and objects. Exhaust gases and components can reach temperatures hot enough to ignite and melt common materials.

***Note:** Always park the unit in a safe location for elevated exhaust temperatures and check for adequate fuel level before beginning the exhaust filter cleaning process. The cleaning cycle can take an extended period of time (approximately 45 minutes). Cleaning is complete when the Regeneration indicator remains off.*

TRANSFER SWITCH

NOTICE

The generator neutral is bonded to ground when shipped from the factory. The bonding plate must be removed when the generator is used as a standby power source. Installation should be in compliance with National Electric Code (NEC), as well as any state and local codes or regulations.

When the generator is used as a standby power supply, it must be equipped with a transfer switch which isolates it from the utility's distribution system. A transfer switch is designed to transfer electrical loads from the normal power source (utility) to the emergency power source (generator) when normal voltage falls below a prescribed level. The transfer switch automatically returns the load back to the normal source when power is restored back to operating levels.

⚠ DANGER

FAILURE TO ISOLATE THE GENERATOR FROM THE NORMAL POWER UTILITY CAN CAUSE POTENTIALLY LETHAL VOLTAGE TO BACKFEED INTO THE UTILITY LINES. THIS MAY RESULT IN INJURY OR ELECTROCUTION OF UTILITY WORKERS NEARBY. VERIFY THE GENERATOR IS ISOLATED BY A TRANSFER SWITCH FROM ANY LOCAL UTILITY LINES. THIS ALSO APPLIES IF THE GENERATOR IS BEING USED AS A BACK UP TO SOME OTHER TYPE OF POWER SUPPLY.

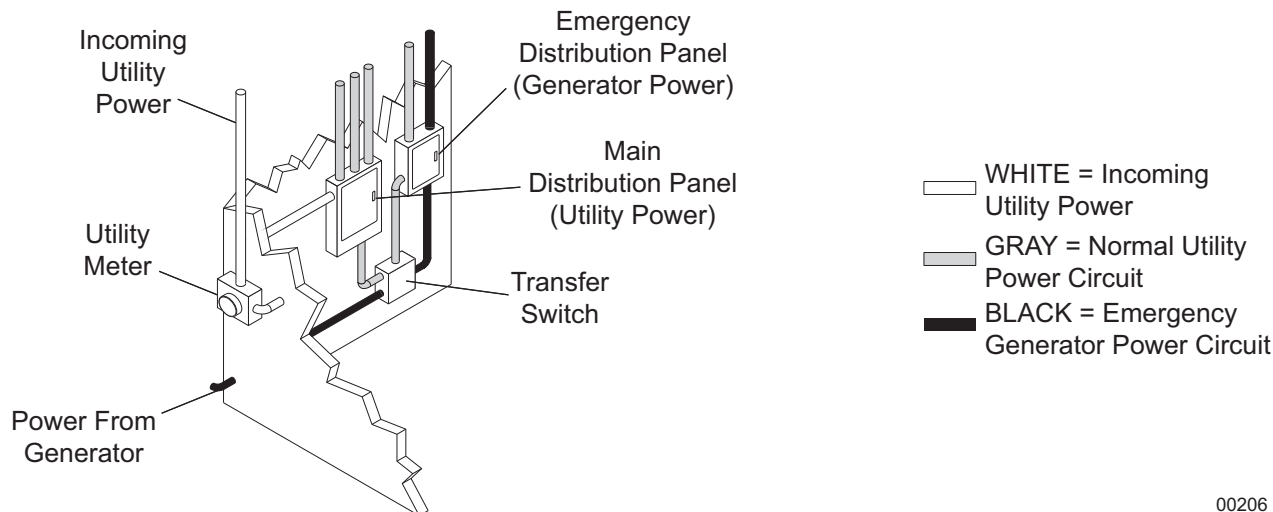

00206

Figure 3-6. Transfer Switch Operation

Installation of a transfer switch or other type of remote starting device is the responsibility of the generator user. Installation of such devices must be performed by following all directions supplied by the manufacturer of the switch. If attaching the generator to a power supply normally serviced by a utility company, notify the utility company and check local and state regulations. Familiarize yourself with all instructions and warning labels supplied with the switch.

⚠ WARNING

Only a trained and licensed electrician should perform wiring and connections to unit. Failure to follow proper installation requirements could result in death, serious injury, and damage to equipment or property. (000155)

NOTICE

When using the generator as a standby or substitute power supply, make sure the output voltage and phase rotation of the generator match those of the local power utility. Improper voltage or phase rotation may cause equipment damage or malfunction.

AUTO EXERCISE TIMER

Generators installed in a standby application should be exercised regularly to maintain operating condition and to ensure responsiveness in an emergency situation. The following procedure demonstrates how to run (exercise) the generator on a time schedule:

1. Press the "PAGE SELECT" button until "Password" appears at the top of the screen.
2. Press the down arrow until "Date/Time" is selected and press "ENTER."
3. Press the down arrow until "Timer1 Repeat" is selected and press "ENTER."
4. Choose the day or days the unit should run and press "ENTER."

5. Press the down arrow until “Timer1 ON Time” is selected and press “ENTER.”
6. Adjust the desired time to start running and press “ENTER.”
7. Press the down arrow until “Timer1Duration” is selected and press “ENTER.”
8. Adjust the time period to the length of time the unit should run after starting, and press “ENTER.”
9. Press “PAGE SELECT” three times to return to the main menu.
10. Press the “AUTO” button to switch modes to automatic.

Note: The controller must be in Auto mode to run at the programmed time. Use a trickle battery charger or solargizer to prevent the controller from draining the battery while in Auto mode.

Schedule Tab

The “Schedule” tab shows the current configuration and status of the scheduler, as well as maintenance configuration status and time remaining until an alarm, electrical trip or shutdown will occur.

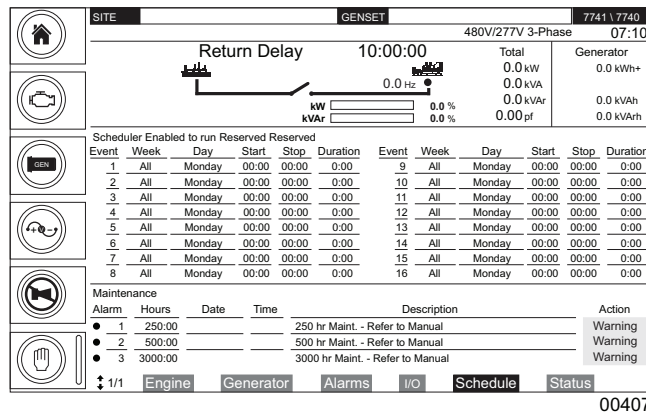

Figure 3-7. Schedule Tab Screen

Set the Controller Clock

The schedule runs based off the time set in the controller clock. Use the following procedure to set the controller clock BEFORE setting the schedule:

1. Navigate to the “Maintenance” group and access it by pressing the right arrow “▶”.
2. Select the “Time” section by pressing the right arrow “▶”.
3. Set the time and date to the correct local time.

Set the Schedule

1. Access the “Scheduler” group by pressing the right arrow “▶”.

The “Scheduler” group is made up of the “Scheduler Options” and “Scheduler Setup” sections. Each section can be accessed and exited using the right “▶” and left “◀” arrows.

2. Access the “Scheduler Options” section. Within this section, the scheduler can be enabled, run mode selected, and load mode selected.

Item	Values
Enable	Yes/No
Run Mode	Monthly/Weekly
Load	Idle, In Island, On Load, Off Load

3. Access the “Scheduler Setup” section. Within this section, each schedule entry can be modified by pressing the Enter “✓” button to select the item and the up “▲” and down “▼” arrows to define them.

Item	Values
Schedule Entry	1-16
Start Time	00:00-23:59
Duration	00:00-99:59
Day	Monday-Sunday
Week (of month)	First, Second, Third, Fourth

Note: The controller must be in “Auto Mode” to run at the programmed time. Use a trickle or solar battery charger to prevent the controller from draining the battery while in “Auto Mode.”

Set the Unit to Auto Mode

1. From any operator or maintenance screen, press and hold the Auto/Manual Mode button for five seconds, or until the “AUTO” icon is shown on the main display.

Note: If any of the scheduled time slots are currently active, the controller will begin the starting sequence and start the unit, provided there are no shutdown conditions present.

SHUTTING DOWN THE GENERATOR

Check with personnel using power supplied by the generator and let them know that the power is going to be turned off. Make sure the power shut down will not create any hazards by accidentally turning off equipment that needs to be kept on (pumps, compressors, lights, etc.).

1. Remove all loads from the generator by opening all circuit breakers (turn to “OFF/O”).
2. Let the engine run for approximately five minutes to allow it to cool down.
3. Push the red Engine Stop/Reset “O” button. Pressing the Engine Stop/Reset “O” button will result in the generator going into the shutdown cycle and starting a 15 second shutdown timer called “Stopping.” If the unit does not shut down within 15 seconds, a “Stop Fail” alarm will be displayed on the main display.
4. After the unit shuts down, move the control power switch to “CONTROL OFF/O”.

Note: For extended storage time, disconnect the battery. See the engine operator’s manual for extended storage requirements.

EMERGENCY STOP SWITCH

The unit is equipped with one Emergency Stop switch. For location of the Emergency Stop switch, see [Component Locations \(MMG330 Shown\)](#). The switch can be accessed and activated with all doors closed and locked.

Activate the Emergency Stop switch by pushing the red button in until it locks down. This will trip the main circuit breaker which will open the contact, disconnecting the load to the connection lugs. This will also open the fuel circuit, shutting down the engine. The emergency stop fault will be displayed on the control panel.

The switch will remain closed until it is pulled out.

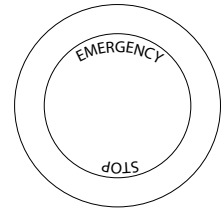

Figure 3-8. Emergency Stop Switch

▲ CAUTION

Equipment Damage. The emergency stop switch is not to be used to power down the unit under normal operating circumstances. Doing so will result in equipment damage. For any other shut down, see [Shutting Down the Generator](#).

Disable Automatic (Auto) Exhaust Filter Cleaning

The auto exhaust filter cleaning feature should always be enabled unless doing so would cause an unsafe working environment. In the event that an unsafe working environment would occur, use the following procedure to disable the auto exhaust filter cleaning feature:

1. Open the control door and locate the switch labeled “EXHAUST FILTER CLEANING.”
2. Move the toggle switch to “DISABLED (O)”.
3. Toggle to the “DPF Status” page on the Power Zone™ controller and verify the Disabled Regeneration indicator appears above the words “DPF Inhib” (see [Diesel Exhaust Filter Monitoring](#) for information regarding the “DPF Status” screen and indicators).

NOTICE

Disabling auto mode is not recommended for any situation unless it is safety related or if the fuel tank lacks the required fuel to complete the cleaning process.

Force a Manual Exhaust Filter Cleaning

If running the unit with the exhaust filter cleaning function disabled, the “DPF Status” screen may display a red alarm, prompting the operator to force a manual exhaust filter cleaning. Use the following procedure to force the manual exhaust filter cleaning feature:

1. Open the control door and locate the switch labeled “Auto Exhaust Filter Cleaning.”
2. Move and hold the toggle switch to “ON / FORCED (I)” for five seconds.
3. Toggle to the “DPF Status” screen on the Power Zone™ controller and verify the Regeneration indicator appears above the words “DPF Lamp” (see [Diesel Exhaust Filter Monitoring](#) for information regarding the “DPF Status” screen and indicators).

Enable Exhaust Filter Cleaning

If the environment no longer requires the function to be disabled and there are no alarms present on the “DPF Status” screen, the auto exhaust filter cleaning function should be enabled. Use the following procedure to enable the auto exhaust filter cleaning feature:

1. Open the control door and locate the switch labeled “EXHAUST FILTER CLEANING.”
2. Move the switch to “ON / AUTO (I/O)”.

Toggle to the “DPF Status” screen on the Power Zone™ controller and verify the Regeneration indicator appears above the words “DPF Lamp” (see [Diesel Exhaust Filter Monitoring](#) for information regarding the “DPF Status” screen and indicators).

POWER ZONE™ CONTROLLER INFORMATION DISPLAYS, FUNCTIONS, AND RESET

The Power Zone™ controller constantly monitors vital generator and engine functions for a number of operation, alarm and fault conditions. When a fault condition occurs, the engine will shut down automatically and the main display will show the fault that has caused the shutdown. To resume operation, the fault condition must be resolved. To reset the controller and resume operation, press the Enter “✓” button.

TOWING THE TRAILER

1. Use the jack to raise or lower the trailer onto the hitch of the towing vehicle.
2. Lock the hitch coupling and attach the safety chains or cables to the vehicle. Raise the jack foot completely.
3. Connect any trailer wiring to the tow vehicle. Verify proper operation of the stop and signal lights.
4. Verify all doors are properly latched.
5. Verify proper inflation of trailer tires. Maximum tire pressures can be found in [Specifications](#).
6. Check wheel lugs. Tighten or replace any that are loose or missing. If a tire has been removed or replaced, tighten lugs in the order shown to the following specifications:
 - a. Start all lug nuts by hand.
 - b. First pass tighten to 20-25 ft-lbs (27-33 Nm).
 - c. Second pass tighten to 50-60 ft-lbs (67-81 Nm).
 - d. Third pass tighten to 90-120 ft-lbs (122-162 Nm).

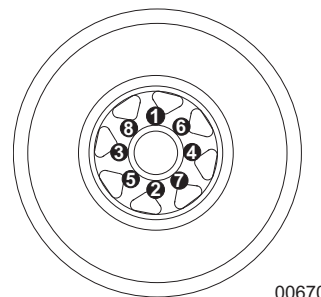

00670

Figure 3-9. Lug Sequence

Note: After the first road use, tighten lug nuts in sequence.

7. Maximum recommended speed for highway towing is 45 mph (72 km/h).
Maximum recommended off-road speed for towing is 10 mph (16 km/h).

LIFTING THE GENERATOR

A large central lift point is located on top of the generator. The central lift point is connected to a lift structure inside the unit. Attach a sling or hook directly to the central lift point only if the devices are in good condition and the equipment being used to raise the unit has sufficient capacity. Approximate weights can be found starting in [Specifications](#). Always remain aware of others when moving or lifting the generator. Keep cabinet doors closed and locked.

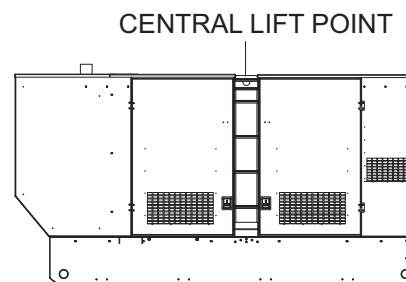

Figure 3-10. Lift Point

Section 4 - Maintenance

EMISSIONS INFORMATION

For emissions information, see the OEM engine manual.

DAILY WALK AROUND INSPECTION

Look for conditions that could hinder performance or safety, such as (but not limited to) oil/coolant/fuel leakage, blocked vents, loose/missing hardware and electrical connections.

Visually inspect the fan belt for cracks, fraying, stretching and that the belt is properly seated in the pulley grooves. Replace the belt according to the manufacturer's recommendations.

Note: *At the 500 hour/12 month service interval, it is recommended that the belt be removed and checked for wear. While the belt is removed, inspect pulleys and bearings. Rotate and feel for hard turning or unusual sounds. If pulleys or bearings need replacement, contact John Deere.*

Failure to perform a daily inspection may result in serious damage to the prime mover.

ENGINE AND GENERATOR MAINTENANCE

Check engine oil level daily before starting the engine. **DO NOT** start the generator if oil level is below the "ADD" mark on the dipstick. Normal operating level for engine oil is between the "FULL" and "ADD" markings. Add oil to the engine only if the level is below the "ADD" mark. **DO NOT OVERFILL.** See the engine operation and maintenance manual for the proper grade of oil, including special operating conditions such as a change in season or climate.

Check coolant level daily by visually inspecting the level in the coolant overflow jug, located near the radiator. Normal operating level is anywhere between the "FULL" and "ADD" markings, with the optimum level noted as "NORMAL RANGE." Coolant may be added directly to the overflow jug **WHEN THE ENGINE IS STOPPED AND COMPLETELY COOL.** See the engine operation and maintenance manual for coolant recommendations and proper mixture.

Check condition of the air filter by viewing the level of vacuum draw on the filter minder gauge. Replace the air filter when the yellow center bar reaches the red section on the gauge (20 in. H₂O).

Poorly maintained equipment can become a safety hazard. In order for the equipment to operate safely and properly over a long period of time, periodic maintenance and occasional repairs are necessary. **NEVER** perform even routine service (oil/filter changes, cleaning, etc.) unless all electrical components are off. When servicing this equipment always follow the instructions below:

- Verify the control power switch is turned "CONTROL OFF/O".
- Verify all circuit breakers are open ("OFF/O").
- Activate (push in) the emergency stop button.
- Disconnect the negative (-) terminal on the battery.
- Attach a "DO NOT START" sign to the control panel. This will notify everyone that the unit is being serviced and will reduce the chance of someone inadvertently trying to start the unit.
- If the unit is connected to a remote start or transfer switch, verify the remote switch is off and tagged.
- Never wash the unit with a high pressure hose or power washer.
- Never wash the engine block or fuel tank with a power washer or steam cleaner. Water may enter the cabinet and collect in the generator windings or other electrical parts, causing damage.
- If the unit is stored outside, check for water inside the cabinet and generator before each use. If wet, dry unit thoroughly before starting.

Normal maintenance service and replacement of parts are the responsibility of the owner and are not considered defects in materials or workmanship within the terms of the warranty. It is strongly recommended that the equipment be periodically checked by a Generac Mobile Products Authorized Dealer.

NOTICE

See original equipment manufacturer's operating manual for a complete list of maintenance requirements. Failure to comply with the procedures as described in the engine operator manual will nullify the warranty, decrease performance and cause equipment damage or premature equipment failure. Maintenance records may be required to complete a warranty request.

Use the schedule in the following table as a guide for regular maintenance intervals. For additional or replacement copies of the engine operator's manual, contact an authorized dealer in your area.

Table 1 - Basic Maintenance Schedule

ITEM	DAILY	250 HRS.	500 HRS./12 Months	2000 HRS./ 24 Months	As Required
Check oil level	◆				
Check coolant level	◆				
Check fuel level	◆				
Check tire pressure	◆				
Check all electrical connections	◆				
Inspect radiator fins for debris, clean as required	◆				
Check fuel filter/water separator bowl	◆				
Check air cleaner dust valve restriction indicator gauge	◆*				
Perform visual walkaround inspection	◆				
Check oil vapor recirculation system/non-return valve		◆			
Bleed fuel system		◆			
Change engine oil and replace oil filter			◆**		
Replace oil vapor recirculation filter			◆		
Service battery			◆		
Check coolant pump weep hole foam filter			◆		
Replace fuel filters/clean water separator			◆		
Check engine mounts			◆		
Check air intake hoses, connections, and system			◆		
Check engine ground connection			◆		
Check belt tensioner and belt wear			◆		
Check cooling system			◆		
Lubricate leveling jack(s)			◆		
Check generator drive plate torque (see <i>Checking Generator Drive Plate Torque</i>)			◆		
Test thermostats				◆	
Replace alternator and fan belts					◆
Replace air cleaner elements					◆
Check fuses					◆
Add coolant					◆
Check electrical wiring and connections					◆

- * Replace primary air cleaner when dust valve restriction indicator gauge shows a vacuum of 25 in. H₂O or at least every 500 hours. Some operating environments will require more frequent changes.
- ** Change the oil and oil filter after the first 100 hours, then every 500 hours. If John Deere Plus-50 II oil or an equivalent is not used, the oil must be changed every 250 hours.

See [Figure 4-1](#).

ENGINE BREAK-IN REQUIREMENTS

Note: During the first 20 hours of operation, avoid long periods of no load or sustained maximum load operation. If the generator is to run for longer than five minutes without a load, shut the generator down.

John Deere engines are supplied with engine break-in oil from the factory. Extra care during the first 100 hours of engine operation will result in better performance and longer engine life. **DO NOT** exceed 100 hours of operation with the break-in oil. Operate the engine at heavy loads (60-90% of maximum) as much as possible. If the engine has spent significant time at idle, constant speed(s) and/or light load or if makeup oil is required, a longer break in period may be needed. See the engine operator's manual for a full description of necessary procedures on the addition of oil and extension of the break-in period. Use [Table 1](#) as a guide for regular maintenance intervals.

RESETTING THE MAINTENANCE ALARMS

The Power Zone™ controller will display a warning message when the unit is due for maintenance or service. The maintenance or service interval is set at 500 hours of engine running time. Once the unit has been serviced, the "Maintenance Alarm" reminder needs to be reset. The following procedure demonstrates how to reset the running hours to zero:

1. Shut unit down.
2. Move the control power switch to "CONTROL ON/I". After initialization, the controller will toggle automatically to the Home screen.
3. Press any directional arrow ("▲", "▶", "▼", "◀") to enter the maintenance screens.
4. Press the Enter "✓" button and the Engine Stop/Reset "O" button simultaneously. The next screen will display the Configuration menu.
5. Press "▼" to move the cursor (blue highlighted text) down to the "Maintenance" group.
6. Press "▶" to access the sections. Press "▼" to highlight the "Maintenance" section.
7. Press "▶" to access the parameters and highlight the maintenance alarm that needs to be reset.
8. Press the Enter "✓" button to select the editable parameters. The cursor will highlight "Not Reset" under the selected maintenance alarm. Press "▲" to highlight "Reset".
9. Press the Enter "✓" button to reset the selected maintenance alarm.

Note: If the selected maintenance alarm does not need to be reset, press the "▼" button to highlight "Not Reset" and press the Enter "✓" button to return to the parameters section.

10. To perform additional maintenance alarm resets, repeat steps 6 - 8.
11. To save changes, press and hold the Enter "✓" button for five seconds. To discard changes made, press and hold the Engine Stop/Reset "O" button for five seconds.

EXHAUST FILTER SERVICE REQUIREMENTS

The exhaust filter system contains a Diesel Particulate Filter (DPF). Over time, the DPF will require professional servicing to remove ash buildup. The expected service interval will be at least 3000 or 4500 hours, based on engine power and operating conditions. Actual service should take place when the indicator light appears on the control panel LCD. The DPF should be cleaned or replaced by an authorized service provider only. The removal of DPF ash must be done by removing the DPF from the unit and placing it into specialized equipment.

⚠ CAUTION

Do not remove ash by using water or other chemicals. Removing ash by these methods may cause equipment damage and create unsafe operating conditions.

⚠ CAUTION

Only a qualified service provider should remove, handle and dispose of diesel particulate filters and ash. These materials may be considered hazardous under federal, state and local regulations, and must be handled and disposed of properly.

To avoid unnecessary buildup of diesel particulates or soot in the exhaust filter system:

- Utilize the Automatic (AUTO) Exhaust Filter Cleaning mode.
- Avoid unnecessary idling.
- Use proper engine oil (see the engine operator's manual).

Use only ultra low sulfur diesel fuel (see the engine operator's manual).

CHECKING GENERATOR DRIVE PLATE TORQUE

Follow the procedure below to check the torque of the generator drive plate bolts in accordance with the maintenance chart in [Table 1](#).

1. Disconnect engine starting battery.
2. Remove generator fan guard.
3. Tighten each of the drive plate bolts to the appropriate specification shown in the table below.

Unit	ft-lbs (Nm)
MMG330DI4	33 (45)
MMG480DI4	

4. Install generator fan guard.
5. Reconnect the battery.

JACK MAINTENANCE

The following procedures should be performed annually.

Side-wind models

- The internal gearing and bushings of the jack must be kept lubricated. Apply a small amount of automotive grease to the internal gearing by removing the jack cover, or if equipped, use a needle nose applicator or

standard grease gun on the lubrication point found on the side of the jack near the crank. Rotate the jack handle to distribute the grease evenly.

- A lightweight oil must be applied to the handle unit at both sides of the tube.
- If equipped, the axle bolt and nut assembly of the caster wheel must also be lubricated with the same lightweight oil.

Top-wind models

- Apply a lightweight oil to the screw stem.

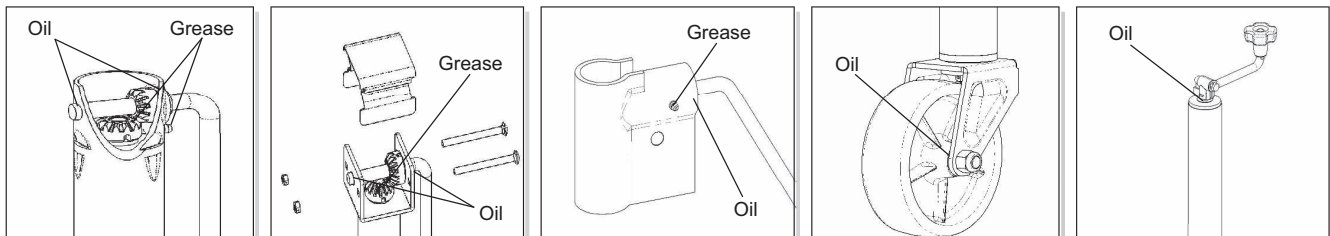

00243

Figure 4-1. Lubrication Points

TRAILER WHEEL BEARINGS

The trailer axles are equipped with a grease zerk fitting to allow lubrication of the wheel bearings without the need to disassemble the axle hub. To lubricate the axle bearings, remove the small rubber plug on the grease cap, attach a standard grease gun fitting to the grease zerk fitting and pump grease into the fitting until new grease is visible around the nozzle of the grease gun. Use only a high quality grease made specifically for lubrication of wheel bearings. Wipe excess grease from the hub with a clean cloth and replace the rubber plug when finished. The minimum recommended lubrication is every 12 months or 12,000 miles (19,312 km). More frequent lubrication may be required under extremely dusty or damp operating conditions.

This Page Intentionally Left Blank

Section 5 - Troubleshooting

⚠ WARNING

Allow engine to cool before performing any troubleshooting procedures. Contacting the engine when it is hot will cause severe personal injury.

Table 2 - Troubleshooting Automatic Shutdown Conditions

<p>LOW FUEL LEVEL SHUTDOWN</p>	<ol style="list-style-type: none"> 1. Check fuel level on the Home screen. Verify generator is sitting level for an accurate reading. 2. Check for leaks in the fuel tank. Fuel tank should not run dry under normal circumstances. The engine controller will shut the engine down when there is five percent of fuel remaining in the tank. This is done to keep the fuel lines from running dry. 3. If fuel level is good and no leaks are found, check fuel level sender and connecting wiring for damage. To check for continuity between the sender and the engine controller, remove the appropriate bolts from the control panel to access the inside of the control box. Consult the appropriate DC wiring diagram in the back of this manual for the proper path between the engine controller and fuel level sender.
<p>LOW OIL PRESSURE SHUTDOWN</p>	<ol style="list-style-type: none"> 1. Check engine oil level with the dipstick. The engine controller will shut the engine down when the oil pressure is less than 20 psi (138 kPa). Add oil if required. 2. Visually inspect engine for oil leaks. 3. If oil level is good, restart unit and verify the loss of oil pressure. Shut engine down immediately if oil pressure value does not read 5 psi (34 kPa) within five seconds. 4. Check the oil pressure sender. To identify corrective action, see the troubleshooting section of the engine operator's manual provided with the unit.
<p>LOW COOLANT LEVEL SHUTDOWN</p>	<ol style="list-style-type: none"> 1. Allow engine to cool. 2. Check coolant level in the radiator. To access the radiator cap, remove the access panel from the top of the enclosure directly above the radiator. Add coolant until it is 3/4 in. (1.9 cm) below the filler neck. Secure the radiator cap back into its original position. 3. Inspect coolant hoses, engine block and water pump for visible leaks. 4. Verify no engine oil has mixed with the coolant (oil will appear milky if coolant is present). See the engine operator's manual for additional information.

Table 2 - Troubleshooting Automatic Shutdown Conditions

<p>HIGH COOLANT TEMPERATURE SHUTDOWN</p>	<ol style="list-style-type: none"> 1. Check coolant level in the overflow jug. 2. Restart engine and read the coolant temperature to verify a high coolant temperature shutdown. Stop engine immediately if coolant temperature is 230°F (110°C) or more. 3. Allow engine to cool. Add coolant to the overflow jug if it is low and check the level of coolant in the radiator. To access the radiator cap, remove the access panel from the top of the enclosure directly above the radiator. Add coolant until it is 3/4 in. (2 cm) below the filler neck. Secure the radiator cap back into its original position. 4. Check radiator shroud and ducting for blockage and remove any foreign matter. 5. Inspect coolant hoses, engine block and water pump for visible leaks. 6. Check tension of serpentine drive belt for the water pump. 7. If no other problems are found, remove load on the generator and restart engine. Check coolant temperature and shut engine down immediately if it starts to overheat. See the engine operator's manual for additional information on engine overheating.
<p>OVERCRANK SHUTDOWN</p>	<ol style="list-style-type: none"> 1. Check fuel level in the tank. 2. Check for proper operation of the fuel pump. 3. Check the air filter for blockage. 4. If engine will not start, see the engine operator's manual for additional information on troubleshooting starting problems.
<p>OVERSPEED OR UNDER-SPEED SHUTDOWN</p>	<ol style="list-style-type: none"> 1. Disconnect all loads and restart the generator. Read the frequency (Hz) on the LCD display. With no loads on the generator, the frequency should read 60.0 Hz. 2. If the frequency is above or below 60.0 Hz, the engine speed will have to be adjusted. See the engine operator's manual for throttle adjustments on mechanically governed units and see the electronic governor manual for electronically controlled units.

Section 6 - Wiring Diagrams

AC WIRING - MMG330DI4

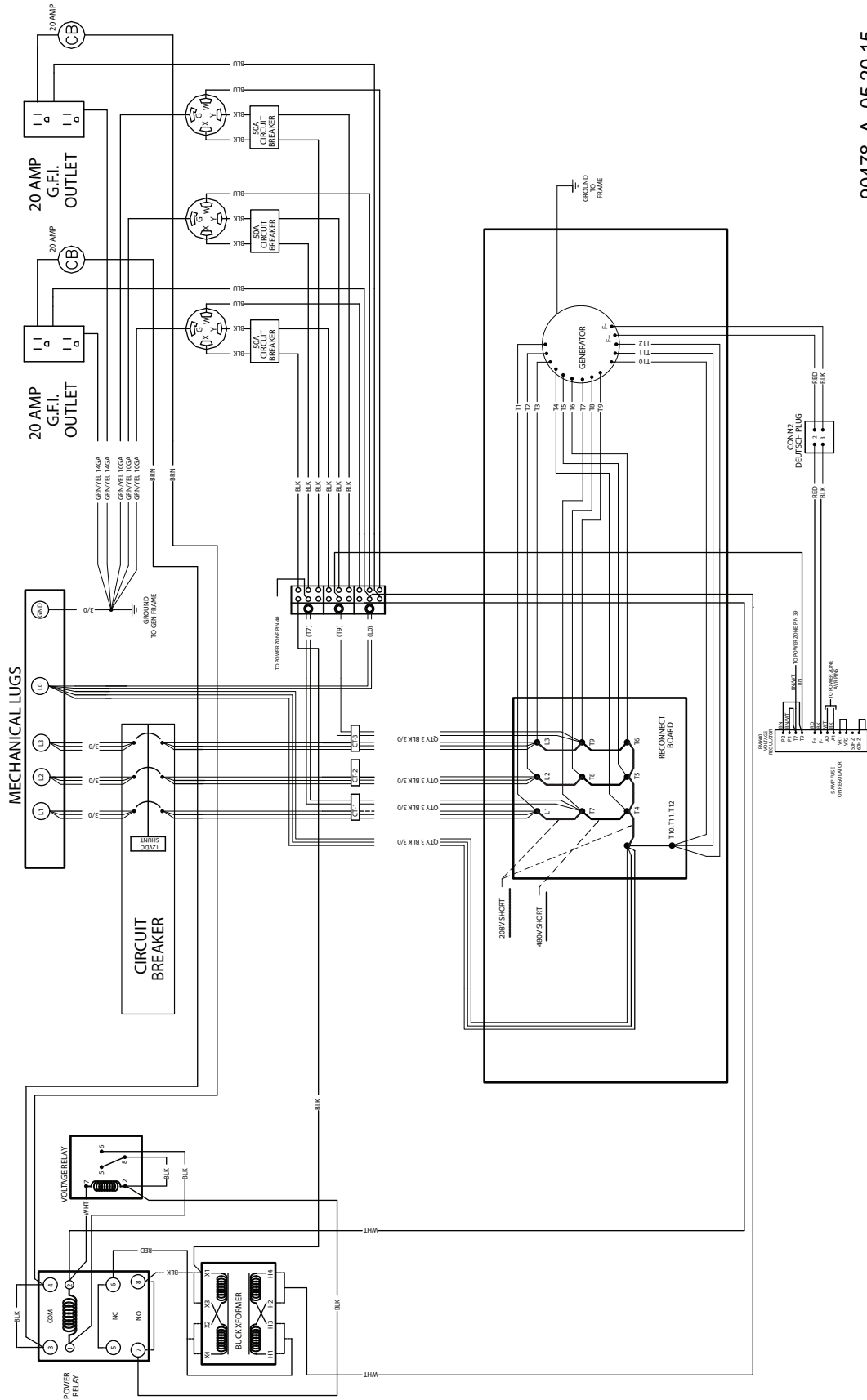

90478_A_05.20.15

AC WIRING - MMG480DI4

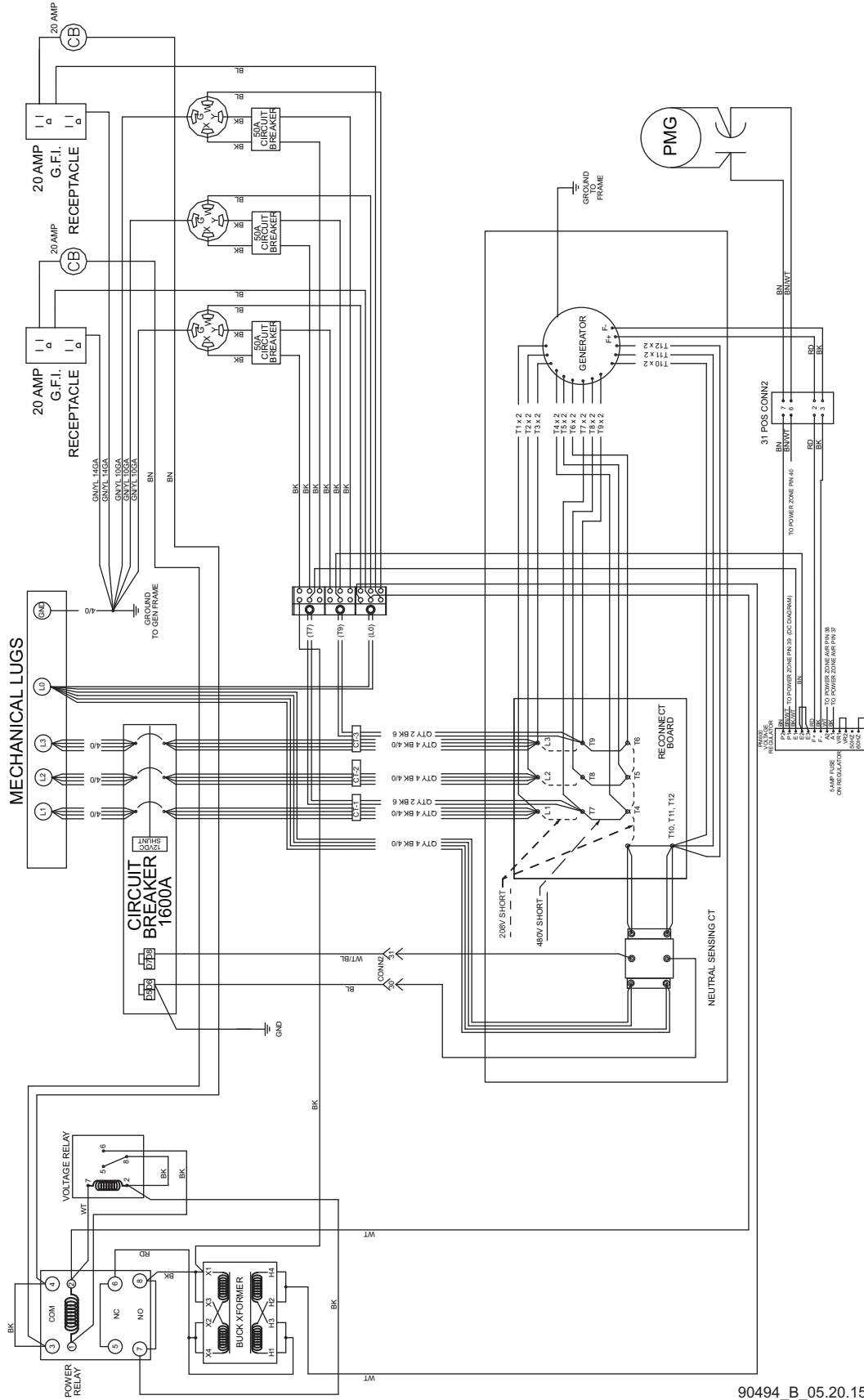

90494_B_05.20.15

WIRING BLOCK DIAGRAM - DEDICATED 12 LEAD GENERATORS OPTION

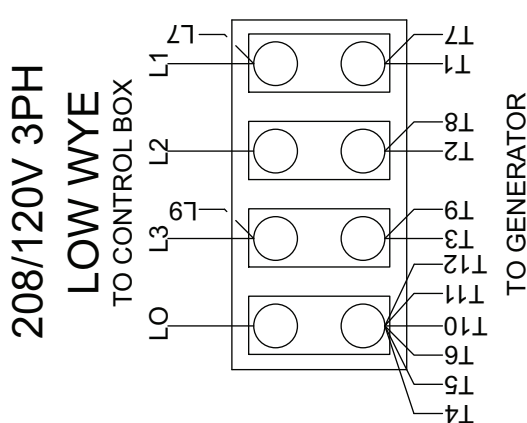
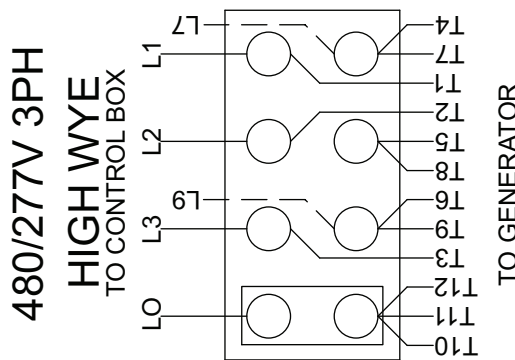
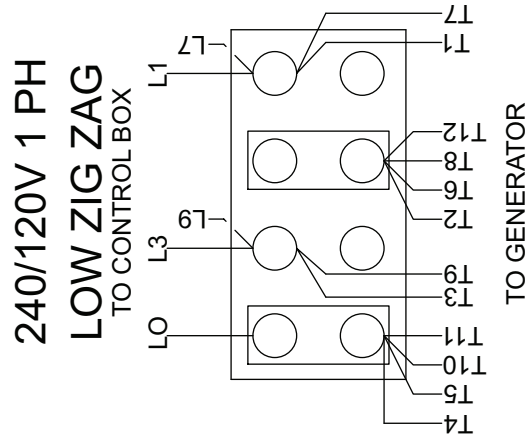
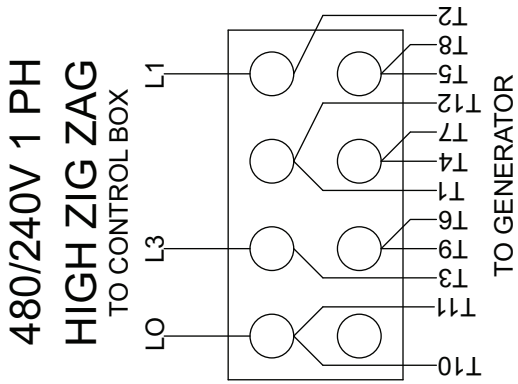
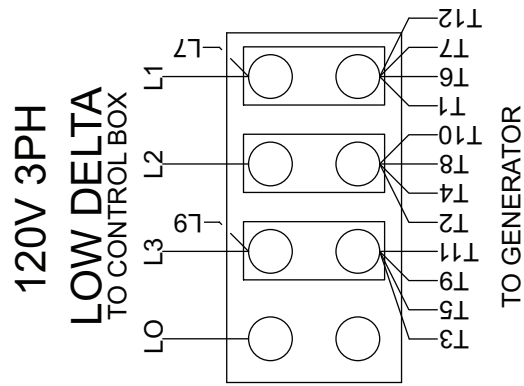
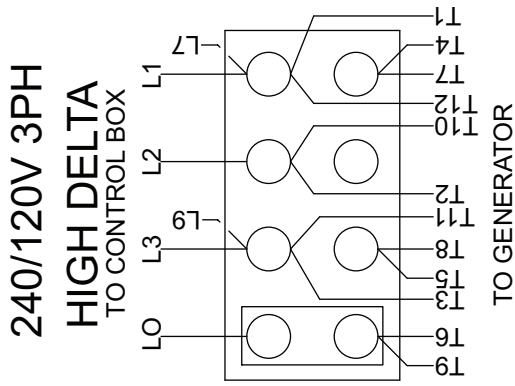

NOTE:
 1. CABLES TO CONTROL BOX MAY CONTAIN 1, 2 OR 3 WIRES DEPENDING ON THE MODEL AND VOLTAGE.
 2. APPLIES TO ALL 12 LEAD GENERATORS TO BE HARD WIRED IN GEN BOX.

90302_A_11.06.12

TRAILER WIRING DIAGRAM

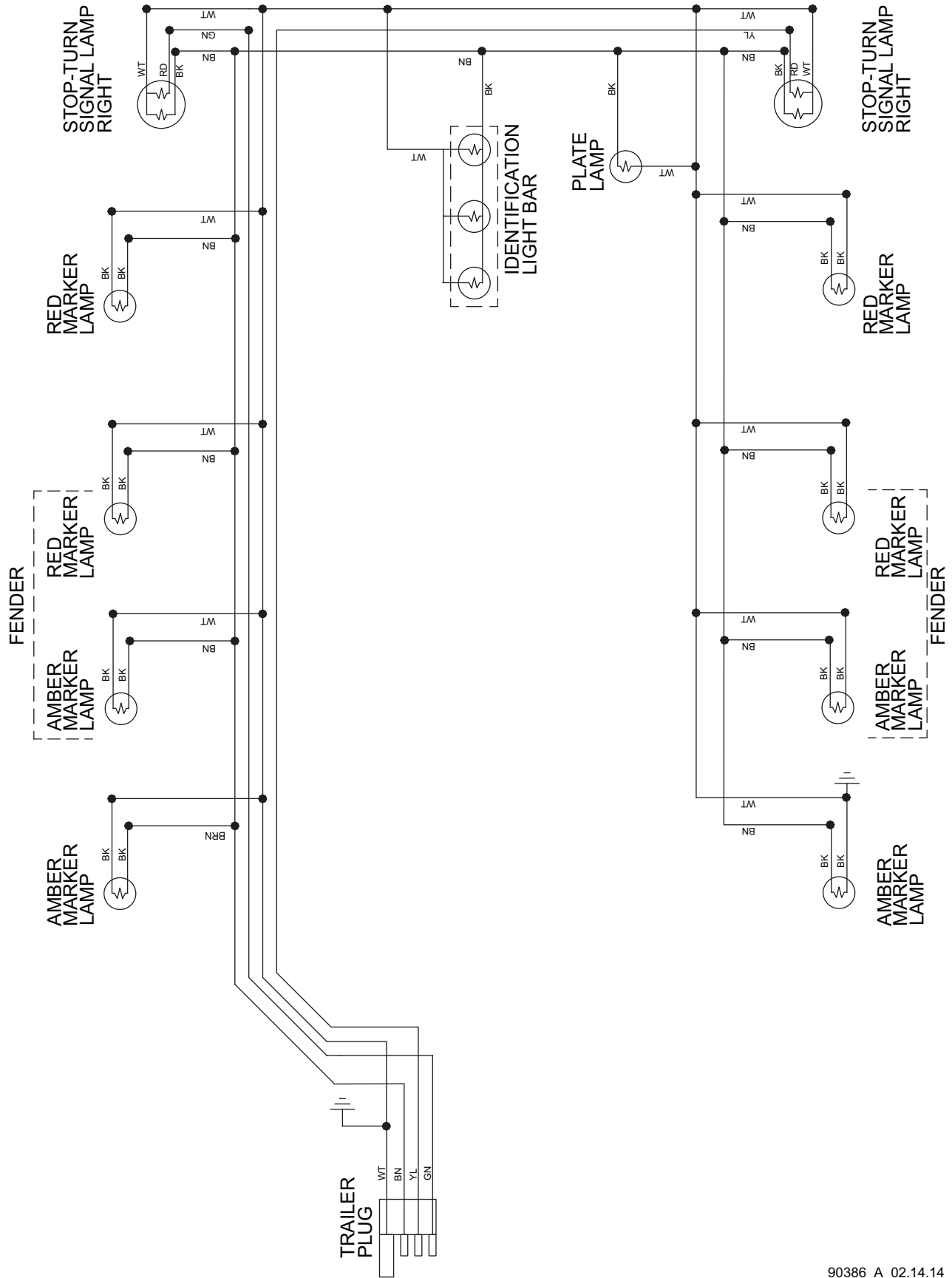

90386_A_02.14.14

WIRING HARNESS - ELECTRIC BRAKE OPTION

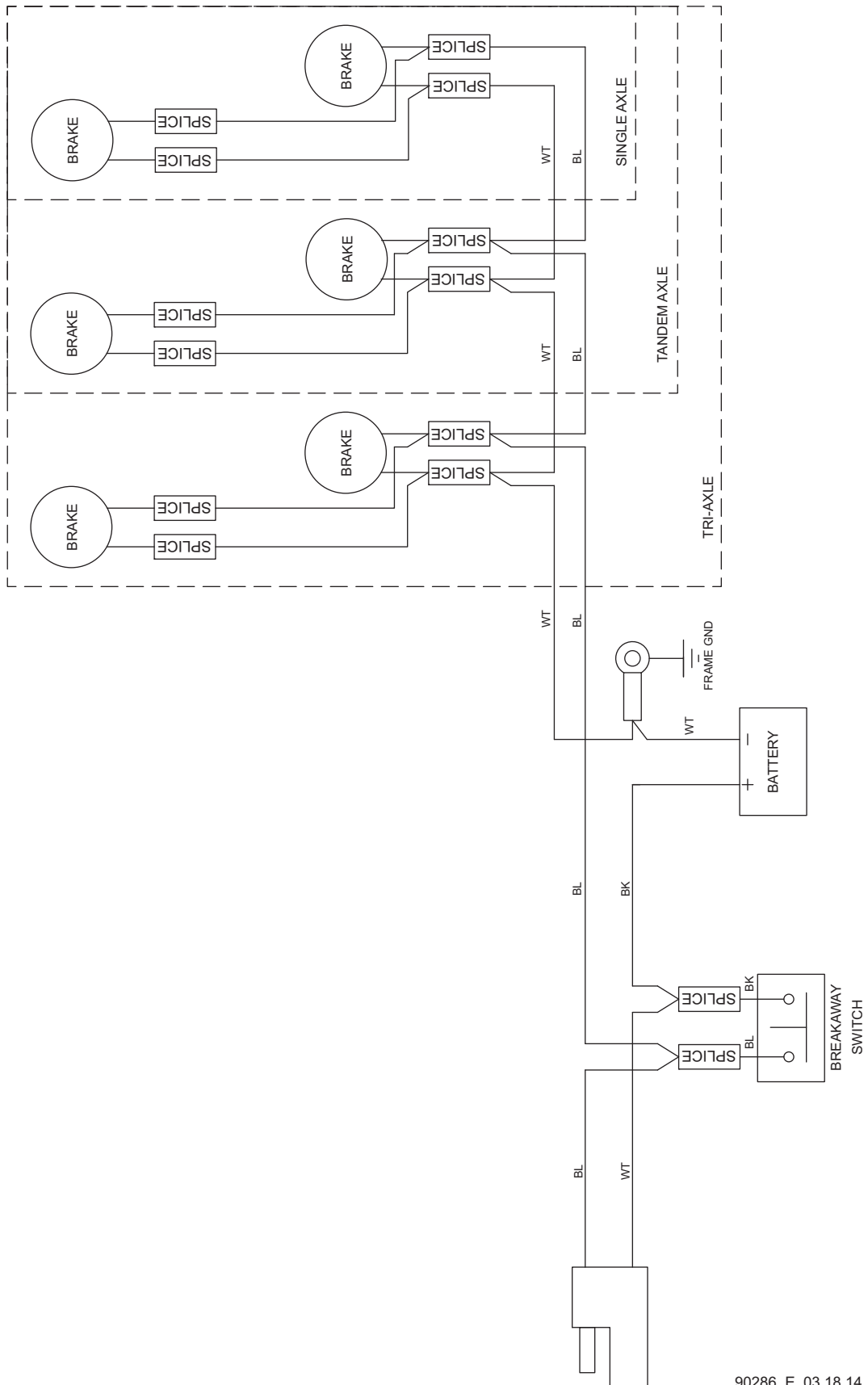

90286_E_03.18.14

This Page Intentionally Left Blank

Section 7 - Options & Accessories

GENERATOR CAM LOCK CONNECTIONS OPTION

The generator may be equipped with cam lock connections, located behind the lug door next to the generator output connection lugs. These receptacles provide connection points for attachment of external loads to the generator. A large decal on the inside of the connection lug door details proper connections for selected voltages.

⚠ WARNING

Only a trained and licensed electrician should perform wiring and connections to unit. Failure to follow proper installation requirements could result in death, serious injury, and damage to equipment or property. (000155)

⚠ WARNING

Before any connections are made to the generator, verify the main circuit breaker and control power switch are “OFF/O” and the negative (-) battery cable is disconnected. Potentially lethal voltages may be present at generator cam lock receptacles.

⚠ DANGER

IMPROPER OR INCORRECT CONNECTIONS TO A BUILDING'S ELECTRICAL SYSTEM CAN CAUSE POTENTIALLY LETHAL VOLTAGES TO BACKFEED INTO UTILITY LINES. THIS MAY RESULT IN INJURY OR ELECTROCUTION TO UTILITY WORKERS NEARBY. VERIFY THE GENERATOR IS SUPPLYING POWER TO AN ISOLATED OBJECT OR BUILDING THAT IS NOT CONNECTED TO ANY UTILITY LINES.

Connections should be made by running power cables equipped with series 16 taper nose 400A/600V cam lock plugs up through the slot in the bottom of the box and into the cam lock receptacles. Secure the connection by rotating the plug a half turn to the right. The connection lug door is equipped with safety interlock switches that will trip the main circuit breaker and disable the voltage regulator if the door is opened while the unit is operating.

⚠ WARNING

Never attempt to disable or modify the lug door safety switches. Equipment damage, personal injury or death may result.

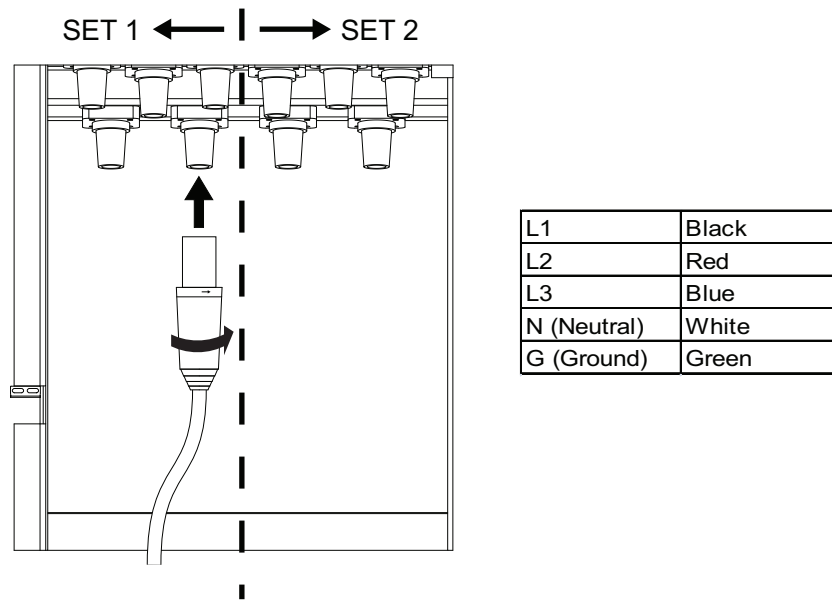

Figure 7-1. Cam Lock Connections

A ground connection is located on the far right of each cam lock set. Each set **MUST** be connected to ground for proper operating safety. The generator neutral is bonded to ground when it is shipped from the factory. The bonding plate must be removed when the generator is used as a standby power source. **INSTALLATION SHOULD BE IN COMPLIANCE WITH NATIONAL ELECTRICAL CODE (NEC), AS WELL AS ANY STATE AND LOCAL CODES OR REGULATIONS.**

⚠ WARNING

On units equipped with two sets of cam locks, verify all connections to the cam lock receptacles are made to one side only. *i.e.* DO NOT attach L1, L2 and L3 to the left side and Neutral and Ground to the right side. See [Control Panel - MMG330DI4](#) or [Control Panel - MMG480DI4](#) for breaker locations.

AUXILIARY FUEL TANK OPTION

The auxiliary fuel tank option is designed so the unit can run from an external fuel tank. The unit is still programmed to shut down when the internal tank's fuel level drops below five percent. In order for the unit to run off of an auxiliary tank, the fuel level in the internal tank must remain over five percent. To operate the unit using an auxiliary fuel tank, use the following procedure:

1. Shut down the unit and verify the fuel level in the tank is above five percent.
2. Attach the auxiliary fuel tank's fuel lines to the "AUXILIARY FUEL INLET" and "AUXILIARY FUEL OUTLET" fittings on the unit.
3. Open the "AUXILIARY FUEL INLET" and "AUXILIARY FUEL OUTLET" valves located inside of the right front door.

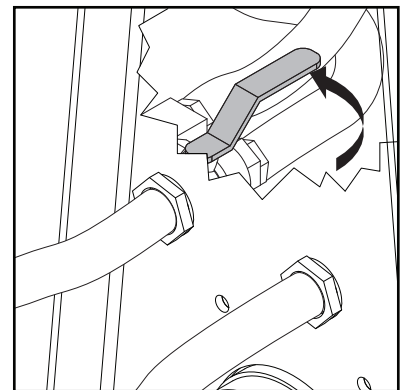

Figure 7-2. Attach Fuel Lines

FUEL TRANSFER PUMP OPTION

The fuel transfer pump option allows the fuel tank to be refilled from an external bulk fuel source. When the fuel transfer switch is on and the fuel level drops below 15%, the fuel transfer pump will begin pumping fuel from an external bulk fuel source into the fuel tank on the unit. The fuel transfer pump will shut off when the fuel level of the internal tank reaches 90%. The pump will also be monitored to ensure a certain percentage increase in fuel level over a given period of time to prevent the pump from running dry. To operate the fuel transfer system, use the following procedure:

1. Shut down the unit.

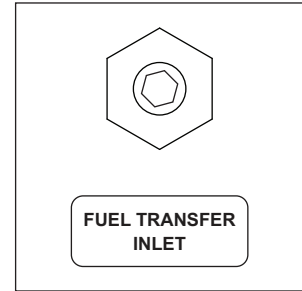

Figure 7-3. Fuel Transfer Inlet

Note: *If the external bulk fuel supply is already connected, the unit does not have to be shut down to turn the fuel transfer pump option on or off.*

2. Attach the external bulk fuel supply to “FUEL TRANSFER INLET” fitting on the unit.
3. Turn on the fuel transfer switch.

VISCOUS FAN CLUTCH OPTION

The viscous fan clutch option allows the engine cooling fan to engage at lower speeds and disengage at higher speeds, increasing cooling system efficiency. The cooling fan will engage at full speed when the coolant temperature rises. When the fan is operating at full speed, it will switch to a slower speed when the coolant temperature drops. There will be an audible difference when the engine cooling fan switches speeds. Depending on unit model, the temperature ranges vary between 170°F and 200°F (77°C and 93°C).

This Page Intentionally Left Blank

