



2021 RAM PROMASTER

BEST IN CLASS WHERE IT COUNTS



ONE VAN. MANY POSSIBILITIES.

When it comes to real-world capability, Ram ProMaster® sets the bar. It starts with **best-in-class** features like **standard cargo height,^{1*} tallest and widest standard cargo area,¹ maximum cargo width,¹ width between the wheel wells,¹ turning diameter¹ and **standard V6 280 horsepower.¹** In three weight classes, with two roof heights and four cargo lengths, a Ram ProMaster is designed to let you do your best by giving you the best. Visit us at ram.com/promaster**

THE RIGHT WIDTH FOR THE RIGHT FIT



BEST-IN-CLASS
MAXIMUM
CARGO WIDTH¹
(CARGO VAN)

BEST-IN-CLASS
WIDTH BETWEEN
WHEEL WELLS¹
(CARGO VAN)



WIDE-OPEN ACCESS. Regardless of which 2021 Ram ProMaster[®] model you choose, fitting a standard pallet between the wheel wells won't be an issue. Need a shelf system? With 6 ft 3 in of interior width and near vertical walls, that won't be an issue either. The cavernous space inside ProMaster is also the perfect space for transporting equipment and materials or creating a mobile work area.



BEST-IN-CLASS STANDARD CARGO HEIGHT¹

THE RIGHT HEIGHT FOR THE RIGHT FIT.

Ram ProMaster[®] wasn't designed just to fit cargo, it was designed to fit people, too. With this best-in-class standard cargo height,¹ convenience is built in. Opt for the available High Roof and you have a rear workspace that most people can walk in without stooping or bending over.



STANDARD ROOF: **BEST-IN-CLASS** STANDARD CARGO HEIGHT¹ (CARGO VAN)



AVAILABLE HIGH ROOF

FOUR LENGTHS TO MEET MANY NEEDS



118-inch wheelbase



136-inch wheelbase

FIND THE RIGHT WHEELBASE.

ONE SIZE DOES NOT FIT ALL.

The size of your product, the amount of gear needed and the area of your parking space are specific to your business. We know that. And it's the reason why we offer Ram ProMaster® Cargo Van in four lengths. Along with the super-wide width, choose from two available roof heights and four lengths built on three wheelbases. Our goal is to always give you multiple possibilities in terms of adaptability, convenience and aftermarket upfit.



159-inch wheelbase



159-inch wheelbase, extended

ADVANTAGE: RAM PROMASTER®



**CLASS-EXCLUSIVE
FWD**

FRONT-WHEEL-DRIVE SYSTEM¹
Excels in adverse weather conditions

**CLASS-EXCLUSIVE
AVAILABLE DIGITAL
REARVIEW MIRROR¹**

**BEST-IN-CLASS
STANDARD V6 HORSEPOWER¹
280 HP**
(with 260 lb-ft of torque)

**BEST-IN-CLASS
4,680-LB
MAXIMUM PAYLOAD⁶**
(3500 Cargo Van, 136-inch wheelbase,
Standard Roof)

**STANDARD
ESC
ELECTRONIC STABILITY
CONTROL²**

**AVAILABLE
BLIND SPOT MONITORING³
WITH REAR CROSS-PATH
DETECTION⁴**

**AVAILABLE FULL-SPEED
FORWARD COLLISION
WARNING PLUS⁵**

**BEST-IN-CLASS
36.3-FT
TURNING DIAMETER¹**
(118-inch-wheelbase Cargo Van models)

**5 YEAR / 60,000 MILE
POWERTRAIN LIMITED WARRANTY⁷**

BEST-IN-CLASS
75.6-INCH
MAXIMUM CARGO WIDTH¹
(Cargo Van)

BEST-IN-CLASS
66.3-INCH
STANDARD CARGO HEIGHT¹
(Cargo Van with standard roof)
77.1-INCH AVAILABLE CARGO HEIGHT¹
(Cargo Van shown here with available High Roof)

BEST-IN-CLASS
56.0-INCH
CARGO WIDTH BETWEEN WHEEL WELLS¹
(Cargo Van)

BEST-IN-CLASS
LOWEST LOAD
FLOOR HEIGHT¹
(Cargo Van)

TALLEST & WIDEST
STANDARD CARGO AREA IN ITS CLASS¹
(Cargo Van)

STANDARD
UCONNECT® 3 WITH
5-INCH TOUCHSCREEN
DISPLAY

DESIGNED FOR EASY ACCESS

NO WORRIES, WE HAVE YOU COVERED

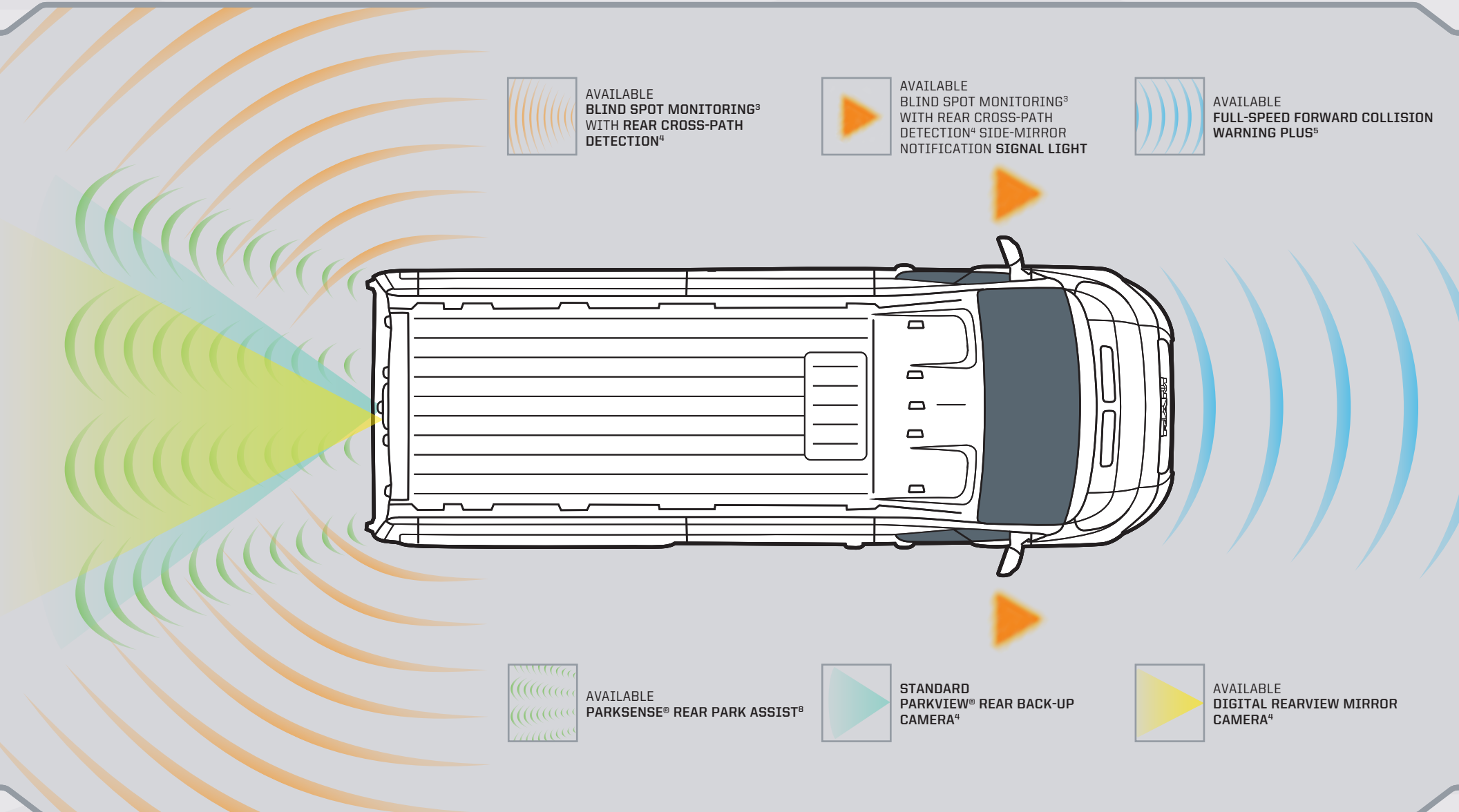

SAFETY-NET COVERAGE.

As you can see, every Ram ProMaster[®] Cargo Van offers a host of standard and available Safety and Security features. We like to think of our comprehensive coverage as a safety net for your whole vehicle. Electronic Stability Control (ESC)², Antilock Braking System (ABS), smartly engineered crumple zones and new standard Crosswind Assist are just a few more of the many features that help give you a secure ride wherever your job takes you.

A NEW LEVEL OF CONTROL

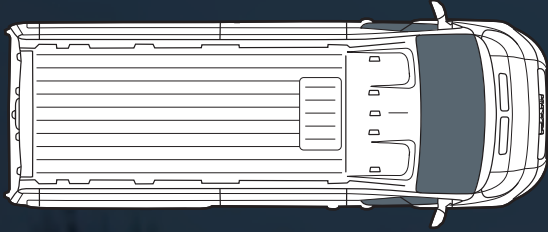

NEW STANDARD CROSSWIND ASSIST.

Crosswind Assist is activated automatically from a minimum speed of 45 mph. Sensors detect the forces acting on the vehicle when crosswinds or sudden gusts occur and apply braking action to individual wheels on the side facing the wind. This braking torque creates a yawing motion which helps counter the effect of the crosswind. The result is deviation that is significantly reduced. This helps reduce the strain on the driver, helping to avoid inappropriate driver responses in gusting winds. The driver's attention is also drawn to the system's intervention by an indicator lamp in the instrument cluster.



STANDARD ELECTRONIC STABILITY CONTROL.²

Our advanced version of the Electronic Stability Control (ESC)² system integrates the Antilock Braking System (ABS) with a variety of All-Speed Traction Control technologies. ESC² helps maintain control under adverse conditions, like wet, icy or snow-covered roads, and during tight turns and evasive maneuvers. Also included: a Brake-Lock Differential, Brake Assist, Hill Start Assist, Trailer Sway Damping⁹ and Electronic Roll Mitigation.

STANDARD PARKVIEW[®] REAR BACK-UP CAMERA.⁴

Automatically engages in Reverse, displaying the rear scene on the Uconnect[®] 3 with 5-inch display radio screen. On-screen grid lines enhance the ease of backing up. The available ParkSense[®] Rear Park Assist⁸ is also activated simply by engaging Reverse.

FRONT CRUMPLE ZONES.

Front crumple zones are engineered to help absorb energy. Our goal is to create a vehicle noted for its Safety and Security features.



CONFIDENCE AND SECURITY



AVAILABLE BLIND SPOT MONITORING³ WITH REAR CROSS-PATH DETECTION.⁴

With dual wide-band radar sensors in the rear of the vehicle, the available Blind Spot Monitoring³ with Rear Cross-Path Detection⁴ scans the blind-spot zones behind the vehicle to help ensure safe maneuvering.

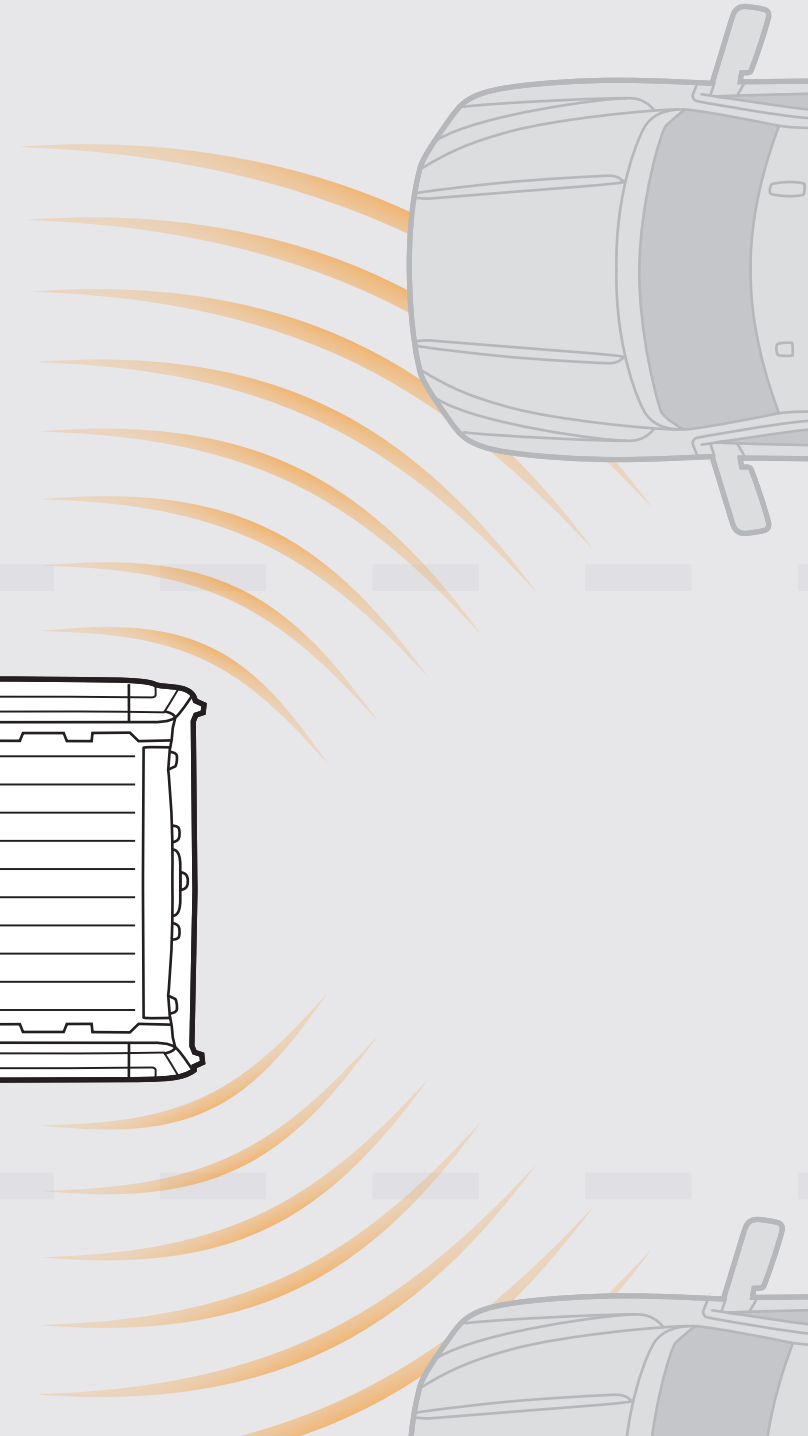
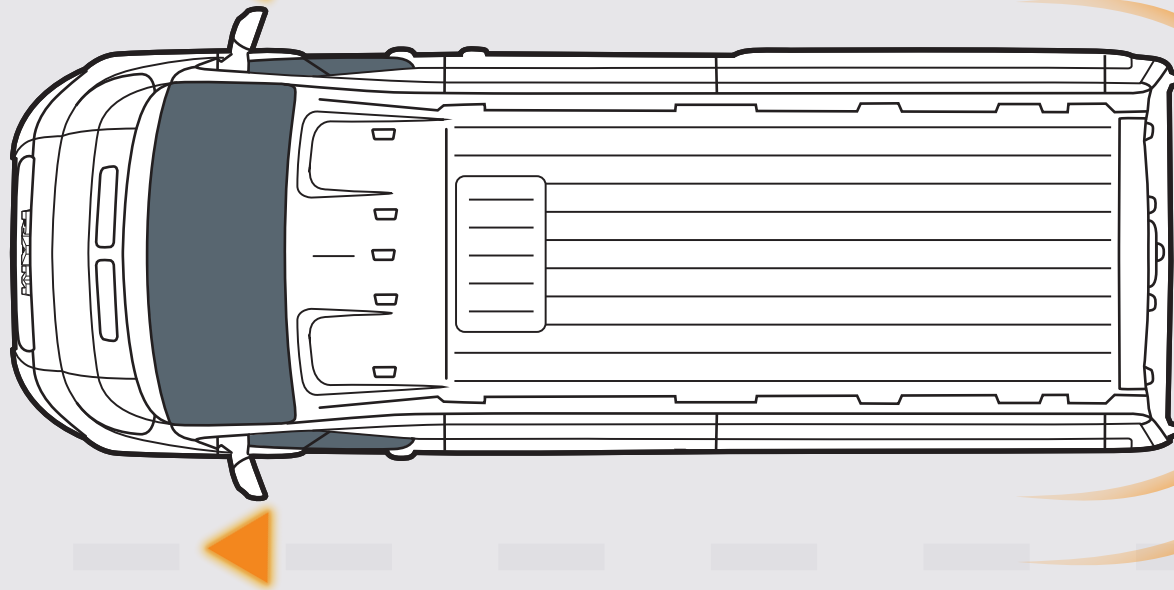

FORWARD THINKING: FRONT-LINE PROTECTION

MONITORING SAFE AREA AHEAD



SENSING POSSIBLE OBSTRUCTION



AVAILABLE FULL-SPEED FORWARD COLLISION WARNING PLUS⁵

The Full-Speed Forward Collision Warning Plus (FSFCW+)⁵ system provides both audible and visual warnings to alert the driver when it detects a potential frontal collision. The warnings are intended to help provide the driver with enough time to react, avoid or mitigate the potential collision.

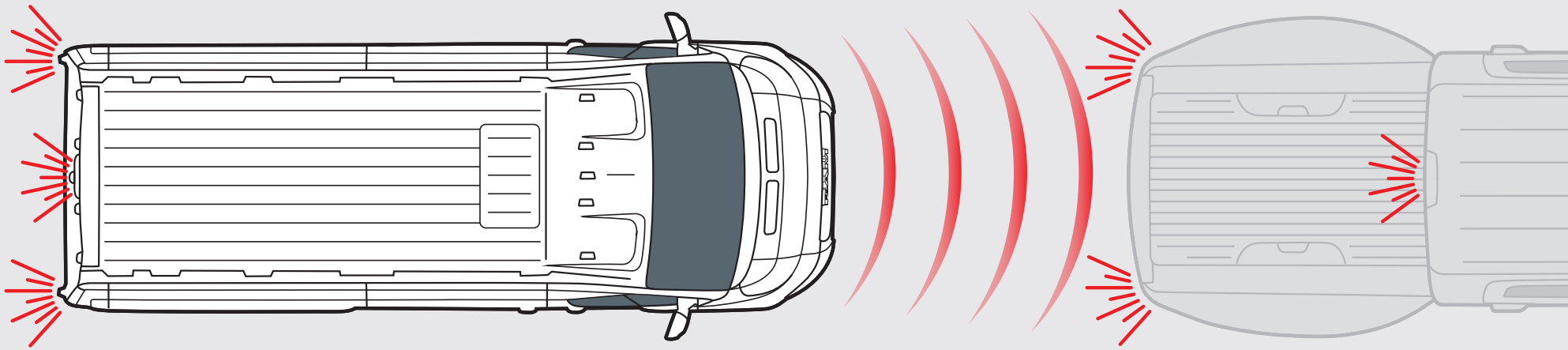

BRAKE!

CLASS-EXCLUSIVE AVAILABLE DIGITAL REARVIEW MIRROR¹



HELPING YOU SEE MORE.

The new, class-exclusive available Digital Rearview Mirror¹ replaces a traditional reflective rearview mirror with a 9.2-inch-wide LCD monitor that displays real-time video from a rear-facing camera. The camera is located on the back of the van, so the view is unobstructed compared to a traditional rearview mirror. Unlike back-up cameras, the vehicle doesn't need to be in Reverse to activate, and the view is a higher resolution.

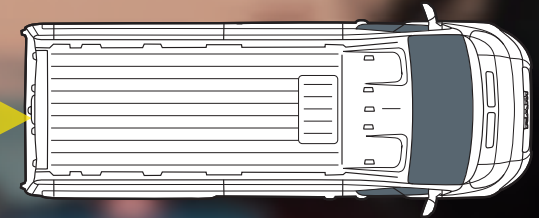

NO MORE OBSTRUCTED VIEWS.

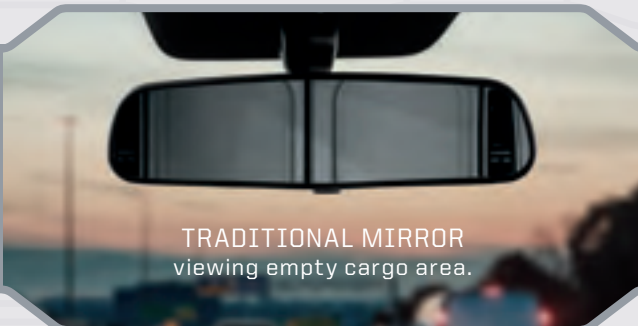

TRADITIONAL MIRROR
viewing empty cargo area.

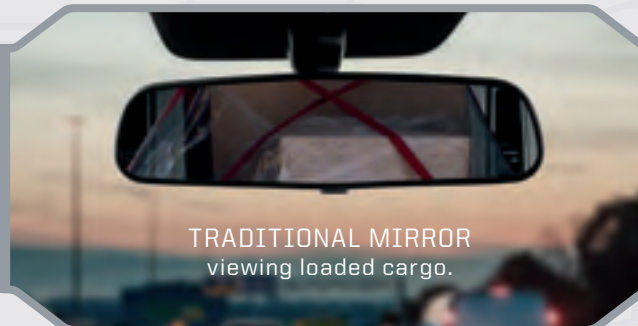

TRADITIONAL MIRROR
viewing loaded cargo.

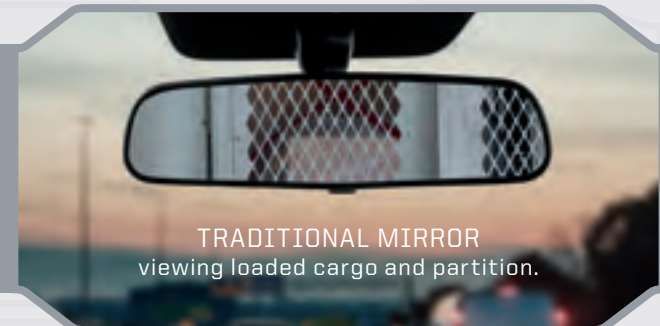

TRADITIONAL MIRROR
viewing loaded cargo and partition.

MANAGE CARGO LIKE A PRO



CARGO TIE-DOWNS.

Cargo Van models feature up to 10 in-floor D-rings to help secure cargo. Want more? Up to an abundant 17 floor and sidewall tie-downs provide stabilization and security for your cargo when you're on the move.

SMART CARGO MANAGEMENT—JUST HIT THE ROOF.

Maximize potential and expand cargo-carrying capability. Cargo Van roof strength can handle up to 330 lb.¹⁰ Six roof mounting points (three per side) enable the aftermarket roof rack of choice.



PROVEN METTLE



YEAR-ROUND CONFIDENCE

CLASS-EXCLUSIVE FRONT-WHEEL DRIVE (FWD)¹

Advantages to FWD are substantial. It enables outstanding control—especially valuable in snowy climates. It also utilizes the weight in the front end to help ensure great front tire “road grab.” By dispensing with the fore-to-aft drivetrain employed by our competitors, FWD also functions as a direct contributor to the best-in-class lowest load floor height.¹

ANTILOCK BRAKING SYSTEM (ABS) AND BREMBO® BRAKES.

Our ABS controls and monitors each wheel independently. The high-performance Brembo brake system provides superb stopping power—notably, when trailering.

PREMIUM RACK AND PINION STEERING.

Our hydraulic-assist system uses a premium steering gear, engineered and tuned for long-term service. Curb-to-curb turning radii—even on longer-wheelbase models—are impressive and ideal for tight city streets. The convenient telescoping steering column is an unusual and welcome feature in the commercial world. We’ve made it standard on all models.

ROBUST FRONT AND REAR SUSPENSION TECHNOLOGY.

In front, a MacPherson strut front suspension utilizes large, 62-mm twin-tube shock absorbers for solid support of the powertrain. This system is enhanced with GVW-tuned cast iron control arms for impressive durability, road manners and handling—even under heavy loads. Rear suspension technology is category-unique: a beam axle/leaf spring design that’s light and simple yet robust.

UNIBODY ENGINEERING.

A solid backbone is a designed-in advantage to the body-frame integral (unibody) engineering of your Ram ProMaster® model, with each chassis mass-optimized and tuned for ideal performance. This integrated frame structure features boxed frame components, multiple crossrails and longitudinal rails—and all are crucially welded together. Depending on wheelbase length, you’ll find up to eight tough structural crossmembers, giving every Ram ProMaster model the ladder-frame integrity that ensures proper stiffness and long-term durability.



BEST-IN-CLASS
LOWEST LOAD FLOOR HEIGHT¹

THE RIGHT LEVEL OF CONVENIENCE

BEST-IN-CLASS LOWEST LOAD FLOOR HEIGHT¹

Our class-exclusive Front-Wheel Drive (FWD)¹ works with a light and robust beam axle/leaf spring rear suspension that's just as tough as those found on Rear-Wheel-Drive (RWD) vehicles. The design eliminates the middle hump of RWD vehicles, giving you an easy-to-load Cargo Van with best-in-class lowest load floor height.¹

BEST-IN-CLASS TURNING DIAMETER¹

We view our cargo vans as your business partner. That's why we spent time crafting small details that yield a big convenience like only a 36.3-foot turning diameter (on 118-inch-wheelbase models). It's perfect for navigating crowded city streets, cramped loading docks or narrow back alleys.

36.3-FT
TURNING
DIAMETER





STRONG & CAPABLE

OPERATE AT FULL CAPACITY



CARGO VAN PAYLOADS <small>(weight given in lb)</small>	1500			2500			3500			
	118" WB	136" WB		136" WB		159" WB	136" WB		159" WB	159" WB, EXT.
	STANDARD ROOF	STANDARD ROOF	HIGH ROOF	STANDARD ROOF	HIGH ROOF	HIGH ROOF	STANDARD ROOF	HIGH ROOF	HIGH ROOF	HIGH ROOF
MAX PAYLOAD¹⁰	4,000	3,890	3,760	4,260	4,130	4,010	4,680	4,550	4,430	4,330

WB = wheelbase. Best-in-class⁹ = 0,000



DESIGNED TO DELIVER

PACK IT UP AND PACK IT IN. Whether you're carrying tools, equipment or deliverables, this Cargo Van is a workhorse. With up to 462.9 cu ft of cargo capacity,¹⁰ a best-in-class 4,680-lb maximum payload⁶ and easy access to the cargo area, Ram ProMaster[®] makes light of heavy work.



Shown with aftermarket upfit.

SERIOUS CABIN VERSATILITY. Without a doubt, this is an interior that was created to be adaptable, customizable and upfitted for business or trade. Regardless of which cargo-length van you choose, each one shares the same baseline of upfitability: nearly vertical side walls and best-in-class standard cargo height;¹ max cargo width;¹ width between the wheel wells¹ and lowest load floor height.¹ The available High Roof option shown above gives you even greater functionality.



HIGHLY FUNCTIONAL WORKSPACES



Shown with aftermarket upfit.

CUSTOM-FIT CAPACITY



- Available left-side Sliding Door with fixed glass
- Available lower-side Wall Panels
- Available Wood Floor
- Rear Doors with available fixed glass



- Available Cargo Partition with sliding window
- Available left-side Sliding Door with fixed glass
- Rear Doors with available fixed glass



- Available Cargo Partition
- Available upper- and lower-side Wall Panels
- Available Wood Floor



- Available aftermarket second-row Crew Van Seat Upfit by Snoeks Automotive

OUR JOB IS TO MAKE YOURS EASIER

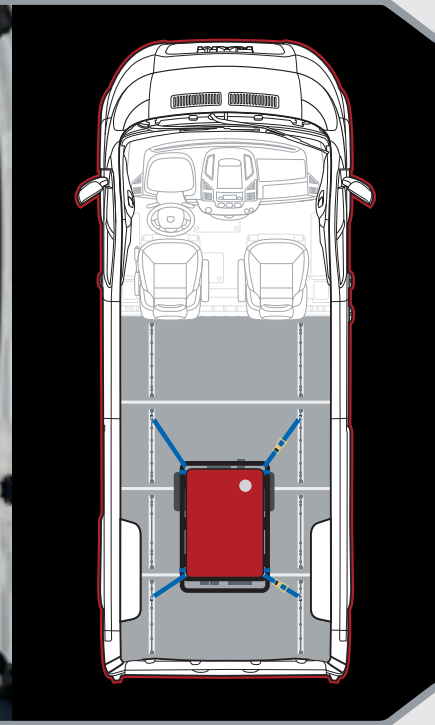

CARGO TIE-DOWN TRACK SYSTEM. This is multitasking at its best. The load floor system includes two in-floor tracks and two side tracks—one on each wall. Fitting all tracks are four 5/16-inch carriage bolts and four L-Channel Quick-Connect rings to securely strap down cargo (straps not included).



CARGO LOAD FLOOR^{11,12} On its own, our limited factory-warranted¹³ Cargo Load Floor is ideal, using a modular design that fits all models and invites add-on kits. Features include an anti-slip surface, aluminum entry-point ramps, two integrated floor rails, four side rails (two per side) plus perfectly fitting hardware for all of it. Available only as an upfit when initially ordering your Ram ProMaster® Cargo Van. Learn more at mopar.com

CUSTOM UPFIT DIRECT FROM THE FACTORY



THE RIGHT FIT. THE RIGHT PARTS. THE RIGHT PROTECTION. When it comes to Ram ProMaster®, not all parts and accessories are created equal. As the official service, parts and customer care provider for the Ram Brand, only Mopar® Parts and Accessories can ensure the proper fit, finish and functionality. That's because they're original equipment, engineered by the same people who designed your vehicle, which means you can personalize your ride with complete confidence.

Mopar is also more than parts and accessories. We're here to help you properly maintain and care for your vehicle. Our certified technicians are trained to know your vehicle best, and our Mopar Express Lane service departments are set up to get you in, out and back on the road. From parts and accessories to expert service and more, always be sure to choose Mopar. Learn more at mopar.com



- A. Rear Assist Handles
- B. LED Cargo-Area Lights
- C. Cargo Load Floor^{11,12}
- D. Hitch Receiver¹⁴
- E. Molded Flat Splash Guards
- F. Passenger Side Step¹⁵
- G. Remote Start^{12,16}
- H. Front and Rear Assist Handles
- I. Rear Window Guards
- J. Rear Step

CHASSIS CAB & CUTAWAY



Shown with aftermarket upfit.

DESIGN IT TO BE YOURS



Illustrated to show Cutaway.

TOUGH UNIBODY STRENGTH AND CUSTOM BODY TREATMENT. Combine industrial-grade capability with the right upfit, and your Ram ProMaster® Chassis Cab or Cutaway is ready for the job. The numbers speak for themselves: 3500 weight class only, built on a 136- or 159-inch wheelbase. Max length of 250.6 inches. Heavy-duty tuned suspension with a MacPherson strut front unit. Muscular 9,350-lb GVWR¹⁷ and towing up to 5,100 lb,¹⁰ with payload up to 5,230 lb.¹⁰ Spec out your ideal model at ram.com/promaster

Shown with aftermarket upfits.

OUR STRENGTH, YOUR DETERMINATION



CHASSIS CAB & CUTAWAY PAYLOADS <small>(weight given in lb; must include weight of upfit)</small>	CHASSIS CAB			CUTAWAY		
	3500			3500		
	136" WB	159" WB	159" WB, EXTENDED	136" WB	159" WB	159" WB, EXTENDED
	82.4" CA	104.7" CA	104.7" CA	82.4" CA	104.7" CA	104.7" CA
MAX PAYLOAD¹⁰	5,170	5,130	5,100	5,230	5,200	5,160

WB = wheelbase. CA = cab-to-axle.

Shown with aftermarket upfit.



WORKHORSE PERFORMANCE



THE 3.6L PENTASTAR® V6

BEST-IN-CLASS STANDARD V6 280 HORSEPOWER¹ WITH 260 LB-FT OF TORQUE.

Advanced technologies like wide-range Variable Valve Timing (VVT) and two-step variable valve lift help deliver best-in-class standard V6 280 horsepower¹, handle payloads of up to a best-in-class 4,680 lb⁶ and support oil change intervals up to 10,000 miles. The 62TE six-speed automatic transmission provides exceptionally smooth driving characteristics, quick changes between gears and impressive capability that's work-ready.

Trailer? No problem. Opt for the available Class IV hitch receiver to boost your max towing up to 6,910 lb.¹⁰

5 YEAR/60,000 MILE
POWERTRAIN LIMITED WARRANTY⁷

HORSEPOWER	280 hp @ 6,400 rpm
TORQUE	260 lb-ft @ 4,175 rpm
CONFIGURATION	60-degree V6
DISPLACEMENT	220 cu in (3604 cc)
BORE x STROKE	3.78 x 3.27 in (96.0 x 83.0 mm)
BLOCK MATERIAL	Aluminum
CYLINDER HEAD MATERIAL	Aluminum alloy
AIR INDUCTION	Naturally aspirated
VALVE TRAIN	Chain-drive DOHC, 24-valve
FUEL DELIVERY	Sequential, multiport injection
RECOMMENDED FUEL	Unleaded regular (87 octane)
COMPRESSION RATIO	10.2:1
ALTERNATOR	180-amp (220-amp available)
OIL CAPACITY	6.0 quarts
MAXIMUM RECOMMENDED OIL CHANGE INTERVAL	10,000 miles



TAKEN TO THE LIMITS AND TESTED TO EXTREMES

What's work-tough capability without the reliability and quality to back it up? We put Ram ProMaster® models through punishing testing under brutal conditions. We took on climates that ranged from the arctic -40°F of northern Sweden to the scorching 125°F heat of west American deserts, and roads far more challenging than you'll likely attempt. We surpassed all with flying colors—solid proof that every model in this portfolio is designed to deliver exceptional durability and unflinching dependability.



MOBILE WORKSTATION

Working on the go requires flexibility, organization and connected technology. Ram ProMaster® has all three. **The NEW available Ambient LED Interior Lighting** provides additional cabin illumination and helps you make the most of your mobile workstation.





BUCKET SEATS

- ▶ Standard four-way with spring suspension
- ▶ Available six-way adjustable seats with manual lumbar support and available heated seat surfaces



DRIVER SUSPENSION BUCKET SEAT

- ▶ Available premium seat adds a pneumatic suspension and a weight-/size-conformity adjustment knob

SEATING OPTIONS TO FIT YOUR BUSINESS NEEDS



THREE-OCCUPANT SEATING

- ▶ Single driver bucket seat joined by an available integrated two-person bench seat. The middle seatback insert folds down to become a convenient writing surface



SWIVEL SEATING

- ▶ Available swivel bucket seats with 180° inboard swivel range, 35° outboard swivel, a 58° recliner and a continuous height adjuster

WORK SMARTER



COMMAND CENTRAL. With integrated Voice Command, hands-free calling,¹⁸ convenient steering-wheel controls and available navigation, our technology helps keep you connected while on the road. The 12-volt and high-speed USB outlet in the front and available auxiliary 12-volt outlet in the back keep devices powered. Opt for extra comfort with the available premium driver suspension bucket seat or swivel bucket seats.

CONVENIENT CONTROL AT YOUR FINGERTIPS

Uconnect® 3.

The standard Uconnect 3 with 5-inch color display radio system delivers true fidelity with easy-to-access info through Bluetooth® technology and the color touchscreen.



Uconnect 3 AT A GLANCE.

- 5-inch Color Touchscreen
- ▶ AM/FM Stereo Audio System
- ▶ Four-speaker Sound System
- ▶ Integrated Voice Command
- ▶ MP3 Capability with Auxiliary Input
- ▶ Steering Wheel-mounted Audio Controls



Uconnect 3 NAV.

The available Uconnect 3 NAV with 5-inch color display delivers precise, Web-based GPS Navigation; the available SiriusXM® Radio¹⁹ includes a six-month trial subscription. Uconnect at your service is made even better by the comprehensive available Ram Telematics.TM



Uconnect 3 NAV AT A GLANCE.

- All features of the Uconnect 3 system, plus:
- ▶ GPS Navigation
 - ▶ Points-of-interest Accessibility
 - ▶ Turn-by-turn Navigation

RAM PROMASTER® WINDOWED VAN



Shown with aftermarket upfit.

BUSINESS AND PLEASURE

6'4"

UPFIT
AREA
HEIGHT



ONE WHEELBASE, EXPANSIVE OPTIONS. Utilize the extended body on Windowed Van to create a significantly larger interior. The 14.3-inch extension adds nearly 43 cu ft of volume—the perfect solution when you need extra room for luggage or storage.

6'4"

UPFIT
AREA
HEIGHT



PEOPLE COME FIRST. Comfort, safety and security. You'll find these and more in our Windowed Van. Designed around the needs of people, it's available in 2500 and 3500 weight classes on the 159-inch wheelbase in your choice of two lengths. For optimum passenger comfort, the High Roof is standard. As with every Ram ProMaster,[®] there is an abundance of upfit possibilities, plenty of cargo room and the solid power of the Pentastar[®] V6 engine.

If you require a Special Needs interior upfit, the flexibility of Windowed Van is your go-to solution. If additional power is needed, our available Auxiliary Switches can help handle the ancillary devices of ambulances, mobile medical clinics and DriveAbility Program applications.



A grayscale photograph of a suspension bridge, likely the Manhattan Bridge, with a thick rope in the foreground. The image is overlaid with a dark blue, semi-transparent graphic element that curves across the top and bottom. The text "SUPPORT THAT MAKES A DIFFERENCE" is centered in the middle of the image in a white, outlined, sans-serif font.

SUPPORT THAT MAKES A DIFFERENCE



Shown with aftermarket upfit.

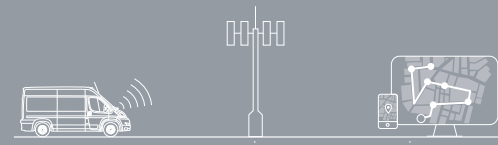

RAM TELEMATICS

— POWERED BY VERIZON CONNECT —

STAY ON TRACK BY KEEPING TRACK.

Simplicity plus complete visibility equals total performance. Vehicle status and history provide insight into vehicle maintenance, workforce management and driver behavior. Just a few of the many advantages:



VEHICLE DIAGNOSTICS

- ▶ Oil Life Monitoring
- ▶ Tire Pressure Monitoring
- ▶ Diagnostic Trouble Codes



VEHICLE PERFORMANCE

- ▶ Fuel Consumption
- ▶ Idling
- ▶ Odometer Readings



VEHICLE TRACKING

- ▶ GPS Location
- ▶ Geo-fencing



DRIVER BEHAVIOR

- ▶ Speeding vs. Posted Speed Limit
- ▶ Hard Braking/Acceleration
- ▶ ABS/Stability Control Events



DRIVER SAFETY & VEHICLE SECURITY

- ▶ Seat Belt Usage
- ▶ Air Bag²¹ Deployment
- ▶ Unauthorized Vehicle Use

KEEP TRACK AND KEEP YOUR FLEET LEAN

AVAILABLE RAM TELEMATICS,™ A COMPREHENSIVE SET OF DIAGNOSTICS FOR YOUR RAM PROMASTER® Scalable to fleets of all sizes, factory-installed and backed by a 3-Year/36,000-Mile Basic Limited Warranty,²⁰ available Ram Telematics monitors key performance metrics in near real time—the power you need to transform your business.

Tracking numerous separate mechanical functions—everything from accelerator pedal position to engine info such as coolant level and oil life monitoring—these detailed notifications help keep your Ram vehicle in top-notch condition, let your drivers make informed decisions and help increase uptime.

RAM TELEMATICS™: THE KEY TO PROFITS

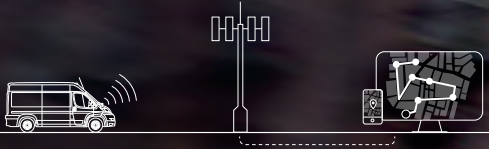

Users reporting **INCREASES:**

 **53%**
PRODUCTIVITY

 **50%**
CUSTOMER SERVICE

 **45%**
ROUTING

YOUR BUSINESS ROLLS WITH BOTTOM-LINE FIGURES. So do we. Here are areas in which fleet tracking users report improvements.

Users reporting **DECREASES:**

 **36%**
FUEL CONSUMPTION

 **22%**
ACCIDENTS

 **13%**
LABOR COSTS

AVAILABLE RAM TELEMATICS, AN ON-THE-GO OPERATING SYSTEM THAT DRIVES YOUR BUSINESS. The successful business is efficient, effective and up to date, and stays on top of any and all technologies that will help it run better. For fleets both large and small, the state-of-the-art available Ram Telematics is the way to get the best from your Ram ProMaster.®

Powered by Verizon Connect, available Ram Telematics gives you near real-time on-screen monitoring, provides complete visibility of fleet operations and helps reduce the total cost of ownership.

Activation is easy, with online registration and your choice from one-, three- and five-year plans available.

Get more at ram.com/telematics

Source: "2020 Fleet Tracking Trends Report, Verizon Connect (2020)."



BUILD YOUR IDEAL WORKHORSE

RAM PROMASTER® BUYER'S GUIDE

ENGINE/TRANSMISSION

3.6L Pentastar® V6/6-speed automatic **ERB/DG2** • • • •

MECHANICAL FEATURES

ADDITIONAL KEY FOBS – Two **GXK** 0 0 0 0

ALTERNATOR – 180-amp **BAD** • • – –

– 220-amp (included with RV-Ready Prep Package) **BAJ** 0/P 0/P • •

AUXILIARY FUEL TAP **XFZ** • • • •

BATTERY – 95-amp **BCY** • • • •

– 100-amp (restrictions apply) **BDC** 0 0 0 0

– Auxiliary Power Connector **BC1** • • • •

CROSSWIND ASSIST **BNU** • • • •

CRUISE CONTROL **NHM** 0 0 0 0

ELECTRONIC STABILITY CONTROL (ESC)² **BNB** • • • •

ELECTRONIC VEHICLE TRACKING SYSTEM (by Mopar®) **AES** 0 0 0 0

ENGINE BLOCK HEATER **NHK** 0 0 0 0

FUEL TANK – 24-gallon **NFE** • • • •

FULL-SIZE SPARE TIRE **TBB** • • • •

POWER STEERING **SBA** • • • •

SPEED LIMITER – 65-mph maximum speed **JJ4** 0 0 0 0

– 70-mph maximum speed **JJ5** 0 0 0 0

– 77-mph maximum speed **JJ9** 0 0 0 0

SUSPENSIONS – Heavy-duty (2500/3500) **SDB** • 0 – –

– Light-duty (118-inch-wheelbase 1500 models only) **SDA** • – – –

– Medium-duty (136-inch-wheelbase 1500 models only) **SDJ** • – – –

– Premium heavy-duty (3500 models only; Cargo Van requires the 159-inch wheelbase) **SDD** 0 0 • •

– Touring **SDC** – • – –

TEMPORARY SPARE TIRE MOUNT **TBA** – – 0 0

UPFITTER ELECTRONIC MODULE – Vehicle System Interface Module (VSIM) **XXS** 0 0 0 0

EXTERIOR FEATURES

DAYTIME RUNNING LAMPS (included with Safety Group) **LMK** 0/P 0/P 0 0

DOORS, REAR – 260-degree-opening **GLF** • • – –

– Rear hinged doors with no glass **GLA** • – – –

– Rear hinged doors with fixed glass **GLB** 0 • – –

EXTERIOR FEATURES (continued)

DOORS, SIDE – Left-side with fixed-glass window and grate (includes deep-tint sunscreen glass; 136-inch-wheelbase models with Standard Roof only) **GKD** 0 – – –

– Left-side with no glass (not available on 118-inch-wheelbase models) **GKE** 0 – – –

– Left-side with fixed window (includes deep-tint sunscreen glass; not available on 118-inch-wheelbase models) **GKT** 0 – – –

– Right-side with fixed glass (Standard Roof models only on Cargo Van; includes window grate and deep-tint sunscreen glass) **GKB** 0 – – –

– Right-side with no glass **GKA** • – – –

– Passenger-sliding door with fixed window (includes deep-tint sunscreen glass; restrictions apply) **GKS** 0 • – –

FRONT FOG LAMPS (included with Convenience Group, Safety Group and Premium Appearance Group) **LNJ** 0/P 0/P 0/P 0/P

FRONT LICENSE PLATE BRACKET **MDA** 0 0 0 0

GRILLE – Chrome, with prominent Ram badging (included with Premium Appearance Group; must have front fog lamps) **MFE** 0/P 0/P 0/P 0/P

– Silver, with prominent Ram badging **MFD** • • • •

HEADLAMPS **LMA** • • • •

HITCH RECEIVER, CLASS IV – Includes four- and seven-pin wiring harness (included with RV-Ready Prep Package) **XFH** 0/P 0/P – –

MIRRORS – Manual-adjustable/manual-folding **GTP** • • • •

– Power-adjustable/power-folding, heated (included with Safety Group) **GTR** 0/P 0/P – –

– Wide power-adjustable, heated **GTB** 0 0 0 0

REAR WALL WINDOW **GEV** – – • –

ROOF CLEARANCE LAMPS – Front Clearance Lamps Delete **LT8** – – 0 0

– Front **LNC** • • • •

– Rear **LNG** • • – –

SPLASH GUARDS – Vehicle Set (by Mopar) **MKN** 0 0 – –

STEP – Rear Bumper Extension (not available with Class IV hitch receiver; see your dealer for availability; by Mopar) **MDM** 0 0 – –

– Sliding-door step, left-side (requires left-side door) **MR3** 0 – – –

• = Standard 0 = Optional P = Available within Package – = Not available

RAM PROMASTER® BUYER'S GUIDE

EXTERIOR FEATURES (continued)

	SALES CODE	Cargo Van	Windowed Van	Chassis Cab	Cutaway
STEP (continued) – Sliding-Door Step, Right-Side (see your dealer for availability; by Mopar®)	MRZ	0	0	–	–
TAILLAMP EXTENSION WIRING	XGF	–	–	•	•
WHEELS – 16-inch aluminum (included with RV-Ready Prep Package)	WDN	O/P	O/P	0	0
– 16-inch Silver-painted steel with center cap	WCS/WMN	•	•	•	•
– 16-inch Silver-painted steel with full wheel cover	W6A	0	0	0	0
– 16-inch Black-painted steel (not available with RV-Ready Prep Package)	WDL	0	0	0	0
– Center Cap Delete	WH8	0	0	0	0
WINDOW – Left-side second-row fixed (includes deep-tint sunscreen glass; optional on High Roof Cargo Van models only)	GEA	0	•	–	–
WINDOW DEFROSTER – Rear (requires rear doors with glass on Cargo Van models)	GFA	0	•	–	–

INTERIOR FEATURES

12-VOLT AUXILIARY POWER OUTLET – Front	JJJ	•	•	•	•
– Rear	JKP	0	0	–	–
AIR CONDITIONING – Air Conditioning Delete; heater only	HCD	0	0	0	0
– Manually controlled, with heat	HAA	•	•	•	•
– Rear Heater/Air Conditioning Prep Package (not available with Air Conditioning Delete; included with RV-Ready Prep Package)	HDG	O/P	O/P	0	0
ASSIST HANDLE – Rear Doors (by Mopar)	CSR	0	0	–	–
AUXILIARY UPFITTER SWITCHES – Two (included with RV-Ready Prep Package)	LHL	O/P	O/P	0	0
CARGO COMPARTMENT FLOOR MAT	CKL	0	–	–	–
CARGO PARTITION – None	CTP	•	•	–	–
– With sliding window	XJ1	0	–	–	–
– Without window	CWC	0	–	–	–
CARGO TIE-DOWNS – Floor		•	–	–	–
– Side wall	CKT	•	–	–	–
CARGO-AREA LIGHTING – Incandescent	LPE	•	•	–	–
– LED (not available with LED rear lamp; by Mopar)	LCP	0	0	–	–
– LED rear lamp (included with Interior LED Lighting Group)	LDB	O/P	O/P	–	–
– Ambient LED interior lighting (packaged with Interior LED Lighting Group and Convenience Group)	LHA	P	P	0	0

INTERIOR FEATURES (continued)

	SALES CODE	Cargo Van	Windowed Van	Chassis Cab	Cutaway
FLOOR MATS – Premium Carpet (not available with passenger double seat; by Mopar)	CCL	0	0	–	–
– All-Weather (not available with passenger double seat; by Mopar)	CCK	0	0	–	–
INSTRUMENT PANEL WITH BRIGHT BEZELS	JBD	0	0	0	0
LOCKING GLOVE BOX (included with Convenience Group)	JKA	P	P	P	P
POWER DOOR LOCKS – Speed-sensitive	JPH	•	•	•	•
REAR-DOOR CARGO NET (included with Convenience Group)	CKR	P	P	–	–
SEATING SURFACES – Cloth	*A7	•	•	•	•
– Vinyl (not available with swivel seats)	*B7	0	0	0	0
SEATS – Four-way manually adjustable driver and front-passenger bucket	CDN/CDT	•	•	•	•
– Driver six-way adjustable with lumbar adjust (not available with driver suspension bucket seat or passenger swivel seat)	CDL	0	0	0	0
– Driver and passenger six-way adjustable with lumbar adjust (not available with passenger double seat, driver swivel seat or driver suspension bucket seat)	CDU	0	0	0	0
– Driver suspension bucket (not available with driver swivel seat, heated driver seat or six-way adjustable seat)	CXX	0	0	0	0
– Driver swivel (requires cloth seating surfaces; not available with six-way adjustable seats or cargo partition; included with RV-Ready Prep Package)	CEA	O/P	O/P	0	0
– Heated driver (requires six-way adjustable driver seat; not available with driver swivel seat)	CMB	0	0	0	0
– Heated passenger (requires six-way adjustable driver/passenger seats)	CMC	0	0	0	0
– Passenger double (requires four-way or six-way adjustable driver seats)	CAA	0	–	0	–
– Passenger Seat Delete (includes deactivate passenger air bag ²¹ and Passenger Seat Belt Mount Delete; not available with RV-Ready Prep Package)	CD9	0	0	0	0
– Passenger swivel - Requires cloth seating surfaces and driver swivel seat; not available with cargo partition or heated seat (included with RV-Ready Prep Package)	CHR	O/P	O/P	0	0

• = Standard 0 = Optional P = Available within Package – = Not available

RAM PROMASTER® BUYER'S GUIDE

INTERIOR FEATURES (continued)

	SALES CODE	Cargo Van	Windowed Van	Chassis Cab	Cutaway
SHELF ABOVE ROOF TRIM (included with Convenience Group)	CTA	P	P	P	P
SPRAY-ON FLOOR LINER (not available with wood floor)	XMF	0	0	-	-
STEERING COLUMN – Telescoping	SUC
STEERING WHEEL – Leather-wrapped	SCC	0	0	0	0
TIRE PRESSURE MONITORING DISPLAY	XGM
UPFIT INTERFACE CONNECTOR (included with Rear-Speaker Wiring Prep)	BC3
WALL PANELS – Upper-side (include lower-side)	CTE	0	-	-	-
– Lower-side	CMG	0	0	-	-
WINDOWS – Power with one-touch-down feature	JPY
– Window Guards, Rear (not available on 118- or 136-inch Standard Roof Cargo Vans or 136-inch-wheelbase 2500 Windowed Van; by Mopar®)	XGC	0	0	-	-
WOOD FLOOR – Rear (not available with Spray-On Floor Liner)	CME	0	0	-	-

UCONNECT® MULTIMEDIA

REAR-SPEAKER WIRING PREP – Includes upfit interface connectors	RED
SIRIUSXM® RADIO ¹⁹ – Includes six-month trial	RSD	0	0	0	0
UCONNECT 3 WITH 5-INCH DISPLAY – Includes Media Hub with USB, integrated Voice Command with Bluetooth® and auxiliary input, and steering wheel-mounted audio controls	UAA
UCONNECT 3 NAV WITH 5-INCH DISPLAY – Includes Navigation	UAB	0	0	0	0
RAM TELEMATICS™ – Includes one-year service	RFQ	0	0	0	0
– Three-year subscription	X9S	0	0	0	0
– Five-year subscription	X9T	0	0	0	0

SAFETY & SECURITY

AIR BAGS ²¹ – Driver and front-passenger	CGW
– Supplemental side-curtain front	CJ4
– Supplemental front-seat side	CJ1
BLIND SPOT MONITORING ³ WITH REAR CROSS-PATH DETECTION ⁴ (included with Safety Group; requires power heated mirrors or power-folding/heated mirrors)	XAN	0/P	0/P	-	-
DIGITAL REARVIEW MIRROR WITH AUTO-DIM (included with Safety Group)	GRG	0/P	0/P	0	0

SAFETY & SECURITY (continued)

DOT-CERTIFIED ROADSIDE SAFETY KIT (by Mopar)	ACL	0	0	0	0
FULL-SPEED FORWARD COLLISION WARNING PLUS ⁵	LSU	0	0	0	0
PARKSENSE® REAR PARK ASSIST ⁹ (included with Safety Group)	XAA	0/P	0/P	-	-
PARKVIEW® REAR BACK-UP CAMERA ⁴	XAC	.	.	-	-
PARKVIEW REAR BACK-UP CAMERA ⁴ KIT – Requires installation by upfitter	XA3	-	-	.	.
REMOTE KEYLESS ENTRY	GXM
REMOTE START ^{12,16} (by Mopar)	JJL	0	0	0	0
SECURITY ALARM ²²	LSA	0	0	0	0

PACKAGES

CONVENIENCE GROUP – Includes locking glove box, front fog lamps, ambient LED interior lighting, shelf above roof trim, underseat storage tray and rear-door cargo net on Cargo Van and Windowed Van models (included with RV-Ready Prep Package)	AJK	0/P	0/P	0	0
DELIVERY PACKAGE 1 – Includes Radio Mute on Reverse, active speed-limiting device and key-in-ignition alert (restrictions apply)	AZA	0	0	0	0
INTERIOR CARGO RACK PACKAGE – Requires cargo partition or cargo partition with sliding window; restrictions apply	CWN	0	-	-	-
INTERIOR LED LIGHTING GROUP – Includes rear cargo LED lamp and ambient LED interior lighting (not available with Convenience Group)	AD6	0	0	-	-
PREMIUM APPEARANCE GROUP – Includes chrome grille and fog lamps (included with RV-Ready Prep Package; not available with Convenience Group)	ALU	0/P	0/P	0	0
RV-READY PREP PACKAGE – Includes Premium Appearance Group, Convenience Group, 220-amp alternator, driver swivel seat, passenger swivel seat, Class IV hitch receiver, Rear Heater/Air Conditioning Prep Package, auxiliary switches and 16-inch aluminum wheels (not available on 118-inch wheelbase)	ACV	0	0	-	-
SAFETY GROUP – Includes digital rearview mirror with auto-dim, power-folding/heated mirrors, front fog lamps, daytime running headlamps, ParkSense Rear Park Assist ⁹ and Blind Spot Monitoring ³ with Rear Cross-Path Detection ⁴	AJ1	0	0	-	-

* = Standard 0 = Optional P = Available within Package - = Not available

For more information, visit ram.com/promaster

EXTERIOR COLORS



Sandstone Pearl



Bright Silver Metallic



Granite Crystal Metallic



Black



Broom Yellow



Flame Red



Deep Cherry Red Crystal Pearl



Patriot Blue Pearl Coat



Bright White



INTERIOR FABRICS

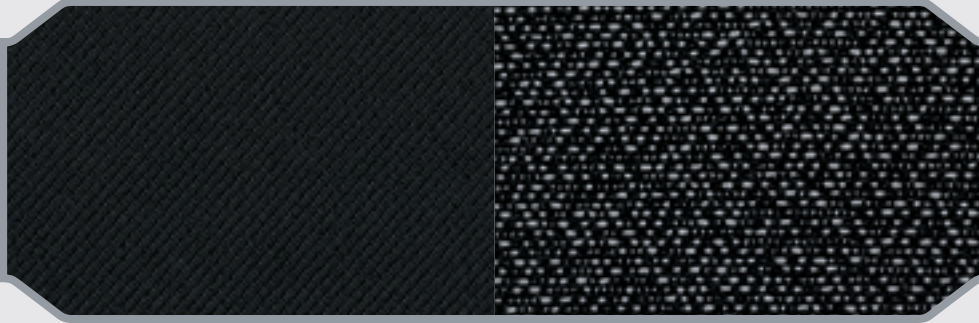

Black Cloth
[standard]

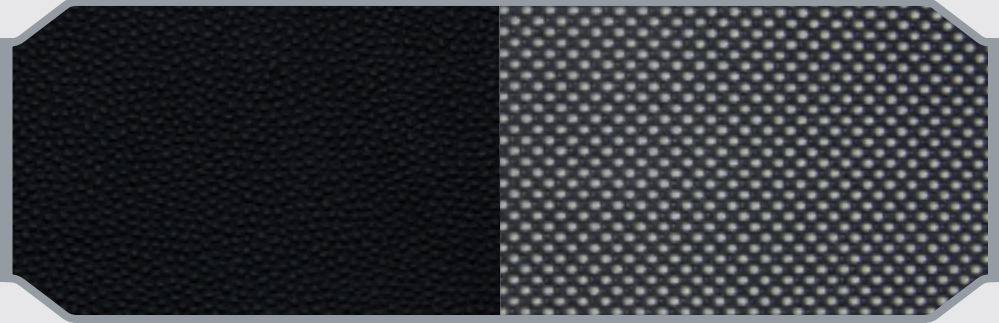

Black Vinyl
[available]

WHEELS



**16-inch Painted Steel Wheel
with Center Cap**
[standard]



**16-inch Black-Painted Steel Wheel
with Center Cap**
[available]



**16-inch Painted Steel Wheel
with Wheel Cover**
[available]



16-inch Aluminum Wheel
[available]



CHOOSE THE BEST FIT FOR YOU

RAM PROMASTER® CARGO VAN AND WINDOWED VAN SPECIFICATIONS

CAPABILITY	CARGO VAN										WINDOWED VAN	
	1500			2500			3500				2500	3500
	118" WB	136" WB		136" WB		159" WB	136" WB		159" WB	159" WB, EXTENDED	159" WB	159" WB, EXTENDED
	STANDARD ROOF	STANDARD ROOF	HIGH ROOF	STANDARD ROOF	HIGH ROOF	HIGH ROOF	STANDARD ROOF	HIGH ROOF	HIGH ROOF	HIGH ROOF	HIGH ROOF	HIGH ROOF
GVWR¹⁷ (lb)	8,550	8,550	8,550	8,900	8,900	8,900	9,350	9,350	9,350	9,350	8,900	9,350
GCWR¹⁷ (lb)	12,000	12,000	12,000	12,000	12,000	12,000	12,000	12,000	12,000	12,000	12,000	12,000
BASE CURB WEIGHT (lb)	4,554	4,662	4,787	4,644	4,768	4,895	4,669	4,796	4,923	5,020	4,957	5,061
MAXIMUM PAYLOAD¹⁰ (lb)	4,000	3,890	3,760	4,260	4,130	4,010	4,680	4,550	4,430	4,330	3,940	4,290
FRONT GAWR¹⁷ (lb)	4,629	4,629	4,629	4,629	4,629	4,629	4,629	4,629	4,629	4,629	4,629	4,629
REAR GAWR¹⁷ (lb)	5,004	5,291	5,291	5,291	5,291	5,291	5,291	5,291	5,291	5,291	5,291	5,291
CURB-TO-CURB TURNING (ft)	36.3	40.7	40.7	40.7	40.7	46.8	40.7	40.7	46.8	46.8	46.8	46.8
MAXIMUM TOWING¹⁰ (lb) SAE J2807 Compliant	6,910	6,800	6,700	6,800	6,700	6,480	6,700	6,600	6,480	6,410	6,480	6,410

DIMENSIONS

BODY HEIGHT (in)	91.7	93.0	103.6	93.0	103.6	102.1	93.0	103.6	102.1	102.5	102.1	102.5
OVERALL BODY LENGTH (in)	195.4	213.2	213.2	213.2	213.2	236.2	213.2	213.2	236.2	250.6	236.2	250.6
VEHICLE WIDTH WITHOUT MIRRORS (in)	81.3	81.3	81.3	81.3	81.3	81.3	81.3	81.3	81.3	81.3	81.3	81.3
VEHICLE WIDTH WITH MIRRORS EXTENDED (in)	112.2	112.2	112.2	112.2	112.2	112.2	112.2	112.2	112.2	112.2	112.2	112.2
CARGO BODY LENGTH AT FLOOR (in)	103.1	120.6	120.6	120.6	120.6	147.0	120.6	120.6	147.0	161.3	147.0	161.3
CARGO WIDTH AT FLOOR (in)	75.6	75.6	75.6	75.6	75.6	75.6	75.6	75.6	75.6	75.6	75.6	75.6
CARGO WIDTH AT WHEEL WELL (in)	56.0	56.0	56.0	56.0	56.0	56.0	56.0	56.0	56.0	56.0	56.0	56.0
SIDE-DOOR OPENING WIDTH (in)	42.3	49.2	49.2	49.2	49.2	49.2	49.2	49.2	49.2	49.2	49.2	49.2
SIDE-DOOR OPENING HEIGHT (in)	58.5	58.5	69.1	58.5	69.1	69.1	58.5	69.1	69.1	69.1	69.1	69.1
REAR DOORS OPENING WIDTH (in)	63.4	63.4	63.4	63.4	63.4	63.4	63.4	63.4	63.4	63.4	63.4	63.4
REAR DOORS OPENING HEIGHT (in)	59.8	59.8	70.5	59.8	70.5	70.5	59.8	70.5	70.5	70.5	70.5	70.5
MAXIMUM CARGO HEIGHT (in)	66.9	66.9	77.1	66.9	77.1	77.1	66.9	77.1	77.1	77.1	77.1	77.1
MAXIMUM CARGO VOLUME¹⁰ (cu ft)	259.2	303.7	352.9	303.7	352.9	420.2	303.7	352.9	420.2	462.9	420.2	462.9

WB = wheelbase.

RAM PROMASTER® CHASSIS CAB AND CUTAWAY SPECIFICATIONS

	CHASSIS CAB			CUTAWAY		
	3500			3500		
	136" WB	159" WB	159" WB, EXTENDED	136" WB	159" WB	159" WB, EXTENDED
	82.4" CA	104.7" CA	104.7" CA	82.4" CA	104.7" CA	104.7" CA
CAPABILITY						
GVWR¹⁷ (lb)	9,350	9,350	9,350	9,350	9,350	9,350
GCWR¹⁷ (lb)	11,500	11,500	11,500	11,500	11,500	11,500
BASE CURB WEIGHT (lb)	4,177	4,217	4,246	4,116	4,147	4,195
MAXIMUM PAYLOAD¹⁰ (lb)	5,170	5,130	5,100	5,230	5,200	5,160
FRONT GAWR¹⁷ (lb)	4,629	4,629	4,629	4,629	4,629	4,629
REAR GAWR¹⁷ (lb)	5,291	5,291	5,291	5,291	5,291	5,291
CURB-TO-CURB TURNING (ft)	36.3	40.7	46.8	36.3	40.7	46.8
MAXIMUM TOWING¹⁰ (lb)	5,100	5,100	5,100	5,100	5,100	5,100

DIMENSIONS

BODY HEIGHT (in)	87.7	87.3	87.3	87.7	87.3	87.3
OVERALL BODY LENGTH (in)	213.2	236.2	250.6	213.2	236.2	250.6
VEHICLE WIDTH WITHOUT MIRRORS (in)	81.3	81.3	81.3	81.3	81.3	81.3
VEHICLE WIDTH WITH MIRRORS EXTENDED (in)	112.2	112.2	112.2	112.2	112.2	112.2
CAB TO REAR AXLE²³ (in)	82.4	104.7	104.7	82.4	104.7	104.7
OVERHANG REAR AXLE TO END OF FRAME²⁴ (in)	39.6	39.6	53.9	39.6	39.6	53.9

WB = wheelbase. CA = cab-to-axle.











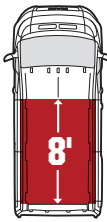
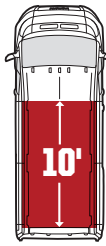

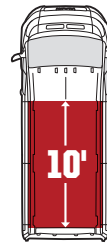
CHASSIS CAB

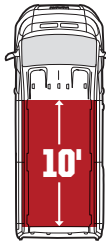



CUTAWAY

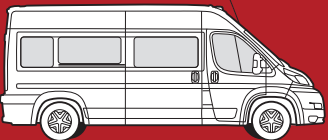
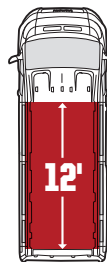
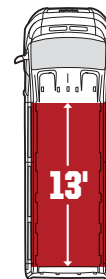

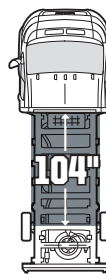
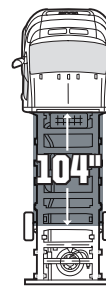
RAM PROMASTER® CONFIGURATIONS

	1500		2500		3500		
	118" WB	136" WB	136" WB	159" WB	136" WB	159" WB	159" WB, EXTENDED
 <p>CARGO VAN STANDARD ROOF</p>							
 <p>CARGO VAN AVAILABLE HIGH ROOF</p>							
 <p>WINDOWED VAN HIGH ROOF ONLY</p>							
 <p>CHASSIS CAB/CUTAWAY STANDARD ROOF ONLY</p>							

 = LOAD FLOOR LENGTH

 = CAB-TO-AXLE LENGTH

WB = WHEELBASE

BUSINESS SUPPORT AT THE READY



Shown with aftermarket upfit.



THE DEALER NETWORK FOR YOUR BUSINESS.

Your **BusinessLink** dealer is committed to providing you, the small business owner, with the vehicle support you need for your business, from servicing all makes and models of your existing lineup to selling you the right vehicles needed to perform the work that you do. Your **BusinessLink** dealer provides priority service because we know downtime is costing you money. **BusinessLink** sales professionals are trained to properly “job-rate” the right vehicle for your work application and provide commercial finance options. New vehicle sales to qualified small business owners also include a free alternate transportation contract, in the event your vehicle is in for service.

Membership is free. Membership helps us to identify you as a small business owner so we can provide you with both the service you deserve and update you with offers that can help reduce the cost of doing business. Ask your **BusinessLink** dealer to register today.

BusinessLink has you covered.

- ▶ Full Range of FCA Commercial Vehicles
- ▶ Free Membership
- ▶ Priority Service
- ▶ Extended Service Hours
- ▶ Dedicated Staff of Commercial Vehicle Experts
- ▶ Free Alternate Transportation
- ▶ Commercial Incentives
- ▶ Expertise in Commercial Financing Options
- ▶ 24/7 Towing Service Available

ON THE JOB

INCENTIVES FOR SMALL BUSINESSES.

Running a business presents plenty of challenges. Like cutting costs, not corners. Like saving time and money while avoiding hassles. The **ON THE JOB**²⁵ commercial incentive program provides assistance in customizing and servicing your business vehicles.

ON THE JOB²⁵ allowances make your business more profitable!

- ▶ UP TO \$1,000 Commercial Graphics Program Allowances²⁶
- ▶ UP TO \$1,000 Commercial Equipment/Upfit Allowances²⁷

CHRYSLER CAPITAL

A commercial line of credit from Chrysler Capital is ideal for qualified business customers looking for a flexible, easy way to manage growing vehicle needs. Chrysler Capital streamlines the process—and with prequalification, you're ready to buy a vehicle when you need it. Ask your **BusinessLink** dealer for details.

For more information, go to fcausfleet.com/programs/business-link-dealers.html or call us toll-free at **877-2THELINK (877-284-3546)**.

RAM OUTFITTER

BORN UNDER THE RAM LOGO. Ram Outfitter is where you'll find the useful, the cool and the stylish—from clothing and caps to coolers and tools. Make the Ram identity part of your everyday lifestyle. It's all at ram.com/outfitter



RAM

Join fellow Ram enthusiasts and tell your story by posting comments, participating in discussions, and sharing your photos and videos. Join our community on Facebook, Twitter, YouTube and Instagram.

Explore Ram Life at ram.com/ram-life.html



1 Class is based on Large Commercial Van segment (Class 2). 2 Always drive carefully, consistent with conditions. Always wear your seat belt and obey traffic laws. 3 Always check visually for vehicles prior to changing lanes. 4 Always check entire surroundings visually before proceeding. 5 This system is an alert system for the front of the vehicle. It is not a substitute for active driver involvement. The driver must remain aware of traffic conditions and be prepared to use the brakes to avoid collisions. 6 Class is based on Large Commercial Van segment (Class 2). When properly equipped. See dealer for details. 7 Visit Mopar.com for complete details and a copy of the Powertrain Limited Warranty. 8 Always look before proceeding. An electronic drive aid is not a substitute for conscientious driving. Always be aware of your surroundings. 9 Always drive carefully, consistent with conditions. 10 When properly equipped. See dealer for details. 11 Part numbers vary by wheelbase. 12 Available only at time of vehicle order. 13 Backed by the 3-Year/36,000-Mile Basic Limited Warranty. Visit Mopar.com for complete details and a copy of the Basic Limited Warranty. 14 Check Owner's Manual for hitch type, load capacity and heavy-duty equipment required. Do not exceed rated tow capacity of the vehicle as equipped. Trailer may require items not supplied by Mopar. 15 Not available for vehicles equipped with 118-inch wheelbase. 16 Check state and local laws regarding the use of remote start systems. 17 Assumes properly equipped vehicle and 150-lb allowance for driver. Additional options, equipment, passengers and cargo weight must be subtracted. See dealer for details. 18 The Uconnect Phone requires a mobile phone equipped with the Bluetooth Hands-Free Profile. To check phone compatibility, please visit UconnectPhone.com. 19 **DETAILS:** Your service will automatically stop at the end of your trial subscription unless you decide to continue service. If you do not wish to enjoy your trial, you can cancel by calling the number below. **If you decide to continue service after your trial, the subscription plan you choose will automatically renew thereafter and you will be charged according to your chosen payment method at the then-current rates.** Fees and taxes apply. See the SiriusXM Customer Agreement at siriusxm.com for complete terms and how to cancel, which includes calling 1-866-635-2349. All fees, content and features are subject to change. 20 Visit Mopar.com for complete details and a copy of the Basic Limited Warranty. 21 Always sit properly in designated seating positions with seat belts securely fastened at all times. 22 Vehicle must be locked and system activated for alarm to sound. 23 Measured from center cab back to center of rear axle. 24 Measured from center of axle to rear frame. 25 ON THE JOB is a retail incentive program; see your dealer for official rules. Inquire about eligibility by calling 877-ONTHEJOB or by logging on to fcausfleet.com/programs/business-link-dealers.html. The purchaser or lessee must be a qualified commercial customer for more than 30 days prior to the date of the vehicle purchase. An official ON THE JOB Customer Acknowledgment Form must be signed by the customer (provided by the dealer). 26 Allowance varies by graphic program. See dealer for details. Take retail delivery by 01/03/2022. 27 Allowance varies by upfit and model. See dealer for details. Take retail delivery by 01/03/2022.

©2020 FCA US LLC. All Rights Reserved. Ram, Mopar, Ram ProMaster, the Ram's Head logo, the BusinessLink design, ParkSense, ParkView, Pentastar and Uconnect are registered trademarks, and DriveAbility & design, the On The Job design and Ram Telematics are trademarks of FCA US LLC. Chrysler Capital is a registered trademark of FCA US LLC and licensed to Santander Consumer USA Inc.

Sortimo is a registered trademark of Sortimo International GmbH. Knapheide is a registered trademark of Knapheide Manufacturing Company. Brembo is a registered trademark of Brembo SpA. Facebook and logo are registered trademarks of Facebook, Inc. The Twitter logo is a service mark of Twitter, Inc. YouTube and other marks are registered trademarks of Google LLC. Instagram and logo are registered trademarks of Instagram, Inc. Bluetooth is a registered trademark of Bluetooth SIG, Inc. SiriusXM Connected Vehicles Services Inc. Sirius, XM, SiriusXM and all related marks and logos are trademarks of Sirius XM Radio Inc. Snoeks Automotive is a trademark of Snoeks Beheer B.V.

About this catalog: since the time of publication, some of the information you'll find in this catalog may have been updated. Ask your dealer for details. Some of the equipment shown or described throughout this catalog may be available at extra cost. Specifications, descriptions, illustrative materials and all competitive comparisons contained herein are as accurate as known at the time this publication was approved for printing. FCA US LLC reserves the right to discontinue models at any time or change specifications without notice or without incurring obligation. Options may be required in combination with other options. For the price of the model with the equipment you desire, or verification of specifications contained here, see your Ram dealer.



For more information, visit ram.com/promaster

Ram is a registered trademark of FCA US LLC.
74-383-2125_02/21