

Owner's Manual & Safety Instructions

Save This Manual Keep this manual for the safety warnings and precautions, assembly, operating, inspection, maintenance and cleaning procedures. Write the product's serial number in the back of the manual near the assembly diagram (or month and year of purchase if product has no number). Keep this manual and the receipt in a safe and dry place for future reference.

21d

CENTRALPNEUMATIC®

3/4 oz. deluxe airbrush kit



NOTICE

CLEAN IMMEDIATELY

**Clean the Spray Gun
IMMEDIATELY after use.**

**Delayed or inadequate cleaning will
permanently clog the Spray Gun.**

Visit our website at: <http://www.harborfreight.com>
Email our technical support at: productsupport@harborfreight.com

95810

When unpacking, make sure that the product is intact and undamaged. If any parts are missing or broken, please call 1-888-866-5797 as soon as possible.

Copyright© 2021 by Harbor Freight Tools®. All rights reserved.

No portion of this manual or any artwork contained herein may be reproduced in any shape or form without the express written consent of Harbor Freight Tools. Diagrams within this manual may not be drawn proportionally. Due to continuing improvements, actual product may differ slightly from the product described herein. Tools required for assembly and service may not be included.

⚠WARNING

Read this material before using this product.
Failure to do so can result in serious injury.
SAVE THIS MANUAL.

NOTICE





Clean the Spray Gun IMMEDIATELY after use.
Delayed or inadequate cleaning will permanently clog the Spray Gun.

Table of Contents

Safety	2	Maintenance	12
Specifications	5	Parts List and Diagram	15
Setup	6	Warranty	16
Operation	10		

CENTRALPNEUMATIC®

WARNING SYMBOLS AND DEFINITIONS

	This is the safety alert symbol. It is used to alert you to potential personal injury hazards. Obey all safety messages that follow this symbol to avoid possible injury or death.
	Indicates a hazardous situation which, if not avoided, will result in death or serious injury.
	Indicates a hazardous situation which, if not avoided, could result in death or serious injury.
	Indicates a hazardous situation which, if not avoided, could result in minor or moderate injury.
	Addresses practices not related to personal injury.

IMPORTANT SAFETY INSTRUCTIONS

INSTRUCTIONS PERTAINING TO A RISK OF FIRE, ELECTRIC SHOCK, OR INJURY TO PERSONS

The warnings and precautions discussed in this manual cannot cover all possible conditions and situations that may occur. It must be understood by the operator that common sense and caution are factors which cannot be built into this product, but must be supplied by the operator.

WARNING – When using tools, basic precautions should always be followed, including the following:



Work Area

- Keep the work area clean and well lighted.**
Cluttered benches and dark areas increase the risks of electric shock, fire, and injury to persons.
- Keep bystanders, children, and visitors away while operating the tool.**
Distractions are able to result in the loss of control of the tool.

NOTICE

Clean the Spray Gun **IMMEDIATELY** after use.
Delayed or inadequate cleaning will permanently clog the Spray Gun.

Personal Safety

- a. **Stay alert. Watch what you are doing and use common sense when operating the tool. Do not use the tool while tired or under the influence of drugs, alcohol, or medication.**
A moment of inattention while operating the tool increases the risk of injury to persons.
- b. **Dress properly. Do not wear loose clothing or jewelry. Contain long hair. Keep hair, clothing, and gloves away from moving parts.**
Loose clothes, jewelry, or long hair increases the risk of injury to persons as a result of being caught in moving parts.
- c. **Do not overreach. Keep proper footing and balance at all times.**
Proper footing and balance enables better control of the tool in unexpected situations.
- d.  **Use safety equipment.**
Wear heavy-duty work gloves and a NIOSH-approved respirator during use. Non-skid safety shoes and a hard hat must be used for the applicable conditions.
- e.  **Always wear eye protection.**
Wear ANSI-approved safety goggles.

Tool Use and Care

- a. **Do not force the tool.** Use the correct tool for the application. The correct tool will do the job better and safer at the rate for which the tool is designed.
- b. **Disconnect the tool from the air source before making any adjustments, changing accessories, or storing the tool.**
Such preventive safety measures reduce the risk of starting the tool unintentionally. Turn off and detach the air supply, safely discharge any residual air pressure, and release the throttle and/or turn the switch to its off position before leaving the work area.
- c. **Store the tool when it is idle out of reach of children and other untrained persons.**
A tool is dangerous in the hands of untrained users.
- d. **Check for misalignment or binding of moving parts, breakage of parts, and any other condition that affects the tool's operation.** If damaged, have the tool serviced before using. Many accidents are caused by poorly maintained tools. There is a risk of bursting if the tool is damaged.
- e. **Use only accessories that are identified by the manufacturer for the specific tool model.** Use of an accessory not intended for use with the specific tool model, increases the risk of injury to persons.

Service

- a. **Tool service must be performed only by qualified repair personnel.**
- b. **When servicing a tool, use only identical replacement parts. Use only authorized parts.**
- c. **Use only lubricants supplied with the tool or specified by the manufacturer.**

NOTICE

Clean the Spray Gun IMMEDIATELY after use.
Delayed or inadequate cleaning will permanently clog the Spray Gun.

Air Source



- a.  **Never connect to an air source that is capable of exceeding 200 psi.** Over pressurizing the tool may cause bursting, abnormal operation, breakage of the tool or serious injury to persons. Use only clean, dry, regulated compressed air at the rated pressure or within the rated pressure range as marked on the tool. Always verify prior to using the tool that the air source has been adjusted to the rated air pressure or within the rated air-pressure range.
- b. **Never use oxygen, carbon dioxide, combustible gases or any bottled gas as an air source for the tool.** Such gases are capable of explosion and serious injury to persons.



SAVE THESE INSTRUCTIONS.

Symbol Definitions

Symbol	Property or Statement
PSI	Pounds per square inch of pressure
CFM	Cubic Feet per Minute flow
SCFM	Cubic Feet per Minute flow at standard conditions
NPT	National pipe thread, tapered

Symbol	Property or Statement
NPS	National pipe thread, straight
	WARNING marking concerning Risk of Eye Injury. Wear ANSI-approved eye protection.
	WARNING marking concerning Risk of Respiratory Injury. Wear NIOSH-approved respirator.
	WARNING marking concerning Risk of Explosion.

NOTICE

Clean the Spray Gun IMMEDIATELY after use.
Delayed or inadequate cleaning will permanently clog the Spray Gun.

Specific Safety Instructions

1. Do not direct spray at people or animals.
2. Do not exceed maximum air pressure.
3. Do not spray near open flames, pilot lights, stoves, heaters, the air compressor, or any other heat source. Most solvents and coatings are highly flammable, particularly when sprayed. Maintain a distance of at least 25 feet from the air compressor. If possible, locate the air compressor in a separate room.
4. Read all of the information concerning coating products and cleaning solvents. **Do not use chlorinated solvents (e.g. 1-1-1 trichloroethylene and dichloromethane, also known as methylene chloride) to clean Airbrushes. Many Airbrushes contain aluminum, which reacts strongly to chlorinated solvents.** Contact the solvent or coating manufacturer as needed regarding potential chemical reactions.
5. Industrial applications must follow OSHA requirements.
6. Spraying hazardous materials may result in serious injury or death. Do not spray pesticide, acid, corrosive material, fertilizer, or toxic chemicals.
7. Paints and solvents may be harmful or fatal if swallowed or inhaled. Avoid prolonged skin contact with solvents or paints as they will irritate skin. After any contact, immediately wash off exposed area with hot, soapy water.
8. Attach all accessories properly to the tool before connecting the air supply. A loose accessory may detach or break during operation.
9. Install an in-line shutoff valve to allow immediate control over the air supply in an emergency, even if a hose is ruptured.

Specifications

Maximum Air Pressure	25 - 60 PSI
Air Inlet	1/8" - 27 NPS
Glass Jar Capacity	22 cc

NOTICE

Clean the Spray Gun IMMEDIATELY after use.
Delayed or inadequate cleaning will permanently clog the Spray Gun.

Initial Set Up



Read the **ENTIRE IMPORTANT SAFETY INFORMATION** section at the beginning of this manual including all text under subheadings therein before set up or use of this product.

Note: For additional information regarding the parts listed in the following pages, refer to the Assembly Diagram near the end of this manual.

Before Setup

1. This air tool may be shipped with a protective plug covering the air inlet. Remove this plug before set up.
2. **Before first use, clean the Airbrush using a solvent-based thinner.** If not removed, the material used for testing and corrosion prevention will contaminate paint.
3. The Metal Cup (28) has two uses. It is used for excess correctly thinned paint, and also for solvent when it is time to clean the Airbrush.
4. The Metal Hook (30) can be attached to a secure surface and used to hang the Airbrush for drying, or when it is not being used.

CENTRALPNEUMATIC®

NOTICE

Clean the Spray Gun IMMEDIATELY after use.
Delayed or inadequate cleaning will permanently clog the Spray Gun.

Air Supply Setup

⚠ WARNING



TO PREVENT SERIOUS INJURY FROM EXPLOSION:

Use only clean, dry, regulated, compressed air to power this tool. Do not use oxygen, carbon dioxide, combustible gases, or any other bottled gas as a power source for this tool.

1. Incorporate a filter, regulator with pressure gauge, in-line shutoff valve, and quick coupler for best service, as shown on Figure A on page 8 and Figure B on page 9. **An in-line shutoff ball valve is an important safety device because it controls the air supply even if the air hose is ruptured. The shutoff valve should be a ball valve because it can be closed quickly.**
2. Attach an air hose to the compressor's air outlet. Connect the air hose to the air inlet of the tool. Other components, such as a coupler plug and quick coupler, will make operation more efficient, but are not required.
3. The air hose must be long enough to reach the work area with enough extra length to allow free movement while working.
4. Close the in-line shutoff valve between the compressor and the tool.
5. Turn on the air compressor according to the manufacturer's directions and allow it to build up pressure until it cycles off.
6. Adjust the air compressor's output regulator so that the air output is enough to properly power the tool, but the output will not exceed the tool's maximum air pressure at any time. Adjust the pressure gradually, while checking the air output gauge to set the right pressure range.
7. Inspect the air connections for leaks. Repair any leaks found.
8. If the tool will not be used at this time, turn off and detach the air supply and safely discharge any residual air pressure to prevent accidental operation.

Note: Do not use an automatic oiler system or add oil to airline. The oil will contaminate the material being propelled, ruining the final result.

⚠ WARNING! TO PREVENT SERIOUS INJURY FROM ACCIDENTAL OPERATION:

Do not install a female quick coupler on the tool. Such a coupler contains an air valve that will allow the air tool to retain pressure and operate accidentally after the air supply is disconnected.

Note: Air flow, and therefore tool performance, can be hindered by undersized air supply components.

Note: Residual air pressure should not be present after the tool is disconnected from the air supply. However, it is a good safety measure to attempt to discharge the tool in a safe fashion after disconnecting to ensure that the tool is disconnected and unpowered.

NOTICE

Clean the Spray Gun IMMEDIATELY after use.
Delayed or inadequate cleaning will permanently clog the Spray Gun.

Figure A: Portable Air Supply Setup

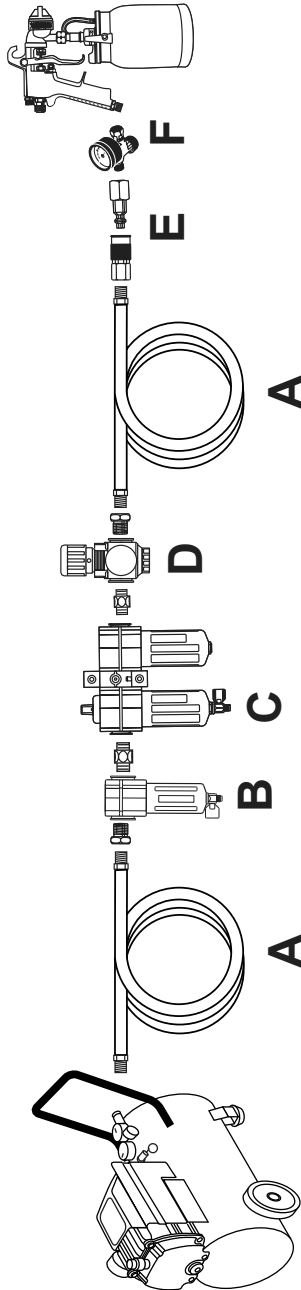

	Description	Function
A	Air Hose	Connects air to tool
B	Filter	Prevents dirt and condensation from damaging tool or workpiece
D	Regulator	Adjusts air pressure to tool
E	Coupler and Plug	Provides quick connection and release
C	Air Cleaner / Dryer*	Prevents water vapor from damaging workpiece
F	Air Adjusting Valve*	For fine tuning airflow at tool

*Optional components.

NOTICE

Clean the Spray Gun IMMEDIATELY after use.
Delayed or inadequate cleaning will permanently clog the Spray Gun.

OPERATING INSTRUCTIONS



Read the **ENTIRE IMPORTANT SAFETY INFORMATION** section at the beginning of this manual including all text under subheadings therein before set up or use of this product.

Inspect tool before use, looking for damaged, loose, and missing parts.
If any problems are found, do not use tool until repaired.

Workpiece and Work Area Set Up

1. Designate a work area that is clean and well-lit. The work area must not allow access by children or pets to prevent distraction and injury.
2. Route the air hose along a safe path to reach the work area without creating a tripping hazard or exposing the air hose to possible damage. The air hose must be long enough to reach the work area with enough extra length to allow free movement while working.
3. Before spraying, mask nearby objects not being sprayed and lay cloths (not included) on the floors.



Figure C: Components and Controls

Paint Preparation and Filling

WARNING TO PREVENT SERIOUS INJURY: Do not adjust or tamper with any control or component in a way not specifically explained within this manual. Improper adjustment can result in tool failure or other serious hazards.

Note: Proper paint mixture is essential. Follow the manufacturer's directions. Most paints will spray easily if they are thinned properly.

1. Thin the paint according to manufacturer's directions and mix thoroughly.
2. Carefully strain the paint through a paint strainer or a piece of cheesecloth.
3. Fill the Jar to 3/4 full. Close the Jar.
4. Hold the Housing lightly in your hand and push the tapered fitting on the lid of the Jar into the base of the Housing. It is held in place with friction and is not threaded.
5. Start the air compressor and set the regulator to needed pressure. **Do not exceed maximum air pressure.**
6. Test the consistency by spraying on a piece of scrap material.

If it still appears too thick, add a very small amount of thinner (not included) and mix thoroughly. Use the proper thinner for the type of paint. Thin CAUTIOUSLY. Proceed slowly, adding minimal amounts at a time. **DO NOT exceed the manufacturer's thinning recommendations.**

NOTICE

Clean the Spray Gun IMMEDIATELY after use.
Delayed or inadequate cleaning will permanently clog the Spray Gun.

General Operation

IMPORTANT: Proper spraying technique is ESSENTIAL to achieve good results.

1. First, prepare the Airbrush according to the instructions under **Paint Preparation and Filling** on page 10.
2. Press the Finger Lever and air will flow from the Nozzle. Draw back slowly/gently on the Finger Lever and the fluid will atomize. Continue to move the Lever back slowly to achieve the volume you need for your spray technique.

NOTE: Test spraying on another piece of material is a must in order to make sure you have the right air pressure and that your paint is properly thinned.

3. Continue to adjust the spray volume by using the Finger Lever, moving it front to back.

Note: When you have the correct spray volume, you may fix the position using the Adjustment Screw.

4. The size of your spray pattern will be in accordance with the distance between the work surface and the Nozzle of the Airbrush. For extra-fine spray, remove the Cap and hold the Airbrush nearer the work surface.
5. When you are finished painting, loosen the Adjustment Screw and gently release the pressure on the Finger Lever.

NOTE: If any fluid blocks the Nozzle during use, move the Needle Chucking Guide (13) back and forth. If this method does not clear the Nozzle, try loosening the Needle Adjustment Screw (18) to allow the blocked fluid to escape, clearing the Nozzle.

6. After flushing the Airbrush completely with the proper solvent: lacquer thinner if you used lacquer paint, paint thinner/mineral spirits if you used oil based enamels and clean water if you used latex paint, spray the remaining solvent through the Nozzle until clear solvent sprays from the Airbrush tip.
7. **Clean Airbrush thoroughly immediately after EVERY use, according to instructions on the following pages.**

CENTRALPNEUMATIC®

NOTICE

Clean the Spray Gun IMMEDIATELY after use.
Delayed or inadequate cleaning will permanently clog the Spray Gun.

USER-MAINTENANCE INSTRUCTIONS



Procedures not specifically explained in this manual must be performed only by a qualified technician.

⚠ WARNING

TO PREVENT SERIOUS INJURY:

Detach the air supply and safely discharge any residual air pressure in the tool before performing any inspection, maintenance, or cleaning procedures.

TO PREVENT SERIOUS INJURY FROM TOOL FAILURE:

Do not use damaged equipment. If abnormal noise, vibration, or leaking air occurs, have the problem corrected before further use.

Inspection

Note: These procedures are in addition to the regular checks and maintenance explained as part of the regular operation of the air-operated tool.

BEFORE EACH USE, inspect the general condition of the tool. Check for:

- loose screws,
- misalignment or binding of moving parts,
- clogged nozzle,
- damaged air supply hose,
- cracked or broken parts, and
- any other condition that may affect its safe operation.

NOTICE

Clean the Spray Gun IMMEDIATELY after use.
Delayed or inadequate cleaning will permanently clog the Spray Gun.

Cleaning

Solvent Selection

Follow the paint manufacturer's recommendations for cleaning, solvent type, and disposing of used solvent.

- **Latex Paints:** Use water as a solvent.

IMPORTANT: Do not use mineral spirits on latex paints or the mixture will congeal, making it very difficult to remove.

- **Oil Based Paints:** Use mineral spirits.



WARNING! TO PREVENT FIRE, IF A FLAMMABLE SOLVENT NEEDS TO BE USED, ADHERE TO THE FOLLOWING:

- a. Follow solvent manufacturer's clean up instructions and safety precautions.
- b. Flush Airbrush a full hose length from air compressor.
- c. If collecting flushed solvents in metal container, transfer to nonmetal container, and flush metal container.
- d. Work far away from any ignition sources in a vapor free area.
- e. Keep class ABC fire extinguisher nearby.

After each use:

1. Empty the Jar and clean it with the solvent.
2. Fill the Jar with solvent and spray it through the Airbrush into a container, while shaking the Airbrush. Once the Jar is empty, repeat the process until the solvent comes out clean.
3. Disconnect from the air source.
4. After disconnecting, point the Airbrush into the spent solvent container and squeeze the Trigger again to make sure no air remains.
5. Remove Nozzle and soak it in solvent until it is clean. Use old toothbrush and toothpicks to remove any paint.

NOTICE: Do not immerse Airbrush.

Note: Do not use metal objects to clean the Nozzle to prevent damage to the passages.

6. Inspect fluid needle and make sure it is not bent. If it is bent, have it replaced by a qualified technician.
7. Use appropriate solvent (see **Solvent Selection**, left) to wipe down Airbrush body.
8. Lubricate Airbrush after cleaning. A non-silicon oil or a light lubricant may be used on threaded connections before storing.

Solution Disposal

After cleaning, dispose of cleaning solution according to the solution manufacturer's directions and local hazardous waste standards.

Air Supply Maintenance

Every day, perform maintenance on the air supply according to the component manufacturers' instructions.

Storage

Store in a dry, secure area out of reach of children.

NOTICE

Clean the Spray Gun IMMEDIATELY after use.
Delayed or inadequate cleaning will permanently clog the Spray Gun.

General Troubleshooting Chart

Problem	Possible Causes	Likely Solutions
Sputtering Spray	1. Low paint level. 2. Jar tipped.	1. Refill. 2. Hold upright.
Will Not Spray	1. No pressure at Airbrush. 2. Fluid too thick.	1. Check air hoses. 2. Thin fluid or increase air pressure. (Do not exceed maximum.)
Overspray (Paint drifting to unintended objects.)	1. Improper application speed. 2. Improper distance from workpiece. 3. Too much air pressure.	1. Move moderately and parallel. 2. Adjust distance. 3. Reduce air pressure.
Poor atomization of paint	1. Air connection not tight, or leaking. 2. Paint not thinned properly. 3. Nozzle (3) is partially plugged	1. Check all air connections. 2. Add more solvent in very small amounts to the paint you are using and mix thoroughly. 3. Wash, or change the Nozzle (3)
 Follow all safety precautions whenever diagnosing or servicing the tool. Disconnect air supply before service.		

PLEASE READ THE FOLLOWING CAREFULLY

THE MANUFACTURER AND/OR DISTRIBUTOR HAS PROVIDED THE PARTS LIST AND ASSEMBLY DIAGRAM IN THIS MANUAL AS A REFERENCE TOOL ONLY. NEITHER THE MANUFACTURER OR DISTRIBUTOR MAKES ANY REPRESENTATION OR WARRANTY OF ANY KIND TO THE BUYER THAT HE OR SHE IS QUALIFIED TO MAKE ANY REPAIRS TO THE PRODUCT, OR THAT HE OR SHE IS QUALIFIED TO REPLACE ANY PARTS OF THE PRODUCT. IN FACT, THE MANUFACTURER AND/OR DISTRIBUTOR EXPRESSLY STATES THAT ALL REPAIRS AND PARTS REPLACEMENTS SHOULD BE UNDERTAKEN BY CERTIFIED AND LICENSED TECHNICIANS, AND NOT BY THE BUYER. THE BUYER ASSUMES ALL RISK AND LIABILITY ARISING OUT OF HIS OR HER REPAIRS TO THE ORIGINAL PRODUCT OR REPLACEMENT PARTS THERETO, OR ARISING OUT OF HIS OR HER INSTALLATION OF REPLACEMENT PARTS THERETO.

NOTICE

Clean the Spray Gun IMMEDIATELY after use.
Delayed or inadequate cleaning will permanently clog the Spray Gun.

PARTS LIST AND DIAGRAM

Part	Description	Qty
1	Cap	1
2	Air Cap	1
3	Nozzle	1
4	Air Cap Body	1
5	O-Ring	1
6	Packing	1
7	Packing Nut	1
8	Housing	1
9	Needle Adjustment Screw	1
10	Finger Lever	1
11	Rocker	1
12	Needle Adjusting Sleeve	1
13	Needle Chucking Guide	1
14	Spring	1
15	Needle Chucking Nut	1
16	Needle Cover (Handle)	1

Part	Description	Qty
17	Rear Cover	1
18	Needle	1
19	O-Ring	1
20	Valve Rod	1
21	O-Ring	1
22	Spring	1
23	Valve Screw	1
24	Valve Body	1
25	Hose Connector Nut	1
26	Hose Connector O-Ring	1
27	Hose Connector	1
28	Metal Cup	1
29	7mm Wrench	1
30	Metal Hanger	1
31	0.74 fl. oz. Jar	1

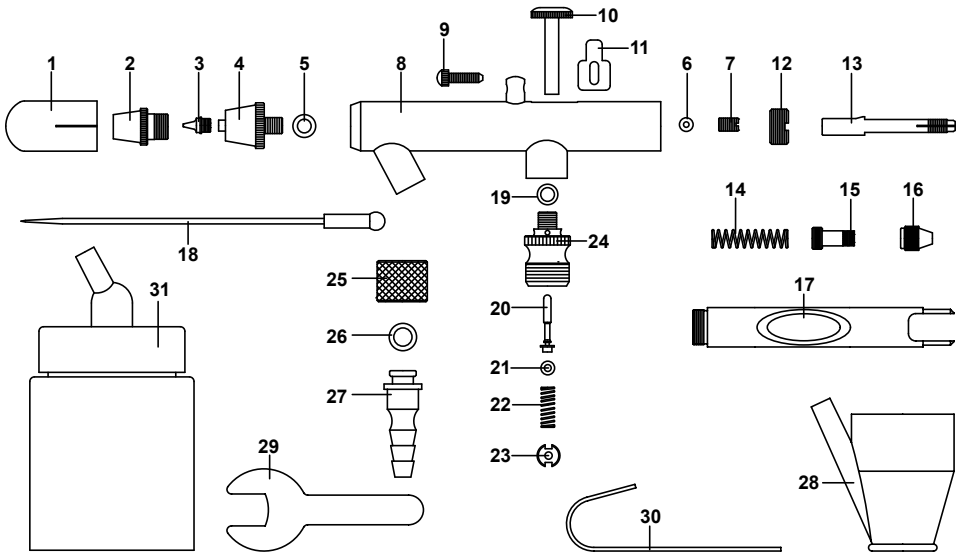

Record Product's Serial Number Here: _____

Note: If product has no serial number, record month and year of purchase instead.

Note: Some parts are listed and shown for illustration purposes only, and are not available individually as replacement parts. Specify UPC 792363958103 when ordering parts.

LIMITED 90 DAY WARRANTY

Harbor Freight Tools Co. makes every effort to assure that its products meet high quality and durability standards, and warrants to the original purchaser that this product is free from defects in materials and workmanship for the period of 90 days from the date of purchase. This warranty does not apply to damage due directly or indirectly, to misuse, abuse, negligence or accidents, repairs or alterations outside our facilities, criminal activity, improper installation, normal wear and tear, or to lack of maintenance. We shall in no event be liable for death, injuries to persons or property, or for incidental, contingent, special or consequential damages arising from the use of our product. Some states do not allow the exclusion or limitation of incidental or consequential damages, so the above limitation of exclusion may not apply to you. THIS WARRANTY IS EXPRESSLY IN LIEU OF ALL OTHER WARRANTIES, EXPRESS OR IMPLIED, INCLUDING THE WARRANTIES OF MERCHANTABILITY AND FITNESS.

To take advantage of this warranty, the product or part must be returned to us with transportation charges prepaid. Proof of purchase date and an explanation of the complaint must accompany the merchandise. If our inspection verifies the defect, we will either repair or replace the product at our election or we may elect to refund the purchase price if we cannot readily and quickly provide you with a replacement. We will return repaired products at our expense, but if we determine there is no defect, or that the defect resulted from causes not within the scope of our warranty, then you must bear the cost of returning the product.

This warranty gives you specific legal rights and you may also have other rights which vary from state to state.

CENTRALPNEUMATIC®