



HBN 531E0B



en Instruction manual



BOSCH





Making cooking as much fun as eating

Please read this instruction manual. This will ensure that you make use of all the technical benefits the cooker has to offer.

It will provide you with important safety information. You will then be familiarised with the individual components of your new cooker. And we will show you how to make settings step by step. It is quite simple.

The tables list the settings and shelf positions for numerous well-known dishes. All these dishes are tested in our cooking studio.

In the unlikely event of a fault, look here for information on how to rectify minor faults yourself.

A detailed table of contents will help you to find your way around quickly.

Enjoy your meal!

Instruction manual



HBN 531E0B

en 9000484380

B-011090-04

Important information	6
Before installation	6
Safety information	6
Reasons for damage	8
Your new cooker	9
Control panel	9
Oven	10
Temperature selector	11
Oven and shelving accessories	12
Cooling fan	13
Before using for the first time	14
Removing packaging material	14
Heating up the oven	15
Pre-cleaning the accessories	15
Setting the oven	16
Setting procedure	16
If the oven is to switch off automatically	18
If the oven is to switch on and off automatically	20
Time	22
Setting procedure	22
Timer	23
Setting procedure	23
Rapid heating	24
Setting procedure	24
Childproof lock	25
Care and cleaning	26
Cleaning agents	26
Oven ceiling and back panel	27

Table of contents

Detaching and attaching the oven door	28
Cleaning the shelf frames	30
Troubleshooting	32
Replacing the oven light on the ceiling of the oven	32
After-sales service	33
Tables and tips	34
Cakes and pastries	34
Baking tips	37
Meat, poultry, fish	38
Tips for roasting and grilling	40
Frozen foods	40
Defrosting	41
Drying	41
Preserving	42
Special dishes	44
Energy saving tips	45
Acrylamide in foodstuffs	45
Test dishes	46

Important information

Read this instruction manual carefully. Only then will you be able to operate your appliance safely and correctly.

Please keep the instruction and installation manual in a safe place. Please pass on these instruction manuals to the new owner if you sell the appliance.

Before installation

Disposing in an environmentally-responsible manner

Unpack the appliance and dispose of the packaging in an environmentally-responsible manner.



This appliance is labelled in accordance with the European Directive 2002/96/EC concerning used electrical and electronic appliances (waste electrical and electronic equipment – WEEE).

The guideline determines the framework for the return and recycling of used appliances as applicable.

Transport damage

Check the appliance for damage after unpacking it. Do not connect the appliance if it has been damaged in transport.

Electrical connection



If the power cable is damaged, it must be replaced by a specialist trained by the manufacturer in order to prevent hazards.

Safety information

This appliance is intended only for domestic use. This appliance must only be used for food preparation.

Adults and children must not operate the appliance without supervision

- if they are physically or mentally incapable of doing so
- or if they lack the knowledge and experience required to operate the appliance correctly and safely.

		Never let children play with the appliance.
Children		Children may prepare meals only if they have been properly instructed. They must be able to operate the appliance correctly. They must understand the hazards indicated in the instruction manual. Children must be supervised when using the appliance, to ensure that they do not play with it.
Hot oven		Open the oven door carefully. Hot steam may escape. Never touch the internal surfaces of the oven or the heating elements. There is a risk of being burnt. Children must be kept at a safe distance from the appliance. Never place combustible items in the oven. There is a risk of fire. Never trap cables of electrical appliances in the hot oven door. The cable insulation could melt. There is a risk of short-circuiting. Be careful with food that is prepared with drinks with a high alcohol content (e.g. cognac, rum). Alcohol evaporates at high temperatures. In unfavourable circumstances, the alcoholic vapours could catch fire in the oven. There is a risk of burning. Only use small quantities of drinks with a high alcohol content and open the oven door carefully.
Repairs		Incorrect repairs are dangerous. There is a risk of electrocution. Repairs may only be carried out by one of our experienced after-sales engineers. If the appliance is faulty, disconnect the fuse in the fuse box. Call the after-sales service.

Reasons for damage

Baking tray, aluminium foil or dishes on the oven floor

Do not place the baking tray on the oven floor. Do not cover it with aluminium foil.

Do not place dishes on the oven floor.

This will cause heat accumulation. The baking and roasting times will no longer be correct and the enamel will be damaged.

Water in the oven

Never pour water directly into a hot oven. This could damage the enamel.

Fruit juice

When baking very moist fruit cakes, do not put too much on the baking sheet. Fruit juice dripping from the baking sheet leaves stains that cannot be removed.

It is recommended that you use the deeper universal pan.

Cooling with the oven door open

Only leave the oven to cool with the door closed. Do not allow anything to become trapped in the oven door. Even if you only leave the oven door open slightly, the fronts of adjacent units may become damaged over time.

Very dirty oven seal

If the oven seal is very dirty, the oven door will no longer close properly when the oven is in use. The fronts of adjacent units could be damaged. Keep the oven seal clean.

Using the oven door as a seat

Do not stand or sit on the oven door.

Transporting the cooker

Do not hold or carry the cooker by the door handle. The door handle cannot hold the weight of the cooker and may break off.

Your new cooker

Here you will learn more about your new oven. The control panel and its switches and indicators are explained here. The heating modes and the accessories included with your oven will be explained here.

Control panel

Details vary according to the appliance model.

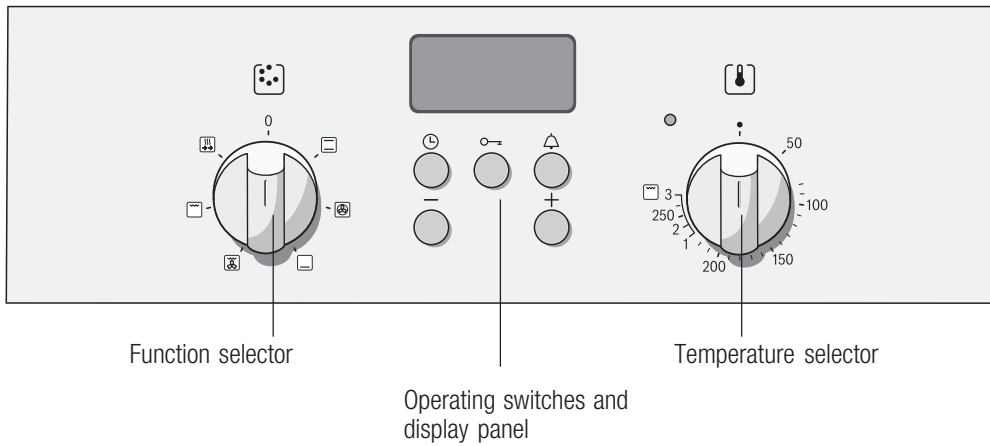

Oven

Function selector

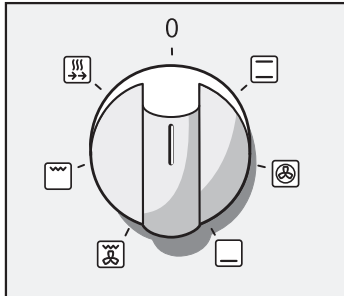

With the function selector knob you can set the heating mode for the oven.
The function selector knob can be rotated to the right or to the left.

The Positions

0	Off
Rapid heating	for heating food rapidly.
Large area grill	Can be used to grill a large number of beefsteaks, sausages, fish, and to toast bread.
Hot air circulation assisted grilling	Can be used for grilling larger pieces of meat.
Lower heat	Use this for food items where a darker crusty bottom surface is required.
3D Hot air*	You can bake cakes, pizza, biscuits, muffins and puff pastry on two levels at the same time.
Upper and Lower Heat	Baking, roasting or grilling is possible on a single level only. Cakes can be baked in a cake mould/tray, pizzas can be baked in a tray, lean beef, veal and game can be roasted in a roasting tray.

*Heating mode with an energy efficiency rating specified by EN50304.

When the function selector knob is set the oven lighting is switched on.

Control buttons and display panel



Clock button	Use this button to set the time of day, the cooking time and the completion time .
Key button	Use this button to switch the childproof lock on and off.
Timer button	Use this button to set the timer.
Minus button -	Use this button to reduce the values set.
Plus button +	Use this button to increase the values set.

The values set can be seen in the display panel.

Temperature selector

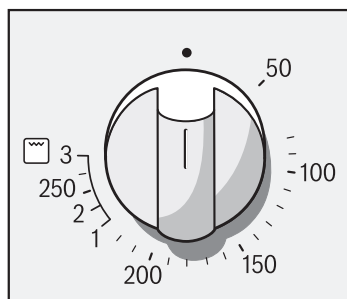

Use the temperature selector to set the temperature or grill setting.

Temperature	
50 - 270	Temperature range in °C
Grill	
1	Low grill
2	Medium grill
3	High grill

The indicator light by the temperature selector comes on while the oven is heating up. It goes out during pauses in heating.

Grill settings

You can select a grill setting on the radiant grill using the temperature selector.

Oven and shelving accessories

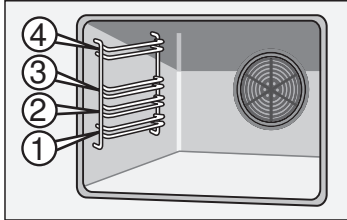

The shelf can be inserted at 4 different heights in the oven.

You can remove the shelf two thirds of the way without it tipping. This makes it easier to take food out of the oven.

Accessories

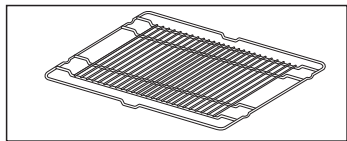

HEZ 434000 wire rack

for ovenware, cake tins, roasts, grilling and frozen meals.

Insert the wire grill curving downwards .

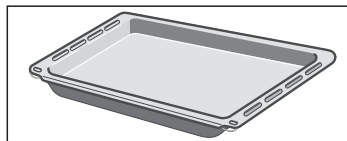

Universal pan HEZ 432000

for moist cakes, pastries, frozen food and large roasts. It can also be used to catch dripping fat when you are grilling directly on the wire grill.

Push the universal pan with the sloping edge facing towards the oven door.



Aluminium baking tray HEZ430000

For cakes and biscuits.

Push the baking tray into the oven with the sloping edge facing towards the oven door.

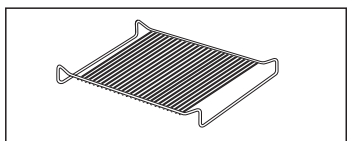

HEZ2400 wire rack insert

for grilling. Always place the wire grill in the universal pan. Fat and meat juices are collected.

Optional accessories*

Aluminium baking tray HEZ430000	For cakes and pastries.
Wire rack HEZ434000	For ovenware, cake tins, roasts, grilling and frozen meals.
Universal pan HEZ432000	For moist cakes, pastries, frozen meals and large roasts.
Enamel baking tray HEZ431000	For cakes and pastries.
Protective grid	The protective grid is fixed to the oven door. This prevents small children from touching the hot oven door. The protective grid can be ordered from the factory after-sales service with number 440651.

* You will find a comprehensive range of products for your cooker in our brochures and on the Internet. You can buy optional accessories from your local retailer.

Cooling fan

The oven is fitted with a cooling fan. It switches itself on and off as necessary. The warm air escapes above the door.

Before using for the first time



This section will tell you everything you need to do before using the cooker for the first time.

Heat the oven and clean the accessories. Read the safety instructions in the “Important information” section.

Firstly, check to see if the  symbol and three zeros are flashing in the display.

If the  symbol and three zeros are flashing in the display

Set the time.

1. Press the  clock button.
12:00 appears and the  clock symbol flashes.
2. Set the time using the + or – button.

The time selected is adopted after a few seconds. The cooker is now ready for use.

Removing packaging material

You must remove the packaging material before using the oven for the first time.

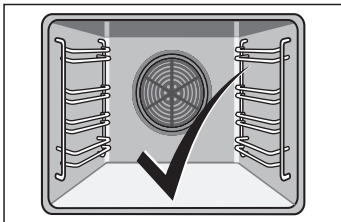

Packaging material such as polystyrene foam and cardboard will be found between the shelves and the oven casing, and in front of the back panel. Remove this.

Your oven is now ready for use.

Heating up the oven

Method

Heat the empty oven with the door closed to remove the new oven smell.

1. Set the function selector to .
2. Use the temperature selector to set the temperature to 240 °C.

Switch off the function selector after 60 minutes.

Pre-cleaning the accessories

Please wash the accessories thoroughly with soapy water and a cleaning cloth before using them.

Setting the oven

Switching off the oven manually

You have various options for setting the oven.

When your meal is ready, switch off the oven yourself.

The oven switches off automatically

You can leave the kitchen for a long period.

The oven switches on and off automatically

You can put your meal in the oven in the morning, for example, and set the oven so that your meal is ready at midday.

Tables and tips

The correct settings for many dishes can be found in the Tables and tips section.

Setting procedure

Example:
Top/bottom heating ,
200 °C

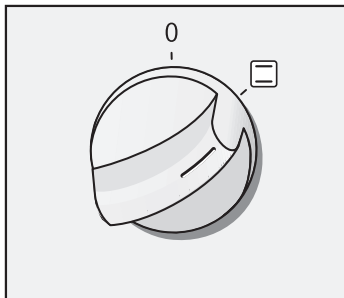

1. Select the desired type of heating using the function selector.

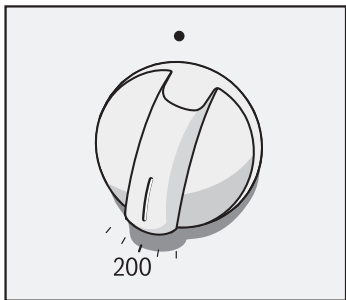

2. Use the temperature selector to set the temperature or grill setting.

Switching off

Switch off the function selector when the meal is ready.

Changing the setting

You may change the temperature or grill setting at any time.

If the oven is to switch off automatically

Example:
Top/bottom heating , 200 °C, cooking time of 45 minutes

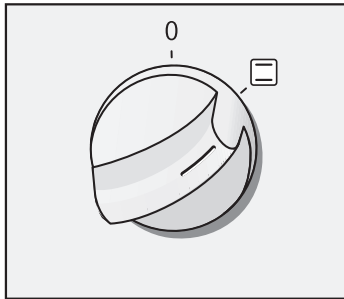

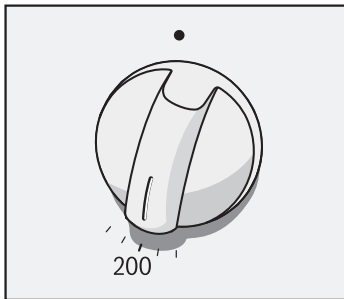

1. Select the desired type of heating using the function selector.



2. Use the temperature selector to set the temperature or grill setting.



3. Press the  clock button.
The cooking time symbol  will flash.

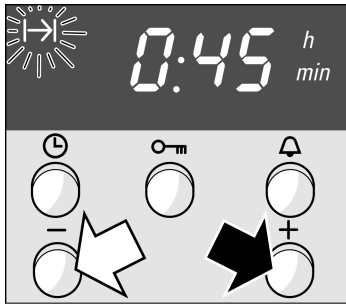

4. Set the cooking time using the + or – button.
+ button default value = 30 minutes.
– button default value = 10 minutes.

The oven switches on after a few seconds.
The I→I symbol lights up in the display.

The cooking time has elapsed

A signal sounds. The oven switches off.
Press the ⌚ button twice and switch off the function selector.

Changing the setting

Press the ⌚ clock button. Change the cooking time using the + or – button.

Cancelling the setting

Press the ⌚ clock button. Press the – button until the display is at zero. Switch off the function selector.

Setting the cooking time when the clock time is hidden

Press the ⌚ clock button twice and perform the setting as described in item 4.

If the oven is to switch on and off automatically

Please remember that easily spoiled foods must not be allowed to remain in the oven for too long.

Example:

Imagine – it's 10:45 a.m. The meal will take 45 minutes to cook and must be ready at 12:45 pm.

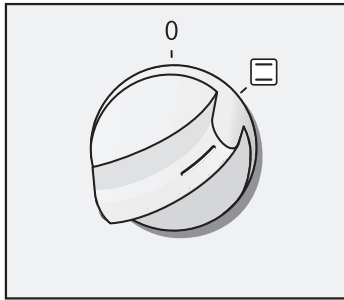

1. Select the desired type of heating using the function selector.

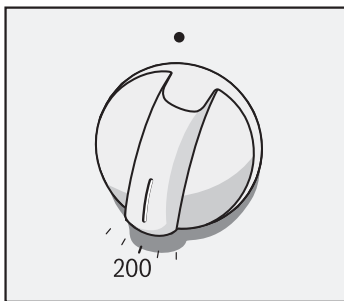

2. Use the temperature selector to set the temperature or grill setting.

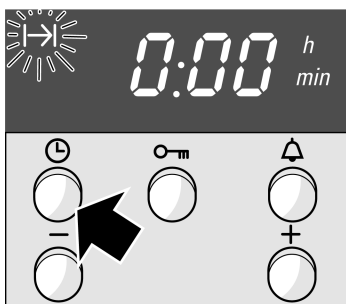

3. Press the ⌚ clock button.
The cooking time symbol ⌚ will flash.

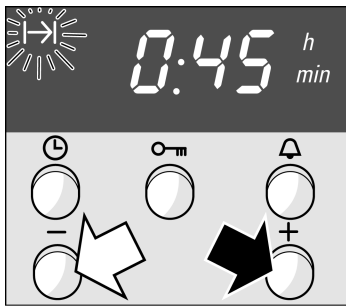

- Set the cooking time using the + or – button.
+ button default value = 30 minutes.
– button default value = 10 minutes.



- Press the ⌚ clock button until the →| end symbol flashes.
In the display you will see the time when the meal will be ready.



- Use the + button to set a later end time.

The setting is adopted after a few seconds. The display will show the end time until the oven switches on.

The cooking time has elapsed

A signal sounds. The oven switches off. Press the ⌚ button twice and switch off the function selector.

Note

You can change the setting while the symbol is flashing. The setting has been adopted if the symbol lights up permanently.

Time

When the oven is first connected, or following a power cut, the ⌚ symbol and three zeros flash in the display. Set the time.

The function selector must be switched off.

Setting procedure

Example: 13:00

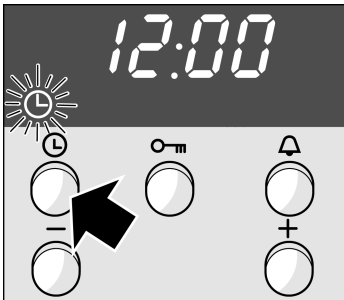

1. Press the ⌚ clock button.
12.00 appears in the display and the ⌚ symbol flashes.



2. Set the time using the + or – button.

The time selected is adopted after a few seconds.

Changing the time e.g. from summer to winter time

Press the ⌚ clock button twice and change the time with the + or – button.



Timer

You can use the timer as a kitchen timer. It operates independently of the oven.
The timer has a special signal. This means that you can tell whether the set timer period has elapsed or the cooking time is complete.
You can also set the timer if the childproof lock is active.

Setting procedure

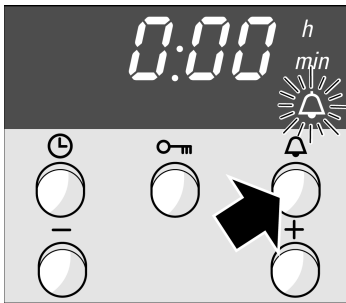
Example: 20 minutes



1. Press the  timer button.
The  symbol will flash.



2. Set the timer period using the + or – button.
+ button default value = 10 minutes.
– button default value = 5 minutes.

The timer starts after a few seconds. The  symbol lights up in the display. The time counts down visibly.

The time has elapsed

A signal sounds. Press the  timer button. The timer display will go out.

Changing the timer period





Press the  timer button. Change the time using the + or – button.

Cancelling the setting

Press the  timer button. Press the – button until the display is at zero.

The timer and cooking time count down simultaneously

The symbols light up. The timer period counts down visibly in the display.

To call up the remaining cooking time , end time  or time : Press the  clock button until the symbol in question flashes.

The value called up will then appear in the display for a few seconds.

Rapid heating

This allows you to heat up the oven particularly quickly.

Setting procedure

1. Switch the function selector to rapid heating .
2. Use the temperature selector to set the required temperature.

The oven switches on after a few seconds. The indicator light above the temperature selector will come on.

The rapid heating process is complete



The indicator light goes out.

Put your meal in the oven and set the oven.

Childproof lock

The oven has a childproof lock to prevent children from switching it on accidentally.

Locking the oven

Press the  key button until the  symbol appears in the display. This will take approximately 4 seconds.

Unlocking

Press the  key button until the  goes out.

Notes

You can set the timer and the clock even when the oven is locked.

The childproof lock setting will be lost if there is a power cut.

Care and cleaning



Do not use high-pressure cleaners or steam jets. There is a danger of short-circuiting.

Do not use caustic or abrasive cleaning agents. The surface could be damaged. If an abrasive substance comes into contact with the frontage, wash it off immediately with water.

Cleaning agents

Appliance exterior:

Stainless steel surfaces

Clean with warm soapy water and a soft cloth. For stainless steel surfaces, always wipe in the direction of the grain so as not to scratch the surface. Dry with a soft cloth. Always remove any flecks of limescale, grease, starch and egg white immediately.

Harsh cleaning products, scratchy sponges and rough cleaning cloths are not suitable. Use a stainless steel cleaning agent for shiny surfaces. Please observe the manufacturer's instructions. Special stainless steel cleaning agents can be obtained from the after-sales service or from specialist shops.

Enamel surfaces and lacquered surfaces

Clean with warm soapy water and a dish cloth. Dry with a soft cloth.

Knobs

Clean with warm soapy water and a dish cloth. Dry with a soft cloth.

Door glass

Use glass cleaner. Do not use sharp or abrasive cleaning agents or a glass scraper. The glass could be damaged.

Seal

Clean with warm water and a cloth. Dry with a soft cloth.

Oven floor and side walls

Clean with warm soapy water and a dish cloth. Dry with a soft cloth.



For heavy soiling: only use oven cleaner in a cold oven. Never use on the oven ceiling and back panel.

Glass cover on the oven light	Clean with warm soapy water and a dish cloth. Dry with a soft cloth.
Accessories	Soak in hot soapy water. Clean with a brush or sponge.
Aluminium baking tray (optional)	Do not wash in the dishwasher. On no account use oven cleaner. The surface should not be touched with a knife or other similar sharp objects. Risk of scratching. Wipe the surfaces horizontally and without applying pressure with soapy water and a soft window cloth or a lint-free microfibre cloth. Dry with a soft cloth. Harsh cleaning products, scratchy sponges and rough cleaning cloths are not suitable. They will scratch the baking tray.
Door lock (optional)	Remove the door lock for cleaning. Soak all plastic parts in hot soapy water and clean with a sponge. Dry with a soft cloth. If there is heavy soiling, the door lock may jam and no longer function.
Hob	Refer to the hob instruction manual for information about care and cleaning.

Oven ceiling and back panel

The oven ceiling and back panel are coated with a highly porous ceramic layer. This coating absorbs and dispels splashes from baking and roasting while the oven is in operation. You will obtain a better result, the higher the temperature and the longer the oven is in operation.

If there is still soiling after several uses of the oven, proceed as follows:

First clean the oven floor and the side walls. Set the oven to  hot air or  top and bottom heating. Heat up the empty oven for approximately 2 hours at maximum temperature.

The ceramic coating is regenerated. Brownish or whitish residues can then be removed with water and a soft sponge.

Slight colour variations of the coating have no effect on the self-cleaning function.

Important notes

Never use abrasive cleaners. These types of cleaning agents can scratch and/or damage porous coatings.

Never treat the oven ceiling and back wall with oven cleaner.

If oven cleaner accidentally gets onto these surfaces, wipe it away immediately with a sponge and plenty of water.

Detaching and attaching the oven door

For cleaning purposes and to remove the door panels, you can detach the oven door.

The oven door hinges each have a locking lever.

When the locking levers are closed (Fig. A), the oven door is secured in place. It cannot be detached.

When the locking levers are open in order to detach the oven door (Fig. B), the hinges are locked. They cannot snap shut.

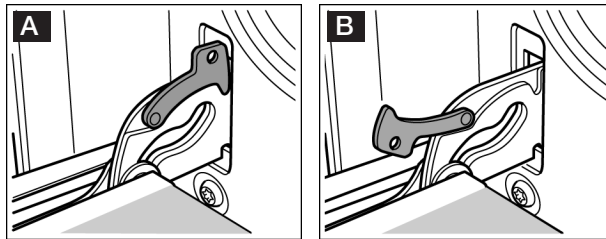

There is a risk of injury. Whenever the hinges are not locked, they snap shut with great force.

Ensure that the locking levers are always fully closed or, when detaching the oven door, fully open.

Detaching the door

1. Open the oven door fully.
2. Open the locking levers on the left and right-hand sides (Fig. A).
3. Close the oven door up to the limit stop (Fig. B). Grip the door on the left and right-hand sides with both hands. Close the door a little more and pull it out.

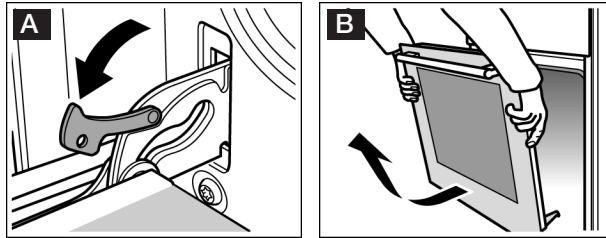

Attaching the door

Reattach the oven door in the reverse sequence to removal.

1. When attaching the oven door, ensure that both hinges are inserted straight into the opening (Fig. A).
2. The notch on the hinge must engage on both sides (Fig. B).

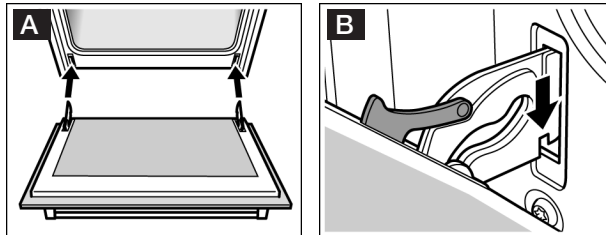

3. Close both locking levers again (Fig. C).
Close the oven door.

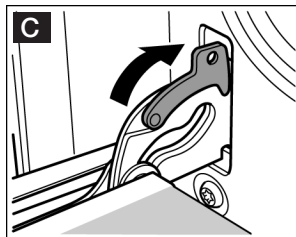

There is a risk of injury. If the oven door falls out accidentally or a hinge snaps shut, do not reach into the hinge.
Call the after-sales service.

Cleaning the shelf frames

The shelf frames can be removed for cleaning.

To remove the shelf frames:

1. Hold the shelf frames from underneath and pull slightly forward. Pull out the projections at the bottom from the apertures they are inserted in.

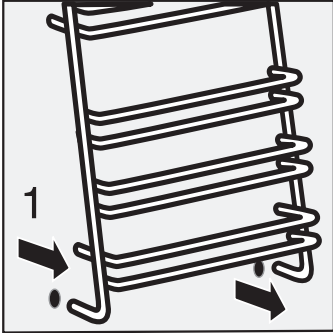

2. Then remove the complete frame by first pulling it downward and then forward.

Clean the shelf frames using washing-up liquid and a sponge or a brush.

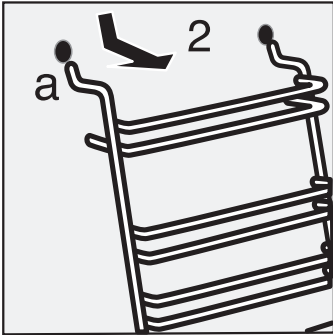

To hook rails back into position:

1. Insert the two hooks carefully into the upper holes.

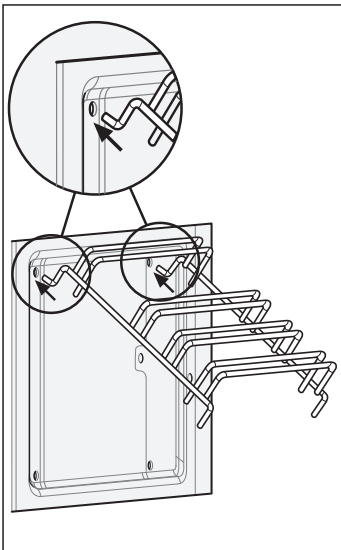

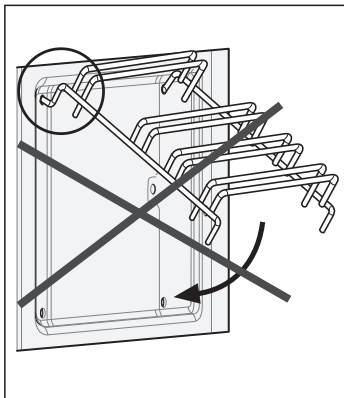

- **Caution. Incorrect assembly:** never move the rail before the two hooks are secured fully in the upper holes.

The enamel can become damaged and break.

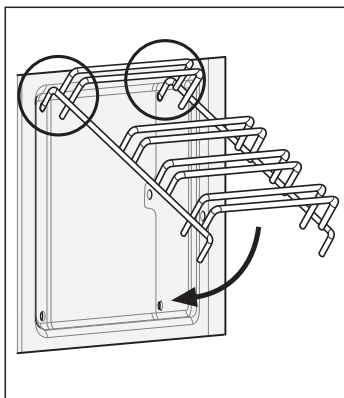

2. **Correct assembly:** the two hooks must be inserted fully into the upper holes. Now move down the rail slowly and carefully and insert into the lower holes.

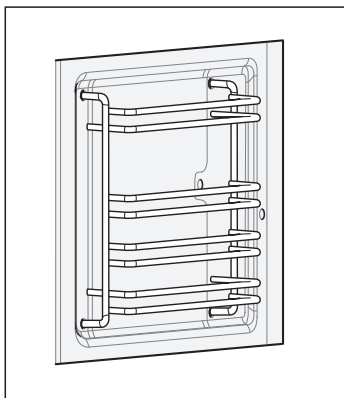

3. Insert both rails.

If the rails are fitted correctly, the distance between the two upper shelf positions is greater.

Troubleshooting

Should a malfunction occur, it is often only due to a minor fault. Please read the following instructions before calling the after-sales service:

Problem	Possible cause	Comments/remedy
The oven does not work.	Blown fuse.	Look in the fuse box and check that the fuse is in working order.
The clock display flashes.	Power cut	Reset the time.

Repairs may only be carried out by fully trained after-sales service technicians.

Improper repairs may constitute serious hazards to the user.

Replacing the oven light on the ceiling of the oven

If the oven light fails, it must be replaced. 25 watt heat-resistant replacement bulbs can be obtained from the after-sales service or specialist shops. Please specify the E number and FD number of your appliance. Only use these bulbs.

Method

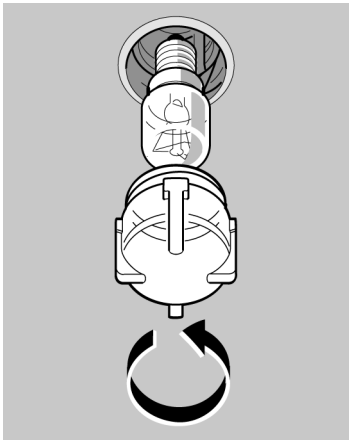

1. Switch off the oven fuse in the fuse box.
2. Place a tea towel in the cold oven to prevent damage.
3. Unscrew the lamp cover in the oven interior by turning it to the left.
4. Replace the bulb with one of the same type.
5. Screw the lamp cover back in.
6. Remove the tea towel and switch the fuse back on.

Replacing the glass cover

The glass cover on the oven light must be replaced if it is damaged. Replacement glass covers may be obtained from the after-sales service. To this end, please specify the E number and FD number of your appliance.

After-sales service

Our after-sales service is there for you if your oven needs repairing. You will find the address and telephone number of your nearest after-sales service centre in the phone book. The after-sales service centres listed will also be happy to advise you of a service point in your local area.

E number and FD number

Please quote the E number (product number) and the FD number (production number) of your appliance when contacting the after-sales service. The rating plate containing these numbers is found on the right, on the side of the oven door. You can make a note of these numbers in the space below to save time in the event of your appliance malfunctioning.

E no.	FD no.
-------	--------

After-sales service ☎

Tables and tips

This table contains a selection of dishes and the optimum settings at which to cook them. You can find out which type of heating and temperature is best for your dish, which accessories to use, and at which oven level the dish should be inserted. You will find a variety of tips about ovenware and preparation, and a small troubleshooting section in case anything should go wrong.

Cakes and pastries

Baking on one level

If you are baking cakes on one level, you should use top/bottom heating . This will give the best results for your cakes.

Baking tins

It is best to use dark-coloured baking tins made of metal. Baking times are increased when light-coloured baking tins made of thin metal or glass dishes are used, and cakes do not brown so evenly.

Place the cake tin on the wire rack.

Tables

The values in the table apply to dishes placed in a cold oven. This saves energy. Shorten the baking times indicated by 5 to 10 minutes if you have preheated the oven.

The tables show which type of heating is best for different cakes and bakes.

The temperature and cooking time you select depends on the quantity and type of pastry. This is why “ranges” are given in the tables. You should try to use a lower temperature setting to start with, since this allows more even browning. If necessary, use a higher temperature setting the next time.

More information can be found in the “Baking tips” section which follows the tables.

Conventional heat

Food	Dish	Shelf position	Cooking method	Temp. °C	Time, minutes
Victoria sandwich	20 cm tin	2	☐	170	20-30
Light fruit cake	20 cm tin	2	☐	160	75-85
Fruit crumble	Glass dish	3	☐	180	35-45
Jam tarts*	12 hole bun tin	2	☐	200	15-20
Yeast cookery (f.ex. Pizza)	universal pan	3	☐	190	25-30
Tarts**	20 cm plate or pie tin	1	☐	210	40-50
Quiches**	Glass dish	1	☐	210	40-50
Swiss Roll*	Swiss roll tin	2	☐	200	10-12
Rich Biscuits	baking tray	3	☐	180	15-20
Soufflés*	1,2 l soufflé dish	2	☐	180	35-45
Pies**	Pie dish	2	☐	200	40-50

* Preheat oven



** For a crispy bottom always place dish on the universal pan

3D-Hot air

Food	Dish	Shelf position	Cooking method	Temp. °C	Time, minutes
Rich fruit cake	23 cm round tin or 20 cm square cake tin	2	☐	140	170-190
Meringues	universal pan	3	☐	80	100-130
Pavlova	universal pan	3	☐	150*+ 100	100-120
Jacket Potatoes	universal pan	2	☐	160	70-80







* Preheat oven.

Conventional heat

Food	Dish	Shelf position	Cooking method	Temp. °C	Time, minutes
Bread	loaf tin (900 g or 2x 450 g)	1		220	25-35
Scones*	baking tray	1		210	15-20
Yorkshire Pudding*	12 hole bun tin	3		200	20-30

* Preheat oven.



3D-Hot air: Baking on 2 levels

Food	Dish	Shelf position	Cooking method	Temp. °C	Time, minutes
Victoria sandwich	20 cm tin	1+3		160	35-40
Scones*	baking trays	1+3		170	20-30
Jacket potatoes	wire shelves	1+3		170	70-80
Biscuits	baking trays**	1+3		160	20-25
Small Cakes*	baking trays**	1+3		160-180	20-30
Meringues	baking trays**	1+3		80	100-150
Full meal	wire racks	1+3		180	75-85

* Preheat oven

** When baking on two levels, use the universal pan provided, at shelf position three.

Baking tips

You wish to cook to your own recipe.	Refer to the instructions in the tables for similar types of food.
How to check that a sponge cake is cooked properly.	Approximately 10 minutes before the end of the baking time given in the recipe, pierce the tallest point of the cake with a cocktail stick. The cake is done if the cocktail stick comes out clean.
The cake collapses.	Next time, use less liquid or decrease the oven temperature by 10 degrees. Observe the cooking times in the recipe.
The cake has risen in the centre but is lower at the edges.	Do not grease the sides of the springform cake tin. As soon as the cake is done, carefully loosen the cake around the edges using a knife.
The cake is too dark at the top.	Insert it at a lower level in the oven, select a lower temperature and cook the cake a little while longer.
The cake is too dry.	Use a toothpick to make small holes in the finished cake. Then drizzle fruit juice or alcohol over the top. Next time you should decrease the temperature by around 10 degrees and reduce the baking times.
The bread or cake (e.g. cheesecake) looks fine, but is soggy on the inside (soft, with watery areas).	Next time you should add a little less liquid and cook for a little longer at a lower temperature. Cakes with fruit topping: Precook the base first of all. Sprinkle with almonds or breadcrumbs and then place the topping over this. Please observe the recipe and the baking times.
The pastry is unevenly browned.	Select a slightly lower temperature to ensure that the pastry is baked more evenly. Delicate pastry should be baked on one level using top/bottom heating  . Baking paper that protrudes over the food can affect the air circulation. For this reason, always cut the baking paper to fit the baking tray.
The fruit cake is too light at the bottom. The fruit juice flows over.	Use the deeper universal pan next time.
You were baking on several levels. The food on the top baking tray is darker than that on the bottom baking tray.	Always use 3D hot air  when baking on several levels. Baking trays that are placed in the oven at the same time will not necessarily be ready at the same time.

Condensation is formed when baking cakes containing fresh fruit.

Baking may result in the formation of water vapour. It escapes above the door handle. The steam may settle and form water droplets on the control panel or on the fronts of adjacent units. This is a normal physical process.

Meat, poultry, fish

Ovenware

You may use any heat-resistant dishes. The universal pan is also suitable for larger roasts.

Always place the dishes in the centre of the wire grill.

Hot glass dishes should be placed on a dry kitchen towel after being removed from the oven. The glass could crack if placed on a cold or wet surface.

Advice on roasting

The roasting result depends on the type and quality of meat.

Add 2 to 3 soup spoons of liquid to lean meat, and 8 to 10 soup spoons of liquid to pot roasts, depending on the size.

Meat should be turned half way through the cooking time.

When the roast is ready, switch off the oven and leave the roast to stand for 10 minutes with the oven door closed. This allows the meat juices to distribute more favourably.

Advice on grilling

Always close the oven door when grilling.

If possible, use pieces of meat which are of the same thickness. They should be at least 2 to 3 cm thick. Such pieces will be browned evenly and stay juicy and soft in the middle. Only salt the steaks after they have been grilled.

Place the pieces of meat directly onto the wire grill. If you are grilling just one piece of meat, it will turn out best if you place it in the centre of the wire grill. You should also insert the universal pan at level 1. The meat juices are collected here and the oven is kept clean.

Turn the pieces of meat and poultry after half of the cooking time indicated but turkey has to be placed breast side up and not to be turned!.

The grill element automatically switches itself off and back on again. This is normal. The number of times this happens depends on the grill setting you have selected.

Roasting

Food	Shelf position	Cooking method	Temperature °C	Cooking time mins per 1 lb + add. time
Beef rare	1		210-230	15+20
Beef medium	1		210-230	20+20
Beef well done	1		210-230	25+25
Beef fillet	1		210-230	20+20
Lamb medium	1		160-180	20+20
Lamb well done	1		160-180	25+25
Pork	1		180-200	35+30
Chicken, Duck, Goose up to 5 kilo	1		150-190	17+20
Large Turkey up to 7 kilo	1		170-190	10+20
Chops and chicken joints	3		200-220	40

Grilling





Food	Shelf position	Cooking method	Grill setting	Cooking time mins
Meat steaks	4		2 or 3	15-20
Sausages	3		3	15-20
Fish	4		2	20-25
Toast, 9 pieces	3		3	5-8

Tips for roasting and grilling

The table does not contain specifications for the weight of the roast.	Select the next lowest weight from the instructions and extend the time.
How can you tell when the roast is ready.	Use a meat thermometer (available from specialist stores) or implement a “spoon test”. Press a spoon onto the roast. If it feels firm, it is ready. If it can be pressed in, it needs to be cooked for a little longer.
The roast is too dark and the crackling is partly burnt.	Check the insertion level and temperature.
The roast looks good, but the sauce is burnt.	Next time, use a smaller roasting dish and add more liquid.
The roast looks good, but the sauce is too light and watery.	Next time, use a larger roasting dish and add less liquid.
Steam rises from the roast when the stock is added.	Most escapes through the steam outlet, some may condense on the cool control panel front or the surrounding cabinets where it will drip off. This will be dependent on the physical conditions.

Frozen foods

Please observe the instructions on the packaging.
The values in the table apply to dishes placed in a cold oven.

Meal		Level	Type of heating	Temperature in °C	Cooking time in minutes
Fruit strudel*	Universal pan	3		190-210	45-55
French fries*	Universal pan	3		210-230	25-30
Pizza*	Wire grill	2		200-220	15-20
Pizza baguette*	Wire grill	2		190-210	15-20

* Line the accessories with greaseproof paper. Please ensure that the greaseproof paper is suitable for use at these temperatures.

Note

The universal pan may become warped when baking frozen foods. This is caused by the considerable temperature fluctuations which affect the accessories. This warping is eliminated during the baking process.

Defrosting

Remove the food from its packaging and place it in a suitable dish on the wire grill.

Please observe the instructions on the packaging.

The defrosting times depend on the type and amount of food.





Meal	Accessories	Level	Type of heating	Temperature in °C
Frozen foods* e.g. cream gateaux, cream cakes, cakes with chocolate or icing, fruit, chicken, sausages and meat, bread, rolls, pastries and other baked goods	Wire rack	2		The temperature selector remains switched off
* Place poultry onto the plate with the breast side down.				

Drying

Only use perfectly fresh fruit and vegetables, and wash them thoroughly.

Allow the food to drain well and dry it yourself.

Line the universal pan and wire rack with baking paper or greaseproof paper.

Meal	Level	Type of heating	Temperature in °C	Cooking time in hours
600 g apple rings	1 + 3		80	Approx. 5
800 g sliced pears	1 + 3		80	Approx. 8
1.5 kg prunes or plums	1 + 3		80	Approx. 8 - 10
200 g fresh herbs, washed	1 + 3		80	Approx. 1½

Note

Very moist fruit or vegetables should be turned several times. Once dried, remove the food from the paper immediately.

Preserving

Preparation

The jars and rubber sealing rings must be clean and intact. Use jars of the same size if possible. The instructions in the table refer to round 1-litre jars. Caution Do not use larger or taller jars. The lid could crack.

Only use perfectly fresh fruit and vegetables. Wash them thoroughly.

Pour the fruit or vegetables into the jars. Wipe clean the tops of the jars again if necessary. They must be clean. Place a wet rubber sealing ring and lid on each jar and lock the jars using clamps.

Do not place more than six jars in the oven.

The times specified in the tables are guidelines only. They can be influenced by the room temperature, the number of jars and the amount and temperature of the jar contents. Before you change settings or switch off the appliance, make sure that the contents of the jars are actually bubbling.

Setting procedure

1. Place the universal pan on level 2. Place the jars inside the pan so that they do not come into contact with each other.
2. Pour ½ litre of hot water (approx. 80 °C) into the universal pan.
3. Close the oven door.
4. Switch the function selector to .
5. Set the temperature selector to 170 to 180 °C.

Preserving fruit

As soon as the contents of the jars begins to simmer, that is when small bubbles appear at short intervals - after about 40 to 50 minutes - turn off the temperature selector. The function selector remains switched on.

The jars should be removed from the oven after being reheated for 25 to 35 minutes. If the food is left to cool in the oven for longer, bacteria might form, causing the preserved fruit to spoil prematurely. Switch off the function selector.

Fruit in 1-litre jars	After bubbling	Reheating
Apples, red/blackcurrants, strawberries	turn off	approx. 25 minutes
Cherries, apricots, peaches, gooseberries	turn off	approx. 30 minutes
Apple purée, pears, plums	turn off	approx. 35 minutes

Preserving vegetables

As soon as the contents of the jars begins to simmer, set the temperature selector back to approximately 120 to 140 °C. The table shows when you can switch off the temperature selector. Allow the vegetables to stand in the oven for a further 30 to 35 minutes. The function selector remains switched on during this time.

Vegetables with cold stock in 1-litre jars	After bubbling 120 - 140 °C	Reheating
Cucumbers	–	approx. 35 minutes
Beetroot	approx. 35 minutes	approx. 30 minutes
Brussel sprouts	approx. 45 minutes	approx. 30 minutes
Beans, kohlrabi, red cabbage	approx. 60 minutes	approx. 30 minutes
Peas	approx. 70 minutes	approx. 30 minutes

Remove the jars

Never place the hot jars on a cold or wet surface as this could cause the glass to crack.

Special dishes

Your appliance can be set to temperatures between 50 and 270 °C. 50 °C is equally useful for producing creamy yoghurt as it is for light yeast dough.



Yoghurt

Bring the milk (3.5 % fat) to the boil, then allow to cool to 50 °C. Stir in 150 g of yoghurt. Pour into cups or small screw-lid jars, then cover and place them on the wire rack. Preheat for 5 minutes to 50 °C, then prepare as indicated.

Proving dough

Prepare the yeast dough as per usual. Place it in a heat-resistant ceramic dish and cover. Preheat the cooking compartment for 5 minutes. Switch off the appliance and leave the dough to prove in the cooking compartment.

Preparation

Dish	Ovenware	Level	Type of heating	Temperature in °C	Cooking time
Yoghurt	Place the cups or screw-lid jars on the wire rack	1		50	6-8 hrs
Proving dough	Heat-resistant dish	Place on the cooking compartment floor		Preheat to 50 °C, switch off the appliance, place the yeast dough in the cooking compartment	5 mins 20-30 mins

Energy saving tips

Only preheat the oven if it specifies in the recipe or in the table in the instruction manual that you should do so.

Use non-stick, black painted or enamelled tins. They absorb the heat especially well.

If you have several cakes to bake it is best to bake them one after the other. The oven is still warm. This shortens the baking time for the second cake. You can also put two baking tins in one after the other.

For long cooking times, the oven can be switched off 10 minutes before the end of the cooking time and the remaining heat can be used to finish the cooking.

Acrylamide in foodstuffs





Which foods are affected? Acrylamide is mainly produced in grain and potato products heated at high temperatures, such as potato crisps, chips, toast, rolls, bread, baked goods (biscuits, gingerbread, cookies).

	Tips for keeping acrylamide to a minimum when preparing food
General	Keep cooking times to a minimum. Cook meals until they are golden brown, not too dark. Large, thick pieces of food contain less acrylamide.
Baking	With top/bottom heating, maximum 200 °C, with 3D hot air or hot air, maximum 180 °C.
Biscuits	With top/bottom heating, maximum 190 °C, with 3D hot air or hot air, maximum 170 °C. Egg white and egg yolk reduce the formation of acrylamide.
Oven chips	Spread out a single layer evenly on the baking tray. Bake at least 400 g per baking tray so that the chips do not dry out.

Test dishes



referring to EN 60350.

Baking

Food	Dish and notes	Shelf position	Cooking method	Temp. °C	Cooking time min
Small Cakes	baking tray	2		160-180	25-35
Small Cakes (preheat oven)	baking tray + universal pan*	1+3		160-180	20-30
Fatless sponge cake	baking tin (dark coated)	2		160-180	30-40
Apple pie	2 wire racks + 2 tinplate springform cake tins Ø 20 cm	1+3, placed diagonally		170-190	65-75
	universal pan + 2 tinplate springform cake tins Ø 20 cm	1 in the centre alongside one another		190-210	70-80

* When baking on two levels, use the universal pan provided, at shelf position three.

Grilling

Food	Dish and notes	Shelf position	Cooking method	Grill setting	Cooking time min
White bread (preheat oven 10 min)	wire rack	4		Setting 3	1-2
Beefburger*	wire rack	4		Setting 3	25-30

* Turn the burgers over after 15-17 min. Insert the universal pan at level 1.



ROBERT BOSCH HAUSGERÄTE GMBH

Carl-Wery-Straße 34

81739 München

DEUTSCHLAND

9000484380

BO • en • 011090-04