

VOL. 29 NO. 12
DECEMBER 1970

CHILTON'S **THE** **ELECTRONIC** **ENGINEER**

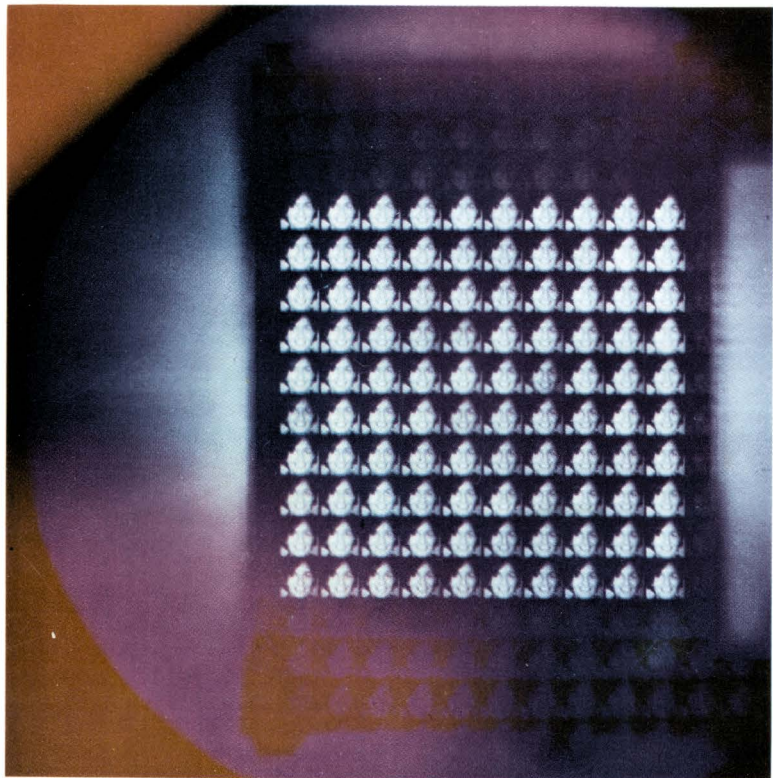

IC mask production through the holographic multiplication of images, p. 3.

A way of thinking about memories

Pomeroy's complaint

More optoelectronic applications

Measure impedance easily

1+1=1

The Formula for Making Teledyne's New Dual Monolithic Transistor

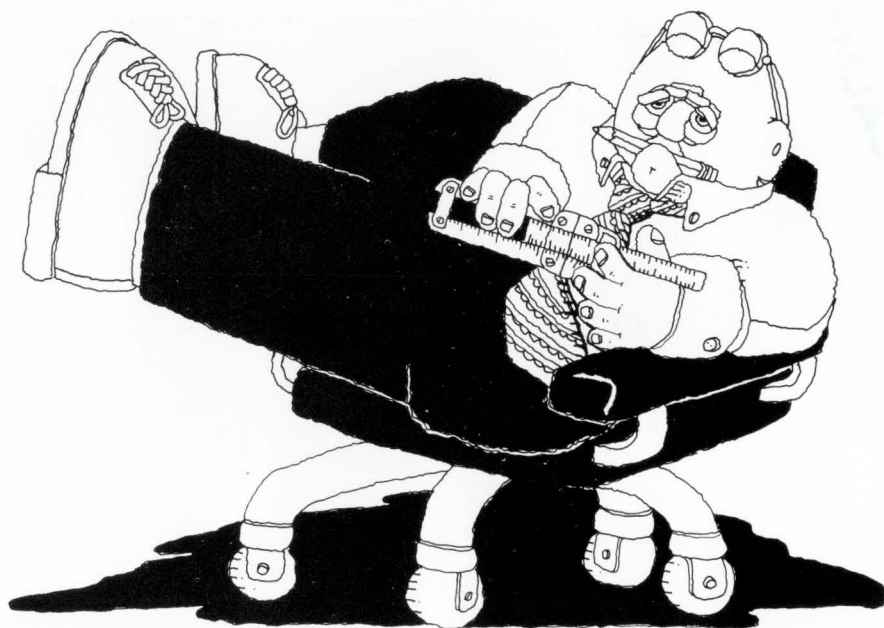

Conventional dual transistors consist of two electrically and physically isolated chips. When two transistors are diffused on the same chip, they act as a single device and out-perform the conventional transistor pair in all critical categories. Current gain is more closely matched and parameter and temperature tracking far surpass the performance capabilities of the dual transistor. Graphically depicted below, Teledyne's dual monolithic transistor has much tighter thermal coupling over the conventional pair by a factor of four. Teledyne Semiconductor has designed its dual monolithic transistors for superior performance in differential amplifier type applications, so if your

design needs fall into this category, call your local Teledyne field sales office or circle our inquiry card number for new application notes and data sheets. Teledyne Semiconductor, for high quality components, better prices and faster delivery.

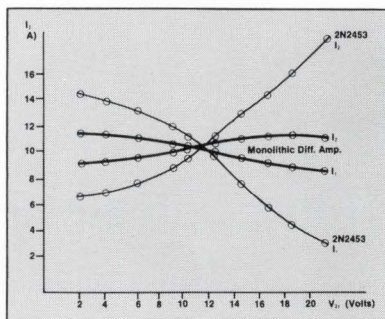

Their No.

2N2913
2N2914
2N2915
2N2915A
2N2916
2N2916A
2N2917
2N2918
2N2919
2N2919A
2N2920
2N2920A
2N2453
2N2453A
2N2642

Our No.

SA2913
SA2914
SA2915
SA2915A
SA2916
SA2916A
SA2917
SA2918
SA2919
SA2919A
SA2920
SA2920A
SA2453
SA2453A
SA2642

TELEDYNE SEMICONDUCTOR

12515 Chadron Ave.
Hawthorne, Calif. 90250
Phone: (213) 772-4551
TWX: (910) 325-6217

TELEDYNE FIELD SALES OFFICES: Palo Alto, California (415) 321-4681 • Hawthorne, California (213) 772-4551 • Anaheim, California (714) 635-3171 • Dallas, Texas (214) 357-0259 • Des Plaines, Illinois (312) 299-6196 • Westwood, Massachusetts (617) 326-6600 • Lutherville, Maryland (301) 825-1920 • Little Falls, New Jersey (201) 256-8557 • Wappingers Falls, New York (914) 297-4316 • Winter Park, Florida (305) 647-7813 • Dayton, Ohio (513) 298-7207 • Liverpool, New York (315) 622-2021 • Wiesbaden, Germany 370243 • Hong Kong K 207764.

...like more capacitance in aluminum 'lytics?

Get SPRAGUE Type 36D POWERLYTIC[®] CAPACITORS



INFORMATION RETRIEVAL NO. 4

- Large cylindrical electrolytic capacitors for use in digital computer power supplies, industrial control equipment, energy storage applications, etc
- Low impedance construction
- Largest case (3" dia. x 8 5/8" high) provides 650,000 μ F at 3 volts!
- Can be operated at +85 C
- Tapped No. 10-32 terminals simplify filter bank assembly
- Available with or without outer plastic insulating sleeves
- Request Engineering Bulletin 3431C

45C-9153R2

...want high volume efficiency in tubular 'lytics?

Use SPRAGUE Type 39D POWERLYTIC[®] CAPACITORS

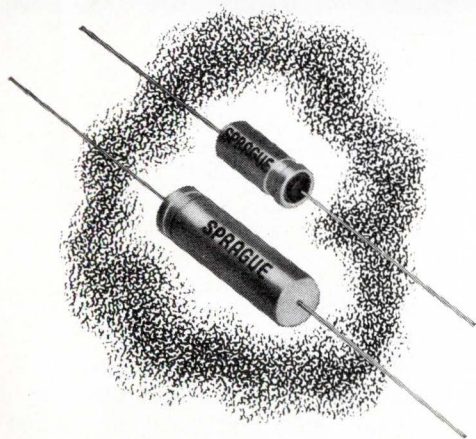

INFORMATION RETRIEVAL NO. 5

- Provide maximum capacitance in smaller cases with axial leads
- No internal riveted or pressure connections
- Welds at critical anode and cathode terminals
- Molded end covers
- Life expectancy of 10 years or more in normal service
- Very low effective series resistance and leakage current
- Request Engineering Bulletin 3415

For Engineering Bulletins as noted above, write to:
Technical Literature Service, Sprague Electric Co., 233
Marshall Street, North Adams, Massachusetts 01247.

45C-9154R2



THE BROAD-LINE PRODUCER OF ELECTRONIC PARTS

'Sprague' and '®' are registered trademarks of the Sprague Electric Co.

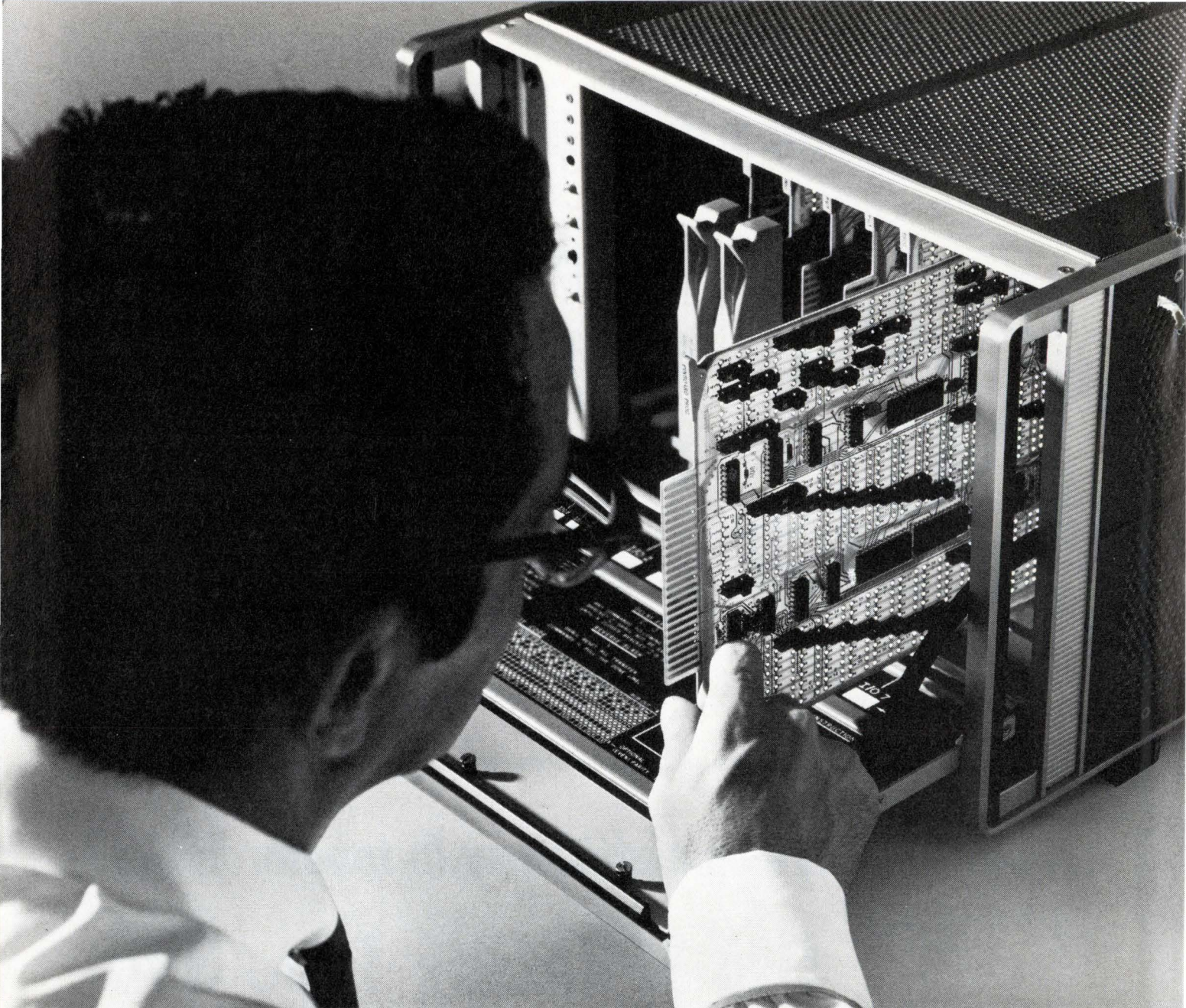

The plug-in go-between box. It makes your instruments a system.

Just plug your instruments into one of our new Coupler/Controllers and you'll have a complete data acquisition or automatic test system of your own.

It really is that simple.

Our 2570A and 2575A Coupler/Controllers let your measuring instruments communicate with digital printers, tape punches, teletypewriters and plotters. As well as with your voltage and frequency sources and other stimuli. And, you can process your measurements *on-line* with an HP 9100 Calculator, HP 2100 series computer

or a computer time-sharing system.

Any kind of setup you want to assemble goes together simply, quickly and inexpensively, by plugging the proper interface cards into the Coupler/Controller. Control of your system can come from a pinboard within the Coupler/Controller, a punched tape loop, the HP Calculator or Computer, or from the time-shared computer.

Price of the 2570A Coupler/Controller, which can interface up to eight devices simultaneously, is \$1875. For smaller systems, the 2575A, at \$1275,

interfaces up to four devices. Interface cards range from \$450 to \$1775.

Data sheets on the couplers and interface cards, and technical information on instrumentation, calculator and time-sharing applications are available from your HP field engineer. Or write Hewlett-Packard, Palo Alto, California 94304; Europe: 1217 Meyrin-Geneva, Switzerland.

06007

HEWLETT  PACKARD

DATA ACQUISITION SYSTEMS

Circle Reader Service #3.

THE ELECTRONIC ENGINEER

December 1970 Vol. 29 No. 12

Cover: Because the methods used to reproduce integrated circuits photographically have been too slow or suffer from excessive aberrations, several companies have been looking to the laser for a solution. One of these companies is RCA. At RCA's Zurich Labs., work has been progressing on a method of holographic image multiplication wherein a transparency is reproduced the number of times required in a single optical imaging step. The resolution obtained at present exceeds 4 microns. The cover photograph was achieved by projecting the image directly onto the camera lens, instead of an IC wafer. (Photo by Erich Hartmann)

6 Editorial	54 Design Features	67 Microworld New Products
8 Up To Date	59 IC Ideas	69 Literature
25 Speak Up	63 New Product Features	73 Advertising Index
40 Welcome	64 New Products	74 Abstracts
43 Careers		

30 A WAY OF THINKING ABOUT MEMORIES By Stephen A. Thompson

Streamline choosing the ideal memory for your special application with a brand new aid—the Thompson chart. Using capacity, performance, and price, and three basic assumptions, your memory choice can be eased.

43 POMEROY'S COMPLAINT By Roger D'Aprix

In a not-too-far-from-true-life playlet, Fred Pomeroy, unemployed engineer, learns the facts of life from the infamous Dr. Fried, industrial psychiatrist. As Pomeroy walks into the sunset, he is a wiser man for a few basic ground rules from Dr. Fried.

OPTOELECTRONICS—PART 3b

49 MORE APPLICATION IDEAS

We're adding more ideas for applying your optoelectronics expertise picked up in earlier installments of this popular course. From earth moving to saving lives, the design possibilities are almost infinite.

54 MEASURE IMPEDANCE THE EASY WAY . . .

USE A VECTOR VOLTMETER By J. R. Heck

In the past, impedance and admittance bridges, elaborate correction formulas, and an extra step in the case of VSWR, would give you impedance and VSWR values. Now, a vector voltmeter and Smith chart curves will solve your problems without calculations.

59 IC IDEAS

A sure start square wave oscillator by Jack Cramer and Ed Matsumoto

A low cost microwave field strength meter by J. Agnew

Convert BCD 8421 to self-complementing BCD 2421 by J. V. Sastrey

Mid-value selector doubles as a voltage limiter by Adrian Moses



KEPCO TALKS POWER SUPPLY TECHNOLOGY:

FERRORESONANCE... the key to simple stabilization

In this age of high gain, solid-state integrated feedback circuit, it is easy to overlook the simpler ways of controlling voltage and current. The ferroresonant flux-oscillating power transformer, used as the control for a d-c power supply, provides an extremely simple—therefore reliable—stabilizer that suffers no risk of the overvoltage danger to which so many loads are so vulnerable.

A ferroresonant system consists of two coils on a common core separated by a magnetic shunt. The primary coil is permitted to function linearly, while the secondary is paralleled with a resonating capacitor to excite its iron into saturation on alternate half-cycles. The shunt provides a flux path for the secondary so that the primary is not saturated.

The voltage waveform across the tank has a roughly square aspect because the iron transition from unsaturated to saturated state is a rather abrupt phenomenon triggering a rapid discharge from the capacitor (whose energy then builds the flux in the reverse direction).

When rectified, this square waveform presents a much smaller peak/average ratio to a capacitor input filter, resulting in a much lower output impedance and smaller ripple amplitude than would an equivalent sinusoid.

Because the tank's voltage, which controls the output is independent of the driving source amplitude, the load voltage is entirely a function of the magnetic structure with about 30 dB or more isolation from source changes.

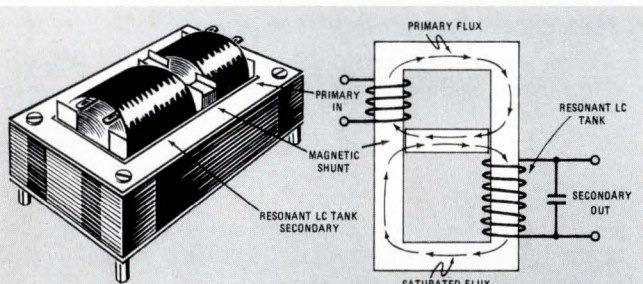

THE FERRORESONANT POWER TRANSFORMER WITH ITS TANK CAPACITOR STABILIZES A d-c OUTPUT WITH A MINIMUM OF FUSS AND BOTHER; AND A MAXIMUM OF RELIABILITY

The ferroresonant approach, in addition to providing stabilization versus the source, and a reduced load effect, through lowered impedance, is also self-protecting for overloads. Short the output and the lowered tank "Q" causes the tank oscillations to diminish and cease. This provides a current limiting effect which protects both supply and load.

Power Supplies with the Kepco ferroresonant transformer, Flux-O-Tran®, range from 60 watt modules to 300 watt supplies in single and dual output configurations. The Kepco PRM Series has 58 models in all from 4.5V d-c to 240V d-c, easily tailored to your application. Check out their advantages in *your* circuit. Get Kepco Catalog B-703.

KEPCO®

Write Department DO-19

KEPCO, INC. • 131-38 SANFORD AVENUE • FLUSHING, N.Y. 11352
(212) 461-7000 • TWX #710-582-2631

THE ELECTRONIC ENGINEER

December 1970
Vol. 29 No. 12

K. Robert Brink.....Publisher
Alberto Socolovsky.....Editor
John E. Hickey, Jr.....Managing Editor
Smedley B. Ruth.....Associate Editor
Sheldon Edelman.....Western Editor S. F.
Stephen A. Thompson.....Western Editor L. A.
Arthur J. Boyle.....Technical Editor
John McNichol.....Assistant Editor
Dr. O. M. Salati.....Consultant
Anne Axe.....Editorial Assistant
Alice C. Bach.....Editorial Assistant
Lynda Rothstein.....Editorial Assistant
Deborah P. Wilkins.....Editorial Assistant
Mae Moyer.....Editorial Reader Service
Andrew Mittelbrunn.....Chilton Art Director
Phaue Featherson.....Artist
George Baker.....Washington News Bureau
Neil Regeimbal.....Washington News Bureau

Executive and Editorial Offices:
One Decker Square, Bala-Cynwyd, Pa. 19004
Tel. (215) SH 8-2000

Address Mail to:
56th & Chestnut Sts., Philadelphia, Pa. 19139

Western Offices:
Stephen A. Thompson
3727 W. 6th St., #202, Los Angeles, Calif. 90005
Tel. (213) DU 7-1271

Sheldon Z. Edelman
199 First St. Rm. 335, Los Altos, Calif. 94022
Tel. (415) 941-6655

Chilton Officers & Directors: R. E. McKenna, President; J. Kofron, C. W. Hevner, Sr. Vice Presidents; W. A. Barbour, R. H. Groves, K. Robert Brink, Publishing Vice Presidents; James Miades, Treasurer; J. A. Montgomery, Jr., Secretary; T. J. Casper, S. H. Collmann, R. Rimbach, Jr., J. P. Kushnerick, R. O. Nelson, E. C. Beaudet, Other Directors; I. C. Holloway, Asst. Secretary.

Monthly publication of Chilton Company, Chestnut & 56th Sts., Phila., Pa. 19139. (Area Code 215) SHerwood 8-2000. Controlled circulation postage paid at Philadelphia, Pa. \$1 a copy. Subscription rates U. S. and U. S. Possessions: 1 yr. \$12.00; 2 yrs. \$20.00. Canada 1 year \$14.00; 2 yrs. \$25.00. All other countries 1 yr. \$20.00; 2 yrs. \$35.00. © Chilton Company 1970. Title Reg. U.S. Patent Office. Reproduction or reprinting prohibited except by written authorization.

The Chilton Electronics and Instrumentation Group
The Electronic Engineer
Instruments and Control Systems
Instrument & Apparatus News
Medical Electronic News
Electronic Components News

Chilton

NEW

LOW-COST, SOLID STATE AC RELAYS

To Turn on:

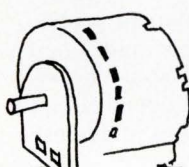

MOTORS



SOLENOIDS



LIGHTS



HEATERS

etc.

ETC.

Choose from 70 new SPST Solid State Relays

SERIES 601 FEATURES:

- Amazingly low cost
- 1 - 10 AMPS at 140 V RMS or 280 V RMS
- Drive directly from TTL logic
- Total isolation between control and load circuits (4-Terminal Network)
- All solid state (NO REEDS)
- Zero voltage switching available to minimize RFI
- Transient protected on input and output
- PC board or screw terminal mounted

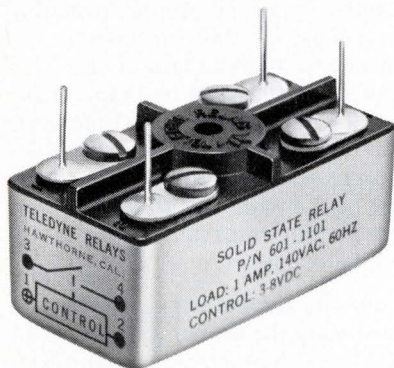

PART NUMBERING (Economy Line)

INPUT (CONTROL) VOLTAGE RANGE	OUTPUT VOLTAGE RATING	OUTPUT (LOAD) CURRENT RATING & PART NUMBERS				
		1 AMP	3 AMP	5 AMP	7 AMP	10 AMP
3-10 VDC	140 VAC	601-1001	601-1002	601-1003	601-1004	601-1005
	280 VAC	601-1006	601-1007	601-1008	601-1009	601-1010
6-32 VDC	140 VAC	601-1011	601-1012	601-1013	601-1014	601-1015
	280 VAC	601-1016	601-1017	601-1018	601-1019	601-1020
15-45 VDC	140 VAC	601-1021	601-1022	601-1023	601-1024	601-1025
	280 VAC	601-1026	601-1027	601-1028	601-1029	601-1030
20-75 VDC	140 VAC	601-1031	601-1032	601-1033	601-1034	601-1035
	280 VAC	601-1036	601-1037	601-1038	601-1039	601-1040

NOTE: Add "P" to P/N for printed circuit (pin) mounting only.

ECONOMY LINE PRICE / QUANTITY (Typical)

LOAD	QUANTITY		
Amps @ 140 VAC	10 - 24	100 - 249	1000 - 2499
1	\$12.20	\$ 8.75	\$ 6.65
3	13.50	9.70	7.35
5	15.30	10.60	8.10
7	16.60	11.55	8.80
10	18.45	12.80	9.75

PART NUMBERING (Zero Voltage Turn-On)

INPUT (CONTROL) VOLTAGE RANGE	OUTPUT VOLTAGE RATING	OUTPUT (LOAD) CURRENT RATING & PART NUMBERS				
		1 AMP	3 AMP	5 AMP	7 AMP	10 AMP
3-8 VDC	140 VAC	601-1101	601-1102	601-1103	601-1104	601-1105
	280 VAC	601-1106	601-1107	601-1108	601-1109	601-1110
7-85 VDC	140 VAC	601-1111	601-1112	601-1113	601-1114	601-1115
	280 VAC	601-1116	601-1117	601-1118	601-1119	601-1120
90-280 VAC	140 VAC	601-1121	601-1122	601-1123	601-1124	601-1125
	280 VAC	601-1126	601-1127	601-1128	601-1129	601-1130

ZERO VOLTAGE TURN-ON LINE PRICE / QUANTITY (Typical)

LOAD	QUANTITY		
Amps @ 140 VAC	10 - 24	100 - 249	1000 - 2499
1	\$21.60	\$15.00	\$11.40
3	22.95	15.94	12.11
5	24.30	16.88	12.83
7	25.65	17.81	13.55
10	27.45	19.06	14.50

For complete information on quantity prices and delivery, call your nearest Teledyne Relay Distributor — or us.



TELEDYNE RELAYS

3155 West El Segundo Boulevard, Hawthorne, California 90250 • Telephone (213) 679-2205

Jobs, concern and leadership

The year 1970 will certainly be remembered as the year of the slump, the year when unemployment among electronic engineers reached an all-time high of almost 10%, the year when American manufacturers of electronic equipment saw their sales shrink while costs continued to rise. While the prospects for 1971 aren't any better, there is no question that the products and services of electronic companies must be in high demand in this decade.

If so, if in the 1970's the world will need the technology of our industry and the brainpower of our engineers, shouldn't the engineers be employed NOW, when the products must be developed? They certainly should. However, in this competitive technological world of the 1970's, American electronic companies will need more than just the natural incentives provided by the Free Enterprise system. And the reason they need help is that they are competing with manufacturers from other countries whose governments give them positive economic help to conquer new markets.

For this reason, we have engaged in a campaign to make our government aware of the plight of our engineers, and of the opportunities for electronic companies which could not only solve the engineering unemployment problem, but also help our exports of electronic equipment. First, this magazine endorsed an initiative by Mr. Benjamin Friedman, President of Solitron Devices Inc., who back in August 1970 wrote an open letter to President Nixon bringing to his attention the plight of engineers who lost their jobs in defense cutbacks.

Then, this editor visited leaders from many electronic companies across the country, as well as officials from the Department of Commerce, to discuss and single out the opportunities that the 1970's are already offering in the design of data terminals, video recording, and communications equipment, to name a few, and to enlist their aid in presenting the industry's case to government.

Also, we contacted editors of other electronic magazines and agreed with some of them to cooperate in bringing the engineering unemployment problem to the attention of government officials. As a first step, we have requested an audience with Senators Warren G. Magnuson and Norris Cotton (of the Senate Commerce Committee), bringing to their attention the following paradox:

"While at least 35,000 engineers (14,000 of them electronic) have been laid off from defense and aerospace industries, the United States will import from Japan about 80% of the electronic calculators it will use in 1971, for an estimated \$185 million. Since both the development and manufacture of electronic calculators requires precisely the kind of skills mastered by many of the engineers who are laid off, doesn't it follow that, had American manufacturers been able to compete with Japanese manufacturers, there would have been more jobs available to the unemployed engineers? And, even if we write calculators off, the same jobs can be made available by the manufacture of data terminals, video recording, pollution control instruments, communications equipment, medical instrumentation and teaching machines."

There is a long and difficult road ahead, not only for the industry in weathering the hard times next year, but also in convincing the proper authorities of our need for help, and in obtaining meaningful and constructive help. But we are willing to tread that road because on it depends not only the health of our industry and the job of many of our readers, but also whether or not the United States will continue to be a technological leader in the 1970's.

Alberto Socolovsky
Editor

PIN diodes

Industry's longest carrier lifetime
(typically 7 μ s)

Low series resistance
(typically 0.3 Ω at 100mA)

Available off-the-shelf

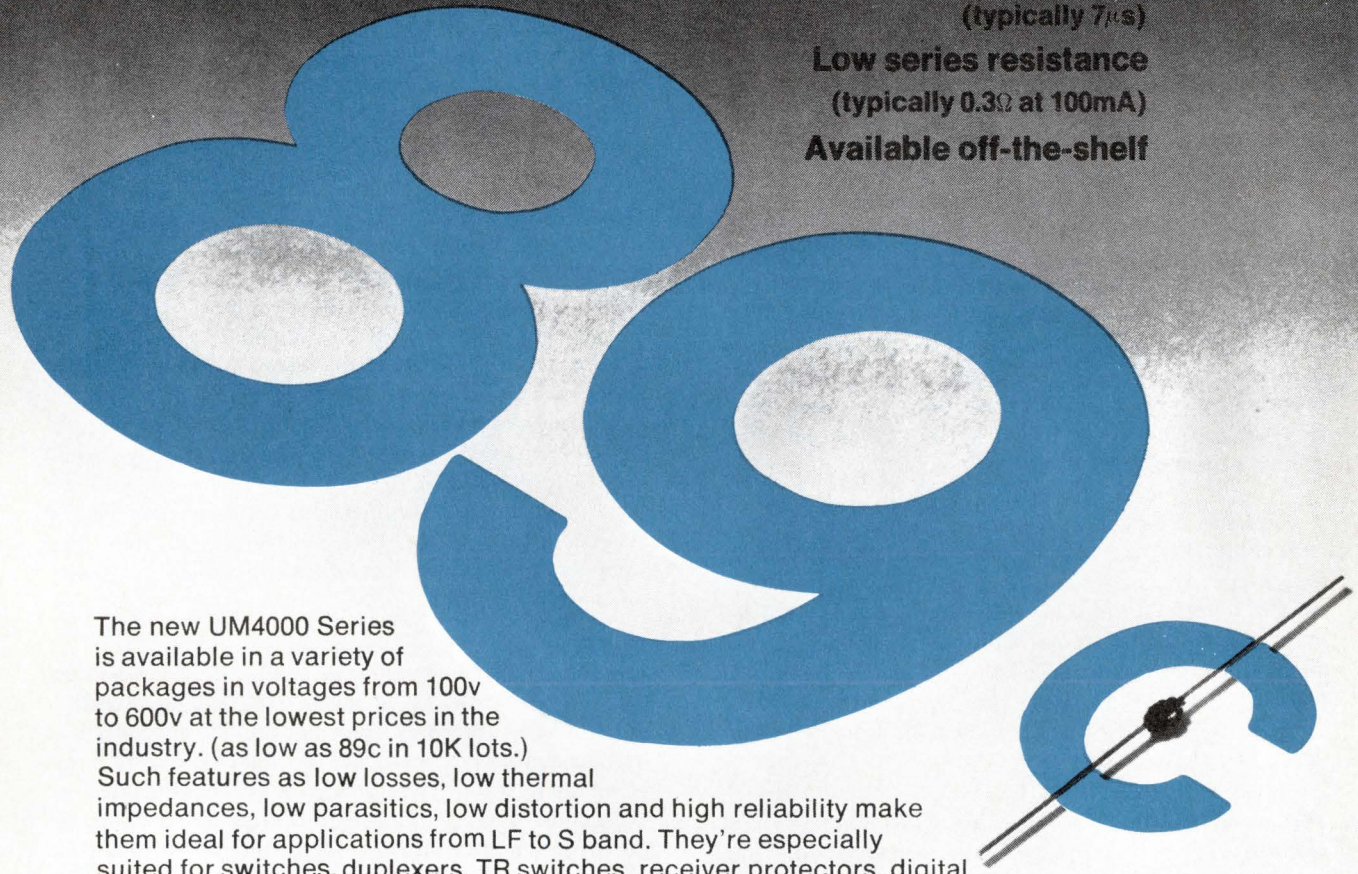

The new UM4000 Series is available in a variety of packages in voltages from 100v to 600v at the lowest prices in the industry. (as low as 89c in 10K lots.)

Such features as low losses, low thermal impedances, low parasitics, low distortion and high reliability make them ideal for applications from LF to S band. They're especially suited for switches, duplexers, TR switches, receiver protectors, digital phase shifters, attenuator circuits and AGC loops. For fast action, call Steve Nannis collect at (617) 926-0404.

Unitrode Corporation, 580 Pleasant Street, Watertown, Mass. 02172.

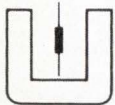

UNITRODE quality takes the worry out of paying less.

Circle Reader Service #8.

Unitrode Corporation

Inquiry Processing Dept.12D, 63 Atlantic Ave., Boston, Mass. 02110

Please send me free UM4001 sample as well as Application Bulletin and complete specs.

NAME _____ TITLE _____

COMPANY _____

ADDRESS _____

CITY _____ STATE _____ ZIP _____

Connect with this thinking . . . N. B. Shain, Free Lance Consultant, made the following comments at the recent connector symposium: contact resistance of connectors will no longer be a prime consideration in many applications—instead, attention will be directed to impedance because of the movement to higher pulse rates. And, because of their terminal lengths and inherent Z effects, solder connections will be replacing wire wrapping.

Information processing . . . An approach to computer design that embodies an array of independent hardware elements—processors, peripherals, and controllers—interconnected through an exchange network and operating in a dynamically self-regulating manner was announced by Burroughs. The Burroughs “700” system consists of three series—the B5700 which offers an auxiliary memory subsystem, a shared disk system, and a new data communications processor; the 6700 which has greater speed, more processors and a new memory capability (as compared to its predecessor); and the B7700 which is a fast paralleled process system with good versatility of configuration.

A skin tan? . . . Amana Refrigeration, Inc. is the first to be cleared by HEW of producing units that are safety hazards (microwave ovens). Amana President, George Foerstner, believes that this hazard has been blown out of proportion by publicity-seekers. He has enlisted the support of radiation expert Dr. James Van Allen of the University of Iowa, who says, “My judgement of its hazard is about the same as the likelihood of getting a skin tan from the moonlight.”

Talk about growth . . . The Korean GNP grew in real terms in 1969 by 15.9%, the largest ever recorded in the world, outpacing Japan’s record high of 15.5% in 1961. The electronics industry was no small contributor to the growth. Exports of electronic goods to the U.S. jumped from \$19.4 million in 1968 to \$41.9 million in 1969.

Its realistic . . . The Conductor Corp. has delivered a computerized locomotive simulator to the Southern Pacific railroad for training engineers. The student engineer operates an exact replica of an engine and is surrounded by very realistic audio and visual inputs that duplicate portions of SP’s routes. The cab is hydraulically actuated to simulate appropriate train motion.

NASA the book publisher . . . NASA, from its knowledge of many technologies, has some best seller books on their hands. The latest is a book called “Contamination Control Handbook,” a 400-page manual that tells manufacturers how to produce, pack, and deliver super-clean, uncontaminated products. This book is available through the Clearinghouse for Federal Scientific and Technical Information, Springfield, Va., for \$3.00. Two other best sellers are “Selected Welding Techniques” and “Soldering for Electrical Connection.”

Light lines . . . Commercially operating fiber-optic telephone and TV transmission systems, according to the engineers of ITT’s British subsidiary, STL, are anticipated within the next five years. STL has developed a single-mode optical waveguide fiber with dimensions ideal for very wide-band communications. Optical systems are possible with bit rates in each pair of fibers from 100 to 500 Mb/s (1500-7500 telephone channels). Systems capacity is expected to increase 1 to 2 Gb/s (30,000 two-way phone channels) per fiber pair.

Help is on the way . . . Two professional societies have developed employment services to help their out-of-work members. The American Institute of Aeronautics and Astronautics has a Professional Referral Service, which will list unemployed engineers and available jobs. A similar action was taken by the National Society of Professional Engineers with their recent launching of PEERS (Professional Engineers Employment Referral Service). According to NSPE, unemployed or soon-to-be-unemployed engineers will fill out a short resume and return it to the national headquarters. These resumes are then compiled and assigned a code number before being sent to more than 1000 firms. If the firm is interested, it can contact NSPE for more information.

You can be sure . . . Westinghouse Electric Corp. is moving into the commercial computer field. Taking advantage of its in-house capability, the company has announced its first general purpose machine, the 2500. The 2500 has a 16-bit word, 850 ns cycle time, and 4k words of memory expandable to 65k words. First deliveries are scheduled for the second quarter of 1971. Westinghouse will build the computer at a new installation in Orlando, Fla. The new plant will have 100 people by the end of this year and will add 300 more employees during 1971.

A standard credit card . . . A proposal that provides for standardization of credit-card specifications has been approved by the ANSI Committee X4, Office Machines and Supplies, after nearly two years of work. The proposal includes specifications for credit cards; alternate specs where name and address are required; alternate specifications for small size cards; and a credit-card account numbering system. Free copies of the proposed standard may be obtained from BEMA, 1828 L St., NW, Washington, D.C.

All number one . . . Almost immediately after Sylvania Electric Products Inc. announced that it would phase out semiconductor manufacturing operations, at least five other companies stepped in. One of the product lines being dropped by Sylvania is their Suhl 1 and 2, encouraging the other manufacturers to claim that they are now the number one Suhl manufacturer. Which one really will be the Suhl leader remains to be seen.

ϕ-LINE POWER DARLINGTONS



integrated switching
circuits
cost you less...

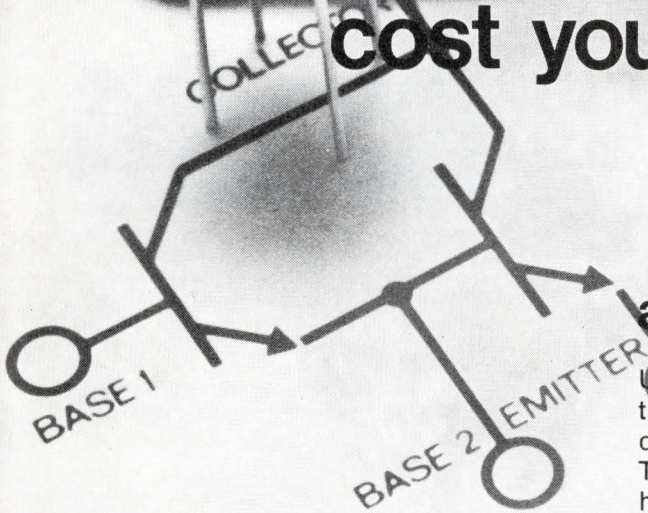

and make your work a lot easier.

Unitrode's new industrial 10 Amp silicon planar NPN Darlington transistors offer you the advantages of a monolithic two transistor circuit for less than the price of comparable discrete devices. They're ideal for high gain switching applications such as print hammer drivers, solenoid, servo and lamp drivers and for amplifying applications such as motor controls and linear amplifiers. They're available in two hermetically sealed metal packages — a lead-mounted TO-33 (U2T101) and a chassis-mounted TO-66 (U2T201). Both utilize overlay (multiple emitter) techniques on driver and output transistors. Saturation voltage is 1.5V max. @ 5A and current gain is 2000 min @ 5A. Collector-Emitter voltage ratings are available up to 150 volts. U2T201 has a power dissipation rating of 25W @ a case temperature of 100°C. For whatever Darlington application you have, Unitrode ϕ-Line Darlington transistors are more efficient and less expensive than any other method of performing the function. Why not make us prove it? (U2T101 is \$2.75 ea. in lots of 100.)

For fast action, call sales engineering collect at (617) 926-0404
Unitrode Corporation,
Dept. 12D, 580 Pleasant St., Watertown, Mass. 02172

Free samples on request.



UNITRODE quality takes the worry out of paying less.

Computer card reader

RCA has developed a stationary card reader composed of a flat array of 960 photosensitive elements, auxiliary components and interconnections, and a light-sensitive thin-film circuit, all deposited on a 4 x 8 in. plate of glass. The reader follows a layout of 12 rows of 80 elements each, matching the 960 positions on a computer card.

When a card passes through the reader, photoconductive elements sense the light passing through the punched holes. This then triggers the necessary signal. Each of the 960 elements in the sensor array consists of a "lateral-flow" photoconductor in series with a thin-film Schottky diode connected to mutually perpendicular address strips. Diode action is obtained from the dissimilar contacts to the photoconductor.

Lookout behind

Anti-collision devices for automobiles are big in the news, but unfortunately that's the only place they're big at the moment. Many companies, large and small, are working on anti-collision devices, most of which use some form of radar.

But there's a new one that's different. It's an ultrasonic detector that automatically warns a driver when another vehicle is approaching from his left or right rear blind zone. The system, designed to be installed in a side mirror or in the rear light assembly of a vehicle, responds to noise generated by engines and tires. A signal sensed by the small receivers triggers a dashboard-mounted warning light when a vehicle traveling at least 35 mph comes within 25 feet of a protected car.

With an ultrasonic system, it is possible to have "eyes in your behind" when driving. Here, noise from an approaching vehicle triggers a warning light on the dashboard.

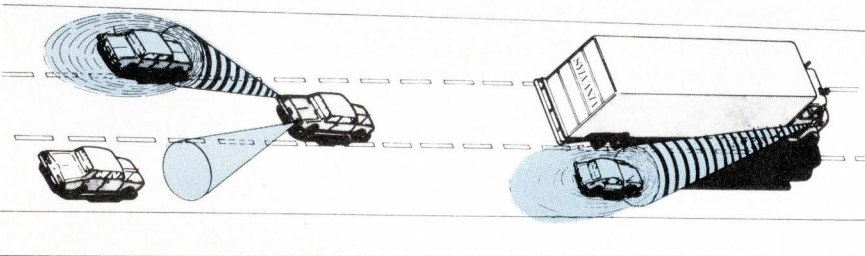

Sound moves light

Much research is being done toward use of guided light waves in thin film structures. (The Electronic Engineer, p. 14, Sept. 1970). Hopefully, this will lead to a high information-carrying capacity of laser light.

With the use of laser light, IC methods could be used to fabricate complex dielectric optical waveguide networks on film surfaces. Switching would control light once it had entered the surface of a thin glass film.

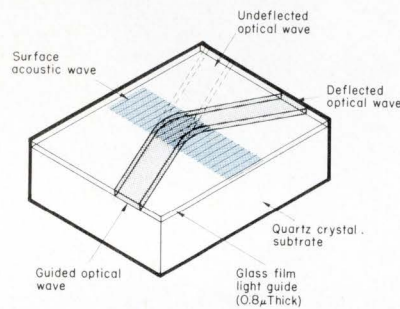

By using surface acoustic waves, IBM research Scientists have achieved a bending or deflection of laser light in a thin glass film. A 6328 Å laser light was coupled by diffraction into an optical light guide. The guide was made of a thin glass film deposited on a quartz crystal substrate. On the Crystal surface, at right angles to the optical guided wave, an acoustic surface wave of about 200 MHz frequency was propagated. The acoustic wave was not disturbed by the glass film light guide because of its "thinness," which is much less than the wavelength of the ultrasound.

The acoustic wave produced a periodic strain in the film, causing deflection in the film plane of the optical wave being guided through it. A maximum deflection efficiency of 66% was obtained for 0.18 W of acoustic power.

Pressure packaging

How many times would you have liked to put your package into a vise to squeeze it into a smaller size? Well, here's one company that almost did the same thing.

A rugged, new computer smaller than a desk telephone—but with an 8192-word memory of 18-bit words—was made through new packaging by the Bunker-Ramo Corp.'s Electronic Systems Division in Westlake Village, Calif.

As a result of Bunker-Ramo's proprietary Planar Coax packaging, the tiny computer offers reduced mainframe, memory, and input/output units equivalent in size to soap bars.

This packaging method provides a means for coaxially interconnecting circuits in extremely dense packages with negligible heat and cross-talk problems. All fabrication is by batch processing, with no plug-in cards.



Close-up of component mounting wafer in proprietary Planar Coax packaging shows dielectric ridges over buried, cross-talk-proof leads. By stacking wafers, interconnects are made in all planes—X, Y and Z.

All devices are built up from three basic wafers:

- Component wafers
- Interconnect wafers
- Connector screen wafers

The component wafers are mounted on the integrated circuits and provide leads from the ICs to the rest of the planar coax system. The interconnect wafers provide coaxial X, Y interconnections as needed. Finally, the connector screen wafers provide coaxial Z-axis interconnections between the component and interconnect wafers. Then the three types of wafers are stacked vertically to provide a finished system with ICs mounted and interconnected. The completed stack is held together by high mechanical pressure but may be easily disassembled for repair or modification.

Wafer sizes range from 1- through 3-in. squares. The vertical stack height varies from a fraction to several inches.

Time to settle down



In only 300nsec. the new Model 1025 FET op amp reaches 0.01% of final value. Model 1019 takes just 200nsec. longer.

Both of these new FET op amps are ideal for high speed analog applications such as A/D conversion, peak detection, high speed integration, coaxial line driving and fast sample and hold circuits.

Model 1019 is a differential FET op amp featuring, in addition to its 500nsec. to 0.01% settling time, a 1000V/ μ sec. slew rate and a high gain-bandwidth product of 100 MHz. Other characteristics include: a full power frequency of 10 MHz, a CMRR of 100dB, and a low bias current of -50 pA.

Model 1025 is a FET input op amp designed for inverting applications where very fast settling time and economy are desired. In addition to its 300nsec. to 0.01% settling time, the 1025 features a slew rate of 500V/ μ sec. and a high output current of 50mA at ± 10 V.

If you don't want to settle for less than the best, contact your local TPN representative or Teledyne Philbrick Nexus, Allied Drive at Route 128, Dedham, Mass. 02026. Tel. (617) 329-1600. Prices F.O.B. Factory U.S.A.



Send today for complete specs and new Product Guide.

**TELEDYNE
PHILBRICK NEXUS**

What makes ours the world's best MOS?

Unique features. Like PSG passivation, cerdip, MOSAB.

Things that make Philco[®] MOS the most reliable on the market.

First, our PSG passivation. We apply a unique phosphosilicate glass over the entire surface of the chip—not just over the metallization. This produces the most trouble-free MOS you can buy.

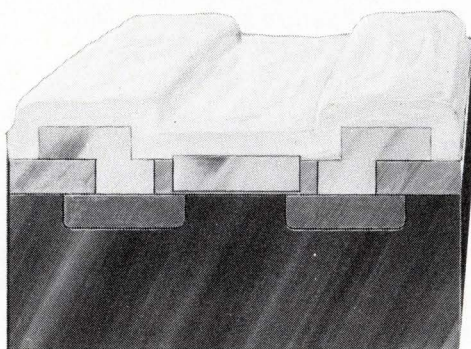

All-over PSG passivation

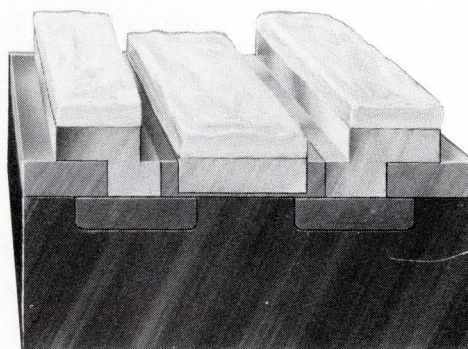

Passivation over metal only

Our special PSG process ends surface ion migration and eliminates field inversion voltage effects—the “Fahrenheit freakout” that can cause all sorts of logic errors when chip temperatures rise. It also prevents corrosion, scratched metallization, and bridging of metal lines by stray conductive particles.

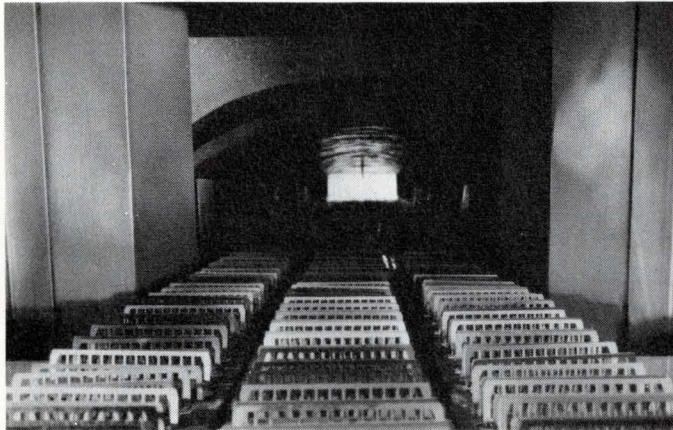
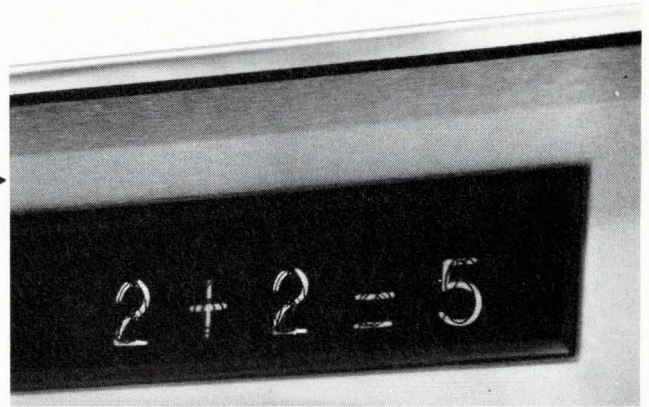

Sealing cerdip at 550° C

And PSG's high-temperature capability lets us give you MOS in cerdip—the low-cost hermetic packaging that meets all the environmental requirements of MIL Standard 883.

Then there's our patented MOSAB input device. It ensures permanent over-voltage protection at every input on every circuit. In conventional MOS circuits the voltage limit increases each time there's a transient surge, as shown on the curve tracer. Until eventually there's no over-voltage protection left.

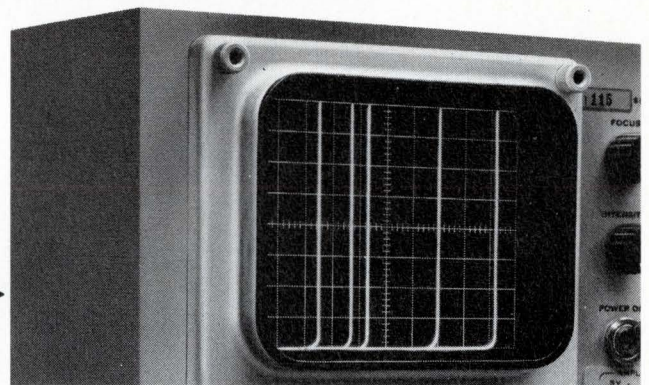

These all add up to yields that are double the industry average . . . from a plant that can make up to a million perfect chips a week. And that means top reliability at attractive prices. See for yourself. Write Philco-Ford Corporation, Microelectronics Division, MOS Marketing, Blue Bell, Pa. 19422. (215) 646-9100.

Or call our nearest sales office: Los Angeles, Calif., (213) 641-8105 • Palo Alto, Calif., (415) 321-8740 • Melrose Park, Ill., (312) 345-1000 • Burlington, Mass., (617) 272-1600 • Dearborn, Mich., (313) 323-3797 • Union, N.J., (201) 686-7512 • Syracuse, N.Y., (315) 422-3154 • Dayton, Ohio, (513) 223-1832 • Don Mills, Ontario, (416) 444-2541.

PHILCO 

The better idea people in MOS.

Cut the Size of Your Power Supply in Half with Fast, High-Voltage Transistors from RCA.

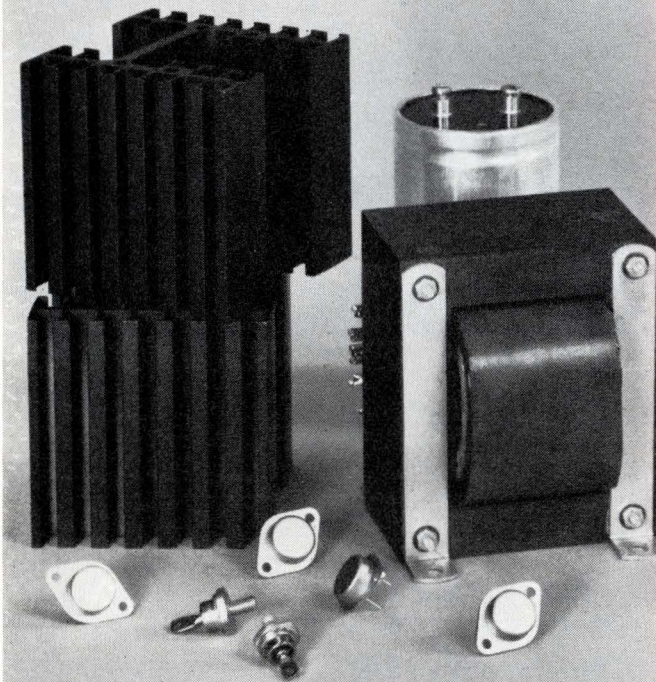

Conventional 5 V, 25 A Supply

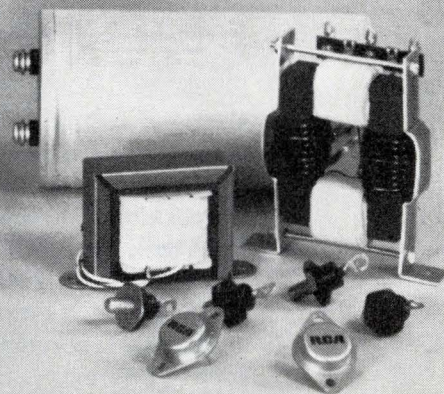

New 5 V, 50 A Supply

RCA

For details and application note, write: RCA, Commercial Engineering, Section 59L/UT14, Harrison, N.J. 07029



**A good bench DVM
is fast
and accurate...**

**A great bench DVM
is fast, accurate,
and easy to use!**

HP's 3480 is a great bench DVM. Simple, foolproof controls and full, five-decade autoranging reduce operating effort and errors. Fast response time and low noise make millivolt adjustments easy. And high noise rejection makes the last digit fully useable.

Low injected noise will not disturb the circuit under test. And constant $> 10^{10} \Omega$ input resistance on the lower three voltage ranges reduces loading errors.

The digital readout display is presented in standard format for easy reading, easy understanding; i.e., +143.17 mV—not backwards, or inside out. Other convenience features include a sampling-rate indicator and a manual trigger for quick one-shot samples.

Options and plug-ins are available to give you combinations of five DC ranges, five true-RMS AC ranges, and six ohms ranges. And you pay for only the capabilities you want. Prices begin at \$1500 for five ranges of fully autoranging DC.

For further information, contact your local HP field engineer, or write to Hewlett-Packard, Palo Alto, California 94304. In Europe: 1217 Meyrin-Geneva, Switzerland.

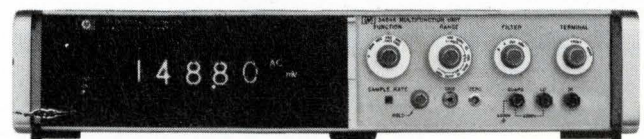

HEWLETT  PACKARD

DIGITAL VOLTMETERS
090/45

Circle Reader Service #13.

PUT THE SWITCH WHERE THE ACTION IS!



WITH SWITCHCRAFT PENDANT SWITCHES FOR REMOTE CONTROL VERSATILITY

Now, an all-new, ultra-versatile line of Pendant (Cord) Switches for control, indicating, counter and data entry applications without costly relays or custom engineering. A host of never-before-available features give remote switching the kind of reliable action, long life and broad range of functions you'd expect only from console-mounted

leaf-spring switches. By all odds, the best looking switches of their type—in a broad range of consumer- or industrial-oriented colors. Choose from momentary non-locking action, locking, push-to-lock/ push-to-release, or locking with remote electrical release . . . with standard circuitry arrangements from 1-A to 2-C plus 2-A.

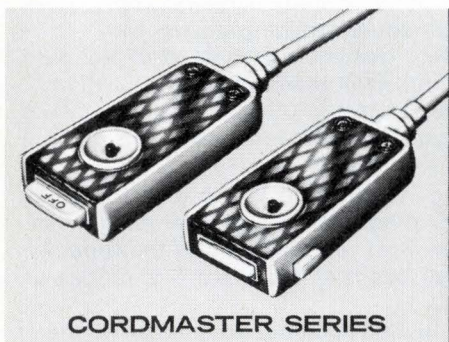

CORDMASTER SERIES



CORLETTE SERIES

Most versatile line ever created. Top or edge button operation; exclusive remote lighting, standard illuminated, or non-illuminated models. Four different functions (including remote release), with choice of 5 different circuits. Lightweight styled to fit the hand. Accepts cables up to .270 diameter.

Standout styling in a momentary-action remote switch with choice of A, B or C contact arrangements. Any length standard 2- to 4-conductor cable can be permanently molded on; or switch supplied with standard phono plug termination for use with any phono-jack equipped cable.

WRITE FOR BULLETINS E-534, E-537 and 165

SWITCHCRAFT[®]
INC.

5539 No. Elston Ave., Chicago, Ill. 60630

Canada: Atlas Radio Corp., LTD., 50 Wingold Ave., Toronto, Canada

Circle Reader Service #14.

Here is your copy of a brand new reference chart sponsored by

RCA

Memory Products Div.



GUIDE TO MAIN FRAME MEMORIES CHART

Tear it out,



NOW

. . . and mount it on your wall

If the chart has been removed, Circle Number 41 on the Inquiry Card for a copy.

Who speaks for EEs in times of crisis?

Sir:

I commend you on your editorial "Who speaks for EEs in times of crisis?" [*The Electronic Engineer*, September 1970, p. 7.] An article in the *Boston Globe* on August 16, 1970 by Col. R. D. Heinl, Jr. stated . . . "Russia will have outstripped the United States in every meaningful military and technological field by 1973." We must do everything we can to prevent this.

Max W. Clere
Sharon, Mass. 02067

Roll up your sleeves

Sir:

It seems to be characteristic of the times we live in. Individuals with mutual bonds of political ideologies, ethnic backgrounds, occupations, or economic levels band together and "demand" justice, their rights, or just a bigger piece of the pie from their particular authority image. This authority image can be

parents, school administrations, police, or the federal government.

Your editorial, "A call for action" (*The Electronic Engineer*, October 1970), asks the electronics industry to join the parade of whiners with palms outstretched for federal subsidization. Call it "sponsorship" or "cooperation" or whatever, it still amounts to the same thing.

During the past twenty years the electronics industry has enjoyed meteoric growth and prosperity. . . . enjoyed it as a glutton enjoys a seven course meal with double servings. At every managerial, administrative and technical level the industry as a whole has become fat and lazy. Why? For the simple reason that nasty old Uncle Sam gave us too much money to play with and we were too immature to handle it properly.

Ah, those were the good years. Those were the years of abundant CPFF contracts. Those were the years of over-staffing and over-spending condoned and even encouraged by the government. ("Better tell the contractor on the Belch Project to put fifty more engi-

neers on the job. If we don't spend our budget, they'll cut it next year.")

Shortage of engineers in the '60s? A myth. Possibly there was a shortage of good engineers. Certainly there was a shortage of mature, responsible and industrious engineers. Here, Management must also share the blame. We engineers took our cue from them.

What's that your Reader says, Mr. Editor? "Well, he certainly can't be talking about me," The hell I can't. I'm talking about him and me and all of us. The present situation calls for us to get up off of our overstuffed rears and roll up our sleeves. The situation calls for creativity, imagination and leadership. The situation does *not* call for a federal handout to accomplish for us what we should have been accomplishing through our own initiative while the gravy train was still rolling.

James LaMar
Annapolis, Md.

Letters to the editor are published at the discretion of the magazine. Please say so if you do not want to be quoted. Signed letters have preference over anonymous ones.

improve MTBF with MS-180

MS-180 FREON® TF Degreaser increases the reliability of electronic equipment by removing grease and dirt. Use MS-180 on the production line or in your maintenance program to clean up assemblies, components and connections. It's safe to apply



even while equipment is operating. MS-180 is available in 16-oz. cans for plant use, convenient 6-oz. cans for field service kits. You can try it—FREE—merely by writing for a sample on your company letterhead.



miller-stephenson chemical co.,inc.

Route 7, Danbury, Conn. 06813

© DuPont TM



If you need 500 ns get us this coupon the fastest

You'll get the facts on our new 500ns memories and stacks. Memories and stacks that you can get two months faster than anybody else's.

Ours will likely beat anybody else's price per bit, too. On any size order.

Here's the new line: The CC-50 stack and the CC-50 memory. The CEX-50 stack and the CEX-50 memory.

Between them they'll meet about any need you have for 500ns cycle times.

If it's a million bits or less you need, you're best off with our CC-50. It's 3-wire, 3D. With 4K, 8K or 16K words.

Over a million bits puts you in our CEX-50 class. It comes in 3-wire, 2½D organization. Words: 16K, 32K or 64K.

And, stack or system—CC-50 or CEX-



memories or stacks fast, way you can.

50—you'll get the only modular 500ns design anywhere.

There's something else unique about this new line. Something brand new. We don't have space enough to explain it here, but our spec sheets will give it all to you in glorious detail.

Quick, the coupon.

LOCKHEED ELECTRONICS Data Products Division/Los Angeles (213) 722-6810

- I'm drooling. E. E. 12/70
Get me CC-50 and CEX-50 data immediately.
- Take your time.
I only need CC-50 and CEX-50 data for my archives.

Name _____
Position _____
Company _____
Street _____
City _____ State _____ Zip _____

Lockheed Electronics Company

Data Products Division 6201 East Randolph Street, Los Angeles, California 90022

Circle Reader Service #16.

COMES WITH EVERY
GENERAL ELECTRIC
CAPACITOR

Reliability through people

Capacitor reliability, just like the reliability in your aerospace equipment, is only as good as the people behind the product. At General Electric capacitor reliability is built in, start to finish, by quality-oriented people, assuring the dependability you require in your equipment design.

Reliability starts with our Research and Development teams. These inquisitive and creative people, who have greatly advanced electrolytic capacitor technology, are continually exploring materials and methods to develop new and better ways to meet your needs.

It continues with the involvement of scores of men and women who subject capacitors to exhaustive quality control during manufacture, with units receiving hundreds of quality checks.

It concludes with exacting test people who precisely verify capacitor performance through rigorous test procedures.

Reliability comes from people like these . . . in research, design, quality control, manufacturing and testing. People who share your pride in producing reliable equipment . . . and do something about it.

To learn more about reliable GE capacitors through people, contact one of the "problem solvers" — your GE Electronic Distributor or ECSO District Sales Manager. Or write Section 430-43, General Electric Company, 1 River Road, Schenectady, N. Y. 12305.

Electronic Capacitor and Battery Dept., Irmo, S. C.

Tantalum Foil

Tubular or Rectangular
Meets or exceeds performance and environmental requirements of MIL-C-3965.
For polar and nonpolar applications in military and high-performance industrial equipment.

- Voltage range . Up to 450 VDC
- uf range 0.15 to 3500 uf
- Temp. range — 55C to 85C or 125C

Tantalum Wet-Slug

Tubular or Rectangular
Meets or exceeds performance and environmental requirements of MIL-C-3965.
Used in military and high-performance industrial systems.

- Voltage range . Up to 125 VDC
- uf range 1.7 to 2400 uf
- Temp. range — 55C to 85C and up to 125C

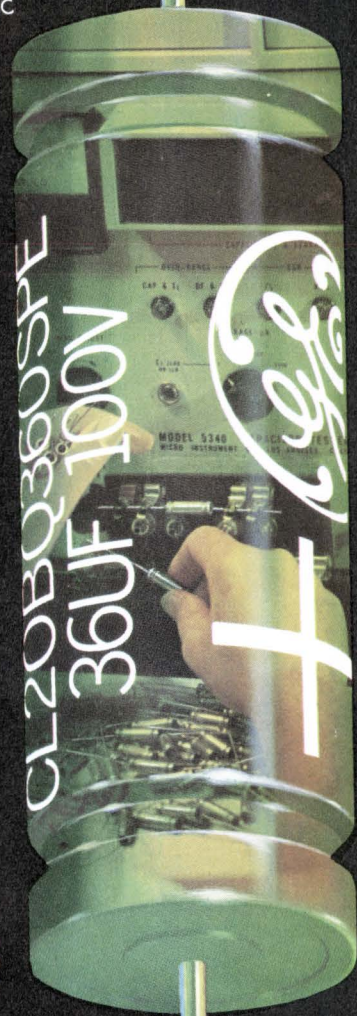
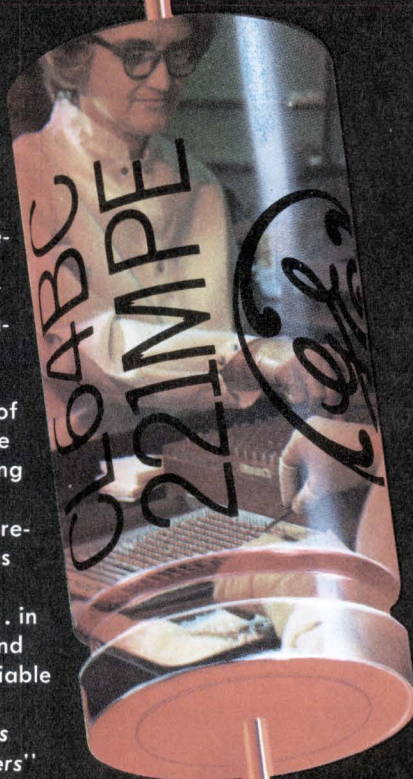

GENERAL  ELECTRIC

Circle Reader Service #17.

**High-Reliability Tubular
Tantalum Foil**

Tantalum to glass true hermetic seal. For military or aerospace use where outstanding performance and reliability are prime factors. Meets or exceeds performance and environmental requirements of MIL-C-39006

- Voltage range . Up to 200 VDC
- uf range 1.2 to 450 uf
- Temp. range -55C to 125C



Polyester Film Foil

With axial leads meets or exceeds performance and environmental requirements of MIL-C-27287. Use where size, weight, cost and reliability offers an advantage over metal-clad tubulars, molded or ceramic case units.

- Voltage range . Up to 300V
- uf range0010 to 1 uf
- Temp. range -55C to 125C



**Subminiature Tantalum
Wet-slug Capacitor**

In military and high-performance industrial miniature applications where an extremely small unit with highest volumetric efficiency is required.

- Voltage range . Up to 60 VDC
- uf range 3.3 to 450 uf
- Temp. range -55C to 85C

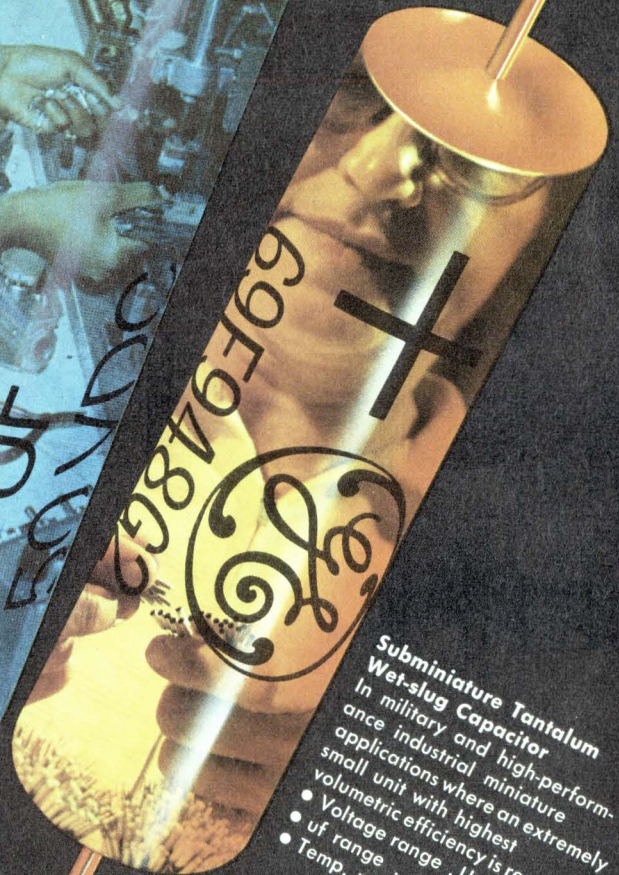

A way of thinking about MEMORIES

Dollars, speed, and many bits—
memories are made of this

Steve Thompson Western Editor

Looking at a pile of product spec sheets and price lists, a semiconductor memory user could easily be overwhelmed by an impression of chaos. With the aid of a few basic assumptions, however, all of this data can be correlated, and individual memories can be compared. These assumptions are carefully explained below. And after looking at the charts, you'll see that their validity lies in the uncommon regular linearity of the resulting plots over many orders of magnitude.

Assumption 1: *The memory user is concerned primarily with three things: capacity (number of bits), performance (speed), and price.* Factors such as power dissipation, MOS-bipolar compatibility, reliability, package size, etc., are usually of secondary importance. Our goal here is simply to relate capacity, performance, and price on a single plot.

One of the primary parameters—capacity—tends to be a design constraint rather than a design variable: there's a job to be done, and it requires a certain capacity.

Few would argue with the usual measure of price, cost/bit. The inverse, bits/\$, is used here so that on the charts an increasing number reflects an increasing value.

The remaining parameter is performance, and the problem here is how to rate memory speed. The two figures commonly quoted are access time, t_a , and cycle time, t_c . Since cycle time can be severely derated by system considerations beyond the control of the manufacturer, access time was chosen for the charts. Access time remains constant because it is a direct measure of memory capability.

However, t_a is a spec in a vacuum. Considering only t_a , an 8-bit memory with a t_a of 10 ns would be judged superior to a 1024-bit memory with a t_a of 20

ns. The important question, then, is how many bits per unit time do we have access to?

Assumption 2: *The ratio, bits/ t_a , is the measure of a memory's performance, or computing power.* In rating a memory, bits/ t_a is a measure of the manufacturer's engineering capability, and bits/\$ is a measure of his manufacturing capability. (copy continues on p. 34)

TABLE I

Manufacturers' Code & Inquiry Card Numbers

CODE	MANUFACTURER	INQUIRY CARD NUMBER
A	Advanced Memory Systems	250
Am	American Micro-Systems	251
C	Cogar	252
CM	Computer Microtechnology	253
E	Electronic Arrays	254
F	Fairchild Semiconductor	255
G	General Instruments	256
H	Hughes Aircraft Co.	257
I	Intel	258
Is	Intersil	259
M	Mostek	260
Mo	Motorola	261
N	National Semiconductor	262
NA	North American Rockwell Microelectronics	263
P	Philco-Ford	264
R	Radiation Incorporated	265
Ry	Raytheon	266
S	SEMI	267
Sg	Signetics	268
So	Solitron	269
Sy	Sylvania	270
T	Texas Instruments	271

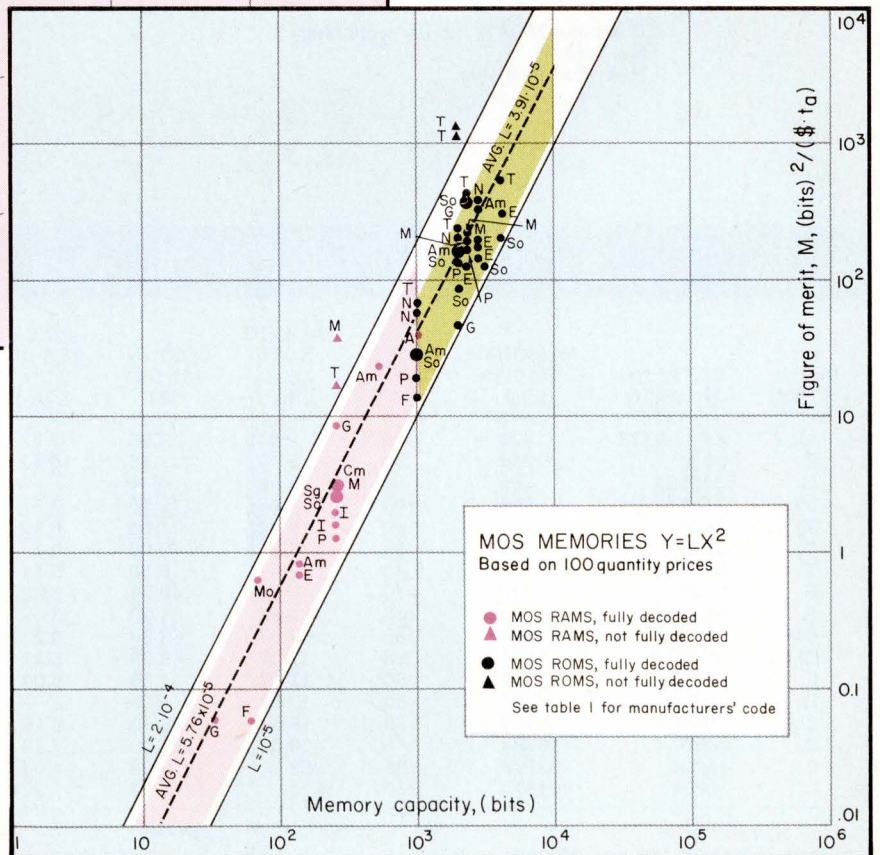
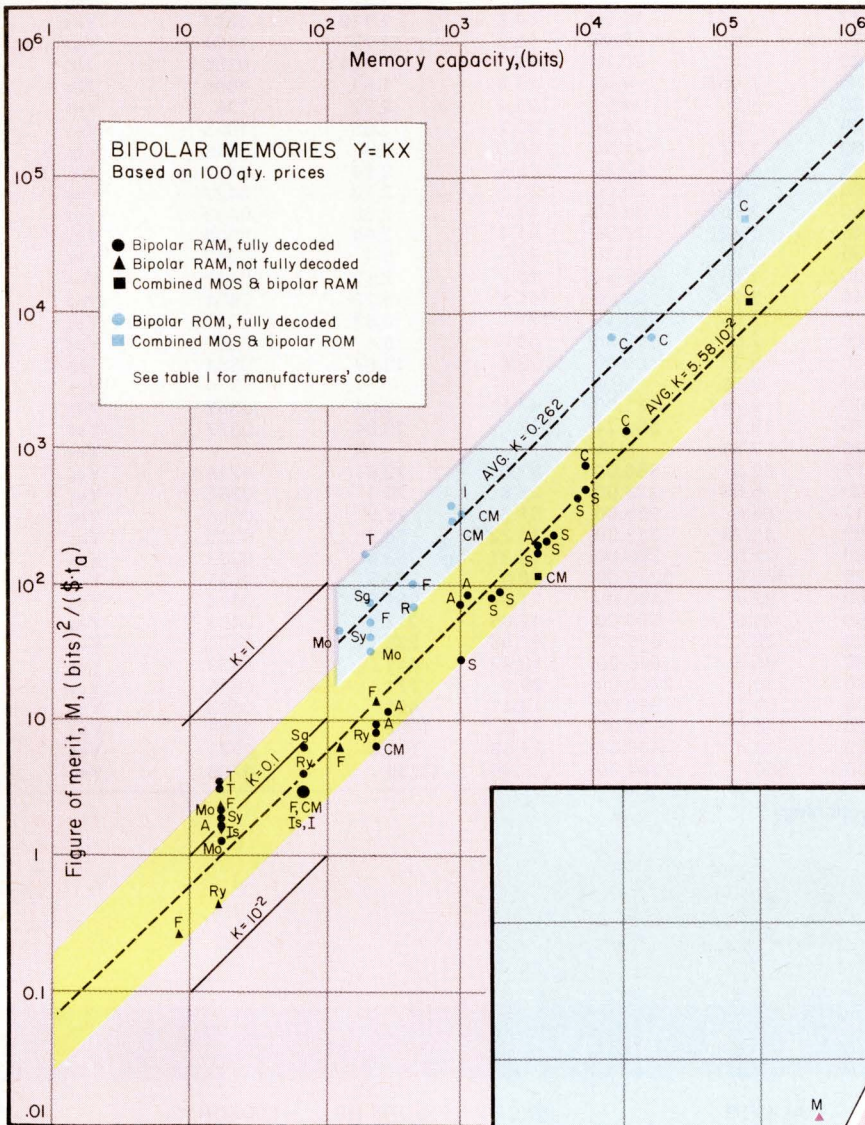

TABLE II BIPOLAR RAMs

MFGR ⁷ CODE	CATALOG NUMBER	MEMORY CAPACITY (bits)	ACCESS TIME, t _a (ns)	ACCESS RATE (bits/ns)	COST IN 100 QTY (\$)	PRICE PER BIT (¢/bit)	FIGURE OF MERIT, M (bits) ² (\$ · t _a)	MEMORY CONSTANT, K (bits (\$ · t _a))	FULL DECODE
F	9030	8	25	.32	10.50	131	.244	.0305	No
A	AMS0161	16	8	2.0	21.30	133	1.5	.0938	Yes
F	9033	16	20	.8	7.00	43.7	1.83	.1142	No
Is	IM5502	16	20	.8	9.00	56.2	1.42	.0888	No
Mo	MC1036/37	16	17	.941	13.50	84.3	1.116	.0697	Yes
Mo	MC4004/5	16	20	.8	7.25	45.3	1.77	.1104	Yes
Ry	RL80,81/82,83	16	20	.8	30.20	189	.424	.0265	No
Sy	SM80	16	35	.457	4.55	28.4	1.61	.1005	No
T	SN54/7481	16	20	.8	4.54	28.4	2.82	.176	Yes
T	SN54/7484	16	20	.8	4.84	30.2	2.65	.1655	Yes
CM	CM2100	64	60	1.07	25.60	40.0	2.67	.0416	Yes
F	9035	64	35	1.83	42.80	66.8	2.74	.0427	No
F	4103	64	60	1.067	25.00	39.1	2.73	.0427	Yes
Is	IM5501	64	60	1.067	26.50	41.4	2.58	.0403	Yes
Ry	RR5100/6100	64	45	1.422	26.50	41.4	3.44	.0538	Yes
Sg	8225	64	35	1.83	21.70	33.9	5.4	.0842	Yes
I	3101	64	60	1.067	25.60	40.0	2.67	.0419	Yes
F	4027	128	40	3.2	66.00	51.5	6.22	.0484	No
A	AMS0328E/T	256	15	17.06	453.10	177	9.63	.0377	Yes
CM	2150	256	100	2.56	102.40	40.0	6.4	.025	Yes
F	4100	256	80	3.2	60.00	23.4	13.67	.0534	No
Is	IM5503	256	100	2.56	N/A	—	—	—	Yes
Ry	RR5110/6110	256	60	4.267	121.00	47.1	9.06	.0352	Yes
A	AMS0329E/T	288	15	19.2	509.74	177	10.84	.0377	Yes
Ry	RR5120/6120	512	70	7.31	N/A	—	—	—	Yes
A	AMS1288E/T	1024	17	60.3	850.00	83.0	72.6	.0719	Yes
S	RAM18A	1024	180	5.68	223.00	21.8	26.1	.0261	Yes
A	AMS1289E/T	1132	17	66.5	955.00	84.3	78.9	.0698	Yes
S	RAM28A	2048	180	11.38	312.00	15.22	74.7	.0365	Yes
S	RAM29A	2304	180	12.8	355.00	15.37	83.4	.0362	Yes
A	AMS40961E	4096	25	163.6	3275.00	80.0	204.5	.0501	Yes
S	RAM48A	4096	180	22.7	490.00	11.97	189.5	.0464	Yes
S	RAM49A	4608	180	25.6	555.00	12.05	212.2	.0461	Yes
S	RAM50A	5120	180	28.4	618.00	12.08	235	.0460	Yes
S	RAM88B	8192	180	45.5	845.00	10.32	441	.0538	Yes
C	08C05	9216	40	230.4	2760.00	29.9	771	.0835	Yes
S	RAM89B	9216	180	51.2	960.00	10.41	491	.0533	Yes
C	15C07	18432	125	148.5	2120.00	11.5	1292	.0696	Yes
CM	CM2400-1-2	4096 ⁴	250	16.4	600.00	14.68	111.8	.0273	Yes
C	30C06	147456 ⁴	250	580	7280.00	4.94	11750	.0798	Yes

⁴Combined MOS & Bipolar technology

⁷See Table I

N/A - Not Available

TABLE III BIPOLAR ROMs

MFGR ⁷ CODE	CATALOG NUMBER	MEMORY CAPACITY (bits)	ACCESS TIME, t _a (ns)	ACCESS RATE (bits/ns)	COST IN ⁵ 100 QTY (\$)	PRICE PER BIT (¢/bit)	FIGURE OF MERIT, M (bits) ² (\$ · t _a)	MEMORY CONSTANT, K (bits (\$ · t _a))	FULL DECODE
Mo	XC170/171	128	45	2.845	9.95	7.77	36.6	.288	Yes
F	9034	256	50	5.12	27.75	10.82	47.3	.1845	Yes
Is	IM5601	256	50	5.12	N/A	—	—	—	Yes
Mo	XC270/271	256	100	2.56	19.90	7.77	32.9	.1286	Yes
Sg	8224	256	50	5.12	17.90	6.99	73.3	.276	Yes
Sy	SM320	256	35	7.31	49.00 ²	19.1	38.2	.1495	Yes
T	SN7488	256	40	6.4	8.80	3.44	186	.728	Yes
F	4104	512	70	7.31	40.00	7.82	93.5	.183	Yes
R	ROM0512	512	65	7.88	61.50	12.0	65.6	.1282	Yes
CM	CM2800	1024	60	17.07	63.60	6.21	274	.269	Yes
CM	CM2850	1024	60	17.07	63.60	6.21	274	.269	Yes
I	3301	1024	60	17.07	51.60	5.04	339	.331	Yes
Is	IM5602	1024	60	17.07	N/A	—	—	—	Yes
CM	CM2900	1120	60	18.67	69.40	6.19	302	.269	Yes
C	06P07	16384	40	409.6	1220.00	7.44	5500	.336	Yes
C	15P06	32768	125	262	1310.00	4.00	6550	.200	Yes
C	30P06	131072 ⁴	250	524	1710.00	1.301	40100	.305	Yes

²1-9 quantity price

⁵Mask charges, if any, are unknown

⁷See Table I

⁴Combined MOS & Bipolar technology

N/A - Not Available

TABLE IV MOS RAMs

MFGR ⁷ CODE	CATALOG NUMBER	MEMORY CAPACITY (bits)	ACCESS TIME, t _a (ns)	ACCESS RATE (bits/ns)	COST IN 100 QTY (\$)	PRICE PER BIT (¢/bit)	FIGURE OF MERIT, M (bits) ² (\$ · t _a)	MEMORY CONSTANT, L 1 (\$ · t _a)	FULL DECODE
G	RA-6-4803	32	1500	.0213	11.80	36.9	.0577	5.65 x 10 ⁻⁵	Yes
F	3530	64	3000	.0213	24.00	37.5	.0568	1.39	Yes
Mo	MC1170	64	500	.128	13.90	21.7	.59	14.4	Yes
Am	RM51	128	700	.183	32.00 ¹	25.0	.732	4.46	Yes
E	EA 1400	128	1000	.128	25.80	20.15	.645	3.88	Yes
CM	CM1900	256	800	.32	25.60	10.0	3.2	4.88	Yes
G	RA-1-0256	256	500	.512	13.00	5.08	10.04	15.4	Yes
I	1101	256	1500	.171	25.60	10.0	1.71	2.61	Yes
I	11011	256	1000	.256	30.75	12.0	2.144	3.25	Yes
M	MK4001P	256	50	5.12	32.50	12.7	40.3	61.5	No
M	MK4002P	256	800	.32	26.50	10.35	3.09	4.72	Yes
P	PRW256X1C	256	1000	.256	51.50	20.1	1.273	1.94	Yes
Sg	2301	256	750	.341	30.00	11.73	2.805	4.45	Yes
So	UC6550/7550	256	900	.271	25.00	9.77	2.77	4.64	Yes
T	TMS4003JC	256	150	1.71	24.00	9.38	18.2	27.8	No
T	TMS4008JC	256	120	2.13	N/A	—	—	—	No
Am	RM52	512	200	2.56	50.00 ¹	9.77	26.2	10.0	Yes
NA	RAM30023	512	500	1.024	N/A	—	—	—	No
NA	RAM30024	512	500	1.024	N/A	—	—	—	No
A	AMS 10241	1024	400	2.06	53.00	5.175	39.8	4.72	Yes

¹ 1,000 quantity price

⁷ See Table I

N/A - Not Available

TABLE V MOS ROMs

MFGR ⁷ CODE	CATALOG NUMBER	MEMORY CAPACITY (bits)	ACCESS TIME, t _a (ns)	ACCESS RATE (bits/ns)	COST IN ⁶ 100 QTY (\$)	PRICE PER BIT (¢/bit)	FIGURE OF MERIT, M (bits) ² (\$ · t _a)	MEMORY CONSTANT, L 1 (\$ · t _a)	FULL DECODE
Am	256X4	1024	2000	.512	18.00 ¹	1.756	29.1	2.78 x 10 ⁻⁵	Yes
F	3501	1024	2500	.4096	32.00	3.12	13.12	1.25	Yes
Is	IM7601	1024	600	1.707	N/A	—	—	—	Yes
Is	IM7602	1024	600	1.707	N/A	—	—	—	Yes
N	MMN521	1024	1000	1.024	15.00	1.465	69.8	6.67	Yes
N	MMN522	1024	1000	1.024	16.50	1.61	63.6	6.67	Yes
P	PMS 1024C	1024	2000	.512	25.60	2.5	20.48	1.955	Yes
So	UC6525/7525	1024	900	1.138	40.00	3.91	28.1	2.78	Yes
P	PM1024C	1024	2000	.512	25.60	2.5	20.48	1.955	Yes
T	TMS2880JC	1024	600	1.707	25.00 ³	2.44	70	6.67	Yes
Am	MB52	2048	1000	2.048	25.00 ¹	1.218	168	4.00	Yes
Am	512X4	2048	2000	1.024	25.00 ¹	1.218	84.2	2.00	Yes
F	3507	2048	700	2.926	N/A	—	—	—	Yes
F	3580	2048	750	2.73	N/A	—	—	—	Yes
G	RO-1-2048	2048	1000	2.048	90.00	4.39	46.7	1.11	Yes
H	HROM2048	2048	500	4.096	N/A	—	—	—	Yes
Is	IM7603	2048	750	2.73	N/A	—	—	—	Yes
N	MMN523	2048	1000	2.048	20.00	.976	210	5.0	Yes
P	PMS 2048C	2048	800	2.56	39.75	1.94	132	3.14	Yes
So	RUC6548/7548	2048	1000	2.048	50.00	2.44	84	2.00	Yes
T	TMS2600JC	2048	600	3.413	26.30 ³	1.284	266	6.34	Yes
T	TMS4500JC	2048	100	20.48	38.70 ³	1.89	1083	25.9	No
T	TMS4600JC	2048	100	20.48	32.50 ³	1.586	1292	30.8	No
T	TMS4700JC	2048	100	20.48	32.50 ³	1.586	1292	30.8	No
G	RO-1-2240	2240	500	4.48	28.00	1.25	358	7.15	Yes
M	MK2000P	2240	700	3.2	35.00	1.563	205	4.18	Yes
M	MK2001P	2240	600	3.73	35.00	1.563	238	4.77	Yes
P	PMS 2240C	2240	700	3.2	40.50	1.806	177	3.52	Yes
So	UC6577/7577	2240	600	3.73	23.00	1.025	364	7.25	Yes
T	TMS2400JC	2240	500	4.48	25.00 ³	1.115	402	8.0	Yes
T	TMS4100JC	2240	500	4.48	26.30 ³	1.173	382	7.6	Yes
E	EA3000	2304	1000	2.304	42.50 ³	1.843	125	2.35	Yes
Am	MA52	2560	700	3.66	30.00 ¹	1.172	312	4.76	Yes
E	EA3100	2560	1000	2.56	42.50 ³	1.658	154.5	2.35	Yes
E	EA3500	2560	850	3.01	42.50 ³	1.658	181.5	2.77	Yes
Is	IM7604	2560	750	3.41	N/A	—	—	—	Yes
Is	IM7605	2560	750	3.41	N/A	—	—	—	Yes
M	MK2400P	2560	700	3.66	47.00	1.835	199.5	3.04	Yes
N	MM5240	2560	600	4.267	30.00	1.171	368	5.55	Yes
So	UC6572/7572	3072	1100	2.79	67.00	2.18	128	1.36	Yes
E	EA3300	4096	1000	4.096	54.00 ³	1.32	310	1.85	Yes
NA	ROM30022	4096	350	14.3	N/A	—	—	—	No
So	UC6596/7596	4096	2000	2.048	40.00	.977	210	1.25	Yes
T	TMS4300JC	4096	800	5.12	41.20	1.006	508	3.03	Yes

¹ 1,000 quantity price
³ Includes mask charge

⁶ Mask charges, if any, are unknown except for note ³

⁷ See Table I
N/A - Not Available

Assumption 3: *The bits/ t_a and bits/\$ ratios are weighted equally.* If both are equally desirable, then one can be traded against the other in the marketplace, and their product $(bits)^2/(\$ \cdot t_a)$, is a figure of merit, M , which can be used for rating memories. All that remains is to calculate M for all memories and plot it against capacity to come up with a plot that relates the three primary user concerns.

Tabulations are broken down by memory types in Tables II through V, and results are plotted in the figures. Except where indicated, memory costs are for quantities of 100. Letters inside the data point shape correspond to the manufacturers' code in Table I. In spite of the deviations in the marketing strategy of individual companies, both the bipolar and MOS markets behave in accordance with the assumptions listed.

Bipolar is well-behaved

Values of M for bipolar RAMS and ROMS fall into well-defined bands. The equation of a line within either band is of the linear form $Y = KX$, where K is the constant of proportionality that positions the line vertically. Calculating K allows a user to rate memories by a single computation. A higher K indicates a better capacity-cost-performance (CCP) tradeoff. If we let $B =$ the number of bits in the memory, solving for K yields:

$$\begin{aligned} B^2/(\$ \cdot t_a) &= KB \\ K &= B/(\$ \cdot t_a) \end{aligned}$$

Values for K are also listed in the tables. The sensitivity of the market to the CCP tradeoff can be inferred by noting that 50% of the bipolar RAMS have values within the range of $K = 0.045 \pm 0.01$. All but one bipolar ROM falls in the range of $K = 0.128$ to 0.336 . It's reassuring that the graph confirms intuition by showing that virtually all bipolar ROMS have higher K s than bipolar RAMS, because they are cheaper.

The plot may be considered as a snapshot of bipolar memories in the June-July 1970 period. Another interesting analysis would be the vertical motion of the average K value as speed and price improve. And another plot could include core memories. The areas of overlap would be the market battlegrounds which would also change with time.

MOS-due to change soon

Two things stand out among the interesting things revealed by the MOS plots: MOS RAMS and ROMS have well-defined, non-overlapping (except for one product) capacity ranges; and the slope of the plot closely approximates a square law relationship of the form $Y = LX^2$, where L is the constant of proportionality that positions the line vertically on the chart. There is no technological explanation to support the square law phenomenon. The best explanation seems to be the young, untested nature of the MOS market. We're probably seeing the result of marketing strategy, rather than that of the numerous transactions which have shaped the more mature bipolar areas. Solving for L supports

this line of reasoning since

$$L = 1/(\$ \cdot t_a).$$

Just as the CCP tradeoff for bipolar memories could be specified by calculating K , a tradeoff for MOS memories can be made by calculating L . MOS memories behave as if they were marketed solely on the basis of the $(\$ \cdot t_a)$ tradeoff independent of the memory capacity. This represents an ideal case in the seller's market. Since MOS is in short supply, those users who want the characteristics MFS offers are willing to pay a given price for a given t_a at any capacity. As MOS production increases and competition takes hold, the slope of the MOS line will have to change. But where will the pivot point be?

Computing the average K s and L s, the tradeoff intercepts of bipolar and MOS technologies for RAMS and ROMS are at 970 and 7380 bits, respectively. Memories that are not fully decoded are not included in these calculations because they distort the end result, especially in the MOS area. As technology and pricing shift the lines upward, and the marketplace pivots the MOS slope to something less than X^2 , the crossover points will change. Right now, the plot indicates that if larger MOS memories could be built, they would have the best cost-performance tradeoff.

Three other memories, indicated by squares, are plotted on the charts in the bipolar areas. They are the MOS and bipolar hybrid technology memories from Cogar and Computer Microtechnology. Plotting their figure of merit reinforces or extends the bipolar lines and indicates that they are being marketed much like the pure bipolar products.

As a design aid

Designers should find the information in the charts helpful. Once he knows the required memory capacity, the designer can choose, according to his needs, from the products within that group. After deciding the necessary speed and what cost he can afford, he can calculate a K or an L and use the charts to determine if he is within the state-of-the-art. Should he find the K or L too large, he'll have to wait for progress to catch up to him or modify his demands. He can go with a low K or L and have a design margin. Even if the calculation falls within the band, he could have problems. A K of $5 \cdot 10^{-2}$ for a 1024-bit bipolar RAM would be all right, but not if it is predicated on a willingness to pay \$10,000 for a t_a of 2 ns.

There is no suggestion here that the designer use the highest rated memory on the chart. Each point represents a tradeoff based on certain assumptions. If a single item dominates the design, such as price, a memory with a non-optimum K or L could easily be the best choice.

INFORMATION RETRIEVAL
Semiconductors, Integrated Circuits,
Computers, Charts and nomographs

NOW...

the only one of its kind available!

A Course in MOS INTEGRATED CIRCUITS

The editors of *The Electronic Engineer* have just compiled a complete 9 part course on MOS technology, applications and costs which appeared originally in *The Electronic Engineer*. It is a definitive volume that provides you with all the background you need as a user or a designer to master this new technology.

This state of the art course in MOS technology presents completely authoritative, up-to-the-minute guidance in using every aspect of this dynamic science. It covers the processing of MOS circuits, applications of MOS circuits, complementary MOS, MOS memories (random access, read only, associative memories and cost) and the testing of complex MOS integrated circuits.

This course is an exclusive from *The Electronic Engineer*. It is, in fact, the only one of its kind available. The authors, all recognized experts in their respective fields, take you with technical precision from the fundamentals on through to the most sophisticated phases of this dramatic technology. This course is the *one* authoritative way to keep ahead in these changing times.

Order your copy of the *only* course available on the new MOS technology and manufacturing processes for only \$5.00 per copy. Send your order today to: *The Electronic Engineer*, One Decker Square, Bala Cynwyd, Penna. 19004, Dept. E-12

Enclosed is my check or money order for \$_____ for _____ course(s) on MOS technology at a cost of \$5.00 each. Send as soon as possible to:

Name _____

Address _____ Company _____

City _____ State _____ Zip _____

Send me special quantity prices E-12

GRC[®] SAMPLES SHOW THE BIG DIFFERENCE

small plastic molded parts
more uniform! more precise!

Your products and profits benefit when you specify Gries tiny plastic moldings. 30 years of research, development, and experience; special patented, automatic, injection molding machines . . . advanced tooling and production skills. They add up GRC's BIG DIFFERENCE.

NO MINIMUM SIZE! Maximum Size: .05 oz., 1 3/4" long.

Ask for: PLASTICS SAMPLE KIT, FACTUAL BROCHURES TODAY!

Gries Reproducer Co.

Division of Coats & Clark Inc.

165 Beechwood Ave., New Rochelle, N.Y. 10802 (914) 633-8600

Plants in: New Rochelle, N. Y.; Warren, R. I.; Toccoa, Ga.

In Canada: Gries Div., Dynacast Ltd., Lachine, Que.

Circle Reader Service #20.

ELEXON

*** ONLY \$90.00**

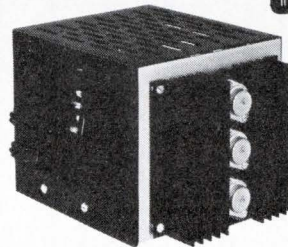

**5 VOLTS
15 AMP
POWER
SUPPLIES**

SPECIFICATIONS

INPUT: 120 or 240 VAC ±10% 47-63 Hz

OUTPUT: MODEL

ELV-75-5 5 Vdc at 15 amps

ELV-75-12 . . . 12 Vdc at 6 amps

ELV-75-18 . . . 18 Vdc at 4 amps

ELV-75-24 . . . 24 Vdc at 3 amps

LINE REG: .1%, LOAD REG: .1%, RIPPLE & NOISE: .1%
• SHORT CIRCUIT PROTECTION • OPERATES 0°C-55°C
• OFF THE SHELF DELIVERY!

* PRICES	1-9	10-24	25-49	50-99
ELV-75-5	\$90.00	\$85.00	\$80.00	\$75.00
ELV-75-12	90.00	85.00	80.00	75.00
ELV-75-18	90.00	85.00	80.00	75.00
ELV-75-24	90.00	85.00	80.00	75.00

*ELV-75 Crowbar Optional — \$10.00

ELEXON INC.

1422 E. St. Gertrude • Santa Ana, California 92705
• (714) 540-9510

Circle Reader Service #19.

Our TTL family gives you freedom where it counts.

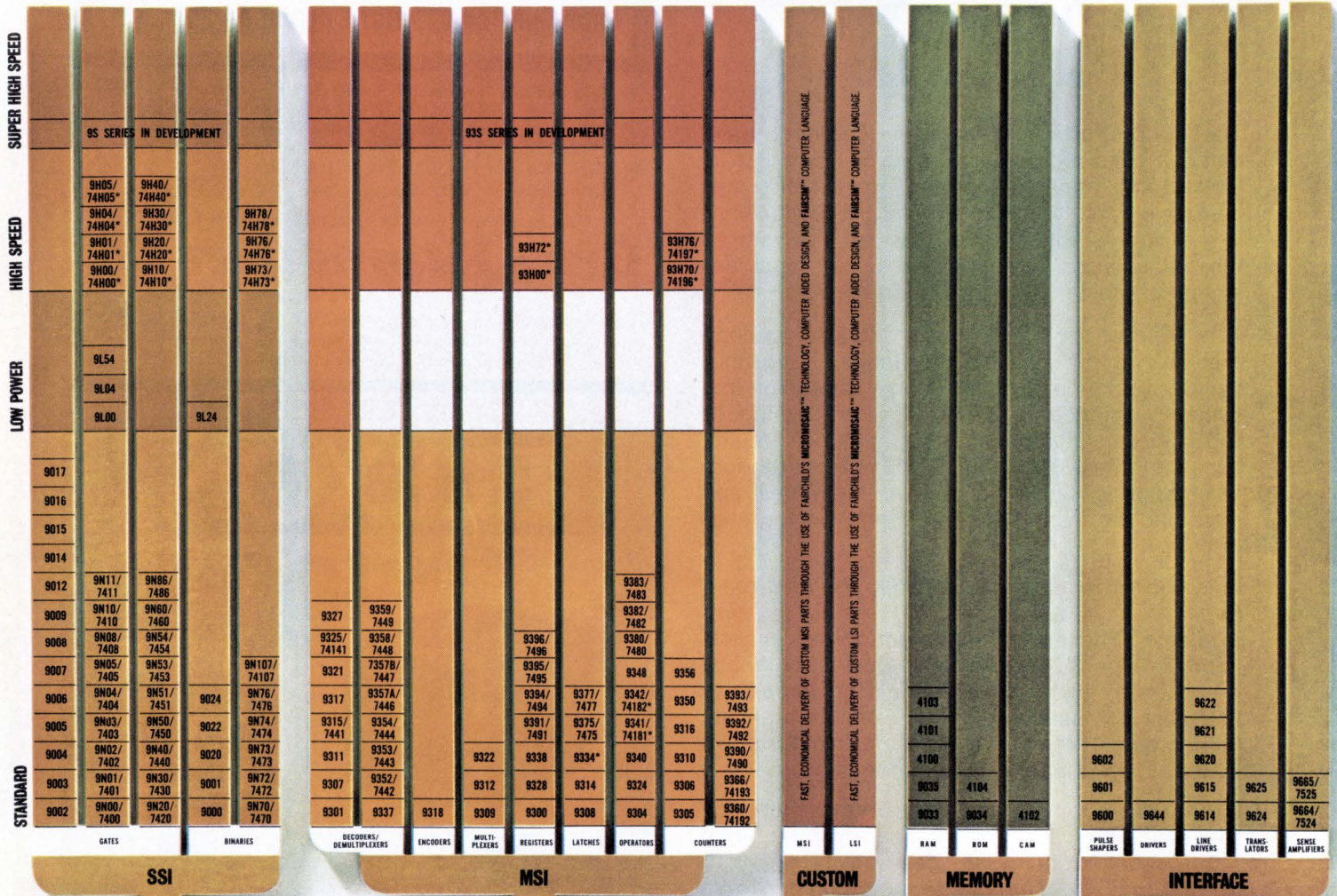

The Fairchild TTL family offers the freedom-loving designer the broadest range of speed/power trade-offs and an extraordinary variety of logic and memory and interface support functions.

FAIRCHILD TTL FAMILY

*Available January, 1971.

Now you can design with Low Power TTL/MSI at even less cost than with Standard!

93L21 Dual 1 of 4 Decoder		93L22 Quad 2 Input Multiplexer				
93L11 1 of 16 Decoder		93L12 8 Input Multiplexer	93L28 Dual 8 Bit Shift Register	93L14 4 Bit Latch	93L40 4 Bit Arithmetic Logic Unit	93L16 Binary Counter
93L01 1 of 10 Decoder	93L18 8 Input Priority Encoder	93L09 Dual 4 Input Multiplexer	93L00 4 Bit Shift Register	93L08 Dual 4 Bit Latch	93L24 5 Bit Comparator	93L10 Decade Counter
DECODERS/ DEMULTIPLEXERS	ENCODERS	MULTI- PLEXERS	REGISTERS	LATCHES	OPERATORS	COUNTERS

Our Low Power TTL now sells for the same price as Standard TTL and costs even less to use.

If you don't need the speed of Standard, why pay the freight? In our TTL Family you'll find 15 low cost Low Power MSI devices to choose from. All compatible. All off the shelf.

It's the largest, most complete, most versatile selection in the business. Designed to give the cost-conscious designer freedom now. And freedom where it really counts:

- No board redesign (pin-for-pin equivalent to and compatible with Standard TTL/MSI devices).
- Smaller power supply.
- Less noise (fewer decoupling elements required).
- Less heat.
- High fanout (fewer buffers needed).
- Largest Low Power MSI/TTL family around.

Typical performance:

Gate Tpd = 20ns Gate Pd = 2mW
Binary Toggle Rate = 10MHz
MSI Clock Rate = 10MHz

You might re-examine your current design. If speed is not a critical factor, then look at our 93L Low Power series. If you care about costs, they have a lot to give. Our new catalog tells the whole story. Send for it.

FAIRCHILD
SEMICONDUCTOR

Circle Reader Service #21.

There's something in everything we

HDR Series Connectors

High density pin and socket connectors. Available in nine sizes—12 to 106 contact positions on .100" grid. Size 20 contacts for wire size ranges 20-30 AWG. Posted contacts available for wrap type or TERMINAL POINT★ point-to-point wiring devices. Also available with crimp, snap in contacts applicable at speeds to 4000 terminations per hour.

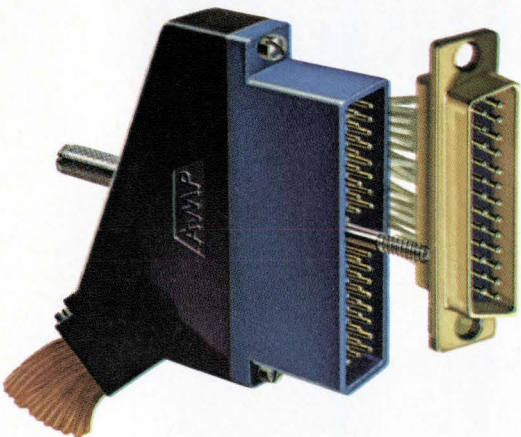

ARINC Type Connectors

In both sealed and unsealed versions. Fully intermateable with all connectors designed to the specification. Other features include: higher specified dielectric performance, greater contact stability, front serviceable keying, and faster contact application. Up to 1200 complete wire terminations with the AMP-O-MATIC★ Stripper Crimper machine. Crimp configuration conforms to MS-3191 or MS-3108 and meet the specification of MIL-C-81659.

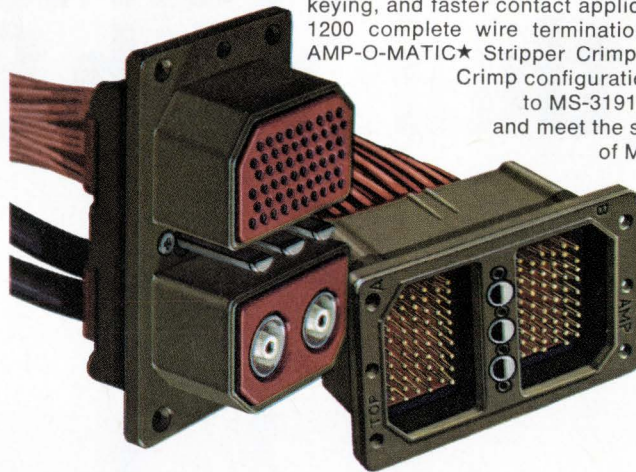

High Density Printed Circuit Connectors

Easily hand-mated, two piece printed circuit connectors featuring self-aligning contacts. Available in .075" and .100" centers. Low insertion and withdrawal forces, yet highly resistant to humidity, shock, vibration, and other adverse environmental conditions. Unique elliptical spring construction of socket for four-point redundant contact. Can be soldered, wrapped or welded. Individual contacts are removable even after connector is mounted.

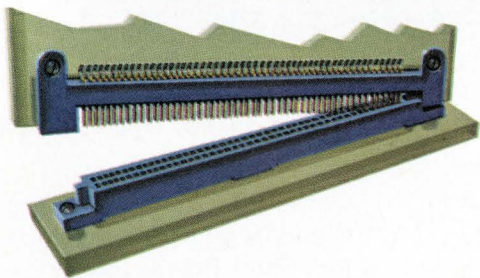

Flexible Flat Cable Connectors

AMP's Flexible Flat Cable connector is specially designed to match the cable's characteristics and requirements. Available in 9 to 33 circuits. Unique high-speed automated machinery crimps contacts to cable at rates up to 5000 per hour. Contacts snap into housing for cable-to-cable, cable-to-board, and cable-to-round wire connections. High reliability, low installed costs through automated tooling.

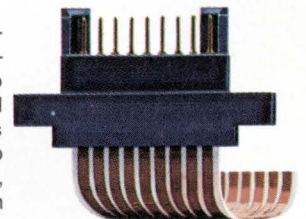

Micro-Connectors

Ideal for all micro-system packaging. AMP design spiral spring construction assures redundant contact and maintains reliability under severe conditions. Stamped and formed chevron shaped receptacle and mating pin contact are spaced in housing in either .050" or .025" centers. Connectors can be "stacked" without loss of critical contact spacing. Circuit contact tines are pre-solder coated and need only reflow and plug in.

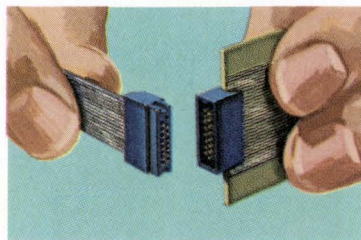

Coaxial Connectors

Full line of COAXICON★ connectors includes standard, miniature and subminiature types. All are fully crimpable. Industry's first automated process for termination of subminiature types produces a fully crimped terminal in approximately 20 seconds. Low VSWR and reduced noise level. Inner contact stability. See-through port for easy inspection. Available for all standard cable sizes. AMP's matched tool and terminal concept assures uniform reliability. Cuts rejects to absolute minimum.

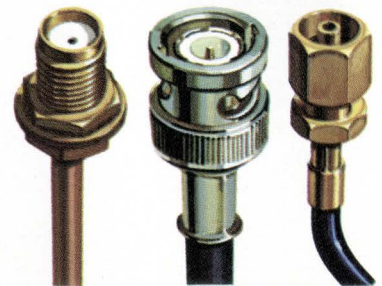

standard make for black boxes

From input to output, every connection we make for a black box (and we make them all) takes into account avionics standards for space, weight, modularity, reliability and maintainability. Our technology is aimed at making things smaller, lighter, stackable, reliable and easily maintainable. And the proof of our capability is on wings everywhere in the world—in business aircraft, military planes of every type and the jumbo jets.

Whatever the need—communications, navigation, radar . . . airborne electronic systems of all kinds . . . AMP's first packaging requirement in any black box is reliability. And we offer application tooling and techniques that make it available at the lowest applied cost.

For more complete details or ideas to fit your black box design requirements write:

Industrial Division

AMP Incorporated, Harrisburg, Pa. 17105



AMP
INCORPORATED

★A trademark of AMP Incorporated.

Making it in MOS

MOS Technology Inc. has developed with an air of efficiency and ambition that indicates it's not just another spinoff struggling to survive in the midst of a booming semiconductor technology.

Although concentrating primarily on custom service, MOS Technology intends to manufacture several standard products. These will include shift registers, RAMS, and ROMS. "I don't intend to go too far beyond this," says John Paivinen, president and founder of the new company. "Our company will deal primarily in custom service since we're getting so much in the way of electronics on a chip that it's difficult to come up with a standard product that does everything for everybody."

Standard products include the dual 100-bit dynamic and 32-bit static 1-MHz shift registers. One line of shift registers is already operational, and they're now working on high-density shift registers on the order of 512 bits per package. Five ROM products are under development and the RAMS are on their way. "We're con-

cerned about having top-notch engineering and manufacturing ability built into our products and this, for us, dictates a conservative approach rather than going for the flash."

As indicated, the major emphasis at MOS Technology Inc. will be on custom memory products and custom circuitry. The new company has the facilities and capabilities at their new building in the Valley Forge Industrial Park to handle the entire process of MOS design, from conception, to completed product, to final test analysis. MOS Technology will work with the schematics and/or logic diagrams submitted by its customers. In most cases their work will involve putting entire systems on four or five LSI chips via MOS technology.

Probably one of the most unique aspects of this company's development is the fact that they were financed as a production facility right off the bat. And the confidence that those at MOS Technology have in the future of their small semiconductor company today reflects the confidence the entire engineering market has in the MOS field. The four founders, three

of whom are from General Instrument and one from ITT, all believe the future is golden for a small business. "Each of the small companies in our business today represents talented, independent men who have left the larger companies. Today, engineering theory comes from the smaller companies and the large companies will get their share of the business simply because they're so big."

The men at MOS Technology are staying with a line of products which has wide applicability, and the memory field is certainly an area where standard products are being used and there is a growing demand for custom design. Shift registers, RAMS, and ROMS represent product lines available from a number of companies, thus offering the customer the security of an alternative supply. "It is worth our while to market these standard products. In addition, when we work within this large market, we can also incorporate the extra design adjustments for those customers that require custom service. For this reason, we know our engineering effort is worthwhile."

Circle Reader Service #450.

New Free: 11-70 120 Pg. Guide

HELPS YOU FIND 1,000,000
ELECTRO-MECHANICAL
COMPONENTS AT A FRACTION
OF OEM COSTS—
FOR IMMEDIATE DELIVERY.

- Accelerometers • Autosyns
- Blowers • Counters • Flow Meters • Gyros • Motors
- Oscillographs • Precision Potentiometers • Pressure Transducers • Recorders
- Relays • Servo Motors
- Synchronos • Test Equipment
- Timing Devices • Transformers
- 400 Cycle Power Sources

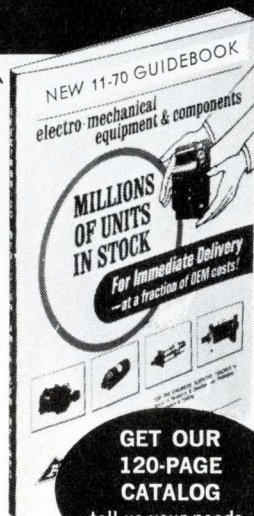

GET OUR
120-PAGE
CATALOG
tell us your needs.

American *Electronics Division*
Relays 39 Lispenard St., New York,
N.Y. 10013 (212) 966-5650

SPDT DPDT 3PDT 4PDT

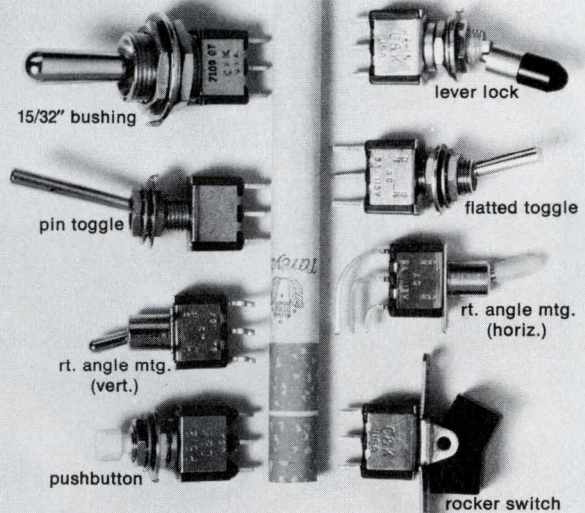

We'd rather switch than fight.

And have we ever switched! If you put any one of these 8 new subminiature switches on your "whatever", you'll have a better performing "whatever." All C&K switches are competitively-priced and Made-in-America. How's that for a switch? Ask for our new catalog.

C&K COMPONENTS, INC.
103 Morse Street, Watertown, Massachusetts 02172
Tel: (617) 926-0800

Second generation IC "Multiplier Plus"

Plus What?... Plus built-in voltage regulator and current converter

Motorola's new MC1594/1494 introduces the second generation of monolithic IC four-quadrant multipliers based on the variable transconductance principle. The "multiplier plus" is easier to use than the familiar industry standard MC1595/1495, and it offers a new high level of performance.

"Plus" features for cost reduction

The built-in current and voltage regulator eliminates the effects of power supply fluctuation and reduces the number of external components required. It regulates all current sources on the monolithic chip, effectively immunizing the multiplier to supply voltage fluctuations. It also provides two (+4.3 V) regulated voltages to bias the offset adjust potentiometers. Interaction among the pots during adjustment is eliminated.

Changes in offset voltage caused by supply irregularities are eliminated. Four external resistors are eliminated.

At the other end of the multiplier the differential current converter provides a single-ended output current referenced to ground.

"Plus" features for Improved Performance

Linearity of 0.5% max (X or Y) for the MC1594 sets a new standard of excellence, and the MC1494 offers a fine 1.0% max error (X or Y). The "multiplier plus" is easier for the designer to use because it handles input and output voltages of ± 10 V with ± 15 V supplies. And power supply sensitivity is also significantly improved.

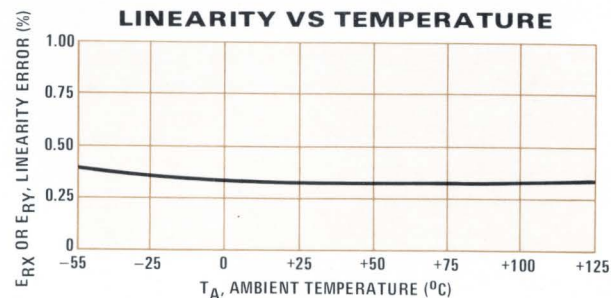

Please turn page for circuit information

 **MOTOROLA LINEAR**
— serving a greater range of analog designs!

Here Is The Second Generation Monolithic IC Multiplier Motorola's MC1594/1494 "Multiplier Plus"

BLOCK DIAGRAM

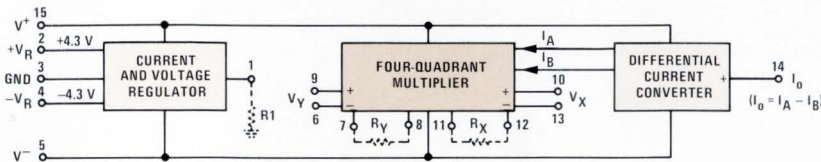

COMPLETE CIRCUIT SCHEMATIC

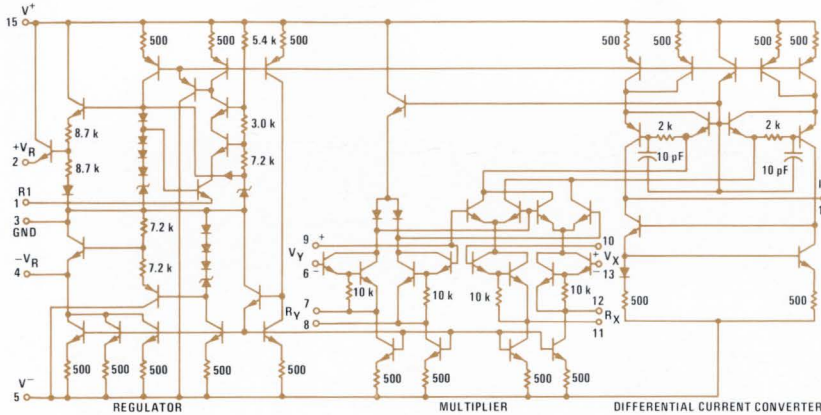

TYPICAL MULTIPLIER CONNECTION

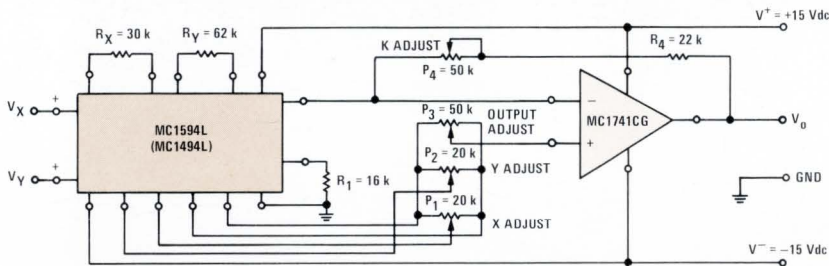

Check these performance features

- Excellent linearity
0.5% max (X or Y) — MC1594L
1.0% max (X or Y) — MC1494L
- Wide input voltage range — ± 10 V
- ± 15 V supply operation
- Single ended output referenced to ground
- Improved offset adjust circuitry
- Adjustable scale factor
- Power supply sensitivity — 30 mV/V (typ)

Learn all about the "Multiplier Plus" right away

The MC1594L and MC1494L are available now from your nearest Motorola distributor at 100-up prices of \$12.00 - MC1594 and \$8.00 - MC1494. Both devices are in the 16-pin ceramic dual in-line package. For a 14-page applications-specifications data sheet, circle the reader service number or write Motorola Semiconductor Products Inc., P.O. Box 20912, Phoenix, Arizona 85036.

Circle No. 25

The circuitry shown external to Motorola products is for illustrative purposes only, and Motorola does not assume any responsibility for its use or warrant its performance or that it is free from patent infringement.

"Multiplier Plus" Special Introductory Offer

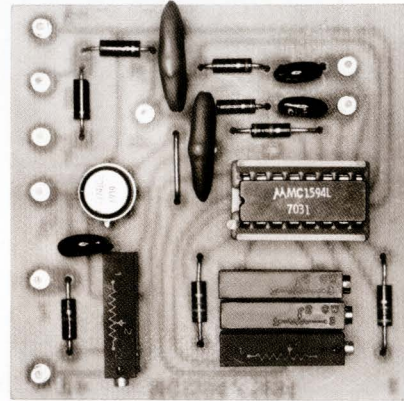

Complete MC1594 or MC1494 Evaluation and Experiment Kit DC and AC applications — All you need to build it for Multiply • Square • Divide • Square Root • Balanced Modulator • Amplitude Modulator • Phase Detector • Frequency Doubler.
40% Off total 1-up price of all components and hardware!

MCK1594 Kit . . . This \$38.45 value only \$23.10

MCK1494 Kit . . . A \$32.45 value at only \$19.50 (substitute MC1494L multiplier)

Parts list MCK1594 and MCK1494

Quantity	Part Description
1	MC1594L or MC1494L
1	MC1741CG op amp
2	1N5241B Zener Diodes
2	510 ohm, 1/4 W, 20% carbon resistors
1	16K, 1/4 W, 5% film resistor
1	22K, 1/4 W, 5% film resistor
1	30K, 1/4 W, 5% film resistor
1	62K, 1/4 W, 5% film resistor
2	20K, 15 turn cermet potentiometers
2	50K, 15 turn cermet potentiometers
2	0.1 μ F ceramic disc capacitors
3	10pF ceramic disc capacitors
1	16-pin dual in-line socket
1	PC board
10	terminals

Also contains complete "How To Do It" construction note and data sheet with applications information.

Specify by MCK1594 or MCK1494 — state quantity — enclose check (P.O. is OK for order over \$20.00) — offer expires May 20, 1971 — limit, 5 (five) kits. Send order to Motorola Semiconductor Products Inc., P.O. Box 20912, Phoenix, Arizona 85036.



MOTOROLA LINEAR

— serving a greater range of analog designs!



POMEROY'S COMPLAINT

Promises, Promises,
but it's every man for himself
in today's up-and-down world
of business employment

By Roger D'Aprix
Contributing Editor



The scene opens in the exit interview office of Quick-Buck Industries where one Fred Pomeroy is awaiting his exit interview, with resignation (no pun intended). He thumbs through a sheaf of resumes and job opportunities as a slight figure with a goatee enters the office and closes the door behind him.

POMEROY: Why, Dr. Fried, what are you doing here? I thought you were still in private psychiatric practice.

DR. FRIED: Ah, yes . . . yes, I am. I'm filling in until Quick-Buck is over the hump of this layoff. I'm sorry . . . I just can't seem to remember your name.

POMEROY: Fred Pomeroy. Don't you remember? I'm one of the guys who came to you last year about engineering obsolescence, and you set me straight.*

DR. FRIED: Of course, of course . . . Now I recall. Well, I told you not to worry about that obsolescence thing, that it was a bunch of . . .

POMEROY: Yeah, but look at me now. I'm being laid off for the first time in my life. Maybe if I had taken the courses and attended the special seminars, things would

have been different. . . . Say, how come they hired a psychiatrist to conduct exit interviews anyway?

DR. FRIED: Well, for lots of engineers this is pretty traumatic. Quick-Buck just wants to live up to their people obligation so they brought me in for the duration. Got anything you want to tell me?

POMEROY: Yeah, plenty. But what's the use now? Nobody around here cares anyway. Let's forget this exercise.

DR. FRIED: Now wait a minute! I've been instructed to read you this letter from the president, and I'm also authorized to give you this sealed, personalized letter of introduction for your very own. Further, you have full access to the typing pool and reproduction services for resume production. And, as if that's not enough, I have here a refund check for \$343.36 for your contributions to the pension fund for the last three years. And, oh yes, you are eligible to continue your group insurance for a paltry \$132.48 per month.

POMEROY: I'm overwhelmed.

DR. FRIED: (*Ignoring the sarcasm*) The letter begins "Dear Fred. In the course of men's lives, there is always a little rainfall. For you this is such a time. No one regrets

*The Electronic Engineer, Sept. 1968, pp. 30-37.

this parting more than I, but I want you to know that the company resources will be at your disposal to find another technical job. Just let us know what we can do. Sincerely, 'Jim' Robinsen."

POMEROY: What they can do is rehire me. I'm fifty-two. Where do I find another job now? Boy, I'm sure not going to let my kids into this racket.

DR. FRIED: Oh come now, let's not be bitter, Pomeroy. You know perfectly well that these are the breaks of the game. You didn't complain when all those nice regular pay increases were coming to you, now did you?

POMEROY: Look, Fried, I earned all that and lots more. What bugs me is that nobody appreciates all that I did—50, 60 hours a week for three years, traveling all over hell's half acre, never having a decent meal at home at night. And what did it get me? First big contract cancellation that comes along, and I'm in the surplus manpower pool. Hey, Fried, why did you say that obsolescence was a bunch of hokum when I went to you before? Look at me. I got laid off because I was obsolete.

DR. FRIED: Now wait a minute! You were obsolete all right, but not because of half-life or any of that kind of stuff. You were obsolete only because there are more bodies around here than the payroll can support. What do you want? A sinecure? Business is off, boy, way off.

POMEROY: For two cents I'd yank that beard off by the roots, you pompous ass! I've given these people an important chunk of my career. I'm also locked into this community with a big fat mortgage and more bills than I can count. I have no pension rights, and my salary is high enough so I probably can't match it outside. And you ask me what I want? This company should care about me. That's what I want.

DR. FRIED: (*With a sigh*) Mr. Pomeroy, what you're trying to tell me is you want to be loved and needed. You expect Quick-Buck to worry about you and your needs.

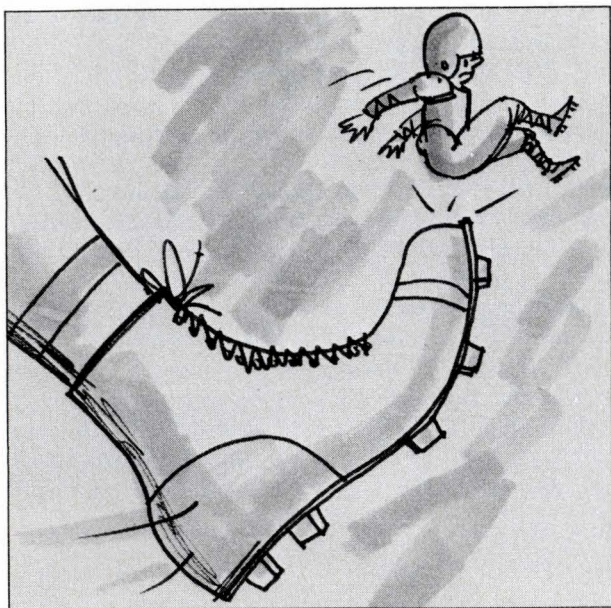

"... I was a key member of the team."

Whether you realize it or not, they can't. In fact if they did, they'd be irresponsible.

POMEROY: Look, Doctor, Quick-Buck claims they are concerned about the people who work here. Now, if they're really concerned why do they allow this kind of thing? I know there are up's and down's, but why should I be the victim? Why can't they take care of us between big contracts? Better yet, why do they get so fat at peak periods that when there's a little dip, they have a mass layoff?

DR. FRIED: Those are good questions, but you should have had the answers a long time ago.

POMEROY: What do you mean—I should have had the answers? What control do I have over all of this? I'm just a working engineer.

DR. FRIED: And that's the trouble. In a large organization of any kind there's only one guy who cares what happens to you. And you're he. Regardless of all the company's high-sounding words, it can't deliver to all individuals. In fact, if you think about it, it would be irresponsible for management to make your career or anybody else's career the number one consideration in a business decision. Pomeroy, old buddy, you and all your compatriots are alone.

POMEROY: But what about all that talk about teamwork? Ever since I graduated from Cal Tech and got into this business, they've been telling me how important the *team* was and how I was a key member of the *team*. Maybe what we need is a union. At least we'd have some protection.

DR. FRIED: About all a union could do for you in a situation like this is make the layoff more orderly—you know—by seniority. Would you like that better?

What you're overlooking is that teams are convenient and flexible groups of people gathered to do a job, like going to the moon. They're not lifelong associations. Pomeroy, you've got to learn to take care of yourself.

POMEROY: Look, I'm not a politician, and I never will be, if that's what you mean.

DR. FRIED: Give me strength. How can you be so naive after all the experience you've had? Taking care of yourself is not being a politician. It's enlightened self-interest.

POMEROY: What the hell is that?

DR. FRIED: It's making your career the number one consideration in any decision. No company will do that, but *you* can. You want to be the master of your fate.

POMEROY: Yes sir! Boy, I will never let my son go into this profession if it's the last thing I do.

DR. FRIED: Well, wait a minute. Things don't have to be this way. The individual needs freedom and independence. The organization needs loyalty and sometimes even obedience.

POMEROY: You don't have to tell me about that. My wife used to get fed up with the travel and the cold dinners, especially when I go home at 8 and 9 o'clock, night after night. And the kids. There were days on end that I barely ever saw them. I won't miss any of that.

It's funny, but they used to get mad at me for doing my job sometimes, but what the hell choice did I have? I'd sit there and explain and defend my hours and the trips, all the time feeling guilty for having to do my job. Sometimes I felt like I was being torn in half.

DR. FRIED: Right, that's what I'm getting at.

POMEROY: Yeah, but how can you fight all of this? No matter where I go it'll be like Quick-Buck. I've been down this road—every stop is the same. There's no difference.

DR. FRIED: That's not necessarily so. You're in a beautiful position right now to make sure the next stop isn't more of the same.

POMEROY: Are you kidding? What choice do I have? I need a job.

DR. FRIED: That's where you're wrong. You have a lot of choice so long as you're willing to make some basic decisions. Like how much money do you want versus how much you really need? Or like what kind of life do you want to lead? Or how much of a sacrifice are you and your family willing to make for a career? Or even how good a political in-fighter are you? When you answer those questions you are ready to decide where your next job will be.

POMEROY: You mean I should decide who I am and who I want to be?

DR. FRIED: Right. And the sooner the better. When that's done you can begin sizing up the job itself. There are any number of specific questions you've got to ask about the job you're considering so as not to make the same mistakes you've been making all these years.

POMEROY: You know you kill me. You act as though I've got all these choices. I don't have time to be choosy.

DR. FRIED: Probably not, in the short range. What you need first is a paycheck. Well, that shouldn't be too difficult. Get yourself a reasonable job so you can keep going until you can find the job you really want.

POMEROY: Well, what about these magical questions? What kind of questions can help me find a company that cares?

DR. FRIED: Man, you've got a fixation on being loved. Look, once and for all, you are *alone*. Nobody is going to take care of you except maybe if you are willing to surrender your soul and your dignity. And even then there are no guarantees. Once you face the fact that you are alone, all the rest is easier.

What you have to know are the conditions that will tend to make your services as an engineer valuable. In other words, what are the company's business prospects? How good is its profit picture? Not just today, but for the next 6 or 7 years. Is it tied to a static market? Is it too dependent on government spending? Does it experience drastic up's and down's? How good is its management—not just at the top but in the middle as well? Does it give a man an opportunity to develop himself? And on and on until you get the whole picture.

POMEROY: Where can I get all of that?

DR. FRIED: You've got to dig. Start with the annual report. Talk to financial analysts and see what they think. Read as much as you can find in magazines and newspapers about the company. Then make your decision as to how you might fit in. If it looks like a good match, pursue a specific job with the company.

POMEROY: Just like that, huh?

DR. FRIED: No, not just like that. It's a tough and nerve-racking assignment, but what's the alternative? I'll tell you—more of what you've just been through.

Information gathering is your responsibility. No company ever spoon feeds information to an engineer or any other professional and what it does spoon feed should be

suspect. It's got to be balanced by the observations and questions of others not because management is necessarily devious, but because it can be myopic. (*The phone rings on Dr. Fried's desk. He reaches slowly for it.*)

DR. FRIED: Excuse me, Pomeroy . . . Dr. Fried speaking. Oh yes, Mr. Robinsen, how are you? (*He winks at Pomeroy and covers the receiver with his hand.*) It's the boss, Pomeroy.

(*Then speaking into the phone.*) You say, Jim, you're worried about morale? Well, this is a tough one at a time like this. Based on my experience, I'd say your best bet is to reassure the survivors that things look a little better now. You know, tell them that you think you're over the hump with this thing and that the job now is to work harder and smarter. Tell them you've got to build a new team of dedicated and competent people. (*Pause as Fried listens to his caller.*)

Yes, definitely. I'd play up that team thing big. None of these guys likes to think of himself as being alone. Tell them how much the company cares about them and don't forget the bit about how people are our most precious asset. That's always reassuring. Don't mention it. When you're ready to put the whole thing together, call me.

POMEROY: Why you double-dealing S.O.B.! That's just what you've been warning me against.

DR. FRIED: Sure, but for him that's both sensible and logical. To get his job done, he's got to play it that way. It would be irresponsible for him not to. His job is to convince you and everyone like you that there is no conflict between you and the organization.

But you're the buyer, and there's an old adage that sort of applies here. It's *caveat emptor* or "let the buyer beware."

POMEROY: But isn't that dishonest to tell people all those lies?

DR. FRIED: No. In the first place, they're not lies. Quick-Buck *does* need these people now, and the team *is* important. The lie is produced by the engineers who interpret this to mean for all time. You know the irony is that management doesn't have to be devious about these things.

In fact, the more honest management is in passing out information to people, the more effective this whole approach is. You can't blame the company. In fact, I suspect that even if they told people that they were hired hands paid to do a job at a profit, they would still invent this idea that somebody cares about their individual careers as much as they do.

Of course, the trick is to maintain awareness of your own best interests while making yourself an asset to the company. That's the proper posture for a guy like you.

POMEROY: I'll try to remember that, but I must say I'm shocked by your blasé attitude about all this. Your cynicism is appalling.

DR. FRIED: Look, I'm not being blasé or cynical, just realistic and I suggest you had better do the same thing if you're going to maintain your sanity, not to mention your dignity and self-respect. It's an uphill fight, my friend, but it can be pretty exhilarating if you've got the guts to admit you're alone and to be your own man.

POMEROY: (*distractedly*) You know there's this garage for rent in town. I wonder if I could start my own electronics firm. . . .

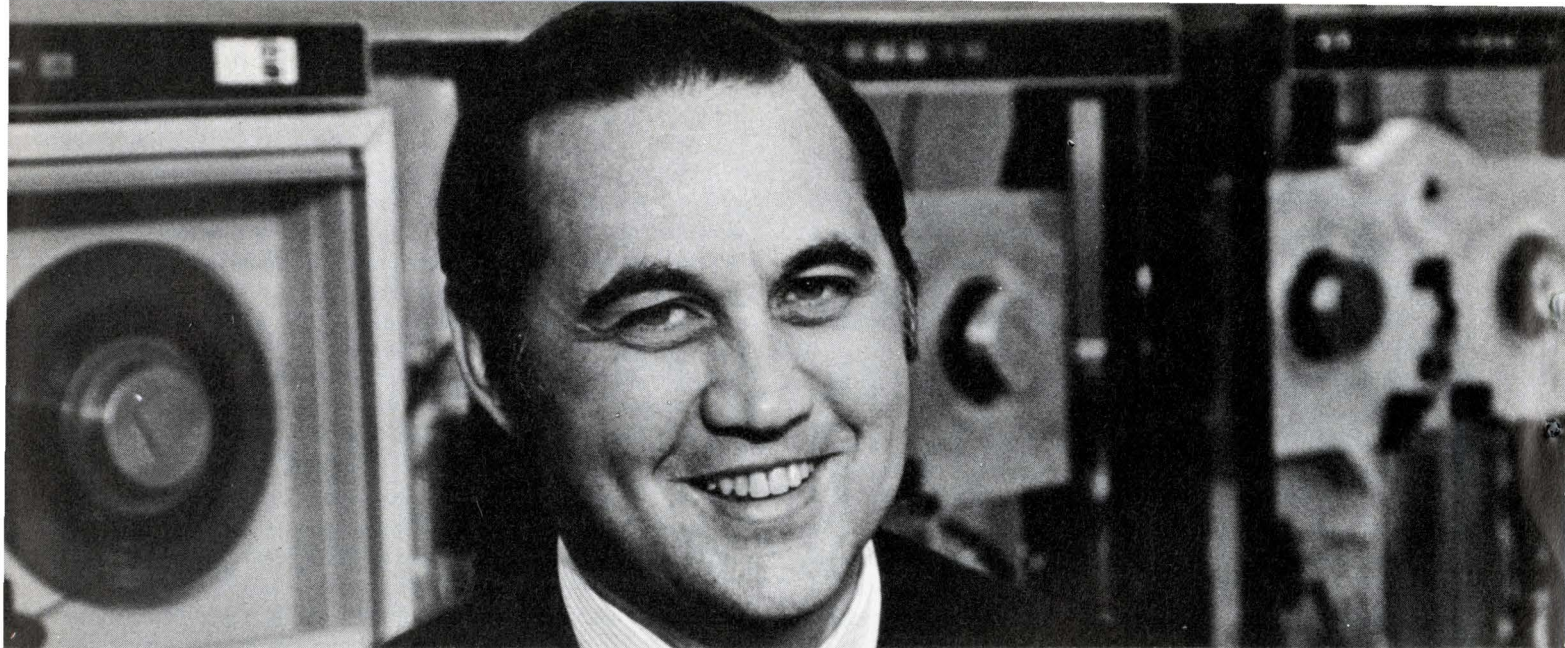

“When Mohawk decided to build a family of tape drives, I went out and hired the sharpest tape men in the business!”

Dave Hemphill, VP, General Manager, MDS-King of Prussia, talks engineering.

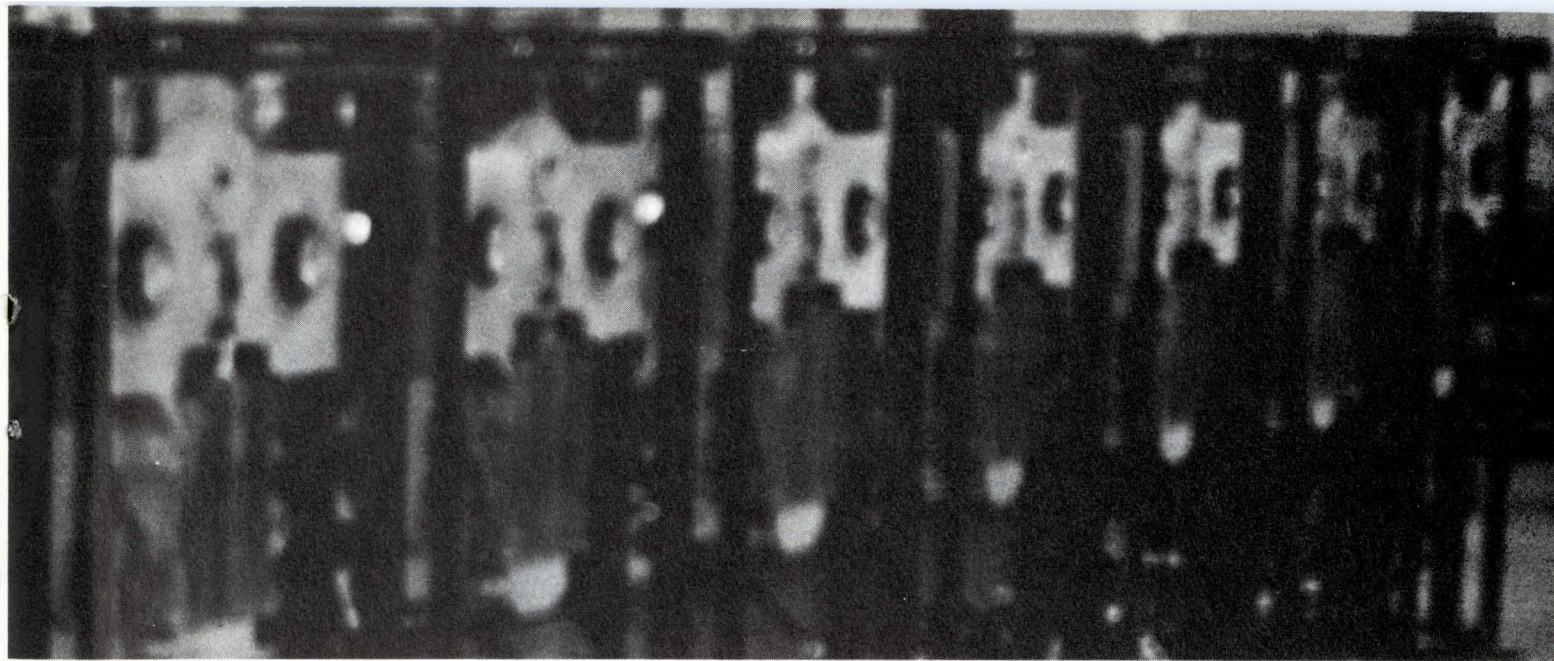

“With our reputation for reliability and performance, we couldn’t afford to make our early mistakes in public. So we budgeted enough time, money, manpower that we could build a whole pilot run, work it to the ground and scrap it before we shipped a drive to a customer.

“We were building a new drive from the casters up; so we could take advantage of the latest techniques.

“Knowing that, we went one step further. We put together a team of men who had grown up designing tape drives.

“With time, money and that kind of talent, we didn’t set out to build just another state-of-the-art tape drive. We wanted to build a drive that would be flexible, mobile, maintainable, reliable, rugged, compatible and economical. Every drive has some of those characteristics. The 2000 series has all of them.

“Our new transports are built to operate at computer drive speeds. They’re not low-speed decks stretched past their design limits to reach a richer market.

“We’ve reached some kind of pinnacle of maintainability with these drives, too. The side panels open up. The library swings out. The single-capstan drive mechanism is a model of simplicity.

“Naturally, the drives are IBM-compatible. And naturally they’re economical.

“What’s most unusual about them, though, is the flexibility. We designed three transport mechanisms. And we built seven electronics packages. That’s a lot of combinations. I figure we can satisfy just about any specifications you have without designing a new machine.

“Right now, we’re introducing five models. We’re particularly proud of the model 2000. It reads both 7-track (200, 556, or 800 bpi) and 9-track tapes at up to 45 ips. And it’s the least expensive model in the 2000 series. That even surprised me.”

Mohawk Data Sciences Corp.
Herkimer, New York



Circle Reader Service #26.

BUSS

THE COMPLETE LINE OF SIGNAL-INDICATING,
ALARM-ACTIVATING FUSES AND FUSEHOLDERS

FOR USE ON COMPUTERS, MICROWAVE UNITS, COMMU-
NICATION EQUIPMENT, ALL ELECTRONIC CIRCUITRY



BUSS Grasshopper Fuse, Visual-Indicating, Alarm-Activating.

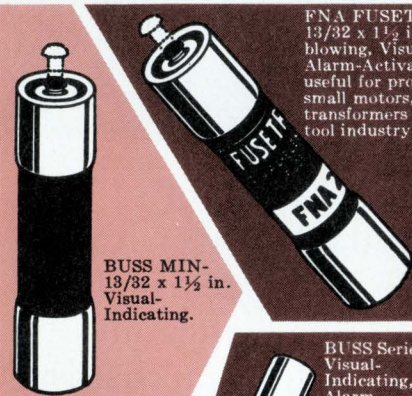

BUSS MIN-13/32 x 1 1/2 in. Visual-Indicating.

FNA FUSETRON Fuse 13/32 x 1 1/2 in. slow-blowing, Visual-Indicating, Alarm-Activating. (Also useful for protection of small motors, solenoids, transformers in machine tool industry.)

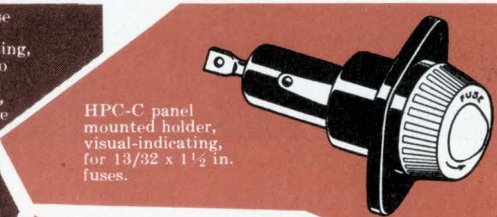

HPC-C panel mounted holder, visual-indicating, for 13/32 x 1 1/2 in. fuses.



BUSS ACH Aircraft Limiter, Visual-Indicating

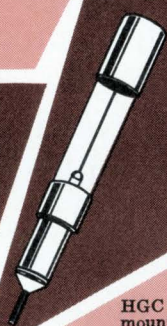

BUSS Series 70. Visual-Indicating, Alarm-Activating. (Used in telephone and similar applications.) Ask for Bulletin 705-C



HLD panel mounted holder, visual-indicating, for 1/4 x 1 1/4 in. BUSS GBA fuses (or GLD fuses) 3/4 to 5 amp.

BUSS GBA-1/4 x 1 1/4 in. Visual-Indicating.

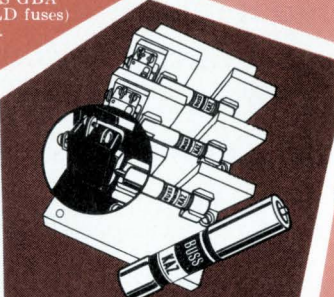

BUSS KAZ Actuator 13/32 x 2 in. Signal-Indicating, Alarm-Activating Device. Use to call attention to the opening of a fuse of 50 amp or larger. Can be mounted "piggy-back" on large fuse or in special block with micro-switch. Ask for Bulletin KAFS.



Signal fuse block No. 3839 for 13/32 x 1 1/2 in. indicating fuse.

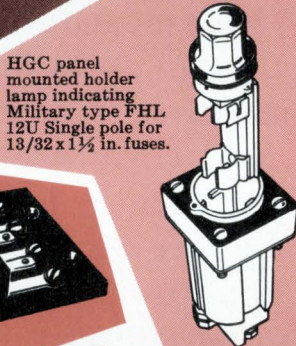

HGC panel mounted holder lamp indicating Military type FHL 12U Single pole for 13/32 x 1 1/2 in. fuses.

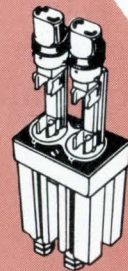

HGA-C panel mounted holder lamp indicating Military type FHL10U Two pole for 1/4 x 1 1/4 in. fuses.

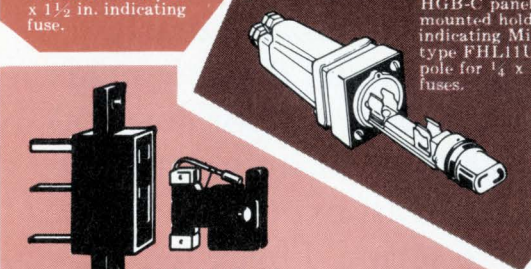

HGB-C panel mounted holder lamp indicating Military type FHL11U Single pole for 1/4 x 1 1/4 in. fuses.

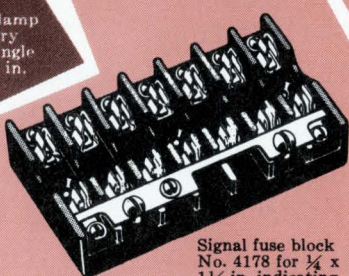

Signal fuse block No. 4178 for 1/4 x 1 1/4 in. indicating fuse.

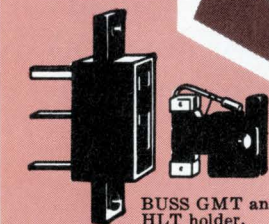

BUSS GMT and HLT holder, Visual-Indicating, Alarm-Activating.



HKA panel mounted holder, lamp indicating-signal activating, for 1/4 x 1 1/4 in. BUSS GLD fuse. 3/4 to 5 amp.



HKL panel mounted holder, lamp indicating, for 1/4 x 1 1/4 in. fuses.

WRITE FOR BUSS BULLETIN SFB

SUPPLIED THE ECONOMICAL WAY
THRU DISTRIBUTORS

BUSS QUALITY
FUSES

BUSSMANN MFG. DIVISION,
McGraw-Edison Co., St. Louis, Mo. 63107

MORE APPLICATION IDEAS

In this last part we continue with more application ideas that will, hopefully, trigger your imagination and stimulate your thinking.

By Jack Hickey, Managing Editor

Here is a list of many known applications for optoelectronic devices. These were supplied by the appli-

cations group at Fairchild Microwave and Optoelectronics Div. Many of those listed will be new ideas for you.

APPLICATIONS OF OPTOELECTRONIC DEVICES

Key: E—emitter

Key: S—sensor

1. Monitoring Applications (E & S).

- A. Counting parts on a conveyor belt by interrupting or reflecting a light beam.
- B. Inspecting for missing labels or components by reflecting a light beam.
- C. Counting parts falling from a bin by interrupting a light beam.
- D. A fluid or bin level indicator by interrupting several light beams at various levels.
- E. Measuring amount of particle or colored gas discharge from a smoke stack by amount of attenuation of light beam.
- F. A slot car lap indicator by reflecting light beam.
- G. RPM indicator by interrupting or reflecting light beam.
- H. Shaft angle indicator by reflecting light beam from a pattern affixed to the shaft.
- I. A security beam to detect intruders by breaking a light beam.
- J. Use in stroboscope instruments by reflected light beam.
- K. An edge sensor for production alignment of parts, sheets or bars by breaking light beams.
- L. Flaw sensing of polished or painted surfaces by reflected light beam.
- M. A hot spot locator for detecting hot spots on printed circuit boards (sensor only).
- N. A fire detector (sensor only)

2. Control and Measurement Applications.

- A. Light sensors to control street lights, yard lights for

home or factory and direction sign illumination. (S).

B. Gasoline engine ignition timing by reflection or transmission of light beam. (E&S)

C. Automatic steering of inplant vehicles that follow painted lines by light reflected from the line. (E&S).

D. Automatic stopping of inplant vehicles that follow a painted line by light reflected from another line. (E&S).

E. Automatic speed control for vehicles by measuring shaft rotation (see IG) or speed (time) between spaced sensors. (E&S).

F. Noncontacting excitation of semiconductor devices for testing by injection of carriers due to source emission. (E).

G. Constant intensity control of light by monitoring ambient light with a sensor. (S).

H. Garage door opener using coded sources and sensors. (E&S).

I. Sensor and operational amplifier as a single unit. (S).

J. Opto-acoustic microphone using a diaphragm to modulate by interruption or reflection of a light beam. (E&S).

K. Dollar bill changer using sources and sensors. (E&S).

L. Simultaneous switching of silicon controlled rectifiers in parallel by sources.

M. Automotive signal light changes by reflection or interruption of a light beam.

3. Optical Couplers (E&S).

A. For ground loop isolation.

B. For use in multiplexing circuits.

D. Prevents reverse signal transmission.

4. Reading Applications (E&S).

A. Tape Reader

B. Card Reader

C. Garment Tag Reader

D. Inventory tag reader

E. Credit card verification

F. Remote page reading with multiplexed sensor arrays.

OPTOELECTRONICS Part 3B

5. Illumination (E).

- A. Panel indicator
- B. Status indicator
- C. Low level red flashlight for darkroom, military or where night vision must not be impaired.
- D. Microscope illuminator
- E. Luminance standard
- F. Wavelength standard
- G. Alphanumeric displays
- H. Small novelty signs.
- I. Warning lights.
- J. Telephone lights.

- K. On-Off light built into switch or push buttons.
- L. Blinking lights on toys.

6. Film annotation (E)

- A. Frame identification
- B. Sound track recording

7. Communications (E&S)

- A. Short distance data link with light beam as the carrier.
- B. Sound track recording.

8. Optical recorders using sources and photochromics (E&S).

9. Armature and hobbyist kits (E&S).

10. Detection of IR Sonobuoys (S).

ANTENNA BORESIGHT SYSTEM

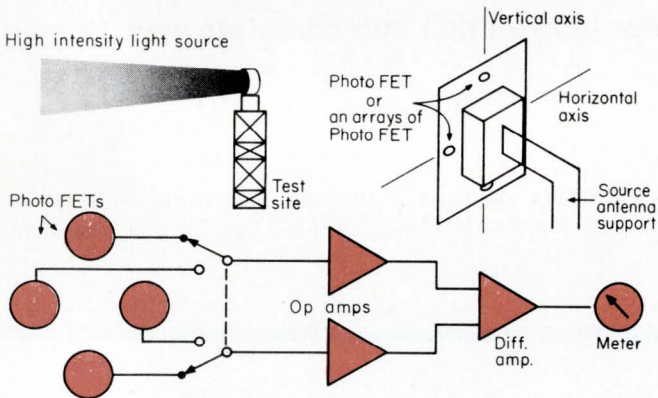

These three applications represent the winners in a Fotofet® applications contest sponsored by Crystalonics, and judged by the editors of THE ELECTRONIC ENGINEER.

An inexpensive antenna range boresight system is possible with a visible light source and an array of photoFETs. Here, with four devices it is possible to "zero" the system in both horizontal and vertical axis. Submitted to Crystalonics by T. W. Pederson of Texas Instruments.

LIGHT PENCIL

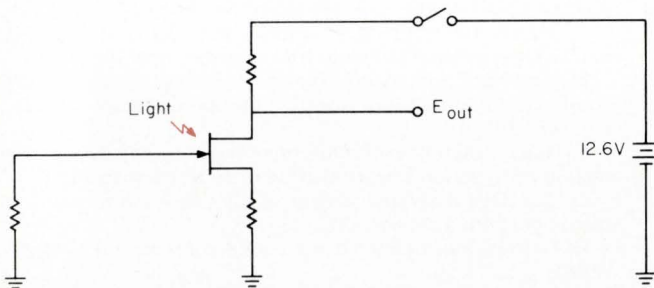

A very simple, yet sensitive light pen is possible with a photoFET. This circuit was used in conjunction with a CRT. The FET had a piece of tubing placed over its lens as a shield to prevent any affect from ambient light. Submitted to Crystalonics by R. Ravenstein, Spiras Systems, Inc.

LIGHT ACTUATED RELAY

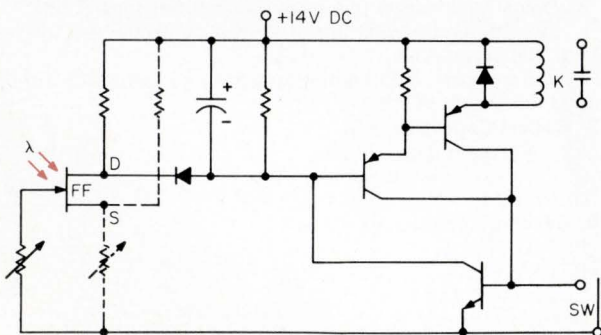

Light actuated relay will respond very rapidly, even to a low level light source. This circuit is somewhat complex because it has time-delay and lockup features included. SW permits unit to be shutoff when desired. Submitted to Crystalonics by L. G. Cowles, The Superior Oil Co.

COMPUTER/PERIPHERAL INTERCONNECT

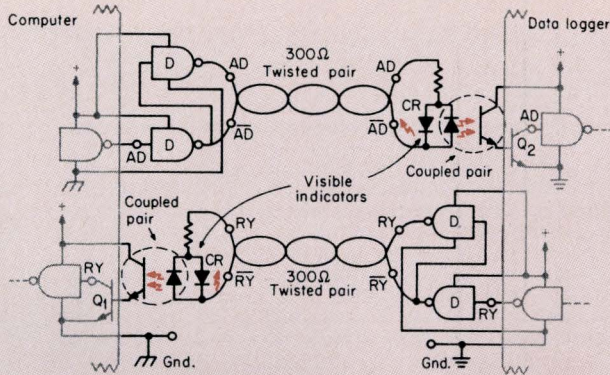

Here is a simple, reliable method of coupling peripheral equipment such as data loggers, card punches, typewriters, etc., to a computer system. It eliminates ground loops, noise spikes, and other common impedance problems. Use a 300 ohm twisted pair as a balanced line, and a coupled pair as the line receiver. You should avoid the attempt to design "photo coupled line drivers, and use an IC line driver. Note the placement of the line drivers and the use of visible indicators.—Monsanto.

A LATCHING RELAY

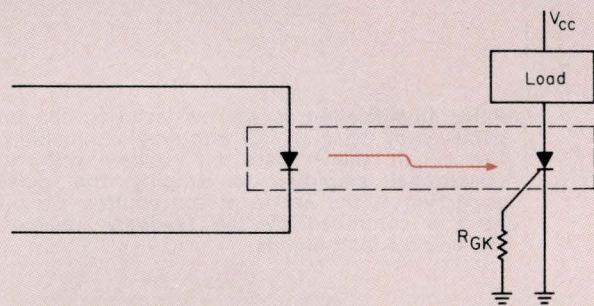

A coupled pair where one of the devices is a photo SCR. Once latched, the relay may be reset only by lowering the load current below I_H—Monsanto

PULSE GENERATOR WITH NEGATIVE AND POSITIVE OUTPUTS

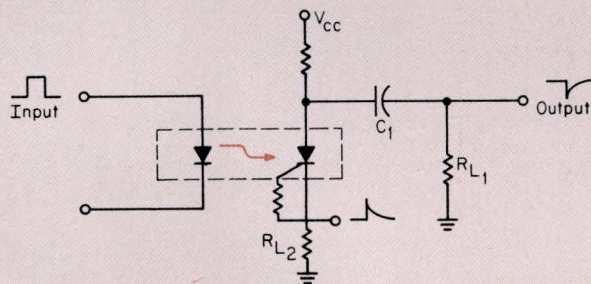

With no signal to the LED, the SCR is off and C₁ is charged. A positive pulse to LED causes the SCR to turn on, discharging C₁ through R_{L1}. Pulse width and amplitude can be controlled by values of R_L/C₁.—Monsanto

HIGH REPETITION RATE PULSE GENERATOR

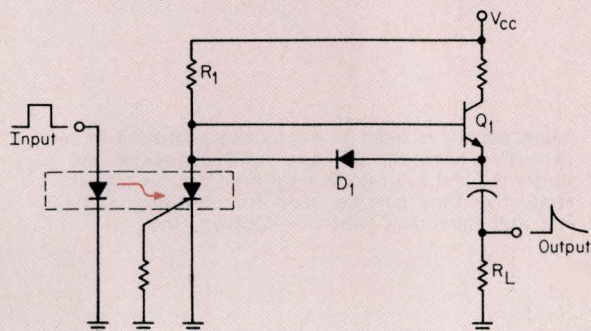

The transistor, Q₁, supplies a low resistance path for C₁ to charge. With the SCR turned on by the LED, C₁ discharges and the voltage drop across D₁ reverses the bias of the base-emitter. This leaves only R₁ between the SCR and power supply.—Monsanto

PC BOARD HOT SPOT DETECTOR

A sensor may be used to detect hot spots on printed circuit boards.—Fairchild

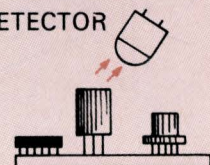

OPTOELECTRONICS Part 3B

SOLID STATE 10A N.C. RELAY

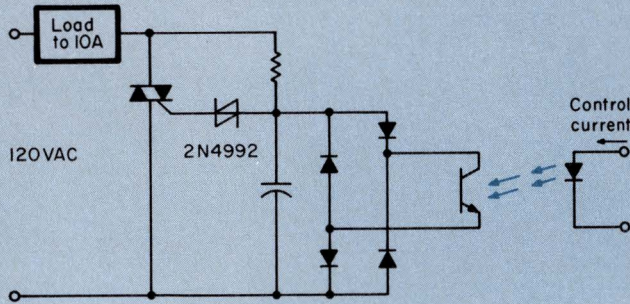

The output of the light-emitting diode increases with decreasing temperature, thus compensating for the photodarlington's temperature coefficient of photosensitivity. The circuit uses a silicon bilateral switch to trigger the triac power switch, operating as a normally closed contact. When the LED is turned on by "coil" current, the photodarlington shunts the bias current from the 2N4992, and prevents triac triggering. The four diodes provide proper polarity biasing to the transistor sensor.—General Electric.

PULSE AMPLIFIER

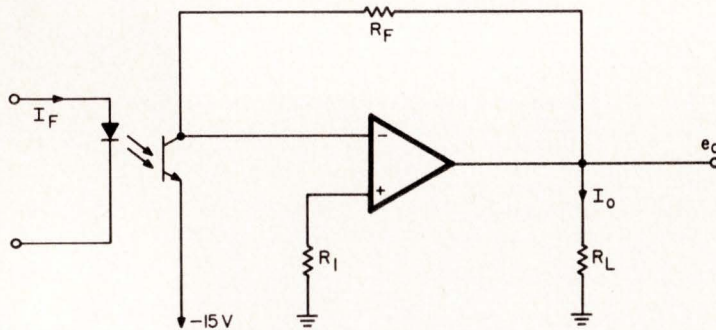

Pulse amplification as well as isolation can be achieved by using an OAI with a pulse amplifier. The circuit shown uses an isolator with an operational amplifier to amplify the pulse appearing at the anode of the emitter. Circuit gain is controlled by the feedback resistor, R_F .—Texas Instruments.

DROP DETECTOR CIRCUIT

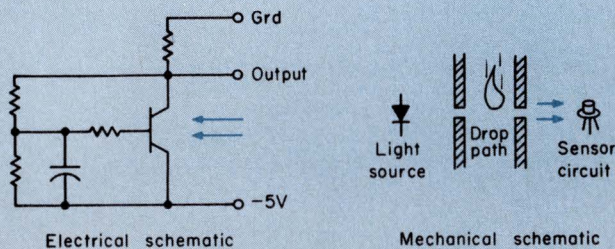

This circuit was designed for use with a light-emitting diode to form a highly reliable drop detector. The output is connected to a simple ac amplifier. Circuit operation is straightforward—General Electric.

REFLECTIVE TAPE SENSOR

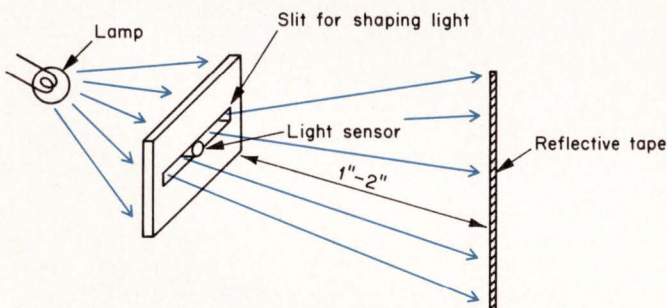

Light sensor is used to sense the presence of a reflective segment of tape; and associate circuitry is used to provide a squared output signal. Reflective tape can be used for counting, sorting and inventory control.—Optron, Inc.

BIOMEDICAL TESTING

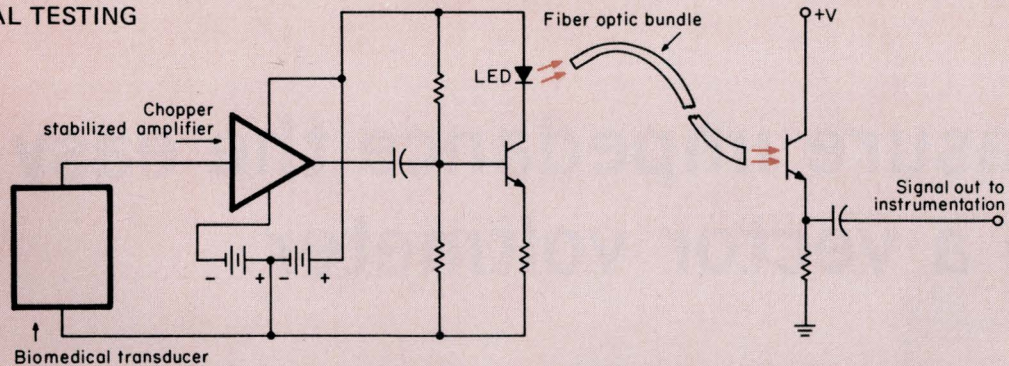

One serious problem found in biomedical electronics is the shock hazard to a patient. This system isolates the patient from all electrical sources external to the body. The output of the transducer is chopped, amplified and used to

modulate the output of the LED. A length of fiber optic then couples the modulated IR signal to the phototransistor. The signal output from the phototransistor can then be demodulated and recorded and/or displayed.—Motorola.

PRECISION BALANCE

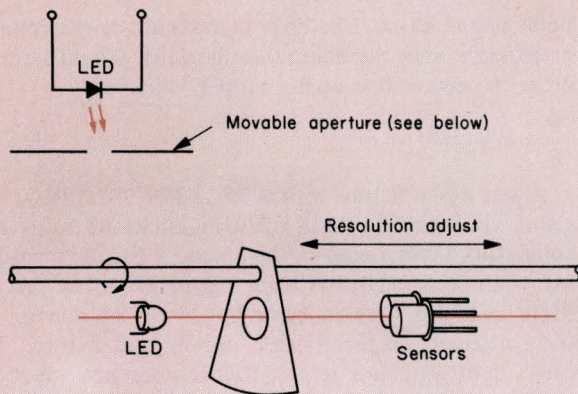

Two phototransistors and an LED can be used in a bridge as a precision balance. The weight difference between the contents of two sample pans rotates a shaft through the pivot of the balance. A single aperture is fixed to the shaft and rotates with it. Movement of the aperture unbalances the LED radiation reaching the two phototransistors. This, in turn, unbalances the bridge causing the meter to indicate the imbalance. By allowing adjustment of the plane of the aperture relative to the planes of the LED and sensors, the resolution can be changed. For example, a coarse range would result by placing the aperture very close to the detectors while a fine range occurs when the aperture is closer to the LED.—Motorola.

LINEAR VELOCITY MEASUREMENT

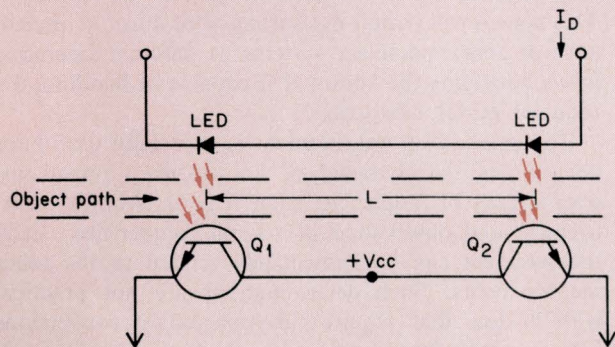

A pair of light emitting diodes and phototransistors can be used in the measurement of linear velocity of high speed objects, such as bullets or other projectiles. The phototransistors are coupled through common base speed-up circuits to a bistable multivibrator. As an object moves along its path it first interrupts the light coupling to Q_1 , then to Q_2 . An electronic counter can be used to measure the period of the multivibrator output pulse. By taking the ratio L/t , the velocity is obtained.—Motorola.

Measure impedance the easy way, use a vector voltmeter

**A vector voltmeter provides a shortcut
to high frequency impedance and VSWR measurements**

By J. R. Heck, Fellow Engineer

Aerospace and Electronics Systems Div., Westinghouse Defense & Space Ctr.,
Baltimore, Md.

In the past, several types of impedance and admittance bridges have been available for making measurements between 1 and 100 MHz. These usually required (1) a balance adjustment, (2) a reconnection of the circuit, (3) a null adjustment and (4) a calculation of values dependent on frequency. In some cases, elaborate correction formulas had to be applied to correct for lead errors. To determine vswr, an additional step was necessary to relate the measured values to the normalized (line) impedance.

Now, the Hewlett-Packard 8405A Vector Voltmeter can be used with a simple set of Smith chart curves to determine impedance and vswr values quickly, with no calculation. All that is required is a simple fixture to feed power from a signal source, through a known resistance, and then to the unknown impedance. The voltmeter also allows measurement of the voltage at each end of the known resistance. Notice, however, that the known resistance is not at ground potential, while the generator and voltmeter must be grounded. Because of this circuit configuration, measurement of the voltage across the resistor is not possible and so a direct reading of the current phase cannot be made.

However, using the test setup shown in Fig. 1, voltage and phase reading can be made. The data can be plotted directly on a Smith chart normalized to the value of R . This is simplified by drawing a set of curves on a standard Smith chart. Figures 2a and 2b show a set of curves drawn through points of constant impedance. These are concentric circles centered on the zero

point of the chart. The lines of constant angle (phase) are straight lines extending through zero. The dB curves cross the center line at the proper value of

$$\frac{E_1}{E_2} = \frac{r + 1}{r}$$

A test probe fixture with a 75- Ω RN 70D75ROF resistor was built in a 1 x 1 x 2¼-in. enclosure using BNC connectors. When used in the setup of Fig. 1, measurements showed negligible error up to 30 MHz. At 60 MHz, readings were in error by 2° or 3° due to the stray reactance in the resistor, switch, and fixture. The cable from generator to test fixture does not affect the readings since the generator is reset before each measurement.

Measurement accuracy is greatest near a value of 1.0 on the chart. The value of R (and the normalized values on the chart) may be any figure desired. The generator may be set at any level within the scale of the voltmeter. This system will permit measurement of effective impedance of active nonlinear systems at different operating levels, providing the known R is capable of handling the required power dissipation.

This method of measurement is especially useful for determining the character of an unknown impedance over a range of frequencies since it permits quick measurement and observation of several frequencies. Each measurement can be immediately related to the other measurements. Such determinations are not practical with bridges that require time-consuming conversions before usable figures are obtained. Since the zero adjustment of the voltmeter does not change rapidly with frequency, the direction of change over a small range may be found immediately by watching the voltmeter

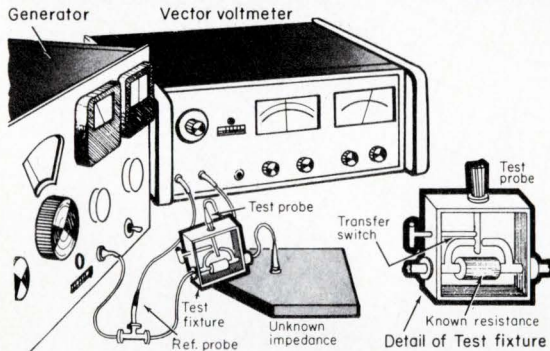
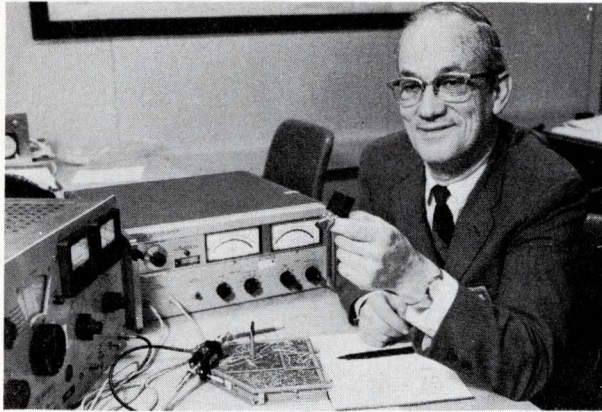
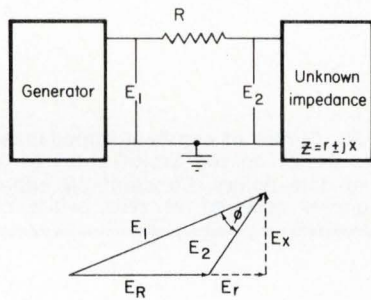
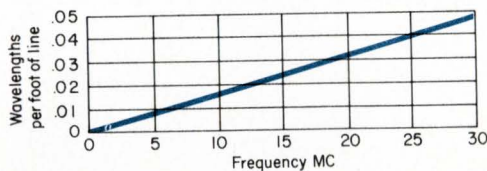

Fig. 1. The test setup shows the simple fixture needed to make impedance measurements. It consists of a known resistance, R , mounted with a transfer switch. To make a measurement, first connect the test probe to the reference probe and set the voltmeter to reference 0 dB, 0 angle. Then read the voltage and angle on the load side of R and plot these on the Smith chart. The unknown impedance can then be read directly off the Smith chart.



The concept behind the impedance measurements. The voltages E_1 and E_2 are determined by the series components of the unknown impedance when an arbitrary constant current flows through R , r , and x . E_2 is always smaller than E_1 , so it is convenient to set E_1 and read E_2 on the vector voltmeter in dB down from E_1 and with a phase angle θ that is positive or negative with respect to the angle of E_1 .



Correction for a long cable between the test point and the unknown impedance. When the unknown impedance cannot be placed close to the test fixture, a correction factor may be applied. The required correction for each Smith chart point when using polyethylene-filled coax line (0.66 propagation factor) is shown above. This correction is easily made if the transmission line impedance is equal to R .

The Vector Voltmeter



Voltage and phase are so basic to electrical engineering that it is surprising to find that while adequate voltmeters are available, no convenient method of measuring phase angle existed until the advent of the vector voltmeter. Introduced 4 years ago, but only now becoming popular, Hewlett-Packard's Model 8405A Vector Voltmeter measures amplitude and phase simultaneously, over the frequency range of 1 MHz to 1 GHz. It has a sensitivity of 100- μ V full-scale, a dynamic range of 95 dB, and a 360° phase range with a resolution of 0.1°. The vector voltmeter allows many measurements that formerly were difficult or impossible. Among the quantities that can be measured are complex impedance, reflection coefficient, VSWR, amplifier gain and phase response, attenuation and phase characteristics of filters, cable characteristics, group delay, and hf transistor parameters.

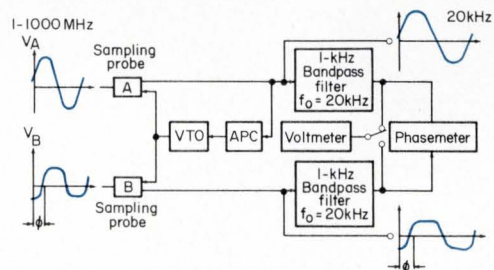

The block diagram of the voltmeter shows the automatic phase control (APC) that uses a phase-locked loop to tune and phase-lock the meter to the signal at channel A. APC adjusts the frequency of the voltage-tuned local oscillator (VTO) which triggers sampling-type mixers in the probes. Voltage and phase are measured from rf signals that are reconstructed at an intermediate frequency of 20 kHz from input samples.

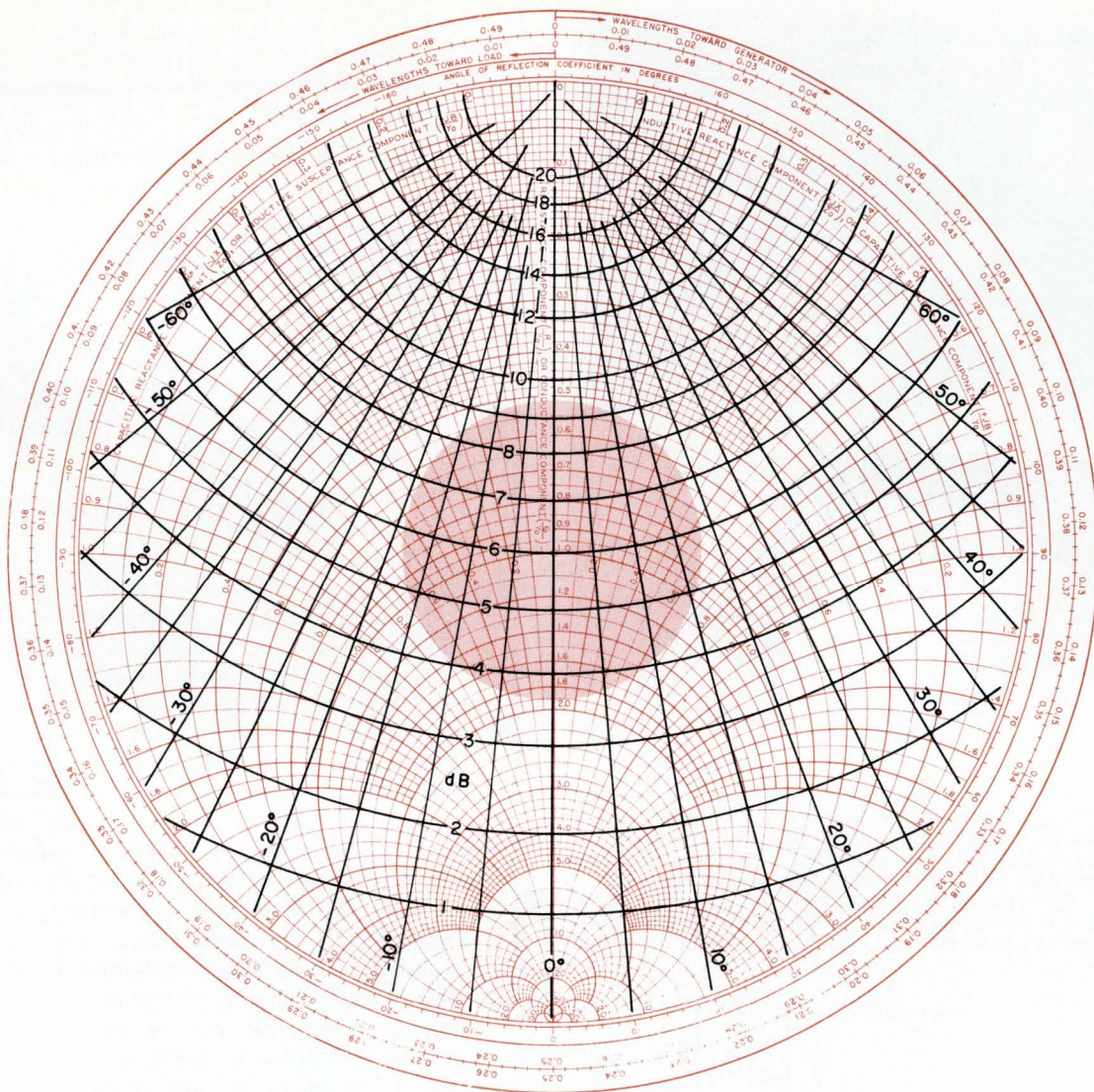

Figs. 2a-2b. Curves of constant impedance and phase angle are drawn on the Smith chart to simplify the plotting of data points. Constant dB curves are concentric circles centered at zero, while phase angle

A sample measurement

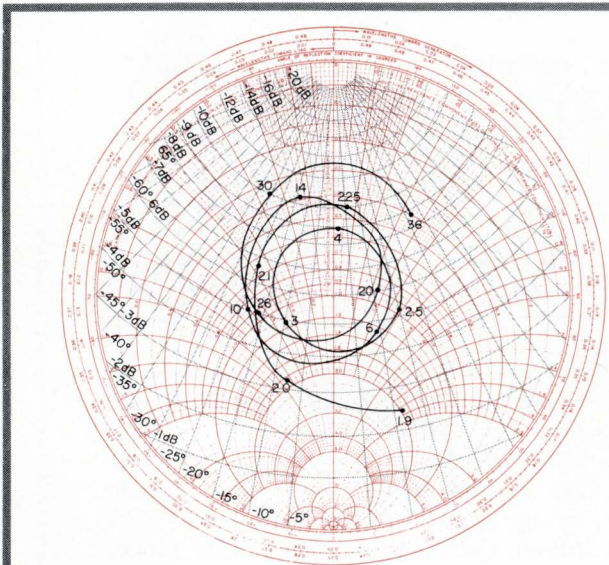

A graph of the input impedance of a 2—32 MHz bandpass filter operating into a mismatched load is shown above. The measurements were made using the test setup described in this article.

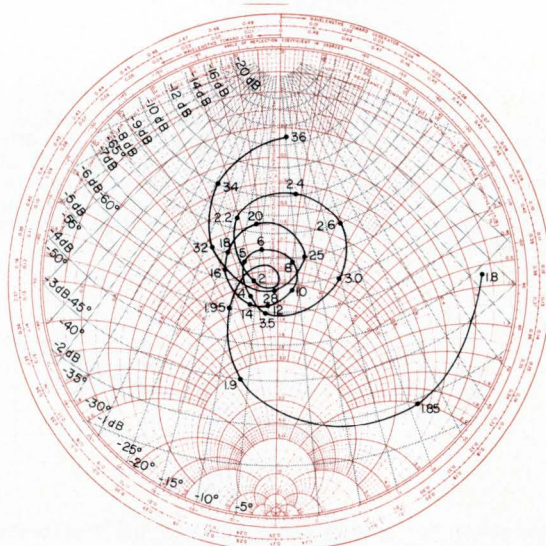

The Smith chart above shows the input impedance when the same 2—32 MHz bandpass filter feeds a transistor amplifier. For this case the input VSWR is also shown. The VSWR is readily derived from the Smith chart by swinging a

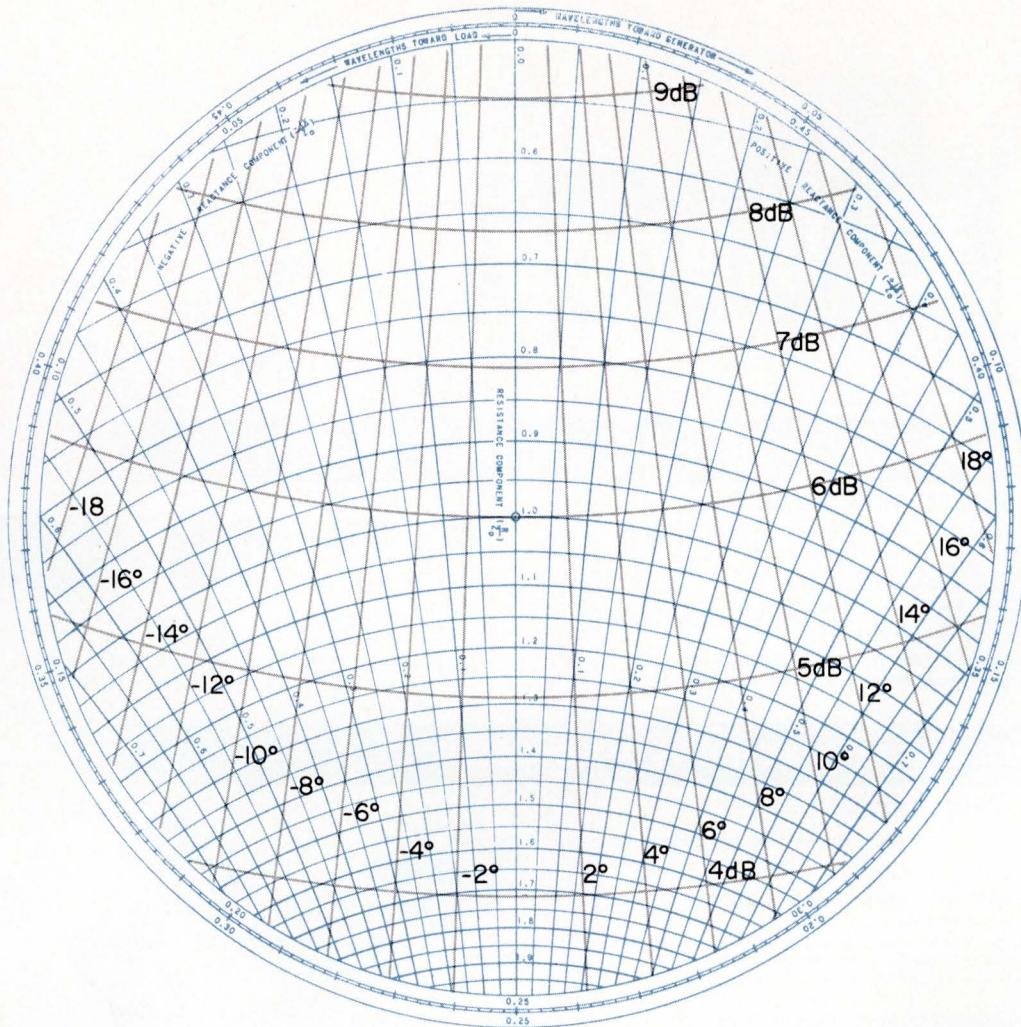

curves are straight lines passing through zero. The expanded Smith chart can be used for increased accuracy around the 1.0 point.

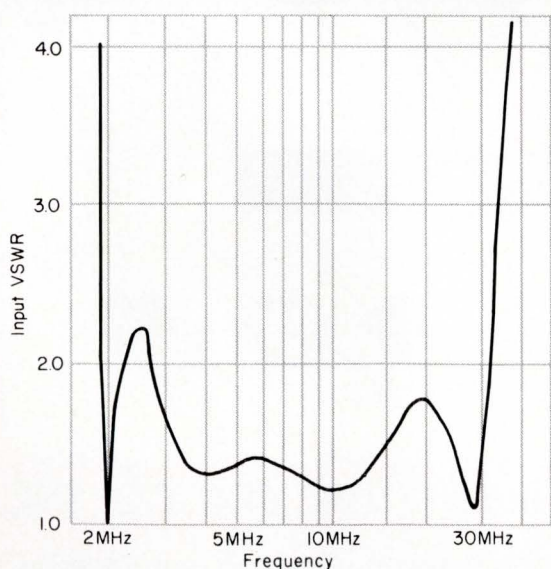

compass from the measured point to the r line and making a reading. The vector voltmeter technique is especially useful for making the type of measurements shown in this example.

reading as the generator is changed. This option is impossible with any type of null bridge.

The vector voltmeter measurements plotted directly onto a Smith chart are easy to make and all parameters of the measurement are immediately apparent. A complex impedance like that of the bandpass filter shown in the example would be practically impossible to measure on a conventional bridge. It is difficult to tell from successive readings with a bridge which direction the impedance is going. Insufficient measuring points or a small error in calculation of impedance values from bridge readings make it impractical to measure this type of impedance with a conventional bridge. However, using a vector voltmeter, each loop on the chart is immediately apparent from the voltage and angle readings.

INFORMATION RETRIEVAL
Instruments and measurements,
Circuit theory

For Capacitors with **GREATER RELIABILITY . . .**

Choose

EL-Menco

The Capacitors You Find Wherever There's Electronics!

EL-MENCO DUR-MICA CAPACITORS

Only 1 Failure Per 43,000,000 Unit-Hours!

- It has been computed that "debugged" DM30, 10,000 MMF units, when subjected to 257,000 hours of life at 85°C with 100% of the rated DC voltage applied, will yield only 1 FAILURE PER 43,000,000 UNIT-HOURS!
- DM15, DM16, DM19, DM20 . . . perfect for miniaturization and for new designs using printed wiring circuits. Also available in DM30, DM42 and DM43.
- New "hairpin" parallel leads insure easy application.
- Exceed all electrical requirements of military specification MIL-C-5A.

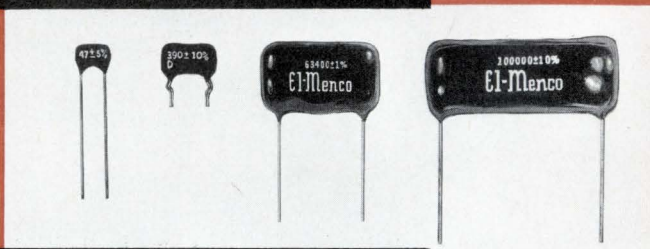

EL-MENCO TRIMMERS & PADDERS

Design Versatility!

- Available in 350 VDC and 500 VDC as well as other test voltages.
- All bases are of low-loss steatite.
- Special lugs are obtainable for printed circuitry.
- Miniature units are available.
- Solder Lugs can be bent in any position without affecting the capacity setting due to the rigid construction.
- Various types of mounting brackets are available for all trimmers.
- Units can be constructed for special applications.

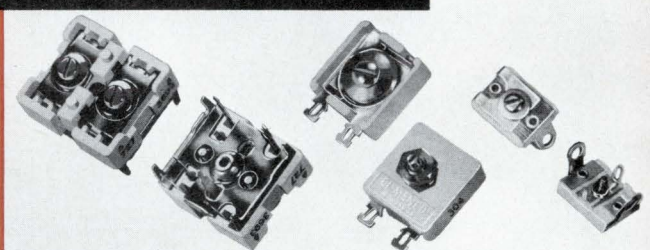

EL-MENCO *MYLAR-PAPER DIPPED CAPACITORS

Only 1 Failure in 7,168,000 Unit-Hours!

- Life tests at 100°C with rated voltage applied have yielding only 1 FAILURE PER 7,168,000 UNIT-HOURS for 1 MFD. Since the number of unit-hours of these capacitors is inversely proportional to the capacitance, 0.1 MFD Mylar-Paper Dipped capacitors will yield only 1 FAILURE PER 7,168,000 UNIT-HOURS!
- Working volts DC: 200, 400, 600, 1000 and 1600.
- Durez phenolic resin impregnated.
- Tolerances: ± 10% and ± 20% (closer tolerances available).
- Dielectric strength: 2 or 2½ times rated voltage, depending upon working voltage.
- Exceed all electrical requirements of E.I.A. specification RS-164 and military specifications MIL-C-91A and MIL-C-25A.

*Registered Trademark of DuPont Co.

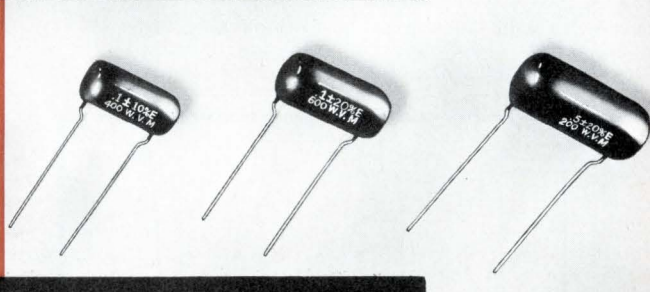

EL-MENCO MOLDED MICA CAPACITORS

Superior Performance!

- Unmatched for excellent stability, dielectric strength, high insulation resistance, extremely high "Q" and correspondingly low power factor.
- Units can be subjected to a short "debugging" life test at elevated voltage and temperature for removal of early life failures and for improved reliability.

Write for Free Samples and Booklets on Any of The Above Capacitors

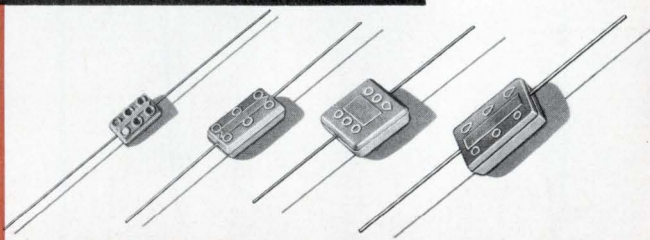

THE ELECTRO MOTIVE MFG. CO., INC.

WILLIMANTIC, CONNECTICUT 06226

Dipped Mica • Molded Mica • Silvered Mica Films • Mica Trimmers & Padders
Mylar-Paper Dipped • Paper Dipped • Mylar Dipped • Tubular Paper

West Coast Manufacturers contact: COLLINS & HYDE CO., 900 N. San Antonio Rd., Los Altos, California 94022
5380 Whittier Blvd., Los Angeles, California 90022

ALSO SOLD NATIONALLY THROUGH ELECTRONIC PARTS DISTRIBUTORS

THIS MONTH'S IDEAS	PAGE
No. 937 A sure start square wave oscillator.....	60
No. 938 A low cost microwave field strength meter.....	60
No. 939 Convert BCD 8421 to self-complementing BCD 2421.....	61
No. 940 Midvalue selector doubles as a voltage limiter.....	61

VOTE for the one you like best
Write the number of the Idea you like best in the box
on the inquiry card and send it to us.

SEND us practical, reproducible ideas that are original with you
and have been implemented with linear or digital ICs.
If we publish your idea, you win a check for \$25.00.
If our readers vote yours the best of the issue in which it appears,
you have your choice of a Simpson 270 or Triplet 600 multimeter.
After 12 issues, our readers will vote on the best idea for all 12 issues.
The winner gets his choice of either a Hewlett-Packard 1206A or a Tektronix 3104A oscilloscope.

Submit your IC Ideas to:
Alberto Socolovsky, Editor
THE ELECTRONIC ENGINEER
Chestnut & 56th Sts.
Philadelphia, Pa. 19139

HOW YOU VOTED

The winning Idea for the July 1970 issue is,
"Simple high duty cycle one-shot".

You may remember the circuit as being a simple and inexpensive
scheme to achieving high duty cycles with a one-shot.
Parviz Ghajar, who is our prize-winning author this month,
is employed at General Electric's Information Devices Dept.
in Oklahoma City, Oklahoma. He is a logic design engineer
and is currently engaged in the design of disc storage devices.
Mr. Ghajar has selected the Triplet Model 600 TVO as his prize.



937 A sure start square wave oscillator

Jack Cramer & Ed Matsumoto, Litton Guidance and Controls, Woodland Hills, Calif.

Many oscillator designs share a common problem in that they do not start reliably. In many cases, the circuit requires you to manually introduce power supply transients.

This design uses diode D_1 to allow the bias circuit to track the gate threshold voltage. This lets the bias circuit keep the gates on but not saturated (active) during start-up even though the power supply varies by as much as $\pm 10\%$.

Resistors R_1 and R_2 set the threshold bias at a minimum of 1.02 V and a maximum of 1.65 V. Threshold voltage is 1.1 V nominally and the max. and min. values account for variations in the gate input diode drop and the resistor tolerances.

Capacitor C_1 dc isolates the output of G_1 and G_2 and its value in pF equals $457/\text{frequency (MHz)}$. The impedance of the crystal can be calculated from the gain equation for oscillators and for this case the math work out such that the impedance should be $\leq 622 \Omega$ at the frequency of operation.

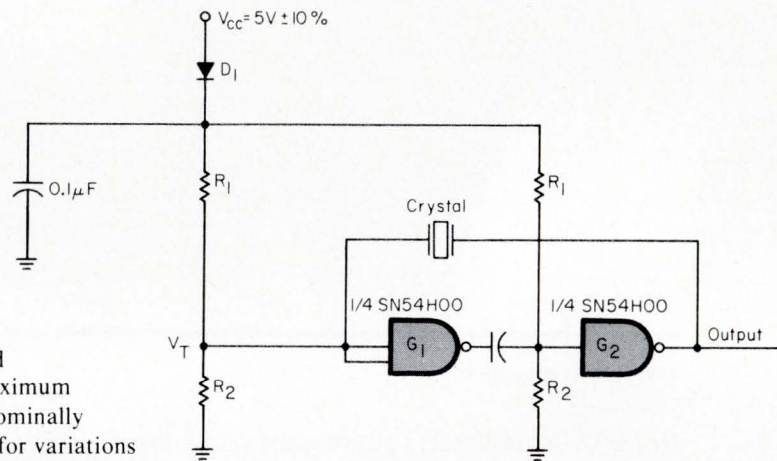

938 A low cost microwave field strength meter

J. Agnew, Vicon Instrument Co., Colorado Springs, Col.

Here's a field strength meter that will cost you about \$30 to build. When operating, a waveguide directs energy onto a crystal detector. The detector converts the energy into a dc output which is amplified by the op amp and read on a sensitive microammeter.

The diode shown is for x-band operation, but you can design the meter for other frequencies. The waveguide is a $1\frac{1}{2}$ inch piece of plastic tubing with the ends flared. The plastic is coated with an electroless copper solution to provide a conducting surface. The dimensions are not critical.

For calibrated readings, the meter is placed in a known field or else compared to a calibrated meter. In this way you can make a chart of meter reading vs. field strength.

To operate the meter, you point it away from the signal. Switch the meter to the desired range and adjust the control for a 0 reading. Now point the waveguide at the signal and read field strength directly.

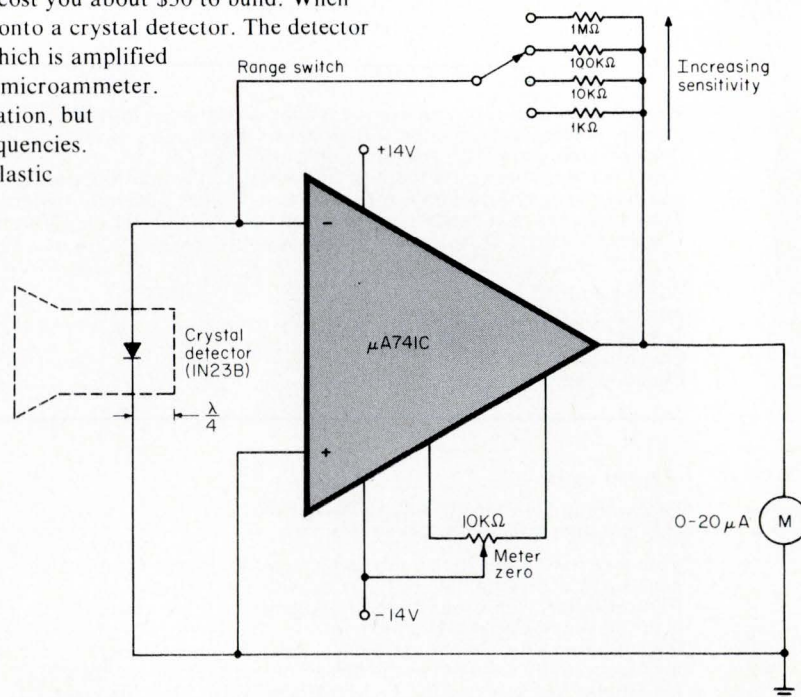

939 Convert BCD 8421 to self-complementing BCD 2421

J. V. Sastry, Westinghouse Transportation Div., Pittsburgh, Pa.

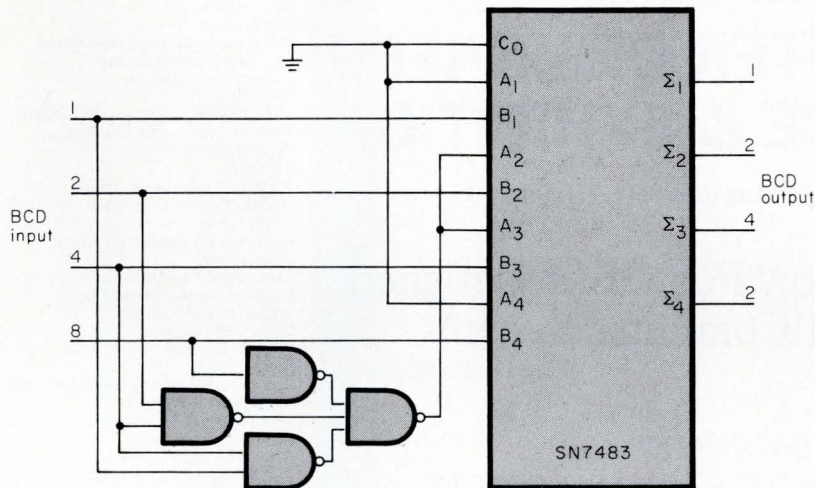

You can convert BCD 8421 code to self-complementing BCD 2421 with one 4-bit binary full adder and four NAND gates. The circuit shown passes the BCD input numbers 0 through 4 to the output without change. The numbers 5 through 9 however have binary 6 (0110) added to convert them to the BCD 2421 code.

The circuit uses a SN7483 full adder and any compatible TTL or DTL NAND gates. If the input is from a BCD 8421 counter, the outputs from this circuit make up a BCD 2421 counter. In this case, the NAND gate used as an inverter can be omitted by using the related Q output from the counter.

940 Midvalue selector doubles as a precise voltage limiter

Adrian Moses, Lear-Siegler Inc., Santa Monica, Calif.

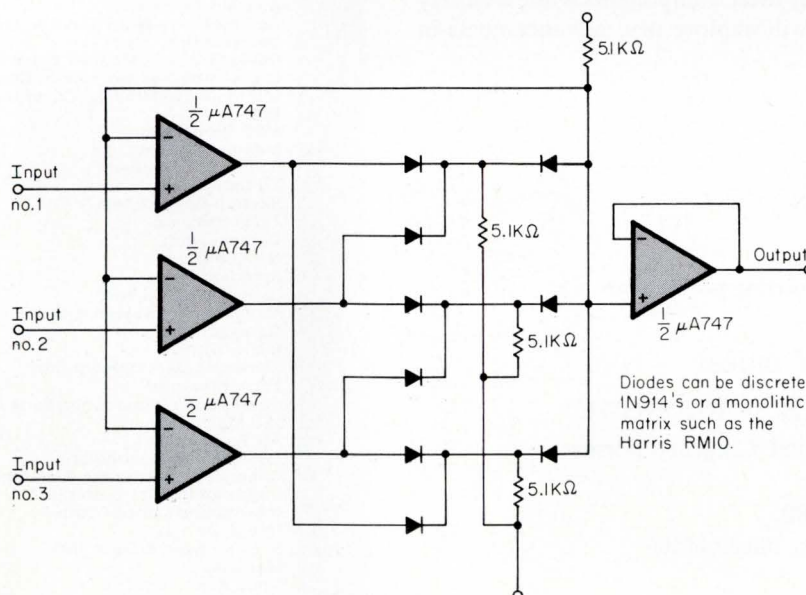

Here's a circuit that was developed as a midvalue selector for the L-1011 flight control system. It's a handy addition to your bag of tricks because it also performs very well as a precise voltage limiter.

The positive limit voltage is applied to one of the inputs, the negative limit to another input and the signal to be limited is applied to the third input. The output will always be equal to the input (\pm about 8 mV due to amplifier offset) as long as the input does not exceed either of the voltage limits.

The limit points are sharp and will be within ± 10 mV. The circuit also features a high input impedance to minimize any errors due to loading of the limit or signal sources.

if you make

Components, Hardware, Instrumentation or Peripherals Required In The Design, Construction, or Testing of Computers and Computer Systems—

JOIN A DISTINGUISHED GROUP OF COMPANIES WHO HAVE ALREADY SIGNED FOR BOOTHS AT THE

COMPUTER DESIGNERS CONFERENCE & EXHIBITION

Anaheim Convention Center, January 19, 20, 21, 1971

The Only National Show For OEM Designers of Computers and Computer Systems
(Not The End Users!)

*PROFESSIONALLY ORGANIZED
TO ASSURE PROFESSIONAL RESULTS*

In contrast to existing computer shows, the **COMPUTER DESIGNER'S CONFERENCE & EXHIBITION** will concentrate **ONLY** on the design, construction and testing of computers and computer systems and peripherals — not on their user applications! The **COMPUTER DESIGNER'S CONFERENCE & EXHIBITION** will bring together an estimated 15,000 OEM computer designers . . . prime customers for all the components that combine to form a system. The 300-booth exhibit area will display these components while a closely related Technical Program will explore new advancements in computer design.

Sponsored by these leading engineering publications

COMPUTER DESIGN
ELECTRONIC ENGINEER
ELECTRONIC INSTRUMENT DIGEST

RESERVE YOUR BOOTH SPACE NOW!

Call or Write For Details and Contract Forms:

**INDUSTRIAL AND SCIENTIFIC
CONFERENCE MANAGEMENT, INC.**

222 West Adams Street, Chicago, Illinois 60606
Phone (312) 263-4866

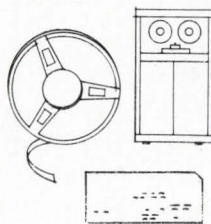

CURRENT LIST OF EXHIBITORS

Analog Devices, Inc.
Davidson Optronics Inc.
Howard Industries
Burndy Corp.
EG&G Corp.
George Risk Industries, Inc.
Electro-Fiber Optics
Stratojet Corp.
Optical Memory Systems
Trompeter Electronics
University Computer Co.
AMCO Engineering Co.
Controls Research Corp.
Heinemann Electric Co.
Borg-Warner
Dynage Inc.
Jonathan Mfg. Co.
Circuit Science, Inc.
Electro-Craft Corp.
Mechanical Enterprises, Inc.
R. Howard Strasbaugh, Inc.
Fairchild Semiconductor
Nortronics
Tetra Corp.
Data Technology Corporation
Harris Semiconductor
Vibrac Corporation
NJE Corp.
TEC, Transistor Electronic Corp.
Talcott Computer Leasing
Quadri Corp.
Accuride
Pioneer Magnetics, Inc.
Digital Equipment Corp.
Hepa Corp.
Burr-Brown Research Corp.
Rotron Inc.
Electronic Controls, Inc.
Mobark Instruments Corp.
Superior Electric Co.
Gast Mfg. Corp.
Pacific Optical
U.S.M. Corp.
Advanced Memory Systems, Inc.
Computer Test Corp.
W. L. Gore & Associates
Applied Dynamics
Applied Logic Corp.
The Birtcher Corporation
DuPont Co.
ITT Cannon
Lockheed Electronics Co.
Signetics Corp.
Fabri-Tek Incorporated
Disc Instruments, Inc.
Hybrid Systems
C & K Components, Inc.
Elco Corp.
Lipps, Inc.
Sealectro Corp.
Electronic Memories & Magnetics Corp.
Nikon Inc.
Sylvania Electric Products, Inc.
Georator Corp.
Princeton Electronic Products, Inc.
Westinghouse Electric Corp.
Baldwin Electronics
Contract Wire Wrap Services Limited
Datascan Inc.
Daven Division, McGraw Edison Corp.
Dressen-Barnes Electronics Corp.
Guardian Electric Mfg. Co. of Calif.
IBM
MPB Corporation
Memory Systems, Inc.
Raymond Engineering
Tri-Data Corp.
Skytron Engineering
Technitrol, Inc.
Datapac, Inc.
Mite Corp.
Standard Logic
Control Devices, Inc.
Measurement Systems, Inc.
General Radio
Microswitch
Advanced Development Corp.
Ferro Precision
International Communications Corp.
ISC Magnetics
Air Techniques
California Microcircuits
Chemical & Aerospace Products, Inc.
Information Data Systems
Information Control Corp.
Interdyne
S. C. Johnson & Sons, Inc.
Memorex
Omni Action Controls
Texas Instruments
Trueline Instruments
Xerox Data Systems

NEW PRODUCTS

Digital multiplexer doesn't miss a thing

Conventional digital data acquisition systems scan and sample data lines, and sequentially print out the information. However, such systems only sample data, and never show what happens between the samples.

Now, a new digital multiplexer corrects this situation. Lassen Electronics' Model CD 101 stores all input data in buffer memories, and draws on these memories as data sources—without losing information.

This concept can be applied wherever you must route BCD data from many sources to one common destination. You can use the 101 with totalizing counters, digital frequency meters, DVMS, and so forth, and all intermixed.

Each of the 101's eight input channels accepts 36 bits of data (nine decimal columns), and sequentially switches these 36-bit groups onto a 40-bit output bus. (Four output buses are hard-wired for source identification.)

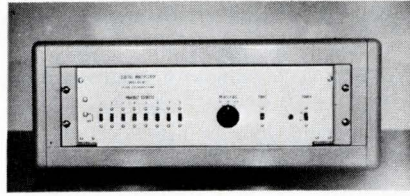

This means that with one 10-column printer connected to the 101, you have available, sequentially, the same amount of data as eight 10-column printers could print simultaneously.

The eight input lines and one output line are TTL-, DTL-, and CDSL-compatible. If you don't need a printout, you can use the 101's output to feed any gear that accepts 40 lines of parallel BCD data.

The multiplexer starts the scan cycle when it receives a remote signal. You can also start the cycle via a front-panel pushbutton. The 101 also commands the data source to store present information

until the print cycle finishes. Further, for counter sources, the multiplexer generates a SOURCE RESET signal that allows the counter to accumulate new data during the print cycle.

Other features include: a SPACE command for printers capable of spacing between groups; selectable print rates of 2.5, 5, and 10 prints/s; and selectable source printout (you can skip unused or undesired channels).

Data input and output connectors are compatible with Systron-Donner, HP, Monsanto, and other printers. The CD 101 works directly with printers such as the Systron-Donner 5103. But present options include an interface for HP printer levels, and printer reference-voltage signals.

The basic CD 101 costs \$2970. Lassen Electronics Corp., Box 1136, Fremont, Calif. 94538. (415) 792-0709.

Circle Reader Service #204.

New Mil-C-81511 connectors added

Twelve new Mil-C-81511 circular connector insert configurations have been added to Amphenol's Astro/348 line. They offer a choice of power, thermocouple or shielded high-density contacts in many of three new shell sizes.

A new one-piece, molded dielectric, contact retention system provides more contacts per square inch while maintaining voltage handling capacity. The result is a significant cost-per-circuit sav-

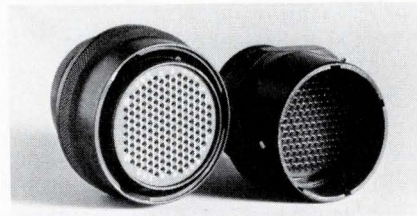

ings in 20, 22 and 24 shell sizes.

In size 12-12 (accepts #12 gauge wire) power versions, you can get 11 contacts in a size 20 shell, 14 contacts in a size

MIL-C-81511

MIL-C-81511 (revision "C" recently became a tri-service coordinated connector spec. Earlier specs were basically limited to a single service such as the Air Force, Army or Navy.

And, when NEPR-64—a document recommending it as the connector standard for all military electronic equipment produced by NATO countries—was adopted and formally released earlier this

year by NATO headquarters, Mil-C-81511 became the first international connector spec. The recommendation must now be ratified by each NATO electronics group member.

The International Electrotechnical Commission's TC-48 "B" committee on high-density connectors for electronic equipment is also considering an evaluation of Mil-C-81511 as a stand-

22 and 19 in a size 24. Beyond the 12-12 for power, you have a choice of 16-16 (#16 AWG), 20-20 (#20 AWG) and 23-22 (#22 AWG) contacts in a variety of high-density configurations with from 24 to 155 contacts per connector insert arrangement.

Highlights of the new connectors include high contact density, contact rear-insertion/front-removal capability, crimped "Poke-Home" contact insertion, and one-piece molded dielectric contact retention system. They also have shell-to-shell fingers that ground prior to contact mating for maximum emi/rfi spurious interference attenuation; captivated, triple track bayonet coupling for positive locking and vibration resistance; multiple mating seal for environmental protection; six key positions in each shell size for prevention of mismatching; and the capability to gang-mount similar insert arrangements.

Amphenol Connector Div., The Bunker-Ramo Corp., 2801 S. 25th Ave., Broadview, Ill. 60153.

Circle Reader Service #205.

SUBSTRATE CONNECTOR

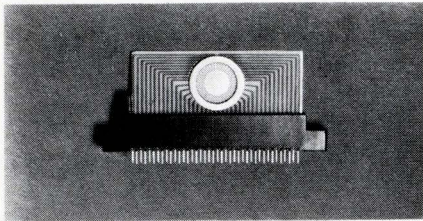

This connector provides a reliable means for connecting 1 x 2 in. pluggable MSI/LSI ceramic circuit devices. A built-in guide (against which the critical side of the substrate is positioned) assures proper substrate seating. Bellows contacts assure reliable connection to the ceramic substrate. Winchester Electronics Div., Main St. & Hillside Ave., Oakville, Conn. 06779. (203) 274-8891. Circle Reader Service #206.

FAST-SETTLING OP AMP

FET-input op amp is built with high-reliability components (such as metal can transistors) throughout. Settling time is $<1 \mu\text{s}$ to 0.01% in both inverting and noninverting modes, with 0.1% settling time of 500 ns. It is for applications whose temp. range can only be met with metal-can transistors, and whose ultra-fast settling requirements can only be satisfied with modular (i.e., discrete component rather than monolithic IC) circuits. Operating temp. range is -55° to $+125^\circ\text{C}$. Analog Devices, Inc., 221 Fifth St., Cambridge, Mass. 02142. (617) 492-6000.

Circle Reader Service #207.

POWER SUPPLY

PM532 encapsulated, PC mounting module provides 5 W of power in a 3.50 x 2.50 x 1.25 in. package. It is intended to provide power for IC logic. Output is 5 Vdc at 1.0 A. Line reg., $\pm 0.05\%$ max.; ripple and noise, $<1.0 \text{ mV rms}$; TC, 0.02%/°C. \$63.95. Computer Products, Inc., 1400 Gateway Dr., Box 23849, Ft. Lauderdale, Fla. 33307. (305) 933-5561.

Circle Reader Service #208.

CRYSTAL OSCILLATOR

Compactly built Model JKTO-78 low power consumption oscillator mounts on PC boards. A wide freq. range of 1.8 MHz to 50 MHz is available. Maximum freq. drift (stability) is better than $\pm 100 \text{ ppm}$ from -55° to $+125^\circ\text{C}$. CTS Knights, Inc., Sandwich, Ill. 60548. (815) 786-8411.

Circle Reader Service #209.

PLASTIC TRANSISTORS

New family of 26 power transistors come in plastic TO-66 containers. The family consists of true npn and pnp complements, each bonded with copper alloy "clip" lead attachments for max. reliability. All operate at collector currents up to 4 A max. and have a power rating of 36 W at a case temp. of 25°C . Voltage capabilities are from 40 to 80 V. Fairchild Semiconductor, 313 Fairchild Dr., Mountain View, Calif. 94040. (415) 962-3563.

Circle Reader Service #210.

REED RELAY

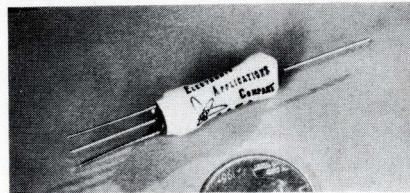

New reed relay is only 0.275 in. in dia. by 0.950 in. long and is available for coil voltages of 1, 3, 5, 6, 12 and 24 V. The coil bobbins are molded directly on the reed capsule allowing greater flux densities and reducing costs through automation. Contacts are rated to 1 A at 20 W and have a 750 Vdc breakdown voltage. \$0.39. Electronic Applications Co., 2213 Edwards Ave., So. El Monte, Calif. 91733.

Circle Reader Service #211.

UNENCAPSULATED POWER

These ac-dc regulated supplies are for use with op amps and micrologic circuitry. The PCB mountable Lambda-Paks™ are fully repairable because the internal components are not encapsulated. They come in an impact resistant, flame retardant plastic housing. Range is from 3 to 30 Vdc with current rating to 900 mA. From \$35.00 to \$65.00. Lambda Electronics Corp., Rte 110, Melville, N.Y. 11746. (516) 694-4200.

Circle Reader Service #212.

TOGGLE SWITCH

New subminiature, high capacity switch features a contact rating of 6 A at 125 Vac. A min. of 100,000 on/off cycles at rated load is guaranteed. Contact res. is 10 mΩ max. at 2-4 Vdc, 1 A; ins. res. 1000 MΩ min. at 500 Vdc; and dielectric strength 1000 Vac at sea level. Shelly Associates, 111 Eucalyptus Dr., El Segundo, Calif. 90245. (213) 322-2374.

Circle Reader Service #213.

HIGH PWR POTENTIOMETER

Model 3369 cermet single-turn adjustment pot has a corrosion-resistant metal cover and silicone O-ring to keep out moisture. Operating temp. range is from -65° to $+175^\circ\text{C}$, and life expectancy is 1000 cycles or better. The cermet resistance element has a $\pm 150 \text{ ppm}/^\circ\text{C}$ TC. Power rating is 1 W at 125°C . The 3369 comes with PC pins or solder lugs. Standard res. range is 100Ω to 5 MΩ. Trimpot Products Div., Bourns, Inc., 1200 Columbia Ave., Riverside, Calif. 92507. (714) 684-1700.

Circle Reader Service #214.

POWER TRANSISTORS

Five new series of complementary, power Darlington transistors provide gain up to 2500 (typ.) and are available in current ratings from 4 to 16 A. With their high gain, they can be driven with IC milliampere output current levels. The silicon transistors come in 60 and 80 V collector-emitter breakdown voltage ratings (a 100 V rating is available in the 16 A series). Motorola Semiconductor Products Inc., Box 20912, Phoenix, Ariz. 85036. (602) 273-3589.

Circle Reader Service #215.

TRIMMING POTS

"Pillpot" pots with the company's infinite-resolution metal glaze (cermet) element are for PCB uses. The 170 series comes in a range of 10Ω to 1 MΩ and has a TC of $\pm 100 \text{ ppm}/^\circ\text{C}$ max. over a temp. range of -55° to $+150^\circ\text{C}$. In lots of 500, Types 170 and 171 are \$1.31 ea.; and Type 172 is \$1.88. TRW Inc., 1100 Glendon Ave., Los Angeles, Calif. 90024. (213) 477-6061.

Circle Reader Service #216.

DIL HEADER AND CASE

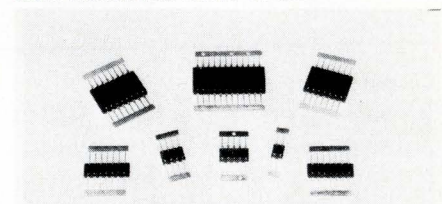

These DIP packages were designed for delay lines, reed relays, hybrid circuits, pulse transformer mountings, and many more uses. Leads of the 100 mil pin spaced units can be formed to fit DIL sockets. Plasmetex Industries, 8217 Lankershim Blvd., N. Hollywood, Calif. 91605. (213) 767-1532.

Circle Reader Service #217.

LIGHT EMITTING DIODE

GaP light source with max. spectral emission region between 630 and 690 nm comes in two configurations: a PC board type, solderable to PCBs by normal methods; and a panel board type in which a std. Tinnerman-type attachment fastens case to panel board. I rev, 3.0 V (max.); I forward, 50 mA (max.); luminance, 1250 fl (avg.). Solar Systems, Inc., Box 128, Skokie, Ill. 60076.

Circle Reader Service #218.

PLUG-IN REED RELAY

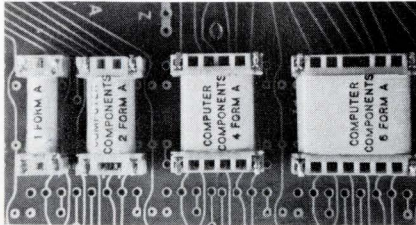

This relay can be plugged into a PC board. If there is a contact failure, the relay can be removed from the PCB, the end plug pushed out and the faulty reed removed. The reed can then be replaced with the end plug and the entire relay plugged back in on the PCB. Available in 1, 2, 4 and 6 pole units with various combinations of Form A, B, A/B and C. Computer Components, Inc., 88-06 Van Wyck Expwy., Jamaica N.Y. 11418. (212) 291-3500.

Circle Reader Service #219.

TC XTAL OSCILLATOR

Model TCXO-2 compensated crystal oscillator has a freq. stab. of $\pm 2/10^7$ over the range of -40° to $+75^\circ\text{C}$. Packaged within 4 in. and weighing only 5.0 oz., it is for use where power, space and weight restrictions preclude the use of an oven for temp. stabilization. Bulova Watch Co., Inc., 61-20 Woodside Ave., Woodside, N.Y. 11377.

Circle Reader Service #220.

DUAL BAND VCO

Model 200302092 consists of a pair of transistor oscillators in an rfi protected enclosure. The oscillators deliver a min. of 65 mW over the freq. bands 3.6 to 4.3 GHz and 5.8 to 6.5 GHz. Integrated ferrite load isolators enable smooth monotonic tuning and assure $< \pm 0.05\%$ freq. shifts into a 1.5:1 VSWR rotated through all phases. Addington Laboratories, Inc., 1043 Di Giulio Ave., Santa Clara, Calif. 95050. (408) 248-5511.

Circle Reader Service #221.

ALPHA-NUMERIC READOUT

New readout features miniature size (character 0.40 x 0.40 in.) readability in sunlight, front relamping, with a choice of colors and filters. Mating ss circuitry is optional. Available as individual units that can be stacked, or as custom integrated blocks with digits, symbols, and decimal points. Oppenheimer, Inc., Wyandotte Rd., Willow Grove, Pa. 19090. (215) OL 9-6000.

Circle Reader Service #222.

STEPPING MOTORS

Stepping motors with complete pulsing circuitry built in eliminates the need for any ext. pulsing of logic circuit network. You only need a dc input to make them step in incremental positions of 30° . Two designs are available: a free running model \$25.20 (1-9) and a self-pulsing design, \$33.00 (1-9). Ledex Inc., 123 Webster St., Dayton, Ohio 45401. (513) 224-9891.

Circle Reader Service #223.

AUTOMATIC IC EXTRACTOR

Model ACE-700 extractor removes ICs and retaining solder from PCBs in 30 s or less. It extracts preformed multihead TO-18, 14 and 16 lead DIL IC modules from single- and double-sided, and multilayer PCBs. \$900.00. Enfield Industries, Inc., Box 225, Flourtown, Pa. 19031.

Circle Reader Service #224.

HEAT DISSIPATOR

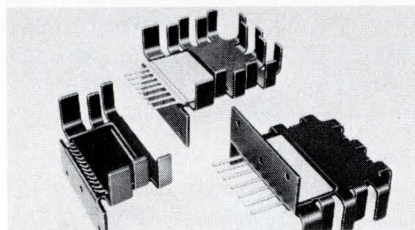

The circuit substrate is potted directly to the dissipator in this method. The substrate-to-dissipator interface lowers thermal resistance to the point that typ. hybrid ICs such as flat 1 x 2 in. packages can be operated in still air at a 100% increase in power over the bare circuit while holding the same circuit temp. The dissipators are staggered finger types modified to include a mounting cup for potting the circuit to the heat sink and encapsulating it with epoxy. International Electronic Research Corp., 125 W. Magnolia Blvd., Burbank, Calif. 91502.

Circle Reader Service #225.

IC BACKPLANE

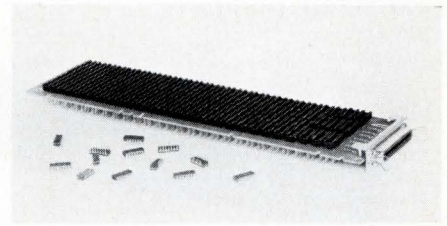

Model 4401 high-density backplane can accommodate 101 DIPS (92 14-pin and 9 16-pin). Complete with solderless-wrap sockets and 50-pin I/O connector, it is made from 3/16 in. copper clad G-10 epoxy. Its double sided construction features a large ground plane area on one side and a V_{CC} voltage plane on the other. \$178.00 Data Technology Corp., 1050 E. Meadow Circle, Palo Alto, Calif. 94303. (415) 321-0551.

Circle Reader Service #226.

CONDUCTIVE LUBRICANT

Dynalube 495 is a silver alloy filled electrically conductive lubricant. It contains no volatiles, requires no mixing and comes ready for use. It is a viscous material that will not drip or run and is stable over a wide temp. range. Volume resistivity is $0.01 \Omega\text{-cm}$ (avg.). Three oz. kits are \$10.00; 8 oz., \$21.00, and 1 lb., \$39.75. Municipex, Inc., 10 Stuyvesant Ave., Lyndhurst, N.J. 07071.

Circle Reader Service #227.

CASTABLE CERAMIC

RTC-60™ precision castable high alumina ceramic cures in 60 min. at room temp. To use, the ceramic powder and liquid activator are mixed and poured into nonabsorbant molds. Most parts can be removed and put into service after 60 min. Trial evaluation kit is \$15.00, fob New York. Cotronics Corp., 37 W. 39th St., New York, N.Y. 10018. (212) 695-7997.

Circle Reader Service #228.

PULSE TRANSFORMERS

Series 1200 balun and isolation pulse transformers are quad-packaged in side egress, molded plastic DIPS. They conform to TO-116 outline specs. The baluns have a 1:1 turns ratio, and are available with a primary range of $5 \mu\text{H}$ to 2 mH. The isolation transformers have either a 1:1 or 2:1 turns ratio, and a primary ind. range of $5 \mu\text{H}$ to 500 μH . \$14.50 ea. (1-9). Ness Pacific, 470 N. San Antonio Rd., Palo Alto, Calif. 94306. (415) 328-7036.

Circle Reader Service #229.

NUMERIC DISPLAY

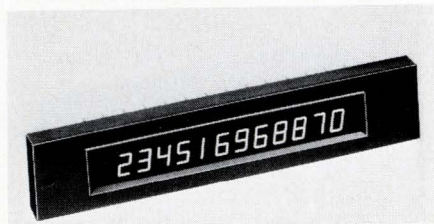

New Panaplex™ numeric panel displays are available in 8 to 16-digit versions. The 9-segment character format eliminates the left or right reading "one." Common cathode construction results in many less terminations, e.g.: a 12-digit panel has only 22 terminations. Burroughs Corp., Electronic Components Div., Plainfield, N.J. 07061. (201) 757-5000.

Circle Reader Service #230.

DIGITAL PANEL METER

New 3 1/2 digit meter functions over a range of input power freqs varying from 50 to 400 Hz at either 115 or 230V. Type 330A meter also features automatic zero adjust and constant high input Z. Maximum sens. is 1 mV, 100 nA, 1Ω. \$175.00 small quan. Price includes connector. Digilin, Inc., 6533 San Fernando Rd., Glendale, Calif. 91201. (213) 245-6754.

Circle Reader Service #231.

CHIP RESISTORS

These 85 x 55 mil chips have a thick film element and a palladium gold termination. Gold is also applied to the underside of the element. Resistance range is 100 kΩ to 100 MΩ, TCR is <200 ppm/°C and tolerances are ±5 and ±10%. Aircor Speer Electronic Components, Niagara Falls, N.Y. 14302. (716) 285-9381.

Circle Reader Service #232.

AVALANCHE DIODE

This high-efficiency diode Y-2075 for operation at S-band is a silicon mesa diode bonded to a copper heat sink. Designed for pulsed service, it produces peak powers suitable for use in several applications not previously served by other ss devices. Typical measured results show 20 to 40 W of pulsed power output at about 3.7 GHz. Measured efficiency is >20% for 1 μs pulses at a 10 kHz pulse rate. General Electric Tube Dept., Owensboro, Ky.

Circle Reader Service #233.

PULSED MAGNETRON

This miniaturized mechanically tunable magnetron has negligible freq. shift under the most severe environmental conditions. The BLM-116 delivers a peak output of at least 1.4 kW over a range of 5.4 to 5.9 GHz. It weighs only 8 oz. About 1.2 x 1.2 x 2.6 in. Varian Eastern Tube Div., Salem Rd., Beverly, Mass. 01915.

Circle Reader Service #234.

ULTRASONIC CLEANER

Models AC-25 and AC-66 are portable, self-contained systems for use with aqueous solutions and chlorinated or fluorinated solvents. Model AC-25 (\$60.00) with tank dimensions of 5 x 5 x 3 in. uses 50 W of ultrasonic energy. Model AC-66 (\$225.00), with work dimensions of 11 x 6 x 6 in., is powered by a 150 W ultrasonic generator. Baron-Blakeslee, Inc., 1620 S. Laramie Ave., Chicago, Ill. 60650.

Circle Reader Service #235.

RF POWER TRANSISTORS

Two new series feature silicon nitride passivation, high-temp. metalization, and emitter-balancing resistors. A 12 V, 470 MHz lineup includes the MT1401, MT1403, MT1412, and MT1425, with outputs of 1, 3, 12, and 25 W, respectively. The 1425 has 4 dB min. gain. The 28 V, 400 MHz series includes the MT2401, MT2403, MT2412, and MT2425, with the same respective outputs. The 2425 has 8-dB gain. Fairchild MOD, 2513 Charleston Rd., Mountain View, Cal. 94040. (415) 961-9573.

Circle Reader Service #236.

DIP SOCKETS

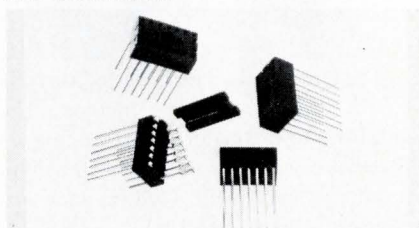

These 14 and 16-pin, 2-piece sockets have removable contacts. Terminal ends of the 20 millionths gold over nickel contacts are available in two types, solderless and solder. Nominal insertion force is 4 - 5.5 lbs. with an extraction force of 1-2 lbs. Scanbe Mfg. Corp., 3445 Fletcher Ave., El Monte, Calif. 91731. (213) 579-2300.

Circle Reader Service #237.

EPOXY RESIN ADHESIVE

Tra-Bond 2101 is suited for bonding, laminating, coating and maintenance uses. It is particularly effective for coating resistors, capacitors, diodes and other components to copper-clad PC boards. Fully cured, it is a good electrical insulator. Tra-Con, Inc., 55 North St., Medford, Mass. 02155. (617) 391-5550.

Circle Reader Service #238.

HEIGHT CONSCIOUS RELAY

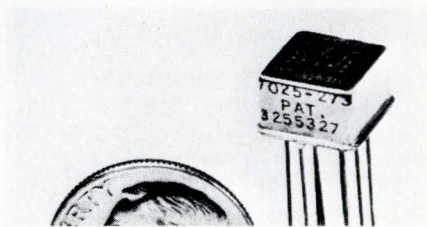

Only 0.225 in. high, the "Centigrid" relay (Series 112) has leads spaced on 0.100 in. centers, with all eight leads on the periphery of the can. By contrast, the normal TO-5 is 0.265 in. high, and requires a 0.080 in. high transpad to achieve a 0.100 in. lead spacing. \$29.95 in single quan. Teledyne Relays, 3155 W. El Segundo Blvd., Hawthorne, Calif. 90250. (213) 679-2205.

Circle Reader Service #239.

PULSE TRANSFORMERS

These transformers come in a choice of three PCB type cases. A wide range of std. designs makes them easy to adapt to instrumentation and computer applications. \$6.50 ea. (1-14). Aries Technology, 3475 Victor St., Santa Clara, Calif. 95050. (408) 244-9366.

Circle Reader Service #240.

COMPUTERS

Two new HP computers have twice as much memory capacity as their predecessors—in the same size mainframes. Thus, they don't need ext. add-on memory extenders, even when their core memories are expanded to max. size. The 2116C is a 16-bit machine with a memory cycle time of 1.6 μs. It's \$20,000 including an 8 k (8192-word) core memory. Model 2114C, is also a 16-bit machine, but with a memory cycle time of 2.0 μs. With 4 k core memory it sells for \$8,500. Additional core can be added to both computers. Hewlett-Packard, 1501 Page Mill Rd., Palo Alto, Calif. 94304. (415) 326-7000.

Circle Reader Service #241.

INSTRUMENTATION AMP

Model ZA701D1 has a gain range of 1 to 1000, a gain non-linearity of $\pm 0.03\%$ and a CMRR of 110 dB. It comes in a 14-pin DIP and requires only one resistor for selection of gain. Price, (1-9) is \$52.00; 10-24 is \$48.00. Zeltex Inc., 1000 Chalomar Rd., Concord, Calif. 94520. (415) 686-6660.

Circle Reader Service #275.

FREQUENCY SYNTHESIZER

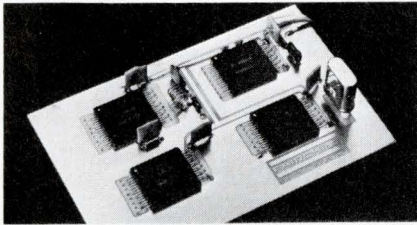

These four multi-chip ICs form a general purpose hybrid frequency synthesizer. The devices are designed for use in telecommunications systems up to 200 MHz. The building blocks are the SH8095 logic prescaler, the SH8096 programmable divider, the SH8097 vhf voltage controlled tuner and oscillator, and the SH8098 programmable reference divider and oscillator. Fairchild Semiconductor, 313 Fairchild Dr., Mountain View, Calif. 94040. (415) 962-3563.

Circle Reader Service #276.

POSITIVE VOLTAGE FOLLOWER

You can use the Model 9708 as a "close to ideal" voltage follower. The unit features 10×10^{-15} A max. input current, 10 m Ω output impedance, ± 10 V swing into 1000 Ω load and 300 kHz small signal bandwidth. Optical Electronics, Inc., Box 11140, Tucson, Ariz. 85706. (602) 624-8358.

Circle Reader Service #277.

BIPOLAR RAM

The IM5503 is a 256-bit TTL random-access memory. It is fully binary decoded, has an access time of 75 ns, and dissipates 1.5 mW/bit. Organization is 256 words x 1 bit. \$57 ea. in 100 pc quantities for 0 to 75°C operation and \$85 for the -55 to 125°C temp. range. Intersil, 10900 N. Tantau Ave., Cupertino, Calif. 95014. (408) 257-5450.

Circle Reader Service #278.

MSI IN SILICONE

Ten of the manufacturer's MSI 9300 series devices as well as its complete five-circuit multi-vibrator family are available in silicone. Prices are at least \$.40/circuit below regular hermetic prices in 1000-piece orders. Advanced Micro Devices Inc., 901 Thompson Pl., Sunnyvale, Calif. 94086.

Circle Reader Service #279.

RF AMPLIFIERS

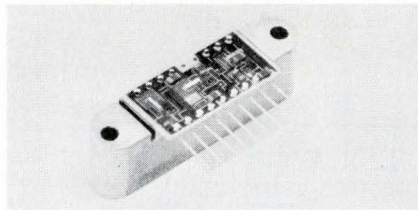

The CA800 has a 5 MHz to 500 MHz bandwidth with 25 dB gain. It is a universal broadband gain block for 50 Ω instrumentation and radio systems. A companion amplifier, the CA600, is designed specifically for 75 Ω CATV use. It has a gain of 28 dB from 40 to 300 MHz using a 24 V source. TRW Semiconductor Div., 14520 Aviation Blvd., Lawndale, Calif. 90260. (213) 679-4561.

Circle Reader Service #280.

MOS RAM

The RM53L is a 512 x 1 bit read/write memory for high speed scratch-pad, main frame and low power applications. The device contains a 512-word x 1-bit array of memory cells a 9-bit address word decoder, a high speed current mode data output, a chip disable function and a multiple data bus interconnect. American Microsystems, Inc., 3800 Homestead Rd., Santa Clara, Calif. 95051. (408) 246-0330.

Circle Reader Service #281.

LINE DRIVING OP AMPS

These op amps have slew rates of 1000 V/ μ s min., and bandwidth of 50 MHz, min. They have an output capability of ± 5 V up to 20 MHz when driving a 50 Ω line. The two models differ only in voltage drift specs: ± 25 μ V/ $^{\circ}$ C for Model 3341/15C (\$69 ea., 1-9) and ± 50 μ V/ $^{\circ}$ C for Model 3342/15C (\$59 ea., 1-9). Burr-Brown Research Corp., Int'l Airport Industrial Park, Tucson, Ariz. 85706. (602) 294-1431.

Circle Reader Service #282.

BCD D/A CONVERTER

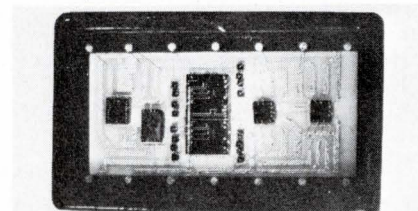

The MN303 is a complete 8-bit converter in a 14-lead DIP. Slew rate is 0.5 V/ μ s, temp. coefficient is ± 10 ppm/ $^{\circ}$ C, and power consumption is 400 mW. Operating temperature range is 0 to 70°C. Price, 1-24 pcs, \$79. Micro Networks Corp., 5 Barbara Lane, Worcester, Mass. 01604. (617) 756-4635.

Circle Reader Service #283.

COUNTER/DECODER/DRIVER

The ITT1107C is a counter/decoder/driver that operates with a seven-segment numeric-read-out vacuum tube. It will directly drive seven-segment display tubes such as the Tung-Sol DT1705D, the GE Y1938 and Sylva 8894. \$15.20 ea. (1-24 pcs) ITT Semiconductors, 3301 Electronics Way, W. Palm Beach, Fla. 33407.

Circle Reader Service #284.

DUAL TRACKING REGULATOR

The SG1501/2501/3501 has positive and negative outputs which are factory set at ± 15 V or are variable from ± 8 to ± 23 V with a single external adjustment. One 1501 will power over 25 op amps and replace two regulators and 8 components in a typical application. \$4.80 to \$9.80 (100 pcs). Silicon General, Inc., 7382 Bolsa Ave., Westminster, Calif. 92683. (714) 839-6200.

Circle Reader Service #285.

UP/DOWN COUNTER

The AM 2501 is synchronously presettable and offers active pullup outputs for high speed with good noise margins. The counter features 25 MHz speeds, and input clamp diodes to minimize adverse line reflection. The industrial unit is \$7.70 ea. in 100-up quantities. Advanced Micro Devices Inc., 901 Thompson Pl., Sunnyvale, Calif. 94086.

Circle Reader Service #286.

STATIC MOS SHIFT REGISTER

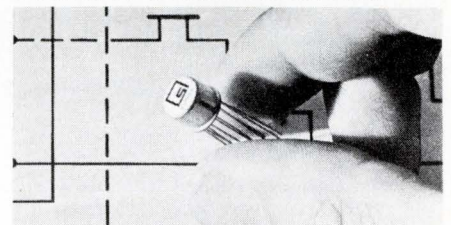

The N2010K is a static shift register which the manufacturer says will replace dynamic registers with their attendant refreshing circuits. In addition, at frequencies over 1.0 MHz, less power is consumed by the N2010K than by many dynamic registers. \$4.00 ea. (100-999). Signetics Corp., 811 E. Arques Ave., Sunnyvale, Calif. 94086.

Circle Reader Service #287.

TWIN 512-BIT DYNAMIC SR

The TMS3309JC is a four-phase dynamic shift register/accumulator. Specifically designed for high-speed applications, the register will operate, at 10 MHz and is the fastest full 1024-bit shift register available. Texas Instruments Incorporated, Inquiry Answering Service, Box 5012, M/S 308, Dallas, Tex. 75222. (214) 238-3741.

Circle Reader Service #288.

COMPLEMENTARY MOS

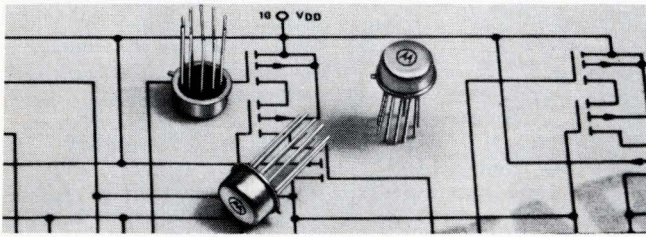

Three new complementary MOS ICs, two gates and a flip-flop, are the initial products in a family of digital logic called MCMOS. Quiescent power dissipation is low, the MC2501L quad 2-input NOR gate and the MC2502L dual 4-input NOR gate typically dissipate 10 nW; the MC2503L dual type flip-flop dissipates 50 nW, typical. Another feature is a noise immunity equal to 45% of V_{DD} (typ). This, combined with the ability to operate on any supply from ± 4.5 to ± 20 Vdc, can provide a 9 V noise immunity (at $V_{DD} = 20$ V). Prices in 100-up quan.: MC2501L, \$5.70; MC2502L, \$5.40; MC2503L, \$9.60. Technical Information Ctr., Motorola Semiconductor Products Inc., Box 20924, Phoenix, Ariz. 85036.

Circle Reader Service #289.

HEX, 32-BIT SHIFT REGISTER

This static MOS/LSI device, the TMS3112, is organized as six registers by 32 bits. Because it uses a low-threshold MOS technology, power-supply requirements are +5 and -12 V. Direct TTL/DTL interface is possible without input or output resistors, and you need only a single clock with a TTL swing. The organization is useful in many CRT displays that use a format of 32 characters/line with a total alphabet of 64 characters. Recirculate gating on the chip, permits the register to store an entire line of text for this type of display. \$11.50 (250-999 quantities). Texas Instruments Incorporated, Inquiry Answering Service, Box 5012, M/S 308, Dallas, Tex. 75222. (214) 238-3741.

Circle Reader Service #290.

MOS/LSI ARRAYS

These new off-the-shelf standard products include two read-only memories, two storage arrays, a shift register, and an analog switch. All will operate from -55 to 125°C and are available in either flat pack or dual in-line packages. Access time of the storage arrays is 40 ns. The products and prices (1-24 pcs) are: 512-word (2560-bit) ROM, \$58.00; 256-word (2560-bit) ROM, \$58.00; 256-bit (64 x 4) read/write storage array, \$42.00; 128-bit (64 x 2) read/write storage array, \$36.00; 1024-bit dynamic shift register, \$45.00; analog switch, \$20.00. Collins Radio Co., Newport Beach, Calif. 92663.

Circle Reader Service #291.

DUAL 100 BIT DYNAMIC REGISTER

The V002 uses a single phase, bipolar compatible clock, and can operate from 10 kHz to 2 MHz over a range of -55 to 125°C. The two separate 100-bit registers have common power and clock devices. Because the phase 2 clock can be independently inhibited for bit positions 2 through 100 of each register, you can use half of the V002 as a divide by 100 ring counter. Power dissipation is typically 1 mW/bit at 2 MHz. Price (1-24) \$5.50. Varadyne, Inc., MOS Operation, Semiconductor Div., 10432 N. Tantau Ave., Cupertino, Calif. 95014. (408) 257-0481.

Circle Reader Service #292.

IC MULTIPLEXER

This digital IC gating array is analogous to a 4-pole, 3-position switch. The array is a 3-input, 4-bit multiplexer. Four bits of digital data are selected from one of three inputs and a 2-bit channel selection code determines the active input. A data complement input can invert data or allow straight data flow by controlling a complement circuit at the multiplexer's output. Two versions are being offered: the 8263 uses active pull-up output structures for minimum delays, and the 8264 has bare collector outputs for expansion of input terms. Price (100-999) is \$15.95 ea. in a 24-pin flat package (0 to 75°C). Signetics Corp., 811 E. Arques Ave., Sunnyvale, Calif. 94086.

Circle Reader Service #293.

STATIC MOS READ-ONLY MEMORIES

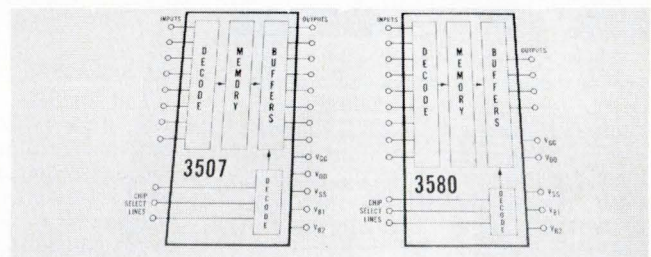

These two devices, the 3507 and 3580 are identical except for their format. The 3507 is organized as 256 words by eight bits, while the 3580 is organized as 512 words by four bits. Each device has three chip select gates that are customized according to a customer's program requirements. The outputs have wired-OR capability, which permits direct stacking of up to eight packages. Both products are priced at \$30 ea. in 1-24 quan. There is a masking charge for customization of the chip select gates for orders of less than 100 pieces. Fairchild Semiconductor, 313 Fairchild Dr., Mountain View, Calif. 94040.

Circle Reader Service #294.

IC MEMORY COMPETES WITH CORES

The 1103 is a 1024-bit MOS random access memory. The manufacturer says that the silicon gate process produces the 1103 at such high yields that the cost dips below cores for memories of any size from 10 k- to 10 M-bits. Read/write memories with the 1103 have a maximum access time of 390 ns and a read-modify-write cycle of 600 ns. The chip has a 1024 x 1 organization and is fully decoded. Price, in quantities of 1-24, \$60.00 ea. In quantities of 100,000 or more, the price is less than \$0.10/bit. Intel Corp., 365 Middlefield Rd., Mountain View, Calif. 94040. (415) 969-1670.

Circle Reader Service #295.

MOS/LSI CALCULATOR CIRCUITS

This set of six circuits provides all the logic required to build an eight-digit, four function (add, subtract, multiply and divide), desk-top calculator. Data entry by the user-supplied keyboard is to eight digits with internal arithmetic operations and storage to 16 digits. A fixed decimal point can be electronically set and constant multiplier/divisor can be entered and stored. Sign and over-flow are indicated and nonsignificant zeroes are suppressed. The max. solution time with a 200 kHz clock is 120 ns. Electronic Arrays, Inc., 501 Ellis St., Mountain View, Calif. 94040. (415) 964-4321.

Circle Reader Service #296.

LITERATURE

Dc power supply handbook

Written for the user, this 138-page handbook discusses both traditional and unusual applications and problems of regulated power supplies. The book is divided into six sections which provide an understanding of operation, perform-

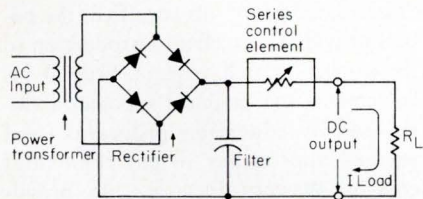

Basic series regulated supply

ance, and connection: definitions, principles of operation, ac and load connections, remote programming, output voltage and current ratings, and performance measurements. Hewlett-Packard Co., 1601 California Ave., Palo Alto, Calif. 94304.

Circle Reader Service #361.

Connector compendium

An expanded series of pin and socket connectors for rack and panel cable applications is described in a 32-pager. Catalog #908 includes specs, applications and dimensional data for the high density rectangular connector family. Semi-automatic and automatic machinery for large volume production wiring, and hand tools for maintenance and production are also discussed. AMP Incorporated, Harrisburg, Pa. 17105.

Circle Reader Service #362.

Logic card guide

Logic cards and logic card accessories are outlined for you in this 12-page logic card selection guide. You'll find data on more than 150 standard products, including DTL, TTL, and analog (A/D, D/A, sample and hold, multiplexer) cards. There's also information on complementary hardware and accessories plus MSI complex function cards. Necessary information includes power requirements, number and type of circuits per card, and color coding. Data Technology Corp., 1050 E. Meadow Cir., Palo Alto, Calif. 94303.

Circle Reader Service #363.

PC handbook

Illustrated with step-by-step instructions for printed circuit fabrication, this handbook details four techniques—direct masking; photomask/cut-and-peel; master artwork, film negative, photographic; and "B" negative drafting system. The handbook also includes tips on PC board layout, design, and fabrication. All techniques can be used for single-piece prototype as well as full-scale manufacturing. 50c. GC Electronics, 400 S. Wyman St., Rockford, Ill. For more information on where to get this item

Circle Reader Service #364.

EIA 1970 yearbook

Here's a great way to bring yourself up-to-date in the electronics world. The 1970 Electronic Market Data Book (known as the EIA yearbook) reviews sales and trends in the electronics industry and analyzes the consumer, industrial, government, electronic com-

MARKETS FOR ELECTRONICS AS PERCENT OF TOTAL FACTORY SALES BY SELECTED YEARS

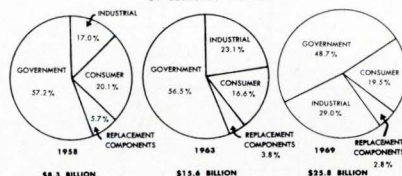

ponents, and world trade markets. More than 90 tables and 12 charts illustrating sales and trends are included in the book. Single copies are \$15; buy 20 or more and they're only \$9. Electronic Industries Assoc., Office of Public Relations, 2001 Eye St., Washington, D.C. 20006.

IEEE publication

Available on a bi-monthly basis from the IEEE, the "IEEE Publications Bulletin" will provide listings for new conference publications, special IEEE journals, new information services, and new standards publications. Recent material available from the IEEE is listed, as are new products. The cumulative information will extend over a one-year period. T. H. Hogan, IEEE Inc., 345 E. 47th St., New York, N.Y. 10017.

Circle Reader Service #365.

Linear chips

Linear ICs available in chip form are detailed in a 12-page catalog. There are chips for 23 linear devices including op amps, voltage regulators, video amps, comparators, multipliers, transistor arrays, and sense amps. Illustrations give you the information you need on chip sizes, pad locations, and pad functions. Silicon General Inc., 7382 Bolsa Ave., Westminster, Calif. 92683.

Circle Reader Service #366.

Semiconductor almanac

A 52-page semiconductor almanac (ETRM-4311F) contains about 20,000 cross references from JEDEC or OEM part number to GE part numbers for universal replacement semiconductors and/or selenium rectifiers for color TVs, dual diodes, and quartz crystals. Applications and technical data on universal transistors, as well as specs, prices, and terminal drawings for GE's entertainment transistors, quartz crystals, and zener and crystal diodes are also included in the 1970 edition. GE Tube Dept., 316 E. 9th St., Owensboro, Kentucky 42301.

Circle Reader Service #367.

Conversion circuits

Application note #25 describes conversion circuits (TTL to MOS and MOS to TTL) which can be used to interface this MOS RAM into DTL/TTL systems. The RAM is a 1024 word x 1 bit random-access read/write MOS memory with low voltage circuit design ($V_{DD} = -15V$)

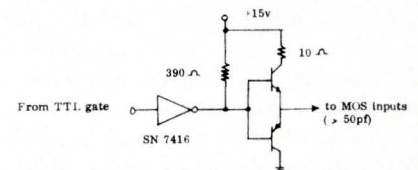

Buffered outputs for loads to 500 pF

and low capacitance inputs. Schematics illustrate the use of both TTL to MOS and MOS to TTL interface for greater drive current and faster access time. Advanced Memory Systems Inc., 1276 Hammerwood Ave., Sunnyvale, Calif. 94086.

Circle Reader Service #368.

Catalog of A/D/A systems

A complete line of A/D/A conversion, signal conditioning, and digital display products are described in this 16-page brochure. Basic specs and technical information are provided for card-mounted and modular devices, complete systems,

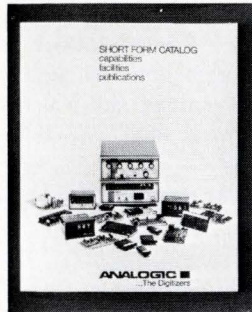

power supplies and other peripheral equipment, digital panel meters and displays, and hardware and enclosures. Also, information on the company's capabilities, facilities, and publications is included. Analogic Corp., Audubon Rd., Wakefield, Mass. 01880.

Circle Reader Service #369.

Temperature compensated ECL

A new series (9500) of ECL circuits, designed to avoid standard design problems of characterization at different temperature levels, is discussed in a technical paper. The paper discusses avoiding system noise immunity loss due to temperature gradients and covers theoretical design, cold temperature operation of the circuits, and saturation performance. Fairchild Semiconductor, Box 880A, Mountain View, Calif. 94040.

Circle Reader Service #370.

Mini servo amps

Bulletin #100 discusses 400 Hz mini ss servo amplifiers which are suitable for commercial, industrial, and military applications. The amplifiers listed range from 2 to 40 W output power and meet Mil spec requirements under Mil-E-5272, Mil-E-5400 and Mil-I-26600. Mechanical and electrical specs and schematics are provided, as is a design guideline chart which shows input and output characteristics. Available from Servo Products, Electronics Div., Bulova Watch Co., Inc., 61-20 Woodside Ave., Woodside, N.Y. 11377.

Circle Reader Service #371.

Ceramic capacitors

A comprehensive 76-page catalog serves as a ceramic capacitor handbook. In addition to standard product information, the brochure contains a guide to the use of ceramic capacitors suggested for those who may be unfamiliar with their nature and behavior. Reference summary charts showing available capacitance ranges, charts depicting monolithic construction, and schematics and specs are provided in this informative guide. Gulton Industries Inc., Metuchen, N.J. 08840.

Circle Reader Service #372.

Integrated circuits

This is a group of 11 data sheets for insertion into your Raytheon Data Manual. The updated data includes specs, descriptions, and schematics for J-K flip-flops, multivibrators, op amps, differential video amplifiers, and lamp drivers. Design features, packaging

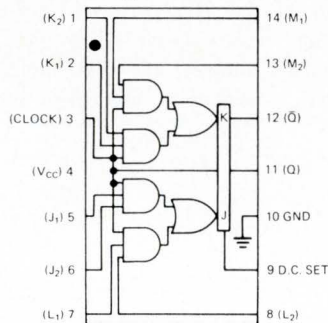

75 MHz OR input J-K flip-flop

data, absolute maximum ratings, operating features, and electrical characteristics are included in the product descriptions. For easy reference a table of contents, data manual instruction sheet, and product line table are included. Raytheon, Semiconductor Operation, 350 Ellis St., Mountain View, Calif.

Circle Reader Service #373.

Electronics catalog

A comprehensive catalog covers engineering information for a range of manufacturers' electronic components. The 110-pager is fully indexed and provides design data, prices, cross references, a breakdown of part numbers, and military specs for such manufacturers as Bendix, Sealectro, Electra, Babcock, and Erie. Powell Electronics Inc., Box 8765, Philadelphia, Pa. 19101.

Circle Reader Service #374.

Environmental control

Back in February of this year, a seminar, "Environmental Control—An Engineering Challenge," was held in San Francisco. Relevant and informative talks were presented by people in public service, engineering, and engineering education. Copies of these talks are available, and although there are no "electronic" proposals specified, the papers provide an excellent introduction to the subject. You'll read of Federal involvement, the engineer's potential involvement, education programs, and various approaches to environmental control. Western Electric, 195 Broadway, New York, N.Y. 10007.

Circle Reader Service #375.

Phase generation

The multiphase generator and refresh circuitry illustrated in Application note #26 perform three basic functions: generate multiphase clocks, define the memory refresh time, and provide the memory with internal addresses for refresh operation. The note and schematics explain the circuitry based on a 12-stage synchronous binary counter triggered by an external clock, and goes on to describe the refresh circuitry, cycle time, and refresh cycles. Advanced Memory Systems Inc., 1276 Hammerwood Ave., Sunnyvale, Calif. 94086.

Circle Reader Service #376.

Components catalog

Called the 747, this large catalog introduces more than 1300 new components being offered by this company. And you can get three other catalogs as

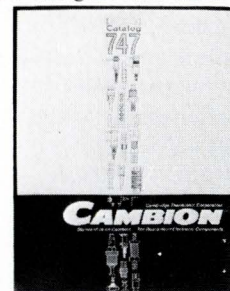

well. In addition to the 747 there's a catalog for IC accessories, logic cards, and thermoelectric devices. Cambridge Thermionic Corp., 445 Concord Ave., Cambridge, Mass. 02138.

Circle Reader Service #377.

FET chips

Junction and MOS FET chips, available in either wafer or chip form, are the subject of this 12-page catalog. It offers you 34 standard FET chip types for use as single and dual amplifiers, analog switches, and current limiters. Electrical

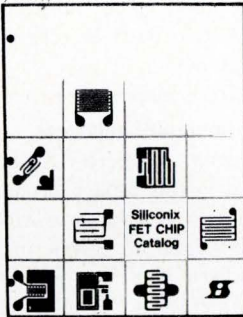

and visual inspection and probe test capability are described, and a cross-reference table lists these types against JEDEC-registered models. Siliconix Inc., 2201 Laurelwood Rd., Santa Clara, Calif. 95054.

Circle Reader Service #378.

Mini computer

A series of "skinny-mini" 16-bit computer systems is covered in an informative 20-page brochure. The systems range from small dedicated controllers with small read only and scratchpad memories occupying 1 3/4 in. of rack space to complete 32k core systems with a range of peripherals. Programmed I/O and direct memory access channels are graphically depicted, and support services, peripherals, and software for the series are listed. Datamate Computer Systems Inc., Box 310, Big Spring, Tex. 79720.

Circle Reader Service #379.

Silicon power transistors

A radiation hardened silicon power transistor manual describes the company's capabilities in manufacturing neutral hardened silicon power transistors. Design parameters for various series are provided, as are processing techniques. The analysis of post-radiation data, with the emphasis on h_{FE} and collector saturation voltage parameters, is covered in a separate section. The 92-pager is available from Solitron Devices Inc., 1177 Blue Heron Blvd., Riviera Beach, Fla. 33404.

Circle Reader Service #380.

Metal plate connectors

A revised 40-page 1971 handbook contains design information for back-panel connector arrays. The Variplate™ metal plate inter-connection concept is defined, and a discussion of the voltage/ground plane and bus bar techniques of power distribution, connector grid pattern, plate size, and layout dimensioning is included. Also described are modular components available for connector arrays and headers, with specs for each. ELCO Corp., Willow Grove, Pa. 19090.

Circle Reader Service #381.

Dc voltage regulators

Specs, tables, diagrams, and photographs supplement the text in this 8-page brochure featuring precision, hybrid dc voltage regulators. The units offer an output voltage range of 5-30V, and an output voltage setting tolerance of $\pm 0.5\%$. The circuit design allows

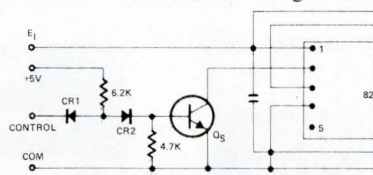

Digital shutdown

programmable foldback current limiting, additional internal reference noise filtering, trimmable output voltage setting, and digital shutdown. Beckman Instruments Inc., 2500 Harbor Blvd., Fullerton, Calif. 92634.

Circle Reader Service #382.

Cathode ray tubes

CRTs for military and industrial applications are outlined in a 20-page brochure. Serving as a guide to specific CRTs, the catalog provides an index to industrial and military types and gives pertinent data on electrostatic focus, and deflection CRTs. Data on fiber optic faceplate and high brightness phosphor tubes is also included. Dimensioned outlines and basic diagrams for listed tube types are provided, as are specs and a table of standard and special phosphors. Westinghouse Electric Corp., Electronic Tube Div., Box 284, Elmira, N.Y. 14902.

Circle Reader Service #383.

Components catalog

The 1970-71 edition of RLC's component catalog is now out. It's 80 pages long, listing their standard product lines (attenuators, filters, switches, etc.) and new products (double balanced mixers, tunable band pass filters, etc.). Also, the catalog features design curves of all the major parameters of the components as well as design charts. RLC Electronics Inc., 83 Radio Cir., Mt. Kisco, N.Y. 10549.

Circle Reader Service #384.

Test and measuring instruments

More than 45 measuring instruments and auxiliary units, all based on 4th generation IC design, are described in a 64-page catalog. The equipment portion of the catalog is in three basic sections: counter/timers, auxiliary instruments, and signal sources. All equipment is indexed both by function and model number. Among the many products included are digital counters, frequency synthesizers, sine and square wave generators, pulse generators, digital programmers, multiplexers, and digital comparators. Monsanto Electronic Instruments, 620 Passaic Ave., West Caldwell, N.J. 07006.

Circle Reader Service #385.

Power supply catalog

Modular dc power supplies and precision voltage references are featured in this 32-page catalog. Characteristics of all CEA power supplies include: series starting, no turn-on or turn-off overshoot, all silicon semiconductors, and



shielded transformers. New additions to the catalog include dc-to-dc converters, high efficiency power supplies, and highly shielded line isolators. CEA, 1221 S. Shamrock Ave., Monrovia, Calif. 91016.

Circle Reader Service #386.

Magnetic components

Mini magnetic components, including pulse transformers, SCR trigger transformers, delay lines, and inverter transformers are the subject of a short form 6-page catalog. Specific applications for the different series of the components are listed in a 1-page application selection guide. Also provided are specs, schematics, prices, and termination diagrams. Pulse Engineering Inc. Box 12235, San Diego, Calif. 92112.

Circle Reader Service #387.

Precision film capacitors

A comprehensive 28-page catalog describes various types of precision film capacitors, including polystyrene, and hermetically sealed mylar and mica types. Included in the guide is capacitor nomenclature, tips for selection, specs, and information on the company's facilities and production techniques. Available from PFC Mkt. Mgr., Arco Electronics, Community Dr., Great Neck, N.Y. 11022.

Circle Reader Service #388.

Lasers and accessories

Laser products ranging from low energy mini types to high power laboratory and materials processing systems are listed in a 16-page catalog. Descriptions for each type are provided, as are specs, illustrations, and suggested applications. Hadron Inc., 800 Shames Dr., Westbury, N.Y. 11590

Circle Reader Service #389.

Thin film deposition

"The Sloan Notebook" explains how this company can fill all your thin film requirements from custom fixtures and components for research to heavy duty deposition systems for high volume production. You'll also receive notes on their deposition control system, y-axis beam control, thin film deposition system, and chamber fixturing. The group of data sheets and brochures provides a full coverage of instrumentation and systems for electronic thin films. Sloan Technology Corp., 535 E. Montecito St., Santa Barbara, Calif. 93103.

Circle Reader Service #390.

Mercury-wetted relays

High speed miniature mercury-wetted contact relays for PC boards are the subject of 28 pages of technical information. You're given electrical and mechanical characteristics, detailed technical data, relay operating characteristics, and contact protection instructions. Throughout the text, figures and tables expand upon given information. C. P. Clare & Co., 3101 W. Pratt Blvd., Chicago, Ill. 60645.

Circle Reader Service #391.

Micro-miniature inductors

Designers of micro-circuits will be interested in this 8-page brochure on micro-miniature inductors. Electrical and physical data are given in convenient chart form for five micro-inductors and a shielded PC variable inductor. Dimensional diagrams supplement the descriptions which indicate the outstanding features of each designated model. Cambridge Thermionic Corp., 445 Concord Ave., Cambridge, Mass. 02138.

Circle Reader Service #392.

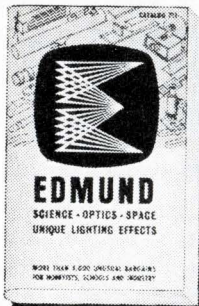

FREE CATALOG!
148 PAGES • MORE THAN 4000
UNUSUAL BARGAINS
SCIENCE • OPTICS • SPACE



1000's OF HARD-TO-FIND
BUYS FOR INDUSTRY.

Speed your work! Improve quality! Cut development and production costs! Completely new edition loaded with on-the-job helps, quality control aids, unique items available nowhere else. 148 easy-to-read pages packed with new products, charts, diagrams, illustrations. A treasure house of optical and scientific equipment available direct from stock for industry, research labs, design engineers, experimenters, hobbyists.

AMERICA'S GREATEST ONE-SOURCE MARKET PLACE
Hard-to-get surplus bargains. Ingenious scientific tools. Thousands of components: lenses, prisms, wedges, mirrors, mounts, accessories of all descriptions. Hundreds of instruments: lasers, comparators, magnifiers, microscopes, projectors, telescopes, binoculars, photo attachments, black light equipment and the largest selection of unique lighting items in the country.

ORDER DIRECT WITH ABSOLUTE CONFIDENCE
Edmund ships more than 5,000 orders monthly to the country's largest industrial. Every item completely guaranteed. You must be satisfied with any purchase or return it in 10 days for your money back. Shop the catalog of America's largest Science-Optics-Space Mart. Send for your free copy today. Absolutely no obligation. Request FREE catalog "EE".

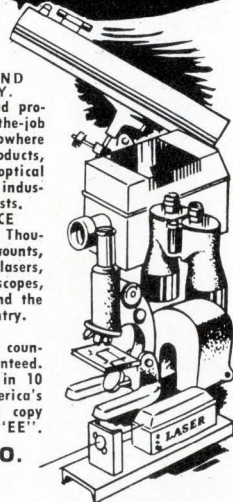

EDMUND SCIENTIFIC CO.
300 EDSCORP BLDG.
BARRINGTON, NEW JERSEY 08007

MAIL COUPON FOR GIANT FREE CATALOG!

EDMUND SCIENTIFIC CO.
300 Edscorp Building, Barrington, N. J. 08007
Please send Free Giant Catalog "EE"

NAME _____
COMPANY _____
ADDRESS _____
CITY _____ STATE _____ ZIP _____



**When the heat's on...
Varglas "500" performs!**

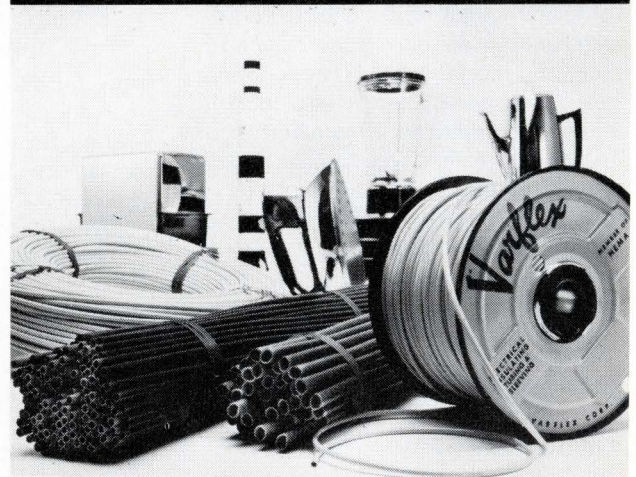

**The flexible silicone resin sleeving on spools,
in coils, in 36" lengths or shorter pieces.**

Varglas Silicone Resin "500" Sleeving is flexible in a range -70° to +500°F. Will not crack or check. Meets government spec. MIL-1-3190, (Class H, 200°C.) .010" I.D. to 3" I.D. available. Up to 7000 volts dielectric strength. Brilliant, non-fading colors. Radiation-resistant. Dependable, fast delivery.

Varglas "500" is one of many sleeveings by Vargflex. Call on our engineers for modification or development to meet new requirements.

Send for FREE Test Samples.

Vargflex
CORP.

506 W. Court St.
Rome, N.Y. 13440

THE
ELECTRONIC
ENGINEER

DISTRICT SALES MANAGERS

- EDWARD G. SHAUD**
BALA-CYNWYD, (Pa.) 19004
One Decker Square
(Area Code 215) SHERWOOD 8-2000
- JOSEPH DRUCKER**
BRYCE GRAY, JR.
NEW YORK 10017-100 East 42nd St.
(Area Code 212) OXFORD 7-3400
- JOHN W. BERNHARDT**
CHICAGO 60606-120 S. Riverside
Plaza
(Area Code 312) 782-1400
- G. T. ALFANO**
NEEDHAM HEIGHTS, MASS. 02194-
570 Hillside Ave.
(Area Code 617) 444-0010
- TERRENCE D. BUCKLEY**
THOMAS R. BORIS
LOS ANGELES 90005-3727 W.
Sixth St. # 202
(Area Code 213) DUNKIRK 7-1271
- RALPH PETERSEN**
LOS ALTOS (San Francisco) 94022
199 First St., Room 335
(Area Code 415) 941-6655
- RICHARD DUTE**
CLEVELAND 44114-601 Rockwell Ave.
(Area Code 216) SUPERIOR 1-2860
- NEWTON B. COLLINSON**
ATLANTA 30309-1776 Peachtree St.
N.W.
(Area Code 404) 872-4723
- HAROLD E. MOTT**
MICHAEL D. CORLEY
DALLAS 75206-Meadows Bldg.
Expressway at Milton
(Area Code 214) EMERSON 3-6426
- BRENT GILBERT**
Houston 77027
4151 Southwest Freeway
Suite 735
(Area Code 713) 621-7550

INTERNATIONAL BUSINESS OFFICES

- London, S. W. 1 Max F. Holsinger
67-68 Jermyn St., St. James's Dir. European Sales
TRA 6318-9 Roy V. C. Hall, A. Berg
Cables WHIP LONDON S.W. 1
- Manchester 22 D. I. Goulden
Haletop, Wythenshawe Civic Centre MERCURY 3293
- 4 Dusseldorf-Rath E. Hillerbrand, R. Schomburg,
Eitelstrasse 32 W. Heckelmann
Dusseldorf 632031
Cables WHIP DUSSELDORF
- Paris, 8e S. Brown-Joussard
70 Rue de Ponthieu ELY sees 65-77
Cables UIHP PARIS 16e
- Tokyo C. T. Sakaguchi
Room 814, Togin Bldg., Marunouchi Tel. 211-3506, 3509
CPO Box No. 1572 CLARENSAKA TOKYO
Cables

BUSINESS STAFF

- K. ROBERT BRINK**
Publisher
- JOHN E. JAENISCH**
Advertising Sales Manager
- DENNIS J. PERKINS**
Promotion Manager
- MARK R. WERTH**
Marketing Services Manager
- WARREN OWENS**
Director of Production
- B. A. TATUM**
Production Assistant
- WILLIAM M. COFFEY**
Circulation Director
- JAMES F. NAGY**
Circulation Manager
- JOSEPH P. BABCOCK**
Reader Service Manager
- JOHN H. KOFRON**
Chilton Research Services
- C. R. WILHIDE**
Washington Vice-President

Advertisers—December 1970

No liability is assumed for errors or omissions.
This index is published for a convenience.

AMERICAN RELAY 40 A.A.D. Advertising	LOCKHEED ELECTRONICS CO.26, 27 McCann-Erickson, Inc.
AMP, INC.38, 39 Aitkin-Kynett Co., Inc.	MILLER-STEPHENSON 25 Michel-Cather, Inc.
BUSSMAN MFG. DIV. 48 Henderson Adv. Co.	MOHAWK DATA SCIENCES CORP.46, 47 The Lampert Agency, Inc.
CIRCUIT-STIK, INC. 73 Haaga Adv.	MOTOROLA SEMICONDUCTOR PRODUCTS 41, 42 Lane & Wampler Adv., Inc.
C&K COMPONENTS, INC. 40 Van Christo Assoc., Inc.	PHILCO-FORD CORP. MICROELECTRONICS DIV.12, 13 Aitkin-Kynett Co., Inc.
EDMUND SCIENTIFIC CO. 72 Walter S. Chittick Co., Inc.	RCA CORP.14, Back Cover Al Paul Lefton Co., Inc.
ELECTRO-MOTIVE CO. 58 Culver Adv.	RCA CORP. 17-24 J. Walter Thompson Co.
ELEXON CORP. 35 Marketing Directions Inc.	SPRAGUE ELECTRIC CO. CAPACITOR DIV. 1 The Harry P. Bridge Co.
FAIRCHILD SEMICONDUCTOR36, 37 Carson/Roberts/Inc.	SWITCHCRAFT, INC. 16 Butfi-Roberts, Adv.
GENERAL ELECTRIC CO., CAPACITOR .. 28, 29 Robert S. Cragin, Inc.	TELEDYNE PHILBRICK NEXUS 11 Impact Advertising Inc.
GRIES REPRODUCER CO. 35 Harold Marshall Adv. Co., Inc.	TELEDYNE RELAYS 5 S. Michelson Adv.
HEWLETT-PACKARD, LOVELAND DIV. 15 Tallant/Yates Adv., Inc.	TELEDYNE SEMICONDUCTOR IFC Monda, Murray & Co.
HEWLETT-PACKARD2, IBC Lennen & Newell/Pacific	UNITRODE CORP.7, 9 Impact Adv. Inc.
KEPCO, INC. 4 Weiss Adv.	VARFLEX CORP. 72 Barlow/Johnson, Inc.

AN INSTANT CIRCUIT BOARD^(TM) SYSTEM!

CIRCUIT-STIK'S system of component sub-elements and materials produce circuit boards that are as durable and reliable as conventional printed circuit boards.

CIRCUIT-STIK ELIMINATES: design • drilling • art work • photo work • etching

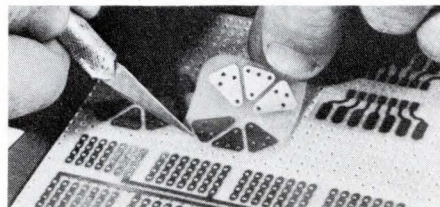

CIRCUIT-STIK sub-elements are pressure sensitive and offer exceptionally good adhesion strength, withstands soldering temperatures and yet may be removed for easy circuit design modifications.

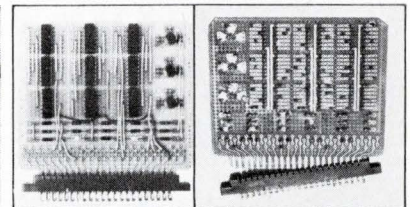

All types of circuit-element configurations may be mixed and combined on the same board.

• SEND FOR YOUR FREE CATALOG AND SAMPLES.

CIRCUIT-STIK'S EVALUATION KIT FOR LARGE SYSTEMS APPLICATIONS
PART #8951-M, \$110.00 VALUE FOR \$89.50 (Plus \$1.00 shipping per kit).

circuit-stik^{INC.}

1518 W. 132nd ST., GARDENA, CALIFORNIA 90249

U.S. PATENT 3,538,389
& other Patents Pending

ABSTRACTS

Published information is vital to your job. To save time in finding this information, we have abstracted the important technical features from eight electronic engineering publications. Should any of these articles interest you, contact the magazine. Reprints of articles with an asterisk are available free. Save this section for future reference.

Amplifiers

Audio noise: why settle for more? J. A. Roberts and N. A. Jolly, University College of Swansea, Great Britain. "Electronics," Vol. 43, No. 20, Sept. 28, 1970, pp. 82-83. Noise figures on small-signal bipolar transistors can be misleading to audio designers. Optimizing a transistor's collector current can yield a much better noise figure. And, this is easily calculated for amplifier design.

Circuits

The analog world of function modules. George Flynn, Senior associate editor. "Electronic Products," Vol. 13, No. 5, Oct. 1970, pp. 28-34. In days gone by, you bought components and circuits. Now you buy "functions" and build subsystems or systems. This article goes through some of the concepts and techniques used in today's function modules.

Components

***Optoelectronic course, Part 3B.** Jack Hickey, Managing Editor. "The Electronic Engineer," Vol. 29, No. 11, Nov. 1970. Continuing the theme of last month's installment, this portion of the optoelectronics course brings you applications for optoelectronic devices.

Integrated Circuits

Programmable digital filter performs multiple functions. A. T. Anderson, Electronic Communications Inc. "Electronics," Vol. 43, No. 22, Oct. 26, 1970, pp. 78-84. You can process signals with a programmable digital filter that cannot be duplicated easily in analog devices. And the digital components are available commercially at reasonable cost.

Coping with feedthrough in ECL integrated circuits. Fred U. Rosenberger, Computer Systems Lab., Washington Univ. "Electronics," Vol. 43, No. 22, Oct. 26, 1970, pp. 98-102. While ECL claims the fastest speed and greatest immunity to many noise sources, there is one problem: ECL is susceptible to feedthrough. By reading this article, you'll learn how to overcome this problem without too much difficulty.

Putting d-a converters to work: 10 examples show versatility. W. R. Spofford, Jr., Analog Devices Inc. "Electronics," Vol. 43, No. 22, Oct. 26, 1970, pp. 91-97. Computers are not the only products to benefit from digital signal processing. Many other possible uses exist, and this article details ten applications for D/A converters.

Miscellaneous

Electronics views the spectacular Japanese market. Staff report. "Electronics," Vol. 43, No. 19, Sept. 14, 1970, pp. 85-100. It is no secret that the Japanese electronic market is booming. This report analyzes the Japanese market and indicates some of the directions that it is taking.

***Hour of decision at the FCC.** John McNichol, Assistant Editor. "The Electronic Engineer," Vol. 29, No. 11, Nov. 1970. The ever-increasing rise of technology may create a serious problem at the FCC that may hamper this same technology's effectiveness. Among other things, the article discusses Chairman Dean Burch, CATV, domestic communications satellites, allocating spectrum space, and the background of the controversial specialized common carrier race.

***Where are the new jobs for EEs?** Deborah P. Wilkins, Editorial Assistant. "The Electronic Engineer," Vol. 29, No. 10, Oct. 1970, pp. 32-36. Three electronic engineers tell about their switch from aerospace to civilian applications and why they believe engineers are capable of making this adjustment. Although the aerospace layoffs have left many engineers without jobs, these men discuss several of the many new fields in which EEs can use their engineering background and experience.

***Pomeroy's complaint.** Roger D'Aprix, Contributing editor. "The Electronic Engineer," Vol. 29, No. 12, Dec. 1970, pp. 43-45. Once again, D'Aprix takes a light-hearted look at a not-so-light-hearted topic—the plight of the unemployed engineer. The author asks for a recognition by the individual engineer of the prime importance of his own long-range career goals. Having done that, the author further calls for a realistic assessment of the employer-employee relationship, particularly in industries where employment peaks and valleys are routine, and gives certain ground rules to aid the about-to-be or unemployed engineer.

Semiconductors

***A way of thinking about memories.** Steve Thompson, Western editor. "The Electronic Engineer," Vol. 29, No. 12, Dec. 1970, pp. 30-34. The author develops an entirely new approach to evaluating semiconductor memories. Two charts (bipolar and MOS) compare commercially available memories, both RAMs and ROMs.

Industry's verdict still a long way from unanimous. Laurence Altman and George F. Watson, editors for "Electronics," Vol. 43, No. 20, Sept. 28, 1970, pp. 74-76. The question still remains as to whether amorphous semiconductors will ever come out of the lab as practical devices. Here is a rundown of where this technology stands, giving the views of several companies.

Nonvolatile and reprogrammable, the read-mostly memory is here. R. G. Neale and D. L. Nelson, Energy Conversion Devices Inc., and Gordon Moore, Intel Corp. "Electronics," Vol. 43, No. 20, Sept. 28, 1970, pp. 56-60. Here is a new one for you—a "read-mostly" memory. It features the nonvolatility of the read-only memory plus the flexibility of the random access type. This new memory, still in development stages, can be programmed, read, and reprogrammed repeatedly. Once it is programmed it stays that way unless deliberately changed. The ICs combine amorphous and crystalline technologies.

Test and Measurement

***Measure impedance the easy way—use a vector voltmeter.** J. R. Heck, Westinghouse Defense and Space Ctr. "The Electronic Engineer," Vol. 29, No. 12, Dec. 1970, pp. 54-57. This article presents a shortcut method of measuring impedance and VSWR at high frequencies. The technique makes use of a HP 8405A vector voltmeter and a set of simple Smith charts.

Forum on programmable test equipment—Part 1. Creighton M. Marcott, Editor. "Electronic Products," Vol. 13, No. 5, Oct. 1970, pp. 22-27. More and more of the test equipment being sold today is programmable. One big problem, however, is that what manufacturer "A" means by programmability may not agree with what manufacturer "B" means. Here's the first of two parts of the discussion that took place when both test equipment and computer manufacturers sat down and discussed this immediate problem.



**These are the
solid-state displays
you'll be
hearing about.**

Starting now!

HP's new solid-state monolithic numeric indicators are ready for you right now. They give solid-state reliability and long operating life to your information display. Their small size (5 digits in 0.750 inch width), low power requirements (200 fL at 5mA per segment) and low cost (\$7.05/digit in 1 K quantities) open up many new applications in the display of numeric data.

All characters are brilliant, easy-to-use, 7-segment figures, available in a standard DIP or flat-pack package. And lead connections are truly minimal — only 13 connections for 5 characters.

For more information on these 5082-7200 series of displays as well as our other numerics, alphanumerics and LED's, call your local HP field engineer. Or write: Hewlett-Packard, Palo Alto, California 94304; Europe: 1217 Meyrin-Geneva, Switzerland.

HEWLETT  PACKARD

COMPONENTS

Circle Reader Service #33.

01012

Take advantage of RCA's ability to supply superior SCR's and Triacs... when you need them.

Ask our solid-state specialists why RCA's broad line of industrial SCR's and triacs excel in quality, reliability, and performance. They'll tell you that RCA thyristors are subjected to some of the toughest quality assurance tests in the industry. Thus, they save design dollars by virtue of superior performance in critical applications.

Ask users of industrial thyristors why RCA is a key supplier and they'll tell you RCA services the industry! Whatever the application—area lighting to avionics, regulators to inverters, or power supplies to modulators—RCA has SCR's and triacs to meet your application requirements.

Use these SCR's and triacs in your control applications:

SCR Family	Rating		Triac Family	Rating	
	$I_T(\text{RMS})$	V_{DROM}		$I_T(\text{RMS})$	V_{DROM}
40740	10 A	600 V	40795	10 A	600 V
40752	20 A	600 V	40797	15 A	600 V
2N690	25 A	600 V	40671	30 A	600 V
2N3899	35 A	600 V	2N5443	40 A	600 V

NOTE: SCR ratings of 100, 200, & 400 volts and triac ratings of 200 & 400 volts are available in each family. Stud packages & isolated-stud packages are also available in each rating.

For further details and your copy of the latest thyristor catalog, THC-500, see your local RCA Representative or your RCA Distributor. Or write RCA Electronic Components, Commercial Engineering Section 59L/UR6, Harrison, N.J. 07029. International: RCA, 2-4 rue du Lièvre, 1227 Geneva, Switzerland, or Post Office Box 112, Hong Kong.

RCA
Thyristors

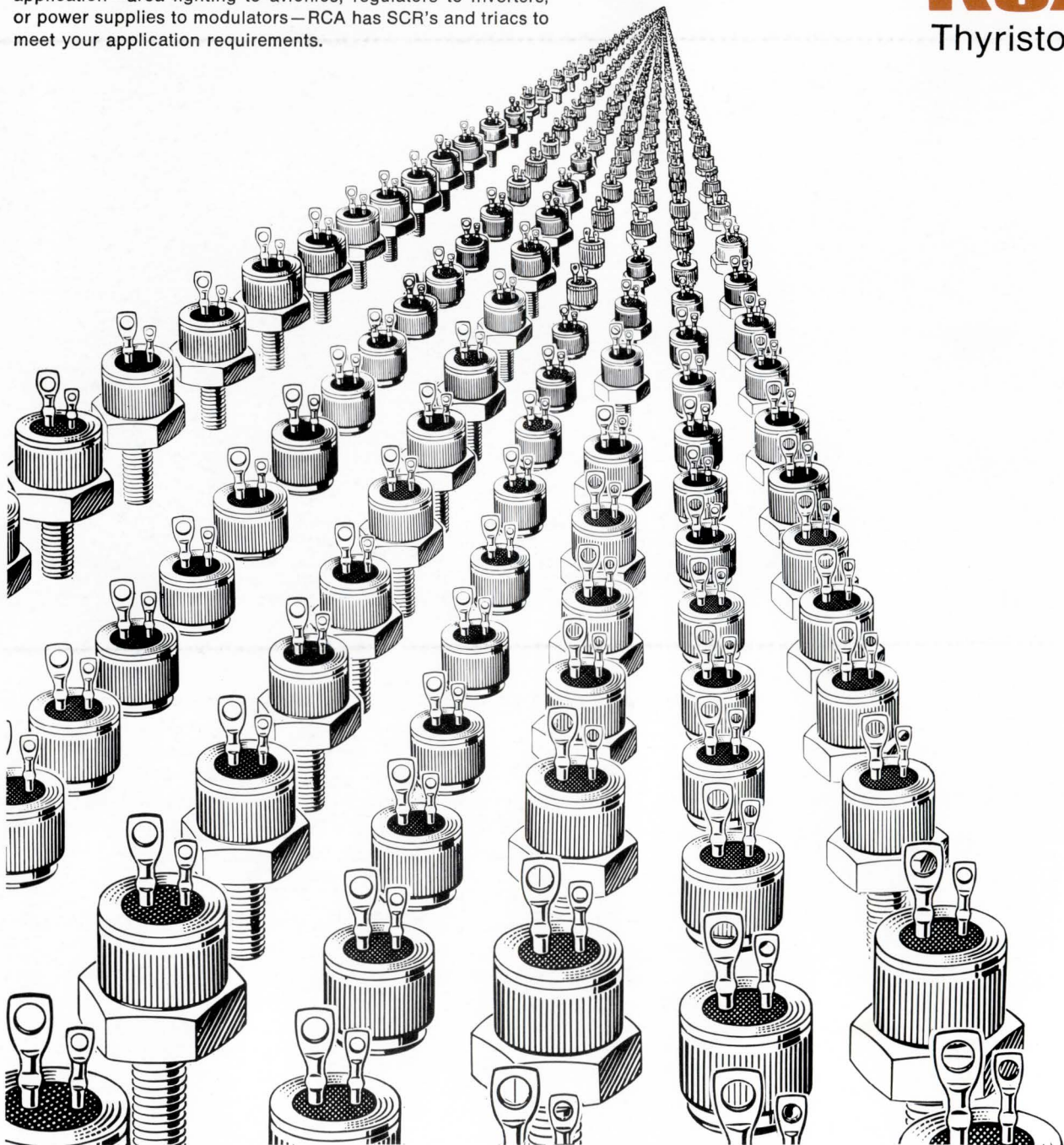

CHILTON'S **THE
ELECTRONIC
ENGINEER**

1970 ANNUAL EDITORIAL INDEX

JANUARY
FEBRUARY
MARCH
APRIL
MAY
JUNE
JULY
AUGUST
SEPTEMBER
OCTOBER
NOVEMBER
DECEMBER



THE
UNIVERSITY OF
CHICAGO

PHYSICS DEPARTMENT

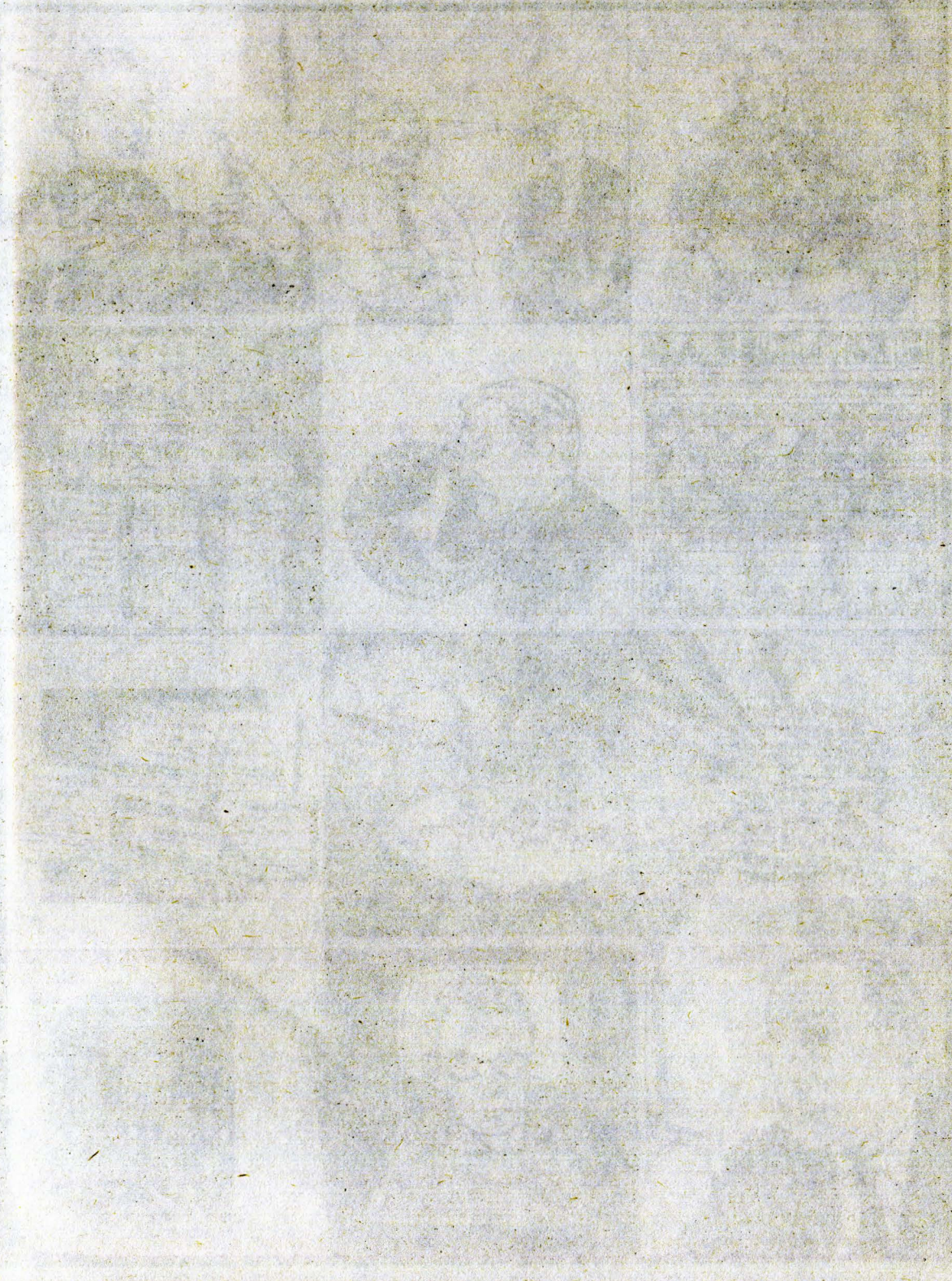

7

Issue index

January

Page

The electronic engineer of the Seventies	Alberto Socolovsky	9
A popular communications link is in danger	Alberto Socolovsky	9
Challenge: Planned parenthood for new electronic companies	John McNichol	36
All word generators are not women	Jerry Heyer	42
Commercially available word generators	Stephen A. Thompson	47
Four ways to get active....with filters	Harmon G. Washington	50
Sweep measurements cut costs	Walter White Jr.	57

IC ideas:

Voltage regulator has extended range, remote shutdown	Walter G. Jung	66	
Add-on network improves op-amp bandwidth and slew rate	Brent Welling	67	
Stable square wave generator	Arnold J. Steinman	67	
Low cost voltage regulator from one IC	Les Toth	68	
For a square-law transfer function, try this op amp connection . . .	Robert P. Hennick	68	
Regulated supply has two outputs	Don Purland	69	
Collector junction compensates current source in this differential .	amplifier	Walter G. Jung	69
Make a crystal-controlled clock with DTL gates . . .	Richard Juengel	70	
Threshold testing too tedious? Automate	R. K. Repass	70	
Bidirectional ripple counter counts up or down	Robert G. Burlingame	71	
Digital filter replaces bulky components . . .	Mario Humberto Acuna	71	
TTL memories get faster, smaller, and cheaper	Staff Report	77	
ISSCC - 1970	Staff Report	81	

February

MOS is ripe, but tender	Alberto Socolovsky	9
"Sandwich" has remote control possibilities	Staff Report	12
Getting Rich	John McNichol	30
Guide to integrated circuits		35
MOS integrated circuits: A six-part course	Arthur J. Boyle	55
The first MOS	Alberto Socolovsky	56
MOS course - Part 1, The basic structures	E. Marshall Wilder	58
Circuit design: The op amp way	C. J. Huber	67

IC ideas:

Single-pulse generator steps digital systems . . .	Jeffrey Lowenson	78
Switching-mode heater control	Dennis R. Morgan	78
Variable-modulus counter	Ron Kostenbauer	79
Digital gain control for op amps	William E. Peterson	79

February (cont'd)

Mil-Std-220A for filters needs updating	John E. Hickey, Jr.	84
Motorola antes up the chips	Staff Report	89
Function generators become more universal	Staff Report	92

March

Think and do	Alberto Socolovsky	9
A test fixture is worth a thousand words	Alberto Socolovsky	9
It's a show; it's a convention; it's IEEE time again!	Staff Report	24
Guide to thick film hybrid circuit design		35
Challenge: Is there an operation breakthrough for electronic engineers? . . .	John McNichol	46
MOS course - Part 2, The MOS circuits	Arthur J. Boyle	55
Doing logic with MOS	William Penney	56
MOS shift registers	George Landers	59
Four-phase logic	Lee L. Boysel, Cloyd E. Marvin, Joe Murphy, and Jim Sorenson	63
Computer-aided design	Frank Schenstrom and Robert Williams	70
Oscillators and function generators revisited	Staff Report	75

IC ideas:

Simple one-shot multivibrator	C. Musquetier	84
Gated latch retains GO/NO GO information	Aaron Mall and C. H. Doeller III	84
Feedback eliminates switch contact transients	Veikko Jaakola	85
Coincident pulse eliminator	John M. Irwin	85
Pulse system components reach 125-MHz rep rate	Staff Report	92

April

Electronic isolationism by default	Alberto Socolovsky	9
Copy is "spotted" with fiber optics	Staff Report	12
Electrical integration - a step closer to molecular electronics?	Staff Report	32
Is anybody out there?	John McNichol	42
Guide to dc power supply selection		53
MOS course - Part 3, Applications of MOS circuits	Arthur J. Boyle	61
Interfacing MOS and bipolar logic	Tom Reynolds	62
MOS arrays in a data terminal	Richard Perrin	67
MOS shift registers in arithmetic operations	Jack Irwin	71
Modern techniques of analog multiplication	Tom Cate	75
Variable frequency multivibrator has wide range	R. J. Surprenant	83

IC ideas:

Low frequency sine wave crystal oscillator	Richard S. Baggett	88
Op amp makes unique one-shot	Maxwell G. Strange	88
TTL compatible lamp driver	Hal Koester	90

IC ideas: (cont'd)

Zero input impedance preamp	Albert E. Hayes	90
One-shot triggers on both edges of input	Ken Erickson	92
Op amp phase shifter for 0 or 180°	Irwin Cohen	92
Low-frequency sweepers beat their way upstream	Staff Report	98
Latch on to phase-locked loops	Staff Report	102

May

The majority carriers need your help	Alberto Socolovsky	9
Challenge: You can't get there from here!	John McNichol	30
MOS course - Part 4, Complementary MOS	Arthur J. Boyle	51
Complementary MOS logic and applications	S. S. Eaton	52
Design shortcuts for microwave frequency dividers	Willie Joseph Goldwasser	61

IC ideas:

Binary number comparator	C. H. Hall, Jr.	68
Triflop - A three-state memory element	Anatole Turecki	68
Digital frequency doubling	David L. Sporre	70
How to select a time-sharing service	Alan G. Hammersmith	C-2
Available time-sharing services	Staff Report	C-5

June

No, Virginia, you are too big for Santa Claus	Alberto Socolovsky	9
Simple, three-layer structure can do IC functions	Staff Report	12
100,000-bit ROM is quick as a flash!	Staff Report	14
Three-pole active filter	Russell Kincaid	46
Printed circuits - make or buy?	Jack Froelich	51
Speed/power chart for digital ICs	Staff Report	58
MOS course - Part 5, Random access memories	Arthur J. Boyle	63
MOS random-access memories	Warren Crews	66
Static or dynamic - two ways to remember	Marcian E. Hoff, Jr.	72
Performance and cost trade-offs for MOS RAMs	Vernon G. McKenny	76
Frequency synthesizing with the phase locked loop	Ed Renschler and Brent Welling	84
Guide to nonlinear circuits		97

IC ideas:

Clock rate limit circuit	Stephen Faris	109
BCD to 9's complement converter	Ken Erickson	109
Noise-insensitive monostable multivibrators	E. G. Faris	110
Super-simple square-wave generator	Paul Franson	113
New keyboard simplifies electronics	Staff Report	115

July

No time for dropouts	Alberto Socolovsky	9
Memories are made of this--two diodes	Staff Report	10
Programmed to tell time	Staff Report	12
Challenge: Innovating for the 21st century	John McNichol	30
Optoelectronics course - Part 1, A new era for semiconductors	John C. Haenichen	40
Optoelectronics course - Part 1, The Basics	Lin C. Wetterau, Jr. and Dr. Robert L. Williams	43
Guide to optoelectronic devices		49
IC op amp selection charts	A. Boyle, L. Rothstein, and D. Wilkins	57
MOS course - Part 5B, Read-only memories	Arthur J. Boyle	63
Performance and convenience trade-offs for MOS read-only memories	Dr. Robert J. Proebsting	64

IC ideas:

Simple high duty cycle one-shot	Parviz Ghajar	72
Ct _{yl} buffer as a digital line driver/receiver	Raymond S. Lim	72
Ripple counter has fixed delay for any count	S. S. Golenski	75
Simple word gate circuit	W. K. Lenhardt	75
High-speed DVM reads true rms values	Staff Report	82

August

The jobs that were	Alberto Socolovsky	6
Is it a battery or a capacitor?	Stephen A. Thompson	12
WESTON - keeping with the times	Stephen A. Thompson	24
Optoelectronics course - Part 2A, Let the light shine out	Dr. Robert Haisty	29
Optoelectronics course - Part 2A, Emitter packaging and performance	Dr. Michael G. Coleman, Richard W. Gurtler and Arnold London	36
MOS course - Part 5C, Associative memories	Arthur J. Boyle	53
MOS associative memories	Leon D. Wald	54
Designing wideband amplifiers: Let the computer help	John A. Eisenberg	59

IC ideas:

Pulse rate filter	Quon S. Chow	65
Low frequency function generator	Barry Schwartz	65
Next pulse synchronizer	Don M. Evans	68
Digital AFSK discriminator	Arleigh B. Baker	68
All solid-state true rms arrives	Staff Report	70
Micropower op amp	Staff Report	72

September

Who speaks for EEs in times of crisis?	Alberto Socolovsky	7
Rate gyro is a vibrating thing	Staff Report	12
Challenge: The glory days are over at DoD	John McNichol	30
Connector and termination selection guide		37
MOS course - Part 5D, Memory costs	Arthur J. Boyle	49
Semiconductor memory systems - what will they cost?	Thomas W. Hart, Jr. and Donald D. Winstead	50
Testing integrated circuits	Sheldon Edelman	58
Optoelectronics course - Part 2B, Devices sense light	Lin Wetterau, Millis Miller, and Dr. Robert Haisty	71

IC ideas:

Minimum hardware decade counter	M. V. Pitke	84
Simple priority detector	Bill Wiley Smith	84
Sine wave oscillator has logic level output	Walter G. Jung	85
Poor packaging produces problems	Joseph DiCerto	91

October

A call for action	Alberto Socolovsky	6
Wire and cable reference chart		17
Where are the new jobs for EEs?	Deborah P. Wilkins	32
MOS course - Part 6, Testing MOS	Arthur J. Boyle	41
Testing complex MOS: the how and why	Ron Danklefs and Homer Thornton	42
Hybrid resistor trimming: an industry report	Stephen A. Thompson	48
Optoelectronics course - Part 3A, Application ideas	John E. Hickey, Jr.	59

IC ideas:

How to gain access to a synchronous device anytime	Don Femling	66
Simple square wave generator uses one IC	Henry D. Olson	66
CCO uses voltage regulator as a comparator	Sam Ben-Yaakov	67
Digital filters become commercial	Staff Report	68
Multi-octave rf amplifiers in TO-8 cans	Staff Report	71

November

Not to help is to hurt	Alberto Socolovsky	6
Hour of decision at the FCC	John McNichol	22
Data terminals: A special report	Staff Report	D1
Creative doodling made easy: CRT terminals	William H. Sass and Harold S. Ramussen	D3

November (cont'd)

Review of interactive CRT terminals	Editorial Staff Instruments and Control Systems	D9
---	--	----

IC ideas

Man-machine interface circuit	Alphonso H. Marsh, Jr.	52
Circuit performs up/down counting and shifting . . .	Ken Erickson	52
Versatile triangle wave generator	Adrian Moses	53
Oven temperature controller	S. W. Billingsley	53
What's your MOS IQ?	Arthur J. Boyle	83

December

Jobs, concern and leadership	Alberto Socolovsky	6
Guide to main frame memories chart		17
A way of thinking about memories	Stephen A. Thompson	30
Pomeroy's complaint	Roger D'Aprix	43
More application ideas	John E. Hickey, Jr.	49
Measure impedance the easy way--use a vector voltmeter . . .	J. R. Heck	54

IC ideas

A sure start square wave oscillator. .	Jack Cramer and Ed Matsumoto	60
A low cost microwave field strength meter.	J. Agnew	60
Convert BCD 8421 to self-complementing BCD 2421. . .	J. V. Sastry	61
Midvalue selector doubles as a precise voltage limiter	Adrian Moses	61

<u>Subject Index</u>	<u>Month & Page No.</u>
<u>Amplifiers</u>	
Circuit design: The op amp way	C. J. Huber 2-67
Designing wideband amplifiers: Let the computer help	John Eisenberg 8-59
Four ways to get active...with filters	Harmon G. Washington 1-50
IC op amp selection charts	A. Boyle, L. Rothstein, and D. Wilkins 7-57
Micropower op amp	Staff Report 8-72
Multi-octave rf amplifiers in TO-8 cans	Staff Report 10-71
<u>Careers</u>	
Getting rich	John McNichol 2-30
The glory days are over a DoD	John McNichol 9-31
The hour of decision at the FCC	John McNichol 11-22
Innovating for the 21st century	John McNichol 7-30
Is anybody out there?	John McNichol 4-42
Is there an operation breakthrough for electronic engineers	John McNichol 3-46
Planned parenthood for new electronic companies	John McNichol 1-36
Pomeroy's complaint	Roger D'aprix 12-43
Where are the new jobs for EE's?	Deborah Wilkins 10-32
You can't get there from here!	John McNichol 5-30
<u>Charts and nomographs</u>	
Connector and termination selection guide	9-37
Guide to dc power supply selection	4-53
Guide to integrated circuits	2-35
Guide to main frame memories chart	12-17
Guide to nonlinear circuits	6-97
Guide to optoelectronic devices	7-49
Guide to thick film hybrid circuit design	3-35
IC op amp selection chart	A. Boyle, L. Rothstein, and D. Wilkins 7-57
Speed/power chart for digital ICs	6-58
A way of thinking about memories	Stephen A. Thompson 12-30
Wire and cable reference chart	10-17
<u>Circuit design</u>	
Circuit design: The op amp way	C. J. Huber 2-67
Designing wideband amplifiers Let the computer help	John Eisenberg 8-59
Four ways to get active...with filters	Harmon G. Washington 1-50

Circuit design (cont'd)

Hybrid resistor trimming: An industry report	Stephen A. Thompson	10-48
IC op amp selection chart	A. Boyle, L. Rothstein, and D. Wilkins	7-57
Modern techniques of analog multiplication	Tom Cate	4-75
Three pole active filter	Russell Kincaid	6-46
Variable frequency multivibrator has wide range.	R. J. Surprenant	4-83

Circuit theory

Circuit design	C. J. Huber	2-67
Four ways to get active...with filters	Harmon G. Washington	1-50
Guide to nonlinear circuits		6-97
Measure impedance the easy way--use a vector voltmeter	J. R. Heck	12-54
Testing integrated circuits	Staff Report	9-58
Variable frequency multivibrator has wide range.	R. J. Surprenant	4-83

Communications

Copy is "spotted" with fiber optics	Staff Report	4-12
Digital filters become commercial	Staff Report	10-68
Frequency synthesizing with the phase locked loop	Ed Renschler and Brent Welling	6-84
Latch on to phase-locked loops	Staff Report	4-102
Sweep measurements cut costs	Walter White, Jr.	1-57

Computers

Complementary MOS logic and applications	S. S. Eaton	5-52
Modern techniques of analog multiplication	Tom Cate	4-75
A way of thinking about memories	Stephen A. Thompson	12-30

Computers and peripherals

Available time-sharing services	Staff Report	5-C5
Complementary MOS logic and applications	S. S. Eaton	5-52
Computer-aided design	Frank Schenstrom and Robert Williams	3-70
Creative doodling made easy: CRT terminals	William H. Sass and Harold S. Rasmussen	11-D3
Data terminals: A special report	Staff Report	11-D1
Doing logic with MOS	William Penney	3-56
The first MOS	Alberto Socolovsky	2-56
Four-phase logic	Lee L. Boysel, Cloyd E. Marvin, Joe Murphy, and Jim Sorenson	3-63

Computers and peripherals (cont'd)

Guide to main frame memories chart 12-17

How to select a time-sharing service Alan G. Hammersmith 5-C2

Interfacing MOS and bipolar logic Tom Reynolds 4-62

Memories are made of this--two diodes Staff Report 7-10

MOS arrays in a data terminal Richard Perrin 4-67

MOS associative memories Leon D. Wald 4-54

MOS course - Part 1, The basic structures E. Marshall Wilder 2-58

MOS integrated circuits: A six-part course Arthur J. Boyle 2-55

MOS random-access memories Warren Crews 6-66

MOS shift registers George Landers 3-59

MOS shift registers in arithmetic operations Jack Irwin 4-71

100,000-bit ROM is quick as a flash! Staff Report 6-14

Performance and convenience trade-offs for MOS read-only memories .
Dr. Robert J. Proebsting 7-64

Performance and cost trade-offs for MOS RAMs . . Vernon G. McKenney 6-76

Review of interactive CRT terminals Staff Report
Instrument and Control Systems 11-D9

Semiconductor memory systems--what will they cost?
Donald D. Winstead and Thomas Hart 9-50

Static or dynamic--two ways to remember Marcian E. Hoff 6-72

Testing complex MOS: The how and why
Ron Danklefs and Homer Thornton 10-42

Time sharing: A special report Staff Report 5-C1

TTL memories get faster, smaller, and cheaper Staff Report 1-77

What's your MOS IQ? Arthur J. Boyle 11-83

Data acquisition and processing

Available time-sharing services Staff Report 5-C5

Digital filters become commercial Staff Report 10-68

How to select a time-sharing service Alan G. Hammersmith 5-C2

Modern techniques of analog multiplication Tom Cate 4-75

New keyboard simplifies electronics Staff Report 6-115

Time sharing: A special report Staff Report 5-C1

Digital design

All word generators are not women Jerry Heyer 1-42

The basic structures E. Marshall Wilder 2-58

Commercially available word generators Stephen A. Thompson 1-47

Computer-aided design Frank Schenstrom and Robert Williams 3-70

Doing logic with MOS William Penney 3-56

Frequency synthesizing with the phase locked loop
Ed Renschler and Brent Welling 6-84

Four-phase logic Lee L. Boyssel, Cloyd E. Marvin,
Joe Murphy, and Jim Sorenson 3-63

Interfacing MOS and bipolar logic Tom Reynolds 4-62

MOS arrays in a data terminal Richard Perrin 4-67

MOS associative memories Leon D. Wald 8-54

MOS random-access memories Warren Crews 6-66

MOS shift registers George Landers 3-59

MOS shift registers in arithmetic operations	Jack Irwin	4-71
Performance and convenience trade-offs for MOS read-only memories	Dr. Robert J. Proebsting	7-64
Performance and cost trade-offs for MOS RAMs	Vernon G. McKenny	6-76
Semiconductor memory systems--What will they cost?	Thomas W. Hart, Jr. and Donald D. Winstead	9-50
Speed/power chart for digital ICs		6-58
Static or dynamic--two ways to remember	Marcian E. Hoff	6-72
Testing complex MOS: The how and why	Ron Danklefs and Homer Thornton	10-42
What's your MOS IQ?	Arthur J. Boyle	11-83

Instruments and measurements

All solid-state true rms arrives	Staff Report	8-70
All word generators are not women	Jerry Heyer	1-42
Commercially available word generators	Stephen A. Thompson	1-47
Digital filters become commercial	Staff Report	10-68
Function generators become more universal	Staff Report	2-92
High-speed DVM reads true rms values	Staff Report	7-82
Hybrid resistor trimming: An industry report	Stephen A. Thompson	10-48
Low-frequency sweepers beat their way upstream	Staff Report	4-98
Measure impedance the easy way--use a vector voltmeter	J. R. Heck	12-54
Oscillators and function generators revisited	Staff Report	3-75
Programmed to tell time	Staff Report	7-12
Sweep measurements cut costs	Walter White, Jr.	1-57
Testing integrated circuits	Staff Report	9-58

Integrated circuits

Circuit design: The op amp way	C. J. Huber	2-67
Complementary MOS logic and applications	S. S. Eaton	5-52
Computer-aided design	Frank Schenstrom and Robert Williams	3-70
Design shortcuts for microwave frequency dividers	Willie J. Goldwasser	5-61
Doing logic with MOS	William Penney	3-56
Electrical integration--step closer to molecular electronics?	Staff Report	4-32
Four ways to get active...with filters...	Harmon G. Washington	1-50
Four-phase logic	Lee Boysel, Cloyd Marvin, Joe Murphy and Jim Sorenson	3-63
Frequency synthesizing with the phase locked loop	Ed Renschler and Brent Welling	6-84
Guide to integrated circuits		2-35
Guide to thick film hybrid circuit design		3-35
IC op amp selection charts	A. Boyle, L. Rothstein, and D. Wilkins	7-57
Interfacing MOS and bipolar logic	Tom Reynolds	4-62
Latch on to phase-locked loops	Staff Report	4-102
Micropower op amp	Staff Report	8-72
MOS arrays in a data terminal	Richard Perrin	4-67
MOS associative memories	Leon D. Wald	8-54
MOS course - Part 1, The basic structures	E. Marshall Wilder	2-58
MOS random-access memories	Warren Crews	6-66
MOS shift registers	George Landers	3-59

MOS shift registers in arithmetic operations	Jack Irwin	4-71
Motorola antes up the chips	Staff Report	2-89
Multi-octave rf amplifiers in TO-8 cans	Staff Report	10-71
Performance and convenience trade-offs for MOS read-only memories	Dr. Robert J. Proebsting	7-64
Performance and cost trade-offs for MOS RAMs	Vernon G. McKenney	6-76
Programmed to tell time	Staff Report	7-12
Semiconductor memory systems--what will they cost?	Thomas W. Hart, Jr. and Donald D. Winstead	9-50
Simple, three-layer structure can do IC functions	Staff Report	6-12
Speed/power chart for digital ICs		6-58
Static or dynamic--two ways to remember	Marcian E. Hoff	6-72
Testing complex MOS: the how and why	Ron Danklefs and Homer Thornton	10-42
Testing integrated circuits	Staff Report	9-58
TTL memories get faster, smaller and cheaper	Staff Report	1-77
A way of thinking about memories	Stephen A. Thompson	12-30
What's your MOS IQ?	Arthut J. Boyle	11-83

Materials

Hybrid resistor trimming: An industry report	Stephen A. Thompson	10-48
Is it a battery or a capacitor?	Stephen A. Thompson	8-12
Printed circuits--make or buy?	Jack Froelich	6-51
Simple, three-layer structure can do IC functions	Staff Report	6-12

Microwaves and microwave products

Design shortcuts for microwave frequency dividers	Willie Joseph Goldwasser	5-61
Designing wideband amplifiers: let the computer help	John A. Eisenberg	8-59
Sweep measurements cut costs	Walter White, Jr.	1-57

Optoelectronic devices

Application ideas	John E. Hickey, Jr.	10-59
The basics	Lin C. Wetterau, Jr. and Dr. Robert L. Williams	7-43
Devices sense light	Lin Wetterau, Millis Miller, and Dr. Robert Haisty	9-71
Emitter packaging and performance	Michael Coleman, Richard W. Gurtler, and Anrold London	8-36
Let the light shine out	Dr. Robert Haisty	8-29
More application ideas	John E. Hickey, Jr.	12-49
A new era for semiconductors	John E. Haenichen	7-40

Oscillators

Function generators become more universal	Staff Report	2-92
Oscillators and function generators revisited	Staff Report	3-75
Pulse system components reach 125-MHz rep rate	Staff Report	3-92
Variable frequency multivibrator has wide range	R. J. Surprenant	4-83

Packaging

Hybrid resistor trimming: An industry report	Stephen A. Thompson	10-48
Motorola antes up the chips	Staff Report	2-89
Poor packaging produces problems	Joseph DiCerto	9-91
Printed circuits -- make or buy?	Jack Froelich	6-51

Passive components

Connector and termination selection guide		9-37
Hybrid resistor trimming: An industry report	Stephen A. Thompson	10-48
Is it a battery or a capacitor	Stephen A. Thompson	8-12
Mil-Std-200A for filters needs updating	John E. Hickey, Jr.	2-84
New keyboard simplifies electronics	Staff Report	6-115
Wire and cable reference chart		10-17

Semiconductors

Application ideas	John E. Hickey, Jr.	10-59
The basics	Lin C. Wetterau, Jr. and Dr. Robert L. Williams	7-43
Devices sense light	Lin Wetterau, Millis Miller, and Dr. Robert Haisty	9-71
Emitter packaging and performance	Michael Coleman, Richard W. Gurtler, and Arnold London	8-36
The first MOS	Alberto Socolovsky	2-56
IC op amp selection chart	A. Boyle, L. Rothstein, and D. Wilkins	7-57
Let the light shine out	Dr. Robert Haisty	8-29
Memories are made of this--two diodes	Staff Report	7-10
More application ideas	John E. Hickey, Jr.	12-49
A new era for semiconductors	John C. Haenichen	7-40
"Sandwich" has remote control possibilities	Staff Report	2-12
A way of thinking about memories	Stephen A. Thompson	12-30

Testing

All word generators are not women	Jerry Hayer	1-42
Commercially available word generators	Stephen A. Thompson	1-47

IC ideas

Add-on network improves op amp bandwidth and slew rate.	Brent Welling	1-67
BCD to 9's complement converter	Ken Erikson	6-109
Bidirectional ripple counter counts up or down	Robert G. Burlingame	1-71
Binary number comparator	C. H. Hall, Jr.	5-68
CCO uses voltage regulator as a comparator	Sam Ben-Yaakov	10-67
Circuit performs up/down counting and shifting	Ken Erikson	11-52
Clock rate limit circuit	Stephen Faris	6-109
Coincident pulse eliminator	John M. Irwin	3-85
Collector junction compensates current source in this differential amplifier	Walter G. Jung	1-69
Convert BCD 8421 to self-complementing BCD 2421	J. V. Sastry	12-61
CTul buffer as a digital line driver/receiver	Raymond S. Lim	7-72
Digital AFSK discriminator	Arleigh B. Baker	8-68
Digital filter replaces bulky components	Mario Humberto Acuna	1-71
Digital frequency doubling	David L. Sporre	5-70
Digital gain control for op amps	William E. Peterson	2-79
Dual bootstrapping improves amplifier performance	Basil T. Barber	5-73
Feedback eliminates switch contact transients	Veikko Jaakola	3-85
For a square-law transfer function, try this op amp connection	Robert P. Hennick	1-68
Gated latch retains GO/NOGO information	Aaron Mall and C. H. Doeller III	3-84
How to gain access to a synchronous device anytime	Don Fleming	10-66
A low cost microwave field strength meter	J. Agnew	12-60
Low cost voltage regulator from one IC	Les Toth	1-68
Low frequency function generator	Barry Schwartz	8-65
Low frequency sine wave crystal oscillator	Richard S. Baggett	4-88
Make a crystal-controlled clock with DTL gates	Richard Juengel	1-70
Man-machine interface circuit	Alphonso H. Marsh, Jr.	11-52
Midvalue selector doubles as a precise voltage limiter	Adrian Moses	12-61
Minimum hardware decade counter	M. V. Pitke	9-84
Next pulse synchronizer	Don M. Evans	8-68
Noise-insensitive monostable multivibrators	E. G. Faris	6-110
One-shot trigger on both edges of input	Ken Erikson	4-92
Op amp makes unique one-shot	Maxwell G. Strange	4-88
Op amp phase shifter for 0 or 180°	Irwin Cohen	4-92
Oven temperature controller	S. W. Billingsley	11-53
Pulse rate filter	Quon S. Chow	8-65
Regulated supply has two outputs	Don Purland	1-69
Ripple counter has fixed delay for any count	S. S. Golenski	7-75
Simple high duty cycle one-shot	Parviz Ghajar	7-72
Simple one-shot multivibrator	C. Musquetier	3-84
Simple priority detector	Bill Wiley Smith	9-84
Simple square wave generator uses one IC	Henry D. Olson	10-66
Simple word gate circuit	W. K. Lenhardt	7-75
Sine wave oscillator has logic level output	Walter G. Jung	9-85
Single-pulse generator steps digital systems	Jeffrey Lowenson	2-78
Stable squarewave generator	Arnold J. Steinman	1-67
Super-simple square-wave generator	Paul Franson	6-113
A sure start square wave oscillator	Jack Cramer and Ed Matsumoto	12-60
Switching-mode heater control	Dennis R. Morgan	2-78
Threshold testing too tedious? Automate	R. K. Repass	1-70
Triflop - A three-state memory element	Anatole Turecki	5-68
TTL compatible lamp driver	Hal Koester	4-90

IC ideas (cont'd)

Variable-modulus counter	Ron Kostenbauer	2-79
Versatile triangle wave generator	Adrian Moses	11-53
voltage regulator has extended range, remote shutdown. .	Walter G. Jung	1-66
Zero input impedance preamp	Albert E. Hayes	4-90