

# GLM 4 System Operating Manual

## Genelec Loudspeaker Manager GLM



**GENELEC®**  
the sonic reference

## Table of Contents

1	Introduction.....	5
2	Glossary .....	6
3	System Components.....	8
3.1	SAM Monitors .....	8
3.2	SAM Subwoofers .....	8
3.3	Adaptive Woofer System .....	8
3.4	Genelec Network Adapter.....	8
3.5	Genelec Loudspeaker Manager Software .....	8
4	Getting Started.....	9
4.1	Placing SAM monitors and subwoofers in the monitoring room.....	9
4.2	Cabling for Audio Signals.....	10
4.2.1	Analog Stereo.....	10
4.2.2	Analog Stereo - Woofer System.....	11
4.2.3	Analog Stereo with a Subwoofer.....	12
4.2.4	Analog 5.1 Surround.....	12
4.2.5	Digital Audio, Stereo with a Subwoofer .....	14
4.2.6	Digital Stereo – Adaptive Woofer System .....	14
4.2.7	Adaptive Woofer System in a multichannel setup .....	15
4.2.8	Digital Audio 5.1 with a 7300 Series Subwoofer with 9301.....	16
4.2.9	Digital Audio 5.1 with 7200 Series Subwoofer.....	17
4.2.10	Digital Audio, Stereo with a SE7261 Subwoofer.....	19
4.2.11	Digital Audio 5.1 with a SE7261 Subwoofer .....	20
4.3	Cabling of the GLM Management network.....	23
4.4	Downloading and Installing GLM Software.....	24
4.5	Downloading and Installing the local AutoCal calibration .....	24
4.5.1	Updating the ‘Mic Serial’ microphone calibration data.....	25
4.5.2	Selecting the Local GLM AutoCal processing .....	26
4.6	Selecting the GLM theme and language .....	26
5	Creating a System Layout and Calibrating a System .....	27
5.1	Creating a SAM Monitor Layout.....	27
5.2	Creating a SAM Monitor Group.....	30
5.3	Automatic Calibration Using GLM AutoCal.....	31
5.4	Aligning Subwoofer Phase with GLM AutoPhase.....	33
5.5	Automatic Calibration of the Adaptive Woofer System GLM WooferCal.....	34
6	Basic Use of GLM.....	38
6.1	Selecting monitoring situations using Group Preset Buttons .....	39
6.2	System Level Control.....	39
6.3	System level indications.....	40
6.4	System Mute and Dim.....	40
6.5	Standardized Level Presets .....	40
6.6	Calibrated Level Selection .....	40

6.7	By-passing bass management.....	41
6.8	Calibrated/Not Calibrated button.....	41
6.9	Solo/mute/info/edit drop-down selection.....	41
6.10	GLM Adapter icon.....	41
6.11	'Play All' button.....	41
6.12	Status and setup name indications.....	42
6.13	Keyboard short-cuts.....	42
7	Advanced Use of GLM.....	43
7.1	Importing GLM 3 Setups.....	43
7.2	Calibration of SPL to Loudness Standards.....	44
7.3	Maximum Number of Group Presets.....	47
7.4	Creating a New System Setup File.....	48
7.5	Solo and Mute Pop-Up Window Controls.....	48
7.6	'Bass Man' Button.....	48
7.7	Menu Commands.....	48
7.8	Cloud Account Login.....	51
7.9	Standalone Startup Level.....	52
7.10	Displaying monitor and subwoofer data in GLM.....	52
7.11	Access to Monitor and Subwoofer Acoustic Settings.....	53
7.12	Rerunning AutoCal Automatic Calibration.....	53
7.13	Rerunning AutoPhase Automatic Phase Calibration.....	53
7.14	Group Settings, Advanced Use.....	54
7.14.1	Access to Group Preset Settings.....	55
7.14.2	Group Name.....	55
7.14.3	System Delay.....	55
7.14.4	Bass Management.....	56
7.14.5	Input Mode.....	56
7.14.6	Monitor Settings.....	56
7.14.6.1	Monitor name.....	57
7.14.6.2	Group Status.....	57
7.14.6.3	Analog Input.....	57
7.14.6.4	Digital Input.....	57
7.14.6.5	Bass Management.....	58
7.14.6.6	LFE Channel.....	58
7.15	Advanced use of AutoCal.....	58
7.15.1	MultiPoint calibration.....	59
7.15.2	Reviewing the AutoCal result.....	60
7.16	Advanced use of AutoPhase.....	60
7.16.1	Acoustical reasons for selecting the crossover frequency.....	60
7.16.2	The steps to run AutoPhase.....	61
8	Editing Acoustic Calibrations.....	62
8.1	Acoustic Editors.....	62

8.2	Descriptions of the Acoustical Settings .....	63
8.2.1	Level and time-of-flight correction Controls in Monitors and Subwoofer .....	64
8.2.2	Room Response Equalizer Controls .....	64
8.2.3	Acoustic editor and scoring system for woofer systems .....	65
8.3	Sound Character Profiler .....	68
9	Stand-Alone Operation .....	69
9.1	Storing values permanently in monitors and subwoofers .....	69
9.2	Using a USB power supply .....	71
9.3	Level Control with GLM Cabled Volume Controller .....	71
9.4	Connecting the GLM Volume Controller.....	71
9.5	Wireless Volume Controllers.....	72
10	Additional Information.....	73
10.1	GLM display indications summary.....	73
10.2	Monitor and subwoofer LED light indications summary .....	75
10.3	Griffin Powermate USB Controller.....	75
10.4	Level-Aligning Subwoofers Reproducing the Same Signal.....	77
11	Frequently Asked Questions .....	79
11.1	Why do ID tones vary in different system configurations? .....	79
11.2	How to duplicate a Group?.....	79
11.3	How to compare a calibrated and uncalibrated SAM system?.....	80
11.4	How to calibrate SAM systems for different listening positions? .....	80
11.5	Can analog and digital signal sources be mixed? .....	80
11.6	How to switch between analog and digital signal? .....	80
11.7	What does ISS mean? .....	81
11.8	Can I power up and shut down the SAM system with GLM? .....	81
11.9	Why are my monitors not going to ISS state? .....	81
11.10	What is the “Not used in this setup” bin in the Layout page? .....	82
11.11	How I replace a monitor with a new one? .....	82
11.12	How I edit the System Layout? .....	82
11.13	Can I use 73xx subwoofers with non-SAM monitors? .....	82
11.14	Can I use SAM monitors in 3D Immersive Audio Systems?.....	84

# 1 Introduction

Congratulations and thank-you for purchasing Genelec Smart Active Monitoring (SAM™) systems. This manual describes the setup, calibration and use of the SAM monitoring system with GLM Genelec Loudspeaker Manager software.

Take a moment to familiarize yourself with the contents of this manual. While the use of the SAM products and GLM software is intuitive, there are many possibilities and options, and we give suggestions in this manual for different types of installations and application scenarios.

We are also ready to help you at any time. GLM software provides the link to Genelec, in the case you have specific questions, or you need support. For support, first contact your local dealer. Genelec sales network is well trained to help and support you. You can also contact Genelec directly at [support@genelec.com](mailto:support@genelec.com)

Happy monitoring!

## 2 Glossary

Abbreviation or term	Explanation
12xx (xx is two numbers)	Family of three-way SAM main monitors.
72xx	Family of digital audio input SAM subwoofers.
73xx	Family of analog and digital audio input SAM subwoofers.
82xx	Family of two-way and three-way SAM monitors.
83xx	Family of two-way and three-way SAM monitors with extended room compensation capability.
9301	Multichannel AES/EBU Interface device for 73xx subwoofers. This device creates up to 8 channels of AES/EBU input for the 73xx subwoofers.
Adapter (8300-416)	Genelec Network Adapter.  GLM Adapter is a device interfacing the GLM Network to a computer USB port. GLM Adapter acts also as a stand-alone volume control master and Genelec measurement microphone interface.
Analog IN	XLR analog line input.
Analog OUT	XLR analog line output.
AutoCal	Genelec automatic room response calibration method.
AutoPhase	Genelec automatic phase calibration method.
Digital IN	AES/EBU digital audio input on XLR.
Digital OUT	AES/EBU digital audio output on XLR.
GLM	Genelec Loudspeaker Manager.  Software described by this manual, for setup, automatic system calibration and management of a Genelec SAM monitoring system.
GLM Network	Genelec's proprietary monitoring system management network, enabling automatic system setup, calibration, and control.
Layout grid	A hexagonal grid, on the GLM user interface, where monitor and subwoofer icons are placed; creates automatically friendly names and, with digital audio selected, assigns digital audio subframe settings automatically.
Group	Collection of monitors and subwoofers playing at one time; each group has its own settings, including the GLM AutoCal calibration.
Layout	Graphically presents a number of monitors/subwoofers on the GLM network, typically assigned such that it describes their physical locations.
SAM	Smart Active Monitoring technology by Genelec.
SE7261	Genelec SAM subwoofer that acts as a centralized processing unit also for 8130 digital input monitors (non-SAM monitors by Genelec).

Abbreviation or term	Explanation
Stack	Software window displaying the collection of icons for the yet unassigned monitors. All monitors are initially in this stack. They are moved during the layout creation onto the Layout Grid.
W371	Adaptive Woofer System, used with The Ones three-way coaxial monitors.
WooferCal	Genelec automatic room response calibration method for the Adaptive Woofer System.

## 3 System Components

### 3.1 SAM Monitors

Smart Active Monitors (SAM) are supported on Genelec's GLM management network. Genelec has an extensive selection of SAM monitors, ranging from compact two-ways to large three-way main monitors.

### 3.2 SAM Subwoofers

Smart active subwoofers are supported on Genelec's GLM management network. Genelec has a wide selection of subwoofers supporting multichannel analog inputs and multichannel digital audio inputs, for all monitoring applications.

### 3.3 Adaptive Woofer System

The W371 Adaptive Woofer System is fully supported on Genelec's GLM management network. The adaptive woofer system supports analog and digital audio inputs and offers neutral bass response also in acoustically challenging loudspeaker placements, for example for free-standing placement.

### 3.4 Genelec Network Adapter

Genelec GLM Network Adapter (8300-416) connects SAM monitor systems to a USB interface in a computer, operates as the audio interface for the measurement microphone, and as the master for the stand-alone volume control function.

### 3.5 Genelec Loudspeaker Manager Software

Genelec Loudspeaker Manager (GLM) software enables monitoring system setup, automatic acoustic calibration, and continuous management of all monitors and subwoofer in the control room.

Download the GLM software at Genelec website, at [www.genelec.com/glm](http://www.genelec.com/glm).

For more details on the monitors and subwoofers, their installations and setting up the system, see the section [Getting Started](#).

**NOTE:** GLM software installation packages are updated regularly to include the latest improvements in the calibration technology. To make sure that you have the newest methods and measurement microphone correction data in use, use the **Genelec Cloud** based AutoCal (preferable method) or, after you have received GLM Kit and after installing the GLM software, download and install the **Local AutoCal Package** software. For more information, visit the Genelec web site.



## 4 Getting Started

To take full advantage of your Smart Active Monitoring (SAM) system it is important to become familiar with all the components in the system.

To set up a monitoring system you will need monitors and subwoofers, audio signal cables, GLM management network cables, GLM network adapter, GLM measurement microphone, and GLM 4 software.

To set up a Genelec SAM system,

- **check DIP switch controls of the SAM subwoofers and monitors. The ‘Stored’ switch, if available, should be ON when to use the stored settings in the standalone use – the stored settings come to force when the devices are re-powered up while the ‘Stored’ DIP is set to the right position**
- place SAM subwoofers and monitors in the monitoring room
- run audio cables to the SAM subwoofers and monitors
- run GLM network cables from the GLM adapter to all SAM subwoofers and monitors
- download and install the GLM 4 software, [www.genelec.com/glm](http://www.genelec.com/glm)
- create a system setup using the GLM 4 software

### 4.1 Placing SAM monitors and subwoofers in the monitoring room

Try to place monitors and subwoofers in optimum locations in relation to surfaces reflecting audio. Aim each SAM monitor towards the listening position. This becomes your System Layout.

1. Select the listening position so that distances from side walls (B) are equal.
2. Place monitors so that distances to the listening position are equal, and distances to the monitors are equal from side walls (A).
3. Place a subwoofer at the front wall and a slightly left or right from the room centre axis.
4. Aim monitors towards the listening position.

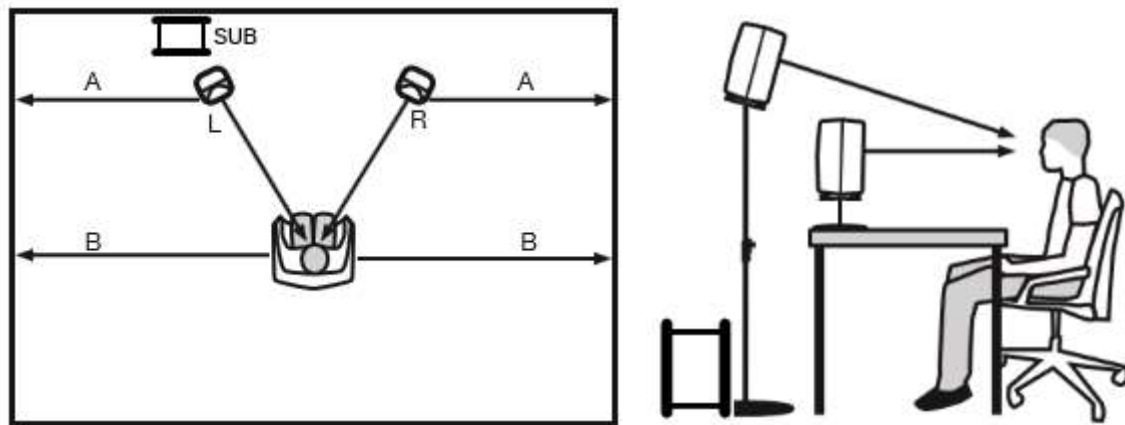

Figure 1. Place monitors symmetrically relative to the walls. Point the acoustical axes towards the listening position.

## 4.2 Cabling for Audio Signals

Run all audio cables from the audio source to the monitors. When a subwoofer is used, run the same signal to the monitor and the subwoofer. We recommend running the signal to the subwoofer first. The subwoofer has output connectors to facilitate onward connection to the monitors.

Bass management means using a subwoofer to reproduce low frequencies for any or all of the audio channels. Audio channels for monitors that are not bass managed can be run directly to the monitors. They do not need to run to the subwoofer.

When you need both analog and digital audio cabling, it is possible to populate both analog and digital inputs and outputs on SAM monitors and subwoofers. GLM allows the Group configuration to select either the analog or digital audio. Note that the 8320 monitor features an analog input only.

The most common audio cabling are introduced next.

### 4.2.1 Analog Stereo

Before cabling, turn off the power in all monitors.

- connect audio cables from the audio source to the monitor ANALOG IN

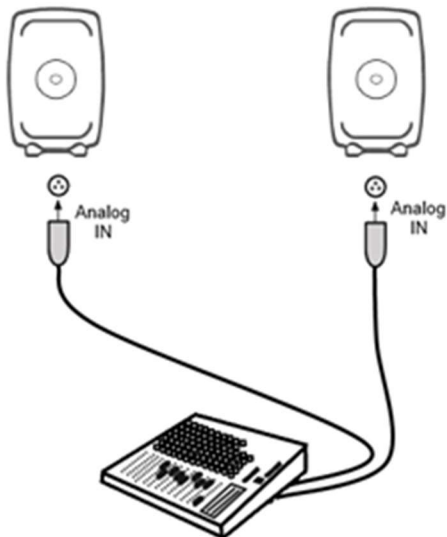

Figure 2. Analog stereo cabling.

#### 4.2.2 Analog Stereo - Woofer System

Before cabling, turn off the power in all monitors.

- connect a cable from the source (left channel) to the left woofer system ANALOG IN.
- connect a cable from the left woofer system ANALOG THRU to the left monitor ANALOG IN.
- connect a cable from the source (right channel) to the right woofer system ANALOG IN.
- connect a cable from the right woofer system ANALOG THRU to the right monitor ANALOG IN

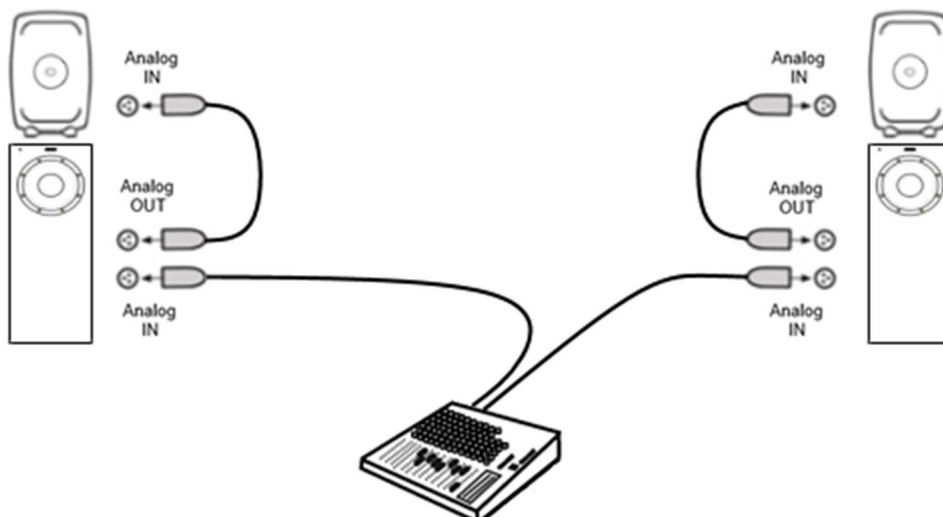

Figure 3. Analog stereo woofer system cabling.

### 4.2.3 Analog Stereo with a Subwoofer

Before cabling, turn off the power in all monitors and subwoofers.

- connect (Left) audio cable from the source to the subwoofer connector ANALOG IN 1.
- connect a cable from subwoofer ANALOG OUT 1 to left monitor ANALOG IN.
- connect (Right) audio cable from audio source to subwoofer ANALOG IN 2.
- connect (Right) audio cable from Subwoofer ANALOG OUT 2 to right monitor ANALOG IN

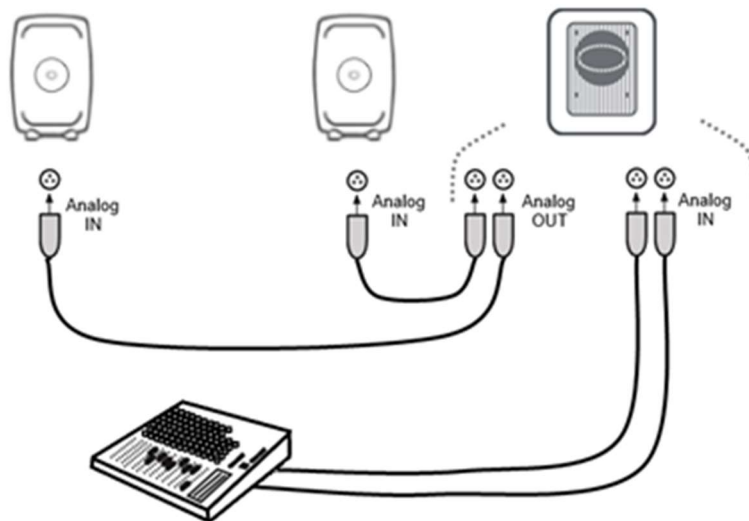

Figure 4. Analog stereo cabling with a subwoofer

### 4.2.4 Analog 5.1 Surround

Before cabling, turn off the power in all monitors and subwoofers.

- connect an audio cable from the audio source to the subwoofer ANALOG IN 1
- continue from the subwoofer ANALOG OUT 1 to the monitor ANALOG IN
- continue connecting all remaining audio input cables to the subwoofer inputs ANALOG IN 2 through to ANALOG IN 5, and from the respective analog outputs to the relevant monitors
- finally, connect the LFE channel from the audio source to the subwoofer LFE IN

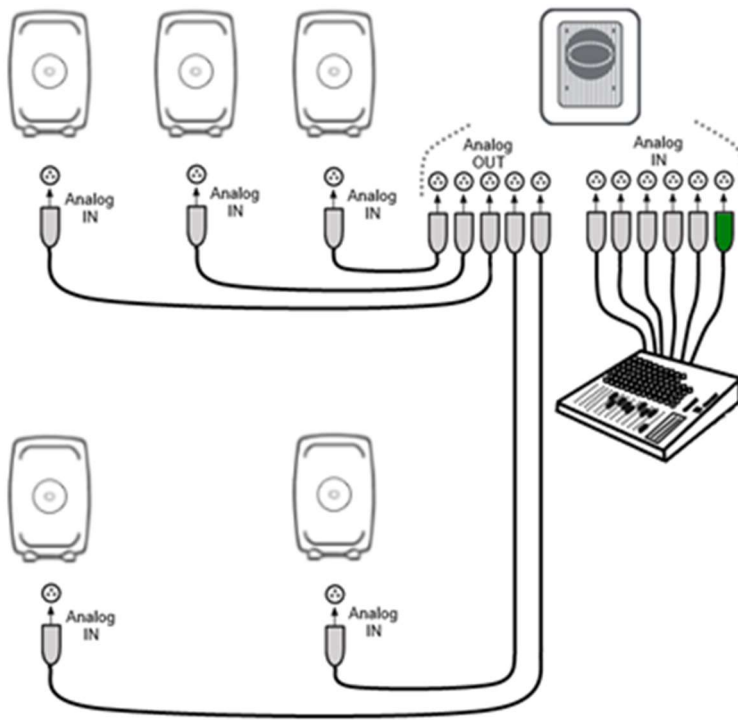

Figure 5. An example of analog 5.1 system cabling

#### 4.2.5 Digital Audio, Stereo with a Subwoofer

Before cabling, turn off the power in all monitors and subwoofers. An example of the audio cabling for AES/EBU digital audio is shown in Figure 6.

Connect the following XLR digital audio cables:

- from the AES/EBU output of the audio source to the subwoofer DIGITAL IN input connector
- from the subwoofer DIGITAL OUT to the right monitor DIGITAL IN
- from the right monitor DIGITAL OUT to left monitor DIGITAL IN

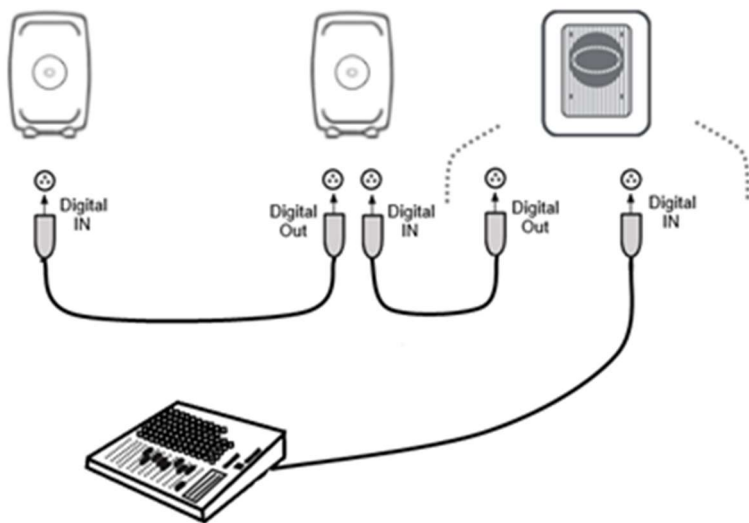

Figure 6. An example of an AES/EBU digital audio stereo cabling

#### 4.2.6 Digital Stereo – Adaptive Woofer System

Before cabling, turn off the power in all monitors.

- from the AES/EBU output of the audio source to the left woofer system DIGITAL IN input connector
- from the left woofer system DIGITAL THRU to the left monitor DIGITAL IN
- from the left monitor DIGITAL THRU to the right woofer system DIGITAL IN
- from the right woofer system DIGITAL THRU to the right monitor DIGITAL IN

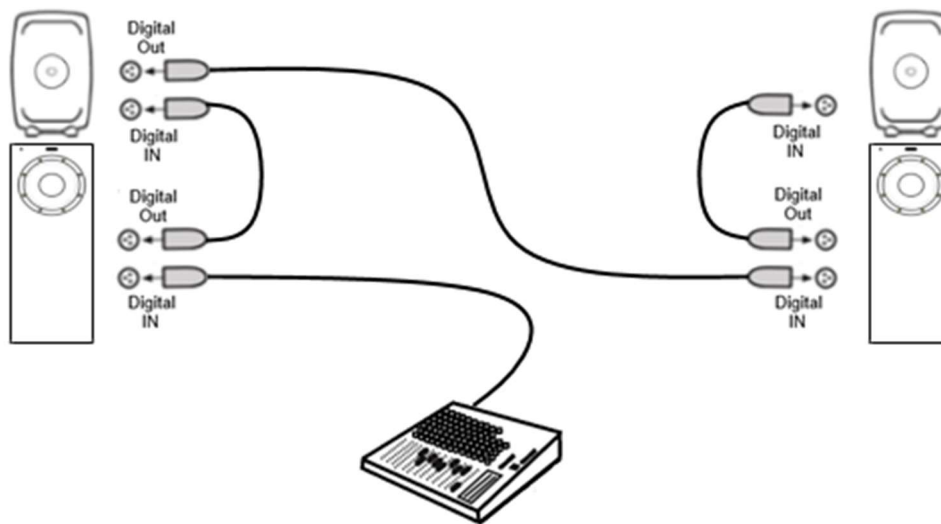

Figure 7. Digital stereo adaptive woofer system cabling.

#### 4.2.7 Adaptive Woofer System in a multichannel setup

The adaptive woofer system can be used in any multichannel setup, but there are some considerations. The adaptive woofer system only is intended to be used with one main monitor, only.

Connect signals to an additional subwoofer(s) to utilize bass management and to reproduction the LFE channel.

The full calibration of the adaptive woofer system is in three steps:

1. Run **AutoCal** for all the main monitors and subwoofer(s)– the woofer systems will not reproduce any sound in this 1st procedure.
2. Run **AutoPhase** for the subwoofer(s) against a selected monitor – this monitor is not a monitor connected to an adaptive woofer system. Typically, a subwoofer is phase aligned with the Center channel monitor. When a second subwoofer is used for the overhead (top-layer) monitors, this subwoofer is paired with one of the overhead monitors.
3. The adaptive woofer system calibration **WooferCal** is done last. To calibrate, pair the adaptive woofer system to a monitor, select the calibration mode and set the crossover frequencies, and then click the 'Start Calibration' button to start calibration.

#### 4.2.8 *Digital Audio 5.1 with a 7300 Series Subwoofer with 9301*

Before cabling, turn off the power in all monitors and subwoofers. 7300 series subwoofers have one (stereo) input for AES/EBU digital audio, and 9301 Multichannel AES/EBU Interface is needed to expand the connectivity for AES/EBU to the subwoofer. An example of the audio cabling for AES/EBU digital audio is shown in Figure 8. An example of an AES/EBU digital audio surround cabling with 7300 series subwoofer and 9301.

Connect the following XLR digital audio cables:

Left/Right channel pair

- from the AES/EBU output of the audio source to the 9301's 'AES IN 1' connector
- from the 9301's 'AES OUT 1' to the right monitor 'DIGITAL IN'
- from the right monitor 'DIGITAL OUT' to left monitor 'DIGITAL IN'

Surround Left/Right channel pair

- from the AES/EBU output of the audio source to the 9301's 'AES IN 2' connector
- from the 9301's 'AES OUT 2' to the surround right monitor 'DIGITAL IN'
- from the surround right monitor 'DIGITAL OUT' to surround left monitor 'DIGITAL IN'

Center/LFE channel pair

- from the AES/EBU output of the audio source to the 9301's 'AES IN 4' connector
- from the 9301's 'AES OUT 4' to the center monitor 'DIGITAL IN'

Sum signal

- from the 9301's 'SUBWOOFER LINK' output to the 7300 series subwoofer 'DIGITAL IN' connector

**NOTE: The AES/EBU digital input mode in the 73xx subwoofer must be set in 'Used with 9301' mode in the Group page. See Digital Input chapter for more details.**



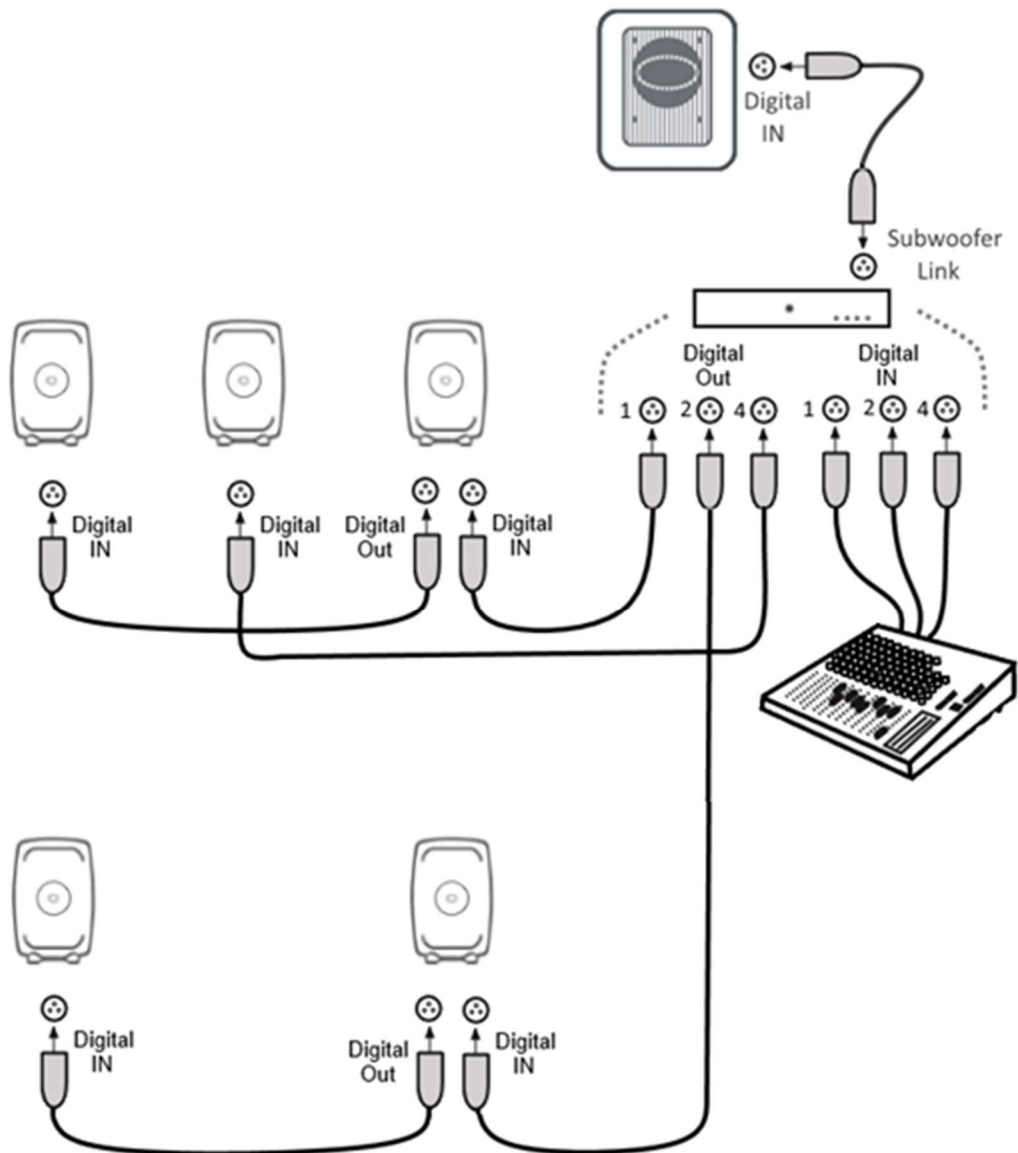

Figure 8. An example of an AES/EBU digital audio surround cabling with 7300 series subwoofer and 9301.

#### 4.2.9 Digital Audio 5.1 with 7200 Series Subwoofer

Before cabling, turn off the power in all monitors and subwoofers. An example of the audio cabling for AES/EBU digital audio is shown in Figure 9. Any cable carrying the LFE channel can only be connected to the subwoofer input 4.

Connect the following XLR digital audio cables:

Left/Right channel pair

- from the AES/EBU output of the audio source to the subwoofer 'DIGITAL INPUT1' connector
- from the subwoofer 'DIGITAL OUTPUT1' to the right monitor 'DIGITAL IN'

- from the right monitor 'DIGITAL OUT' to left monitor 'DIGITAL IN'

#### Surround Left/Right channel pair

- from the AES/EBU output of the audio source to the subwoofer 'DIGITAL INPUT 2' connector
- from the subwoofer 'DIGITAL OUTPUT 2' to the surround right monitor 'DIGITAL IN'
- from the surround right monitor 'DIGITAL OUT' to surround left monitor 'DIGITAL IN'

#### Center/LFE channel pair

- from the AES/EBU output of the audio source to the subwoofer 'DIGITAL INPUT 4' connector
- from the subwoofer 'DIGITAL OUTPUT 4' to the center monitor 'DIGITAL IN'

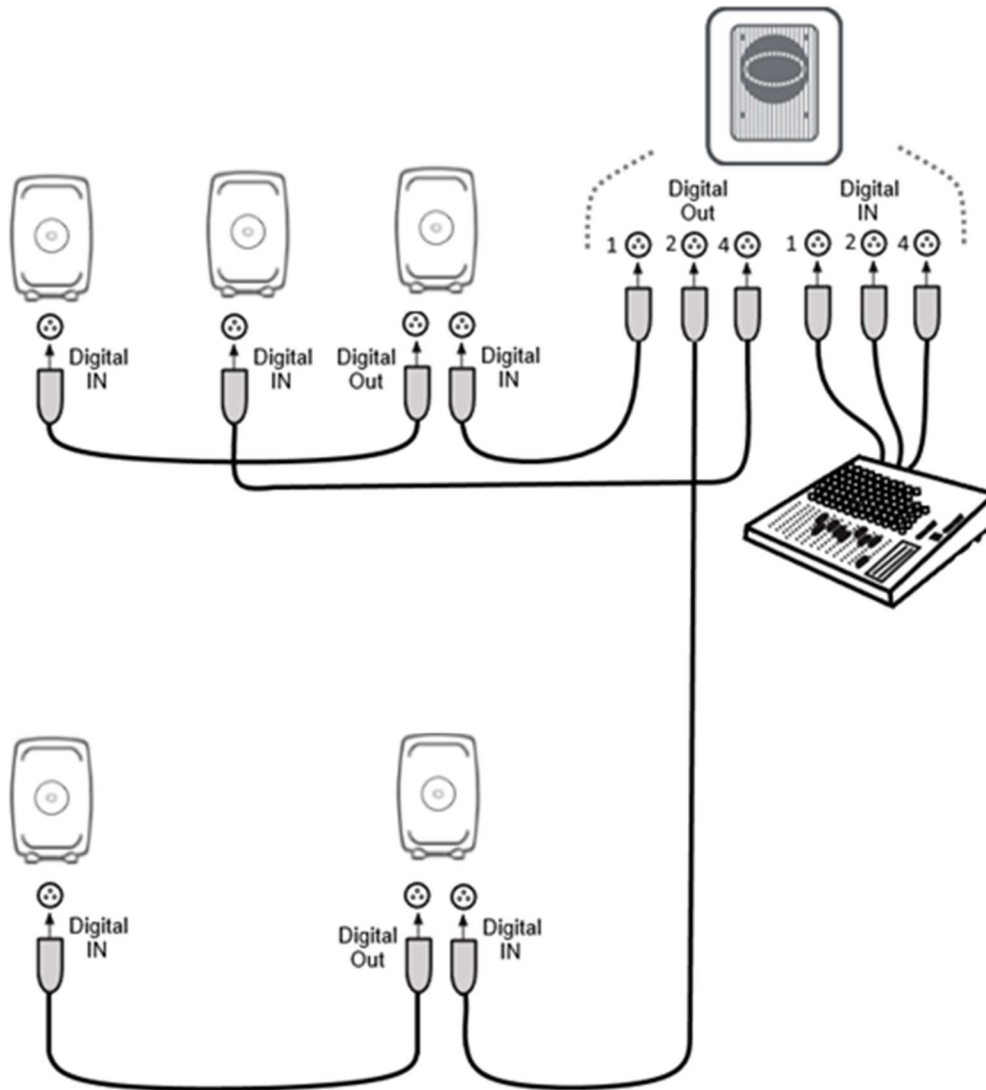

Figure 9. An example of an AES/EBU digital audio surround cabling with 7200 Series subwoofer

#### 4.2.10 Digital Audio, Stereo with a SE7261 Subwoofer

Before cabling, turn off the power in all monitors and subwoofers. An example of the audio cabling for AES/EBU digital audio is shown in Figure 10. Note that the AES/EBU digital audio channels reproduced have to be selected on each monitor. The figure below also shows the dip switches position for the required A or B channel selection.

Connect the following XLR digital audio cables:

- from the AES/EBU output of the audio source to the subwoofer 'DIGITAL INPUT 1' input connector
- from the subwoofer 'DIGITAL OUTPUT' to the right monitor 'DIGITAL IN'
- from the right monitor 'DIGITAL OUT' to left monitor 'DIGITAL IN'

Select the following digital audio channels for the monitor:

- on the left monitor turn ON digital audio channel A
- on the right monitor turn ON digital audio channel B

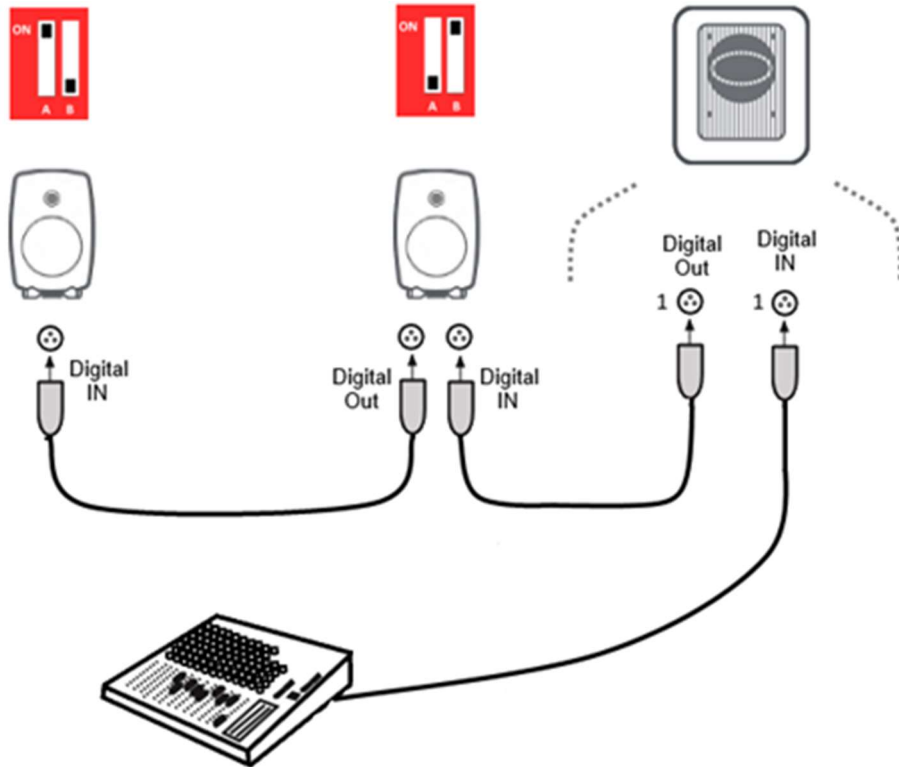

Figure 10. An example of an AES/EBU digital audio stereo cabling with SE7261 and digital channel selections for each monitor.

#### 4.2.11 Digital Audio 5.1 with a SE7261 Subwoofer

Before cabling, turn off the power in all monitors and subwoofers. An example of the audio cabling for AES/EBU digital audio is shown in Figure 11.

Connect the following XLR digital audio cables:

Left/Right channel pair

- from the AES/EBU output of the audio source to the subwoofer 'DIGITAL INPUT1' connector
- from the subwoofer 'DIGITAL OUTPUT1' to the right monitor 'DIGITAL IN'
- from the right monitor 'DIGITAL OUT' to left monitor 'DIGITAL IN'

Surround Left/Right channel pair

- from the AES/EBU output of the audio source to the subwoofer 'DIGITAL INPUT2' connector
- from the subwoofer 'DIGITAL OUTPUT2' to the surround right monitor 'DIGITAL IN'
- from the surround right monitor 'DIGITAL OUT' to surround left monitor 'DIGITAL IN'

#### Center/LFE channel pair

- from the AES/EBU output of the audio source to the subwoofer 'DIGITAL INPUT4' connector
- from the subwoofer 'DIGITAL OUTPUT4' to the center monitor 'DIGITAL IN'

#### Select the following digital audio channels for the monitor

- on the left monitor turn ON digital audio channel A
- on the right monitor turn ON digital audio channel B
- on the surround left monitor turn ON digital audio channel A
- on the surround right monitor turn ON digital audio channel B
- on the center monitor turn ON digital audio channel A

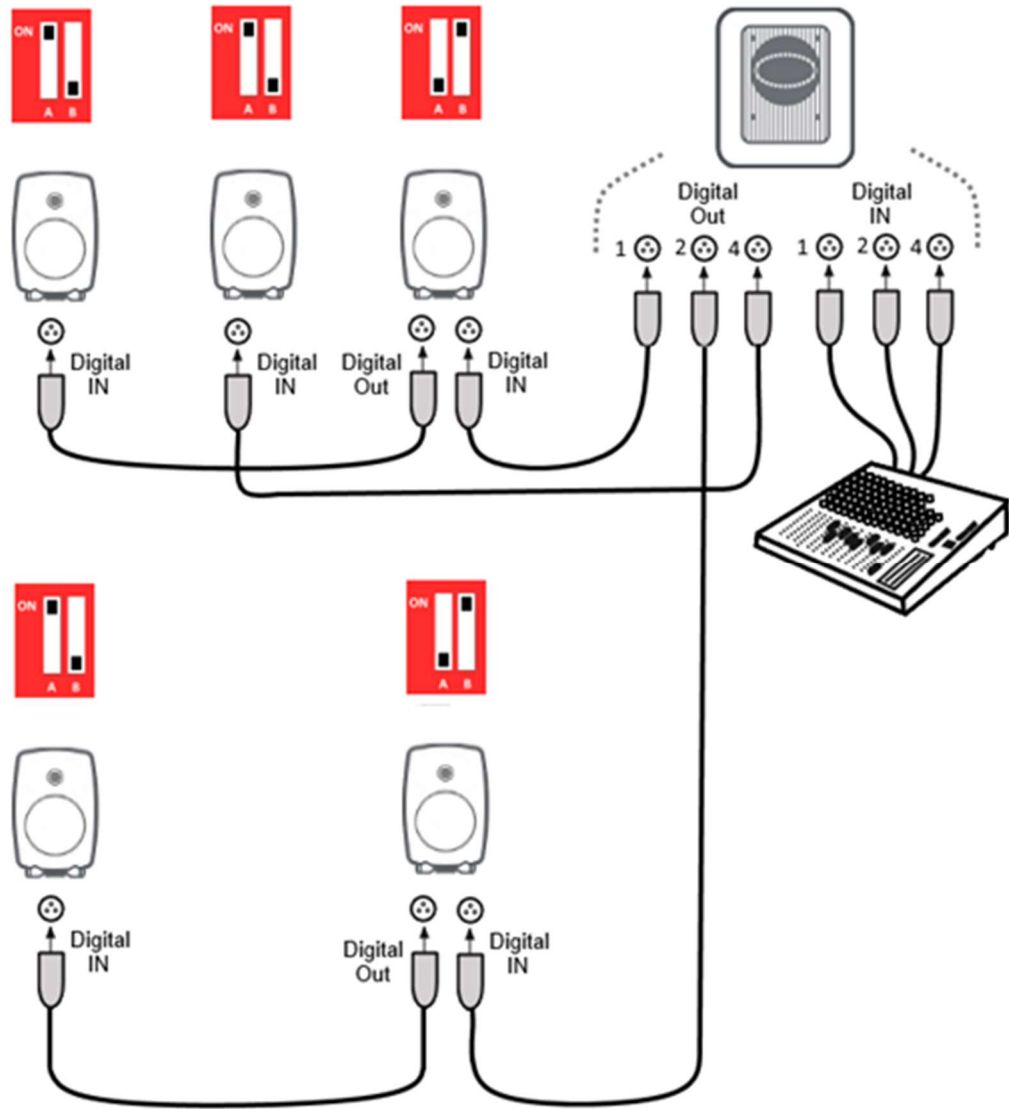

Figure 11. An example of an AES/EBU digital audio surround cabling with SE7261 and digital channel selections for each monitor.

### 4.3 Cabling of the GLM Management network

The GLM management network cabling is very easy. Connect the GLM adapter (8300-416) to the computer USB port using the supplied USB cable, avoid using an USB -hub if possible. Connect the GLM adapter to all SAM monitors and subwoofers in daisy-chain fashion (Figure 12) using the network cables supplied with each monitor and subwoofer. You can connect in any order. Just be sure to connect all monitors and subwoofers.

Table 1. Connections on the GLM adapter (from left to right)

Connector	Use
USB (type B)	Connects the GLM adapter to a computer USB interface or USB power supply (stand-alone volume control)
Volume (3.5 mm jack)	Connection for Genelec volume controller
Microphone (3.5 mm jack)	Connection for Genelec calibration microphone
GLM Net (RJ45)	GLM management network connection
Terminator (RJ45)	Return termination for the GLM management network from the last monitor, in case of network cabling being greater than 100 meters.

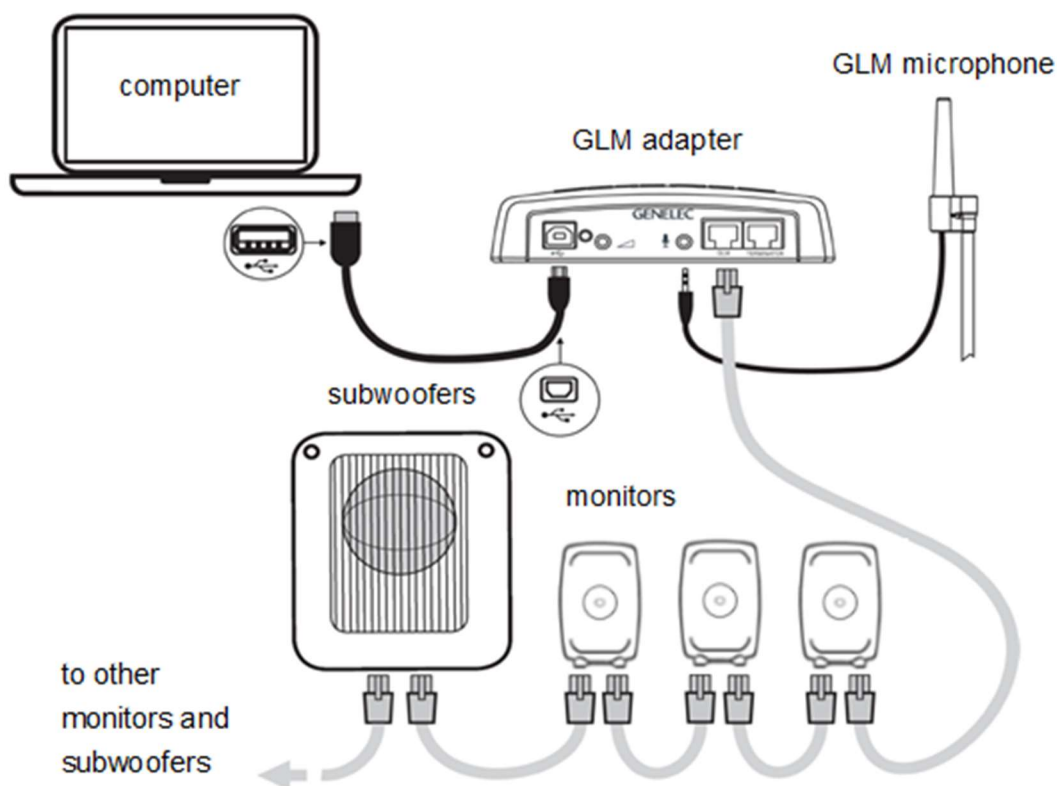

Figure 12. Connections of GLM management network, measurement microphone, and computer

## 4.4 Downloading and Installing GLM Software

The GLM software calibrates and controls Genelec SAM systems. The software can be downloaded at [www.genelec.com/glm](http://www.genelec.com/glm).

Look for 'GLM 4 install package'.

In order to download, you will be asked to give your email address and some contact information. This is very useful as it enables Genelec to support you later. It is not possible to download the package without a valid email address. You will receive a download link into your personal email.

You must have sufficient rights to install the software in your computer. Install the software following the instruction given by the software during the installation process. We recommend you install the software on the local hard drive. There is no need to make any special destination folders, GLM creates these automatically.



Figure 13. GLM software download

GLM requires an Internet connection. The Internet connection is used for the GLM AutoCal calculations in the Genelec Cloud. GLM AutoCal has been continually improving since its introduction 2006 and using the Genelec Cloud service ensures you have always access to the newest, most up-to-date algorithms and tools for calibrating your audio reproduction system.

Genelec Cloud is the default set in the GLM software, Genelec recommends using the Genelec Cloud for AutoCal as this offers the most accurate calibration.

## 4.5 Downloading and Installing the local AutoCal calibration

If you are running a computer that never has an Internet connection, it is possible to install a local calculation needed for GLM AutoCal system calibration. This should be avoided if possible as the local calibration does not develop and improve automatically as does the standard Genelec Cloud based GLM AutoCal calibration.

GLM must installed before installing the local AutoCal. The local AutoCal package does not work without GLM.



The GLM software calibrates and controls Genelec SAM systems. The software can be downloaded at [www.genelec.com/glm](http://www.genelec.com/glm). Look for the 'GLM local AutoCal install package'.

In order to download, you will be asked to give your email address and some contact information. This is very useful as it enables Genelec to support you later. It is not possible to download the package without a valid email address. You will receive a download link into your personal email.

You must have sufficient rights to install the software in your computer. Install the software following the instruction given by the software during the installation process. We recommend you install the software on the local hard drive. There is no need to make any special destination folders, GLM creates these automatically.

Install the package using the defaults in the installation package. Do not modify the install directory as this will prevent correct operation.

#### **4.5.1 Updating the 'Mic Serial' microphone calibration data**

The Local AutoCal needs a microphone calibration file for the most accurate calibration result. In order to obtain the microphone calibration file for your microphone, take the following steps

- enter the microphone serial number in the 'Mic Serial' field – normally this is automatically correct as this has been factory-stored inside the GLM Adapter
- ensure that the 'Local AutoCal' mode is selected
- ensure that the computer is connected to the Internet for the next step
- run AutoCal once by clicking on the 'Start Calibration' – for this have at least one SAM monitor and the GLM measurement microphone connected to the GLM Adapter

This step accesses the microphone calibration in your computer. After having done this, you can continue running Local AutoCal without an Internet connection.

If your computer cannot be connected to the Internet even temporarily, please contact Genelec customer service (<https://support.genelec.com/hc/en-us/requests/new>) and ask for your GLM measurement microphone calibration file for the Local installation of GLM. We will email the file to you. Replace the field <your\_username> with your actual user name.

Copy the microphone calibration file into this folder in the Mac OS computer:

/Users/<your\_username>/Documents/Genelec/GLM4/DSP/Microphone

Copy the microphone calibration file into this folder in the Windows computer:

C:\Users\<your\_username>\Documents\Genelec\GLM4\DSP\Microphones

After this you can run the Local AutoCal calibration without having a connection to the Internet.

Please note that when you are running the Local AutoCal there is no way for Genelec to offer you updates to the software you are running, including the Local AutoCal calculation algorithms.

### **4.5.2 *Selecting the Local GLM AutoCal processing***

When you enter the AutoCal calibration, look for the 'Local AutoCal' selection. Once the local AutoCal Package has been installed, this option can be selected. Only select this option if the computer cannot ever be connected to the Internet, even temporarily.

Once the Local AutoCal has been selected, continue creating the Layout normally.

## **4.6 Selecting the GLM theme and language**

GLM offers a light theme and a dark theme. This is selected on the top menu item 'Settings'.

GLM offers multiple GUI language options. This is selected on the top menu item 'Settings'. These include at the time of writing

- English (default)
- Chinese
- Finnish
- German
- Japanese
- Korean
- Spanish

## 5 Creating a System Layout and Calibrating a System

Before launching the GLM software after installation, stop or mute the audio source, ensure that all monitors and subwoofers are connected to the GLM network and are powered on.

The steps to create a GLM System Setup with a system layout and calibration are

1. create a SAM monitoring system layout
2. define SAM monitoring group
3. run GLM AutoCal automatic calibration
4. run GLM AutoPhase automatic phase calibration for subwoofers (AutoPhase is only available when a subwoofer is included in a group)
5. run GLM WooferCal automatic calibration for woofer system (WooferCal is only available when an adaptive woofer system is included in a group)

For additional groups, repeat steps 2 - 5.

### 5.1 Creating a SAM Monitor Layout

To create a layout all monitors, subwoofers and woofer systems must be powered and GLM network connections be made.

A layout defines your monitors and their locations in the room. An example in Figure 14 shows a stereo system with a subwoofer.

A new system layout is created when the GLM user interface starts the first time. You can always create a new layout by selecting the 'File | New' menu item.

When the creating a new layout, initially all monitors, subwoofers and woofer systems are stacked in the '**UnPlaced**' cell, on the left side of the page.

Select the large enough layout grid to place all your monitors. Use the '**Layout Style**' to change and select a placement template. If you do not find a template suiting your system, select a grid size that has place for all monitors, subwoofers and woofer systems.

The '**Reset Layout**' button clears the layout grid and sends all the monitors and subwoofers back to the 'UnPlaced' cell. This allows you to do the placement again from the start.

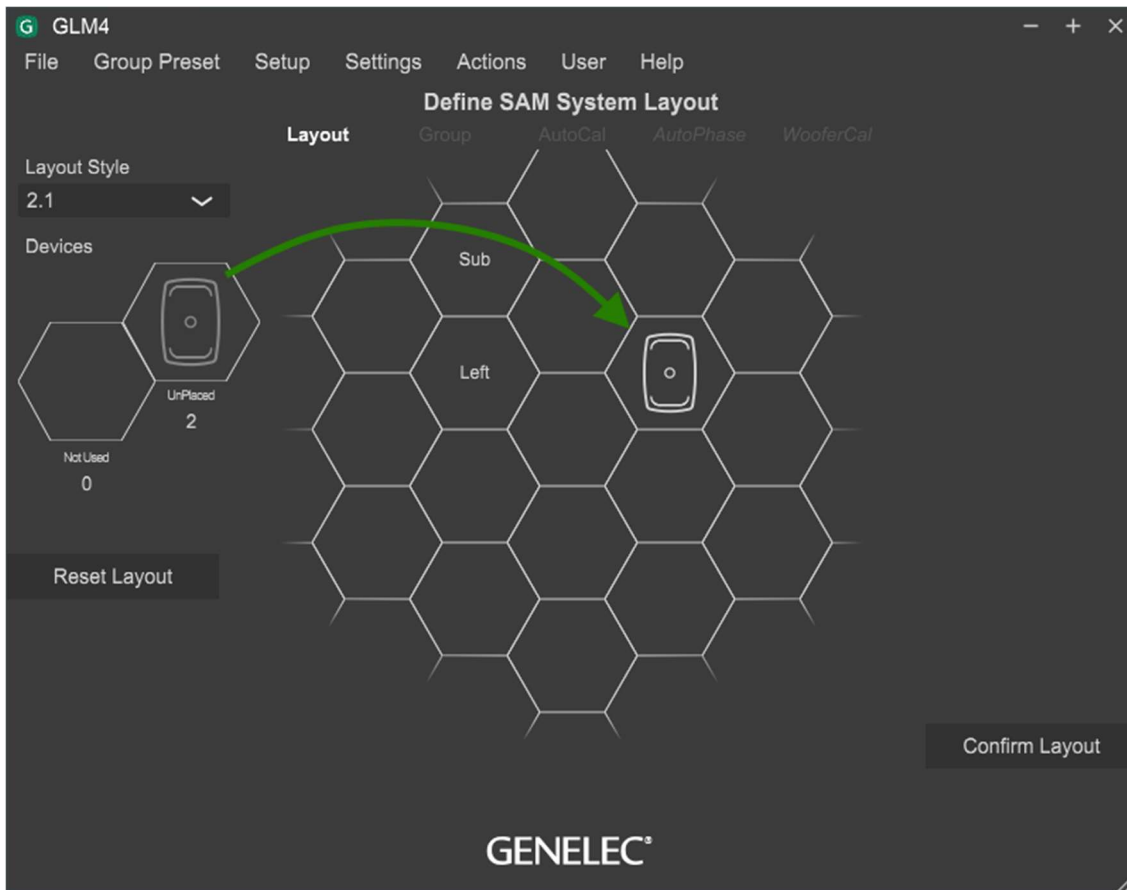

Figure 14. Drag and drop the monitor icons onto the layout grid to build a system layout

To place, drag a monitor or subwoofer icon from the stack to the layout grid on the right and drop it to the position that matches its position in the room. If you know that a certain monitor or subwoofer is not intended to be a part of the current layout, drag and drop this monitor or subwoofer to the **'NotUsed'** cell.

Continue dragging and dropping until the **'UnPlaced'** cell is empty.

**Note:** monitors and subwoofers are automatically named when you place them, by the location information. For example, when the monitor is dropped on the left side, it is named as 'Left 8330A'. If a monitor has AES/EBU digital input it will also be assigned the default AES/EBU subframe to be reproduced in the digital group, e.g. when the monitor is dropped to the left side, it is assigned to subframe A.

When you place monitors at symmetrical positions in the grid, the acoustic calibration is done assuming acoustical symmetry. For example, Left/Right monitor pairs will receive equal room compensations filter designs when Left and Right monitors are placed symmetrically to the grid (see Figure 15) and checking the 'Each front Left-Right pair shares the same equalizer settings' box in the acoustic calibration page.

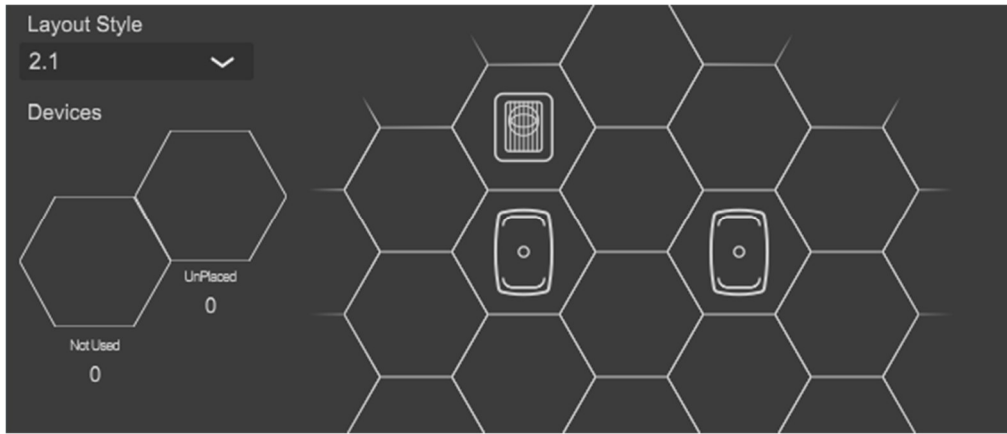

Figure 15. An example of completed placement showing an empty 'UnPlaced' monitor stack

When dragging the icon with the mouse, the monitor loudspeaker will play an identification tone and flash its front panel LED. This identification tones depend on the SAM product type and the tones can vary between products in the same setup.

After all monitors and subwoofer have been moved to the layout, click on the 'Confirm Layout' to continue. The additional cell 'Not Used' can be used for placing those monitors or subwoofers that are not used in the setup.

For example, an SE7261 subwoofer can support up to 8 x 8130 monitors. The system setup for SE7381 starts with eight SE channels on the Stack. They are labeled 1A, 1B all the way through 4B. However, if your SE system only has two actual channels being used, for example in input/outputs 1 for stereo (1A and 1 B), you would take the remaining six (2A thru 4B) off the 'UnPlaced' cell stack and place them into the 'Not Used' cell bin.

Any SAM monitor that you place into the 'Not Used' cell bin (Figure 16) is not a part of the current Setup and is not available for creating other Groups. To start using these, create a new Setup using the File/New syntax, making all monitors available in the 'UnPlaced' cell.



Figure 16. Location of the ' Not Used' bin.

## 5.2 Creating a SAM Monitor Group

A group preset is a set of monitors and subwoofers that reproduce audio together. A group preset contains input and acoustic settings to optimize all monitors and subwoofers active within the group. More group presets can be created to full fill any need e.g. calibrate system to the another listening position.

To define a monitoring group:

1. Give the group a name that describes it (e.g. Analog Stereo)
2. Optionally you can set the System delay. It will be applied to all monitors and subwoofers in the group.
3. Select and check the used bass management crossover frequency. This setting can be a global when all monitors will follow the crossover selection from the crossover selection below. If the setting is an individual, then crossover selections will be done individually for each monitor via a settings popup
4. Select the Input mode (Digital channel can be changed from the Settings popup by clicking a monitor icon).
5. Settings popup will popup when the monitor icon is clicked.
6. Name the monitor.
7. Make a monitor active or inactive within the group (in active monitor are indicated by drawing light gray).
8. Select an input to be used.
9. Light icon indicates inactive within the group state (inactive monitors will be hidden in other pages).
10. Normal icon indicates active within the group state.
11. Confirm the group settings by clicking on the 'Confirm Group' button.

For more detailed information on using and setting up Groups, see the section 'GLM Advanced Use'.

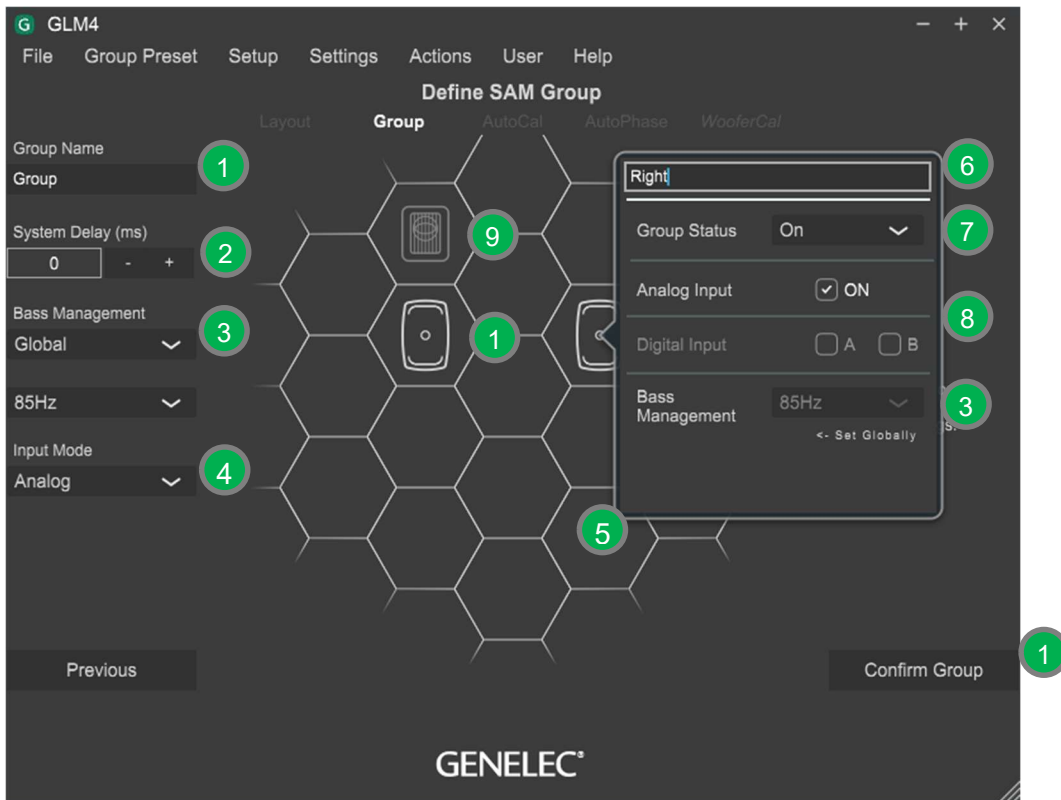

Figure 17. Steps to setup a group settings.

### 5.3 Automatic Calibration Using GLM AutoCal

GLM AutoCal is a powerful monitoring system calibration algorithm running in the Genelec Cloud. Sweeps are generated by each monitor in a group. Responses are recorded with the GLM measurement microphone into your computer.

**NOTE: Adaptive Woofer Systems will be calibrated in WooferCal page after Autocal and Autophase.**

The algorithm analyzes the sweeps and calculates the frequency responses for all monitors and subwoofers, then optimizes level and delay to compensate for differences between monitors, and sets equalization for the individual room responses to remove colorations caused by the room and the location where the monitors have been installed. The end result is to have sound from all monitors arriving at the listening position at the same time, same level, and compensated for the effects of the room acoustics, resulting in very accurate imaging and reliable monitoring.

Each monitor group has its own acoustic settings. This is one of the important features of GLM.

Each setup file can contain several preset definitions. Each monitoring group can have different AutoCal calibrations.

Even the same set of monitors you can have several calibrated listening positions. To do this, define each position as a new group preset and then calibrate each preset separate. For example, one group can be 'Engineer Position' and another 'Producer Position'. Each can have its own

calibration. Then, to quickly load setting for each position, select a group in the GLM software, and this loads all acoustic settings specific to this calibrated position.

To calibrate a monitoring group

1. Check the serial number of the measurement microphone (each specific measurement microphone calibration file is stored in the software)
2. Select the calibration mode; either a single location measurement (SinglePoint) or measurements of multiple measurement positions (MultiPoint). Select the Symmetrical EQ if a Left/Right pair of monitors should receive the same calibration filters. The Individual EQ would be useful for unsymmetrical setups where one monitor is in a corner and the other free-standing. In order for the symmetric filters function to be used, monitors need to be symmetrical on the grid. Monitor pairs not positioned symmetrically on the grid will be handled as individual units.
3. Connect the measurement microphone to the GLM network adapter, place the microphone at the listening position, at ear height, and Click on the 'Start Calibration' button to start the measurement and follow the dialog instructions.
  - All monitors and subwoofers will be measured, if MultiPoint selected then next position(s) will be measured.
  - Optimization starts.
  - Wait until optimization finished.
  - The calibration results can be viewed by clicking any loudspeaker icon.
4. Click 'Confirm Calibration' button to accept and save the settings to the setup file.

If there is a subwoofer in the group, the next step of the process is the automatic adjustment of the phase (AutoPhase)





Figure 18. Steps in running the AutoCal automatic system calibration process

See section [Advanced use of AutoCal](#) for more detailed information on the calibration process.

## 5.4 Aligning Subwoofer Phase with GLM AutoPhase

The purpose of GLM AutoPhase is to set the subwoofer phase at the crossover frequency in relation to a selected monitor so that the combined response of the subwoofer-monitor system is flat across the crossover region.

The steps to run AutoPhase automatic subwoofer phase calibration include

1. Define the monitor to be aligned with the subwoofer by single clicking on the subwoofer icon first and then the monitor icon; this is done for each subwoofer in the group; if there are several subwoofers in the group, associate every subwoofer with a monitor before proceeding to the AutoPhase calibration. The 'Pair' text with number will show the paired subwoofer and monitor.
2. Connect the calibration microphone to the GLM adapter, place the microphone at the listening position, at ear height, and start the AutoPhase measurement process by clicking on the 'Start Calibration' button. Wait until the AutoPhase calibration is completed.
3. Click 'Confirm Calibration' button to accept and save the calibration to the setup file.

If there are several subwoofers in the group, the AutoPhase will move to the next subwoofer automatically.



Figure 19. Steps in running the AutoPhase automatic phase calibration process

For more detailed information, see the section on [Advanced use of AutoPhase](#).

## 5.5 Automatic Calibration of the Adaptive Woofer System GLM WooferCal

For a system containing Adaptive Woofer Systems (WS), the first part of the calibration (calibrating the main monitor) is the same as that shown in Automatic Calibration Using GLM AutoCal.

Once that process has finished (providing WS are active in the group), you will be directed to the Adaptive Woofer System calibration page.

1. The first step is to pair the monitors to the respective stands. This is done by first single-clicking on the stand and then single-clicking on the monitor it should be paired with. This process is repeated for all woofer system + monitor pairs in the Group. Once paired, the pairing will continue to other Groups.
2. Firstly, the calibration mode is selected by using the drop-down menu – selecting between Complementary, Continued directivity, or one of the three directivity null modes. Each calibration mode or setting will require individual group to be created.
3. The parameters for setting the search limits for the crossover to the main monitor should then be set. These controls are available for all modes except the Continued directivity mode, where the crossover value is fixed based on the main monitor connected in the pairing. This crossover has been set to where the main monitor and Adaptive Woofer System have the closest matched directivity.

The default setting (150Hz to 250Hz) should be suitable under most conditions, however, if listening at particularly short distances, if the monitor is separated from the Adaptive Woofer System (i.e. not mounted directly on top) or the WS is visually blocked by obstruction (such as a large mixing desk), it may be beneficial to reduce the upper crossover limit. Listening should be used determine if this is needed.

The crossover setting used will apply to all Adaptive Woofer Systems and main monitor pairs active with the group.

4. Connect the measurement microphone to the GLM network adapter, place the microphone at the listening position, at ear height, and Click on the 'Start Calibration' button to start the measurement and follow the dialog instructions.
  - All Adaptive Woofer Systems and monitors will be measured.
  - Optimization starts.
  - Wait until optimization finished.
  - The calibration results can be viewed by clicking any loudspeaker icon.
5. Click 'Confirm Calibration' button to accept and save the calibration to the setup file.

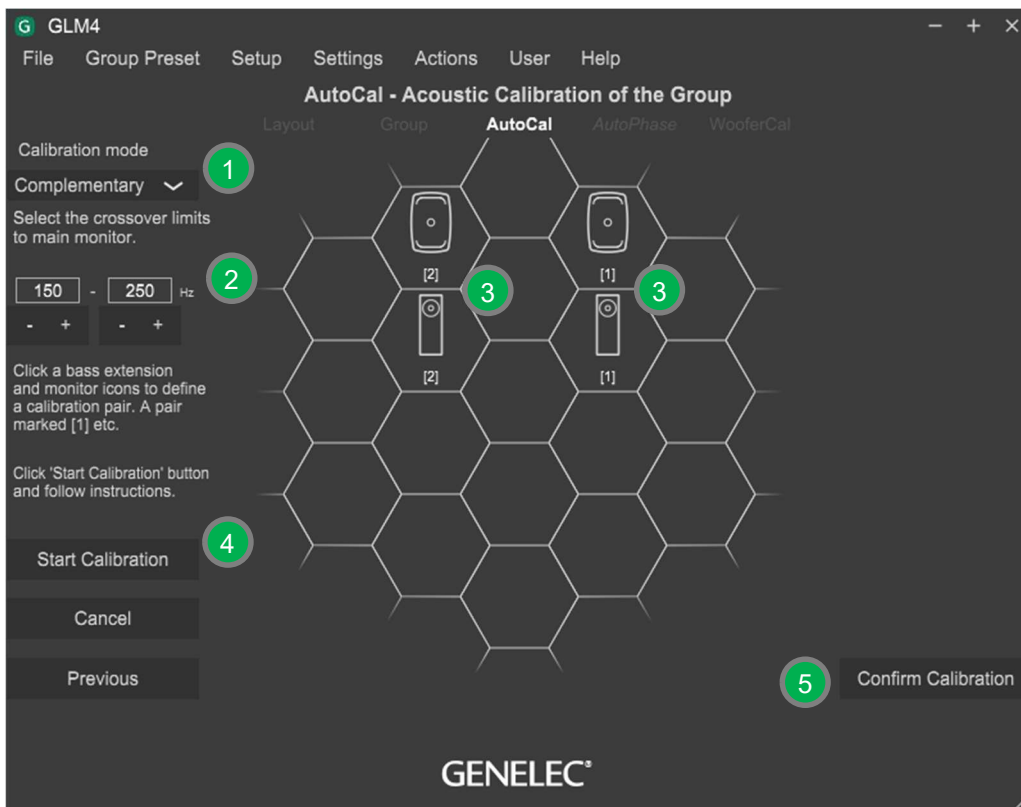

Figure 20. Adaptive Woofer System calibration.

### Description of the different operating modes:

The WS has 5 different calibration modes: Complementary, Continued directivity, and 3 null modes.

#### Complementary:

In this mode, the two drivers within the W371 unit are measured individually, and the operating range of each individual unit determined by evaluating the quality of the responses – with the driver having the best response quality chosen to operate in that range.

The other modes of operation are directivity control modes, where pre-determined filter sets are recalled that have been designed to make set directivity patterns, based on phase and amplitude manipulation of the individual units.

**Continued directivity mode:**

In this mode, a constant horizontal directivity pattern is held as far down in frequency as possible (in this case to 50Hz). The x-over frequency to the monitor is selected based on the monitor paired, to ensure a matched directivity pattern.

### Back, side and floor reduction modes.

The 3 remaining modes of operation are the 'null modes'. In these modes, individual filter sets are recalled, that provide directivity patterns that have been optimised to provide reduced output in the direction of primary reflections from the floor, back wall (behind the speaker) and side wall.

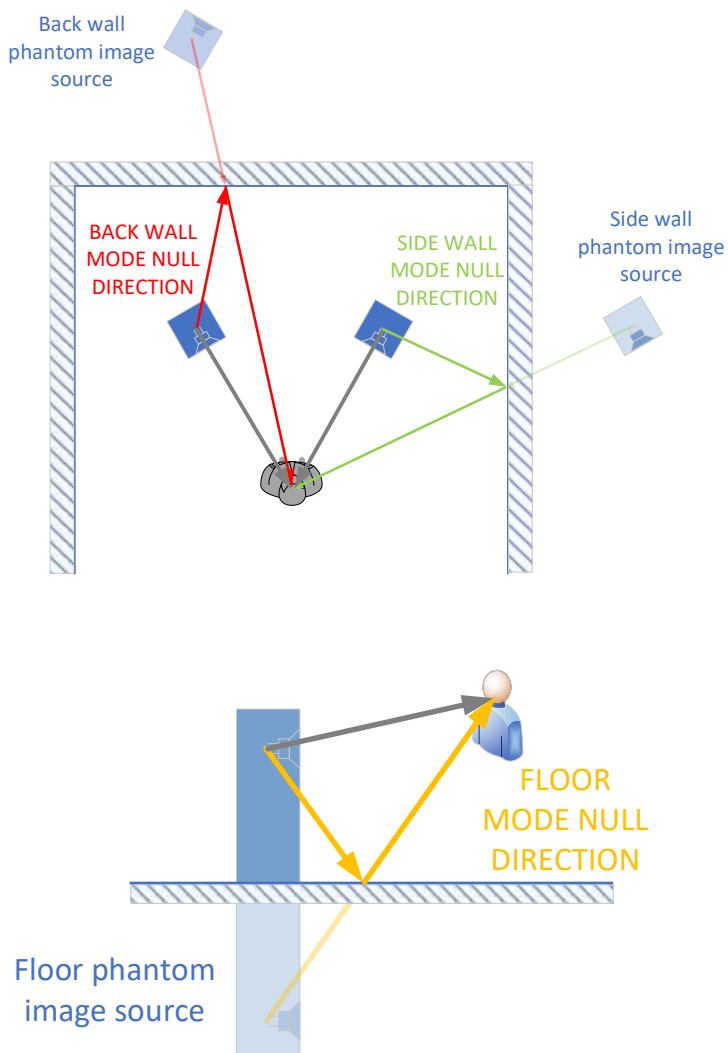

Figure 21. Diagram showing the maximum null location angles for the individual modes\*

\*N.B. diagram only shows the angle of maximum attenuation, however attenuation outside of these angles is also given (see contour plots in operating manual for more detailed plots).

Contour directivity plots for all the directivity modes can be found in the Woofer System operating manual.

## 6 Basic Use of GLM

The main page of the GLM software offers the basic monitoring system controls (Figure 22)

1. System level
2. Selection and activation of group presets
3. Mute, mute all.
4. Dim (-20dB).
5. Standard loudness SPL level (calibration from 'Group Preset : Standard Loudness SPL Calibration' menu)
6. Level preset selections (to set adjust the system level at desired level and click 'Group Preset : Set Preset Levels : Set Current Level to Preset1 )
7. Bass Man, will bypass the Bass Management crossover filter. Subwoofers will mute and monitors will play at the full band.
8. The GLM AutoCal status is indicated on the 'Calibrated' button. This button also allows temporary disabling or bypass of the system acoustic calibration settings, by pressing the 'Calibrated' button.
9. Loudspeaker click mode. Select what happens when the loudspeaker icon (10) is clicked in the main page.
  - Solo* – Clicked loudspeaker will be soloed and others will be mute. Clicking a muted loudspeaker, it will be also soloed. Clicking a loudspeaker multiple time will its toggle state. To clear solo state, click the empty cell or use right click and select 'Play all'.
  - Mute* – Clicked loudspeaker will be muted.
  - Info* – Clicked loudspeaker information popup will be shown.
  - Edit* – Clicked loudspeaker acoustic editor will be shown.
10. The microphone SPL level, shown if the microphone connected.
11. The SAM subwoofer and monitor icon. Use the loudspeaker click mode (8) to select what happen when loudspeaker is clicked.
12. 'Play all' when clicked when solo/mute state active.
13. The currently loaded system setup file and network status.

+ system management menu commands.

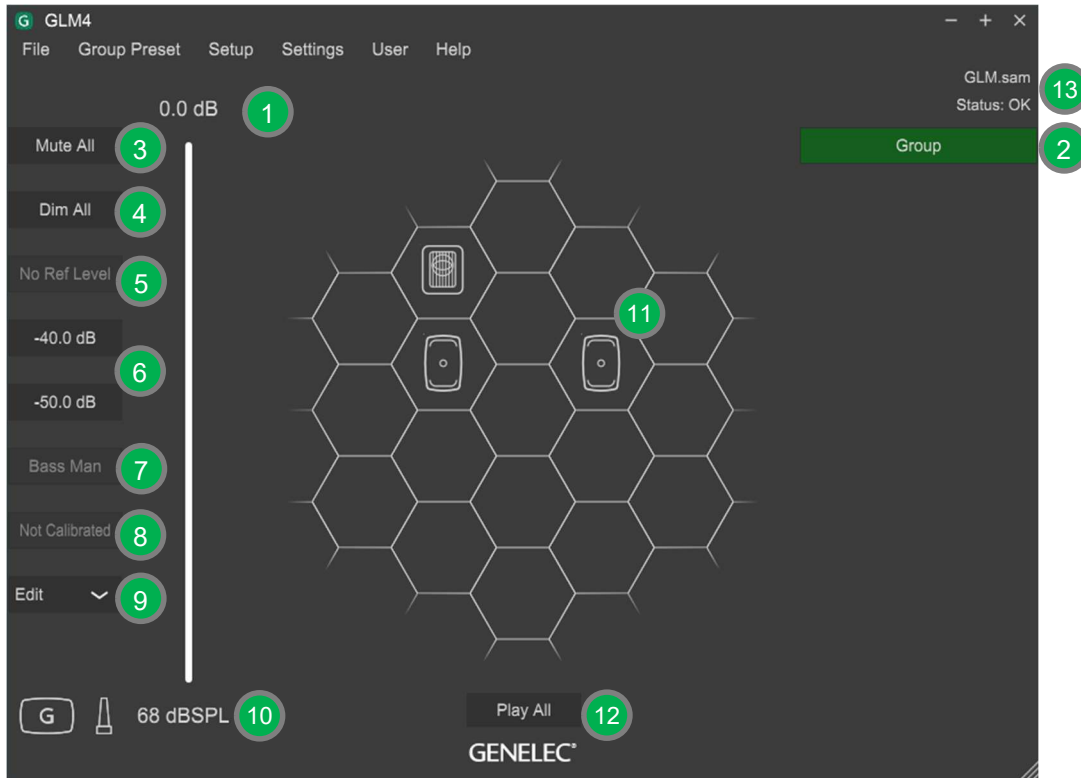

Figure 22. GLM software main page.

## 6.1 Selecting monitoring situations using Group Preset Buttons

A group preset is activated by clicking on the group preset button. When the group is selected,

- monitors and subwoofers belonging in the group preset are activated
- all the acoustic settings defined in this group preset for monitors and subwoofers are loaded
- the monitoring level is set to the level saved for this group preset
- the audio input (analog, AES/EBU) that has been defined for this group preset is selected
- the bass management settings defined for the group preset are activated, determining if a subwoofer is used, and what bass management settings are set in the subwoofer

## 6.2 System Level Control

System Level is controlled with the master level fader.

The system level is controlled separately for each group preset. The system levels are stored for each group in the system setup file so that the levels set before saving the system setup file resume when the system setup file is opened.

The Level Preset buttons do not change the system level fader setting. When a Level Preset button is released, the level setting returns the value set in the fader.

### 6.3 System level indications

The system level is indicated at the top of the system level fader. The level can be set by editing the figure shown and by adjusting the volume fader.

The volume can be adjusted by using the mouse and by up and down arrow buttons.

If the GLM Adapter volume controller is connected, the volume is only set by the controller and the GUI volume control is disabled.

By default, the display shows the level relative to the digital full-scale output, on the dBFS scale. The scale on the fader reads from zero to -130 dB and then full system mute.

After the 'Calibrated Level' setup has been completed the output level is shown as the dB SPL sound level at the listening location. The Calibrated Level selection button selects the data format being shown, as either dBFS relative scale or dB SPL absolute scale.

GLM microphone can continually measure the SPL level at the microphone. Normally, the microphone can be placed at the listening location and then will show the SPL at the listening location. This microphone SPL level is shown below the volume setting.

### 6.4 System Mute and Dim

The states of these buttons are retained for each group.

The Mute button mutes the complete monitoring system.

The Dim button lowers the system level of the current group. While the Dim is active the level is reduced by 20 dB.

### 6.5 Standardized Level Presets

Standardized level presets allow systematic subjective evaluation of the spectral content in audio and audibility of details always in the same way.

Level Preset buttons activate the level presets, and quick way to recall a calibrated system level. When these buttons are active, the system level fader is overridden. Releasing the preset resumes the system level to the value set in the fader.

A level preset can be set to a desired value by first adjusting the system level at the desired level and then the menu item 'Group Preset | Set Preset Levels | Set Current Level to Preset1'.

### 6.6 Calibrated Level Selection

This control can be set to allow quick access to a standardized SPL level that is motivated by one of the existing loudness standards and allows accurate subjective evaluation of the audio content for that use case.

The default is set to 'No Ref Level' and the Calibrated Level button is not selectable.

To set the Calibrated Level, select the loudness standard you want to follow or your 'user specified' loudness target in the 'Group Preset | Standard Loudness SPL Calibration' menu item. After the selection, you will need to run an SPL calibration step with the GLM calibration microphone.



## 6.7 By-passing bass management

The bass management system directs the low frequencies to subwoofer(s), enabling more flexible monitor placement and improved low frequency consistency in the room.

In some cases, we want to temporarily bypass the bass management processing and direct all frequencies to the monitors, including the low bass frequencies. When the 'Bass Man' button is active, all frequencies are directed to the monitors. The subwoofer(s) only output the LFE channel content in that situation.

## 6.8 Calibrated/Not Calibrated button

The GLM AutoCal status is indicated on the 'Calibrated' button. This button also allows temporary disabling or bypass of the system acoustic calibration settings, by pressing the 'Calibrated' button. When bypassed the text in this button changes to say 'Cal bypassed'. Pressing the button again resumes normal operation.

This control becomes available once the GLM AutoCal has been completed on a group. When a group has not been calibrated, this button reads 'Not calibrated'.

## 6.9 Solo/mute/info/edit drop-down selection

The drop-down selection allows actions on individual monitors and subwoofers in the central hexagonal hive, showing all the monitors and subwoofers in the current group.

The functions for individual monitors and subwoofers include

- solo – only this monitor plays, multiple monitors can be soloed simultaneously
- mute – individual monitor is muted
- info – selected monitor settings and status is shown in an info box; this box allows loudspeaker/subwoofer firmware updates
- edit – all acoustic calibration settings inside a monitor or subwoofer are opened into an editor window; multiple settings windows can be opened; editing the settings affects the selected monitor only

These functions can be also accessed with a right mouse click.

## 6.10 GLM Adapter icon

The main page shows an icon for the GLM Adapter. Right-click accesses a 'show info' function and this can open all settings and the status in the GLM Adapter. Also, the Adapter firmware can be updated using this window.

## 6.11 'Play All' button

Pressing this button resumes normal operation for the currently selected group. This removes all mute and solo settings set for the individual monitors and subwoofers.

## 6.12 Status and setup name indications

On the main page top right corner, the GLM management network status and the selected system setup file are indicated.

GLM management network status can be indicated as

- OK – network is working normally with all monitors and subwoofers
- Adapter offline – GLM cannot see the GLM Adapter
- LS offline – one or more of the monitors or subwoofers in the current setup file cannot be seen on the network

## 6.13 Keyboard short-cuts

The keyboard short-cuts are shown in the table below. To access the keyboard short-cuts, the GLM window must be on the top and selected.

Function	Key
Group selection, previous	Left arrow
Group selection, next	Right arrow
Volume up	Up arrow
Volume down	Down arrow
System mute	Space bar
Direct group selection, groups 1...9	Number keys 1-9

## 7 Advanced Use of GLM

GLM is the most powerful tool available to calibrate and control a Genelec SAM monitoring system. The following chapters introduce advanced use of the GLM.

### 7.1 Importing GLM 3 Setups

GLM 3 Setup files can be imported into GLM4. The import function will import the selected GLM 3 setup file so that the original GLM 3 setup file remains unchanged and can be still used with GLM 3. The import can also be repeated later, if needed.

The imported file content defaults to be saved in the GLM 4 working area.

NOTE: The imported GLM 4 formatted setup file cannot be opened in the GLM 3. Retain the original GLM 3 setup file for that purpose.

Follow these steps:

1. Open the GLM 4 main page (to do this, at least one setup with GLM4 must have been created)

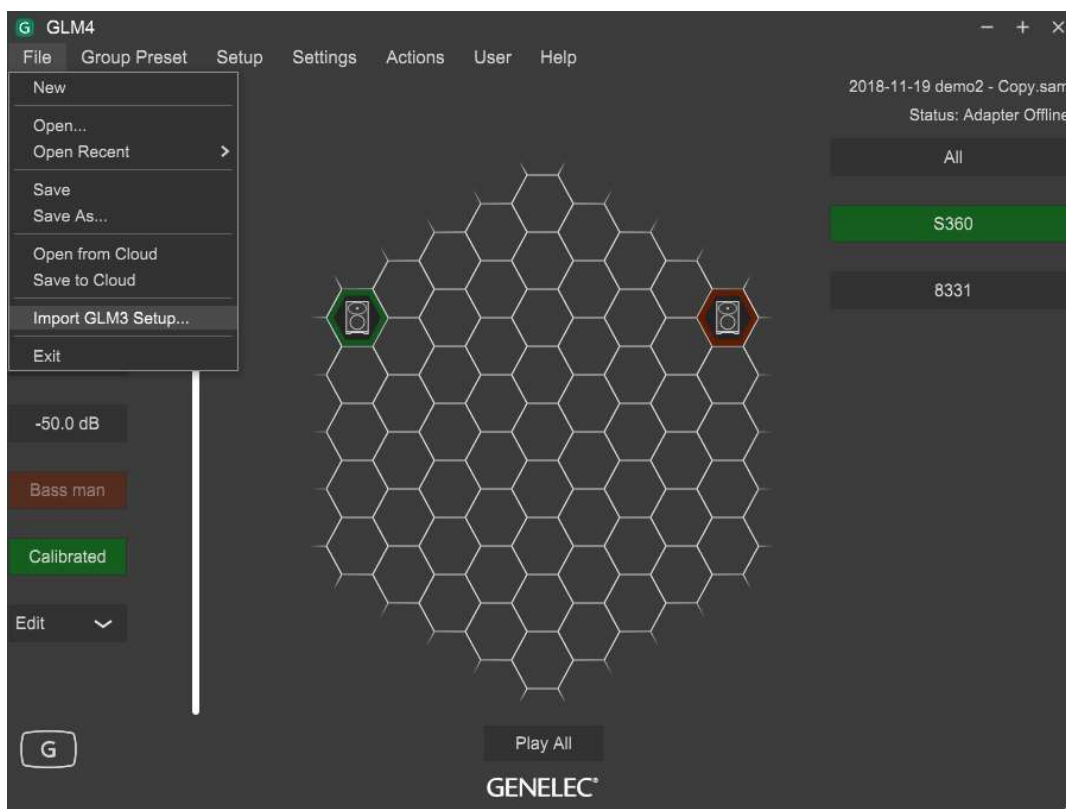

- Click the 'File' menu and select the item 'Import GLM 3 Setup...'

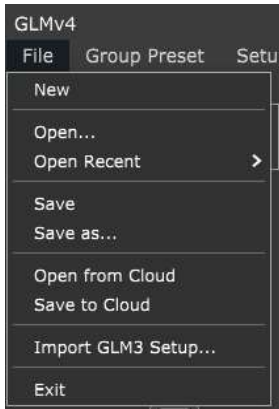

Figure 23. Selecting the 'Import GLM 3 Setup' menu item.

- This will open a new window with the view into the GLM 3 setup file location. Select the GLM 3 setup file to be imported and click 'Open'. This runs the import process. The imported setup will be stored using the same file name but into the GLM 4 setup file working area, so the original GLM 3 setup file is not over-written.

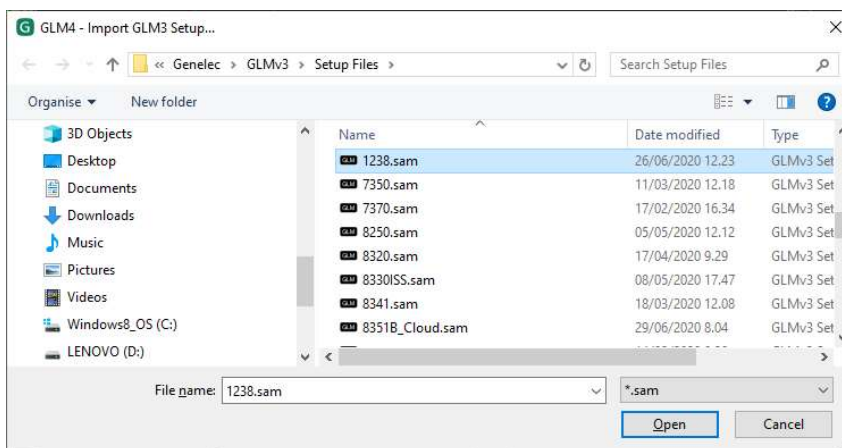

Figure 24. Selecting a setup to be imported from the GLM 3 setup folder.

- The GLM 3 setup has now been imported into GLM 4. All settings except the layout remain the same in the imported file. This includes the acoustic settings, groups etc. The loudspeakers and subwoofers in the layout are placed automatically into the new hive format in GLM 4. You may feel the need to rearrange this automatic layout. If there is a need to edit the layout, do this by selecting the 'Setup' menu and clicking the 'Edit Layout' menu item.

## 7.2 Calibration of SPL to Loudness Standards

The 'Standard Loudness SPL Calibration' feature allows calibrating the listening level in accordance with digital audio loudness standards, such as ATSC A/85 and EBU R128. The calibrated listening level is important for judging correctly aspects of audio quality, such as the speech intelligibility, spectral balance, platform compatibility, etc.

Before running the absolute SPL listening level calibration, the in-room frequency response compensation for each monitor and subwoofer and alignment of the playback levels and times of flight for audio between monitors in the system should be completed first by running GLM AutoCal.

Note: We recommend the use of digital audio inputs to reduce uncertainty and tolerances in setting the signal levels.

- Before SPL calibration, first run GLM AutoCal calibration to compensate the frequency responses, times of flight for audio, and level difference between channels and the to align the subwoofer phase. You typically do this when creating a new 'Group', using the 'Group Preset' menu item 'Add' Group command; or by re-calibrating an existing Group, using the 'Group Preset' menu item 'Calibrate'.
- If you require a frequency response different than flat, for instance a HF roll-off such as x-curve, now make those adjustments. To edit all channels at once, consider using the Sound Character Profiler. For editing per channel, select and edit individual monitor settings.
- SPL calibration should be the final item: Click the 'Group Preset' menu item 'Standard SPL Calibration' on the main page. The Standard Loudness SPL Calibration window opens.

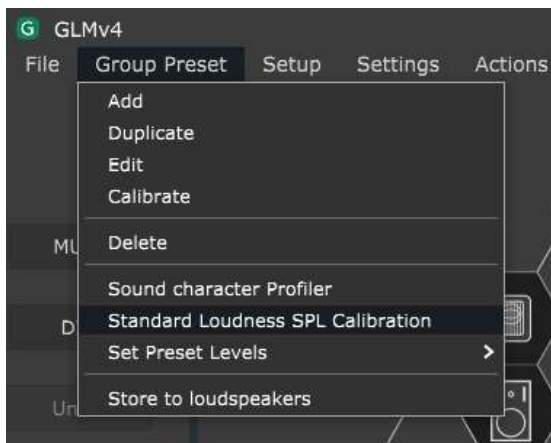

Figure 25. Entering to the Standard Loudness SPL Calibration page.

- Select in the dropdown list the loudness standard used for the level calibration.
- Place the Genelec calibration microphone at the listening position.
- Click the 'Start Calibration' to start the calibration process. Note that the test signal may be loud. If the background noise in the room is higher than 65 dB SPL, the loudness preset cannot be calibrated. Reduce the background noise and calibrate again.

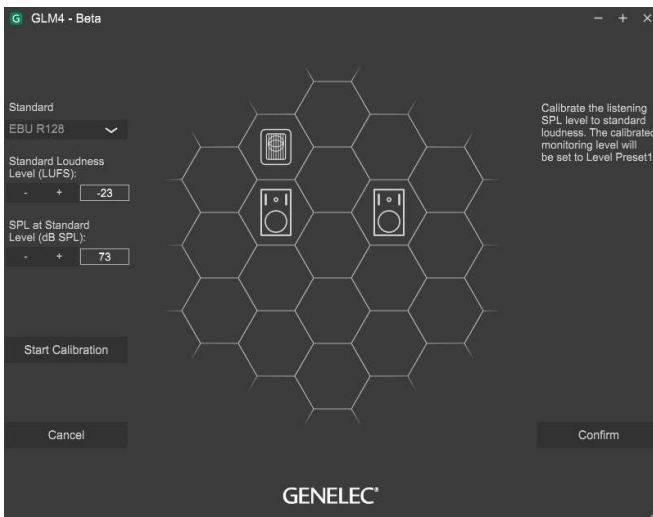

Figure 26. The standard loudness SPL calibration.

- After calibration, click the 'Confirm' button to save the results and return to the main page.

After SPL calibration, the main page level control starts displaying the level on dB SPL scale, and the preset levels change to show dB SPL units. The Level Preset 1 is set at the level given in the Loudness Standard, for example 73 dB SPL for EBU R128. Also notice the graphical link-line between the Cal. Level 'SPL' indication and Level Preset 1 keys.

After an SPL calibration, you can use the Cal. Level key to toggle between displaying levels in dB SPL (absolute) scale or in dB relative to the full scale.

**Note:** If you want to verify the absolute SPL level display later, the same input level and reference signal should be used as indicated by the standard used. Otherwise the dB SPL level indication can erroneously set lower or higher, meaning that the SPL level of e.g. music material is not consistent with the SPL reading indicated by the master fader.

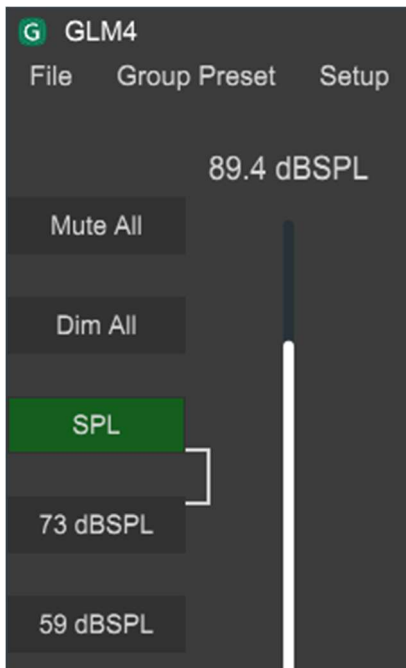
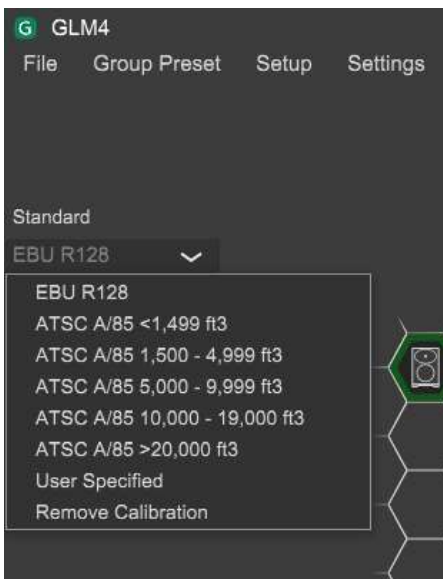

Figure 27. Calibrated SPL level set to the Preset 1 and absolute dB SPL scale enabled.

To remove a Standard SPL calibration, open the calibration page and select the 'Remove Calibration' option in the drop-down menu, at the bottom of the Standards list, and finally click the 'Confirm' button.



### 7.3 Maximum Number of Group Presets

Each system setup file can contain up to ten (10) group presets. You can create new group preset with the 'Group Preset | Add' menu command or the 'Group Preset | Duplicate' menu command.

If you need more than ten group preset definitions, we recommend creating a second system setup file for more groups. You can move between system setup files using the 'File | Open' menu command.

## 7.4 Creating a New System Setup File

A new system setup file is created by selecting the 'File | New' menu command. This starts the system definition process where you create new groups and then run the AutoCal calibration for the new groups. Finally, you can store the new system setup file on your computer hard drive with any suitable name.

To create a new system setup file, you can alternatively save a copy of the current system setup with the 'File | Save as...' command, and then edit this new copy as needed.

## 7.5 Solo and Mute Pop-Up Window Controls

Solo means that only the soloed monitors reproduce audio while others are muted. Mute means that the selected monitors are muted and do not play audio.

Solo and mute can be activated for each monitor and subwoofer. A pop-up menu for these controls opens when right-clicking a monitor or subwoofer icon. Solo and Mute states can be cleared in the menu by selecting 'Play all'. Solo and Mute states are also cleared when the group is changed.

## 7.6 'Bass Man' Button

When the 'Bass Man' button by-passes the Bass Management. When the 'Bass Man' is active, the low frequencies are driven to monitors instead of being sent to a subwoofer. This enables you to understand the impact of using the bass management and driving the low frequencies to the subwoofer. Bass Management bypass can be used to check how mixes behave when the subwoofer is bypassed.

The Bass Management Bypass button is visible if there is a subwoofer in the group.

Regardless of a state of the Bass Management Bypass button, LFE channel will be reproduced by the subwoofer.

## 7.7 Menu Commands

The GLM main window contains a set of menu commands enabling system management. The GLM main window enables you to manage the monitoring system.

### File

The File menu saves and opens system setup files.

'**New**' starts system setup creation from the system layout definition.

'**Open**' popups the open dialog window to load system setup files.

'**Open Recent**' stores recently opened system setup files for quick access.

'**Save**' saves changes to the current system setup file.

'**Save As...**' popups the save dialog window to save the current system setup with a different name.

'**Open from Cloud**' popups the open dialog window to load system setup files from Cloud (Must be logged in to GLM Cloud).



'**Save to Cloud**' popups the save dialog window to save the current system setup to Cloud (Must be logged in to GLM Cloud).

'**Import GLM 3 Setup...**' popups the open dialog window to import GLM 3 system setup files.

'**Exit**' closes the GLM application.

### **Group Preset**

The Group Preset menu is used to control settings in group level.

'**Add**' adds a new group preset to the system setup and opens the Group definition page.

'**Duplicate**' adds a new group preset to the system setup by copying settings of the currently active group.

'**Edit**' opens the Group preset definition page of the currently active group to edit the group settings.

'**Delete**' deletes the currently active group preset from the system setup.

'**Sound Character Profiler**' opens the Sound Character Profiler page to tune the currently active group preset.

'**Standard Loudness SPL Calibration**' opens the Standard Loudness SPL Calibration page to calibrate of the listening level in accordance with digital loudness standards such as ATSC A/85 and EBU R128.

'**Set Preset Levels**' sets the current level to the selected preset level button. If Standard Loudness SPL calibration is active, Preset Level 1 is reserved for that.

'**Store to Loudspeakers**' popups the Store Group settings page that is used to store the acoustic settings, ISS etc. to all monitors and subwoofers active in the currently active group.

### **Setup**

The Setup menu is used to control settings of the whole system.

'**SAM System Power**' -menu can be used to power up and shut down SAM system. In default GLM will send a wake up command, 'Automatically Wake Up System with GLM' menu is checked, to the GLM network when application is launched and all SAM monitors and subwoofer will be powered ON. When GLM application is closed SAM monitors and subwoofers will continue to play audio as default. It's possible to turn OFF whole system when GLM is closed by checking 'Automatically Shut Down System with GLM' menu, selection will send a shut down command to the GLM network when GLM is closed. These two menu items are stored to each GLM setup.

'**Enable USB Controller**' Enables Griffin USB Powermate to control level and mute.

'**LED State**' LED in the monitors and subwoofers can be turned OFF and ON.

'**Edit Layout**' enables to edit existing system layout. Used also to replace/remove monitor or subwoofer from to system.

## **Settings**

The Settings menu is used to control settings of the GLM UI. These settings are common for all GLM setups.

**'Use Dark Theme'** -menu can be used to activate GLM dark mode.

**'Use Light Theme'** -menu can be used to activate GLM light mode.

**'Language'** -menu can be used to change language to be used in GLM. You can select GLM screen language between etc. English, Finnish and Chinese. Selecting each of these languages GLM will change user interface language to the selected one; also, it will remember the selected screen language for next GLM opening.

## **User**

The User menu is used to access the cloud related functions.

**'Login'** menu opens the window to login Genelec Cloud using Genelec community credentials.

**'Logout'** menu is used to logout from Genelec Cloud.

## **Help**

**'GLM Manual'** opens GLM pdf manual.

**'Get Support'** popups the GLM Support Request window to describe the problem and send it to Genelec support team (Must be logged in to GLM Cloud, see 'User : Login' menu).

**'Export Setup to Desktop'** creates zip –file to the desktop.

**'About'** show information about GLM, including the software version information.

## 7.8 Cloud Account Login

The standard calibration method uses the GLM Cloud calculation service. Using this requires a user account in the Genelec Community.

A user account can be created in [www.community.genelec.com](http://www.community.genelec.com). Please note that the user name can only be selected once and cannot be changed after this.

With the valid user account, log-in at the 'User' menu by selecting the 'Login' menu item.

### Logging in

To log in to the Genelec Cloud, type your user name and password to the Genelec community.

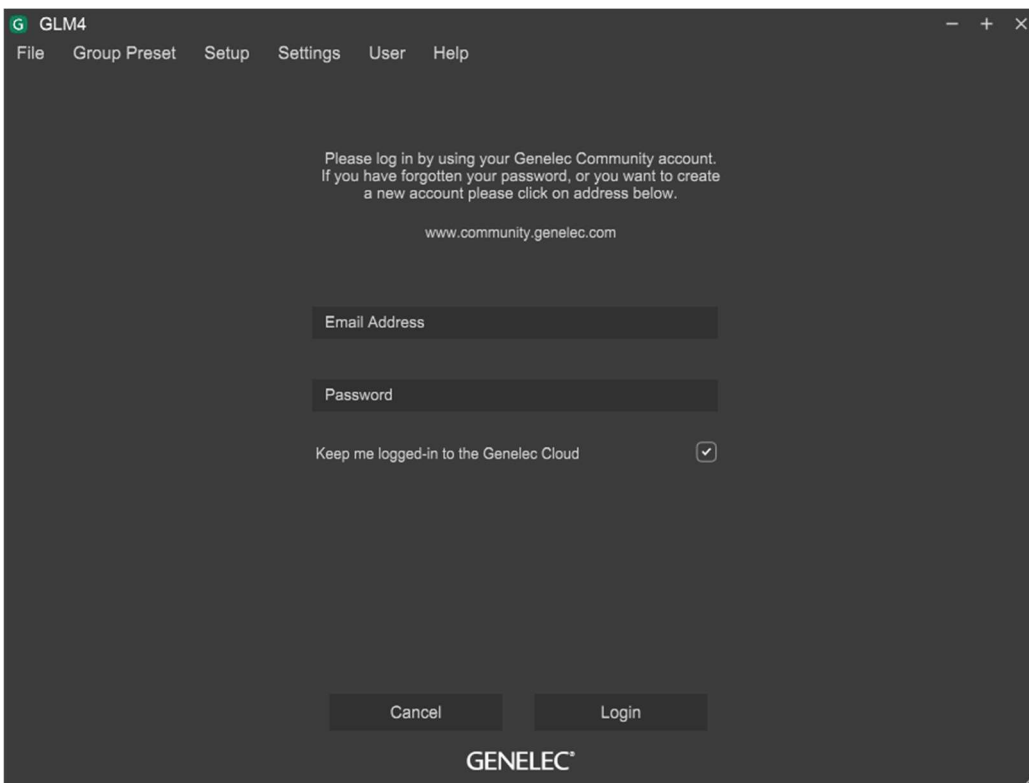

Figure 28. Login to Genelec Community window.

### User information and logout

Selecting the 'User' menu by selecting the 'Login' menu item will display your Genelec Community username when you are logged in. To log out from the GLM Cloud, click the 'Logout' from 'User' menu.

## 7.9 Standalone Startup Level

By default, SAM subwoofers and monitors start up at the maximum output level. This is the output level that get when adjusting the master level setting to the maximum (0 dB) in the GLM user interface. It is possible to set the startup level to a lower value. To do this,

- set the master level fader to the level you want to have at start-up
- store this level permanently into the monitors and subwoofer with the other acoustic settings, using the 'Group Preset' menu item 'Store to Loudspeakers' menu item.

Early SAM models (like 8240A, 8250A etc.) need a firmware update before the Startup level can be stored. The Startup Level is overridden by GLM so when the GLM is running the level is set by GLM, and when using the GLM adapter is powered without a computer and connected to the wired volume control device.

Setting Startup level (sets a specified output level for all online devices):

1. Select a group that has desired acoustic settings and adjust the master level fader to the desired value.
2. Store this level as the Startup level with other Group Settings clicking 'Group Preset: Store to Loudspeakers' menu command, adjusting the 'Startup Level (dB)' in the 'Store Group Settings' page and clicking 'Store' button.

To clear the Startup level (this sets the level to full output level for all online devices): \*\*\*\*\*

1. Select a group that has the desired acoustic settings.
2. Store this level as the Startup level with other Group Settings clicking 'Group Preset : Store to Loudspeakers' menu command, set 'Startup Level' value to 0.0dB in the 'Store Group Settings' page and clicking 'Store' button.

**NOTE:** The monitor or subwoofer can become very quiet if the 'Startup Level' is set to a low value.

## 7.10 Displaying monitor and subwoofer data in GLM

Several types of information for each monitor and subwoofer can be displayed in the GLM main window by using the right click and selecting Show Info. These include

- *Name* : monitor and subwoofer name
- *Barcode* : barcode (Serial number) of the monitor or subwoofer.
- *Serial* : Unique identifier of the monitor or subwoofer.
- *Status*: Shows current status of the monitor or subwoofer.
- *Solo/Mute* : to view solo and mute buttons for each monitors and subwoofers.
- *Stored -switch position* : to view a switch state easily <sup>1)</sup>
- *I/O Levels* : input and output signal levels for each monitor and subwoofer <sup>1)</sup>
- *Temp* : to view a temperature inside a monitor or subwoofer <sup>1) 2)</sup>
- *Bass Management* : bass management crossover frequency

*Flatness % / Correlated %* : to view quality number for the woofer system (see

- Acoustic editor and scoring system for woofer systems chapter) <sup>1)</sup>
- *Input(s) In used* : Analog input or the digital audio subframe selected for reproduction
- *Firmware Version* : to view firmware version for each monitor and subwoofer. Firmware update button enabled if an update available.

<sup>1)</sup> All models won't support the feature and shows 'Info N/A' if information type is not supported.

<sup>2)</sup> The temperature shown is the temperature of the main microcontroller of the speaker, as reported by the microcontroller itself. This information is useful for comparison between speakers, for example in a fault situation. The microcontroller temperature is very local and should be fine up to around 80°C, though in practice it should never reach such a high temperature.

Monitor data display can be useful in many ways. To give an example, when you have the digital audio input selected and want to know how much signal is seen by the monitor input.

## 7.11 Access to Monitor and Subwoofer Acoustic Settings

Access to monitor and subwoofer acoustical calibration and settings is available by right-clicking on the monitor and subwoofer icons from the GLM Main page.

## 7.12 Rerunning AutoCal Automatic Calibration

To rerun AutoCal automatic calibration is available from 'Group Preset : Calibrate' menu. This brings up the AutoCal window and starts the calibration process again.

You can rerun the AutoCal automatic calibration

- to ensure the calibration is still valid
- when there have been significant structural changes in the room (tables or other furniture have been moved or there has been structural changes to the walls, ceiling, or floor)
- when the listening position has changed
- when the locations of items close to the monitors or close to the listening position have changed

It is usually a good idea to take a copy of the current setup file and perform the recalibration in the copy instead of doing it the original setup file. This retains both and enables evaluation of the recalibration outcome. You can take a copy of your setup file with the 'File | Save as...' menu command.

## 7.13 Rerunning AutoPhase Automatic Phase Calibration

To rerun AutoPhase automatic subwoofer phase calibration is available from 'Group Preset : Calibrate' menu. This brings up the AutoCal window, you can confirm the AutoCal settings if AutoCal already done for the group preset. After AutoCal confirmation the AutoPhase window opens and the calibration process can be done again.

You can rerun the AutoPhase automatic phase calibration

- to ensure the calibration is still valid

- the bass management filter crossover frequency has changed
- when there have been significant structural changes in the room (tables or other furniture have been moved or there has been structural changes to the walls, ceiling, or floor)
- when the listening position has changed
- when the locations of items close to the monitors or close to the listening position have changed

## 7.14 Group Settings, Advanced Use

A SAM group is the set of monitors and subwoofers reproducing the audio presentation together. Groups are presented as buttons in the GLM main window. You can start using a group simply by clicking on the group button. This sends all the settings for this group to all monitors and subwoofers included in the group.

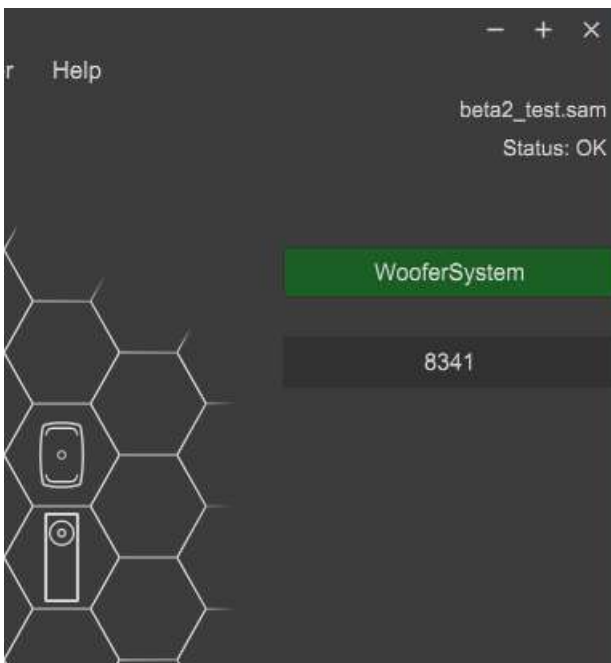

Figure 29. An example of a GLM system setup having three monitoring groups

Each group contains group-specific settings. These settings can optimize the performance of SAM monitors and subwoofers for different situations and purposes. Settings unique for each group include

- group name
- audio signal type, analog or AES/EBU digital
- monitors and subwoofers in the group (playing when this group is selected) and the ones that are not used in this group
- the acoustic calibrations that are applied when this group is playing for all monitors and subwoofers

- monitoring level setting for the group (this can be used e.g. as a monitoring level preset for the group)
- system delay (this can delay the whole reproduction system, for example to synchronize the whole group/audio system with a video presentation)

### 7.14.1 Access to Group Preset Settings

To access or edit the settings common to a group preset, use the menu command 'Group Preset | Edit'. This displays an editing window where the group settings and the settings for individual monitors and subwoofers can be edited. The group settings are shown when you enter the editor. You will see the monitor and subwoofer settings once you single-click on any of the monitors and subwoofers in your layout.

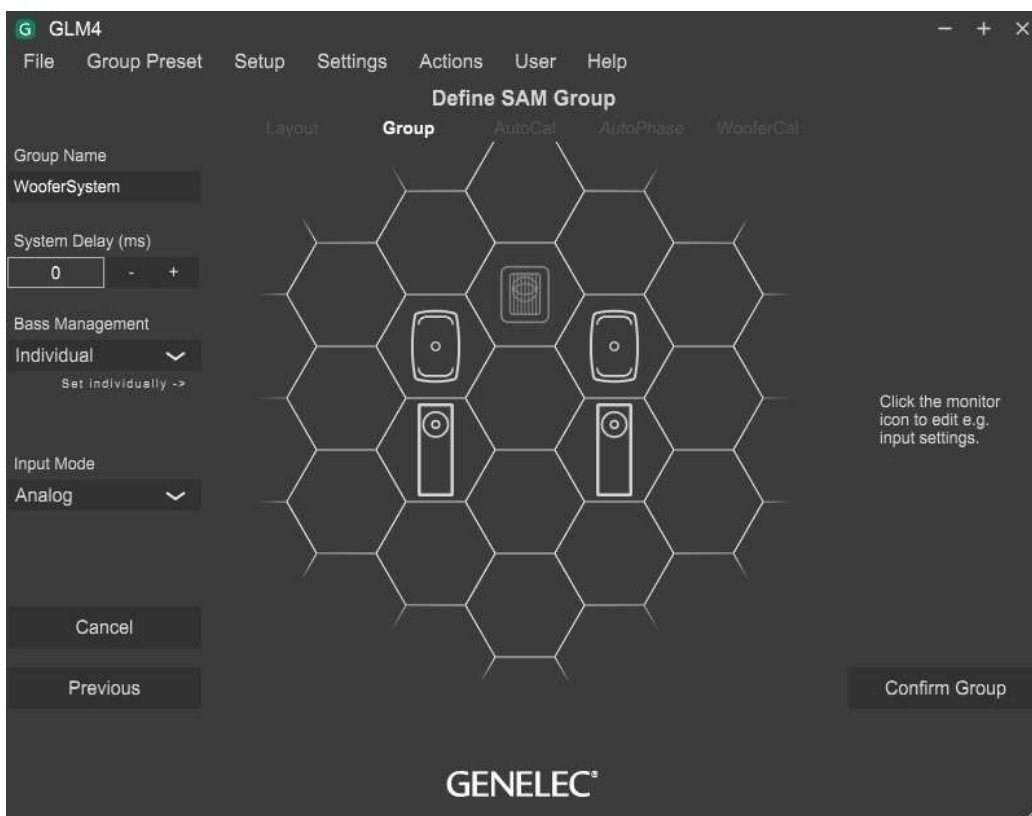

Figure 30. Common settings for a SAM group are presented on the left side of the SAM group definition display.

### 7.14.2 Group Name

A group name can describe

### 7.14.3 System Delay

The System delay is applied to all monitors and subwoofer in the group. This can be used e.g. to synchronize audio with video.

#### 7.14.4 Bass Management

The Bass Management Filter (subwoofer crossover frequency) is normally set globally in the group settings. When the Bass Management setting is marked 'global', the Bass Management Filter setting is applied to all monitors in the group.

In certain special cases you may want to turn off the bass management for certain monitors, for example when you do not want to bass-manage rear monitors in a room having a subwoofer located in the front of the room.

To turn off the bass management for a specific monitor

- set 'Bass management setting' to 'individual'
- select the monitor by clicking on its icon
- set 'Bass management filter' switch to 'Full Band'

We recommend using the 'global' setting for all normal applications. In certain exceptional cases there can be acoustical reasons for setting the Bass Management Filter to 'individual'. This enables you to set the Bass Management Filter individually for each monitor and subwoofer to a value that differs from the rest of the system. Using the 'individual' setting is an expert feature as the Bass Management Filter for all monitors and subwoofer no longer tracks the selection made globally.

#### 7.14.5 Input Mode

A group is configured for analog or AES/EBU digital audio. Certain products only have analog or AES/EBU digital inputs. You cannot include products in a group reproducing selected audio type (analog or digital), if these specific products do not have the correct input type available. If a selected audio signal type is not supported by a monitor or subwoofer, it will be automatically marked as not belonging to the group (we call this Group OFF and indicate it with a yellow glow around the product in the GLM window and a yellow LED color showing on the actual product (Note: If using SE7261 and 8130 monitors (non-SAM monitors), 8130 monitors indicates valid digital signal with yellow LED).

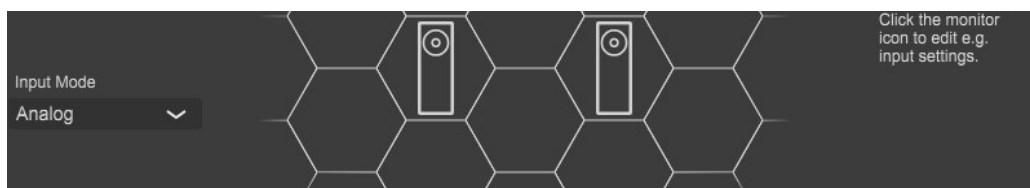

Figure 31. Group Input Mode selection.

#### 7.14.6 Monitor Settings

To edit specific group settings for individual monitor or subwoofer, single-click on the monitor or subwoofer icon. A settings panel opens, and you can:

- rename the monitor to facilitate easy recognition
- include or exclude a monitor in the group using the 'Group Status' selection



- determine if the subwoofer crossover frequency is globally the same for the whole group or specific to the product (monitor or subwoofer) only

For subwoofers, you can also

- set the subwoofer crossover frequency
- set the LFE channel gain (0 or +10 dB)

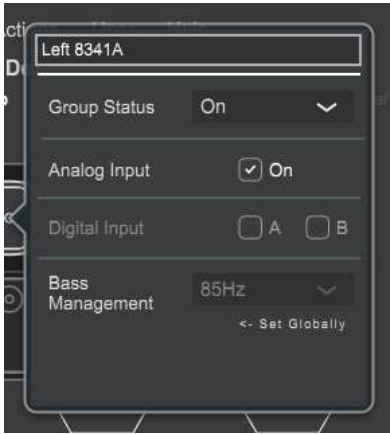

#### 7.14.6.1 Monitor name

Name that helps you identify this monitor.



#### 7.14.6.2 Group Status

When the setting is ON this monitor belongs to the current group. When the setting is OFF this monitor is not in the group and will not play audio.

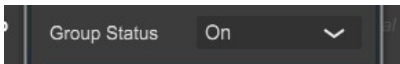

#### 7.14.6.3 Analog Input

When the checkbox is checked this monitor will play analog signal when group is active. This setting is not active when the input mode is digital.



#### 7.14.6.4 Digital Input

When any of digital channel checkboxes is checked this monitor will play digital signal when group is active. This setting is not active when the input mode is analog.



For 7350, 7360, 7370 and 7380 subwoofer models there is also option to use 9301 AES/EBU device. That enables to reproduce digital multichannel content with these models.



For AES/EBU digital audio, the channel assignment needs attention. Typically AES/EBU cables carry two channels of audio, called subframes A and B. In a stereo system the subframe A is usually assigned to the left channel and the subframe B to the right channel. A multichannel audio presentation, using more than one digital audio cable, will split the channels into cables. The correct selection is needed for each monitor and subwoofer.

GLM defaults to the common AES/EBU channel assignments (subframe A is left, B is right).

#### 7.14.6.5 Bass Management

This setting applies the bass management crossover frequency (global) or a customized crossover frequency (individual). When 'Bass Man' button is active on the main page, subwoofer frequencies are reproduced by the monitors.

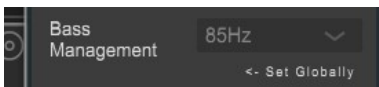

For 7360, 7370 and 7380 subwoofer models there is also option to high pass analog outputs 85Hz. That enables to connect and use analog monitor models, without bass management, to these models.

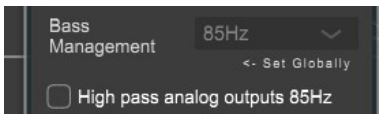

#### 7.14.6.6 LFE Channel

For subwoofer there is an option to define if a digital signal carries the LFE content. If there is LFE channel, it can be selected from the dropdown list (A or B channel). LFE input can be boosted by +10dB, when this gain is not applied in the audio source.

NOTE: with analogue signal all connected main and LFE inputs are automatically reproduced. There is no need to configure anything else than LFE +10dB setting.

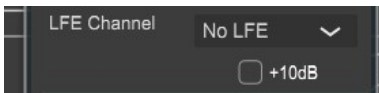

### 7.15 Advanced use of AutoCal

AutoCal automatic calibration offers you the possibility of using multiple microphone positions (MultiPoint) in order to determine the system calibration instead of one microphone position located, for example, at the main listening position (SinglePoint).

MultiPoint calibration uses up to four spatially averaged microphone positions. The first microphone position is the primary position. Timing and level are calibrated to the primary microphone position. Put the microphone first to the primary position.

### 7.15.1 MultiPoint calibration

GLM supports unlimited number of microphone positions in the 'MultiPoint' mode.

The steps of a MultiPoint calibration are

- select 'MultiPoint' in the AutoCal window (additional microphone positions can be measured after the primary position)
- place the microphone in the primary listening position
- press the 'Start Calibration' button to start the measurement and follow the dialogue instructions – keep on selecting new measurement positions as long as needed, following the dialogue instructions
- wait until all the measurement sweeps have been completed for all monitors and subwoofers, then press the 'Optimize' button to start the calculation process and wait until completed
- review the results by clicking on the monitor and subwoofer icons
- continue to AutoPhase when there is a subwoofer in the system – before running the AutoPhase, move the microphone to the primary (first) microphone position and follow the dialogue instructions
- continue to WooferCal when there is a W371 woofer in the system – before running the AutoPhase, move the microphone to the primary (first) microphone position and follow the dialogue instructions
- accept the calibration result with the 'Confirm Calibration' button

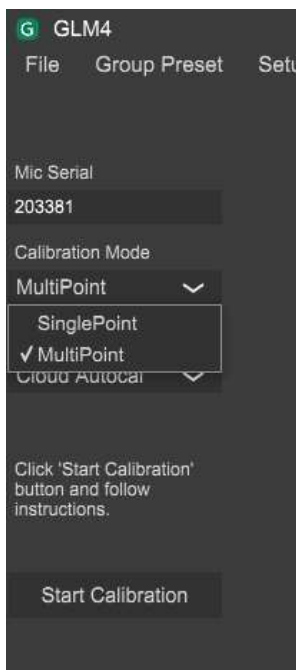

Figure 32. Selecting the MultiPoint calibration

### 7.15.2 Reviewing the AutoCal result

After the AutoCal measurement and calculation process has completed, you can review and evaluate the resulting frequency response compensations. Click on each monitor and subwoofer to review the measurements (red curve), corrections (blue curve), and compensated (green curve) responses in the graph window.

Note that for standard stereo setups placed in a symmetrical manner (equilateral triangle), it often makes sense to manually set to '0' the values for the time-of-flight correction and the level adjustments. Usually, some small correction values appear simply because the measurement microphone is not perfectly and accurately positioned in relation to each monitor. In such cases, deleting such small correction values can improve the stereo imaging and its stability.

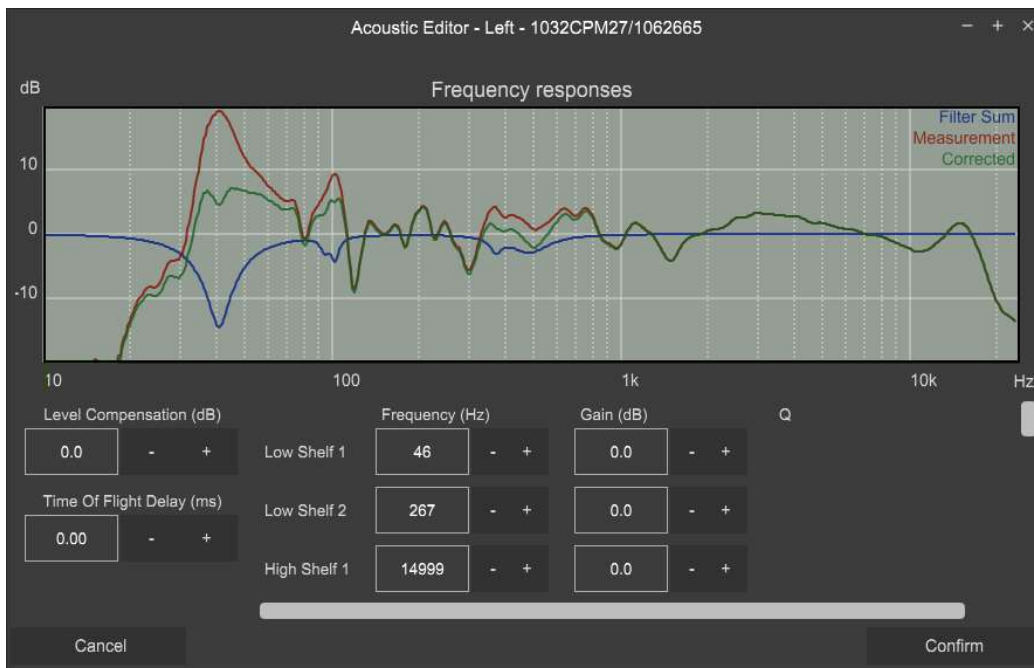

Figure 33. Reviewing the corrections by clicking on the monitor and subwoofer icons

## 7.16 Advanced use of AutoPhase

AutoPhase uses the selected Bass Management Filter frequency setting together with the selected monitor. The purpose of AutoPhase is to align the subwoofer phase with the reference monitor so that the frequency response across the bass management crossover is flat.

### 7.16.1 Acoustical reasons for selecting the crossover frequency

Select a crossover frequency for the group that makes acoustical sense. A good crossover frequency is one that shows good output from at least the subwoofer and the reference monitor. Even better is when there is sufficient output from all monitors at the crossover frequency. The output is sufficient when the level in the equalized frequency response is similar to the midrange level and there is no notch in the frequency response close to the crossover frequency.

### **7.16.2 The steps to run AutoPhase**

The steps to run AutoPhase are

- before you start, select the Bass Management Filter frequency (see group settings)
- select the subwoofer to be AutoPhased by clicking on the subwoofer icon
- select the reference monitor by clicking on a monitor icon (the monitor will be highlighted, and the monitor's LED will flash)
- click 'Start Calibration'
- wait until the measurement process completes
- accept the phase setting by clicking 'Confirm Calibration'

## 8 Editing Acoustic Calibrations

### 8.1 Acoustic Editors

Acoustic settings editor opens with a right-click on the monitor or subwoofer icon in the monitor group hive view. Using the right click (Windows) or Control-Click (Mac) and select the 'Acoustic Editor' option. The measured frequency responses are shown once the group has been calibrated. The data is color coded. The **red curve** is the measured room response. The **blue curve** is the room equalization filter response. The **green curve** is the equalized room response.

The equalized room response is recalculated and shown whenever room calibration filters are manually adjusted. The sound of the monitor or subwoofer changes immediately when the room calibration filters are manually adjusted. This enables audible evaluation of any changes. The settings are saved only after you click the 'Confirm' button. The acoustical editor has a scroll bars to give access to all settings inside the monitors and subwoofers.

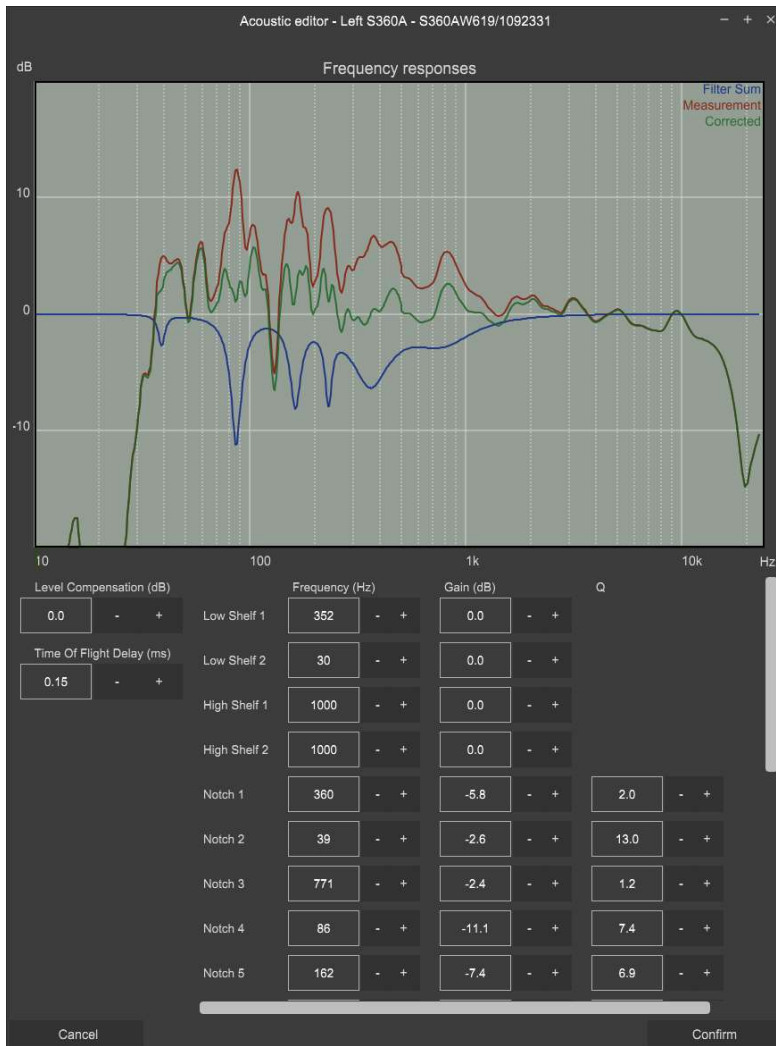
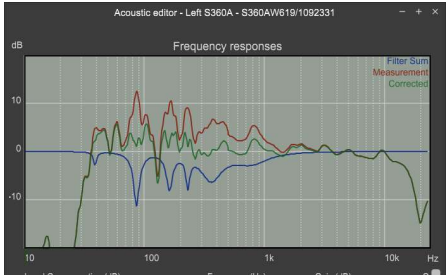

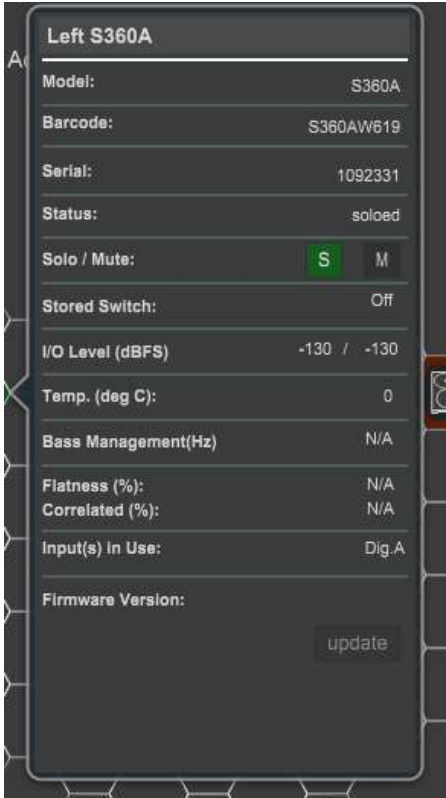

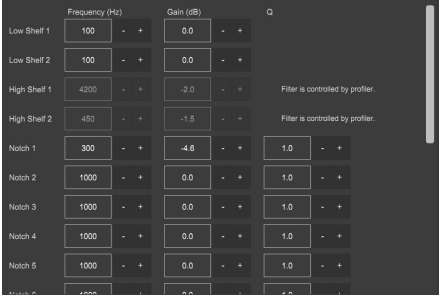

Figure 34. Example of the acoustical calibration editor window

## 8.2 Descriptions of the Acoustical Settings

Table 2. Acoustical settings

Setting	Description	View
<p>Frequency response graphs</p>	<p>Click on the monitor/subwoofer in the monitor group hive view. Using the right click (Windows) or Control-Click (Mac) and select the 'Acoustic Editor' option.</p> <p>This brings up the frequency response and all settings for this monitor or subwoofer.</p> <p>The measured frequency response (red), room calibration filter (blue), compensated room frequency response (green) are shown.</p>	
<p>Monitor Info</p>	<p>Click on the monitor/subwoofer in the monitor group hive view.</p> <p>Using the right click (Windows) or Control-Click (Mac) and select the 'Show Info' option.</p> <p>Information about the monitor is at the top of the pop-up window.</p>	
<p>Test Controls</p>	<p>Click on the monitor/subwoofer in the monitor group hive view.</p> <p>Using the right click (Windows) or Control-Click (Mac) and select the 'Show Info' option.</p> <p>In the pop-up window, you can set the 'Solo S' and 'Mute M' controls to solo or mute individual monitors or subwoofers.</p>	

Setting	Description	View
Level and delay	Sensitivity adjustment (level). Time-of-Flight compensation.	
Room Response Equalizer Filters	<p>Low frequency shelving filters (1-2). High frequency shelving filters (3-4). Parametric notch filters (5-20).</p> <p>The number of filters depends on the product. For example 82xx Series monitors have a different number of parametric filters (5-11).</p> <p><i>Filters 3-4 are shared with the Sound Character Profiler.</i></p> <p><i>When paired with the woofer system, filters 16-20 are cleared and not available.</i></p>	

### 8.2.1 Level and time-of-flight correction Controls in Monitors and Subwoofer

SAM monitors contain adjustment of the input sensitivity. This is called the level setting. The input sensitivity can be adjusted from the nominal maximum (0 dB) down to – 60 dB.

The time-of-flight compensation is needed when the monitors are at different distances from the listening position. The adjustment range for the time-of-flight is from 0 ms (no additional delay) to 45...200 ms, depending on the product. This range enables complex reproduction system with monitors at different distances from the listening positions to be calibrated for the same level and time-of-flight for audio at the listening position.

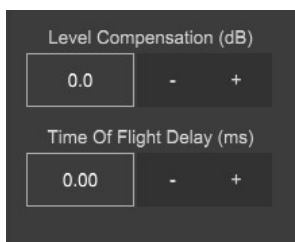

Figure 35. Level and time-of-flight correction controls

### 8.2.2 Room Response Equalizer Controls

Each SAM monitor and subwoofer contains a set of tools to compensate for the acoustical influences of the room. These tools include high frequency Low shelf filters 1 and 2, High shelf filters 1 and 2, and parametric notch filters 1 to 16. The number and type of room calibration filters depends on the SAM product. For example, subwoofers contain parametric notch filters, only.



The room response equalization filters are automatically set by the GLM AutoCal, but all settings are available for manual review, evaluation, and editing.

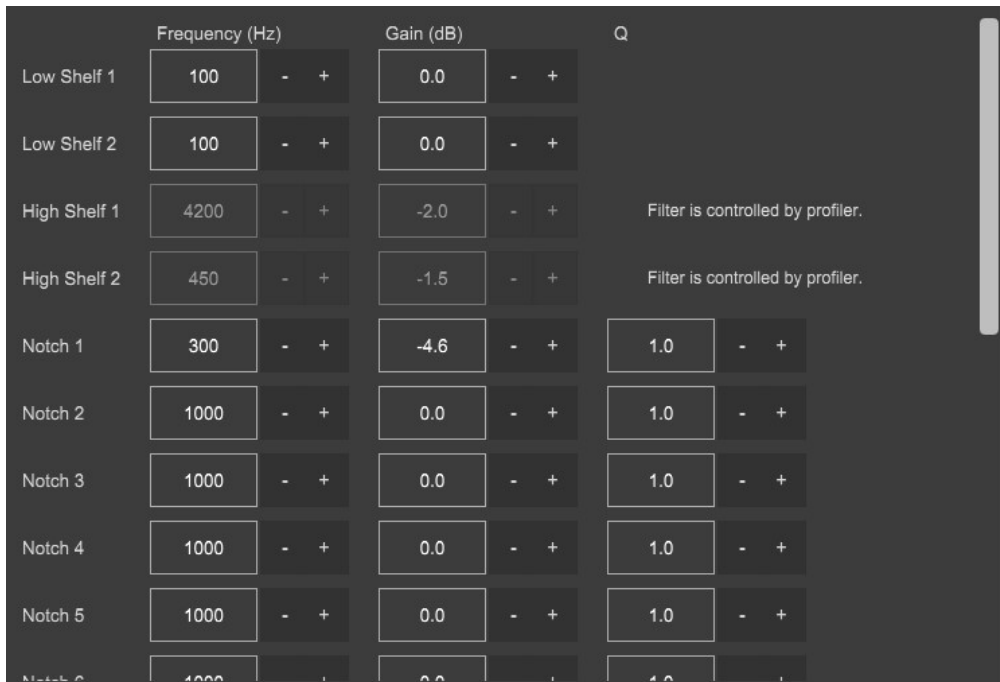

Figure 36. Room response equalizer controls

The parameter values can be toggled up and down with the arrow + and - buttons. A value can be directly written into the parameter value field. Press Enter to accept. Also the keyboard up/down or left/right arrow buttons can adjust a parameter value once it has been selected with a mouse.

When the room response calibrations are adjusted, the outcome is shown in the measurement graph window and also becomes immediately audible in the sound output of the monitor and subwoofer. Use the scroll bar to scroll up and down the control list to get to the control you want to see. NOTE: *Filters 3-4 are shared with the Sound Character Profiler. When a monitor paired with the woofer system, filters 16-20 are cleared and not available.*

### 8.2.3 Acoustic editor and scoring system for woofer systems

The woofer system S371 also shows additional information for the flatness index and the correlation index after the AutoCal for the S371 with the selected monitor. Click on the monitor/subwoofer in the monitor group hive view. Using the right click (Windows) or Control-Click (Mac) and select the 'Show Info' option to access this data.

To see the total system response for the W371 and the associated monitor, bring up the Acoustic Editor. To do this, click on the monitor/subwoofer in the monitor group hive view. Using the right click (Windows) or Control-Click (Mac) and select the 'Acoustic Editor' option. This brings up the frequency response and all settings for this monitor and W371 woofer.

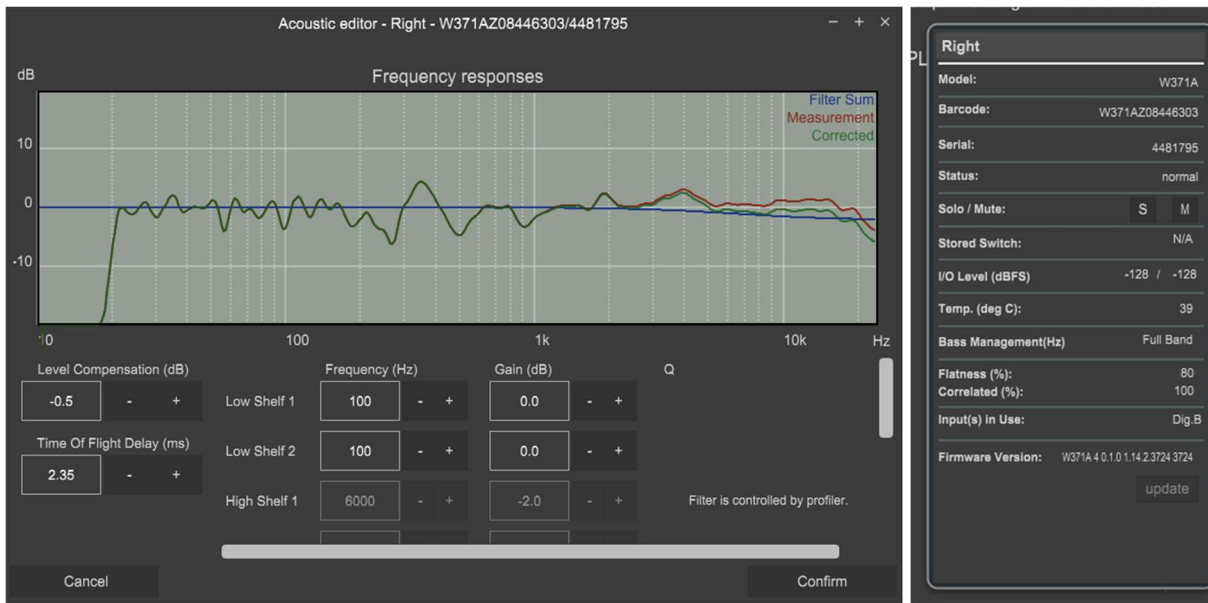

Figure 37. Acoustic editor for Woofer Systems and info on the Flatness and Correlation for Woofer Systems

In the acoustic editor of each WS/monitor pair, the following information (exclusive to Adaptive Woofer System systems) can be found:

**Paired with:** The main monitor that the individual WS was paired with for calibration.

**Calibration mode:** The mode of operation chosen for the Adaptive Woofer System calibration

**System x-over:** The resulting x-over frequency between main monitor and WS.

**System flatness:** This is an indication of how flat the resulting calibrated system response is. This figure is calculated using the system response from 25Hz to 500Hz.

A score of 100% means that the system is perfectly flat in this range, with a lower score indicating there is some deviation.

Values in the range of 85– 95% can be expected for a good system setup. Values lower than this (in all modes) would indicate that a change in position of listener, main monitor or Adaptive Woofer System may be beneficial to produce a flatter response.

**System Correlation:** This is an indication of how well the Left and Right signals of a stereo pair sum at the listener position. This figure is calculated comparing the complex sum (considering phase) of the stereo pair to the absolute sum (ignoring phase). A score of 100% would mean that (for a correlated signal) the summed response at the listener position that there is no destructive interference. Values in the range of 90-99% are typical in a setup with good symmetry. Values lower than this (in all modes) would indicate that a change in position of listener, main monitor or Adaptive Woofer System may be beneficial.

Both the system flatness and correlation scores are designed as simple, quick objective measures to be able to compare the resulting responses of individual calibrations and provide indication if adjustment of the system setup is recommended. However, subjective evaluation should also be considered when making decisions.

**User controls:** In order to preserve the complex interaction between units, following calibration, the woofer system and main monitor are paired together as a single unit. This means that the two units cannot be controlled individually. However, they can be controlled on a 'global' basis - all parameters that are adjusted within the acoustic editor are applied to both units.

Within the acoustic editor the following controls are available:

- Delay
- Gain
- Individual amp-channel mutes (not saved as part of the Group)
- User EQs (4 Shelves and 4 parametric)
- Sound profiler (found under Group Tab. Uses the 2 HF shelving filters)

Detailed description of Sound profiler and EQs can be found in [Sound Character Profiler](#) and [Room Response Equalizer Controls](#) sections respectively.

Also included in the editor is the firmware status and update for the WS.

### 8.3 Sound Character Profiler

The Sound Character Profiler (SCP) can be accessed via the 'Group Presets' menu item 'Sound Character Profiler'. If you feel the *overall* spectral balance of your system needs adjustment, i.e. making the sound generally darker or brighter, the Sound Character Profiler found in the Group pull-down menu is a quick place to start. The settings in the Sound Character Profiler will affect all monitors and subwoofers in the current Group.

Presets include also a Manual option, with adjustable parameters, for even more precise tonal balancing. The 'Extension' parameter in the Manual option is used to select an effective frequency bandwidth of the SCP tool and the 'Strength' parameter is used to set the strength of the SCP tool.

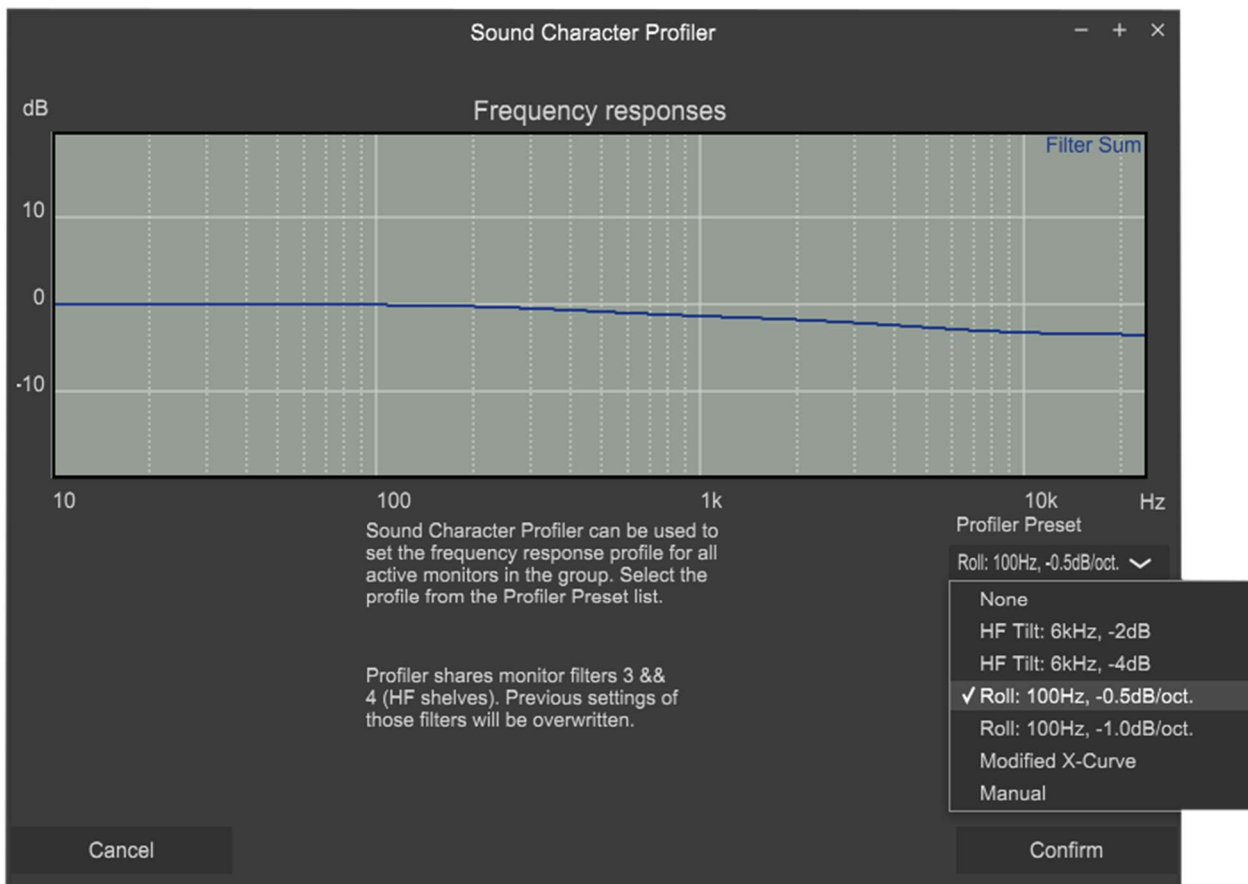

Figure 38. Sound Character Profiler tool

## 9 Stand-Alone Operation

SAM monitors and subwoofers are set up and calibrated using GLM management network and GLM user interface software.

After setup, monitors, subwoofers and the GLM adapter can also operate without having a computer connected to the GLM adapter. This is called stand-alone operation. The functions related to stand-alone mode include

- storing all calibration settings permanently into monitors and subwoofers
- using the GLM adapter as a volume control interface

### 9.1 Storing values permanently in monitors and subwoofers

SAM monitors and subwoofers retain their settings after storing the settings inside the monitors and subwoofers. **In some monitors and subwoofers, the 'Stored Controls' switch must be turned ON for the stored settings to have an effect!**

Storing is done in the 'Group Presets' menu and 'Store to Loudspeakers' menu command.

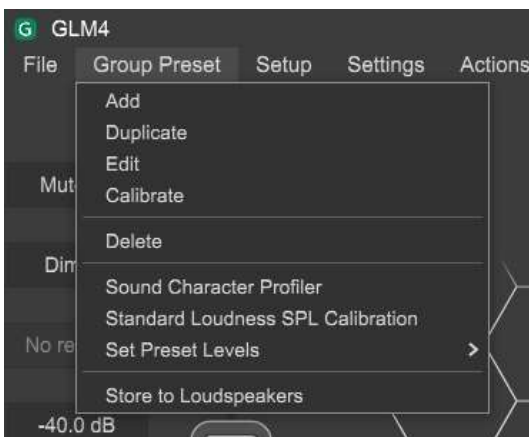

Settings that are stored

- Current Group Acoustic Settings
- Standalone Volume Control Max Level
- Startup Level
- ISS sleep delay settings
- ISS sensitivity settings
- LED usage settings
- Input Selection

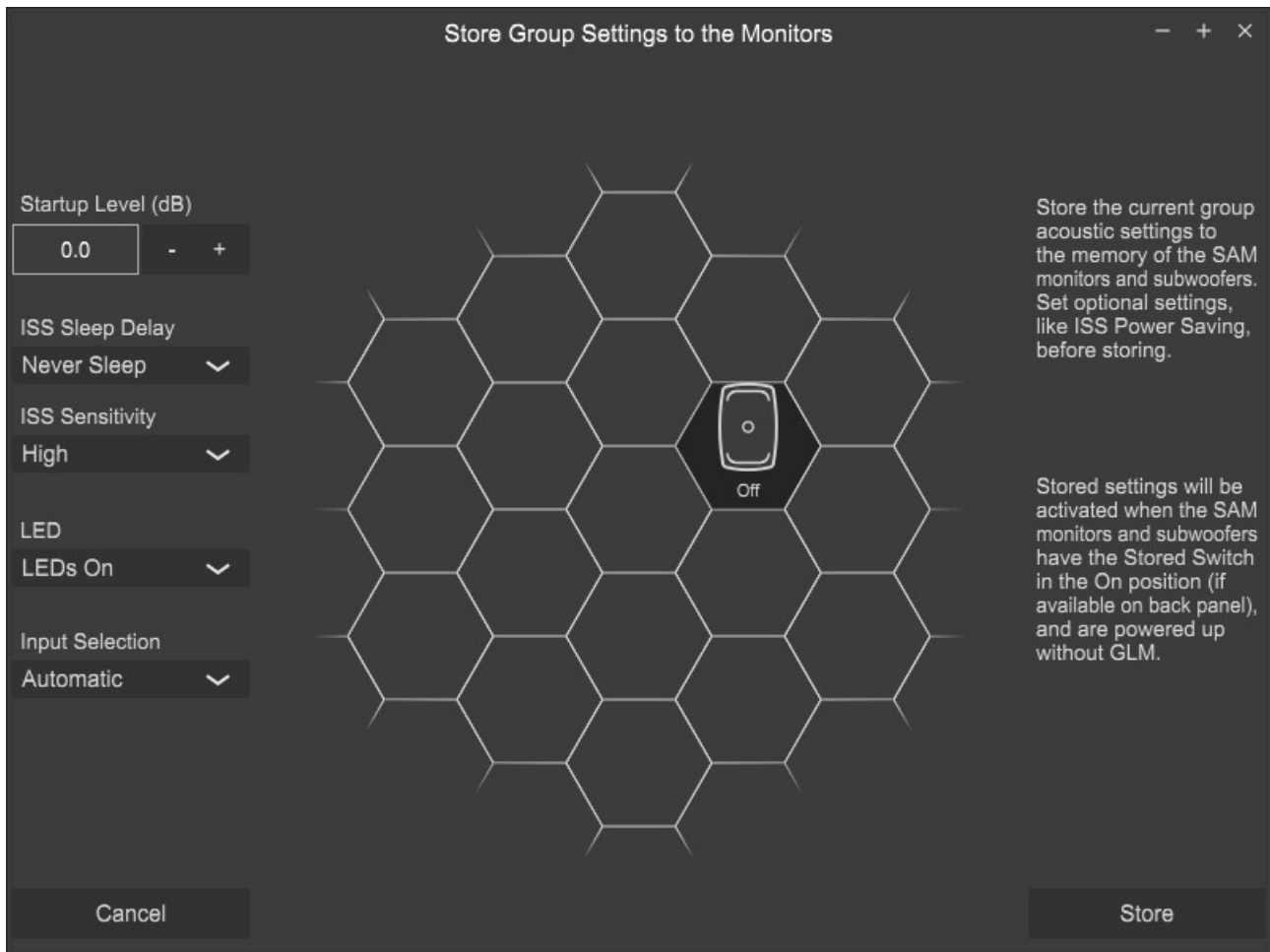

Figure 39. Store Group Settings page

Support for LED Disable and Input selections is not available in the following products:

7260A, 7261A, 7270A, 7271A, 8240A, 8250A, 8260A, 8351A, 1238CF, 1237A, 1238A, 1238AC, 1238DF, 1234A, 1234AC, 1236A

ISS support is not available in the following products:

7260A, 7261A, 7270A, 7271A, 8240A, 8250A, 8260A, 1238CF

## 9.2 Using a USB power supply

The hardware volume controller can also be used for adjusting the sound level when the computer is detached from the GLM adapter. When this is done, the GLM adapter must be powered with a standard USB power supply. The voltage output of the USB supply is 5 VDC.

To use an external USB power supply, remove the USB cable from the computer and attach the cable to a USB power supply, as shown below.



## 9.3 Level Control with GLM Cabled Volume Controller

The monitoring level can be controlled without a computer. GLM volume controllers are available for this. The cabled GLM volume controller connects to the GLM adapter.

When the volume controller has been connected to the GLM adapter and the computer is connected, the system level fader disappears in the GLM main window and is replaced with the icon of the volume knob. The system level is controlled only with the volume knob as long as it is connected to the GLM adapter.



Figure 40. Hardware level controller

## 9.4 Connecting the GLM Volume Controller

The volume controller is connected to the GLM adapter via 3.5 mm jack showing a level control triangular sign. See the bottom of the GLM adapter for more information.

**Caution: Be sure to turn the volume controller fully counterclockwise (level down) before connecting the volume controller to the GLM Network Adapter as the setting on the volume controller will be applied as soon as the controller is connected.**



Figure 41. GLM Network Adapter connections from left to right, USB to computer or to USB power supply, hardware level controller input, GLM measurement microphone input, GLM network and terminator connectors.

## 9.5 Wireless Volume Controllers

Wireless volume controllers are available for adjusting the sound level. The wireless volume controllers use radio frequency communication and do not need a line of sight to the GLM adapter. The typical maximum operating range is 30 meters.

The wireless controllers work with the GLM adapter after pairing.

The pairing happens during the first 10 seconds after powering up the GLM Adapter. To pair with a GLM Adapter, in the RF remote, first press and hold '+' or 'speaker icon +' button and then press and hold '-' or 'speaker icon -' button. To check that the pairing has succeeded, observe the back LEDs on the GLM Adapter. The LEDs will start blinking after successful pairing when you press a button on the RF remote. If you do not observe this, repeat the pairing process.

The wireless controller can increase and decrease the audio output volume level and turn the system on and off. The six-button remote the '<' and '>' buttons select the active group when the GLM software is running in the computer. For more information on the wireless volume controller, consult your Genelec sales representative.







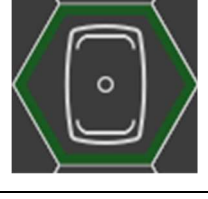

Figure 42. Two wireless remote controllers to use with GLM





## 10 Additional Information

### 10.1 GLM display indications summary

Table 3. Display indications summary

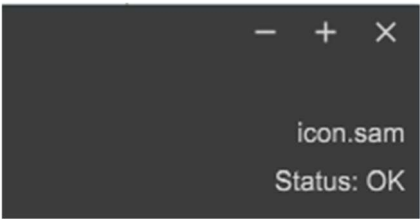
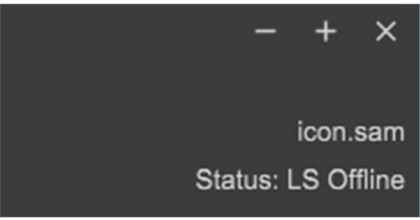
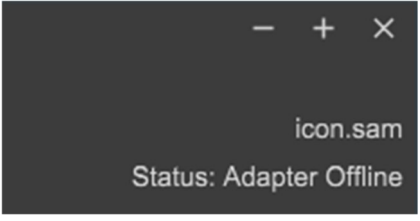
Icon	Icon action	Device LED action	Meaning and solution
	Steady green	Steady green	Device is working normally and passes audio
	Flashing green	Flashing green	Device is working normally and it is selected (under attention) in the GLM
	Light outline	Steady yellow	Device is not part of the group – audio does not pass through
	Black cell	n.a.	Device cannot be found, it may be turned OFF or the network is not working.
	Steady green	Steady green	Device is soloed, audio is passing through.
	Steady red	Steady red	Device is muted, audio is not passing through.

Icon	Icon action	Device LED action	Meaning and solution
		Network adapter is connected and all loudspeakers in the group online.	
		Network adapter is connected and one or more loudspeakers are offline.	Loudspeaker(s) may be turned OFF or the network is not working.
		Network adapter is not found	Check USB cabling and status of LED. Try to connect to different USB port.
		Microphone is connected to the network adapter	Microphone is showing measurements of the sound level.
		Microphone is not connected	Check that the microphone is connected to the Mic in connector.

## 10.2 Monitor and subwoofer LED light indications summary

Table 4. Monitor and subwoofer LED indications summary

Device LED action	Meaning
Steady green	Normal state
Slowly blinking green	Normal ISS power saving state
From yellow to green	Normal operation during device startup
Steady yellow	Monitor or subwoofer is not part of the group
Steady red	Muted from GLM
Flashing red	Signal clip (analog)
Flashing red	Bit errors in the incoming AES/EBU digital audio
Flashing red	Digital signal potential clip (digital audio is very close to 0 dB FS)
Flashing yellow	Protection

**NOTE:** When using the SE7261 subwoofer with digital input monitors (8130), the monitors' LED are not following the actions listed above.

For example: for the 8130, Steady yellow means that the monitor receives a valid digital signal and automatically reproduces this digital signal. Steady green means that the monitor automatically reproduces an analog audio signal because a valid digital signal does not exist.

## 10.3 Griffin Powermate USB Controller

Griffin Powermate is a USB Controller supported by GLM. No drivers are needed to use the Griffin Powermate with GLM. Griffin Powermate functions can be enabled from Setup / Enable USB Controller menu. A Powermate setting is individual for each GLM setup file.

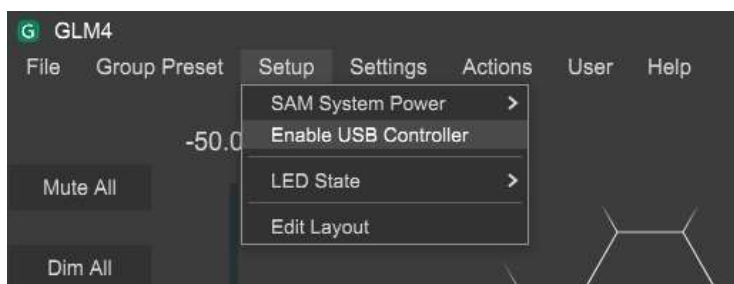

Griffin Powermate functions with GLM are:

Action	Effect
Rotate Clockwise	Increase Level
Rotate Anti-clockwise	Decrease Level
Press	Mute and Unmute



Figure 43. Griffin Powermate USB controller

## 10.4 Level-Aligning Subwoofers Reproducing the Same Signal

When several subwoofers reproduce the **same channels**, the low frequency output by those subwoofers will sum and elevate the output level. After the AutoCal and AutoPhase, the output levels of all the subwoofers reproducing the same signal must be adjusted down. An example of this situation is when subwoofers are daisy-chained to reproduce the same **sum** signal or LFE signal.

To setup a daisy-chain of subwoofers, perform following steps:

- Run AutoCal and AutoPhase – this sets each subwoofer individually
- Find the correction level in the Table 5 corresponding to the number of the subwoofers in the daisy-chain.
- Edit the Acoustic settings of each subwoofer. Reduce the 'Level Compensation' value according to the correction provided in the Table 5. Press the 'Confirm' button to save the new settings. Repeat this for all the subwoofers in the daisy-chain.

Table 5. Subwoofer level corrections for daisy-chained subwoofers.

Number of subwoofers in the daisy-chain	Correction (dB)
1	0
2	-6
3	-9
4	-12
5	-14
6	-16

Figure 44 shows the Level Compensation field where the Autocal calculated single subwoofer level is shown. For the case of two daisy-chained subwoofers reproducing the same signal, this figure is reduced by 6 dB (see Table 15). Click 'Confirm' to accept the change. This completes the setting for this particular subwoofer. Do the same level reduction also for the next subwoofer.

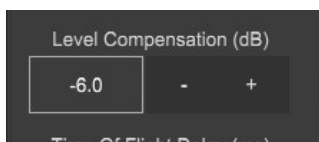

Figure 44. Level compensation setting in the Acoustic Editor.

The level correction for subwoofers are only required if those are reproducing same channels. Audio connections for analog signal is show in Figure 45 and for AES/EBU signal in Figure 46. If subwoofers are used so that the left subwoofer only reproducing the left channel and the right subwoofer only reproducing the right channel, level corrections won't be needed.

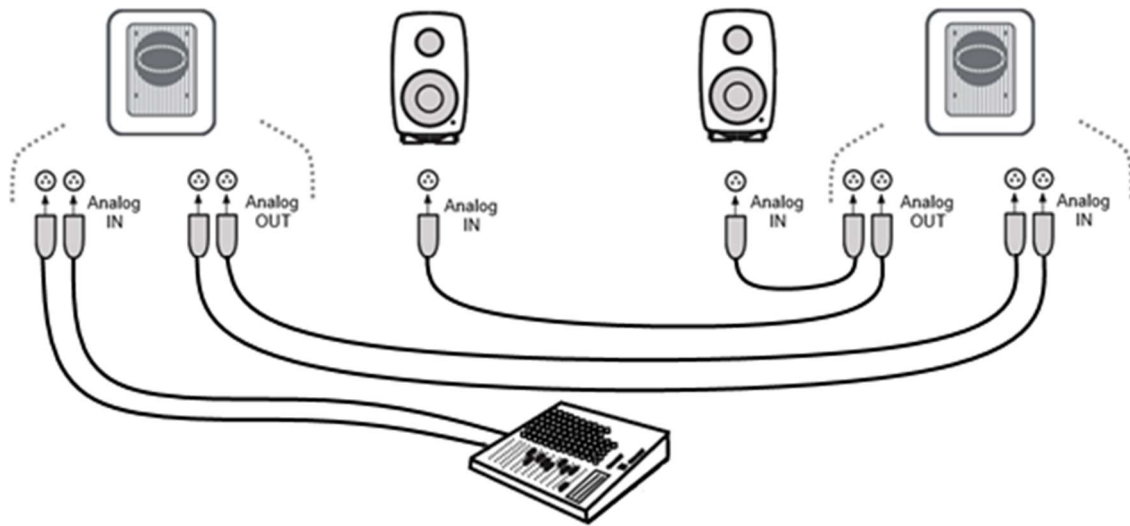

Figure 45. Dual subwoofers with the analogue signal.

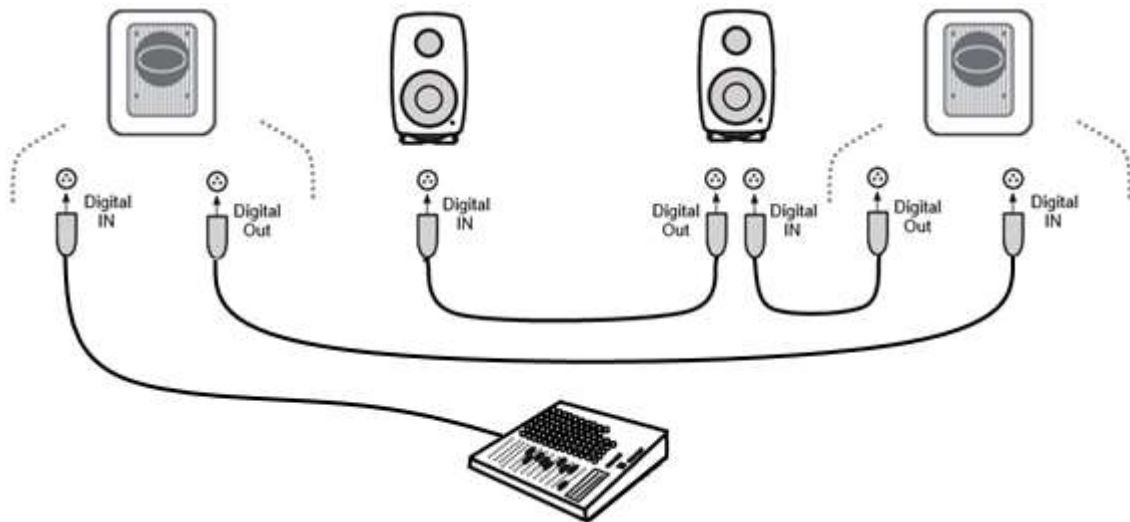

Figure 46. Dual subwoofers with the AES/EBU signal.

## 11 Frequently Asked Questions

### 11.1 Why do ID tones vary in different system configurations?

Different SAM monitors generate different identification tones. The identification tones are listed in the table below.

Table 6. Identification tones

SAM Systems	Used ID tone
82xx Series SAM monitors	Pink noise
83xx Series SAM monitors	Pink noise (SAM system ID tone was used earlier)
72xx Series SAM subwoofers	Low frequency sinewave
73xx Series SAM subwoofers	Low frequency sinewave (SAM system ID tone was used earlier)
12xx Series SAM monitors	Pink noise

### 11.2 How to duplicate a Group?

A Group can be duplicated. This is a safe way to manually edit acoustic settings.

Choose the Group you want to duplicate by clicking on the group name. The active group is highlighted in green colour. To create a duplicate of this group, in the 'Group Preset' menu, choose 'Duplicate'. This creates a full copy of the selected Group including all acoustic settings. The duplicated group gets a default name. You can change the default name to what you want to have by selecting the new group, in the 'Group Preset' menu select 'Edit'. To finalize your edit, choose 'Confirm Group' and 'Confirm AutoCal' to exit the edit.

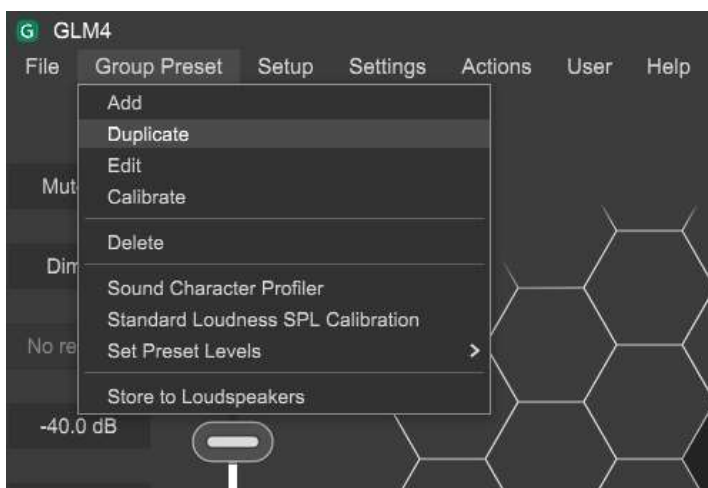

Figure 35. GLM Group tabs.

### 11.3 How to compare a calibrated and uncalibrated SAM system?

A) Using the Autocal Bypass button located on the main page. One can evaluate the benefits of using AutoCal calibration. When the Bypass button is active, all AutoCal optimized acoustic settings are bypassed.

The influence you hear during bypass is complex because all these settings are temporarily set to default values where they have no effect

- equalization to reduce and remove room colorations
- level calibration for the listening position
- time-of-flight compensations for the differences in monitor distances to the listening position
- system delay compensation (system delay is an additional delay applied to all monitors and subwoofers)

B) After a Group has been calibrated and the calibration has been confirmed, the acoustic settings are set for the Group and stored in a setup file.

An uncalibrated Group can be created as follows: select a calibrated Group, then use the menu item 'Group | Add Group' and select 'Confirm Group'. Then click 'Skip Calibration'. This operation retains the Group configuration but clears all the acoustic settings and restore the factory settings.

### 11.4 How to calibrate SAM systems for different listening positions?

Groups can be used to calibrate SAM systems for different listening positions (sweet spots). First, create a group and calibrate it to the first listening position. Then, choose this group and choose menu command 'Group | Add Group'. Name the new group and make the necessary edits to it and click the 'Confirm Group' button. Next, place the Genelec calibration microphone at the second listening position and run calibration by double-clicking on the measurement microphone icon.

After both groups are created and calibrated, the location-specific calibration for each listening position can easily be selected by selecting the corresponding group tab in the main GLM window.

### 11.5 Can analog and digital signal sources be mixed?

Yes and no. One type of signal can be used in one group. However, it is easy to create two groups, one for analog input and another for digital audio input. After this, switching from one group to the other will select the input signal type.

### 11.6 How to switch between analog and digital signal?

Groups can be defined to select analog or digital input signal. Both types of signals can be connected to Genelec SAM monitors.

The group definition contains the selection of analog or digital audio input signals. The selection applies to all monitors and subwoofers in the group.

Note that a digital signal cable carries typically two channels of audio. For this reason, the channel to be reproduced needs to be selected for each SAM monitor by selecting the subframe A or B.



The GLM software offers default values that cover the most common channel pairings (for example, in digital stereo, the subframe A is selected for the left monitor and the subframe B is selected for the right monitor).

## 11.7 What does ISS mean?

ISS a Genelec trademark and it refers to **I**ntelligent **S**ignal **S**ensing. ISS will put monitors or subwoofers to a low power consumption state when there is no audio or control signal detected for a certain period. When in ISS state, monitors and subwoofers wake up when audio or control is detected again.

## 11.8 Can I power up and shut down the SAM system with GLM?

Yes. 'SAM System Power' -menu can be used to power up and shut down a SAM system. By default, GLM will send a wake-up command to the GLM network when application is launched, 'Automatically Wake Up System with GLM' menu is checked, and all SAM monitors and subwoofers will power up.

When the GLM application is closed, SAM monitors and subwoofers will continue to play audio by default. It's possible to turn off whole system when the GLM application closes. Select this functionality by checking 'Automatically Shut Down System with GLM' in the menu. This selection sends a shut/down command to the GLM network when the GLM application is closes.

These two menu items are stored for each GLM setup file.

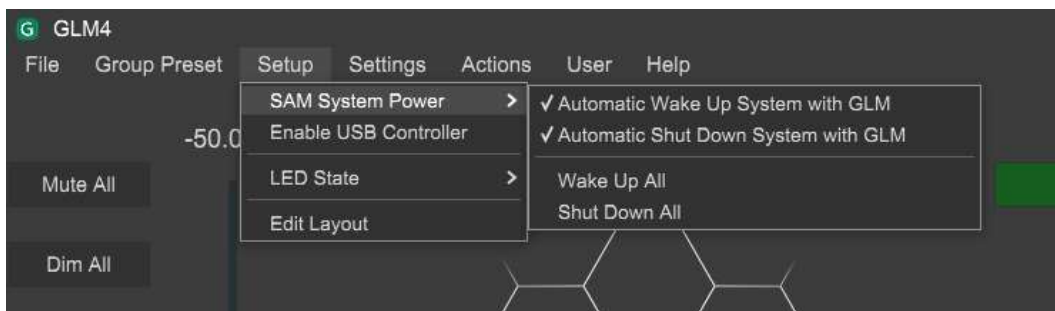

'**Send Wake Up All**' and '**Send Shut Down All**' menu items command GLM network once. These can be used to e.g. wake up monitors that have been powered down by using the power push button on the monitor.

Notes:

- Some older SAM models won't support ISS (8240, 8250, 8260, 1238CF, 7260, SE7260, 7270, 7271) and some models requires a firmware update (8351, 12xx with version 'xxxx x xxxx 0152 xxxx' or older).

## 11.9 Why are my monitors not going to ISS state?

The reason could be also that the monitors are sensing the analog signal. It's possible to change ISS power saving sensitivity. ISS Power Saving sensitivity can be selected between three level, High Sensitivity (default), Medium Sensitivity and Low Sensitivity. High Sensitivity means that smaller analog audio signal needed to wake up / keep active the monitor or subwoofer. Low Sensitivity means that a bigger analog audio signal needed to wake up / keep active the monitor or

subwoofer. Set and store ISS settings with the other group settings from 'Store Group Settings' page clicking 'Group : Store Group Settings' menu command.

Notes:

- GLM network communication and AES/EBU digital audio clock will wake up / keep active the SAM monitor or subwoofer.
- Some older SAM models won't support ISS (8240, 8250, 8260, 1238CF, 7260, SE7260, 7270, 7271) and some models requires a firmware update (8351, 12xx with version 'xxxx x xxxx 0152 xxxx' or older).

### **11.10 What is the “Not used in this setup” bin in the Layout page?**

This bin, or box, is typically used to place unused 8130 channels when defining the number of monitors connected to a SE7261 subwoofer. For example, if 2 x 8130 are connected to input / output #1 on the SE7261, 8130 monitor channels 1A and 1B will come off the Stack and be placed onto the Layout Grid. The unused monitor channels 2A thru 4B (total of 6) should be dragged into the 'Not used in this setup' bin.

### **11.11 How I replace a monitor with a new one?**

To replace the monitor or subwoofer with a new one click 'Setup : Edit Layout' menu command. This will open the Layout page. The monitor or subwoofer to be replaced is grayed out on the grid and a new one is in the Stack. Drag the new monitor or subwoofer and drop it over the old monitor or subwoofer. Devices are swapped and the old monitor or subwoofer is placed into the Stack. Drag the old monitor or subwoofer to the 'Not used in this setup' bin and click 'Confirm Layout' button. Replacement is done and the system can be used normally.

The replacement will copy all settings from the old one to the new one if models are matching. Otherwise recalibration required.

### **11.12 How I edit the System Layout?**

To edit the System layout click 'Setup : Edit Layout' menu command. This will open the Layout page. Move monitor and subwoofer icons as desired and click 'Confirm Layout' button. Replacement is done and the system can be used normally.

### **11.13 Can I use 73xx subwoofers with non-SAM monitors?**

With GLM, the 7360, 7370 and 7380 subwoofers can be used under the control and calibration available with GLM and AutoCal with non-SAM monitors.

Since the 7360, 7370 and 7380 have the built-in 85Hz analog HP filters that are regularly available in Manual mode using the panel dip switches, there is a feature in GLM that enables the 85Hz High Pass outputs and AutoCal filters as well as phase control available for optimization.

Making New Setup with GLM

1. Launch GLM and make File>New

2. Drag the 7360, 7370 or 7380 off the Stack and place in on the Grid. Press “Confirm Layout”
3. Then on the Group Define page check the box marked “High Pass analog outputs 85Hz”. “Confirm Group”
4. On the Calibration Page make all the checks for mic placement and serial number entry. Double click the mic icon and do the AutoCal calibration for the subwoofer. Confirm Calibration and
5. Skip **AutoPhase**
6. Save the Setup and return to Main Screen

#### Setting Manual Phase In Hybrid Mode From the Main Page

1. Increase GLM Master Fader to -0dB (Full up)
2. Double click the sub icon. The Acoustic Settings page will appear. Move it to the left or right of the GLM Main Page.
3. Provide a test signal at the crossover frequency to the subwoofer input.
4. Using the mic SPL reading slowly change **Phase setting** using the < or > keys. We suggest you start at -180 then click > stopping at -135, -90, -45, 00, +45, +90, +135, +180 and then noting which setting is the loudest SPL on the mic. Do this slowly (about 4 seconds secs) as the mic uses a slow update rate. Then Choose Confirm Settings.

#### Adjusting level with Mains

It is possible, with significant subwoofer eq bass reduction in AutoCal (see acoustic traces above), that the Main speakers may need attenuation in order to level match the compensated sub. This may require a bit of experimentation and can be confirmed by Bypassing the Bass Manager 85Hz filter as well as adjusting the sensitivity on the main monitor inputs. Press the Subwoofer Bypass button On, then Off to make this comparison.

### 11.14 Can I use SAM monitors in 3D Immersive Audio Systems?

Yes. The immersive audio systems are very easy to setup and calibrate with SAM monitors and subwoofers. Here is an example of how to create Dolby Atmos 7.1.4 system layout in GLM. Configuration of the system in the room is shown below. The green tags are ear-level surround monitors and the blue tags are overhead monitors (top layer).

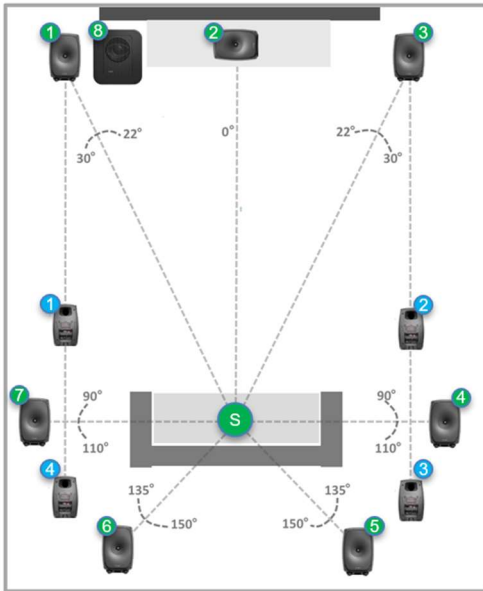

- 1 - Left
- 2 - Center
- 3 - Right
- 4 - Surround Right
- 5 - Rear Right
- 6 - Rear Left
- 7 - Surround Left
- 8 - LFE
- 1 - Top Front Left
- 2 - Top Front Right
- 3 - Top Rear Right
- 4 - Top Rear Left
- S - Seating Position (Sweet Spot)

*Defining a system layout in GLM:* Start by selecting a layout style 7.1.4 and dragging monitors/subwoofers from the Unplaced box to the grid. Each monitor and subwoofer plays an ID tone when dragged and that helps to identify which monitor is handled. For example, when dragging a subwoofer it plays a sine tone and can be placed to the grid. Next page shows an example where each monitor is placed to match an Atmos layout. Note that monitors may not appear in the same order as in these examples.

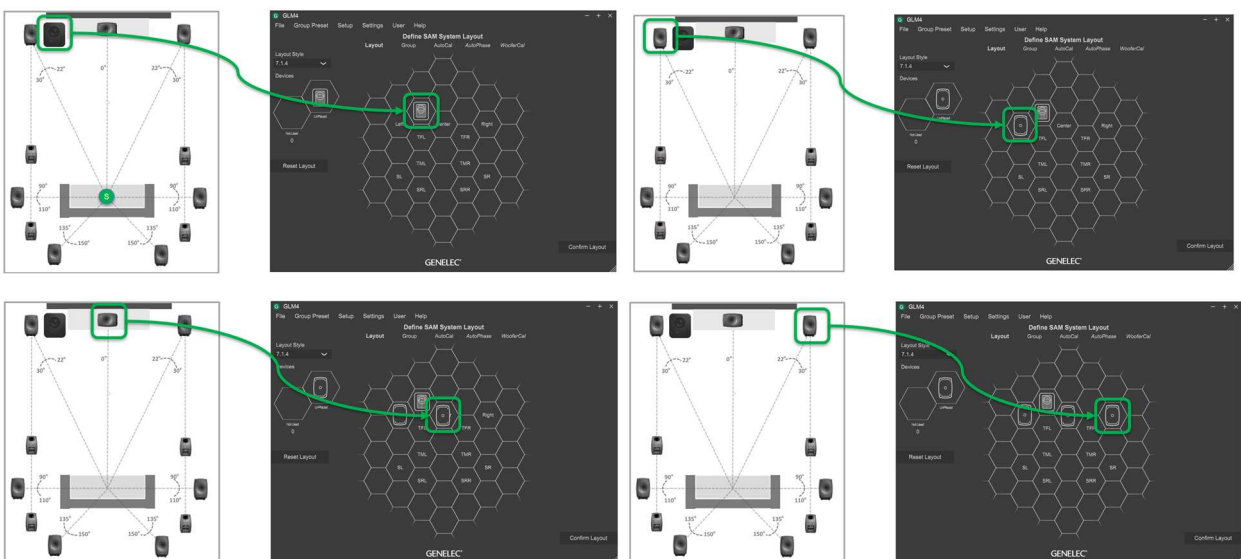

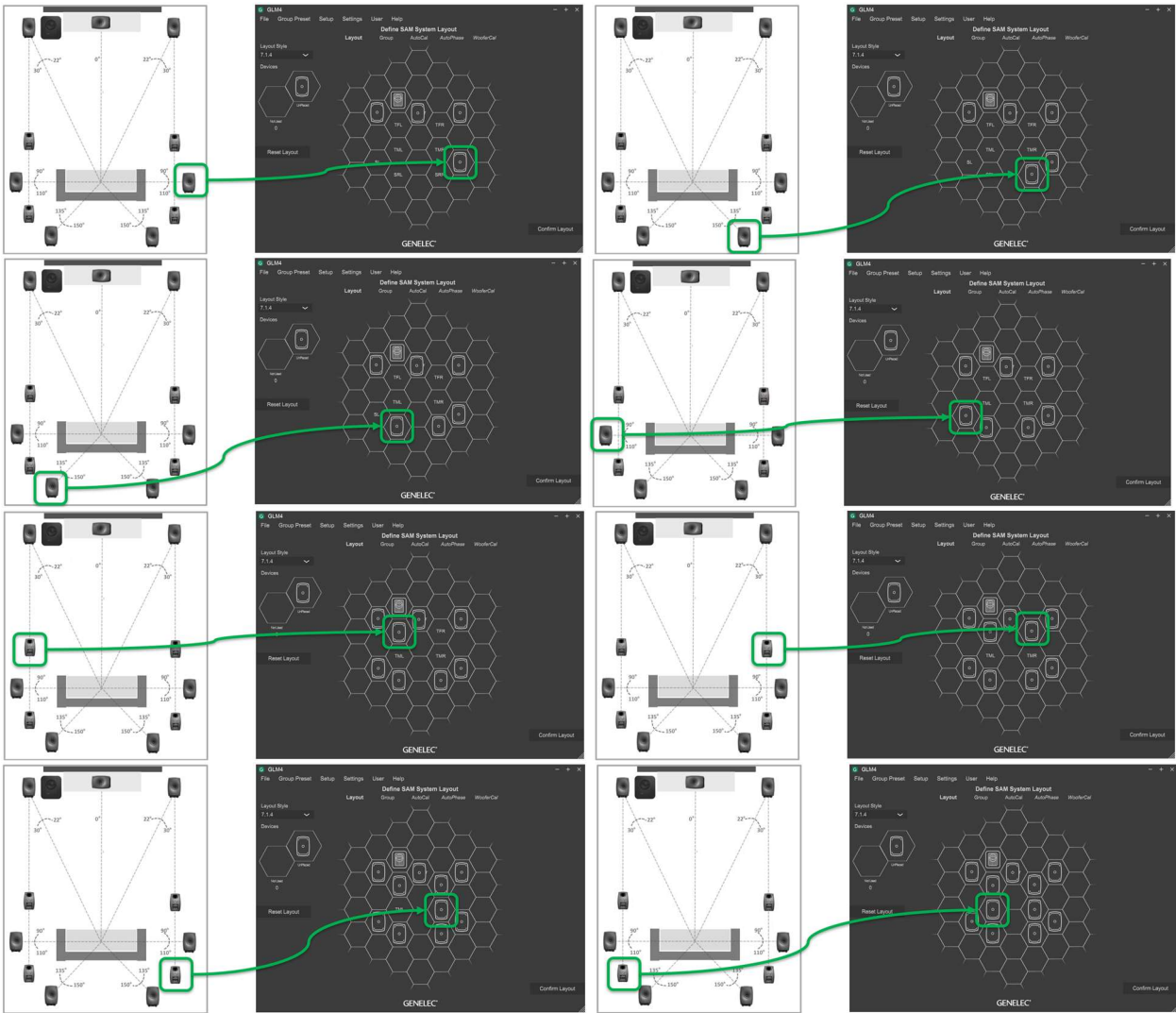

After all monitors and subwoofers are placed in the grid, confirm the layout by clicking the 'Confirm Layout' key. After confirmation, monitors should be shown comparable to the picture below. GLM assigns default names to monitors and 'Top Front Left' in Atmos system is named "Left". To rename, click the 'Top Front Left' monitor icon (Blue 1 tag) and change the name.

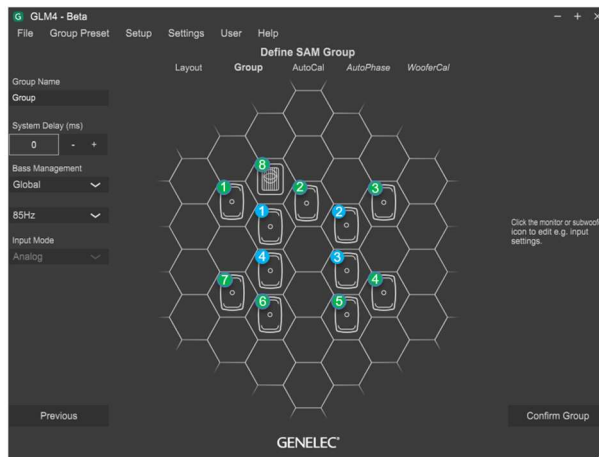
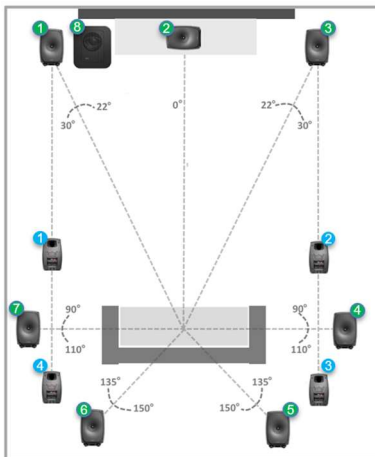

2. Rename monitor Top Front Left

1. Select a Top Front Left



2. Rename monitor Top Front Right

1. Select a Top Front Right

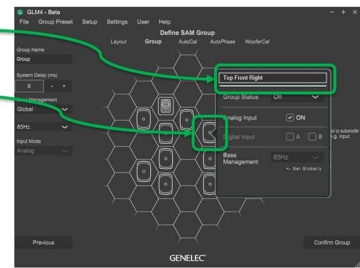

2. Rename monitor Top Rear Right

1. Select a Top Rear Right

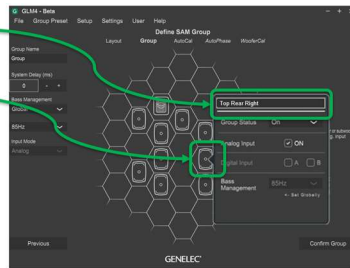

2. Rename monitor Top Rear Left

1. Select a Top Rear Left

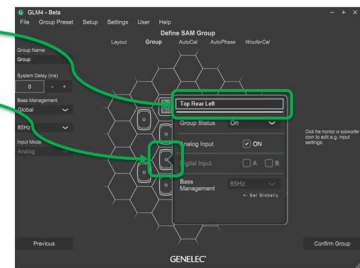

Atmos works like other multichannel or immersive systems, so no special operations are needed in GLM. Autocal compensates room responses, level and time of flight differences automatically; and SPL level calibration is performed as the last step as described previously.

# GENELEC®

the sonic reference

## International enquiries

Genelec, Olvitie 5  
FI 74100, Iisalmi, Finland  
Phone +358 17 83881  
Fax +358 17 812 267  
Email [genelec@genelec.com](mailto:genelec@genelec.com)

## In Sweden

Genelec Sverige  
Ellipsvägen 10A  
SE-141 75 Kungens Kurva  
Sweden  
Phone +46 8 449 5220  
Email [sweden@genelec.com](mailto:sweden@genelec.com)

## In Denmark

Genelec Denmark  
Danmarksvej 32D  
8660 Skanderborg  
Denmark  
Phone +45 71 741 641  
Email [denmark@genelec.com](mailto:denmark@genelec.com)

## In the USA

Genelec, Inc., 7 Tech Circle  
Natick, MA 01760, USA  
Phone +1 508 652 0900  
Fax +1 508 652 0909  
Email [genelec.usa@genelec.com](mailto:genelec.usa@genelec.com)

## In China

Beijing Genelec Audio Co.Ltd  
Room 101, Building B33  
Universal Business Park  
No. 10 Jiuxianquiao Road  
Chaoyang District  
Beijing 100015, China  
Phone +86 10 5823 2014  
Phone +86 400 700 1978  
Email [genelec.china@genelec.com](mailto:genelec.china@genelec.com)

## In Japan

Genelec Japan Inc  
2-22-21 Akasaka  
Minato-ku  
JP-107-0052 Tokyo  
Japan  
Phone +81 3 6441 0591  
Email [genelec.japan@genelec.com](mailto:genelec.japan@genelec.com)