

TEOM® 1405

Ambient Particulate Monitor

42-010976 Revision A.000 15Feb2008



This documentation contains trade secrets and confidential information proprietary to Thermo Fisher Scientific. The software supplied with the instrumentation, documentation and any information contained therein may not be used, duplicated or disclosed to anyone, in whole or in part, other than as authorized in a fully executed Thermo Fisher Scientific End User License Agreement or with the express written permission of Thermo Fisher Scientific.

© 2007 Thermo Fisher Scientific. All rights reserved.

TEOM[®] is a registered trademark of Thermo Fisher Scientific. Other trademarks are the property of their respective holders.

Mention of specific product names (other than Thermo Fisher Scientific products) in this manual does not constitute an endorsement or recommendation by Thermo Fisher Scientific of that equipment.

Warranty

Seller warrants that the Products will operate substantially in conformance with Seller's published specifications, when subjected to normal, proper and intended usage by properly trained personnel, for 12 months from date of installation or 13 months from date of shipment, whichever is less (the "Warranty Period"). Seller agrees during the Warranty Period, provided it is promptly notified in writing upon the discovery of any defect and further provided that all costs of returning the defective Products to Seller are pre-paid by Buyer, to repair or replace, at Seller's option, defective Products so as to cause the same to operate in substantial conformance with said specifications. Replacement parts may be new or refurbished, at the election of Seller. All replaced parts shall become the property of Seller. Shipment to Buyer of repaired or replacement Products shall be made in accordance with the provisions of Section 5 of the Terms and Conditions of Sale agreement. Lamps, fuses, bulbs and other expendable items are expressly excluded from the warranty under Section 9 of the Terms and Conditions of Sale agreement.. Seller's sole liability with respect to equipment, materials, parts or software furnished to Seller by third party suppliers shall be limited to the assignment by Seller to Buyer of any such third party supplier's warranty, to the extent the same is assignable. In no event shall Seller have any obligation to make repairs, replacements or corrections required, in whole or in part, as the result of (i) normal wear and tear, (ii) accident, disaster or event of force majeure, (iii) misuse, fault or negligence of or by Buyer, (iv) use of the Products in a manner for which they were not designed, (v) causes external to the Products such as, but not limited to, power failure or electrical power surges, (vi) improper storage of the Products or (vii) use of the Products in combination with equipment or software not supplied by Seller. If Seller determines that Products for which Buyer has requested warranty services are not covered by the warranty hereunder, Buyer shall pay or reimburse Seller for all costs of investigating and responding to such request at Seller's then prevailing time and materials rates. If Seller provides repair services or replacement parts that are not covered by the warranty provided in Section 9 of the Terms and Conditions of Sale agreement., Buyer shall pay Seller therefore at Seller's then prevailing time and materials rates. With respect to spare parts, the above-referenced warranty applies, however, such warranty is limited to ninety (90) days from the date of shipment.

ANY INSTALLATION, MAINTENANCE, REPAIR, SERVICE, RELOCATION OR ALTERATION TO OR OF, OR OTHER TAMPERING WITH, THE PRODUCTS PERFORMED BY ANY PERSON OR ENTITY OTHER THAN SELLER WITHOUT SELLER'S PRIOR WRITTEN APPROVAL, OR ANY USE OF REPLACEMENT PARTS NOT SUPPLIED BY SELLER, SHALL IMMEDIATELY VOID AND CANCEL ALL WARRANTIES WITH RESPECT TO THE AFFECTED PRODUCTS. THE OBLIGATIONS CREATED BY THIS SECTION TO REPAIR OR REPLACE A DEFECTIVE PRODUCT SHALL BE THE SOLE REMEDY OF BUYER IN THE EVENT OF A DEFECTIVE PRODUCT. EXCEPT AS EXPRESSLY PROVIDED IN THIS SECTION 9, SELLER DISCLAIMS ALL WARRANTIES, WHETHER EXPRESS OR IMPLIED, ORAL OR WRITTEN, WITH RESPECT TO THE PRODUCTS, INCLUDING WITHOUT LIMITATION ALL IMPLIED WARRANTIES OF MERCHANTABILITY OR FITNESS FOR ANY PARTICULAR PURPOSE. SELLER DOES NOT WARRANT THAT THE PRODUCTS ARE ERROR-FREE OR WILL ACCOMPLISH ANY PARTICULAR RESULT.



Safety Notice

Repair of instrumentation manufactured by Thermo Scientific should only be attempted by properly trained service personnel, and should only be conducted in accordance with the Thermo Scientific system documentation. Do not tamper with this hardware. High voltages may be present in all instrument enclosures. Use established safety precautions when working with this instrument.

The seller cannot foresee all possible modes of operation in which the user may attempt to use this instrumentation. The user assumes all liability associated with the use of this instrumentation. The seller further disclaims any responsibility for consequential damages. Use of this product in any manner not intended by the manufacturer will void the safety protection provided by the equipment, and may damage the equipment and subject the user to injury.

Equipment Rating

The following information can be used to determine the power service requirements of this product.



Line Voltage
440VA, 47-63 Hz

IMPORTANT. Disconnect the power cord from the power source (output) while servicing the instrument to prevent electrical hazard. ▲



Environmental Ranges — The instrument and its sample pump must be installed in a weather-sheltered location that is heated in the winter and air conditioned in the summer.

Note. There may be hazardous line (wire) accessible inside the enclosure. ▲

Installation Category — Category 11

FUSES

Ref Designation	Current Rating	Location
Main Fuse (2)	T, 4A, 250VAC	Input Module
F201	F, 5A, 250VAC	Power Distribution Board
F202	F, 4A, 250VAC	Power Distribution Board
F203	F, 1A, 250VAC	Power Distribution Board
F204	F, 2A, 250VAC	Power Distribution Board
F201-F206	F, 2A, 125VAC	Head Controller Board
F401-402	T, 6.3 250VAC	FDMS Board

Electrical/Safety Certifications

The product has been tested and has been documented to be in compliance with the following U.S. and Canadian safety standards:



UL Standard 61010-1:2004 2nd Edition
 CAN/CSA C22.2 No. 1010-1:2004 2nd Edition

Thermo Fisher Scientific certifies that this product operates in compliance with the EC Directive 89/336/EEC in reference to electrical emissions and immunity. Specifically, the equipment meets the requirements of EN 61326-1:1998 for Immunity and Emissions. In addition, the hardware has been tested for personal or fire safety hazards in accordance with EN61010-1:2001 (Safety) in fulfillment of EC Directive 73/23/EEC.

Disposal of the Instrument

This product is required to comply with the European Union’s Waste Electrical & Electronic Equipment (WEEE) Directive 2002/96/EC. It is marked with the WEEE symbol.



Thermo Fisher Scientific has contracted with one or more recycling/disposal companies in each EU Member State, and this product should be disposed of or recycled through them. Further information on Thermo Fisher Scientific’s compliance with these Directives, the recyclers in your country, and information on Thermo Fisher Scientific products which may assist the detection of substances subject to the RoHS Directive are available at: www.thermo.com/WEEERoHS.

Service Information

When you purchase Thermo Fisher Scientific products, you can depend on quality products and expert service. We know that your product's performance is critical to your business, and that you require it to deliver timely and reliable data. We are dedicated to helping you realize a maximum value in your technology investment by providing a high level of personal attention, premium technical assistance, and fast reliable response. Thermo Scientific offers a full suite of warranty and service contract programs designed to meet your specific support needs and keep your instrumentation operating at peak performance.

Section Revision List

As Thermo Fisher Scientific's instrumentation changes, so do our operating manuals. However, these changes may affect only one aspect of an instrument, while leaving the instrument as a whole unchanged. To explain these individual changes to our customers, Thermo Fisher Scientific will update only those sections of its operating manuals that are affected by the instrument updates or improvements.

To help our customers keep track of the changes to the TEOM 1405 sampler and its operating guide, following is a list of the sections with their respective revision numbers:

<i>Section Number and Description</i>	<i>Revision Number</i>
Section 1: Introduction	A.000
Section 2: Setup and Installation	A.000
Section 3: Basic Operation	A.000
Section 4: Screens and Settings	A.000
Section 5: Maintenance and Calibration Procedures	A.000
Appendix A: Troubleshooting	A.000
Appendix B: Serial Communication	A.000

Table of Contents

- Section 1 Introduction 1-1**
 - Overview of Manual 1-3
 - Application Range 1-4
 - Theory of Operation 1-5
 - Mass Transducer Operation 1-6
 - Mass Flow Controllers 1-9

- Section 2 Setup and Installation 2-1**
 - Installation Considerations 2-2
 - Standard System Hardware 2-3
 - Pump Connections 2-4
 - Adjusting the Flow Splitter 2-6
 - Assembling the Tripod 2-8
 - Installing the Inlet 2-9
 - Applying Power to the Instrument 2-14
 - Restarting the Instrument 2-16
 - Turning Off the Instrument 2-16
 - Using the Outdoor Shelter 2-17

- Section 3 Basic Operation 3-1**
 - Starting the Instrument 3-2
 - Performing a Leak Check 3-4
 - Storing Data 3-8
 - Downloading Data 3-10
 - Installing ePort 3-11
 - Connecting to the Series 1405 Unit 3-16
 - Finding Instruments On a Network 3-20
 - Setting Up for 3-22
 - Manual Data Downloads 3-22
 - Setting Up for 3-24
 - Automatic Data Downloads 3-24
 - Performing a Data Download 3-26
 - Downloading Data To a Flash Drive 3-28
 - Viewing Downloaded Data 3-30
 - User I/O Connections 3-31

- Section 4 Screens and Settings 4-1**
 - TEOM Data Screen 4-2
 - Operating Mode 4-6
 - System Status Screen 4-8
 - Instrument Conditions Screen 4-10
 - Ambient Conditions Screen 4-12
 - Flows Screen 4-13
 - Flow Rates Screen 4-14
 - Flow Control Screen 4-15
 - Instrument Temperatures Screen 4-18

	Analog Inputs Screen	4-19
	Settings Screen	4-20
	System Screen	4-22
	Analog & Digital Outputs Screen	4-24
	Analog Outputs Screen	4-25
	Contact Closure Screen	4-26
	RS232 Screen	4-27
	Settings Advanced Screen	4-28
	Service Screen	4-30
	Instrument Control Screen	4-32
	Service Advanced Screen	4-33
	Installing New Firmware	4-34
Section 5	Maintenance and Calibration Procedures	5-1
	Periodic Maintenance	5-1
	Maintenance Wizards	5-2
	Maintenance Schedule	5-3
	Filter Loading	5-4
	TEOM Filter Replacement	5-4
	Changing the TEOM Filters	5-6
	Advanced Filter Change	5-13
	Conditioning the TEOM Filters	5-15
	Cleaning the PM-10 Inlet	5-16
	Exchanging In-Line Filters	5-20
	Cleaning the Air Inlet	5-24
	Audit/Calibration Procedures	5-26
	Auditing the System	5-29
	Calibrating the Ambient Temperature	5-30
	Calibrating the Ambient Pressure	5-31
	Auditing the Flow Rates	5-32
	Calibrating the Flow Rates	5-38
	Calibrating the Analog Outputs	5-44
	Verifying the Calibration Constant	5-50
Appendix A	Troubleshooting	A-1
	Converting Decimal/Hexadecimal Numbers	A-3
	Deciphering Status Codes	A-4
	Example	A-4
Appendix B	Serial Communication	B-1
	AK Protocol	B-1

Section 1 Introduction

The TEOM 1405 Monitor is composed of two major components (Figure 1-1): the sample inlet assembly and the TEOM 1405 unit. The user enters the system parameters into the TEOM 1405 unit using a color touchscreen that is located on the front of the unit. Additionally, the system is furnished with software for personal computers (a PC with an updated version of Windows XP is required to allow the user to download data and update instrument firmware. The instrument does not require a dedicated computer to function in the field.

Figure 1-1.
Schematic of typical installation.

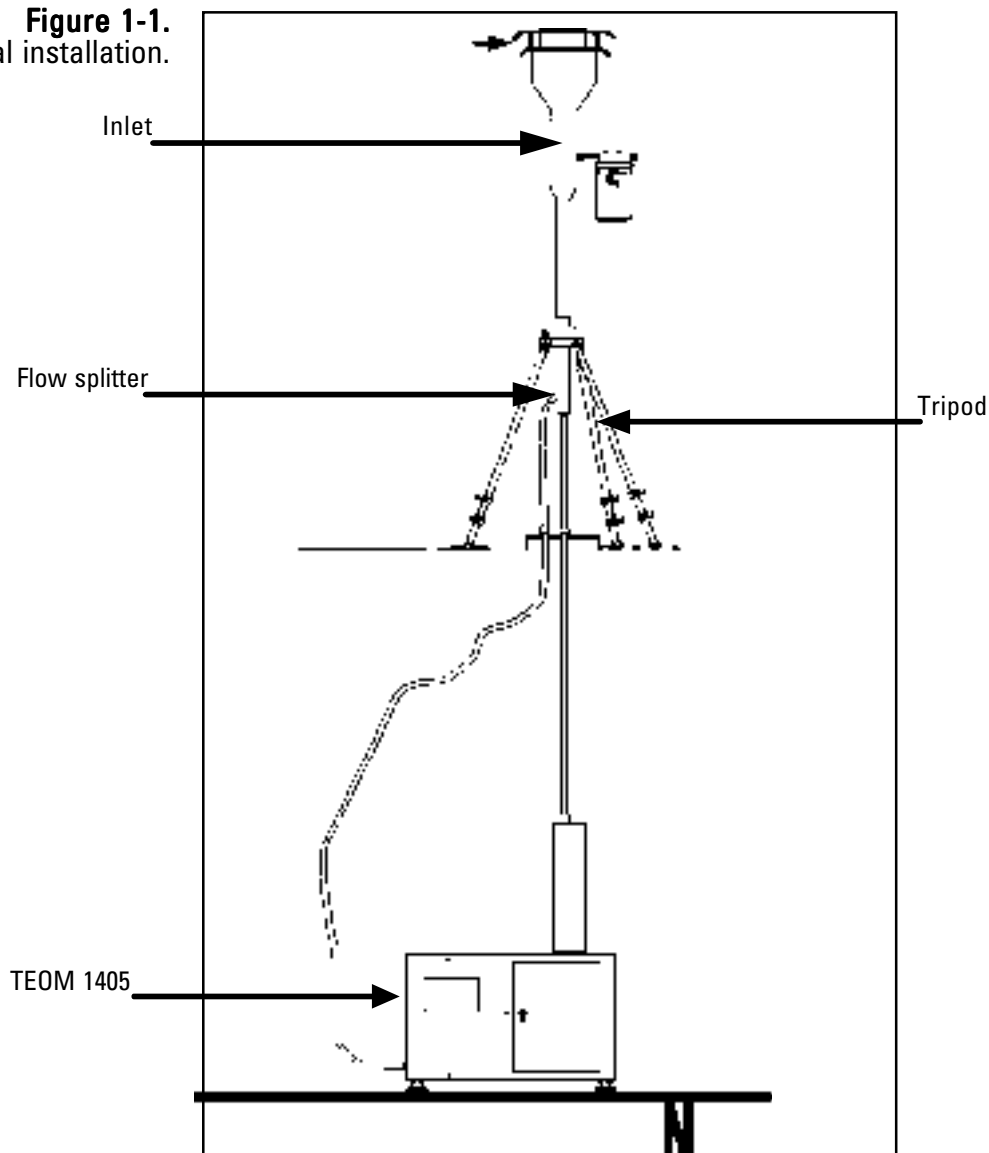

The sensor unit contains a mass measurement hardware systems that monitors Particles that continuously accumulate on the system's exchangeable TEOM filters. By maintaining a flow rate of 3 l/min through the particulate channel, and measuring the total mass accumulated on the TEOM filter, the device can calculate the mass concentration in near real-time.

Overview of Manual

This manual describes the installation and operation of the TEOM 1405 Monitor. Follow the setup instructions contained in Section 2 and before attempting to operate the unit.

This manual is divided into five sections. Sections 1 and 2 explain the system's hardware, while later sections describe the system's software and the setup and operation of the monitor. The following list provides an overview of the topics handled in each section of the manual:

Section 1: Introduction

This section provides an overview of the TEOM 1405 Monitor, as well as the theory of operation of the instrument's mass transducer.

Section 2: Setup and Installation

This section describes how to set up and install the system's hardware and sampling system.

Section 3: Basic Operation

This section provides instructions on how to turn on the instrument and initiate a sampling run. It also explains how to download data and how to leak check the instrument.

Section 4: Screens and Settings

This section explains how to set up the instrument's firmware and its operating modes.

Section 5: Maintenance and Calibration Procedures

This section describes the routine maintenance and verification procedures for the TEOM 1405 Monitor.

Appendix A: Troubleshooting

This appendix includes the information on deciphering status codes and as well as key schematics for troubleshooting purposes.

Appendix B: Serial Communication

This appendix includes information on the instrument's program register codes and built-in AK protocol.

Application Range

The TEOM 1405 Monitor is a real-time device used for measuring the particulate matter mass concentration of particulate matter.

TEOM instruments are the only filter-based mass monitors that measure the mass of particulate matter suspended in gas streams in real time. This is made possible through the use of an inertial mass transducer patented in the U.S. and internationally by Thermo Scientific.

The monitor is ideally suited for applications demanding real-time air particulate matter monitoring in outdoor, indoor or industrial settings. It calculates mass concentration, mass rate and the total mass accumulation on the TEOM filter under the following conditions:

Flow rate through sample inlet	16.7 l/min (1 m ³ /hr)
Main sample flow rate	3 l/min
Temperature of sample stream	30° C
Particulate matter mass concentration	less than 5 µg/m ³ to several g/m ³

Theory of Operation

The TEOM 1405 Monitor is a true “gravimetric” instrument that draws (then heats) ambient air through a filter at constant flow rate, continuously weighing the filter and calculating near real-time mass concentrations of particulate matter. In addition, the instrument computes the 1-hour, 8-hour, 12-hour and 24-hour averages of the mass concentration of particulate.

Analog outputs are available to transmit the measurements to a user’s data acquisition system. An RS232 port allows for serial communication. The instrument’s internal storage buffer can store a large amount of data for later viewing or downloading over a network connection. A USB connection allows easy downloads to a portable USB flash drive.

Mass Transducer Operation

The weighing principle used in the tapered element oscillating microbalance (TEOM) TEOM mass transducer (Figure 1-2) is similar to that of a laboratory microbalance in that the mass change detected by the sensor is the result of the measurement of a change in a parameter (in this case, frequency) that is directly coupled via a physical law (or from first principles).

Figure 1-2.
Schematic of mass transducer.

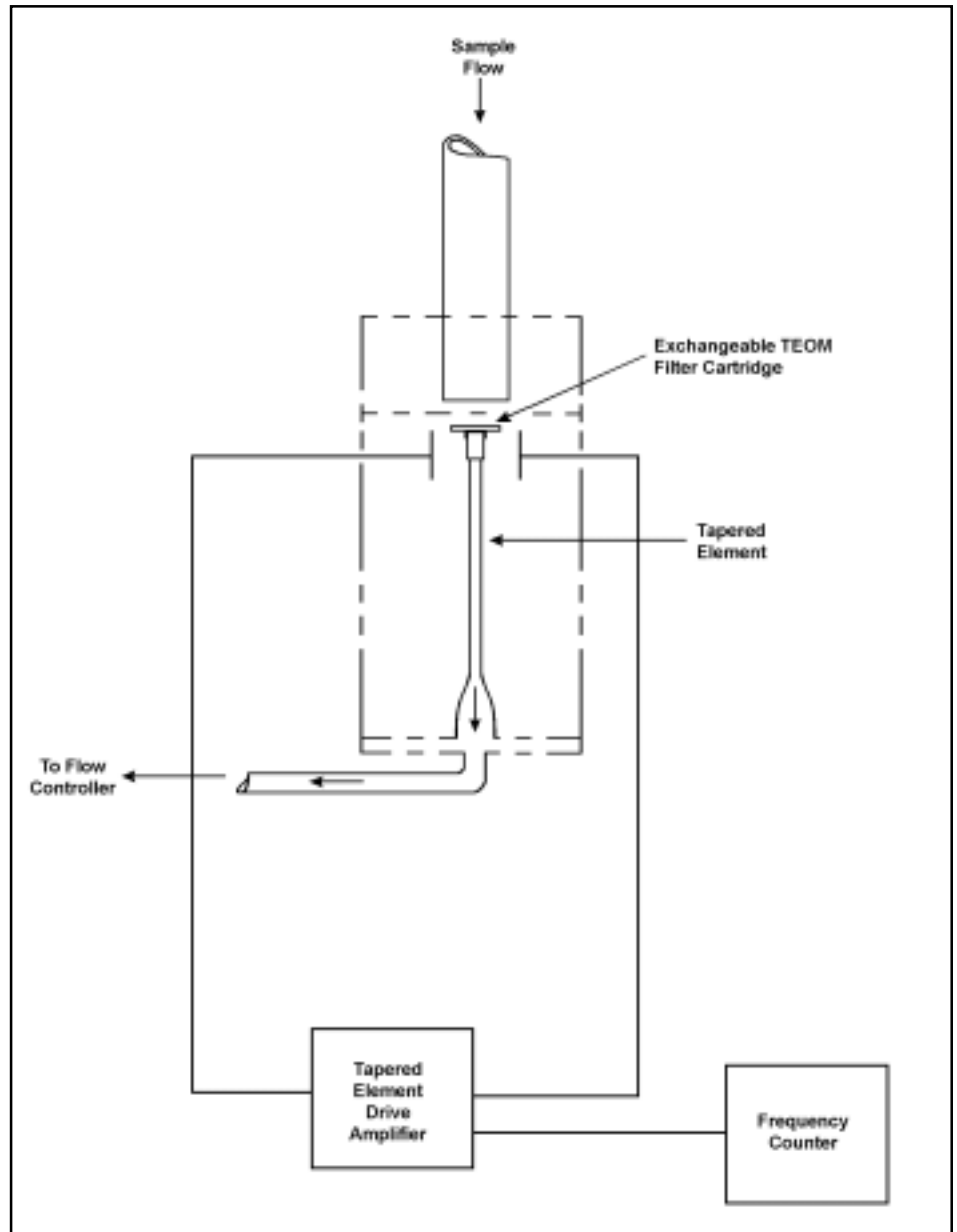

The tapered element at the heart of the mass detection system is a hollow tube, clamped on one end and free to oscillate at the other. An exchangeable TEOM filter cartridge is placed over the tip of the free end. The sample stream is drawn through this filter, and then down the tapered element. This flow is maintained at a constant volume by a mass flow controller that is corrected for local temperature and barometric pressure.

The tapered element oscillates precisely at its natural frequency, much like the tine of a tuning fork. An electronic control circuit senses this oscillation and, through positive feedback, adds sufficient energy to the system to overcome losses. An automatic gain control circuit maintains the oscillation at a constant amplitude. A precision electronic counter measures the oscillation frequency with a 10-second sampling period.

The tapered element is, in essence, a hollow cantilever beam with an associated spring rate and mass. As in any spring-mass system, if additional mass is added, the frequency of the oscillation decreases. This can be seen by observing the frequency on the display of the TEOM 1405 unit (Section 4), and operating the monitor both with and without a filter in place.

In a spring-mass system the frequency follows the equation:

$$f = (K / M)^{0.5}$$

where:

f = frequency
K = spring rate
M = mass

K and M are in consistent units. The relationship between mass and change in frequency can be expressed as:

where:

$$dm = K_0 \frac{1}{f_1^2} - \frac{1}{f_0^2}$$

dm = change in mass
K₀ = spring constant (including mass conversions)
f₀ = initial frequency (Hz)
f₁ = final frequency (Hz)

When this equation is rearranged, you can solve for the spring constant, K_0 :

$$K_0 = \frac{dm}{\frac{1}{f_1^2} - \frac{1}{f_0^2}}$$

Thus, K_0 (the calibration constant for the instrument) can be easily determined by measuring the frequencies with and without a known mass (pre-weighed TEOM filter cartridge).

Mass Flow Controllers

The mass flow controllers (MFCs) in the TEOM 1405 Monitor are internally calibrated for a standard temperature and pressure of 25° C and 1 Atmosphere (1013.2 millibars or 760 mm Hg). For *passive* flow control, the user must enter the seasonal average temperature (Ave. Temp.) and average barometric pressure (Ave. Pres.) at the measurement site to allow the instrument to sample at the correct volumetric flow rate (Section 4). The microprocessor calculates the correct mass flow set point ($\text{Flow_Rate}_{\text{STD}}$) with this information using the following formula:

$$\text{FlowSP}_{\text{Passive}} = \text{FlowSP}_{\text{Vol}} \times \frac{P_{\text{AVG}}}{P_{\text{STD}}} \times \frac{\text{Temp}_{\text{STD}} + 273.15}{\text{Temp}_{\text{AVG}} + 273.15}$$

where:

$\text{FlowSP}_{\text{PASSIVE}}$ = Control set point to mass flow controller (equivalent flow at 25° C and 1 Atmosphere)

$\text{FlowSP}_{\text{Vol}}$ = Volumetric flow rate set point (l/min)

Temp_{AVG} = Average temperature entered by the user (°C)

Temp_{STD} = Standard temperature (25°C)

P_{AVG} = Seasonal average barometric pressure entered by the user (Atmospheres, where 1 Atmosphere = 1013.2 millibars or 760 mm Hg)

P_{STD} = Standard pressure (1 Atm)

Alternately, Active flow control can be set up to automatically measure the ambient temperature and pressure using the hardware supplied.

Note. When using actual conditions for active volumetric flow control, substitute the actual (local) temperature and pressure as measured by the instrument for the average temperature and pressure variables in equation above. ▲

PM-10 mass concentration data reported to the U.S. EPA must be referenced to standard cubic meters of air based on a standard temperature and pressure of 25° C and 1 Atmosphere (atm), respectively. For the instrument to report mass concentrations according to this EPA standard, the user must ensure that the standard temperature (Std. Temp.) and standard pressure (Std. Pres.) entered in the instrument equal 25° C and 1 Atmosphere (Section 4). These are the default values for the instrument.

$$\text{Flow_Rate}_{\text{EPA}} = \text{Flow_Rate}_{\text{STP}} \times \frac{\text{Std. Temp.} + 273.15}{273.15} \times \frac{1 \text{ atm}}{\text{Std. Pres.}}$$

The flow rates referenced internally by the instrument to 0° C are converted to EPA standard conditions.

Note. When reporting concentrations to actual conditions, the system must be set for “Active” flow control (Section 4). This will ensure that the monitor uses the current actual values for temperature and pressure in the equation above. ▲

Section 2 Setup and Installation

This section describes the setup and installation of the TEOM 1405, including the pump, flow splitter, tripod, sample tube and sample inlet. After you have set up the system, you must perform a leak check on the monitor (Section 3) and install a TEOM filter (Section 5) in the mass transducer before starting a sample run.

If you want to install the monitor in an outdoor location, consult Thermo Scientific for specific site recommendations.

Figure 2-1.
TEOM 1405 Monitor.

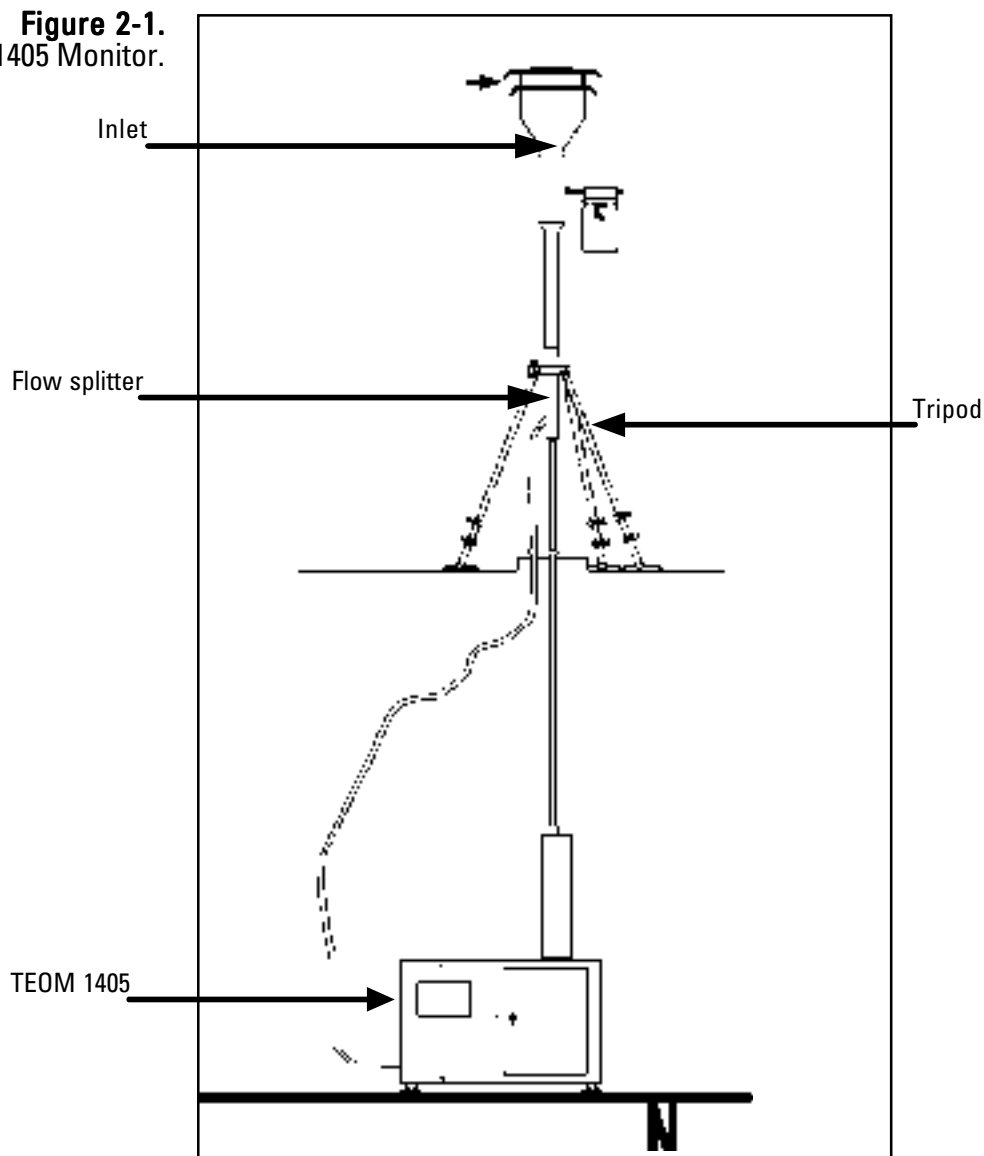

Installation Considerations

The TEOM 1405 may be located in any convenient indoor location which is maintained between 8° and 25° C (46° to 77° F). The user must run a sampling tube through the roof of the monitoring site (refer to the inlet installation instructions later in this section). The entrance to the sample inlet must be 1.8 to 2.1 m (70 to 82 inches) above the roof.

Although the TEOM monitor is inherently rugged, it is a precision instrument. The user will obtain the best operating conditions and longest instrument life when the unit is not exposed to extremes of weather. Filter exchange, in particular, may be best accomplished by a technician operating in an indoor environment where there is no possibility of rain or snow contaminating the filter.

Be sure to install the ambient temperature/humidity sensor. If you do not install the ambient temperature/humidity sensor, you must set the instrument to “Passive” flow control (Section 4) or the mass flow controller will attempt to control the sample flow as if the ambient temperature is absolute zero.

The sample line should proceed in a straight, vertical line from the PM-10 inlet to the inlet of the unit.

To achieve the best results, locate the TEOM sensor unit in an environment with relatively slow temperature fluctuations. Avoid sampling locations with direct exposure to sunlight or that are in close proximity to a heating or air-conditioning outlet. To avoid condensation in the sample tubing, Thermo Scientific strongly recommends that the user insulate the sample tube extensions with pipe insulation when operating the instrument in areas of high humidity.

Standard System Hardware

The TEOM 1405 Monitor is supplied with the following components:

- TEOM 1405 unit
- Temperature/humidity sensor and cable, 10 m
- 3/8" green tubing for bypass flow, 10 m
- 3/8" green tubing to pump, 5 m (16.5 ft)
- 2 Sample tubing extensions, 1 m (40")
- Box of 20 TEOM filter cartridges (Pallflex TX40)
- 1 large bypass filter element
- 1 small filter element
- Filter exchange tool
- Flow splitter
- PM-10 inlet
- Water trap filter assembly
- Flow audit adapter/leak check kit
- Vacuum pump
- 2 Operating Manuals (one hard copy, one on CD)
- Quick Start Guide
- Pre-filter/silicone tubing

Pump Connections

Follow these steps to attach the pump:

1. Locate and cut the piece of the 15m green tubing into two pieces — one about (but not less than) 5m (the lengths may be precut). (The typical setup has 5m of tubing for the pump and 10m for the bypass line.)
2. Push the one end of the 5m pump tubing into the fitting on the vacuum pump (Figure 2-2).

Figure 2-2.
Vacuum pump.



3. Push the other end of the pump tubing into the pump connection on the back of the TEOM 1405 unit (Figure 2-3).

Figure 2-3.
Back of TEOM 1405 unit

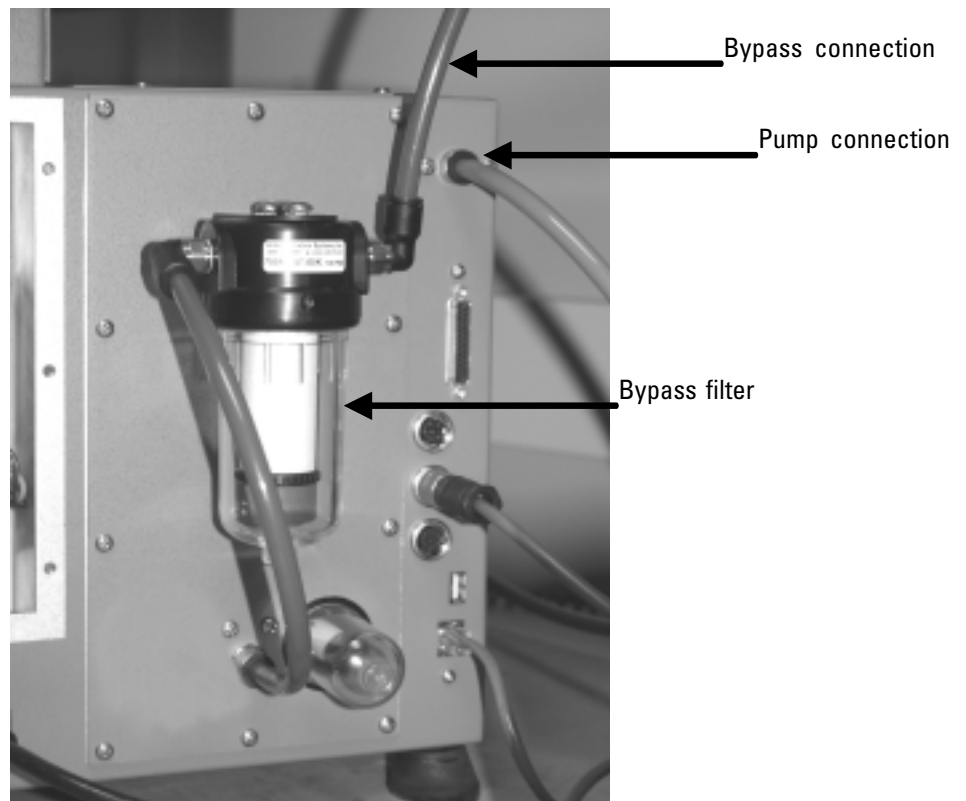

4. Mount the water trap filter assembly near the 1405 unit (Figure 2-4).

Figure 2-4.
Water trap filter assembly.

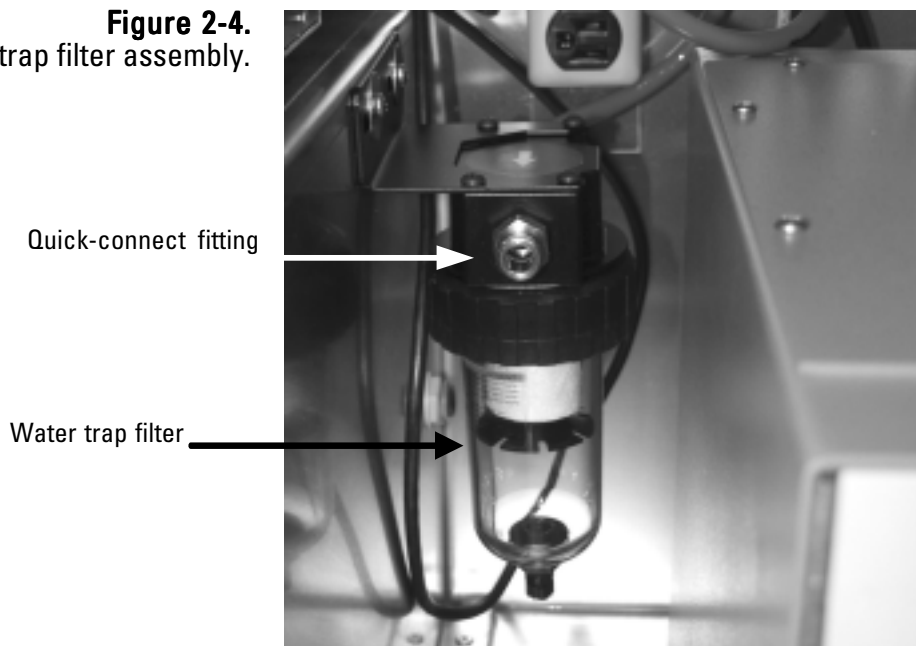

Note. Drain the water trap as needed. ▲

5. From the 10m length of tubing for the bypass line, cut a piece of tubing long enough to reach from the water trap filter to the bypass filter on the back of the 1405 unit (Figure 2-3 and 2-4). Install the tubing into the quick-connect fittings on the water trap filter and bypass filter.
6. Insert one end of the remaining section of bypass tubing into the quick-connect fitting at the end of the coiled piece of tubing connected to the water trap filter.

Note. The other end of the bypass tubing will be connected to the bypass connection on the flow splitter when you assemble and install the sample inlet (following section). ▲

7. Select a location on the pump tubing to install the vacuum gauge. It should allow the gauge to be easily monitored (Thermo Scientific suggests a location about half a meter from where the tubing is installed in the pump connection on the back of the unit.) Cut the tubing and install the two ends into the quick-connect fittings on the vacuum gauge.

Note. Thermo Scientific strongly recommends that you use the vacuum pump provided with the unit. If you choose to install a different pump, it must be oil-free and able to maintain a 21" Hg vacuum at a flow of 16.67 l/min. ▲

Adjusting the Flow Splitter

An isokinetic flow splitter (Figures 2-5 and 2-6) is used in combination with an automatic flow controller to divide the main/bypass flow into two components after the air stream passes through the size-selective inlet. The two sample flow components are the main flow (3 l/min) that flows to the TEOM mass transducer, and the bypass flow (12 l/min).

If a 2 l/min flow adapter is installed in the TEOM 1405 system, replace all references in this manual to a 3 l/min main flow with 2 l/min, and increase all references to the bypass flow by 1 l/min.

Figure 2-5.
Flow splitter.

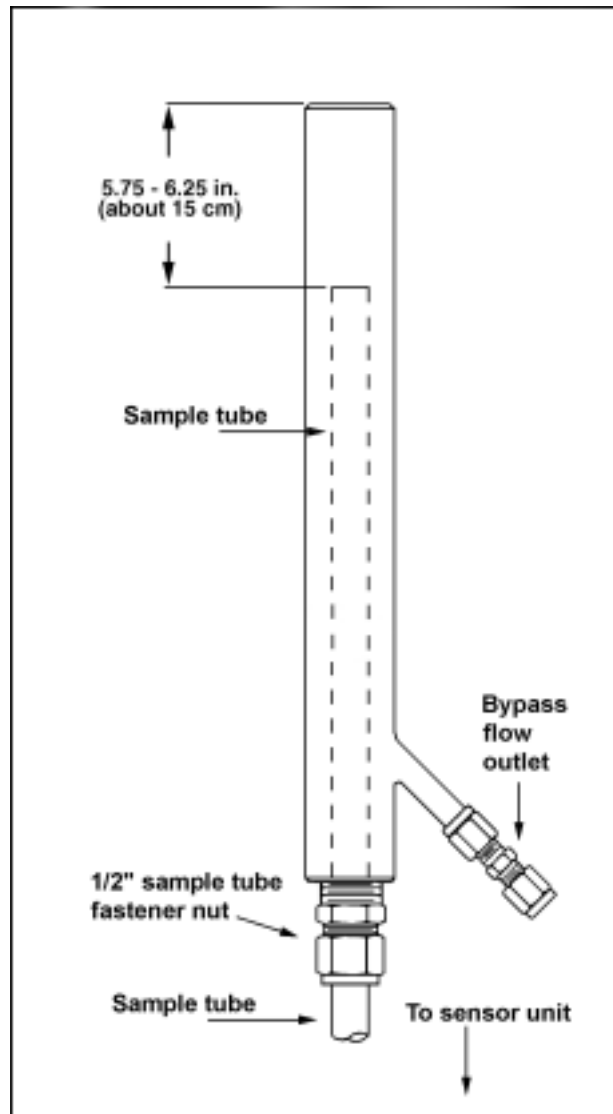

The flow splitter and sample tube are pre-assembled. Should it need to be re assembled, follow the instructions below.

To set up the flow splitter assembly:

1. Locate the flow splitter (Figures 2-5 and 2-6).
2. Loosen the 1/2-inch sample tube fastener nut and slide the sample tube down into the flow splitter so that the top of the installed sample tube (or flow adapter) is approximately 15.5 cm (6") from the top of the flow splitter (it must be between 5.75 and 6.25 inches from the top of the flow splitter) (Figure 2-7).
3. Tighten the 1/2-inch sample tube nut. Ensure that the top of the flow adapter remains between 5.75 and 6.25 inches from the top of the flow splitter (Figure 2-7).

Figure 2-6.
Bottom of the flow splitter.

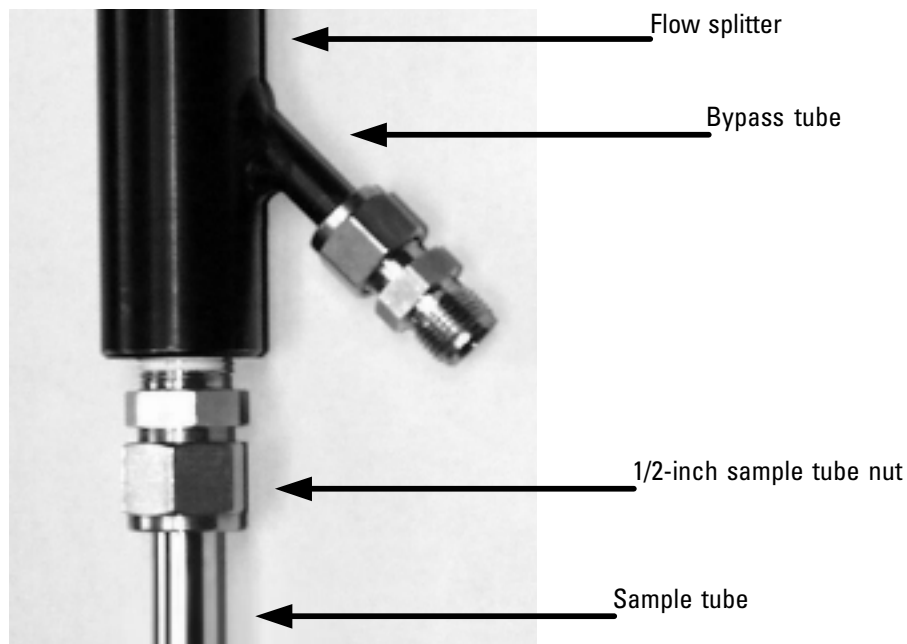

Figure 2-7.
Measuring the distance from the top of the sample tube to the top of the flow splitter.



Assembling the Tripod

An optional tripod is available for installation on the roof of a sampling building.

To assemble the tripod:

1. Locate a tripod foot and pull off the rubber leg holder, if one is attached.
2. Place one leg of the tripod onto the tripod foot.
3. Place a metal bracket over the rubber base of the tripod leg and into the two slots on the tripod foot (Figure 2-8). Ensure that the bracket is placed over the rubber base on the end of the tripod leg.

Figure 2-8.
Placing the metal bracket on the tripod foot.



4. Insert a plain washer then a lock washer onto each threaded end of the bracket, then install the nuts on the threaded ends of the bracket and tighten them with a 3/8" (or adjustable) wrench.

Note. Hand-tighten both nuts on the bracket before tightening them with the wrench to ensure that the bracket is positioned properly on the tripod leg and tripod foot. ▲

5. Repeat steps 1 through 4 for each leg of the tripod.

Installing the Inlet

To install the inlet:

1. Set the 1405 unit on a bench or other support directly below the location of the inlet on the roof of the sampling structure (Figure 2-1). In its finished state, the entrance to the sample inlet must be 1.8 to 2.1 m (70 to 82 inches) above the roof
2. Install the assembled flow splitter into the tripod and lightly tighten the knob to ensure the flow splitter stays in place (Figure 2-9).

Figure 2-9.
Bottom of the flow splitter.

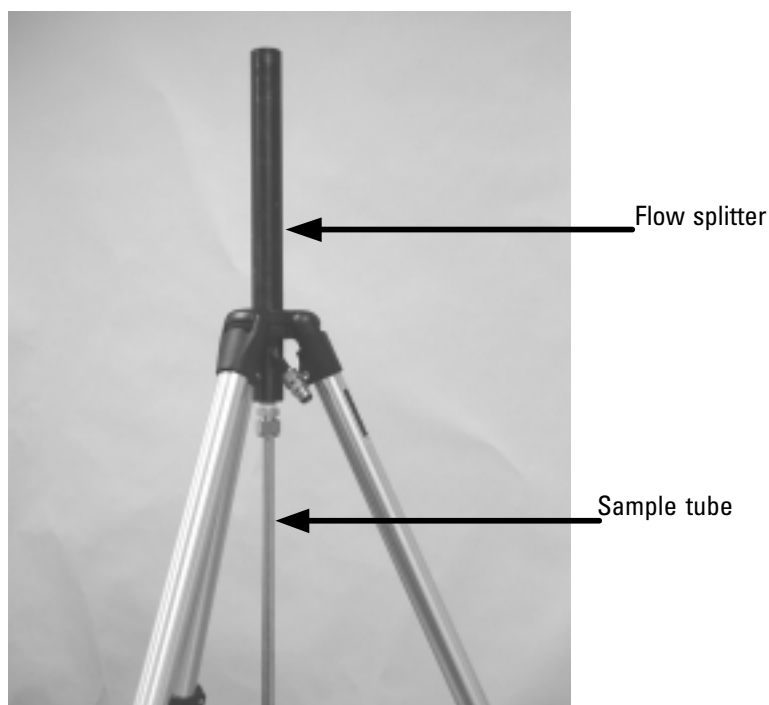

3. Measure and mark a spot in the roof directly above the 1/2-inch sample line on the top of the instrument.

Note. In this example, a 4-inch hole was cut in the roof to accommodate a 4-inch PVC pipe and seal. The cap of the PVC pipe was then drilled to accommodate the sample line. ▲

4. Drill the hole in the roof for the 1/2-inch sample line and another hole for the 3/8-inch bypass line tubing. (The bypass tubing may also be run through a window or other opening.)
5. Set the tripod on the roof above the 1405 unit and adjust the legs so the top of the tripod is above the roof opening.

Figure 2-10.
Installing the sample tubes and
bypass line through the roof.

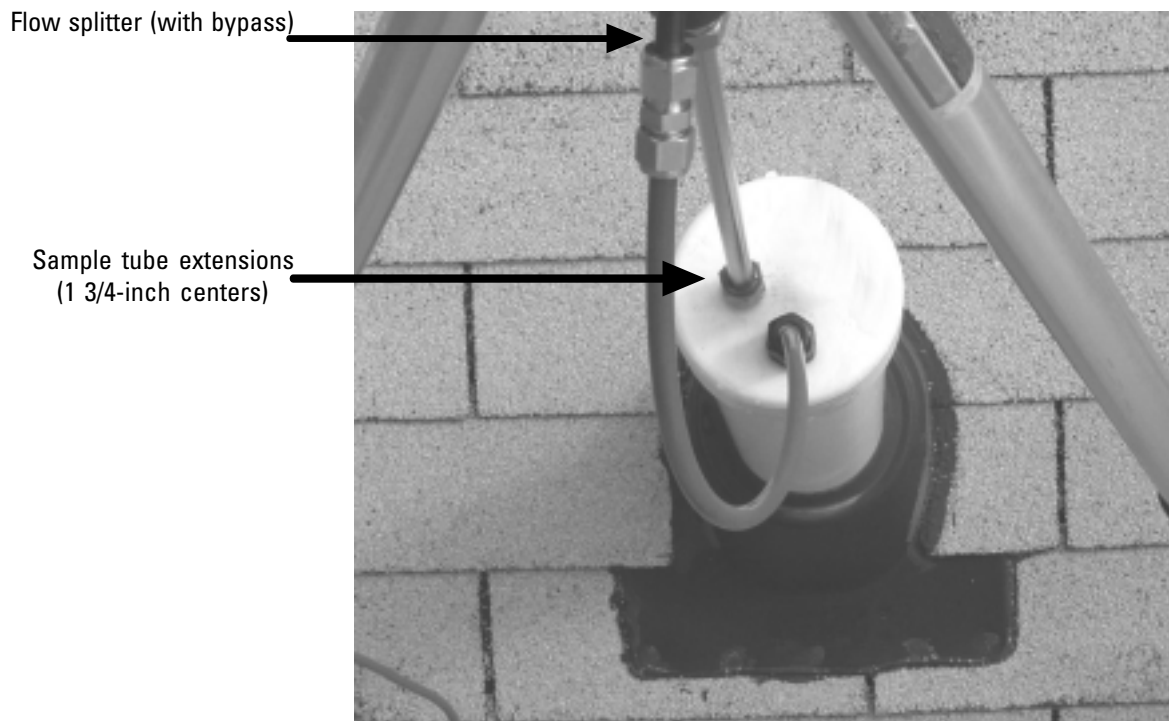

6. Install the inlet on top of the flow splitter and adjust the tripod so the entrance to the sample inlet is 1.8 to 2.1 m (70 to 82 inches) above the roof (Figure 2-11).

Note. This measurement may vary based on the inlet height required by the local regulatory agency. ▲

Figure 2-11.
Inlet installed.

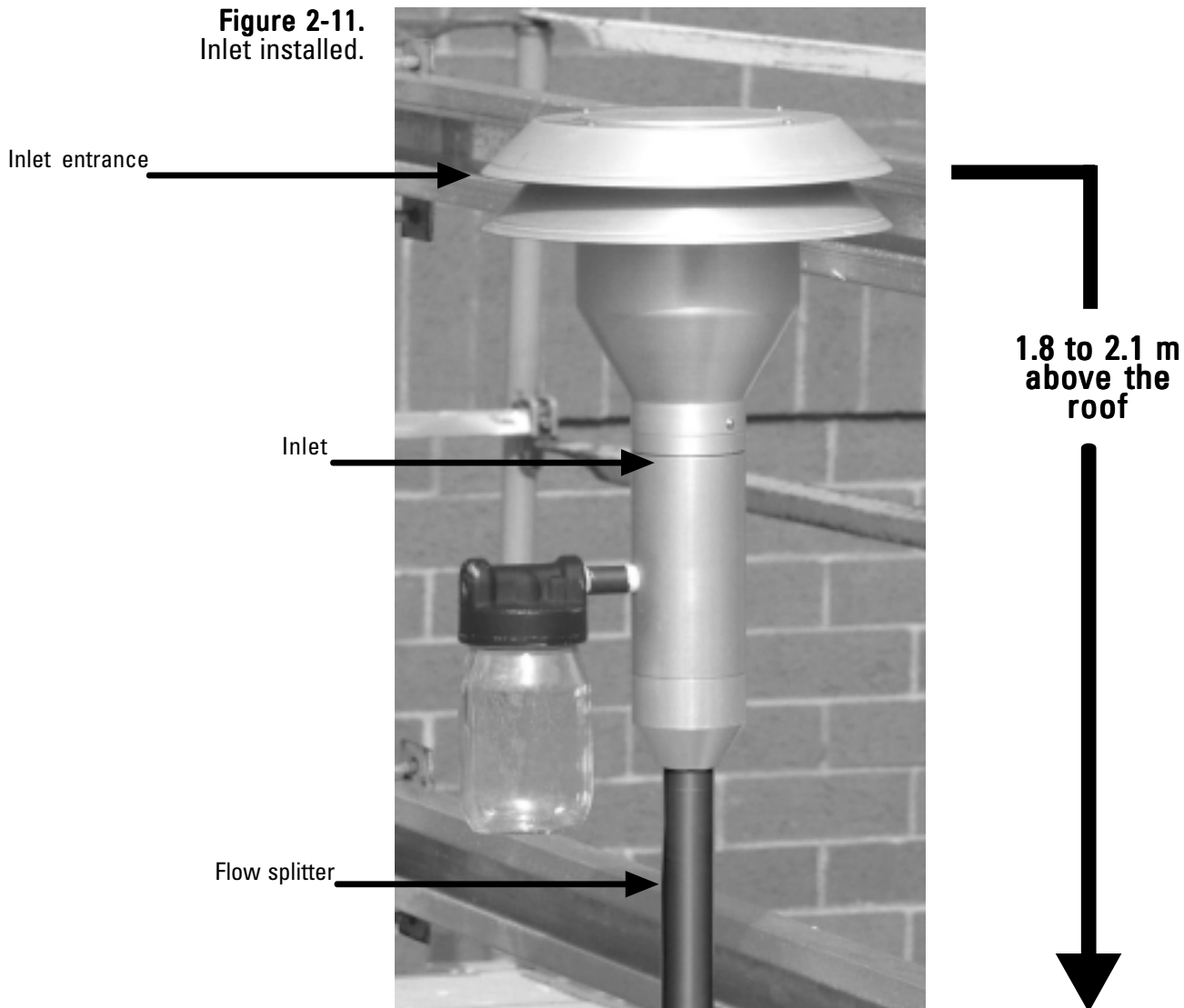

7. Center the tripod over the roof hole. Measure and cut the sample tube extensions from the top of the instrument, through the roof and connect to the flow splitter sample tube. Make sure to clean and deburr the cut ends of the sample tube extensions.

8. Connect the green bypass tubing attached to the back of the instrument to the bypass fitting on the flow splitter using the 3/8-inch Swagelok fitting (Figure 2-12).

Figure 2-12.
Bypass tubing and sample tubes
installed

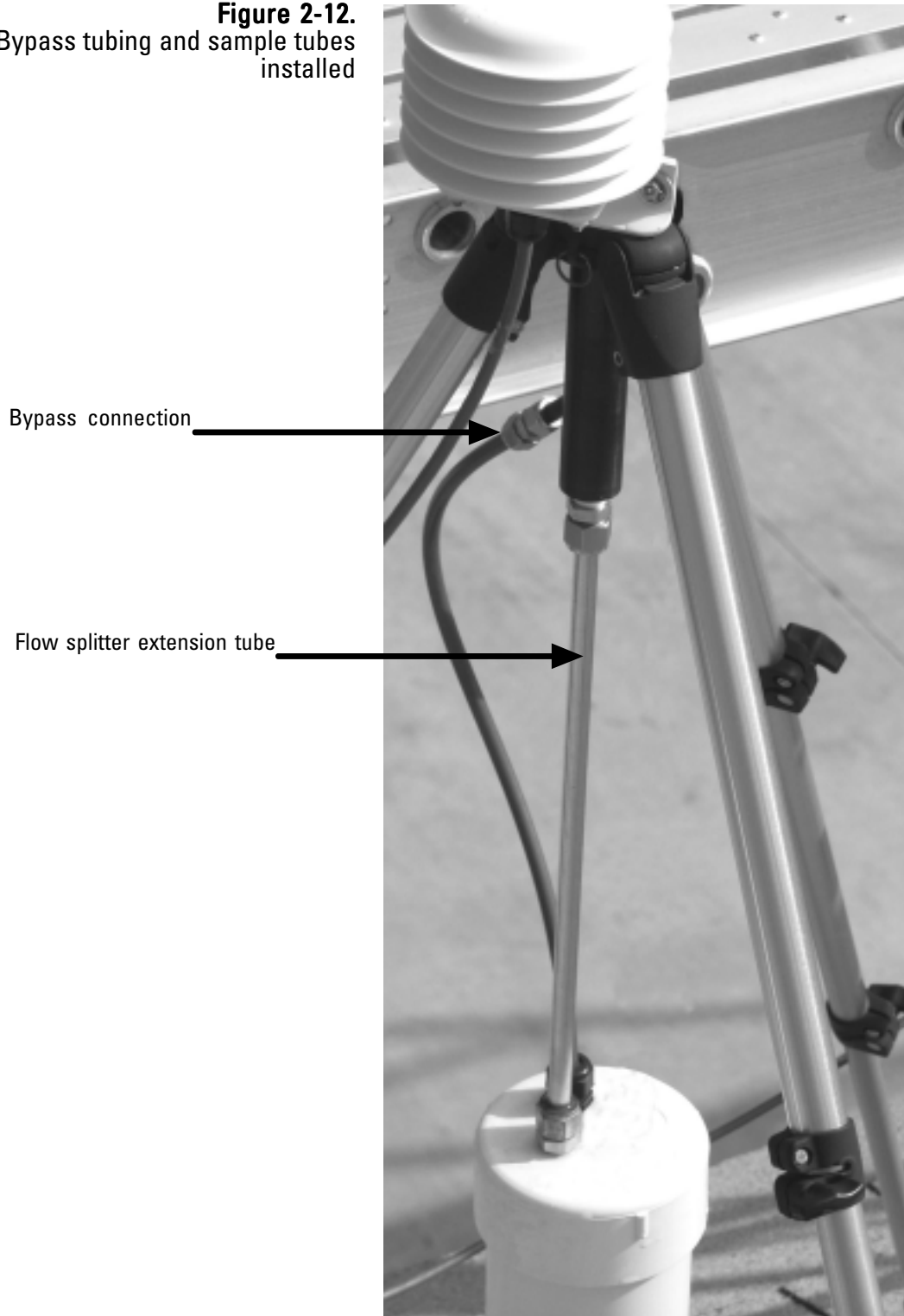

9. Locate the ambient temperature and humidity sensor. Connect the sensor to the flow splitter using the U-bolt provided with the system (Figure 2-13).
10. Attach the sensor cable to the sensor and run the sensor cable to the instrument through an opening in the roof or through a window. Attach the sensor to the sensor connection on the back of the TEOM 1405 unit (Figure 2-14).
11. Fasten the tripod feet to the roof. The length and type of fasteners depends on the type of roof surface. The tripod feet also may be attached to a pallet or 3/4" marine plywood, with the pallet or plywood secured by concrete blocks or sand bags.

Figure 2-13.
Temperature/humidity sensor
installed on flow splitter.

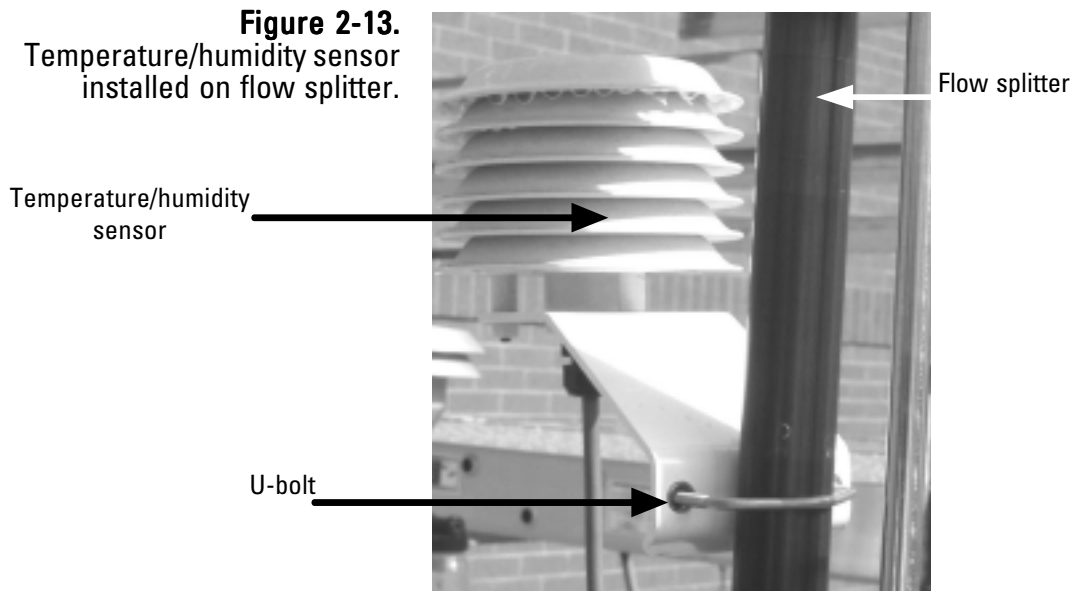
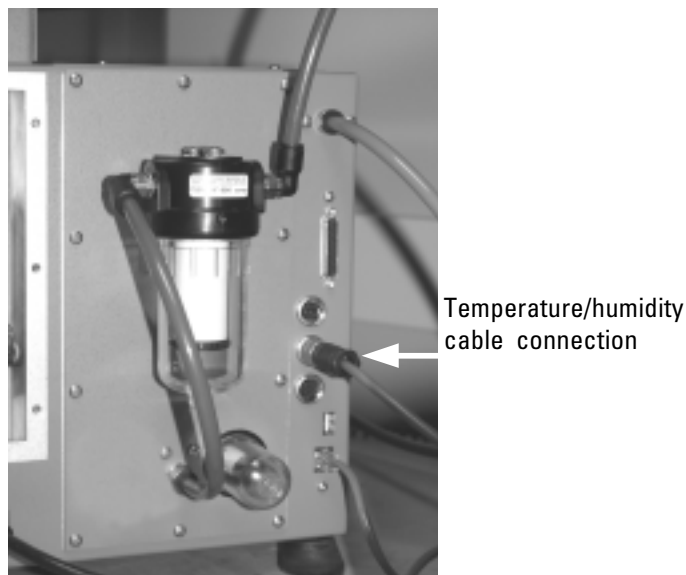

Figure 2-14.
Temperature/humidity sensor
connection of the back of the
Series 1405 unit.



Applying Power to the Instrument

The TEOM 1405 unit accepts all voltage inputs between 85 and 240 volts AC. The unit should be connected to an appropriate, code-approved electrical outlet for the sampler location. Contact a qualified electrician if there is doubt as to whether the power service for the instrument is adequate.

To turn on the monitor:

1. Install an appropriate power cord into the universal power connection on the back of the instrument at the appropriate voltage.

Note. DO NOT attempt to bypass the grounding requirements for the unit. ▲

Figure 2-15.
Power connection
on back of unit.

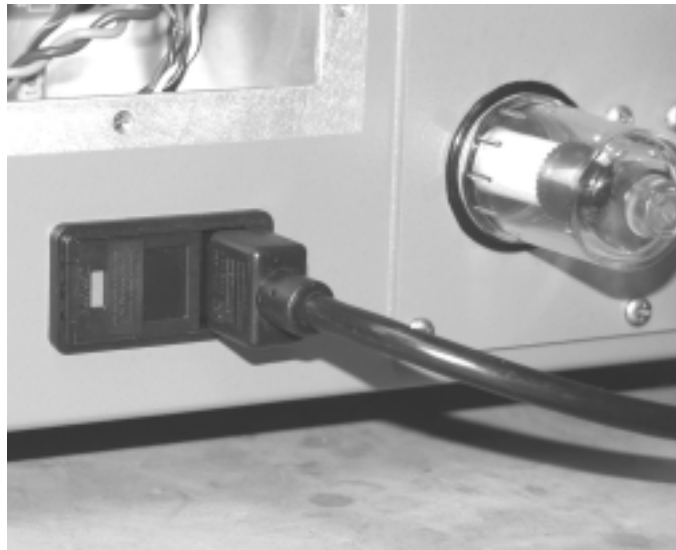

2. Install the other end of the power cord into an appropriate, easily accessible, grounded, code-approved electrical outlet.

Note. Contact a qualified electrician if there is doubt as to whether the power service for the instrument is adequate. ▲

3. Press the “POWER” switch on the front panel of the control unit (Figure 2-16). The unit will begin its startup routine. After a few moments, the Title screen will appear on the control unit’s display and then the TEOM Data (Main) screen. Refer to Sections 3 and 4 for information on the instrument’s software screens.
4. Plug the pump into an appropriate power source to draw a sample stream through the system.

Figure 2-16.
Power switch.



Power switch

The TEOM Data screen will show a warning message (Section 4) because the flow rates and temperatures are outside of tolerance ranges. The warning may remain active during the first 30 minutes after the power switch is pressed while the monitor warms up. The status warning icon automatically disappears after all flow rates and temperatures reach tolerance ranges. The monitor waits until the flow rates and temperatures stabilize within a narrow range before starting data collection. This ensures the validity of all data points computed by the system.

Note. Upon initial instrument start up, the values in the mass concentration fields are the running averages that are accumulated until a 1-hour time period has passed. The values are visible to provide the user with an indication that the instrument is functioning, after instrument power up or reset. These raw values are used for internal calculations only. ▲

Turning Off the Instrument

If the instrument needs to be turned off, turn the power switch on the front of the unit to off (0).

Note. Wait at least 1 minute after shutdown before reapplying power to the unit. ▲

The instrument may also be restarted without turning it off.

Restarting the Instrument

To restart the instrument:

1. In the Service screen (Section 4), select the **Instrument Control** button to display the Instrument Control screen (Figure 2-16).
2. Select the **Reboot** button.

Figure 2-17.
Instrument Control screen.



Using the Outdoor Shelter

Thermo Fisher Scientific offers an outdoor shelter for the 1405 unit. The shelter is fully climate controlled and includes space for the 1405 unit, pump and accessories such as a data logger or additional monitoring devices. It is available in both 120V and 240V version.

Figure 2-18.
1405 unit in the
outdoor enclosure
(FDMS unit pictured).



To install the 1405 unit in an outdoor shelter:

1. Before placing the 1405 unit or pump into the enclosure, install a 3/8-inch elbow fitting provided with the outdoor enclosure into the quick connect-fitting inside the pump compartment, where the pump tubing goes through the bulkhead into the enclosure. Install the other 3/8-inch elbows into the pump connection on the back of the 1405 unit and into the connection on the pump (Figures 2-19, 2-20 and 2-21).

Figure 2-19.
Enclosure.

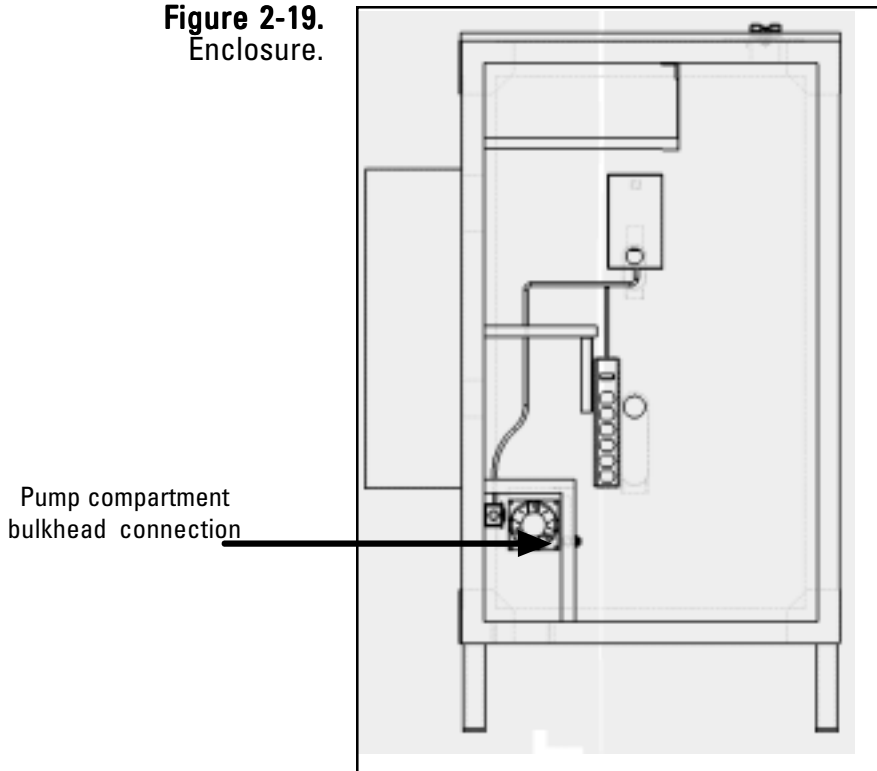
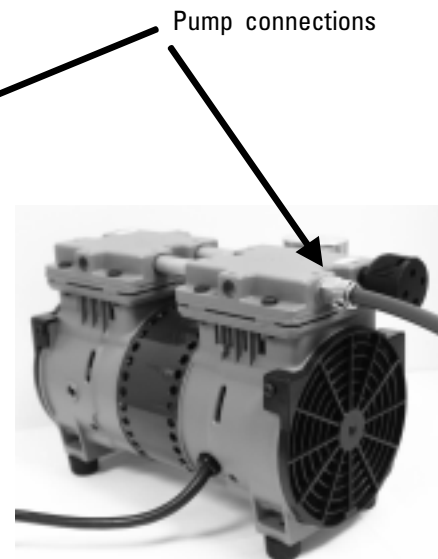
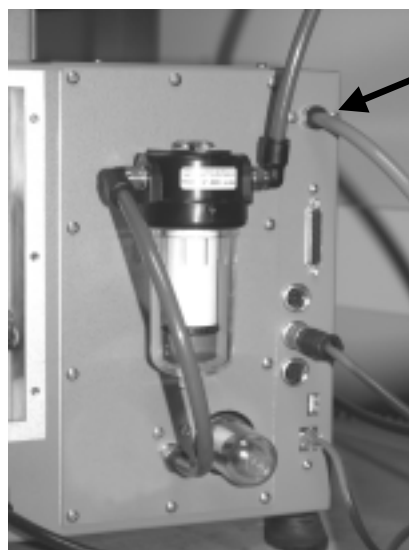

Figure 2-20 (left).
Back of the 1405 unit.

Figure 2-21 (right).
Pump.



2. Install the water trap filter and bracket into the two pre-drilled holes on the side of the pump compartment (Figure 2-22).

Figure 2-22.
Water trap filter.

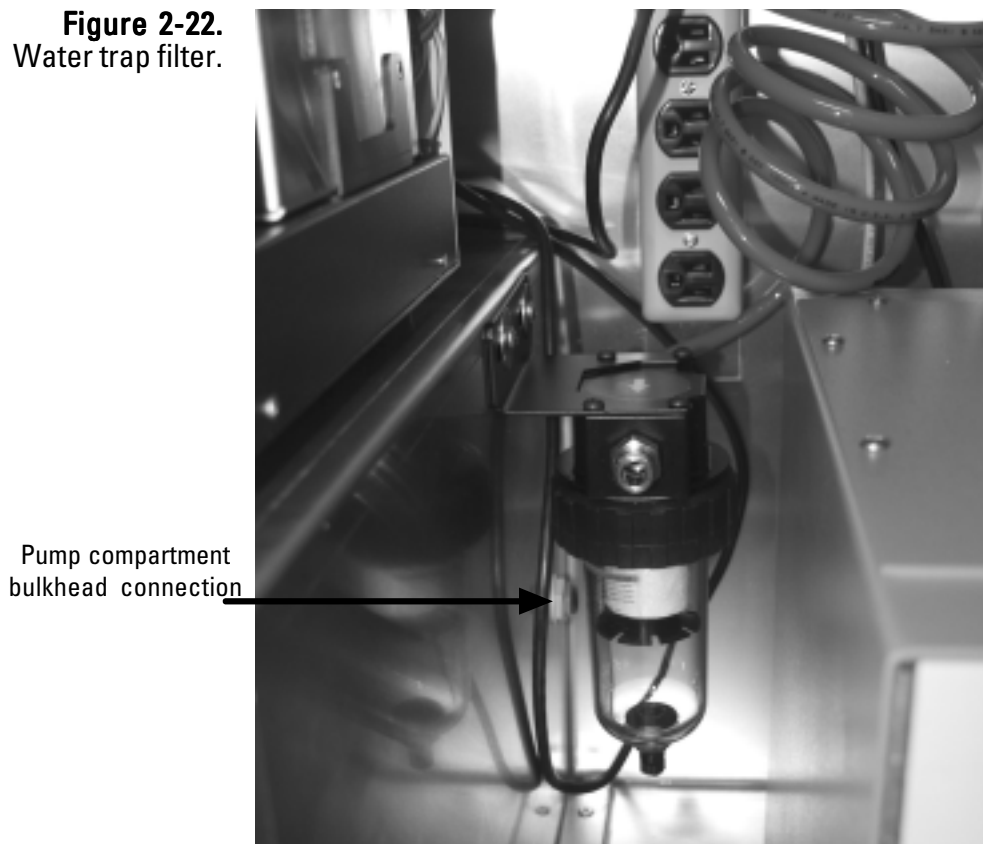

3. Cut a 14-inch (.35m) piece of tubing from the 3-foot section that came with the enclosure package. Place the pump in the enclosure, and connect the elbow fitting on the pump (Figure 2-21) to the elbow fitting on the inside of the pump compartment using the 14-inch piece of tubing.
4. Locate and cut the piece of the 15m green tubing, that came in the 1405 packaging, into two pieces — one about (but not less than) 5m.
5. Install the one end of the 5m pump tubing into the quick-connect fitting on the outside bulkhead wall of the pump compartment (behind the water trap filter, Figure 2-22).
6. Place the 1405 unit into the enclosure install the other end of the 5m tubing that is connected to the bulkhead into the quick-connect elbow fitting for the pump connection on the back of the 1405 unit (Figure 2-20).

7. Select a location on the pump tubing to install the vacuum gauge. It should allow the gauge to be easily monitored (Thermo Scientific suggests a location about half a meter from where the tubing is installed in the pump connection on the back of the unit.) Cut the tubing and install the two ends into the quick-connect fittings on the vacuum gauge.
8. From the 10m length of tubing for the bypass line, cut a piece of tubing long enough to reach from the water trap filter to the bypass filter on the back of the 1405 unit (Figure 2-20 and 2-22). Install the tubing into the quick-connect fittings on the water trap filter and bypass filter.

Note. The bypass tubing will be connected to the bypass connection on the flow splitter and to the water trap when you assemble and install the sample inlet on top of the enclosure later in this section. ▲

9. Ensure that the sample tube is properly installed in the flow splitter (refer to “Adjusting the Flow Splitter” earlier in this section).
10. Install the sample tube from the flow splitter through the roof opening (Figures 2-23 and 2-24).

Note. Cap the extra opening in the enclosure roof. ▲

Figure 2-23 (left).
Sample connections inside enclosure.

Figure 2-24 (right).
Sample connections on top of the enclosure.

Sample tube
Bypass tubing

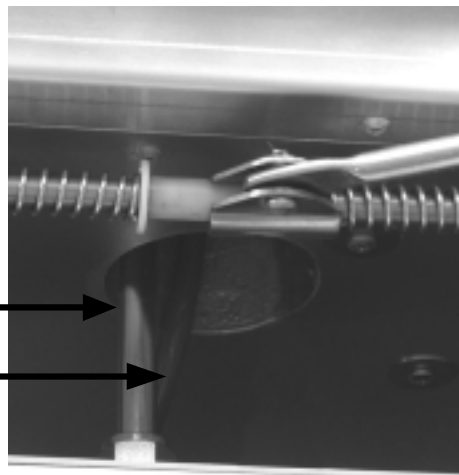

11. Install the adjustable elbow fitting and male swivel fitting from the enclosure package onto the piece of 19-inch section of pipe that came with the enclosure. Lightly tighten the screws. Install the elbow fitting and support pipe onto the flow splitter and enclosure top (Figure 2-25). Slide the support pipe up or down until the flow splitter is sitting plumb, then attach the arm to the shelter and tighten all the screws on the support arm.

Figure 2-25.
Support pipe connections.

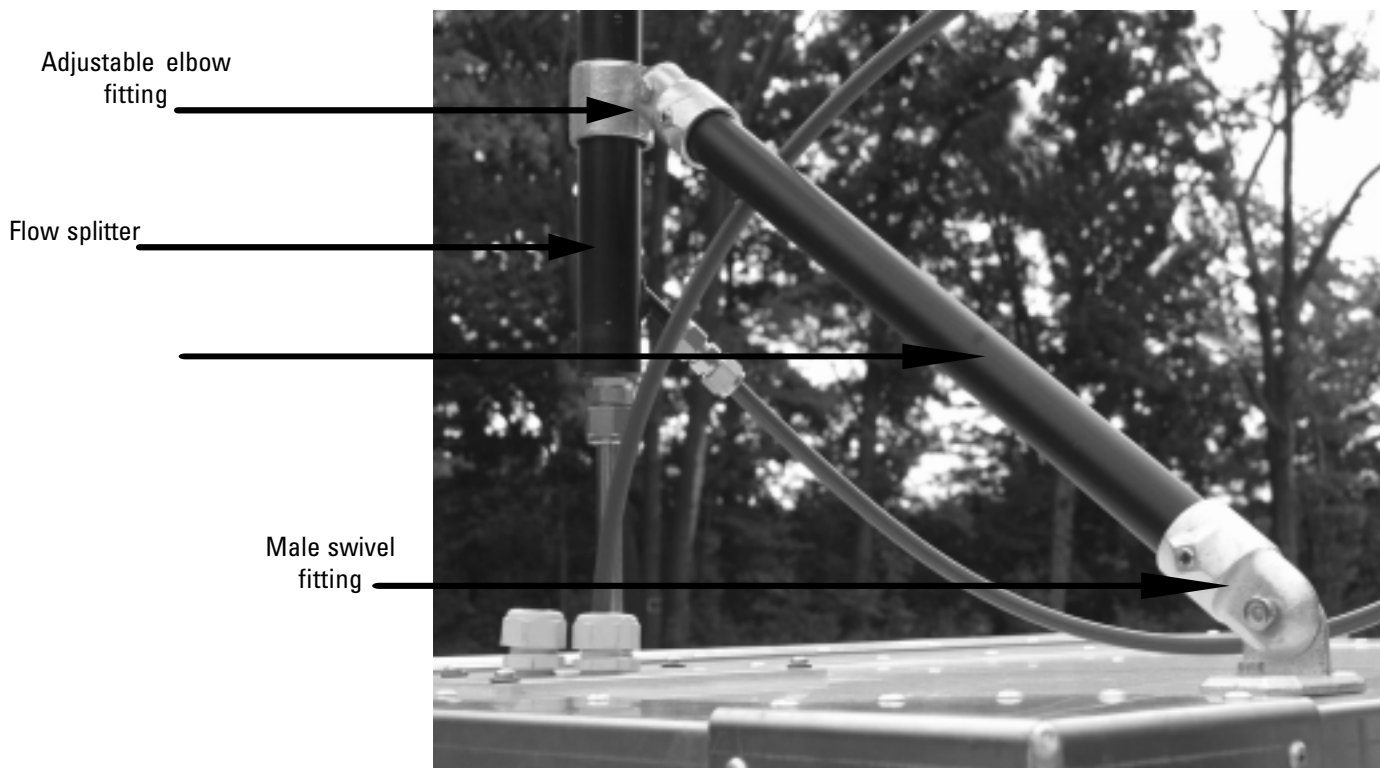

- Cut a piece of tubing from the remaining section of bypass tubing (step 8) long enough to reach from the bypass connection to the top of the 1405 unit. The section should be long enough to include a loop (Figure 2-26) to ensure there will be no kinks in the line when it enters the enclosure. Connect the bypass tubing to the bypass fitting on the flow splitter using the 3/8-inch Swagelok fitting (Figure 2-26). Insert the other end through the fitting on the roof (Figure 2-24) and into the enclosure about 4 to 6 inches. Connect the coiled tubing from the water trap filter to the bypass line near the top of the shelter with the quick-connect fitting. Ensure that the coiled water trap tubing is vertical (Figure 2-18).

Figure 2-26.
Virtual impactor,
temperature/humidity sensor
and sample tubes.

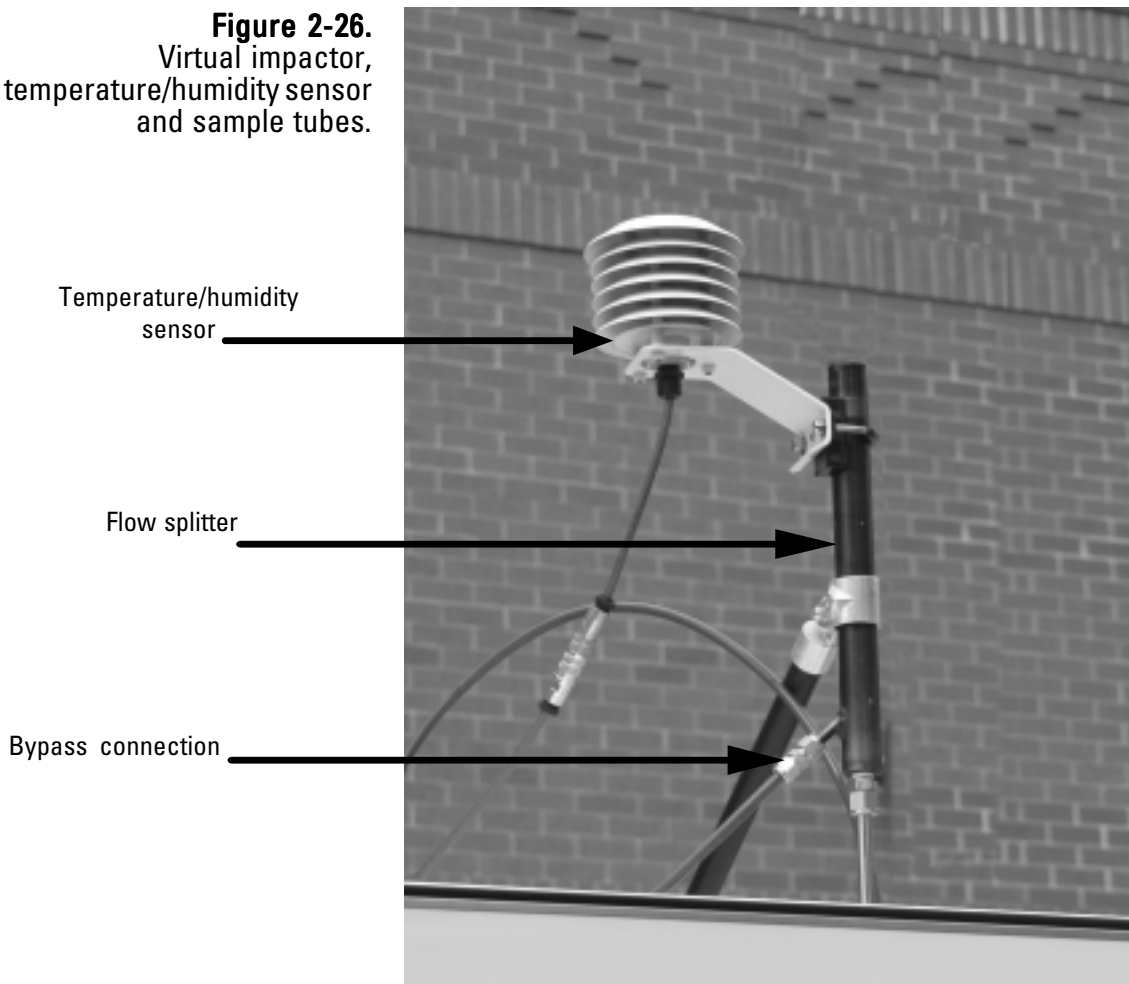

13. Locate the ambient temperature and humidity sensor. Connect the sensor to the flow splitter using the U-bolt provided with the 1405 unit (Figure 2-26).
14. Attach the sensor cable to the sensor and run the sensor cable to the instrument through the opening in the back of the enclosure (Figure 2-27). Attach the sensor to the sensor connection on the back of the TEOM 1405 unit (Figure 2-28).

Note. The opening in the back of the enclosure can also be used for other connections, such as Ethernet connections. ▲

Figure 2-27.
Temperature/humidity sensor
cable entering the outdoor
enclosure.

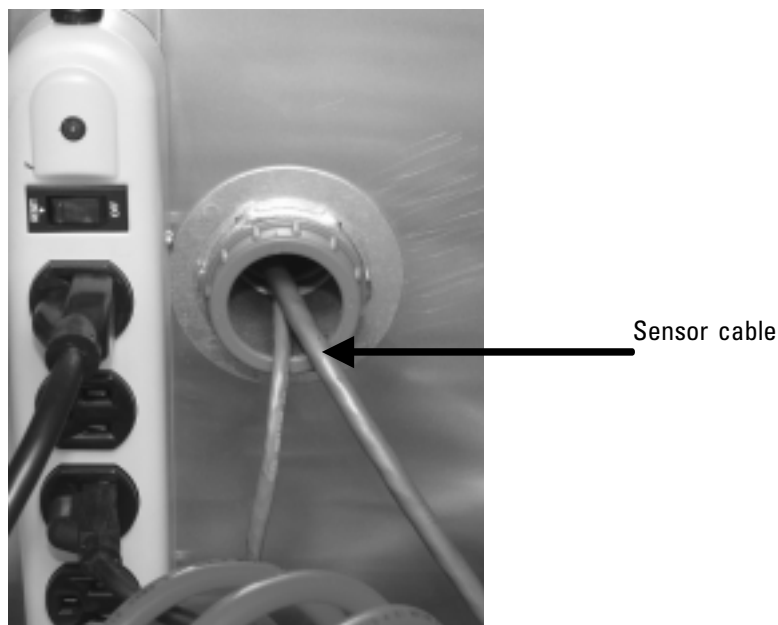
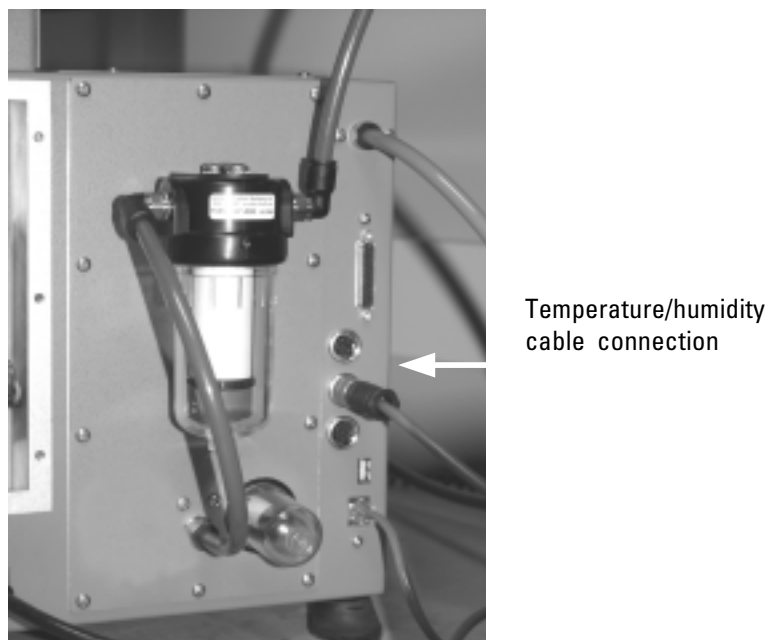

Figure 2-28.
Temperature/humidity sensor
connection of the back of the
TEOM 1405 unit.



15. Install the inlet (Figure 2-29).

Note. Drain the water trap as needed. ▲

Note. Thermo Scientific strongly recommends that you use the vacuum pump provided with the unit. If you choose to install a different pump, it must be oil-free and able to maintain a 21" Hg vacuum at a flow of 16.67 l/min. ▲

Figure 2-29.
Outdoor enclosure with
inlet installed.

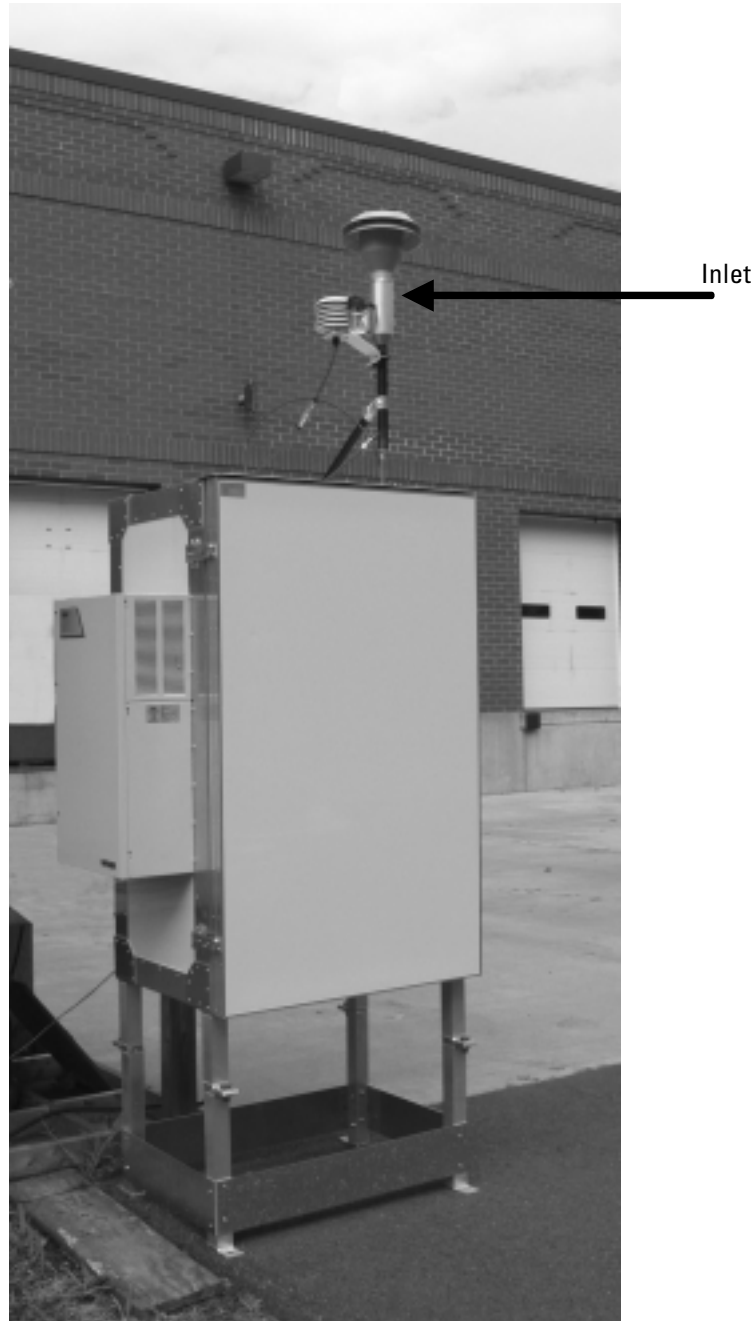

Section 3 Basic Operation

This sections describes the steps to begin data collection with the TEOM 1405 monitor, as well as leak check the instrument and download data.

The instrument will not begin collecting data until the operating mode message in the status bar reads “Fully Operational” (Figure 3-1). Users must install clean, conditioned filters in the unit prior to sampling. Users can select flow rate, data and other settings while waiting for the unit to become fully operational.

Figure 3-1.
TEOM Data screen with
“Fully Operational” message.

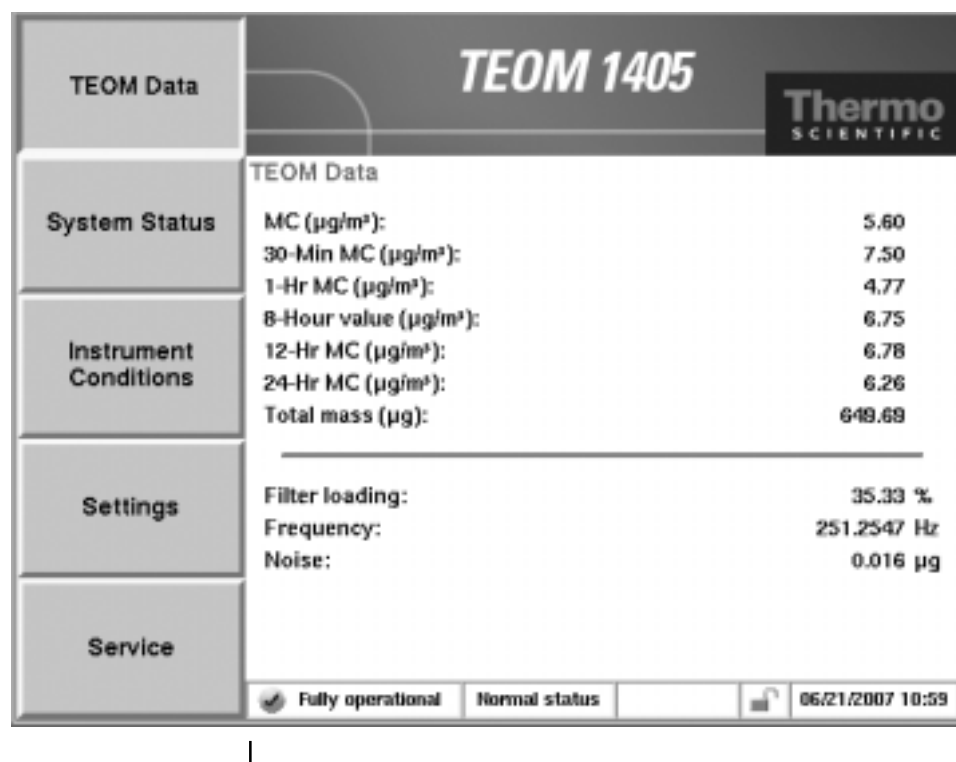

Status bar

Starting the Instrument

To program the instrument and begin collecting data:

1. Perform a leak check (refer to the following section for leak check information).
2. Install a TEOM filter into the mass transducer (Section 5).
3. When in the System Status screen, ensure that the serial number listed for the instrument matches the serial number on the back of the unit.
4. When in the Instrument Conditions screen, select the **Flows** button to display the Flows screen. Select the **Flow Rates** button to select the desired flow rates for the Main and Bypass flow channels. Select the **Flow Control** button to select the desired flow control (“Active” or Passive”) and the desired standard and average temperatures and pressures. (Refer to Section 4 for more information on screens and settings.)
5. When in the Settings screen, select the **System** button, then the **Set Time** button to set the current date and time. (Refer to Section 4 for more information on screens and settings.)
6. When in the Settings screen, select the **Advanced** button, then the **Mass Transducer K0 Constant** button to confirm the current K0 setting of the TEOM unit. The number programmed into the unit must match the K0 constant on the label near the mass transducer. (Refer to Section 4 for more information on screens and settings.)
7. When in the Settings screen, select the **Data Storage** button to display the Data Storage screen. Confirm the desired data is selected to be logged by the instrument. (Refer to “Storing Data” later in this section for more information on selecting storage variables.)
8. If you will be setting up the unit to receive an analog input, to transmit analog outputs, or setting up the unit’s contact closure circuits, refer to Section 4 for information on the screens and settings used for these parameters.
9. If you will be using the password function to control access to the unit’s operation, refer to Section 4 for information on setting up the password function.

10. Select the TEOM Data button to display the TEOM Data screen. The instrument will begin collecting data when the mode status window displays a “Fully operational” message.

Note. Upon initial instrument start up, the values in the mass concentration fields are the running averages that are accumulated until a 1-hour time period has passed. The values are visible to provide the user with an indication that the instrument is functioning, after instrument power up or reset. These raw values are used for internal calculations only. ▲

Performing a Leak Check

The TEOM 1405 should be leak-checked once a month or as needed. The system comes with flow audit/leak check adapter for the 1 1/4-inch flow splitter and the 3/8-inch bypass line.

The Leak Check Wizard compares the measured difference between the units “zero” flow with the vacuum disconnected and flow through the instrument with the inlet blocked (which should also be zero). The leak check passes if the main flow is within 0.15 l/min and the bypass flow is within 0.60 l/min of their “zero” value with the vacuum disconnected.

To perform a leak check:

1. In the 1405 TEOM Data screen, select the **Service** button to display the Service screen, then select the **Verification** button to display the Verification screen.
2. Select the **Leak Check** button to display the Leak Check Wizard screen (Figure 3-2).

Figure 3-2.
Leak Check Wizard start screen.

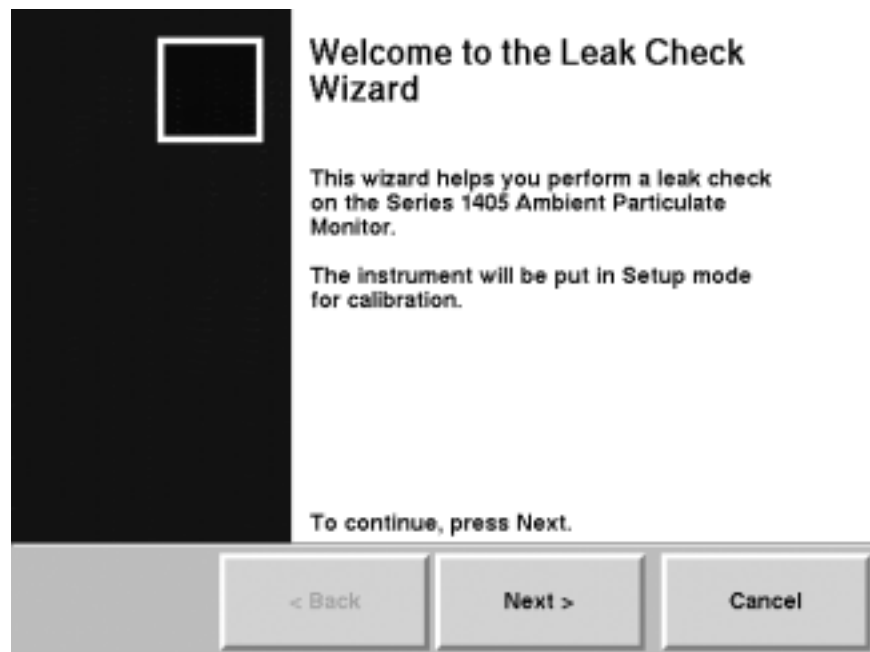

3. The Remove the TEOM filter screen will display. Remove the TEOM filter from the transducer to ensure it isn't damaged during the leak check procedure. Select the **Next >** button.
4. The Disconnect Vacuum Line screen will display. Remove the main vacuum line (pump) connected to the pump from the back of the unit (Figure 3-3). Select the **Next >** button.

Figure 3-3.
Back of TEOM 1405 unit.

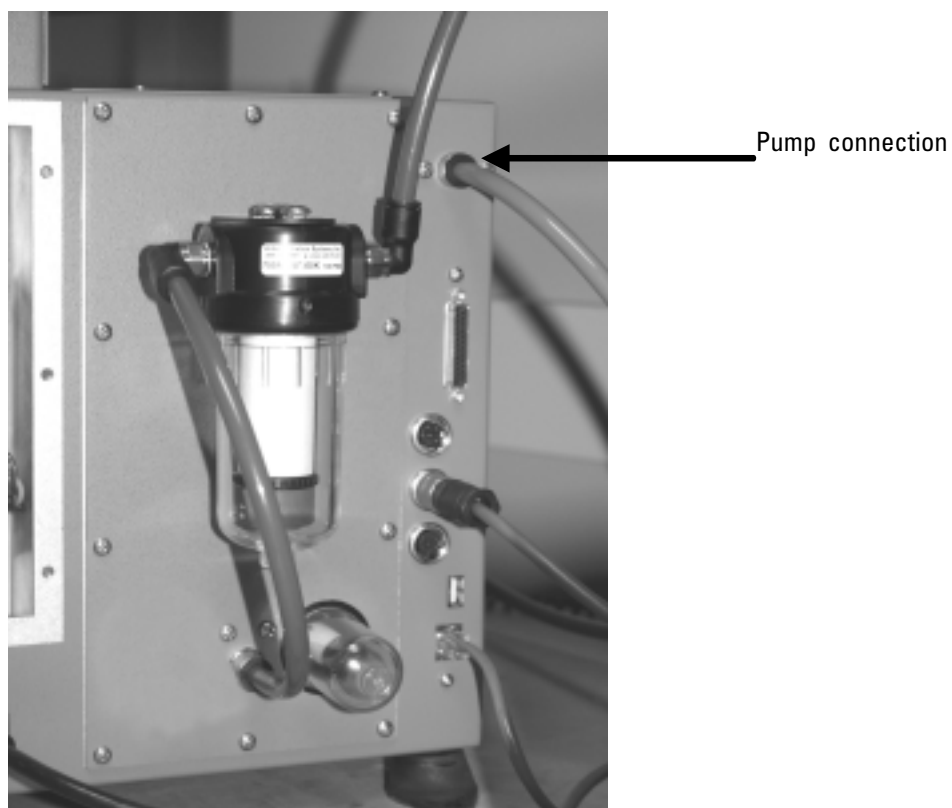

5. The Stabilizing screen will display. Allow 1 minute for the flows to stabilize then select the **Next >** button.
6. The Reconnect Vacuum Line screen will display. Reinstall the pump/vacuum tubing into the back of the unit. Select the **Next >** button.

7. The Remove Inlet screen will display. Remove the inlet (Figure 3-4). Select the **Next >** button.

Figure 3-4.
Inlet assembly.

Figure 3-5.
Leak check adapter.

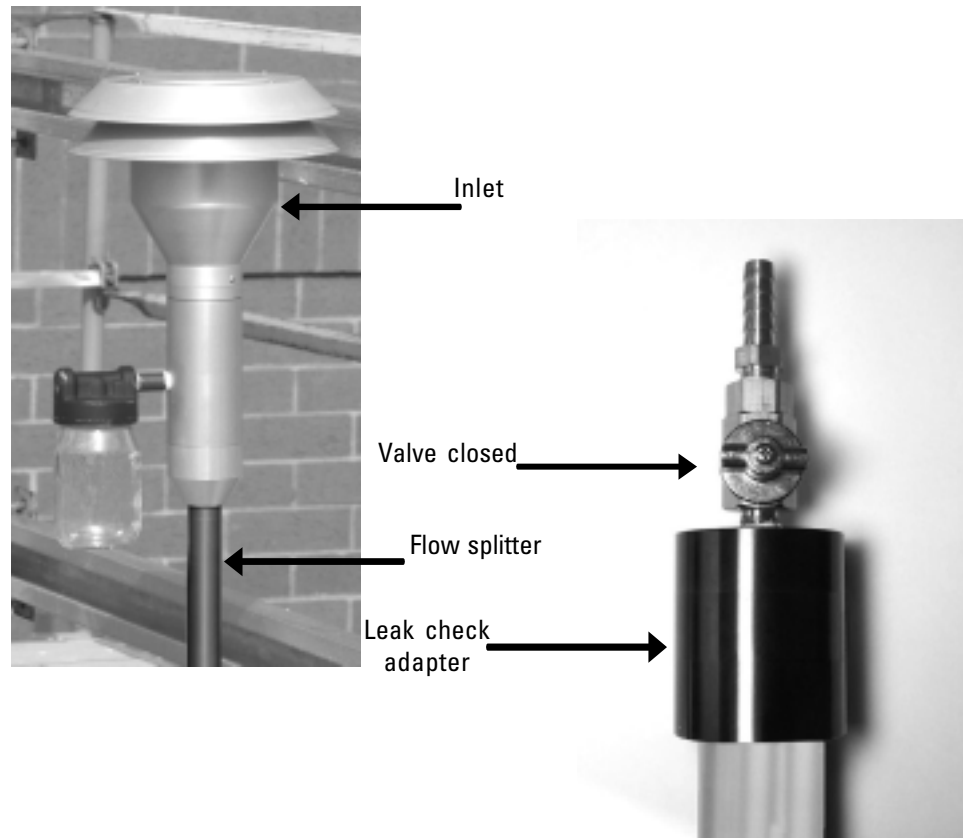

8. The Attach Audit Adapter screen will display. Attach the leak check/flow audit adapter to the top of the flow splitter.
9. Slowly close the valve on the leak check adapter. Select the **Next >** button.
10. The Stabilizing screen will display. Allow 1 minute for the flows to stabilize then select the **Next >** button.
11. The Replace Inlet screen will display. Slowly open the leak check valve to restore flow to the system. Remove the flow audit/leak check adapter and attach the inlet to the top of the sample inlet tube (Figure 3-4). Select the **Next >** button.

12. The Completing the Leak Check Wizard screen will display. If the leak check passes, a “You have successfully completed the Leak Check” message will display (Figure 3-6).

Note. If a leak check fails, a fail message will display (Figure 3-7). Isolate the leak, tighten the appropriate tubing and/or other connections and attempt the leak check again. ▲

Figure 3-6.
Leak Check Wizard finish screen with pass message.

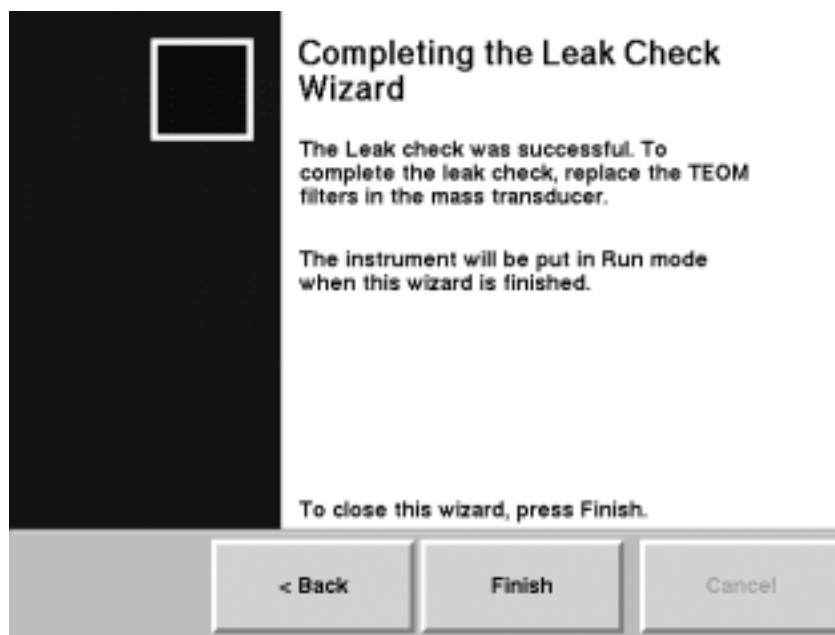
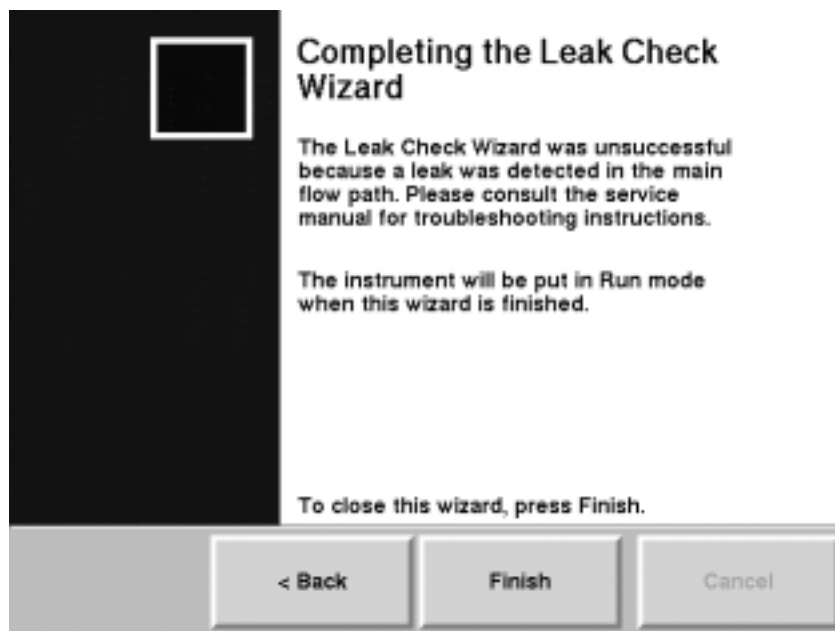

Figure 3-7.
Leak Check Wizard finish screen with fail message.



13. Install a new TEOM filter in the mass transducer (Section 5).

Storing Data

The unit stores only those variables selected by the user. If instrument variables are not set up to be logged, THEY WILL NOT BE SAVED.

To select data storage variables:

1. Select the Settings menu button to display the Settings screen (Figure 3-9).

Figure 3-9.
Settings screen.

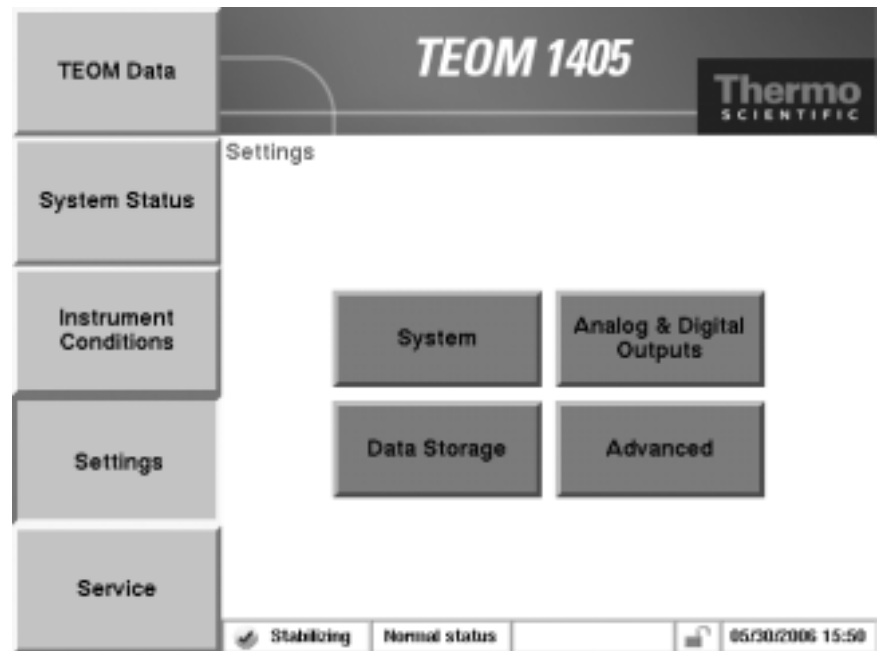

- When in the Settings screen, select the **Data Storage** button to display the Data Storage screen (Figure 3-10).

Figure 3-10.
Data Storage screen.

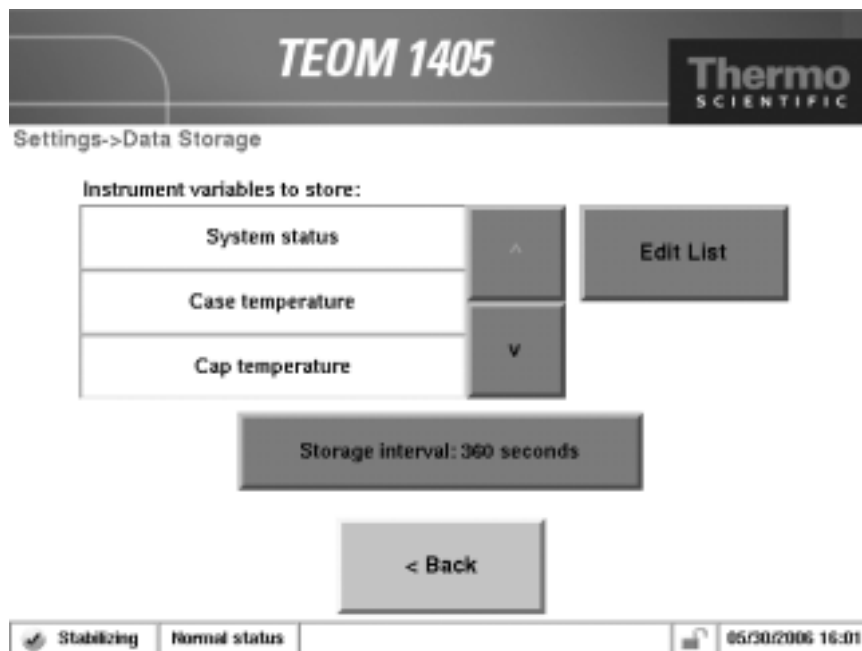

- When in the Data Storage screen, select the Edit List button to display the Edit Data Storage screen. Press the names of the variables you wish to log, up to a maximum of 20. Use the **Next Page >** and **< Previous Page** buttons to scroll through the entire list of variables which can be stored. Select the OK button when all the desired variables have been selected.
- Use the **▼** and **▲** buttons to scroll through the list of selected variables to ensure that all desired variables are selected.
- When in the Data Storage screen, select the **Storage Interval** button to select the interval for data storage. Enter the desired data storage interval into the keypad and select the **Enter** button. For example, if the storage interval is 10 seconds, every 10 seconds the instrument will log (save) the data in the selected variables.
- When all the desired variables are selected and the Storage Interval is set, select the **< Back** button to return to the Settings screen.

Downloading Data

The ePort software allows users to download data from the TEOM 1405 monitor using a personal computer (PC) with the Windows XP operating system. The monitor must be attached to a local area network (LAN) or directly to a router using the Ethernet connection on the back of the instrument (Figure 3-11). In order to use ePort, it must have a valid IP address.

Note. The PC running ePort **MUST** have the most up-to-date version of Windows XP. If you are not sure if the ePort PC has the most recent Windows XP updates installed, ePort should be installed while the PC is in a lab or another location where Windows updates can be obtained using an Internet connection. ▲

Figure 3-11.
Back of instrument.

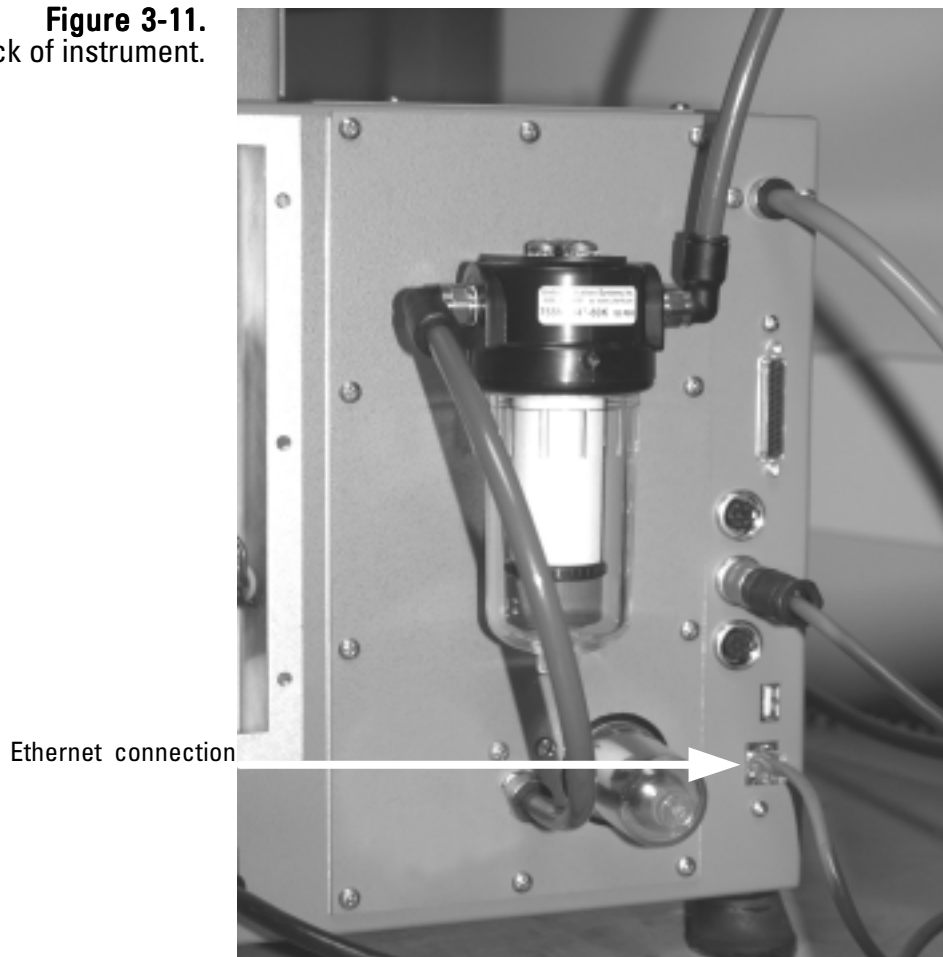

Installing ePort

Users must first install the ePort software on a personal computer (PC) connected to the same network as the TEOM 1405 that data will be downloaded from. At the same time the ePort software is installed, the installer will install Microsoft .NET Framework software if the PC does not already have an up-to-date version of .NET Framework.

To install the ePort software:

1. Locate and double-click on the “setup ePort _XX.exe” file (where “XX” is the version number) on the software CD that came with the TEOM 1405 monitor. The “Welcome to InstallShield Wizard” screen will display (Figure 3-12).

Figure 3-12.
ePort Welcome to InstallShield Wizard screen.

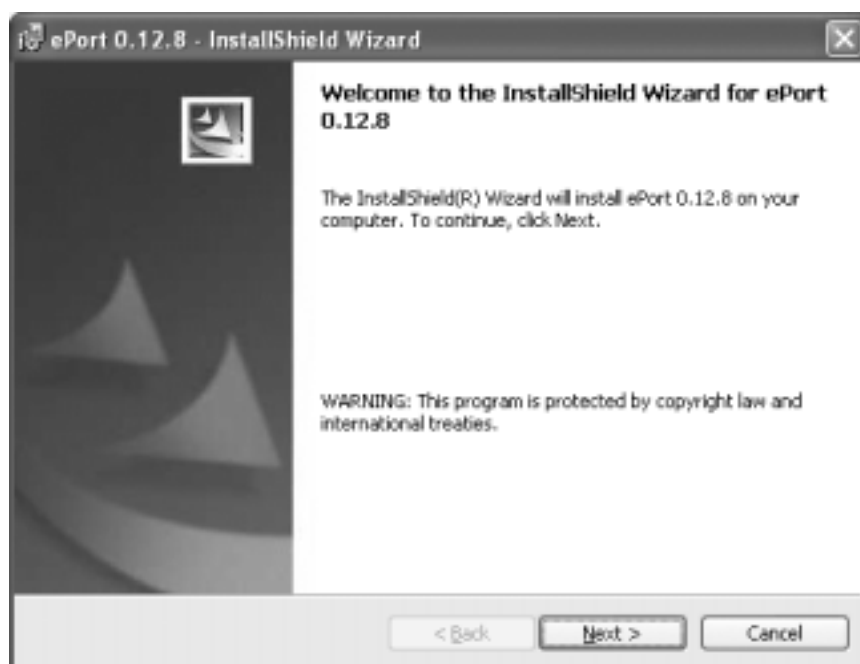

2. Select the “Install” button.
3. The wizard will display the software license agreement. Select “Yes,” then select the **Next >** button.

4. The Windows update screen will display (Figure 3-13). If you have recently updated your Windows XP software, select the **Next >** button.

Note. The ePort software MUST be installed on a PC with the latest Windows XP updates. If you have not updated your Windows XP system, select the “Cancel” button and use the Windows Update function of the PC to update the operating system before attempting to install the ePort software. ▲

Figure 3-13.
Windows Update notice.



5. The Customer Information screen will display. Type in the information and select the **Next >** button.

6. The Ready to Install Program screen will display (Figure 3-14). Select the **Install** button.

Figure 3-14.
Ready to Install the Program
screen.



7. The wizard will post messages showing the progress of the installation. When the process is complete, the Finish screen will display (Figure 3-15). Select the **Finish** button.

Figure 3-15.
InstallShield Wizard
Completed screen.

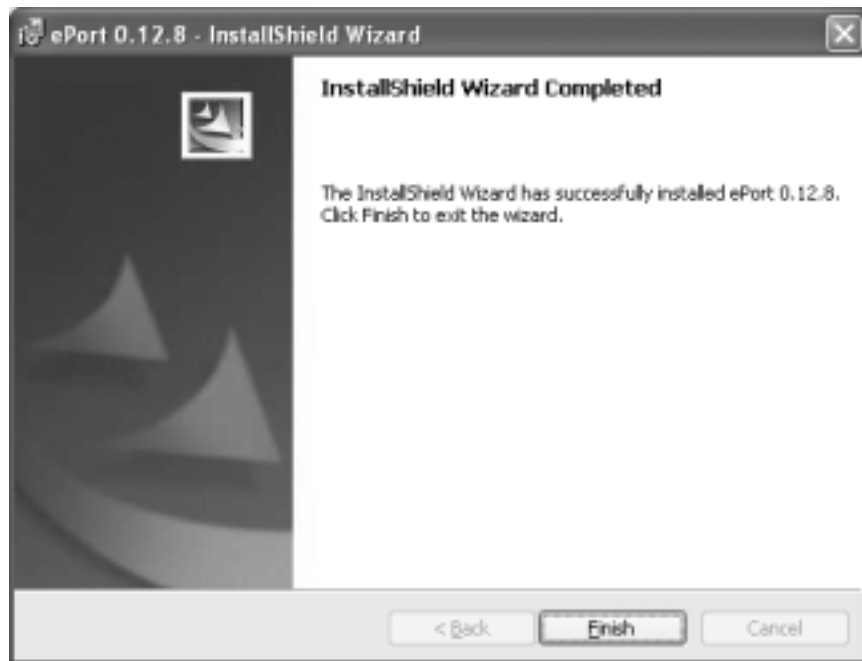

8. If the PC does not have an up-to-date version of Microsoft .NET Framework software, the system will automatically begin installing that software. The Microsoft .NET Framework Welcome screen will display (Figure 3-16). Select the **Next >** button.

Figure 3-16.
Microsoft .NET Framework
Welcome screen.

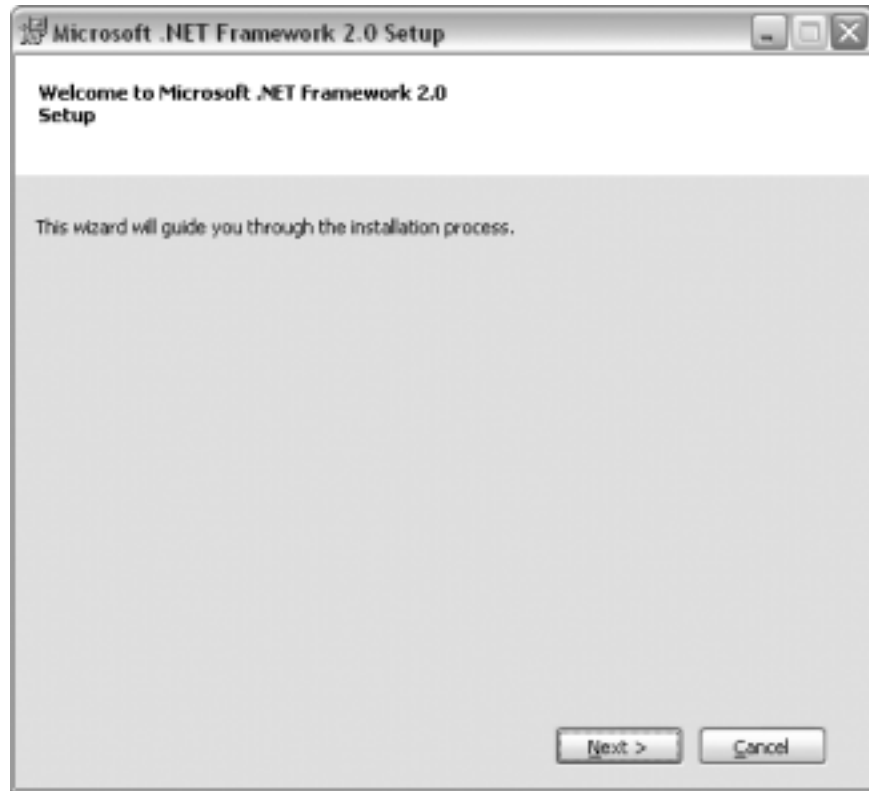

9. Select **Install**. The system will begin installing the Microsoft .NET Framework software. The wizard will post progress messages during the installation.

Note. If the Microsoft .NET Framework software is already installed on the PC, the wizard will ask you to Repair or Remove the software. Select **Repair** to ensure the latest version is installed on the PC, or select **Cancel** to skip the Microsoft .NET Framework installation. ▲

10. When the installation is complete, the Setup Complete screen will display (Figure 3-17). Select the **Finish** button to complete the ePort and Microsoft .NET Framework installation.

Figure 3-17.
Microsoft .NET Framework
Setup Complete screen.

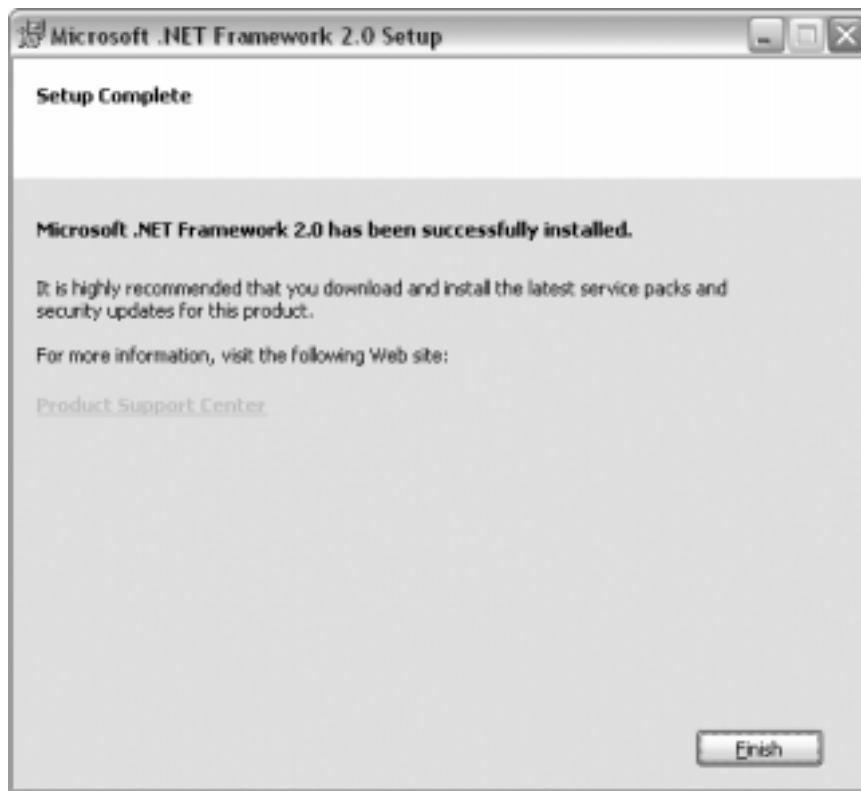

Connecting to the Series 1405 Unit

When the ePort software is installed, and the TEOM 1405 unit and the PC are connected to the same network, the software can connect to the instrument and download data.

Once you have connected to an instrument (or instruments) and saved a configuration file, select **Open Saved Configuration** in the ePort Open screen to open that configuration and automatically connect to all the instruments that were saved in that configuration.

To connect to the instrument:

1. Ensure that the PC and the instrument are connected to the same network using the Ethernet connection on the back of the instrument. (Refer to the previous section for information on connecting the instrument to a network.)
2. In the System Status screen of the machine from which you want to download data, locate and record the IP address (Figure 3-18) of that unit.

Figure 3-18.
System Status screen.

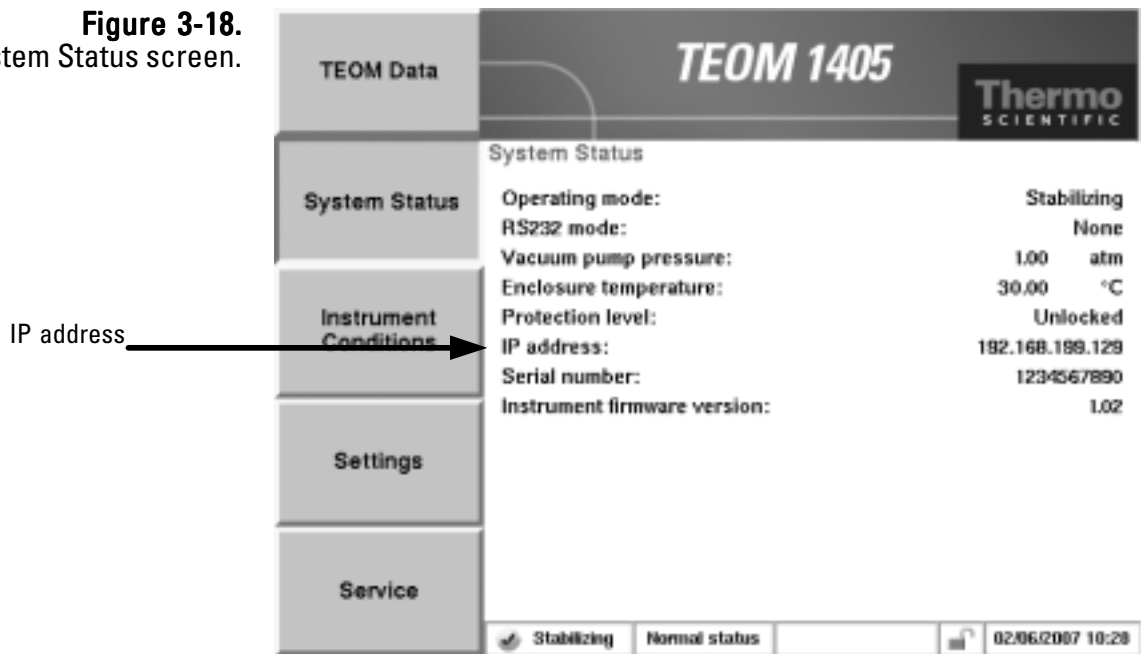

3. Start the ePort PC software, using the icon on the PC desktop or the Start menu of the PC. The ePort Main screen with the Open screen will display (Figure 3-19).

Figure 3-19.
ePort Main screen with Open screen.

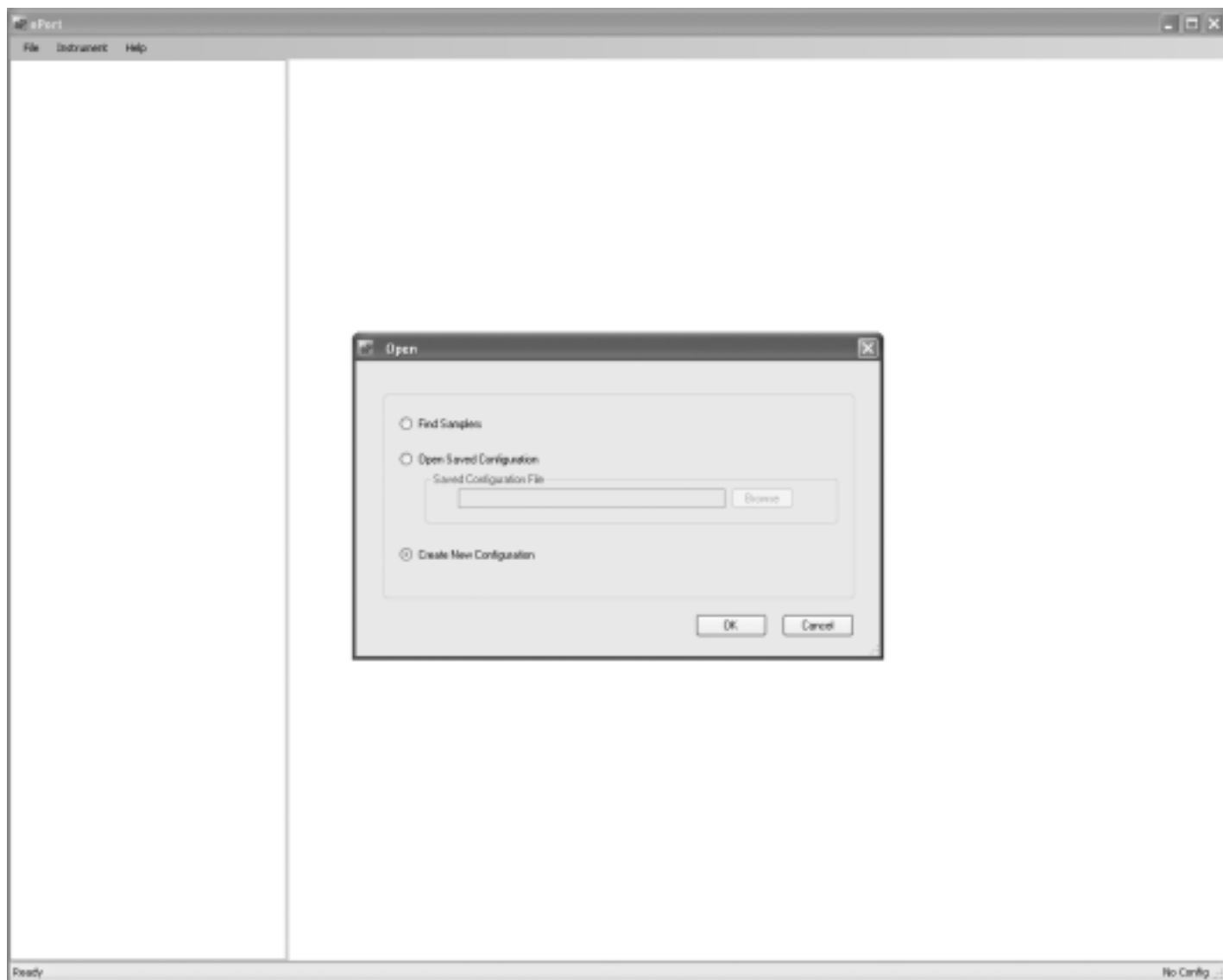

4. In the ePort Open screen (Figure 3-19), select create new configuration. A blank ePort Main screen will display.

5. Select **Instrument** then **New Instrument** from the menu bar at the top of the ePort Main screen (Figure 3-20).

Figure 3-20.
Selecting New Instrument from
the menu bar.

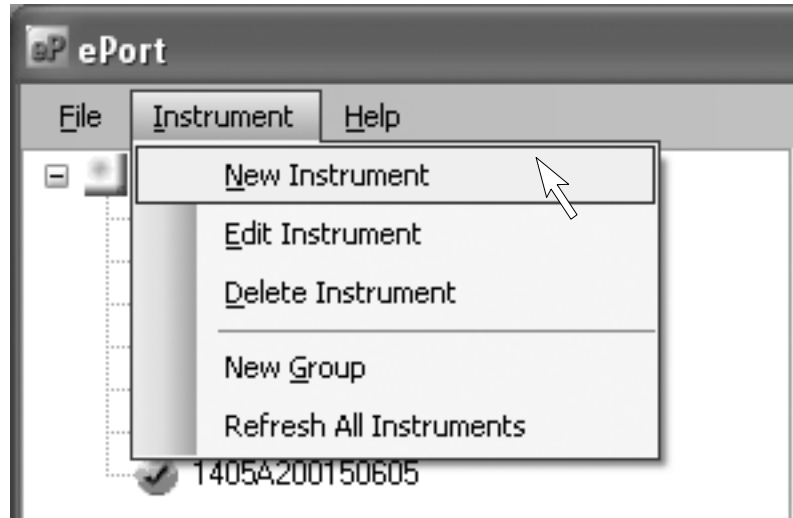

6. The Add New Instrument screen will display (Figure 3-21). Enter the IP address, the name assigned to the instrument and the group (if any) assigned to the instrument and select the **OK** button.

Figure 3-21.
Add New Instrument screen.

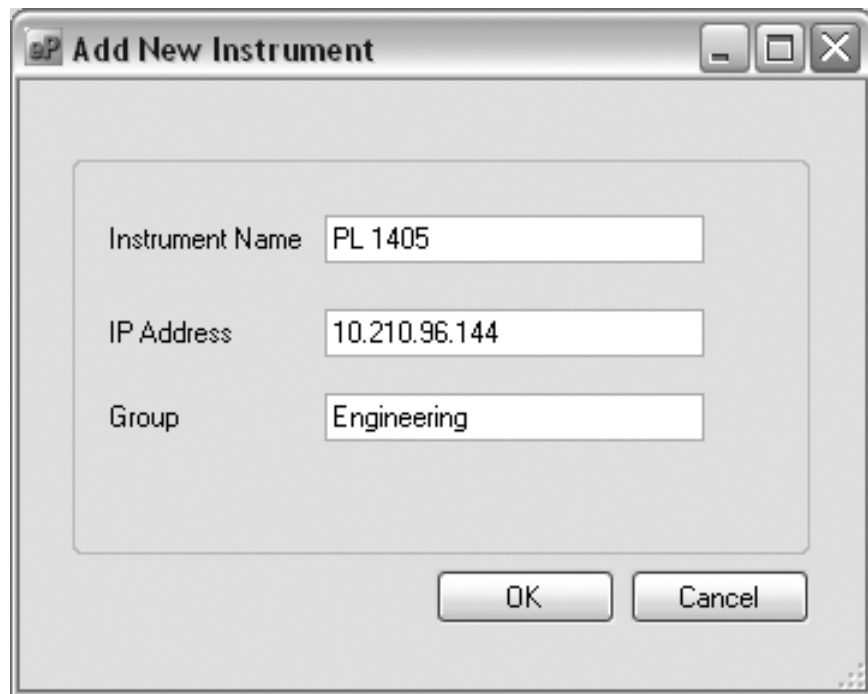

7. The ePort Main screen will display with the selected instrument displayed in the top window (Figure 3-22). Repeat the process to add additional instruments to the list.
8. To save this as a configuration, select **File** then **Save** from the menu bar at the top of the Main screen. The Save As screen will display. Type in the desired name for the configuration and select **Save**.

Note. Once you have connected to an instrument (or instruments) and saved a configuration file, select **Open Saved Configuration** in the ePort Open screen to open that configuration and automatically connect to all the instruments that were saved in that configuration. ▲

Figure 3-22.
ePort Main screen with instrument information displayed.

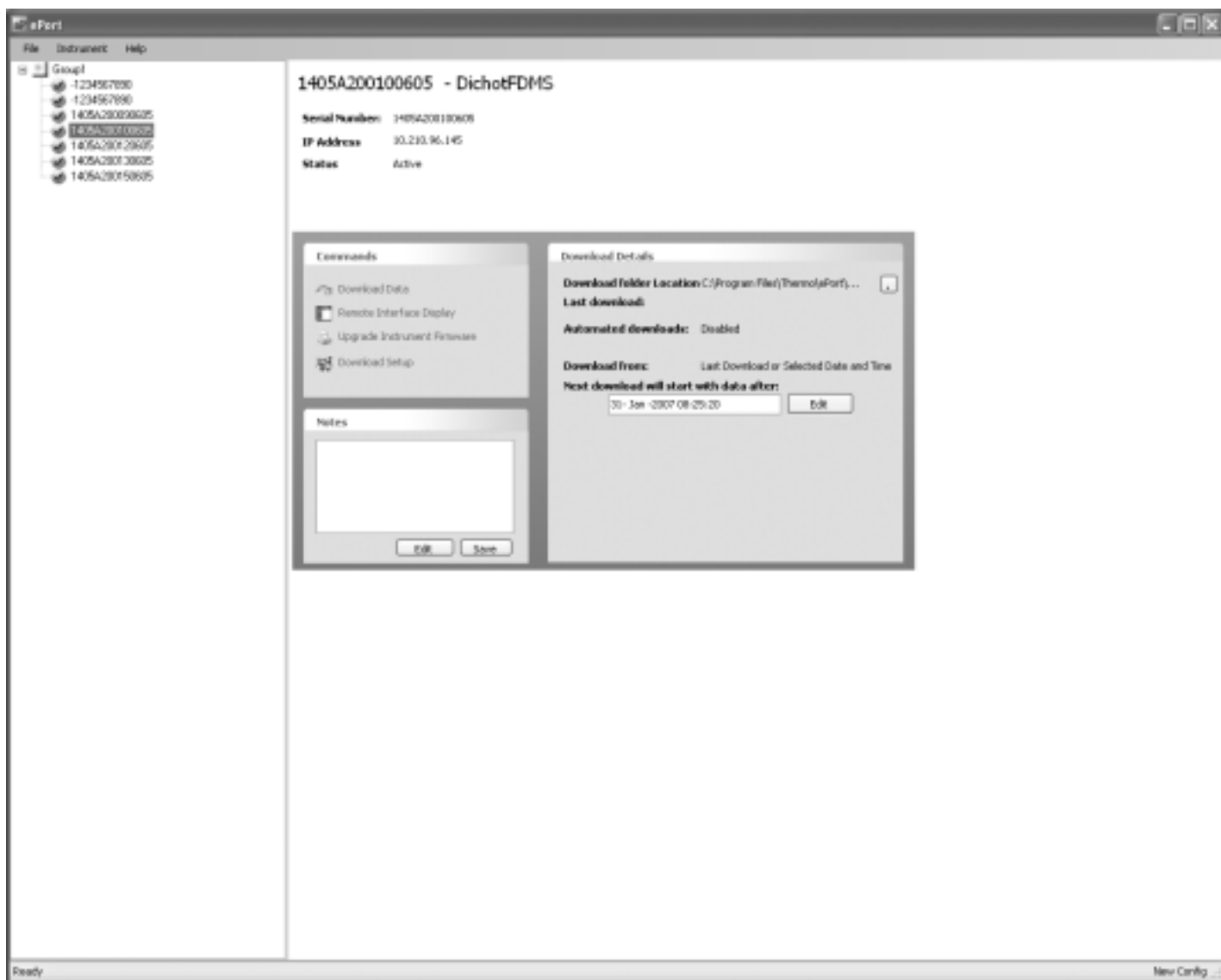

Finding Instruments On a Network

You may use the ePort software to search for all instruments connected to the local network.

This function will only locate instruments on a local network. To connect to instruments on other connected networks, you must know the IP address of the instruments and connect to the unit manually using the **New Instrument** function of the software (Figure 3-20). Refer to the previous section for information on connecting to an instrument off the local network. Instruments on a network must have a unique IP address, or be connected through a router.

To locate all instruments on the network:

1. Open the ePort software program and select “Find Samplers” in the Open screen (Figure 3-19).
2. The ePort Main screen will display with a “Searching for Instruments...” message. As instruments are located by the software they will be added to the list in the Instrument frame on the left side of the screen (Figure 3-23).

Figure 3-23.
ePort Main screen with
“Searching for Instruments...”
message.

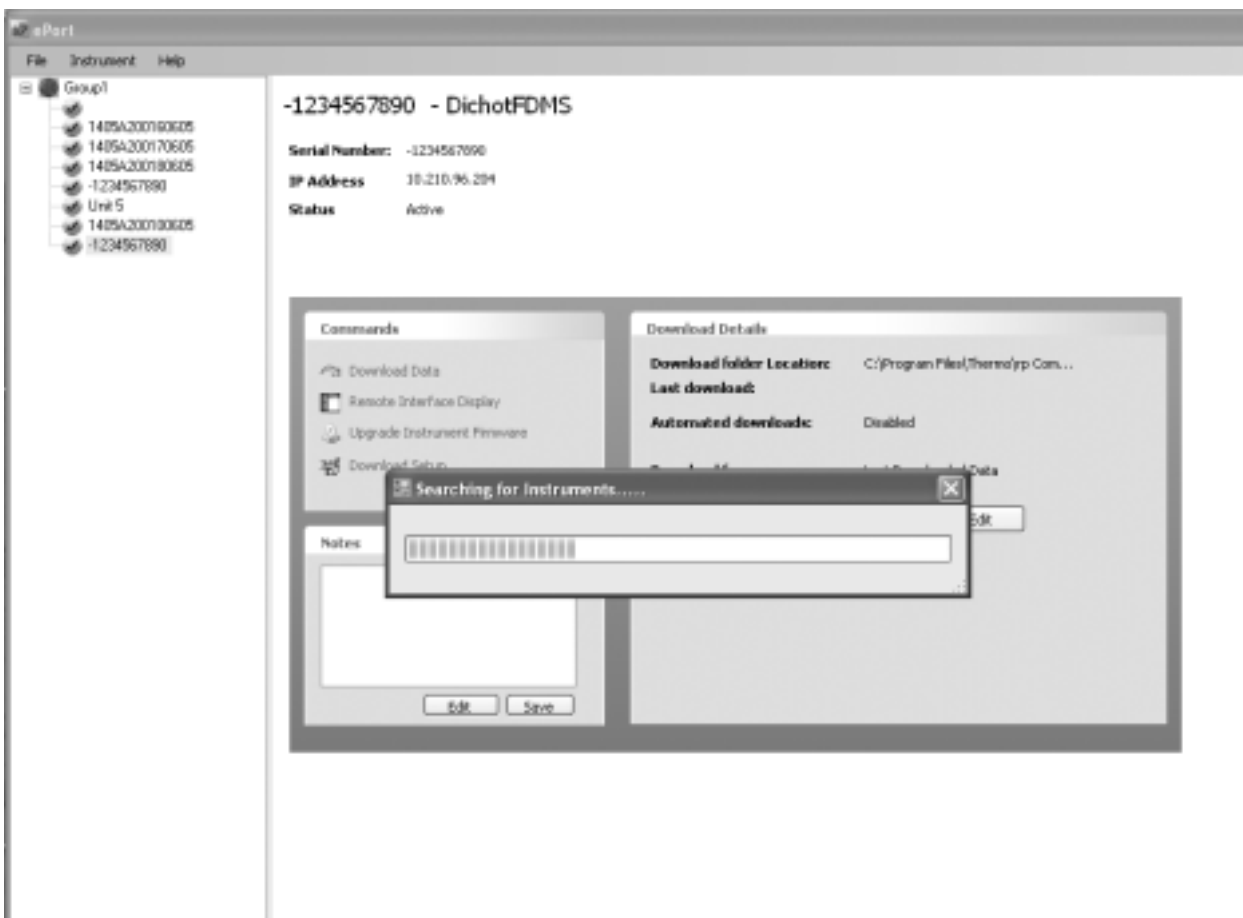

3. All instruments located on the local network will be displayed in the Instrument frame on the left side of the Main screen. To edit a displayed instrument or delete an instrument from the list, right-click on the instrument and select **Edit Instrument** or **Delete Instrument** (Figure 3-24).

Note. To add an instrument from another network connected to the local network select **Instrument** then **New Instrument** from the menu bar. Refer to the previous section for more information on manually adding an instrument to the configuration. ▲

Figure 3-24.
Adding or deleting an instrument from the list.

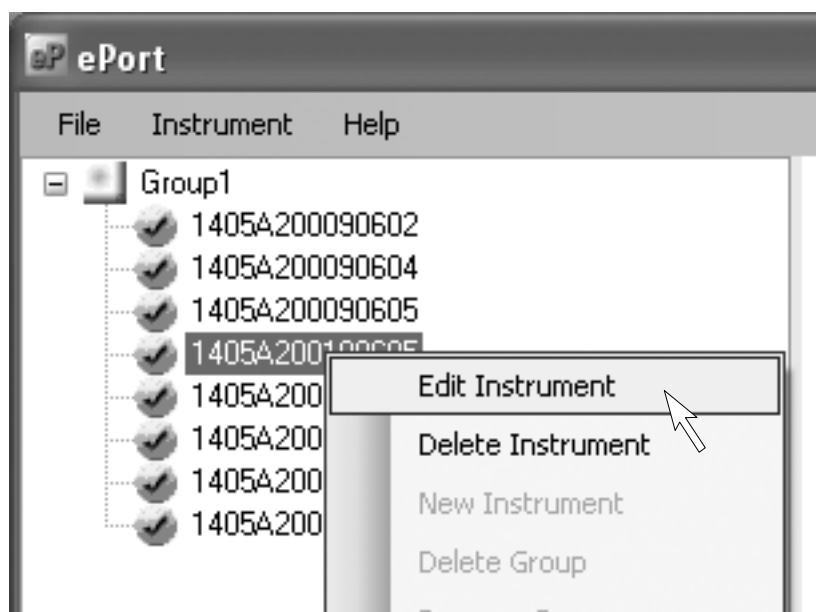

4. To save this list as a configuration, select **File** then **Save** from the menu bar at the top of the Main screen. The Save As screen will display. Type in the desired name for the configuration and select **Save**.

Note. Once you have connected to an instrument (or instruments) and saved a configuration file, select **Open Saved Configuration** in the ePort Open screen to open that configuration and automatically connect to all the instruments that were saved in that configuration. ▲

Setting Up for Manual Data Downloads

Data can be manually downloaded from the TEOM 1405 monitor through the built-in Ethernet connection using the ePort software.

To set up the software to manually download data:

1. Ensure that the PC and the instrument are connected to the same network using the Ethernet connection on the back of the instrument. (Refer to the previous section for information on connecting the instrument to a network.)
2. Use the ePort PC software to connect to the instrument and display the ePort Main screen (Figure 3-25). (Refer to the previous two sections for information on connecting to the instrument or instruments.)

Figure 3-25.
ePort Main screen.

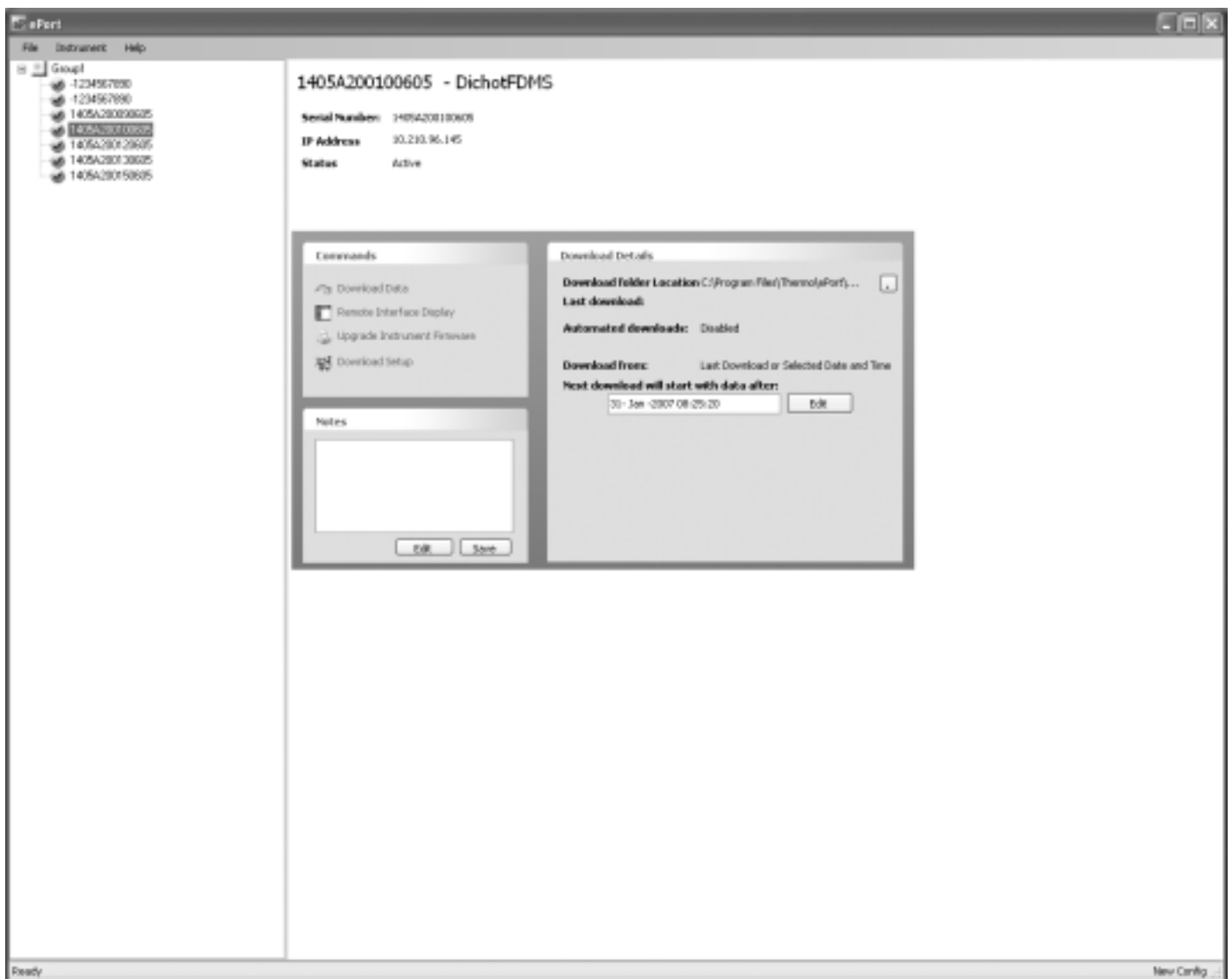

3. Select **Download Setup** in the Commands window of the ePort Main screen. The Download Setup Wizard will display (Figure 3-26). Select the **Next >** button.

Figure 3-26.
Download Setup Wizard.



4. The Select Data screen will display. Select the data to download (either all data on the instrument or the data since the last download). Select the **Next >** button.
5. The Select Location screen will display. Use the Browse button to select a location for the data file downloaded by the software. Select the **Next >** button.
6. The Download Type screen will display. Select manual downloads. Select the **Next >** button.
7. The Completing the Download Setup Wizard screen will display. Select the **Finish** button.

Setting Up for Automatic Data Downloads

Users can set up automatic downloads for the TEOM 1405 monitor using the ePort software.

To set up the software to automatically download data:

1. Ensure that the PC and the instrument are connected to the same network using the Ethernet connection on the back of the instrument. (Refer to the previous section for information on connecting the instrument to a network.)
2. Use the ePort PC software to connect to the instrument and display the ePort Main screen (Figure 3-25). (Refer to the previous sections for information on connecting to the instrument or instruments.)
3. Select **Download Setup** in the Commands window of the ePort Main screen. The Download Setup Wizard will display (Figure 3-26). Select the **Next >** button.
4. The Select Data screen will display. Select the data to download (either all data on the instrument or the data since the last download). Select the **Next >** button.
5. The Select Location screen will display. Use the Browse button to select a location for the data file downloaded by the software. Select the **Next >** button.
6. The Download Type screen will display. Select automatic downloads. Select the **Next >** button.

7. The Download Schedule screen will display (Figure 3-27). Select a starting date and time, and a download frequency (daily, weekly, hourly). Select the **Next >** button.

Figure 3-27.
Download Setup Wizard.

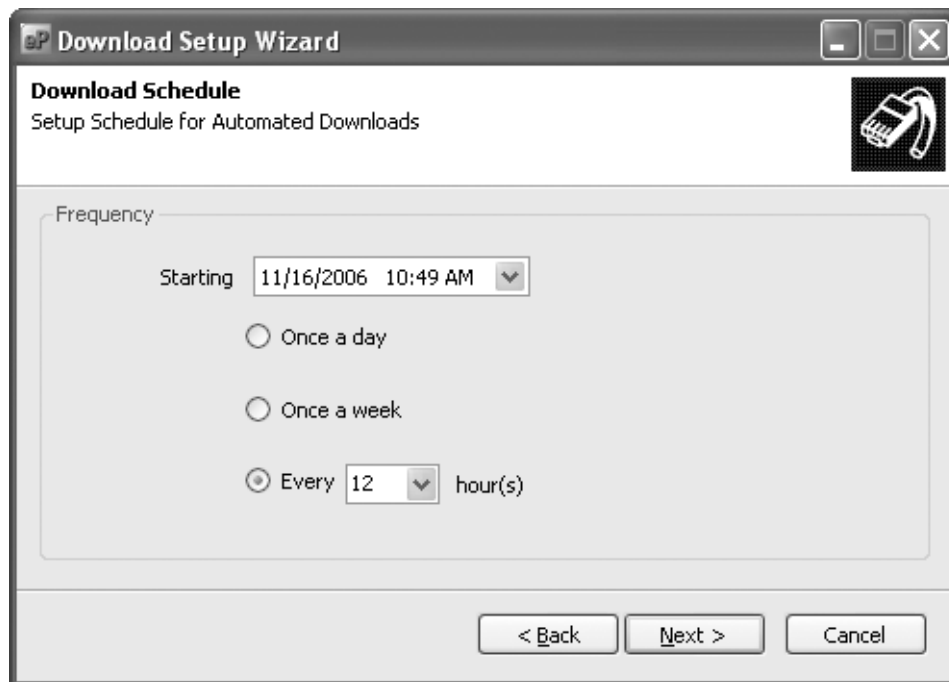

8. The Completing the Download Setup Wizard screen will display. Select the **Finish** button.

Performing a Data Download

To download data:

1. Ensure that the PC and the instrument are connected to the same network using the Ethernet connection on the back of the instrument. (Refer to the Connecting to the TEOM 1405 Unit section for information on connecting the instrument to a network.)
2. Use the ePort PC software to connect to the instrument and display the ePort Main screen (Figure 3-24). (Refer to the Connecting to the TEOM 1405 Unit section for information on connecting to the instrument.)

Note. Once you have connected to an instrument (or instruments) and saved a configuration file, select **Open Saved Configuration** in the ePort Open screen to open that configuration and automatically connect to all the instruments that were saved in that configuration. ▲

Figure 3-24.
ePort Main screen.

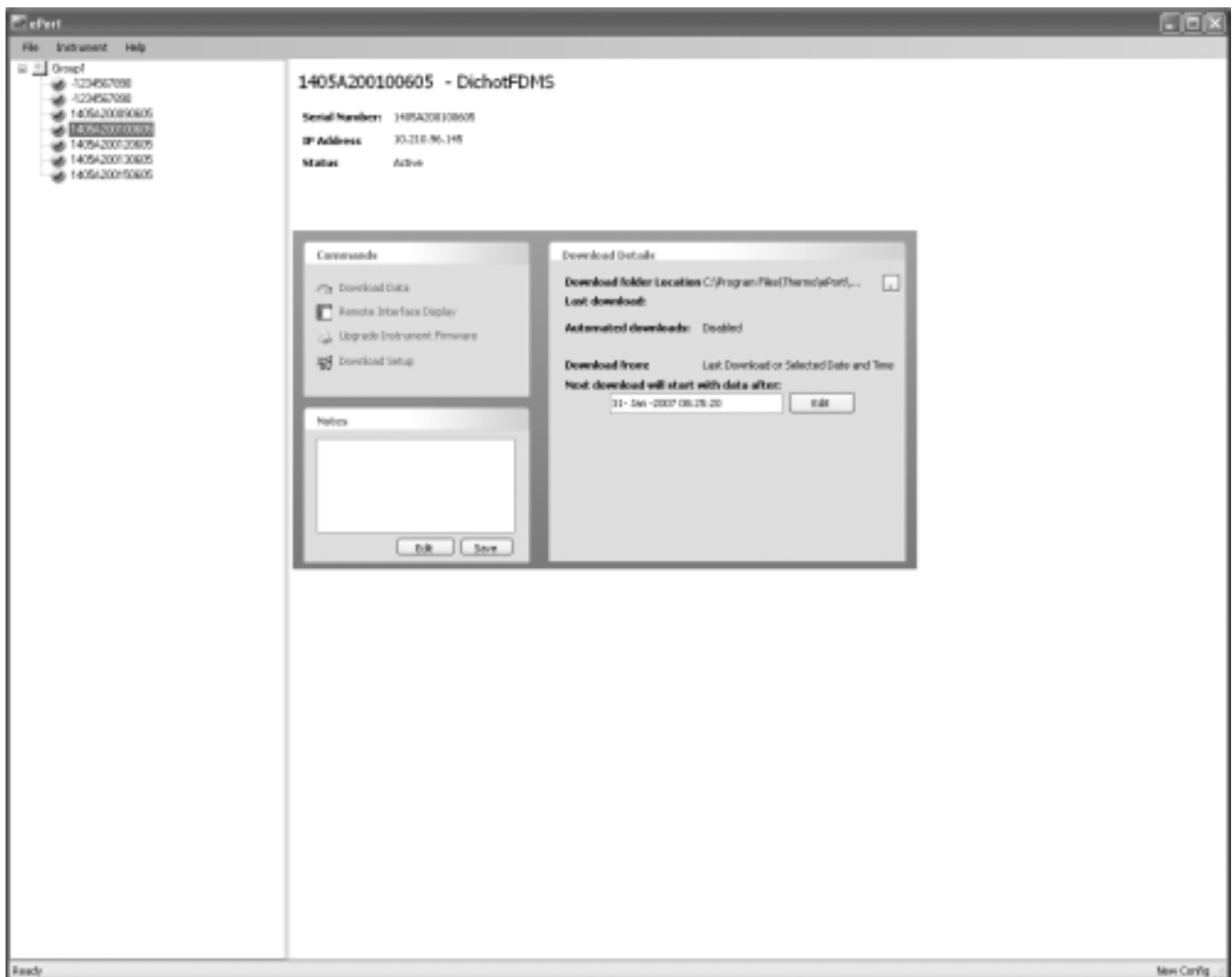

3. Select **Download Data** in the Commands window of the ePort Main screen. The Download Data screen will display (Figure 3-25).

Figure 3-25.
Download Data screen.

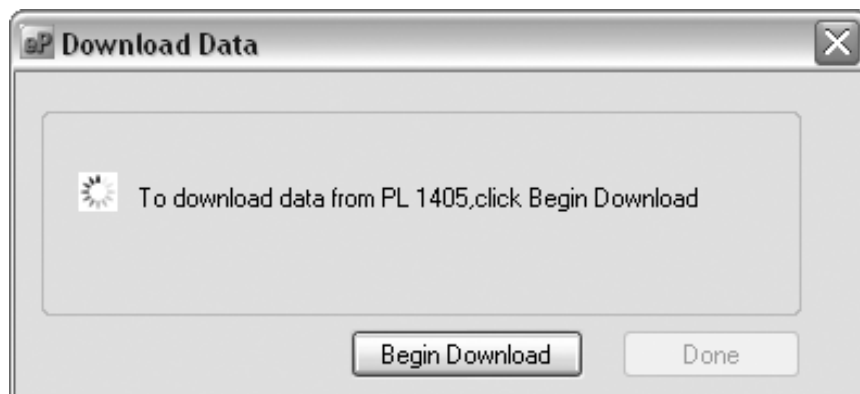

4. Select the **Begin Download** button. The ePort software will download data based on the settings created in the Download Setup wizard. (Refer to the previous section for information on setting up downloads.) The message window will display a “Downloading Data” message while the software is downloading data from the instrument. When the download is complete, it will display a “Download Complete” message. Select the **Done** button to exit the Download Data screen.

Downloading Data To a Flash Drive

The TEOM 1405 also supports data downloads using the USB connection on the front of the instrument and a USB flash drive.

Note. Due to the size of the storage buffer, downloading all stored data may take 30 minutes or more. ▲

To download data using the USB connection:

1. Plug a flash drive into the USB connection on the front of the instrument. The Download Data to USB Flash Drive screen will display (Figure 3-26).

Figure 3-26.
Download Data to USB
Flash Drive screen.



2. To continue with the download, select the **Yes** button. To cancel select the **No** button, then remove the USB drive.

3. The Select Data screen will display (Figure 3-27). Select the **From the beginning** button to download all the data on the instrument. Select the **From last download** button to download only the data stored since the last data download. Select the **OK** button.

Figure 3-27.
Select Data screen.

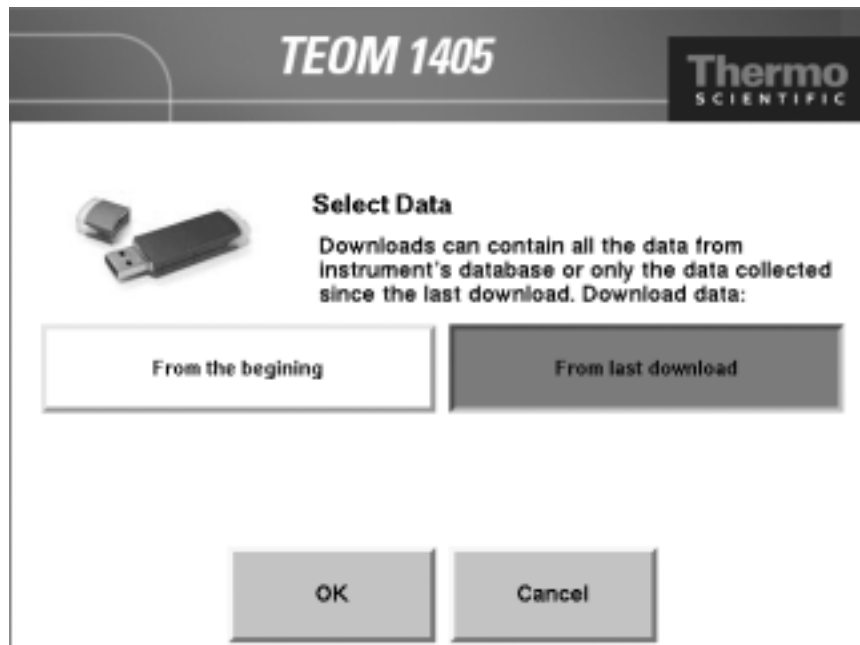

4. The instrument will display a “downloading data” message and begin transferring data to the USB drive.

Note. Do not remove the USB drive from the instrument while the data is downloading. ▲

5. When the data download is complete, the instrument will display a “Download complete” message and display the file name as it is stored on the USB flash drive. (The file name format is the instrument serial number followed by a date/time stamp.) Remove the USB flash drive and select the **OK** button to continue.

Viewing Downloaded Data

Data files are downloaded and saved as “.csv” files (.txt files through USB) that can be opened and viewed with Microsoft Excel. The file name format is the instrument serial number followed by a date/time stamp.

The data files will be saved to the folder selected using the Download Setup Wizard. Refer to the Setting Up for a Data Download section for information on setting up a data folder. The default folder location is:

C:\Program Files\Thermo\Port\Data

Figure 3-28.
Data .csv file opened in Excel.

	A	B	C	D	E	F	G	H	I
	time_stamp	tmoTEOMAHD	tmoTEOMBKD	tmoTEOMAReMCRaw	tmoTEOMABaseMCRaw	tmoTEOMAFreqStart	tmoTEOMAFrequency	tmoTEOMBfreqStart	tmoTEOMBFreq
2	6/5/2006 18:17	19918.42697	14406.26323	0	0	0	265.50621	0	290.4
3	6/5/2006 18:17	19918.42697	14406.26323	0	0	0	265.50621	0	290.4
4	6/5/2006 18:17	19918.42697	14406.26323	0	0	0	265.50621	0	290.4
5	6/5/2006 18:17	19918.42697	14406.26323	0	0	0	265.507901	0	290.4
6	6/5/2006 18:17	19918.42697	14406.26323	0	0	0	265.509008	0	290.4
7	6/5/2006 18:18	19918.42697	14406.26323	0	0	0	265.50951	0	290.4
8	6/5/2006 18:18	19918.42697	14406.26323	0	0	0	265.509693	0	290.4
9	6/5/2006 18:18	19918.42697	14406.26323	0	0	0	265.50977	0	290.4
10	6/5/2006 18:18	19918.42697	14406.26323	0	0	0	265.509807	0	290.4
11	6/5/2006 18:18	19918.42697	14406.26323	0	0	0	265.509939	0	290.4
12	6/5/2006 18:18	19918.42697	14406.26323	0	0	0	265.510035	0	290.4
13	6/5/2006 18:19	19918.42697	14406.26323	0	0	0	265.509966	0	290.4
14	6/5/2006 18:19	19918.42697	14406.26323	0	0	265.509875	265.509875	250.440346	290.4
15	6/5/2006 18:19	19918.42697	14406.26323	0	0	265.509875	265.509851	250.440346	290.4
16	6/5/2006 18:19	19918.42697	14406.26323	0	0	265.509875	265.509852	250.440346	290.4
17	6/5/2006 18:19	19918.42697	14406.26323	0	0	265.509875	265.509955	250.440346	290.4
18	6/5/2006 18:19	19918.42697	14406.26323	0	0	265.509875	265.510019	250.440346	290.4
19	6/5/2006 18:20	19918.42697	14406.26323	0	0	265.509875	265.510078	250.440346	290.4
20	6/5/2006 18:20	19918.42697	14406.26323	0	0	265.509875	265.510115	250.440346	290.4
21	6/5/2006 18:20	19918.42697	14406.26323	0	0	265.509875	265.510115	250.440346	290.4
22	6/5/2006 18:20	19918.42697	14406.26323	0	0	265.509875	265.510143	250.440346	290.4
23	6/5/2006 18:20	19918.42697	14406.26323	0	0	265.509875	265.510178	250.440346	290.4
24	6/5/2006 18:20	19918.42697	14406.26323	0	0	265.509875	265.510187	250.440346	290.4
25	6/5/2006 18:21	19918.42697	14406.26323	0	0	265.509875	265.510184	250.440346	290.4
26	6/5/2006 18:21	19918.42697	14406.26323	0	0	265.509875	265.510168	250.440346	290.4
27	6/5/2006 18:21	19918.42697	14406.26323	0	0	265.509875	265.510159	250.440346	290.4
28	6/5/2006 18:21	19918.42697	14406.26323	0	0	265.509875	265.510081	250.440346	290.4
29	6/5/2006 18:21	19918.42697	14406.26323	0	0	265.509875	265.510015	250.440346	290.4
30	6/5/2006 18:21	19918.42697	14406.26323	0	0	265.509875	265.509926	250.440346	290.4
31	6/5/2006 18:22	19918.42697	14406.26323	0	0	265.509875	265.509805	250.440346	290.4
32	6/5/2006 18:22	19918.42697	14406.26323	0	0	265.509875	265.509692	250.440346	290.4
33	6/5/2006 18:22	19918.42697	14406.26323	0	0	265.509875	265.509692	250.440346	290.4
34	6/5/2006 18:22	19918.42697	14406.26323	0	0	265.509875	265.509599	250.440346	290.4
35	6/5/2006 18:22	19918.42697	14406.26323	0	0	265.509875	265.509393	250.440346	290.4
36	6/5/2006 18:22	19918.42697	14406.26323	0	0	265.509875	265.509273	250.440346	290.4
37	6/5/2006 18:23	19918.42697	14406.26323	0	0	265.509875	265.509103	250.440346	290.4
38	6/5/2006 18:23	19918.42697	14406.26323	0	0	265.509875	265.5089	250.440346	290.4
39	6/5/2006 18:23	19918.42697	14406.26323	0	0	265.509875	265.508719	250.440346	290.4
40	6/5/2006 18:23	19918.42697	14406.26323	0	0	265.509875	265.508518	250.440346	290.4
41	6/5/2006 18:23	19918.42697	14406.26323	0	0	265.509875	265.508318	250.440346	290.4

User I/O Connections

The TEOM 1405 allows users additional analog input and analog and digital output capabilities using the 25-pin “USER I/O” connector on the back of the instrument.

The female 25-pin USER I/O connector (Figures 3-29) has connections for eight analog output, four analog input and two digital output (contact closure) connections.

Figure 3-29.
USER I/O connector.

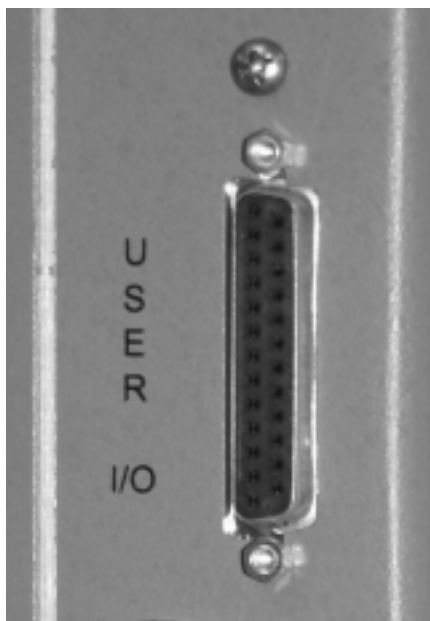

Thermo Scientific offers a 25-pin male connector manufactured by Phoenix Contact that can be wired to match to the USER I/O connector on the back of the instrument. (Figure 3-30).

Figure 3-30.
25-pin connector.



Wire the desired analog input, analog output or digital output connections to the Phoenix Contact 25-pin male connector according to the manufacturer’s instructions and the pin assignments of the TEOM 1405 (Figure 3-31 and Table 3-1).

Figure 3-31.
1405 USER I/O pin assignments.

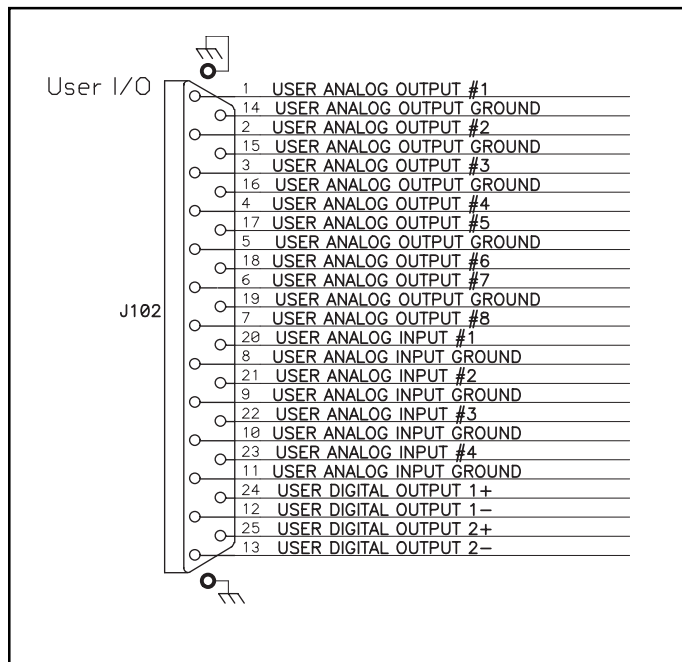

Table 3-1.
1405 USER I/O pin assignments.

Channel	Pin	Channel	Pin
Analog output 1	1	Analog output 1 ground	14
Analog output 2	2	Analog output 2 ground	15
Analog output 3	3	Analog output 3 ground	16
Analog output 4	4	Analog output 4 ground	16
Analog output 5	17	Analog output 5 ground	5
Analog output 6	18	Analog output 6 ground	5
Analog output 7	6	Analog output 7 ground	19
Analog output 8	7	Analog output 8 ground	19
Analog input 1	20	Analog input 1 ground	8
Analog input 2	21	Analog input 2 ground	9
Analog input 3	22	Analog input 3 ground	10
Analog input 4	23	Analog input 4 ground	11
Digital I/O 1+	24	Digital I/O 1-	12
Digital I/O 2+	25	Digital I/O 2-	13

When the 25-pin Phoenix Contact connector is attached to the unit with the wired digital or analog device connections, the inputs/outputs must be set up using the TEOM 1405 software screens:

When in the Instrument Conditions screen, select the **Analog Inputs** button to set up the analog inputs (1-4) and convert the incoming voltage to the desired scale. The analog inputs are self-calibrating.

When in the Settings screen, select the **Analog & Digital Outputs** screen to set up the analog outputs (1-8) and digital outputs (contact closures 1-2):

- When in the Analog & Digital Outputs screen, select the **Analog Outputs** button to set a minimum and maximum value for the output for the desired output channel. Refer to Section 5 for information on calibrating the analog outputs.
- When in the Analog & Digital Outputs screen, select the **Contact Closure** button to select a variable, operator and compare value for the desired contact closure channel (1-2).

Refer to Section 4 for complete information on setting the inputs/outputs in the Analog Inputs and Analog & Digital Outputs screens.

Notes

Section 4 Screens and Settings

This section describes the screens shown in the instrument software and the system's operating modes, as well as how to change instrument settings.

When the instrument is started, it will display the Title screen for a few seconds (Figure 4-1) after the initialization process.

Figure 4-1.
Title screen.

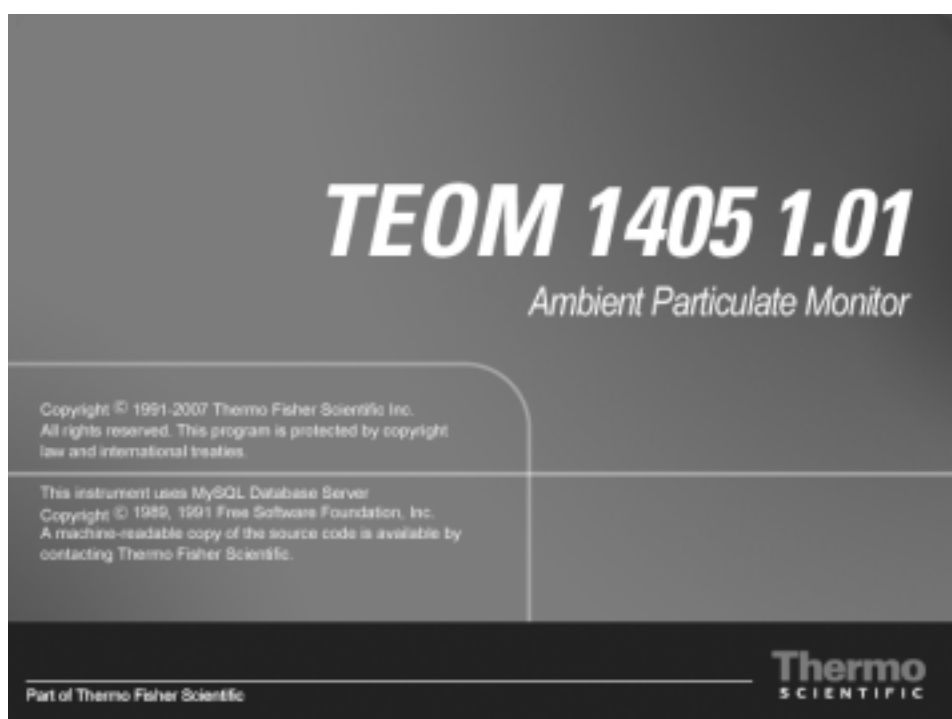

The Title screen includes the instrument model and the firmware version of the instrument.

TEOM Data Screen

After the Title screen, the TEOM Data screen will automatically display (Figure 4-2). The TEOM Data screen shows the basic operating information, as well as status conditions and the instrument operating mode. The TEOM Data screen can be displayed by selecting the TEOM Data button in any of the other four main screens (System Status, Instrument Conditions, Settings, Service).

Figure 4-2.
TEOM Data screen with menu buttons, status and operating and lock modes highlighted.

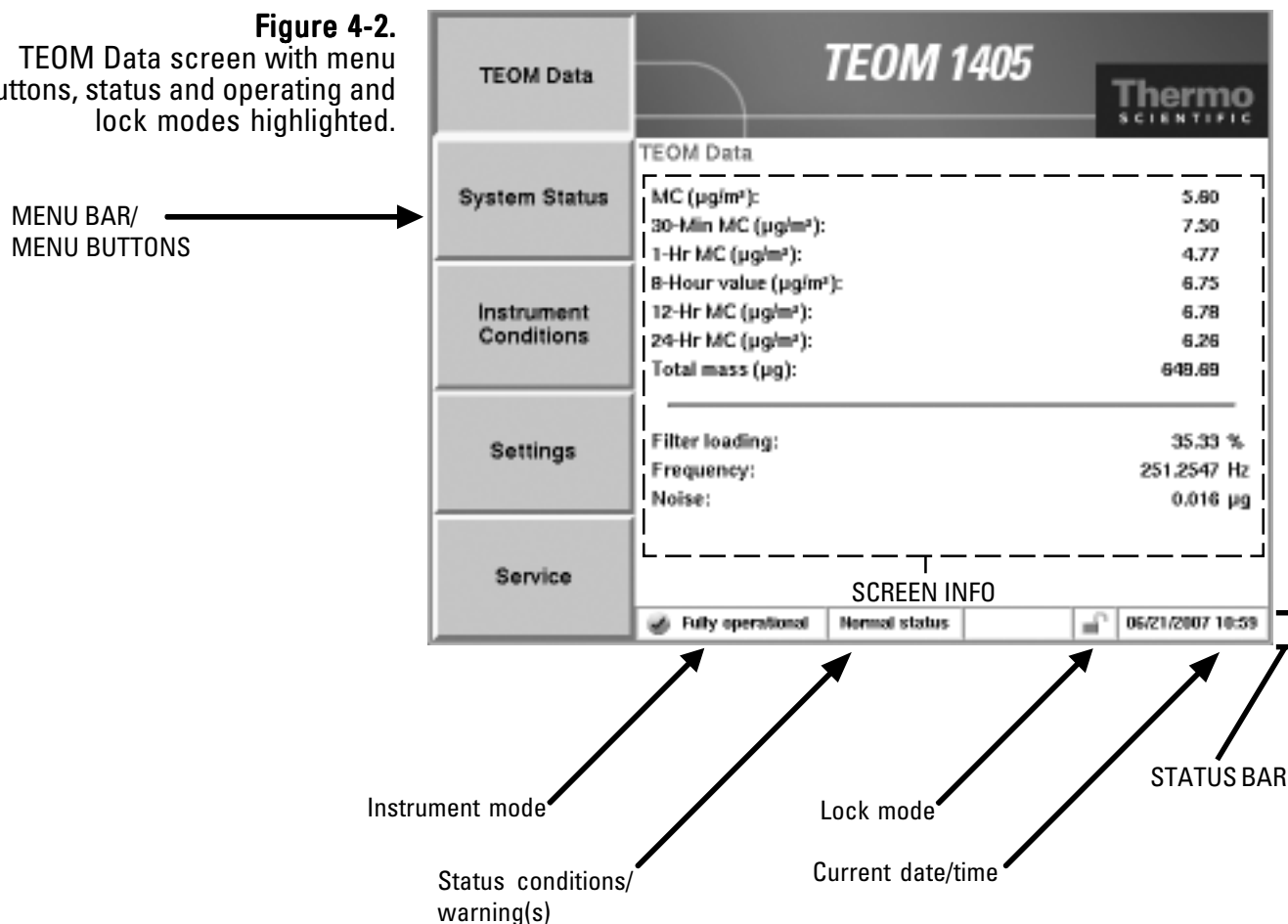

The TEOM Data screen includes menu buttons allowing users to access the other main screens. The status bar at the bottom of the screen displays operating information, including the current operating mode, lock mode and date and time, as well as the current status (“Normal” or “Warning(s)”).

Note. Upon initial instrument start up, the values in the mass concentration fields are the running averages that are accumulated until a 1-hour time period has passed. The values are visible to provide the user with an indication that the instrument is functioning, after instrument power up or reset. These raw values are used for internal calculations only. ▲

The TEOM Data screen contains the following information:

- *MC ($\mu\text{g}/\text{m}^3$):* This field contains the mass concentration value. This is a one-hour average updated every 6 minutes. This value cannot be changed by the user.
- *01-Hr MC ($\mu\text{g}/\text{m}^3$):* This field contains the 1-hour mass concentration average. This is a sliding average that is updated every 60 minutes on the hour. This value cannot be changed by the user.
- *08-Hr MC ($\mu\text{g}/\text{m}^3$):* This field contains the XX-hour mass concentration average. The user may set value to any whole number greater than 1. This is a sliding average that is updated every 60 minutes on the hour. This value cannot be changed by the user.

Note. Mass concentration averages of less than 24 hours can be averaged using data logging equipment to compute sliding 24-hour averages and 24-hour averages that do not necessarily start and end at midnight, as well as averages on other user-defined time scales. ▲

- *12-Hr MC ($\mu\text{g}/\text{m}^3$):* This field contains the 12-hour mass concentration average. This is a sliding average that is updated every 60 minutes on the hour. This value cannot be changed by the user.
- *24-Hr MC ($\mu\text{g}/\text{m}^3$):* This field contains the 24-hour mass concentration average. This is a sliding average that is updated every 60 minutes on the hour. This value cannot be changed by the user.
- *Total Mass ($\mu\text{g}/\text{m}^3$):* This field contains the total mass that has accumulated on the TEOM filter since the last filter change or reset.
- *Frequency:* This field contains the oscillating frequency of the tapered element (TE) in the mass transducer. This value varies from one TEOM 1405 unit to another, but generally ranges between 150 and 400 Hz. This value cannot be changed by the user.
- *Noise:* This field contains the mass transducer's performance. This value should be less than "0.10" after the system has been in Operating Mode 4 for at least 30 minutes. This value cannot be changed by the user.

- *Filter loading:* This field contains the filter loading percentage (Section 5). It indicates the portion of the TEOM filter's total capacity that has been used. The instrument will always show a nonzero value even if no filter is mounted in the mass transducer. New filters generally exhibit filter loading percentages of 15% to 30% at a flow rate of 3 l/min, and less at lower flow rates. TEOM filter cartridges must be exchanged before this value reaches 100% to ensure the validity of the data generated by the instrument. At some point above 100%, the main flow drops below its set point. If the filter loading percentage is higher than 30% when a new TEOM filter is placed on the mass transducer, or if the lifetime of consecutive TEOM filter cartridges becomes noticeably shorter, inspect the in-line filter for the flow line (Section 5) and replace it, if necessary.

Users enter values into the settings screens using a number keypad (Figure 4-3). Select the button for the value that needs to be changed, such as setpoints for flow rates, temperatures or pressures, and a keypad will automatically display. The keypad will display the current setpoint and the current value (when applicable). Enter the value into the keypad, then select the **Enter** button to set the value or press the **Cancel** button to exit the keypad screen and return to the screen.

Figure 4-3.
Number entry keypad showing
current value and setpoint.

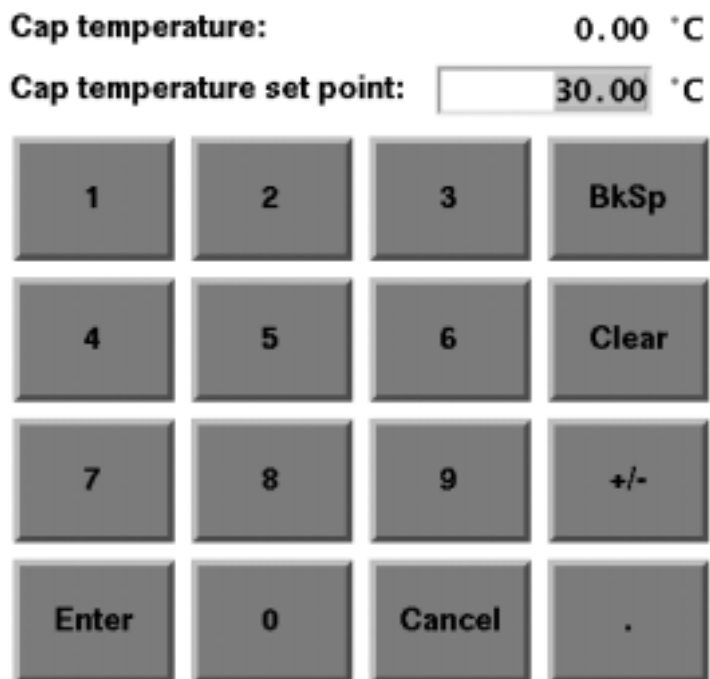

Operating Mode

The TEOM 1405 Monitor displays its current operating mode in the lower left-hand corner of TEOM Data screen (Figure 4-2) and most of the other instrument screens.

The unit's operating modes (Figure 4-2) are defined as follows:

- *Stabilizing:* This operating mode indicates that the unit has not begun to compute mass values, because the monitor's temperatures and flow rates are stabilizing. The temperatures and flow rates must remain within a very narrow range of values for 30 minutes before the instrument enters the next operating mode. The monitor always starts in Stabilizing Mode when it is turned on or reset.
- *Collecting Data:* This operating mode indicates that the unit has begun to collect data records, but the monitor has not yet computed its first mass concentration value.
- *Computing Data:* This operating mode indicates that the unit has computed the first mass concentration value.
- *Fully operational:* This operating mode indicates that the unit is fully operational. The monitor normally resides in this mode. All mass values are being computed by the instrument.
- *Setup Mode:* When the unit is in this operating mode, it continues to draw a sample flow and maintain operational temperatures but it does not collect any data. Certain operating parameters such as temperatures and flow rates can be changed only in this mode, because doing so during data collection would adversely affect the quality of the data. The instrument will automatically prompt the user to enter the Setup Mode when changing a temperature, flow or other adjustable value. After the new value is entered and saved, it will automatically return to one of the four regular operating modes above. If several parameters need to be changed, the user can enter the Setup Mode manually, avoiding the warning prompts when changing each variable. To manually enter the Setup Mode, select the **Instrument Control** button in the Service screen (page 4-30). In the Instrument Control screen (page 4-32), press the **Setup** button. When the unit is in the Setup Mode, the user can change all of the system's parameters. To manually leave the Setup Mode and start data collection, when in the Instrument Control screen, select the **Run** button.

- *Stop All Mode:* Certain situations may arise in which the user may want to turn off all temperatures and flows in the instrument. To enter the Stop All Mode, select the **Instrument Control** button in the Service screen (page 4-30). In the Instrument Control screen select the **Stop** button (page 4-32). When the unit is in this operating mode, it suspends operation of the instrument. In this mode, data collection ceases, flow rates in the system drop to zero, and the output to the temperature circuits is turned off. Also, the monitor will reset its system variables to the original values that were set by the user. However, this does not set the unit to its default parameters. The instrument will remain in the Stop All Mode until you select the **Run** button in the Instrument Control screen.

System Status Screen

The current status condition is located in the status bar at the bottom of the TEOM Data screen (Figure 4-4), and most other instrument screens. If there are no status conditions, the field at the bottom of the screen will read “Normal status” (Figure 4-4). If there are status conditions present, the field at the bottom of the screen will read “Warning(s)” and a warning triangle will appear in the instrument title bar at the top of the screen (Figure 4-5).

Figure 4-4.
TEOM Data screen with
“Normal status” message.

TEOM Data		TEOM 1405		Thermo SCIENTIFIC	
System Status	TEOM Data	MC ($\mu\text{g}/\text{m}^3$):	5.60		
Instrument Conditions		30-Min MC ($\mu\text{g}/\text{m}^3$):	7.50		
		1-Hr MC ($\mu\text{g}/\text{m}^3$):	4.77		
		8-Hour value ($\mu\text{g}/\text{m}^3$):	6.75		
		12-Hr MC ($\mu\text{g}/\text{m}^3$):	6.78		
Settings		24-Hr MC ($\mu\text{g}/\text{m}^3$):	6.26		
		Total mass (μg):	648.69		
		Filter loading:	35.33 %		
Service		Frequency:	251.2547 Hz		
		Noise:	0.016 μg		
		Fully operational		Normal status	05/21/2007 10:59

Figure 4-5.
TEOM Data screen with
“Warning(s)” message and
warning triangle.

TEOM Data		TEOM 1405		Thermo SCIENTIFIC	
System Status	TEOM Data	MC ($\mu\text{g}/\text{m}^3$):	5.60		
Instrument Conditions		30-Min MC ($\mu\text{g}/\text{m}^3$):	7.50		
		1-Hr MC ($\mu\text{g}/\text{m}^3$):	4.77		
		8-Hour value ($\mu\text{g}/\text{m}^3$):	6.75		
		12-Hr MC ($\mu\text{g}/\text{m}^3$):	6.78		
Settings		24-Hr MC ($\mu\text{g}/\text{m}^3$):	6.26		
		Total mass (μg):	648.69		
		Filter loading:	35.33 %		
Service		Frequency:	251.2547 Hz		
		Noise:	0.016 μg		
		Stabilizing		Warning(s)	02/06/2007 11:43

Whenever a status warning is displayed, select the **System Status** button to display the System Status screen (Figure 4-6). The System status screen provides basic operating information and access to the list of the current active status warnings.

Figure 4-6.
System Status screen.

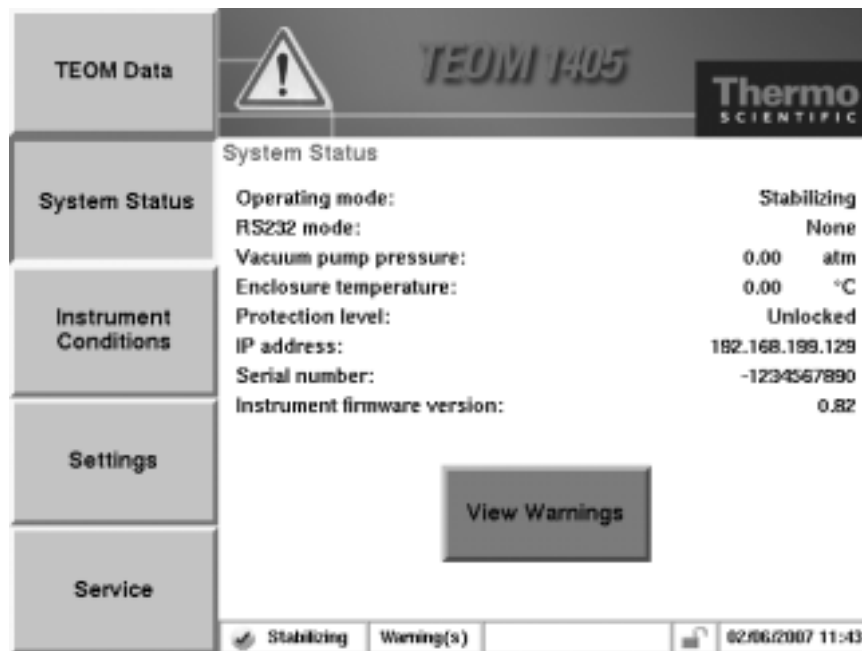

To view the current status warnings, select the **View Warnings** button or touch the warning triangle (or the title bar) when it is visible in any screen. The Warnings screen will display (Figure 4-7). Select the **< Previous Warning** and **Next Warning >** buttons to view the status warnings.

Figure 4-7.
Warnings screen.

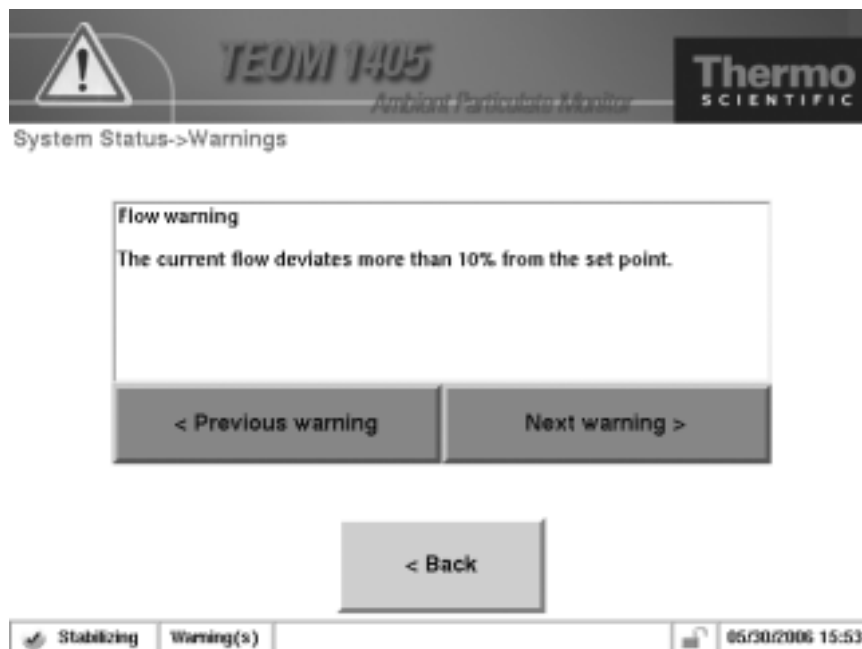

Instrument Conditions Screen

The Instrument Conditions button displays the Instrument Conditions screen (Figure 4-8), and provides access to several temperature and flow settings and the current ambient air conditions for the instrument.

Figure 4-8.
Instrument Conditions screen.

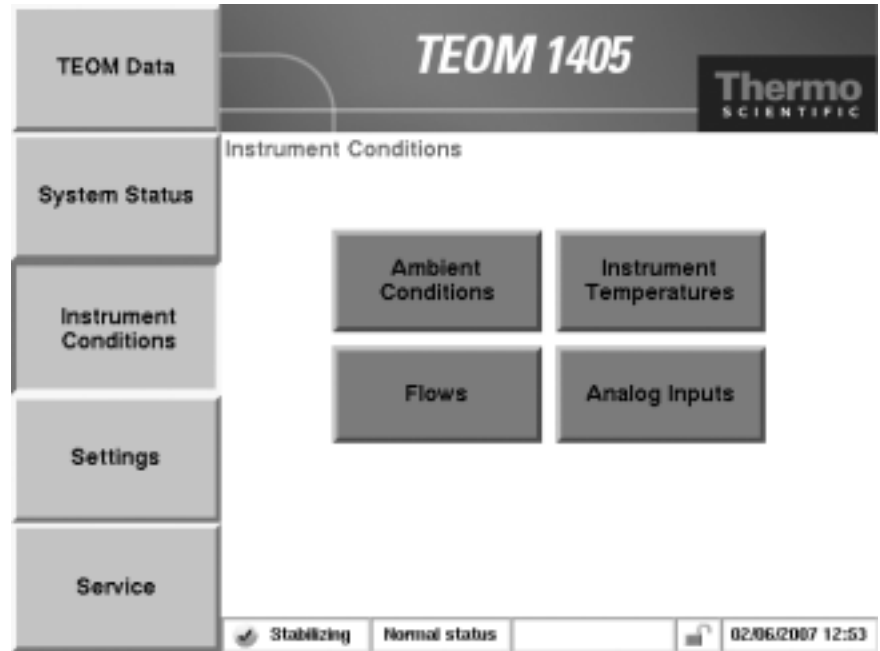

When in the Instrument Conditions screen, select the **Ambient Conditions**, **Instrument Temperatures**, **Flows**, or **Analog Inputs** buttons to reach the desired screens (Figure 4-9).

Figure 4-9.
Screens accessible through the
Instrument Conditions screen.

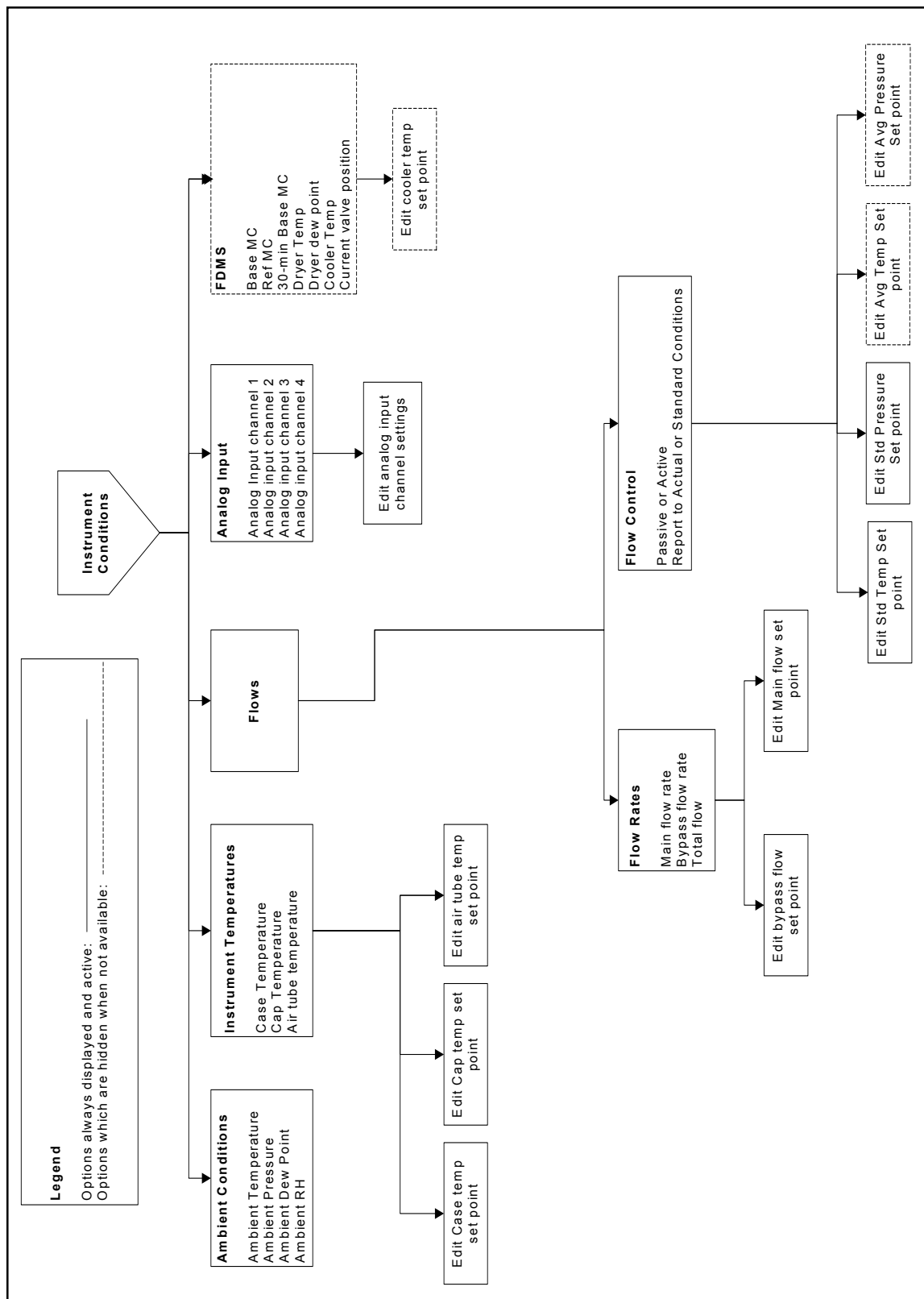

Ambient Conditions Screen

The Ambient Conditions screen (Figure 4-10) shows the current ambient conditions for the monitor.

Figure 4-10.
Ambient Conditions screen.

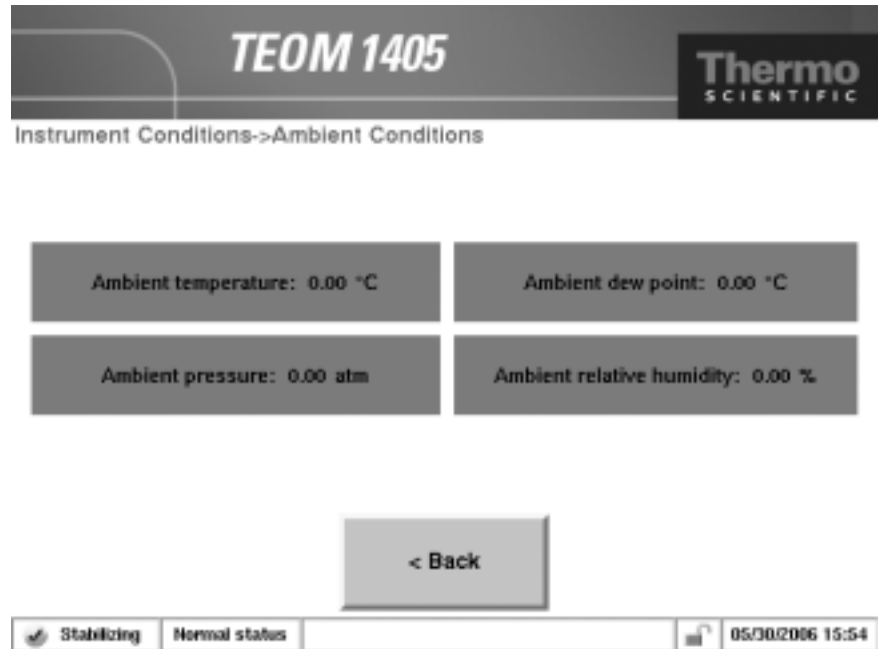

The Ambient Conditions screen contains the following information:

- Ambient Temperature. This field contains the current ambient temperature (°C) at the site. This value cannot be edited and will be correct only when the ambient temperature/humidity sensor is properly installed.
- Ambient Pressure. This field contains the current ambient pressure (atm) at the site. This value cannot be edited.
- Ambient Dew Point. This field contains the current ambient dew point (°C) at the site. This value cannot be edited and will be correct only when the ambient temperature/humidity sensor is properly installed.
- Ambient Relative Humidity. This field contains the current ambient pressure (atm) at the site. This value cannot be edited and will be correct only when the ambient temperature/humidity sensor is properly installed.

Flows Screen The Flows screen (Figure 4-11) offers access to the flow rates and flow controls of the unit.

Figure 4-11.
Flows screen.

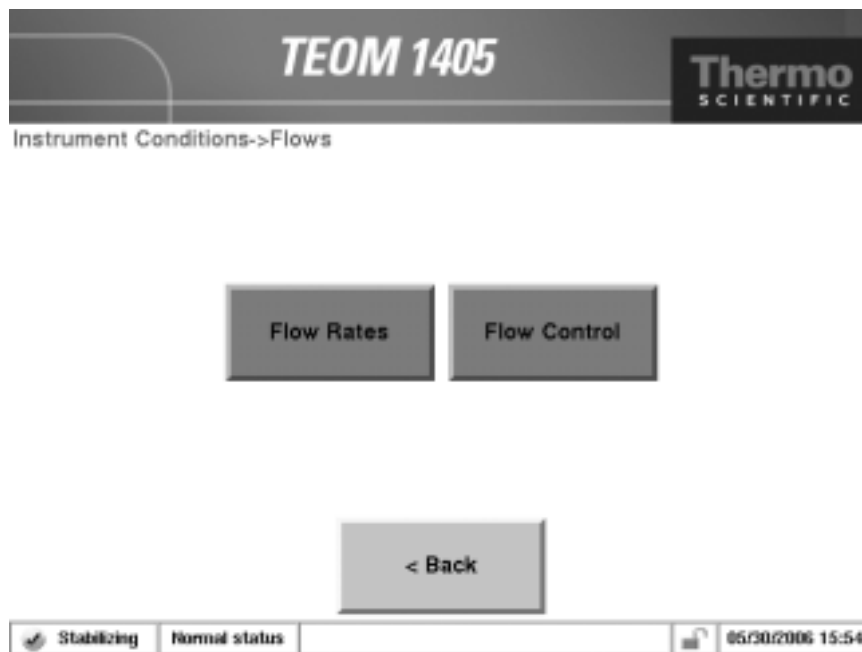

Select the **Flow Rates** button to view or adjust the instrument’s flow rates. Select the **Flow Control** button to view or adjust the units standard temperature and pressure settings or select active or passive flow control.

The TEOM 1405 Monitor uses mass flow controllers to ensure a constant and precise flow through the instrument. The mass flow controllers use the actual (*active* volumetric flow control setting) or average (*passive* volumetric flow control setting) temperature and pressure values to regulate the volumetric flow through the system. The active volumetric flow control setting directs the unit to use the actual ambient temperature and pressure to regulate the volumetric flow through the system. The passive volumetric flow control setting directs the unit to use the average temperature and pressure values to regulate the volumetric flow through the system. Refer to the following sections for information on setting flow rates and flow controls.

Flow Rates Screen

Select the **Flow Rates** button in the Flows screen to display the Flow Rates screen (Figure 4-12). This screen allows users to adjust the flow rates for the main and bypass flow channels.

Figure 4-12.
Flow Rate screen.

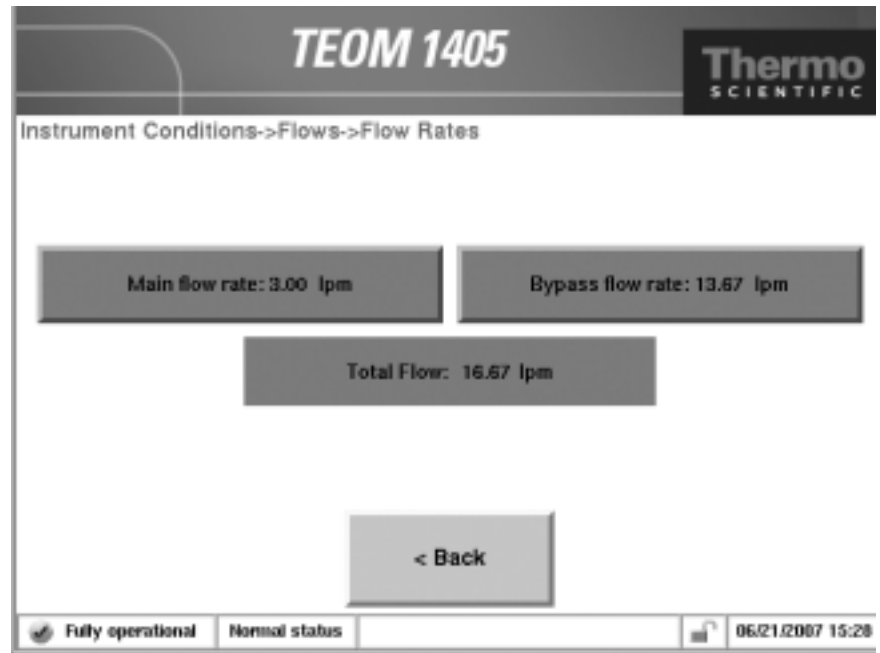

The Flow Rates screen contains the following controls buttons:

- *Main flow rate.* This field contains the current value of the main path flow rate (l/min). The default setting is 3 l/min. To view or adjust the setpoint, select the button to display the keypad (Figure 4-3). The current value can not be edited.
- *Bypass flow rate.* This field contains the current value of the bypass flow rate. The default setting is 13.67 l/min. To view or adjust the setpoint, select the button to display the keypad (Figure 4-3). The current value can not be edited.
- *Total flow.* This field contains the current value of the total flow rate of the instrument (l/min). The current value can not be edited.

Flow Control Screen Select the **Flow Control** button in the Flows screen to display the Flow Control screen (Figure 4-13). This screen allows users to adjust the flow control method.

Figure 4-13.
Flow Control screen.

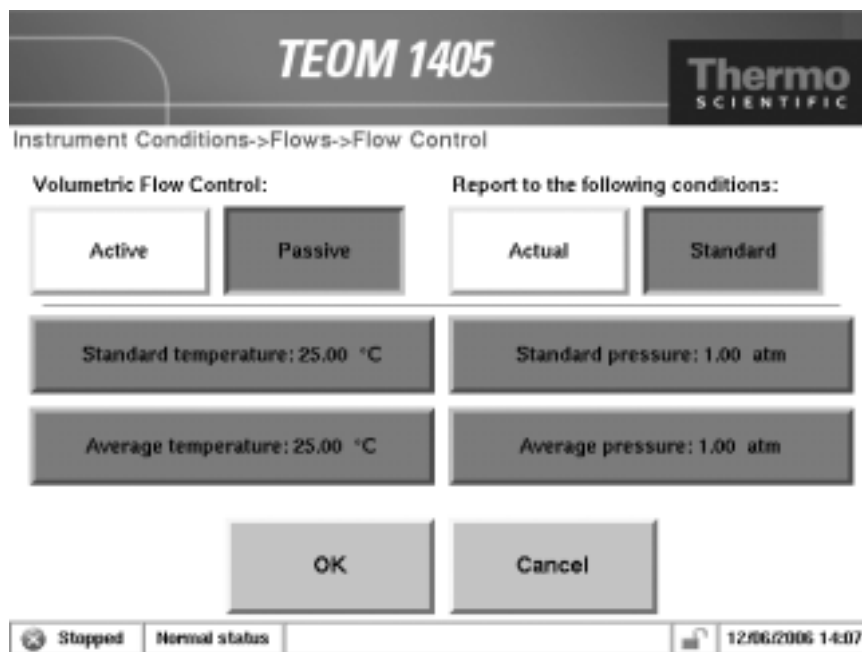

The Flow Control screen contains the following control buttons:

- *Volumetric Flow Control (Active or Passive).* These buttons allow the user to select “active” (using actual temperature and pressure) or “passive” (using average temperature and pressure) to adjust the flow.
- *Report to the following conditions: (Actual or Standard).* These buttons allow the user to select “Actual” reporting (the mass concentration measured per actual volume sampled through the inlet) or “Standard” reporting (the mass concentration adjusted based on a set standard temperature and pressure).
- *Standard temperature.* This field contains the standard temperature (°C) setting. The default setting is 25° C. To adjust the setpoint, select the button to display the keypad (Figure 4-3).
- *Average temperature.* This field (visible only when passive is selected) contains the average temperature (°C) setting for passive flow control. The default setting is 25° C. To adjust the setpoint, select the button to display the keypad (Figure 4-3).
- *Standard pressure.* This field contains the standard pressure (atm) setting. The default setting is 1 atm. To adjust the setpoint, select the button to display the keypad (Figure 4-3).

- *Average pressure.* This field (visible only when passive is selected) contains the average pressure (atm) setting for passive flow control. The default setting is 1 atm. To adjust the setpoint, select the button to display the keypad (Figure 4-3).

The instrument is delivered with the following temperature and pressure settings:

Standard temperature	25° C	Standard pressure	1 atmosphere (atm)
Average temperature	25° C	Average pressure	1 atmosphere (atm)

The user must choose how they want the monitor to control the volumetric flow: actively or passively:

- **Active Flow Control** uses actual ambient pressure and ambient temperature from instrument sensors to set the flow rates
- **Passive Flow Control** uses operator input ambient temperature and ambient pressure to control flow. At their discretion, operators can input seasonal average temperature and pressure.

To select *active* flow control, select the **Active** flow control button (Figure 4-13). To use the actual temperature and pressure to control the volumetric flow, you must install the ambient temperature/humidity sensor. The instrument's mass flow controllers measure flow on a mass basis. All of the size-selective inlets, including the PM-10 inlet, operate on a constant volumetric flow basis.

If the user chooses to use *passive* flow control, they must select the **Passive** flow control button (Figure 4-13). The average temperature and average pressure, used by the instrument, may vary with season and altitude. If the user wants the unit to use the average temperature and pressure to control the volumetric flow, they should manually adjust the average temperature and average pressure settings as climatic conditions change. The user usually has to adjust the average pressure only once for the average barometric pressure at the sampling site (i.e., station pressure — not adjusted to sea level). However, the user generally must adjust the average temperature periodically (often 4 times per year) in accordance with changing average ambient temperatures.

The mass concentration is reported based on the volume sampled through the TEOM inlet. It can be reported in terms of the mass collected per actual volume sampled through the inlet or reported in terms of mass collected per standard volume sampled through the inlet.

If the user chooses to set the unit to report the mass concentration levels to **Actual** conditions, they must select the **Active** flow control button (Figure 4-13). This will cause the monitor to use the actual ambient temperature and ambient pressure in its flow rate calculations.

If the user chooses to set the unit to report the mass concentration levels to **Standard** conditions, they must set the standard temperatures and pressures to the appropriate standard regulatory values.

Instrument Temperatures Screen

The Instrument Temperatures screen (Figure 4-14) shows the current temperatures of the unit.

Figure 4-14.
Instrument Temperatures screen.

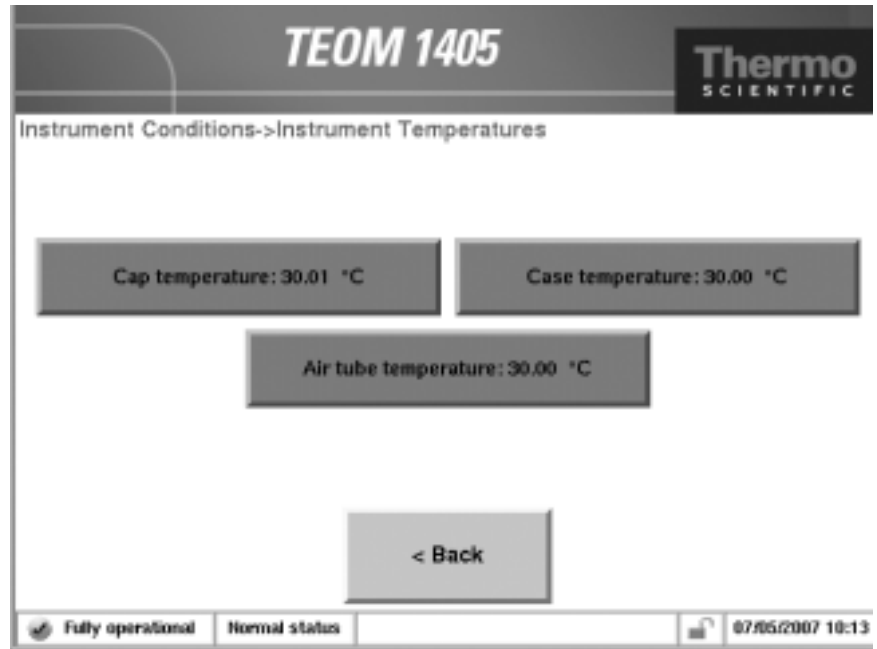

The Instrument Temperatures screen contains the following control buttons:

- *Cap temperature.* This field contains the current value of the temperature (°C) of the mass transducer's cap. The default setting is 30° C. To view or adjust the setpoint, select the button to display the keypad (Figure 4-3). DO NOT adjust this value without contacting Thermo Scientific.
- *Case temperature.* This field contains the current value of the temperature (°C) of the mass transducer case. The default setting is 30° C. To view or adjust the setpoint, select the button to display the keypad (Figure 4-3). DO NOT adjust this value without contacting Thermo Scientific.
- *Air tube temperature.* This field contains the current value of the temperature (°C) of the air stream. The default setting is 30° C. To view or adjust the setpoint, select the button to display the keypad (Figure 4-3). DO NOT adjust this value without contacting Thermo Scientific.

Analog Inputs Screen

The Analog Inputs screen (Figure 4-15) gives the current values of the units four analog input channels. The inputs accept 0-5 VDC, and can be converted to a desired scale. Select the **Analog Input #1**, **Analog Input #2**, **Analog Input #3**, or **Analog Input #4** buttons to convert the analog input to a desired scale.

Figure 4-15.
Analog Inputs screen.

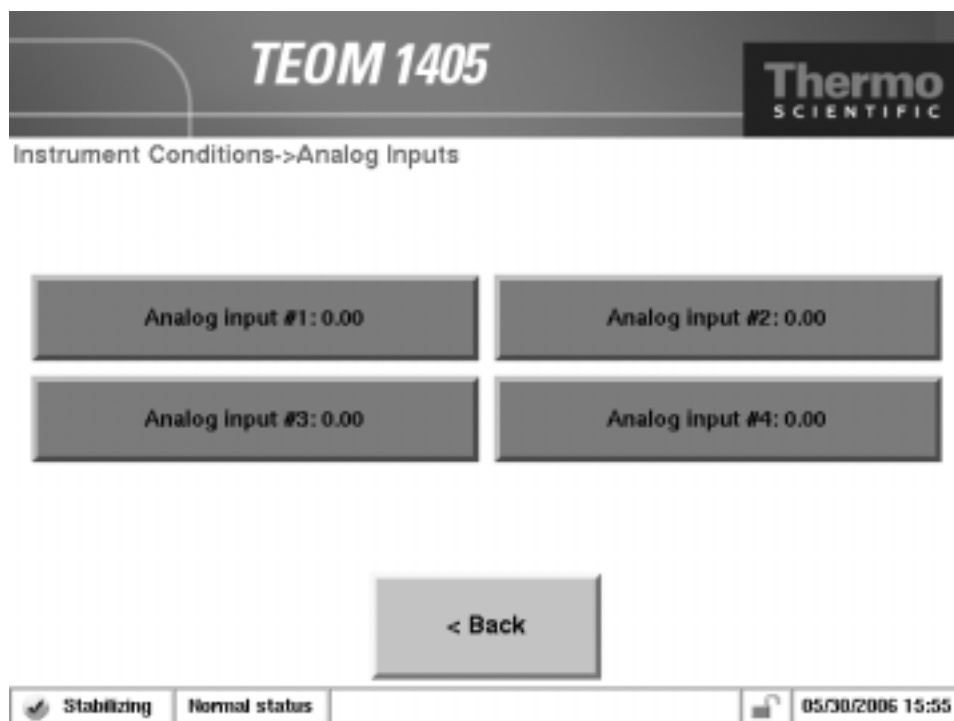

Settings Screen

The **Settings** button displays the Settings screen (Figure 4-17), and provides access to system, data and advanced settings for the instrument.

Figure 4-17.
Settings screen.

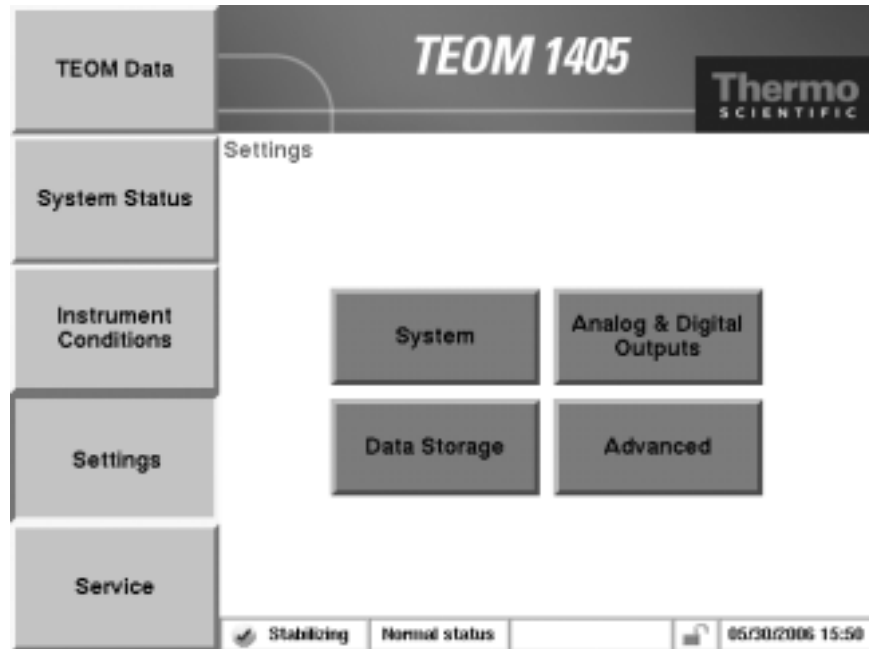

When in the Settings screen, select the **System**, **Analog & Digital Outputs**, **Data Storage** and **Advanced** buttons to reach the desired screens (Figure 4-18).

Note. Refer to Section 3 for information on using the Data Storage button to select variables for data storage. ▲

Figure 4-18.
Screens accessible through the
Settings button.

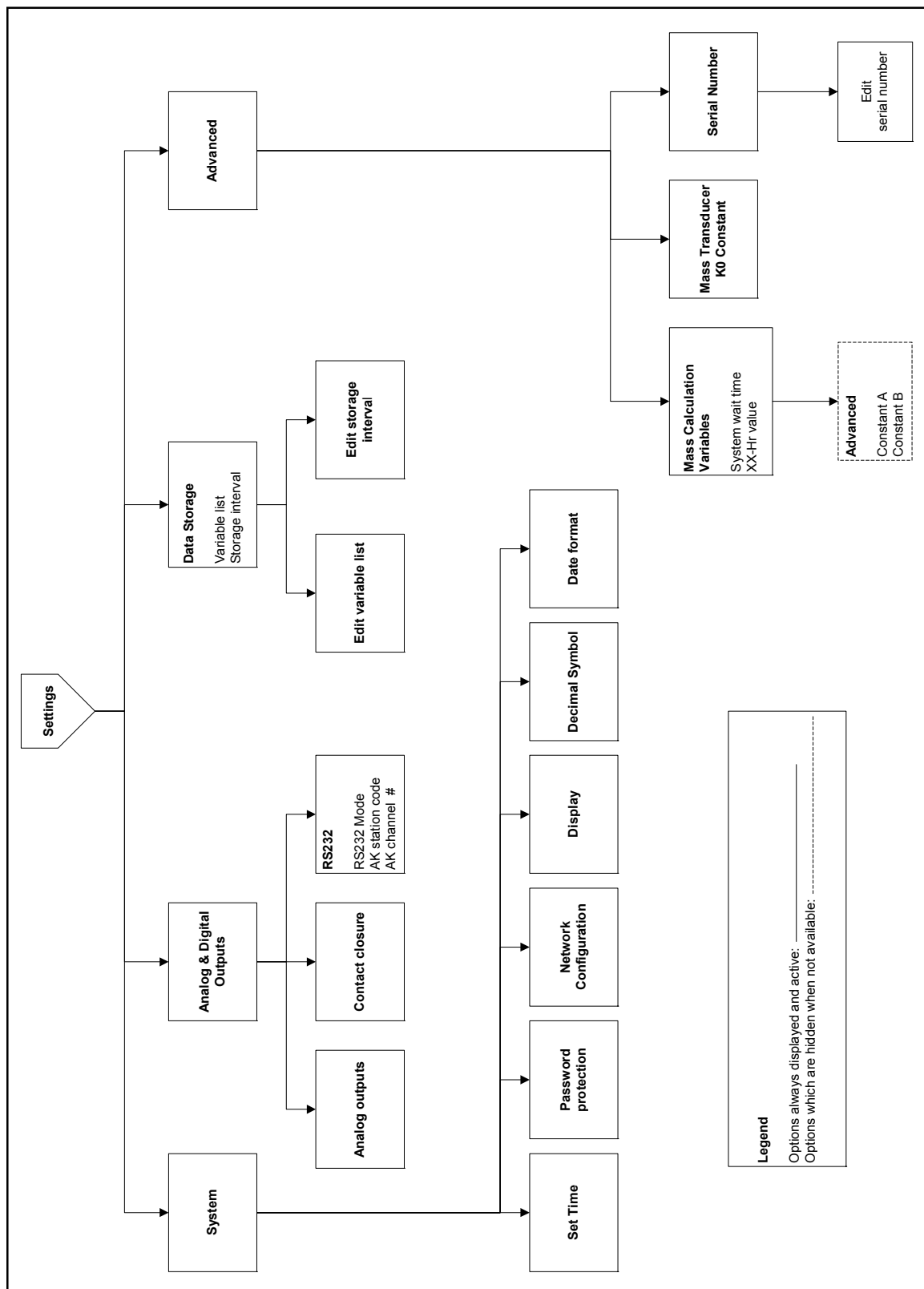

System Screen The System screen (Figure 4-19) allows users to set the basic configuration of the unit.

Figure 4-19.
System screen.

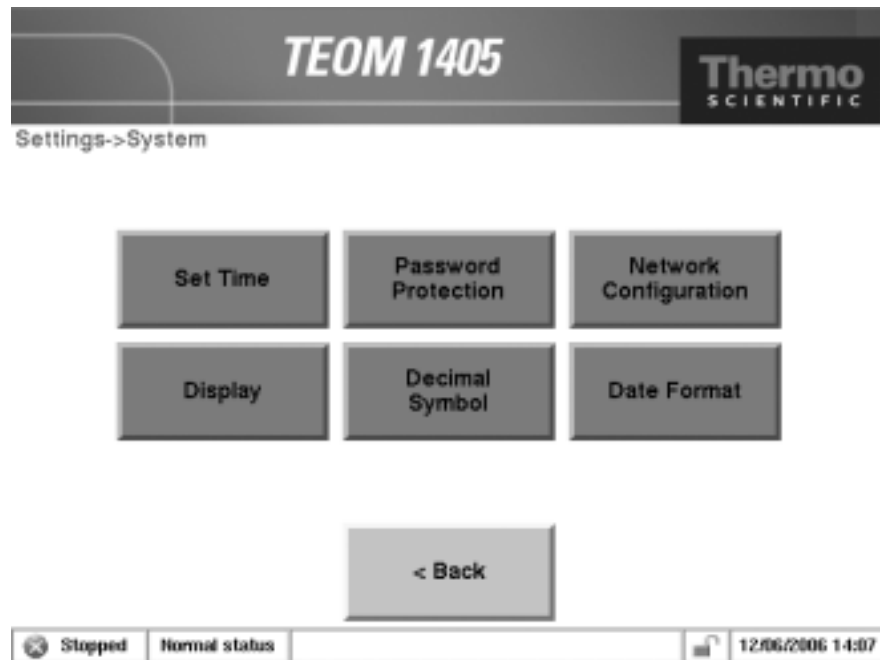

When in the System screen:

- *Set Time.* Select the **Set Time** button to enter the current time and date.
- *Password Protection.* Select the **Password Protection** button to initiate High Lock or Low Lock mode. In Low Lock mode, the user can view all instrument screens and can change the operating mode to perform filter changes. High Lock mode means the user cannot view any screens other than the TEOM Data screen. The user can also set the password using this button.
- *Network Configuration.* Select the **Network Configuration** button to determine whether the unit's Internet Protocol (IP) address will be selected automatically or entered manually. If the user wishes to specify an IP address, the user must enter both the correct IP address and the Subnet mask for the system.
- *Display.* Select the **Display** button to choose the preferred viewing mode of the instrument screen: white background with black text or black background with white text.

- *Decimal Symbol.* Select the **Decimal Symbol** button to choose whether to separate decimal numbers with a period (“.”) or a comma (“,”). The unit must be restarted for this change to take effect.
- *Date Format.* Select the **Date Format** button to choose whether to display the date in the “Month/Day/Year” or the “Day/Month/Year” format. The unit must be restarted for this change to take effect.

Analog & Digital Outputs Screen

The Analog & Digital Outputs screen (Figure 4-20) allows users to set the basic parameters of the unit.

Figure 4-20.
Analog & Digital Outputs screen.

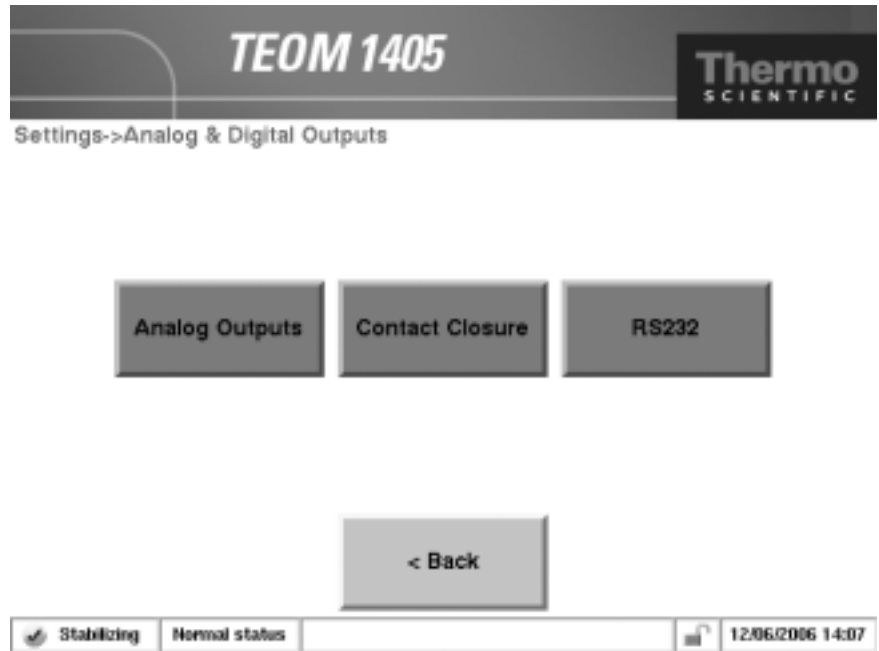

When in the Analog & Digital Outputs screen, select the **Analog Outputs** or **Contact Closure** buttons to set up the analog output and contact closure functions. Select the **RS232** button to set up the unit for serial connections using RPComm or other programs using AK protocol.

Analog Outputs Screen Select the **Analog Outputs** button to display the Analog Outputs screen (Figure 4-21). In the Analog Outputs screen, use the buttons to select a variable, and set a minimum and maximum value for the output for the desired output channel (1-8). Refer to Section 5 for information on calibrating the analog outputs.

Settings->output->Analog Outputs

Figure 4-21.
Analog Outputs screen.

	Instrument Variable:	Minimum value:	Maximum value:
#1:	<None selected>	0.00	1.00
#2:	<None selected>	0.00	0.00
#3:	<None selected>	0.00	0.00
#4:	<None selected>	0.00	0.00

< Back	More >
--------	--------

Contact Closure Screen Select the **Contact Closure** button to display the Contact Closure screen (Figure 4-22). When in the Contact Closure screen, use the buttons to select a variable, operator and compare value for the desired contact closure channel (1-2).

Figure 4-22.
Contact Closure screen.

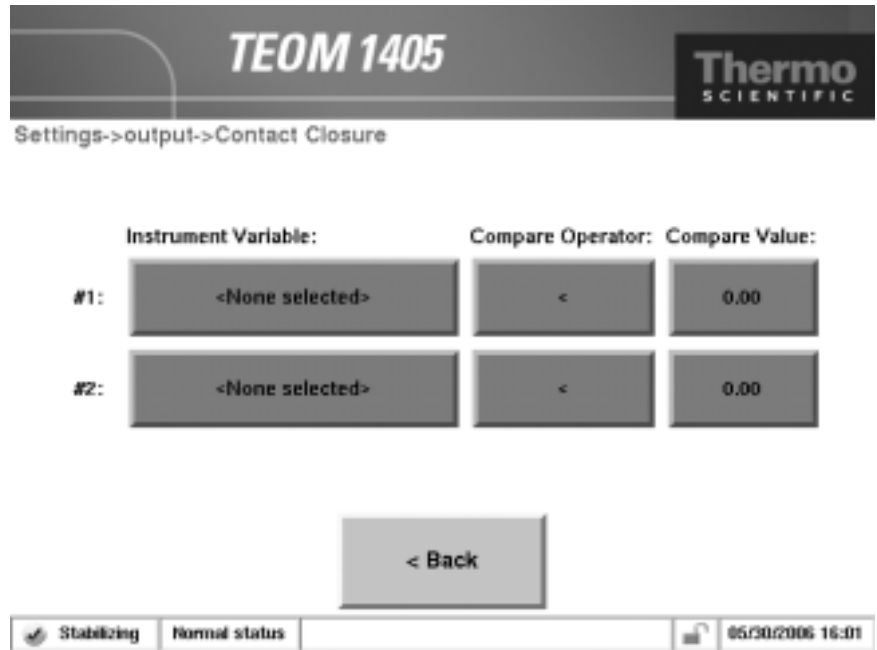

RS232 Screen Select the **RS232** button to display the RS232 screen (Figure 4-23). The RS232 screen allows users to set up the serial port for communication with the RP Comm software, or AK protocol.

Figure 4-23.
RS232 screen.

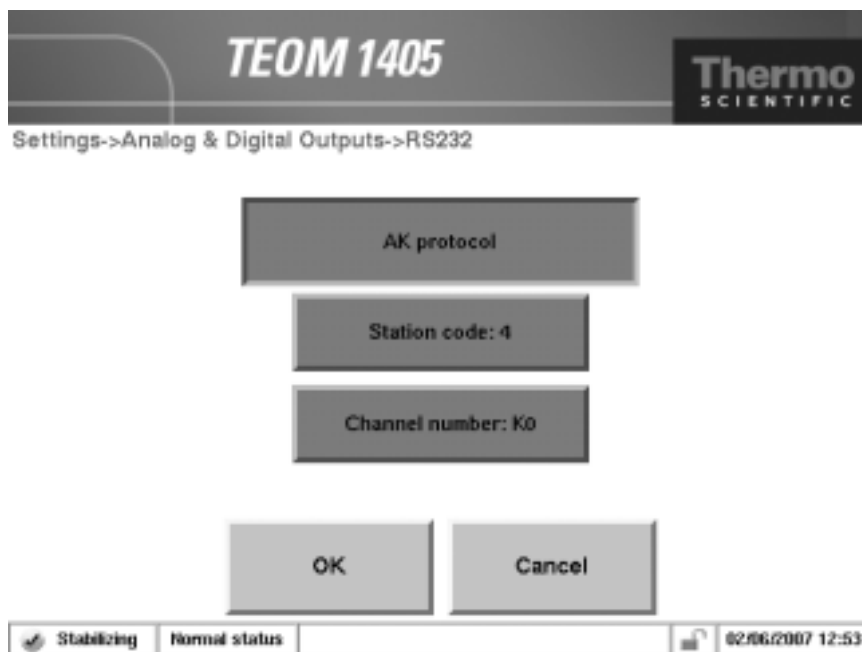

Settings Advanced Screen

Select the **Advanced** button to display the Advanced screen (Figure 4-24), which allows users to adjust the advanced settings of the unit.

Figure 4-24.
Advanced Screen

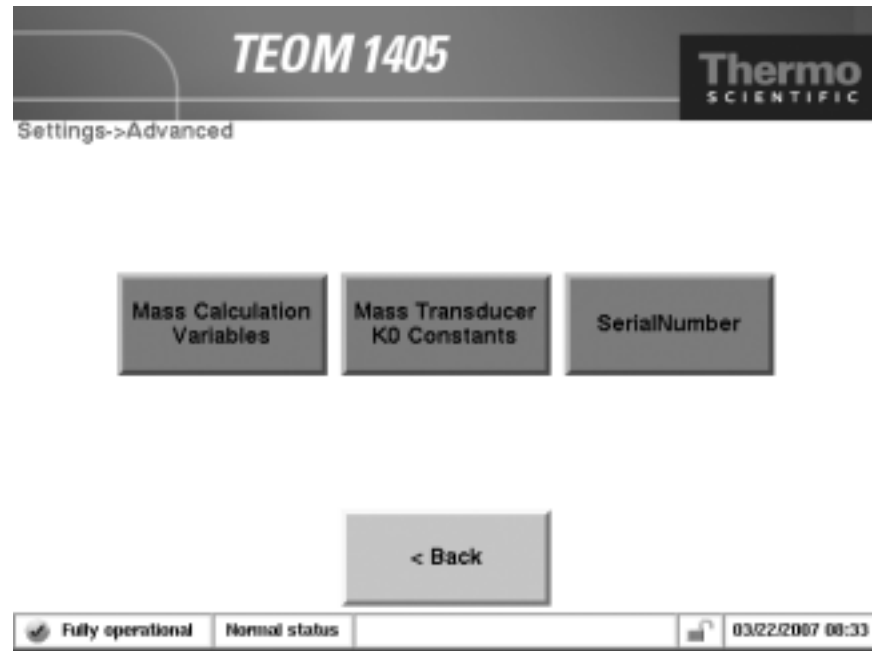

When in the Advanced screen, select the **Mass Calculation Variables**, **Mass Transducer** or **Serial Number** buttons to set advanced frequency parameters and check the K0 constant and serial number.

Select the **Serial Number** button to display the Serial Number screen. The screen shows the instrument's serial number. DO NOT adjust this value.

Select the **Mass Calculation Variables** button to display the Mass Calculation Variables screen.

The Mass Calculation Variables screen contains the following control buttons:

- *System wait time.* This field contains the length of time (sec) in which the temperatures and flow rates must remain (within a range around their setpoints) before the instrument changes from Stabilizing Mode to Collecting Data Mode. The default setting is “1800” seconds. To adjust the setpoint, select the button to display the keypad.

Note. Thermo Scientific recommends that the user set the “Wait Time” to “1000” or higher to avoid damaging the instrument, and to maintain accurate data reporting. ▲

- *Frequency gate time.* The basis of mass change is raw frequency. Raw frequency is calculated by comparing cycle counts of a highly stable 10 megahertz (Mhz) clock to the cycle counts of the oscillating tapered element (TE). The gate time controls how often the comparisons are made. To adjust the setpoint, select the button to display the keypad. DO NOT adjust this value without contacting Thermo Scientific.
- *Frequency wait time.* This field contains the time interval (sec) after a valve position change before the instrument begins collecting frequency data. The default setting is 90 seconds. To adjust the setpoint, select the button to display the keypad. DO NOT adjust this value without contacting Thermo Scientific.
- *Mass averaging time.* This field contains the time interval (sec) at which the monitor switches the sample between the base mode and the reference mode (Section 1). To adjust the setpoint, select the button to display the keypad. DO NOT adjust this value without contacting Thermo Scientific.
- *XX-HrMC.* This field contains the XX-Hr MC parameter. This value gives the user a choice of averaging times (hours) shown on the Main screen, following the 1-hour mass concentration average. The default value for this parameter is “8,” which causes the monitor to compute 8-hour averages. The user can set an averaging time of any whole hour greater than 1 hour for this parameter. To adjust the setpoint, select the button to display the keypad.

Select the **Mass Transducer K0 Constants** button to display the Mass Transducer K0 Constants screen.

The Mass Transducer K0 Constants screen contains the following information:

- *TEOM K0.* This field contains the calibration constant, K_0 (K0) (Section 1), for the TEOM.

Note. You can find your monitor’s K0 number on the label located near the mass transducer. Each TEOM 1405 monitor has a unique K0 for the TEOM in the unit. The constant listed in the Mass Transducer K0 Constants screen must match the value shown on the label near the mass transducer, or the mass concentration data will be incorrect. To adjust the value, select the button to display the keypad. ▲

Service Screen

The **Service** button displays the Service screen (Figure 4-25) and provides access to maintenance and verification wizards and procedures, as well as advanced troubleshooting and service tools.

Figure 4-25.
Service screen.

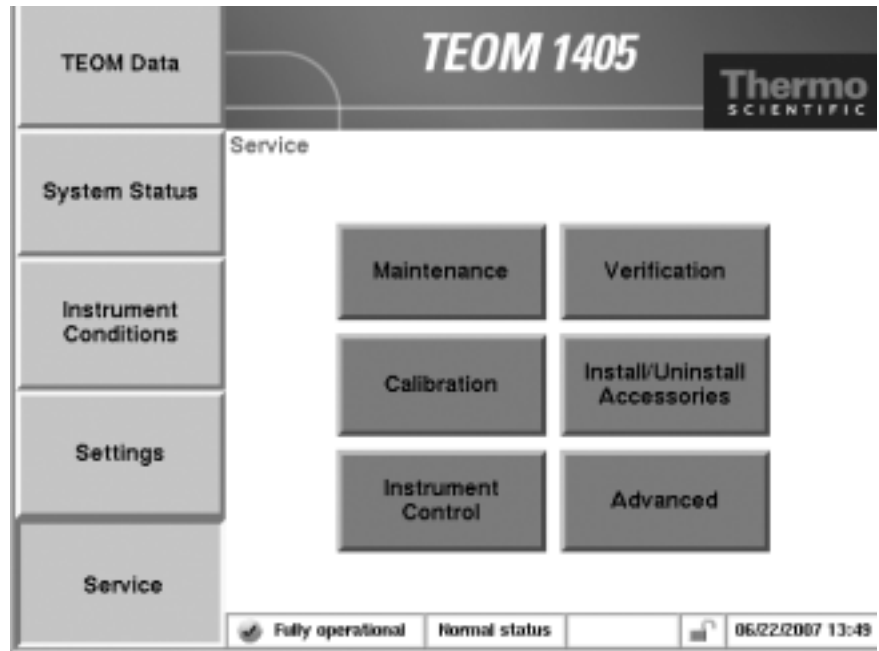

When in the Service screen, select the **Maintenance, Verification, Calibration, Install/Uninstall Accessories, Advanced** and **Instrument Control** buttons to reach the desired screens (Figure 4-26).

Note. Refer to Section 5 for information on the Maintenance, Verification, Calibration and Install/Uninstall Accessories screens and other screens accessible through those buttons. ▲

Figure 4-26.
Screens accessible through the
Service screen.

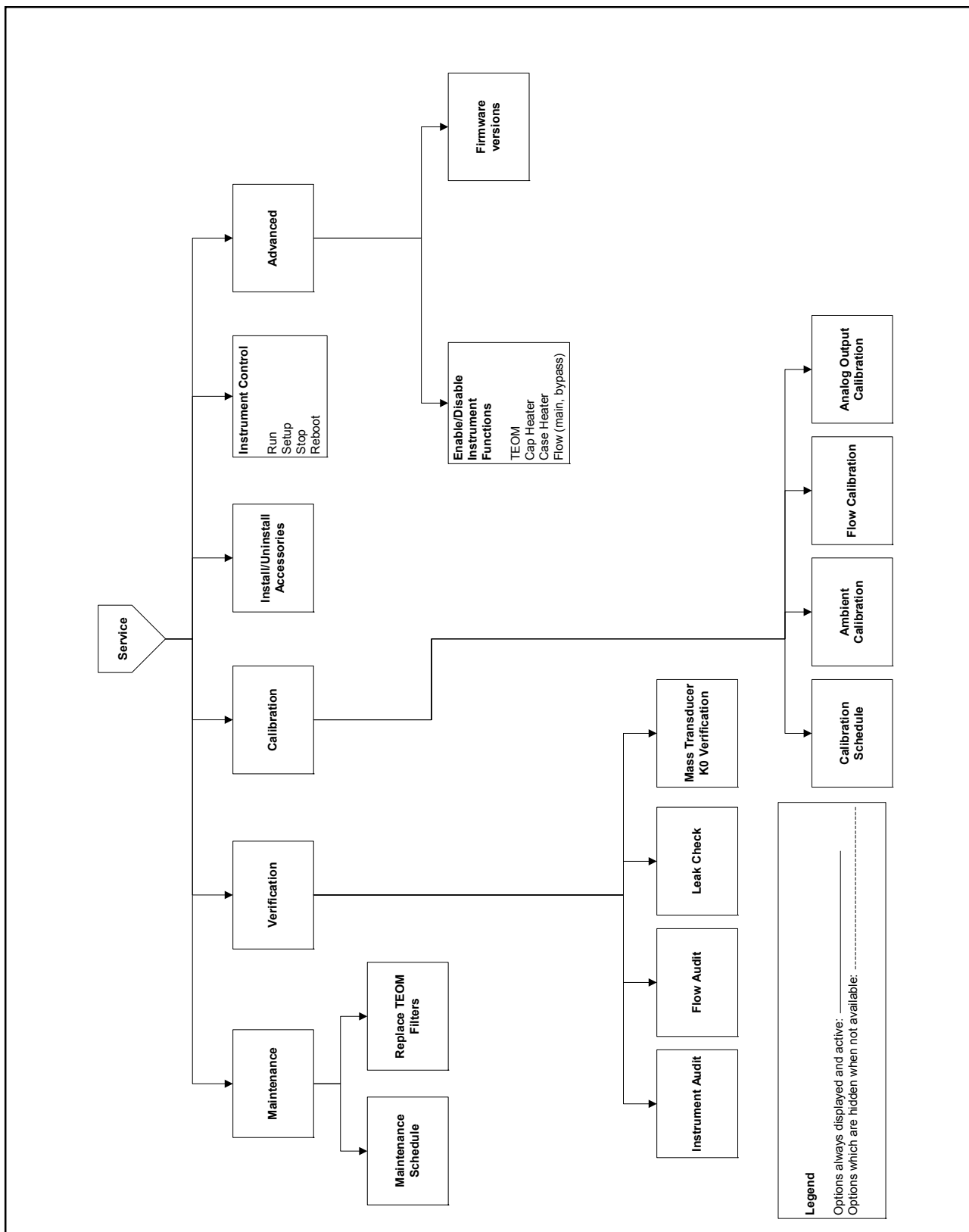

Instrument Control Screen

Select the **Instrument Control** button to display the Instrument Control screen (Figure 4-27). The Instrument Control screen allows users to change the unit operating mode and restart or shut down the instrument..

Figure 4-27.
Instrument Control screen.



When in the Instrument Control screen, select the **Run**, **Setup**, **Stop**, or **Reboot** buttons to change the instrument operating mode.

The Instrument Control screen contains the following control buttons:

- *Run*. This button returns the instrument to normal operating mode (Fully Operational). Refer to the beginning of this section for more information on operating modes.
- *Setup*. This button manually puts the instrument in Setup Mode. Refer to the beginning of this section for more information on operating modes.
- *Stop*. This button manually puts the instrument in Stop All Mode. Refer to the beginning of this section for more information on operating modes.
- *Reboot*. This button IMMEDIATELY restarts the instrument. Pressing the button returns the unit to Stabilizing Mode and will require the full warm-up period before restarting data collection

Service Advanced Screen

Select the **Advanced** button to display the Advanced screen (Figure 4-28). The Advanced screen allows users to manually adjust the status, temperatures or flows of several instrument components.

Figure 4-28.
Advanced screen.

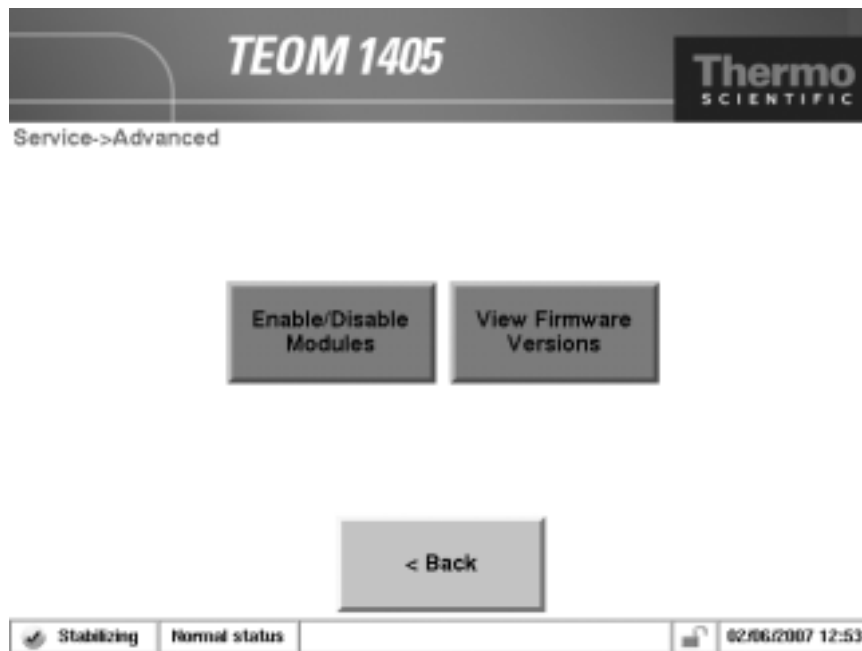

Only qualified service personnel should attempt to adjust these settings. Contact Thermo Scientific before adjusting any of these settings.

Installing New Firmware

If the instrument needs new firmware, it can be uploaded to the instrument using the ePort software regularly used for data downloading. Refer to Section 3 for information on installing and starting the ePort software. New versions of the TEOM 1405 instrument software are periodically made available either on computer CD or on the company website (www.rpco.com).

To install new firmware:

1. Download the new firmware file onto a personal computer (PC) from the company website or locate the updated version on the software CD. Note the file name.
2. Ensure that the PC and the instrument are connected to the same network using the Ethernet connection on the back of the instrument. (Refer to Section 3 for information on connecting the instrument to a network.)
3. In the System Status screen of the machine you want to update, locate and record the IP address (Figure 4-29).

Figure 4-29.
System Status screen.

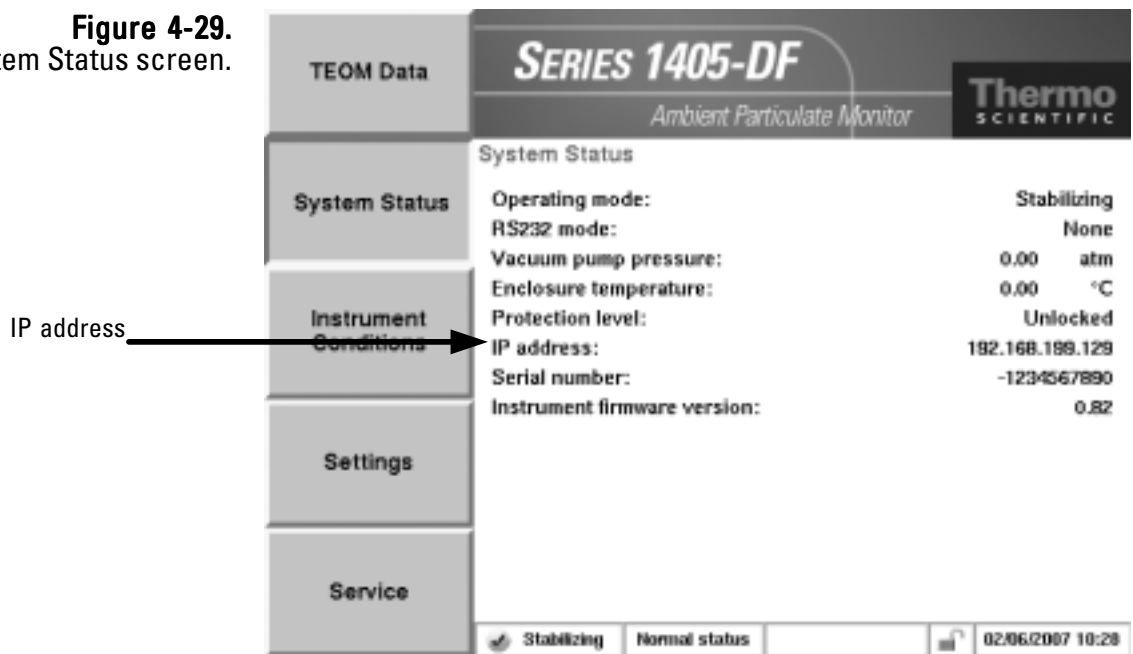

4. Use the ePort PC software to connect to the instrument (refer to Section 3 for information on connection to the instrument.)
5. In the ePort Main screen (Figure 4-30), select Upgrade Instrument Software.

Figure 4-30.
ePort Main screen.

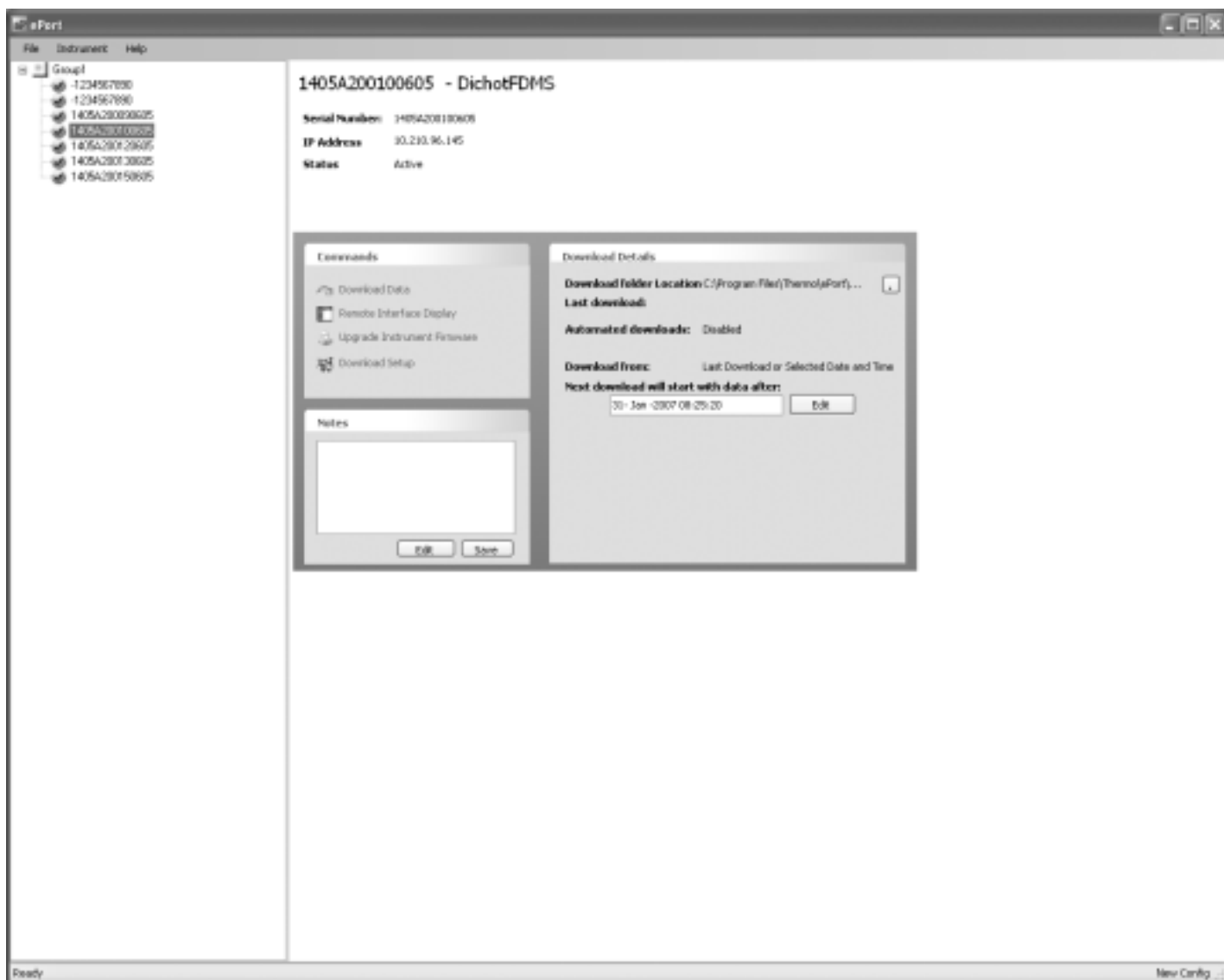

Note. Data will not be collected during the upload procedure and the instrument will be restarted. ▲

6. The Thermo 1405 Installer Wizard screen will display (Figure 4-31). Select the **Next >** button.

Figure 4-31.
Thermo 1405 Installer screen.



7. The Software File screen will display. Select the Browse button to locate and select the file from the CD or the file that was downloaded from the company website. When the file is selected, it will display in the window below “Choose the File to Upload.” Select the **Next >** button.

8. The Upload Software screen will display (Figure 4-32). The software will restart the instrument then install the firmware. The “Upload Progress” bar will show the status of the upload. When the process is complete, select the **Next >** button.

Figure 4-32.
Upload Software screen.

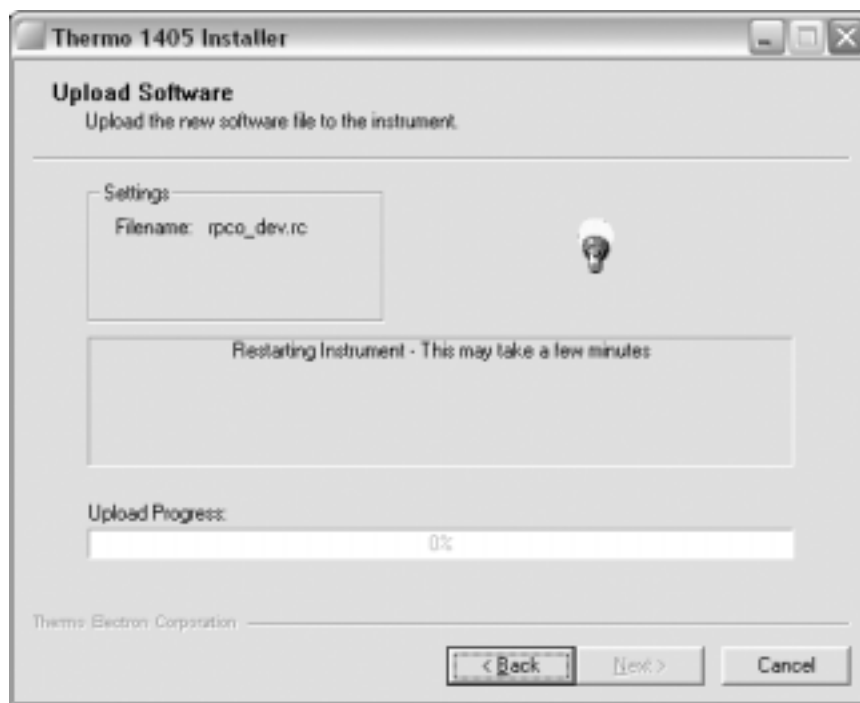

Note. It may take several minutes to upload the new firmware, depending on the speed of the uploading PC and the speed of the network. During the upload, the TEOM 1405 instrument touch screen will display a text message, then a scrolling cursor to indicate progress. ▲

9. The Software Upload Completed screen will display (Figure 4-33). Select the Finish button. Close ePort and return to normal operation.

Figure 4-33.
Software Upload Completed
screen.



Note. The instrument will restart automatically after the firmware is uploaded. ▲

Section 5 Maintenance and Calibration Procedures

Periodic Maintenance

Thermo Scientific recommends the following regular maintenance procedures for the TEOM 1405:

Replace the TEOM filters	Replace the TEOM filter when the filter loading percentage (displayed in the Main screen) nears 100% or every 30 days.
Clean the sample inlet	Clean the sample inlet that is mounted on the tripod each time that you replace a TEOM filter (every 30 days).
Replace the in-line filters	Replace the main flow in-line filter and the bypass in-line filter every 6 months, or as necessary.
Clean the air inlet system	Clean the air inlet system inside the mass transducer once a year, or as necessary.
Rebuild the sample pump	Rebuild the sample pump once every 18 months, or as necessary. The pump rebuild kit (59-008630) contains instructions for rebuilding the pump.

These maintenance intervals are guidelines. Requirements for routine maintenance are site-specific, and may vary from one location to another.

Maintenance Wizards

The TEOM 1405 software allows users to step through the periodic maintenance procedures. Select the **Service** button to display the Service screen. When in the Service screen, select the **Maintenance** button to display the Maintenance screen.

Figure 5-1.
 TEOM Data screen.

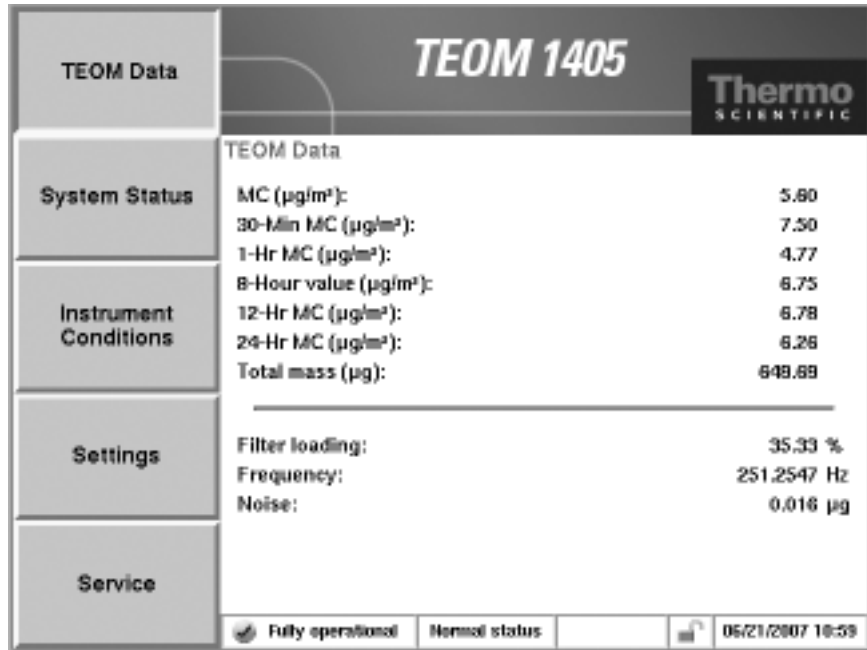

Figure 5-2.
 1405 Service screen.

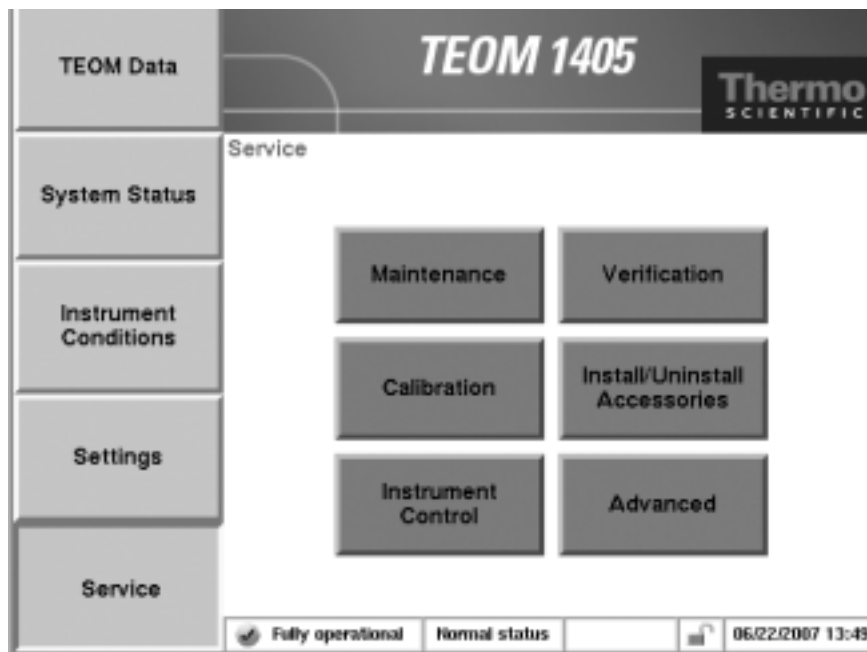
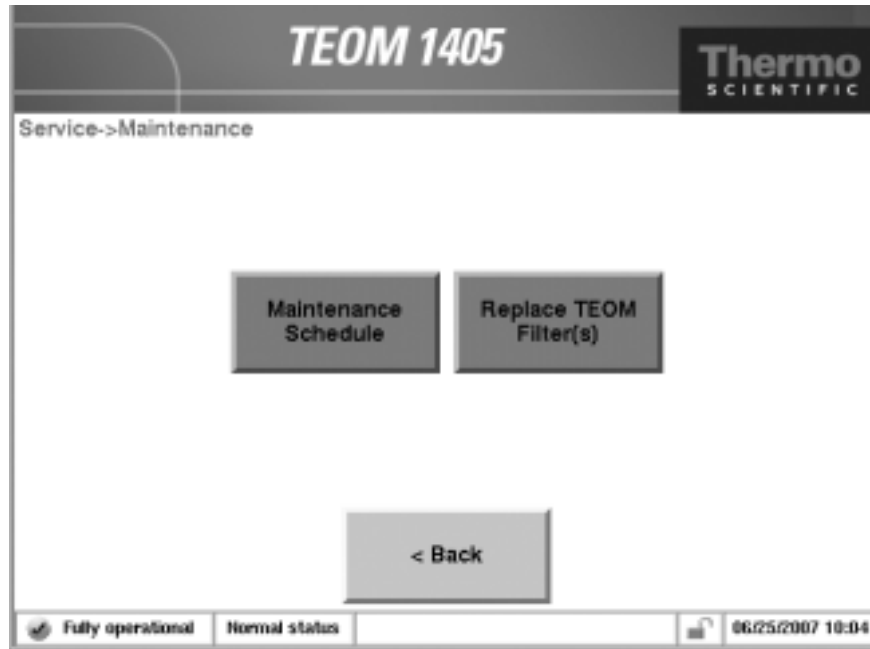

Figure 5-3.
 1405 Maintenance screen.



Maintenance Schedule

The Maintenance schedule button in the Maintenance screen allows users access to a list of some of the basic maintenance tasks for the TEOM 1405 Monitor. Refer to the beginning of this section for a full maintenance schedule.

Figure 5-3.
 1405 Maintenance Schedule screen.

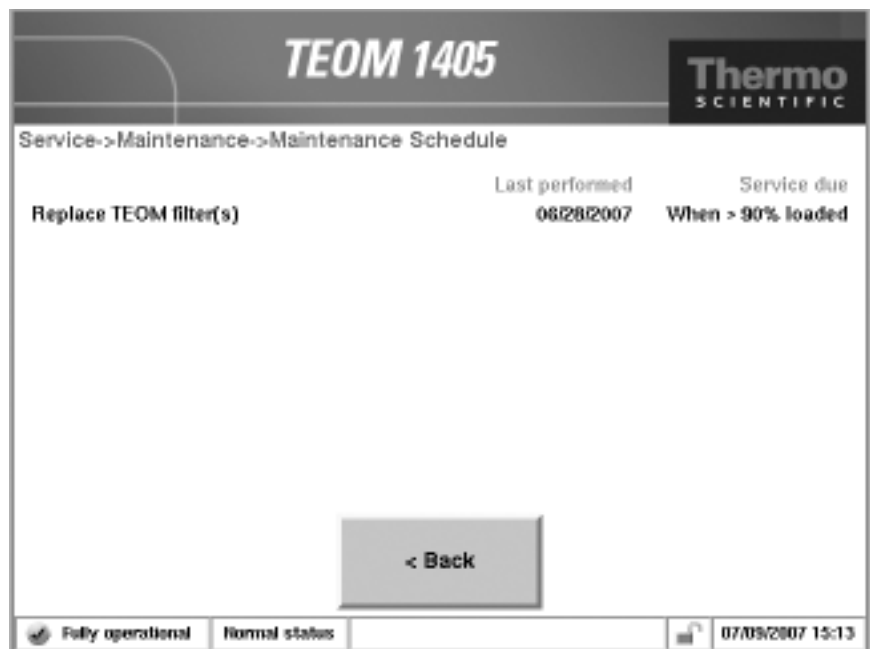

TEOM Filter Replacement

The Series 1405 TEOM filter needs to be changed periodically before filter loading can affect the flow, or at least every 30 days.

Note. Change the filter at least every 30 days. ▲

Filter Loading

The filter loading percentage value indicates the percentage of the TEOM filter's total capacity that has been used. You can check the TEOM filter loading percentage on the monitor's TEOM Data screen (Figure 5-4). Because this value is determined by the pressure drop of the main sample flow line, the instrument always shows a non-zero value even if no TEOM filter is mounted in the mass transducer. New TEOM filters generally exhibit filter loading percentages of 15% to 30% at a main flow rate of 3 l/min, and less at lower flow rates.

Figure 5-4.
 TEOM Data screen.

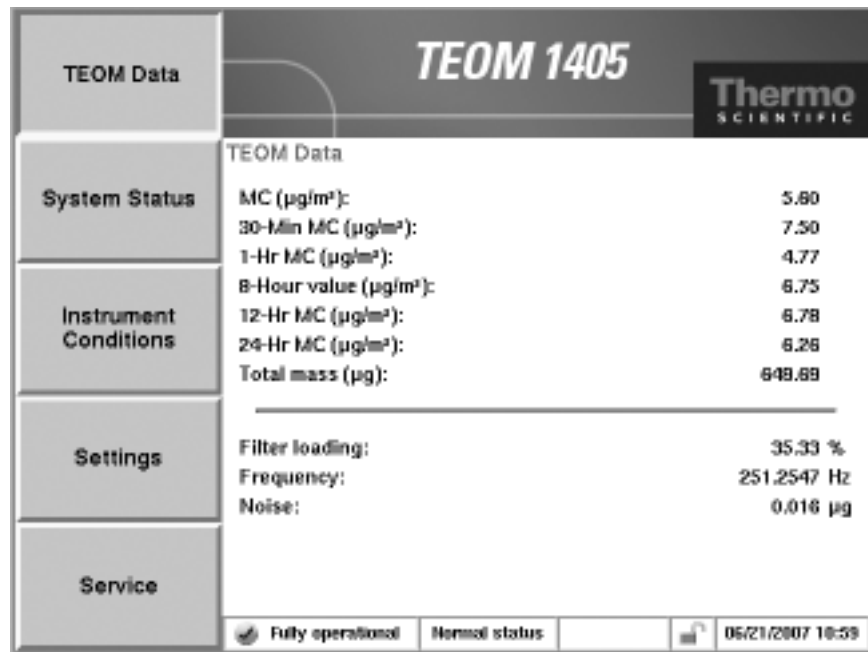

TEOM filters must be replaced before the filter loading percentage reaches 100% to ensure the quality of the data generated by the instrument. At some point above 100%, the main flow drops below its set point.

If the filter loading percentage is higher than 30% (at a main flow rate of 3 l/min) when a new TEOM filter is placed on the mass transducer, or if the lifetime of consecutive TEOM filters becomes noticeably shorter, you may need to replace the in-line filter. Refer to “Exchanging the In-Line Filters” later in this section.

Filters should be stored inside the unit for easy access and to keep them dry and warm.

TEOM filter life depends upon the nature and concentration of the particulate matter sampled, as well as the flow rate settings. TEOM filters must be replaced when the filter loading value approaches 100%. This generally corresponds to a total mass accumulation on the filter of approximately 3-5 mg. TEOM filter life at a main flow rate of 3 l/min is generally 21 days at an average PM-10 concentration of 50 µg/m³. TEOM filter life is longer at lower flow rates because the particulate matter accumulation on the TEOM filter is slower.

TEOM filters must be replaced before the filter loading percentage on the status line of the Main screen reaches 100%. When the filter loading percentage is greater than 90%, the unit will trigger a status condition. You must replace the 47 mm filter every time that you replace a TEOM filter.

Note. Do not handle new TEOM filters with your fingers. Use the filter exchange tool provided with the instrument to replace filters. ▲

Changing the TEOM Filters **To install a TEOM filter:**

1. Ensure that the filter exchange tool is clean and free of any contamination that might be transferred to the TEOM filter.
2. In the 1405 TEOM Data screen, select the **Service** button to display the Service screen, then select the **Maintenance** button to display the Maintenance screen (Figure 5-3).
3. Select the **Replace TEOM Filter** button to start the TEOM Filter Replacement Wizard (Figure 5-5). Select the **Next >** button to begin the procedure.

Note. If you are an experienced user and comfortable with changing TEOM filters, select the **Advanced User Mode** button to stop the movement of the mass transducer and proceed with a quick exchange procedure. Refer to the next section for a complete explanation of the Advanced User Mode for filter changes. ▲

Figure 5-5.
TEOM Filter Replacement Wizard
starting screen.

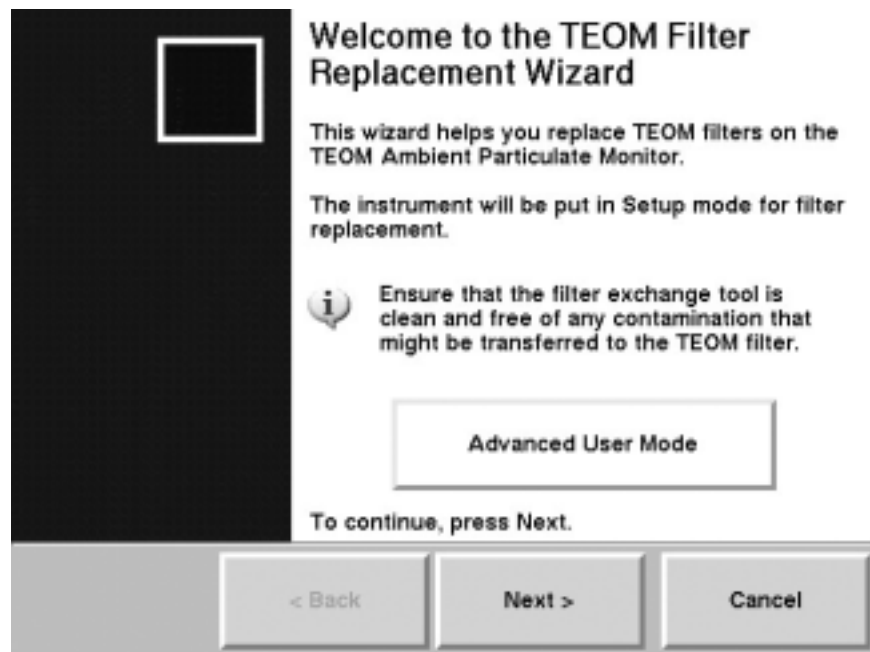

4. The Open Mass Transducer screen will display. Open the door of the sampler.
5. Pull the TEOM latch toward you to open the transducer latch.
6. With the mass transducer unlatched, swing the bottom of the mass transducer downward, exposing the tapered element (TE) (Figure 5-6). Select the **Next >** button.

Figure 5-6.
 Opening the mass transducer.

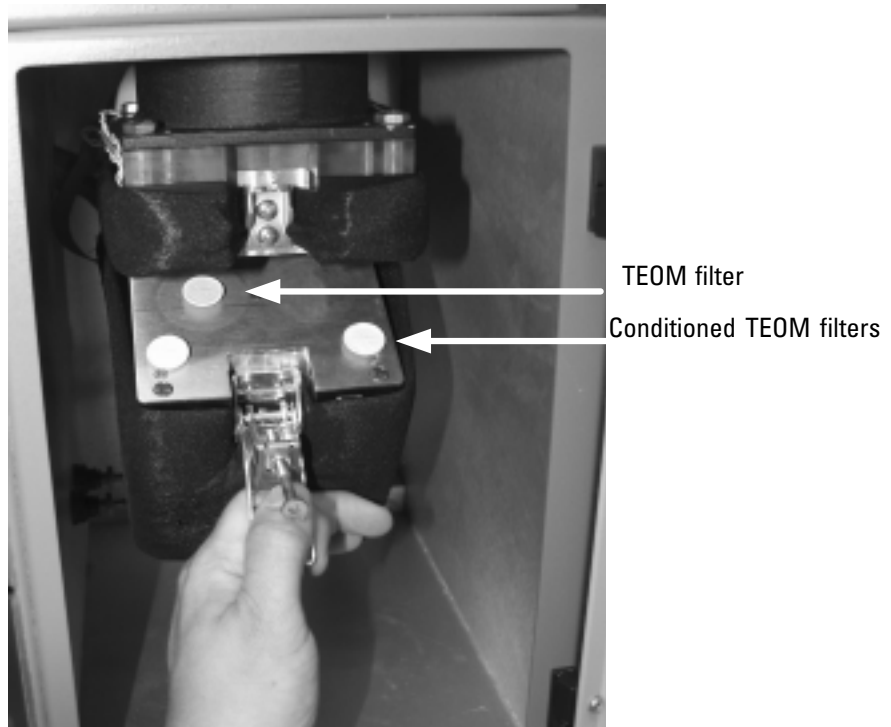

7. The Remove Old Filter screen will display. Carefully insert the lower fork of the filter exchange tool under the used TEOM filter so that the filter disk is between the fork and the upper tab of the filter exchange tool (Figure 5-7). The tines of the fork should straddle the hub of the filter base.

Figure 5-7.
 Opening the mass transducer.

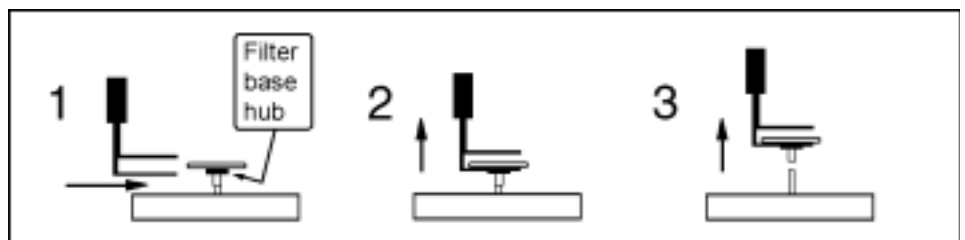

8. Gently pull straight up, lifting the TEOM filter from the tapered element (TE). Do not twist or tilt the filter exchange tool from side-to-side while removing the filter from the TE. This will damage the TE.

9. The Replace Filter screen will display. Pick up a new, conditioned TEOM filter from one of the filter holders with the filter exchange tool so that the filter disk lies between the fork and the upper tab of the tool and the hub of the filter lies between the tines of the fork (Figures 5-8 and 5-9).

Note. TEOM filters must be preconditioned to avoid excessive moisture buildup prior to their use in the system. Refer to the next section. ▲

Note. Do not touch the filter with your fingers while picking it up with the filter exchange tool. ▲

10. Hold the filter exchange tool in line with the tapered element (Figures 5-8 and 5-9) and lightly place the hub of the filter onto the tip of the tapered element. Select the **Next >** button.

Figure 5-8.
Placing the filter on the tapered element.

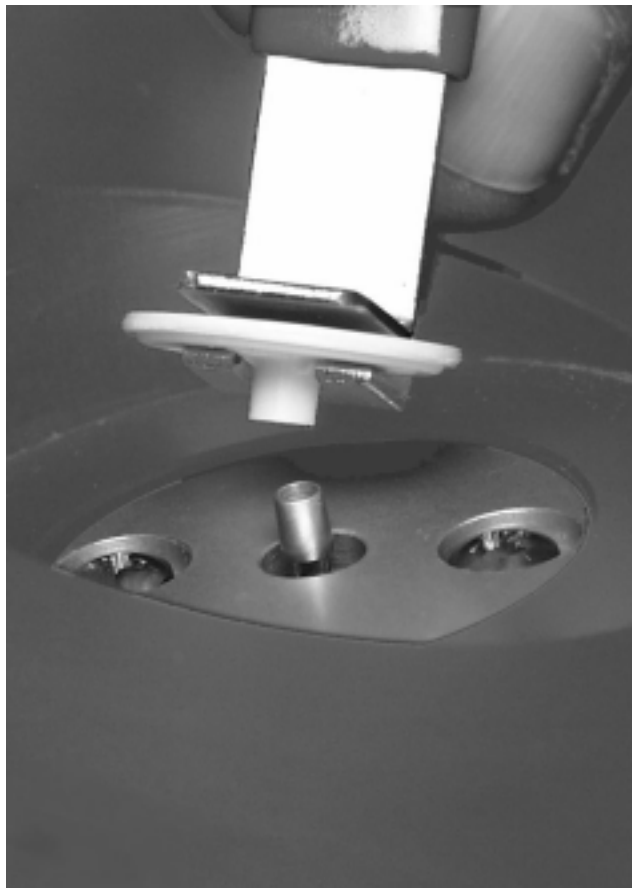

11. The Seat Filter screen will display. Gently press down on the TEOM filter to ensure that it is seated properly (Figure 5-9).
12. Remove the filter exchange tool by slowly retracting it until it clears the filter (Figure 5-9). Do not disturb the filter.
13. Place the bottom of the filter exchange tool on top of the TEOM filter (Figures 5-9) and apply downward pressure (approximately 0.5 kg or 1 lb) to seat the filter firmly in place.

Figure 5-9.
 Placing the filter on the tapered element.

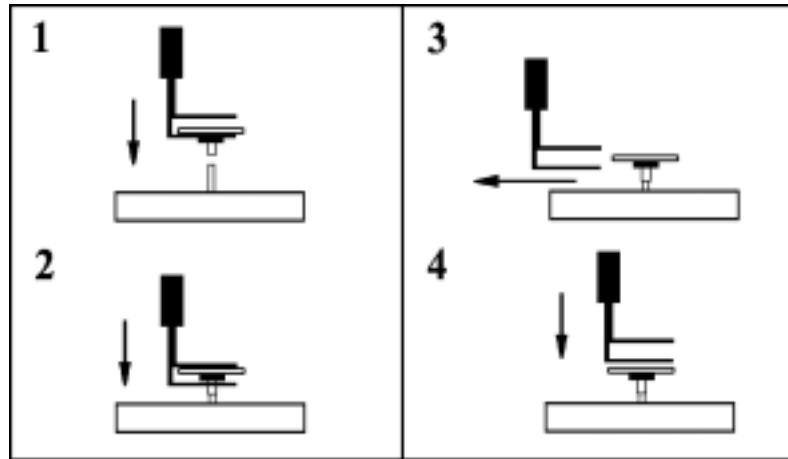

14. The Precondition Filter screen will display. Place a new TEOM filter on the empty conditioning post on the mass transducer. (Refer to the next section for more information on conditioning filters.) Select the **Next >** button.
15. The Close Instrument screen will display. Raise the mass transducer to the closed position and fasten the holding rod onto the latch plate.
16. Close and latch the door to the sensor unit. Keep the door open for as short a time as possible to minimize the temperature change in the system. Select the **Next >** button.

17. The system will automatically test the newly installed TEOM filter to ensure it is firmly seated. The system will display a screen with the wait time (Figure 5-10).

Figure 5-10.
Stabilizing screen.

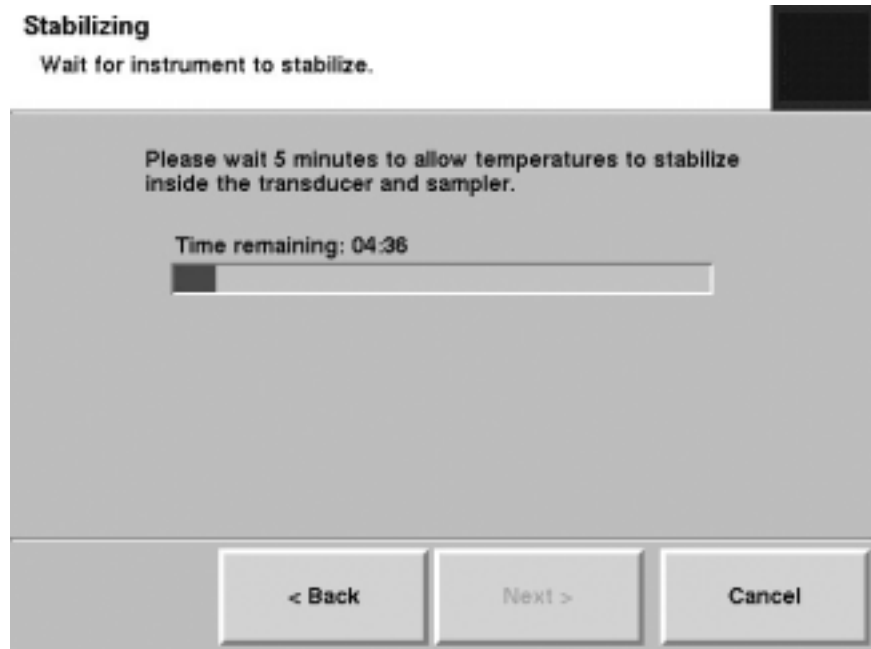

18. If the system is unable to obtain a stable frequency for the filter, it will display a screen stating the filter needs to be re-seated (Figure 5-11). Otherwise, the filter change is complete (go to step 21).

Figure 5-11.
Re-seat Filters screen.

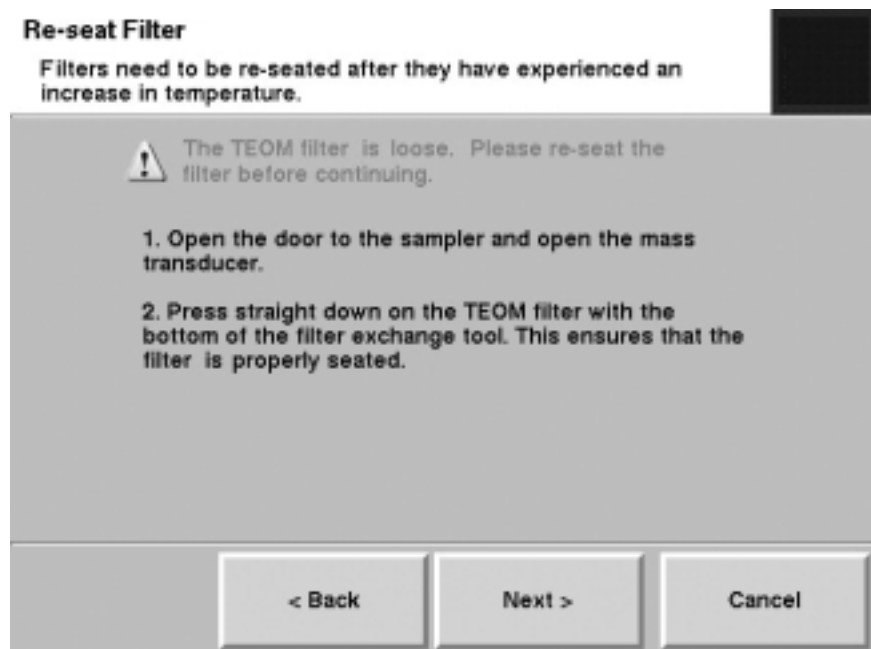

19. If the filter needs to be re-seated, open the door to the sampler and the mass transducer and press straight down on the TEOM filter with the bottom of the filter exchange tool (Figure 5-9). This ensures that the filter is properly seated. Close the mass transducer and sensor unit door. Select the **Next >** button
20. The system will again display the waiting screen while it is testing for a stable frequency. If it still cannot obtain a frequency for the filter, it will prompt the user to re-seat the filter a second time. If it still cannot obtain a stable frequency, the procedure will prompt to replace the filter or post a fail message (Figures 5-13 and 14)
21. When the frequency stable, the system will display the Completing the TEOM Filter Replacement Wizard screen (Figure 5-12). Select the **Finish >** button.

Figure 5-12.
Finish screen with successfully completed message.



Note. If the system still cannot detect a stable frequency for the filter, it will display a “filter could be damaged” message, and prompt for replacement of the filter (Figure 5-13). If the system fails to establish the frequency again, the filter change procedure will fail completely and recommend appropriate service (Figure 5-14). ▲

Figure 5-13.
Try Another Filter screen.



Figure 5-14.
Fail/service message.

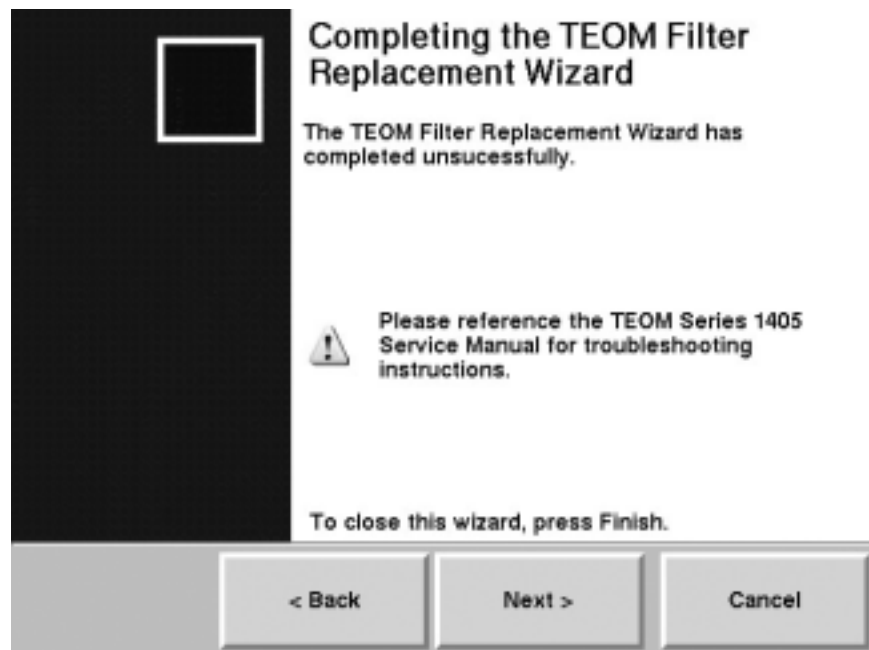

Advanced Filter Change

For experienced users who are comfortable with the filter change operation, the monitor offers an advanced filter change mode. When the users selects the advanced mode in the TEOM Filter Replacement starting screen, (Figure 5-5), the system automatically stops the TEOM filter and displays a screen to prompt the filter change operation (Figure 5-15).

Figure 5-15.
Advanced filter change screen.



When the screen displays, change the filters and select the **Next >** button. The finished screen will display (Figure 5-16).

Figure 5-16.
Wizard complete message.

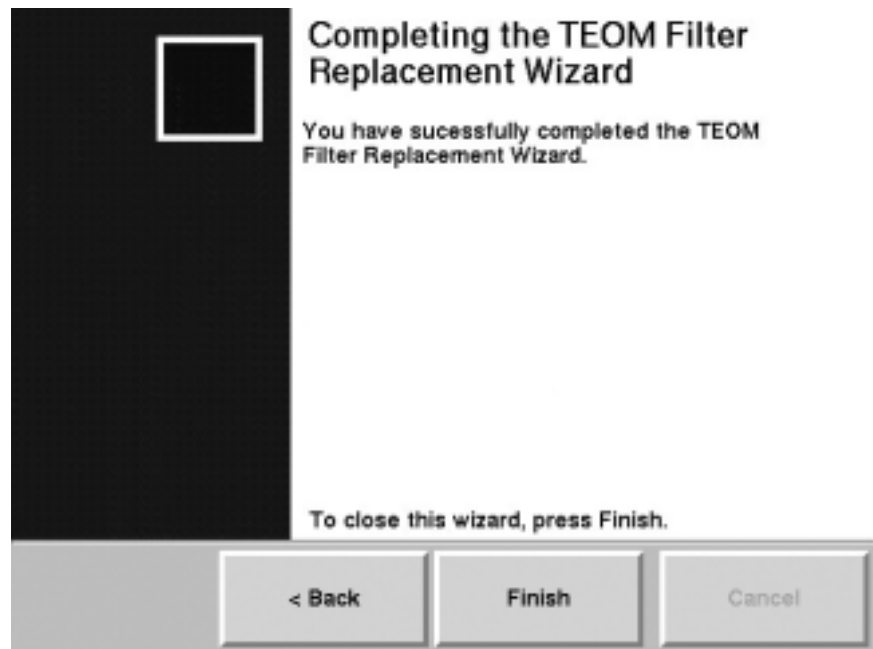

Note. The advanced filter wizard DOES NOT automatically check the frequency. Users MUST ensure that the frequency is stable in order to ensure valid test data. Look at the change in the TE's oscillating frequency on the TEOM Data screen (Figure 5-17). The last two digits of the reading will fluctuate (due to noise) and the rest will remain steady. If more than the last two digits fluctuate in this reading, this indicates that the TEOM filter is loose. Re-seat the filter and check the frequency again.

Figure 5-17.
 TEOM Data screen.

<i>TEOM 1405</i>		Thermo SCIENTIFIC
TEOM Data	TEOM Data	
System Status	MC ($\mu\text{g}/\text{m}^3$):	5.80
	30-Min MC ($\mu\text{g}/\text{m}^3$):	7.50
	1-Hr MC ($\mu\text{g}/\text{m}^3$):	4.77
Instrument Conditions	8-Hour value ($\mu\text{g}/\text{m}^3$):	6.75
	12-Hr MC ($\mu\text{g}/\text{m}^3$):	6.78
	24-Hr MC ($\mu\text{g}/\text{m}^3$):	6.26
	Total mass (μg):	648.89
Settings	Filter loading:	35.33 %
	Frequency:	251.2547 Hz
	Noise:	0.016 μg
Service	<div style="display: flex; justify-content: space-between; align-items: center;"> Fully operational Normal status 05/21/2007 18:39 </div>	

Conditioning the TEOM Filters

TEOM filters must be preconditioned to avoid excessive moisture buildup prior to their use in the system. The TEOM 1405 has two posts for preconditioning filters.

To precondition a TEOM filter:

1. Place two TEOM filters on the TEOM filter holders of the mass transducer (Figure 5-18) to condition the filters.
2. When it is time to install a new TEOM filter, use a conditioned filter from one of the filter holders.
3. Replace the conditioned TEOM filter that was on the filter holder with a new filter.

Figure 5-18.
Conditioned TEOM Filters.

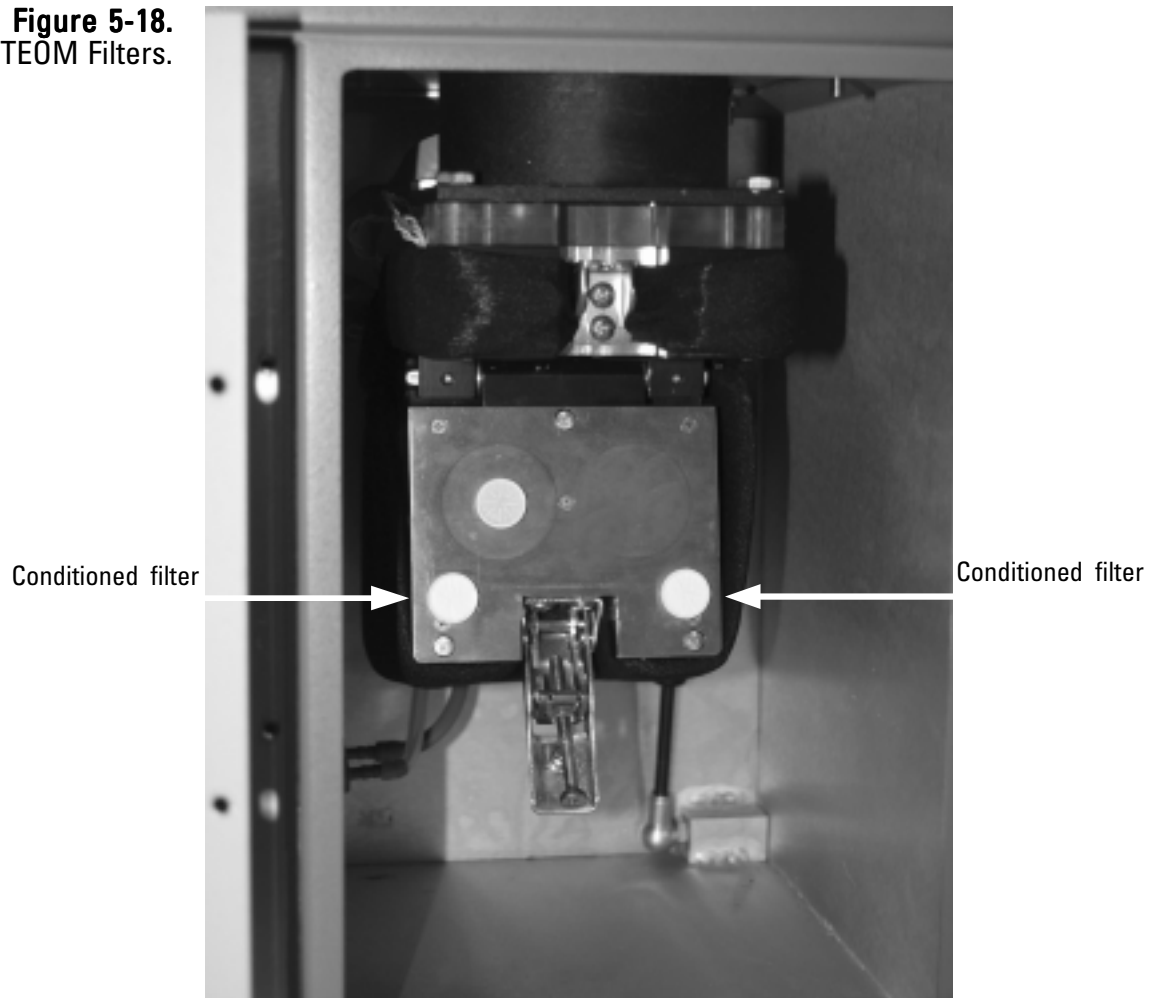

Note. Extra filters should be stored inside the carrier box, in the interior of the unit near the mass transducer to ensure they are at or near the appropriate temperature and humidity level for sampling. ▲

Cleaning the PM-10 Inlet

The PM-10 inlet should be cleaned every time the TEOM filter is changed, or as necessary. To clean the unit you will need an ammonia-based general-purpose cleaner, cotton swabs, a small soft-bristle brush, paper towels, distilled water, silicone-based stopcock grease, a small screwdriver, a small adjustable wrench and a pocket knife

To clean/maintain the PM-10 inlet:

1. Remove rain jar from the inlet and the inlet from the sample tube. Unscrew the top acceleration assembly from the lower collector assembly (Figure 5-19).

Figure 5-19.
Top of inlet assembly.

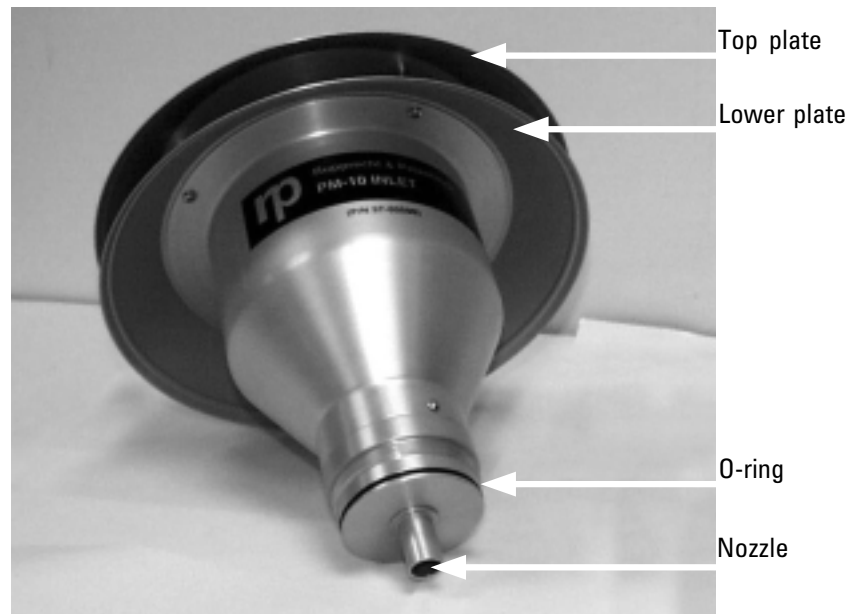

2. Mark the top plate deflector cone and lower plate with a pencil to facilitate proper orientation when reassembling, then use a Phillips screwdriver to remove the four pan head screws from the top of the top plate (Figure 5-19). Lift the top plate off the four threaded, spacer standoffs and set aside.
3. Clean the insect screen (with brush or water) then dry.
4. Using a general-purpose cleaner and paper towel, clean the deflector cone on the inside of the top plate.

5. Clean the internal wall surface of the acceleration assembly (Figure 5-20).

Note. Ensure the acceleration nozzle is clean. If not, use a cotton swab and cleaner to remove any contamination. ▲

Figure 5-20.
Interior wall of inlet.

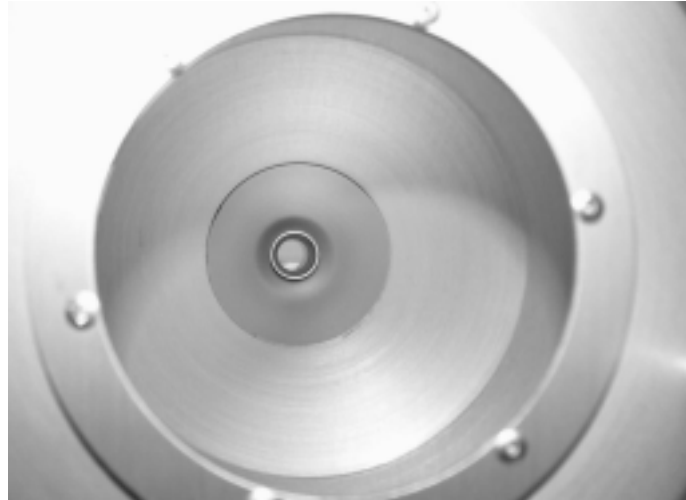

6. Inspect the large diameter, impactor nozzle O-ring for damage or wear (Figure 5-20). Replace it, if necessary. Apply a thin film of silicone grease to the O-ring. Also, apply a light coating of silicone grease to the aluminum threads of the upper acceleration assembly.
7. Using a general-purpose cleaner with a paper towel, clean the collector assembly walls and plate (Figure 5-21).

Note. Most of the contamination in the inlet is usually found on the collector plate. ▲

Figure 5-21.
Inside of inlet collector assembly.

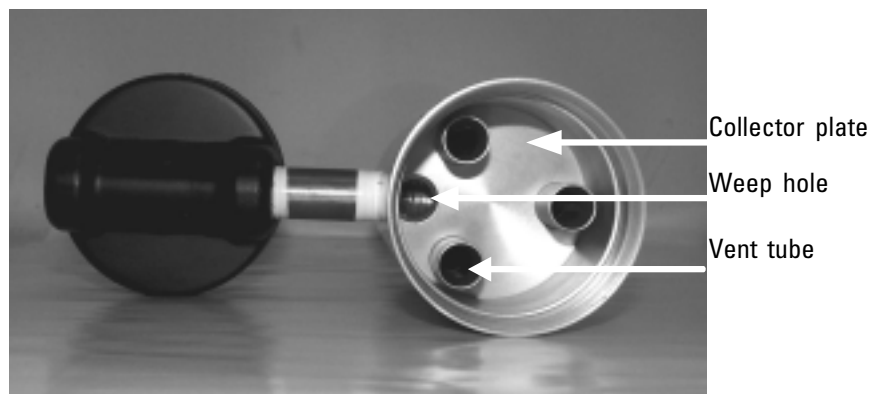

8. Clean the three vent tubes (Figure 5-21). You may need to use a cotton swab to clean these vent tubes.
9. Clean the bottom side of the collector assembly (Figure 5-22). Inspect the two inlet tube-sealing O-rings for damage or wear. If necessary, replace the O-rings.

Figure 5-22.
Bottom of collector assembly
with O-rings.

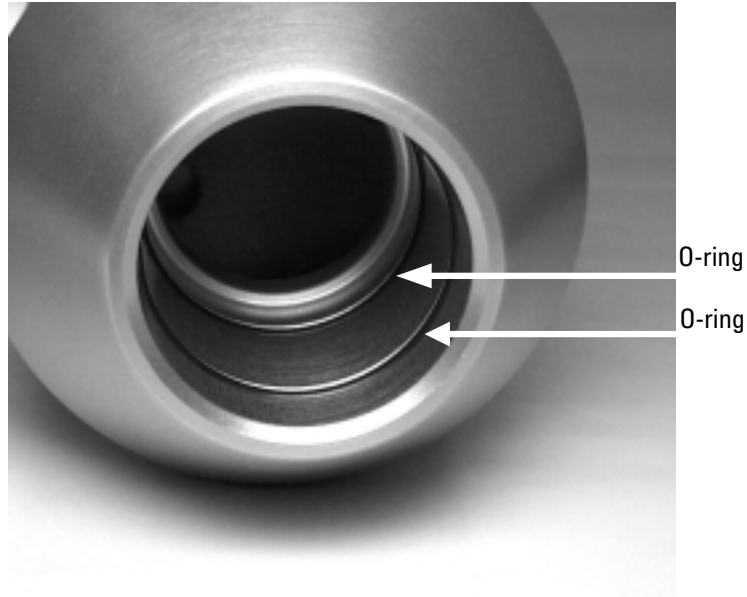

10. Clean the weep hole in the collector plate where the moisture runs out to the moisture trap (Figure 5-21).
11. Clean the rain jar. Inspect the rain jar cover's brass nipple fitting to ensure that it is secure and free from blockages (Figure 5-23).

Figure 5-23.
Rain jar cover.



12. Apply a light coating of silicone grease to the O-rings (Figure 5-22) to ensure that a seal is made when they are reinstalled on the flow splitter.
13. Clean the lower collector assembly's threads to ensure a tight seal when the two halves are reassembled.
14. Reassemble the top and bottom inlet assemblies until the threads tighten. Hand-tighten only.
15. Reinstall the insect screen and align the top plate markings with the lower plate markings. Install the top plate onto the lower plate and tighten the four pan-head screws.
16. Place a light coating of silicone grease on the gasket inside the cap of the rain jar. This will ensure a leak-free fit. Reinstall the rain jar.
17. Place the inlet on the flow splitter. Take care not to damage the internal O-rings.

Exchanging In-Line Filters

The main flow in-line filter (57-010745) and the large bypass flow filter (57-010755) should be changed every 6 months or as necessary. They are located on the back of the unit (Figure 5-24). These filters prevent contamination from reaching the flow controller. For convenience, replace the large in-line filters immediately following one of the regularly-scheduled TEOM filter exchanges. This allows you to exchange the in-line filters during the 30-minute flow and temperature stabilization period.

Figure 5-24.
Back of 1405 unit.

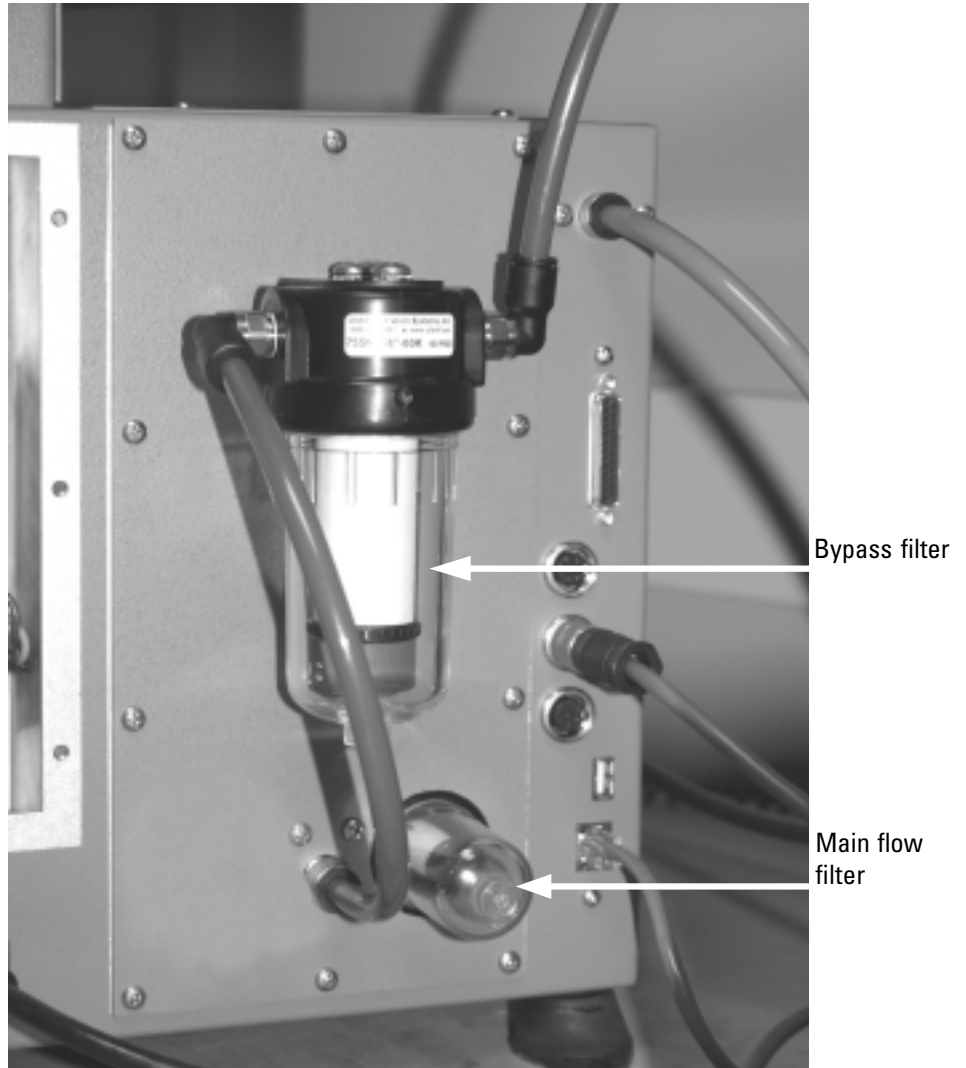

To exchange the in-line filters:

1. Unplug the sample pump.
2. Unscrew and remove the small filter cover for the main flow channel on the back of the unit (Figure 5-25).

Figure 5-25.
Removing the filter cover.



3. Unscrew the filter mount for main flow channel (Figure 5-26).

Figure 5-26.
Removing the filter mount.



- Slide the filter cartridges off the mount and install a new cartridge onto the mount (Figure 5-27).

Figure 5-27.
Filter cartridge and mount.

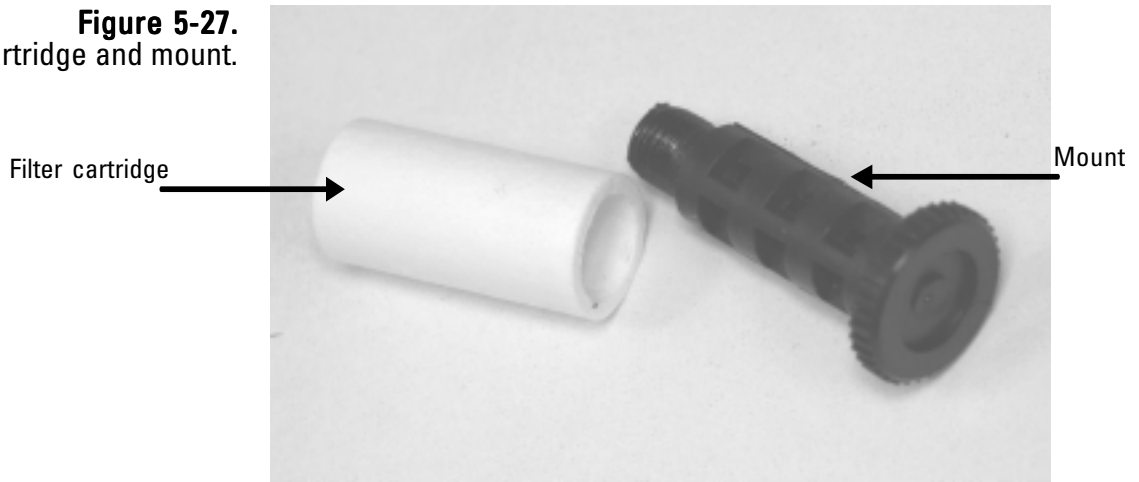

- Install the mount into the unit, then install the cover.
- Unscrew and remove the large filter cover from the bypass flow channel on the back of the unit (Figure 5-28).

Figure 5-28.
Bypass in-line filter.

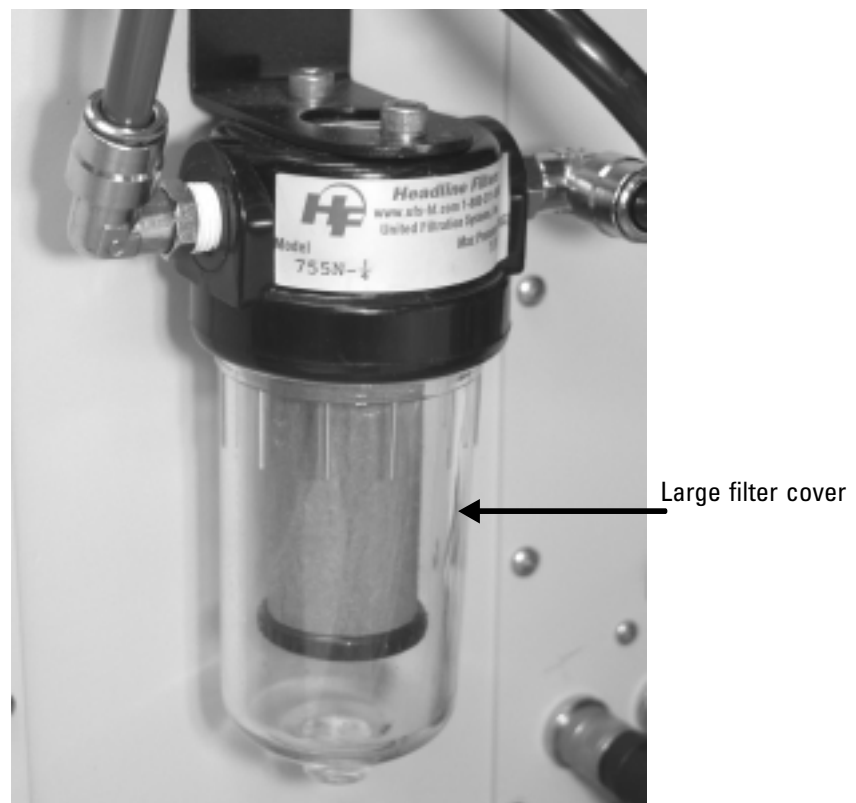

7. Unscrew the filter mount for the bypass flow channel.
8. Slide the large filter cartridge off the mount and install a new cartridge onto the mount (Figure 5-29).

Figure 5-29.
Bypass filter mount with clean
and dirty filter cartridges.

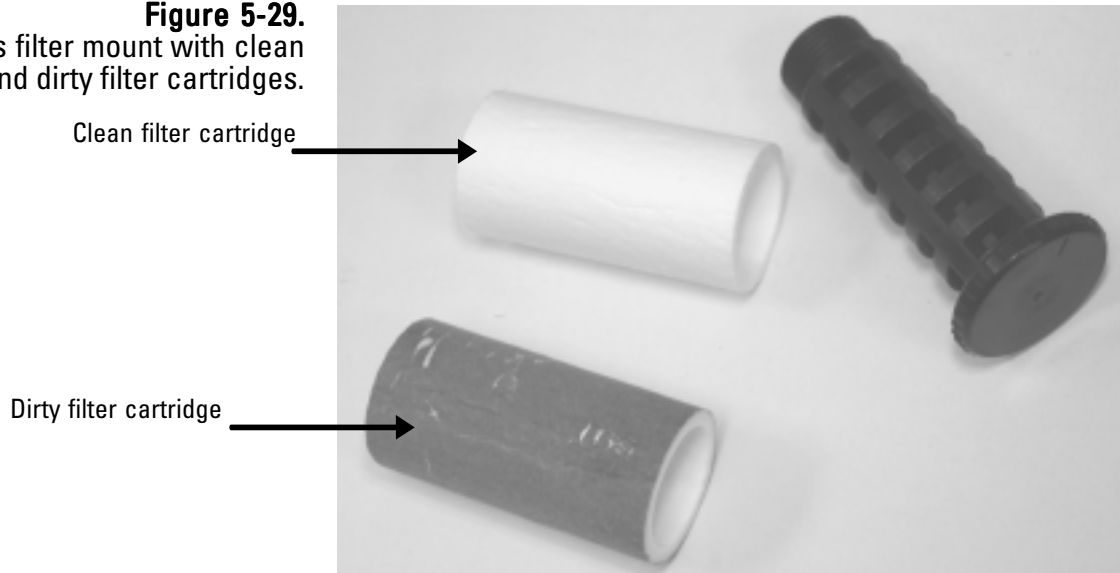

9. Install the mount into the unit, then install the cover for the bypass flow.
10. Plug in the sample pump and return to normal operation.

Cleaning the Air Inlet

You must clean the heated air inlet in the TEOM 1405 once a year to remove the buildup of particulate matter on its inner walls. You can order a tapered bristle brush that is appropriate for cleaning the air inlet system from Thermo Scientific. You will need a piece of plastic or another protective material; soapy water, alcohol or freon solution; a 1/2-inch (or adjustable) wrench and a soft brush to clean the air inlet.

Follow these steps to clean the air inlet system:

1. Turn off the TEOM 1405 unit.
2. Open the door of the unit (Figure 5-30) and locate the thermistor in the top of the mass transducer assembly.

Figure 5-30.
Thermistor on top of mass transducer.

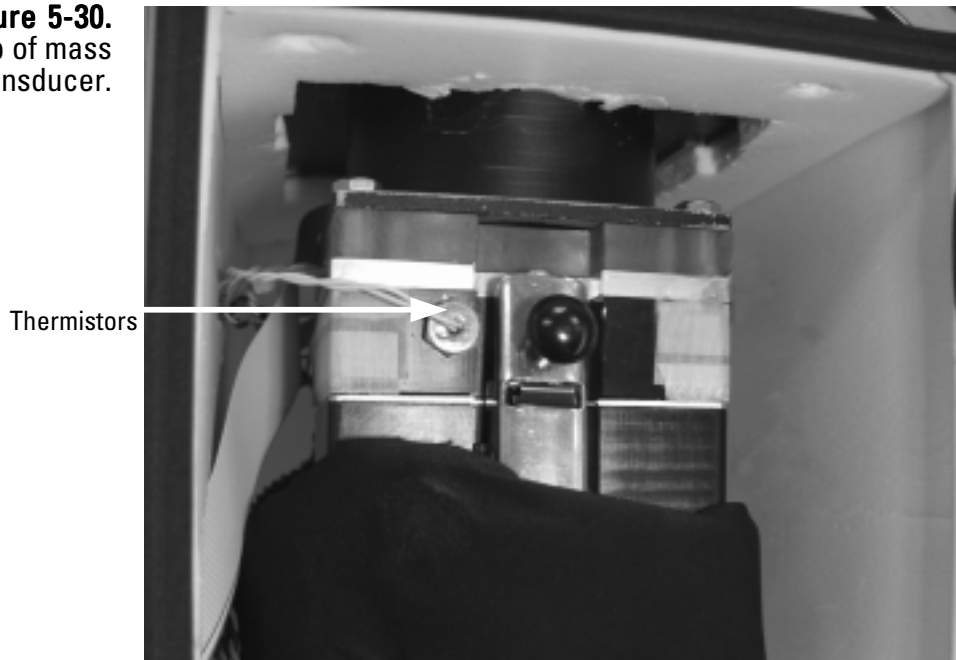

3. Using the 1/2-inch wrench, remove the thermistor from the top of the mass transducer assembly.

Note. The thermistor has a short thread depth. Installation/removal should take 1 1/2 to 2 1/2 turns. ▲

4. Open the mass transducer (refer to the Replacing the TEOM Filter section earlier in this chapter for instructions on opening the mass transducer).

5. Place a piece of plastic or another protective material over the exposed TEOM filters.
6. Using a soapy water, alcohol or freon solution, clean the left side of the air inlet (Figure 5-31). A soft brush may be used to remove particulate matter on the insides of the walls.

Figure 5-31.
Air inlets.

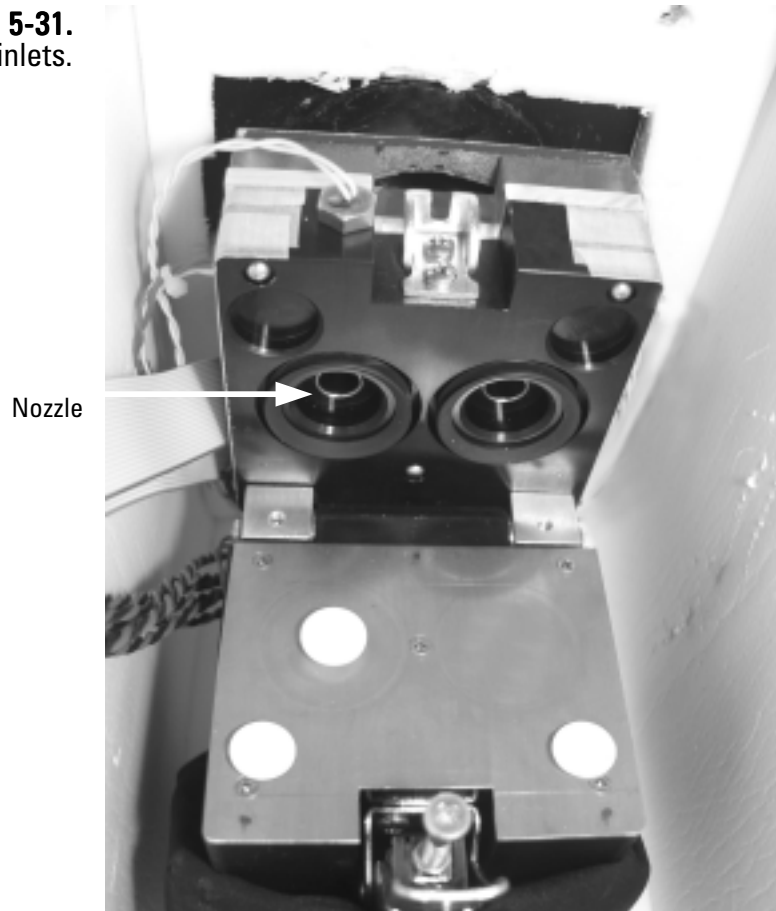

7. Allow the air inlet to dry.
8. Remove the protective material from the exposed TEOM filters.
9. Close the mass transducer and latch the latch.
10. Install the air thermistors into the cap of the mass transducer assembly and tighten lightly with the wrench.
11. Close and latch the door to the unit. Keep the door open for as short a time as possible to minimize the temperature change in the system.
12. Turn on the TEOM 1405 unit.

Audit/Calibration Procedures

Thermo Scientific recommends the following regular maintenance procedures for the TEOM 1405:

Ambient temperature	Audit/calibrate the ambient air temperature measurement once a year.
Ambient pressure	Audit/calibrate the ambient pressure measurement once a year.
Flow	Audit/calibrate the main and bypass flows once a month.
Leak check	Perform a leak check once a month or as necessary (refer to Section 3 for leak check instructions).
Analog outputs	Calibrate the analog output channels once a year or as necessary, for example any time the voltage range setting is changed.
Mass transducer	Audit the calibration of the mass transducer once a year.

The TEOM 1405 software allows users to step through the standard calibration and audit procedures. Select the **Service** button to display the Service screen. When in the Service screen, select the **Verification** or **Calibration** buttons to display the Verification and Calibration screens (Figure 5-32 and 5-33).

Figure 5-32.
 Calibration screen.

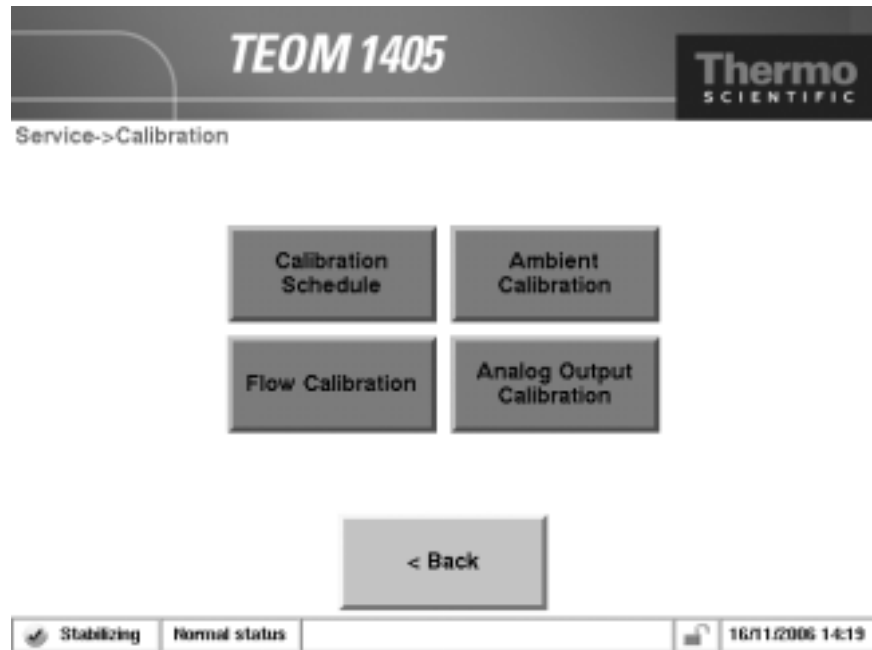
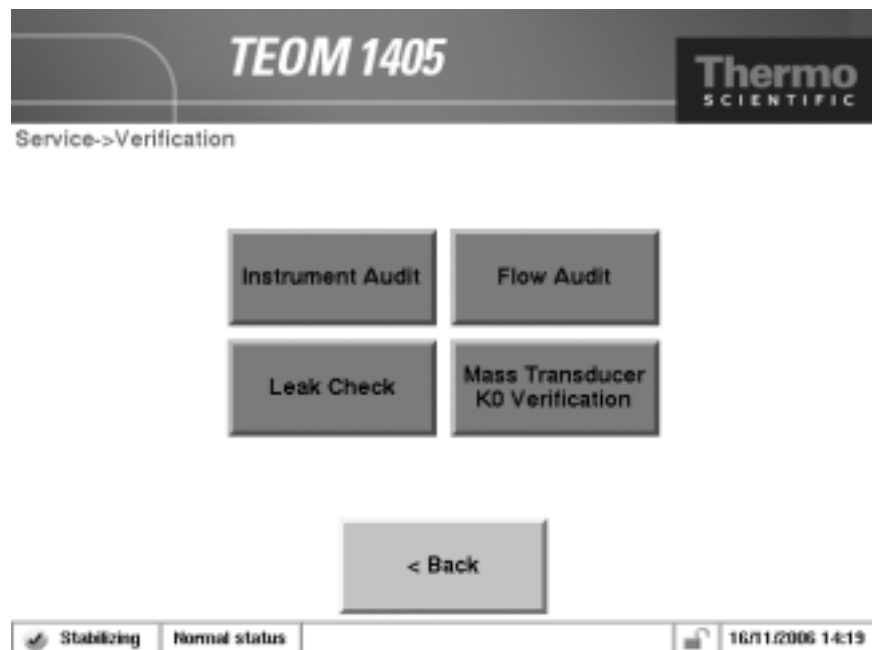
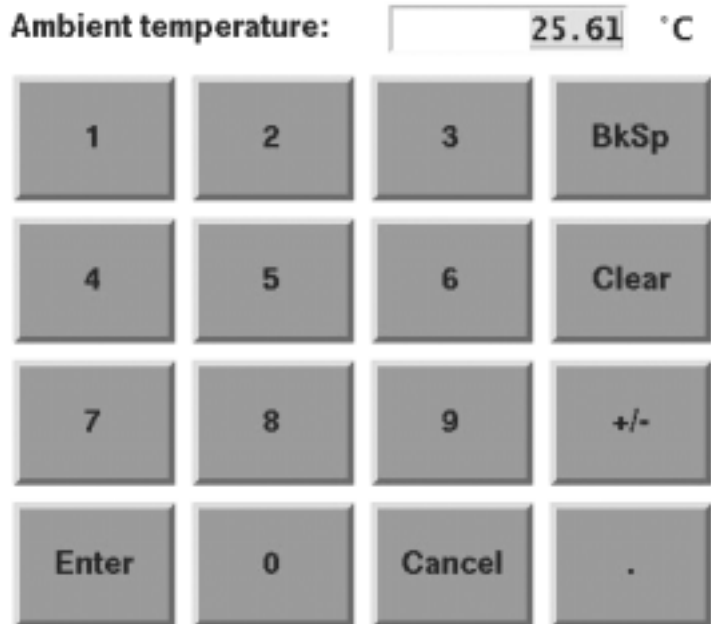

Figure 5-33.
 Verification screen.



Users enter values into the calibration screens using a number keypad (Figure 5-34). Whenever the user is prompted to enter a value, such as an externally measured temperature, pressure or flow rate, the calibration wizard will automatically display a keypad. Enter the value into the keypad as instructed by the wizard, then select the **Enter** button to set the value or press the **Cancel** button to exit the keypad screen and return to the wizard.

Figure 5-34.
Number entry keypad.



Auditing the System

Users can instantly audit all of the instruments functions through a single software screen. When in the Verification screen, select the **Instrument Audit** button to display the Instrument Audit screen (Figure 5-35).

The Instrument Audit screen shows the temperature, flow and other values that can be audited by the user. Placing a temperature or barometer in the desired location, allows users to audit those values compared to an external measurement device. Flows can be individually audited for accuracy using the flow audit wizard. For changing or “calibrating” the values, refer to the following sections. Refer to the flow, temperature and pressure calibration section for information on how to attach external measurement devices to the TEOM 1405 unit.

Figure 5-35.
 Instrument Audit screen.

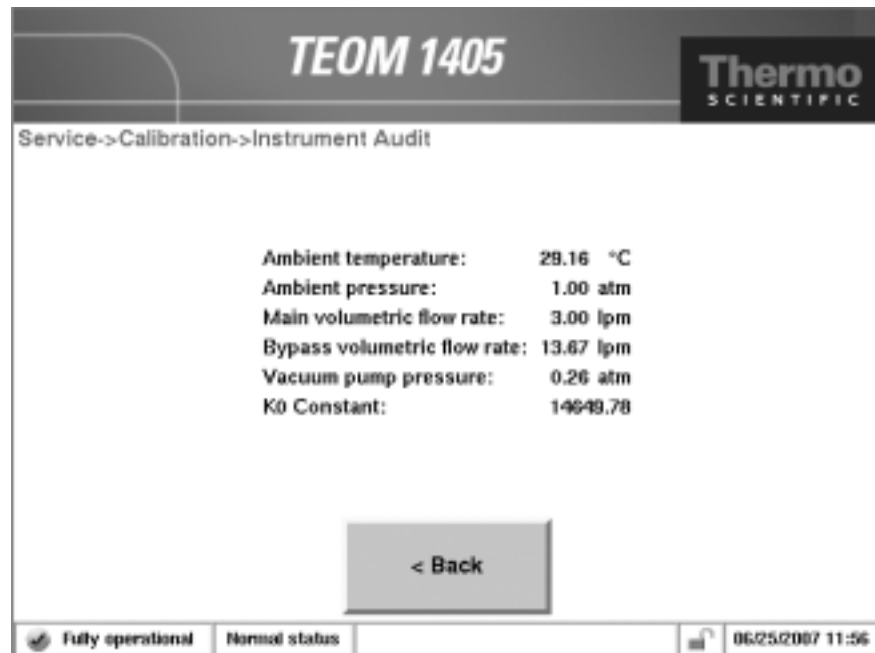

Calibrating the Ambient Temperature

Perform the ambient air temperature calibration, pressure calibration and leak check (Section 3) before executing the flow calibration procedure.

To calibrate the ambient air temperature:

1. In the TEOM Data screen, select the **Service** button to display the Service screen, then select the **Calibration** button to display the Calibration screen (Figure 5-32).
2. Select the **Ambient Calibration** button to display the Ambient Calibration screen (Figure 5-36).

Figure 5-36.
Ambient Calibration screen.

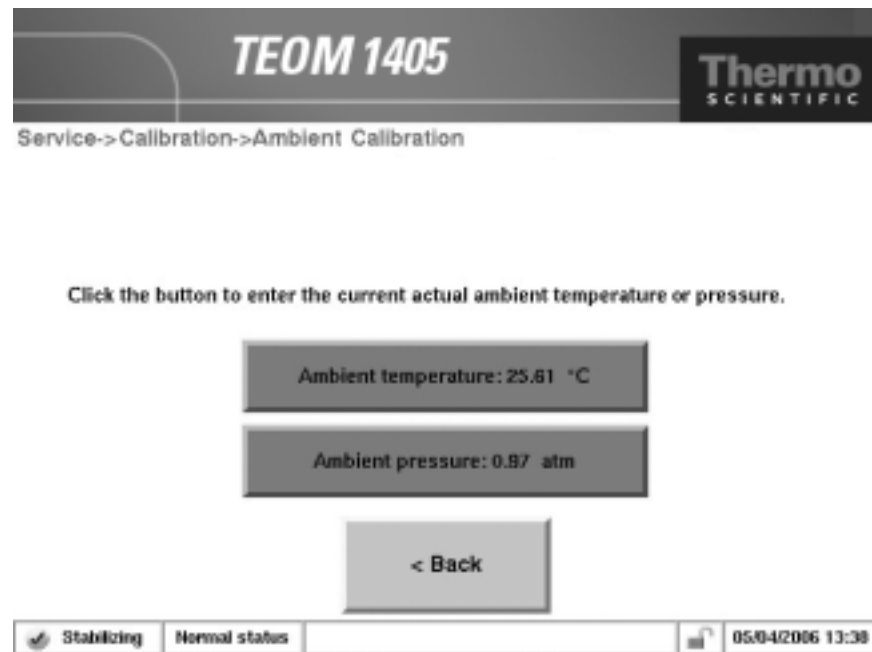

3. Determine the current temperature (°C) at the ambient temperature sensor using an external thermometer, [$^{\circ}\text{C} = 5/9 \times (^{\circ}\text{F} - 32)$].
4. If the measured value is within $\pm 2^{\circ}\text{C}$ of the temperature displayed in the **Ambient Temperature:** field of the button, no further action is necessary. Select the **< Back** button to return to the Calibration screen. If the value is not within $\pm 2^{\circ}\text{C}$ of the temperature displayed in the **Ambient Temperature:** field of the button, select the Ambient Temperature: button. A keypad will display. Enter the actual temperature as measured by the external thermometer and press the **Enter** button. The Ambient Temperature Calibration screen will display with the new entered value. Select the **< Back** button to return to the Calibration screen.

Calibrating the Ambient Pressure

Perform the ambient air temperature calibration, pressure calibration and leak check (Section 3) before executing the flow calibration procedure.

To calibrate the ambient pressure:

1. In the TEOM Data screen, select the **Service** button to display the Service screen, then select the **Calibration** button to display the Calibration screen (Figure 5-32).
2. Select the **Ambient Calibration** button to display the Ambient Calibration screen (Figure 5-37).

Figure 5-37.
 Ambient Calibration screen.

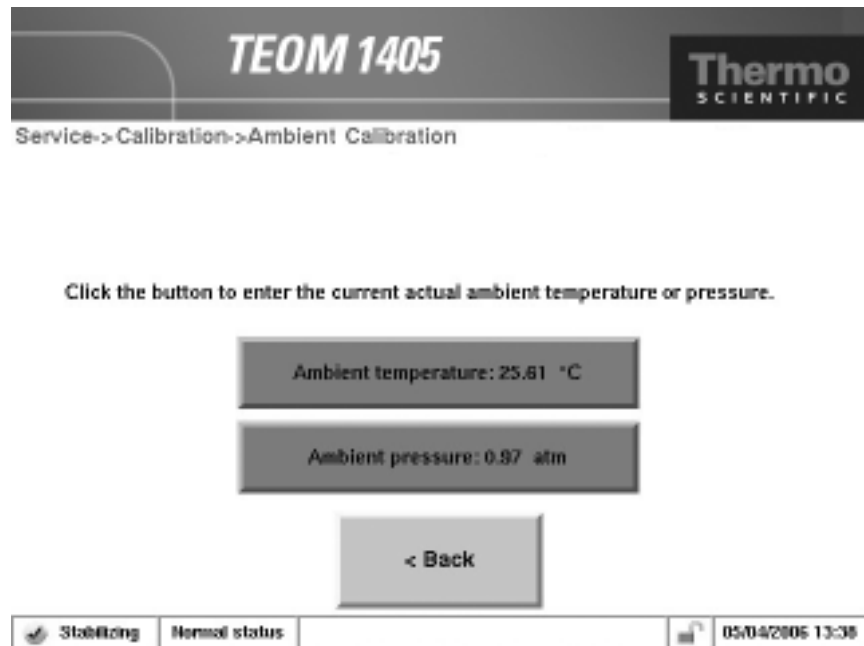

3. Determine the current ambient pressure in atmospheres (absolute pressure, not corrected to sea level).
4. If the measured value is within ± 0.01 atm of the pressure displayed in the **Ambient Pressure:** field of the button, no further action is necessary. Select the **< Back** button to return to the Calibration screen. If the value is not within ± 0.01 atm of the pressure displayed in the **Ambient Pressure:** field of the button, select the **Ambient Pressure:** button. A keypad will display. Enter the actual pressure as measured by the external device and press the **Enter** button. The Ambient Pressure Calibration screen will display with the new entered value. Select the **< Back** button to return to the Calibration screen.

Auditing the Flow Rates

To audit the main or bypass flow:

1. In the TEOM Data screen, select the **Service** button to display the Service screen, then select the **Verification** button to display the Verification screen (Figure 5-33).
2. Select the **Flow Audit** button to begin the Flow Audit Wizard (Figure 5-38). Select the **Next >** button.

Figure 5-38.
Flow Audit Wizard.

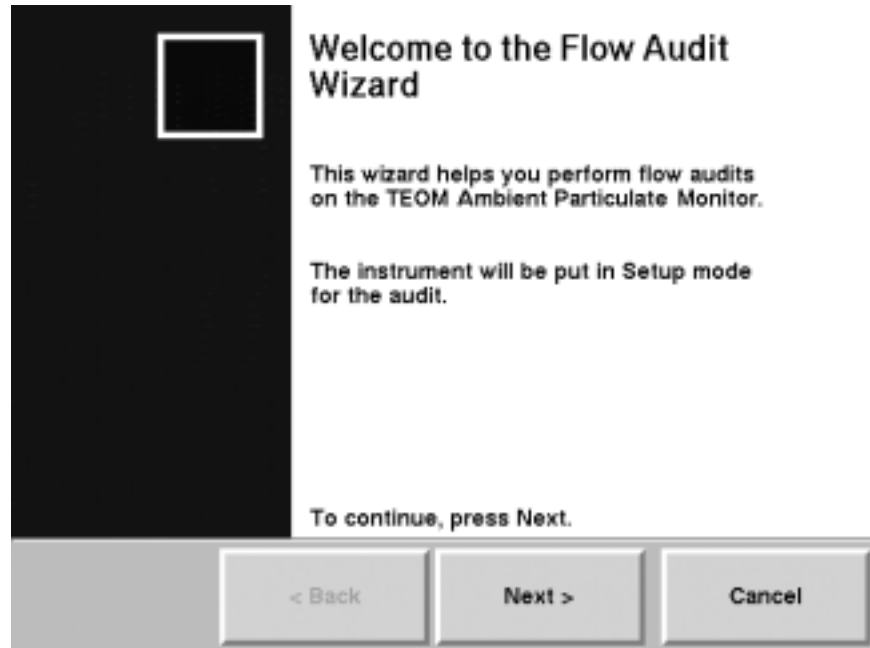

3. The Select a Flow Audit Device screen will display. Select a flow audit device. Select “Direct Flow Device” to audit the flow using a direct flow measuring device (reading “l/min” adjusted for temperature and pressure) such as the Streamline Pro. Select “FTS” to audit the flow using the FTS system. FTS users will enter the device calibration constant and the change in pressure from the FTS. Select the “Next >” button.
4. The Select Flow to Audit screen will display. Select which flow to audit. Press the “Next > “ button.

Note. If you selected the FTS option in the previous screen, you will be prompted to enter the correct calibration constants before proceeding with the audit (Figure 5-39). ▲

Figure 5-39.
Enter FTS Constants screen.

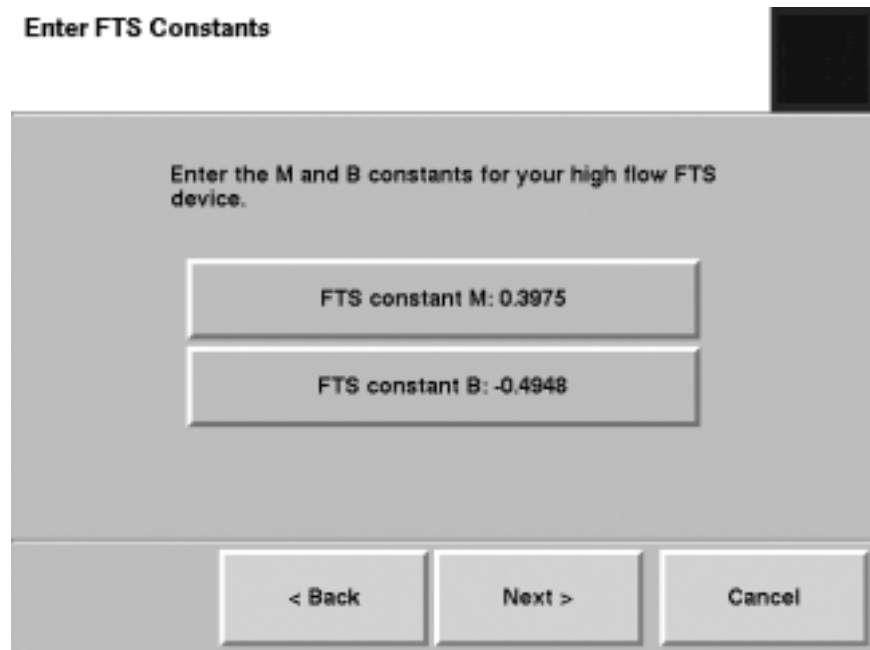

5. The Connect Flow Audit Device screen will display. Attach a flow meter to the appropriate flow channel:
 - a. To audit the **main flow channel**, remove the inlet and attach the 1 1/4-inch flow adapter/meter to the top of the flow splitter (Figure 5-40). Disconnect the bypass line from the side of the flow splitter (don't let it fall to the ground) and cap the bypass fitting with the 3/8-inch Swagelok cap provided with the system (Figure 5-41).

Figure 5-40.
Flow adapter/meter attached to the flow splitter.

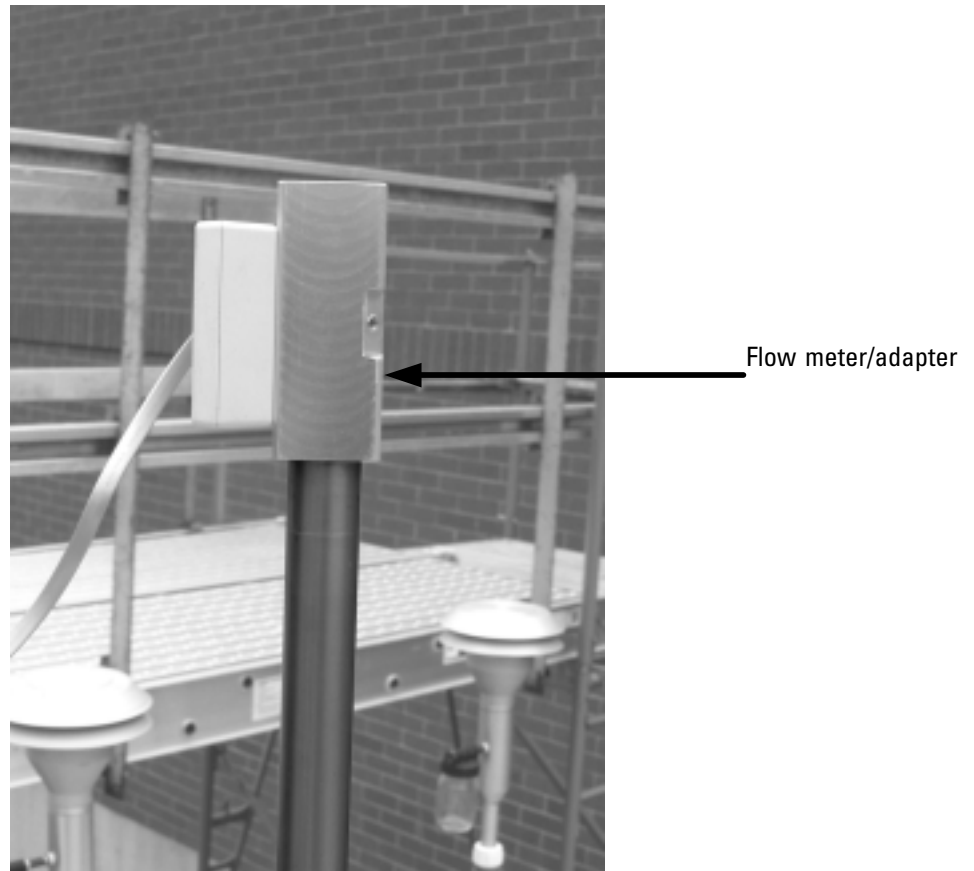
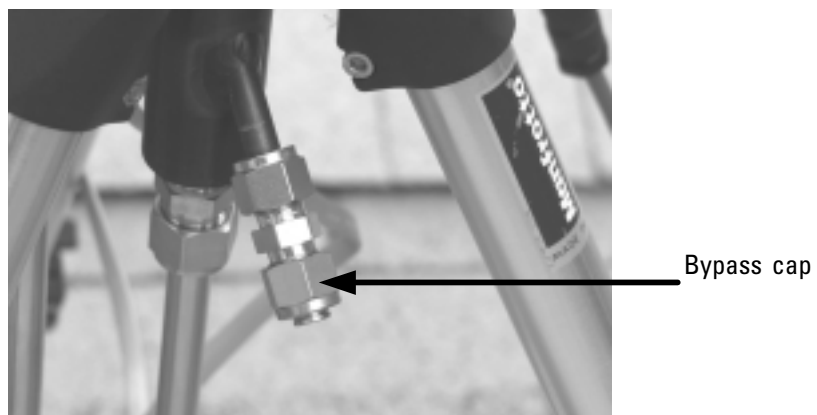

Figure 5-41.
Bypass line capped.



- b. To audit the **bypass flow channel**, remove the bypass line from the flow splitter and connect the 3/8-inch flow adapter to the green tubing of the bypass line (Figure 5-42). Connect the flow meter/adapter to the flow audit adapter.

When the flow meter is attached, select the **Next >** button.

Figure 5-42.
Bypass connection.

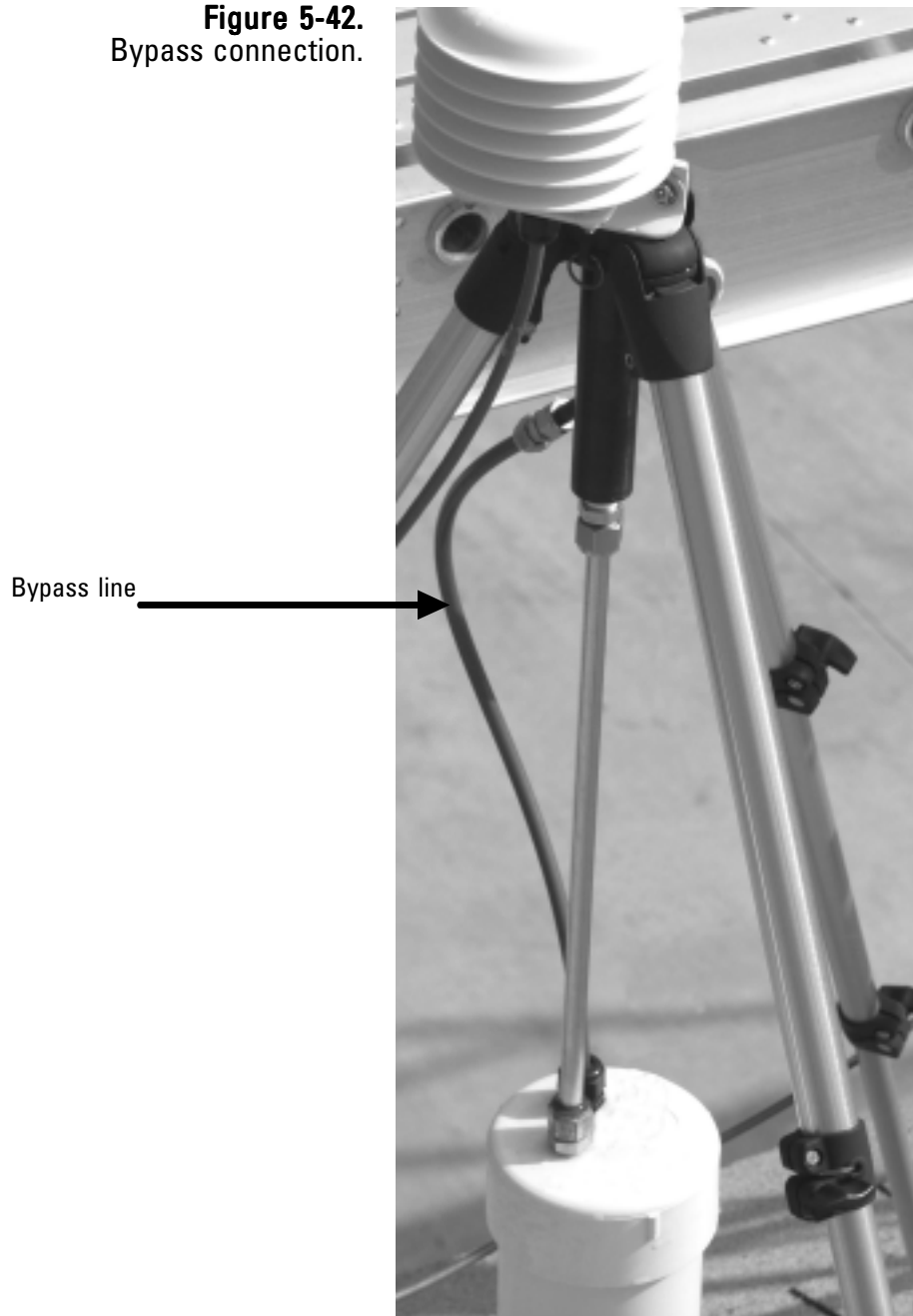

6. The Measure Flow screen will display. *Allow the flow to stabilize.* When the flow is stable, press the flow button and enter the reading from the flow device. Select the **Next >** button.
7. The Flow Audit Results screen will display the difference between the flow rate of the instrument and the flow rate on the measurement device (Figure 5-43). If the difference is less than 10 percent, you may adjust the flow rate to reflect the value on the audit device. Select the **Yes** button to adjust the flow based on the results of the flow audit. Select the **No** button to leave the original flow settings in place. Select the **Next >** button to return to the Select Flow screen and audit another flow channel.

Figure 5-43.
Flow Audit Results screen.

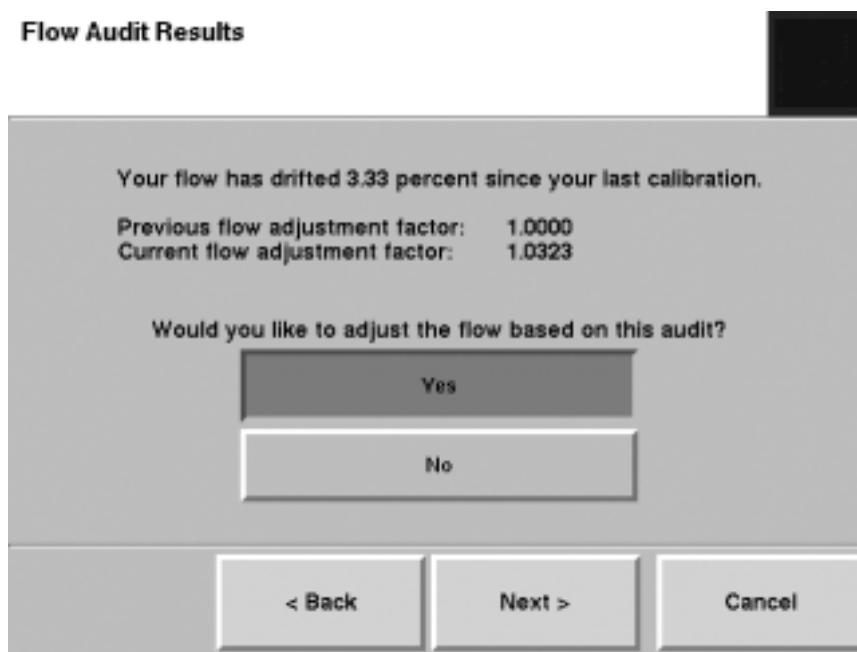

8. The Select Flow to Audit screen will display again. The flow channel that was just audited will be “grayed out” on the screen to show it was audited during this session. If you want to audit another flow channel, select another channel and follow steps 3 - 8 (and the wizard) to complete additional flow channels. Otherwise, ensure that no flow channel buttons are selected, and select the **Next >** button.

Note. If the difference is more than 10 percent, the flow will fail the audit and the unit requires a leak check/flow calibration (Figure 5-45). ▲

9. The Completing the Flow Audit Wizard screen will display (Figure 5-44). Remove the flow meter and flow adapter(s) and install the inlet. Ensure all lines, including the bypass, are reconnected. Select the **Finish** button to exit the wizard and return to the Verification screen, or select the **< Back** button to move backward one step in the procedure.

Figure 5-44.
Finish screen with flow audit results.

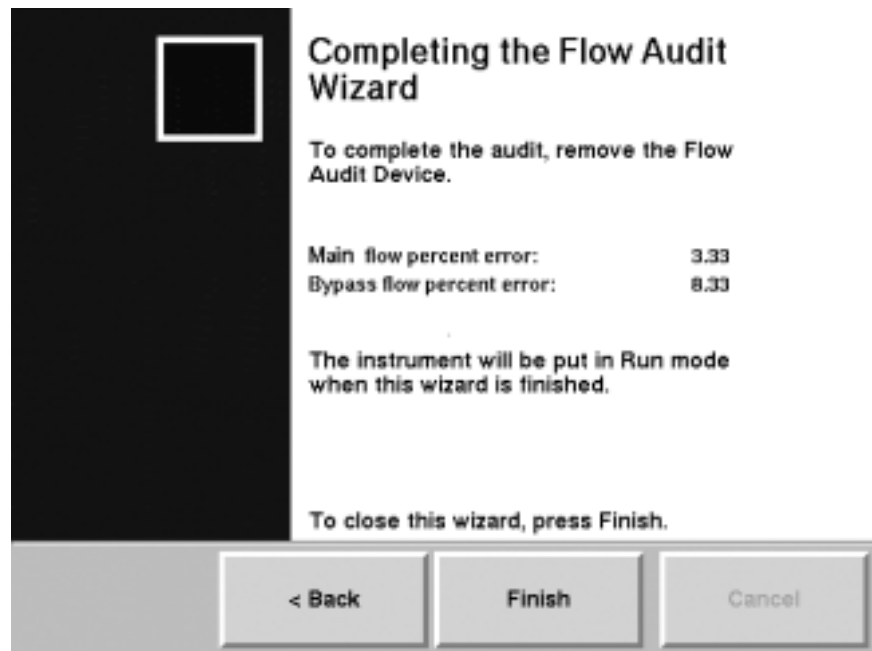
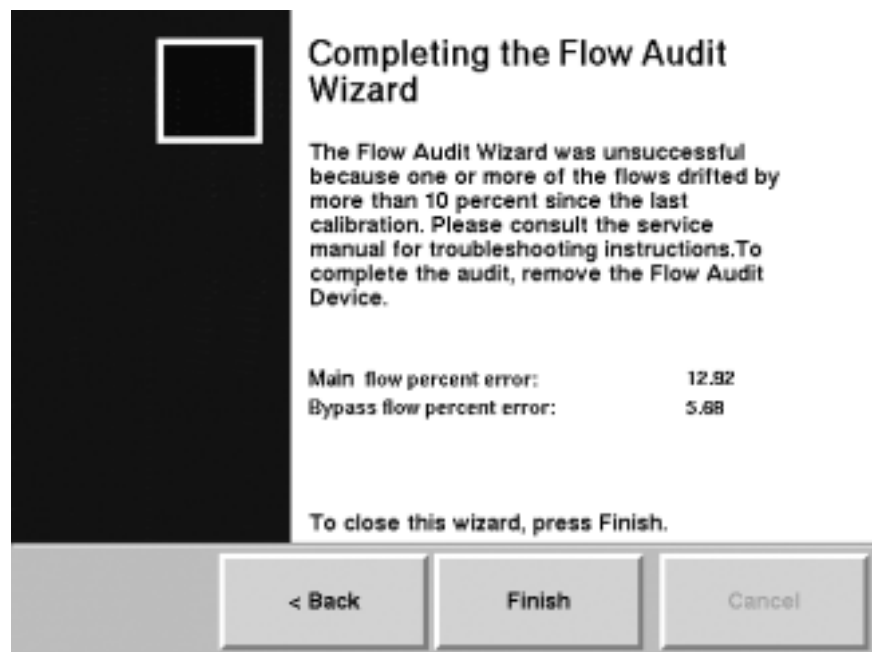

Figure 5-45.
Finish screen with a failed audit.



Calibrating the Flow Rates

Perform the ambient air temperature calibration, pressure calibration and leak check (Section 3) before executing the flow calibration procedure. To calibrate (or audit) the main and bypass flows, you will need a 1 1/4-inch flow adapter, a 3/8-inch Swagelok flow adapter and a flow measurement device.

The reference flow meter, such as a bubble meter, dry gas meter, or mass flow meter should have been recently calibrated to a primary standard, and should have an accuracy of $\pm 1\%$ at 3 l/min and 16.67 l/min, and a pressure drop of less than 0.07 bar (1 psi). If you are using a mass flow meter, you must make any necessary corrections to translate this reading to volumetric l/min at the current ambient temperature and barometric pressure. No adjustment is necessary in the case of a volumetric flow meter. Thermo Scientific offers the Streamline Pro Multi-Cal system (57-008887) to measure volumetric flow measurements.

Note. To audit the total flow, you will need a 1 1/4-inch flow adapter. Remove the inlet and attach the flow adapter and meter to the top of the inlet tube (Figure 5-46). ▲

Figure 5-46.
Flow meter/adapter attached to top of inlet tube for total flow audit.

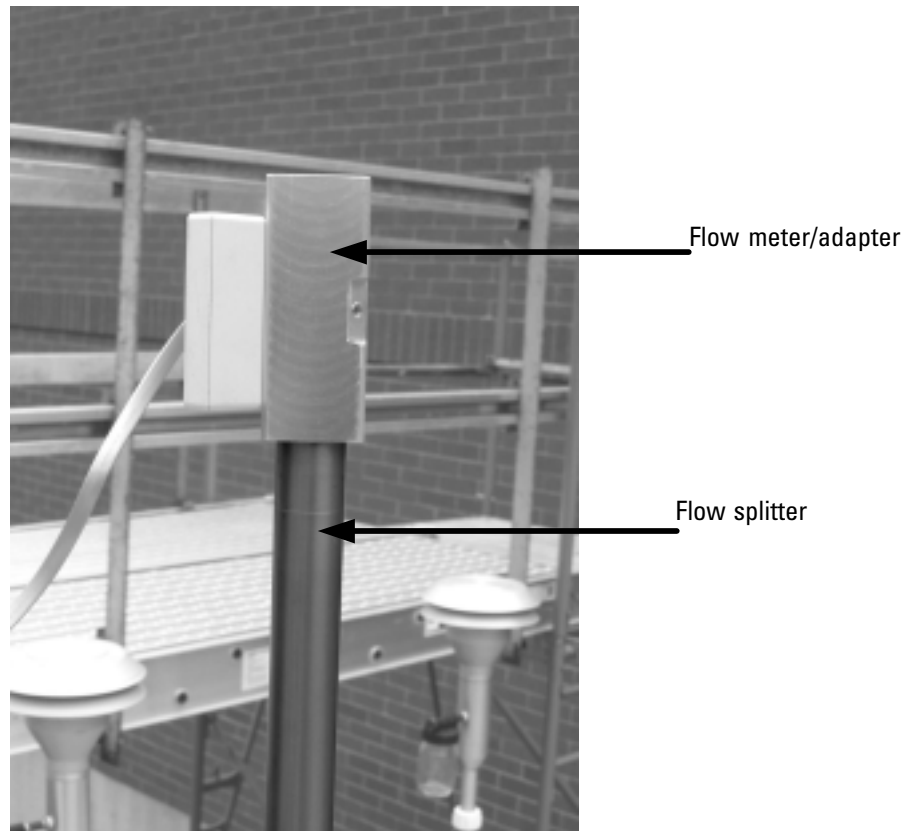

To calibrate the main or bypass flow:

1. In the TEOM Data screen, select the **Service** button to display the Service screen, then select the **Calibration** button to display the Calibration screen (Figure 5-42).
2. Select the **Flow Calibration** button to start the Flow Calibration Wizard (Figure 5-47). Select the **Next >** button to begin the procedure.

Figure 5-47.
Welcome to the Flow
Calibration Wizard screen.

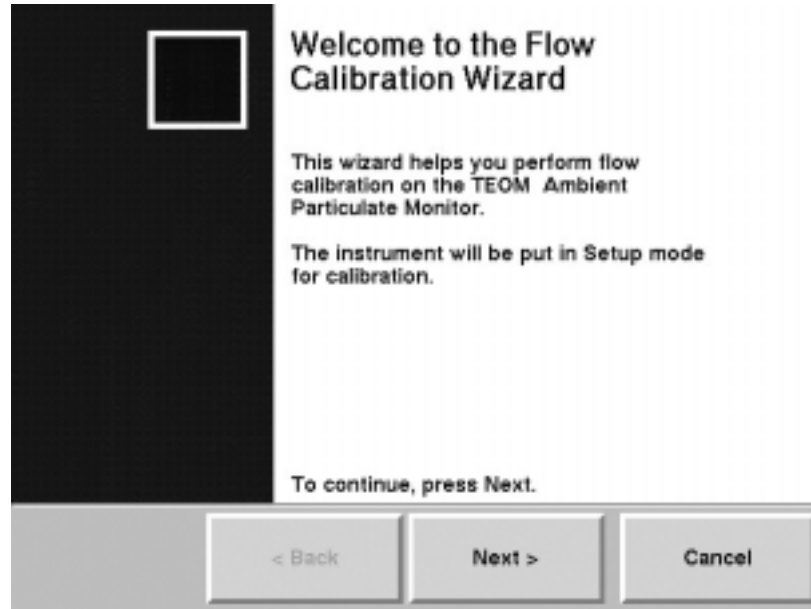

3. The Select a Flow Audit Device screen will display. Select a flow audit device. Select "Direct Flow Device" to audit the flow using a direct flow measuring device (reading "l/min" adjusted for temperature and pressure) such as the Streamline Pro. Select "FTS" to audit the flow using the FTS system. FTS users will enter the device calibration constant and the change in pressure from the FTS. Select the "Next >" button.
4. The Select Flow to Calibrate screen will display. Select the **Calibrate Main Flow** or **Calibrate Bypass Flow** button to calibrate the selected flow. Select the **Next >** button.

5. The wizard will prompt you to attach a flow meter to the appropriate flow channel:
 - a. To calibrate the **main flow channel**, remove the inlet and attach the 1 1/4-inch flow adapter/meter to the top of the flow splitter (Figure 5-48). Disconnect the bypass line from the side of the flow splitter (don't let it fall to the ground) and cap the bypass fitting with the 3/8-inch Swagelok cap provided with the system (Figure 5-49).

Figure 5-48.
Flow adapter/meter attached to the flow splitter.

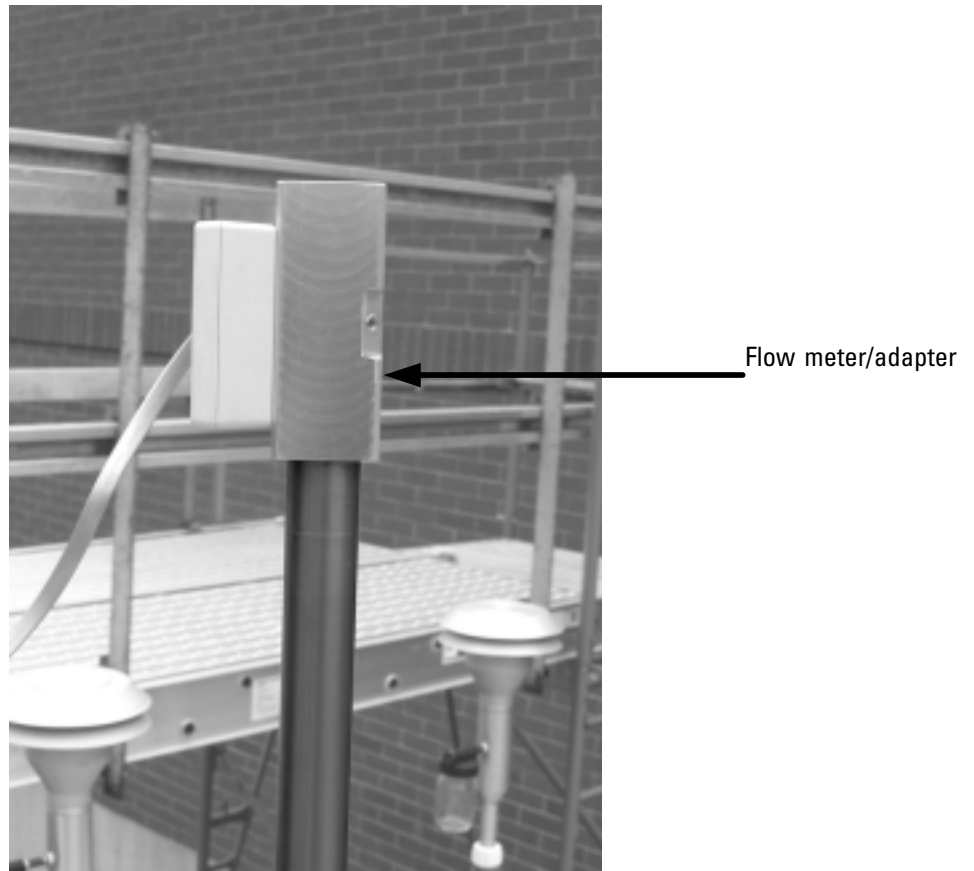
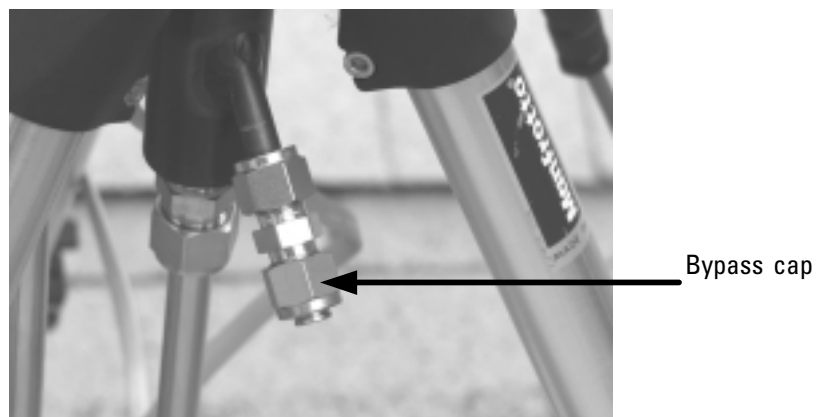

Figure 5-49.
Bypass line capped.



- b. To calibrate the **bypass flow channel**, remove the bypass line from the flow splitter and connect the 3/8-inch flow adapter to the green tubing of the bypass line (Figure 5-50). Connect the flow meter/adapter to the flow audit adapter.

When the flow audit device is attached to the correct channel, select the **Next >** button.

Figure 5-50.
Bypass connection.

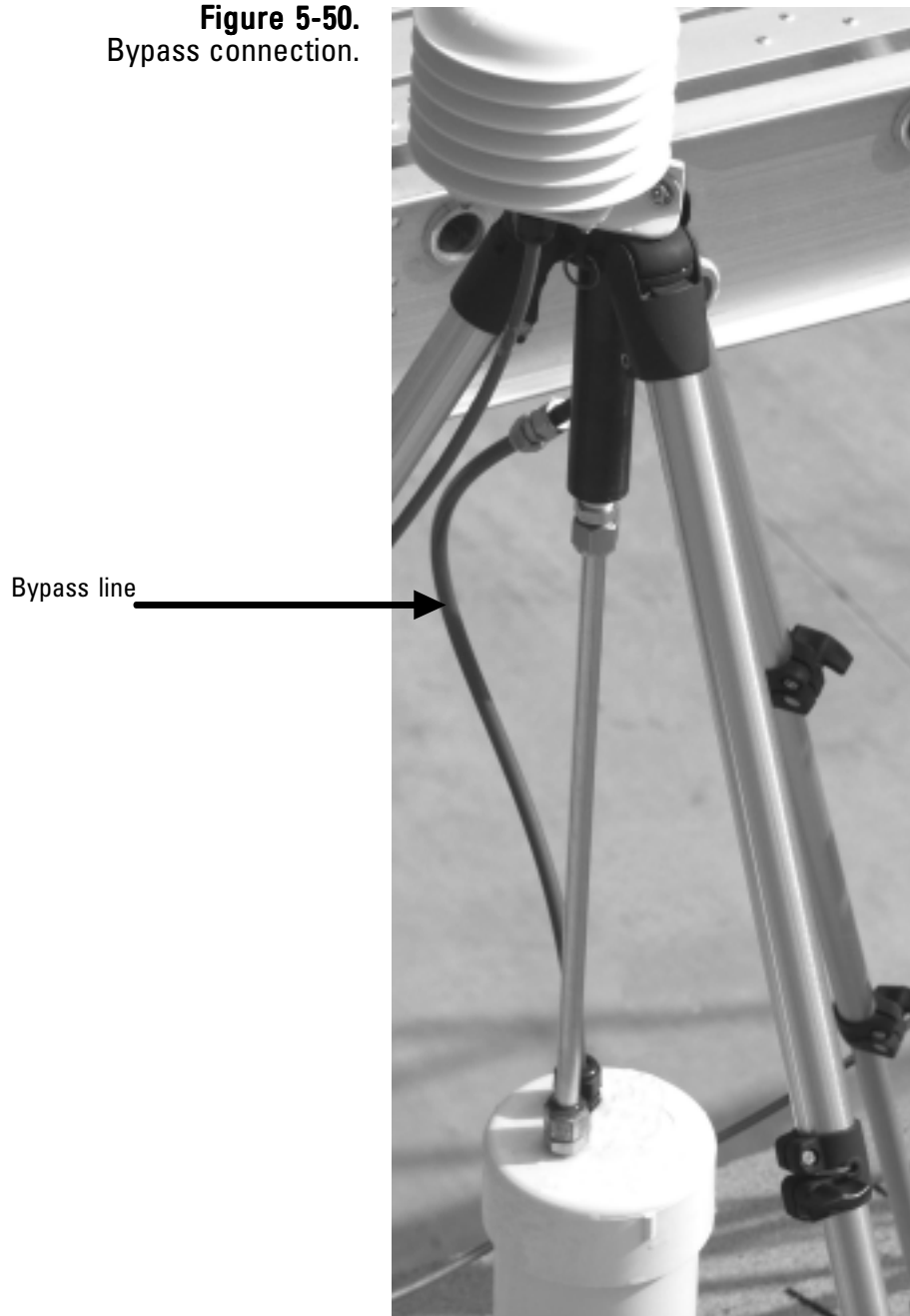

- The wizard will display a screen that shows the current low-setpoint flow rate (as measured by the instrument) in the **TEOM flow rate:** button (Figure 5-51). *Allow the flow to stabilize.* Select the **TEOM flow rate:** button and enter the current flow rate (to two decimal places) as measured by the flow meter into the number pad and select the **Enter** button. The newly entered flow rate will display in the **TEOM flow rate:** button. Select the **Next >** button.

Figure 5-51.
Flow Calibration screen.

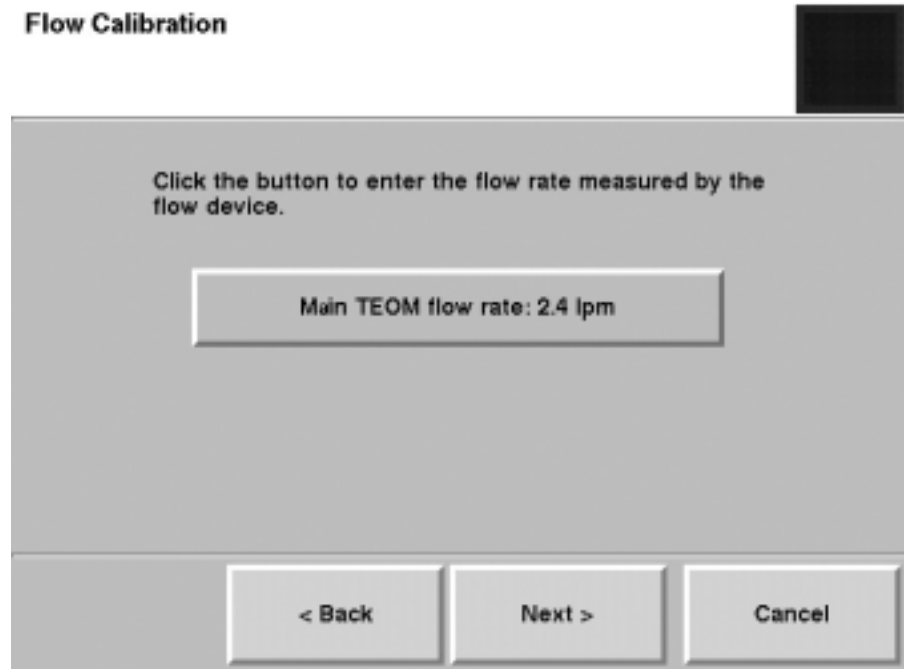

- The wizard will display a screen that shows the current high-setpoint flow rate (as measured by the instrument) in the **TEOM flow rate:** button. *Allow the flow to stabilize.* Select the **TEOM flow rate:** button and enter the current flow rate (to two decimal places) as measured by the flow meter into the number pad and select the **Enter** button. The newly entered flow rate will display in the **TEOM flow rate:** button. Select the **Next >** button.
- The wizard will display a screen that shows the current setpoint flow rate (as measured by the instrument) in the **TEOM flow rate:** button. *Allow the flow to stabilize.* Select the **TEOM flow rate:** button and enter the current flow rate (to two decimal places) as measured by the flow meter into the number pad and select the **Enter** button. The newly entered flow rate will display in the **TEOM flow rate:** button. Select the **Next >** button.

9. After the third flow value has been entered, the Select Flow to Calibrate screen will display again. The flow channel that was just calibrated will be “grayed out” on the screen to show it was calibrated during this calibration session. If you want to calibrate another flow channel, select another channel and follow steps 4 - 9 (and the wizard) to complete additional flow channels. Otherwise, ensure that no flow channel buttons are selected, and select the **Next >** button.
10. The Completing the Flow Calibration Wizard screen will display Figure 5-52). Remove the flow meter and flow adapter(s) and install the inlet. Ensure all lines, including the bypass, are reconnected. Select the **Finish** button to exit the wizard and return to the Calibration screen, or select the **< Back** button to move backward one step in the procedure.

Note. If you want to audit the total flow rate following the calibration procedure, see Figure 5-46. ▲

Figure 5-52.
Completing the Flow Calibration Wizard screen.



Calibrating the Analog Outputs

The Analog Output Calibration Wizard allows users to calibrate the eight analog output channels to either 0-1 VDC or 0-5 VDC.

Note. Always wear appropriate anti-static devices when working with the system electronics. ▲

To calibrate the analog outputs:

1. Attach an antistatic wrist strap to your wrist. Attach the other end of the wrist strap to the chassis of the control unit to discharge any static electricity while working on the unit.

Note. Always wear appropriate anti-static devices when working with the system electronics. ▲

2. Open the door to the unit (Figure 5-53) and locate the interface board mounted to the bottom of the unit.

Figure 5-53.
1405-DF unit with left door open.

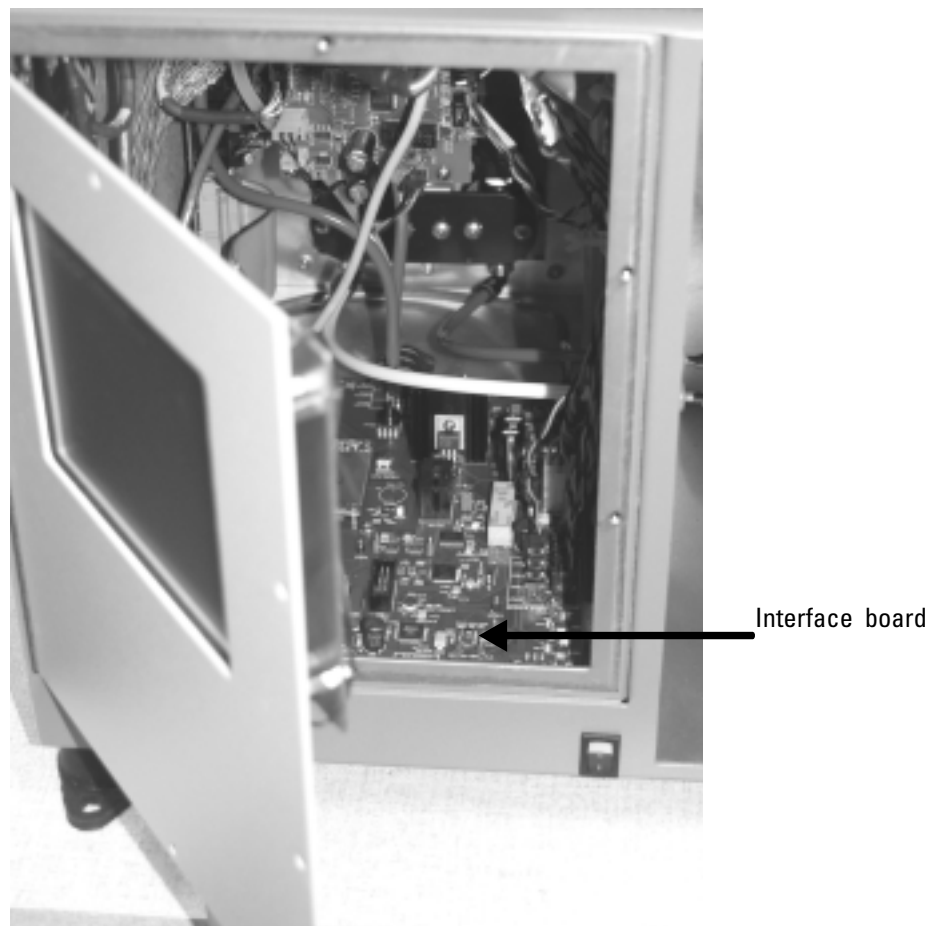

3. Locate the analog outputs jumpers and test points located at the front of the board and ensure that the jumper for the channel you are calibrating is set to the correct voltage limit (Figures 5-54 and 5-55).

Note. Set the jumper on the right and middle posts (pictured) for 0-1 VDC and over the middle and left posts for 0-5 VDC. ▲

Figure 5-54.
 Front of interface board with jumpers and testpoints highlighted.

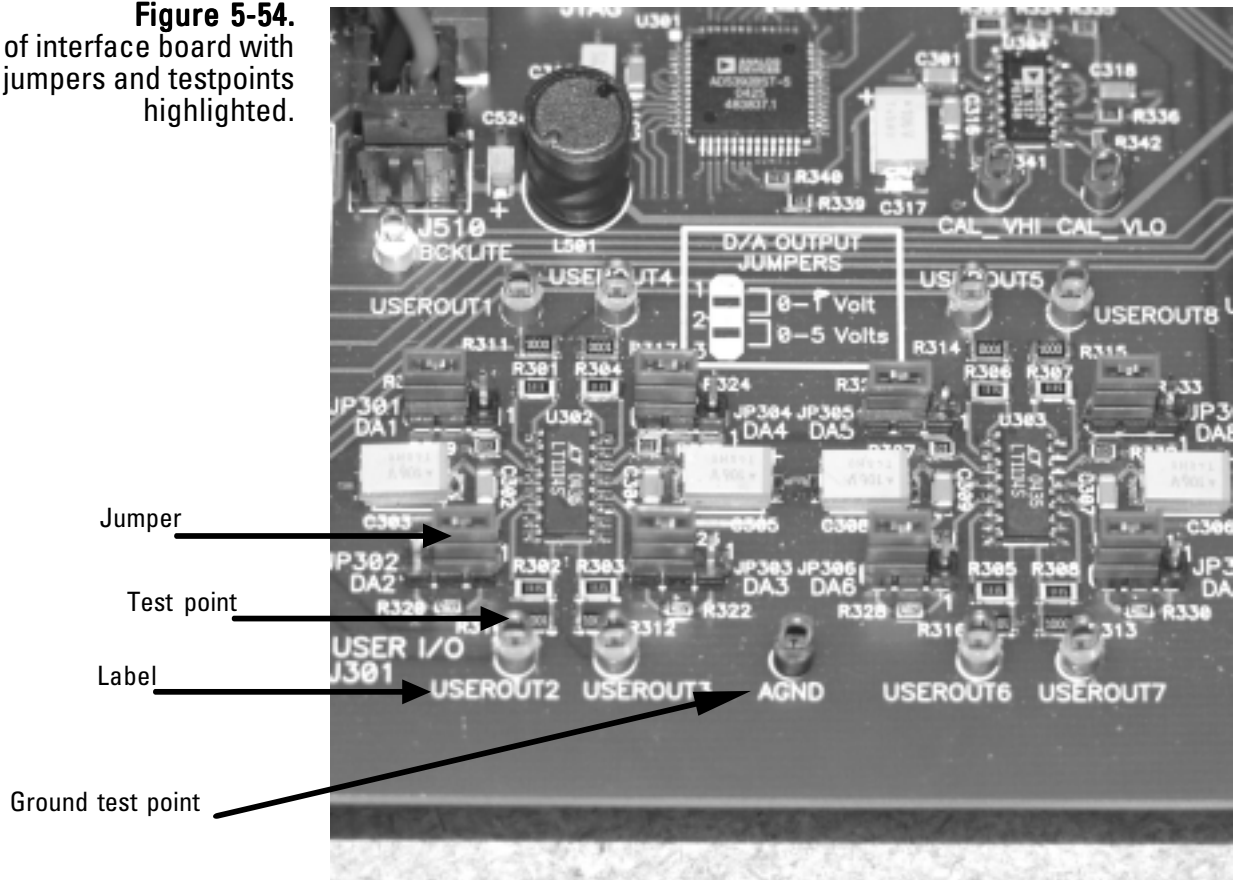
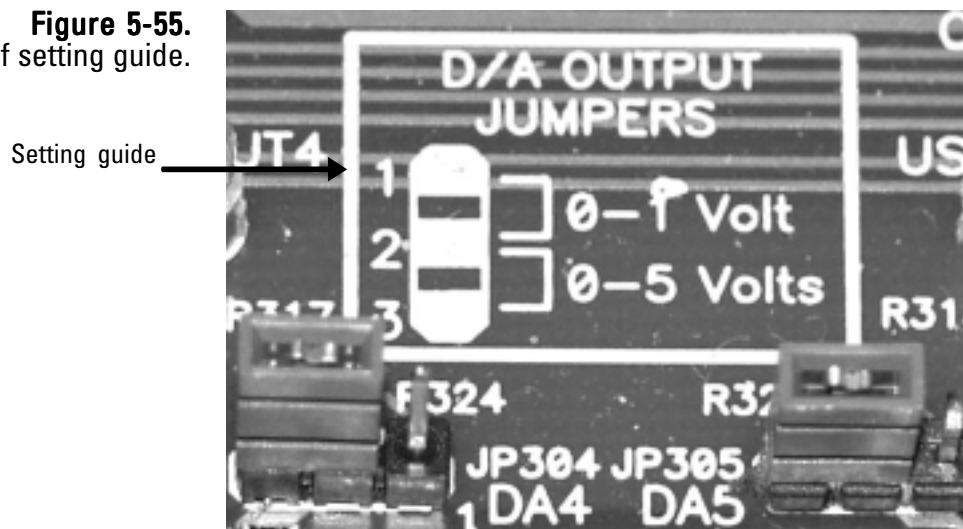

Figure 5-55.
 Close-up of setting guide.



4. In the 1405 Data screen, select the **Service** button to display the Service screen, then select the **Calibration** button to display the Calibration screen (Figure 5-32).
5. Select the **Analog Output Calibration** button to start the Analog Output Calibration Wizard (Figure 5-55). Select the **Next >** button to begin the procedure.

Figure 5-55.
Welcome to the Analog Output Calibration Wizard screen.



6. The Select Channel to Calibrate screen will display (Figure 5-56). Select which analog output channel you want to calibrate. Select the **Next >** button.

Figure 5-56.
Select Channel to Calibrate screen.

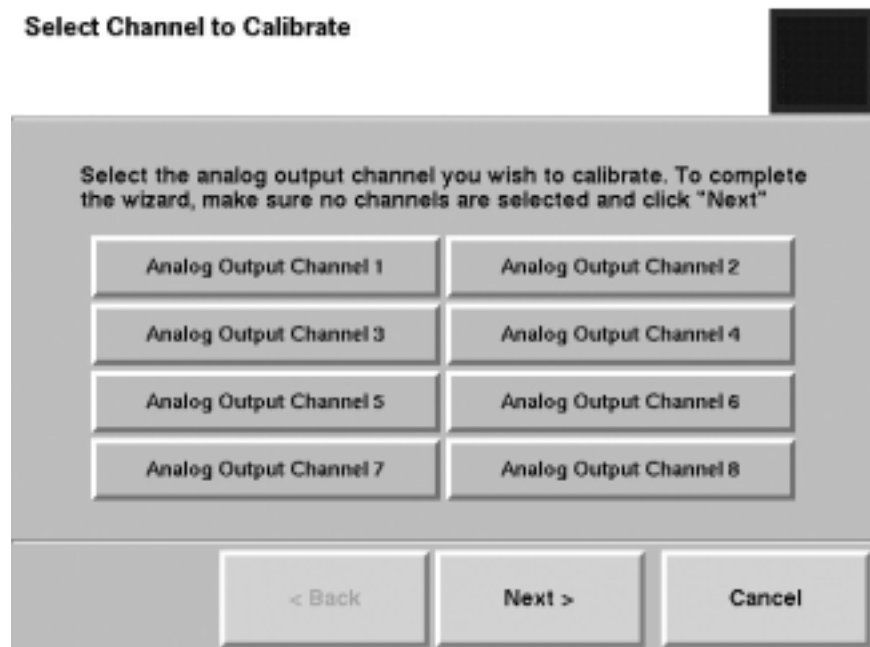

7. The Select Analog Output Range screen will display (Figure 5-57). Set the voltage range for the analog output. Select the **Next >** button.

Note. Ensure that the voltage range selected for the analog output channel matches the jumper voltage setting for the analog output channel (step 3). ▲

Figure 5-57.
Select Analog Output
Range screen

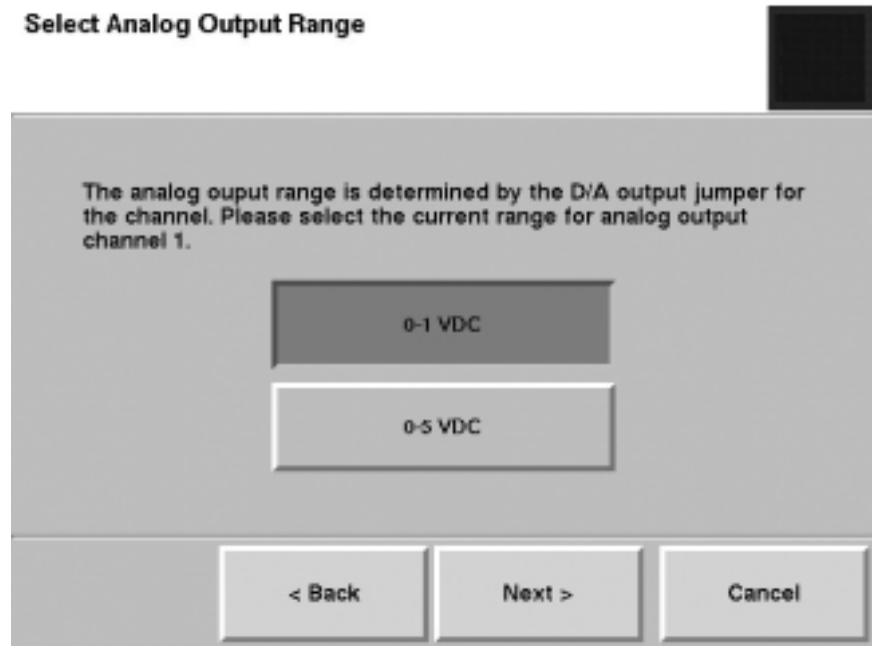

8. The Connect Meter screen will display (Figure 5-58). Locate the test point (Figure 5-54) for the analog output being calibrated and attach a voltmeter set to VDC to the test point and to the ground test point on the board. Select the **Next >** button.

Figure 5-58.
Connect Meter screen.

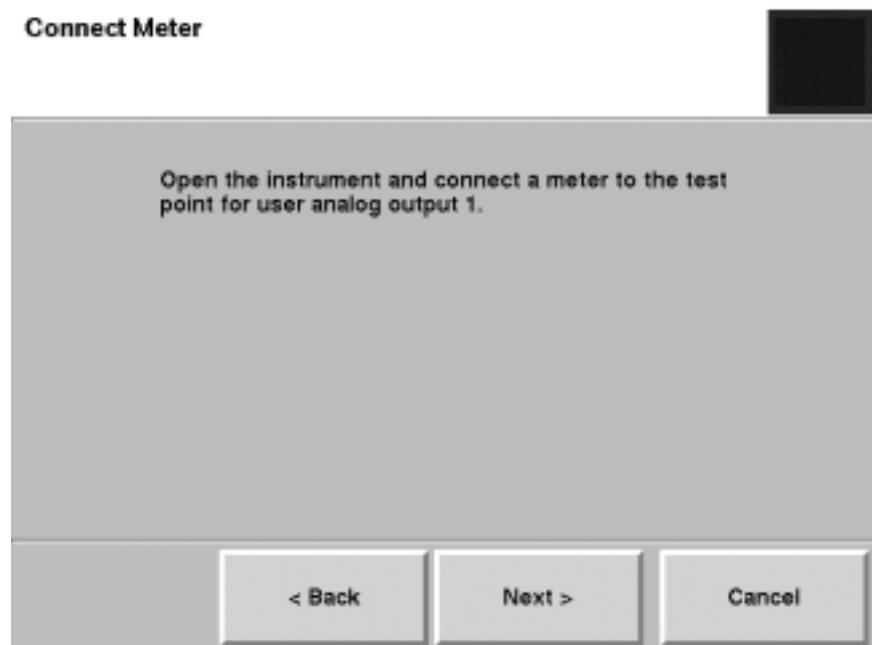

9. The Measure Low Setting screen will display (Figure 5-59). Compare the reading on the volt meter to the reading on the screen. If the readings are different, select the **Current reading:** button to display the number keypad and enter the current reading, and press the **Enter** button. Select the **Next >** button.

Figure 5-59.
Measure Low Setting screen.

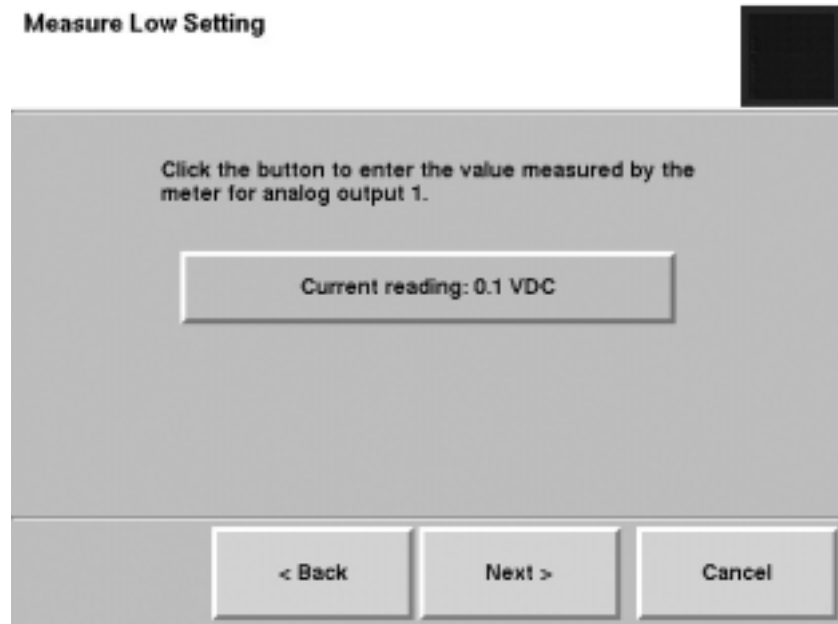

10. The Measure High Setting screen will display (Figure 5-60). Compare the reading on the volt meter to the reading on the screen. If the readings are different, select the **Current reading:** button to display the number keypad and enter the current reading, and press the **Enter** button. Select the **Next >** button.

Figure 5-60.
Measure High Setting screen.

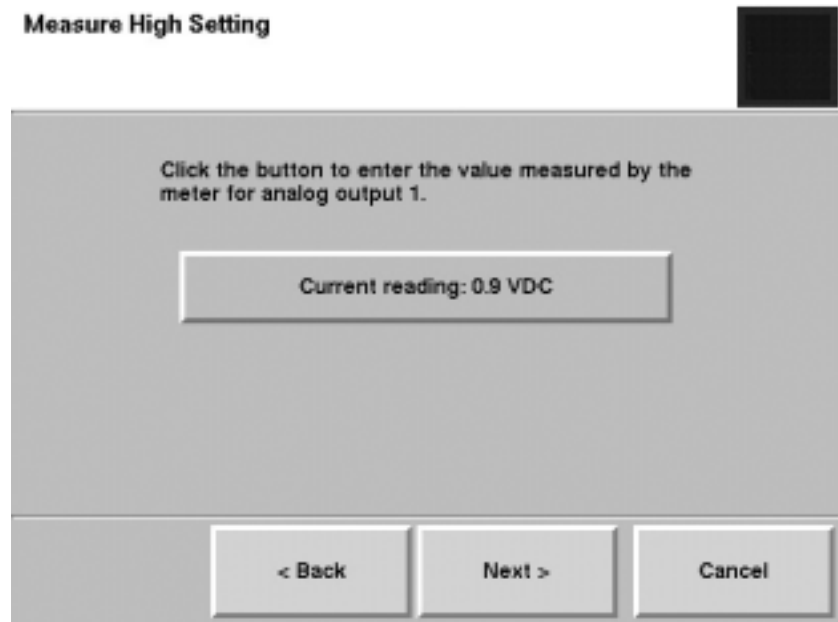

11. The Select Channel to Calibrate screen will display again. The channel that was just calibrated will be “grayed out” on the screen to show it was calibrated during this calibration session. If you want to calibrate another analog output channel, select another channel then the **Next >** button and follow steps 1 - 9 (and the wizard) to complete additional channels. Otherwise, ensure that no Analog Output Channel buttons are selected, and select the **Next >** button.
12. The Completing the Analog Output Calibration Wizard screen will display (Figure 5-61). Select the **Finish** button to exit the wizard and return to the Verification & Calibration screen, or select the **< Back** button to move backward one step in the procedure.

Figure 5-61.
Completing the Analog Output
Calibration Wizard screen.

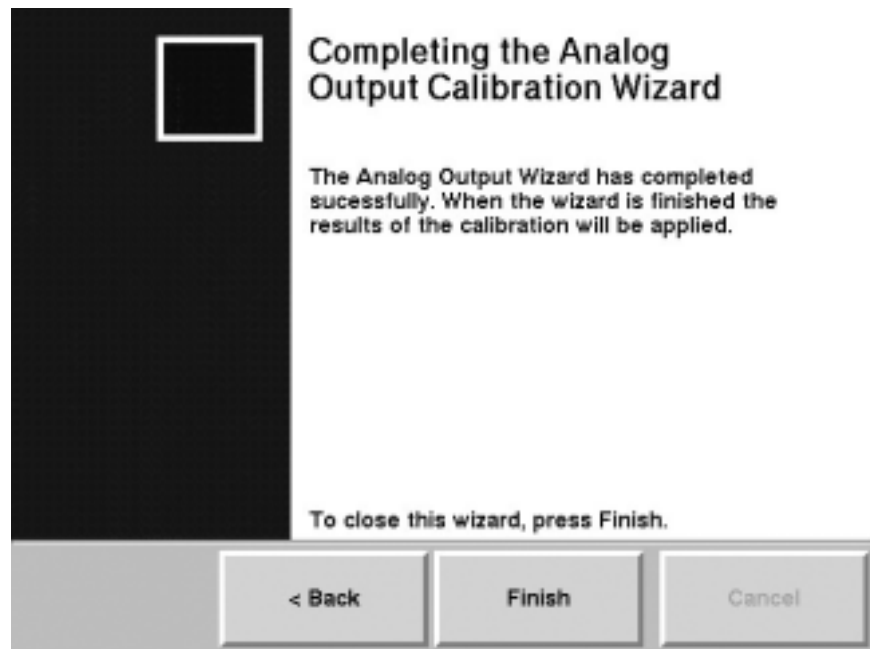

Verifying the Calibration Constant

The calibration of the mass transducer in the TEOM 1405 Monitor is determined by the mass transducer's physical mechanical properties. Under normal circumstances, the calibration does not change materially over the life of the instrument. Contact Thermo Scientific if the results of the verification procedure fails. You can locate the original calibration constant on the "Instrument Checkout Record" or the "Final Test Record" documents that are shipped from the factory with the instrument.

Before the TEOM 1405 is shipped to the customer, it is calibrated with a new, pre-weighed TEOM filter installed in its mass transducer as a calibration weight. Because the mass of the filter cartridge with particulate matter differs from the mass of a new filter cartridge by only a small fraction, calibrating the system with a calibration mass equivalent to the filter mass allows all measurements to be made at essentially the same operating point as the original calibration. Refer to Section 1 for a detailed explanation of how the calibration constant, K_p , is derived.

To audit/verify the K0 number requires a mass calibration verification kit (59-002107), which includes a pre-weighed filter, a filter exchange tool, desiccant and a humidity indicator) and the pre-filter with a half-inch quick-connect fitting supplied with the instrument.

Note. Refill kits for the mass calibration verification kit are available from Thermo Scientific (59-002019). ▲

To confirm the system's K₀ calibration:

1. Confirm that the K0 number entered into the instrument and the K0 number on the plate near the mass transducer are the same. The K0 number entered into the unit can be found in the Audit screen (Figure 5-35)
2. Ensure the instrument is at the normal operating temperature and condition.
3. Ensure that the pre-weighed filter in the kit matches the humidity conditions for the test, as shown on the card provided with the kit.

Note. If the filter does not match the conditions listed on the humidity indicator, follow the instructions provided with the kit to dry the filter to an acceptable level. ▲

4. In the TEOM Data screen, select the **Service** button to display the Service screen, then select the **Calibration** button to display the Calibration screen (Figure 5-33).
5. Select the **Mass Transducer K0 Verification** button to start the K0 Verification Wizard (Figure 5-62). Select the **Next >** button to begin the procedure.

Figure 5-62.
Welcome to K0 Verification
Wizard screen.

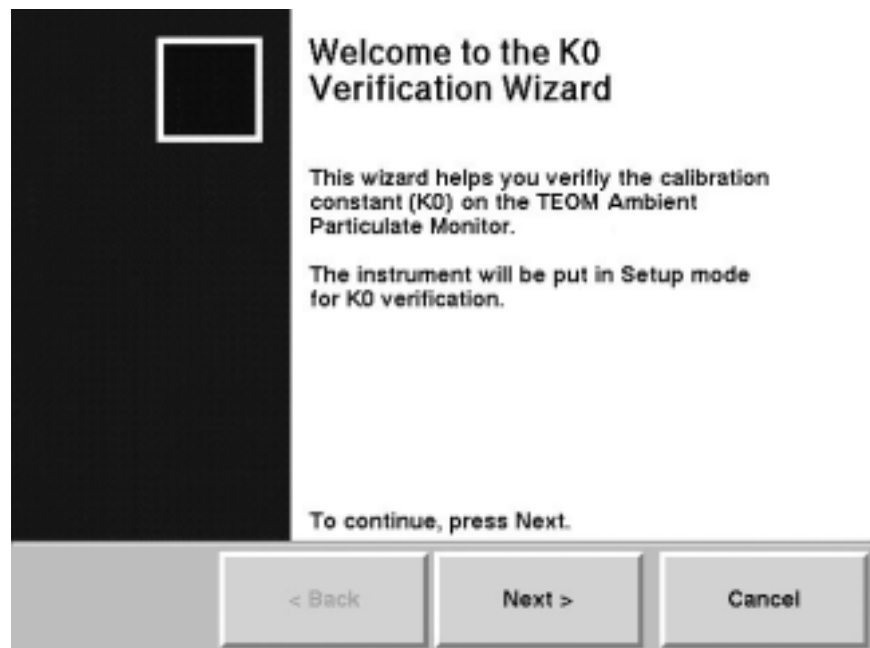

SECTION 5

MAINTENANCE AND CALIBRATION PROCEDURES

6. The Install Pre-Filter screen will display (Figure 5-63). Remove the inlet and install the flow audit adapter onto the flow splitter, then install the pre-filter assembly (the filter and short length of silicone tubing) onto the flow audit adapter (Figure 5-64). Select the **Next >** button.

Figure 5-63.
Install Pre-Filter screen.

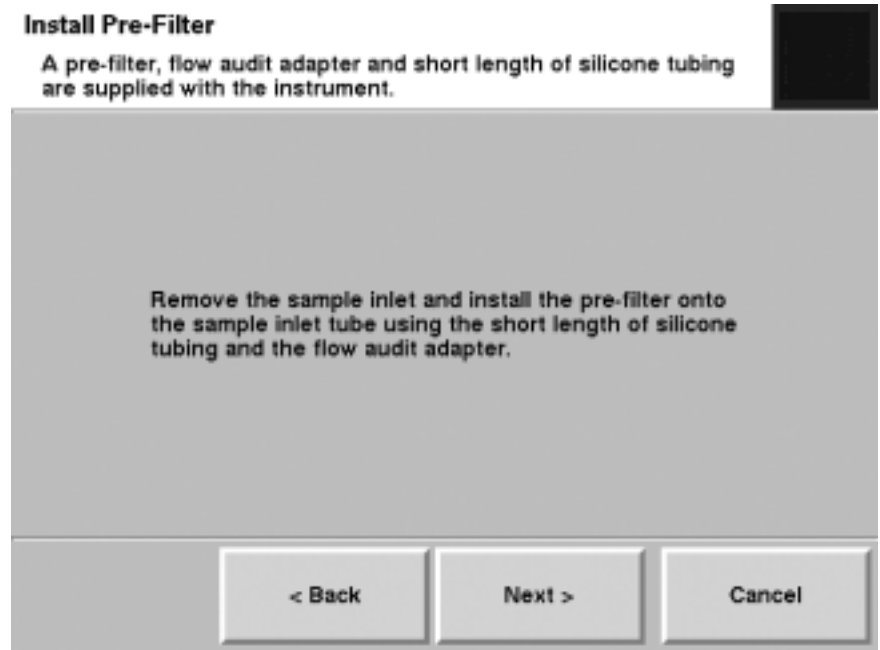
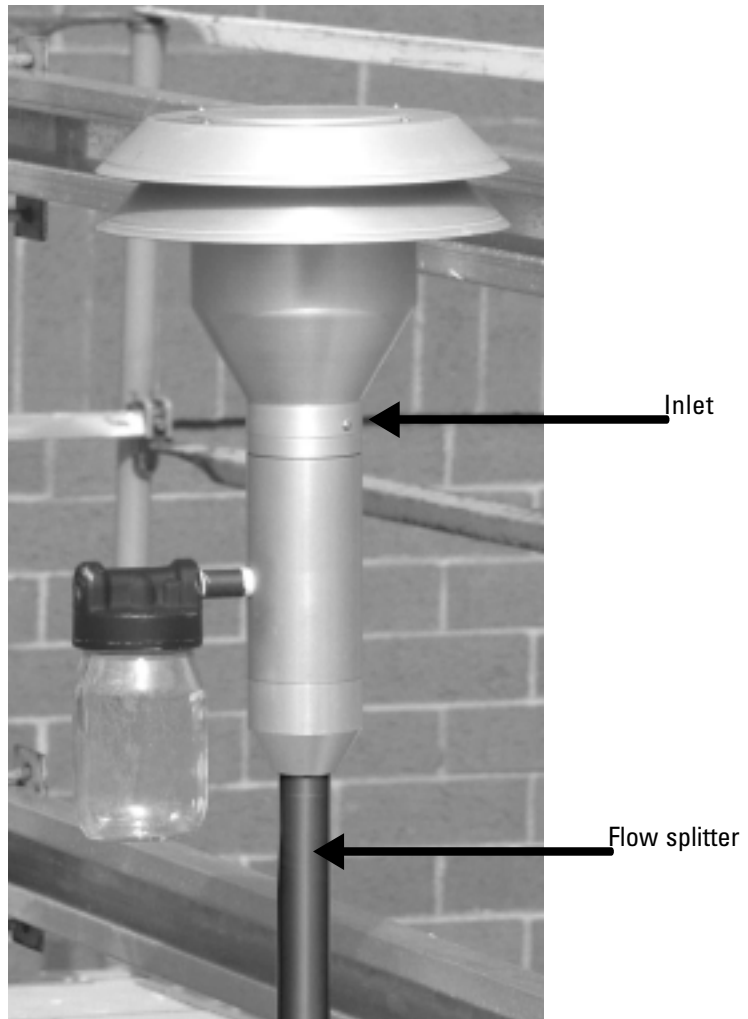

Figure 5-64.
Series 1405 inlet assembly.



7. The Remove Sample Filter screen will display. Open the mass transducer and remove the standard TEOM filter from the mass transducer. (Refer to the section on installing/removing TEOM filter for assistance on removing the filter.) Close the mass transducer (without installing another filter). Select the **Next >** button.

Note. DO NOT use the calibration filter exchange tool for installing or removing ANY filter other than the pre-weighed calibration filter. ▲

8. The Stabilizing screen will display (Figure 5-65). While the instrument waits to measure the frequency of the system with no TEOM filter installed, a countdown timer on the screen will show the progress of the stabilization step. When the stabilization “Complete” message displays, select the **Next >** button.

Figure 5-65.
Stabilizing screen.

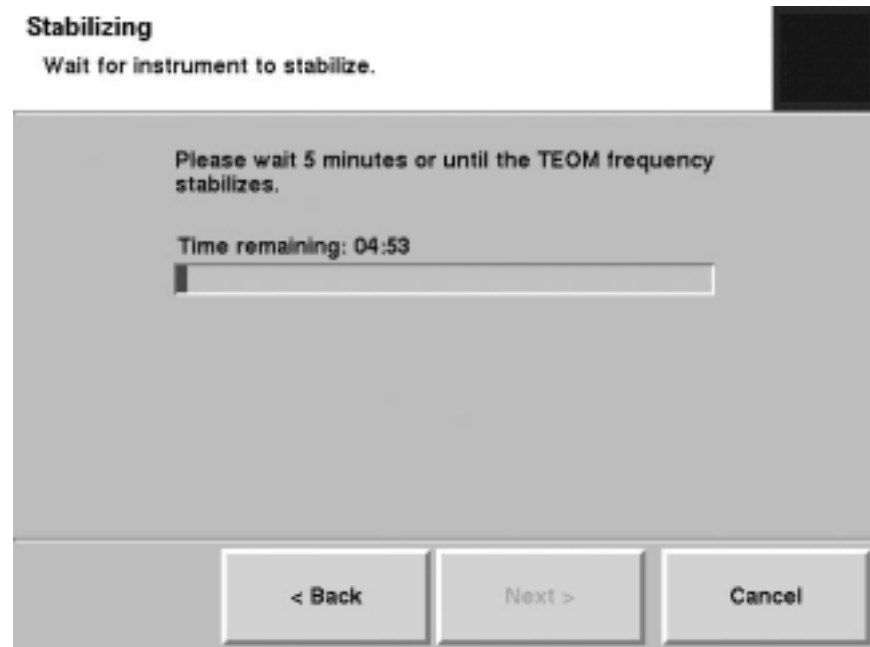

9. The Enter Filter Weight screen will display (Figure 5-66). Select the **Filter Weight:** button. The keypad will display. Enter the weight of the pre-weighed filter into the system and press the **Enter** button to save the value and exit the keypad. Select the **Next >** button.

Figure 5-66.
Enter Filter Weight screen.



10. The Install Calibration Filter screen will display (Figure 5-67). Correctly install and properly seat the pre-weighed calibration/verification filter onto the mass transducer using the calibration filter exchange tool. (Follow the instructions for changing a filter earlier in this section.) Select the **Next >** button.

Note. DO NOT use the calibration filter exchange tool for installing or removing ANY filter other than the pre-weighed calibration filter. ▲

Figure 5-67.
Install Calibration Filter screen.

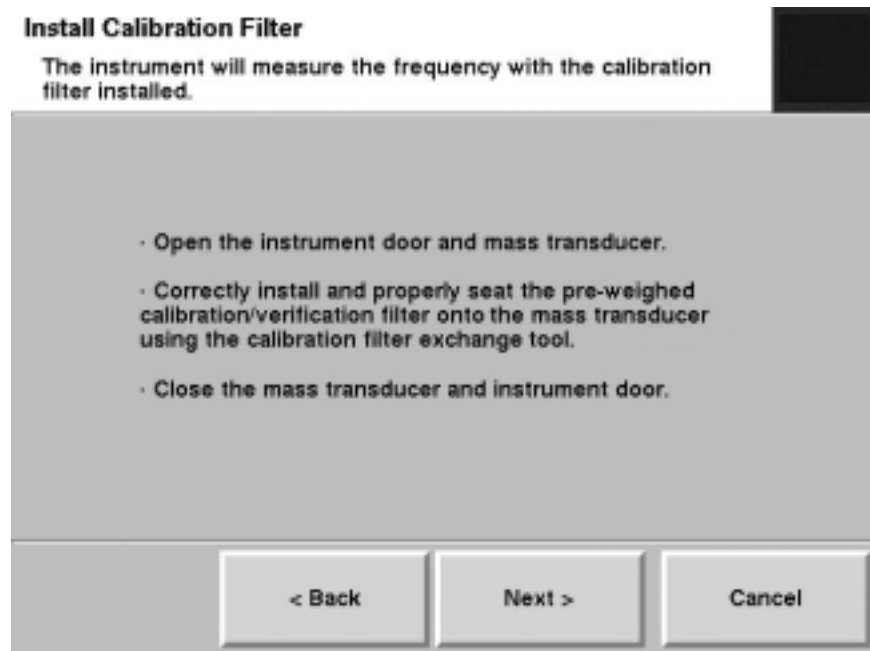

11. The Stabilizing screen will display while the instrument waits for the frequency of the TEOM calibration filter. A countdown timer on the screen will show the progress of the stabilization step (Figure 5-68). When the stabilization “Complete” message displays, select the **Next >** button.

Note. If the frequency doesn’t stabilize, the wizard will display a screen with instructions to re-seat the filter. Re-seat the filter and select the **Next >** button. The Stabilizing screen will display. If the unit is unable find a stable frequency the second time, the unit will fail the K0 audit (Figure 5-70). ▲

12. The Replace Sample Filter screen will display (Figure 5-68). Remove the calibration filter with the calibration filter removal tool. Correctly install and properly seat a new TEOM filter onto the mass transducer using the regular filter exchange tool. (Follow the instructions for changing a filter earlier in this section.) Select the **Next >** button.

Note. DO NOT use the calibration filter exchange tool for installing or removing ANY filter other than the pre-weighed calibration filter. ▲

Note. If the frequency doesn't stabilize, the wizard will display a screen with instructions to re-seat the filter. Re-seat the filter and select the **Next >** button. The Stabilizing screen will display. If the unit is unable find a stable frequency the second time, the unit will fail the KO audit (Figure 5-70). ▲

Figure 5-68.
Replace Sample Filter screen.

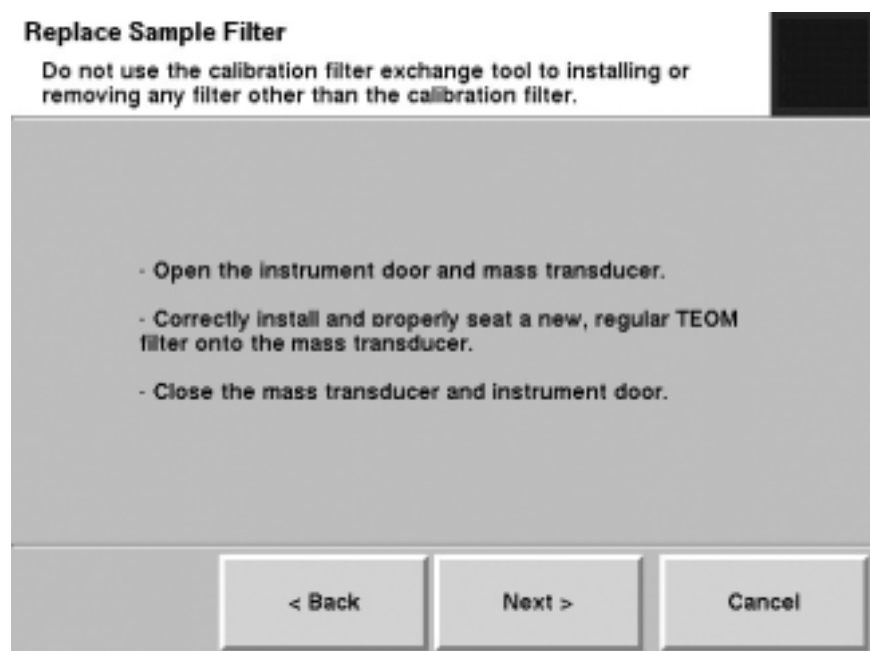

- When the final verification has been performed, the Completing the K0 Verification Wizard screen will display. The screen will display either a pass (Figure 5-69) or a fail (Figure 5-70) message for each K0 number. Select the **Finish** button.

Note. If one or both of the K0 verifications fail, repeat the procedure for that K0 number. If the verification fails again, contact Thermo Scientific. ▲

Figure 5-69.
Completing to K0 Verification Wizard screen with a pass message.



Figure 5-70.
Completing the K0 Verification Wizard screen with a fail message.



Appendix A Troubleshooting

The current status condition is located in the status bar at the bottom of the TEOM Data screen (Section 4), and most other instrument screens. In data files, however, status codes are reported as decimal/hexadecimal numbers). The decimal number reported by the unit must be compared to the list of status codes (Table A-1). If the exact decimal code does not appear in the list, multiple status codes are present, and the decimal must be converted to hexadecimal number in order to determine which codes are being reported by the unit.

Note. The status code list in this section (Table A-1) shows codes for both single and dual 1405 systems, as well as those equipped with the FDMS system. ▲

Table A-1. 1405 Status Codes

Code	Warning	Decimal	Reason for warning
0x40000000	%RH High Side A	1,073,741,824	>= 98%
0x20000000	Dryer A	536,870,912	> 2
0x10000000	Cooler A	268,435,456	> 0.5 C deviation
0x08000000	Exchange Filter A	134,217,728	> 90
0x04000000	Flow A	67,108,864	> 10% deviation
0x02000000	Heaters Side A	33,554,432	> 2% deviation
0x01000000	Mass Transducer A	16,777,216	frequency < 10 Hz
0x00400000	%RH High Side B	4,194,304	>= 98%
0x00200000	Dryer B	2,097,152	> 2
0x00100000	Cooler B	1,048,576	> 0.5 C deviation
0x00080000	Exchange Filter B	524,288	> 90
0x00040000	Flow B	262,144	> 10% deviation
0x00020000	Heaters Side B	131,072	> 2% deviation
0x00010000	Mass Transducer B	65,536	frequency < 10 Hz
0x00004000	User I/O Device	16,384	
0x00002000	FDMS Device	8,192	
0x00001000	Head 1	4,096	
0x00000800	Head 0	2,048	
0x00000400	MFC 1 Device	1,024	
0x00000200	MFC 0 Device	512	
0x00000100	System Bus	256	
0x00000080	Vacuum Pressure	128	(Ambient - Vac) < 0.1 atm
0x00000040	Case or Cap Heater	64	> 2% deviation
0x00000020	FDMS Valve	32	
0x00000010	Bypass Flow	16	> 10% deviation
0x00000004	Database	4	Unable to log to the database
0x00000002	Enclosure Temp	2	temperature exceeds 60 C
0x00000001	Power Failure	1	

Converting Decimal/Hexadecimal Numbers

The easiest way to convert the decimal numbers reported by the unit is to use the calculator on a Windows-based PC.

To convert a decimal status code to a hexadecimal number:

- 1) Open the Windows calculator (it's located in **Accessories** under **All Programs** in the Start menu.
- 2) Select **View**, then **Scientific** to open the scientific-style calculator.
- 3) Select **Dec** to choose the decimal calculator option, and then enter the decimal status number into the calculator
- 4) Select **Hex** to choose the hexadecimal calculator option. The new number displayed in the calculator is the hexadecimal number you will use to decipher the status code list.

Note. To convert a hexadecimal to a decimal number, select **Hex**, type in the hexadecimal number then select **Dec**. ▲

To properly use the hexadecimal numbers converted from the decimal data download, separate the converted number and the status codes on the table into place holders: the “one’s,” “ten’s,” “100’s,” “1,000’s,” “10,000’s,” and “100,000’s” and the “1,000,000’s” place. Each “place” in the converted code will have a hexadecimal digit. Each hexadecimal digit (0 -F) in each place will have a unique status code (or set of status codes) that go with it.

Table A-2.
Hex digits and status codes.

Decimal Number	Hex Number	Code (Sum of Codes)
0	0	0
1	1	H(1)
2	2	H(2)
3	3	H(1), (H)2
4	4	H(4)
5	5	H(1), H(4)
6	6	H(2), H(4)
7	7	H(1), H(2), H(4)
8	8	H(8)
9	9	H(1), H(8)
10	A	H(2), H(8)
11	B	H(1), H(2), H(8)
12	C	H(4), H(8)
13	D	H(1), H(4), H(8)
14	E	H(2), H(4), H(8)
15	F	H(1), H(2), H(4), H(8)

Deciphering Status Codes

When the unit shows more than one status code, it adds the codes together and displays them as a decimal sum. For example, if the unit displays a Memory status code (listed as hexadecimal number “(H)1” on the instrument’s specific status code table) and a Valve A status code (listed as hexadecimal number “(H)4” on the instrument’s specific status code table) at the same time, the two status codes (when downloaded) would be displayed as the decimal number “5.”

The decimal number “5” must then be converted back to hexadecimal (in this case also “5”) to match the status code table. Only two status codes would add up to a value of 5 (Table A-2). By looking at instrument’s specific table and breaking down the downloaded status codes, you will be able to decipher which status codes the unit has displayed. Repeat the operation for each place in the hexadecimal code (10’s, 100’s, etc.).

Example For example, decipher the following decimal status code (8433666) for an instrument with the given example status code table (Table A-3).

First convert the decimal status code downloaded from the monitor to a hexadecimal number using the Windows (or another scientific) calculator:
8433666 = (H)80B002

Table A-3. Example status code table

Code	Warning	Code	Warning
&H1	Flash Memory	&H4000	Leak on Loop A
&H2	Power Switch (TPIC)	&H8000	Leak on Loop B
&H4	Valve A	&H10000	Audit Failure
&H8	Valve B	&H20000	System Reset
&H10	Filter A Temperature	&H40000	Power Failure
&H20	Filter B Temperature	&H80000	Sample volume low
&H40	Heater A Temperature	&H100000	Meter Out of Range (>98%)
&H80	Heater B Temperature	&H400000	AC Voltage Out of Bounds
&H800	External Sample Tube Temperature	&H800000	Sensor Comm Problem
&H1000	Serial Port Problem	&H10000000	Pinch Valve
&H2000	Line Printer Problem		

- In the “one’s” place of the status code, a status code of “2” is displayed. In the “one’s” place of the status code table, the “2” status code matches the (H)2 “Power Switch (TPIC)” status code. This is one of the status codes that the unit is displaying in its status code.
- In the “ten’s” place of the status code, there are no (0) status codes displayed.
- In the “100’s” place of the status code, there are no (0) status codes displayed.
- In the “1,000’s” place of the status code, a status code of “B” is displayed. Because there are no status codes in the status code table that match this number, the numbers needs to be broken down further. Convert “B” to a decimal number using Table A-2 — which converts B to “11.” Next, look at the status code table to decipher the status code. In the “1,000’s” place of the table, there are three status codes that, when added together, will total 11: (H)1000 “Serial Port Problem,” (H)2000 “Line Printer Problem” and (H)8000 “Leak on Loop B.” These are three more of the status codes that the unit is displaying in its status code.
- In the “10,000’s” place of the status code, there are no (0) status codes displayed.
- In the “100,000’s” place of the status code (800000), a status code of “800000” is displayed, which matches: (H)800000: “Sensor Comm Problem.”
- In the “1,000,000’s” place of the status code, there are no (0) status codes displayed.

Therefore, the downloaded status code “8433666” ((H)80B002) breaks down into the following status codes, according to the example status code table:

(H)2 “Power Switch (TPIC)”
 (H)1000 “Serial Port Problem”
 (H)2000 “Line Printer Problem”
 (H)8000 “Leak on Loop B”
 (H)800000: “Sensor Comm Problem.”

Notes

Appendix B Serial Communication

The TEOM 1405 Monitor supports AK Protocol. This protocol permits a locally or remotely located computer to obtain information electronically from the unit. These protocols are described in this appendix.

AK Protocol

The AK Protocol allows the user to query the present value of any system variable remotely, and allows the user to change those system variable values. The user also can download information from the internal data logger. The RPComm software program uses this protocol for two-way communication directly to a personal computer or through a modem.

The following AK Protocol commands are presented in detail on the following pages:

- **AREG (Ask Register Command).** The user can query the TEOM 1405 Monitor for the current value of any system variable.
- **EREG (Enter Register Command).** The user can assign a new value to any system variable. Great care must be taken when using this command, as the value of variables should only be changed when the monitor is in the appropriate operating mode.
- **SFxx (Set Function xx Command).** The user can send commands using the <RUN> key and the <DATA STOP> key to the instrument. Each command is designated by a two-digit code, xx.
- **ASTO (Ask Storage Command).** The user can download a specified number of records from the internal data logger from the current position of the data storage pointer. The location of this storage pointer may be defined by the SSTO command. The values on each line of output are delimited by commas.
- **SSTO (Set Storage Command).** The user can change the location of the data storage pointer in the internal data logger, and is used in conjunction with the ASTO command described above. The data storage pointer is always located immediately after the last record transmitted through the RS232 port via the AK Protocol. If the circular buffer overwrites this location or if the ASTO or SSTO commands have not been used, the data storage pointer is positioned at the oldest record in the internal data logger.

For AK communication, the COM port settings are:

Figure B-1.
AL COM Port Settings.



The following pages list the common PRC codes and show how RS-Para 1 through RS-Para 4 are defined in the AK Protocol, and also detail the format of the transmission and response messages of the commands listed on the previous page.

Table B-1. 1405 Main PRC Codes

PRC Code	Description
001	Serial Number
007	Operating Mode
008	Status Condition
047	Current Case Temperature
058	Current Cap Temperature
061	Current Ambient Temperature
063	Current Ambient Relative Humidity
064	Ambient Dew Point
066	Current Ambient Pressure
090	Bypass Flow
096	Vacuum Pump Pressure
217	TEOM Flow
231	TEOM Current Air Temperature
237	TEOM Filter Loading Percentage
240	TEOM Mass Concentration
244	TEOM 1-Hour Average Mass Concentration
245	TEOM XX-Hour Average Mass Concentration
246	TEOM 12-Hour Average Mass Concentration
247	TEOM 24-Hour Average Mass Concentration
248	TEOM Mass Rate
252	TEOM Frequency
253	TEOM Noise

AK Protocol						
Ask Register Command (AREG)						
COM 2-WAY SETTINGS						
RS-Para 1	52	ASCII code for the 1-digit Station Number (for example "4": 052). The Station Number is always 1 digit in length.				
RS-Para 2	75048	ASCII code representation of the 2-digit Channel Number (for example: "K0": 075, 048). The Channel Number is always 2 digits in length.				
RS-Para 3	13010	Optional: Up to 3 ASCII codes can be added to response from the instrument. In this case, <CR> and <LF> (ASCII codes 013 and 010) are appended to the response. Enter 0 if nothing is to be appended.				
RS-Para 4	0	Not used.				
Transmission to Instrument			Response from Instrument			
Byte	Example	Description	B	No Err	Error	Description
1	<STX>	ASCII code 002.	1	<STX>	<STX>	ASCII code 002.
2	4	1-digit Station Number, RS-Para 1.	2	4	4	1-digit Station Number, RS-Para 1.
3	A	Ask Register command.	3	A	A	4-digit Ask Register command.
4	R		4	R	R	
5	E		5	E	E	
6	G		6	G	G	
7	<space>	Space.	7	<space>	<space>	Space.
8	K	2-digit Channel Number as defined by RS Para 2.	8	0	0	Number of current status conditions.
9	0		9	<space>	<space>	Space.
10	<space>	Space.	10	9	S	Program Register Code of the variable whose value is being requested. The PRC may be up to 3 digits long and is not right-filled in the response.
11	9	Program Register Code of the variable whose value is being requested. The PRC may be up to 3 digits long. Do not right-fill if the PRC is less than 3 characters long.	11		E	
12			12		<ETX>	
13			13	<space>	<CR>	Space.
14	<ETX>	ASCII code 003.	14	9	<LF>	Current value of the variable referenced by the Ask Register command. NOTE: This value can be of varying length.
15			15	7		
16			16	4		
17			17	.		
18			18	3		
19			19	8		

AK Protocol

Ask Register Command (AREG) (continued)

Transmission to Instrument			Response from Instrument			
Byte	Example	Description	B	No Err	Error	Description
20			20	<ETX>		ASCII code 003.
21			21	<CR>		Up to 3 digits appended to the end of the response transmission, according to the entry for RS-Para 3.
22			22	<LF>		
23	Description of Status Codes (PRC 008) 1 Mass Transducer 2 Temperature 4 Flow Rate 8 Filter Exchange 16 Voltage		23			
24			24			
25			25			
26			26			
27			27			
28			28			
29			29			
30			30			
31			31			
32			32			
33			33			
34			34			
35			35			
36			36			
37			37			
38			38			
39			39			
40			40			
41			41			
42			42			
43			43			
44			44			
45			45			
46			46			

AK Protocol						
Enter Register Command (EREG)						
COM 2-WAY SETTINGS						
RS-Para 1	52	ASCII code for the 1-digit Station Number (for example "4": 052). The Station Number is always 1 digit in length.				
RS-Para 2	75048	ASCII code representation of the 2-digit Channel Number (for example: "K0": 075, 048). The Channel Number is always 2 digits in length.				
RS-Para 3	13010	Optional: Up to 3 ASCII codes can be added to response from the instrument. In this case, <CR> and <LF> (ASCII codes 013 and 010) are appended to the response. Enter 0 if nothing is to be appended.				
RS-Para 4	0	Not used.				
Transmission to Instrument			Response from Instrument			
Byte	Example	Description	B	No Err	Error	Description
1	<STX>	ASCII code 002.	1	<STX>	<STX>	ASCII code 002.
2	4	1-digit Station Number, RS-Para 1.	2	4	4	1-digit Station Number, RS-Para 1.
3	E	Enter Register command.	3	E	E	4-digit Enter Register command.
4	R		4	R	R	
5	E		5	E	E	
6	G		6	G	G	
7	<space>	Space.	7	<space>	<space>	Space.
8	K	2-digit Channel Number, as defined by RS Para 2.	8	0	0	Number of current status conditions.
9	0		9	<space>	<space>	Space.
10	<space>	Space.	10	6	S	Program Register Code of the variable whose value was entered. The PRC may be 1 to 3 digits long and is not right-filled in the response.
11	6	Program Register Code of the variable whose value is being requested. The PRC may be up to 3 digits long. Do not right-fill if the PRC is less than 3 characters long.	11	3	E	
12	3		12		<ETX>	
13			13	<ETX>	<CR>	ASCII code 003.
14	<space>	Space.	14	<CR>	<LF>	Up to 3 digits appended to the end of the response transmission, according to the entry for RS-Para 3.
15	2	New value to be entered for variable referenced by Program Register Code in bytes 11 to 13 above.	15	<LF>		
16	3		16			
17	8	NOTE: The value entered may be of varying length, and is not restricted to 4 bytes.	17			
18	0		18			
19	<ETX>	ASCII code 003.	19			

AK Protocol						
Set Function Command (SFxx)						
RS-Para 1	52	ASCII code for the 1-digit Station Number (for example "4": 052). The Station Number is always 1 digit in length.				
RS-Para 2	75048	ASCII code representation of the 2-digit Channel Number (for example: "K0": 075, 048). The Channel Number is always 2 digits in length.				
RS-Para 3	13010	Optional: Up to 3 ASCII codes can be added to response from the instrument. In this case, <CR> and <LF> (ASCII codes 013 and 010) are appended to the response. Enter 0 if nothing is to be appended.				
RS-Para 4	0	Not used.				
Transmission to Instrument			Response from Instrument			
Byte	Example	Description	B	No Err	Error	Description
1	<STX>	ASCII code 002.	1	<STX>	<STX>	ASCII code 002.
2	4	1-digit Station Number, RS-Para 1.	2	4	4	1-digit Station Number, RS-Para 1.
3	S	Set Function command, where xx represents a 2-digit code between 00 and 32. These codes are defined below.	3	S	S	4-digit Set Function command, with the 2-digit xx code corresponding to the function that was set.
4	F					
5	x					
6	x					
7	<space>	Space.	7	<space>	<space>	Space.
8	K	2-digit Channel Number, as defined by RS Para 2.	8	0	0	Number of current status conditions.
9	0		9	<ETX>	<space>	Space.
10	<ETX>	ASCII code 003.	10	<CR>	S	Upto 3 digits appended to the end of the response transmission, according to the entry for RS-Para 3.
			11	<LF>	E	
			12		<ETX>	
			13		<CR>	
			14		<LF>	
<p>LISTING OF FUNCTION CODES (xx):</p> <p>03 <Run> 06 <Data Stop> 09 <F1> 17 <F5> 25 <Stop All> 26 Set Time</p>			15	<p>To Set Time Remotely:</p> <p>1) Ensure that the instrument is in the Stop Mode. 2) Transmit the proper values in PRCs 2 through 6. 3) Execute the SF26 command.</p>		
			16			
			17			
			18			
			19			

AK Protocol						
Ask Storage Command (ASTO)						
COM 2-WAY SETTINGS						
RS-Para 1	52	ASCII code for the 1-digit Station Number (for example "4": 052). The Station Number is always 1 digit in length.				
RS-Para 2	75048	ASCII code representation of the 2-digit Channel Number (for example: "K0": 075, 048). The Channel Number is always 2 digits in length.				
RS-Para 3	13010	Optional: Up to 3 ASCII codes can be added to response from the instrument. In this case, <CR> and <LF> (ASCII codes 013 and 010) are appended to the response. Enter 0 if nothing is to be appended.				
RS-Para 4	0	Not used.				
Transmission to Instrument			Response from Instrument			
Byte	Example	Description	B	No Err	Error	Description
1	<STX>	ASCII code 002.	1	<STX>	<STX>	ASCII code 002.
2	4	1-digit Station Number, RS-Para 1.	2	4	4	1-digit Station Number, RS-Para 1.
3	A	Ask Storage command.	3	A	A	4-digit Ask Storage command.
4	S		4	S	S	
5	T		5	T	T	
6	O		6	O	O	
7	<space>	Space.	7	<space>	<space>	Space.
8	K	2-digit Channel Number, as defined by RS Para 2.	8	0	0	Number of current status conditions.
9	0		9	<space>	<space>	Space.
10	<space>	Space.	10	3	S	Records to be downloaded from storage. This can be smaller than requested number due to end of file. Storage Marker moved to after last record transmitted. Not right-filled.
11	5	The number of records to be downloaded from the instrument's storage. Downloading begins at the storage marker, which can be set using the SSTO command.	11	1	E	
12	0		12	<ETX>		
13			13	<ETX>	<CR>	ASCII code 003.
14	<ETX>	ASCII code 003.	14	<CR>	<LF>	Up to 3 digits appended to the end of the response transmission, according to the entry for RS-Para 3.
15			15	<LF>		
16			16			
17			17	The instrument then transmits the number of storage records shown in response bytes 10 through 12 above. Each record is followed by <CR><LF>.		
18			18			
19			19			

AK Protocol						
Set Storage Marker Command (SSTO)						
COM 2-WAY SETTINGS						
RS-Para 1	52	ASCII code for the 1-digit Station Number (for example "4": 052). The Station Number is always 1 digit in length.				
RS-Para 2	75048	ASCII code representation of the 2-digit Channel Number (for example: "K0": 075, 048). The Channel Number is always 2 digits in length.				
RS-Para 3	13010	Optional: Up to 3 ASCII codes can be added to response from the instrument. In this case, <CR> and <LF> (ASCII codes 013 and 010) are appended to the response. Enter 0 if nothing is to be appended.				
RS-Para 4	0	Not used.				
Transmission to Instrument			Response from Instrument			
Byte	Example	Description	B	No Err	Error	Description
1	<STX>	ASCII code 002.	1	<STX>	<STX>	ASCII code 002.
2	4	1-digit Station Number, RS-Para 1.	2	4	4	1-digit Station Number, RS-Para 1.
3	S	Set Storage Marker command.	3	S	S	4-digit Set Storage Marker command.
4	S		4	S	S	
5	T		5	T	T	
6	O		6	O	O	
7	<space>	Space.	7	<space>	<space>	Space.
8	K	2-digit Channel Number, as defined by RS Para 2.	8	0	0	Number of current status conditions.
9	0		9	<ETX>	<space>	ASCII code 003.
10	<space>	Space.	10	<CR>	S	Up to 3 digits appended to the end of the response transmission, according to the entry for RS-Para 3.
11	B	New location of the Storage Marker. B:move to beginning of storage buffer. E: move to end of storage buffer. Enter positive numbers, such as 250, to move forward by 250 records, and negative numbers, such as -1000, to move backwards by 1000 records. Do not right fill.	11	<LF>	E	
12			12		<ETX>	
13			13		<CR>	
14			14		<LF>	
15			15			
16	<ETX>	ASCII code 003.	16			
17			17			
18			18			
19			19			

AK Protocol						
Response if Command Addressed to Instrument is Unrecognizable						
COM 2-WAY SETTINGS						
RS-Para 1	52	ASCII code for the 1-digit Station Number (for example "4": 052). The Station Number is always 1 digit in length.				
RS-Para 2	75048	ASCII code representation of the 2-digit Channel Number (for example: "K0": 075, 048). The Channel Number is always 2 digits in length.				
RS-Para 3	13010	Optional: Up to 3 ASCII codes can be added to response from the instrument. In this case, <CR> and <LF> (ASCII codes 013 and 010) are appended to the response. Enter 0 if nothing is to be appended.				
RS-Para 4	0	Not used.				
Transmission to Instrument			Response from Instrument			
Byte	Example	Description	B	No Err	Error	Description
1			1		<STX>	ASCII code 002.
2			2		4	1-digit Station Number, RS-Para 1.
3			3		?	Question marks inserted in place of unrecognizable command.
4			4		?	
5			5		?	
6			6		?	
7			7		<space>	Space.
8			8		0	Number of current status conditions.
9			9		<space>	Space.
10			10		S	Syntax error.
11			11		E	
12			12		<ETX>	ASCII code 003.
13			13		<CR>	Up to 3 digits appended to the end of the response transmission, according to the entry for RS-Para 3.
14			14		<LF>	
15			15			
16			16			
17			17			
18			18			
19			19			