

Cables & Connectors

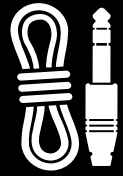

■ Adaptors	96	■ Plugs & Sockets	59
■ AV Plug Adaptors	98	■ Alligator	81
■ BNC Plug Adaptors	101	■ Banana 4mm	82
■ Cross Reference	96	■ BNC	87
■ End Caps	106	■ Car Antenna	95
■ F Plug Adaptors	100	■ CB Microphone Plugs	95
■ PAL Adaptors	100	■ DC Multi-Pin	76
■ RF Plug Adaptors	101	■ DC Plugs	84
		■ DC Wiring Loom	80
		■ "F"	90
■ Cable & Wire	34	■ Jack Plug	73
■ AC Mains Cable - Approved	44	■ Multi-Pin Misc	76
■ Amp Wiring Kits	38	■ Multi-Pin Misc	95
■ Audio Shielded Cable	34	■ PAL	89
■ Automotive Amplifier Cable Kits	39	■ RCA	70
■ Automotive Low Voltage Cable	40	■ RF	91
■ Cable Anchors	49	■ RF Miscellaneous	94
■ Cable Entry	53	■ SCART	76
■ Cable Sleeving	54	■ Spade & Ring Gold Plated	81
■ Cable Ties	52	■ Speaker	83
■ CB Communication Cable	48	■ Speaker PA Amphenol	69
■ Coax Shielded Cable	36	■ SpeakON® Neutrik	63
■ Data & Communication Cable	46	■ SpeakON® Type Aerpro	69
■ Double Insulated - 600V	44	■ S-Video	76
■ Double Insulated Low Voltage	41	■ XLR Adaptors Misc	68
■ General Purpose Low Voltage Cable	42	■ XLR Amphenol	65
■ Heat Shrink	56	■ XLR Amphenol 1/4" & 3.5mm	64
■ Hook & Loop - Prolink	50	■ XLR Misc	68
■ Hook & Loop - Velcro®	51	■ XLR Neutrik	59
■ Microphone Shielded Cable	34	■ XLR PowerCON	62
■ Security and Control Cable	35		
■ Security, Data	48	■ Prepared Leads	2
■ Speaker and GP Cable	43	■ 1/4" & 1/8" Jack Leads	23
■ Video Shielded Cable	34	■ Antenna Cables	31
		■ Apple® Audio Leads	26
■ Chogori Connectors	121	■ Apple® Digital Video Leads	14
■ Chogori 500 Series	121	■ Audio Visual Deluxe OFC	20
■ Chogori D-Sub Series	130	■ Audio Visual Leads	21
■ Chogori HDMI Series	130	■ Camera Video Leads	22
■ Chogori Large Series	128	■ Digital Audio leads	16
■ Chogori Middle Series - Push	127	■ DIN Leads	26
■ Chogori Middle Series - Screw	126	■ DisplayPort Leads	12
■ Chogori Mini Series	122	■ DVI Leads	10
■ Chogori RJ45 Series	129	■ HDMI Cables	3
■ Chogori Standard Series	123	■ HDMI Cables New 8K	2
■ Chogori Standard Series - Push	124	■ Mini DisplayPort Leads	13
■ Chogori USB Series	130	■ Monitor Adaptors	9
		■ Quad 3.5mm AV Leads	14
■ Connectors Misc	107	■ RF Flyleads	29
■ Modular & Telephone	115	■ SCART Leads	15
■ Quick Disconnect	120	■ S-Video Leads	22
■ Terminal Blocks	119	■ VGA Monitor Leads	11
■ Wall Plates	107	■ Video Composite Leads	22
		■ Video Leads RCA	28
		■ White Pearl Audio Leads	18
		■ XLR Professional Leads	27



HDMI 2.1

HIGH-DEFINITION MULTIMEDIA INTERFACE

8K
HDMI 2.1

48Gbps
BANDWIDTH

33.2MP
MEGAPIXEL

8K
HDR

prolink

8K 60Hz PREMIUM HDMI CABLES - PROLINK

HDMI 2.1 SERIES COPPER INTERCONNECTS

HDMI® Specification 2.1 is the most recent update of the HDMI specification and supports a range of higher video resolutions and refresh rates including 8K60 and 4K120, and resolutions up to 10K. Dynamic HDR formats are also supported, and bandwidth capability is increased up to 48Gbps. Supporting the 48Gbps bandwidth is the new Ultra High Speed HDMI Cable. The cable ensures high-bandwidth dependent features are delivered including uncompressed 8K video with HDR. It features exceptionally low EMI (electromagnetic interference), which reduces interference with nearby wireless devices. The cable is backwards compatible and can be used with the existing installed base of HDMI devices.

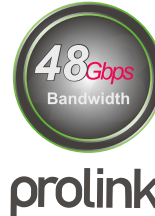

- Supports all HDMI® resolutions up to 10K, including 3D and Multiview video
- Supports Dynamic HDR (High Dynamic Range) for brighter, deeper, and more lifelike colours
- Supports extended CEC (Consumer Electronics Control) commands and functions, the HDMI Ethernet Channel, and the eARC (Enhanced Audio Return Channel) features Supports AMD® Free Sync™ on PlayStation® 4 Pro and Xbox One™ X
- Supports SA-CD, DVD-Audio, DTS-HD Master Audio™, Dolby TrueHD™, and other high-definition audio standards
- Supports the 21:9 cinema aspect ratio
- Supports up to 32 audio channels and a 1536 kHz audio sampling rate
- Supports Deep Colour with up to 16-bits per channel, including Sony's x.v.Color™ standard
- Supports simultaneous delivery of dual video streams to multiple users on the same screen
- Supports Game Mode VRR and produces a more fluid and better detailed gameplay experience

HDMI 2.1 LEADS 8K PREMIUM

Length	Resolution	Bandwidth	Code
0.5M	8K@60	48Gbps	PHC201-0050
1M	8K@60	48Gbps	PHC201-0100
1.5M	8K@60	48Gbps	PHC201-0150
2M	8K@60	48Gbps	PHC201-0200
3M	8K@60	48Gbps	PHC201-0300



HDMI 2.1 LEADS CERTIFIED BY HDMI.ORG

Length	Resolution	Bandwidth	Code
0.3M	8K@60	48Gbps	PHC202-0030
1M	8K@60	48Gbps	PHC202-0100
1.8M	8K@60	48Gbps	PHC202-0180
3M	8K@60	48Gbps	PHC202-0300



8K 60Hz HDMI EXTENDED OPTICAL FIBRE ARMORED CABLES

HDMI 2.1 SERIES FIBRE-OPTIC INTERCONNECTS

HDMI 2.1 Over Fibre Cable for Enabled Devices, 8K@60Hz, HDR, YUV 4:4:4 up to 100M, No Need for a Power Supply. Dynamic View Ultra 8K High Speed HDMI® Cables are the next generation of HDMI cables. Supporting resolutions up to 8K@60Hz and 48Gbps bandwidth, this future proofed cable just might be the last HDMI cable you'll ever need. Dynamic View Ultra 8K enables 8K and 4K with higher refresh rates, meaning sharper high-speed content. Dynamic View supports Dynamic HDR, meaning content will be able to take advantage of HDR's expanded contrast ranges, brightness levels, and heightened levels of detail, optimized on a scene-by-scene or even a frame-by-frame basis.



- Supports all HDMI® resolutions up to 10K, including 3D and Multiview video
- Supports Dynamic HDR (High Dynamic Range) for brighter, deeper, and more lifelike colours
- Supports extended CEC (Consumer Electronics Control) commands and functions, the HDMI Ethernet Channel, and the eARC (Enhanced Audio Return Channel) features
- Supports AMD® FreeSync™ on PlayStation® 4 Pro and Xbox One™ X
- Supports SA-CD, DVD-Audio, DTS-HD Master Audio™, Dolby TrueHD™, and more
- Supports the 21:9 cinema aspect ratio
- Supports up to 32 audio channels and a 1536 kHz audio sampling rate
- Supports Deep Colour with up to 16-bits per channel, including Sony's x.v.Color™ standard
- Supports simultaneous delivery of dual video streams to multiple users on the same screen
- Supports Game Mode VRR and produces a more fluid and better detailed gameplay experience

Length	Resolution	Bandwidth	Code
5M	8K@60	48Gbps	CLF2005
10M	8K@60	48Gbps	CLF2010
15M	8K@60	48Gbps	CLF2015
20M	8K@60	48Gbps	CLF2020
30M	8K@60	48Gbps	CLF2030
40M	8K@60	48Gbps	CLF2040
50M	8K@60	48Gbps	CLF2050
60M	8K@60	48Gbps	CLF2060
70M	8K@60	48Gbps	CLF2070
80M	8K@60	48Gbps	CLF2080
100M	8K@60	48Gbps	CLF20100





□ HDMI Cables



4K 60Hz UHD HDMI PREMIUM CERTIFIED CABLES - PROLINK

HDMI V2.0 HIGH BANDWIDTH 4K 60Hz HDR 18GBPS

Prolink Premium HDMI cables are designed to meet the high bandwidth demands of the latest HDMI V2.0b specification supporting the full 18Gbps bandwidth. High quality materials & construction ensures ultimate performance and High reliability for 4K/60HZ HDR content. Tested and certified by the HDMI Labs Authorised test centre, this ensures that these cables support all the latest features in the HDMI V2.0b specification

- Full 18Gbps 4K60(4:4:4) bandwidth certified
- UltraHD 4K@60 2160p and other VESA Resolutions
- Support for the wide angle theatrical 21:9 aspect ratio
- Certified Premium HDMI ensures 4K/UltraHD ready
- ARC (Audio Return Channel)
- Low Latency
- HDMI 2.0b, HDCP 2.2, 3D Signals
- HDR - High Dynamic Range video
- Dolby® Vision
- Dolby® True HD, DTS-HD Master Audio and up to 32 audio channels for a multi-dimensional immersive audio experience

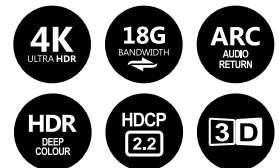

Length	Resolution	Bandwidth	Code
0.5M	4K@60	18Gbps	PHC101-0050
1.0M	4K@60	18Gbps	PHC101-0100
1.5M	4K@60	18Gbps	PHC101-0150
2M	4K@60	18Gbps	PHC101-0200
3M	4K@60	18Gbps	PHC101-0300
5M	4K@60	18Gbps	PHC101-0500
7.5M	4K@60	18Gbps	PHC101-0750
10M	4K@60	18Gbps	PHC101-1000



Certified by HDMI Testing Labs

4K 60Hz UHD HDMI CABLES EXTENDED - PROLINK

HDMI V2.0 HIGH BANDWIDTH 4K 60Hz HDR 18GBPS - DIRECTIONAL

Prolink Active directional HDMI cables designed for high bandwidth 18Gbps throughput of 4K/60Hz HDR content over long distances. Advanced signal processing with in-cable equalisation technology ensures that maximum signal integrity is maintained for ultimate performance, stability and reliability over long distances without the need of any external power supplies.

Length	Resolution	Bandwidth	Code
12.5M	4K@60	18Gbps	PHC102-1250
15M	4K@60	18Gbps	PHC102-1500
20M	4K@60	18Gbps	PHC102-2000



4K 60Hz HDMI ULTRA SLIM CABLES - PROLINK

5MM FLEXIBLE CABLE WITH NEW GRIP CONNECTOR

High-speed HDMI cable securely connects HDMI-enabled devices. The gripping connectors help ensure components stay firmly attached to avoid viewing interruptions. Ultra-Slim cable allows extra flexibility and less tangles.

- Full 4K 60Hz 4.4.4 18Gbps
- Flexible install jacket only 5mmØ
- 0.5m to 3.0m with 32AWG all copper
- 5.0m with 30AWG all copper
- Gold plated grip connector

Length	Resolution	Bandwidth	Code
0.5M	4K@60	18Gbps	CL2101-05
0.75M	4K@60	18Gbps	CL2101-075
1M	4K@60	18Gbps	CL2101-1
1.5M	4K@60	18Gbps	CL2101-1.5
2M	4K@60	18Gbps	CL2101-2
2.5M	4K@60	18Gbps	CL2101-2.5
3M	4K@60	18Gbps	CL2101-3
5M	4K@60	18Gbps	CL2101-5





4K 60Hz HDMI EXTENDED OPTICAL FIBRE CABLES - PROLINK

HIGH STRENGTH LONG RUN AOC HDMI CABLE. HDMI V2.0 HIGH BANDWIDTH 4K 60Hz HDR 18GBPS

The HDMI cable is designed to be extremely durable thanks to the integrated stainless steel corrugated tube that protects the internal optical fibres, the cable can withstand short term tensile forces of up to 80 kg and short term forces of 65Kg on the the strain relief. Despite these extreme values, the cable is just 5.8 mm in diameter. Thanks to AOC (Active Optical Cable) technology, the transfer of the high speed contents is based on optical fibres – this facilitates a maximum transfer distance of up to 100 m with maximum data rate of 18Gbps with no noise! HDCP 2.2 support. Plug and play. No external power required.

Length	Resolution	Bandwidth	Code
10M	4K@60	18Gbps	CLF1310
15M	4K@60	18Gbps	CLF1315
20M	4K@60	18Gbps	CLF1320
30M	4K@60	18Gbps	CLF1330
40M	4K@60	18Gbps	CLF1340
50M	4K@60	18Gbps	CLF1350
60M	4K@60	18Gbps	CLF1360
70M	4K@60	18Gbps	CLF1370
80M	4K@60	18Gbps	CLF1380
100M	4K@60	18Gbps	CLF13100

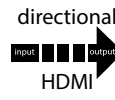

4K 60Hz HDMI EXTENDED OPTICAL FIBRE ARMORED CABLES - PROLINK

HIGH STRENGTH LONG RUN AOC HDMI CABLE. HDMI V2.0 HIGH BANDWIDTH 4K 60Hz HDR 18GBPS

The armoured HDMI cable is designed to be extremely durable thanks to the integrated stainless steel corrugated tube that protects the internal optical fibres, the cable can withstand short term tensile forces of up to 80 kg and short term forces of 65Kg on the the strain relief. Despite these extreme values, the cable is just 5.8 mm in diameter. Thanks to AOC (Active Optical Cable) technology, the transfer of the high speed contents is based on optical fibres – this facilitates a maximum transfer distance of up to 100 m with maximum data rate of 18Gbps with no noise! HDCP 2.2 support. Plug and play. No external power required.

Length	Resolution	Bandwidth	Code
10M	4K@60	18Gbps	CLF1010
15M	4K@60	18Gbps	CLF1015
20M	4K@60	18Gbps	CLF1020
30M	4K@60	18Gbps	CLF1030
40M	4K@60	18Gbps	CLF1040
50M	4K@60	18Gbps	CLF1050
60M	4K@60	18Gbps	CLF1060
70M	4K@60	18Gbps	CLF1070
80M	4K@60	18Gbps	CLF1080
90M	4K@60	18Gbps	CLF1090
100M	4K@60	18Gbps	CLF10100

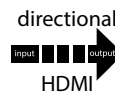

4K 60Hz HDMI EXTENDED OPTICAL FIBRE DETACHABLE CABLES - PROLINK

EASY INSTALL LONG RUN AOC HDMI CABLE. HDMI V2.0 HIGH BANDWIDTH 4K 60Hz HDR 18GBPS

HDMI Active Optical Cable (AOC) suited for critical and versatile installations. The detachable HDMI head reduces the connector to a micro HDMI plug making this series extremely installer friendly can be run through small and tight spaces. Maximum data rate of 18Gbps & HDCP 2.2 with light weight, flexible and ultra-small long-term bending radius (20mm) hybrid cable with our advanced optical engine embedded. This HDMI Hybrid Cable provides full HDMI signal integrity, support up to 100m maximum length, plug and play. No external power required. Includes one protector jacket for protection of HDMI micro plug during cable runs.

Length	Resolution	Bandwidth	Code
10M	4K@60	18Gbps	CLF1210
15M	4K@60	18Gbps	CLF1215
20M	4K@60	18Gbps	CLF1220
30M	4K@60	18Gbps	CLF1230
40M	4K@60	18Gbps	CLF1240
50M	4K@60	18Gbps	CLF1250
60M	4K@60	18Gbps	CLF1260
70M	4K@60	18Gbps	CLF1270
80M	4K@60	18Gbps	CLF1280
90M	4K@60	18Gbps	CLF1290
100M	4K@60	18Gbps	CLF12100

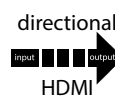



EASYLOCK HDMI LOCKING PLUGS - 1080P/4K60

KEEP YOUR LEADS SECURELY LOCKED IN POSITION

Locking plugs that extend and hold the plug in place
 Fully compatible with any existing HDMI receptacle.
 Tested to 4K 60Hz (30Hz 10M) uncompressed video.
 Keep your HDMI locked in position securely.
 World's first ATC certified integrally Locking HDMI
 Barrel switch with green-free / red-locked indication
 Patented wave soldering molded plug assembly
 Patented secure locking technology
 High Speed 3D 2k and 4K compatible
 Includes ethernet Network-Internet connection
 Gold-plated pins and shroud
 Mylar & AI Shielding 30AWG OFC cable
 Attractive modern professional interconnect
 Un-compressed all-digital interface
 Transmit digital AV through a single high-speed link
 Enables IP-based applications over HDMI
 3D support up to 1080p
 2K / 4K Support - up to 4x resolution of 1080p
 Huge bandwidth capacity for AV clarity and faster gaming

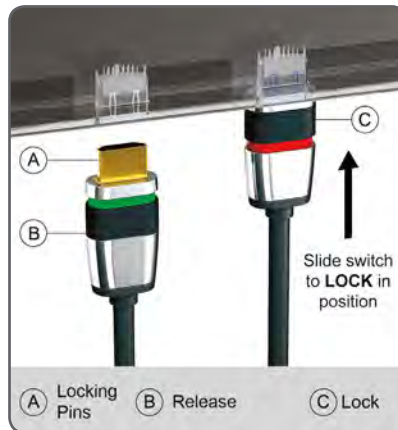

- Keep your HDMI locked in position
- World's first ATC certified integrally Locking HDMI
- Barrel switch for use with all receptacles
- Universal fit utilises the existing HDMI receptacle
- Backwards and forwards compatible
- Patented wave soldering and locking technology



Length	Resolution	Bandwidth	Code
0.5M	4K@60	18Gbps	CL5000-05
1.0M	4K@60	18Gbps	CL5001
1.5M	4K@60	18Gbps	CL50015
2.0M	4K@60	18Gbps	CL5002
3.0M	4K@60	18Gbps	CL5003
5.0M	1080p	10.2Gbps	CL5005
7.5M	1080p	10.2Gbps	CL50075
10M	1080p	10.2Gbps	CL5010

4K HDMI FLAT CABLES - DAICHI

24K GOLD PIN WIDEBAND SUIT 3D & 4K

High Speed With Ethernet HDMI A-Male To A-Male leads
 24K Gold Plated Pins & Metal Plugs with modern style
 Premium copper for maximum signal integrity
 Innovative Flat Flexible Cable
 Daichi hanger bag packaged



Length	Resolution	Bandwidth	Code
0.5M	4K@60	18Gbps	CL2000-05
1M	4K@60	18Gbps	CL2001
2M	4K@60	18Gbps	CL2002
3M	4K@60	18Gbps	CL2003
5M	4K@60	18Gbps	CL2005
7M	4K@30	10.2Gbps	CL2007
10M	4K@30	10.2Gbps	CL2010



4K 60Hz HDMI ULTRA SLIM CABLES - DAICHI

4MM HIGH SPEED WITH ETHERNET, 3D & 4K FEATURES

4mm extra flexible 36AWG cable construction for low profile slim line connections with high speed digital video, audio and ethernet.



Length	Resolution	Bandwidth	Code
0.5M	4K@60	18Gbps	CL2100-05
0.75M	4K@60	18Gbps	CL2100-075
1.0M	4K@60	18Gbps	CL2100-1
1.5M	4K@60	18Gbps	CL2100-1.5
2.0M	4K@60	18Gbps	CL2100-2



HDMI ULTRA-SLIM WHITE LEAD - PROLINK

Length	Resolution	Bandwidth	Code
2.0M	4K@60	18Gbps	MP270



4mm ULTRA-SLIM





Cables & Connectors

4K 60Hz UHD HDMI PREMIUM WIRE CABLES - PROLINK

COMPACT SIZE - PREMIUM SPECIFICATIONS - PROLINK

These High Speed HDMI 2.0 cables feature 18Gbps bandwidth. They are compatible with high bandwidth video resolution up to 4K @ 60Hz. These cables also include High-Speed Ethernet and high quality multi-channel audio. Ideal for bringing the best out of your home theatre, entertainment system, Blu-ray and DVD players, LED, OLED, LCD and plasma TVs, projectors, media players and games consoles such as the PS4PRO and more. They feature two standard type-A HDMI connectors with cable lengths ranging between 1M to 3M. They are backwards compatible with older HDMI devices. Supports DDC, CEC, HDCP 2.2, x.v.Colour, HDR, etc.

Length	Resolution	Bandwidth	Code
1.0M	4K@60	18Gbps	HMM280-0100
1.5M	4K@60	18Gbps	HMM280-0150
2.0M	4K@60	18Gbps	HMM280-0200
3.0M	4K@60	18Gbps	HMM280-0300



4K 60Hz UHD HDMI PREMIUM WIRE EXTENDED CABLES - PROLINK

ACTIVE EXTRA LONG CABLE RANGE - DIRECTIONAL

High Speed HDMI 2.0 cables feature incredible 18Gbps bandwidth. Compatible with high bandwidth video resolution such as 4K2K @ 60Hz and 3D. Features in-line booster(s) to amplify the video signal for longer cables. Supports CEC.

Length	Resolution	Bandwidth	Code
5M	4K@60	18Gbps	PLT280-0500
8M	4K@60	18Gbps	PLT280-0800
10M	4K@60	18Gbps	PLT280-1000
12M	4K@60	8.9Gbps	PLT280-1200
15M	4K@60	8.9Gbps	PLT280-1500



AVLINK HDMI HIGH GRADE CABLES

HIGH SPEED UP TO 18GBPS - PREMIUM VIDEOPHILE GRADE

24Awg heavy-duty quad shielded cable Full 4K Ultra-High Definition Picture Quality Support. 24k Gold Plated Contacts. For Optimum Signal Transfer. Plug is encased in attractive sturdy metal housing. Double blister packaging for a very attractive product.

Length	Resolution	Bandwidth	Code
*0.5M	4K@60	18Gbps	AVL6900-05
1M	4K@60	18Gbps	AVL6901
2M	4K@60	18Gbps	AVL6902
3M	4K@60	18Gbps	AVL6903
5M	4K@60	18Gbps	AVL6905
7.5M	4K@60	18Gbps	AVL6907
10M	4K@60	18Gbps	AVL6910
15M	4K@30	10.2Gbps	AVL6915
20M	1080p	4.95Gbps	AVL6920

*0.5M version has no ferrules.





4K HDMI HI-GRADE CABLES - DAICHI

28AWG WITH HIGH SPEED ETHERNET

Hi grade Daichi HDMI Certified ATC Tested. 160 Braiding. Gold plated plugs With noise cancelling ferrites

Length	Resolution	Bandwidth	Code
*0.5M	4K@60	18Gbps	CL6900-05
1M	4K@60	18Gbps	CL6901
2M	4K@60	18Gbps	CL6902
3M	4K@60	18Gbps	CL6903
5M	4K@60	18Gbps	CL6905

*No Ferrites on 0.5M.



HDMI CABLES - DAICHI

High Speed With Ethernet. HDMI Plugs "A"-Male To "A"-Male. Full Copper Conductors plus Gold Plated Pins.

Length	Resolution	Bandwidth	Code
1M	4K@60	18Gbps	CL5301
2M	4K@60	18Gbps	CL5302
3M	4K@60	18Gbps	CL5303
5M	4K@60	18Gbps	CL5305
7M	4K@60	18Gbps	CL5307
10M	4K@60	18Gbps	CL5310
15M	4K@30	10.2Gbps	CL5315
20M	1080p	4.95Gbps	CL5320



Style may change depending on stock.

HDMI-C [MINI] MALE TO HDMI-A MALE LEAD

Hi grade Daichi HDMI Certified. 160 Braiding. Gold plated plugs. With noise cancelling ferrites.

Length	Code
1M	CL7401
2M	CL7402
3M	CL7403
5M	CL7405



HDMI-D [MICRO] TO HDMI-A MALE LEAD

As used with mobile hand held devices, etc. High speed ethernet.

Length	Code
1.0M	CL5501
1.5M	CL55015
2.0M	CL5502BK
3.0M	CL5503



HDMI-C [MINI] MALE TO HDMI-C [MINI] MALE LEAD

28AWG WITH ETHERNET

Hi grade Daichi HDMI Certified. 160 Braiding. Gold plated plugs With noise cancelling ferrites

Length	Code
1M	CL7301



HDMI-D [MICRO] TO HDMI-A MALE LEAD

Suitable for connection between a smart phone which has a Micro HDMI output to HDTV with high resolution up to 1080p. High Speed.

Length	Code
2M	MP290



prolink

HDMI-C [MINI] MALE TO HDMI-A MALE LEAD

HDMI mini High Speed.

Length	Code
2M	MP287

prolink



RETRACTABLE HDMI TO HDMI CABLE 1.8M

Retractable HDMI male to HDMI male cable. Gold-plated conductors provide high-frequency responses, for optimal resolution. 1.8 metres in maximum extended length. Supports 1080p full HD resolution.

Length	Code
1.8M	CL54018





HDMI-A MALE TO VGA + AUDIO CONVERTER

Digital AV to analogue converter module. HDMI input to VGA HD15 Socket and 3.5mm socket stereo audio output. Micro-USB Socket for optional Power Input if required. Bulk. 1080p 60Hz



Colour	Code
Black	MP2990BK
White	MP2990WH

HDMI-A MALE TO VGA + AUDIO CONVERTER

Digital AV to analogue converter module. HDMI input to VGA HD15 Socket and 3.5mm socket stereo audio output. Micro-USB Socket for optional Power Input if required. 1080p 60Hz



Length	Code
0.15M	MP299A

prolink

USB TYPE-C TO HDMI MALE

18Gbps V2.0 UHD 4K60 COMPATIBLE 2M - PROLINK

- 18Gbps bandwidth
- 4K @ 60Hz HDMI
- 2 metres male-male

Code
MP406



prolink

USB TYPE-C TO HDMI ADAPTOR

USB-C to HDMI adaptor suits MacBook/ChromeBook. Support the resolution 3840x2160p/30hz, 1080p/60Hz up to 2.25Gbps. This adaptor allows you to mirror your MacBook/ChromeBook display



Length	Code
0.1M	CA3100
0.1M	PF403A

USB TYPE-C MULTIMEDIA ADAPTOR

USB 3 / ETHERNET / HDMI / TYPE-C

- USB-C Hub with power through
- Includes Superspeed USB-3.0
- RJ-45 Gigabit LAN 1000Mbps
- HDMI full UHD 4K@30Hz



Code
CA3109

USB TYPE-C TO VGA

Code
MP401



prolink

HDMI-C/D [MINI/MICRO] TO VGA CONVERTER

HD DIGITAL TO ANALOGUE

720P/1080I/P Input to VGA + Stereo Audio Output.

Plug	Colour	Code
Mini HDMI	Black	CA417
Micro HDMI	White	CA418WH
Micro HDMI	Black	CA418BK
Micro HDMI*	White	CA459



HDMI EXTENDERS

HDMI Enhancer amplifies and equalizes the signal, providing high quality audio and video through an HDMI cable for distances up to 15 metres, ensuring no loss of data. Powered by the HDMI output of suitability equipped source equipment.

Bandwidth	Code
4K UHD	CPRU-UHH
1080p FHD	CS-HH



USB TYPE-C TO DVI-D ADAPTOR

The USB Type C to DVI adaptor lets you connect your MacBook/ChromeBook with USB Type C port to a DVI display, this adaptor allows you to mirror your device's display to your DVI-D enabled monitor at up to 1080p HD.

Length	Code
0.1M	CA3102



USB TYPE-C TO HDMI CABLE

VIDEO CABLE 4K@30Hz

- USB3.1 Type-C plug
- To HDMI Plug
- 1080p@60Hz, 4K@30Hz
- Compatible with inbuilt drivers

Length	Colour	Code
0.5M	Black	CL8804-0050
0.75M	Black	CL8804-0075
1M	Black	CL8804-1
1.5M	Black	CL8804-1.5
2M	Black	CL8804-2
2M	White	MP406
3M	Black	CL8804-3.0
4.5M	Black	CL8804-4.5



USB TYPE-C TO HDMI/USB 3.0/USB-C ADAPTOR

Connect a MacBook or any computer equipped with a Type-C port to a 4K Ultra HD TV or monitor & a standard USB device. Pass-through USB-C power port.

Code
CA3108



LIGHTNING® TO HDMI/VGA/AUDIO ADAPTOR

This video adaptor allows you to display your iPhone or iPad screen to a larger HDTV screen or computer monitor. Size: 85x50x10mm. Includes 1x micro USB cable for power, 3.5mm stereo.

Code
CA9103





DVI / HDMI Adaptors

HDMI FEMALE TO HDMI FEMALE

Gold plated HDMI Full band-width

Code
CA412



HDMI FEMALE TO HDMI FEMALE RIGHT-ANGLE

Gold plated HDMI Full band-width.
Female to female. HDMI Type A.

Code
CA411



HDMI MALE TO HDMI FEMALE - RIGHT ANGLE

BEND

Removes cable strain.
Solves many tight fit problems.
Quality low loss. Gold plated.
HDMI-A Male to Female.

Code
CA413



HDMI MALE TO HDMI FEMALE - TWISTY

BEND & TWIST

Tilts 180° Up and Down Angle.
Twists 180° Left and Right.
Quality low loss. Gold plated.
HDMI-A Male to Female.

Code
CA414



HDMI-A FEMALE TO HDMI-C MALE [MINI]

MINI HDMI

HDMI-A Plug is the Standard sized
HDMI HDMI-C Plug is new Mini plug
HDMI-A Female
HDMI-C Male

Code
CA410



HDMI TO MINI-HDMI TO MICRO-HDMI ADAPTOR

Gold plated HDMI converter adaptor.
Quality low loss. Convert a HDMI
cable to connect to either Mini
HDMI-C or Micro HDMI-D

Code
CA472



DVI-D FEMALE TO HDMI ADAPTORS

HDMI male -> DVI female
For converting a HDTV with HDMI output to DVI.

Plug A	Plug B	Code
DVI Female	HDMI Male	CA400
DVI Female	HDMI Female	CA458

CA400



CA458

DVI-D MALE TO HDMI FEMALE

Code
CA401



Monitor Adaptors

MINI-DISPLAYPORT TO HDMI FEMALE

0.15M ADAPTOR LEAD

Bandwidth	Type	Code
1080p	Passive	CA439
1080p	Passive	MP352
4K30	Passive	CA449
4K30	Active	CA453



MINI-DISPLAYPORT TO DVI ADAPTOR

DVI DIGITAL

Type	Code
Active DVI-I	CA452
Installer DVI-I	CA429
Prolink DVI-D	MP350



M1-DA TO RCA COMPONENT VIDEO ADAPTOR

ANALOGUE YUV OUTPUT

Code
CA422



M1-DA TO VGA ADAPTOR

M1-DA MALE TO VGA FEMALE

15cm adaptor cable allows
M1-DA port to connect to
VGA analogue output. M1-DA
also known as EVC & P&D
connectors projectors and
some display monitors.

Code
CA424



M1-DA TO DVI-D ADAPTOR

M1-DA MALE TO DVI FEMALE

M1-DA also known as EVC & P&D connectors

Code
CA420



M1-DA TO HDMI ADAPTOR

M1-DA MALE TO HDMI FEMALE

M1-DA Plug to HDMI
Socket. M1-DA also
known as EVC & P&D
connectors commonly used
on projectors and some
display monitors. No Audio.

Code
CA423





□ DVI Leads

DVI-I DUAL LINK DIGITAL/ANALOGUE LEADS

DVI-I DUAL LINK M-M

Length	Code
2.0M	CL5102



DVI-I DUAL LINK M-F

Length	Code
2.0M	CL5202

DVI-D SINGLE LINK MALE TO MALE LEAD

28AWG DVI-D LEAD M-M

Length	Code
1M	CL6601
2M	CL6602
3M	CL6603
5M	CL6605



24AWG DVI-D LEAD M-M

Length	Code
5M	CL6606
7.5M	CL6607
10M	CL6610
15M	CL6615

BUY IN BULK & SAVE !
Purchase 10 or more and save 10%

DVI-D SINGLE LINK MALE TO FEMALE LEAD

DVI EXTENSION CABLE

Length	Code
1M	CL7701
2M	CL7702
15M	CL6715



DVI-D DUAL LINK MALE TO MALE LEAD

28AWG DVI-D LEAD M-M

Length	Code
1M	CL7601
2M	CL7602
3M	CL7603
5M	CL7605
7.5M	CL7607
10M	CL7610
15M	CL7615



DVI-D DUAL LINK MALE TO FEMALE 28AWG LEAD

28AWG LEAD

Length	Code
1M	CL7701
2M	CL7702



DVI-D TO HDMI-A MALE TO MALE LEAD

DIGITAL VIDEO ADAPTOR LEAD

Length	Code
1M	CL6801
2M	CL6802
3M	CL6803
5M	CL6805
7.5M	CL6807
10M	CL6810
15M	CL6815



White ProLink

Length	Code
2M	MP269

DVI-I GENDER CHANGER

FEMALE TO FEMALE

All Pins wired DVI-I (A & D)

Code	CA406
------	-------



DVI-I SPLITTER

DVI-I [M] TO 2X DVI-I [F]

Connect two monitors to the one video source

Code	CA217
------	-------



LFH59/DMS59 TO DUAL DVI SPLITTER ADAPTOR

Design for DMS59 workstations to connect to multiple DVI monitors. This DMS59 cable can connect 2 monitors with a DVI outlet.

Code	CA219
------	-------



DVI-A MALE TO 2xVGA FEMALE ADAPTOR

Extracts VGA from DVI-I (Integrated)
Requires DVI-A (Analogue Out)
Then splits to 2x VGA HD-15 Females

Code	CA6504
------	--------



MICRO DVI TO VGA ADAPTOR

MICRO DVI MALE TO VGA FEMALE

Code	CA446
------	-------



HDMI TO VGA CONVERTER

WITH ANALOGUE 3.5mm AUDIO OUTPUT

Flexible design & a line through function.
Simply plug n play, no external power supply or driver required. HDMI Input. VGA out up to 720p/1080i/1080p.

Code	MP2990BK
------	----------



[MORE ACTIVE ADAPTORS SEE PREVIOUS PAGE](#)



□ DVI, VGA

DVI-A TO VGA ANALOG ADAPTOR LEAD

DVI-A TO VGA

M1-DA port to VGA output. M1-DA also known as EVC & P&D connectors commonly used on projectors and some display monitors.

Length	Code
1.8M	CL6502
5M	CL6505



DVI-A FEMALE TO VGA MALE ADAPTOR

Code
CA6503



DVI-A MALE TO VGA FEMALE ADAPTOR

Code
CA6502



LFH59/DMS59 TO DUAL VGA-F ADAPTOR CABLE

The LHF59/DMS59 to dual VGA female adaptor cable allows you to break out one LHF59/DMS59 to connect to two VGA displays. Quality molded connectors for reliability and long lifespan. Suitable for workstation type PCs with a DMS-59 video output.

Code
CA224



□ VGA Monitor Leads

VGA EXTENSION MALE TO FEMALE

HD15 Monitor Interconnect. Gold Plated Pins. Black. High Quality cable with noise filter.

Length	Code
2M	CL6302
5M	CL6305
7.5M	CL6307
10M	CL6310
15M	CL6315
20M	CL6320
30M	CL6330
40M	CL6340



VGA CABLE MALE TO MALE

HD15 Monitor Interconnect. All pins wired. High Quality cable with noise filter.

Length	Code
0.5M**	CL6399
0.5M	CL6400
1.0M	CL6401
2.0M	CL6402
3.0M	CL6403
5.0M	CL6405
7.5M	CL6407
10M	CL6410
15M	CL6415
20M	CL6420
30M	CL6430
40M	CL6440



**CL6399 uses a lighter flexible cable without noise filters.

15 PIN VGA MALE TO MALE

STRAIGHT TO RIGHT ANGLE CONNECTOR

High performance VGA cable. Dual noise filter.

Length	Code
1.8M	CL4102
3M	CL4103
5M	CL4105
10M	CL4110



VGA CABLE MALE TO MALE WITH AUDIO

HD15D & 3.5mm MALE TO MALE

High grade video monitor leads with stereo audio built in for convenient connections to VGA monitors and speakers.

Length	Code
1M	CL6201
2M	CL6202
3M	CL6203
5M	CL6205
7.5M	CL6207
10M	CL6210
15M	CL6215
20M	CL6220
30M	CL6230



VGA GENDER CHANGER

Description	Code
Female-Female	CA206
Male-Male	CA204



VGA TO RGB BREAK-OUT CABLE [3x RCA]

High density HD15 pin to 3x RCA plugs. Red Green Blue. Suit projectors, etc. Gold plated pins. Double shielded.

Length	Code
1.8M	CL7102
3.0M	CL7103
5.0M	CL7105



VGA RGBVH BREAK-OUT CABLE [5x RCA]

High density HD15 pin Male Plug to 5x RCA Male Plugs. RCA: RGB Plus V&H Sync. Suit projectors, pro-monitors, etc. Gold plated pins. High-Grade Double shielded. Analogue video.

Length	Code
1.8M	CL7202
3.0M	CL7203
5.0M	CL7205





□ DisplayPort Leads

DISPLAYPORT LEADS - FULL RANGE

Displayport Cable Male to Male Packaged.

Length	Bandwidth	Resolution	Colour	Code
1.0M	32.4Gbps	8K @60	Black	CL810-0100
1.5M	32.4Gbps	8K @60	Black	CL810-0150
2.0M	18Gbps*	4K @60*	Black	CL8102
2.0M	10Gbps*	4K @30*	White	MP379
2.0M	32.4Gbps	8K @60	Black	CL810-0200
3.0M	32.4Gbps	8K @60	Black	CL810-0300
5.0M	10Gbps*	4K @30*	Black	CL8105
7.5M	10Gbps*	1080p	Black	CL8107
10M	10Gbps*	1080p	Black	CL8110

*Manufacturers specifications not independently verified



DISPLAYPORT SPLITTER LEAD

Two Displayport monitors can be connected to mirror image on both monitors (does not allow extended desktop display).

Length	Code
0.3M	CA434



DISPLAYPORT EXTENSION CABLE

Displayport Male to Displayport Female extension cable.

Length	Code
2.0M	CL8112



DISPLAYPORT [M] TO HDMI [M] LEADS

Length	Resolution	Code
1.0M	4K @60Hz	CL811-0100
1.5M	1080p	CL83015
1.5M	4K @60Hz	CL811-0150
2.0M	1080p	MP416
2.0M	4K @60Hz	CL811-0200
3.0M	1080p	CL8303
3.0M	4K @60Hz	CL811-0300
5.0M	4K @60Hz	CL811-0500

MP416 = White Prolink Deluxe Packaging



DISPLAYPORT [M] TO HDMI [F] ADAPTOR LEAD

Type	Colour	Brand	Code
Passive	White	Prolink	MP355
Passive	Black	Installer	CA443
Active	Black	Installer	CA451
Active	Black	4K	CA455
Active	White	4K	CA403



DISPLAYPORT [M] TO HDMI [F] ADAPTOR

Displayport 1.1a Graphics AV Outputs to HDMI Monitor

Type	Code
Passive	CA436
Active	CDPH-1P



USB TYPE-C [M] TO DISPLAYPORT [F] ADAPTOR

- USB3.1 Type C Male & Displayport Female
- Supports resolution up to 3840x2160p @ 30hz
- ChromeBook®, Macbook® and Windows™

Length	Code
0.1M	CA3103



DISPLAYPORT [M] TO VGA [F] ADAPTOR

Displayport to VGA Adaptor

Length	Type	Colour	Code
0.15M	Prolink	Black	CA437
0.15M	Prolink	White	MP354



DISPLAYPORT [M] TO VGA [M] CABLE

Displayport to VGA unidirectional cable, suitable for connecting from a source with Displayport interface to a monitor, or projector with a VGA interface.

Length	Code
1.8M	CL8402
3.0M	CL8403
5.0M	CL8405



DISPLAYPORT [M] TO DVI [F] ADAPTOR

DisplayPort to passive DVI-D adaptor.

Type	Colour	Code
Passive	Black	CA435

ACTIVE

Type	Colour	Code
Active	Black	CA450



DISPLAYPORT [M] TO DVI-D [M] CABLE

1.8M Displayport to DVI unidirectional cable, suitable for connecting from a source with Displayport interface to a monitor or other output devices with a DVI outlet.

Length	Code
1.8M	CL8502
1.0M	CL8501
3.0M	CL8503
5.0M	CL8505



LFH59/DMS59 TO DUAL DISPLAYPORT [F] LEAD

Design for DMS59 workstations to connect to multiple DP monitors. This DMS59 cable can connect 2 monitors with DisplayPort leads.

Quality molded connectors for reliability and long lifespan.

Code
CA218



DISPLAYPORT TO MINI DISPLAYPORT CABLE

Connect your desktop, notebooks and other mobile devices with mini Displayport to monitors or TVs with a Displayport interface.

Length	Colour	Code
1.0m	White	CL8201
2.0m	Black	CL8202BK
2.0m	White	CL8202WH
3.0m	White	CL8203



DISPLAYPORT TO MINI-DISPLAYPORT ADAPTOR

Male Displayport to Female Mini-Displayport.

Length	Colour	Code
0.2m	Black	CL8202F



USB TYPE-C TO DISPLAYPORT CABLE

- Input USB Type-C male
- Output: DisplayPort male
- 1080p@60Hz, 4K@30Hz
- Macs and Windows, etc.
- No external drivers or power required

Length	Code
1M	CL8800-1
2M	CL8800-2





Mini DisplayPort Leads

MINI-DISPLAYPORT CABLE

MALE TO MALE

Length	Bandwidth	Code
2.0M	1080p	MP394
2.0M	1600p	CL8602

MP394 is white with Prolink Packaging
CL8602 is Black (may change) 4K+



MINI-DISPLAYPORT EXTENSION LEAD

MALE TO FEMALE

8.64Gbps full bandwidth 2560x1600@60Hz
colour depth 16bits. DPCP, etc.

Length	Colour	Code
2.0M	White	CL8602F



MINI-DISPLAYPORT TO DISPLAYPORT SPLITTER

It can mirror image on both monitors. But It does not allow extended desktop display. 30CM overall length. Fully molded ends ensure heavy duty usages.

Length	Code
0.3M	CA431



MINI-DISPLAYPORT TO DISPLAYPORT ADAPTOR

MINI-DP PLUG TO DISPLAYPORT FEMALE

Mini Displayport Plug to Displayport Socket Adaptor Lead 15cm. 4K60Hz

Bandwidth	Code
4K	MP347
4K	CA432

* MP347 is white and Prolink Packaged



MINI-DISPLAYPORT TO HDMI SOCKET

To convert Mini Displayport signal to HDMI format signal, connect MacBook®, Mac-mini®, iMac® to HDTV. V1.1a

Bandwidth	Code
1080p	CA439
1080p	MP352

* MP352 is Prolink Packaged



MINI-DP V1.2

Bandwidth	Code
4K30	CA449

MP352 (Black)
CA449 (Black)



ACTIVE MINI-DP HDMI

Bandwidth	Code
4K30	CA453

MINI-DISPLAYPORT TO HDMI LEAD WHITE

High quality interconnects for Mini-DP and displays with standard HDMI, such as connection between Macbook® and HDTV. DP 1.1a 1080P 12bit HBR or UHD 4K 24bit HBR2.

Length	Bandwidth	Code
2.0M	1080p	MP340
2.0M	4K UHD	MP426



MINI-DISPLAYPORT TO HDMI LEAD BLACK

Length	Resolution	Code
0.5M	1080p	CL87005
1.0M	1080p	CL8701
1.0M	4K @60Hz	CL812-0100
1.5M	4K @60Hz	CL812-0150
2.0M	1080p	CL8702
2.0M	4K @60Hz	CL812-0200
3.0M	1080p	CL8703
3.0M	4K @60Hz	CL812-0300



MINI-DISPLAYPORT TO VGA ADAPTOR

APPLE® iMAC® & MACBOOK®

Mini-Displayport Plug to VGA 15 Pin Socket so as to connect a standard analogue VGA type monitor to an Apple® Mini-DisplayPort Short length lead 15cm

Length	Type	Code
0.15M	Prolink	MP351



MINI-DISPLAYPORT TO VGA LEAD

MINI-DP MALE TO VGA MALE

Connect an analogue monitor to a Mac.

Length	Code
2.0M	CL8902



MINI-DISPLAYPORT TO DVI ADAPTOR

MINI-DP MALE TO DVI FEMALE

Connect a Digital Video DVI type monitor to an Apple® Mini-DisplayPort. Short length lead 15cm

Length	Type	Code
0.15M	Active DVI-I	CA452
0.15M	Installer DVI-I	CA429
0.15M	Prolink DVI-D	MP350



MINI-DISPLAYPORT TO DVI-D LEAD

MINI-DP MALE TO DVI-D MALE

Connects Mac to DVI Monitors.

Length	Code
2.0M	CL8802
3.0M	CL8803



MINI-DISPLAYPORT TO HDMI / DVI / DISPLAY PORT

MINI-DISPLAYPORT MALE TO HDMI, DVI-D & DISPLAY PORT FEMALE

Length	Type	Code
0.15M	Installer	CA441



USB TYPE-C TO MINI DISPLAYPORT ADAPTOR

- USB3.1 Type C Male to Mini-Displayport Female
- Supports resolution up to 3840x2160p @ 30Hz
- ChromeBook®, Macbook® and Windows®.

Length	Code
0.1M	CA3104



USB TYPE-C TO MINI DISPLAYPORT CABLE

- Input USB Type-C male
- To Mini-DisplayPort male
- 1080p@60Hz, 4K@30Hz
- Macs and Windows, etc.
- No external drivers or power required

Length	Code
1M	CL8801-1
2M	CL8801-2





Apple® Digital Video Leads

MINI-DVI TO DVI-D & HDMI FEMALE

Code
CA427



11x7mm



MINI-DVI TO VGA FEMALE

Code
CA425



MINI-DVI TO DVI-D FEMALE

Code
CA426



MINI-DVI TO HDMI FEMALE

Code
CA428



APPLE 30 PIN TO HDMI FEMALE ADAPTOR

HDMI FEMALE

For iPad® only.

Length Code
200mm MDC9060



APPLE® AUDIO VIDEO DATA CABLE

APPLE® CERTIFIED

iPod®, iPhone®, iPad® Approved.
Composite video out.
Stereo Audio out to RCA.
Data to USB out & charge.
1.5M Length. White.
Attractively Packaged.

Code
APL35



APPLE® AUDIO VIDEO CABLE

APPLE® CERTIFIED

Uses Apple® docking adaptor.
Composite video out.
Stereo Audio out to RCA.
Data to USB out & charge.
1.5M Length. White.
Attractively Packaged.

Code
APL40



QUAD AUDIO VIDEO SPLITTER

3.5mm 4 Pin Plug To 2x
3.5mm 4 Pin Sockets.

Code
AD9052



Quad 3.5mm AV Leads

QUAD 3.5MM TO COMPONENT RGB LEAD

LG® SAMSUNG® HISENSE

This 3.5mm to RCA component cable features a 4-pin 3.5mm male plug and standard female component video outlets (Red/Green/Blue), tested for major brand TV monitor such as Samsung, LG and Hisense

- 1/ Green
- 2/ Blue
- 3/ Red
- 4/ Ground

Code
VC83



QUAD 3.5MM TO RCA AV LEAD - SUIT SAMSUNG

SAMSUNG® HISENSE & TV

4 Pin 3.5mm Quad Plug To 3xRCA Stereo Audio Red/White and Composite Video Yellow.

- 1/ Yellow
- 2/ Red
- 3/ White
- 4/ Ground

Code
VC81

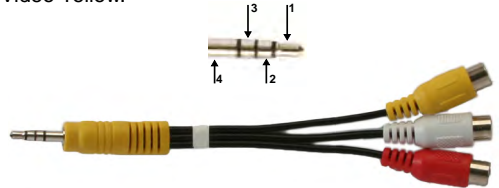

QUAD 3.5MM TO RCA AV LEAD - SUIT LG

LG® PHONE & TV

4 Pin 3.5mm Quad Plug To 3xRCA Stereo Audio Red/White and Composite Video Yellow.

- 1/ Yellow
- 2/ White
- 3/ Red
- 4/ Ground

Code
VC84

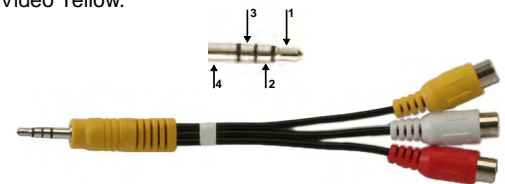

QUAD 3.5MM TO RCA AV LEAD - WHITE TIP #A

4 Pin 3.5mm Quad Plug To 3xRCA Stereo Audio Red/White and Composite Video Yellow.

Code
VC89



QUAD 3.5MM TO RCA AV LEAD - WHITE TIP #B

4 Pin 3.5mm Quad Plug To 3xRCA Stereo Audio Red/White and Composite Video Yellow.

Type	Code
RCA Plugs	VC86
RCA Sockets	VC487

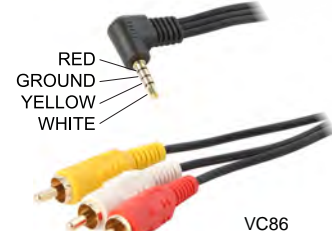

VC86

QUAD 2.5MM TO RCA AV LEAD - MINI PLUG

4 Pin 2.5mm Quad Plug To 3xRCA Stereo Audio Red/White and Composite Video Yellow.

- 1/ White (Tip)
- 2/ Yellow
- 3/ Ground
- 4/ Red

Code
VC286

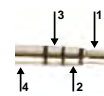



SCART Leads

SCART

SYNDICAT DES CONSTRUCTEURS D' APPAREILS RADIORECEPTEURS ET TELEVISEURS

21-Pin Euro-SCART Euroconnector as used with analogue video, Pay-TV, Satellite Set-Top Boxes, DVRs, etc.

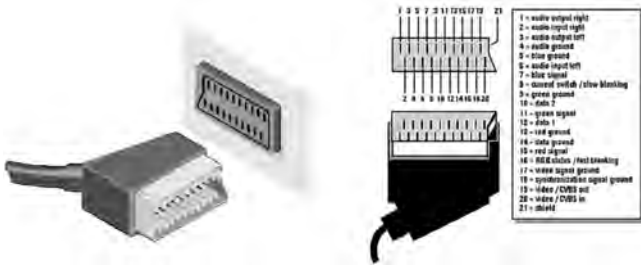

SCART TO S-VIDEO

SCART AV INPUT

To SCART Monitor S-VHS & Composite Video. Stereo Audio.

Code
AD904



SCART AV IN/OUT

Switchable as I/O S-VHS & Composite Video. Stereo Audio.

Code
AD905



SCART RGB/YUV ADAPTOR

Suits both Input/Output. 3x RCA Video I/O Only. No Audio.

Code
AD906



SCART TO SCART

All relevant pins wired straight through
Shielded Video & Audio. Both ways.
Cable is 19 wires + ground (shield).

Description	Code
SCART Plug to SCART Plug - All Pins Wired 1.5m	VC19
SCART Plug to SCART Plug - All Pins Wired 1.2m (Bulk)	VC18
SCART Plug to SCART Plug - All Pins Wired 3.0m	VC20



SCART BREAK-OUT COMPOSITE RCA & STEREO I/O

Description	Code
SCART Plug To 4 x RCA (Audio) and 2 x RCA Plugs. (Video) 1.5 Metres In Length.	VC24
SCART Plug To 4 x RCA (Audio) and 2 x RCA Plugs. (Video) 3.0 Metres In Length.	VC25



SCART TO RGB WITH AUDIO

RGB / YUV SCART CONNECTOR

3x Video Out & 2x Audio out. For connecting a SCART Output Source to an RCA Input on a Monitor or TV

Description	Code
SCART Plug to 5 x RCA. 1.2 Metres In Length	VC28
SCART Plug to 5 x RCA. 3.0 Metres In Length	VC29

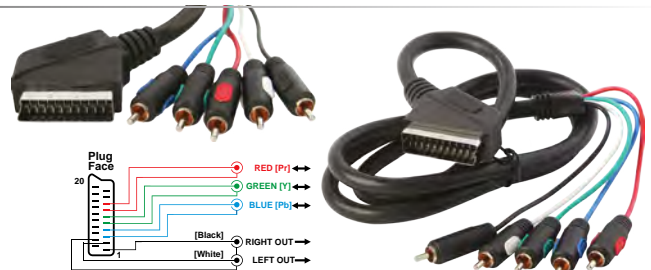

FOXTEL® SCART [GENUINE]

FOXTEL® SCART to VCR-DVR Record and Playback (I/O)

Description	Code
Composite Video/Audio I/O . 1.5M SCART Plug to 6 x RCA	FOX320





Digital Audio leads

TOSLINK TO TOSLINK - MICRO FLEX

2mm Quality Flexible. Bulk.

Length	Code
1.0M	OPTO111
2.0M	OPTO112
3.0M	OPTO113



TOSLINK TO TOSLINK - PROLINK

Toslink optical digital interconnect 4mm.

Length	Code
2M	MP111



TOSLINK TO TOSLINK - OPTOLINK PREMIUM GRADE

5mm tough protective casing. Gold tip with polished window, spring loaded for best optical contact. Heavy duty plug casing with rubber finger grip and cable strain relief. Made in Taiwan. Quality product suitable for Audiophile applications.

Length	Code
0.5M	OPTO2000
1.0M	OPTO2001
2.0M	OPTO2002
3.0M	OPTO2003
5.0M	OPTO2005
7.5M	OPTO2007
10M	OPTO2010
12.5M	OPTO2012
15M	OPTO2015



TOSLINK TO TOSLINK - WHITE PEARL SERIES

Metal Plugs. High grade cable. Beautiful exclusive cables

Length	Code
1.0M	CXS1502
2.0M	CXS1503
3.0M	CXS1504



MINI TOSLINK TO MINI TOSLINK - MICRO FLEX LEAD

4mm Quality Flexible black interconnect.

1.0M	OPTO211
3.0M	OPTO213
5.0M	OPTO215



MINI TOSLINK TO TOSLINK - MICRO FLEX LEAD

4mm Quality Flexible black interconnect.

1.0M	OPTO221
3.0M	OPTO223
5.0M	OPTO225



MINI TOSLINK TO TOSLINK - WHITE PEARL SERIES LEAD

Metal Plugs. High grade cable. Beautiful exclusive cables

Length	Code
3.0M	CXS1522



Digital Audio, Audio Visual

TOSLINK & RCA LEAD (Composite Video)

1x RCA Composite Video and 1x TOS-Link Optical fibre cable

Length	Code
1.0M	OPTO301



DIGITAL AUDIO INTERCONNECT - ORANGE RCA LEAD

WIDE-BAND DIGITAL COAXIAL LEAD 75Ω 6mm QUAD SHIELDING RG6 PREMIUM GRADE. GOLD PLATED METAL PLUGS.

Length	Code
0.8M	OFC501
1.5M	OFC502
3.0M	OFC503
5.0M	OFC505
10M	OFC510

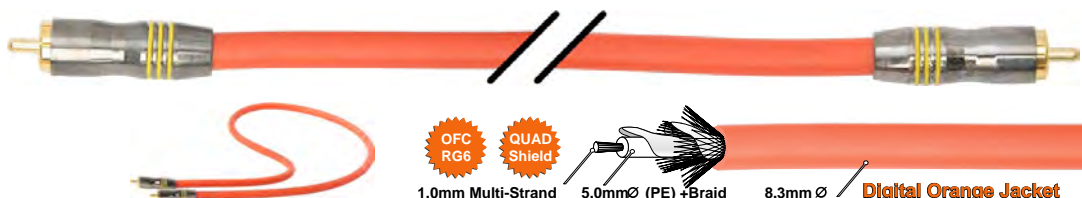



Digital Audio

TOSLINK ADAPTOR

For Toslink to Toslink extension.

Code
OPTO709



TOSLINK SPLITTER

Divide an optical output into two. Splits Toslink using a lens. All sockets.

Code
OPTO810



MINI TOSLINK ADAPTOR

For Toslink to 3.5mm plug adaptor.

Code
OPTO710



TOSLINK RIGHT ANGLE

Male end rotates 360°

Code
OPTO708



OPTICAL CABLE SELECTOR

TOS-LINK

Select between three sources. Bi-directional. Positive click select wheel.

Code
OPTO-SW3



DIGITAL OPTICAL AUDIO SWITCHER

COMPACT TOSLINK SELECTOR

Select from two digital optical inputs to one output, using TOSLink (Optical Fibre) cables. Can run up to 5 metres and provide reliable and lossless audio signal transmission.



DCT17 Has Remote Control

Input	Output	Code
Optical x 2	Optical x 1	DT-21
Optical x 4	Optical x 1	DCT-17

DIGITAL OPTICAL AUDIO SPLITTER

DIGITAL OPTICAL AUDIO SPLITTER

TOSLink (Optical Fibre) cables required. The Optical Fibre cables connected to both ends of the unit can run up to a range of 5 metres while still able to provide reliable and lossless audio signal transmission. The product is compact and easy to install, which makes it a very handy gadget, recommended for either home or professional audio distribution.

Input	Output	Code
Optical x 1	Optical x 2	DT-12



OPTICAL TO COAX CONVERTER

Digital stream I/O. 70x45x22mm. P/Pack supplied.

Code
OPTO830



COAX TO OPTICAL CONVERTER

Digital stream I/O. 70x45x22mm. P/Pack supplied.

Code
OPTO820



AUDIO FORMAT CONVERTER

VICE-VERSA and/or LINE EXTENDER

Converts Coaxial (S/PDIF) to Toslink or Toslink to Coaxial and repeater, Accepts S/PDIF audio signal input through either Coaxial cable or Toslink cable, and passes the signal (as is) to both its coaxial and Toslink output ports. With its built-in amplification feature, can also serve as a repeater to extend (double) the cable transferring distance.

Code
DCT-2



OPTICAL PCM TO STEREO ANALOGUE

CYPRESS DIGITAL DECODER

Compact unit with stereo audio output converted from Standard 16 bit PCM (Digital) Input is Toslink Optical or RCA PCM connections. Compatible with DCT4 and LPCM Stereo CD players. Accepts sampling frequencies 32KHz, 44.1KHz, 48KHz, 96KHz, 196KHz. White 42x40x22mm compact

Code
DCT-3A



STEREO ANALOGUE TO OPTICAL PCM

CYPRESS FORMAT CONVERTER

Compact unit with stereo audio in and converts it to 16 bit PCM (Digital) output to Toslink Optical and RCA PCM connections. Compatible with Digital home-theatre and receivers or other digital items, etc. Sampling rate 48KHz LPCM Linear Pulse Code Modulation

Code
DCT-4





White Pearl Audio Leads



STEREO RCA AUDIO LEAD - WHITE PEARL

2x RCA to 2x RCA Plugs

Length	Code
0.8M	CXS1102
1.5M	CXS1104
3.0M	CXS1106
5.0M	CXS1108
10M	CXS1110
15M	CXS1112

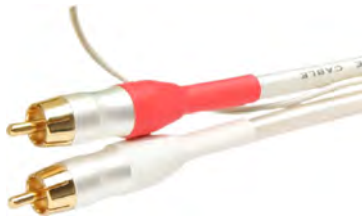

Premium RCA Stereo audio cable. Suits most audio HiFi & Home theatre. With centre "trigger wire" for Car-Audio, or as earth, etc.

AUDIO SPLITTER LEAD - WHITE PEARL

RCA Plug to 2x RCA Plugs

Length	Code
1.2M	CXS1060
3.0M	CXS1062
5.0M	CXS1064



Gold plated Lam-Spring All-Metal RCA Plugs Audiophile grade lead Popular adaptor cable Splits a single channel into two for use with Subwoofers, car audio, etc.

AUDIO SPLITTER LEAD - WHITE PEARL

RCA Plug to 2x RCA Sockets

Length	Code
0.1M	CXS1020

Gold plated Lam-Spring All-Metal RCA Plugs Audiophile grade lead Popular adaptor cable Splits a single channel into two for use with Subwoofers, car audio, etc.



AUDIO SPLITTER LEAD - WHITE PEARL

RCA Socket to 2x RCA Plugs

Length	Code
0.1M	CXS1002

Gold plated Lam-Spring All-Metal RCA Plugs Audiophile grade lead Popular adaptor cable Splits a single channel into two for use with Subwoofers, car audio, etc.

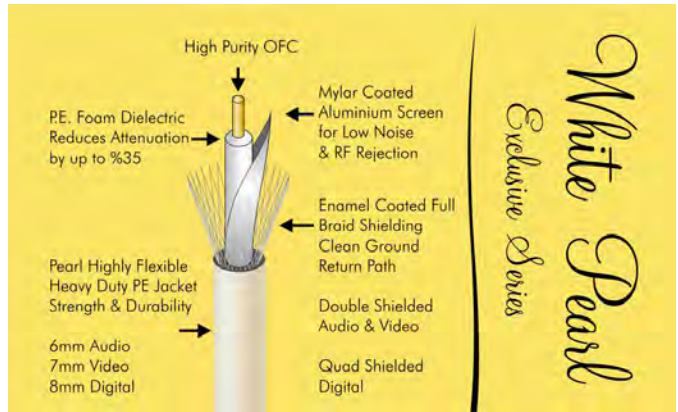

AUDIO SINGLE LEAD - WHITE PEARL

1 RCA Plug - 1 RCA Plug

Length	Code
1.5M	CXS1050
3.0M	CXS1052
5.0M	CXS1054
10M	CXS1056



AUDIO TYPE 6mm
Audiophile grade lead Suitable for Sub-woofers Centre channel & other audio

COMPOSITE VIDEO LEAD - WHITE PEARL

75Ω RCA Plug to Plug

Length	Code
0.8M	CXS1200
1.5M	CXS1202
5.0M	CXS1206
10M	CXS1208
15M	CXS1210



VIDEO LEAD 7mm Single
Video 75Ω Coax lead Double shielded 7mm Ø Pearl Jacket

DIGITAL COAX LEAD - WHITE PEARL

WIDE-BANDWIDTH COAX

Length	Code
0.8M	CXS1220
1.5M	CXS1222
3.0M	CXS1224
5.0M	CXS1226
10M	CXS1228



75Ω RCA TO RCA Video or Digital Quad shielding 8mmØ Cable Jacket Twist-Lock plug

RF TV FLYLEAD - WHITE PEARL

PAL 75Ω Plug to Plug

Length	Code
1.0M	CXS1601
1.5M	CXS1602
3.0M	CXS1603
5.0M	CXS1605
10M	CXS1610



ANTENNA LEAD PAL Antenna Plug Male to Male 75Ω Coax 7mm Double Shield Gun-Metal Plug



White Pearl

HAND CRAFTED FOR LONG LIFE
INTERCONNECT DEPENDABILITY
EUROPEAN DESIGNED HIGH-END
AUDIOPHILE PERFORMANCE

WHITE PEARL - EXCLUSIVE SERIES:

COLOUR CODED HEAT-SHRINK STRAIN RELIEF BOOTS
PREMIUM GRADE PLUGS - HAND SOLDERED RELIABILITY
HIGH-GLOSS PEARL FINISH - EXTRA STRONG METAL JACKET
24CT GOLD-PLATED CLEAN CONNECTIONS
RCA LAM-SPRING GRIPS SURE-CONTACT PLUGS
VISUALLY BEAUTIFUL
ELECTRONICALLY TRANSPARENT

White Pearl
Exclusive Series



3.5MM STEREO TO 2x RCA AUDIO - WHITE PEARL

3.5mm to 2x RCA Plugs

Length	Code
1.5M	CXS1450
3.0M	CXS1452
5.0M	CXS1454

HEADPHONE TO HIFI

Suit any iPod® & MP3 to
Auxiliary-In Home Theatre



3.5mm QUAD A/V LEAD - WHITE PEARL

3.5mm to 3x RCA Plugs

Length	Code
1.5M	CXS1490

AUDIO & VIDEO

Suit iPod® & MP4 to
Auxiliary input Home
Theatre & TV



OPTICAL TOSLINK - WHITE PEARL

Toslink to Toslink

Length	Code
1.0M	CXS1502
2.0M	CXS1503
3.0M	CXS1504

FIBRE-OPTICS

Beautifully crafted
Digital Interconnect
Transfers light from
one unit to another



OPTICAL TOSLINK TO 3.5MM - WHITE PEARL

Toslink to 3.5mm

Length	Code
3.0M	CXS1522

MINI-TOSLINK

Adaptor cable for
transferring light
from units with
3.5mm Optical I/O



SCART VCR LEAD - WHITE PEARL

1x RCA Video & 2x RCA Audio 2x Sets for Input + Output

Length	Code
1.5M	CXS1310

VCR CONNECT

STB to VCR
Vice-Versa
Bi-Directional
Composite Video
Stereo Audio L/R



STEREO AUDIO & VIDEO LEAD - WHITE PEARL

2x RCA Stereo Audio and 1x RCA 75Ω Video Plug to Plug

Length	Code
0.8M	CXS1150
1.5M	CXS1152
3.0M	CXS1154
5.0M	CXS1156
10M	CXS1158
15M	CXS1160

QUICK CONNECT

Home theatre solution premium
quality image and sound transfer



STEREO AUDIO & S-VIDEO LEAD - WHITE PEARL

2x RCA Stereo Audio and 1x S-Video MD4 Plug to Plug

Length	Code
1.5M	CXS1422
3.0M	CXS1424

QUICK CONNECT

Home theatre solution
premium quality image
and sound transfer
4-Pin S-Video plugs



COMPONENT VIDEO LEAD - WHITE PEARL

YUV/RGB 3x RCA 75Ω Plug to Plug

Length	Code
0.8M 3x RCA METAL plugs	CXS1250
1.5M 3x RCA METAL plugs	CXS1252
3.0M 3x RCA METAL plugs	CXS1254
5.0M 3x RCA METAL plugs	CXS1256
10M 3x RCA METAL plugs	CXS1258
15M 3x RCA METAL plugs	CXS1260

DVD & STB CONNECT

SD/HD Compatible Video
3x Plug to 3x Plug 75Ω
7mm Coax Double shield
Premium Video transfer

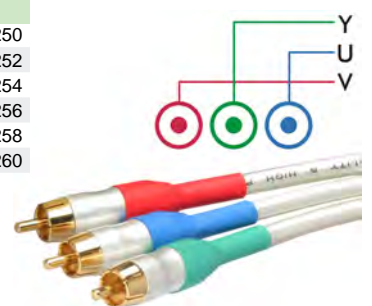



Cables & Connectors

Audio Visual Deluxe OFC

HIGH QUALITY OFC AUDIO AND VIDEO LEADS

These cables are 99.99% pure Copper with double shielding and a Cellular Polyethylene insulated jacket. The plugs are Gold plated, Teflon insulated, molded, RCA connectors. The figure 8 cable has an earth/remote power lead. Blister packed.

0.1M SOCKET TO 2-PLUGS HQ-OFC

Length	Code
0.1M	OFC622



0.1M PLUG TO 2-SOCKETS HQ-OFC

Length	Code
0.1M	OFC625



STEREO RCA WITH TRIGGER / EARTH WIRE

10CM STEREO HQ-OFC

Length	Code
0.1M	OFC606



0.8M STEREO HQ-OFC

Length	Code
0.8M	OFC607



1.5M STEREO HQ-OFC

Length	Code
1.5M	OFC608



3M STEREO HQ-OFC

Length	Code
3.0M	OFC612



5M STEREO HQ-OFC

Length	Code
5.0M	OFC614



8M STEREO HQ-OFC

Length	Code
8.0M	OFC615



15M STEREO HQ-OFC

Length	Code
15M	OFC616



STEREO AUDIO VIDEO HQ-OFC

Stereo Audio + Video 75Ω Composite Video Interconnect 99.99% Pure Copper. Electric Blue.

SUPPLIED PACKAGED

Length	Code
1.5M	OFC50
3.0M	OFC60
5.0M	OFC61
8.0M	OFC62
15M	OFC65



COMPONENT VIDEO LEADS HQ-OFC

3x 75Ω OFC Double Shielded 99.99% OFC Component Video Interconnect RGB/YUV Heavy duty electric blue jacketed

SUPPLIED PACKAGED

Length	Code
1.5M	OFC70
3.0M	OFC72
5.0M	OFC73
8.0M	OFC74
15M	OFC75



Audio Visual Installer OFC

INSTALLER OFC RCA LEADS PACKAGED & BULK

Low Loss OFC Fully Shielded Cable with Gold Plated Plugs. Quality Interconnects for longer reliability connections.



INSTALLER OFC 1x RCA PLUG TO 2x RCA SOCKETS

Description	Code
Bulk 15cm	RCA10B



PACKAGED OFC 1x RCA PLUG TO 2x RCA PLUGS

Description	Code
Packaged 1.0M	RCA15



PACKAGED OFC 2x RCA PLUGS TO 2x RCA PLUGS

Description	Code
Packaged 1.0M	RCA60
Packaged 3.0M	RCA200
Packaged 5.0M	RCA250



INSTALLER OFC 2x RCA PLUGS TO 2x RCA PLUGS

Description	Code
Bulk 1.0M	RCA60B
Bulk 1.8M	RCA180B
Bulk 3.0M	RCA200B
Bulk 5.0M	RCA250B
Bulk 10M	RCA260B
Bulk 15M	RCA270B



INSTALLER OFC 3x RCA PLUGS TO 3x RCA PLUGS

COMPONENT VIDEO YUV/RGB BULK

Description	Code
Bulk 1.5M	RCA302
Bulk 3.0M	RCA303
Bulk 5.0M	RCA305
Bulk 10M	RCA310
Bulk 15M	RCA315



Audio Visual Hand-Soldered OFC

PACKAGED OFC 3x RCA PLUGS TO 3x RCA PLUGS

3x RCA TO 3x RCA COMPONENT / RGB VIDEO

Description	Code
Packaged 1.5M	OFC76
Packaged 3.0M	OFC78
Packaged 5.0M	OFC79
Packaged 8.0M	OFC80
Packaged 15M	OFC81



RCA VIDEO OR DIGITAL AUDIO INTERCONNECT

75Ω Quad-Shielded Video Interconnect

Length	Code
0.8M	OFC501
1.5M	OFC502
3.0M	OFC503
5.0M	OFC505
10M	OFC510





□ Audio Visual Leads

ONE RCA PLUG TO ONE RCA PLUG SHIELDED

Flexible coax fully shielded Audio Leads. All black. For Video Cable, see the VC214 Range...

Description	Code
1.2 Metre long	AL600
1.2 Metre long BULK.	AL601
3 Metre long	AL602
3 Metre long BULK	AL603



ONE RCA PLUG TO TWO RCA PLUGS SHIELDED

Description	Code
1.2 Metre long Packaged	AL604
1.2 Metre long in BULK.	AL604B
3 Metre long Packaged	AL605
3 Metre long in BULK.	AL605B
5 Metre long Packaged	AL606
5 Metre long in BULK	AL606B



TWO RCA PLUGS TO TWO RCA PLUGS SHIELDED

Description	Code
1.2 Metre long	AL608
1.2 Metre long in BULK.	AL609
3 Metre long	AL612
3 Metre long in BULK.	AL613
5 Metre long	AL614
5 Metre long in BULK	AL614B



THREE RCA PLUGS TO PLUGS AUDIO+VIDEO LEAD

Description	Code
1.5M Stereo + RG59U(75Ω) Bulk	VC51
1.5M Stereo + RG59U(75Ω) Packaged	VC50
3.0M Stereo + RG59U(75Ω) Bulk	VC62
3.0M Stereo + RG59U(75Ω) Packaged	VC60
5.0M Stereo + RG59U(75Ω) Bulk	VC66
5.0M Stereo + RG59U(75Ω) Packaged	VC65
8.0M Stereo + RG59U(75Ω) Bulk	VC69
8.0M Stereo + RG59U(75Ω) Packaged	VC68
10M Stereo + RG59U(75Ω) Bulk	VC611



FOUR RCA PLUGS TO FOUR RCA PLUGS SHIELDED

Description	Code
4 X RCA Plugs To 4 X RCA Plugs 1.2 Metre Shielded Cable	AL616
4 X RCA Plugs To 4 X RCA Plugs 3 Metre Shielded Cable	AL618



RCA EXTENSION LEAD SINGLE AUDIO

Description	Code
RCA Plug To RCA Socket 1.2 Metre Shielded Cable	AL620



RCA SPLITTER LEAD AUDIO

Description	Code
RCA Plug To 2 X RCA Sockets 10 Centimetre Shielded Cable	AL624
RCA Plug To 2 X RCA Sockets 1.2 Metre Shielded Cable	AL626



RCA EXTENSION LEAD STEREO AUDIO

Description	Code
2 X RCA Plugs To 2 X RCA Sockets 1.2 Metre Shielded Cable	AL628
2 X RCA Plugs To 2 X RCA Sockets 3 Metre Shielded Cable	AL632



RCA EXTENSION LEAD QUAD AUDIO

Description	Code
4 X RCA Plugs To 4 X RCA Sockets 3.0 Metre Shielded Cable	AL634





S-Video Leads

S-VIDEO INTERCONNECTS

Length	Code
1.5M	VC70
3.0M	VC703
5.0M	VC71
8.0M	VC72

4 PIN MINI-DIN INTERCONNECTS



S-VIDEO & AUDIO INTERCONNECT

S-VHS Audio/Video lead Video; 4 pin mini DIN male to male Audio; 2x RCA to 2x RCA male. Gold plated plugs. OFC cable.

Length	Code
1.5M	VC90
3.0M	VC91
5.0M	VC92
8.0M	VC93



S-VIDEO EXTRACTOR

S-VHS adaptor lead 4 pin mini DIN to 2 x RCA plugs 1.5M

RED = Chrominance
BLACK = Luminance

Code
VC78



Video Composite Leads

RCA TO BNC 75Ω

Length	Code
1.5M	VC6



RCA TO RCA 75Ω

Length	Code
1.5M	VC212
3.0M	VC213
5.0M	VC214
10M	VC215



RCA TO RCA 75Ω ORANGE QUAD SHIELDED

Length	Code
0.8M	OFC501
1.5M	OFC502
3.0M	OFC503
5.0M	OFC505
10M	OFC510



BNC TO BNC 75Ω

Length	Code
1.5M	VC201
3.0M	VC203
10M	VC210



BNC TO BNC 50Ω

Ethernet and Test Instrument cables 50Ω

Length	Code
2.0M	CL102
5.0M	CL105
10M	CL110



PL259 TO BNC 75Ω

Length	Code
1.5M	VC2



PL259 TO PL259 75Ω

Length	Code
1.8M	VC3



Camera Video Leads

CAMERA BREAKOUT LEAD 8 PIN SANYO MONO

Audio video cable for SANYO 8 pin mini DIN plug to 2 RCA plugs. Gold plated. 1.5M
Orig. P/No.636-020-9282

Code
VC82



CAMERA EXTENSION LEAD 8 PIN JVC, PANASONIC

VHS-C camera extension lead 8 pin male to female (Plastic plug as used by JVC, etc.) 1.5M

Code
VC75



CAMERA BREAKOUT LEAD 8 PIN S-VIDEO VCR

VHS-C camera to a Stereo VCR. 8 pin to 3 RCA plugs. (Video + Stereo Audio) Gold plated. 1.5M

Code
VC85



CAMERA BREAKOUT LEAD 5 PIN S-VIDEO VCR

Digi-Cam to a Stereo Video 5 pin to 3 RCA and S-Video. 1.8M (Video + Video + Audio Stereo)
Sony 1-823-156-13 DCR-IP7

Code
VC292



CAMERA BREAKOUT LEAD 3.5MM MONO

Camera or Video Card lead. Mono 3.5mm plug to RCA Video 3.5mm plug to 2x RCA Audio (for stereo inputs) Cable Length - 1.5M

Code
VC87



CAMERA BREAKOUT LEAD 3.5MM STEREO

Camera or Video Card lead. Stereo 3.5mm plug to RCA Video and 3.5mm stereo plug to 2x RCA Audio Cable Length - 1.5M

Code
VC88



DVC BREAKOUT LEAD 3.5MM QUAD PIN

4 pin 3.5mm plug (Used by DVC) 3xRCA out. Suit JVC & Sony, etc. Composite Video, Stereo Audio Out. 1.5M Long. RCA Plugs

Type	Code
RCA Plugs	VC86
RCA Sockets	VC487



DVC BREAKOUT LEAD 2.5MM QUAD PIN

4 pin 2.5mm plug (Used by DVC) 3xRCA out. Suit Panasonic, etc. Composite Video, Stereo Audio Out.

Code
VC286





□ 1/4" & 1/8" Jack Leads

RCA TO PHONO MONO

Description	Code
RCA Plug To 3.5mm Plug 1.2 Metre Shielded Cable	AL636



RCA TO PHONO SPLITTER MONO

Description	Code
2 X RCA Plugs To 3.5mm Plug 1.2 Metre Shielded Cable	AL640
2 X RCA Plugs To 3.5mm Plug 1.2M w/ 100K Resistor	AL644



RCA TO PHONO 1/4" INSTRUMENT LEAD

Description	Code
2 X RCA Plugs To 6.35mm Plug 1.2 Metre Shielded Cable	AL648
100K Ohm In-line Resistor Adapts Line to mic-in, etc.	



RCA TO PHONO STEREO LEAD

Description	Code
2 X RCA Plugs To 2 X 3.5mm Plugs 1.2 Metre Shielded Cable	AL652



RCA TO 3.5MM STEREO ADAPTOR LEAD

Description	Code
2 X RCA To 3.5mm Stereo Plug 0.1M	AL641
2 X RCA To 3.5mm Stereo Plug 1.5M	AL656
2 X RCA To 3.5mm Right-Angle Plug 1.5M	AL657
2 X RCA To 3.5mm Stereo Plug 3M	AL658
2 X RCA To 3.5mm Stereo Plug 5M	AL659



AL657

RCA TO STEREO SOCKET ADAPTOR LEAD

Description	Code
2 X RCA Plugs To 3.5mm Stereo Socket 0.1 Metre (10cm)	AL638
Shielded Cable Black Adapts Line I/O to Headphone Socket	



3.5MM TO RCA STEREO ADAPTOR LEAD

Description	Code
2x RCA Sockets to 3.5mm Stereo Plug 10cm	AL642



WHITE-PEARL MP3 LEAD

HEADPHONE TO HIFI
Suit any iPod® & MP3 to
Auxiliary-In Home Theatre

Length	Code
1.5M	CXS1450
3.0M	CXS1452
5.0M	CXS1454



WHITE-PEARL QUAD A/V LEAD

AUDIO & VIDEO
Suit iPod® & MP4
to Auxiliary input
Home Theatre & TV

3.5mm Quad to 3x RCA Plugs

Length	Code
1.5M	CXS1490



3.5MM STEREO TO RCA PLUGS

3.5mm Stereo plug to
RCA plugs x2 Stereo audio.

Length	Code
2M	MP147



RCA STEREO TO RCA STEREO

2x RCA plugs to 2x RCA plugs.
Stereo audio.

Length	Code
2M	MP101





□ 1/4" & 1/8" Jack Leads

MICRO INTERCONNECT

Description	Code
2.5 mm Plug To 2.5 mm Plug. Mono. 1.2M	AL700
2.5 mm Plug To 2.5 mm Socket. Mono. 5.0M	AL702
2.5 mm Plug To 3.5 mm Plug. Mono. 1.2M	AL704



MICRO & MINI REPLACEMENT LEADS - MONO & QUAD

Description	Code
2.5mm Mono Plug to 6.0M Lead	RCC25
3.5mm Mono Plug to 1.8M Lead	DCL3514ST
3.5mm Mono Plug to 6.0M Lead	RCC35
2.5mm Quad Plug to 2.5M Lead	VC1254
3.5mm Quad Plug to 2.5M Lead	VC1354



MONO INTERCONNECT 3.5mm

Description	Code
3.5 mm Plug To 3.5 mm Plug. 1.2 Metre Shielded Cable	AL708
3.5 mm Plug To 3.5 mm Plug. 1.2 Metre Shielded Cable 100KΩ inline attenuation resistor (connect to mic in, etc.)	AL712
3.5 mm Right Angle Plug To 3.5 mm Right Angle Plug. 2M	AL710



STEREO INTERCONNECT 3.5mm [and 2.5mm]

Description	Code
2.5mm Stereo Plug To Plug 1.5M	AL751
2.5mm Stereo Plug To Plug 3.0M	AL753
3.5mm Stereo Plug To Plug 0.5M	AL7200
1 Metre, 3.5mm To 3.5mm Stereo Lead	AP135
3.5mm Stereo Plug To Plug 1.0M Prolink Red Lead	AL719
3.5mm Stereo Plug To Plug 1.0M Prolink Red R/A Plug	AL729
3.5mm Stereo Plug To Plug 1.2M	AL720
3.5mm Stereo Plug To Plug 1.2M Bulk	AL720B
1.5M 3.5MM To 3.5MM Stereo Lead White	APL60WS
3.5mm Stereo Plug To Plug 1.5M Blister Packed Jackson	AV2001
3.5mm Stereo Plug To Plug 1.5M R/A	AL721
3.5mm Stereo Plug To Plug 2.0M	AL7202
3.5mm Stereo Plug To Plug 2.0M Prolink Curly Cord Black	HMM105S
3.5mm Stereo Plug To Plug 2.0M Prolink White	MP146
3.5mm Stereo Plug To Plug 3.0M	AL722
3.5mm Stereo Plug To Plug 5.0M	AL723
3.5mm Stereo Plug To Plug 10M	AL7210



5 PORTS 3.5MM STEREO

3.5mm Plug to five 3.5mm Jacks.
Splits to multiple headphones

Code
AD1206



3.5MM SPLITTER

Headphone Splitter Cable
3.5mm plug TO 2x 3.5mm Sockets

Colour	Code
Black	AL725
White	AL1725



QUAD PLUG SPLITTER

Splitting a 3.5mm Quad plug into two 3.5mm Quad sockets.
4 pole 3.5mm connection supports AV & control of smart phones, etc.

Length	Code
0.2M	MP155



QUAD PLUG INTERCONNECT 3.5mm & 2.5mm

Description	Code
2.5mm Quad Plug To 2.5mm Quad Plug 1.5M	VC432
2.5mm Quad Plug To 2.5mm Quad Plug 3.0M	VC433
2.5mm Quad Plug To 2.5mm Quad Plug 5.0M	VC435
3.5mm Quad Plug To 2.5mm Quad Plug 1.5M	VC442
3.5mm Quad Plug To 2.5mm Quad Plug 3.0M	VC443
3.5mm Quad Plug To 2.5mm Quad Plug 5.0M	VC445
3.5mm Quad Plug To 3.5mm Quad Plug 1.5M	VC422
3.5mm Quad Plug To 3.5mm Quad Plug 3.0M	VC423
3.5mm Quad Plug To 3.5mm Quad Plug 5.0M	VC425
3.5mm Quad Plug To 3.5mm Quad Plug 1.2M Red R/A Plug	VC426
3.5mm Quad Plug To 3.5mm Quad Socket 1.2M Red	VC427



QUAD-PLUG LEAD SETS

Special QUAD version 1/8" Plugs. Four connectors.
2.5 metres with molded plugs to 3+ Shield.

Description	Code
2.5mm Quad Plug to 2.5M Lead	VC1254
3.5mm Quad Plug to 2.5M Lead	VC1354





2.5mm STEREO CABLE

Stereo Lead with a 2.5mm plug to 2.5mm plug interconnect cable

Length	Code
1.5M	AL751
3.0M	AL753



2.5MM HEADPHONE ADAPTOR

2.5mm Plug To 3.5mm Socket

Short adaptor Cable for plugging headphones into media devices that use the micro-phono 2.5mm socket.

Type	Code
3 Pin	AD111



3.5MM STEREO COILED CABLE

2M long corded cable made with 99.96% oxygen free copper wire.

Length	Code
2.0M	HMM105S

PROLINK



3.5MM STEREO LEAD - AERPRO

1.5 metres long. 3.5mm stereo male to male audio. White colour. Aerpro brand.

Length	Code
1.5M	APL60WS



3.5MM STEREO CABLE

3.5mm Stereo Male-Male Prolink White Lead

Length	Code
2.0M	MP146



QUAD 3.5MM/2.5MM

2.5mm TO 3.5mm

Four pin connection Black 3mm flex lead

Length	Code
1.5M	VC442
3.0M	VC443
5.0M	VC445



QUAD 2.5MM

2.5mm TO 2.5mm

Four pin Black 3mm flex lead

Length	Code
1.5M	VC432
3.0M	VC433
5.0M	VC435



QUAD 3.5MM

3.5mm TO 3.5mm

Four pin Black 3mm flex lead

Length	Code
1.5M	VC422
3.0M	VC423
5.0M	VC425



STEREO 3.5MM MALE TO MALE

3.5mm Male to male Gold plated Plugs Compact

Length	Code
1.0M	AL719



QUAD 3.5MM MALE TO MALE

3.5mm Quad Gold plated Right angle

Length	Code
1.2M	VC426



QUAD 3.5MM EXTENSION CABLE

3.5mm QUAD MALE TO FEMALE

Quad 3.5mm Male to Female Gold plated

Length	Code
1.2M	VC427



SPLITTER LEAD STEREO 3.5mm TO MONO 3.5mm

Length	Code
1.2M	AL724



EXTENSION LEAD STEREO 3.5mm MALE-FEMALE

Length	Code
1.8M	AL726
3.0M	AL727
5.0M	AL728



1/4" HEADPHONE EXTENSION LEAD STEREO

Length	Cord	Code
8.0M	Straight	AL732
8.0M	Curly	AL736



3.5mm PC TO QUAD ADAPTOR

2X STEREO 3.5MM PLUGS (PC) TO QUAD 3.5MM SOCKET

The adaptor allows the use of a mobile phone type handsfree head set with quad plug on a computer that has separate speaker and microphone ports. Length: 17cm

Code
AD921



DIGITAL USB LEADS

Suits connection to USB for media view, transfer and charging.

See Computer Section for more...



SEE DATA SECTION 04

USB TYPE-C TO 3.5MM AUDIO ADAPTOR

- USB-C ADC 3.5mm Headphone Socket
- Includes Power through for charging

Code
USB3102B



USB TYPE-C TO 3.5MM AUDIO ADAPTOR

- USB-C ADC To 3.5mm Audio
- Compact Adaptor type
- USB-C for charging

Code
CA3113



USB TYPE-C TO 3.5MM AUDIO ADAPTOR

- USB-C To 3.5mm ADC
- Short cable adaptor

Colour	Code
Black	CA3112B
White	CA3112W



USB TYPE-C TO 3.5MM STEREO AUDIO CABLE

- USB-C to 3.5mm Plug
- 1.0 metre in length
- Nylon weave braid

Length	Code
1M	AL731





Cables & Connectors

Apple® Audio Leads

LIGHTNING® TO 2x 3.5MM AUDIO ADAPTOR

This Apple Lightning to 2x 3.5mm audio socket adaptor is suitable for connecting 3.5mm earphones or headphones to the newer version of Apple iPhones and iPads that have no audio socket.

Code
AHF9107



LIGHTNING® TO MICRO-USB & 3.5MM AUDIO

- 8 Pin to Micro USB & 3.5mm audio AUX cable headset converter.
- Support apple iPhone and iPad ≤iOS9 series
- Does Not support iOS 10.3.1 or above.

Code
AHF9101



LIGHTNING® TO 3.5MM FEMALE AUDIO ADAPTOR

This Apple Lightning to 3.5mm audio socket adaptor is suitable for connecting a 3.5mm earphone or headphone to Apple® iPhones® (7 and above) and iPads® that now have no audio socket.

Code
AHF9106



LIGHTNING® TO LIGHTNING® + 3.5MM AUDIO

This splitter allows you to connect your 3.5mm earphones and charge your iPhone® or iPad® at the same time. Apple iPhone® and iPad® compatible.

Code
AHF9103



COMPACT DUAL APPLE LIGHTNING® ADAPTOR

CONNECT CHARGER AND HEADPHONES

Code
AHF9108



LIGHTNING® TO 3.5MM AUDIO WITH VOLUME

- 8 Pin to 3.5mm AUX audio cable headset converter.
- With In-line volume & answer control
- 180mm braided cord, metal cased
- Optional Micro-USB input for charging
- Support iPhone and iPad ≤iOS9 series
- Does Not support iOS 10.3.1 or above.

Code
AHF9102



iPOD® / iPHONE® AUDIO & VIDEO

Composite video output
Stereo audio output RCA
USB to Micro USB
1.5 metre cable

Code
APL40



USB TO APPLE® 30 PIN DOCK

USB Plug to iPod® Connector

Type	Length	Code
Apple Certified	1.5M	APL30
Apple Certified	3.0M	APL55
Apple 30 pin	1.0M	MDC9003
Retractable	0.8M	CL1018



iPOD® AUDIO VIDEO CABLE

Composite video output
Stereo audio output 1.5 Metre

Code
APL35



DIN Leads

DIN BREAK-OUT LEAD MONO

Description	Code
2 X RCA Plugs To 5 Pin DIN Plug 1.2 Metre Shielded Cable. Mono I/O Suit older videos, etc. with mono audio input/output.	AL660



DIN BREAK-OUT LEAD STEREO

Description	Code
4 X RCA Plugs To 5 Pin DIN Plug 1.2 Metre Shielded Cable	AL664
4 X RCA Plugs To 5 Pin DIN Plug 3.0 Metre Shielded Cable	AL668



DIN BREAK-OUT LEAD SOCKETS

Description	Code
4 X RCA Sockets To 5 Pin DIN Plug 1.2 Metre Shielded Cable	AL672



DIN [5 PIN]

Description	Code
5 Pin Din Plug To 5 Pin DIN Plug. 1.2 Metre Shielded Cable	AL676
5 Pin Din Plug To 5 Pin DIN Plug. 3.0 Metre Shielded Cable	AL680



DIN [5 PIN] EXTENSION

Description	Code
5 Pin DIN Plug To 5 Pin DIN Socket 1.2 Metre Shielded Extension Cable	AL684





XLR Professional Leads

XLR 1/4" MICROPHONE LEAD UNBALANCED

Unbalanced microphone lead
6.35mm Plug to 3 Pin Female
Metal Plugs. Suit PA, etc. 5 Metre
Heavy Duty cable.

Length	5M
Code	ML10



XLR MICROPHONE LEAD BALANCED

Balanced microphone lead.
3 Pin Female to Male Metal Plugs.
Suit PA, etc. Metal Plugs.
5 Metre Heavy Duty cable.

Length	5M
Code	ML12



DMX LIGHTING 5 PIN CABLE - AMPHENOL

Genuine Amphenol made Amphe-DMX Lead 5
PIN XLR-F To XLR-M lighting cable. Design
for heavy duty stage lighting applications.
Premium Amphenol connectors with
rugged diecast housings. Heavy
duty screened cable.

Amphenol

Plug A	5 Pin XLR Male				
Plug B	5 Pin XLR Female				
Length	1M	5M	10M	15M	20M
Code	PR7075D001	PR7075D005	PR7075D010	PR7075D015	PR7075D020



XLR TO RCA 3M X2 - AERPRO

RCA Male (x2) to XLR Male (x2)
Sold As a Stereo Pair of 2x 3 Metre
Line-Level-In etc. to PA Amplifier Input
Sturdy Rubber covered Shielded cable

Length	3M
Plug A	XLR Male
Plug B	RCA Male
QTY	2
Code	ALXRCA3



NL4 TO BANANA 6M SPEAKER LEADS - AERPRO

1.1M (x2) NL4 to NL4 with 2 Pins Wired
4mm Banana Pair to PA Speaker (NL4)
Smart Push type lock in connectors.
Sturdy Rubber covered black lead.
Stereo (Leads x2) in hang sell blister.

Length	6M x2	L	NL4	R	NL4
Plug A	NL4				
Plug B	Banana				
Code	ALPASC6				



SPEAKON® TYPE LEAD NL4

SpeakON high quality pre-made
cables ready for you to use in your
audio system. 2 Core (NL4 Plugs).

Length	Code
5M x1	AL730-5
10M x1	AL730-10



MICROPHONE INSTRUMENT LEADS - AMPHENOL

XLR-F TO XLR-M

Nickel Barrel Amphenol Leads Musician Series
Instrument Cable Microphone Extension
Balanced AC3-FJ to AC3-MMJ

Length	Code
1M	PR0110A001
3M	PR0110A003
6M	PR0110A006
9M	PR0110A009
12M	PR0110A012
15M	PR0110A015
20M	PR0110A020
30M	PR0110A030



Amphenol

XLR-F TO 6.35mm STEREO

Length	Code
1M	PR0124A001
3M	PR0124A003
6M	PR0124A006
9M	PR0124A009



XLR-F TO 6.35mm MONO

Length	Code
1M	PR0120A001
3M	PR0120A003
6M	PR0120A006
9M	PR0120A009
12M	PR0120A012



XLR-M TO 6.35MM

Length	Code
6M	PR1024A006



6.35mm TO 6.35mm MONO

Nickel Barrel / Gold plated Leads Musician
Series Instrument Cable Instrument connect,
Guitar, etc. AC3-FJ to TM2-PJ

Length	Code
1M	GD3030B001
3M	GD3030B003
6M	GD3030B006
9M	GD3030B009



Amphenol

6.35mm TO 6.35mm RIGHT/ANGLE

Length	Code
1M	GD3034B001
3M	GD3034B003
6M	GD3034B006
9M	GD3034B009



1/4" INSTRUMENT LEAD

Length	Code
8M	AL717



1/4" HQ INSTRUMENT LEAD

Length	Code
6M	AL718



1/4" HQ INSTRUMENT LEAD - CURLY

Length	Code
8M	AL716





Video Leads RCA

RCA VIDEO LEAD COMPOSITE [SINGLE]

1x 75Ω RG59U COAX & YELLOW MOLDED PLUGS

Description	Code
RCA Plug To RCA Plug. 1.5 metres 75 Ohm Coax	VC212
RCA Plug To RCA Plug. 3 metres 75 Ohm Coax	VC213
RCA Plug To RCA Plug. 5 metres 75 Ohm Coax	VC214
RCA Plug To RCA Plug. 10 metres 75 Ohm Coax	VC215



RCA DIGITAL & VIDEO INTERCONNECT - ORANGE MOLDED PLUG & LEAD

75Ω Quad-Shielded Digital Wide-Band Interconnect. Also suitable for use as 75Ω Video Coax Lead

0.8M RCA To RCA Digital	OFC501
1.5M RCA To RCA Digital	OFC502
3.0M RCA To RCA Digital	OFC503
5.0M RCA To RCA Digital	OFC505
10M RCA To RCA Digital	OFC510



RCA DIGITAL & VIDEO INTERCONNECT - WHITE PEARL DELUXE SERIES

White Pearl OFC RCA Double Shielded 0.8M	CXS1200
White Pearl OFC RCA Double Shielded 1.5M	CXS1202
White Pearl OFC RCA Double Shielded 5.0M	CXS1206
White Pearl OFC RCA Double Shielded 10M	CXS1208
White Pearl OFC RCA Double Shielded 15M	CXS1210
White Pearl OFC RCA Quad Shielded 0.8M	CXS1220
White Pearl OFC RCA Quad Shielded 1.5M	CXS1222
White Pearl OFC RCA Quad Shielded 3.0M	CXS1224
White Pearl OFC RCA Quad Shielded 5.0M	CXS1226
White Pearl OFC RCA Quad Shielded 10M	CXS1228

Gold plated plugs.
Metal barrel.
Pearl white.
Quad Shielded
is suitable for
Video & Wide-
Bandwidth Digital
transmission



STEREO AV CABLE - AUDIO/VIDEO COMBO LEADS

Black Shielded Stereo Audio + RG59U 75Ω Black Coax Cable

Description	Code
1.5M Stereo + RG59U(75Ω) Packaged	VC50
3.0M Stereo + RG59U(75Ω) Packaged	VC60
8.0M Stereo + RG59U(75Ω) Packaged	VC68
1.5M Stereo + RG59U(75Ω) Bulk	VC51
3.0M Stereo + RG59U(75Ω) Bulk	VC62
5.0M Stereo + RG59U(75Ω) Packaged	VC65
5.0M Stereo + RG59U(75Ω) Bulk	VC66
8.0M Stereo + RG59U(75Ω) Bulk	VC69
10M Stereo + RG59U(75Ω) Packaged	VC610
10M Stereo + RG59U(75Ω) Bulk	VC611

BLUE OFC SERIES Gold plated Plugs 99.99% OFC. Electric Blue Jacket

1.5M 3xRCA Double Shielded	OFC50
3.0M 3xRCA Double Shielded	OFC60
5.0M 3xRCA Double Shielded	OFC61
8.0M 3xRCA Double Shielded	OFC62
15M 3xRCA Double Shielded	OFC65

WHITE PEARL DELUXE SERIES Gold plated plugs. Metal barrel. Pearl white.

0.8M	CXS1150
1.5M	CXS1152
3.0M	CXS1154
5.0M	CXS1156
10M	CXS1158
15M	CXS1160

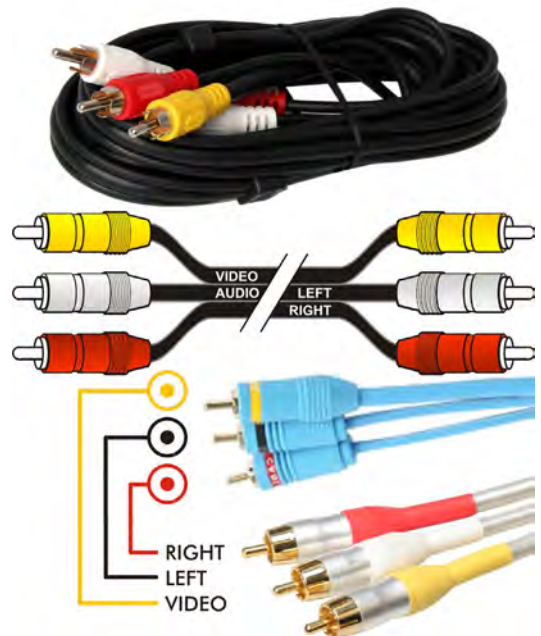

RGB / YUV VIDEO INTERCONNECT 3x RCA 75Ω

Triple 75Ω OFC Video Cable for Component Video. Gold Plated Plugs.

Description	Code
1.5M 3x RCA Molded plugs	OFC70
3.0M 3x RCA Molded plugs	OFC72

ELECTRIC BLUE OFC SERIES Gold plated Plugs 99.99% OFC. Electric Blue Jacket

1.5M 3x RCA METAL plugs	OFC76
3.0M 3x RCA METAL plugs	OFC78
5.0M 3x RCA METAL plugs	OFC79
8.0M 3x RCA METAL plugs	OFC80
15M 3x RCA Metal Plugs	OFC75

WHITE PEARL DELUXE SERIES Gold plated plugs. Metal barrel. Pearl white.

0.8M 3x RCA METAL plugs	CXS1250
1.5M 3x RCA METAL plugs	CXS1252
3.0M 3x RCA METAL plugs	CXS1254
5.0M 3x RCA METAL plugs	CXS1256
10M 3x RCA METAL plugs	CXS1258
15M 3x RCA METAL plugs	CXS1260





RF Flyleads

PAL FLYLEADS 3C-2V 75Ω

Black or White leads for making antenna connections inside. Molded plugs. 3C-2V Coax Twin Shield 75Ω in Black or White. Available in Packaged or Bulk form.

PAL PLUG TO PAL PLUG

Description	Code
WHITE. Plug to Plug, 1.8M Blister Pack	TVL1W
BLACK. Plug to Plug, 1.8M Blister Pack	TVL1B
WHITE. Plug to Plug, 1.8M BULK	TVL11W
BLACK. Plug to Plug, 1.8M BULK	TVL11B
WHITE. Plug to plug, 4.5M Blister Pack	TVL4W
BLACK. Plug to plug, 4.5M Blister Pack	TVL4B
WHITE. Plug to plug, 10M Blister Pack	TVL5W
BLACK. Plug to plug, 10M Blister Pack	TVL5B

PAL PLUG TO PAL SOCKET

Description	Code
WHITE. Plug to Socket, 1.8M Blister Pack	TVL2W
BLACK. Plug to Socket, 1.8M Blister Pack	TVL2B
WHITE. Plug to Socket, 1.8M BULK	TVL12W
BLACK. Plug to Socket, 1.8M BULK	TVL12B

PAL FLYLEADS 3C-2V 75Ω RIGHT-ANGLE

PAL PLUG TO PAL RIGHT-ANGLE PLUG

Description	Code
WHITE. Right Angle Plug 1.8m BULK	TVL11W-RA
BLACK. Right Angle Plug 1.8m BULK	TVL11B-RA
BLACK. Right Angle Plug 4.5m BULK	TVL4B-RA

PAL FLYLEADS RG6 QUAD SHIELD 75Ω

Ultra Low Loss RG6 Coax Quad shielding with molded plugs. Black or White leads for making antenna connections inside.

Description	Code
WHITE. Plug to Plug 1.8M - Bulk	TVL121W
BLACK. Plug to Plug 1.8M - Bulk	TVL121B
WHITE. Plug to Plug 3M - Bulk	TVL123W
BLACK. Plug to Plug 3M - Bulk	TVL123B
WHITE. Plug to Plug 5M - Bulk	TVL125W
BLACK. Plug to Plug 5M - Bulk	TVL125B

Description	Code
Pal Male to female 1.8M, White	TVL131W
Pal Male to female 1.8M, Black	TVL131B
Pal Male to female 3M, White	TVL133W
Pal Male to female 5M, Black	TVL135B

PAL FLYLEADS 3C-2V 75Ω + ADAPTOR

Black or White leads for making antenna connections inside. Molded plugs. 3C-2V Coax Twin Shield 75Ω in Black or White. Includes Female to Female adaptor.

Description	Code
WHITE. Plug to Plug. 1.8M Blister Pack. w/ F/F Adaptor.	TVL1W-AD
BLACK. Plug to Plug. 1.8M Blister Pack. w/ F/F Adaptor.	TVL1B-AD
WHITE. Plug to Plug. 4.5M Blister Pack. w/ F/F Adaptor.	TVL4W-AD
BLACK. Plug to Plug. 4.5M Blister Pack. w/ F/F Adaptor.	TVL4B-AD
WHITE. Plug to Plug. 10M Blister Pack. w/ F/F Adaptor.	TVL5W-AD
BLACK. Plug to Plug. 10M Blister Pack. w/ F/F Adaptor.	TVL5B-AD

PAL FLYLEADS RG6 QUAD SHIELD 75Ω DELUXE KIT

Plug to Plug. With gold plated connectors and bonus Female to Female adaptor

Description	Code
BLACK. Plug to Plug 1.5M - Packaged	TVL161
BLACK. Plug to Plug 3.0M - Packaged	TVL163





PAL FLYLEADS RG6 QUAD SHIELD 75Ω WHITE-PEARL SERIES

Plug to Plug. With gold plated Metal Plugs on Deluxe OFC Cable

Description	Code
OFC 1 PAL to 1 PAL Male 75Ω 1.5M	CXS1602
OFC 1 PAL to 1 PAL Male 75Ω 3.0M	CXS1603
OFC 1 PAL to 1 PAL Male 75Ω 5.0M	CXS1605
OFC 1 PAL to 1 PAL Male 75Ω 10M	CXS1610



“F” PLUG TO “F” PLUG

75Ω COAX INTERCONNECTS

Save time on crimping the shorter connections!
Molded plugs. High spec, twin shield RG59U,
Reliable, Packaged interconnects. 75Ω.

Description	Code
BLACK. RG59U 1.8M	TVL15
BLACK. RG59U 3.0M	TVL16
BLACK. RG59U 5.0M	TVL17



“F” PLUG TO “F” PLUG RG6

75Ω COAX RG6 QUAD SHIELD

Ultra Low Loss RG6 Coax with Quad shielding
“F” to “F” Screw-On connectors

Description	Code
WHITE. F Plug to F Plug 1.8M - Bulk	TVL151W
BLACK. F Plug to F Plug 1.8M - Bulk	TVL151B
WHITE. F Plug to F Plug 3.0M - Bulk	TVL153W
BLACK. F Plug to F Plug 3.0M - Bulk	TVL153B
BLACK. F Plug to F Plug 5.0M - Bulk	TVL155B
WHITE. F Plug to F Plug 7.5M - Bulk	TVL157WH
WHITE. F Plug to F Plug 10M - Bulk	TVL160WH
BLACK. F Plug to F Plug 10M - Bulk	TVL160BK



PAL PLUG TO “F” PLUG

75Ω COAX INTERCONNECTS

Twin Shield 75Ω As used in Cable TV connections, etc. Molded plugs.
High spec, Reliable, Black Male PAL Plug to “F” Male Plug

Description	Code
WHITE. 3C-2V Packaged 1.8M	TVL8W
BLACK. 3C-2V Packaged 1.8M	TVL8B
BLACK. RG59U Packaged 3.0M	TVL9
BLACK. RG59U Packaged 5.0M	TVL10



PAL PLUG TO “F” PLUG RG6

75Ω COAX RG6 QUAD SHIELD

Ultra Low Loss RG6 Coax with Quad shielding PAL to F connectors

Description	Code
WHITE. PAL Plug to F Plug 1.8M - Bulk	TVL141W
BLACK. PAL Plug to F Plug 1.8M - Bulk	TVL141B
WHITE. PAL Plug to F Plug 3M - Bulk	TVL143W
BLACK. PAL Plug to F Plug 3M - Bulk	TVL143B
WHITE. PAL Plug to F Plug 5M - Bulk	TVL145W
BLACK. PAL Plug to F Plug 5M - Bulk	TVL145B





Antenna Cables

FME MALE TO FME FEMALE LEADS

Length	Coax	Code
1.5M	RG58CU	CAL5063
3.0M	RG58CU	CAL30
5.0M	RG58CU	CAL50
10M	RG58CU	CAL100
1.5M	LL195	CAL5064
3.0M	LL195	CAL31
5.0M	LL195	CAL51
10M	LL195	CAL101
15M	LL195	CAL102
20M	LL195	CAL103



SMA MALE TO "N" MALE LEADS

Length	Coax	Code
1.5M	LL195	CAL5060
3.0M	LL195	CAL5043
5.0M	LL195	CAL5044
10M	LL195	CAL5045
15M	LL195	CAL5046
20M	LL195	CAL5047
5.0M	LL400	CAL5080
10M	LL400	CAL5081
15M	LL400	CAL5082
20M	LL400	CAL5083
25M	LL400	CAL5084



FME FEMALE TO "N" MALE LEADS

Length	Coax	Code
1.5M	RG58CU	CAL5061
3.0M	RG58CU	CAL5003
5.0M	RG58CU	CAL5004
10M	RG58CU	CAL5005
15M	RG58CU	CAL5006
20M	RG58CU	CAL5007
1.5M	LL195	CAL5062
3.0M	LL195	CAL5008
5.0M	LL195	CAL5009
10M	LL195	CAL5010
15M	LL195	CAL5011
20M	LL195	CAL5012
11M	LL195	CAL5010-11
5.0M	LL400	CAL5090
10M	LL400	CAL5091
15M	LL400	CAL5092
20M	LL400	CAL5093
25M	LL400	CAL5094
30M	LL400	CAL5095



SMA MALE TO SMA MALE LEADS

Length	Coax	Code
1.5M	LL195	CAL5048
3.0M	LL195	CAL5049
5.0M	LL195	CAL5050



SMA-M TO SMA-F PANEL MOUNT LEADS

Length	Coax	Code
6.0M	LL195	CAL5098
3.0M	LL195	CAL5099
4.0M	LL195	CAL5103



TNC-RP FEMALE TO TNC-RP MALE LEADS

Length	Coax	Code
1.5M	LL195	CAL5055
3.0M	LL195	CAL5056
5.0M	LL195	CAL5057
10M	LL195	CAL5058



"N" MALE TO "N" MALE LEADS

Length	Coax	Code
1.5M	RG58CU	CAL5065
3.0M	RG58CU	CAL5033
5.0M	RG58CU	CAL5034
10M	RG58CU	CAL5035
15M	RG58CU	CAL5036
20M	RG58CU	CAL5037
1.5M	LL195	CAL5066
3.0M	LL195	CAL5038
5.0M	LL195	CAL5039
10M	LL195	CAL5040
15M	LL195	CAL5041
20M	LL195	CAL5042
5.0M	LL400	CAL5070
10M	LL400	CAL5071
15M	LL400	CAL5072
20M	LL400	CAL5073
25M	LL400	CAL5074
30M	LL400	CAL5075



"N" MALE TO TNC-RP MALE LEADS

Length	Coax	Code
1.5M	LL195	CAL6060
3.0M	LL195	CAL6061
5.0M	LL195	CAL6062
10M	LL195	CAL6063



SMA-RP FEMALE TO SMA-RP MALE LEADS

Length	Coax	Code
3.0M	RG58CU	CAL5013
3.0M	LL195	CAL5018
5.0M	RG58CU	CAL5014
5.0M	LL195	CAL5019
6.0M	LL195	CAL5019-6
10M	RG58CU	CAL5015
10M	LL195	CAL5020
15M	RG58CU	CAL5016
15M	LL195	CAL5021
20M	RG58CU	CAL5017
20M	LL195	CAL5022



SMA-RP MALE TO "N" MALE LEAD TP-LINK

Length	Code
0.5M	TL-ANT200PT
3.0M	TL-ANT24PT3



SMA-RP MALE TO "N" MALE LEADS

Length	Coax	Code
3.0M	RG58CU	CAL5023
5.0M	RG58CU	CAL5024
10M	RG58CU	CAL5025
15M	RG58CU	CAL5026
20M	RG58CU	CAL5027
3.0M	LL195	CAL5028
5.0M	LL195	CAL5029
10M	LL195	CAL5030
15M	LL195	CAL5031
20M	LL195	CAL5032





RF PATCH LEADS

High frequency antenna patch cables. Adapts specialised product sockets to standard antenna connections. Lengths vary, however are generally kept short to maintain bandwidth and gain.

ANTENNA CRADLES

Model specific cradles with an external antenna connection. To suit your phone see...

www.cellink.com.au



Requires Antenna & Base (See Below)

FME PATCH CABLE - BARE END

FME MALE

Code CAL829



CRC9 R/A TO FME - PATCH

Plug A CRC9 Male R/A
Plug B FME Male
Cable RG174U
Length 0.5M
Code CAL802



CRC9 R/A TO SMA - PATCH

Plug A CRC9 Male R/A
Plug B SMA Female
Cable RG316U
Length 0.5M
Code CAL820



MC LUCENT R/A TO FME - PATCH

Plug A MC Lucent Male R/A
Plug B FME Male
Cable RG174U
Length 0.5M
Code CAL712



MC LUCENT R/A TO SMA - PATCH

Plug A MC Lucent Male R/A
Plug B SMA Female
Cable RG174U
Length 0.5M
Code CAL716



MC LUCENT TO SMA R/P - PATCH

Plug A MC Lucent Male R/A
Plug B SMA R/P Female
Cable RG174U
Length 0.5M
Code CAL711



MCX R/A TO 'N' - PATCH

Plug A MCX Male R/A
Plug B N Female
Cable RG174U
Length 0.2M
Code CAL715



MCX R/A TO SMA - PATCH

Plug A MCX Male R/A
Plug B SMA Female
Cable RG174
Length 0.2M
Code CAL714



MCX TO SMA R/P - PATCH

Plug A MCX Male
Plug B SMA-R/P Female
Cable RG174U
Length 0.5M
Code CAL710



MMCX TO FME - PATCH

Plug A MMCX Male MMCX Male R/A
Plug B FME Male FME Male
Cable RG174U RG174U
Length 0.5M 0.5M
Code CAL812 CAL807



MMCX R/A TO SMA - PATCH

Plug A MMCX Male R/A
Plug B SMA Female
Cable RG174U
Length 0.5M
Code CAL808



MS147 R/A TO FME - PATCH

Plug A MS147 Male R/A
Plug B FME Male
Cable RG174u
Length 0.5M
Code CAL2560



MS147 R/A X2 TO FME - PATCH

Plug A MS-147 R/A x2
Plug B FME Male
Cable RG174u
Length 0.5M
Code CAL2563



MS147 R/A X2 TO FME - PATCH

Plug A MS-147 R/A x2
Plug B SMA Female
Cable RG174u
Length 0.5M
Code CAL2564



MS147 R/A X2 TO SMA - PATCH

Plug A MS-147 R/A
Plug B SMA Female
Cable RG316u
Length 0.5M
Code CAL2562



SMA F TO 2 X SMA - PATCH

Plug A SMA Female
Plug B SMA Male x2
Cable RG316U
Length 0.12M
Code CAL851



SMB TO SMA - PATCH

Plug A SMB Female
Plug B SMA Female
Cable RG316U
Length 0.5M
Code CAL816



SMK TS6 TO SMA - PATCH

Plug A SMK TS-6 Male
Plug B SMA Female
Cable RG316U
Length 0.12M
Code CAL702



SMK TS9 R/A TO FME - PATCH

Plug A SMK TS-9 Male R/A
Plug B FME Male
Cable RG174U
Length 0.5M
Code CAL811



SMK TS9 TO FME - PATCH

Plug A SMK TS9 Short
Plug B FME Male
Cable RG174u
Length 0.5M
Code CAL825



SMK TS9 TO FME - PATCH

Plug A SMK TS9 Long
Plug B FME Male
Cable RG174U
Length 0.5M
Code CAL821





SMK TS9 TO FME - PATCH

Plug A SMK TS9 x2 Long
 Plug B FME Male
 Cable RG174u
 Length 0.5M
 Code CAL828



SMK TS9 TO SMA - PATCH

Plug A SMA TS9 x2
 Plug B SMA Female
 Cable RG316u
 Length 0.5M
 Code CAL836



TS5 TO FME - PATCH

Plug A TS5 Male
 Plug B FME Male
 Cable RG174
 Length 0.5M
 Code CAL844



SMK TS9 TO FME - PATCH

Plug A SMK TS9 R/A x2 Long
 Plug B FME Male
 Cable RG174u
 Length 0.5M
 Code CAL834



SMK TS9 TO SMA - PATCH

Plug A SMK TP9 x2
 Plug B SMA Female x2
 Cable RG316u
 Length 0.5M
 Code CAL835



TS5 TO FME - PATCH

Plug A TS5 Male
 Plug B FME Male
 Cable RG174
 Length 0.5M x2
 Code CAL846



SMK TS9 TO FME - PATCH

Plug A SMK TS9 R/A x2 Short
 Plug B FME Male x2
 Cable RG174u
 Length 0.5M x2
 Code CAL830



SMK TS9 TO SMA - PATCH

Plug A SMK TS9 x2
 Plug B SMA Female x2
 Cable RG316u
 Length 0.5M x2
 Code CAL831



TS5 TO FME R/A - PATCH

Plug A TS5 Male
 Plug B FME Male
 Cable RG174
 Length 0.5M x2
 Code CAL842



SMK TS9 TO FME - PATCH

Plug A SMK TS-9 Male x2 Long
 Plug B FME Male x2
 Cable RG174u
 Length 0.5M
 Code CAL823



SSMB TO FME - PATCH

Plug A SSMB Male
 Plug B FME Male
 Cable RG174U
 Length 0.5M
 Code CAL809



TS5 TO SMA - PATCH

Plug A TS5 Male
 Plug B SAM Female
 Cable RG316
 Length 0.5M
 Code CAL845



SMK TS9 TO SMA - PATCH

Plug A SMK TS9 Short
 Plug B SMA Female
 Cable RG316u
 Length 0.5M
 Code CAL827



SSMB R/A TO FME - PATCH

Plug A SSMB Male R/A
 Plug B FME Male
 Cable RG174U
 Length 0.5M
 Code CAL805



TS5 TO SMA - PATCH

Plug A TS5 Male
 Plug B SMA Female
 Cable RG316
 Length 0.5M x2
 Code CAL847



SMK TS9 TO SMA - PATCH

Plug A SMK TS-9 Long
 Plug B SMA Female
 Cable RG316U
 Length 0.5M
 Code CAL822



SSMB TO SMA - PATCH

Plug A SSMB Male R/A
 Plug B SMA Female
 Cable RG316U
 Length 0.5M
 Code CAL819



TS5 TO SMA - PATCH

Plug A TS5 Male
 Plug B SMA Female
 Cable RG316
 Length 0.5M x2
 Code CAL843



SMK TS9 R/A TO SMA - PATCH

Plug A SMK TS-9 Male R/A Medium
 Plug B SMA Female
 Cable RG316U
 Length 0.5M
 Code CAL817



TMC TO FME - PATCH

Plug A TMC Male
 Plug B FME Male
 Cable RG174U
 Length 0.5M
 Code CAL804



UFL(IPX) R/A TO RP SMA - PATCH

Plug A SMA-RP Male
 Plug B UFL Male
 Cable RG316U
 Length 0.3M
 Code CAL848



SMK TS9 TO SMA - PATCH

Plug A SMK TS9 x2
 Plug B SMA Female
 Cable RG316u
 Length 0.5M
 Code CAL838



TS5 TO FME R/A - PATCH

Plug A TS5
 Plug B FME Male
 Cable RG174
 Length 0.5M
 Code CAL839



ZTE T20 R/A TO FME - PATCH

Plug A ZTE T20
 Plug B FME Male
 Cable RG174U
 Length 0.5M
 Code CAL8176





□ Cable & Wire □ Audio Shielded Cable

AUDIO SINGLE CORE SHIELDED CABLE 2mm

7 strands of 0.12mm centre with copper shielding. Compact outside diameter = 2mmØ Black Jacket. Suitable for general purpose audio & control leads. and for internal jumpers and short connections, etc.

Length Code
100M SHW1207



AUDIO SHIELDED CABLE 7mm SOUNDLINK

Low loss interconnect audio by Soundlink 100% double shielded. 99.99% OFC copper braid + Aluminium Foil. 55 Strand OFC centre. Foam-PE Double insulated for super low capacitance wide bandwidth. Heavy duty PVC Jacket. A deep red crimson in colour. OD=7mmØ

Length Code
50M AIC227



AUDIO PAIR SHIELDED CABLE 3mm

Two internal wires with a common shield. Suit audio applications. As used in wiring up headphones, 3.5mm extension cables, etc. 3mm Black Jacket. 7x0.12mm(x2) + 40x0.12mm(Shield)

Length Code
100M SAC312



AUDIO PAIR SINGLE FOIL SHIELDED CABLE 4mm

As used for some signal transfer systems and A/V modulators, etc. Also suitable for balanced audio transmission or short unbalanced. Grey PVC 4mmØ jacket. 7x0.20mm(0.22mm²) Al Mylar + Drain wire.

Length Code
100M SHW3035
300M SHW3036



AUDIO PAIR+PAIR FOIL SHIELDED CABLE 5mm

Suitable for data and audio applications like DIN plug wiring, etc. Each pair individually shielded. Dark Grey PVC 4.6mmØ jacket. 4X (7x0.20mm(0.22mm²)). Al + Mylar + Drain wire. 60°C

Length Code
100M SHW3032
305M SHW3033



AUDIO STEREO SHIELDED CABLE 2x3mm TWIN

Grey outer, red and white individually shielded inner cables. 10 strands of 0.12mm each with copper shielding. OD = 3mmØ Mostly used for internal jumpers and short connections, etc. Popular stereo interconnect for general purpose applications.

Length Code
100M SHW1210



AUDIO STEREO SHIELDED CABLE 2x4mm TWIN

Dual shielded and suitable for low loss in HiFi audio connections. 10 strand (10x0.1mm) heavy gauge (24AWG) wire with optimum braided shielding and protected by a tough flexible outer coating (2x4mm). We highly recommend this as a superior quality stereo audio cable.

Length Code
100M SQS100



AUDIO STEREO SHIELDED CABLE 2x6mm TWIN

Low loss stereo interconnect audio cable 100% shielded by OFC braid & Alumina-Mylar with FOAM-PE insulation. Heavy duty PVC Jacket. Suitable for Car or Home HiFi applications. Colour Deep Navy Blue OD=6mmØ ID=3mm.

Length Code
50M AIC236



□ Microphone Shielded Cable

MICROPHONE & AUDIO SHIELDED CABLE 4.5mm

Single core, tough but flexible cable for audio & microphone. Good cable suitable for short runs, or longer with slight losses. 16 strands of 0.14mm with full braided copper shielding. SOUNDLINK. Black PVC jacket OD=4.5mmØ

Length Code
100M SAC451



MICROPHONE & AUDIO SHIELDED CABLE 6mm

Single core, highly flexible cable with heavy duty protective matte jacket. 56 strands of 0.07mm with full copper shielding. Primarily for mic leads. Suit our high-grade 6.35mm Gold Plated Phono and the XLR type plugs. Supplied on 100M reels. Black in colour. OD=6.0mmØ

Length Code
100M SAC601



MICROPHONE BALANCED SHIELDED CABLE 7mm

Premium microphone cable with dual conductors, 14x 0.19mm strands. Wrapped in the one copper shielding with cotton rope for added strength. Primarily for balanced microphone applications. Suit Cannon type plugs. Supplied on 100M reels. OD=7mmØ

Length Code
100M SHW1914



□ Video Shielded Cable

75Ω VIDEO CABLE 7mm SOUNDLINK

75Ω low loss coaxial video interconnect by SOUNDLINK USA. 7 Strand OFC centre core. 100% Shielded by OFC & Alumina Mylar. PVC/FOAM-PE double insulated. Heavy duty PVC Jacket. Wide Band. Colour: Navy Blue. OD=7mmØ ID=5mm.

Length Code
50M VIC206



75Ω VIDEO CABLE 8mm HEAVY DUTY SOUNDLINK

75Ω low loss coaxial video interconnect by SOUNDLINK USA. 7 Strand OFC centre core. 100% Shielded by OFC & Alumina Mylar. PVC/FOAM-PE double insulated. EXTRA HEAVY DUTY PVC Jacket. Colour: Navy Blue. OD=8mmØ ID=5mm.

Length Code
50M VIC207



75Ω VIDEO DUAL AGGREGATE CABLE 5.5mm

75Ω low loss OFC Dual interconnect by SOUNDLINK USA. This cable is designed for S-Video applications and is also suitable for long cable runs with minimal signal degradation of video signals. 10 Strand OFC centre, each is 100% shielded by OFC braid then insulated for improved visual reproduction, the pair is then protected by FOAM-PE & a tough Black PVC jacket. OD=5.5mmØ ID=2mm.

Length Code
50M VIC240



SOUNDLINK PREMIUM CABLES

Interconnect cables by SOUNDLINK USA. Offers Superior performance and quality for reliable longevity as expected when constructing your own audio video connections.





□ Video

75Ω TRIPLE RG59U COAX 6mm SINGLE-CORE FOAM X3

DVD-HDTV. Black PVC 6mm outer diameter Jacket.
Dual shield Tinned Copper Braid Plus Aluminium foil.
Colour coded [Red Green Blue] Foam PE Dielectric insulators.
Single solid core tinned copper. Suit Crimp, compression, etc.

Length	Code
100M	RG59TRIO



VIDEO CABLE RGB/COMPONENT (3X 75Ω COAX) 7mm ELECTRIC-BLUE

Triple High Grade OFC 75Ω Interconnect by SoundLink. Multi-strand core. Suit HD-TV, DVD, Colour-Difference, Colour-Stream, Computers, etc. Attractive Blue PVC jacket. Red/Green/Blue cores. Double shielded.

Same specifications as our Popular Video Soundlink 7mm cable (VIC206).

Length	Code
50M	VIC252
100M	VIC1252

PVC Jacket 6mmØ
95% Copper Screen OFC
100% Aluminium Screen
Multi-Strand OFC Core
P.E. Dielectric Insulator



AUDIO & VIDEO CABLE 6mm OFC

75Ω Low loss 6mm OFC video interconnect with OFC and Aluminium screen.
3.5mm Low loss OFC Shielded Audio pair for Left and Right Audio.
Tough PVC Jacket, Light blue in colour. Attractive finish.
Runs stereo audio and Composite Video in a triple lead.

Length	Code
50M	VIC250
100M	VIC1250

100% Aluminium Screen
Multi-Strand OFC Core
P.E. Dielectric Insulator

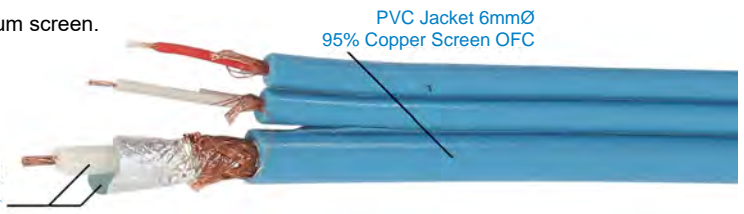

VIDEO DUAL & AUDIO DUAL CABLE 12mm

HEAVY DUTY AV DATA AGGREGATE CABLE

Large 12mm Orange Jacket with nylon rope reinforced.
Dual Coax 75Ω Video individually double shielded with common foil shield and jacket. Plus 2x Double shielded coax for Stereo Audio. Multi-purpose cable.

Length	Code
50M	VIC304

Double Shielded

Nylon Rope Strengthened



Tough ORANGE Outer



TRIPLE COAX +4 CABLE WIDE BANDWIDTH DOUBLE SHIELDED COMPUTER MONITOR VGA (RGB-HV)

Typical replacement style VGA cable.
All double shielded. Black 8mm Jacket.
3x Shielded wires RGB (75 Ohm Coax)
4x Control wires (Common shield)

Length	Code
100M	SQS1407

3x Shielded Video RGB

4x Control Lines

double Shielded

Heavy Duty Jacket



□ Security and Control Cable

SECURITY CABLE AGGREGATE - VIDEO & 5X MULTICORE SHIELDED

Grey coloured 5.5mm diameter. Internal double shielded coaxial cable suitable for video. Five colour coded wires suitable for low voltage. All encased in single shielding foil and pull-cord.

Length	Code
100M	SEC7505

75ohm VIDEO COAX

PULL CORD

FOIL SHIELD

LOW VOLTAGE CONTROL WIRES COLOUR CODED

IDEAL SECURITY CAMERA CCTV INTERCONNECT

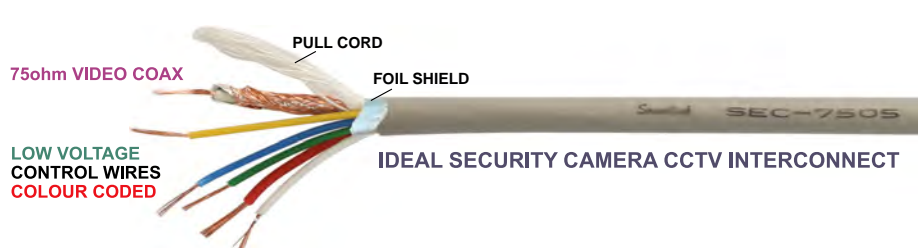

SECURITY CABLE AGGREGATE - VIDEO & 2X LOW VOLTAGE WIRES

2 CORE + 75Ω COAX RG59 BLACK 6mm

Single Heavy duty double jacket weather resistant camera installation cable.
2x 7.5A for low voltage power bundled with 75Ω RG59B/U double shielded coax

Length	Code
100M	SEC101
305M	SEC103





Coax Shielded Cable

50Ω RG174/U COAX 2.5mm

Multi-strand steel/copper (0.48mm) with braid tinned copper 90% shield. PE Dielectric (1.5mm). PVC Jacket Black (2.79mm). 100pF/M. 50 Metres.

Length	Code
50M	RG174U-50
1M*	RG174U-1



50Ω RG58U / RG58AU COAX 5mm

RG-58A/U type. 20AWG multi-stranded (19x0.18mm 33AWG) 0.9mm copper conductor, polyethylene insulation, single copper braid shield

Equip.	Length	Code
RG58U	100M	RG58AU
RG58U	1M*	RG58AU-1



50Ω RG58CU COAX 5mm

Mobile communications and computer ethernet installations. Tinned Multi-Strand High-shielding. 0.9mm diameter multi-strand 19x0.18mm

Length	Code
100M	RG58CU
1M*	RG58CU-1



50Ω LL195 COAX 5mm

Double shielded with over 93% coverage copper braid + aluminium tape 100%. Gas-Injected Foam Polyethylene 2.95mm insulator. Solid core copper 1.12mm centre. Suits a majority of crimp plugs, etc. Black polyethylene outdoor flooded weather-proof UV resistant jacket.

Length	Code
100M	LL195-100
1M*	LL195-1



50Ω RG213U COAX 10mm

HEAVY DUTY flooded cable with UV-Resistance, etc. Multi-Strand. High-shielding.

Length	Code
100M	RG213U
1M*	RG213U-1



50Ω LL400 COAX 10mm

Solid Copper Centre 2.75mm. Double shielded with over 93% coverage copper braid + aluminium tape 100%. Extra wide bandwidth Gas-Injected Foam Polyethylene 7.25mm insulator. Black polyethylene outdoor flooded weather-proof UV resistant jacket.

Length	Code
305M	LL400-305
100M	LL400-100
50M	LL400-50
1M*	LL400-1



Coax Foxtel® Approved

75Ω RG6 QUAD-SHIELDED COAX CABLE FOXTEL® APPROVED

Premium quality pay TV approved RG6 Quad shielded coax cable with 0.86mm thick outer PVC jacket. 1.02mm copper clad steel centre conductor. 4.57mm foamed HD polyethylene dielectric. 60 micron thick bonded laminated aluminium foil shielding tape. 4.78mm core diameter. Aluminium alloy wire braided. Overall diameter 7.54mm.

Foxtel	Packaging	Length	Code
F10129	Reel	100M	CRG6UBQ-1
F10129	Reel	305M	CRG6UBQ/R
F10129	Box	305M	CRG6UBQ/B



75Ω RG6 QUAD-SHIELDED COAX CABLE FLOODED FOXTEL® APPROVED

Premium quality pay TV approved RG6 Quad shielded coax cable with 0.86mm thick outer PVC jacket. The cable is filled with gel under the sheath for extra protection. 1.02mm copper clad steel centre conductor. 4.57mm foamed HD polyethylene dielectric. 60 micron thick bonded laminated aluminium foil shielding tape. 4.78mm core diameter. Aluminium alloy wire braided. Overall diameter 7.54mm. 305M wooden drum.

Foxtel	Packaging	Length	Code
F30059	Reel	305M	CRG6UBQF



75Ω RG6 QUAD-SHIELDED COAX CABLE SIAMESE FOXTEL® APPROVED

Premium quality pay TV approved RG6 Quad shielded coax cable with 0.86mm thick outer PVC jacket. 1.02mm copper clad steel centre conductor. 4.57mm foamed HD polyethylene dielectric. 60 micron thick bonded laminated aluminium foil shielding tape. 4.78mm core diameter. Aluminium alloy wire braided. Overall diameter 7.54mm. 150M wooden drum.

Foxtel	Packaging	Length	Code
F30432	Reel	150M	CRG6UBQS





□ Coax Shielded Cable 75 Ohm

75Ω RG59AU COAX 6mm MULTI-STRAND

6mm outer diameter. Single Copper Shielding.
Clear plastic dielectric. Multi-strand. Reel.

Length Code

100M	RG59AU
1M	RG59AU-1



75Ω RG59U COAX 6mm SINGLE-CORE FOAM

6mm outer diameter. Dual Tinned Copper & Aluminium foil shielding.
Foam PE dielectric. Single core.

Length Code

100M	RG59U
1M	RG59U-1



TRIPLE 75Ω RG59U COAX 6mm SINGLE-CORE FOAM X3

DVD-HDTV. Black PVC 6mm outer diameter Jacket.
Dual shield Tinned Copper Braid Plus Aluminium foil.
Colour coded [Red Green Blue] Foam PE Dielectric insulators.
Single solid core tinned copper. Suit Crimp, compression, etc.

Length Code

100M	RG59TRIO
1M	RG59TRIO-1



75Ω RG6 COAX 6.8mm SINGLE-CORE PE DUAL-SHIELD

Grade "A" UV resistant PVC outer protected. Aluminium(Al) and braided (96 x 0.12mm) shielding. 4.57mm diameter polyethylene dielectric.
1.02mm Copper clad steel solid centre core.

Length Packaging Code

100M	Reel	RG6PE
1M	Per Metre	RG6PE-1



75Ω RG6 COAX 7.5mm SINGLE-CORE PE QUAD SHIELD

Grade "A" cable w/ UV resistant PVC outer jacket protected. Multi Aluminium braiding (96 x 0.12mm) & foil shielding.
4.57mm diameter polyethylene (Foam-PE) dielectric 1.02mm Copper clad steel solid centre core.

Length Packaging Code

100M	Reel	RG6Q100
305M	Reel	RG6Q305-RL
305M	Pull-Box	RG6Q305-BX
1M	Per Metre	RG6Q100-1



75Ω RG6 COAX 7.5mm SINGLE-CORE PE QUAD SHIELD - WHITE

This RG6 Quad shield coax cable is constructed with 4 layers of shielding (Aluminium Foil / Aluminium Braid / Aluminium Foil / Aluminium Braid) and foamed PE dielectric and finished with a White PVC jacket. Suitable for TV antenna, satellite TV and analogue CCTV installations.

Length Packaging Code

100M	Reel	RG6Q-100WH
305M	Reel	RG6Q-305WH

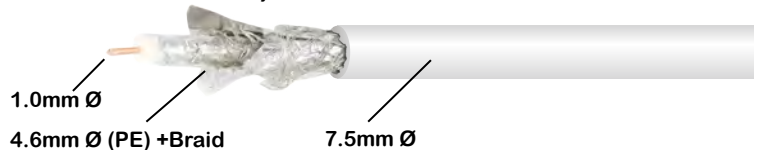

75Ω RG11 COAX 10.2mm FOAM-PE QUAD-SHIELD

Grade "A" UV resistant PVC outer protected extra heavy-duty cable.
Aluminium(Al) x2 braided (16 x 0.16mm x2) shielding.
7.11mm diameter polyethylene dielectric.
1.63mm Copper clad steel solid centre core.

Length Packaging Type Code

305M	Reel	Flooded	RG11QD305FL
305M	Reel	Standard	RG11QD305

Flooded indicates GEL filled for outdoor life extended purposes



AVAILABLE IN STANDARD OR FLOODED VERSIONS

75Ω RG11 QUAD-SHIELDED COAXIAL CABLE FOXTEL® APPROVED

Premium quality Pay TV approved RG11 Quad shielded coax cable with 0.94mm thick outer PVC jacket. 1.63mm copper clad steel centre conductor. 7.11mm foamed HD polyethylene dielectric. 60 micron thick bonded laminated aluminium foil shielding tape. 7.32mm core diameter. Aluminium alloy wire braided. Overall diameter 10.34mm. 305 metre per reel.

Foxtel Packaging Length Code

F10175	Reel	305M	CRG11BQ
--------	------	------	---------





□ Amp Wiring Kits

2 AWG MAXCOR 1500 WATT POWER CABLE KIT

AERPRO - MAXCOR 2AWG AMP POWER INSTALL KIT

MAXCOR wiring kits combine high quality components to ensure you receive blistering performance from your amplifier. All cables in the range are guaranteed to meet or exceed AWG (American Wire Gauge) Standards so you can be reassured you are delivering the maximum power and quality signal to your amplifier and speakers. The Soft Touch Super Flex (STSF) PVC insulation throughout the MAXCOR range allows cables to easily bend around tight corners with no loss in performance allowing for a neat and professional installation.

The MX02 will power up to a massive 1500W and includes everything you need to power up an amplifier. The kit is ideal for those who want to either upgrade their current power cables or already have RCA's and/or speaker cable. The kit includes; 5.5M 2AWG power cable, 0.8M 2AWG earth cable, 5M 20AWG trigger cable, 180A ANL fuse and fuse holder, distribution block, cable ties and all required professional fitting terminals. If you are looking for an installation kit that offers MAXIMUM performance, you can't go past MAXCOR.

Code
MX02



4 AWG MAXCOR 800 WATT POWER CABLE KIT

The MX04 will power up to a massive 800W and includes everything you need to power up an amplifier. If you are looking for an installation kit that offers MAXIMUM performance, you can't go past MAXCOR.

The kit includes;
6M 4AWG power cable,
0.8M 4AWG earth cable,
5M 20AWG trigger cable,
120A ANL fuse and fuse holder,
cable ties and fitting terminals.

Code
MX04



8 AWG MAXCOR 600 WATT POWER CABLE KIT

The MX08 will power up to a massive 600W and includes everything you need to power up an amplifier. The kit is ideal for those who want to either upgrade their current power cables or already have RCA's and/or speaker cable.

The kit includes;
6M 8AWG power cable,
0.8M 8AWG earth cable,
5M 20AWG trigger cable,
60A ANL fuse and fuse holder,
cable ties and fitting terminals.

Code
MX08

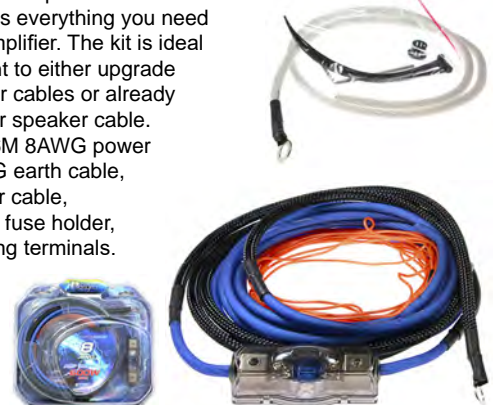

8 AWG 450W POWER CABLE KIT

The BSX008 will power up to 450W and includes everything you need to power up an amplifier. The kit is ideal for those who want to either upgrade their current power cables or already have RCA's and/or speaker cable. The kit includes; 5.5M 8GA power cable, 0.8M 8GA earth cable, 5M 20GA trigger cable, 80A mini ANL fuse and fuse holder, cable ties and fitting terminals.

- 5.5M Red 8GA Power Cable with O-Ring Terminal
- 0.8M Black 8GA Earth Cable
- 80A Mini ANL Fuse With Holder
- 1.8M Split Loom Tubing
- 5M 20GA Blue Trigger Wire
- Hex Key For Fuse Holder
- 450W max power.
- Includes Cable Ties, 8GA Wiring Grommet & Fitting Terminals

Code
BSX008



AUTOMOTIVE POWER - THICK JACKET

Red & Black pair for speakers or DC power Extra thick PVC jacket for protection in high wear and hostile environments. Multi-stranded copper wire pair. Figure 8 cable. Supplied on 100M reels.

13AWG DC CABLE HEAVY DUTY JACKET

2x 4.5mmO/D with 2mmØ wire (61 x 0.18mm strands).

AWG	Length	Code
13AWG	100M	AW1861

21AWG DC CABLE HEAVY DUTY JACKET

37x0.12mm Strands. 2x3.2mm Jacket.

AWG	Length	Code
21AWG	100M	AW1237

Soundlink



EXTRA TOUGH JACKET 100M



Automotive Amplifier Cable Kits

4 AWG MAXCOR 800 WATT 4-CH CABLE KIT

The MX44 will power up to a massive 800W and includes everything you need to install a 4 channel amplifier into your vehicle.

The kit includes; 6M 4AWG power cable, 0.8M 4AWG earth cable, 5M 20AWG trigger cable, 120A ANL fuse and fuse holder, 2 x 2 channel 5M RCA's, cable ties and all required professional fitting terminals and also includes 16 metres of 14AWG speaker cable.



Code
MX44

8 AWG MAXCOR 600 WATT QUAD CABLE KIT

AERPRO - MAXCOR 8AWG 4CH AMP INSTALL KIT

The MX48 will power up to a massive 600W and includes everything you need to install a 4 channel amplifier into your vehicle.

The kit includes; 6M 8AWG power cable, 0.8M 8AWG earth cable, 5M 20AWG trigger cable, 60A ANL fuse and fuse holder, 2 x 2 channel 5M RCA's, cable ties and all required terminals and also includes 13 metres of 16AWG speaker cable.



Code
MX48

4 AWG 650 WATT 4-CH AMP KIT

- 650W Max Power Suits 4 Channel amplifiers
- 5.5M Red 4 Gauge power cable with O-Ring terminal
- 0.8M Black 4 Gauge earth cable
- 120A Mini ANL fuse with holder
- 2 x 5M 2 Channel RCA leads
- 1.8M Split loom tubing
- Twisted Pair RCA's With Gold plated connectors
- Includes cable ties, wiring grommet & fitting terminals



Code
BSX404

8 AWG 450W MAX AMP WIRING KIT 2CH

The BSX208 will power up to 450W and includes everything you need to install a 2 channel or monoblock amplifier into your vehicle. The kit includes: 5.5M 8GA power cable, 0.8M 8GA earth cable, 5M 20GA trigger cable, 80A mini ANL fuse and fuse holder, 2 channel 5M RCA's, cable ties and fitting terminals.



Code
BSX208

8 AWG 450W MAX AMP WIRING KIT 4CH

The BSX408 will power up to 450W and includes everything you need to install a 4 channel amplifier into your vehicle. The kit includes: 5.5M 8GA power cable, 0.8M 8GA earth cable, 5M 20GA trigger cable, 80A mini ANL fuse and fuse holder, 2 x 2 channel 5M RCA's, cable ties and fitting terminals.



Code
BSX408

AWG/METRIC

AWG	Ømm	mm ²
0	8.25	53.4
1	7.35	42.4
2	6.54	33.6
3	5.83	26.7
4	5.19	21.2
5	4.62	16.8
6	4.11	13.3
7	3.67	10.6
8	3.26	8.35
9	2.91	6.62
10	2.59	5.27
11	2.30	4.15
12	2.05	3.31
13	1.83	2.63
14	1.63	2.08
15	1.45	1.65
16	1.29	1.31
17	1.15	1.04
18	1.02	0.82
19	0.91	0.65
20	0.81	0.52
21	0.72	0.41
22	0.64	0.33
23	0.57	0.26
24	0.51	0.21
25	0.46	0.16
26	0.41	0.13
27	0.36	0.10
28	0.32	0.08
29	0.29	0.06
30	0.26	0.05
31	0.23	0.04
32	0.20	0.03
33	0.18	.025
34	0.16	.020
35	0.14	.016
36	0.13	.012
37	0.11	.010
38	0.10	.008
39	0.09	.006

*Approximations Only



Automotive Low Voltage Cable

EXTREME-POWER OFC INTERCONNECT 2AWG

Pure Oxygen-Free Copper Power Interconnect. Incredible current limits beyond measurement. Automotive grade red tinted outer jac For shorter lengths see our installation kits. Supplied on 30 Metre reels.

2AWG 6.5mmØ + Jacket

Colour	AWG	Length	Code
Black	2AWG	30M	BSX230B



HIGH-POWER OFC INTERCONNECT 4AWG / 8AWG

High Grade Flexible 99.95% OFC SoundLink in Red or Black. 50 Metre reels (BSX is 30M).

4AWG 180A 5.2mmØ Jacket 10mmØ

Heavy Duty Jacket. 30 Metres.

Colour	AWG	Length	Code
Black Clear	4AWG	30M	BSX430B
Red Clear	4AWG	30M	BSX430R
Black Solid	4AWG	50M	APC1041



8AWG 92A 3.3mmØ Jacket 7mmØ

Transparent Jacket. 50 Metres.

Colour	AWG	Length	Code
Red	8AWG	50M	APC1280
Black	8AWG	50M	APC1281



LOW-POWER INTERCONNECT 20AWG

Single multi-strand small gauge cable with 1.8mm O/D colour coded jacket for low power accessories, trigger, etc.

20 AWG ACCESSORIES CABLE 100M

Colour	AWG	Length	Code
Red	20	100M	AP916R
Black	20	100M	AP916BK
Green	20	100M	AP916GR
Yellow	20	100M	AP916Y
Blue	20	100M	AP916BL
Orange	20	100M	AP916OR



Supplied 100M Reels.

16 AWG ACCESSORIES CABLE 100M

Colour	AWG	Length	Code
Orange	16	100M	MX16100

18AWG HOOK UP CABLE - HIGH TEMP 90°C

24 strand, 18AWG heavy duty tinned copper wire with a PVC insulator suitable for indoor general purpose wiring.

- Size: 1 x 24/0.20
- Voltage Rating: 300V AC
- Current Rating: 7.5 Amps
- Outside Diameter: 2.25mm
- Conductor Area: 0.75mm²
- Conductor Gauge: 18AWG
- Temperature Rating: 90°C
- Roll Length: 100m



Colour	Length	Code
Red	100M	CAB2420RD
Black	100M	CAB2420BK

13AWG TINNED HEAVY DUTY HOOK UP CABLE

50 strand, 13AWG Heavy duty, high current tinned copper wire with a high temperature rated PVC insulator. Designed for applications where high temperatures may be encountered.

- Size: 1 x 50/0.25
- Voltage Rating: 300V AC
- Current Rating: 22 Amps
- Outside Diameter: 3.9mm
- Conductor Area: 2.45mm²
- Conductor Gauge: 13AWG
- Temperature Rating: 105°C
- Roll Size: 100m



Colour	Length	Code
Red	100m	CAB5025RD

22 AWG CLOTH COVERED WIRE 600V 105°C

VINTAGE SOLID CORE SINGLE CORD REEL 15 METRES

Authentic wire for restoration work and high temperature applications. Double woven cloth jacket, wax coated, with Celanese inner braiding. Real Deal. From the same manufacturer that supplies Fender, etc.

AWG	Colour	Length	Code
22AWG	Black	15M	PBW50BK
22AWG	Blue	15M	PBW50BU
22AWG	Brown	15M	PBW50BN
22AWG	Red	15M	PBW50RD
22AWG	White	15M	PBW50WH
22AWG	Yellow	15M	PBW50YL
18AWG	Green	6M	PBW20GN

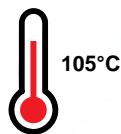

HIGH-TEMPERATURE CLOTH WAXED

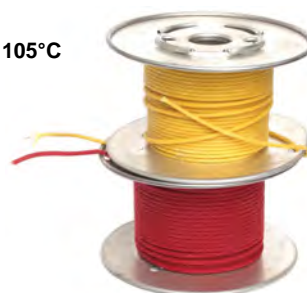



□ Double Insulated Low Voltage

12AWG HEAVY DUTY AUTOMOTIVE CABLE PAIR 75°C

DOUBLE PVC INSULATION HIGH TEMPERATURE HIGH CURRENT

- Size: 2 x 56/0/30
- Voltage Rating: 300V AC
- Current Rating: 20Amps
- Outside Dimensions: ≈5.6 x 9.2mm
- Conductor Area: 4.0mm²
- Conductor Gauge: ≈12AWG
- Temperature Rating: 75°C
- Roll Size: 100m

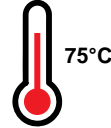

Length	Code
100M	AW5630BK

13AWG DOUBLE INSULATED "DROP" CABLE PAIR

High grade, high current, low loss, low capacitance. Suitable for many applications including-Speaker wire, both 8 ohms and 100v line, Video intercoms , Low voltage applications (AC or DC) eg, security, garden lights etc. Twisted pair in black PVC Jacket, ideal for running through walls and areas which are damp and prone to water penetration or applications where a better quality cable is required.

- 8mm Outer sheath 1mm thick
- UV Resistant. Water proof PVC.
- 3mmØ with 48 strands x 0.2mm
- 300Vac* max. (10A < 32V)
- Twisted pair 360° / 10cm
- Cotton draw cord



Length	Code
100M	CAB4822

18AWG DOUBLE INSULATED SPEAKER CABLE

Double insulated 24/0.20 Professional Speaker Cable

- Copper: Pair 24x0.20mm
- Voltage rating: 240V AC
- Current rating: 7.5A
- Outside diameter: 6mm
- Conductor area: 0.75mm²
- Conductor gauge: 18AWG
- Roll Length: 200 Metres



Length	Code
200M	SPW2420BK

18AWG PAIR SHIELDED CONTROL CABLE HEAVY DUTY

RED AND BLACK CORES OVERALL SCREENED + DRAIN WIRE

2 wire plain annealed copper wire with aluminium tape screen and polyester mylar tape lapping plus a 7/0.20mm tinned copper drain wire. Covered by PVC Sheath. Suitable for a wide range of applications include internal and external inter-connections of electronic apparatus such as computer, intercoms, telemetering, signaling and alarm systems. Complies with AS1125 (conductor) AS/NZS 3808 (PVC).

- 1 pair 24x 0.2mm Strands
- Reel Length 100M
- Outside Diameter 6.8mm
- Nom. Area 0.75mm²
- Insulation Thickness 0.6mm
- Sheath Thickness 0.8mm



Length	Code
100M	EAS2421-100

MULTI-CORE DATA & SIGNAL DOUBLE INSULATED

PVC outer Fire Retardant. 14 multi-strand inner cores with colour ID. 100Vdc/32Vac As used in security and telecommunications. AS1125 AS/NZS3808

Core	Colour	Length	Code
2+2 Shielded	Grey	100M	SHW3032
2+2 Shielded	Grey	305M	SHW3033
4	White	100M	SEC414WH-100
4	Grey	100M	SEC414GY-100
6	White	100M	SEC614WH-100
6	Grey	100M	SEC614GY-100
4	Brown	100M	SEC414BR-100
4	Grey	305M	SEC414GY-305



Core	Colour	Length	Code
4	White	305M	SEC414WH-305
4	Brown	305M	SEC414BR-305
6	Brown	100M	SEC614BR-100
6	Grey	305M	SEC614GY-305
6	White	305M	SEC614WH-305
6	Brown	305M	SEC614BR-305

More Data & Control cable is available as Computer Ethernet cable CAT5/6e and other styles like Telephone, etc. See following pages...



General Purpose Low Voltage Cable

14AWG QUAD-CORE SPEAKER CABLE

INSTALLER 100V-LINE PA & MORE!

High-grade high-current speaker cable Low-loss, low-capacitance, heavy gauge Quad core for Stereo or Dual-Amp runs. Suit 100V Line PA Compatible. Heavy duty protective 9mm PVC Jacket.

- Quad 14AWG (2.5mm² x4)
- 42x 0.2mm multi-strands.
- 9mmØ PVC Mauve Jacket.
- Reel length 100 metres
- Neutrik NLT4MX Compatible

Length Code
100M CAB4220



24AWG GENERAL PURPOSE - TWIN 1.5mm

Grey with black tracer for low voltage. 1.5mm x 2 core with 11 x 0.16mm strands

Length Code
100M SPW1611



22AWG GENERAL PURPOSE - TWIN 2.5mm

Grey with red tracer for low voltage. 2.5mm x 2 core with 24 x 0.12mm strands

Length Code
100M SPW1224



21AWG DC HEAVY DUTY JACKET

Red/Black heavy duty for high current. 3.25mm x 2 with 37 x 0.12mm strands

Length Code
100M AW1237



13AWG DC HEAVY DUTY JACKET

Red/Black thicker jacket for under-bonet durability. 2x 4.5mmO/D with 2mmØ wire (61 x 0.18mm strands).

Length Code
100M AW1861



19AWG GARLAND PRO SERIES TWIN CORE FIGURE 8 CABLES

OUTSTANDING QUALITY & REDUCE ENVIRONMENTAL IMPACTS OF PVC ON YOUR PROJECT

This twin connecting wire is a figure-8 construction based on a 0.2mm strand diameter. The PRO24 series (24/0.2mm) is suitable for used in light duty audio and security applications. These PVC cables are made to meet Vinyl council of Australia's best environmental practice guidelines and can help you earn credits towards the Green Building Council of Australia's (GBCA) Green Star Certification. Available with multiple colour options to allow for easy colour coding of multiple run installations. Each roll has a length of 100M.



Colour	Strands	Length	AWG	Nom. Area (mm ²)	Voltage Rating	O/D	Code
Black	24/0.2mm	100M	19AWG	0.75mm ²	ELV	2.7x5.4mm	PRO24BK100
Brown	24/0.2mm	100M	19AWG	0.75mm ²	ELV	2.7x5.4mm	PRO24BN100
Blue	24/0.2mm	100M	19AWG	0.75mm ²	ELV	2.7x5.4mm	PRO24BU100
Grey	24/0.2mm	100M	19AWG	0.75mm ²	ELV	2.7x5.4mm	PRO24GY100
Red	24/0.2mm	100M	19AWG	0.75mm ²	ELV	2.7x5.4mm	PRO24RD100
White	24/0.2mm	100M	19AWG	0.75mm ²	ELV	2.7x5.4mm	PRO24WH100



□ Speaker and GP Cable

20AWG SPEAKER CABLE - CLEAR JACKET

Classic Speaker Interconnect.
Clear with Silver(+) & Copper(-) strands.
2.5mm x 2 core 18 x 0.16mm strands

Length	Code
100M	SPW1618



18AWG SPEAKER CABLE - CLEAR JACKET

Clear PVC with Pure Copper strands.
Extra flexible thin jacket for easy bend.
Tracer for easy polarity ID.
2x 2.2mm with 24x 0.20mm strands

Length	Code
100M	SPW2024



18AWG SPEAKER CABLE - CLEAR JACKET

Popular Classic Speaker Interconnect.
Extra-thick heavy-duty jacket (OD 3mm)
Clear with Silver(+) & Copper(-) strands.
3mm x 2 core 41 x 0.16mm strands

Length	Code
100M	SPW1641



SOUNDLINK PREMIUM OFC SPEAKER CABLE - CLEAR JACKET

HIGH-DENSITY MULTI-STRAND LOW-LOSS AUDIOPHILE GRADE

This High Grade speaker interconnect cable is designed for low loss signal transfer for optimum home and car audio applications. 99.95% OFC. Figure 8 Clear PVC jacket. Looks as good as the performance.

- 99.95% Oxygen-Free-Copper
- Clear PVC Jacket with stripe
- Super fine Multi-Strand copper
- Extra flexible for tight bends
- Audiophile speaker cable



AWG	Length	Code
18AWG	50M	AIC335
18AWG	100M	AIC1335
15AWG	50M	AIC727
15AWG	100M	AIC1727
13AWG	50M	AIC745
13AWG	100M	AIC1745
11AWG	50M	AIC772
11AWG	100M	AIC1772
10AWG	50M	AP945

16AWG SOUNDLINK-QUAD OFC SPEAKER CABLE FOUR PLY

High grade OFC in a unique quad form. Suit Bi-wire, Bi-amp or stereo runs under carpets in car audio or home HiFi. Excellent long-run characteristics. Will split down the middle for normal stereo left/right cable runs. Supplied in a 50M length (which is actually 100M if split down the middle!) 0.12 X 132 STRANDS (x4) 16AWG/12AWG

Length	Code
50M	OFC132
1M	OFC132-1

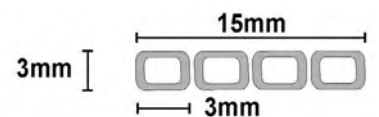



□ Double Insulated - 600V

17AWG DOUBLE INSULATED 600V 10A

32/0.20 TWIN CORE

Specification
 Size: 2 by 32 strands of 0.20mm
 Voltage rating: 600V AC
 Current rating: 10 Amps
 Jacket: 6.8 x 4mm
 Conductor area: 1mm²
 Conductor gauge: ≈17AWG
 Temperature rating: 75°C



Length	Colour	Code
300M	Red	CAB3223RD
500M	Red	CAB3225RD
300M	White	CAB3223WH
500M	White	CAB3225WH

15AWG DOUBLE INSULATED 600V 14A

7/0.50 TWIN CORE

Specification
 Size: 2 by 7 Strands of 0.5mm
 Voltage rating: 600V AC
 Current rating: 14 Amps
 Jacket: 9.4 x 5mm
 Conductor area: 1.4mm²
 Conductor gauge: ≈15AWG
 Temperature rating: 75°C



Length	Colour	Code
300M	Red	CAB7053RD
500M	Red	CAB7055RD
300M	White	CAB7053WH
500M	White	CAB7055WH

18AWG DOUBLE INSULATED 600V 7.5A

24/0.20 TWIN CORE

General purpose double PVC insulated figure-8 cable suitable for speakers, security systems, fire system and other low voltage applications. Separate conductors with non-bonded sheath. Red & White coloured cores provides easy identification to avoid polarity-reversals during installation. Each conductor has 24 strands of 0.20mm diameter copper wire giving an overall conductor-size of 0.75mm² (18AWG). Available in many colours. Supplied on 100, 200, and 300 Metre strong polypropylene reels.

Size: 2 by 24 strands of 0.20mm
 Voltage Rating: 600V AC
 Current Rating: 7.5 Amps
 Jacket: 6 x 3.5mm
 Conductor Area: 0.75mm²
 Conductor Gauge: ~18AWG
 Temperature Rating: 75°C

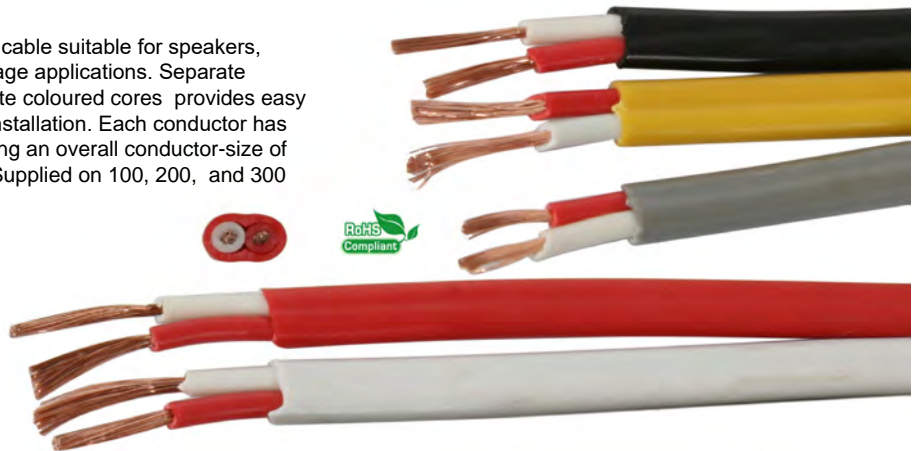

Colour	Length	Code
Black	100M	CAB2421BK
Black	200M	CAB2422BK
Black	300M	CAB2423BK
Black	500M	CAB2425BK
Brown	100M	CAB2421BR
Brown	200M	CAB2422BR
Brown	300M	CAB2423BR
Brown	500M	CAB2425BR

Colour	Length	Code
Grey	100M	CAB2421GY
Grey	200M	CAB2422GY
Grey	300M	CAB2423GY
Grey	500M	CAB2425GY
Red	100M	CAB2421RD
Red	200M	CAB2422RD
Red	300M	CAB2423RD
Red	500M	CAB2425RD

Colour	Length	Code
White	100M	CAB2421WH
White	200M	CAB2422WH
White	300M	CAB2423WH
White	500M	CAB2425WH
Yellow	100M	CAB2421YL
Yellow	200M	CAB2422YL
Yellow	300M	CAB2423YL
Yellow	500M	CAB2425YL

□ AC Mains Cable - Approved

MAINS 240VAC 7A 2-CORE CABLE & MAINS 240VAC 10A 3-CORE CABLE

Typical Mains Cord, Extra Flexible type. 3 Core Multi-strand Flex. 10A cable. Double Insulated. Supplied on 100M Reels. Save money with ProLink.

Length	100M	100M
O/D	6.8mmØ	6.8mmØ
Colour	Grey	Black
Amps	10A	10A
Nom. Area	1.0mm ²	1.0mm ²
Code	PWC3-10G	PWC3-10B

prolink



Mains Twin Lamp Cord. Flat, in white or black. 2 Core Multi-strand Flex. 7A cable. Double Insulated. Supplied on 100M Reels.

Length	100M
O/D	3.6x5.5mm
Colour	Black
Amps	7.5A
Nom. Area	0.75mm ²
Code	PWC2-10B





AC Mains Cable - Approved

3 CORE 7.5A MAINS ELECTRICAL CABLE

This 3-core ordinary duty power cable can be used for extension leads and for domestic appliances. Plain annealed copper conductor. 0.75mm². 100M per roll. Complies with AS/NZS 3191 and AS/NZS 3808 standards.

Length	100M	100M
O/D	6.8mm	6.8mm
Colour	White	Grey
Amps	7.5A	7.5A
Size	24x 0.2mm	24x 0.2mm
Nom. Area	0.75mm ²	0.75mm ²
Code	PWC3751WH	PWC3751GY



3 CORE 15A MAINS ELECTRICAL CABLE ORANGE

This 3-core ordinary duty power cable can be used for extension leads and for domestic appliances. Plain annealed copper conductor. Orange sheath. 1.5mm². 100M per roll. Complies with AS/NZS 3191 and AS/NZS 3808 standards.

Length	100M
O/D	8.3mm
Colour	Orange
Amps	15A
Size	30x 0.25mm
Nom. Area	1.5mm ²
Code	PWC3151OR



BUILDING CABLE FLAT

SINGLE / TWIN / TWIN & EARTH AUSTRALIAN STANDARDS APPROVED

Designed for general wiring in domestic, commercial and industrial applications where the cable is not subject to mechanical damage. 450/750V Made from plain annealed copper (AS/NZS 1125), easy tear 3V-90 sheath, and is protected by PVC 90 insulation. Cables comply with AS/NZS 5000.2 standard.

Size	Nom. Area	Core	Length	Code
7x 0.5mm	1.5mm ²	1	100M	SD1151
7x 0.5mm	1.5mm ²	2	100M	PWF2151
7x 0.67mm	2.5mm ²	2	100M	PWF2251
7x 0.5mm	1.5mm ²	3	100M	PWF3151
7x 0.67mm	2.5mm ²	3	100M	PWF3251
7x 0.85mm	4.0mm ²	3	100M	PWF3401
7x 1.04mm	6.0mm ²	3	100M	PWF3601

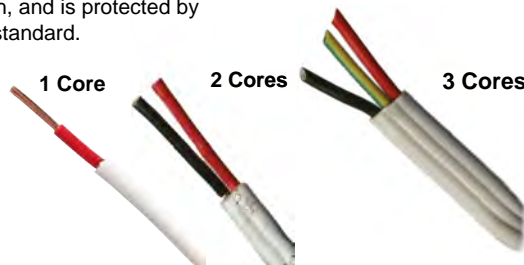

SINGLE CORE FLEXIBLE EARTH CABLE 100M

AS/NZS 1125, AS/NZS 5000.1, AS/NZS3808

Single core earth cable, 0.75mm². Yellow and green colour. 100M per roll. Suitable for enclosed wiring in control panels and electrical appliances.

Length	100M
O/D	2.8mm
Colour	Green/Yellow
Strands	24x 0.2mm
Nom. Area	0.75mm ²
Code	F1075VT-GRN/YL

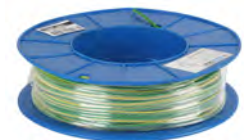

SINGLE CORE FLEXIBLE EARTH CABLE 100M

For separate earth conductors, switchboard and control panel wiring within other enclosures or apparatus where the cable is not accessible without the use of tools. It is also suitable for glanding.

Length	100M
O/D	3.6mm
Colour	Yellow/Green
Size	7x 0.67mm
Nom. Area	2.5mm ²
Code	SR1251GN/Y





Data & Communication Cable

NETWORKING CABLE CAT-5e & CAT6 - PREMIUM GRADE

CATEGORY 5e & 6 CABLE AUSTEL APPROVED FULL COPPER IN PULL BOX 100M & 305M

8x copper conductors in colour coded twisted pairs. Flame retardant polyethylene insulated, PVC sheathed. Suitable for a myriad of communication applications. Premium grade. Fully Austel Approved. Installers choice. See Section DATA & COMPUTER for Connection Solutions. Crimp. Pre-made CAT5/6 leads, etc.



CAT-5e SOLID CORE ETHERNET CABLE

Category-5e 8x Single-Strand Full Copper Conductors

1GBps/100M Max. Twisted pairs (4x2) Full Copper w/ Colour coded insulation. Fully Austel Approved ISO/IEC 11801 and TIA/EIA 506 channel tested. Flame Retardant Polyethylene jacket. Nylon cord. Reverse metred Pull box.

SOLID CORE 100 Metre

Pull-Box Reverse-Metre-Marked 24AWG ISO/IEC 11801 and TIA/EIA 568 Verified

Length	Core	Colour	Code
100M	Solid	Blue	CNC5100BU

SOLID CORE 305 Metre

Pull-Box with Reverse-Metre-Marked cable ISO/IEC 11801 and TIA/EIA 568 Verified

Length	Core	Colour	Code
305M	Solid	Blue	CCU5305BU
305M	Solid	Black	CCU5305BK
305M	Solid	Green	CCU5305GN
305M	Solid	Grey	CCU5305GY
305M	Solid	Red	CCU5305RD
305M	Solid	Yellow	CCU5305YL

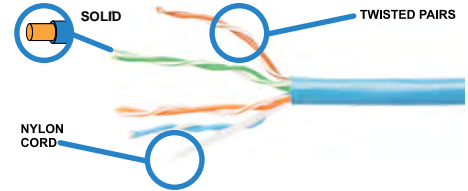

CAT-5e MULTI-STRAND ETHERNET CABLE

Category-5e 8x Multi-Strand Full Copper Conductors

1GBps/100M Max. Twisted pairs (4x2) Full Copper w/ Colour coded insulation. Fully Austel Approved ISO/IEC 11801 and TIA/EIA 506 channel tested. Flame Retardant Polyethylene jacket. Nylon cord. Reverse metred Pull box.

MULTI-STRAND 100 Metre

Pull-Box Reverse-Metre-Marked 24AWG ISO/IEC 11801 and TIA/EIA 568 Verified

Length	Core	Colour	Code
100M	Multi	Blue	CNC5101BU
100M	Multi	Grey	CNC5101GY
100M	Multi	Green	CNC5101GN

MULTI-STRAND 305 Metre

Pull-Box Reverse-Metre-Marked 24AWG ISO/IEC 11801 and TIA/EIA 568 Verified

Length	Core	Colour	Code
305M	Multi	Blue	CNC5306
305M	Multi	Yellow	CNC5306YL

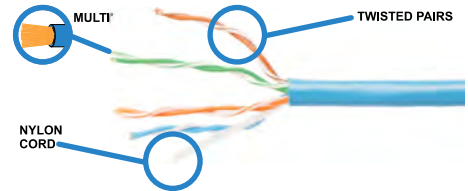

CAT-6 SOLID CORE ETHERNET CABLE

Category-6 8x Single-Strand Full Copper Conductors

10GBps/250M max. Twisted pairs (4x2) Full Copper w/ Colour coded insulation. Fully Austel Approved. Low cross-talk, low noise, premium grade cable. Class-E Flame Retardant Polyethylene jacket. Reverse metred Pull box.

SOLID CORE 100 Metre

Pull-Box Reverse-Metre-Marked 24AWG ISO/IEC 11801 and TIA/EIA 568 Verified

Length	Core	Colour	Code
100M	Solid	Blue	CNC6100
100M	Solid	Grey	CNC6100GY
100M	Solid	Green	CNC6100GN

SOLID CORE 305 Metre

Pull-Box with Reverse-Metre-Marked cable ISO/IEC 11801 and TIA/EIA 568 Verified

Length	Core	Colour	Code
305M	Solid	Blue	CCU6305BU
305M	Solid	Black	CCU6305BK
305M	Solid	Green	CCU6305GN
305M	Solid	Grey	CCU6305GY
305M	Solid	Pink	CCU6305PK
305M	Solid	Purple	CCU6305PU
305M	Solid	Red	CCU6305RD
305M	Solid	Yellow	CCU6305YL

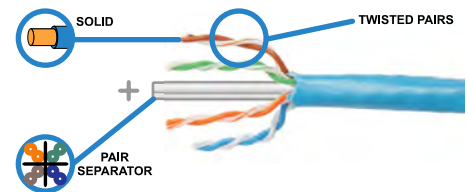

CAT-6 MULTI-STRAND ETHERNET CABLE

Category-6 8x Multi-Strand Wires

10GBps/250M max. Twisted pairs (4x2) Full Copper w/ Colour coded insulation. Fully Austel Approved. Low cross-talk, low noise, premium grade cable. Class-E Flame Retardant Polyethylene jacket. Reverse metred Pull box.

MULTI-STRAND 100 Metre

Pull-Box Reverse-Metre-Marked 24AWG ISO/IEC 11801 and TIA/EIA 568 Verified

Length	Core	Colour	Code
100M	Multi	Blue	CNC6101BU

MULTI-STRAND 305 Metre

Pull-Box Reverse-Metre-Marked 24AWG ISO/IEC 11801 and TIA/EIA 568 Verified

Length	Core	Colour	Code
305M	Multi	Blue	CNC6306BU
305M	Multi	Red	CNC6306RD

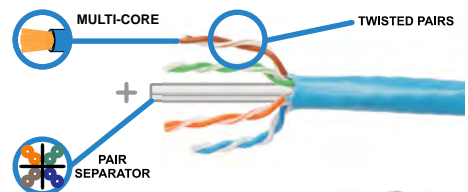



CAT5e ETHERNET CABLE SHIELDED

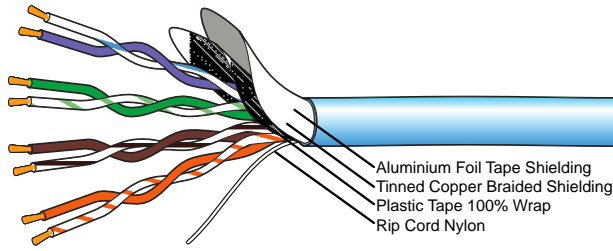

MULTI-STRAND SFTP 26AWG

Pull-Box Reverse-Metre-Marked 26AWG
ISO/IEC 11801 and TIA/EIA 568 Verified

Length	Core	Colour	Code
100M	Multi	Blue	CNC5103
305M	Multi	Blue	CNC5308



SOLID-STRAND SFTP 24AWG

Length	Core	Colour	Code
100M	Solid	Blue	CNC5102
305M	Solid	Blue	CNC5307

CAT6 ETHERNET CABLE SHIELDED

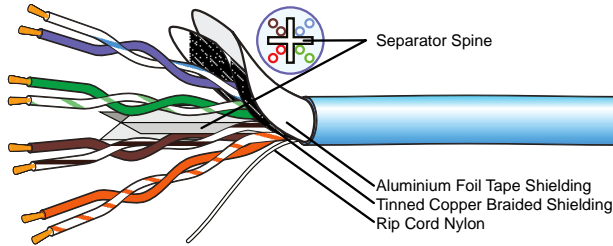

MULTI-STRAND SFTP

Pull-Box Reverse-Metre-Marked 24AWG
ISO/IEC 11801 and TIA/EIA 568 Verified

Length	Core	Colour	Code
100M	Multi	Blue	CNC6103
305M	Multi	Blue	CNC6308



SOLID-STRAND SFTP

Length	Core	Colour	Code
100M	Solid	Blue	CNC6102
305M	Solid	Blue	CNC6307

SOLID CORE ETHERNET IN AN EASY-PULL BOX

PREMIUM CABLE - TANGLE FREE DISPENSER

Reel on a base for easy pull of cable to reduce twist and tangles.
Supplied in a 1000 foot box. Full copper conductors. 24AWG
ISO/IEC 11801 and TIA/EIA 568 Verified. Reverse-Metre-Marked.

CAT5e

Length	Type	Code
305M	CAT5e	CNC5305BU

CAT6

Length	Type	Code
305M	CAT6A	CNC6305BU



REEL STYLE MAY VARY

CAT6A SOLID-CORE F/UTP ETHERNET CABLE

CAT6A FULL COPPER CONDUCTORS - SINGLE FOIL SHIELD

10GBps/100M max. Consists of four twisted pairs with separator spine, encased in an overall aluminium foil shield. Fully Austel Approved. Low cross-talk, low noise, with outer flame retardant LSZH polyethylene outer jacket. Full copper conductors.

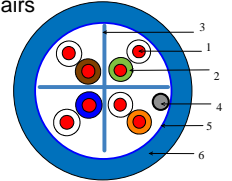

Length	Type	Colour	Code
305M	CAT6A	Blue	CNC6310BU
305M	CAT6A	Grey	CNC6310GY



Note.
Supplied on timber reels, approx. 18kg weight.
Additional delivery charges will apply in some areas

SOLID CORE ETHERNET UNDERGROUND OUTDOOR

GEL FILLED SOLID CORE

Bare copper solid core wires with individual HDPE insulated set in a gel filled heavy duty UV resistant black LDPE outer jacket 7.0mmØ (0.7mm thick). Suitable for long life heavy duty applications where a moisture resistant data cable is required. Rated temp' -20°C to 60°C. Reverse metre marked.



CAT5e

Length	Type	Code
305M	CAT5e	CNC5309BK

CAT6

Length	Type	Code
305M	CAT6A	CNC6309BK

Note.
Supplied on timber reels, approx. 18kg weight.
Additional delivery charges will apply in some areas

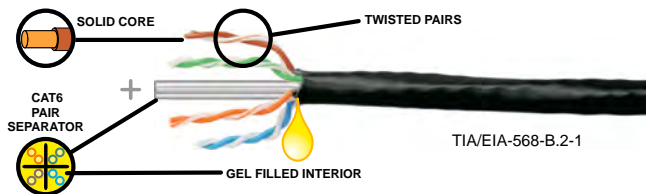

COMPUTER CABLE MULTI-CONDUCTOR

Multi-coloured wires in one sheath protected by Aluminium wrap shielding with steel earth wire. As used in computer communication cords.



Description	Reel	Code
9 Conductor + Earth/Screen	100M	CC90
25 Conductor + Earth/Screen	100M	CC250

FLAT IDC CABLE MULTI-CONDUCTOR

Multi-Strand Ribbon Cable. As used in PCs. 0.050"/1.127mm Spacing.

Length	Description	Code
60M	9 Core	FC9
60M	15 Core	FC15
60M	16 Core	FC16
60M	25 Core	FC25
30M	40 Core	FC40





□ CB Communication Cable

CB RADIO MICROPHONE CURLY CORDS

Primarily for CB microphones, etc. Will suit other applications. 3 or 5 core plus braid shielding.

Description	Length	Code
3 Core + Shield	1.8M	ML3-6
3 Core + Shield	2.75M	ML3-9
3 Core + Shield	3.65M	ML3-12
5 Core + Shield	1.8M	ML5-6
5 Core + Shield	2.75M	ML5-9
5 Core + Shield	3.65M	ML5-12



□ Security, Data, Communication

SECURITY & CONTROL CABLE SHIELDED

Twisted Pair 7x0.22mm wrapped in Aluminium Mylar Shielding with drain wire.

Description	Length	Colour	Code
2 Core + Shield	100M	Grey	SHW3035
2 Core + Shield	300M	Grey	SHW3036
2+2 Core + Shield	100M	Grey	SHW3032
2+2 Core + Shield	305M	Grey	SHW3033

Blue CAT5/6e Shielded now available. Please Enquire...

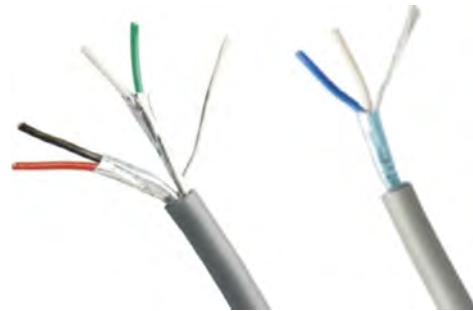

SECURITY & CONTROL CABLE 4 CORE

Colour	Length	Code
Grey	100M	SHW3032
Grey	305M	SHW3033
White	100M	SEC414WH-100
Grey	100M	SEC414GY-100
Brown	100M	SEC414BR-100
Grey	305M	SEC414GY-305
White	305M	SEC414WH-305
Brown	305M	SEC414BR-305

PVC outer Fire Retardant.
14 multi-strand inner cores
with colour ID.

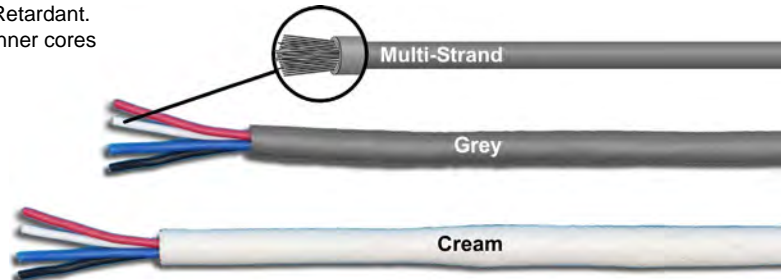

SECURITY & CONTROL CABLE 6 CORE

Colour	Length	Code
White	100M	SEC614WH-100
Grey	100M	SEC614GY-100
Brown	100M	SEC614BR-100
White	305M	SEC614WH-305
Grey	305M	SEC614GY-305
Brown	305M	SEC614BR-305

PVC outer, Diameter 6mm.
Twisted Pair. 14 multi-strand
core by 6 with colour ID.

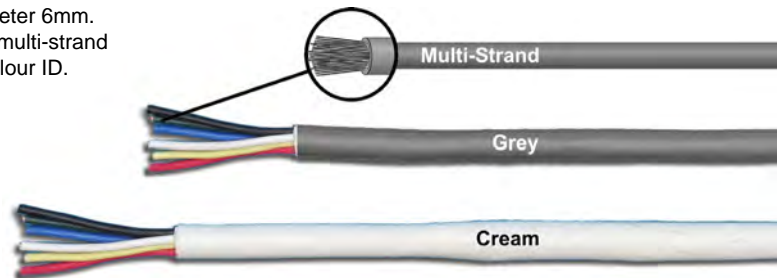

MODULAR FLAT MULTI-CONDUCTOR COMMUNICATION CABLE

Designed for use with modular connectors for extension leads etc.
Can be used for many applications, burglar alarms etc.
Cream in colour, supplied in a 100M pull box.

Length	Strands	Code
100M	4	FMC4
100M	6	FMC6
100M	8	FMC8





□ Slewing

SPIRAL WIRE WRAP LIGHT

Winds around to secure messy wiring from behind computers, stereos, etc. Approx. 10 Metres at 5mmØ. Stretches to about 25mm

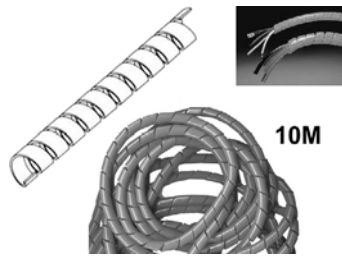

Colour	Code
Black	SPWR10BK
White	SPWR10WH

SPIRAL WIRE WRAP

Winds around messy cabling and protects. Aerpro. BLACK Length is approx. 10M



Diam.	Code
4-50mm	SLT4
7.5-60mm	SLT75
15-100mm	SLT15

SPIRAL WIRE WRAP HEAVY DUTY

Winds around to secure messy wiring from behind computers, stereos, etc. Approx. 10 Metres at 20mmØ. Stretches to around 120mm+



Colour	Code
Black	SPRL15B
White	SPRL15W

EASY-WRAP CABLE TIDY

NEAT & TIDY ORGANIZER

CABAC Easy Wrap Solution Puts all your messy cords neatly in one place! Includes a handy applicator making assembly quick n' easy! A unique solution to a messy problem Easy to remove and re-use too....

20mm x 1.5M

Code
EW20BK

16mm x 1.5M

Code
EW16BK



SPLIT WIRE WRAP REINFORCED

AUTOMOTIVE LOOM TYPE

Split down the middle for inserting multiple wiring. Protective ribbed casing, like a vacuum hose, so will bend for easy installation. Diameter does not stretch. Flexible UV Black ABS Plastic. 10 Metre lengths, several sizes.

7mm x 10M

Code
PST7

10mm x 10M

Code
PST10

16mm x 10M

Code
PST16



□ Cable Anchors

CABLE CLIPS FLAT - HPM

DUAL [X2] CABLE

Order One to receive 20. Suits flat cable White. Nail inclusive.

Size	QTY	Code
5x4mm	x20	DQ5
13x6mm	x20	DQ13
15x6mm	x20	DQ15



CABLE CLIPS FLAT - BULK

Plastic cable clamp with nail. Supplied in buckets bulk.

Size	QTY	Code
10x6mm	500	CC10-500WH
12x6mm	500	CC12-500WH
14x6mm	250	CC14-250WH



CABLE CLIPS ROUND - BULK

Size	QTY	Colour	Code
4mm	x100	White	CC401WH
5mm	x100	Black	CC500BK
5mm	x100	White	CC500WH
6mm	x100	Black	CC600BK
6mm	x100	White	CC600WH
7mm	x100	Black	CC700BK
7mm	x100	White	CC700WH
8mm	x100	Black	CC800BK
8mm	x100	White	CC800WH
10mm	x20*	White	DQ10
12mm	x100	Black	CC1200BK
12mm	x100	White	CC1200WH

Order One to receive 100 (or 20*)



CABLE CLIPS ROUND STICK-ON 7MM

Adhesive backed clips. Accepts up to 7mm diameter. Receive a bag of 10.

Size	QTY	Code
7mm	x10	CTC10
7mm	x10	CTC12



TWIST-LOCK CABLE HOLDER

Cable hold twist secure 20mm stand-off Snap fits into a 4mm panel hole.

Cable	QTY	Code
11mm	100	WTL11
17mm	100	WTL17



CABLE HOLDER

Cable tidy snap-fits into a 4mm panel hole. Sold in bags of a hundred.

Cable	QTY	Code
16x11mm	100	WH1
25x11mm	100	WH2



XMAS TREE PLUG FOR CABLE TIES

TO SUIT 9mm CABLE TIE

Container of 150 pieces.

QTY	Code
150	SCR1010



CABLE TIE MOUNTS

Suit standard Cable ties Panel mount anchoring 28mm² Adhesive Backed Packaged in bags of 10,

Colour	Code
White	CTM100
Black	CTM101





□ Hook & Loop - Prolink

HOOK & LOOP CABLE TIES 125MM

These hook and loop cable ties are suitable for cable support and cable management. Easy to use and reusable. 12.5mm wide. They are available in a bag of 10 pieces and a bag of 100 pieces.

Length	Width	QTY	Code
123mm	12.5mm	10 pcs	CT125-10BK
123mm	12.5mm	100 pcs	CT125-100BK



HOOK & LOOP CABLE TIES 300MM

These hook and loop cable ties are suitable for cable support and cable management. Easy to use and reusable. 15mm wide. They are available in a bag of 10 pieces and a bag of 100 pieces.

Colour	Length	Width	QTY	Code
Black	302mm	15mm	10 pcs	CT15-10BK
Black	302mm	15mm	100 pcs	CT15-100BK



HOOK & LOOP CABLE TIES COLOUR 125MM

These hook and loop cable ties are 12.5mm wide and are available in a bag of 10 pieces in 5 different colours. These cable ties are suitable for cable support and cable management. Reusable, easy to open and close.

Width	Length	QTY	Code
12.5mm	123mm	10 pcs	CT125-10MC



HOOK & LOOP CABLE WRAP COLOURS 1M

Self adhesive hook and loop cable wraps. 6 rolls x 1 metre length x 16mm width. Colours included black, blue, green, red, white and yellow.

Width	Length	QTY	Code
16mm	1M for each colour	6 pcs	HKL16-6MC



HOOK & LOOP CABLE WRAP

These hook and loop cable wraps are available in a roll of 5M and 25M in length. They are suitable for cable support and cable management. Reusable, easy to open, close, and cut to any length required.

Width	Length	Code
6mm	5M	HKL6-5M
6mm	25M	HKL6-25M

Width	Length	Code
12mm	5M	HKL12-5M
12mm	25M	HKL12-25M

Width	Length	Code
16mm	5M	HKL16-5M
16mm	25M	HKL16-25M

Width	Length	Code
20mm	5M	HKL20-5M
20mm	25M	HKL20-25M



HOOK AND LOOP CABLE TIES - PROLINK

Handy solutions for keeping your cables in a nice and neat order. Ideal for entertainment systems, network rack cabinets, automotive, etc. Packaged in bulk form plastic bags.



HOOK & LOOP CABLE WRAP STICK 90MM

WITH ADHESIVE STRIP BASE

These hook and loop cable wraps with adhesive mounting surface are 16mm wide and available in black and white. These cable wraps are suitable for organising cables and fixing to a flat surface.



Colour	Length	Width	QTY	Code
Black	90mm	16mm	10 pcs	CT16-10BK
White	90mm	16mm	10 pcs	CT16-10WH



HOOK & LOOP ADHESIVE TAPE FASTENERS 150MM

Adhesive backs. 26 x 150mm. 10 pcs per bag

Code
AFT10

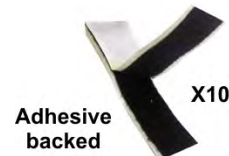

DOUBLE-SIDED TAPE

FOAM & CLOTH STICKY TAPES

Adhesive on both sides
Various types available
Foam sponge thick types
Extra thin tissue types
Heavy-duty Gaffa types



See Section TOOLS & TEST EQUIPMENT



□ Hook & Loop - Velcro®

VELCRO® BRAND ONE-WRAP® FASTENER

Double sided fastener. Hook one side, Loop the other. Unlike cable ties, this is reusable. Supplied in 2 Metre rolls. 25mm width.

Colour	Length	Code
Black	2M	FT25572
White	2M	FT25573



VELCRO® BRAND ONE-WRAP® FASTENER LONG

Double sided fastener. Hook one side, Loop the other. Secures items and cables, etc. Supplied in 5 Metre rolls

Colour	Length	Width	Code
Black	5M	25mm	FT25578
White	5M	25mm	FT25579
Black	22.8M	12mm	FT189755
Black	22.8M	19mm	FT189645



VELCRO® BRAND STICKY-BACK FASTENERS

Sticky-Back is a weather resistant adhesive backed Hook-Loop fastener. 2x1M rolls= 1M Total.

Colour	Length	Code
Black	1M	FT25570
White	1M	FT25571



VELCRO® BRAND HANDY-DOTS FASTENERS

Weather resistant adhesive backed Hook-Loop fasteners pre-cut 22mm (~1") circles. Light duty hold points ~100g. 40x Pairs supplied packaged

Colour	Code
Black	FT25568
White	FT25569



VELCRO® BRAND HOLD-DOWN FASTENERS

Pre-cut strips with an adhesive bond backing for fastening over a 500g each! 50x25mm. Six sets in a pack.

Colour	Code
Black	FT25558



VELCRO® BRAND HOLD-DOWN FASTENERS

Pre-cut strips with an adhesive bond backing for fastening to most porous surfaces. Heavy duty, holds up to 3kg. 100x25mm. Three sets in a pack.

Colour	Code
Grey	FT25546



VELCRO® BRAND TIES

19mm x 200mm Double sided. Hook one side, Loop the other with feed-thru 1/2" buckle hold. Ideal re-usable cable organiser. Supplied no packaging (bulk).

Colour	Code
Black	FT20017

Bulk Roll quantity is 100 pcs (POA)



VELCRO® BRAND TIES PACK

25x200mm Double sided. Hook one side, Loop the other with feed-through 1" buckle hold. Excellent cable organiser. Supplied in blister pack hanger. Order one to receive a box of 5.

Colour	Code
Black	FT25564



VELCRO® BRAND TIES IN COLOUR

25x200mm Double sided. Hook one side, Loop the other with feed-through 1" buckle hold. Supplied in blister pack hanger. Order one to receive a box of 5 Red Blue Green Yellow Orange

Code
FT25565



VELCRO® BRAND VELSTRAP® FASTENERS

STRAP WITH A 1" BUCKLE

25mm wide strip with a ring for a secure hold of bulky items.

Length	Code
300mm	FT22002
450mm	FT22102
600mm	FT22202
900mm	FT22302



VELCRO® BRAND EASY HANG STRAP

The heavy duty hang strap is designed to allow users to hang heavy items off the wall, or other structures. Allows easy storage of cable cords, pipes, hoses and ladder, etc.

Weight	Size	Code
40Kg	430x25mm	FT21126
80Kg	630x25mm	FT21127
120Kg	830x40mm	FT21128





□ Cable Ties

CABLE TIES - STANDARD

ORDER ONE BAG TO RECEIVE 100 PIECES

Colour	QTY	Size	Code
White	100 per bag	100mm x 2.5mm	CT2510WH
Black	100 per bag	100mm x 2.5mm	CT2510BK
White	100 per bag	150mm x 2.5mm	CT2515WH
Black	100 per bag	150mm x 2.5mm	CT2515BK
White	100 per bag	200mm x 2.5mm	CT2520WH
Black	100 per bag	200mm x 2.5mm	CT2520BK
White	100 per bag	142mm x 3.6mm	CT3614WH
Black	100 per bag	142mm x 3.6mm	CT3614BK
White	100 per bag	203mm x 3.6mm	CT3620WH
Black	100 per bag	203mm x 3.6mm	CT3620BK
White	100 per bag	250mm x 3.6mm	CT3625WH
Black	100 per bag	250mm x 3.6mm	CT3625BK
White	100 per bag	300mm x 3.6mm	CT3630WH
Black	100 per bag	300mm x 3.6mm	CT3630BK
White	100 per bag	120mm x 4.8mm	CT4812WH
Black	100 per bag	120mm x 4.8mm	CT4812BK
White	100 per bag	190mm x 4.8mm	CT4819WH
Black	100 per bag	190mm x 4.8mm	CT4819BK
White	100 per bag	250mm x 4.8mm	CT4825WH
Black	100 per bag	250mm x 4.8mm	CT4825BK
White	100 per bag	292mm x 4.8mm	CT4830WH
Black	100 per bag	292mm x 4.8mm	CT4830BK
White	100 per bag	200mm x 7.2mm	CT7220WH
Black	100 per bag	200mm x 7.2mm	CT7220BK
White	100 per bag	350mm x 7.2mm	CT7235WH
Black	100 per bag	350mm x 7.2mm	CT7235BK
Black	100 per bag	380mm x 7.6mm	NCT3807-100
Black	100 per bag	550mm x 8mm	NCT5508BK



CABLE TIES - RELEASABLE

These releasable cable ties are manufactured from Nylon 66 for its high mechanical strength, UV resistance and durable properties. Easy to assemble by hand or with pliers, and remain securely locked. It can be released by operating the finger catch.

Colour	QTY	Size	Code
White	100 per bag	150mm x 7.2mm	RCT7215WH
Black	100 per bag	150mm x 7.2mm	RCT7215BK
White	100 per bag	250mm x 7.2mm	RCT7225WH
Black	100 per bag	250mm x 7.2mm	RCT7225BK



CABLE TIES - STAINLESS STEEL

Made from high quality type 304 stainless steel for indoor or outdoor. Durable, sturdy and provide excellent resistance against the elements. Sold in a bag of 20 pieces.



QTY	Size	Code
20 per bag	127mm x 4.6mm	SST46127
20 per bag	152mm x 4.6mm	SST46152
20 per bag	200mm x 4.6mm	SST46200
20 per bag	250mm x 4.6mm	SST46250
20 per bag	300mm x 4.6mm	SST46300
20 per bag	400mm x 4.6mm	SST46400



CABLE TIES IN A KIT

100 PIECES ASSORTED

Excellent hobby or tradesman solution with a selection of popular sizes of cable ties and stick-on holders too. Nylon. Assorted colours. Supplied in a plastic jar.

- 50x 2.5 x 100mm
- 25x 2.5 x 200mm
- 25x Stick-N-Hold

Code
NCT500



CABLE TIES - ANCHORED

Terminates to a ring for securing with a screw, etc. Order ONE to receive a bag of 100 pieces.

Colour	QTY	Size	Code
Black	100 per bag	100mm x 2.5mm	ACT2510BK
White	100 per bag	100mm x 2.5mm	ACT2510WH
Black	100 per bag	156mm x 3.6mm	ACT3615BK
White	100 per bag	156mm x 3.6mm	ACT3615WH
Black	100 per bag	200mm x 4.8mm	ACT4820BK
White	100 per bag	200mm x 4.8mm	ACT4820WH

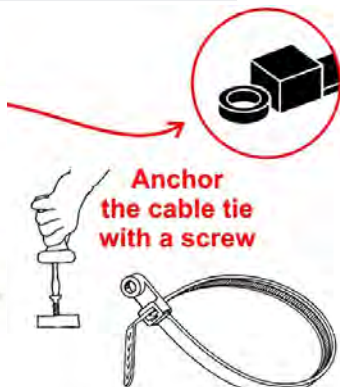

CABLE TIE GUN

Tightens cable ties with a trigger. Automatic tension, pull and cut in one action, then twist to cut off excess.

Code
HT381



RAPSTRAP™ - FLEXIBLE CABLE TIES

ELASTIC CABLE TIES

- Soft and flexible design
- Controllable tension - pull to required grip
- Gives up to 5 ties per strip
- Can be released and reused if required
- Can be double-looped for use on plants
- Reinforced rear cells
- Supplied in tear-off sheets of 6

QTY	Colour	Length	Code
24x	Clear	300mm	RTS24TP



www.rapstrap.com



THE HERBIE CLIP™

When it comes to hose clamps, nothing beats the reliability and speed of fitting the Herbie Clip. Available in a comprehensive range of sizes, the Herbie Clip is a one piece nylon hose clamp that uses a proven double row of interlocking teeth to produce an extremely secure and reliable fit. Near perfect circle fitting for a better, tighter seal as a hose clamp. Quality molded from Nylon 6.6 carbon based polymer for extra long life, it is totally resistant to any atmospheric conditions. Impervious to a majority of chemicals and fuels, salt water, etc. Excellent in hostile environments. A popular solution in many industries worldwide for twenty years now.

*Very Strong and Reliable
Very Fast Application
Nylon Hose Fastener
18 Years Strong*

HERBIE CLIP™

*The Double Grip Hose Clip
Available in 5mm to 105mm*



A min	B max	C width	D	E	F	G	Code
5.60	6.50	4.2	1.4	8.3	17.5	0.53	HC0642
6.50	7.90	4.5	1.6	9.9	20.9	0.82	HC0745
7.90	9.20	4.4	1.6	9.3	20.7	0.90	HC0844
9.20	10.3	4.5	1.7	10.9	22.2	1.11	HC1045
10.2	11.8	5.8	1.7	12.2	27.9	1.73	HC1158
11.1	12.9	6.1	1.7	12.3	28.7	1.94	HC1261
12.0	13.8	6.1	1.7	12.9	28.9	1.95	HC1361
13.5	15.1	7.1	2.0	13.6	32.7	3.26	HC1471
15.0	17.1	7.1	2.0	12.9	34.8	3.18	HC1671
16.9	19.1	6.9	2.1	12.5	32.4	2.00	HC1869
18.1	20.6	7.1	2.1	12.7	35.7	3.23	HC1971
20.3	23.0	6.4	2.1	14.2	39.0	1.08	HC2264
22.2	24.9	7.0	2.0	13.0	37.0	3.61	HC2470
24.5	27.6	7.1	2.1	12.5	37.3	3.43	HC2671
26.5	29.5	7.4	2.2	13.4	40.0	4.80	HC2874
28.8	32.2	9.0	2.0	13.4	42.0	5.60	HC3090
32.0	34.8	9.1	1.9	13.8	40.0	6.15	HC3391
34.3	37.9	8.9	2.1	13.5	42.0	7.05	HC3689
37.0	40.4	8.9	2.1	13.3	42.2	6.48	HC3989
40.1	44.2	9.0	2.2	13.4	42.2	6.60	HC4290
43.2	46.2	8.9	2.1	12.8	42.5	6.81	HC4589
45.8	50.4	9.0	2.0	13.9	45.0	7.31	HC4790
48.5	53.8	9.0	2.1	14.4	48.0	8.17	HC5190
53.0	57.0	9.0	2.1	14.7	49.0	7.61	HC5590
54.9	60.1	9.3	2.3	16.0	53.4	9.95	HC5793
59.0	64.7	17.0	9.3	10.7	9.3	7.93	HC6393

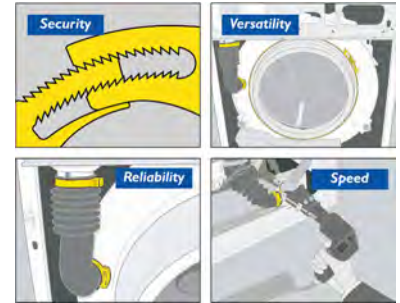

THE SMART SOLUTION FOR MANY APPLICATIONS:

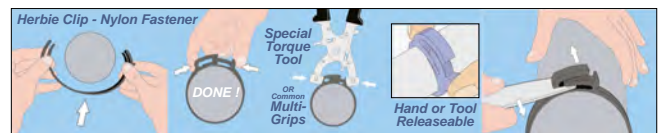

Prices PER CLIP. For larger sizes & quantities, Please enquire.

HERBIE CLIP™ REMOVAL TOOL

You can use any Multi-Grip type hand tool to fasten. And this handy Twist-To-Remove hand tool from Herbie Clip.

Code
HCT4000

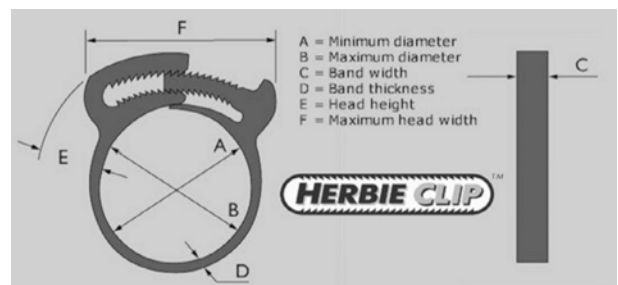

□ Cable Entry

STRAIN RELIEF BUSHING

CABLE CLAMPS Chassis mount

6.2Ø - 7.4Ø 10pcs

Code
SRC510



7.4Ø - 8.2Ø 10pcs

Code
SRC610



RUBBER GROMMETS

CHASSIS MOUNT 10pcs

Please Order ONE to Receive a bag of 10.

A	B	C	D	E	Code
11	8.0	4.5	1.6	4.5	GM210
15	9.5	6.3	1.6	7.0	GM310
18	13	9.5	1.6	6.8	GM410

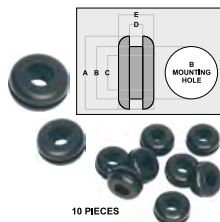

NYLON CABLE GLAND PAIR

Twist to lock strain relief for weather-proof cable entry. Order One to receive a bag of Two.

Cable Range	Hole	Pack of	Code
3-6mmØ	12mmØ	2	HP0720
6-12mmØ	20mmØ	2	HP0732



NYLON CABLE GLAND

Cable	Hole	Code
5-7mmØ	12mmØ	NCG1012
6-8mmØ	16mmØ	NCG1016
8-12mmØ	20mmØ	NCG1020
12-18mmØ	25mmØ	NCG1025
18-20mmØ	32mmØ	NCG1032
24-30mmØ	40mmØ	NCG1040
31-40mmØ	50mmØ	NCG1050
40-44mmØ	63mmØ	NCG1063





□ Cable Sleeving

PPS EXPANDABLE BRAIDED SLEEVING

HEAVY-DUTY CABLE ORGANISER AND PROTECTOR FOR HOSTILE ENVIRONMENTS

Strong expandable firm polyphenylene sulfide braid sleeving that not only provides a professional look but also protects cables, wires and hoses from abrasion. It has high temperature stability, chemical and UV resistance, low moisture absorption and excellent dimensional stability. Neat, tidy and protected cabling. Stretches to allow plugs to feed through, then returns to "Min." diameter. Cut with a heat knife. PPS can be terminated using electrical tape, wire ties or heat shrink to prevent the braid unravelling.

Reels are sold Cut-To-Length required. Codes listed below is per metre.
To order a full reel, please quote the appropriate Length in metres.
eg. For a full reel of 150M, order 150x PPS-032

Nominal Size	Min.	Max.	Colour	Code
6mm	3mmØ	9mmØ	Black	PPS-006
10mm	7mmØ	19mmØ	Black	PPS-010
19mm	14mmØ	30mmØ	Black	PPS-019
32mm	20mmØ	50mmØ	Black	PPS-032
50mm	40mmØ	80mmØ	Black	PPS-050

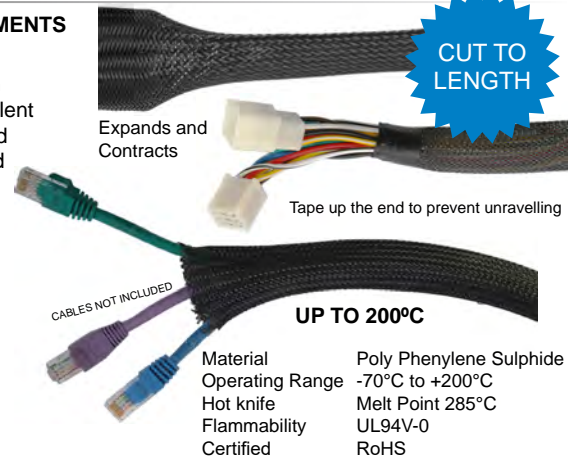

POLYESTER CABLE SLEEVING EXPANDABLE

Polyester cable sleeving is Flame-retardant and halogen free. Closed round has expandable diameter - (Min to Max), relaxed is Diam. Protects and secures cables, offering durable abrasion resistance in a wide range of industrial, domestic, automotive applications, etc. The open weave construction allows an easy installation on a bundle of hoses and cables, even if some have bulky or large end connectors.

Diam.	Min.	Max.	Code
6mm	3mm	9mm	FR-006BK
10mm	7mm	19mm	FR-010BK
12mm	8mm	24mm	FR-012BK
16mm	10mm	27mm	FR-016BK
19mm	14mm	30mm	FR-019BK
25mm	18mm	35mm	FR-025BK
32mm	20mm	50mm	FR-032BK
38mm	30mm	60mm	FR-038BK
45mm	35mm	75mm	FR-045BK
50mm	40mm	80mm	FR-050BK



SELF CLOSING SLEEVING FINE-WEAVE WRAP

SCS Self-Closing Sleeving is a non-expandable Polyethylene material woven from monofilament weft and multifilament warp polyester yarns. It provides a lightweight, cost-effective and tough solution for the protection of cable assemblies from ingress and abrasion for a neat installation. Inherent flexibility allows it to bend, coil and conform to irregular shapes. Open side design allows it to be installed on to completed assemblies.

Diam.	Max.	Code
5mmØ	6mmØ	SCS-005
8mmØ	9mmØ	SCS-008
10mmØ	11mmØ	SCS-010
13mmØ	14mmØ	SCS-013
16mmØ	17mmØ	SCS-016
19mmØ	20mmØ	SCS-019
25mmØ	27mmØ	SCS-025
29mmØ	31mmØ	SCS-029
32mmØ	34mmØ	SCS-032
38mmØ	40mmØ	SCS-038
50mmØ	52mmØ	SCS-050



SELF-CLOSING BRAIDED WRAP

Rugged construction side-entry self-closing wrap offers innovative solutions for the protection of cable bundles that's also ideal in breakout areas. SCW provides easy removal when it is necessary for inspection or maintenance of cables and allows it to be installed after cable connection. Strong resilience force prevents the wire or cable from exposure, while providing excellent abrasion and hostile environment resistance.

Diam.	Max.	Code
3mmØ	4mmØ	SCW-003
6mmØ	7mmØ	SCW-006
9mmØ	10mmØ	SCW-009
13mmØ	14mmØ	SCW-013
16mmØ	17mmØ	SCW-016
19mmØ	20mmØ	SCW-019
25mmØ	26mmØ	SCW-025
32mmØ	33mmØ	SCW-032
38mmØ	40mmØ	SCW-038
50mmØ	52mmØ	SCW-050





HOOK-N-LOOP BRAIDED WRAP

RUGGED CABLE SLEEVE WITH HOOK-N-LOOP SIDE ACCESS

VCW wrap is woven from expandable polyester braid for a heavy-duty, high strength cable protector with excellent flame & abrasion resistance. A hook and loop strip runs the full length of the sleeve so that it can be easily wrapped and closed over an existing cable bundle for a neat appearance. It can be re-open rapidly to allow adding or removing cables, and breakouts can be made simply by bringing cables out through the seam. Diameter listed is fully stretched (Max), nominal diameter is about 50%.

Material Polyester & Polyamide
 Operating Range -70°C to +150°C (Melt Point 240°C)
 Flammability VW-1
 Certified RoHS, Halogen Free

Nominal Size	Fastener	Max Bundle	Code
13mm	10mm	8mmØ	VCW-013
19mm	10mm	12mmØ	VCW-019
32mm	20mm	20mmØ	VCW-032
51mm	20mm	32mmØ	VCW-051
64mm	20mm	40mmØ	VCW-064

Available for sale by the metre, cut to length, or in a full reel.



HOOK-N-LOOP CLOTH WRAP

CABLE SLEEVE WITH HOOK-N-LOOP SIDE ACCESS

PVTW wrap is woven from non-expandable polyester multifilament yarns for a lightweight, high strength material with excellent flame and abrasion resistance. A hook and loop strip runs the full length of the sleeve so that it can be easily wrapped and closed over an existing cable bundle. It can be re-opened rapidly to allow adding or removing cables, and breakouts can be made simply by bringing cables out through the seam.

Material Polyester & Nylon (Hook and Loop Fastener)
 Operating Range -70°C to +150°C (Melt Point 240°C)
 Flammability VW-1
 Certified RoHS, Halogen Free

ID	Open Width	Code
20mmØ	80mm	PVTW-20
25mmØ	95mm	PVTW-25
30mmØ	115mm	PVTW-30
35mmØ	130mm	PVTW-35
40mmØ	146mm	PVTW-40
45mmØ	162mm	PVTW-45
50mmØ	178mm	PVTW-50

Available for sale by the metre, cut to length, or in a full reel.



HOOK & LOOP NEOPRENE CABLE WRAP

HOOK & LOOP WRAP ALLOWS EASY CABLE BREAK-OUT

The neoprene made cable wrap is made with a lightweight and high strength material with excellent flame and abrasion resistance. A hook and loop strip runs the full length of the sleeve so that it can be easily wrapped and closed over an existing cable bundle. It can be re-opened rapidly to allow adding or removing cables, and breakouts can be made simply by bringing cables out through the seam.

Available in 3M or 5M.

Diam.	Width	Length	Code
25mmØ	100mm	3M	CW10025-3
25mmØ	100mm	5M	CW10025-5
35mmØ	135mm	3M	CW13035-3
35mmØ	135mm	5M	CW13035-5



HOOK-N-LOOP CARPET FIX

HOLDS CABLES DOWN ONTO CARPET

DHS Double Hook Sleeve is a cable solution that consists of polyester multifilament material with dual hook (only) strip all-along its edges. It is designed for holding and protecting cable runs which are normally exposed in a carpeted area by affixing directly to the carpets loop pile. This product has excellent abrasion resistance and makes for a neat and tidy home or office solution. Available in two widths, edge to edge.

Material Polyester Multifilament
 Operating Range -50°C to +150°C (Melt Point 240°C)
 Flammability VW-1
 Certified RoHS

Width	Code
76mm	DHS-076
100mm	DHS-100

Available for sale by the metre, cut to length, or in a full reel of 25 metres. To receive a full reel, order 25 pieces.





Heat Shrink

HEAT SHRINK TUBING MIL. SPEC.

1.2 Metre Lengths. MIL-1-23053

Premium grade. Flame retardant. Long Life. Optimum performance. XLP series is cross-linked tubing that conforms to MIL-1-23053/3 class 3. It will withstand -45°C to 125°C for normal operating conditions & 200°C for short intervals. Black tubing also resists ultraviolet radiation. It can be easily shrunk with a 100°C+ heat gun, etc. See Section TOOLS & TEST EQUIPMENT. All tubing is flame retardant except clear, which is flammable & conforms to MIL-1-23053/5 class 2. Highly flexible. 2:1 shrink ratio. Ideal for insulation, colour coding & mechanical protection, etc. 600V rated. Only 5% longitudinal shrinkage. Premium quality series. Pre-cut to 1.2 metre lengths.

BEFORE DiamØ=Code("Size" mm) - AFTER DiamØ=50% PRE-CUT 1.2M

Size	Black	Clear	Red	Blue	White
1.5mm	XLP1.5BK	XLP1.5C	XLP1.5RD	XLP1.5BU	XLP1.5WH
2.5mm	XLP2.5BK	XLP2.5CL	XLP2.5RD	XLP2.5BU	XLP2.5WH
3.5mm	XLP3BK	XLP3CL	XLP3RD	XLP3BU	XLP3WH
5.0mm	XLP5BK	XLP5CL	XLP5RD	XLP5BU	XLP5WH
7.0mm	XLP7BK	XLP7CL	XLP7RD	XLP7BU	XLP7WH
10mm	XLP10BK	XLP10CL	XLP10RD	XLP10BU	XLP10WH
13mm	XLP13BK	XLP13CL	XLP13RD	XLP13BU	XLP13WH
20mm	XLP20BK	XLP20CL	XLP20RD	XLP20BU	XLP20WH
25mm	XLP25BK	XLP25CL	XLP25RD	XLP25BU	XLP25WH
76mm	XLP76BK				

Also available in Yellow/Green Striped Earth Identification colours
See the XLP-YG Range on the opposite page...



HEAT SHRINK TUBING

Flexible heat shrinkable tubing Flame retardant, good resistance to most fluids and solvents, etc. High dielectric and tensile strength. Excellent for electrical identification, insulation, strain relief, cable bonding. 600V 50% shrink ratio at 90 g 120°C. Sold in pre-cut lengths of 1.2 Metres. Assorted colours.

BEFORE DiamØ=Code(mm) - AFTER DiamØ=50% PRE-CUT 1.2M

Size	Black	Yellow	Red	White	Green	Blue
1.0mm	CB102-1.0BK	CB102-1.0YL	CB102-1.0RD	CB102-1.0WH	CB102-1.0GN	CB102-1.0BU
2.0mm	CB102-2.0BK	CB102-2.0YL	CB102-2.0RD	CB102-2.0WH	CB102-2.0GN	CB102-2.0BU
2.5mm	CB102-2.5BK	CB102-2.5YL	CB102-2.5RD	CB102-2.5WH	CB102-2.5GN	CB102-2.5BU
3.0mm	CB102-3.0BK	CB102-3.0YL	CB102-3.0RD	CB102-3.0WH	CB102-3.0GN	CB102-3.0BU
4.5mm	CB102-4.5BK	CB102-4.5YL	CB102-4.5RD	CB102-4.5WH	CB102-4.5GN	CB102-4.5BU
5.0mm	CB102-5.0BK	CB102-5.0YL	CB102-5.0RD	CB102-5.0WH	CB102-5.0GN	CB102-5.0BU
6.5mm	CB102-6.5BK	CB102-6.5YL	CB102-6.5RD	CB102-6.5WH	CB102-6.5GN	CB102-6.5BU
7.0mm	CB102-7.0BK	CB102-7.0YL	CB102-7.0RD	CB102-7.0WH	CB102-7.0GN	CB102-7.0BU
10mm	CB102-10.0BK	CB102-10.0YL	CB102-10.0RD	CB102-10.0WH	CB102-10.0GN	CB102-10.0BU
13mm	CB102-13.0BK	CB102-13.0YL	CB102-13.0RD	CB102-13.0WH	CB102-13.0GN	CB102-13.0BU
20mm	CB102-20.0BK	CB102-20.0YL	CB102-20.0RD	CB102-20.0WH	CB102-20.0GN	CB102-20.0BU
25mm	CB102-25.0BK	CB102-25.0YL	CB102-25.0RD	CB102-25.0WH	CB102-25.0GN	CB102-25.0BU



HEAT SHRINK TUBING - NORMAL WALL

MRSG heat shrinkable tube is a newly developed environmentally friendly flame retardant heat shrinkable tube, using modified polymers and cross-linked by electronic accelerator.

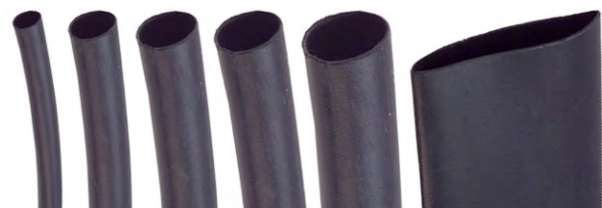

Code is per metre. Sold cut to length.
Order 10 metres or more and receive a 10% discount.
To order a full reel, please enquire.

Before	After	Black	Clear	Red	Green	Blue	White
1mmØ	0.7mmØ	MRSG-1.0BK	MRSG-1.0CL	MRSG-1.0RD	MRSG-1.0GN	MRSG-1.0BU	MRSG-1.0WH
2mmØ	1.0mmØ	MRSG-2.0BK	MRSG-2.0CL	MRSG-2.0RD	MRSG-2.0GN	MRSG-2.0BU	MRSG-2.0WH
3mmØ	1.5mmØ	MRSG-3.0BK	MRSG-3.0CL	MRSG-3.0RD	MRSG-3.0GN	MRSG-3.0BU	MRSG-3.0WH
4mmØ	2.0mmØ	MRSG-4.0BK	MRSG-4.0CL	MRSG-4.0RD	MRSG-4.0GN	MRSG-4.0BU	MRSG-4.0WH
5mmØ	2.5mmØ	MRSG-5.0BK	MRSG-5.0CL	MRSG-5.0RD	MRSG-5.0GN	MRSG-5.0BU	MRSG-5.0WH
6mmØ	3.0mmØ	MRSG-6.0BK	MRSG-6.0CL	MRSG-6.0RD	MRSG-6.0GN	MRSG-6.0BU	MRSG-6.0WH
7mmØ	3.5mmØ	MRSG-7.0BK	MRSG-7.0CL	MRSG-7.0RD	MRSG-7.0GN	MRSG-7.0BU	MRSG-7.0WH
8mmØ	4.0mmØ	MRSG-8.0BK	MRSG-8.0CL	MRSG-8.0RD	MRSG-8.0GN	MRSG-8.0BU	MRSG-8.0WH
9mmØ	4.5mmØ	MRSG-9.0BK	MRSG-9.0CL	MRSG-9.0RD	MRSG-9.0GN	MRSG-9.0BU	MRSG-9.0WH
10mmØ	5.0mmØ	MRSG-10.0BK	MRSG-10.0CL	MRSG-10.0RD	MRSG-10.0GN	MRSG-10.0BU	MRSG-10.0WH
12mmØ	6.0mmØ	MRSG-12.0BK	MRSG-12.0CL	MRSG-12.0RD	MRSG-12.0GN	MRSG-12.0BU	MRSG-12.0WH
14mmØ	7.0mmØ	MRSG-14.0BK	MRSG-14.0CL	MRSG-14.0RD	MRSG-14.0GN	MRSG-14.0BU	MRSG-14.0WH
16mmØ	8.0mmØ	MRSG-16.0BK	MRSG-16.0CL	MRSG-16.0RD	MRSG-16.0GN	MRSG-16.0BU	MRSG-16.0WH
20mmØ	10mmØ	MRSG-20.0BK	MRSG-20.0CL	MRSG-20.0RD	MRSG-20.0GN	MRSG-20.0BU	MRSG-20.0WH
30mmØ	15mmØ	MRSG-30.0BK	MRSG-30.0CL	MRSG-30.0RD	MRSG-30.0GN	MRSG-30.0BU	MRSG-30.0WH
40mmØ	20mmØ	MRSG-40.0BK	MRSG-40.0CL	MRSG-40.0RD	MRSG-40.0GN	MRSG-40.0BU	MRSG-40.0WH
50mmØ	25mmØ	MRSG-50.0BK	MRSG-50.0CL	MRSG-50.0RD	MRSG-50.0GN	MRSG-50.0BU	MRSG-50.0WH
25mmØ	12mmØ	MRSG-25.0BK	MRSG-25.0CL	MRSG-25.0RD	MRSG-25.0GN	MRSG-25.0BU	MRSG-25.0WH



HEAT SHRINK TUBING - WITH ADHESIVE

A co-extrusion of irradiated crosslinking polyolefin with specially designed internal hot-melt adhesive. Excellent for back-end connector sealing, breakouts and connector to cable transition supports, etc. High expansion ratio makes it possible to repair most damaged cable jackets without removing connectors. 600V Insulation rated. Supplied in pre-cut lengths of 1.2 metres. Matte black. 50% shrink ratio at 90 g 120°C.

BEFORE DiamØ = Code (mm)
AFTER DiamØ = 50%

Pre-Cut to 1.2 Metre lengths:

Size	Code
1.5mm	DWT-1.5BK
2.0mm	DWT-2.0BK
2.5mm	DWT-2.5BK
3.0mm	DWT-3.0BK
4.5mm	DWT-4.5BK
5.0mm	DWT-5.0BK
6.5mm	DWT-6.5BK
7.0mm	DWT-7.0BK
10mm	DWT-10.0BK
13mm	DWT-13.0BK
20mm	DWT-20.0BK
25mm	DWT-25.0BK



CABLES NOT INCLUDED

ALL 1.2 Metre in BLACK

DUAL WALL HEAT SHRINKABLE TUBE

MSBG dual wall heat-shrinkable tube is made of the high quality polymer layer with hot melt adhesive inner layer. When exposed to heat source, the inner layer begin to melt and flow. When it cools down, inner layer forms an adhesion layer between the tubing and the component or wire. This provides a water-tight seal and protection for the connectors or wire. Available in Black only. Available in any length required, cut to order. Code listed is per metre.



Available in full reels. Please enquire.

Before	After	Code
2.4mmØ	0.8mmØ	MSBG024
3.2mmØ	1.0mmØ	MSBG032
4.8mmØ	1.6mmØ	MSBG048
6.4mmØ	2.0mmØ	MSBG064
7.9mmØ	2.7mmØ	MSBG079
9.5mmØ	3.2mmØ	MSBG095

Code is per metre. Sold cut to length. Order 10 metres or more and receive a 10% discount. To order a full reel, please enquire.

EARTH IDENTIFICATION HEAT SHRINK

BRIGHT GREEN/YELLOW STRIPED

Dual colour stripe tubing for Easy identification of common Earth wire cables to ground. -75°C to 135°C (200°C short term) Flame retardant XLP Mil. Spec. Listed as pre-shrunk diameter Shrinks to approx. half diameter.

Size	Code
7mm	XLP7YG
10mm	XLP10YG
13mm	XLP13YG
20mm	XLP20YG
25mm	XLP25YG
3mm	XLP3YG
5mm	XLP5YG

Sold in pre-cut lengths of 1.2 metres.

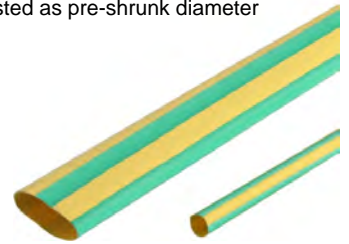

HEAT SHRINK TUBING - GREEN & YELLOW

AS USED TO IDENTIFY EARTH CONNECTIONS

MRSG heat shrinkable tube is a newly developed environmentally friendly flame retardant heat shrinkable tube, using modified polymers and cross-linked by electronic accelerator.

Code is per metre. Sold cut to length. Order 10 metres or more and receive a 10% discount. To order a full reel, please enquire.

Before	After	Code
1mmØ	0.7mmØ	MRSG-1.0YG
2mmØ	1.0mmØ	MRSG-2.0YG
3mmØ	1.5mmØ	MRSG-3.0YG
4mmØ	2.0mmØ	MRSG-4.0YG
5mmØ	2.5mmØ	MRSG-5.0YG
6mmØ	3.0mmØ	MRSG-6.0YG
7mmØ	3.5mmØ	MRSG-7.0YG
8mmØ	4.0mmØ	MRSG-8.0YG
9mmØ	4.5mmØ	MRSG-9.0YG
10mmØ	5.0mmØ	MRSG-10.0YG
12mmØ	6.0mmØ	MRSG-12.0YG
14mmØ	7.0mmØ	MRSG-14.0YG
16mmØ	8.0mmØ	MRSG-16.0YG
20mmØ	10mmØ	MRSG-20.0YG
25mmØ	12mmØ	MRSG-25.0YG
30mmØ	15mmØ	MRSG-30.0YG
40mmØ	20mmØ	MRSG-40.0YG
50mmØ	25mmØ	MRSG-50.0YG



CABLE PANTS

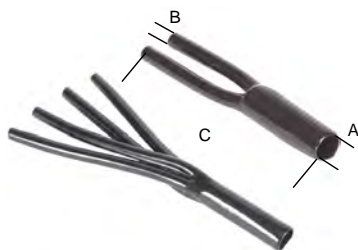

Out "A"	"B"	"C"	Code
2	6mm	3.5mm	98mm SCP26
2	7mm	3.5mm	98mm SCP27
2	8mm	3.5mm	108mm SCP28
2	9mm	4.0mm	78mm SCP29
2	10mm	4.0mm	98mm SCP210
2	11mm	4.8mm	90mm SCP211
2	14mm	4.8mm	98mm SCP214
4	9.5mm	4.0mm	160mm SCP49
4	11mm	4.0mm	145mm SCP411



HEAT SHRINK KIT

SEVEN PIECE BAG

A selection of popular sizes
1.2 Metre lengths x7 pieces:
XLP Series mil. spec.

XLP1.5BK,
XLP2.5BK,
XLP3BK,
XLP5BK,
XLP7BK,
XLP10BK,
XLP13BK

Code
HSK1BK



HEAT SHRINK KIT - PROLINK 9 PIECE

Consist of 1.2 Metre long polyethylene heat shrink tubes with assorted diameters ranged from 1mmØ to 13mmØ. The diameter will reduce by up to 50% when heated to 125°C.

Includes:
1x 1.0mmØ (black)
1x 2.0mmØ (black)
1x 2.5mmØ (black)
1x 3.0mmØ (black)
1x 4.5mmØ (black)
1x 6.5mmØ (black)
1x 7.0mmØ (black)
1x 10mmØ (black)
1x 13mmØ (black)

Colour Code
Black HSK9



HEAT SHRINK KIT - RED & BLACK 18 PIECE

Consist of 1.2 Metre long polyethylene heat shrink tubes with assorted diameters ranged from 1mmØ to 13mmØ. The diameter will reduce by up to 50% when heated to 125°C.

Includes:
1x 1mmØ (black), 1x 1mmØ (red)
1x 2mmØ (black), 1x 2mmØ (red)
1x 2.5mmØ (black), 1x 2.5mmØ (red)
1x 3mmØ (black), 1x 3mmØ (red)
1x 4.5mmØ (black), 1x 4.5mmØ (red)
1x 6.5mmØ (black), 1x 6.5mmØ (red)
1x 7mmØ (black), 1x 7mmØ (red)
1x 10mmØ (black), 1x 10mmØ (red)
1x 13mmØ (black), 1x 13mmØ (red)

Colour Code
Black & Red HSK18



HEAT-SHRINK TAPE

SHRINKS TO SEAL

Thin Irradiated Polyolefin tape.
Shrinks and amalgamates forming a rigid seal on even complex items. Make Y shapes, etc. Simply wrap & heat Black. 20mm x 50 Metres

Code
HST20



CABLES NOT INCLUDED

HEAT SHRINK KIT - DUAL WALL WITH ADHESIVE

47 PIECE KIT 95MM IN BLACK

Black polyethylene heat shrink tubes from 3.2mm to 19mm. It has a polymer layer on the outside and an inner adhesive layer which provides a water-tight seal and protection for the wires and connectors. Each are 95mm in length. Shrinking ratio: 3:1, operating temperature range: -45 - 125°C

Type Code
47 pcs HSK47BK



HEAT SHRINK KIT - DUAL WALL ADHESIVE B&R

47 PIECE KIT 95MM IN BLACK & RED

Black and Red polyethylene heat shrink tubes from 3.2mm to 19mm. It has a polymer layer on the outside and an inner adhesive layer which provides a water-tight seal and protection for the wires and connectors. 95mm lengths. Shrinking ratio: 3:1, operating temperature range: -45 - 125°C

Type Code
47 pcs HSK47RB



HEAT SHRINK KIT - MULTI COLOUR 163

163 PIECE KIT 95MM

Colour coded heat shrink tubes from 1mm to 16mm diameter. 95mm lengths in white, black, green, red, blue & yellow colour. Diameter will reduce by up to 50% when heated to 125°C.

Type Code
163 pcs HSK163



HEAT SHRINK KIT - MULTI COLOUR 180

180 PIECE KIT 45mm

Colour coded heat shrink tubes from 2mm to 9mm diameter. 45mm lengths in white, black, green, red, blue & yellow colour. Diameter will reduce by up to 50% when heated to 125°C.

Type Code
180 pcs HSK1800



HEAT SHRINK KIT - MULTI COLOUR 350

40MM LENGTHS 1.5MM TO 20MM CABAC

Assorted, pre-cut to 40mm lengths of chemically, cross linked, thermally stabilised flame retardant (except clear tubing) polyolefin heat shrink tubes in a handy plastic storage case. Low cost solution for the hobbyist & handyman.

- Black Clear Blue Green Red White
- 1.5, 2.5, 3.5, 5.0, 7.0, 10, 13, 20mm
- Handy tool box storage

Type Code
350 pcs HSK350





Plugs & Sockets

XLR Neutrik

XLR FEMALE CONNECTOR

FX Series. World XLR standard.
Heavy duty die-cast shell
Chuck type strain relief.
Solder terminals.

Pins	Code
3	NC3FXX
4	NC4FXX
5	NC5FXX



XLR MALE CONNECTOR

MX Series. World XLR standard.
Heavy duty die-cast shell
Chuck type strain relief.
Solder terminals.

Pins	Code
3	NC3MXX
4	NC4MXX
5	NC5MX



XLR FEMALE CONNECTOR - DELUXE

Same as the FX Series,
but Black die-cast shell
and Gold contacts.
World XLR standard.
Chuck type strain relief.
Solder terminals.

Pins	Code
3	NC3FXX-B
4	NC4FXX-B
5	NC5FXX-B



XLR MALE CONNECTOR - DELUXE

Same as the MX Series,
but Black die-cast shell
and Gold contacts.
World XLR standard.
Chuck type strain relief.
Solder terminals.

Pins	Code
3	NC3MXX-B
4	NC4MXX-B
5	NC5MXX-B



XLR FEMALE CONNECTOR - RIGHT ANGLE

Ideal solution for mobile
equipment and rear cable
protection from bumps, etc.
Heavy duty die-cast shell
Plug is 360° rotatable at
assembly stage then locked.

Pins	Code
3	NC3FRX
4	NC4FRX
5	NC5FRX



XLR MALE CONNECTOR - RIGHT ANGLE

Heavy duty construction.
Plug is 360° rotatable at
assembly stage then locked.
Chuck type cable hold.
Solder terminals.
7.5mm cable entry.

Pins	Code
3	NC3MRX
4	NC4MRX
5	NC5MRX
7	NC7MRX



XLR UNISEX CONNECTOR

BOTH MALE & FEMALE IN ONE PLUG

3 pole male and female cable connector in one housing
Easy selectable gender - converted by sliding housing
back and forth

Pins	Code
3	NC3FM-C



XLR FEMALE CHASSIS

Popular new flush or surface mount
design. Die-cast. Solder terminals.
Black version has gold contacts.

Pins	Colour	Code
3	Nickel	NC3FD-LX
4	Nickel	NC4FD-LX
5	Nickel	NC5FD-LX
3	Black	NC3FD-LX-B
4	Black	NC4FD-LX-B
5	Black	NC5FD-LX-B



26x31mm

XLR MALE CHASSIS

Die-cast heavy duty. Solid pins.
Solder terminals. Flush/surface mount.
Black version has gold contacts.

Pins	Colour	Code
3	Nickel	NC3MD-LX
4	Nickel	NC4MD-LX
5	Nickel	NC5MD-LX
3	Black	NC3MD-LX-B
4	Black	NC4MD-LX-B
5	Black	NC5MD-LX-B



26x31mm

XLR FEMALE CHASSIS P SERIES

Female receptacle, Nickel housing,
silver contacts. Push-Lock.
Large solder cups for ease wiring.

Pins	Colour	Code
3	Nickel	NC3FP-1
3	Black	NC3FP-B-1
4	Nickel	NC4FP-1
4	Black	NC4FP-B-1
5	Nickel	NC5FP-1
5	Black	NC5FP-B-1



27x37mm

XLR MALE CHASSIS P SERIES

Male receptacle, solder contacts,
Nickel housing, silver contacts,
Black housing gold contacts.

Pins	Colour	Code
3	Nickel	NC3MP
3	Black	NC3MP-B
4	Nickel	NC4MP
4	Black	NC4MP-B
5	Nickel	NC5MP



22x37mm



XLR Neutrik

COLOURED ID TAGS - SUIT XX SERIES

Save time and effort connecting and tracing cables. Brightly coloured rings with write-on marker labels. Can be inserted after cable manufacturing. XXCR is transparent for a label.



Collar	Code
Black	XXR0
Brown	XXR1
Red	XXR2
Orange	XXR3
Yellow	XXR4
Green	XXR5
Blue	XXR6
Violet	XXR7
Grey	XXR8
White	XXR9
Clear	XXCR

COLOURED BOOT - SUIT XX SERIES

Coloured coding boot to suit XX series plugs.



Colour	Code
Black	BXX-0
Brown	BXX-1
Red	BXX-2
Orange	BXX-3
Yellow	BXX-4
Green	BXX-5
Blue	BXX-6
Violet	BXX-7
Grey	BXX-8
White	BXX-9

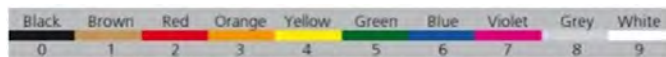

COLOURED ID PLATES

Coloured lettering plate for "D" shape chassis sockets.

Colour	Code
Black	DSS-0
Brown	DSS-1
Red	DSS-2
Orange	DSS-3
Yellow	DSS-4
Green	DSS-5
Blue	DSS-6
Violet	DSS-7
Grey	DSS-8
White	DSS-9

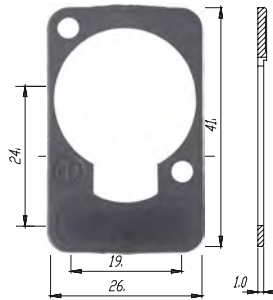

NA HOUSING

MAKE AN ADAPTOR

Extrusion profile set including screws, black plated, for combination with all D Shape connectors.

Size	Code
26x31x65mm	NA-HOUSING

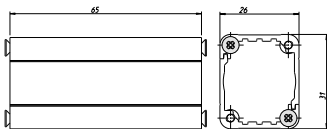

BALUN LINE TRANSFORMERS

RCA TO XLR

Isolation and balancing adaptor. Suit long runs between CD and Mixing Desk, etc. Metal housing. 200Ω/200Ω

XLR	Code
Female	NA2F-D2B-TX
Male	NA2M-D2B-TX

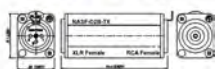

ETHERCON XLR RJ45 CONNECTOR

LATCH LOCKING

Requires a Cat5/6e type RJ45 pre-made ethernet lead assembly, Converts to a protected plug.

Colour	Code
Silver	NE8MC
Black	NE8MX-B

ETHERNET LEADS TO SUIT
See DATA & COMPUTER Section for Leads with any standard CAT Plugs to suit NE8 shells



Actually Supplied Empty. Requires the RJ45 Cable

ETHERCON XLR PANEL MOUNT

RJ45 SOCKET TO PUSH-DOWN

Accepts the NE8MC Plug above. Rear terminates to punch-down terminals for solid core Cat5.

Code
NE8FDV-YK



ETHERCON XLR PANEL MOUNT

RJ45 SOCKET TO RJ45 SOCKET

Premium Metal construction Accepts the NE8MC Plug above. Rear terminates to RJ45 Socket

Colour	Code
Silver	NE8FDP
Black	NE8FDP-B



ETHERCON XLR PANEL MOUNT PCB

Horizontal PCB mount RJ45 receptacle, A-Series cutout with latch lock.

Code
NE8FAH



ETHERCON XLR CONNECTOR - CAT6

PUSH-PULL LOCKING

Requires a Cat5/6e type RJ45 pre-made ethernet lead assembly, Converts to a protected plug. Compatible only with NE8FDY Series.

Code
NE8MC6-MO

ETHERNET LEADS TO SUIT
See DATA & COMPUTER Section for Leads with any standard CAT Plugs to suit NE8 shells



ETHERCON XLR PANEL MOUNT - CAT6

RJ45 TO IDC PUSH-DOWN

IP65 CAT6 D-shape panel Push-Pull locking. Fully shielded IDC termination.

Colour	Code
Nickel	NE8FDY-C6
Black	NE8FDY-C6-B

Compatible only with NE8MC6-MO.



BLANKING PLATE

Dummy-plate to cover D-shape cutouts. Same size as the above receptacles. Black plastic. Suit Neutrik type and some Amphenol.

Code
NU-DBA-BL

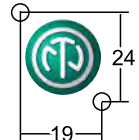



□ XLR Neutrik

USB PANEL MOUNT

USB-A TO USB-B

Reversible for both A & B connection possibilities. Recessed for protection.



Colour Code

Silver NAUSB
Black NAUSB-W-B

FIRE-WIRE PANEL MOUNT

FIREWIRE-6 IEE1394

Audio/Visual gets digital! Standard XLR Metal Fitting. Recessed for protection.



Colour Code

Silver NA1394-6-W
Black NA1394-6-W-B

HDMI PANEL MOUNT NEUTRIK

Standard XLR Mounting Extremely robust diecast HDMI Feed-Through connect HDMI Socket to Socket Suit Digital Video/Audio



Colour Code

Nickel NAHDMI-W
Black NAHDMI-W-B

RCA PANEL MOUNT NEUTRIK

GOLD PLATED RECESSED RCA

Chromium Bezel. Coloured insulator.

Collar Code

Black NF2D0
Red NF2D2
Yellow NF2D4
White NF2D9



BLACK BEZEL VERSION

Collar Code

White NF2D-B9
Red NF2D-B2

BNC PANEL MOUNT NEUTRIK

BNC TO BNC THROUGH

Code
NU-NBB75DF1



SOLDER BACK GROUNDED

Code
NBB75DSG

1/4" PANEL MOUNT NEUTRIK

LOCKING JACK

Professional Heavy Duty Stereo 6.35mm



Code
NJ3FP6C

1/4" CONNECTOR FEMALE NEUTRIK

LOCKING JACK

Professional Heavy Duty All Metal Rubber Boot Stereo 6.35mm



Code
NJ3FC6

3.5MM CONNECTOR NEUTRIK

With black metal handle Stereo 3.5mm.



Code
NYS231-B

3.5mm CONNECTOR NEUTRIK

Stereo 3.5mm

Professional Heavy Duty. Black or Nickel Barrel. All Metal. Rubber Boot.



Collar Code

Nickel NTP3RC
Black NTP3RCB

3.5MM CONNECTOR FEMALE NEUTRIK

Metal handle. Stereo 3.5mm Max cable O.D. 4mm



Code
NYS240

1/4" CONNECTOR NEUTRIK

Professional Heavy Duty Black Barrel. Nickel tip. 6.35mm. All Metal with Rubber Boot



Type Code

Mono NP2X
Stereo NP3X

1/4" CONNECTOR RIGHT ANGLE NEUTRIK

Professional Heavy Duty. Nickel barrel and tip. Right Angle Strain Relief 6.35mm



Type Code

Mono NP2RX
Stereo NP3RX

1/4" MONO CONNECTOR - SILENT

Type Code
Mono NP2X-AU-S

"Silent" is a magnetic reed switch shorting mechanism. When unplugged, the tip is grounded to prevent hum.



1/4" MONO R/A CONNECTOR - SILENT

Silent is a shorting mechanism when unplugged, so no guitar buzz.



Type Code
Mono NP2RX-AU-S



□ XLR PowerCON

POWERCON NEUTRIK POWER

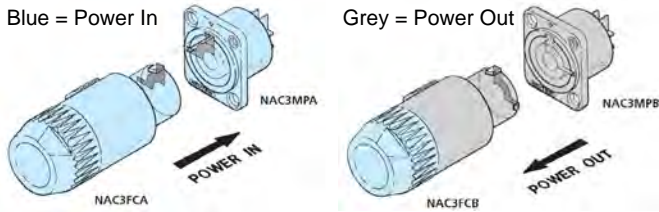

POWERCON NEUTRIK CONNECTOR POWER-IN

MAINS PLUG 3 PIN FEMALE

Appliance power 250Vac 30A
3 Contacts. Blue = Power In

Colour Code
Blue NAC3FCA



AMPHENOL VERSION

240Vac 24A

Colour Code
Blue HP-3-F

Amphenol

POWERCON NEUTRIK PANEL MOUNT POWER-IN

MAINS INLET 3 PIN MALE

Appliance power 250Vac 30A
3 Contacts. Blue = Power In

Colour Code
Blue NAC3MPA-1



POWERCON NEUTRIK CONNECTOR POWER-OUT

MAINS PLUG 3 PIN FEMALE

Appliance power 250Vac 30A
3 Contacts. Grey = Power Out

Colour Code
Grey NAC3FCB



AMPHENOL VERSION

240Vac 25A

Colour Code
Grey HP-3-FG

Amphenol

POWERCON TRUE1 NEUTRIK POWER-IN

MAINS OUTLET 3 PIN MALE

Appliance power 250Vac 30A
3 Contacts. Grey = Power Out

Colour Code
Grey NAC3MPB-1



POWERCON NEUTRIK LINK

COUPLER FOR LINKING CABLES

Power-In to Power-Out
250Vac 30A 3 Contacts.

Colour Code
Blue-Grey NAC3MM-1



POWERCON TO PIGGYBACK GPO LEAD

PRE-MADE 240VAC 3 CORE 1.5mm CABLE

Length Code
0.5M ACL149-05
2M ACL149-2
3M ACL149-3
5M ACL149-5



POWERCON TRUE1 NEUTRIK POWER

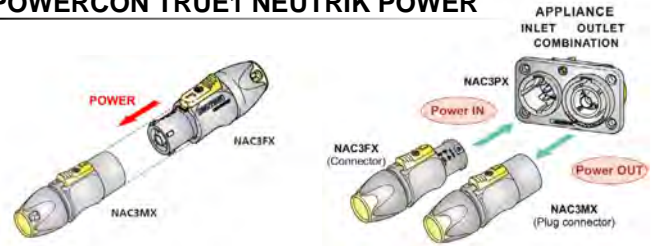

POWERCON TRUE1 NEUTRIK POWER PLUG [OUT]

MAINS PLUG 3 PIN FEMALE

Rugged 16A 240Vac Locking

Code
NAC3FX-W-TOP



POWERCON TRUE1 NEUTRIK POWER SOCKET [IN]

MAINS INLET 3 PIN MALE

Rugged 16A 240Vac Locking

Code
NAC3MPX



POWERCON TRUE1 NEUTRIK POWER IN-LINE [IN]

MAINS SOCKET 3 PIN MALE

Rugged 16A 240Vac Locking

Code
NAC3MX



POWERCON TRUE1 NEUTRIK POWER PANEL [OUT]

MAINS OUTLET 3 PIN FEMALE

Rugged 16A 240Vac Locking

Code
NAC3FPX



POWERCON TRUE1 NEUTRIK POWER PANEL [I/O]

MAINS IN-OUT COMBINATION

Rugged 16A 240Vac Locking

Code
NAC3PX

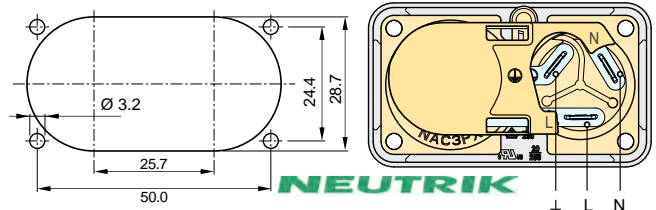



□ SpeakON® Neutrik

SPEAKON® LOUDSPEAKER CONNECTOR 2 PIN

Extremely reliable and robust with bayonet locking Heavy duty 30A Becoming popular alternative to Banana & XLR. Suit NL-2MP & 4MP



Type Code
2 pin NL2FC

SPEAKON® CONNECTOR RIGHT ANGLE CASE

SUITS NL2FC

Change the existing case for right angle use.

Code
LRX



SPEAKON® LOUDSPEAKER COUPLER F-F

Extremely reliable Made from high impact plastic Heavy duty 30A Enables connecting and extending speaker leads.

Type Code
2/4 pin NL4MXX



SPEAKON® LOUDSPEAKER CONNECTOR 4 PIN

Bayonet locking. Heavy duty 40A. This 4 pin plug will only suit 4 pin receptacles NOT 2 PIN types!

Type Code
4 pin NL4FX



SPEAKON® LOUDSPEAKER IN-LINE METAL

4 POLE FEMALE Heavy duty metal Extremely reliable and robust with bayonet locking 40A 4 terminals Nickel chromium. Heavy duty.

Type Code
4 pin NLT4MX



SPEAKON® LOUDSPEAKER CONNECTOR METAL

4 POLE MALE New metal version. Extremely reliable and robust with bayonet locking 40A 4 terminals Nickel chromium Heavy duty.

Type Code
4 pin NLT4FX

NEUTRIK



SPEAKON® LOUDSPEAKER PANEL MOUNT

Extremely reliable. Fail safe. 30A. Chassis / panel mount jack. Standard cut-out. Robust solution speaker connect.

Type Code
2 pin NL2MP
4 pin NL4MP



SPEAKON® CONNECTOR 8 PIN

8 pole cable connector, latch lock, chuck type strain relief for cables 8 - 20 mm diameter, 30A continuous per screw-type terminals.

Type Code
8 Pin NL8FC



SPEAKON® LOUDSPEAKER PANEL MOUNT

Extremely reliable bayonet & locking. Robust. 30A. Large radius mounting jack for speaker bin speaker connect. Accepts NL2FC & NL4FC/FX, etc.

Type Code
4 pin NL4MPR



SPEAKON® CHASSIS PANEL MOUNT 8 PIN

Nickel metal square G-size flange, countersunk thru holes, 3/16" flat tabs. Suits NL8 speaker plugs 30A each terminal.

Pins Code
8 NL8MPR



SPEAKON® COLOUR ID BANDS

Coloured coding rings for right angle connector of the SPX Series.

Colour Code
Red LCR-2
Yellow LCR-4
Green LCR-5
Blue LCR-6
White LCR-9



SPEAKON® SPEAKER DUST CAP - NEUTRIK

Dust protection cover for most speakON and powerCON chassis connectors. It can be used, when no cable connector is mated. The cover is easy to use and does not block the connectors in the panel below when not in use.
• Suitable for speakON NL2M* and NL4M*

Code
SCL





Cables & Connectors

□ XLR Amphenol 1/4" & 3.5mm

BLACK MONO 1/4" RIGHT ANGLE

Type Code
Mono ACPM-RB

Black Metal finish
Silver contact plating
Solder type contacts

Amphenol



BLACK MONO 1/4"

Type Code
Mono ACPM-GB

Black Metal finish
Silver contact plating
Solder type contacts

Amphenol



BLACK MONO 1/4"

Type Code
Mono TM2PBJ

Black Metal finish
Silver contact plating
Solder type contacts

Amphenol



SATIN MONO 1/4" RIGHT ANGLE

Type Code
Mono ACPM-RN

Satin Nickel finish
Silver contact plating
Solder type contacts

Amphenol



SATIN MONO 1/4"

Type Code
Mono ACPM-GN

Satin Nickel finish.
Silver contact plating.
Solder type contacts.

Amphenol



SATIN MONO 1/4"

Type Code
Mono TM2PJ

Satin Nickel finish
Silver contact plating
Solder type contacts

Amphenol



BLACK MONO 1/4" GOLD

Type Code
Mono ACPM-RB-AU

Black metal diecast shell.
High quality gold contact
plating. Solder type
contacts

Amphenol



BLACK MONO 1/4" GOLD PLATED

Type Code
Mono ACPM-GB-AU

Black Metal diecast shell
High quality gold contact
plating Solder type
contacts

Amphenol



SATIN STEREO 1/4"

Type Code
Stereo TS3PJ

Satin Nickel finish
Silver contact plating
Solder type contacts

Amphenol



SATIN STEREO 1/4" RIGHT ANGLE

Type Code
Stereo ACPS-RN

Satin Nickel finish
Silver contact plating
Solder type contacts

Amphenol



BLACK STEREO 1/4"

Type Code
Stereo ACPS-GB

Black Metal finish
Silver contact plating
Solder type contacts

Amphenol



BLACK STEREO 1/4"

Type Code
Stereo TS3PBJ

Black Metal finish
Silver contact plating
Solder type contacts

Amphenol



BLACK STEREO 1/4" RIGHT ANGLE

Type Code
Stereo ACPS-RB

Black Metal finish
Silver contact plating
Solder type contacts



SATIN STEREO 1/4"

Type Code
Stereo ACPS-GN

Satin Nickel finish
Silver contact plating
Solder type contacts

Amphenol



BLACK STEREO 3.5MM

Type Code
Stereo KS3PB-AU

3.5mm Stereo plug,
Diecast Shell, Black
finish, Flexible
grommet.

Amphenol





□ XLR Amphenol

AMPHENOL (AKA: ALCATEL / CANNON)

Amphenol

"J" = "Jaw" Cable clamp
 "MM" = Machined Pins
 "B" = Black Barrel

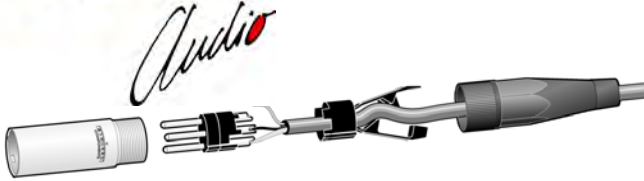

METAL BARREL AC3

Female Connector Solder

Cable	Code
6mm	AC3F
8mm	AC3FJ

Amphenol



PLASTIC BARREL

Tough Black Thermoplastic
 Female Connector Solder

Cable	Code
6mm	AC3FCP
8mm	AC3FCPJ

Amphenol



METAL BARREL AC3

Male Connector Solder

Cable	Code
6mm	AC3M
8mm	AC3MJ

Amphenol



PLASTIC BARREL

Tough Black Thermoplastic
 Male Connector Solder

Cable	Code
6mm	AC3MCP
8mm	AC3MCPJ

Amphenol



METAL BARREL SOLID PINS

Machined Pins (Solid) Solder

Cable	Code
6mm	AC3MM
8mm	AC3MMJ

Amphenol



PLASTIC BOOTS AC3

Colour	Code
Brown	AC-NUT-BRN
Red	AC-NUT-RED
Orange	AC-NUT-ORG
Yellow	AC-NUT-YEL
Green	AC-NUT-GRN
Blue	AC-NUT-BLU
Violet	AC-NUT-VIO
Grey	AC-NUT-GRY
White	AC-NUT-WHT



Amphenol

METAL BARREL BLACK

Female All Black Solder

Cable	Code
6mm	AC3FB
8mm	AC3FBJ

Amphenol



METAL BOOT AC3

Made tough for
 Heavy Duty &
 RF Applications

Code
AC-NUT-METAL

Amphenol



METAL BARREL BLACK

Male All Black Solder
 "M" Stamped Pins
 "MM" Machined

Cable	Code
6mm	AC3MB
8mm	AC3MMBJ

Amphenol





□ XLR Amphenol

METAL CHASSIS

XLR 3 pole female, Wide flange, Stamped contacts

Code
AC3FPZ

Amphenol

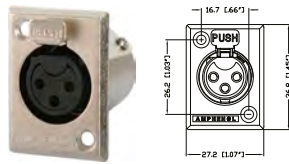

METAL CHASSIS

XLR 3 pole male, D Flange, Stamped contacts, Nickel Finish

Code
AC3MDZ

Also Available in Multi-pin

Amphenol

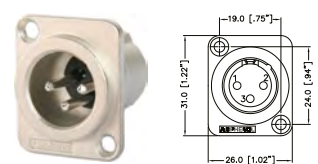

METAL CHASSIS

XLR 3 pole male, Wide flange, Stamped contacts

Code
AC3MP

Amphenol

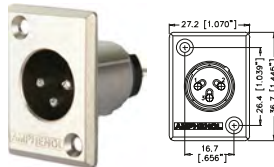

METAL CHASSIS SOLID PIN

XLR 3 pole male, D flange, Machined contacts, Nickel Finish

Code
AC3MMDZ

Amphenol

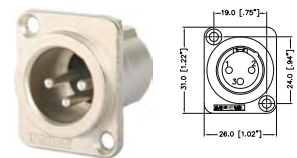

METAL CHASSIS SOLID PIN

XLR 3 pole male, Narrow flange, Machined contacts, Nickel Finish

Code
AC3MMPNZ

Amphenol

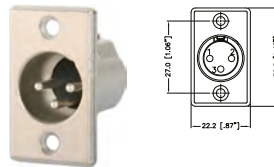

METAL CHASSIS BLACK

XLR 3 pole female, D flange, Stamped contacts, Black Finish

Code
AC3FDZB

Amphenol

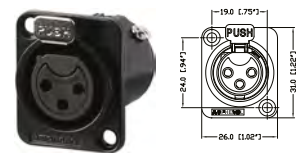

METAL CHASSIS

XLR 3 pole female, D flange, Stamped contacts, Nickel Finish

Code
AC3FDZ

Also Available in Multi-pin

Amphenol

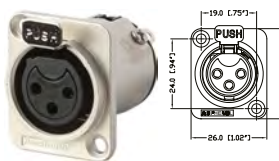

METAL CHASSIS BLACK

XLR 3 pole male, D flange, Stamped contacts, Black Finish

Code
AC3MDZB

Amphenol

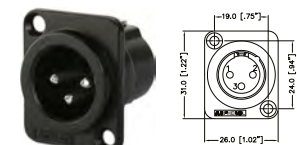

FEMALE TO FEMALE

Wired through pin 1-1, etc.

Code
AC3F3FBW

Amphenol



MALE TO MALE

Wired through pin 1-1, etc.

Code
AC3M3MBW

Amphenol



MALE TO FEMALE

Wired through pin 1-1, etc.

Code
AC3F3MBW

Amphenol



XLR / 6.35mm DUAL SOCKET

HORIZONTAL PCB MOUNT

XLR 3 pole female with 1/4" jack.

Type Code
Mono ACJC5H
Stereo ACJC6H

Amphenol

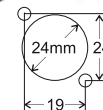

XLR / 6.35mm DUAL SOCKET

VERTICAL PCB MOUNT

XLR 3 pole female with 1/4" jack.

Type Code
Mono ACJC5V
Stereo ACJC6V

Amphenol

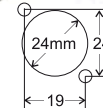

3 PIN XLR ADAPTOR MODULE - NEUTRIK

Build your own adaptor and wire as required. Housing barrel is compatible with either end plug. Make M-M, F-F or M-F.

BARREL 32 X 16MMØ

Code
KM

XLR 3 PIN MALE END

Code
NM3MXI

XLR 3 PIN FEMALE END

Code
NM3FXI



XLR D FLANGE HOUSING

AMPHENOL SHELL ADAPTOR

D shell adaptor to suit Amphenol XLR metal chassis. It allows users to customise the outlets. This product includes 4 screws for installation.

- This product is compatible with the following Amphenol connectors:
- AC3FDZB
- AC3MDZB
- AC5FDZB
- AC5MDZB
- SP-2-MD
- SP-4-MD
- AC-BNC-JS-75B

Code
AC-D-ADAPTER

Amphenol





□ XLR Amphenol

AMPHENOL XLR MULTI-PIN METAL

Amphenol



4 PIN AMPHENOL

Description	Code
Metal Plug F	AC4F
Metal Plug M	AC4M
Wide Flange F	AC4FPZ
Wide Flange M	AC4MP
Small Flange F	AC4FDZ
Small Flange M	AC4MDZ
Narrow Flange M	AC4MPNZ
Metal Black F	AX4FB

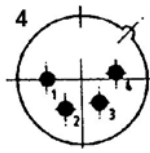

Amphenol

5 PIN AMPHENOL

Description	Code
Metal Plug F	AC5F
Metal Plug M	AC5M
Wide Flange F	AC5FPZ
Wide Flange M	AC5MP
Small Flange F	AC5FDZ
Small Flange M	AC5MDZ
Narrow Flange M	AC5MPNZ
Metal Black F	AX5FB

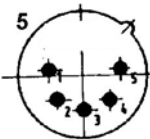

Amphenol

6 PIN AMPHENOL

Description	Code
Metal Plug F	AC6AF
Metal Plug M	AC6AMJ
Wide Flange F	AC6AFPZ
Wide Flange M	AC6AMP
Small Flange F	AC6AFDZ
Small Flange M	AC6AMDZ

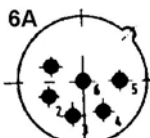

Amphenol

7 PIN AMPHENOL

Description	Code
Metal Plug F	AC7F
Metal Plug M	AC7M
Wide Flange F	AC7FPZ
Wide Flange M	AC7MP
Small Flange F	AC7FDZ
Small Flange M	AC7MDZ

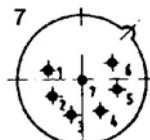

Amphenol

MINI-XLR

AVAILABLE IN 3, 4 & 5 PIN

8mmØ Mini-XLR [Not Amphenol Branded]

Description	Code
3 Pin Male	XLR501-3P
3 Pin Female	XLR502-3P
4 Pin Male	XLR501-4P
4 Pin Female	XLR502-4P
5 Pin Male	XLR501-5P
5 Pin Female	XLR502-5P



HIGH POWER 4 PIN

9-16mm Cable Entry 12AWG 50V 20A

Type	Code
Female	EP411P
Male	EP412



Amphenol

HIGH POWER 4 PIN

30mmØ Mount 50V 20A

Type	Code
Female	EP413P
Male	EP414



HIGH POWER 4 PIN AP

Modified PPE Resin

Type	Code
Female	AP-4-21
Male	AP-4-22



HIGH POWER 5 PIN

Type	Code
Female	EP-5-11P
Male	EP-5-12



Amphenol

HIGH POWER 5 PIN

Type	Code
Female	EP-5-13
Male	EP-5-14



Amphenol

HIGH POWER 6 PIN

Type	Code
Female	EP-6-11P
Male	EP-6-12



Amphenol

HIGH POWER 6 PIN

Type	Code
Male	EP-6-14
Female	EP-6-13



Amphenol

HIGH POWER 6 PIN AP

Modified PPE Resin

Type	Code
Female	AP-6-21

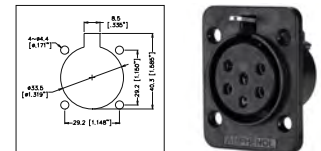

Amphenol

HIGH POWER 8 PIN FEMALE

9-16mm 12AWG 50V 15A

Type	Code
Female	EP811P



Amphenol

HIGH POWER 8 PIN MALE

30mm Diameter Mount. 50V 15A

Type	Code
Male	EP814



Amphenol



XLR Amphenol

BNC SOCKET D-SHELL [XLR]

BNC TO BNC Satin Nickel finish
Silver contact plating

Colour	Code
Silver	AC-BNC-JJ-75
Black	AC-BNC-JJ-75B

Amphenol



RCA SOCKET D-SHELL [XLR]

Colour	Code
Red	ACJD-RED
Black	ACJD-BLK
Yellow	ACJD-YEL
White	ACJD-WHT
Blue	ACJD-BLU
Green	ACJD-GRN

Amphenol



BLANKING PLATE

Black plastic

Code
NU-DBA-BL

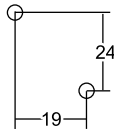

XLR Adaptors Misc

3 PIN XLR FEMALE TO RCA SOCKET

XLR Female to RCA Female

Code
AD977

Daichi Brand.



XLR FEMALE TO RCA PLUG

XLR Female to RCA male adaptor
Metal chassis.

Code
AD978



1/4" STEREO TO XLR

3-pole XLR male - stereo 1/4" plug
(Tip, Ring, Sleeve contact)

Code
NA3MP



XLR Misc

1RU 12x XLR SOCKET UNEQUIPPED 19" RACK

XLR CONNECTORS ARE SOLD SEPARATELY

Pre-punched with 12 empty slots to suit XLR panel mount connectors. There are 4 mounting holes available for easy installation.
Suits standard 19" rack cabinets. 1RU.

Code
CMR314



XLR WALL PLATE

STAINLESS STEEL

Stainless steel pre-punched wall plate suits XLR sockets. Size 71x115mm.
Hole diameter 24mm. Suits Neutrik type and some Amphenol.

Type	Code
Single	XLRP1
Double	XLRP2

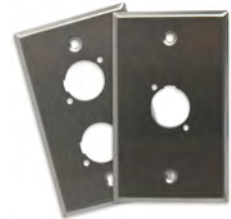

3 PIN XLR WALLPLATE - STEEL

Screw terminals.
Stainless steel.
3 Pin Female.

Code
PA0442



3 PIN XLR WALLPLATE - DUAL

Screw terminals.
Stainless steel.
3 Pin Female x2

Code
PA0447



3 PIN XLR WALLPLATE - PLASTIC

Screw terminals. White plastic.
Female. 3 Pin XLR

Type	Code
3 Pin	PA446



5 PIN XLR WALLPLATE - PLASTIC

Screw terminals. White plastic.
Female. 5 Pin XLR

Type	Code
5 Pin	PA0456A



3 PIN XLR DESKTOP BASE

Screw down on table top. 100mm. Rubber insulated reducing knocking noises.
3 Pin XLR socket for goose necks, etc.

Dia.	Code
~100mm	PA482





□ Speaker PA Amphenol

SP LOUDSPEAKER AMPHENOL

The SP Series are available in 2 or 4 pole chassis mount connectors. The durable thermoplastic housings are fitted with high power contacts to ensure optimal current carrying capacity. Completely intermateable with industry standard loudspeaker connections. 30A Contacts.

Amphenol



SP LOUDSPEAKER CHASSIS SOCKET

D flange 26x31mm
Solder tabs 4.8mm

Pins	Code
2	SP-2-MD
4	SP-4-MD

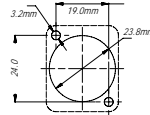

Amphenol

SP LOUDSPEAKER POLY SLEEVE

Thermoplastic shell,
Blue Sleeve 8-12mm
cable entry.

Pins	Code
2	SP-2-F
4	SP-4-F



Amphenol

SP LOUDSPEAKER NICKEL SLEEVE

Nickel / Black shell, Blue sleeve,
8-12mm cable entry.

Colour	Pins	Code
Nickel	2	SP-2-FN
Black	2	SP-2-FB
Nickel	4	SP-4-FN
Black	4	SP-4-FB



Amphenol

SP LOUDSPEAKER POLY GLAND

Thermoplastic shell, Blue sleeve,
PG Gland with locking nut
8-14mm cable entry.

Pins	Code
2	SP-2-FG
4	SP-4-FG



Amphenol

SP LOUDSPEAKER NICKEL GLAND

Nickel / Black shell, Blue sleeve,
PG Gland with locking nut
8-14mm cable entry.

Colour	Pins	Code
Nickel	2	SP-2-FNG
Black	2	SP-2-FBG
Nickel	4	SP-4-FNG
Black	4	SP-4-FBG



Amphenol

SP LOUDSPEAKER POLY STRAIN RELIEF

Thermoplastic shell, Blue sleeve,
Heavy duty 14mm cable entry
strain relief 100mm long.

Pins	Code
2	SP-2-FL
4	SP-4-FL



Amphenol

SP LOUDSPEAKER NICKEL STRAIN RELIEF

Nickel / Black shell, Blue sleeve,
Heavy duty 14mm cable entry
strain relief 100mm long.

Colour	Pins	Code
Nickel	2	SP-2-FNL
Black	2	SP-2-FBL
Nickel	4	SP-4-FNL
Black	4	SP-4-FBL



Amphenol

□ SpeakON® Type Aerpro

SPEAKON® TYPE LEAD NL4

SpeakON high quality pre-made
cables ready for you to use in your
audio system. 2 Core (NL4 Plugs).

Length	Code
5M x1	AL730-5
10M x1	AL730-10



SPEAKON® TYPE LEADS NL4 TO BANANA

PR BANANA PLUG-NL4 6M LEADS (x2)

4mm Banana Pair to PA Speaker (NL4)
Sturdy Rubber covered black lead
Supplied in a stereo pair (2x leads)
Packed in sealed hang sell blister

Length	Code
6M x2	ALPASC6

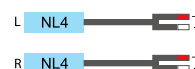



□ RCA

SUPPLIED IN BULK [SINGLES]

RCA AUDIO INTERCONNECTS

All plugs are supplied in BULK form. Unless indicated as Packaged or Pairs.



RCA PLUGS - GOLD PLATED RCA LOCKING

Order One To Receive A Pack of Two

Cable	Stripe	Code
8-9mm	Red	P850
8-9mm	Black	P851



RCA PLUGS - 6mm ZINC ALLOY GREY GOLD

Stripe	Code
White	P880
Red	P881
Green	P882
Blue	P883
Yellow	P884



RCA PLUGS - 7mm ZINC ALLOY GREY GOLD

Stripe	Code
White	P885
Red	P886
Green	P887
Blue	P888
Yellow	P889



RCA PLUGS - 6mm PLATINUM

6mm CABLE ENTRY

Stripe	Code
White	P870
Red	P871



RCA PLUGS - 8mm ZINC ALLOY GREY GOLD

Stripe	Code
White	P890
Red	P891
Green	P892
Blue	P893
Yellow	P894



RCA PLUGS - 8mm PLATINUM

8mm CABLE ENTRY

Stripe	Code
White	P875
Red	P876



RCA PLUGS - GOLD PLATED LARGE

Order One To Receive A Pack of Two

Cable	Stripe	QTY	Code
8-9mm	Red	2	P830
8-9mm	Black	2	P831



RCA PLUGS - BLUE METAL

Cable	Insert	Code
7mm	Red	P860
7mm	Green	P861
7mm	Blue	P862



RCA PLUGS - GOLD PLATED

Order One To Receive A Pack of Two

Cable	Stripe	QTY	Code
5-7mm	Red	2	P824
5-7mm	Black	2	P825
4-6mm	Red	2	P820
4-6mm	Black	2	P821



RCA PLUGS - VIDEO & DIGITAL YELLOW

Grey with Orange 6 to 8.5mm Cable

Code
P865



RCA PLUGS - GOLD PLATED

Order One To Receive A Pack of Two

Cable	Stripe	QTY	Code
5-7mm	Red	2	P840
5-7mm	Black	2	P841
4-6mm	Red	2	P834
4-6mm	Black	2	P835





□ RCA

RCA PLUGS - GOLD PLATED

Gold plated. 6mm cable entry.
Black & Red ID ring
One may be removed if req.

Code
P343



RCA PLUGS - GOLD PLATED

Colour ID Ring.
6mm Strain relief.

Colour	Code
Red	P344
Black	P345
Green	P346
Blue	P347
Yellow	P349
White	P350



RCA PLUGS - CHROMIUM & COLOUR BAND

R, B, OR, GN, YL, BU, WH
RCA Plug metal. Add colour code.
As above with colour band for ID

Colour	Code
Red	P342RD
Black	P342BK
Green	P342GN
Blue	P342BU
White	P342WH
Orange	P342OR



RCA PLUGS - CHROMIUM

RCA plug metal All chrome
with spring strain relief.

Code
P341



RCA PLUGS - CRIMP

Suit	Code
RG59	P360
RG58	P361



RCA PLUGS - PLASTIC

R, B, OR, GN, YL, BU, WH
RCA plug strain relief P351 then colour code

Colour	Code
Black	P351BK
Red	P351RD
Green	P351GN
Yellow	P351YL
Orange	P351OR
Blue	P351BU
White	P351WH



RCA PLUGS - CLASSIC

RCA Plastic Barrel

Colour	Code
Black	P311B
Red	P311R



RCA PLUGS - SCREW BACK

Screw terminals

Code
AD-RCA1



RCA PLUGS - AMPHENOL

SATIN SHELL COLOUR BOOT
Premium grade Amphenol brand

Amphenol

Collar	Code
Red	ACPR-SRD
Black	ACPR-SBK
Yellow	ACPR-SYL
White	ACPR-SWH
Blue	ACPR-SBL
Green	ACPR-SGR



RCA PLUGS - AMPHENOL

COLOUR METAL SHELL
Premium grade Amphenol brand

Amphenol

Collar	Code
Red	ACPR-RED
Black	ACPR-BLK
Yellow	ACPR-YEL
White	ACPR-WHT
Blue	ACPR-BLU
Green	ACPR-GRN



RCA PLUGS - COMPRESSION GOLD RG59

Gold Plated. Req Compression tool.

Collar	Code
Red	P370GLD
Green	P371GLD
Blue	P372GLD
White	P373GLD
Black	P374GLD
Yellow	P375GLD



RCA PLUGS - COMPRESSION RG59

Requires Compression tool.

Collar	Code
Red	P370
Green	P371
Blue	P372
Black	P374
Yellow	P375



RCA PLUGS - COMPRESSION RG6

Requires Compression tool.

Collar	Code
Red	P380
Green	P381
Blue	P382
White	P383
Black	P384
Yellow	P385



RCA PLUGS - COMPRESSION DELUXE

GOLD PLUG WITH GUN-METAL BARREL
High quality gold plated compression plug.
Supplied with 6 colour rings for identification.

Cable	Code
RG59U	P386
RG6QUAD	P387





RCA PLATE X2

RCA Fibreglass mounting board

Code
J302



RCA PLATE X4

RCA Fibreglass mounting board

Code
J304



RCA PCB MOUNT SOCKET GOLD

PCB Mount

Collar Code
Red J387R
Black J387B
Yellow J387Y



RCA PCB MOUNT SOCKET GOLD SWITCHED

Collar Code
Red J381R
Black J381B
White J381W
Orange J381O
Yellow J381Y

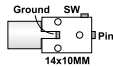

RCA PANEL SOCKET

Nickel 6mm panel Ø

Collar Code
Red J310R
Black J310B
Blue J310BU
Green J310GN



RCA PANEL SOCKET INSULATED

Nickel 8mm panel Ø

Collar Code
Red J370R
Black J370B
Blue J370BU
Green J370GN



RCA PANEL SOCKET GOLD PLATED

Order One To Receive A Pack of Two

Insert Code
Red J920
Black J921
White J922
Yellow J923
Green J924
Blue J925
Orange J926



RCA PANEL SOCKET GOLD PLATED INSULATED

Order One To Receive A Pack of Two

Insert Code
Red J930
Black J931
White J932
Yellow J933
Green J934
Blue J935
Orange J936



RCA PANEL SOCKET GOLD PLATED RECESSED

XLR FITTING Solder Back
Insulator Identifier Neutrik Brand Product

Collar Code
Black NF2D0
Red NF2D2
Yellow NF2D4
White NF2D9



RCA PANEL SOCKET GOLD PLATED RECESSED

XLR FITTING Solder Back Amphenol Brand Product

Colour Code
Red ACJD-RED
Black ACJD-BLK
Yellow ACJD-YEL
White ACJD-WHT
Blue ACJD-BLU
Green ACJD-GRN

Amphenol



RCA INLINE SOCKET

RCA socket

Colour Code
Black S310B
Red S310R



RCA INLINE SOCKET

Colour Code
Black S350B
Red S350R



RCA INLINE SOCKET METAL

RCA socket metal

Code
S340B
S340R



RCA INLINE SOCKET GOLD PLATED

Gold plated socket 6mm cable entry

Code
S343



RCA INLINE SOCKET GOLD PLATED PAIR

Order One To Receive A Pack of Two

Cable	Stripe	QTY	Code
5-7mm	Red	2	S840
5-7mm	Black	2	S841
4-6mm	Red	2	S834
4-6mm	Black	2	S835



RCA INLINE SOCKET GOLD PLATED PAIR

Order One To Receive A Pack of Two

Cable	Stripe	QTY	Code
5-7mm	Red	2	S824
5-7mm	Black	2	S825
4-6mm	Red	2	S820
4-6mm	Black	2	S821



RCA INLINE SOCKET GOLD PLATED PAIR LARGE

Order One To Receive A Pack of Two

Cable	Stripe	QTY	Code
8-9mm	Red	2	S830
8-9mm	Black	2	S831



RCA INLINE SOCKET AMPHENOL

Amphenol

SATIN SHELL COLOUR BOOT
Premium grade Amphenol brand

Collar Code
Red ACJR-SRD
Black ACJR-SBK
Yellow ACJR-SYL
White ACJR-SWH
Blue ACJR-SBL
Green ACJR-SGR



RCA INLINE SOCKET AMPHENOL

Amphenol

COLOUR METAL SHELL
Premium grade Amphenol brand

Collar Code
Red ACJR-RED
Black ACJR-BLK
Yellow ACJR-YEL
White ACJR-WHT
Blue ACJR-BLU
Green ACJR-GRN



RCA INLINE SOCKET TO SCREW TERMINALS

Screw terminals

Code
AD-RCA2





□ Jack Plug

2.5mm MONO PLUG

2.5mm subminiature plug

Colour	Code
Black	P125B
Red	P125R



2.5mm STEREO PLUG

2.5mm stereo plug.

Code
P115



2.5mm QUAD PLUG

2.5mm QUAD plug. Four (4) Terminal

Code
P1254



2.5mm STEREO PLUG RIGHT-ANGLE

SOLDER TYPE

2.5mm 3 pole 6mm max cable entry

Code
P115RA



2.5mm QUAD PLUG RIGHT-ANGLE

SOLDER TYPE

Quad 2.5mm 4 pole 6mm max cable entry

Code
P1254RA



3.5mm MONO PLUG

3.5mm miniature plug

Colour	Code
Red	P110R
Black	P110B



3.5mm MONO PLUG

3.5mm miniature plug strain relief

Colour	Code
Red	P150R
Black	P150B



3.5mm MONO PLUG METAL

3.5mm metal plug

Code
P140



3.5mm MONO TO SCREW

Screw terminals for bare wire.

Code
AD-P35



3.5mm STEREO PLUG PLASTIC

3.5mm stereo plug

Code
P120



3.5mm STEREO PLUG GOLD PLATED

5mm cable diameter. TWO per blister pack.

QTY	Code
2	P122



3.5MM PLUG NEUTRIK

With black metal handle

Code
NYS231-B



3.5mm STEREO PLUG RIGHT-ANGLE

Stereo 3.5mm 3 pole 6mm max cable entry

Code
P120RA



3.5mm STEREO PLUGS RIGHT ANGLE NEUTRIK

Colour	Code
Silver	NTP3RC
Black	NTP3RCB



3.5mm QUAD PLUG

3.5mm QUAD plug. Four (4) Terminal Plug

Code
P1354



3.5mm QUAD PLUG RIGHT-ANGLE

Quad 3.5mm 4 pole 6mm max cable entry

Code
P1354RA



2.5mm STEREO SOCKET

2.5mm stereo socket

Code
S115



2.5mm MONO SOCKET

2.5mm submini' socket

Colour	Code
Red	S126R
Black	S126B

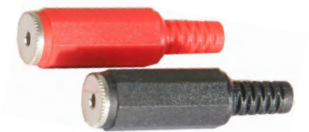

2.5mm QUAD SOCKET

Quad 2.5mm 4 pole 6mm max cable entry

Code
S1254



3.5mm MONO SOCKET

3.5mm in-line socket Mono

Colour	Code
Red	S110R
Black	S110B



3.5mm MONO SOCKET

Code
S140



3.5mm STEREO SOCKET

Code
S142



3.5mm STEREO SOCKET NEUTRIK

Metal handle. Max cable O.D. 4mm

Code
NYS240



3.5mm MONO SOCKET

3.5mm in-line socket strain relief Mono

Colour	Code
Red	S150R
Black	S150B



3.5mm STEREO SOCKET

3.5mm stereo in-line socket

Code
S120



3.5mm QUAD SOCKET

Four pins, four pole.

Code
S1354



PRE-MADE LEADS

Molded Plugs - Shielded Cable - Blank End

Description	Length	Code
2.5mm Mono Plug to 6.0M Lead	6M	RCC25
3.5mm Mono Plug to 1.8M Lead	1.8M	DCL3514ST
3.5mm Mono Plug to 6.0M Lead	6M	RCC35
2.5mm Quad Plug to 2.5M Lead	2.5M	VC1254
3.5mm Quad Plug to 2.5M Lead	2.5M	VC1354





PANEL MOUNT SOCKET

Size	Type	Code
2.5mm	Mono (Switched)	J125
3.5mm	Mono (Switched)	J110
2.5mm	Stereo (Unswitched)	J126



3.5mm STEREO SOCKET PANEL MOUNT

Chassis Mount

Code
J124



3.5mm MONO SOCKET PANEL MOUNT SWITCHED

3.5mm Mono Switched
Panel Mount

Code
J160



3.5mm STEREO SOCKET PCB MOUNT

Unswitched

Code
J123



3.5mm STEREO SOCKET PCB MOUNT SWITCHED

Switched

Code
J127



3.5mm STEREO SOCKET DPDT SWITCHED

3.5mm stereo

Code
J130



6.35mm PLUG

Plastic Barrel. Mono or stereo.

Type	Code
Mono	P215
Stereo	P220



6.35mm MONO PLUG STRAIN RELIEF

Plastic Mono

Collar	Code
Red	P250R
Black	P250B



6.35mm PLUG STRAIN RELIEF

Plastic Stereo. 6mmØ Cable Entry.

Collar	Code
Red	P225R
Black	P225B



6.35mm PLUG METAL

Spring strain relief

Type	Code
Mono	P245
Stereo	P224



6.35mm MONO PLUG GOLD PAIR

Buy one to receive a pair.
All metal. Gold Plated.

Type	QTY	Code
Mono	2	P270



6.35mm STEREO PLUG GOLD PLATED PAIR

Buy one to receive a pair.
All metal. Gold plated.

Type	QTY	Code
Stereo	2	P280



6.35mm HEAVY DUTY PLUG

Neutrik All Metal

Type	Code
Mono	NP2X
Stereo	NP3X



6.35mm RIGHT ANGLE PLUG

Type	Code
Mono	P243
Stereo	P244



6.35mm RIGHT ANGLE HEAVY DUTY

Neutrik Quality

Code
NP2RX



6.35mm T-SERIES METAL PLUGS

Colour	Type	Code
Nickel	Mono	TM2PJ
Black	Mono	TM2PBJ
Nickel	Stereo	TS3PJ
Black	Stereo	TS3PBJ



6.35mm MUSICIAN RANGE

Colour	Type	Code
Nickel	Mono	ACPM-GN
Black	Mono	ACPM-GB
Nickel	Stereo	ACPS-GN
Black	Stereo	ACPS-GB



6.35mm RIGHT-ANGLE

Type	Colour	Plug	Code
Mono	Black	Chrome	ACPM-RB
Mono	Nickel	Chrome	ACPM-RN
Stereo	Black	Chrome	ACPS-RB
Stereo	Nickel	Chrome	ACPS-RN



6.35mm TO SCREW

Screw terminals removable

Code
AD-P63



6.35mm PLASTIC IN-LINE

Type	Code
Mono	S210
Stereo	S220

Heavy Duty Plastic Barrel. Made in Japan.

Type	Code
Mono	S210ME



6.35mm METAL IN-LINE

Type	Code
Mono	S240
Stereo	S224



6.35mm PLASTIC IN-LINE RED/BLACK

Mono with Strain relief

Colour	Code
Red	S215R
Black	S215B



6.35mm PLASTIC IN-LINE STEREO

Stereo with strain relief

Colour	Code
Black	S225



6.35mm STEREO INLINE LOCKED

Neutrik Quality With Locking.

Type	Code
Stereo	NJ3FC6





6.35mm SOCKET FULL SWITCHED

DPDT switched.

Type	Code
Stereo	J227



6.35mm SOCKET PCB MOUNT

Stereo switched

Type	Code
Stereo	J228



6.35mm SOCKET UNSWITCHED

Type	Code
Mono	J213
Stereo	J222



6.35mm SOCKET 1/2 SWITCHED

Only tip is switched.

Type	Code
Mono	J215
Stereo	J223



1/4" SWITCHCRAFT OPEN MONO SOCKET

1/4" female. Open circuit. Can be used as replacement in Fender®, external speaker/guitar output/effects pedals.

Type	Mounting	Code
Mono	Panel	SCJ11



1/4" SWITCHCRAFT SHORTING MONO SOCKET

SHORTING TYPE

1/4" female. Shorting type. Fender® type replacement.

Type	Mounting	Code
Mono	Panel	SCJ12A



1/4" SWITCHCRAFT OPEN STEREO SOCKET

STEREO DOUBLE OPEN CIRCUIT

1/4" female. Stereo double open circuit. Can be used for effect pedal input.

Type	Mounting	Code
Stereo	Panel	SCJ12B



6.35mm STEREO SOCKET LOCKED

Neutrik Quality With Locking

Type	Code
Stereo	NJ3FP6C



XLR / 6.35mm DUAL SOCKET

XLR 3 pole female receptacle with 1/4" jack.

Type	Code
Mono	ACJC5H
Stereo	ACJC6H

HORIZONTAL MOUNT



XLR / 6.35mm DUAL SOCKET

XLR 3 pole female receptacle with 1/4" jack.

Type	Code
Mono	ACJC5V
Stereo	ACJC6V

VERTICAL MOUNT



1/4" MONO SOCKET PCB

Fender® PCB Mount jack. Mono 4 pins.

Type	Pins	Mounting	Code
Mono	4 Pin	PCB	BJ106



1/4" STEREO SOCKET PCB

Fender® PCB Mount jack. Stereo 9 pins.

Type	Pins	Mounting	Code
Stereo	9 Pins	PCB	BJ107



1/4" MONO SOCKET VINTAGE PCB

SWITCHED

Mono input jack, 4 PCB Mount terminals. Switched. Vintage Type with metal ferrule.

Type	Pins	Mounting	Code
Mono	4 Pins	PCB	BJ121



1/4" STEREO SOCKET VINTAGE PCB

Switched

Stereo input jack, 6 PCB mount terminals. Switched. MXR replacement jack.

Type	Pins	Mounting	Code
Stereo	6 pins	PCB	BJ124



1/4" MONO SOCKET VINTAGE SOLDER

SWITCHED

Mono input, 4 Solder terminals. Switched. Vintage Type with metal ferrule.

Type	Pins	Mounting	Code
Mono	4 Pins	Panel	BJ101



6.35mm MONO SOCKET - MARSHALL® TYPE

SWITCHED

Mono input jack, 4 Solder terminals.

Type	Pins	Mounting	Code
Mono	4 Pins	Panel	BJ102
Nut	Spare	BJ	BJ-NUT1



1/4" MONO SOCKET MARSHALL® TYPE PCB

SWITCHED

Mono input jack, 4 PCB mount terminals.

Type	Pins	Mounting	Code
Mono	4 Pins	PCB	BJ103
Nut	Spare	BJ	BJ-NUT1



1/4" STEREO SOCKET MARSHALL® TYPE PCB

SWITCHED

Stereo input jack, 6 pin PCB board connector.

Type	Pins	Mounting	Code
Stereo	6 Pins	PCB	BJ104
Nut	Spare	BJ	BJ-NUT1



SPARE NUT SUIT BJ SERIES

Suit BJ102, BJ103, BJ104, BJ105

Code
BJ-NUT1





Multi-Pin Misc

VP80 CLASSIC 8 PIN VIDEO CONNECTOR

RGB 8 pin square plug
For Video connections

Code
VP80



14 PIN FEMALE PLUG - SONY BETAMAX

BETA camera 14 pin

Code
VS141



14 PIN MALE PLUG - SONY BETAMAX

14 pin SONY BETAMAX male
connector plug assembly.

Code
VP140



SCART

SCART PLUG

21 pin Euro Plug
Adjustable cable entry
21 pin

Code
P901



DC Multi-Pin

DIN POWER 4 PIN PLUG

10mm Barrel Mini Din 30V-7A

Code
DPP4



DIN POWER 4 PIN INLINE SOCKET

7mm CABLE ENTRY

Code
DPS4



DIN POWER 4 PIN SOCKET

PCB MOUNT

Code
DPJ4



S-Video

S-VIDEO PLUG IS DIFFERENT

With SVHS Plugs the Keyway is "Out".
This is different to the standard MDP4
where the Keyway is "In".
The socket will accept both.

- Pin 1 = Luminance Ground
- Pin 2 = Chrominance Ground
- Pin 3 = Luminance Signal
- Pin 4 = Chrominance Signal



S-VIDEO PLUGS

Differs from Mini Din Key way dips out.

Code
MDP4SVHS



S-VIDEO PLUGS GOLD PLATED

ZINC ALLOY GREY

Cable Code
8mm P848
6mm P846



S-VIDEO INLINE SOCKET

Accepts both SVHS Keyway "Out"
and standard MDP4 Keyway "In".

Code
MDS4SVHS



S-VIDEO PANEL SOCKET

Accepts both SVHS Keyway "Out"
and standard MDP4 Keyway "In".

Code
MDJ4SVHS



DIN PLUG 2 PIN DP2

Solder

Code
DP2



DIN PLUG 2 PIN DP2S

Screw terminal

Code
DP2S



DIN PLUG 2 PIN R/ANGLE

Solder type

Code
DP2M



DIN INLINE 2 PIN DS2

Solder

Code
DS2



DIN SOCKET 2 PIN

Code
DJ2





DIN

DIN PLUGS



Description	Code
2 Pin Plug	DP2
2 Pin Screw Terminal	DP2S
3 Pin Plug	DP3
4 Pin 220°	DP4
5 Pin 180°	DP5
5 Pin 360°	DP5A
5 Pin 240°	DP5B
5 Pin 180° metal	DP5M
6 Pin Plug	DP6
7 Pin Plug	DP7
8 Pin 270°	DP8
13 Pin Plug	DP13
2 Pin Plug Right Angle	DP2M
8 Pin 262° Plug	DP8A

MINI DIN PLUGS



Description	Code
3 Pin Micro Plug	MDP3
4 Pin Micro Plug	MDP4
5 Pin Micro Plug	MDP5
6 Pin Micro Plug	MDP6
7 Pin Micro Plug	MDP7
8 Pin Micro Plug	MDP8
9 Pin Micro Plug	MDP9
10 Pin Micro Plug	MDP10
4 Pin SVHS Plug	MDP4SVHS
4 Pin Metal 6mm Cable Entry	P846
4 Pin Metal 8mm Cable Entry	P848

DIN CHASSIS SOCKETS



Description	Code
2 Pin Chassis Socket	DJ2
3 Pin Socket	DJ3
4 Pin 220°	DJ4
5 Pin 180°	DJ5
5 Pin 240°	DJ5B
6 Pin Socket	DJ6
7 Pin Socket	DJ7
8 Pin 270°	DJ8

MINI DIN CHASSIS SOCKETS



Description	Code
3 Pin Micro Socket	MDJ3
4 Pin Micro Socket	MDJ4
5 Pin Micro Socket	MDJ5
6 Pin Micro Socket	MDJ6
7 Pin Micro Socket	MDJ7
8 Pin Micro Socket	MDJ8
4 Pin SVHS Socket	MDJ4SVHS

DIN INLINE SOCKETS



Description	Code
2 Pin Inline Socket	DS2
3 Pin Socket	DS3
4 Pin 220°	DS4
5 Pin 180°	DS5
6 Pin Socket	DS6
7 Pin Socket	DS7
8 Pin 270°	DS8
13 Pin Socket	DS13

MINI DIN INLINE SOCKETS



Description	Code
3 Pin Micro Socket	MDS3
4 Pin Micro Socket	MDS4
5 Pin Micro Socket	MDS5
6 Pin Micro Socket	MDS6
7 Pin Micro Socket	MDS7
8 Pin Micro Socket	MDS8
9 Pin Micro Socket	MDS9
4 Pin SVHS Socket	MDS4SVHS

DIN 4 PIN POWER

30Vdc 7A



Description	Code
4 Pin Plug Male	DPP4
4 Pin PCB Jack	DPJ4
4 Pin Inline Socket	DPS4

MINI DIN GENDER CHANGERS



Description	Code
3 Pin F to F	CA170
4 Pin F to F	CA172
4 Pin F to F (S-VHS)	AD4SVHS
6 Pin F to F	CA173
8 Pin F to F	CA174



□ DC Plugs

MERIT TYPE AUTOMOTIVE PLUG

12V 16A EURO CAR PLUG

Code
MER101



MERIT TYPE AUTOMOTIVE IN-LINE SOCKET

12V 16A IN-LINE SOCKET

Code
MER110



MERIT AUTOMOTIVE PANEL MOUNT DIN SOCKET

DIN 4165 - Hella Plug

Code
MER116



MERIT TYPE AUTOMOTIVE PANEL MOUNT SOCKET

DIN 4165 - Hella Plug Power: 12Vdc 16A max. Popular European car plug. Premium build panel socket. High temp for high power. Removable Spring hold Dust cap ingress protection.

Code
MER112



MERIT TYPE AUTOMOTIVE UNIVERSAL ADAPTOR

Suits both European and Standard Australian type accessories connections. Removable shunt so as to also fit the Hella Plug. Screw terminals. Fuse GBC.

Fuse Code
8A MER102
16A MER103



MERIT AUTOMOTIVE ADAPTOR

ACCESSORIES PLUG

Adapts new to old. Hella Plug DIN4165 12Vdc 16A max. 15cm Accessories socket

Code
MER201



ACCESSORIES SOCKET REPLACEMENT USB 2.1A

- Replaces most standard Accessories socket
- 12/24V car USB charger 2.1A
- USB to Device lead not included

Code
APUSBE



ACCESSORIES SOCKET REPLACEMENT USB-USB

- Replaces most standard Accessories sockets
- 2 Metre USB to USB dash lead extension
- (USB to Device lead not included)

Code
APUSB2



ACCESSORIES SOCKET REPLACE USB+3.5mm

- Replaces most standard Accessories sockets
- 12/24V car to 2.1A USB charger
- USB to Device lead not included

Code
APUSB35E

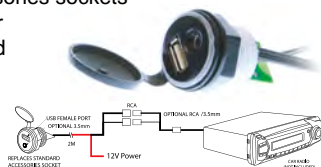

CAR ACCESSORIES PLUG

High Temp Bakelite

Code
P801



CAR ACCESSORIES PLUG FUSED

Code
P810



CAR ACCESSORIES PLUG LEAD 8A

Car Accessories Plug 5M Long cable to bare end wires Fused 8 Amp

Code
DCL50



CAR ACCESSORIES PLUG LEAD 5A

2M HEAVY-DUTY

Plug Code
Bare Wire DCL18
2.1mm DC DCL21
2.5mm DC DCL25



CAR ACCESSORIES EXTENSION

Description Code
Cigarette lighter CA600
extension cable



Description Code
To DC Plugs MW-CP1

CAR ACCESSORIES SPLITTERS

PLUG TO MULTIPLE SOCKETS

12Vdc Power Splitters. See Automotive Section for details...

Type Code
Double DCL30



Type Code
Triple DCP330

CAR ACCESSORIES INLINE SOCKET

In-line socket

Code
J802



CAR ACCESSORIES SOCKET

Lighter high temperature grade

Code
J800



CAR ACCESSORIES SOCKET & DUST CAP

Panel mount with dust cap

Code
J804



CAR ACCESSORIES TWIN SOCKET

Two 12V Accessories High temperature sockets (But not for lighters) Bare wire connection Inline 20A fuse 3AG. Under dash mount.

Code
DPV-63





PANEL MOUNT CAR ACCESSORY SOCKET

12V POWER 20A
Panel mount 60x43mm

Code
J808



CAR ACCESSORIES SOCKET SURFACE MOUNT

Under-dash mount Water resistant all-round rubber cover. 12V 20A

Code
J806



PANEL MOUNT CAR ACCESSORY SOCKET

- Input: 12/24Vdc
- Output: 20A
- Size: 59.8x42.5x39mm

Code
APDCP2



SURFACE MOUNT ACCESSORY SOCKET

- Input: 12/24Vdc
- Output: 20A
- Size: 84x55x49mm

Code
APDCH2



PANEL MOUNT MERIT SOCKET

- Input: 12/24Vdc
- Output: 20A
- Size: 84x55x49mm

Code
APDCP4



SURFACE MOUNT MERIT SOCKET

- Input: 12/24Vdc
- Output: 20A
- Size: 84x55x49mm

Code
APDCH4



PANEL MOUNT USB 2.4A SOCKET

SINGLE USB-A OUTLET

12Vdc 6.35mm input to 5Vdc USB output.
30mmØ hole. 60x43mm panel.

Code
ELI524



MERIT TYPE AUTOMOTIVE PANEL MOUNT SOCKET

12V 16A EURO CAR PLUG

DIN 4165 - Hella Plug 30mmØ hole.
Compatible with Aerpro APDCP Series.

Code
MER114



PANEL MOUNT 2.1A DUAL USB SOCKET

- Input: 12/24Vdc
- Output: 2.1A Total 5V
- Size: 84x55x49mm

Code
APDCP6



SURFACE MOUNT DUAL USB SOCKET

- Input: 12/24Vdc
- Output: 2.1A max @ 5V
- Size: 84x55x49mm

Code
APDCH6



PANEL MOUNT LED VOLTMETER

- LED voltage display
- Size: 84x55x49mm

Code
APDCP8



SURFACE MOUNT LED VOLTMETER

- LED voltage display
- Size: 84x55x49mm

Code
APDCH8



PANEL MOUNT DUAL USB & ACCESSORY SOCKET

- Input: 12/24Vdc
- Accessories Output: 20A
- USB socket: 2.1A total 5V
- Size: 105x45x51mm

Code
APDCP26



SURFACE MOUNT USB & ACCESSORY SOCKET

- Input: 12/24Vdc
- Accessories socket: 20A
- USB socket: 2.1A @ 5V
- Size: 84x55x49mm

Code
APDCH26



PANEL ACCESSORY SOCKET & VOLTMETER

- Input: 12/24Vdc
- Accessories socket 20A
- LED voltage display
- Size: 105x45x51mm

Code
APDCP28



SURFACE ACCESSORY SOCKET & VOLTMETER

- Input: 12/24Vdc
- Accessories socket 20A
- LED voltage display
- Size: 84x55x49mm

Code
APDCH28



PANEL MOUNT USB SOCKET & LED VOLTMETER

- Input: 12/24Vdc
- USB socket: 2.1A total 5V
- Size: 105x45x51mm

Code
APDCP68



SURFACE MOUNT USB SOCKET & VOLTMETER

- Input: 12/24Vdc
- Dual USB: 2.1A total 5V
- LED voltage display
- Size: 84x55x49mm

Code
APDCH68





□ DC Wiring Loom

BATTERY FIGHTER CHARGER LEADS

Constar Quick Disconnect Plug to Socket Extensions.

Length	Code
30cm	QD2P
3M	BFL7



4.8mm SPADE

45cm Battery terminal

Code
BFL5



6.35mm SPADE

45cm Battery terminal

Code
BFL6



LEAD & ALLIGATOR CLIP

540mm long UL SPT-2, 18AWG lead, with the alligator clips on one end and the Constar quick disconnect plug on the other end.

Code
BFL1



ACCESSORIES PLUG

45cm Car accessories plug

Code
BFL4



ACCESSORIES SOCKET

45cm Car accessories socket

Code
BFL8



RING TERMINALS

50cm M5 Screw connect

Code
BFL2



CONSTAR 2 PIN MONITOR METER

INLINE VOLTAGE

Plugs inline with the "Constar" charger lead Measures voltage 5-40Vdc LCD 4 Digit Display Monitors charge voltage or battery voltage.

Code
BFL9



AUTOMOTIVE HARNESS

SEE AUTOMOTIVE SECTION 09



DEANS 1300 ULTRA CONNECT KIT

Gold Plated upgrade terminals as used by RC champions for quicker and more reliable RC battery connections. Original Deans USA made. Inc. Plug, Socket, Heatsrink.

Code
P1300



DEANS 1300 ULTRA SOCKETS

Set of four sockets for upgrading your battery leads. Gives quicker and more reliable RC battery power connections. Original Deans USA made. Compatible with the P1300 kit.

Code
S1304

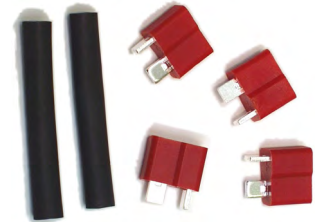

TAMIYA® PLUGS (SQUARE)

Heavy duty quality. High current lead.

BATTERY PLUG 20cm FEMALE

Code
WH3TF

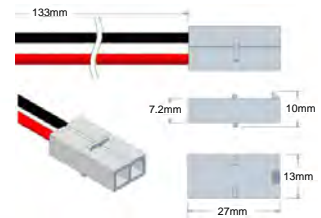

CHARGER PLUG 10cm MALE

Code
WH3TM

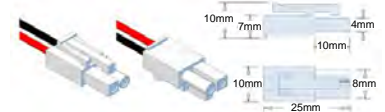

FUTABA® "J" CONNECTOR

High Grade, Long Life. 3 pins Futaba (polarised).

MALE TO FEMALE 30cm

Code
WH3FE

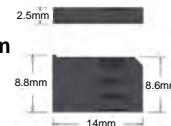

MALE TO MALE 30cm

Code
WH3FM



FEMALE TO WIRE 30cm

Code
WH3FF



JR® CONNECTORS

High Grade. Long Life. 3 pin polarised.

MALE TO FEMALE 30cm

Code
WH3JRE

MALE TO MALE 30cm

Code
WH3JRM

FEMALE TO FEMALE 30cm

Code
WH3JRF

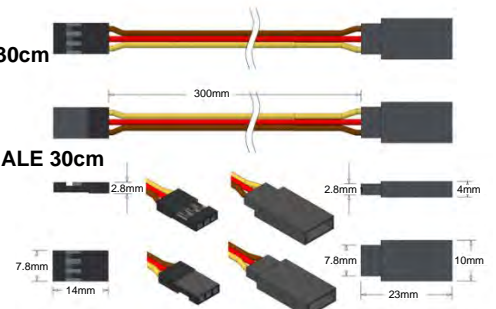



□ Alligator

HOOK CLIPS

Colour	Code
Red	ICC2R
Black	ICC2B



ALLIGATOR CLIP 26MM

Colour	Code
Red	P726R
Black	P726B



ALLIGATOR CLIP 32MM

Colour	Code
Red	P732R
Black	P732B



ALLIGATOR CLIP 34MM

Alligator clip 34mm

Colour	Code
Red	P734R
Black	P734B



ALLIGATOR CLIP 10A

Jaw 8mm, Width 8mm.

Colour	Code
Red	LGC006R
Black	LGC006B



ALLIGATOR CLIP 20A

Jaw 10mm, Width 10mm.

Colour	Code
Red	LGC007R
Black	LGC007B



ALLIGATOR CLIP 15A

Jaw 20mm
Width 10mm

Colour	Code
Red	LGC015R
Black	LGC015B



ALLIGATOR CLIP 30A

Jaw 20mm
Width 12mm

Colour	Code
Red	LGC016R
Black	LGC016B



ALLIGATOR CLIP 50A

28mm Jaw, 16mm Wide.

Colour	Code
Red	LGC017R
Black	LGC017B



ALLIGATOR CLIP 200A

Heavy Duty type Full hand grip

Jaw 25mm
Width 23mm

Colour	Code
Red	LGC022R
Black	LGC022B



ALLIGATOR CLIP 600A

Super Heavy Duty Full hand grip

Jaw 35mm
Width 20mm

Colour	Code
Red	LGC023R
Black	LGC023B



STAINLESS STEEL ALLIGATOR CLIP

Jaws and spring are stainless steel T304-BA giving protection from erosion and rust for a long term reliable contact. 6.35mm spade. 80mm long plastic 18mm wide jaw grasp.

REQUIRES 6.35mm SPADE CONNECTOR



Colour	Code
Red	LGC020R
Black	LGC020B
Green	LGC020G

1.3M LEAD & RING TERMINAL

Colour	Code
Red	LGC020R-CA
Green	LGC020G-CA
Black	LGC020B-CA

1.2M LEAD TO DC 2.5MM

Code
LGC020RB-DC

□ Spade & Ring Gold Plated

SPADE CONNECTORS 4MM

Spade	Boot	Code
4mm	Red	TS300
4mm	Black	TS301



SPADE CONNECTORS 6.3MM

Spade	Boot	Code
6.3mm	Red	TS310
6.3mm	Black	TS311



SCREW CONNECTORS 4MM

Cable	Boot	Code
8AWG	Red	TS200
8AWG	Black	TS201

SCREW CONNECTORS 4MM

Cable	Boot	Code
6AWG	Red	TS500
6AWG	Black	TS501



SCREW RIGHT ANGLE 4MM

Cable	Boot	Code
9AWG	Red	TS250
9AWG	Black	TS251

SCREW RIGHT ANGLE 4MM

Cable	Boot	Code
6AWG	Red	TS550
6AWG	Black	TS551



RING TERMINALS 4MM

Cable	Boot	Code
6AWG	Red	TR85
6AWG	Black	TR86

RING TERMINALS 8MM

Cable	Boot	Code
6AWG	Red	TR80
6AWG	Black	TR81



RING TERMINALS 8MM

Cable	Boot	Code
4AWG	Red	TR40
4AWG	Black	TR41



LARGE RING TERMINALS 8MM

Cable	Code
00 AWG	PRT500
02 AWG	PRT502
04 AWG	PRT504
08 AWG	PRT508





□ Banana 4mm

BANANA PLUG GOLD PLATED

Banana plug 4mm Screw terminating

Colour	Code
Red	P756
Black	P758



BANANA PLUG NICKEL PLATED

Banana plug 4mm Screw terminating

Colour	Code
Red	P754R
Black	P754B



BANANA PLUG NICKEL PLATED

Banana plug 4mm Nickel plated

Colour	Code
Red	P704R
Black	P704B



BANANA PLUG GOLD PLATED

GOLD PLATED

4mm system Multi-Lam tip Spring cage plug Screw terminal Wire 1.5mm I/D Stackable plugs Colour rubber boot Strain relief accepts 3mm cable Gold plated metal.

Colour	Code
Red	P752RD
Black	P752BK
Green	P752GN
Blue	P752BU
Yellow	P752YL
White	P752WH



BANANA PLUG GOLD PLATED 8AWG

Order One To Receive A Pack of Two 4mm cable entry.

Cable	Colour	QTY	Code
8awg	Red	2	P760
8awg	Black	2	P761



BANANA PLUG GOLD PLATED 6AWG

Order One To Receive A Pack of Two 5mm cable entry.

Cable	Colour	QTY	Code
6awg	Red	2	P765
6awg	Black	2	P766



BANANA PLUG PLATED 4AWG

Order One To Receive A Pack of Two 6mm cable entry.

Cable	Colour	QTY	Code
4awg	Red	2	P769
4awg	Black	2	P768



BANANA SOCKETS PANEL MOUNT 4MM

Banana socket 4mm

Colour	Code
Red	J724R
Black	J724B
Blue	J724BU
Yellow	J724YL
White	J724WH
Green	J724GN



4MM SAFETY SOCKET PANEL MOUNTS

35A 12mmØ

Colour	Code
Black	HCK31BK
Red	HCK31RD
Yellow	HCK31YL
Blue	HCK31BU
Green	HCK31GN



BANANA SOCKET/BINDING POST 4MM

20x12mmØ Banana socket/binding post 4mm

Colour	Code
Red	J714R
Black	J714B



BANANA SOCKET/BINDING POST LARGE

22x15mmØ Banana socket/binding post 4mm large

Colour	Code
Red	J715R
Black	J715B



BANANA SOCKET/BINDING POST DUAL

Dual binding posts, accepts 4mm banana plugs.

Code
J720



BANANA SOCKET/BINDING POST GOLD PLATED

Will accept either a 4mm plug and/or up to 5mm wire diameter at R/A. 20mm max panel thickness. Order One To Receive A Pack of Two.

Colour	QTY	Code
Red	2	P780
Black	2	P781



BANANA SOCKET/BINDING POST GOLD PLATED

Up to 7.5mm wire diameter. M2.5 threaded connection post Order One To Receive A Pack of Two

Colour	QTY	Code
Red	2	P770
Black	2	P771



BANANA SOCKET/BINDING POST TERMINATOR

RA post for terminating Up to 4mm wire diameters. Order One To Receive A Pack of Two

Colour	QTY	Code
Red	2	P775
Black	2	P776





Speaker

SPEAKER TERMINAL PLATE 4" SILVER

High-performance terminal cup solution from Dayton Audio. Made from 3mm brushed aluminium. Requires Dayton Binding Posts BPP Series. 2x 12mmØ with keyway. 100mm²

BRUSHED ALUMINIUM 3MM

Code
SBPP-SI



BLACK ANODISED ALUMINIUM 3MM

Code
SBPP-BK

SPEAKER TERMINAL PLATE 4x5½" SILVER

High-performance terminal cup solution from Dayton Audio. Made from 3mm brushed aluminium. Requires Dayton Binding Posts BPP Series. 4x 12mmØ with keyway. 100x140mm

BRUSHED ALUMINIUM 3MM

Code
DBPP-SI



BLACK ANODISED ALUMINIUM 3MM

Code
DBPP-BK

BANANA SOCKET/BINDING POSTS

Dayton audio high-quality 5-way binding posts offer audiophile features at a reasonable price. A free-spinning metal ferrule on the tightening knob allows a secure connection without any tendency to work loose.



SATIN NICKEL PAIR

QTY Code
2 BPP-SN

NICKEL PAIR

QTY Code
2 BPP-NI

GOLD PLATED PAIR

QTY Code
2 BPP-G

COMPATIBLE WITH
SBPP & DBPP PLATES



BANANA SOCKET/BINDING CABINET POSTS

The high-quality plating process eliminates the possibility of corrosion to maintain the highest possible signal transfer and be professional and attractive.

For mounting in speaker cabinets with walls up to 25.4mm thick (9.5mm minimum thickness). Overall length is 57.2mm.

SATIN NICKEL PAIR

QTY Code
2 BPA-38SN

NICKEL PAIR

QTY Code
2 BPA-38NI

GOLD PLATED PAIR

QTY Code
2 BPA-38G



ROUND SPEAKER BOX TERMINAL

50MM HOLE

Code
J709



ROUND SQUARE SPEAKER BOX TERMINAL

68MM HOLE

Code
J710



SPEAKER PANEL SQUARE

Supplied Packaged

2x 4mm. Hole 72x52mm.
Plate 92x78mm.

Code
J706

No Packaging BULK

Code
J707



SPEAKER PANEL BI-TERMINAL

Screw binding posts
4 x 4mm Red/Black.
Includes removable
straps. Hole 95x76mm.
Plate 122x95mm.

Code
J708



SPEAKER TERMINAL DUAL

2 x Push release
speaker terminals

Code
J702



SPEAKER TERMINAL QUAD

4 x Push release speaker terminals

Code
J704





□ DC Plugs

1.0mm P411

1.0mm centre
3.2mm O/D

Barrel Plug	Code
9mm	1.0mm P411



1.3mm P413

1.3mm centre
3.2mm O/D

Barrel Plug	Code
9mm	1.3mm P413



1.3mm MJ99

1.3mm centre
3.2mm O/D

Plug	Code
1.3mm	MJ99



1.3mm DC PLUG WITH LEAD

Pre-Made 1.8M DC Lead and plug.

Type	Barrel Plug	Code
Straight	9mm	1.3mm DCL1309ST
R/Angle	9mm	1.3mm DCL1309RA
Straight	12mm	1.3mm DCL1312ST
R/Angle	12mm	1.3mm DCL1312RA



2.1mm P421 SHORT-LONG BARREL

2.1mm centre 5.5mm O/D

Barrel	Plug	Code
9mm Long	2.1mm	P421S
12mm Long	2.1mm	P421L



2.1mm DC PLUG RIGHT ANGLE

5.5Ø x 2.1mmØ

Plug	Code
2.1mm	P421RA



2.1mm DC INLINE

5.5Ø x 2.1Ømm

Plug	Code
2.1mm DC	MS421



2.1mm DC SOCKET SCREW

Screw connector back

Size	Plug	Code
2.1mm	Pos. Tip	AD-DCJ21



2.1mm DC SOCKET PCB MOUNT

5.5Ø x 2.1Ømm

Plug	Code
2.1mm DC	J421



2.1mm DC SOCKET PCB MOUNT

5.5 x 2.1mm

Plug	Code
2.1mm DC	J427



2.1mm DC PANEL SOCKET

5.5Ø x 2.1Ømm

Plug	Code
2.1mm DC	MJ421

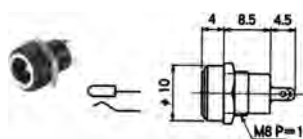

2.1mm DC PANEL SOCKET

O/D 5.5mmØ

I/D 2.1mmØ

Mount 14mmØ

Plug	Code
2.1mm DC	MJ100

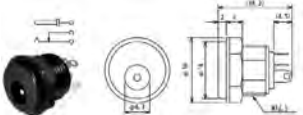

2.1mm DC PLUG SCREW

Screw connector back

Size	Plug	Code
2.1mm	Pos. Tip	AD-DCP21



2.1mm DC PLUG SCREW

Removable 2 pin connector

Size	Plug	Code
2.1mm	Pos. Tip	AD-DCP21RA

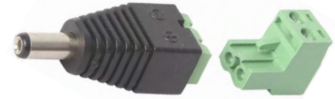

2.1mm DC PLUG WITH LEAD

Pre-Made 1.8M DC Lead & Plug

Type	Barrel Plug	Code
Straight	9mm	2.1mm DCL2109ST
R/Angle	9mm	2.1mm DCL2109RA
Straight	12mm	2.1mm DCL2112ST
R/Angle	12mm	2.1mm DCL2112RA



2.1mm DC PLUG PIGTAIL

30cm lead to bare end. 1A R&B.

Size	Plug	Code
2.1mm	Pos. Tip	DCL-P21



2.1mm PLUG TO 2 WAY TERMINAL BLOCK

2.1mm DC plug to 2 way terminal block.
With cable length of 25cm.

Plug	Code
2.1mm	DCL-P21TB



2.1mm DC SOCKET PIGTAIL

30cm lead to bare end. Red & Black Cable.

Size	Plug	Code
2.1mm	Pos. Tip	DCL-J21



10cm lead to bare end. Black round cable.

Plug	Code
2.1mm	DCL2119ST

2.1mm DC EXTENSION LEAD

2.1mm MALE TO FEMALE

Length	Code
1M	DCL21121
3M	DCL21123



2.1mm DC SPLITTERS

SOCKET TO MULTIPLE PLUGS

Plug	Size	Length	Code
2	2.1mm	30cm	ADC-221
4	2.1mm	30cm	ADC-421
8	2.1mm	30cm	ADC-821
5	2.1mm	30cm	ADC-521



USB-A MALE TO DC POWER PLUG

USB-A Male To DC PLUG 5.5mm x 2.1mm Positive Tip

Size	Code
2.1mm DC	CA448
0.7mm DC	CA456



USB-A FEMALE TO 2.1MM DC SOCKET

USB 'A' type socket converter cable.
Use standard 5V DC power supply
with 2.1mm plug Positive Tip.

Length	Code
150mm	DCL21USB

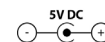

5.5 x 2.1mm



2.5mm SHORT OR LONG BARREL

2.5mm centre 5.5mm O/D

Barrel	Plug	Code
9mm	2.5mm DC	P425S
12mm	2.5mm DC	P425L



2.5mm DC PLUG RIGHT ANGLE

5.5Ø x 2.5mmØ

Plug	Code
2.5mm	P425RA



2.5mm DC INLINE SOCKET

5.5Ø x 2.5Ømm

Plug	Code
2.5mm DC	MS425



2.5mm DC SOCKET SCREW

Screw connector back

Size	Plug	Code
2.5mm	Pos. Tip	AD-DCJ25



2.5mm DC SOCKET PCB MOUNT

5.5Ø x 2.5Ømm

Plug	Code
2.5mm DC	J425



2.5mm DC SOCKET PCB MOUNT

5.5 x 2.5mm

Plug	Code
2.5mm DC	J428

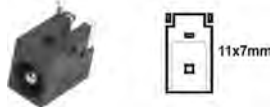

2.5mm DC SOCKET PANEL MOUNT

5.5Ø x 2.5Ømm

Plug	Code
2.5mm DC	MJ425

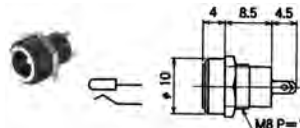

2.5mm DC SOCKET PANEL MOUNT - SWITCHED

O/D 5.5mmØ
I/D 2.5mmØ
Mount 14mmØ

Plug	Code
2.5mm DC	MJ110

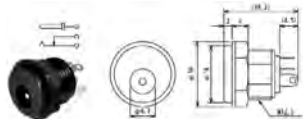

2.5mm DC PLUG SCREW

Screw connector back

Size	Plug	Code
2.5mm	Pos. Tip	AD-DCP25



2.5mm DC PLUG SCREW

Removable 2 pin connector

Size	Plug	Code
2.5mm	Pos. Tip	AD-DCP25RA



MULTI PLUG DC LEAD

2M Long lead 2 Amp with 8 interchangeable DC plugs.

Length	Plug	Code
2M	8x	MW-CP1



USB-A TO 0.7mm DC PLUG [2.5mmØ O/D]

USB male to DC power plug cable. The DC plug has an outside diameter of 2.5mm and inside diameter of 0.7mm. Cable lead is 0.6M.

Code
CA456



2.5mm DC PLUG WITH LEAD

PRE-MADE 1.8M LEAD

Pre-Made 1.8M DC Lead & Plug

Type	Barrel	Plug	Code
Straight	9mm	2.5mm	DCL2509ST
R/Angle	9mm	2.5mm	DCL2509RA
Straight	12mm	2.5mm	DCL2512ST
R/Angle	12mm	2.5mm	DCL2512RA



2.5mm DC PLUG REVERSIBLE CHANGEABLE "R" PLUGS

Pre-Made 1.8M DC Lead

Type	Plug	Code
Straight	DC 2.5mm	FSR-04
R/Angle	DC 2.5mm	FLR04
2Amp 1.8M Required		DCL-R2A
5Amp 1.8M Required		DCL-R5A



2.5mm DC PLUG PIGTAIL

30cm lead to bare end

Size	Plug	Code
2.5mm	Pos. Tip	DCL-P25



2.5mm PLUG TO 2 WAY TERMINAL BLOCK

2.5mm DC plug to 2 way terminal block. With cable length of 25cm.

Plug	Code
2.5mm	DCL-P25TB



2.5mm DC SOCKET PIGTAIL

30cm lead to bare end

Size	Plug	Code
2.5mm	Pos. Tip	DCL-J25



2.5mm PLUG TO PLUG

30cm LEAD

Pre-Made 30cm DC Lead

Plug	Type	Code
2.5mm DC	M-M	KLE01



2.5mm DC SPLITTERS

Plug	Size	Length	Code
2	2.5MM	30CM	ADC-225
4	2.5MM	30CM	ADC-425
8	2.5MM	30CM	ADC-825
5	2.5MM	30CM	ADC-525



DC ADAPTOR 2.5mm PLUG TO 2.1mm SOCKET

2.1mm FEMALE TO 2.5mm MALE

Length	Code
150mm	DCL2521



DC ADAPTOR 2.1mm PLUG TO 2.5mm SOCKET

Code
ADC2125



3.1mm DC PLUG

3.1mm I/D
6.3mm O/D

Barrel	Plug	Code
9mm	3.1mm DC	P431





EIAJ-01 DC PLUG

0.7ø x 2.35ømm

Plug	Code
EIAJ-01	MP201



EIAJ-01 R/A DC PLUG

0.7ø x 2.35ømm

Type	Plug	Code
R/Angle	EIAJ-01	MP201RA



EIAJ-01 DC INLINE SOCKET

Centre 0.7ømm

Plug	Code
EIAJ-01	S201

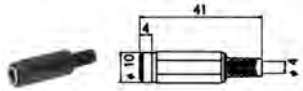

EIAJ-01 DC PANEL MOUNT

Centre 0.7ømm

Plug	Code
EIAJ-01	MJ201

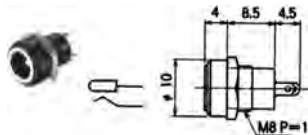

EIAJ-02 DC PLUG

1.7ø x 4ømm

Plug	Code
EIAJ-02	MP202



EIAJ-02 R/A DC PLUG

1.7ø x 4ømm

Type	Plug	Code
R/Angle	EIAJ-02	MP202RA



EIAJ-02 DC INLINE SOCKET

1.7ø x 4ømm

Plug	Code
EIAJ-02	S202

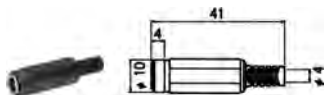

EIAJ-02 DC PANEL MOUNT

1.7ømm x 4ømm

Plug	Code
EIAJ-02	MJ202

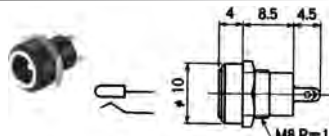

EIAJ-02 DC PANEL MOUNT SWITCHED

O/D 4.0mmø

I/D 1.7mmø

Mount 14mmø

Plug	Code
EIAJ-02	MJ120

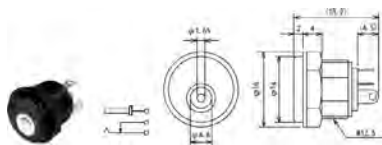

"R" PLUG AND LEAD SYSTEM

1.8M Prepared Lead with "R" Socket and Grommet.

Type	Plug	Code
2Amp 1.8M Required	DCL-R2A	
5Amp 1.8M Required	DCL-R5A	

"R" DC PLUGS TO SUIT DCL

Straight	DC 1.3mm	FSR-05
Straight	DC 2.1mm	FSR-02
Straight	DC 2.5mm	FSR-04
Straight	EIAJ-02	FSR-06
Straight	EIAJ-03	FSR-07
Straight	TRS 2.5mm	MSR01
Straight	TRS 3.5mm	MSR02
R/Angle	DC 1.3mm	FLR05
R/Angle	DC 2.1mm	FLR02
R/Angle	DC 2.5mm	FLR04
R/Angle	EIAJ-02	FLR06
R/Angle	EIAJ-03	FLR07
R/Angle	TRS 2.5mm	MLR01
R/Angle	TRS 3.5mm	MLR02



EIAJ-03 DC PLUG

1.7ø x 4.75ømm

Plug	Code
EIAJ-03	MP203



EIAJ-03 R/A DC PLUG

1.7ø x 4.75ømm

Type	Plug	Code
R/Angle	EIAJ-03	MP203L

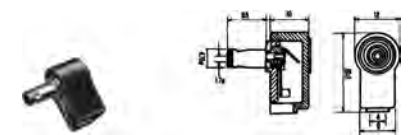

EIAJ-03 DC INLINE SOCKET

1.7ømm x 4.75ømm

Plug	Code
EIAJ-03	MS203

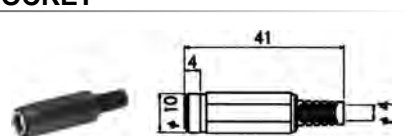

EIAJ-03 DC PANEL MOUNT SWITCHED

O/D 4.75mmø

I/D 1.7mmø

Mount 14mmø

Plug	Code
EIAJ-03	MJ203



EIAJ-04 DC PLUG

3.4ø x 5.5ømm

1.0øCentre Pin

Plug	Code
EIAJ-04	MP204



EIAJ-04 R/A DC PLUG

3.4ø x 5.5ømm

1.0ømm Centre Pin

Type	Plug	Code
R/Angle	EIAJ-04	MP204RA

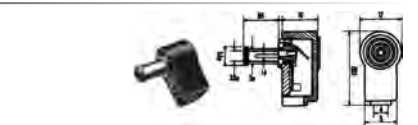

EIAJ-04 DC PANEL MOUNT SWITCHED

Centre 1.0ømm

Inside 3.4ømm

Plug	Code
EIAJ-04	MJ204

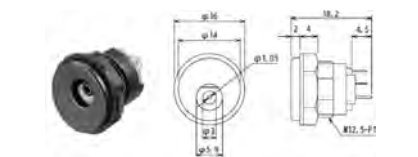

EIAJ-05 DC PLUG

4.4ø x 6.5ømm

1.4øCentre Pin

Plug	Code
EIAJ-05	MP205

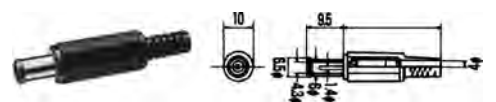

EIAJ-05 DC PANEL MOUNT SWITCHED

O/D 6.5mmø

I/D 4.3mmø

Centre 1.4mmø

Mount 14mmø

Plug	Code
EIAJ-05	MJ205



EIAJ LEAD 1.8M

1.8M Lead to bare end wires

1.7ø x 4.75ømm + Barrel length

Barrel	Plug	Code
12mm	EIAJ-03	DCL1712RA
9mm	EIAJ-03	DCL1709RA
1.7ø x 4.0ømm + barrel Length		
Barrel	Plug	Code
12MM	EIAJ-02	DCL1712RA-4





□ BNC

BNC PLUG COMPRESSION

New weather proof crimp
See compression page..

Cable	Code
RG58au/cu	P640
RG59u	P642
RG59au	P643
RG6	P644
RG6-Quad	P645



BNC PLUG CRIMP RG58U

Cable	Pins	Code
RG58u	0.9mmØ	P659



BNC PLUG CRIMP RG58CU

Cable	Pins	Code
RG58cu	1.2mmØ	P660



BNC PLUG CRIMP LMR400

Cable	Code
LMR400	BNC7025



BNC PLUG CRIMP RG59U

Cable	Pins	Code
RG59u	0.7mmØ	P662



BNC PLUG CRIMP RG59AU

Cable	Pins	Code
RG59au	0.9mmØ	P661



BNC PLUG CRIMP RG6

Cable	Pins	Code
RG6	1.1mmØ	P663



BNC PLUG CRIMP RG174

Cable	Code
RG174	BNC7001



BNC PLUG CRIMP RG59 HEAVY-DUTY

Barrel crush

Suit	Code
RG59u	P632



BNC PLUG CRIMP RG6 HEAVY-DUTY

Barrel crush

Suit	Code
RG6	P634



BNC PLUG CRIMP RG213 HEAVY-DUTY

Barrel crush

Suit	Code
RG213	P667



BNC PLUG COMPRESSION DELUXE

GOLD PLUG WITH GUN-METAL BARREL
High quality gold plated compression plug.
Supplied with 6 colour rings for identification.

Cable	Code
RG59U	P646
RG6QUAD	P647



BNC PLUG CRIMP RG213 RIGHT-ANGLE

Right Angle

Suit	Code
RG8 & RG213	BNC7002



BNC PLUG CRIMP - NEUTRIK

Crimp Centre: 1.6 mm (square)
Crimp Shield: see table (hex)

Coax	Shield	Pin	Code
RG59B/U	6.47mm	1.6mm	NBNC75-BLP7
L-4CFB	6.47mm	1.6mm	NBNC75-BLP9
L-5CFB	8.23mm	1.6mm	NBNC75BYY11



Colour Boots Available:
See web.

BNC PLUG RG58 SOLDER

BNC plug solder type
Suit 1.2mm RG58 cable

Code
P601



BNC PLUG RG59 SOLDER

BNC plug solder type
Suit 0.9mm RG59 cable

Code
P602



BNC PLUG SCREW TERMINATING RG58 RG59

BNC plug
screw terminating

Code
P651



BNC PLUG SCREW TERMINATING RG58 RG59

BNC right angle
screw terminating

Code
P653



BNC TO 2 PIN SCREW

Screw terminals

Code
AD-BNC1



BNC PLUG TWIST-ON

Cable	Code
RG58	P664
RG59U	P665



BNC PLUG RG213 TWIST-ON

Suit RG213
Heavy duty twist-on
Compression assembly

Code
P603



BNC PLUG LOAD TERMINATOR

BNC Plug with load

Type	Code
50Ω	BNT50
75Ω	BNT75
93Ω	BNT93





BNC SOCKET PANEL MOU

BNC panel socket
silver plated

Code
J600



BNC SOCKET TO SOCKET PANEL AMPHENOL

Metal Chassis BNC-BNC Rear.
Amphenol Plate 31x26mm

Colour Code
Silver AC-BNC-JJ-75
Black AC-BNC-JJ-75B



BNC SOCKET TO SOCKET PANEL NEUTRIK

31x26mm Neutrik. BNC Feed Through.
Extremely robust diecast.

Code
NU-NBB75DFI



BNC SOCKET PANEL NEUTRIK

Grounded BNC chassis connector, solder
version in nickel D-shape housing.

Code
NBB75DSG



BNC SOCKET TO SOCKET PANEL MOUNT

BNC female - female
Panel Mount.

Code
P682



BNC SOCKET CRIMP PANEL MOUNT RG58

BNC panel mount.

Code
J605



BNC SOCKET CRIMP PANEL MOUNT RG59U

BNC panel mount.

Code
J606



BNC SOCKET CRIMP RG58

BNC female crimp RG58

Code
P670



BNC SOCKET CRIMP RG59

BNC female crimp RG59

Code
P672



BNC SOCKET CRIMP RG174

BNC female crimp RG174

Code
BNC7022



BNC SOCKET CRIMP RG213U

Cable Code
RG213U BNC7024



BNC SOCKET CRIMP RG6QUAD

Cable Code
RG6QUAD BNC7023



BNC SOCKET CRIMP LMR195

Cable Code
LMR195 BNC7026



BNC SOCKET CRIMP LMR400

Cable Code
LMR400 BNC7027



BNC SOCKET TO 2 PIN SCREW

Screw terminals

Cable Code
Wire AD-BNC2



BNC PLUG REVERSE CRIMP

Cable Code
RG174 BNC2001



BNC SOCKET REVERSE CRIMP

Cable Code
RG174 BNC2022





□ PAL

PAL PLUGS COMPRESSION

Nickel Plated Barrel

Cable	Code
RG59	P542
RG6	P543
RG6-Quad	P544



PAL PLUG IN LINE PLASTIC

TV coaxial plug
screw terminating
Plastic plug.

Code
P515



PAL PLUG IN LINE METAL

TV coaxial plug
Screw terminating
Metal plug.

Code
P540



PAL PLUG CRIMP RG6

Suit RG6, etc.
(6-7mmØ)

Code
P541



PAL SOCKET IN LINE PLASTIC

TV coaxial in-line socket
screw terminal Plastic

Code
S512



PAL SOCKET IN LINE PLASTIC DELUXE

TV coaxial in-line
socket screw terminal
Plastic Deluxe style

Code
S511



PAL SOCKET RIGHT ANGLE PLASTIC

TV coax right angle
screw terminating
Plastic socket.

Code
S535



PAL SOCKET IN LINE METAL

TV coax metal in-line socket
screw terminal Metal socket.

Code
S520



PAL SOCKET CRIMP RG6

Suit RG6, etc.
(6-7mmØ)

Code
S521



PAL PLUG PANEL MOUNT

75Ω coax chassis
PAL Male

Code
J501



PAL SOCKET PANEL MOUNT

75Ω coax chassis PAL Socket Female

Code
J500



PAL SOCKET PCB MOUNT

75Ω PCB mount PAL
Socket Female

Code
J561



PAL SOCKET PANEL MOUNT

Panel Mount
PAL Socket
Female

Code
J510



PAL SOCKET PANEL MOUNT

Female chassis mount.
Suit 14-17mm hole.

Code
J512



PAL TO "F"

CLIPSAL® COMPATIBLE

Code
WPI250



Clipsal®
Compatible
Wall Plates
and Assorted
Sockets
Available:
Page 02-110

300 OHM PLUG

Classic 2 pin wall plug suit older
ribbon type antenna cable.

Type Code
2mm P521



COAX CABLE JOINER SCREW TERMINATING

Coax cable joiner Screw terminating

Collar Code
Black CJ500B
White CJ500W





□ "F"

"F" PLUG CRIMP RG59

Attached Crimp Collar

Code
FL59



"F" PLUG RG59 PUSH-ON

Code
F367



"F" PLUG - TWIST ON RG59

O/D 6mmØ, RG59

Code
FT59



"F" PLUG RG59 QUICK DISCONNECT

Suit 6.0-6.5mm O/D Slip-On

Code
F70



"F" PLUG CRIMP RG6

Attached Crimp Collar
For added strain relief.

Code
FL65



"F" PLUG CRIMP RG6QUAD - GILBERT

Suit RG6 Quad Shield Cable
Gilbert USA standard Unsealed

Code
F322



"F" PLUG CRIMP RG6QUAD - GILBERT IP

Suit RG6 Quad Shielded Cable
Gilbert USA Sealing Grommet

Code
F325



"F" PLUG RG6QUAD PUSH-ON

Rust proof. 6.0-7.2mm O/D Coax.

Code
F368



"F" PLUG RG6-DUAL TWIST-ON

O/D 6.5mmØ, RG6

Code
FT65



"F" PLUG RG6-QUAD TWIST-ON

O/D 6.5mmØ, RG6

Code
FT65Q



"F" PLUG CRIMP RG11

Suit RG11 Cable
Separate Pin

Code
F335



"F" PLUG CRIMP RG11

Suit RG11 Cable Integrated pin

Code
F336

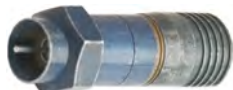

"F" PLUG CRIMP LMR400 LL400

Code
F514



"F" PLUG CONICAL COMPRESSION RG6Q

Suit HT507 Tool

Cable Code
RG6QUAD F507



"F" PLUG COMPRESSION

Nickel Plated Barrel

Cable Code
RG59 F331
RG6 F333



"F" COMPRESSION RG6 QUAD

PREMIUM CONTACT TRI/QUAD

3GHz bandwidth universal to suit
most RG6 Tri & Quad shielded coax.

Cable Code
RG6-Quad F334



"F" PLUG COMPRESSION SHORT RG6 RG6Q

RG6 & RG6QUAD

Only 22mm when compressed

Cable Code
RG6/RG6-Quad F337



"F" COMPRESSION RG6 - FOXTEL® APPROVED

FOXTEL® F30574

Cable Code
RG6-Quad APFTRSF6L

Tool: TKIT4



"F" COMPRESSION RG11 - FOXTEL® APPROVED

FOXTEL® APPROVAL F30709

Foxtel Code
F30709 APFTRSF11L



"F" PLUG TERMINATOR 75Ω

Code
FTM75

FOXTEL® APPROVED F30732

Foxtel Code
F30732 APFDM1



"F" TERMINATOR 75Ω DC BLOCKING - KINGRAY

75 ohm terminator that is DC blocked.

Code
KFTERM01



"F" FEMALE CRIMP RG59

Suit RG59 Cable 6.0mm O/D Push On

Code
FS59



"F" FEMALE CRIMP RG6

Suit RG6 Cable 6.5mm O/D Push On

Code
FS65





□ RF

FME FEMALE CRIMP RG58

FME Female Crimp RG58

Cable Code
RG58 FME100



FME FEMALE CRIMP RG174

FME Female crimp RG174

Cable Code
RG174 FME8001



FME FEMALE CRIMP LMR400

Cable Code
LMR400 FME8002



FME MALE CRIMP RG58

FME Male RG58

Cable Code
RG58 FME158



FME MALE CRIMP RG174

FME Male RG174

Cable Code
RG174 FME8015



FME MALE CRIMP LMR400

Cable Code
LMR400 FME8016



SMA MALE CRIMP RG58

SMA male crimp, RG58

Cable Code
RG58 SMA58



SMA MALE CRIMP RG174

SMA Male crimp type
suit RG174 cable.

Cable Code
RG174 SMA174



SMA MALE CRIMP RG174 RIGHT ANGLE

SMA Male crimp Right Angle
suit RG174 cable.

Cable Code
RG174 SMA174R



SMA MALE CRIMP LMR400

Cable Code
LMR400 SMA2811



SMA MALE CRIMP LMR195

Cable Code
LMR195 SMA2808



SMA MALE CRIMP RG58 PANEL MOUNT

Cable Code
RG58 SMA258



SMA FEMALE CRIMP RG58

Cable Code
RG58 SMF58



SMA FEMALE CRIMP RG174U BULKHEAD

Cable Code
RG174U SMA176



SMA FEMALE CRIMP RG174U

Cable Code
RG174U SMA175



SMA FEMALE CRIMP LMR195 LMR400

Cable Code
LMR400 SMA2812
LMR195 SMA2813



SMA-RP REVERSE MALE CRIMP

Suit Code
RG58 SMA158
RG174 SMA2801
LL195 SMA159
LMR195 SMA2815



SMA-RP REVERSE MALE CRIMP LMR400

Cable Code
LMR400 SMA2817



SMA-RP REVERSE FEMALE CRIMP

Suit Code
RG58 SMF158
RG174 SMA2809
LL195 SMF159
LMR195 SMA2816



SMA-RP REVERSE FEMALE CRIMP LMR400

Cable Code
LMR400 SMA2818



SMB MALE CRIMP RG174

Male with Centre Female pin.
Crimp type to suit RG174 cable.

Suit Code
RG174 SMB101



SMB FEMALE CRIMP RG174

Female with Centre Male pin.
Crimp type to suit RG174 cable.

Suit Code
RG174 SMB105





TNC PLUGS CRIMP

Cable	Code
RG58	TNC28
RG59	TNC29
RG213	TNC7402



TNC PLUG CRIMP RG174

TNC Male crimp
Suit RG174 cable

Cable	Code
RG174	TNC7401



TNC PLUG SCREW-ON RG58U

TNC thread-on plug

Cable	Code
RG58U	TNC218



TNC28 CRIMP TYPE RG58U RIGHT ANGLE

Cable	Code
RG58U	TNC28RA



TNC SOCKET CRIMP RG58 PANEL MOUNT

TNC panel mount
crimp type RG58.

Cable	Code
RG58	TNC45



TNC SOCKET CRIMP RG58

TNC female crimp type to suit RG58 cable.

Cable	Code
RG58	TNC99
RG213	TNC7416



TNC SOCKET CRIMP RG174

TNC Female crimp
Suit RG174 cable

Cable	Code
RG174	TNC7415



TNC SOCKET PANEL MOUNT SOLDER

TNC chassis mount.

Cable	Code
Solder	TNC232



TNC PLUG CRIMP LMR195

Cable	Code
LMR195	TNC2419



TNC SOCKET CRIMP LMR195

Cable	Code
LMR195	TNC2420



TNC PLUG CRIMP LMR400

Cable	Code
LMR400	TNC2421



TNC SOCKET CRIMP LMR400

Cable	Code
LMR400	TNC2424



TNC PLUG REVERSE CRIMP

Reverse TNC Plug

Cable	Code
RG58	TNC27
RG174	TNC2401



TNC SOCKET REVERSE CRIMP

Reverse TNC Socket

Cable	Code
RG58	TNC98
RG174	TNC2415



TNC PLUG REVERSE CRIMP LMR400

Cable	Code
LMR400	TNC2422



TNC SOCKET REVERSE CRIMP LMR400

Cable	Code
LMR400	TNC2423



TNC PLUG REVERSE CRIMP LMR195

Cable	Code
LMR195	TNC2425



TNC REVERSE CRIMP LMR195

Cable	Code
LMR195	TNC2426



TWIN AXIAL SOCKET SOLDER

Twin Axial Female plug

Cable	Code
Solder	TAC105



LUCENT PLUG CRIMP RG174

Lucent WiFi Crimp Suits MC Cards, etc.
LMR100 RG174 Cable

Cable	Code
RG174	LPC101



LUCENT PLUG TO REVERSE SMA SOCKET

Fly lead 50cm Lucent MC-Card WiFi Connector
to SMA-RP Plug

Code
CAL711



MCX PLUG CRIMP RG174

MCX 6GHz Gold Plated RG174

Cable	Code
RG174	MCX101



MCX PLUG CRIMP RG174 RIGHT ANGLE

MCX 6GHz Gold Plated
RG174 Right Angle

Cable	Code
RG174	MCX102



MCX PLUG CRIMP RG58

MCX 6GHz Gold Plated
RG58 Coax Crimp

Cable	Code
RG58	MCX103





MCX PLUG CRIMP RG58

MCX 6GHz Gold Plated
RG58 Coax Crimp

Cable	Code
RG58	MCX112



MCX SOCKET CRIMP RG174

MCX 6GHz Gold Plated
RG174 Female

Cable	Code
RG174	MCX111



MMCX PLUG CRIMP RG174

MMCX 6GHz Gold Plated
RG174 RG178 RG188 RG318

Cable	Code
RG174	MMCX101



MMCX PLUG CRIMP RIGHT ANGLE RG174

MMCX 6GHz Gold Plated
RG174 RG178 RG188 RG316

Cable	Code
RG174	MMCX101RA



MMCX SOCKET CRIMP RG174

Gold Plated 6GHz RG174

Cable	Code
RG174	MMCX102



"N" SOCKET CRIMP RG174

Cable	Code
RG174	N7303



"N" SOCKET CRIMP RG8U LL400 LMR400

"N" Female LL400 LMR400 RG8u Cable

Cable	Code
RG8	N129
LL400	
LMR400	



"N" SOCKET CRIMP RG58/RG213

"N" Female RG58 or RG213 Cable

Cable	Code
RG58CU	N127
RG213	N128



"N" SOCKET CRIMP LMR195 LMR400

Cable	Code
LMR195	N7305
LMR400	N7307



"N" PLUGS CRIMP

Cable	Code
RG174	N7301
RG58CU	N120
RG213	N112
LL400	N113
LMR195	N7304
LMR400	N7306



"N" PLUG SCREW-ON

Screw-down compression

Cable	Code
RG58	N115
RG213	N110



"N" PLUG CRIMP RG8 RG213

"N" Male crimp RG8 &
RG213 cable. Right Angle

Cable	Code
RG8 RG213	N7302



"N" PLUG SCREW-DOWN LL400 RG213

"N" Male Right/Angle LL400 RG213
Cable Screw-down compression

Cable	Code
RG213 LL400	N126



"N" PLUG SCREW-DOWN RG58

"N" male right angle for RG58 type cable.
Screw-down compression

Cable	Code
RG58	N125



"N" SOCKET PANEL MOUNT SOLDER

"N" type female
chassis mount.

Cable	Code
Solder	N145



"N" SOCKET PANEL MOUNT SOLDER

"N" female waterproof Earthed
chassis mount Solder rear terminal

Cable	Code
Solder	N150



"N" SOCKET CRIMP RG58 BULKHEAD

"N" female waterproof Earthed
chassis mount RG58 Crimp rear

Cable	Code
RG58	N152



"N" SOCKET SCREW-DOWN RG8 RG213

"N" female waterproof
Earthed chassis mount
RG8 & RG213 Collar twist

Cable	Code
RG8 RG213	N154



"N" REVERSE POLARITY PLUG

Cable	Code
RG213U	N201
RG58U	N203
RG174	N205
LMR400	N207



"N" REVERSE POLARITY SOCKET

Cable	Code
RG213U	N202
RG58U	N204
RG174U	N206
LMR400	N208





UHF PLUG PL-259 SOLDER RG58

UHF Plug for RG58 Short Barrel Type.
Twist-on shield, solder tip.

Cable	Code
RG58	PL259A



UHF PLUG PL259 SOLDER RG213-JU RG58

UHF Plug for **RG213-JU**
REDUCER for **RG58**

Cable	Code
RG58	PL259R



UHF PLUG PL259 SCREW ON RG58 RG59

UHF Plug with strain relief suit RG58 RG59

Cable	Code
RG58 RG59	PL259S



UHF PLUG PL259 SCREW ON RG58 RG59

Right angle strain relief suit RG58 RG59

Cable	Code
RG58 RG59	PL259SRA



UHF PLUG PL259 CRIMP

Suit	Code
RG58	PL259-58
RG59	PL259-59



UHF PLUG PL259 SOLDER RG58

Suit **RG58** Cable
Screw Collar (Short)

Cable	Code
RG58	PL259-CL58



UHF PLUG PL259 SOLDER HEAVY-DUTY

Suit	Code
RG58	PL259-SC58
RG213	PL259-SC213



UHF PLUG PL259 CRIMP RG213

Suit **RG213** Cable
Locking Collar

Cable	Code
RG213	PL259-213



UHF SOCKET SO239 SOLDER PANEL MOUNT

Panel socket UHF

Cable	Code
Solder	SO239



UHF SOCKET SO239 SOLDER

RG58u Twist-On Wide Bandwidth

Cable	Code
Solder	IL239-58

RG213u Twist-On Wide Bandwidth

Cable	Code
RG213U	IL259-213



UHF SOCKET SO239 SOLDER PANEL MOUNT

Panel socket UHF

Cable	Code
Solder	PM239



UHF SOCKET SO239 SOLDER BULKHEAD

Panel Socket Solder Gold pin
wide-band

Cable	Code
Solder	SPM239



UHF SOCKET SO239 SOLDER RG58U BULKHEAD

Panel Socket Solder
Twist-On RG58u

Cable	Code
RG58	SPM239-58



UHF SOCKET SO239 SOLDER RG213 BULKHEAD

Panel Socket PL259 Solder
Twist-On RG213

Cable	Code
RG213	SPM239-213



MINI UHF PLUG CRIMP

Suit	Code
RG174	M259-174
RG58	M259-58
RG59	M259-59



MINI UHF SOCKET CRIMP RG58

Mini UHF crimp inline socket RG58 coax

Cable	Code
RG58	S259-58



MINI UHF SOCKET CRIMP RG174

Mini UHF crimp inline socket RG174 coax

Cable	Code
RG174	S259-174



RCA PLUG CRIMP

Suit	Code
RG59	P360
RG58	P361



RF Miscellaneous

GOLD PINS BNC TNC

Suit BNC,TNC,etc. 10 pcs.

Type	Code
0.7mm hole	BNP7
0.9mm hole	BNP9
1.2mm hole	BNP12



CRIMP FERRULES

Suit crimp plugs. 10pcs

Type	Code
RG58 type	FER58
RG59 type	FER59



STRAIN RELIEF BOOTS

Suit	Colour	Code
RG58 Cable	Black	58SRB-BK
RG58 Cable	Blue	58SRB-BU
RG58 Cable	Green	58SRB-GN
RG58 Cable	Red	58SRB-RD
RG58 Cable	White	58SRB-WH
RG58 Cable	Yellow	58SRB-YL
RG59U Cable	Black	59SRB-BK
RG59U Cable	Blue	59SRB-BU
RG59U Cable	Green	59SRB-GN
RG59U Cable	Red	59SRB-RD
RG59U Cable	White	59SRB-WH
RG59U Cable	Yellow	59SRB-YL
RG6 Cable	Black	6SRB-BK
RG6 Cable	Blue	6SRB-BU
RG6 Cable	Green	6SRB-GN
RG6 Cable	Red	6SRB-RD
RG6 Cable	White	6SRB-WH
RG6 Cable	Yellow	6SRB-YL





Multi-Pin Misc

AUTOMOTIVE PLUG IP67 KIT [DTP]

Amphenol

AMPHENOL AT SERIES PAIR KITS - SUIT DTP

IP67 waterproof plug set compatible with DTP Deutsch plugs as used in marine, automotive, industrial, lighting. Up to 13A. 20-14AWG. -55°C to 125°C

Pin	QTY	Plug	Code
2	2	Male & Female	AT2PS-CKIT
4	2	Male & Female	AT4PS-CKIT
6	2	Male & Female	AT6PS-CKIT



NBN/UFB POWER CONNECTION TO 30XM CABLE

This NBN/UFB replacement connector is a Molex 8 Pin plug pre-assembled with 2 wire cable and bare ends.

Code
DCL2028

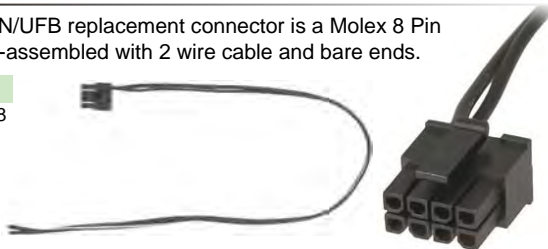

CB Microphone Plugs

MICROPHONE PLUGS

Type	Code
2 pin	NC514-2
3 pin	NC514-3
4 pin	NC514-4
5 pin	NC514-5
6 pin	NC514-6
7 pin	NC514-7
8 pin	NC514-8



MICROPHONE PLUGS RIGHT ANGLE

Type	Code
2 pin	NC516-2
3 pin	NC516-3
4 pin	NC516-4
5 pin	NC516-5
6 pin	NC516-6
7 pin	NC516-7
8 pin	NC516-8



MICROPHONE PANEL MOUNT SOCKETS

Type	Code
2 pin	NC515-2
3 pin	NC515-3
4 pin	NC515-4
5 pin	NC515-5
6 pin	NC515-6
7 pin	NC515-7
8 pin	NC515-8



MICROPHONE INLINE SOCKETS

Type	Code
2 pin	NC518-2
3 pin	NC518-3
4 pin	NC518-4
5 pin	NC518-5
6 pin	NC518-6
7 pin	NC518-7
8 pin	NC518-8



Car Antenna

CAR ANTENNA PLUG

Screw terminating type.

Code
CAP20



CAR ANTENNA PLUG

Standard solder type.

Code
CAP10



CAR ANTENNA SOCKET

Screw terminating type.

Code
CAS50



CAR ANTENNA SOCKET

Standard solder type.

Code
CAS10



CAR ANTENNA INPUT

"PIG TAIL"

Hangs out the back of the car stereo.

Code
APT1



CAR ANTENNA ADAPTOR

Standard to the new European

Code
AD653



CAR ANTENNA ADAPTOR

European to Standard

Plug

Code
AD655

Lead

Code
CAL655



CAR ANTENNA EXTENSION LEADS

Length	Code
0.6M	CAL60
1.2M	CAL120
3.6M	CAL360
5.0M	CAL500





Adaptors Cross Reference

ADAPTOR CROSS-REFERENCE

Quick reference guide for adaptors. See following pages for descriptions.

2.5mm Mono Male

3.5mm Mono Female	AD11
-------------------	------

2.5mm Stereo Male

3.5mm Mono Female	AD112
3.5mm Stereo Female	AD111

2.5mm Stereo Female

3.5mm Male Stereo	AD115
-------------------	-------

3.5mm Mono Female

6.35mm Male Mono	AD21
RCA Male	AD31
3.5mm Male Mono R/A	AD114
2.5mm Male Mono	AD11

3.5mm Mono Male

6.35mm Female Mono	AD12
RCA Female	AD13
6.35mm Female Stereo	AD123
3.5mm Stereo Female	AD113
3.5mm Female Mono R/A	AD114
PAL Female	TVA25
RCA Female x 2	AD1130

3.5mm Stereo Female

2.5mm Stereo Plug	AD112
2.5mm Stereo Plug	AD111
3.5mm Female Stereo	AD217
3.5mm Female Stereo	AD218
3.5mm Male Stereo R/A	AD216
3.5mm Mono Male	AD113
6.35mm Mono Male	AD213
6.35mm Stereo Male	AD212

3.5mm Stereo Female x 2

3.5mm Stereo Male	AD1210
6.35mm Male Stereo	AD2210

3.5mm Stereo Male

6.35mm Stereo Socket	AD122
RCA Female x 2	AD1230
3.5mm Stereo Female x 2	AD1210
2.5mm Stereo Female	AD115
3.5mm Stereo Female	AD216
3.5mm Stereo Female x5	AD1206

3.5mm QUAD

Quad Splitter	AD9052
Quad Splitter	MP155
Quad To Stereo x2	AD921

6.35mm Mono Female

3.5mm Male Mono	AD12
RCA Male	AD32

6.35mm Mono Male

3.5mm Female Mono	AD21
RCA Female	AD23
6.35mm Female Stereo	AD223
3.5mm Female Stereo	AD213
RCA Female x 2	AD2130
6.35mm Female Mono x2	AD2120

6.35mm Stereo Female

3.5mm Male Mono	AD123
3.5mm Stereo Male	AD122
6.35mm Mono Male	AD223

6.35mm Stereo Male

3.5mm Stereo Female	AD212
RCA Female x 2	AD2230
6.35mm Sockets x 2	AD2220
3.5mm Sockets x 2	AD2210
XLR Female	NA3MP

6.35mm x 2

6.35mm Male Stereo	AD2220
6.35mm Male Mono	AD2120

BNC Female

BNC Male right angle	P680
BNC Male x 2	P696
BNC Female X2	P693
BNC Female	P694
F Male	AD290
F Female	AD291
FME Female	FME145
SMA Female	SFB148
Mini UHF Male (S259)	MUF339
UHF Male (PL259)	AD210
N Male	N155
PAL Male	AD292
PAL Female	AD294
RCA Male	AD260
SMA Male	SMA230
TNC Male	TNC268
TNC Female	AD1175
UHF Female	AD241

BNC Female x 2

BNC Male	P695
BNC Male	P697
BNC Female	P693

BNC Male

BNC Male	AD1190
Banana binding posts X 2	BP60
BNC Female, right angle	P680
BNC Female X 2	P695
BNC Female X 2	P697
F Female	AD280
FME Male	FME140
FME Female	FME146
N Male	N157
N Female	N156
Mini UHF Female (S259)	MUF439
PAL Female	AD235
RCA Female	AD230
UHF Female (SO239)	AD240
SMA Female	SMA430
TNC Female	TNC254

BNC Male x 2

BNC Female	P696
------------	------

CRC9 Male

FME Male	CAL802
SMA Female	CAL820

F Female

BNC Male	AD280
BNC Female	AD291
BNC Male	AD328
F Male Push-On	F72
RCA Male	AD340
F Female Short	AD327
F Female Long	AD327L
F Female 3GHz	AD327-3GHZ
F Female Long	APFF/FF3NV
MCX Male	AD1152
PAL Male	AD320
PAL Male	AP1/FF
PAL Female	AD325
PAL Male R/A	AD329
SMA Female	AD1106
SMA Male	AD1105
N Male	AD1050

F Male

BNC Female	AD290
F Female R/A	AD328
F Male	AD315
PAL Female	AD310
PAL Female	AP3/F
RCA Female	AD330
F Female Push-On	F72

FME Female

BNC Male	FME146
BNC Female	FME145
FME Female	AD1111
N Male	AD1077
N Female	AD1075
SMA Male	AD1103
SMA Female	AD1104
TNC Female	FME110
Mini UHF Female (S259)	FME250

FME Male

BNC Male	FME140
CRC9 Male R/A	CAL802
FME Female	FME122
FME Male	FME120
MC Lucent (Patch Lead)	CAL712
Mini UHF Male M259 Long	FME265
Mini UHF Male M259 Short	FME150
MMCX Male	CAL807
MMCX Male RA	CAL812
N Female	AD1145
N Male	FME160
SMA Male	AD1112
SMK TS-9 Male	CAL821
SMK TS9 x2	CAL828
SSMB Male	CAL809
SSMB Male R/A	CAL805
TNC Male	FME130
UHF Male (PL259)	FME259

FME Male x2

SMK TS-9 Male x2	CAL823
SMK TS9 R/A x2	CAL830

MC Lucent Male

SMA-RP Male	CAL711
FME Male	CAL712
SMA Female	CAL716

MCX Female

SMA-RP Male	AD1143
-------------	--------

MCX Male

F Female	AD1152
N Male	AD1141
N Female	AD1142
PAL Female	AD1151
SMA Female	AD1140
SMA Female	CAL714
N Female	CAL715
SMA-RP Female	CAL710



MMCX Male

SMA Female	AD1120
SMA-RP Female	AD1122
FME Male	CAL807
FMA Male	CAL812
SMA Female	CAL808

MMXC Female

SMA Female	AD1121
------------	--------

N Female

BNC Male	N156
FME Female	AD1075
FME Male	AD1145
MCX Male	AD1142
MCX Male	CAL715
N Female	N135
N Male R/A	AD412
RP-TNC Male	AD1049
SMA Female	AD1073
SMA Male	AD1074
SMA-RP Female	AD1005
SMA-RP Male	AD1012
TNC Female	TNC279
TNC Male	TNC278
TNC-RP Female	AD1044
TNC-RP Male	AD1041
UHF Male (PL259)	AD1076



N Female x 2

N Male (T type)	N140
N Female	N141



N Male

BNC Female	N155
BNC Male	N157
F Female	AD1050
FME Female	AD1077
FME Male	FME160
MCX Male	AD1141
N Female R/A	AD412
N Female x 2 (T type)	N140
N Male	N130
SMA Female	AD1071
SMA Male	AD1072
SMA-RP Female	AD1006
SMA-RP Male	AD1001
TNC-RP Female	AD1044
TNC-RP Male	AD1042
UHF Female (SO239)	N160

PAL Female

BNC Male	AD235
BNC Female	AD294
F Male	AD310
F Male	AP3/F
F Female	AD325
PAL Female	AD500
PAL Male	AD510
RCA Female	AD503
RCA Female Chassis	AD504
RCA Male	AD505
3.5mm Male Mono	TVA25
MCX Male	AD1151
Samsung	BN39-01154Q
PAL Male	AD512

PAL Male

BNC Female	AD292
F Female	AD320
F Female	AP1/FF
PAL Female	AD510
PAL Male	AD511
RCA Female	AD513
F Female R/A	AD329
PAL Female	AD512



□ Adaptors Cross Reference

RCA Female

3.5mm Male Mono	AD13
6.35mm Male Mono	AD23
BNC Male	AD230
F Male	AD330
PAL Female	AD503
PAL Female (chassis)	AD504
PAL Male	AD513
RCA Female	AD33
RCA Female [gold]	AD955
RCA Female Splitter	AD3131
RCA Female Triple	AD35
RCA Male Long R/A	AD960
RCA Male R/A Black	AD42
RCA Male R/A Red	AD44
RCA Male Short R/A	AD962
S-VHS Male	SVHS322
UHF Male PL259	AD220
XLR Socket	AD977



RCA Female x 2

3.5mm Male Mono	AD1130
3.5mm Male Stereo	AD1230
6.35mm Male Mono	AD2130
6.35mm Male Stereo	AD2230
RCA Female Pair	AD34
RCA Female Splitter	AD3131
RCA Male	AD3130
RCA Male [gold]	AD965



RCA Female x 3

RCA Female x3	AD35
SCART Male Input	AD904
SCART Male w/ I/O SW	AD905
SCART Male YUV/RGB	AD906

RCA Male

3.5mm Mono Female	AD31
6.35mm Mono Female	AD32
BNC Female	AD260
F Female	AD340
PAL Female	AD505
RCA Female R/A Black	AD42
RCA Female R/A Gold	AD962
RCA Female R/A Long	AD960
RCA Female R/A Red	AD44
RCA Female X 2	AD3130
RCA Female X 2 [gold]	AD965
RCA Male	AD40
RCA Male [gold]	AD950
SVHS Female	SVHS321
UHF Female (SO239)	AD270
XLR Female	AD978



SCART Male

RCA & S-Video IN	AD904
RCA & S-Video IN/OUT	AD905
RCA x3 [RGB/YUV]	AD906



AD904

SMA Female

BNC Female	SFB148
BNC Male	SMA430
GRC9 Male R/A	CAL820
F Female	AD1106
FME Female	AD1104
Lucent MC Lead	CAL716
MCX Male	AD1140
MCX Male	CAL714
Mini UHF (M259)	SMA319
MMCX Female	AD1121
MMCX Male	AD1120
MMCX Male R/A	CAL808
N Female	AD1073
N Male	AD1071
SMA Female	AD1102
SMA Male R/A	SMA390
SMA-RP Female	AD1007
SMA-RP Male	AD1002
SMB Female	CAL816
SMB Male	CT27AA97
SMK TS-6 Male	CAL702
SMK TS-9 Male	CAL822
SMK TS-9 R/A x2	CAL831
SMK TS-9 x2	CAL835
SMK TS-9 x2	CAL836
SSMB Male R/A	CAL819
TNC Female	SMA452
TNC Male	SMA451
TNC-RP Male	AD1043
TNC-RP Female	AD1045

SMA Male

BNC Female	SMA230
F Female	AD1105
FME Female	AD1103
FME Male	AD1112
N Female	AD1074
N Male	AD1072
SMA Female R/Angle	SMA390
SMA Male	AD1101
SMA-RP Female	AD1008
SMA-RP Male	AD1003
TNC Female	SMA150
TNC-RP Female	AD1046
UHF Female PL259	AD312

SMA-RP Female

MMCX Male	AD1122
N Female	AD1005
N Male	AD1006
SMA Female	AD1007
SMA Male	AD1008
SMA-RP Female	AD1010
TNC-RP Male	AD1009

SMA-RP Male

Lucent MC	CAL711
MCX Female	AD1143
N Female	AD1012
N Male	AD1001
SMA Female	AD1002
SMA Male	AD1003
SMA-RP Male	AD1011
TNC-RP Female	AD1004

SMB Female

SMA Female	CAL816
------------	--------

SMB Male

SMA Female	CT27AA97
------------	----------

SMK TS-6 Male

SMA Female	CAL702
------------	--------

SMK TS-9 Male

SMK TS-9 Male	CAL821
SMK TS-9 Male	CAL822

SMK TS-9 Male x2

SMK TS-9 Male x2	CAL828
SMK TS-9 Male x2	CAL830
SMK TS-9 Male R/A x2	CAL823
SMK TS-9 Male x2	CAL836
SMK TS-9 Male x2	CAL835
SMK TS-9 Male x2	CAL831

SSMB Male

FME Male	CAL805
FME Male	CAL809
SMA Female	CAL819

S-Video Female

SVHS Female	AD4SVHS
RCA Male	SVHS321
SCART Male	AD904
SCART Male I/O switch	AD905

S-Video Male

RCA Female	SVHS322
------------	---------

TMC Male

TNC Male	CAL804
----------	--------

TNC Female

BNC Female	AD1175
BNC Male	TNC254
FME Female	FME110
Mini UHF Male (M259)	MUF250
N Female	TNC279
SMA Female	SMA452
SMA Male	SMA150
TNC Female	TNC262
TNC Female Panel Mount	TNC246
TNC Male R/Angle	TNC240

TNC Female x 2

TNC Male (T type)	TNC224
-------------------	--------

TNC Male

BNC Female	TNC268
FME Male	FME130
Mini UHF Female (S259)	TNC274
N Female	TNC278
SMA Female	SMA451
TNC Female x2	TNC224
TNC Female R/A	TNC240

TNC-RP Female

N Male	AD1044
SMA Female	AD1045
SMA Male	AD1046
SMA-RP Male	AD1004
TNC-RP Female	AD1048



TNC-RP Male

N Male	AD1042
N Female	AD1041
SMA Female	AD1043
SMA-RP Female	AD1009
TNC-RP Male	AD1047



UHF Female (SO239)

BNC Female	AD241
BNC Male	AD240
Mini UHF Male (M259)	MUF379
N Male	N160
RCA Male	AD270
SMA Male	AD312
UHF Female (SO239)	PL258
UHF Female x 2 (T type)	P698
UHF Male (PL259)	PL259T
UHF Male (PL259)	AD259RA



UHF Male (PL259)

BNC Female	AD210
FME Male	FME259
N Female	AD1076
RCA Female	AD220
SO239 R/Angle	AD259RA
UHF Male	AD2259
UHF Female x2	PL259T

UHF Mini Female (S259)

BNC Male	MUF439
FME Female	FME250
SMA Female	SMA319
TNC Male	TNC274
Mini UHF Male M259 R/A	M259RA

UHF Mini Male (M259)

BNC Female	MUF339
FME Male (Short body)	FME150
FME Male (Long body)	FME265
TNC Female	MUF250
Mini UHF Female M259 R/A	M259RA
UHF Female (SO239)	MUF379



XLR Male

XLR Male	AC3M3MBW
XLR Male	AC3F3MBW
XLR Male	NA3MP
XLR Male	NA2M-D2B-TX



XLR Female

XLR Female	AC3F3FBW
XLR Male	AC3F3MBW
RCA Female	AD977
RCA Female [TX]	NA2F-D2B-TX
RCA Male	AD978

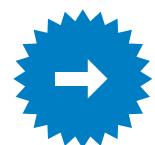

See Adaptors Here →

For details of each adaptor, see the following pages...



AV Plug Adaptors

AUDIO ADAPTORS

Quick reference is available using our cross-reference on the previous pages. Some adaptors may be achievable via pre-assembled leads. See Page 2.



2.5MM STEREO PLUG TO 3.5MM STEREO SOCKET

2.5mm plug stereo 3.5mm socket stereo

Code
AD112



2.5MM STEREO PLUG TO 3.5MM STEREO SOCKET

2.5mm Stereo Plug TO
3.5mm Stereo Socket

Code
AD111



2.5MM STEREO SOCKET TO 3.5MM STEREO PLUG

2.5MM-3.5MM STEREO

2.5mm Stereo Socket TO 3.5mm Stereo Plug

Code
AD115



2.5MM MONO PLUG TO 3.5MM MONO SOCKET

2.5mm plug to
3.5mm socket

Code
AD11



3.5MM MONO SOCKET TO 6.35MM MONO PLUG

3.5mm socket TO 6.35mm plug

Code
AD21



6.35MM MONO PLUG TO RCA SOCKET

RCA socket to 6.35mm plug.

Code
AD23



3.5MM MONO SOCKET RCA PLUG

RCA plug to 3.5mm socket mono

Code
AD31



6.35MM MONO SOCKET TO RCA PLUG

RCA plug to 6.35mm socket mono

Code
AD32



3.5MM MONO PLUG TO RCA SOCKET

3.5mm plug to
RCA socket

Code
AD13



S-VIDEO MALE TO RCA SOCKET

Passive circuitry RCA
Socket to SVHS Plug

Code
SVHS322



S-VIDEO SOCKET TO RCA PLUG

Passive circuitry RCA
Plug to SVHS Socket

Code
SVHS321



S-VIDEO JOINER SOCKET TO SOCKET

S-VHS Gender Changer
Metal case. F to F.

Code
AD4SVHS



3.5MM STEREO SOCKET TO SOCKET JOINER

3.5mm Socket To Socket. Stereo or Mono.

Type Code
Plastic AD217
Metal AD218



3.5MM MONO PLUGS TO 3.5MM STEREO SOCKET

AIRLINE HEADPHONE ADAPTOR
Dual 3.5mm Mono Plugs.

Code
AD215



3.5MM MONO PLUG TO 6.35MM MONO SOCKET

3.5mm plug to 6.35mm mono socket

Code
AD12



3.5MM MONO PLUG TO 6.35MM STEREO SOCKET

3.5mm mono plug to
6.35mm stereo socket.

Code
AD123



3.5MM STEREO PLUG TO 6.3MM STEREO SOCKET

3.5mm stereo plug to
6.35mm stereo socket

Code
AD122



6.35MM STEREO PLUG TO 3.5MM STEREO SOCKET

6.35mm stereo plug to
3.5mm stereo socket

Code
AD212



3.5MM MONO PLUG TO 3.5MM STEREO SOCKET

3.5mm mono plug to 3.5mm stereo socket

Code
AD113



3.5MM MONO PLUG TO 3.5MM MONO SOCKET

3.5mm Mono Plug to 3.5mm Mono Socket
Right Angle Adaptor

Code
AD114



3.5MM STEREO PLUG TO 3.5MM STEREO SOCKET

3.5MM RIGHT-ANGLE ADAPTOR

Stereo 3.5mm Male to Female Stereo socket.

Code
AD216



6.35MM MONO PLUG TO 6.35MM STEREO SOCKET

6.35mm mono plug to
6.35mm stereo socket

Code
AD223



6.35MM MONO PLUG TO 3.5MM STEREO SOCKET

6.35mm mono plug to
3.5mm stereo socket

Code
AD213



1/4" STEREO TO XLR

3-pole XLR male - stereo 1/4" plug
(Tip, Ring, Sleeve contact)

Code
NA3MP





3.5MM STEREO PLUG TO 2X STEREO SOCKET

3.5mm stereo plug to 2x sockets

Code
AD1210



3.5MM STEREO 5 PORTS

3.5mm Plug to five 3.5mm Jacks.
Splits to multiple headphones

Code
AD1206



3.5MM QUAD SPLITTERS

3.5mm Quad Plug to two Quad Sockets.

Type	Code
Block	AD9052
Twin Lead	MP155



3.5mm PC TO QUAD ADAPTOR

2X STEREO 3.5MM PLUGS
(PC) TO QUAD 3.5MM SOCKET

Code
AD921



3.5MM MONO PLUG TO 2X RCA SOCKET

3.5mm plug to 2x RCA sockets

Code
AD1130



3.5MM STEREO PLUG TO 2X RCA SOCKET

3.5mm stereo plug to 2x RCA sockets

Code
AD1230



6.35MM MONO PLUG TO 2X RCA SOCKET

6.35mm plug to
2x RCA sockets

Code
AD2130



6.35MM STEREO PLUG TO 2X RCA SOCKET

6.35mm stereo plug to 2x RCA sockets

Code
AD2230



6.35MM PLUG TO 2X 3.5MM SOCKET STEREO

6.35mm stereo plug to
2x 3.5mm stereo sockets

Code
AD2210



6.35MM STEREO PLUG TO 2X STEREO SOCKET

6.35mm stereo plug to
2x 6.35mm stereo sockets

Code
AD2220



6.35MM MONO PLUG TO 2X 6.35MM MONO SOCKET

6.35mm plug to 2x 6.35mm sockets

Code
AD2120



RCA RIGHT ANGLE ADAPTOR

Order One To Receive A Pack of Two Plug to Socket **Pair** Gold Plated.

Type	QTY	Code
Short	2	AD962
Long	2	AD960



RCA DOUBLE ADAPTOR

Order One To Receive A Pack of Two
Gold Plated

QTY	Code
2	AD965



RCA RIGHT-ANGLE ADAPTORS

Colour	Code
Black	AD44
Red	AD42



RCA SOCKET TO 2X RCA SOCKET

RCA Socket to
2x RCA Sockets

Code
AD3131



RCA PLUG TO 2X RCA SOCKET

RCA plug to 2x RCA sockets

Code
AD3130



RCA SOCKET TO RCA SOCKET

RCA socket to RCA socket Gold Plated

Code
AD33



RCA SOCKET TO RCA SOCKET DUAL

RCA socket Pair RCA socket Pair Gold Plated

Code
AD34



RCA SOCKET TO RCA SOCKET TRIPLE

RCA socket Triple RCA socket
Triple Gold Plated

Code
AD35



RCA SOCKET TO RCA SOCKET GOLD PLATED

SOCKET TO SOCKET

Order One To Receive A Pack of Two

QTY	Code
2	AD955



RCA PLUG TO RCA PLUG

PLUG TO PLUG

Code
AD40



RCA PLUG TO RCA PLUG GOLD PLATED

PLUG TO PLUG

Order One To Receive A Pack of Two

QTY	Code
2	AD950





□ PAL Adaptors

PAL SOCKET TO PAL SOCKET

PAL coaxial joiner socket to socket

Code
AD500



PAL PLUG TO PAL PLUG

PAL coaxial joiner Plug to plug

Code
AD511



PAL PLUG TO PAL SOCKET

PAL coaxial joiner plug to socket

Code
AD510



PAL PLUG TO PAL SOCKET R/A

PAL coaxial joiner plug to socket. Right angled.

Code
AD512



PAL PLUG TO RCA SOCKET

PAL coax plug to RCA socket

Code
AD513



PAL PLUG TO BNC SOCKET

PAL coax plug to BNC socket

Code
AD292



PAL SOCKET TO RCA SOCKET

PAL coax socket to RCA socket

Code
AD503



PAL SOCKET TO RCA SOCKET PANEL MOUNT

Panel mount PAL Socket to RCA Socket

Code
AD504



PAL SOCKET TO RCA PLUG

PAL Socket to RCA Plug

Code
AD505



PAL SOCKET TO BNC PLUG

PAL Socket to BNC plug adaptor

Code
AD235



PAL SOCKET TO BNC SOCKET

PAL socket to BNC socket

Code
AD294



PAL SOCKET TO 3.5MM PLUG ADAPTOR

PAL Socket to 3.5mm Suit little TVs.

Code
TVA25



PAL SOCKET TO MCX MALE

PAL Socket to MCX Male

Code
AD1151



□ F Plug Adaptors

'F' SOCKET RIGHT ANGLE TO PAL PLUG

Right Angle PAL plug to "F" socket

Code
AD329



'F' PLUG TO PAL SOCKET

Plug adaptor "F" plug to PAL socket

Foxtel Code
- AD310
F10156 AP3/F



'F' SOCKET TO PAL PLUG

'F' Socket to PAL plug

Foxtel Code
- AD320
F10437 AP1/FF



'F' SOCKET TO PAL SOCKET

F socket to PAL 75 ohm socket.

Code
AD325



'F' SOCKET TO 'F' PLUG PUSH-ON

Code
F72



'F' PLUG TO 'F' PLUG

Code
AD315



'F' SOCKET TO 'F' SOCKET

Length Code
20mm AD327
27mm AD327L
20mm AD327-3GHZ
27mm APFF/FF3NW

APFF/FF3NW Foxtel® Approved F30583



Chassis or Line joiner

'F' PLUG TO 'F' SOCKET RIGHT ANGLE

"F" Right Angle Male to Female

Foxtel Code
F30573 AD328



'F' SOCKET TO RCA MALE

"F" Female to RCA Male

Code
AD340



'F' PLUG TO RCA SOCKET

"F" Male to RCA Female

Code
AD330



'F' SOCKET TO BNC SOCKET

"F" Female to BNC Female

Code
AD291



"F" SOCKET TO MCX PLUG

Plug adaptor "F" Female to MCX Male

Code
AD1152





□ BNC Plug Adaptors

BNC PLUG TO RCA SOCKET

Plug adaptor BNC plug to RCA socket

Code
AD230



BNC SOCKET TO RCA PLUG

Plug adaptor RCA plug to BNC socket

Code
AD260



BNC PLUG TO 'F' SOCKET

Plug adaptor BNC plug to "F" socket

Code
AD280



BNC SOCKET TO 'F' PLUG

Plug adaptor "F" plug to BNC socket

Code
AD290



BNC PLUG TO BNC SOCKET RIGHT ANGLE

BNC "L"
adaptor

Code
P680



BNC PLUG TO 2X BANANA SOCKET 'Y' ADAPTOR

Dual binding posts to
BNC adaptor.

Code
BP60



BNC PLUG TO BNC PLUG

BNC adaptor 2 Male

Code
AD1190



BNC SOCKET TO BNC SOCKET

BNC adaptor 2 female silver plated

Code
P694



BNC SOCKET TO 2X BNC SOCKET "T" ADAPTOR

Silver plated BNC Y adaptor. All Female. F-F/F

Code
P693



BNC PLUG TO 2X BNC SOCKET "T" ADAPTOR

Silver plated BNC Y adaptor Male M-F/F

Code
P695



BNC PLUG TO 2X BNC SOCKET "Y" ADAPTOR

Silver plated BNC Y adaptor Male M-F/F

Code
P697



BNC SOCKET TO 2X BNC PLUG "T" ADAPTOR

Silver plated BNC
Y adaptor Female F-M/M

Code
P696



□ RF Plug Adaptors

BNC PLUG TO UHF SOCKET SO239

Plug adaptor BNC plug to SO239 socket

Code
AD240



BNC SOCKET TO UHF PLUG PL259

Plug adaptor PL259 plug to BNC socket

Code
AD210



SMA SOCKET TO BNC PLUG

SMA Female - BNC MALE

Code
SMA430



SMA PLUG TO BNC SOCKET

SMA male - BNC female

Code
SMA230



SMA SOCKET TO BNC SOCKET

SMA Female BNC Female

Code
SFB148



SMA SOCKET TO 'F' SOCKET

SMA FEMALE - "F" FEMALE

Code
AD1106



SMA PLUG TO 'F' SOCKET

SMA MALE - "F" FEMALE

Code
AD1105



SMA PLUG TO SMA PLUG

Plug adaptor SMA Plug to
SMA Plug

Code
AD1101



SMA SOCKET TO SMA SOCKET

SMA Female to SMA Female

Code
AD1102



SMA SOCKET TO SMA SOCKET PANEL MOUNT

Panel Mountable SMA
Female to SMA Female

Code
SMA291



SMA SOCKET TO SMA SOCKET PANEL MOUNT

Panel Mountable HEX Collar for Wall
plates SMA Female to SMA Female

Code
SMA292



SMA PLUG TO SMA SOCKET RIGHT ANGLE

SMA male - female R/A

Code
SMA390





SMA SOCKET TO TNC SOCKET

TNC Female SMA Female

Code
SMA452



SMA PLUG TO TNC SOCKET

SMA male - TNC female

Code
SMA150



SMA PLUG TO FME SOCKET

Plug adaptor SMA Plug to
FME Socket

Code
AD1103



SMA PLUG TO FME PLUG

Plug adaptor SMA Plug to
FME Plug

Code
AD1112



SMA PLUG TO REVERSE SMA PLUG

Plug adaptor SMA Plug to
SMA-RP Plug

Code
AD1003



SMA PLUG TO REVERSE SMA SOCKET

Plug adaptor SMA Plug to
SMA-RP Socket

Code
AD1008



SMA PLUG TO 'N' PLUG

Plug adaptor SMA Plug to "N" Plug

Code
AD1072



SMA PLUG TO 'N' SOCKET

Plug adaptor SMA Plug to
"N" Socket

Code
AD1074



SMA SOCKET TO FME SOCKET

Plug adaptor SMA Socket to
FME Socket

Code
AD1104



SMA SOCKET TO REVERSE SMA PLUG

Plug adaptor SMA Socket
to SMA-RP Plug

Code
AD1002



SMA SOCKET TO REVERSE TNC PLUG

Plug adaptor SMA Socket to TNC-RP Plug

Code
AD1043



SMA SOCKET TO REVERSE TNC SOCKET

Plug adaptor SMA Socket to TNC-RP Socket

Code
AD1045



SMA SOCKET TO 'N' SOCKET

Plug adaptor SMA Socket to
"N" Socket

Code
AD1073



SMA SOCKET TO MCX PLUG

Plug Adaptor SMA Socket to
MCX plug

Code
AD1140



SMA SOCKET TO MMCX PLUG

Plug Adaptor SMA Socket to
MMCX plug

Code
AD1120



SMA SOCKET TO MMCX SOCKET

Plug Adaptor SMA Socket to
MMCX Socket

Code
AD1121



SMA SOCKET TO REVERSE SMA SOCKET

Plug adaptor SMA Socket to SMA-RP Socket

Code
AD1007



SMA SOCKET TO "N" PLUG

Plug adaptor SMA Socket to "N" Plug

Code
AD1071



SMA SOCKET TO TNC PLUG

SMA female - TNC Male

Code
SMA451



SMA PLUG TO REVERSE TNC SOCKET

Plug adaptor SMA Plug to
TNC-RP Socket

Code
AD1046



SMC PLUG TO SMA SOCKET

Code
AD1013



REVERSE SMA SOCKET TO SMA PLUG

Plug adaptor SMA-RP Socket to SMA Plug

Code
AD1008



REVERSE SMA SOCKET TO SMA SOCKET

Plug adaptor SMA-RP
Socket to SMA Socket

Code
AD1007



REVERSE SMA PLUG TO SMA PLUG

Plug adaptor SMA-RP Plug to SMA Plug

Code
AD1003





REVERSE SMA PLUG TO REVERSE SMA PLUG

Plug adaptor SMA-RP
Plug to SMA-RP Plug

Code
AD1011



REVERSE SMA SOCKET TO REVERSE SMA SOCKET

Plug adaptor SMA-RP Socket
to SMA-RP Socket

Code
AD1010



REVERSE SMA SOCKET TO MMCX PLUG

Plug Adaptor SMA-RP Male to
MMCX Male

Code
AD1122



MCX PLUG TO REVERSE SMA SOCKET

Plug adaptor MCX Female to
SMA-RP Male

Code
AD1143



REVERSE SMA SOCKET TO REVERSE TNC PLUG

Plug adaptor SMA-RP Socket
to TNC-RP Plug

Code
AD1009



REVERSE SMA PLUG TO "N" PLUG

Plug adaptor SMA-RP Plug to "N" Plug

Code
AD1001



REVERSE SMA PLUG TO REVERSE TNC SOCKET

Plug adaptor SMA-RP Plug
to TNC-RP Socket

Code
AD1004



REVERSE SMA PLUG TO "N" SOCKET

Plug adaptor SMA-RP
Plug to "N" Socket

Code
AD1012



REVERSE SMA SOCKET TO "N" SOCKET

Plug adaptor "N" Socket to SMA-RP Socket

Code
AD1005



REVERSE SMA SOCKET TO "N" PLUG

Plug adaptor SMA-RP Socket to "N" Plug

Code
AD1006



FME PLUG TO SMA PLUG

Plug adaptor FME Plug to SMA Plug

Code
AD1112



FME PLUG TO "N" PLUG

FME Male to N Male

Code
FME160



FME MALE TO FEMALE RIGHT ANGLE

Code
FME122



FME PLUG TO FME PLUG

FME-FME Male/male

Code
FME120



FME SOCKET TO FME SOCKET

Plug adaptor FME Socket to FME Socket

Code
AD1111



FME SOCKET TO TNC SOCKET

TNC Female to FME Female

Code
FME110



FME PLUG TO TNC PLUG

FME-TNC Male/male

Code
FME130



FME PLUG TO BNC PLUG

FME-BNC Male/male

Code
FME140



FME SOCKET TO BNC SOCKET

FME Female to BNC Female

Code
FME145



FME SOCKET TO BNC PLUG

FME Female to BNC Male

Code
FME146



FME PLUG TO MINI UHF PLUG SHORT

FME-Mini UHF Male to male

Code
FME150



FME PLUG TO MINI UHF PLUG LONG

FME-Mini UHF Male to male

Code
FME265



FME SOCKET TO MINI UHF SOCKET

FME-Mini UHF Female to female

Code
FME250



FME PLUG TO UHF PLUG PL259

FME Male to PL259 Male

Code
FME259





TNC SOCKET TO TNC SOCKET

TNC female to female inline adaptor.

Code
TNC262



TNC TO TNC ADAPTORS

Type Code
"L" Adaptor TNC240



TNC TO TNC SPLITTER

Type Code
"T" Adaptor TNC224



TNC SOCKET TO TNC SOCKET PANEL MOUNT

TNC female to female with mounting nut.

Code
TNC246



TNC SOCKET TO BNC PLUG

TNC female to BNC plug adaptor.

Code
TNC254



TNC SOCKET TO BNC SOCKET

TNC Female to BNC Female

Code
AD1175



TNC PLUG TO BNC SOCKET

TNC male to BNC female adaptor.

Code
TNC268



TNC PLUG TO MINI UHF SOCKET

TNC male adaptor to mini-UHF M259 female

Code
TNC274



TNC PLUG TO "N" SOCKET

TNC MALE "N" FEMALE

Code
TNC278



TNC SOCKET TO SMA PLUG

TNC female - SMA male

Code
SMA150



TNC SOCKET TO SMA SOCKET

TNC Female SMA Female

Code
SMA452



TNC SOCKET TO MINI UHF PLUG

TNC female - Mini UHF male

Code
MUF250



REVERSE TNC FEMALE to "N" SOCKET

Plug adaptor "N" Socket to TNC-RP Plug

Code
AD1041



REVERSE TNC MALE TO "N" SOCKET

Code
AD1049



REVERSE TNC PLUG TO "N" SOCKET

Plug adaptor TNC-RP Plug to "N" Socket

Code
AD1041



REVERSE TNC PLUG TO "N" PLUG

Plug adaptor TNC-RP Plug to "N" Plug

Code
AD1042



REVERSE TNC PLUG TO SMA SOCKET

Plug adaptor TNC-RP Plug to SMA Socket

Code
AD1043



REVERSE TNC PLUG TO REVERSE TNC PLUG

Plug adaptor TNC-RP Plug to TNC-RP Plug

Code
AD1047



REVERSE TNC PLUG TO REVERSE SMA SOCKET

Plug adaptor TNC-RP Plug to SMA-RP Socket

Code
AD1009



REVERSE TNC SOCKET TO "N" PLUG

Plug adaptor TNC-RP Socket to "N" Plug

Code
AD1044



REVERSE TNC SOCKET TO SMA SOCKET

Plug adaptor TNC-RP Socket to SMA Socket

Code
AD1045



REVERSE TNC SOCKET TO SMA PLUG

Plug adaptor TNC-RP Socket to SMA Plug

Code
AD1046



REVERSE TNC SOCKET TO REVERSE TNC SOCKET

Plug adaptor TNC-RP Socket to TNC-RP Socket

Code
AD1048



REVERSE TNC SOCKET TO REVERSE SMA PLUG

Plug adaptor TNC-RP Socket to SMA-RP Plug

Code
AD1004





"N" MALE TO "N" FEMALE RIGHT ANGLE

Code
AD412



"N" MALE TO "N" MALE

"N" male to male inline adaptor.

Code
N130



"N" FEMALE TO "N" FEMALE

"N" female to female inline adaptor.

Type	Code
"T"	N140
F-F	N135



"N" 2 WAY CAVITY WIDE-BAND SPLITTER

All "N" Female. Low loss.
800MHz - 2500MHz.

Code
N141



"N" SOCKET TO BNC PLUG

BNC Male to "N" Female

Code
N156



"N" PLUG TO BNC SOCKET

"N" male to BNC female adaptor.

Code
N155



"N" PLUG TO BNC PLUG

"N" male to BNC male adaptor

Code
N157



"N" PLUG TO UHF SOCKET SO239

"N" male to SO239 Female adaptor.

Code
N160



"N" SOCKET TO TNC SOCKET

Code
TNC279



"N" PLUG TO "F" SOCKET

"N" male to "F" female adaptor

Code
AD1050



"N" SOCKET TO UHF PLUG PL259

Plug adaptor PL259 Male to "N" Socket

Code
AD1076



"N" PLUG TO FME FEMALE

Code
AD1077



"N" SOCKET TO FME PLUG

N Female to FME Male Adaptor

Code
AD1145



"N" PLUG TO SMA SOCKET

Plug adaptor "N" Plug to SMA Socket

Code
AD1071



"N" PLUG TO SMA PLUG

Plug adaptor "N" Plug to SMA Plug

Code
AD1072



"N" PLUG TO REVERSE SMA PLUG

Plug adaptor SMA-RP Plug to "N" Plug

Code
AD1001



"N" PLUG TO REVERSE SMA SOCKET

Plug adaptor "N" Plug to SMA-RP Socket

Code
AD1006



"N" SOCKET TO SMA SOCKET

Plug adaptor "N" Socket to SMA Socket

Code
AD1073



"N" SOCKET TO SMA PLUG

Plug adaptor "N" Socket to SMA Plug

Code
AD1074



"N" SOCKET TO FME SOCKET

Plug adaptor "N" Socket to FME Socket

Code
AD1075



"N" SOCKET TO REVERSE SMA SOCKET

Plug adaptor SMA-RP Socket to "N" Socket

Code
AD1005



"N" SOCKET TO REVERSE SMA PLUG

Plug adaptor "N" Socket to SMA-RP Plug

Code
AD1012



"N" PLUG TO MCX PLUG

Plug adaptor "N" Male to MCX Male

Code
AD1141



"N" SOCKET TO MCX PLUG

Plug adaptor "N" Socket to MCX Plug

Code
AD1142



"N" PLUG TO REVERSE TNC PLUG

Plug adaptor "N" Plug to TNC-RP Plug

Code
AD1042



"N" PLUG TO REVERSE TNC SOCKET

Plug adaptor "N" Plug to TNC-RP Socket

Code
AD1044





UHF PLUG PL259 TO UHF PLUG PL259

PL259 To PL259

Code
AD2259



UHF PLUG PL259 TO UHF SOCKET SO239

Right-Angle PL259
To SO239 Adaptor.

Code
AD259RA



UHF PLUG PL259 TO 2X UHF SOCKET SO239

PL259 UHF Plug To 2x
SO239 "T" Adaptor.

Code
PL259T



UHF SOCKET SO239 'T' ADAPTOR

SO239 UHF x3 "T" Adaptor

Code
P698



UHF PLUG PL259 TO BNC SOCKET

Plug adaptor PL259 plug to BNC socket

Code
AD210



UHF PLUG PL259 TO RCA SOCKET

Plug adaptor PL259 plug to RCA socket

Code
AD220



UHF SOCKET SO239 TO BNC PLUG

Plug adaptor BNC plug to SO239 socket

Code
AD240



UHF SOCKET SO239 TO RCA PLUG

Plug adaptor RCA plug to SO239 socket

Code
AD270



UHF SOCKET SO239 TO SMA PLUG

Plug Adaptor SMA Male to SO239 UHF

Code
AD312



MINI UHF PLUG TO UHF SOCKET SO239

Mini UHF male to UHF
PL259 female

Code
MUF379



MINI UHF PLUG TO MINI UHF SOCKET

M259 Plug-Socket right angle.

Code
M259RA



UHF SOCKET SO239 TO UHF SOCKET SO239

Female to female SO239 to SO239

Code
PL258



MINI UHF SOCKET TO SMA SOCKET

Mini UHF-SMA F/F

Code
SMA319



MINI UHF PLUG TO TNC SOCKET

Mini UHF male - TNC female adaptor.

Code
MUF250



MINI UHF PLUG TO BNC SOCKET

Mini UHF Male - BNC
female adaptor.

Code
MUF339



MINI UHF SOCKET TO BNC PLUG

Mini UHF Female - BNC
male adaptor.

Code
MUF439



UHF SOCKET SO239 TO BNC SOCKET

BNC Female To UHF Female SO239

Code
AD241



End Caps

BNC END CAP

MALE

With chain

Code
CP-BNC-M



BNC END CAP

FEMALE

Cap is Female

Code
CP-BNC-F



"N" END CAP

MALE

No centre pin

Code
CP-N-M



"N" END CAP

FEMALE

Seals & protects

Code
CP-N-F



UHF END CAP

PL259 MALE

Close out dirt

Code
CP-UHF-M



UHF END CAP

SO239 FEMALE

W/ retaining chain

Code
CP-UHF-F





Connectors Misc

Wall Plates

WALL PLATE VGA & 3.5mm

VGA D15 Female
3.5mm Stereo Socket
Code PK3307



Right Angle
Code PK3309

WALL PLATE VGA & AUDIO

Clipsal® Compatible
D15HD VGA and Dual
RCA Sockets Rear are
all Sockets to Sockets
With 3.5mm adaptor
Code WPD15FSA

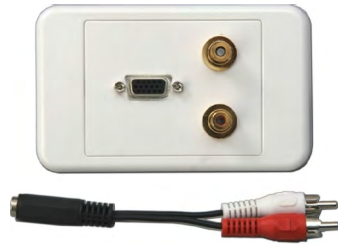

HDMI / VGA / 3xRCA / PC AUDIO WALLPLATE

HDMI, VGA,
Stereo 3.5mm,
3x RCA.
Code PRO1310



WALL PLATE VGA USB

VGA, 3.5mm Stereo,
USB
Code PRO1314



WALL PLATE VGA USB +

USB, VGA,
3.5mm Stereo
and 3x RCA.
Code PRO1309



WALL PLATE HDMI - RIGHT ANGLE ADAPTOR

Socket to Right/Angle OR
2x Sockets to Right/Angle
Type Single Double
Code WP-HDMI1 WP-HDMI2



WALL PLATE HDMI - PIGTAIL OR ADAPTOR

Socket To Socket
Type Socket Pigtail
Code WP-HDMI21 WP-HDMI21PT



WALL PLATE HDMI + "F"

HDMI WITH "F" CONNECTOR
Type Socket Pigtail
Code WP-HDMI28 WP-HDMI28PT



WALL PLATE HDMI COMPONENT

HDMI WITH 3x RCA SOCKETS
Type Socket Pigtail
Code WP-HDMI24 WP-HDMI24PT



WALL PLATE HDMI + A/V

HDMI WITH 3x RCA SOCKETS
Type Pigtail
Code WP-HDMI26PT





SINGLE "F" CONNECTOR

GOLD PLATED CONNECTOR

Code
SA1F



SINGLE RCA SOCKET

1x RCA SOCKET GOLD PLATED CONNECTORS

Colour	Code
Red	SA1R
Yellow	SA1YL



DUAL RCA SOCKETS

2x RCA SOCKETS GOLD PLATED

Code
SA2R



TRIPLE RCA SOCKETS

GOLD PLATED CONNECTORS

Code
SA3R



"F" & DUAL RCA SOCKETS

'F' (Male to Male)
RCA Stereo pair

Code
SA1F2R



"F" & TRIPLE RCA SOCKETS

GOLD PLATED CONNECTORS

Code
SA1F3R



DUAL BANANA SOCKETS

GOLD PLATED CONNECTORS

Code
SA2BJ



SPEAKER WALL PLATE

4 BANANA SOCKET

Code
SA4BJM



PHONE & DATA WALL PLATE

PUNCH DOWN
With RJ12 &
RJ45 connector.

Code
SA1T1D



"F" PHONE & DATA WALL PLATE

PUNCH DOWN
'F' connector with
RJ12 & RJ45
Connector

Code
SA1T1D1F



XLR WALL PLATE

STAINLESS STEEL

Type	Code
Single	XLRP1
Double	XLRP2

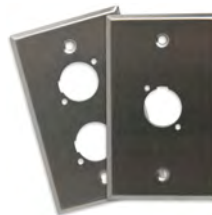

DVI WALL PLATE

SOCKET TO SOCKET

Code WPD29DF



"D" PLUG WALL PLATES

Front	Back	Type	Code
D9F	Solder	Dual	WP2D9F
D15F	Solder	Single	WPD15F
D15F	Solder	Dual	WPD15F2
D15F	D15F	Single	WPD15DF
D15F	D15F	Dual	WPD15DF2
D25F	Solder	Single	WD25F

WALL PLATE BLANK

None of the above suitable.
You could make your own.

Code
WBP10



PAL ENTRY BOX

SADDLE & SCREW

Code
TVS3



"F" SOCKET REAR

Code
TVS3F

WALL PLATE PAL DAISY-CHAIN

Flush mount screw terminated. 75Ω I/O
Includes Tap-off for multiple installations.
Daisy-chain impedance matching system:

Code
TVS5
TVS5A

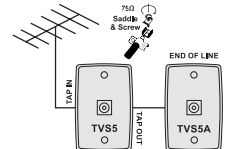

WALL PLATE PAL SOCKET

"F" BACK

PAL Socket front to
"F" Socket back.

Code
TVS65



SADDLE & SCREW

Code
TVS5A

DOUBLE WALL PLATE PAL

Flush mount 1x75Ω
Coax input to splitter
& 2x 75Ω sockets.

Code
TVS6



TV/FM SPLITTER WALL SOCKET

Single saddle & screw to
two 75Ω PAL Sockets. One
socket goes direct to TV and
the other is filtered for the FM
band to reduce interference.

Type	Code
Horizontal	TVS67
Vertical	TVS97



"F" WALL SOCKET

"F" to "F" sockets
through plate for
minimum loss.
Teflon insulator.

Code
TVS60

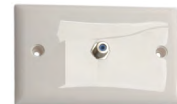

Foxtel	Code
F30577	APO2FOX3



2x "F" to "F" sockets wall
plate. 3GHz rating for high
definition applications.
Foxtel approved F30578.

Foxtel	Code
F30578	AP022FOX3



"F" ENTRY BOX

"F" to "F" sockets through plate for
minimum loss. Teflon insulator.

Code
TVS70S



Foxtel	Code
F30582	APO1FOX3



RECESSED HIDDEN MEDIA HUB

HIDES UP TO 5 WALL PLATES

- Box Dimensions: 285x250x70mm
- Can hold up to 5 standard face plates
- Store units like HDMI converters, etc.
- Paintable facia 330x295mm
- In-wall and ceiling applications

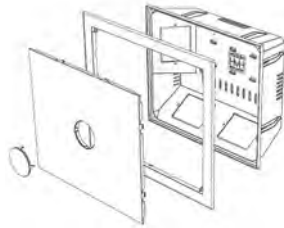

Accepts up to 5 wall plates.

Code

MHUB1

Supplied empty.



RECESSED POWER POINT

Compatible with all wall outlets,
(Does not include wall outlet itself).
Metal bracket. White.
70mm/90mm depth.

Code

WP-REC1



RECESSED WALL - 2X INSERTS

CLIPSAL® COMPATIBLE INSERTS x2

Code

AV-RPS02

Face: 185x145mm
Cutout: 166x100mm
Depth: 60mm

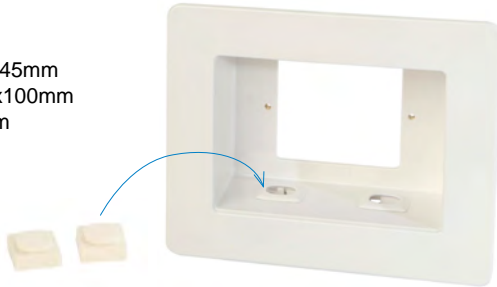

RECESSED 240V POWER OUTLET

SINGLE OUTLET 60mm

Code

AV-RPS01



SPEEDPORT™ UNIVERSAL CABLE 2" HOLE

PATENTED - MADE IN USA

Universal cable pass through wall mount system. Ideal for wall mounted box speakers, smoke detectors and cameras. The ultra low profile design features a rubber grommet insert for cable pass through. An extra centre screw can be used for the items mounting. Installation is quick and simple using a 2" (50mm) hole saw.



QTY Code

Single 1SPW

CABLE-DROP HOOD

CLIPSAL® STYLE

Includes a Flush and Bull-nose facia for a cable management wall plate where you simply swap out the type required, so now you only need to carry the one product item. Includes built-in nylon brush dust screen. Available in Black or White.

Plate 73x120mm

Hole 27x50mm

Colour Code

White WP-HOOD21

Black WP-HOOD22



LEADS NOT INCLUDED

CABLE DROP HOOD

Horizontal wall plate Clipsal® Compatible.

Feed cables neatly into a wall cavity.

Plate 70x115mm Two Piece Type.

New! Slim Version

Hole Colour Code

35x65mm White WP-HOOD1

35x65mm Black WP-HOOD2

15x50mm White WP-HOOD3



REAR BRUSH COVER
LEADS NOT INCLUDED

CABLE-DROP HOOD

WALL PLATE OPENING (REVERSE TYPE)

Hood for bringing out cable from wall. Hole 35x55mm.

Horizontal Mounting. Wall Plate: 70x115mm

Colour Code

White WPHOOD1R

Black WP-HOOD2R

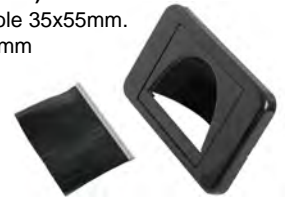

CABLE WALL PLATE

CLIPSAL® COMPATIBLE

Allows wall cavity access with dust resistant and neat cable solution.

Colour Hole Code

White 53x19mm WP60WH

White 53x30mm WP63WH

Black 53x19mm WP60BK

Black 53x30mm WP63BK



SILICON INGRESS BOOT

REMOVABLE BULL NOSE COVER

Code

WP61



WALL PLATE WITH SNAP BUSHING

Allows wall cavity access with dust resistant snap-in grommet. Designed to protect wires and cables, as keeping the cable in place.

Code

WP65



SILICONE INGRESS BOOT +2

CLIPSAL® INSERT COMPATIBLE WITH 2 BLANK INSERTS

Code

WP62





CLIPSAL® COMPATIBLE WALL PLATES METAL

Stainless steel wall plate.
Size: 87x136mm 1mm thick.

Type	Code
1	WPSS-1
2	WPSS-2
3	WPSS-3
4	WPSS-4
5	WPSS-5
6	WPSS-6



CLIPSAL® COMPATIBLE WALL PLATES 2000

White 118x72mm Two piece plate.

Type	Code
1way	CWP01
1way	CWP01B
2way	CWP02
3way	CWP03
4way	CWP04
5way	CWP05
6way	CWP06



CLIPSAL® COMPATIBLE WALL PLATES CLASSIC

White 116x75mm. Two piece wallplate.

Type	Code
1	CWP-201
2	CWP-202
3	CWP-203
4	CWP-204
5	CWP-205
6	CWP-206



CLIPSAL® COMPATIBLE WITH LABEL SINGLE

Standard White 118x72mm Premium
Two piece plate Single hole for inserts.
Paper label with plastic cover.

Code
WPL100



CLIPSAL® COMPATIBLE WITH LABEL DOUBLE

White 118x72mm Two piece plate.
Paper label with plastic cover.

Code
WPL200



CLIPSAL® COMPATIBLE WALL PLATE BLANK

Blank wall plate future expansion or
customisation. Hole punch markers.
10mm Thick is standard, 8mm Thick is
low profile

Size	Code
120x76x10mm	CWP-001
120x76x8mm	CWP00



CLIPSAL® COMPATIBLE WALL PLATE ARCHITRAVE

Accepts a switch or any of the following
inserts. Surrounds hides screws and eases
painting. Compatible with Clipsal® 2000 series.

Type	Code
1	CWP101
2	CWP102



RCA TO SOLDER

CLIPSAL® COMPATIBLE
Gold Plated. Solder back.

Colour	Code
Black	WPI231
White	WPI232
Red	WPI233
Green	WPI234
Blue	WPI235
Yellow	WPI236



RCA TO RCA

GOLD PLATED CLIPSAL® COMPATIBLE

Colour	Code
Black	WPI321
White	WPI322
Red	WPI323
Green	WPI324
Blue	WPI325
Yellow	WPI326



BNC TO BNC

BNC REAR
BNC Socket to
BNC Socket
Quick install
Wide-bandwidth

Code
WPI255



RCA TO "F" FLUSH

CLIPSAL® COMPATIBLE

Colour	Code
Black	WPI211
White	WPI212
Red	WPI213
Green	WPI214
Blue	WPI215
Yellow	WPI216



RCA TO RCA

CHROMIUM

Colour	Code
Black	WPI221
White	WPI222
Red	WPI223
Green	WPI224
Blue	WPI225
Yellow	WPI226



BNC TO "F"

"F" REAR
BNC Socket to F"
Socket Quick install
Wide-bandwidth

Code
WPI265



RCA TO "F"

CLIPSAL® COMPATIBLE

Colour	Code
Black	WPI281
White	WPI282
Red	WPI283
Green	WPI284
Blue	WPI285
Yellow	WPI286



S-VIDEO

4 Pin Mini-Din
Socket to Socket
Clipsal® compatible.

Code
WPI260



SMA TO SMA

SMA REAR
SMA Socket to
SMA Socket
Wide-bandwidth

Code
WPI290



PAL TO "F"

CLIPSAL® COMPATIBLE

PAL Socket to
"F" Socket Quick
install Flush mount

Code
WPI250



"F" TO "F" FOXTEL® APPROVED

CLIPSAL® COMPATIBLE

Chrome Wide-Band
Socket to socket

Foxtel Code
F30561 WPI245





BLANK - CLIPSAL® COMPATIBLE

For blanking off empty unused holes or for custom fitting connectors

Code
WPI200



HEX INSERT

Blank empty receptacle.

Code
WPI201

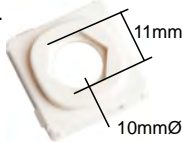

SPEAKER BINDING POST 4mm

Gold plated post
Colour ID Band
4mm plug entry or
Screw side-entry
Loose speaker wire

Colour Code
Red WPI271
Black WPI272



3.5mm STEREO INSERT

CLIPSAL 2000 COMPATIBLE

3.5mm Stereo
female to 3.5mm
stereo female with
20cm pig-tail.

Code
WPI299



VGA UNIVERSAL

CLIPSAL® COMPATIBLE

VGA Socket plus
4 blank sockets for
customisation. Includes
blanking caps.

Code
WPI401



HDMI DONGLE INSERT

HDMI Socket to socket with a short lead.

Type	Colour	Code
1080p	White	WPI297
4K@60Hz	White	WPI399WH
4K@60Hz	Black	WPI399BK



HDMI INSERT

CLIPSAL® COMPATIBLE

Socket to Socket Gold
plated pins Inline type

Code
WPI295



HDMI INSERT R/A

CLIPSAL® COMPATIBLE

Socket to Socket Gold
plated pins Right-Angle

Code
WPI296



USB 3.0 SOCKET

CLIPSAL® COMPATIBLE

USB 2.0 & 3.0
150mm Dongle
Socket to Socket
Round or Flat cable.

Type	Code
Round	WPI298
Flat	WPI398



CAT3 VOICE JACK 4 PINS 3456

CLIPSAL® COMPATIBLE

Punch tool insert
as used in voice
communications.
2 line / Dual
Appearance
Certified CAT3

Socket	Colour	Code
8P4C	White	DT100WHT
8P4C	Black	DT100BLK
8P4C	Blue	DT100BLU



CAT3 VOICE JACK 4 PINS 2345

CLIPSAL® COMPATIBLE

Punch tool insert 2 line
/ 2 appearance
as used in voice
communications.
Certified CAT3
4 Pins wired

Socket	Colour	Code
6P4C	White	TD1006P



CAT3 VOICE JACK 2 PINS 45

CLIPSAL® COMPATIBLE

As used in voice
communications.
Certified CAT3
2 Pins wired
Single line Dual
appearance

Socket	Colour	Code
8P2C	White	DT1002WHT



RJ45 CAT5e 8P8C DUST CAP

PUNCH DOWN

Dust cap

Code
CSM-CVR

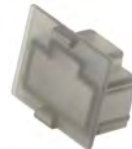

CABLE JOINER

PUNCH TOOL TYPE

Krone® 110 compatible
Eight in / Eight out
Enclosed case
50x25mm

Type	Colour	Size	Code
CAT5e	White	48x25x25mm	DA215C5E
CAT6	White	48x25x25mm	DA215C6
CAT6	Black	84x36x24mm	LY-SB33



CAT5e THROUGH - CSM/CLIPSAL®

CSM & CLIPSAL® COMPATIBLE

CAT-5e Ethernet RJ45
8-Pin Socket to Socket
CSM & Clipsal Adaptor

Code
WPI241



CAT5E INSERT CLIPSAL® TYPE

RJ45 WALL INSERT 8P8C

Type	QTY	Code
CAT5e	1	KJ5-26
CAT5e	10	KJ5-26-10
CAT5e	100	KJ5-26-100

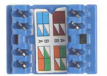

CAT5e CLIPSAL® COMPATIBLE

CLIPSAL® COMPATIBLE

Punch tool insert 8P8C
Certified CAT5e Compliant.

Colour	Code
White	DA103WHT
Black	DA103BLK
Red	DA103RED
Blue	DA103BLU
Yellow	DA103YEL
Green	DA103GRN



CAT6 INSERT CLIPSAL® TYPE

RJ45 WALL INSERT 8P8C

Type	QTY	Code
CAT6	1	KJ6-09
CAT6	10	KJ6-09-10
CAT6	100	KJ6-09-100



CAT6 CLIPSAL® COMPATIBLE

CLIPSAL® COMPATIBLE

Punch tool insert 8P8C
Certified CAT6 Compliant.

Colour	Code
White	DA600WHT
Black	DA600BLK
Red	DA600RED
Blue	DA600BLU
Yellow	DA600YEL
Green	DA600GRN



CAT5 PANEL MOUNT CABLE

RJ45 SOCKET TO PLUG

- 1.5M Cat5 RJ45 male to female shielded ethernet extension cable with panel mount.

Length	Code
1.5M	CL1815MF





WALL PLATES MODULAR PRO2

UNIVERSAL PLATE AND INSERTS TO SUIT

Pro2 understand that each job is different and each setup is unique. So that's why Pro2 created the MW13 modular wall plate range. Need 2 HDMI sockets and a Foxtel point on the wall? No problem, just pick your parts and assemble your own. Need to replace an old USB2 port with USB3? Just swap out the old one and replace it with the new without touching any other connector. With our modular design you can simply mix and match up two 3 modules to suit your needs. They snap on tightly and securely giving a perfect finish, each time.

MODULAR WALL PLATE FRAME PRO2

AUSTRALIAN STANDARD SIZE WALL PLATE

The Pro2 modular wall plate allows users to pick and assemble any outlets they need on their wall plate. This wall plate frame allows users to add 3x Pro2 wall plate modules to it. The modular design allows great flexibility to mix and match the modules to suit their needs. And the modules can be snapped to the wall plate frame with ease, simple installation and perfect finish. Size: 116x75x13mm



Code
MW13FR

PAL MODULE PRO2

Pro2 PAL socket to F-type socket wall plate insert module. To suit Pro2 Modular wall plate. Panel Size: 47x24x11mm



Code
MWI13PF

"F" TYPE FOXTEL APPROVED MODULE PRO2

Pro2 F-type sockets to F-type sockets wall plate insert module. Foxtel Approved Available in single or double To suit Pro2 Modular wall plate. Panel Size: 47x24x11mm



Types	Code
Single F-Type Connector	MWI13FF
Double F-Type Connector	MWI13FF2



BNC MODULE PRO2

Pro2 BNC socket to BNC socket wall plate insert module. To suit Pro2 Modular wall plate. Nickel plated with white colour insulator and washer Panel Size: 47x24x11mm



Code
MWI13BNC

STEP 1

Grab the MW13FR blank frame

STEP 2

Choose up to 3 modules to make the exact wall plate you need

Easy!



FRAME WALL PLATE

- Suits all MW13 type inserts
- Fits 3 inserts



Pro.2
Providing AV Solutions

Mix and match 3 modules and create your own design!

BRUSH MODULE PRO2

The Pro2 brush module fits perfectly with the Pro2 wall plate frame. It occupies 3 module positions on the wall plate frame. The brush module allows cable to enter a wall cavity without the additional wall plate connections. The brush helps to keep the dust away.

Brush dimension: 54x30mm



Code
MWI13BR

HOLE CUTOUT MODULE PRO2

This insert module is designed to allow you to pass a power cable or HDMI cable through the wall. This may be necessary for 4K 18GBPS HDMI installs for a direct cable run.

To suit Pro2 Modular wall plate (MW13FR). Panel Size: 47x24x11mm O.D. 11mmØ pass through



Code
MWI13B11



Example
Requires MW13FR

RCA MODULE PRO2

Pro2 RCA sockets to RCA sockets wall plate insert modules. Available for Video, Stereo and AV Module to suit your application. To suit Pro2 Modular wall plate. Panel Size: 47x24x11mm Connector Dimensions: 32x8mmØ



Types	Code
RCA Video Module	MWI13RCA1
RCA Stereo Module	MWI13RCA2
RCA AV Module	MWI13RCA3

RGB MODULE PRO2

Pro2 Component RCA sockets to Component RCA sockets wall plate insert module. To suit Pro2 Modular wall plate. Panel Size: 47x24x11mm Gold plated connectors Connector Dimensions: 32x8mmØ



Code
MWI13RGB



TOSLINK MODULE PRO2

Pro2 Toslink socket to toslink socket wall plate insert module. To suit Pro2 Modular wall plate. With nickel plated connectors and black insulator
Size: 47x24x11mm



Code
MWI13TOS

3.5MM AUDIO MODULE PRO2

Pro2 3.5mm stereo socket to 3.5mm stereo socket wall plate insert module. To suit Pro2 Modular wall plate. Lead length: 200mm
Size: 47x24x11mm



Code
MWI13A35

SPEAKER MODULE PRO2

Pro2 2x banana sockets to 2x banana sockets wall plate insert module. To suit Pro2 Modular wall plate. Gold plated connectors with Black/Red rings
Panel Size: 47x24x11mm



Code
MWI13SPK

USB-A MODULE PRO2

Pro2 USB 2.0 and 3.0 socket to socket wall plate insert module. with 0.2M lead
To suit Pro2 Modular wall plate. Panel Size: 47x24x11mm



Types	Code
USB 2.0 to USB 2.0	MWI13USB2
USB 3.0 to USB 3.0	MWI13USB3

USB-B MODULE PRO2

TO SUIT PRO2 MW13FR BLANK FRAME

Pro2 USB 2.0 B socket to USB 2.0 A socket wall plate insert module. With 0.2M lead
To suit Pro2 Modular wall plate. Panel Size: 47x24x11mm



Connector	Code
USB-BF to USB-AF	MWI13USBB

DVI MODULE PRO2

Pro2 DVI socket to DVI socket wall plate insert module. with 0.2M UL20276 type lead
Lead diameter: 9.5mm
Gold plated connector
To suit Pro2 Modular wall plate. Panel Size: 47x24x11mm



Code
MWI13DVI

HDMI MODULE PRO2

Pro2 HDMI socket to HDMI socket wall plate insert module. with 0.2M UL30276 type lead
Lead diameter: 6mm
Gold plated connector
To suit Pro2 Modular wall plate. Panel Size: 47x24x11mm



Code
MWI13HDMI

VGA MODULE PRO2

Pro2 DB15 VGA socket to DB15 VGA socket wall plate insert module. Nickel plated connector with screw terminals on both sides
To suit Pro2 Modular wall plate. Panel Size: 47x24x11mm



Code
MWI13VGA

CAT5e & CAT6 JOINER MODULE PRO2

Pro2 CAT5e and CAT6 socket to socket wall plate insert module. To suit Pro2 Modular wall plate. Panel Size: 47x24x11mm



Types	Code
CAT5e	MWI13C5J
CAT6	MWI13C6J

CAT6 KEYSTONE MODULE PRO2

Pro2 CAT6 punch tool insert wall plate insert module. Includes CAT6 keystone and keystone plate
To suit Pro2 Modular wall plate. Panel Size: 47x24x11mm



Code
MWI13C6M

KEYSTONE PLATE MODULE PRO2

Pro2 Keystone plate for the Pro2 wall plate. White colour
Panel Size: 47x24x11mm

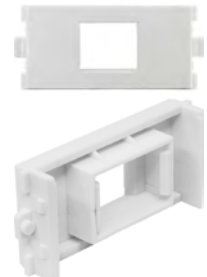

Code
MWI13KS

KEYSTONE
SEE NEXT PAGE...

BLANK PLATE MODULE PRO2

Pro2 Blank plate for the Pro2 wall plate. White colour
Panel Size: 47x24x11mm



Code
MWI13BL



Wall Plates Keystone

"CSM" KEYSTONE MODULES

"F" KEYSTONE

"F" to "F" (Back)

Code
CSM130



"F" KEYSTONE FOX

Code
CSM131BK

"CSM" OPTO KEYSTONE

"ST" Type bayonet

Code
CSM122



"SC" Type Snap-Lock

Code
CSM120



"LC" Type Keystone

Code
OPTO1004K

IR RECEIVER 3.5MM KEYSTONE ADAPTOR

PUSH-LOCK BARE WIRE

Connector Code
3.5mm socket x1 PK4914



HDMI KEYSTONE INSERT

Code
PK4910



"CSM" SURFACE MOUNT BOXES

No holder plate required Plug in Keystone directly Simple. Comprehensive. Professional. Includes labels, cable ties, etc. Requires "CSM" modules.

Outlet Code
1 Way CSB110
2 Way CSB120



Note: Not compatible with CSM150 and CSM151 Connectors

"CSM" WALLPLATES

No holder plate required Plug in Keystone directly Standard "Light-Switch" size wall plate. White. Labels. Screws, etc. Requires "CSM" modules

Ports Code
1 CWP110
2 CWP120
4 CWP140

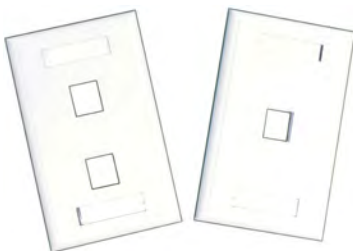

CLIPSAL® COMPATIBLE KEYSTONE COLLAR

Adapts a standard CAT5/6 Type Keystone module to a Clipsal® type receptacle.

Code
CLP-KSCLR



HPM® COMPATIBLE KEYSTONE COLLAR

Adapts a standard CAT5/6 Type Keystone module to a HPM® type receptacle.

Code
HPM-KSCLR



"CSM" CAT6 KEYSTONE JACKS

Three colours available.
3x Labelled dust covers ea.

Colour Code
White CSM102
Red CSM104
Yellow CSM106



CAT5e KEYSTONE WITH CLIPSAL COLLAR

KS series CAT5 8P8C keystone, easy to install. Clipsal® type bezel included.

Code
KS-CAT5E



CAT6 KEYSTONE 8P8C WITH CLIPSAL COLLAR

KS series CAT6 8P8C keystone. Clipsal® type bezel included.

Code
KS-CAT6



CAT6 KEYSTONE JACKS

Punch-down wire connector.

Colour Code
White CSM150
Black CSM152



Note: This series is not compatible with CSB110, CSB120 Surface Mount Boxes.

CAT6 STP KEYSTONE SHIELDED

Fully shielded front and back. Gold plated connections. Punch-down. Suit CAT6, UTP & STP. 1G bandwidth.

Type Code
CAT6 CSM151

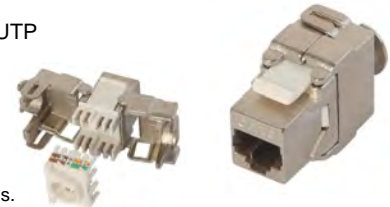

Note: This series is not compatible with CSB110, CSB120 Surface Mount Boxes.

CAT3 KEYSTONE 8P4C WITH CLIPSAL COLLAR

KS series CAT3 8P4C keystone, Clipsal® type bezel included.

Code
KS-CAT3



CAT3 KEYSTONE GEL FILLED 8P4C

CAT3 8P4C keystone with Gel filled RJ plug and IDC connectors. Clipsal® type bezel included.

Code
KS-CAT3-GEL



CAT3 KEYSTONE WITH MOD3 FUNCTION 8P4C

CAT3 8P4C keystone with Mod 3 function, Clipsal® type bezel included.

Code
KS-CAT3-MOD3





Wall Plates Keystone

"SIM" WALL PLATE

3 unit height for either 2x 1½" SIMs or 3x 1" SIMs or say a 1½" & 1" SIMs with a ½" blanking plate. Enables many combinations, a max of 6x "CSM" ports.

Code
CWP200

Requires SIM220 & CSM Keystones



"SIM" TO "CSM" MODULE HOLDER PLATES

1" (25mm) height Snap-In-Modules. See "CSM" ports. Use CWP200 wall or CSB240 boxes.

Ports	Code
1	SIM210
2	SIM220



"SIM" TO "CSM" 45° MODULE HOLDER PLATE

1½" (37mm) height Snap-In-Modules. Same as SIM210, 20 but angled for cable strain relief, etc.

Ports	Code
1	SIM211
2	SIM221



"SIM" BLANKING PLATES

Fill-in blank spaces or use for future system expandability

Height	Code
½" 12mm	SIM202
1" 25mm	SIM200
1½" 37mm	SIM204

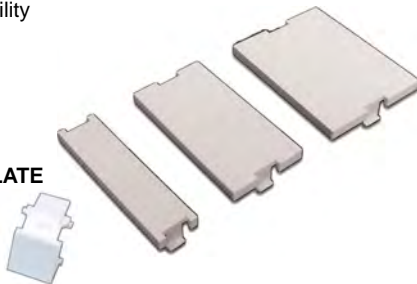

SINGLE BLANKING PLATE

Blank off unused ports. Leave room to expand!

Code
CSM100

CAT5e/6 NETWORK PRODUCTS

SEE DATA & COMPUTER SECTION

Comprehensive range of computer related networking items are available. Too many to list here...

See Section 04...

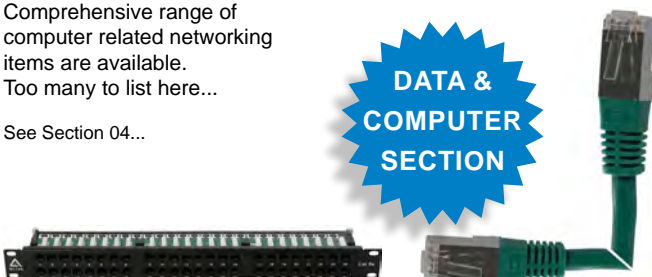

Modular & Telephone

MODULAR LEADS - CROSSED

Male to Male - Pin 1 to Pin # (eg. 4P4C Handset Cord)

Type	Pins	Colour	Length	Code
Curly	4P4C	Beige	1.8M	TC12IVY
Curly	4P4C	Black	1.8M	TC12BK
Curly	4P4C	Beige	3.6M	TC14
Curly	4P4C	Black	3.6M	TC14BK
Ribbon	6P4C	Beige	2.0M	TC20
Ribbon	6P4C	Beige	4.0M	TC22
Ribbon	6P6C	Beige	1.8M	TC26
Ribbon	6P6C	Beige	3.6M	TC28
Ribbon	8P8C	Beige	1.8M	TC32
Ribbon	8P8C	Beige	3.6M	TC34

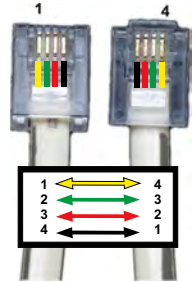

MODULAR LEADS - PLUG TO PLUG

Male to Male - Wired Pin 1 to Pin 1

Type	Pins	Colour	Length	Code
Curly	4P4C	Beige	~1M	TC40
Curly	4P4C	Beige	~3M	TC42IVY
Curly	4P4C	Black	~3M	TC42BK
Curly	6P6C	Beige	1M	TC60
Ribbon	6P2C	Beige	150mm	TC10
Ribbon	6P4C	Beige	2M	TC44
Ribbon	6P4C	Beige	4M	TC46
Ribbon	6P6C	Beige	1.8M	TC48
Ribbon	6P6C	Beige	3.6M	TC51
Ribbon	6P4C	Beige	3M	TC72
Ribbon	6P4C	Beige	5M	TC74
Ribbon	6P4C	Beige	10M	TC76
Ribbon	6P4C	Grey	3M	TC82LG
Ribbon	6P4C	Grey	5M	TC74LG
Ribbon	6P4C	Grey	10M	TC87LG
Ribbon	6P4C	Grey	15M	TC95LG
Ribbon	6P4C	Black	2M	TC80
Ribbon	6P4C	Black	3M	TC82BK
Ribbon	6P4C	Black	5M	TC74BK
Ribbon	6P4C	Black	10M	TC87
Ribbon	6P4C	Black	15M	TC95BK
Ribbon	8P8C	Beige	1.8M	TC52
Ribbon	8P8C	Beige	3.6M	TC54
Ribbon	8P8C	Beige	10M	TC55

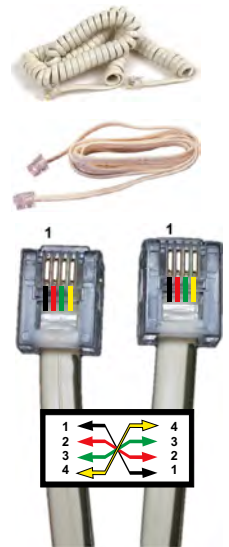

MODULAR GENDER CHANGERS

PIN 1 TO PIN 1

*6 PIN
Code
MOD49

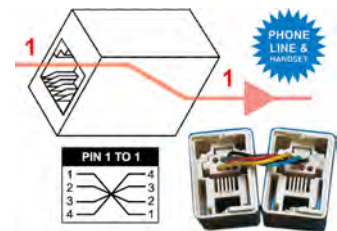

8 PIN
Code
MOD50



MODULAR GENDER CHANGERS

PIN 1 TO PIN 4/6/8

4 PIN
Code
MOD58

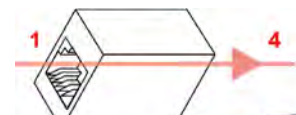

6 PIN
Code
MOD59



*8 PIN
Code
MOD60

MODULAR PLUGS

Crimp Plugs supplied 10 pieces per bag *Please note: 4P4C means Miniature 4 pin type ie. Physically smaller than 6P4C (Standard RJ12) Multi-Strand or Solid. For crimp tools see Tools Section...

Pins	Code
4P4C	MOD4M
6P4C	MOD4
6P6C	MOD6
8P8C	MOD8
10P10C	MOD10





Cables & Connectors

TELEPHONE PLUG 600 TELECOM

No Longer Available!

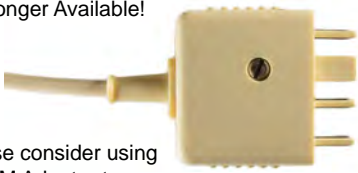

Please consider using P606M Adaptor to Modular Phone Plug.

TELEPHONE SOCKET

IN-LINE

Code
S610

WALL SOCKET

Code
S613

MODE 3 WALL SOCKET

Code
S611



SOLDERLESS TERMINALS

Copper Crimp type for S610 etc.

QTY Code
20 PT20
100 PT100



MODULAR ADAPTORS

Standard phone plug adapted to:

6P4C

Code
P606M

8P4C

Code
P608M



ADAPTOR

Standard Socket to Modular socket

Code
S610M



ADAPTOR

Telecom Socket to Modular Plug. S610 TO 6P4C Two wires. Suit any standard telephone connection.

Code
TC150



DOUBLE ADAPTOR

Double Adaptor All Telecom type

Code
TD2401



DOUBLE ADAPTOR

P605 Plug to 2 x 6P4C

Colour Code
Ivory TD2406



DOUBLE ADAPTOR MODULAR

P605 TO S610 & 6P4C

Colour Code
Black TD2408BK
Ivory TD2408IV



TELEPHONE CABLE TELECOM

Fully Austel Approved Used with popular standard phones (2 Pins Wired)

Length Code
2 Metres TC160



EXTENSION CABLES

Length Code
5 Metre TXT5



6P4C TO 8P4C ADAPTOR

6 pin RJ12 to 8 pin RJ45 with 4 pins wired.

Length Code
2.0M TC86



MODULAR DOUBLE ADAPTOR

TELEPHONE SPLITTER

4/6 pin plug 6P4C to two female sockets

Code
TD101

RJ45 / 8P8C

Split communications

Code
CA104



"Y" ADAPTOR SOCKETS

Double adaptors. All sockets type.

6P6C RJ12

Code
TD163

8P8C RJ45

Code
TD183



ANSWER-MACHINE ADAPTOR

Disconnects the answering machines' line when you pick up the phones' line. Stops it rudely interrupting !

Code
MPS2



MODULAR PRIVACY SWITCH

Adapts two telephone devices to share the one line without interruption. This is done by disconnecting the unused device so it cannot then interrupt the unit that was used first. Suit FAX, Modems, Answer, etc.

Code
MPS1



CAT5e MOD-8 CRIMP PLUGS

MULTI-STRAND CABLE

Code
MOD81



SOLID-CORE CABLE

Round cable entry

Code
MOD82



See Section Data & Computer for CAT5/5e/6



TELEPHONE WALL MOUNT

NEW Type now supplied: Wall mount a Telstra phone with its mounting plate. 200mm connection lead included. Adapts from the standard 6P4C on todays phones to the NEW 8P4C wall socket (future compatible). IDC push terminals rear.



Code
MOD84I

6P6C WALL PLATE

Suit Code
4/6 Pin MOD65



WALLPLATE & INSERT

INSERT & PLATE SOLD SEPARATELY

Suit Clipsal® Type keystone / collar. With removable finger plate for painting. TD1006P is for common telephone Voice Jack CAT3, others are 8 pin CAT5

Description	Code
Clipsal® Compatible Wall plate.	CWP01
8 Pins wired of 8	DA103WHT
4 Pins wired of 8	DT100WHT
2 Pins wired of 8	DT1002WHT
4 Pins wired of 6	TD1006P



Wall plate and insert sold separate.

RJ45 SURFACE MOUNT BOX

Suit 4/6 Pin

Standard plug or 7.5mm 4 pin. (Inc. adaptor.) Screw terminals.

Code
MOD66



Suit 8 Pin

Code
MOD68

KRONE™ COMPATIBLE

Code
MOD68-IDC



MODE 3 SOCKET 8P8C

WITH SHORTING BAR

Surface mount
Screw terminated
RJ45 8P8C socket

Code
MOD83



KEYSTONE SURFACE MOUNT BOX CSM SERIES

EMPTY - REQUIRES KEYSTONE

These mount boxes are compatible with KS series CAT5/6 keystone inserts. They include a piece of mounting tape, label, screws and cable ties. These have automatically closing spring loaded dust protection doors.

Outlet	Code
1 Way	SMB-01
2 Way	SMB-02



TWIST STOPPER

Stop your handset cord from tying you up in knots. Allows 360° rotation. Standard 4P4C Plug to socket.

Code
TS01



INDUCTION MICROPHONE

Pickup induction coil type (Not a microphone as such). Place on a standard telephone earpiece and it records to any standard mic input. 1M cable. 3.5mm plug.

Code
TIC1



MAINS POWER PROTECTOR WITH RJ12

Protects your appliances from the hazards of damaging power surges and voltage spikes. With telephone line (Voice) protection too. MOV x3 & Gas Arrester. Slimline for powerboard mounting. Fully approved C-tick. RJ12 (6P4C) x2 telephone socket. Once the MSPT has been triggered, the indication light will extinguish and the MSPT has done its job and will need replacement.

Code
MSPT10



TELEPHONE LINE SURGE PROTECTOR

Highly effective Gas Arrester type voltage spike protection inline Male to Female RJ12 6P2C for voice phones & fax machines.

Code
LPU01



OVERSEAS MODEM ADAPTOR

Suit mobile travellers with Laptops and inbuilt modems. 7 adaptors from RJ11/12 to most popular world plugs. Suit more that 60 countries. Guide & carry bag included.

Code
MA14

Click to: www.korjo.com.au



TELEPHONE CABLE

Multi-Core Multi-Strand Classic Cream Jacket Cable Sold in 100m pull boxes.

Core	Type	Code
4	Flat	FMC4
6	Flat	FMC6
8	Flat	FMC8





ADSL IN-LINE FILTER

ADSL2/2+ POTS FILTER RJ11 RJ12

Filters ADSL signal from the ADSL line to your analogue phone. New high quality low pass 4 stage filter for cordless phones. RCIT.0004 ETSI/Telstra



ADSL 2+

Code
DSL002

ADSL IN-LINE FILTER/SPLITTER

Splits the incoming ADSL line into one filtered RJ socket for the phone & non-filtered RJ socket for an ADSL2/2+ modem



Code
DSL008

ADSL/VDSL IN-LINE FILTER/SPLITTER

WITH RJ45/RJ45 CONNECTIONS FOR LINE, MODEM AND PHONE

Suits ADSL1, ADSL2 and ADSL2+ and VDSL2 services. CE Approved.

ADSL VDSL



Code
EM1690B

ADSL FILTER/SPLITTER

Ideal for wiring from first point. One filter for the whole house. Can be hard wired or use the modular connections.



Code
DSL0042+

ADSL MODE-3 SECURITY

ALARM SPLITTER/FILTER RJ11 RJ12

Mode-3 Connection
RoHS and RCIT.0004.
AS/ACIF SO41:2005
Hard wired input
Multiple outputs
Internal IDC pins and/or RJ Sockets



Code
DSL019

ADSL WALL PLATE FILTER/SPLITTER

For new wall plate installations for phone on-wall mounting. Uses IDC terminals for the incoming line. Side entry non-filtered RJ socket for modem and filtered for extra phones or side entry. Voice only.

Code
DSL018



ADSL FILTER/SPLITTER

EXTERNAL RJ11 RJ12

RoHS Compliant
IDC Terminations
ACA Compliant
4 Stage Filter
Minimises Noise
Mode-3 Compatible
Surge Arrestor



Code
DSL101

TELEPHONE RING EXTENDER

Loud 90dB Phone ringer with adjustable Pitch and Volume control. Does not require a power supply
Line-powered RJ12



Code
TR001B

TELEPHONE HANDSET

LAND-LINE

Standard DTMF Phone.
Keypad on handset.
Desk or Wall mount base.
RJ12 1.2M Lead (Removable)
Ring volume switch
Compact 185x65x75mm



Code
SLP001

PABX MUSIC ON HOLD

Connects any music source to a majority of commander and PABX systems via 3.5mm plug. Compact, easy to setup, requires music source.



Code
LIUM

4 ANNOUNCEMENT DIGITAL PLAYER

MUSIC-ON-HOLD OR PA

Four channel, programmable, Recorder/Playback for use with a PA or phone system. Digital storage up to 10min. Triggers on external switch, PABX or Line-In silence. Compact, easy to operate.

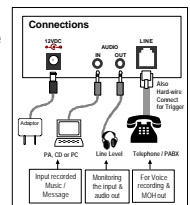

Code
MOH540





Terminal Blocks

TERMINAL BLOCK 5mm Pitch

20A 300V
14-22AWG
1mm Pins
Label face.

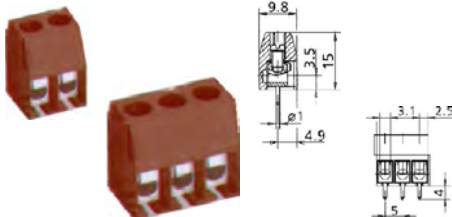

Type	Code
2Way	MTB812
3Way	MTB813

TERMINAL BLOCK 0.2" Pitch

20A 300V
14-22AWG
1mm Pins
Label face.

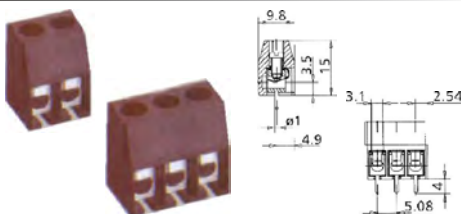

Type	Code
2Way	MTB832
3Way	MTB833

LOW-PROFILE 5mm Pitch

15A 300V
14-22AWG
0.9mm Pins
Label face.

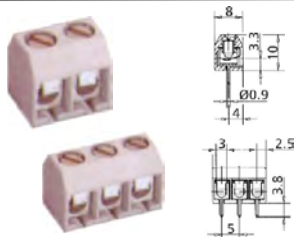

Type	Code
2Way	MTB012
3Way	MTB013

LOW-PROFILE 0.2" Pitch

15A 300V
14-22AWG
1mm Pins
Label face.

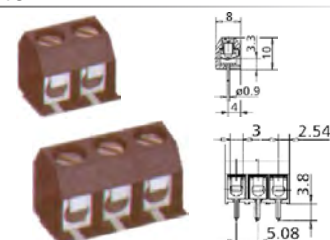

Type	Code
2Way	MTB1012
3Way	MTB1013

LARGE GAUGE 10mm Pitch

30A 300V (UL)
32A 750V (IEC)
10-26AWG
1mm Pins

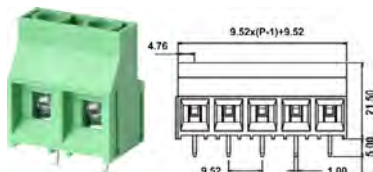

Type	Code
2Way	MTB952
3Way	MTB953

LARGE GAUGE 10mm Pitch

40A 600V
6-20AWG
Double Anchor
Solder Pins
Heavy duty



Type	Code
2way	MTB1162

PLUGGABLE 5mm Pitch

12A 300V 12-28AWG
Compatible with PHOENIX CONTACT

Phoenix 2 Way

Description	Code
Plug	MTB3492
PCB	MTB3292

Phoenix 3 Way

Description	Code
Plug	MTB3493
PCB	MTB3293

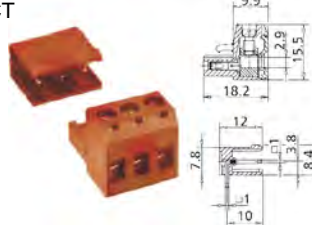

SEALED CRIMP CONNECTORS

FLOODED CHAMBER JOINERS

Quick and easy cable joining for many applications including computer and phone telecommunications, etc. Small gauge cable joiner solution. The crimp action crushes the cable into the blade terminal and floods the connection internally with silicone sealant. This pushes the oxygen out and prevents moisture getting in. The result is a long lasting, weather resistant seal for a reliable non-corrosive connection.

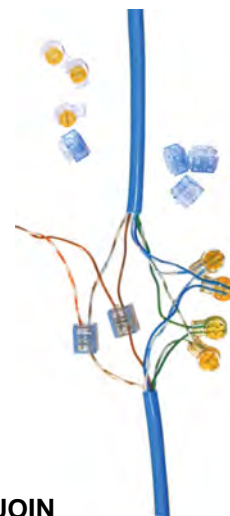

SEALED CRIMP CONNECTORS - JOIN

TWISTED PAIR CABLE JOINERS

"Crush to make" terminals. Floods sealed chamber with silicone for a long-term reliable IP connection.



QTY	Code
20	TM44020
100	TM44100

SPLICER

For intersecting an existing cable
Buy ONE to receive a bag.
Suit 19-26AWG



BAG OF 20

Code
TM45020

BAG OF 100

Code
TM45100

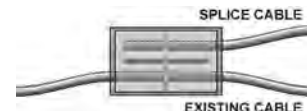

TERMINAL STRIP 12 WAY

Stamped chromium
steel closed inserts 2.8mm
96x17x13mm nylon 240V 10A

Code
TB240

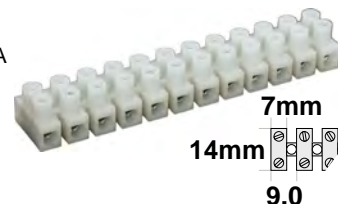

TERMINAL STRIPS IN ALL SIZES

NYLON WITH BRASS + STEEL SCREWS

Heavy duty quality for reliability. 5A to 60A. Insulation Voltage 380V. 12 Terminals with mounting Holes between each. Cut to length.

I _{max}	Length	Ø _{max}	Code
5A	110x16mm	3.6mm	TS1236
10A	115x20mm	4.0mm	TS1240
15A	136x22mm	4.8mm	TS1248
30A	170x26mm	5.1mm	TS1251
60A	186x29mm	6.7mm	TS1267





Quick Disconnect

SPADE TERMINALS MALE & FEMALE

Type	Colour	TAB.	AWG	Code
Female	Red	6.4mm	22-18	TM20251
Female	Blue	6.4mm	16-14	TM20252
Female	Yellow	6.4mm	12-10	TM20253
Female	Red	4.7mm	22-18	TM20181
Female	Blue	4.7mm	16-14	TM20182
Female	Red	2.8mm	22-18	TM20111
Male	Red	2.8mm	22-18	TM21111
Male	Red	4.7mm	22-18	TM21181
Male	Blue	4.7mm	16-14	TM21182
Male	Red	6.4mm	22-18	TM21251
Male	Blue	6.4mm	16-14	TM21252
Male	Yellow	6.4mm	12-10	TM21253

Bag of 100



QUICK DISCONNECT KIT

300 PIECES IN A BOX
Suit 22-14 AWG
Most popular crimps.
Box 210x110x30mm.

Code
TMK300



SPADE TERMINALS FEMALE

Colour	TAB.	AWG	Code
Red	6.4mm	22-18	TM22251
Blue	6.4mm	16-14	TM22252
Yellow	6.4mm	12-10	TM22253
Red	4.7mm	22-18	TM22181
Blue	4.7mm	16-14	TM22182
Red	2.8mm	22-18	TM22111
Blue	2.8mm	16-14	TM22112

Bag of 100



SPADE TERMINALS - TELEPHONE 4mm

Solderless terminals of brass.
Available in bags of 20 or 100 pieces.
Small 4mm terminal size. 28-20AWG.

TAB	QTY	Code
4mm	20	PT20
4mm	100	PT100



PIN TERMINALS

Colour	TAB	Length	AWG	Code
Red	1.9mm	9mm	22-16	TM32276
Blue	1.9mm	10mm	16-14	TM32278
Yellow	2.8mm	13mm	12-10	TM32280

Bag of 100



SLA BATTERY TERMINAL ADAPTORS

SLA battery terminal adaptor to change batteries.
Description is of battery terminals. Sold in pairs.

Description	Code
Convert 4.8mm to 6.3mm male	F1TOF2
Convert 6.3mm to 4.8mm male	F2TOF1



F1TOF2 [PAIR]

TAP SPLICES

AWG	Colour	Code
22-18	Red	TM42001
16-14	Blue	TM42002
12-10	Yellow	TM42003

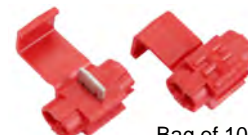

Bag of 100

BULLET CONNECTORS

Type	Colour	TAB.	AWG	Code
Male	Red	4mm	22-18	TM24151
Male	Blue	4mm	16-14	TM24152
Male	Blue	5mm	16-14	TM24192
Male	Yellow	5mm	12-10	TM24193
Female	Red	4mm	22-18	TM25151
Female	Blue	4mm	16-14	TM25152
Female	Blue	5mm	16-14	TM25192
Female	Yellow	5mm	12-10	TM25193

Bag of 100



BUTT SPLICES

AWG	Colour	Code
22-18	Red	TM40001
16-14	Blue	TM40002
12-10	Yellow	TM40003

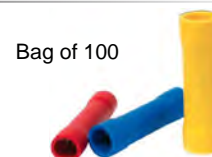

Bag of 100

CLOSED END CRIMPS

AWG	Code	Bag of 100
22-18	TM41001	
16-14	TM41002	
12-10	TM41003	



Bag of 100

RING TERMINALS

Stud.	Colour	AWG	Code
8.0mm	Blue	16-14	TM10142
8.0mm	Yellow	12-10	TM10143
6.4mm	Red	22-18	TM10121
6.4mm	Blue	16-14	TM10122
6.4mm	Yellow	12-10	TM10123
5.3mm	Red	22-18	TM10101
5.3mm	Blue	16-14	TM10102
5.3mm	Yellow	12-10	TM10103
4.3mm	Red	22-18	TM10081
4.3mm	Blue	16-14	TM10082
4.3mm	Yellow	12-10	TM10083
3.7mm	Red	22-18	TM10061
3.7mm	Blue	16-14	TM10062

Bag of 100



SCREW TERMINATORS

Single ended connectors.
Order one to receive 10.

QTY	Code
10	SC40



Bag of 100

WIRE CONNECTION NUTS

Bare end of wires & twist in.

AWG	Colour	Code	Bag of 100
22-18	Orange	TM43001	
16-14	Yellow	TM43002	



Bag of 100

SPADE TERMINALS

Stud.	Colour	AWG	Code
6.4mm	Red	22-18	TM11121
6.4mm	Blue	16-14	TM11122
6.4mm	Yellow	12-10	TM11123
5.3mm	Red	22-18	TM11101
5.3mm	Blue	16-14	TM11102
5.3mm	Yellow	12-10	TM11103
4.3mm	Red	22-18	TM11081
4.3mm	Blue	16-14	TM11082
4.3mm	Yellow	12-10	TM11083
3.7mm	Red	22-18	TM11061
3.7mm	Blue	16-14	TM11062

Bag of 100



TWISTER® WIRE CONNECTORS

Rating	Wire	Colour	QTY	Code
450V 32A max	0.5mm to 4mm ²	Orange	250	TWC32
600V 41A max	0.5mm to 6mm ²	Tan	150	TWC41
600V 57A max	2.5mm to 10mm ²	Grey	75	TWC57



Bag of 250



Bag of 150



Bag of 75



Chogori Connectors



CHOGORI® Waterproof Connectors

Chogori 500 Series

500 SERIES PLUGS & SOCKETS

500 series waterproof connector is manufactured with high quality materials to meet different requirements of various environments. Its plastic material used is high performance PA66. Male pins are phosphor bronze assembly with good electrical conductivity brass. Female contacts are lathed and milled of two solid brass rods and reeds are stamped of beryllium copper. Terminals' surfaces are gold-plated with 4u"-20u". Superior mechanical properties ensure long effective application with insert and withdraw lifetime up to 3000 times. 500 series connector has a good performance is ideal for harsh working environments.



500 SERIES SOCKET - PUSH LOCK

FRONT PANEL MOUNT - FEMALE PINS

500 series IP65 push lock front panel mount socket.

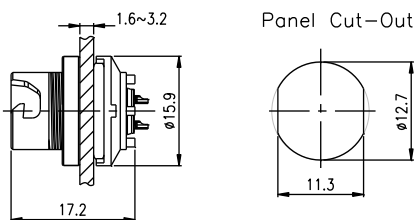

Contact	Wire Gauge	Voltage Rating	Rated Current	Code
2	0.34mm ²	110V	2A	11002635-01
3	0.34mm ²	110V	2A	11003635-01
4	0.34mm ²	110V	2A	11004635-01
5	0.34mm ²	60V	2A	11005635-01
6	0.34mm ²	60V	2A	11006635-01
10	0.13mm ²	30V	1A	11010635-01

500 SERIES PLUG - PUSH LOCK

MALE PUSH LOCK - MALE PINS

500 series IP65 push lock plug with male pins.

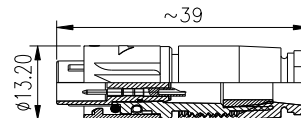

Contact	Wire Gauge	Voltage Rating	Rated Current	Code
2	0.34mm ²	110V	2A	11002131-01
3	0.34mm ²	110V	2A	11003131-01
4	0.34mm ²	110V	2A	11004131-01
5	0.34mm ²	60V	2A	11005131-01
6	0.34mm ²	60V	2A	11006131-01

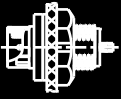

□ Chogori Mini Series

FIELD INSTALLABLE 180° SOLDER SCREW TYPES



Mini series waterproof connector with high quality materials to meet different requirements of various environments. Its plastic material used is high performance PA66. Pins used have excellent mechanical properties with phosphor bronze assembly and good electrical conductivity brass. Mini series connector has a good performance with waterproof rating of IP67.

MINI SERIES PLUG BAYONET

MALE BAYONET - FEMALE PINS

Mini series IP67 bayonet type plug with female pins. 42.3x14.3mmØ
Cable entry 3.5-6.8mmØ

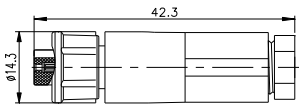

**Includes molded plug to 2M lead

Contact	Wire Gauge	Voltage Rating	Rated Current	Code
2	0.519mm ²	110V	5A	21002221-01
2	0.5mm ²	110V	5A	11C03321011901
3	0.519mm ²	110V	5A	21003221-01
4(5A)	0.519mm ²	110V	5A	21004221-01
4(2A)	0.34mm ²	50V	2A	21004221-02
4(2A)**	0.519mm ²	50V	2A	11C02416090701
5	0.34mm ²	50V	2A	21005221-01
6	0.34mm ²	50V	2A	21006221-01
2+4	0.34mm ²	50V	5A+2A	21204221-01

MINI SERIES SOCKET BAYONET

REAR PANEL MOUNT - MALE PINS

Mini series IP67 bayonet type rear panel mount with male pins.

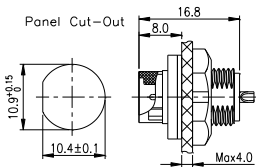

Contact	Wire Gauge	Voltage Rating	Rated Current	Code
2	0.519mm ²	110V	5A	21002525-03
3	0.519mm ²	110V	5A	21003525-03
4(2A)	0.34mm ²	50V	2A	21004525-02
4(5A)	0.519mm ²	110V	5A	21004525-03
4(2A)	0.34mm ²	50V	2A	21004525-04
5	0.34mm ²	50V	2A	21005525-03
6	0.34mm ²	50V	2A	21006525-03
2+4	0.34mm ²	50V	5A+2A	21204525-03

MINI SERIES PLUG SCREW

MALE SCREW - FEMALE PINS

Mini series IP68 screw type plug with female pins. 42x14mmØ in size.
Cable entry 3.5-6.8mmØ

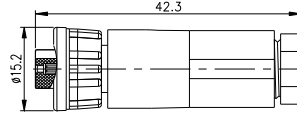

Contact	Wire Gauge	Voltage Rating	Rated Current	Code
2	0.519mm ²	110V	5A	21002211-01
3	0.519mm ²	110V	5A	21003211-01
4(5A)	0.519mm ²	110V	5A	21004211-01
4(2A)	0.34mm ²	110V	2A	21004211-02
5	0.34mm ²	50V	2A	21005211-01
6	0.34mm ²	50V	2A	21006211-01
2+4	0.34mm ²	50V	5A+2A	21204211-01
8	0.34mm ²	50V	2A	21008211-01

MINI SERIES SOCKET SCREW FRONT

FRONT PANEL MOUNT - MALE PINS

Mini Series screw type front panel socket with male pins

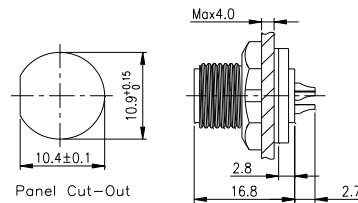

Contact	Wire Gauge	Voltage Rating	Rated Current	Code
3	20AWG	110V	5A	21003515-01
4	20AWG	110V	5A	21004515-01
5	22AWG	50V	2A	21005515-01
6	22AWG	50V	2A	21006515-01
2+4	22AWG	50V	5A+2A	21204515-01

MINI SERIES SOCKET SCREW BACK

REAR PANEL MOUNT - MALE PINS

Mini series IP67 screw type rear panel mount socket with male pins. To be mounted to a 11mmØ hole.

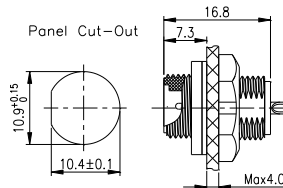

Contact	Wire Gauge	Voltage Rating	Rated Current	Code
2	0.519mm ²	110V	5A	21002515-03
3	0.519mm ²	110V	5A	21003515-03
4	0.519mm ²	110V	5A	21004515-03
5	0.34mm ²	50V	2A	21005515-03
6	0.34mm ²	50V	2A	21006515-03
2+4	0.34mm ²	50V	5A+2A	21204515-03
8	0.34mm ²	50V	2A	21008515-03

MINI SERIES WATERPROOF CAP SCREW

CHOGORI

Mini Waterproof Cover for Panel Mount Connector(Screw Type).

Code
806-00028-00





□ Chogori Standard Series

FIELD INSTALLABLE 180° SOLDER SCREW TYPES

MEDIUM SIZED PLUG & SOCKET SYSTEM

- Standard circular connectors Chogori. Field installable. Solder pins.
- Designed to withstand harsh industrial and climatic environment, its superior quality ensures reliable connection for the higher standards and reliability of industrial machinery and equipment, marine electronics, LED display of power and signal control components, etc.
- This high quality connector can insert and withdraw simply and quickly. Addition to the lock bayonet and screw type docking type, the push-locking connection can also be simple and fast plug in and out.
- Pins from 2 to 12 can satisfy the various requirements of customers.
- All the products are manufactured with high quality materials to meet the various requirements of different environments, the plastic material used is high performance PA66. Pins used has excellent mechanical properties with phosphor bronze assembly and good electrical conductivity brass. Contacts are gold-plated with 4u"-20u"
- Superior mechanical properties ensure long effective application with insert and extract lifetime up to 3000 times.

STANDARD SERIES PLUG (R) SCREW

MALE SCREW - FEMALE PINS

Standard series screw type circular connectors. Field installable with female pins. IP68 water resistance, size: 48x19mmØ.



Contact	Wire Gauge	Voltage Rating	Rated Current	Code
2	0.823mm ²	300V	10A	22002211-01
3	0.823mm ²	300V	10A	22003211-01
5	0.519mm ²	60V	5A	22005211-01
6	0.519mm ²	60V	5A	22006211-01
2+4	0.823mm ² *2C + 0.519mm ² *4C	60V	10A+5A	22204211-01
3+4	0.823mm ² *3C + 0.519mm ² *4C	60V	10A+2A	22304211-01
8	0.519mm ²	60V	5A	22008211-01
12	0.34mm ²	30V	2A	22012211-01

STANDARD SERIES SOCKET (R) SCREW

REAR PANEL MOUNT - MALE PINS

Standard series circular screw type rear panel mount. Field installable with male pins. IP68 water resistance. Mounted in a 16mmØ hole.

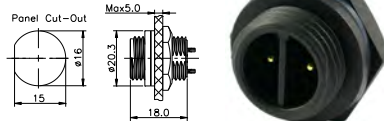

Contact	Wire Gauge	Voltage Rating	Rated Current	Code
2	0.823mm ²	300V	10A	22002515-03
3	0.823mm ²	300V	10A	22003515-03
5	0.519mm ²	60V	5A	22005515-03
6	0.519mm ²	60V	5A	22006515-03
2+4	0.823mm ² *2C + 0.519mm ² *4C	60V	10A+5A	22204515-03
3+4	0.823mm ² *3C + 0.519mm ² *4C	60V	10A+2A	22304515-03
8	0.519mm ²	60V	5A	22008515-03
12	0.34mm ²	30V	2A	22012515-03

STANDARD SERIES WATERPROOF CAP SCREW

Waterproof cap for standard series connectors. Compatible with screw type connectors.

Code
806-00030-00



STANDARD SERIES PLUG SCREW

MALE SCREW - MALE PINS

Standard series screw type circular connectors. Field installable with male pins. IP68 water resistance, size: 48x19mmØ.

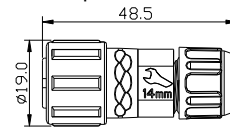

Contact	Wire Gauge	Voltage Rating	Rated Current	Code
2	0.823mm ²	300V	10A	22002111-01
3	0.823mm ²	300V	10A	22003111-01
4	0.823mm ²	125V	10A	22004111-01
5	0.519mm ²	60V	5A	22005111-01
6	0.519mm ²	60V	5A	22006111-01
2+4	0.823mm ² *2C + 0.519mm ² *4C	60V	10A+2A	22204111-01
2+6	0.519mm ² *2C + 0.34mm ² *6C	30V	5A+2A	22206111-01

STANDARD SERIES INLINE SOCKET SCREW

FEMALE SCREW - FEMALE PINS

Standard series circular screw type plug. Field installable with female pins. IP68 water resistance, Size: 46x19mmØ.



Contact	Wire Gauge	Voltage Rating	Rated Current	Code
3	0.823mm ²	300V	10A	22003411-01
4	0.823mm ²	125V	10A	22004411-01
6	0.519mm ²	60V	5A	22006411-01
2+6	0.519mm ² *2C + 0.34mm ² *6C	30V	5A+2A	22206411-01

STANDARD SERIES SOCKET SCREW (BACK)

Standard series screw type panel mount. Panel screws from the back. Female pins. IP68 water resistance. To be fit into a 16mmØ hole.

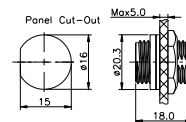

Contact	Wire Gauge	Voltage Rating	Rated Current	Code
2	0.823mm ²	300V	10A	22002615-03
3	0.823mm ²	300V	10A	22003615-03
4	0.823mm ²	125V	10A	22004615-03
5	0.519mm ²	60V	5A	22005615-03
6	0.519mm ²	60V	5A	22006615-03
2+4	0.823mm ² *2C + 0.519mm ² *4C	60V	10A+2A	22204615-03
2+6	0.519mm ² *2C + 0.34mm ² *6C	30V	5A+2A	22206615-03

STANDARD SERIES PANEL MOUNT (F) SCREW

Standard series screw type panel mount. Panel screws from the front. Female pins. IP68 water resistance. To be fit into a 16mmØ hole.

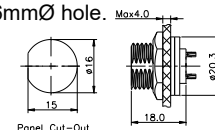

Contact	Wire Gauge	Voltage Rating	Rated Current	Code
2	0.823mm ²	300V	10A	22002615-01
4	0.823mm ²	125V	10A	22004615-01
6	0.519mm ²	60V	5A	22006615-01
2+4	0.823mm ² *2C + 0.3319mm ² *6C	60V	10A+2A	22204615-01
2+6	0.519mm ² *2C + 0.3319mm ² *6C	30V	5A + 2A	22206615-01

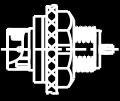

□ Chogori Standard Series - Push

STANDARD SERIES PUSH-LOCK

PUSH LOCK SYSTEM FOR SECURE AND FAST CONNECTION

- Standard sized circular connectors. Field installable. Solder pins.
- Designed to withstand harsh industrial and climatic environment, its superior quality ensures reliable connection for the higher standards and reliability of industrial machinery and equipment, marine electronics, LED display of power and signal control components, etc.
- This high quality connector can insert and withdraw simply and quickly. Addition to the lock bayonet and screw type docking type, the push-locking connection can also be simple and fast plug in and out.
- Pins from 2 to 12 can satisfy the various requirements of different customers.
- All the products are manufactured with high quality materials to meet the various requirements of different environments, the plastic material used is high performance PA66. Pins used has excellent mechanical properties with phosphor bronze assembly and good electrical conductivity brass. The contact surface is gold-plated with 4u"-20u"
- Superior mechanical properties ensure long effective application with insert and extract lifetime up to 3000 times.
- Good performance in waterproof, 5 sealing structure making its ingress rating reach IP68 standards.

STANDARD SERIES PLUG (R) PUSH-LOCK

MALE PUSH LOCK - FEMALE PINS

Standard series circular push lock type connector. Field installable with female pins. IP67 water resistance, Size: 46x19mmØ. Not compatible with blue connectors.

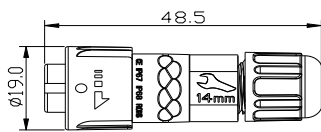

Contact	Wire Gauge	Voltage Rating	Rated Current	Code
2	0.823mm ²	300V	10A	22002231-01
3	0.823mm ²	300V	10A	22003231-01
4	0.823mm ²	125V	10A	22004231-01
5	0.519mm ²	60V	5A	22005231-01
6	0.519mm ²	60V	5A	22006231-01
2+4	0.823mm ² *2C + 0.519mm ² *4C	60V	10A+5A	22204231-01
3+4	0.823mm ² *3C + 0.519mm ² *4C	60V	10A+2A	22304231-01
8	0.519mm ²	60V	5A	22008231-01

STANDARD SERIES SOCKET (R) PUSH-LOCK

REAR PANEL MOUNT - MALE PINS

Standard series circular push lock type rear panel mount. Field installable with male pins. IP67 water resistance, to be fitted on 16mmØ holes. Not compatible with blue connectors.

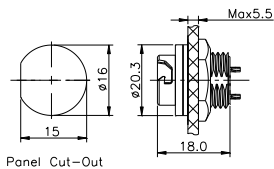

Contact	Wire Gauge	Voltage Rating	Rated Current	Code
2	0.823mm ²	300V	10A	22002535-03
3	0.823mm ²	300V	10A	22003535-03
4	0.823mm ²	125V	10A	22004535-03
5	0.519mm ²	60V	5A	22005535-03
6	0.519mm ²	60V	5A	22006535-03
2+4	0.823mm ² *2C + 0.519mm ² *4C	60V	10A+5A	22204535-03
8	0.519mm ²	60V	5A	22008535-03

STANDARD SERIES PLUG PUSH-LOCK

MALE PUSH LOCK - MALE PINS

Standard series circular push lock type connectors. Field installable with male pins. IP67 water resistance, Size: 48x19mmØ. Not compatible with Yellow connectors.

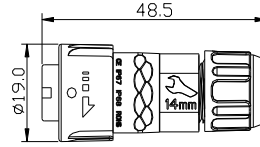

Contact	Wire Gauge	Voltage Rating	Rated Current	Code
2	0.823mm ²	300V	10A	22002131-01
3	0.823mm ²	300V	10A	22003131-01
4	0.823mm ²	125V	10A	22004131-01
5	0.519mm ²	60V	5A	22005131-01
6	0.519mm ²	60V	5A	22006131-01
2+4	0.823mm ² *2C + 0.519mm ² *4C	60V	10A+2A	22204131-01
2+6	0.519mm ² *2C + 0.34mm ² *6C	30V	5A+2A	22206131-01

STANDARD SERIES INLINE SOCKET PUSH-LOCK

FEMALE PUSH LOCK - FEMALE PINS

Standard series circular push lock type connector. Field installable with female pins. IP67 water resistance, Size: 46x19mmØ.

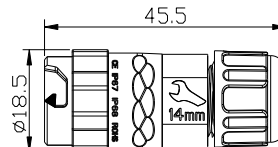

Contact	Wire Gauge	Voltage Rating	Rated Current	Code
2	0.823mm ²	300V	10A	22002431-01
3	0.823mm ²	300V	10A	22003431-01
4	0.823mm ²	125V	10A	22004431-01
5	0.519mm ²	60V	5A	22005431-01
6	0.519mm ²	60V	5A	22006431-01
2+4	0.823mm ² *2C + 0.519mm ² *4C	60V	10A+2A	22204431-01
2+6	0.519mm ² *2C + 0.34mm ² *6C	30V	5A+2A	22206431-01

STANDARD SERIES SOCKET PUSH-LOCK

REAR PANEL MOUNT - FEMALE PINS

Standard series circular push lock type rear panel mount. Field installable with female pins. IP67 water resistance, to be fitted on 16mmØ holes. Not compatible with yellow connectors.

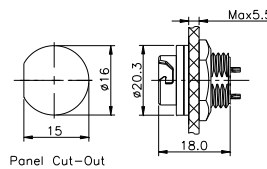

Contact	Wire Gauge	Voltage Rating	Rated Current	Code
2	0.823mm ²	300V	10A	22002635-03
3	0.823mm ²	300V	10A	22003635-03
4	0.823mm ²	125V	10A	22004635-03
5	0.519mm ²	60V	5A	22005635-03
6	0.519mm ²	60V	5A	22006635-03
2+4	0.823mm ² *2C + 0.519mm ² *4C	60V	10A+2A	22204635-03



STANDARD SERIES PLUG BAYONET

MALE PINS

Standard series plug lock bayonet connector plugs with male pins.
Field installable. IP67. Size: 4/8x19mmØ

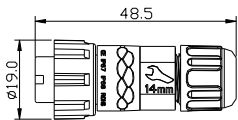

Contact	Wire Gauge	Voltage Rating	Rated Current	Code
2	0.823mm ²	300V	10A	22002121-01
3	0.823mm ²	300V	10A	22003121-01
4	0.823mm ²	125V	10A	22004121-01
5	0.519mm ²	60V	5A	22005121-01
6	0.519mm ²	60V	5A	22006121-01
2+4	0.823mm ² *2C + 0.519mm ² *4C	60V	10A+2A	22204121-01
2+6	0.519mm ² *2C + 0.34mm ² *6C	30V	5A+2A	22206121-01

STANDARD SERIES INLINE SOCKET BAYONET

FEMALE SOCKET

Standard series plug lock bayonet connector plugs.
Field installable. IP67. Size: 46x19mmØ

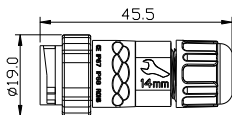

Contact	Wire Gauge	Voltage Rating	Rated Current	Code
2	0.823mm ²	300V	10A	22002421-01
3	0.823mm ²	300V	10A	22003421-01
4	0.823mm ²	125V	10A	22004421-01
5	0.519mm ²	60V	5A	22005421-01
6	0.519mm ²	60V	5A	22006421-01
2+4	0.823mm ² *2C + 0.519mm ² *4C	60V	10A+2A	22204421-01
2+6	0.519mm ² *2C + 0.34mm ² *6C	30V	5A+2A	22206421-01

STANDARD SERIES FRONT PANEL BAYONET

FRONT PANEL MOUNT - FEMALE SOCKET

Twist-on to lock bayonet front panel mount Standard series
Screw fixing behind panel with rubber grommet. Solder back. IP67.
To be fitted in a 16mmØ hole.

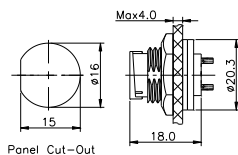

Contact	Wire Gauge	Voltage Rating	Rated Current	Code
2	0.823mm ²	300V	10A	22002625-01
3	0.823mm ²	300V	10A	22003625-01
4	0.823mm ²	125V	10A	22004625-01
5	0.519mm ²	60V	5A	22005625-01
6	0.519mm ²	60V	5A	22006625-01
2+4	0.823mm ² *2C + 0.3319mm ² *4C	60V	10A+2A	22204625-01
2+6	0.519mm ² *2C + 0.3319mm ² *6C	30V	5A+2A	22206625-01

STANDARD SERIES PLUG (R) BAYONET

FEMALE SOCKET

Twist-on to lock bayonet plug Standard series 19mmØ
3.5-6.8mm Cable Entry Field installable version.

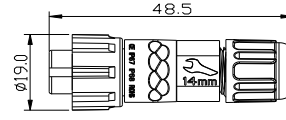

Contact	Wire Gauge	Voltage Rating	Rated Current	Code
2	0.823mm ²	300V	10A	22002221-01
3	0.823mm ²	300V	10A	22003221-01
4	0.823mm ²	125V	10A	22004221-01
5	0.519mm ²	60V	5A	22005221-01
6	0.519mm ²	60V	5A	22006221-01
2+4	0.823mm ² *2C + 0.519mm ² *4C	30V	10A+5A	22204221-01
3+4	0.823mm ² *3C + 0.519mm ² *4C	30V	10A+2A	22304221-01
8	0.519mm ²	60V	5A	22008221-01
10	0.33mm ²	60V	2A	22010221-01
12	0.33mm ²	60V	2A	22012221-01

STANDARD SERIES INLINE SOCKET (R) BAYONET

MALE PINS

Twist-on to lock bayonet plug Standard series 19mmØ
3.5-6.8mm Cable Entry Field installable version.

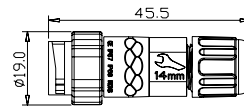

Contact	Wire Gauge	Voltage Rating	Rated Current	Code
2	0.823mm ²	300V	10A	22002321-01
3	0.823mm ²	300V	10A	22003321-01
4	0.823mm ²	125V	10A	22004321-01
5	0.519mm ²	60V	5A	22005321-01
6	0.519mm ²	60V	5A	22006321-01
2+4	0.823mm ² *2C + 0.519mm ² *4C	30V	10A+5A	22204321-01
3+4	0.823mm ² *3C + 0.519mm ² *4C	30V	10A+2A	22304321-01
8	0.519mm ²	60V	5A	22008321-01
10	0.33mm ²	60V	2A	22010321-01
12	0.33mm ²	60V	2A	22012321-01

STANDARD SERIES REAR SOCKET (R) BAYONET

REAR PANEL MOUNT - MALE PINS

Twist-on to lock bayonet chassis mount Standard series
Screw fixing behind panel with rubber grommet. Solder back.

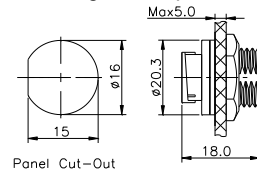

Contact	Wire Gauge	Voltage Rating	Rated Current	Code
2	0.823mm ²	300V	10A	22002525-03
3	0.823mm ²	300V	10A	22003525-03
4	0.823mm ²	125V	10A	22004525-03
5	0.519mm ²	60V	5A	22005525-03
6	0.519mm ²	60V	5A	22006525-03
2+4	0.823mm ² *2C + 0.519mm ² *4C	60V	10A+5A	22204525-03
3+4	0.823mm ² *3C + 0.519mm ² *4C	60V	10A+2A	22304525-03
8	0.519mm ²	60V	5A	22008525-03
10	0.3319mm ²	30V	2A	22010525-03
12	0.3319mm ²	30V	2A	22012525-03

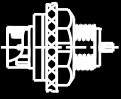

□ Chogori Middle Series - Screw

MIDDLE SERIES PLUGS & SOCKETS

SCREW TYPE FOR EXCELLENT WEATHER PROOFING

- The Middle Series Connector is designed for application in harsh industrial and climatic environments. Its superior quality can ensure a reliable connection for industrial machinery and equipment, marine electronics, power and signal control elements, etc.
- The Middle Series Connector products are manufactured with high quality materials to meet the various requirements of different environments. The plastic material used is high performance PA66. Copper pins used have the excellent mechanical properties of a phosphor bronze assembly with the good electrical conductivity of brass. The connector can insert and extract up to 3000 times or more.
- The Middle Series Connectors have good performance in waterproofing, their rating can reach IP67 and IP68 standards, thus are ideal for indoor and outdoor harsh working environments.
- The Middle Series Connectors are a professional, neat and functional solution available in screw plug or quick push lock types.
- Larger plugs allow higher wattage transfer up to 20A x 300V.
- Larger plugs give positive action when in outdoor environments.

MIDDLE SERIES PLUG (R) SCREW

FEMALE SOCKET

Middle series screw type connectors with female socket, IP68 water resistant. Size: 45x24mmØ

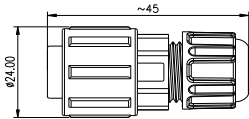

Contact	Wire Gauge	Voltage Rating	Rated Current	Code
2	2.5mm ²	300V	20A	23002211-01
2	2.5mm ²	300V	20A	23002211-02
3	2.5mm ²	300V	20A	23003211-02
4	1.0mm ²	300V	15A	23004211-02
5	0.75mm ²	125V	10A	23005211-02
6	0.75mm ²	125V	10A	23006211-02
7	0.34mm ²	60V	5A	23007211-02
8	0.34mm ²	60V	5A	23008211-02
3+5	1.00mm ² *3C + 0.25mm ² *5C	125+30V	15A+2A	23305211-02

MIDDLE SERIES SOCKET (R) SCREW

FRONT PANEL MOUNT - MALE PINS

Middle series screw type panel mount with male pins. IP68 water resistant. To be fit into a 20mmØ hole.

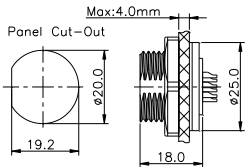

Contact	Wire Gauge	Voltage Rating	Rated Current	Code
2	2.5mm ²	300V	20A	23002515-01
3	2.5mm ²	300V	20A	23003515-01
4	1.0mm ²	300V	15A	23004515-01
5	0.75mm ²	125V	10A	23005515-01
6	0.75mm ²	125V	10A	23006515-01
8	0.34mm ²	60V	5A	23008515-01
2	2.5mm ²	300V	20A	23002525-02

MIDDLE SERIES WATERPROOF CAP

Screw type waterproof cap to suit panel mount and inline screw sockets

Code
806-00021-00



MIDDLE SERIES PLUG SCREW

Middle series screw type connectors with male pins, IP68 water resistant. Size: 45x24mmØ

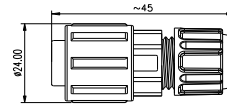

Contact	Wire Gauge	Voltage Rating	Rated Current	Code
2	2.5mm ²	300V	20A	23002111-01
2	2.5mm ²	300V	20A	23002111-02
3	2.5mm ²	300V	20A	23003111-02
4	1.0mm ²	300V	15A	23004111-02
5	0.75mm ²	125V	10A	23005111-02
6	0.75mm ²	125V	10A	23006111-02
7	0.34mm ²	60V	5A	23007111-02
8	0.34mm ²	60V	5A	23008111-02
3+5	1.00mm ² *3C + 0.25mm ² *5C	125 + 30V	15A + 2A	23305111-02

MIDDLE SERIES INLINE SOCKET SCREW

FEMALE SCREW - FEMALE PINS

Middle series screw type inline socket with female pins, IP68 water resistant. Size: 50x24mmØ

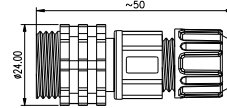

Contact	Wire Gauge	Voltage Rating	Rated Current	Code
2	2.5mm ²	300V	20A	23002411-02
3	2.5mm ²	300V	20A	23003411-02
4	1.0mm ²	300V	15A	23004411-02
5	0.75mm ²	125V	10A	23005411-01
5	0.75mm ²	125V	10A	23005411-02
6	0.75mm ²	125V	10A	23006411-02
7	0.34mm ²	60V	5A	23007411-02
8	0.34mm ²	60V	5A	23008411-02
3+5	1.00mm ² *3C + 0.25mm ² *5C	125 + 30V	15A + 2A	23305411-02

MIDDLE SERIES SOCKET SCREW (BACK)

FEMALE SCREW TYPE REAR PANEL MOUNT - FEMALE PINS

Middle series screw type panel mount with female pins. IP68 water resistant. To be fit into a 20mmØ hole.

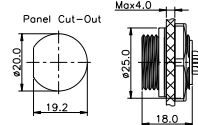

Contact	Wire Gauge	Voltage Rating	Rated Current	Code
2	2.5mm ²	300V	20A	23002615-03
3	2.5mm ²	300V	20A	23003615-03
4	1.0mm ²	300V	15A	23004615-03
5	0.75mm ²	125V	10A	23005615-03
6	0.75mm ²	125V	10A	23006615-03
7	0.34mm ²	60V	5A	23007615-03
8	0.34mm ²	60V	5A	23008615-03
3+5	1.00mm ² *3C + 0.25mm ² *5C	125 + 30V	15A + 2A	23305615-03

MIDDLE SERIES SOCKET SCREW (FORWARD)

Middle series screw type panel mount with female pins. IP68 water resistant. To be fit into a 20mmØ hole.

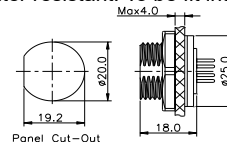

Contact	Wire Gauge	Voltage Rating	Rated Current	Code
2	0.75mm ²	300V	20A	23002615-01
4	1.0mm ²	300V	15A	23004615-02



Chogori Middle Series - Push

MIDDLE SERIES PLUG PUSH-LOCK

MALE PUSH LOCK - MALE PINS

Middle series push lock type connectors with male pins. IP67 water resistant. Size: 45x24mmØ

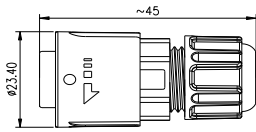

Contact	Wire Gauge	Voltage Rating	Rated Current	Code
2	2.5mm ²	300V	20A	23002131-02
3	2.5mm ²	300V	20A	23003131-02
4	1.0mm ²	300V	15A	23004131-02
5	0.75mm ²	125V	10A	23005131-02
6	0.75mm ²	125V	10A	23006131-02
7	0.34mm ²	60V	5A	23007131-02
8	0.34mm ²	60V	5A	23008131-02
3+5	1.00mm ² *3C + 0.25mm ² *5C	125 + 30V	15A + 2A	23305131-02

MIDDLE SERIES INLINE SOCKET PUSH-LOCK

FEMALE PUSH LOCK - FEMALE SOCKET

Middle series push lock type connectors with female pins. IP67 water resistant. Size: 50x23mmØ.

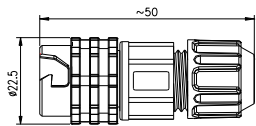

Contact	Wire Gauge	Voltage Rating	Rated Current	Code
2	2.5mm ²	300V	20A	23002431-02
3	2.5mm ²	300V	20A	23003431-02
4	1.0mm ²	300V	15A	23004431-02
6	0.75mm ²	125V	10A	23006431-02
8	0.34mm ²	60V	5A	23008431-02
5	0.75mm ²	125V	10A	23005431-02
7	0.34mm ²	60V	5A	23007431-02
3+5	1.00mm ² *3C + 0.25mm ² *5C	125 + 30V	15A + 2A	23305431-02

MIDDLE SERIES PLUG (R) PUSH-LOCK

MALE PUSH LOCK - FEMALE PINS

Middle series push lock type connectors with female pins. IP67 water resistant. Size: 45x24mmØ. Not compatible with blue connectors.

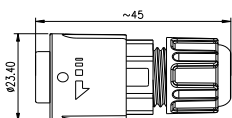

Contact	Wire Gauge	Voltage Rating	Rated Current	Code
2	2.5mm ²	300V	20A	23002231-02
3	2.5mm ²	300V	20A	23003231-02
4	1.0mm ²	300V	15A	23004231-02
5	0.75mm ²	125V	10A	23005231-02
6	0.75mm ²	125V	10A	23006231-02
8	0.34mm ²	60V	5A	23008231-02

MIDDLE SERIES SOCKET PUSH-LOCK

REAR PANEL MOUNT - FEMALE SOCKET

Middle series push lock type panel mount with female socket. IP67 water resistant. To be fit into a 20mmØ hole.

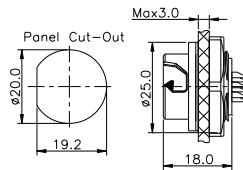

Contact	Wire Gauge	Voltage Rating	Rated Current	Code
2	2.5mm ²	300V	20A	23002635-03
3	2.5mm ²	300V	20A	23003635-03
4	1.0mm ²	300V	15A	23004635-03
5	0.75mm ²	125V	10A	23005635-03
6	0.75mm ²	125V	10A	23006635-03
7	0.34mm ²	60V	5A	23007635-03
8	0.34mm ²	60V	5A	23008635-03

MIDDLE SERIES SOCKET PUSH-LOCK

SQUARE PANEL MOUNT - FEMALE PINS

Middle Series push lock rear panel connector with female pins. IP67 water resistant. To be fitted in 25mmØ holes.

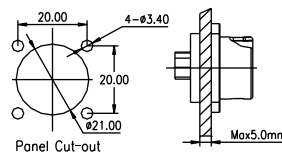

Contact	Wire Gauge	Voltage Rating	Rated Current	Code
2	2.5mm ²	250V	20A	23002636-01
3	2.5mm ²	250V	20A	23003636-01
4	1.0mm ²	250V	15A	23004636-01
5	0.75mm ²	125V	10A	23005636-01
6	0.75mm ²	125V	10A	23006636-01
7	0.34mm ²	60V	5A	23007636-01
8	0.34mm ²	60V	5A	23008636-01
9	0.34mm ²	60V	5A	23009636-01
10	0.25mm ²	30V	5A	23010636-01

MIDDLE SERIES SOCKET (R) PUSH-LOCK

FEMALE PUSH LOCK - MALE PINS

Middle series push lock type panel mount with male pins. IP67 water resistant. To be fit into a 20mmØ hole. Not compatible with blue connectors.

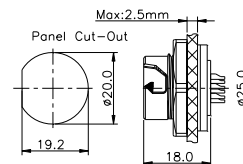

Contact	Wire Gauge	Voltage Rating	Rated Current	Code
2	2.5mm ²	300V	20A	23002535-01
3	2.5mm ²	300V	20A	23003535-01
4	1.0mm ²	300V	15A	23004535-01
5	0.75mm ²	125V	10A	23005535-01
6	0.75mm ²	125V	10A	23006535-01
8	0.34mm ²	60V	5A	23008535-01
3+5	1.00mm ² *3C + 0.25mm ² *5C	125+30V	15A+2A	23305535-01

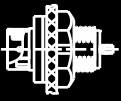

□ Chogori Large Series

LARGE SERIES PLUGS & SOCKETS

29MMØ PUSH LOCK SYSTEM IP68 WATER PROOF UP TO 20A

- Large series connector are found used in the LED display industry because their superior quality ensures reliable connection for the LED display of power and signal control components.
- The push-locking connector is simple and fast to plug in and out. Pins from 2 to 9, and additional 3+9 & 3+11. Installation type has nut, square flange and rhombus flange. What's more, the square flange is compatible with standard Amphenol® / Neutrik® installation holes.
- All the products are manufactured with high quality materials to meet the various requirements of different environments. The plastic material used is high performance PA66. Pins used has excellent mechanical properties with phosphor bronze assembly and good electrical conductivity brass. Products have certificate by CE, UL, TUV and ROHS environmental protection requirements.
- Large series connector has good performance in waterproofing to IP67 standards. Thus it is ideal for indoor and outdoor harsh working environments. The connector can insert and withdraw to 3000 times or more, and ensure a reliable contact every time.

LARGE SERIES PLUG PUSH LOCK

MALE PUSH LOCK - FEMALE PINS

Large series push lock type connectors with female pins. IP67 water resistance. Size: 55x29mmØ. This connector is not compatible with the blue capped Large series connectors.

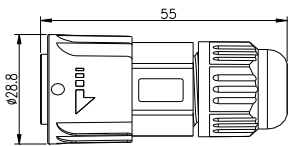

Contact	Wire Gauge	Voltage Rating	Rated Current	Code
2	4.0mm ²	300V	20A	24002231-02
3(20A)	4.0mm ²	300V	20A	24003231-02
3(50A)	8.4mm ²	300V	50A	24003231-04
9	0.75mm ²	125V	5A	24009231-02
3+9(FM)	2.5mm ² *3C + 0.2mm ² *9C	300V	20A+5A	24309231-02
3+11(FM)	2.5mm ² *3C + 0.2mm ² *11C	300V	20A+5A	24311231-02

LARGE SERIES INLINE PLUG PUSH LOCK

FEMALE PUSH LOCK - MALE PINS

Large Series push lock extending connector with male pins. IP67 water resistant. Size: 57x27mmØ.



Contact	Wire Gauge	Voltage Rating	Rated Current	Code
3(20A)	4.0mm ²	300V	20A	24003331-02
3(50A)	8.4mm ²	300V	50A	24003331-04
3+11(FM)	4mm ² *3C + 0.2mm ² *11C	300V	20A+5A	24311331-02

LARGE SERIES SOCKET PUSH LOCK

FRONT PANEL MOUNT - MALE PINS

Large Series push lock rear panel connector with male pins. IP67 water resistant. To be fitted in 25mmØ holes.

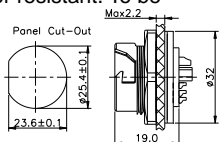

Contact	Wire Gauge	Voltage Rating	Rated Current	Code
2	4.0mm ²	300V	20A	24002535-01
3(20A)	4.0mm ²	300V	20A	24003535-01
3(50A)	8.4mm ²	300V	50A	24003535-02

LARGE SERIES PLUG PUSH LOCK

MALE PUSH LOCK - MALE PINS

Large series push lock type connector with male pins. IP67 water resistance. Size: 55x29mmØ. This connector is not compatible with the yellow capped Large series connectors.

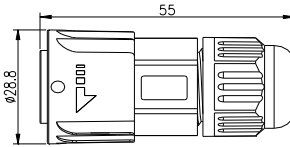

Contact	Wire Gauge	Voltage Rating	Rated Current	Code
2	4.0mm ²	300V	20A	24002131-02
3(20A)	4.0mm ²	300V	20A	24003131-02
3(50A)	8.4mm ²	300V	50A	24003131-04
9	0.75mm ²	125V	5A	24009131-02
3+9(FM)	2.5mm ² *3C + 0.2mm ² *9C	300V	20A+5A	24309131-02
3+11(FM)	2.5mm ² *3C + 0.2mm ² *11C	300V	20A+5A	24311131-02

LARGE SERIES SOCKET PUSH LOCK

FRONT PANEL MOUNT - FEMALE PINS

Large Series push lock front panel mount connector with female pins. IP67 water resistant. With screw on four corners to fix to the mounting surface. To be fitted in 25mmØ holes.

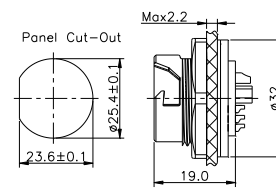

Contact	Wire Gauge	Voltage Rating	Rated Current	Code
2	4.0mm ²	300V	20A	24002635-01
3(20A)	4.0mm ²	300V	20A	24003635-01
3(50A)	8.4mm ²	300V	50A	24003635-02
9	0.75mm ²	125V	5A	24009635-01
3+9(FM)	2.5mm ² *3C + 0.2mm ² *9C	300V	20A+5A	24309635-01
3+11(FM)	2.5mm ² *3C + 0.2mm ² *11C	300V	20A+5A	24311635-01

LARGE SERIES SOCKET PUSH LOCK

SQUARE PANEL MOUNT - FEMALE PIN

Large Series push lock rear panel connector with female pins. With screws on two sides to lock the panel mount to the mounting surface. IP67 water resistant. To be fitted in XLR size holes.

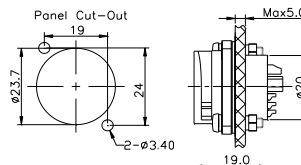

Contact	Wire Gauge	Voltage Rating	Rated Current	Code
2	4.0mm ²	300V	20A	24002636-01
3(20A)	4.0mm ²	300V	20A	24003636-01

CHOGORI®

Waterproof Connectors



□ Chogori RJ45 Series - Fine Thread

RJ45 PLUG JACKET SCREW FINE-THREAD

Jacket plug that fits over a standard RJ45 CAT5e/6 type plug and lead combination. Suits most cables with 24AWG wiring, 6.5 to 2.5mm Diameter. Compatible with screw type sockets. Weather proof to IP67 standards. Quality PA66 plastic materials. Up to CAT6 compatible.

FITS OVER RJ45 & 24AWG

Code
33000000-03



RJ45 PANEL SOCKET SCREW FINE-THREAD

RJ45 IN AND OUT

Panel Mount 20mm hole with front mounting screw. Compatible with the Screw plug. Rear is a RJ45 socket. All pins gold plated. Weather proof to IP67 standards. Quality PA66 plastic materials. Up to CAT6 compatible.

Code
33000000-01



REAR RJ45 IS ANGLED

Code
33000000-02

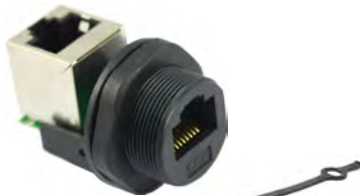

OPTIONAL WATERPROOF SCREW CAP

Code
806-00001-00



RJ45 PLUG COVER METAL SCREW

Jacket plug that fits over a standard RJ45 CAT5e/6 type plug and lead combination. Suits most cables with 24AWG wiring (6.5 to 2.5mm). Compatible with metal thread screw jacks. Weather proof to IP67 standards. Quality PA66 plastic materials with a metal threaded collar.

SUITS 33000000-12, 15

Code
33000111-01



RJ45 PANEL SOCKET METAL SCREW

RJ45 IN AND OUT

Panel Mount 20mm hole with front mounting screw. Compatible with the Screw plug. Rear is a RJ45 socket. All pins gold plated. Weather proof to IP67 standards. Quality All-Metal construction. Up to CAT6 compatible.

Code
33000000-12



REAR RJ45 SOCKET IS ANGLED

Code
33000000-15



OPTIONAL WATERPROOF SCREW CAP

Code
806-00001-00



□ Chogori RJ45 Series - Course Thread

RJ45 PANEL SOCKET COURSE-THREAD

Panel Mount sockets and plug cover screw type with a coarser thread. All pins gold plated. Weather proof to IP67 standards. Quality PA66 plastic materials. Up to CAT6 compatible.

Description	Code
RJ45 Plug Cover (course screw)	33000111-02
RJ45 panel socket to socket 180° (course screw)	33000000-10
RJ45 panel socket PCB back (course screw)	33000000-07
RJ45 panel socket to RJ45 Lead (course screw)	11C03319103001



□ Chogori RJ45 Series - Bayonet

RJ45 PLUG JACKET BAYONET

FITS OVER RJ45 & 24AWG

Code
33000000-06



RJ45 PANEL SOCKET 180° BAYONET

RJ45 IN AND OUT

Panel Mount 20mm hole with front mounting screw. Compatible with the Bayonet plug. Rear is a RJ45 socket. All pins gold plated. Weather proof to IP67 standards. Up to CAT6 compatible. Thread refers to panel mount screw type.

Thread	Code
Bayonet Narrow	33000000-04
Bayonet Wide	33000000-11



WATERPROOF CAP BAYONET

Code
806-00017-00



RJ45 JACK SOLDER BAYONET

PCB PINS REAR

Panel Mount 20mm hole with front mounting screw. Compatible with the Bayonet plug. Rear is solder pins (x8). All pins gold plated.

Code
33000000-08



RJ45 PANEL SOCKET 90° BAYONET

REAR RJ45 IS ANGLED

Panel Mount 20mm hole with front mounting screw. Compatible with the Bayonet plug. Rear is a RJ45 socket. All pins gold plated. Weather proof to IP67 standards. Quality PA66 plastic materials. Up to CAT6 compatible.

Code
33000000-05



WATERPROOF CAP BAYONET

Code
806-00017-00



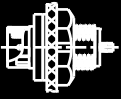

Chogori USB Series

USB 2.0 PLUG SCREW

SOLDER BACK

USB 2.0 Type "B" Plug with solder back 4 pins plus earth. Quality PA66 plastics rated to IP68 weatherproofing connection. Compatible with USB socket screw.



Code
34000000-01

USB 2.0 PLUG SCREW 3M LEAD

USB-A 2.0 Plug with screw flange. Pre-wired with 3 metre cable to 4 pin plug JST PH Series. 480Mbps IP68 PA16 Plastics.



Length Code
3.0M 11C02416061304

USB 2.0 SOCKET SCREW

SOLDER PINS REAR

Circle Panel Mount. Screw front mount. Solder pins back. 480Mbps IP68



Code
34000000-03

USB2.0 PANEL SCREW TYPE WITH LEAD

USB 2.0 Type "A" socket on a screw mount with a 0.5M USB lead. Made with quality PA66 plastics rated to IP68 weatherproofing connection. Compatible with a USB male plug screw type.



Code
IC02415041504

OPTIONAL WATERPROOF CAP

Code
806-00001-00

USB 2.0 PLUG BAYONET

SOLDER BACK

USB 2.0 Type "B" Plug with solder back 4 pins plus earth. Quality PA66 plastics rated to IP67 weatherproofing connection. Compatible with USB bayonet.



Code
34000000-02

USB 2.0 SOCKET BAYONET

SOLDER PINS REAR

Circle Panel Mount. Screw front mount. Solder pins back. 480Mbps IP68 Bayonet.



Code
34000000-04

USB 2.0 SOCKET BAYONET & CAP

SPRING CLOSE DUST CAP

Rhombus Panel Mount with IP67 weather sealed dust cap. USB 2.0 to 5 pins solder back. Bayonet.



Code
34000000-05

CHOGORI®

Waterproof Connectors

International Protection System Marking (IPxx)

1st Digit	Protection Against Solid Ingress	2nd Digit	Protection Against Liquid Ingress
0	Non-protected (not rated)	0	Non-protected or rated
1	> 50mm gap for entry	1	Vertically dripping water
2	> 12 mm gap for entry	2	Dripping water tilted at 15 deg
3	> 2.5 mm gap for entry	3	Spraying water at an angle up to 60 deg
4	1.0 mm gap for entry	4	Splashing water at any direction
5	Dust protected	5	Jets of water from any direction
6	Dust tight	6	Heavy seas or powerful jets of water
		6K	Powerful water jets with increased pressure
		7	Harmful ingress of water when immersed between a depth of 150 to 1000 mm (5.9 - 40 in)
		8	Continuous immersion in water
		9K	Powerful high temperature water jets

Example: IP67 = 6 dust tight + 7 protection from liquids, immersable to specification

Chogori D-Sub Series

D PLUG MALE

SOLDER BACK RS232

IP 67 Suit cable 4.5-6.5mm



Pins Code
9 31009111-01
15 31015111-01

D SOCKET FEMALE

SOLDER BACK RS232

IP 67 Suit cable 4.5-6.5mm



Pins Code
9 31009211-01
15 31015211-01

D SOCKET FEMALE

SOLDER BACK RS232

2.0mm Max. Panel Depth.



Pins Code
15 31015516-01

Chogori HDMI Series

HDMI FRONT PANEL MOUNT BAYONET TYPE

Bayonet type jacket HDMI socket connector for mounting into a panel 26mm hole. Rear of socket has a mini connector to aid installation. 30cm length cable to HDMI Plug.



Length Code
300mm CON-HDMIP-P02



HDMI LEAD BAYONET TYPE

Bayonet type HDMI plug connector compatible with the Bayonet socket. 1.7M Lead to a standard HDMI type plug. Heavy duty quality cable & plugs.

Length Code
1.7M CON-HDMIAM-P01

