

BUYING GUIDE

PAX & KOMPLEMENT

Wardrobe system

10
Year Limited
Warranty
Included

Includes a free 10-year limited warranty. For details see page 19 of this guide or visit IKEA-USA.com/warranty

SAFETY

Secure It! Prevent tip-over injury. Furniture with included restraints must be secured to the wall according to the assembly instructions.

Different wall materials require different types of hardware. Use hardware (sold separately) suitable for the walls in your home.

PAX frames must be mounted flush to the wall, according to assembly instructions.

ASSEMBLY

Minimum ceiling heights required:
D22 $\frac{7}{8}$ ×H79 $\frac{1}{4}$ " : 82 $\frac{1}{2}$ "
D22 $\frac{7}{8}$ ×H93 $\frac{3}{8}$ " : 95 $\frac{3}{4}$ "

IMPORTANT: Two people are required to assemble this furniture safely.



Create your own wardrobe

By combining frames and doors from the PAX series with items from the KOMPLEMENT series of interior organizers, you can create exactly the wardrobe you need. Or you can choose one of our suggested storage solutions and add or remove interior organizers as you wish. Whatever you choose, the result is a wardrobe to suit both your home and your clothes.

Use our planning tools

You can create your wardrobe in the planner found in the PAX area of the store or in the comfort of your own home. Just visit the bedroom section of the IKEA website, go to the PAX planner at IKEA-USA.com/PAXplanner and start making a wardrobe uniquely designed for you, by you.

Do it yourself or let us help

You might well be able to do everything yourself, but you don't have to! Let us help make your wardrobe dream a reality with our service offers like home delivery, assembly and order picking with delivery. Read more on page 20 of this buying guide or visit IKEA-USA.com/services

A high standard of accuracy has been sought in the preparation of this buying guide. We apologize for, but will not be bound by or responsible for, errors and omissions in this buying guide.

Not all products may be available in all stores. See what is available at your local store by visiting IKEA-USA.com. For more detailed product information, see the price tag or visit IKEA-USA.com. All products shown require assembly. All textiles shown are imported.



Choose your wardrobe

We have a wide range of PAX/KOMPLEMENT combinations to choose from which you can find in the store or on our website at IKEA-USA.com. If you don't find a pre-designed solution that you like, you can use our PAX/KOMPLEMENT planner to create the perfect solution that suits your needs and taste.

Begin by looking through the ready-made combinations on the web or in the planner gallery and choose one that inspires you. You will then have a pre-designed combination to start from that you can customize to your needs. You can, for example, change the size and the color of the wardrobe, or the interior organizers.

You can also use the planner to design your own unique PAX/KOMPLEMENT combination from scratch. There are three simple steps to follow when choosing your wardrobe solution.

1. Choose frames. Consider how much space you have available in your room. It's important to know the maximum height and width of your new wardrobe. Remember, you can also make the most of unused space with corner units.

2. Pick your style. What color do you want your wardrobe to be? We can offer a wide selection selection of doors in different colors.

3. Choose interior organizers. Think through your day-to-day needs. Do you have a lot of shoes? Then a pull out tray with shoe inserts could be a good option for you. Or perhaps you have a lot of pants? Then a pants hanger will come in handy. If you keep your summer and winter clothes in the same place, deep baskets will store your clothes neatly away.

Once you have decided on the interior organizers, it's time to add the finishing touches. Complete your new wardrobe with your choice of boxes and inserts from our extensive range of interior accessories. And for a really great result, don't forget the integrated lighting! Simple to install and makes it so much easier for you to find the right outfit.

The PAX/KOMPLEMENT planner helps you to calculate the price of your wardrobe and allows you to print or save a product list that you can bring to the store or use to buy online.

The planner can be found in the wardrobe area of the store or in the comfort of your own home. Just visit the wardrobe department on the [IKEA website](http://IKEA.com) and go to the PAX/KOMPLEMENT wardrobe planner: IKEA-USA.com/PAXplanner

Good to know measurements

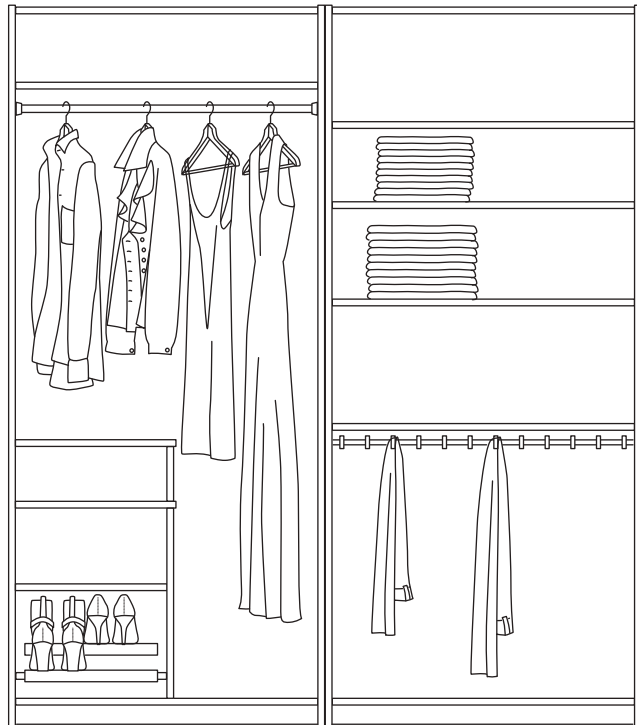

Hard to know how much space your clothes will take? Here's a useful guide of a few measurements and generic clothes sizes that could come in handy when planning your wardrobe.

1. Plan 8¼" to fit SKUBB storage boxes.
2. Plan appr. 39" for coats.
3. Plan appr. 32" for blouses.
4. Short dresses needs appr. 47".
5. Really long garments might need up to 75".
6. Plan 13" for a pull-out shoe shelf.
7. Plan appr. 10" for ten folded t-shirts.
8. Plan appr. 12" for ten pairs of folded sweaters.
9. Plan appr. 9-10" for hanging pants.

ALL FRAMES AND PRICES

Width×Depth×Height

Choose frames in the height, width and depth that suits your home. You can choose between 79¼" and 93⅜" high frames, a depth of 13¾" or 22⅞" and a width of 19⅞", 29½" and 39¼". Available colors for each size are listed below.

DEPTH 13¾", HEIGHT 79¼"



Wardrobe frame 19⅞×13¾×79¼".

White	602.145.69	\$85
Black-brown	902.602.82	\$85



Wardrobe frame 29½×13¾×79¼".

White	402.119.77	\$90
Black-brown	702.586.28	\$90

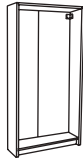

Wardrobe frame 39¼×13¾×79¼".

White	902.145.63	\$95
Black-brown	102.602.81	\$95

DEPTH 13¾", HEIGHT 93⅜"



Wardrobe frame 19⅞×13¾×93⅜".

White	402.145.65	\$95
Black-brown	802.468.85	\$95

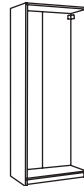

Wardrobe frame 29½×13¾×93⅜".

White	802.074.93	\$100
Black-blown	702.468.95	\$100



Wardrobe frame 39¼×13¾×93⅜".

White	002.145.72	\$105
Black-brown	002.468.94	\$105

DEPTH 22⅞", HEIGHT 79¼"



Wardrobe frame 19⅞×22⅞×79¼".

White	702.145.59	\$95
Black-brown	501.413.90	\$95
Gray stained ash effect	004.746.64	\$95

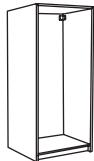

Wardrobe frame 29½×22⅞×79¼".

White	702.145.64	\$100
Black-brown	701.413.89	\$100
Gray stained ash effect	704.746.89	\$100

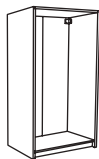

Wardrobe frame 39¼×22⅞×79¼".

White	202.145.66	\$105
Black-brown	301.413.91	\$105
Gray stained ash effect	204.746.58	\$105

DEPTH 22⅞", HEIGHT 93⅜"



Wardrobe frame 19⅞×22⅞×93⅜".

White	802.145.68	\$105
Black-brown	401.215.85	\$105
Gray stained ash effect	904.746.88	\$105



Wardrobe frame 29½×22⅞×93⅜".

White	202.145.71	\$110
Black-brown	701.215.84	\$110
Gray stained ash effect	504.746.90	\$110

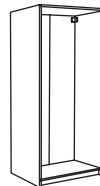

Wardrobe frame 39¼×22⅞×93⅜".

White	502.145.60	\$115
Black-brown	901.215.83	\$115
Gray stained ash effect	204.746.63	\$115

HOW TO BUILD A CORNER SOLUTION

Here you can see how the add-on unit for corner frame can be used with other frames. The examples shown here are combinations that work together with hinged doors. For open storage solutions, there are even more possibilities – please see more at IKEA-USA.com/PAX or ask a co-worker at your local IKEA store.

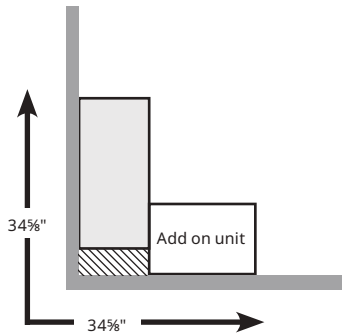

13 $\frac{3}{4}$ " deep add-on unit for corner with one 29 $\frac{1}{2}$ ×13 $\frac{3}{4}$ " frame.

Suggestions of interior organizers to use in this combination:

Standard frame 29 $\frac{1}{2}$ ×13 $\frac{3}{4}$ ":

Clothes rail 29 $\frac{1}{2}$ ×13 $\frac{3}{4}$ "

Shelf 29 $\frac{1}{2}$ ×13 $\frac{3}{4}$ "

Shoe shelf 29 $\frac{1}{2}$ ×13 $\frac{3}{4}$ "

Multi-use hanger 13 $\frac{3}{4}$ "

Add-on unit for corner:

All 13 $\frac{3}{4}$ " deep KOMPLEMENT interior organizers.

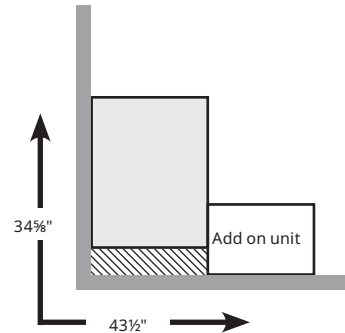

13 $\frac{3}{4}$ " deep add-on unit for corner with one 29 $\frac{1}{2}$ ×22 $\frac{7}{8}$ " frame.

Suggestions of interior organizers to use in this combination:

Standard frame 29 $\frac{1}{2}$ ×22 $\frac{7}{8}$ ":

Clothes rail 29 $\frac{1}{2}$ ×22 $\frac{7}{8}$ "

Shelf 29 $\frac{1}{2}$ ×22 $\frac{7}{8}$ "

Multi-use hanger 22 $\frac{7}{8}$ "

Add-on unit for corner:

All 13 $\frac{3}{4}$ " deep KOMPLEMENT interior organizers.

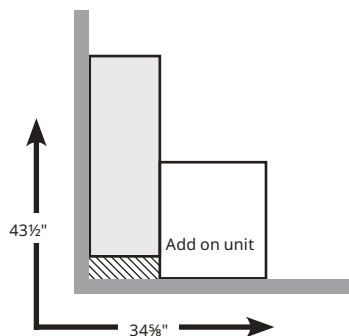

22 $\frac{7}{8}$ " deep add-on unit for corner with one 39 $\frac{1}{4}$ ×13 $\frac{3}{4}$ " frame.

Suggestions of interior organizers to use in this combination:

Standard frame 39 $\frac{1}{4}$ ×13 $\frac{3}{4}$ ":

Clothes rail 39 $\frac{1}{4}$ ×13 $\frac{3}{4}$ "

Shelf 39 $\frac{1}{4}$ ×13 $\frac{3}{4}$ "

Shoe shelf 39 $\frac{1}{4}$ ×13 $\frac{3}{4}$ "

Divider for frame 19 $\frac{5}{8}$ " with your choice of pull-out interior organizers

Multi-use hanger 13 $\frac{3}{4}$ "

Add-on unit for corner:

All 13 $\frac{3}{4}$ " deep KOMPLEMENT interior organizers.

Clothes rail 19 $\frac{5}{8}$ ×22 $\frac{7}{8}$ " (turn the fixture around).

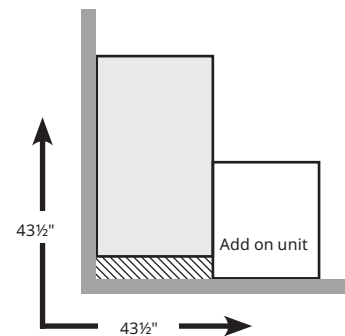

22 $\frac{7}{8}$ " deep add-on unit for corner with one 39 $\frac{1}{4}$ ×22 $\frac{7}{8}$ " frame.

Suggestions of interior organizers to use in this combination:

Standard frame 39 $\frac{1}{4}$ ×22 $\frac{7}{8}$ ":

Clothes rail 39 $\frac{1}{4}$ ×22 $\frac{7}{8}$ "

Shelf 39 $\frac{1}{4}$ ×22 $\frac{7}{8}$ "

Divider for frame 19 $\frac{5}{8}$ " with your choice of pull-out interior organizers

Multi-use hanger 22 $\frac{7}{8}$ "

Add-on unit for corner:

All 13 $\frac{3}{4}$ " deep KOMPLEMENT interior organizers.

Clothes rail 19 $\frac{5}{8}$ ×22 $\frac{7}{8}$ " (turn the fixture around).

CREATE A CORNER SOLUTION

Width×Depth×Height

With this add-on unit for corner frame, you can also make use of the corners when building your wardrobe. It fits all frames in the PAX wardrobe system, so all you need to do is combine the add-on unit with the frame that suits your space best. No matter which depth or height you choose for your add-on unit, four adjustable shelves are always included. You can also complete with 13¾" interior organizers from the KOMPLEMENT series to create exactly the wardrobe you've dreamed of.

DEPTH 13¾", HEIGHT 79¼"



Add-on unit for corner 20%×13¾×79¼".

Black-brown	203.469.44	\$130
White	403.469.38	\$130

DEPTH 13¾", HEIGHT 93⅛"



Add-on unit for corner 20%×13¾×93⅛".

Black-brown	503.469.47	\$140
White	803.469.41	\$140

DEPTH 22⅞", HEIGHT 79¼"



Add-on unit for corner 20%×22⅞×79¼".

Black-brown	903.469.50	\$140
White	703.469.32	\$140
Gray stained ash effect	904.746.31	\$140

DEPTH 22⅞", HEIGHT 93⅛"



Add-on unit for corner 20%×22⅞×93⅛".

Black-brown	303.469.53	\$150
White	303.469.34	\$150
Gray stained ash effect	404.746.57	\$150

ALL HINGED DOORS AND PRICES

Handles and knobs are sold separately except where noted. See our complete range of knobs and handles in the store or at IKEA-USA.com/knobshandles

All available hinged doors are listed below. Remember to pick up one 3-pack of KOMPLEMENT hinges for each 76¾" tall door, and one 4-pack of KOMPLEMENT hinges for each 90¾" tall door. If you choose to add doors to a corner frame, remember to purchase a 6-pack of corner-specific hinges for 76¾" doors, and an 8-pack for 90¾" doors. The soft closing hinges catches the door and close it slowly, silently and softly.



BERGSBO Door

White		
19½×76¾"	202.074.10	\$50
19½×90¾"	301.604.07	\$60
Black-brown		
19½×76¾"	002.234.87	\$50
19½×90¾"	002.234.92	\$60
Brown stained ash		
19½×76¾"	804.730.19	\$40
19½×90¾"	404.730.21	\$50



VIKANES Door

White		
19½×76¾"	703.115.60	\$110
19½×90¾"	503.115.61	\$120



BERGSBO Door

White/frosted glass		
19½×90¾"	501.604.06	\$90



VINTERBRO Door

White		
19½×76¾"	102.690.50	\$120
19½×90¾"	902.690.51	\$130



VIKEDAL Door Handle included.

Mirror		
9¾×76¾"	403.011.24	\$40
9¾×90¾"	103.011.25	\$50
19½×76¾"	700.233.19	\$50
19½×90¾"	300.233.21	\$60



TYSSDAL Door

White		
19½×76¾"	902.981.24	\$110
19½×90¾"	402.981.26	\$130



GRIMO Door

White		
19½×76¾"	403.434.64	\$40
19½×90¾"	903.434.66	\$50
Dark blue		
19½×76¾"	504.806.48	\$40
19½×90¾"	104.806.50	\$50



TYSSDAL Door

White/glass		
19½×76¾"	203.291.95	\$120
19½×90¾"	803.291.97	\$130

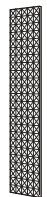

VINGROM Door

Resjön white		
19½×76¾"	904.318.92	\$120
19½×90¾"	104.318.91	\$130



REINSVOLL Door

Gray-beige		
19½×76¾"	303.823.47	\$80
19½×90¾"	604.731.38	\$90



FARDAL Door

High-gloss white		
19½×76¾"	901.905.24	\$110
19½×90¾"	801.905.29	\$120
High-gloss light blue		
19½×76¾"	204.730.36	\$110
19½×90¾"	104.730.32	\$120
High-gloss yellow		
19½×76¾"	904.730.33	\$110
19½×90¾"	704.730.29	\$120
High-gloss light gray		
19½×76¾"	603.306.20	\$110
19½×90¾"	503.306.06	\$120



FLISBERGET Door

Light beige		
19½×90¾"	603.447.35	\$60

ALL HINGED DOORS AND PRICES

Handles and knobs are sold separately except where noted. See our complete range of knobs and handles in the store or at IKEA-USA.com/knobshandles

All available hinged doors are listed below. Remember to pick up one 3-pack of KOMPLEMENT hinges for each 79¼" tall door, and one 4-pack of KOMPLEMENT hinges for each 93½" tall door. If you choose to add doors to a corner frame, remember to purchase a 6-pack of corner-specific hinges for 76¾" doors, and an 8-pack for 90¾" doors. The soft closing hinges catches the door and close it slowly, silently and softly.



FORSAND Door

White

9¾×76¾"	204.236.02	\$30
9¾×90½"	804.236.04	\$40
19½×76¾"	604.423.83	\$30
19½×90¾"	104.423.85	\$40

Black-brown stained ash effect

19½×76¾"	704.348.15	\$30
19½×90¾"	304.348.17	\$40

Gray stained ash effect

9¾×76¾"	704.939.37	\$20
9¾×90¼"	504.939.38	\$30
19½×76¾"	404.829.16	\$30
19½×90¾"	004.830.41	\$40



KOMPLEMENT Soft closing hinges

For doors with a height of 76¾".

3pk	002.145.05	\$20
-----	------------	-------------

For doors with a height of 90¾".

4pk	302.145.04	\$20
-----	------------	-------------



KOMPLEMENT Soft closing hinges for add on corner unit

For doors with a height of 76¾".

6pk	103.684.89	\$40
-----	------------	-------------

For doors with a height of 90¾".

8pk	503.684.92	\$40
-----	------------	-------------



REPVÅG Door

White stain oak veneer

19½×90¾"	304.278.69	\$90
----------	------------	-------------

Black-brown stained ash veneer

19½×76¾"	704.278.72	\$80
19½×90¾"	304.278.74	\$90



TYSSEDAL Mirror door

19¾×76¾"	004.522.47	\$120
19¾×90¾"	004.491.13	\$130

HANDLES

The handles below are developed specially to fit doors for PAX wardrobes. You can find even more knobs and handles to choose from at IKEA-USA.com/knobshandles and in your local store.

	BILLSBRO Handle white		
	L87 $\frac{3}{8}$ "	203.343.09	\$30
	BILLSBRO Handle Stainless steel		
	L74"	303.235.98	\$25
	L87 $\frac{3}{8}$ "	103.235.99	\$30

CREATE YOUR OWN SLIDING DOOR

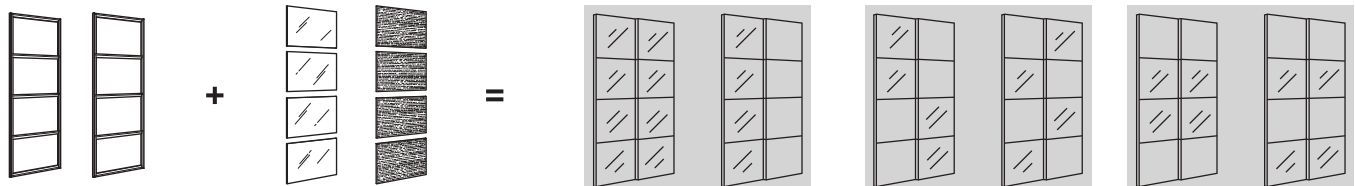

You can also choose your own combination of metal frames and panels for your sliding doors. The metal frame is available in white, black and aluminum and the panels come in a variety of materials and colors. Choose one frame and two packages of panels for each sliding door.

You will find all sliding door frames and panels on our website IKEA-USA.com/PAXplanner

You can also create your own sliding door in the PAX planning tool or contact staff at the PAX area in the store for more info.

HOW TO COMBINE FRAMES FOR SLIDING DOORS

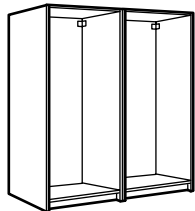

W59" combination
29 $\frac{1}{2}$ + 29 $\frac{1}{2}$ "

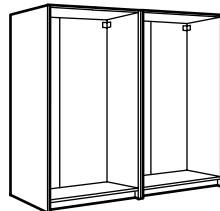

W78 $\frac{3}{4}$ " combination
39 $\frac{1}{4}$ + 39 $\frac{1}{4}$ "
Alternatives:
39 $\frac{1}{4}$ + 19 $\frac{3}{8}$ + 19 $\frac{3}{8}$ "
19 $\frac{3}{8}$ + 19 $\frac{3}{8}$ + 39 $\frac{1}{4}$ "
19 $\frac{3}{8}$ + 19 $\frac{3}{8}$ + 19 $\frac{3}{8}$ + 19 $\frac{3}{8}$ "

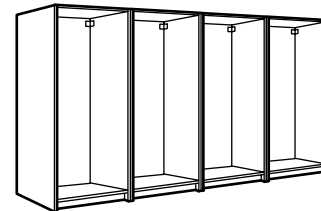

W118" combination
29 $\frac{1}{2}$ + 29 $\frac{1}{2}$ + 29 $\frac{1}{2}$ + 29 $\frac{1}{2}$ "
Note: Two pairs of 59" wide sliding doors are needed to build a 118" wide combination.

ALL SLIDING DOORS AND PRICES

Width×Height

The sliding doors are sold in pairs. The size and price refers to the total measurement of the two doors together. Add a soft closing device that catches the running doors so that they close slowly, silently and softly.

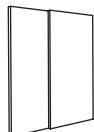

HASVIK Pair of sliding doors Price includes KOMPLEMENT soft-closing dampers 2pk. We recommend you attach the soft-closing dampers to the sliding door before hanging the door on the frame.

White		
59×79½"	891.779.86	\$159
78¾×79½"	091.779.90	\$209
59×92½"	491.779.88	\$209
78¾×92½"	691.779.92	\$279
High-gloss white		
59×79½"	191.780.03	\$279
78¾×79½"	291.780.07	\$329
59×92½"	691.780.05	\$329
78¾×92½"	891.780.09	\$379

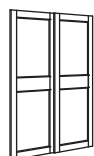

GRIMO Pair of sliding doors * Price includes KOMPLEMENT soft closing dampers 2pk.

White		
59×79½"	393.935.01	\$159
78¾×79½"	293.935.06	\$209
59×92½"	993.935.03	\$209
78¾×92½"	893.935.08	\$259

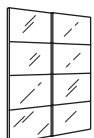

SVARTISDAL Pair of sliding doors* Price includes KOMPLEMENT soft closing dampers 2pk.

White paper effect with aluminum metal frame		
59×79½"	993.362.30	\$309
78¾×79½"	693.362.36	\$339
59×92½"	393.362.33	\$339
78¾×92½"	093.362.39	\$379

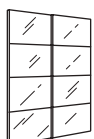

BJÖRNÖYA Pair of sliding doors* Price includes KOMPLEMENT soft closing dampers 2pk.

Gray tinted effect with aluminum metal frame		
59×79½"	493.362.42	\$359
78¾×79½"	193.362.48	\$409
59×92½"	793.362.45	\$409
78¾×92½"	593.362.51	\$459

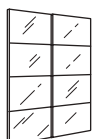

TJÖRHOM Pair of sliding doors* Price includes KOMPLEMENT soft closing dampers 2pk.

White with white metal frame		
59×79½"	693.362.60	\$359
78¾×79½"	593.362.65	\$409
59×92½"	293.362.62	\$409
78¾×92½"	193.362.67	\$459

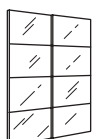

AULI Pair of sliding doors* Price includes KOMPLEMENT soft closing dampers 2pk.

Mirror with aluminum metal frame		
59×79½"	593.111.61	\$309
78¾×79½"	293.111.67	\$339
59×92½"	993.111.64	\$339
78¾×92½"	693.111.70	\$379



FÄRVIK Pair of sliding doors* Price includes KOMPLEMENT soft closing dampers 2pk.

White with white metal frame		
59×92½"	093.116.20	\$459
78¾×92½"	293.116.24	\$509



AULI/FÄRVIK Pair of sliding doors* Price includes KOMPLEMENT soft closing dampers 2pk.

Mirror/white with white metal frame		
59×92½"	593.111.75	\$399
78¾×92½"	593.111.80	\$444



HOKKSUND Pair of sliding doors, high-gloss* Price includes KOMPLEMENT soft-closing dampers 2pk.

Light gray with aluminum metal frame		
59×79½"	092.202.34	\$359
59×92½"	993.117.10	\$409
78¾×92½"	893.117.15	\$459

Light green with aluminum metal frame

59×79½"	393.323.05	\$359
78¾×79½"	393.323.10	\$409
59×92½"	993.323.07	\$409
78¾×92½"	993.323.12	\$459



TJODALYNG Pair of sliding doors* Price includes KOMPLEMENT soft-closing dampers 2pk.

Dark blue/light green double-sided textile		
59×79½"	993.883.23	\$359
78¾×79½"	293.883.26	\$409
59×92½"	793.883.24	\$409
78¾×92½"	093.883.27	\$459



SEKKEN Pair of sliding doors* Price includes KOMPLEMENT soft closing dampers 2pk.

Frosted glass with aluminum metal frame		
59×79½"	193.117.28	\$309
78¾×79½"	993.117.34	\$339
59×92½"	593.117.31	\$339
78¾×92½"	293.117.37	\$379



AULI/SEKKEN Pair of sliding doors* Price includes KOMPLEMENT soft-closing dampers 2pk.

Mirror/frosted glass with aluminum metal frame		
59×79½"	693.111.89	\$309
78¾×79½"	093.111.92	\$339
59×92½"	993.111.83	\$339
78¾×92½"	293.111.86	\$379

*The door is divided into three packages. Please use a picking list to ensure you collect one door frame and two packages of door panels for each door. We recommend you attach the soft-closing dampers to the sliding door before hanging the door on the frame.

ALL SLIDING DOORS AND PRICES

Width×Height

The sliding doors are sold in pairs. The size and price refers to the total measurement of the two doors together. Add a soft closing device that catches the running doors so that they close slowly, silently and softly.



MEHAMN Pair of sliding doors* Double sided, wooden effect. Price includes KOMPLEMENT soft-closing dampers 2pk.

White/white stained oak with aluminium metal frame

59×92½"	593.195.10	\$329
78¾×92½"	493.195.20	\$359

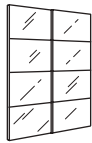

NYKIRKE Pair of sliding doors* Frosted glass check pattern

59×92½"	993.188.01	\$459
78¾×92½"	893.188.06	\$509



KOMPLEMENT Soft-closing devices Fits HASVIK and SVORKMO doors, designed for PAX.

2pk	503.274.54	\$30
-----	------------	-------------

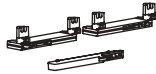

KOMPLEMENT Soft open/closing device Fits all panel sliding doors designed for PAX.

2pk	504.437.74	\$30
-----	------------	-------------

*The door is divided into three packages. Please use a picking list to ensure you collect one door frame and two packages of door panels for each door. We recommend you attach the soft-closing dampers to the sliding door before hanging the door on the frame.

INTERIOR ORGANIZERS

Organize all your shoes, ties, bed linen, lingerie, scarves, pants, handbags, shoes, jewelry etc. The KOMPLEMENT series perfectly matches the different doors and frames in the PAX series. Width and depth of KOMPLEMENT articles is stated to match the dimensions of the corresponding frame, actual dimensions vary.

FITS 13³/₄" DEEP FRAMES



KOMPLEMENT Clothes rail		
19 ¹ / ₂ ×13 ³ / ₄ ".		
Black-brown	604.464.61	\$10
White	504.464.52	\$10
29 ¹ / ₂ ×13 ³ / ₄ ".		
Black-brown	004.464.64	\$15
White	804.464.55	\$15
39 ³ / ₄ ×13 ³ / ₄ ".		
Black-brown	204.464.58	\$15
White	104.464.49	\$15

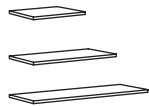

KOMPLEMENT Shelf		
For 19 ¹ / ₂ ×13 ³ / ₄ ".		
Black-brown	502.780.00	\$5
White	402.779.92	\$5
For 29 ¹ / ₂ ×13 ³ / ₄ ".		
Black-brown	902.780.03	\$10
White	702.779.95	\$10
For 39 ³ / ₄ ×13 ³ / ₄ ".		
Black-brown	302.779.97	\$10
White	002.779.89	\$10



KOMPLEMENT Glass shelf		
For 19 ¹ / ₂ ×13 ³ / ₄ ".		
Black-brown	904.375.49	\$20
White	404.339.78	\$20
For 29 ¹ / ₂ ×13 ³ / ₄ ".		
Black-brown	104.375.53	\$25
White	804.339.81	\$25
For 39 ³ / ₄ ×13 ³ / ₄ ".		
Black-brown	504.375.46	\$30
White	004.339.75	\$30

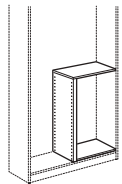

KOMPLEMENT divider for frames, 29¹/₂-39³/₄×13³/₄". Fits 29¹/₂" and 39³/₄" wide PAX frames, 13³/₄" deep.		
Black-brown	404.375.42	\$35
White	704.339.72	\$35



KOMPLEMENT Mesh basket To be completed with KOMPLEMENT pull-out rail for basket 13 ³ / ₄ ". Sold separately.		
19 ¹ / ₂ ×13 ³ / ₄ ".		
Dark gray	402.573.00	\$6
White	002.573.02	\$6
29 ¹ / ₂ ×13 ³ / ₄ ".		
Dark gray	702.573.08	\$10
White	102.573.11	\$10
39 ³ / ₄ ×13 ³ / ₄ ".		
Dark gray	302.572.92	\$15
White	902.572.94	\$15

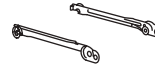

KOMPLEMENT Pull-out rails for baskets 13³/₄".		
Dark gray	902.632.33	\$5/2pk
White	602.632.44	\$5/2pk

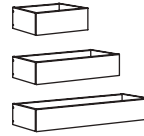

KOMPLEMENT Drawer		
19 ¹ / ₂ ×13 ³ / ₄ ".		
Black-brown	502.467.16	\$20
White	302.467.22	\$20
29 ¹ / ₂ ×13 ³ / ₄ ".		
Black-brown	802.467.48	\$25
White	702.467.44	\$25
39 ³ / ₄ ×13 ³ / ₄ ".		
Black-brown	802.467.53	\$30
White	702.467.58	\$30

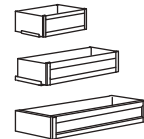

KOMPLEMENT Drawer with framed front		
19 ¹ / ₂ ×13 ³ / ₄ ".		
Black-brown	604.471.25	\$20
White	804.465.92	\$20
29 ¹ / ₂ ×13 ³ / ₄ ".		
Black-brown	004.471.28	\$25
White	104.465.95	\$25
39 ³ / ₄ ×13 ³ / ₄ ".		
Black-brown	304.471.22	\$30
White	404.465.89	\$30

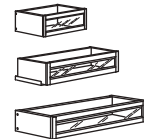

KOMPLEMENT Drawer with framed glass front		
19 ¹ / ₂ ×13 ³ / ₄ ".		
Black-brown	704.471.44	\$40
White	204.470.14	\$40
29 ¹ / ₂ ×13 ³ / ₄ ".		
Black-brown	004.471.47	\$45
White	504.470.17	\$45
39 ³ / ₄ ×13 ³ / ₄ ".		
Black-brown	304.471.41	\$50
White	804.470.11	\$50



KOMPLEMENT Pull-out tray		
19 ¹ / ₂ ×13 ³ / ₄ ".		
Black-brown	804.375.59	\$15
White	504.339.87	\$15
29 ¹ / ₂ ×13 ³ / ₄ ".		
Black-brown	204.375.62	\$20
White	904.339.90	\$20
39 ³ / ₄ ×13 ³ / ₄ ".		
Black-brown	404.375.56	\$25
White	204.339.84	\$25

INTERIOR ORGANIZERS



KOMPLEMENT Pull-out pants hanger

19%×13¾".		
Black-brown	304.465.18	\$20
White	804.465.49	\$20
29½×13¾".		
Black-brown	104.465.24	\$25
White	204.465.52	\$25
39%×13¾".		
Black-brown	804.465.11	\$30
White	604.465.45	\$30

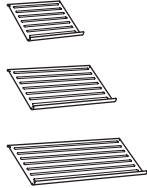

KOMPLEMENT Shoe shelf

19%×13¾".		
Dark gray	002.572.55	\$15
White	602.572.57	\$15
29½×13¾".		
Dark gray	202.572.59	\$20
White	802.572.61	\$20
39%×13¾".		
Dark gray	902.572.51	\$25
White	502.572.53	\$25

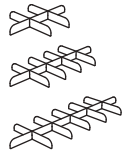

KOMPLEMENT Divider for pull-out tray, felt.

19%×13¾".		
Light gray	504.675.62	\$5
29½×13¾".		
Light gray	804.675.65	\$10
39%×13¾".		
Light gray	104.675.59	\$15

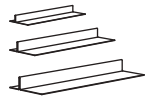

KOMPLEMENT Shoe insert for pull-out tray, felt.

19%×13¾".		
Light gray	504.465.60	\$5
29½×13¾".		
Light gray	904.465.63	\$10
39%×13¾".		
Light gray	104.465.57	\$15



KOMPLEMENT Pull-out multi-use hanger D13¾".

Dark gray	702.571.86	\$10
White	302.569.09	\$10



KOMPLEMENT Valet hanger 6¾×3½".

Dark gray	602.571.82	\$5
White	702.569.31	\$5

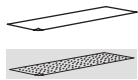

KOMPLEMENT Drawer liner 35%×11¾". Easy to cut to the desired size.

Light gray	304.339.93	\$5
Light gray patterned	004.470.29	\$5

FITS 22⅞" DEEP FRAMES



KOMPLEMENT Clothes rail

19".		
Dark gray	402.569.42	\$5
White	902.568.93	\$5
29½".		
Dark gray	002.569.44	\$10
White	402.568.95	\$10
39%".		
Dark gray	802.569.40	\$10
White	302.568.91	\$10

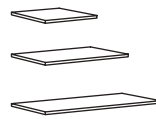

KOMPLEMENT Shelf

For 19%×22%".		
Black-brown	402.779.68	\$10
Gray stained ash effect	904.750.89	\$10
White	302.779.59	\$10
For 29½×22%".		
Black-brown	002.779.65	\$15
Gray stained ash effect	704.750.90	\$15
White	902.779.61	\$15

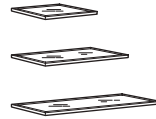

KOMPLEMENT Glass shelf

For 19%×22%".		
Black-brown	902.576.56	\$25
Gray stained ash effect	904.749.85	\$25
White	002.576.46	\$25
For 29½×22%".		
Black-brown	702.576.62	\$30
Gray stained ash effect	704.749.86	\$30
White	802.576.47	\$30

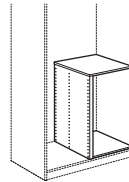

KOMPLEMENT Divider for frame 29½-39%×22%". Fits 29½" and 39% wide PAX frames, 22% deep.

Black-brown	402.576.49	\$35
Gray stained ash effect	304.749.74	\$35
White	702.576.38	\$35

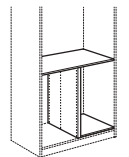

KOMPLEMENT Divider for frame 39%×22%×32%".

Black-brown	402.464.20	\$50
Gray stained ash effect	904.746.93	\$50
White	002.464.17	\$50

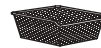

KOMPLEMENT Mesh basket 19%×22%". To be used with KOMPLEMENT pull-out rail for basket 22%", sold separately.

Dark gray	602.573.04	\$10
White	102.573.06	\$10



KOMPLEMENT Mesh basket 29½×22%". To be used with KOMPLEMENT pull-out rail for basket 22%", sold separately.

Dark gray	702.573.13	\$15
White	202.573.15	\$15



KOMPLEMENT Mesh basket 39%×22%". To be used with KOMPLEMENT pull-out rail for basket 22%", sold separately.

Dark gray	402.572.96	\$20
White	002.572.98	\$20

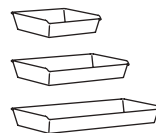

KOMPLEMENT Metal basket To be completed with KOMPLEMENT pull-out rail for basket 22%". Sold separately.

19%×22%".		
Patterned/dark gray	302.573.29	\$30
Patterned/white	902.573.31	\$30
29½×22%".		
Patterned/dark gray	602.573.37	\$35
Patterned/white	202.573.39	\$35
39%×22%".		
Patterned/dark gray	002.573.21	\$40
Patterned/white	602.573.23	\$40

INTERIOR ORGANIZERS

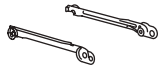

KOMPLEMENT Pull-out rails for baskets 22 7/8".

Dark gray	102.632.32	\$5/2pk
White	302.632.45	\$5/2pk



KOMPLEMENT Drawer

19 1/2" x 22 7/8".

Black-brown	802.463.00	\$30
Gray-stained ash effect	804.748.15	\$30
White	102.463.08	\$30



29 1/2" x 22 7/8".

Black-brown	202.463.22	\$35
Gray-stained ash effect	604.748.16	\$35
White	102.463.32	\$35



39 3/8" x 22 7/8".

Black-brown	002.463.42	\$40
Gray-stained ash effect	404.748.17	\$40
White	902.463.52	\$40



KOMPLEMENT Drawer with framed front

19 1/2" x 22 7/8".

Black-brown	804.471.34	\$30
White	704.466.01	\$30



29 1/2" x 22 7/8".

Black-brown	104.471.37	\$35
White	104.466.04	\$35



39 3/8" x 22 7/8".

Black-brown	404.471.31	\$40
White	504.465.98	\$40



KOMPLEMENT Drawer with glass front

19 1/2" x 22 7/8".

Black-brown	602.466.88	\$45
Gray-stained ash effect	704.748.54	\$45
White	702.466.83	\$45



29 1/2" x 22 7/8".

Black-brown	602.466.93	\$50
Gray-stained ash effect	404.748.55	\$50
White	102.466.95	\$50



39 3/8" x 22 7/8".

Black-brown	402.467.12	\$55
Gray-stained ash effect	204.748.56	\$55
White	202.467.08	\$55



KOMPLEMENT Drawer with framed glass front

19 1/2" x 22 7/8".

Black-brown	804.471.53	\$45
White	304.470.23	\$45



29 1/2" x 22 7/8".

Black-brown	104.471.56	\$50
White	604.470.26	\$50



39 3/8" x 22 7/8".

Black-brown	404.471.50	\$55
White	904.470.20	\$55



KOMPLEMENT Pull-out tray

Combines with different inserts and shoe racks, see organizing accessories.

19 1/2" x 22 7/8".

Black-brown	802.463.62	\$20
Gray-stained ash effect	704.750.71	\$20
White	202.463.60	\$20



29 1/2" x 22 7/8".

Black-brown	502.463.68	\$25
Gray-stained ash effect	504.750.72	\$25
White	302.463.74	\$25



39 3/8" x 22 7/8".

Black-brown	002.463.80	\$30
Gray-stained ash effect	304.750.73	\$30
White	702.463.86	\$30

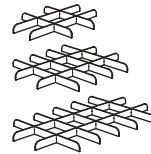

KOMPLEMENT Divider for pull-out tray Felt.

19 1/2" x 22 7/8".	204.667.95	\$10
29 1/2" x 22 7/8".	804.667.97	\$15
39 3/8" x 22 7/8".	704.667.93	\$20



KOMPLEMENT Insert for pull-out tray, Light gray

To fit KOMPLEMENT pull-out tray 19 1/2" x 22 7/8" you will need: one KOMPLEMENT insert 9 7/8" x 22 7/8" and one KOMPLEMENT insert 5 3/4" x 22 7/8" or one KOMPLEMENT insert 15 3/4" x 22 7/8".

To fit KOMPLEMENT pull-out tray 29 1/2" x 22 7/8" you will need: two KOMPLEMENT inserts 9 7/8" x 22 7/8" and one KOMPLEMENT insert 5 3/4" x 22 7/8" or one KOMPLEMENT insert 9 7/8" x 22 7/8" and one KOMPLEMENT insert 15 3/4" x 22 7/8".

To fit KOMPLEMENT pull out tray 39 3/8" x 22 7/8" you will need: two KOMPLEMENT inserts 9 7/8" x 22 7/8" and one KOMPLEMENT insert 15 3/4" x 22 7/8" or three KOMPLEMENT inserts 9 7/8" x 22 7/8" and one KOMPLEMENT insert 5 3/4" x 22 7/8".

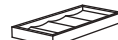

5 3/4" x 20 7/8" with 4 compartments	704.040.26	\$15
9 7/8" x 20 7/8" with 4 compartments	504.040.32	\$25
9 7/8" x 20 7/8" for jewelry	304.040.28	\$25
15 3/4" x 20 7/8" with compartments	504.040.27	\$30



KOMPLEMENT Pull-out pants hanger

19 1/2" x 22 7/8".

Black-brown	704.465.21	\$25
White	304.465.37	\$25



29 1/2" x 22 7/8".

Black-brown	404.465.27	\$30
White	704.465.40	\$30



39 3/8" x 22 7/8".

Black-brown	904.465.15	\$35
White	004.465.34	\$35



KOMPLEMENT Pull-out shoe shelf

19 1/2" x 22 7/8".

Dark gray	702.574.69	\$25
White	802.574.64	\$25



29 1/2" x 22 7/8".

Dark gray	302.574.71	\$30
White	302.574.66	\$30



39 3/8" x 22 7/8".

Dark gray	102.574.67	\$35
White	002.574.63	\$35

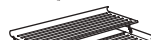

KOMPLEMENT Pull-out multi-use hanger 22 7/8".

Dark gray	202.624.87	\$15
White	802.624.89	\$15



KOMPLEMENT Valet hanger W6 3/4" x D3 1/2" x H2".

Dark gray	602.571.82	\$5
White	702.569.31	\$5

INTERIOR ACCESSORIES

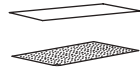

KOMPLEMENT Drawer liner W35½×D20⅞". Easy to cut to the desired size.

Light gray	304.055.65	\$10
Light gray patterned	504.653.89	\$10

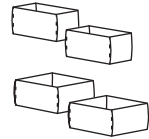

KOMPLEMENT Boxes Light gray

W5⅞×D10½×H4¾".	104.040.53	\$9.99/ set of 2
W9¾×D10½×H4¾".	404.057.77	\$12.99/ set of 2



KOMPLEMENT Boxes Perfect fit in KOMPLEMENT drawer 19⅞×22⅞".

19⅞×22⅞".	992.608.38	\$22.98/ set of 4
-----------	------------	--------------------------

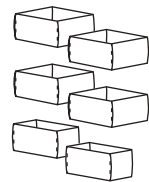

KOMPLEMENT Boxes Perfect fit in KOMPLEMENT drawer 29⅞×22⅞".

29⅞×22⅞".	392.608.41	\$35.97/ set of 6
-----------	------------	--------------------------



KOMPLEMENT Boxes Perfect fit in KOMPLEMENT drawer 39⅞×22⅞".

39⅞×22⅞".	792.608.44	\$48.96/ set of 8
-----------	------------	--------------------------

FITS 13¾" DEEP FRAMES

Width×Depth×Height



KOMPLEMENT Multi-use hanger White

12½×28¼".	603.872.11	\$6.99
-----------	------------	---------------



TJOG Storage box with lid Dark gray

9¾×14¼×6".	404.776.65	\$3.99
------------	------------	---------------

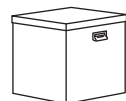

12½×12¼×11¾".	204.776.71	\$5.99
---------------	------------	---------------



TJENA Storage box 7×9¾×6".

White	103.954.21	\$1.99
Black	603.954.85	\$1.99



9¾×13¾×7¾".

White	603.954.28	\$3.99
Black	303.954.77	\$3.99

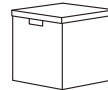

12½×13¾×12½".

White	404.693.02	\$4.99
Black	204.692.99	\$4.99



RAGGISAR Tray 11¾×15¾×2⅞".

Dark gray	103.480.19	\$11.99
-----------	------------	----------------



STUK Box with compartments White

7¾×13½×4".	204.744.27	\$2.99
------------	------------	---------------

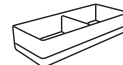

7¾×20×4".	404.744.31	\$3.99
-----------	------------	---------------

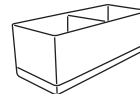

7¾×20×7".	504.744.35	\$4.99
-----------	------------	---------------

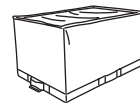

STUK Storage case 13½×20×11".

White	004.813.01	\$6.99
-------	------------	---------------



STUK Storage with seven compartments 11¾×11¾×35½".

White/gray	404.813.04	\$8.99
------------	------------	---------------



LACKISAR Storage case 13×20×11".

White	904.609.26	\$9.99
-------	------------	---------------

INTERIOR ACCESSORIES

FITS 22⁷/₈" DEEP FRAMES

Width×Depth×Height



SKUBB Storage case 17 ¹ / ₄ ×21 ³ / ₄ ×7 ¹ / ₂ "		
White	803.000.47	\$4.99
Dark gray	804.729.82	\$4.99



SKUBB Storage case 27 ¹ / ₂ ×21 ³ / ₄ ×7 ¹ / ₂ "		
White	203.000.50	\$6.99
Dark gray	904.729.86	\$6.99



SKUBB Storage case 36 ¹ / ₂ ×21 ³ / ₄ ×7 ¹ / ₂ "		
White	603.000.48	\$8.99
Dark gray	904.729.91	\$8.99

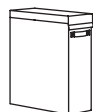

SKUBB Laundry bag with stand 8 ³ / ₄ ×21 ³ / ₄ ×25 ¹ / ₂ "		
White	902.240.48	\$9.99



SKUBB Storage with six compartments 13 ³ / ₄ ×17 ³ / ₄ ×49 ¹ / ₂ "		
White	403.000.49	\$6.99
Dark gray	504.729.93	\$6.99



RAGGISAR Tray 11 ³ / ₄ ×15 ³ / ₄ "		
Dark gray	103.480.19	\$11.99



TJENA Storage box with lid 7×9 ³ / ₄ ×6"		
White	103.954.21	\$1.99
Black	603.954.85	\$1.99



9 ³ / ₄ ×13 ³ / ₄ ×7 ³ / ₄ "		
White	603.954.28	\$3.99
Black	303.954.77	\$3.99

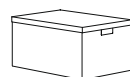

12 ¹ / ₂ ×13 ³ / ₄ ×12 ¹ / ₂ "		
White	404.693.02	\$4.99
Black	204.692.99	\$4.99



13 ³ / ₄ ×19 ³ / ₄ ×11 ³ / ₄ "		
White	903.743.49	\$9.99



KOMPLEMENT Boxes Light gray		
5 ⁷ / ₈ ×10 ¹ / ₂ ×4 ³ / ₄ "	104.040.53	\$9.99/2pk
9 ³ / ₄ ×10 ³ / ₄ ×4 ³ / ₄ "	404.057.77	\$12.99/2pk



KOMPLEMENT Boxes Includes: two boxes (L6×W10 ¹ / ₂ ×H4 ³ / ₄ "") and two boxes (L9 ³ / ₄ ×W10 ³ / ₄ ×H4 ³ / ₄ ""). Perfect fit in 19%×22% KOMPLEMENT drawer.		
Light gray	992.608.38	\$22.98/ set of 4

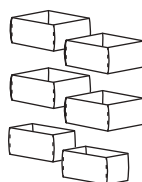

KOMPLEMENT Boxes Includes: two boxes (L6×W10 ¹ / ₂ ×H4 ³ / ₄ "") and four boxes (L10×W10 ³ / ₄ ×H4 ³ / ₄ ""). Perfect fit in 19%×22% KOMPLEMENT drawer.		
Light gray	392.608.41	\$35.97/ set of 6



KOMPLEMENT Boxes Includes: two boxes (L6×W10 ¹ / ₂ ×H4 ³ / ₄ "") and six boxes (L9 ³ / ₄ ×W10 ³ / ₄ ×H4 ³ / ₄ ""). Perfect fit in 19%×22% KOMPLEMENT drawer.		
Light gray	792.608.44	\$48.96/ set of 8



LACKISAR Storage case		
13×20×11"	904.609.26	\$9.99
17×20×7"	704.609.27	\$9.99
27×20×7"	304.609.29	\$14.99



KUGGIS Box with lid 14 ¹ / ₂ ×21 ¹ / ₄ ×8 ¹ / ₄ "		
White	102.802.03	\$14.99
Turquoise	104.768.27	\$14.99



TJOG Storage box with lid 13 ³ / ₄ ×22×11 ³ / ₄ "		
Dark gray	804.776.68	\$12.99

INTEGRATED LIGHTING

HOW TO CHOOSE

Now you don't need to worry about getting bright light in your eyes or it waking up your partner when you look for clothes. Instead, you start the day when you open your wardrobe and the soft light from our LED lighting strips turns on. Or choose cabinet lighting placed on top of the wardrobe to help

you see what's on the top shelf also provides a nice and cozy atmosphere in the entire room when the wardrobe doors are closed. You can even connect to IKEA Smart lighting using the TRÅDFRI gateway.

BASIC PARTS

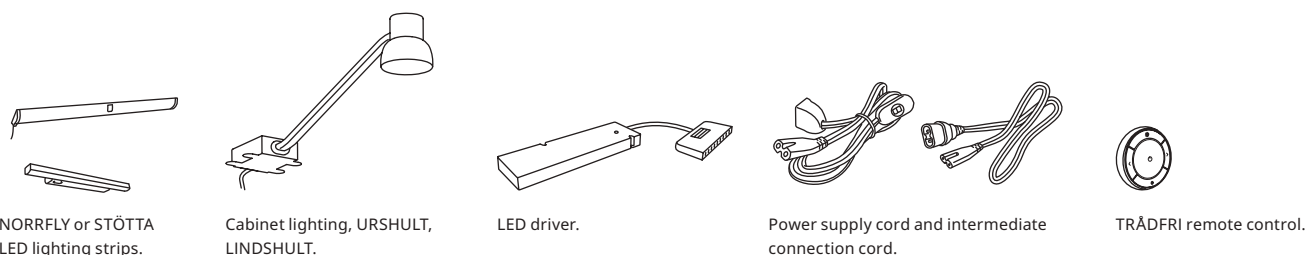

See All Parts and Prices list on page 18 for more information about each product.

HOW TO CHOOSE A DRIVER

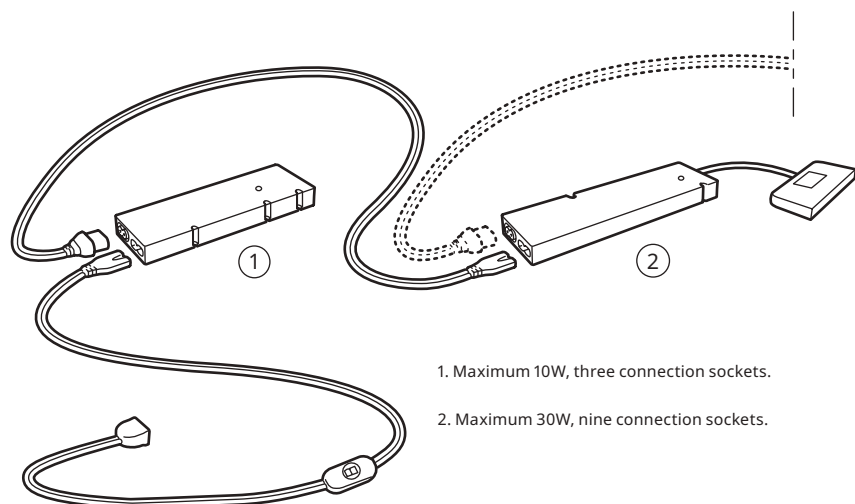

There are two LED drivers. Choose based on how many units you want to connect. You can connect up to three units to the 10W LED driver, as long as the total wattage does not exceed 10W. The 30W LED driver can support up to nine units, max. wattage 30W. You can connect up to ten drivers in one installation cord. Flashing lights indicate that the maximum wattage of the LED driver is exceeded. If you want to use more

than one LED driver, make sure to synchronize each LED driver with the TRÅDFRI remote control so that the entire combination can be dimmed at the same time. Make your cabinet lighting smart by adding the TRÅDFRI gateway. With the gateway, you can control your lights from the IKEA Home Smart App and create a mood together with your other TRÅDFRI lighting.

HOW TO BUILD

NORRFLY lighting strips

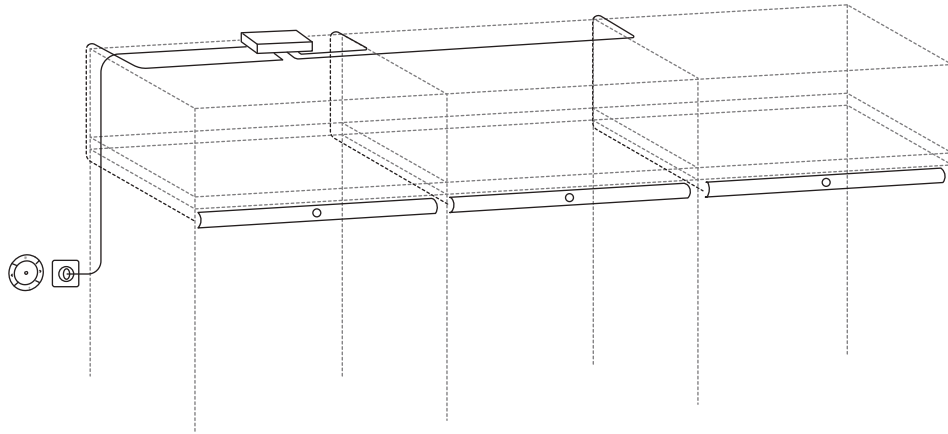

Cabinet lighting

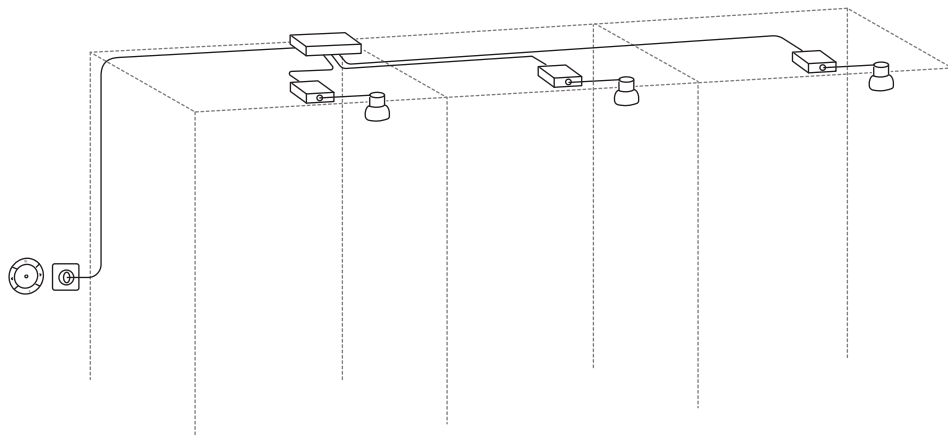

NORRFLY and cabinet lighting with smart lighting remote

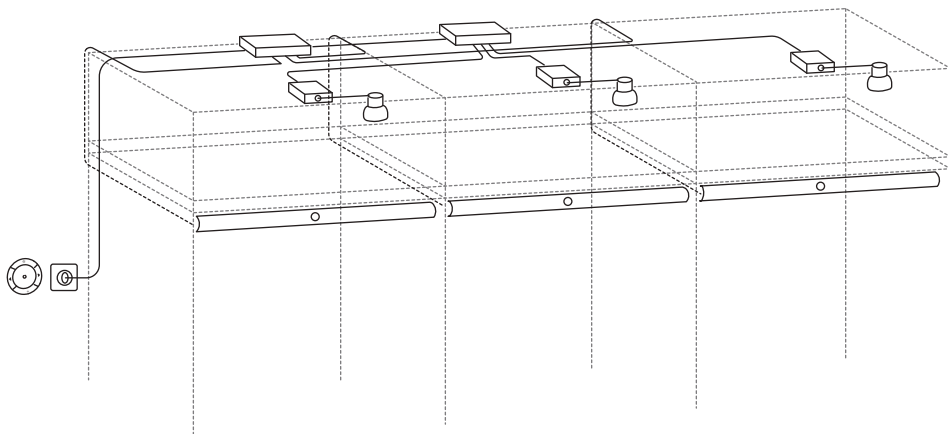

COMBINATIONS

HINGED DOORS

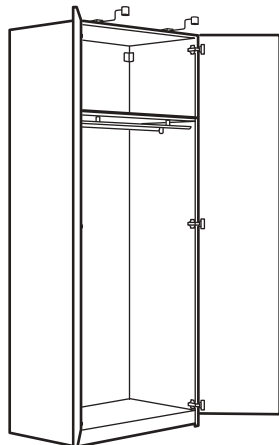

NORRFLY LED lighting strip is perfect so that you can see what you have stored in your wardrobe. Place the lighting strip under the top of the wardrobe or under any upper shelf so that the light can shine down. Besides a lighting strip, you can add cabinet lighting if you like, which is not only functional but also provides a nice light in the room when the wardrobe is closed.

Shopping list

Qty

NORRFLY LED lighting strip, Aluminum-color, 36", 5W	803.323.07	1 pc
URSHULT LED cabinet light, Nickel-plated, 2W	602.604.05	2 pcs
TRÅDFRI LED driver, 10W	103.561.89	1 pc

SLIDING DOORS

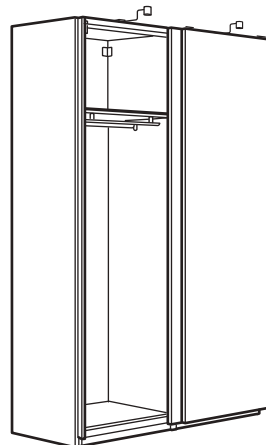

If you have a wardrobe with sliding doors and a soft-closing mechanism under the top of the wardrobe, you need a lighting strip with a specific length when installing a lighting strip under the top of the cabinet. The mechanism needs 7", so the lighting strip must be shorter than the width of the wardrobe in order to fit. For frames with 29½" width, you need a 16½" long lighting strip, and for frames with 39¼" width, you choose a 26" long lighting strip. When installing a lighting strip one shelf lower, you can use the normal sizes.

Shopping list

Qty

NORRFLY LED lighting strip, Aluminum-color, 26", 4W	103.323.01	1 pc
URSHULT LED cabinet lighting, Nickel-plated, 2W	602.604.05	2 pcs
TRÅDFRI LED driver, 10W	103.561.89	1 pc

INTEGRATED LIGHTING ALL PARTS AND PRICES



NORRFLY LED light strips* Aluminum-color. To be completed with TRÅDFRI LED driver and ANSLUTA power cord, sold separately. Dimmable with TRÅDFRI remote control and TRÅDFRI gateway, sold separately.

14"	603.322.90	\$19.99
17"	203.322.92	\$24.99
22"	703.322.99	\$26.99
26"	103.323.01	\$29.99
36"	803.323.07	\$34.99

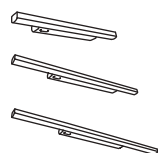

STÖTTA LED cabinet lighting strip with sensor* White. Easy to place anywhere as it is battery operated and does not need to be connected to the mains supply. The light switches on and off automatically when you open or close the door so no energy is wasted. Batteries are sold separately; 2 pcs for the 13"; 4 pcs for the 20" and 28". IKEA recommends LADDA rechargeable batteries. Only for wardrobes with hinged doors.

13"	103.600.87	\$8.99
20"	503.600.90	\$12.99
28"	903.600.93	\$14.99

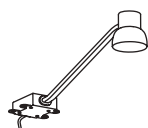

LINDSHULT LED cabinet light* To be used with TRÅDFRI LED driver and ANSLUTA power supply cord, sold separately. 2W.

Nickel-plated	302.604.40	\$24.99
---------------	------------	----------------

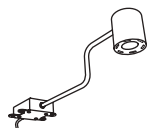

URSHULT LED cabinet light* To be used with TRÅDFRI LED driver and ANSLUTA power supply cord, sold separately. 2W.

Nickel-plated	602.604.05	\$24.99
---------------	------------	----------------

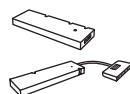

TRÅDFRI LED driver To be completed with TRÅDFRI LED driver, sold separately. Can be used with TRÅDFRI remote control and TRÅDFRI gateway.

Up to 10W, connect up to 3 units.	103.561.89	\$27
Up to 30W, connect up to 9 units.	603.426.61	\$37



TRÅDFRI Remote control Dim your lights without a hardwired installation.

	004.431.30	\$15.99
--	------------	----------------



TRÅDFRI Gateway With TRÅDFRI gateway and app you can control each light source individually, create different types of lighting settings – and control them by remote control or the app.

White	003.378.13	\$35
-------	------------	-------------

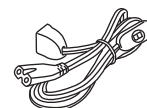

ANSLUTA Power cord

L11'6"	301.214.11	\$7
--------	------------	------------



ANSLUTA Intermediate connection cord

L28"	401.199.26	\$6
L79"	601.199.25	\$7

* These lights contain built-in LED bulbs. The bulbs can not be changed in the light.

PAX/KOMPLEMENT LIMITED WARRANTY



Everyday life at home puts high demands on wardrobes. PAX/KOMPLEMENT wardrobes and interior organizers endure rigorous tests to meet our strict standards for quality, strength and durability. The PAX/KOMPLEMENT wardrobes and interior organizers are tested under the highest standards in domestic applications. That means we can offer you a 10-year limited warranty that covers PAX/KOMPLEMENT wardrobes and interior organizers marked with the logo below, against defects in materials and workmanship. This limited warranty is subject to the terms and conditions stated here.

How long is this limited warranty valid?

The limited warranty for PAX/KOMPLEMENT wardrobes and interior organizers remains in force for ten (10) years, and is valid from the date of purchase. The original purchase receipt is required as proof of purchase.

What is covered under this limited warranty?

This limited warranty applies to residential use only, and covers defects in material and workmanship in the following components of the PAX/KOMPLEMENT wardrobes and interior organizers:

- Frames
- Hinged doors and hinges
- Dividers for frames and shelf inserts.
- Sliding doors and sliding door mechanism
- KOMPLEMENT interior organizers

Products not covered under this limited warranty

KOMPLEMENT insert for pull-out tray, KOMPLEMENT jewelry insert for pull-out tray, KOMPLEMENT divider for pull-out tray, and KOMPLEMENT trays 3-pack.

What will IKEA do to correct the problem?

IKEA will examine the product and decide, at its sole discretion, if it is covered under this limited warranty. If considered covered, IKEA through its own service operations, will then, at its sole discretion, either repair the defective product or replace it with the same or a comparable product. If it is covered by this limited warranty, IKEA will pay the costs of repairs, spare parts, labor and travel for repair staff, that IKEA incur, provided that the product is accessible for repair without special expenditure. This does not apply to any repair work not authorized by IKEA. Replaced parts become the property of IKEA. If the item is no longer sold by IKEA, IKEA will provide an appropriate replacement. It is IKEA that determines, at its sole discretion, what constitutes an appropriate replacement.

What is not covered under this limited warranty?

This limited warranty does not apply to products that have been stored or installed incorrectly, used inappropriately, abused, misused, altered, or cleaned with wrong cleaning methods or cleaning products.

This limited warranty does not cover normal wear and tear, cuts, scratches, or damage caused by impacts or accidents.

This limited warranty does not apply if products have been placed outdoors or in a humid environment, e.g. a bathroom.

This limited warranty does not cover consequential or incidental damages.

For customers in the US only: Some states do not allow the limitation or exclusion of incidental or consequential damage, so this limitation or exclusion may not apply to you.

Care instructions

Assemble according to the assembly instruction and secure the wardrobe frames by attaching them flush to a wall. Keep in mind that different wall materials require different types of hardware. If you are uncertain, contact your local hardware specialist. Follow the recommended weight loads. Wipe clean with a cloth dampened in mild cleaner. Then wipe clean with a dry cloth.

How country, provincial and state law applies

This limited warranty gives you specific legal rights, and is in addition to your statutory legal rights.

How to reach us if you need service

Contact your local IKEA store. You will find the store addresses at [IKEA-USA.com/directions](https://www.ikea.com/usa/en/directions)

SAVE THE SALES RECEIPT!

It is your proof of purchase and required for the limited warranty to apply.

SERVICES

IKEA products are designed to be taken home and assembled by you. That way, you'll save the most money. But if you would like some help, we can offer a range of services. Assembly and delivery services are fulfilled by an Independent Service Provider. Contact your local IKEA store or visit the IKEA website for details: IKEA-USA.com/services



DELIVERY SERVICE

Most of our products are designed and packaged so that you can take them home yourself. If you prefer, we can arrange for delivery of your purchases directly to your home or business. Same day, next day or same week deliveries are available. We can also arrange for delivery at a later date if you would like.



PICKING WITH DELIVERY SERVICE

We'll collect the products on your shopping list from throughout the store and arrange to have everything delivered to your home or office. See an IKEA co-worker and tell them what you're looking for and they will book and print your items on a customer order. Take this order to the check-outs and pay for your purchases, both goods and services. And you're on your way!



ASSEMBLY SERVICE

For online and in-store purchases, TaskRabbit offers quick and convenient assembly and mounting for your IKEA purchases made online and in select stores.

Services and prices may vary, please see IKEA-USA.com/services or talk to us in your local IKEA store.



IKEA Projekt credit card

Now, you don't have to pay for IKEA product purchases all at once. This card has special financing options to make your dream more affordable. Visit IKEA-USA.com/creditcard or drop by your local IKEA store. Promotional financing available with the IKEA Projekt credit card accounts offered by Comenity Capital Bank which determines qualifications for credit and promotion eligibility. Minimum purchase and minimum monthly payments are required. See Store Associate for details. Subject to credit approval.