

Electronic Design 26

FOR ENGINEERS AND ENGINEERING MANAGERS

VOL. 18 NO.

DEC. 20, 1970

'Twas a week before Christmas and the Post Office tried to sort, route and carry the mountainous tide. There were letters, cards and packages, too. By billions they came, and the backlog it grew. Something was needed to prevent a collapse. But what was that something? Electronics, perhaps? For details see p. 22.

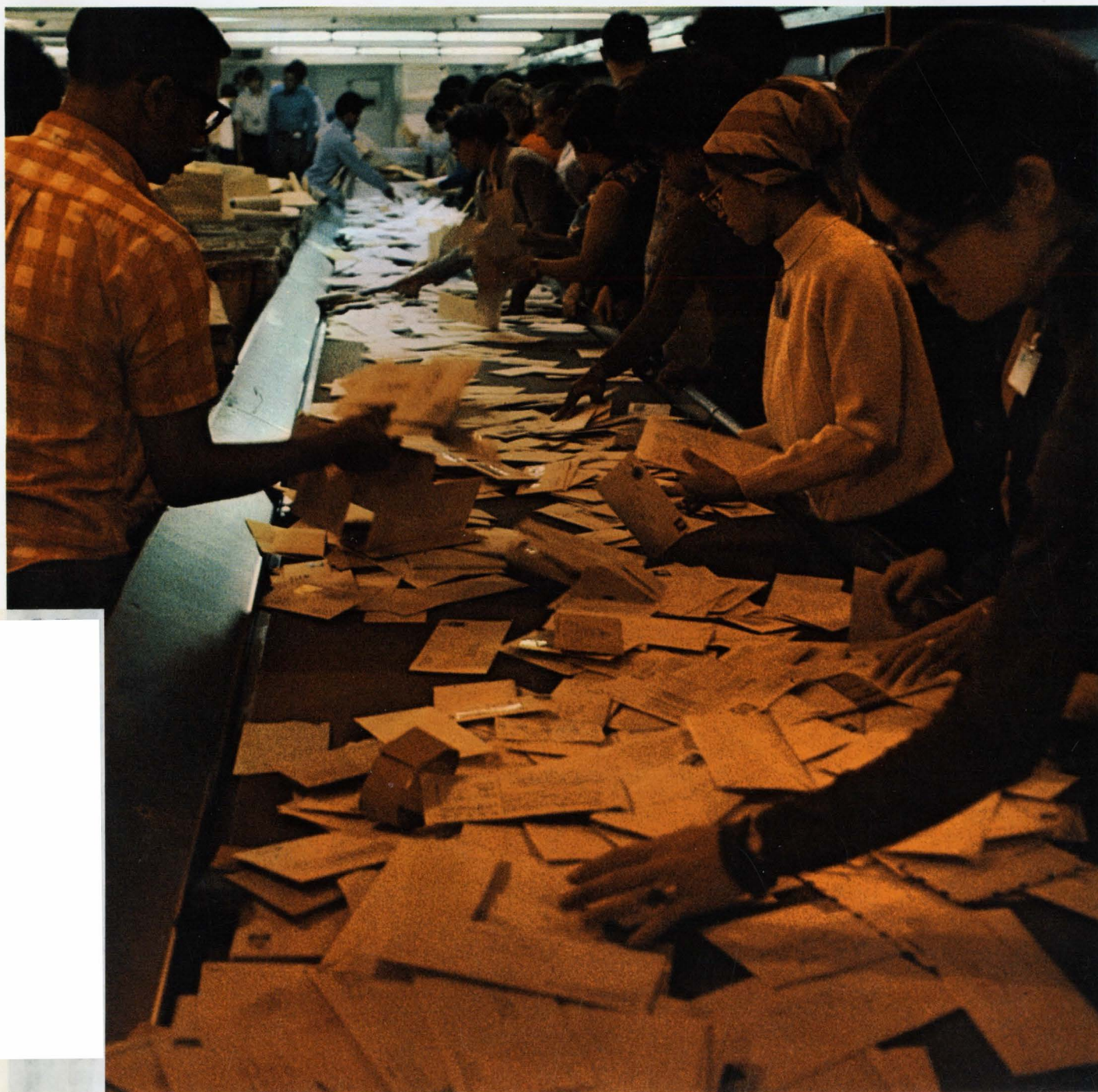

7 problem-solving accessories you get free with every HP scope

Repair/Calibration Technician

Field Engineer

Field-Office Secretary

Factory Applications Engineer

Field-Office Staff Engineer

Order Co-ordinator

When you own an HP 180 System scope, you're not stuck with an "orphan." That's because, at HP, we care about you and your problems—not just when you're looking for a new scope, but afterwards, as well.

Hardware is only half the story in scope selection; after all, what you're really looking for is a solution to your measurement problems. So, when we give you state-of-the-art performance, plug-in versatility, and an unequalled value for your money—that's just the beginning. In addition, you get the back-up necessary to let you get the most out of your scope—to get what you paid for.

Specifically, with every HP 180 System scope, you get seven problem-solving accessories money can't buy.

- A field engineer—"your man at HP," always available to give you personal counseling on measurement problems, drawing both on his own knowledge and that of other HP experts.

- A field-office staff engineer—the first of these experts, whose broad knowledge of measurement instruments is available to help you choose those best for your needs.

- An order co-ordinator, who makes sure that your order is taken care of smoothly and efficiently.

- A training consultant, who works with your field engineer to provide your people with the know-how to operate, calibrate, and repair your scope—via live demonstrations, seminars, video tapes, and literature.

- Repair/calibration technicians, who will perform any service you need, at local, regional, or factory calibration-and-repair centers.

- A factory applications engineer, to provide economical solutions to "impossible" measurement problems.

- And a field-office secretary, to coordinate communications between you, your field engineer, and the other "problem-solvers."

Training Consultant



Things are changing in the world of oscilloscopes... and if your ability to do your job depends on your scope, you have to change, too. Call your local HP field engineer, and ask him about HP's seven problem-solving accessories. Have him show you HP's new video training tapes on the 180 System. Or write to Hewlett-Packard, Palo Alto, California 94304. In Europe: 1217 Meyrin-Geneva, Switzerland.

Scopes are changing.
Are you?

HEWLETT  PACKARD

081/1

so that's what a $\frac{1}{2}$ -millisecond attenuator looks like!

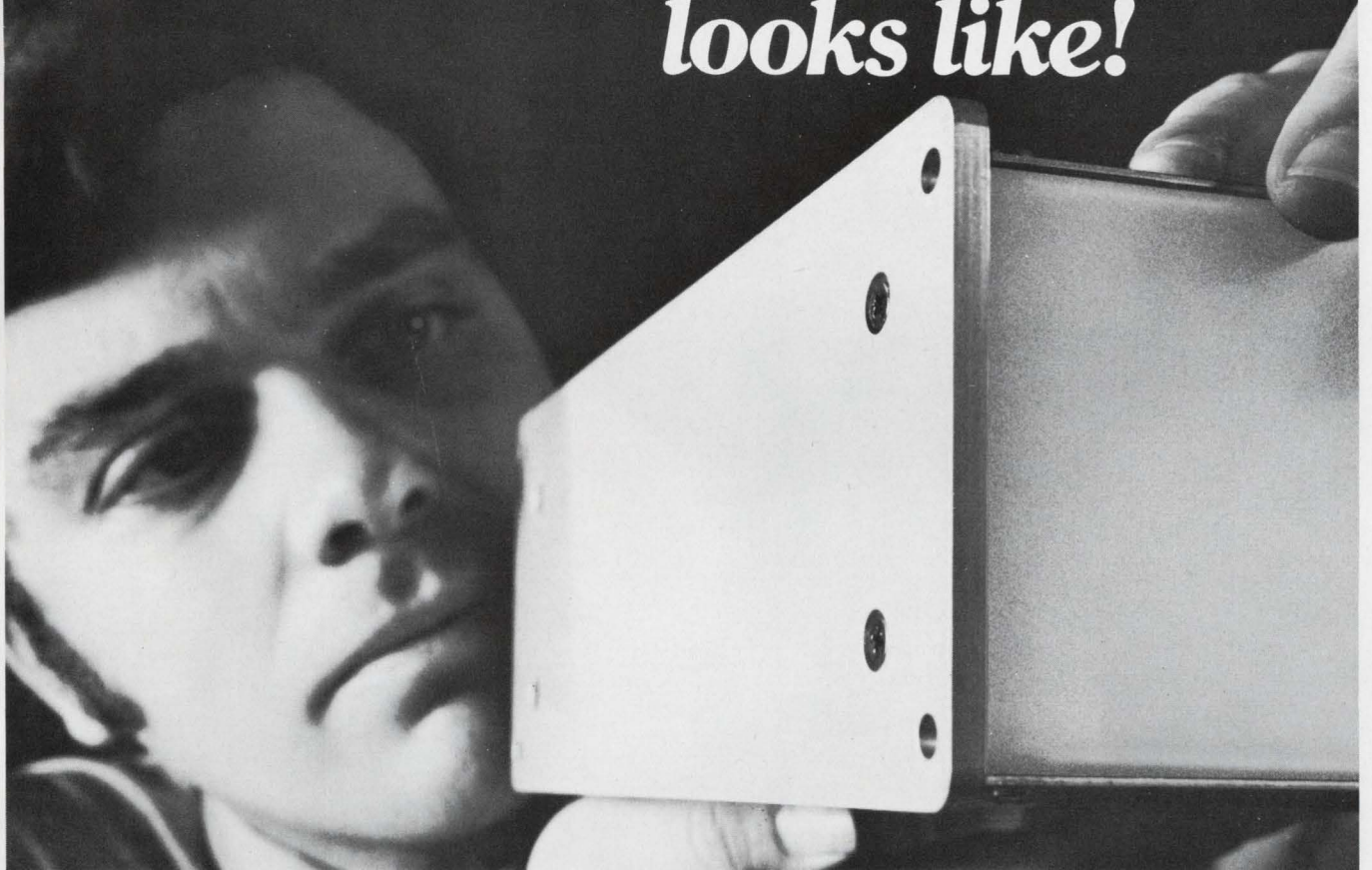

Don't let the blank expression fool you. Behind it lurks GR's 1452 Attenuator with the eloquent specs for high-speed systems applications.

Suppose you're planning an automatic rf testing system. Before the 1452, the limiting factor in system speed and life was the attenuator. Now, with a 1452, you can switch attenuation levels in half a millisecond (including settling time) and your attenuator will last forever because it uses solid-state switches.

In any application, the 1452 gives you a basic accuracy of 0.7 dB, an insertion loss of only 1.7 dB, and an SWR under 1.4 – all the way across the 10 kHz-to-500 MHz band. Attenuation is incremented in 1-dB steps over an 80-dB range. The maximum input is 5 V (0.5 W) over most of the frequency range. Long-term stability is assured, too, because the 1452 uses precision metal-film resistors. That's a lot of attenuator for \$700!

If you can't resist the urge to turn knobs, the manual/remote version will satisfy the urge; this version comes in a bench model for \$775 and a rack model for \$800.

Whichever face you choose, get your 1452 Attenuators by calling the GR office nearest you or by writing to 300 Baker Ave., Concord, Mass. 01742 or Postfach 124, CH 8034, Zurich, Switzerland.

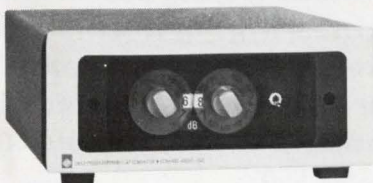

The manual/remote 1452



General Radio

BOSTON 617 646-0550 / CHICAGO 312 992-0800 / DALLAS 214 637-2240
LOS ANGELES 714 540-9830 / NEW YORK (N.Y.) 212 964-2722 (N.J.) 201 943-3140
SAN FRANCISCO 415 948-8233 / SEATTLE 206 747-9190 / WASHINGTON, D.C. 301 881-5333
TORONTO 416 252-3395 / ZURICH (051) 47 70 20

INFORMATION RETRIEVAL NUMBER 2

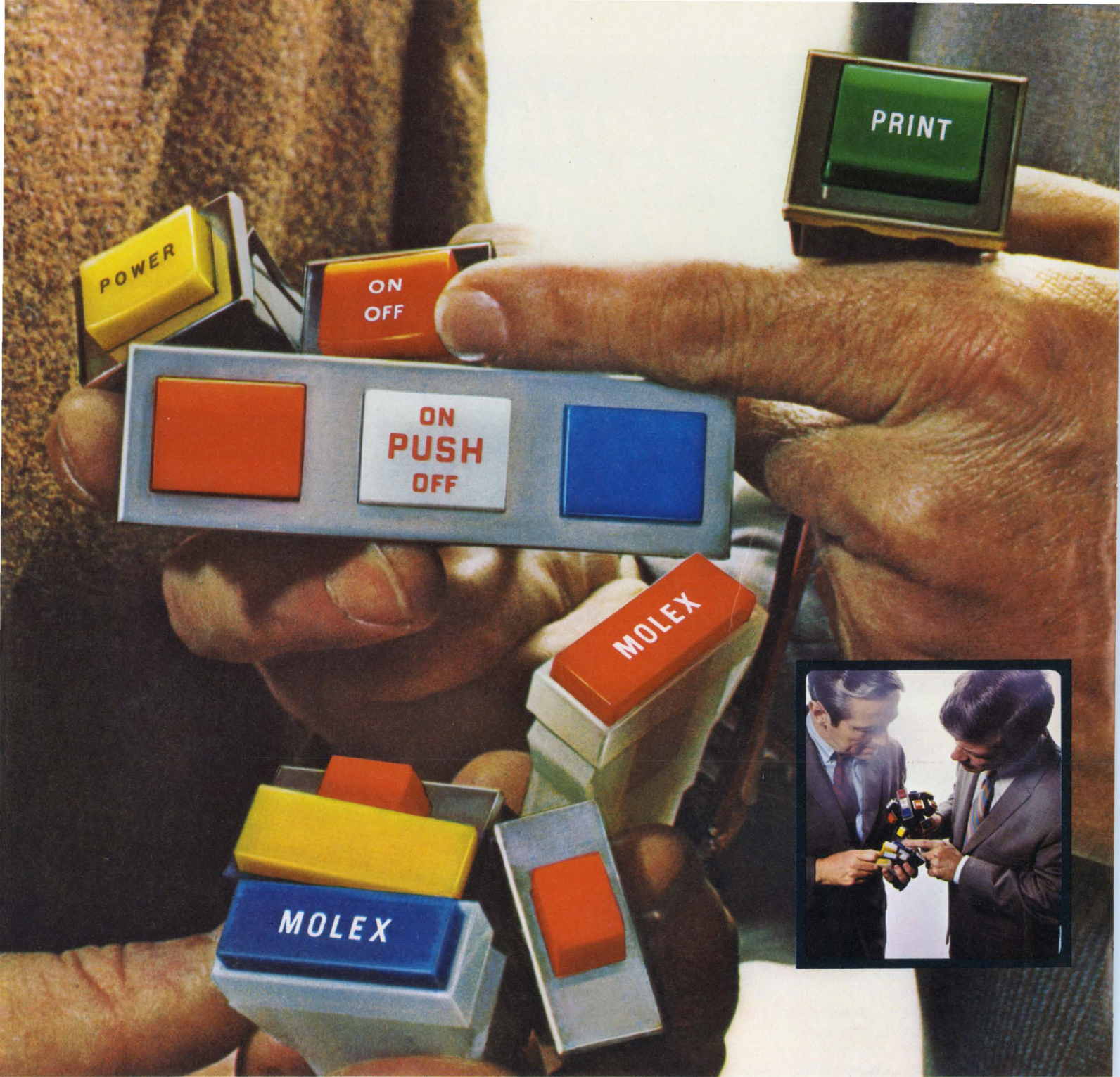

HERE ARE TWO EASY WAYS TO SOLVE LIGHTED PUSH BUTTON SWITCH PROBLEMS. Economically. Reliably. Fast. The Molex 1175 snap mounts. Offers spade or wire terminals for fast, easy assembly. A choice of nine colors, 500 variations. And look at the Molex 1820. You can use one, or a gang of them, for an infinite variety of applications. Lighted push button can be wired to light independently of the switch. And it's available in colors galore. Best of all . . . both switches are priced considerably under one

dollar in quantity. ■ These components are good examples of the Molex creative approach to design problems. And we have the ability to design reliability and ease of assembly into a product without letting costs run wild due to over-engineering. ■ If this makes sense, and you would like a *free sample* of either the 1175 or 1820 switch, write: Molex Incorporated, Downers Grove, Illinois 60515. Or phone (312) 969-4550.

... creating components that simplify circuitry



Electronic Design 26

VOL. 18 NO.

FOR ENGINEERS AND ENGINEERING MANAGERS

DEC. 20, 1970

NEWS

- 9 Letters
- 19 News Scope
- 22 **The new Postal Service plans a rapid, 'hands off' system.** Automated centers are being designed to end increasing bottlenecks.
- 28 **New surface-charge transistor has high data-storage potential.** GE is investigating device for use as a serial shift register.
- 30 **LEDs find wider use in biomedical instruments**
- 32 **Technology Abroad**
- 35 **Washington Report**

TECHNOLOGY

- 40 **Evaluate transistor bandwidths the easy way.** Circuit Qs and interstage resistance levels provide a rapid measure of available bandwidth.
- 44 **Fluid dielectric cuts size and weight** of high-power airborne equipment. It's particularly effective with high-frequency transmitters.
- 48 **Whet your data-gathering/sharing skill** to a fine edge. Practice can improve your ability to learn, says this management trainer.
- 53 **Ideas for Design**
- 56 **Product Source Directory: Digital Panel Meters**

PRODUCTS

- 60 **Modules & Subassemblies:** 64-channel MOS multiplexer works at ± 15 V.
- 63 **Components:** Solid-state inductors provide up to 100 henries.
- 64 **Data Processing:** New 12-digit calculator costs only \$395.
- 61 Instrumentation
- 62 ICs & Semiconductors
- 63 Microwaves & Lasers
- 64 Packaging & Materials
- 65 Tools & Engineering Aids
- 72 Product Index

Departments

- 39 **Editorial:** New trade quota bill—can we let history repeat itself?
- 13 Designer's Calendar
- 66 Evaluation Samples
- 66 Design Aids
- 66 Application Notes
- 67 New Literature
- 68 Bulletin Board
- 69 Advertisers' Index

Information Retrieval Service Card inside back cover.

Cover: Sorting mail in the General Post Office, 8th Ave. and 33rd St., New York City. Photo by John F. Mason, News Editor.

ELECTRONIC DESIGN is published biweekly by Hayden Publishing Company, Inc., 850 Third Avenue, New York, N.Y. 10022. James S. Mulholland, Jr., President. Printed at Brown Printing Co., Inc., Waseca, Minn. Controlled circulation postage paid at Waseca, Minn., and New York, N.Y. Copyright © 1970, Hayden Publishing Company, Inc. 82,501 copies this issue.

Fight noise pollution

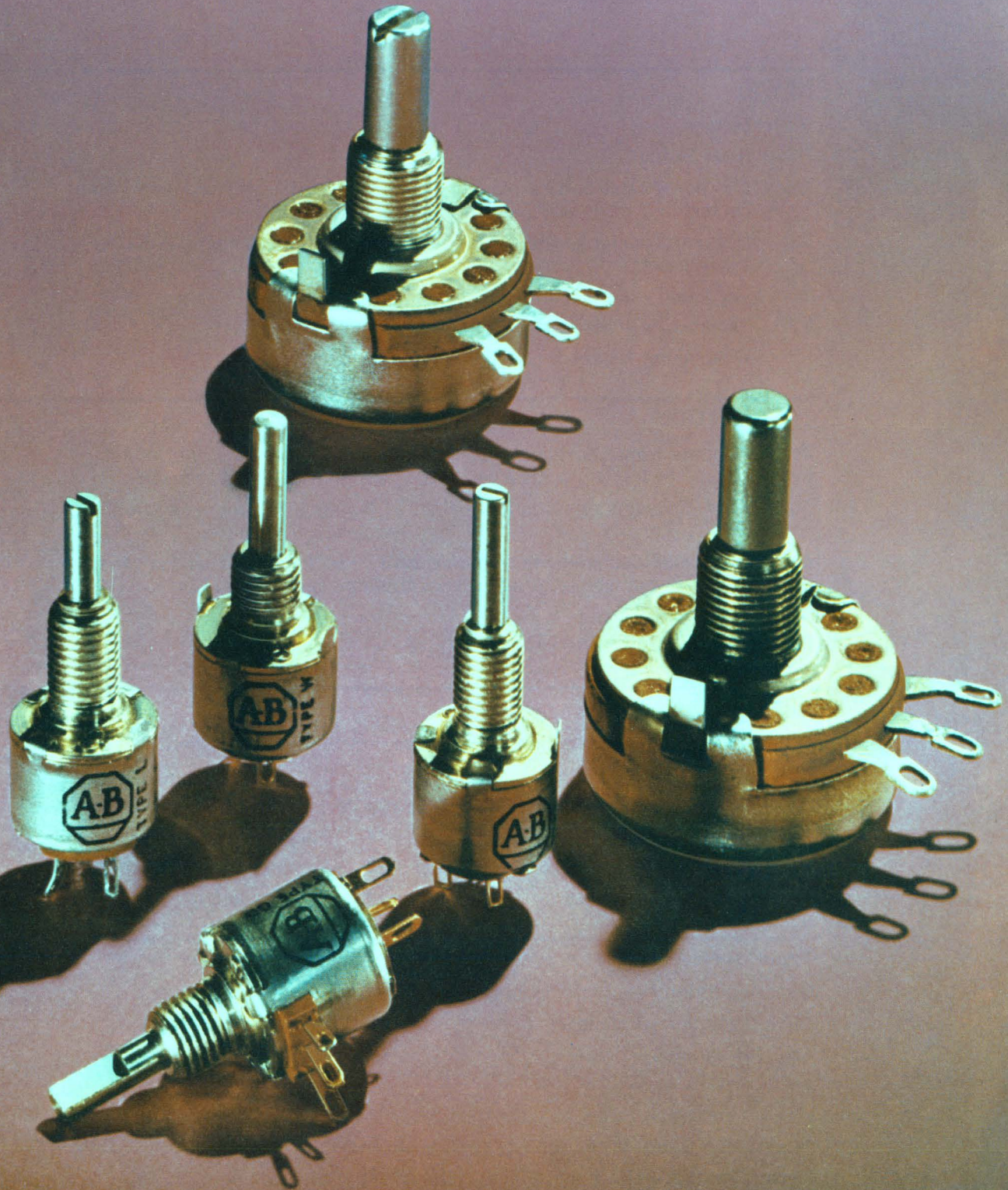

with this quiet family.

Hot Molding with Allen-Bradley's exclusive technique, gives these composition variable resistors an unusually low noise level. And importantly, this low noise level actually decreases in use. Under tremendous heat and pressure the resistance track is molded into place. A solid element with a large cross-section is produced.

This important Allen-Bradley difference means better short-time overload capacity and a long operating life. Control is smooth, resolution almost infinite. These variable resistors are ideal for high frequency circuits. Why should you trust the performance of

your designs or your reputation to anything less than Allen-Bradley quality? Use the most thoroughly "field tested" (over 20 years) variable resistors available today. Quantity stocks of popular types J, G, W and GD available for immediate delivery from your appointed A-B industrial electronics distributor.

For information write: Marketing Department, Electronics Division, Allen-Bradley Co., 1201 South Second Street, Milwaukee, Wisconsin 53204. Export office: 1293 Broad Street, Bloomfield, N. J. 07003, U.S.A. In Canada: Allen-Bradley, Canada Ltd., 135 Dundas Street, Galt, Ontario.

SPECIFICATIONS

	TYPE J— STYLE RV4	TYPE K	TYPE G— STYLE RV6	TYPE L	TYPE W	TYPE GD
CASE DIMENSIONS	5/8" deep x 1-5/32" dia. (single section)	5/8" deep x 1-5/32" dia. (single section)	15/32" deep x 1/2" dia.	15/32" deep x 1/2" dia.	15/32" deep x 1/2" dia.	35/64" deep x 1/2" dia.
POWER at + 70°C	2.25 W	3 W	0.5 W	0.8 W	0.5 W	0.5 W
TEMPERATURE RANGE	-55°C to +120°C	-55°C to +150°C	-55°C to +120°C	-55°C to +150°C	-55°C to +120°C	-55°C to +120°C
RESISTANCE RANGE (Tolerances: ±10 and 20%)	50 ohms to 5.0 megs	50 ohms to 5.0 megs	100 ohms to 5.0 megs	100 ohms to 5.0 megs	100 ohms to 5.0 megs	100 ohms to 5.0 megs
TAPERS Linear (U), Modified Linear (S), Clockwise Modified Log (A), Counter-Clockwise Modified Log (B), Clockwise Exact Log (DB). (Special tapers available from factory)						
FEATURES (Many electrical and mechanical options available from factory)	Single, dual, and triple versions available. Long rotational life. Ideal for attenuator applications. Snap switches can be attached to single and dual.	Single, dual, and triple versions available. Long rotational life.	Miniature size. Immersion-proof. SPST switch can be attached.	Miniature size. Immersion-proof.	Commercial version of type G. Immersion-proof.	DUAL section version of type G. Ideal for attenuator applications. Immersion-proof.

ALLEN-BRADLEY

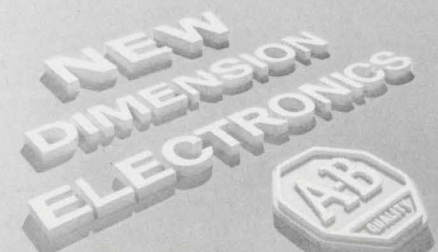
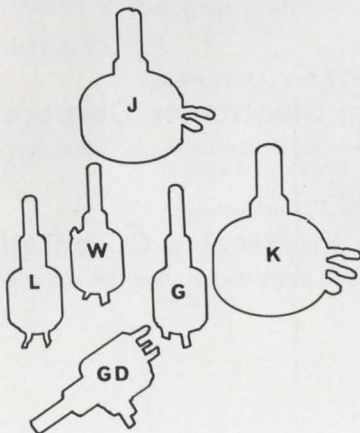

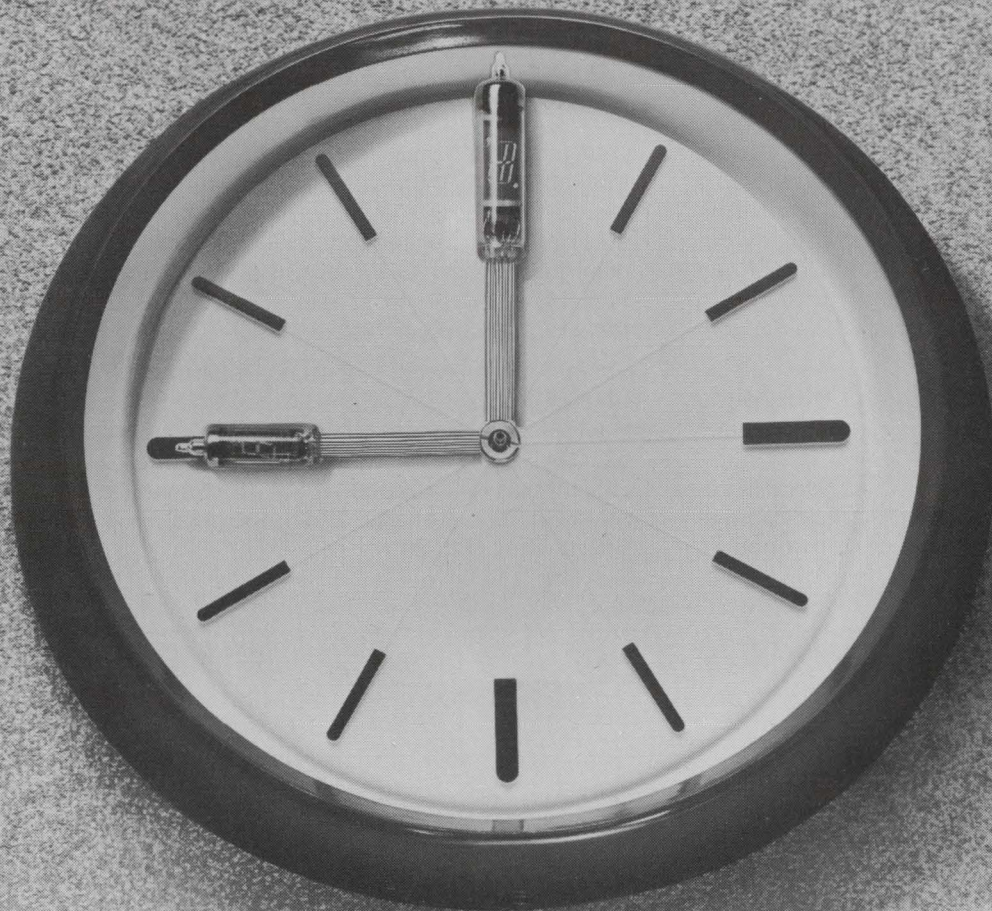

IT'S TIME... TO SEE THINGS IN A NEW LIGHT

When multi-faceted display problems dictate 9 to 9 work days, it's high time you saw things in a new light, on a single plane with no "dancing" digits and with no eye strain.

Legi DG 12C numerical indicator tube segments are an eye-easy phosphor green for a readout as bright and clear as day, legible at distances over 35 feet. These tubes offer low-voltage, low current drain, and high stability advantages so definitive and pack a performance punch so large, you can't afford not to afford to examine full particulars. They fit to the "T" perfectly portable and circuit-board mounting applications and are available at mass production prices. Look at these important particulars, then write for comprehensive data

that show display tube performance in an entirely new light:

LEGI DG 12C

- Filament voltage at 95 mA 0.85 volts \pm 10%
- Phosphor segments & control grid 20 Vdc
- Brightness 80 foot -lamberts
- Operating temperature -10° to $+70^{\circ}$ C
- * Dynamic life expectancy 200,000 hrs.

U.S. PATENT 3508101

Legi Sole U.S. Distributor:

Legi Electronics Corporation

3118 West Jefferson Blvd. Los Angeles, California 90018 U.S.A.
Phone: RE 3-4508, 733-9105



Manufacturer:

Ise Electronics Corporation

P.O. Box 46, Ise City Mie Pref., Japan Phone: Mie (059627)-26

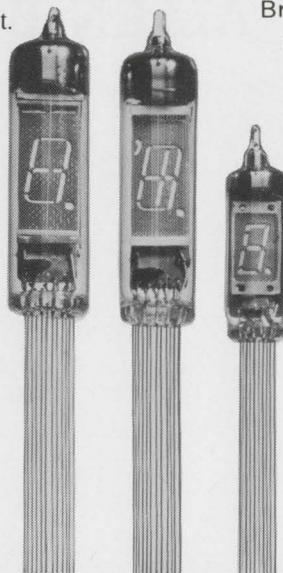

DG 12H

DG 10A

INFORMATION RETRIEVAL NUMBER 5



Look at Acopian's new mini-module dc power supplies

Look at their size. Single output models (there are duals, too) are as small as 2.32" x 1.82" x 1.00". And they can all be soldered directly into printed circuit boards.

Look at their performance. Load and line regulation is 0.02 to 0.1% depending on the model selected. Ripple is only 0.5 mv RMS. And Acopian's long experience in power supply technology assures high reliability.

Look at the choice of outputs. There are 58 different single output modules ranging from 1 to 28 volts, 40 ma to 500 ma. Duals are available in 406 different combinations

of voltages. And these are **true** dual power supplies, with like or different outputs in each section that are electrically independent of each other. Perfect for powering operational amplifiers. Or for unbalanced loads.

Acopian mini-module power supplies		
	Singles	Duals
Output Voltages (vdc):	1 to 28	1 to 28
Output Currents (ma):	40 to 500	40 to 250
Line and Load Regulation:	.02 to 0.1% depending on model	
Ripple:	0.5 mv RMS	
Ambient Temperature (without derating)	0 to 55°C	
Polarity:	outputs floating and isolated	

Look at their price. Single output models start at \$39, duals at \$58.

For a look at all the facts, write or call Acopian Corp., Easton, Pa. 18042. And just like Acopian's other 82,000 power supplies, every mini-module is shipped with a tag that looks like this . . .



**If 48 hour delivery on capacitors
is important, test us.
Call Jim DeSanty at (413) 774-4358.**

**it's on time.
it's up to specs.
it's as quoted.**

When you order production quantities of close tolerance capacitors, WESCO lives up to its commitment. You get the precise value you order from .001 μf to 10.0 μf —to $\pm 2\%$ tolerances (or lower). And, delivered generally, within three weeks *at the quoted price*. WESCO's design and testing techniques assure production of capacitors that meet the most demanding specifications. Sizes, values and tolerances can be provided in an infinite number of variations. Your computer can set the exact capacitance. WESCO produces it exactly. The result: every capacitor we deliver "goes into the circuit."

WESCO makes film dielectric capacitors in Mylar, metalized Mylar, Polystyrene, Polycarbonate and metalized Polycarbonate. We make custom capacitors at "off-the-shelf" prices. When you order evaluation quantities we ship in 48 hours. Write for WESCO's new capacitor catalog today. WESCO Electrical Co., Inc., 27 Olive St., Greenfield, Mass. 01301. Tel: (413) 774-4358.

WESCO

it's wesco.

Publisher

Hugh R. Roome

Editors

New York Office
850 Third Ave.
New York, N.Y. 10022
(212) 751-5530
TWX: 710-581-2874
Cable: Haydenpub

Editor: Frank Egan
Managing Editor: Ralph Dobriner
Managing Editor: Raymond D. Speer
Microelectronics, Steven A. Erenburg
Computers, Milton J. Lowenstein
Microwaves, Michael J. Riezenman
Management, Richard L. Turmail
News, John N. Kessler
Military-Aerospace, John F. Mason
New Products, Roger Allan
New Products, Lucinda Mattera
Copy, Marion Allen

Field Offices

Massachusetts
Jim McDermott
P.O. Box 272
Easthampton, Mass. 01027
(413) 527-3632

San Francisco
Elizabeth de Atley
Suite 6, 95 Main St.
Los Altos, Calif. 94022
(415) 941-3087

Los Angeles
David Kaye
2930 Imperial Highway
Inglewood, Calif. 90303
(213) 757-0183

Washington
Don Byrne
1425 N St. NW
Washington, D.C. 20005
(202) 667-6568

Editorial Production

Dollie S. Viebig
Richard D. Grissom

Art

Art Director, Clifford M. Gardiner
Assistant, William Kelly
Rita Jendrzewski

Production

Manager, Thomas V. Sedita
Helen De Polo
Kathleen McConkey
Leslie Stein

Circulation

Manager, Nancy L. Merritt

Information Retrieval

Peggy Long

letters

Interactive graphics— to be or not to be?

Sir:

I read with great interest Milton Lowenstein's article, "Peripherals: Cinderella of the Computer Industry" (ED 23, Nov. 8, 1970, p. C4). However, I would disagree with one comment in the article: "So, although the dream of interactive graphics isn't yet dead, it is fading." As Mark Twain was reported to have said, "The reports of my death are premature."

Certainly the observation that high cost and lack of support software has impeded the growth of this system is appropriate. However, the last two years have seen dramatic improvements in cost-performance ratios, as well as dramatic reductions in prices for interactive graphic systems of somewhat lower capability. This trend, coupled with the increasing availability of complete packages, leads me to conclude that the dream, instead of fading, is rapidly becoming a broad-based reality.

C. Machover

Vice president, Marketing
Information Displays, Inc.
333 N. Bedford Rd.
Mount Kisco, N. Y. 10549

Here's a switch on a design idea

Sir:

The article "Improve Amplifier Efficiency with Positive Feedback" (ED, Oct. 11, 1970, p. 96) shows a useful circuit configuration for providing a specified output impedance to a grounded load by using positive feedback to increase the apparent value of a series output resistor and thereby increasing the over-all circuit efficiency.

I'd like to point out another configuration that has some advantages when the load to be matched is floating (as in the authors' example when transformer coupling is used). The advantages of the circuit below are high input resistance, three precision resistors instead of five, and the possibility of greater efficiency.

The author's circuit provides a voltage gain of 5 into a load of 150 ohms, with an output resistance of 150 ohms and 17% (of load power) loss in R_s . The circuit shown does the same with 10% (of load power) loss in R_s .

Closed-loop gain:

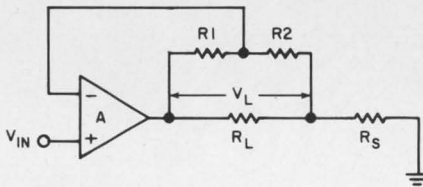

$$\frac{V_L}{V_{IN}} = \frac{1}{\frac{1}{A} \left(1 + \frac{R_o + R_s}{R_L} \right) + \frac{R_s}{R_L} + \frac{R_2}{R_1 + R_2}}$$

Closed-loop output resistance:

$$Z_o = \frac{R_s + \frac{1}{A} (R_s + R_o)}{\frac{1}{A} + \frac{R_2}{R_1 + R_2}}$$

where A = open-loop unloaded gain

R_o = open-loop output resistance

When $R_s = 150 \Omega$

$R_1 = 90 \text{ k}\Omega$

$R_2 = 10 \text{ k}\Omega$

$R_L = 150 \Omega$

Then $\frac{V_L}{V_{IN}} = 5$

and $Z_o = 150 \Omega$

Horace T. Jones, Jr.

10308 Rockville Pike
Rockville, Md. 20852.

Electronic Design welcomes the opinions of its readers on the issues raised in the magazine's editorial columns. Address letters to Managing Editor, Electronic Design, 850 Third Ave., New York, N. Y. 10022. Try to keep letters under 200 words. Letters must be signed. Names will be withheld on request.

power
module
users:

**DON'T
ORDER
ANOTHER
POWER
MODULE**

until you've
checked Deltron's
series "N"

WE GUARANTEE

**the BEST at the
LOWEST price**



**GET
THE
FACTS**

send for
**FREE
catalog**

Deltron

WISSAHICKON AVE., NORTH WALES, PA. 19454
PHONE: (215) 699-9261 • TWX: (510) 661-8061

D 112

INFORMATION RETRIEVAL NUMBER 8

0.0625
200V
GE

**Special Film Foil or
Metalized Film Capacitor**
Can be custom designed to
meet customer specifications

69F948G
+

**Subminiature Tantalum
Wet-slug Capacitor**
For highest volumetric
efficiency in industrial
miniature applications

- Voltage range . . . Up to 60 VDC
- uf range . . . 3.3 to 450 uf
- Temp. range -55C to 85C

0.33 uF
±100%
400VDC
GE

**LECTROFILM[®]-B Polyester
Film Foil Capacitor**
Axial leads for use where
size, weight, cost and
reliability offer advantages
over other capacitor types.

- Voltage range . . . Up to 200 V
- uf range0010 to 1 uf
- Temp. range -55C to 125C

**Aluminum Electrolytic
Computer Grade**

High performance, High
capacitance Capacitor
Used in bulk filtering and energy
storage applications.

- Voltage range . . . Up to 450 VDC
- uf range . . . 75 to 540,000uf
- Temp. range -40C to 65C, 85C

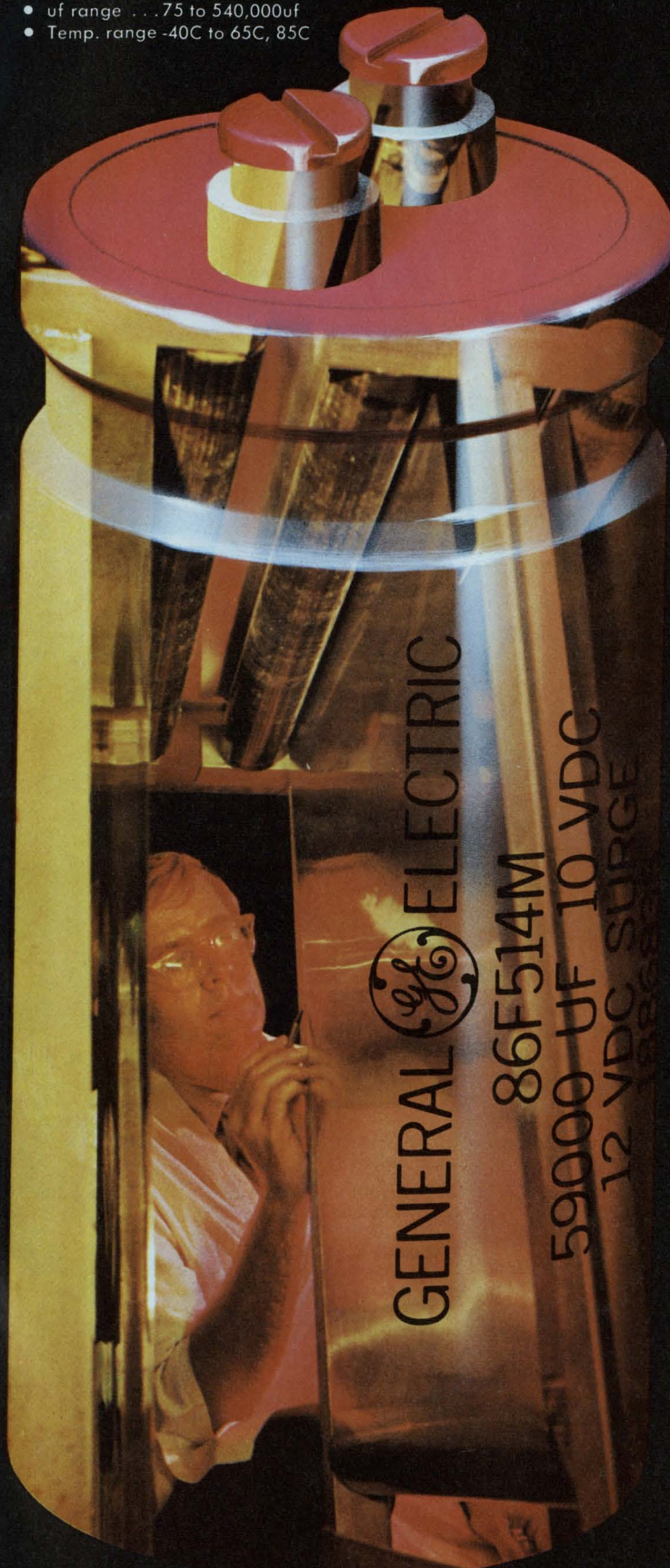

COMES WITH EVERY
GENERAL ELECTRIC
CAPACITOR

Reliability through people

Capacitor reliability is only as good as the people behind the product. At General Electric capacitor reliability is built in, start to finish, by quality-oriented people, assuring the dependability you require in the equipment you produce.

Reliability starts with our Research and Development teams. These inquisitive and creative people, who have greatly advanced electrolytic capacitor technology, are continually exploring materials and methods to develop new and better ways to meet your needs.

It continues with the involvement of scores of men and women who subject capacitors to exhaustive quality control during manufacture, with units receiving hundreds of quality checks.

It concludes with exacting test people who precisely verify capacitor performance through rigorous test procedures.

Reliability comes from people like these . . . in research, design quality control, manufacturing and testing. People who share your pride in producing reliable equipment . . . and do something about it.

To learn more about reliable GE capacitors through people, contact one of General Electric's "problem solvers"—your GE Electronic Distributor or ESCO District Sales Manager. Or write Section 430-42, General Electric Company, 1 River Road, Schenectady, N. Y. 12305

Electronic Capacitor and Battery Dept., Irmo, S.C.

GENERAL  ELECTRIC

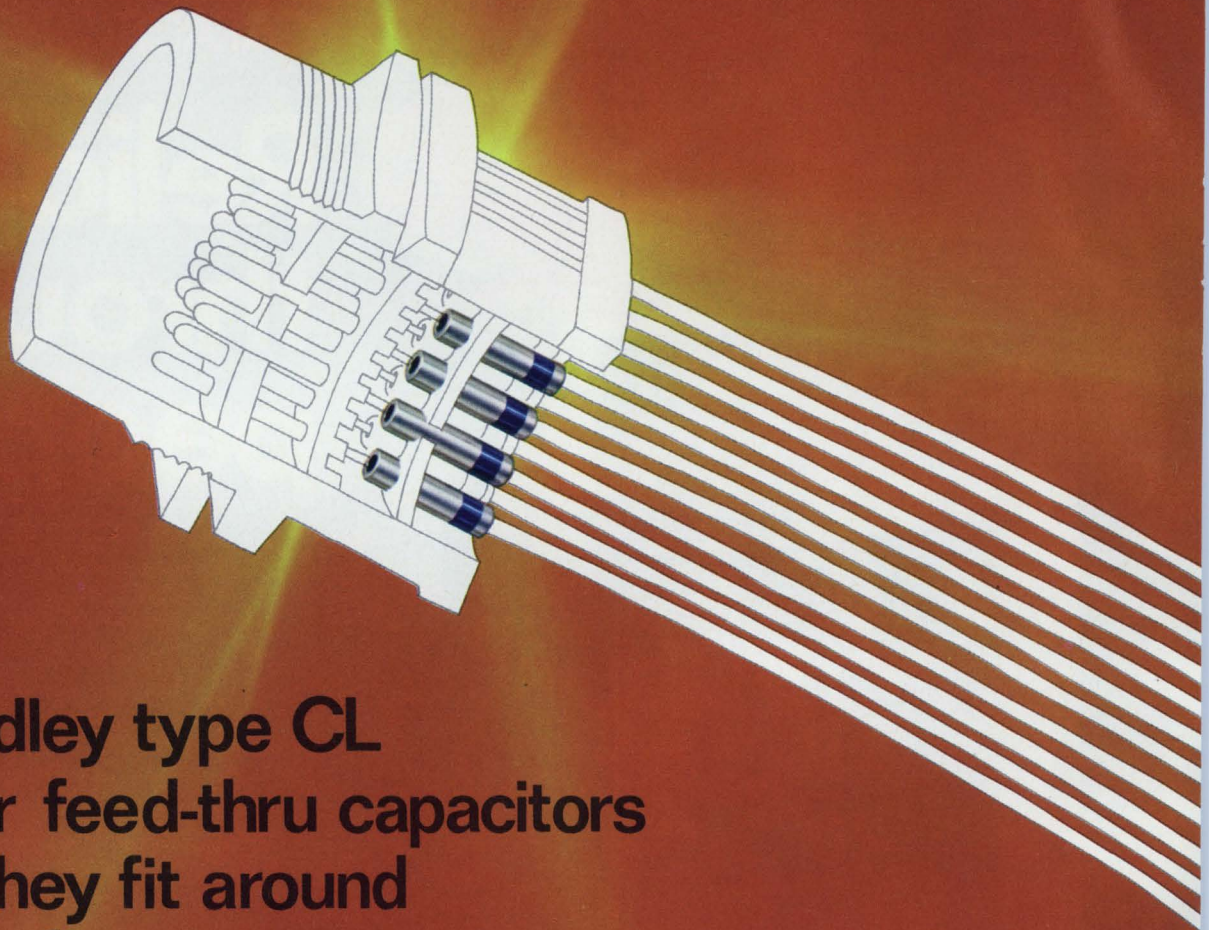

Allen-Bradley type CL multi-layer feed-thru capacitors so small they fit around the head of a pin.

VOLUMETRIC EFFICIENCY. Big words that explain why Allen-Bradley type CL feed-thru capacitors are so small. Our unique multi-layer concept shaves size to a minimum, without affecting performance. It took Allen-Bradley to get filter capacitors down to their fighting weight. Now rolled capacitors are no longer a design alternative.

Concentric layers of proprietary Allen-Bradley ceramic and noble metal electrodes are fired together for unmatched protection against moisture and contamination. Rugged. Non-polar. With lower inductance and far less noise.

Voltages to 200 WVDC. Temperatures to 125°C. Capacities to 1.0 μ F. High dielectric strength and reliability.

Several styles and sizes are available through your appointed A-B industrial electronic distributors. For further information write: Marketing Department, Electronics Division, Allen-Bradley Co., 1201 South Second Street, Milwaukee,

Wisconsin 53204. Export office: 1293 Broad Street, Bloomfield, N.J. 07003 U.S.A. In Canada: Allen-Bradley Canada Ltd., 135 Dundas St., Galt, Ontario.

ALLEN-BRADLEY

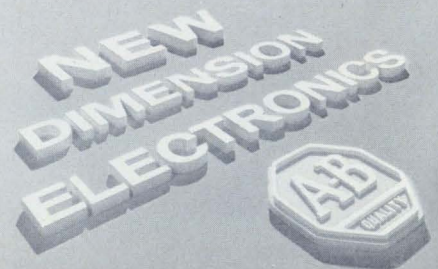

designer's calendar

JANUARY 1971						
S	M	T	W	T	F	S
					1	2
3	4	5	6	7	8	9
10	11	12	13	14	15	16
17	18	19	20	21	22	23
24	25	26	27	28	29	30
31						

Jan. 12-14
Symposium on Reliability (Washington, D. C.) Sponsors: IEEE et al. J. W. Thomas, Vitro Labs., 14000 Georgia Ave., Silver Spring, Md. 20910.

CIRCLE NO. 401

Jan. 25-26
Optics in Microelectronics Conference (Las Vegas, Nev.) Sponsor: Optical Society of America, Microelectronics Meeting, 2100 Pennsylvania Ave., N. W., Washington, D. C. 20037.

CIRCLE NO. 402

FEBRUARY 1971						
S	M	T	W	T	F	S
	1	2	3	4	5	6
7	8	9	10	11	12	13
14	15	16	17	18	19	20
21	22	23	24	25	26	27
28						

Feb. 9-11
Aerospace & Electronic Systems Winter Convention (WINCON), (Los Angeles). Sponsors: IEEE et al. William H. Herrman, Wincon '71, IEEE Los Angeles Council, 3600 Wilshire Blvd., Los Angeles, Calif. 90005.

CIRCLE NO. 403

Feb. 17-19
International Solid State Circuits Conference (Philadelphia, Pa.) Sponsors: IEEE et al. Lewis Winner, 152 W. 42nd St., New York, N. Y. 10036.

CIRCLE NO. 404

NOW!

9 POWER/MATE POWER SUPPLIES REPLACES OVER 127 LAMBDA MODELS

WITH ... MORE POWER IN LESS
SPACE WITH BETTER REGULATION
AND WITH THE
SAME HIGH QUALITY
YET AT LOWER COST.
PLUS SAME DAY DELIVERY

A unique design concept developed by Power/Mate Corp. allows any UniPower supply to be set for a range of voltages. Therefore, you need only buy one supply in place of dozens. The entire UniPower Series can replace literally thousands of narrow-range supplies! Find out more how Power/Mate can cut your power supply costs. Write or call POWER/MATE CORP. today.

Uni-30C

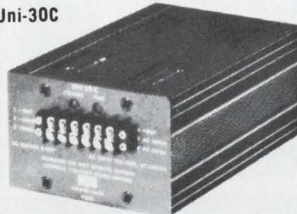

Price: \$134.00

The UniPower Series of Nine

- Uni-76 — 0-34 volts, 0.5 amps — \$76.00
- Uni-88 — 0-34 volts, 1.5 amps — \$99.00
- Uni-30C — 0-30 volts, up to 4 amps — \$134.00
- Uni-30D — 0-30 volts, up to 6 amps — \$151.00
- Uni-30E — 0-30 volts, up to 12 amps — \$174.00
- Uni-30F — 0-30 volts, up to 15 amps — \$205.00
- Uni-30G — 0-30 volts, up to 24 amps — \$265.00
- Uni-30H — 0-30 volts, up to 34 amps — \$315.00
- UniTwin-164 — dual output 0-25 volts, 0.75 amps — \$164.00

OUTPUT VOLTAGE vs. OUTPUT CURRENT FOR VARI-RATED UNI SERIES

MODEL	VOLTAGE															
	0-3	5	6	8	10	12	14	15	16	18	20	22	24	26	28	30
UNI-76	0.5 amp throughout range															
UNI-88	1.5 amps throughout range															
UNI-30C	4	4	4	4	4	3.75	3.6	3.5	3.4	3.25	3.0	2.9	2.75	2.5	2.5	2.1
UNI-30D	6	6	6	5.6	5.2	5.0	4.7	4.5	4.3	4.2	4.1	3.7	3.5	3.4	3.3	3.1
UNI-30E	12	12	11	10.5	9.5	9.3	8.5	8.0	7.7	7.5	7.0	6.5	6.0	5.7	5.5	5.2
UNI-30F	15	15	15	14.2	12.8	12.0	11.5	11.0	10.0	9.9	9.4	8.9	8.7	8.5	8.0	7.6
UNI-30G	24	22	21	20	18	17	16.5	16.0	15.5	15	14	13.5	13	12.5	12	11.5
UNI-30H	34	32	31	29	25	23	22	21	20	19	17	16.5	16	15.5	15	14.3

SPECIFICATIONS: Regulation — up to $\pm 0.005\%$ or 1 MV for line and load; Ripple — Less than 250 microvolts; Response Time — Less than 20 microseconds; Overload and Short Circuit Protection — Solid state. Instantaneous recovery, and automatic reset. Cannot be damaged by prolonged short circuit or overload. Internal or External Adjustable OVP Available.

P/M/C

POWER/MATE CORP.

514 S. RIVER STREET, HACKENSACK, N. J. 07601
Phone (201) 343-6294 / TWX 710-990-5023

INFORMATION RETRIEVAL NUMBER 10

The more complicated it seems...



The simpler it gets... **CONCENTRATE!**

FROM 4 TO 85 MAGAZINES In May, 1953, only *four* magazines appeared with basic listings in SRDS's newly created section 40—"Electronic Engineering." They were *Electronic Design*, *Electronic Equipment*, *Electronics*, and *Tele Tech*. Now media buyers are confronted with 85 publications under this heading. Confusing? To say the least. Of course, the 13,706 advertising pages placed in the electronic press last year were mostly divided among the top publications. But even so, making the correct media choice has become a difficult problem.

THE SHAKEOUT TO COME

Today there simply aren't enough advertising pages to go around. In the last 3 years, only three magazines increased their total pages (one of the gainers is *Electronic Design*). The other five lost ground, some drastically. One or two may fall by the wayside this year. There is nothing unusual about such a shakeout. It has occurred in other industries. *There is great duplication of effort among the publications which tends to complicate rather than simplify the advertiser's problem.*

CONCENTRATE—BUT WHERE? To reach most engineering prospects most efficiently, advertising should be *concentrated* in the strongest publications. The fewer publications you use, the more impact you will get in those publications. But how do you decide *which* publications to concentrate in?

WHAT IS REALLY NEEDED is a "Simmons" type study in the electronics field—not to determine a simple winner, but to illuminate real differences and strengths. *Electronic Design* has long urged that such a study be undertaken. In the meantime, there is something you can do to make your buying a more enlightened process. *You can make your own readership studies work harder!* They can tell you what *combination of magazines to use for optimum efficiency in reaching your market.*

BEGIN WITH YOUR READERSHIP STUDIES Circulation doesn't buy—*readers* buy. For this reason, many electronics manufacturers have conducted their own studies of magazine readership over their own customer and prospect lists. Although it is good to find out which publications are best read—it is even better to go one step farther and explore *duplication* of readership. A list of publications ranked by "Read Most"—while valuable for selecting a first book—can be misleading in choosing the second or third book for your schedule.

WHAT DUPLICATION STUDIES REVEAL

When you conduct your own readership study, it will tell you which publication gives you the most reach in your market. This is your *basic* book. (In over 90% of all such independent studies this publication is *Electronic Design*.) *It may be that Electronic Design, alone, provides the best means of reaching most prospects at optimum cost.* However, if budget permits, the next step is to extend market coverage as efficiently as possible. Let us assume *Electronic Design* gives you 68% of the market. The next best read book gives 48%. However, if duplication is analyzed, the publication to add is not the runner-up in readership, *it is the publication that adds the most unduplicated readers.* It might be the second or it might be the seventh in terms of "read most"—*only your duplication studies will tell you for sure.*

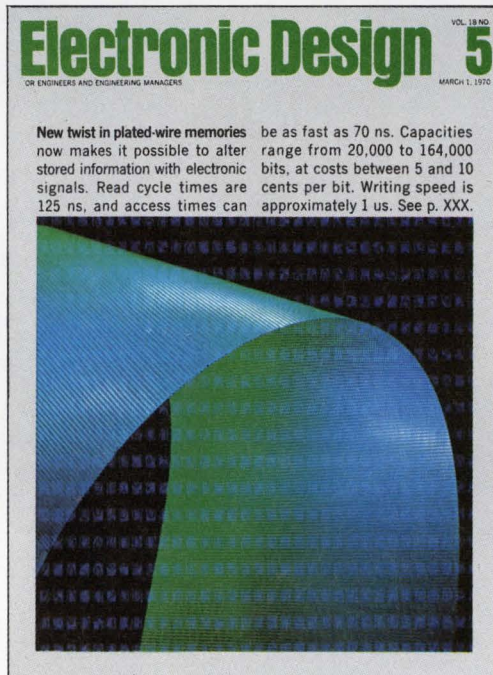

ELECTRONIC DESIGN WILL HELP In addition to sharing the cost of your readership study, *Electronic Design* now makes it easy for you to analyze duplication! On request, we will send you a set of cards with complete instructions for your computer service. The program takes no more than a minute of computer time; you can tabulate your studies faster, more accurately, and with much more information resulting. You can untangle the media puzzle! In the OEM, marketing *begins with Design.*

Electronic Design

For Engineers and Engineering Managers

A HAYDEN PUBLICATION

850 THIRD AVENUE, NEW YORK 10022 • 212-751-5530

let Stalwart help you design custom rubber parts

You wouldn't try to invent the wheel. But, are you spending time trying to solve rubber parts problems that have already been solved? With 50 years behind us, we've helped develop an impressive number of custom rubber parts. Chances are that we already have a solution to the problem that's filling your

wastebasket. We know how to handle hot fuels, solvents, and corrosive fluids . . . combat dielectric problems, corona, ozone, heat aging . . . minimize the effects of severe weathering—to mention only a few. Write for your copy of the "Stalwart Rubber Selector" today.



SR
Subsidiary of
BLASIUS
INDUSTRIES, INC.

Stalwart Rubber Company • 160 Northfield Road • Bedford, Ohio 44146

HANDY

Handy by virtue of its operating convenience and its small size, Triplet's Model 310 V-O-M is no miniature when it comes to rugged capability on the job.

With outstanding readability from 0.05 to 1200 V DC in 5 ranges at 20,000 ohms per volt . . . 0.05 to 1200 V AC in 5 ranges at 5,000 ohms per volt . . . 5 ohms to 20 megohms in 4 ranges . . . 10 μ A to 600 mA DC . . . 0.1 to 300 A AC with the optional Model 10 clamp-on adapter . . . the Model 310 can handle practically every electrical measurement you'll need to make. Accuracy on the DC ranges is 3%—4% on AC.

For all its conveniences and features, this great Triplet instrument . . . the World's most popular miniature V-O-M . . . is only **\$44** suggested USA user net. If you'd rather have a high voltage range of 600 V (AC and DC) and an AC sensitivity of 15,000 ohms per volt, ask for the Triplet Model 310-C at \$56 suggested USA user net. See them both at your local Triplet distributor or, for more information, call him or your Triplet sales representative. Triplet Corporation, Bluffton, Ohio 45817.

TRIPLETT

The World's most complete line of V-O-M's . . .
choose the one that's just right for you

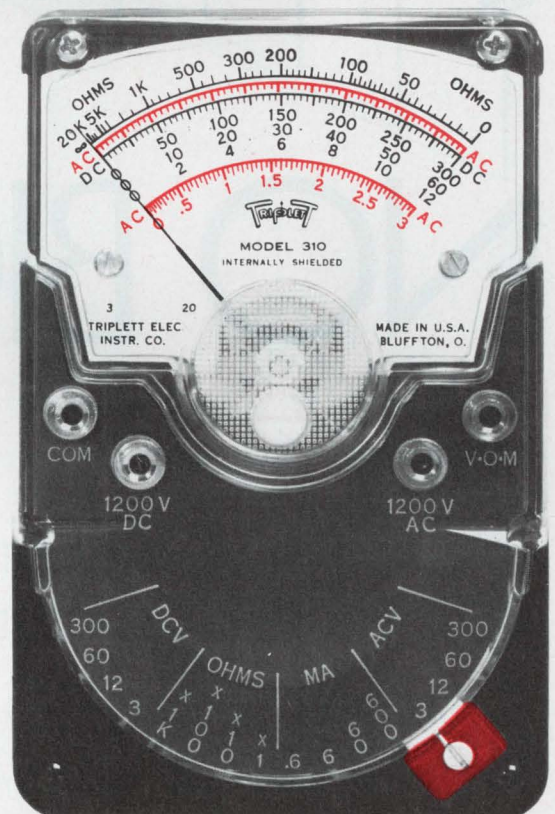

1. Hand size V-O-M with provision for attaching AC clamp-on ammeter.
2. 20,000 Ohms per volt DC sensitivity 5,000 AC.
3. One selector switch minimizes chance of incorrect settings and burnouts.

Shown actual size



SIZE & COST: NO BIG THING.

EASIER THAN EVER TO FIT
YOUR BOARD & BUDGET.

BROAD LINE GETS BROADER.
8 LOWER CAPACITANCE VALUES
(100 pF thru 390 pF @ 200 V).

Type 192P Pacer® Polyester Film Capacitors are mass-produced to beat the space/cost squeeze in commercial and industrial applications. Extended-foil PETP film sections with metal end caps provide best possible non-inductive construction. End caps also act as moisture barriers. Ideal for automatic insertion on printed wiring boards. Expanded line includes capacitance values from 100 pF to .47 μ F. Voltage range, 80 to 600vdc. Write for Bulletin 2066C.

Technical Literature Service
Sprague Electric Company
347 Marshall Street
North Adams, Mass. 01247

SPRAGUE®

THE MARK OF RELIABILITY

THE BROAD-LINE PRODUCER OF ELECTRONIC PARTS

43M-0143

CRTs being improved to counter competition

NEW YORK CITY—While solid-state and plasma displays have made dramatic advances in the last year, manufacturers of the oldest electronic display—the cathode-ray tube—don't intend to roll over and play dead.

At this month's IEEE Display Devices Conference here, Peter Seats, president of Thomas Electronics, Inc., Wayne, N. J.—which deals exclusively in CRTs and counts major corporations and NASA among its customers—pointed to CRT progress in:

- Deflection techniques.
- Electronic beam power and resolution.
- Screen target materials.
- Envelope materials and geometry.

Seats said that wide-angle electrostatic deflection CRTs had been developed through the use of post-deflection magnification systems. This means that bandwidths of better than 20 MHz are possible with only medium-power deflection amplifiers.

Seats also mentioned the emergence of improved phosphor screens derived from the rare-earth family. Gadolinium oxysulfide, for example, promises high-brightness and near-white displays because of its relatively linear response to increasing electron-beam power. Other rare-earth phosphors, he said, can be expected to rival current zinc/cadmium-sulfide materials for color CRT applications, with the added advantage of better current-saturation characteristics.

New voltage-penetration color screens for single-gun CRTs make it possible to display five distinct color shades over a voltage range of 6 to 12 kV.

"Current-sensitive color screens," Seats said, "are still largely in the hands of the phosphor chemists. Investigations into superlinear and

sublinear responsive phosphors may be expected to provide a useful two-color cross-over at brightness levels of about 50 foot-lamberts."

According to Seats, fused fiber-optic faceplates are "perhaps the most significant recent development in CRT envelope components." Another envelope material development involves glass compositions that reduce X-ray radiation hazards and come in two types—either clear or neutral-density tinted glass.

Voice print of threat is clue in oil blast

The telephoned threat to the Linden, N. J., police headquarters an hour and 40 minutes before the Humble Oil and Refining Co. plant burst into flames is now a neat, pictorial pattern on electrosensitive paper.

The pattern will be compared with those of known suspects in the hope that one will match. The pattern is made by a sound spectrograph that converts voice signals to pictorial patterns.

The accuracy of voiceprint identification is unique to a person's vocal cavities and the articulators (such as the teeth and lips). The chance of two persons having the same vocal cavities and using the articulators in exactly the same way is remote.

Although Linden police and the Voiceprint Laboratories, Inc., in Somerville, N. J., decline to say where the voice prints were made and are now being studied, reliable sources indicate that Voiceprint Labs is doing the work.

Such work, Voiceprint Labs president Lawrence G. Kersta told ELECTRONIC DESIGN, is routinely done by a sound spectrograph that

was originally developed by a team of engineers, which included Kersta, at Bell Laboratories, Murray Hill, N. J., during the second World War.

Now under license with Bell, Voiceprint Labs manufactures simple sound spectrographs for sale to law-enforcement agencies for approximately \$5000 and multimode units for medical and industrial centers that sell for up to \$15,000.

An automated system using a Varian 620/i computer has just been built, Kersta says, and is now being tested in Voiceprint's research center. Next, according to Kersta, the memory will be enlarged and the system made available for speaker identification for banks and credit-card users.

New unit lets deaf see or feel phone messages

At a subscriber cost of \$3 a month, deaf people, including those who are also blind, can now "talk" to each other over the phone with a Code-Com set devised by the Bell Telephone System.

The set consists of a light, a sending key and a vibrating disc. Transmitted signals are converted at the receiver into flashes of light for deaf people, and into vibrations that a deaf-blind person can feel on a sensor disc. Morse Code or any other prearranged code is used to transmit messages.

The system went into commercial service in Columbus, Ohio, recently when two girls, Phyllis Levi and Cheryl Wilson—both partly deaf since birth and with speech difficulties—tapped out Morse Code messages.

Code-Com is produced at the Indianapolis plant of Western Electric, the manufacturing unit of the Bell System.

Automatic meter reading by microwaves seen

A utility truck cruises through a neighborhood and automatically reads the electric, gas and water meters in every house without anyone setting foot near the houses.

That's the way Sangamo Electric Co., Springfield, Ill., envisions meter reading in the not-too-distant

future. It has built a system, called Purdax, to help do the job.

Purdax is a data accumulator for meters—a solid-state electronic package that scans the counters in the meter. On request from a microwave transmitter in a cruising utility truck, a transducer converts the readings to electrical signals, which are transmitted via a low-voltage dc pulse train to the truck.

A typical eight-channel unit might have a complete message length of 2330 bits, which would be passed in repetitive fashion through voltage wiring to the passive transponder. The distance is not critical, Sangamo says, but should be held under 300 feet.

The transponder uses a receiving and transmitting antenna, coupled through harmonic generation circuitry to the accumulator's output. It is completely passive, except during the one-second interrogation each month.

In the truck, the data is recorded on tape and later fed into a master computer for billing.

Bell Labs simplifies magnetic-bubble device

Working toward magnetic bubble devices that are cheaper and easier to manufacture, scientists at Bell Telephone Laboratories, Murray Hill, N. J., have for the first time grown homogeneous uniaxial magnetic garnet films by using liquid phase epitaxial techniques.

The use of these techniques permits the fabrication of devices with more than a million bubbles per square inch. The devices will find ready application in computers of the future and in digital communications, the laboratory says.

The advances in magnetic bubble technology were reported at the Conference on Magnetism and Magnetic Materials in Miami.

The bubble materials, which are homogeneous and crack-free, are grown by a method called liquid-phase epitaxy, according to a spokesman for Bell Labs. The epitaxy is heated and used to cover a substrate. The substrate is allowed to cool, and it then becomes a thin film. This film is then covered with a thin silicon oxide layer, upon which a nickel-cobalt-phosphorus

propagation circuit is directly fabricated. An electrodeless deposition technique is used for this purpose.

Since these magnetic films have already been used in shift registers with over 100 working steps, much larger shift registers will be produced, the company predicts, as small, scattered imperfections are weeded out.

One of the films used in an experimental bubble shift register, the laboratory reports, was made of erbium-europium-gallium-iron garnet. The film itself was grown in less than an hour with a liquid-phase epitaxial process at temperatures in the vicinity of 1650°F. By contrast, bulk flux-grown garnet material requires about 21 days.

Semiconductor and TWT mated in new device

A device that combines the long life of a semiconductor with the high power of a traveling-wave tube—and at substantially lower cost than a TWT—is reported near the production stage at Watkins-Johnson in Palo Alto, Calif.

Called an Electron Beam Semiconductor, the device is designed to supply a minimum of 2 kW of pulsed rf power (240 W average) with a 250-MHz bandwidth at frequencies between 1 and 2 GHz.

The device works by bombarding a reverse-biased PN junction with a modulated electron beam. This creates carriers in the diode and produces high current gain at the output.

The Electron Beam Semiconductor is 1.5 inches long and 2.5 inches across. Unlike the traveling wave tube, it requires no expensive focusing magnets because the beam power is only a small fraction of the total input power.

David J. Bates, head of the

medium power tube R & D section at Watkins-Johnson, estimates that in two to three years an electron-bombarded semiconductor device will cost a fourth to a tenth as much as a medium-power (100 W) traveling-wave tube and that it will do the same job. But right now the company is shooting for products in the submicrowave region and expects to have them available in about six months. Watkins-Johnson will manufacture two types, Bates says.

■ Video pulse amplifiers that will amplify a TTL logic pulse to hundreds of volts. For example, Bates says, a device that will produce 200 V in a 50-ohm load with 0.5-nsec rise time. The best available pulse amplifier now has a 9-V output, he says.

■ Frequency amplifiers with a low-pass characteristic that will allow amplification of frequencies from dc to 350-400 MHz with an output of 200 V.

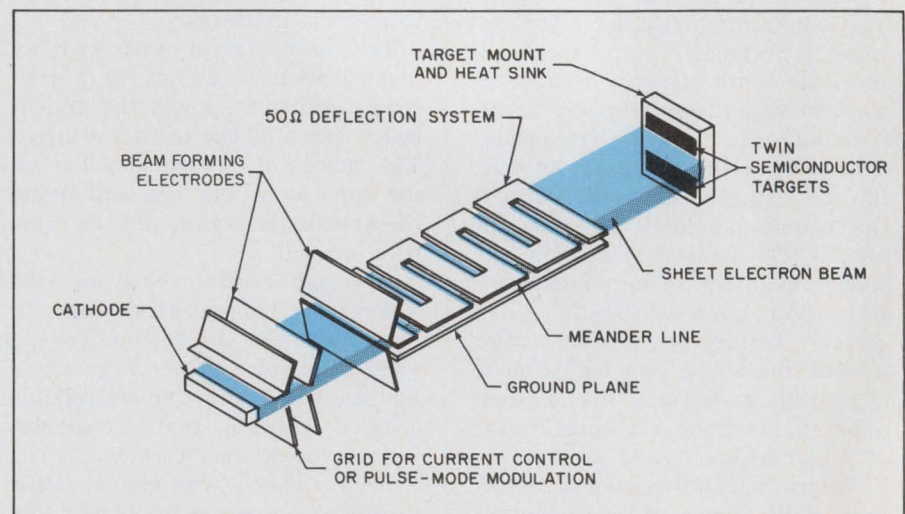

Electron Beam Semiconductor operates at kilowatt level and is scheduled to go into production at Watkins-Johnson in six months.

When is True RMS Really True RMS?

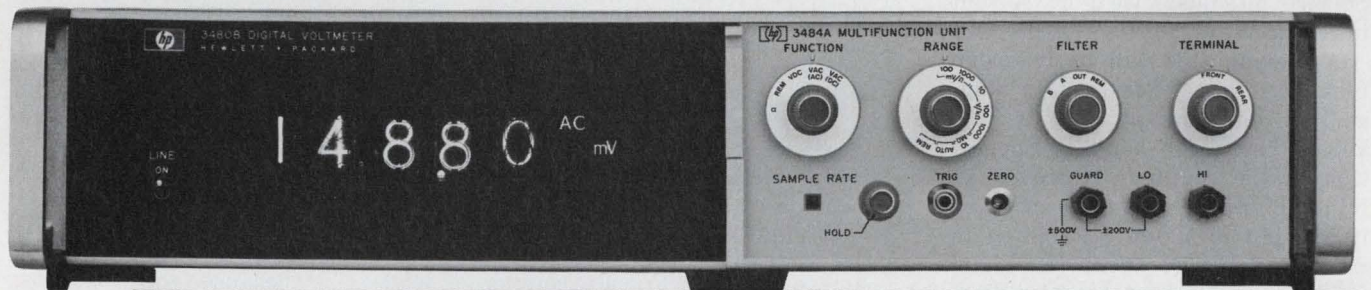

$$\sqrt{(DC)^2 + (AC_{rms})^2}$$

TRUE RMS = $\sqrt{(dc)^2 + (ac_{rms})^2}$ — and HP's new 3480 DVM is the only four-digit multi-function meter that can give you this true RMS value — ac, dc, or **ac plus dc**. And, the 3480 eliminates the errors caused by odd harmonic distortion added by average responding converters. With the 3480 you get measurements within 0.1%, not just to within 1%! (A 1% third harmonic distortion = $\pm 0.33\%$ error or ± 33 counts of error in a four-digit average responding DVM.)

Whatever type of signal you're measuring — from the purest sine wave to the most irregular pulse train — the HP 3480 DVM gives you the results you need in one second. And, when you're working with an ac-plus-

dc signal, you don't have to make two separate readings and then calculate the combined RMS value. It's all there, in one set of figures.

THE SECRET: A PAIR OF MATCHED THERMOPILES. At the heart of the 3480, there is a tiny chip, less than $\frac{1}{4}$ " square, which contains matched sets of thermopiles. One measures the heat produced by the signal you're testing; the other does the same for a reference voltage.

The full scale ranges of the HP 3480 DVM are from 100 mV to 1000 Vac and the frequency range is from 1 Hz to 1 MHz. And with the correct plug-in, the 3480 can give you up to 1,000 **straight-dc** or **ohms** readings per second — with 5 dc ranges and 6

ohms ranges.

Prices range from \$1150 for one range of dc to \$3375 for multi-function ac, dc and ohms capabilities with isolated BCD and isolated remote control.

Find out how the HP 3480 DVM can help solve *your* measurement problems. Contact your local HP field engineer, or write to Hewlett-Packard, Palo Alto, California 94304. In Europe: 1217 Meyrin-Geneva, Switzerland.

090/12

HEWLETT  PACKARD
DIGITAL VOLTMETERS

INFORMATION RETRIEVAL NUMBER 14

The new Postal Service plans a rapid, 'hands off' mail system

The U. S. Postal Service is moving into the electronics era. And it's moving fast. "We're on a cautious crash program," Postmaster General Winton M. Blount says. And, according to Postal Service officials, "we'll be solvent in seven years."

Achieving this will be no mean feat. The Postal Service is a staggering phenomenon: It is the largest materials-handling operation in the country: It moved 85 billion pieces of mail in fiscal 1970; it brought in a cool \$6.5-billion in revenues; but it spent \$8-billion, sending approximately \$4-million a day down the drain. And its performance, despite the large infusions of Government funds, continues to get worse. Every month the volume of mail grows heavier, and letters seem to take longer to reach their destination.

"You should see some of our big post offices around the country," says one of the young engineers hired recently by the Postal Service to help automate its sprawling, unwieldy operation. "It's like walking into the world of Dickens. You wouldn't believe it."

Massive innovations due

Fortunately the right people do believe it. The Postal Service is now an independent, nonpolitical establishment; it has attracted new blood from industrial management teams; it plans massive innovations; and it has money to pay for them.

Attacking the Postal Service's problems is its Bureau of Research and Engineering, headed by Assistant Postmaster General H. F. Fought, who came from Westing-

John F. Mason
News Editor

There'll be billions for industrial contractors

On Aug. 12, 1970, the U. S. Postal Service became an independent establishment within the Executive Branch of the Government. On Aug. 12, 1971, the Post Office Dept. and the Office of Postmaster General will be abolished, and all duties will be transferred to the new Postal Service.

But already, change is under way. Key management people from industry have joined the service, money is being spent and contracts awarded, including quite a few for electronics.

The Reform Act has authorized the Postal Service to borrow up to \$10-billion from the public at the rate of \$2-billion a year.

"Don't quote me on this," a spokesman for a large electronics corporation told ELECTRONIC DESIGN, "but the pot at the end of this rainbow is fantastic. The Postal Service has got a million problems. The solutions are expensive. And the best designs are going to win. We're in there fighting like the rest of them, and we're fighting hard."

The reason the pot is so big and money is so available, according to another industry contender, is because the Postal Service's deficit is so big. "If you're losing \$1.5-billion to \$2-billion a year, as the post office does," he says, "what's so daring about spending a billion or two to get in the black?"

house Electric Corp.'s Astronuclear Laboratory in Pittsburgh, where he was general manager.

To fill the most costly sink-hole—processing letter mail—the Postal Service plans to establish 200 highly automated centers throughout the U. S., similar to one now being tested in Cincinnati. Preparatory work on setting up the network of centers is expected to get under way by spring. The centers, which will serve the 32,000 post offices in the country, will have equipment that costs in the neighborhood of \$1.6-billion, but, the service calculates, it will save \$500-million a year in operating costs by 1975. At present the processing of letters in post offices is largely a hand operation.

The new equipment includes optical systems to read printed or typed addresses, computers to convert the addresses to codes, printers to encode the letters, and readers to read the codes.

For bulk mail, which comes in all shapes, sizes and weights, the Postal Service plans to build 38 to 40 special facilities outside urban areas. They will service the entire country. The one for the New York City area, for example, is already under construction near Jersey City, N. J.

These facilities will be designed to process only parcels and sacked second and third-class mail. They will be highly mechanized units of modular design, each capable of handling from 125,000 to 500,000 pieces of parcel post in a 16-hour work day.

The development of self-service postal units is a third major area of concentration for the Bureau of Research and Engineering. The new units will provide a variety of products and services. One machine, for example, will weigh a parcel, and, after the patron has indicated the destination, will provide information electronically on post-

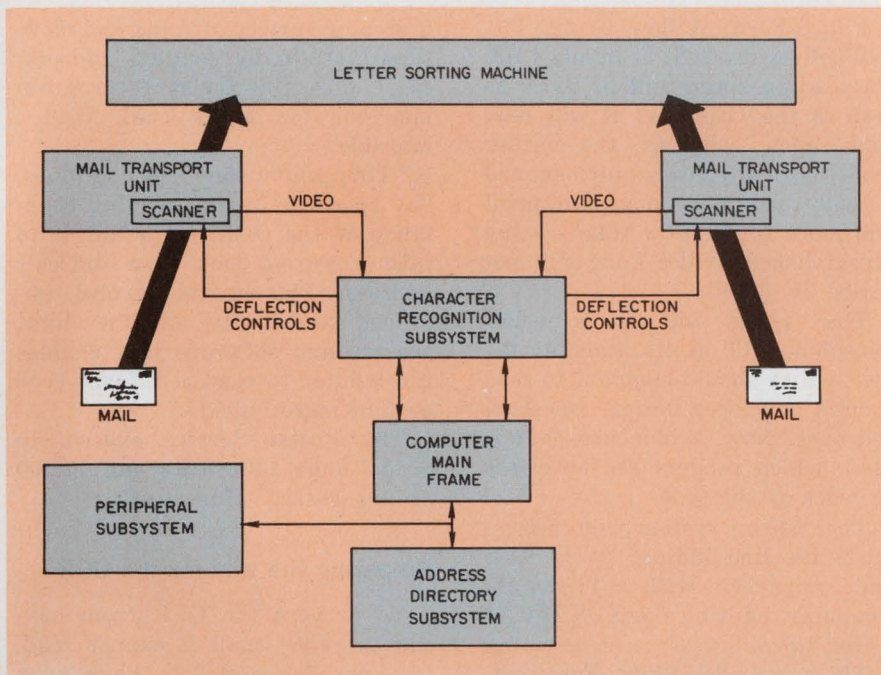

Letter mail, printed or typed, will be put on the mail transport unit of Philco-Ford's optical character reader (OCR) II, which will shoot it past an optical scanner. Reflected light from the envelope is converted to electrical signals, which are sent to the computer mainframe, where the address and the bottom line are located. The character-recognition subsystem then reads the characters, out of context, and sends the data to the computer mainframe, which combines them into words. Addresses are then sent to an address directory subsystem for comparison with an up-to-date list of addresses stored in a disk memory. If the address is accurate, the letter goes to the letter sorting machine and on to the right destination bin. The peripheral subsystem is used to change the sorting scheme. If all Texas letters are going into one bin, and it becomes evident that most of these are for Dallas, the sorting scheme can be changed to provide Dallas with a separate bin. The OCR II will handle 43,200 letters an hour.

age, insurance and special handling costs. It will then total the costs, accept the customer's money and give him a receipt.

A fourth area for improvement is field engineering—updating equipment in post offices without upsetting day-by-day operations.

Let's examine the planned improvements in greater detail.

Getting a letter through the postal system means getting it from one island of operation to another. "We want to mechanize these islands and eventually tie them together," says A. P. Hanes, program director for letter mail at postal headquarters in Washington.

The present degree of automation varies, ranging from systems that are all manual to the experimental station in Cincinnati that is relatively automatic. LTV Electro-systems, Inc., Garland, Tex., is the prime contractor for the latter system with the Plessey Airborne Corp., Hillside, N. J., supplying the

equipment. The major feature of the system is encoding an envelope so that it can be read thereafter by machines.

Letters enter the Cincinnati system via a culling conveyor belt, where hotel keys, packages and other items that would not go through the canceling machine are removed by hand. From there they go to an edger-stacker, a device that stacks the letters on their edges. Next is a gauger, a piece of equipment that fine-culls the mail, removing oversized envelopes missed on the first culling belt. From there they go to a facer-canceler, where phosphor in the stamp is sensed and turned face up, and the stamp is canceled.

Next, the letters are taken manually to a storage and dispatch unit and fed by conveyor to 24 coding desks, where operators read each address and, via a keyboard, type it in abbreviated form.

A computer interprets the ex-

Hard and software will speed the mails

What will the Postal Service need in the way of electronics to revamp its system? Here's a partial list of the requirements:

- Optical character readers (OCRs) that can read a greater variety of types, fonts, letter sizes and faint print.

- Software to aid the OCR to recognize a variety of print.

- Bar code printers, noncontact.

- Bar code readers, which consist of a light-sensing device and a memory, to permit automatic letter sorting. Sorting begins with the correct city destination bin and later the correct sequence for the letter carrier.

- Medium-sized computers, such as the Sigma II and III, for the OCRs and for logistics, inventory and scheduling.

- A better letter facer-sensor to detect phosphor-treated stamps, for turning them face-up for canceling.

- A sensor to locate a label on a parcel and turn it face up.

- A hand-held reading device for sorting parcels.

- An electronic device to detect explosives and other harmful devices in parcels.

tracted address and translates it to a bar code, which is printed on the back of the envelope in phosphorescent ink.

The letters are then sent through a sorting machine, which reads the code and sends the letters to the proper sorting channel.

The system at Cincinnati is being tested through October, 1971. After changes and replacements, some form of the system will be the nucleus for the 200 letter centers to be established throughout the U. S.

"More reliability must be built into the system, first," Hanes says. "Letters jam in the coding desk, for example, and we don't want that."

Also, optical character readers (OCRs) will augment the human operators, who must read each address and punch out an extraction code for a computer. Twenty OCRs already exist and are in operation in 13 post offices. These machines

read 43,200 addresses an hour and automatically sort them to the correct destination bins. They were built by Philco-Ford Corp.

These units, which cost about \$700,000 each, locate the address by scanning from right to left with a flying spot of light generated by a CRT and focused on the envelope by a lens. An array of five photomultiplier tubes locates the address by transforming the light reflected



Optical character reader (OCR), Model I, in New York City's Church Street Post Office, reads 43,200 printed and typed letter envelopes an hour.

from the envelope into electrical signals fed to a computer. With this scan, the reader orients itself to the lower left edge of the address block and then reverses the lateral direction of the scan.

The scanner then measures the height of the first character and, using this to adjust its vertical sweep, it obtains a detailed image of each character on the line.

Computer circuits identify each character by comparing it with stored features of standard characters. The accuracy of the address itself is then compared with a master list of addresses in the memory drum. When an exact match is found, the letter is sorted to the correct destination bin.

But the Postal Service wants a more advanced OCR and has contracted with three companies to develop such systems.

Philco-Ford, Willow Grove, Pa., will deliver its OCR II in mid-1971. Its reading speed will be twice as fast as the OCR I's; it will read four lines, whereas the earlier model normally reads only one, and it will read more degraded print and more fonts. How this is being accomplished Philco-Ford will not reveal in detail.

The system will use a yellow phosphor CRT as its scanning device, which should enable it to read colored envelopes better, especially red ones. Now, a blue phosphor is used, which renders red envelopes as black as the type.

The newer system will accomplish its line-finding, recognition and comparison with a Sigma III computer, built by the XDS Div. of Xerox Corp.

The new model, Philco-Ford says, will benefit from computer-aided logic, which will enable it to fill in gaps of information that the present reader cannot comprehend. For example, if the "D" in Detroit looks like an "O," the computer will search through its memory to see if there's an "Oetroit" in the state of Michigan with a 48224 ZIP code. The answer will be, "No, but there is a Detroit."

IBM Corp.'s Federal Systems Div., in Gaithersburg, Md., and its General Systems Div. in Rochester, Minn., are working jointly to develop an advanced OCR that will go beyond Philco Ford's OCR II.

That system will use a solid-state diode array as its detector, which is cheaper than photomultiplier tubes, and a 360/40 computer for recognition and comparison. IBM will deliver a prototype in mid-1972. The machine is to process 86,000 letters an hour.

Recognition Equipment, Inc., of Dallas, Tex., is competing with IBM and will also deliver a prototype in mid-1972. Its design will also use a solid-state light-sensitive diode array.

The Postal Service considered specifying a laser to scan the address but decided the technology wasn't advanced enough yet. Lasers, the engineers reported, might require too much maintenance.

The advanced OCR is still not the final answer, the Bureau of Research and Engineering says. "There's a long way to go to handle

a greater variety of fonts and more skew [crookedly printed addresses]," says the assistant program manager for letter mail, Walter Marable.

"This can be done," he continues, "by speeding up the reading capability of the OCR, to permit it to take a second look at a difficult address. This would involve improved sensitivity of the light sensors and software that enables a computer to read a difficult type or font more quickly."

The Postal Service expects to need "some 140 OCRs and 17,500 coding desks," Hanes says.

Preparing the way for the OCR

To prevent the OCR from having to reject mail it cannot read, two parallel contracts have been awarded to develop presorters. These devices will weed out unusual type or fonts, type that is too large or too small, addresses printed on a slant or too high or too low on the envelope.

Philco-Ford is building one presorter prototype. It will use the same yellow phosphor CRT used in its OCR II. Line-find and character-height measurement techniques will also be identical to those used in the OCR II. The computer will be smaller—Digital Equipment Corp.'s PDP-8.

FMC Corp. of San Jose, Calif., will use a 135-channel fiber optics module in conjunction with a recently developed photodiode sensor array. As the letter travels past the receiving end of the optics fiber, video data will be transmitted to the photosensors for insertion into a shift register.

Selecting a code

The Postal Service is anxious to standardize on a bar code that can be used throughout the system. "A lot of projects are being held up until we do this," Hanes says.

A phosphorescent code has been used for some time, but "we can't live with this," he says. "There aren't any good ways to print rapidly in the phosphorescent media, and it confines us to impact printing, which we don't consider practical for OCRs.

"At this time," Hanes says, "we are tending to go to a black bar

NEW 567.

Tone and frequency decoder, utilizing high stability of phase locked loop. Detection bandwidth adjustable from 0.5 to 14% of center frequency. DTL, TTL logic compatible.

NEW 528.

4-channel plated wire memory sense amp. Channel select, strobe and output DTL and TTL compatible. Can be used in "WIRED-OR" configuration.

NEW 566.

Function Generator. Monolithic voltage controlled oscillator in a chip. Frequency programmable over 10/1 range. For test equipment, tone control, Touch Tone®.

NEW 5556.

Precision op amp. General purpose applications. Direct replacement for MC1556.

Signetics counts in linear:

- and
5. 560 Monolithic Phase Locked Loop
 6. 561 Same as 560 with AM Synchronous Detector... both introduced in April and
 7. 5741 Op Amp (pin-for-pin μ A741)
 8. 5723 Voltage Regulator (pin-for-pin μ A723)
 9. 5748 Op Amp (pin-for-pin μ A748)
 10. 5558 Dual Op Amp (pin-for-pin MC1558)
 11. 5596 Balanced Modulator (pin-for-pin MC1596)
 12. 5595 Four Quadrant Multiplier (pin-for-pin MC1595)
 13. 550 Voltage Regulator
 14. 531 High Slew Op Amp
 15. 5101 Op Amp (pin-for-pin LM101)
 16. 565 Low cost Phase Locked Loop
 17. 562 Same as 560 with Open Loop sounded off in August.

Seventeen new linear devices announced AND ON THE SHELF in nine months. (More on the way.) Immediate delivery. Reliable permanent stocking. Cost competitive—ask your distributor or salesman.



Signetics-Linear

811 E. Arques Avenue, Sunnyvale, California 94086

Count me in-terested.

Please rush app notes, spec sheets, data and price lists immediately for the entire 1970 new linear numbers (all seventeen).

Just send the stuff for the new Big Four.

I want individual attention. Have someone in-the-know call me pronto.

Name _____ Title _____

Company _____

Address _____

City _____ State _____ Zip _____

Telephone _____

SIGNETICS CORPORATION—A SUBSIDIARY OF CORNING GLASS WORKS

TOUCH TONE TELEPHONE A REGISTERED TRADEMARK OF WESTERN ELECTRIC CO., INC.



Operators read addresses on envelopes passing through windows in front of them and punch out an extraction code on a keyboard. A computer translates this to a bar code that allows machines to route the letters from then on.

code." It is simple to print, simple to read, and it would encourage businesses to print their own codes on outgoing letters, and certainly on printed envelopes addressed to the company.

The printer for this black bar code will probably use a noncontact technique. This will prevent wear and tear of the printer and smearing of the ink. Sprayed ink also adheres to rough or absorbent paper surfaces.

Recognition Equipment, Inc., is offering one such device that prints binary bar code with fluorescent ink that is charged and deflected in an electrical field.

Another candidate is a jet-spray printer under development by A. B. Dick of Chicago that is based on the company's Videojet, built for printout of computer data transmission.

Under pressure, the ink is forced through a nozzle, which is energized with an ultrasonic signal (66 KHz) to cause velocity-modulation

of the ink stream. The modulation causes the ink stream to break up into 66,000 discrete droplets per second. The droplets are of uniform size and spacing, both being a function of pressure at the nozzle, the viscosity of the ink, the nozzle diameter and the vibration frequency of the nozzle.

Helping the letter carrier

Besides something to repel dogs, the letter carrier is most in need of help in the time-consuming task of sorting the mail for his route. To aid him, the Postal Service has awarded two contracts for electro-optic letter sequencers that can sort 30,000 letters an hour in the proper order for delivery. Burroughs delivered its candidate last month, and IBM will deliver its model in January.

One area that needs "some first class inventive thought," Hanes says, "is the culling operation in letter mail—one of our most labor-

intense operations." (see cover photo).

An experimental culling machine under development operates by controlled air. The device forces air at high pressure through an open-mesh screen type of conveyor at the bottom of a culling chamber. Letters and cards are floated to the top by the air stream of the chamber and carried away against another conveyor. The heavier parcels and other items are carried away by the conveyor belt.

Also using air is a facer-canceler under development by Univac in Salt Lake City. Operating by controlled jets of air, instead of belts, the device will face letters for stamp cancellation and stack them for sorting.

Computers will handle a number of bookkeeping and logistical tasks in the new postal system. National Cash Register, Inc., of Dayton, Ohio, for example, is working on a system that will figure out the best way to send a sack of airmail letters to its destination. Given the departure time, the computer will choose the airline, taking into account the quickest and cheapest route; it will balance out, as well as possible, the business given all competing airlines, and it will keep a record of the bill owed each airline for the month.

Bulk-mail processors needed

"To the maximum extent possible, we are going to utilize the techniques developed for letter sorting for processing bulk mail," says George R. Cavel, program director for bulk mail.

"If the electronics industry could show us how we could read parcel-post labels effectively and easily by electronic means, it would be a real contribution," Cavel says.

"We have a development contract with IBM to read imprinted code on a sack label, but there are difficulties. Letters have two sides and can be easily faced—turned right-side up—mechanically by a device that senses the phosphor on the stamp. Parcels are difficult because they may be six-sided or even round.

"If we could get codes put on labels by the sender, we could possibly read them with electronic wands." ■■

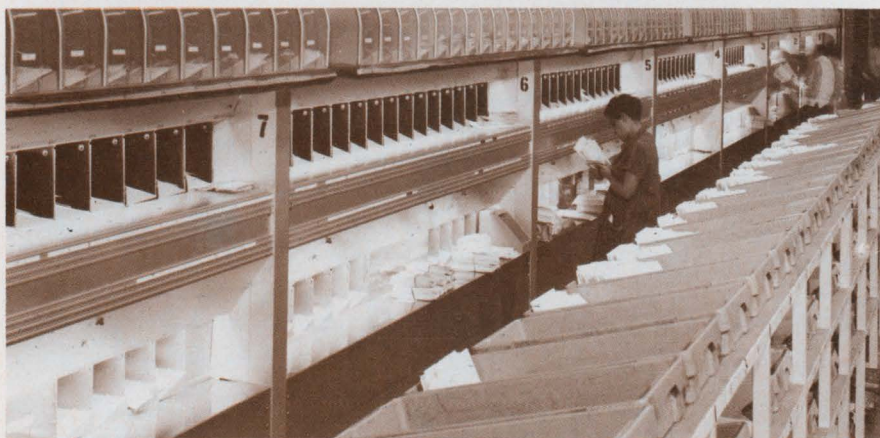

Destination bins are filled automatically after an optical scanner reads the address and sends the letter to the right slot.

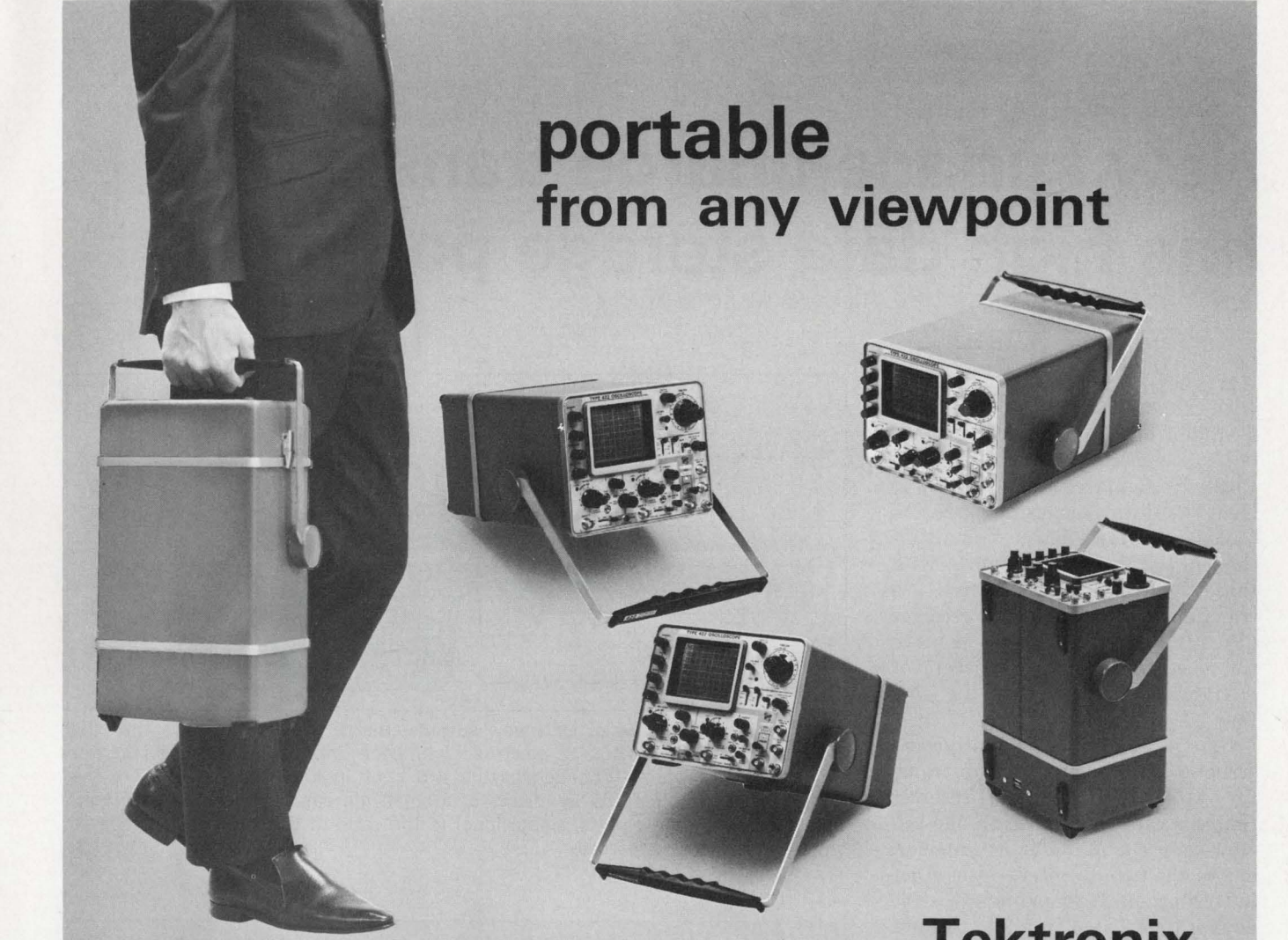

portable
from any viewpoint

Tektronix 422 Oscilloscope

The 422 isn't portable as an afterthought—it was designed that way for your convenience. It's designed to travel in your car, aboard airplanes and boats, in mobile electronic facilities—anywhere you have room for a small 22-pound package. When you reach your destination, simply remove the panel cover and the ruggedized 422 is ready to display waveforms with laboratory precision. Dual channel, 10 mV/div (ch 2 is 1 mV/div AC), 50 ns/div sweep rate with X10 mag, 15-MHz performance in a "portable designed" package. Take along a 422 when you need a truly portable, high-performance oscilloscope.

The 422 is available in AC and AC/DC models. The AC model operates from 115 or 230 VAC, 45 to 440 Hz; the AC/DC model operates from AC, an internal rechargeable battery pack or from external 11.5 to 35 VDC.

For a demonstration of the 422 in your application call your Tektronix Field Engineer or write, Tektronix, Inc., P. O. Box 500, Beaverton, Oregon 97005.

422 AC Model \$1500—422 AC/DC Model with batteries \$1990,
FOB Beaverton, Oregon.

Available in U.S. through the Tektronix lease plan



TEKTRONIX®

committed to progress
in waveform measurement

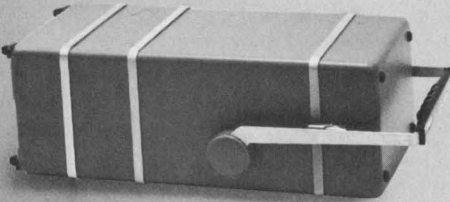

AC/DC Model

New surface-charge transistor has high data storage potential

A new semiconductor device with a potential data storage of a million bits per square inch, has been invented at the General Electric Research and Development Center, Schenectady, N. Y. Called a surface-charge transistor, the new circuit element, with three electrodes—a source, a transfer gate, and a receiver (Fig. 1)—uses a unique concept for controlling the transfer of electrical charges across the surface of a semiconductor.

GE is currently investigating structures, comprised of two transfer gates, a source and receiver that are capable of storing one bit. However, Dr. William E. Engeler, one of the two inventors—the other is Dr. Jerome J. Tiemann—sees the devices fabricated in a line to form a serial shift register.

Begin with a silicon chip

Fabrication of the basic new transistor begins with a silicon chip covered with a layer of insulating film 1000 Å thick. The source of the receiver electrodes—separated by a narrow slit—are formed by depositing a layer of refractory metal, such as molybdenum, over the insulating film. A second insulating film is deposited over these electrodes, and the third narrow electrode—the transfer gate—is then deposited so that it overlaps the thin slit between the source and the receiver electrodes.

According to Dr. Engeler, the transfer gate, acting like a sluice gate in a water system, controls the transfer of charges between the source (higher-level) and receiver (lower-level) electrodes. Only a small amount of charge on the gate

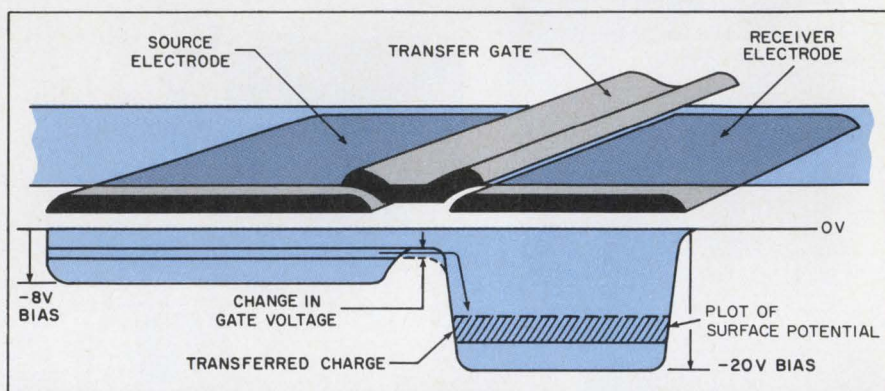

1. The schematic view of GE's new surface-charge transistor shows that the charge on the larger source electrode has been transferred from its center open potential region (bounded by the two lines in the potential plot) to the smaller receiver electrode by means of a small increase in negative gate voltage. Device voltage gain is proportional to the ratio of the source electrode to the receiver electrode areas.

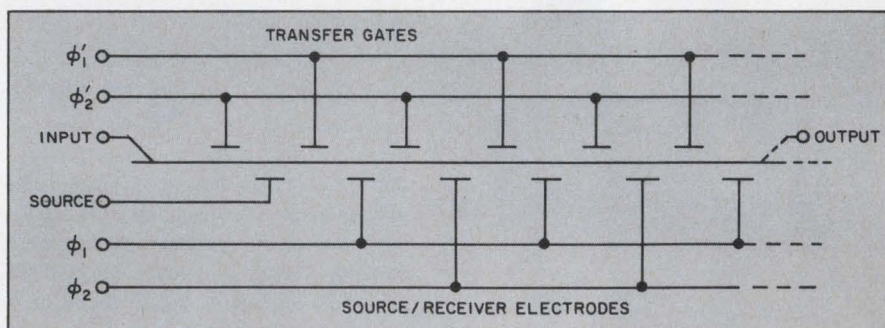

2. A serial type of surface-charge transistor shift register has a sequence of electrodes deposited on a single silicon substrate. Two driving phases are required, with bits entering the register at the left-hand source.

is required to control the transfer of a much larger charge across the gap between the electrodes. As a result, the device has both charge and voltage gains.

With zero voltage on the gate, all mobile charges stay within the source region. Applying a potential to the gate transfers these charges to the receiver electrode. The charge gain is approximately equal to the ratio of the source-electrode capacitance to the transfer-gate capacitance. A surface potential gain

equal to the ratio of the source to the receiver electrode capacitance is simultaneously obtained.

In the serial shift-register application, the electrodes will be deposited in sequence on the surface of the silicon chip, with the receiver electrode of one unit serving as the source electrode of the next. Contact will not be made with the silicon surface except for input and output leads. Shift-register operating speeds of about 1 MHz are anticipated. ■■

Jim McDermott
East Coast Editor

1+1=1

The Formula for Making Teledyne's New Dual Monolithic Transistor

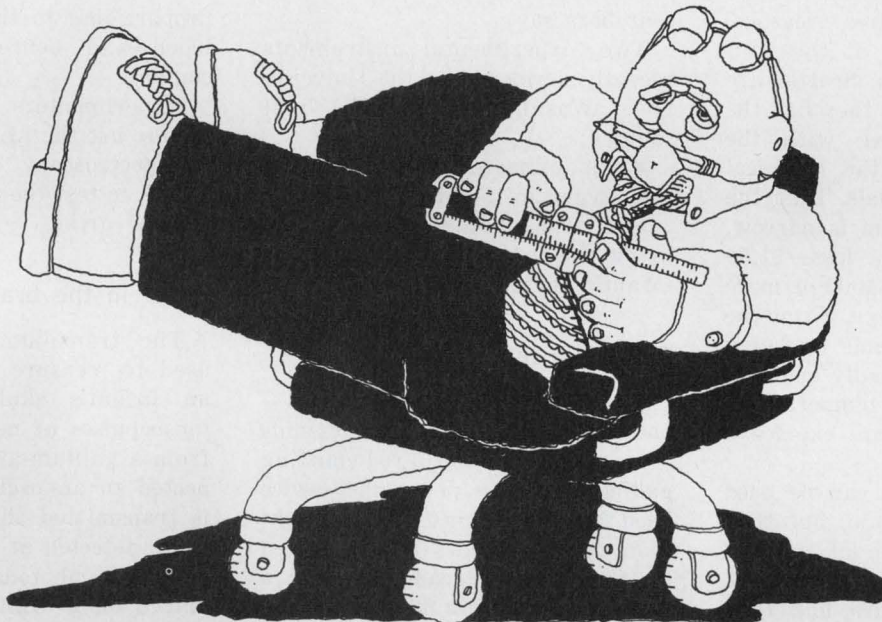

Conventional dual transistors consist of two electrically and physically isolated chips. When two transistors are diffused on the same chip, they act as a single device and out-perform the conventional transistor pair in all critical categories. Current gain is more closely matched and parameter and temperature tracking far surpass the performance capabilities of the dual transistor. Graphically depicted below, Teledyne's dual monolithic transistor has much tighter thermal coupling over the conventional pair by a factor of four. Teledyne Semiconductor has designed its dual monolithic transistors for superior performance in differential amplifier type applications, so if your

design needs fall into this category, call your local Teledyne field sales office or circle our inquiry card number for new application notes and data sheets. Teledyne Semiconductor, for high quality components, better prices and faster delivery.

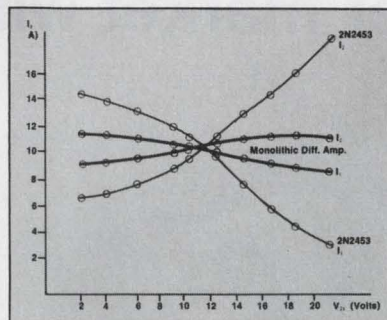

Their No.

2N2913
2N2914
2N2915
2N2915A
2N2916
2N2916A
2N2917
2N2918
2N2919
2N2919A
2N2920
2N2920A
2N2453
2N2453A
2N2642

Our No.

SA2913
SA2914
SA2915
SA2915A
SA2916
SA2916A
SA2917
SA2918
SA2919
SA2919A
SA2920
SA2920A
SA2453
SA2453A
SA2642

**TELEDYNE
SEMICONDUCTOR**

12515 Chadron Ave.
Hawthorne, Calif. 90250
Phone: (213) 772-4551
TWX: (910) 325-6217

TELEDYNE FIELD SALES OFFICES: Palo Alto, California (415) 321-4681 • Hawthorne, California (213) 772-4551 • Anaheim, California (714) 635-3171 • Dallas, Texas (214) 357-0259 • Des Plaines, Illinois (312) 299-6196 • Westwood, Massachusetts (617) 326-6600 • Lutherville, Maryland (301) 825-1920 • Little Falls, New Jersey (201) 256-8557 • Wappingers Falls, New York (914) 297-4316 • Winter Park, Florida (305) 647-7813 • Dayton, Ohio (513) 298-7207 • Liverpool, New York (315) 622-2021 • Wiesbaden, Germany 370243 • Hong Kong K 207764.

INFORMATION RETRIEVAL NUMBER 17

LEDs find wider use in biomedical areas

The light-emitting diode is beginning to replace both the laser and the white-light source in R&D prototypes of biomedical instruments.

Some instrument companies admit privately that they are working on LEDs, but decline to give details for competitive reasons. However, researchers at the University of Washington, Seattle, are less reticent. They say they find the LED very competitive with the laser for analyzing the chemical composition of materials. Like the laser, its spectral beam is narrow, but it costs far less—\$1.50 to \$2 compared with \$1000 or more for a ruby or gas laser. Even the semiconductor laser ends up being costly because it normally operates at liquid-nitrogen temperatures and thus requires an expensive cooling system.

White-light sources can be used for special analysis, too, but they require a combination of mirrors and filters to produce light of the required spectral width and thus are not only expensive but bulky. Furthermore, in applications that require placing a bright light close

to a patient's body, the LED is preferable to the white-light source because it can be pulsed much more rapidly and thus gives off less heat for a comparable light intensity. Also, its voltage requirements are much lower, and therefore it is safer to use around patients, researchers say.

Two experimental instruments recently developed at the University of Washington use LED light sources:

- An oximeter for measuring the oxygen in the blood.
- A transilluminator for measuring the amount of water in an infant's skull.

Oxygen in the blood

The oximeter has two diodes—one an infrared gallium-arsenide device, and the other a red-emitting gallium-arsenide phosphide device used as a reference. Pulsed light from the two diodes is transmitted to the blood stream through a catheter containing fiber optics and reflected by the red cells, whose degree of redness is proportional to their oxygen content. The reflected

light is transmitted to a photodetector, where it is converted to electrical pulses that are amplified and processed by an electronic sampling circuit. Sync pulses from the pulse generator time the sampling and ratio-calculating circuits, and the latter delivers an output voltage proportional to the redness of the blood and hence to its oxygen content.

Experimenters at the university plan to use the LED for other kinds of spectroscopy as well—for example, to test the chemical composition of urine.

Water in the brain

The transilluminator, which is used to measure water content in an infant's skull, generates intense pulses of near infrared light from a gallium-arsenide diode connected to an oscillator. This light is transmitted through the baby's head, detected at the other side by a silicon photodetector, and displayed on a digital voltmeter. Dr. Johnson says that the amplitude of the transmitted pulse is proportional to the fluid in the skull. ■■

H-P in consumer market with tiny radar

A microwave doppler radar transmitter-receiver module that can fit into the palm of your hand is Hewlett-Packard's first product for the consumer market.

The module, built with hybrid, thin-film integrated circuits, contains a Gunn diode oscillator that produces 50 mW at 10.525 GHz.

Doug Spreng, marketing manager for H-P's microwave components operation, Palo Alto, Calif., says the radar will go on sale in Janu-

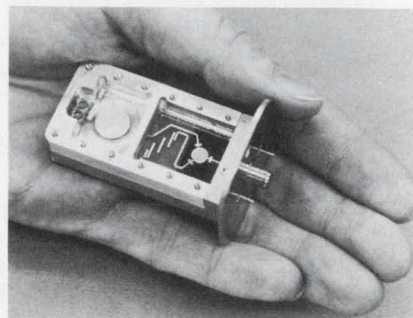

Doppler radar with Gunn diode produces 50 mW at 10.525 GHz.

ary at below \$200 for small quantities. Potential applications?

"A microwave doppler radar for autos, would be capable of detecting approaching vehicles and automatically avoiding collisions," Spreng says. "The module operates on only a few watts of power, and it's inexpensive enough so a complete system, with interconnections to operate a car's brakes, should add no more to the price of a car than an air-conditioner." ■■

COMING JAN. 7

1971 TOP TEN CONTEST ISSUE

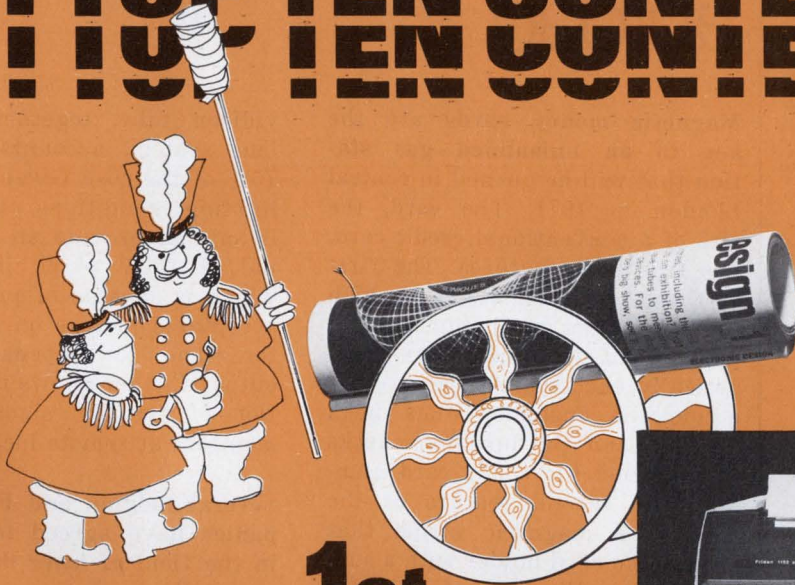

NEW PRIZES!
NEW RULES!

1st PRIZE
FRIDEN MODEL 1152
PROGRAMMABLE
PRINTING CALCULATOR



Friden Electronic Display Calculator



Friden Adding Machine



EICO "Light Fantastic"



Bulova Accutron® Timepiece

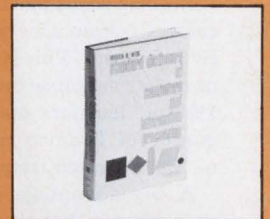

Std. Dictionary of Computers and Information Processing

HERE'S ALL YOU HAVE TO DO TO ENTER:

(1) Examine the January 7 issue of Electronic Design with extra care. (2) Pick the ten advertisements that you think will be best READ by your fellow engineer-subscribers. (3) List these advertisements (in the rank order you think our readers will select them) on the special entry form bound in the January 7 issue. Your Top Ten list will be compared with the ten ads ranking highest in the "Recall READ MOST" category of Reader Recall—Electronic Design's method of measuring readership.

CAUTION: In other years, your rankings were judged on the basis of "Recall Seen" scores. This year they will be judged on the basis of "Recall READ MOST" scores. This means that some striking ads will step back in favor of those offering greater content and usefulness to the reader.

Test your skill! See if you can pick the Top Ten . . . valuable prizes are waiting for the winners.

PRIZES—READER CONTEST

FIRST PRIZE: FRIDEN MODEL 1152 PROGRAMMABLE PRINTING CALCULATOR

SECOND PRIZE: FRIDEN MODEL 1114 ELECTRONIC DISPLAY CALCULATOR

THIRD PRIZE: FRIDEN MODEL 213 ADDING MACHINE (with automatic recall)

4th & 5th PRIZES: EICO "LIGHT FANTASTIC" COLOR-IMAGE AUDIO LIGHTING SYSTEM

6th through 13th PRIZES: BULOVA ACCUTRON® "SPACEVIEW" ELECTRONIC WRIST TIMEPIECES

14th through 75th PRIZES: COPIES OF THE "STANDARD DICTIONARY OF COMPUTERS AND INFORMATION PROCESSING." Martin H. Weik, 326 pp.

COMPLETE INFORMATION, RULES, AND ENTRY BLANKS
WILL APPEAR IN ELECTRONIC DESIGN'S JAN. 7 ISSUE

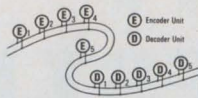

A single pair of wires, or a leased telephone line, can carry the audio signals for a complete control system.

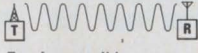

For inaccessible areas or mobile installations, a radio transmitter and receiver system can carry the signals.

REMOTE CONTROL SWITCHING WITH AUDIO SIGNALS

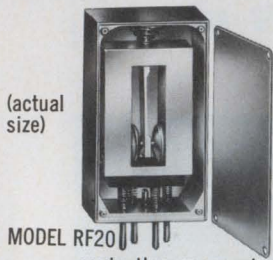

MODEL RF20
contactless resonant
reed encoder/decoder
.395 x .620 x 1.100

An audio tone can be generated by an electronic oscillator or resonant reed encoder circuit, then transmitted by wire or radio. The tone activates a resonant reed relay to perform a control function.

Bramco reeds permit over 100 selective control frequencies within the 67 to 3000 Hz. spectrum. This is assured by: (1) the narrow response band-width of about 1% for decoders and (2) the high accuracy of Bramco reed encoders (1/10 of 1% of design frequency).

A big advantage of reeds in control switching is that they are ideally suited for simultaneous and sequential coded tone systems. The actual number of control functions possible in such a system is virtually unlimited. For example, over 3300 individual control functions are possible with only 16 frequencies coded sequentially in groups of three.

Compared to other types of tone filters, resonant reeds are small and inexpensive. They give more control functions per spectrum, per size, per dollar.

If you work with controls that select, command, regulate, or indicate, you should know how it can be done with audio signals. We custom design and stock a broad line of encoder/decoder components and modules. Bramco also custom designs LC filters from 0 to 200 KHz.

For literature write Bramco Controls Division, Ledex Inc., College and South Streets, Piqua, Ohio, or call 513-773-8271.

LEDEX

BRAMCO CONTROLS DIVISION
LEDEX INC.

College and South Streets, Piqua, Ohio 45356

INFORMATION RETRIEVAL NUMBER 18

technology abroad

Magnetic money cards are the key to an unmanned gas station that will be opened in central London in 1971. The card, the size of a conventional credit card, has two main features. The first of these is a laminate into which the customer's credit number and other fixed data have been magnetically encoded. At each transaction the customer dials in a number, and the terminal checks this against his coded card number. The second feature of the card is a magnetic stripe that credits the card holder with a sum of money in the form of magnetic "blips." Each blip corresponds to an exact sum so a card-user must first pay cash to have the magnetic strip "filled up." Then, at each transaction the card is inserted into an electric cash register, and when the transaction is computed, that sum of money is automatically erased from the card. Other schemes using these cards are now being negotiated by Revenue Systems, the Luton-based manufacturer of the card and its electronic terminal.

A programmable read-only-memory using thick-film technology, has been developed in Oberdisingen, West Germany, by Andreas Lewicki, a former AEG-Telefunken employee. A precision thick-film matrix is fired onto a ceramic substrate. It can be programmed by the customer, who applies current pulses, to burn out junctions. The hybrids can be hermetically sealed. They are said to have a high voltage capability and a high environmental and radiation resistance.

A do-it-yourself TV camera is being produced as a construction project for schools by the Mullard Educational Service of the British firm, Mullard Ltd. The closed-circuit unit can be built for a half to a third of the cost of the cheapest professional camera, according to Mullard. Very simple basic circuitry is used, and a 1-inch

vidicon tube, together with the lens system, accounts for about 75% of the cost. Given reasonable lighting conditions, the camera is said to provide an output signal of 10 V pk-pk in 75 ohms, which is capable of producing an acceptable picture on a TV monitor. The low-impedance signal output further allows the distribution of the TV signal to other monitors at remote locations.

Several Belgian and French companies have agreed to cooperate in the field of laser development, especially in the use of lasers in welding, drilling and cutting operations. A joint laboratory has been set up at Marcoussis, France, not far from Paris, by the French Compagnie General d'Electricite, the Sondure Autogene Française, and the Belgian Societe Optique et Instruments de Precision. A laboratory will also be set up in Belgium for experimental work on lasers, including ruby and carbon-dioxide systems.

A magazine-fed ion implanter for production processing of semiconductor wafers has been developed by engineers at the U.K. Atomic Energy Authority's Atomic Energy Research Establishment at Harwell, Berkshire, England. Until the development of this machine, only a handful of semiconductor slices could be processed at once, because after each loading, time was required to pump the older machine down to a near-perfect vacuum. Now, however, the magazine-fed Harwell implant chamber can take two hundred and forty 1.75-inch wafers or one hundred and twenty 2-inch slices at a loading. Typically, the machine can handle thirty 2-inch wafers an hour, doping them with 5×10^{15} ions per cm^2 . Only Hitachi appears to be able to match these throughputs. In England, Mullard and GEC will both be evaluating the economics of these machines for the U.K. Atomic Energy Authority. ■■

You can beat a silicon chip with the biggest whips you can find, and you won't improve it more than a few percent. Dope it, bake it, soak it, gas it, etch it—and all you get is metallurgical progress, an inch at a time. The giant chip mills have been proving that for five years.

The only way to make real progress is to combine the talents of the best circuit men with those of creative processing engineers . . . preferably in a new facility, planned from the ground up to exploit that combination of talents.

For almost three years, Analog Devices has been planning, building, staffing, and operating just such a program. The results? Seven spectacular new designs—a whole "fourth generation" of new IC devices, years ahead of the well-beaten chips you're being offered today by the flip-flop farms.

Here's a perfect example of how a great circuit idea can liberate the imagination of a great semiconductor team—and make genuine progress . . . the AD550.

The AD550 is a Current-Switching Quad—four fast, near-ideal switches, which, combined with an appropriate resistor network, create an IC D/A converter of unprecedented accuracy, linearity, and stability. Why so accurate? Check the diagram.

By proportioning the number of junctions to the current switched, order-of-magnitude improvements in accuracy and linearity are realized! And this is only one of five major improvements embodied in the AD550 Quad Switch . . . including a unique temperature-compensating circuit. Using three such quads and a good (ADI) network, you have a solid 0.01% D/A Converter over a wide temperature range, without external trimming or selection . . . at a remarkably low price.

There's a pair of engineering design publications that you ought to read. One describes our entire fourth-generation family of years-ahead IC's, and one tells you how to design D/A and A/D converters, using the AD550 and others. Write for them today. ANALOG DEVICES, INC., 221 Fifth St., Cambridge, Mass. 02142.

Evaluation units? Certainly! Immediately! Call Fred Molinari at: (617) 492-6000; TWX: (710) 320-0326; and he'll send you up to 5—at the 100-piece price!

The "C" in IC's stands for CIRCUITS

—therefore the AD550...

... a Quad current switch for 12-bit D/A accuracy.

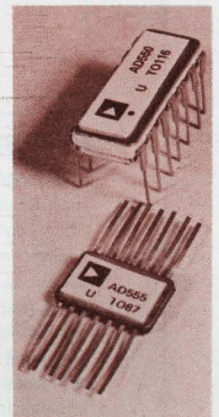
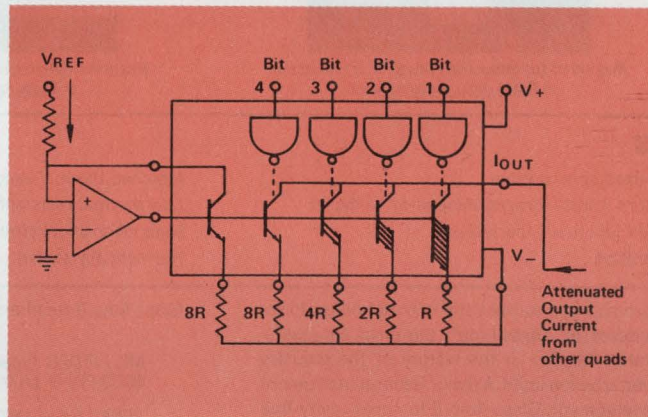

Logic Inputs "0" (switch on) 0.8V max, -1.6mA
 "1" (switch off) 2.0V min, 100µA max
 Input Coding: Compl. Binary
 Output Current (nom) MSB: 1.0mA, Bit 2: 0.5mA
 Bit 3: 0.25mA, Bit 4: 0.125mA
 Setting Time: (to ±½ LSB) 12 bits: 1.8µs
 10 bits: 0.8µs
 Absolute error (contributed when used in the most significant position in a D/A Converter with 10V Ref.)
 Types J and S ±1%
 Types K and T ±0.1%
 Types L and U ±0.01%
 Temp. Coefficient of error: ±5ppm/°C max
 Power Supply: +5V, -15V
 Operating Temperature Range:
 Types J, K, L 0°C to 70°C
 Types S, T, U -55°C to 125°C
 Specifications @ 25°C



 **ANALOG DEVICES**
 Circuit Specialists

"look ma, no cavities"

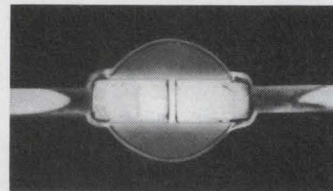

Glass-Amp II™

After 1/2 billion Glass-Amps... General Instrument announces
Glass-Amp II—the rectifier offering the best combination of reliability,
performance and price available in the industry today

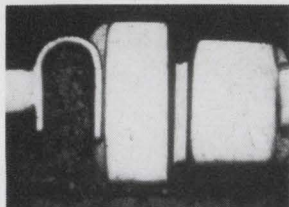

Magnified (unretouched) photo of cross section
of Glass-Amp soldered joint

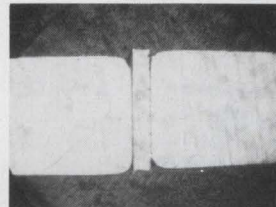

Magnified (unretouched) photo of cross section
of Glass-Amp II brazed joint

FEATURES

Cavity-free unitized construction
High temperature joints—brazed instead of soldered
Glass passivated junction—low leakage
Avalanche operation

Matched thermal expansion of glass to metal
Low thermal resistance
High mechanical strength
Hermetically sealed

Glass-Amp II promises to surpass the unmatched performance of its predecessor, Glass-Amp®, the most successful and most imitated rectifier in the history of the industry with sales of over 1/2 billion units. A major General Instrument engineering development, Glass-Amp II features cavity-free construction with a specially developed, extremely pure glass in direct contact with the silicon junction. The carefully matched expansion characteristics of the glass and metal, plus the double heat sink design obviate the need for solder joints and compression contact parts. No organic materials are required for passivation, and no voids are present to interfere with long term stability. Glass-Amp II is, in fact, a solid unit as reliable and long lived as silicon, glass and metal of which it is made. Furthermore, only high temperature brazing operations are used to withstand the 800°C required to melt and fuse the glass. This technique tremendously enhances mechanical strength, temperature cycling capability and reduces thermal resistance.

These characteristics of void-free double heat sink brazed construction together with General Instrument's expertise in silicon rectifier junction design provide Glass-Amp II with unsurpassed operating characteristics at high temperatures. High temperature performance over extended periods of time is superior. Moreover, the unit is designed to withstand repetitive reverse avalanche power surges up to 1000 Watts.

Glass-Amp II rectifiers available for immediate delivery are:

MIL/JEDEC types 1N4245 thru 1N4249 (200 PIV to 1000 PIV @ 1A @ 55°C) to meet MIL-S-19500/286C

JEDEC types 1N5059 thru 1N5062 (200 PIV to 800 PIV @ 1A @ 75°C)

G1 Series (50 PIV to 1200 PIV @ 1A @ 100°C)

G2 Series (50 PIV to 1200 PIV @ 2A @ 75°C)

General Instrument technology is making possible large scale production of high voltage (greater than 1000 Volts) versions of Glass-Amp II for highly reliable high temperature operation.

For full information write General Instrument Corporation, Dept. G, 600 West John St., Hicksville, N.Y. 11802, or call in New York: 516-733-3333; in Chicago: 312-774-7800; in Los Angeles: 213-873-6500. In Canada, call or write to General Instrument Canada, Ltd., 61 Industry St., Toronto 337, Ontario, Canada, Tel: 416-763-4133. (In Europe, write to General Instrument Europe S.P.A., Piazza Amendola 9, 20149 Milano, Italy; in the U.K., to General Instrument U.K. Ltd., Stonefield Way, Victoria Road, South Ruislip, Middlesex, England.)



GENERAL INSTRUMENT CORPORATION • 600 WEST JOHN STREET, HICKSVILLE, L. I., NEW YORK

washington report

DON BYRNE, WASHINGTON BUREAU

FAA testing new traffic control system

The Federal Aviation Administration is testing a data-link aircraft identification system in commercial aircraft flying between San Francisco and Hawaii that gives aircraft position and other information without the use of radar. The data is displayed on a CRT in FAA's Oakland Traffic Control Center. At present, coverage is limited to 440 miles, using Aeronautical Radio Inc.'s extended range vhf station in San Francisco. With a satellite the entire distance could be covered.

Aircraft must be equipped with an inertial navigation system, an altitude transducer and data-link transmission equipment.

The system also has the capability of serving as a collision-prevention device. The computer extends the aircraft courses and flashes a warning if the aircraft are on a collision course.

Government data-processing leasing under fire

An investigation by the General Accounting Office of the leasing of data-processing equipment by the Government Printing Office has triggered a virtually Government-wide inquiry of this practice. The GAO, which is the investigative arm of Congress, found that the printing office, by leasing the equipment directly from IBM instead of purchasing it or leasing through a commercial leasing firm, would spend more than \$1.2-million extra over a five-year period.

As a result of its findings, the GAO says it is now investigating data-processing leasing practices at the General Services Administration, NASA, the Post Office, the Defense Department and other agencies.

In its defense, the Printing Office said that it was unable to forecast its long-term data-processing needs and that it had little faith in computer leasing firms, which it described as "speculative and transitory."

SST could yet survive Senate defeat

Battered and bloodied by the Senate fray, the SST program may still be alive. Proponents in the Senate and the Administration indicate that a reduced appropriation to continue R&D work will be sought in the coming Congress. Estimates hover at about \$100-million as opposed to the \$290-million the Administration was asking this year.

In the confusion left by the Senate defeat, two points were glaringly obvious: SST supporters completely underestimated the strength of the environmental movement, and government lobbyists simply didn't do their homework. Three hours before the vote a Department of Transportation official told ELECTRONIC DESIGN that the measure would pass by five votes, yet 24 hours earlier sources in the offices of Senators Warren G. Magnuson (D. Wash.) and Henry M. Jackson (D. Wash.) said they counted 52 negative votes. The final vote was 52 to 41.

Prime contractor Boeing says the setback may cost 5000 jobs. General Electric, the engine contractor, says it would lay off a number of

employees—as yet undetermined—in Cincinnati. Major electronic sub-contractors also affected are the Sperry Flight Systems of Sperry Rand at Phoenix; Moog, Inc.'s Control Div., East Aurora, N. Y.; GE's Aircraft Equipment Div., Binghamton, N. Y.; LTV's Electrosystems Div., Dallas; and Kollsman Instrument Corp., Elmhurst, N. Y. The five firms held \$15.5-million in electronic contracts.

AT&T to ease equipment restrictions

The American Telephone & Telegraph Co. intends to file with the Federal Communications Commission major changes in its tariffs governing the connection of private equipment to the AT&T telephone network. The new tariffs will further ease restrictions on customer-owned computers and other business machines.

Under the proposed changes, customers will be able to use their own address signaling equipment, provided it is of the "touch-tone" type. A new, protective AT&T interface will be available that will not block or alter the signaling, even if the customer's machine is faulty. The interface is designed to prevent harm to the switched network and to AT&T employees.

Under present tariffs, computer operators must use address signaling equipment provided and maintained by Bell on their data machines to dial destinations.

Industry-Government aviation meeting scheduled

The FAA has set April 27-29 for its third annual Government/Industry National Aviation System Planning Review Conference in Washington. The meeting will cover aviation needs for the next 10 years, including R&D, navigational satellites and other aids, communications, air traffic control and automation facilities. You can register by writing the FAA, Attention HQ-200, 800 Independence Ave. S. W., Washington, D. C.

Capital Capsules: The big surprise of the SST debate, say Senate sources, was the lack of White House "heat." **Little pressure was felt from the Executive Branch** as the debate wound down. . . . The U. S. Tariff Commission has ruled that **the Japanese are dumping TV and radio tuners in this country at less than fair-value prices**, opening the door for the Treasury Dept. to start setting antidumping duties in addition to normal import duties. Imports are valued at about \$5-million annually. . . . **AT&T is compiling a "most comprehensive" market study on the data communications field**, but it doesn't expect to have it finished before the FCC rules on whether specialized carriers should be allowed to compete with AT&T in the field. The FCC is expected to rule early next year. . . . Rep. L. Mendel Rivers (D-S. C.), Chairman of the House Armed Services Committee, has fired another broadside in his battle to modernize the Navy. He says he expects to introduce a bill in January that could mean **a \$50-billion shipbuilding program over the next 10 years**. Under his plan, the Navy modernization program would be funded at a rate of \$5-billion to \$6-billion a year for the next decade. . . . **The FCC has extended until March 1 the deadline for filing applications for building and operating a domestic communications satellite system**. Originally the cutoff was to have been the first of this month. . . . **The Air Force plans to buy 325 F-5 twin-engine aircraft**—sometimes called the International Freedom Fighters—for use by U. S. allies, mainly in Southeast Asia. The Northrop-built planes will cost approximately \$1.6-million each, amounting to a total of \$520-million.

500-MHz Direct Counter

with
Trigger Point Indication

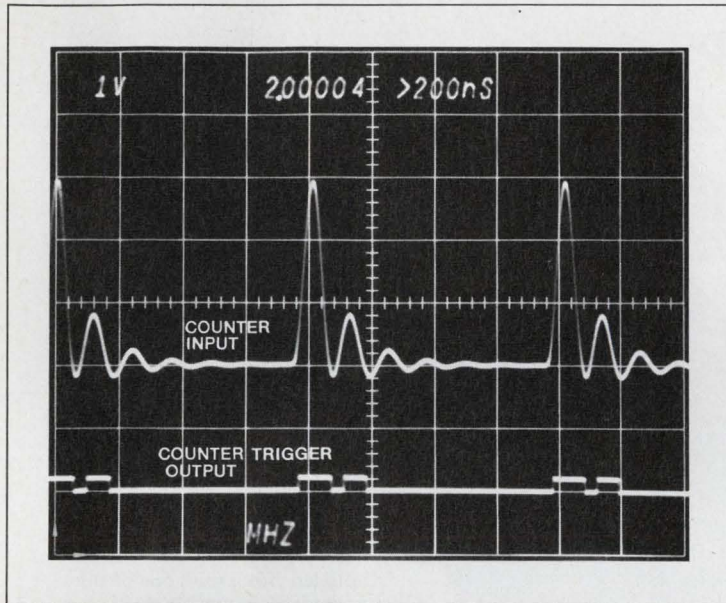

and
Signal Conditioning

- 10 μ V sensitivity at 1 MHz
- 5 mV at 150 MHz
- Current from 1 mA
- DC to 500 MHz, 50- Ω and 1-M Ω inputs
- Differential with 20,000:1 (86 dB) CMRR

The 7D14 Digital Counter Plug-In is compatible with all five 7000-Series Oscilloscope mainframes. For a demonstration or more information, contact your nearby Tektronix field engineer or write: Tektronix, Inc., P.O. Box 500, Beaverton, Oregon 97005. Price of the 7D14 is \$1400, 7000-Series Oscilloscopes start at \$1775.

U.S. Sales Prices FOB Beaverton, Oregon
Available in the U.S. through the Tektronix lease plan

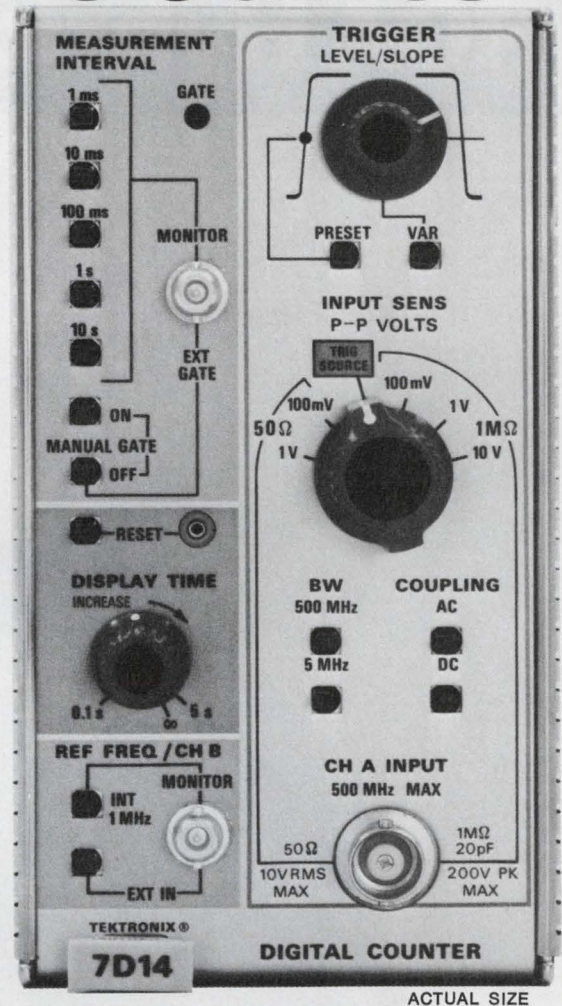

TEKTRONIX®

committed to
technical excellence

INFORMATION RETRIEVAL NUMBER 21

Introducing... A New Modular Concept in RCA Hybrid Power Circuits

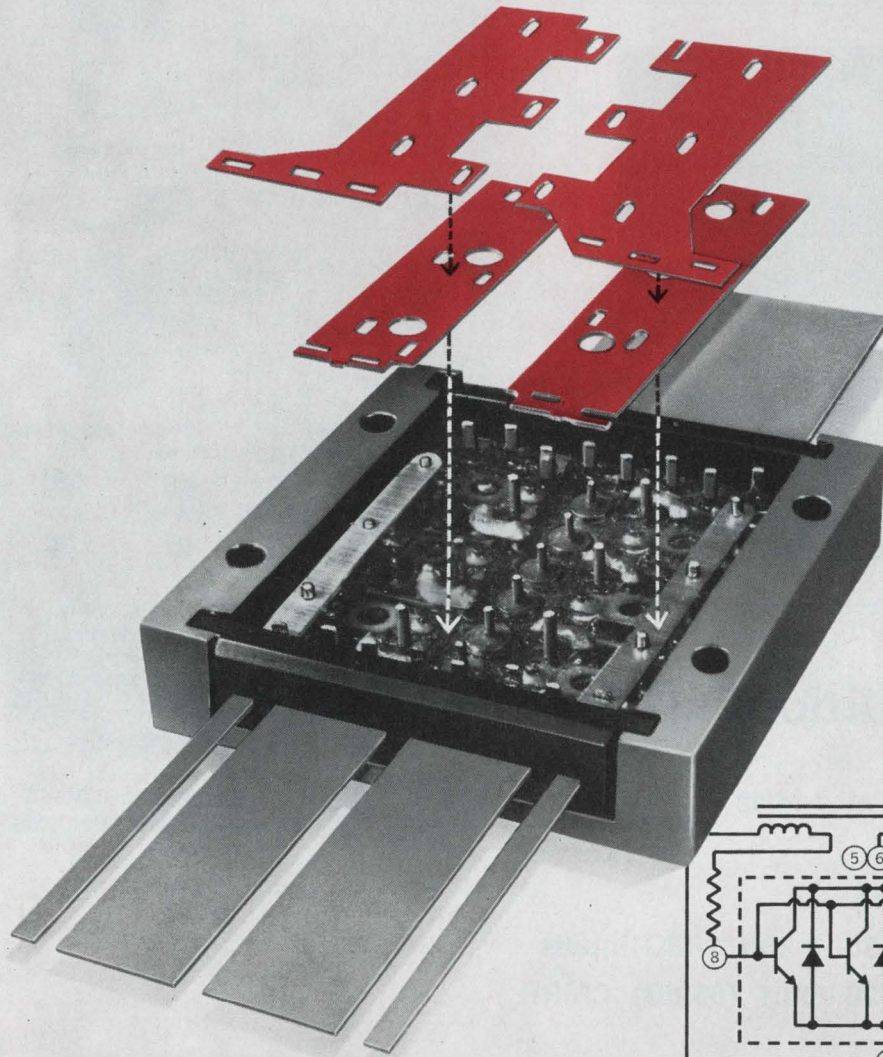

Exploded view shows one of the standard interconnections of the RCA hybrid power module as used in a common-emitter inverter. That portion within the dotted lines in the circuit schematic represents the RCA module.

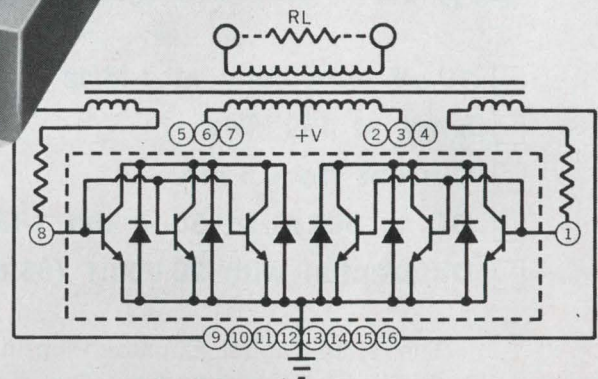

Module shown actual size

Take RCA transistor chips with current capabilities up to 80 A, rectifiers with peak currents to 80 A, and resistors to 10 watts. Interconnect them — in any number of ways. What do you get? A power capability up to 800 W, current capability up to 300 A!

Right now, RCA is mass-assembling a variety of thick-film hybrid high-power arrays that are ideal for switching and amplifier applications in military and industrial equipment. Modules are also available in unconnected versions, if you prefer to create your own design. These hybrid power circuits offer obvious power circuit advantages, including: compact-

ness, light weight, fewer parts, minimum assembly costs, factory-selected and matched components, and efficient built-in heat dissipation.

Look over the inverter example illustrated. Then call your local RCA Representative or your RCA Distributor for more information on the modular concept. For RCA's new, detailed brochure, "High-Power Arrays" (HPA-100), write: RCA, Commercial Engineering, Section 57L-20/UC2R, Harrison, N. J. 07029. International, RCA, 2-4 rue du Lièvre, 1227 Geneva, Switzerland, or P.O. Box 112, Hong Kong.



New trade bill--can we let history repeat itself?

Is recent economic history repeating itself? There are disturbing parallels between 1930 and 1970.

In 1930, Congress passed the Smoot-Hawley tariff, a trade-protection measure—and it backfired. Instead of helping to ease this country's economic depression, it aggravated it. Unable to compete in U. S. markets, other nations raised trade barriers. From 1930 to 1934 the value of U. S. exports dropped 70%, and world trade virtually ceased.

Now, in 1970, Congress is seriously considering a bill that would impose quotas on a wide variety of foreign products. The bill specifically limits imports of textiles and shoes, for instance. And it has a so-called "trigger mechanism." It forces the President to impose quotas or higher tariffs on any foreign product that is increasing rapidly in sales and has captured 15% of the U. S. market—provided the domestic industry can prove injury and the U. S. Tariff Commission recommends action. An estimated 125 foreign products, including TVs, radioactive isotopes, sewing machines and automobiles, could be affected.

Even the Smoot-Hawley tariff had a less destructive effect on trade than the proposed quota would. The tariff could be offset by depreciation of a foreign currency or by an export subsidy, but the quota constitutes a rigid bar to imports. European governments are reportedly conferring already on ways to retaliate against U. S. imports. The first target would probably be the soybean industry. Next would come computers, light machinery, and small airplanes.

The quota bill threatens the livelihood of all of us in the electronics industry. Overseas sales are propping up many troubled U. S. electronics firms right now, and we must not discourage world trade.

Can we in the electronics industry afford to sit and watch history repeat itself? Write your Congressman. Tell him to vote NO on the quota bill.

ELIZABETH DE ATLEY

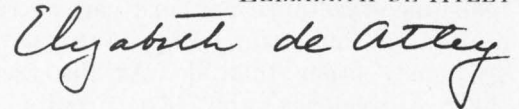

Evaluate transistor bandwidths

the easy way. Circuit Q_s and interstage resistance levels provide a rough but rapid measure of available bandwidth.

A lot of time can be wasted in trying to select a transistor for a wideband application. Typically, a tentative choice is made on the basis of gain, center frequency and power; then the engineer uses a Smith chart to see if the suggested transistor's immittances (Z_{in} and Y_{out}) when incorporated into a matching network, can provide the required bandwidth. If they can't, another tentative selection is made, and the process is repeated.

This can be quite tedious if several matching sections must be varied in an attempt to optimize the gain and VSWR over, say, an octave of bandwidth.

A better approach is to recognize that two major factors limit the available bandwidth of any transistor. These factors, which can be evaluated very quickly, are:

- The ratio of the transistor's series input reactance to input resistance, X_s/R_s .

- The quantity $[(R_1/R_2) - 1]^{1/2}$, where R_1 and R_2 are any two resistance levels that must be matched. For example, one can be a source resistance and the other the input resistance of the transistor. (When $R_1 \neq R_2$, R_1 is always the larger of the two.)

Series-to-parallel transformations

To see how the preceding factors affect transistor bandwidth, we must recall that any series resistance-reactance network can be replaced by a parallel equivalent (Fig. 1) at any specified frequency other than dc. At the frequency of their equivalence, the two circuits, naturally, have the same Q :

$$(X_s/R_s) = (R_p/X_p) = Q. \quad (1)$$

The conversion equations are:

$$R_s = R_p/(Q^2 + 1) \quad (2a)$$

$$X_s = R_s Q \quad (2b)$$

$$R_p = R_s(Q^2 + 1) \quad (2c)$$

$$X_p = R_p/Q. \quad (2d)$$

The main facts that emerge from Eq. 2 are that R_p is always greater than R_s and that the

reactances are always of the same type but will usually not be of the same value.

The quantity $X_s/R_s = Q$ imposes a fundamental limitation on a transistor because

$(1/Q) = BW_{3\text{ dB}}/f_0 = \text{fractional bandwidth}$ (3) where $BW_{3\text{ dB}}$ is the 3-dB bandwidth of the transistor's input circuit and f_0 is the center frequency at which the measurements of X_s and R_s were made.

To see how the second quantity, $[(R_1/R_2) - 1]^{1/2}$, comes into play, imagine that the combination of the transistor's series input reactance, X_L , and its series input resistance, R_s , is lower than $50\ \Omega$ and that it must be matched to a $50\text{-}\Omega$ source. If a suitable inductive reactance, X_L , is added in series with R_s and X_s it will build up the impedance to the desired level, $R_p = 50\ \Omega$, when the series combination is paralleled by a suitable value of capacitive reactance, X_C (Fig. 2). R_s and the series combination $X_L + X_s$ are transformed into the parallel combination R_p and X_p . The capacitive reactance is chosen so that $X_C + X_p = 0$ at f_0 , thus making the circuit look like a pure resistance at the frequency of interest.

To see how this matching procedure affects the bandwidth, rewrite Eq. 2c to read

$$(R_p/R_s) = Q^2 + 1 \quad (4)$$

or

$$f_0/BW_{3\text{ dB}} = Q = [(R_p/R_s) - 1]^{1/2}. \quad (5)$$

This equation, which is very useful for practical, rapid, impedance matching makes clear that *the greater the difference in resistive levels to be matched, the narrower the bandwidth conveniently attainable.*

In deriving Eq. 5, it was assumed that R_s and X_s were so low that an additional reactance, X_L , had to be added to raise the impedance level. Actually, the inductance of the transistor leads often is too high, making it necessary to match up from the source to the transistor input, further restricting the bandwidth. Each matching section, of course, has its own fractional bandwidth and reduces the available bandwidth in proportion to it.

Since either sign of reactance may be used for matching, what is often done in this case is to add a capacitor (C_1) in series with the $50\text{-}\Omega$ generator to raise its impedance up to the level of the transistor's input (Fig. 3a). Inductor L_1

Vincent F. Perna, Vice President, Microwave Engineering, American Technical Ceramics, One Norden Lane, Huntington Station, N. Y. 11746.

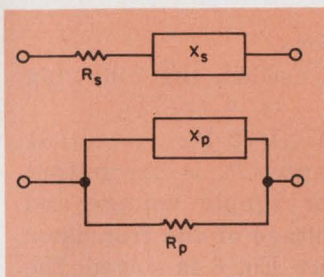

1. At any specified frequency, a series resistance-reactance pair can be represented by a parallel equivalent. The parallel resistance equivalent, R_p , will always be greater than the series resistance, R_s .

2. Adding X_L raises the apparent input resistance of the transistor (top) by increasing its effective parallel equivalent, R_p , (bottom). X_c is added to cancel the inductance at the operating frequency.

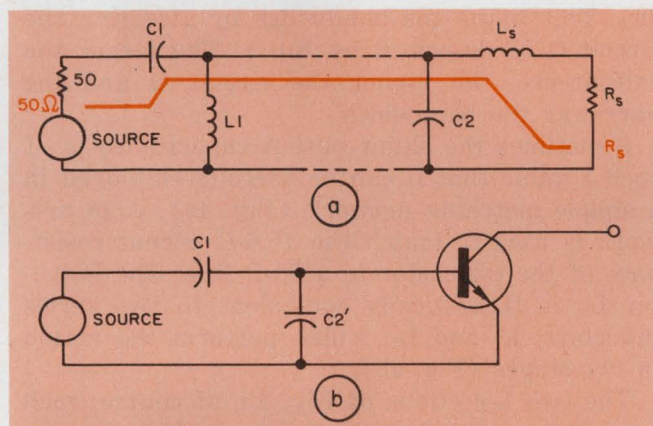
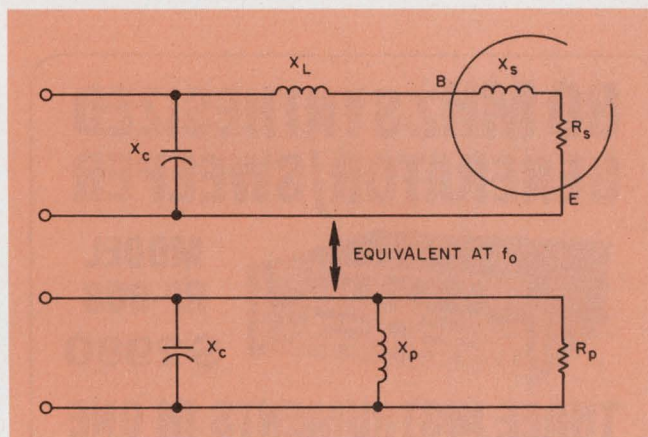

3. The parasitic inductance compounds the problem by making two impedance changes necessary (a). The colored line represents the impedance (to ground) of the various portions of the circuit. L_s raises the transistor resistance R_s above 50Ω so that C_2 is needed to bring it down again. L_1 and C_2 can be combined, resulting in C_2' and a two-capacitor matching network (b).

is used to resonate with C_1 at f_0 and C_2 is used to similarly resonate L_s .

If the admittances of L_1 and C_2 are combined, a capacitor, C_2' , usually results. This leads to the often-seen circuit of Fig. 3b.

Let's try a quick example

To see how easy it is to use these ideas, let's try to get a rough idea of the input circuit bandwidth available from a 2N3375. According to the manufacturer's data, taken at a collector current of 200 mA and a frequency of 300 MHz, the input impedance is $12.8 + j5.5 \Omega$. For a rough approximation we can neglect the 6-dB-per-octave gain slope and the variation of Q with frequency, and simply write: $Q = X_s/R_s = 5.5/12.8 = 0.43$. Thus the fractional bandwidth is $(1/Q) = 2.33$. At 300 MHz, this gives a bandwidth of 699 MHz, or a passband extending from dc to beyond 600 MHz.

All this assumes, of course, that a driver is

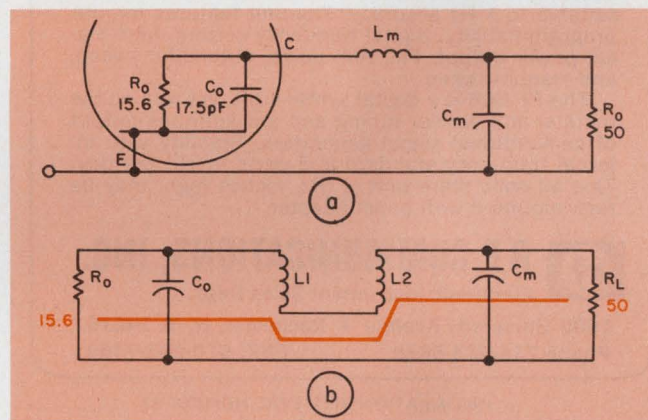

4. Output capacitance C_0 can be integrated into a matching network (a) at the output of a transistor. The easiest way to see how the circuit works is to imagine the inductor, L_m , to be broken into two series inductors, L_1 and L_2 (b). The colored line shows how the impedance is affected by the inductors. C_0 cancels out the effect of L_1 at f_0 ; C_m does a similar job for L_2 .

available with a suitably low output impedance, conjugate over the full range. Alternatively, if we assume a purely resistive source, plugging into Eq. 2c, we see that a generator with a resistance of 14.7Ω is needed.

Most likely, such a driver will not be available. Probably a $50\text{-}\Omega$ unit will have to be used. As a result, the available bandwidth (using a single L-section matching network) would be reduced to 176 MHz, as can be verified by plugging into Eq. 5.

Don't forget the output circuit

So far, so good. But we have been dealing only with the transistor's input circuit. The output circuit will also restrict the bandwidth, and, unfortunately, output-resistance information is not always available from the manufacturer. It must either be measured, which is tedious, or calculated, which is quicker but less accurate since it

80 MHz SYNTHESIZED GENERATOR/SWEEPER



**MODEL
RF-808
\$2980**

THREE INSTRUMENTS IN ONE

**Generator And Sweeper Versatility
Synthesizer Accuracy And Programmability**

The RF-808 Signal Generator is a synthesizer and sweeper in addition to a standard signal generator covering .05 to 80 MHz in 1 KHz steps with a vernier settable to 1 Hz accuracy. The unit features remote programmability, digital frequency setting, high signal power output, FM, AM, pulse, automatic sweep, and manual sweep.

The RF-808 is a digital synthesizer, yet retains the manual and vernier tuning and low spurious output of conventional signal generators. Stability with internal frequency standard is 5 parts in 10^9 per day. This all solid state unit is 5 1/4 inches high, may be rack mounted with panel adapter.



RF COMMUNICATIONS, INC.

Electronic Instrument Sales Dept.

1680 University Avenue • Rochester, N. Y. 14610
Phone 716-244-5830 TWX: 510-253-7469

INFORMATION RETRIEVAL NUMBER 23

PRECISION DISC, REEL, DRUM AND CAPSTAN DRIVE MOTORS

SUB-FRACTIONAL H.P. HYST. SYNCH., INDUCTION AND TORQUE MOTOR SIZES FROM 1.00" TO 4.38" DIA.
• RATINGS FROM 1/2000 TO 1/4 H.P. • CHOICE OF OPERATING VOLTAGES • SINGLE OR POLY-PHASE DESIGN • FIXED OR VARIABLE FREQUENCIES •

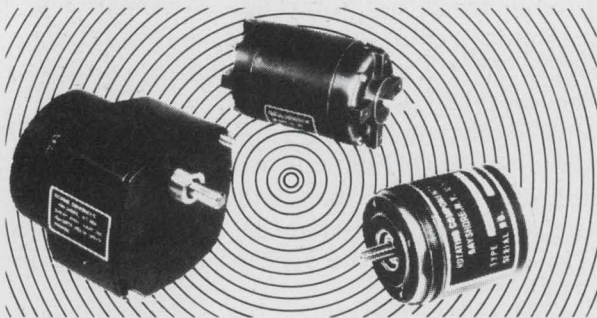

Also a complete line of: Precision Gear Motors, AC Tach Generators, AC Induction Tachs, PM Tach Generators, Drag Cup Motors, Servo Motors, Fans, Blowers

SEND FOR OUR 40 PAGE DESIGNERS GUIDE AND CATALOG



ROTATING COMPONENTS

Division of INSTRUMENT SYSTEMS CORPORATION
1560 FIFTH AVE., BAY SHORE, N. Y. 11706
(516) 666-8500 TWX 516-666-7047

INFORMATION RETRIEVAL NUMBER 24

involves several assumptions.

If high accuracy is not needed, the following equation can be used:

$$R_o = (V_{cc} - V_{sat})^2 / 2 P_o \quad (6)$$

R_o is the output resistance, P_o is the output power, V_{cc} is the collector supply voltage and V_{sat} is the rf saturation voltage of the transistor (on the order of 3 V). Once Eq. 6 is solved, the result can be plugged into Eq. 5 for an estimate of the output-circuit bandwidth.

For example, for a 2N5637 at 20 W with $V_{cc} = 28$ V and $V_{sat} = 3$ V, Eq. 6 yields $R_o = 15.6 \Omega$. Therefore, from Eq. 5, an initial estimate of the output-circuit bandwidth for a 50- Ω system operating at 300 MHz is 202 MHz.

Of course, the transistor's output really has a capacitance across the output resistance (Fig. 4a). This limits the bandwidth by affecting the circuit Q as described by Eq. 1. The larger the capacitance, the higher the circuit Q and the narrower the bandwidth.

Sometimes the shunt output capacitance is of such a value that it can be usefully employed in a simple matching network (Fig. 4a). A pi network is used to match the 15.6- Ω output resistance of the transistor to a 50- Ω line. The inductor L_m is theoretically equivalent to two series inductors, L_1 and L_2 , which perform the match in two stages (Fig. 4b).

The two L-sections of Fig. 4b, of course, each contribute to bandwidth shrinkage, but the section represented by L_1 usually has a very low Q, and its effect on the bandwidth is therefore minimal.

As with other tightly coupled interactive networks, a wide variety of passband-gain combinations can be obtained through tuning trade-offs. For quick transistor evaluations, assuming synchronously single-tuned inputs and outputs, the expected over-all stage bandwidth (from Eq. 3) is approximately equal to:

$$BW_{3\text{ dB}} = f_o / (Q_{\text{input}} + Q_{\text{output}}) \quad (7)$$

Harmonic effects can be a problem

The usable portion of the available bandwidth is influenced by harmonic currents which can flow in the output circuit, lowering the output resistance and thus shrinking the bandwidth. (Some multi-octave circuits may, in fact, need to go push-pull to get rid of even-order harmonics.) Where efficiency is critical, circuit element values must be chosen to reflect an open circuit at the collector, even if the harmonics are out of the desired passband.

Thus, as broader bandwidths are required, space will have to be increased to accommodate the more elaborate matching networks that will be needed. Or, the engineer can reconsider his choice of transistor. ■■

Little Fort Knox.



Our new HM miniature has its own reserve of gold. Reliable gold contacts give the operational dependability required for low-energy applications.

The HM, and our slightly larger HS, are hermetically sealed for all-weather, multi-environment applications.

The metal-to-metal and glass-to-metal construction is specifically designed for military/aerospace use.

We've also given a new look to our environmentally-sealed SE and XE subminiatures. More updated design. More functional reliability.

And all four switches meet the applicable requirements of MIL-S-8805.

For more information, contact your MICRO SWITCH Branch Office, or write for Catalog 52.

MICRO SWITCH

FREEPORT, ILLINOIS 61032
A DIVISION OF HONEYWELL

HONEYWELL INTERNATIONAL: Sales and service offices in all principal cities of the world.

INFORMATION RETRIEVAL NUMBER 25

Fluid dielectric cuts size and weight

of high-power airborne equipment. It's particularly effective with high-frequency radio and radar transmitters.

High-power airborne electronic equipment has to be operated in a rarefied atmosphere, and this creates two design problems: how to prevent voltage breakdown and how to provide adequate cooling. The usual solutions to these problems result in equipment that is excessively bulky and heavy.

All clearances and leakage paths in such equipment have to be enlarged, and exposed high-potential points have to be shaped to keep the electric-field concentration below the ionization level. The cooling equipment, also, has to be scaled up in size to compensate for the reduced heat-transfer capability of rarefied air.

Alternatively, the equipment can be built into a pressurized case. This, however, adds not only the case's bulk and weight but also that of the heat-exchanging equipment needed to cool it.

Of course, the equipment could simply be put in the aircraft's pressurized compartment, but it would then be subject to failure if cabin pressure were lost.

Replace the air with a dielectric fluid

A better solution to the problem is to replace the air in such a piece of equipment with a non-flammable dielectric fluid. The fluid can be circulated to carry away the heat dissipated by the equipment. At the same time, its superior dielectric strength (see table) allows it to act as a more effective insulator than air. This permits significant size reductions in the equipment by allowing closer spacing of high-voltage structures.

Furthermore, the fluid has a higher dielectric constant than air, permitting reductions in the size of the distributed circuits in rf equipment.

There is one potential disadvantage of dielectric fluids: the temperature dependence of their dielectric constants. In rf circuitry this can cause the tuning of resonant components to vary with the temperature of the fluid. Since a fluid with a very low temperature coefficient has not been

found, the best solution to this problem is to add a control system for the fluid temperature where frequency drift is a problem.

No other undesirable characteristics were experienced during initial laboratory testing of this design approach. The tests were performed using DC 200 silicon oil as the dielectric fluid in a 1-kW uhf cavity amplifier.

To take advantage of the fluid's characteristics, a compact amplifier tube was required. After several tubes were tested in an air-cooled cavity, the RCA 7650 uhf beam power tetrode was selected. Its radiator is rated at 600-W dissipation in air, but with the dielectric fluid substituted for air, the radiator can dissipate several kW. The cathode current was rated at 500 mA; however, tests proved that good life expectancy could be realized at 750 mA even in air. The manufacturer is now constructing developmental tubes in the same basic shape, with 50% more cathode area to permit conservative operation at the 1-kW output level.

The test cavity was operated at a 1-kW output level at a fluid flow rate of 1 gal/min. With an incoming fluid temperature of 45°C, no point on the tube surface or in the cavity circuit exceeded 100°C. The maximum temperature rating of the tube in air is 250°C.

Added advantages of fluid dielectrics

In addition to the expected size and weight reductions (Fig. 1), the use of a fluid dielectric brought three extra advantages:

- It kept all operating temperatures considerably below those that are usual with air cooling. This could significantly extend the lifetime of the equipment.

- It practically eliminated the usual thermal drifts caused by initial warmup.

- It kept moving mechanical parts clean, well lubricated and free from corrosion, even after much operational testing.

In a later testing phase, a complete amplifier was built with its cavity and power supply immersed in the fluid. Putting the power supply in the fluid disclosed three more benefits of this

Lauren K. Findley, Principal Project Engineer, Electronic Communications, Inc., 1501 72 Street N., Box 12248, St. Petersburg, Fla. 33733.

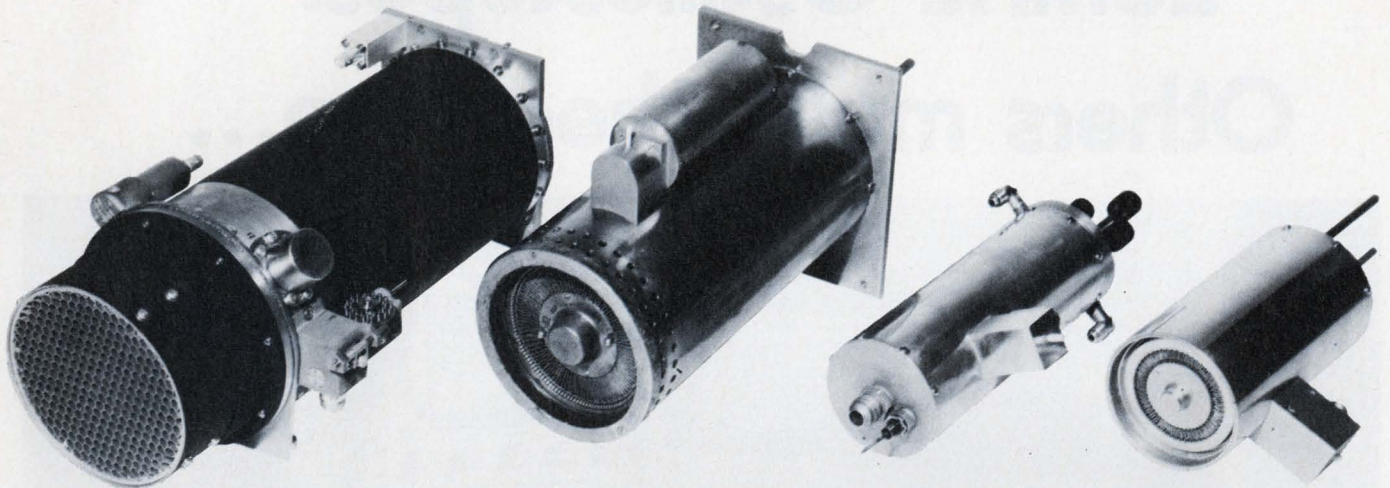

1. **Dramatic size reductions are possible** when a fluid dielectric is used. These are all 1-kW uhf cavities covering 225 to 400 MHz. Starting from the left, the first one is an air-cooled production unit that has been used in many installations. The second cavity uses the same tube, but has a re-entrant output circuit, which reduces its

length by four inches. Cavity No. 3 is the fluid-dielectric unit. Cavity No. 4 is air-cooled; its size reduction was obtained by folding its output circuit. Of all the cavities, only the fluid-dielectric unit is capable of producing full power over the full 225-to-400-MHz frequency range at an altitude of 100,000 feet.

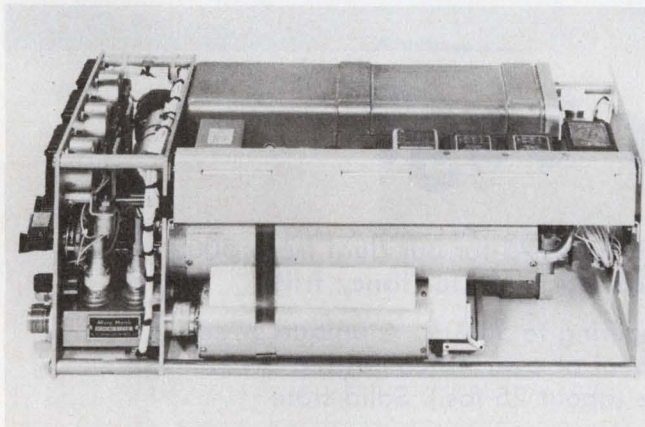

2. **This 1-kW uhf amplifier is only 6.5 × 7.5 × 17 inches.** The package contains the cavity, power supply, control and monitoring circuitry, and low-pass output filter. Only the heat exchanger is packaged separately.

Advantages of dielectric fluids

This chart demonstrates the most significant advantages enjoyed by a typical dielectric fluid.

	Fluid	Air (sea level)	Air (10,000 ft.)
Dielectric constant	2.75	1.0	1.0
Dielectric strength (V/mil)	350	35	3.5
Working voltage (V rms/mil)	100	10	1.0
Flow rate for equal cooling capability	1.0 gal/min	180 ft ³ /min	14,000 ft ³ /min

fluid-dielectric design technique:

- Smaller resistors and rectifiers could be used because of the improved cooling.
- No high-voltage posts were required on transformer chokes and capacitors—a further size reduction.
- Temperature stabilization was enhanced because the power-supply compartment acted as a secondary reservoir for the fluid and tended to stabilize the fluid temperature.

The complete test amplifier—including cavity, power supply, all control and monitoring circuits and a low-pass output filter—was mounted in a case measuring 6.5 × 7.5 × 17 inches (Fig. 2).

The heat exchanger was packaged separately and measured 11 × 10 × 10 inches. However, it should be emphasized that no effort was made to minimize the size of the heat exchanger, since its detailed design depends upon the exact nature of the aircraft in which it is to be used. ■■

We make two 25MHz Oscilloscopes. Others make them, too...

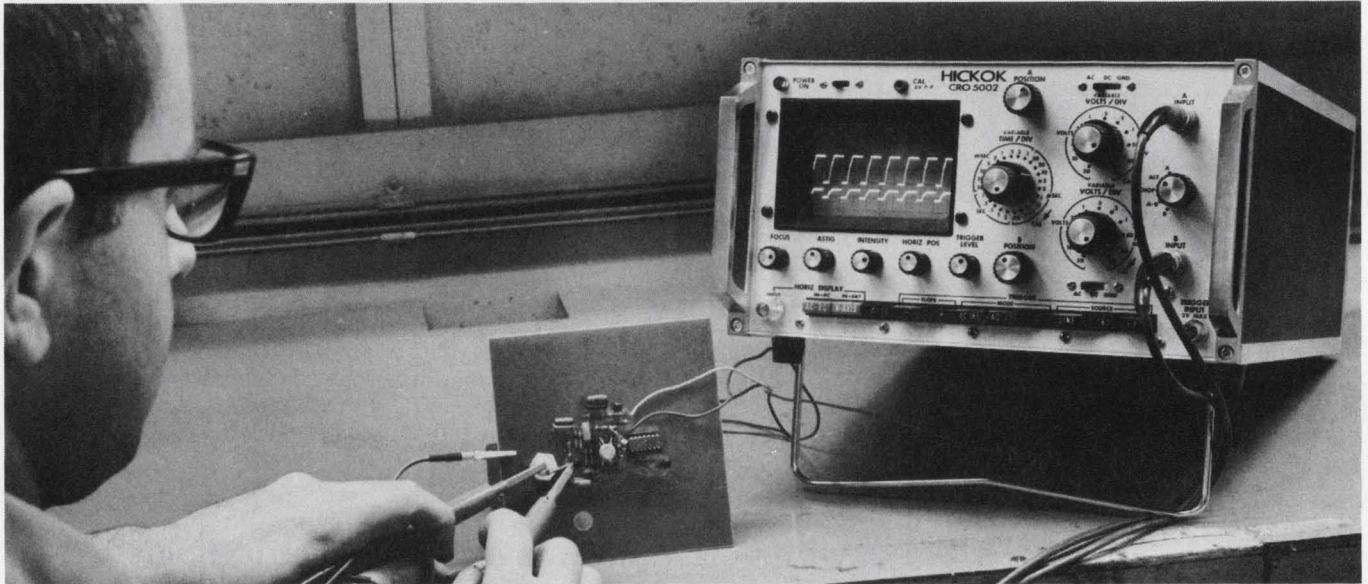

...so what's our bag?

First: price—\$725 for our single trace Model 5000, \$995 for our dual trace 5002. You pay only for precise measurement characteristics, not for fancy frills.

Second: special features—like ultra-stable triggering to 50MHz. A unique sweep circuit that lets you view any 10-division segment of over 40 calibrated divisions of sweep—a simplified, delayed sweep. Portable (about 25 lbs.). Solid-state reliable. Overload protected.

Third: your local Hickok man will gladly make a side-by-side competitive demo in your plant so that you can compare before you buy. Just ask him. Then decide.

There's more to tell. Circle Reader Service Card # or call us for complete information.

HICKOK

INSTRUMENTATION AND
CONTROLS DIVISION

10514 Dupont Ave. • Cleveland, Ohio 44108
Telephone: (216) 541-8060

Cut yourself in.

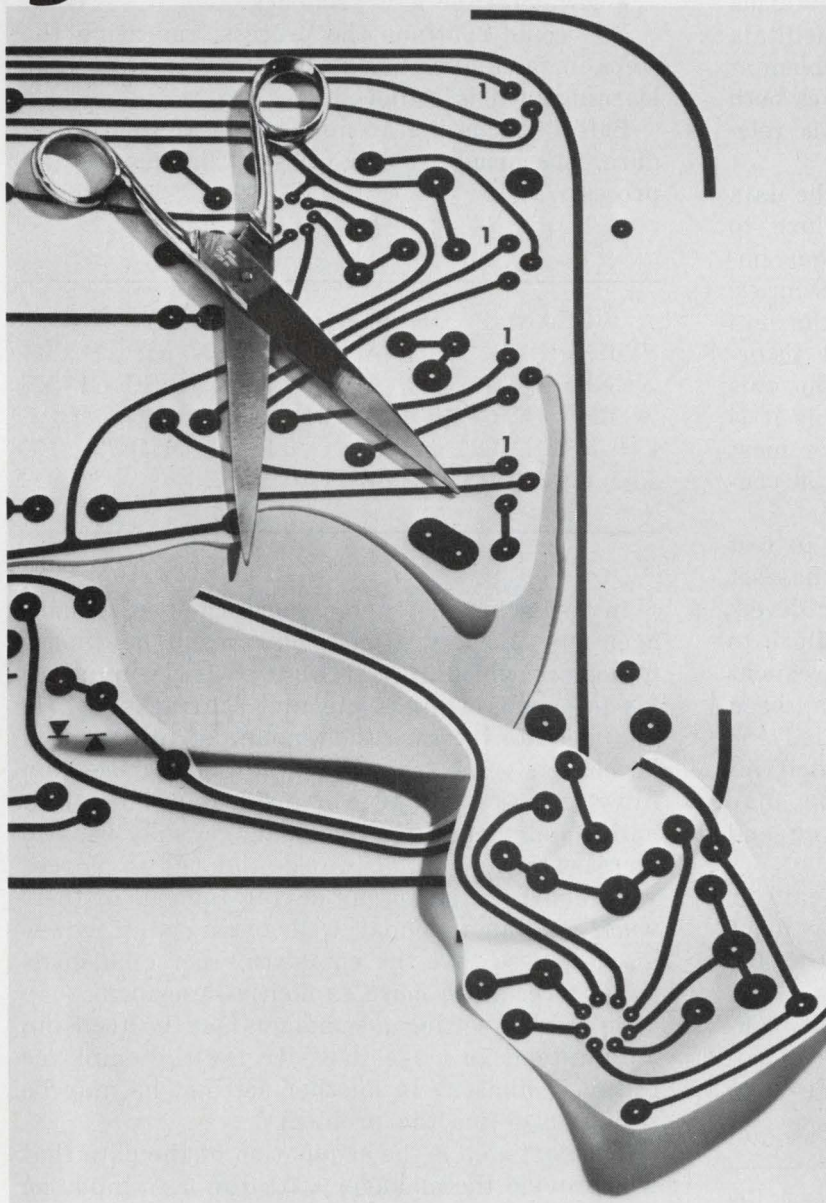

“Scissors draft” your way to increased production with KODAGRAPH Films and Papers.

Why retrace an entire drawing needing only revision? Instead, copy your original photographically on KODAGRAPH Film or Paper. Cut out the unchanged portions (often much of your drawing), mount them on a new drawing form, have a second original made on KODAGRAPH Film, and make your revisions on that.

For more on “scissors drafting” and other time-saving techniques, contact your Kodak Technical Sales Representative, or write Eastman Kodak Company, Business Systems Markets Division, Dept. DP841, Rochester, N.Y. 14650

DRAWING REPRODUCTION SYSTEMS BY KODAK

Kodak

Whet your data-gathering/sharing skill to a fine edge. Practice can improve your ability to learn and interchange, says this management trainer.

As an engineering manager, you spend a major portion of each business day talking with the people who report to you—negotiating work goals, discussing career interests and plans, exploring alternate solutions to problems, critiquing a presentation for a customer, and the like. During each of these discussions or transactions, you try to make it easy for information to flow back and forth between you. You also try to facilitate reaching a satisfactory solution to the problem at the conclusion of the meeting. This involves both gathering and sharing information that is relevant to the topic being discussed.

One major barrier to improvement of the data gathering and sharing task is the failure to recognize that a skill is involved and that improvement, with practice, is possible. Often we assume that if we can speak and hear the language, we are able to gather and share information efficiently and effectively. For some, this may be a valid assumption. For most of us it is not. And it's an especially critical area for most managers, because the exchange of data is central to most of their activities.

A measure that a manager might use to test his skill is whether or not the goals he has set for these data exchanges are, in fact, achieved. If you as a manager are experiencing failure to achieve these goals and are encountering frequent reappearances of problems you thought had been laid to rest; failure of candidates selected for jobs to work out successfully; or repeated inaccurate identification of problems, you may wish to re-examine your skill in gathering and sharing data.

If you decide that your skill is inadequate or needs modification or refinement, you may adopt a simple procedure to try to bring about the wished-for improvement. You could:

- Define your learning goal as a specific, concrete, measurable result you wish to achieve.
- Acquire the new knowledge you need to help you achieve this learning goal.

- Apply the newly acquired knowledge in situations that allow you to test out its impact.

- Evaluate the feedback supplied by the application in terms of how it improves your ability to produce the result you seek.

- Reapply the modified knowledge, using the feedback from the previous application.

- Evaluate the new feedback.

You could continue the process, repeating the steps in the application-feedback cycle until your learning goal is achieved.

Before discussing an application of this procedure, let's briefly review each of the steps in the process.

A CLEARLY DEFINED GOAL NOT ONLY SIMPLIFIES THE ACQUISITION OF DATA NEEDED TO SUPPORT IT, BUT ALSO GIVES SOME INDICATION OF THE POSSIBLE COURSES OF ACTION THAT MIGHT BE TAKEN TO ACHIEVE IT.

In reviewing his current performance, a manager may identify a particular result he wishes to achieve which may be realized if he improves his information gathering and sharing skill. He may need to increase the amount of information he collects—for example, in candidate selection interviews so that he can make more discriminating judgments. Another manager may wish to increase the amount of information the employees who report to him supply during reviews of their work. Still another may wish to carry out career discussion so that the employee's personal goals and interests are more explicitly described.

So, in one setting a manager may be focusing on questions to make it easier for the employee to reveal himself. In another setting, he may be trying to define the problem.

The next step is the acquisition of the data that will provide the manager with the new input he needs to refine the skill he's attempting to improve. The traditional methods for doing this

Charles D. Lothridge, Program Manager, Personal Development Programs, General Electric Co., Ossining, N. Y. 10562.

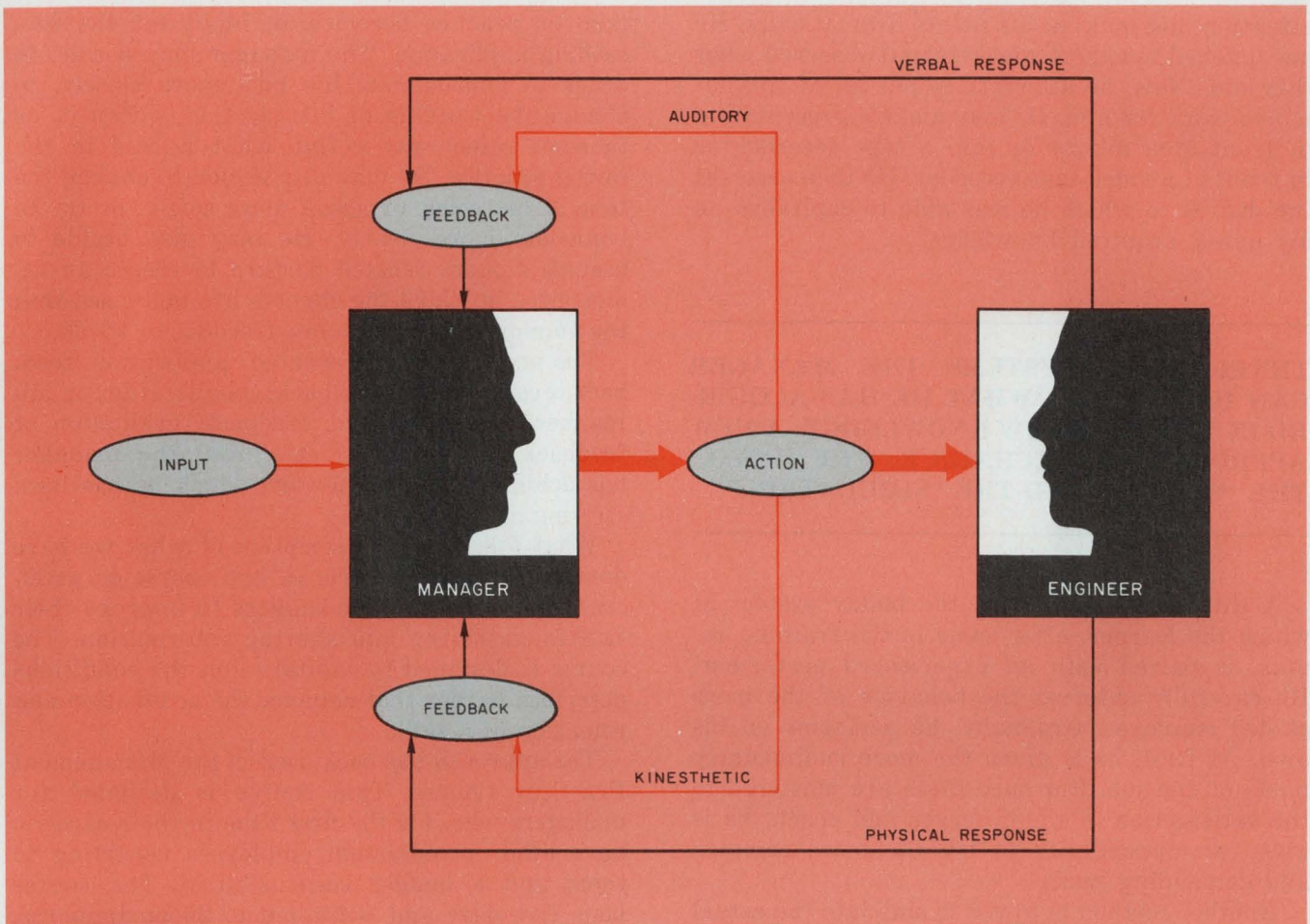

This feedback loop illustrates an interchange between a man and his manager. The manager has framed an open end question, one requiring an explanatory answer. This technique is aimed at helping him realize his goal of gathering more information without imposing constraints about what may or may not be discussed. The large colored arrows indicate the open end question asked by the manager. The small colored

arrows are the manager's feedback. He may evaluate the feedback in terms of how he constructed the question (tone of voice; gestures; words used; etc.) and how he used his body (posture and facial). The black arrows indicate the employee's verbal and nonverbal responses. This evaluation is extremely powerful feedback because it is immediate and relevant, that is, it is directly related to the skill the manager is attempting to practice.

have not changed radically.

Textbooks are still primary sources of information. There have been recent attempts to increase the impact of printed material by presenting a programmed instruction. The reader is asked, after being presented with a small amount of material, to make a response through multiple-choice selection, etc. The correct answer is shown. The textbook becomes, in effect, a workbook, and constant repetition helps the reader to retain the information.

Another source of data is lectures, both live and recorded. A variation is filmed lectures, which provide examples of problem situations in which the manager sees different ways in which the material can be used. They may serve as a prelude to a small group discussion.

One other approach for the manager is to attend a workshop or seminar in which information is presented by the instructor in such a way as to maximize interaction among the participants

and minimize formal presentation. The manager becomes actively involved with the material. In addition he taps the learning potential inherent in open discussion of the subject matter and in sharing his experiences and knowledge with the other participants.

A critical aspect of skill development is testing out what we have acquired in terms of a new knowledge, or a new approach, or a new technique. In this way the learner assesses how well the particular application moves him toward the desired result. It also indicates how much additional practice he may need to reach the goal.

There are several ways to arrange the application or practice sessions. A common way is to go it alone. This is the solo system in which the learner applies the technique by himself.

An example is the manager who may wish to increase his impact in making public presentations. He has read books on the organization of the material, on tips for gaining the audience's

attention and making his points dramatically. He has listened to expert speakers and observed what they did. Now, he attempts to put all of this input to work for him. He may make a presentation in front of a mirror or into a tape recorder or in front of a video-tape recorder. He then assesses the degree to which he was able to capitalize on his newly acquired knowledge.

THREE SOLID SYSTEMS THE MANAGER CAN USE TO TEST WHAT HE HAS ACQUIRED IN TERMS OF NEW KNOWLEDGE, A NEW APPROACH, OR TECHNIQUE: THE "SOLO," THE "BUDDY," AND THE "SIMULATION."

A different approach is the buddy system in which the learner, after some initial training inputs, is paired with an experienced performer. He carefully observes the behavior of the more skilled employee. Gradually, he performs on his own. At first, he is given the more rudimentary parts of the job. But once these are mastered to the satisfaction of the observer and coach, he is given an opportunity to try the more complex and demanding tasks.

Another method is to try to simulate the actual conditions under which the manager will be working as the setting for the application or practice session. The more closely the constructed situation matches the real one, the more meaningful the experience for the manager.

Simulation provides the manager with a relatively threat-free environment in which to practice, under conditions that approximate those he will face when he returns to his job. It also minimizes the consequences of a misapplication or a failure to perform adequately. The employee or the customer with whom the manager is working is, in fact, another manager who is also engaged in trying to develop his skill. It is a setting conducive to learning.

The feedback generated during an application or practice session provides the manager with information he can use to modify the skill he is attempting to improve. Repeated practice moves the manager close to his ultimate goal. Feedback helps him identify and assess the discrepancy between where he is and where he would like to be. (See the feedback loop shown on p. 49.)

One additional assist for the evaluation of feedback is to have a precise target against which the results of each practice can be evaluated. The more specific the definition of your goal, the better able you are to assess how close or how far you are from the target.

The evaluation of the outcome of the initial

trial or practice becomes an input for the succeeding application. The manager may decide, in order to approximate his goal more closely, to change the wording of his question, soften it, or in some other way refine what he did in the initial practice. He may also decide to change the tone of his voice, or speak more softly, or try to enunciate more clearly. He may also decide to assume a more relaxed posture to create an atmosphere in which the chances are increased that the employee will feel more freedom to speak.

The process is then repeated: application, feedback, evaluation of feedback, modification or adjustment, re-application, feedback, evaluation of feedback, modification, etc., until the manager has achieved the goal toward which he has been striving.

What follows is a description of what we have done at General Electric in one course to accelerate the attempts of managers to improve their skill in gathering and sharing information. The course is designed to capitalize on the conditions described earlier that enhance the acquisition and retention of a skill.

The approach has been used in the Management Practices Course. This course is designed for managers who, for the first time in their careers, have other professional employees reporting to them and a budget responsibility. The course lasts five days and is limited to 20 participants. It covers a variety of subjects appropriate to the problems that newly appointed managers face. However, only the portion that covers information gathering and sharing activity is discussed here.

This part of the course is essentially an introduction to the basics of man-manager communication. It consists of two four-hour modules. The goal of the first module is to provide the managers with input about:

- A model for an interpersonal communication system.
- Factors that impact such a communication system.
- A generalized structure for carrying on a discussion.
- Techniques or approaches that may help build and maintain a serviceable, workable, productive communication system within the framework of three settings:
 1. Work-planning conferences
 2. Selection interviews
 3. Career discussions

The module uses a workshop style in which the managers are involved in exploring the techniques, discussing their application, developing the material and practicing skills. Small group tasks have been devised to maintain their involvement and to enhance their understanding.

A role-playing situation is also used. It has as its

focus a discussion between a newly appointed manager and one of his men, a direct report. Two members of the course assume these roles. The "manager's" task is to obtain a description of the "man's" major job responsibilities. The focus is on the manager's use of the information-gathering and sharing techniques which had been developed and discussed in the course.

The 18 non-role-playing members serve as consultant/observer for the manager. They offer suggestions for possible application of the techniques and respond when the manager and the employee are going through the exercise. The course leader stops the discussion periodically to highlight particular aspects of the manager's approach, to elicit comments, suggestions and observations from the other managers and to ask the employee what his reactions are to the approach being used by the manager. The purpose of the interruptions is to provide feedback to the manager from multiple sources, to provide it immediately, and to give him an opportunity to evaluate the feedback and reapply the modified approach immediately.

The second module is designed to provide maximum opportunity for the managers to practice. It is devoted entirely to practice sessions in which the techniques developed and discussed in the first module are put to use.

The managers rotate through four roles during this module. They simulate two man-manager discussions: a selection interview and a career discussion. Each participant has an opportunity to be (1) a manager (the interviewer), (2) a candidate for a position or an employee (the interviewee), (3) an observer of the manager and (4) an observer of the candidate or employee. Each interview takes 30 minutes. This includes 10 minutes of preparation time. Written instructions are distributed to each participant for each role.

GE'S DATA GATHERING TRAINING COURSE IS DESIGNED TO IMPROVE SKILLS THROUGH WORKSHOPS AND ROLE PLAYING INTERVIEWS THAT ARE VIDEO-TAPED FOR EACH PARTICIPATING MANAGER'S SELF EXAMINATION.

Each 20-minute interview is video-taped. In the past we had used observers, then observers and audio tapes. With the availability of compact video-tape equipment, another dimension was added to the feedback for the manager. The video tape is played back immediately after the completion of the interview, and it becomes the focal point of the critique. The critique is the respon-

sibility of the two observers, and it is most customary for the observers, using their printed instructions, to stop the tape several times during their comments to amplify points they are making. It's also fairly common to replay certain portions to clarify particular points.

Both the manager and the employee contribute their observations during the critique. The manager talks about how it "feels" to ask a question a certain way and what it's like to have to "field" the response. It's quite different from talking about it in the workshop environment. The man being interviewed talks about how he felt when the manager did certain things and what impact that feeling had on the way in which he responded. As a consequence, the manager's own feedback is augmented by that of the two observers and the interviewee.

The manager's response to the replay of the video tape varies from person to person, but the initial responses are fairly consistent. They consist of such comments as: "I can't believe I sound like that!" or "My hair is really getting thin on top" and the inevitable "I should have worn a blue shirt." But in an amazingly short time the manager's anxiety disappears, and the focus is on the learning aspects of the experience. He now makes such remarks as: "I should have known that he would have responded with the school solution to a dumb question like that" or "If I had only thought to insert a softening phrase, he would not have been so defensive" or "That one really worked, and it felt good when I asked it!"

In summary, what we have tried to do is this:

- Make the feedback relevant by focusing on the specific techniques the manager is trying to improve during the practice session.
- Make the feedback immediate by providing the observers' and the interviewee's inputs as soon as possible and after the practice session.
- Enhance the quality of the feedback by making the actual behavior available for observation via the video tape.
- Capitalize on the dramatic effect of the video tape to highlight the impact of the experience.
- Set up the practice session so that it is perceived and used by the participants as a rewarding learning experience and not as a deflating punitive one.
- Make the practice sessions as close as possible to what the participant will face when he returns to his job.
- Encourage experimentation with the approaches so that they can be tested and adapted to fit the participant's own style in a supportive environment.

Remember the process: set a goal, acquire the input, apply, evaluate the feedback, modify or adjust, and repeat . . . repeat . . . repeat . . . repeat. ■■

New Helipot DAC & ADC Hybrids are MOS system compatible



Model 847 DAC & Model 871 ADC offer:

■ Integration of the best DAC/ADC functional elements from MOS/LSI, Bipolar and cermet thick-film technologies into *complete* hybrid converters.

■ MOS system compatibility (using 3750 & 3751).

■ Small, hermetic metal package & environmental specs per MIL-STD-883.

- Resolution
- Accuracy: (Code) at 25°C
-20 to 85°C
- Price (50-99 Quantity)
- Power Consumption

MODEL 847 DAC 10 bit

D1	D2	D3
±0.025%	±0.05%	±0.1%
±0.05%	±0.1%	±0.2%
\$165.00	\$148.75	\$136.00

350mW max.

MODEL 871 ADC 12 bit

D1	D2	D3
±0.025%	±0.05%	±0.1%
±0.05%	±0.1%	±0.2%
\$252.25	\$191.25	\$165.00

950mW max.

Call your local Helipot Sales Engineering Representative for additional information and application assistance.

Beckman

INSTRUMENTS, INC.

HELIPOT DIVISION FULLERTON, CALIFORNIA

INTERNATIONAL SUBSIDIARIES: AMSTERDAM; CAPE TOWN; GENEVA; GLENROTHES, SCOTLAND; LONDON; MEXICO CITY; MUNICH; PARIS; STOCKHOLM; TOKYO; VIENNA

INFORMATION RETRIEVAL NUMBER 28

ideas for design

Simultaneously measure four avalanche characteristics

Transistors in the avalanche mode usually produce pulses with rise times and delays of nano-second duration, depending on the transistor type, working conditions and trigger voltage. Measurements of these parameters can be done using the circuit shown and a sampling oscilloscope such as the Tektronix 661.

This circuit can display four parameters on the same oscilloscope beam:

- Delay between trigger and output pulses.
- Rise time of the output pulse.
- Amplitude of the trigger pulse.
- Amplitude of the output pulse.

These measurements are done by the algebraic addition of the trigger and the output pulses, using carbon resistors of known values. The diode-resistor combination at the transistor base prevents reflection of high-amplitude pulses from the avalanche output to the trigger generator. R_7 , R_6 , R_5 , and C_1 serve as a bias network and also as a 50-ohm termination to the generator.

The Tektronix 661 scope has two separate beams. One beam can be used to observe the output only, and the second beam for the four parameters mentioned.

The scope input impedance terminates the transmission lines so that there is no reflection in

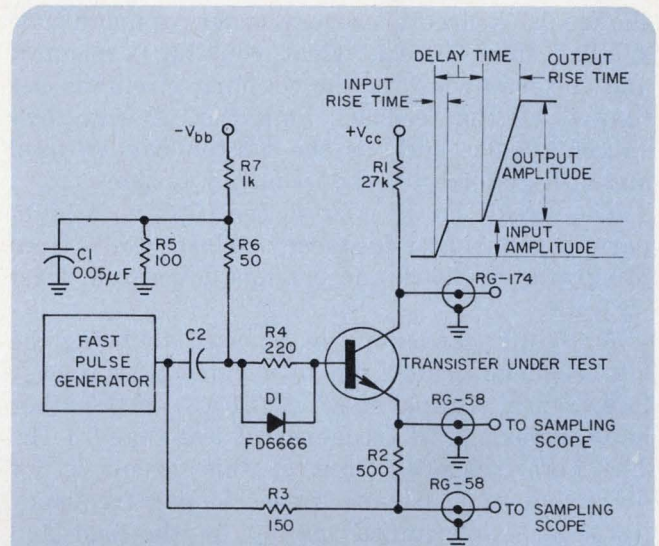

Measurement of the characteristics of transistors operating in the avalanche mode is simplified by displaying both amplitude and timing parameters simultaneously on a single oscilloscope beam.

the circuit. The shortest possible wire lengths should be used across the ground plane.

The following transistors were measured in this circuit: 2N2219, 2N2369, 2N918, 2N3033.

S. Eylon and Y. Carmel, Ministry of Defense, Scientific Dept., P. O. Box 7063, Tel Aviv, Israel.

VOTE FOR 311

Two spst relays can work as one spdt unit

Here's a simple way to connect two solid-state spst relays to form a single spdt unit. When no input is applied, load No. 2 is energized and load No. 1 is not. An input reverses this condition.

With no input, relay No. 2 is energized by the trickle current through load No. 1. This keeps the NORM CLOSED contacts closed and load No. 2 energized. When an input is applied to relay No. 1, the input to relay No. 2 drops to about $1/6$ V, and the relay de-energizes.

The resistive divider between the relays is needed to suppress inductive transients.

Needless to say, the two load power sources can be a common ac or dc supply.

Malcolm Field, Teledyne Relays, 3155 W. El Segundo Blvd., Hawthorne, Calif. 90250.

VOTE FOR 312

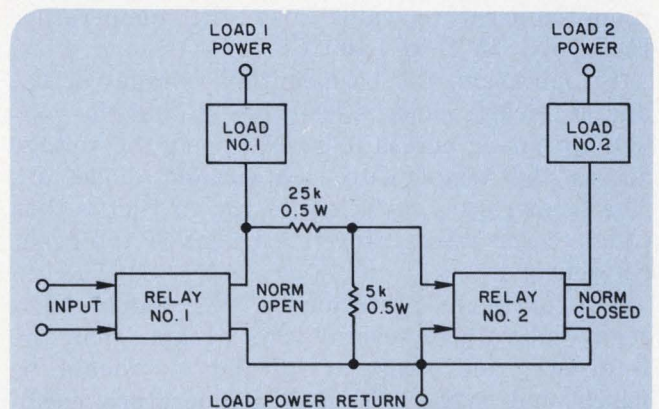

With no input, relay No. 2 is kept energized by the trickle current through load No. 1. This keeps load No. 2 normally on.

Ac amplifier eliminates use of coupling capacitor

A dc component in an input signal can be removed by feedback rather than by capacitor coupling. The advantages are that the capacitor in the feedback circuit is several orders of magnitude smaller than an equivalent coupling capacitor, and the bandwidth of the coupling circuit is not limited by the feedback amplifier. A very low-current device such as the LM108 can be used and still give megahertz frequency response.

The circuit shown is an active filter with high-pass response. Low-frequency rolloff results from integrator feedback and extends down to at least -80 dB.

A 100-pF capacitor can be used to bring the low-frequency cutoff up to a value that is easy to measure. A capacitance of 0.1 μF , on the other hand, gives a 3-dB frequency of less than 0.1 Hz. The high-frequency limit of this circuit is 1.4 MHz due to load capacitance. Upper frequency limits are determined mainly by the load and stray capacitance rather than by the operational-amplifier characteristics.

The lower 3-dB frequency can be calculated by writing node equations and finding the transfer function:

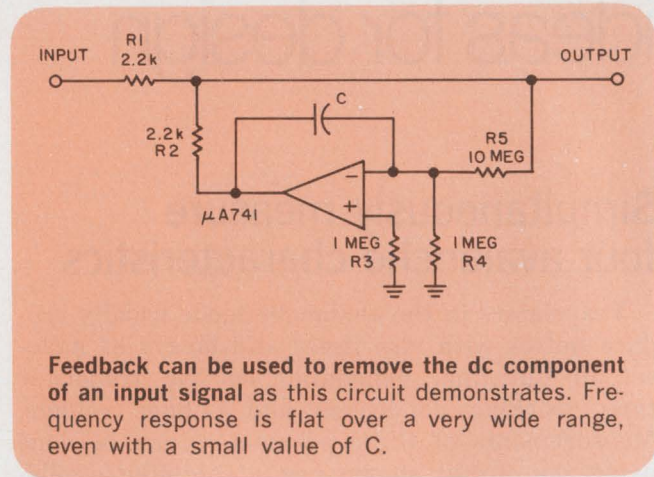

Feedback can be used to remove the dc component of an input signal as this circuit demonstrates. Frequency response is flat over a very wide range, even with a small value of C.

$$\frac{\text{Output}}{\text{Input}} = \frac{s R_2 / (R_1 + R_2)}{s + R_1 / R_5 C (R_1 + R_2)}$$

Evaluating the denominator with $s = j\omega$ and $C = 100 \text{ pF}$, shows the low-frequency cutoff to be approximately 80 Hz. The price paid for the benefits of this circuit is a 6-dB insertion loss and an output impedance not less than 1.1 k Ω .

Russell Kincaid, *Electronic Engineer, Sanders Associates, Inc., 95 Canal St., Nashua, N. H. 03060.*

VOTE FOR 313

Constant-current source uses dual transistor

The excellent base-emitter voltage-matching and temperature-tracking characteristics of monolithic dual transistors may be used with a temperature-compensated zener diode to produce an extremely stable current source. The circuit shown maintains the current within 0.7% of its room-temperature value over the temperature range of -55°C to +100°C.

In operation, the base-emitter voltages of Q_{1a} and Q_{1b} nearly cancel each other so that the voltage appearing across R_2 is effectively the voltage across the temperature-compensated diode, D_1 . The temperature coefficient of the current is thus equal to the temperature coefficient of the zener reference.

For optimum performance, V_{cc} should be a regulated voltage several volts greater than the reference, and resistors R_1 and R_2 should be wirewound types with low temperature coefficients.

R_1 and R_2 are chosen by using the equations:
 $R_1 = [V_{cc} - V_z - V_{be(Q1a)}] / [I_z + I_{b(Q1b)}]$
 and

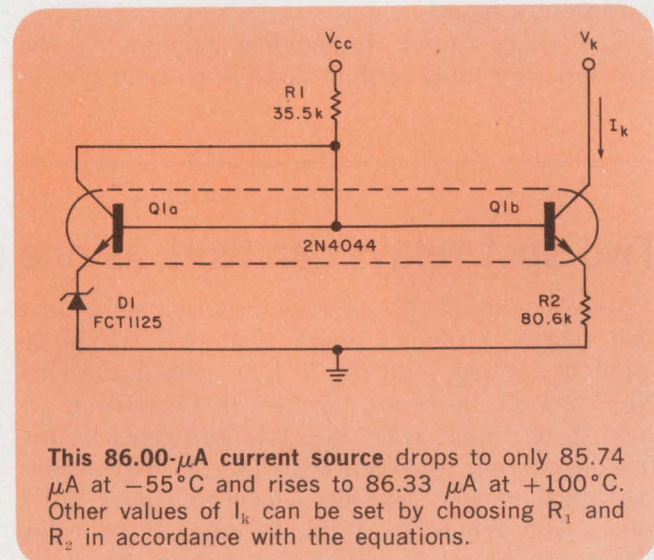

This 86.00- μA current source drops to only 85.74 μA at -55°C and rises to 86.33 μA at +100°C. Other values of I_k can be set by choosing R_1 and R_2 in accordance with the equations.

$$R_2 = V_z / [I_k + I_{b(Q1b)}].$$

Richard W. Smith, *Senior Development Engineer, Tempo Computers, Inc., 1550 S. State College Blvd., Anaheim, Calif. 92806.*

VOTE FOR 314

Low-pass filter has asymmetrical time constants

This circuit was developed to provide a long time constant for a positive step function and a considerably shorter one for the return to zero.

During the charging of C_1 , the base-to-emitter junction is reverse-biased and, therefore, Q has no effect on the time constant, R_1C_1 . However, when the input V_2 is about 0.5 V below V_1 , Q conducts and discharges C_1 so that V_1 tracks V_2 with a very short time constant. Note that Q does not conduct when $V_2 = 0$ and V_1 is less than V_{BE} ; the only way for C_1 to discharge to zero would be due to leakage and through any load resistance.

Base current is supplied by C_1 through R_1 and the low dc source resistance of V_2 . The forward resistance of diode D should be many times less than R_1 in order to have negligible effect on the

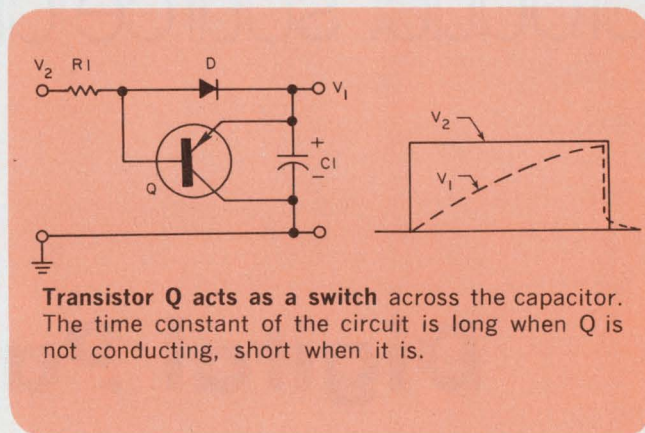

Transistor Q acts as a switch across the capacitor. The time constant of the circuit is long when Q is not conducting, short when it is.

charging time constant.

David C. Hobart, Electronics Engineer, Rancho Los Amigos Hospital, Neuromuscular Controls, 12826 Hawthorn St., Downey, Calif. 90242.

VOTE FOR 315

Get two voltages from one bridge rectifier

Electronic systems often require two power bus voltages, such as $+V$ and $+2V$. There are many schemes for obtaining two supply voltages, but one very effective method combines a full-wave rectifier with a full-wave bridge rectifier. This technique is shown in the figure.

Voltage V is obtained from the full-wave rectifier provided by D_1 and D_2 , which act as though D_3 and D_4 were not in the circuit. The voltage $2V$ is obtained from the full-wave bridge of D_1 , D_2 , D_3 and D_4 , which act as though the transformer center tap was not in the circuit. Diodes D_1 and D_2 carry current both V and $2V$ outputs, of course, and this must be considered when selecting the diodes. The diodes D_3 and D_4 carry output current for the $2V$ output only.

James M. Loe, Engineering Specialist, Philco-Ford Corp., 1400 Union Meeting Road, Blue Bell, Pa. 19422.

VOTE FOR 316

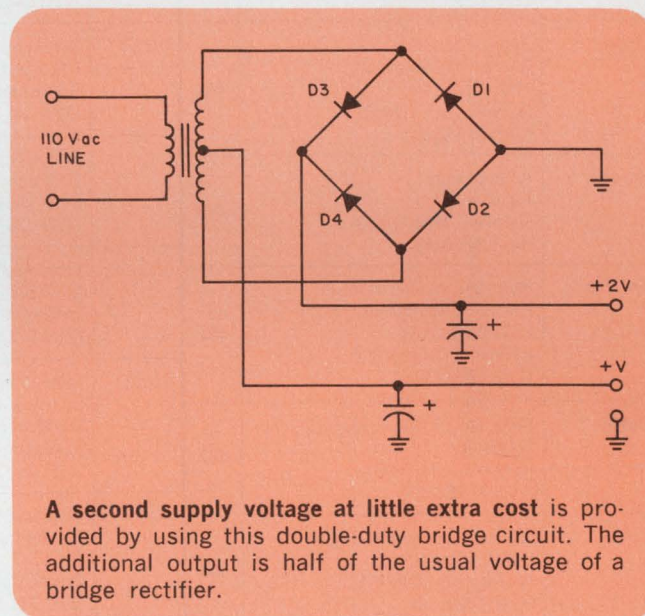

A second supply voltage at little extra cost is provided by using this double-duty bridge circuit. The additional output is half of the usual voltage of a bridge rectifier.

IFD Winner for September 27, 1970

Davis E. Wilson, Supervisor, Support Systems, Lockheed Missiles & Space Co., P. O. Box 4097, Patrick AFB, Fla. His idea "Tunable Low-Cost LC Oscillator Has Excellent Stability" has been voted the Most Valuable of Issue award.

Vote for the Best Idea in this Issue.

IFD Winner for October 11, 1970

Ronald J. Turner and Richard W. Spencer, General Atronics Corp., 1200 E. Mermaid Lane, Philadelphia, Pa. 19118. Their idea "Improve Amplifier Efficiency With Positive Feedback" has been voted the Most Valuable of Issue award.

Vote for the Best Idea in this Issue.

product source directory

Digital Panel Meters

The digital panel meters in this Product Source Directory are arranged in ascending order by the number of digits they offer and then alphabetized according to manufacturer.

Manufacturers are identified by the abbreviations shown in the Master Cross Index below.

The following abbreviations are used in the tables: ext—extended; req—price on request.

Abbrev.	Company	Info. Ret. No.	Abbrev.	Company	Info. Ret. No.	Abbrev.	Company	Info. Ret. No.
API	API Instruments Co. 11655 Chillicothe Rd. Chesterland, Ohio 44026 (216) 729-1611	448	Digilin	Digilin, Inc. 1007 Air Way Glendale, Calif. 91201 (213) 240-1200	457	Neutronic	Neutronic Corp. Park & Church St. St. Peters, Mo. 63376 (314) 278-4446	466
Abbey	Abbey Electronics Div. of Liquidonics Inc. 45 S. Service Rd. Plainview, N.Y. 11803 (516) 293-6800	449	Dixon	Dixon Instruments P.O. Box 1449 Grand Junction, Colo. 81501 (303) 242-8863	458	Newport	Newport Laboratories, Inc. 630 E. Young St. Santa Ana, Calif. 92705 (714) 540-4914	467
Analogic	Analogic Corp. Audobon Rd. Wakefield, Mass. 01880 (617) 246-0300	450	E-N	Electro-Numerics Corp. 2961 Corvin Dr. Santa Clara, Calif. 95051 (408) 738-1840	459	Preston	Preston Scientific, Inc. 805 E. Cerritos Ave. Anaheim, Calif. 92805 (714) 776-6400	468
Beckman	Beckman Instruments Inc. Electronic Instruments Div. 2200 Wright Ave. Richmond, Calif. 94804 (415) 526-7730	451	EDL	Electronic Design Laboratories, Inc. Box 7837 Philadelphia, Pa. 19101 (215) 925-9500	460	Simpson	Simpson Electric Co. 5200 W. Kinzie St. Chicago, Ill. 60644 (312) 379-1121	469
Beede	Beede Electrical Instrument Co., Inc. S. Main St. Penacook, N.H. 03301 (603) 753-6362	452	Gralex	Gralex Industries Div. of General Microwave Corp. 155 Marine St. Farmingdale, N.Y. 11735 (516) 694-3607	461	Systron	Systron-Donner Corp. 888 Galindo St. Concord, Calif. 94520 (415) 682-6161	470
Calico	California Instruments Corp. 5150 Convoy St. San Diego, Calif. 92111 (714) 279-8620	453	Honeywell	Honeywell Inc. Test Instrument Div. Box 5227 Denver, Colo. 80217 (303) 771-4700	462	TSC	Time Systems Corp. 265 Whisman Rd. Mountain View, Calif. 94040 (415) 961-9321	471
Comp. Prod.	Computer Products, Inc. 1400 N.W. 70th St. P.O. Box 23849 Fort Lauderdale, Fla. 33307 (305) 933-5561	454	ID	Instrument Displays, Inc. Sub. of Burns & Towne Inc. 18 Granite St. Haverhill, Mass. 01830 (617) 374-0311	463	Triplett	Triplett Electrical Instruments Co. 280 Harmon Rd. Bluffton, Ohio 45817 (419) 358-5015	472
Data Tech	Data Technology Corp. 1050 E. Meadow Circle Palo Alto, Calif. 94303 (415) 321-0551	455	IEC	International Electronics Corp. Box 151 Fairport, N.Y. 14450 (716) 377-5990	464	United	United Systems Corp. 918 Woodley Rd. Dayton, Ohio 45403 (513) 254-6251	473
Datascan	Datascan, Inc. 1111 Paulison Ave. Clifton, N.J. 07013 (201) 478-2800	456	NLS	Non-Linear Systems, Inc. Box N Del Mar, Calif. 92014 (714) 755-1134	465	Weston	Weston Instruments Div. Weston Instruments, Inc. 614 Frelinghuysen Ave. Newark, N.J. 07114	474

Measure, monitor, count, convert, test...

Only Weston does it all.

Weston started the "digital revolution" in 1967, and already we're well into our second generation. These eight examples include two of the most advanced portable instruments ever built. All benefit from the logic and dual slope[®] circuitry that Weston pioneered and patented.

All Weston digital panel meters feature repairable (non-potted) circuit boards, overranging, compact functional styling,

*U.S. Pat. = 3,051,939

**NIXIE—Reg. trademark, Burroughs Corp.

outstanding noise rejection, front panel mounting, Nixies** and top-rated interchangeable components. Most are available with BCD output, and they can be coupled to standard transducers for precise reading of any engineering unit.

The 26-range DMM offers full AC/DC voltage, current and resistance measuring capability with complete circuit overload protection. Its "sister" VOM is an 11-range

portable with 0.1% accuracy. Both models are panel-convertible and battery powerable.

You'll find the answer to your OEM or replacement needs in our digital line catalog. Write for it today, and go digital with Weston. WESTON INSTRUMENTS DIVISION, Weston Instruments, Inc., Newark, N.J. 07114 a Schlumberger company

WESTON[®]

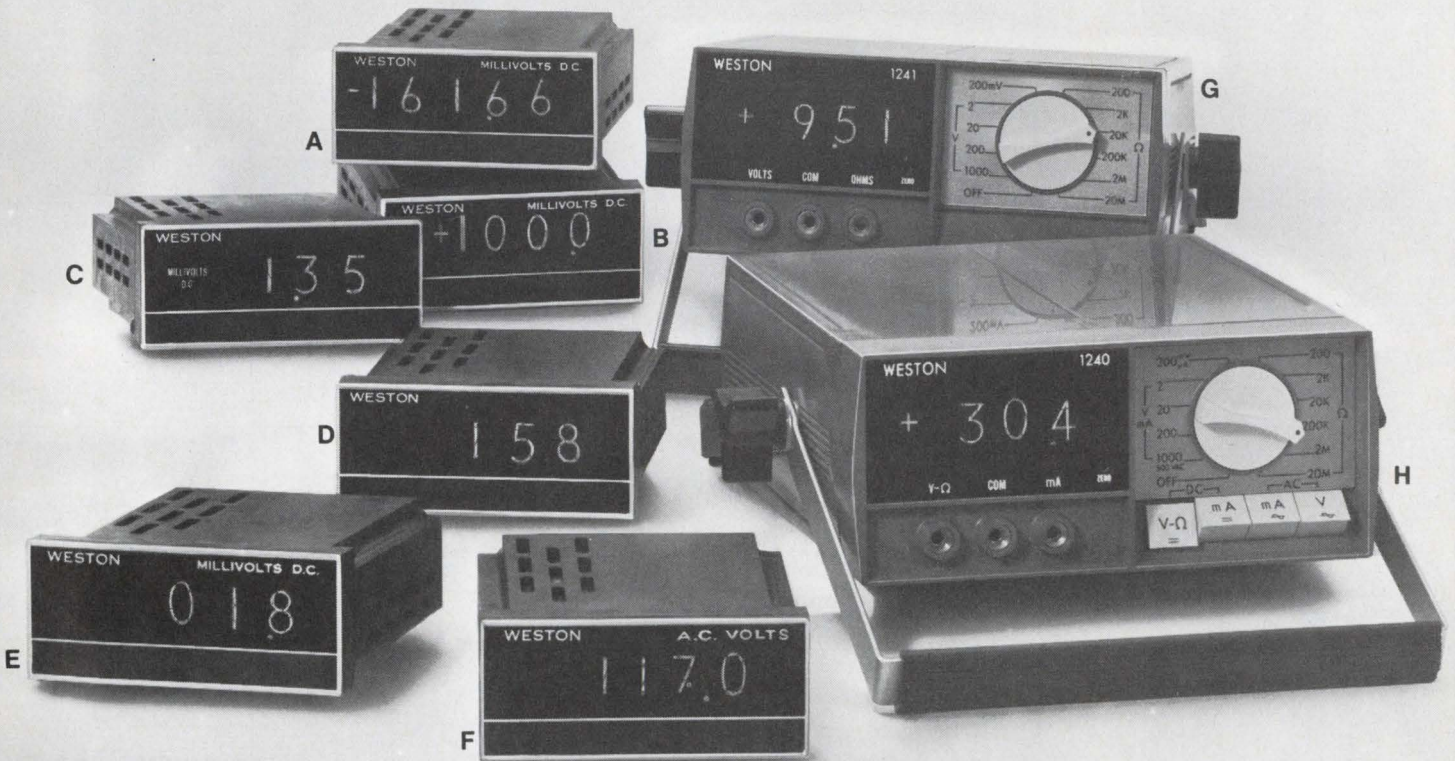

A. 4 1/2-digit bi-polar Model 1294 B. 3 1/2-digit bi-polar Model 1292 C. 2 1/2-digit Model 1260 D. Event Counter Model 1266 E. 3-digit Model 1261
F. AC Line Monitor Model 1262 G. Digital VOM Model 1241 H. Digital Multimeter Model 1240

Manufacturer	Model	No. of Digits	Full-scale Accuracy (%)	Full-scale Ranges Available Min-Max	Speed (read/s)	Basic Price (\$)	Notes
United	271A, 272A	3-½	0.1	199.9 mV-1 kV dc; 19.99 µA-199.9 mA dc	60	195	b,e,m,r,s
Weston	1262	3-½	0.2	150 V ac	5	195	r,s
Weston	1290	3-½	0.1	0.1 V-1 kV; 10 µA-0.1 A	6	260	c,k,s
Weston	1292	3-½	0.1	0.1 V-1 kV; 1 µA-0.1 A	5	283	c,d,h,m,s
Analogic	2511-1A	3 (ext)	0.05	299.9 mV-999 V dc; 2.999 mA-29.99 A dc; 29 Ω-29.99 MΩ	60	269	a,b,c,r,s
Analogic	2511-1B	3 (ext)	0.05	299.9 mV-999 V dc; 2.999 mA-29.99 A dc; 29 Ω-29.99 MΩ	60	249	a,b,c,r,s
Analogic	2511-2A	3 (ext)	0.05	299.9 mV-999 V dc; 2.999 mA-29.99 A dc; 29 Ω-29.99 MΩ	60	259	a,b,c,r,s
Analogic	2511-2B	3 (ext)	0.05	199.9 mV-999 V dc; 1.999 nA-19.99 A dc; 19 Ω-19.99 MΩ	60	239	a,b,c,r,s
Abbey	DM-25A	4	0.1	0.1 V-1 kV dc; 1 µA-100 A dc	0.25	429	
Comp. Prod.	DP400 series	4	0.02	999.9 mV-99.99 V dc	5	273-288	f,s
Data Tech	345	4	0.03	999.9 mV-999.9 V dc	5	295	h
Dixson	VT-200	4	0.05	99.99 mV dc; 99.99 µA dc	3-10	330	c,h,j,m,v
E-N	3304	4	0.01	1.1999 V-1 kV; 1.1999 µA-1.1999 A	60	335	f,k
E-N	3400	4	0.01	0.9999 V-1 kV dc; 9.999 µA-99.99 mA dc	20	495	c,m
United	275A	4	0.05	999.9 mV-999.9 V dc	60	295	b,e,m,r,s
Analogic	2516	4-½	0.01	±1.5±15 V or dual range	4.5	110	r,s
Calico	8440	4-½	0.01	1.5-150 V dc or ac; 1 kΩ-10 MΩ	4	395	
Data Tech	344	4-½	0.01	140 mV-999.9 V dc; 140 µA-100 mA dc	5	475	c
Datascan	720	4-½	0.02	1-100 V; 10 µA-0.1 A	2	370	d
Datascan	721	4-½	0.02	1-100 V	2	250	
E-N	3240	4-½	0.005	1.9999 V-1 kV; 1999.9 µA-1.9999 A	60	369	
E-N	3305	4-½	0.005	1.9999 V-1 kV; 1.9999 µA-1.9999 A	10	375	
E-N	3410	4-½	0.005	1.9999 V-1 kV dc; 19.999 µA-199.99 mA dc	20	550	c,m
E-N	3412	4-½	0.0025	3.9999 V-1 kV dc; 39.999 µA-399.99 mA dc	20	595	c,m
Neutronic	100B	4-½	0.1	199.9 mV-999 V dc or ac; 199.9 nA-199.9 mA dc or ac; 199.9 Ω-1.999 MΩ	2	req	c,d,f,g,h,j,k,m
Newport	Series 2000	4-½	0.01	199.99 mV-199.99 V dc; 1.9999 V-199.99 V ac; 19.999 µA-199.99 mA dc;	30	385	b,c,d,f,h,k,m,n,y
Systron	7040	4-½	0.01	1 V-1 kV	3	475	
Weston	1294	4-½	0.05	0.1 V-1 kV; 10 µA-0.1 A	5	350	a,d,m,r,s

- a. Features low power dissipation
- b. High-stability unit
- c. Includes BCD output
- d. Bipolar unit
- e. Unipolar unit
- f. Programmable
- g. Transformer-isolated input
- h. Features auto-polarity
- i. Features solid-state display
- j. Features automatic zero
- k. Display can be held
- m. Includes out-of-range indicator
- n. Can be battery operated
- p. Display can be held or updated automatically or manually
- q. Has differential input
- r. Accuracy is percentage of reading
- s. Accuracy also variable by plus-and-minus one digit
- t. Accuracy also variable by plus-and-minus one-half digit
- u. Ratiometric unit
- v. Includes built-in calibration reference
- w. Includes analog light-meter indicator
- x. Features step-ramp front end
- y. Features input and output isolation
- z. Includes pushbutton range control that provides equivalent 4-½-digit accuracy

Seven-month index to the Product Source Directories

The index below covers all Product Source Directories published since May, 1970. This index and the Directory in this issue end our Directory-in-issue program. ELECTRONIC DESIGN, however, will continue to publish comprehensive directories

in meaningful product areas on occasion.

For each product category, the index shows both the issue in which the Directory was published and the number assigned to the Directory table(s).

Product	Table(s)	Issue
Calculators, electronic	106-107	ED 15, July 19
Connectors, PC-board	126-129	ED 20, Sept. 27
Connectors, rack-and-panel	124-125	ED 19, Sept. 13
Converters, a/d	108-112	ED 16, Aug. 2
Converters, d/a	113-118	ED 16, Aug. 2
Digital panel meters	163-164	ED 26, Dec. 20
Digital voltmeters	146-147	ED 24, Nov. 22
Display devices	96-100	ED 14, July 5
Display devices, addendum	96a-100a	ED 17, Aug. 16
Frequency counters	148-149	ED 24, Nov. 22
Frequency synthesizers	82	ED 12, June 7
IC testers	139-141	ED 22, Oct. 25
Keyboards	144-145	ED 23, Nov. 8

Product	Table(s)	Issue
Memories, semiconductor	101-105	ED 15, July 19
Microwave oscillators, low-power tubes	130-138	ED 21, Oct. 11
Microwave oscillators, solid-state	157-162	ED 25, Dec. 6
Operational amplifiers	83-95	ED 13, June 21
Operational amplifiers, addendum	83a-95a	ED 17, Aug. 16
Oscilloscopes	150-154	ED 24, Nov. 22
Semiconductor testers	142-143	ED 22, Oct. 25
Spectrum analyzers	155-156	ED 24, Nov. 22
Trimmer potentiometers	120-123	ED 18, Sept. 1
Word generators	119	ED 17, Aug. 16
Word generators, addendum	119a	ED 24, Nov. 22

new products

MOSFET multiplexer expands to 64 channels

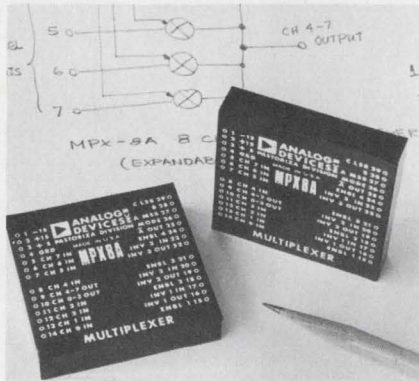

Analog Devices, Inc., Pastoriza Div., 385 Elliot St., Newton Upper Falls, Mass. Phone: (617) 332-2131. P&A: \$175; stock.

The MPX-8A is a complete eight-channel high-speed MOSFET multiplexer that operates from ± 15 -V power supplies and is expandable up to 64 signal channels in single-ended or differential form.

This DTL/TTL-compatible unit operates over an analog voltage range of ± 10 V and is over-voltage protected to ± 20 V. Its switching time to $\pm 0.01\%$ of full scale is only 300 ns when going from -10 to $+10$ V. A worst-case switching time of $2 \mu\text{s}$ maximum occurs when going from $+10$ to -10 V.

The MPX-8A has all the needed logic elements required to expand to 64 channels, internally. Mode control, programmed by the user with a jumper at the terminals, determines whether eight-channel single-ended or four-channel differential switching takes place.

Because it is a unipolar device, the MPX-8A contributes no offset voltage to the processed signal. Since the new multiplexer requires gate excitation to turn on, all switches are turned off upon removal or degradation of power, thus guarding active signal sources against damage due to inadvertent turning on of more than one channel. The binary address control further guards against inadvertent turning on of more than one channel at a time.

ON resistance is $1 \text{ k}\Omega$ and OFF resistance is $1 \text{ M}\Omega$ for each channel. Input capacitance is only 10 pF and crosstalk is -80 dB .

CICRLE NO. 250

Uhf 12-V amplifiers give 12 W of power

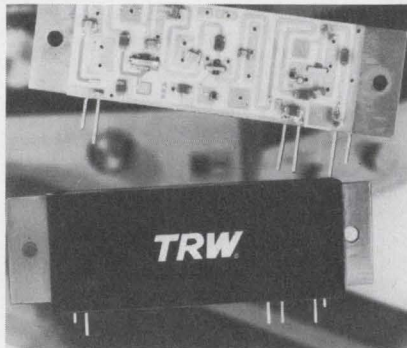

TRW Semiconductor Div., 14520 Aviation Blvd., Lawndale, Calif. Phone: (213) 679-4561. Availability: stock.

Five new broadband 12-V uhf amplifiers, designated MX 0.75, 1.5, 2.5, 7.5, and 12, deliver from $3/4$ to 12 W of output power with 16 to 21 dB of gain and withstand infinite VSWR at 15 V. They give a high level of harmonic rejection and measure only 2.5-in.-long by 0.82-in.-wide by 0.3-in.-deep. They meet stringent rf specifications and exhibit good stabilities.

CIRCLE NO. 251

12-bit a/d converter is 0.05% accurate

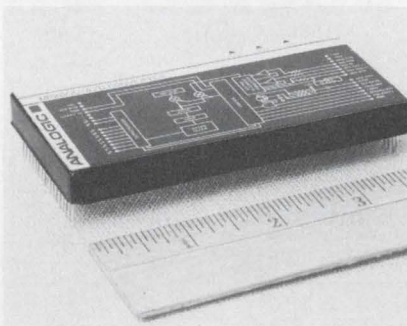

Analogic Corp., Audubon Rd., Wakefield, Mass. Phone: (617) 246-0300. P&A: \$175; 3 to 4 wks.

The new Adpac MP2600 integrating-type a/d converter provides 12-bit binary-bit or 3-1/2-digit-BCD outputs at 0.05% accuracy and 7.5-ms total conversion time. Its true differential input presents $100\text{-M}\Omega$ impedance and its digital inputs and outputs are DTL/TTL compatible. The converter measures 4 by 2 by 0.39 in. and is electrically and mechanically shielded.

CIRCLE NO. 252

Op amp power booster supplies 100 mA at 10 V

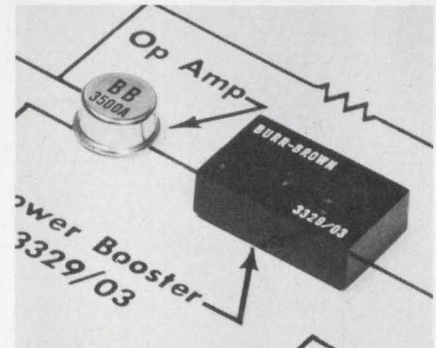

Burr-Brown Research Corp., International Airport Industrial Park, Tucson, Ariz. Phone: (602) 294-1431. P&A: \$20; stock.

Model 3329/03 power booster amplifier features $10\text{-}\Omega$ output impedance (open loop), output current of $\pm 100 \text{ mA}$ at $\pm 10 \text{ V}$, and full-output short circuit protection. It is designed for cascading and functions as a high-current output stage. It is used inside feedback loops as though it were an integral part of an operational amplifier. No heat sink is required.

CIRCLE NO. 253

LED segmented readout plugs-in vertically

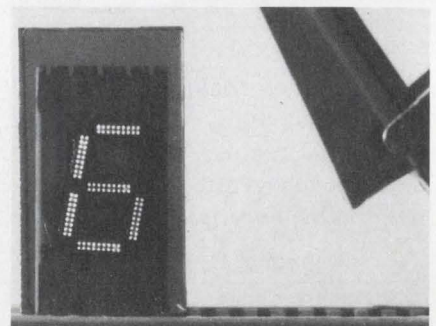

Litronix, 10440 N. Tantau Ave., Cupertino, Calif. Phone: (415) 329-0810. P&A: \$9.85; stock.

A seven-segment numeric LED readout, the Data-Lit 3, can be plugged into a PC-board edge card connector for a vertical display. The unit is built with common-anode lead construction for easier and more reliable insertion. Made of gallium-arsenide-phosphide, the DTL-TTL-compatible display uses one chip for each segment. It requires only 1.7 V per segment.

CIRCLE NO. 254

Linear IC tester performs 14 checks



Microdyne Instruments, sub. of Computest Corp., 203 Middlesex Turnpike, Burlington, Mass. 01803. Phone: (617) 272-5691. Price: \$7850.

Designed for both the manufacturer and the end user, a new benchtop linear IC tester, model 735, can check operational amplifiers, regulators and comparators with up to 14 individual tests, allowing analysis of monolithic, hybrid, or discrete circuits. Test time is typically under one second and can be adjusted to fit individual high-speed applications.

CIRCLE NO. 255

Multi-function generator carries \$365 price tag



Clarke-Hess Communication Research Corp., 43 W. 16th St., New York, N. Y. Phone: (212) 255-2940. P&A: \$365; stock.

Tagged for only \$365, the model 743 function generator provides low-distortion sine, square, and triangular waves over six dial-controlled ranges from 1 Hz to 2 MHz. Outputs of up to 20 V pk-pk are adjustable over a 60-dB range. The new instrument also includes both tone-burst and synchronization or phase-lock capabilities.

CIRCLE NO. 256

AIRPAX makes

- THE HIGHEST QUALITY
 - MOST RELIABLE
 - BEST PERFORMING
- magnetic circuit breakers**
—in the world

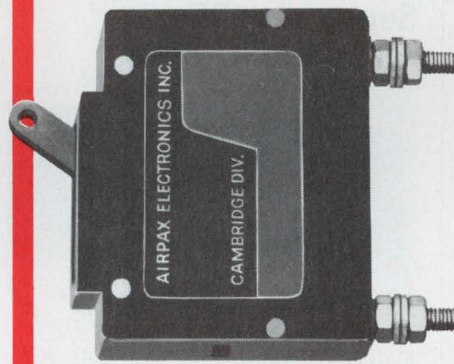

250
VOLTS

5000
AMPS

Quality, reliability, performance, and service. The circuit breakers you use *must* have these essential characteristics. Your equipment and your reputation will depend on it. Airpax has a reputation to uphold, too. That's why they will never sacrifice the quality of their circuit breakers for *any* reason — manufacturing economies, lower selling price, or whatever. Want to know more? Call or write Airpax Electronics, Cambridge Division, Cambridge, Maryland 21613. Phone (301) 228-4600. Telex: 8-7715. TWX: (710) 865-9655.

AIRPAX ... components of confidence.

Field-effect transistors have 5-Ω ON resistance

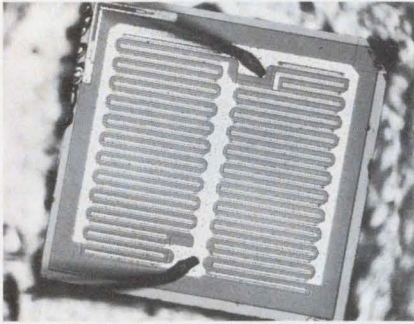

Intersil Inc., 10900 N. Tantau Ave., Cupertino, Calif. Phone: (408) 257-5450. P&A: \$24.90, \$19.90, \$15; stock.

A new n-channel FET family exhibits exceptionally low drain-to-source ON resistance as low as 5 Ω. The 2N5432, 2N5433 and 2N5434 are specified at 5, 7 and 10 Ω, respectively. These silicon planar epitaxial-junction FETs, switching on in 6 ns, have 0.2-nA leakage currents and gains of 25,000 μmhos. Each FET occupies a 0.031-by-0.033-in. chip.

CIRCLE NO. 257

Plastic 6-A rectifiers cost less than \$1.00

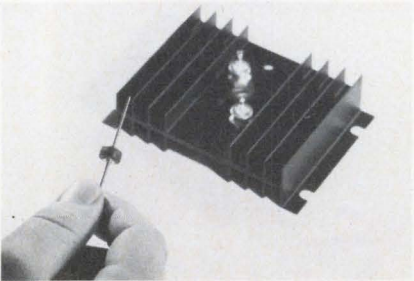

Motorola Semiconductor Products Inc., P. O. Box 20924, Phoenix, Ariz. Phone: (602) 949-2703. Price: 45¢ to 90¢.

Supplied in plastic axial-lead cases, series MR751 6-A silicon rectifiers range in cost from 45¢ to 90¢ for 100-unit quantities. The new devices are available in four working peak reverse voltage ratings—100, 200, 400 and 600 V. Their maximum forward voltage drop is 0.9 V, and their maximum reverse current is 0.25 mA at rated dc voltage.

CIRCLE NO. 258

High-speed thyristors can switch 150 kW

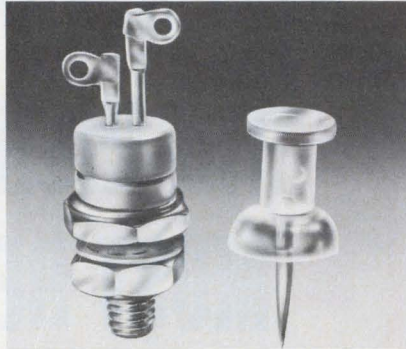

Mullard Inc., 100 Finn Court, Farmingdale, N. Y. Phone: (516) 694-8989.

Primarily designed for use as pulse modulators in radar equipment, series BTX95 high-speed thyristors can switch peak powers of 150 kW at rates as fast as 5 kHz. Voltage ratings for the units vary from 500 to 800 V. Their maximum operating junction temperature is 105°C. The standard housing for the new thyristors is a TO-64 package.

CIRCLE NO. 259

Sense amplifier responds in 25 ns

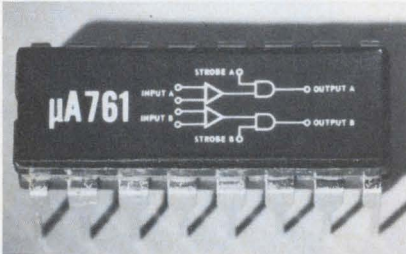

Fairchild Semiconductor, 464 Ellis St., Mountain View, Calif. Phone: (415) 962-3563. Price: \$3.75 to \$7.13.

A new two-channel core-memory sense amplifier, model μA761, provides a 25-ns response time and a typical threshold accuracy of ±2 mV. The device features two independent channels, each of which can sense up to 4000 bits of information. The channels share common reference and supply voltages but have independent strobe inputs to enable the amplifier during core peaking times.

CIRCLE NO. 260

Chip capacitors minimize drift

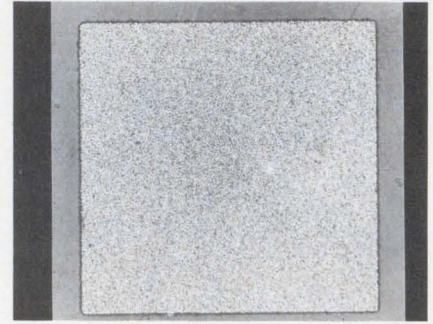

Sloan Microelectronics, div. of Sloan Technology Corp., 130 Maryland St., El Segundo, Calif. Phone: (213) 322-9340. Availability: stock.

Featuring a temperature coefficient of capacitance of just 25 ppm/°C ±10 ppm/°C, a new line of chip capacitors provides a voltage rating of 20 V at 0.18 pF per square mil. The units measure only 40 mils square and offer capacitance values of 1 to 180 pF. Maximum drift is 0.5%, dissipation factor is 0.2% at 1 kHz, and leakage current is 500 pA.

CIRCLE NO. 261

Full-wave rectifier rates 40 A per leg

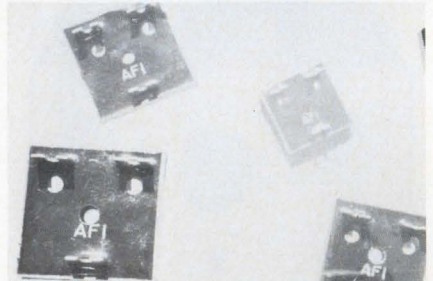

Arthur Fallon Industries, Industrial Way West, Eatontown, N. J. Phone: (201) 542-1393. P&A: \$2.25; 14 days.

A new full-wave rectifier packaged in a 1-1/2-in. square encapsulated case features a current rating of 40 A dc per leg at a case temperature of 55°C. Other specifications of the new device include reverse voltage rating up to 400 V, 1000-A peak one-cycle surge current and a junction operating and storage temperature range from -50 to +175°C.

CIRCLE NO. 262

Solid-state inductor provides 1 to 100 H

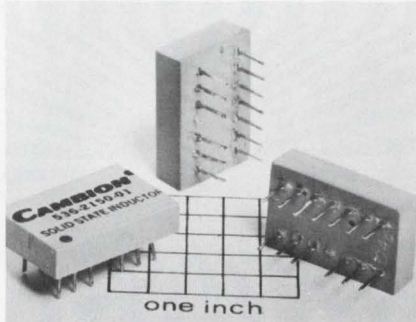

Cambridge Thermionic Corp., 445 Concord Ave., Cambridge, Mass. Phone: (617) 491-5400. P&A: approx. \$15; stock.

A new solid-state 14-pin DIP inductor weighing less than 3 grams provides an externally variable inductance from 1 to over 100 H. The 536-2150-01 inductor has no external magnetic field, contains no magnetic materials and no windings. Usable below 100 Hz, it has Q values of 15 at 1 Hz or less. Inductances greater than 100 H are also available.

CIRCLE NO. 263

DIP resistors match to 0.5%

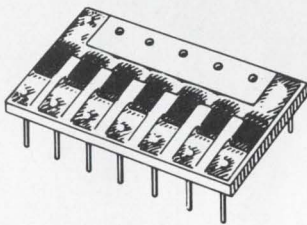

Microtek Div. Components, Inc., Biddeford, Me. Phone: (207) 282-5111.

Series SN DIP-compatible thick-film resistor networks provide up to seven $\pm 2\%$ precision resistors that are matched to $\pm 0.5\%$. The units also feature a tracking specification that is better than 10 ppm over the temperature range of -65 to $+125^\circ\text{C}$. They are said to be unaffected by moisture, salt spray or hydrogen atmosphere. Resistances range from $10\ \Omega$ to $1\ \text{M}\Omega$.

CIRCLE NO. 264

Solid-state relays interface power devices

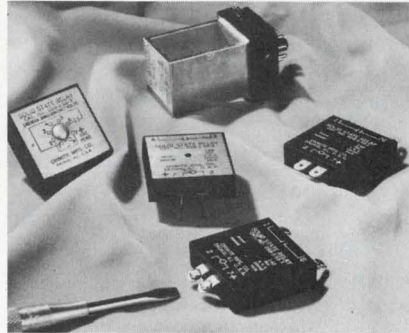

Ohmite Manufacturing Co., 3601 Howard St., Skokie, Ill. Phone: (312) 675-2600. P&A: \$21.90 (SSB), \$10.95; \$12.95 (SSS8, SSS15).

A new line of solid-state relays and switches provide interface between low-power relays or switches and high-power loads. SSB relays operate from 3.5 V at 2 mA with a 200-mV hysteresis and 1-ms speed. SSH hybrid relays operate with voltages of 5, 10 and 20 V at 33, 17 and 10 mA, respectively. They also operate at 1 ms. SSS switches can switch 8 or 15-A loads.

CIRCLE NO. 265

Small film resistor stacks up 333 M Ω

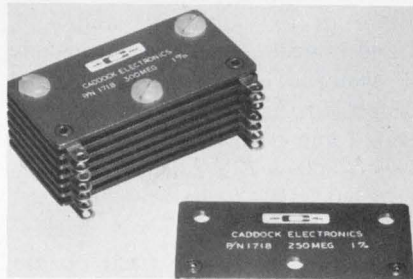

Caddock Electronics, 3127 Chicago Ave., Riverside, Calif. Phone: (714) 683-5361.

A multi-megohm precision film resistor can provide resistance values of a billion ohms or more with its series-connected stack-up configuration. Protected by conformal encapsulation, model 1718 measures just 2.02 by 0.01 by 0.09 in. Resistances range from 1 to $333\ \text{M}\Omega$ with power ratings of 2 W at 125°C .

CIRCLE NO. 266

Phototransistors deliver 12 mA

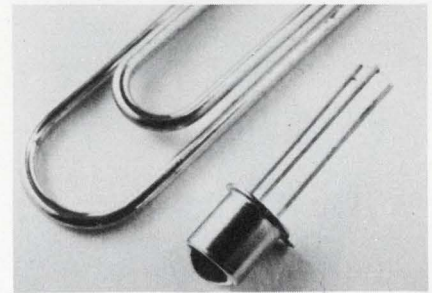

Clairex Electronics, 560 S. Third Ave., Mt. Vernon, N. Y. Phone: (914) 664-6602. Price: \$1.15 to \$1.38.

Series CLT 2100 high-gain phototransistors provide light currents of up to 12 mA at 5 V and 5 mW per square centimeter. Dark currents are 25 nA at 10 V with collector-to-emitter breakdown voltages of up to 50 V. A narrow 3:1 light-sensitivity range is standard, and rise and fall times of $3\ \mu\text{s}$ are typical. The devices come in hermetically sealed three-lead TO-18 packages.

CIRCLE NO. 267

Wideband amplifier holds noise to 2 dB



KMC Semiconductor Corp., Microwave Products Div., Parker Rd., Long Valley, N. J. Phone: (201) 876-3811.

Boasting a maximum noise figure of less than 2 dB, a new wideband amplifier performs over the frequency range of 225 to 450 MHz. Model 0225-20 also features better than 30 dB of gain. The unit furnishes a compression level of 1 dB when output power is 100 mW. The new amplifier is an addition to an existing family of devices ranging in price from \$130 to \$550.

CIRCLE NO. 268

**12-digit calculator
retails at \$395**



National Cash Register Co., Dayton, Ohio. Phone: (513) 449-2150. Price: \$395.

The new NCR 18-15 MOS/MSI calculator features a 12-digit display in a 6 by 4 by 11-in. case at a price of only \$395. It performs the four basic arithmetic functions of addition, subtraction, multiplication and division and offers chain multiplication and division without intermediate use of the equals operation. It also has automatic credit balance with negative and overflow indications.

CIRCLE NO. 269

**Economy tape transport
retails at only \$250**

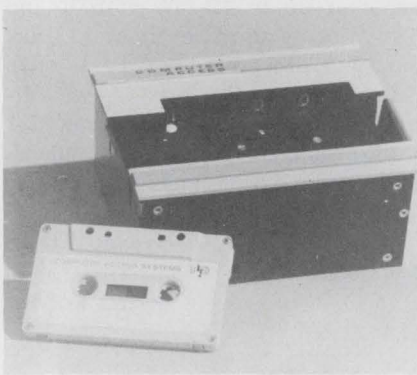

Computer Access Systems, Inc., 3050 W. Clarendon, Phoenix, Ariz. Phone: (602) 279-5591. P&A: \$250; 30 days.

A new low-cost cassette-tape transport with a recording and retrieval rate of 1000 8-bit characters/second is priced at just \$250 in OEM quantities. The model 1250 is a 4.5 by 6 by 2.5-in. unit with a read/write capability in incremental and continuous operations. Forward and reverse tape speed is 10 in./s, start times are 40 ms and stop time is 80 ms.

CIRCLE NO. 270

**Data generator/analyzer
simplifies testing**

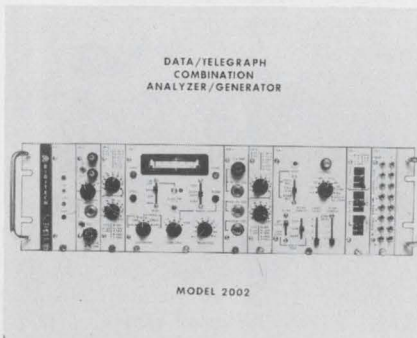

Digitech Data Industries, Inc., 66 Grove St., Ridgefield, Conn. Phone: (203) 438-3731.

The 2002 combination generator/analyzer can generate and analyze data signals from 45.5 to 9600 bits/s in 16 increments and 5, 6, 7 and 8-level codes, asynchronously as well as synchronously. Signal distortions up to 49% may be generated and read in 1% increments. The 2002 is RS-232C compatible and can also generate Fox test messages and parity error checks.

CIRCLE NO. 271

**40.8-kbit/s data set
transmits to 1/2 mile**



Tuck Electronics, 235 Market St., New Cumberland, Pa. Phone: (717) 232-3431. P&A: \$800; 30 days.

The new model 1098 data set directly replaces the Bell 301B data set for distances up to 1/2 mile at 40.8 kbit/s and up to 1000 feet at 240 kbits/s. The set includes crystal clocks and full duplex service. Asynchronous, bi-synchronous or synchronous-transmit-receive service is available.

CIRCLE NO. 272

**Low-cost marking ink
withstands 2500°F**

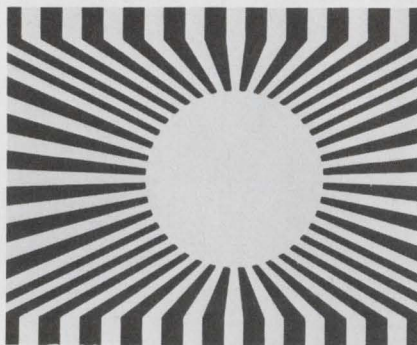

Starnetics Co., 10639 Riverside Dr., N. Hollywood, Calif. Phone: (213) 769-8437. P&A: \$2.50/oz.; stock.

Inexpensive imprinting of refractory and ceramic materials is possible with a new coating that will not be volatilized by temperatures to 2500°F. When exposed to temperatures of above 400°F, CHT601 ink becomes a permanent part of the surface it is applied to. It can be applied by brush, pen, spray gun, or a silk-screening process. It is packaged in handy 16-oz. containers.

CIRCLE NO. 273

**Flat ribbon cable
controls wire spacings**

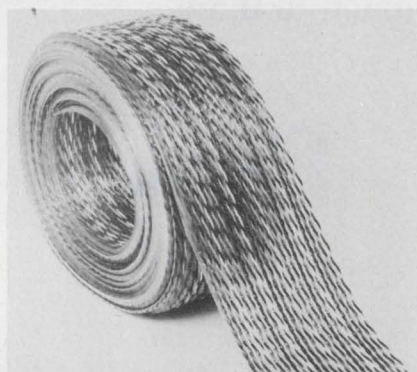

Spectra-Strip Corp., P. O. Box 415 Garden Grove, Calif. Phone: (714) 892-3361.

A new flat ribbon cable, made up of twisted pairs of conductors that are laminated between two sheets of PVC film, enables spacing between pairs of conductors to be held to ±0.003 in. for minimum cross talk. The cable can be made of conductors ranging from #22 to #30 AWG and is available with color coding and striped conductors.

CIRCLE NO. 274

Light-probe kit eases QC inspections

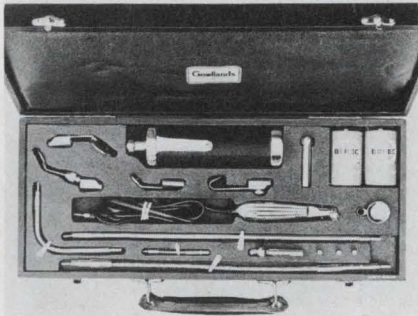

Technical Specialties International, Inc., 422 First Ave. West, Seattle, Wash. Phone: (206) 282-0997.

A new inspection kit for quality control applications contains both straight and angled probes in rigid and flexible versions to facilitate inspection of hard-to-get-at areas. Each probe contains a miniature medical-type lamp that is powered by two 1.5-V batteries located in the probe's handle. The probes can be used with slip-on magnifiers and mirrors.

CIRCLE NO. 275

Thermal wire stripper accepts #1 to #43 wires

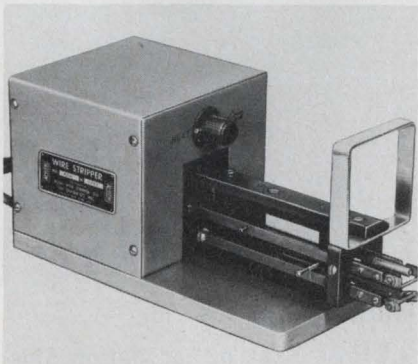

The Eraser Co., P. O. Box 1342, Oliva Dr., Syracuse, N. Y. Phone: (315) 454-3237.

Model A5C thermal wire stripper removes insulations safely and quickly for wire sizes from #1 to #43 AWG without adjustment. A multi-level temperature control provides a choice of temperature for fast insulation removal, while a finger-tip lever precisely controls the stripping element's contact pressure to permit stripping standard wires.

CIRCLE NO. 276

HIGH PERFORMANCE MOSFETS TO 500 MHz

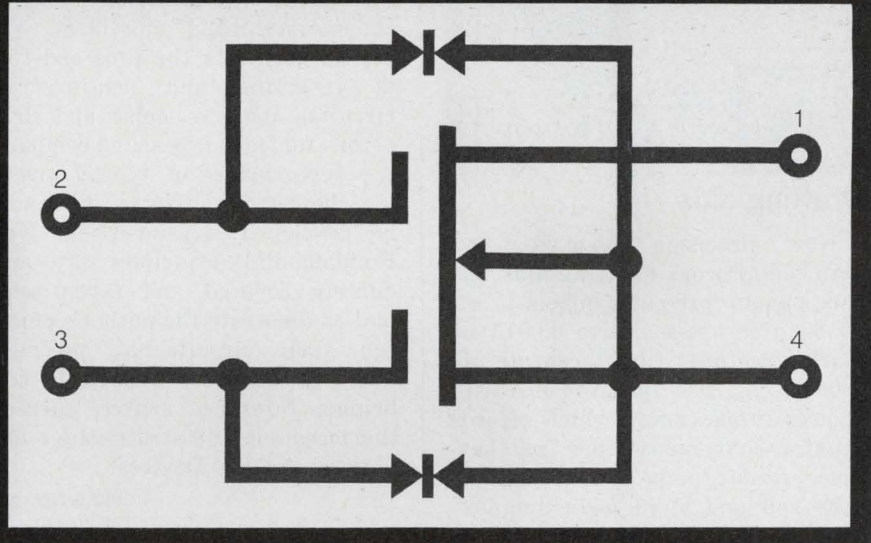

Another RCA breakthrough: dual-gate-protected MOSFETs for 300 and 500 MHz

You bet it's a breakthrough! The electronics industry, communications in particular, has been waiting a long time for an exceptionally high-performance, VHF MOSFET. Now RCA has two of them—the 3N187 dual-gate MOSFET for space, military, and industrial applications up to 300 MHz, and the 3N200 dual-gate MOSFET for similar applications up to 500 MHz.

RCA dual-insulated-gate MOSFETs are protected by special back-to-back diodes diffused directly into the MOS pellet. These diodes protect against voltage transients encountered in normal handling and usage. Here are two more bonus features:

Low VHF noise figure

- 3N187—3.5 dB (typ) at 200 MHz
- 3N200 { 3.0 dB (typ) at 200 MHz
4.5 dB (typ) at 400 MHz

High RF power gain—Gps—(No neutralization required)

- 3N187—18.0 dB (typ) at 200 MHz
- 3N200 { 12.5 dB (typ) at 400 MHz
19.0 dB (typ) at 200 MHz

For further information, see your local RCA Representative or your RCA Distributor, or write: RCA, Commercial Engineering, Section 57L-20/ZT3, Harrison, New Jersey 07029. International: RCA, 2-4 rue du Lièvre, 1227 Geneva, Switzerland, or P. O. Box 112, Hong Kong.



evaluation samples

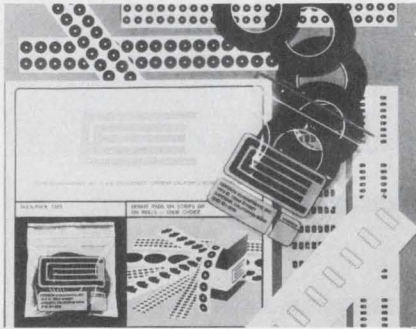

Drafting aids

New precision component matched-artwork drafting aids feature opaque pre-cut symbols printed on pressure-sensitive 0.0015 in. matte acetate film accurate to ± 0.001 in. Also featured are user choices in packaging which affords greater convenience and cost savings. Donut pads are offered in both roll and strip form and precision tape is packaged in airtight zipper bags to preserve freshness even after use. A free catalog and samples are available. Centron Engineering, Inc.

CIRCLE NO. 277

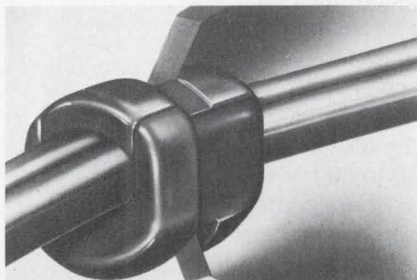

Strain relief bushings

Free samples of a line of nylon strain relief bushings are available. They come in seven standard sizes to accommodate 0.345 to 0.730-in. diameters. The rugged one-piece bushings guide cords through chassis and panels, locking them firmly in place at the point of entry. Cords are simply placed through the opened bushings which are then pinched closed for a positive grip and snapped into the chassis or panel knockout hole. The tight locking action does not puncture the insulation or conductor. Richlok Corp.

CIRCLE NO. 278

application notes

Chopper op amps

An eight-page application article entitled "Designing with Chopper Stabilized Operational Amplifiers" introduces non-inverting types of chopper-stabilized amplifiers. The article goes into the pros and cons of inverting and non-inverting circuits, analyzes noise and drift errors for both types, and compares the performance of typical inverting chopper amplifiers with a newly developed non-inverting type. Fundamental principles are adequately covered and seven schematics illustrate the author's points for such circuits as precision micro-voltmeters, biological cell, bridge, reference source, current, thermocouple and strain-gauge amplifiers. Analog Devices.

CIRCLE NO. 279

IC notes

Two recently published IC application notes are available. One 10-page paper describes a TTL/MSI BCD decimal counter and a binary hexadecimal counter, with three control inputs for mode selection. Another 12 page report discusses the construction, performance and circuit design considerations of a new dual-gate MOSFET. Fairchild Semiconductor Div.

CIRCLE NO. 280

Pressure transducers

A handbook entitled "Variable Capacitance Finds Wide Application in Vacuum/Pressure Measurements for Gases and Liquids" describes the theory of operation for precision measurements of pressure and vacuum conditions in the range of 10^{-7} to 100 lb/in.² The handbook serves as a valuable aid for engineers and scientists who are engaged in vacuum gauging, aerodynamic studies, meteorology, leak detection, process control, fluidics and cryogenics. CGS/Data-metrics, Div. of CGS Scientific Corp.

CIRCLE NO. 281

design aids

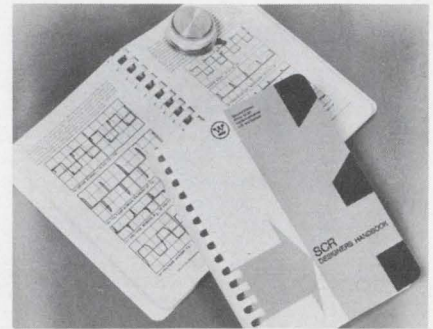

SCR handbook

The new Westinghouse SCR Designers Handbook contains 504 pages crammed with useful SCR design techniques. This comprehensive and up-to-date publication has relevant portions of SCR theory integrated with practical circuit design discussions. Examples cited in the text are actual design case histories. Over-all emphasis of the book is on providing practical, useful information for those working in all areas of SCR circuit design and application. Westinghouse Electric Corp.

CIRCLE NO. 282

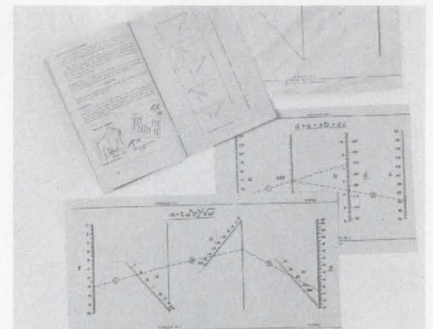

Nomograph kit

Three types of calculation aids: do-it-yourself nomographs, custom-tailored nomographs and nomograph books can all be obtained from a single kit. The do-it-yourself kit provides everything necessary to make nomographs for as little as 22¢ each. It supplies basic forms and scales, plus a concise step-by-step instruction book with specific directions for selecting kit parts, putting them together, finishing the nomograph, and instructing the user. The price per kit is \$10.00. The Nomographer.

CIRCLE NO. 283

new literature



Crystal filters

Crystal filters and oscillators are the subjects of a new brochure. It specifies quartz crystals for the frequency range of 700 Hz to 250 MHz, filters for 1 kHz to 200 MHz and oscillators for 1 Hz to 160 MHz. McCoy Electronics Co.

CIRCLE NO. 284

Ladder networks

A new catalog covering a large selection of encapsulated ladder networks features extensive ordering and design information for binary and BCD ladders. Angstrom Precision Inc.

CIRCLE NO. 285

Measurement journal

A free subscription to a bi-annual technical journal known as "Disa Information-Measurement and Analysis" is available. The journal is dedicated to research dealing with problems connected with analysis of stochastic events and with the measurement of flow velocities. Disa-S&B, Inc.

CIRCLE NO. 286

Digital plotters

A new four-page short-form catalog describes a line of digital plotting systems. Houston Instrument, Div. of Bausch & Lomb.

CIRCLE NO. 287

Power Supplies

Dual-polarity operational-amplifier and single-output IC logic power supplies are described in a four-page bulletin. Palomar Engineers.

CIRCLE NO. 288

Hewlett-Packard Journal

The Nov. 1970 Hewlett-Packard Journal is devoted to a new solid-state microwave sweeper. Articles discuss ways of sweeping the microwave spectrum and the sweeper's circuitry. Hewlett-Packard.

CIRCLE NO. 289

Liquid epoxy resins

Liquid epoxy resin systems for electrical/electronic reinforced plastics, coatings and adhesives applications are featured in a new 21-page booklet. Union Carbide Corp.

CIRCLE NO. 290

Magnetic components

A new magnetic-components brochure on coil-wound devices includes pulse transformers, delay lines, and common-mode chokes. BH Electronics.

CIRCLE NO. 291

Encapsulating shells

A handy specification chart gives the basic dimensions for 400 stock styles of encapsulating shells. The chart lists all shells according to size and indicates their characteristics. Milross Controls Inc.

CIRCLE NO. 292

Volt-ohmmeters

Catalog 57-T features the newest FET-input and digital VOMs, accessories, sales and service data. A VOM selection chart is included. Triplett Corp.

CIRCLE NO. 293

Connectors

High-density multi-pin connectors with bayonet coupling are described in a brochure. Given are various shell sizes, pin layouts and gauges. Microdot Inc.

CIRCLE NO. 294

DIGITAL PRINTERS

OEM-RACK-PORTABLE

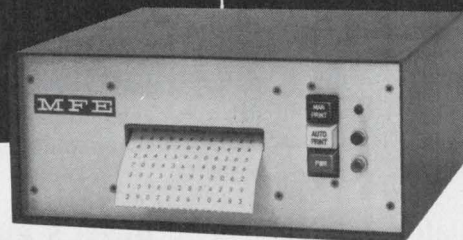

- BCD INPUTS — PARALLEL ENTRY
- UP TO 24 COLUMNS PRINTOUT
- FLOATING DECIMAL OPTION
- 400 MSEC/LINE PRINT RATE
- MANY OPTIONS — CHARACTER WHEELS

VALUE
PRICED
FROM
\$84.



MFE

MECHANICS FOR ELECTRONICS, INC.

340 Fordham Rd., Wilmington, Mass. 01887 (617) 658-5500 TWX 710-347-6938

INFORMATION RETRIEVAL NUMBER 32

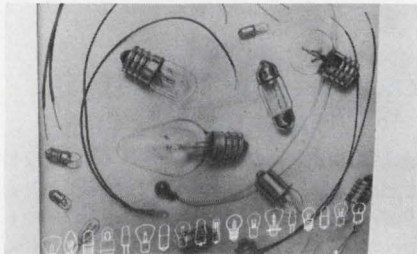

Lamps

A new 16-page catalog contains information on low-cost miniature, subminiature and microminiature lamps for computer, digital display, indicator, instrument and many other electronic applications. Shigoto Industries Ltd.

CIRCLE NO. 295

Indicators

An informative brochure on electromagnetic indicators describes five basic indicator types and explains how these may be used as single elements or as stacked assemblies to operate from a variety of digital computer signals. Singer-General Precision, Inc.

CIRCLE NO. 296

Conductive gaskets

Properties for seven conductive plastic gaskets for emi/rfi use are given in a new brochure. Emerson & Cuming, Inc.

CIRCLE NO. 297

Transistor transformers

New literature describes a series of miniature transformers and transistor transformer substitutions. Solid State Electronics Corp.

CIRCLE NO. 298

Book/calculator catalog

A new 32-page 1971 catalog contains full descriptions of design slide rules and data selectors, drafting templates, handbooks, manuals, technical books, curves, kits, converters and other time-saving devices and reference works. Fields covered include mechanical, electronic, chemical, manufacturing, and structural design as well as drafting, quality control, inspection and data processing. TAD Products Corp.

CIRCLE NO. 299

Computer guide

The "Blue Book of Computer Prices" is a new tool for those who buy or sell used equipment. It contains current information about prices and availability of a wide variety of used computers. In addition, the guide tells buyers and sellers how to conduct used equipment transactions and how to avoid some of the pitfalls in this market. Time Brokers, Inc.

CIRCLE NO. 300

Disc controllers

A new eight-page bulletin describes use, compatibilities and general specifications for a line of disc memory controllers. Electronic Engineering Co. of California.

CIRCLE NO. 301

Cable clamps

A complete line of cable ties, clamps and markers is described in a new four-page bulletin. Panduit Corp.

CIRCLE NO. 302

Switches and indicators

A new six-page comprehensive guide describes a line of four-lamp illuminated pushbutton switches and indicators. Master Specialties Co.

CIRCLE NO. 303

Gearmotors/reducers

Two new catalogs feature lines of horizontal and vertical precision gearmotors and heavy duty in-line speed reducers. Rex Chainbelt Inc.

CIRCLE NO. 304

Buyer's guide

A new buyer's guide covers a broad range of products such as airborne electronics, military electronic products, burglar and fire alarm systems and data processing systems. It also covers electronic components, semiconductors, IR systems, microwave products, scientific instruments and devices, television transmitting equipment and automated machine tools. EMI U. K. Electronics and Industrial Operations.

CIRCLE NO. 305

bulletin board

of product news and developments



The new **Night Hawk TV camera system** of Spectran, Inc., can see in total darkness and provides a picture as bright and clear as one taken under bright lighting. It also performs equally well under visible lighting. The camera system consists of an IR source, a CCTV camera and a tube mounted on the camera for converting IR light to visible light.

CIRCLE NO. 306

An easy-to-operate **video cartridge recorder** that records video and audio information with a simple connection to a TV camera or set or microphone has been developed by Victor Co. of Japan. Victor expects to market its new recorder in the U.S. in late 1971.

CIRCLE NO. 307

An experimental **monolithic bipolar shift register** that operates with four-phase clocks which store information at collector-substrate capacitances was described by an IBM engineer at the International Society for Hybrid Microelectronics.

Monsanto Co. has slashed prices on several of its **Gunn-effect diodes and oscillators**. Examples are the DC2424 diode now priced at \$270 and previously priced at \$316. The VX2020C, formerly costing \$465 now costs \$420.

Precision Monolithics has cut prices on its SSS101A, SSS107, SSS741, SSS747 and SSS725 **IC operational amplifiers** by more than 50%.

advertiser's index

Advertiser	Page
Acopian Corp.	7
Airpax Electronics, Cambridge Division	61
Allen-Bradley Co.	4, 5, 12
Analog Devices, Inc.	33
Beckman Instruments, Inc., Helipot Division	52
Bishop Graphics, Inc.	71
Bramco Controls Division, Ledex, Inc.	32
Dale Electronics, Inc.	Cover III
Deltron, Inc.	9
Eastman Kodak Company	47
Electro Cube, Inc.	70
Electronic Design	14, 15, 31
Federal Scientific Corporation	70
General Electric Company, Capacitor and Battery Dept.	10, 11
General Instrument Corporation	34
General Radio Company	1
Hayden Book Company, Inc.	16D, 70
Hewlett-Packard	Cover II, 21
Hickok Instrumentation and Controls Division	46
ISE Electronics Corporation	6
Mechanics for Electronics, Inc.	67
MicroSwitch, A division of Honeywell	43
Molex, Incorporated	2
Philips Electronic Components and Materials Division	16B, 16C
Power/Mate Corp.	13, 71
RCA Electronic Components and Devices	38, 65, Cover IV
RF Communications Inc.	42
Radio Materials Company	69
Rotating Components	42
Schauer Manufacturing Corp.	72
Sercel	16A
Signetics Corporation	25
Sprague Electric Company	18
Stalwart Rubber Company	16
Tektronix, Inc.	27, 37
Teledyne Semiconductor	29
Triplett Corporation	17
Wesco Electrical Company, Inc.	8
Weston Instruments, Inc.	57
Winchester Electronics, Division of Litton Industries	71

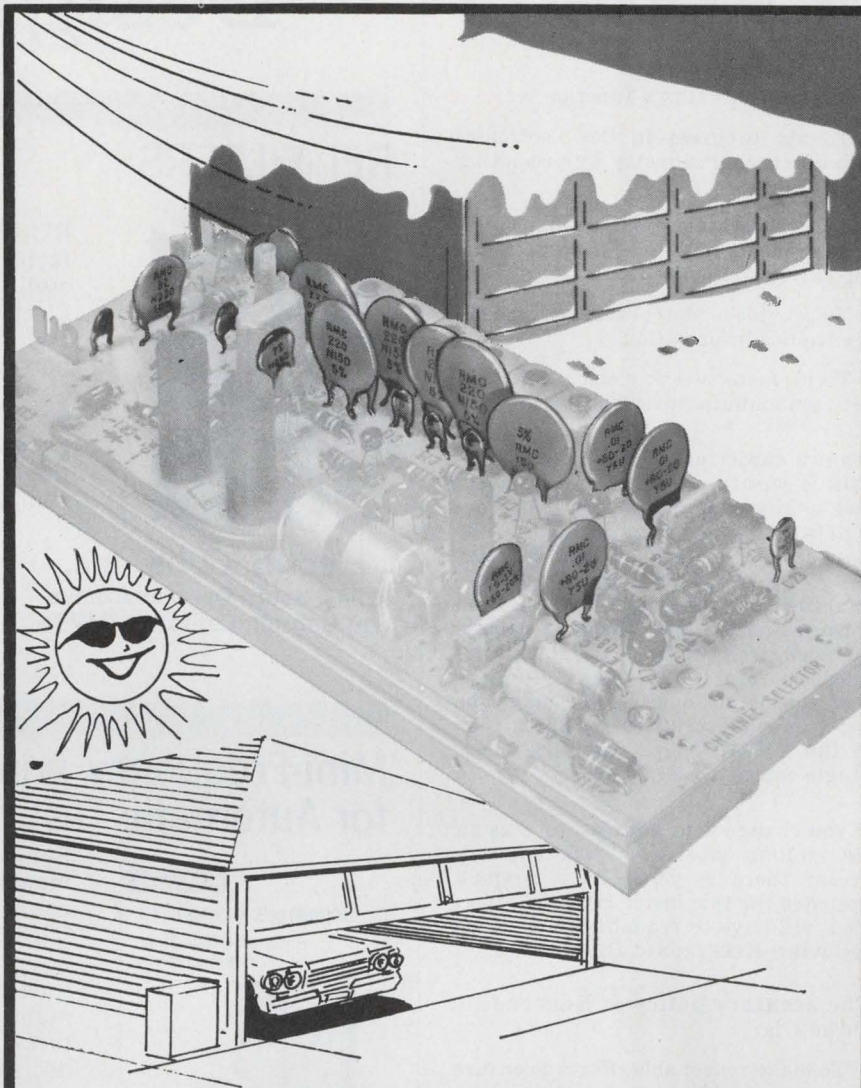

RMC DISCAPS FOR TEMPERATURE SENSITIVE APPLICATIONS

Perma-Power, a division of Chamberlain Mfg. Corp., a leading manufacturer of radio controlled garage door openers, specifies RMC DISCAPS to assure reliability under extreme environmental conditions.

RMC produces a full range of DISCAPS for temperature sensitive circuitry or applications requiring exact temperature compensation. Frequency and temperature stable types, as well as units of predictable variability, are available.

DISCAPS are produced to the highest standard of quality and may be specified with complete confidence.

If your application requires special physical or electrical characteristics, contact RMC's Engineering Department.

*Write today on your company letterhead
for your copy of the complete RMC catalog.*



RADIO MATERIALS COMPANY
A DIVISION OF P. R. MALLORY & CO., INC.
GENERAL OFFICE: 4242 W. Bryn Mawr Ave., Chicago 46, Ill.
Two RMC Plants Devoted Exclusively to Ceramic Capacitors
FACTORIES AT CHICAGO, ILL. AND ATTICA, IND.

ELECTRONIC DESIGN'S function is:

- To aid progress in the electronics manufacturing industry by promoting good design.
- To give the electronic design engineer concepts and ideas that make his job easier and more productive.
- To provide a central source of timely electronics information.
- To promote two-way communication between manufacturer and engineer.

Want a subscription? ELECTRONIC DESIGN is sent free to qualified engineers and engineering managers doing design work, supervising design or setting standards in the United States and Western Europe. For a free subscription, use the postfree application form inside the back cover. If none is included, write to us direct for an application form.

If you do not qualify, you may take out a paid subscription for \$25 a year in the U.S.A., \$35 a year elsewhere. Single copies are \$1.50 each.

If you change your address, send us an old mailing label and your new address; there is generally a prepaid postcard for this inside the back cover. You will have to requalify to continue receiving ELECTRONIC DESIGN free.

The accuracy policy of ELECTRONIC DESIGN is:

- To make reasonable efforts to ensure the accuracy of editorial matter.
- To publish prompt corrections whenever inaccuracies are brought to our attention. Corrections appear at the end of the Letters column.
- To refuse any advertisement deemed to be misleading or fraudulent.

Microfilm copies are available of complete volumes of ELECTRONIC DESIGN at \$19.00 per volume, beginning with Volume 9, 1961. Work is now in process to complete the microfilm edition of Volumes 1-8. Reprints of individual articles may be obtained for \$2.00 each, prepaid (\$.50 for each additional copy of the same article) no matter how long the article. For further details and to place orders, contact the Customer Services Department, University Microfilms, 300 North Zeeb Road, Ann Arbor, Michigan 48106; telephone (313) 761-4700.

Want to contact us? If you have any comments or wish to submit a manuscript or article outline, address your correspondence to:

Editor
ELECTRONIC DESIGN,
850 Third Avenue,
New York, N.Y. 10022.

RFI FILTERS



RFI filters and capabilities for design and manufacture of filters to customer requirements, are outlined in this new four-page brochure from Electro Cube, Inc.

The brochure presents electrical rating information, and examples of mechanical package configurations for single and multi-circuit filters, high voltage and screen room filters.

Electro Cube, Inc., manufacture capacitors, RFI filters, RC networks and other current control components.

CIRCLE NO. 171

Electro Cube, Inc.
1710 South Del Mar Avenue
San Gabriel, California 91776

Mini-Frequency Analyzer with Mini-Computer for Automatic Testing



Real-time calibrated frequency domain measurements are interpreted automatically by a mini-computer easily interfaced with the new 200-line MINI-UBIQ™, latest Ubiquitous® Spectrum Analyzer. It can be upgraded to 400 lines at any time by the addition of one circuit card. • Automatic comparison of vibration or acoustic signatures of good/bad products for accept/reject decisions in production or QC • Automatic scaling and equalization of the response characteristics of a pickup transducer • Ensemble averaging and storage of many spectra • Detection and location of peaks • Automatic analysis with thousands of resolution elements.

CIRCLE NO. 172

Federal Scientific Corporation
a subsidiary of Elgin National Industries, Inc.
615 West 131st Street, New York, N. Y. 10027

FUNDAMENTALS OF INTEGRATED CIRCUITS

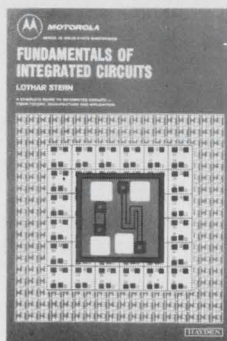

A practical guide to integrated circuits, their theory, manufacture, and applications. This new guide by Lothar Stern offers complete, highly readable coverage of the various techniques of circuit fabrication, and their effect on circuit design and performance. As to marketing considerations, it compares the characteristics of the numerous IC structures devised to date in terms of economics and logistics. A volume in the **Motorola Series in Solid-State Electronics**. 198 pages, 7 x 10, illustrated. \$8.95, clothbound. Circle the reader-service number below for 15-day examination copies.

CIRCLE NO. 173

Hayden Book Company, Inc.
116 West 14th Street
New York, N.Y. 10011

Manufacturers

Advertisements of booklets, brochures, catalogs and data sheets. To order use Reader-ServiceCard.
(Advertisement)

New Low Cost Mini Power Supplies



Power/Mate Corp. has introduced a new complete line of 119 models of miniature DC regulated power supplies—now described in this 6-page catalog. These 119 Mini Mate models collectively cover from 3.6 to 48 vdc and currents up to 2 amps. The Mini Mates feature adjustable DC outputs, low cost, high performance and Power/Mate's full five year warranty. The catalog covers complete specifications, model numbers, sizes and prices. Write, call or twx for your free copy.

CIRCLE NO. 174

Power/Mate Corporation

514 South River Street
Hackensack, New Jersey 07601
(201) 343-6294 TWX (710) 990-5023

BISHOP CIRCUIT ZAPS



PRE-ETCHED, PRESSURE-SENSITIVE COPPER COMPONENT PATTERNS FOR INSTANT PC BOARDS. Circuit Zaps® are 1 ounce copper circuit components patterns, pads, and conductor paths, precision-etched on 5 mil (.005") glass epoxy base material, backed by a special pressure-sensitive adhesive. Circuit Zaps® completely eliminate the artwork, photography, photoprinting, touch up, etching, stripping, and other time-consuming steps in PC board development. Circuit Zaps® provide maximum flexibility.

Now you can save time and money in making designs, proving theories, checking circuits and densities — for all prototype PC work. Write today for the **FREE TECHNICAL BULLETIN 1003** with **FREE SAMPLE.**

CIRCLE NO. 175

Bishop Graphics, Inc.

7300 Radford Avenue (ED)
North Hollywood, California 91605
(213) 982-2000 Telex: 674672

Get All the Facts About Interconnection-Packaging Systems



Free illustrated 10-page brochure describes the connector industry's most comprehensive line of back-panel mounting and precision connectors. Shows how unique AccurSystem® packaging line meets all interconnect requirements for PC logic boards, dual-in-line devices and advanced MSI/LSI circuitry. Includes data on aluminum AccurFrame and AccurPlate back panel mountings for wrappable edgeboard connectors. AccurPlane Glass-epoxy PC back panels with unique solderless terminations, substrate connectors — everything you need for your next generation applications. Circle the reader-service number below for your free copy.

CIRCLE NO. 176

WINCHESTER ELECTRONICS
DIVISION OF LITTON INDUSTRIES

Main Street and Hillside Avenue
Oakville, Connecticut 06779

Electronic Design

Advertising Sales Staff

Keith Aldrich
Sales Manager

New York 10022

Robert W. Gascoigne
Samuel M. Deitch
Daniel J. Rowland
850 Third Avenue
(212) Plaza 1-5530
TWX: 710-581-2874

Philadelphia 19025

Mort Sullivan
P.O. Box 126
Dresher, Pa.
(215) 884-6880

Boston 02154

Joseph F. Palmer
1268 Main Street
Waltham, Mass.
(617) 894-2700

Chicago 60611

Thomas P. Kavooras
Berry Conner, Jr.
200 East Ontario
(312) 337-0588

Cleveland

Thomas P. Kavooras
(Chicago)
(312) 337-0588
(call collect)

Los Angeles 90303

Stanley I. Ehrenclou
Jerry D. Latta
2930 Imperial Highway
Inglewood, Calif.
(213) 757-0183

San Francisco 94022

Arthur R. Shields, Jr.
95 Main Street
Los Altos, Calif.
(415) 941-3084

London W. 1

For United Kingdom and Holland
Brayton C. Nichols
44 Conduit Street
Tel: REGent 4714

Verviers, Belgium

For Continental Europe
Andre Jamar
1, Rue Mallar, 1
087) 253.83 Telex 41563

Tokyo

Haruki Hirayama
Electronic Media Service
5th Floor, Lila Bldg.,
4-9-8 Roppongi
Minato-ku
Phone: 402-4556
Cable: Electronicmedia, Tokyo



AMERICAN BUSINESS PRESS, INC.

SCHAUER

1%

tolerance

1 WATT ZENERS ARE A REAL BUY!

IMMEDIATE SHIPMENT

ANY voltage from 2.0 to 16.0 at the industry's LOWEST PRICES!

Quantity	Price each
1-99	\$1.07
100-499	.97
500-999	.91
1000-4999	.86
5000 up	.82

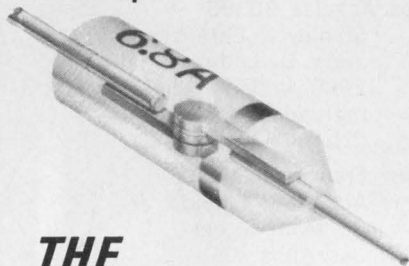

THE HI-RELIABLE!

No fragile nail heads.

Silicon junction aligned between two, parallel, offset tantalum heat sinks . . . great lead tension strength.

All welded and brazed assembly.

High pressure molded package.

Gold plated nickel-clad copper leads.

Write or phone for Form 68-4 for complete rating data and other tolerance prices.

Semiconductor Division

**SCHAUER
MANUFACTURING
CORP.** 4511 Alpine Avenue
Cincinnati, O. 45242
Ph. (513) 791-3030

product index

Information Retrieval Service. New Products, Evaluation Samples (ES), Design Aids (DA), Application Notes (AN), and New Literature (NL) in this issue are listed here with page and Information Retrieval numbers. Reader requests will be promptly processed by computer and mailed to the manufacturer within three days.

Category	Page	IRN	Category	Page	IRN
Components			clamps, cable (NL)	68	302
bushings, strain (ES)	66	278	connectors (NL)	67	294
filter, solid-state	63	263	gaskets (NL)	68	297
filters, crystal (NL)	67	284	ink, marking	64	273
gearmotors (NL)	68	304	resins, epoxy (NL)	67	290
lamps (NL)	68	295	shells (NL)	67	292
magnetic components (NL)	67	291	Tools & Engineering Aids		
reducers (NL)	68	304	book catalog (NL)	68	299
relays, solid-state	63	265	drafting aids (ES)	66	277
resistor, film	63	266	handbook, SCR (DA)	66	282
resistors, DIP	63	264	inspection kit	65	275
switches (NL)	68	303	measurement journal (NL)	67	286
transducers (AN)	66	281	nomograph kit (DA)	66	283
transformers (NL)	68	298	stripper, wire	65	276
Data Processing			new literature		
calculator, 12-digit	64	269	buyer's guide	68	305
computer guide (NL)	68	300	catalog, book	68	299
controllers, disc (NL)	68	301	clamps, cable	68	302
data set	64	272	computer guide	68	300
generator/analyzer, data	64	271	connectors	67	294
plotters, digital (NL)	67	287	controllers, disc	68	301
transport, tape	64	270	filters, crystal	67	284
ICs & Semiconductors			gaskets	68	297
amplifier, sense	62	260	gearmotors	68	304
capacitors, chip	62	261	Hewlett-Packard Journal	67	289
FETs	62	257	indicators	68	296
IC notes (AN)	66	280	indicators	68	303
ladders (NL)	67	285	journal, measurement	67	286
rectifier, full-wave	62	262	ladder networks	67	285
rectifiers, 6-A	62	258	lamps	68	295
SCR handbook (DA)	66	282	magnetic components	67	291
thyristors	62	259	plotters, digital	67	287
Instrumentation			power supplies	67	288
generator, function	61	256	reducers	68	304
measurements (NL)	67	286	resins, epoxy	67	290
power supplies (NL)	67	288	shells, encapsulating	67	292
sweeper (NL)	67	289	switches	68	303
tester, linear IC	61	255	transformers	68	298
VOMs (NL)	67	293	VOMs	67	293
Microwaves & Lasers			application notes		
amplifier, low-noise	63	268	IC notes	66	280
phototransistors	63	267	op amps, chopper	66	279
sweeper, microwave (NL)	67	289	transducers	66	281
Modules & Subassemblies			design aids		
amplifiers, uhf	60	251	handbook, SCR	66	282
booster, IC power	60	253	nomograph kit	66	283
converter, a/d	60	252	evaluation samples		
filters, crystal (NL)	67	284	bushings, strain	66	278
indicators (NL)	68	296	drafting aids	66	277
ladder networks (NL)	67	285			
multiplexer, 8-channel	60	250			
op amps, chopper (AN)	66	279			
power supplies (NL)	67	288			
readout, solid-state	60	254			
Packaging & Materials					
bushings, strain (ES)	66	278			
cable, flat ribbon	64	274			

Dale RH and RS resistors are used
in Burroughs' popular TC 500
on-line terminal computer.



The
everywhere
resistors
...and why.

DALE WIREWOUNDS:
Found wherever power must be
precisely dissipated. Why? Because
of these unequalled advantages:

SELECTION—Dale's new resistor catalog gives
you the industry's widest choice of standard
precision power models—most of them ready to
ship from your nearby distributor.

VERSATILITY—Your requirements for variations in
configuration and function can be quickly matched from
a design bank of more than 4000 pre-engineered specials.

DELIVERY—2-3 weeks on 1 watt MIL-R-26E models.
Comparable fast times on all other popular styles.

*If you think there's no difference in wirewounds—you haven't
dealt with Dale. PHONE 402-564-3131 or write for our new
expanded Resistor Catalog.*



DALE ELECTRONICS, INC., 1300 28th Ave., Columbus, Nebr. 68601
In Canada: Dale Electronics Canada, Ltd. • A subsidiary of The Lionel Corporation

INFORMATION RETRIEVAL NUMBER 181

RCA TWTs...for ECM sleight of hand



You see it, but where? That's the protection of electronic countermeasures. And high gain over octave bandwidths at microwave frequencies makes RCA traveling-wave tubes key components for ECM systems.

Among the newest in RCA's extensive line are A1378, a medium unit with PPM focusing; A1397, an intermediate power amplifier, again with PPM focusing; and J2053, a wideband unit with integral power supply.

For each of the major functions in your ECM system, RCA has a 20-year background and product for the low-level amplifier stage, the recirculating RF memory stage, and the driver stage.

Along with customized TWTs for RF memory subsystems, there's a wide range of standard product for both ground-based and satellite microwave radio communications systems, too.

RCA has been deeply involved in every chapter of TWT development and has participated in most major ECM systems. Tubes cover the frequency bands from L through Ku, and offer diverse com-

binations of power, gain, size and weight. Check the chart for a few of them.

For more information on these and other RCA TWTs, see your local RCA Representative. For technical data, write: RCA, Commercial Engineering, Section 57L-20/ZM9, Harrison, N.J. 07029. International: RCA, 2-4 rue du Lièvre, 1227 Geneva, Switzerland, or P.O. Box 112, Hong Kong.

New ECM TWTs

A1378	7-11 GHz	10 watts	40 dB gain
A1397	5-10 GHz	4 watts	43 dB gain
A1428	7-11 GHz	2 watts	40 dB gain
A1429	4 - 8 GHz	2 watts	40 dB gain

Customized RF Memory Subsystems

New TWT Amplifiers with Integral Power Supplies

J2053	7.5-12 GHz	200 mW	40 dB gain
J2055	4 - 8 GHz	100 mW	40 dB gain

Communications TWTs

A1378	7.9 - 8.4 GHz	20 watts	46 dB gain
A1390	10.7 - 11.7 GHz	20 watts	40 dB gain
A1427	7.9 - 8.4 GHz	5 watts	50 dB gain



RCA