

---

# Corometrics® 170 Series

---

SERVICE MANUAL

MANUAL P/N 2000947-004 REV. D

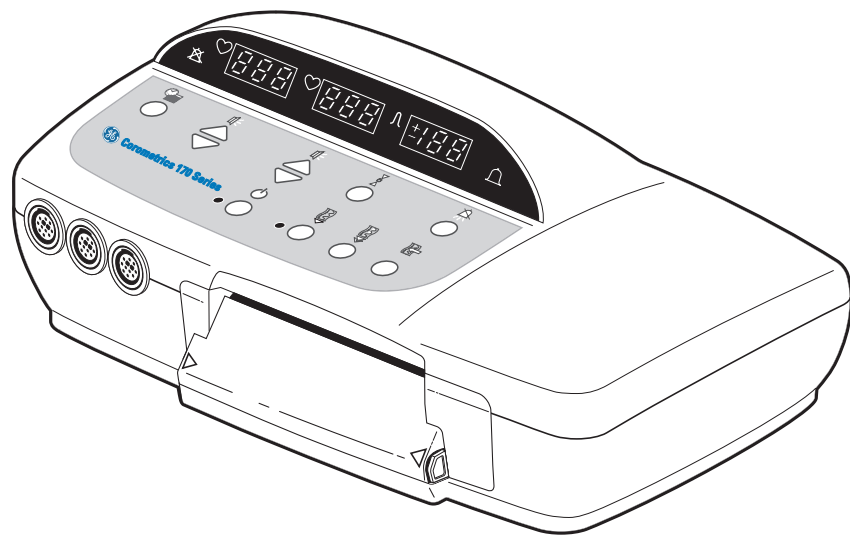

**GE Medical Systems**  
*Information Technologies*

---

[gemedicalsystems.com](http://gemedicalsystems.com)

---



# Corometrics® 170 Series

SERVICE MANUAL

MANUAL P/N 2000947-004 REV. D

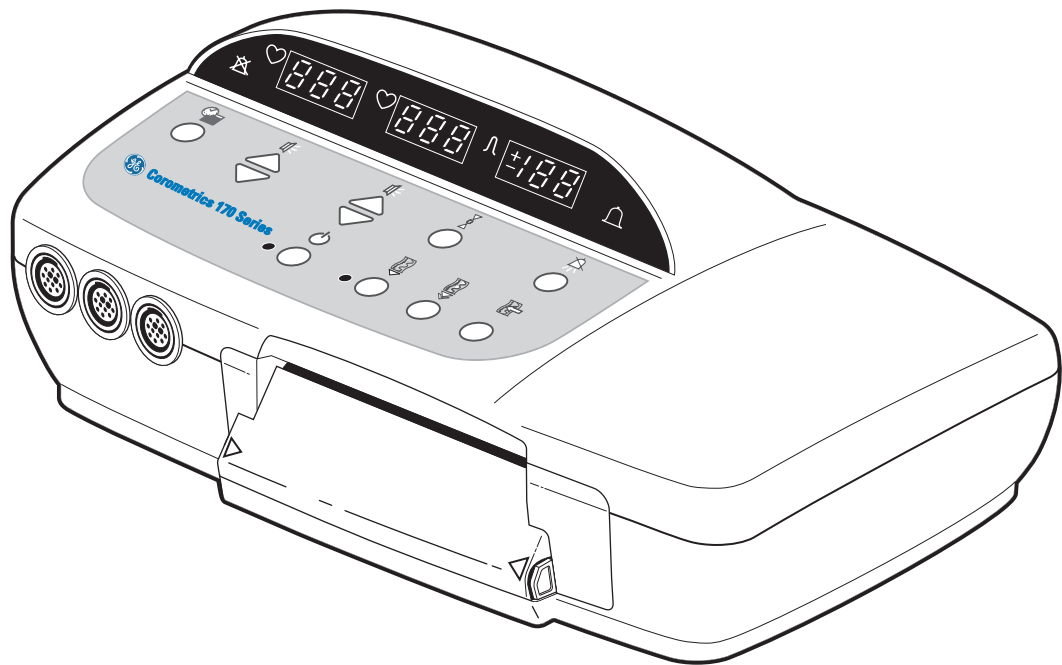

**GE Medical Systems**  
Information Technologies

[gemedicalsystems.com](http://gemedicalsystems.com)

## GUARANTEE

All equipment sold by GE Medical Systems Information Technologies, is fully guaranteed as to materials and workmanship for a period of 1 year. Information Technologies reserves the right to perform guarantee service operations in its own factory, at an authorized repair station, or in the customer's installation.

Our obligation under this guarantee is limited to repairing, or, at our option, replacing any defective parts of our equipment, except fuses or batteries, without charge, if such defects occur in normal service.





Claims for damage in shipment should be filed promptly with the transportation company. All correspondence covering the instrument should specify the model and serial numbers.





GE Medical Systems Information Technologies  
A GE Medical Systems Company



GE Medical Systems *Information Technologies* will make available on request such circuit diagrams, component diagrams, component parts lists, descriptions, calibration instructions, or other information which will assist the users or appropriately qualified technical personnel to repair those parts of the equipment which are classified by GE Medical Systems *Information Technologies* as repairable. Refer to the service manual for further information.





 **CAUTION:** In the United States of America, Federal Law restricts this device to sale by or on the order of a physician.

*Corometrics* and *Marquette* are registered trademarks of GE Medical Systems *Information Technologies*. *GE* is a registered trademark of General Electric Company. All other product and brand names are trademarks or registered trademarks of their respective companies. ©2002-2004 GE Medical Systems *Information Technologies*. All rights reserved. No part of this manual may be reproduced without the permission of GE Medical Systems *Information Technologies*.





 (BG)	<p><b><u>ПРЕДУПРЕЖДЕНИЕ</u></b></p> <p>Това упътване за работа е налично само на английски език.</p> <ul style="list-style-type: none"> <li>• Ако доставчикът на услугата на клиента изиска друг език, задължение на клиента е да осигури превод.</li> <li>• Не използвайте оборудването, преди да сте се консултирали и разбрали упътването за работа.</li> <li>• Неспазването на това предупреждение може да доведе до нараняване на доставчика на услугата, оператора или пациента в резултат на токов удар, механична или друга опасност.</li> </ul>
 (ZH-CN)	<p><b><u>警告</u></b></p> <ul style="list-style-type: none"> <li>• 本维修手册仅提供英文版本。</li> <li>• 如果客户的维修服务人员需要非英文版本，则客户需自行提供翻译服务。</li> <li>• 未详细阅读和完全理解本维修手册之前，不得进行维修。</li> <li>• 忽略本警告可能对维修服务人员、操作人员或患者造成电击、机械伤害或其他形式的伤害。</li> </ul>
 (ZH-HK)	<p><b><u>警告</u></b></p> <p>本服務手冊僅提供英文版本。</p> <ul style="list-style-type: none"> <li>• 倘若客戶的服務供應商需要英文以外之服務手冊，客戶有責任提供翻譯服務。</li> <li>• 除非已參閱本服務手冊及明白其內容，否則切勿嘗試維修設備。</li> <li>• 不遵從本警告或會令服務供應商、網絡供應商或病人受到觸電、機械性或其他危險。</li> </ul>
 (ZH-TW)	<p><b><u>警告</u></b></p> <p>本維修手冊僅有英文版。</p> <ul style="list-style-type: none"> <li>• 若客戶的維修廠商需要英文版以外的語言，應由客戶自行提供翻譯服務。</li> <li>• 請勿試圖維修本設備，除非 您已查閱並瞭解本維修手冊。</li> <li>• 若未留意本警告，可能導致維修廠商、操作員或病患因觸電、機械或其他危險而受傷。</li> </ul>
(HR)	<p><b><u>UPOZORENJE</u></b></p> <p>Ovaj servisni priručnik dostupan je na engleskom jeziku.</p> <ul style="list-style-type: none"> <li>• Ako davatelj usluge klijenta treba neki drugi jezik, klijent je dužan osigurati prijevod.</li> <li>• Ne pokušavajte servisirati opremu ako niste u potpunosti pročitali i razumjeli ovaj servisni priručnik.</li> <li>• Zanemarite li ovo upozorenje, može doći do ozljede davatelja usluge, operatera ili pacijenta uslijed strujnog udara, mehaničkih ili drugih rizika.</li> </ul>



 (CS)	<p><b><u>VÝSTRAHA</u></b></p> <p>Tento provozní návod existuje pouze v anglickém jazyce.</p> <ul style="list-style-type: none"> <li>• V případě, že externí služba zákazníkům potřebuje návod v jiném jazyce, je zajištění překladu do odpovídajícího jazyka úkolem zákazníka.</li> <li>• Nesnažte se o údržbu tohoto zařízení, aniž byste si přečetli tento provozní návod a pochopili jeho obsah.</li> <li>• V případě nedodržování této výstrahy může dojít k poranění pracovníka prodejního servisu, obslužného personálu nebo pacientů vlivem elektrického proudu, respektive vlivem mechanických či jiných rizik.</li> </ul>
 (DA)	<p><b><u>ADVARSEL</u></b></p> <p>Denne servicemanual findes kun på engelsk.</p> <ul style="list-style-type: none"> <li>• Hvis en kundes tekniker har brug for et andet sprog end engelsk, er det kundens ansvar at sørge for oversættelse.</li> <li>• Forsøg ikke at servicere udstyret uden at læse og forstå denne servicemanual.</li> <li>• Manglende overholdelse af denne advarsel kan medføre skade på grund af elektrisk stød, mekanisk eller anden fare for teknikeren, operatøren eller patienten.</li> </ul>
 (NL)	<p><b><u>WAARSCHUWING</u></b></p> <p>Deze onderhoudshandleiding is enkel in het Engels verkrijgbaar.</p> <ul style="list-style-type: none"> <li>• Als het onderhoudspersoneel een andere taal vereist, dan is de klant verantwoordelijk voor de vertaling ervan.</li> <li>• Probeer de apparatuur niet te onderhouden alvorens deze onderhoudshandleiding werd geraadpleegd en begrepen is.</li> <li>• Indien deze waarschuwing niet wordt opgevolgd, zou het onderhoudspersoneel, de operator of een patiënt gewond kunnen raken als gevolg van een elektrische schok, mechanische of andere gevaren.</li> </ul>
 (EN)	<p><b><u>WARNING:</u></b></p> <p>This service manual is available in English only.</p> <ul style="list-style-type: none"> <li>• If a customer's service provider requires a language other than English, it is the customer's responsibility to provide translation services.</li> <li>• Do not attempt to service the equipment unless this service manual has been consulted and is understood.</li> <li>• Failure to heed this warning may result in injury to the service provider, operator, or patient from electric shock, mechanical hazards, or other hazards.</li> </ul>
 (ET)	<p><b><u>HOIATUS</u></b></p> <p>See teenindusjuhend on saadaval ainult inglise keeles</p> <ul style="list-style-type: none"> <li>• Kui klienditeeninduse osutaja nõuab juhendit inglise keelest erinevas keeles, vastutab klient</li> </ul>





	<p>tõlketeenuse osutamise eest.</p> <ul style="list-style-type: none"> <li>• Ärge üritage seadmeid teenindada enne eelnevalt käesoleva teenindusjuhendiga tutvumist ja sellest aru saamist.</li> <li>• Käesoleva hoiatuse eiramine võib põhjustada teenuseosutaja, operaatori või patsiendi vigastamist elektrilöögi, mehaanilise või muu ohu tagajärjel.</li> </ul>
 (FI)	<p><b><u>VAROITUS</u></b></p> <p>Tämä huolto-ohje on saatavilla vain englanniksi.</p> <ul style="list-style-type: none"> <li>• Jos asiakkaan huoltohenkilöstö vaatii muuta kuin englanninkielistä materiaalia, tarvittavan käännöksen hankkiminen on asiakkaan vastuulla.</li> <li>• Älä yritä korjata laitteistoa ennen kuin olet varmasti lukenut ja ymmärtänyt tämän huolto-ohjeen.</li> <li>• Mikäli tätä varoitusta ei noudateta, seurauksena voi olla huoltohenkilöstön, laitteiston käyttäjän tai potilaan vahingoittuminen sähköiskun, mekaanisen vian tai muun vaaratilanteen vuoksi.</li> </ul>
 (FR)	<p><b><u>ATTENTION</u></b></p> <p>Ce manuel d'installation et de maintenance est disponible uniquement en anglais.</p> <ul style="list-style-type: none"> <li>• Si le technicien d'un client a besoin de ce manuel dans une langue autre que l'anglais, il incombe au client de le faire traduire.</li> <li>• Ne pas tenter d'intervenir sur les équipements tant que ce manuel d'installation et de maintenance n'a pas été consulté et compris.</li> <li>• Le non-respect de cet avertissement peut entraîner chez le technicien, l'opérateur ou le patient des blessures dues à des dangers électriques, mécaniques ou autres.</li> </ul>
 (DE)	<p><b><u>WARNUNG</u></b></p> <p>Diese Serviceanleitung existiert nur in englischer Sprache.</p> <ul style="list-style-type: none"> <li>• Falls ein fremder Kundendienst eine andere Sprache benötigt, ist es Aufgabe des Kunden für eine entsprechende Übersetzung zu sorgen.</li> <li>• Versuchen Sie nicht diese Anlage zu warten, ohne diese Serviceanleitung gelesen und verstanden zu haben.</li> <li>• Wird diese Warnung nicht beachtet, so kann es zu Verletzungen des Kundendiensttechnikers, des Bedieners oder des Patienten durch Stromschläge, mechanische oder sonstige Gefahren kommen.</li> </ul>
(EL)	<p><b><u>ΠΡΟΕΙΔΟΠΟΙΗΣΗ</u></b></p> <p>Το παρόν εγχειρίδιο σέρβις διατίθεται μόνο στα αγγλικά.</p> <ul style="list-style-type: none"> <li>• Εάν ο τεχνικός σέρβις ενός πελάτη απαιτεί το παρόν εγχειρίδιο σε γλώσσα εκτός των αγγλικών, αποτελεί ευθύνη του πελάτη να παρέχει τις υπηρεσίες μετάφρασης.</li> <li>• Μην επιχειρήσετε την εκτέλεση εργασιών σέρβις στον εξοπλισμό αν δεν έχετε συμβουλευτεί και κατανοήσει το παρόν εγχειρίδιο σέρβις.</li> </ul>

	<ul style="list-style-type: none"> <li>• Αν δεν προσέξετε την προειδοποίηση αυτή, ενδέχεται να προκληθεί τραυματισμός στον τεχνικό σέρβις, στο χειριστή ή στον ασθενή από ηλεκτροπληξία, μηχανικούς ή άλλους κινδύνους.</li> </ul>
 (HU)	<p><b><u>FIGYELMEZTETÉS</u></b></p> <p>Ezen karbantartási kézikönyv kizárólag angol nyelven érhető el.</p> <ul style="list-style-type: none"> <li>• Ha a vevő szolgáltatója angoltól eltérő nyelvre tart igényt, akkor a vevő felelőssége a fordítás elkészíttetése.</li> <li>• Ne próbálja elkezdeni használni a berendezést, amíg a karbantartási kézikönyvben leírtakat nem értelmezték.</li> <li>• Ezen figyelmeztetés figyelmen kívül hagyása a szolgáltató, működtető vagy a beteg áramütés, mechanikai vagy egyéb veszélyhelyzet miatti sérülését eredményezheti.</li> </ul>
 (IS)	<p><b><u>AÐVÖRUN</u></b></p> <p>Þessi þjónustuhandbók er aðeins fánleg á ensku.</p> <ul style="list-style-type: none"> <li>• Ef að þjónustuveitandi viðskiptamanns þarfnast annas tungumáls en ensku, er það skylda viðskiptamanns að skaffa tungumálþjónustu.</li> <li>• Reynið ekki að afgreiða tækið nema að þessi þjónustuhandbók hefur verið skoðuð og skilin.</li> <li>• Brot á sinna þessari aðvörun getur leitt til meiðsla á þjónustuveitanda, stjórnanda eða sjúklings frá raflosti, vélrænu eða öðrum áhættum.</li> </ul>
 (IT)	<p><b><u>AVVERTENZA</u></b></p> <p>Il presente manuale di manutenzione è disponibile soltanto in lingua inglese.</p> <ul style="list-style-type: none"> <li>• Se un addetto alla manutenzione richiede il manuale in una lingua diversa, il cliente è tenuto a provvedere direttamente alla traduzione.</li> <li>• Procedere alla manutenzione dell'apparecchiatura solo dopo aver consultato il presente manuale ed averne compreso il contenuto.</li> <li>• Il mancato rispetto della presente avvertenza potrebbe causare lesioni all'addetto alla manutenzione, all'operatore o ai pazienti provocate da scosse elettriche, urti meccanici o altri rischi.</li> </ul>
 (JA)	<p><b><u>警告</u></b></p> <p>このサービスマニュアルには英語版しかありません。</p> <ul style="list-style-type: none"> <li>• サービスを担当される業者が英語以外の言語を要求される場合、翻訳作業はその業者の責任で行うものとさせていただきます。</li> <li>• このサービスマニュアルを熟読し理解せずに、装置のサービスを行わないでください</li> <li>• この警告に従わない場合、サービスを担当される方、操作員あるいは患者さんが、感電や機械的又はその他の危険により負傷する可能性があります。</li> </ul>



 (KO)	<p><b><u>경고</u></b></p> <p>본 4비스 매뉴얼은 영어로만 이용하실 수 있습니다.</p> <ul style="list-style-type: none"> <li>• 고객의 4비스 제공자가 영어 이외의 언어를 요구할 경우, 번역 4비스를 제공하는 것은 고객의 책임입니다.</li> <li>• 본 4비스 매뉴얼을 참조하여 숙지하지 않은 이상 해당 장비를 수리하려고 시도하지 마십시오.</li> <li>• 본 경고 사항에 유의하지 않으면 전기 쇼크, 기계적 위험, 또는 기타 위험으로 인해 4-비스 제공자, 사용자 또는 환자에게 부상을 입힐 수 있습니다.</li> </ul>
 (LV)	<p><b><u>BRĪDINĀJUMS</u></b></p> <p>Šī apkopes rokasgrāmata ir pieejama tikai angļu valodā.</p> <ul style="list-style-type: none"> <li>• Ja klienta apkopes sniedzējam nepieciešama informācija citā valodā, klienta pienākums ir nodrošināt tulkojumu.</li> <li>• Neveiciet aprikojuma apkopi bez apkopes rokasgrāmatas izlasīšanas un saprašanas.</li> <li>• Šī brīdinājuma neievērošanas rezultātā var rasties elektriskās strāvas trieciena, mehānisku vai citu faktoru izraisītu traumu risks apkopes sniedzējam, operatoram vai pacientam.</li> </ul>
 (LT)	<p><b><u>ISPĖJIMAS</u></b></p> <p>Šis eksploataavimo vadovas yra tik anglų kalba.</p> <ul style="list-style-type: none"> <li>• Jei kliento paslaugų tiekėjas reikalauja vadovo kita kalba – ne anglų, suteikti vertimo paslaugas privalo klientas.</li> <li>• Nemėginkite atlikti įrangos techninės priežiūros, jei neperskaitėte ar nesupratote šio eksploataavimo vadovo.</li> <li>• Jei nepaisysite šio įspėjimo, galimi paslaugų tiekėjo, operatoriaus ar paciento sužalojimai dėl elektros šoko, mechaninių ar kitų pavojų.</li> </ul>
 (NO)	<p><b><u>ADVARSEL</u></b></p> <p>Denne servicehåndboken finnes bare på engelsk.</p> <ul style="list-style-type: none"> <li>• Hvis kundens serviceleverandør har bruk for et annet språk, er det kundens ansvar å sørge for oversettelse.</li> <li>• Ikke forsøk å reparere utstyret uten at denne servicehåndboken er lest og forstått.</li> <li>• Manglende hensyn til denne advarselen kan føre til at serviceleverandøren, operatøren eller pasienten skades på grunn av elektrisk støt, mekaniske eller andre farer.</li> </ul>
 (PL)	<p><b><u>OSTRZEŻENIE</u></b></p> <p>Niniejszy podręcznik serwisowy dostępny jest jedynie w języku angielskim.</p> <ul style="list-style-type: none"> <li>• Jeśli serwisant klienta wymaga języka innego niż angielski, zapewnienie usługi tłumaczenia jest obowiązkiem klienta.</li> <li>• Nie próbować serwisować urządzenia bez zapoznania się z niniejszym podręcznikiem</li> </ul>

	<p>serwisowym i zrozumienia go.</p> <ul style="list-style-type: none"> <li>• Niezastosowanie się do tego ostrzeżenia może doprowadzić do obrażeń serwisanta, operatora lub pacjenta w wyniku porażenia prądem elektrycznym, zagrożenia mechanicznego bądź innego.</li> </ul>
 (PT-BR)	<p><b><u>AVISO</u></b></p> <p>Este manual de assistência técnica encontra-se disponível unicamente em inglês.</p> <ul style="list-style-type: none"> <li>• Se outro serviço de assistência técnica solicitar a tradução deste manual, caberá ao cliente fornecer os serviços de tradução.</li> <li>• Não tente reparar o equipamento sem ter consultado e compreendido este manual de assistência técnica.</li> <li>• A não observância deste aviso pode ocasionar ferimentos no técnico, operador ou paciente decorrentes de choques elétricos, mecânicos ou outros.</li> </ul>
 (PT-PT)	<p><b><u>ATENÇÃO</u></b></p> <p>Este manual de assistência técnica só se encontra disponível em inglês.</p> <ul style="list-style-type: none"> <li>• Se qualquer outro serviço de assistência técnica solicitar este manual noutra língua, é da responsabilidade do cliente fornecer os serviços de tradução.</li> <li>• Não tente reparar o equipamento sem ter consultado e compreendido este manual de assistência técnica.</li> <li>• O não cumprimento deste aviso pode colocar em perigo a segurança do técnico, do operador ou do paciente devido a choques eléctricos, mecânicos ou outros.</li> </ul>
 (RO)	<p><b><u>ATENȚIE</u></b></p> <p>Acest manual de service este disponibil doar în limba engleză.</p> <ul style="list-style-type: none"> <li>• Dacă un furnizor de servicii pentru clienți necesită o altă limbă decât cea engleză, este de datoria clientului să furnizeze o traducere.</li> <li>• Nu încercați să reparați echipamentul decât ulterior consultării și înțelegerii acestui manual de service.</li> <li>• Ignorarea acestui avertisment ar putea duce la rănirea depanatorului, operatorului sau pacientului în urma pericolelor de electrocutare, mecanice sau de altă natură.</li> </ul>
( RU )	<p><b><u>ОСТОРОЖНО!</u></b></p> <p>Данное руководство по техническому обслуживанию представлено только на английском языке.</p> <ul style="list-style-type: none"> <li>• Если сервисному персоналу клиента необходимо руководство не на английском, а на каком-то другом языке, клиенту следует самостоятельно обеспечить перевод.</li> <li>• Перед техническим обслуживанием оборудования обязательно обратитесь к данному руководству и поймите изложенные в нем сведения.</li> <li>• Несоблюдение требований данного предупреждения может привести к тому, что специалист по техобслуживанию, оператор или пациент получит удар электрическим</li> </ul>

	<p>током, механическую травму или другое повреждение.</p>
 (SR)	<p><b><u>UPOZORENJE</u></b></p> <p>Ovo servisno uputstvo je dostupno samo na engleskom jeziku.</p> <ul style="list-style-type: none"> <li>• Ako klijentov serviser zahteva neki drugi jezik, klijent je dužan da obezbedi prevodilačke usluge.</li> <li>• Ne pokušavajte da opravite uređaj ako niste pročitali i razumeli ovo servisno uputstvo.</li> <li>• Zanemarivanje ovog upozorenja može dovesti do povređivanja serviseru, rukovaoca ili pacijenta usled strujnog udara ili mehaničkih i drugih opasnosti.</li> </ul>
 (SK)	<p><b><u>UPOZORNENIE</u></b></p> <p>Tento návod na obsluhu je k dispozícii len v angličtine.</p> <ul style="list-style-type: none"> <li>• Ak zákazníkovi poskytovateľ služieb vyžaduje iný jazyk ako angličtinu, poskytnutie prekladateľských služieb je zodpovednosťou zákazníka.</li> <li>• Nepokúšajte sa o obsluhu zariadenia, kým si neprečítate návod na obsluhu a neporozumiete mu.</li> <li>• Zanedbanie tohto upozornenia môže spôsobiť zranenie poskytovateľa služieb, obsluhujúcej osoby alebo pacienta elektrickým prúdom, mechanické alebo iné ohrozenie.</li> </ul>
 (ES)	<p><b><u>ATENCION</u></b></p> <p>Este manual de servicio sólo existe en inglés.</p> <ul style="list-style-type: none"> <li>• Si el encargado de mantenimiento de un cliente necesita un idioma que no sea el inglés, el cliente deberá encargarse de la traducción del manual.</li> <li>• No se deberá dar servicio técnico al equipo, sin haber consultado y comprendido este manual de servicio.</li> <li>• La no observancia del presente aviso puede dar lugar a que el proveedor de servicios, el operador o el paciente sufran lesiones provocadas por causas eléctricas, mecánicas o de otra naturaleza.</li> </ul>
 (SV)	<p><b><u>VARNING</u></b></p> <p>Den här servicehandboken finns bara tillgänglig på engelska.</p> <ul style="list-style-type: none"> <li>• Om en kunds servicetekniker har behov av ett annat språk än engelska, ansvarar kunden för att tillhandahålla översättningstjänster.</li> <li>• Försök inte utföra service på utrustningen om du inte har läst och förstår den här servicehandboken.</li> <li>• Om du inte tar hänsyn till den här varningen kan det resultera i skador på serviceteknikern, operatören eller patienten till följd av elektriska stötar, mekaniska faror eller andra faror.</li> </ul>
	<p><b><u>OPOZORILO</u></b></p> <p>Ta servisni priročnik je na voljo samo v angleškem jeziku.</p>

(SL)	<ul style="list-style-type: none"><li>• Če ponudnik storitve stranke potrebuje priročnik v drugem jeziku, mora stranka zagotoviti prevod.</li><li>• Ne poskušajte servisirati opreme, če tega priročnika niste v celoti prebrali in razumeli.</li><li>• Če tega opozorila ne upoštevate, se lahko zaradi električnega udara, mehanskih ali drugih nevarnosti poškoduje ponudnik storitev, operater ali bolnik.</li></ul>
 (TR)	<p><b><u>DİKKAT</u></b></p> <p>Bu servis kılavuzunun sadece ingilizcesi mevcuttur.</p> <ul style="list-style-type: none"><li>• Eğer müşteri teknisyeni bu kılavuzu ingilizce dışında bir başka lisandan talep ederse, bunu tercüme ettirmek müşteriye düşer.</li><li>• Servis kılavuzunu okuyup anlamadan ekipmanlara müdahale etmeyiniz.</li><li>• Bu uyarıya uyulmaması, elektrik, mekanik veya diğer tehlikelerden dolayı teknisyen, operatör veya hastanın yaralanmasına yol açabilir.</li></ul>

# Contents

<b>1</b>	<b>Safety</b> .....	<b>1-1</b>
	General Information .....	1-2
	Definitions of Terminology .....	1-3
	Monitor Contraindications, Warnings, and Precautions .....	1-4
	Equipment Symbols .....	1-9
<b>2</b>	<b>Introduction</b> .....	<b>2-1</b>
	Indications for Use .....	2-2
	Monitoring Methods .....	2-3
	Features .....	2-4
	About Your Monitor .....	2-5
<b>3</b>	<b>Controls, Indicators, and Connectors</b> .....	<b>3-1</b>
	Front Panel Controls .....	3-2
	Front Panel Displays and Indicators .....	3-6
	Front Panel Connectors .....	3-8
	Strip Chart Recorder .....	3-12
	Rear Panel Connectors .....	3-14
<b>4</b>	<b>Setup Procedures</b> .....	<b>4-1</b>
	Loading Strip Chart Paper .....	4-2
	Turning the Monitor On .....	4-7

Monitor Self-Test Routines .....	4-8
Customizing the Monitor .....	4-10
Quick Reference Card .....	4-18
Flasher Software Utility Upgrade .....	4-20

# 5

<b>Theory of Operation .....</b>	<b>5-1</b>
Functional Overview .....	5-2
Main Board Theory of Operation .....	5-17
FECG/IUP Board Theory of Operation .....	5-36

# 6

<b>Functional Checkout Procedure .....</b>	<b>6-1</b>
Equipment Required .....	6-2
General .....	6-3
Monitor Self-Test .....	6-4
Front Panel Pushbutton Test .....	6-5
Connecting the Simulator .....	6-6
FECG Test .....	6-7
Legplate Inspection .....	6-12
Ultrasound Test .....	6-13
Fetal Movement Detection Test .....	6-16
Ultrasound Transducer Test .....	6-18
Uterine Activity Test .....	6-19
Tocotransducer Test .....	6-21
Strain Gauge Transducer Test .....	6-22
Pattern Memory Test .....	6-23
Dual Heart Rate Test (Non-Pattern) .....	6-24

Alarm Test ..... 6-28

# 7

**Serviceable Assemblies ..... 7-1**

General Anti-Static Handling Precautions ..... 7-2

Transducer Plug Replacement Kits ..... 7-3

Nautilus Transducer Cable Replacement ..... 7-15

Removing the Monitor Top Cover ..... 7-19

Tocotransducer Calibration ..... 7-20

Nautilus Ultrasound Transducer Top Cover Replacement ..... 7-30

Nautilus Transducer Reassembly ..... 7-32

Testing a Repaired Transducer (TOCO or US) ..... 7-34

Replacing the Main Board ..... 7-35

Replacing the FECG/IUP Board ..... 7-36

Replacing the Membrane Switch Panel ..... 7-37

Replacing a Front Panel Connector ..... 7-40

Servicing the Recorder ..... 7-41

Boot ROM Error Codes ..... 7-49

# 8

**Peripheral Devices ..... 8-1**

Remote Marks Connectors ..... 8-2

Telemetry Connector ..... 8-3

RS-232 Connectors ..... 8-4

# 9

**Maintenance ..... 9-1**

Cleaning ..... 9-2

Preventative Maintenance Inspection ..... 9-5

<b>10</b>	<b>Specifications</b> .....	<b>10-1</b>
	General Monitor .....	10-2
	Operating Modes .....	10-3
	Strip Chart Recorder .....	10-4

<b>11</b>	<b>Parts Lists</b> .....	<b>11-1</b>
	2000268-188, Model 171 Final Assembly .....	11-2
	2000268-189, Model 172 Final Assembly .....	11-5
	2001972-037, Model 173 Final Assembly .....	11-8
	2001972-038, Model 174 Final Assembly .....	11-11
	2264AAX, Button-Style Nautilus Tocotransducer Assembly Parts List .....	11-14
	5700GAX, Button-Style Nautilus Ultrasound Transducer Assembly Parts List	11-15
	5700KAX, Loop-Style Nautilus Ultrasound Transducer Assembly Parts List .	11-16
	2264DAX, Loop-Style Nautilus Tocotransducer Assembly Parts List (5-ft cord)	11-17
	1509AAO/BAO, Qwik Connect Plus Legplate Assembly Parts List .....	11-18
	Block Diagrams .....	11-19





# Chapter 1

## Safety

The information presented in this section is important for the safety of both the patient and operator and also serves to enhance equipment reliability. This chapter describes how the terms Danger, Warning, Caution, Important, and Note are used throughout the manual. In addition, standard equipment symbols are defined.

This section includes the following important information:

General Information .....	1-2
Definitions of Terminology .....	1-3
Monitor Contraindications, Warnings, and Precautions .....	1-4
Equipment Symbols .....	1-9

# Revision History

Each page of this manual has a revision letter located at the bottom of the page. This letter identifies the revision level of the entire manual. This may be important if you have different manuals and you do not know which is the most current.

For the initial release, all pages have the revision letter A. For the second update, all pages receive the revision letter B. The latest letter of the alphabet added to the table below corresponds to the most current revision.

Revision	Date	Comment
A	22 July 2002	Initial Release
B	26 Mar 2004	<ol style="list-style-type: none"> <li>1) Updated GE Asia and Europe addresses and phone numbers on back cover and deleted GE addresses and Revision letter and date on the Title Guarantee page.</li> <li>2) On page 4-15, changed code #21 (HBC) from "0=off, 1=off" to "0=off, 1=on"</li> <li>3) On page 7-49, added Boot ROM error codes</li> </ol>
C	14 Nov 2007	Addition of TYPE CF equipment symbol
D	10 Feb 2012	<ol style="list-style-type: none"> <li>1) Addition of addendum for use of PS320 Simulator</li> <li>2) Updated Electrical Safety Test section for Patient Leakage tests with reference to IEC 60601-2-49 standard.</li> <li>3) Updated procedure to test Ultrasound and TOCO Transducer.</li> <li>4) Corrected the Symbol for FAST.</li> <li>5) Added Service Manual Disclaimer</li> <li>6) Functional Checkout Procedure: Connecting the simulator Section: Added note to "Refer addendum for using PS320 Simulator".</li> </ol>

# General Information

## General Use

If the monitor is cold to the touch or below ambient temperature, allow it to stabilize before use.

To ensure patient safety, use only parts and accessories manufactured or recommended by GE Medical Systems *Information Technologies*. Parts and accessories used shall meet the requirements of EN60601.1.1.

Disposable devices are intended for single use only. They should not be reused.

Periodically, and whenever the integrity of the monitor is in doubt, test all functions.

Refer to the “**Maternal/Fetal Monitoring Operator’s Manual**” for information concerning the limitations of internal and external fetal heart rate monitoring techniques.

## Responsibility of the Manufacturer

GE is responsible for the effects on safety, reliability, and performance if:

- assembly operations, extensions, readjustments, modifications, or repairs are carried out by persons authorized by GE;
- the electrical installation of the relevant room complies with the requirements of appropriate regulations; and
- the monitor is used in accordance with the instructions of use.

## Responsibility of the User

This device is intended for use by clinical professionals who are expected to know the medical procedures, practices, and terminology required to monitor obstetrical patients. This manual documents all possible parameters available in the 170 Series of monitors. It is the responsibility of each hospital to ensure that the Labor and Delivery staff is trained in all aspects of the selected model.

The 170 Series Monitor is designed to assist the perinatal staff by providing information regarding the clinical status of the fetus during labor. The monitor does not replace observation and evaluation of the mother and fetus at regular intervals, by a qualified care provider, who will make diagnoses and decide on treatments or interventions. Visual assessment of the monitor display and strip chart must be combined with knowledge of patient history and risk factors to properly care for the mother and fetus.

# Definitions of Terminology

Six types of special notices are used *throughout* this manual. They are: Danger, Warning, Caution, Contraindication, Important, and Note. The warnings and cautions in this Safety section relate to the equipment in general and apply to all aspects of the monitor. Be sure to read the other chapters because there are additional warnings and cautions which relate to specific features of the monitor.

When grouped, warnings and cautions are listed alphabetically and do not imply any order of importance.

Table 1-1. Definitions of Terminology	
<b>Danger</b>	A <b>DANGER</b> notice indicates an imminently hazardous situation which, if not avoided, will result in death or serious injury.
<b>Warning</b>	A <b>WARNING</b> indicates a potentially hazardous situation which, if not avoided, could result in death or serious injury.
<b>Caution</b>	A <b>CAUTION</b> indicates a potentially hazardous situation which, if not avoided, may result in minor or moderate injury. Cautions are also used to avoid damage to equipment.
<b>Contraindication</b>	A <b>CONTRAINDICATION</b> describes any special symptom or circumstance that renders the use of a remedy or the carrying out of a procedure inadvisable, usually because of a risk.
<b>Important</b>	An <b>IMPORTANT</b> notice indicates an emphasized note. It is something you should be particularly aware of; something not readily apparent.
<b>Note</b>	A <b>NOTE</b> indicates a particular point of information; something on which to focus your attention.

# Monitor Contraindications, Warnings, and Precautions

## Warnings

---

---

### **WARNINGS**

**ACCIDENTAL SPILLS**—In the event that fluids are accidentally spilled on the monitor, take the monitor out of operation and inspect for damage.

**APPLICATION**—This monitor is not designed for direct cardiac connection.

**CONDUCTIVE CONNECTIONS**—Avoid making any conductive connections to applied parts (patient connection) which are likely to degrade safety.

**CONDUCTIVE PARTS**—Ensure that the conductive parts of the lead electrodes and associated connectors do not contact other conductive parts including earth.

**DEFIBRILLATION**—During defibrillation, all personnel must avoid contact with the patient and monitor to avoid a dangerous shock hazard. In addition, proper placement of the paddles in relation to the electrodes is required to minimize harm to the patient.

**ELECTRICAL SHOCK**—To reduce the risk of electrical shock, do not remove monitor cover. Refer servicing to qualified personnel.

**ELECTROMAGNETIC INTERFERENCE**—Be aware that strong electromagnetic fields may interfere with monitor operation. Interference prevents the clear reception of signals by the monitor. If the hospital is close to a strong transmitter such as TV, AM or FM radio, police or fire stations, a HAM radio operator, an airport, or cellular phone, their signals could be picked up as signals by the monitor. If you feel interference is affecting the monitor, contact your Service Representative to check the monitor in your environment. Refer to [page 1-8](#) for additional information.

---

---

---

---

**WARNINGS**

**ELECTROSURGERY**—The monitor is not designed for use with high-frequency surgical devices. In addition, measurements may be affected in the presence of strong electromagnetic sources such as electrosurgery equipment.

**EXPLOSION HAZARD**—Do not use this equipment in the presence of flammable anesthetics or inside an oxygen tent.

**GROUNDING**—Do not defeat the three-wire grounding feature of the power cord by means of adaptors, plug modifications, or other methods. A dangerous shock hazard to both patient and operator may result.

**INSTRUCTIONS**—For continued and safe use of this equipment, it is necessary to follow all listed instructions. However, the instructions provided in this manual in no way supersede established medical procedures concerning patient care. The monitor does not replace observation and evaluation of the patient, at regular intervals, by a qualified care provider who will make diagnoses and decide on treatments and interventions.

**INTERFACING OTHER EQUIPMENT**—Monitoring equipment must be interfaced with other types of medical equipment by qualified biomedical engineering personnel. Be certain to consult manufacturers' specifications to maintain safe operation.

**LEAKAGE CURRENT TEST**—The interconnection of auxiliary equipment with this device may increase the total leakage current. When interfacing with other equipment, a test for leakage current must be performed by qualified biomedical engineering personnel before using with patients. Serious injury or death could result if the leakage current exceeds applicable standards. The use of accessory equipment not complying with the equivalent safety requirements of this equipment may lead to a reduced level of safety of the resulting system. Consideration relating to the choice shall include: use of the accessory in the patient vicinity; and evidence that the safety certification of the accessory has been performed in accordance with the appropriate EN60601.1 and/or EN60601.1.1 harmonized national standard.

---

---

---

---

**WARNINGS**

**LINE ISOLATION MONITOR TRANSIENTS**—Line isolation monitor transients may resemble actual cardiac waveforms, and thus cause incorrect heart rate determinations and alarm activation (or inhibition).

**STRANGULATION**—Make sure all patient cables, leadwires, and tubing are positioned away from the patient's head to minimize the risk of accidental strangulation.

**WATER BIRTHS**—Do not use the monitor to directly monitor patients during water births, in whirlpool or submersion water baths, during showers, or in any other situation where the mother is immersed in water. Doing so may result in electrical shock hazard.

---

---

## Cautions

---

---

### **CAUTIONS**

**ANNUAL SERVICING**—For continued safety and performance of the monitor, it is recommended that the calibration, accuracy, and electrical safety of the monitor be verified on an annual basis by an GE Service Representative.

**DAILY TESTING**—It is essential that the monitor and accessories be inspected every day. It is recommended practice to initiate the monitor's self-test feature at the beginning of each monitoring session; follow the instructions in "[Chapter 4, Setup Procedures](#)".

**ENVIRONMENT**—The performance of the monitor has not been tested in certain areas, such as x-ray and imaging suites. The monitor is not recommended for use in these environments.

**PERFORMANCE**—Report all problems experienced with the monitor. If the monitor is not working properly, contact your Service Representative for service. The monitor should not be used if it is not working properly.

**PINCHING**—Keep fingers clear of the paper roller because the roller could pinch your fingers.

**TRAPPING**—Keep hands, hair, jewelry, and loose clothing away from the paper roller because the roller could trap these items.

**TRIPPING**—Arrange monitoring equipment so that cords and cables do not present a tripping hazard.

---

---



## Electromagnetic Interference

This device has been tested and found to comply with the limits for medical devices to the IEC 601-1-2:1993, EN60601-1-2:1994, Medical Device Directive 93/42/EEC. These limits are designed to provide reasonable protection against harmful interference in a typical medical installation.

However, because of the proliferation of radio-frequency transmitting equipment and other sources of electrical noise in the health-care and home environments (for example, cellular phones, mobile two-way radios, electrical appliances), it is possible that high levels of such interference due to close proximity or strength of a source, may result in disruption of performance of this device.







This equipment generates, uses, and can radiate radio frequency energy and, if not installed and used in accordance with these instructions, may cause harmful interference with other devices in the vicinity. Disruption or interference may be evidenced by erratic readings, cessation of operation, or incorrect functioning. If this occurs, the site of use should be surveyed to determine the source of this disruption, and actions taken to eliminate the source.

The user is encouraged to try to correct the interference by one or more of the following measures:

- Turn equipment in the vicinity off and on to isolate the offending equipment.
- Reorient or relocate the other receiving device.
- Increase the separation between the interfering equipment and this equipment.
- If assistance is required, contact your GE Service Representative.

# Equipment Symbols

The following is a list of symbols used on products manufactured by GE. Some symbols may not appear on your unit.

Table 1-2. Equipment Symbols	
	ATTENTION: Consult accompanying documents.
	TYPE B EQUIPMENT. Type B equipment is suitable for intentional external and internal application to the patient, excluding direct cardiac application.
	TYPE BF EQUIPMENT. Type BF equipment is suitable for intentional external and internal application to the patient, excluding direct cardiac application. Type BF equipment has an F-type applied part.
	TYPE CF EQUIPMENT. Type CF equipment is suitable for intentional external and internal application to the patient, including direct cardiac application. Type CF equipment has an F-type applied part.
	ALTERNATING CURRENT (AC).
	EQUIPOTENTIALITY.
	ON/STANDBY: button toggles between full power and standby.

---



---

### CAUTION

AC MAINS—The On/Standby switch does not disconnect the monitor from AC mains power. To completely remove power, you must disconnect the power cord from the AC wall outlet.

---



---



# Chapter 2

## Introduction

This section lists the indications for use for monitors in the 170 Series as well as provides an explanation of the different patient monitoring modalities.

This section summarizes the clinical applications of monitors in the 170 Series:

Indications for Use .....	2-2
Monitoring Methods .....	2-3
Features .....	2-4
About Your Monitor .....	2-5

## Indications for Use

### Models 171 and 172

Models 171 and 172 Fetal Monitors are indicated for use in the monitoring of the fetus during the antepartum period as well as throughout labor and delivery. Each monitor also has an optional monitoring mode to detect fetal body movements.

### Models 173 and 174

Models 173 and 174 Fetal Monitors are indicated for use in the monitoring of the fetus throughout labor and delivery. Each monitor also has an optional monitoring mode to detect fetal body movements.

# Monitoring Methods

The following is a summary of *all* the clinical monitoring methods found in the 170 Series.

## Fetal Heart Rate

### External Method, Pulsed Doppler Ultrasound

Ultrasound monitoring is available on all 170 Series Monitors. Models 171 and 173 provide a single ultrasound channel, while Models 172 and 174 provide two ultrasound channels.

Fetal heart rate can be measured externally using pulsed Doppler Ultrasound. A transducer placed on the mother's abdomen is used to direct an ultrasonic beam toward the fetal heart and to sense Doppler shifted echoes created by moving cardiac structures. A patented autocorrelation process is used to determine the timing of successive cardiac cycles. The resulting fetal heart rate (FHR) pattern is recorded on the strip chart paper and the FHR appears on the digital display.

### Internal Method, Direct Fetal Electrocardiogram (FECG)

FECG is available on Models 173 and 174 only. The Model 173 provides a dedicated FECG connector. The Model 174 provides a combi-connector which can be used for either FECG or US.

FECG signals are obtained via a spiral electrode attached to the fetal presenting part. FHR is computed on a beat-to-beat basis using the R-to-R time interval of the QRS complexes. The instantaneous FHR pattern is printed on the strip chart paper and the FHR appears on the digital display.

## Maternal Uterine Activity

### External Method, Tocotransducer (TOCO)

Maternal uterine activity is measured externally using a tocotransducer (toco). Relative pressure within the uterus is measured using a tocotransducer attached to the mother's abdomen in the area of the uterine fundus. The readings are plotted on the strip chart paper in a relative scale from 0 to 100 as well as shown on the digital display. All 170 Series Monitors provide external uterine activity monitoring.

### Internal Method, Intrauterine Pressure Catheter and Strain Gauge (IUP)

IUP is available on Models 173 and 174 only.

Intrauterine pressure is measured using a transcervical catheter. The pressure trend is plotted over the range of 0 to 100 mmHg and the readings appear on the digital display.

# Features

The 170 Series is a family of fetal monitors offering various combinations of modalities to suit your institution's needs. Each monitor boasts the following qualities:

- The strip chart recorder is a quiet, easy-to-load, high resolution thermal array printer. The recorder prints continuous trends and alphanumeric data on one strip chart.
- Automatic mode selection is provided simply by inserting the appropriate transducer plug into the front panel receptacle.
- Wide beam ultrasound transducer provides an advanced level of system performance.
- Transducer connectors are easy-to-use, color-coded, and durable.
- Frequently-used functions are controlled by front panel buttons—including audio volume, uterine activity reference, alarm silence, event mark, paper advance, and user setup controls.
- The ultrasound mode provides clean accurate traces with few “dropouts” because of a patented autocorrelation processing.
- Fetal heart rate alarm limits are user-defined, with pre-set defaults.
- Alarm silencing is controlled by a front panel pushbutton—colored for easy recognition.
- Fetal heart rate alarm conditions have both audible and visual indications. The audible indicator can be silenced on an alarm-by-alarm basis.
- Two RS-232C ports provide interfacing to external devices.

# About Your Monitor

This manual describes all monitors in the 170 Series; therefore some sections may not apply to your model monitor. Refer to [Table 2-1](#).

## Model 171

The Model 171 Antepartum Fetal Monitor provides singleton ultrasound and external uterine activity monitoring.

## Model 172

The Model 172 Antepartum Fetal Monitor provides dual ultrasound and external uterine activity monitoring.

## Model 173

The Model 173 Intrapartum Monitor provides dual heart rate monitoring using FECG and ultrasound. The monitor also provides external uterine activity monitoring using a tocotransducer or internal monitoring using an intrauterine pressure catheter (IUPC).

## Model 174

The Model 174 Intrapartum Monitor provides dual heart rate monitoring using FECG/ultrasound or dual ultrasound. The monitor also provides external uterine activity monitoring using a tocotransducer or internal monitoring using an IUPC.

Feature	171	172	173	174
External uterine activity (TOCO)	✓	✓	✓	✓
Internal uterine activity (IUPC)			✓	✓
Ultrasound <sup>a</sup>	✓	✓	✓	✓
Dual ultrasound		✓		✓
FECG <sup>a</sup>			✓	✓
Fetal heart rate alarms	✓	✓	✓	✓
Fetal movement detection (optional)	✓	✓	✓	✓
Heartbeat coincidence		✓	✓	✓
Fetal heart rate offset		✓	✓	✓

<sup>a</sup> The Model 174 has a combi-connector for the primary FHR that can be used for either US or FECG.

**For your notes**





## Chapter 3

# Controls, Indicators, and Connectors

This section describes all possible controls, indicators, and connectors in the 170 Series.

This section contains the following information:

Front Panel Controls .....	3-2
Front Panel Displays and Indicators .....	3-6
Front Panel Connectors .....	3-8
Strip Chart Recorder .....	3-12
Rear Panel Connectors .....	3-14

# Front Panel Controls

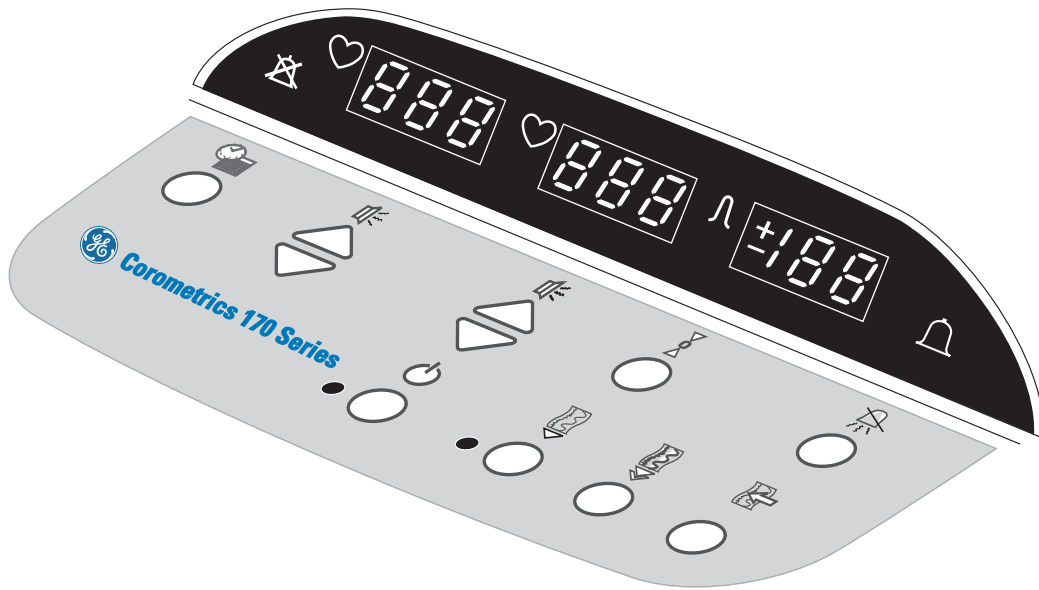

Figure 3-1. Front Panel Controls (Model 172 shown)









Table 3-1. Front Panel Controls	
Symbol	Name
	Power
	Record
	Paper Advance
	Mark/Offset
	Setup
	Volume

Table 3-1. Front Panel Controls	
	UA Reference
	Alarm Silence

## Power Button and Indicator

Pressing the blue Power button turns the monitor on and illuminates the green indicator to the left of the button. Pressing the button again puts the monitor in standby and extinguishes the indicator.

## Record Button and Indicator

Pressing the Record pushbutton activates the recorder, provided paper is installed; the amber indicator illuminates to the left of the button. Pressing the button again turns the recorder off and extinguishes the indicator.

## Paper Advance Button

Pressing the Paper Advance button causes the recorder to advance chart paper at a rate of 40 cm/min for as long as the button is pressed. If the recorder is on, twenty seconds after the button is released, the recorder prints the time, date, active trends legends, and chart speed.

## Mark/Offset Button

The Mark/Offset button is a multifunction button:

### Mark

Briefly pressing the button prints an event mark  on the bottom two lines of the heart rate grid.

### Offset (Models 172, 173, and 174 Only)

When the heart rate offset mode is enabled, pressing and *holding* the Mark/Offset button for at least two seconds shifts the secondary FHR trend +20 BPM for visibility purposes. You will hear a “beep” for confirmation. Refer to the “[170 Series Operator’s Manual](#)” for more information.



## Setup Button

Pressing and holding this button while the monitor is on enters a user setup mode for configuring the monitor.

Pressing and holding this button during power up enters a service setup mode.

Refer to “[Chapter 4, Setup Procedures](#)” for instructions.



## Volume Buttons

The Volume buttons are used to raise ( $\triangle$ ) and lower ( $\nabla$ ) the volume of the audio signals emitted by the speaker. The volume buttons are also used during setup.

### Model 171

This monitor has two volume buttons used to control the ultrasound audio.

### Models 172, 173, and 174

These monitors have four volume buttons. The left pair controls the audio signals for the mode shown in the primary FHR display; likewise, the right pair of buttons controls the audio for the mode shown in the secondary FHR display.

### Setup Mode

When the monitor is in setup mode (user or service), the volume buttons change: the setting or value shown in the FHR display; or the monitor feature code shown in the UA display. (For Models 172, 173, and 174, only the leftmost volume controls are active during setup mode.)

## UA Reference Button

The UA Reference button is used to set the uterine activity pressure reference. This button is also used during setup.

### Setting a Baseline for External Monitoring (Tocotransducer)

Briefly pressing the UA Reference button sets the pressure baseline at a preset default. The monitor is shipped from the factory with a default setting of 10 relative units. Qualified service personnel can access a service screen to set the default to 5, 10, 15, 20, or 25 relative units.

Pressing this button for more than two seconds causes the uterine activity reference value to override the default setting and cycle through all available selections: 5, 10, 15, 20, or 25 relative units, starting at the *default* setting—until the button is released. While the button is held down, the strip chart tracing remains unchanged. Once the button is released, the recorder trace takes on this new value. This value is stored as the new baseline for the currently measured uterine activity signal.

### Setting a Baseline for Internal Monitoring (IUPC)

Pressing the UA Reference button sets the pressure baseline at 0 mmHg.

**NOTE:** IUPC monitoring is only available on Models 173 and 174.

### Setup Mode

When the monitor is in setup mode, the UA Reference button selects the active display. Pressing the button alternates between the UA display (which shows a monitor feature code) and the FHR display (which shows the setting or value for the selected feature code). When the UA display is active, the  $\pm$  sign lights. When the FHR display is active, the heartbeat indicator  lights.

## Alarm Silence Button

This button is yellow for easy recognition. Pressing the Alarm Silence button removes the audible indication of an individual fetal heart rate alarm.

**NOTE:** Silencing an alarm does not affect the visual indications.

# Front Panel Displays and Indicators

## Fetal Heart Rate Display(s) and Indicator(s)

### FHR Display

A three-digit yellow numeric display indicates the fetal heart rate in beats per minute. The value flashes during an alarm condition.

### Heartbeat Indicator

A yellow heart shaped indicator flashes with each detected valid heartbeat for the fetal heart.

### Primary Versus Secondary (Models 172, 173, and 174 only)

Refer to [Table 3-2](#) for a summary of display positions relative to connectors.

## Uterine Activity Display

This green three-digit display indicates the uterine activity values.























### Tocotransducer

If uterine activity is measured using a tocotransducer, the uterine activity value displays in relative units. A plus sign flashes when the uterine activity value exceeds the strip chart range of 100 relative units.

### IUP (Models 173 and 174 Only)

If uterine activity is measured using an intrauterine pressure catheter or a strain gauge pressure transducer, the uterine activity value displays in mmHg.

**Table 3-2. Display/Connector Summary**

Monitor	Model 171		Model 172			Model 173			Model 174		
Mode	US	TOCO	US1	US2	TOCO	US	FECG	TOCO or IUP	US1 or FECG	US2	TOCO or IUP
Display											
Connector											



## Alarms Disabled Indicator

This yellow indicator illuminates when all alarms have been disabled. The indicator is unlit when alarms are enabled. Refer to “[Chapter 4, Setup Procedures](#)” for information on enabling/disabling alarms.



## Audio Alarm Indicator

### Active Patient Alarms

For active patient alarms, this yellow indicator flashes; it continues to flash even if the alarm is silenced.

### Resolved Patient Alarms

For resolved patient alarms, the indicator continues to flash until you silence the alarm. This ensures that the alarm is acknowledged by a clinician.

### Signal Quality Alarms

For signal quality alarms, the indicator flashes during an active alarm and turns off as soon as the condition is resolved. The indicator is unaffected by silencing the audio alarm.

# Front Panel Connectors

## Model 171 Connectors

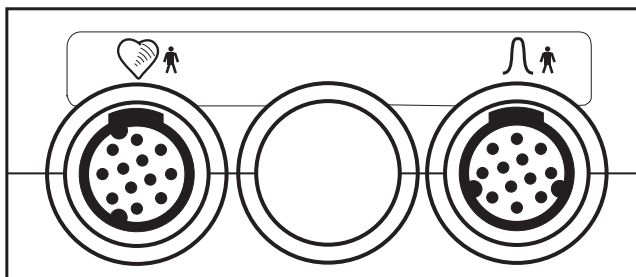

Figure 3-2. Model 171 Connectors

### Ultrasound Connector

The ultrasound connector<sup>1</sup> is a blue, round receptacle mechanically keyed to accept only a Corometrics ultrasound transducer plug. The fetal heart rate derived from this transducer shows in the fetal heart rate display.

### Uterine Activity Connector

The uterine activity connector is a white, round receptacle mechanically keyed to accept a Corometrics tocotransducer. The uterine activity value obtained from this transducer shows in the uterine activity display.

<sup>1</sup> If the Model 171 is interfaced to a clinical information system (CIS), be aware that the CIS may be designed to alarm when there is no fetal heart rate signal. Therefore it is recommended that you unplug the ultrasound transducer from the monitor, when not in use, to eliminate false alarms.



## Model 172 Connectors

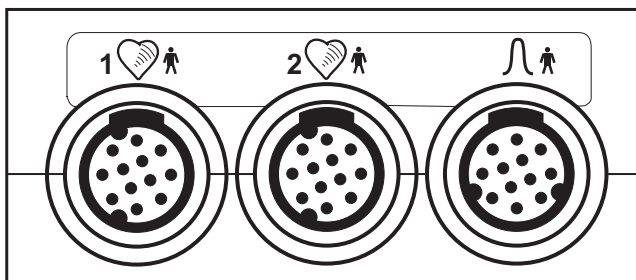

Figure 3-3. Model 172 Connectors

### 1 Primary Ultrasound Connector

The primary ultrasound connector<sup>1</sup> is a blue, round receptacle mechanically keyed to accept only a Corometrics ultrasound transducer plug. The fetal heart rate derived from this transducer shows in the primary fetal heart rate display.

### 2 Secondary Ultrasound Connector

The secondary ultrasound connector<sup>1</sup> is a blue, round receptacle identical to the primary ultrasound connector described above. The fetal heart rate derived from this connector displays in the secondary fetal heart rate display.

### Uterine Activity Connector

The uterine activity connector is a white, round receptacle mechanically keyed to accept a Corometrics tocotransducer. The uterine activity value obtained from this transducer shows in the uterine activity display.

<sup>1</sup> If the Model 172 is interfaced to a clinical information system (CIS), be aware that the CIS may be designed to alarm when there is no fetal heart rate signal. Therefore it is recommended that you unplug the ultrasound transducer(s) from the monitor, when not in use, to eliminate false alarms.

## Model 173 Connectors

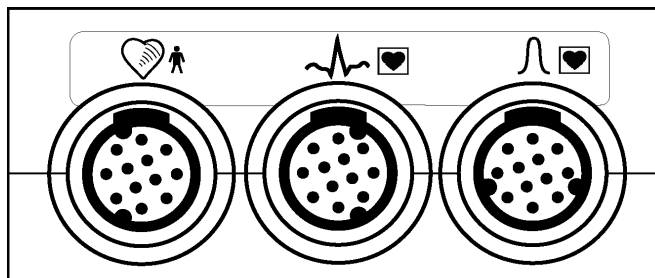

Figure 3-4. Model 173 Connectors

### Ultrasound Connector

The ultrasound connector<sup>1</sup> is a blue, round receptacle mechanically keyed to accept only a Corometrics ultrasound transducer plug. The fetal heart rate derived from this transducer shows in the *primary* fetal heart display.

### FECG Connector

The FECG connector<sup>1</sup> is a dark grey, round receptacle mechanically keyed to accept a Corometrics FECG cable/legplate plug. The fetal heart rate derived from the spiral electrode displays in the *secondary* fetal heart rate display.

### Uterine Activity Connector

The uterine activity connector is a white, round receptacle mechanically keyed to accept a Corometrics tocotransducer, a Corometrics strain gauge transducer plug, or any intrauterine pressure catheter with compatible cable plug. The uterine activity value obtained from this transducer shows in the uterine activity display.

<sup>1</sup> If the Model 173 is interfaced to a clinical information system (CIS), be aware that the CIS may be designed to alarm when there is no fetal heart rate signal. Therefore it is recommended that you unplug the ultrasound and/or FECG transducers from the monitor, when not in use, to eliminate false alarms.

## Model 174 Connectors

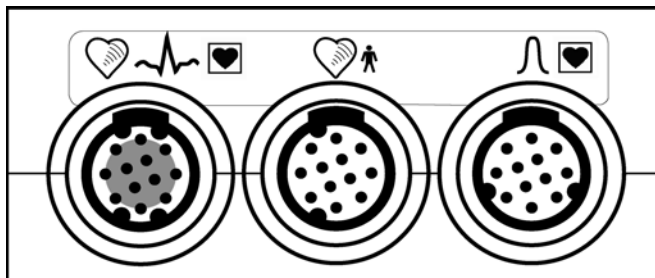

Figure 3-5. Model 174 Connectors

### Combi-Connector (Primary Ultrasound or FECG)

The combi-connector is a blue connector<sup>1</sup> with a dark grey inner center. This round receptacle is mechanically keyed to accept only a Corometrics ultrasound transducer plug or a Corometrics FECG cable/legplate plug. The fetal heart rate derived from this transducer or cable/legplate shows in the *primary* fetal heart display.

---



---

#### **IMPORTANT**

**COMBI-CONNECTOR**—The combi-connector can be used for monitoring ultrasound *or* FECG depending on what you plug in (US transducer or FECG cable/legplate). When used in conjunction with the secondary ultrasound connector, you have the option of monitoring twins using dual US or FECG/US.

---



---

### Secondary Ultrasound Connector

The secondary ultrasound connector<sup>1</sup> is a blue, round receptacle mechanically keyed to accept only a Corometrics ultrasound transducer plug. The fetal heart rate derived from this connector shows in the *secondary* fetal heart rate display.

### Uterine Activity Connector

The uterine activity connector is a white, round receptacle mechanically keyed to accept a Corometrics tocotransducer, a Corometrics strain gauge transducer plug, or any intrauterine pressure catheter with compatible cable plug. The uterine activity value obtained from this transducer shows in the uterine activity display.

---

<sup>1</sup> If the Model 174 is interfaced to a clinical information system (CIS), be aware that the CIS may be designed to alarm when there is no fetal heart rate signal. Therefore it is recommended that you unplug the ultrasound and/or FECG transducers from the monitor; when not in use, to eliminate false alarms.

# Strip Chart Recorder

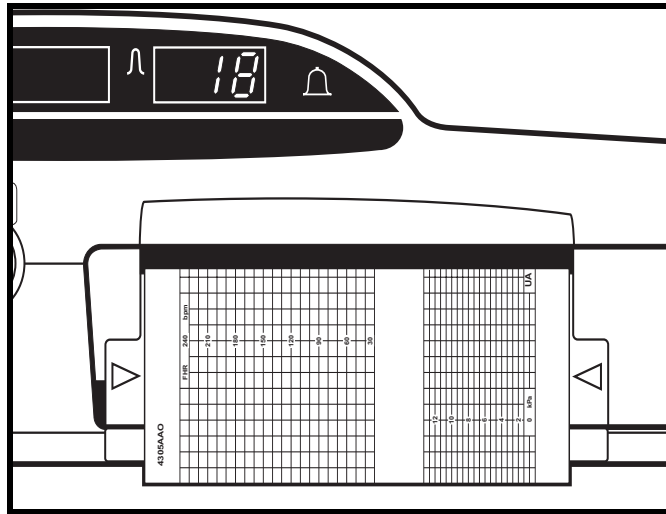

**Figure 3-6. Strip Chart Recorder**

The strip chart recorder is located on the right side of the front panel. Latches on each side of the recorder open the paper drawer.

Two styles of paper are available: 30-240 BPM scale and 50-210 BPM scale.

Refer to “[Chapter 4, Setup Procedures](#)” for instructions on loading strip chart paper into the recorder.

## Heart Rate Grid

One or two fetal heart rate trends print in the top (or left) grid of the strip chart paper—depending on your model monitor and the active modalities.

If only one fetal heart rate is being monitored, the FHR trend is printed in black. If twins are being monitored, the primary trend is printed in plain black while the secondary trend is bolded.

Refer to the “[170 Series Operator’s Manual](#)” for additional information about fetal heart rate trends and annotations.

## Uterine Activity Grid

The uterine activity trend prints in black on the bottom (or right) grid of the strip chart paper.

Refer to the “[170 Series Operator’s Manual](#)” for more information about uterine activity trends and annotations.

## Annotation Area

An annotation area is provided between the fetal heart rate and uterine activity grids.

## Rear Panel Connectors

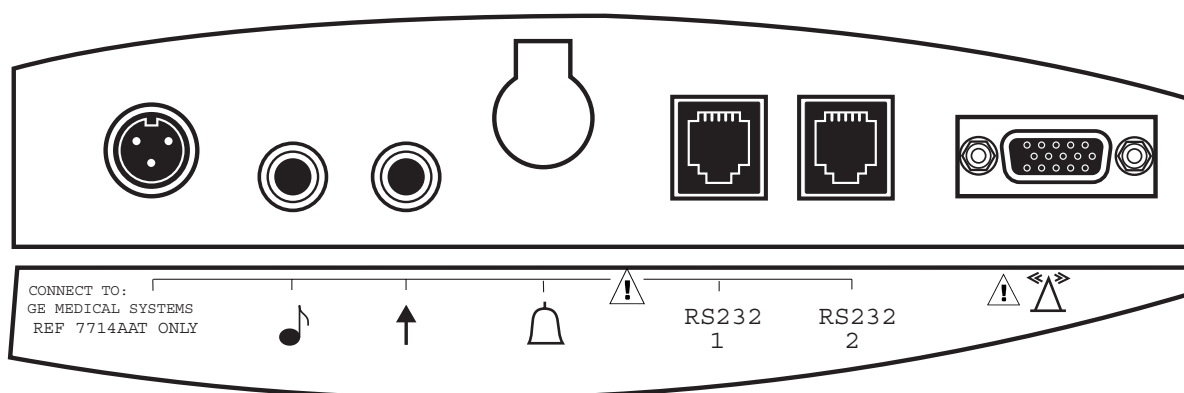

Figure 3-7. Rear Panel Connectors

## Power Supply Connector

This is the receptacle for the AC adapter, P/N 7714AAT only. A line cord connects from the other end of the adapter to an AC wall outlet. The connector is labeled **CONNECT TO GE MEDICAL SYSTEMS REF 7714AAT ONLY**. The power supply is a universal AC-to-DC converter which can accept an AC input in the range 100–230 VAC. The converter supplies a regulated 12 Vdc to the monitor.

## ♪ FAST Connector

This connector is provided for attaching an optional Corometrics Model 146 Fetal Acoustic Stimulator (FAST). The annotation ♪ prints on the strip chart each time the Model 146 is used.

## ↑ Remote Mark Connector

This connector is provided for attaching an optional Corometrics Remote Event Marker. This accessory annotates the strip chart recorder paper with a marker which can be configured as one of the following:

↑ : This annotation is commonly used to record an “event.”

<sup>FM</sup>↑ : This annotation is commonly used as an indication that the mother has perceived fetal movement.

The monitor is factory set to use the <sup>FM</sup>↑ annotation. Refer to the “[Chapter 4, Setup Procedures](#)” for information about selecting the annotation.



## Nurse Call Interface

This connector is intended for future interfacing to a standard Nurse Call System.

## RS-232C Connectors

Two RS-232C connectors are provided for interfacing to peripheral equipment such as:

- a maternal non-invasive blood pressure monitor
- a central information system that uses Hewlett-Packard's Digital Series Interface Protocol

Contact your Service Representative for more information.

---

---

### **CAUTION**

**NON-DESTRUCTIVE VOLTAGE**—The maximum non-destructive voltage that may be applied to the rear panel connectors is 0 V. Do not attempt to connect cables to these connectors without contacting your Biomedical Engineering Department or Service Representative. This is to ensure the connectors comply with leakage-current requirements of one of the following applicable standards: Underwriters Laboratories UL-2601.1, Canadian Standards Associations CSA 22.2 No. 125, or International Electrotechnical Commission EN60601.1.

---

---



## Telemetry Connector

This high-density 15-pin connector is intended for future interfacing to the receiver of a Corometrics telemetry system. Contact your Service Representative for more information.

---

---

### **IMPORTANT**

**TELEMETRY**—For proper operation when using a telemetry system, disconnect all transducers from the front panel of the 170 Series Monitor. Refer to the operator's manual for your telemetry system for more information.

---

---

**For your notes**





# Chapter 4

## Setup Procedures

This section contains information about configuring a 170 Series Monitor to meet the individual needs of your clinic or hospital. Use of the monitor will vary according to the accessories attached to it, the clinical applications in which it is used, and the personal preferences of the users.

This chapter lists all available user setup options in the monitor and provides step-by-step instructions for making selections:

Loading Strip Chart Paper .....	4-2
Turning the Monitor On .....	4-7
Recorder Test .....	4-9
Customizing the Monitor .....	4-10
Printing a Summary of Configuration Settings .....	4-17
Quick Reference Card .....	4-18
Flasher Software Utility Upgrade .....	4-20

# Loading Strip Chart Paper

The *required* paper for use with the 170 Series Monitor is:

- catalog number (REF) 4305AAO/CAO (HR scale of 30–240 BPM); or
- catalog number (REF) 4305BAO/DAO (HR scale of 50–210 BPM).

---

---

## CAUTIONS

**LOADING PAPER**—The instructions for loading paper into a 120 or 170 Series Monitor *are different* than the instructions for loading paper into other Corometrics monitors with which you may be familiar. Improper loading can cause paper jams. Follow the instructions carefully.

**PAPER TYPE**—Do not use *non*-Corometrics paper or paper designed for use with *other* Corometrics monitors. Using paper other than catalog number (REF) 4305AAO/BAO/CAO/DAO: may produce inferior print quality; could result in permanent damage to the recorder's print head; and may void your warranty.

**STORAGE/TRANSPORT**—Paper should be installed in the monitor's strip chart recorder at *all* times. This reduces particle build up on the printhead and facilitates opening the recorder door.

---

---

To protect against paper jams, the 170 Series recorder contains a paper-loading sensor which detects if the paper has been incorrectly loaded. When the recorder detects a paper-load-error condition:

- the recorder will not print;
- the **Record** indicator flashes on and off every second; and
- three short beeps (low tones) sound every three seconds at a fixed volume.

The most likely cause of a paper-load-error condition is that you loaded the paper with the black squares facing up. The correct method is to load the paper with the black squares down, as explained later in this section.

To install Corometrics catalog number (REF) 4305AAO/BAO/CAO/DAO chart paper in the 170 Series Monitor, follow these steps:

---

---

**CAUTION**

LOADING PAPER—Paper loading instructions for a 170 or 120 Series Monitor *are different* than other Corometrics monitors with which you may be familiar.

---

---

1. Press on each side of the paper drawer to release the drawer latches.

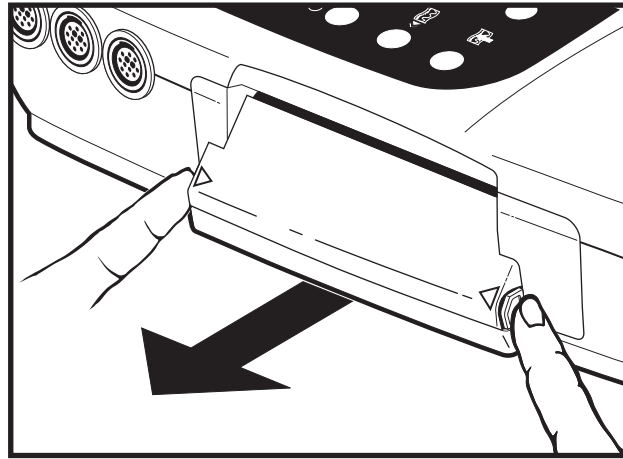

Figure 4-1. Releasing the Drawer Latches

2. Slide the paper drawer out toward you.

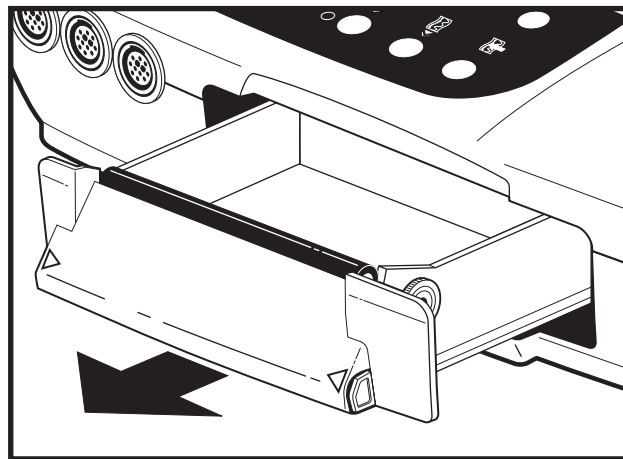

Figure 4-2. Opening the Paper Drawer

3. Remove the plastic wrapper from the paper and discard.

- Fan the pack of Z-fold paper on all sides to loosen any folds and to ensure proper feed of the paper throughout the recorder.

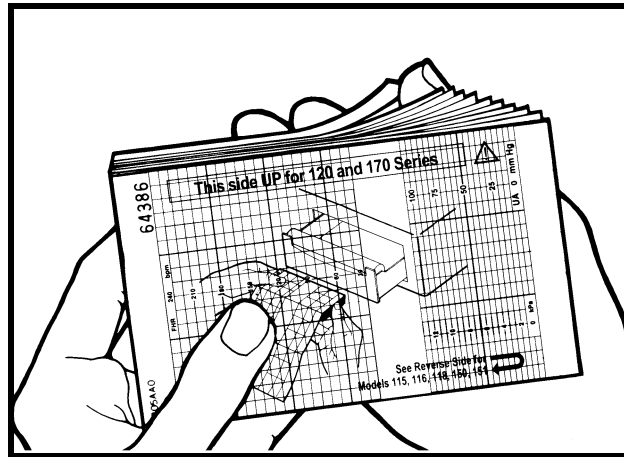

Figure 4-3. Fanning the Paper

- Hold the package of paper so that:
  - ◆ the black squares are on the *bottom* of the pack; and
  - ◆ the *Information Technologies* name and page numbers are on the *left* side of the pack.

**NOTE:** The black squares indicate the end of the recorder paper. When the black squares appear, the strip chart recorder has approximately 20 minutes of paper remaining, when running at a speed of 3 cm/min.

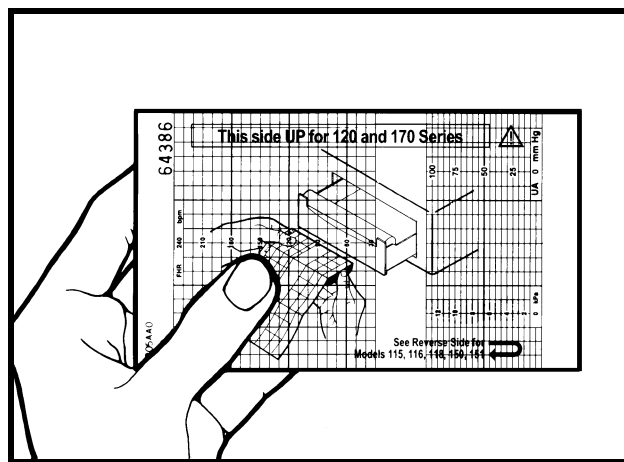

Figure 4-4. Orienting the Paper

6. Unfold two sheets from the *top* of the pack so that they extend toward you.

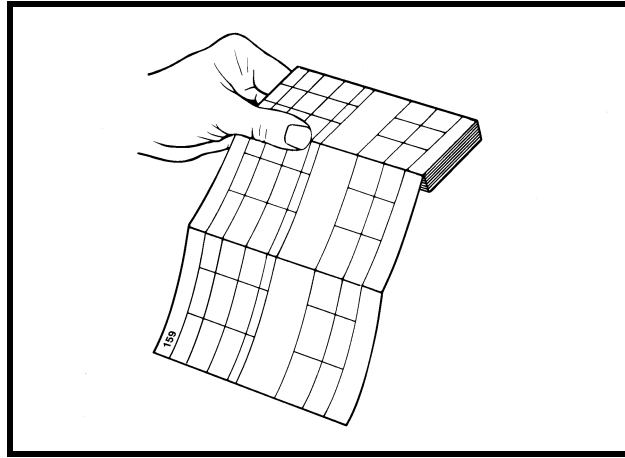

Figure 4-5. Creating a Paper Leader

7. Place the pack in the drawer so that the pack is laying *flat* in the bottom of the paper tray.

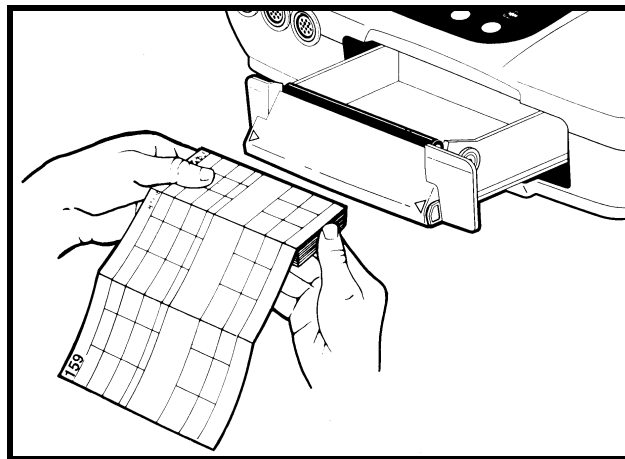

Figure 4-6. Inserting the Paper

- Pull the paper leader taut at an angle between remaining pack and the paper guides. The balance of the paper pack should stay flat in the drawer as shown in Figure 4-7. (The paper guides are shown in Figure 4-8.)

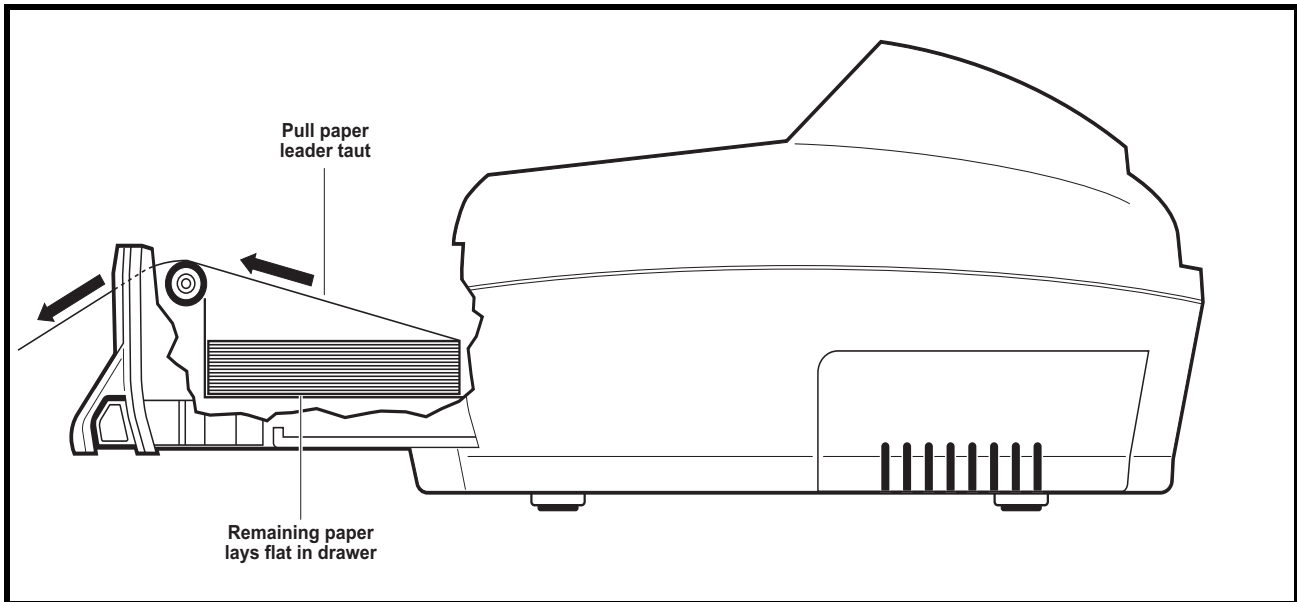

Figure 4-7. Paper Drawer Side Cutaway View

- Slide the drawer closed by exerting even pressure on both sides of the drawer. Avoid skewing the drawer in its tracks. (The pre-printed vertical lines on the paper should be parallel to the printhead.) You will hear a click when the drawer is locked in place.

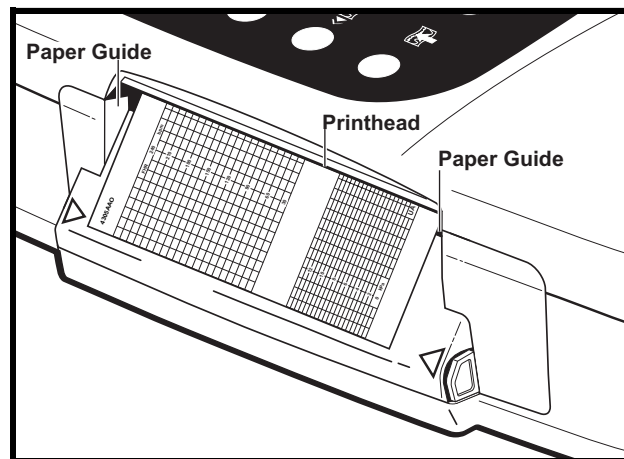

Figure 4-8. Closing the Paper Drawer

---

---

**IMPORTANT**

PAPER—Paper should *always* be installed in the monitor. The monitor runs a self-test routine each time it is powered on; part of this routine includes a recorder test.

---

---

## Turning the Monitor On

The 170 Series uses a universal AC-to-DC converter which accepts an AC input in the range 100–230 VAC. The converter supplies a regulated 12 Vdc to the 170 Series Monitor.

1. Connect the AC adapter into the power supply connector labeled: **CONNECT TO GE MEDICAL SYSTEMS REF 7714AAT ONLY.**

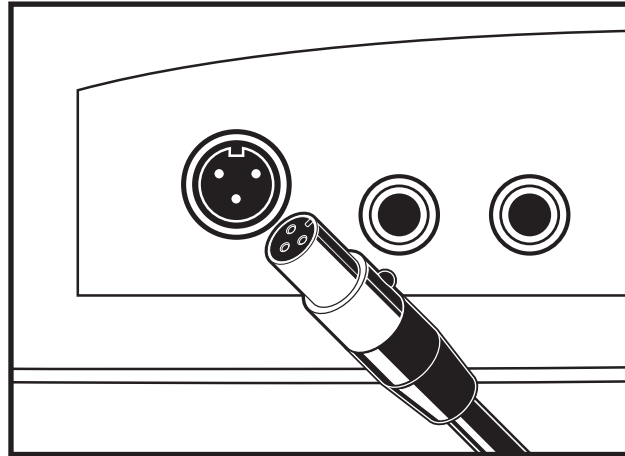



Figure 4-9. Connecting the AC Adapter

2. Connect one end of the detachable line cord to the AC adapter; connect the other end into a hospital grade grounded wall outlet.
3. Press the monitor's **Power** button . The green indicator next to the button illuminates. A self-test routine automatically runs. Read "[Monitor Self-Test Routines](#)" on the next page.

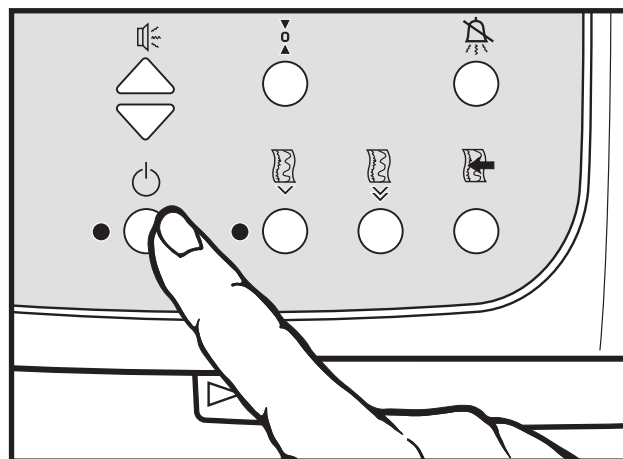

Figure 4-10. Turning the Monitor On

# Monitor Self-Test Routines

**NOTE:** Ensure paper is installed in the recorder in order to verify a successful recorder test.

Each 170 Series Monitor contains a self-test routine which checks the internal circuitry of the monitor, the displays and indicators, and the strip chart recorder. The self-test routine is automatically initiated each time you turn on the monitor.

---



---

## CAUTION

SELF-TEST FAILURE—If there is any problem with the self-test routine, turn off the monitor and remove it from operation. Notify your Biomedical Engineering Department or Service Representative.

---



---

After completion of a successful self-test routine, the monitor is ready for use.

**NOTE:** If the recorder was off at the time the monitor was turned off, the test routine will turn the recorder on, then turn it off after the tests are complete. If the recorder was on at the time the monitor was turned off, the tests will be performed and the recorder will remain on.

Test Description	What to Verify
<b>Display/Indicator Test:</b> All displays and indicators illuminate.	Ensure all indicators and each segment of the displays illuminate throughout the entire self-test routine.
<b>Internal Test:</b> The internal circuitry of the monitor is verified.	Make sure the monitor performs the recorder test. If there is a problem with the internal circuitry, the recorder test will not be performed.
<b>Recorder Test:</b> The following message prints on the strip chart paper: TEST: ARE ALL DOTS PRINTED? Three continuous lines are drawn across the strip chart recorder paper, testing the integrity of the printhead. See <a href="#">Figure 4-11</a> .	Ensure that the lines are printed in the correct positions on the paper. Verify that the lines are continuous and no gaps appear on the traces.



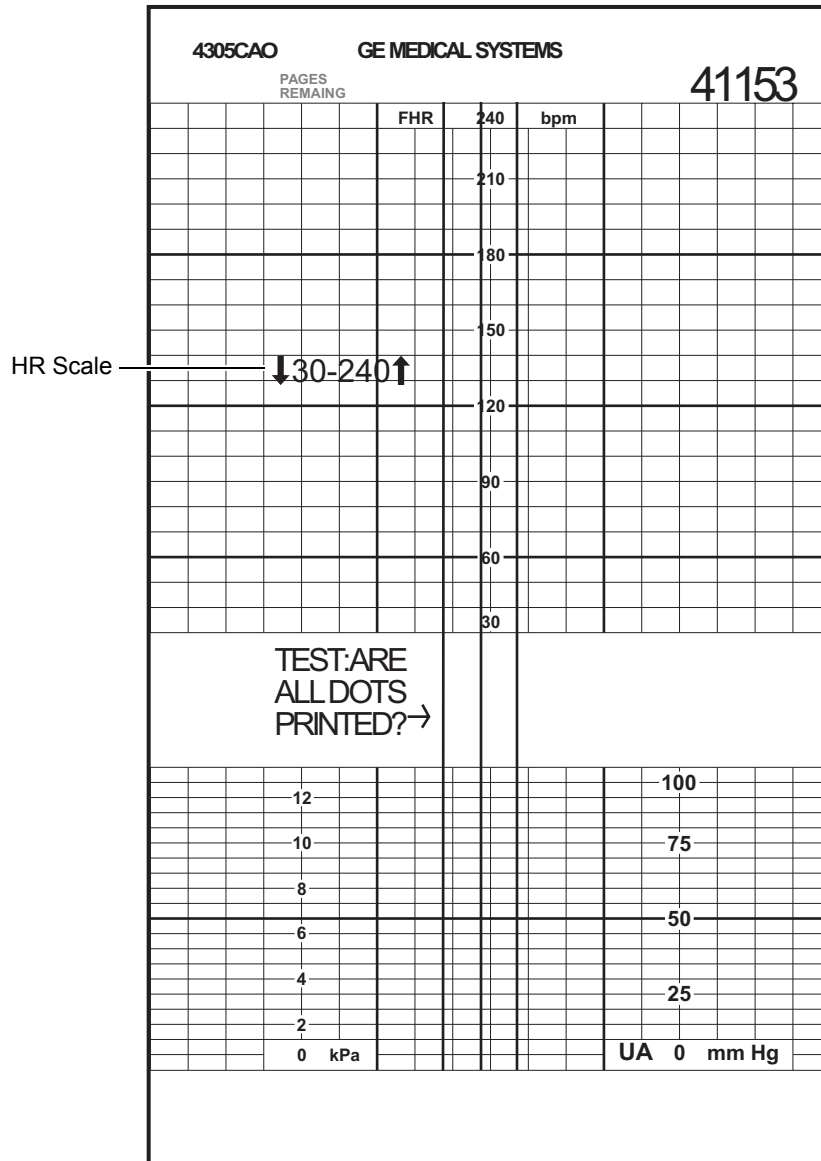

Figure 4-11. Recorder Test

# Customizing the Monitor

## User Setup Mode

The monitor includes a user setup mode where you can:

- ◆ enable/disable alarm functionality
- ◆ set the high alarm limit for the fetal heart rate
- ◆ set the low alarm limit for the fetal heart rate
- ◆ set the alarm volume
- ◆ set the time and date

## Service Setup Mode

The monitor includes a service setup mode where you can access all user setup modes as well as the following:

- ◆ enable/disable fetal movement detection (if purchased and installed)
- ◆ select the language for printing on the strip chart paper
- ◆ set the chart speed
- ◆ select the paper scale
- ◆ choose a communication mode for each rear panel communications port
- ◆ set the baud rate for each communications port
- ◆ select the remote mark annotation style
- ◆ enable/disable fetal heart rate offset (Models 172, 173, and 174 only)
- ◆ enable/disable ECG artifact elimination (Models 173 and 174 only)
- ◆ enable/disable heartbeat coincidence (Models 172, 173, and 174 only)
- ◆ set the default UA reference value
- ◆ perform a recorder alignment test
- ◆ print the software version number along with a summary of all current configuration settings

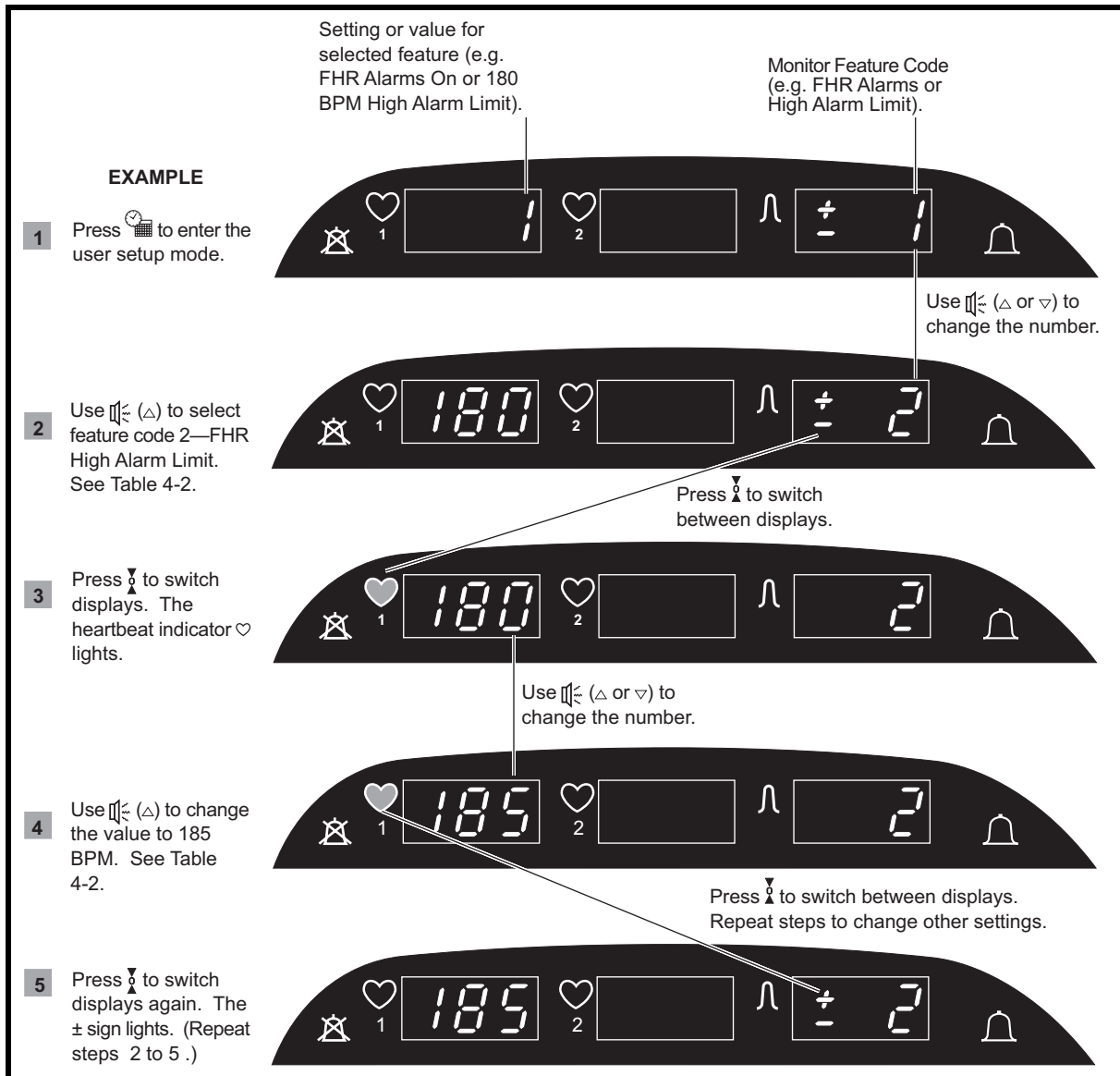

**NOTE:** For Models 172, 173, and 174, use the leftmost set of volume controls.

Figure 4-12. Setup Mode Summary (Model 172 shown)



You can enter the *user* setup mode during an active monitoring session. The fetal heart rate and uterine activity trends print without interruption and the FHR tones remain audible; however you will be unable to see the heart rate and uterine activity values on the display while in the user setup mode.

You can only enter the *service* setup mode from a power *off* state.



**NOTE:** If an alarm occurs while in user setup mode, the heart rate display will not flash; however, the alarm indicator  flashes and the audio alarm sounds. As soon as you exit the setup mode, the affected display flashes to indicate the alarm condition.





1. Enter the appropriate mode, user or service, as follows:

*User:* To enter the user mode:

- ◆ Press the monitor's **Power** button  to turn on the monitor. Wait until the monitor completes the self-test routine and enters the normal operating mode.
- ◆ Press and hold the **Setup** button , for three seconds, to enter the user setup mode.

*Service:* To enter the service mode:

- ◆ Press and hold the **Setup** button .
- ◆ Press and hold the blue **Power** button .
- ◆ Release both buttons. The service mode is now activated.

2. Use the **UA Reference** button  to toggle between the setup code (shown in the UA display) and the setting or value (shown in the primary FHR display). The UA display is active when the  $\pm$  qualifier illuminates; the FHR display is active when the heartbeat indicator () illuminates.
3. Use the **Volume** buttons  to increase ( $\triangle$ ) or decrease ( $\nabla$ ) the code, value, or setting shown in the active display. Refer to [Table 4-2](#) (user codes) or [Table 4-3](#) (service codes). (For Models 172, 173, and 174, use the leftmost set of volume controls.)
4. Repeat steps 2 and 3 until all settings are configured.
5. Press the **Setup** button  to exit the setup mode. Exiting the *user* setup mode returns to the monitoring mode; exiting the *service* setup mode turns the monitor to standby.

**NOTE:** If you press the **Power** button  to exit the setup mode (user or service) any changes you made will not be stored in memory.

**NOTE:** You must exit by pressing the **Setup** button  in order for changes to take effect.

**NOTE:** If an alarm is in progress when you exit the user setup mode, any changes to an alarm setting do not take effect until the alarm condition is resolved.

Table 4-2 lists the available settings for the user setup mode. Table 4-3 lists the available settings for the service setup mode. Table 4-4 provides a summary of the factory default settings for both the user and service setup options.

Table 4-2. Summary of User Setup Codes		
Code (UA Display)		Setting or Value (Primary FHR Display)
Code	Description	
1	FHR Alarms	0 = off (disabled) 1 = on (enabled)
2	FHR High Alarm Limit	140–210 (BPM, in increments of 5 BPM)
3	FHR Low Alarm Limit	50–140 (BPM, in increments of 5 BPM)
4	FHR Alarm Volume	2–10
10	Minutes (time setting)	0–59 (minutes)
11	Hours (time setting)	0–23 (hours)
12	Day of Month (date setting)	1–31 (day)
13	Month (date setting)	1–12 (month)
14	Year (date setting)	00–99 (year)

Table 4-3. Summary of Service Setup Codes		
Code (UA Display)		Setting Or Value (Primary FHR Display)
Code #	Code Description	
20	ECG artifact elimination (173, 174 only)	0 = off; 1 = on
21	heartbeat coincidence (172, 173, 174 only)	0 = off; 1 = on
22	fetal movement enable/disable	0 = off 1 = on (if option installed)
23	language	0 = English; 1 = Spanish; 2 = German; 3 = French; 4 = Japanese; 5 = Italian; 6 = Swedish; 7 = Dutch; 8 = Portuguese; 9 = Chinese
24	chart speed	1= 1; 2 = 2; 3 = 3 (cm/min)
25	paper scale	0 = 30–240; 1 = 50–210 (BPM)
30, 40	communications mode (port 1, 2)	0 = HP; 1 = HP w/notes; 2 = ext BP; 3 = factory test; 4 = ext. FSpO <sub>2</sub> ; 5 = 115 update; 6 = 115 transmit/receive
31, 41	baud rate (port 1, 2)	<u>300</u> ; <u>600</u> ; <u>1200</u> ; <u>2400</u> ; <u>4800</u> ; <u>9600</u> ; <u>19200</u> ; <u>38400</u>
50	remote mark annotation style	0 = FM; 1 = arrow
51	future use (Japanese units only)	0 = off; 1 = on
52	fetal heart rate offset enable/disable	0 = off; 1 = 10 minute auto-revert; 2 = on
53	UA reference default	5, 10, 15, 20, 25 (relative units)
100	recorder alignment	0–255

Table 4-4. Summary of Factory Defaults		
Setup Option	Factory Default	Hospital/Clinic Setting
FHR Alarms	on	
FHR High Alarm Limit	160 BPM	
FHR Low Alarm Limit	120 BPM	
FHR Alarm Volume	5	
Time/Date	Eastern Standard Time or Daylight-Saving Time—whichever is applicable	
*ECG Artifact Elimination (Models 173 and 174 only)	off	
*Heartbeat Coincidence (Models 172, 173, and 174 only)	off	
*Fetal Movement Detection (if purchased and installed)	on	
*Language	set according to shipping destination	
*Recorder Speed	United States: 3 cm/min International: 1 cm/min	
*Paper Scale	United States: 30–240 BPM International: 50–210 BPM	
*RS-232 Port 1 Communications Mode	HP	
*RS-232 Port 1 Baud Rate	1200	
*RS-232 Port 2 Communications Mode	ext. BP	
*RS-232 Port 2 Baud Rate	600	
*Remote Mark Annotation	on ( $\overset{FM}{\uparrow}$ )	
*HR Offset (Models 172, 173, and 174 only)	on with 10-minute auto-revert	
*UA Reference	10 relative units	

\* = service setup mode

NOTE: User shall verify and save the settings required by the Hospital before using the monitor.





## Printing a Summary of Configuration Settings

To print the software version number and a summary of configuration settings on the strip chart paper:

**NOTE:** You can only enter the service setup mode from a power *off* state.

1. Enter the service mode:

- ◆ Press and hold the **Setup** button 
- ◆ Press and hold the blue **Power** button .
- ◆ Release both buttons. The service mode is now activated.

2. Press the **Record** button . Figure 4-13 shows a sample printout.

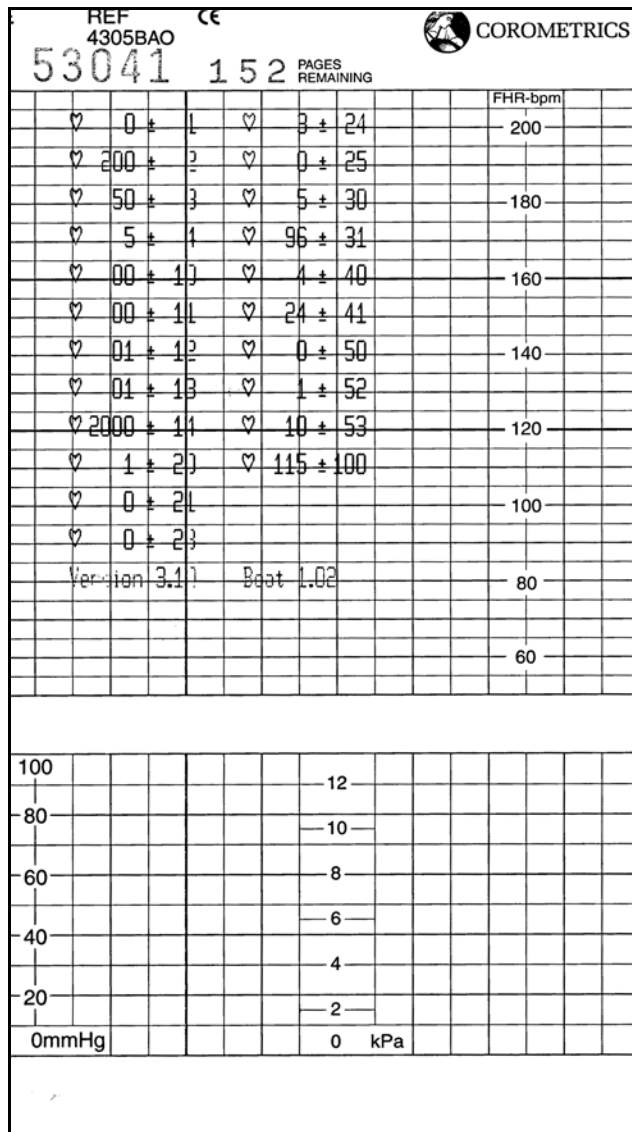

Figure 4-13. Configuration Summary Printout

# Quick Reference Card

Your monitor was shipped with a Quick Reference Card in the appropriate language. The front side lists the *user* setup codes while the reverse lists the *service* setup codes. The card is laminated and comes with hook and loop adhesives to attach to your monitor.

A copy of this card is included on the following page if you wish to make additional copies for training. Additional Quick Reference Cards can be purchased by calling one of the numbers listed in the front of this manual. [Table 4-5](#) provides a summary of the Quick Reference Card re-order numbers:

Table 4-5. 170 Series Quick Reference Card	
Language	Document Part Number
English	2003024-001
Chinese	2003024-002
Dutch	2003024-003
French	2003024-004
German	2003024-005
Italian	2003024-006
Japanese	2003024-007
Portuguese	2003024-008
Spanish	2003024-009
Swedish	2003024-010
Polish	2003024-011
Greek	2003024-013
Russian	2003024-014
Czechoslovakian	2003024-015

**COROMETRICS®**  
170 SERIES MONITOR **QUICK REFERENCE**

INDICATORS	CONNECTORS	BUTTONS	
Alarms Disabled 	Ultrasound 	Setup 	On/Standby 
Alarm Active 	FECG 	Volume Increase/Decrease 	Record 
Fetal Heart Rate 	Uterine Activity 	Uterine Activity Reference 	Paper Advance 
Uterine Activity 	(IUP included with FECG units only)	Alarm Silence 	Event Mark 

**SETUP**

1. Press and hold to enter/exit the user setup mode. Refer to the table at the bottom for feature codes and available settings. The feature code displays in the UA display; the setting or value displays in the FHR display.
2. Press to alternate between displays. The  $\pm$  sign lights when the UA display is active; the heartbeat indicator lights when the FHR display is active.
3. Use ( $\Delta$  or  $\nabla$ ) to change the number in the active display. (On dual FHR units, use the left set of volume controls.) In the example below, the FHR high alarm limit (code 2) is set to 185 BPM.



SETTING OR VALUE (♥) IN FHR DISPLAY	MONITOR FEATURE CODE (±) IN UA DISPLAY
0 = off 1 = on	1 FHR alarm enable/disable
140–210 BPM (by 5 BPM)	2 FHR high alarm limit
50–140 BPM (by 5 BPM)	3 FHR low alarm limit
2–10	4 FHR alarm volume
0–59	10 minutes
0–23	11 hours
1–31	12 day
1–12	13 month
00–99	14 year

**SERVICE CODES**

1. Enter the Service Setup Mode:
  - Press and hold the Setup button .
  - Press and hold the blue Power button .
  - Release both buttons.
2. Refer to the table below for feature codes and available settings.
3. Press the Setup button to exit the Service Setup Mode. The monitor automatically turns to standby.

SETTING OR VALUE (♥) IN FHR DISPLAY	MONITOR FEATURE CODE (±) IN UA DISPLAY
0 = off; 1 = on (173/174)	20 ECG Artifact Elimination
0 = off; 1 = on (172/173/174)	21 Heartbeat Coincidence
0 = off; 1 = on (if installed)	22 Fetal Movement Enable/Disable
0 = English; 1 = Spanish; 2 = German; 3 = French; 4 = Japanese; 5 = Italian; 6 = Swedish; 7 = Dutch; 8 = Portuguese; 9 = Chinese	23 Language
1 = 1; 2 = 2; 3 = 3 (cm/min)	24 Chart Speed
0 = 30–240; 1 = 50–210 (BPM)	25 Paper Scale
0 = HP; 1 = HP w/notes; 2 = Ext. BP; 3 = Factory Test; 4 = Ext. FSpO <sub>2</sub> ; 5 = 115 Update; 6 = 115 Transmit/Receive	30, 40 Communications Mode (port 1, 2)*
300; 600; 1200; 2400; 4800; 9600; 19200; 38400	31, 41 Baud Rate (port 1, 2)
0 = ; 1 =	50 Remote Mark Annotation Style
0 = off; 1 = 10 min; 2 = on (172/173/174)	52 Fetal Heart Rate Offset Enable/Disable
5, 10, 15, 20, 25 (relative units)	53 UA Reference Default
0–255	100 Recorder Alignment

\* Refer to the 170 Series Service Manual for more information.

Corometrics and Marquette are registered trademarks of GE Medical Systems Information Technologies. GE is a registered trademark of General Electric Company. © 2000 GE Medical Systems Information Technologies. All rights reserved. No part of this document may be reproduced without the permission of GE Medical Systems Information Technologies.

⚠ CAUTION: In the United States of America, Federal Law restricts this device to sale by or on the order of a physician.



GE Medical Systems  
Information Technologies  
www.ge.com

P/N 2003024-001 REV. A 01/01



# Flasher Software Utility Upgrade

The Corometrics Flasher is a software utility program which uses one of the monitor's RS-232 serial ports to upgrade to a newer software release; or to install a purchased option such as fetal movement detection. Each Flasher disk contains the software upgrade for one-time use only. (In other words, you need an individual Flasher disk for each monitor being upgraded.) Table 4-6 lists the Flasher kits available for the 170 Series.

Kit Description	Catalog Number
Fetal Movement Detection Feature Addition	1700AAO
Software Upgrade to Version 3.23 which includes the following features: <ul style="list-style-type: none"><li>■ Heartbeat coincidence</li><li>■ Communications interface to external FSpO2 monitors</li><li>■ Communications support of 115 Update and 115 Transmit/Receive protocols</li></ul>	2005770-004 (English language units)



# Chapter 5

## Theory of Operation

This section of the manual contains the electronic theory of operation for the 170 Series Monitor. When possible, references are made to the appropriate schematic contained in “Chapter 11, Parts Lists” of this manual

Throughout this chapter, signal names ending with an asterisk (\*) are active low.

This chapter contains the following information:

Functional Overview .....	5-2
Main Board Theory of Operation.....	5-17
FECG/IUP Board Theory of Operation.....	5-36

# Functional Overview

For all 170 Series Monitors, the Main Board controls the majority of the 170 Series functionality including:

- ◆ antepartum (US, TOCO) front ends and connector(s)
- ◆ uterine activity front end and connector
- ◆ seven-segment displays
- ◆ user-interface buttons
- ◆ peripheral device communications
- ◆ processing

For Models 173 and 174, a separate FECG/IUP Board controls:

- ◆ intrapartum front ends
- ◆ isolation for analog signals

Figure 5-1 provides an overview of the system architecture. Table 5-1 through Table 5-17 provide pinouts for each of the external connectors and the internal main board harness connectors. Figure 5-2 through Figure 5-9 provide illustrations of the front and rear panel connectors.

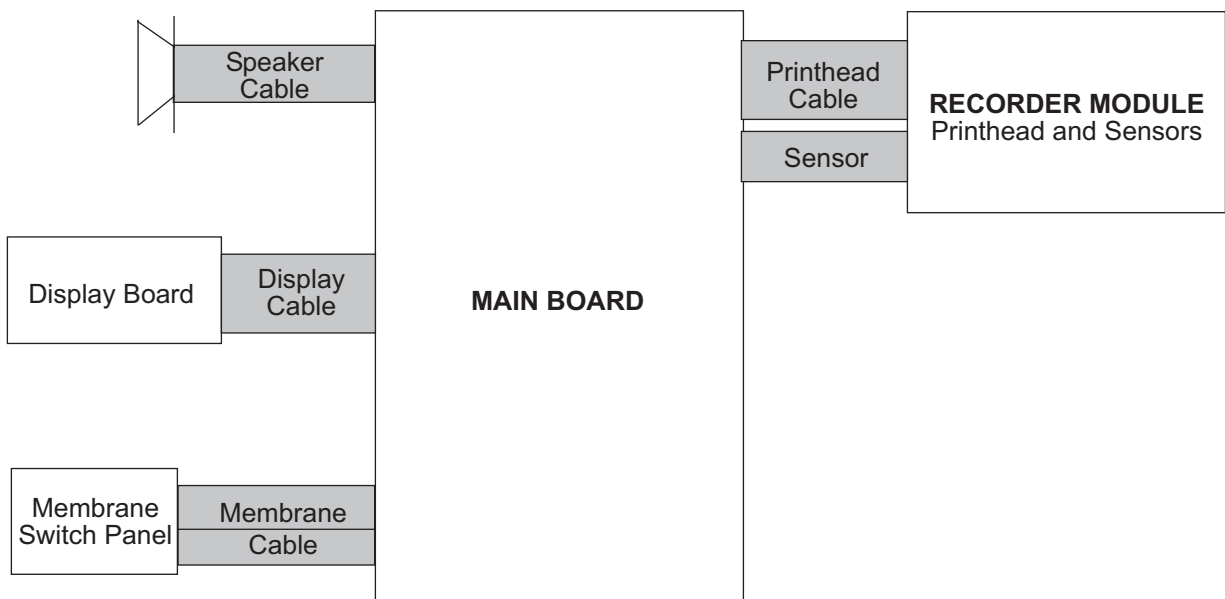

Figure 5-1. Overview of System Architecture

Table 5-1. Main Power Connector	
Pin Number	Description
1	+12 Vdc Input
2	Negative Input
3	Shield

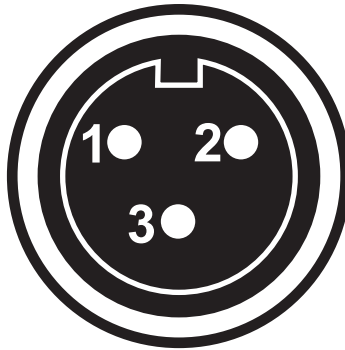

Figure 5-2. Main Power Connector

Table 5-2. Recorder Printhead Connector			
Pin Number	Signal Name	Signal Type (Relative To Recorder Board)	Signal Description
1	+24V	Input	+24 Volts for Recorder
2	+24V	Input	+24 Volts for Recorder
3	+24V	Input	+24 Volts for Recorder
4	+24V	Input	+24 Volts for Recorder
5	HGND	Input	Ground for +24V
6	HGND	Input	Ground for +24V
7	HGND	Input	Ground for +24v
8	HGND	Input	Ground for +24V
9	HGND	Input	Ground for +24V
10	+5v	Input	+5V for Logic
11	NC		No Connection
12	NC		No Connection
13	STB0*	Input	Head Strobe 0
14	STB1*	Input	Head Strobe 1
15	STB2*	Input	Head Strobe 2
16	STB3*	Input	Head Strobe 3
17	BCK	Input	Head Serial Clock (3.07 MHz)
18	LD*	Input	Head Load Line
19	PDATA	Input	Head Serial Data
20	NC		No Connection

\* Active low.



<b>Table 5-3. Recorder Motor Connector</b>			
<b>Pin Number</b>	<b>Signal Name</b>	<b>Signal Type (Relative to Main board)</b>	<b>Signal Description</b>
1	NC		No Connection
2	P3	Output	Motor Phase 3
3	P4	Output	Motor Phase 4
4	+5VM	Output	+5 Volts for Motor
5	NC		No Connection
6	P2	Output	Motor Phase 2
7	P1	Output	Motor Phase 1
8	+5VM	Output	+5 Volts for Motor

<b>Table 5-4. Recorder Sensor Connector</b>			
<b>Pin Number</b>	<b>Signal Name</b>	<b>Signal Type (Relative to Main board)</b>	<b>Signal Description</b>
1	NC		No Connection
2	MISCOL	Input	Paper Misload Sensor Collector
3	MISLED	Output	Paper Misload Sensor LED Voltage
4	GND	Output	Ground for Sensor
5	NC		No Connection
6	OUTCOL	Input	Paper Out Sensor Collector
7	OUTLED	Output	Paper Out Sensor LED Voltage
8	GND	Output	Ground for Sensor
9	DOOR	Input	Door Switch Input
10	GND	Output	Ground for Door Switch

Table 5-5. RS-232 Connector 1		
Pin Number	Signal Name	Signal Description
1	+5V	200 mA Fused
2	RTS	Request to Send Output from Monitor
3	RXD	Receive Data Input to Monitor
4	GND	Signal Ground
5	GND	Signal Ground
6	TXD	Transmit Data Output from Monitor
7	CTS	Clear to Send Input to Monitor
8	+5V	200 mA Fused

Table 5-6. RS-232 Connector 2		
Pin Number	Signal Name	Signal Description
1	GND	Signal Ground
2	RTS	Request to Send Output from Monitor
3	RXD	Receive Data Input to Monitor
4	GND	Signal Ground
5	GND	Signal Ground
6	TXD	Transmit Data Output from Monitor
7	CTS	Clear to Send Input to Monitor
8	GND	Signal Ground

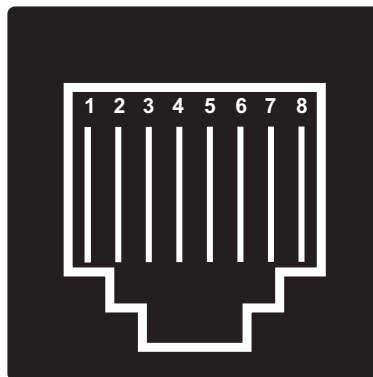

Figure 5-3. RJ-45 Connector (facing the rear panel from the outside)

Table 5-7. Speaker Connector		
Pin Number	Signal Name	Signal Description
1	SPKR-LO	Speaker Low Side Connection
2	SPKR-HI	Speaker High Side Connection

Table 5-8. Remote Mark Connectors (Remote Event Marker and Fetal Acoustic Stimulator)		
Pin Number	Signal Name	Signal Description
1	Tip	Remote Event Marker or Fetal Acoustic Stimulator
2	Shunt	No Connection
3	NC	No Connection
4	Sleeve	Ground

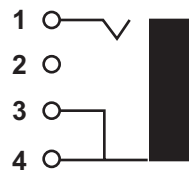

Figure 5-4. Remote Mark Connectors

Table 5-9. Ultrasound Connector(s)		
Pin #	Signal Name	Signal Description
1	NC	No Connection
2	NC	No Connection
3	GND	Chassis Ground
4	XMIT/RCV SHIELD	Shield for Transmit/Receive
5	XMIT/RCV	Transmit/Receive
6	NC	No Connection
7	NC	No Connection
8	NC	No Connection
9	GND	Chassis Ground
10	NC	No Connection
11	U/S ENABLE*	Enable for Ultrasound Channel
12	GND	Chassis Ground

\* Active low.

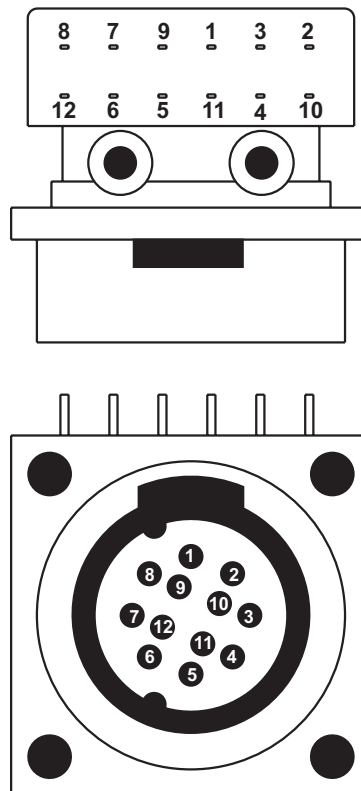

Figure 5-5. US Connector(s) (facing the front panel from the outside)

Table 5-10. FECG Connector (Model 173)		
Pin #	Signal Name	Signal Description
1	NC	No Connection
2	FECGEN*	Enable for FECG Channel
3	GND	Chassis Ground
4	NC	No Connection
5	NC	No Connection
6	LA	Left Arm
7	RA	Right Arm
8	SHIELD	Shield
9	NC	No Connection
10	NC	No Connection
11	NC	No Connection
12	RL	Right Leg

\* Active low.

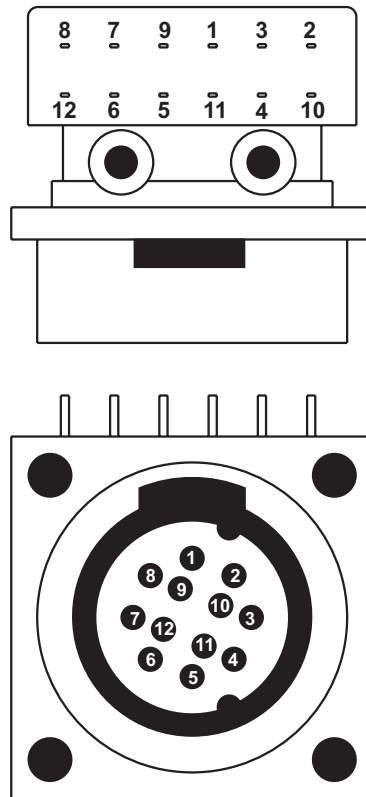

Figure 5-6. FECG Connector (facing the front panel from the outside)

Table 5-11. Ultrasound/FECG Combi-Connector (Model 174)		
Pin #	Signal Name	Signal Description
1	NC	No Connection
2	FECGEN*	Enable for FECG Channel
3	ISOGND	Isolated Ground
4	XMIT/RCV SHIELD	Shield for Transmit/Receive (isolated ground)
5	XMIT/RCV	Transmit/Receive (isolated ground)
6	LA	Left Arm
7	RA	Right Arm
8	SHIELD	Shield (isolated ground)
9	NC	No Connection
10	NC	No Connection
11	U/S ENABLE*	Enable for Ultrasound Channel
12	RL	Right Leg

\* Active low.

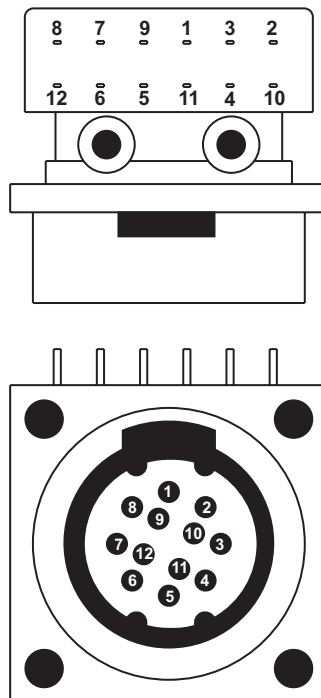

Figure 5-7. US/FECG Combi-Connector (facing the front panel from the outside)

Table 5-12. Uterine Activity Connector		
Pin#	Signal Name	Signal Description
1	+PRESSURE	Positive Input to Pressure Amplifier
2	-PRESSURE	Negative Input to Pressure Amplifier
3	NC	No Connection
4	+4 VOLT EXCITATION	+4 Volt Reference
5	NC	No Connection
6	GND (EXCITATION REF)	+4 Volt Reference Ground
7	UA SHIELD	Shield
8	NC	No Connection
9	NC	No Connection
10	NC	No Connection
11	NC (171/172) IUP ENABLE (173/174)	No Connection (171/172) Mode Enable for IUP (173/174)
12	TOCO ENABLE *	Mode Enable for TOCO

\* Active low.

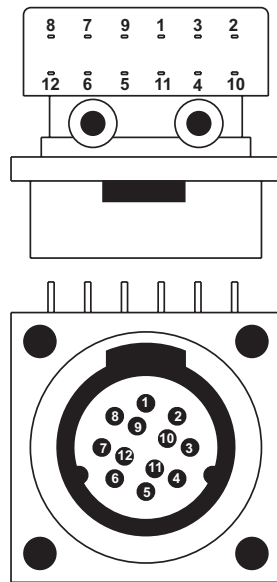

Figure 5-8. Uterine Activity Connector (facing the front panel from the outside)

Table 5-13. Telemetry Connector			
Pin Number	Signal Name	Signal Type (Relative To Main Board)	Signal Description
1	TMARK/	Input	Telemetry Mark Line (active low)
2	TELPR/	Input	Telemetry Present (active low)
3	NC (171/172) TECGEN/ (173)	Input	No Connection (171/172) Telemetry FECG Enable (173/174)
4	NC		No Connection
5	NC (171/172) TECG (173)	Input	No Connection (171/172) Telemetry FECG (173/174)
6	TTOCO	Input	Telemetry TOCO
7	AGND	Output	Analog Ground
8	TELMAUDIO	Input	Telemetry US Audio
9	DGND	Output	Digital Ground
10	NC		No Connection
11	TTOCOEN/	Input	Telemetry TOCO Enable
12	TUSEN/	Input	Telemetry US Enable
13	NC (171/172) TIUPEN/ (173)	Input	No Connection (171/172) Telemetry IUP Enable (173/174)
14	NC		No Connection
15	NC		No Connection

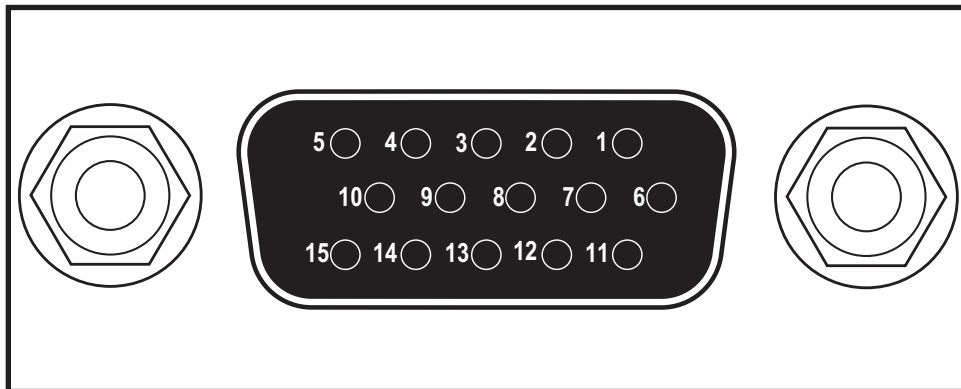

Figure 5-9. Telemetry Connector (facing the rear panel from the outside)



Pin Number	Signal Name	Signal Type (Relative To Main Board)	Signal Description
1	D6	Output	Main Board Data Bit 6
2	D5	Output	Main Board Data Bit 5
3	D7	Output	Main Board Data Bit 7
4	DISPLCS*	Output	Not Used
5	A0	Output	Telemetry ECG (173/174)
6	D4	Output	Main Board Data Bit 4
7	D1	Output	Main Board Data Bit 1
8	D0	Output	Main Board Data Bit 0
9	D2	Output	Main Board Data Bit 2
10	D3	Output	Main Board Data Bit 3
11	SEGA	Output	Segment A for Pressure $\pm 1$ LED
12	SEGB	Output	Segment B for Pressure $\pm 1$ LED
13	SEGC	Output	Segment C for Pressure $\pm 1$ LED
14	SEGD	Output	Segment D for Pressure $\pm 1$ LED
15	+5V	Output	+5 Volts for LEDs
16	GND	Output	Ground for LEDs

<b>Table 5-15. Membrane Switch Panel Interface (J19)</b>			
<b>Pin Number</b>	<b>Signal Name</b>	<b>Signal Type (Relative To Main Board)</b>	<b>Signal Description</b>
1	UAREF*	Input	UA Ref Switch Input
2	PWRANODE	Output	Power Indicator LED Anode
3	REC*	Input	Recorder On Switch Input
4	NC	Output	No Connection
5	MARK*	Input	Mark Switch Input
7	PADV*	Input	Paper Advance Switch Input
6	GND	Output	Ground
8	RECANODE	Output	Recorder on LED Anode
9	VOLDN*	Input	Volume Down Channel 1 Switch Input
10	CANCEL	Input	Alarm Cancel Switch Input
11	VOLUP*	Input	Volume Up Channel 1 Switch Input
12	VOLDN2*	Input	Volume Down Channel 2 Switch Input
13	PWRSWITCH	Input	Power Switch Input
14	VOLUP2*	Input	Volume Up Channel 2 Switch Input
15	GND	Output	Ground for LEDS and Switches
16	MENU	Input	Menu Switch Input

\* Active low.

<b>Table 5-16. FECG/UA Option Interface Part One (J16), Models 173/174 Only</b>			
<b>Pin Number</b>	<b>Signal Name</b>	<b>Signal Type (Relative To Main Board)</b>	<b>Signal Description</b>
1	+12V	Output	+12 V for FECG Isolated Power Supply
2	GND	Output	+12 V Ground
3	+5V	Output	+5 V Supply
4	+7.5V	Output	+7.5 V Supply
5	2.5VREF	Output	2.5 V Reference
6	IUPEN*	Input	IUP Enable Output
7	+3.3VANA	Output	+3.3 V for Analog
8	144KC	Output	144 KHz for Isolated Power Supply
9	-3.3VANA	Output	-3.3 V for Analog
10	AGND	Output	Analog Ground
11	FECGOUT	Input	FECG Analog Output
12	PRESSOUT	Input	Pressure Analog Output
13	FECGEN*	Input	FECG Enable (Active Low)
14	NC (171/172/173) CLEAR* (174)	— Output	No Connection (171/172/173) Clear (Model 174)
15	TOCOEN*	Input	TOCO Enable
16	NC	—	No Connection

\* Active low.

<b>Table 5-17. FECG/UA Option Interface Part Two (J15), Models 173/174 Only</b>			
<b>Pin Number</b>	<b>Signal Name</b>	<b>Signal Type (Relative To Main Board)</b>	<b>Signal Description</b>
1	RA	Output	Right Arm Input from Patient Connector
2	LA	Output	Left Arm Input from Patient Connector
3	RL	Input	Right Leg Drive Signal from FECG/IUP Board
4	SHIELDF	Output	Isolated Shield
5	-PRESS	Output	UA Channel Negative Input
6	+PRESS	Output	UA Channel Positive Input
7	ISO4V	Input	Isolated 4 V Reference
8	ECGEN*	Output	Enable for FECG Cable
9	4VISOGND	Input	Isolated 4 V Reference Ground
10	PEN*	Output	Isolated IUP Enable
11	NC	—	No Connection
12	ENTOCO*	Output	Isolated TOCO Enable

\* Active low.

# Main Board Theory of Operation

Figure 5-10 provides a block diagram of the Main Board in the 170 Series Monitor. The board number varies according to the particular model in the series as summarized in Table 5-18.

Table 5-18. Main Board Variations			
170 Series Model	Main Board FRU Number	Ultrasound Channels	FECG/IUP Board Mount
Model 171	2000244	Single	No
Model 172	15269	Dual	No
Model 173	2000324	Single	Yes
Model 174	2000952	Dual	Yes

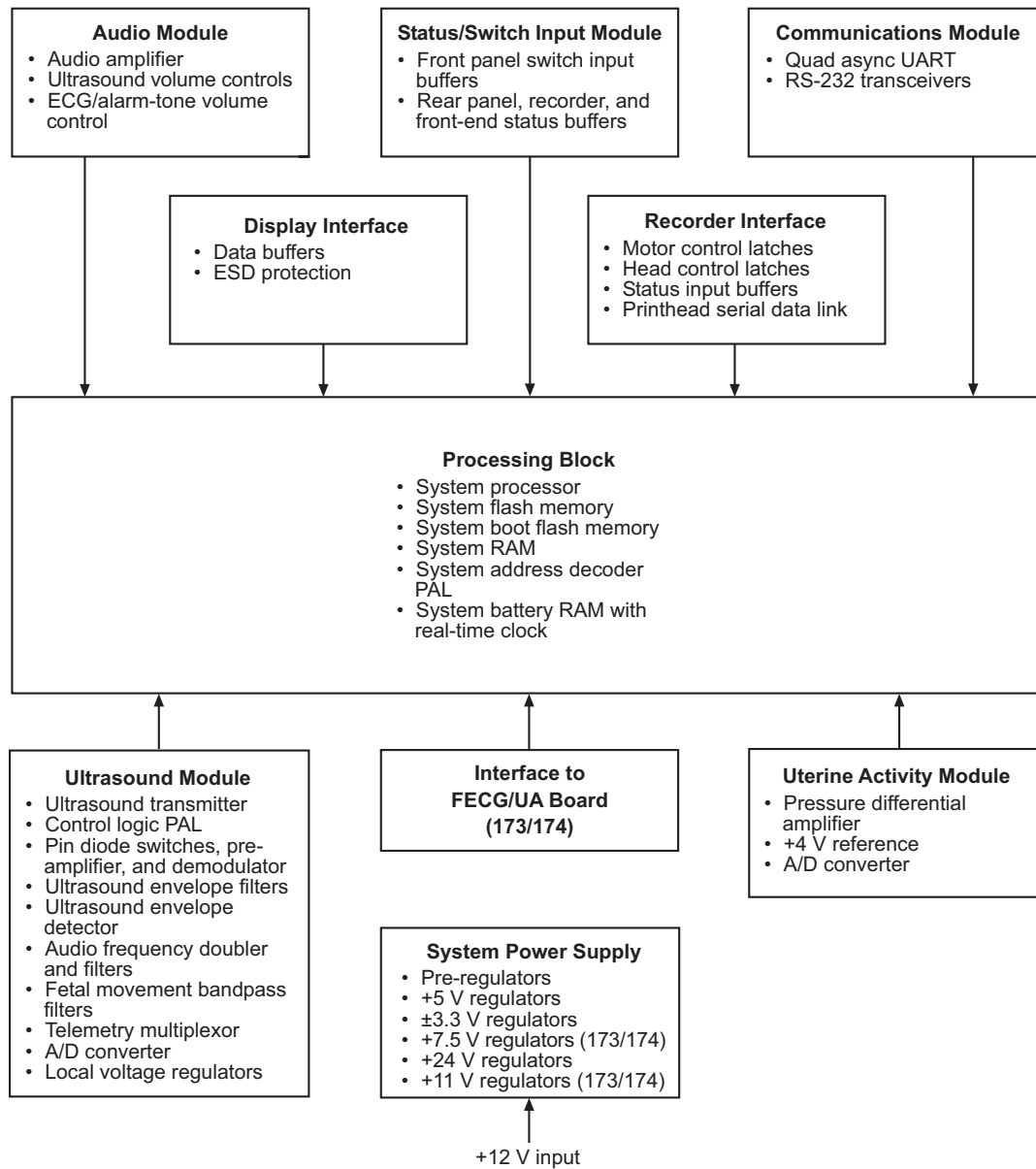
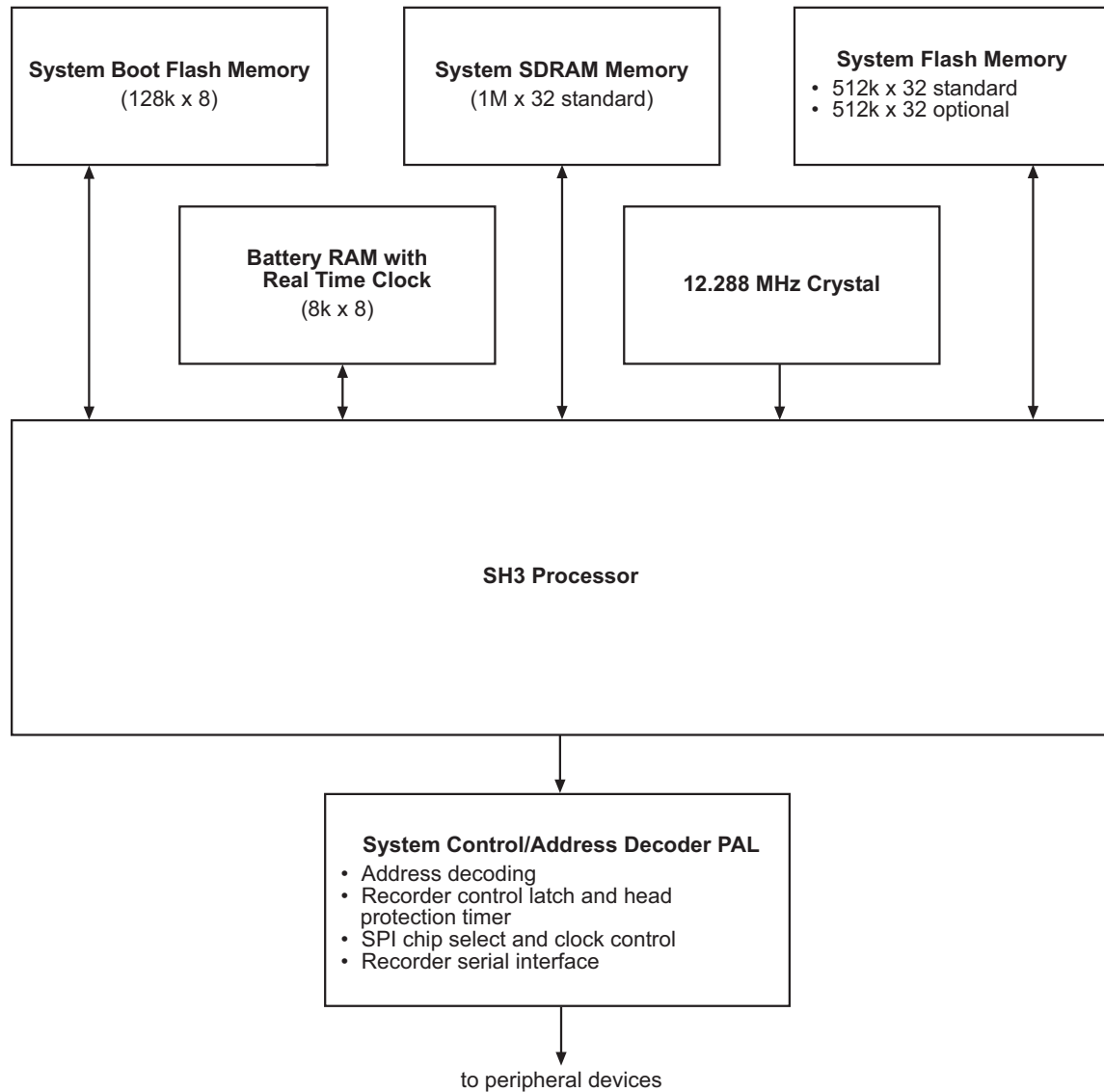

Figure 5-10. Main Board Block Diagram

## Processing Block

The processing block consists of the processor, system memory, battery RAM (with real time clock), and address decoder PAL. [Figure 5-11](#) provides a block diagram of the processing block.



**Figure 5-11. Processing Circuitry Block Diagram**

The processor (U1) is an Hitachi SH3 used with a 32-bit data bus and 24-bit address bus. Series 100  $\Omega$  resistors and 100 k $\Omega$  pull-up resistors are provided for all address, data bus and output lines. The series resistors limit transient response resulting in better EMI performance. Pull-up resistors prevent these lines from floating if the processor enters sleep mode which tri-states these lines. Crystal X2 is the main crystal for the processor running at 12.288 MHz. Mode lines which the CPU examines at power up are pulled up and down to set the CPU to mode 4. This allows the CPU to run internally at either X2 x 1 (12.288 MHz) or X2 x 4 (49.152 MHz). The external bus and SYSCLK run at the X1 frequency. Crystal X1 is for the processor's real-time clock. The real-time clock is not used; however, in addition to time/date, it can be used to process interrupts for exiting sleep mode. A MAX809 reset IC (U2) monitors 3 V backup power to hold RESET\* low during power up from the AC line cord and or the DC power cable. Power-up reset using the power button is accomplished through an external RC circuit (R544 and C285) for a shorter on reset time.

Four AMD AM29LV800B 8 Mb flash memory parts (U23–U26) are used to provide 4 MB of data storage and non-volatile program memory. The flash parts are arranged in pairs to allow 32-bit data access. Separate write enable lines allow access to individual 16-bit words, if required. Chip selects for each flash pair are controlled by the programmable array logic device (PAL) U4 and are memory mapped to make all 4 MB appear as a single area of memory.

The system RAM consists of two Hitachi HM5216165 16-Mb SDRAMs (U27, U28). The processor provides all of the DRAM support signals (RAS, CAS, etc.). A 32-bit data bus is used and 8- and 16-bit access are supported.

An AT29LV010A 1 Mb flash memory part (U29) is used as a boot ROM. The processor begins execution from this area of memory (Area 0 / CS0\*). An 8-bit data bus is used.

A battery RAM, with real-time clock MT48T18 (U31), provides the clock and 8k x 8 data storage function for parameters, error logs, etc. Transceiver U30 buffers and voltage translates data from the 5 V battery RAM.

The PAL (U4) provides the address decoding for the system flash memory, UART, battery RAM, display, input buffers, and recorder control latches. The PAL also contains latches which allow control of the printhead, serial peripheral interface (SPI) chip selects, telemetry, and fetal movement signal controls. PAL U4 also provides the parallel-to-serial conversion for the printhead data. The PFAIL and software enable bits are used to disable battery RAM writes. [Figure 5-12](#) provides a block diagram of the PAL.



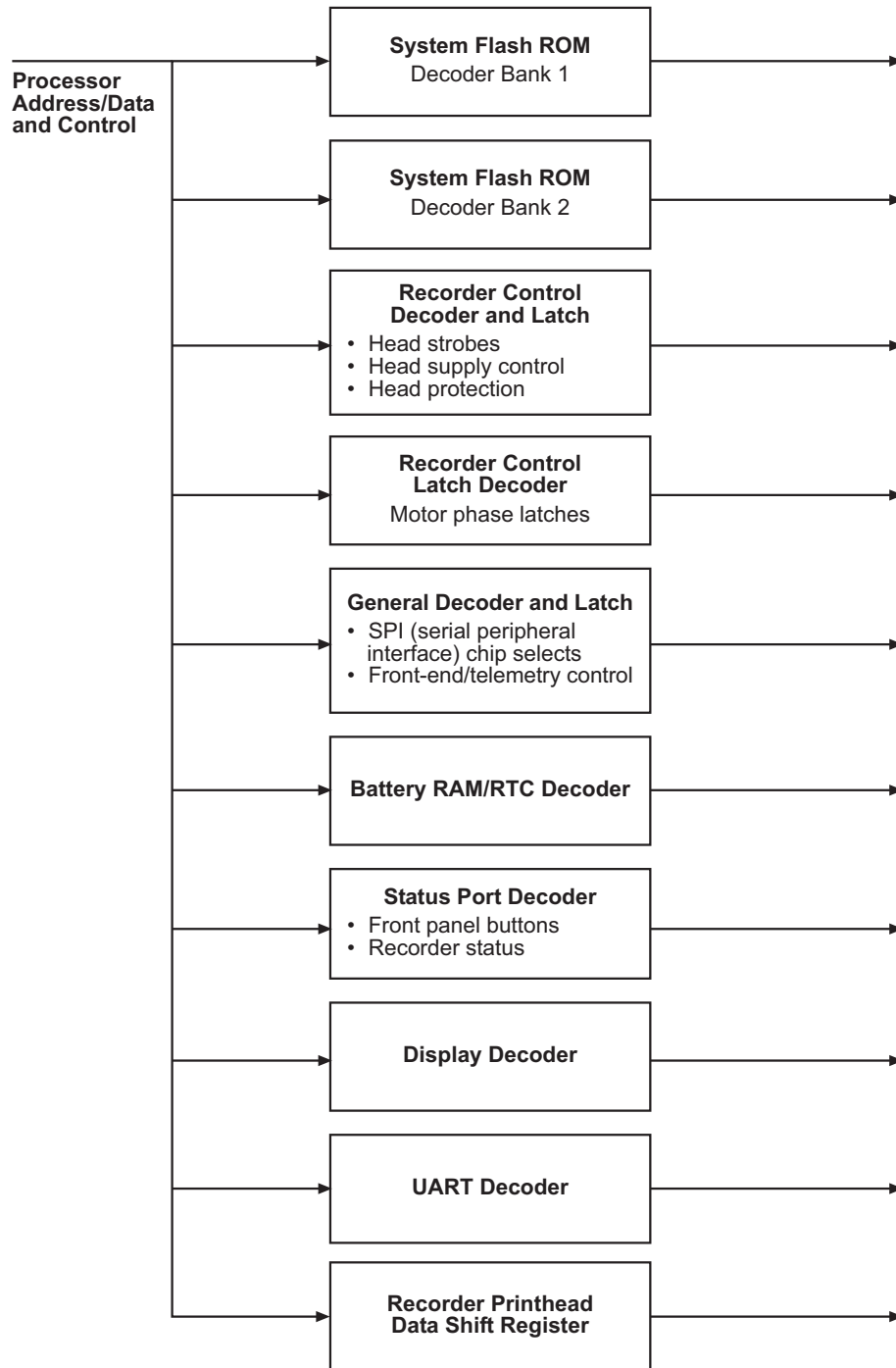

Figure 5-12. PAL Block Diagram

## Display Interface Module

The display interface consists of a data buffer (U14) for D0–D7 which interfaces to the ICM7228A seven-segment LED driver IC (U1 on the display board), and D flip-flop U3 which drives the  $\pm 1$  UA segments through Q1–Q4 transistors. Data lines have 100  $\Omega$  series resistors (R524–R531) which help to reduce emissions. A diode clamp device (U18) on the data bus is used to protect against ESD to the display area. Figure 5-13 provides a block diagram of the display interface module.

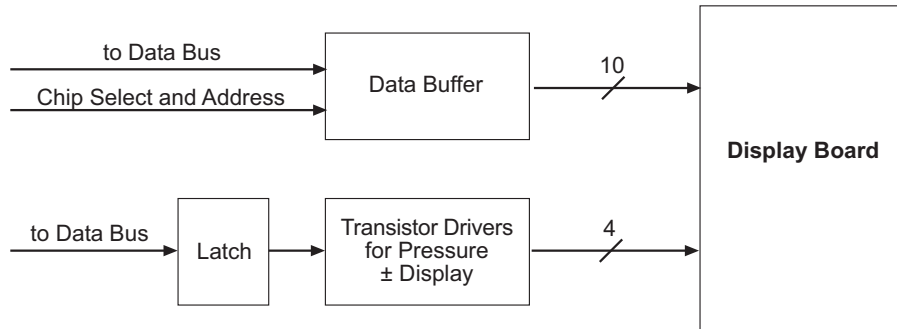

Figure 5-13. Display Module Interface Block Diagram

## Status/Switch Input Module

The status/switch input module consists of buffers U15 and U16 and series/parallel elements for protection against ESD. The monitor membrane switch panel provides 11 switch closures to ground which are fed to 100 k $\Omega$  pull up resistors and through 10 k $\Omega$  series elements. Buffers U14 and U15 are further protected by capacitors to ground and diode clamp devices U17 and U22. Two LEDs are present on the membrane switch panel: the power LED is driven by +5 V through resistor R350; the recorder LED is driven from PAL U4 through buffer U6 and resistor R351. Figure 5-14 provides a block diagram of the status/switch input module.

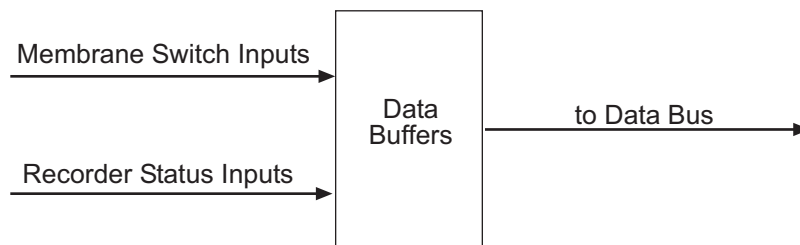

Figure 5-14. Status/Switch Input Module Block Diagram

## Communications Module

The communications section consists of quad UART U21 and RS-232 transceivers U19 and U20. The baud rate frequencies are generated from crystal X3 (3.6864 MHz). Two of the RS-232 channels are used for external communications while the remaining two provide spare internal channels. Each channel has four ports for RTS/CTS/general input-output. Both external channels support the RTS/CTS lines. Transceivers U19 and U20 convert the UART 3 V digital communications lines to RS-232 levels ( $\pm 7$  V typically) for transmission; and  $\pm 7$  V RS-232 levels to 3 V levels for reception. RJ-45 connectors J7 and J8 provide center connection compatibility to the 6-pin RJ-11 connectors found on the 120 Series Maternal/Fetal Monitors. The 170 Series uses the larger 8-pin connectors to provide fused power for future interfacing. Each channel has shunt 1000 pF shunt capacitors for emissions, 100  $\Omega$  series resistors, and clamp devices D6 and D7 for ESD protection. Figure 5-15 provides a block diagram of the communications module.

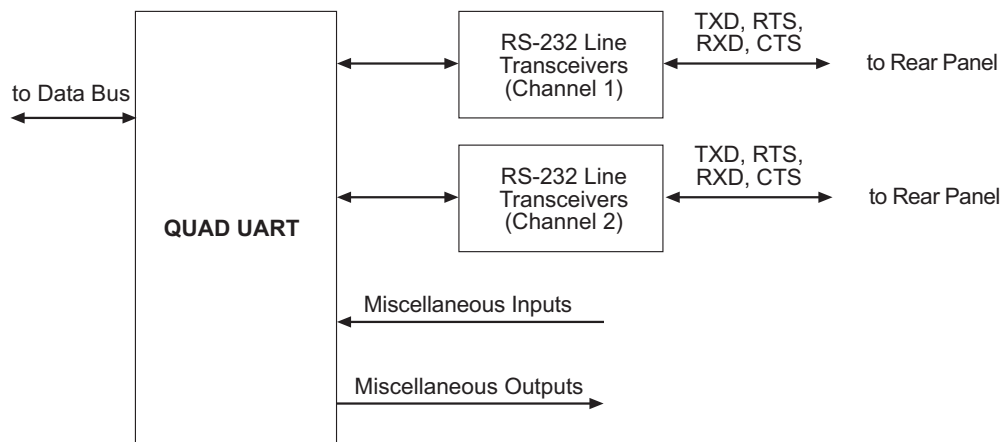

Figure 5-15. Communications Module Block Diagram

## Recorder Interface Module

The recorder interface consists of motor control, paper status logic, and printhead control logic. The motor control consists of latch U3, buffer U6, and FET transistors Q5–Q8. The four phase signals are generated by the processor using U3. These phases are translated to 5 V and buffered by U6 to drive the FETs which in turn drive the unipolar motor. Clamp diodes are used to limit the inductive spike generated when the switches open. The paper status logic consists of paper out and paper misload optical sensor interface circuitry as well as a door switch interface. The paper status logic consists of dual digital potentiometer U9, resistors R216 and R217 for LED drive to the paper out sensor, and R219 and R220 for LED drive to the paper misload sensor. The digital potentiometer connects to the collector of the sensor transistor and becomes the variable pull-up. These signals (MISCOIL and OUTCOIL) are further processed by the analog-to-digital converter to determine the correct threshold for the two sensors. Clamp device U8 is used for ESD protection. The door switch input is a switch closure to ground and is read by the processor through buffer U15. The printhead interface consists of PAL U4 which contains the printhead control latch, head protection circuitry, and printhead shift register. The printhead control latch contains the four strobes for the printhead sections, the printhead load line, and the printhead power supply enable line. The printhead protection timer consists of a four-bit counter which uses a 2 kHz clock [Umode, U4 (pin 35)] to count off six clocks. The counter is enabled when any one of the four processor-latched strobes is active. After six counts of any active strobe (3 ms), the counter disables all four output strobes and turns off the +24 V head supply. The circuit resets when the processor-latched strobes return to an inactive state. The power fail control line input U4 (pin 76) is also a form of protection which turns off all strobes and the power supply when the +12 V drops to about 10 V. The printhead shift register consists of an 8-bit shift register which clocks out D7 first and clock counters which allow eight clocks to be output for every processor write to the register. The clock counter also provides a done status bit (BUSY\*) which goes high after all eight bits are shifted out. This status bit is read through the UART spare port line U21 (pin 28).

Figure 5-16 provides a block diagram of the recorder interface.

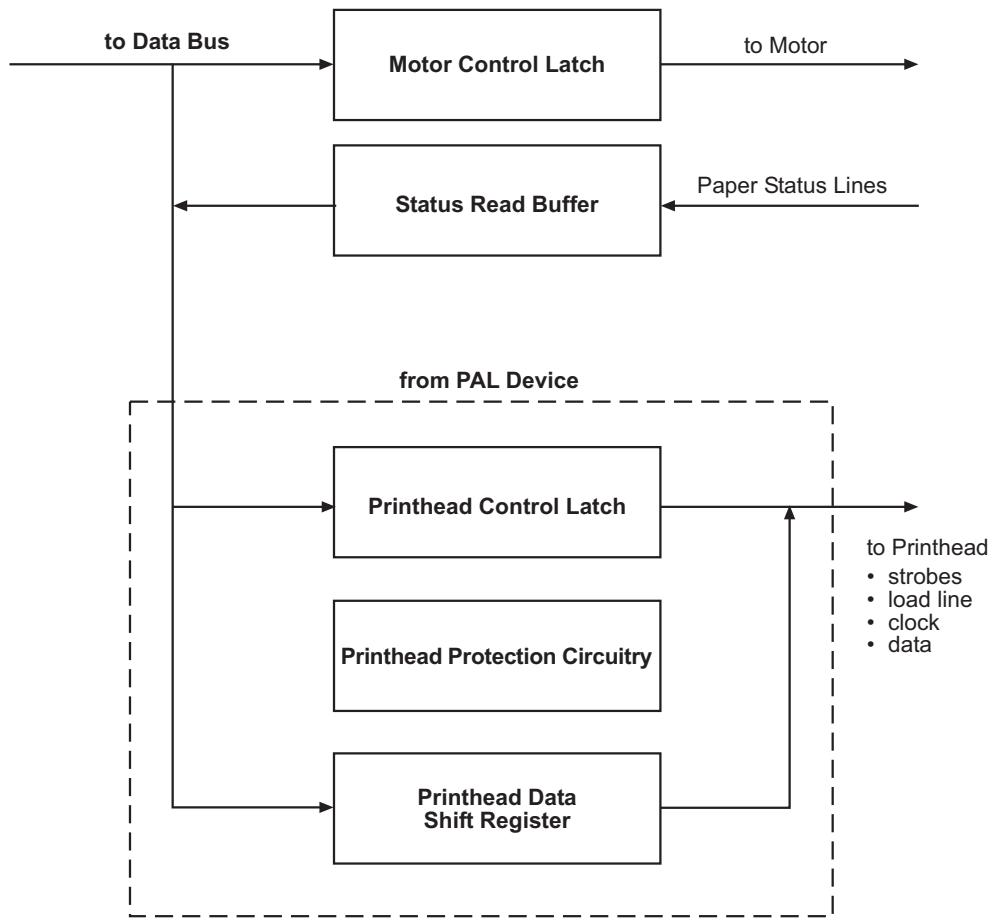

Figure 5-16. Recorder Interface Block Diagram

## Ultrasound Module

Model 171 and Model 173 Monitors contain a single ultrasound channel board. Model 172 and Model 174 Monitors contain a dual ultrasound channel board. The theory contained in this section references the dual ultrasound board but is applicable to the single ultrasound board as well.

### Overview

The ultrasound circuitry is a dual channel pulsed Doppler system with Channel 1 and Channel 2. Each channel generates a 1.151 MHz (center frequency) pulsed carrier signal. This signal carrier causes the crystals in the transducer to emit ultrasonic waves. When these sound waves enter the maternal abdomen, they create echoes when encountering an interface between tissues of differing acoustic impedance. If the interface is moving either toward or away from the ultrasound transducer, the frequency of the reflected sound differs from the frequency sent from the transducer.

### Isolation Transformer

Model 174 Monitors have an isolation transformer for US Channel 1 signals since the connector is shared with the FECG Channel.

### Ultrasound Transducer

When the reflected sound wave is received by the transducer crystals, it is converted to an electrical signal. After being amplified, detected, and filtered, this signal is split into two paths: ultrasound audio and ultrasound envelope. The audio signal is amplified for driving the speaker, while the ultrasound envelope is processed for heart rate data.

The center frequency of the transmitted carrier is 1.151 MHz with a pulse repetition frequency of 2 kHz (single or dual use).

When both ultrasound channels are being used, Channel 1 completes a transmit/receive cycle while Channel 2 is muted; then Channel 2 completes a transmit/receive cycle while Channel 1 is muted.

### Programmable Array Logic (PAL)

All functions of the pulsed Doppler ultrasound circuit are controlled by a PAL U50. Integrated circuit U48 latches the transmit and demodulator signals to prevent race conditions and phase jitter caused by the PAL U50.

**Table 5-19** provides a summary of PAL outputs. **Figure 5-17** provides a block diagram of the ultrasound module.

Table 5-19. PAL Outputs		
Pin Number	Signal Name	Signal Description
1	TRANS_BURST	Operates the Ultrasound Transmitter.
2	DET_BURST1	Activates the Demodulator.
18	575KC	Synchronizes the Power Supplies
19	USMODE	Signals the Processor that the US Channel is Active
21	PIN1	Selects Channel 1 Transducer
22	PIN2	Selects Channel 2 Transducer
42	CH2	Selects CH2 Track and Hold Circuit
43	CH1	Selects CH1 Track and Hold Circuit

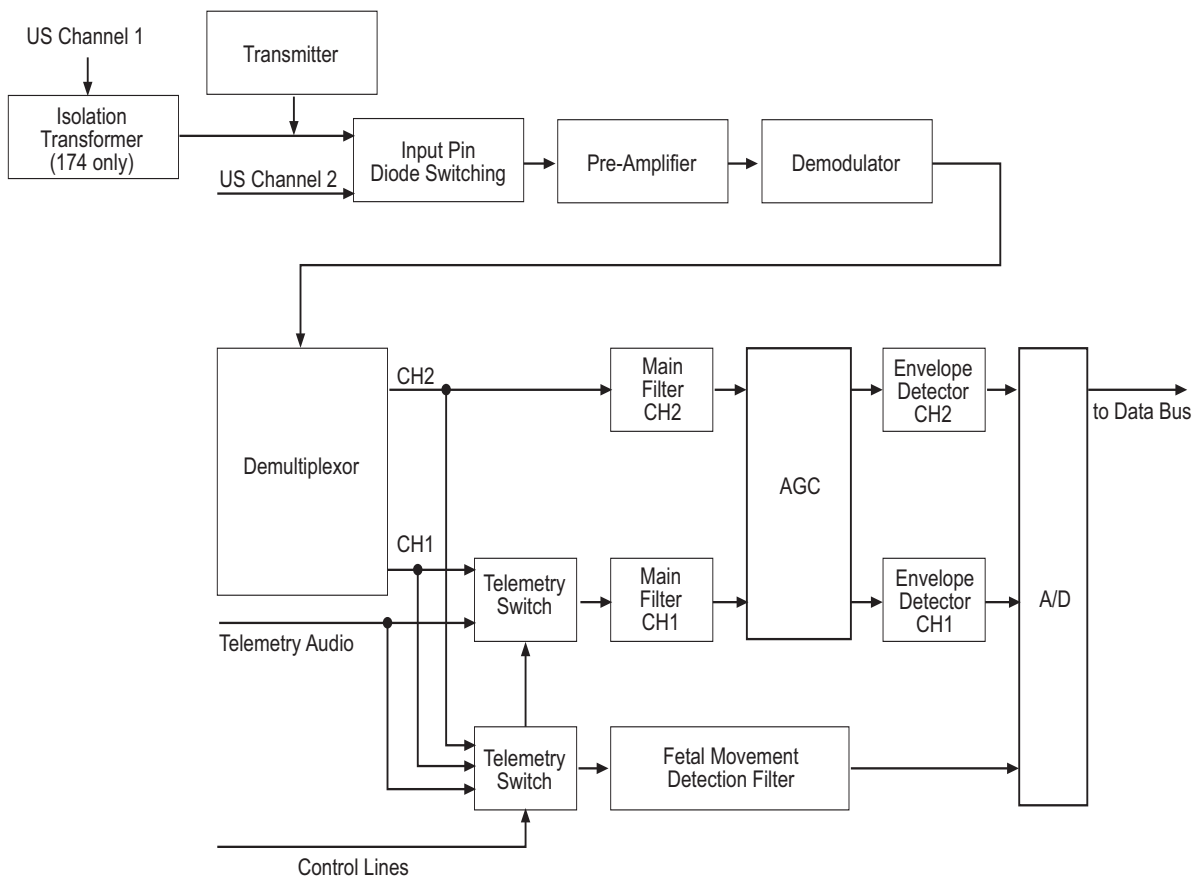

Figure 5-17. Ultrasound Module Block Diagram

## Ultrasound Oscillator

Internal gates located in integrated circuit U50, X4, and associated components comprise a crystal-controlled oscillator running at 4.604 MHz. The inverted output of this oscillator is the clock that is used to clock latch U48; therefore changes at the outputs of U50 are not clocked out of U48 until one-half clock cycle later. The system runs at a frequency of 2 kHz  $[(4.604 \text{ MHz}/1151)/2=2 \text{ kHz}]$  and the time for each transmission and reception is 250  $\mu\text{s}$   $[(1/2000)/2=250 \mu\text{s}]$ . The signal TRANS\_BURST is a square wave at a frequency of 1.151 MHz. It is initiated four clock cycles after the internal reset of the binary counter within U50 used to decode the signals used by the ultrasound system and continues 428 clock cycles. The signal DET\_BURST1 is also a square wave at a frequency of 1.151 MHz. This signal is output 640 clock cycles after reset, and continues up to 1020 clock cycles.

## Pin Diode Circuitry

The signals PIN1 and PIN2, from PAL U50, turn on the appropriate switches of U47 so as to bias pin diodes D21 and D22 on; this in turn provides a low impedance path for the Channel 1 transducer to the ultrasound transmitter and preamplifier. Diodes D23 and D24 are biased off, providing a high impedance path to the ultrasound transmitter and preamplifier for the Channel 2 transducer. The opposite of the above is true when the Channel 2 transducer is activated.

## Transmission/Reception

Integrated circuits U53, U54, and U55 are voltage regulators used to provide stable, low-noise power supplies for the ultrasound receiver and transmitter. Transistor Q11, inductor L1, and capacitor C208 form the ultrasound transmitter. Q11 is driven by the signal TRANS\_BURST. Inductor L2 and capacitors C209, C210, and CV1 provide tuning for the transmitter output. The transmitter has a nominal output impedance of 30  $\Omega$ , and can typically drive 4 V peak-to-peak into a 20  $\Omega$  load.

Transistors Q12, Q13, and Q14, and associated components, form the preamplifier. Capacitors C213, C215, C229, and C216 provide power supply rejection for the preamplifier. Inductor L3, along with capacitors C211 and C212, form a series resonant tank circuit. This tank circuit provides a low impedance path for the received signals from the transducer, and a voltage gain of approximately 28 dB. The typical input impedance to this tank circuit is 30  $\Omega$ s.

Transistors Q12 and Q13 form a cascode amplifier. Transistor Q13 is a dual n-channel field effect transistor connected in parallel. This parallel connection provides an improvement of 3 dB in signal-to-noise ratio due to the gain doubling and the noise adding in quadrature. Inductor L4 and capacitors C214 and CV3 form a parallel resonant tank circuit with an impedance of approximately 17 k $\Omega$ s. The shunt impedance of resistors R388, R389, R390, R391, and R392 effectively lower this impedance to 3.6 k $\Omega$ . The gain of the preamplifier is approximately 19 dB and is defined by:

$$R1/((1/(2*gm))+R386)= 3.6k/((1/.002)+200)$$

Transistor Q14 and transformer T1 provide a differential output for the preamplifier. Diode D19 provides protection for Q13 and removes the low impedance tank circuit L3 and C211, and C212 during transmission by shunting L3. Diode D20 provides overload recovery for the preamplifier and voltage limiting to the demodulator through Q14 and T1.



U43 is a quad-switched capacitor integrated circuit configured as a balanced ring demodulator. Its analog inputs are connected to the differential outputs of the pre-amplifier at the secondary of T1. The switches within the device are actuated by the signal DET\_BURST1.

The two analog outputs of U43 drive the difference amplifier U44 and its associated components. Integrated circuit U45 switches the output of the difference amplifier U44 (pin 14) to the track-and-hold circuit of either Channel 1 or Channel 2.

The track-and-hold circuit for Channel 1 is comprised of components R408, C225, and buffer amplifier U46 (pin 7). The track-and-hold circuit for Channel 2 is comprised of components R409, C226 and buffer amplifier U46 (pin1).

The track-and-hold circuits retain the amplitude of the last value from the previous demodulator activation. If this method were not employed, the system gain would have to be twice as high since it is a time sampled system. The samples must be integrated over time (averaged) to produce the desired output. In summary, this method improves the signal-to-noise ratio of the system.

Since the DET signal is driven at the same frequency as the transmitted signal, any return signal of the same frequency will be averaged and produce either 0 V or a dc offset at the output of the demodulator; this is not seen by the main filter driven by the demodulator since it is AC coupled by capacitors C253 and C262. Therefore, a difference frequency (Doppler shift frequency) must be present to produce an output from the demodulator. The output of the track-and-hold circuit of Channel 1 at U46 (pin 7) is switched to the Channel 1 main filter through U39 (pin 11) to U39 (pins 6 and 10).

Telemetry (if present) is switched to the Channel 1 main filter through U39 (pin 7) to U39 (pins 6 and 10). Telemetry FECG (if present) is switched by U39 (pin 3) to U39 (pins 2 and 15) to the analog-to-digital converter. The main filter is a band-pass amplifier. Its 3 dB points are 120 Hz and 300 Hz, respectively. The bandwidth slopes are greater than 40 dB/octave. The maximum gain of the filter is 46 dB with peaking of approximately 48 dB at 250 Hz. The nominal gain in the system is approximately 36 dB and is controlled by R454. The Channel 1 main filter is comprised of U51 and associated components.

## Filtering

The main filter is a band-pass amplifier with 3 dB points at 120 Hz and 300 Hz, respectively. The band width slopes are greater than 40 dB/octave. The maximum gain of the filter is 46 dB with peaking of approximately 48 dB at 250 Hz. The nominal gain in the system is approximately 36 dB and is controlled by R454. The Channel 1 main filter is comprised of U51 and associated components.

The output of the track-and-hold circuit of Channel 2 at U46 (pin 1) is connected directly to the Channel 2 main filter. The main filter is a band-pass amplifier with 3 dB points are 120 Hz and 300 Hz, respectively. The band width slopes are greater than 40 dB/octave. The maximum gain of the filter is 46 dB with peaking of approximately 48 dB at 250 Hz. The nominal gain in the system is approximately 36 dB and is controlled by R467. The Channel 2 main filter is comprised of U52 and associated components. Integrated circuit U40 switches the output of either the Channel 1 demodulator, the Channel 2 demodulator, or telemetry audio to the fetal movement band-pass filter. This filter has a gain of 3.5 and corner frequencies of 15 Hz and 39 Hz, respectively. It is comprised of U41 and associated components. The output of the fetal movement filter is input to the analog-to-digital converter.

The output of the main filters are input to U10 through capacitors C44 and C45. The input impedance of these inputs is 10 k $\Omega$ , thus producing a high-pass filter at 72 Hz. A tone is also one of the inputs to U10 through a high-pass filter at 15 Hz and a gain reduction of -21 dB. The components comprising the filter are C47 and R223. U10 is a quad digital potentiometer with 255 step producing a gain range from 0 to -48 dB. It is controlled by the serial peripheral interface (SPI) system bus.

## Ultrasound Audio

Ultrasound audio (Channel 1 and Channel 2) is output on U10 (pin 8) and U10 (pin 4), respectively. These outputs are buffered by U11 (pin 7) and U11 (pin 8), respectively. The buffered outputs are high-pass filtered at 80 Hz by C57/R236 and C58/R237. They are then half-wave rectified by U13 (pin 8) and its associated components. The output of the rectifier is band-pass filtered from 43 to 260 Hz at a gain of 7.3 by U13 (pin 1) and its associated components. This effectively doubles the frequency which is necessary because the transducer operates at a low RF frequency (1.151 MHz); and the frequencies produced from the fetal heart would not produce acceptable audio quality.

The output of U13 (pin 1) is input to summing amplifier U11 (pin 14). The tone output of U10 (pin 18) is also summed by U11 (pin 14) which is a low-pass filter at 2600 Hz with a slope of -12dB/octave. The output of U11 (pin 14) is high-pass filtered at 72 Hz by C52/R231 to the audio power amplifier.

The audio power amplifier U12 is a bridge type configuration with a gain of 2.5 and capable of delivering 1.5 W of power into 8  $\Omega$ . [Figure 5-18](#) provides block diagram of the audio module.

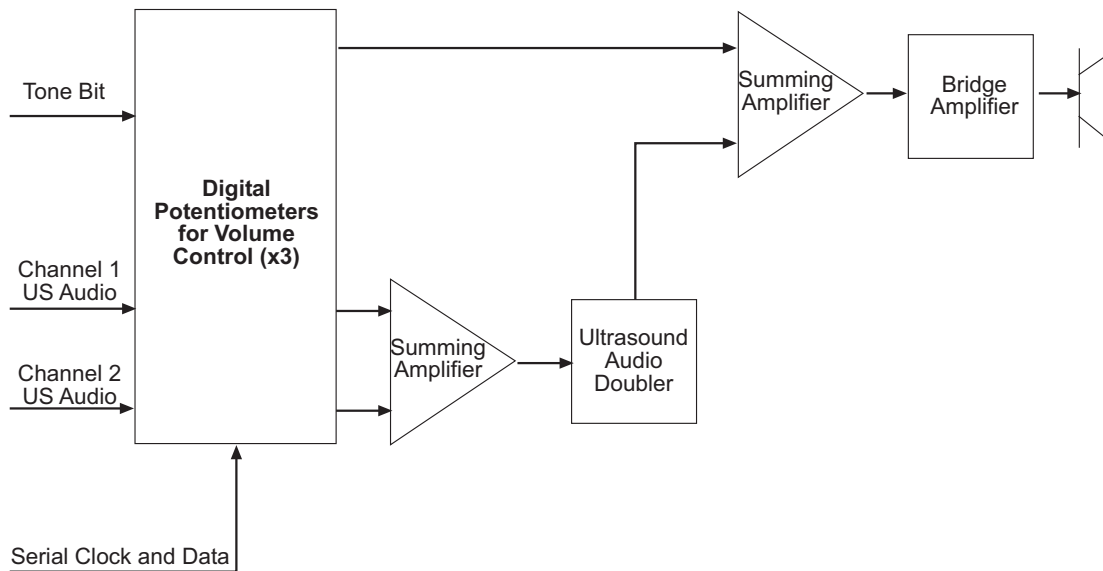

Figure 5-18. Audio Module Block Diagram

## Ultrasound Envelopes

The outputs of the main filters are also input to U32 and U35. The input to U35 is through high-pass filters at 63 Hz. The high pass components for Channel 1 and Channel 2 are C154/R338 and C159/R357, respectively. The output of the main filters are also input to U32; this integrated circuit, in conjunction with U35, forms an AGC (automatic gain control) circuit for both ultrasound channels.

Each of these AGC circuit has a maximum gain of 200 with a dynamic range of 46 dB. Each of the AGC outputs are high-pass filtered by C169/R343 at 90 Hz with a gain of one, then input to a half-wave detector U36 (pin 7) with a gain of 1.47. The output of the detector circuits are low-pass filtered by U36 (pin 1) at 20 Hz at gain of ten.

These envelopes are then input to the analog-to-digital converter U38. Other inputs to the analog-to-digital converter are the telemetry TOCO signal. This signal is scaled and offset to provide -100 to +400 relative UA units.

## Uterine Activity

Integrated circuit U33, with a gain of 200, and U34 (pin 7), with a gain of 1.25, provide a total gain of 250 for the on-board tocotransducer pressure channel. The output of U34 (pin 7) is offset +0.5 V, providing a dynamic range of -80 to +400 relative units. Each relative unit represents 20  $\mu\text{V}$  at the input of U33 through resistors R318 and R320.

Integrated circuit U42, and its associated components, comprise a charge pump that converts the +3.3 V to -3.3 V. U38 (pin 11) and U34 (pin 1) comprise a 2.5 V reference voltage. U71 (pin 7) provides a reference voltage which is half the 2.5 V reference, called VREF/2. Integrated circuit U56 (pin 7), and associated components, provides the +4 V required for the tocotransducer.

Figure 5-19 provides a block diagram of the antepartum uterine activity section.

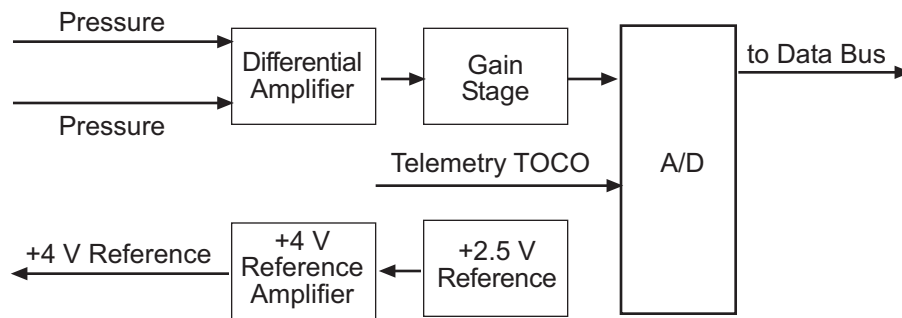

Figure 5-19. Antepartum UA Module Block Diagram

## Power Supplies

Integrated circuit U60 is a voltage comparator that senses that the power has been removed, and inhibits battery RAM access and recorder printing when the supply drops to approximately 10 V.

Integrated circuit U58 forms an R-S flip-flop. U58 (pin 6) is set high when the **Power** button is pressed. Q19 collector also goes to a logic 1 whenever the **Power** button is pressed. When U58 (pin 6) is pulled high, it enables the SYNC signal at U59 (pin 4) which is inverted by U59 (pin 3) to reach all the switching power supplies. The sync frequency is 575 kHz and is derived, and hence synchronized to the ultrasound system. U62 and its associated components comprise a buck converter with an output voltage of +5.8 V. This is used as the pre-regulator for linear regulators U65, U66, U68, and U69. U65 provides the system +5 V. U66 provides the +5 V for the recorder motor. U67 provides the +5 V for the audio amplifier. U68 provides +3.3 V for the analog circuitry. U69 provides the +3.3 V for the digital circuitry. U61, and its associated components, comprise a linear regulator with an output voltage of +7.5 V. This is used as the pre-regulator for the linear regulator U55 which provides the +6 V for the ultrasound front end; it also powers U53 which provides the -6 V and powers U56 which is used to generate the +4 V for the tocotransducer circuitry. U64, and its associated components, comprise a boost converter with an output voltage of +24 V.

Integrated circuit U70, under microprocessor control, is used to control the +24 V for the recorder printhead. The +24 V output is current limited by Q20, Q21, and associated components. The power output is limited to 17 W.

Figure 5-20 provides a block diagram of the power supply section.

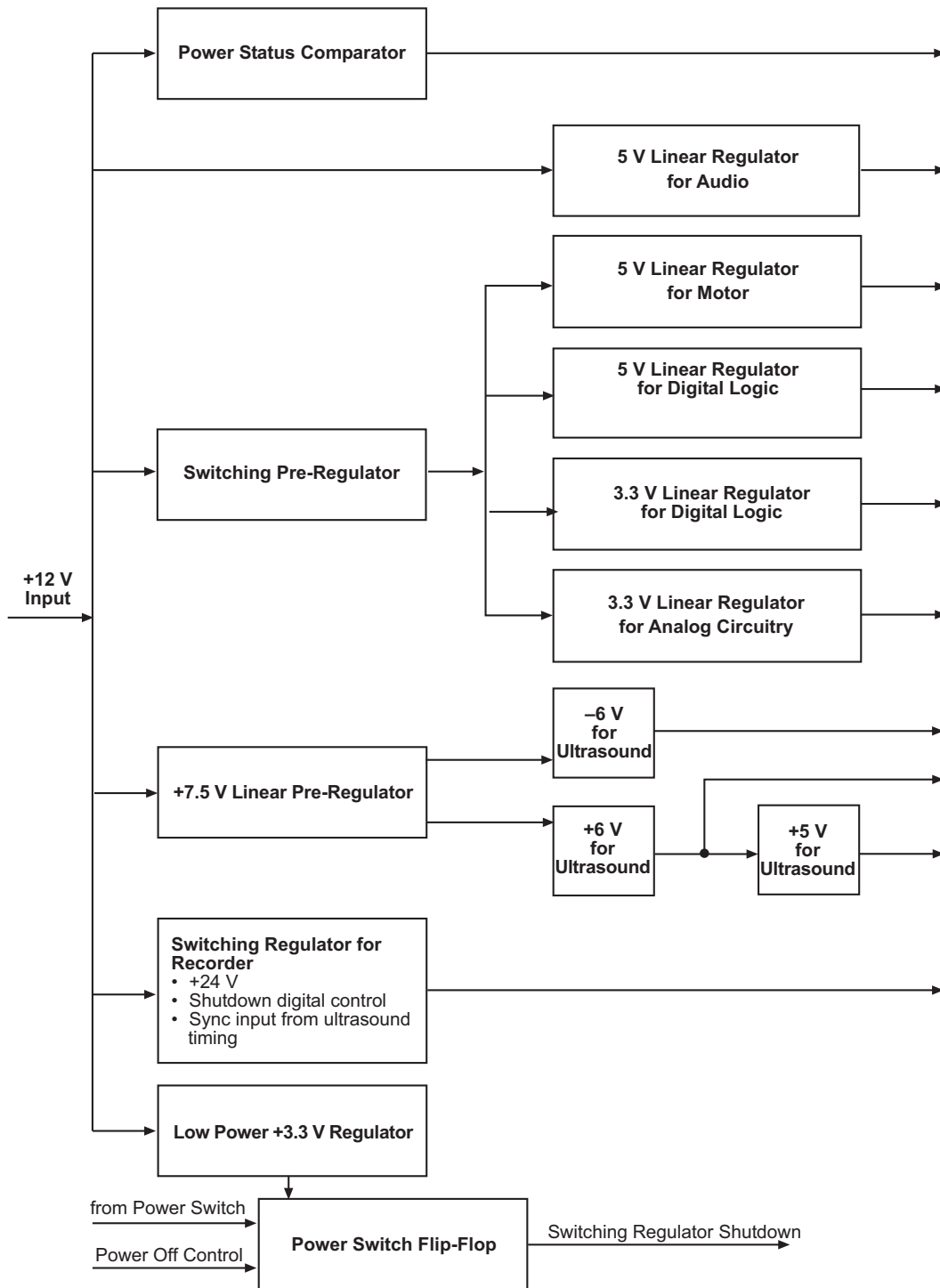

Figure 5-20. Power Supply Section Block Diagram

## FECG/IUP Board Interface

J16 and J15 provide the interface to the FECG/IUP Board. J15 is patient isolated.

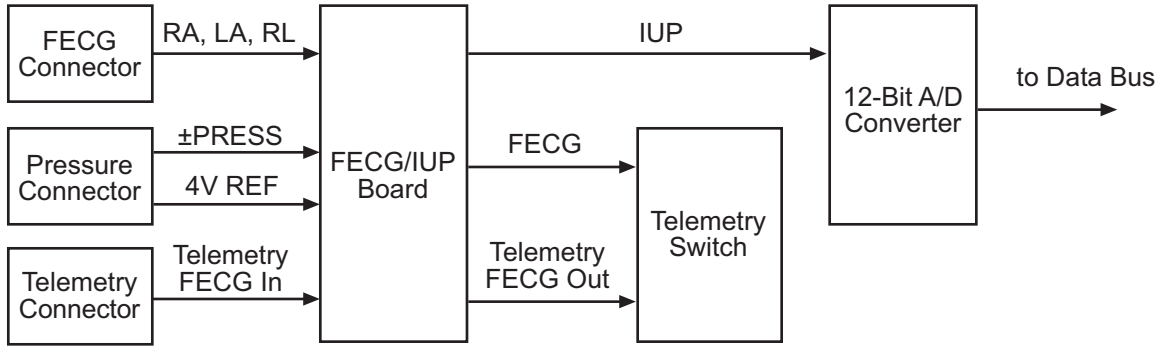

Figure 5-21. FECG/IUP Board Interface Block Diagram

# FECG/IUP Board Theory of Operation

## Isolated Power Supply

Patient isolation for the FECG and the IUP catheter is accomplished by providing floating power supplies to power the FECG and IUP front end electronics. Integrated circuit U12 provides non-overlapping drive signals to dual FET U9 which in turn drives the primary of transformer T1. Resistor R94 and capacitor C12 provide dampening for the primary of T1 so as to limit the voltage at the drains of U9 to a level below their breakdown voltage. The frequency at which the primary of T1 is switched is 35968.75 Hz which is derived by dividing the signal 144 kHz by four. The actual frequency of this signal is 143875 Hz and is derived from the PAL U50 in the ultrasound circuit. Thus the transformer switching frequency is synchronized to the ultrasound circuit. The secondary of transformer T1 drives rectifiers D9 and D10. These rectifiers are filtered by C8 and C10 for the positive power supply, and by C9 and C11 for the negative power supply. Integrated circuit U3 and its associated components provide a regulated positive voltage (+10 V for Model 173; +9.3 V for Model 174), while integrated circuit U4 provide a regulated negative voltage (-10 V for Model 173; -9.3 V for Model 174). Integrated circuit U1 is a positive precision 2.5 volt reference. The output of U1 is input to the non inverting input of amplifier U2 (pin 3). The output of this amplifier U2 (pin 1) drives the emitter follower Q1. The gain of the amplifier-emitter follower is 1.6 and is set by resistors R3 and R4. The output of Q1 emitter is 4 V (1.6 x 2.5). This voltage is used to power either an IUP transducer or tocotransducer. Resistor R1 in the collector of Q1 is used to sense the current drain from other manufacturers of IUP transducers who don't have an IUP enable associated with them. When the voltage at the junction of resistors R36 and R37 falls below 1.164 V (4 mA) the output of the voltage comparator U16 (pin 8) switches from a high state to a low state, which in turn causes transistor Q3 to turn on and transfer the IUP enable across the isolated barrier. This signal is named IUPEN\*. However If a tocotransducer is present, this signal is ignored. Transistor Q3 can also be turned on by the signal PEN\*.

For Model 173 and 174 Monitors, integrated circuit U33 and associated components provide regulation of the power supplied to the FECG/IUP Board circuitry (+12 V for Model 173; +11.6 V for Model 174).

For a Model 174 only, the CLEAR signal synchronizes the counter in the PAL; this in effect stops the power supply during the receive cycle of the ultrasound process for noise reduction purposes.



## Pressure Channel

The input to the pressure channel is to resistors R9 and R10 with the signal names of -PRESS and +PRESS respectively. Resistors R9 through R12 and capacitors C16 through C18 provide RF filtering, and in conjunction with diode limiters D1 and D2, provide protection from electro-static discharge. Instrumentation amplifier U5 provides a gain of 248 which is given by  $(49.4E3/R13)+1$ . The output of U5 which is inverting with respect to the signal -PRESS, drives the inverting amplifier U6 (pin 1). This amplifier has a gain of -4.99 and rolls off at approximately 32 Hz. The output of U6 (pin 1) drives U6 (pin 5) with a division of two formed by resistors R18 and R19. The operation of this amplifier is best understood if analyzed from its quiescent condition of no input signal. Under this condition U6 (pin 5) is at zero volts, therefore U6 (pin 6) must also be at zero volts. This forces a quiescent current of 75  $\mu$ A through R20. This current is produced by U6 (pin 7) driving the LED that illuminates the photodiode at U10 (pins 3 and 4) which is the feedback path. The LED also illuminates the photodiode at U10 (pins 5 and 6) which are on the non-isolated side. The current transfer ratio of this photodiode with respect to the photodiode on U10 (pins 3 and 4) is 0.85 to 1.05. The tocotransducer and the IUP transducer have the transfer function of 5 $\mu$ V/UA-Unit/Volt-excitation. Therefore since the excitation voltage is 4 V, the input voltage is 0.002V/100UA-Units. This corresponds to 2.475 V at U6 (pin 1) and 1.2375 V at U6 (pin 5). This causes a delta current of 9.3  $\mu$ A through R20, which is also transferred across the barrier with the same transfer ratio of 0.85 to 1.05. This current is input to U13 (pin 6) through R32. Potentiometer R25 sets the gain at U13 (pin 8) to 0.5 V/100UA-Units. Potentiometer R30 sets the initial offset voltage to +0.5 V. The output amplifier U13 (pin 8) is a unity gain amplifier with 3 poles of filtering with its 3 dB frequency of 3 Hz. Since the system analog-to-digital converter has an input range of 0 to 2.5 V, the dynamic range is from -100 to +400UA-Units.

## FECG Channel

The input to the FECG channel is two resistors R42 and R43 with the signal names of RA and LA respectively. Resistors R42, R43, R45, and R462 and capacitors C38 through C40 provide RF filtering, and in conjunction with diode limiters D3 through D6 provide protection from electro-static discharge. Resistors R40, R41, and R44 cause amplifier U7 to saturate when the FECG cable is not connected to a fetus. This disables the FECG channel from counting noise and flashing LEDs and causing tones to be generated by the speaker. Instrumentation amplifier U7 provides a gain of 13.7 which is given by  $(49.4E3/R54)+1$ . Amplifier U2 (pins 5, 6, and 7) is an integrator which has high gain at DC with reducing gain as frequency increases.

Amplifier U2 (pin 7) drives amplifier U2 (pin8). Amplifier U2 (pin 8) is non-inverting and is patient protected in the event of a failure of this device. The two sections of U2 provide the right leg drive circuit. The right leg drive is a feedback circuit that provides drive in the opposite polarity to a common mode voltage. Its purpose is to cancel DC offset from the electrode, and to help reject 50 and 60 Hz components. The output of U7, which is inverting with respect to the signal RA, drives the non-inverting amplifier U2 (pin 12) through a high-pass filter of 10 Hz. Resistor R58 and diode D7 provide voltage limiting at U2 (pin 12). This amplifier has a gain of 22.5 and rolls off at approximately 224 Hz. The output of U2 (pin 14) drives U8 (pin 3) through R64. Resistor R64 and diode D8 provide voltage limiting at U8 (pin 3). This amplifier has a gain of 22.5 and rolls off at approximately 224 Hz. The composite bandwidth and gain at this point is from 10 Hz to 320 Hz with a gain of 6936. The output of U8 (pin 1) drives amplifier U8 (pin 5) with a division of 10/11 formed by resistors R67 and R68. The operation of this amplifier is best understood if analyzed from its quiescent condition of no input signal. Under this condition U8 (pin 5) is at zero volts, therefore U8 (pin 6) must also be at zero volts. This forces a quiescent current of 75  $\mu$ A through R69. This current is produced by U8 (pin 7) driving the LED that illuminates the photodiode at U11 (pins 3 and 4) which is the feedback path. The LED also illuminates the photodiode at U11 (pins 5 and 6) which are on the un-isolated side. The current transfer ratio of this photodiode, with respect to the photodiode, on U11 (pins 3 and 4) is 0.85 to 1.05. The input voltage required to drive U8 (pin 1) to either of its power supply limits is approximately  $\pm 1.44$  mV peak. This corresponds to approximately  $\pm 5$  V at U8 (pin 1) for  $\pm 0.72$  mV input, and  $\pm 4.55$  V at U8 (pin 5). This causes a delta current of 34.2  $\mu$ A through R69, which is also transferred across the barrier with the same transfer ratio of 0.85 to 1.05. This current is input to U15 (pin 3) with resistor R75 being the load resistor that produces a voltage proportional to the current transferred to it. Amplifier U15 (pin 7) produces an offset voltage of  $-1.97$  V. The quiescent current of 75  $\mu$ A flowing through R75 will produce a voltage of approximately +1.25 V at U15 (pin 3). A 0.72 mV signal peak-to-peak at the input will produce approximately 1.26 V at U15 (pin 1). Thus  $\pm 1.44$  mV at the input will produce  $\pm 2.52$  V at U15 (pin 8). Amplifier U15 (pin 14) is a non-inverting amplifier with a gain of one. It also provides 3 sections of high-pass filtering at 25 Hz. Amplifier U15 (pin 8) is a non-inverting amplifier with a gain of one. It also provides 3 sections of low-pass filtering at 90 Hz.

## Mode Enables

The FECG enable ties resistor R87 to the floating ground when the FECG cable is attached. This causes approximately 4.5 mA to flow in the LED of opto-coupler U17. The current transfer function of the coupler is 19% typically which causes 860  $\mu$ A to flow in the photo-transistor of U17 in turn causing R103 to be pulled to

ground on the non-floating side of the barrier. It is then sensed by the system microprocessor.

The IUP enable ties resistor R97 to the floating ground when the IUP transducer cable is attached. This causes approximately 4.5 mA to flow in the LED of opto-coupler U17. The current transfer function of the coupler is 19% typically which causes 860  $\mu$ A to flow in the photo-transistor of U17 in turn causing R104 to be pulled to ground on the non-floating side of the barrier. It is then sensed by the system microprocessor. The tocotransducer enable ties resistor R100 to the floating ground when the IUP transducer cable is attached. This causes approximately 4.5 mA to flow in the LED of opto-coupler U17. The current transfer function of the coupler is 19% typically which causes 860  $\mu$ A to flow in the photo-transistor of U17 in turn causing R105 to be pulled to ground on the non-floating side of the barrier. It is then sensed by the system microprocessor.

For a Model 174 only, the ultrasound enable ties resistor R109 to the RL when the ultrasound cable is attached. This causes approximately 4.5 mA to flow in the LED of opto-coupler U17. The current transfer function of the coupler is 19% typically which causes 860  $\mu$ A to flow in the photo-transistor of U17 in turn causing P16 (pin 6) to be pulled to ground on the non-floating side of the barrier. It is then sensed by the system microprocessor. In summary, the US1 enable isolated one channel of US from the Main Board along with a mode enable from the FECG/IUP Board.

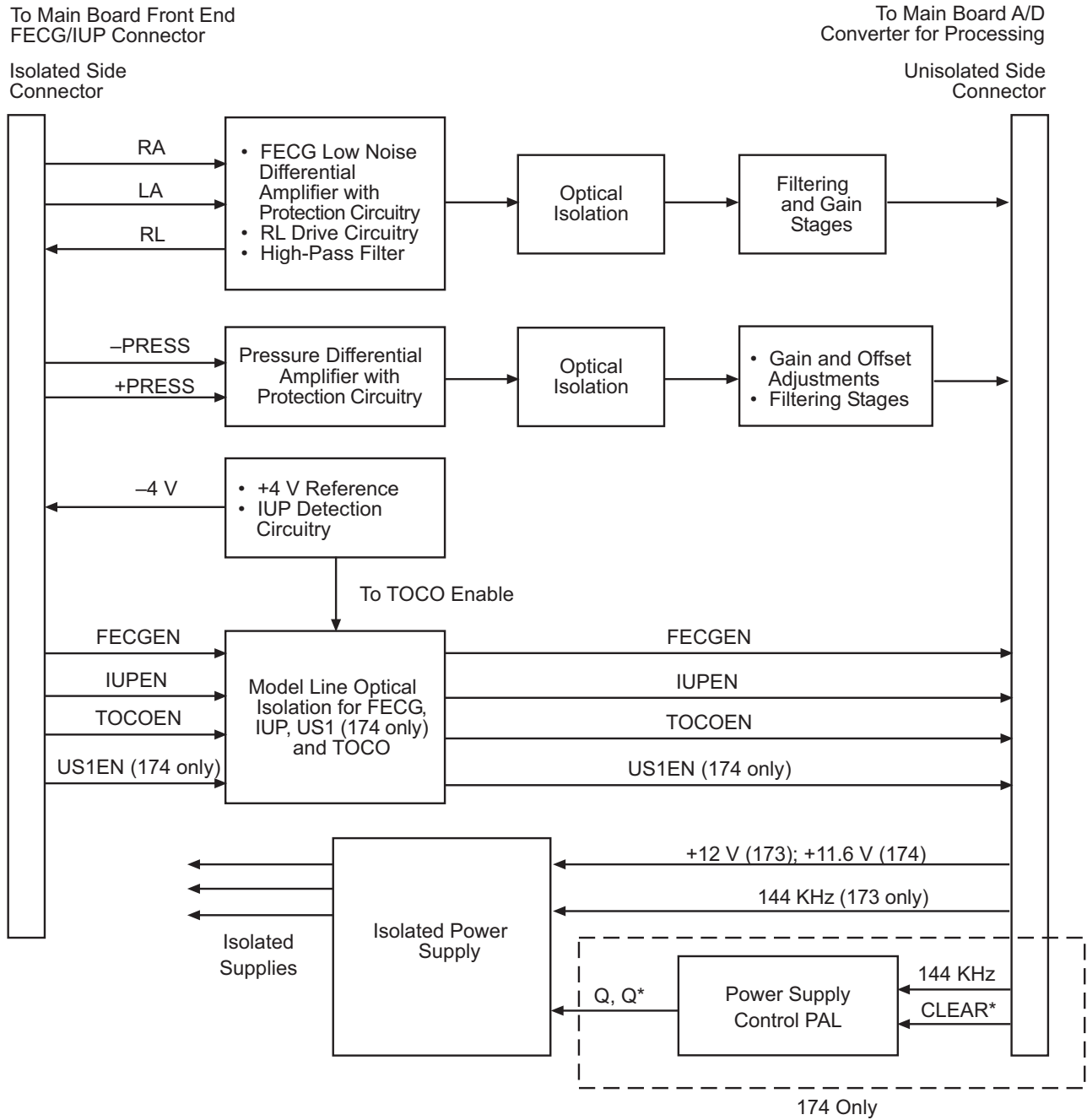

Figure 5-22. FECG/IUP Board Block Diagram

Table 5-20. FECG/UA Unisolated Output (P16), Models 173/174 Only			
Pin Number	Signal Name	Signal Type (Relative To Main Board)	Signal Description
1	+12 V (173) +11.6V (174)	Output	+12 V for FECG Isolated Power Supply (Model 173 only) +11.6 V for FECG Isolated Power Supply (Model 174 only)
2	GND	Output	Digital Ground
3	+5V	Output	+5 V Supply
4	+7.5V	Output	+7.5 V Supply
5	2.5VREF	Output	2.5 V Reference
6	IUPEN*	Input	IUP Enable Output
7	+3.3VANA	Output	+3.3 V for Analog
8	144KC	Output	144 KHz for Isolated Power Supply
9	-3.3VANA	Output	-3.3 V for Analog
10	AGND	Output	Analog Ground
11	FECGOUT	Input	FECG Analog Output
12	PRESSOUT	Input	Pressure Analog Output
13	FECGEN*	Input	FECG Enable
14	CLR*	Output	Ultrasound Sync Timing Line (Model 174 only)
15	TOCOEN*	Input	TOCO Enable
16	US1EN*	Input	US1 Mode Enable (Model 174 only)

\* Active low.

<b>Table 5-21. FECG/UA Isolated Output (P15), Models 173/174 Only</b>			
<b>Pin Number</b>	<b>Signal Name</b>	<b>Signal Type (Relative To Main Board)</b>	<b>Signal Description</b>
1	RA	Output	Right Arm Input from Patient Connector
2	LA	Output	Left Arm Input from Patient Connector
3	RL	Input	Right Leg Drive Signal from FECG Board
4	SHIELDF	Output	Isolated Shield
5	-PRESS	Output	UA Channel Negative Input
6	+PRESS	Output	UA Channel Positive Input
7	ISO4V	Input	Isolated 4 V Reference
8	ECGEN*	Output	Enable for FECG Cable
9	4VISOGND	Input	Isolated 4 V Reference Ground
10	PEN*	Output	Isolated IUP Enable
11	USEN* (174 only)	Output	US1 Mode Enable (Model 174 only)
12	ENTOCO*	Output	Isolated TOCO Enable

\* Active low.



## Chapter 6

# Functional Checkout Procedure

Like all electronic monitoring devices, internal and external components are subject to fatigue, wear, and the potential for failure over time and under varying conditions of use. Additionally, events such as dropping the monitor, spilling liquids on the monitor, or crimping the lead wires or patient cables can cause damage which may affect the overall system performance.

This chapter contains the following:

Equipment Required .....	6-2
General .....	6-3
Monitor Self-Test .....	6-4
Front Panel Pushbutton Test .....	6-5
Connecting the Simulator .....	6-6
FECG Test .....	6-7
Legplate Inspection .....	6-12
Ultrasound Test .....	6-13
Fetal Movement Detection Test .....	6-16
Ultrasound Transducer Test .....	6-18
Uterine Activity Test .....	6-19
Tocotransducer Test .....	6-21
Strain Gauge Transducer Test .....	6-22
Pattern Memory Test .....	6-23
Dual Heart Rate Test (Non-Pattern) .....	6-24
Alarm Test .....	6-28

# Equipment Required

Table 6-1 provides a complete listing of equipment required for a functional checkout procedure.

Table 6-1. Equipment Required	
Test	Equipment
FECG	<ul style="list-style-type: none"> <li>■ Model 325 Simulator # (14203A/B)</li> <li>■ Monitor Interconnect Cable (14212A/B)</li> </ul>
Legplate	<ul style="list-style-type: none"> <li>■ Legplate for Qwik Connect Plus with round connector (1590AAO)</li> </ul>
US/FMD	<ul style="list-style-type: none"> <li>■ Model 325 Simulator # (14203A/B)</li> <li>■ Monitor Interconnect Cable (14212A/B)</li> </ul>
US Transducer	<ul style="list-style-type: none"> <li>■ Nautilus Ultrasound Transducer (5700GAX–5700MAX Series)</li> </ul>
TOCO/IUP	<ul style="list-style-type: none"> <li>■ Model 325 Simulator # (14203A/B)</li> <li>■ Monitor Interconnect Cable (14212A/B)</li> </ul>
Tocotransducer	<ul style="list-style-type: none"> <li>■ Nautilus Tocotransducer (2264GAX–2264MAX Series)</li> </ul>
Strain Gauge Transducer	<ul style="list-style-type: none"> <li>■ Reusable Strain Gauge with holder (4007BAX); or</li> <li>■ Reusable Strain Gauge without holder (4007LAX); or</li> <li>■ Disposable Strain Gauge (4009AAX)</li> </ul> <p>NOTE: These items are no longer sold by GE. However, transducers in the field are compatible with the 170 Series Monitor.</p>
Pattern Memory	<ul style="list-style-type: none"> <li>■ Model 325 Simulator # (14203A/B)</li> <li>■ Monitor Interconnect Cable (14212A/B)</li> </ul>
Dual Heart Rate (FECG/US)	<ul style="list-style-type: none"> <li>■ Model 325 Simulator # (14203A/B)</li> <li>■ Monitor Interconnect Cable (14212A/B)</li> </ul>
Dual Heart Rate (US/US2)	<ul style="list-style-type: none"> <li>■ Two Model 325 Simulators # (14203A/B) with two sets of Monitor Interconnect Cables (14212A/B); or</li> <li>■ Two Nautilus Ultrasound Transducers 5700GAX–5700MAX Series)</li> </ul>
Alarms	<ul style="list-style-type: none"> <li>■ Model 325 Simulator # (14203A/B)</li> <li>■ Monitor Interconnect Cable (14212A/B)</li> </ul>



# General

Between Factory Service visits it is necessary that the proper operation of each monitor be verified by performing the functional checkout procedure described in this section. This procedure should be completed prior to initially placing the monitor on a patient, when monitor performance needs to be verified, on a semi-annual basis, or more frequently as dictated by your equipment maintenance and management policies.

**NOTE:** Read each step of this procedure thoroughly before actually performing the test.

Visually inspect the monitor, patient cables, and other accessories for cracks, fissures, or other signs of wear or damage. Do not use any monitor or accessory which appears to be worn or damaged. If unsure, contact your GE Service Representative to arrange for evaluation, replacement, or repair of the suspect item(s).

# Monitor Self-Test

The 170 Series Monitor contains test routines which verify the unit's calibration and internal circuitry. These routines are initiated by each time the monitor is turned on. The test results are printed on the strip chart recorder paper, verifying the integrity of the unit.

This information is covered in detail in [“Monitor Self-Test Routines”](#) on page 4-8.

# Front Panel Pushbutton Test

This procedure ensures the functionality of the front panel pushbuttons.

1. Disconnect all transducers from the front panel.
2. Enter the service setup mode (see page 4-10) and set the recorder speed to 1 cm/min.
3. Press the **Setup** button to exit the setup mode.
4. Press the monitor's **Power** button to turn on the monitor.
5. Press the monitor's **Record** button and verify the following:
  - ◆ The yellow indicator next to the button illuminates continuously.
  - ◆ The recorder paper advances at a rate of 1 cm/min.
  - ◆ The recorder prints the correct time and date information on the strip chart paper. (If an incorrect time or date is listed, refer to “[Chapter 4, Setup Procedures](#)” in this manual.)
  - ◆ The recorder prints the messages **CARDIO INOP** and **UA INOP**, indicating that no ultrasound or uterine activity transducers are plugged into the front panel **US**, **US2**, or **UA** connectors.
  - ◆ The recorder prints the message **1 CM/MIN**, indicating the selected chart speed.
6. Press the monitor's front panel **Paper Advance** pushbutton and verify that the recorder paper advances at a rate of 36 cm/min.
7. Press the **Paper Advance** pushbutton again and verify that the recorder prints the message **1 CM/MIN**.
8. Access the service setup mode and set the recorder speed to 3 cm/min.
9. Press the **Setup** button to exit the service setup mode.
10. Press the monitor's **Power** button to turn the monitor back on.
11. Verify that the recorder paper advances at a rate of 3 cm/min and that after approximately 40 seconds, the message **3 CM/MIN** prints on the recorder paper. (The time, date and monitoring modes also print again.)
12. Press the **Mark** button and verify that an event mark (↑) prints on the bottom two lines of the recorder paper.

# Connecting the Simulator

This part of the procedure prepares the simulator for use.

**NOTE:** You must use a Model 325 Simulator for the functional checkout procedure. (Monitors in the 170 Series do not work with Model 305 Simulators.)

1. Ensure the Model 325 **Power** switch is in the *off* position.
2. Connect the Model 325 Simulator's power cord to the power receptacle on the rear panel of the simulator; plug the other end of the power cord into a properly grounded wall outlet of appropriate voltage.
3. Ensure the 170 Series Monitor is turned off.
4. Connect the simulator interconnect cable's 50-pin end to the simulator's **Fetal Monitor** connector.
5. Connect the sub-cables of the other end of the simulator interconnect cable into the color-coded connectors on the monitor/adaptor: **US** and **UA** (as required by the procedure).
6. Turn *on* the Model 325 Simulator. Verify that the green **Power** indicator illuminates.
7. Turn *on* the 170 Series Monitor.xt

# FECG Test

This portion of the functional checkout procedure ensures the integrity of the FECG circuitry and the heart rate channel of the recorder.

1. Connect the Model 325 Simulator's ECG sub-cable to the **FECG** receptacle on the monitor
2. Set the switches on the Model 325 Input Simulator according to [Table 6-2](#).
3. If not already on, press the monitor's **Record** button.
4. Turn the simulator's **Manual Adjustment** knob fully counterclockwise and verify the following on the monitor:
  - The FHR1 value is 30 BPM.
  - The FHR1 heartbeat indicator (♥) flashes at a rate of 30 times per minute.
  - The ECG "beep" volume of the rear panel speaker can be increased or decreased using the **Volume** buttons. (Set the volume to the desired level.)
  - The recorder prints a continuous line at 30 BPM on the top grid of the strip chart paper.
    - ◆ The recorder prints the message FECG on the center margin of the strip chart paper after approximately 20 seconds.
5. Turn the simulator's **Manual Adjustment** knob to input an FECG signal of approximately 120 BPM. Verify the following on the monitor:
  - ◆ The FHR1 value is 120 BPM.
  - ◆ FHR1 heartbeat indicator (♥) flashes at a rate of 120 times per minute.
  - ◆ The ECG "beep" volume of the rear panel speaker can be increased or decreased using the **Volume** buttons. (Set the volume to the desired level.)
  - ◆ The recorder prints a continuous line at 120 BPM on the strip chart paper.

Table 6-2. Model 325 Simulator Settings for FECG Test		
Section	Switch	Setting
FECG/MECG	Main	RATE
	Rate	MANUAL
	Mode	FECG
	QRS Amplitude	15 $\mu$ V
	QRS Polarity	+
GENERAL	Pattern Memory	OFF
UA	Main	CMR
	Mode	TOCO

6. Repeat step 5 for each of the following rates: 60, 210, and 240 BPM.
7. Change the simulator's **QRS Polarity** switch from + to -. Verify that the monitor does not skip any beats.
8. Set the simulator's **ECG Rate** switch to the RAMP setting. Verify that the monitor's FHR1 value counts between approximately 30 and 240 BPM and that the FHR1 trend is a ramp between the same values on the strip chart paper. (See [Figure 6-1.](#))
9. Access the Service Setup Mode and disable ECG Artifact Elimination.
10. Set the simulator's **ECG Rate** switch to the  $\Delta 15$  position. Verify the following on the monitor:
  - ◆ The FHR1 value oscillates by 15 BPM.
  - ◆ The FHR1 heartbeat indicator (♥) flashes for each input signal.
  - ◆ The ECG "beep" is heard from the rear panel speaker.
  - ◆ The FHR trend oscillates 15 BPM between 115 and 130 BPM on the top grid of the strip chart paper. (See [Figure 6-2.](#))
11. Repeat step 10 for rate values of  $\Delta 22$  and  $\Delta 27$ . The results should be the same except that the FHR1 value oscillates by either 22 or 27 BPM and the FHR trend is an oscillation of 22 or 27 BPM. The top value is always at approximately 130 BPM. (Refer to [Figure 6-2.](#))
12. Access the Service Setup Mode and enable ECG Artifact Elimination.

13. Set the simulator's **ECG Rate** switch to the  $\Delta 15$  position. Verify the following on the monitor:
  - ◆ The FHR1 value oscillates by 15 BPM.
  - ◆ The FHR1 heartbeat indicator (♥) flashes for each input signal.
  - ◆ The ECG "beep" is heard from the rear panel speaker.
  - ◆ The recorder prints an oscillation of 15 BPM between 115 and 130 BPM on the top grid of the strip chart paper. (Figure 6-2. shows the strip chart paper results.)
14. Repeat step 13 for the rate value of  $\Delta 22$ . The result should be the same as step 13 except that the FHR1 value oscillates by 22 BPM and the trend is an oscillation of 22 BPM between the 108 and 130 BPM on the strip chart paper.
15. Set the simulator's **ECG Rate** switch to the  $\Delta 27$  position. Verify the following on the monitor:
  - ◆ The FHR1 value oscillates by 27 BPM.
  - ◆ The FHR1 heartbeat indicator (♥) flashes for each input signal.
  - ◆ The ECG "beep" is heard from the rear panel speaker.
  - ◆ The trend does *not* indicate any oscillation.
16. Access the Service Setup Mode and disable ECG Artifact Elimination.
17. Set the simulator's **ECG Rate** switch to the MANUAL position and the **Manual Adjustment** knob to the fully counterclockwise position. Disconnect the ECG simulator sub-cable from the monitor's FECG receptacle. Verify the following on the monitor:
  - ◆ The FHR1 value is blank.
  - ◆ The FHR1 trend stops plotting on the strip chart paper.
  - ◆ After approximately 30 seconds, the message **CARDIO INOP** prints on the center margin of the strip chart paper.
18. Set the simulator's **ECG Mode** switch to the OFF position.

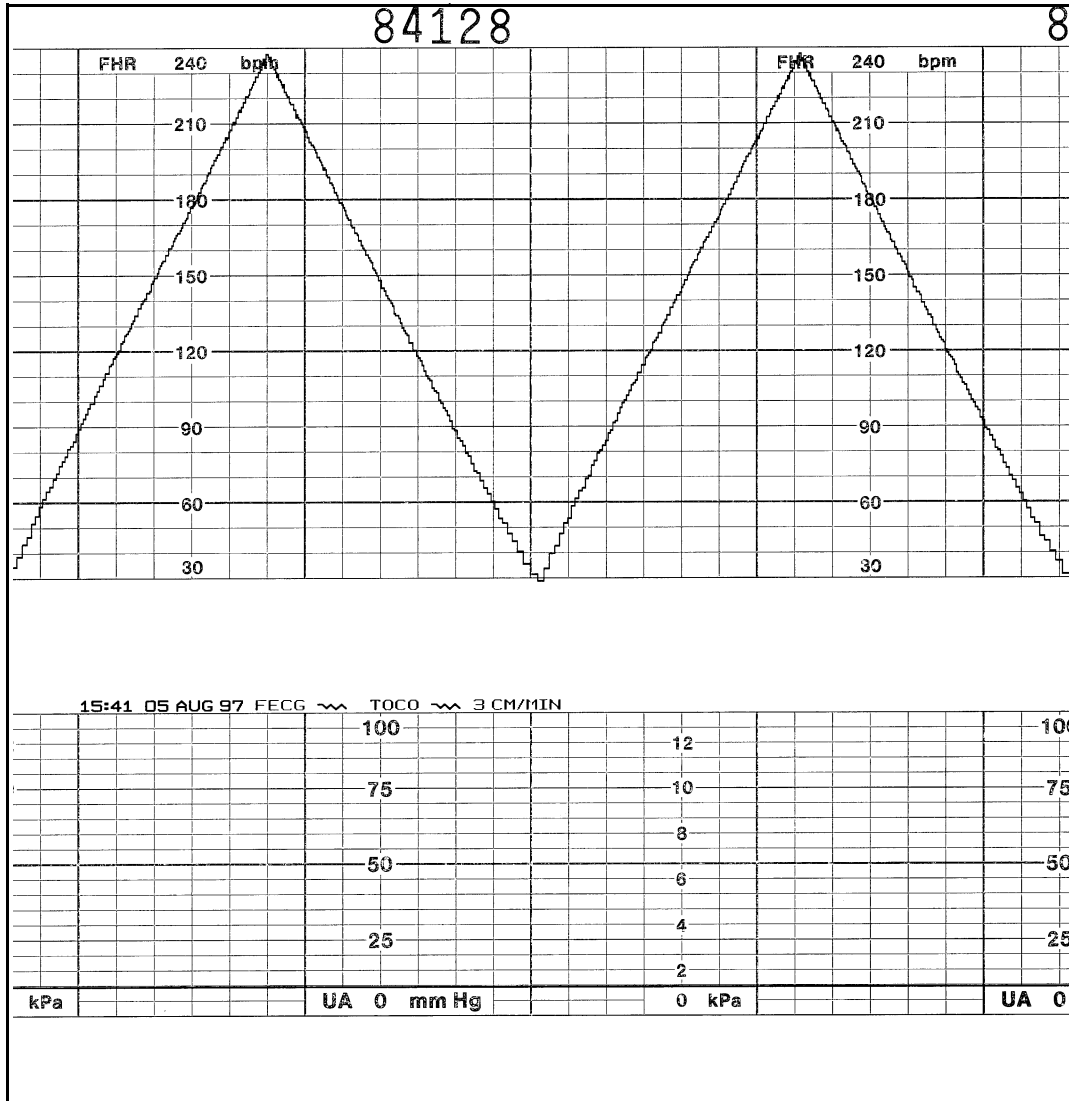

Figure 6-1. FECG Ramp



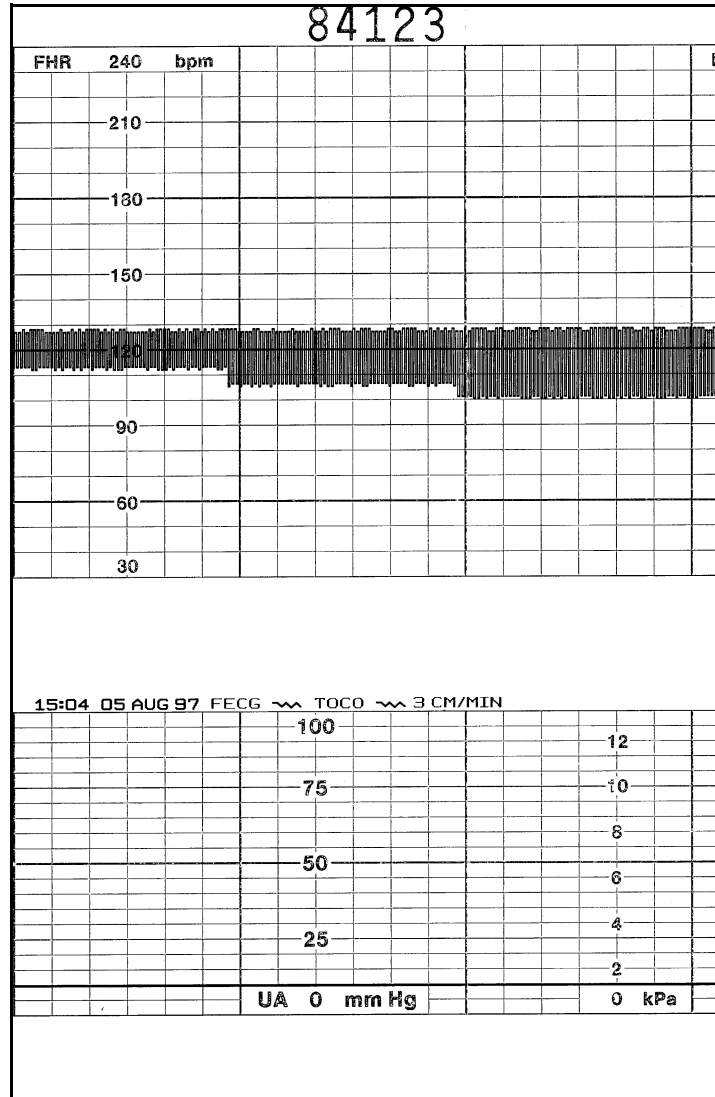

Figure 6-2. FECG Artifact Elimination

# Legplate Inspection

Inspect the legplate as follows:

1. Check for a proper seal around the ground plate.
2. Ensure that no contaminants are present on either the ground plate or the push posts.
3. Visibly assess the condition of the cable, strain relief, and connector pins.

# Ultrasound Test

This portion of the functional checkout procedure ensures the integrity of the ultrasound circuitry and the heart rate channel of the recorder.

1. Connect the simulator's US sub-cable to the **US** receptacle on the monitor.
2. Set the switches on the Model 325 Input Simulator according to [Table 6-3](#).
3. If not already on, press the monitor's **Record** pushbutton.
4. Turn the simulator's **Manual Adjustment** knob to input an ultrasound signal of approximately 120 BPM. Verify the following on the monitor:
  - ◆ The FHR1 value is 120 BPM.
  - ◆ The FHR1 heartbeat indicator (♥) flashes at a rate of 120 times per minute.
  - ◆ Ultrasound audio volume from the rear panel speaker can be increased or decreased using the left pair of **Volume** pushbuttons. (Set the volume to the desired level.)
  - ◆ The recorder prints a continuous line at 120 BPM on the top grid of the strip chart paper.
  - ◆ The recorder prints the message US on the center margin of the strip chart paper after approximately 20 seconds.
5. Use the simulator's **Manual Adjustment knob** to increase the heart rate value by less than 13 BPM from the 120 BPM baseline. Verify the following on the monitor:
  - ◆ The FHR1 value immediately reflects this new input rate.
  - ◆ The strip chart recorder immediately reflects this new input rate.
  - ◆ Use the simulator's **Manual Adjustment** knob to decrease the heart rate value by more than 13 BPM from the 120 BPM baseline. Verify the following on the monitor:
    - ◆ The FHR1 value immediately reflects this new input rate.
    - ◆ The strip chart recorder prints at the last input rate for an additional 3 seconds before blanking the heart rate data and printing a continuous line at the new input rate.
6. Set the simulator's **US Rate** switch to the RAMP position. Verify that the FHR1 value counts between approximately 50 and 210 BPM and that the recorder prints a ramp between the same values. (Refer to [Figure 6-3](#).)

Table 6-3. Ultrasound Test Simulator Settings		
Section	Switch	Setting
US/FMD	Mode	US
	Signal Level	MED
	Rate	MANUAL

Table 6-3. Ultrasound Test Simulator Settings		
Section	Switch	Setting
General	Pattern Memory	OFF
UA	Main	CMR
	Mode	TOCO

7. Place the simulator's **US Rate** switch in each of the individual rate settings (50, 60, 120, and 210 BPM). Verify the following on the monitor:
  - ◆ The FHR1 value reflects the simulator setting  $\pm 1$  BPM.
  - ◆ The FHR1 heartbeat indicator (♥) flashes at the simulator setting.
  - ◆ Ultrasound audio is heard coming from the rear panel speaker.
  - ◆ The recorder prints a continuous line at the respective value  $\pm 3$  BPM on the top grid of the strip chart paper.
8. Repeat step 4 through step 7 using the second ultrasound channel.
9. Place the simulator's **US Mode** switch in the OFF position. Verify the following on the monitor:
  - ◆ The FHR1 value is blank.
  - ◆ The recorder stops printing the fetal heart rate trace.
  - ◆ The recorder prints the message **CARDIO INOP** on the center margin of the strip chart paper after approximately 20 seconds.

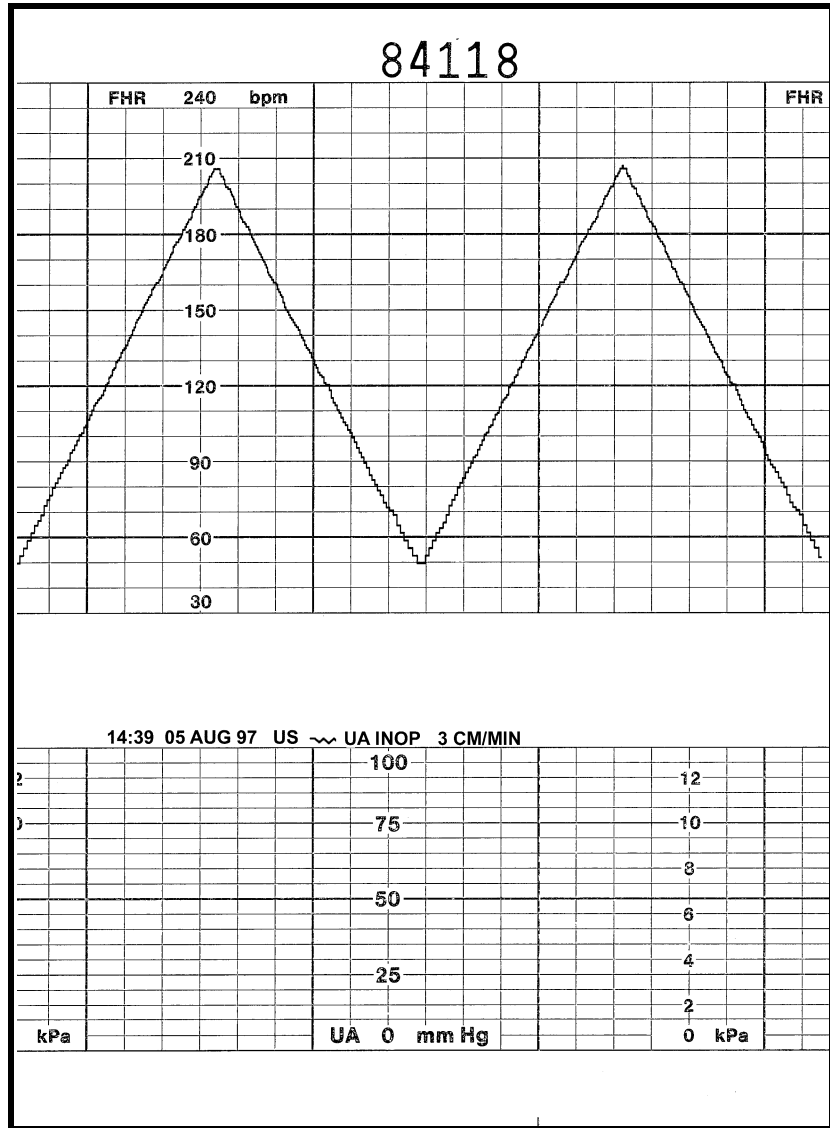

Figure 6-3. Ultrasound Ramp

# Fetal Movement Detection Test

This portion of the functional checkout procedure ensures the integrity of the fetal movement detection circuitry and the heart rate channel of the recorder. (Refer to [Figure 6-4](#).)

**NOTE:** Fetal movement detection is an option which must be installed and enabled for use on your monitor.

1. Connect the simulator's US sub-cable to the **US** receptacle on the monitor.
2. Set the switches on the Model 325 Input Simulator according to [Table 6-4](#).
3. If not already on, press the monitor's **Record** pushbutton.
4. Turn the simulator's **Manual Adjustment** knob to input an ultrasound signal of approximately 120 BPM. Verify the following on the monitor:
  - ◆ The FHR1 value is 120 BPM.
  - ◆ The FHR1 heartbeat indicator (♥) flashes at a rate of 120 times per minute.
  - ◆ Ultrasound audio volume from the rear panel speaker can be increased or decreased using the left pair of **Volume** pushbuttons. (Set the volume to the desired level.)
  - ◆ The recorder prints a continuous line at 120 BPM on the top grid of the strip chart paper.
  - ◆ Fetal movement markers - — are shown on for a duration of one second, then off for eight seconds, then on for one second, etc.
  - ◆ The recorder prints the messages US and FMD - — on the center margin of the strip chart paper after approximately 20 seconds.

Table 6-4. Fetal Movement Detection Test Simulator Settings		
Section	Switch	Setting
US/FMD	Mode	US/FMD
	Signal Level	MED
	Rate	MANUAL
General	Pattern Memory	OFF
UA	Main	CMR
	Mode	TOCO

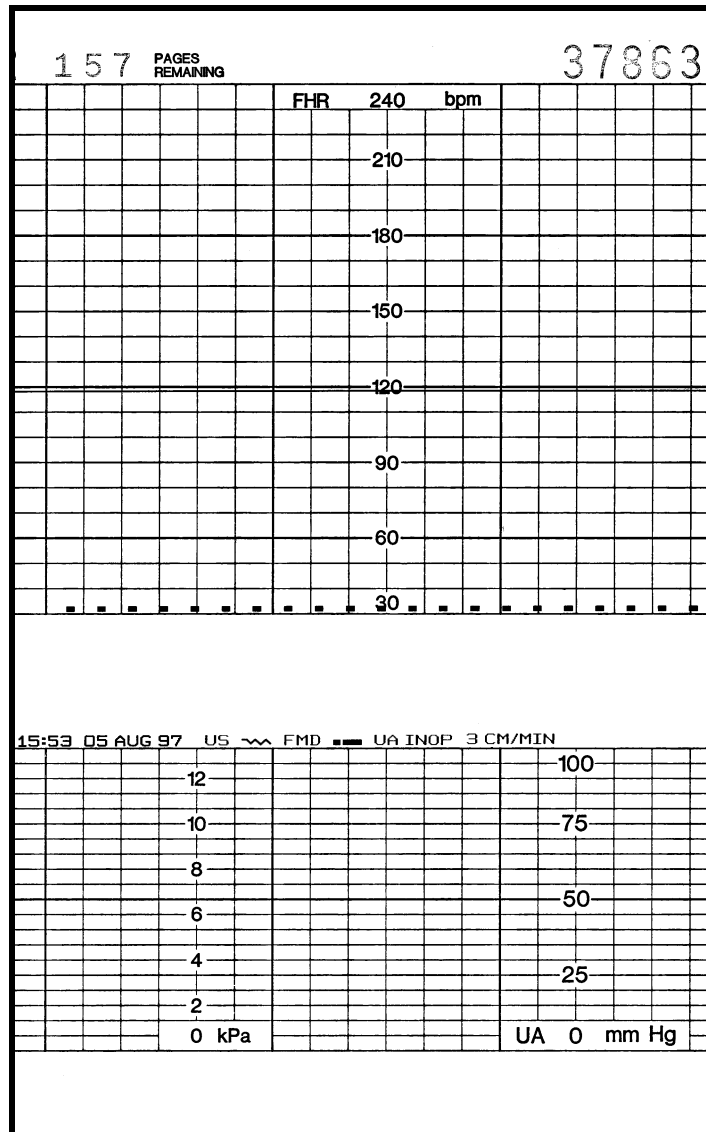

Figure 6-4. Fetal Movement Detection

## Ultrasound Transducer Test

1. Inspect a Model 170/250 ultrasound transducer as follows:
  - ◆ Ensure there are no cracks around the transducer face.
  - ◆ Visibly assess the condition of the cable, strain relief, and connector pins.
2. Disconnect the simulator's ultrasound cable from the front panel of the 170 Series Monitor.

3. Connect the ultrasound transducer to either US input receptacle on the front panel of the monitor. Verify the following on the monitor:
  - ◆ The value shows three steady dashes “- - -” in the FHR1 display.
  - ◆ The recorder prints the message US on the center margin of the strip chart paper after approximately 20 seconds.
4. Connect the MFH-1 (Mechanical Fetal Heart) to the US1 port on the PS320 Simulator via the cable supplied with MFH-1.

NOTE 1: MFH-1 cannot be used with Corometrics 325 Simulator

5. Place the Ultrasound Transducer face up on the work surface and coat it with Ultrasound conductive gel and place the MFH-1 on the Ultrasound transducer, as shown in Figure below

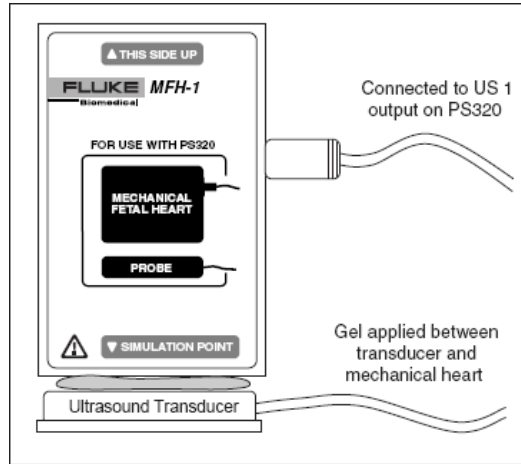

6. For MFH-1 to function, power the PS320 Simulator using the battery eliminator, the MFH-1 will not function on battery power.
7. Set the rate of the MFH-1 to 120 BPM by setting the US1 value in the PS320 Simulator to 120 BPM and verify the following on the monitor. (Refer appendix for Using PS320 Simulator)
  - ◆ The FHR value in the Monitor is 120±1 BPM
  - ◆ The recorder prints a continuous line at 120 ±3 BPM on the top grid of the strip chart paper.
  - ◆ The FHR1 heartbeat indicator (♥) flashes at a rate of 120 times per minute.
  - ◆ Ultrasound audio is heard coming from the monitor’s rear panel speaker.
8. Disconnect the ultrasound transducer from the front panel of the monitor. Verify the following on the monitor:
  - ◆ The FHR1 value and heartbeat indicator are both blank.
  - ◆ The recorder stops printing the fetal heart rate trace.
  - ◆ The recorder prints the message **CARDIO INOP** on the center margin of the strip chart paper after approximately 20 seconds

**ABOUT LATCHING ALARMS**

The fetal heart rate alarms are latching alarms which means that a clinician must acknowledge the alarm using the monitor’s Alarm Silence button in order to clear the alarm. Active Threshold Alarm: Press the Alarm Silence button to cancel the audio component of an active threshold alarm. The visual indications remain present until the FHR value returns to within the defined acceptable range. (This is tested in steps 14 to 16 for a high alarm, and steps 22 to 24 for a low alarm.)

Unsilenced, Resolved Threshold Alarm: If a threshold alarm condition is resolved, prior to be silenced (clinical acknowledgement), the visual and audible indications both remain present. Press the Alarm Silence button to cancel both the audible and visual indications. (This is tested in steps 17 to 19 for a high alarm and 25 to 27 for a low alarm.)NOTE: For continuous limit violations: a high alarm activates after 5 minutes; a low alarm activates after 30 seconds.



# Uterine Activity Test

This portion of the functional checkout procedure tests the uterine activity section of the 170 Series Monitor.

1. Set the switches on the Model 325 Simulator according to [Table 6-5](#).
2. Connect the simulator's UA sub-cable to the **UA** receptacle on the monitor.
3. Access the service setup mode and note the UA reference default value. (The monitor is shipped from the factory with this value set at 10 relative units; however, your unit may have been custom configured.) Exit the service mode.
4. Press the monitor's **Power** button to turn on the monitor.
5. Press the monitor's **Record** pushbutton.
6. Briefly press the monitor's **UA Reference** pushbutton. Verify the following on the monitor:
  - ◆ The UA value matches the *default* setting.
  - ◆ The recorder prints a continuous line at the *default* value on the uterine activity channel of the strip chart paper.
  - ◆ The recorder prints the messages TOCO and UA REF on the strip chart paper.
7. Press and hold the **UA Reference** button on the monitor to cycle through the available selections for UA reference: 5, 10, 15, 20, or 25 relative units. Test each of these reference settings. Verify that the UA value is displayed accordingly and that the recorder prints a continuous line at the corresponding value on the uterine activity channel of the strip chart paper.
8. Place the simulator's **UA Level** switch at each of the level settings: 0, 10, 50, and 100 relative units. Verify that the UA value is displayed accordingly and that the recorder prints a continuous line at the corresponding value on the heart rate channel of the strip chart paper.

Table 6-5. Uterine Activity Test Simulator Settings		
Section	Switch	Setting
General	Pattern Memory	OFF
UA	Main	LEVEL
	Level	0 mmHg
	Mode	TOCO

9. Press the **UA Reference** button to reference to 10 relative units. If the default is set to a different value, press and hold the **UA Reference** button to cycle to 10.
10. Place the simulator's **UA Level** switch to the RAMP position. Verify that the UA value measures a ramp between 10 and 100 relative units and that the recorder prints a ramp between the same values. Refer to [Figure 6-5](#).

11. Disconnect the Model 325 Simulator's uterine activity sub-cable from the **UA** input receptacle on the front panel of the monitor. Verify the following on the monitor:

- ◆ The UA value is blank.
- ◆ The recorder stops printing the uterine activity trace.
- ◆ The recorder prints the message **UA INOP** on the center margin of the strip chart paper after approximately 20 seconds.

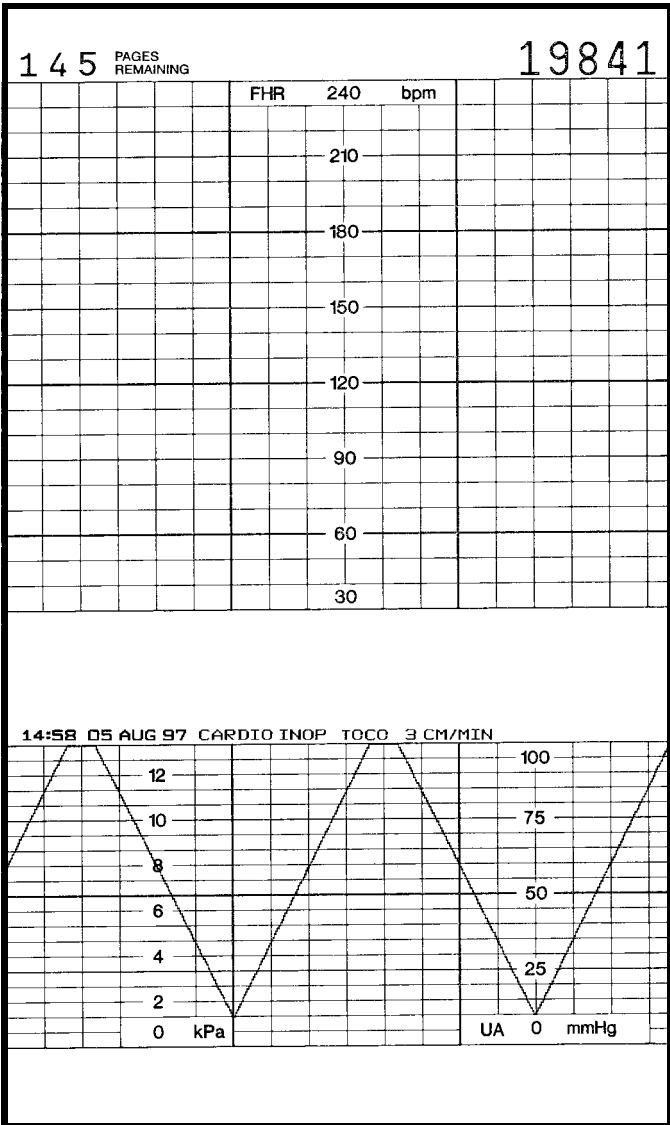

Figure 6-5. Uterine Activity Ramp

# Tocotransducer Test

1. Inspect a Nautilus tocotransducer as follows:
  - ◆ Check for any cracks or contaminants on the tocotransducer especially on the diaphragm located on the bottom of the tocotransducer.
  - ◆ Visibly assess the condition of the cable, strain relief, and connector pins.
2. Connect the tocotransducer to the **UA** input receptacle on the front panel of the 170 Series Monitor.
3. Access service setup mode and note the default TOCO reference setting.
4. Exit the service setup mode.
5. Press the monitor's **Power** button to turn the monitor back on.
6. Momentarily press the monitor's **UA Reference pushbutton**. Verify the following:
  - ◆ The UA value shows the *default* setting.
  - ◆ The recorder prints the messages UA REF and TOCO on the strip chart paper.
7. Plug the TOCO transducer connector to the monitor and set the US reference as 10 on the monitor.
8. Place 52.5 gm Teflon Weight on the transducer face and verify the value as "32" ( $\pm 5.0$  UA).
9. Place 100 gm Teflon Weight on the transducer face and verify the value as "53" ( $\pm 5.0$  UA).
10. Place 150 gm Teflon Weight on the transducer face and verify the value as "73" ( $\pm 5.0$  UA).
11. Remove the TOCO transducer from the monitor's UA input receptacle. Verify the following on the monitor:
  - ◆ The UA value is blank.
  - ◆ The recorder stops printing the uterine activity trace.
  - ◆ The recorder prints the message UA INOP on the center margin of the strip chart paper after approximately 20 seconds.

# Strain Gauge Transducer Test

1. Inspect a strain gauge as follows:
  - ◆ Unscrew the plastic dome from the transducer and check for any cracks or contaminants on the transducer.
  - ◆ Visibly assess the condition of the cable, strain relief, and the connector pins.
2. Connect the strain gauge to the **UA** input receptacle on the front panel of the monitor. Verify the following on the monitor:
  - ◆ The UA value may read negative numbers indicating baseline pressure is off scale. In this case, the message BASELINE PRESSURE OFF SCALE prints on the strip chart paper.
  - ◆ After approximately 20 seconds, the message IUP prints on the center margin of the strip chart paper.
3. Select the monitor's **UA Reference** button and verify the following on the monitor:
  - ◆ The UA value is 0 mmHg.
  - ◆ The UA trend is a continuous line at 0 mmHg on the strip chart paper.
  - ◆ The message UA REF prints on the strip chart paper.
4. Apply gentle pressure on the strain gauge diaphragm and verify that the UA value and trend respond to the input. Increasing force should produce an increasing value and vice versa.
5. Disconnect the strain gauge from the front panel of the monitor. Verify the following on the monitor:
  - ◆ The UA value is blank.
  - ◆ The UA trend stops plotting on the strip chart paper.
  - ◆ After approximately 20 seconds, the message UA INOP prints on the strip chart paper.

# Pattern Memory Test

The pattern memory of the simulator can be used to test any of the following mode combinations of the monitor.

- ◆ FECG/TOCO
- ◆ FECG/IUP
- ◆ US/TOCO or US2/TOCO
- ◆ US/IUP or US2/IUP
- ◆ US/FMD/TOCO
- ◆ US/FMD/IUP
- ◆ FECG/US/TOCO
- ◆ FECG/US/IUP

**NOTE:** US/US2 cannot be tested simultaneously unless two Model 325 Simulators or two ultrasound transducers are used. Do not attempt to test dual ultrasound using one Model 325 Simulator and one ultrasound transducer or a conflict between enable lines will occur.

**NOTE:** Although dual heart rate can be verified using the pattern memory, an additional procedure is given in this functional checkout procedure.

To check any of the mode combinations listed above:

1. Connect the appropriate simulator sub-cables to the corresponding receptacles on the monitor.
2. Enable the modes on the simulator.
3. Set the simulator's **Pattern Memory** switch to the ON position.
4. If not already on, press the monitor's **Record** pushbutton.
5. Verify the following on the monitor:
  - ◆ Each heart rate display (FHR1 and FHR2) responds accordingly for value and heartbeat indicator.
  - ◆ The UA display responds accordingly for the value.
  - ◆ The recorder responds appropriately in both trending and message information.

**NOTE:** Refer to the "[Model 325 Simulator Product Manual](#)" for illustrations of the patterns to be expected on the monitor.

# Dual Heart Rate Test (Non-Pattern)

## FECG/US Modes

1. Connect the Model 325 Simulator's ECG sub-cable to the monitor's **FECG** input receptacle.
2. Connect the simulator's US sub-cable to the monitor's **US** input receptacle.
3. Set the switches on the Model 325 Simulator according to [Table 6-6](#).
4. If not already on, select the monitor's **Record** button.
5. Verify the following on the monitor:
  - ◆ The FHR1 value reads 120 BPM.
  - ◆ The FHR1 heartbeat indicator (♥) flashes at a rate of 120 times per minute.
  - ◆ The FHR2 value varies between approximately 50 and 210 BPM.
  - ◆ The FHR2 heartbeat indicator (♥) flashes at a rate consistent with the value.
  - ◆ The messages FECG and US print on the center margin of the strip chart paper.
  - ◆ The FHR1 trend is a continuous plain black line (—∩∩∩) on the 120 BPM mark on the top grid of the strip chart paper. (Refer to [Figure 6-6](#).)
  - ◆ The FHR2 trend is a bold black ramp trace (—∩∩∩) between 50 and 210 BPM on the top grid of the strip chart paper. (Refer to [Figure 6-6](#).)

<b>Table 6-6. Model 325 Simulator Settings for FECG/US Test</b>		
<b>Section</b>	<b>Switch</b>	<b>Setting</b>
FECG/MECG	Main	RATE
	Rate	120 BPM
	Mode	FECG
	QRS Amplitude	50 $\mu$ V
	QRS Polarity	+
ULTRASOUND/FMD	Mode	US
	Level	MED
	Rate	RAMP
General	Pattern Memory	OFF

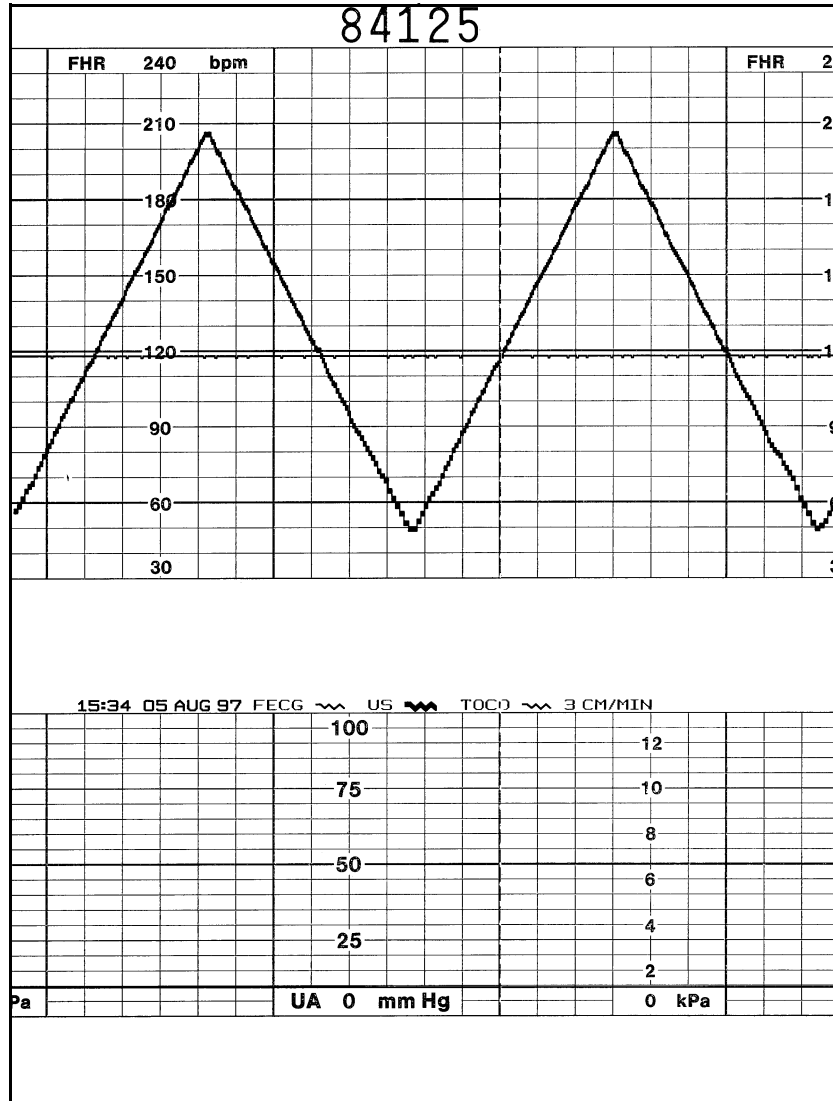

Figure 6-6. Dual Heart Rate, FECG and US



## Dual Ultrasound Modes

As stated previously, the dual ultrasound mode of the 170 Series Monitor cannot be tested unless two Model 325 Simulators are used or two Nautilus ultrasound transducers. **Do not** attempt to test dual ultrasound using one Model 325 Simulator and one ultrasound transducer. This procedure details using two transducers since it is more practical for a test site.

1. If not already on, press the monitor's **Record** pushbutton.
2. Plug one ultrasound transducer into the monitor's **US** input receptacle and the other into the monitor's **US2** receptacle. Verify the following on the monitor:
  - ◆ The FHR1 value shows three steady dashes “---.”
  - ◆ The FHR2 value shows three steady dashes “---.”
  - ◆ The recorder prints the messages **US** and **US2** on the center margin of the strip chart paper.
3. Use your finger to rub the face of the ultrasound transducer connected to the monitor's **US** input receptacle; try to maintain a steady rate and verify the following on the monitor:
  - ◆ The FHR1 value responds to the rubbing.
  - ◆ The FHR1 heartbeat indicator (♥) responds to the input.
  - ◆ The recorder prints the heart rate tracing corresponding to the rate and the trace is plain black (∩∩∩).
4. Use your finger to rub the face of the ultrasound transducer connected to the monitor's **US2** input receptacle; try to maintain a steady rate and verify the following on the monitor:
  - ◆ The FHR2 value responds to the rubbing.
  - ◆ The FHR2 heartbeat indicator (♥) responds to the input.
  - ◆ The recorder prints the heart rate tracing corresponding to the rate and the trace is bold black (∩∩∩).

# Alarm Test

This portion of the test ensures the integrity of the audio alarms and tests the alarm limit software.

1. Connect the Model 325 Simulator's US sub-cable to the monitor's **US** input.
2. Press and hold (for three seconds) **Setup** to enter the monitor's setup mode.
3. Set the FHR alarm enable to *on*.
4. Set the FHR high alarm limit value to 180 BPM.
5. Set the FHR low alarm limit value to 100 BPM.
6. Set the FHR audio alarm to a level you can easily hear.
7. Press the **Setup** button to exit the setup mode.
8. Press the monitor's **Record** button.
9. Verify that the FHR high and low limits print in the annotation area of the strip chart paper.
10. Turn off the monitor's recorder.
11. Set the switches on the Model 325 Input Simulator according to [Table 6-7](#).
12. Using the simulator's **Manual Adjustment** knob, input an US signal of 179 BPM as indicated on the monitor. Verify that there is no alarm tone sounding from the monitor's speaker.
13. Using the simulator's **Manual Adjustment** knob, increase the US rate to 180 BPM. Again, verify that there is no alarm tone sounding from the monitor's speaker.
14. Using the simulator's **Manual Adjustment** knob, increase the US rate to 181 BPM. *After five minutes*, verify the following on the monitor:
  - ◆ An alarm tone is emitted from the monitor's speaker (alternating high/low tones).
  - ◆ The Alarm indicator flashes.
  - ◆ The affected heart rate numerics flash.
15. Press the monitor's front panel **Alarm Silence** pushbutton and verify that the alarm tone silences but the visual indications remain present.

Table 6-7. Alarm Test Simulator Settings		
Section	Switch	Setting
US	Main	RATE
	Rate	MANUAL
	Mode	US
General	Pattern Memory	OFF

16. Use the simulator's **Manual Adjustment** knob to decrease the US rate to 180 BPM. Verify that the Alarm indicator goes out and the heart rate numerics stop flashing.
17. Use the simulator's **Manual Adjustment** knob to increase the US rate to 181 BPM to set off the alarm once more. It will take five minutes for the alarm appear.
18. Use the simulator's **Manual Adjustment** knob to decrease the US rate to 180 BPM. Verify the following on the monitor:
  - ◆ The alarm tone continues sounding.
  - ◆ The Alarm indicator continues flashing.
  - ◆ The affected heart rate numerics continue flashing.
19. Press the monitor's front panel **Alarm Silence** pushbutton. Verify that the visual *and* audio alarm indications disappear.
20. Using the simulator's **Manual Adjustment** knob, input an US signal of 101 BPM. Verify that there is no alarm tone sounding from the monitor's speaker.
21. Using the simulator's **Manual Adjustment** knob, decrease the US rate to 100 BPM. Again, verify that there is no alarm tone sounding from the monitor's speaker.
22. Using the simulator's **Manual Adjustment** knob, decrease the US rate to 99 bpm. *After 30 seconds*, verify the following on the monitor:
  - ◆ The alarm tone is emitted from the monitor's speaker.
  - ◆ The Alarm indicator flashes.
  - ◆ The affected heart rate numerics flash.
23. Press the monitor's front panel **Alarm Silence** pushbutton. Verify that the visual and audio alarm indications disappear.
24. Use the simulator's **Manual Adjustment** knob to increase the US signal to 100 BPM. Verify that the Alarm indicator goes out and the heart rate numerics stop flashing.
25. Use the simulator's **Manual Adjustment** knob to decrease the US signal to 99 BPM to set off the alarm one more time. It will take 30 seconds for the alarm to appear.

26. Use the simulator's **Manual Adjustment** knob to increase the US signal to 100 bpm. Verify the following on the monitor:
  - ◆ The alarm tone continues sounding.
  - ◆ The Alarm indicator stops continues flashing.
  - ◆ The affected heart rate numerics continue flashing.
27. Press the monitor's front panel **Alarm Silence** pushbutton. Verify that the visual *and* audio alarm indications disappear.
28. This concludes the functional checkout procedure.



## Chapter 7

# Serviceable Assemblies

This chapter provides information to aid in performing routine service and maintenance on a 170 Series Monitor. This section of the manual is not intended as a substitute for proper professional training, or familiarity with the 170 Series Monitor. Only qualified service personnel should attempt servicing a 170 Series Monitor.

This chapter contains the following information:

General Anti-Static Handling Precautions .....	7-2
Transducer Plug Replacement Kits .....	7-3
Nautilus Transducer Cable Replacement .....	7-15
Removing the Monitor Top Cover .....	7-19
Tocotransducer Calibration .....	7-20
Nautilus Ultrasound Transducer Top Cover Replacement .....	7-30
Nautilus Transducer Reassembly .....	7-32
Testing a Repaired Transducer (TOCO or US) .....	7-34
Replacing the Main Board .....	7-35
Replacing the Membrane Switch Panel .....	7-37
Replacing a Front Panel Connector .....	7-40
Servicing the Recorder .....	7-41

## General Anti-Static Handling Precautions

The following guidelines should be followed when handling *circuit boards* or *assemblies containing circuit boards*. Following these procedures helps resist damage that can be caused by static electricity.

- ◆ Discharge any static charge you may have built up before handling parts.
- ◆ Wear a grounded, anti-static wristband at all times.
- ◆ Use a static-free work surface.
- ◆ Store items in anti-static bags or boxes.
- ◆ Do not remove items from anti-static containers until needed.

# Transducer Plug Replacement Kits

Refer to [Table 7-2](#) and ensure you have the correct kit. Unpack the kit and ensure it contains the items listed in [Table 7-1](#). If something is missing, contact your GE Service Representative immediately.

<b>Plug Type</b>	<b>Plug Kit Cat. No. (REF)</b>
Tocotransducer Cable: T ■ Nautilus, 2264 Series	6158J
Ultrasound Transducer Cable: ■ Standard, 5700 Series ■ Nautilus, 5700 Series	8675A
FECG Cable/Legplate	6158F

<b>Item</b>	<b>Quantity</b>
Contact Pin, male, #24 AWG, 16.5 mm	11
Contact Pin, male, #24 AWG, 18 mm	1
Gripper of appropriate size: ■ 3-5 mm for smaller cables (TOCO) ■ 5-7 mm for larger cables (US, FECG)	1
Plastic Ring 21.8 x 4 mm	1
Retaining Ring	1
Strain Relief Clamp, 3-7 mm	1
Screw (for above clamp), M 2.6 x 10	2
Half-Shell with Clamp of appropriate size: ■ 3-5 mm for smaller cables ■ 5-7 mm for larger cables	1
Half-Shell with Tongue	1
Color-Coded Connector Plug, 12-pin	1
Oetiker Clamp <sup>a</sup>	1

<sup>a</sup> The Oetiker clamp is used only for Nautilus Tocotransducers (2264 Series).

## Handling Precautions

Transducers are delicate measuring instruments and must be handled accordingly. Transducer damage can be avoided by taking the following precautions:

- Avoid banging or dropping transducers.
- Refrain from wrapping transducer cables around transducer body.
- Do not immerse transducers in aqueous *cleaning* solutions.
- Do not pull on cables when removing transducer plugs from the monitor front-panel connectors; remove plugs by grasping the gripper.

## Equipment Required

You will need the following equipment:

- Green<sup>1</sup> Stranded Wire (approximately 6 inches)
  - ◆ #24 AWG for tocotransducers and ultrasound transducers
  - ◆ #26 AWG for FECG cable/legplates
- #26 AWG Blue Stranded Wire (approximately 4 inches) for FECG Cable
- Wire Cutter/Stripper
- Soldering Iron and Solder
- Shrink Tubing
- Oetiker Pincers (for Nautilus Tocotransducers only)<sup>2</sup>

---

<sup>1</sup> The color green is specified for consistency with factory builds and the wiring charts contained in this document.

<sup>2</sup> This tool is required to place an Oetiker clamp on a 2264 Series Nautilus Tocotransducer. You can order the Standard Pincers (No. 1098) or Side Jaw Pincers (No. 1099) from Oetiker, Inc., P.O. Box 93, Livingston, NJ 07039. The telephone number is: 201-992-1920.



## Tocotransducer Cable Preparation

Refer to [Figure 7-1](#) and [Table 7-3](#) while following these steps:

1. Cut #24 AWG green wire (not supplied) to 1- $\frac{1}{2}$  inches long and strip each end  $\frac{1}{8}$  inch. This will be used as a jumper wire.
2. Cut #24 AWG green wire to 2 inches long. Strip one end  $\frac{3}{4}$  inch.
3. Route the transducer cable through the gripper. Slide the gripper, followed by the retaining ring, down the cable until they are out of the way.
4. *For Nautilus Tocotransducers only:* Slide Oetiker clamp over end of cable.
5. Score around grey cable jacket 1 inch. Peel and remove jacket. Trim filler flush to jacket.
6. *For Nautilus Tocotransducers only:* Cut vent tubing flush with jacket being careful not to restrict air flow.
7. Pull back the braided shield and twist into pigtail.
8. Solder the 2-inch prepared green wire to the shield, wrapping the  $\frac{3}{4}$ -inch strip on to the shield. Cut wire flush with other conductors of the cable.
9. Install shrink tubing over the solder joint of the shield.
10. Strip all conductors  $\frac{1}{8}$  inch. Twist and tin conductors.
11. Locate the grounding contact pin (longer pin) in the kit. Solder this pin to the shield wire.
12. Solder a short pin to the yellow wire *and* one end of the green jumper wire. Both wires share this pin.
13. Solder a short pin to the free end of the green jumper wire.
14. Solder a short pin to each of the other conductors.
15. *For Nautilus Tocotransducers only:* Crimp Oetiker clamp over cable jacket  $\frac{1}{8}$  inch from end.
16. Continue with “[Plug Assembly](#)” on [page 7-13](#).

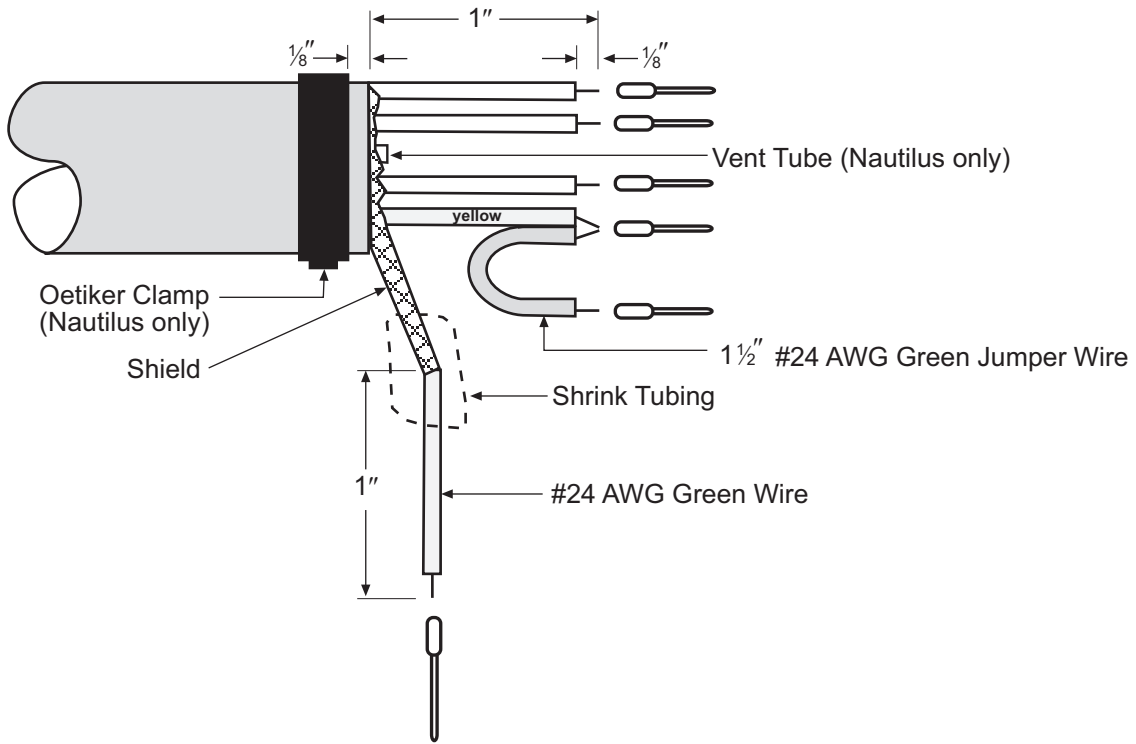

Figure 7-1. Tocotransducer Cable Preparation

Table 7-3. Tocotransducer Cable Wiring			
Pin Number	Pin Length	Description	Wire Color
1	short	+PRESS	Red
2	short	-PRESS	White
3	short	—	—
4	short	+4 V	Blue
5	short	—	—
6	short	Reference/Enable	#24 AWG Green Jumper and Yellow
7	LONG	Shield Ground	#24 AWG Green
8	short	—	—
9	short	—	—
10	short	—	—
11	short	—	—
12	short	TOCO Enable	#24 AWG Green Jumper

## Ultrasound Transducer Cable Preparation

Refer to [Figure 7-2](#) and [Table 7-4](#) while following these steps:

1. Cut #24 AWG green wire (not supplied) to 1- $\frac{1}{2}$  inches long and strip each end  $\frac{1}{8}$  inch. This will be used as a jumper wire.
2. Cut #24 AWG green wire to 4 inches long and strip each end  $\frac{3}{4}$  inch.
3. Route the transducer cable through the gripper. Slide the gripper, followed by the retaining ring, down the cable until they are out of the way.
4. Score around grey jacket of cable 1 inch. Peel and remove jacket.
5. Pull back the outer braided shield and twist into pigtail.
6. Solder the 4-inch prepared green wire to the outer shield, wrapping the  $\frac{3}{4}$ -inch strip onto shield. Cut wire flush with other conductor(s) of cable. Retain remaining piece of wire for inner shield.
7. This step varies according to the ultrasound transducer type:
  - ◆ *Standard* Ultrasound Transducer: This cable is a dual-coaxial cable. Cut off black coaxial cable and fillers flush to jacket.
  - ◆ *Nautilus* Ultrasound Transducer: This cable is a single-coaxial cable. Trim fillers flush to jacket.
8. Score around the white jacket leaving  $\frac{3}{16}$  inch of the jacket remaining.
9. Pull back the inner shield and twist into a pigtail. The clear dielectric is now exposed.
10. Solder remaining piece of green wire to inner shield, wrapping the  $\frac{3}{4}$  inch strip onto shield. Cut wire flush with other conductors.
11. Install shrink tubing over the solder joint between the white coaxial cable and the inner shield.
12. Strip the three conductors  $\frac{1}{8}$  inch (clear and both green). Twist and tin conductors.
13. Locate the grounding contact pin (longer pin) in the kit. Solder this pin to the inner shield.
14. Solder a short pin to the clear conductor and the outer shield.
15. Solder a short pin to each end of the green jumper wire (1- $\frac{1}{2}$  inches long).
16. Continue with “[Plug Assembly](#)” on [page 7-13](#).





	<ul style="list-style-type: none"> <li>■ Score around length of jacket 1 inch. Peel jacket and remove.</li> </ul>
	<ul style="list-style-type: none"> <li>■ Separate outer braided shield and twist.</li> <li>■ For <i>Standard</i> ultrasound transducers, the cable is a dual coaxial cable.</li> <li>■ For <i>Nautilus</i> ultrasound transducers, the cable is a single coaxial cable.</li> </ul>
	<ul style="list-style-type: none"> <li>■ If present, cut black coax and fillers flush with grey jacket.</li> <li>■ Solder #24 AWG green wire to outer shield.</li> </ul>
	<ul style="list-style-type: none"> <li>■ Score around white jacket leaving <math>\frac{3}{16}</math> inch.</li> </ul>
	<ul style="list-style-type: none"> <li>■ Separate inner braided shield and twist.</li> <li>■ Solder #24 AWG green wire to inner shield.</li> </ul>
	<ul style="list-style-type: none"> <li>■ Apply shrink tubing over clear wire and solder joint of inner shield.</li> <li>■ Strip conductors <math>\frac{1}{8}</math> inch. Twist and tin conductors.</li> <li>■ Solder contact pins to conductors and jumper wire.</li> </ul>

Figure 7-2. Ultrasound Transducer Cable Preparation

<b>Table 7-4. Ultrasound Cable Wiring</b>			
<b>Pin Number</b>	<b>Pin Length</b>	<b>Description</b>	<b>Wire Color</b>
1	short	—	—
2	short	—	—
3	short	Overall Shield	#24 AWG Green
4	LONG	US Transmit/Receive Shield	#24 AWG Green
5	short	White Coax	—
6	short	—	—
7	short	—	—
8	short	—	—
9	short	—	—
10	short	—	—
11	short	US Enable	#24 AWG Green Jumper
12	short	US Enable Ground	#24 AWG Green Jumper

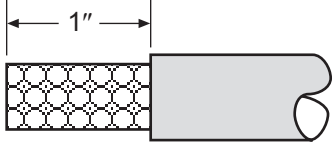
## FECG Cable Preparation

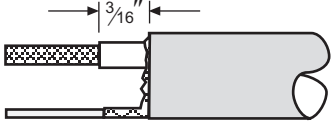
Refer to [Figure 7-3](#) and [Table 7-5](#) while following these steps:

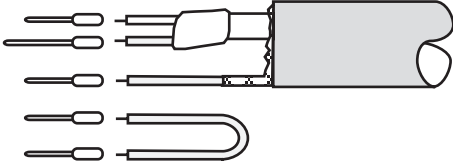
1. Cut #26 AWG green wire (not supplied) to 2 inches long. Strip one end  $\frac{3}{4}$  inch.
2. Cut #26 AWG blue wire (not supplied) to 1- $\frac{1}{2}$  inches long and strip each end  $\frac{1}{8}$  inch. This will be used as a jumper wire.
3. Route the transducer cable through the gripper. Slide the gripper, followed by the retaining ring, down the cable until they are out of the way.
4. Score around cable jacket 1 inch. Peel and remove jacket. Trim filler flush to jacket.
5. Pull back the braided shield and twist into pigtail.
6. Strip black conductive coating back to the outer jacket.
7. Solder the 2-inch prepared green wire to the shield, wrapping the  $\frac{3}{4}$ -inch strip onto the shield. Cut the wire flush with other conductors of cable.
8. Install shrink tubing over the solder joint of the shield.
9. Strip all conductors  $\frac{1}{8}$  inch. Twist and tin conductors.

---

---

### CAUTIONS

**CABLE IDENTIFICATION**—Identify each cable as it is stripped since colors will be difficult to determine once the sleeving contracts.

**HEAT**—Avoid excess heat when tinning ends and soldering braids since the polyethylene inner insulation melts very easily.

---

---

10. Slide shrink tubing over cable.
11. Locate the grounding contact pin (longer pin) in the kit. Solder this pin to one end of the blue jumper wire.
12. Solder a short pin to the blue wire and the free end of the blue jumper wire. Both wires share this pin.
13. Solder a short pin to each of the other conductors.
14. Continue with “[Plug Assembly](#)” on [page 7-13](#).

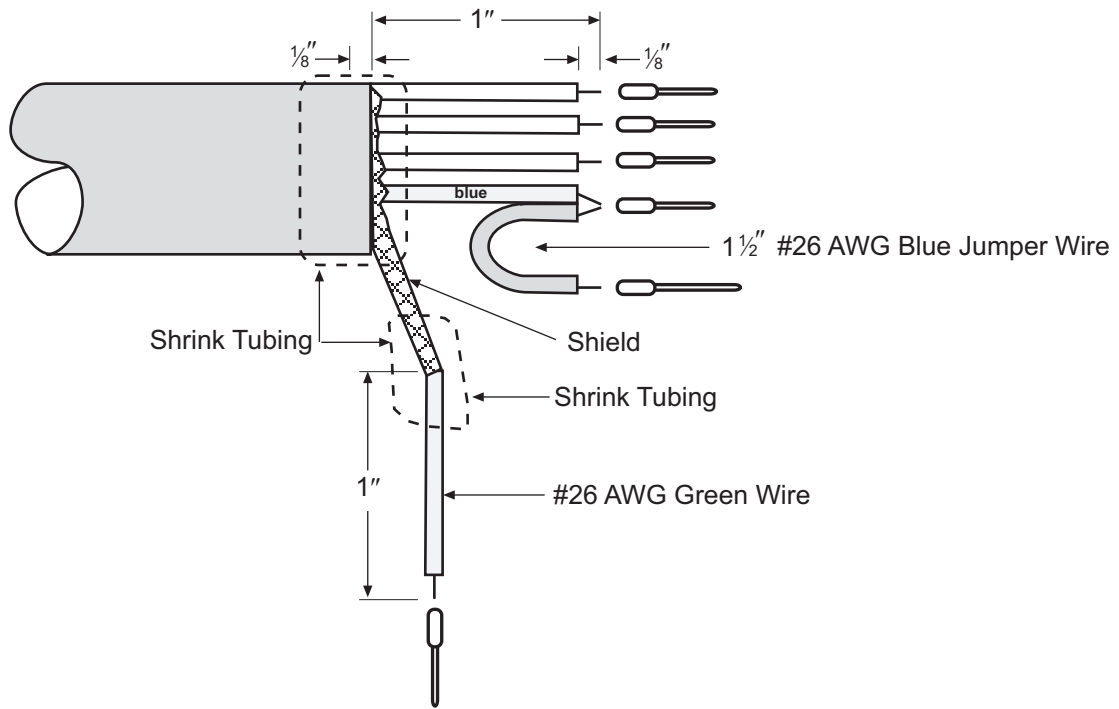

Figure 7-3. FECG Cable Preparation

Table 7-5. FECG Cable Wiring			
Pin Number	Pin Length	Description	Wire Color
1	short	—	—
2	short	ECG Enable	Blue and #26 AWG Blue Jumper
3	LONG	Ground	#26 AWG Blue Jumper
4	short	—	—
5	short	—	—
6	short	LA (red terminal)	White/Black
7	short	RA (green terminal)	White
8	short	Shield	#26 AWG Green
9	short	—	—
10	short	—	—
11	short	—	—
12	short	RL (plate)	White/Red



## Plug Assembly

Refer to [Figure 7-4](#) while replacing a transducer plug. Note that the strain relief clamp (3) orientation is different between tocotransducers and all other transducers (ultrasound, FECG). In addition, the Oetiker clamp (11) is used for *Nautilus* Tocotransducers only.

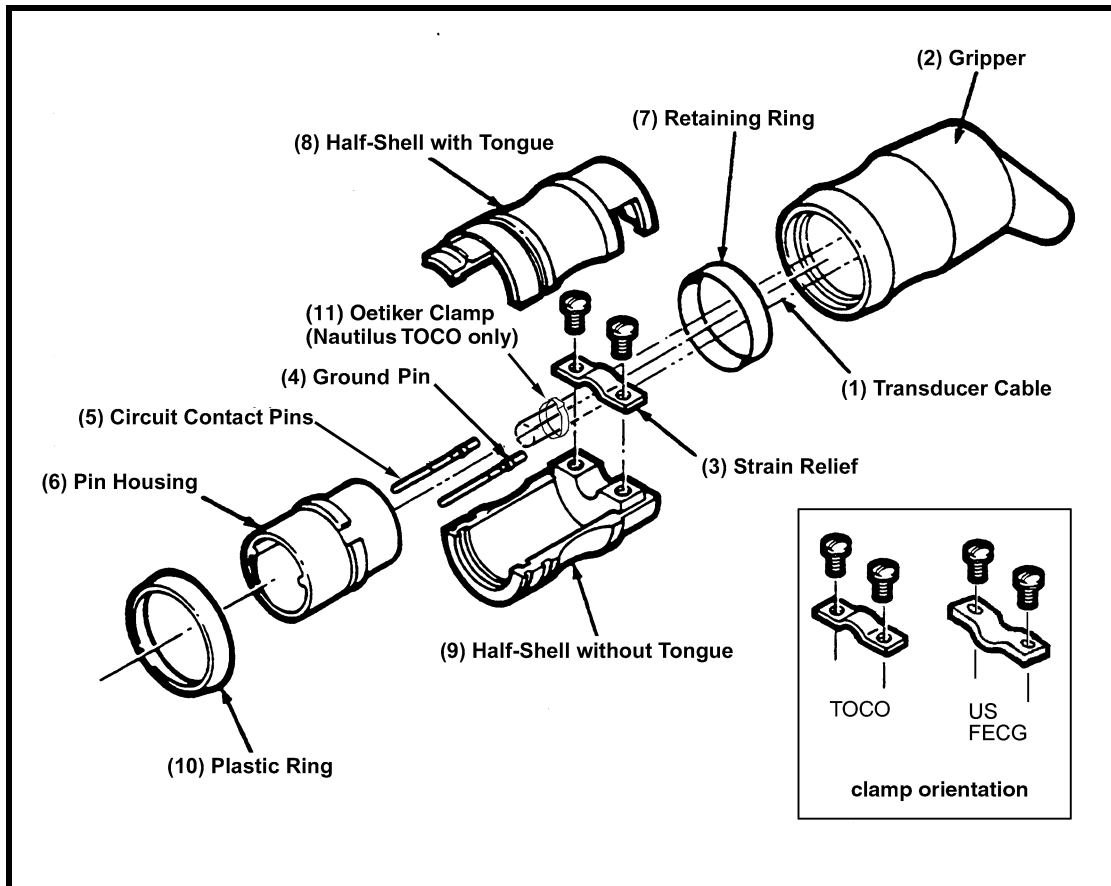

Figure 7-4. Transducer Plug Construction

1. Remove the old plug.
2. Follow cable preparation procedures earlier in this document: "[Tocotransducer Cable Preparation](#)", "[Ultrasound Transducer Cable Preparation](#)", or "[FECG Cable Preparation](#)".
3. Insert pinned wires into corresponding positions in the pin housing according to the wiring table in each of the above listed sections. Push in each pin until it bottoms out and is retained by the pin spring fingers which prevent it from backing out of the hole.

**NOTE:** If a pin is removed from the sprocket housing, it *must* be discarded and replaced.

4. Insert remaining pins into unused positions in the pin housing.

5. Insert the pin housing into the corresponding recess of the half-shell (with strain-relief mounting holes). Position the housing so that the two dots at the back are visible and at right angles to the plane of the half-shell. Push the cable into the strain-relief slot. Ensure the slot surrounds a portion of the cable with the outer covering intact.
6. Fasten the strain-relief clamp to the half-shell using the two metric screws. Refer to inset of [Figure 7-4](#).
  - ◆ *Tocotransducer*: the indent of the strain relief should face *outward*.
  - ◆ *Ultrasound and FECG Transducers*: the indent of the strain relief should face *inward*.
7. Place the half-shell (with tongue) on the pin housing, aligning it with the two dots on the back of the housing. The half-shells should snap together evenly. Slip the retaining ring over them to hold the assembly together.
8. Slide the gripper back up the cable and align the two projections at the rear of the plug assembly with the two recesses at the rear of the gripper.

**NOTE:** Do not allow projections and recesses to become misaligned while sliding the gripper onto the plug or the gripper will not seat properly. Position the tongue opposite the gripper boot through which the cable extends. This ensures that the cable will extend downward once the plug is inserted into the monitor.

---

---

**CAUTION**

KINKING—When sliding the gripper over the plug assembly, pull the cable through the boot to prevent any kinking inside the gripper.

---

---

9. Install the plastic ring on the front of the plug.

# Nautilus Transducer Cable Replacement

You can replace the cable on a Nautilus Tocotransducer or Ultrasound Transducer using one of four kits. Refer to [Table 7-6](#) and ensure you have the correct kit. The text of the instruction sheet is repeated here for informational purposes. Unpack the kit and ensure it contains the items listed in [Table 7-7](#). If something is missing, contact your GE Service Representative immediately.

**NOTE:** Transducers are available in 5-, 8-, and 10-foot cable lengths. However, the cable assembly included in a replacement kit is available in an 8-foot length only.

Nautilus Transducer Type and Cat. No. (REF)	Cable Kit Cat. No. (REF)
Loop-Style Ultrasound Transducer, 5700 KAX/LAX/MAX	2003659-001
Button-Style Ultrasound Transducer, 5700 GAX/HAX/JAX	2003660-001
Loop-Style Tocotransducer, 2264 DAX/EAX/FAX/KAX/LAX/MAX	2003661-001
Button-Style Tocotransducer, 2264 AAX/BAX/CAX/GAX/HAX/JAX	2003662-001

Item	Qty
Transducer Case Top	1
Cable Assembly, 8-ft	1
Flat-Seal O-Ring	1
Sealing Screw, #4-40 x 5/16 in	6
Screw Cap, Curved	4
Screw Cap, Flat	1
Belt Knob <sup>a</sup>	1

<sup>a</sup> The belt knob is included in button-style kits 2003660-001 and 2003662-001 only.

## Equipment Required

You will need the following equipment:

- Phillips Head Torque Driver
- Screw Cap Extraction Tool (cat. no. 2004084-001)
- Soldering Iron and Solder (ultrasound transducers only)
- Loctite Adhesive #454 (recommended)
- Anti-Static Wristband
- Static-Free Work Surface

## Reference Figures

Refer to [Figure 7-5](#) and [Figure 7-6](#) while using the cable replacement kit.

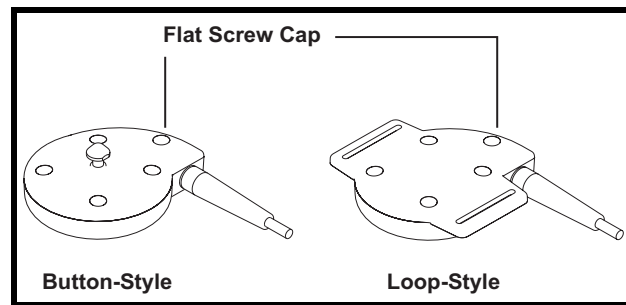

Figure 7-5. Sealing Screw Caps

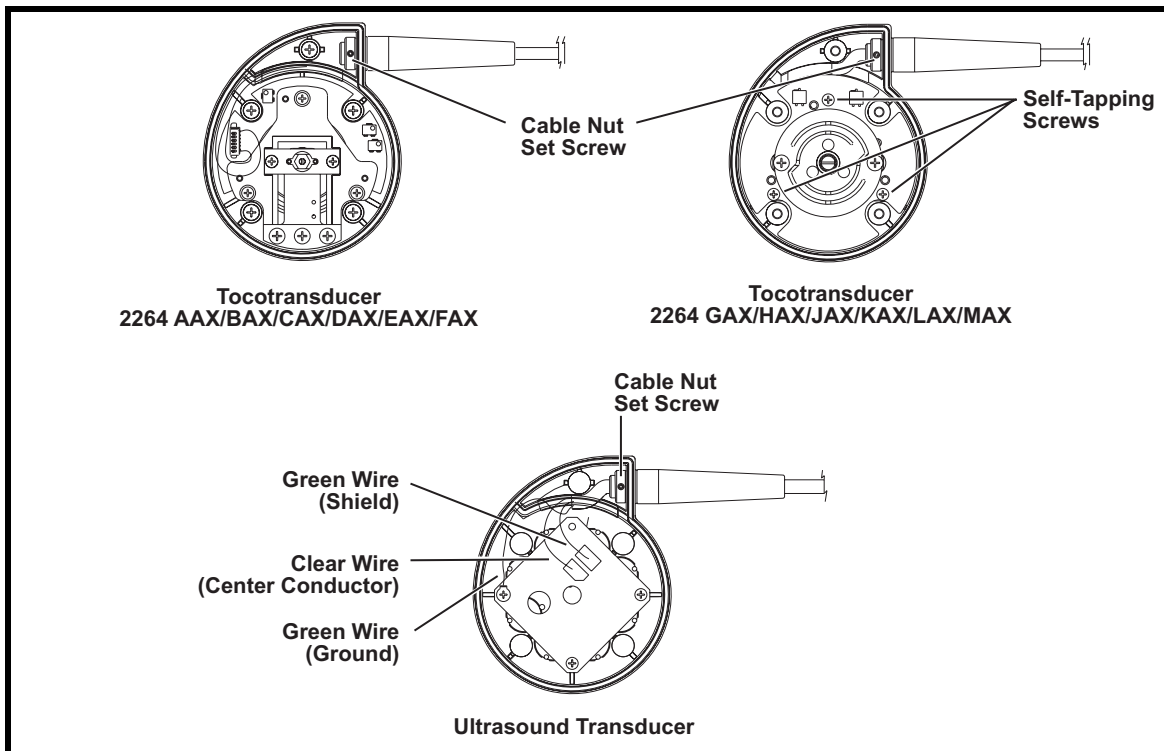

Figure 7-6. Nautilus Transducers—Cover Removed

## Procedure

1. Unplug the transducer from the monitor or telemetry transmitter.
2. Use the screw cap extraction tool to pry off the five screw caps (Figure 7-5). Discard all caps.

---

---

**CAUTION**

HANDLING—Take care not to damage the base sealing groove.

---

---

3. Remove the five sealing screws and discard.
4. Remove the transducer cover and flat-seal o-ring. Discard both items.
5. Remove the cable connector according to the transducer type (Figure 7-6):

**Tocotransducer**

- a. If the PC board header is on the underside of the board (2264 GAX/HAX/JAX/KAX/LAX/MAX only), remove the three self-tapping screws from the board to gain access. Set aside screws.
- b. Observe the orientation of the cable connector in the PC board header, then unplug.

**Ultrasound Transducer**

- a. Unscrew the green cable ground wire from the PC board. Set aside screw.
  - b. Unsolder the green and clear cable wires from the PC board.
6. Loosen the cable nut set screw, then unscrew the cable from the cable nut. Set aside screw and cable nut.
  7. Remove the cable from the transducer base.

---

---

**CAUTION**

CABLE HANDLING—Do not place undue stress on cable wires and shielding. Do not damage the cable o-ring or the hole in the transducer base.

---

---

8. Feed the connector end of the new cable through the hole in the transducer base. The cable o-ring should be seated in hole.

9. Secure the molded strain relief end of the cable in the cable nut:
  - a. Place the flat side of the cable nut against the case base.
  - b. Rotate the cable assembly into the cable nut; continue threading until the two are completely seated. Ensure the o-ring is seated in the hole and one of the cable's four set screw holes is centered under the hole in the cable nut.
  - c. Tighten the set screw until flush with the cable nut.
10. Connect cable according to transducer type (refer to [Figure 7-6](#)):

#### **Tocotransducer**

---

---

#### **CAUTION**

PRESSURE SENSITIVE BUTTON—Do not turn the pressure sensitive button. Doing so will change the button height and affect the tocotransducer calibration.

---

---

- a. Plug the cable connector into the PC board header conforming to the keying observed earlier.
- b. If removed earlier, replace the PC board and tighten the three self-tapping screws in the transducer base.

---

---

#### **CAUTION**

OVERTIGHTENING—Do not overtighten the screws. Doing so could damage the threads in base.

---

---

#### **Ultrasound Transducer**

- a. Solder the green and clear cable wires to the PC board ([Figure 7-6](#)).
  - b. Replace and tighten the green ground wire on the PC board.
11. Install new flat-seal o-ring.
  12. *Nautilus Tocotransducers only:* Prior to replacing the case top, it is recommended that you calibrate the transducer. Refer to "[Tocotransducer Calibration](#)" on [page 7-20](#) prior to completing the cable replacement procedure.
  13. Follow the instructions for "[Nautilus Transducer Reassembly](#)" on [page 7-32](#).

# Removing the Monitor Top Cover

1. Unplug the AC adapter from the monitor to completely remove power.
2. Remove the four bottom panel screws.

---

---

**CAUTION**

TOP COVER—The top cover remains tethered to the main board via the display board and membrane switch panel cables. Do not attempt to remove the monitor cover without first disconnecting these cables.

---

---

3. Partially lift the top cover and slide it partways back to reveal the cables connecting to the main board.
4. Disconnect the display board cable from J18 on the main board.
5. Disconnect the membrane switch panel cable from J19 on the main board.

# Tocotransducer Calibration

Any of the following three transducers can be used with the 170 Series Monitor:

- ◆ Corometrics Nautilus Tocotransducer
- ◆ C
- ◆

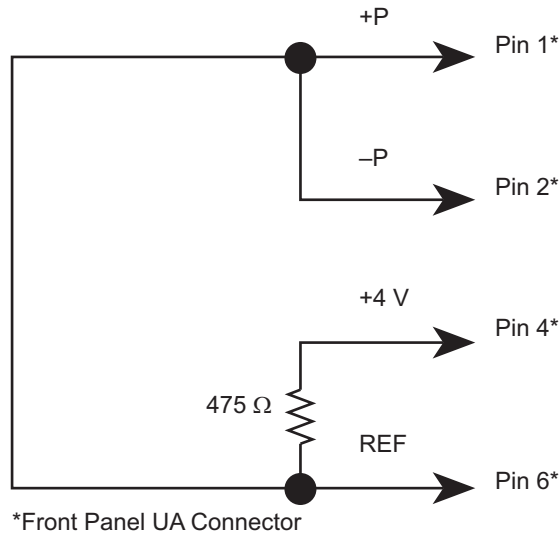

Figure 7-7. CMR Test Jack

Table 7-8. CMR Test Jack Components	
Part Description	Catalog Number
Pressure Connector	6158J
475 Ω, 1/8 W, 1% Resistor	472127



## Nautilus Tocotransducers

Calibrating a Nautilus Tocotransducer requires a Calibration Kit. Refer to [Table 7-9](#) to order the correct kit. Unpack the kit and ensure it contains the items listed in [Table 7-10](#). If something is missing, contact your GE Service Representative immediately. The text of the instruction sheet is repeated here for informational purposes.

<b>Nautilus Transducer Type and Cat. No. (REF)</b>	<b>Cable Kit Cat. No. (REF)</b>
Loop-Style Tocotransducer, 2264 DAX/EAX/FAX/KAX/LAX/MAX	2003663-001
Button-Style Tocotransducer, 2264 AAX/BAX/CAX/GAX/HAX/JAX	2003664-001

<b>Item</b>	<b>Qty</b>
Transducer Case Top	1
Flat-Seal O-Ring	1
Sealing Screw, #4-40 x 5/16 in	6
Screw Cap, Curved	4
Screw Cap, Flat	1
Belt Knob <sup>a</sup>	1
Instruction Sheet	1

<sup>a</sup>The belt knob is included in button-style kit 2003664-001 only.

## Equipment Required

---

---

### **IMPORTANT**

WEIGHT TYPE—The specified weight, cat. no. (REF) 2003005-001, is designed specifically for testing Nautilus Tocotransducers.

---

---

You will need the following equipment:

- Phillips Head Torque Driver
- Screw Cap Extraction Tool (cat. no. 2004084-001)
- Digital Voltmeter: DM501 or equivalent with x1 probe or leads
- Common Mode Rejection (CMR) Test Jack (Figure 7-7 and Table 7-8)
- Potentiometer Adjustment Tool
- 52.5 gram Weight (cat. no. 2003005-001)
- Torque Seal
- Loctite Adhesive #454 (recommended)
- Anti-Static Wristband
- Static-Free Work Surface
- Calibrated 170 Series Monitor

## Disassembly

---

---

### **CAUTION**

HANDLING—Take care not to damage the transducer base sealing groove.

---

---

1. Turn off the monitor.
2. Unplug the transducer from the monitor.
3. Use the screw cap extraction tool to pry off the five screw caps (Figure 7-5). Discard all caps.
4. Remove the five sealing screws and discard.
5. Remove the transducer cover and flat-seal o-ring. Discard both items.

## Calibration for Cat. No. (REF) 2264 GAX/HAX/JAX/KAX/LAX/MAX

Refer to [Figure 7-6](#) during calibration.

1. Set the Gain (R11) and Offset (R6) potentiometers fully clockwise.
2. Connect the positive lead of the digital voltmeter to TP2 on the Main Board; connect the negative lead to TP9.
3. Turn on the monitor.
4. Plug the CMR Test Jack into the monitor's **UA** connector.
5. Measure the voltage across the test points and record the value.
6. Replace the CMR Test Jack with the transducer to be calibrated.
7. Place the tocotransducer on a flat surface so that the button is face up, then center the 52.5 gram weight on the pressure sensitive button.
8. Adjust the Offset (R6) potentiometer so that the voltage matches the reading recorded in step 5  $\pm 0.04$  V. This voltage is referred to as the "weight on" voltage.
9. Remove the weight and observe the voltage reading; this voltage is referred to as the "weight off" voltage. A correctly adjusted transducer will show a voltage change of  $+0.115 \text{ V} \pm 0.015 \text{ V}$ . If the change is less, adjust the Gain (R11) potentiometer counterclockwise to increase the gain. If the change is more, adjust the Gain (R11) potentiometer clockwise to decrease the gain.
10. Repeat step 7 through step 9 until the change in voltage between the "weight on" and "weight off" conditions falls into specification.
11. Torque seal all potentiometers.
12. Follow the instructions for "[Nautilus Transducer Reassembly](#)" on [page 7-32](#).

## Calibration for Cat. No. (REF) 2264 AAX/BAX/CAX/DAX/EAX/FAX

Refer to [Figure 7-6](#) during calibration.

1. Set the Gain (R15) and Offset (R5) potentiometers fully counterclockwise.
2. Set the Offset Trim (R6) potentiometer to its mid-position—approximately six turns from fully counterclockwise.
3. Connect the positive lead of the digital voltmeter to TP2 on the Main Board; connect the negative lead to TP9.
4. Turn on the monitor.
5. Plug the CMR Test Jack into the monitor's **UA** connector.
6. Measure the voltage across the test points and record the value.
7. Replace the CMR Test Jack with the transducer to be calibrated.
8. Place the tocotransducer on a flat surface so that the button is face up, then center the 52.5 gram weight on the pressure sensitive button.
9. Adjust the Offset (R5) and Offset Trim (R6) potentiometers so that the voltage matches the reading recorded in step 6  $\pm 0.04$  V. This voltage is referred to as the “weight on” voltage.
  - ◆ The Offset (R5) potentiometer provides course adjustment.
  - ◆ The Offset Trim (R6) potentiometer provides fine adjustment.
10. Remove the weight and observe the voltage reading; this voltage is referred to as the “weight off” voltage. A correctly adjusted transducer will show a voltage change of  $+0.115 \text{ V} \pm 0.015 \text{ V}$ . If the change is less, adjust the Gain (R15) potentiometer counterclockwise to increase the gain. If the change is more, adjust the Gain (R15) potentiometer clockwise to decrease the gain.
11. Repeat step 8 through step 10 until the change in voltage between the “weight on” and “weight off” conditions falls into specification.
12. Torque seal all potentiometers.
13. Follow the instructions for “[Nautilus Transducer Reassembly](#)” on [page 7-32](#).

# Nautilus Ultrasound Transducer Top Cover Replacement

In order to replace the top cover of a Nautilus Ultrasound Transducer in the field, you will require one of two kits. Refer to [Table 7-11](#) and ensure you have the correct kit. Unpack the kit and ensure it contains the items listed in [Table 7-12](#). If something is missing, contact your GE Service Representative immediately. The text of the instruction sheet is repeated here for informational purposes.

<b>Nautilus Ultrasound Transducer Type and Cat. No. (REF)</b>	<b>Cable Kit Cat. No. (REF)</b>
Loop-Style Ultrasound Transducer, 5700 KAX/LAX/MAX	2011679-001
Button-Style Ultrasound Transducer, 5700GAX/HAX/JAX	2011680-001

<b>Item</b>	<b>Qty</b>
Transducer Case Top	1
Flat-Seal O-Ring	1
Sealing Screw, #4-40 x 5/16 in	6
Screw Cap, Curved	4
Screw Cap, Flat	1
Belt Knob <sup>a</sup>	
Screw Cap Extraction Tool	1

<sup>a</sup> The belt knob is included in button-style kits 2011680-001 only.

## Equipment Required

You will need the following equipment:

- Phillips Head Torque Driver
- Loctite Adhesive #454 (recommended)
- Anti-Static Wristband
- Static-Free Work Surface

## Procedure

1. Turn off the monitor.
2. Unplug the transducer from the monitor.
3. Use the screw cap extraction tool to pry off the five screw caps (Refer to [Figure 7-5](#)). Discard all caps.

---

---

**CAUTION**

HANDLING—Take care not to damage the transducer base sealing groove.

---

---

4. Remove the five sealing screws and discard.
5. Remove the transducer cover and flat-seal o-ring. Discard both items.
6. Follow the instructions for “[Nautilus Transducer Reassembly](#)” on [page 7-32](#).

# Nautilus Transducer Reassembly

---

---

## CAUTIONS

VISIBLE INSPECTION—Ensure the base sealing groove, flat-seal o-ring, sealing surface, and sealing screws are free of visible surface defects, dust, dirt, and foreign material.

SINGLE-USE COMPONENTS—Do **not** reuse case top, flat-seal o-ring, sealing screws, or screw caps. Discard these items *each* time a transducer is opened.

SEALS—Wetting of seals is **not** required.

---

---

1. Install new flat-seal o-ring.
2. Install case top and tighten five sealing screws. Hand tighten each screw a small amount going in a clockwise direction, skipping every other screw. Repeat until all screws are torqued to 48 in-oz.
3. Apply one drop of Loctite adhesive<sup>1</sup> to the perimeter of the hole for the flat screw cap (Figure 7-5). Insert flat screw cap and press into place.
4. Apply one drop of Loctite adhesive<sup>1</sup> to the perimeter of the hole for a curved screw cap. Insert the curved screw cap being careful to align it according to the curvature of the case top; the small burr on the screw cap side should face the outside edge of the transducer. (See Figure 7-10 and Figure 7-11.) Press the screw cap firmly into place. Repeat for the remaining three curved screw caps.
5. For button-style transducers only, install and torque belt knob to 48 in-oz.
6. Refer to “Testing a Repaired Transducer (TOCO or US)” on page 7-34.

---

<sup>1</sup> Using Loctite Adhesive #454 is recommended in order to secure the screw caps.

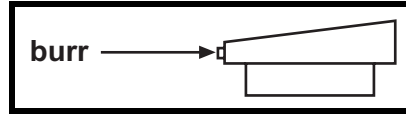

Figure 7-10. Curved Screw Cap Shape, Nautilus Transducer

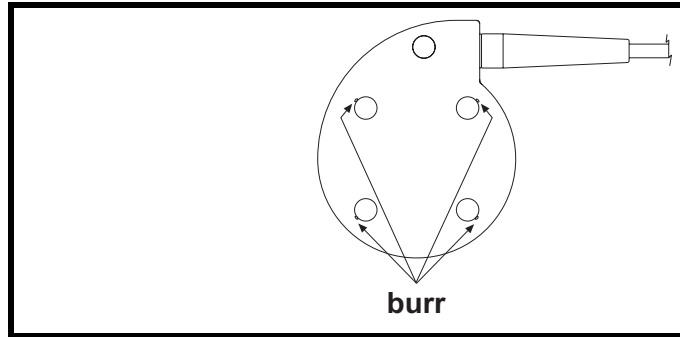

Figure 7-11. Curved Screw Cap Alignment, Nautilus Transducer



## Testing a Repaired Transducer (TOCO or US)

---

---

### **CAUTIONS**

Following completion of the cable replacement procedure:

**LEAKAGE TEST**—Perform a leakage and dielectric test on the transducer per applicable standards.

**FUNCTIONAL TEST**—Perform a functional response test on the transducer.

---

---

# Replacing the Main Board

## Equipment Required

- Phillips screwdriver
- Main board
  - ◆ part no. 2000243 (Model 171)
  - ◆ part no. 15269 (Model 172)
  - ◆ part no. 2000324 (Model 173)
  - ◆ part no. 2000973 (Model 174)

## Procedure

1. Disconnect the AC adapter from the monitor to completely remove power.
2. Remove the monitor top cover, disconnecting the display board cable and membrane switch panel cable from J18 and J19, respectively.
3. Disconnect the sensor board cable from J3 on the main board.
4. Disconnect the printhead cable from J1 on the main board.
5. Disconnect the motor cable from J2 on the main board.
6. Disconnect the speaker cable from J4 on the main board.
7. Remove the nine mounting screws from the main board and carefully place the board on an anti-static surface.
8. For Models 173/174, you will need to transfer the FECG/IUP Board to the new Main Board. Remove the four mounting screws, then carefully detach the FECG/IUP Board from J15 and J16 on the Main Board. Carefully align the FECG/IUP Board onto J15 and J16 on the new Main Board and push into place. Secure to the stand-offs with the four screws removed earlier.
9. Position the new board in place and follow steps 1–7 in reverse.

# Replacing the FECG/IUP Board

Follow the instructions for “[Replacing the Main Board](#)” on [page 7-35](#) with the following exceptions:

- ◆ Retain the existing Main Board
- ◆ Mount a new FECG/IUP Board onto the existing Main Board

# Replacing the Membrane Switch Panel

The membrane switch panel *cannot be removed from the top cover* without possible damage to the monitor. You must order a new top cover assembly in order to replace the membrane switch panel.

## Equipment Required

- ◆ Phillips screwdriver
- ◆ Wrench
- ◆ Hand file
- ◆ Top cover
- ◆ Rear panel adhesive gasket
- ◆ Rear panel label
- ◆ Membrane switch panel
- ◆ Display overlay

Refer to [Table 7-13](#) for order numbers.

Item	Model 171	Model 172	Model 173	Model 174
Top Cover	2004993-003 <sup>a</sup>	2004993-001 <sup>b</sup>	2004993-002 <sup>c</sup>	2004993-004 <sup>d</sup>
Rear Panel Adhesive Gasket	14561AA			
Rear Panel Label	2003930-001			
Membrane Switch Panel	15323BA	15323AA		
Display Overlay	15324BA	15324AA	15324CA	15324DA

<sup>a</sup> Replaces older 15453CA top covers.

<sup>b</sup> Replaces older 15453AA top covers.

<sup>c</sup> Replaces older 15453BA top covers.

<sup>d</sup> Replaces older 15453DA top covers.

## Procedure

1. Disconnect the AC adapter from the monitor to completely remove power.
2. Follow the instructions for “[Removing the Monitor Top Cover](#)” on [page 7-19](#).
3. Unscrew the top cover standoff and set aside. You may need a wrench to loosen the standoff.
4. Remove the two display board bracket screws. Set aside the display board and screws.
5. Remove the screw fastening the membrane shield tongue. Set aside the screw.
6. Remove the rear panel plug in **J4** and set aside.
7. Newer monitors have top covers with tabs which fit into corresponding slots in the bottom enclosure. (Refer to [Figure 7-12](#) and [Figure 7-13](#).) If you are installing a newer tabbed top cover onto an older bottom enclosure (without slots), you must remove the tabs. Use a small hand file or other tool to remove the plastic tabs.
8. Apply the new membrane switch panel: peel off the adhesive backing and position on the new top cover making sure the shield tongue is threaded through the slot.

---

---

### **IMPORTANT**

SHIELD TONGUE—If the shield tongue is caught between the top cover and the switch panel, the panel cannot be properly positioned.

---

---

9. Screw the shield tongue in place using the old screw.
10. Replace the display board and secure all four screws.
11. Replace the top cover standoff.
12. Install the rear panel gasket on the *inside* of the cover: remove the adhesive backing and align over the rear panel connectors.
13. Install the display overlay: remove the adhesive backing and align on the *outside* of the top cover.
14. Install the rear panel label on the *outside* of the cover: remove the adhesive backing and align over the rear panel connectors.
15. Re-connect the display board and membrane switch panel cables to J18 and J19 on the main board.
16. If you are installing a tabbed cover onto a bottom slotted enclosure, ensure that the tabs align with the slots.
17. Secure the top cover with the four bottom panel screws.
18. Discard previous top cover assembly.

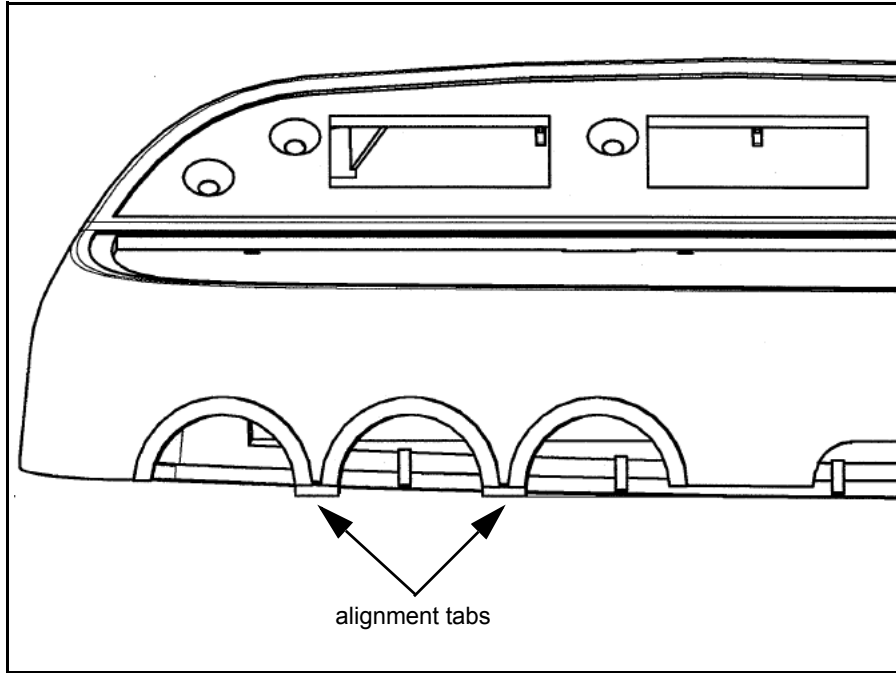

Figure 7-12. Top Cover Alignment Tabs

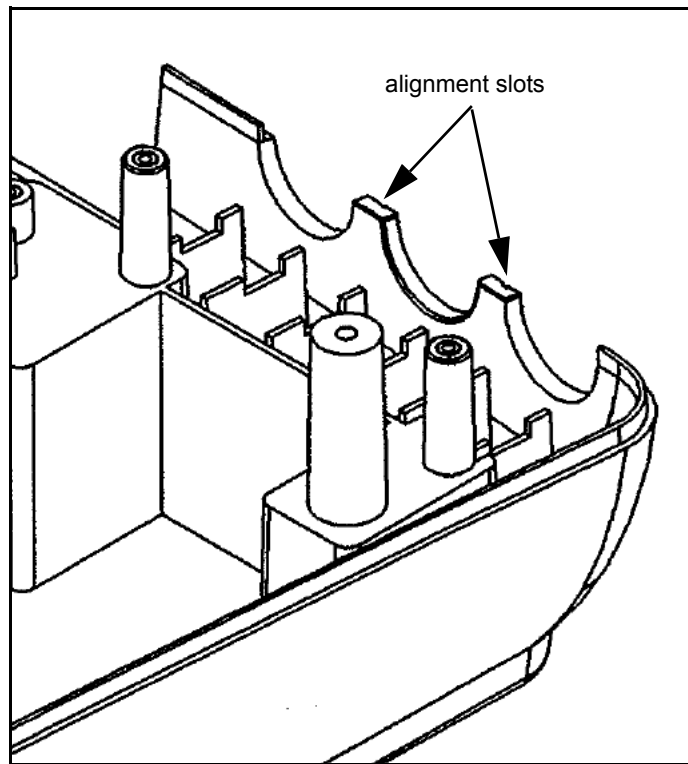

Figure 7-13. Bottom Enclosure Alignment Slots

# Replacing a Front Panel Connector

## Equipment Required

- ◆ Screwdriver
- ◆ Connector (see [Table 7-14](#))
- ◆ De-soldering tool
- ◆ Soldering iron
- ◆ Solder

Table 7-14. Front Panel Connectors		
Connector	Color	Part Number
US/US2	Blue	212174
UA (TOCO/IUP)	White	212173
FECG	Dark Grey	212175
COMBI (US/FECG)	Blue and Grey	2003692-001

## Procedure

1. Disconnect the AC adapter from the monitor to completely remove power.
2. Follow the instructions for [“Removing the Monitor Top Cover”](#) on [page 7-19](#). It is not necessary to disconnect the cables. You only need access to the front panel connectors.
3. Follow the instructions for [“Replacing the Main Board”](#) on [page 7-35](#). (There is no need to remove the FECG/IUP Board.)
4. Remove the six screws from the front-end connector shield.
5. De-solder the damaged connector and discard.
6. Solder a new connector in place.
7. Replace the connector shield, main board, and top cover.

# Servicing the Recorder

## Replacing the Printhead

### Equipment Required

- ◆ Phillips screwdriver
- ◆ Vernier caliper
- ◆ Printhead (part no. 2000133-001)

### Procedure

1. Remove the AC line cord from the monitor to completely remove power.
2. Follow the instructions for [“Removing the Monitor Top Cover”](#) on [page 7-19](#).
3. Pry the printhead cable connectors free from the back of the printhead.
4. Open the recorder drawer.
5. Remove the four screws (two per side) holding the printhead in place. The printhead will drop out.
6. Insert the new printhead, aligning the edges near the ends flush with the support plate. Secure with the four screws.
7. Slowly close the drawer observing the roller and printhead. Ensure that the roller is parallel to the printhead striking the printhead evenly as the drawer shuts.
8. Replace the printhead cable.
9. Verify that there is a slight gap (0.003 in minimum) between the shoulder nut standoff and the downstop plate (without paper installed). Adjust accordingly.
10. Follow the instructions for [“Aligning the Printhead”](#) on [page 7-43](#).
11. Once the recorder prints satisfactorily, secure the monitor top cover in place.



## Adjusting the Printhead Current

### Equipment Required

- ◆ Phillips screwdriver
- ◆ Digital voltmeter
- ◆ 30  $\Omega$ , 20 W, 5% resistor

### Procedure

---

---

**CAUTION**

RECORDER STATUS—Ensure the recorder remains off during this procedure.

---





---

1. Remove the AC line cord from the monitor to completely remove power.
2. Follow the instructions for “[Removing the Monitor Top Cover](#)” on [page 7-19](#), including disconnection of the display board cable and the membrane switch panel cable from the main board.
3. Disconnect the printhead cable from J1 on the main board.
4. Locate resistor R562 and potentiometer R507 on the main board.
5. Attach the leads of the digital voltmeter across R562.
6. Re-connect the AC adapter cord to the monitor and turn on the monitor.
7. Measure the voltage across R562 and record the value.
8. Turn off the monitor.
9. Attach a 30  $\Omega$  (20 W, 5%) resistor across R562.
10. Turn on the monitor.
11. Adjust potentiometer R507 until the voltage across R562 is 0.5 V less than the voltage recorded in step 5.
12. Turn off the monitor and remove the voltmeter leads and the 30  $\Omega$  resistor.

## Aligning the Printhead

- ◆ Equipment Required
- ◆ Phillips screwdriver
- ◆ Vernier caliper

## Printing a Continuous Test Pattern

1. Re-connect the AC adapter cord to the monitor.
2. Access the service setup mode: press and hold the **Setup** button ; press and hold the blue **Power** button; release both buttons.
3. Use the **Volume** buttons  ( $\triangle$  or  $\nabla$ ) to change the number in the UA display to 100. (On Model 172 Monitors, use the left set of volume controls.)
4. Press the **UA Reference** button  to activate the FHR display and start printing the test pattern. See [Figure 7-14](#).
5. Follow the instructions under “[Left/Right Alignment](#)” and “[Front/Back Alignment](#)”.
6. Press the **Setup** button  to exit the service setup mode. The monitor automatically turns to standby.

## Front/Back Alignment

1. Follow the instructions for “[Adjusting the Printhead Current](#)” on [page 7-42](#).
2. Print the recorder test pattern. (See “[Printing a Continuous Test Pattern](#)” above.)
3. Load paper and close the recorder drawer.
4. Observe the printing quality under the following conditions:
  - ◆ Press and hold the door toward the rear of the monitor. If the printing darkens on either side: loosen the four mounting screws; move the printhead forward slightly on the affected side; then re-tighten the screws.
  - ◆ Pull and hold the drawer forward slightly. If the printing darkens on either side: loosen the four mounting screws; move the printhead back slightly on the affected side; then re-tighten the screws.
5. Verify that the print quality is satisfactory when the drawer is latched in place.

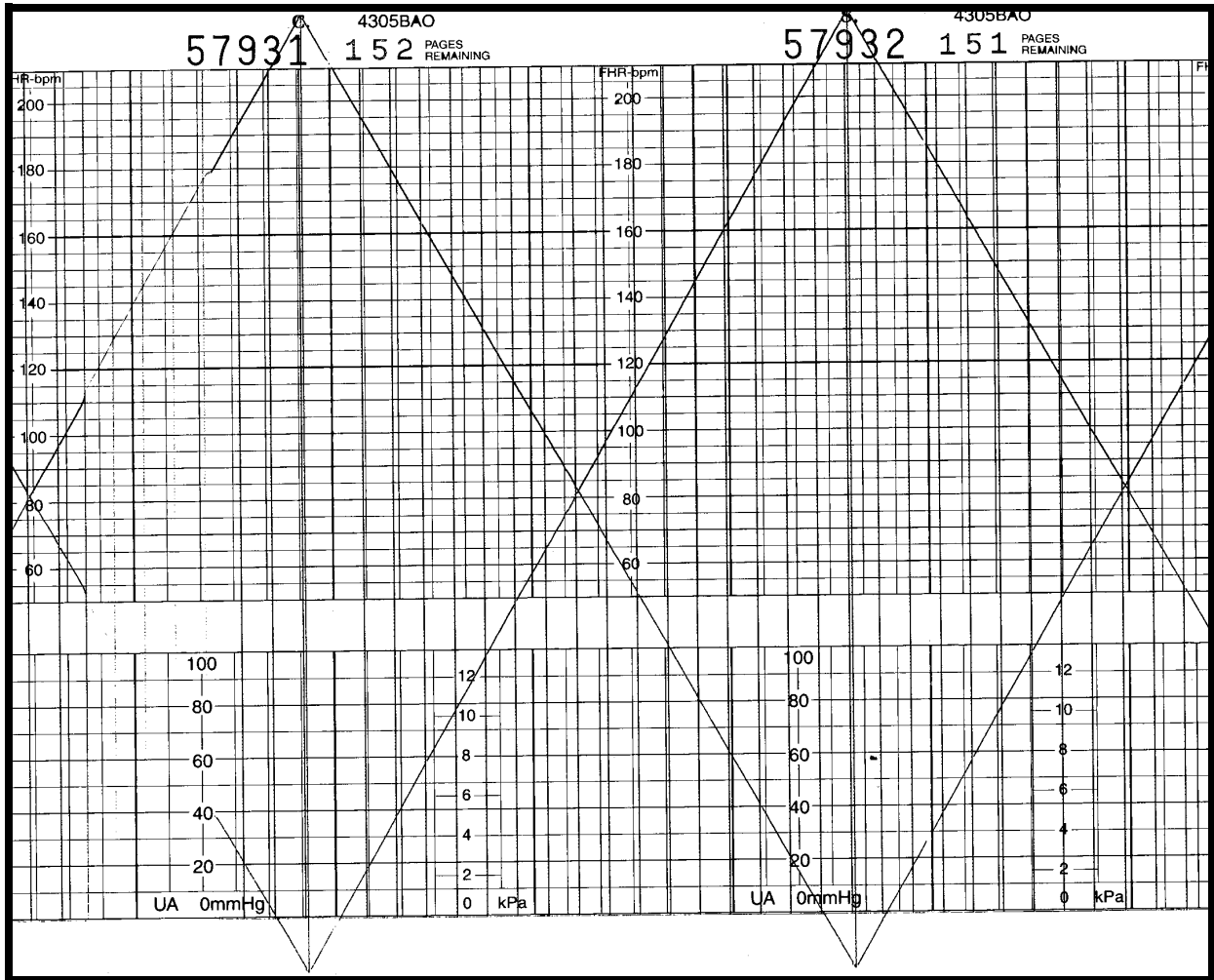

Figure 7-14. Recorder Test Pattern

## Left/Right Alignment

1. Print the continuous recorder test pattern. (See “[Printing a Continuous Test Pattern](#)” above.)
2. Check the quality of the printed lines. Verify that the horizontal lines print evenly. Ideally the distance between the right paper guide at the roller and the first line printed by the test pattern should be 0.490 in which represents a nominal value. Use a vernier caliper to measure this distance.
3. Use the **Volume** buttons  $\updownarrow$  ( $\triangle$  or  $\nabla$ ) to align the printhead left or right, respectively. A number between 0 and 255 shows in the FHR display. The number increases or decreased as you make adjustments using the **Volume** buttons.

---

---

### **IMPORTANT**

**ACCURACY**—A common mistake in the field is to adjust the printhead so that the first test pattern line prints at 0 mmHg on the paper, rather than by measuring the nominal distance. This method is often inaccurate as it does not account for paper variations.

---

---

For best results:

- ◆ Use only GE paper.
- ◆ Ensure paper is correctly loaded as instructed on page 4-2.
- ◆ Use a vernier caliper to adjust the printhead to its nominal position.

## Replacing the Recorder Motor Assembly

### Equipment Required

- ◆ Phillips screwdriver
- ◆ Motor assembly (part no. 15136A)

### Procedure

1. Remove the AC line cord from the monitor to completely remove power.
2. Follow the instructions for “[Removing the Monitor Top Cover](#)” on [page 7-19](#).
3. Follow the instructions for “[Replacing the Main Board](#)” on [page 7-35](#).
4. Remove the two screws holding the motor mount in place.
5. Remove the two screws holding the motor assembly on the motor mount. Retain the motor mount and all screws.
6. Install the new motor on the motor mount and tighten both screws.
7. Position the new motor in place, aligning the motor gear with the roller gear. Push the motor assembly slightly forward against the roller gear. There should be a slight clearance between the teeth. Check clearance by rotating the print roller back and forth. (There should be a slight rotation.)
8. Secure the motor mount to the main board mounting plate. Tighten both screws.
9. Replace and align the printhead by following the instructions on [page 7-41](#) and [page 7-43](#).
10. Replace the main board and secure all eight mounting screws.
11. Re-connect all cables.
12. Replace the monitor top cover.

## Cleaning the Printhead

The thermal printhead heater elements must be cleaned at regular intervals to remove any accumulated paper dust. The heater elements may be cleaned with methanol or isopropyl alcohol. Care must be taken to avoid touching the heater elements with bare hands.

---

---

### **CAUTION**

AIR DRY—Allow to air dry completely prior to using the monitor.

---

---

## Replacing the Sensor Board

### Equipment Required

- ◆ Phillips screwdriver
- ◆ Sensor board (part no. 15231)
- ◆ Sensor board insulator (part no. 2000147-001)
- ◆ Cable tie, x2 (part no. 608036)
- ◆ Cable mount adhesive back, x2 (part no. 608030)

### Procedure

1. Remove the AC line cord from the monitor to completely remove power.
2. Follow the instructions for “[Removing the Monitor Top Cover](#)” on [page 7-19](#).
3. Follow the instructions for “[Replacing the Main Board](#)” on [page 7-35](#).
4. Note the location of the printhead assembly relative to the notches on each side. This is the nominal location for when it is replaced later. Remove the four screws from the printhead assembly downstop plate and set aside.
5. Remove the three screws from the main board mounting plate and slide back and out to remove.
6. Remove the two screws holding the drawer microswitch in place.
7. Snip the sensor board cable tie located on the monitor bottom panel.
8. Pull the recorder drawer forward slightly.
9. Snip the cable tie on the back of the recorder drawer.
10. Pull drawer forward and lift out.

---

---

**CAUTION**

LOOSE ROLLERS—The drawer rollers are normally held in place by the drawer. Take care not to dislodge them while the drawer is removed.

---

---

11. Turn drawer over and peel off the sensor board insulator.
12. Remove the four flathead screws securing the sensor board. Discard the board, but retain the screws.
13. Insert the new board, secure all four screws, and cover with a new insulated sheet.
14. Secure the sensor board cable with a cable tie on the back of the recorder drawer.
15. Align the drawer over the slot, drop down, and slide into place.
16. Pull drawer fully forward to allow slack on the sensor board cable.
17. Secure the sensor board cable with a cable tie on the monitor bottom panel.

18. Replace the microswitch and secure both screws. Make sure the microswitch clicks when the drawer is closed.
19. Replace the main board mounting plate, pulling the plate forward, parallel with the roller while tightening the screws.
20. Return the printhead assembly to its original position as noted in step 4.
21. Replace the main board, re-connect all cables, and replace the monitor top cover.
22. Check printing and re-align the printhead as necessary. (See [“Aligning the Printhead”](#) on page 7-43.)

## Boot ROM Error Codes

If the error codes in the following table display during the boot process, cycle power. If the error codes reappear when you power up, phone GE Technical Support for assistance.

Table 7-15. Boot ROM Error Codes	
Error Code	Description
E1	Configuration data incorrect for program target
E2	Configuration data checksum error
E3	Boot code CRC error



**For your notes**



## Chapter 8

# Peripheral Devices

The 170 Series Monitor allows connection to optional peripheral equipment.

This section discusses the following:

Remote Marks Connectors .....	8-2
Telemetry Connector .....	8-3
RS-232 Connectors .....	8-4



## Remote Marks Connectors

### Remote Mark, Fetal Acoustic Stimulator

This receptacle is provided for connection to a Corometrics Model 146 Fetal Acoustic Stimulator.

### Remote Mark, Remote Event Marker

This receptacle is provided for connection to an optional Corometrics Remote Event Marker. A Corometrics Remote Event Marker is used to annotate the strip chart recorder paper with a mark.

The printed mark can be configured as , commonly used to record an “event”; or it can be configured as , commonly used as an indication that the mother has perceived fetal movement. The monitor is factory set with the mark configured as . Refer to “[Customizing the Monitor](#)” on [page 4-10](#) for more information on selecting the mark. Refer to the instructions accompanying the Remote Event Marker for more information about using the accessory.

# Telemetry Connector

This connector is for *future* interfacing to the receiver of a Corometrics Model 340 Telemetry System.

**NOTE:** The monitor, receiver, and transmitter must all be turned on.

**NOTE:** When any telemetry mode is detected (US or TOCO), all equivalent front panel modes (US, US2, or TOCO) are ignored. You *cannot* “mix and match” telemetry and monitor modes.

The telemetry *connected* annotation  is printed on the bottom line of the top grid of the strip chart paper:

- ◆ upon commencement of telemetry monitoring; and
- ◆ every 30 minutes along with the modes.

The telemetry *disconnected* annotation  is printed on the strip chart paper if:

- ◆ you unplug the telemetry receiver from the 170 Series Monitor;
- ◆ you turn off the receiver;
- ◆ you turn off the transmitter; or
- ◆ the receiver does not detect any active mode information from the transmitter.

# RS-232 Connectors

Two RS-232C serial interface receptacles (RJ-45) allow connecting the 170 Series Monitor to the following devices:

- ◆ Critikon Model 1846/1846SX Blood Pressure Monitor
- ◆ Quantitative Sentinel/Perinatal System
- ◆ Nellcor N-400 Fetal Pulse Oximeter
- ◆ 115-Compatible Device

Table 8-1 lists the factory default settings for each port. Refer to *Customizing the Monitor* on page 4-10 for information on using the service setup mode to change these settings.

RS-232 Port	Intended Device	Mode	Baud Rate
1	QS System	HP	1200
2	Critikon Model 1846/1846SX	ext. BP	600

## Baud Rate

Select a baud rate that is compatible with the external device. The available settings: 600, 1200, 2400, 4800, 9600, 19,200, and 384,000 bps.

## Mode

Select a communications mode compatible with the external device.

### HP or HP with Notes

Select HP or HP w/notes for connecting to a Marquette Quantitative/Perinatal System or another central system that uses the Hewlett Packard communications protocol. HP mode does not print central station annotations on the fetal monitor strip chart, whereas HP w/notes does.

### Ext. BP

Select ext. BP for connecting to a Critikon Model 1846/1846SX Blood Pressure Monitor.

## Ext. FSpO<sub>2</sub>

Select ext. FSpO<sub>2</sub> for connecting to a Nellcor Fetal Pulse Oximeter.

## Factory

The FACTORY mode is reserved for factory testing only.

## 115 Update

Select for backward-compatibility so the 170 Series Monitor can operate in a Model 115-compatible communication mode. This mode outputs all available information and ignores requests from a host computer system.

## 115 Transmit/Receive

Select for backward-compatibility so the 170 Series Monitor can operate in a Model 115-compatible communication mode. This mode only outputs data requested from a host computer system.

## Critikon Model 1846/1846SX

Critikon Model 1846/1846SX Monitors can be interfaced to a 170 Series Monitor to provide a printout of NBP values on the strip chart paper.

1. Refer to [Table 8-2](#) for the appropriate interface cable. Connect one end to an available **RS-232C** port (1 or 2) on the 170 Series Monitor; connect the other end to the serial communications port on the blood pressure monitor. Refer to the Critikon documentation for information on the name of the connector.
2. Access the fetal monitor service setup mode and set the baud rate and mode for the appropriate port to 600 and ext. BP, respectively; then exit the service setup mode.
3. Be aware of the following information specific to Critikon monitors:
  - ◆ The clock on the Critikon Modes 1846/1846SX Monitors must be set to within 10 minutes of the 170 Series Monitor. If the clocks are *not* within 10 minutes of each other, the time will print with each blood pressure reading.
  - ◆ Due to the storage capabilities of Critikon monitors, it is recommended that power be cycled at the beginning of each data session. This ensures that any previously stored data is cleared.
  - ◆ When using STAT mode on a Critikon monitor, the 170 Series Monitor does not print the time with each reading due to overcrowding on the strip chart. Instead the time is printed once every three to five minutes.
  - ◆ The Critikon Model 1846SX discards NBP values after 90 minutes.

## Quantitative Sentinel/Perinatal System

Through this interface, the 170 Series Monitor outputs FHR and UA data to a central information system such as GE's Quantitative Sentinel/Perinatal System. Annotations made at the central station can be optionally printed on the strip chart paper of the 170 Series Monitor as summarized below:

- ◆ Each message is preceded by a computer icon (.
- ◆ Messages are restricted to a maximum length of 50 characters.
- ◆ Lower-case letters are converted to upper-case letters.
- ◆ Non-standard characters are replaced with spaces.

The 170 Series Monitor can be configured with the remote annotation capability enabled (HP w/notes mode) or disabled (HP mode). The following is an example of a remote message sent to a 170 Series Monitor from a central information system using this serial communications protocol:



<SPW> AVERAGE VARIABILITY

where SPW is an example of a physician's initials.

To connect a central information system:

1. Refer to [Table 8-2](#) for the appropriate interface cable. Connect one end to an available **RS-232C** connector (1 or 2) on the 170 Series Monitor; connect the other end to the wallplate wired to the central information system. For a Marquette Quantitative Sentinel/Perinatal System: the interface cable is catalog number (REF) 1376AAO; the corresponding wallplate connector is labeled **RS-232 COMMUNICATIONS**.
2. Access the monitor's service setup mode and set the baud rate and mode to either HP or HP w/notes mode, respectively; then exit the service setup mode.



## Nellcor Puritan Bennett Model N-400 Fetal Pulse Oximeter

Through this interface, FSpO<sub>2</sub> readings provided by an NPB Model N-400 are printed every five minutes on the strip chart paper of the 170 Series Monitor. The reading is printed in the annotation area between the top and bottom grids. A solid diamond marker, above the data, marks the time of the reading and identifies the data source as an external device. The following is an example annotation:



FSpO<sub>2</sub> 47%

In addition, the FSpO<sub>2</sub> data is trended on the bottom grid of the strip chart paper as a beaded trace. The trend uses a 0-100% scale. Refer to [Figure 8-1](#).

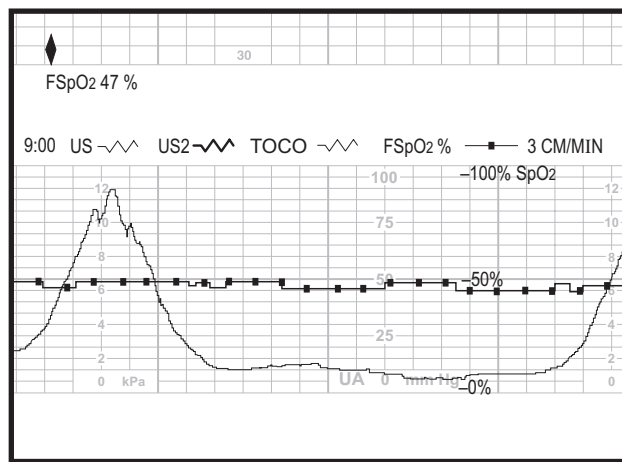

Figure 8-1. FSpO<sub>2</sub> Data Example

To connect the Model N-400:

1. Using interface cable catalog number (REF) 1557AAO/BAO: connect one end to an available **RS-232C** port on the 170 Series Monitor; connect the other end to the **Serial Communications** port on the pulse oximeter.

**NOTE:** This cable can be used with both 120/2121*is* and 170 Series Monitors. Although the 120/2120*is* uses 6-pin RJ-11 connectors and the 170 uses 8-pin RJ-45 connectors, the latter is center keyed to account for this. The 170 uses RJ-45 connectors to provide for future interface features.

2. Access the monitor's service setup mode and set the baud rate to 2400 and the mode to ext. FSpO<sub>2</sub>; then exit the service setup mode.

Table 8-2. External Device Summary				
External Device	Parameter(s)	170 Series Baud Rate	170 Series Mode	Interconnect Cable Cat. No.
Critikon Model 1846/1846SX	NBP	600	ext. BP	1562AAO (1 foot) 1562BAO (6 feet)
Quantitative Sentinel System	Annotations (optional)	1200	HP or HP w/notes	1558AAO (10 feet) 1558BAO (20 feet)
Nellcor N-400	FSpO <sub>2</sub>	2400	ext. FSpO <sub>2</sub>	1557AAO (1 foot) 1557BAO (6 feet)

**NOTE:** The interface cables can be used with both 120/2120*is* and 170 Series Monitors. Although the 120/2120*is* uses 6-pin RJ-11 connectors and the 170 uses 8-pin RJ-45 connectors, the latter is center keyed to account for this. The 170 uses RJ-45 connectors to provide for future interface features.

## Model 115-Compatible Communications Protocols

Two options provide backward-compatibility so that the 170 Series Monitor can operate in a Model 115-compatible communication mode:

- 115 Update Mode: The 115 Update mode outputs all available information and ignores requests from a host computer system.
- 115 Transmit/Receive: The 115 Transmit/Receive mode only outputs data requested from a host computer system.

When the Model 115 Fetal Monitor was released, many customers developed their own interfaces for communicating with the monitor. Setting the 170 Series Monitor to one of these communication modes allows these users to use their existing interfaces with the 170 Series Monitor as well.

The 170 Series Monitor emulates the Corometrics Model 830 Converter's implementation of the 115 Communication Protocols. This protocol is named after the Corometrics Model 115 Fetal Monitor in which it originated.

**NOTE:** The baud rate must match the external computer; however, the recommended baud rate is 9600. Lower baud rates may result in some data loss.

## 115 Update Mode

All information is transmitted from the 170 Series Monitor as soon as the information becomes available.

---

---

### **IMPORTANT**

DATA REQUESTS—When set to the 115 Update Mode, the 170 Series Monitor will *not* respond to any requests for information sent from an external (host) computer.

---

---

Heart rate data is transmitted on a quarter second basis. Uterine activity is transmitted eight times per second. Modes are transmitted once per minute, and whenever a mode change occurs. Annotation messages are sent as they are entered from the Annotations window. Event marks are transmitted each time the **Mark** button is selected. Fetal movement data is transmitted four times per second. Recorder status (PAPER OUT) information is transmitted once per second, when active, until the condition is resolved.

**NOTE:** Refer to *Requested Data Format* on [page 8-12](#) for information about the response data format. The format is the same for both the 115 Update mode and the 115 Transmit/Receive mode.

## 115 Transmit/Receive Mode

Once a valid request for data is received, the 170 Series Monitor will send only the information that is requested. The selection of this information is done by sending a request stream to the 170 Series Monitor. After processing the request, the 170 Series Monitor will then send only the *selected* parameters to the external computer. The information selected by the external computer will be transmitted following the same criteria described for the 115 Update Mode. The requested parameters may be changed at any time by the host computer by sending a new request sequence.

**NOTE:** Refer to *Requested Data Format* on [page 8-12](#) for information about the response data format. The format is the same for both the 115 Update mode and the 115 Transmit/Receive mode.

## Requested Data Format

The format of the data *requested* by the external computer from the monitor is shown in [Figure 8-2](#).

**NOTE:** This applies to 115 Transmit/Receive mode only.

The definitions of the bytes are as follows:

### Monitor Type

This field contains a 1-byte ASCII value indicating the type of monitor from which information is being requested. The 170 Series Monitor is set to a fixed value of 9 (39H).

### Data Field

This field of 1 to 8 bytes indicates which parameters the external computer wishes to receive. The values for the bytes are given in [Table 8-3](#).

### End of Text

This 1-byte field contains the value 03H. If this byte is sent immediately following the Monitor ID, then the 170 Series Monitor will cancel transmission of all data.

## Transmitted Data Format

The format of the information *transmitted* from the 170 Series Monitor to the external computer is shown in [Figure 8-3](#).

**NOTE:** This applies to both 115 Update mode and 115 Transmit/Receive mode.

The definitions of the bytes are as follows:

### Monitor Type

This field contains a 1-byte ASCII value indicating the type of monitor sending the information. The 170 Series Monitor is set to a fixed value of 9 (39H).

### Response Type

This 1-byte value indicates the type of information being sent from the 170 Series Monitor as shown in [Table 8-3](#).

### Monitor ID

This 1-byte ASCII value indicates the ID number of the monitor information. The 170 Series Monitor sets this byte to a fixed value of 0 (30H).

### Data Field

This field of n-bytes contains the actual data sent from the monitor to the external computer. The contents of this field for each response is given below:

- **Event Mark:** This data field is empty whenever the monitor's **Mark** button is selected.
- **Heart Rate:** This data field contains two or three ASCII characters representing the value of the heart rate. A value of 00 (30H, 30H) indicates a penlift condition. Heart rate data (including penlift data) is transmitted four times per second.
- **Uterine Activity:** This data field contains two or three ASCII characters representing the value of uterine activity. A value of 128 (31H, 32H, 38H) indicates a penlift condition. Uterine activity data (including penlift data) is transmitted eight times per second.
- **Modes:** This data field contains two ASCII characters indicating the mode. The first character is the combined mode of both heart rates according to [Table 8-4](#). The second character is the mode for uterine activity as listed in [Table 8-5](#). Mode data is transmitted at startup, with each mode change, with each request, and once every minute.

- **Fetal Movement:** This field contains one ASCII character representing the current status of the FM signal: low or high. If the data byte is a 0 (30H), then the signal is low indicating no movement is detected; if the data byte is 1 (31H), then the signal is high indicating fetal movement is detected. If the fetal movement feature is not in the monitor, the data byte is 2 (32H). If the fetal movement feature is present but not *enabled*, the data byte is 4 (34H). This data is transmitted four times per second. (Fetal movement detection circuitry is an option which can be purchased for the 170 Series Monitor.
- **Recorder Status:** This field contains one ASCII character representing the current status of the PAPER OUT\* signal: low or high. If the data byte is a 0 (30H), then the signal is low indicating paper is loaded and the recorder door is closed; if the data byte is 1 (31H), then the signal is high indicating a paper out condition. This data is transmitted once per second, when active.

### End of Text

This 1-byte field contains the value 03H. If this byte is sent immediately following the Monitor ID, then the 170 Series Monitor will cancel transmission of all data.

### Limitations

The only restriction on the information transmitted during either 115 communication mode occurs when the baud rate is set below 4800 baud. Under this condition, data loss may occur.

**NOTE:** The recommended baud rate is 9600.

## Error Conditions

### Transmission Errors

Transmission errors may be detected by the external computer as parity errors, framing errors (no valid stop bit), or invalid characters. There is no facility in the 170 Series Monitor to re-transmit any information found to contain an error. It is therefore up to the user to decide what action to take as a result of an error.

### Request Errors

These errors apply to the 115 Transmit/Receive Mode only.

Request errors are detected by the monitor as parity errors, framing errors, and invalid Monitor ID. If the monitor fails to respond properly to a request, it is suggested that the external computer re-transmit a request sequence.

MONITOR TYPE	FIRST DATA FIELD	DATA FIELD(S)	Nth DATA FIELD	END OF TEXT
--------------	------------------	---------------	----------------	-------------

Figure 8-2. Data Request Format—115 Transmit/Receive Mode Only

MONITOR TYPE	RESPONSE TYPE	MONITOR ID	DATA FIELD	END OF TEXT
--------------	---------------	------------	------------	-------------

Figure 8-3. Transmitted Data Format

Response Type	ASCII Character	Hexadecimal Value
Heart Rate 1	`	60
Uterine Activity	a	61
Modes	b	62
Event Mark	d	64
Heart Rate 2	e	65
Fetal Movement	f	66
Paper Out	g	67



<b>Table 8-4. Heart Rate Modes</b>			
<b>HR1 Mode</b>	<b>HR2 Mode</b>	<b>ASCII Character</b>	<b>Hexadecimal Value</b>
INOP	INOP	0	30
FECG	INOP	1	31
US	INOP	2	32
US	FECG	9	39
US	US2	;	3B
FECG	US	<	3C
INOP	US2	>	3E

<b>Table 8-5. Uterine Activity Modes</b>		
<b>UA Mode</b>	<b>ASCII Character</b>	<b>Hexadecimal Value</b>
INOP	0	30
TOCO	1	31
IUP	2	32

## Cabling Information

### Monitor RS-232 Connector

The 170 Series Monitor's RS-232C Ports each use an 8-pin RJ-45 connector, shown in [Figure 8-4](#).

The following control signals are supported:

- **Request to Send (RTS):** This output line is asserted (+12 V) whenever the 170 Series Monitor is on and operating; it can be used to determine whether the monitor is powered on.
- **Transmit Data (TXD):** This output line provides the serial data sent to the external computer from the 170 Series Monitor.
- **Clear to Send (CTS):** This input line must be asserted in order to enable the transmission of data from the 170 Series Monitor. Under conditions where no modem is used, the line can be tied to the RTS line of the monitor. If a modem is used, this line should be tied to the CTS line of the modem.
- **Receive Data (RXD):** This input line provides the serial data sent from the external computer to the 170 Series Monitor.

## Standard RS-232C Rules

The following rules must be observed:

- When a direct connection is made between a 170 Series Monitor and another Data Terminal Equipment (DTE), a standard null-modem cable must be used.
- When an indirect connection is made, using a modem, a 170 Series Monitor requires a normal-modem cable.

## Cable Distance

The RS-232C Interface supplied with the 170 Series Monitor is capable of operating over varying distances depending upon the data rate used and whether the cabling is shielded or unshielded. Refer to the manufacturer's specifications.

## Data Terminal Equipment Cabling

When the 170 Series Monitor is directly connected to another Data Terminal Equipment (DTE) device, a standard null-modem cable is required as shown in [Figure 8-5](#).

## Data Communications Equipment Cabling

When the 170 Series Monitor is connected to a Data Communications Equipment (DCE) device (a modem), a standard normal-modem cable is required as shown in [Figure 8-6](#).

Table 8-6. RS-232 Connector 1		
Pin Number	Signal Name	Signal Description
1	+5V	200 mA Fused
2	RTS	Request to Send Output from Monitor
3	RXD	Receive Data Input to Monitor
4	GND	Signal Ground
5	GND	Signal Ground
6	TXD	Transmit Data Output from Monitor
7	CTS	Clear to Send Input to Monitor
8	+5V	200 mA Fused

Table 8-7. RS-232 Connector 2		
Pin Number	Signal Name	Signal Description
1	GND	Signal Ground
2	RTS	Request to Send Output from Monitor
3	RXD	Receive Data Input to Monitor
4	GND	Signal Ground
5	GND	Signal Ground
6	TXD	Transmit Data Output from Monitor
7	CTS	Clear to Send Input to Monitor
8	GND	Signal Ground

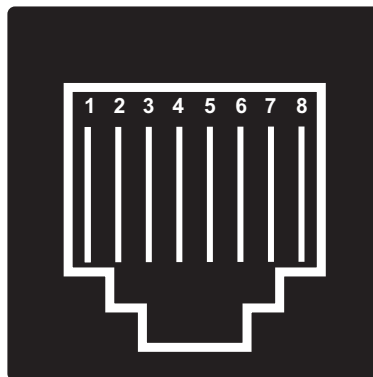

Figure 8-4. RJ-45 Connector (facing the rear panel from the outside)

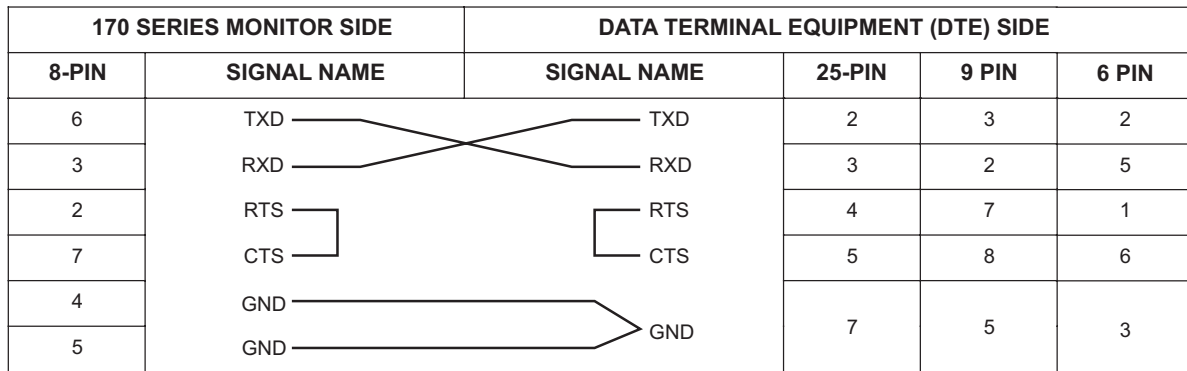

Figure 8-5. Standard Null-Modem Cable

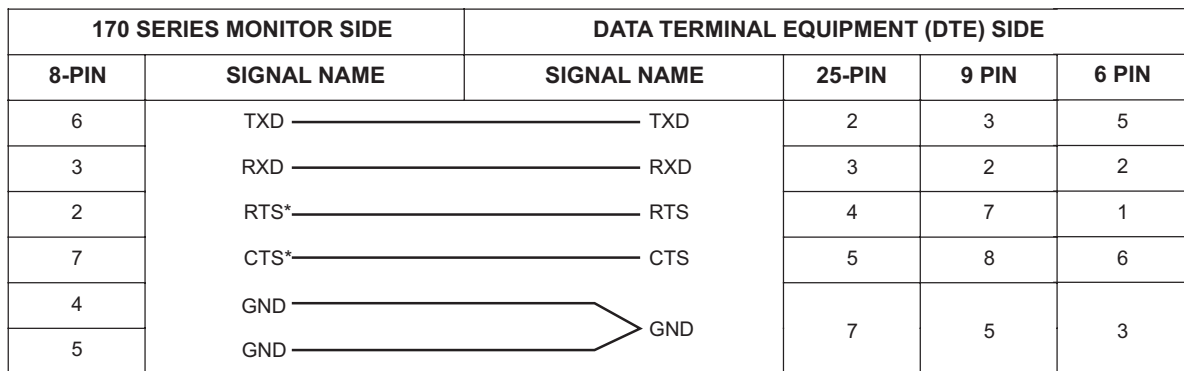

Figure 8-6. Standard Normal-Modem Cable

**For your notes**



## Chapter 9

# Maintenance

All equipment, no matter how reliable, needs to be maintained on a regular basis. This chapter describes general care and cleaning instructions for the 170 Series Monitor and its accessories. If an accessory is not listed, consult the manufacturer's instructions.

This chapter describes the following:

Cleaning .....	9-2
Preventative Maintenance Inspection .....	9-5

# Cleaning

---

---

**CAUTION**

PREPARATION—Unplug the monitor from the AC power source and detach all accessories from the monitor. Do not immerse accessories in any liquid. Do not use abrasive cloth or cleaners on monitor or accessories.

---

---

## Cleaning the Monitor Exterior

To clean the exterior of the monitor, including the displays and the membrane switch panel:

1. Wipe any fluids from the surface of the monitor.
2. Dampen a cloth or paper towel with isopropyl alcohol and gently rub soiled area until clean.

## Cleaning the Tocotransducer, Ultrasound Transducer, and Legplate

---

---

### CAUTIONS

**ABRASION**—Do not use abrasive cloth, sharp objects, or abrasive cleaners.

**ALCOHOL**—Do not use Alcohol in cleaning solutions.

**DISCONNECTION**—Detach the transducers/cables/legplate from the monitor.

**IMMERSION**—Do not immerse transducers/cables/legplate or hold under running water.

---

---

1. Dampen a cloth or paper towel with one of the following products; then wring out until only slightly wet:
  - ◆ Sodium Hypochlorite 5.25 % (Bleach) diluted 10:1
  - ◆ Cidex
  - ◆ Sporicidin
  - ◆ Soap and water
2. Rub soiled area until clean, taking care not to excessively wet the tocotransducer diaphragm seal or the contact surface of the ultrasound transducer.
3. Use a cloth dampened with water on the contact surface of the ultrasound transducer and around the seal of the tocotransducer. Do not use a sharp object which might damage the seal of the tocotransducer.
4. Dry all accessories with a soft, dry cloth.



## Cleaning the UA Strain Gauge

1. Remove the plastic dome.
2. If desired, wash the transducer with sterile water or saline solution.
3. Carefully clean the diaphragm seal with a cotton swab to remove deposits. Avoid excessive pressure since this may damage the diaphragm. If there are excessive stains on the diaphragm or sides of the transducer, remove with a cotton swab and solvents of increasing strength. Do not use pumice, Ajax, Bon Ami or other abrasives.
4. After cleaning, rinse the transducer thoroughly in distilled water and replace the dome loosely.
5. Dry the transducer with sterile gauze.

---

---

### **CAUTIONS**

**AUTOCLAVE**—Do not autoclave pressure transducer.

**IMMERSION**—Do not immerse any part of the electrical connector of the transducer in the cleaning solution at any time. Examine the outer sheath of the cable for perforations. If the outer covering is damaged in any way, do not immerse the cable in the cleaning solution; this may result in moisture entering the transducer case, which is vented through the cable.

---

---

---

---

### **WARNING**

**LIQUIDS**—If liquids enter the electrical connector, check the resistance between the electrical element and the transducer case. A resistance level of greater than 10 M<sup>3</sup>/<sub>4</sub> ensures that the leakage current is within acceptable levels for safe use on patients.

---

---

6. Leave transparent dome attached to the transducer during storage, but slacken the locking ring at least one quarter of a turn.

---

---

### **CAUTION**

**STERILIZATION**—Prior to patient use, ensure the dome is sterile.

---

---

# Preventative Maintenance Inspection

## Equipment Required

- ◆ Digital Multimeter
- ◆ Dielectric Tester
- ◆ Leakage Current Tester
- ◆ Aluminum Foil
- ◆ Ultrasound Test Body  
(ultrasound transducer wrapped in aluminum foil)
- ◆ Tocotransducer Test Body  
(tocotransducer wrapped in aluminum foil)
- ◆ FECG Test Body for Model 173 or 174 only  
(Shorted legplate with all three leads tied together)
- ◆ IUP Test Body for Model 173 or 174 only  
(SensorTip transducer wrapped in aluminum foil)
- ◆ Anti-Static Wristband
- ◆ Static-Free Work Surface
- ◆ 170 Series Operator's Manual

## Visual Inspection

Inspect the following for excess wear and/or signs of damage:

- Power Supply Cord
- AC-to-DC Converter
- AC Line Cord
- Ultrasound Transducer(s)
- Legplate(s)
- IUPC Transducer(s)
- Remote Event Marker
- Monitor Input Receptacles
- Chassis
- Membrane Switch Panel
- Internal Harnesses/Connectors
- Display Panel

## Cleaning

- Clean the monitor's exterior. Refer to "Cleaning the Monitor Exterior" on page 9-2.
- Clean the recorder printhead. Refer to "Cleaning the Printhead" on page 7-46.
- Clean the monitor's accessories. Refer to "Cleaning the Tocotransducer, Ultrasound Transducer, and Legplate" on page 9-3.
- Clean the monitor's interior using a hand-held vacuum.

## Calibration

- Adjust the printhead. Refer to "Aligning the Printhead" on page 7-43.
- Calibrate the tocotransducer(s). Refer to "Tocotransducer Calibration" on page 7-20.

## Electrical Safety Tests

Electrical safety tests provide a method of determining if potential electrical hazards to the patient or operator of the device exist.

### Recommendations

GE recommends that you perform all safety tests presented in this chapter:

- ◆ upon receipt of the device (monitor and its associated equipment)
- ◆ every twelve months thereafter
- ◆ each time the main enclosure is disassembled or a circuit board is removed, tested, repaired, or replaced, and
- ◆ record the date and results in a Maintenance Repair Log.

These instructions are intended for every component in the system.

---

---

#### **WARNING**

MAINTENANCE SCHEDULE—Failure to implement a satisfactory maintenance schedule may cause undue equipment failure and possible health hazards. Unless you have an Equipment Maintenance Contract, GE does not in any manner assume the responsibility for performing the recommended maintenance procedures. The sole responsibility rests with the individual or institution using the equipment. GE service personnel may, at their discretion, follow the procedures provided in this manual as a guide during visits to the equipment site.

---

---

### Test Conditions

Electrical safety tests may be performed under normal ambient conditions of temperature, humidity, and pressure.

## Unit to Primary Leakage

1. Configure a leakage tester to perform a unit AC line leakage test. Refer Figure 9-1 for safety tester connection and switch details.
2. Turn ON the monitor using the monitor's On/Standby button.
3. Verify the following:  
 <math><300 \mu A</math>  
 (132–253 VAC, or at the line voltage at your facility +10%)
4. Record the primary leakage for the following conditions:

Test Description 	S1: DPDT		S2: SPDT		S3: SPDT		S4: SPDT		Maximum Limits (uA)	
	Polarity		Neutral		Ground		Test Point			
	a) Normal b) reverse		a) Closed b) Open		a) Closed b) Open		a) Internal b) TP1			
	Position		Position		Position		Position		EN/IEC	UL
	a	b	a	b	a	b	a	b		
Unit to primary leakage current measurements. TP1 connected to metal part of the UUT.										
Polarity: Normal Neutral: Normal (Closed) Ground: Normal (Closed)	X		X		X			X	10	10
Polarity: Normal Neutral: Open Ground: Normal (Closed)	X			X	X			X	50	50
Polarity: Normal Neutral: Normal (Closed) Ground: Open	X		X			X		X	50	50
Polarity: Reverse Neutral: Normal (Closed) Ground: Open		X	X			X		X	50	50
Polarity: Reverse Neutral: Open Ground: Normal (Closed)		X		X	X			X	50	50
Polarity: Reverse Neutral: Normal (Closed) Ground: Normal (Closed)		X	X		X			X	50	50

Figure 9-1. Unit to Primary leakage test connection diagram and switch settings

-

## Patient-to-Ground Leakage for US1, US2 and TOCO (Type BF applied parts)

1. Connect the Ultrasound Transducer test body to monitors front panel US1, and/or US2 input.
2. Connect a TOCO transducer test body to the monitor's front panel UA input.

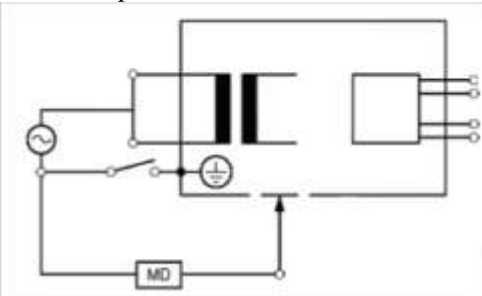
Note: Refer below table to connect the applicable Type BF parts specific for each model.

Model →	171	172	173	174
Type of Connectors to be Shorted for the Leakage test for each of the Model	US1 (BF)	US1 (BF)	US1 (BF)	US1 (BF)
	-----	US2 (BF)	-----	US2 (BF)
	TOCO (BF)	TOCO (BF)	TOCO (BF)	TOCO (BF)

3. Configure a leakage tester to perform a patient leakage test. Refer Figure 9-2 as shown below for the Safety Tester connection and switch details.
4. Turn ON the monitor using the monitor's On/Standby button.
5. Verify the following:
  - Normal Condition: <10  $\mu$ A
  - Single Fault Condition: <50  $\mu$ A  
(132–253 VAC, or at the line voltage at your facility +10%)
6. Record the patient-to-ground leakage for the following conditions:

Test Description 	S1: DPDT		S2: SPDT		S3: SPDT		S4: SPDT		Maximum Limits (uA)	
	Polarity		Neutral		Ground		Test Point			
	a) Normal b) reverse		a) Closed b) Open		a) Closed b) Open		a) Internal b) TP1			
	Position		Position		Position		Position			
	a	b	a	b	a	b	a	b	EN/IEC	UL
Patient to Ground Leakage Current Measurements: LEADS TP1 connected to LEADS (all LEADS connected together).										
Polarity: Normal Neutral: Normal (Closed) Ground: Normal (Closed)	X		X		X			X	10	10
Polarity: Normal Neutral: Open Ground: Normal (Closed)	X			X	X			X	50	50
Polarity: Normal Neutral: Normal (Closed) Ground: Open	X		X			X		X	50	50
Polarity: Reverse Neutral: Normal (Closed) Ground: Open		X	X			X		X	50	50
Polarity: Reverse Neutral: Open Ground: Normal (Closed)		X		X	X			X	50	50
Polarity: Reverse Neutral: Normal (Closed) Ground: Normal (Closed)		X	X		X			X	50	50

Figure 9- 2. Patient to Ground leakage test connection diagram and switch settings

## Patient-to-Line Leakage for US1, US2 and TOCO (Type BF applied parts)

1. Connect the Ultrasound test body to monitors front panel US1, and/or US2.
2. Connect a tocotransducer test body to the monitor's front panel **UA** input.

Note: Refer below table to connect the applicable Type BF parts specific for each model.

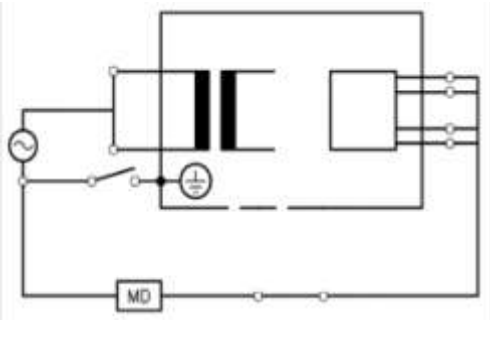
Model →	171	172	173	174
Type of Connectors to be Shorted for the Leakage test for each of the Model	US1 (BF)	US1 (BF)	US1 (BF)	US1 (BF)
	-----	US2 (BF)	-----	US2 (BF)
	TOCO (BF)	TOCO (BF)	TOCO (BF)	TOCO (BF)

3. Configure a leakage tester to perform a patient leakage test. Refer Figure 9-3 as shown below for the Safety Tester connection and switch details.
4. Turn ON the monitor using the monitor's On/Standby button.
5. Verify the following:
  - Normal Condition: <50  $\mu$ A
  - Single Fault Condition: <50  $\mu$ A
 (132–253 VAC, or at the line voltage at your facility +10%)
6. Record the patient-to-line leakage for the following conditions:

Test Description 	S1: DPDT		S2: SPDT		S3: SPDT		S4: SPDT		Maximum Limits (uA)		
	Polarity		Neutral		Ground		Test Point				
	a	b	a	b	a	b	a	b	EN/IEC	UL	
a) Normal b) reverse			a) Closed b) Open		a) Closed b) Open		a) Internal b) TP1				
Position			Position		Position		Position				
Patient Leakage Current Measurements: LEADS TP1 connected to LEADS (all LEADS connected together).											
Polarity: Normal Neutral: Open Ground: Normal (Closed)	X				X	X			X	50	50
Polarity: Reverse Neutral: Open Ground: Normal (Closed)		X			X	X			X	50	50

Figure 9-3. Patient to Line leakage test connection diagram and switch settings



## Patient-to-Ground Leakage for FECG and IUP (Type CF applied parts)

1. Connect an FECG test body to the monitor's front panel FECG input.
2. Connect an IUP test body to the monitor's front panel UA input.

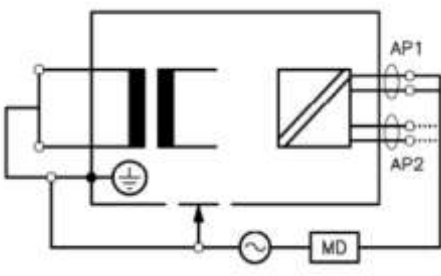
Note: Refer below table to connect the applicable Type CF parts specific for each model.

Model →	171	172	173	174
Type of Connectors to be Shorted for the Leakage test for each of the Model	-----	-----	-----	-----
	-----	-----	FECG (CF)	FECG (CF)
	-----	-----	IUP (CF)	IUP (CF)

3. Configure a leakage tester to perform a patient leakage test. Refer Figure 9-4 as shown below for the Safety Tester connection and switch details.
4. Turn ON the monitor using the monitor's On/Standby button.
5. Verify the following:
  - Normal Condition: <10  $\mu$ A
  - Single Fault Condition: <50  $\mu$ A
 (132–253 VAC, or at the line voltage at your facility +10%)
6. Record the patient-to-line leakage for the following conditions:

Maintenance: Preventative Maintenance Inspection

Test Description 	S1: DPDT		S2: SPDT		S3: PDT		S4: SPDT		Maximum Limits (uA)	
	Polarity		Neutral		Ground		Test Point			
	a) Normal b) reverse		a) Closed b) Open		a) Closed b) Open		a) Internal b) TP1			
	Position		Position		Position		Position		EN/IEC	UL
a	b	a	b	a	b	a	b			
Patient to Ground Leakage Current Measurements: LEADS TP1 connected to LEADS (all LEADS connected together).										
Polarity: Normal		X		X		X		X	10	10
Neutral: Normal (Closed)										
Ground: Normal (Closed)										
Polarity: Normal		X			X	X		X	50	50
Neutral: Open										
Ground: Normal (Closed)										
Polarity: Normal		X		X			X	X	50	50
Neutral: Normal (Closed)										
Ground: Open										
Polarity: Reverse			X	X			X	X	50	50
Neutral: Normal (Closed)										
Ground: Open										
Polarity: Reverse			X		X	X		X	50	50
Neutral: Open										
Ground: Normal (Closed)										
Polarity: Reverse			X	X		X		X	50	50
Neutral: Normal (Closed)										
Ground: Normal (Closed)										

Figure 9-4. Patient to Ground leakage test connection diagram and switch settings

### Patient-to-Line Leakage for FECG and IUP (Type CF applied parts)

1. Connect an FECG test body to the monitor's front panel FECG input.
2. Connect an IUP test body to the monitor's front panel UA input.

Note: Refer below table to connect the applicable Type CF parts specific for each model.

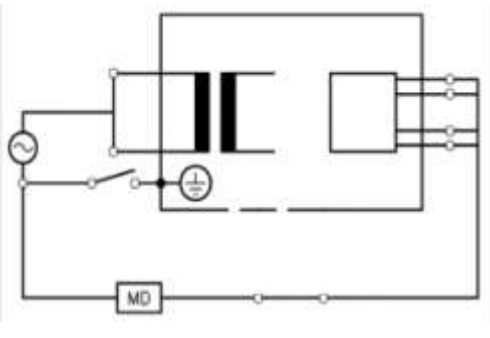
Model →	171	172	173	174
Type of Connectors to be Shorted for the Leakage test for each of the Model	-----	-----	-----	-----
	-----	-----	FECG (CF)	FECG (CF)
	-----	-----	IUP (CF)	IUP (CF)

3. Configure a leakage tester to perform a patient leakage test. Refer Figure 9-5 as shown below for the Safety Tester connection and switch details.
4. Turn ON the monitor using the monitor's On/Standby button.
5. Verify the following:
  - Normal Condition: <50 µA
  - Single Fault Condition: <50 µA (132–253 VAC, or at the line voltage at your facility +10%)
6. Record the patient-to-line leakage for the following conditions:

Test Description 	S1: DPDT		S2: SPDT		S3: SPDT		S4: SPDT		Maximum Limits (uA)  EN/IEC    UL	
	Polarity		Neutral		Ground		Test Point			
	a) Normal b) reverse		a) Closed b) Open		a) Closed b) Open		a) Internal b) TP1			
	Position		Position		Position		Position			
	a	b	a	b	a	b	a	b		
Patient Leakage Current Measurements: LEADS TP1 connected to LEADS (all LEADS connected together).										
Polarity: Normal Neutral: Open Ground: Normal (Closed)	X			X	X			X	50	50
Polarity: Reverse Neutral: Open Ground: Normal (Closed)		X		X	X			X	50	50

Figure 9-5. Patient to Line leakage test connection diagram and switch settings



# Chapter 10

## Specifications

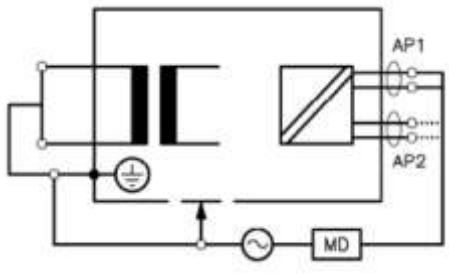
This section contains a detailed list of the technical specifications for the 170 Series Monitor.

This chapter lists specifications for the following:

General Monitor .....	10-2
Operating Modes .....	10-3
Strip Chart Recorder .....	10-4

# General Monitor

**Table 10-1. General Monitor Technical Specifications**

Category	Technical Specifications	
<b>Power Requirements</b> Nominal Line Voltage: Line Frequency: Power Consumption (maximum): Monitor DC Input:	100–230 VAC 50/60 Hz (operates over 47–63 Hz) ≤30 VA 12 Vdc at 2.5 A	
<b>Physical Characteristics</b> Height: Width: Depth: Weight:	5.75 in (14.6 cm) 16.75 in (42.5 cm) 10.0 in (25.4 cm) 8 lbs (3.6 kg) approx.	
<b>Environmental Conditions</b> Monitor: Ambient Temperature: Relative Humidity: Strip Chart Paper <sup>a</sup> : Ambient Temperature: Relative Humidity:	<b>Operating</b> 50°F to 104°F (10°C to 40°C) 10% to 75%, non-condensing 50°F to 104°F (10°C to 40°C) 30% to 70%, non-condensing	<b>Storage</b> 14°F to 131°F (–10°C to 55°C) 10% to 90%, non-condensing < 80°F (< 26.5°C) 45% to 65%, non-condensing
<b>Certification</b> UL-2601.1:  CUL:	Designed to meet UL-2601.1 Medical electrical equipment classified by Underwriter’s Laboratories, Inc., with respect to fire, shock, and mechanical hazards in accordance with UL-2601.1. Classified with respect to electric shock, fire, mechanical, and other specified hazards only, in accordance with CAN/CSA C22.2 No. 601.1	



<sup>a</sup> Paper operating environmental conditions are for a period of less than one month. Paper storage environmental conditions are for extended storage.

# Operating Modes

<b>Table 10-2. Operating Mode Specifications</b>		
<p><b>FECG Mode</b>                      Technique:                      Heart Rate Counting Range:                      Heart Rate Resolution:                      Artifact Elimination:                      Countable Input Signal Range:                      Offset Voltage Tolerance (Differential):                      Maximum Common Mode Voltage:                      Preamplifier Bandwidth:                      Common Mode Rejection:                          Balanced:                          Unbalanced 5kΩ RA or LA:                      Input Equivalent Noise:                      Input Impedance:                          Differential:                          Common Mode:                      Mains Frequency Rejection:                      Leakage Current:                      Isolation, Mains-to-Patient:</p>	<p>Peak detecting, beat-to-beat cardi tachometer                      30–240 BPM                      ±1 BPM                      Selectable, ±25 BPM artifact rejection                      15 μV to 2 mV peak-to-peak                      ±300 mVdc maximum                      20 V peak-to-peak                      1–100 Hz                      &gt; 120 dB at mains frequency, with patient cable                      &gt; 110 dB at mains frequency                      &lt; 10 μV peak-to-peak                      &gt; 10 MΩ                      &gt; 20 MΩ                      &gt; 40 dB                      &lt; 60 μA at 254 VAC, electrically isolated                      &gt; 4 kVAC</p>	
<p><b>Ultrasound Mode</b>                      Technique:                      Transducer Type:                      Pulse Repetition Frequency:                      Pulse Duration:                      Transmitter Frequency:                      Spatial-Average Temporal Average Intensity:                      Focal 20 dB Beam Area:                      Peak Instantaneous Intensity:                      Peak-Negative Acoustic Pressure:                      Heart Rate Counting Range:                      Leakage Current:</p>	<p>Pulsed Doppler with autocorrelation processing                      9-crystal                      2 kHz (all modes)                      92 μs                      1.151 MHz                      Isata &lt; 5 mW/cm<sup>2</sup>                      16.6 cm<sup>2</sup>, at a range = 7 cm                      1.8 mW/cm<sup>2</sup>                      p &lt; 10.0 kPa                      50–210 BPM                      Complies with IEC 60601-2-49</p>	
<p><b>Uterine Activity Mode</b>                      Range:                      Resolution:                      Bandwidth:                      Excitation Voltage:                      Zero Set Temperature Drift:                      Leakage Current:</p>	<p><b>Strain Gauge</b>                      0–100 mmHg                      1 mmHg                      dc to 3Hz                      +4.0 Vdc                      &lt; 0.1 mmHg/°C (0.013 kPa/°C), excluding transducer                      Complies with IEC 60601-2-49</p>	<p><b>Tocotransducer</b>                      0–100 relative units                      1 relative unit                      dc to 0.5 Hz</p>

# Strip Chart Recorder

**Table 10-3. Strip Chart Recorder Technical Specifications**

<b>Heart Rate Scale</b>	<b>Domestic</b>	<b>International</b>
Chart Width: Scaling: Range: Resolution:	7 cm 30 BPM/cm 30–240 BPM 1 BPM	8 cm 20 BPM/cm 50–210 BPM 1 BPM
<b>Uterine Activity Scale</b>	<b>Strain Gauge</b>	<b>Tocotransducer</b>
Chart Width: Scaling: Range: Resolution:	4 cm 25 mmHg/cm 0–100 mmHg 1 mmHg	4 cm 25 relative units/cm 0–100 relative units 1 relative unit
<b>Recorder Drive</b>		
Speeds: Speed Accuracy:	1, 2, and 3 cm/min ±1 %	

**NOTE:** Specifications are subject to change without notice.



# Chapter 11

## Parts Lists

This chapter of the manual provides parts lists and block diagrams.

**NOTE:** GE makes every effort possible to provide the most up-to-date reference documentation for your Corometrics equipment. However, in special cases involving field-installed upgrades, a drawing or parts list in this manual may not reflect the revision level of your unit's subassemblies. When discrepancies are found, contact the GE Service Department at one of the numbers found on the back cover of this manual.



## 2000268-188, Model 171 Final Assembly

Table 11-1. Model 171 Final Assembly, 200268-188			
Item Number	Part Number	Description	Qty
1	2000281-001	ENCL BOTTOM SHIELDED 170 SERIES	1
2	15451AA	COVER SPEAKER	1
3	140173	FOOT RUBBER .50D .26H	4
4	15222AA	BRG DRAWER	2
5	15212AA	PIN BEARING-170	2
6	15200A	ASSY ROLLER	1
7	250096	BEARING,FLANGED,.187 BORE	2
8	11717AA	ROLLER GEAR-120REC	1
9	15207A	ASSY DRAWER, WELDED	1
10	15224AA	SPACER DRAWER	1
11	15223AA	PLASTIC 9 CM PARTITION	1
12	15231A	ASSY PCB SENSOR BOARD	1
13	2000147-001	SENSOR INSULATOR 170 SERIES	1
14	250099	SPRING COMPRESSION,.24 OD,,.38L	1
15	2000222-001	SPRING CPRSN .3 OD .022WIRE SS	2
16	15136A	MOTOR STEPPER ASSY	1
17	15202AA	MOUNT MOTOR	1
18	15201AA	PLATE PC MOUNTING	1
19	2000133-001	PRINthead 8 DOTS/MM 216MM WIDE	1
20	15203AA	PLATE HEAD MOUNTING	1
21	2000223-001	SPRING CPRSN .56L .240 OD .024 WIRE	2
22	15204AA	BRACKET HEADSTOP	1
23	280201	STANDOFF, 1/4HEX, 1/8SL, 4-4, 0 THD	2
24	281501	NUT, HEX, 4-40, 5/64 X 1/4	2
25	2000234-001	CABLE ASSY RIBBON RECORDER 170 SERIES	1
26	2000235-001	CABLE ASSY SPEAKER WIRE 170 SERIES	1
27	2000146-001	CLIP GROUND	2

Table 11-1. Model 171 Final Assembly, 200268-188 (Continued)			
Item Number	Part Number	Description	Qty
28	2000243-004	PCB MAIN SINGLE U/S COMPLETE	1
29	284105	SCREW #4 PH 1/4L THD FORM	7
30	284072	SCR 4-40 PH 5/16L PHL LL STRIP	29
31	284285	SCR 4-40 FH UNDERCUT 3/16 PHIL 2PS NYLON PATCH	4
32	289516	SCR M3X5 PH PHIL ZP W/NYLOK PATCH	4
33	2000220-001	SCR PH #2 1/2L PHIL ZPS PLASTITE	2
34	2000221-001	SCR #4 PH 1/4L TYPE F PHIL ZPS	4
35	2000142-001	SPRING FRONT GROUND	1
36	15301A	ASSY PCB DISPLAY BOARD	1
37	15461AA	GASKET REAR PANEL	1
38	15453CA	PAD PRINT, TOP COVER-MODEL175	1
39	15323BA	KYBD MEMBRANE US1	1
40	15324BA	LABEL DISPLAY OVERLAY US1	1
41	14943AA	CLIP, SPEAKER,	2
42	2000178-001	PLUG CALL LIGHT	1
43	2000359-001	STANDOFF M-F 440 1IN LG ALUM	1
44	2000246-001	PLUG TELEMETRY	1
45	2000186-001	PLUG NICOLAY CONN	1
46	2000240-001	LABEL CUSTOM REAR PANEL OVERLAYS 170	1
47	284031	SCR 4-40 BH 1/4 LG SLTD N YLON	2
49	608030	CABLE MOUNT ADHESIVE BACK	2
50	608036	TYRAPS CABLE TIES	2
51	7714AAT	POWER SUPPLY 12V 30W EXTERNAL SUPPLY	1
52	600028	ASSY LINE CORD IEC	1
55	2000890-001	PACKAGING RIGHT CAP 170 SERIES	1
56	2000891-001	PACKAGING LEFT CAP 170 SERIES	1
57	2000892-001	PACKAGING BOXES 170 SERIES	1

<b>Table 11-1. Model 171 Final Assembly, 200268-188 (Continued)</b>			
<b>Item Number</b>	<b>Part Number</b>	<b>Description</b>	<b>Qty</b>
58	2000893-001	PACKAGING SLOTTED TRAY 170 SERIES	1
59	13984AA	LBL PACKING LIST 340	1
60	2000555-001	SHLD SPEAKER - 170	1
61	410066	POLY BAG 23X26X.006	1
62	410097	TAPE SHIPPING 3IN WIDE	4
63	4281CA	LBL SERIAL# UL APPV'D-155	1
64	4281DA	LABEL C-UL HAZZARD TAG120 SERIES	1

## 2000268-189, Model 172 Final Assembly

Item Number	Part Number	Description	Qty
1	2000281-001	ENCL BOTTOM SHIELDED 170 SERIES	1
2	15451AA	COVER SPEAKER	1
3	140173	FOOT RUBBER .50D .26H	4
4	15222AA	BRG DRAWER	2
5	15212AA	PIN BEARING-170	2
6	15200A	ASSY ROLLER	1
7	250096	BEARING FLANGED .187 BORE	2
8	11717AA	ROLLER GEAR-120REC	1
9	15207A	ASSY DRAWER WELDED	1
10	15224AA	SPACER DRAWER	1
11	15223AA	PLASTIC 9 CM PARTITION	1
12	15231A	ASSY PCB SENSOR BOARD	1
13	2000147-001	SENSOR INSULATOR 170 SERIES	1
14	250099	SPRING COMPRESSION .24 OD .38L	1
15	2000222-001	SPRING CPRSN .3 OD .022WIRE SS	2
16	15136A	MOTOR STEPPER ASSY	1
17	15202AA	MOUNT MOTOR	1
18	15201AA	PLATE PC MOUNTING	1
19	2000133-001	PRINthead 8 DOTS/MM 216MM WIDE	1
20	15203AA	PLATE HEAD MOUNTING	1
21	2000223-001	SPRING CPRSN .56L .240 OD .024 WIRE	2
22	15204AA	BRACKET HEADSTOP	1
23	280201	STANDOFF 1/4HEX 1/8SL 4-4 0 THD	2
24	281501	NUT HEX 4-40 5/64 X 1/4	2
25	2000234-001	CABLE ASSY RIBBON RECORDER 170 SERIES	1
26	2000235-001	CABLE ASSY SPEAKER WIRE 170 SERIES	1
27	2000146-001	CLIP GROUND	2

Table 11-2. Model 172 Final Assembly, 2000268-189 (Continued)			
Item Number	Part Number	Description	Qty
28	15269E	PCB ASSY MAIN PCB DUAL US COMP	1
29	284105	SCREW #4 PH 1/4L THD FORM	7
30	284072	SCR 4-40 PH 5/16L PHL LL STRIP	29
31	284285	SCR 4-40 FH UNDERCUT 3/16 PHIL 2PS NYLON PATCH	4
32	289516	SCR M3X5 PH PHIL ZP W/NYLOK PATCH	4
33	2000220-001	SCR PH #2 1/2L PHIL ZPS PLASTITE	2
34	2000221-001	SCR #4 PH 1/4L TYPE F PHIL ZPS	6
35	2000142-001	SPRING FRONT GROUND	1
36	15301A	ASSY PCB DISPLAY BOARD	1
37	15461AA	GASKET REAR PANEL	1
38	15453AA	PAD PRINT TOP COVER-MODEL 170	1
39	15323AA	KYBD MEMBRANE US2	1
40	15324AA	LABEL DISPLAY OVERLAY US2	1
41	14943AA	CLIP SPEAKER	2
42	2000178-001	PLUG CALL LIGHT	1
43	2000359-001	STANDOFF M-F 440 1IN LG ALUM	1
44	2000246-001	PLUG TELEMETRY	1
46	2000240-001	LABEL CUSTOM REAR PANEL OVERLAYS 170	1
47	284031	SCR 4-40 BH 1/4 LG SLTD N YLON	2
49	608030	CABLE MOUNT ADHESIVE BACK	2
50	608036	TYRAPS CABLE TIES	2
51	7714AAT	POWER SUPPLY 12V 30W EXTERNAL SUPPLY	1
52	600028	ASSY LINE CORD IEC	1
55	2000890-001	PACKAGING RIGHT CAP 170 SERIES	1
56	2000891-001	PACKAGING LEFT CAP 170 SERIES	1
57	2000892-001	PACKAGING BOXES 170 SERIES	1
58	2000893-001	PACKAGING SLOTTED TRAY 170 SERIES	1

<b>Table 11-2. Model 172 Final Assembly, 2000268-189 (Continued)</b>			
<b>Item Number</b>	<b>Part Number</b>	<b>Description</b>	<b>Qty</b>
59	13984AA	LBL PACKING LIST 340	.0001
60	2000555-001	SHLD SPEAKER - 170	1
61	410066	POLY BAG 23X26X.006	1
62	410097	TAPE SHIPPING 3IN WIDE	4
63	4281CA	LBL SERIAL# UL APPV'D-155	1
64	4281DA	LABEL C-UL HAZZARD TAG120 SERIES	1

## 2001972-037, Model 173 Final Assembly

Find Num	Item Number	Item Description	Qty
1	2007385-001	ENCL ,BOTTOM, SHIELDED-170 SERIES	1
2	15451AA	COVER SPEAKER	1
3	140173	FOOT RUBBER .50D .26H	4
4	15222AA	BRG DRAWER	2
5	15212AA	PIN BEARING-170	2
6	15200A	ASSY ROLLER	1
7	250096	BEARING,FLANGED,.187 BORE,	2
8	11717AA	ROLLER GEAR-120REC,	1
9	15207A	ASSY DRAWER, WELDED	1
10	15224AA	SPACER DRAWER	1
11	15223AA	PLASTIC 9 CM PARTITION	1
12	15231A	ASSY PCB SENSOR BOARD	1
13	2000147-001	SENSOR INSULATOR 170 SERIES	1
14	250099	SPRING COMPRESSION,.24 OD,,.38L	1
15	2000222-001	SPRING CPRSN .3 OD .022WIRE SS	2
16	15136A	MOTOR STEPPER ASSY	1
17	15202AA	MOUNT MOTOR	1
18	15201AA	PLATE PC MOUNTING	1
19	2000133-001	PRINthead 8 DOTS/MM 216MM WIDE	1
20	15203AA	PLATE HEAD MOUNTING	1
21	2000223-001	SPRING CPRSN .56L .240 OD .024 WIRE	2
22	15204AA	BRACKET HEADSTOP	1
23	2002433-001	STANDOFF 1/4 HEX SWAGE 4-40	2
24	281501	NUT,HEX,4-40,3/32 X 1/4	2
25	2000234-001	CABLE ASSY RIBBON RECORDER 170 SERIES	1
26	2000235-001	CABLE ASSY SPEAKER WIRE 170 SERIES	1
27	2000146-001	CLIP GROUND	2
28	2000324-007	PCB ASSY MAIN FECG/PRS COMP V3.20-173	1

<b>Table 11-3. Model 173 Final Assembly, 2001972-037 (Continued)</b>			
<b>Find Num</b>	<b>Item Number</b>	<b>Item Description</b>	<b>Qty</b>
29	284105	SCREW #4 PH 1/4L THD FORM	7
30	284072	SCR,4-40,PH,5/16L,PHL,LL,STRIP	33
31	284285	SCR,4-40,FH UNDERCUT 3/16,PHIL 2PS NYLON PATCH	4
32	289516	SCR,M3X5,PH,PHIL,ZP,W/NYLOK PATCH	4
33	2000220-001	SCR PH #2 , 1/2L PHIL ZPS PLASTITE	2
34	2000221-001	SCR #4 PH 1/4L TYPE F PHIL ZPS	2
35	2001894-001	SPRING FRONT GROUND-173	1
36	15301A	ASSY PCB DISPLAY BOARD	1
37	15461AA	GASKET REAR PANEL	1
38	2004993-002	PAD PRINT, TOP COVER, MODEL 173	1
39	15323AA	KYBD MEMBRANE US2	1
40	15324CA	LABEL DISPLAY OVERLAY FECG MODEL 173	1
41	14943AA	CLIP, SPEAKER, ACCESS HOME MONITOR	2
42	2000178-001	PLUG CALL LIGHT	1
43	2000359-001	STANDOFF M-F 440 1IN LG ALUM	1
44	2000246-001	PLUG TELEMETRY	1
45	15287AP	PCB ASSY FECG/UA BOARD-PURCH	1
46	2003930-001	LABEL REAR PANEL 170 SERIES	1
47	284031	SCR,4-40,BH,1/4 LG,SLTD,N,YLON	2
49	608030	CABLE MOUNT,ADHESIVE BACK,	2
50	608036	TYRAPS,CABLE TIES	2
51	7714AAT	POWER SUPPLY 12V 30W EXTERNAL SUPPLY	1
55	2000890-001	PACKAGING RIGHT CAP, 170 SERIES	1
56	2000891-001	PACKAGING LEFT CAP, 170 SERIES	1
57	2000892-001	PACKAGING BOXES , 170 SERIES	1
58	2000893-001	PACKAGING SLOTTED TRAY, 170 SERIES	1
59	410010	PACKING LIST ENVELOPES,	1
60	2000555-001	SHLD SPEAKER - 170	1
61	410066	POLY BAG 23X26X.006,	1



<b>Table 11-3. Model 173 Final Assembly, 2001972-037 (Continued)</b>			
<b>Find Num</b>	<b>Item Number</b>	<b>Item Description</b>	<b>Qty</b>
62	410097	TAPE, SHIPPING, 3IN WIDE,	4
63	4281DA	LABEL, C-UL HAZZARD TAG120, SERIES	1
64	4281EA	LABEL SERIAL NUMBER, UL & MODEL NUMBER	1
65	408230-008	LABEL CE MARK	1
66	160019	SEALANT MED BLUE,	0
67	2000741-001	LABEL TRANS & STOR COND 170 SERIES	1

## 2001972-038, Model 174 Final Assembly

Find Num	Item Number	Item Description	Qty
1	2007385-001	ENCL ,BOTTOM, SHIELDED-170 SERIES	1
2	15451AA	COVER SPEAKER	1
3	140173	FOOT RUBBER .50D .26H	4
4	15222AA	BRG DRAWER	2
5	15212AA	PIN BEARING-170	2
6	15200A	ASSY ROLLER	1
7	250096	BEARING,FLANGED,.187 BORE,	2
8	11717AA	ROLLER GEAR-120REC,	1
9	15207A	ASSY DRAWER, WELDED	1
10	15224AA	SPACER DRAWER	1
11	15223AA	PLASTIC 9 CM PARTITION	1
12	15231A	ASSY PCB SENSOR BOARD	1
13	2000147-001	SENSOR INSULATOR 170 SERIES	1
14	250099	SPRING COMPRESSION,.24 OD,,.38L	1
15	2000222-001	SPRING CPRSN .3 OD .022WIRE SS	2
16	15136A	MOTOR STEPPER ASSY	1
17	15202AA	MOUNT MOTOR	1
18	15201AA	PLATE PC MOUNTING	1
19	2000133-001	PRINthead 8 DOTS/MM 216MM WIDE	1
20	15203AA	PLATE HEAD MOUNTING	1
21	2000223-001	SPRING CPRSN .56L .240 OD .024 WIRE	2
22	15204AA	BRACKET HEADSTOP	1
23	2002433-001	STANDOFF 1/4 HEX SWAGE 4-40	2
24	281501	NUT,HEX,4-40,3/32 X 1/4	2
25	2000234-001	CABLE ASSY RIBBON RECORDER 170 SERIES	1
26	2000235-001	CABLE ASSY SPEAKER WIRE 170 SERIES	1
27	2000146-001	CLIP GROUND	2
28	2000973-005	PCB ASSY MAIN FECG/PRS DUAL U/S-174	1

<b>Table 11-4. Model 174 Final Assembly, 2001972-038 (Continued)</b>			
<b>Find Num</b>	<b>Item Number</b>	<b>Item Description</b>	<b>Qty</b>
29	284105	SCREW #4 PH 1/4L THD FORM	7
30	284072	SCR,4-40,PH,5/16L,PHL,LL,STRIP	33
31	284285	SCR,4-40,FH UNDERCUT 3/16,PHIL 2PS NYLON PATCH	4
32	289516	SCR,M3X5,PH,PHIL,ZP,W/NYLOK PATCH	4
33	2000220-001	SCR PH #2 , 1/2L PHIL ZPS PLASTITE	2
34	2000221-001	SCR #4 PH 1/4L TYPE F PHIL ZPS	2
35	2001894-001	SPRING FRONT GROUND-173	1
36	15301A	ASSY PCB DISPLAY BOARD	1
37	15461AA	GASKET REAR PANEL	1
38	2004993-004	PAD PRINT, TOP COVER, MODEL 174	1
39	15323AA	KYBD MEMBRANE US2	1
40	15324DA	LABEL DISPLAY OVERLAY FECG MODEL 174	1
41	14943AA	CLIP, SPEAKER, ACCESS HOME MONITOR	2
42	2000178-001	PLUG CALL LIGHT	1
43	2000359-001	STANDOFF M-F 440 1IN LG ALUM	1
44	2000246-001	PLUG TELEMETRY	1
45	2000952-001	PCB DUAL U/S FECG-174	1
46	2003930-001	LABEL REAR PANEL 170 SERIES	1
47	284031	SCR,4-40,BH,1/4 LG,SLTD,N,YLON	2
49	608030	CABLE MOUNT,ADHESIVE BACK,	2
50	608036	TYRAPS,CABLE TIES	2
51	7714AAT	POWER SUPPLY 12V 30W EXTERNAL SUPPLY	1
55	2000890-001	PACKAGING RIGHT CAP, 170 SERIES	1
56	2000891-001	PACKAGING LEFT CAP, 170 SERIES	1
57	2000892-001	PACKAGING BOXES , 170 SERIES	1
58	2000893-001	PACKAGING SLOTTED TRAY, 170 SERIES	1
59	410010	PACKING LIST ENVELOPES,	1
60	2000555-001	SHLD SPEAKER - 170	1
61	410066	POLY BAG 23X26X.006,	1

<b>Table 11-4. Model 174 Final Assembly, 2001972-038 (Continued)</b>			
<b>Find Num</b>	<b>Item Number</b>	<b>Item Description</b>	<b>Qty</b>
62	410097	TAPE, SHIPPING, 3IN WIDE,	4
63	4281DA	LABEL, C-UL HAZZARD TAG120, SERIES	1
64	4281EA	LABEL SERIAL NUMBER, UL & MODEL NUMBER	1
65	408230-008	LABEL CE MARK	1
66	160019	SEALANT MED BLUE,	0
67	2000741-001	LABEL TRANS & STOR COND 170 SERIES	1

## 2264AAX, Button-Style Nautilus Tocotransducer Assembly Parts List (5-ft cord)

Table 11-5. 2264AAX, Button-Style Nautilus Tocotransducer Assembly Parts List (5-ft cord)			
Find Num	Item Number	Item Description	Qty
1	14894A	TOCO CBL ASSY OB 5' LG,WATERTIGHT	1
4	15079AA	MARKING CASE BUTTON TOP-TOCO,WATERTIGHT	1
6	14790B	CASE BOTTOM ASSY TOCO OB,WATERTIGHT	1
7	14594AA	FLAT SEAL TOCO U/S WATERTIGHT XDCR	1
8	14640AA	CABLE MOUNTING NUT TOCO US WATERTIGHT	1
9	284106	SCR,4-40,PH,5/16L,W/SEAL,PHIL,SS,LL	5
10	14638AA	SCREW CAP WATERTIGHT	4
11	15254AA	SCREW CAP FLAT MARING,WATERTIGHT SCUCERS	1
12	7529DA	KNOB,TOCO-KNOB TOP XDCR K,IT116	1
13	281260	SCR SET 2-56 1/8L OVAL PT SS	1
17	8974AA	ABD STRAP-BUTTON STYLE BE,LT	1
18	14855AA	WARNING TAG CABLES WATERTIGHT	1
19	13658FA	LBL,CE,CAUTION IP68,WATERTIGHT XDCR	1
20	440011	LABEL,2.25X.75,SELF-LAM,WHITE	1
21	4991AA	ACC PACKER,	1
22	410069	PACK MATERIAL ST	1
23	410112	BAG,AIRCAP, 6 X 8-1/2,	1
24	15264AA	SHIPPING LBL, 2264AAX WATERTIGHT XDUCERS	1
30	13434AA	LBL,SHIP CRTN CE MARK-VAR,	1
31	160034	LOCTITE,SUPERBONDE,	0
32	162004	OIL,SILICONE,3ML TUBE,	0

# 5700GAX, Button-Style Nautilus Ultrasound Transducer Assembly Parts List (5-ft cord)

Find Num	Item Number	Item Description	Qty
1	14895A	U/S CBL ASSY 5' OB,WATERTIGHT	1
4	15081AA	MARKING,CASE BUTTON TOP U/S,WATERTIGHT	1
6	14791A	CASE BOTTOM ASSY U/S,WATERTIGHT	1
7	14594AA	FLAT SEAL TOCO U/S WATERTIGHT XDRC	1
8	14640AA	CABLE MOUNTING NUT TOCO US WATERTIGHT	1
9	284106	SCR,4-40,PH,5/16L,W/SEAL,PHIL,SS,LL	5
10	2008660-001	SCR CAP, TOCO, U/S	4
11	15254AA	SCREW CAP FLAT MARING,WATERTIGHT SCUCERS	1
12	7529EA	KNOB TOP, NAUTILUS WATERTIGHT TOCO	1
13	281260	SCR SET 2-56 1/8L OVAL PT SS	1
17	8974AA	ABD STRAP-BUTTON STYLE BE,LT	1
18	14855AA	WARNING TAG CABLES WATERTIGHT	1
19	13658FA	LBL,CE,CAUTION IP68,WATERTIGHT XDRC	1
20	440011	LABEL,2.25X.75,SELF-LAM,WHITE	1
22	4991AA	ACC PACKER,	1
23	410069	PACK MATERIAL ST	1
24	410113	BAG,AIRCAP, 8 X 11-1/2,	1
25	15265AA	SHIPPING LBL, 5700GAX WATERTIGHT XDUCERS	1
31	13434AA	LBL,SHIP CRTN CE MARK-VAR	1
32	160103	ADHESIVE,454	0
33	162004	OIL,SILICONE,3ML TUBE	0
34	OBSER-003	ADDENDUM,WATERTIGHT XDRC	1
35	14957AA	WARNING LABEL KIT U/S TOCO WATERTIGHT	1
36	14897AA	INSTRUCTION SHEET,WATERTIGHT TOCO	1
37	474045	NETWORK,RES,SIP,47 OHM,9,RES	1

# 5700KAX, Loop-Style Nautilus Ultrasound Transducer Assembly Parts List (5-ft cord)

Table 11-7. 5700LAX, Loop-Style Nautilus Ultrasound Transducer Assembly Parts List (5-ft cord)			
Find Num	Item Number	Item Description	Qty
1	14895A	U/S CBL ASSY 5' OB,WATERTIGHT	1
5	15082AA	MKG CASE TOP U/S,WATERTIGHT	1
6	14791A	CASE BOTTOM ASSY U/S,WATERTIGHT	1
7	14594AA	FLAT SEAL TOCO U/S WATERTIGHT XDCR	1
8	14640AA	CABLE MOUNTING NUT TOCO US WATERTIGHT	1
9	284106	SCR,4-40,PH,5/16L,W/SEAL,PHIL,SS,LL	5
10	2008660-001	SCR CAP, TOCO, U/S	4
11	15254AA	SCREW CAP FLAT MARING,WATERTIGHT SCUCERS	1
13	281260	SCR SET 2-56 1/8L OVAL PT SS	1
16	7514DA	ABDOMINAL STRAP-BLUE	1
18	14855AA	WARNING TAG CABLES WATERTIGHT	1
19	13658FA	LBL,CE,CAUTION IP68,WATERTIGHT XDCR	1
20	440011	LABEL,2.25X.75,SELF-LAM,WHITE	1
22	4991AA	ACC PACKER	1
23	410069	PACK MATERIAL ST	1
24	410113	BAG,AIRCAP, 8 X 11-1/2	1
28	15265DA	SHIPPING LBL, 5700KAX WATERTIGHT XDUCERS	1
31	13434AA	LBL,SHIP CRTN CE MARK-VAR	1
32	160103	ADHESIVE,454	0
33	162004	OIL,SILICONE,3ML TUBE	0
34	OBSER-003	ADDENDUM,WATERTIGHT XDCR	1
35	14957AA	WARNING LABEL KIT U/S TOCO WATERTIGHT	1
36	14897AA	INSTRUCTION SHEET,WATERTIGHT TOCO	1
37	474045	NETWORK,RES,SIP,47 OHM,9,RES	1

## 2264DAX, Loop-Style Nautilus Tocotransducer Assembly Parts List (5-ft cord)

Table 11-8. 2264, Loop-Style Nautilus Tocotransducer Assembly Parts List (5-ft cord)			
Find Num	Item Number	Item Description	Qty
1	14894A	TOCO CBL ASSY OB 5' LG,WATERTIGHT	1
5	15080AA	MARKING CASE TOP TOCO,WATERTIGHT	1
6	14790B	CASE BOTTOM ASSY TOCO OB,WATERTIGHT	1
7	14594AA	FLAT SEAL TOCO U/S WATERTIGHT XDCR	1
8	14640AA	CABLE MOUNTING NUT TOCO US WATERTIGHT	1
9	284106	SCR,4-40,PH,5/16L,W/SEAL,PHIL,SS,LL	5
10	14638AA	SCREW CAP WATERTIGHT	4
11	15254AA	SCREW CAP FLAT MARING,WATERTIGHT SCUCERS	1
13	281260	SCR SET 2-56 1/8L OVAL PT SS	1
16	7514CA	ABDOMINAL STRAP-GRAY	1
18	14855AA	WARNING TAG CABLES WATERTIGHT	1
19	13658FA	LBL,CE,CAUTION IP68,WATERTIGHT XDCR	1
20	440011	LABEL,2.25X.75,SELF-LAM,WHITE	1
21	4991AA	ACC PACKER	1
22	410069	PACK MATERIAL ST	1
23	410112	BAG,AIRCAP, 6 X 8-1/2	1
27	15264CA	SHIPPING LBL, 2264CAX WATERTIGHT XDUCERS	1
30	13434AA	LBL,SHIP CRTN CE MARK-VAR	1
31	160034	LOCTITE,SUPERBONDE	0
32	162004	OIL,SILICONE,3ML TUBE	0
227	15264DA	SHIPPING LBL, 2264DAX WATERTIGHT XDUCERS	1



# 1509AAO/BAO, Qwik Connect Plus Legplate Assembly Parts List

Table 11-9. 1509AAO/BAO, Qwik Connect Plus Legplate Assembly Parts List			
Find Num	Item Number	Item Description	Qty
1	2000532-001	CABLE STRAIN RELIEF 8 FEET	1
2	210227	CONTACT,MALE,24AWG,16.5MM,LG	11
3	210180	HALF-SHELL,W/CLAMP,3-5MM	1
4	210181	CLAMP,3-7MM	1
5	210176	RING	1
6	210183	GRIPPER,3-5MM	1
7	210182	SCREW,CLAMP,M 2.6 X 10	2
8	608048	SHRINK TUBING,1/4 BLK,	.021
9	605105	WIRE,#24 STRANDED,GRN,	.125
10	210179	HALF-SHELL,W/TONGUE	1
11	210178	RING,PLASTIC,21.8 X4	1
12	212133	PLUG,12 CKT GREY/BRN,A-D,	1
13	210226	CONTACT,MALE,24AWG,18MM L,G	1
14	2000528-001	COVER INTERFACE CABLE	1
15	2002641-001	O-RING .101 ID, .070THK, 70DUR, SILICONE	1
16	2000529-001	PIN COAX RECEPTACLE	1
17	2000527-001	CABLE BASE INTERFACE	1
18	2000429-003	PCB LEG PLATE BD	1
19	2000208-001	SPRING WIRE,LEG PLATE SNAP .125 STUD	1
20	440011	LABEL,2.25X.75,SELF-LAM,WHITE	1
22	2000595-001	LABEL SHIPPING FOR 1590AAO	1
23	410112	BAG,AIRCAP, 6 X 8-1/2	1
24	605106	WIRE,#24 STRANDED,BLUE	.083
25	2002357-001	SPACER SPRING QWIK CONNECT PLUS	1
26	13658AA	LABEL,CE MARK-ACCESSORIES,WATERPROOF	1

Item	Description	Availability
<b>Corometrics Series 170 Model 171 / 172 / 173 / 174</b>		
<b>Corometrics Series 170 Power Supply.</b>		
2020760-002	Power Supply	Orderable
<b>Corometrics Series 170 Recorder Parts.</b>		
2000223-001	Printhead Springs	Orderable
512018	Door Microswitch	Orderable
2000147-001	Sensor Bd Insulator	Orderable
2000234-001	Printhead Cable Assy	Orderable
250096	Drive Roller Bearings	Orderable
2021595-001	ASSY FRU 170 SERIES PRINthead	Orderable
487710	Optosensor	Orderable
15203AA	Plate Head mounting	Orderable
11717AA		Orderable
15202AA	Motor mounting bracket	Orderable
15136A	Stepper Motor Assy	Orderable
15207A	Drawer Assy (Paper Box - Plastic only)	Orderable
2015527-001	Drive Roller Assy	Orderable
<b>Corometrics Series 170 Label Sets.</b>		
2003930-001	Label Rear Panel for Model 171 / 172 / 173 / 174	Orderable
15324BA	Label Display Overlay for Model 171	Orderable
15324CA	Label Display Overlay for Model 173	Orderable
15324DA	Label Display Overlay for Model 174	Orderable
15324AA	Label Display Overlay for Model 172	Orderable
<b>Corometrics Series 170 Keypads.</b>		
15323AA	Keyboard Membrane Switch for Model 172/173 /174	Orderable
15323BA	Keyboard Membrane Switch for Model 171	Orderable
<b>Corometrics Series 170 Switches / Connectors.</b>		
2003692-001	Dual input connector US / FECG for Model 174 only	Orderable
404579-015	15 pin Telemetry Input Connector J13	Orderable
212174	12 pin US Input Connector Blue / Gray J11&J12	Orderable
212173	12 pin UA Input Connector White J10	Orderable
422255-001	3 pin Power Input Connector J17	Orderable
422256-001	8 pin RJ45 RS232 Connecxtor for RS23#1 and RS232#2	Orderable
212175	FECG Input Connector	Orderable
2000221-001	Screws to fix the connectors to the mainboard	
<b>Corometrics Series 170 Repair-Kit Nautilus Transducer.</b>		
2003661-001	Loop Style Cable Replacement kit, TOCO	Orderable
2011679-001	Kit Nautilus Top Cover replacement for Loop Style US Transducer without Cable	Orderable
2011680-001	Kit Nautilus Top Cover replacement for Buttom Style US Transducer without Cable	Orderable
2003659-001	Loop Style Cable Replacement kit, Ultrasound	Orderable
14594AA	Flat Seal Toco/ US Watertight	Orderable
2003660-001	Button Style Cable Replacement kit, Ultrasound	Orderable
2003662-001	Button Style Cable Replacement kit, TOCO	Orderable
15254AA	Screw plastic cap for TOCO and US Tranc.	Orderable
<b>Corometrics Series 170 Calibration kit.</b>		
2003664-001	Button Style Nautilus TOCO Calibration kit	Orderable
2003663-001	Loop Style Nautilus TOCO Calibration kit	Orderable
<b>Corometrics Series 170 Service Tool.</b>		
1203AAO	Flasher Cable Kit	Orderable
2003005-001	Weight 52.5 Gram	Orderable

<b>Corometrics Series 170 Housing Parts.</b>		
2004993-003	Top Cover for Model 171 ( Please order also bottom Cover 200240-001) The new Top Cover does not fit	Orderable
2004993-001	PAD PRINT, TOP COVER-MODEL 172	Orderable
2004993-002	Top Cover for Model 173 ( Please order also bottom Cover 200240-001) The new Top Cover does not fit	Orderable
2004993-004	Top Cover for Model 174 ( Please order also bottom Cover 200240-001) The new Top Cover does not fit	Orderable
2007385-001	ENCL ,BOTTOM, SHIELDED-170 SERIES	Orderable
15451AA	COVER with SPEAKER	Orderable
<b>Corometrics Series 170 Miscellaneous Parts.</b>		
2000235-001	Speaker Cable Assy	Orderable
15461AA	Gasket on Rear Panel	Orderable
140173		Orderable
418830-001	Battery for time-Keeper RAM	Orderable
2000222-001	Drawer Release Spring	Orderable
2000178-001	Plug Call Light	Orderable
2000186-001	Plug Nicoly	Orderable
2000246-001	Plug Telemetry	Orderable
2000235-002	Speaker Cable Assy	Orderable
<b>Corometrics Series 170 Printed Circuit Boards.</b>		
15301A	Display Board for Model 171 / 172 / 173 / 174	Orderable
2027372-002	Main Board Dual U/S for Model 172 loaded with V 3.23	Orderable
2027376-002	Main Board Single U/S for Model 173 loaded with software version 3.23	Orderable
2027385-001	FECG / UA Board for Model 173	Orderable
2000243-014	Main Board Single U/S for Model 171 loaded with software version 3.23	Orderable
2027380-002	Main Board Dual U/S for Model 174 without U/S FECG-174 board.	Orderable
2027389-001	Dual FECG / US Board for Model 174	Orderable
2027368-002	Main Board Single U/S for Model 171 loaded with software version 3.23	Orderable
15231A	Sensor Board for Model 171 / 172 / 173 / 174	Orderable



# Addendum to use PS320 Simulator

## PS 320 Simulator startup

1. Connect the correct simulation cables to the PS320 and fetal monitor. Single or twin ultrasound simulation is available (1 or 2 US cables). Refer the Manufacturer part number mentioned below for the correct cable.

2462519: GE-Corometrics EXT. TOCO Simulation Cable  
 2462469: GE-Corometrics IUP TOCO Simulation Cable  
 2651757: MFH-1 Mechanical Fetal Heart Probe  
 2056279-001: Multilink 3 Lead FECG cable (To be purchased from GE)

2. Connect the Monitors Cables to the ECG / US / TOCO Output posts on the PS320 Simulator.

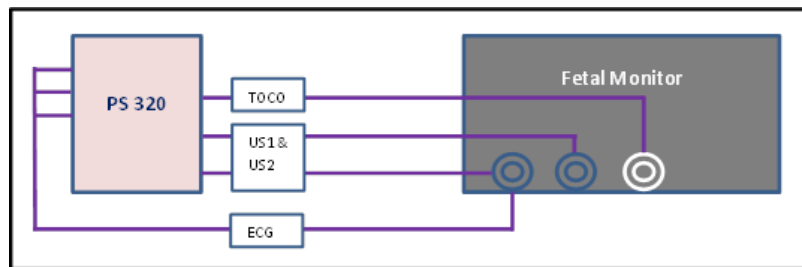

3. Switch ON the PS320 Fetal Simulator, the default settings of the simulator is given below

### Default settings on the PS320:

US 1 = 150 BPM (static)  
 US 2 = NORMAL  
 FETAL ECG = 150 BPM (sensitivity 1 $\mu$ V)  
 MAT. ECG = 80 BPM (sensitivity 1 $\mu$ V)  
 TOCO = 00 (sensitivity 5  $\mu$ V)

4. Use the front panel of the unit to
  - Increase or decrease FETAL ECG rate and amplitude
  - Increase or decrease MATERNAL ECG rate and amplitude (Only for Coro 250 Series)
  - Select TOCO level and sensitivity
  - Adjust display contrast
5. Press the Enter Key to confirm your selection.

6. For additional and advanced information, utilize the MAIN, SUB and SCROLL keys below the display.

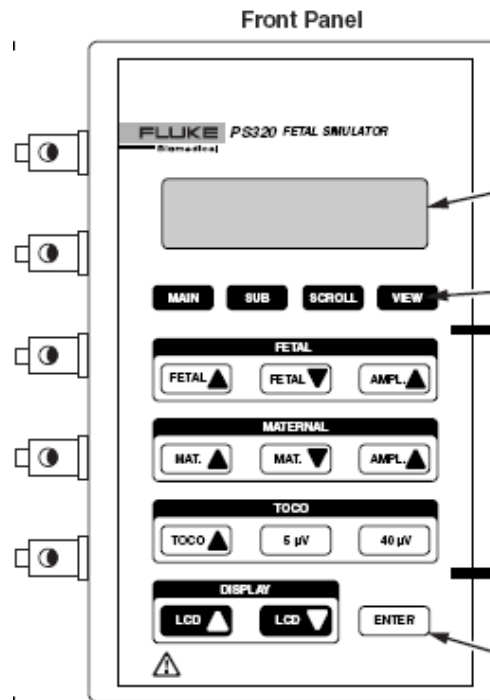

- a) Make a selection from MAIN menu options
  - FETAL ECG
  - UTERINE ACTIVITY
  - MATERNAL ECG
  - FETAL PATTERNS
  - AUXILIARY
- b) Use the SUB key to look at the selection available within the MAIN selection.
- c) Use the SCROLL key to move back through the selections in the SUB menu.
- d) Press ENTER to confirm the selection and make the changes.

**Note 1:** The Fluke Simulator and its accessories (except FECG Cable) are orderable from FLUKE Biomedical, for your nearest location refer [www.flukebiomedical.com](http://www.flukebiomedical.com)

**Note 2:** The Fluke simulator needs to be calibrated periodically (Annual calibration).

## FECG Test

This portion of the functional checkout procedure ensures the integrity of the FECG circuitry and the heart rate channel of the recorder.

1. Connect the 3 Lead FECG cable from the Coro Monitor to the left panel Terminals of the PS 320 Simulator. As per below mentioned Table

3 Lead ECG Terminal	Left Panel Terminal of PS320 Simulator
LA	Fet / Mat
LL	Maternal
RA	Reference

2. Set the values on the PS320 Simulator according to Table below

Section	Function Key	Setting
Fetal ECG	Fetal (Rate)	30 BPM
	Amplitude	50 $\mu$ V

3. Verify the following on the monitors display:
  - The FHR1 Value is 30 BPM.
  - The FHR1 heartbeat indicator (♥) flashes at a rate of 30 times per minute.
  - The ECG “beep” volume of the rear panel speaker can be increased or decreased using the Volume buttons. (Set the volume to the desired level.)
  - The recorder prints a continuous line at 30 BPM on the top grid of the strip chart paper.
  - The recorder prints the message FECG on the center margin of the strip chart paper after approximately 20 seconds.
4. Set the value on the PS320 Simulator to 120 BPM. Verify the following on the monitor:
  - The FHR1 Value is 120 BPM.
  - The FHR1 heartbeat indicator (♥) flashes at a rate of 120 times per minute.
  - The ECG “beep” volume of the rear panel speaker can be increased or decreased using the left pair of Volume buttons. (Set the volume to the desired level.)
  - The recorder prints a continuous line at 120 BPM on the HR grid of the strip chart paper.
5. Repeat Step 4 for each of the following rates: 60, 90, 150, 180, 210 and 240 BPM.

# Ultrasound Test

This portion of the functional checkout procedure ensures the integrity of the ultrasound circuitry and the heart rate channel of the recorder.

**Note:**

- This section Requires Mechanical Fetal Heart (MFH) and Ultrasound Transducer for testing the Coro monitor.
  - For MFH-1 to function, power the PS320 Simulator using the battery eliminator, the MFH-1 will not function on battery power.
1. Connect the MFH to **US1** port in PS320 Simulator via the cable supplied with the MFH-1.
  2. Place the Ultrasound Transducer face up on the work surface and coat it with Ultrasound conductive gel and place the MFH-1 on the Ultrasound transducer and connect the Ultrasound Transducer to US1 channel on the Coro Monitor.
  3. Set the values on the PS320 Simulator according to Table below,

Table 12-2. Ultrasound Test Simulator Settings		
Section	Function Key	Setting
Ultrasound (Fetal Heart Rate)	Fetal (Rate)	120 BPM
	Amplitude	50 $\mu$ V

4. If not already on, depress the monitor's **Record** button.
5. Set the simulator to input an Ultrasound signal of 120 BPM. Verify the following on the monitor
  - The FHR1 value is 120 BPM.
  - The FHR1 heartbeat indicator (♥) flashes at a rate of 120 times per minute.
  - Ultrasound audio volume from the rear panel speaker can be increased or decreased using the upper-left pair of Volume buttons. (Set the volume to the desired level.)
  - The recorder prints a continuous line at 120 BPM on the top grid of the strip chart paper.
  - The recorder prints the message US on the center margin of the strip chart paper after approximately 20 seconds.
6. Increase the value of US from 120 BPM baseline to 150 BPM in the simulator. Verify the following on the monitor.
  - The FHR1 value immediately reflects this new input rate.
  - The strip chart recorder immediately reflects this new input rate.
7. Decrease the value of US from 120 BPM baseline to 90 BPM in the simulator. Verify the following on the monitor.
  - The FHR1 value immediately reflects this new input rate.
  - The strip chart recorder prints at the last input rate for an additional 3 seconds before blanking the heart rate data and printing a continuous line at the new input rate.



8. Set the simulator value for each of rate 60, 90, 120, 150, 180 and 210 BPM. Verify the following on the monitor.
  - The FHR1 value reflects the simulator setting  $\pm 1$  BPM.
  - The FHR1 heartbeat indicator (♥) flashes at the simulator setting.
  - Ultrasound audio is heard coming from the rear panel speaker.
  - The recorder prints a continuous line at the respective value  $\pm 3$  BPM on the top grid of the strip chart paper.
9. Remove the US simulator cable from US connector of the Monitor. Verify the following on the monitor.
  - The FHR1 value and mode are both blank.
  - The recorder stops printing the fetal heart rate trace.
  - The recorder prints the message **CARDIO INOP** on the center margin of the strip chart paper after approximately 20 seconds.
10. Repeat Steps 1 to 9 using the second Ultrasound channel of the monitor.

## Uterine Activity Test

This portion of the functional checkout procedure tests the uterine activity section of the 170 Series Monitor.

1. Connect the TOCO cable (Cable No: 2462469) from TOCO connector in PS320 Simulator to the UA receptacle of the monitor.
2. Access the service setup mode and note the UA reference default value. (The monitor is shipped from the factory with this value set at 10 relative units; however, your unit may have been custom configured.) Exit the service mode.
3. Press the monitor's Power button to turn on the monitor.
4. Press the monitor's Record pushbutton.
5. Briefly press the monitor's UA Reference pushbutton. Verify the following on the monitor:
  - The UA value is the default setting.
  - The recorder prints a continuous line at the default value on the uterine activity channel of the strip chart paper.
  - The recorder prints the messages TOCO and UA REF on the strip chart paper.
6. Press and hold the UA Reference button on the monitor to cycle through the available selections for UA reference: 5, 10, 15, 20, or 25 relative units. Test each of these reference settings. Verify that the UA value is displayed accordingly and that the recorder prints a continuous line at the corresponding value on the uterine activity channel of the strip chart paper.
7. Set the simulator's TOCO amplitude to 5 $\mu$ V and TOCO Level switch at each of the level settings: 0, 20, 40, 60, 80 and 100 relative units. Verify that the UA value is displayed accordingly and that the recorder prints a continuous line at the corresponding value on the heart rate channel of the strip chart paper.
8. Press the UA Reference button to reference to 10 relative units. If the default is set to a different value, press and hold the UA Reference button to cycle to 10.
9. Disconnect the TOCO cable from the UA input receptacle on the front panel of the monitor. Verify the following on the monitor:
  - The UA value is blank.
  - The recorder stops printing the uterine activity trace.

## **Fetal Pattern: TREND # 1 (Pattern Memory Test)**

Selects real patient trend of fetal heart rate and TOCO

1. Connect the FECG and UA cable to the corresponding connector on the monitor
2. Select FETAL PATTERNS by repeatedly pressing MAIN button on the PS320 Simulator.
3. Select TREND 1 from the Menu by pressing the SUB button, and press ENTER after selecting the TREND 1 pattern.
4. If not already on, depress the monitor's Record button.
5. Verify the following on the monitor:
  - Recorder should print out a value equal to that displayed on the Monitor at each heart rate area (FHR1, FHR2) and UA area (TOCO).

## Dual Heart Rate Test (FECG/US Modes)

**Note:** 2 PS320 Simulator, 1 MFH and 1 Ultrasound Transducer are required to perform this test case. One for giving FECG Signal and the other for Ultrasound signal

### FECG/US Modes:

1. Connect the 3 lead ECG Cable from the PS320 simulator to the FECG input on the monitor.
2. Connect the MFH to US1 port in PS320 Simulator via the cable supplied with the MFH-1.
3. Place the Ultrasound Transducer face up on the work surface and coat it with Ultrasound conductive gel and place the MFH-1 on the Ultrasound transducer and connect the Ultrasound Transducer to US1 channel on the Coro Monitor.
4. Set the values on the PS320 Simulator according to Table below,

Section	Function Key	Setting
Fetal ECG	Fetal (Rate)	120 BPM
	Amplitude	50 $\mu$ V
Ultrasound (US1 Port)	Fetal (Rate)	150 BPM
	Amplitude	50 $\mu$ V

5. If not already on, depress the monitor's Record button.
6. Verify the following on the monitor:
  - The FHR1 value reads  $120 \pm 1$  BPM.
  - The FHR1 heartbeat indicator (♥) flashes at a rate of 120 times per minute.
  - The FHR2 heartbeat indicator (♥) flashes at a rate of 150 times per minute.
  - The messages FECG and US print on the center margin of the strip chart paper.
  - The FHR1 trend is a continuous plain black line (—) on the 120 BPM mark on the top grid of the strip chart paper.
  - The FHR2 trend is a bold black ramp trace (—) on the 150 BPM mark on the top grid of the strip chart paper.

## Dual Ultrasound Modes (Applicable for Corometrics 172 & 174 Monitors only)

1. The dual ultrasound mode of the 170 Series Monitor cannot be tested unless two PS320 Simulators are used or two Model 170 Series ultrasound transducers. Do not attempt to test dual ultrasound using one PS320 Simulator and one ultrasound transducer. This procedure details using two transducers since it is more practical for a test site.
2. If not already on, depress the monitor's **Record** button.
3. Plug one ultrasound transducer into the monitor's **US1** input connector and the other into the monitor's **US2** connector. Verify the following on the monitor:
  - The FHR1 value shows three steady dashes “- - -.”
  - The FHR2 value shows three steady dashes “- - -.”
  - The recorder prints the messages US and US2 on the center margin of the strip chart paper.
4. Connect the transducer to monitor's US1 input connector and Hold the transducer in your hand and rub the back of the hand holding the transducer; try to maintain a steady rate and verify the following on the monitor:
  - The FHR1 value responds to the rubbing.
  - The FHR1 heartbeat indicator (♥) responds to the input.
  - The recorder prints the heart rate tracing corresponding to the rate and the trace is plain black (~~~~).
5. Connect the transducer to monitor's US2 input connector and Hold the transducer in your hand and rub the back of the hand holding the transducer; try to maintain a steady rate and verify the following on the monitor:
  - The FHR2 value responds to the rubbing.
  - The FHR2 heartbeat indicator (♥) responds to the input.
  - The recorder prints the heart rate tracing corresponding to the rate and the trace is bold black (~~~~).

## Alarm Tests

This portion of the test ensures the integrity of the audio alarms and tests the alarm limit software.

1. Connect the MFH to US1 port in PS320 Simulator via the cable supplied with the MFH-1.
2. Place the Ultrasound Transducer face up on the work surface and coat it with Ultrasound conductive gel and place the MFH-1 on the Ultrasound transducer and connect the Ultrasound Transducer to US1 channel on the Coro Monitor.
3. Press and hold (for three seconds) Setup to enter the monitor's setup mode.
4. Set the FHR alarm enable to on.
5. Set the FHR high alarm limit value to 180 BPM.
6. Set the FHR low alarm limit value to 100 BPM.
7. Set the FHR audio alarm to a level you can easily hear.
8. Press the Setup button to exit the setup mode.
9. Press the monitor's Record button.
10. Verify that the FHR high and low limits print in the annotation area of the strip chart paper.
11. Turn off the monitor's recorder.
12. Set the values on the PS320 Simulator according to Table below

<b>Table 12-4 . Alarm Test Simulator Settings</b>		
Section	Function Key	Setting
Ultrasound (US1 Port)	US (Rate)	120 BPM
	Amplitude	0.5 mV

13. Set the PS320 simulator to input an US signal of 180 BPM as indicated on the monitor. Verify that there is no alarm tone sounding from the monitor's speaker.
14. Set the simulator's value to input an US signal of 210 BPM as indicated on the monitor. Verify the following on the monitor:
  - An alarm tone is emitted from the monitor's speaker (alternating high/low tones).
  - The Alarm indicator flashes.
  - The affected heart rate numerics flash.

15. Press the monitor's front panel Alarm Silence pushbutton and verify that the alarm tone silences but the visual indications remain present.
16. Set the simulator to input an US signal of 180 BPM.. Verify that the Alarm indicator goes out and the heart rate numerics stop flashing.
17. Set the simulator to input an US signal of 120 BPM. Verify that there is no alarm tone sounding from the monitor's speaker.
18. Set the simulator to input an US signal of 90 BPM. After 30 seconds, verify the following on the monitor:
  - The alarm tone is emitted from the monitor's speaker.
  - The Alarm indicator flashes.
  - The affected heart rate numerics flash.
19. Press the monitor's front panel Alarm Silence pushbutton. Verify that the visual and audio alarm indications disappear.
20. Set the simulator to input an US signal of 120 BPM. Verify that the Alarm indicator goes out and the heart rate numerics stop flashing.
21. Set the simulator to input an US signal of 90 BPM to set off the alarm one more time. It will take 30 seconds for the alarm to appear.
22. Set the simulator to input an US signal of 120 BPM. Verify the following on the monitor:
  - The alarm tone continues sounding.
  - The Alarm indicator stops continuous flashing.
  - The affected heart rate numerics continue flashing.
23. Press the monitor's front panel Alarm Silence pushbutton. Verify that the visual and audio alarm indications disappear.
24. This concludes the functional checkout procedure.



**GE Medical Systems**  
*Information Technologies*



[gemedicalsystems.com](http://gemedicalsystems.com)



World Headquarters  
Wipro GE Healthcare Private Limited  
No: 4 Kadugodi Industrial Area  
Bangalore. 560 067  
Karnataka, INDIA.  
Tel: + 1 414 355 5000  
1 800 558 5120 (US only)  
Fax: + 1 414 355 3790



European Representative  
GE Medical systems SCS  
283 Rue de la Minière,  
78530 BUC, FRANCE

Asia Headquarters  
GE Medical Systems  
*Information Technologies* Asia; GE (China) Co., Ltd.  
24th Floor, Shanghai MAXDO Center,  
8 Xing Yi Road, Hong Qiao Development Zone  
Shanghai 200336, P.R. China  
Tel: + 86 21 5257 4650  
Fax: + 86 21 5208 2008