



# GarrettCom®

*Industrial Networking at Its Best™*

## **Magnum S14 Convenient Switch & PS14P Power Source Switch (PoE)**



## **Installation and User Guide**

[www . GarrettCom . com](http://www.GarrettCom.com)

\$5.00 USD

---

# **Magnum™ S14 & PS14P (PoE) Convenient Switches**

## **Installation and User Guide**

Part #: 84-00100Z Rev. D

### **Trademarks**

**GarrettCom** is a registered trademark and **Magnum, Dymec, DynaStar, Personal Switch, Link-Loss-Learn, S-Ring, Convenient Switch** and **Converter Switch** are trademarks of GarrettCom, Inc.

Ethernet is a trademark of Xerox Corporation

NEBS is a trademark of Telcordia Technologies

UL is a registered trademark of Underwriters Laboratories

**Important:** The Magnum S14 & PS14P(PoE), 10/100 Mb/s Convenient Switches contain no user serviceable parts. Attempted service by unauthorized personnel shall render all warranties null and void. If problems are experienced with Magnum S14 & PS14P 10/100 Mb/s Convenient Switches, consult Section 5, Troubleshooting, of this User Guide.

Copyright © 2005 GarrettCom, Inc. All rights reserved. No part of this publication may be reproduced without prior written permission from GarrettCom, Inc.

Printed in the United States of America.

GarrettCom, Inc. reserves the right to change specifications, performance characteristics and/or model offerings without notice.

**Federal Communications Commission****Radio Frequency Interference Statement**

*This equipment generates, uses and can radiate frequency energy and if not installed and used properly, that is in strict accordance with the manufacturer's instructions, may cause interference to radio communication. It has been tested and found to comply with the limits for a Class A computing device in accordance with the specifications in Subpart J of Part 15 of FCC rules, which are designed to provide reasonable protection against such interference when operated in a commercial environment. Operation of this equipment in a residential area is likely to cause interference, in which case the user at his own expense will be required to take whatever measures may be required to correct the interference.*

**Electrical Safety requirements:**

1. This product is to be installed Only in Restricted Access Areas (Dedicated Equipment Rooms, Electrical Closets, or the like).
2. 48VDC products shall be installed with a readily accessible disconnect device in the building installation supply circuit to the product.
3. This product shall be provided with a maximum 5A DC Listed fuse or circuit breaker in the supply circuit when connected to a 48V centralized source.
4. The external power supply for DC units shall be Listed, Direct Plug In power unit, marked Class 2, or listed ITE Power Supply, marked LPS, which has suitably rated output voltage (i.e. 24VDC or 48VDC) and suitable rated output current.
5. Product does not contain user replaceable fuses. Any internal fuses can ONLY be replaced by GarrettCom personnel through the RMA process.

## **Contacting GarrettCom, Inc**

Please use the mailing address, phone and fax numbers and email address listed below:

GarrettCom, Inc.  
*47823 Westinghouse Dr.*  
*Fremont, CA 94539*  
**Phone (510) 438-9071**  
*Fax (510) 438-9072*

Website: <http://www.GarrettCom.com>

**Email: [support@garrettcom.com](mailto:support@garrettcom.com)**

**TABLE OF CONTENTS****Page**

<b>1.0</b>	<b><u>SPECIFICATIONS</u></b> .....	<b>1</b>
1.1	Technical Specifications .....	1
1.2	Summary of models and descriptions .....	10
<b>2.0</b>	<b><u>INTRODUCTION</u></b> .....	<b>12</b>
2.1	Inspecting the Package and the Product.....	12
2.2	Product Description .....	13
2.2.1	Magnum PS14P : 4-port PoE Power Source Switch.....	18
2.3	Magnum PS14P & S14-Series, with four (RJ-45) Copper ports .....	24
2.4	Frame Buffering and Latency .....	25
2.5	Features and Benefits .....	28
2.6	Applications (S14 Series and PS14P(POE) Switches) .....	31
<b>3.0</b>	<b><u>INSTALLATION</u></b> .....	<b>41</b>
3.1	Locating the Convenient Switch Unit.....	41
3.2	MC14-TRAY for Rack Mounting of S14-Series Switches.....	43
3.3	MC14-TR+PS9 & MC14-TR+PS9X2 for Rack Mounting .....	44
3.4	DIN-Rail mounting option.....	46

3.5	Power Requirements for S14 Series Switches .....	47
3.6	Powering the S14 Series (DC internal) with 12V, 24V or -48VDC .... power input .....	49
3.7	S14H & S14P, DC-powered, -48VDC, 24VDC and 12VDC Installation .....	51
3.7.1	Power Requirement for PS14P(PoE) Power Source Switch.....	53
3.8	Connecting Twisted Pair (RJ-45 ports).....	54
3.8.1	Connecting Twisted Pair (RJ-45, CAT 3 or CAT 5, Unshielded or Shielded).....	55
3.8.2	Connections to NICs which support Auto-Negotiation, RJ-45 ports .....	56
<b>4.0</b>	<b><u>OPERATION</u></b> .....	<b>57</b>
4.1	Dual-Speed Functionality, and Switching .....	57
4.2	Auto-cross (MDIX), Auto-negotiation and Speed-sensing.....	59
4.3	Dual LEDs, Front-panel and side-panel.....	61
<b>5.0</b>	<b><u>TROUBLESHOOTING</u></b> .....	<b>62</b>
5.1	Before Calling for Assistance .....	63



5.2	When Calling for Assistance .....	64
5.3	Return Material Authorization (RMA) Procedure .....	65
5.4	Shipping and Packaging Information.....	66
<b><u>APPENDIX A: WARRANTY INFORMATION</u></b> .....		<b>68</b>

### **Revisions**

**Rev D 11/09:** updated DIN Rail mount photo (pg. 46)

**Rev C 08/08:** revised S14 weight specifications on page-4

**01/06:** Updated the PS14P(POE) Power Source Switch

**Rev B 05/05:** Added Magnum PS14P(POE) Power Source Switch

**10/04:** Small edit and updates on power supply option.

**09/04:** Small edit and updates on UL.

**06/04:** Small revision of the Agency Approvals

**Rev A 03/04:** Initial release of this user manual for the S14 Converter Switch

## **1.0 SPECIFICATIONS**

### **1.1 Technical Specifications**

#### **Ports Performance**

When a port is operating at 100Mbps:

Data Rate: 100Mbps

When a port is operating at 10 Mbps:

Data Rate: 10 Mbps

#### **Network Standards**

100Mb: Ethernet IEEE 802.3u, 100BASE-TX, IEEE 802.1p

10 Mb: Ethernet IEEE 802.3, 10BASE-T

Power Over Ethernet: IEEE 802.3af (PS14P model only)

Auto-sensing for speed: IEEE 802.3u

Data packets that have the 4-bytes tagged VLAN field (802.1q) inserted in them are received and transmitted unchanged.

**Packet-Processing Between Domains**

Filter / Forwarding Rate from 100Mbps ports: 148,800 pps max

Filtering and Forwarding Rate from 10 Mbps ports: 14,880 pps max.

Processing type: Store and Forward, non-blocking

Auto-learning: 2K address table

Address buffer age-out time: 300 sec.

Packet buffers memory: 128KB, dynamically shared on all domains  
(Non-blocking switching)

Latency (not including packet time):	100 to 10 Mbps:	5 $\mu$ s
	10 to 100Mbps:	5 $\mu$ s

**Path Delay Value:** 50 BT on all ports

**Maximum Ethernet Segment (or Domain) Lengths**

10BASE-T (Unshielded twisted pair) - 100 m (328 ft)

100BASE-TX (CAT 5 UTP) - 100 m (328 ft)

**Operating Environment:**

Ambient Temperature (S14): 32°F to 104°F (0°C to 40°C)  
(S14H): -13°F to 140°F (-25°C to 60°C)

Long term per independent agency tests (UL)  
-40°F to 167°F (-40°C to 75°C)

Short term per IEC Type tests  
(S14P & PS14P): -40°F to 185°F (-40°C to 85°C)

Long term per independent agency tests (UL)  
-40°F to 167°F (-40°C to 75°C)

Short term per IEC Type tests

Storage Temperature, All models: -40°F to 185°F (-40°C to 85°C)

Cold Start:  
(S14H) model to -20°C  
(S14P) model to -40°C

Ambient Relative Humidity: 5% to 95% (non-condensing)

Altitude (All models): -200 to 5000ft. (-60 – 15,000 m)

Conformal Coating (optional) Humidity protection

Note: H and P models are designed for NEBS compliance, including, vibration, shock and altitude.

### Packaging:

Enclosure: Robust sheet metal (Steel).

Dimensions, Switch unit: Height x Width x Depth

**S14, S14H, S14P & PS14P:** 3.5 in H x 3.0 in W x 1.0 in D (8.9 cm x 7.6 cm x 2.5 cm)

**Weight:** all **S14 models:** 8.6 oz. (243g);

power supply, -d, and i: 5.9 oz (170g)

-Hd, and Hi: 5.8 oz (165g)

-Pd, and =Pi: 7.9 oz (225g)

**PS14P units:** 9.6 oz (272g)

### Cooling Method:

Convection on regular model, plus the case is used as a heat sink on “H” and “P” models.

**POWER SUPPLY (S14 Model only)**

These products are intended to be supplied by a Listed, Direct Plug-In power unit, marked “Class 2”, or a Listed ITE Power Supply, marked “LPS”, which has suitably rated output voltage (i.e. 9vdc, 12vdc, 24vdc, 48vdc), and suitably rated output current (i.e. 100mA to 500mA). When connected to a 48 V centralized dc source these products shall be provided with a Listed 5A DC fuse in the supply circuit.

**UL listed class II Power Supply, ( AC External):**

Power input (8-15)V DC, jack is 2.5mm center +ve , with 6ft. cord

Input: **120vac at 60 Hz for “d” models, 240vac at 50Hz for “i”** models that have IEC320 power connector built-in the PS unit. Out put- 12vdc, 1 Amps

Input: **100-240V AC at 47-63Hz**, for “-Hd” high temp., **100-240V AC at 47-63Hz “-for Hi”** models that have IEC320 power connector built-in the PS unit.

Out put- 12vdc, 1.25 Amps

Input: **100-240V AC at 47-63Hz**, for “-Pd” high temp. **100-240V AC at 47-63Hz, “-Pi”** models that have IEC320 power connector built-in the PS unit.

Out put- 12vdc, 2 Amps

**DC to unit:** 12V DC, 2.5mm jack, center +ve, 6ft. cord

**Power Supply ( Direct DC ): built-in screw terminal block for +, -, ground. The 12V DC jack is also present.**

**12V DC** internal (range of 8.0 to 15V DC),

**24V DC** internal (range of 18 to 36V DC)

**-48V DC** internal (range of 36 to 60V DC) t.

**Power Consumption:** 3 watts typical, 4 watts max.

**Note 1:** 8-15V DC can be used for dual source DC input

**Note 2:** Internal DC power floats, user may ground “+” or “-” if desired.



**POWER INPUT: (PS14P(POE) unit only)**

Total Power Consumption: 66 watts max. (1.4A @48VDC)

Terminal block for -48v DC input (range of 46 to 60V dc), built in for +, -, ground. The 8-15V DC jack is also present, but it can only be used to power the PS14P unit itself, not PoE devices attached.

**POWER OUTPUT: (PS14P(POE) unit only)**

PoE available on all four RJ-45 ports via Ethernet twisted pair cabling on port pins using spare pairs 4,5(+) 7,8(-), not the data pair 1,2(-), 3,6(+)

802,3af Power Consumption: 61.6 watts max. (15.4(max)/port)

PoE Ports Output voltage: 44 to 57 VDC

Over Current Protection, per port: resettable fuse

**Port Connectors:**

RJ-45 Port: Auto-cross(MDIX), 100BASE-TX and 10BASE-T:shielded 8-pin female. Three RJ-45 ports provided in front, and one on the rear. Supports shielded (STP) and unshielded (UTP) Cat 3, 4, 5 cable. For PoE pass-through option on P models, use Model # PS14P.



**LED Indicators (Dual- front and end, port #4 has front only)**

POWER: Steady ON when power applied (S14 model)

ON for -48V power applied to the PS14P unit

PoE, ports 1,2,3,4: ON when delivering power (PS14P)

10/100: = 100Mbps; OFF = 10 Mbps

LK/ACT: Steady ON for LINK with no traffic, blinking indicates port is transmitting / receiving.

F/H: ON = full-duplex, OFF = half-duplex

**Mounting option for S14 Family of Switches:**

**Metal Mounting clips for panel mounting** : included

**DIN-Rail mounting option:** Model # DIN-RAIL MC2 (see Section 3.4)

**Rack-mount option:** MC14-TRAY, see [http://www.garrettcom.com/mc\\_tray.htm](http://www.garrettcom.com/mc_tray.htm)

**Mean Time Between Failure (MTBF)** – 15+ years, Telcordia (Bellcore SR-332) Method

**Agency Approvals and Standard Compliance:**

UL Listed (UL 60950), cUL, CE, Emissions meet FCC Part 15, Class A.

NEBS L3 and ETSI compliant

H & P models: IEEE P1613 Env. Std for Electric Power Substations

P model: NEMA TS-2 and TEES for traffic control equipment

P model: designed for UL 2043 above-the-ceiling installation

IEC61850 EMC and Operating Conditions Class C for Power Substations

Designed for above-the-ceiling (plenum) installation

**Warranty:** Three years, return to factory

Made in USA

## 1.2 Summary of models and descriptions

S14-d,i = four 10/100 RJ-45 ports Switch, for office and wiring closet env., ext. AC Pwr Supply

S14H-Hd, Hi = Hardened, four 10/100 RJ-45 ports Switch, Factory floor, Int. 8-15VDC,

Ext. AC Hardened power supply included .

S14H-12VDC = Same as S14H model, except Ext. AC Hardened power supply not included

S14H-24VDC = Same as S14H-12VDC model, except for 24VDC power input

S14HR-24VDC = Same as S14H-24VDC model, but includes DIN-RAIL-MC2 option.

S14H-48VDC = Same as S14H-24VDC model, except for -48VDC power input.

S14P-Pd, Pi = ,Premium rated, four 10/100 RJ-45 ports Switch, for un-controlled(outdoor) env.

Int. 8 to 15V terminal block, Ext. AC Premium-rated Power Supply included.

S14P-12VDC = Same as S14P-Pd, Pi, except ext. AC Premium Power Supply is not included.

S14P-24VDC = Same as S14P-12VDC model, except Ext. AC Premium power supply not included

S14PR-24VDC = Same as S14P-24VDC model, but includes DIN-RAIL-MC2 option.

S14P-48VDC = Same as S14P-24VDC model, except for -48VDC input

MC14-TRAY = 19" Rack-mount tray for 14-series Switch models, up to 16 units

DIN-RAIL-MC2 = Metal DIN-Rail mounting bracket for one S14-Series

---

**Magnum PS14P (PoE) Power Source Switch (model and descriptions)**

PS14P = ,Premium rated, four 10/100 RJ-45 ports Switch in a compact package, rated for un-controlled(outdoor) env. All four RJ-45 Ethernet ports support Power Source PoE as per the IEEE 802.3ad standard. Includes integral -48V DC terminal block for power unit.

NOTE: If you want a heavy-duty Industrial power supply that plugs into AC and delivers -48VDC at 50 watts to support one PS14P-48VDC Switch and up to 4 attached PoE devices, Try this URL –

<http://www.lanstore.com/ps.htm>

MC14-TRAY = 19” Rack-mount tray for 14-series Switch models

DIN-RAIL-MC2 = Metal DIN-Rail mounting bracket for one PS14P Switch

## 2.0 INTRODUCTION

This section describes S14-Series models, including appearance, features and typical applications.

### 2.1 Inspecting the Package and the Product

Examine the shipping container for obvious damage prior to installing this product; notify the carrier immediately of any damage which you believe occurred during shipment or delivery. Inspect the contents of this package for any signs of damage and ensure that the items listed below are included.

This package should contain:

- |       |   |                       |
|-------|---|-----------------------|
| 1     | Magnum S14-Series or PS14P Switch Unit                          |                       |
| 1     | External Power Supply, (for S14, S14H, S14P), (d, i model only) |                       |
| 1 set | Metal panel mounting clips and screws, 2 each                   |                       |
| 1     | User Guide, i.e., this manual                                   | (continued next page) |

Remove the Magnum S14-Series Switch from the shipping container. Be sure to keep the shipping container should you need to ship the unit at a later date.

In the event there are items missing or damaged contact your supplier. If you need to return the unit, use the original shipping container. Refer to Section 5 Troubleshooting, for specific return procedures.

## **2.2 Product Description**

The Magnum S14 family of Convenient Switches covers the full range of application environments, with regular (office), Hardened (factory floor), and Premium-rated (outdoor) versions. Extra features for heavy-duty and extended temperature operation ranges are included selectively in the Hardened factory-floor and Premium-rated outdoor models. Input power may be AC, or DC at 12V, 24V or –48V, providing a selection for office or for heavy duty industrial applications. This selection of models offers the best price / value unit for each user and installation.

For any user who needs a small chunk of Ethernet connectivity, a 4-port “go anywhere” Magnum S14 Switch is a versatile and handy solution, and can provide it in a convenient compact package.

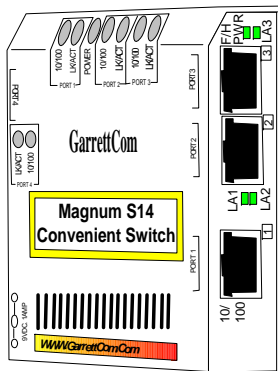

GarrettCom Magnum S14  
Convenient Switch

Fig 2.2a

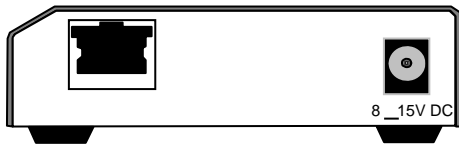

Fig. 2.2b  
GarrettCom S14  
Left Side View

Fig2.2a. Magnum S14, Front view (three RJ-45 ports on Front side of the unit, as shown in Fig

Fig2.2b. Magnum S14, Rear view (one RJ-45 port on rear side)

The Yellow label S14 shown above are for office and wiring closet environments and use an external AC power supply. A metal case with convection cooling is featured. Operation may be in 0° to 50°C ambient temperature. The units can be mounted securely on a closet wall or metal cabinet, or by using the metal panel mounting clips included.

The orange-label Magnum S14H as shown above in Fig 2.2c is a hardened unit designed for factory floor and other industrial applications. The S14H models are built with high-grade components and use special thermal techniques and a rugged metal case for extended temperature industrial applications. The S14H Hardened unit features a sealed metal case that is also used as a heat sink. No air inflow is required for cooling, so the S14H resists dust, dirt, moisture, smoke and insects, and is above-the-ceiling (plenum) rated. Choices of models for external AC or internal DC power are available. Ambient temperature rating is up to -25°C to +60°C for any of the power input types, AC or DC.



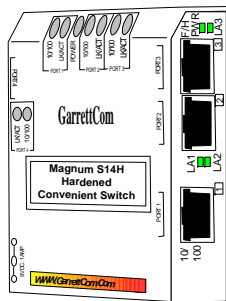

GarrettCom Magnum S14H  
Hardened Convenient Switch

Fig 2.2c

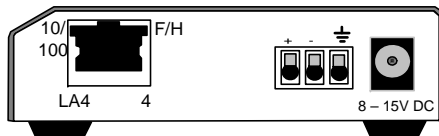

GarrettCom S14  
Left Side View

Fig 2.2d

Fig 2.2c- Magnum S14H, Front view (three RJ-45 ports on Front side of the unit, as shown in Fig.

Fig2.2d. Magnum S14H, Rear view (one RJ-45 port and DC option on rear side) as shown in Fig.

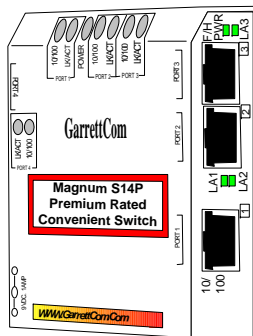

GarrettCom Magnum S14P  
Premium Rated Convenient Switch

The red-label Magnum S14P, as shown in Fig. 2.2e, is a premium rated unit suitable for temperature un-controlled outdoor applications. Specially designed with premium-grade extended temperature components, the S14P uses similar thermal techniques as the S14H hardened units for cooling. Mounting options include panel-mounting, DIN-rail, or rack-mount tray. Choices of models for external AC or internal DC powers are available.

Ambient temperature rating is  $-40^{\circ}\text{C}$  to  $+75^{\circ}\text{C}$  for any of the power input types, AC or DC.

### 2.2.1 Magnum PS14P : 4-port PoE Power Source Switch

GarrettCom's continuous efforts of designing reliable and premium-rated Industrial Ethernet products with the latest technology while being a cost effective solution has successfully yielded their first Industrial PoE switch called the Magnum PS14P Convenient Switch. Designed and developed with premium-grade extended temperature components, premium-rated PS14P switches are suitable for use in sheltered outdoor locations and temperature-uncontrolled environments with a temperature rating of  $-40^{\circ}\text{C}$  to  $75^{\circ}\text{C}$ .

The Magnum PS14P PoE Power source Convenient Switch combines standard 802.3af Power over Ethernet (PoE) with a small heavy duty 4-port Industrial Switch. Using an external -48vdc power source, all four of the PS14P's Ethernet



ports can provide Power as well as 10/100 Mb data transmission over the inter-connecting Ethernet cables. So a single Ethernet twisted pair cable will be able to transmit voice, data and power from the attached devices.

The PS14P switches are Power Sourcing Equipment (PSE), and are fully compatible with Powered Devices (PD)(e.g wireless access points, IP phones) that comply with the IEEE 802.3af PoE standard. The PS14P switch ports have an auto-sensing algorithm, so that they provide power only to 802.3af, PoE end devices. **PoE is managed by a multi-stage handshake to protect equipment from damage and to manage power budgets** .The PS14P ports will discontinue supplying power when the PoE powered devices are disconnected, and support the



802.3af PoE PSE standard for over-current protection, under-current detection, and fault protection.

The PS14P is a standards-compliant way to power and connect a few small Ethernet devices at the edge of a network where AC power is not cost-effective to deploy. Since PoE is rapidly emerging as an Ethernet option in industrial, commercial, outdoor and military applications, the Magnum PS14P is enabling the efficient deployment of reliable VoIP and wireless access networking devices to increase the efficiency of heavy duty industrial communications. Furthermore, using PoE switches like the Magnum PS14P can produce significant cost savings as well as flexibility and reliability over traditional AC-powered devices. The simplicity of PoE increases reliability and reduces the overall cost of installation and operation.

These are applications where the Magnum PS14P can be used to provide the

power and data for these PoE Powered Devices, which require 12-13watts maximum.

- Wireless LAN access points and WLAN Mobility system
- VOIP phones
- Remote Security Camera
- SNTP Clock
- Factory floor and building control monitoring  
(Temperature, Smoke, Heat and other environmental sensors).
- Fire alarms
- Security devices, like retinal scanners or fingerprint readers.
- Lighting control.
- Home automation systems

Because of the approval of 802.3af PoE standard, the RJ-45 Ethernet jack will become the

first worldwide standard power plug. The futuristic applications of PoE look promising as a convenient point (providing Notebook computer, Cell phone charger, and PDA games through the PoE devices).

The sleek and efficient PS14P, featured with special thermal techniques for harsh temperatures and hardened, rugged enclosures qualify easily to provide a multi-purpose choice for all PoE device applications. The PS14P is a very important convenient source to meet all PoE requirements with a multi-choice of options.

The Magnum PS14P(PoE) Switch provides edge access Ethernet ports in a convenient and compact package. For fiber connectivity or additional non- PoE ports, simply add a Magnum CS14- converter switch (two RJ-45 and a 10 or 100Mb fiber port) or an ES42 Edge Switch (six ports with Fiber option) to meet the Fiber requirement. All PS14P Power Source Convenient Switch models come with two (2) sets of LED indicators. One set is mounted in the end adjacent to three of the RJ-4 ports for easy viewing when the

unit is mounted in a rack mount tray.

The Magnum PS14P Power Source Switch requires a heavy-duty power supply of -48VDC 1.4Amps (66 watts total consumption) to provide 13-15w power on each port to the PoE unit. The heavy duty Din rail mounted, -48V DC power supply can be purchased using this URL:

<http://www.lanstore.com/ps.htm>

**Note:** *The 8-15vdc option is also present, but can only be used to power the PS14P unit when **no** PoE devices are attached. While using a 12vdc Adaptor to power on the switch, the unit will not function as a PoE power source switch but as a non-PoE switch only.*





### 2.3 Magnum PS14P & S14-Series, with four (RJ-45) Copper ports

The Magnum S14-Series & PS14P chassis house one main PC board. The power supply is an external AC unit or internal DC via a screw terminal block. The front side of the chassis has three twisted-pair switched ports and one port is provided on the rear side. All four ports of the S14-Series convenient switch support auto-cross (MDIX), and perform the auto-cross in the auto-negotiation mode only.

Dual LEDs indicating the operating status of ports are mounted on the top as well as end for convenience and may be viewed from any direction. There are power (PWR) indicators for the unit to validate that the unit is turned ON. For each port, there are Link and Activity (LK/ACT) LEDs indicating traffic that are mounted on the top of the unit as well as the end. LEDs mounted next to each port indicate (LK/ACT as LA1, LA2, LA3, LA4), 10/100 (ON for 100Mbps), and full/half duplex (F/H is ON for full duplex).

The DC power plug connector or “jack” is in the right rear of the chassis. The internal DC input terminal block is also provided on the rear side of the unit.

## **2.4 Frame Buffering and Latency**

The Magnum S14-Series & PS14P(PoE) Switches are store-and-forward switches. Each frame (or packet) is loaded into the Switch’s memory and inspected before forwarding can occur. This technique ensures that all forwarded frames are of a valid length and have the correct CRC, i.e., are good packets. This eliminates the propagation of bad packets, enabling all of the available bandwidth to be used for valid information.

While other switching technologies such as "cut-through" or "express" impose minimal frame latency, they will also permit bad frames to propagate out to the Ethernet segments connected. This "cut-through" technique permits collision fragment frames, which are a result of late collisions, to be forwarded which add to the network traffic.

Since there is no way to filter frames with a bad CRC (the frame must be present in order for CRC to be calculated), the result of indiscriminate cut-through forwarding is greater traffic congestion, especially at peak activity. Since collisions and bad packets are more likely when traffic is heavy, the result of store-and-forward operation is that more bandwidth is available for good packets when the traffic load is greatest.

When the Switch detects that its free buffer queue space is low, the Switch sends industry standard (full-duplex only) PAUSE packets out to the devices sending packets to cause “flow control”. This tells the sending devices to temporarily stop sending traffic, which allows a traffic catch-up to occur without dropping packets. Then, normal packet buffering and processing resumes. This flow-control sequence occurs in a small fraction of a second and is transparent to an observer. See Section 4.6 for additional details.

Another feature implemented in Magnum S14-Series & PS14P(PoE) Convenient

Switches is a collision-based flow-control mechanism (when operating at half-duplex only). When the Switch detects that its free buffer queue space is low, the Switch prevents more frames from entering by forcing a collision signal on all receiving half-duplex ports in order to stop incoming traffic.

The latency (the time the frame spends in the Switch before it is sent along or forwarded to its destination) of the S14-Series & PS14P(PoE) Convenient Switches varies with the port-speed types. The length of the frame is a variable here as it is with all store-and-forward switches. For 10 Mb-to-10 Mb or 10 Mb-to-100Mb or 100Mb-to-10 Mb forwarding, the latency is 15 microseconds plus the packet time at 10 Mb. For 100Mb-to-100Mb forwarding, the latency is 5 microseconds plus the packet time at 100Mb.

## 2.5 Features and Benefits

### ■ **Small 4-port 10/100 Switch unit for edge-of-network applications**

Expansion of Ethernet connectivity is needed to connect edge devices into the LAN, the Magnum S14-Series & Switches provide 10/100 switching in a convenient and compact package that fits right into the site.

### ■ **PS14P, Sleek 4-port 10/100 Power Source Switch for PoE devices**

The compact and robust PS14P(PoE) acts as a Power plug for all the PoE devices, e.g CCTV camera, VOIP phone, digital clock, and wireless point through its RJ-45 ports and provides a convenient cost-effective power source.

### ■ **Three models for three application environments (S14-series)**

- Yellow-label for the office and wiring closet
- Orange-label, Hardened for the factory floor.
- Red-label, premium rated for un-controlled temperatures, outdoors

- **Installation is “Plug and Play”, operation is transparent to software**

The Magnum S14-Series & PS14P Switches operate as LAN switches only forwarding those packets from each domain that are needed on the other domains. Internal address tables are self-learning. All ports are auto-cross.

- **Two sets of LEDs for viewing status from any angle.**

Each S14-Series & PS14P Convenient Switch is equipped with two sets (front and side) of LEDs to provide status information when viewed at any angle or mounting arrangement, rack-mount, DIN-Rail, or panel-mount.

- **Rugged metal case, Industrial grade**

S14-Series & PS14P are packaged in rugged sheet metal enclosures to ensure durability and noise immunity, even when placed in extended temperature environments or high EMI noise sites; e.g industrial or outdoor applications.

- **AC and DC Power Supplies with extended temperature ratings**

S14-Series power input may be a variety of types, external AC and internal

---

DC at 12V, 24V, or -48VDC. AC may be at extreme temperatures.

■ **DC-input models can operate as dual-source (S14-series)**

The 12V DC jack is present on DC-input models, so that the unit can operate from an external AC PS, or from DC applied to the terminal block, either or both present. Dual-source power may increase availability, or be convenient to move the unit from a test lab out to the factory floor.

■ **DC-Power input for PoE Power Source Switch(PS14P)**

The 802.3af PoE standard PS14P power source switch requires 1.4Amps-48VDC to provide enough power for 13-15watts on each RJ-45 port. The Terminal block for -48V DC input is a range of 46V to 60V DC.

■ **Efficient Compact design, for all-purpose convenient mounting**

Featuring a compact metal case, Magnum S14-Series & PS14P(POE) can be installed in minimal space in a rack-mount MC14-TRAY, on DIN-Rail (optional) or panel mounting.

---

## 2.6 Applications (S14 Series and PS14P(POE) Switches)

### For S14-Series

With the three tier “YOR” hardness ratings, Yellow for “office”, Orange for “Hardened”, Red for “Premium rated (outdoor)”, the Magnum S-14 Series Convenient Switch unit fits in any environment where users need to add a few RJ-45 ports to a LAN quickly and cost effectively. The edge-of-the-network connectivity product makes challenging industrial applications easier, more economical, and more-reliable. The compact Magnum S14-series 10/100 Mbps switch functions support a mixed environment of 10 Mbps and 100Mbps users. The switching full / half duplex capability on all four ports provide bandwidth for high performance. Port #1 (on the back end) is typically used for an up-stream connection. When expansion is needed, add another S14 and connect it into port #1 with twisted pair cabling to add 3 more ports.



**Example 1. S14's**-In this example, the Magnum S14 Convenient Switch is used to serve a small office in a factory with multi-servers, print server, internet access and mixed-

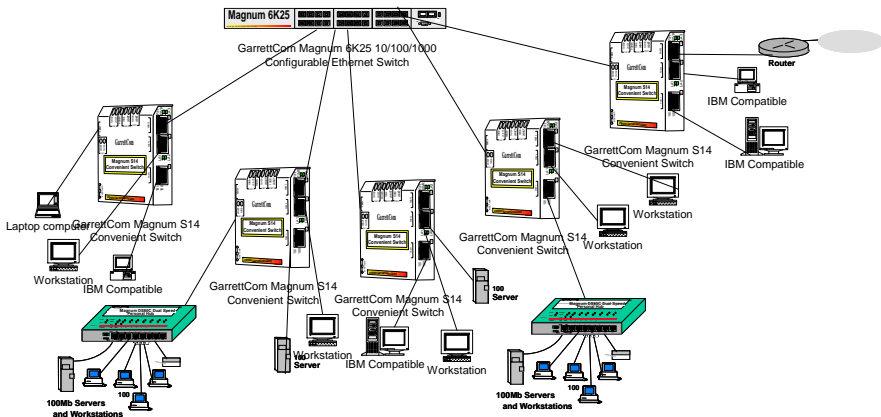

S14 Convenient Switches used as a useful & reliable expanding solution for the non-stopping network demand

speed requirements. The users operate at 100Mb as well as at 10 Mb, and utility devices (such as print servers) run at 10 Mbps. High performance users need a high bandwidth up-link for access to a central LAN and central file servers. Any attached node can change speed at any time without affecting network operation or impacting other users. The multi-functional S14 Convenient switches provide this solution very efficiently and economically. Various features included MDIX, plug-n-play, Din-Rail mountings and dual LEDs make this compact and convenient switch a very effective solution for this requirement.

**Example 2. S14Hs:** In this application in an expanding Industrial network environment, the new PLC units are deployed on all the present networks and need an Ethernet port to carry the data to the main workstation being controlled by the Industrial Engineering crews. The hardened version of Magnum S14Hs are typically used where 10/100BASE-T networking equipment is being installed in highly controlled temp environments and

require an effective and economical solution to satisfy the need.

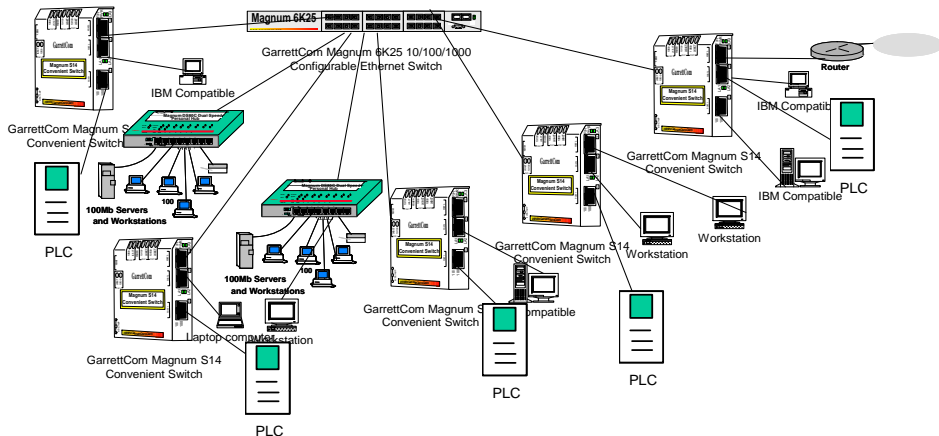

S14H Convenient Switches provided a secure economical solution for expanding Industrial network

Built with high-grade components, efficient thermal techniques of cooling, and equipped with a wide variety of options of AC and DC power supplies, the cost-effective Magnum S14Hs Convenient Switches easily qualify to be used in highly controllable industrial applications. The S14H Switches act as a network edge connectivity unit to satisfy ongoing needs very efficiently and economically.

**Example 3: S14Ps**

The Magnum S14Ps fit very well in high temperature locations (control rooms) experiencing a need to scale their LAN quickly and cost effectively. With its half / full duplex switching capability, the S14Ps provide a very economical high bandwidth solution at each copper-cable user-access point. The 10/100 dual-speed functions support a mixed environment of 10 Mbps and 100Mbps users and devices unconditionally. The switching capability on all ports provides bandwidth for high performance. The ruggedness of the S14Ps steel case and the high reliability of the design compliments the temperature controlled packaging to provide an exceptional Ethernet product.

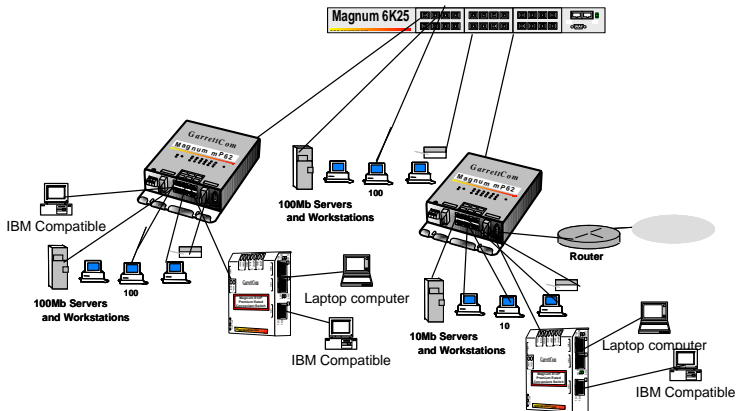

S14P Convenient Switches provided a secure dependable, reliable solution for un-controlled temp. environment

In this example, the extended temperature rated S14Ps take care of the LAN connectivity requirement in a harsh temperature environment mounted above the ceiling in the building. The steel enclosure and wide selections of DC power inputs qualifies the Magnum S14Ps to provide a dependable, reliable and economical solution for any temperature un-controlled environments. This sleek designed convenient Switch can easily meet the ongoing demand of a growing network.

#### **Example 4a. Magnum PS14P (Power Source Switch) for PoE device only**

This example is an Industrial application, where the expansion of their factory network is being done to extend their capacity and make it more secure through CCTV cameras which monitor the day-to day manufacturing process. The blue tooth wireless was also implemented to eliminate the cable wiring between the PS14P (PoE) switches. The un-controlled temperature and the electric wiring were the big challenges to meet at this requirement.

The Magnum PS14P(PoE) Power source switch is an effective and convenient solution for remote locations where providing power through wire is not only difficult but expensive too. The cost-effective and efficient Magnum PS14P with its robust enclosure provides a very economical solution through its 4-PoE RJ-45 ports. The Power Source Switch with PoE ports are capable of carrying data, power, and voice over RJ-45 cable using Magnum PS14P(PoE) units.



**Example 4b. Magnum PS14P (Power Source Switch) for PoE device only**

In another application for the Industrial floor, the requirement is to provide the complete floor with wireless to avoid more cabling mess and connect all the status delivery joints with VOIP phones.

The PS14P(PoE) is being recommended to fulfill this requirement to make the upgrade more cost-effective and avoid another un-necessary electrical cable expansions. The sleek industrial proof Magnum PS14P(PoE) with its power Source Switch capability, easily meets the demand to provide power through its RJ-45 cable, and allows for a very neat Network setup.

The Magnum PS14P(POE) is enabling the efficient deployment of reliable VoIP and wireless networking tools to increase the efficiency of communication across the enterprise. Furthermore, using PoE devices like the Magnum PS14P(PoE) has significant cost savings, flexibility, and reliability advantages over traditional AC power. They reduce the overall cost of network ownership. The PoE devices used for this industrial application are VOIP for voice, Wireless points for wi-fi connection, and a PoE Clock to synchronize the time with the SNTP server for every second correct timing.



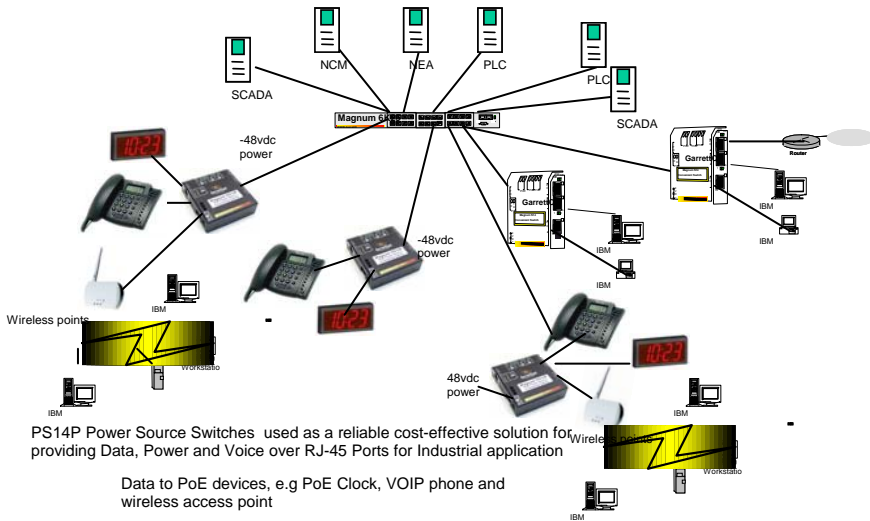

### **3.0      INSTALLATION**

This section describes the installation of the Magnum S14-Series & PS14P(PoE) Convenient Switches, including location, mountings, power supply and media connection.

#### **3.1    Locating the Convenient Switch Unit**

All the S14-Series & PS14P(PoE) Switches operate in transparent half-and full-duplex mode. The store and forward switch easily take care of the network traffic and can be used as a useful economical tool to expand the existing network. The compact and lightweight design of the Magnum S-Series allows it to be easily installed in almost any location. Metal mounting clips and screws are included for a rugged and secure mounting in any orientation. An option DIN-Rail bracket is available.

Installation of the Magnum S14-Series & PS14P(PoE) Switches is a simple procedure. The installation location is dependent upon the physical layout of the Ethernet network and associated cabling. Make sure the unit is installed in a location that is easily accessible to an AC power outlet or power strip and where convection cooling is not inhibited. The green Power (PWR) Led must turn ON when power is applied through the internal DC input 12V, 24V or -48V DC or external AC through 9V DC jack.

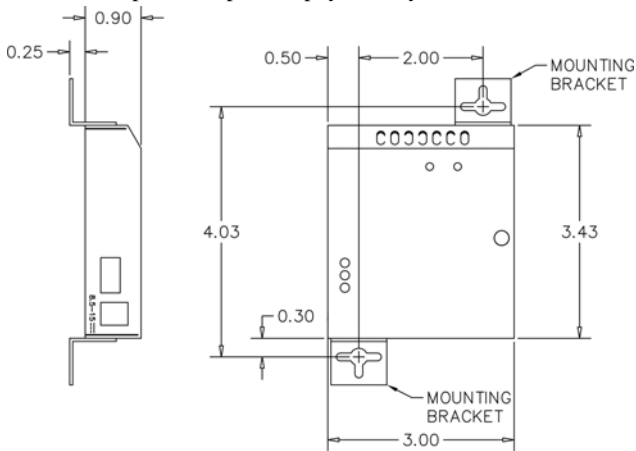

### 3.2 MC14-TRAY for Rack Mounting of S14-Series Switches

For 19" rack-mounting of Magnum S14-Series & PS14P(PoE) Convenient Switches, a rack-mount tray is available, the part number is MC14-TRAY. The Convenient Switches along with Media Converter units are mounted with their RJ-45 ports and DC power jacks in the back, with either fiber or BNC cable in the

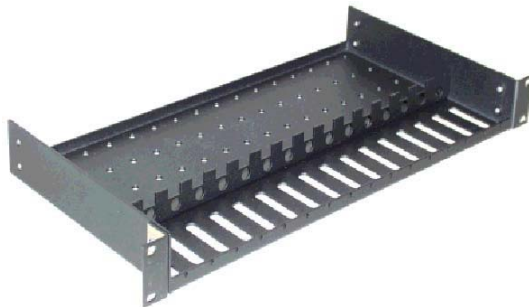

front. Any mix of the Convenient Switches, Media Converters may be placed on a tray, up to a maximum of 16 units. (The mounting spaces of the MC14-TRAY are specific to the "S14"-series, and do not permit other models). A typical installation of the model MC14-TRAY, 19" rack-mount tray will hold a few (often three to eight) S14-Series &

PS14P(PoE) Convenient Switches, with their power supplies plugged into power strips (not included) in the rear area of the tray. Metal mounting screws in the bottom-front hold the Media Converters firmly in place. The beveled-top edge of the units permit the LEDs of each unit to be viewed for operational status, even when the units are very close together.

### **3.3 MC14-TR+PS9 & MC14-TR+PS9X2 for Rack Mounting**

The MC14-TR+ PS9 and MC14-TR+PS9X2's are another option available for Rack Mounting the mix-match of 10Mbps and 100Mbps Media Converters and the S14-Series & PS14P(POE) Switches together in a 19" rack-mount tray. These models comes with built-in common universal AC power supplies rated at 55 watts at 50°C ambient, 12VDC output, and supporting up to 10 Switches for MC14-TR+PS9 and 16 units S14-Series for MC14-TR+PS9X2. The MC14-TR+PS9X2 Model has two groups of eight units per power supply. These models are equipped with auto-ranging AC input to the power supplies for use worldwide.

(The MC mounting spaces of the MC14 -TR models are specific to the Magnum S14-Series 10Mbps (FT14 and TB14) and 100Mb (14E) series, and do not permit other models to be put in the tray).

The side-view picture shown here is an example of an installation of the model MC14-TR+PS9, 19" rack-mount tray, holding a few S14-Series , 10Mbps FT14's and 100Mb 14E



Media Converters, each with their power input plugged into the built-in common AC power supply in the rear area of the tray. (PS units that come with the MC's are not used).

Metal mounting screws in the bottom-front hold each of the media converters secure in the tray, separately removable for service. The dual LEDs permit viewing operating status of the S14-Series Convenient Switches from any angle.

### 3.4 DIN-Rail mounting option

The Magnum PS14P, S14HR & S14PR Convenient Switches, designed for use in “Factory Floor” Industrial Ethernet environments, are also available for DIN-Rail mounting in an enclosure having DIN Rails.



The metal DIN-Rail mounting hardware is optional and needs to be ordered as a separate item, e.g. Model # DIN-RAIL-MC2. It comes with four screws to attach the bracket to the MC unit.

**A Magnum PS14P(PoE) with -48VDC supply (left) and S14H (right) is shown alongside the DIN-Rail-MC2 bracket**

The Magnum S14 Models with “HR” have 24VDC power, and have the DIN-Rail-MC2 bracket included and assembled with the MC unit at the factory.

### 3.5 Power Requirements for S14 Series Switches

Magnum S14-Series Switches are power-efficient and can work with an external AC power supply. Magnum S14-Series require a nominal 12VDC input (range 8 to 15V, see Specifications) at the jack in the rear. The extended temperature –Hd version is used for heavy duty and industrial applications, up to 55°C ambient.

The 12V DC power input has a plug of 2.5mm, center +ve , with 6 ft. cord. All the AC power supply designed to be used with UL listed Class II power supplies and the detail info is being provided in Technical Specifications Section 1.1.

The S14-Series are designed to provide reliable operation, withstand higher temperature environments, and provide the Direct DC power choices to the user to deploy in uncontrolled temperature environments.



**12VDC****24VDC****-48VDC**

The Internal 12V DC (8 – 15V DC) has a built-in terminal block for +, -, ground. The 9V DC jack is also present. Detail information about the 12 VDC, the 24V DC and the –48V DC is provided in the Technical Specifications Section 1.1.

The various models of Direct DC power type and extended ambient temperature power supplies are numerous and your choice needs to be called out on your order.

*Note: When connected to a - 48 V centralized dc source these products are to be installed only in Restricted Access Areas (dedicated equipment rooms, electrical closets or the like).*

### 3.6 Powering the S14 Series (DC internal) with 12V, 24V or -48VDC power input

Each Magnum S14H/S14P is reliably equipped with a Direct DC power supply, and have built-in screw terminals for secure attachment of the power leads. Three models support a range of power input types. The three model choices are for use with 12VDC, 24VDC or -48VDC power. DC power input may be chosen for high-availability.

The extended temperature capability of the Direct DC-powered S14P's can go into temperature uncontrolled environments, rated at  $-40^{\circ}\text{C}$  to  $+75^{\circ}\text{C}$ . The DC jack is also present and optionally can be used with an external P-rated AC power supply to provide “dual source” power input.



**DC Power Terminals:** “+”, “-”, floating

**GND:** Terminal for “earth” or ground wire connection to the S14H chassis

**Input Voltage:** 8 - 15V DC (12V DC)  
18 – 36V DC (24V DC)  
36 – 60V DC (-48V DC)

**Input current:** 0.8 amp.(12V DC)  
0.4 amp max.(24V DC)  
0.2 amp max.(-48V DC)

**Power Consumption:** 3 watts typical, 4 watts max.

### 3.7 S14H & S14P, DC-powered, -48VDC, 24VDC and 12VDC Installation

This section describes the proper connection of the -48VDC leads (or 24VDC, 12VDC leads) to the Direct DC power terminal block on the Magnum S14H hardened media converter (as shown in Figure above). The DC terminal block on the Magnum S14H is located on the left side of the unit and is equipped with three (3) screw-down lead posts. The power terminals are identified as positive (+) and negative (-), and they are floating inside the unit so that the user if desired may ground either of the terminals. The chassis is “earth” or ground (GND).

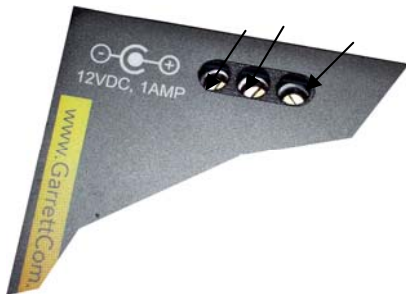

The connection procedure is straightforward. Simply insert the DC leads to the S14H's power terminals, positive (+) and negative (-) screws. The use of Ground (GND) is optional; it connects to the S14H chassis. Ensure that each lead is securely tightened from the top, as shown here.

***NOTE: Always use a voltmeter to measure the voltage of the incoming power supply and figure out the +ve potential lead or -ve potential lead. The more +ve potential lead will connect to the post labeled “+ve” and the rest to the “-ve”.***

***The GND can be hooked up last.***

When power is applied, the green PWR LED will illuminate.

### 3.7.1 Power Requirement for PS14P(PoE) Power Source Switch

**POWER INPUT:** Total Power Consumption: 66 watts max. (1.4A @48VDC)  
Terminal block for -48v DC input (range of 46 to 60V dc), built in for +, -, ground.

**Note:** *The 8-15V DC option is also present, but can only be used to power the PS14P(POE) unit when no PoE devices are attached. The device will not function as PoE Switch while powered up via 12VDC power, but as a normal non-PoE Switch.*

**POWER OUTPUT:**

PoE available on all four RJ-45 ports via Ethernet twisted pair cabling on port pins using spare pairs 4,5(+) 7,8(-), not the data pair 1,2(-), 3,6(+)

802,3af Power Consumption: 61.6 watts max.

(15.4(max)/port)

PoE Ports Output voltage: 44 to 57 VDC

Over Current Protection, per port: reset able fuse

Power Consumption: Typical 3 watts, 4 watts max.

Note: Din-Rail mounted, Powerful -48vdc supply used for Magnum PS14P(POE) can be bought directly using this URL: <http://www.lanstore.com/ps.htm>



### 3.8 Connecting Twisted Pair (RJ-45 ports)

The Magnum S14-Series & PS14P(POE) Convenient Switches can be connected to only one media type with two different speed i.e. 100BASE-TX and 10BASE-T. CAT 5 cables should be used when making 100BASE-TX connections. When the ports are used as 10BASE-T ports, CAT 3 may be used. In either case, the maximum distance for unshielded twisted pair cabling is 100 meters (328 ft).

<u>Media</u>	<u>IEEE Standard</u>	<u>Connector</u>
Twisted Pair (CAT 3 or 5)	10BASE-T	RJ-45
Twisted Pair (CAT 5)	100BASE-TX	RJ-45

**NOTE :** *It is recommended that high quality CAT. 5 cables (which work for both 10 Mbps and 100Mbps) be used whenever possible in order to provide flexibility in a mixed-speed network, since S14-Series & PS14P(POE) switch ports are auto-cross(MDIX) for either 10 and 100Mbps. Note that the auto-cross function does not operate, if the port is fixed or not supporting auto-negotiation.*

### 3.8.1 Connecting Twisted Pair (RJ-45, CAT 3 or CAT 5, Unshielded or Shielded)

The following procedure describes how to connect a 10BASE-T or 100BASE-TX twisted pair segment to the RJ-45 port. The procedure is the same for both unshielded and shielded twisted pair cables.

1. Using standard twisted pair media, insert either end of the cable with a RJ-45 plug into the RJ-45 connector of the port. Note that, even though the connector is shielded, either unshielded or shielded cables and wiring may be used.
2. Connect the other end of the cable to the corresponding device.
3. Use the LINK LED to ensure proper connectivity by noting that the LED will be illuminated when the unit is powered and proper connection is established. If this does not help, ensure that the cable is connected properly and that the device on the other end is powered and is not defective.
4. For Port # 1 or 1SW, if the LINK LED is not illuminated, move the switch which has a cross-over or up-link for linking to another hub or Switch.



---

**3.8.2 Connections to NICs which support Auto-Negotiation, RJ-45 ports**

The copper ports of Magnum S14-Series Convenient Switches will function properly with NICs (Network Interface Cards) which support Auto-Negotiation, and the Fast Link Pulse (FLP) coding for the 100BASE-TX signaling system. When connecting a NIC to the S14-Series, it may be necessary to reload the NIC drivers on the user device if the NIC has been communicating with a protocol other than 100BASE-TX (such as 10BASE-T). When 100Mb operation is agreed and in use, the 10/100 LED is illuminated steady ON and is OFF, if 10 Mbps traffic.

## **4.0 OPERATION**

### **4.1 Dual-Speed Functionality, and Switching**

The Magnum S14-Series & PS14P(PoE) Convenient Switches provide four switched ports(three ports in the front and one on the rear). The architecture supports a dual speed switching environment, with auto-negotiation capability.

The switched RJ-45 ports are full-duplex and auto-sensing for speed. (See section 2.2). When the connected device is 10 Mbps, the S14s obeys all the rules of 10 Mbps Ethernet configurations. The 10 Mbps users share a 10 Mbps traffic domain, and can “communicate with” 100Mbps users as well as 100Mbps domain. Similarly, the 100Mbps traffic obeys the rules of 100Mbps Ethernet, and can communicate with 10 Mb domain too.

Magnum S14-Series & PS14P(PoE) units are plug-and-play devices. There is no software configuring to be done at installation or for maintenance. The internal functions of both are described below.

**Switching, Filtering and Forwarding**

Each time a packet arrives on one of the switched ports, the decision is taken to either filter or to forward the packet. Packets whose source and destination addresses on the same port segment will be filtered, constraining them to one port and relieving the rest of the network from processing them. A packet whose destination address is on another port segment will be forwarded to the appropriate port, and will not be sent to the other ports where it is not needed. Packets needed for maintaining the operation of the network (such as occasional multi-cast packets) are forwarded to all ports.

The Magnum S14-Series & PS14P(PoE) Convenient Switches operate in the store-and-forward switching mode, which eliminates bad packets and enables peak performance.

### **Switching, Address Learning**

The Magnum S14-Series & PS14P(PoE) units have address table capacity of 2K node addresses, and are suitable for use in large networks. They are self-learning, so that as nodes are added or changed, the S14-Series & PS14P(PoE) automatically keeps up with node locations.

An address-aging algorithm causes least-used addresses to fall out in favor of new frequently-used addresses. To reset the address buffer, cycle power down-and-up.

#### **4.2 Auto-cross (MDIX), Auto-negotiation and Speed-sensing**

The RJ-45 ports support auto-cross (MDI or MDIX) in the auto-negotiation mode according to the IEEE 802.3u standard. No crossover cables are needed when connecting the S14/PS14P(PoE)'s to other unmanaged switches, legacy hubs, managed switches, media-converters etc. Please note that there can be conditions with managed switches where the switch manager fixes the port settings via software, and the result of the auto-negotiation is changed in the managed switch by the manager commands. In such cases, the 10/100 speed or the F/H mode may be affected, but auto-cross in the

S14 and PS14P(PoE) Switches will still work. The auto-cross function cannot be disabled.

When an RJ-45 cable connection is made, and each time LINK is enabled, auto-negotiation takes place (except for legacy products, which do not have auto-negotiation and which go to the default state accordingly). The Magnum Switch advertises its capability for 10 or 100 Mbps speed and F/H duplex mode, and the device at the other end of the cable should similarly advertise / respond. Both sides will agree to the speed and mode to be used per the IEEE 802.3u standard. Depending upon the devices connected, this will result in agreement to operate at either 10 Mbps or 100Mbps speed, and full- or half-duplex mode.

### 4.3 Dual LEDs, Front-panel and side-panel

<u>LED</u>	<u>Description</u>
------------	--------------------

<b>PWR</b>	Illuminates GREEN to indicate power applied.
------------	--

<b>LK/ ACT</b>	Steady ON for LINK w/no traffic, blinking for activity per port. LINK will turn off in the event connectivity is lost between the ends of the twisted pair segment or a loss of power occurs in the unit or remote device. The Link ports are also represented by LA1, LA2, LA3, & LA4. (Steady On or steady Off indicates no Receive Activity).
----------------	--

<b>10/100</b>	Steady ON for 100Mb speed, OFF for 10Mb speed per port
---------------	--

<b>F/H</b>	Steady ON for Full duplex mode, OFF for half duplex per port
------------	--

## **5.0 TROUBLESHOOTING**

All Magnum Ethernet products are designed to provide reliability and consistently high performance in all network environments. The installation of Magnum S14-Series & PS14P(PoE) 10/100 Mb/s Switches is a straightforward procedure (see INSTALLATION, Section 3.0); the operation is also straightforward and is discussed in Section 4.

Should problems develop during installation or operation, this section is intended to help locate, identify and correct these types of problems. Please follow the suggestions listed below prior to contacting your supplier. However, if you are unsure of the procedures described in this section or if the Magnum S14-Series & PS14P(PoE) 10/100 Mb/s Switch is not performing as expected, do not attempt to repair the unit; instead contact your supplier for assistance or contact GarrettCom Customer Support.

**5.1 Before Calling for Assistance**

1. If difficulty is encountered when installing or operating the unit, refer back to the Installation Section of the applicable chapter of this manual. Also check to make sure that the various components of the network are interoperable.
2. Check the cables and connectors to ensure that they have been properly connected and the cables/wires have not been crimped or in some way impaired during installation. (About 90% of network downtime can be attributed to wiring and connector problems.)
3. Make sure that an AC power cord is properly attached to each Magnum S14-Series & PS14P(PoE) unit. Be certain that each AC power cord is plugged into a functioning electrical outlet. Use the PWR LEDs to verify each unit is receiving power.
4. If the problem is isolated to a network device other than the Magnum S14-Series & PS14P(PoE) 10/100 Mb/s switch product, it is recommended that the problem device is replaced with a known good device. Verify whether or not the problem is corrected. If not, go to Step 5 below. If the problem is corrected, the Magnum S14-Series & PS14P(PoE) Switch and its associated cables are



functioning properly.

5. If the problem continues after completing Step 4 above, contact your supplier of the Magnum S14-Series & PS14P(PoE) 10/100 Mb/s Switch unit or if unknown, contact GarrettCom, Inc by fax, phone or email (*support@garrettcom.com*) for assistance.

## 5.2 When Calling for Assistance

Please be prepared to provide the following information.

1. A complete description of the problem, including the following points:
  - a. The nature and duration of the problem;
  - b. Situations when the problem occurs;
  - c. The components involved in the problem;
  - d. Any particular application that, when used, appears to create the problem;
2. An accurate list of GarrettCom product model(s)involved, with serial number(s). Include the date(s) that you purchased the products from your supplier.
3. It is useful to include other network equipment models and related hardware, including Convenient computers, workstations, terminals and printers; plus, the

various network media types being used.

4. A record of changes that have been made to your network configuration prior to the occurrence of the problem. Any changes to system administration procedures should all be noted in this record.

### 5.3 Return Material Authorization (RMA) Procedure

All returns for repair must be accompanied by a Return Material Authorization (RMA) number. To obtain an RMA number, please use this URL -

[https://rma.garrettcom.com/rma/rma\\_request\\_noaccount.php](https://rma.garrettcom.com/rma/rma_request_noaccount.php) to fill out the form.

Please have the following information readily available:

Name and phone number of your contact person.

Name of your company / institution

Your shipping address

Product name

Serial Number (or Invoice Number)

Packing List Number (or Sales Order Number)

Date of installation

Failure symptoms, including a full description of the problem.

GarrettCom will carefully test and evaluate all returned products, will repair products that are under warranty at no charge, and will return the warranty-repaired units to the sender with shipping charges prepaid (see Warranty Information, Appendix A, for complete details). However, if the problem or condition causing the return cannot be duplicated by GarrettCom, the unit will be returned as:

**No Problem Found.**

GarrettCom reserves the right to charge for the testing of non-defective units under warranty. Testing and repair of product that is not under warranty will result in a customer (user) charge.

#### **5.4 Shipping and Packaging Information**

Should you need to ship the unit back to GarrettCom, please follow these instructions:

1. Package the unit carefully. It is recommended that you use the original container if available. Units should be wrapped in a "bubble-wrap" plastic sheet or bag for shipping protection. ( You may retain all connectors and this Installation Guide.)

---

**CAUTION: Do not pack the unit in Styrofoam "popcorn" type packing material. This material may cause electro-static shock damage to the unit.**

2. Clearly mark the Return Material Authorization (RMA) number on the outside of the shipping container.
3. GarrettCom is not responsible for your return shipping charges.
4. Ship the package to:

**GarrettCom, Inc.**

**47823 Westinghouse Dr.**

**Fremont, CA 94539**

**Attn.: Customer Service**

---

**APPENDIX A: WARRANTY INFORMATION**

GarrettCom, Inc. warrants its products to be free from defects in materials and workmanship for a period of three (3) years from the date of shipment by GarrettCom.

During this warranty period, GarrettCom will repair or, at its option, replace components in the products that prove to be defective at no charge other than shipping and handling, provided that the product is returned pre-paid to GarrettCom.

This warranty will not be effective if, in the opinion of GarrettCom, the product has been damaged by misuse, misapplication, or as a result of service or modification other than by GarrettCom.

GarrettCom reserves the right to make a charge for handling and inspecting any product returned for warranty repair which turns out not to be faulty.

Please complete the warranty card as this acts as a product registration, and mail it to GarrettCom within two weeks of your purchase.