

analog dialogue

A forum for the exchange of circuits and systems for measurement and control

HIGH-RESOLUTION VIDEO CONVERTERS (Page 3)

Voltage-to-Current (4-20mA) Converters (Page 8)

Complete Contents on page 3

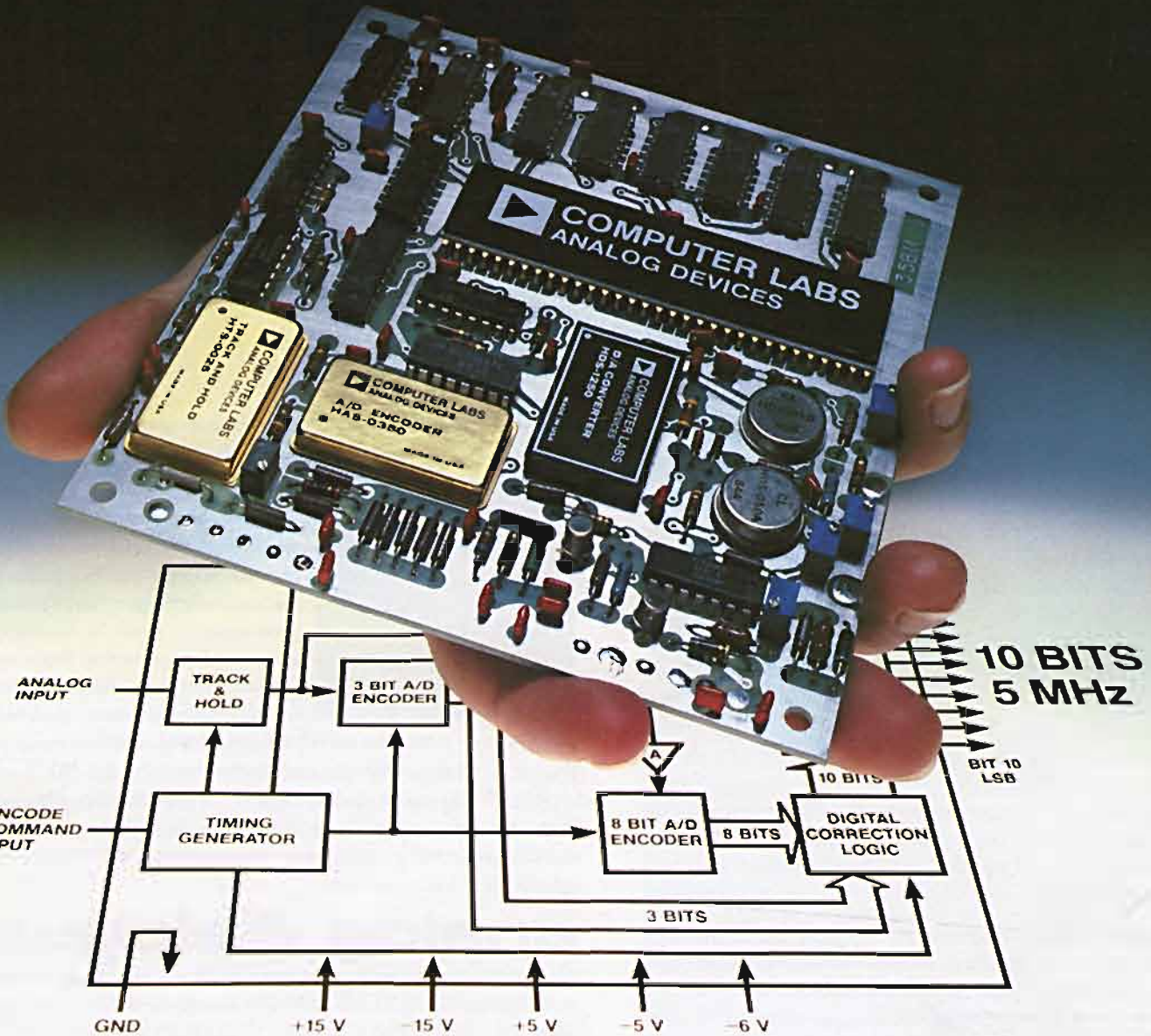

Editor's Notes

A seatmate on an airplane, on ascertaining the source of our bread-and-butter, recently remarked, "Analog Devices, eh? How are you people going to survive, now that the world is going digital?" Fortunately, it was a long flight; so it was possible to discuss the semantic, philosophical, technological, and business implications of his question at length and get across the conviction that the future could indeed be bright for a company named "Analog Devices."



Webster's New Collegiate Dictionary defines an *analog* computer as "a computer that operates with numbers represented by *directly measurable quantities*." If operations with numbers are considered to be in the province of a computer, "analog" then has to do with directly measurable quantities. If you can measure it, it's analog — even the output of a flip-flop! (We won't say that digital is a special case of analog — but we'll listen with appreciation to anyone who makes that assertion.) Since our business is devices for measurement and control, and real-world measurements are analog in nature, the word "analog" would not appear to restrict our ambitions unduly.

Our analog technologies started with the most general kind of analog signal processor, the operational amplifier, but we have long since extended our reach in signal conditioning, with devices that amplify, modulate, translate, isolate, furnish excitations and references, and perform simple analog computations. But that's not all: for digital signal processing, the analog signals have to be translated into digital form and back, calling for converters in great variety, in speed, resolution, packaging, and interface capabilities. And at the analog input to the system, we are starting to make our mark with sensors and transducers to measure temperature and denier.

Our readers know that it doesn't end there: single-channel and scanning panel instruments, for electrical and physical measurements; real-time interface boards for microcomputers; and the comprehensive Measurement And Control SYstem (MACSYM)—all provide digital functions that are sympathetically oriented towards both the analog world and the system designer who has recognized that specialized "buy-rather-than-make" system solutions save time and money and help him do his *real* job better, especially if he is not at once a circuit designer, debugger, designer-for-manufacturing, hardware-and-software expert, packaging engineer, and — oh, yes — a productive expert in his own field as well ("when you're up to your hips in alligators, it's hard to remember that your original objective was to drain the swamp!")

The future outlook is bright for measurement and control, hence for analog and related techniques; Industry, here and abroad, is investing heavily in automation to improve plant efficiencies, control cost and quality, meet environmental constraints, etc. As for the survival of "Analog Devices," our sunny business results and prospects, described in a number of recent corporate reports in rather concrete form, are available via the reply card.

Dan Sheingold

THE AUTHORS

Ed Graves (pages 3, 9) is Marketing Manager of Computer Labs Division, recently acquired by Analog Devices. Ed joined Computer Labs in 1968 and has held various positions in Engineering and — within the last few years — Marketing. Before joining Computer Labs, Ed worked in Design and Applications Engineering at the General Electric Company for eight years. His hobbies include music and auto racing.



Frank Goodenough (pages 8, 11) Technical Promotion Manager at Analog Devices, is best-known for his contributions in V-f-V converter applications at Teledyne Philbrick. In a multi-faceted career, he has designed everything from anchors and antennas to amplifiers at Brown & Root, Lockheed, Westinghouse, etc. His present activities include technical training, trade shows, editing, and writing.

Janusz Kobel (page 18) is Marketing Manager, signal-conditioning products, for ADI's Instruments and System Group. A native of Poland, he holds an MSEE from Warsaw Polytechnic Institute and an MBA from Boston University. Before joining us, he was employed at Bowmar/ALI and BLH Electronics, where he has developed a number of transducer-oriented process-control instruments and systems.



Dr. D. Philip Burton (page 10) is Manager of Development Engineering at Analog Devices B.V. in Limerick, Ireland. He holds a postgraduate degree in control systems and a Ph.D. in logic system design. He has been an independent consultant, Chief Engineer of Infotronics, Ltd., and Lecturer at the National Institute of Higher Education.

The MACSYM series (DIALOGUE 13-1) could not have happened without *Roland Johnson*, Senior Technical Writer in the Measurement & Control Products Group. He assembled and coordinated it and made the widely ramified material cohesive and understandable.

analog dialogue

Route 1 Industrial Park, P.O. Box 280, Norwood, Mass. 02062

Published by Analog Devices, Inc., and available at no charge to engineers and scientists who use or think about I.C. or discrete analog, conversion, data handling and display circuits. Correspondence is welcome and should be addressed to Editor, *Analog Dialogue*, P.O. Box 280, Norwood, Massachusetts, U.S.A. 02062. Analog Devices, Inc., has representatives and sales offices throughout the world. For information regarding our products and their applications, you are invited to use the enclosed Business Reply card, write to the above address, or phone 617-329-4700, TWX 710-394-6577 or 710-336-0562, Telex 924 491, or cable ANALOG NORWOOD MASS.

VERY HIGH SPEED DATA ACQUISITION

Pertinent Information About High-Resolution "Video" Converters

by Ed Graves

Until now, we have given readers of this Journal and other Analog Devices publications little opportunity to find information about very high-speed converters and their applications. Now, in this and the following pages, our colleagues at the Computer Labs Division seek to provide you with the information necessary for a basic understanding of the technology. In the future, you can expect to read more about the increasing applications of these techniques and some exciting new products that will place these powerful tools more firmly within your grasp.

The world of multi-MHz conversion differs, to a greater or a lesser extent, from the lower-frequency fields: in circuitry, terminology, applications, testing, and emphasis. As the uses of digital technology spread, the analog-digital interface must handle increased amounts of information; for this reason, knowledge of this heretofore esoteric technology becomes increasingly necessary, even for engineers not specifically involved in radar or TV projects.

The discussion that follows is not intended to be complete or all-encompassing; we hope that it will tempt you to read further in the literature (some of it available from Analog Devices).^{*} A brief Bibliography, with a great deal of fanout, appears at the end of this article.

WHAT DO WE MEAN BY "VIDEO"?

The spectrum of high-resolution conversion equipment that is commercially available in the form of "subsystem-solution" products^{*} covers the range of resolutions from 4 to 13 bits, with sample (word) rates from 2MHz to more than 100MHz. Such products are designed to encode or decode analog signals with maximum bandwidths exceeding 1 to 2 MHz.

A good example of such a device is the MOD-1005 a/d converter, depicted on this issue's cover. Characterized by 10-bit resolution and a 5MHz sample (or throughput) word rate, this converter is really a complete single-channel data-acquisition subsystem; it includes an input track-and-hold, a 10-bit encoder, an output latch, and all the necessary timing circuitry — all on a single circuit card suitable for plugging into a mother board. The only external connections needed to digitize an analog input are external power supplies and an *encode* (convert) pulse. The MOD-1005 has a systemic aperture uncertainty (at the instant the sampling switch is opened) of $\pm 25\text{ps}$ ($25 \times 10^{-12}\text{s}$). This means that analog signals having frequencies in excess of 6MHz can be digitized with slew-rate errors less than $1/2\text{LSB}$ (0.05% of full scale).[†] That is,

$$f_s = \frac{2^{-n}}{2\pi\tau_A} = \frac{1}{2\pi \cdot 1024 \cdot 25 \times 10^{-12}\text{s}} = 6.2\text{MHz} \quad (1)$$

Other typical video a/d converters available from us include the MATV-0820 (8 bits at 20MHz), the CLB-1310 (13 bits at 10MHz), and the CL-7120 (10 bits at 20MHz). The overriding

^{*}Use the reply card for a short-form catalog, for data on specific products mentioned here, or for reprints of articles available from Analog Devices.

[†]If the input signal in 5MHz sampling must be restricted to the Nyquist rate (2.5MHz) or less, the slewing error will be considerably less than $1/2\text{LSB}$ for a 10-bit conversion.

advantage of these converters is that they are *complete*. No extensive interface design is required to use them; in effect, just apply power, and they are ready to go!

ARE YOU A POTENTIAL "VIDEO" CONVERTER USER?

With the advent of less-expensive monolithic and hybrid state-of-the-art components, many new applications for video-converter products are surfacing that were out of the question just a few years ago because of their high cost. High-resolution converters are now used extensively in commercial, industrial, military, and research applications, such as radar, sonar, television, communications, spectrum analysis, and others. Figure 1 illustrates an application in the field of spectrum (or signature) analysis.

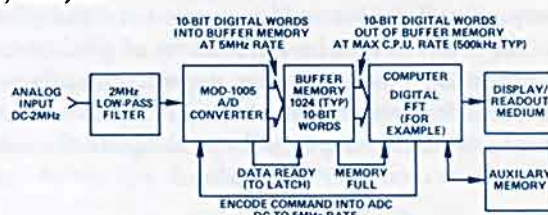

Figure 1. Typical digital signal-processing system.

In this example, the MOD-1005 ADC is used to digitize a band-limited analog signal at sample rates up to 5MHz. The digital output of the a/d converter is entered into a buffer

(continued on the next page)

IN THIS ISSUE

Volume 13, Number 1, 1979, 20 Pages

Editor's Notes, Authors	2
<i>Very High Speed Data Acquisition</i>	3
<i>Voltage-to-Current Converters for Process Control</i>	8
<i>300kHz Conversion System</i>	9
<i>Checking Analog-to-Digital Converter Linearity</i>	10
<i>High-Resolution Temperature-Difference Measurement</i>	11
New-Product Briefs:	
Single-Chip Fast 12-Bit D/A Converter	12
Monolithic Instrumentation Amplifier.	12
Three New IC Families with Existing Second Sources:	
AD DAC-08, AD ADC80, AD DAC87.	13
12-Bit Data-Acquisition Modules	14
Fast 14-Bit Sample-Hold Amplifier	14
Two New CMOS Switches with Existing Second Sources:	
ADG200, ADG201	15
Three New DC-to-DC Converters with Dual 15V Output:	
Synchro/Resolver Power Amplifier	16
Synchro-to-Digital Converters with 3-State Latches	16
Interface Card for STD BUS Computers.	16
Application Brief: <i>Statistics Using Analog Techniques</i>	17
Worth Reading: <i>1979 Short-Form Guide; Computer Labs Capabilities</i>	18
Across the Editor's Desk: <i>Four-Quadrant Division</i>	18
Potpourri.	19
Advertisement	20

memory capable of writing large blocks of data at this rapid rate. Under control of the central processing-unit (CPU), the data is then shifted into the computer for number-crunching.

These days, it is feasible to consider using a microprocessor to implement a relatively inexpensive spectrum analyzer by the execution of Fourier-transform algorithms. Since the μP , in its least-expensive form, is a slow device, the buffer memory is needed to hold the rapidly acquired fast data from the converter for processing at a comfortable pace. Such a system, using a fast ADC — such as the MOD-1005, in this case — makes analysis of the spectra of 10-bit signals, at rates extending into the video range, economically feasible. The same basic system concept can be used for transient analysis, using proper input signal-level detection and processing (triggering).

The “system-solution” approach can be applied to the design and application of fast *d/a converters*, too. In many applications, including video, the effect of *glitches* in the DAC output can be intolerable. Glitches are the result of a combination of causes: bit-timing asymmetry, conversion-circuit switch asymmetry, circuit layout, and numerous less-than-obvious sources. The errors caused by a typical set of glitches can be seen in Figure 2a, which illustrates the spectrum of a reconstructed 1.05MHz waveform, sampled at a 14.32MHz rate. Note that filtering the DAC output will not eliminate the in-band spurious products created by the glitch.

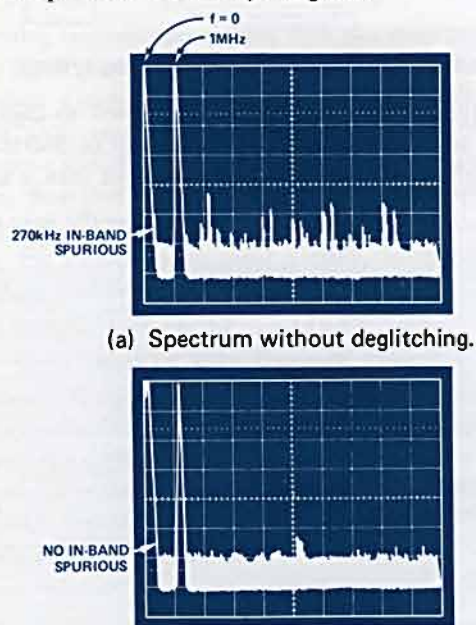

(a) Spectrum without deglitching.

(b) Spectrum of deglitched waveform.

Figure 2. Deglitcher in action. Spectrum of 1.05MHz sine wave sampled and reconstructed at 14.32MHz rate. Scales: 1MHz/div horizontally, 10dB/div vertically. Spreading of single frequency spikes is due to filter limitations in spectrum analyzer. Note 270kHz spike in (a) removed in (b).

A good solution is to use a video DAC that includes a track-and-hold type deglitcher (Figure 3). In this type of *d/a* subsystem, the T/H seizes the DAC output just before the DAC is updated and holds the output constant while the *d/a* converter is changing states. During this time, the output ignores the glitch. After the DAC has had time to settle, the T/H returns to the *track* state, and the subsystem output slews smoothly to the next level, eliminating the effect of the nonlinear

glitches. As Figure 2b shows, the remaining considerably smaller noise components tend to be of essentially uniform amplitude; they can be handled with relative ease by filtering.

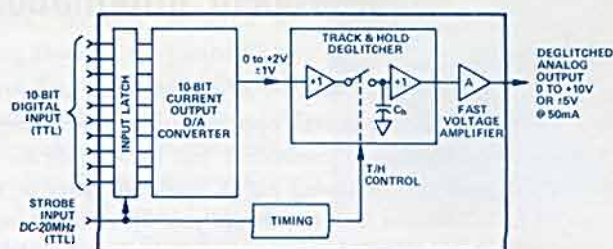

Figure 3. Functional diagram of MDD-1020A deglitched D/A subsystem module.

Applications for “video” *d/a*-conversion subsystems include cathode-ray-tube graphics displays, for X & Y (position) and Z (intensity) modulation, fast X-Y plotters, composite television-picture reconstruction, digitally controlled voltage-controlled oscillators (VCO’s), and others.

CONVERSION TECHNIQUES

The first commercially available high-resolution video *a/d* converter, originated more than a decade ago by Computer Labs, utilized the *serial (or cascade) Gray code* technique. It was implemented by having one basic gain-element and one digital comparator per bit. The resulting output, in Gray code*, was converted to binary within the *a/d* converter.

A block diagram of a serial Gray-code converter is shown in Figure 4. For an *n*-bit converter, there are *n* cascaded decision stages. Each stage exhibits a transfer characteristic similar to the ones shown, with gain of +2 for inputs from 0 to $E_{MAX}/2$ and gain of -2 for inputs from $E_{MAX}/2$ to E_{MAX} . For values of input between 0 and $E_{MAX}/2$, the digital bit value is 0, and for inputs between $E_{MAX}/2$ and E_{MAX} , the digital bit value is 1.

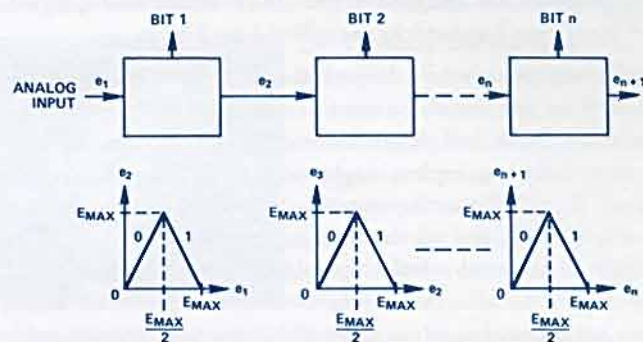

Figure 4. General A/D converter with Gray-code output.

When an analog signal, e_1 , is applied at the input, and held constant by a track-and-hold, it will propagate quickly through the stages and produce a steady state in which the outputs of the stages, both analog and digital, bear a unique relationship to the analog input. For example, if the analog input to the first stage is equal to $E_{MAX}/3$, the digital output will be “0”, since the input is less than $E_{MAX}/2$, and the analog output will be $2E_{MAX}/3$. This output, e_2 , applied to the next stage, will produce an analog output of $2E_{MAX}/3$ and a digital output of “1”. In this example, the outputs of all the following stages will be $2E_{MAX}/3$, and the digital outputs will be “1”, hence

*See *Analog-Digital Conversion Notes*, D. H. Sheingold, ed., 1977, pages 102-104 for a discussion of Gray Code and its relationship to binary. Analog Devices, Inc., Box 796, Norwood MA 02062, \$5.95.

the output word will be 01111...1. That is the Gray code for $E_{MAX}/3$ can be demonstrated by performing a conversion from Gray code to binary.*

The complete time for one conversion is determined by the overall propagation delay through the ADC and the settling time of the last stage that settles. However, the digital output of each stage can be latched as soon as that stage has settled, and a new conversion can, in principle, be started as soon as the first bit has been latched, permitting the conversion rate to be based on a much shorter time interval than the time for a complete conversion (cf. delay lines). By contrast to methods, such as successive approximations, in which decisions must be made one bit at a time, this technique can permit encoding at rates approaching word-at-a-time.

The serial (actually serial-analog, parallel-digital) Gray-code technique is still to be found in many of our video-converter products, such as the MATV series ADC's. The technique requires the use of extremely wide-band amplifiers, which must at the same time exhibit extraordinary dc stability. In the real world, there is a practical limit to the number of stages that can be cascaded; for example, the 8-bit MATV series ADC's use the serial Gray-code technique for the first six bits and a parallel "flash" encoder (see below) for the remaining two bits. Such combinations of techniques have been used to construct a/d converters with resolutions of up to 13 bits and word rates up to 10MHz.

Another useful, and increasingly popular, type of conversion technique is the all-parallel, or "flash" encoder, illustrated in Figure 5. It calls for 2^{N-1} analog comparators, where N is the number of bits. For an eight-bit encoder, this requires 255 comparators; for 10 bits, 1023 comparators are needed. The V_{REF} of each comparator is set by I_{REF} and the total resistance below its level; the V_{REF} of each comparator is one LSB higher than that of the comparator below it.

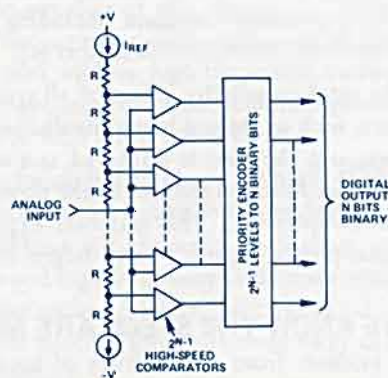

Figure 5. N-bit "flash" encoder.

When an analog input signal is present at the input of the comparator bank, all comparators which have V_{REF} below the level of the input signal will assume logic "1" output. The comparators with V_{REF} above the input signal level will have logic "0" output. The output of the comparator bank is applied to a

*In a Gray-code-to-binary conversion, the MSB is left unchanged. Each succeeding bit of the Gray-code word determines whether the binary bit is to be changed (1) or unchanged (0). In this example, the corresponding binary word is 0 1 0 1 0 1 When evaluated in fractional binary ($2^{-2} + 2^{-4} + 2^{-6} + 2^{-8} + \dots$), the sum amounts to 0.333. . .

digital priority encoder, which converts the "thermometer" input to a binary output. Since the comparator inputs and outputs have parallel configurations, the "flash" converter is extremely fast.

It is easy to see that the flash encoder, though simple in concept, is an extremely complex device to build, requiring a very high parts count and high power dissipation for high-speed use beyond about 8-bit resolution. In its lower-resolution versions, the flash encoder can be a useful subsystem component upon which complex high-resolution ADC's can be based. The 10-bit MOD-1005, which uses flash encoders in a unique *digital subrange correction* technique, is a pertinent example of this approach, employing *subranging*.

An example of subranging, as applied to an 8-bit a/d converter, is shown in Figure 6. In this encoder, the analog signal from a track-and-hold is applied through two buffer amplifiers to a 4-bit flash encoder and a summation network simultaneously. The 4-bit encoder converts the signal to the four more-significant bits of digital information; these are stored in a holding latch and also applied to a 4-bit d/a converter. The 4-bit DAC must be *at least 8-bit accurate* in this application. The inverted analog output is summed with the buffered analog input; the output of the summation network is the difference between the original input signal and the quantized value represented by the first four bits.

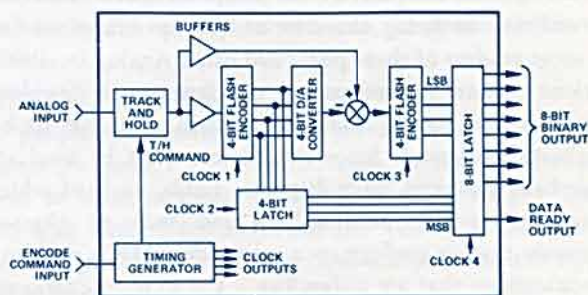

Figure 6. 8-bit subranging A/D converter.

4-bit "residue" is then converted to digital form by a 4-bit flash encoder and provides the four less-significant information. The outputs of the first 4-bit holding latch and the second 4-bit encoder are then combined in an output latch to yield an 8-bit all-parallel output from the ADC.

Timing is of vital importance in this type of ADC, since each element of the conversion process must be allowed time to settle adequately before the required strobe signals are applied. The subranging high-speed ADC is perhaps one of the most challenging kinds of converter to design and manufacture, because both speed and accuracy are essential for each circuit element. It is not easy, even in 8-bit video a/d converters of this design, to avoid differential-linearity discontinuities around the 1/32-scale (Bit 5) transition points, due to mismatch between the first and second encoding sections. These discontinuities, which could exceed 1 LSB and cause skipped codes, can be eliminated by careful design and — more powerfully — by the use of a "smart" encoding technique called *digitally corrected subranging* (DCS).

In converters using DCS, the architecture is very similar to that of other converters employing subranging, but the analog signal is *over-resolved*; the excess resolution is used in digitally cor-

recting incremental errors that are inherent in subranging converters employing practical components. The technique, used in the MOD-1005, is outlined in Figure 7.

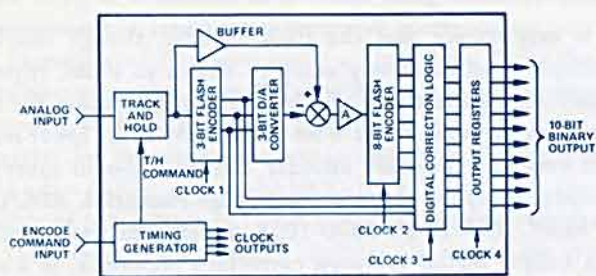

Figure 7. MOD-1005 A/D converter employs digitally corrected subranging (DCS).

Though basically similar to the 8-bit ADC shown in Figure 6, the MOD-1005 uses a 3-bit flash encoder in the front end and an 8-bit flash encoder as the second bank. The 11 bits that are encoded, combined with digital correction logic and a 12-bit-accurate 3-bit DAC, serve to preserve 10-bit accuracy at the output at word rates through 5MHz. Further developments in hybrid and monolithic technology promise to yield even higher resolutions and speeds utilizing this technology in the very near future.

FAST CONVERTERS — A DIFFERENT WORLD

In addition to being characterized by specifications familiar to most readers of these pages and other Analog Devices publications (linearity, temperature coefficients, etc.), video converters require further characterization in terms that are heavily application-oriented. Since the devices must be used at very high bandwidths in quite-disparate fields, each of which has developed specific terminology and tests to characterize dynamic system performance, our video ADC's require some specifications that are unfamiliar — and in some cases unguessable — to the low-frequency aficionado.

Some of these specifications appear in Table 1, together with a list of fields for which they are principally applicable. Since their definitions would require lengthy explanations, which the limited space in this brief survey does not permit, we urge the interested reader to use the reply card to request those reprints, listed in the Bibliography with an asterisk (*), that seem most relevant.

SPECIFICATION	APPLICATION
Signal-to-noise ratio (S/N)	Radar, communications, spectrum analysis
AC Linearity	Radar, spectrum analysis
Noise power ratio (NPR)	Communications
Two-tone intermod distortion	Communications, spectrum analysis
Transient response	Transient analysis, radar
Overvoltage recovery	Radar
Aperture uncertainty	All
Differential phase	Television
Differential gain	Television

Table 1. Dynamic specifications typically applied to high-speed converters.

However, as an example of how one of these specifications would apply to a real-world application, let's consider *noise-power ratio* (NPR), a specification which is of particular importance to users of telecommunications transmission equipment. With the advent of a/d and d/a converters for coding/

decoding (CODECS), which have the resolution and speed to handle baseband signals greater than the basic 4kHz voice channel, this spec has recently gained increased significance.

NPR is the measure of the spectral power of all contributed errors, such as intermodulation and harmonic distortion, in a narrow frequency-slot within the baseband of the composite signal being processed. An example of such a communication system, including the testing hookup that may be used, is shown in Figure 8.

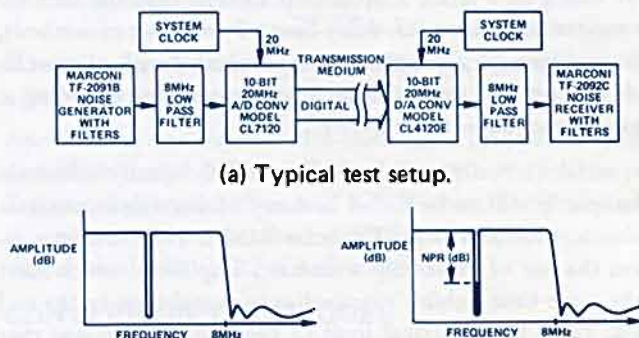

(a) Typical test setup.

(b) Transmitted spectrum,

(c) Received spectrum, slot partly filled with garbage.

Figure 8. 1600 channel digital communication system.

In such a system, the baseband signal is dc to about 8MHz, and the a/d and d/a encoding rates are 20 megawords per second. The NPR test consists of encoding a limited band of white noise, being produced by the noise generator, and examining this signal at the output of the DAC, using the noise receiver. The noise generator is equipped with band-stop filters, which eliminate very narrow "slots" from the transmitted frequency spectrum (b). At the receiving end, the noise receiver is equipped with complementary filters to allow the receiver to examine power spectral-density of the "noise" contributed by the transmission medium (including the ADC and the DAC) within these ideally noiseless slots (c).

This noise, the total cumulative effect of all transmission and encoding errors, such as IM and harmonic-distortion products, aperture errors, and the like, is displayed as a weighted ratio of the output noise found in the slot to the power of the total transmitted noise-spectrum. This number, expressed in dB, is called "noise-power ratio" — the larger its magnitude, the better.

HOW DO WE KNOW THE SPECS ARE MET?

It should be evident, from the diversity of applications, that the field of high-resolution video conversion is becoming more complex. While every user of these conversion products wants the "best device for the job," the many different types of users have equally many divergent interests in differing operational parameters, none of which is easy to measure objectively. To meet this variety of requirements, our engineers and technicians at Computer Labs have devised a sophisticated computer-controlled testing system, which goes well beyond the "dc linearity testing" that is often adequate for conversion equipment designed for use at conversion rates well below 1MHz.

Since most high-speed conversion products are used with computers or microprocessors, we have devised a method of ADC and DAC testing which uses a DEC PDP-11 minicomputer to

analyze the dynamic characteristics of the product under test. If you will refer back to Figure 1, you can get an idea of how this works. The ADC under test is provided with a test signal of known spectral content. The computer can then analyze the converter's output under controlled conditions to provide assurance that the device will meet almost any specification within its capability for which a test can be programmed. Various input signals, such as fast linear ramps, pure sine waves, or white noise can be used as inputs to test dc and ac linearity, distortion products, and NPR — just to name a few.

All these tests (and more) can be performed rapidly under software control on a time-sharing basis from different locations in our factory. The system is capable of testing ADC's with analog input bandwidths up to 10MHz, encoding rates up to 20MHz, and resolutions up to 16 bits. In addition, up-to-date specialized system test equipment is available to perform tests calling for specific configurations of test hardware.

TROUBLE — AND HOW TO AVOID IT

Probably the most ubiquitous problem in the implementation of high-speed systems involving analog signals and a/d conversion is noise. This should not be surprising when you consider that the value of the LSB for a 13-bit ADC with a full-scale range of $\pm 2V$ is less than $500\mu V$ — which makes the ADC a pretty good radio receiver: with $250\mu V$ p-p noise at the input, the LSB would be lost. Here are some key suggestions for minimizing the effects of noise and interference in high-speed conversion systems.

- Use massive, low impedance ground systems. The analog and digital grounds are connected together inside converters of these types, so bus bars are essential for system grounding and power distribution; use lots of ground plane on PC boards.

- Use linear regulated power supplies wherever possible. Yes, switching regulators are more efficient, and the ripple and noise specs look pretty good — but remember that the noise specs for most supplies of this type are in terms of *rms*. The peak-to-peak output noise of switchers can be several hundred millivolts — with vicious high-frequency components. Such spikes love to get into the most-elaborate grounding systems and create havoc with video converters.

- Watch out for digital feedback. (What?) If the ADC's output lines are in close proximity to the analog input, the output signals can feed back into the input. Remember, you're working with rf signals and high-frequency front ends — many involving frequencies that exceed 50MHz. Use coaxial cabling for analog signals wherever possible and route them away as far as possible from the digital junk.

- Use lots of power-supply bypassing capacitors. They are cheap compared to the cost of debugging and adding them later. Bypass each power-supply line with a good ceramic ($0.1\mu F$) in parallel with a good tantalum (1 to $10\mu F$) capacitor to ground right at the converter. When in doubt, add more capacitors — you can always take them out later (after carefully checking) if you need to save a few cents of parts cost.

- When interfacing, use source and load terminations for analog signals wherever possible to prevent reflections on the lines. Keep impedances as low as feasible, bearing in mind that the lower the impedance, the lower the probability of noise pickup. (On the other hand, the lower the impedance, the more

difficult it is to drive, and the higher the circuit distortion and power-driving requirements.) Observe proper shielding techniques. One of the most commonly encountered sources of difficulty in this regard seems to be the use of unshielded twisted wiring. Avoid it like the Plague — unless there's no other way.

EXPENSIVE BUT MORE COST-EFFECTIVE

As we have shown, video converters, such as the MOD-1005, are (the) critical building blocks in wide-band signal-processing systems. Since they straddle the gap between component and system engineering, and between analog and digital technology, they are among the most misunderstood of system elements and the most tricky to implement (much less design!) Though they are considerably more expensive than their low-frequency cousins, their cost has usually been small in relation to the cost of systems in which they have been used.

Consequently, with the advent of complete "system-solution" converter products having increasingly smaller size and lower cost — with every reason to expect a continuation of the trend — systems engineers should think twice about committing expensive design talent and hardware toward designing their own high-speed a/d conversion subsystems or seeking to implement patch-work solutions. Such efforts generally turn out to be more costly and time-consuming than using complete, tested, guaranteed devices, backed up by the technical commitment and knowhow of the Computer Labs Division of Analog Devices. The wheel would be easy to re-invent, compared to the video ADC!

ACKNOWLEDGEMENT

Many people have contributed to the advancement of video-converter technology at Computer Labs. In particular, thanks are due to these members of our engineering staff — Bryan Smith, Walt Kester, Bill Pratt and Joe Young, — for their invaluable help in the preparation of this article and the Application Brief on page 9.



BIBLIOGRAPHY

SUGGESTED READING — HIGH-SPEED CONVERTER TOPICS

Only starred items (*) are available from Analog Devices

**Short-Form Catalog*, Computer Labs Division of Analog Devices, Inc., 1978

*Kester, W.A., "Characterizing and Testing A/D and D/A Converters for Color Video Applications", *IEEE Transactions on Circuits and Systems*, Volume CAS-25, No. 7, July 1978

*Oliver, W., "White Noise Loading of Multi-Channel Communication Systems", Marconi Instruments, 1964

*Pratt, W.J., "Test A/D Converters Digitally", *Electronic Design*, December 6, 1975

Schmid, Hermann, *Electronic Analog/Digital Conversions*, Van Nostrand Reinhold Company, New York, 1970

*Smith, B.F. and Pratt, W.J., "Understanding High-Speed A/D Converter Specifications", Computer Labs, 1974

Digital Video, Society of Motion Picture and Television Engineers, 862 Scarsdale Ave., Scarsdale, N.Y. 10583, March, 1977

"Matthey Video Filters", Catalog, Television Equipment Associates, South Salem, N.Y.

Bosch, B.G., "Gigabit Electronics - A Review", *Proceedings of the IEEE*, 67-3, March, 1979, 340-379

V/I CONVERTERS FOR PROCESS CONTROL

2B20 & 2B22 Translate 0 to +10V to 4 to 20mA

2B20 Shares System Common; 2B22 Has 1500V I/O ISOLATION

by Frank Goodenough and Janusz Kobel

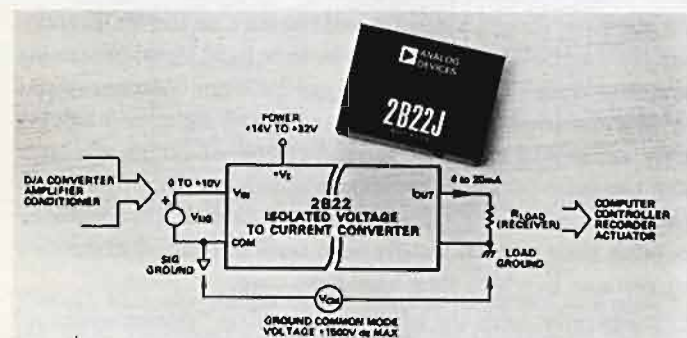

WHY USE 4-TO-20mA CURRENT SIGNALS?

Many of our readers work in fields where analog transmission of information is in the form of signals (usually voltage) referenced to zero: zero is either at one end of the range or in the middle. In the world of process control, however, analog information is more-often-than-not transmitted in the form of current variation from 4 to 20mA. Why no zero? Why use current instead of voltage?

The answers make good common sense. In the early days of electrical measurement and control, process engineers were faced with the problem of transmitting dc analog signals accurately over long lines in noisy environments reliably and at low cost. Since identification of broken wires was important, it was essential to establish the distinction between zero and absence of signal. The solution, the 4-to-20mA current loop, which became the U.S. standard, served both purposes. The analog information was scaled, to provide a 16mA full-scale span of current variation, and translated, so that 4mA corresponded to the minimum value and 20mA to the maximum. No information (viz., an open line) resulted in zero current. The driven current, flowing in a low-impedance remote load, could produce an output essentially unaffected by line drops, contact voltage or resistance, and induced voltage noise.

The 2B20* and 2B22* modular voltage-to-current converters are compact low-cost devices that convert a nominal 0 to +10V signal (the 2B22 can be programmed for input spans as low as 0 to +1V) to a 4-to-20mA current-loop signal that meets ISA Standard S50.1, "Compatibility of Analog Signals for Electronic Industrial Process Instruments."† Both types require just a single, positive supply (same polarity as the input), +10V to +32V for the 2B20, and +14V to +32V for the 2B22. The 2B22 is specified to withstand ±1500V dc or peak ac continuous isolation voltage between the input and the output.

These devices have been specifically designed for applications in process control and monitoring systems to transmit information between subsystems or separated system elements, such as transmitters, indicators, controllers, recorders, computers, actuators, and signal conditioners, at low cost.

*For technical data on these devices, use the reply card.

†The 2B20 meets the requirements for Type 3, Classes L and U (non-isolated); 2B22 meets requirements for Type 4, Class U (isolated).

TRANSMITTING AND RECEIVING

Figure 1 shows a typical loop involving the 2B20 as a transmitter. V/I converters may act as *generators* of the loop current or as *modulators* of power supplied by the loop. The 2B20 is a *generator*; its power supply is the source of all the excitation needed by the loop.

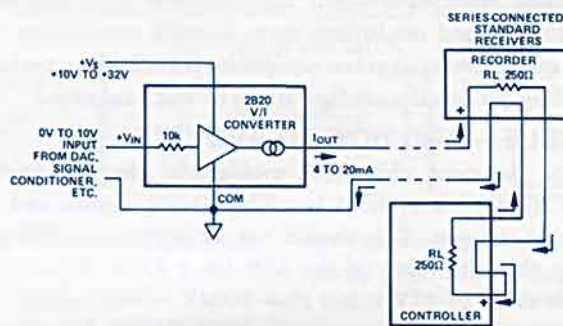

Figure 1. Typical 4-to-20mA process-control loop using the 2B20 as a transmitter.

The high-level input to the 2B20 may carry *input* information or *output* information. The former might be the output of a signal conditioner, such as the 2B31* (which can excite a bridge transducer and amplify & filter its output); the information might be transmitted to a recorder or a data-acquisition system. An example of *output* information might be the output of d/a converter, representing the desired setting of a valve, to be transmitted to the valve.

The output current of the 2B20 is proportional to the input voltage and is independent of the load voltage over a range of load voltage from zero (short circuit) to $(V_S - 5V)$. The output current circulates (usually via a twisted pair) through the external circuit, which may consist of one or more load elements in series; a standard load-resistance value is 250Ω. Since line resistance and induced potentials do not affect the current, it can be accurately transduced into voltage in each receiver, as long as sufficient voltage is available. For example, if the supply voltage is 28V, a total load of 1150Ω (or 23V) may be serviced. It is worth noting that the total resistance of a 3-mile loop of #20 twisted-pair wire is less than 350Ω.

For applications in which high potentials may be present, affecting the safety of humans and equipment, galvanic isolation is needed. The 2B22 provides this capability, which solves five major measurement-system design problems: *ground loops, high common-mode voltage, electrical noise, fault protection, and safety*. The 2B22 may be used either as a *generator* (Figure 2a), supplying the loop power, or as a *modulator*, using available loop power (Figure 2b). In the former case, both power and signal are transferred across the isolation barrier; in the latter case, the external loop voltage is used instead of the 2B22's isolated loop-power supply. For systems employing more than one 2B22, housed in close proximity, the devices

may be synchronized to avoid the possibility of errors due to crosstalk between their internal oscillators and signal circuits.

300kHz CONVERSION SYSTEM

Uses Microcircuit T/H and ADC For Continuous 12-Bit Conversion

by Ed Graves

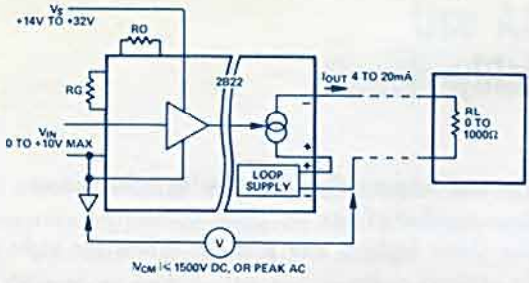

Figure 2a. Typical isolated 4-to-20mA process-control loop using the 2B22 as a generator.

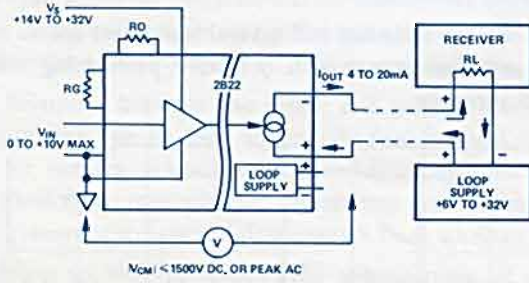

Figure 2b. Typical isolated 4-to-20mA process-control loop using the 2B22 as a modulator.

PERFORMANCE

Both devices are characterized by good initial precision, low drift with temperature, low nonlinearity, and low cost. For example, guaranteed performance characteristics of the 2B20B include 0.005% max nonlinearity (13-bit capability), 0.1% and 0.2% max offset and span errors (pretrimmed), and a max tempco of 0.005%/°C (-25°C to +85°C) for both offset and span. Though it has its own internal precision reference, an external voltage or current reference may be used to extend the range of applicability. Prices of the 2B20A/B are \$26/\$33 in 100's.

For the 2B22L, max nonlinearity is 0.05%, max offset and span errors are 0.1%, and max offset/span tempcos are 0.0025/0.005%/°C (0°C to 70°C). Prices of 2B22J/K/L are \$59/\$74/\$92 in 100's. Details of performance are tabulated below.

PERFORMANCE SUMMARY

Model	2B22J(2B22K)(2B22L)	2B20A(2B20B)
Input		
Voltage Range - V	0 to +10V	0 to +10
Impedance - Ω	10M	10k
Output		
Current Range - mA	4 to 20	4 to 20
Load Resistance Range - Ω	0 to 1000 max	0 to 500 max (V _S = +15V)
Nonlinearity (% Span) - max	±0.2(±0.1)(±0.05)	±0.025(±0.005)
Common Mode - Isolation Voltage		
Input to Output		
AC, 60Hz, 1 min Duration - V rms	1500	NA
Continuous, ac or dc - V pk max	±1500	NA
Common Mode Rejection @ 60Hz	90dB typ	NA
Calibrated Accuracy (% of Span)		
Offset - Initial - % max	±0.25(±0.25)(±0.1)	±0.4(±0.1)
Offset vs. Temperature - ppm/°C	±100(±50)(±25) max	±100(±50) max
Span - Initial - % max	±0.23(±0.25)(±0.1)	±0.6(±0.2)
Span vs. Temperature - ppm/°C	±150(±100)(±50) max	±100(±50) max
Power Supply		
Voltage, Rated Performance - V dc	+15	+15
Voltage, Operating - V dc	+14 to +32	+10 to +32
Current (for 20mA out, 10V in)		
Current Source Mode - mA	100	26
Temperature Range - °C		
Rated Performance		
Operating	0 to +70	-25 to +85
Package Size - Inches		
mm	2.2 x 3 x 0.6	1.125 x 1.125 x 0.4
	56 x 76 x 15.3	28.6 x 28.6 x 10.2

The HAS-1202* 12-bit a/d converter performs a complete conversion in 2.8μs (max); the HTC-0300* track-and-hold has an acquisition time of about 150ns to 12 bits and an aperture uncertainty of 100ps. They can be used together to form a system that will continuously sample and convert at a rate >300kHz. With suitable band-limiting, it can handle signals containing information at frequencies up to more than 100kHz with minimal slewing, sampling, or aliasing errors.

The maximum frequency that can be handled with less than 1/2 LSB slewing error is a function of the aperture uncertainty:

$$f_{max} = \frac{2^{-n}}{2\pi T_A} = 389kHz$$

for n = 12 bits and aperture time, T_A, of 100ps. Since the droop rate is about 5μV/μs, and feedthrough rejection is greater than 75dB, the signal being converted will change less than 1 LSB during sampling. Finally, frequencies less than 100kHz will be sampled at least three times per cycle, comfortably meeting the requirements of the sampling theorem.

The basic circuit is shown in the Figure. When the data-ready line goes low, the data is strobed into an external register and the one-shot generates a 230ns pulse. On the leading edge, the HTC-0300 starts to acquire the analog input, and the ADC is reset. On the trailing edge, the HTC-0300 goes into hold, and the successive-approximations conversion begins. At the end of conversion, the data-ready line goes low, and a new cycle is initiated.

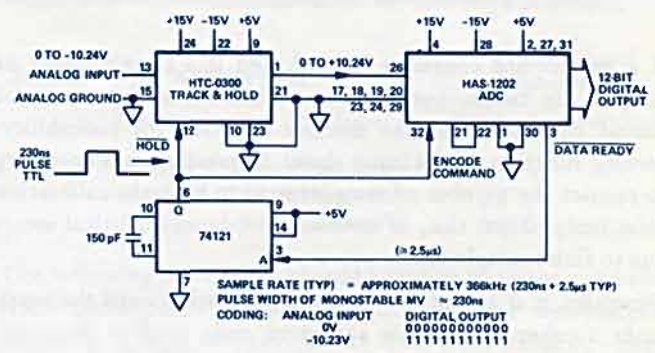

Naturally, care in circuit layout should be exercised in order to obtain best results. In particular, input and output runs should be as short as possible, a ground plane should be used to tie all ground pins together, and power-supply leads should be bypassed as close to the hybrid-circuit power-supply pins as possible. Do not allow input or other analog signals to be in close proximity to or to cross over any digital output line. This circuit provides the maximum self-generated conversion rate, which is a function of the ADC clock frequency and loop delays. For precise control of sampling frequency an external crystal clock may be employed instead.

*For technical data on these hybrid microcircuits, use the reply card.

CHECKING A/D CONVERTER LINEARITY

Without a Precision Reference.

Statistical Technique Finds Missing Codes Quickly

by Dr. D. Philip Burton

The linearity of an analog-to-digital converter is usually measured by calibrating the ADC against a d/a converter that is at least 2 bits more accurate than the device under test.¹ For example, a 10-bit ADC should be calibrated against (at least) a 12-bit converter. However, a precision DAC may not always be available for the purpose of calibration; even if one is available, it may be difficult to instrument a measuring circuit with the necessary accuracy. The technique described here (which has been described elsewhere^{2,3}) provides a simple way of measuring the linearity of a/d converters without using a precision dc reference signal.

Figure 1 shows the basic circuit. A waveform generator feeds a free-running low-frequency waveform into the ADC, which is connected to perform repeated conversions. The results of each conversion are fed into the microcomputer, which makes a record of the number of times each binary code appears in the output of the ADC. In this way, based on the number of "hits", a probability-density function can be built up for each of the 2^n binary codes.

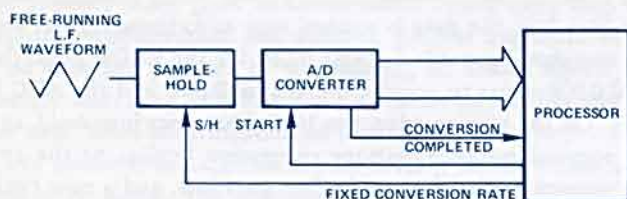

Figure 1. Basic scheme for statistical linearity testing.

If a perfect a/d converter is used, and if a large number of samples are taken, the number of hits for all binary codes should correspond to the number expected for probability-density function of the input signal. In practice, it is necessary to restrict the number of samples so as to keep the calibration time fairly short; this, of course, introduces statistical errors due to finite sample size.

Generally, it is acceptable to run a calibration until the maximum number of hits for any given code reaches about 50. Then, the number of hits for each code may be displayed as a bar chart or in the form of an analog plot as shown in Figure 2. An a/d converter with missing codes will show up by having no hits at those codes. Since a complete listing and analysis of the desired probability-density function is time-consuming, it is perhaps better to use the microcomputer to scan through

¹ *Analog-Digital Conversion Notes*, D. H. Sheingold, ed., pages 211-215, 1977, Analog Devices, Inc., Box 796 Norwood, Mass. 02062, \$5.95

² O. J. Downing, P. T. Johnson, "A Method for the Assessment of the Performance of High-Speed Analogue/Digital Converters." *Electronics Letters*, 13th April 1978, Vol. 14, No. 8, pp. 238-240

³ G. Pretzl, "Dynamic Testing of High-Speed A/D Converters," *IEEE Journal of Solid-State Circuits*, Vol. SC-13, No. 3, June, 1978, pp. 368-370

the results and output only the following information:

- 1) Mean number of hits
- 2) The three highest hits and the values for eight places each side of those codes
- 3) The three lowest hits and the values for eight places each side of those codes.

Clearly, if each code has had several hits, there are no missing codes, and the converter is probably performing with the required accuracy.

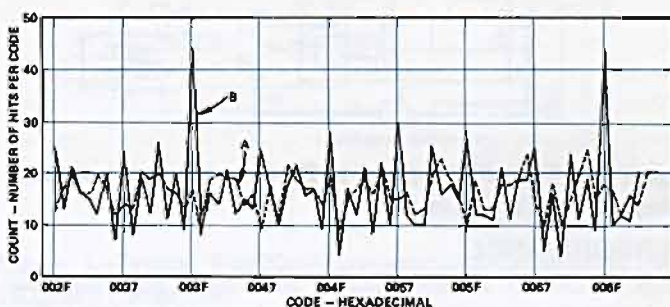

Figure 2. A portion of the probability density function of two different a/d converters sampling a triangular wave.

The input signal can be any signal whose p.d.f. is known; sinusoids, filtered noise, and triangular waves have been suggested. For most ADC's with conversion times of $5\mu\text{s}$ or more, the triangular wave is the best choice, since its p.d.f. is a horizontal line; this makes analysis of the results relatively easy. It is best to use a triangular wave which has extreme values just outside of the a/d converter's range. This will guarantee coverage of the full range but will produce undue concentrations of hits at the all-0's and all-1's binary codes; these extreme values may be discounted.

In Figure 2, the results show a portion of the pattern for two AD571 10-bit ADC's connected to the same input signal and being activated at the same time (Figure 3). Both converters are within the 10-bit accuracy specifications, but converter B has a greater degree of nonlinearity and shows a distinct preference for binary codes ending with the hexadecimal value "F". Note that the two values either side of the enhanced value are depleted, since some of the hits which should have occurred in these regions have been shifted into the enhanced region.

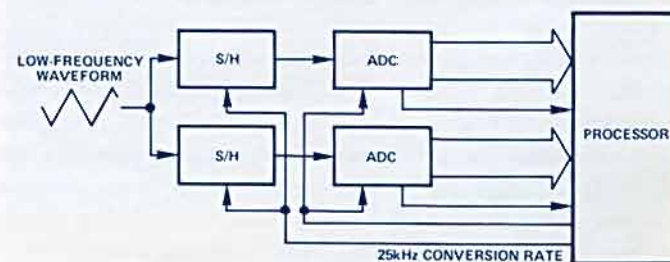

Figure 3. The basic scheme used to obtain the plot of Figure 2.

HIGH-RESOLUTION ΔT MEASUREMENT

Use AD590 Temperature Sensors or AD2626 Probes

Resolve Temperature Change or Difference to Millidegrees

by Frank Goodenough

It is often necessary to measure, record, and control the temperature *difference* between two physically close – or widely separated – entities. A few examples of such temperature differences include the temperature rise above ambient inside a piece of equipment, temperature rise of a power transistor over ambient, the temperature differences between the inside and outside of an air-conditioning duct or plenum, and temperature gradients inside an oven or a refrigerator.

The difference between the inside and outside temperatures of a building can be used to provide feed-forward (advance) data for turning a heating or air-conditioning system *on* or *off*. Fluid flow rate can be determined by measuring the temperatures upstream and downstream from a heater.

Depending on the application, the measurement of temperature differences may require resolutions as fine as a few millidegrees with full-scale ranges as great as several hundred degrees. For such applications, in the range from -55°C to $+150^{\circ}\text{C}$, it is easy to implement ΔT measurements using the AD590 sensor* or the AC2626 probe transducer*.

Figure 1 shows how simple the basic circuitry can be: two AD590's, two 9V transistor-radio batteries, and a microammeter.

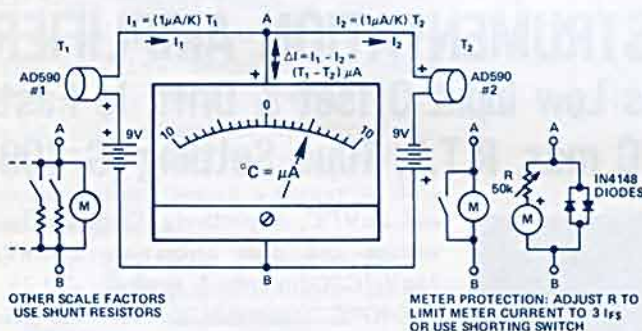

Figure 1. Differential temperature meter.

Currents I_1 and I_2 are generated independently in response to the temperatures of the two sensors. The currents flow in opposite directions through the meter, which reads their difference. For example, for temperatures of 35°C and 25°C , the current through the meter will be $+10\mu\text{A}$, corresponding to a difference of $+10\text{K}$, or $+10^{\circ}\text{C}$. If I_1 is less than I_2 , the reading will be negative. For perfectly matched IC's at the same temperature, the reading will be zero. If they aren't perfectly matched, zero can be trimmed by adjusting the mechan-

*The AD590 is a two-terminal temperature sensor, with current flow proportional to absolute temperature, packaged in a TO-52 can or a miniature flat pack. With excitation from $+4\text{V}$ to $+30\text{V}$, the current in microamperes is equal to the kelvin temperature, e.g., at 27°C (300K), the current is $300\mu\text{A}$. The current output is linear and independent of series voltage drops or induced voltage noise. The AC2626 is a stainless-steel probe using the AD590 as the measuring element. Use the reply card for technical data on either device or other Analog Devices products described here.

ical zero of the analog meter. The meter can be protected by shunt diodes and an empirically determined value of series resistance, as shown in Figure 1, and/or by a shunting switch.

If the meter has a 5" scale, it can resolve changes of 0.1°C in a distance of $0.025''$. For wider ranges of temperature change, a less-sensitive meter can be used, or range switching can be obtained by using resistive shunts across the sensitive meter. If greater sensitivity/resolution is desired, and one AD590 is always warmer than the other, a $10\mu\text{A}$ meter with 8" scale length provides 0.025° resolution. Note that *resolution* is limited by the meter scale, not the errors of the AD590's.

If even finer resolution, a digital display, or wide dynamic range are required, the active circuit of Figure 2 may be used. Based on Figure 12 of the AD590 data sheet*, this circuit adds range switching, the higher-performance parts required for 100x greater sensitivity, and readout devices.

Here's how it works: the AD542L TRI-FET op amp,† acting as a current-to-voltage converter, sums the opposing currents and converts them to voltage at a level determined by the feedback resistance. The $10\text{k}\Omega$ potentiometer is used to zero the output when the AD590's are at equal temperature. In switch position A ($1\text{M}\Omega$ feedback resistance), the scale factor is $1\text{V}/^{\circ}\text{C}$. The least-significant digit of the 999mV full-scale low-cost AD2026 panel meter permits a resolution of one millidegree Celsius over the range from -0.1°C to $+1.0^{\circ}\text{C}$. Or, an analog meter with an 8" scale can easily resolve 10 millidegrees over a $\pm 1^{\circ}\text{C}$ range. Resolution and scale factor for all switch positions:

Position	AD2026 DPM		8" Zero-Center Analog Meter	
	Resolution	Full Scale	Resolution	Full Scale
A	0.001°C	-0.099°C to $+0.999^{\circ}\text{C}$	0.01°C	$\pm 1^{\circ}\text{C}$
B	0.01°C	-0.99°C to $+9.99^{\circ}\text{C}$	0.1°C	$\pm 10^{\circ}\text{C}$
C	0.1°C	-9.9°C to $+99.9^{\circ}\text{C}$	1.0°C	$\pm 100^{\circ}\text{C}$

The following precautions should be taken to insure good electrical performance at high sensitivities: Use well-matched AD590's (L or M suffixes); excite them from stable dc voltage (AD581* precision references), and use a low bias-current op amp (e.g., AD517L*).

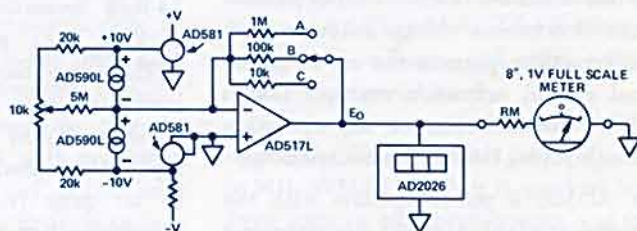
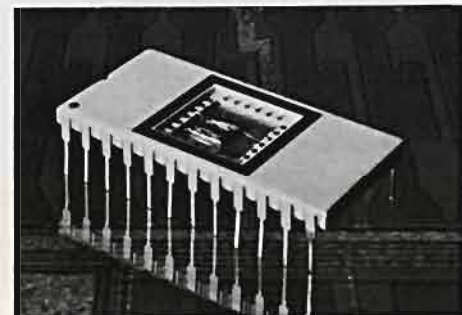

Figure 2. High-resolution ΔT measurement with the AD590 or the AC2626.

†Trimmed-Resistor Implanted FET Op Amp.

SINGLE-CHIP FAST 12-BIT D/A CONVERTER

AD566 Has max Settling Time of 400ns to $\pm 1/2$ LSB; 200ns Typical Single-Supply Operation; Guaranteed Monotonic Over Temperature



The AD566* is a monolithic 12-bit current-output digital-to-analog converter in a 24-pin dual in-line package, designed for applications calling for speed, accuracy, flexibility, and low cost. Its fast current-settling makes it a natural for a/d converter applications employing successive-approximation or tracking techniques.

The on-board Si-Cr application resistors, trimmed to match the DAC, track with temperature. These resistors, combined with the uncommitted current output and the user's option for output op-amp selection, permit a variety of output voltage ranges and an optimized tradeoff between speed, cost, and accuracy. For example, with a +10V reference, output ranges of $\pm 10V$, $\pm 5V$, $\pm 2.5V$, 0 to +10V, and 0 to +5V can be programmed by external connections. The output op amp can be chosen for high speed, low drift, low cost, or low power consumption (Figure 1).

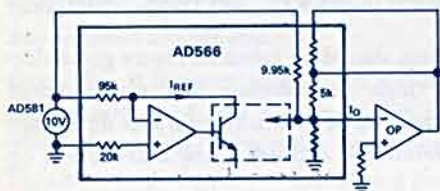

The uncommitted reference input permits values of reference voltage as low as +1V. This versatility permits the use of an external system reference, multiple DAC's with a common reference, and operation as a multiplying DAC over a limited range.

The AD566 is pin-compatible with the industry-standard AD562* d/a converter in most applications and is complete on a single silicon chip. Using the AD566, a

system originally designed for the AD562 can be upgraded in speed of response while power consumption is reduced to 180mW from a single power supply. Figure 2 shows the typical settling time of the AD566 from all-bits-off to all-bits-on (scale: 100ns/horizontal division, 1 LSB/vertical division), driving a 50- Ω load.

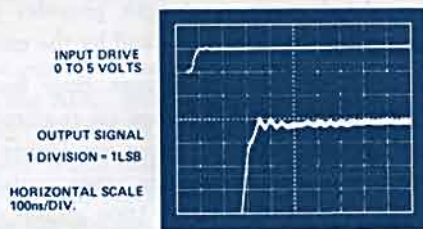

Because of its speed, the AD566 will produce an analog output faster than most common microprocessors can up-

date the digital information (especially with two-byte, 12-bit resolution). In addition, the combination of speed and accuracy make the AD566 highly useful in driving displays.

Available in two grades for the 0°C to 70°C range (J/K) and two grades for the -55°C to +125°C range (S/T), the AD566 has max nonlinearity over temperature of $\pm 3/4$ or $\pm 1/2$ LSB. The AD566J/K/S/T are available in a hermetically sealed side-braced ceramic package, and the AD566 J/K are also available in a low-cost plastic DIP package. The S/T are also available to meet the requirements of MIL-STD-883B, Class B. Prices (100's) for ceramic J/K/S/T are \$17.50/\$25.75/\$50/\$77.50, and in plastic (J/K): \$15/\$22.50. >>>

MONOLITHIC INSTRUMENTATION AMPLIFIER

AD521L Has Low Input Offset & Drift, Is Fast. 1mV/2 μ V/°C max, R.T.I., 10 μ s Settling (G=100)



The AD521L* is a high-performance monolithic instrumentation amplifier in a 14-lead hermetically sealed dual in-line package. The newest member of the AD521 amplifier family, it is a complete instrumentation amplifier, a committed differential gain block that requires only a pair of external resistances, R_S and R_G , to set gains (R_S/R_G) in the specified range from 1 to 1000.

The AD521L has maximum input offset voltage and drift errors of 1mV (nullable)

and 2 μ V/°C, respectively. Output offset voltage and drift errors are 100mV/75 μ V/°C. Gain error is typically ($\pm 0.25 - 0.004G$)%, trimmable to zero, and gain drift is $\pm(3 \pm 0.05G)$ ppm/°C. Maximum nonlinearity is 0.1%; minimum common-mode rejection is 104dB at $G = 100$ (dc to 60Hz, with 1k Ω source unbalance).

In addition to its differential inputs, the AD521L has a pair of feedback inputs, for output *sense* and *reference*. These terminals can be used to offset the output, convert the output voltage to current, provide remote load sensing, or provide additional gain via feedback attenuation.

The AD521 family is described in a new, expanded data sheet, with a great deal of new applications information. Other members of the AD521 family include the low-cost J, medium-performance K, and wide-temperature range S. Prices (100's): \$8.50/\$12/\$17.50/\$20 (J/K/L/S). >>>

*Use the reply card to request technical data.

*For a complete data sheet, use the reply card.

3 NEW IC FAMILIES PROVIDE SUPERIOR 2nd SOURCES

AD DAC-08 Fast 8-Bit Monolithic M-DAC

AD ADC80 12-Bit Successive-Approximation ADC Low Chip Count, High Reliability, Fast

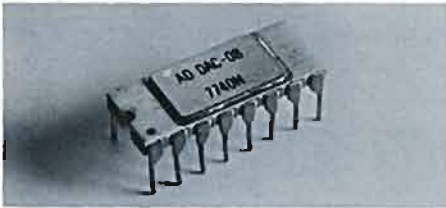

The AD DAC-08* is a fast, single-chip current-output digital-to-analog converter, available in a hermetically sealed 16-pin ceramic dual in-line package and in chip form. With a typical full-scale current-settling time of 85ns (135ns max), the AD DAC-08 is recommended for such applications as CRT displays, waveform generators, and high-speed a/d converters.

As the block diagram shows, the AD DAC-08 contains eight matched bipolar current-steering switches, a precision diffused resistor network, and a high-speed control amplifier. Its versatile uncommitted design permits choice of reference voltage and polarity. At the output, the -10V to +18V minimum compliance range permits significant output voltage to be developed without an external amplifier; in addition, the complementary current outputs permit a variety of output configurations.

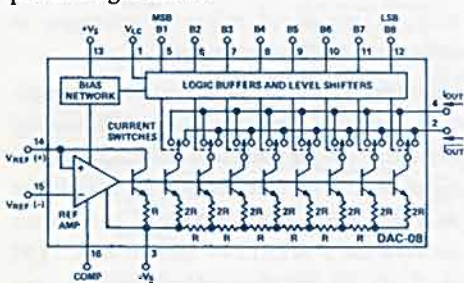

The AD DAC-08 is physically and electrically interchangeable with DAC-08's from other manufacturers. The maximum nonlinearity of $\pm 1/4$ LSB (0.1%) is guaranteed over the whole temperature range (-55°C to +125°C for the AD DAC-08A, 0°C to 70°C for the AD DAC-08H). Maximum nonlinearity of 1/2 LSB (0.19%) is guaranteed for the -08 and -08E over the same ranges, and 1 LSB (0.39%) for the -08C from 0° to 70°C. Prices are low: \$4.95/\$6.25/\$2.05/\$2.40/\$3.95 for the -08/A/C/E/H in 100's.



*Use the reply card for technical data.

The AD ADC80* is a complete 12-bit successive-approximation a/d converter that includes clock, reference, comparator, and a 12-bit monolithic DAC, packaged in a ceramic triple-width DIP. No external components are needed to perform a 12-bit conversion in 25 μ s.

It can handle a variety of input voltage ranges, $\pm 10V$, $\pm 5V$, $\pm 2.5V$, 0 to +10V and 0 to +5V, using external pin-programming. The serial and parallel TTL outputs use complementary binary coding† (COB for bipolar inputs).

The AD ADC80 performs a complete 12-bit conversion in less than 25 μ s max, using the internal clock; with an external clock, the 12-bit conversion time can be more than halved. The resolution can be truncated to fewer bits for faster conversion

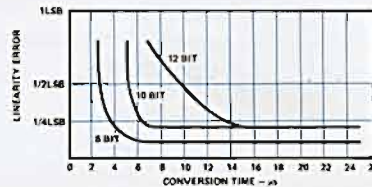

AD DAC87: 12-Bit 3-Chip D/A Converter Wide Temperature Range (-55°C to +125°C)

The AD DAC87* is a high-reliability 12-bit digital-to-analog converter designed for applications where reliability and performance over the entire temperature range are paramount. It is directly interchangeable with other devices of this type, including AD DAC80, AD DAC85, and DAC87-type units from other manufacturers, but has significantly improved performance and smaller overall size. The advantages of the AD DAC87 stem principally from its 3-chip construction, of which a key ingredient is the single-chip high-performance current-output DAC.

The AD DAC87 is monotonic over the entire temperature range, with maximum differential nonlinearity of ± 1 LSB over temperature. Max gain drift is a low 25ppm/°C, including the internal reference, 10ppm/°C without the reference.

†For 12-bit conversion with positive-true output, consider the AD574 or the AD572.

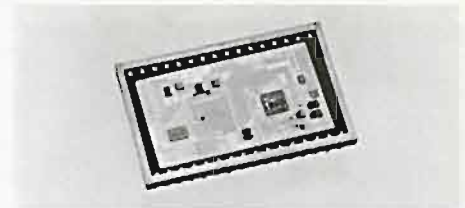

(see the graph). In 12-bit conversion, using the internal clock, there are no missing codes at any temperature in the -25°C to +85°C range.

The device's 6.3V precision temperature-compensated reference can furnish up to 1.5mA of external current without degradation of its specifications. Because the AD ADC80 has a considerably lower component count than other devices of its type — with which it is pin- and function-compatible — it is both more reliable and less costly to produce. Available for 12-bits (as above) and 10-bits (0.05% max nonlinearity over temperature) the AD ADC80 is also available in two "Z" versions for $\pm 12V$ operation. Prices (100's), -12/-10/-12Z/-10Z: \$47.50/\$45/\$49.50/\$47.



Settling time for output current after a full-scale digital code change is 300ns to within 0.01% of full-scale range. For voltage-output models, the settling time is 3 μ s to 0.01%, with 5k Ω feedback resistance. Both voltage- and current-output versions are available.

As one might expect, the AD DAC87 is optionally available with 100% screening to MIL-STD-883B, Class B, method 5004. Even with its high performance and reliability and full temperature-range performance, the AD DAC87 is a low-cost MIL-range DAC, \$93 for the AD DAC87-CBI-I, \$99 for the CBI-V in 100's.



12-BIT DATA-ACQUISITION MODULES Resistor-Programmable Gain (1-1000) in DAS1150 Software-Programmable Gain (1-2-4-8) in DAS1151



The DAS1150* and DAS1151* are small, low-cost, high-performance, single-channel 12-bit data-acquisition-system modules that are ideal components for the designer of custom computer-interface subsystems. Both devices contain a programmable-gain differential instrumentation amplifier, a sample-hold amplifier, and a 12-bit analog-to-digital converter, housed in a compact 2" X 4" X 0.4" (51 X 102 X 10.2mm³) module.

In the only significant difference between the modules, the DAS1150's amplifier is programmed by connecting (or switching in) fixed values of resistance to set the gain to any value in the range, 1 to 1000, while the DAS1151's amplifier is programmed digitally, by the user's system software, for gains of 1-2-4-8. Throughput rate of the DAS1150 is 25kHz, except at the highest gains (13.3kHz at G = 1000); throughput rate of the DAS1151 at all gains is 28.5kHz.

The DAS1150 is designed for applications where preamplification is desirable for full-scale signals as low as $\pm 10\text{mV}$, without degradation of linearity or substantial loss of speed or accuracy at the highest gains. Maximum overall error of the DAS1150 is $\pm 1\text{LSB}$, increasing to only $\pm 2\text{LSB}$ at G = 1000.

The DAS1151 can be used to extend dynamic range capability of the analog input from 12 to 15 bits through sub-ranging; in addition, the system can be programmed to provide different gain settings for each input channel to accommodate the various input signal levels.

*Use the reply card for technical data.

Why no multiplexer? Multiplexing, if necessary, is provided externally by the user to meet the specific needs for his system (high-level, low-level, differential, single-ended, number of channels, incrementing vs. random access, etc.) This approach saves real estate and money, and improves the integrity of custom designs.

The DAS1150/51 were designed to be small, low-cost, basic, standard components of custom microcomputer interface

installations. They solve the difficult part of the interfacing problem predictably and reliably; and they are proven products, already in widespread use as key elements of the RTI* series of microcomputer interface cards. These modules permit the user to tailor his designs to the required number of channels, method of multiplexing and isolation, and processor-interfacing scheme. And in 100's, they cost only \$176/\$200 (1150/51). ▶▶▶

14-BIT SAMPLE-HOLD SHA1144 Designed for ADC1130 and 1131 Where You Need High Speed and Resolution

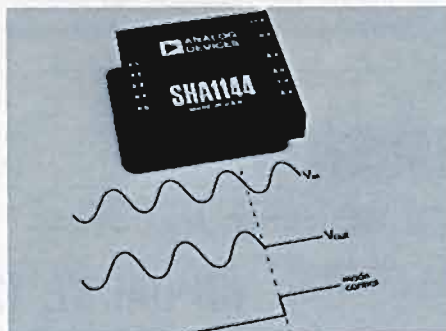

The SHA1144* is a high-speed, high resolution sample-hold amplifier designed for 14-bit high-speed data-acquisition applications, i.e., for compatibility with 14-bit ADC's, such as the Analog Devices ADC 1130 & 1131. Such applications call for high speed plus wide dynamic range and accuracy, and include digitized audio, vibration analysis, and seismic data-acquisition. That the SHA1144 is now available solves a perplexing make-or-buy problem for equipment designers for these applications.

Its gain nonlinearity of $\pm 0.001\%$ of full scale (max) insures high accuracy; in *hold*, the $1\mu\text{V}/\mu\text{s}$ droop rate lets the SHA hold an input signal to within 0.003% F.S. (20V p-p) for over 600 μs ; *sample-to-hold* offset nonlinearity is only 160 μV . The SHA1144 can be configured as an inverter or a follower, and the gain is user-programmable.

*For technical data, use the reply card.

Dynamically, the 8 μs acquisition time to 14 bits, combined with the ADC1131's 12 μs conversion time, permits a 50kHz sampling rate. For the SHA's 0.5ns aperture uncertainty and 14 bits, the maximum frequency for 1/2 LSB slewing error is 19.4kHz, and a 50kHz sampling rate for 20Hz-19kHz band-limited audio signals is comfortably above the Nyquist rate.

Other applications include vibration analysis (e.g., shake tables) and multiplexing many channels of reference voltages, as in automatic test equipment.

High-speed, high-resolution data acquisition demands considerable care in wiring, even for simple laboratory-bench evaluations. A convenient aid to the user is the AC1580 4.5" X 6" prewired card, with sockets for a SHA1144 and an ADC1130 or 1131 to be plugged in directly (see photo).

Price of the SHA1144 (1-9) is \$129. ▶▶▶

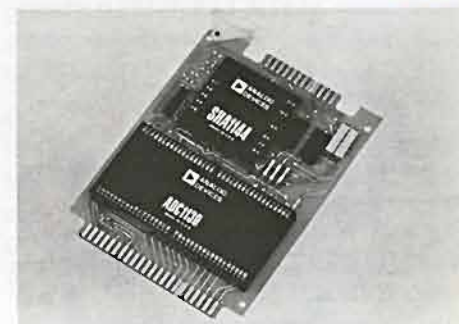

TWO NEW CMOS SWITCHES WITH EXISTING 2nd SOURCES

ADG200 Dual S.P.S.T. and ADG201 Quad S.P.S.T. Families

Latchproof and Overvoltage-Proof to 25V Beyond the Supplies

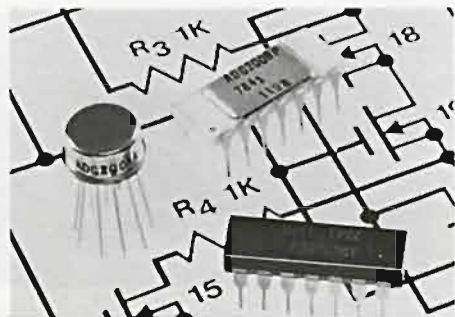

The ADG200* and the ADG201* are new dual- and quad-switch families that are pin-compatible with and have superior overvoltage protection to DG200's and DG201's currently on the market.

The ADG200 consists of a pair of single-pole single-throw CMOS analog switches that can be operated by CMOS or TTL logic ("1" open, "0" closed). Like other Analog Devices switches (such as the 7510DI* series), it is dielectrically isolated for latch-proof operation and protection against overvoltage to 25V beyond either of the supply voltages. It has break-before-make action, and its *on* resistance is less than 100Ω over the operating temperature range. Dissipation is only 30mW.

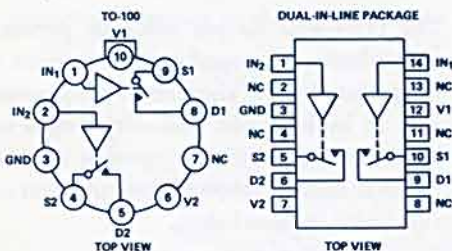

Six standard versions are available, the ADG200CJ in a 14-pin plastic DIP (0° to 70°C), the BP and AP (suffixes) in a 14-pin hermetically sealed ceramic DIP, for -25°C to +85°C and -55°C to +125°C, and the BA and AA in a TO-100 can, for the same respective temperature ranges. Finally, there is an AA/883, an AA 100% screened to MIL-STD-883B, Class B. Prices (100's) for CJ/BP/BA/AP/AA/883 are \$2.50/\$7/\$2.50/\$8.50/\$7.75/\$11.25.

The ADG201 consists of four single-pole single-throw dielectrically isolated CMOS

*For data sheets on these devices, use the reply card.

analog switches. In the *on* state, each switch (like those in the ADG200) conducts current in either direction, maintaining nearly constant *on* resistance over its signal-handling range. In the *off* state, it blocks voltages equal to the V+ and V- supplies of the switch; switch action is break-before-make. The digital inputs interface directly to TTL or CMOS logic over the full operating temperature range.

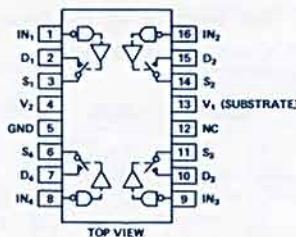

Like the ADG200, the ADG201 is fabricated with an advanced dielectrically isolated monolithic CMOS process. Its

advantages over existing DG201 designs include lower *R_{ON}* (125Ω max over the temperature range), lower power dissipation (30mW max), faster switching time (1μs max *t_{ON}*, 0.5μs max *t_{OFF}* at 25°C), overvoltage protection (to 25V beyond the supplies), and latch-free operation.

Four standard versions are available, the ADG201CJ in a 16-pin plastic DIP (0°C to 70°C), the BP and AP in a hermetically sealed ceramic DIP (-25°C to +85°C and -55°C to +125°C, respectively), and the AP/883, an AP 100% screened to MIL-STD-883B, Class B. Prices (100's) for CJ/BP/AP/883 (100's) are \$4.50/\$9/\$11.50/\$15.25.

These switches are useful in most analog applications, including integrator circuitry, sample-holds, signal routing, and ramp generation.



THREE NEW POWER SUPPLIES

DC/DC Converters Provide Dual 15V Outputs

Models 949, 951, and 953* are three new dc-to-dc converters recently added to our line of power supplies.* All have 500V isolation, all have efficiencies greater than 58% at full load, and all three will furnish ±15V output.

Model 949 converts from +5V digital supply voltage to two 15V supplies with ±0.5% maximum regulation (no load to full load). The outputs, which may be connected for ±15V/±60mA, +30V/±60mA, and +15V/+120mA, may be used to furnish unbalanced loads, as long as the total output current does not exceed 120mA and the output power does not exceed 1.8W. An important advantage of the 949 is its small size, 1"×2"×0.375" (25.4×51×9.6mm³). It requires no derating over the -25°C to +70°C operating temperature range. And its price is low, \$45 (1-9).

Model 951 converts from +5V to ±15V/±410mA with 0.05% maximum load regulation; minimum efficiency is 62% at full load. It is packaged in a 6-side-shielded 2.5"×3.5"×0.88" module (63.5×89×22.4mm³). Small-quantity price is \$99.



Model 953 converts from +12V to ±15V ±150mA with 0.05% maximum load regulation and only 1mV max rms output noise and ripple. The 6-side-shielded package is small in size, 2"×2"×0.375" (51×51×9.6mm³), and price, \$79 (1-9).



*For information on power supplies, use the reply card.

SYNCHRO/RESOLVER POWER AMPLIFIER SPA1695 Has 5VA Output; Can Drive 4 Size 11 CT's Operates Without Derating to 105°C

S/D CONVERTERS With 3-State Latches & Continuous Tracking

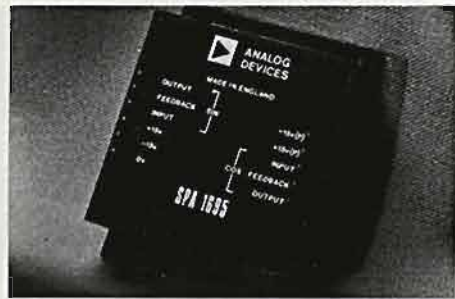

resolver), provides the interface to the control transformer (CT).

The SPA1695 is provided with remote-sensing feedback to compensate for voltage drops in the output line as the synchro angle or output load changes. The compact, 3.46" X 2.68" X 0.98" (88 X 68 X 25mm³), metal case provides heat-sinking and facilitates heat conduction when mounted on a metal heat sink. The amplifier can operate at temperatures up to 105°C without derating.

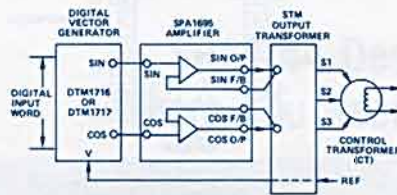

The SPA1695* is a two-channel synchro power amplifier that accepts angular information in resolver format and drives as many as four control transformers (size 11). Since the device is capable of supplying 5VA to the load, it is used in cases where the internal amplifiers of a digital-to-synchro converter do not have sufficient power (e.g., when the load exceeds 1.3VA for the DSC1705 or 1706*).

The block diagram shows a typical application where the angular input, in the form of a digital word, is converted to resolver format by a DTM1716 or 1717* digital vector generator. The SPA1695 provides power amplification for the orthogonal sine/cosine inputs. The external transformer (STM), which is chosen for the appropriate voltage, frequency, and format (synchro/

Typical applications of the SPA1695 may be found in aircraft simulators, synchro communication systems, machine-tool controls, or wherever a digital command or synchro signal must position mechanical loads. It may be used with either 60Hz or 400Hz references. Price in small quantity is only \$250, plus \$70 for the STM transformer. ▶▶▶

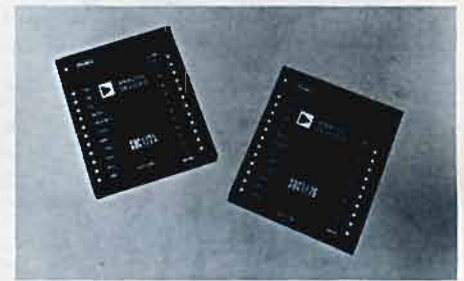

The SDC1725/1726* are modular continuously tracking synchro(/resolver)-to-digital converters with three-state latched digital outputs. The SDC1725 is a 12-bit converter with a resolution of 5.3 arc-minutes and an overall accuracy of ±3.2 arc-minutes ±1 LSB; the SDC1726 is a 10-bit converter with resolution and accuracy of 21 and ±22 arc-minutes.

The input signals, depending on the option chosen, can be either 3-wire synchro plus reference, or 4-wire synchro plus reference. The input circuits employ precision Scott T and reference micro-transformers, which make it possible to include the transformers within the module, even for the 60Hz option, without losing the advantages of low profile height (0.35", 8.9mm).

The three-state output not only permits multiplexing of several converters onto a single data bus; it also allows the conversion to be inhibited, and output data to be transferred, without opening up the internal control loop. A block diagram of the device appears below.

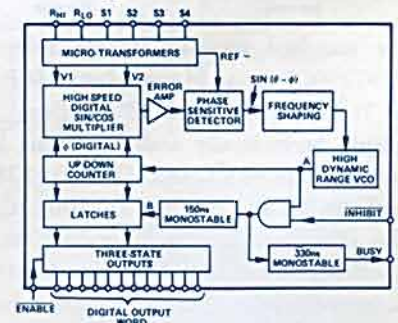

A number of options are available, depending on operating temperature range, line voltage, reference voltage and frequency, and format. Prices start at \$295.

*Use the reply card for technical data. ▶▶▶

INTERFACE CARD FOR STD BUS μC's RTI-1225 Analog I/O Subsystem Interfaces with Pro-Log and Mostek Microcomputers

The cost-effective RTI-1225* is the first combination analog I/O board that is compatible with Pro-Log and Mostek STD BUS computers. It offers 8 differential or 16 single-ended input channels (protected for overvoltage to ±35V), a differential-input instrumentation amplifier with 60dB CMR at 60Hz, a sample-hold amplifier for accurate sampling of fast-slewing signals, a fast (40μs) monolithic ADC, two independent 8-bit DAC outputs, and a compact dc-to-dc converter for +5V supply compatibility.



addresses, providing efficient and easy-to-program operation for OEM applications. Available in June, 1979, the RTI-1225 is priced at an attractive \$399 in small quantity.

▶▶▶

STATISTICS USING ANALOG TECHNIQUES

Calculation of Exponentially Mapped Past Statistical Variables Using a True RMS-to-DC Converter

by Dr. R. H. Smallwood*

It is often useful to be able to calculate both the average frequency of a signal and the way the average frequency varies with time, that is, the *variance* of the average. The calculation of the Exponentially Mapped Past (EMP) statistical variables¹ and their use with the electrical signals from the human stomach^{2,3} have appeared in the literature.

The EMP average frequency is given by

$$\overline{f}_\tau(0) = \frac{1}{\tau} \int_{-\infty}^0 f(t) \epsilon^{-t/\tau} dt \quad (1)$$

where τ is the weighting (RC) time constant. (1) will be recognized as the RC average of the input frequency $f(t)$ †. The EMP variance is given by

$$\sigma_\tau^2(0) = \int_{-\infty}^0 [f(t) - \overline{f}_\tau(t)]^2 \epsilon^{-t/\tau} dt \quad (2)$$

where $f(t)$ is the instantaneous frequency and $\overline{f}_\tau(t)$ is the EMP average frequency. As the variance is the mean-square value of a zero-mean process and

$$\int_{-\infty}^0 [f(t) - \overline{f}_\tau(t)] dt = 0 \quad (3)$$

it will be seen that the EMP standard deviation, $\sigma_\tau(0)$, is given by the rms value of the difference between the instantaneous and the mean frequency. This is shown symbolically in Figure 1a, and in circuit form using an AD520§ as the difference amplifier and the AD536§ as the rms-to-dc converter, in Figure 1b. The input is from a circuit that calculates the instantaneous frequency of the signal using an AD7520 DAC⁴.

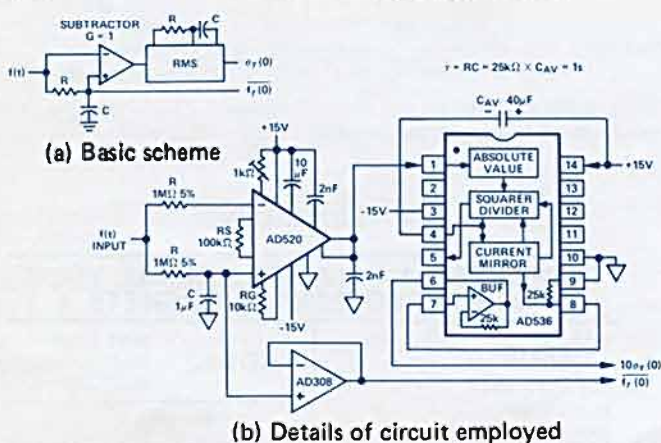

(b) Details of circuit employed

Figure 1. Scheme for measuring average and standard deviation.

The circuit of Figure 1b has been used to calculate the average frequency and its variance for the electrical signals, at about 0.05Hz, which are produced by the human stomach. In this example, they were recorded on tape at 15/16in/s and replayed at 60in/s, giving a frequency of about 3.2Hz (upper trace in Figure 2). A phase-locked-loop system tracked the signal, and the loop oscillator's instantaneous frequency was found by

counting the number of cycles of a 1kHz oscillator between successive positive-going transitions of the signal. This gives a measure of each period of the input signal, and a voltage proportional to frequency was obtained using the AD7520 as a divider⁴ (second trace, Figure 2).

The EMP average frequency is given by the buffered output of the RC filter on the lagged input of the AD520 (third trace in Figure 2). The amplified difference between the two inputs (10V F.S., gain of 10) is rms'd in the AD536, with a time-constant of τ . The rms output is fourth trace in Figure 2.

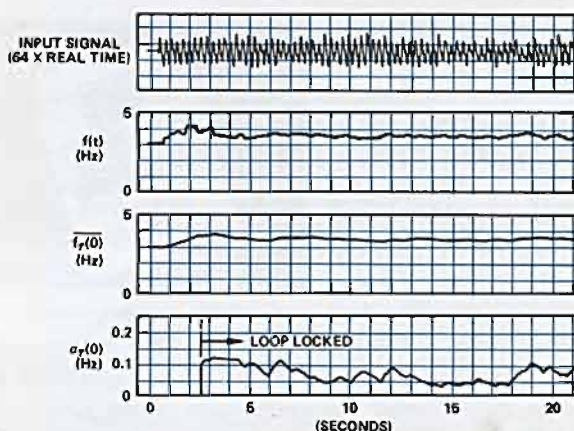

Figure 2. Chart recordings of variables (a) measured electrical activity, (b) frequency (input to EMP computer), (c) average frequency, (d) variance function (amplified). Real time scale – 64s/s.

The time constant was set at 1s (3.2Hz input) so that the EMP average was effectively taken over the last 10 cycles of the signal. Using a Student's *t* test, it could be demonstrated (less than 5% probability of pure chance) that the frequency of the electrical signals from the human stomach changes over a period of a few minutes. The biological meaning of this observation is obscure!



*Principal Physicist, Department of Medical Physics, Hallamshire Hospital, Sheffield, England

†Here, the variable we are considering is not the voltage or current of a signal, but its frequency (see top waveforms in Figure 2)

§The AD521 and the AD536A, more-recent designs, would be used in future implementations of this technique. Use the reply card for technical data.

¹J. Otterman, "The Properties and Methods for Computation of Exponentially Mapped Past Statistical Variables, *IRE Trans. AC-5*, 11-17, 1960

²T.S. Nelson & T.M. Wallace, "An Instrumentation System for On-Line Processing and Statistical Analysis of Electroenterographic and Electrogastric Data." *Digest of the 6th International Conference on Medical Electronics*, Tokyo, 1965, 369-370

³R.H. Smallwood, "Analysis of Gastric Electrical Signals from Surface Electrodes Using Phaselock Techniques, I. System Design, II. System Performance with Gastric Signals." *Med. & Biol. Eng.*, 1978

⁴R.H. Smallwood, "An Instantaneous Ratemeter for Low-Frequency Signals", *Electronic Engineering* 50, 27, 1978

1979 SHORT-FORM GUIDE

Replacing last year's "in-a-nutshell" Guide to *Electronic Products for Precision Measurement and Control*, here is the latest comprehensive listing of Analog Devices products. In 44 information-packed pages, you will find information on conversion products, signal-conditioning products, data-conversion products, temperature instrumentation, digital panel instruments, and power supplies, as well as our unique MACSYM Measurement And Control SYsteM. If you're on our mailing list, you've probably received your copy. If you haven't, or if need one for a friend, use the reply card.



COMPUTER-LABS CAPABILITIES

When it comes to high-speed "video" data acquisition, a comprehensive line of standard products just may not be sufficient for some important applications. Computer Labs has a history of developing custom high-speed products for special applications in digital communications, radar, medical electronics, computer time-sharing, mass information-processing and storage, and automatic testing and process control. Their capabilities are outlined in this colorful 16-page brochure. For your copy, use the reply card.



UNUSUAL NEW MAGAZINE

Electronics Test is a controlled-circulation "free" magazine that started publishing in 1978. A down-to-earth periodical that is somewhat off the usual design-oriented beaten path, it might be worth looking into if you haven't heard about it. For information, write to the publisher, Benwill Publishing Corp., 1050 Commonwealth Avenue, Boston, Massachusetts 02215, (617) 232-5470. (Please don't write to us!)

ADVERTISEMENT

ISOLATION AMPLIFIERS SOLVE 5 COMMON MEASUREMENT PROBLEMS

- 1 Ground Loops
- 2 Safety
- 3 Electrical Noise
- 4 Fault Protection
- 5 High Common Mode Voltages

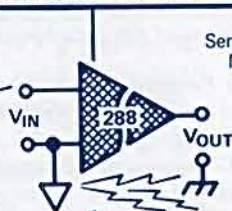

Send for FREE Copy of New 24-Page, DESIGNERS GUIDE for Isolation Amplifiers



WAY OUT IN FRONT

TRUE GALVANIC ISOLATION TO 5kV

FOUR-QUADRANT ANALOG DIVIDER?

Basic multiplier/divider circuits, such as the AD535,* used as dividers, require that the denominator be of a single polarity, to avoid positive feedback, but the numerator can be either unipolar or bipolar. The result is a one- or two-quadrant divider. Four-quadrant division can be provided, with correct polarity relationships, by switching of denominator and of output polarities. Of course, you can't divide by zero, and there are practical limitations to the dynamic range of the ratio.

With these limitations, it would be difficult to find an application for four-quadrant division. For example, in direct impedance measurement, it might be necessary to divide two sine waves. If they were (say) 90° out of phase, there would be two divisions of full-scale magnitude by zero per cycle. Considering the frightful errors that are possible, one would be better advised to divide *measures* of the voltage or current, for example, rms or peak values.

It is easy to see that a 4-quadrant divider is more of a conversation piece than a useful instrument. With this prelude, one might ask whether it is possible to describe a 4-quadrant divider circuit in which the sign of the feedback loop is automatically changed *without* discontinuous polarity-recognition and switching circuitry. Our former colleague, Bob Pease, has discovered one in *Electronic Engineering* (Mid-October, 1978, page 23), described by J. R. Ball, and called it to our attention. It uses three multipliers and employs the absolute-value property of squaring to provide the proper loop polarity. It still won't "divide by zero" and its errors increase with the inverse square of the denominator, but it apparently works! ▶▶▶

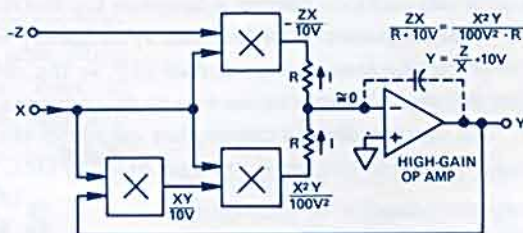

LOOP GAIN IS PROPORTIONAL TO $-X^2$, HENCE ALWAYS NEGATIVE (OR ZERO)

*For technical data on the divider-optimized AD535 and the multiplier-optimized AD534, use the reply card.

ADVERTISEMENT

CAN THESE 4 OP-AMPS FILL ALL YOUR HIGH PERFORMANCE SOCKETS ?

AD515

THE ULTIMATE ELECTROMETER
75fA BIAS CURRENT

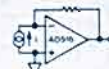

IDEAL FOR pH

AD545

LOWEST: DRIFT, NOISE, OFFSET
1pA IBIAS FET

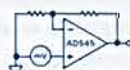

AD542

BEST BIFET
25pA
BIAS CURRENT

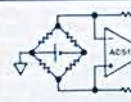

AD517

TAMES MILLIVOLT TRANSDUCERS WITH AN OFFSET TC OF 0.5μV/°C



MAIL CARD FOR DATA

WAY OUT IN FRONT

An Eclectic Collection of Miscellaneous Items of Timely and Topical Interest. Further Information on Products Mentioned Here May Be Obtained Via the Reply Card.

IN THE LAST ISSUE (Volume 13, No. 1, 1979) . . . MACSYM II Measurement And Control SYsteM: Survey, 16-Bit Processor, ADIO (Input/Output) Controller and Bus, Card Library, MACBASIC Software, Applications . . . New-Product Briefs: General-Purpose Temperature Probe (AD2626), Tiny Flat-Package Version of the AD590 Temperature Sensor (AD590F), Complete Monolithic 8-Bit A/D Converter (AD570), Improved RMS-to-DC Converter IC (AD536A), Transducer Power Supply (2B35), Interface Boards for LSI-11 (RTI-1250 Family), Digital-to-Synchro Converters (DSC1705) . . . Worth Reading - Three New Publications: Computer Labs Short-Form Catalog, Designer's Guide to Isolation and Instrumentation Amplifiers, and Synchro-to-Digital Converter Short-Form Catalog . . . Plus Authors, Potpourri, Editorial welcome to Computer Labs Division. Request information on the reply card.

TRADE SHOWS IN THE U.S.A. . . . After a successful return to the trade-show scene in 1978, we are planning to exhibit our components at the following shows in 1979 (as starters). Mark your calendar: WESCON, in San Francisco, September 18, 19, 20 . . . MIDCON, in Chicago, November 6, 7, 8 . . . At press-time, we will have already exhibited at ELECTRO, in New York, April 24-26.

PRODUCT NOTES . . . Most-often-given advice: Always be sure that there is a return leak for bias current from instrumentation-amplifier inputs to power-supply common, otherwise they will drift off to limits and you will phone our application engineers for help and get this same advice. On the other hand, isolation amplifiers have floating inputs and don't need leaks . . . Plus or minus 5V? Our 5V logic supplies (Models 903, 905, 906, 922) don't care whether they're used for +5V or -5V; either terminal may be used as the ground reference. Our supplies are spec'd to furnish from 250mA to 2A at plus or minus 5V . . . What decoder-driver to use with the AD2020 I-L 3-digit DPM chip? Try Fairchild 9374 or T.I. 7447 (with pullup resistor). How eliminate leading zero with the 9374 (e.g., 9.1 instead of 09.1)? Connect pin 3 of the 9374 (RBI) to the most-significant digit . . . In DSC1605/1606, all positive power is derived from the +15V connection. The +5V pin, no longer necessary, is omitted.

NEW DATA SHEET . . . The AD521 Instrumentation-Amplifier data sheet has been revised and expanded. Its 6 pages now include a great deal of useful applications advice; also included are specifications for the new high-performance-grade AD521L.

ERRATA . . . DAC1122 data sheet: +V is pin 24, -V is pin 26, not the reverse! Bits 8-12 are on pins 9-13 (not 8-12) . . . ANALOG DIALOGUE 9-3, 1975, headline for DAC1108 on page 16 should show 150ns settling time, to agree with the text . . . ANALOG DIALOGUE 12-2, last line on page 8: offset should be 460mV (not 492mV) for a correct $\text{lmV}/^{\circ}\text{F}$ scale. Both the circuitry and the data sheet have the correct offset; only the published number in DIALOGUE is wrong. We are indebted to the sharp eyes of reader William Kraengel, Jr., of Valley Stream, N.Y., for calling it to our attention.

PATENTS . . . 4,136,349, IC Chip with Buried Zener Diode, Wei K. (Bob) Tsang. If you copy our AD534, or other products using buried Zener diodes, this is one of the patents you will be infringing . . . 4,141,004, Solid-State Digital-to-Analog Converter, Robert B. Craven. If you copy our AD562 or 563, this is one of the patents you will be infringing.

MISTAKEN IDENTITY . . . If you want an IC, order an AD311; if you want a non-inverting parametric op-amp module, order a Model 311. In this case (and those of 111, 301, 108, 101), the prefix is all-important!

MULTIBUS . . . The RTI-1200, 1201, and 1202 are compatible with all MULTIBUS-compatible computers, including INTEL's new 16-bitter. Others include INTEL SBC-80 (except 80/04), MDS, and System-80, National Semiconductor BLC-80, RMC-80, Starplex Development System, Advanced Micro Computers 95/4000, Monolithic Systems Corp. MSC8001, Iasis, Inc., SBC-80, Henrikon Corp. MLZ-80, and Mupro MBC-80CRT.

GSA CONTRACT . . . A cover sheet and a price list for GSA Contract No. GS-00S-86209, covering converters, panel meters, and RTI product lines, effective from March 12, 1979 through February 29, 1980, are now available. To receive a copy, write to the Analog Devices Sales Department on your company letterhead, if your outfit is qualified to purchase against GSA contract numbers - or consult your regular Analog Devices sales engineer.

M.I.T. ASSOCIATES . . . Analog Devices is now a member of the M.I.T. Associates program. This means that technical and management talent and resources of the Massachusetts Institute of Technology, the Sloan School of Management, and the Lincoln Laboratories are now more easily accessible to all Analog Devices employees, to augment the already impressive capabilities of our own staff.

ANALOG I/O FOR MICROCOMPUTERS? WE HOLD ALL THE CARDS.

- Analog input cards, output cards, combination I/O Cards.
- Compatible with all popular single board microcomputers.
- Pick a card, any card, right now, and get two week delivery.

Intel SBC 80



ADI RTI 1200 Series

- 16 Input Channels \$399
- 4 Output Channels \$379
- Combination I/O \$629

Motorola Micromodule



ADI RTI 1230 Series

- 16 Input Channels \$399
- 4 Output Channels \$375
- Combination I/O \$515

Texas Instruments TMM 990



ADI RTI 1240 Series

- 16 Input Channels \$445
- 8 Output Channels \$675
- 4 Output Channels \$395
- Combination I/O \$560

DEC LSI-11[®]



ADI RTI 1250 Series

- 16 Input Channels \$560
- 4 Output Channels \$550
- Combination I/O \$695

Mostek & Pro-Log



ADI RTI 1220 Series

- 16 Input Channels \$330
- 4 Output Channels \$275
- Combination I/O \$399

For complete information on the Analog Devices RTI Series Analog I/O Subsystems, call Russ Ver Nooy at (617) 329-4700. Or write Analog Devices, P.O. Box 280, Norwood, MA 02062.

[®]Registered trademark of Digital Equipment Corporation.



WAY OUT IN FRONT