

KwikSplice™ Aluminum Cable Tray - Straight Sections & Accessories

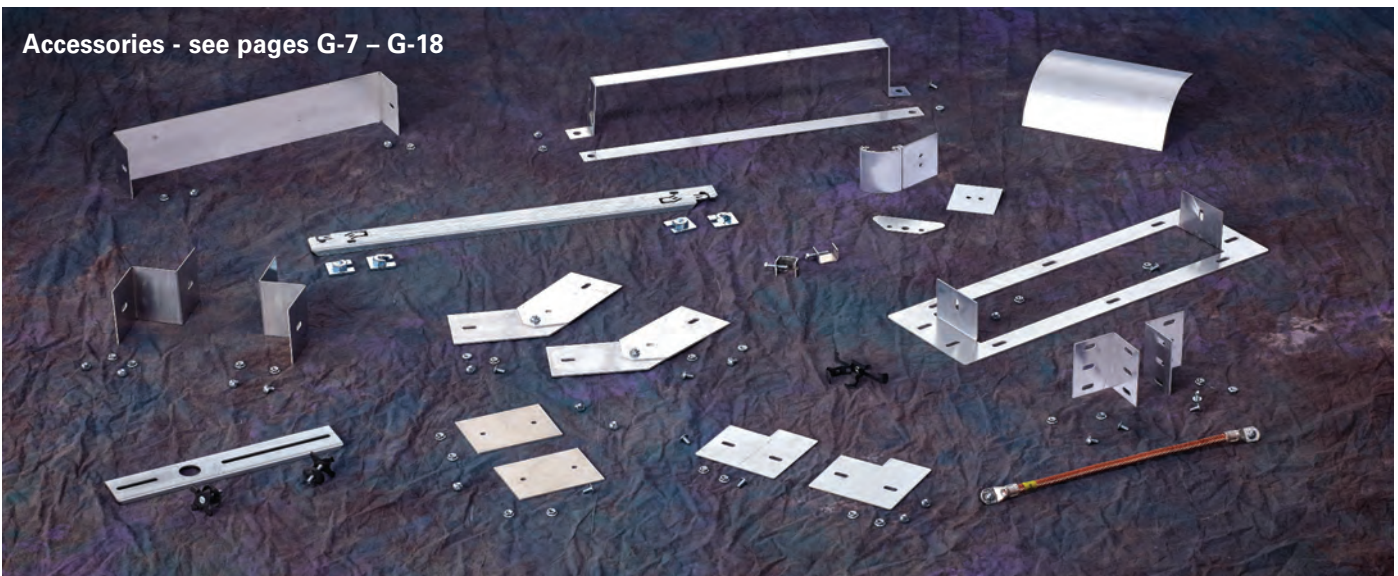

Straight Sections - see pages G-3 – G-6
Covers - see page G-13



Accessories - see pages G-7 – G-18

Fittings - see pages 21-33



KwikSplice Cable Tray

How The Service Advisor Works

We know that your time is important! That's why the color-coding system in this catalog is designed to help you select products that fit your service needs. Products are marked to indicate the typical lead time for orders of 50 pieces or less.

Customer: How do I select my straight sections, covers, or fittings so that I get the quickest turnaround?

Service Advisor: Each part of our selection chart is shown in colors. If any section of a part number is a different color, the part will typically ship with the longer lead time represented by the colors.

- Green = Fastest shipped items
- Black = Normal lead-time items
- Red = Normally long lead-time items

Example: **KSA** **4** **A** **SB** - **12** - **144**
 ● ● ● ● ● ●

Part will have a normal lead time because of the solid bottom.

KSA4A and KSA5A Straight Sections

Straight Section Part Numbering

Prefix

Example: **KS A 4 A 09 - 12 - 144**

Series	NEMA Class	Height	Material	Type	Width	Length
KS	A = 50 Lbs/Ft NEMA 12A (12 ft. span)	4 = 4" 5 = 5"	A = Aluminum	Ladder- 06 = 6" rung spacing 09 = 9" rung spacing 12 = 12" rung spacing Trough- 04 = 4" rung spacing SB = Solid Bottom	06 = 6" 09 = 9" 12 = 12" 18 = 18" 24 = 24" 30 = 30" 36 = 36"	①144 = 12 ft. ②120 = 10 ft. ①Primary ②Secondary

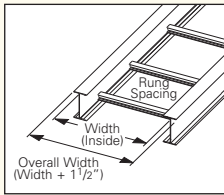

Values are based on simple beam tests per VE-1 on 36" wide cable tray with rungs spaced on 12" centers. The published load safety factor is 1.5. To convert 1.5 safety factor to 2.0, multiply the published load by 0.75. To obtain mid-span deflection, multiply a load by the deflection multiplier. Cable tray must be supported on spans shorter than or equal to the length of the tray.

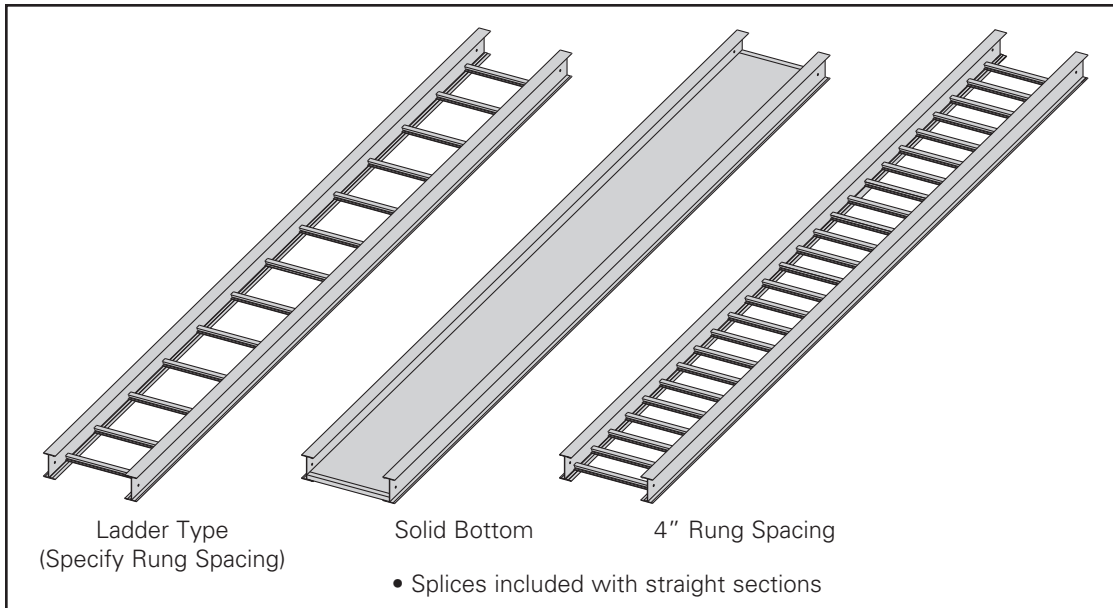

All dimensions in parentheses are millimeters unless otherwise specified.

KSA4A and KSA5A Straight Section Technical Data

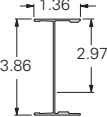
B-Line Series Side Rail Dimensions	NEMA, CSA & UL Classifications	Span ft	Load lbs/ft	Deflection Multiplier	Design Factors for Two Rails	Span meters	Load kg/m	Deflection Multiplier	Design Factors for Two Rails
KSA4A 	NEMA: 12A	6	221	0.0016	Area = 0.80 in ² Sx = 0.90 in ³ Ix = 1.79 in ⁴	1.8	328	0.028	Area = 5.16 cm ² Sx = 14.75 cm ³ Ix = 74.51 cm ⁴
	CSA: C-3m	8	124	0.0051		2.4	185	0.088	
	UL Cross-Sectional	10	79	0.0126		3.0	125	0.215	
	Area: 0.60 in ²	12	55	0.0261		3.7	82	0.445	

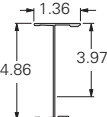
B-Line Series Side Rail Dimensions	NEMA, CSA & UL Classifications	Span ft	Load lbs/ft	Deflection Multiplier	Design Factors for Two Rails	Span meters	Load kg/m	Deflection Multiplier	Design Factors for Two Rails
KSA5A 	NEMA: 12A	6	219	0.0009	Area = 0.92 in ² Sx = 1.24 in ³ Ix = 3.08 in ⁴	1.8	326	0.016	Area = 5.94 cm ² Sx = 20.32 cm ³ Ix = 128.20 cm ⁴
	CSA: C-3m	8	123	0.0030		2.4	183	0.051	
	UL Cross-Sectional	10	79	0.0073		3.0	120	0.125	
	Area: 0.60 in ²	12	55	0.0151		3.7	81	0.259	

When cable trays are used in continuous spans, the deflection of the cable tray is reduced by as much as 50%.
 Design factors: Ix = Moment of Inertia, Sx = Section Modulus.

KSB4A, KSB5A, and KSB6A Straight Sections

Straight Section Part Numbering

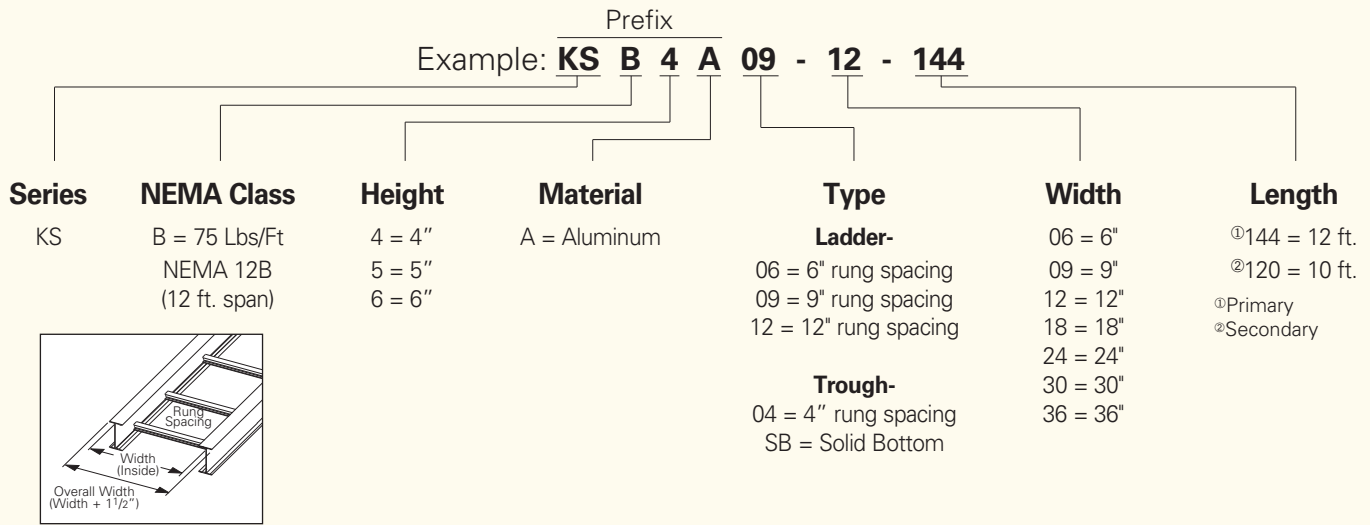

Values are based on simple beam tests per VE-1 on 36" wide cable tray with rungs spaced on 12" centers. The published load safety factor is 1.5. To convert 1.5 safety factor to 2.0, multiply the published load by 0.75. To obtain mid-span deflection, multiply a load by the deflection multiplier. Cable tray must be supported on spans shorter than or equal to the length of the tray.

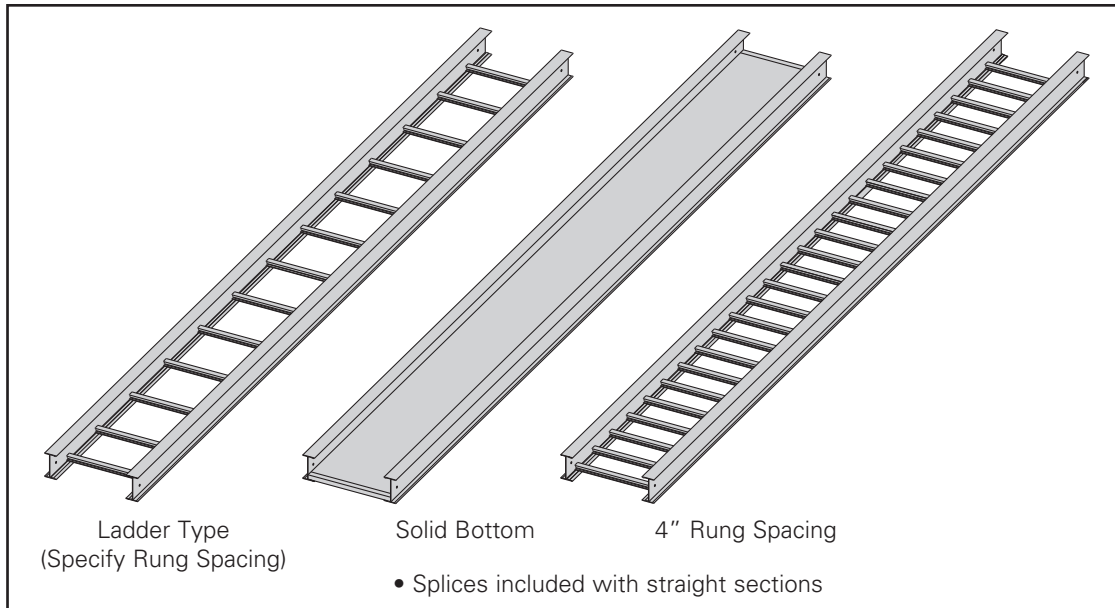

All dimensions in parentheses are millimeters unless otherwise specified.

KwikSplice™ Aluminum Cable Tray - Straight Sections

KSB4A, KSB5A and KSB6A Straight Section Technical Data

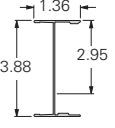
B-Line Series Side Rail Dimensions	NEMA, CSA & UL Classifications	Span ft	Load lbs/ft	Deflection Multiplier	Design Factors for Two Rails	Span meters	Load kg/m	Deflection Multiplier	Design Factors for Two Rails
KSB4A 	NEMA: 12B CSA: D-3m UL Cross-Sectional Area: 0.60 in ²	8	198	0.0040	Area = 0.99 in ² Sx = 1.07 in ³ Ix = 2.32 in ⁴	2.4	295	0.068	Area = 6.39 cm ² Sx = 17.53 cm ³ Ix = 96.57 cm ⁴
		10	127	0.0097		3.0	195	0.166	
		12	88	0.0201		3.7	131	0.343	

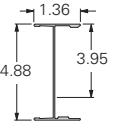
B-Line Series Side Rail Dimensions	NEMA, CSA & UL Classifications	Span ft	Load lbs/ft	Deflection Multiplier	Design Factors for Two Rails	Span meters	Load kg/m	Deflection Multiplier	Design Factors for Two Rails
KSB5A 	NEMA: 12B CSA: D-3m UL Cross-Sectional Area: 0.60 in ²	8	188	0.0023	Area = 1.12 in ² Sx = 1.47 in ³ Ix = 3.96 in ⁴	2.4	279	0.040	Area = 7.23 cm ² Sx = 24.09 cm ³ Ix = 164.83 cm ⁴
		10	120	0.0057		3.0	180	0.097	
		12	83	0.0228		3.7	124	0.201	

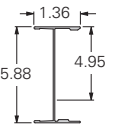
B-Line Series Side Rail Dimensions	NEMA, CSA & UL Classifications	Span ft	Load lbs/ft	Deflection Multiplier	Design Factors for Two Rails	Span meters	Load kg/m	Deflection Multiplier	Design Factors for Two Rails
KSB6A 	NEMA: 12B CSA: D-3m UL Cross-Sectional Area: 1.00 in ²	8	170	0.0015	Area = 1.25 in ² Sx = 1.91 in ³ Ix = 6.16 in ⁴	2.4	266	0.026	Area = 8.06 cm ² Sx = 31.30 cm ³ Ix = 256.40 cm ⁴
		10	114	0.0037		3.0	179	0.062	
		12	79	0.0076		3.7	118	0.129	

When cable trays are used in continuous spans, the deflection of the cable tray is reduced by as much as 50%.
 Design factors: Ix = Moment of Inertia, Sx = Section Modulus.

All dimensions in parentheses are millimeters unless otherwise specified.

KwikSplice™ Aluminum Cable Tray - Accessories

Standard Splice Plates

- Furnished in pairs with 1/4" hardware.
- UL Classified.
- One pair including hardware provided with each straight section. (Expansion splice quantity subtracted)

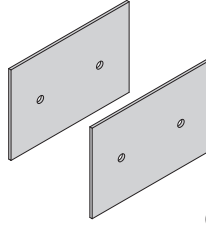

Tray Series	Catalog No.
KS_4A	KS4A-SSP
KS_5A	KS5A-SSP
KS_6A	KS6A-SSP

— Can be used with both NEMA Class A and B KwikSplice trays.

Expansion Splice Plates

- Furnished in pairs with 1/4" hardware.
- Bonding jumpers required on each side rail.

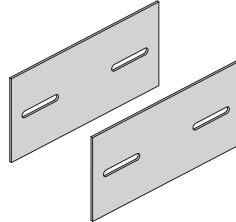

Tray Series	Catalog No.
KS_4A	KS4A-ESP
KS_5A	KS5A-ESP
KS_6A	KS6A-ESP

Step Down Splice Plates

- Furnished in pairs with 1/4" hardware.
- UL Classified.

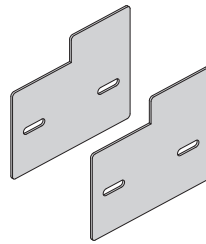

Tray Series	Catalog No.
KS_4A	KS4A-DSP
KS_5A	KS5A-DSP
KS_6A	KS6A-DSP

Vertical Adjustable Splice Plates

- Furnished in pairs with 1/4" hardware.
- UL Classified.
- Bonding jumpers not required.

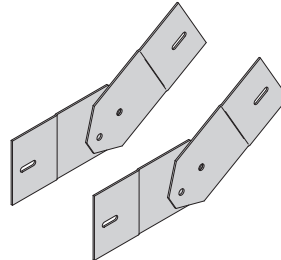

Requires supports within 24" on both sides, per NEMA VE 2.

Tray Series	Catalog No.
KS_4A	KS4A-VSP
KS_5A	KS5A-VSP
KS_6A	KS6A-VSP

Horizontal Adjustable Splice Plates

- Furnished in pairs with 1/4" hardware.
- Horizontally adjustable to 90°.
- Vertically adjustable to 15°.
- UL Classified.
- For optional rung, see page KSA-17.

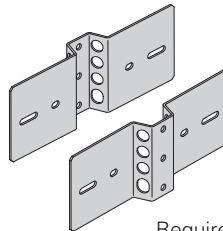

Requires supports within 24" on both sides, per NEMA VE 2.

Tray Series	Catalog No.
KS_4A	KS4A-FSP
KS_5A	KS5A-FSP
KS_6A	KS6A-FSP

Tray To Box Splice Plates

- Furnished in pairs with 1/4" hardware.
- UL Classified.

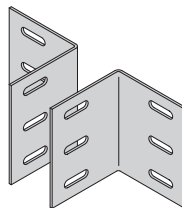

Tray Series	Catalog No.
KS_4A	KS4A-TTB
KS_5A	KS5A-TTB
KS_6A	KS6A-TTB

All dimensions in parentheses are millimeters unless otherwise specified.

KwikSplice™ Aluminum Cable Tray - Accessories

Offset Reducing Splice Plates

- Furnished in pairs with 1/4" hardware.
- UL Classified.

Specify the following:

- † C = center reducer
- S = side reducer

r (tray reduction) 3", 6", 9", 12", 15", 18", 21", 24", 27", or 30"

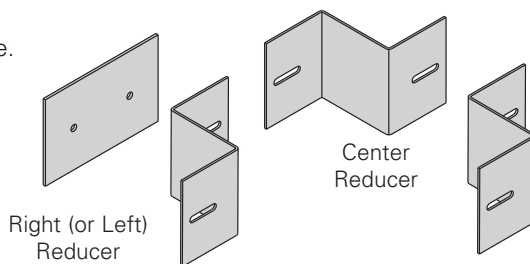

Tray Series	Catalog No.
KS_4A	KS4A-RSP-†r
KS_5A	KS5A-RSP-†r
KS_6A	KS6A-RSP-†r

— Can be used with both NEMA Class A and B KwikSplice trays.

Bonding Jumper

- Furnished with 1/4" hardware.
- Sold individually.
- UL Classified.
- Length: 14 1/2" (368mm)

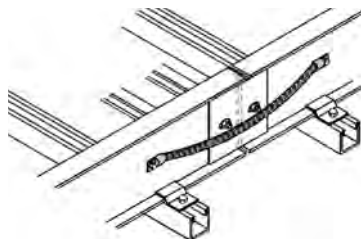

Ampacity	Catalog No.
1200	99-30

Grounding Clamp

- Accepts #6 AWG to 250 MCM.
- UL Classified as to its suitability as an equipment grounding conductor.

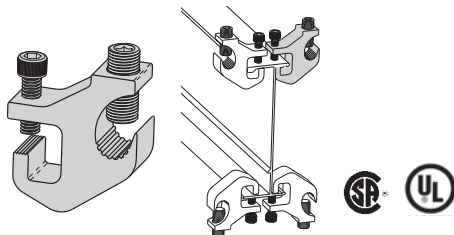

Material	Catalog No.
Tin Plated Aluminum	9A-2130

Conduit to Tray Adaptors

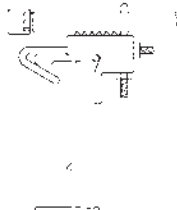
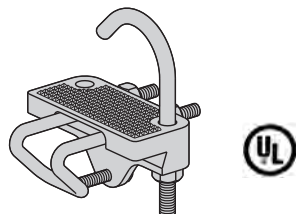

Conduit Size in. (mm)	Catalog No.
1/2, 3/4 (15, 20)	9G-1158-1/2, 3/4
1, 1 1/4 (25, 32)	9G-1158-1, 1 1/4
1 1/2, 2 (40, 50)	9G-1158-1 1/2, 2
2 1/2, 3 (65, 80)	9G-1158-2 1/2, 3
3 1/2, 4 (90, 100)	9G-1158-3 1/2, 4

Guide-Rite™ Conduit to Tray Adaptor

- Assemblies support 1/2", 3/4", & 1" conduit.
- Attaches to top or bottom of I-Beam side rail flange.

Patent #4958792

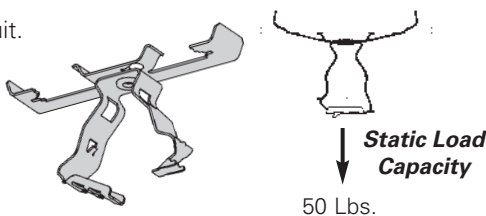

Conduit Size in. (mm)	Catalog No.
1/2, 3/4 (15, 20)	BG-8-12-W2
1, 1 1/4 (25, 32)	BG-16-W2

Vertical Conduit Hanger Adapter

- Furnished as one plate with fastener attachments.
- Utilizes (2) BAX-4-16 Under Rung Fastener Attachments.
- Accepts 1/2" to 4" conduit.

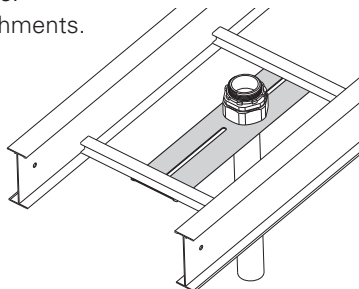
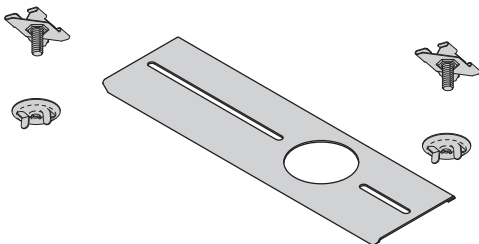

Conduit Size in. (mm)	Catalog No.
1/2 (15)	KSA-VCH-1/2
3/4 (20)	KSA-VCH-3/4
1 (25)	KSA-VCH-1
1 1/4 (32)	KSA-VCH-1 1/4
1 1/2 (40)	KSA-VCH-1 1/2
2 (50)	KSA-VCH-2
3 (75)	KSA-VCH-3
4 (100)	KSA-VCH-4

All dimensions in parentheses are millimeters unless otherwise specified.

KwikSplice™ Aluminum Cable Tray - Accessories

Drop-Out

- Snaps on to cable tray side rail.
- Provides 4" (101mm) radius.
- Holes provided to secure cables.

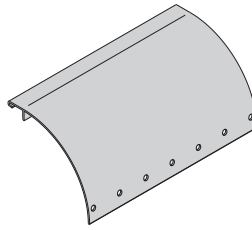

Catalog No.
KSA-OUT-†

† = Insert tray width

Side Rail Drop-Out

- Snaps on to cable tray side rail.
- Provides 4" (101mm) radius.
- Holes provided to secure cables.

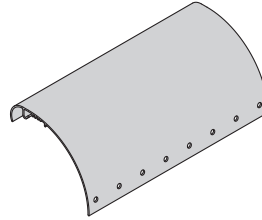
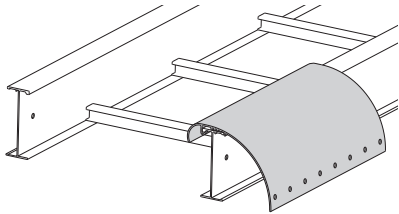

Catalog No.	Length	
	in.	(mm)
KSA-SDO-06	6	(152)
KSA-SDO-12	12	(305)
KSA-SDO-18	18	(457)

Clamp/Guide

- Features a no-twist design.
- Each side is labeled to ensure proper installation.
- Designed for 1/4" hardware.
- Furnished in pairs with or without hardware.

Patent No.
RE35479

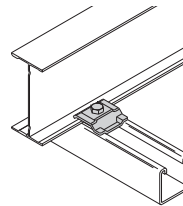
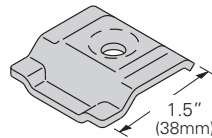

Catalog No.

9ZN-1204 (without hardware)
9ZN-1204NB (with hardware)

Frame Type Box Connector

- Furnished with 1/4" hardware for tray connection.

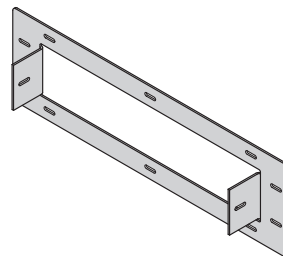

Tray Series	Catalog No.
KS_4A	KS4A-FTB-†
KS_5A	KS5A-FTB-†
KS_6A	KS6A-FTB-†

† = Insert tray width

Blind End

- Furnished as one plate with 1/4" hardware.

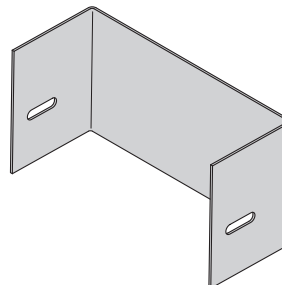

Tray Series	Catalog No.
KS_4A	KS4A-END-†
KS_5A	KS5A-END-†
KS_6A	KS6A-END-†

† = Insert tray width

— Can be used with both NEMA Class A and B Kwik Splice trays.

All dimensions in parentheses are millimeters unless otherwise specified.

KwikSplice™ Aluminum Cable Tray - Accessories

Tab & Lock Trapeze Support

- Hardware purchased separately.
- Accepts up to 3/8" rod.
- Accepts traditional hold down clamps (9ZN-1204) if necessary.
- Ability to adjust tabs with flat head screw driver (not included).
- Tabs clamp cable tray to trapeze support.
- Load capacity: Rated for maximum load of KwikSplice cable tray system.
- Corrosion resistant pre-galvanized zinc finish.
- Other finishes available upon request.

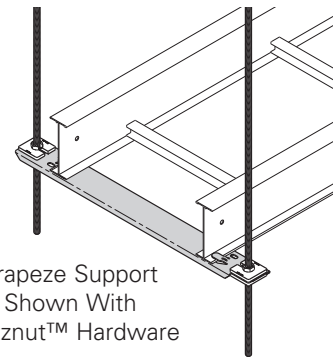

Trapeze Support Only

Hardware	Qty.	Catalog No
Standard	(4)	B201
	(4)	3/8" HN
or		
Buzznut	(4)	SLWN3/8

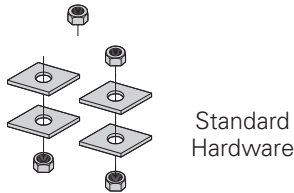

Catalog No.	Tray Width
	in. (mm)
KSA-6CT	6 (152)
KSA-9CT	9 (229)
KSA-12CT	12 (305)
KSA-18CT	18 (457)
KSA-24CT	24 (610)
KSA-30CT	30 (762)
KSA-36CT	36 (914)

Trapeze Support Kit

Our trapeze kits provide the components required for a single trapeze support in one package. These kits are available in pre-galvanized steel with zinc-plated hardware or hot dip galvanized steel with 316 stainless steel hardware.

The SH channel provides the convenience of pre-punched slots, which eliminate the need for field drilling.

The illustrated hardware is sealed in a plastic bag and boxed with the channel, which is pre-cut to the appropriate length as shown in the chart.

Designed for use with 1/2" threaded rod. Order rod separately.

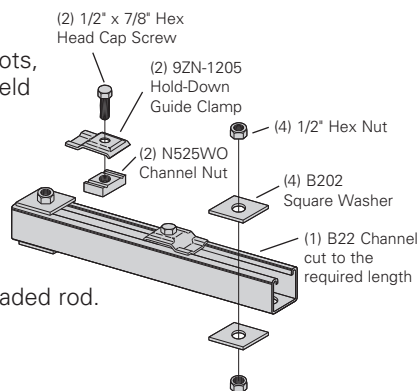
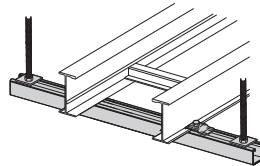

Catalog No.	Tray Width	Channel Length	Uniform Load
	in. (mm)	in. (mm)	lbs (kN)
9(*)-5506-22SH(†)	6 (152)	16 (406)	1600 (7.11)
9(*)-5509-22SH(†)	9 (229)	18 (457)	1250 (5.56)
9(*)-5512-22SH(†)	12 (305)	22 (559)	1125 (5.00)
9(*)-5518-22SH(†)	18 (457)	28 (711)	865 (3.85)
9(*)-5524-22SH(†)	24 (610)	34 (864)	700 (3.11)
9(*)-5530-22SH(†)	30 (762)	40 (1016)	590 (2.62)
9(*)-5536-22SH(†)	36 (914)	46 (1168)	510 (2.27)

- (*) Insert **P** or **G**
- (†) Insert 3/8 for 3/8" threaded rod hardware. Safety factor of 3.0 on all loads.

Trapeze Hardware Kit

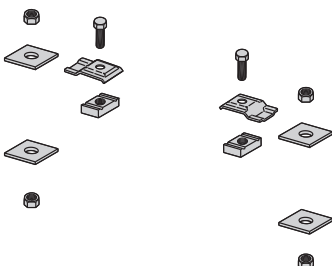

Catalog No.	9ZN-5500-1/2	9G-5500-1/2
In plastic bag	(1) pr. 9ZN-1205 (2) HHC Screw 1/2 x 7/8 ZN (2) N525 WO ZN (4) B202 ZN 1/2" sq washer (4) HN 1/2 ZN	(1) pr. 9G-1205 (2) HHC Screw 1/2 x 7/8 SS6 (2) N525 WO SS6 (4) B202 HDG 1/2" sq washer (4) HN 1/2 SS6

All dimensions in parentheses are millimeters unless otherwise specified.

KwikSplice™ Aluminum Cable Tray - Accessories

Bracket (12" - 42")

- Finishes available: ZN, GRN, or HDG
- Safety Load Factor 2.5

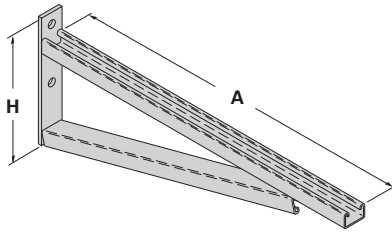

Bottom brace is B42 channel on B494-24 and smaller and B22 channel on B494-30 and larger

Catalog No.	Uniform Load		Tray Width		'A'		'H'	
	lbs	(kN)	in.	(mm)	in.	(mm)	in.	(mm)
B494-12	2500	(11.12)	6 & 9	(152 & 229)	12	(305)	8 ³ / ₄	(222)
B494-18	1700	(7.56)	12	(305)	18	(457)	8 ³ / ₄	(222)
B494-24	1300	(5.78)	18	(457)	24	(610)	8 ³ / ₄	(222)
B494-30	1600	(7.11)	24	(610)	30	(762)	11 ¹ / ₄	(286)
B494-36	1100	(4.89)	30	(762)	36	(914)	11 ¹ / ₄	(286)
B494-42	980	(4.36)	36	(914)	42	(1067)	16	(406)

For more dimensional data see Strut Systems catalog

Cantilever Bracket (12"-24")

- Finishes available: ZN, GRN, HDG, SS4 or SS6
- Safety Load Factor 2.5

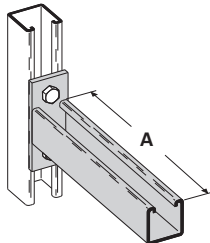

Catalog No.	Uniform Load		Tray Width		'A'	
	lbs	(kN)	in.	(mm)	in.	(mm)
B409-12	960	(4.27)	6 & 9	(152 & 229)	12	(305)
B409-18	640	(2.84)	12	(305)	18	(457)
B409-24	480	(2.13)	18	(457)	24	(610)

For more dimensional data see Strut Systems catalog

Cantilever Bracket (12"-42")

- Finishes available: ZN, GRN, HDG, or SS4
- Safety Load Factor 2.5

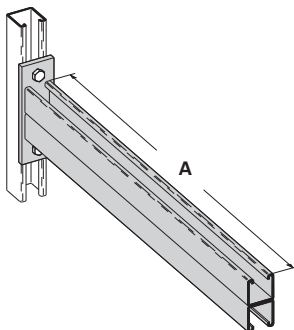

Catalog No.	Uniform Load		Tray Width		'A'	
	lbs	(kN)	in.	(mm)	in.	(mm)
B297-12	1660	(7.38)	6 & 9	(152 & 229)	12	(305)
B297-18	1100	(4.89)	12	(305)	18	(457)
B297-24	835	(3.71)	18	(457)	24	(610)
B297-30	665	(2.95)	24	(610)	30	(762)
B297-36	550	(2.44)	30	(762)	36	(914)
B297-42	465	(2.06)	36	(914)	42	(1067)

For more dimensional data see Strut Systems catalog

All dimensions in parentheses are millimeters unless otherwise specified.

KwikSplice™ Aluminum Cable Tray - Accessories

Underfloor Support (U-Bolts not included)

- Finishes available: ZN
- Safety Load Factor 2.5

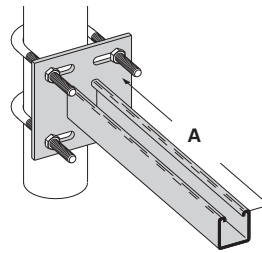

U-Bolt Size	Fits Pipe O.D.	
	in.	(mm)
B501-3/4	.841 - 1.050	(21 - 26)
B501-1	1.051 - 1.315	(27 - 33)
B501-1 1/4	1.316 - 1.660	(33 - 42)
B501-1 1/2	1.661 - 1.900	(42 - 48)
B501-2	1.901 - 2.375	(48 - 60)
B501-2 1/2	2.376 - 2.875	(60 - 73)

- Order 2 properly sized U-Bolts (sold separately) for each underfloor support.

Catalog No.	Uniform Load		Tray Width		'A'	
	lbs	(kN)	in.	(mm)	in.	(mm)
B409UF-12	800	(3.55)	6 & 9	(152 & 229)	12	(305)
B409UF-21	450	(2.00)	12 & 18	(305 & 457)	21	(533)

Heavy Duty Hold Down Bracket

- Design load is 2000 lbs/pair.
- Two bolt design.
- Sold in pairs.
- 3/8" cable tray attachment hardware provided.
- 1/2" support attachment hardware **not** provided.
- (*) Insert ZN, SS4, or SS6

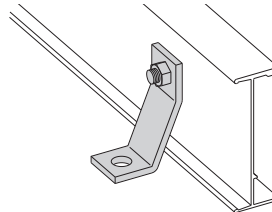

Catalog No.

9(*)-1241

Under Rung Fastener Attachment

- Supports electrical fixtures from bottom of rung or siderails.
- Wing nut included.
- Various 1/4"-20 stud lengths available.
- Static Load Capacity: 75 Lbs. (34kg).

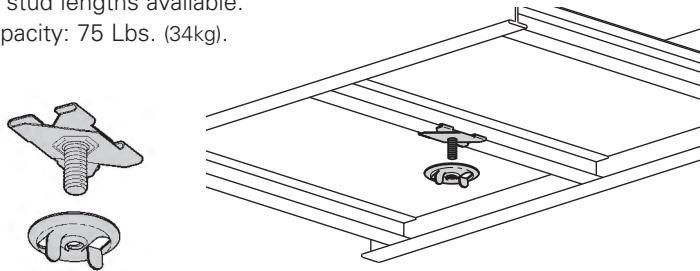

Catalog No.	Stud Length
	in. (mm)
BAX-4-16	5/8 (16)
BAX-4-16-24	1 1/2 (38)
BAX-4-16-32	2 (51)
BAX-4-16-48	3 (76)

DURA-BLOK™ Support Bases with B22 Channel

- Designed as a superior rooftop support for cable tray, UV resistant and approved for most roofing material or other flat surfaces.
- Can be used with any of our cable tray clamps and guides.
- Ultimate Uniform Load Capacity: 1,000 lbs. (4.45kN)



Catalog No.	Height x Width x Length	
	in.	(mm)
DB10-28	5 5/8 x 6 x 28	(143 x 152 x 711)
DB10-36	5 5/8 x 6 x 36	(143 x 152 x 914)
DB10-42	5 5/8 x 6 x 42	(143 x 152 x 1067)
DB10-50	5 5/8 x 6 x 50	(143 x 152 x 1270)
DB10-60	5 5/8 x 6 x 60	(143 x 152 x 1524)

General Note: Consult roofing manufacturer or engineer for roof load capacity. The weakest point may be the insulation board beneath the rubber membrane.



LEEDS credit available, base made from 100% recycled material.

All dimensions in parentheses are millimeters unless otherwise specified.

KwikSplice™ Aluminum Cable Tray - Accessories

Covers for KSA4A, KSA5A, KSB4A, KSB5A, and KSB6A

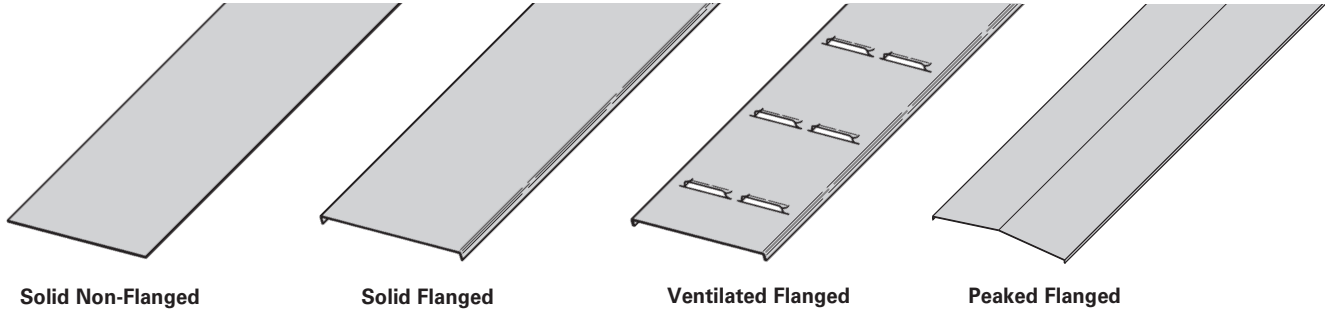

A full range of covers are available for straight sections and fittings.

Solid covers should be used when maximum enclosure of the cable is desired and no accumulation of heat is expected.

Ventilated covers provide cable protection, while allowing heat to escape.

Flanged covers have a 1/2 in. (13 mm) flange. Cover clamps are not included with the cover and must be ordered separately.

We recommend that covers be placed on vertical cable tray runs to a height of 6 ft. (1.83 m) to 8 ft. (2.44 m) above the floor to isolate both cables and protect personnel.

Aluminum Cover Part Numbering

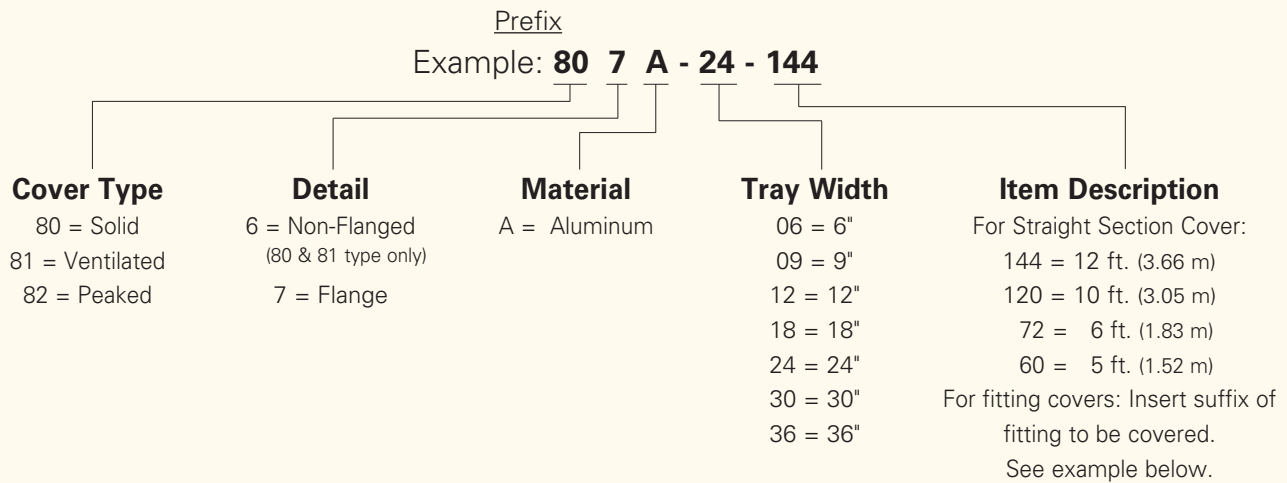

Examples of Catalog Numbers for Fitting Covers:

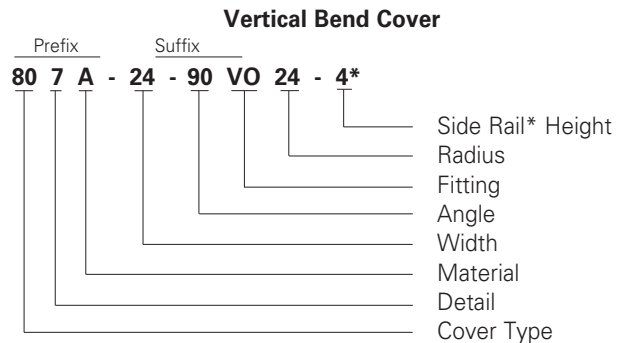
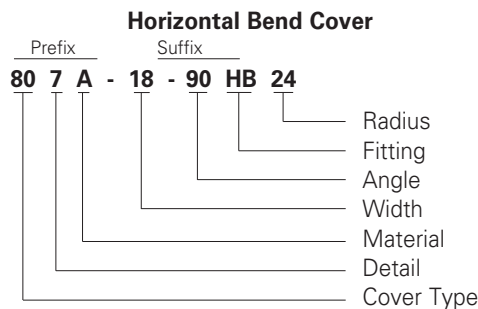

* Required for VO fittings only

All dimensions in parentheses are millimeters unless otherwise specified.

KwikSplice™ Aluminum Cable Tray - Accessories

Standard Cover Clamp

- For indoor service only.
- Setscrew included.
- Sold per piece.



Tray Type	Side Rail Height	Catalog No.
KS Series	All Sizes	9ZN-9012
		9A-9012

Heavy Duty Cover Clamp

- Recommended for outdoor service.

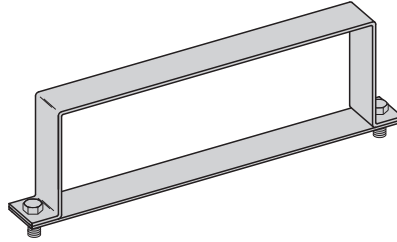

Side Rail Height in. (mm)	Catalog No.
4 (101)	KS4A-HDCC-(‡)
5 (127)	KS5A-HDCC-(‡)
6 (152)	KS6A-HDCC-(‡)

(‡) Insert tray width

Quantity of Standard Cover Clamps Required

Straight Section 60" or 72"	4 pcs.
Straight Section 120" or 144"	6 pcs.
Horizontal/Vertical Bends	4 pcs.
Tees	6 pcs.
Crosses	8 pcs.

Notes:

When using the Heavy Duty Cover Clamp, only one-half the number of clamps stated above is required.

Additional clamps may be necessary in extreme wind applications.

Cover Joint Strip

- Used to join covers
- Plastic
- (‡) Insert tray width

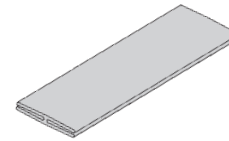

Catalog No.
99-9980-(‡)

Cable Cleats

(see Cable Tray Systems catalog)

Trefoil Cable Cleats

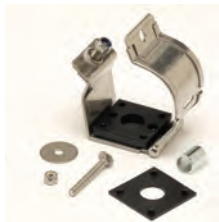

Single Cable Cleats

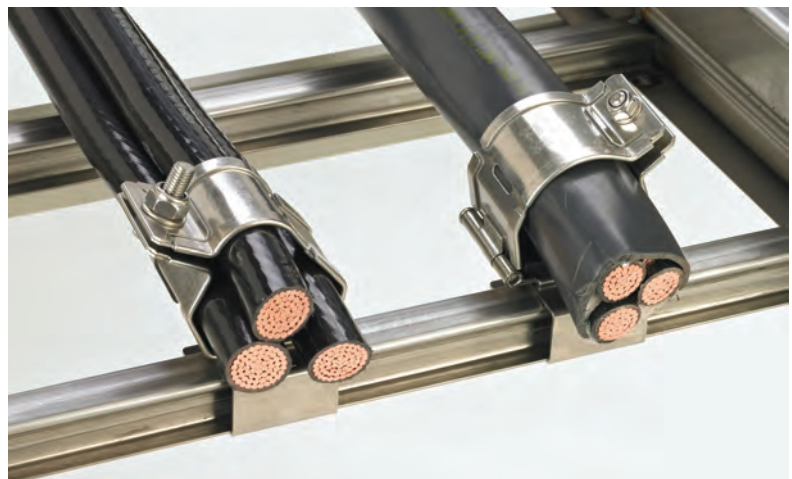

All dimensions in parentheses are millimeters unless otherwise specified.

KwikSplice™ Aluminum Cable Tray - Accessories

Universal Fitting

- Aluminum construction.
- 2" smooth radius.
- UL Classified.
- Shipped as a 90° horizontal bend.
- Field modify to create a tee or cross.
- Includes four pairs of toolless hinge splice plates.
- Patent Pending.

Tray Series	Catalog No.	
	Punched	Solid
KS_4A	KS4A-UF-(†)	KS4ASB-UF-(†)
KS_5A	KS5A-UF-(†)	KS5ASB-UF-(†)
KS_6A	KS6A-UF-(†)	KS6ASB-UF-(†)

(†) Insert Tray Width 6" (152mm) to 24" (609mm)

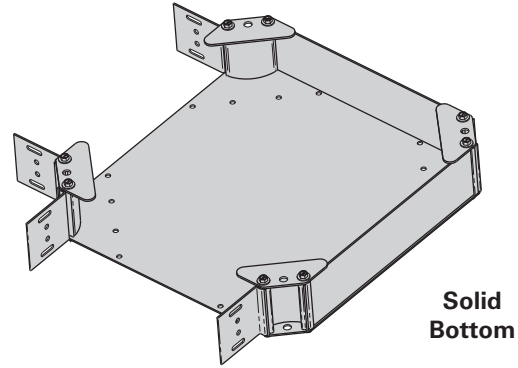
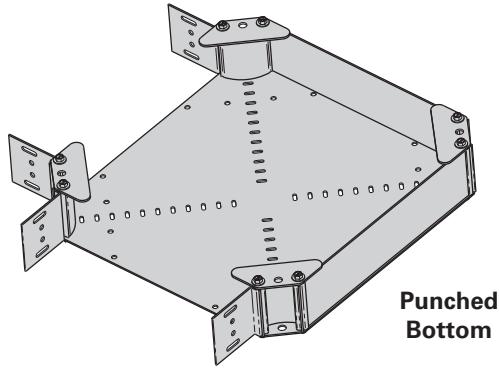

Corner Post For Universal Fitting

- Use to create reducing fittings.
- Furnished with hardware.
- 2" inside radius.
- Used on punched bottom only.
- UL Classified.
- Patent Pending.

Tray Series	Catalog No.
KS_4A	KS4A-CP
KS_5A	KS5A-CP
KS_6A	KS6A-CP

† = tray width

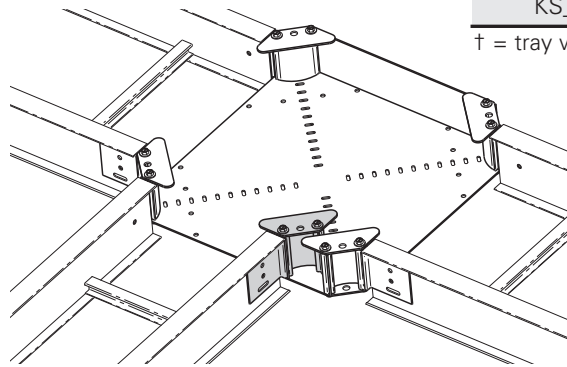
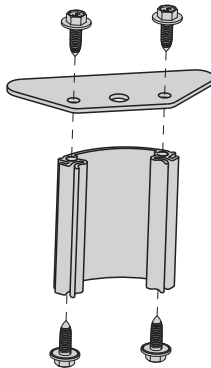

Universal Fitting Shown as a Reducing Tee

Barrier Strip Clip

- Provides attachment to KwikSplice rung.
- Allows for installed barrier adjustment.
- Asymmetrical clip provides a wide range for screw location.
- Barrier strip clips and hardware are included with all barriers.

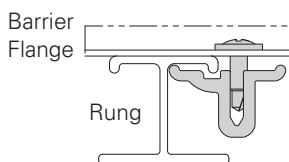

Screw slot for sheet metal screw

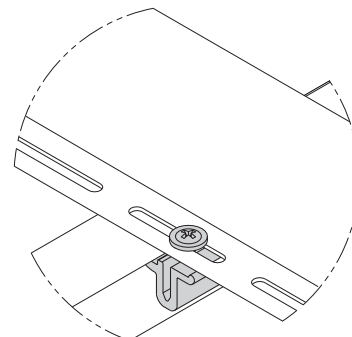
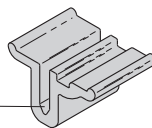

Catalog No.
9A-RBC

All dimensions in parentheses are millimeters unless otherwise specified.

Straight Section Barrier Strip

- Furnished with four (4) barrier strip clips, mounting hardware and splice.
- Standard lengths are 144" or 12 ft (3.7m) & 120" or 10 ft (3.0m).
- Order catalog number based on loading depth 'H'.

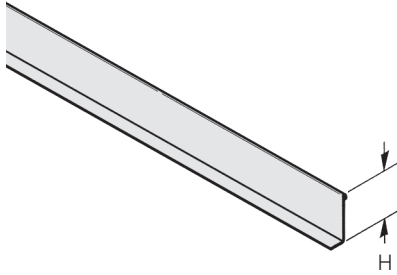

Tray Series	Catalog No.	H	
		in.	(mm)
KS_4A	R4A-DSL-Length	3	(76)
KS_5A	R5A-DSL-Length	4	(101)
KS_6A	R6A-DSL-Length	5	(127)

Horizontal Bend Barrier Strip

- Furnished with three (3) barrier strip clips, mounting hardware and splice.
- Standard length is 72" or 6 ft (1.8m).
- Flexible to fit desired angles.
- Order catalog number based on loading depth 'H'.

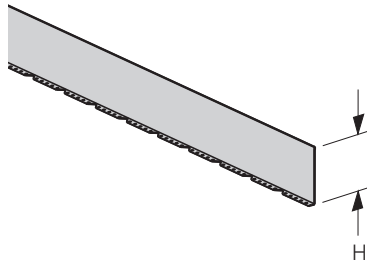

Tray Series	Catalog No.	H	
		in.	(mm)
KS_4A	R4A-DHB	3	(76)
KS_5A	R5A-DHB	4	(101)
KS_6A	R6A-DHB	5	(127)

Vertical Bend Barrier Strip

- Furnished with three (3) barrier strip clips, mounting hardware and splice.

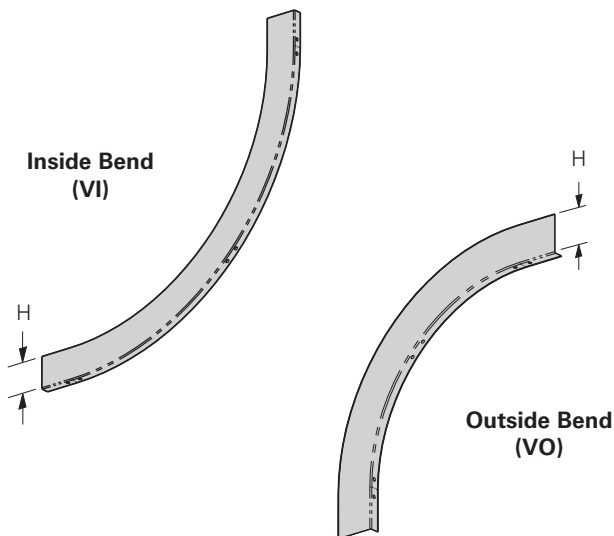

Tray Series	Catalog No.		H	
	Inside Bend	Outside Bend	in.	(mm)
KS_4A	R4A-DVI-(**)R(†)	R4A-DVO-(**)R(†)	3	(76)
KS_5A	R5A-DVI-(**)R(†)	R5A-DVO-(**)R(†)	4	(101)
KS_6A	R6A-DVI-(**)R(†)	R6A-DVO-(**)R(†)	5	(127)

(**) Insert 30°, 45°, 60°, 90° for angles
 (†) Insert 12, 24 for radius

All dimensions in parentheses are millimeters unless otherwise specified.

KwikSplice™ Aluminum Cable Tray - Accessories

How to miter cut KwikSplice cable tray for use with Horizontal Adjustable splice plates.

- Mark desired hole/cut locations per chart.
- Remove any rungs (if necessary) affected by cuts.
- Cut side rails through center of required holes per chart.
- Mount outside Horizontal Adjustable splice plate with provided hardware and bend KwikSplice sections to desired angle.
- Form inside Horizontal Adjustable splice plate to fit contour of inner rails and bolt into place.
- Reinstall (if necessary) appropriate rungs. Torque to 18 ft•lbs.
- If Splice Rung Kit (see below) is required, order separately.
- Recommend adding one to the value in the chart if the first hole is less than $\frac{3}{8}$ " (9.5mm) from the end of tray.

Tray Width in. (mm)	Cut Length from Rail End For Desired Angle			
	30° in. (mm)	45° in. (mm)	60° in. (mm)	90° in. (mm)
6 (152)	1 ⁵ / ₈ (41.3)	3 ¹ / ₈ (79.4)	3 ¹ / ₈ (79.4)	6 ¹ / ₄ (158.7)
9 (228)	3 ¹ / ₈ (79.4)	3 ¹ / ₈ (79.4)	4 ³ / ₄ (120.6)	9 ³ / ₈ (238.2)
12 (305)	3 ¹ / ₈ (79.4)	4 ¹ / ₈ (120.6)	6 ¹ / ₄ (158.7)	12 ⁵ / ₈ (320.7)
18 (457)	4 ³ / ₄ (120.6)	7 ⁷ / ₈ (200.0)	11 (279.4)	17 ¹ / ₄ (438.1)
24 (609)	6 ¹ / ₄ (158.7)	9 ³ / ₈ (238.2)	14 ¹ / ₈ (358.8)	23 ⁵ / ₈ (600.1)
30 (762)	7 ⁷ / ₈ (200.0)	12 ⁵ / ₈ (320.7)	17 ¹ / ₄ (438.1)	29 ⁷ / ₈ (758.8)
36 (914)	9 ³ / ₈ (238.2)	15 ³ / ₄ (400.0)	20 ³ / ₈ (517.5)	36 ¹ / ₈ (917.6)

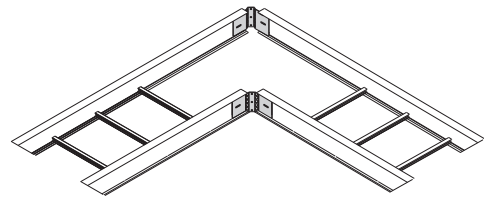
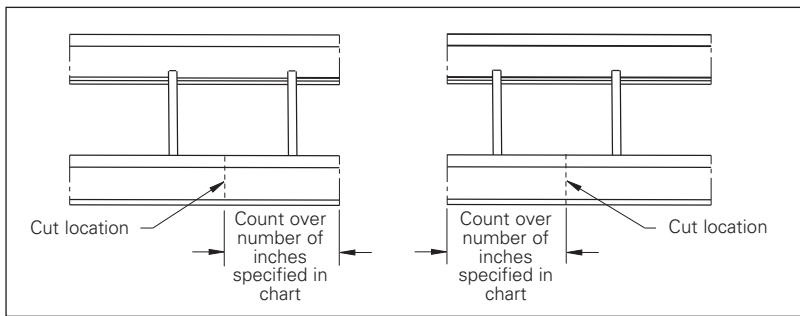

KSA5A09-12-144 Straight Section shown with required side rail removed to form 90° fitting.

Example: For a 12" (305mm) wide 90° bend, the cuts must be made 12⁵/₈" (320.7mm) from the end.

Horizontal Adjustable Splice Rung Kit

- Kit allows a support rung to be added to Horizontal Adjustable splice plates so that cables may be supported through a bend.
- The support rung is available in three lengths and should be ordered based upon tray width.
- The rung length is sized so that it will fit a maximum tray width when Horizontal Adjustable splices are used to make a bend up to 90°.
- Once the Horizontal Adjustable splices are installed in the cable tray system, the distance between the splice mounting surfaces should be measured. Cut support rung to the measured distance and install using the hardware included. Torque to 18 ft•lbs.

For Tray Width in. (mm)	Catalog No.	Actual Rung Length in. (mm)
Up to 12 (Up to 305)	9A-RFM-12RK	20" (508)
18 & 24 (453 to 609)	9A-RFM-24RK	37" (940)
30 & 36 (762 to 914)	9A-RFM-36RK	54" (1448)

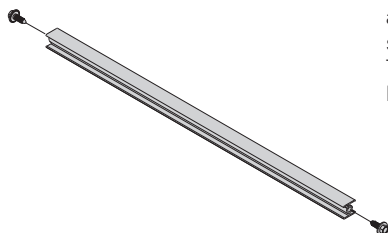

Example: Flex connectors are installed on an 18" (452mm) wide tray with approximately a 45° bend. The correct support rung kit is 9A-RFM-24RK. The tray width is 24" (609mm) or less and the angle is less than 90°.

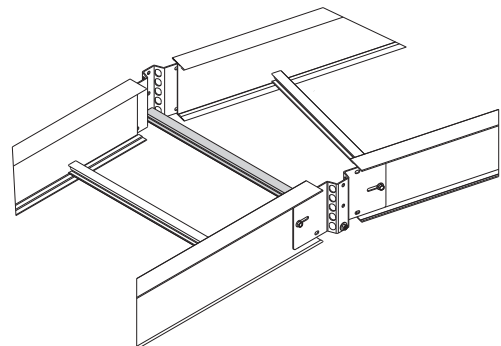

All dimensions in parentheses are millimeters unless otherwise specified.

Data Cables

The National Electrical Code allows for 50% fill of ventilated cable tray for control or signal wiring (Article 392-9(b)).

This rule requires that all the individual cable cross-sectional areas added up may not exceed one half the cable tray area.

The cable tray area is equal to the width times the load depth.

In actual practice with data cables, however, the cable tray becomes completely full in reaching the "50% cable fill".

The tray is completely full, but the sum of the cable areas is only 50% of the tray area, due to the empty spaces between the cables.

Data Cable Fill and Weight Chart

Number of Category 5/5e/6 Cables and Calculated Cable Weight in Lbs/Ft

Tray Depth	Tray Width													
	6" (152mm)		9" (228mm)		12" (305mm)		18" (457mm)		24" (609mm)		30" (762mm)		36" (914mm)	
	Cables	lbs/ft	Cables	lbs/ft	Cables	lbs/ft	Cables	lbs/ft	Cables	lbs/ft	Cables	lbs/ft	Cables	lbs/ft
4" (101)	347	9	520	13	693	18	1040	27	1386	35	1733	43	2079	54
5" (127)	433	12	650	17	866	23	1299	34	1733	43	2166	53	2599	68
6" (152)	520	14	780	20	1040	27	1559	41	2079	52	2599	64	3119	81

This chart was based on 50% fill of 4 UTP Category 5, 5e, or 6 cables (O.D. = .21" .026 lbs/ft).

In the above loading grid, the weight of the cables is not the issue. The volume capacity of the tray governs. For example, the worst case (6" load depth, 36" wide) has a total cable weight of 81 lbs/ft.

All dimensions in parentheses are millimeters unless otherwise specified.

Section 161xx - KwikSplice™ Cable Tray

PART 1 GENERAL

- 1.1 Summary
 - A. The work covered under this section consists of the furnishing of all necessary labor, supervision, materials, equipment, tests and services to install complete cable tray systems as shown on the drawings.
 - B. Cable tray systems are defined to include, but are not limited to straight sections of cable trays, fittings, drop-outs, supports and accessories.
- 1.2 References
 - A. NEMA VE 1-2009 - Metal Cable Tray Systems.
 - B. NEMA VE 2-2013 - Cable Tray Installation Guidelines.
 - C. ANSI/NFPA 70 – National Electrical Code
- 1.3 Drawings
 - A. The drawings, which constitute a part of these specifications, indicate the general route of the cable runway systems. Data presented on these drawings is as accurate as preliminary surveys and planning can determine until final equipment selection is made. Accuracy is not guaranteed and field verification of all dimensions, routing, etc., is required.
 - B. Specifications and drawings are for assistance and guidance, but exact routing, locations, distances and levels will be governed by actual field conditions. Contractor is directed to make field surveys as part of his work prior to submitting system layout drawings.
- 1.4 Quality Assurance
 - A. Manufacturers: Firms regularly engaged in manufacture of cable trays and fittings of types and capacities required, whose products have been in satisfactory use in similar service for not less than 10 years.
 - B. NEMA Compliance: Comply with NEMA Standards Publication Number VE1, "Cable Tray Systems".
 - C. NEC Compliance: Comply with NEC, as applicable to construction and installation of cable tray and cable channel systems (Article 392, NEC).
 - D. UL Compliance: Provide products that are UL-classified and labeled.
 - E. NFPA Compliance: Comply with NFPA 70B, "Recommended Practice for Electrical Equipment Maintenance" pertaining to installation of cable tray systems.
- 1.5 Delivery, Storage and Handling
 - A. Deliver cable tray systems and components carefully to avoid breakage, denting and scoring finishes. Do not install damaged equipment.
 - B. Store cable trays and accessories in original cartons and in clean dry space; protect from weather and construction traffic. Wet materials should be unpacked and dried before storage.
- 1.6 Submittals
 - A. Shop Drawings: Indicate tray type, dimensions, support points, and finishes.
 - B. Product Data: Submit fittings and accessories.
 - C. Manufacturer's Installation Instructions: Submit application conditions and limitations of use stipulated by Product testing agency specified under Regulatory Requirements. Include instructions for storage, handling, protection, examination, preparation, and installation of Product.

PART 2 PRODUCTS

- 2.1 Acceptable Manufacturers
 - A. Manufacturer: Subject to compliance with these specifications, B-Line series cable tray systems shall be as manufactured by Eaton.
- 2.2 Cable Tray Sections and Components
 - A. General: Except as otherwise indicated, provide metal cable trays, of types, classes, and sizes indicated; with splice plates, bolts, nuts and washers for connecting units. Construct units with rounded edges and smooth surfaces; in compliance with applicable standards; and with the following additional construction features. Cable tray shall be installed according to the latest revision of NEMA VE-2.
 - B. Material and Finish: Straight section, fitting side rails, rungs and splice plates shall be extruded from Aluminum Association Alloy 6063. All fabricated parts shall be made from Aluminum Association Alloy 5052.
- 2.3 Type of Tray System
 - A. Ladder Cable Trays shall consist of two longitudinal members (side rails) with transverse members (rungs) welded to both side rails. Both side rails and rungs shall be I-beam configuration. Side rails shall have a splice retention groove to accept a splice plate. Rungs shall be spaced [4] [6] [9] [12] inches apart. Rung spacing in radiused fittings shall be industry standard 9" and measured at the center of the tray's width.

(continued on page G-20)

(continued from page KSA-19)

- B. Ventilated Bottom Cable Trays shall consist of two longitudinal members (side rails) with rungs spaced 4" apart.
- C. Solid Bottom Cable Trays shall consist of two longitudinal members (side rails) with a solid sheet over rungs spaced on 12" centers.
- D. Cable tray loading depth shall be [3] [4] [5] inches per NEMA VE-1.
- E. Straight sections shall be supplied in standard [10 foot (3.05m)] [12 foot (3.65m)] lengths.
- F. Cable tray widths shall be [6] [9] [12] [18] [24] [30] [36] inches or as shown on drawings.
- G. Splice plates shall have a maximum of (2) two nuts and bolts per plate. The resistance of fixed splice connections between adjacent sections of tray shall not exceed 0.00033 ohms. Splice plates shall be furnished with straight sections and fittings. All horizontal fittings (horizontal bend, horizontal tee, horizontal cross) to be installed utilizing Eaton's B-Line series Kwik Splice™ Universal Fitting. All vertical fittings must have a minimum radius of [12] [24] inches.

***** [OR] *****

All fittings must have a minimum radius of [12] [24] inches.

2.4 Loading Capacities

- A. Cable trays shall meet NEMA class designation:

{NEMA 12A: [50 lbs./ft. on a 12 ft. span]} OR {NEMA 12B: [75 lbs./ft. on a 12 ft. span]}.

***** [OR] *****

- B. Cable tray shall be capable of carrying a uniformly distributed load of _____ lbs./ft on a _____ foot support span with a safety factor of 1.5 when supported as a simple span and tested per NEMA VE 1 Section 5.2.

2.5 Accessories

- A. Covers:

1. Furnish only where indicated on the Drawings.
2. Solid or ventilated as indicated.
3. Same manufacturer and material as the tray.
4. Secure covers with manufacturer's approved clamps.
5. Clamp spacing per manufacturer's recommendations.

- B. Dividers:

1. Manufactured by the cable tray manufacturer of the same material as the tray.

- C. Mounting hardware:

1. Zinc coated tray bolts, nuts, and fasteners: quantity not to exceed two each per splice plate.

- D. Trapeze Supports

1. Manufactured by the cable tray manufacturer.

- E. Cable Exit Options

1. Radiused drop outs must be utilized for cables exiting the cable tray through the rungs or over either side rail

***** [OR] *****

2. Conduit connectors must be utilized to securely connect the conduit runs to the cable tray when a cable exits through the rungs or over either side rail.

PART 3 EXECUTION

3.1 Installation

- A. Install cable trays as indicated: Installation shall be in accordance with equipment manufacturer's instructions, and with recognized industry practices to ensure that cable tray equipment comply with requirements of NEC and applicable portions of NFPA 70B. Reference NEMA-VE2 for general cable tray installation guidelines.
- B. Coordinate cable tray with other electrical work as necessary to properly integrate installation of cable tray work with other work.
- C. Provide sufficient space encompassing cable trays to permit access for installing and maintaining cables.
- D. Cable tray fitting supports shall be located such that they meet the strength requirements of straight sections. Install fitting supports per NEMA VE-2 guidelines, or in accordance with manufacturer's instructions.

3.2 Testing

- A. Test cable trays to ensure electrical continuity of bonding and grounding connections, and to demonstrate compliance with specified maximum grounding resistance. See NFPA 70B, Chapter 18, for testing and test methods.
- B. Manufacturer shall provide test reports witnessed by an independent testing laboratory of the "worst case" loading conditions outlined in this specification and performed in accordance with the latest revision of NEMA VE-1/CSA C22.2 No. 126. 1-09.

END OF SECTION

KwikSplice™ Aluminum Cable Tray - Fittings

Fittings For KSA4A, KSA5A, KSB4A, KSB5A and KSB6A

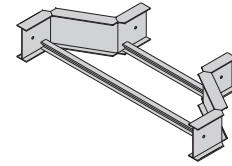
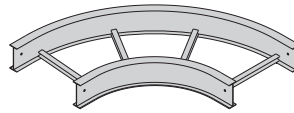
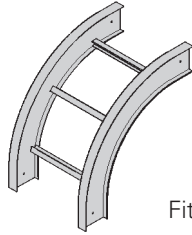
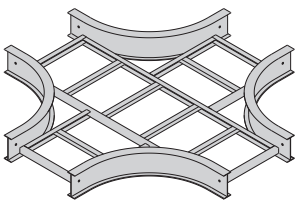

Fittings engineered with 3" tangents for splicing integrity.

Fitting Part Numbering

Example: **KS 4 A 09 - 12 - 90 HB 24**

Series	Height	Material	Type	Width	Angle*	Fitting Type	Radius
KS = KwikSplice	4 = 4" 5 = 5" 6 = 6"	A = Aluminum	Ladder 09 = 9" rung spacing Other 04 = 4" rung spacing SB = Solid Bottom	06 = 6" 09 = 9" 12 = 12" 18 = 18" 24 = 24" 30 = 30" 36 = 36"	30 = 30° 45 = 45° 60 = 60° 90 = 90°	*HB = Horizontal Bend HT = Horizontal Tee HX = Horizontal Cross *VI = Vertical Inside Bend *VO = Vertical Outside Bend VT = Vertical Tee, Down VTU = Vertical Tee, Up LR = Left Reducer RR = Right Reducer SR = Straight Reducer	12 = 12" 24 = 24"

Expanding & Reducing Horizontal Tee & Cross Fitting Part Numbering

Example: **KS 4 A 04 - 24 - 12 - HT 24**

Series	Height	Material	Type	Width 1	Width 2	Fitting Type	Radius
KS = KwikSplice	4 = 4" 5 = 5" 6 = 6"	A = Aluminum	Ladder 09 = 9" rung spacing Other 04 = 4" rung spacing SB = Solid Bottom	06 = 6" 09 = 9" 12 = 12" 18 = 18" 24 = 24" 30 = 30" 36 = 36"	06 = 6" 09 = 9" 12 = 12" 18 = 18" 24 = 24" 30 = 30" 36 = 36"	HT = Horizontal Tee (Reducing - where Width 1 is larger than Width 2) (Expanding - where Width 1 is smaller than Width 2) HX = Horizontal Cross (Reducing/Expanding - where Width 1 is larger than Width 2)	12 = 12" 24 = 24"

For ventilated or solid bottom, add 04 or SB as shown below: Available 6" thru 36"

Prefix
KS5A04 - 24 - 90HB24

4" Rung Spacing Bottom

Prefix
KS5ASB - 24 - 90HB24

Solid Bottom

All dimensions in parentheses are millimeters unless otherwise specified.

KwikSplice™ Aluminum Cable Tray - Fittings

Horizontal Bend 90° 60° (HB)

1 pair splice plates with hardware included.

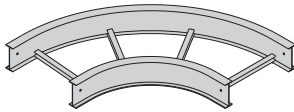

90° Horizontal Bend

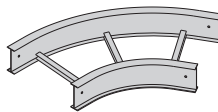

60° Horizontal Bend

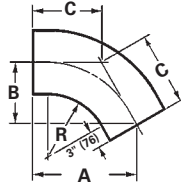
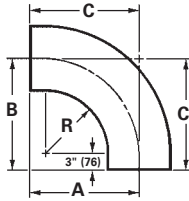

Bottoms manufactured:

Ladder = 9" Rung Spacing

04 = 4" Rung Spacing

SB = Flat sheet over 9" Rung Spacing

Bend Radius R	Tray Width	90° Horizontal Bend Dimensions				60° Horizontal Bend Dimensions			
		Catalog No.	A	B	C	Catalog No.	A	B	C
in. (mm)	in. (mm)		in. (mm)	in. (mm)	in. (mm)		in. (mm)	in. (mm)	in. (mm)
12 (305)	6 (152)	(Pre)-06-90HB12	18 (457)	18 (457)	18 (457)	(Pre)-06-60HB12	17 ¹ / ₂ (445)	10 ¹ / ₈ (257)	11 ¹¹ / ₁₆ (297)
	9 (228)	(Pre)-09-90HB12	19 ¹ / ₂ (495)	19 ¹ / ₂ (495)	19 ¹ / ₂ (495)	(Pre)-09-60HB12	18 ¹³ / ₁₆ (478)	10 ⁷ / ₈ (276)	12 ¹ / ₂ (318)
	12 (305)	(Pre)-12-90HB12	21 (533)	21 (533)	21 (533)	(Pre)-12-60HB12	20 ¹ / ₁₆ (510)	11 ⁵ / ₈ (295)	13 ³ / ₈ (340)
	18 (457)	(Pre)-18-90HB12	24 (610)	24 (610)	24 (610)	(Pre)-18-60HB12	22 ¹¹ / ₁₆ (576)	13 ¹ / ₈ (333)	15 ¹ / ₈ (384)
	24 (610)	(Pre)-24-90HB12	27 (686)	27 (686)	27 (686)	(Pre)-24-60HB12	25 ⁵ / ₁₆ (643)	14 ⁵ / ₈ (372)	16 ⁷ / ₈ (429)
	30 (762)	(Pre)-30-90HB12	30 (762)	30 (762)	30 (762)	(Pre)-30-60HB12	27 ⁷ / ₈ (708)	16 ¹ / ₈ (410)	18 ⁹ / ₁₆ (472)
	36 (914)	(Pre)-36-90HB12	33 (838)	33 (838)	33 (838)	(Pre)-36-60HB12	30 ¹ / ₂ (775)	17 ⁵ / ₈ (448)	20 ⁵ / ₁₆ (516)
24 (610)	6 (152)	(Pre)-06-90HB24	30 (762)	30 (762)	30 (762)	(Pre)-30-60HB12	27 ⁷ / ₈ (708)	16 ¹ / ₈ (410)	18 ⁹ / ₁₆ (472)
	9 (228)	(Pre)-09-90HB24	31 ¹ / ₂ (800)	31 ¹ / ₂ (800)	31 ¹ / ₂ (800)	(Pre)-09-60HB24	29 ³ / ₁₆ (741)	16 ⁷ / ₈ (429)	19 ⁷ / ₁₆ (494)
	12 (305)	(Pre)-12-90HB24	33 (838)	33 (838)	33 (838)	(Pre)-36-60HB12	30 ¹ / ₂ (775)	17 ⁵ / ₈ (448)	20 ⁵ / ₁₆ (516)
	18 (457)	(Pre)-18-90HB24	36 (914)	36 (914)	36 (914)	(Pre)-18-60HB24	33 ¹ / ₁₆ (708)	19 ¹ / ₈ (486)	22 ¹ / ₁₆ (560)
	24 (610)	(Pre)-24-90HB24	39 (991)	39 (991)	39 (991)	(Pre)-24-60HB24	35 ¹¹ / ₁₆ (907)	20 ⁵ / ₈ (524)	23 ¹³ / ₁₆ (605)
	30 (762)	(Pre)-30-90HB24	42 (1067)	42 (1067)	42 (1067)	(Pre)-30-60HB24	38 ¹ / ₄ (972)	22 ¹ / ₈ (564)	25 ¹ / ₂ (648)
	36 (914)	(Pre)-36-90HB24	45 (1143)	45 (1143)	45 (1143)	(Pre)-36-60HB24	40 ⁷ / ₈ (1038)	23 ⁵ / ₈ (600)	27 ¹ / ₄ (692)

(Pre) See page G-21 for catalog number prefix.

Width dimensions are to inside wall. For aluminum fittings add 1.5 inches for total outside width.

Manufacturing tolerances apply to all dimensions.

All dimensions in parentheses are millimeters unless otherwise specified.

KwikSplice™ Aluminum Cable Tray - Fittings

Horizontal Bend 45° 30° (HB)

1 pair splice plates with hardware included.

Bottoms manufactured:

Ladder = 9" Rung Spacing

04 = 4" Rung Spacing

SB = Flat sheet over 9" Rung Spacing

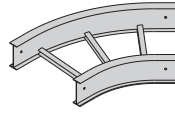

45° Horizontal Bend

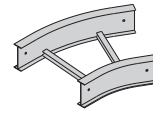

30° Horizontal Bend

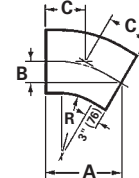
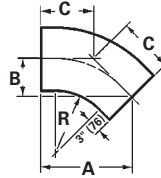

KwikSplice Cable Tray

Bend Radius R	Tray Width	45° Horizontal Bend Dimensions				30° Horizontal Bend Dimensions			
		Catalog No.	A	B	C	Catalog No.	A	B	C
in. (mm)	in. (mm)		in. (mm)	in. (mm)	in. (mm)		in. (mm)	in. (mm)	in. (mm)
12 (305)	6 (152)	(Pre)-06-45HB12	15 ³ / ₄ (400)	6 ¹ / ₂ (165)	9 ³ / ₁₆ (233)	(Pre)-06-30HB12	13 ¹ / ₈ (333)	3 ¹ / ₂ (89)	7 (179)
	9 (228)	(Pre)-09-45HB12	16 ¹³ / ₁₆ (427)	6 ¹⁵ / ₁₆ (176)	9 ¹³ / ₁₆ (249)	(Pre)-09-30HB12	13 ⁷ / ₈ (352)	3 ¹¹ / ₁₆ (94)	7 ⁷ / ₁₆ (189)
	12 (305)	(Pre)-12-45HB12	17 ⁷ / ₈ (454)	7 ³ / ₈ (187)	10 ⁷ / ₁₆ (265)	(Pre)-12-30HB12	14 ⁵ / ₈ (372)	3 ¹⁵ / ₁₆ (100)	7 ¹³ / ₁₆ (198)
	18 (457)	(Pre)-18-45HB12	20 (508)	8 ¹ / ₄ (210)	11 ¹¹ / ₁₆ (297)	(Pre)-18-30HB12	16 ¹ / ₈ (410)	4 ⁵ / ₁₆ (109)	8 ⁵ / ₈ (219)
	24 (610)	(Pre)-24-45HB12	22 ¹ / ₁₆ (560)	9 ¹ / ₈ (232)	12 ¹⁵ / ₁₆ (329)	(Pre)-24-30HB12	17 ⁵ / ₈ (448)	4 ¹¹ / ₁₆ (119)	9 ⁷ / ₁₆ (240)
	30 (762)	(Pre)-30-45HB12	24 ³ / ₁₆ (614)	10 (254)	14 ³ / ₁₆ (360)	(Pre)-30-30HB12	19 ¹ / ₈ (486)	5 ¹ / ₈ (130)	10 ¹ / ₄ (260)
	36 (914)	(Pre)-36-45HB12	26 ⁵ / ₁₆ (668)	10 ¹⁵ / ₁₆ (278)	15 ⁷ / ₁₆ (392)	(Pre)-36-30HB12	20 ⁵ / ₈ (524)	5 ¹ / ₂ (140)	11 ¹ / ₁₆ (281)
24 (610)	6 (152)	(Pre)-06-45HB24	24 ³ / ₁₆ (614)	10 (254)	14 ³ / ₁₆ (360)	(Pre)-06-30HB24	19 ¹ / ₈ (486)	5 ¹ / ₈ (130)	10 ¹ / ₄ (260)
	9 (228)	(Pre)-09-45HB24	25 ¹ / ₄ (641)	10 ¹ / ₂ (267)	14 ¹³ / ₁₆ (376)	(Pre)-09-30HB24	19 ⁷ / ₈ (505)	5 ⁵ / ₁₆ (135)	10 ⁵ / ₈ (270)
	12 (305)	(Pre)-12-45HB24	26 ⁵ / ₁₆ (668)	10 ¹⁵ / ₁₆ (278)	15 ⁷ / ₁₆ (392)	(Pre)-12-30HB24	20 ⁵ / ₈ (524)	5 ¹ / ₂ (140)	11 ¹ / ₁₆ (281)
	18 (457)	(Pre)-18-45HB24	28 ⁷ / ₁₆ (722)	11 ¹³ / ₁₆ (300)	16 ¹¹ / ₁₆ (424)	(Pre)-18-30HB24	22 ¹ / ₈ (562)	5 ¹⁵ / ₁₆ (151)	11 ¹³ / ₁₆ (300)
	24 (610)	(Pre)-24-45HB24	30 ⁹ / ₁₆ (766)	12 ¹¹ / ₁₆ (322)	17 ¹⁵ / ₁₆ (456)	(Pre)-24-30HB24	23 ⁵ / ₈ (600)	6 ⁵ / ₁₆ (160)	12 ⁵ / ₈ (321)
	30 (762)	(Pre)-30-45HB24	32 ¹¹ / ₁₆ (830)	13 ⁹ / ₁₆ (344)	19 ¹ / ₈ (486)	(Pre)-30-30HB24	25 ¹ / ₈ (638)	6 ³ / ₄ (172)	13 ⁷ / ₁₆ (341)
	36 (914)	(Pre)-36-45HB24	34 ¹³ / ₁₆ (884)	14 ⁷ / ₁₆ (367)	20 ³ / ₈ (518)	(Pre)-36-30HB24	26 ⁵ / ₈ (676)	7 ¹ / ₈ (181)	14 ¹ / ₄ (362)

(Pre) See page G-21 for catalog number prefix.

Width dimensions are to inside wall. For aluminum fittings add 1.5 inches for total outside width.

Manufacturing tolerances apply to all dimensions.

All dimensions in parentheses are millimeters unless otherwise specified.

KwikSplice™ Aluminum Cable Tray - Fittings

Horizontal Tee (HT)

2 pair splice plates with hardware included.

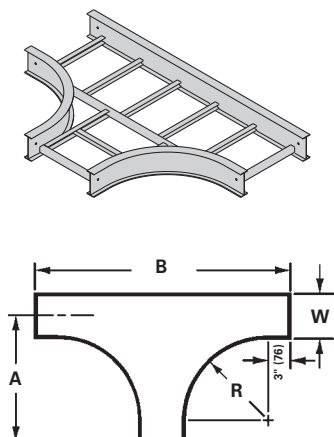

Horizontal Cross (HX)

3 pair splice plates with hardware included.

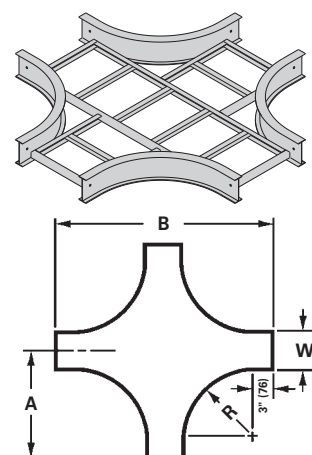

Bend Radius R in. (mm)	Tray Width in. (mm)	Horizontal Tee Dimensions			Horizontal Cross Dimensions		
		Catalog Number	A in. (mm)	B in. (mm)	Catalog Number	A in. (mm)	B in. (mm)
12 (305)	6 (152)	(Prefix)-06-HT12	18 (457)	36 (914)	(Prefix)-06-HX12	18 (457)	36 (914)
	9 (229)	(Prefix)-09-HT12	19½ (496)	39 (991)	(Prefix)-09-HX12	19½ (496)	39 (991)
	12 (305)	(Prefix)-12-HT12	21 (533)	42 (1067)	(Prefix)-12-HX12	21 (533)	42 (1067)
	18 (457)	(Prefix)-18-HT12	24 (609)	48 (1219)	(Prefix)-18-HX12	24 (609)	48 (1219)
	24 (609)	(Prefix)-24-HT12	27 (686)	54 (1372)	(Prefix)-24-HX12	27 (686)	54 (1372)
	30 (762)	(Prefix)-30-HT12	30 (762)	60 (1524)	(Prefix)-30-HX12	30 (762)	60 (1524)
	36 (914)	(Prefix)-36-HT12	33 (838)	66 (1676)	(Prefix)-36-HX12	33 (838)	66 (1676)
24 (610)	6 (152)	(Prefix)-06-HT24	30 (762)	60 (1524)	(Prefix)-06-HX24	30 (762)	60 (1524)
	9 (229)	(Prefix)-09-HT24	31½ (800)	63 (1600)	(Prefix)-09-HX24	31½ (800)	63 (1600)
	12 (305)	(Prefix)-12-HT24	33 (838)	66 (1676)	(Prefix)-12-HX24	33 (838)	66 (1676)
	18 (457)	(Prefix)-18-HT24	36 (914)	72 (1828)	(Prefix)-18-HX24	36 (914)	72 (1828)
	24 (609)	(Prefix)-24-HT24	39 (991)	78 (1982)	(Prefix)-24-HX24	39 (991)	78 (1982)
	30 (762)	(Prefix)-30-HT24	42 (1067)	84 (2134)	(Prefix)-30-HX24	42 (1067)	84 (2134)
	36 (914)	(Prefix)-36-HT24	45 (1143)	90 (2286)	(Prefix)-36-HX24	45 (1143)	90 (2286)

(Prefix) See page G-21 for catalog number prefix.

Width dimensions are to inside wall. For aluminum fittings add 1.5 inches for total outside width.

Manufacturing tolerances apply to all dimensions.

All dimensions in parentheses are millimeters unless otherwise specified.

KwikSplice™ Aluminum Cable Tray - Fittings

Reducers (LR, SR, RR)

1 pair splice plates with hardware included.

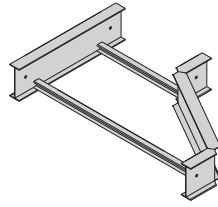

Left Reducer - LR

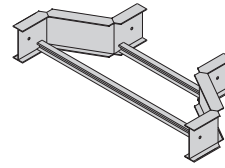

Straight Reducer - SR

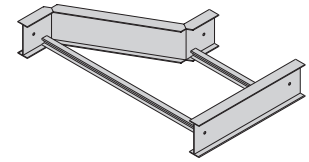

Right Reducer - RR

Reducer Part Numbering

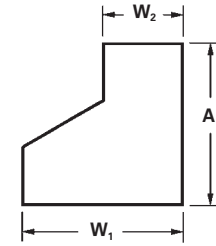
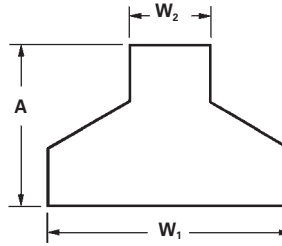
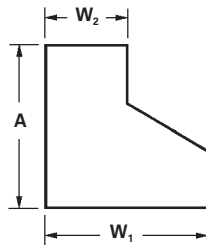
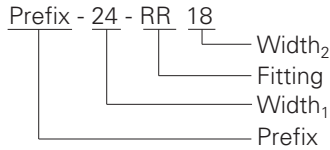

Tray Width		Left Reducer - LR		Straight Reducer - SR		Right Reducer - RR	
W ₁	W ₂	Catalog No.	A	Catalog No.	A	Catalog No.	A
in. (mm)	in. (mm)		in. (mm)		in. (mm)		in. (mm)
9 (228)	6 (152)	(Prefix)-09-LR06	9 ³ / ₄ (248)	(Prefix)-09-SR06	8 ⁷ / ₈ (225)	(Prefix)-09-RR06	9 ³ / ₄ (248)
12 (305)	6 (152)	(Prefix)-12-LR06	11 ¹ / ₂ (292)	(Prefix)-12-SR06	9 ³ / ₄ (248)	(Prefix)-12-RR06	11 ¹ / ₂ (292)
	9 (228)	(Prefix)-12-LR09	9 ³ / ₄ (248)	(Prefix)-12-SR09	8 ⁷ / ₈ (225)	(Prefix)-12-RR09	9 ³ / ₄ (248)
18 (457)	6 (152)	(Prefix)-18-LR06	14 ¹⁵ / ₁₆ (379)	(Prefix)-18-SR06	11 ¹ / ₂ (292)	(Prefix)-18-RR06	14 ¹⁵ / ₁₆ (379)
	9 (228)	(Prefix)-18-LR09	13 ³ / ₁₆ (335)	(Prefix)-18-SR09	10 ⁵ / ₈ (270)	(Prefix)-18-RR09	13 ³ / ₁₆ (335)
	12 (305)	(Prefix)-18-LR12	11 ¹ / ₂ (292)	(Prefix)-18-SR12	9 ³ / ₄ (248)	(Prefix)-18-RR12	11 ¹ / ₂ (292)
24 (609)	6 (152)	(Prefix)-24-LR06	18 ³ / ₈ (467)	(Prefix)-24-SR06	13 ³ / ₁₆ (335)	(Prefix)-24-RR06	18 ³ / ₈ (467)
	9 (228)	(Prefix)-24-LR09	16 ¹¹ / ₁₆ (424)	(Prefix)-24-SR09	12 ³ / ₈ (314)	(Prefix)-24-RR09	16 ¹¹ / ₁₆ (424)
	12 (305)	(Prefix)-24-LR12	14 ¹⁵ / ₁₆ (379)	(Prefix)-24-SR12	11 ¹ / ₂ (292)	(Prefix)-24-RR12	14 ¹⁵ / ₁₆ (379)
	18 (457)	(Prefix)-24-LR18	11 ¹ / ₂ (292)	(Prefix)-24-SR18	9 ³ / ₄ (248)	(Prefix)-24-RR18	11 ¹ / ₂ (292)
30 (762)	6 (152)	(Prefix)-30-LR06	21 ⁷ / ₈ (555)	(Prefix)-30-SR06	14 ¹⁵ / ₁₆ (379)	(Prefix)-30-RR06	21 ⁷ / ₈ (555)
	9 (228)	(Prefix)-30-LR09	20 ¹ / ₈ (511)	(Prefix)-30-SR09	14 ¹ / ₁₆ (358)	(Prefix)-30-RR09	20 ¹ / ₈ (511)
	12 (305)	(Prefix)-30-LR12	18 ³ / ₈ (467)	(Prefix)-30-SR12	13 ³ / ₁₆ (335)	(Prefix)-30-RR12	18 ³ / ₈ (467)
	18 (457)	(Prefix)-30-LR18	14 ¹⁵ / ₁₆ (379)	(Prefix)-30-SR18	11 ¹ / ₂ (292)	(Prefix)-30-RR18	14 ¹⁵ / ₁₆ (379)
	24 (609)	(Prefix)-30-LR24	11 ¹ / ₂ (292)	(Prefix)-30-SR24	9 ³ / ₄ (248)	(Prefix)-30-RR24	11 ¹ / ₂ (292)
36 (914)	6 (152)	(Prefix)-36-LR06	25 ⁵ / ₁₆ (643)	(Prefix)-36-SR06	16 ¹¹ / ₁₆ (424)	(Prefix)-36-RR06	23 ⁵ / ₁₆ (643)
	9 (228)	(Prefix)-36-LR09	23 ⁹ / ₁₆ (598)	(Prefix)-36-SR09	15 ¹³ / ₁₆ (402)	(Prefix)-36-RR09	23 ⁹ / ₁₆ (598)
	12 (305)	(Prefix)-36-LR12	21 ⁷ / ₈ (555)	(Prefix)-36-SR12	14 ¹⁵ / ₁₆ (379)	(Prefix)-36-RR12	21 ⁷ / ₈ (555)
	18 (457)	(Prefix)-36-LR18	18 ³ / ₈ (467)	(Prefix)-36-SR18	13 ³ / ₁₆ (335)	(Prefix)-36-RR18	18 ³ / ₈ (467)
	24 (609)	(Prefix)-36-LR24	14 ¹⁵ / ₁₆ (379)	(Prefix)-36-SR24	11 ¹ / ₂ (292)	(Prefix)-36-RR24	14 ¹⁵ / ₁₆ (379)
	30 (762)	(Prefix)-36-LR30	11 ¹ / ₂ (292)	(Prefix)-36-SR30	9 ³ / ₄ (248)	(Prefix)-36-RR30	11 ¹ / ₂ (292)

(Prefix) See page G-21 for catalog number prefix.

Width dimensions are to inside wall. For aluminum fittings add 1.5 inches for total outside width. Manufacturing tolerances apply to all dimensions.

All dimensions in parentheses are millimeters unless otherwise specified.

Horizontal Reducing Tee (HT)

2 pair splice plates with hardware included.

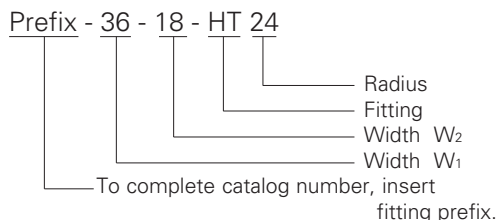
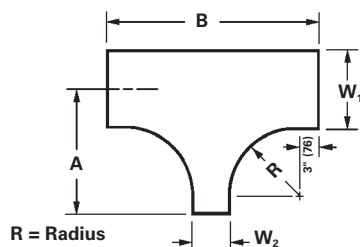
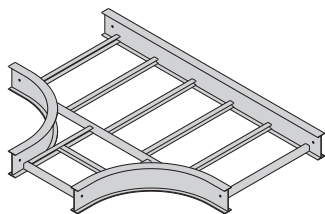

Tray Width		* Insert Radius (12" or 24") Catalog No.	R = 12" Radius (305)		R = 24" Radius (609)	
W ₁ in. (mm)	W ₂ in. (mm)		A in. (mm)	B in. (mm)	A in. (mm)	B in. (mm)
9 (228)	6 (152)	(Prefix)-09-06-HT*	19 ¹ / ₂ (496)	36 (914)	31 ¹ / ₂ (800)	60 (1524)
12 (305)	6 (152)	(Prefix)-12-06-HT*	21 (533)	36 (914)	33 (838)	60 (1524)
	9 (228)	(Prefix)-12-09-HT*	21 (533)	39 (991)	33 (838)	63 (1600)
18 (457)	6 (152)	(Prefix)-18-06-HT*	24 (609)	36 (914)	36 (914)	60 (1524)
	9 (228)	(Prefix)-18-09-HT*	24 (609)	39 (991)	36 (914)	63 (1600)
	12 (305)	(Prefix)-18-12-HT*	24 (609)	42 (1067)	36 (914)	66 (1676)
24 (609)	6 (152)	(Prefix)-24-06-HT*	27 (686)	36 (914)	39 (991)	60 (1524)
	9 (228)	(Prefix)-24-09-HT*	27 (686)	39 (991)	39 (991)	63 (1600)
	12 (305)	(Prefix)-24-12-HT*	27 (686)	42 (1067)	39 (991)	66 (1676)
	18 (457)	(Prefix)-24-18-HT*	27 (686)	48 (1219)	39 (991)	72 (1829)
30 (762)	6 (152)	(Prefix)-30-06-HT*	30 (762)	36 (914)	42 (1067)	60 (1524)
	9 (228)	(Prefix)-30-09-HT*	30 (762)	39 (991)	42 (1067)	63 (1600)
	12 (305)	(Prefix)-30-12-HT*	30 (762)	42 (1067)	42 (1067)	66 (1676)
	18 (457)	(Prefix)-30-18-HT*	30 (762)	48 (1219)	42 (1067)	72 (1829)
	24 (609)	(Prefix)-30-24-HT*	30 (762)	54 (1372)	42 (1067)	78 (1981)
36 (914)	6 (152)	(Prefix)-36-06-HT*	33 (838)	36 (914)	45 (1143)	60 (1524)
	9 (228)	(Prefix)-36-09-HT*	33 (838)	39 (991)	45 (1143)	63 (1600)
	12 (305)	(Prefix)-36-12-HT*	33 (838)	42 (1067)	45 (1143)	66 (1676)
	18 (457)	(Prefix)-36-18-HT*	33 (838)	48 (1219)	45 (1143)	72 (1829)
	24 (609)	(Prefix)-36-24-HT*	33 (838)	54 (1372)	45 (1143)	78 (1981)
	30 (762)	(Prefix)-36-30-HT*	33 (838)	60 (1524)	45 (1143)	84 (2134)

(Prefix) See page G-21 for catalog number prefix.

Width dimensions are to inside wall. For aluminum fittings add 1.5 inches for total outside width.

Manufacturing tolerances apply to all dimensions.

All dimensions in parentheses are millimeters unless otherwise specified.

KwikSplice™ Aluminum Cable Tray - Fittings

Horizontal Expanding Tee (HT)

2 pair splice plates with hardware included.

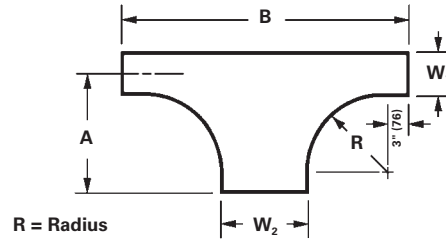
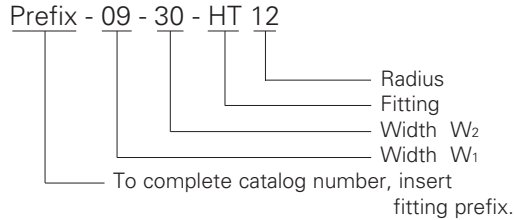
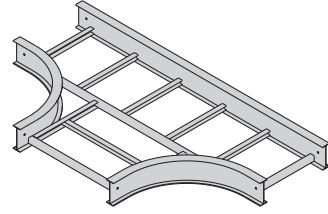

Tray Width		* Insert Radius (12" or 24") Catalog No.	R = 12" Radius (305)		R = 24" Radius (609)	
W ₁ in. (mm)	W ₂ in. (mm)		A in. (mm)	B in. (mm)	A in. (mm)	B in. (mm)
6 (152)	9 (228)	(Prefix)-06-09-HT*	18 (457)	39 (991)	30 (762)	63 (1600)
	12 (305)	(Prefix)-06-12-HT*	18 (457)	42 (1067)	30 (762)	66 (1676)
	18 (457)	(Prefix)-06-18-HT*	18 (457)	48 (1219)	30 (762)	72 (1829)
	24 (609)	(Prefix)-06-24-HT*	18 (457)	54 (1372)	30 (762)	78 (1981)
	30 (762)	(Prefix)-06-30-HT*	18 (457)	60 (1524)	30 (762)	84 (2134)
	36 (914)	(Prefix)-06-36-HT*	18 (457)	66 (1676)	30 (762)	90 (2286)
9 (228)	12 (305)	(Prefix)-09-12-HT*	19 ¹ / ₂ (496)	42 (1067)	31 ¹ / ₂ (800)	66 (1676)
	18 (457)	(Prefix)-09-18-HT*	19 ¹ / ₂ (496)	48 (1219)	31 ¹ / ₂ (800)	72 (1829)
	24 (609)	(Prefix)-09-24-HT*	19 ¹ / ₂ (496)	54 (1372)	31 ¹ / ₂ (800)	78 (1981)
	30 (762)	(Prefix)-09-30-HT*	19 ¹ / ₂ (496)	60 (1524)	31 ¹ / ₂ (800)	84 (2134)
	36 (914)	(Prefix)-09-36-HT*	19 ¹ / ₂ (496)	66 (1676)	31 ¹ / ₂ (800)	90 (2286)
12 (305)	18 (457)	(Prefix)-12-18-HT*	21 (533)	48 (1219)	33 (838)	72 (1829)
	24 (609)	(Prefix)-12-24-HT*	21 (533)	54 (1372)	33 (838)	78 (1981)
	30 (762)	(Prefix)-12-30-HT*	21 (533)	60 (1524)	33 (838)	84 (2134)
	36 (914)	(Prefix)-12-36-HT*	21 (533)	66 (1676)	33 (838)	90 (2286)
18 (457)	24 (609)	(Prefix)-18-24-HT*	24 (609)	54 (1372)	36 (914)	78 (1981)
	30 (762)	(Prefix)-18-30-HT*	24 (609)	60 (1524)	36 (914)	84 (2134)
	36 (914)	(Prefix)-18-36-HT*	24 (609)	66 (1676)	36 (914)	90 (2286)
24 (609)	30 (762)	(Prefix)-24-30-HT*	27 (686)	60 (1524)	39 (991)	84 (2134)
	36 (914)	(Prefix)-24-36-HT*	27 (686)	66 (1676)	39 (991)	90 (2286)
36 (762)	36 (914)	(Prefix)-30-36-HT*	30 (762)	66 (1676)	42 (1067)	90 (2286)

(Prefix) See page G-21 for catalog number prefix.

Width dimensions are to inside wall. For aluminum fittings add 1.5 inches for total outside width.

Manufacturing tolerances apply to all dimensions.

All dimensions in parentheses are millimeters unless otherwise specified.

Horizontal Expanding/Reducing Cross (HX)

3 pair splice plates with hardware included.

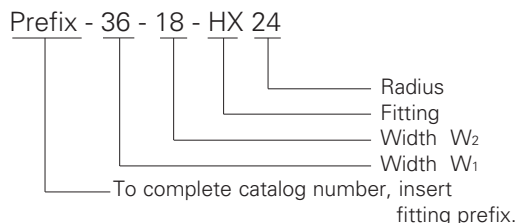
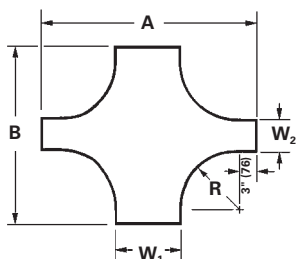
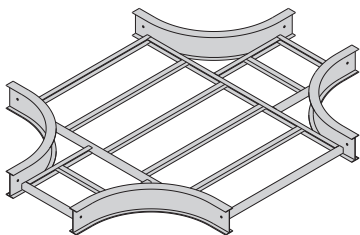

Tray Width		* Insert Radius (12" or 24") Catalog No.	R = 12" Radius (305)		R = 24" Radius (609)	
W ₁ in. (mm)	W ₂ in. (mm)		A in. (mm)	B in. (mm)	A in. (mm)	B in. (mm)
9 (228)	6 (152)	(Prefix)-09-06-HX*	39 (991)	36 (914)	63 (1600)	60 (1524)
12 (305)	6 (152)	(Prefix)-12-06-HX*	42 (1067)	36 (914)	66 (1676)	60 (1524)
	9 (228)	(Prefix)-12-09-HX*	42 (1067)	39 (991)	66 (1676)	63 (1600)
18 (457)	6 (152)	(Prefix)-18-06-HX*	48 (1219)	36 (914)	72 (1829)	60 (1524)
	9 (228)	(Prefix)-18-09-HX*	48 (1219)	39 (991)	72 (1829)	63 (1600)
	12 (305)	(Prefix)-18-12-HX*	48 (1219)	42 (1067)	72 (1829)	66 (1676)
24 (609)	6 (152)	(Prefix)-24-06-HX*	54 (1372)	36 (914)	78 (1981)	60 (1524)
	9 (228)	(Prefix)-24-09-HX*	54 (1372)	39 (991)	78 (1981)	63 (1600)
	12 (305)	(Prefix)-24-12-HX*	54 (1372)	42 (1067)	78 (1981)	66 (1676)
	18 (457)	(Prefix)-24-18-HX*	54 (1372)	48 (1219)	78 (1981)	72 (1829)
30 (762)	6 (152)	(Prefix)-30-06-HX*	60 (1524)	36 (914)	84 (2134)	60 (1524)
	9 (228)	(Prefix)-30-09-HX*	60 (1524)	39 (991)	84 (2134)	63 (1600)
	12 (305)	(Prefix)-30-12-HX*	60 (1524)	42 (1067)	84 (2134)	66 (1676)
	18 (457)	(Prefix)-30-18-HX*	60 (1524)	48 (1219)	84 (2134)	72 (1829)
	24 (609)	(Prefix)-30-24-HX*	60 (1524)	54 (1372)	84 (2134)	78 (1981)
36 (914)	6 (152)	(Prefix)-36-06-HX*	66 (1676)	36 (914)	90 (2286)	60 (1524)
	9 (228)	(Prefix)-36-09-HX*	66 (1676)	39 (991)	90 (2286)	63 (1600)
	12 (305)	(Prefix)-36-12-HX*	66 (1676)	42 (1067)	90 (2286)	66 (1676)
	18 (457)	(Prefix)-36-18-HX*	66 (1676)	48 (1219)	90 (2286)	72 (1829)
	24 (609)	(Prefix)-36-24-HX*	66 (1676)	54 (1372)	90 (2286)	78 (1981)
	30 (762)	(Prefix)-36-30-HX*	66 (1676)	60 (1524)	90 (2286)	84 (2134)

(Prefix) See page G-21 for catalog number prefix.

Width dimensions are to inside wall. For aluminum fittings add 1.5 inches for total outside width.

Manufacturing tolerances apply to all dimensions.

All dimensions in parentheses are millimeters unless otherwise specified.

KwikSplice™ Aluminum Cable Tray - Fittings

Vertical Bend 90° (VO, VI)

1 pair splice plates with hardware included.

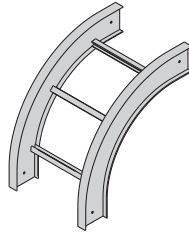

90° Vertical Outside

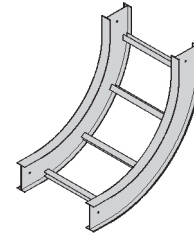

90° Vertical Inside

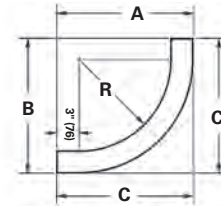
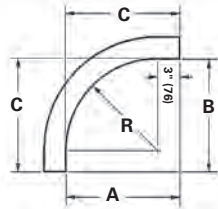

KwikSplice Cable Tray

Bend Radius R	Tray Width Insert	(*) Insert "VO" for Vert. Outside Bend "VI" for Vert. Inside Bend Catalog No.	VO Side Rail Height			VI Side Rail Height									
			4" - 6" (101-152)			4" (101)			5" (127)			6" (152)			
in. (mm)	in. (mm)		A	B	C	A	B	C	A	B	C	A	B	C	
			in. (mm)	in. (mm)	in. (mm)	in. (mm)	in. (mm)	in. (mm)	in. (mm)	in. (mm)	in. (mm)	in. (mm)	in. (mm)	in. (mm)	in. (mm)
12 (305)	6 (152)	(Prefix)-06-90(*)12													
	9 (228)	(Prefix)-09-90(*)12													
	12 (305)	(Prefix)-12-90(*)12													
	18 (457)	(Prefix)-18-90(*)12	15 (381)	15 (381)	15 (381)	19 (483)	19 (483)	19 (483)	20 (508)	20 (508)	20 (508)	21 (533)	21 (533)	21 (533)	
	24 (609)	(Prefix)-24-90(*)12													
	30 (762)	(Prefix)-30-90(*)12													
	36 (914)	(Prefix)-36-90(*)12													
24 (609)	6 (152)	(Prefix)-06-90(*)24													
	9 (228)	(Prefix)-09-90(*)24													
	12 (305)	(Prefix)-12-90(*)24													
	18 (457)	(Prefix)-18-90(*)24	27 (686)	27 (686)	27 (686)	31 (787)	31 (787)	31 (787)	32 (813)	32 (813)	32 (813)	33 (838)	33 (838)	33 (838)	
	24 (609)	(Prefix)-24-90(*)24													
	30 (762)	(Prefix)-30-90(*)24													
	36 (914)	(Prefix)-36-90(*)24													

(Prefix) See page G-21 for catalog number prefix.

Manufacturing tolerances apply to all dimensions.

All dimensions in parentheses are millimeters unless otherwise specified.

Vertical Bend 60° (VO, VI)

1 pair splice plates with hardware included.

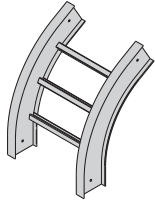

60° Vertical Outside

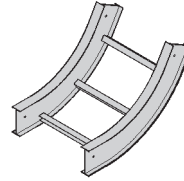

60° Vertical Inside

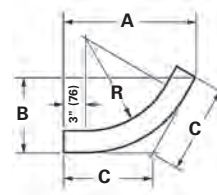
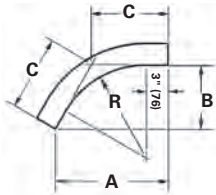

Bend Radius R	Tray Width Insert	(*) Insert "VO" for Vert. Outside Bend "VI" for Vert. Inside Bend Catalog No.	VO Side Rail Height			VI Side Rail Height									
			4" - 6" (101-152)			4" (101)			5" (127)			6" (152)			
in. (mm)	in. (mm)		A	B	C	A	B	C	A	B	C	A	B	C	
			in. (mm)	in. (mm)	in. (mm)	in. (mm)	in. (mm)	in. (mm)	in. (mm)	in. (mm)	in. (mm)	in. (mm)	in. (mm)	in. (mm)	in. (mm)
12 (305)	6 (152)	(Prefix)-06-60(*)12													
	9 (228)	(Prefix)-09-60(*)12													
	12 (305)	(Prefix)-12-60(*)12													
	18 (457)	(Prefix)-18-60(*)12	147/8 (378)	85/8 (219)	915/16 (253)	183/8 (467)	105/8 (270)	121/4 (311)	191/4 (489)	111/8 (283)	1213/16 (326)	201/16 (510)	115/8 (296)	133/8 (340)	
	24 (609)	(Prefix)-24-60(*)12													
	30 (762)	(Prefix)-30-60(*)12													
24 (609)	6 (152)	(Prefix)-06-60(*)24													
	9 (228)	(Prefix)-09-60(*)24													
	12 (305)	(Prefix)-12-60(*)24													
	18 (457)	(Prefix)-18-60(*)24	255/16 (643)	145/8 (372)	167/8 (428)	283/4 (730)	165/8 (422)	193/16 (488)	295/8 (753)	171/8 (435)	193/4 (502)	301/2 (775)	175/8 (448)	205/16 (516)	
	24 (609)	(Prefix)-24-60(*)24													
	30 (762)	(Prefix)-30-60(*)24													
36 (914)	(Prefix)-36-60(*)24														

(Prefix) See page G-21 for catalog number prefix.
Manufacturing tolerances apply to all dimensions.

All dimensions in parentheses are millimeters unless otherwise specified.

KwikSplice™ Aluminum Cable Tray - Fittings

Vertical Bend 45° (VO, VI)

1 pair splice plates with hardware included.

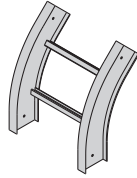

45° Vertical Outside

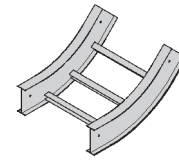

45° Vertical Inside

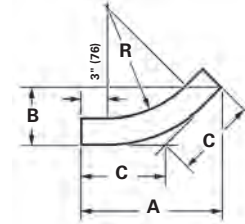
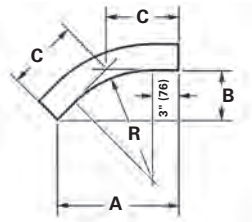

KwikSplice Cable Tray

Bend Radius R	Tray Width Insert	(*) Insert "VO" for Vert. Outside Bend "VI" for Vert. Inside Bend Catalog No.	VO Side Rail Height			VI Side Rail Height								
			4" - 6" (101-152)			4" (101)			5" (127)			6" (152)		
in. (mm)	in. (mm)		A in. (mm)	B in. (mm)	C in. (mm)	A in. (mm)	B in. (mm)	C in. (mm)	A in. (mm)	B in. (mm)	C in. (mm)	A in. (mm)	B in. (mm)	C in. (mm)
12 (305)	6 (152)	(Prefix)-06-45(*)12												
	9 (228)	(Prefix)-09-45(*)12												
	12 (305)	(Prefix)-12-45(*)12												
	18 (457)	(Prefix)-18-45(*)12	13 ⁵ / ₈ (346)	5 ⁵ / ₈ (143)	8 (203)	16 ⁷ / ₁₆ (417)	6 ¹³ / ₁₆ (173)	9 ⁵ / ₈ (245)	17 ¹ / ₈ (435)	7 ¹ / ₈ (181)	10 ¹ / ₁₆ (256)	17 ⁷ / ₈ (454)	7 ³ / ₈ (188)	10 ⁷ / ₁₆ (265)
	24 (609)	(Prefix)-24-45(*)12												
	30 (762)	(Prefix)-30-45(*)12												
36 (914)	(Prefix)-36-45(*)12													
24 (609)	6 (152)	(Prefix)-06-45(*)24												
	9 (228)	(Prefix)-09-45(*)24												
	12 (305)	(Prefix)-12-45(*)24												
	18 (457)	(Prefix)-18-45(*)24	22 ¹ / ₁₆ (561)	9 ¹ / ₈ (232)	12 ¹⁵ / ₁₆ (329)	24 ¹⁵ / ₁₆ (634)	10 ⁵ / ₁₆ (262)	14 ⁵ / ₈ (372)	25 ⁵ / ₈ (651)	10 ⁵ / ₈ (270)	15 (381)	26 ⁵ / ₁₆ (668)	10 ¹⁵ / ₁₆ (278)	15 ⁷ / ₁₆ (392)
	24 (609)	(Prefix)-24-45(*)24												
	30 (762)	(Prefix)-30-45(*)24												
36 (914)	(Prefix)-36-45(*)24													

(Prefix) See page G-21 for catalog number prefix.

Manufacturing tolerances apply to all dimensions.

All dimensions in parentheses are millimeters unless otherwise specified.

Vertical Bend 30° (VO, VI)

1 pair splice plates with hardware included.

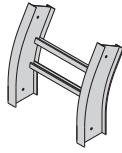

30° Vertical Outside

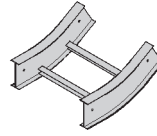

30° Vertical Inside

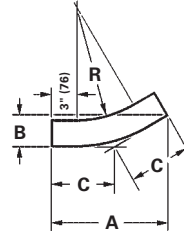
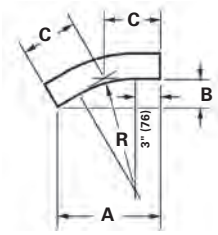

Bend Radius R	Tray Width Insert	(*) Insert "VO" for Vert. Outside Bend "VI" for Vert. Inside Bend Catalog No.	VO Side Rail Height			VI Side Rail Height								
			4" - 6" (101-152)			4" (101)			5" (127)			6" (152)		
in. (mm)	in. (mm)		A	B	C	A	B	C	A	B	C	A	B	C
			in. (mm)	in. (mm)	in. (mm)	in. (mm)	in. (mm)	in. (mm)	in. (mm)	in. (mm)	in. (mm)	in. (mm)	in. (mm)	in. (mm)
12 (305)	6 (152)	(Prefix)-06-30(*)12												
	9 (228)	(Prefix)-09-30(*)12												
	12 (305)	(Prefix)-12-30(*)12												
	18 (457)	(Prefix)-18-30(*)12	11 ⁵ / ₈ (296)	3 ¹ / ₈ (79)	6 ³ / ₁₆ (157)	13 ⁵ / ₈ (346)	3 ⁵ / ₈ (92)	7 ⁵ / ₁₆ (186)	14 ¹ / ₈ (359)	3 ³ / ₄ (95)	7 ⁹ / ₁₆ (192)	14 ⁵ / ₈ (372)	3 ¹⁵ / ₁₆ (100)	7 ¹³ / ₁₆ (199)
	24 (609)	(Prefix)-24-30(*)12												
	30 (762)	(Prefix)-30-30(*)12												
24 (609)	6 (152)	(Prefix)-06-30(*)24												
	9 (228)	(Prefix)-09-30(*)24												
	12 (305)	(Prefix)-12-30(*)24												
	18 (457)	(Prefix)-18-30(*)24	17 ⁵ / ₈ (448)	4 ¹¹ / ₁₆ (120)	9 ⁷ / ₁₆ (240)	19 ⁵ / ₈ (499)	5 ¹ / ₄ (133)	10 ¹ / ₂ (267)	20 ¹ / ₈ (511)	5 ³ / ₈ (137)	10 ³ / ₄ (273)	20 ⁵ / ₈ (524)	5 ¹ / ₂ (140)	11 ¹ / ₁₆ (282)
	24 (609)	(Prefix)-24-30(*)24												
	30 (762)	(Prefix)-30-30(*)24												
36 (914)	(Prefix)-36-30(*)24													

(Prefix) See page G-21 for catalog number prefix.

Manufacturing tolerances apply to all dimensions.

All dimensions in parentheses are millimeters unless otherwise specified.

KwikSplice™ Aluminum Cable Tray - Fittings

Vertical Tee Up/Down (VTU/VT)

2 pair splice plates with hardware included.

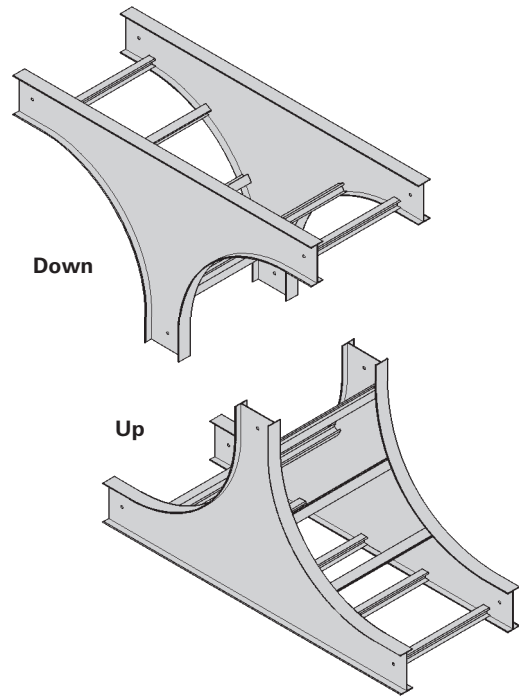
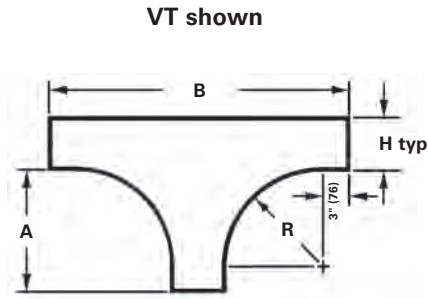

KwikSplice Cable Tray

Bend Radius R in. (mm)	Tray Width in. (mm)	Vertical Tee Down Catalog No.	Vertical Tee Up Catalog No.	Side Rail Height "H"					
				4" (101)		5" (127)		6" (152)	
				A in. (mm)	B in. (mm)	A in. (mm)	B in. (mm)	A in. (mm)	B in. (mm)
12 (305)	6 (152)	(Prefix)-06-VT12	(Prefix)-06-VTU12						
	9 (228)	(Prefix)-09-VT12	(Prefix)-09-VTU12						
	12 (305)	(Prefix)-12-VT12	(Prefix)-12-VTU12						
	18 (457)	(Prefix)-18-VT12	(Prefix)-18-VTU12	15 (381)	34 (846)	15 (381)	35 (889)	15 (381)	36 (914)
	24 (609)	(Prefix)-24-VT12	(Prefix)-24-VTU12						
	30 (762)	(Prefix)-30-VT12	(Prefix)-30-VTU12						
	36 (914)	(Prefix)-36-VT12	(Prefix)-36-VTU12						
24 (609)	6 (152)	(Prefix)-06-VT24	(Prefix)-06-VTU24						
	9 (228)	(Prefix)-09-VT24	(Prefix)-09-VTU24						
	12 (305)	(Prefix)-12-VT24	(Prefix)-12-VTU24						
	18 (457)	(Prefix)-18-VT24	(Prefix)-18-VTU24	27 (686)	58 (1473)	27 (686)	59 (1498)	27 (686)	60 (1524)
	24 (609)	(Prefix)-24-VT24	(Prefix)-24-VTU24						
	30 (762)	(Prefix)-30-VT24	(Prefix)-30-VTU24						
	36 (914)	(Prefix)-36-VT24	(Prefix)-36-VTU24						

(Prefix) See page G-21 for catalog number prefix.

Manufacturing tolerances apply to all dimensions.

All dimensions in parentheses are millimeters unless otherwise specified.

