

OWNER'S MANUAL

ELECTRIC

RANGE

Read this owner's manual thoroughly before operating the appliance and keep it handy for reference at all times.

LRE3083** LRE3061**
LRE3193** LRE3060**



TABLE OF CONTENTS

3 IMPORTANT SAFETY INSTRUCTIONS

9 PRODUCT OVERVIEW

- 9 Parts
- 9 Accessories

10 INSTALLATION

- 10 Installation Overview
- 10 Product Specifications
- 11 Before Installing the Range
- 12 Installing the Range
- 14 Connecting Electricity
- 18 Engaging the Anti-tip Device
- 18 Test Run

19 OPERATION

- 19 Control Panel Overview
- 20 Changing Oven Settings
 - 20 Clock
 - Setting the Hour Mode
 - 20 Oven Light
 - 20 Minimum & Maximum Default Settings
 - 21 Timer On/Off
 - 21 Settings
 - Setting Convection Auto Conversion (For Model: LRE3061 / LRE3193 / LRE3083)
 - Adjusting the Oven Temperature
 - Language
 - Turning the Preheat Alarm Light On/Off
 - Adjusting the Beeper Volume
 - Selecting Fahrenheit or Celsius
 - 22 Lockout
 - 23 Start Time (Delayed Timed Cook)
 - 23 Cook Time (Timed Cook)
- 24 Using the Cooktop
 - 24 Cooking Areas
 - 24 Hot Surface Indicator
 - 24 Using the Cooktop Elements
 - 25 The Recommended Surface Cooking Setting
 - 26 Using the Proper Cookware
 - 26 Choosing Cookware
 - 26 Home Canning Tips

- 27 Using the Oven
 - 27 Before Using the Oven
 - 27 Oven Vent
 - 27 Using Oven Racks
 - 27 Bake
 - 28 Convection Mode (For Model: LRE3061 / LRE3193 / LRE3083)
 - 29 Recommended Baking and Roasting Guide
 - 30 Broil
 - 31 Recommended Broiling Guide
 - 32 Warm
 - 32 Proof
 - 33 Sabbath Mode (For Model: LRE3083)

34 MAINTENANCE

- 34 Cleaning the Glass-Ceramic Cooktop
- 35 EasyClean®
- 38 Self Clean (For Model: LRE3083)
- 40 Changing the Oven Light
- 41 Cleaning the Exterior
- 42 Removing and Replacing the Lift-Off Oven Doors and Drawer
- 43 Door Care Instructions

44 TROUBLESHOOTING

- 44 FAQs
- 46 Before Calling for Service

50 SMART DIAGNOSIS™ FUNCTION

51 LIMITED WARRANTY

IMPORTANT SAFETY INSTRUCTIONS

Read and follow all instructions when using the range to prevent the risk of fire, electric shock, personal injury, or damage. This guide does not cover all possible conditions that may occur. Always contact your service agent or manufacturer about problems that you do not understand.

Download this owner's manual at: <http://www.lg.com>



This is the safety alert symbol. This symbol alerts you to potential hazards that can result in property damage and/or serious bodily harm or death.

All safety messages will follow the safety alert symbol and either the word **WARNING** or **CAUTION**. These words mean:



WARNING - Indicates a hazardous situation which, if not avoided, could result in death or serious injury.



CAUTION - Indicates a hazardous situation which, if not avoided, could result in minor or moderate injury.

ANTI-TIP DEVICE



WARNING

TO REDUCE THE RISK OF TIPPING, THE APPLIANCE MUST BE SECURED BY A PROPERLY INSTALLED ANTI-TIP DEVICE. TO CHECK IF THE DEVICE IS INSTALLED PROPERLY, REMOVE THE DRAWER BODY AND VERIFY THAT THE ANTI-TIP DEVICE IS ENGAGED, OR GRASP THE TOP REAR EDGE OF THE RANGE BACK GUARD AND CAREFULLY ATTEMPT TO TILT IT FORWARD. Refer to the installation section for instructions.

- It is possible for a child or adult to tip the range and be killed.
- Verify that the anti-tip device has been properly installed and attached to the floor or wall and engaged to the leveling leg of the range.
- Do not operate the range without the anti-tip device in place and engaged.
- Never remove the oven legs. The range will not be secured to the anti-tip bracket if the legs are removed.
- Do not step or sit on the oven door. The range could be tipped and injury might result from spilled hot liquid, food, or the range itself.
- Do not rest large, heavy items such as whole turkeys on the open oven door. The range could tip forward and cause injury.
- Reengage the anti-tip device after pulling the range out for cleaning, service, or any other reason.
- Failure to follow these instructions can result in death or serious burns to children or adults.

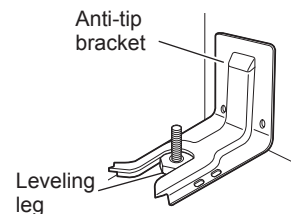

SAFETY PRECAUTIONS

- **DO NOT TOUCH HEATING ELEMENTS OR INTERIOR SURFACES OF OVEN.** Heating elements may be hot even though they are dark in color. Interior surfaces of an oven become hot enough to cause burns. During and after use, do not touch or let clothing or other flammable materials contact heating elements or interior surfaces of oven until they have had sufficient time to cool. Other surfaces, such as oven vent openings and surfaces near these openings, oven doors, and windows of oven doors, also get hot and may cause burns if not cooled.
- **Use care when opening door.** The hot air and steam that escape can cause burns to hands, face and eyes. Let hot air or steam escape from the oven before removing or replacing food in the oven.
- Do not repair or replace any part of the appliance unless specifically recommended in the manual. All other servicing should be performed by a qualified technician.
- Do not use harsh etching, abrasive cleaners or sharp metal scrapers to clean the oven door glass since they can scratch the surface. Scratches may cause the glass to shatter.



WARNING

If the door glass, cooktop glass, surface, or oven heating unit of the range are damaged, discontinue use of the range and call for service.

- Do not operate the oven without the charcoal heater mesh.
- Do not use plastic to cover food. Use foil or oven-safe lids only.
- Do not allow anyone to climb, stand or hang on the door, storage drawer or cooktop. They could damage the range and even tip it over, causing severe personal injury.
- Do not line the oven walls, racks, bottom, or any other part of the oven with aluminum foil or any other material. Doing so will disrupt heat distribution, produce poor baking results and cause permanent damage to the oven interior (aluminum foil will melt to the interior surface of the oven)
- Never attempt to dry a pet in the oven.
- **Never use your appliance for warming or heating the room.**
- Always use pot holders or oven mitts when removing food from the oven or the surface element. Cookware will be hot. **Use only dry pot holders.** Moist or damp pot holders on hot surfaces may result in burns from steam. Do not let the pot holder touch hot heating elements. Do not use a towel or other bulky cloth to remove food.
- **Do not heat unopened food containers.** Pressure in the containers may cause them to burst which may result in injury.

FLAMMABLE MATERIALS



WARNING

Be certain that all packing materials are removed from the appliance before operating. Keep plastic, clothes, paper, and other flammable materials away from parts of the appliance that may become hot.

- Do not store or use flammable material in the oven or near or on the cooktop. Flammable materials include paper, plastic, pot holders, linens, wall coverings, curtains, and gasoline or other flammable vapors and liquids such as grease or cooking oil. These materials can be ignited when the oven and cooktop are in use.
- **Wear proper apparel.** Do not wear loose-fitting or hanging garments, which may ignite if they contact hot surfaces, and cause severe burns.
- Do not use the oven for drying clothes. Only use the oven for its intended purpose.
- If a cabinet storage is provided directly above cooking surface, place items that are not frequently used and can be safely stored in an area subjected to heat. Temperatures may be unsafe for volatile items such as flammable liquids, cleaners or aerosol sprays.

ELECTRICAL SAFETY



CAUTION

Be certain that all packing materials are removed from the appliance before operating. Keep plastic, clothes, paper, and other flammable materials away from parts of the appliance that may become hot.

- Always disconnect power from the appliance before servicing.
- Do not use aluminum foil or any other material to line the oven bottom. Improper installation of these liners may result in a risk of electric shock or fire.
- Do not allow aluminum foil or the temperature probe to contact heating elements.



WARNING

Before replacing the oven light bulb, switch off the electrical power to the oven at the main fuse or circuit breaker panel. Failure to do so can result in severe personal injury, death, or electrical shock.

DEEP FAT FRYER

- Use extreme caution when moving or disposing of hot grease.
- Always heat fat slowly, and watch as it heats.
- If frying combinations of oils and fats, stir them together before heating.
- Use a deep fat thermometer, if possible, to prevent overheating fat beyond the smoking point.
- Use the least possible amount of fat for effective shallow or deep-fat frying. Filling the pan with too much fat can cause spillovers when food is added.

CHILD SAFETY

- Do not touch the hot surface between the bottom of the oven door and the top of the drawer on the front of the oven while the oven is in operation. The surface becomes hot and can cause burns and other injury.
- Do not leave small children unattended near the oven.



WARNING

Do not leave children alone or unsupervised near the appliance when it is in use or is still hot. Children should never be allowed to sit or stand on any part of the appliance as they could be injured or burned.



CAUTION

Do not store items of interest to children in cabinets above a range or on the back guard of a range – children climbing on the range to reach items could be seriously injured.

- Never let a child hang on the oven door.
- Do not allow children to crawl into the oven.
- Let hot utensils cool in a safe place, out of reach of small children.
- Children should not be allowed to play with controls or other parts of the appliance.

GLASS-CERAMIC COOKING SURFACE

- Surface units may be hot even though they are dark in color. Areas near surface units may become hot enough to cause burns. During and after use, **DO NOT TOUCH SURFACE UNITS OR AREAS NEAR UNITS** or let clothing or other flammable materials contact surface units or areas near units until they have had sufficient time to cool. This includes the cooktop and the area above the oven door.
- **Do not cook on a broken cooktop.** If the cooktop is broken, cleaning solutions and spillovers may penetrate the broken cooktop and create a risk of electric shock. Contact a qualified technician immediately.
- Do not use the glass cooktop surface as a cutting board.
- Do not place or store items that can melt or catch fire on the glass cooktop, even when it is not being used.
- **Choose proper burner size.** For smaller pots and pans, use the smaller heating elements. For larger pots and pans, use the larger heating elements. Select pans that have flat bottoms large enough to cover the heating elements. Using undersized pans exposes a portion of the heating element to direct contact and may result in clothing burning.
- **Glazed cookware.** Only certain types of glass, glass-ceramic, ceramic, earthenware, or other glazed cookware are suitable for range-top service without breaking due to the sudden change in temperature.
- Never cook directly on the glass. Always use cookware.
- Always turn the surface units off before removing cookware.
- **Turn cookware handles inward so they don't extend over adjacent surface units.** This reduces the risk of burns, ignition of flammable materials, and spillage due to unintentional contact with the cookware.
- Immediately clean spills on the cooking area to prevent a tough cleaning chore later.
- Some cleaners can produce dangerous fumes if applied to a hot surface.

- Always place the pan in the center of the surface unit you are cooking on. **Never leave surface units unattended at high heat settings.** Proper contact of cookware to burner also will improve efficiency. Boilovers cause smoking and greasy spills that may catch on fire.
- **Clean cooktop with caution.** Do not use sponges or cloth to wipe spills on a hot cooking area. Use a proper metal scraper. If a wet sponge or cloth is used to wipe spills on a hot cooking area, it can cause steam burns. Some cleaners can produce noxious fumes if applied to a hot surface.
- Do not turn surface units on before placing cookware.
- Do not store heavy items above the cooktop surface that could fall and damage it.
- Do not place aluminum foil or plastic items such as salt and pepper shakers, spoon holders, or plastic wrappings or any other material on the range when it is in use.
- Do not use a steel-wool pad or scrub pad or abrasive cleaning pads. They can scratch the surface.

ENERGY SAVING TIPS

- Multiple-rack cooking saves time and energy. Whenever possible, cook foods requiring the same cooking temperature together in one oven.
- For optimal performance and energy savings, follow the guides on page 29 for proper rack and pan placements.
- Match the size of the cookware to the amount of food being cooked to save energy when heating. Heating $\frac{1}{2}$ quart of water requires more energy in a 3-quart pot than in a 1-quart pot.
- Use cookware with flat bottoms to provide the best contact with the cooktop surface when cooking on the glass-ceramic cooktop.
- Match the size of the cooktop burner or element to the size of the cookware in use. Using a large element for a small pan wastes heating energy, and the exposed surface of the element is a burn or fire hazard.
- Reduce energy use by cleaning light oven soils with the EasyClean® feature instead of self-clean.
- Avoid opening the oven door more than necessary during use. This helps the oven maintain temperature, prevents unnecessary heat loss, and saves on energy use.

SAFETY DURING USE

- Do not touch the oven racks while they are hot.
- If a rack must be moved while the oven is hot, do not let the pot holder contact the hot heating element in the oven.
- Use caution with the Timed Cook or Delayed Timed Cook features. Use the automatic timer when cooking cured or frozen meats and most fruits and vegetables. Foods that can easily spoil, such as milk, eggs, fish, meat or poultry, should be chilled in the refrigerator first. Even when chilled, they should not stand in the oven for more than 1 hour before cooking begins, and should be removed promptly when cooking is complete. Eating spoiled food can result in sickness from food poisoning.
- Accessible parts may become hot when the grill is in use.
- Do not place food or cookware on the bottom of the oven cavity. Doing so will cause permanent damage to the oven bottom finish.
- **Do not use water on grease fires.** Should an oven fire occur, leave the oven door closed and turn the oven off. If the fire continues, throw baking soda on the fire or use a fire extinguisher. Do not put water or flour on the fire. Flour may be explosive and water can spread a grease fire and cause personal injury.

- Pull the oven rack to the stop-lock position when loading and unloading food from the oven. This helps prevent burns caused by touching hot surfaces of the door and oven walls.
- Do not use the oven if a heating element develops a glowing spot during use or shows other signs of damage. A glowing spot indicates the heating element may fail and present a potential burn, fire, or shock hazard. Turn the oven off immediately and have the heating element replaced by a qualified service technician.
- When using cooking or roasting bags in the oven, follow the manufacturer's directions.

SAFETY WHEN CLEANING

- Open a window or turn on a ventilation fan or hood before self-cleaning.
- If the oven is heavily soiled with oil, self-clean the oven before using the oven again. The oil could cause a fire.
- Wipe up heavy soil on the bottom of the oven before using the Self Clean function.
- **Do not use oven cleaners.** Commercial oven cleaner or oven liner protective coating of any kind should not be used in or around any part of the oven.
- Never keep pet birds in the kitchen. The health of birds is extremely sensitive to the fumes released during an oven self-clean cycle. Fumes may be harmful or fatal to birds. Move birds to a well-ventilated room.
- Clean in the self-clean cycle only parts listed in this manual. Before self-cleaning the oven, remove the broiler pan, all oven racks, the meat probe and any utensils or food from the oven.
- Important Instruction. The oven displays an F error code and sounds three long beeps during the self-cleaning process if it malfunctions in the self-clean mode. Switch off the electrical power to the main fuse or breaker and have the oven serviced by a qualified technician.
- It is normal for the cooktop of the range to become hot during a self-clean cycle. Therefore, touching the cooktop during a self-clean cycle should be avoided.
- Never pour cold water over a hot oven for cleaning. Doing so may cause the oven to malfunction.
- Make sure oven lights are cool before cleaning.
- **Do not clean door gasket.** The door gasket is essential for a good seal. Care should be taken not to rub, damage, or move the gasket.
- If there is a fire in the oven during self-clean, turn the oven off and wait for the fire to go out. Do not force the door open. Introduction of fresh air at self-clean temperatures may lead to a burst of flame from the oven. Failure to follow this instruction may result in severe burns.

COOK MEAT AND POULTRY THOROUGHLY

- To protect against food-borne illnesses, cook meat and poultry thoroughly. The USDA has indicated the following as safe minimum internal temperatures for consumption:
 - Ground beef: 160 °F (71.1 °C)
 - Poultry: 165 °F (73.9 °C)
 - Beef, veal, pork, or lamb: 145 °F (62.8 °C)
 - Fish/seafood: 145 °F (62.8 °C)

PRODUCT OVERVIEW

Parts

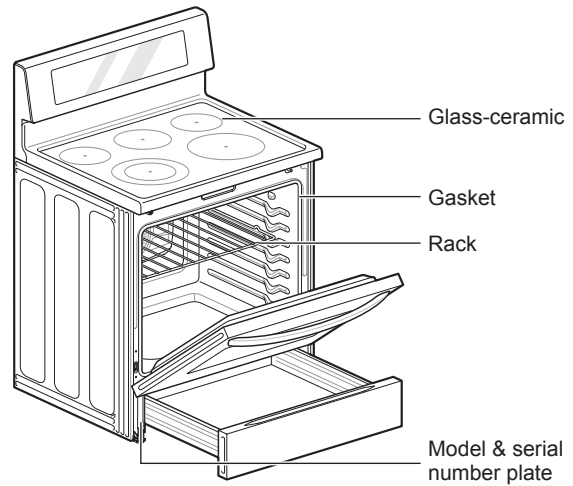
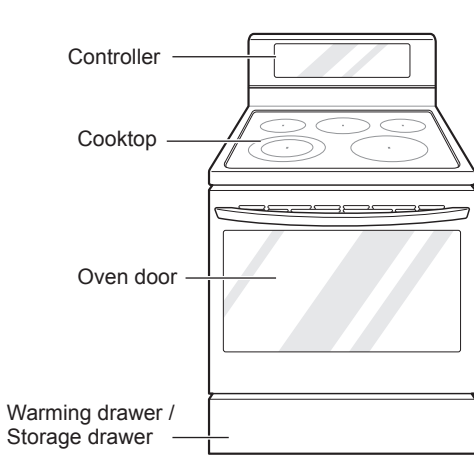

Accessories

Included Accessories

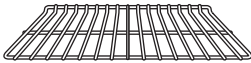

Standard Rack
 - LRE3061/LRE3193/LRE3060 (2ea)
 - LRE3083 (3ea)



Spray bottle (1ea)
 (For Model: LRE3061 /
 LRE3193 / LRE3083)

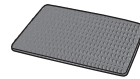

Non-scratch scouring pad (1ea)
 (For Model: LRE3061 /
 LRE3193 / LRE3083)

Optional Accessories

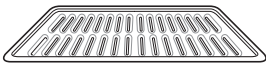

Grid

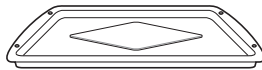

Broiler pan

NOTE

- Contact LG Customer Service at 1-800-243-0000 (1-888-542-2623 in Canada) if any accessories are missing.
- For your safety and for extended product life, only use authorized components.
- The manufacturer is not responsible for product malfunction or accidents caused by the use of separately purchased, unauthorized components or parts.
- The images in this guide may be different from the actual components and accessories, which are subject to change by the manufacturer without prior notice for product improvement purposes.

INSTALLATION

Installation Overview

Please read the following installation instructions first after purchasing this product or transporting it to another location.

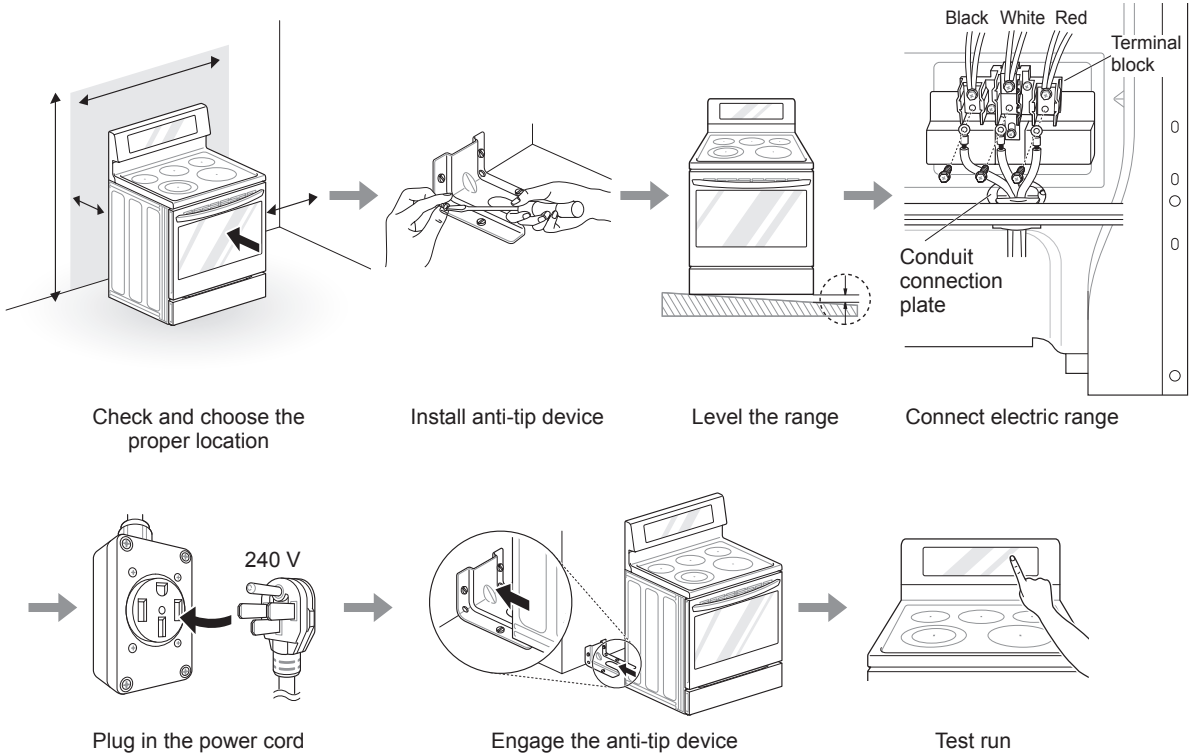

Product Specifications

The appearance and specifications listed in this manual may vary due to constant product improvements.

Oven Range Models	LRE3083, LRE3061, LRE3193, LRE3060
Description	Electric Single Oven Range
Electrical requirements	LRE3083 - 120/240 V: 13.1 kW, 120/208 V: 9.8 kW LRE3061 - 120/240 V: 14.5 kW, 120/208 V: 11.5 kW LRE3193 - 120/240 V: 13.4 kW, 120/208 V: 10.0 kW LRE3060 - 120/240 V: 12.6 kW, 120/208 V: 9.6 kW
Exterior Dimensions	29 7/8" (W) x 47 7/16" (H) x 26 1/2" (D) (D with door closed and excluding door handle) 75.7 cm (W) x 120.4 cm (H) x 67.3 cm (D) (D with door closed and excluding door handle)
Height to cooking surface	36" (91.4 cm)
Net weight	LRE3083: 157 lb (71 kg) LRE3061: 148 lb (67 kg) LRE3193 : 157 lb (71 kg) LRE3060: 167 lb (76 kg)
Total capacity	6.3 cu.ft.

Self Clean function is provided only for model LRE3083.

Before Installing the Range

WARNING

Tip - Over Hazard

A child or adult can tip the range and be killed. Verify the anti-tip bracket has been installed. Ensure the anti-tip bracket is engaged when the range is moved.



Do not operate the range without the anti-tip bracket in place. Failure to follow these instructions can result in death or serious burns to children and adults.

If you did not receive an anti-tip bracket with your purchase, call 1-800-243-0000 (1-888-542-2623 in CANADA) to receive one at no cost.

WARNING

- **The information in this manual should be followed exactly.** Failure to do so may result in fire, electrical shock, property damage, personal injury, or death.
- **Wear gloves during the installation procedure.** Failure to do so can result in bodily injury.

To check that leveling leg is inserted into anti-tip bracket, grasp the top rear edge of the range and carefully attempt to tilt it forward.

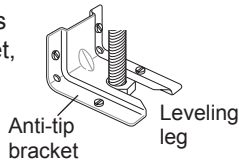

Tools Needed



Phillips screwdriver



Flat-blade screwdriver

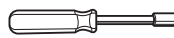

1/4" Nut driver

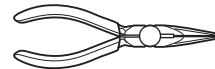

Pliers

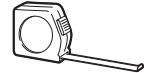

Tape measure



Level



Adjustable wrench



Drill



Safety glasses



Gloves

Parts Provided



Template (1)

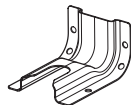

Anti-tip bracket kit (1)



Anchor sleeves (4)



Lag bolts (4)

Parts not Provided



4-Wire cord or 3-Wire cord (UL approved 40 or 50 AMP)

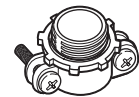

Strain relief (For conduit installations only)

NOTE

- Observe all governing codes and ordinances.
- Have the installer show you the location of the circuit breaker or fuse. Mark it for easy reference.
- As when using any appliance generating heat, there are certain safety precautions you should follow.
- Be sure your range is installed and grounded properly by a qualified installer or service technician.

Installing the Range

Unpacking and Moving the Range

CAUTION

- **You should use two or more people to move and install the range. (Excessive Weight Hazard)** Failure to do so can result in back or other injury.
- **Do not use the door handles to push or pull the range during installation or when moving the range out for cleaning or service.** Doing so can result in serious damage to the door of the range.

Remove packing material, tape and any temporary labels from your range before using. Do not remove any warning-type labels, the model and serial number label, or the Tech Sheet that is located on the back of the range.

To remove any remaining tape or glue, rub the area briskly with your thumb. Tape or glue residue can also be easily removed by rubbing a small amount of liquid dish soap over the adhesive with your fingers. Wipe with warm water and dry.

Do not use sharp instruments, rubbing alcohol, flammable fluids, or abrasive cleaners to remove tape or glue. These products can damage the surface of your range.

Your range is heavy and can be installed on soft floor coverings such as cushioned vinyl or carpeting. Use care when moving the range on this type of flooring. Use a belt when moving the range to prevent damaging the floor. Or slide the range onto cardboard or plywood to avoid damaging the floor covering.

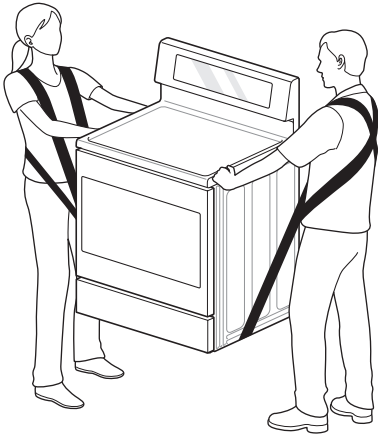

Choosing the Proper Location

CAUTION

- **Avoid placing cabinets above the range.** To minimize the hazard caused by reaching over the open flames of operating burners, install a ventilation hood over the range that projects forward at least five inches beyond the front of the cabinets.
- **Make sure wall covering, countertop and cabinets around the range can withstand the heat (up to 194 °F) generated by the range.** Discoloration, delamination or melting may occur. This range has been designed to comply with the maximum allowable wood cabinet temperature of 194 °F.
- **Before installing the range in an area covered with linoleum or other synthetic floor covering, make sure the floor covering can withstand temperatures of at least 200 °F (93 °C).**
- **Use an insulated pad or 1/4 in. (0.64 cm) plywood under the range if installing the range over carpeting.**

The range should always be plugged into its own individual properly grounded electrical outlet. This prevents overloading house wiring circuits which could cause a fire hazard from overheated wires. It is recommended that a separate circuit serving only this appliance be provided.

Mobile Home - Additional Installation Requirements

The installation of this range must conform to the Manufactured Home Construction and Safety Standard, Title 24 CFR, Part 3280 (formerly the Federal Standard for Mobile Home Construction and Safety, Title 24, HUD Part 280), or when such standard is not applicable, the Standard for Manufactured Home Installations, ANSI A225.1/NFPA 501A or with local codes.

- When this range is installed in a mobile home, it must be secured to the floor during transit. Any method of securing the range is adequate as long as it conforms to the standards listed above.
- A four-wire power supply cord or cable must be used in a mobile home installation.

Dimensions and Clearances

NOTE

Save for the use of the local electrical inspector.

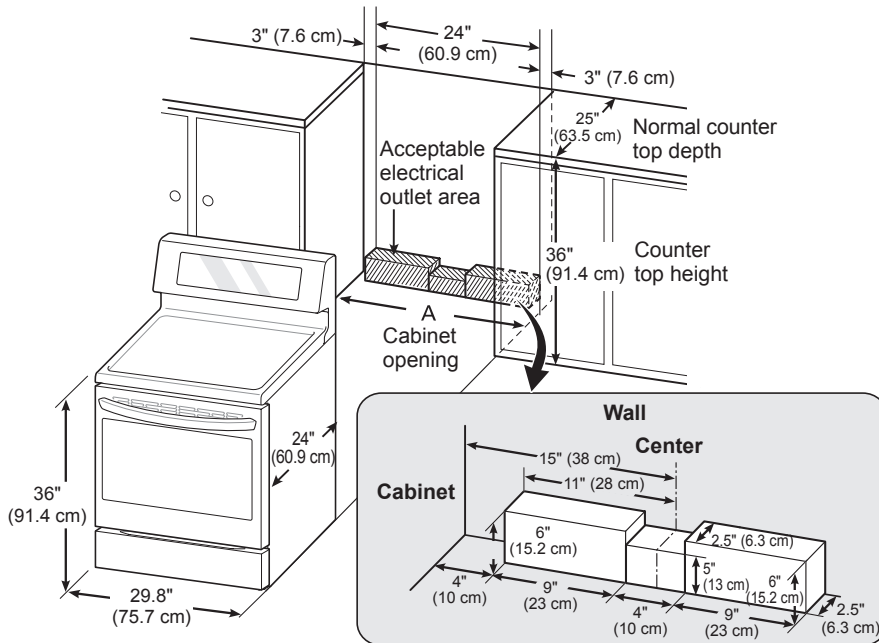

A = 30" (76.2 cm) For U.S.A
 = 30" (76.2 cm) ~ 31" (78.7 cm) For CANADA

For installation in Canada, a free-standing range is not to be installed closer than $1\frac{5}{32}$ " (12 mm) from any adjacent surface.

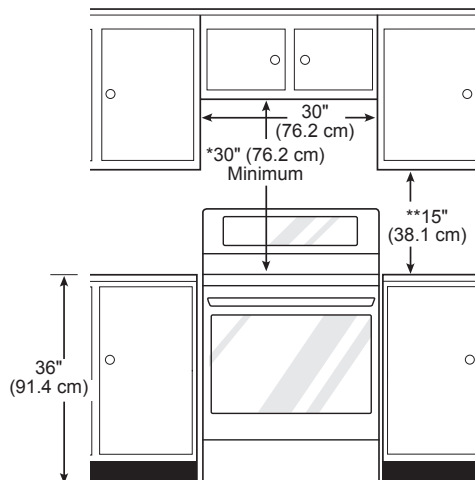

Minimum Dimensions

* 30" (76.2 cm) minimum clearance between the top of the cooking surface and the bottom of an unprotected wood or metal cabinet; or 24" (60.9 cm) minimum when bottom of wood or metal cabinet is protected by not less than $\frac{1}{4}$ " (6.4 cm) flame retardant millboard covered with not less than no. 28 MSG sheet steel, 0.015" (0.381 mm) stainless steel, 0.024" (0.610 mm) aluminum or 0.020" (0.508 mm) copper.

** 15" (38.1 cm) minimum between countertop and adjacent cabinet bottom.

Installing the Anti-tip Device

WARNING

Tip - Over Hazard

A child or adult can tip the range and be killed. Verify the anti-tip bracket has been installed. Ensure the anti-tip bracket is engaged when the range is moved. Do not operate the range without the anti-tip bracket in place. Failure to follow these instructions can result in death or serious burns to children and adults.



To check that leveling leg is inserted into anti-tip bracket, grasp the top rear edge of the range and carefully attempt to tilt it forward.

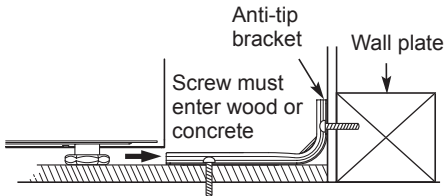
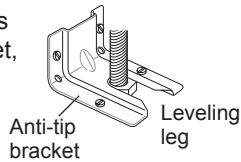

Locate the anti-tip bracket using the template

An anti-tip bracket is packaged with the template. The instructions include necessary information to complete the installation. Read and follow the range installation instruction sheet (template).

Leveling the Range

Level the range by adjusting the leveling legs with a wrench. Extending the legs slightly may also make it easier to insert the rear leg into the anti-tip bracket.

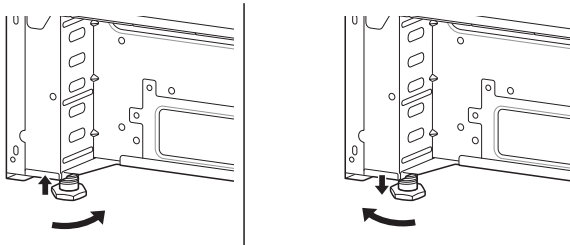

Use a level to check your adjustments. Place the level diagonally on the oven rack, and check each direction for level.

First check direction ①.

Then check direction ②. If the level doesn't show level on the rack, adjust the leveling legs with a wrench.

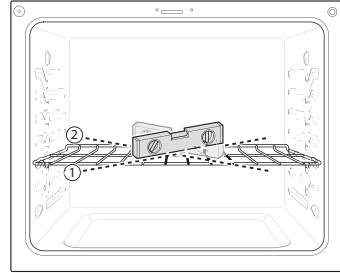

Connecting Electricity

Electrical Requirements

This appliance must be installed and grounded on a branch circuit by a qualified technician in accordance with the National Electrical code ANSI/NFPA NO. 70 - latest edition.

All wiring should conform to Local and NEC codes. This range requires a single-phase, 3 wire, A.C 120/208 V or 120/240 V 60 Hz electrical system. Use only a 3-conductor or a 4-conductor UL-listed range cord with closed-loop terminals, open-end spade lugs with upturned ends or similar termination. Do not install the power cord without a strain relief.

A range cord rated at 40 amps with 120/240 minimum volt range is required. If a 50 amp range cord is used, it should be marked for use with 1 3/8" diameter connection openings. This appliance may be connected by means of a conduit or power cord. If a conduit is being used, go to page 17 for **3 wire conduit connections** or **4 wire conduit connections**.



WARNING

- Allow 2 to 3 ft (61.0 cm to 91.4 cm) of slack in the line so that the range can be moved if servicing is ever necessary.
- The power supply cord and plug should not be modified. If it will not fit the outlet, have a proper outlet installed by a qualified electrician.
- Using an extension cord to connect the power is prohibited. Connect the power cord and plug directly.
- Electrical ground is required on this appliance.
- Make sure that the power cord is not pinched by the range or heavy objects. Failure to do so can result in serious burns or electrical shock.

Specified power-supply-cord kit rating

Range rating, watts		Specified rating of power supply-cord kit, amperes	Diameter (inches) of Range connection Opening	
120/240 volts 3-wire	120/208 volts 3-wire		Power cord	Conduit
8,750 - 16,500	7,801 - 12,500	40 or 50A	1 3/8"	1 1/8"
16,501 - 22,500	12,501 - 18,500	50	1 3/4"	1 3/8"

3, 4 - Wire electrical wall Receptacle

	4 Wire receptacle (14-50R)
	3 Wire receptacle (10-50R)

Connecting the Power Cord

The rear access cover must be removed. Loosen the two screws with a screwdriver. The terminal block will then be accessible.

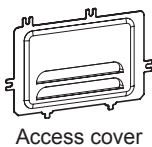

Use the cord/conduit connection plate to install the power cord or conduit. Leave the connection plate as installed for power cord installations. Remove the connection plate for conduit installations and use the smaller 1 1/8 in. (2.8 cm) conduit hole instead of the 1 3/8 in. (3.5 cm) power cord hole.

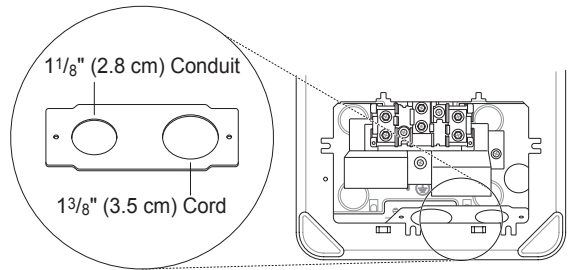

Remove the Conduit connection plate

For power cord installations, hook the strain relief over the 1 3/8 in. (3.5 cm) power cord hole located below the rear of the oven. Insert the power cord through the strain relief and tighten it.

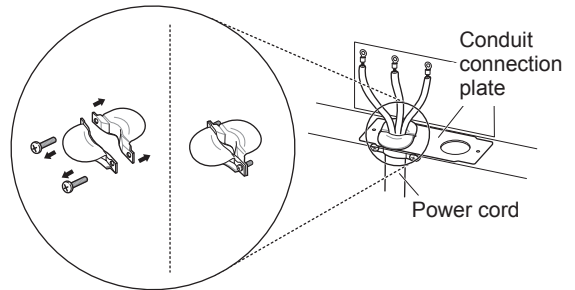

Assembling power cord strain relief at the 1 3/8" opening

For conduit installations, insert the conduit strain relief in the 1 1/8 in. (2.8 cm) conduit hole. Then install the conduit through the body of the strain relief and fasten the strain relief with its ring.

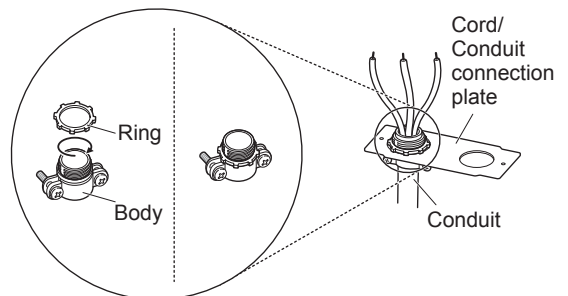

Assembling conduit cord strain relief at the 1 1/8" opening

3-Wire Connection : Power Cord

⚠ WARNING

- The middle (neutral or ground) wire, which is white, of a 3-wire power cord or a 3-wire conduit has to be connected to the middle post of the main terminal block. The remaining two wires of the power cord or conduit have to be connected to the outside posts of the main terminal connection block. Failure to do so can result in electrical shock, severe personal injury or death.

Install the power cord as follows:

For power cord installations, hook the strain relief over the power cord hole (1³/₈") located below the rear of the oven. Insert the power cord through the strain relief and tighten it.

Do not install the power cord without a strain relief.

- 1 Remove the lower 3 screws from the terminal block and retain them.
- 2 Insert the 3 screws through each power cord terminal ring and into the lower terminals of the terminal block. Make sure that the center (neutral) wire, which is white, is connected to the center lower position of the terminal block.
- 3 Tighten the 3 screws securely into the terminal block. Do not remove the ground strap connections.

3-wire connection

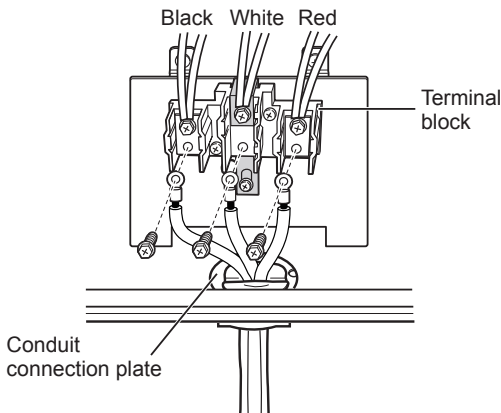

If screws are not tightened securely, it can result in electrical spark and severe personal injury or death.

4-Wire Connection : Power Cord

⚠ WARNING

- Only a 4-conductor power-supply cord kit rated 120/240 volts, 50 amperes and marked for use with ranges with closed-loop connectors or opened spade lugs with upturned ends shall be used. The white middle (neutral) wire of the power cord or 4-wire conduit has to be connected to the middle post of the main terminal block. The other two wires of the power cord or conduit have to be connected to the outside posts of the main terminal connection block. The 4th ground wire (green) must be connected to the frame of the range with the ground screw. Failure to do so can result in electrical shock, severe personal injury or death.

Install the power cord as follows:

Do not install the power cord without a strain relief.

- 1 Remove the lower 3 screws from the terminal block and retain them.
- 2 Remove the ground screw and bend the end of the ground strap up so the slot is over the hole of the center screw removed in step 1.
- 3 Insert the ground screw into the power cord ground wire (green) terminal ring and secure it to the range frame.
- 4 Insert the 3 screws through each power cord terminal ring and into the lower terminals of the terminal block. Make sure that the white center (neutral) wire is connected to the center lower position of the terminal block.
- 5 Tighten the 3 screws securely into the terminal block. The center screw now attaches the bent up ground strap to the block.

4-wire connection

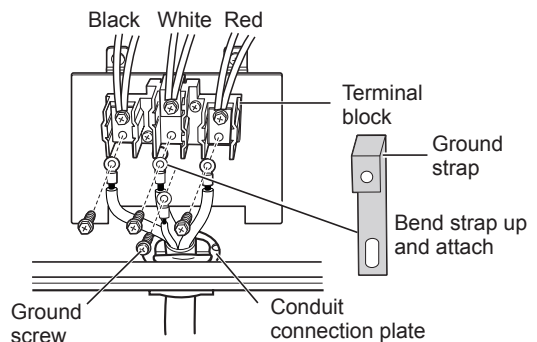

If screws are not tightened securely, it can result in electrical spark and severe personal injury or death.

3-Wire Connection: Conduit

Install the conduit as follows:

Remove the conduit connection plate from the rear of the oven and rotate it. The conduit hole ($1\frac{1}{8}$ " must be used.

First, prepare the conduit wires as shown below.

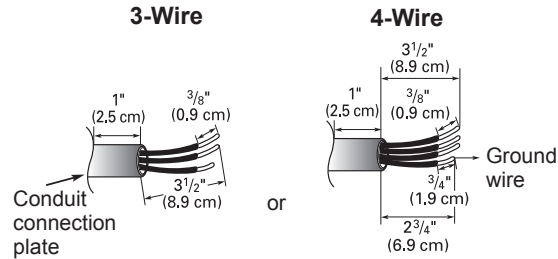

Second, install the conduit strain relief.

For conduit installations, purchase a strain relief and insert it in the $1\frac{1}{8}$ in. (2.8 cm) conduit hole. Then install the conduit through the body of the strain relief and fasten the strain relief with its ring. Reinstall the bracket.

For conduit connections:

If the wire in the conduit is copper it must be 8 or 10 AWG wiring.

If the wire in the conduit is aluminum it must be 6 or 8 AWG wiring.

- 1 Loosen the lower 3 screws from the terminal block.
- 2 Insert the bare wire (white/neutral) end through the center terminal block opening. Do not remove the ground strap connections.
- 3 Insert the two side bare wire ends into the lower left and the lower right terminal block openings. Tighten the 3 screws securely into the terminal block. (approximately 35 - 50 IN-LB)

3-wire connection

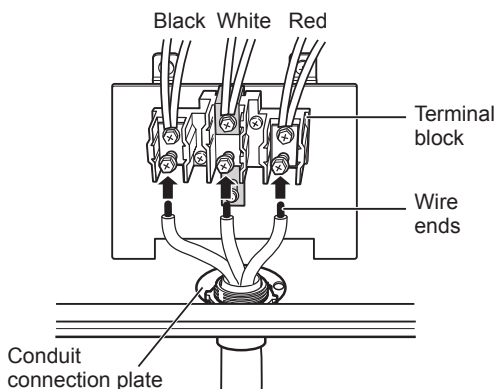

If screws are not tightened securely, it can result in electrical spark and severe personal injury or death.

4-Wire Connection: Conduit

WARNING

- The white middle (neutral) wire of the power cord or 4-wire conduit has to be connected to the middle post of the main terminal block. The other two wires of the power cord or conduit have to be connected to the outside posts of the main terminal connection block. The 4th ground wire (green) must be connected to the frame of the range with the ground screw. Failure to do so can result in electrical shock, severe personal injury or death.

- 1 Follow the instructions for installing the conduit under 3-Wire Connection: Conduit until the strain relief and bracket are installed. Do not install the conduit without a strain relief.
- 2 Loosen the 2 lower left and right screws from the terminal block. Remove the lower 2 center screws. Do not discard any screws.
- 3 Remove the ground screw and bend the end of the ground strap up so the slot is over the hole of the center screw removed in step 1.
- 4 Attach the ground (green) bare wire end to the range frame and secure it in place with the ground screw.
- 5 Insert the bare wire (white/neutral) end through the center terminal block opening. The center screw now attaches the bent up ground strap to the block.
- 6 Insert the two side bare wire ends into the left and the right terminal block openings. Tighten the 3 screws securely into the terminal block. (approximately 35 - 50 IN-LB)

4-wire connection

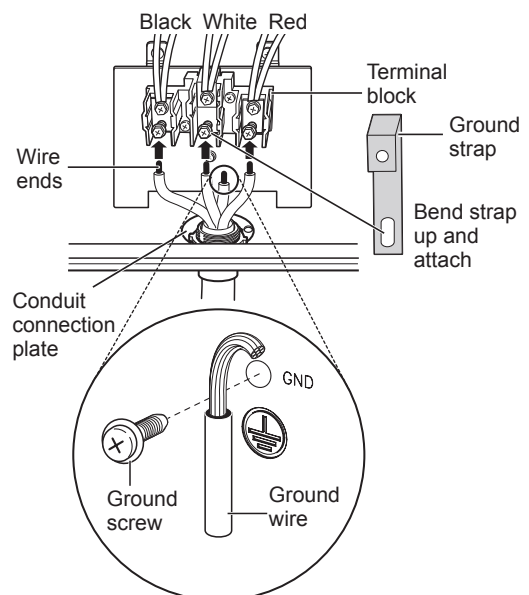

If screws are not tightened securely, it can result in electrical spark and severe personal injury or death.

Engaging the Anti-tip Device

- Move the range close enough to the opening to plug into the receptacle.
- Slide the range into position ensuring that the back leg slides under the anti-tip bracket. The range should sit flush against the back wall when properly installed.
- Carefully attempt to tip the range forward to ensure that the anti-tip bracket is engaged properly. If properly installed, the anti-tip bracket will prevent the range from being tipped. If the range can be tipped, reinstall the range until the anti-tip bracket is properly installed and the range will not tip forward.
- Turn on electrical power. Check the range for proper operation.

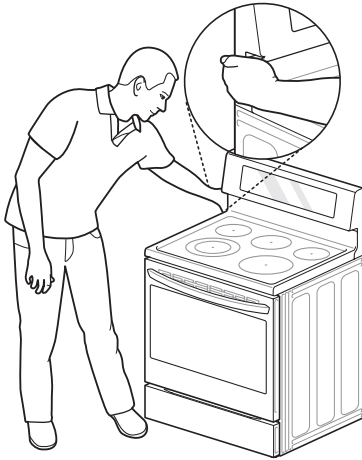

Test Run

Check if the range is properly installed and run a test cycle.

- 1** Before using the cooktop for the first time, clean it with a ceramic cooktop cleaner. This helps protect the top and makes cleanup easier.
- 2** Press **Clear/Off** to start test.
- 3** Turn on each burner to the **Hi** setting to check that the surface heating elements are working properly. The elements should glow red and radiate heat, and they should cycle on and off periodically even when the setting is in the **Hi** position. This cycling prevents the glass-ceramic from being cracked by thermal shock.
IMPORTANT : The warming zone does not consume enough power to glow red.
- 4** After checking all the surface heating elements, check the locking system by pressing **Clear/Off** for three seconds. The oven door should lock and the cooktop should not operate while the Lockout function is turned on. Press **Clear/Off** for three seconds to disable Lockout.
On the LRE3061 / LRE3193 models, the oven door cannot lock. The Lockout function should disable controls for the oven and cooktop.
- 5** Now check the oven's operation. Press **Bake** and press the number keys to set the oven temperature to 350 °F.
- 6** The oven should finish preheating in 15 minutes, and the convection fan should operate while the oven is preheating. (For Model: LRE3061 / LRE3193 / LRE3083)
- 7** After checking the oven's operation, turn the temperature up to 450 °F and leave the oven on for at least an hour to help remove any oil which might cause smoke and odors when first using the oven.

NOTE

Smoke may come out of the range when it is first used.

OPERATION

Control Panel Overview

For Model: LRE3061

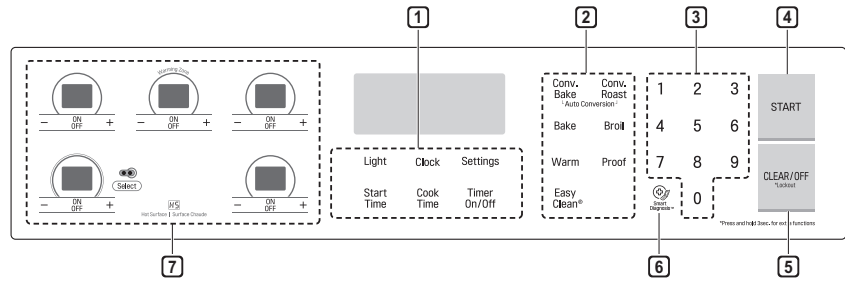

For Model: LRE3083

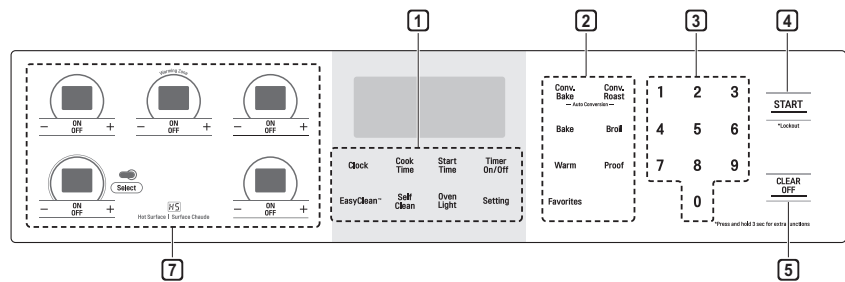

For Model: LRE3193

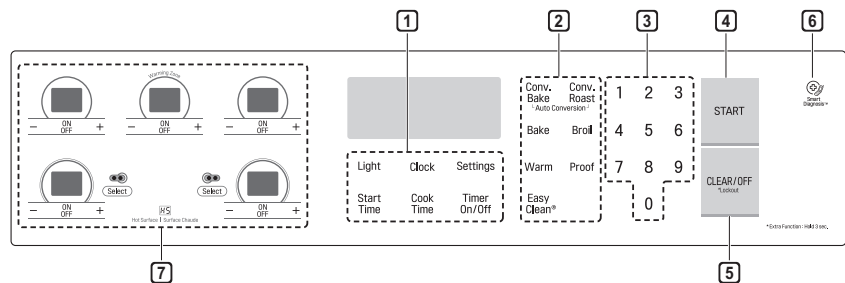

For Model: LRE3060

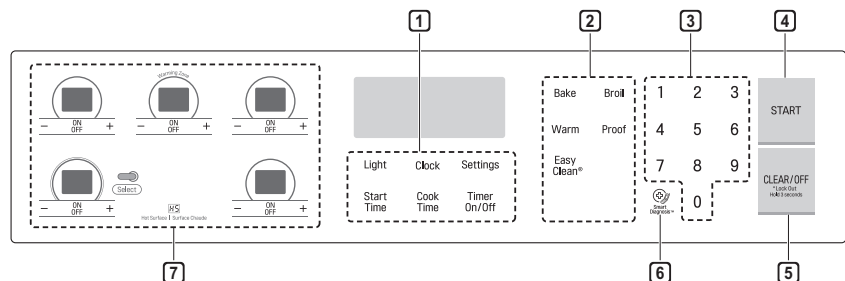

1 Features

2 Oven Control

3 Number Keys

4 Start Key

5 Clear Off / Lockout Key

6 Smart Diagnosis™
(For Model: LRE3061 / LRE3193 / LRE3060)

7 Cooktop Control

Hot Surface Indicator

The HS (hot surface) indicator appears in the display as long as any surface cooking area is too hot to touch. It remains on after the element is turned off and until the surface has cooled to approximately 150 °F. Also, The HS indicator appears during the self clean cycle.

Flashing Time

If your oven displays a flashing clock, press **Clock** and reset the time, or press any key to stop the flashing.

Changing Oven Settings

Clock

The clock must be set to the correct time of day in order for the automatic oven timing functions to work properly.

- 1 Press **Clock**.
- 2 Press the numbers to enter the time. For example, to set the clock for 10:30, press the numbers: **1**, **0**, **3** and **0**.
- 3 Press **START**.

NOTE

- The time of day cannot be changed during a timed baking or self-clean cycle (For Model: LRE3083).
- To check the time of day when the display is showing other information, press **Clock**.
- If no other keys are pressed within 25 seconds of pressing **Clock**, the display reverts to the original setting.
- If the display time is blinking, you may have experienced a power failure. Reset the time.

Setting the Hour Mode

The control is set to use a 12-hour clock. To reset the clock to 24-hour mode, follow the steps below.

- 1 Press and hold **Clock** for three seconds.
- 2 Press **1** for 12-hour or press **2** for 24-hour.
- 3 Press **Start** to accept the change.

Oven Light

The interior oven light automatically turns on when the door is opened. Press **Light** to manually turn the oven light on.

NOTE

The oven light cannot be turned on if the Self Clean (For Model: LRE3083) function is active.

Minimum & Maximum Default Settings

All of the features listed have a minimum and a maximum time or temperature setting that may be entered into the control. An entry acceptance beep sounds each time a control key is pressed.

An entry error tone (two short tones) sounds if the entry of the temperature or time is below the minimum or above the maximum setting for the feature.

Feature	min. Temp. / Time	max. Temp. / Time	Default
Clock	12 Hr.	1:00 Hr. / min.	12:59 Hr. / min.
	24 Hr.	0:00 Hr. / min.	23:59 Hr. / min.
Timer	12 Hr.	0:01 min. / sec.	11:59 Hr. / min.
	24 Hr.	0:01 min. / sec.	11:59 Hr. / min.
Cook Time	12 Hr.	0:01 min.	11:59 Hr. / min.
	24 Hr.	0:01 min.	11:59 Hr. / min.
Conv. Bake (For Model: LRE3061 / LRE3193 / LRE3083)	300 °F / 150 °C	550 °F / 285 °C	350 °F (*325 °F) / 12 Hr.
Conv. Roast (For Model: LRE3061 / LRE3193 / LRE3083)	300 °F / 150 °C	550 °F / 285 °C	350 °F (*325 °F) / 12 Hr.
Broil	Lo	Hi	Hi / 3 Hr.
Bake	170 °F / 80 °C	550 °F / 285 °C	350 °F / 12 Hr.
Proof			12 Hr.
Warm			3 Hr.
Self Clean (For Model: LRE3083)	3 Hr.	5 Hr.	4 Hr.
EasyClean®			20min (For Model: LRE3083, LRE3061, LRE3193) 10min (For Model: LRE3060)

* Using Auto Conversion (For Model: LRE3061 / LRE3193 / LRE3083)

- Default cook mode times are without setting cook time.

Timer On/Off

The Timer On/Off serves as an extra timer in the kitchen that beeps when the set time has run out. It does not start or stop cooking.

The Timer On/Off feature can be used during any of the other oven control functions.

Setting the Timer

Steps	Hours and Minutes		Minutes and Seconds	
1	Press Timer On/Off once. (0:00 appears and Timer flashes in the display.)		Press Timer On/Off twice. (0:00 appears and Timer flashes in the display.)	
2	To set 5 hours, press 5, 0, 0. (5:00)	To set 5 minutes, press 5. (0:05)	To set 5 minutes, press 5, 0, 0. (5:00)	To set 5 seconds, press 5. (0:05)
3	Press Timer On/Off or START to begin.			

NOTE

- If **Timer On/Off** is not pressed, the timer returns to the time of day.
- When the set time runs out, **End** shows in the display. The indicator tones sound every 15 seconds until **Timer On/Off** is pressed.

Canceling the Timer

- 1** Press **Timer On/Off** once. The display returns to the time of day.

NOTE

Pressing **Clear/Off** will not turn off the timer.

Settings

Press the **Settings** key repeatedly to toggle through and change oven settings.

The **Settings** key allows you to:

- enable/disable convection auto conversion
- adjust the oven temperature (For Model: LRE3061 / LRE3193 / LRE3083)
- set the language
- activate/deactivate the preheating alarm light
- set the beeper volume
- switch the temperature scale between Fahrenheit and Celsius

Setting Convection Auto Conversion (For Model: LRE3061 / LRE3193 / LRE3083)

When **Conv. Bake** and **Conv. Roast** are selected, Convection Auto Conversion automatically converts the standard recipe temperature entered to a convection temperature by subtracting 25 °F / 14 °C. This auto-converted temperature shows on the display. For example, select **Conv. Bake**, enter 350 °F, and 325 °F shows on the display after preheat.

Convection Auto Conversion is enabled by default. To change the setting, follow these instructions.

- 1** Press **Settings** repeatedly until **Auto** appears in the display.
- 2** Press **1** to enable or press **2** to disable.
- 3** Press **START** to accept the change.

Adjusting the Oven Temperature

Your new oven may cook differently from the one it replaced. Use your new oven for a few weeks to become more familiar with it before changing the temperature settings. If after familiarizing yourself with the new oven, you still think that it is too hot or too cold, you can adjust the oven temperature yourself.

NOTE

To begin, either raise or lower the thermostat 15 °F (8 °C). Try the oven with the new setting. If the oven still needs adjustment, raise or lower the thermostat again, using the first adjustment as a gauge. For example, if the adjustment was too much, raise or lower the thermostat 10 °F (5 °C). If the adjustment was not enough, raise or lower the thermostat 20 °F (12 °C). Proceed in this way until the oven is adjusted to your satisfaction.

To increase the temperature

- 1 Press **Settings** repeatedly until **AdJU** appears in the display.
- 2 Use the number keys to enter the number of degrees you want to adjust the oven temperature.
- 3 Press **START**.

To decrease the temperature

- 1 Press **Settings** repeatedly until **AdJU** appears in the display.
- 2 Use the number keys to enter the number of degrees you want to adjust the oven temperature.
- 3 Press **Settings** once to add a minus sign (-) in front of the temperature in the display.
- 4 Press **START**.

NOTE

- This adjustment does not affect the Broil or Self Clean temperatures on models with these features. The adjustment is retained in memory after a power failure.
- The oven temperature can be increased or decreased by a maximum of 35 °F (19 °C).
- Once the temperature is increased or decreased, the adjustment shows in the AdJU setting display until it is reset.

Language

The default language of the display is English. It can be changed to Spanish or French.

- 1 Press **Settings** repeatedly until **Lng** appears in the display.
- 2 Press **1** for English or Press **2** for Spanish or Press **3** for French.
- 3 Press **START** to accept the change.

Turning the Preheat Alarm Light On/Off

When the oven reaches its set-temperature, the preheating alarm light flashes 5 times or until the oven door is opened.

You can activate or deactivate the preheating alarm light.

- 1 Press **Settings** repeatedly until **PrE** appears in the display.
- 2 Press **1** for on or press **2** for off.
- 3 Press **START** to accept the change.

Adjusting the Beeper Volume

- 1 Press **Settings** repeatedly until **BEEP** appears in the display.
- 2 Press **1** for NORMAL or press **2** for MUTE.
- 3 Press **START** to accept the change.



Selecting Fahrenheit or Celsius

Set the oven temperature display to show either Fahrenheit (°F) or Celsius (°C) units. The oven defaults to Fahrenheit unless changed by the user.

- 1 Press **Settings** repeatedly until **Unit** appears in the display.
- 2 Press **1** for °F (Fahrenheit) or press **2** for °C (Celsius).
- 3 Press **START** to accept the change.

Lockout

The Lockout feature automatically locks the oven door and prevents most oven controls from being turned on. It does not disable the timer and the interior oven light.

- 1 Press and hold **Clear/Off** for three seconds. (For model LRE3083 : Press and hold **START** for three seconds.)
- 2 The lock melody sounds, **OVEN LOCKOUT** appears in the display and the lock  blinks in the display.
- 3 Once the oven door is locked, the lock  indicator stops blinking and remains on.
- 4 To deactivate the Lockout feature, press and hold **Clear/Off** for three seconds. The unlock melody sounds and the door and the controls unlock.

NOTE

In models without a self-clean mode, the Lockout feature locks the controls but not the oven door. The lock  indicator does not blink.

Start Time (Delayed Timed Cook)

The automatic timer of the Delayed Timed Cook function turns the oven on and off at the time you select. This feature can be used with the **Bake**, **Conv. Bake** and **Conv. Roast** modes. (For Model: LRE3061 / LRE3193 / LRE3083)

Setting a Delayed Timed Cook

For example, to bake at 300 °F and delay the start of baking until 4:30, first set the clock for the correct time of day.

- 1 Press **Bake**. 350 °F appears in the display.
- 2 Set the temperature: Press **3**, **0** and **0**.
- 3 Press **Cook Time** and set the baking time.
- 4 Press **Start Time**.
- 5 Set the start time: Press **4**, **3** and **0** for 4:30.
- 6 Press **START**. A short beep sounds and **Timed Delay** and the start time appear in the display. The oven begins baking at the set start time.

NOTE

- To cancel the Delayed Timed Cook function, Press **Clear/Off** at any time.
- To change the cooking time, repeat step 3 and press **START**.
- If the oven clock is set as a 12-hour clock, you can delay the cook time for 12 hours. If the oven clock is set as a 24-hour clock, you can delay the cook time for 24 hours.

The oven will continue to cook for the set amount of time and then turn off automatically. When the cooking time has elapsed:

- **End** and the time of day show in the display.
- The cook end indicator tone sounds every 60 seconds until **Clear/Off** is pressed.
- When **Warm** is set, the warming function is activated after the cooking time ends.



CAUTION

- Use the automatic timer when cooking cured or frozen meats and most fruits and vegetables. Foods that can easily spoil, such as milk, eggs, fish, meat or poultry, should be chilled in the refrigerator. Even when chilled, they should not stand in the oven for more than 1 hour before cooking begins, and should be removed promptly when cooking is completed.
- Eating spoiled food can result in sickness from food poisoning.

Cook Time (Timed Cook)

Set the oven to cook for a specific length of time using the Timed Cook feature. This feature can only be used with the **Bake**, **Conv. Bake** and **Conv. Roast** modes. (For Model: LRE3061 / LRE3193 / LRE3083)

Setting the Cook Time Function

For example, to bake at 300 °F for 30 minutes, first set the clock to the correct time of day.

- 1 Press **Bake**. 350 °F appears in the display.
- 2 Set the temperature. Press **3**, **0** and **0**.
- 3 Press **Cook Time**. **Timed** flashes in the display. **Bake**, 0:00 and 300 °F appear in the display.
- 4 Set the baking time: press **3** and **0** (for 30 minutes). The baking time can be set for any amount of time between 1 minute and 11 hours and 59 minutes.
- 5 Press **START**.

NOTE

To activate the Warm function at the end of the timed cook cycle, repeat steps 1-4 and then press **Warm**. **Warm** appears in the display. (Refer to the Warm section on page 32)

The oven will continue to cook for the set amount of time and then turn off automatically. When the cooking time has elapsed:

- **End** and the time of day show in the display.
- The cook end indicator tone sounds every 60 seconds until **Clear/Off** is pressed.
- When **Warm** is set, the warming function is activated after the cooking time ends.

Changing the Cook Time during Cooking

For example, to change the cook time from 30 minutes to 1 hour and 30 minutes, do the following.

- 1 Press **Cook Time**.
- 2 Change the baking time: press **1**, **3**, **0**.
- 3 Press **START** to accept the change.

Using the Cooktop

Cooking Areas

The cooking areas on your range are identified by permanent circles on the glass cooktop surface. For the most efficient cooking, fit the pan size to the element size.

Pans should not extend more than 1/2 to 1-inch beyond the cooking area.

When a control is turned on, a glow can be seen through the glass cooktop surface.

NOTE

It is normal for the surface elements to cycle on and off during cooking, even on higher settings. This will happen more frequently if cooking on a lower temperature setting.

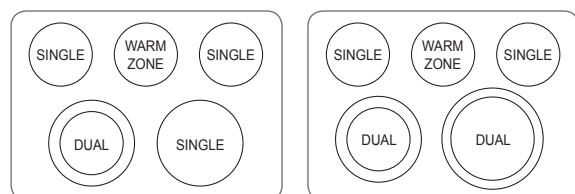

LRE3083 / LRE3061 /
LRE3060

LRE3193

NOTE

It is normal to see a very faint red ring around the outer edge of a dual or triple element when using it as a single element at a high heat setting. This is only a reflection from the bright glow of the center element and is not a malfunction.

Hot Surface Indicator

Once the element is turned off, HS (hot surface indicator) appears in the display as long as the surface cooking area is too hot to touch.

It remains on until the surface has cooled to approximately 150 °F.

NOTE

During Self Clean (For Model: LRE3083), HS remains on.

Using the Cooktop Elements

CAUTION

- Only use cookware and dishes that are safe for oven and cooktop use.
- Always use oven mitts when removing food from the cooktop and oven.
- Do not place sealed containers on the cooktop.
- Do not use plastic wrap to cover food while on the cooktop. Plastic may melt onto the surface and be very difficult to remove.
- **Never leave food on the cooktop unattended. Spillovers can cause smoke. Greasy spillovers may catch on fire.**
- The surface element may appear to have cooled after it has been turned off. The element may still be hot and touching the element before it has cooled sufficiently can cause burns.

Turning on a Single Element

- 1 Press the **ON/OFF** button that controls the desired surface element.
- 2 Press the **+** button once to adjust the element temperature to Hi, or the **-** button once to adjust the element temperature to Lo.
- 3 Use the **- / +** buttons to adjust the element temperature settings. The element temperature settings are adjustable at all times.
- 4 To turn off the element after cooking, press the **ON/OFF** button once.

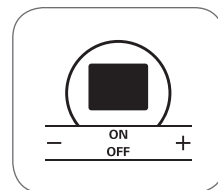
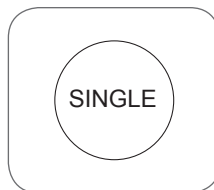

NOTE

- Hi is the highest temperature available.
- Lo is the lowest temperature available.
- Press and hold the **+** or **-** buttons to quickly scroll through the temperature settings.

Turning on the Dual Element

Adjust the dual element according to the pot/pan size being used.

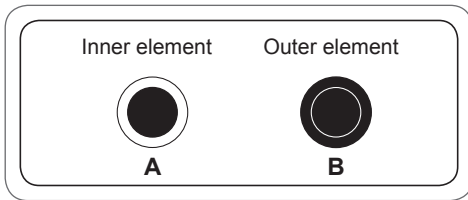

- 1 Press the **ON/OFF** button that controls the desired surface element.
- 2 Press the **SELECT** button to select either the inner (smaller) or outer (larger) element function. The dual elements default to the inner element function. The light bars above the **SELECT** button indicate whether the element is adjusted for the inner or outer element function. One bar will display for the inner element and two bars will display for outer element.
- 3 Press the **+** button once to adjust the element temperature to Hi, or the **-** button once to adjust the element temperature to Lo.
- 4 Use the **- / +** buttons to adjust the element temperature settings. The element temperature settings are adjustable at all times.
- 5 To turn off the element after cooking, press the **ON/OFF** button once.

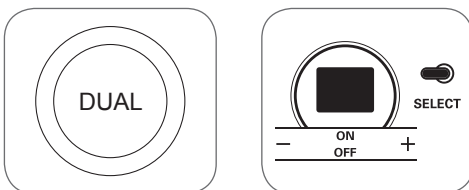

NOTE

- Hi is the highest temperature available.
- Lo is the lowest temperature available.
- Press and hold the **+** or **-** buttons to quickly scroll through the temperature settings.

Turning on the Warming Zone

Use the Warming Zone to keep food warm after it has already been cooked. The warming zone is not meant for cooking food. Attempting to cook uncooked or cold food on the warming zone could result in a food-borne illness.

- 1 Press the warming zone **ON/OFF** button. The warming zone indicator light flashes.
- 2 Press the **+** button once to adjust the temperature to Hi, or the **-** button once to adjust the temperature to Lo. Power level sequence is from **-** Lo, 2, 3, 4, Hi or from **+** Hi, 4, 3, 2, Lo.
- 3 Use the **- / +** buttons to adjust the temperature settings. The temperature settings are adjustable at all times.
- 4 To turn off the warming zone, press the **ON/OFF** button once.

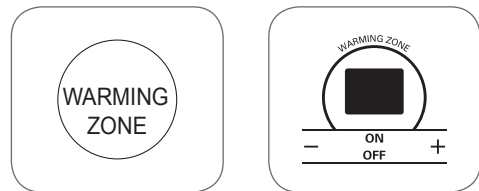

The Recommended Surface Cooking Setting

Setting	Recommended Use
8.5-Hi	<ul style="list-style-type: none"> • Bring liquid to a boil • Start cooking
5.5-8.0	<ul style="list-style-type: none"> • Hold a rapid boil, frying, deep fat fry • Quickly brown or sea food
3.5-5.0	<ul style="list-style-type: none"> • Maintain a slow boil • Fry or saute foods • Cook soups, sauces and gravies
2.2-3.0	<ul style="list-style-type: none"> • Stew or steam food • Simmer
Lo-2.0	<ul style="list-style-type: none"> • Keep food warm • Melt chocolate or butter • Simmer

Using the Proper Cookware

The size and type of cookware will influence the settings needed for the best cooking results. Be sure to follow the recommendations for using proper cookware.

Cookware should have flat bottoms that make good contact with the entire surface heating element. Check for flatness by placing a ruler across the bottom of the cookware. The ruler should touch the cookware across the entire bottom, with no gaps.

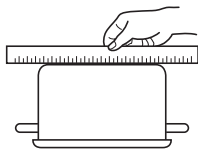

Cookware recommendations

- Flat bottom and straight sides
- Heavy-gauge pans
- Pan sizes that match the amount of food to be prepared and the size of the surface element
- Weight of handle does not tilt pan. Pan is well balanced
- Tight-fitting lids
- Flat bottom woks

Cookware should not

- have a curved or warped bottom.
- be smaller or larger than the surface burner.
- have a heavy handle that tilts the pan.
- be a wok with a ring stand.
- have loose or broken handles.
- have loose-fitting lids.

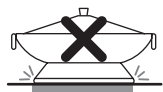
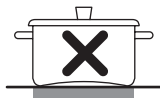

NOTE

- **Do not use pans less than 7 inches in diameter on the front elements.**
- Do not use foil or foil-type containers. Foil may melt onto the glass. Do not use the cooktop if metal has melted on it. Call an authorized LG Service Center.

Choosing Cookware

The cookware material determines how evenly and quickly heat is transferred from the surface element to the pan bottom. The most popular materials available are:

- **Aluminum** - Excellent heat conductor. Some types of food will cause it to darken (anodized aluminum cookware resists staining and pitting). If aluminum pans slide across the ceramic cooktop, they may leave metal marks which will resemble scratches. Remove these marks immediately.
- **Copper** - Excellent heat conductor but discolors easily. May leave metal marks on glass-ceramic (see Aluminum above).
- **Stainless steel** - Slow heat conductor with uneven cooking results. Is durable, easy to clean and resists staining.
- **Cast iron** - A poor heat conductor but retains heat very well. Cooks evenly once cooking temperature is reached. Not recommended for use on ceramic cooktops.
- **Porcelain-enamel on metal** - Heating characteristics will vary depending on base material. Porcelain-enamel coating must be smooth to avoid scratching ceramic cooktops.
- **Glass** - Slow heat conductor. Not recommended for ceramic cooktop surfaces because it may scratch the glass.

Home Canning Tips

Be sure that the canner is centered over the surface element and is flat on the bottom.

- The base must not be more than 1 inch larger than the element. Use of water bath canners with rippled bottoms may extend the time required to bring the water to a boil and may damage the cooktop.
- Some canners are designed with smaller bases for use on smooth surfaces.
- Use the high heat setting only until the water comes to a boil or pressure is reached in the canner.
- Reduce to the lowest heat setting that maintains the boil, or pressure. If the heat is not turned down, the cooktop may be damaged.

Using the Oven

Before Using the Oven

NOTE

- Because the oven temperature cycles, an oven thermometer placed in the oven cavity may not show the same temperature that is set on the oven.
- It is normal for the convection fan to run while preheating during a regular bake cycle.
- The convection fan motor may run periodically during a regular bake cycle.
- The fan turns off if the door is left open during baking. The fan turns back on automatically once the door is closed.

Oven Vent

Areas near the vent may become hot during operation and may cause burns. Do not block the vent opening. Avoid placing plastics near the vent as heat may distort or melt the plastic.

It is normal for steam to be visible when cooking foods with high moisture content.

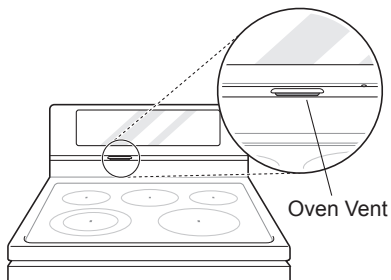

Using Oven Racks

The racks have a turned-up back edge that prevents them from being pulled out of the oven cavity.

Removing Racks

- 1 Pull the rack straight out until it stops.
- 2 Lift up the front of the rack and pull it out.

Replacing Racks

- 1 Place the end of the rack on the support.
- 2 Tilt the front end up and push the rack in.



CAUTION

- Replace oven racks before turning the oven on to prevent burns.
- Do not cover the racks with aluminum foil, or any other material, or place anything on the bottom of the oven. Doing so will result in poor baking and may damage the oven bottom.
- Only arrange oven racks when the oven is cool.

Bake

Bake is used to prepare foods such as pastries, breads and casseroles. The oven can be programmed to bake at any temperature from 170 °F (80 °C) to 550 °F (285 °C). The default temperature is 350 °F (175 °C).

Setting the Bake Function (example, 375 °F)

- 1 Press **Bake**.
- 2 Set the oven temperature: press **3**, **7** and **5**.
- 3 Press **START**. The oven starts to preheat.

As the oven preheats, the temperature is displayed and rises in 5-degree increments. Once the oven reaches the set temperature, a tone sounds and the oven light blinks on and off.

- 4 When cooking is complete, press **Clear/Off**.
- 5 Remove food from the oven.

NOTE

It is normal for the convection fan to operate (For Model: LRE3061 / LRE3193 / LRE3083) periodically throughout a normal bake cycle in the oven. This is to ensure even baking results.

Baking Tips

- Baking time and temperature will vary depending on the characteristics, size, and shape of the baking pan used.
- Check for food doneness at the minimum recipe time.
- Use metal bakeware (with or without a nonstick finish), heatproof glass-ceramic, ceramic or other bakeware recommended for oven use.
- Dark metal pans or nonstick coatings will cook food faster with more browning. Insulated bakeware will slightly lengthen the cooking time for most foods.

NOTE

The oven bottom has a porcelain-enamel finish. To make cleaning easier, protect the oven bottom from excessive spillovers by placing a cookie sheet on the rack below the rack you are cooking on. This is particularly important when baking a fruit pie or other foods with a high acid content. Hot fruit fillings or other foods that are highly acidic may cause pitting and damage to the porcelain-enamel surface and should be wiped up immediately.

Convection Mode

(For Model: LRE3061 / LRE3193 / LRE3083)

The convection system uses a fan to circulate the heat evenly within the oven. Improved heat distribution allows for even cooking and excellent results while cooking with single or multiple racks.

Setting the Convection Function (example, 375 °F)

- 1 Press **Conv. Bake** or **Conv. Roast**. The display flashes 350 °F.
- 2 Set the oven temperature: press **3**, **7** and **5**.
- 3 Press **START**. The display shows **Conv. Bake** or **Conv. Roast** and the oven temperature starting at 100 °F.

As the oven preheats, the display shows increasing temperatures in 5-degree increments. Once the oven reaches the set adjusted temperature, a tone sounds and the oven light flashes on and off. The display shows the auto converted oven temperature, 350 °F and the fan icon.

- 4 When cooking has finished or to cancel, press **Clear/Off**.

NOTE

The oven fan runs while convection baking. The fan stops when the door is open. In some cases, the fan may shut off during a convection bake cycle.

Tips for Convection Baking

- Use Convection Bake for faster and more even multiple-rack cooking of pastries, cookies, muffins, biscuits, and breads of all kinds.
- Bake cookies and biscuits on pans with no sides or very low sides to allow heated air to circulate around the food. Food baked on pans with a dark finish will cook faster.
- When using Convection Bake with a single rack, place the oven rack in position 4. If cooking on multiple racks, place the oven racks in positions 2 and 4 (or 5) for two racks.
- Multiple oven rack cooking may slightly increase cook times for some foods.
- Cakes, cookies and muffins have better results when using multiple racks.

The Convection Roast feature is designed to give optimum roasting performance. Convection Roast combines cooking with the convection fan to roast meats and poultry. The heated air circulates around the food from all sides, sealing in juices and flavors. Foods are crispy brown on the outside while staying moist on the inside. Convection roasting is especially good for large tender cuts of meat, uncovered.

Tips for Convection Roasting

Use a broiler pan and grid when preparing meats for convection roasting. The broiler pan catches grease spills and the grid helps prevent grease splatters.

- 1 Place the oven rack on the bottom.
- 2 Place the grid in the broiler pan.
- 3 Place the broiler pan on the oven rack.

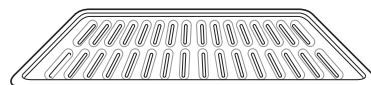

Grid (sold separately)

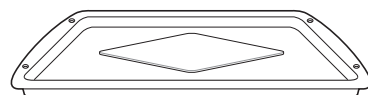

Broiler pan (sold separately)

CAUTION

- Do not use a broiler pan without a grid.
- Do not cover the grid with aluminum foil.
- Position food (fat side up) on the grid.

Recommended Baking and Roasting Guide

Baking results will be better if baking pans are centered in the oven as much as possible. If cooking on multiple racks, place the oven racks in the positions shown.

Rack and Pan Placement

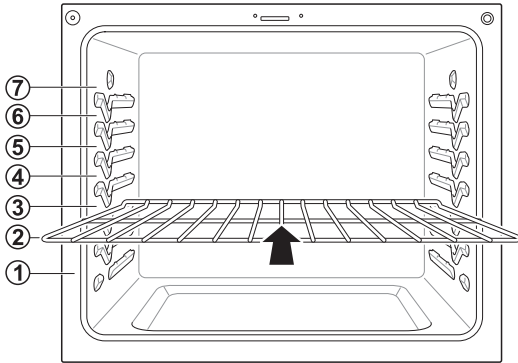

Single rack baking

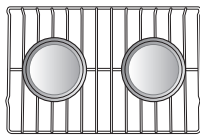

Rack
(Position 4)

Multiple rack baking

For Model: LRE3061

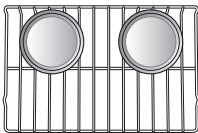

Rack
(Position 3)

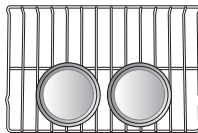

Rack
(Position 5)

For Model: LRE3083

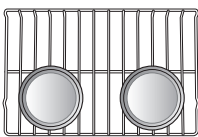

Rack
(Position 2)

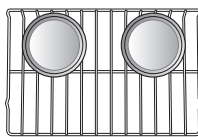

Rack
(Position 4)

For Model: LRE3193 / LRE3060

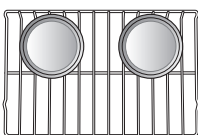

Rack
(Position 2)

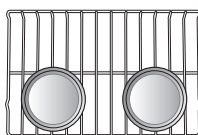

Rack
(Position 4)

Baking rack guide

	Food	Rack position
Cakes	• Layer cakes	4
	• Bundt cakes	3
	• Angel food cake	3
Cookies	• Sugar cookies	4
	• Chocolate chips	4
	• Brownies	4
Pizza	• Fresh	3
	• Frozen	3
Pastry Crust	• From scratch	4
	• Refrigerator	4
Breads	• Biscuit, canned	5
	• Biscuit, from scratch	5
	• Muffins	5
Desserts	• Fruit crisps and cobblers, from scratch	4
	• Pies, from scratch, 2-crust fruit	4
Custards	• Cheesecake, crème brûlée	2
Soufflés	• Sweet or savory	2
Casserole	• Frozen lasagna	5

Roasting rack guide

	Food	Rack position	
Beef	Rib	Rare	2
		Medium	2
		Well done	2
	Boneless rib, top sirloin	Rare	2
		Medium	2
		Well done	2
Beef tenderloin	Rare	2	
	Medium	2	
Pork	Rib	2	
	Bone-in, sirloin	2	
	Ham, cooked	2	
Poultry	Whole chicken	2	
	Chicken pieces	2	
	Turkey	2	

Broil

The Broil function uses intense heat from the upper heating element to cook food. Broiling works best for tender cuts of meat, fish, and thinly cut vegetables.

Some models may feature a hybrid broiler consisting of an inner broiler that utilizes a carbon heating element which provides instantaneous heat, and a traditional outer broiling element. During normal broiler operation, it is normal for either element to cycle off intermittently.

CAUTION

- Do not use a broiler pan without a grid. Oil can cause a grease fire.
- Do not cover the grid and broiler pan with aluminum foil. Doing so will cause a fire.
- Always use a broiler pan and grid for excess fat and grease drainage. This will help to reduce splatter, smoke, and flare-ups.

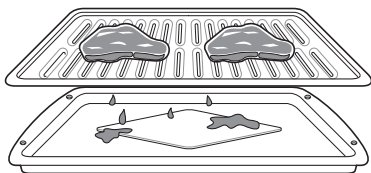

Setting the Oven to Broil

- 1 Oven door must always be closed during **Broil** mode.
- 2 Press **Broil** or **Speed Broil** once for **Hi** or twice for **Lo**.
- 3 Press **START**. The oven begins to heat.
- 4 Let the oven preheat for approximately five minutes before cooking the food if using broil.
- 5 Press **Clear/Off** to cancel at any time or when cooking is complete.

Smoking

Due to the intense heat associated with broiling, it is normal to experience smoke during the cooking process. This smoke is a natural byproduct of searing and should not cause you to worry. If you are experiencing more smoke than you are comfortable with, use the following tips to reduce the amount of smoke in your oven.

- 1 Always use a broiler pan. Do not use saute pans or regular baking sheets for safety reasons.
- 2 The broiler pan should always be thoroughly cleaned and at room temperature at the beginning of cooking.
- 3 Always run your cooktop ventilation system or vent hood during broiling.
- 4 Keep the interior of your oven as clean as possible. Leftover debris from prior meals can burn or catch fire.
- 5 Avoid fatty marinades and sugary glazes. Both of these will increase the amount of smoke you experience. If you would like to use a glaze, apply it at the very end of cooking.
- 6 If you are experiencing significant smoke with any food item, consider:
 - Lowering the broiler to the Lo setting.
 - Lowering the rack position to cook the food further away from the broiler.
 - Using the Hi broil setting to achieve the level of searing you desire, and then either switching to the Lo broil setting, or switching to the Bake function.
- 7 As a rule, fattier cuts of meat and fish will produce more smoke than leaner items.
- 8 Adhere to the recommended broil settings and cooking guidelines in the chart on the following page whenever possible.

Recommended Broiling Guide

The size, weight, thickness, starting temperature, and your preference of doneness will affect broiling times.

This guide is based on meats at refrigerator temperature. For best results when broiling, use a pan designed for broiling.

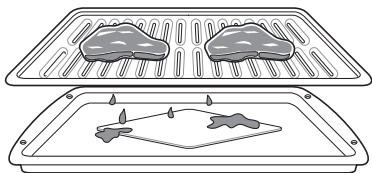

Food	Quantity and/or Thickness	Rack Position	First Side (minutes)	Second Side (minutes)	Comments
Ground Beef	1 lb. (4 patties) 1/2 to 3/4" thick	7	4-6	2-4	Space evenly. Up to 8 patties may be broiled at once.
Beef Steaks					Steaks less than 1" thick cook through before browning. Pan frying is recommended. Slash fat.
Rare	1" thick	7	3-5	2-4	
Medium	1 to 1 1/2 lbs.	7	4-6	2-4	
Well done		7	5-7	3-5	
Rare	1 1/2" thick	5	7-9	4-6	
Medium	2 to 2 1/2 lbs.	5	9-11	6-8	
Well done		5	11-13	8-10	
Toast		7	0.5-1	0.5	
Chicken	1 whole cut up 2 to 2 1/2 lbs., split lengthwise 2 Breasts	5	8-10	4-6	Broil skin-side-down first.
		5	8-10	5-7	
Lobster Tails	2-4 10 to 12 oz. each	5	9-12	Do not turn over	Cut through back of shell. Spread open. Brush with melted butter before broiling and after half of broiling time.
Fish Fillets	1/4 to 1/2" thick	6	2-4	2-4	Handle and turn very carefully. Brush with lemon butter before and during cooking, if desired.
Ham Slices (precooked)	1/2" thick	5	2-4	2-4	Increase time 5 to 10 minutes per side for 1 1/2" thick or home-cured ham.
Pork Chops	1 (1/2" thick)	6	3-6	4-7	
Well done	2 (1" thick) about 1 lb.	5	5-8	5-8	
Lamb Chops					
Medium	2 (1" thick) about	6	3-5	2-5	
Well done	10 to 12 oz.	6	5-7	4-7	
Medium	2 (1 1/2" thick)	6	7-9	7-9	
Well done	about 1 lb.	6	9-11	7-9	
Salmon Steaks	2 (1" thick)	5	8-10	3-5	Grease pan. Brush steaks with melted butter.
	4 (1" thick) about 1 lb.	5	9-11	4-6	

- This guide is only for reference. Adjust cook time according to your preference.

NOTE

The USDA advises that consuming raw or undercooked fish, meat, or poultry can increase your risk of food-borne illness.

The USDA has indicated the following as safe minimum internal temperatures for consumption:

- Ground beef: 160 °F (71.1 °C)
- Poultry: 165 °F (73.9 °C)
- Beef, veal, pork, or lamb: 145 °F (62.8 °C)
- Fish / Seafood: 145 °F (62.8 °C)

Tips for Broiling

Beef

- Steaks and chops should always be allowed to rest for five minutes before being cut into and eaten. This allows the heat to distribute evenly through the food and creates a more tender and juicy result.
- Pieces of meat that are thicker than two inches should be removed from the refrigerator 30 minutes prior to cooking. This will help them cook more quickly and evenly, and will produce less smoke when broiling. Cooking times will likely be shorter than the times indicated in the Broiling Chart.
- For bone-in steaks or chops that have been *frenched* (all meat removed from around the bone), wrap the exposed sections of bone in foil to reduce burning.

Seafood

- When broiling skin-on fish, always use the Lo broil setting and always broil the skin side last.
- Seafood is best consumed immediately after cooking. Allowing seafood to rest after cooking can cause the food to dry out.
- It is a good idea to rub a thin coating of oil on the surface of the broiling pan before cooking to reduce sticking, especially with fish and seafood. You can also use a light coating of non-stick pan spray.

Vegetables

- Toss your vegetables lightly in oil before cooking to improve browning.

Warm

This function will maintain an oven temperature of 170 °F. The Warm function will keep cooked food warm for serving up to three hours after cooking has finished. The Warm function may be used without any other cooking operations or can be used after cooking has finished using a Timed Cook or a Delayed Timed Cook.

Setting the Warm Function

- 1 Press **Warm**.
- 2 Press **Start**.
- 3 Press **Clear/Off** at any time to cancel.

Setting the Warm Function after a Timed Cook

- 1 Select the cooking function.
- 2 Enter the oven temperature using the number keys.
- 3 Press **Cook Time** and enter the cook time using the number keys.
- 4 Press **Warm**.
- 5 Press **Start**.
- 6 When cooking is finished, press **Clear/Off** to cancel the Warm function.

NOTE

- The Warm function is intended to keep food warm. Do not use it to cool food down.
- It is normal for the fan to operate during the Warm function.

Proof

This feature maintains a warm oven for rising yeast leavened products before baking.

Setting the Proof Function

- 1 Use rack position 2 or 3 for proofing.
- 2 Press **Proof** until **PrF** appears in the display.
- 3 Press **Start**.
- 4 Press **Clear/Off** when proofing is finished.

NOTE

- To avoid lowering the oven temperature and lengthening proofing time, do not open the oven door unnecessarily. Check bread products early to avoid over proofing.
- Do not use the proofing mode for warming food or keeping food hot. The proofing oven temperature is not hot enough to keep foods at safe temperatures. Use the Warm feature to keep food warm. Proofing does not operate when the oven is above 125 °F. **Hot** shows in the display.
- It is normal for the fan to operate during the Proof function.

Sabbath Mode (For Model: LRE3083)

Sabbath mode is typically used on the Jewish Sabbath and Holidays. When the SABBATH mode is activated, the oven does not turn off until the SABBATH mode is deactivated. In SABBATH mode, all function buttons, except for the CLEAR/OFF is inactive. Sb will appear in both the cooktop and oven displays.

NOTE

- If the oven light is turned ON and the SABBATH mode is active, the oven light will remain ON until the SABBATH mode is turned OFF. If the oven light needs to be OFF, be sure to turn the oven light OFF before activating the SABBATH mode. SABBATH mode can only be used while baking (BAKE mode).

Setting the SABBATH mode

- 1 Press the **Bake** button.
- 2 Press the number buttons to enter the bake temperature.
- 3 Press the **START** button.
- 4 Press and hold the **Settings** button for three seconds. SB and will appear in the display when the Sabbath mode is activated.
- 5 To cancel the Sabbath mode, press and hold the Settings button for three seconds. To cancel the Bake function, press the **CLEAR/OFF** button at any time.

Changing the temperature while in SABBATH mode

- 1 Press the **Bake** button. (No tones will sound and the display will not change.)
- 2 Set the temperature using the number buttons.
- 3 Press the **START** button.

NOTE

- There is a 15 second delay before the oven will recognize the temperature change.

MAINTENANCE

Cleaning the Glass-Ceramic Cooktop

CAUTION

- Do not use scrub pads or abrasive cleaning pads. They may damage your cooktop surface.
- For your safety, wear an oven mitt or pot holder while using a scraper on the hot cooking surface.

Use ceramic cooktop cleaner on the glass cooktop. Other creams may not be as effective or may scratch, damage or stain the cooktop surface.

To maintain and protect the surface of the glass cooktop, follow these steps:

- 1 Before using the cooktop for the first time, clean it with a ceramic cooktop cleaner. This helps protect the top and makes cleanup easier.
- 2 Use ceramic cooktop cleaner daily to help keep the cooktop looking new.
- 3 Shake the cleaning cream well. Apply a few drops of cleaner directly to the cooktop.
- 4 Use a paper towel to clean the entire cooktop surface.
- 5 Rinse with clear water and use a dry cloth or paper towel to remove all cleaning residue.

NOTE

Do not heat the cooktop until it has been cleaned thoroughly.

IMPORTANT

If any sugar or food containing sugar (preserves, ketchup, tomato sauce, jellies, fudge, candy, syrups, chocolate) spills, or plastic or foil melts on the cooktop, remove the molten material IMMEDIATELY with a metal razor scraper (it will not damage the decorated cooking surface) while the cooking surface is still hot to avoid the risk of damage to the glass-ceramic surface. For your safety, please use an oven mitt or pot holder while scraping the hot cooking surface.

NOTE

Sugary spillovers (such as preserves, ketchup, tomato sauce, jellies, fudge, candy, syrups, chocolate) or melted plastics can cause pitting of the surface of your cooktop. (Not covered by the warranty)

Burned-On Residue

- 1 While the cooktop is still hot, remove any burnt on deposits or spilled food from the glass-ceramic cooking surface with a suitable metal razor scraper. (Similar to scraping paint off of a windowpane, it will not damage the decorated cooking surface.) Hold the scraper at an approximate 30° angle to the cooktop.

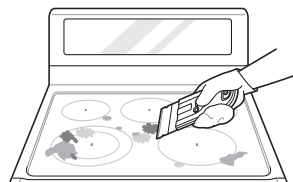

NOTE

- Do not use a dull or nicked blade.
 - To prevent burns, wear an oven mitt or pot holder while using the metal scraper.
- 2 When the cooking surface has cooled down, apply a few dabs (about the size of a dime) of an approved cleaner in each burner area and work the cleaning cream over the cooktop surface with a damp paper towel.



NOTE

Approved Ceramic Cooktop Cleaning Creams

- Weiman Cooktop Cleaning Cream (www.weiman.com)
- Cerama Bryte (www.ceramabryte.com)
- Golden Ventures Cerama Bryte

- 3 Rinse with clean water and wipe the cooktop surface with a clean, dry paper towel.

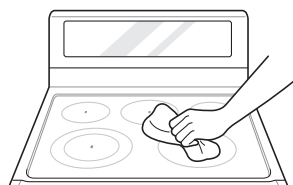

NOTE

If you don't have any ceramic cooktop cleaning cream handy, you can use Easy-Off® 3 in 1 Glass Top Cleaner Spray, BonAmi® or Soft Scrub (without bleach) to clean the cooktop. Rinse and dry the cooktop after cleaning.

Maintaining the Cooktop

DO NOT use chlorine bleach, ammonia, or other cleaners not specifically recommended for use on glass-ceramic cooktops.

Let your glass-ceramic cooking surface cool off before cleaning.

- Wipe off with a damp towel and mild detergent
- Use a metal scraper
- Apply cooktop cleaning cream. Rub with a towel.
- Rinse with a damp towel, then wipe dry.

Regular
Recommended after each use



Occasional
Recommended every week



Thorough
Recommended for tough stains or burnt-on food

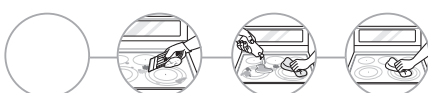

For additional product information, visit our website at www.lg.com

Metal Marks and Scratches

- 1** Be careful not to slide pots and pans across the cooktop. Doing so will leave metal markings on the cooktop surface. To help remove these marks, use a ceramic cooktop cleaner with a cleaning pad for ceramic cooktops.
- 2** If pots with a thin overlay of aluminum or copper are allowed to boil dry, the overlay may leave black discoloration on the cooktop. This should be removed immediately before heating again or the discoloration may be permanent.

CAUTION

Cookware with rough or uneven bottoms can mark or scratch the cooktop surface.

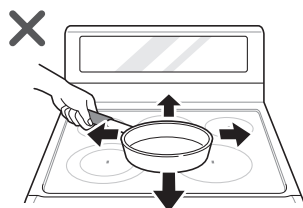

- Do not slide metal or glass across the cooktop surface.
- Do not use cookware with any dirt build-up on the bottom.

EasyClean®

LG's EasyClean® enamel technology provides two cleaning options for the inside of the range. The EasyClean® feature takes advantage of LG's new enamel to help lift soils without harsh chemicals, and it runs using **ONLY WATER** for just 20 minutes (10 minutes for Model LRE3060) in low temperatures to help loosen **LIGHT** soils before hand-cleaning.

• For Model : LRE3083

While EasyClean® is quick and effective for small and **LIGHT** soils, the Self Clean feature can be used to remove **HEAVY**, built up soils. The intensity and high heat of the Self Clean cycle may result in smoke which will require the opening up of windows to provide ventilation. Compared to the more intense Self Clean process, your LG oven gives you the option of cleaning with **LESS HEAT, LESS TIME,** and virtually **NO SMOKE OR FUMES.**

When needed, the range still provides the Self Clean option for longer, more thorough oven cleaning for heavier, built up soils.

Benefits of EasyClean®

- Helps loosen light soils before hand-cleaning
- EasyClean® only uses water; no chemical cleaners
- Makes for a better self-clean experience (For Model : LRE3083)
 - Delays the need for a self-clean cycle
 - Minimizes smoke and odors
 - Can allow shorter self-clean time

NOTE

Some models don't include a self-clean option. The EasyClean® feature may not be effective in removing heavy, built-up soils. If the range does not include a self-clean option, clean the oven regularly using the EasyClean® feature to prevent heavy, burnt-on soil from building up in the oven.

When to Use EasyClean®

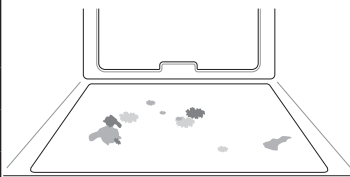
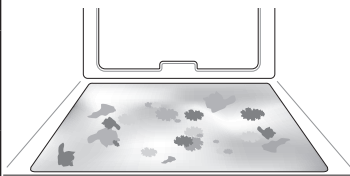
Suggested Cleaning Method	Example of Oven Soiling	Soil Pattern	Types of Soils	Common Food Items That Can Soil Your Oven
EasyClean®		Small drops or spots	Cheese or other ingredients	Pizza
		Light splatter	Fat/grease	Steaks, broiled
				Fish, broiled
				Meat roasted at low temperatures
Self Clean* (For Model : LRE3083)		Medium to heavy splatter	Fat/grease	Meat roasted at high temperatures
		Drops or spots	Filling or sugar based soils	Pies
			Cream or tomato sauce	Casseroles

* The Self Clean cycle can be used for soil that has been built up over time.

On models without the self-clean option, clean the oven frequently using EasyClean® to avoid the build up of tough, burnt-on soil.

Cleaning Tips

- Allow the oven to cool to room temperature before using the EasyClean® cycle. If your oven cavity is above 150 °F (65 °C), **Hot** will appear in the display, and the EasyClean® cycle will not be activated until the oven cavity cools down.
- Scraper can be used to scrape off any chunks or debris before and during oven cleaning.
- Using the rough side of a non-scratch scouring pad or scrubbing sponges may help to take off burnt-on stains better than a soft sponge or towel.
- Certain non-scratch scrubbing sponges, such as those made of melamine foam, available at your local stores, can also help improve cleaning.
- The range should be level to ensure that the bottom surface of the oven cavity is entirely covered by water at the beginning of the EasyClean® cycle.
- For best results, use distilled or filtered water. Tap water may leave mineral deposits on the oven bottom.
- Soil baked on through several cooking cycles will be more difficult to remove with the EasyClean® cycle.
- Do not open the oven door during the EasyClean® cycle. Water will not get hot enough if the door is opened during the cycle.
- For hard to reach areas such as the back surface it is better to use the Self Clean cycle.(For Model : LRE3083)

EasyClean® Instruction Guide

- 1 Remove oven racks and accessories from the oven.
- 2 Scrape off and remove any burnt-on debris with a plastic scraper.

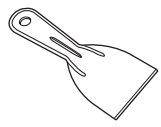

Suggested plastic scrapers:

 - Hard plastic spatula
 - Plastic pan scraper
 - Plastic paint scraper
 - Old credit card
- 3 Fill a spray bottle with water and use the spray bottle to thoroughly spray the inside surfaces of the oven.
- 4 Use at least 3.5 oz (for models LRE3061/ LRE3193/LRE3083) or 7 oz (for model LRE3060) of water in the bottle to completely saturate the soil on both of the oven walls and in the corners of the oven.

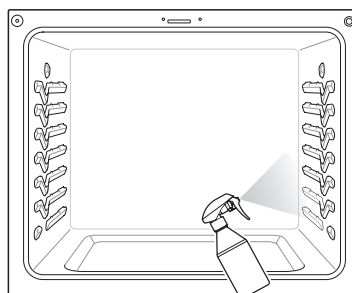

- 5 Spray or pour the remaining water onto the bottom center of the oven cavity. The indentation on the oven bottom should be fully covered to submerge all soils. Add water if necessary.

NOTE

If cleaning multiple ovens, use an entire bottle of water to clean each oven. Do not spray water directly on the door. Doing so will result in water dripping to the floor.

- 6 Close the oven door.
Press **EasyClean®**.
Press **Start**.



CAUTION

- Some surfaces may be hot after the EasyClean® cycle. Wear rubber gloves while cleaning to prevent burns.
- During the EasyClean® cycle, the oven becomes hot enough to cause burns. Wait until the cycle is over before wiping the inside surface of the oven. Failure to do so may result in burns.
- Avoid leaning or resting on the oven door glass while cleaning the oven cavity.

- 7 A chime will sound at the end of the 20 minutes cycle (10 minutes for Model LRE3060). Press **Clear/Off** to clear the display and turn off the chime.

- 8 After the cleaning cycle and during hand-cleaning, enough water should remain on the oven bottom to completely submerge all soils. Add water if necessary. Place a towel on the floor in front of the oven to capture any water that may spill out during hand-cleaning.

- 9 Clean the oven cavity immediately after the EasyClean® cycle by scrubbing with a wet, non-scratch scouring sponge or pad. (The scouring side will not scratch the finish.)

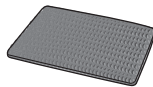

NOTE

Do not use any steel scouring pads, abrasive pads or cleaners as these materials can permanently damage the oven surface.

- 10 Once the oven cavity is cleaned, wipe any excess water with a clean dry towel. Replace racks and any other accessories.

- 11 If some light soils remain, repeat the above steps, making sure to thoroughly soak the soiled areas.

- For Model : LRE3083

If stubborn soils remain after multiple EasyClean® cycles, run the Self Clean cycle. Be sure that the oven cavity is empty of oven racks and other accessories, and that the oven cavity surface is dry before running the Self Clean cycle. Consult the Self Clean section of your owner's manual for further details.

If a self-clean option is not available, scrape off and remove stubborn soil using a scraper.

NOTE

- If you forget to saturate the inside of the oven with water before starting EasyClean®, press **Clear/Off** to end the cycle. Wait for the range to cool to room temperature and then spray or pour water into the oven and start another EasyClean® cycle.
- The cavity gasket may be wet when the EasyClean® cycle finishes. This is normal. Do not clean the gasket.
- If mineral deposits remain on the oven bottom after cleaning, use a cloth or sponge soaked in vinegar to remove them.
- It is normal for the fan to operate during the EasyClean® cycle.

Self Clean (For Model: LRE3083)

The Self Clean cycle uses extremely hot temperatures to clean the oven cavity. While running the Self Clean cycle, you may notice smoking or an odor. This is normal; especially if the oven is heavily soiled.

During Self Clean, the kitchen should be well ventilated to minimize the odors from cleaning.

Before Starting Self Clean

- Remove the oven racks, broiler pan, broiler grid, all cookware, aluminum foil or any other material from the oven.
- The kitchen should be well ventilated to minimize the odors from cleaning.
- Wipe any heavy spillovers on the bottom of the oven.
- Make sure that the oven light bulb cover is in place and the oven light is off.
- The oven light cannot be turned on during a Self Clean cycle. The oven light cannot be turned on until the oven temperature has cooled below 500 °F (260 °C) after a Self Clean cycle is complete.

CAUTION

- Do not leave small children unattended near the appliance. During the Self Clean cycle, the outside of the range can become very hot to the touch.
- If you have pet birds, move them to another well-ventilated room. The health of some birds is extremely sensitive to the fumes given off during the Self Clean cycle of any range.
- Do not line the oven walls, racks, bottom or any other part of the range with aluminum foil or any other material. Doing so will destroy heat distribution, produce poor baking results and cause permanent damage to the oven interior (aluminum foil will melt to the interior surface of the oven).
- Do not force the door open. This can damage the automatic door locking system. Use care when opening the oven door after the Self Clean cycle. Stand to the side of the oven when opening the door to allow hot air or steam to escape. The oven may still be VERY HOT.

During the Self Clean cycle, the cooktop elements cannot be used.

NOTE

- Remove oven racks and accessories before starting the Self Clean cycle.
- If oven racks are left in the oven cavity during the Self Clean cycle, they will discolor and become difficult to slide in and out.
- Clean the frame of the oven and door with hot soapy water. Rinse well.
- Do not clean the gasket. The fiberglass material of the oven door gasket cannot withstand abrasion. It is essential for the gasket to remain intact. If you notice it becoming worn or frayed, replace it.
- Wipe up any heavy spillovers on the oven bottom.
- Make sure that the oven light bulb cover is in place and the oven light is off.

Setting Self Clean

The Self Clean function has cycle times of 3, 4, or 5 hours.

Self Clean Soil Guide

Soil Level	Cycle Setting
Lightly Soiled Oven Cavity	3-Hour Self Clean
Moderately Soiled Oven Cavity	4-Hour Self Clean
Heavily Soiled Oven Cavity	5-Hour Self Clean

- 1 Remove all racks and accessories from the oven.
- 2 Press **Self Clean**. The oven defaults to the recommended four-hour self clean for a moderately soiled oven. Press twice for a five-hour self clean or three times for a three-hour self clean.
- 3 Press **Start**.
- 4 Once the self-clean cycle is set, the oven door locks automatically and the lock icon displays. You will not be able to open the oven door until the oven has cooled. The lock releases automatically when the oven has cooled.



CAUTION

Do not force the oven door open when the lock icon is displayed. The oven door remains locked until the oven temperature has cooled. Forcing the door open will damage the door.

Setting Self Clean with a Delayed Start

- 1 Remove all racks and accessories from the oven.
- 2 Press **Self Clean**. The oven defaults to the recommended four-hour self clean for a moderately soiled oven. Press twice for a five-hour self clean or three times for a three-hour self clean.
- 3 Press **Start Time**.
- 4 Use the number keys to enter the time of day you would like the Self Clean to start.
- 5 Press **Start**.

NOTE

It may become necessary to cancel or interrupt a Self Clean cycle due to excessive smoke or fire in the oven. To cancel the Self Clean function, press **Clear/Off**.

During Self Clean

- The Self Clean cycle uses extremely hot temperatures to clean the oven cavity. While running the Self Clean cycle, you may notice smoking or an odor. This is normal, especially if the oven is heavily soiled.
- As the oven heats, you may hear sounds of metal parts expanding and contracting. This is normal and will not damage the oven.
- Do not force the oven door open when the lock  is displayed. The oven door remains locked until the oven temperature has cooled. Forcing the door open will damage the door.

After the Self Clean Cycle

- The oven door remains locked until the oven temperature has cooled.
- You may notice some white ash in the oven. Wipe it off with a damp cloth or a soap-filled steel wool pad after the oven cools. If the oven is not clean after one self-clean cycle, repeat the cycle.
- If oven racks were left in the oven and do not slide smoothly after a self-clean cycle, wipe racks and rack supports with a small amount of vegetable oil to make them glide more easily.
- Fine lines may appear in the porcelain because it went through heating and cooling. This is normal and will not affect performance.

NOTE

- The Self Clean cycle cannot be started if the Lockout feature is active.
- Once the Self Clean cycle is set, the oven door locks automatically. You will not be able to open the oven door until the oven is cooled. The lock releases automatically.
- Once the door has been locked, the lock  indicator light stops flashing and remains on. Allow about 15 seconds for the oven door lock to activate.
- If the clock is set for a 12-hour display (default) the Delayed Self Clean can never be set to start more than 12 hours in advance.

Changing the Oven Light

The oven light is a standard 40-watt appliance bulb. It turns on when the oven door is open. When the oven door is closed, press **Light** to turn it on or off.

- 1 Unplug the range or disconnect power.
- 2 Turn the glass bulb cover in the back of the oven counterclockwise to remove.
- 3 Turn the bulb counterclockwise to remove it from the socket.
- 4 Insert the new bulb and turn it clockwise.
- 5 Insert the glass bulb cover and turn it clockwise.
- 6 Plug in the range or reconnect the power.

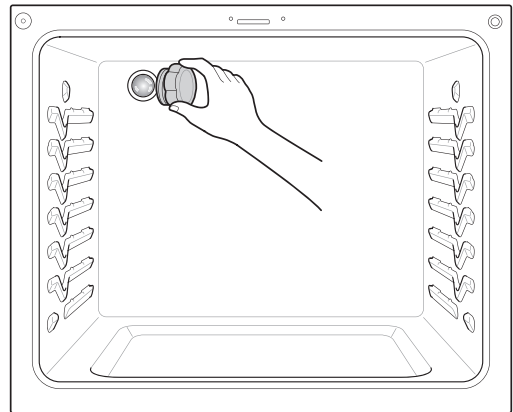

WARNING

- Make sure that the oven and bulb are cool.
- Disconnect the electrical power to the range at the main fuse or circuit breaker panel. Failure to do so can result in severe personal injury, death, or electrical shock.

Cleaning the Exterior

Painted and Decorative Trim

For general cleaning, use a cloth with hot soapy water. For more difficult soils and built-up grease, apply a liquid detergent directly onto the soil. Leave it on for 30 to 60 minutes. Rinse with a damp cloth and dry. Do not use abrasive cleaners.

Stainless Steel Surfaces

To avoid scratches, do not use steel wool pads.

- 1 Place a small amount of stainless steel appliance cleaner or polish on a damp cloth or paper towel.
- 2 Clean a small area, rubbing with the grain of the stainless steel if applicable.
- 3 Dry and buff with a clean, dry paper towel or soft cloth.
- 4 Repeat as necessary.

NOTE

To prevent scratching, do not use abrasive cleaners on any of these materials.

NOTE

- Do not use a steel wool pad. It will scratch the surface.
- To clean the stainless steel surface, use warm sudsy water or a stainless steel cleaner or polish.
- Always wipe in the direction of the metal surface finish.
- To purchase stainless steel appliance cleaner or polish, or to locate a dealer near you, call our toll-free customer service number:
1-800-243-0000 (USA),
1-888-542-2623 (CANADA)
or visit our website at: www.lg.com

Oven Door

- Use soapy water to thoroughly clean the oven door. Rinse well. Do not immerse the door in water.
- You may use a glass cleaner on the outside glass of the oven door. Do not spray water or glass cleaner on the door vents.
- Do not use oven cleaners, cleaning powders, or harsh abrasive cleaning materials on the outside of the oven door.
- Do not clean the oven door gasket. The oven door gasket is made of a woven material that is essential for a good seal. Care should be taken not to rub, damage, or remove this gasket.



CAUTION

Do not use harsh cleaners or harsh abrasive cleaning materials on the outside of the oven door. Doing so can cause damage.

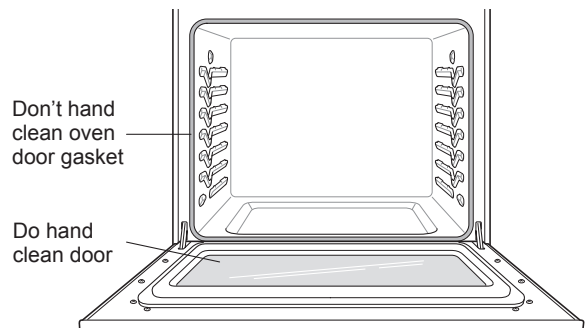

Broiler Pan and Grid

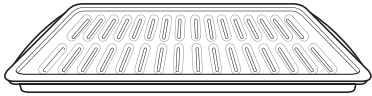

- Do not store a soiled broiler pan or grid anywhere in the range.
- Do not clean the broiler pan or grid in a self-cleaning mode.
- Remove the grid from the pan. Carefully pour out the grease from the pan into a proper container.
- Wash and rinse the broiler pan and grid in hot water with a soap-filled or plastic scouring pad.
- If food has burned on, sprinkle the grid with cleaner while hot and cover with wet paper towels or a dishcloth. Soaking the pan will remove burned-on foods.
- Both the broiler pan and grid may be cleaned with a commercial oven cleaner or in the dishwasher.

Oven Racks

Remove the oven racks before operating the self clean cycle.

- 1 Food spilled into the tracks could cause the racks to become stuck. Clean racks with a mild, abrasive cleaner.
- 2 Rinse with clean water and dry.

NOTE

If the racks are cleaned using the self clean cycle (not recommended), the color will turn slightly blue and the finish will become dull. After the self clean cycle is complete, and the oven has cooled, rub the sides of the racks with wax paper or a cloth containing a small amount of vegetable oil. This will make the racks glide more easily into the rack tracks.

Removing and Replacing the Lift-Off Oven Doors and Drawer

CAUTION

- Be careful when removing and lifting the door.
- Do not lift the door by the handle. The door is very heavy.

Removing the Door

- 1 Fully open the door.
- 2 Unlock the hinge locks, rotating them as far toward the open door frame as they will go.

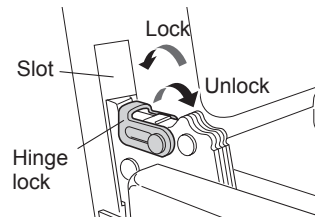

- 3 Firmly grasp both sides of the door at the top.
- 4 Close the door to the removal position (approximately five degrees) which is halfway between the broil stop position and fully closed. If the position is correct, the hinge arms will move freely.

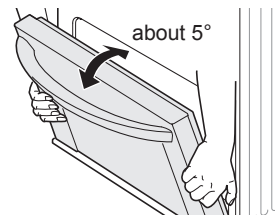

- 5 Lift door up and out until the hinge arms are clear of the slots.

Replacing the Door

- 1 Firmly grasp both sides of the door at the top.
- 2 With the door at the same angle as the removal position, seat the indentation of the hinge arms into the bottom edge of the hinge slots. The notch in the hinge arms must be fully seated into the bottom edge of the slots.

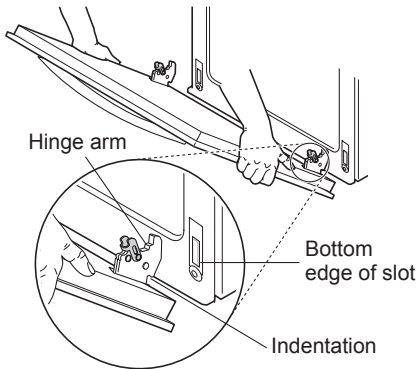

- 3 Open the door fully. If the door will not open fully, the indentation is not seated correctly in the bottom edge of the slots.
- 4 Lock the hinge locks, rotating them back toward the slots in the oven frame until they lock.

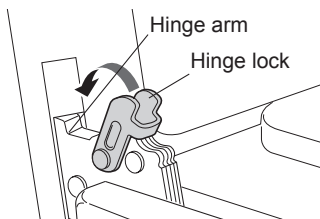

- 5 Close the oven door.

Removing the Drawer



CAUTION

Disconnect the electrical power to the range at the main fuse or circuit breaker panel. Failure to do so can result in severe personal injury, death, or electrical shock.

Most cleaning can be done with the drawer in place; however, the drawer may be removed if further cleaning is needed. Use warm water to thoroughly clean.

- 1 Fully open the drawer.
- 2 Locate the glide lever on each side of the drawer. Push down on the left glide lever and pull up on the right glide lever.

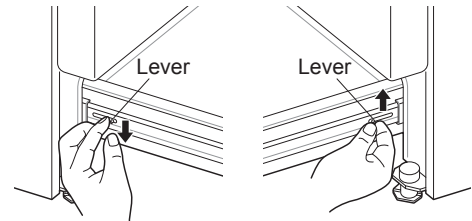

- 3 While holding both levers, carefully pull the drawer away from the range.

Replacing the Drawer

- 1 Pull the bearing glides to the front of the chassis glide.
- 2 Align the glide on each side of the drawer with the glide slots on the range.
- 3 Push the drawer into the range until levers click (approximately 2 inch).
- 4 Pull the drawer open again to seat bearing glides into position.

Door Care Instructions

Most oven doors contain glass that can break.



CAUTION

- Do not close the oven door until all the oven racks are fully in place.
- Do not hit the glass with pots, pans, or any other object.
- Scratching, hitting, jarring, or stressing the glass may weaken its structure causing an increased risk of breakage at a later time.

TROUBLESHOOTING

FAQs

What types of cookware are recommended for use with the cooktop?

- The pans must have a flat bottom and straight sides.
- Only use heavy-gauge pans.
- The pan size must match the amount of food to be prepared and the size of the surface element.
- Use tight fitting lids.
- Only use flat-bottom woks.

Why does “HS” appear on the cooktop display?

HS (Hot Surface) will appear in the display once the element is turned off or during the self clean cycle. The HS indicator will stay on until the surface has cooled to approximately 150°F (66°C) or when the self clean cycle ends.

Why do the heating elements appear to be turning ON and OFF during use of the cooktop or oven?

Depending on your cooktop element setting or the temperature selected in your oven, it is NORMAL for the cooking elements to cycle on and off.

My new oven doesn't cook like my old one. Is there something wrong with the temperature settings?

No, your oven has been factory tested and calibrated. For the first few uses, follow your recipe times and temperatures carefully. If you still think your new oven is too hot or too cold, you can adjust the oven temperature yourself to meet your specific cooking needs. Refer to the Oven Temperature Adjustment section in this manual for easy instructions on how to adjust your thermostat.

Is it normal to hear a clicking noise coming from the back of my oven when I am using it?

Your new range is designed to maintain a tighter control over your oven's temperature. You may hear your oven's heating elements click on and off more frequently on your new oven. This is NORMAL.

Why is the time flashing?

This means that the product has just been plugged in, or that it has experienced a power interruption. To clear the flashing time, press any button and reset the clock if needed.

During convection cooking the fan stops when I open the door. Is that normal? (For Model: LRE3061 / LRE3193 / LRE3083)

Yes, this is normal. When the door is opened, the convection fan will stop until the door is closed.

Can I use aluminum foil to catch drippings in my oven cavity?

Never use aluminum foil to line the bottom or sides of the oven or the warming drawer. The foil will melt and stick to the bottom surface of the oven and will not be removable. Use a sheet pan placed on a lower oven rack to catch drippings instead. (If foil has already melted onto the bottom of the oven, it will not interfere with the oven's performance.)

Can I use aluminum foil on the racks?

Do not cover racks with aluminum foil. Covering entire racks with foil restricts air flow, leading to poor cooking results. Use a sheet pan lined with foil under fruit pies or other acidic or sugary foods to prevent spillovers from damaging the oven finish.

CAUTION

Foil may be used to wrap food in the oven or warming drawer, but do not allow the foil to come into contact with the exposed heating/broiling elements in the oven. The foil could melt or ignite, causing smoke, fire, or injury.

Can I leave my racks in the oven when running a Self Clean cycle? (For Model : LRE3083)

No. Although it will not damage the racks, it will discolor them and may make them hard to slide in and out during use. Remove all items from the oven before starting a Self Clean cycle.

What should I do if my racks are sticky and have become hard to slide in and out?

Over time, the racks may become hard to slide in and out. Apply a small amount of olive oil to the ends of the racks. This will work as a lubricant for easier gliding.

What should I do for hard to remove stains on my cooktop?

The cooktop should be cleaned after every use to prevent permanent staining. When cooking foods with high sugar content, such as tomato sauce, clean the stain off with a scraper while the cooktop is still warm. Use an oven mitt when scraping to prevent burns. Refer to the MAINTENANCE section of this owner's manual for further instruction.

Why aren't the function buttons working?

Make sure that the range is not in Lockout mode. The lock  will show in the display if Lockout is activated. To deactivate Lockout, press and hold **Clear/Off** for three seconds. The unlock melody sounds and **Loc** appears in the display until the controls are unlocked.

How can I help keep children safe around the range?

Children should be supervised around the range whenever it is in use, and after use until surfaces have cooled. You can also use the Lockout feature to help prevent children from accidentally turning on the cooktop or oven. The Lockout feature disables most control panel buttons and the cooktop control knobs. On some models, it also locks the oven door. Consult the Lockout section of your owner's manual for details. (In models without a self-clean option, the Lockout feature locks the controls but does not lock the oven door.)

My range is still dirty after running the EasyClean® cycle. What else should I do?

The EasyClean® cycle only helps to loosen light soils in your oven range to assist in hand-cleaning of your oven. It does not automatically remove all soils after the cycle. Some scrubbing of your oven range is required after running the EasyClean® cycle.

I tried scrubbing my oven after running EasyClean®, but some soils still remain. What can I do?

The EasyClean® feature works best when the soils are fully soaked and submerged in water before running the cycle and during hand-cleaning. If soils are not sufficiently soaked in water, it can negatively affect the cleaning performance. Repeat the EasyClean® process using sufficient water. Sugar-based and certain greasy soils are especially hard to clean. If some stubborn soils remain, use the Self Clean feature to thoroughly clean your oven. If a self-clean feature is not available, use a scraper to remove stubborn soil.

Soils on my oven walls are not coming off. How can I get my walls clean?

Soil on the side and rear walls of the oven may be more difficult to soak with water. Repeat the EasyClean® process using more water on stubborn soil than the directions call for.

Will EasyClean® get all of the soils and stains out completely?

It depends on the soil type. Sugar-based and certain grease stains are especially hard to clean. Also, if stains are not sufficiently soaked in water, this can negatively affect cleaning performance. If stubborn or built-up stains remain, use the Self Clean feature. Refer to the Self Clean section of your owner's manual. Some models do not include a self-clean option. The EasyClean® feature may not be effective in removing heavy, built up soil. If a self-clean option is not available, it may help to use EasyClean® more often to avoid heavy soil build up.

Are there any tricks to getting some of the stubborn soils out?

Scraping the soils with a plastic scraper before and during hand cleaning is recommended. If using a metal scraper, be careful not to damage the oven surface. Fully saturating soils with water is also recommended.

- For Model : LRE3083
Certain types of soil are harder to clean than others. For these stubborn soils, use the Self Clean cycle. Consult the Self Clean section of the owner's manual for details.

Is it safe for my convection fan, broil burner or heater element to get wet during EasyClean®?

Yes. The convection fan, broiler burner or heater element may get a little wet during cleaning. However, direct spray onto the broil burner and heater elements is not necessary because these are self-cleaning during regular use.

Do I need to use the full contents of the spray bottle for EasyClean®?

Yes. For best results, use 3 ½ oz of water (for models LRE3061/LRE3193/LRE3083) or 7 oz of water (for models with an 18 oz spray bottle) to spray the oven walls and corners until they are saturated. Then spray or pour the remaining water on the bottom of the oven. Soil must be fully saturated with water and the bottom surface of the oven fully covered by water for best cleaning performance.

I see smoke coming out of my oven range's cooktop vents during EasyClean®. Is this normal?

This is normal. This is not smoke. It is actually water vapor (steam) from the water in the oven cavity. As the oven heats briefly during EasyClean®, the water in the cavity evaporates and escapes through the oven vents.

How often should I use EasyClean®?

EasyClean® can be performed as often as you wish. However, if a self-clean option is not available on your oven, you may want to use the EasyClean® option often to prevent heavy, burnt-on soil from building up. EasyClean® works best when your oven is LIGHTLY soiled from such things as LIGHT grease splatter and small drops of cheese. Please refer to the EasyClean® section in your owner's manual for more information.

What is required for EasyClean®?

A spray bottle filled with water, a scraper, a nonscratch scrubbing pad and a towel. You should not use abrasive scrubbers such as heavy-duty scouring pads or steel wool. Except for a towel and a scraper, all of the materials you need are included in a special cleaning kit with your new range.

Before Calling for Service

Before you call for service, review this list. It may save you time and expense. The list includes common occurrences that are not the result of defective workmanship or materials in this appliance.

Symptoms	Possible Causes / Solutions						
Range is not level.	<ul style="list-style-type: none"> • Poor installation. Place oven rack in center of oven. Place a level on the oven rack. Adjust leveling legs at base of range until the oven rack is level. • Be sure floor is level and strong and stable enough to adequately support range. • If floor is sagging or sloping, contact a carpenter to correct the situation. • Kitchen cabinet alignment may make range appear unlevel. Be sure cabinets are square and have sufficient room for range clearance. 						
Cannot move appliance easily. Appliance must be accessible for service.	<ul style="list-style-type: none"> • Cabinets not square or are built in too tightly. Contact builder or installer to make appliance accessible. • Carpet interferes with range. Provide sufficient space so range can be lifted over carpet. • Anti-tip device engaged. 						
Oven control beeps and displays any F code error.	<ul style="list-style-type: none"> • Electronic control has detected a fault condition. Press Clear/Off to clear the display and stop beeping. Reprogram oven. If fault recurs, record fault number. Press Clear/Off and contact a Service agent. <table border="1" data-bbox="842 717 1277 858"> <thead> <tr> <th>CODE</th> <th>CAUSE</th> </tr> </thead> <tbody> <tr> <td>F-3</td> <td>Key short error</td> </tr> <tr> <td>F-9</td> <td>Oven not heating</td> </tr> </tbody> </table>	CODE	CAUSE	F-3	Key short error	F-9	Oven not heating
CODE	CAUSE						
F-3	Key short error						
F-9	Oven not heating						
Surface units will not maintain a rolling boil or cooking is not fast enough	<ul style="list-style-type: none"> • Improper cookware being used. <ul style="list-style-type: none"> - Use pans which are flat and match the diameter of the surface unit selected. • In some areas, the power (voltage) may be low. <ul style="list-style-type: none"> - Cover pan with a lid until desired heat is obtained. 						
Surface units do not work properly	<ul style="list-style-type: none"> • A fuse in your home may be blown or the circuit breaker tripped. <ul style="list-style-type: none"> - Replace the fuse or reset the circuit breaker. • Cooktop controls improperly set. <ul style="list-style-type: none"> - Check to see the correct control is set for the surface unit you are using. 						
Surface unit stops glowing when changed to a lower setting	<ul style="list-style-type: none"> • This is normal. The unit is still on and hot. 						
Areas of discoloration on the cooktop	<ul style="list-style-type: none"> • Food spillovers not cleaned before next use. <ul style="list-style-type: none"> - See Cleaning the Glass-Ceramic Cooktop section. • Hot surface on a model with a light-colored cooktop. <ul style="list-style-type: none"> - This is normal. The surface may appear discolored when it is hot. This is temporary and will disappear as the glass cools. 						
Frequent cycling on and off of surface units	<ul style="list-style-type: none"> • This is normal. <ul style="list-style-type: none"> - The element will cycle on and off to maintain the heat setting. 						

Symptoms	Possible Causes / Solutions
Oven will not work	<ul style="list-style-type: none"> • Plug on range is not completely inserted in the electrical outlet. <ul style="list-style-type: none"> - Make sure electrical plug is plugged into a live, properly grounded outlet. • A fuse in your home may be blown or the circuit breaker tripped. <ul style="list-style-type: none"> - Replace the fuse or reset the circuit breaker. • Oven controls improperly set. <ul style="list-style-type: none"> - See the Using the Oven section. • Oven too hot. <ul style="list-style-type: none"> - Allow the oven to cool to below locking temperature.
Steam is exhausted through the oven vent.	<ul style="list-style-type: none"> • Cooking foods with high moisture produces steam. This is normal.
Appliance does not operate.	<ul style="list-style-type: none"> • Make sure cord is plugged correctly into outlet. Check circuit breakers. • Service wiring is not complete. Contact your electrician for assistance. • Power outage. Check house lights to be sure. Call your local electric company for service.
Oven light does not work.	<ul style="list-style-type: none"> • Replace or tighten bulb. See Changing the Oven Light section in this Owner's Manual.
Oven smokes excessively during broiling.	<ul style="list-style-type: none"> • Control not set properly. Follow instructions under Setting Oven Controls. • Meat too close to the element. Reposition the rack to provide proper clearance between the meat and the element. Preheat broil element for searing. • Meat not properly prepared. Remove excess fat from meat. Cut remaining fatty edges to prevent curling. • Insert on broiler pan wrong side up and grease not draining. Always place grid on the broiler pan with ribs up and slots down to allow grease to drip into pan. • Grease has built up on oven surfaces. Regular cleaning is necessary when broiling frequently. <ul style="list-style-type: none"> - Old grease or food spatters cause excessive smoking.
Food does not bake or roast properly	<ul style="list-style-type: none"> • Oven controls improperly set. <ul style="list-style-type: none"> - See the Using the Oven section. • Rack position is incorrect or the rack is not level. <ul style="list-style-type: none"> - See the Using the Oven section. • Incorrect cookware or cookware of improper size being used. <ul style="list-style-type: none"> - See the Using the Oven section. • Oven sensor needs to be adjusted. <ul style="list-style-type: none"> - See Oven Temperature Adjustment in the Features section.
Food does not broil properly	<ul style="list-style-type: none"> • Oven controls improperly set. <ul style="list-style-type: none"> - Make sure you press Broil. • Improper rack position being used. <ul style="list-style-type: none"> - See the Broiling Guide. • Cookware not suited for broiling. <ul style="list-style-type: none"> - Use broiling pan and grid.

Symptoms	Possible Causes / Solutions
Food does not broil properly	<ul style="list-style-type: none"> Aluminum foil used on the broiling pan and grid has not been fitted properly and slit as recommended. <ul style="list-style-type: none"> - See the Using the Oven section. In some areas the power voltage may be low. <ul style="list-style-type: none"> - Preheat the broil element for 5-7 minutes. - See the Broiling Guide.
Oven temperature too hot or too cold	<ul style="list-style-type: none"> Oven sensor needs to be adjusted. <ul style="list-style-type: none"> - See Oven Temperature Adjustment in the Features section.
Scratches or abrasions on cooktop surface	<ul style="list-style-type: none"> Coarse particles such as salt or sand between cooktop and utensils can cause scratches. Be sure the cooktop surface and bottoms of utensils are clean before using. Small scratches do not affect cooking and will become less visible with time. Cleaning materials not recommended for glass-ceramic cooktop have been used. See Cleaning the Glass-Ceramic Cooktop in the MAINTENANCE section. Cookware with rough bottom has been used. Use smooth, flat-bottomed cookware.
Metal marks	<ul style="list-style-type: none"> Scraping of metal utensils on cooktop surface. Do not slide metal utensils on cooktop surface. Use a glass-ceramic cooktop cleaning creme to remove the marks. See Cleaning the Glass-Ceramic Cooktop in the MAINTENANCE section.
Brown streaks or specks	<ul style="list-style-type: none"> Boilovers are cooked onto surface. Use a blade scraper to remove soil. See Cleaning the Glass-Ceramic Cooktop in the MAINTENANCE section.
Areas of discoloration on cooktop	<ul style="list-style-type: none"> Mineral deposits from water and food. Remove using a glass-ceramic cooktop cleaning creme. Use cookware with clean, dry bottoms.
Oven will not Self Clean*	<ul style="list-style-type: none"> The oven temperature is too high to set a Self Clean operation. <ul style="list-style-type: none"> - Allow the range to cool and reset the controls. Oven controls improperly set. <ul style="list-style-type: none"> - See the Self Clean section. A Self Clean cycle cannot be started if the oven lockout feature is active.
"Crackling" or "popping" sound*	<ul style="list-style-type: none"> This is the sound of the metal heating and cooling during both the cooking and Self Clean functions. <ul style="list-style-type: none"> - This is normal.
Fan noise	<ul style="list-style-type: none"> A convection fan may automatically turn on and off. <ul style="list-style-type: none"> - This is normal.
Convection Fan stops	<ul style="list-style-type: none"> Convection fan stops during a convection bake cycle. <ul style="list-style-type: none"> - This is normal and is done to allow for more even heating during the cycle. This is not a failure of the range and should be considered normal operation.
Displayed Time is flashing	<ul style="list-style-type: none"> This is normal. This means that the product has just been plugged in, or that it has experienced a power interruption. Press the Clock key and reset the time, or press any key to stop the flashing.

* For Model : LRE3083

Symptoms	Possible Causes / Solutions
Excessive smoking during a Self Clean cycle.*	<ul style="list-style-type: none"> Excessive soil. <ul style="list-style-type: none"> Press the Clear/Off button. Open the windows to rid the room of smoke. Wait until the Self Clean mode is cancelled. Wipe up the excess soil and reset the clean.
Oven door does not open after a Self Clean cycle.*	<ul style="list-style-type: none"> Oven is too hot. <ul style="list-style-type: none"> Allow the oven to cool below locking temperature. Allow about one hour for the oven to cool after the completion of a Self Clean cycle. The door can be opened when the lock  is no longer displayed. The control and door may be locked.
The oven does not clean after a Self Clean cycle.*	<ul style="list-style-type: none"> Oven controls not properly set. <ul style="list-style-type: none"> See the Self Clean section. Oven was heavily soiled. <ul style="list-style-type: none"> Clean up heavy spillovers before starting the clean cycle. Heavily soiled ovens may need to Self Clean again or for a longer period of time.
CLEAN and door flash in the display.*	<ul style="list-style-type: none"> The Self Clean cycle has been selected, but the door is not closed. <ul style="list-style-type: none"> Close the oven door.
LOCKED is on in the display when you want to cook.*	<ul style="list-style-type: none"> The oven door is locked because the temperature inside the oven has not dropped below the locking temperature. <ul style="list-style-type: none"> Press the Clear/Off button. Allow the oven to cool.
Burning or oily odor emitting from the vent.*	<ul style="list-style-type: none"> This is normal in a new oven and will disappear in time. <ul style="list-style-type: none"> To speed the process, set a Self Clean cycle for a minimum of 3 hours. See the Self Clean section.
Oven racks are difficult to slide.*	<ul style="list-style-type: none"> The shiny, silver-colored racks were cleaned in a Self Clean cycle. <ul style="list-style-type: none"> Apply a small amount of vegetable oil to a paper towel and wipe the edges of the oven racks with the paper towel.
Moisture collects on oven window or steam comes from oven vent	<ul style="list-style-type: none"> This is normal when cooking foods high in moisture. Excessive moisture was used when cleaning the window.

* For Model : LRE3083

SMART DIAGNOSIS™ FUNCTION

(For Model: LRE3061 / LRE3193 / LRE3060)

Should you experience any problems with the appliance, it has the capability of transmitting data via your telephone to the LG Customer Information Center. NFC or Wi-Fi equipped models can also transmit data to a smartphone using the LG SmartThinQ application.

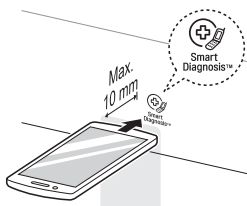

Smart Diagnosis™ through the Customer Information Center

- For appliances with the  or  logo

This method allows you to speak directly to our trained specialists. The specialist records the data transmitted from the appliance and uses it to analyze the issue, providing a fast and effective diagnosis.

- 1 Call the LG call center at: (LG U.S.) 1-800-243-0000 (LG Canada) 1-888-542-2623.
- 2 When instructed to do so by the call center agent, hold the mouthpiece of your phone over the Smart Diagnosis™ logo on the machine. Hold the phone no more than one inch from (but not pressing) the machine.

NOTE

Do not press any other buttons or icons on the display screen.

- 3 Press and hold the **Start** button for three seconds.
- 4 Keep the phone in place until the tone transmission has finished. This takes about 6 seconds and the display will count down the time.
- 5 Once the countdown is over and the tones have stopped, resume your conversation with the call center agent, who will then be able to assist you in using the information transmitted for analysis.

NOTE

- For best results, do not move the phone while the tones are being transmitted.
- If the call center agent is not able to get an accurate recording of the data, you may be asked to try again.

LG SmartThinQ Smart Diagnosis™

- For appliances with the  or  logo

Use the Smart Diagnosis feature in the LG SmartThinQ application for help diagnosing issues with the appliance without the assistance of the LG Customer Information Center.

Follow the instructions in the LG SmartThinQ application to perform a Smart Diagnosis using your smartphone.

- 1 Download the LG SmartThinQ application on your smart phone by searching for **LG SmartThinQ** at Play Store.
- 2 Open the LG SmartThinQ application on your smart phone.
- 3 Follow directions of the application. The application will show how to use Audible Diagnosis.
- 4 Press [?] in the LG SmartThinQ application for a more detailed guide on how to use the Smart Diagnosis function.

NOTE

- Smart Diagnosis™ cannot be activated unless the appliance can be turned on using the **Power** button. If the appliance cannot be turned on, troubleshooting must be done without using Smart Diagnosis™.
- Call quality differences by region may affect the function.
- Use the home telephone for better communication performance, resulting in better service.
- Bad call quality may result in poor data transmission from your phone to the machine, which could cause Smart Diagnosis™ to malfunction.

LIMITED WARRANTY (USA)

ARBITRATION NOTICE: THIS LIMITED WARRANTY CONTAINS AN ARBITRATION PROVISION THAT REQUIRES YOU AND LG TO RESOLVE DISPUTES BY BINDING ARBITRATION INSTEAD OF IN COURT, UNLESS YOU CHOOSE TO OPT OUT. IN ARBITRATION, CLASS ACTIONS AND JURY TRIALS ARE NOT PERMITTED. PLEASE SEE THE SECTION TITLED "PROCEDURE FOR RESOLVING DISPUTES" BELOW.

Should your LG Electric Range ("Product") fail due to a defect in materials or workmanship under normal and proper use, during the warranty period set forth below, LG Electronics ("LG") will, at its option, repair or replace the Product. This limited warranty is valid only to the original retail purchaser of the Product and applies only when purchased and used within the United States including U.S. Territories.

Warranty Period	Scope of Warranty	HOW SERVICE IS HANDLED
One (1) year from date of original retail purchase	Parts and Labor (internal / functional parts only)	LG will provide, free of charge, all labor and in-home service to replace defective part(s).

- Replacement products and parts are warranted for the remaining portion of the original warranty period or ninety (90) days, whichever is greater.
- Replacement products and parts may be new, reconditioned, refurbished, or otherwise factory remanufactured.
- Proof of original retail purchase specifying the Product model and date of purchase is required to obtain warranty service under this limited warranty.

EXCEPT TO THE EXTENT PROHIBITED BY APPLICABLE LAW, ANY IMPLIED WARRANTY OF MERCHANTABILITY OR FITNESS FOR A PARTICULAR PURPOSE ON THE PRODUCT IS LIMITED IN DURATION TO THE DURATION OF THE ABOVE LIMITED WARRANTY. UNDER NO CIRCUMSTANCES SHALL LG OR ITS U.S. DISTRIBUTORS/DEALERS BE LIABLE FOR ANY INDIRECT, INCIDENTAL, CONSEQUENTIAL, SPECIAL, OR PUNITIVE DAMAGES, INCLUDING, WITHOUT LIMITATION, LOST GOODWILL, LOST REVENUES OR PROFITS, WORK STOPPAGE, IMPAIRMENT OF OTHER GOODS, COST OF REMOVAL AND REINSTALLATION OF THE PRODUCT, LOSS OF USE, OR ANY OTHER DAMAGES WHETHER BASED IN CONTRACT, TORT, OR OTHERWISE. LG'S TOTAL LIABILITY, IF ANY, SHALL NOT EXCEED THE PURCHASE PRICE PAID BY YOU FOR THE PRODUCT.

Some states do not allow the exclusion or limitation of incidental or consequential damages or limitations on how long an implied warranty lasts, so the above exclusions or limitations may not apply to you. This limited warranty gives you specific legal rights and you may also have other rights that vary from state to state.

THIS LIMITED WARRANTY DOES NOT COVER:

- Service trips to deliver, pick up, or install, educate how to operate, correct wiring, or correct unauthorized repairs.
- Damage or failure of the Product to perform during power failures and interrupted or inadequate electrical service.
- Damage or failure resulting from operating the Product in a corrosive atmosphere or contrary to the Product owner's manual.
- Damage or failure to the Product caused by accidents, pests and vermin, lightning, wind, fire, floods, acts of God, or any other causes beyond the control of LG.
- Damage or failure caused by unauthorized modification or alteration, or if used for other than the intended purpose.
- Damage or failure resulting from misuse, abuse, improper installation, repair, or maintenance. Improper repair includes use of parts not authorized by LG. Improper installation or maintenance includes installation or maintenance contrary to the Product owner's manual.
- Damage or failure caused by incorrect electrical current, voltage, or ventilation/plumbing codes.
- Damage or failure caused by transportation and handling, including scratches, dents, chips, and/or other damage to the finish of the Product, unless such damage is reported within one (1) week of delivery.
- Damage or missing items to any display, open box, or discounted Product.
- Refurbished Product or any Product sold "As Is", "Where Is", "With all Faults", or similar disclaimer.
- Products with original serial numbers that have been removed, altered, or cannot be readily determined.
- Increases in utility costs and additional utility expenses.

- Any noises associated with normal operation.
- Use of accessories, components, or consumable cleaning products that are not authorized by LG.
- Replacement of light bulbs, filters, or any consumable parts.
- When Product is used for other than normal and proper household use (e.g. commercial or industrial use, offices, and recreational facilities or vehicles) or contrary to the Product's owner's manual.
- Costs associated with removal and reinstallation of your Product for repairs.
- Shelves, drawers and accessories, except for internal/functional parts covered under this limited warranty.

Not Covered by this Limited Warranty

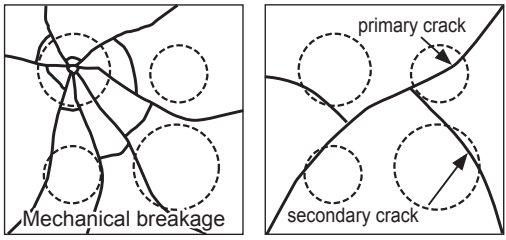
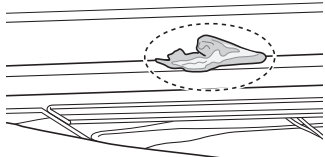
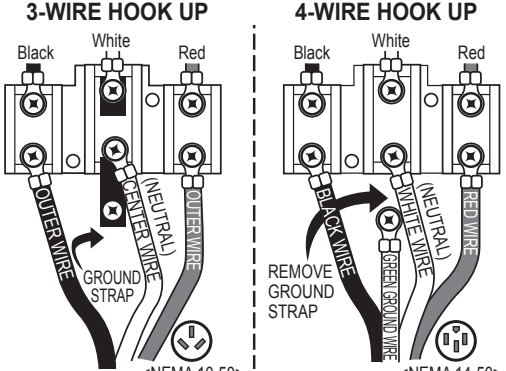
Problem	Cause	Prevention
<ul style="list-style-type: none"> • Cooktop crack 	<p>Cooktop crack caused by impact of object</p>  <p>out of warranty in warranty</p> <ul style="list-style-type: none"> • Damage caused after delivery (Not covered by warranty) 	<ul style="list-style-type: none"> • DO NOT store heavy items above the cooktop surface as they could fall and damage it. • DO NOT scratch the cooktop or the cooktop could crack. • Clean the cooktop before and after using.
<ul style="list-style-type: none"> • Cooktop enamel chipping off 	<p>Improper usage</p> 	<ul style="list-style-type: none"> • Do not hit the enamel cooktop.
<ul style="list-style-type: none"> • Pitting of the cooktop glass 	<ul style="list-style-type: none"> • If not removed immediately, sugary spillovers (such as preserves, ketchup, tomato sauce, jellies, fudge, candy, syrups, or chocolate) or melted plastic or foil can cause surface pitting of the cooktop. (Not covered by warranty) 	<ul style="list-style-type: none"> • Remove the molten material IMMEDIATELY with a metal razor scraper. • For safety, wear an oven mitt or hot pad while scraping the hot surface.
<ul style="list-style-type: none"> • Unit has no power 	<ol style="list-style-type: none"> 1. House power turned off (power supply) 2. Tripped breaker 3. The power cord is not installed properly.  <p>3-WIRE HOOK UP 4-WIRE HOOK UP</p> <p><NEMA 10-50> <NEMA 14-50></p>	<ul style="list-style-type: none"> • Check power at main board before calling for service. • Match power cord type and outlet type • Properly install the power cord

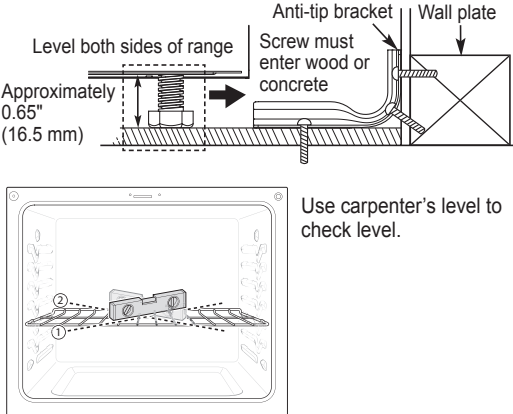
Problem	Cause	Prevention
<ul style="list-style-type: none"> Oven or racks are stained after using aluminum foil 	<p>Aluminum foil has melted in the oven</p> 	<ul style="list-style-type: none"> Never cover the oven bottom or cover an entire rack with materials such as aluminum foil. If the foil has already melted onto the oven, it will not affect the performance of the oven.
<ul style="list-style-type: none"> Surface is not level Oven is tipping 	<ol style="list-style-type: none"> Range not leveled Anti-tip device not installed correctly  <p>Use carpenter's level to check level.</p>	<ul style="list-style-type: none"> Check with installer first

The cost of repair or replacement under the above excluded circumstances shall be borne by the consumer.

TO OBTAIN WARRANTY SERVICE AND ADDITIONAL INFORMATION

Call 1-800-243-0000 and select the appropriate option from the menu.

Or visit our website at <http://www.lg.com>

Or by mail: LG Electronics Customer Service P.O. Box 240007 Huntsville, AL 35813 ATTN: CIC

PROCEDURE FOR RESOLVING DISPUTES:

ALL DISPUTES BETWEEN YOU AND LG ARISING OUT OF OR RELATING IN ANY WAY TO THIS LIMITED WARRANTY OR THE PRODUCT SHALL BE RESOLVED EXCLUSIVELY THROUGH BINDING ARBITRATION, AND NOT IN A COURT OF GENERAL JURISDICTION. BINDING ARBITRATION MEANS THAT YOU AND LG ARE EACH WAIVING THE RIGHT TO A JURY TRIAL AND TO BRING OR PARTICIPATE IN A CLASS ACTION.

Definitions. For the purposes of this section, references to "LG" mean LG Electronics U.S.A., Inc., its parents, subsidiaries and affiliates, and each of their officers, directors, employees, agents, beneficiaries, predecessors in interest, successors, assigns and suppliers; references to "dispute" or "claim" shall include any dispute, claim or controversy of any kind whatsoever (whether based in contract, tort, statute, regulation, ordinance, fraud, misrepresentation or any other legal or equitable theory) arising out of or relating in any way to the sale, condition or performance of the product or this Limited Warranty.

Notice of Dispute. In the event you intend to commence an arbitration proceeding, you must first notify LG in writing at least 30 days in advance of initiating the arbitration by sending a letter to LG at LG Electronics, USA, Inc. Attn: Legal Department- Arbitration 1000 Sylvan Ave, Englewood Cliffs 07632. You and LG agree to engage in good faith discussions in an attempt to amicably resolve your claim. The notice must provide your name, address, and telephone number; identify the product that is the subject of the claim; and describe the nature of the claim and the relief being sought. If you and LG are unable to resolve the dispute within 30 days, either party may proceed to file a claim for arbitration.

Agreement to Binding Arbitration and Class Action Waiver. Upon failure to resolve the dispute during the 30 day period after sending written notice to LG, you and LG agree to resolve any claims between us only by binding arbitration on an individual basis, unless you opt out as provided below. Any dispute between you and LG shall not be combined or consolidated with a dispute involving any other person's or entity's product or claim. More specifically, without limitation of the foregoing, any dispute between you and LG shall not under any circumstances proceed as part of a class or representative action. Instead of arbitration, either party may bring an individual action in small claims court, but that small claims court action may not be brought on a class or representative basis.

Arbitration Rules and Procedures. To begin arbitration of a claim, either you or LG must make a written demand for arbitration. The arbitration will be administered by the American Arbitration Association ("AAA") and will be conducted before a single arbitrator under the AAA's Consumer Arbitration Rules that are in effect at the time the arbitration is initiated (referred to as the "AAA Rules") and under the procedures set forth in this section. The AAA Rules are available online at www.adr.org/consumer. Send a copy of your written demand for arbitration, as well as a copy of this provision, to the AAA in the manner described in the AAA Rules. You must also send a copy of your written demand to LG at LG Electronics, USA, Inc. Attn: Legal Department- Arbitration 1000 Sylvan Avenue Englewood Cliffs, NJ 07632. If there is a conflict between the AAA Rules and the rules set forth in this section, the rules set forth in this section will govern. This arbitration provision is governed by the Federal Arbitration Act. Judgment may be entered on the arbitrator's award in any court of competent jurisdiction. All issues are for the arbitrator to decide, except that issues relating to the scope and enforceability of the arbitration provision and to the arbitrability of the dispute are for the court to decide. The arbitrator is bound by the terms of this provision.

Governing Law. The law of the state of your residence shall govern this Limited Warranty and any disputes between us except to the extent that such law is preempted by or inconsistent with applicable federal law.

Fees/Costs. You do not need to pay any fee to begin an arbitration. Upon receipt of your written demand for arbitration, LG will promptly pay all arbitration filing fees to the AAA unless you seek more than \$25,000 in damages, in which case the payment of these fees will be governed by the AAA Rules. Except as otherwise provided for herein, LG will pay all AAA filing, administration and arbitrator fees for any arbitration initiated in accordance with the AAA Rules and this arbitration provision. If you prevail in the arbitration, LG will pay your attorneys' fees and expenses as long as they are reasonable, by considering factors including, but not limited to, the purchase amount and claim amount. Notwithstanding the foregoing, if applicable law allows for an award of reasonable attorneys' fees and expenses, an arbitrator can award them to the same extent that a court would. If the arbitrator finds either the substance of your claim or the relief sought in the demand is frivolous or brought for an improper purpose (as measured by the standards set forth in Federal Rule of Civil Procedure 11(b)), then the payment of all arbitration fees will be governed by the AAA Rules. In such a situation, you agree to reimburse LG for all monies previously disbursed by it that are otherwise your obligation to pay under the AAA Rules. Except as otherwise provided for, LG waives any rights it may have to seek attorneys' fees and expenses from you if LG prevails in the arbitration.

Hearings and Location. If your claim is for \$25,000 or less, you may choose to have the arbitration conducted solely on the basis of (1) documents submitted to the arbitrator, (2) through a telephonic hearing, or (3) by an in-person hearing as established by the AAA Rules. If your claim exceeds \$25,000, the right to a hearing will be determined by the AAA Rules. Any in-person arbitration hearings will be held at a location within the federal judicial district in which you reside unless we both agree to another location or we agree to a telephonic arbitration.

Opt Out. You may opt out of this dispute resolution procedure. If you opt out, neither you nor LG can require the other to participate in an arbitration proceeding. To opt out, you must send notice to LG no later than 30 calendar days from the date of the first consumer purchaser's purchase of the product by either: (i) sending an e-mail to optout@lge.com, with the subject line: "Arbitration Opt Out" or (ii) calling 1-800-980-2973. You must include in the opt out e-mail or provide by telephone: (a) your name and address; (b) the date on which the product was purchased; (c) the product model name or model number; and (d) the serial number (the serial number can be found (i) on the product; or (ii) online by accessing <https://www.lg.com/us/support/repair-service/schedule-repair-continued> and clicking on "Find My Model & Serial Number").

You may only opt out of the dispute resolution procedure in the manner described above (that is, by e-mail or telephone); no other form of notice will be effective to opt out of this dispute resolution procedure. Opting out of this dispute resolution procedure will not affect the coverage of the Limited Warranty in any way, and you will continue to enjoy the full benefits of the Limited Warranty. If you keep this product and do not opt out, then you accept all terms and conditions of the arbitration provision described above.



LG Customer Information Center

1-800-243-0000 USA

1-888-542-2623 CANADA

Register your product Online!

www.lg.com