

# THE Radio Constructor

RADIO  
TELEVISION  
AUDIO  
ELECTRONICS

VOLUME 18                      NUMBER 3  
A DATA PUBLICATION  
TWO SHILLINGS & THREEPENCE

October 1964

*extra features  
for your*

**TAPE  
RECORDER**



Top Pocket  
Transistor Radio



Transistorised  
Calibrating Oscillator



Simple M.W. Receiver  
for Beginners



Transistor Mains  
Intercom

# A NEW EDDYSTONE MODEL THE RUGGED COMPACT 'EC 10' TRANSISTORISED COMMUNICATIONS RECEIVER

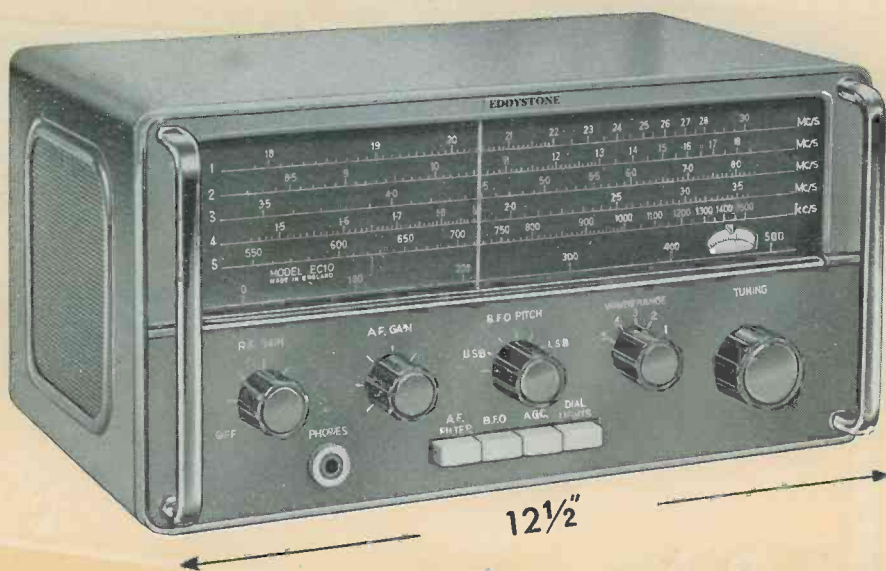

**LIGHT and PORTABLE**  
**REALLY GOOD**  
**PERFORMANCE**

**IDEAL AS A**  
**MOBILE RECEIVER**

**USEFUL IN CAR, CARAVAN,**  
**BOAT, LOUNGE and SHACK**

**550 kc/s to 30 Mc/s**

Five ranges give complete coverage from 550 kc/s to 30 Mc/s. Precision flywheel-loaded slow-motion drive with 110 to 1 reduction ratio. Uses thirteen semi-conductors, including stabilising Zener diode, resulting in excellent performance on all ranges. Internal speaker and panel jack for telephones.

Self-contained battery unit. Aerial inputs for single wire aerial, balanced or unbalanced feeder, and for short rod or whip. Selective audio filter for improved c.w. reception. Robust construction and modern styling.

Dimensions are 12½ inches by 6¾ inches by 8 inches. Weight with battery 14lb.

**List Price £48**

**STRATTON & CO. LTD. BIRMINGHAM · England**

# THE NEW RADIO AND TELEVISION

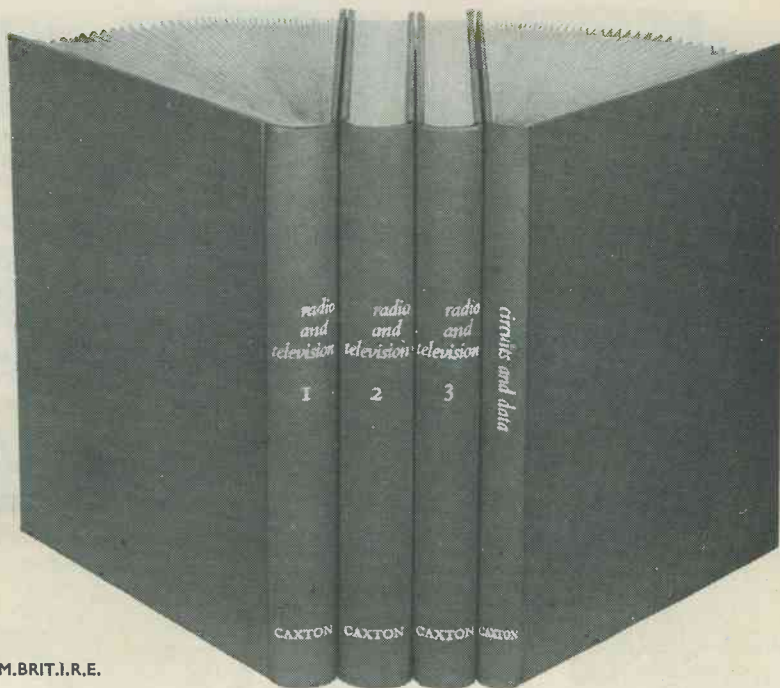

by C. A. QUARRINGTON, A.M.BRIT.I.R.E.

**RADIO AND TELEVISION** is the most up-to-date work which deals with the principles, design considerations, applications, component parts, maintenance, adjustment and repair of radio and television. Essential for every radio and television engineer and enthusiast, these four magnificent volumes have been designed to meet the needs of all connected with this branch of engineering. By mastering everything in this work and using it for reference, you can join the ranks of men who are sought after because they know the trade from A to Z.

**FREE INFORMATION BUREAU.** To every purchaser we offer a free postal information service to keep him in touch with what is happening today, what happened yesterday, and even what may happen tomorrow.

## SOME OF THE CONTENTS

Waves in free space - Inductance - Capacitance - The tuned circuit - Detection - R.F. pentode - R.F. amplifier - The superheterodyne - Frequency changing stage - A.G.C. and tuning indicators - R.F. coils, screens and switches - Output stage - Press-button tuning - Combined A.M. and F.M. receivers - Transistors and diodes - Power supply and decoupling - High fidelity and stereo reproduction - Microphones and pre-amplification - Tape recording - Car radio - Low-power transmission - Video signal - Waveform generator - Synchronising circuits - Automatic gain control - Vision detection and amplification - Interference limiters - Colour television - Aerials - Fault diagnosis - Workshop equipment - Voltage and current testing - Testing basic components - Instability and motor-boating - Mains hum and background noise - Tracing distortion - Radio receiver alignment - Blank screen - Poor interlacing, television - Pattern on screen - Television receiver alignment - Projection television.

## SEND NOW FOR FULL INFORMATION

To THE CAXTON PUBLISHING CO. LTD.,  
Dept. 73/28, Gatehouse Industrial Estate, Aylesbury, Bucks

Please send me full information about "Radio and Television"

NAME .....  
(BLOCK LETTERS PLEASE)

ADDRESS .....

RT 73/28

## HI-FI AMPLIFIERS      TUNERS      RECORD PLAYERS

S-33



S-99



AT-6



MA-12



**HI-FI 6W STEREO AMPLIFIER.** Model S-33. 3 watts per channel 0.3% distortion at 2.5W/chnl., 20dB N.F.B. Inputs for Radio (or Tape) and Gram. Stereo or Monaural, ganged controls. Kit **£13.7.6** Assembled **£18.18.0**

**DE LUXE STEREO AMPLIFIER.** Model S-33H. De luxe version of the S-33 with two-tone grey perspex panel, and higher sensitivity necessary to accept the Decca Deram pick-up. Kit **£15.17.6** Assembled **£21.7.6**

**HI-FI STEREO AMPLIFIER.** Model S-99. 18W output. Ganged controls. Stereo/Mono gram., radio and tape inputs. Push-button selection. Printed circuit construction. Kit **£27.19.6** Assembled **£37.19.6**

**POWER SUPPLY UNIT.** Model MGP-1. Input 100/120V, 200/250V. 40-60 c/s. Output 6.3V, 2.5A A.C. 200, 250, 270V, 120mA max. D.C. Kit **£5.2.6** Assembled **£6.12.6**

A wide range of American equipment available under direct mail order scheme. Full details and catalogue 1/- post paid.

**GOLDRING Lenco TRANSCRIPTION PLAYER.** Model GL-58. With G-60 pick-up arm and Ronette 105 cartridge. **£20.1.3**

**GARRARD AUTO/RECORD PLAYER.** Model AT-6. With R 105 cartridge. **£13.12.1** With Decca Deram pick-up **£14.6.1**

**SUGDEN MOTOR UNIT "CONNOISSEUR CRAFTSMAN".** Heavy duty motor operating at 33½ and 45 r.p.m. Very heavy 12" turntable. Virtually no rumble. **£17.2.11**

**HI-FI MONO AMPLIFIER.** Model MA-5. A general purpose 5W Amplifier, with inputs for Gram., Radio. Presentation similar to S-33. Kit **£10.19.6** Assembled **£15.10.0**

**HI-FI MONO AMPLIFIER.** Model MA-12. 12W output, wide freq. range, low distortion. Kit **£11.18.0** Assembled **£15.18.0**



## Choose Heathkit models for Performance

### FOR THE INSTRUMENTALIST



PA-1

**PA AMPLIFIER PA-1.** The ideal compact unit for VOCALISTS, INSTRUMENTALISTS, RECORDS, with 50 Watt output, 2 Heavy Duty Speakers. Variable TREMOLO. Elegant modern cabinet. Kit **£54.15.0**  
Assembled **£74.0.0**

Legs optional extra 17/6 set of 4

**POWER AMPLIFIER MA-50**  
50W output. Kit **£19.18.0**  
Assembled **£27.18.0**

### ELECTRONIC ORGAN

(fully transistorised). Ideal for Soloists, Home use, Groups. FULL 20 WATTS VOLUME. **£187.10.0** Matching bench **£14.10.0** extra.

### TRANSISTOR RADIOS

#### "OXFORD" LUXURY PORTABLE.

Model UXR-2. Specially designed for use as a domestic, car or personal portable receiver. Many features, including solid leather case. Kit **£14.18.0**



UXR-2

**TRANSISTOR PORTABLE.** Model UXR-1. Pre-aligned I.F. transformers, printed circuit. Covers L.W. and M.W. Has 7" x 4" loudspeaker. Real hide case. Kit **£12.11.0**



UXR-1

**TRANSISTOR PORTABLE RECEIVER.** Model RSW-1. In a handsome leather case, it has retractable whip aerial and socket for car radio use. Covers Med., Trawler and two S wave bands. Kit **£19.17.6**



RSW-1

**JUNIOR TRANSISTOR RADIO.** Model UJR-1. Single transistor set. Excellent introduction to radio. Kit **£2.7.6**



UJR-1

### Money-back Guarantee

Daystrom Limited unconditionally guarantees that each Heathkit product assembled in accordance with our easy-to-understand instruction manual must meet our published specifications for performance or the purchase price will be cheerfully refunded.

### TEST INSTRUMENTS

**T.V. ALIGNMENT GENERATOR.** Model HFW-1. Offers max performance at lowest cost. Covers 3.6 to 220 Mc/s fundamentals. Electronic sweep oscillators. Built in marker generators (5 Mc/s crystal) **£30.15.0** Kit  
**£44.10.0** Assembled



HFW-1

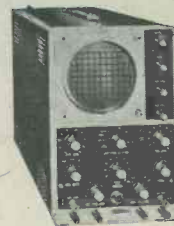

IO-12U

**5" GENERAL-PURPOSE LABORATORY OSCILLOSCOPE.** Model IO-12U. This outstanding oscilloscope, with its professional specification and styling, fulfills most laboratory and service requirements. Vertical frequency response 3 c/s to over 4.5Mc/s, sensitivity 10mV r.m.s. per cm. at 1 kc/s. T/B covers 10 c/s-500 kc/s. Kit **£32.12.6** Assembled **£41.10.0**

**2½" PORTABLE SERVICE SCOPE.** Model OS-1. This is a light, compact oscilloscope, ideal for servicing, etc. Dimensions 5" x 8" x 1 1/4". Wt. 10½ lb. Kit **£21.18.0** Assembled **£29.8.0**



S-3U

**ELECTRONIC SWITCH.** Model S-3U (Oscilloscope Trace Doubler). Enables a single beam oscilloscope to give simultaneous traces of two separate and independent signals. Switching rates approx. 150, 500, 1,500, 5,000 and 15,000 c/s. Sig. freq. response 0-100 kc/s. ±1dB. Separate gain controls and sync. output. Sig. input range 0.1-1.8V r.m.s. Kit **£12.18.0** Assembled **£18.10.0**

**DE LUXE LARGE-SCALE VALVE VOLTMETER.** Model IM-13U. Circuit and specification based on the well known model V-7A but with many worth-while refinements. 6" Ernest Turner meter. Unique gimbal bracket allows operation of instrument in many positions. Modern styling. Kit **£18.18.0** Assembled **£26.18.0**



IM-13U

**AUDIO SIGNAL GENERATOR.** Model AG-9U. 10 c/s to 100 kc/s, switch selected. Distortion less than 0.1%. 10V sine wave output metered in volts and dB's. Kit **£22.10.0** Assembled **£30.10.0**

**VALVE VOLTMETER.** Model V-7A. 7 voltage ranges d.c. volts to 1,500. A.c. to 1,500 r.m.s. and 4,000 peak to peak. Resistance 0.1Ω to 1,000MΩ with internal battery. D.c. input impedance 11MΩ. dB measurement, has centre-zero scale. Complete with test probes, lead and standardising battery. Kit **£13.18.6** Assembled **£19.18.6**



V-7A

**MULTIMETER.** Model MM-1U. Ranges 0-1.5V to 1,500V a.c. and d.c.; 150μA to 15A d.c.; 0.2Ω to 20MΩ. 44" 50μA meter. Kit **£12.18.0** Assembled **£18.11.6**

**R.F. SIGNAL GENERATOR.** Model RF-1U. Up to 100 Mc/s fundamental and 200 Mc/s on harmonics. Up to 100 mV output. Kit **£13.8.0** Assembled **£19.18.0**



RF-1U

A WIDE RANGE OF BOOKS ON ELECTRONICS AND RADIO AVAILABLE. SEND FOR LISTS OF PRICES

## TAPE DECKS — CONTROL UNITS — TAPE AMPLIFIERS



COLLARO



D-93



FM-4U



AM/FM

**COLLARO "STUDIO" TAPE DECK.** The finest buy in its price range. Operating speeds:  $1\frac{1}{2}$ ",  $3\frac{1}{4}$ " and  $7\frac{1}{2}$ " p.s. Two tracks, "wow" and "flutter" not greater than 0.15% at  $7\frac{1}{2}$ " p.s. **£17.10.0**

**TRUVOX D93 TAPE DECKS.** High quality stereo/mono tape decks.

D93/2,  $\frac{1}{2}$  track, **£36.15.0** D93/4,  $\frac{1}{4}$  track, **£36.15.0**

**HI-FI AM/FM TUNER. Model AFM-1.** Available in two units which, for your convenience, are sold separately. Tuning heart (AFM-T1—£4.13.6 incl. P.T.) and I.F. amplifier (AFM-A1—£21.16.6). Printed circuit board, 8 valves. Covers L.W., M.W., S.W., and F.M. Built-in power supply. **Total Kit £26.10.0**

**HI-FI FM TUNER. Model FM-4U.** Also available in two units. R.F. tuning unit (£2.15.0 incl. P.T.) with I.F. output of 10.7 Mc/s, and amplifier unit, with power supply and valves (£13.3.0). **Total Kit £15.18.0**

**TAPE RECORDING/PLAYBACK AMPLIFIER.** Thermometer 'type recording indicators, press-button speed compensation and input selection. Mono Model TA-1M, Kit **£19.18.0** Assembled **£28.18.0**  
Stereo Model TA-1S, Kit **£25.10.0** Assembled **£35.18.0**

**MONO CONTROL UNIT. Model UMC-1.** Designed to work with the MA-12 or similar amplifier requiring 0.25V or less for full output. 5 inputs. Baxandall type controls. **Kit £8.12.6** Assembled **£13.12.6**

**STEREO CONTROL UNIT. Model USC-1.** Push-button selection, accurately matched ganged controls to  $\pm 1$ dB. Rumble and variable low-pass filters. Printed circuit boards. **Kit £19.10.0** Assembled **£26.10.0**

## Reliability - The kitsets anyone can build

**Heathkit**  
DAYSTROM

### "AMATEUR" EQUIPMENT

**AMATEUR BANDS RECEIVER. Model RA-1.** To cover all the Amateur Bands from 160-10 metres. Many special features, including: half-lattice crystal filter; 8 valves; signal strength "S" meter; tuned R.F. Amp. stage.

Kit **£39.6.6** Assembled **£52.10.0**

**THE "MOHICAN" GENERAL COVERAGE RECEIVER. Model GC-1U.** With 4 piezo-electric transmitters, variable tuned B.F.O. and Zener diode stabiliser, this is an excellent fully transistorised general purpose receiver for Amateur and Short wave listeners. Printed circuits, telescopic aerials, tuning meter and large slide-rule dial.

Kit **£37.17.6** Assembled **£45.17.6**

**160-10M TRANSMITTER. Model DX-100U.** Careful design has achieved high performance and stability. Completely self-contained.

Kit **£79.10.0** Assembled **£104.15.0**



SB-10U

**COMMUNICATIONS TYPE RECEIVER. Model RG-1.** A high performance, low cost receiver for the discriminating listener. Frequency coverage: 600 kc/s-1.5 Mc/s and 1.7 Mc/s-32 Mc/s.

Kit **£39.16.0** Assembled **£53.0.0**

**SINGLE SIDEBAND ADAPTOR. Model SB-10U.** May be used with most A.M. transmitters. Less than 3W R.F. input power required for 10W output. Operation on 80, 40, 20, 15 and 10m bands on U.S.B., L.S.B. or D.S.B.

Kit **£39.5.0** Assembled **£54.18.0**

Many other British 'Amateur' models. Send for Catalogue.

### AMERICAN HEATHKIT "AMATEUR" EQUIPMENT

(As stocks in U.K. are limited, order as early as possible to avoid disappointment)

**80-10M RECEIVER. Model SB-300E.**

This de luxe receiver offers unsurpassed value to the Radio Amateur. Of advanced design employing up-to-date construction techniques, its specification ensures unparalleled performance. Full details on request. Size  $14\frac{1}{2}$ " x  $6\frac{1}{2}$ " x  $13\frac{3}{4}$ ".

Kit **£133.14.0** less speaker

A fitting companion to this receiver is model

**SB-400E TRANSMITTER:** Kit **£165.4.0**

**SEND FOR AMERICAN CATALOGUE.** 1/- Post Paid

Deferred Terms available in U.K. on all purchases over £10.

Full details available.



SB-300E

DEPT. RC. 10  
GLOUCESTER

### SPEAKER SYSTEMS

**COTSWOLD "MFS" SYSTEM.** Specially developed to give best possible results in small rooms. This minimum floor space model is based on standard Cotswold. Size:  $36$ " high x  $16\frac{1}{2}$ " wide x  $14\frac{1}{2}$ " deep.

Kit **£23.4.0** Assembled **£30.15.0**

**THE "COTSWOLD".** This is an acoustically designed enclosure  $26$ " x  $23$ " x  $15\frac{1}{2}$ " housing a  $12$ " bass speaker with  $2$ " speech coil, elliptical middle speaker together with a pressure unit to cover the full frequency range of 32-20,000 c/s. Capable of doing justice to the finest programme source, its polar distribution makes it ideal for really Hi-Fi Stereo.

Kit **£23.4.0** Assembled **£30.15.0**

**HI-FI SPEAKER SYSTEM. Model SSU-1.** Ducted-port bass reflex cabinet "in the white". Two speakers. Vertical or horizontal models with legs, Kit **£11.12.0**, without legs, Kit **£10.17.6**.



MFS



SSU-1

### HI-FI CABINETS

A wide range of equipment cabinets are available to meet the differing needs of enthusiasts. Designed for max. operating convenience or for where room space is an overriding consideration, this range includes kits, ready assembled cabinets or fully finished cabinets, and has at least one model to suit your requirements. Send for full details.

Prices from **£7.7.0** to **£37.16.0**



MALVERN

### SEND FOR FREE BRITISH HEATHKIT CATALOGUE

American catalogue also available 1/- post paid

Without obligation please send me **FREE BRITISH HEATHKIT CATALOGUE**.....

(Tick here)

**FULL DETAILS OF MODEL(S)**.....  
(Please write in BLOCK CAPITALS)

**NAME**.....

**ADDRESS**.....

DEPT. RC.10

**DAYSTROM LTD**

# LASKY'S RADIO

## FOR THE FINEST RANGE OF TRANSISTOR RECEIVERS

We consider our construction parcels to be the finest value on the home constructor market. If on receipt you feel not competent to build the set, you may return it as received within 7 days, when the sum paid will be refunded, less postage.

### THE SKYROVER AND THE SKYROVER DE LUXE



★ LONG WAVEBAND COVERAGE IS NOW AVAILABLE FOR THESE WELL-KNOWN SETS

A simple additional circuit provides coverage of the 1100/1950 M. band (including 1500 M. Light programme). This is in addition to all existing Medium and Short wavebands. All necessary components with construction data. **Only 10/- extra Post Free** This conversion is suitable for both models that have already been constructed.

**GENERAL SPECIFICATION.** 7 transistor plus 2 diode superhet, 6 waveband portable receiver. Operating from four 1.5V torch batteries. The SKYROVER and SKYROVER DE LUXE cover the full medium waveband and short waveband 31-94 M, and also 4 separate switched band-spread ranges, 13 M, 16 M, 19 M and 25 M, with band-spread tuning for accurate station selection. The coil pack and tuning heart is completely factory assembled, wired and tested. The remaining assembly can be completed in under three hours from our easy to follow, stage by stage instructions.

**SPECIFICATION:** Superhet, 470 kc/s. All Mullard transistors and diode. Uses 4 U2 batteries. 5" Ceramic Magnet P.M. Speaker. Easy to read Dial Scale. Band-spread Tuning. 500mW Output. Telescopic Aerial and Ferrite Rod Aerial.

**WAVEBAND COVERAGE:** 180-576 M, 31-94 M, and band-spread on 13, 16, 19 and 25 metre bands. All components available separately. Four U2 batteries 3/4 extra. Data for each receiver, 2/6 extra, refunded if you purchase the parcel.

### THE SKYROVER

Controls: Waveband Selector, Volume Control with On/Off Switch, Tuning Control. In plastic cabinet, size 10" x 6 1/2" x 3 1/2", with metal trim and carrying handle.

Can now be built for

**£8.19.6**

P. and P. 5/- extra

H.P.

Terms—

20/- dep. &

11 months

at 16/6

### THE SKYROVER DE LUXE

Tone Control circuit is incorporated, with separate Tone Control in addition to Volume Control, Tuning Control and Waveband Selector. In a wood cabinet, size 11 1/2" x 6 1/2" x 3", covered with a washable material, with plastic trim and carrying handle. Also car aerial socket fitted.

Can now be built for

**£10.19.6**

P. and P. 5/- extra

H.P. Terms—25/-

deposit and 11

months at 20/-



### REALISTIC SEVEN

★ 7-transistor Superhet. ★ 350 milliwatt output into 4" high flux speaker. ★ All components mounted on a single printed circuit board, size 5 1/2" x 5 1/2" in one complete assembly.

★ Plastic cabinet with carrying handle, size 7" x 10" x 3 1/2", available in Blue/Grey or all Grey. Easy to read dial. ★ External socket for car aerial.

★ I.F. frequency 470 kc/s. ★ Ferrite rod internal aerial. Operates from PP9 or similar battery. ★ Full comprehensive data supplied with each receiver. ★ All coils and I.F.s, etc., fully wound ready for immediate assembly.

An Outstanding Receiver. **LASKY'S PRICE** for the complete parcel including Transistors, Cabinet, Speaker, etc., and Full Construction Data. Can be built for: **£5.19.6**

P. and P. 4/6

PP9 Battery, 3/9. Data and instructions separately, 2/6. Refunded if you purchase the parcel.

### REALISTIC 'Seven' De Luxe

With the same specification as standard model —PLUS a superior wood cabinet in contemporary styling. ALSO a full vision circular dial

FOR ONLY **£1** EXTRA  
P. & P. as std. model

### SINCLAIR SUPER MINIATURES THE SINCLAIR SLIMLINE

The new 2-transistor pocket radio, size only 2 3/4" x 1 5/8" x 1 5/8". Micro alloy transistors and printed circuit. Easy to assemble.

CAN BE BUILT FOR **49/6**

### THE SINCLAIR MICRO-6

Self-contained pocket radio. Size only 1 3/10" x 1 1/2" —truly amazing performance. Without doubt the most advanced transistor circuit ever offered to home constructors—yet may be built in an evening. Complete with earphone and detailed construction data. Mercury cell CAN BE BUILT FOR **59/6** 1/11 extra (2 required).

### THE SINCLAIR TR750

Power amplifier—measures only 2" x 2". Full 750mW transformerless output for 10mV into 10kΩ. Built-in vol. control and on/off switch. Ideal for use with Micro-6 or Slimline receivers.

CAN BE BUILT FOR **39/6** READY BUILT **45/-**  
All parts on the above sold sep.

### TRANSFILTERS by BRUSH CRYSTAL CO.

TO-01B 465 kc/s ± 2 kc/s  
TO-01D 470 kc/s ± 2 kc/s  
TO-02B 465 kc/s ± 1 kc/s  
TO-02D 470 kc/s ± 1 kc/s  
TF-01B 465 kc/s ± 2 kc/s  
TF-01D 470 kc/s ± 2 kc/s

**6/6** each  
P. & P. 6d.

### GUITAR PICK-UP

Crystal—high imp. Size only 1 1/2" x 1/2" x 1/2". Clips to fingerboard—no screws. Complete with cable.

LASKY'S PRICE **15/11** P. & P. 1/-

### TAPE POSITION INDICATOR

Open type—as used by most makers. With re-set knob: 3 DIGIT 7/6; 4 DIGIT 10/6. P. & P. 9d. on each.

### 12" FANE DUAL CONE HI-FI SPEAKER

Type 122/17A. Power handling 25 watts—15 ohms imp. Flux density 17,000 gauss. Special Anisotropic magnet. Listed at 12 gns. Limited stock.

LASKY'S PRICE **£6.19.6** P. & P. 5/-

### DEAC RECHARGEABLE NICKEL CADMIUM CELLS

Rating 1.22V 3.5 A.H. at 10 hour rate. 1,001 uses for model makers, miniature electronic equipment, portable radios and tape recs., trans receivers, photo flash, etc. Hermetically sealed. Size 3 1/2" x 1 1/2" x 1 1/2". Listed at 35/- each.

LASKY'S PRICE **15/-** each

POST FREE, BANK OF 9, 79/6.

### PICK-UP CARTRIDGES

Crystal P.U. Cartridges complete with styli—at lowest prices ever!

Mono C.T.I. ... 4/11  
Collaro Type C, stereo, 2 sapphires. ... 15/-  
Coller S.C.I. Stereo Diamond LP Suppl. ... 17/6  
std. ... 19/11  
Sonotone 8T, stereo, 2 sapphires ... 15/-  
Sonotone 2TA, mono, 2 sapphires ... 15/-  
Postage 1/- each extra.

### TAPE DECK MOTORS

Motors for the Collaro Studio Deck—new and unused, 200-150V A.C. Take-up and rewind. Listed at £2.5s. each. LASKY'S PRICE **14/11** each. P. & P. 2/6.

State motor required when ordering.

High quality tape deck capstan motor made by E.M.I. Holland. Bi-directional. Size: 4" dia., x 2" high. 1" x 1/2" spindle. LASKY'S PRICE **19/11**. P. & P. 3/6.

### RECORDING TAPE SPLICER

By famous manufacturer—all metal construction. Listed at 18/6 LASKY'S PRICE **14/6** Post Free

### LAFAYETTE TAPE

Famous American Brand—Fully Guaranteed at record low prices. In sealed cartons.

5in double play, 1,200ft. Mylar base ... 15/-  
5in long play, 900ft. Acetate base ... 10/-  
5in standard play, 600ft. PVC base ... 8/6  
5 1/2in long play, 1,200ft. Mylar base ... 15/-  
5 1/2in double play, 1,800ft. Mylar base ... 22/6  
5 1/2in long play, 1,200ft. Acetate base ... 12/6  
5 1/2in standard play, 850ft. PVC base ... 11/6  
7in standard play, 1,200ft. Mylar base ... 12/6  
7in long play, 1,800ft. Mylar base ... 19/6  
7in double play, 2,400ft. Mylar base ... 25/-  
7in long play, 1,800ft. Acetate base ... 15/-  
3in message tape, 150ft. ... 3/6  
3in message tape, 225ft. ... 4/11  
3in message tape, 300ft. ... 7/6  
3in triple play, 450ft. Mylar base ... 12/6  
4in triple play, 900ft. Mylar base ... 22/6  
5in triple play, 1,800ft. Mylar base ... 42/6  
5 1/2in triple play, 2,400ft. Mylar base ... 55/-  
7in triple play, 3,600ft. Mylar base ... 75/-  
P. & P. 1/- extra per reel; 4 reels and over Post Free.

### HI-FI TAPE RECORDER HEADS

High Impedance Record Play. Low impedance erase. Upper or lower track.

LASKY'S PRICE **29/6** Post free per pair. State track required when ordering.

MARRIOTT "X" Type 1/2 track heads. Record/Play and Erase.

LASKY'S PRICE **4 GNS. PAIR**  
1/2-Track heads Record/Play and Erase 59/6 pair.

### TRANSISTORS

All New and Guaranteed  
GET.51. GET.55. GET.56—2/6; 837A, 874P—3/6; OC.45, OC.71, OC.81D—4/6; OC.44, OC.70, OC.76, OC.81 (matched pair 10/6); 5/6; AF.117, OC.75, OC.171, OC.200—6/6; OC.42, OC.43, OC.73, OC.82D—7/6; OCP.71—9/6; OC.28, OC.201, OC.204—15/-; OC.205, OC.206—19/6; OC.28—24/6.

33 TOTTENHAM COURT ROAD · W1

2 mins. Oxford St. Nearest Station: Goudge St. MUSEum 2605

Tottenham Ct. Rd. & Edgware Rd. addresses open all day Sat. Close 1 Thur.

207 EDGWARE ROAD · W2

Few yards from Praed St. PADDington 3271/2

Please address all Mail Orders to Dept. W at above Edgware Road address

152/3 FLEET STREET · EC4

(ELECTRONICS Fleet St. Ltd.) FLEet 2833. Open all day Thurs. Closed 1 p.m. Sat.

# EXCEL in

# RADIO AND ELECTRONICS

AS A CAREER OR AS A FASCINATING HOBBY...

THERE IS AN ICS COURSE FOR YOU!

By taking an ICS specialised home study course you gain a sound theoretical and practical knowledge of valve and transistor circuits and servicing work while building your own 5-valve receiver, transistor portable (or a.f. amplifier), signal generator and multi-test meter. *All under expert tuition!*

ICS Construction Courses have been specially written and designed by experienced radio engineers to enable YOU to learn easily and quickly, in your own home, in your own time.

ICS training will take you from basic principles to advanced applications of various circuits, all made up from the kits supplied.

With the ICS Complete Radio and Electronics Construction Course you get SIX kits, including testing instruments, tools and first class components. And, what is most important, a personal library of Instruction Manuals.

If you are making a career in the Radio Industry, you will be interested in the wide range of examination and specialist diploma courses offered by ICS. These include:

Radio and Television Engineering, Industrial Television, Radio and Television Servicing, Colour Television, Electronic Technicians, Servomechanisms, Radio-Electronic Telemetry, Instrumentation, Principles of Automation, Calculus for Electronics, Digital and Analogue Computers.

Specialised coaching for Grad.I.E.R.E., C.&G. Telecommunication Technician's Cert. Radio & TV Servicing Cert.(R.T.E.B.), P.M.G. Certs. and Radio Amateur's Exam.

Examination students coached until successful

PRACTICAL INSTRUCTION!

1

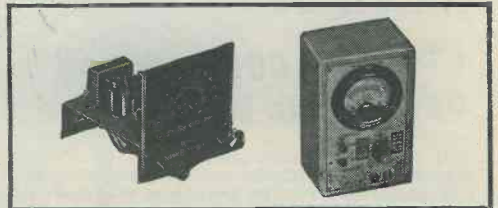

Assembly and use of signal generator and multi-test meter (especially valuable in servicing work).

2

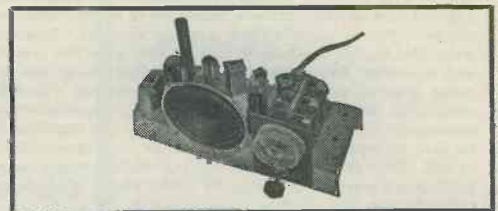

Construction of 5-valve 2-waveband AC/DC superheterodyne receiver, and a number of instructional experiments, using testing instruments.

3



Construction of 6-transistor (with semiconductor diode) 2-waveband portable, and a number of instructional experiments, including a.f. amplifier with microphone pre-amplifier.

For full details  
of ICS Radio and  
Electronics Courses  
post coupon  
TODAY

ICS (DEPT. 248) INTERTEXT HOUSE  
PARKGATE ROAD, LONDON, S.W.11

NAME .....

AGE .....

ADDRESS .....

10.64

INTERNATIONAL CORRESPONDENCE SCHOOLS

Member of the Association of British Correspondence Colleges

# THE SMALLEST SET ON EARTH

## SINCLAIR MICRO-6 SIX STAGE RECEIVER

*Over 8,000 built and in use in all parts of the world*

THE SINCLAIR MICRO-6 continues unchallenged as the most remarkable receiver of its kind ever made available to the public anywhere in the world. It has special 6-stage circuitry, and is, at the same time, the smallest set on earth. Everything except the lightweight earpiece is contained in the smart, minute white, gold and black case which is appreciably smaller than a matchbox, as the illustration shows. With vernier-type tuning control, bandspread over the higher frequency end of the medium waveband and powerful A.G.C. to ensure fade free reception of the most distant stations, the Micro-6 provides remarkable standards of performance. Quality of reproduction is outstandingly good, and again and again, the set is reported to give excellent results where other sets cannot be used at all. The Micro-6 cannot be too highly recommended, both as an intriguing design to build, and a most practical radio to use.

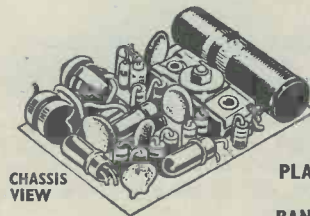

CHASSIS VIEW

ACTUAL SIZE

1 1/5" x 1 3/10" x 1/2"

WEIGHS UNDER 1 oz

TUNES OVER M.W.

PLAYS IN CARS, BUSES, TRAINS

BANDSPREAD TUNING FOR EASY RECEPTION OF LUXEMBOURG

## SINCLAIR TR750 POWER AMPLIFIER

With built-in volume control and switch

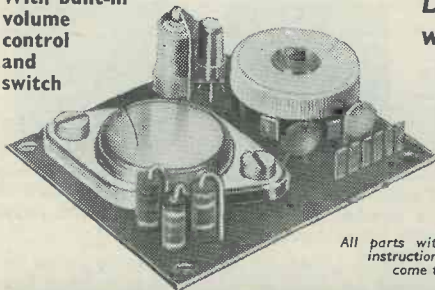

All parts with instructions come to

*Designed specially for use with the Sinclair Micro-6*

THE TR750 (for building yourself or available ready built) measures only 2" x 2". It will provide powerful loudspeaker reproduction from the Micro-6 which can then be used as a car radio or domestic or portable loudspeaker set. The TR750 also has many other applications such as record reproducer, intercom or baby alarm. An output of 750 milliwatts for feeding into a standard 25-30Ω loudspeaker requires only a 10mV input into 2kΩ. Frequency response 30-20,000 c/s ± 1dB. Power required—9 to 12 volts.

39/6

Ready built and tested with instructions

45/-

*Easily built in a single evening*

Using components never before made available to the public, the Micro-6 is nevertheless easy to build. All parts including lightweight earpiece and 8-page instructions manual come to

59/6

"TRANSISTA" black nylon strap for wearing the Micro-6 like a wrist-watch.

MALLORY MERCURY CELL ZM312 (2 required) each

Handy pack of 6 cells

7/6

1/11

10/6

# SINCLAIR

SINCLAIR RADIONICS LTD  
COMBERTON, CAMBRIDGE

Telephone COMBERTON 682

## UNIQUE SINCLAIR GUARANTEE

The following unconditional guarantee applies to everything you buy from Sinclair Radionics Ltd:  
If you are not completely satisfied with your purchase (we are confident you will be delighted) your full purchase price will be refunded instantly and without question.

★ FULL SERVICE FACILITIES ALWAYS AVAILABLE TO SINCLAIR CUSTOMERS



# SINCLAIR X-10

## INTEGRATED 10 WATT HI-FI AMPLIFIER AND PRE-AMP

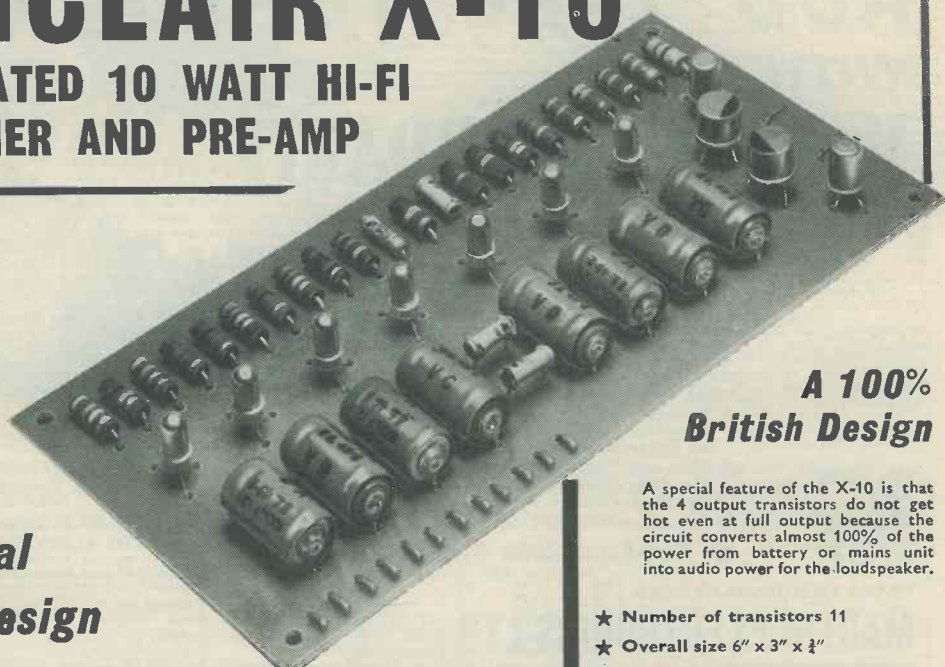

**A  
radical  
departure  
from  
conventional  
amplifier design**

**A 100%  
British Design**

A special feature of the X-10 is that the 4 output transistors do not get hot even at full output because the circuit converts almost 100% of the power from battery or mains unit into audio power for the loudspeaker.

**THE SINCLAIR X-10** combined 10 watt amplifier and pre-amplifier (Pats. applied for) is so advanced in design that it outdates every type of amplifier ever made available to constructors, hi-fi enthusiasts, experimenters and industrial users. Its unique eleven transistor circuit solves once and for all problems inherent in conventional transistor amplifier design so that users of the Sinclair X-10 system enjoy far better reproduction, true 10 watt output for less current consumption (the amplifier

will run for about 3 months with ordinary use from two 4/- Ever Ready 996 batteries) and great savings in space AND COST. Furthermore, the Sinclair X-10 is so designed that the purchaser can select the tone control and input matching system appropriate to his requirements. A fully descriptive manual is supplied with each X-10 purchased complete or for building. This is truly the amplifier of tomorrow—and it can be yours today!

- ★ Number of transistors 11
- ★ Overall size 6" x 3" x 1/2"
- ★ Input Sensitivity 1mV
- ★ Total harmonic distortion >0.1%
- ★ Output power 10 watts
- ★ Frequency response 5-20,000 c/s ± 0.5dB
- ★ Speaker impedance 15Ω
- ★ Damping factor Greater than 100
- ★ Quiescent consumption 75mA
- ★ Supply voltage 12 to 15 volts

## PWM ensures greatly improved standards of performance

The Sinclair X-10 is the only amplifier in the world which enables constructors and domestic users to enjoy the benefits of this unique system. The use of P.W.M. ensures much better transient response—it is instantly noticeable the moment you hear it—no falling off in the higher audio-frequencies, no inter-modulation distortion and a response curve so flat you could draw it with a ruler! Eleven

transistors, four of which are used in a new type of output stage and P.V.M. plus many other circuit refinements result in an amplifier which is compact, rugged, stable and does not require a heat sink—and it costs so little. Used in pairs the X-10 brings new depths to stereo listening and there are no channel matching problems.

Cost of all parts for building together with Instruction Manual

**£5.19.6**

Ready Built and Tested together with Instruction Manual

**£6.19.6**

Mains power supply unit (A.C. 200-240 volt)

**£2.14.0**

**TO SINCLAIR RADIONICS LTD., COMBERTON, CAMBRIDGE. Comberton 682**

Please send items detailed below

£ s d |

NAME .....

ADDRESS .....

TOTAL £ .....

For which I enclose cash/cheque/money order

RC.10

# ADD TAPE TO YOUR HI-FI WITH A MARTIN RECORDAKIT

Like famous Martin Audiokits, Martin Recordakits make building easy no matter how little experience you may have had. With a Martin Recordakit you can either build a complete tape recorder (with deck and portable-type case if desired) or assemble a pre-amp to connect the deck to existing amplifier system. There are Recordakits for two or four track decks and, when finished, you will enjoy performance and quality of wonderfully high standards more usually associated with far costlier equipment. Building is very easy and prefabricated sections are tested individually before despatch from our factory.

- Printed circuit board sections supplied complete tested and with valves in position on Recordakits.
- Kits well packed in fitted cartons and complete down to last screw and measured length of wire.
- Full assembling and operation instructions.
- **Build and save with Martin**

**PRE-AMPS  
AND  
COMPLETE  
UNITS IN  
EASY-TO-BUILD  
KIT FORM**

TRADE ENQUIRIES INVITED

**MARTIN ELECTRONICS LTD** 154-155 HIGH STREET,  
BRENTFORD, MIDDLESEX  
Telephone ISL 1161/2

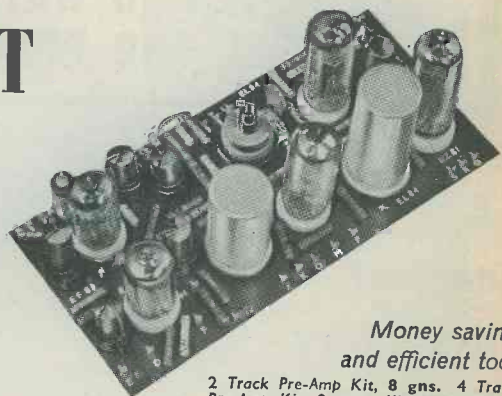

*Money saving  
and efficient tool*

2 Track Pre-Amp Kit, 8 gns. 4 Track  
Pre-Amp Kit, 9 gns. Kit with polished  
wood Cabinet and Deck from 17 gns.

**MARTIN ELECTRONICS LTD.**

Details of your Recordakits please to

Name .....

Address .....

RC.10

**LATEST HIGH QUALITY COMPONENTS FROM THE MAXI-Q RANGE . . .**

TESTED AND TRIED OVER 5 FREQUENCY RANGES

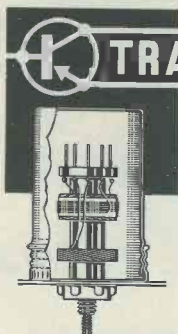

## TRANSISTOR TUNING COILS

Coils for transistor superhets or converters, with or without an R.F. stage and using 465 kc/s or 1.6 Mc/s I.F.

- ★ Noval B9A Based for Plug-in application—Screw threaded for Chassis application.
- ★ Formers moulded in low-loss polystyrene for best results.
- ★ Each coil is packed in an aluminium container which may be used as a screening can.
- ★ Brass threaded adjustable iron-dust cores.

The following colour code identifies the coils:

BLUE—Aerial coil with base input winding.

YELLOW—Interstage R.F. coil with couplings.

RED—Oscillator coil for 465 kc/s I.F.

WHITE—Oscillator coil for 1.6 Mc/s I.F.

**PRICE 4/9 each.**

Coverages: Range 1T—15/4 Mc/s; 2T—.515/1.545 Mc/s; 3T—1.67/5.3 Mc/s; 4T—5/15 Mc/s; 5T—10.5/31.5 Mc/s.

Full technical details now included in Technical Bulletin DTB.4—1/6d.

IFT.13 Miniature 465 kc/s I.F. Transformer .. 7/6d. each

IFT.14 Miniature 465 kc/s Last I.F. Transformer 7/6d. each

IFT.16 Miniature 1.6 Mc/s I.F. Transformer .. 6/6d. each

IFT.17 Miniature 1.6 Mc/s Last I.F. Transformer 6/6d. each

GENERAL CATALOGUE covering full range of components send 1/6d. in stamps. PLEASE SEND S.A.E. WITH ALL OTHER ENQUIRIES.

**DENGO (GLACTON) LTD** (DEPT. R.C.) 357/9 Old Road Clacton-on-Sea Essex

## 7 VALVE AM/FM RADIOGRAM CHASSIS

Three Waveband & Switched Gram positions. Med. 200-550m. Long. 1,000-2,000m. VHF/FM 88-95 Mc/s. Phillips Continental Tuning insert with permeability tuning on FM & combined AM/FM IF transformers. 460 kc/s and 10.7 Mc/s. Dust core tuning all coils. Latest circuitry including AVC & Neg. Feedback. 3 watt output. Sensitivity and reproduction of a very high standard. Chassis size 13 1/2" x 6 1/2" x 7 1/2". Edge illuminated glass dial 11 1/2" x 3 1/2". Vert. pointer Horiz. station names. Gold on brown background. A.C. 200/250V operation. Magic-eye tuning. Circuit diag. now available.

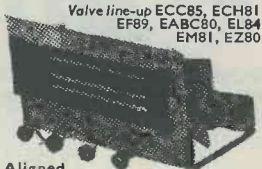

Aligned and tested ready for £13.10.0 Carr. & Ins. 7/6.

Comp. with 4 knobs—walnut or ivory to choice. Indoor FM serial 3/6 ex. 3. 2 P.M. Speaker only required. Recommended Quality Speakers 10" Elac H/D, 30/-, 13 1/2" x 8" E.M.I. Fidelity, 37/6. 12" R.A. with conc. Tweeter, 42/6. Carr. 2/6.

**Volume Controls**—SK-2 Megohms, 3" Spindles Morganite Midget Type 1 1/2" diam. Guar. 1 year. LOG or LIN ratios less Sw. 3/- DP. Sw. 4/6. Twin Stereo less Sw. 6/6. D.P. Sw. 9/6 (100 k. to 2 Meg. only). 1/2 Meg. VOL Controls D.P. Sw. 4/- flatted spindle. Famous Mfrs. 4 for 10/- post free.

**BONDACUST Speaker Cab.** Acoustic Wadding, superior grade, 1" thick, 12" wide, any length cut 1/6 per ft. 4/- per yd.

**ENAMELLED COPPER WIRE**—1lb reels, 14g-20g, 2/6; 22g-28g, 3/-; 36g-38g, 4/3; 39g-40g, 4/6, etc.

**TINNED COPPER WIRE**—14-22g 2/6 1 lb.

**PVC CONNECTING WIRE**—10 colours (for chassis wiring, etc.)—Single or stranded conductor, per yd., 2d. Sleeving, 1mm, and 2mm., 2d. yd., etc.

**KNOB**—Modern Continental types: Brown or Ivory with Gold Ring, 1" dia., 9d. each; 1 1/2", 1/- each; Brown or Ivory with Gold Centre, 1" dia., 10d. each; 1 1/2", 1/3 each. LARGE SELECTION AVAILABLE.

### TRANSISTOR COMPONENTS

Midget I.F.'s—465 kc/s 1/2" diam. 5/6  
Osc. coil 1/2" diam. M/W. 5/3  
Osc. coil M. & L.W. 5/9  
Midget Drive Trans. 3.5:1 6/9  
Ditto O/Put Push-pull 3 ohms 6/9

**Elect. Condensers**—Midget Type 15V lmf-50mfd, ea. 1/9. 100mfd. 2/-.  
Ferrite Aerial—M. & L.W. with car aerial coupling coil, 9/3.

**Condensers**—150V. wkgs. .01 mfd. to .04 mfd. 2d. .05 mfd. 1 mfd., 1/- .25 mfd. 1/3. .5 mfd. 1/6, etc.

**Tuning Condensers**. J.B. "00" 208 + 176pF, 8/6. Ditto with trimmers, 9/6. 365pF single, 7/6. Sub-min. 2" DILEMIN 100pF, 300pF, 500pF, 7/-.

**Midget Vol. Control** with edge control knob, 5k $\Omega$  with switch, 4/9. ditto less switch, 3/9.

**Speakers P.M.**—2" Plessey 75 ohms, 15/6. 2" Continental 8 ohms, 13/6. 7" x 4" Plessey 35 ohms, 23/6.

**Ear Plug Phones**—Min. Continental type, 3ft. lead, jack plug and socket. High Imp. 8/- Low Imp., 7/6. High sensitivity M/cil 8-10 ohms, 12/6.

**Brand New Mfrs. surplus 1st grade.**  
1 OC44 + 2 OC45, 15/6.  
1 OC81D + 2 OC81, 15/-.

All above and OAB1, 32/6, post free.

### JASON FM TUNER UNITS

Designer-approved kit of parts:  
FMT1, 5 gns. 4 valves, 20/-.  
FMT2, £7. 5 valves, 35/-.  
JTV MERCURY 10 gns.  
3 valves, 22/6.

JTV2 £13.19.6. 4 valves, 28/6.  
NEW JASOF FM H.A.N.D. BOOK 2/6. 48 hr. Alignment Service 7/6. P. & P. 2/6.

**TRIMMERS**, Ceramic (Compression Type)—30pF, 50pF, 70pF, 9d.; 100pF, 150pF, 1/3; 250pF, 1/6; 600pF, 1/9. Philips Concentric Type—2-10pF, 1/-; 3-30pF, 1/-.

**METAL RECTIFIERS—STC Types**—RM1, 4/9; RM2, 6/3; RM3, 7/6; RM4, 16/-; RM5, 21/-; RM4B, 17/6.

## ANOTHER TAPE RECORDER BARGAIN

Manufacturers' end of production Surplus Offer



A 24 gns. Tape Recorder offered at the bargain price of only 15 gns. plus 10/- carr. Supplied in 3 Units already wired and tested. A modern Circuit for quality recording from Mike Gram or Radio, using latest B.S.R. Twin Track Monardeck Type TD2. Valve line-up—EF86, ECL82, EM84, EZ80 and Silicon Diode. Send for detailed list—3d. stamp.

**Completed Kit** comprising items below  
**BARGAIN PRICE 15 Gns.** + 10/- Carr.

- |   |                     |
|---|---------------------|
| 2-tone Cabinet and 8" x 5" Speaker. Size 14" x 10 1/2" x 7 1/2" .....                 | £3 10 0 + 5/- Carr. |
| Wired Amplifier complete with 4 Valves, front Panel, Knobs, etc. ....                 | £5 12 6 + 3/6 Carr. |
| B.S.R. Monardeck Type TD2 .....   | £7 7 0 + 4/6 Carr.  |
| Accessories: Mike, Tape, empty Reel, screened Lead and Plugs, Instructions, etc. .... | £1 0 0 + 2/- Carr.  |

**Jack Plugs**. Standard 2 1/2" Igranite Type, 2/6. Screened Ditto, 3/3. Miniature scr. 1 1/2", 2/3. Sub-min. 1/3.

**Jack Sockets**. Open Igranite Moulded Type, 3/6. Closed Ditto, 4/-. Miniature Closed Type, 1/6. Sub-min. (deaf aid) ditto, 1/6. Stereo Jack Sockets, 3/6. Stereo Jack Plugs, 3/6.

**Phono Plugs**, 9d. Phono Sockets (open), 9d. Ditto (closed), 1/-. Twin Phono Sockets (open), 1/3.

Grundig Continental. 3 p. or 5 p. plug, 3/6. Sockets, 1/6.

**Soldering Irons**. Mains 200/220V or 230/250V. Solon 25 watt Inst., 22/6. Spare Elements 4/6. Bits, 1/- 65 watt, 27/6 etc.

**Alumin. Chassis**, 18g. Plain Undrilled, folded 4 sides, 2" deep, 6" x 4", 4/6, 8" x 6", 5/9, 10" x 7", 6/9, 12" x 6", 7/6, 12" x 8", 8/-, etc.

**Alumin. Sheet**. 18g. 6" x 6", 1/-, 6" x 9", 1/6, 6" x 12", 2/-, 12" x 12", 4/6 etc.

## RECORDING TAPE

Famous American Columbia (CBS) Premier quality tape at NEW REDUCED PRICES. A genuine recommended Quality Tape—TRY IT Brand new, boxed and fully guaranteed. Fitted with leader and stop foils.

Standard	Double Play	Long Play	
5" 600'	13/- 1,200'	31/6 900'	17/6
5 1/2" 900'	10/- 1,800'	37/6 1,200'	19/6
7" 1,200'	21/- 2,400'	47/6 1,800'	28/6

Post & Package per reel, 1/- plus 6d. each for additional reels.

**SPECIAL OFFER**. 3" Message tape 150', 3/9; 3" L.P. 225', 4/9; 3" D.P. 300', 6/6. P. & P. per reel 6d.

**TAPE REELS**. Mfrs. surplus 7", 2/3; 5 1/2", 2/-; 5", 2/-; 3", 1/3; Plastic spool containers, 5", 1/9; 5 1/2", 2/-; 7", 2/3.

New Boxed	VALVES		Electrolytics All Types New Stock		
	Reduced	Bargain Prices	TUBULAR	CAN TYPES	
1T4	3/6	ECC83 7/-	PCC84 8/-	25/25V 1/9	8+8/450V 4/6
1R5	6/-	ECL82 10/-	PCF80 8/-	50/12V 1/9	16+16/450V 5/6
1S5	6/-	ECL80 9/-	PCL83 10/6	50/50V 2/-	32+32/275V 4/6
1S4	7/-	EF80 7/6	PCL84 10/-	100/25V 2/-	50+50/350V 6/6
3V4	7/-	EF86 8/6	PL81 9/6	8/450V 2/3	60+250/275V 12/6
DAF96	8/-	EL84 7/-	PL82 9/-	4/350V 2/3	100+100/275V 12/6
DF96	8/-	EY51 9/-	PL83 8/-	16+16/450V 5/6	2000+4000/6V 12/6
DK96	8/-	EY86 9/-	PY32 10/6	32+32/450V 6/6	
DL96	8/-	EZ81 7/-	PY81 8/-	1000/25V 3/9	
ECC81	7/-	EY32 9/6	PY82 8/-	Erstin Multicores Solder 60/40, 4d.	
ECC82	7/-	EM84 8/6	U25 10/6	per yard. Cartons 2/6, etc.	

## DE LUXE R/PLAYER KIT

Incorporating 4 Speed Garrard Auto-Slim unit and Mullard latest 3 watt amplifier (ECL 86 and EZ 80), volume, bass and treble controls, with 8" x 5" 10,000 line speaker.

Contemporary styled two-tone cabinet, charcoal grey and off-white with matching blue relief. Size: 17 1/2" x 16" x 8".

**COMPLETE KIT £13.19.6** Carr. & ins. 10/-.

Catalogue & construction details 2/6 (free with kit)

**STANDARD RECORD PLAYER KIT**  
Using BSR UA14 Unit, complete kit £11.10.0, carr. 7/6. Ready wired Amplifier, 7" x 4" quality Speaker and O/P trans., £3.19.6, carr. 2/6. BSR UA14 Unit, £6.10.0, carr. & ins. 5/-.

Rexine covered cabinet in two-tone maroon and cream, size 15 1/2" x 14 1/2" x 8 1/2" with all accessories plus uncult record player mounting board 14" x 13", 59/6, carr. & ins. 5/-.

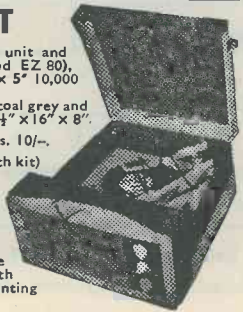

## MULLARD "3-3" HI-FI AMPLIFIER

### 3 VALVES 3 WATT



3 ohm and 15 ohm Output.

A really first-class Amplifier giving Hi-Fi quality at a reasonable cost. Mullard's latest circuit. Valve line-up: EF86, EL84, EZ81. Extra H.T. and L.T. available for Tuner Unit addition. This is the ideal companion Amplifier for FM tuner units.

**TECHNICAL SPECIFICATION**—Freq. Response:  $\pm$ 1dB. 40 c/s-25 kc/s. Tone controls, max. treble cut 12dB at 10 kc/s. Max. Bass Boost 14dB at 80 c/s sensitivity: 100MV for 3W output. Output Power (at 400 c/s): 3W at 1% total harmonic distortion. Hum and Noise Level: At least 70dB below 3W.

**COMPLETE KIT** (incl. valves, all components, wiring diagram and special quality sectional Output Trans.) **BARGAIN PRICE** £6.19.6 carr. 4/6. Complete wired and tested, 8 gns. Wired power O/P socket and additional smoothing for Tuner Unit, 10/6 extra.

**Bronze Escutcheon Panel**, Printed Vol., Treble, Bass, On-Off, supplied with each kit. Recommended Speakers—R. Allen 12" with tweeter 42/6, WBHF10-12 £4.7.6, Goodmans Axiette £5.5.0, Axiom 10 £6.5.0, Audiom 8 £8.10.0, Carr. extra.



Est. 1946

Send for detailed bargain lists, 3d. stamp. We manufacture all types Radio Mains Trans. Chokes, Quality O/P Trans., etc. Enquiries invited for Specials, Prototypes for small production runs. Quotation by return.

**RADIO COMPONENT SPECIALISTS**  
70 Brigstock Rd., Thornton Heath, Surrey  
THO 2188 Hours: 9 a.m.-6 p.m., 1 p.m. Even. Terms  
C.O.D. Post and Packing up to 1 lb. 9d., 1 lb. H3, 3 lb. 2/3, 5 lb. 2/9, 8 lb. 3/6.

# HOME RADIO of MITCHAM

DEPT. RC, 187 London Road, Mitcham, Surrey. MIT 3282

## SOME UNREPEATABLE BARGAINS!!

Some exceptionally well made S.W. Tuning Condensers, silver plated and split end vanes.  $\frac{1}{4}$ " spindle with extension for coupling two or more together.

Single gang size  $1\frac{1}{2}" \times 1\frac{1}{2}" \times 1\frac{1}{2}"$  Cap. 50 Pf. 4/6 Worth 10/-

Single gang size  $1\frac{1}{2}" \times 1\frac{1}{2}" \times 1\frac{1}{2}"$  Cap. 60 Pf. 5/6 Worth 11/6

Twin gang size  $2\frac{1}{2}" \times 1\frac{1}{2}" \times 1\frac{1}{2}"$  Cap. 50 Pf. 8/6 Worth 15/-

### Also for S.W. Work:

Air Tuner Condensers.  $1\frac{1}{2}" \times 1\frac{1}{2}" \times 1"$  Cap. 20 Pf. 3/9  
Worth 6/9

Air Trimmer Condensers.  $1\frac{1}{2}" \times 1\frac{1}{2}" \times 1"$  Cap. 100 Pf. 2/6 for 3  
Worth 21/-

Air Dielectric High Efficiency Tuning Condensers with widely spaced Log-shaped Plates.  $2" \times 2" \times 1\frac{1}{2}"$  20 Pf. 4/6  
Worth 10/6

Similar Condenser to above, but plates not so widely spaced.  
 $2" \times 1\frac{1}{2}" \times 1\frac{1}{2}"$  160 Pf. 4/-  
Worth 7/6

## WE ARE STOCKISTS OF THE WHOLE RANGE OF MARTIN AUDIO KITS

Send Today for Descriptive Leaflet

### Meters by Weston 2-inch scale

500 Micro Amp full scale deflection. Scaled 0-15 and 0-600.

Price 17/6

### A high quality Output Transformer

Primary 7000 Ohms. Secondary 3 Ohms:  
Suitable for Mullard ECL 86 Valve.

Price 6/6 Worth 12/6

## WE ARE STOCKISTS OF RADIONICS KITS AND CIRCUITS

Send Today for Free Leaflet

Please add 1/6 for Postage & Packing on all the above items

# HOME RADIO CATALOGUE

## New Edition! New Policy!

With the arrival of the 10th Edition of the famous Home Radio Catalogue we announce a fresh policy. The new price of 5/- will just cover the cost of the paper and printing, but on the first page of the catalogue you will find 5 coupons, each worth 1/- if used as directed. Briefly the system will operate thus: for each complete £1 of your order you enclose one of the coupons and deduct 1/- from the money you send. There is no time limit so if you purchase £5 worth of components from us—even though spread over several years—your catalogue will have cost you nothing!

We need only add that our new Catalogue is bigger and better than ever . . . so fill in the Coupon, enclose 6/- (5/- plus 1/- postage), and pop it in a letter box right away!

Please write your Name and Address in block capitals

Name \_\_\_\_\_

Address \_\_\_\_\_

Home Radio Ltd. Dept. R.C., 187 London Road, Mitcham

# THE Radio Constructor



Incorporating THE RADIO AMATEUR

## OCTOBER 1964

Vol. 18, No. 3  
Published Monthly  
(1st of month)

*Editorial and  
Advertising Offices*

57 MAIDA VALE LONDON W9

*Telephone*  
CUNningham 6141

*Telegrams*  
Databux, London

First Published  
1947

Top Pocket Transistor Radio, <i>by G. Jeffries</i>	156
Suggested Circuits No. 167: "Blowing Out" an Electric Light Bulb, <i>by G. A. French</i>	159
News and Comment	161
Transistorised Calibrating Oscillator, <i>by D. H. Leslie</i>	162
Inexpensive Output Meter, <i>by E. S. Barker</i>	164
Using the OCP71, <i>by G. C. Dobbs, G3RJV</i>	165
Simple M.W. Receiver for the Beginner, <i>by E. Govier</i>	166
Ferroxcube Decoupling Beads, <i>by M. J. Darby</i>	169
Understanding Radio, <i>by W. G. Morley</i>	170
In Your Workshop	174
Experiences of an Early Amateur, Part 3, <i>by C. H. Gardner</i>	179
Experimental 12AX7-12AU7 Gram Amplifier, <i>by J. C. Noakes</i>	182
Extra Features for Your Tape Recorder, <i>by G. D. Howat</i>	184
National TV and Radio Show Report	187
Gas Filled Counting Tubes, <i>by J. B. Dance, M.Sc.</i>	188
The New Dual-Standard TV Sets, Part 6, <i>by Gordon J. King, Assoc.Brit.I.R.E., M.T.S., M.I.P.R.E.</i>	194
The "Single-Span" Mains Driven Receiver, <i>by Sir Douglas Hall, K.C.M.G., B.A.(Oxon)</i>	197
Recent Publications	200
Simple Quality Oscilloscope, Part 1, <i>by D. M. Williams, B.Sc.</i>	201
Transistor Mains Intercom, <i>by I. M. Rees</i>	204
Radio Topics, <i>by Recorder</i>	208

© Data Publications Ltd., 1964. Contents may only be reproduced after obtaining prior permission from the Editor. Short abstracts or references are allowable provided acknowledgement of source is given.

Annual Subscription 33s. (U.S.A. and Canada \$5) including postage. Remittances should be made payable to "Data Publications Ltd". Overseas readers please pay by cheque or International Money Order.

# TOP POCKET TRANSISTOR RADIO

By G. Jeffries

**T**HIS LITTLE TRANSISTOR RADIO IS INTENDED FOR fitting into the top pocket, and it was designed after most of the bus and coach companies had barred the use of loudspeaker sets.

The circuit employs the minimum number of components to obtain the desired performance, and its overall dimensions are only  $4\frac{1}{2}$ in long by  $2\frac{3}{8}$ in wide with a cabinet depth of approximately 1in. The receiver incorporates two transistors, operates over the medium waveband, and drives a high impedance earphone. It can also be used to feed a push-pull amplifier when operated at home, thereby giving loudspeaker reception.

## The Circuit

The circuit diagram of the two-transistor receiver appears in Fig. 1. In order to achieve the desired sensitivity with a ferrite rod whose length is limited to  $2\frac{1}{2}$ in, the first stage is a reflexed r.f. and a.f. amplifier with regeneration.

The required signal is tuned in by the ferrite rod aerial,  $L_1$ , in conjunction with  $C_1$ , and is fed to the base of  $TR_1$  via  $C_3$ . An amplified r.f. signal appears at the collector of  $TR_1$ , and is prevented from being passed to the following a.f. stage by the r.f. choke,  $L_2$ . A portion of the amplified signal is fed back to the ferrite rod winding by  $C_2$  in order to provide regeneration.

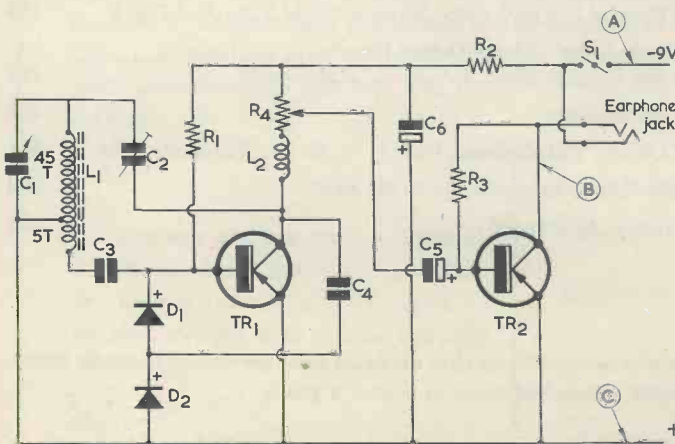

Fig. 1: The circuit of the 2-transistor receiver

The collector of  $TR_1$  is coupled via  $C_4$  to the detector circuit given by the diodes  $D_1$  and  $D_2$ . These allow the detected signal to appear at the base of  $TR_1$  which then carries out its secondary function of a.f. amplifier. The polarity of the two diodes is such that the base of  $TR_1$  tends to go positive with increase in signal strength, with a result that a rudimentary form of a.g.c. is obtained.

## Components List (Fig. 1)

### Resistors

(All fixed resistors  $\frac{1}{4}$  watt 10%)

- $R_1$  390k $\Omega$
- $R_2$  1k $\Omega$
- $R_3$  270k $\Omega$
- $R_4$  5k $\Omega$  potentiometer, log track, miniature, rim adjust. (May be ganged with  $S_1$ —see text)

### Capacitors

- $C_1$  500pF variable, miniature, solid dielectric
- $C_2$  2–8pF concentric trimmer
- $C_3$  0.01 $\mu$ F
- $C_4$  500pF
- $C_5$  8 $\mu$ F electrolytic, 12V wkg.
- $C_6$  100 $\mu$ F electrolytic, 12V wkg.

### Inductors

- $L_1$  Ferrite rod aerial (see text)
- $L_2$  R.F. choke, 2.5mH (Elpico)

### Semiconductors

- $TR_1$  OC44
- $TR_2$  OC71
- $D_1$  OA81
- $D_2$  OA81

### Switch

- $S_1$  s.p.s.t. on/off (see text)

### Earphone

- 500 $\Omega$  to 1k $\Omega$  impedance

### Battery

- 9V, type PP3 (EverReady)

### Miscellaneous

- Groupboard, eyelets, cabinet, etc.

## Components List (Fig. 2)

### Resistors

(All resistors  $\frac{1}{4}$  watt 10%)

- R<sub>5</sub> 100 $\Omega$   
R<sub>6</sub> 4.7k $\Omega$   
R<sub>7</sub> 10 $\Omega$

### Capacitor

- C<sub>7</sub> 0.1 $\mu$ F

### Transistors

- TR<sub>3</sub> GET114 } Matched pair  
TR<sub>4</sub> GET114 }

### Transformers

- T<sub>1</sub> Driver transformer type LT44 (Henry's Radio Ltd.)  
T<sub>2</sub> Output transformer type LT700 (Henry's Radio Ltd.)

### Switch

- S<sub>2</sub> s.p.s.t. on/off switch

### Battery

- 9 volt (see text)

### Loudspeaker

- 3 $\Omega$  impedance

The amplified a.f. at the collector of TR<sub>1</sub> passes through the r.f. choke L<sub>2</sub>, and is applied to the volume control R<sub>4</sub>. The slider of R<sub>4</sub> taps off the desired a.f. level, which is then fed to the base of TR<sub>2</sub>. The latter functions as a high gain common emitter stage, driving the high impedance earphone. A small amount of feedback is applied via R<sub>3</sub>.

There is no stabilising circuit for TR<sub>2</sub>, which passes a relatively low current of about 1.5mA. In the writer's experience, and after a considerable period of use, there has been no evidence of thermal runaway using the circuit shown.

Fig. 2 gives the circuit of the additional a.f. amplifier. This is quite optional and is only employed when loudspeaker reception is required. The circuit is quite conventional and consists of two transistors in push-pull offering an output of the order of 300mW. The amplifier couples to the receiver circuit of Fig. 1 by way of the terminal points indicated as A, B and C.

### Construction

A very convenient method of construction for the Fig. 1 circuit is given by the Paxolin groupboard technique, and the layout employed in the prototype is illustrated in Fig. 3. This diagram also shows the outside dimensions of the groupboard.

The groupboard should initially be marked out and all the holes drilled. Holes required for connection points may then be fitted with eyelets. With the exception of R<sub>4</sub>, the components are all mounted on one side of the board and take up the positions shown in the diagram. Capacitor C<sub>5</sub> is omitted

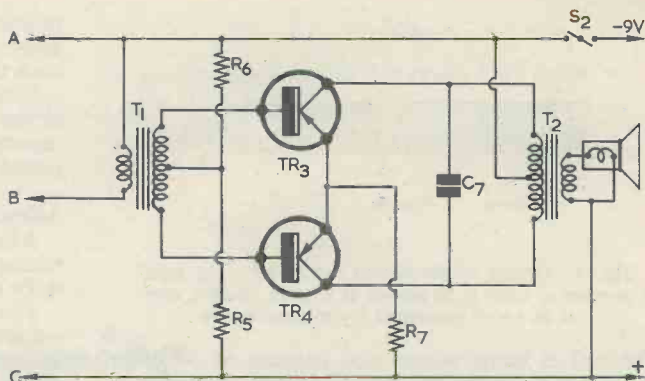

Fig. 2. The optional power output stage. This enables the receiver to operate a loudspeaker

from this diagram for ease of presentation, and it connects between the centre tag of the volume control R<sub>4</sub> and the base of TR<sub>2</sub>, the positive end connecting to the transistor.

The on/off switch, S<sub>1</sub>, is not shown in Fig. 3. This component is inserted between the negative supply terminal on the groupboard and the negative terminal of the battery. S<sub>1</sub> may be a miniature slide type fitted to the side of the cabinet, or a switch which is incorporated in R<sub>4</sub>. In the latter case, the wiring to R<sub>4</sub> may vary from that illustrated in Fig. 3, which shows the connections applicable to a potentiometer without a switch.

### The Ferrite Rod Aerial

Details of the ferrite rod aerial are given in Fig. 4.

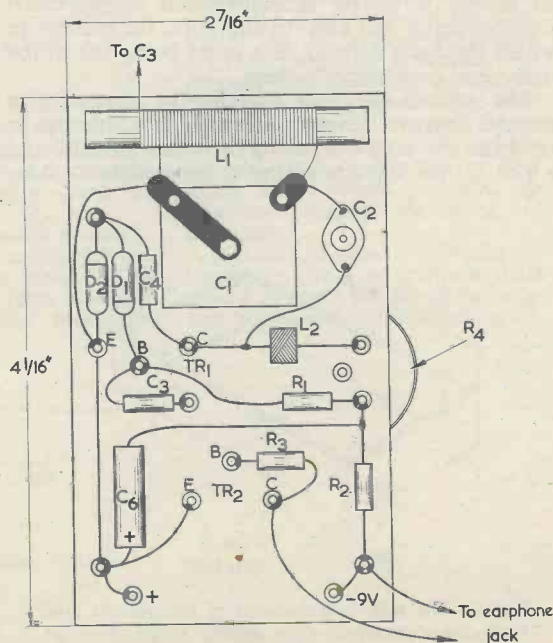

Fig. 3. The layout employed with the prototype

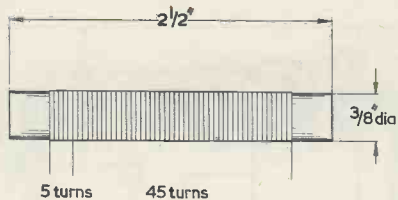

Fig. 4. Details of the ferrite rod aerial. The total number of turns is 50 tapped at 5 turns, and the wire is 36 s.w.g. enamelled rayon-covered wire

The coil is home-wound and consists of 50 turns of 36 s.w.g. enamelled rayon-covered copper wire with a tap of 5 turns. The ferrite rod is  $2\frac{1}{2}$  in long with a diameter of  $\frac{3}{8}$  in. The ferrite rod assembly may be secured to the groupboard by clips or, more simply, by tying it in place with suitable thread. It is important to ensure, when clips are used, that these do not cause an effective "shorted turn" to be formed around the rod.

#### The Cabinet

The prototype cabinet was made from  $\frac{1}{8}$  in Perspex, made up to the outside dimensions shown in Fig. 5. These allow a clearance of  $\frac{1}{8}$  in on all four sides of the groupboard. The depth of the cabinet, shown provisionally as 1 in, depends partly upon the clearance required on the non-component side of the board by the volume control, and on the size of the components around TR<sub>2</sub>. It is necessary to fit the PP3 battery at the TR<sub>2</sub> end of the board, and the cabinet depth must be sufficient to enable it to be accommodated comfortably. Cabinet depth will also depend upon the manner in which the back is fitted, this point being left to the individual constructor's ideas.

The cabinet is glued together by means of a suitable Perspex adhesive, after which a hole has to be drilled to take the tuning capacitor spindle, and a slot cut for the rim of the volume control. Also

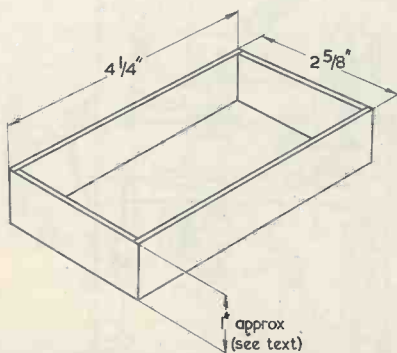

Fig. 5. The outside dimensions of the cabinet used with the prototype. The depth, shown here as approximately 1 in, may vary according to the components employed in the receiver

required are a hole for the earphone jack, and an aperture for the on/off switch (if this is not ganged with the volume control).

With the prototype, the groupboard was secured in the cabinet by a single nut fitted over the tuning capacitor bush. The final appearance of the completed receiver in its cabinet is shown in Fig. 6.

#### Adjustment

After the receiver has been completed and the wiring carefully checked, the regeneration level has to be adjusted.

The receiver should be switched on and the volume control set to maximum. A strong local station is then tuned in and the receiver oriented for maximum pick-up by the ferrite rod aerial. Trimmer C<sub>2</sub> is then adjusted until the receiver is just short of going into oscillation. This procedure is then finally repeated at the high frequency end of the band, working preferably with the Radio Luxembourg signal.

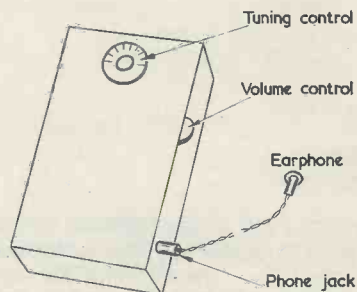

Fig. 6. The appearance of the completed receiver

#### Using the Additional Power Stage

If desired, the receiver may be employed from time to time with the optional power output stage shown in Fig. 2. In this instance, it is necessary to provide a simple means of interconnection between the two sections. It is also desirable to disconnect the small receiver battery and to employ a larger battery installed in the power amplifier unit.

A simple means of interconnection for terminals A and C consists of fitting battery clips at the power amplifier, whereupon the battery leads in the receiver may be clipped to these. Connection to terminal B may be achieved by inserting a jack plug having a single wire soldered to its appropriate contact.\*

In the writer's case, the additional power unit was built into an extension speaker cabinet, and fed to a 3Ω 10 in loudspeaker.

\* Although, as stated by the writer, there was no evidence of thermal runaway in TR<sub>2</sub> with the prototype, the theoretical risk of damage to TR<sub>2</sub> is increased when the circuits of Fig. 1 and 2 are used in combination because the primary of T<sub>1</sub> will have a much lower resistance than is offered by the earphone. If this risk is considered sufficiently high it may be reduced by inserting a 470Ω resistor between the negative supply line and the upper end of T<sub>1</sub> primary, bypassing the junction with a capacitor of around 8μF.  
—EDITOR.



The circuits presented in this series have been designed by G. A. French, specially for the enthusiast who needs only the circuit and essential data

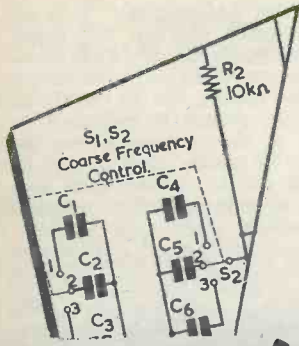

## suggested circuits

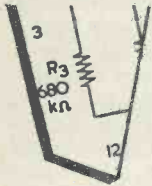

### No. 167 "Blowing Out" an Electric Light Bulb

BY THE TIME THIS ARTICLE APPEARS in print we will be well into the autumn, and many of us will be turning our minds to the indoor pastimes which are applicable at this time of the year and in the months to come. Typical of such pursuits are parties, and in this respect the more technically minded members of the family can often earn additional feathers for their caps by producing simple toys and games which not only amuse but mystify as well. The device which is described in this month's contribution to the "Suggested Circuit" series meets both these requirements and it employs components which can be purchased for several shillings only. So far as the writer is aware, the particular application involved has not been described before so far as the field of "party gadgetry" is concerned. The circuit has a more serious use also, since it can provide a convincing demonstration of the functioning of a common electronic component.

In its complete form, the device may be presented as a box on which is mounted a small electric light bulb shining at full brilliance. A participant is then asked to "blow out" the bulb in the same manner as one blows out a candle. It will be found that, after three or four vigorous puffs, the bulb is completely extinguished, it becoming dimmer after each puff. Some moments after the lamp is extinguished it will commence to glow again, reaching full

brilliance in some 20 seconds, after which it may be "blown out" once more.

To the uninitiated the effect is quite puzzling. If desired, the device may be made the focal point of a game, the object of which is to "blow out" the bulb with the minimum number of puffs. A game of this nature can be particularly useful for children's parties.

#### The Circuit

The circuit of the device accompanies this article. As will be seen it consists, quite simply, of a 6 volt low-consumption bulb, a thermistor, a pre-set resistor, and a source of 27 volts.

When the on-off switch is closed, the 27 volt supply is applied to the three components in series. The thermistor is, at this time, cold and it offers a high initial resistance.

The current flowing through it causes its temperature to rise and its resistance to drop until, after a period, it reaches maximum temperature and the bulb glows at full brilliance. If one blows on the thermistor, its temperature drops and its resistance increases. By blowing vigorously three or four times, the temperature of the thermistor can be sufficiently reduced, and its resistance sufficiently increased, for the bulb to become completely extinguished. The thermistor commences to warm up as soon as the blowing ceases and the filament of the bulb starts to glow again after several seconds, its brilliance quickly increasing to maximum.

It should be noted that, whilst the thermistor takes a relatively long period to reach maximum temperature immediately after switching on,

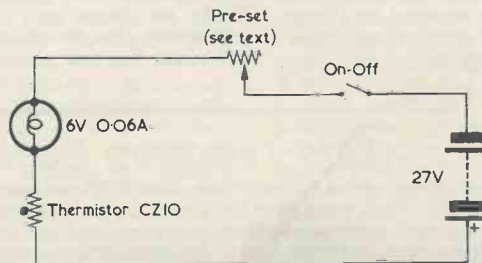

The circuit of the device which allows an electric light bulb to be apparently "blown out". The polarity of the 27 volt battery is unimportant

the time required for the lamp to become illuminated again after it has been "blown out" is very short. This is because, in use, the thermistor works over a small temperature range whose limits correspond to full illumination and extinction of the bulb.

The "secret" of the device lies, of course, in the fact that it is the thermistor which is blown upon and not the bulb. In practice, the thermistor is mounted close to the bulb, whereupon its very small size enables it to be rendered almost completely inconspicuous. The thermistor specified is a wire-ended component having a length of  $\frac{1}{8}$  in and a maximum diameter of  $\frac{3}{32}$  in only. Also, its body is black with silvered ends, and the latter can be given a light coat of matt black enamel to prevent their reflecting the light from the bulb. As such, the thermistor may be easily "camouflaged" by adjacent wiring or decoration. It must be remembered, however, that the thermistor requires reasonable access to free air, so that it may stabilise by losing heat by radiation and convection.

#### The Components

The two major components are the light bulb and the thermistor. The former is a Radio Spares m.e.s. pilot lamp having a rating of 6 volts at 0.06 amp. The latter is a Brimistor type CZ10, manufactured by Standard Telephones and Cables Ltd. The 60mA required by the bulb falls comfortably within the 75mA maximum operating current specified for the CZ10 thermistor. At the time of writing, the retail cost of the bulb is 9d. only, and that of the thermistor 1s. 6d.

The pre-set resistor should be a wirewound type capable of being set to values of the order of 50 to 120 $\Omega$ . Any component having a value of 150 to 500 $\Omega$  should be satisfactory here. The track of the resistor should be capable of carrying 60mA. Since the pre-set resistor is only required to take up small variations between individual thermistors, it can be replaced by a fixed resistor of the appropriate value after initial setting up.

The on-off switch may be any rotary or toggle type, as desired.

The 27 volt supply is provided by a dry battery, the writer employing three 9 volt transistor batteries in series for the prototype. A drain of 60mA is rather high for dry batteries, however, and alternative supplies are discussed later.

#### Setting Up

To set up the circuit it is necessary to have available a milliammeter capable of giving reliable readings at 60mA. Meters with full-scale deflections between 100 and 250mA will be satisfactory here. The meter is inserted in series with one of the battery leads. The pre-set resistor is then adjusted to insert about 50 $\Omega$  into circuit and the on-off switch closed. Initial current will be low, gradually increasing, after 40 seconds or so, to about 20 to 30mA, after which it will commence to rise rapidly. If there is any indication of the current increasing above 60mA, more resistance must be immediately inserted into circuit by the variable resistor. The variable resistor should be adjusted finally so that the current stabilises at 60mA.

Circuit operation may next be checked by blowing on the thermistor, and it should be possible to completely extinguish the bulb by this means. The bulb should take about 20 seconds to reach full brilliance again after it has been extinguished in this manner.

The on-off switch may next be opened and the thermistor allowed to cool to room temperature. The switch should then be closed once more, whereupon it should be found that about 60 to 70 seconds are needed for the thermistor to reach full operating temperature.

If desired, the value of resistance inserted by the pre-set resistor may be measured, whereupon it can be replaced by a fixed resistor of the same value. With the prototype circuit it was found that 80 $\Omega$  was required with one particular thermistor of the type specified and 75 $\Omega$  with a second. The milliammeter may finally be taken out of circuit, whereupon the device is complete and ready for use.

#### Alternative Combinations

The writer checked the circuit using more than one bulb in series and a correspondingly higher voltage from the battery, but he found that the larger change in resistance required of the thermistor was too great to be readily accomplished by blowing on it. Experiments with more than one thermistor were also unrewarding.

Fairly good results were given by using a single 6.3 volt 0.15 amp dial lamp with a single thermistor, the circuit running at 70mA. The lamp did not, of course, glow at full brilliance, but the circuit functioned satisfactorily otherwise.

By far the best results were given with the single thermistor and the single 6 volt 0.06 amp lamp.

#### Power Supply

As mentioned above, it may be considered that the 60mA drain required by the circuit is rather heavy for dry batteries, and an alternative supply may be preferred. Although not checked by the author, there is no reason why the circuit should not work equally well when powered by a 50 c/s voltage whose r.m.s. value is of the order of 27 volts. Such a voltage could be obtained from the secondary of a mains transformer. Because of the risk of shock the a.c. supply must, of course, be isolated from the mains.

It should be pointed out, here, that the voltage required for powering the circuit is rather critical. If it is too low the thermistor will not pass enough current initially to warm up. If it is too high the resistance change required in the thermistor increases. These points have to be borne in mind when using power supplies other than the dry battery.

With the a.c. supply, the circuit may be set up to 60mA by inserting an a.c. milliammeter in series with one of the supply leads. Alternatively, an a.c. voltmeter (provided it is a high resistance instrument) can be connected across the bulb, the pre-set resistor being adjusted for a reading in the meter of 6 volts.

## Eldo Telemetry Contract for EMI

The Ministry of Aviation has recently extended EMI's responsibilities for the supply of telemetry equipment and services to Blue Streak, the first stage of the ELDO three-stage launcher, Europa 1. These responsibilities now include the development of a new telemetry sender for use on the Blue Streak flight trials programme as from early 1965.

Telemetry plays a very important part in the development programme. On the first Blue Streak firing at Woomera on 5th June, 1964, some 200 parameters were monitored and telemetered back to ground. This extensive and detailed information about the rocket's in-flight performance is essential so that each firing in the trials programme contributes in full to an orderly sequence of design proving tests.

# NEWS AND COMMENT . . .

## Stereophonic Radio—1880

Shortly after these notes have been written, judging for the Italia Prize 1964 will be taking place in Genoa. The Italia Prize itself, is for the best radio programme, and the two B.B.C. entries are: "The Flip Side" by Maxwell Charles Cohen, produced by H. B. Fortuin, and "November Day" by Bill Naughton, produced by Douglas Cleverdon.

The B.B.C. has, from time to time, been criticised for not supporting stereophonic radio more enthusiastically, but it has an entry in this category in one of the associated events run in conjunction with the Italia Prize.

The B.B.C. entry is "The Hearing Aid", a programme not in fact yet heard, but due for transmission on the Third Network and TV sound in October. This is a brief history of Stereophony, which, surprising as it may seem, was the subject of early experiment as long ago as the 1880s. A very early U.S. stereo recording machine bore the incredible name of the Multiplex Graphophone Grand. The programme written by Edward Greenfield and narrated by Sir Adrian Boult includes early tests and interviews with some of the pioneer workers. The production is by Richard Keen.

## Another Prize

We referred in last month's issue to the Radio Society of Great Britain's annual International Radio Communications Exhibition, to be held again at the Seymour Hall, Marble Arch, London W.1, from the 28th to the 31st of October inclusive. Readers of *The Radio Constructor* who attend are entitled to enter a free competition, the prize for which is a £140 Hammerlund HQ 170A Communication Receiver.

Readers attending, who wish to enter the competition, should cut out the advertisement for the exhibition which appears on Page 212 and exchange it for the free entry form at the door.

## Lecture Quotation

"Almost 13 million homes in Britain now have television. Only about 2½ million are left with radio only. If television were

going to throttle radio, sound broadcasting would be dead by now. Yet consider these facts. A recent research inquiry found only 4 per cent of the population declaring that they did not listen to radio at all, or had no radio sets. Over the last six years, radio's average daily audience in Britain has been rising steadily, with marked increases each year. By the early weeks of 1964, the figure had risen to a total of 28 million people listening at some time or other every day."

From *Sound Radio in the Television Age*, by Frank Gillard.

## Tape Recorder in Court

Some readers will have read of the unauthorised use of a tape recorder at Bow Street Magistrates' Court recently.

Learned Counsel interrupted a policewoman witness to inform the Magistrate that "there is a gentleman in court with an attaché case which, it has been noticed, has been pointing at the witness box".

The man had to leave the court while the matter was looked into. The attaché case proved to have a tape recorder inside and the Magistrate ordered it to be retained so that enquiries could be made as to whether it was an offence or not to use a recorder in court.

When the court was reconvened it was announced that, although it was an offence to take a photograph in court, it was not an offence to record the proceedings on a tape recorder. The owner of the recorder duly started it up again, unfortunately it then began to emit a whining noise. The case was again stopped and Mr. Babington, the Magistrate, told the owner " . . . you can play it to your heart's content, but you must stop it squeaking."

The above true story is amusing, but it does raise important issues for the owners of tape recorders. We have previously remarked on invasions of privacy by transistor set owners, and we have heard of a friendship which was terminated because a private conversation was recorded without the knowledge of the participants and then it was played back to the embarrassment of all concerned.

## E.E.V. and A.E.I. Statement

Agreement has been reached for the English Electric Valve Co. Ltd. to purchase from Associated Electrical Industries Ltd. their Carholme Road factory at Lincoln, together with the valve business being carried on there.

The transfer of the factory will enable the English Electric Valve Company to meet the rapid expansion of its business which is outgrowing the facilities now provided by their factory at Chelmsford, Essex. It is their intention to increase still further the production of specialised electronic valves and tubes used in television transmission and telecommunications and eventually to build up the labour force at the Lincoln factory to some 1,000 people.

The English Electric Valve Company will lease to Associated Electrical Industries a part of the factory, and A.E.I. are able to continue the development and manufacture of semi-conductors in the present premises.

Associated Electrical Industries, one of the major manufacturers of semi-conductor devices in the United Kingdom, will extend its operations in this field and semi-conductor production will continue at the Lincoln factory and at the A.E.I. Rugby Works as at present; output is to be stepped up.

## A Real Constructor!

We would like to quote, part of a letter quote, in the August issue of *Mobile News*, the excellent monthly journal of the Amateur Radio Mobile Society. ". . . I think we might cheerfully add that anyone who does not build his own motor car has no right to a driver's licence."

At what stage do we become, or cease to become, radio constructors? If we put together a kit, are we just a radio assembler? If we save a considerable amount of time by not winding our own coils, are we sort of cheating?

The foregoing reminded us of another true story. A hobbyist friend of a former member of our editorial staff purchased a lathe. As far as is known he only ever used it to make tools to use on the lathe!

# TRANSISTORISED CALIBRATING OSCILLATOR

By D. H. Leslie

ONE OF THE CHIEF DIFFICULTIES FACING THE constructor of short wave receivers is the calibration of the tuning dial. A very simple method is to use a crystal controlled oscillator with a fundamental frequency of 100 kc/s. The harmonics of this oscillator provide markers at 100 kc/s intervals which can be heard well into the short wave range, and the dial marked accordingly. Having marked these points, one only requires to identify one particular frequency on each tuning range to have identified the corresponding 100 kc/s point. Standard frequency transmissions on 2.5, 5, 10, 15, 20 and 25 Mc/s and stations in the broadcast bands can be used to fix the 100 kc/s points.

By plotting graphs of logging dial readings against marker points, intermediate frequencies can easily be found. Having once calibrated the receiver, the 100 kc/s marker is still useful as most receivers, even after initial warm-up, suffer from a slight variation in frequency from day to day or when returning to one range from another. Thus one can mentally add or subtract the odd degree or so from one's normal calibration for a desired frequency after checking the nearest 100 kc/s point.

The transmitting amateur can use his v.f.o. near the band edges with complete peace of mind if he knows precisely where the band edge really is!

## Gouriet Oscillator

Recently, whilst experimenting with transistor crystal oscillators, the idea of modernising his

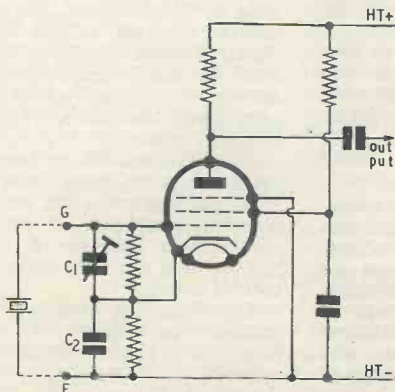

Fig. 1. The basic Gouriet oscillator

100 kc/s calibrator occurred to the writer. The original valve model had been made up on a small chassis, relying on the equipment under test for its power supply. The circuit was of the Gouriet type (Fig. 1) and gave harmonics up to about 15 Mc/s, but as the frequency increased these became very weak and were often masked by signals picked up on the short leads between the oscillator and the receiver.

In Fig. 1 a negative resistance proportional to the  $g_m$  of the valve appears at the terminals G and E.\* A tuned circuit connected at these points will oscillate provided the negative resistance is sufficient to overcome the loss resistance of the circuit. Small adjustments in frequency may be made by adjusting the trimmer  $C_1$ .

An important point to be noted with this type of circuit is that if a triode is used the anode must be at earth potential with respect to r.f. Where a pentode is used the screen grid is bypassed to earth and this acts as a virtual anode. A load can then be placed in the anode circuit.

Using the basic circuit in Fig. 2, experiments were made using one of the new diffused alloy transistors, type MAT121. This has a very high current gain and thus, by analogy, a high  $g_m$ . As it is a "triode" the output was taken from the emitter. At first the circuit just would not oscillate. It was then realised that the bias resistor  $R_1$  was effectively connected across the crystal and was probably causing too much damping. After a little "cut and try", component values were adjusted to give a reliable oscillator which "took off" each time the switch was operated, irrespective of the setting of the trimmer.

\* A full mathematical analysis of the circuit, due to G. G. Gouriet, was published in *Wireless Engineer*, April 1950.

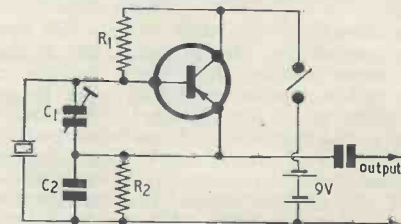

Fig. 2. The basic transistor version

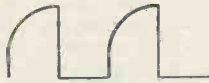

Fig. 3. The amplifier output waveform

Harmonics were strongly audible up to about 4 Mc/s but very weak beyond 9 Mc/s, even on a good communications receiver. What was required was a distorting amplifier to enhance the harmonic output. This turned out to be the easiest part of the design.

#### Adding An Amplifier

Using a transistor (MAT100) with a high collector load and a high bias resistor to ensure bottoming on negative input peaks, and cut-off on positive peaks, an almost ideal (square) waveform was produced. (See Fig. 3.) The harmonics were now found to be quite strong even at 32 Mc/s, which is as high as the author's receiver tunes; and this for a total battery consumption of about 0.5mA!

The final circuit, shown in Fig. 4, was made up in an old tobacco tin measuring approximately 4 x 3 x 1in. This gave ample room for all components, including a PP3 9V battery, without cramping. A  $\frac{1}{16}$ in hole in the side allows a trimming tool to be inserted to adjust the concentric trimmer  $C_1$ . A 15pF ceramic padding capacitor,  $C_4$ , was wired across  $C_1$  in order to allow the correct frequency to be obtained with the trimmer roughly in the mid-position. With other crystals a slightly different value may be required. In the interests of good frequency stability, mica compression types of trimmer are not advised.

#### Oscillator Adjustment

To adjust the oscillator a short lead from the output terminal can be placed near a long wave receiver tuned to the Droitwich 200 kc/s Light Programme.  $C_1$  is adjusted until the low ripple is reduced to very slow beats. Alternatively a standard frequency transmission on 2.5, 5 or 10 Mc/s, etc., may be used. Once adjusted, the oscillator will stay within a few cycles per megacycle indefinitely. There is no point in trying to be too precise about this adjustment. Five beats per second at 5 Mc/s is an accuracy of one part in a million, and without putting the crystal in a temperature controlled oven one cannot expect anything better!

To calibrate a receiver short twisted leads or screened cable are used to reduce stray pick-up, and the receiver should have been switched on for at least half an hour to avoid any drifting during warm-up.

A graph should be plotted of dial readings against markers as the calibration proceeds. In this

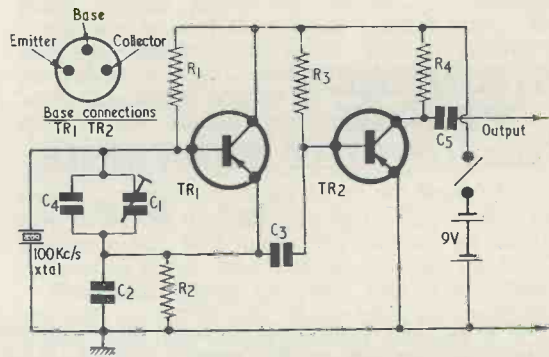

Fig. 4. The final circuit of the calibrating oscillator

#### Components List (Fig. 4)

##### Resistors

(All resistors  $\frac{1}{10}$  watt)

$R_1$	2.2M $\Omega$
$R_2$	10k $\Omega$
$R_3$	1M $\Omega$
$R_4$	47k $\Omega$

##### Capacitors

$C_1$	5-35pF, air-spaced, concentric
$C_2$	2,000pF
$C_3$	200pF
$C_4$	15pF (see text)
$C_5$	56pF

##### Transistors

TR <sub>1</sub>	MAT121
TR <sub>2</sub>	MAT100

way errors due to stray pick-up, image responses or a missed marker can easily be seen and avoided. It is easier on the higher ranges to find the markers with the aid of the b.f.o. if the set has one, although this should not be necessary if the set is reasonably sensitive. If there is any doubt as to a signal being a marker the oscillator can be switched off for a moment.

Using 1in graph paper with, say, 100 kc/s per inch, one can accommodate the calibration charts of a general coverage receiver very conveniently in a "spiral" graph paper notebook. Parts of the band of special interest, e.g. a broadcast band, can be plotted using a larger scale.

The value of this simple and reliable instrument is out of all proportion to the moderate cost and effort involved in its construction, and it is recommended to any short wave listener or constructor.

## Corrections

In the September issue, several diagrams were inadvertently transposed. On pages 94 and 95, Fig. 5 should be in the Fig. 4 position, Fig. 6 in the Fig. 5 position and Fig. 4 in the Fig. 6 position. Similarly, on pages 127 and 128, Fig. 18 should be in the Fig. 16 position, Fig. 16 in the Fig. 17 position and Fig. 17 in the Fig. 18 position.



# USING THE OCP71

G. C. DOBBS G3RJV

Some simple applications for this readily available phototransistor

**T**HE OCP71 IS A NORMAL P.N.P. TRANSISTOR IN which the photo-electric effect is used. It is similar in construction to the OC71 except that it does not have the latter's opaque coating and its clear plastic capsule is filled with silicon grease to diffuse the light.

In the basic circuit of Fig. 1 the collector current, with the transistor in darkness, is in the order of microamperes. When light reaches the sensitive area of the transistor the collector current increases, and may rise as high as 4mA. This change is large enough to operate a small relay without the use of an amplifier. In effect the phototransistor is a photodiode with a built-in amplifier, and is a very useful component.

## Exposure Meter

By using the circuit of Fig. 1, a very simple exposure meter can be made. A 1mA meter is used to measure the collector current and a Mallory cell type RM-1 can be used as a voltage source. It may be possible to mount the components within the meter case, with a small hole to enable light to reach the OCP71. The dark current is so low that a switch may not be necessary, but one could be added in series with the battery if desired.

## Light Switch

The usual application of the OCP71 is that of a light switch. In this type of circuit, the relatively

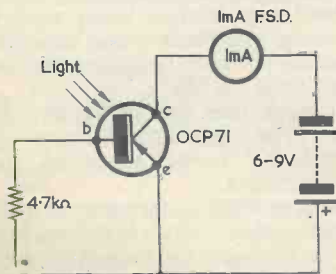

Fig. 1. Using an OCP71 as an exposure meter

heavy current passed by the OCP71, when illuminated, is used to energise a small relay. The relay is connected in series with the collector as shown in Fig. 2, and should be able to close when passing a current of 1 to 3mA. A relay that is very suitable can be found in the U.S. Army surplus Beacon Receivers type BC-357-L. Alternatively, the ex-government relay type P.27258 can be adjusted to close at about 2mA. Failing this, a normal G.P.O. type 200 relay, with a coil resistance of 5kΩ and one contact set should close with about 3mA passing through the coil.

The diode across the relay coil is a desirable addition to the circuit. If the relay coil is passing about 3mA and this is suddenly reduced to a few microamperes, self-induction within the coil may cause a large back e.m.f. to be produced. This e.m.f. may be as large as 40 volts, and will be in the reverse polarity to the normal transistor supply, but it could still damage the phototransistor.

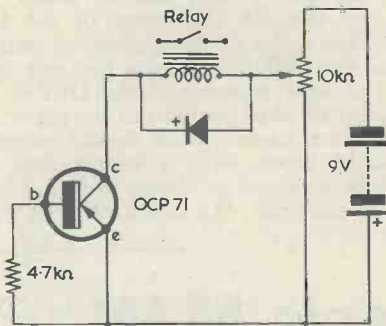

Fig. 2. An OCP71 can control a sensitive relay directly, without an intermediate amplifier

The diode, which can be just a normal germanium type such as the OA71, prevents the formation of the back e.m.f. The 10kΩ potentiometer functions as a sensitivity control, but changing tappings on the battery would have the same effect.\*

The applications of the circuit are numerous: garage door opener, liquid level control, article counter, smoke detector, and so on.

\* When setting up the circuit of Fig. 2, or any similar circuit, the OCP71 collector current must not be allowed to exceed its limiting maximum rating of 20mA. It may be added, incidentally, that the OCP71 will function in the applications shown here with its base open-circuit.—EDITOR.

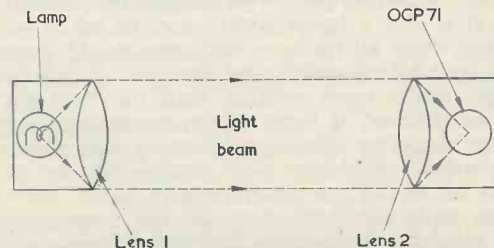

Fig. 3. A simple burglar alarm. The OCP71 is continuously illuminated by the lamp unless an intruder breaks the light beam

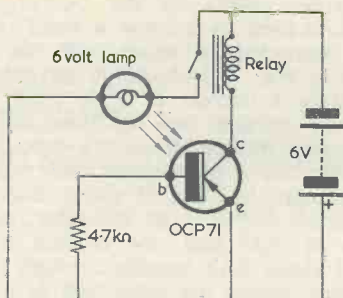

Fig. 4. An experimental "light oscillator"

### Burglar Alarm

With the aid of two lenses a simple burglar alarm can be constructed. The lenses used by the author were taken from sixpenny plastic magnifying glasses. The focal length can be found, during daylight, by focusing the image of the window frames of the room on to a piece of paper, and measuring the distance between the lens and the paper. The light source and the OCP71 should be placed in the same position as the paper behind their respective lenses. Both should be enclosed in light-tight boxes with a simple lens shield. They can be arranged as shown in Fig. 3, so that the relay is energised. An object crossing the light



Fig. 5. Illustrating the lead-out connections and the sensitive area of the OCP71

beam will release the relay, which can then switch on any warning device.

### Light Oscillator

A novel circuit is shown in Fig. 4, in which a lamp is illuminated by the relay contact when the relay is de-energised. If the lamp is brought close to the OCP71 it causes the transistor to conduct and switch the lamp off. This results in the relay falling out and switching the lamp back on again, and the whole cycle is repeated. The lamp, therefore, will flash on and off giving us a novel form of oscillator. The uses of this circuit are doubtful but it is fun, nevertheless!

# Simple M.W. Receiver for the Beginner

E. GOVIER

A SIMPLE, INEXPENSIVE AND EASY-TO-CONSTRUCT receiver for medium wave coverage is often required by the beginner who feels that he would like to produce such a radio for the workshop, the kitchen or for use as a bedside radio. For most beginners the writer has found that medium wave coverage only is required.

Apart from simplicity of design, the question of cost is also a factor which must be taken into account. Not all readers—beginners or old timers alike—can afford multi-valve designs. A superhet design, whilst more efficient than the "straight" type of receiver, is more expensive and complex, and so the latter category of receiver was chosen. The actual prototype was constructed by the writer for an old age pensioner with rather limited means and, although many of the components were available in the junk box, two of the valves had to be purchased. Those most cheaply obtainable on the surplus market were therefore included in the design.

### Circuit

From the diagram it will be seen that the circuit consists of a detector stage constructed around the 6SL7 octal based high- $\mu$  double-triode, the second half of the valve being utilised as the first audio amplifier stage. For those readers who happen to have on hand a 6SN7 double-triode, this may be employed instead of the 6SL7 type specified without any changes being made to the valveholder wiring, since both valves have the same base connections. The 6SN7 will, however, produce less audio gain than the 6SL7.

The output stage uses the well-known 6V6GT beam tetrode. The "metal" 6V6 may also be employed. With the "metal" valve, pin 1 should be connected to chassis.

The rectifier is a 5Y3GT operating in a conventional full-wave circuit. Full isolation from the mains supply is given by the inclusion of a small mains transformer. In the interests of safety, especially where old persons or children are con-



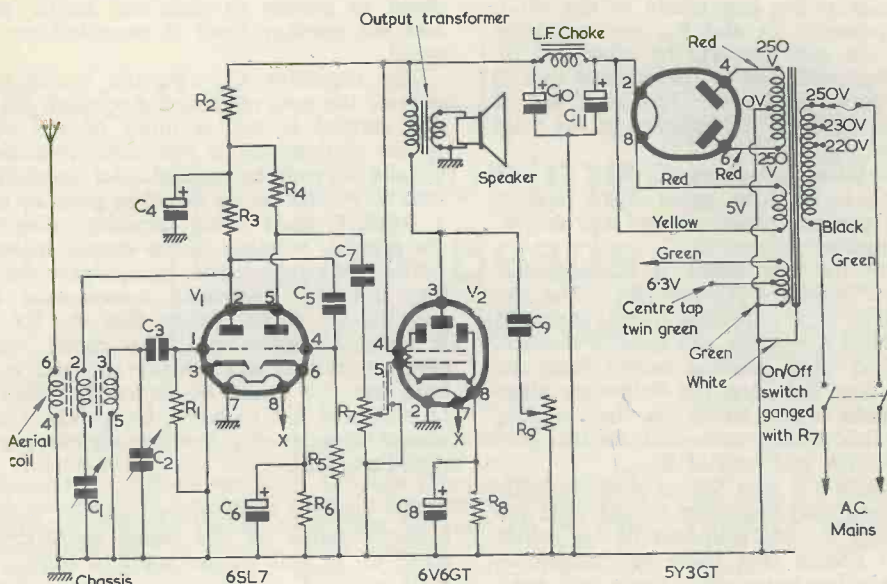

### Components List

#### Resistors

(All  $\frac{1}{2}$  watt 20% unless otherwise specified)

- R<sub>1</sub> 2M $\Omega$
- R<sub>2</sub> 150k $\Omega$
- R<sub>3</sub> 47k $\Omega$
- R<sub>4</sub> 47k $\Omega$
- R<sub>5</sub> 470k $\Omega$
- R<sub>6</sub> 1k $\Omega$
- R<sub>7</sub> 1M $\Omega$  pot. log track with d.p.s.t. switch
- R<sub>8</sub> 300 $\Omega$
- R<sub>9</sub> 50k $\Omega$  pot. log track

#### Valves

- V<sub>1</sub> 6SL7 (see text)
- V<sub>2</sub> 6V6GT
- V<sub>3</sub> 5Y3GT

#### Speaker

5in round (or other convenient size), 3 $\Omega$  impedance

#### Choke

10H, 60mA (see text) (H. L. Smith & Co. Ltd.)

#### Valveholders

International Octal (3)

#### Miscellaneous

Knobs (4); panel-Signs Set No. 6; wire, nuts and bolts, grommets, etc.

cerned, the writer prefers complete isolation from the mains even though the small mains transformer required is slightly more expensive.

A short aerial, some twenty feet in length, is connected to the primary winding of the coil type

#### Capacitors

- C<sub>1</sub> 500pF variable, Cat. No. 2093 (Jackson Bros.)
  - C<sub>2</sub> As for C<sub>1</sub>
  - C<sub>3</sub> 200pF silver mica
  - C<sub>4</sub> 8 $\mu$ F, electrolytic, 350V wkg.
  - C<sub>5</sub> 0.01 $\mu$ F, paper, 350V wkg.
  - C<sub>6</sub> 25 $\mu$ F, electrolytic, 12V wkg.
  - C<sub>7</sub> 0.01 $\mu$ F, paper, 350V wkg.
  - C<sub>8</sub> 25 $\mu$ F, electrolytic, 25V wkg.
  - C<sub>9</sub> 0.1 $\mu$ F, tubular, 350V wkg.
  - \*C<sub>10</sub> 16 $\mu$ F, electrolytic, 350V wkg.
  - \*C<sub>11</sub> 8 $\mu$ F, electrolytic, 350V wkg.
- \*Contained in single can

#### Aerial Coil

Type QR11 (Osmor Radio Ltd.)

#### Mains Transformer

Secondary voltages: 250-0-250V, 60mA; 5V, 2A; 6.3V, 2A. Type MT161 (Ellison)

#### Output Transformer

45:1 ratio (6V6 matching or multi-ratio type)

#### Chassis and Panel

6 x 8 x 2 $\frac{1}{2}$ in. (H. L. Smith & Co. Ltd)  
Panel, aluminium

QR11 (see Components List), the third (grid) winding being tuned by the variable capacitor C<sub>2</sub>.

Reaction is provided in the normal manner by the variable capacitor C<sub>1</sub>, this being connected between the second winding and chassis. The

other end of the reaction winding is connected to anode (pin 2) of the first triode of the 6SL7. The grid components,  $C_3$  and  $R_1$ , are connected at one end to the grid (pin 1), the other end of, resistor  $R_1$  being connected to the cathode (pin 3) and therefore direct to chassis. The other end of  $C_3$  is connected direct to the junction of the third coil winding and  $C_2$ .

Both the variable capacitors  $C_1$  and  $C_2$  are mounted directly to the front panel of the receiver as also are the ganged volume control and switch, and the tone control.

The anode of the first triode is taken to h.t. positive via the resistors  $R_2$  and  $R_3$ . The decoupling capacitor  $C_4$  is important in that it should be of good quality if efficient and smooth reaction is to be achieved. The detected output from the first triode is now fed into the following stage (the second triode of the 6SL7) via the coupling capacitor  $C_5$ , this being connected to the grid (pin 4) as also is the grid resistor  $R_5$ .

The components  $C_6$  and  $R_6$  provide cathode bias for this stage, and beginners should note the polarity markings for the lead-outs of  $C_6$  before wiring up and ensure that these are connected correctly. The other electrolytic capacitors used in the circuit must also be connected with correct polarity.

The anode of the second triode (pin 5) is taken, via the resistor  $R_4$ , to the junction of the components  $R_2$ ,  $R_3$  and  $C_4$ . The amplified audio signal is now fed to the output stage via the coupling capacitor  $C_7$  and the volume control  $R_7$ . This latter component also includes the on/off switch shown in the a.c. mains input lines to the primary winding of the mains transformer.

The output stage grid (pin 5) is connected to the centre tag of the volume control and a short length of screened (braided) wire should be used for this connection, the braiding being soldered to the chassis tag of the volume control. This will greatly assist in minimising undesirable a.c. hum pick up.

The components  $R_8$  and  $C_8$  provide cathode bias voltage for this stage. Pin 4 of the valveholder is taken direct to h.t. positive. Pin 3 of the valveholder (the anode) is connected to h.t. positive via the primary winding of the output transformer, the secondary winding being connected to the

loudspeaker. One tag of the speaker is connected direct to chassis (it does not matter which tag) and the speaker itself is mounted on the front panel.

The capacitor  $C_9$  and the potentiometer  $R_9$  provide the tone control components. If, however, this control is not required or the added cost of the components is not considered worthwhile,  $C_9$  and  $R_9$  may be omitted. An alternative simple tone correction circuit would be given by connecting a  $0.002\mu\text{F}$  fixed value capacitor directly across the primary winding of the output transformer.

The full-wave rectifier circuit provides adequate h.t. and the smoothing components  $C_{10}$ ,  $C_{11}$  and the l.f. choke ensure that the h.t. potential is virtually ripple-free. The choke was a 10H 60mA type that was already to hand in the junk box, but this could be replaced, where such an l.f. choke is not to hand, by a  $4\text{k}\Omega$  3 watt wire-wound resistor—this being much cheaper than the choke specified.

The rectifier heaters are supplied from the 5V heater winding of the mains transformer whilst those of  $V_1$  and  $V_2$  are supplied from a separate 6.3V winding on the same transformer. Pin 7 of  $V_1$  and pin 2 of  $V_2$  are connected direct to chassis as also is one side of the 6.3V heater winding of the mains transformer. No connection is made to the 6.3V centre-tap, which should be taped up out of the way.

The whole receiver was constructed on a chassis measuring  $6 \times 8 \times 2\frac{1}{2}$  in, the metal panel (aluminium) being secured to the chassis by the controls  $C_1$  (reaction),  $R_7$  (volume) and  $R_9$  (tone); these controls being mounted under the chassis and direct to the front panel. The tuning capacitor  $C_2$  was mounted above the chassis, directly to the panel and in a central position. The tuning scale used with this latter control was that available from Panel-Signs Set No. 6.

Once constructed, the receiver may be easily housed in a small wooden (or hardboard with wood bracing) cabinet. Alternatively it could, like the prototype, be housed in a bookshelf; in which case (provided it is fitted at one end of a shelf) only an additional side piece will need to be secured to the chassis side—that between the radio and the books.

# Scout Amateur Radio Club

The inaugural meeting of the Baden-Powell House Scout Amateur Radio Group was held on 23rd July at Baden-Powell House. The Group's aims include the organising of GB3BPH for Jamboree on the Air (17th/18th October) and the interest of Scouting in Amateur Radio and vice versa.

The establishment of a permanent amateur radio Club Station, G3TGS at Baden-Powell House will demonstrate amateur radio to Scouts visiting the House and encourage other Scouts who are licensed amateurs to contact each other.

The officers elected were, chairman Eric White G3KSO, secretary Alf Watts G3FXC, and treasurer Reg Flower. Meetings are held at 7.15 p.m. on the third Thursday in each month at Baden-Powell House, Queen's Gate, S.W.7.

The group would like to hear from other amateurs and listeners who are members of the Boy Scouts Association.

# Ferroxcube

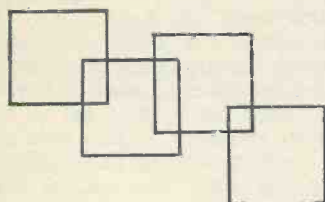

# Decoupling Beads

By M. J. Darby

order to obtain a considerable increase in impedance.

## Types of Bead

Beads with a single hole for threading on to a wire can be obtained in two different materials, as shown in the Table. The type FX 1115, which is made from grade A1 Ferrocube, is most satisfactory for a frequency range of about 3 to 16 Mc/s. Above this frequency range the type FX 1242, made of grade B2 Ferrocube, provides a higher impedance. Each bead of type FX 1115 provides an impedance of about 10Ω at 3 Mc/s, 20Ω at 15 Mc/s, rising to a maximum of about 32Ω at 50 Mc/s. An FX 1242 bead provides an impedance of about 4Ω at 3 Mc/s, 20Ω at 15 Mc/s and 50Ω at 100 Mc/s.

A twin heater supply is conveniently decoupled by a somewhat larger bead with two holes (type FX 1516). This bead is made only in grade B2 Ferrocube. Bare wires can be used owing to the high resistivity of this material.

Another type of bead consisting of grade B2 material (type FX 1898) has six holes through which the wire to be decoupled may be threaded. A comparatively large impedance may be introduced if a single coil of 2½ turns or two coils of 1½ turns each are wound using one of these beads.

The number of beads required and the most suitable type of bead for any particular purpose are best found experimentally, as the calculations are rather awkward and not very reliable.

The normal method of illustrating the use of a Ferrocube bead in a theoretical circuit is shown in the accompanying diagram. This shows the ferrite core alongside the wire.

Acknowledgements are due to Mullard Ltd., for making available details of their range of Ferrocube materials.

**T**HE PROBLEM OF DECOUPLING high frequency r.f. and i.f. amplifiers is a difficult one, especially if a high gain is required, but is nevertheless important owing to the widespread use of such amplifiers in TV, f.m. and radar receivers. At high frequencies undesired coupling between stages can occur via the h.t., heater, a.g.c. or any other leads which feed several stages, and may result in oscillation. The use of decoupling capacitors does not always give satisfactory results owing to the inductance of these components, although feedthrough capacitors (which have a very low inductance) may provide a satisfactory solution. Similarly, chokes may not be effective owing to their self-capacitance.

An extremely simple method of introducing the necessary impedance into the supply lead consists of using one or more beads made of Ferrocube which are threaded on to the lead to be decoupled. Ferrocube is

a special magnetic material (a ferrite) made by Mullard Ltd.

Although Ferrocube is normally used as a core material at frequencies such that the losses are low, these losses increase rapidly with frequency. This property, which would normally be undesirable, can be made to serve a useful purpose. The bead, which is threaded on to the supply lead, acts as an inductor of poor Q; it therefore absorbs r.f. power and prevents it from passing along the wire.

## Some Advantages

The beads are small (see Table 1) and are so light in weight that they require no soldering or fixing. They can, therefore, be easily used in places where the available space is very limited. The passage of d.c. or low frequencies along the decoupled wire is virtually unaffected by the use of the beads, and no d.c. voltage drop occurs. Several beads can be used to increase the impedance presented to high frequency currents. Alternatively the wire may be threaded through the bead more than once in



To heater supply

Ferrocube beads are depicted in theoretical circuits by dashed lines (to represent a ferrite core) drawn alongside the wire on to which they are threaded. In this diagram there are two Ferrocube beads, one on each heater lead

TABLE  
The Mullard Range of Ferrocube Decoupling Beads

Type No.	Length (inches)	Outside diameter (inches)	Hole size (inches)	No. of holes	Material
FX 1115	0.197	0.157	0.079	1	A1
FX 1242	0.216	0.159	0.059	1	B2
FX 1516	0.472	0.220	For 0.026in diam. wire (23 s.w.g.)	2	B2
FX 1898	0.394	0.236	For 0.020in diam. wire (25 s.w.g.)	6	B2



# understanding radio

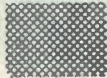

By W. G. MORLEY

A further article in our series which, starting from first principles, discusses the basic theory and practice of radio

IN LAST MONTH'S CONTRIBUTION TO THIS SERIES we discussed loudspeaker resonance and impedance, examining these points with respect to generally encountered moving-coil loudspeakers. After briefly dealing with the desirability of expressing loudspeaker response curves against a logarithmic frequency scale, we next discussed restoring force and speech coil displacement. We shall now conclude on the subject of moving-coil loudspeakers by dealing with magnet types and strengths.

## Loudspeaker Magnets

When we introduced the moving-coil loudspeaker<sup>1</sup> we used, for purposes of illustration, the magnet assembly shown in Fig. 235 (a). This assembly employs a cylindrical rod magnet at the centre, together with pole-pieces which allow the pole at the lower end of the magnet to be effectively shifted to the gap. In consequence, a strong magnetic field appears across the gap.

The assembly illustrated in Fig. 235 (a) represents only one of a number of methods of providing a magnetic field in the gap. An alternative construction is shown in Fig. 235 (b). In this instance a ring magnet is employed, this having the shape illustrated in Fig. 235 (c). The upper flat surface of the ring magnet offers one pole and the lower flat surface the other pole. The pole-pieces shown in Fig. 235 (b) then cause these poles to be effectively shifted to the gap.

The ring magnet assembly is shown again in Fig. 235 (b), but in this case the magnet is significantly shorter than occurs in Fig. 235 (b).

Fig. 235 (e) depicts a slug magnet assembly with pole-pieces, the slug magnet being illustrated, on its own, in Fig. 235 (f). As will be noted, the assembly is rather similar to that of Fig. 235 (a), with the exception that the magnet does not extend right into the gap. Instead, a small central pole-piece extends the field from the upper surface of the magnet into the gap.

The magnet constructions shown in Figs. 235 (a), (b) and (d) represent those which are most likely to be encountered at present or in recent years. The ring magnet construction shown in Fig. 235 (b) is used very extensively.

In all the types shown, with the exception of Fig. 235 (d), the material employed for the magnets normally consists of one of the metallic alloys specifically intended for this application, such as "Alcomax" or "Alnico".<sup>2</sup> Ceramic magnetic materials for loudspeakers have recently been introduced, and they are particularly suitable for the ring magnet assembly. They may be produced with a comparatively short length, with the result that the overall dimensions of the loudspeaker become reduced. The construction shown in

<sup>1</sup> In "Understanding Radio", part 32, May 1964 issue.

<sup>2</sup> "Alcomax" is a trade name for an alloy consisting basically of nickel, iron and aluminium, and "Alnico" is a trade name for an alloy consisting basically of aluminium, nickel, cobalt and iron. Different grades of these materials have different proportions of the basic metals together with, in some cases, further metals. Thus, some of the Alnico grades include a small proportion of copper.

Fig. 235 (d) would, for instance, normally use a ceramic ring magnet. This type of magnet assembly is very useful for small radio receivers and the like, where space is at a premium.

The magnet assembly shown in Fig. 235 (a) has the advantage that the external magnetic field (i.e. the field radiating outside the assembly) is weak. As a result this construction is useful for loudspeakers fitted to television receivers. In such receivers, stray magnetic fields are undesirable as they may distort the shape of the picture reproduced by the cathode ray tube.<sup>3</sup>

The slug magnet assembly of Fig. 235 (e) was commonly used in loudspeakers in the past, although it has now been largely superseded by the ring magnet assembly.

In earlier years, when the production of reliable permanent magnets at low cost was difficult to achieve, many moving-coil loudspeakers employed "energising coils" to provide the magnetic field in the gap. An energising coil was fitted into the pole-piece assembly in the manner shown in Fig. 236 whereupon, when a direct current was passed through its turns, the lines of force produced about it flowed through the metal of the pole-pieces and gave a strong magnetic field in the gap. Despite the cost of the copper wire employed for the coil and the disadvantage of having to provide the direct current, "energised" loudspeakers still proved, at the time when they were produced, to be more economic for many applications than permanent magnet types. As the development of permanent magnet materials progressed, however, it was the energised loudspeaker which became the more costly. It is hardly ever encouraged nowadays except in equipment of early design and manufacture.

### Magnet Strength

As is to be expected, the strength of the permanent magnet in a moving-coil loudspeaker has an important bearing on performance. If, without altering the dimensions of the pole-pieces, the air gap or the speech coil, the strength of a loudspeaker magnet is increased, the loudspeaker will offer a greater sound output for a given electrical input signal. There may also, in practice, be a slight change in the frequency response of the loudspeaker.

However, the strength of the magnet does not provide a complete measure of loudspeaker efficiency as there are a number of other factors which have to be taken into account. One of these is the resistance and number of turns in the speech coil, and another is the area of the air gap.

It is usual to refer to loudspeaker magnet strength in *gauss*, this being a unit of magnetic flux density. Since the term "gauss" refers to a *density*, it follows that it applies to the amount of flux in a unit area and not to an overall amount of flux. The latter may be measured in *maxwells*,

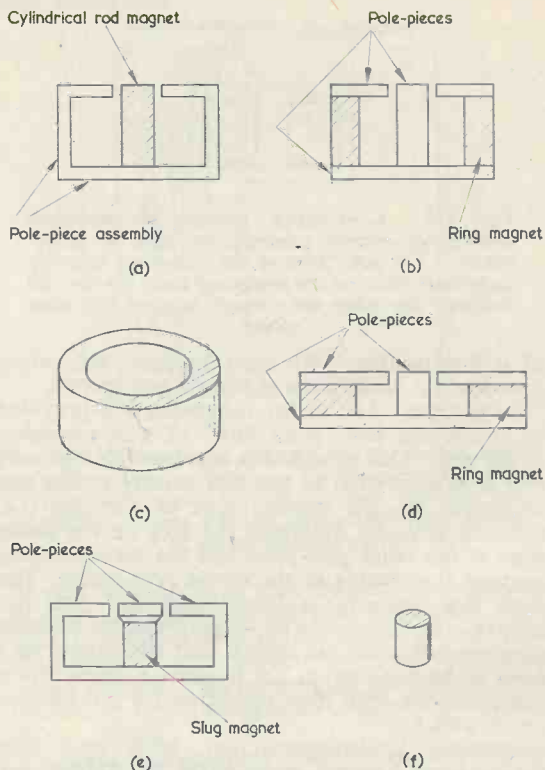

Fig. 235. The basic types of magnet assembly employed in moving-coil loudspeakers. In each assembly diagram the magnet is shown shaded. A centre rod magnet assembly is illustrated in (a) and a ring magnet assembly in (b). The shape of the ring magnet is illustrated in (c) whilst (d) shows the reduced depth which is possible with ceramic ring magnets. An example of the slug magnet assembly is given in (e), and a view of the slug magnet on its own in (f). The slug magnet shown in (e) is narrower than the central pole-piece above it, but in many loudspeakers using this type of assembly it may be wider than the pole-piece

1 gauss being equal to 1 maxwell per square centimetre.

Let us assume that we have two magnets of equal flux density and that these are fitted to two loudspeaker assemblies both having the same air gap length (i.e. the same distance between the outside edge of the centre pole-piece and the inside edge of the outer pole-piece). However, the diameter of the centre pole-piece of one loudspeaker assembly is twice that of the other. It will be possible to put a larger speech coil, having more winding wire, into the magnet assembly with the larger centre pole-piece with the result that, apart from considerations of sensitivity, the loudspeaker will be capable of handling a greater power. Because of factors such as this, the flux density of the magnet does not, on its own, provide sufficient information concerning the performance

<sup>3</sup> If the magnetic field passes into the cathode ray tube, it causes the moving electron beam which builds up the picture to be deflected from its proper route.

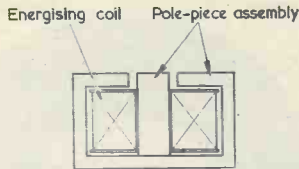

Fig. 236. Cross-section through an energised loudspeaker magnet assembly, as used in earlier models. The outer part of the pole-piece assembly completely encircles the energising coil. The two coil lead-outs are taken out through holes in this outer section

of a loudspeaker. We need further information covering the dimensions of the air gap as well.

In practice, this further information is provided by specifying the "total flux" of a loudspeaker at the gap. This total flux is expressed in maxwells and is proportional to the flux density at the gap multiplied by the average area of the gap (i.e. the area given by averaging the area on the inside edge of the outer pole-piece and the corresponding area on the outside of the centre pole-piece). The total flux figure for a loudspeaker still does not offer a complete guide to its performance because other points (such as speech coil resistance, etc.) have to be considered, but it offers a more representative idea than does the figure for flux density on its own.<sup>4</sup>

Practical loudspeakers may have total flux figures lying between some 6,000 to 200,000 (or more) maxwells. High total flux figures usually appear in the more expensive loudspeakers which are intended for high fidelity reproduction, and they are obtained by employing relatively costly magnet systems.

Before concluding on this subject, two other terms of measurement need to be mentioned. The first of these is the *weber*. This is another unit of magnetic flux, 1 weber being equal to  $10^8$  maxwells. Similarly, 1 weber per square metre equals  $10^4$  gauss. The flux density of loudspeakers may sometimes be quoted in webers per square metre. The second unit is the *line* (or *line of flux*), 1 line being equal to 1 maxwell. However, there seems to be a tendency to use this term somewhat loosely, and one occasionally encounters references to loudspeaker specifications where "line" is employed as though it were synonymous with "gauss". Whenever the term "line" appears with reference to a loudspeaker specification, it should be confirmed that it does in fact apply to the total flux.

### The Balanced Armature Loudspeaker

We have now concluded our examination of the moving-coil loudspeaker, and shall carry on next to a brief consideration of other types. The first of these is the balanced armature loudspeaker.

Fig. 237 (a) illustrates the basic balanced armature

assembly. An armature made of magnetic material is pivoted at its centre, and it remains centrally positioned between two pole-pieces of the shape shown. The pole-pieces effectively bring the poles of a permanent horseshoe magnet close to the ends of the armature. Fitted around the armature is a stationary coil. This is shown in the diagram as having a few turns only, but in practice it would be wound with a large number of turns. The centre of the coil is sufficiently large to provide clearance for armature movement.

In Fig. 237 (b) we cause a current to flow through the coil, thereby energising the armature. Let us assume that the left hand pole of the permanent magnet is its north pole, and that the current flows in the direction which causes the upper end of the armature to become a north pole also. The upper end of the armature is, therefore, repelled by the north pole of the magnet and attracted to its south pole. At the same time its lower end, now a south pole, is repelled by the south pole of the magnet and attracted to the north pole. The result is that the armature moves over to the position illustrated in Fig. 237 (b).

In Fig. 237 (c) we reverse the current through the coil, with the result that the upper end of the armature becomes a south pole and the lower end a north pole. The consequent repulsions and attractions then cause the armature to move over in the opposite direction to that of Fig. 237 (b).

It may be seen that, if an alternating current

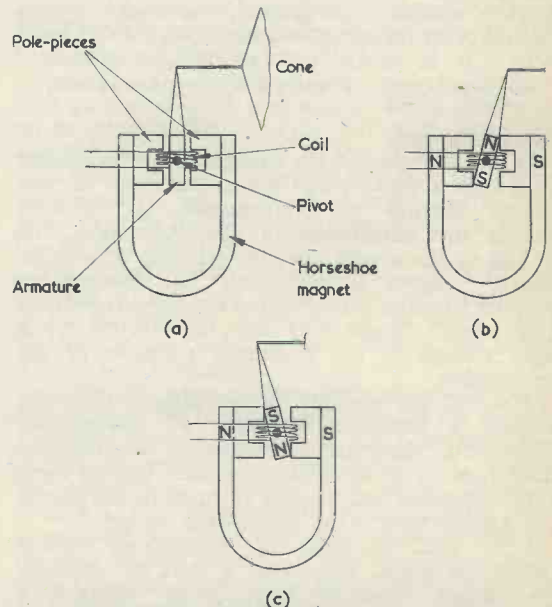

Fig. 237 (a). The basic construction of the moving armature loudspeaker. The coil is stationary, and does not move with the armature  
 (b). Passing a current through the coil causes the armature to be displaced as shown here  
 (c). Reversing the current in the coil causes the armature to be displaced in the opposite direction

<sup>4</sup> The flux density in the gap may sometimes be referred to, in gauss, as the "gap flux".

is caused to flow through the coil, the armature will move back and forth at the same frequency as that of the current. Further, if a restoring force is applied to the armature causing it to return to its central position in the absence of current, the amplitude of the armature movement will be proportional to the current flowing through the coil. By coupling an extension from the armature to a cone (as in Fig. 237 (a)) the latter may be made to move back and forth in sympathy with the frequency and amplitude of the current in the coil. We have, therefore, a loudspeaker; and the cone will reproduce, as sound, any electrical signal which has been derived from a microphone or similar device.

The balanced armature loudspeaker was employed fairly extensively in the early days of radio, being superseded, around the '30's, by the moving-coil loudspeaker. Nevertheless, the balanced armature technique may still be occasionally encountered (in, for instance, the balanced armature earphones used by the Services) and in other applications. Also, the principle employed is of interest, and merits a short description here.

#### The Ribbon Loudspeaker

The ribbon loudspeaker has the basic construction shown in Fig. 238. In this diagram a springy metal ribbon having corrugations along its length is positioned between the pole-pieces of a powerful magnet system. The ribbon is secured at its ends. When a current is passed through the ribbon it is subjected to the same force as occurred with the single conductor in a magnetic field which we examined in Part 32 of this series.<sup>5</sup> If the current is passed in one direction the ribbon will tend to move forwards. If the current is passed in the other direction it will move backwards. Since the ends of the ribbon are secured, the centre will suffer the greatest displacement, the corrugations in the strip allowing this displacement to take place. The restoring force is provided by the springiness of the metal itself.

Since the ribbon is capable of moving in sympathy with the frequency and amplitude of the current

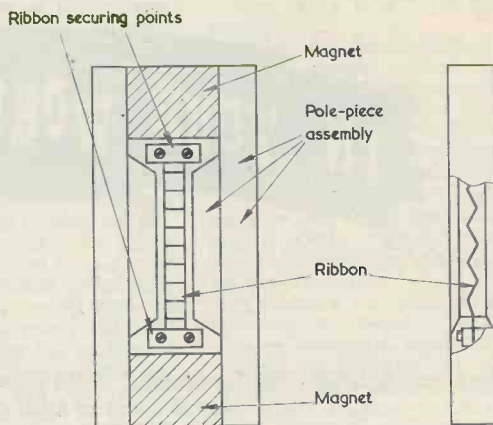

Fig. 238. Front view and side view (partly cut away) of the ribbon loudspeaker. The inner sections of the pole-pieces taper inwards as they approach the ribbon. Current is passed through the ribbon by way of the two securing points

flowing through it, it may be used to reproduce, as sound, a sound-derived electrical signal. However, the surface area of the ribbon is small, and it is necessary to fit a horn to it to obtain an adequate sound output. The horn has a rectangular cross-section, its throat being close to one of the surfaces of the ribbon.

Ribbon loudspeakers offer a useful response at the higher audio frequencies and may be employed as tweeters. Due to the necessarily wide gap, a powerful magnet has to be employed to provide an adequate total flux. The impedance of the device is very low, as may be imagined by comparing it with a moving-coil loudspeaker. The ribbon is roughly analogous to a single turn of the speech coil in the latter.

#### Next Month

In next month's article we shall examine further types of loudspeaker, these including the electrostatic loudspeaker and, if space permits, the Ionophone.

<sup>5</sup> "Understanding Television" Part 32, May 1964 issue.

## New Switch Adjusts Lighting — Saves Power and Bulbs too!

A new lighting control switch has been introduced by Regentong which enables you to adjust room lighting to any level required for reading, TV viewing, cine shows or just decorative effect.

Called the Varilite, the new control replaces the normal on/off wall switch. Unlike previous lighting control units the Varilite uses a new kind of rectifier which enables it to control up to 300 watts of lighting without generating wasteful heat and without taking up too much space.

The Varilite uses no power itself and cuts electricity bills since you pay only for the light you select. It also prolongs bulb life to a surprising degree: by reducing the light only 17 per cent you double the life of your lamps.

The Varilite costs 6½ gns., fits any standard wall switch box and can be installed in a few minutes with the aid of a screwdriver. It is designed for filament bulb lighting only and is not suitable for controlling fluorescent tubes.

# IN YOUR WORKSHOP



This month, Smithy the Serviceman, aided as always by his able assistant Dick, deals with the latest batch of hints contributed by readers.

"BLIMEY," SAID DICK, "another pill?"

Startled at the voice which had unexpectedly materialised behind him, Smithy swallowed involuntarily. He immediately gave vent to a strangled gasp, followed by a violent bout of coughing. After some moments, he spat out a large green capsule which dropped to the floor and rolled under his bench. The Serviceman fell back on to his stool and, whilst he regained his breath, glared through bloodshot eyes at his assistant.

Eventually, he arrived at a condition where speech was possible.

"What do you mean," he snarled, "by creeping up on me like that? I nearly choked myself over that blasted pill."

"It was because of the pill," replied Dick, "that I made the remark."

"And what," snorted Smithy, "is wrong with taking a pill?"

"You've taken three already this morning."

The Serviceman drew himself up.

"If," he remarked, with dignity, "I choose to take advantage of the preparations which modern medical science has made available, I would suggest that that is a matter which concerns nobody else but me."

"Fair enough," commented Dick equably, "but if you carry on like you have been this morning you'll be rattling away like a box of dried peas by the time you get home!"

## Readers' Hints

"That," repeated Smithy, "is my business. In any case, how is it that you've got the time to watch what I'm doing anyway?"

"That's easy," replied Dick. "I've got nothing to do."

Smithy sighed. When there was plenty to do, Dick took up his time with pleas for assistance. When there was nothing to do, Dick took up his time with requests for something to occupy himself with. In general, Smithy preferred the former state of affairs.

Looking around at the racks and then at his own bench, Smithy realised with a start that he, too, would very shortly have nothing to do. He had just completed a repair on the only chassis which was outstanding and it now merely remained for this to be fitted into its cabinet.

A thought struck him and he turned to a drawer in his bench.

"How about a sesh," he asked, "with the readers' hints, then?"

"That would be fine," responded Dick enthusiastically, "we haven't had a go with those for quite a long time."

"Fair enough," said Smithy, extracting a sheaf of letters from the drawer. "I'll start off with the first one right away."

Smithy thumbed through the letters and quickly extracted one.

"Ah, here we are," he said.

"Now, this is an idea which will be of assistance when you want to make up grub screws from ordinary bolts. All that the gadget comprises are two pieces of metal bolted together. (Fig. 1). The bottom piece is plain, whilst the top piece has a number of holes drilled and tapped to suit the grub screws it is anticipated will be required. I would guess, myself, that three holes, tapped 2BA, 4BA and 6BA, should meet most cases. When you want to make up a grub screw you simply insert a bolt into the appropriate hole and screw it down hard against the lower piece of metal. It will

then stay firmly in place whilst you cut and slot it to suit. You can also give the resulting grub screw a little touch round the top with a file to clean off the rough edges given by the cutting and slotting operations."

"That's a good idea," commented Dick approvingly. "With jobs like that I usually find myself trying to put lock-nuts on the bolt and holding these in the vice!"

"Well, you know a better way now," said Smithy, turning to another letter. "Now let's have a look at this one! In this instance we have two hints from one reader. The first describes a method of making connections to a transistor without applying any heat. You obtain three short lengths of rubber covered or p.v.c. covered flex, using different colours for base, emitter and collector. You next pull three or four strands out of each piece of flex and solder the other ends into position in the circuit. The lead-outs of the transistor may then be slipped into the open ends of the flex. They slip in quite easily because of the space left by the strands which have been removed, and you get a nice reliable contact. Apart from the fact that no heat is applied to the transistor there is the further advantage that it may be used many times in different circuits, being 'plugged in' to the bits of flex in the same way as a valve can be plugged into different valve-holders."

"I should imagine," commented Dick, "that the best flex to use for this job would be the type employed for mains lighting and similar jobs."

"I would think so," agreed Smithy. "The second hint in this letter is concerned with valves



whose top caps have come off and which only have a small stub of wire projecting from the glass. At attempts at soldering may, in some cases, ruin the otherwise undamaged valve. With the present dodge you take about 3 inches of replacement wire and apply solder to one end so that a large blob forms. The wire is held at the other end with pliers and is taken to the valve so that the blob is above, and just touching, the projecting stub of wire. You next apply the soldering iron to the wire mid-way between the pliers and the solder blob, and allow the heat to travel along it. After a short while the solder at the end will begin to run, whereupon you remove the iron. If everything is held steady the two wire ends will join and a good joint will be made. You then replace the top cap, soldering this to the new bit of wire you've added."

"That's quite a novel way," commented Dick, "of obtaining a solder joint in places which are awkwardly positioned, or where too much heat may damage insulation. I should imagine that this idea has quite a few other applications, apart from the valve top cap idea."

"Very probably," said Smithy. "I would suggest, incidentally, that a little flux should be applied to the projecting stub of wire before you start the operation. However, I now want to pass on to another two hints. As in the previous case, both of these appear in a single letter."

Smithy paused and cleared his throat.

"The first of these," he continued, "is of a very simple nature. It seems that mains transformers with 4 volt heater windings are so little needed these days that it is possible to pick them up, if you shop around carefully, for several shillings each. At the same time, it isn't at all a

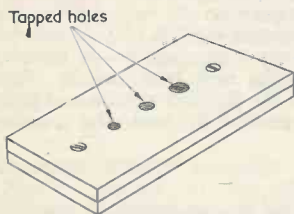

Fig. 1. A simple piece of equipment which simplifies the making of grub screws. Two pieces of metal are bolted together, the lower piece being plain and the upper piece having a number of tapped holes

difficult job to wind on a few extra turns and bring the heater windings up to 6.3 volts. You then have an excellent mains transformer at very low cost, just by the expenditure of a little time and trouble. The extra turns can be wound on the outside of the existing winding and they are, of course, connected in series with the 4 volt windings already fitted. You'll need an a.c. voltmeter to find out how many turns are required and to get your phasing right. I should guess that, in many cases, you won't have to remove the laminations at all. You could just poke the additional wire through the space between the existing winding and the inside edge of the laminations."

"You could save quite a few bob with that idea," interjected Dick. "Added to which is the fact that many of those old transformers with 4 volt windings give quite hefty currents from the h.t. secondary."

"True enough," said Smithy. "The second hint in this letter deals with something entirely different. You sometimes have to mount polystyrene coil formers in very awkward positions, with the result that it's extremely difficult to fit the nut on to the fixing bolt even with taper-nosed pliers. So what do you do?"

"I don't know," said Dick. "What do you do?"

"You put a thread on the holes in the former," replied Smithy. "You start off by selecting a bolt which is slightly too large for the hole, and you heat it just enough to melt the plastic. You then push it into the mounting hole. If it's at the right temperature it will slip in quite easily. Take care the bolt isn't too hot or it will distort the entire mounting lug. The screw is then allowed to cool in a vertical position, after which it may be removed. However, it will have to be unscrewed because the polystyrene will have now formed a thread around it. Repeat the process for the other hole, and you have two threaded holes in the former which make mounting in awkward positions considerably easier."

#### Capsule Recovery

"That's a knobby idea, too," commented Dick. "You've certainly brought out some useful hints this time, Smithy."

But the Serviceman had suddenly remembered something. He placed his sheaf of letters on the surface of the bench and was looking carefully at the floor.

"Ah, there it is!" he exclaimed triumphantly.

Under the horrified eye of his assistant, Smithy picked up a 12 inch steel rule, leaned under his bench, and flicked out the green capsule which had earlier caused him so much discomfort. He stooped down and picked it up.

"You surely aren't going to swallow that thing now, are you?" gasped Dick. "Dash it all, it's all wet and it's been running around all over the floor."

"Of course I'm going to swallow it," replied Smithy indignantly. "It's my vitamin C tablet."

"But it's all dirty."

"Nonsense," snorted Smithy. "It just needs swilling under the tap, that's all."

With Dick's fascinated gaze on him, Smithy walked over to the sink, held his pill under the tap, then swallowed it.

"What do you want vitamin C tablets for, anyway?" asked Dick. "Are you coming down with scurvy or something?"

"Of course I'm not," snapped Smithy, walking back from the sink. "It's just that vitamin C helps to protect you from colds and things. There are a lot of colds and things around at this time of the year."

By this time he had returned to his bench, whereupon he reached

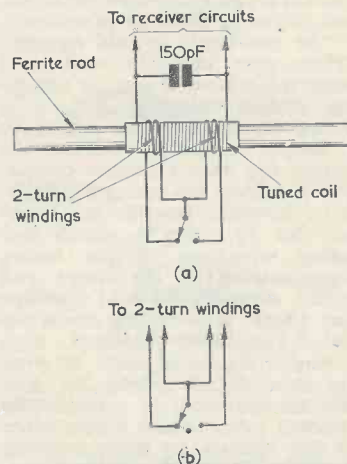

Fig. 2 (a). Two station switching: The switch short-circuits either of the 2-turn windings, the latter being moved as required along the coil tuned by the 150pF fixed capacitor

(b). If a 3-way switch is employed, neither of the 2-turn windings are short-circuited in its central position. Three stations may then be selected

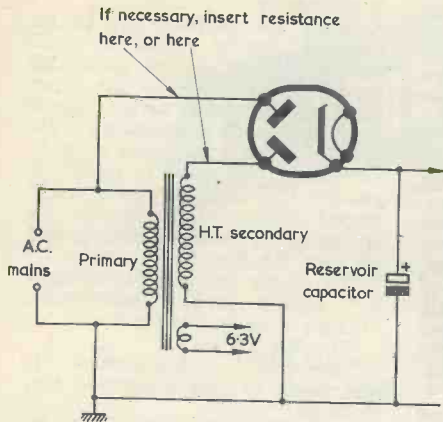

Fig. 3. Obtaining a full-wave output from a mains transformer with a half-wave secondary. If the same voltage does not appear across the primary and the h.t. secondary, resistance is inserted, as indicated, in series with the winding having the higher voltage

behind his oscilloscope and produced a tin. He next extracted a large tablet, which he proceeded to munch with great vigour.

"What's that, a purple heart?"

"It's vitamin D," said Smithy, ceasing his chewing for a moment. "It's good for thickening the blood. Stops nose-bleeding, for instance."

"Well, I don't know," remarked Dick helplessly. "I think the best thing we can do is to get back to some more of these readers' hints."

Smithy swallowed the last fragment of his anti-nose-bleeding tablet, and picked up his sheaf of letters.

"As you like," he said serenely.

"Here goes with the next one! Now, this is a novel idea for obtaining station selection without a tuning capacitor. When you make a simple miniature receiver, the largest and most expensive component is usually the tuning capacitor. It is, however, possible to eliminate this by using a switch and taking advantage of the tuning characteristics of the ferrite rod aerial. A small-value fixed capacitor (say 150pF) is connected across the coil. Two small windings, each having a couple of turns of wire, are then placed around the coil, and are connected to a single-pole two-way switch which selects either of two stations by short-circuiting the appropriate winding. (Fig. 2(a)). The short-circuited turns cause a station to be selected by altering the inductance of the aerial. It is very easy to tune in the chosen stations, this being done by sliding the windings along the coil. The components required are inexpensive and take up little space, and the idea has been successfully used by the reader for a 'radio jack' intended for plugging into a tape recorder."

"That's something new," said Dick. "I'll have a bash at it with the next small transistor set I knock up."

"There's a bit more to come yet," said Smithy. "If you use a switch which has a central position, such as a miniature slide switch, the central position leaves the two additional windings open. (Fig. 2(b)). Under this condition you can set up the coil on the rod so that this picks up a third station. So you've then got three station switching!"

"Better and better," remarked Dick. "The sliding winding idea is certainly cheaper than using switched trimmers."

"Definitely," agreed Smithy. "I should add that the third station offered by the scheme will have to have a longer wavelength than the other two. Still, that's obvious enough anyway."

#### Full-Wave Rectification

Smithy drew another letter from the pile.

"This is a hint," he pronounced after a few moments' perusal, "which enables you to get a full-wave output from a mains transformer having a half-wave secondary. (Fig. 3). The idea is quite simple but it does necessitate having a live chassis. The transformer required should have an h.t. secondary voltage which is the same, or very nearly the same, as the primary voltage, whereupon you simply connect together one end of each winding and apply the other ends to the anodes of a full-wave rectifier. If the h.t. secondary doesn't give precisely the same voltage as the primary you insert a resistor in series with the winding which offers the higher voltage."

"What value should the resistor

have?"

"It depends on the transformer," said Smithy. "The easiest way of finding the required value is by experiment, and our correspondent suggests that it will, in most cases, need to be of the order of 200Ω and that it should have a dissipation of 2 or 3 watts. One method of finding the required value which springs to my mind consists of obtaining the same rectified voltage, at half load current, across the reservoir capacitor for either of the windings. That is to say, you first connect the lower voltage winding to one anode of the rectifier and check the voltage across the capacitor. You then disconnect this, apply the other winding, and adjust the series resistor for the same voltage. Another, and perhaps simpler, method would consist of setting up the complete circuit with full load, and of adjusting the resistor so that the same a.c. voltage with respect to chassis appears on each anode of the rectifier. Yet another idea, which assumes that a scope is available, would be given by connecting up the full circuit and adjusting the resistor until the alternate charging peaks across the reservoir capacitor all have the same size. A further point to watch out for is that the two windings must, of course, be series-aiding. You should get about twice the mains voltage across the rectifier anodes as measured with an a.c. voltmeter. If one of the windings is connected wrong way round, then you'll get zero or very nearly zero volts across the two anodes."

"Any more hints?" queried Dick.

"Plenty!" replied Smithy. "Here are two more in a single letter. Both of these are improvisations from cycle wheel spokes, which seem to have quite a variety of unexpected applications. The first hint is a useful little tip for use with tape recorders. When it is necessary to fit new driving belts to certain models of tape recorder, the top plate has to be raised so that the new belts can be slipped over the flywheel spindle and thence round the flywheel and capstans.



Fig. 4. A simple hook, fabricated from a cycle wheel spoke, which can be of considerable assistance when fitting tape recorder drive belts

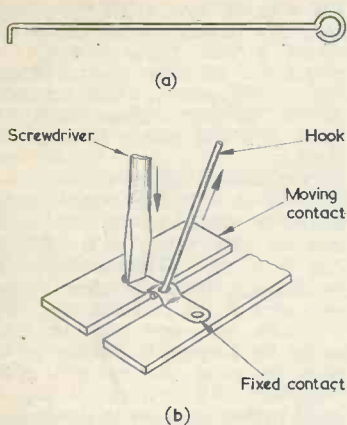

Fig. 5. A method of retensioning switch contacts. The hook, shown in (a), gently pulls the centre of the contact upwards as illustrated in (b), a screwdriver being held against the contact tip

All this is rather a fiddling operation, and it can be made a lot easier by using two hooks made from cycle wheel spokes. (Fig. 4). The hooks are used to handle the belts, and with their aid it is possible to position these very easily, raising, lowering and stretching them as required. The belts can be guided into their correct positions without having to dismantle more than the minimum of parts."

"That's something else I'll have to knock up," said Dick. "We could do with a couple of those in the Workshop ourselves."

"They'd certainly be very useful," asserted Smithy. "The second hint in this letter also has to do with a hook made from cycle wheel spokes. In this case the hook is used for retensioning contacts on wafer switches and similar types. The gadget is hooked through the hole in the contact, or is hooked underneath if there isn't a hole, and is then gently pulled outwards whilst the point of a screwdriver is pressed on to the contact tip. (Fig. 5). In this way the contact is bent so that it applies more pressure."

#### Substitution Resistor Assembly

Smithy glanced at the clock, put down the letters he was holding and reached across the bench. Pushing his testmeter to one side he extracted a large bottle from which he gravely counted out four pills.

"This," gasped Dick, "is getting beyond belief. What are those pills?"

"Vitamin B," said Smithy, "with a dash of vitamin E."

"What a mixture! What are they for?"

"The vitamin B," said Smithy, "is to buck you up, and the vitamin E is to make it worthwhile bucking yourself up."

"Well, I just don't know," said Dich helplessly. "What started you on this pill jag, anyway?"

By now Smithy had once more reached the Workshop sink, whereupon he swallowed his four pills with the aid of copious draughts of water.

"I've been feeling rather low lately," he said, after all the pills had been safely dispatched, "and I've been talking about it to the chaps down at my club. They've all been feeling low too, and they're all taking pills to get over it. So I'm trying out a selection of the different pills which each one has advised me to take."

"But dash it all," protested Dick. "you aren't supposed to take them all at the same time."

"I don't see why not," replied Smithy. "So long as I spread the vitamins and things out a bit. Over the last hour, for instance, I've had a nicely balanced mixture of vitamins B, C, D and E. I haven't been able to locate anything with vitamin A in it yet, but, when I do, I should have pretty near a full set so far as the vitamins are concerned. In the meantime I'm building up on the minerals as well, and I've got some tablets which contain iron, copper and cobalt."

"Blimey," said Dick, "take enough of those and you'll be pointing permanently to the North. Your medicine cabinet at home must be bulging at the seams by now."

"I must confess," said Smithy, with a note of pride in his voice, "that I have acquired a pretty wide-ranging collection of medicaments over the last day or so."

"An you swallow *all* of them?"

"Of course I don't," replied Smithy. "Not every medical preparation is intended to be taken by way of the mouth."

"I beg your pardon?"

"Some preparations," explained Smithy, "have to be squirted up the hooter. And they're very good for clearing out the old nasal passages, too."

"Charming," said Dick hastily, "I think the less I hear about that alchemist's hoard of yours the more unblighted my young life is going to be! Let's get back to the hints."

"Very well," said Smithy, "if you insist."

He leaned over and once more picked up the letters.

"This one," he announced after a moment, "offers a method of obtaining a miniature substitution resistor assembly. The assembly is very small and you can wire or clip it into compact layouts directly. Once you've done that, it offers you a choice of ten different fixed resistance values."

"That sounds interesting," remarked Dick. "How is it done?"

"You start off," said Smithy, "with two of the Bakelite pin protectors which fit on to B9A valves. These types have ten small

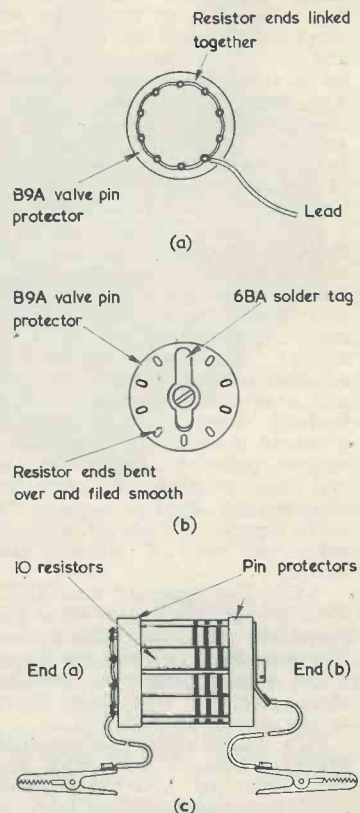

Fig. 6 (a). At one end of the miniature substitution resistor assembly discussed by Dick and Smithy, the resistor ends are all connected together  
(b). At the other end of the assembly, a solder tag is free to rotate and make contact to any of the resistor lead-outs  
(c). The complete assembly. The ten resistors have values extending over the particular range required by the constructor

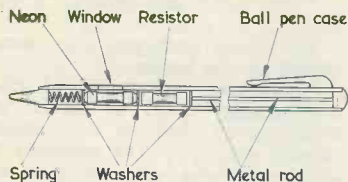

Fig. 7. Assembling the components of a neon screwdriver in a ball pen case. The metal rod from the series resistor connects to the pocket clip

holes in them. You drill a 6BA clear hole through the centre of one of the protectors and bolt a solder tag to it. The solder tag has to be able to rotate, so you don't do the bolt up too tightly, and you fit a pair of lock-nuts on the side opposite to the bolt head. You then take ten  $\frac{1}{4}$  or  $\frac{1}{2}$  watt resistors of suitable value and size and pass their wires through the holes in the protectors. At one end of the assembly you solder all the lead-out wires together and connect a short flexible lead with a clip to them. (Fig. 6 (a)). At the other end of the assembly you cut the resistor wires back so that they protrude by about  $\frac{1}{8}$  in, bend them over, and file them smooth. (Fig. 6 (b)). The solder tag is next adjusted so that it can be rotated and is capable of resting on each lead-out wire in turn. Solder a second short clip-lead to a convenient point on the solder tag and the assembly is complete. (Fig. 6 (c)). You just rotate the solder tag so that whatever resistance value you need is brought into circuit."

"Well, I'm jiggered," said Dick. "I've got quite a few of those pin protectors knocking round, and I've never liked to chuck them out. I can now put them to use and make myself a neat little device in the process as well!"

"It's surprising," commented Smithy, "how all these odds and ends seem to have applications which their designers never intended them to have! I've got another one here which takes advantage of discarded ball point pens. Our correspondent broke the blade on his neon screwdriver and decided to reassemble the bits into a ball pen which had sufficient internal diameter to take the neon and its series resistor. (Fig. 7). In this particular instance, the two halves of the pen screwed together, but the idea is applicable to other types. The brass tip forms the business end of the assembly and

the neon makes contact to this via a spring. The series resistor comes next, after which there is a rod to take the circuit back to the metal pocket-clip. If the case of the pen is opaque a window may be cut in it at the same level as the neon."

"Is the resistor a wire-ended job?"

"Oh no," replied Smithy. "The resistors fitted in these neon screwdrivers have two brass caps and are similar in shape to a cartridge fuse. The value is usually around 1M $\Omega$ ."

#### Easing Nuts

"I see," said Dick. "Any more hints?"

"There are," replied Smithy, "just two left. The next idea is a modification of an old dodge which is often employed when drilling holes. If you're making a hole with a power drill, it occasionally happens that you need the hole to be a 'thou' or two larger than is given by a particular size drill. The trouble is that the next size drill would make a hole that's too large." "I've bumped into that one, myself," said Dick. "What I do is to drill the hole initially, slip one or two thicknesses of thin paper into the hole, and apply the drill once more. The paper gets chewed up as soon as the drill enters the hole but it still provides a little bulk and causes the sides of the drill to press more tightly against the sides of the hole. The result is that the hole is a few 'thou' wider than occurs without the paper."

"That's the idea," agreed Smithy, "and it is, of course, an old dodge. A good point in its favour is that the trick can be used even when the work being drilled is a thick piece of metal. Also, the sides of the hole are just as smooth and straight as are given by the drill on its own. However, let's now get down to the actual hint! An idea similar to the paper dodge can be used when one is faced with the problem of getting a nut on to a tight screw. The tip is to cut a piece of paper into the shape of a triangle with a sharp angle, the sharp angle then being inserted into the nut. (Fig. 8). After this a tap of the appropriate size is put into the nut and run through. The nut should then screw on to the bolt quite easily. It is best to start off with a thin bit of paper since it is very easy to take too much out of the nut, whereupon it becomes useless. In

the case of, say, a  $\frac{1}{8}$  in Whitworth nut, and larger, it might be worth trying a thin shim of brass or even tin if the paper doesn't do the trick. Apparently, this idea is as old as the drilling dodge. I think it's still worth passing on, though."

"Definitely," agreed Dick.

"And now," said Smithy, "we come to the final idea for this session, after which we'll have to call it a day. This hint comes, incidentally, from the same reader who sent in the previous one. It's a simple but very effective little dodge for keeping ferrite rod aerial coils in place during and after alignment. All you do is slip a small rubber band on to the former and then 'double' it over so that one turn of the band stays on the former and the other stays on the rod."

"The rod," interjected Dick, "being the latter?"

"Don't confuse me!" said Smithy sternly. "This rubber band dodge is a jolly good idea and it enables coil adjustment to be made quite easily. At the same time, it holds the coil firmly in place after it's been set up, and there's no need to use any other means of securing, such as wax."

#### Future Policy

Smithy put the letter he had been reading down on the bench beside him.

"And that," he said with an air of finality, "is that."

"We've certainly had some interesting hints this time," remarked Dick. "I enjoy these little sessions."

"They're very pleasant," assented Smithy, "and they make a nice break from the usual run of things. We'll have another one as soon as we can."

"Good show," said Dick. "Incidentally, isn't it time for another of your pills?"

"Very shortly," agreed Smithy. "I'm just about due for the odd spot of riboflavin."

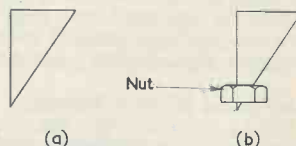

Fig. 8. Easing a tight nut and bolt assembly. A piece of thin paper is cut to the shape shown in (a), the sharp angle being inserted into the nut, as in (b). A tap is then put into the nut and run through

The Serviceman stood up and stretched himself.

"Do you know, Dick," he remarked, "I only started taking these vitamins and things this morning and yet I feel better already. In a couple of weeks I should be a new man!"

"You'd better be careful," warned Dick, "that you don't accidentally take the wrong combination of pills."

"Why's that?"

"You might suddenly," said Dick, "go like Dr. Jekyll and Mr. Hyde. During the day you'll be fixing tellys and, during the night, you'll turn into an 'orrid monster and go around bashing them all up again!"

"That's a possibility," commented Smithy musingly, "which I find rather attractive. If these pills continue to buck me up, I'll give it serious consideration."

And with this sinister threat for the future, the Serviceman

reached behind his signal generator for yet another means of defence in his battle against the ravages of Time.

The hints described in this month's episode of "In Your Workshop" were contributed (in the order in which they appear) by E. E. Meachen, B. Barker, C. J. Collister, T. E. Millsom, J. F. Reed, S. E. Stratton, R. Achilles, B. H. Wynn and G. M. Watson.

Further hints for this feature are welcomed, and payment is made for all that are published—EDITOR.

## Experiences of an



## Early Amateur

### The Third of a Five-part Series

by C. H. Gardner

**T**O UNDERTAKE SOMETHING NEW AND ORIGINAL in radio these days would almost certainly be the result of lengthy technical discussions, followed by laboratory work by a team of engineers and considerable final development before trial. Forty years ago there were many interesting things which had not been attempted either because no one had thought of them or because, in some cases, the difficulties had appeared too great. I do not know into which category one would place the idea of transmitting messages from a racing car in 1922, but the difficulties certainly appeared after the idea entered the head of Mr. S. F. Edge, the racing motorist, the day before he was due to try to break the World's Record for the double twelve hours. In my last article I explained how the job was put fairly and squarely on my own shoulders with the provision that the installation would have to be made during a refueling stop of less than two minutes and that the equipment would have to be available in rather less than 12 hours after I had first heard of the idea. I also mentioned that valves were too fragile to use for the job. Also, the available space in the car was such that the whole transmitter would

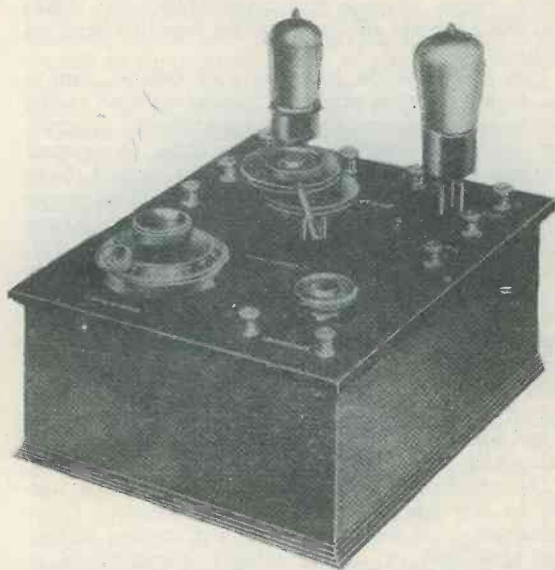

have to be small enough to rest between the operator's feet. I was to be the operator.

#### Racing Car Transmitter

Searching through my spares, I was lucky enough to come across a sparking coil and spark gap from an early aircraft transmitter. This, together with a small capacity 16 volt accumulator, would seem to supply the necessary "prime mover". A tuning helix was embodied in this transmitter and the whole outfit could be fitted into a wooden box less than one foot square. The transmitter was, however, too tall to allow a lid to be fitted so the aerial and earth terminals were well and truly exposed—a matter which was to cause some concern a little later in the proceedings. The morse key was screwed down on the edge of the box and I estimated that the whole outfit could sit on the floor of the car between my feet. They key would have to be operated by passing my hand underneath my right leg, a little foresight causing me to realise that my left hand would be fully engaged in hanging on to a bar provided for this purpose for the mechanic.

The Brooklands track, where the record attempt

was to be made, consisted of a concrete oval banked at each end and providing a distance of approximately two and a half miles per lap. In appearance it was deceptively smooth but, from experience, I knew that this was far from being the case when one really got going. There was one particular bump on what was known as the home banking which could cause one to become literally airborne. At very moderate or very high speeds this bump could be dodged but, over the upper middle range, it coincided with the position it was necessary to take up on the banking. I also surmised that Edge, being engaged on a long distance record, would be travelling within this upper middle speed range. Hence the unsuitability of valves and the necessity of having a free hand to hang on with.

The aerial would have to trail behind, and a fair length of wire would be needed to tune to the 440 metres intended for the experiment. Aircraft can trail their aerials beneath them (a normal practice at that time) but the car would have to trail its aerial above it. This indicated some form of kite which would stand up to the speed and not materially reduce the speed of the car. Luckily, Vickers had an aircraft factory on the side of the track and, on arrival at Brooklands, the problem was put to them. Edge had thoughtfully provided a fast touring car for preliminary trials and the idea of designing a suitable "kite" was sheer joy to the Vickers staff who, within an hour, had produced a most lethal-looking miniature glider which they had tested in their wind tunnel and which they guaranteed to "fly beautifully" at the necessary speed. Its lethal appearance was due to the wings having been constructed from aluminium and having very sharp leading edges. The nose end of the "fuselage" consisted of a hefty lump of lead and these two features suggested that the glider would knock me out even if it didn't decapitate me, should its flight become erratic.

First things had to come first, and a preliminary trial was made. The aerial was coiled up on the seat of the car, one end being attached to the car and the other to a hook thoughtfully provided in the correct position on the glider. Speed was then worked up until "flying speed" was indicated on the speedometer, whereupon the glider was launched into space. But we had forgotten the turbulence behind the car. This resulted in a most devastating display of aerobatics in which dive-bombing played a major part and in which the lead nose and razor-sharp leading edges of the wings whistled past my head with only inches to spare. So far as I was concerned I could duck at the approach of the glider, but the driver was blissfully ignorant of the goings-on immediately behind him, and I pictured that at any minute his stunned body would slump over the wheel and that we would follow the example of many others who had vanished into space over the top of the banking. My howls of anguish for an immediate stop eventually penetrated and the glider experiment terminated.

### Receiving Equipment

Whilst these experiments with aerials had been taking place the necessary receiving equipment had been erected. The receiver was, as described in the Press at that time, a "detector with reaction and two valve note magnifier". The equipment was erected on what was known as Test Hill, this providing an elevated site to assist in reception when the car was at the more distant part of the track. The fact that any message received had then to be sent to the refuelling depot on the side of the track by "runner" only goes to verify that the undertaking was more in the nature of an experiment than a useful means of rapid communication. A much more certain and rapid means of passing messages was evolved by the writer when a painful emergency terminated the transmissions.

In the meantime, a rushed trip had been made to the local butchers from whom a good strong bladder, such as is normally used for sausage skins, had been obtained. It was hoped that this might be instrumental in lifting the aerial from the track, and it had at any rate the merit of being non-lethal should any further dive-bombing incidents take place. At this critical juncture we were informed that the transmitting equipment should be installed in the record breaking car during its next refuelling stop in a few minutes time.

Immediately the car came to a standstill the transmitter was lifted into it and placed on the floor in front of the mechanic's seat. The earth connection was connected to the metal body of the car and the aerial laid out behind it and connected to the appropriate terminal on the transmitter. By the time I had jumped into the mechanic's seat the car was already on the move again. Just as we started a large fish basket was handed to me with a shouted injunction that it contained Edge's "lunch" and would I please feed him as we circled the track. This additional piece of equipment was, in fact, the basic cause of all the trouble to come. It had to sit on my knee and, unbeknown to me at the time, contained grapes, pears and other juicy fruits, all equally fragile and as susceptible to bumps and jars as the valves that I had discarded as unsuitable for transportation.

After we had circled the track a few times Edge suggested that I should transmit a message asking for an air cushion to be provided for him at the next fuel stop. Disentangling myself from the fruit, I managed to find the key and to my joy found that a long dash showed a radiation of some 300 milliamps. I was a little dubious as to intelligibility of the morse that I was transmitting as the jolting of the car was not conducive to accuracy but a few laps later a message on the blackboard at the fuelling depot showed "message received".

This encouraged Edge to request the transmission of further messages with similar results, but tiring of this game he decided that it was time for lunch and demanded to be fed. It was then that I discovered that the jolting had reduced much of

the fruit I was holding to pulp and that a damp sticky juice was trickling down my overall legs. It was not long before this somewhat sticky waterfall had reached the lower extremities of my trousers. At about the same time Edge altered course a little taking us well and truly over the famous home banking bump. The jolt of the car on landing after this bump was sufficient to cause the complete transmitter to become airborne, with the result that the key made contact. At the same time the bottom of the leg of my overall hit the spark gap and the major portion of the discharge found its way up my overall leg via the fruit juice and returned to earth via that portion of my trousers separating me from my metal seat. As this occurred once each lap at intervals of less than two minutes and as I knew I was doomed to sit in that seat for at least another hour I felt justified in feeling that the success of the experiment had been proved and I managed to disconnect the low tension supply. For subsequent messages I brought into use my reserve method which consisted of writing these on slips of paper and hurling them discreetly out of the car as we passed the pits.

### Two World Records

Nevertheless the experiment had been successful, and we had made history. Edge so kindly wrote in a letter received a few days later "it had been nice to be instrumental in breaking two World's Records at the same time." Although the whole episode was great fun and there was some sense of achievement in being the first to transmit from a car actually engaged in record breaking, there was little to be proud of on the technical side other than the satisfaction of overcoming the impossible time elements.

The episode made me anxious to see what might be possible with a little more time for preparation. Having obtained permission from the G.P.O. and being given a special call sign for the job, it was decided to attempt the transmission of speech from a car in motion. 180 metres was the wavelength allowed and a limit of 10 watts was imposed. A standard A.C. open two-seater tourer was used for the experiments and this was fitted up with a six foot wooden mast at front and rear carrying a twin T aerial. The transmitter used a suitably adjusted grid controlled circuit, the h.t. and l.t. supply being provided by dry batteries.

The first experiments were again carried out on the Brooklands track using the same receiving equipment as before, and the results were entirely successful over the range of the mile or so which was available. As *The Motor* reported at the time: "It is quite possible technically, but impossible legally, to transmit telephony from a moving car".\* My own view was that, without considerable development of the equipment, no sane motorist would want to be saddled with a couple of wooden masts, a box full of batteries, and a transmitter which took up the whole of the passenger's seat

\* *The Motor*, 20th February, 1923.

in order to be able to speak over a distance of a mile. It may be noted that no attempt had been made to make the communication two-way.

### Reception On A Train

I suppose there was something about those early days which inspired one to undertake something which had not been attempted before and it was perhaps natural that, having tried mobile experiments with a car, one's mind should turn to the possibility of wireless reception on trains.

It is quite astonishing how often, acting on an impulse and whilst full of enthusiasm, one finds quite unexpected co-operation and enthusiasm from unexpected sources. Within half an hour of thinking of the idea in the spring of 1924, I found myself in the central offices of the Great Western Railway and actually telling an official what I wanted to do; whereupon, less than an hour later, I received a promise of a suitable van to be placed in a siding close to my home. After I had installed the necessary equipment this van would then be attached to a main line express running between Birmingham and Paddington.

A visit to view the van on its arrival indicated two major matters. Firstly, it was constructed from wood and this would ease the aerial problem. Secondly, it had very recently been engaged in its normal duties of fish transportation, and some treatment would be necessary before installation commenced!

The van was a good length and provided plenty of space for an internal aerial, which was soon erected in the form of a twin inverted L suitable for reception of 2LO. The design of the receiver required a little forethought. The screen-grid valve had not at that time made its debut and the superhet was still some distance away, so a limit was imposed on the level of r.f. amplification available. The mutual conductance of the r.f. valves of that time was less than unity and the amplification factor something under 20. With the type of valve and circuit information available, and taking into consideration the frequency that had to be received, two stages of r.f. amplification with tuned circuits were about the most that was possible. A detector valve with reaction and a single stage transformer-coupled a.f. valve completed the receiver. On looking back, I note that we fed the output from this receiver into a separate two valve a.f. amplifier. This may strike readers as curious until it is realised that no form of decoupling was used, and if too many stages were run from a single set of batteries, weird and wonderful effects resulted. The aerial tuning was by variometer, the two tuned-anode r.f. amplifiers each being tuned by its own variable capacitor. As there was, in addition, an adjustable reaction coupling control and each valve had a separate adjustable resistance in its filament circuit, setting up for maximum sensitivity at a particular frequency was quite a tricky business.

This receiver proved to be surprisingly efficient when put on test with the aerial in the fish van.

It seemed reasonable to suppose that reception of broadcasts would be possible on most of the journey so, after a telephone call to G.W.R. headquarters, it was arranged to tack the van on to one of their crack two hour expresses running between Birmingham and Paddington. The next morning an engine collected us and in due course backed us on to the express as it stood in Birmingham Snow Hill station. The shunting operation took a little time with the result that we left some ten minutes late, a matter for some concern later in the proceedings.

The complete log of the journey appeared in the Great Western Railway magazine of the period but unfortunately my copy went adrift during the last war. Loudspeaker reception was obtained both on the outward and home journeys, this only being blotted out when passing through tunnels, or weakened when passing through deep cuttings. A little difficulty was experienced in keeping the equipment on the tables provided when negotiating the somewhat twisty piece of line around High Wycombe. Being "Tail-End Charlie" with an engine driver determined to arrive at Paddington on time in spite of the ten

minutes delay, my log for this part of the journey showed a short blank whilst I endeavoured to retain my balance and keep the equipment intact at the same time.

On arrival at Paddington we were met by station officials who informed us that senior officials of the line would accompany us on the return journey and that for their use the van would be furnished with easy chairs. They also told us the time of departure and this immediately introduced difficulty, as no broadcasting was due to take place at that time.

A telephone call to the B.B.C. resulted, a little surprisingly, in their agreeing to fill the gap for us. This is something which must seem quite incredible to readers who have not experienced the enthusiasm evinced by everyone concerned with radio in those early days.

I gathered that, although interested in participating in the experiment, the senior railway officials were not displeased that their return journey would be in more salubrious and comfortable conditions.

(To be continued)

## Experimental

# 12AX7-12AU7

## Gram Amplifier

J. C. Noakes

*Our contributor describes a simple a.f. amplifier which incorporates a number of unusual features. We present the unit as an experimental project for readers who are interested in somewhat unconventional circuits*

THE ACCOMPANYING CIRCUIT DIAGRAM illustrates a simple gram amplifier which employs two inexpensive double-triodes. The prototype has given good results and was designed to operate with a minimum of components. A feature of the circuit is that the low h.t. consumption enables a "converter" mains transformer to be employed, with the result that complete isolation from the mains supply is achieved at low cost.

### The Circuit

In the circuit diagram, a crystal pick-up connects to the tone-

correction circuit offered by  $R_1$ ,  $R_2$  and  $C_1$ , and to the volume control  $R_3$ . The a.f. tapped off by the slider of this control is then fed to the grid of the voltage amplifier  $V_{1(a)}$ . The anode of  $V_{1(a)}$  couples directly to the grid of the phase-splitter triode,  $V_{1(b)}$ . Out-of-phase voltages then appear at the anode and cathode of  $V_{1(b)}$  and are applied, via  $C_3$  and  $C_4$ , to the grids of the 12AU7,  $V_2$ . The anodes of  $V_2$  finally connect to a push-pull output transformer,  $T_1$ , capacitor  $C_5$  providing a level of top-cut.

The h.t. supply is obtained

from the half-wave secondary of the mains transformer,  $T_2$ , and is rectified by any suitable rectifier capable of operating at the secondary voltage and at a current of 20mA. The rectified voltage is applied to the reservoir capacitor  $C_7$ , and is smoothed by  $L_1$  and  $C_6$ . It is possible for the choke to be replaced by a resistor having a value of  $2.7k\Omega$  and a rating of 2 watts, but this was not tried by the author.

It will be noted that bias for  $V_{1(a)}$  and  $V_2$  is provided by a dry cell and dry battery respectively. This method of biasing was employed as it was felt that the cost was less than would be given with normal cathode bias components and because, in the case of  $V_2$ , the valve received a higher effective h.t. voltage. As no current is drawn from the dry cell and battery, their life is equivalent to their shelf life. If desired, however, it would be possible to dispense with the 1.5 volt cell biasing  $V_{1(a)}$  and insert a  $2.7k\Omega$  resistor in the cathode lead instead. This could then be bypassed by a  $25\mu F$  electrolytic capacitor if it was found that gain was too low or that hum was introduced into the cathode circuit. If the cathode bias resistor is fitted, the lower ends of  $R_2$  and  $R_3$ , and the lower terminal of the pick-up, are returned to chassis.

The  $100k\Omega$  preset potentiometer,  $R_5$ , offers a convenient method of



setting  $V_1(b)$  to its optimum working condition with respect to bias, and is adjusted at various volume levels to obtain the best performance.

The output transformer employed in the prototype was a component offering  $8k\Omega$  impedance anode-to-anode (i.e. 26+26:1 for a  $3\Omega$  speaker), but it is probable that better results would be given by a transformer offering 12 to  $14k\Omega$  anode-to-anode impedance. These impedances correspond, for a  $3\Omega$  speaker, to a ratio of the order of 33+33:1.

### Components List

#### Resistors

(All fixed resistors 20%  $\frac{1}{4}$  watt unless otherwise stated)

- R<sub>1</sub> 220k $\Omega$
- R<sub>2</sub> 100k $\Omega$
- R<sub>3</sub> 1M $\Omega$  potentiometer, log track, ganged with S<sub>1</sub>.
- R<sub>4</sub> 100k $\Omega$
- R<sub>5</sub> 100k $\Omega$  pre-set potentiometer, linear track
- R<sub>6,7</sub> 100k $\Omega$  matched 2%
- R<sub>8,9</sub> 1M $\Omega$  10%

#### Capacitors

- C<sub>1</sub> 0.01 $\mu$ F paper
- C<sub>2</sub> 8 $\mu$ F electrolytic, 250V wkg.
- C<sub>3,4</sub> 0.05 $\mu$ F paper
- C<sub>5</sub> 0.001 $\mu$ F paper
- C<sub>6,7</sub> 32 $\mu$ F electrolytic, 250V wkg.

#### Inductors

- T<sub>1</sub> Push-pull output transformer (See text)

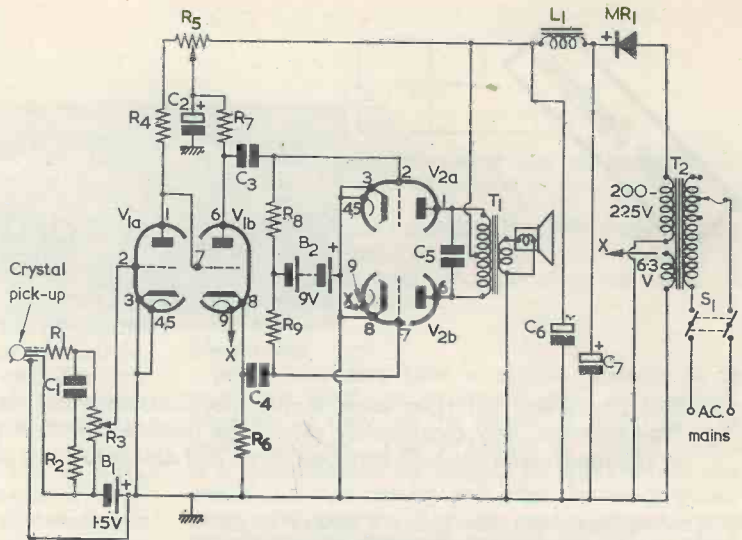

The circuit of the experimental two valve gram amplifier.  
V<sub>1</sub>, 12AX7, V<sub>2</sub>, 12AU7

- T<sub>2</sub> Mains transformer. Secondaries: 200-225 volts at 20mA (minimum), 6.3 volts at 0.6A (minimum)
- L<sub>1</sub> Smoothing choke (See text)
- Valves  
V<sub>1</sub> 12AX7  
V<sub>2</sub> 12AU7
- Rectifier  
MR<sub>1</sub> Metal or contact-cooled h.t. rectifier, 20mA minimum
- Switch  
S<sub>1</sub> d.p.s.t. on-off. Ganged with R<sub>3</sub>
- Batteries  
B<sub>1</sub> 1.5 volt cell  
B<sub>2</sub> 9 volt battery. (Ever Ready PP4 would be suitable)
- Pick-up  
Crystal pick-up

## ITA Orders Two Reserve Transmitting Aerials

Independent Television Authority is taking steps to reduce to a minimum the time that an ITV programme would be off the air if a transmitting aerial were seriously damaged. Contracts have been placed with EMI Electronics Ltd. to supply a reserve mast and two aerials—one vertically and one horizontally polarised. Subcontractor for the supply of the mast is Access Equipment Ltd.

This is the first time that precautions of this kind have been taken by a broadcasting organisation in the United Kingdom. Both aerials will be stored at the ITA's station at Lichfield, near the centre of England, for speedy transportation to any transmitting station in this country of whichever aerial is required. The mast can be erected in eight hours by a team of seven men, ready for the appropriate aerial to be erected and powered.

The mast is 250ft tall. Both aerials are omnidirectional, with facilities for giving a figure-eight diagram if required, and will transmit on Band III. Each is of 20ft vertical aperture, giving a gain of approximately 4 times.

The vertically polarised aerial consists of four stacks of dipole clusters in a quadrature feed arrangement. The horizontally polarised aerial consists of four stacks of super-turnstile elements similarly fed.

## JUST ANNOUNCED . . .

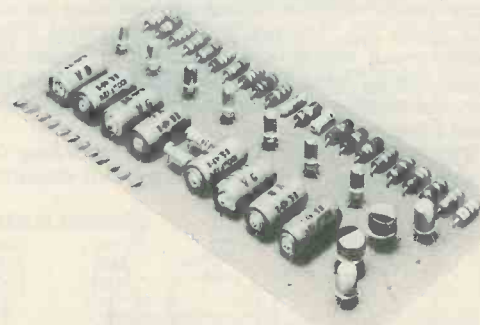

Sinclair Radionics Ltd. have just announced the release of their new 10 watt integrated amplifier. The Sinclair "X-10" is a high fidelity integrated power amplifier and pre-amp using 11 transistors and having a transformerless output of 10 watts for feeding into a  $15\Omega$  loud-speaker system. The overall size of the unit is  $6 \times 3 \times \frac{3}{4}$ in and the whole compact arrangement is shown in the illustration above.

# Extra Features for Your Tape Recorder

By G. D. Howat

*Our contributor describes some simple modifications which, when carried out on a low-cost tape recorder, may considerably extend the facilities which it provides. This article is aimed at the reader who has sufficient experience and ability to carry out the simple changes described*

**D**URING THE PAST TEN YEARS A GREAT NUMBER of tape recorders have become available in this country. Most are in the £20-£100 price range and have become very popular with the public: there are nearly a million privately owned tape recorders in Britain today. Although many recorders are excellent machines of high quality, there are often certain special features lacking. For instance, input mixing or superimposing are available on some models but not on others. Facilities such as these greatly enlarge the range of uses to which the recorder can be put, and recorders not having them can usually be converted at a very reasonable cost. It is the aim of this article to describe how these modifications can be effected.

## Adding "Superimpose"

As an example of a typical modification a simple alteration will be discussed first—the addition of a "superimpose" facility. When a tape recorder is switched to "record" the tape first passes over the erase head, which removes any existing recording and leaves the tape blank. It then moves past the record head where the signal to be recorded is applied to it. In order to superimpose a fresh signal over the existing one, it is necessary to stop the erase head from working.

The block diagram of a normal recording chain is shown in Fig. 1. In order to prevent erasure, the

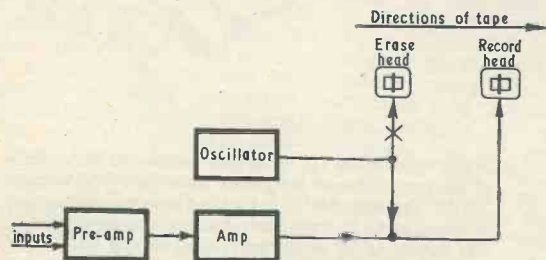

Fig. 1. Simplified diagram showing the basic recording system. (The bias circuit is omitted)

circuit must be broken at the point X. For technical reasons it is not possible simply to open-circuit the leads to the erase head because, if this were done, the changing load on the oscillator circuits could cause serious trouble. It is, however, a simple matter to overcome this difficulty and all that is needed is to switch the oscillator leads from the erase head to a resistor of equivalent value, as shown in Fig. 2. In position 1 the circuit functions normally as an erase unit, but in position 2 the oscillator output is connected across the resistor R. This simple circuit, requiring one switch and one resistor, is all that is needed to provide superimpose facilities! The value of the resistor R should be of the same order as the impedance of the erase head at the oscillator frequency.<sup>1</sup> The writer had a machine whose erase head impedance was 500 to 600Ω and a 1kΩ resistor was used for R. The switch can be an ordinary toggle or rotary type, to suit individual requirements.

## Input Mixing

A rather useful feature is mixing of inputs. This enables two inputs to be varied in amplitude independently of each other. Many recorders claiming to have mixing facilities do not, in fact, have them, and although these machines can record from two inputs at once, they cannot alter their level separately.

<sup>1</sup> In a typical modern commercial recorder using this technique, the resistive load switched into circuit for superimpose has a rating of ½ watt only. It is probable, however, that higher wattage ratings will be required with earlier machines, and this point will have to be determined by experiment.—EDITOR.

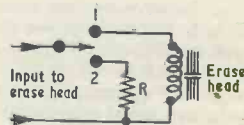

Fig. 2. Obtaining "superimpose" by means of an additional switch and resistor

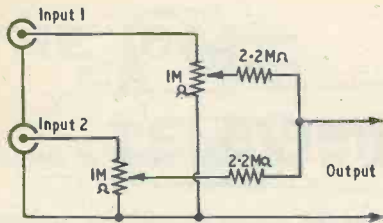

Fig. 3. An external mixer circuit

There are two possible ways of adding mixers to a recorder. Either an external mixer can be used or the internal circuits of the record pre-amplifier can be altered. Mixers vary from simple potentiometers to complex electronic types using several valves.

A simple external mixer is shown in Fig. 3. This circuit will work tolerably well provided that perfection is not sought by the user. Fig. 4 shows the basic simplified circuit found at the input in many of the cheaper tape recorders. It is seen that the microphone input is amplified by a low-noise amplifier and applied, together with the "gram" input, to the input gain control. Clearly, the two inputs cannot be varied independently by this arrangement. There is another snag in this system. If the input to the microphone stage is excessively high, it may overload the EF86 and cause serious distortion. As there is no way of reducing the input to this stage nothing can be done about it with the circuit as it stands. However, the circuit can be modified by replacing  $R_1$  in Fig. 4 by a  $2M\Omega$  potentiometer, as in Fig. 5. This provides independent mixing of the inputs and also prevents the possibility of overloading. If this system is adopted care must be taken to screen all wiring and the metal potentiometer case, as these circuits are very susceptible to hum. In addition, a modification must be made to prevent the "gram" input control from varying the microphone gain—the fully modified circuit is shown in Fig. 6. The writer has used this arrangement in practice and found it to work very well.

An alternative mixer is formed by retaining the

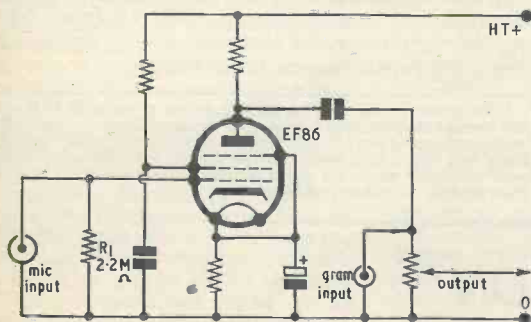

Fig. 4. A typical tape recorder microphone input stage

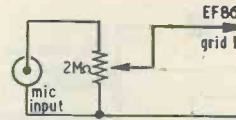

Fig. 5. Fitting a gain control after the microphone input socket

initial microphone input circuit of Fig. 4 and mixing the output of the EF86 with the "gram" input as in Fig. 7. This is really incorporating the mixer of Fig. 3 into the amplifier.

### Monitoring

Some recorders have a system whereby it is possible to use the internal loudspeaker and playback amplifier to listen to the recording signal as it is being recorded. This is known as "monitoring". It is accomplished by tapping off a portion of the recorded signal, usually just after the pre-amplifier stage, and applying it to the audio output stage, usually via the playback volume control. In some recorders the audio output valve operates as the oscillator when recording and, in these cases, monitoring is impossible. Most modern recorders incorporate monitoring facilities when it is possible to do so but older models may not. The addition of this feature is an easy matter if the audio output stage is available when recording and it is not being used for any other function. All that is needed is a link between the signal (i.e. non-earthed) end of the volume control, and the input to the record main amplifier. If the record amplifier doubles as a playback pre-amplifier a switch should be inserted in the monitor lead so that it can be disconnected on playback, otherwise feedback may occur, leading to violent oscillation. The monitor link should be made with screened lead to prevent the introduction of hum.<sup>2</sup>

<sup>2</sup> We would advise a careful check of the tape recorder circuit diagram before carrying out this modification, as it may not be applicable to a number of models. It will be desirable, also, to ensure that a means exists for cutting out the monitor facilities when the recorder microphone is close to the recorder loudspeaker, otherwise, acoustic feedback may occur. If there is a possibility of the link upsetting bias conditions in either of the circuits joined, or if there is a difference in d.c. potential between the two circuits, an  $0.01\mu\text{F}$  capacitor should be inserted in series.—EDITOR.

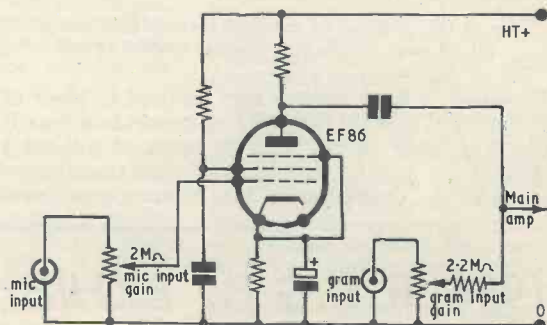

Fig. 6. Providing microphone and "gram" mixing facilities

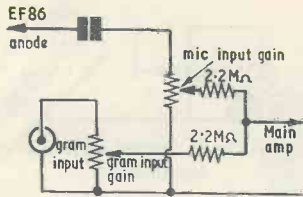

Fig. 7. An alternative method of mixing microphone and "gram" inputs

### External Loudspeaker

Another item fitted on most modern recorders but absent from some earlier types is an external loudspeaker socket. Due to the acoustic limitations of a recorder cabinet an external loudspeaker is usually necessary to obtain maximum fidelity. Fitting a jack socket is of course a perfectly simple matter and, in its simplest form, the external speaker is connected in parallel across the internal unit as in Fig. 8 (a). However, this presents the wrong impedance to the circuit as the two speakers are in parallel, and the effective impedance is halved. Also the available power must be shared between both speakers, so that there is a reduction in the power available at each. To prevent this a special jack socket can be used which switches out the internal speaker when the jack plug for the external one is inserted. Such jack sockets are readily available and are connected as shown in Fig. 8 (b).

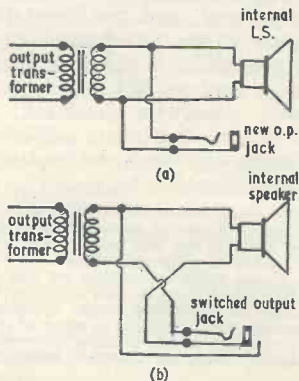

Fig. 8 (a). Adding an external speaker jack socket  
(b). A more satisfactory external speaker circuit

If desired, a fixed resistor may be used in place of the internal speaker. A point of importance here is that a recorder should *never* be operated without a speaker (i.e. with an open-circuit output transformer secondary). Operation in this manner can cause

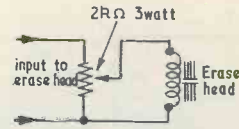

Fig. 9. An experimental method of obtaining an erase-fade facility

damage to the output transformer and associated components.

### Erase-Fade Control

The modifications just described can be incorporated in many commercial tape recorders. In conclusion, a few notes will now be given concerning changes which may be made with slightly more difficulty. The first concerns the superimpose unit described previously. Instead of having a simple superimpose on/off switch it is possible to use a potentiometer to give an erase-fade control. This is useful in adding endings to recordings having a sudden finish, and for other uses. The only difficulty in fitting this control lies in the fact that a 3-watt potentiometer must be used, and some trouble could arise in fitting such a large component in a congested cabinet. The circuit for the erase-fade unit is shown in Fig. 9.<sup>3</sup>

### Experimental Echo

A circuit which has recently caught the writer's attention is an echo unit working on the following principle. The signal from the playback head after amplification is returned to the erase head and re-recorded there (this is quite feasible). After a time lag dependent on the tape speed, the signal again reaches the playback head and the cycle is repeated. Theoretically the number of echoes is infinite, but in practice the inherent distortion in the circuits produces a badly distorted output after more than about eight repeats. The writer took a signal from the loudspeaker output jack via a 1:10 matching transformer back to the erase head. Bias was supplied from an external 50 kc/s oscillator and mixed with the returned signal. This arrangement worked fairly well but the writer cannot guarantee the success of any similar experiments.

With the exception of this last example, all these modifications can be incorporated in most commercial tape recorders and will greatly extend the operating capabilities of the machines.

<sup>3</sup> The potentiometer shown in Fig. 9 has a value of 2kΩ, but this may be considerably higher than the impedance of some erase heads, and would put this modification in the experimental category. There is a slight risk, also, that the varying load presented to the erase oscillator when the potentiometer is adjusted may have an effect on bias amplitude.—EDITOR.

## 1964 R.S.G.B. EXHIBITION

This Exhibition will again be held at the Seymour Hall, Seymour Place, Marble Arch, London, from 28th to 31st October. The hall will be open daily from 10 a.m. until 9 p.m. and the admission fee will be 3s. See "News and Comment" on page 161 of this issue for further details.

# THE 1964

## TELEVISION AND RADIO SHOW

**T**HE 1964 TELEVISION AND RADIO Show at Earls Court was open to the general public from 26th August to 5th September, 24th and 25th August being given over to the Press and the trade.

It was a little disappointing to find in this, the first Radio Show for two years, that only the ground floor at Earls Court was occupied. In the more ambitious Radio Shows of earlier years emphasis has been placed on such things as colour television, the 405/625 line controversy, the introduction of transistors, and spectacular stagings of radio and TV personalities, but nothing of this nature was evident at the present exhibition. Nevertheless, despite what the butler would have described as its "reduced circumstances", the Show still had plenty to offer that was of interest to both the radio enthusiast and the layman.

### Radio and Audio

In the sound reproducing field, a number of manufacturers exhibited single-cabinet stereo equipment.

R.G.D., for instance, showed their RGD 211 stereogram. This offers an output of 6 watts per channel fed to four loudspeakers, and incorporates a 5-band radio (long, medium, 2 short waves and v.h.f./f.m.) together with a Garrard AT6 record changer. Featured in the design is a switch which offers bass boost at low listening levels. The cabinet is 5ft long and includes a space which may be used for record storage or the installation of a tape recorder.

Pye introduced their Model "Double One Double One" receiver, which reproduces stereo broadcasts over two speakers, one of which may be moved to any position. This unit is capable of working with the current B.B.C. test transmissions, and sockets allow stereo records and tapes to be played through the radio. The "Double One Double One" is completely transistorised, as were four new stereograms demonstrated by Pye. Also shown by Pye was the "Achoic" Stereo Projection System. In this, a cluster of six speakers allows twin-channel sound to be reflected from the walls of the room. The "Achoic" unit is only 22in wide, but it incorporates a transistorised

amplifier giving 5 watts per channel and a gram deck. The latter has a special lightweight pick-up having a diamond stylus and a pressure of only 2 grams.

Transistorised record players and radiograms were also featured by H.M.V. and Ferguson.

Apart from the introduction of band-spreading at the high frequency end of the medium wave band—to facilitate the selection of Radio Luxembourg and the pirate stations which appear at these wavelengths—and the gradual introduction of complementary Class B output stages—in which one p.n.p. output transistor handles the negative half of the signal and one n.p.n. transistor handles the positive half—transistor radios tended to exhibit few outstanding changes. Two portables from Ekco had push-button pre-tuned selection of Radio Luxembourg in addition to manual tuning over the medium and long wave bands.

One innovation was, however, evident on the Perdio stand. This consisted of a communications-type portable receiver known as the "Marco Polo", which covers 1.6 to 30 Mc/s as well as medium and long waves and v.h.f./f.m. A b.f.o. is included in the design, and the circuit employs 16 transistors.

In the past, Roberts Radio have exhibited portable transistor receivers in diamond-studded and solid gold cases. (In the latter, the gold was so solid that the receiver had to have an external telescopic aerial.) This year the tradition was maintained, and Roberts presented a portable covered in real leopard skin at 120 guineas. This price includes the batteries!

### Television

Ferguson exhibited their new "900 Series" TV chassis, which has the feature of cool running due to the use of an autotransformer for the heaters instead of the usual dropper resistor. There is only a single circuit board, this being mounted at the bottom of the cabinet.

All television receivers were 405/625 line models, having separate tuners for v.h.f. and u.h.f. U.H.F.

tuners follow the standard two-triode line-up, the first triode acting as r.f. amplifier and the second as mixer/oscillator. Lecher lines with continuously variable tuning are standard practice, a tuned line being employed instead of aperiodic tuning in the aerial stage. R.G.D., however, exhibited sets employing a transistorised u.h.f. tuner, it being claimed that this could work with 50 per cent less signal, for equivalent noise level, as compared with a valve tuner. A demonstration was provided, by means of which a direct comparison between a valve and a transistor tuner could be made under fringe conditions by touching a button.

The Pye stand included a very well-attended demonstration of final test and alignment, under factory conditions, of u.h.f. tuners. The tuner under test was swept across the u.h.f. band, the response being shown on a large receiver-type cathode ray tube. Demonstrations of this type tend to attract a crowd, and a thoughtfully provided closed-circuit camera and monitors enabled people on the outskirts to see, in close-up, the actual process of alignment.

### Other Exhibits

In addition to the domestic radio and TV stands, there were comprehensive displays by the Services. The Royal Air Force presentation included a full-scale replica of an Air Traffic Control Tower, whilst the Royal Navy exhibited a Wessex HAS1 helicopter with its covers opened so that all internal equipment could be examined.

The home-constructor was amply catered for, both by Daystrom and by Mullard. The Daystrom stand carried an impressive array of complete Heathkit equipment, and the Mullard home-constructor stand was fully staffed to cater for amateur enquiries. Mullard home-constructor designs on view included an electronic organ, a baby alarm, a burglar alarm, an electric fence unit and transistorised high fidelity amplifiers.

# GAS FILLED COUNTING TUBES

By J. B. Dance, M.Sc.

WHENEVER ONE VISITS AN EXHIBITION of modern electronic equipment, one can almost always see apparatus containing tubes in which a rather fascinating red glow is rotating. The speed of rotation can have any value up to some hundreds per second, at which speed the discharge appears as a circle of red light.

Such tubes are employed in one of the most common types of circuit for counting electrical impulses. The first tubes of this type were designed about 1950.<sup>1</sup> The tube on the right-hand side of the display indicates the number of units counted, the tube next to it indicates the number of tens, the tube next to that the number of hundreds, and so on. The glow in the units tube rotates at ten times the speed of the glow in the tens tube. Decade tubes divide the number of input pulses by ten so that the output pulses from any tube may (after amplification and phase inversion) be used to operate the succeeding tube. Ten pulses must be fed into the equipment to cause the units tube to make

one complete revolution. An output pulse is provided each time the glow in a tube moves from position 9 to position 0.

Counting circuits are known as scalars, since each decade divides or scales down the number of input pulses by a factor of ten. Gas filled decade tubes are often known as "Dekatrons", but this term is a registered trade mark for the gas filled decade tubes made by Ericsson Telephones Ltd., and should not be applied to tubes of other manufacturers.

Pulse counting equipment is a very important part of modern electronic instrumentation. Apart from its use in radioisotope work, counting circuitry is much used in the automation processes of modern factories for such applications as counting shaft rotations, or for counting the number of articles coming off a production line and automatically placing the desired number in each batch for sale. The pulses need not necessarily be evenly spaced in time.

Some types of gas filled decade tube can count at speeds up to 4 kc/s, but a few types are limited to about 1 kc/s. Counting tubes of these types are very useful for use with Geiger-Müller tubes for radioisotope work. Faster gas filled decade tubes have also been developed for counting at speeds up to 10 kc/s, 20 kc/s, 50 kc/s, 100 kc/s and 1 Mc/s. They do not all function on the same principle, although certain aspects of the principles of operation of all gas filled decade tubes are very similar. The colour of the discharge is usually red, but some of the higher speed tubes (such as the GC10D and the EZ10B) are filled with a different gas mixture and emit a bluish glow.

High vacuum decade tubes (the EIT and Beam Switching Tubes) are also available, but do not, of course, come within the scope of this article.

## Cold Cathodes

In common with all other types of cold cathode tube, gas filled decade tubes have characteristic striking and maintaining voltages. They must always be used in series with a resistive load. They have a very long life when correctly used, but will be quickly damaged by excessive currents. The life of the tubes is prolonged if care is taken to ensure that the discharge does not remain at any one cathode for a period which is longer than a week or so.

## Double Pulse Operation

Many tubes operate on the double pulse principle. A double pulse tube consists of a circular anode with thirty rod-shaped electrodes placed around it as shown in Fig. 1. All of the rod-shaped electrodes are identical. Ten are main cathodes and the other twenty are known as guide or transfer electrodes. The guide electrodes serve to transfer the discharge from one main cathode to the succeeding main cathode. They normally receive a positive bias and the discharge will therefore not rest at a guide electrode for any appreciable time, since the anode to main cathode potential is greater than the anode to guide potential.

The ten guide electrodes which are on the clockwise side of the adjacent main cathodes are all connected together and are known as first guides. (Fig. 1.) The guides on the anti-clockwise side of the adjacent main cathodes are also connected together and are known as second guides.

If the glow discharge is resting at the zero position,  $K_0$ , an input pulse must cause it to be transferred to the next main cathode,  $K_1$ , for a count to be registered. This involves three separate steps. Initially the input pulse, after suitable amplification and shaping, is applied as a negative-going rectangular pulse to the first guides so that the potential of these

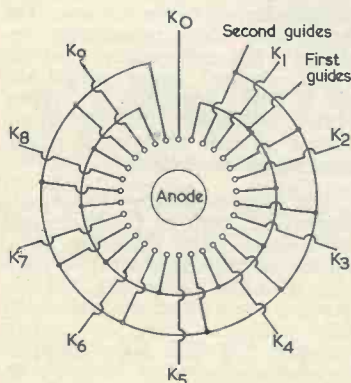

Fig. 1. The structure of a double pulse selector tube

guides falls to a value which is well below the earth potential. The discharge therefore moves from the main cathode  $K_0$  to the succeeding first guide, since the anode to first guide voltage is greater than the anode to main cathode voltage. It does not move to any other first guide, since only the first guide succeeding the main cathode which is glowing is "primed" by the ions in the gas formed by the discharge. The ions only travel a short distance in the gas and therefore the priming effect is not very great except between neighbouring cathodes and guides.

When the discharge has rested at the first guide for a short time (about 75 microseconds), a negative-going pulse is applied to the second guides and the first guide pulse terminates shortly afterwards. When the first guide potential returns to its quiescent positive value, the discharge moves to the second guide which is on the clockwise side of the previously glowing first guide. This is the only second guide which is strongly primed. At the end of the pulse the second guides return to their positive bias potential and the discharge moves to the succeeding main cathode which is strongly primed, namely  $K_1$ . A count has now been registered.

Double pulse tubes derive their name from the two guide pulses which must be applied to them to cause one count to be registered. The two pulses must overlap slightly in time. If the second guide pulse is applied before the first guide pulse, the glow will move in an anti-clockwise direction and the counting will be in reverse (that is, subtraction will take place). Double pulse tubes are symmetrical in each direction and it is only the order in which the pulses are applied to the two sets of guides which determines the direction in which the counting will occur.

In practice the two guide pulses must be derived from a single input pulse. The usual type of circuit which is used to derive the two overlapping pulses from a single input pulse is shown in Fig. 2. The square brackets inside the tube show that there is more than one first guide and more than one second guide, but only one of each is shown for simplicity. When a negative-going pulse is applied to the circuit, the capacitor  $C$  maintains the second guide voltage constant for a short time. Similarly at the end of the input pulse  $C$  holds the voltage of the second guides constant for a short time. Thus the pulse at the second guides is effectively later in time than the first guide pulse. This

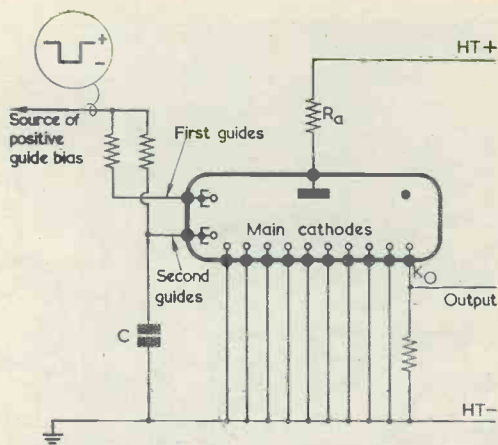

Fig. 2. The basic integrator input circuit for double pulse tubes

simple type of circuit is known as an integrator circuit, since a graph of the second guide voltage against time is (for short times) approximately the waveform which would have been obtained by mathematically integrating the voltage/time waveform applied to the first guides.

#### Outputs

An output pulse can be obtained from any cathode by inserting a suitable resistor in that cathode circuit. Normally an output is required from the zero cathode of each tube for the operation of the succeeding tube, as shown in Fig. 2. In this case the tube may have all of the main cathodes from 1 to 9 inclusive joined to a common base pin, only the zero cathode having a separate external connection. Such tubes are sometimes known as "counter" tubes to distinguish them from "selector" tubes which have each main cathode returned to a separate base pin. An output pulse can be obtained from any main cathode of a selector tube.

The output pulses obtained from gas filled decade tubes are positive-going. These positive-going pulses must be changed in phase before they can operate a succeeding tube. In addition the output pulse voltage is only about thirty volts and must be amplified to about 120 volts before it is suitable for the operation of a succeeding tube. Some form of coupling amplifier is therefore required.

#### 4 kc/s Double Pulse Tube Circuit

A typical circuit designed by the Ericsson Company for use with their double pulse tubes is shown in Fig. 3.<sup>2</sup> This circuit is suitable for the 4 kc/s tubes type GC10B, GC10B/S, GC10/4B, GS10C/S, and

for the GS10H and 12-way tubes types GS12D and GC12/4B. It will count up to one hundred, but further decades similar to the second decade shown may be added so that the circuit can count up to any desired number.

The input pulses applied to this circuit should be positive-going and have an amplitude of at least 20 volts.  $V_{1(a)}$  and  $V_{1(b)}$  form a monostable multivibrator. In the quiescent state  $V_{1(b)}$  is saturated, since its grid is returned to the h.t. positive line, whilst  $V_{1(a)}$  is cut off by the bias developed by the  $V_{1(b)}$  anode current flowing through the common cathode resistor. A positive-going input pulse causes  $V_{1(a)}$  to conduct. The anode voltage of  $V_{1(a)}$  therefore falls and  $V_{1(b)}$  is cut off. The circuit remains in this state whilst the capacitor  $C$  is charging through the grid resistor of  $V_{1(b)}$ . As soon as  $V_{1(b)}$  commences to conduct again, the circuit quickly switches itself back to its quiescent state in which

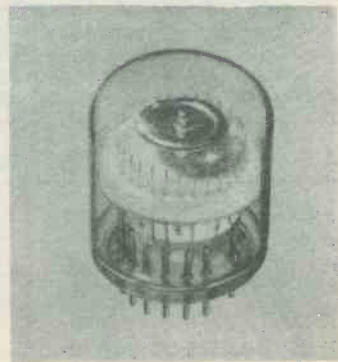

A modern miniature Dekatron  
—the Ericsson GS10H (Ericsson  
Telephones Ltd)

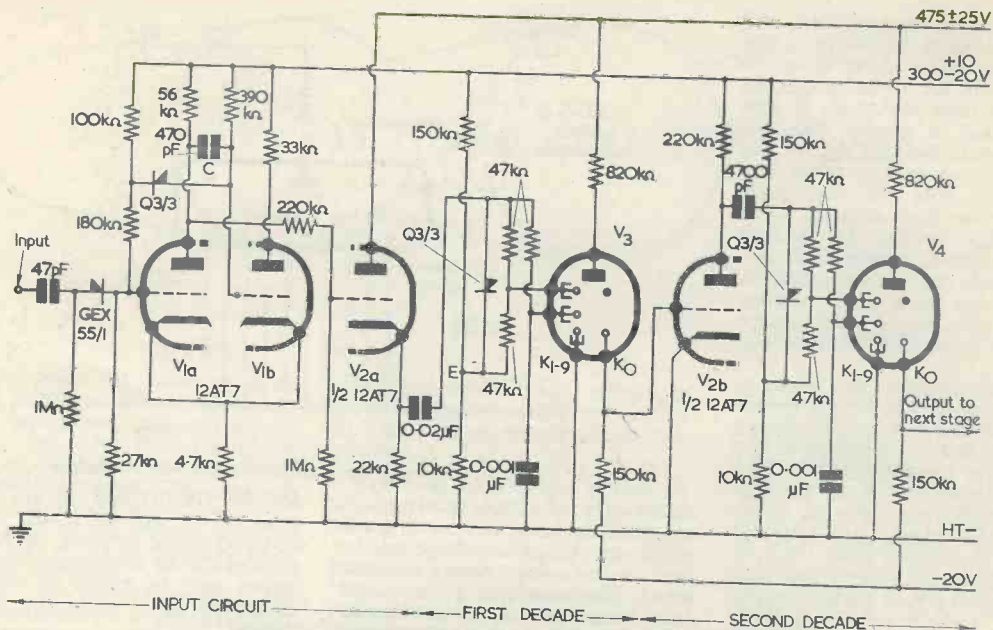

Fig. 3. A two-decade circuit for counting at speeds up to 4 kc/s.  $V_3$  and  $V_4$  may be GS10H, GC10B, GC10B/S, GC10/4B, GC12/4B, GS10C/S or GS12D

$V_{1(a)}$  is cut off. Thus the amplitude and duration of the pulse at the anode of  $V_{1(a)}$  are independent of the input pulse characteristics. The GEX55/1 diode in the input circuit prevents the negative trailing edge of the input pulse from reaching  $V_{1(a)}$ , and causing this tube to be cut off prematurely. The duration of the pulse at the anode of  $V_{1(a)}$  can be controlled by choosing an appropriate value of C. In the circuit shown the pulse fed from  $V_{1(a)}$  to  $V_{2(a)}$  has a duration of about 80 microseconds. The cathode follower stage,  $V_{2(a)}$ , provides a low impedance output suitable for the operation of the counting tube,  $V_3$ .

A portion of the pulse from  $V_{2(a)}$  is fed to the first guides of  $V_3$ , whilst the second guide pulse is obtained by means of the normal integrator circuit. The guide bias supply is obtained from the point marked E,

at the junction of the 10k $\Omega$  and 150k $\Omega$  resistors.

The zero cathode of each counter tube is returned to a -20 volt supply so that larger output pulses can be obtained from the tube. The output pulses are fed to the coupling valve  $V_{2(b)}$ . This valve is normally cut off by the negative voltage applied to the output cathode, but when the discharge rests at the output cathode,  $V_{2(b)}$  conducts. The positive-going pulse from  $V_3$  is thus amplified and phase-inverted so that it is suitable for feeding to  $V_4$ . The capacitor coupling ensures that the pulse applied to  $V_4$  does not have an excessive duration even if  $V_{2(b)}$  is conducting for a long time.

Ericsson circuits using trigger tubes and also circuits using transistors instead of valves for coupling double pulse tubes have been pub-

lished.<sup>2</sup> Mullard circuits for driving their tubes from valves,<sup>3,4</sup> trigger tubes,<sup>5,6</sup> and transistors<sup>7</sup> are also available. American manufacturers have designed rather different types of circuits.<sup>8,9</sup>

#### Asymmetrical Tubes

Double pulse tubes are symmetrical with respect to the clockwise and anti-clockwise directions, but two guide electrodes are required between each two main cathodes to ensure that counting occurs only in the desired direction. Other types of tube are available in which the direction of counting is determined by the asymmetrical structure of either the guide electrodes or of the main cathodes or both. Such tubes employ only one set of guide electrodes. Examples are the Elesta EZ10B<sup>10</sup> and the S.T.C. G10/241E "Nomotron".<sup>11</sup>

If the discharge is resting at the zero cathode of one of these tubes, an input pulse applied to all of the guide electrodes will cause the discharge to move to the guide following the zero main cathode. At the end of the input pulse the discharge moves to the main cathode following the zero cathode, since the guides receive a positive bias. The shape of the guides and/or of the main cathodes ensures that the discharge can move only in a clockwise direction. These tubes cannot

#### Counter Tube Equivalents and Near Equivalents

American	CV Code	Ericsson	Mullard
6476	CV2325	GS10C/S	Z502S
6482	CV2271	GC10B/S	Z303C
6802	CV1739	GC10/4B	
	CV6100	GC10/4B/L	
	CV6044	GC10B/L	
	CV5143	GC10D	
6879		GC10/2P (Maintenance type only)	



be used to count in the reverse direction.

**The GC10D Tube**

Another type of tube is the Ericsson single pulse Dekatron type GC10D<sup>12</sup>. The construction of the GC10D is similar to that of the double pulse tube shown in Fig. 1, but forty electrodes are employed around the central anode instead of thirty. Ten of the electrodes are main cathodes whilst the remaining thirty are first, second and third guide electrodes. There are three guide electrodes between each two main cathodes. All of the first guides are joined together and are brought out to a common base pin. Similarly all of the second guides are brought out to one external connection. The third guide preceding the zero cathode is connected to its own base pin, whilst the remaining third guides are connected to a common base pin.

The GC10D can be used in the type of circuit shown in Fig. 4 for counting at frequencies up to 20 kc/s.<sup>2</sup> Normally a GC10D tube is only employed in the first decade, since a slower and slightly cheaper 4 kc/s tube is perfectly satisfactory for use in the second decade. The input circuit of Fig. 4 is very similar to that of Fig. 3, but the capacitor which is connected between the anodes of V<sub>1(a)</sub> and V<sub>1(b)</sub> has been reduced in value from 470pF to 100pF so that the pulses provided by the input circuit are shorter. The GC10D can operate with input pulses of about 25 microseconds duration.



The Ekco automatic scaler type N610A for nucleonic work. The upper row of tubes performs the counting operation on the input pulses, whilst the lower row performs the automatic timing operations which enable the scaler to switch itself off after a pre-set time. The two tubes on the top right hand side of this scaler are not counting tubes; they are tubes for indicating the state of the count in two high speed valve counting circuits. (Ekco Electronics Ltd)

The input pulses are applied simultaneously to the first and second guides of the GC10D (V<sub>3</sub>). The discharge moves first to the primed first guide, but when the anode

current flows through the first guide resistor, the first guide potential is raised and the discharge quickly steps to the second guide. At the end of the input pulse, the discharge

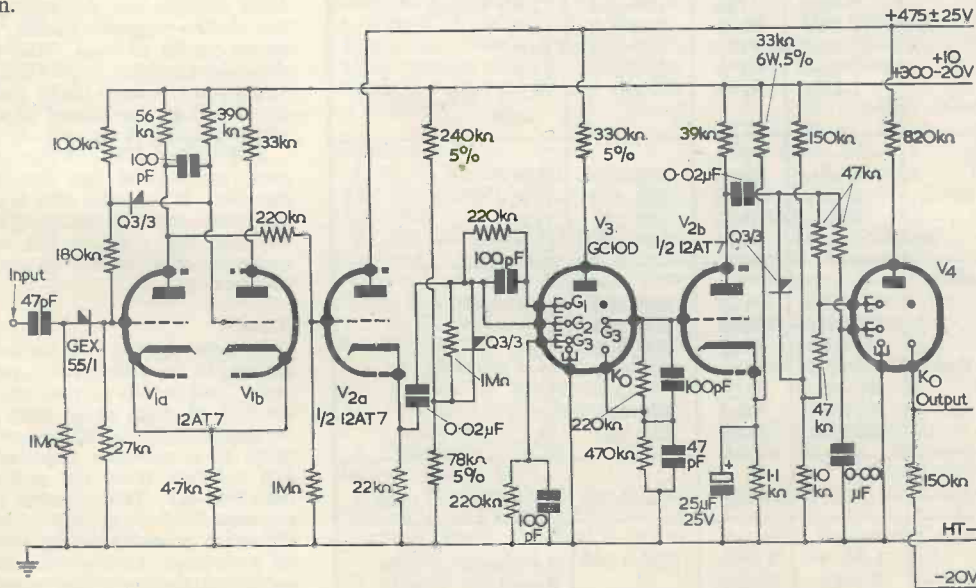

Fig. 4. A GC10D 20 kc/s circuit with coupling to a succeeding 4 kc/s tube (V<sub>4</sub>)

moves to the third guide, but the current flowing through the third guide resistor causes the third guide potential to be increased until the discharge moves to the succeeding main cathode.

If the third guide preceding the zero main cathode were connected directly to earth, the discharge might step back from the main cathode to this guide when the main cathode became positive due to the flow of the tube current through the zero main cathode resistor. The third guide preceding the zero main cathode (shown on the right of the tube symbol) is therefore returned through a 220kΩ resistor to the zero main cathode. This ensures that as the main cathode potential increases when the anode current flows through the cathode resistor, the third guide potential will also in-

crease so that the glow will not step back to this third guide.

The output pulses from the coupling tube, V<sub>2(b)</sub>, in Fig. 4 are used to operate a normal 4 kc/s decade tube. Any further decades which may be required may be similar to the second decade shown in the circuit of Fig. 3.

Although there are four separate stepping movements of the discharge in the operation of the GC10D, two of these occur automatically. The overall operating speed can therefore be greater than that of the simple double pulse tubes in which three stepping operations occur for each pulse which is counted. Double pulse tubes are available for operation at 10 kc/s, 50 kc/s and 100 kc/s; the input pulses fed to these tubes have a shorter duration than those required by 4 kc/s tubes.

### The Use of Decade Tubes With E-M Counters

The electro-magnetic counter<sup>13</sup> can normally count at speeds not exceeding about 25 pulses per second, but has the advantage that one small, compact and reasonably cheap unit can indicate up to at least six digits. Each decade tube can only indicate a single digit. If it is required to count pulses at frequencies up to 1 kc/s, it is common practice to employ two cascaded tubes followed by an electro-magnetic counter. The decade tubes each divide the pulse rate by ten, so that the electro-magnetic counter will not be required to count at a speed greater than ten counts per second. This method is more economical than if decade tubes alone are employed to display six or eight figure counts.

The output pulses from the decade tube do not have nearly enough power for them to be able to operate an electro-magnetic counter directly. In addition their duration is not usually suitable. A circuit such as that shown in Fig. 5 may be used to amplify and shape the pulses so that they are suitable for the operation of an electro-magnetic counter.<sup>14</sup>

The input circuit which operates the decade tube, V<sub>1</sub>, may be similar to that of Fig. 3. The positive-going output pulses from V<sub>1</sub> of Fig. 5 are short-circuited to earth by the OA85 diode. The negative going trailing edges are used to trigger the monostable multivibrator circuit of V<sub>2</sub> which shapes the pulses into a form suitable for the operation of the electro-magnetic counter in the anode circuit of V<sub>2(b)</sub>. The voltage dependent resistor, VDR820B, short-circuits any voltage peaks which are developed as the current in the coil of the counter is cut off.

The value of R can be adjusted until each pulse has the desired duration. If the value of R is 120kΩ, the duration of the pulses of current through the coil of the electro-magnetic counter will be about 20 milliseconds.

### Reset

In most circuits it is desirable to be able to reset the decade tubes to zero. This can be carried out in the circuits of Figs. 3, 4 and 5 by returning the cathodes 1 to 9 of all tubes to a common negative reset line separate from the earth line. (See Fig. 6.) This negative line is connected to earth via a resistor (R) which is normally short-circuited by a switch. During the resetting operation the switch is opened so that all of the main cathodes except the zero cathodes rise in potential.

Table of Gas Filled Counting Tubes

	Max. Operating Freq.	Base	Anode Current (Micro-amp)	Remarks (D.P.—Double Pulse)
<i>Ericsson:</i> GC10B GC10B/S GC10B/L GC10/4B GC10/4B/L GC12/4B GC10D GCA10G GSA10G GS10C/S GS12D GS10D GS10E GS10H GS10J	4 kc/s 4 kc/s 4 kc/s 20 kc/s 10 kc/s 4 kc/s 4 kc/s 10 kc/s 10 kc/s 5 kc/s 1 kc/s	Octal Octal Octal B27A B12E B12E B12E B12E B13B B17A	250-550 250-550 700-1,200 500-900 250-550 190-350 700-900 700-900 250-550 350	D.P. D.P.; 12-way Single pulse decade D.P.; Ten auxil: anodes D.P. D.P.; 12-way D.P. D.P. D.P. D.P.; low voltage tube
<i>Mullard:</i> Z303C Z502S Z504S Z505S	4 kc/s 4 kc/s 5 kc/s 50 kc/s	Octal B12E B13B B13B	250-550 250-550 250-550 600-1,000	D.P. D.P. D.P. D.P.
<i>American:</i> 6476 6802 6879 7978 6910 6909 7155	4 kc/s 4 kc/s 5 kc/s 5 kc/s 100 kc/s 100 kc/s 100 kc/s	B12E Octal B7G 13 pin B12E Octal B12E	300-600 300-600 300-600 300-600 600-800 600-800 600-800	D.P. D.P. D.P. D.P. D.P. D.P. D.P.
<i>S.T.C.:</i> G10/241E	20 kc/s	B12E	2,400-5,000	Asymmetrical tube
<i>Elesta:</i> EZ10B ECT100	1 Mc/s 1 Mc/s	13 pin Special	1,200-1,900	Asymmetrical tube Reversible decade tube

The glow in each tube therefore moves to the zero cathode. The value of the resistor joining the common return line to earth varies with the number of decade tubes employed, but should be chosen so that the cathodes (other than the zero cathodes) of the decade tubes rise in potential by about 100 volts during the resetting operation.

The switch S of Fig. 5 must be closed during the resetting operation to prevent a spurious pulse being recorded by the electro-magnetic counter. Normally this is carried out by contacts on the relay or switch which is used for reset. The switch S should open after the decade tube resetting contacts have returned to their normal position.

### Accurate Timing

Decade tubes are often useful when an operation must be accurately timed. For example, in welding operations it is often required to apply the power for a certain time and decade tubes can be used for this purpose.<sup>15,16</sup> They may also be used to provide small marks on an oscilloscope screen which correspond to very short time intervals.<sup>17</sup> Thus the X axis is calibrated in time units directly.

In many Geiger counting systems it is desirable to have an automatic timer which will stop the counting

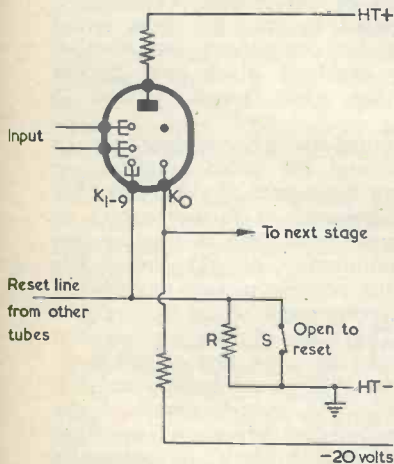

Fig. 6. A circuit which enables the tubes to be reset to zero

after a pre-set time. This may be achieved by using decade tubes to divide the mains frequency a number of times. The 50 c/s mains may be full wave rectified so that 100 c/s pulses are obtained. These may be divided in frequency by two cascaded

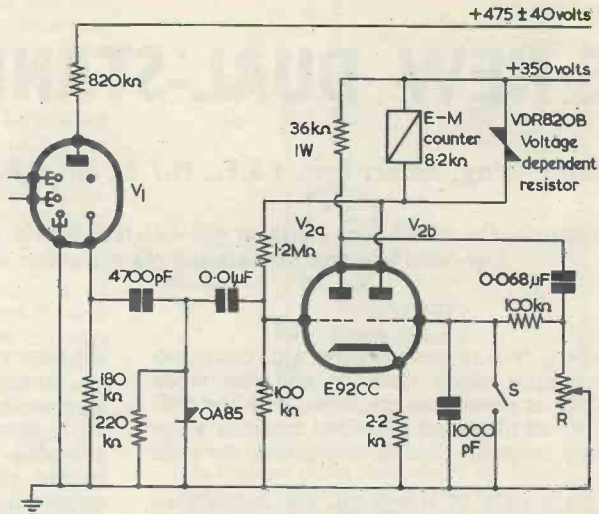

Fig. 5. Using a decade tube to drive an electro-magnetic counter.  $V_1$  is a 4 kc/s Dekatron

decade tubes so that the second decade tube provides one output pulse per second. If another three decade tubes are added, the final tube will provide one pulse each thousand seconds. This pulse may be used to cut off a valve and stop the counting process in a separate counting circuit.

Alternatively a scale of twelve tubes combined with a decade tube used as a scale of five can be used to divide the 1 c/s pulses by 60 in order to obtain 1 pulse per minute. Circuits have been published which enable decade tubes to divide the incoming pulse rate by any number up to nine.<sup>9</sup>

### References

1. R. C. Bacon and J. R. Pollard. "The Dekatron", *Electronic Eng.*, May 1950.
2. *The Ericsson Tube Technical Handbook*. (Available on a subscription basis from Ericsson Telephones Ltd., Beeston, Nottingham.)
3. G. F. Jeynes. "Decade Stepping Tubes and Their Operation". *Mullard Technical Communications*, Vol. 4, No. 37 (February 1959). (Also reprinted as a separate booklet of the same title.)
4. "Stepping Tubes", *Mullard Outlook*, March 1959.
5. G. F. Jeynes and S. Zilkha. "Trigger Tube Coupling Circuits for Counting Tubes". *Mullard Technical Communications*, Vol. 7, No. 64, p. 184 (August 1963).
6. G. F. Jeynes and S. Zilkha. "Cold Cathode Trigger Tube Cou-

ling Circuits for the Z504S Stepping Tube". *Mullard Applications Lab. Report*, ARL594.

7. G. C. Chappell and G. F. Jeynes. "Transistorised Coupling Circuits for the Z504S Stepping Tube". *Mullard Applications Lab. Report*, ARL612.

8. *Sylvania Counter Tube Handbook*.

9. "Operation of Decade Counter Tubes". *Raytheon Publication No. SP1097* (1963).

10. "Die Zählrohre EZ10B in Transistorschaltungen". *Elesta Technische Mitteilungen*, Nr. 18, April 1962.

11. "G10/241E Nomotron". *S.T.C. Valve Division Application Report*, No. MS/114.

12. J. R. Acton. "The Single Pulse Dekatron". *Electronic Eng.*, February 1952.

13. J. B. Dance. "Electromagnetic Counters". *The Radio Constructor*, October 1963, p. 190.

14. "Dekatron-Tube Circuit for Reducing the Frequency of Impulses for Operating TCE Counters". *Sodeco Information Sheet E48*.

15. T. W. Brady. "The Use of Cold Cathode Counting Tubes for the Control of Resistance Welding". *Electronic Eng.*, February 1956.

16. G. F. Jeynes and M. Veeraju. "Synchronous Resistance Welder Controller for 1 to 130 cycles". *Mullard Technical Communications*, Vol. 6, No. 54, p. 172.

17. J. H. L. McAuslan. "A Dekatron C.R.O. Time Marker". *Electronic Eng.*, December 1952.

# THE NEW DUAL-STANDARD TV SETS

By Gordon J. King, Assoc. Brit. I.R.E., M.T.S., M.I.P.R.E.

PART 6

*This article, the sixth in our series on 405-625 line receivers, deals with a.c. and d.c. couplings, high-level contrast controls and the extraction of the intercarrier signal*

**L**AST MONTH IT WAS SHOWN HOW A.C. COUPLING between the vision detector and the video amplifier is sometimes employed with the 625-line signal so as to permit the video amplifier valve to be biased towards class A conditions on both standards.

In the early days of television, the importance of retaining the d.c. component of the picture signal was stressed in technical articles and books dealing with TV reception. Where it was necessary to break the d.c. connection in the chain from the vision detector to the tube grid or cathode in those early models a small diode was often used to restore the d.c. component. The diode was caused to conduct on the sync pulse tips and the resulting voltage across its load had the missing d.c. component restored.

## Black Level

As time passed and designers had more field experience to draw upon, it was found undesirable under certain conditions to retain the full value of the d.c. of the vision signal. While full value d.c. stabilises the black level to an optimum degree, it also tends to emphasise the flutter effect associated with passing aircraft and other like media.

Consequently, d.c. attenuation was adopted (and is in use still) between the video amplifier anode and the picture tube cathode. This is accomplished by an RC parallel combination, as shown in Fig. 20. Although d.c. attenuation reduces

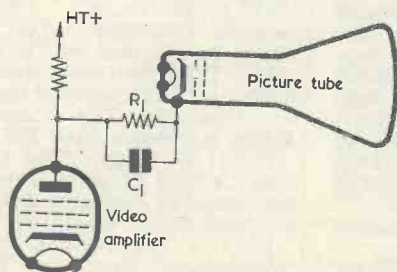

Fig. 20. The d.c. component of the picture signal is attenuated by passing it through an RC combination to the tube cathode.  $R_1$  effectively attenuates the d.c. while  $C_1$  passes the a.c. component of the video signal

the annoyance of aircraft flutter it also, unfortunately, causes the black level of the picture to vary in accordance with the mean of the picture content.

Of recent years the effect has been further aggravated by the use of mean-level a.g.c. systems in the vision channel in which, as we saw last month, the control bias depends not only upon the amplitude of the actual signal but also upon the video modulation itself.

It has been said that the sum effect is now deleterious to the picture display. This can, in fact, be true of low key scenes, for when the picture is mainly dark the resulting rise in the black level produces the appearance of a sooty grey background. Lack of d.c. in the picture signal also shows up as streaking from captions, a symptom which is present on almost all recent models.

Keyed a.g.c. systems, in which the true signal level at the porches of the picture waveform is sampled and converted to an a.g.c. bias, avoid the deletion of the d.c. component, but whether or not a correctly stabilised black level picture results also upon the other factors referred to above.

We have already noted that a.c. coupling between the vision detector and the video amplifier on 625 lines assists from the aspect of video amplifier biasing. There is, however, a further aspect in this respect when mean-level a.g.c. is used on the negative picture modulation of 625 lines. We have seen that on the positive picture modulation of 405 lines the a.c. component of the video signal is held constant. The same applies on negative modulation but since here the tips of the sync pulses correspond to 100% modulation, and the black level to about 77% over-emphasis of the black level can occur on low key scenes, resulting in black going "blacker than black". This can be avoided by switching over to a.c. coupling from the video detector to the video amplifier on 625 lines.

Some dual-standard models use a.c. coupling and a restoring diode, others use a.c. and d.c. coupling and others d.c. coupling throughout, depending upon the exact design of the receiver.

When gated a.g.c. systems are used, complications can arise with regard to the operation of the manual contrast control. With this control in the normal

position, a reversal in the sense of the control action can take place. This, then, demands contrast control switching on changing from one standard to the other.

### High-Level Contrast Control

These last difficulties may be overcome by the use of so-called "high-level" contrast controls. A typical circuit is shown in Fig. 21, and this uses one section of the new double-pentode valve, type PLF200. The other pentode section is used as an intercarrier sound amplifier, and the valve is mounted on the new decal (10-pin) base.

The pentode video section of this valve is of the frame grid construction and thus has a very high gm and can handle high peak anode currents without distress. To give extended video response the anode load,  $R_1$ , is only  $2.7k\Omega$ , a value which, although small in comparison with conventional video circuits, is made possible by the high gm of the valve. Moreover, the shunt capacitances of the contrast control network in the anode would impair the top video response if a larger, more conventional, value were used. The gain is retained, of course, with the low value load because of the high gm.

The video signal across the load is reflected across the contrast control and this control taps off the requisite amplitude of signal to fully drive the picture tube. This, then, means that the r.f./i.f. gain of the vision channel can be retained at a constant level, and this is facilitated by the a.g.c. system. Note also that by keeping a constant level r.f./i.f. signal the sync separator operating conditions remain similarly constant, which is not so when the contrast is varied gain-wise in the signal channel proper. On 625 lines, the same reasoning applies to the intercarrier signal which, as we shall see later, is itself derived from the vision detector. The video amplifier valve thus needs to continuously handle the full video signal amplitude.

It will be seen that the brightness control is also fed from the contrast control network, and this ensures that alteration of the brightness is generally unnecessary each time the contrast control is adjusted.

A "black level potential" is also obtained due to the fact that resistor  $R_2$  is connected to a circuit which causes a current of 12mA to flow through it, and the final i.f. amplifier may be used for this purpose. The current is drawn through  $R_3$  from the upper end of  $R_1$  and about 40 volts develops across  $R_3$ , which is the black level potential. This tends to hold the black level constant—or reasonably so—over the range of the contrast control.

The network provides for de-emphasis of the d.c. gain of the video amplifier as the result of the relatively high impedance of the power supply circuits at the lower and d.c. signal components.

There are various schemes available for high-level contrast control, but most of them approximate that shown in Fig. 21. Video correction is usually provided over the entire range of the contrast

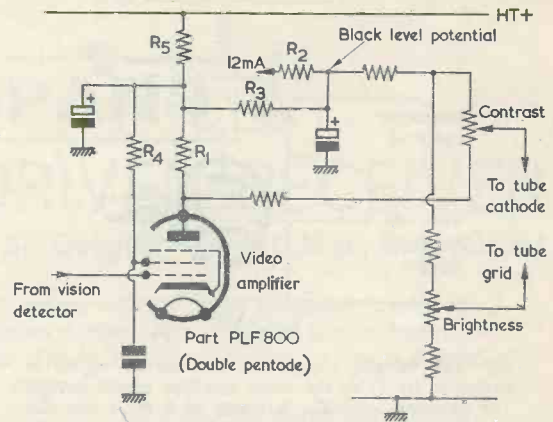

Fig. 21. High level contrast control. The video signal across the load  $R_1$  is fed to the contrast control and the required signal level tapped off for application to the tube. The circuit also compensates for black level and avoids this changing as the controls are operated (Note: For PLF800 read PLF200)

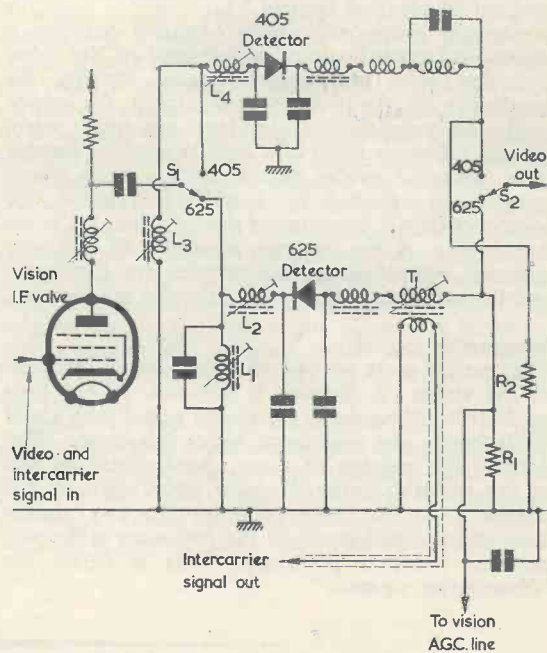

Fig. 22. In this circuit two vision detectors are used, one for 405 and the other for 625 lines.  $S_1$  selects the detectors and  $S_2$  selects the video signal from the appropriate load. On 625 lines the intercarrier signal is developed across the primary of  $T_1$  and is taken off from its low impedance secondary winding.  $L_1$  and  $L_2$  are the 625 video i.f. filters while  $L_3$  and  $L_4$  are similar filters for the 405 i.f.  $R_1$  is the 625 detector load and  $R_2$  the 405 load, the former coupling to the a.g.c. line, as has been discussed in the text

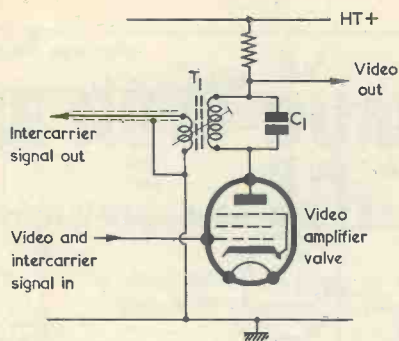

Fig. 23. In this circuit the intercarrier signal is extracted by  $T_1$  in the video amplifier anode circuit. The primary, with  $C_1$ , is tuned to 6 Mc/s and the secondary gives a low impedance link to the intercarrier channel

control. Ordinary video amplifier valves, however, have the disadvantage that they are working towards the limit of their peak current capabilities when used in this way, but the new valve mentioned—and others like it—is well able to stand up to this method of contrast control.

Another mode of contrast control features a screen-grid potentiometer, adjustment of the video amplifier valve screen-grid voltage varying the amplitude of the video signal across the anode load. An extension of high-level contrast control circuits takes the form of a light dependent resistor in a potential-divider circuit, with a bulb whose intensity is adjusted by a variable resistor, the former changing the value of the l.d.r. and the latter functioning as the contrast control. In this way contrast control stray capacitances are minimised and the response of the video amplifier is enhanced.

#### Intercarrier Signal

In earlier parts we saw that the overall response of the vision i.f. channel is adjusted on 625 lines so that the response to the sound signal falls about 30dB below the maximum vision response. This permits the passage of some sound signal as well as the correctly tailored vision signal through the channel. At the vision detector the two signals beat and a signal equal to the frequency difference between them is produced. This is called the "intercarrier signal".

The vision detector acts, in fact, as a kind of modulator due to its non-linear characteristics. It thus produces the demodulated picture signal plus the intercarrier signal, the former rising to about 5.5 Mc/s from a little above d.c. and the latter appearing at 6 Mc/s (i.e. the frequency difference between the 625-line sound and vision signals).

The intercarrier signal can be filtered out either at the output of the vision detector (Fig. 22) or from a suitable point in the video amplifier stage. In Fig. 19 (published last month), for instance, the signal is tuned at the amplifier cathode and taken via a capacitor ( $C_{54}$ ) to the intercarrier amplifier. Alternatively, the signal may be filtered out at the video amplifier anode circuit, as shown in Fig. 23.

The intercarrier filter usually takes the form of a parallel tuned LC circuit or transformer. In Fig. 22 two semiconductor diodes are used in the vision detector, one for the 405 signal and the other for the 625 signal. The circuits are switched by  $S_1$  and  $S_2$ . In the "625" position, the detector responds to both the vision signal and the 6 Mc/s sound-vision difference signal, and the intercarrier signal is developed across the primary of  $T_1$ . This transformer also acts as a 6 Mc/s rejector and prevents the intercarrier signal from gaining admittance to the video amplifier stage.

A coupling winding on  $T_1$  permits the intercarrier signal to be extracted at low impedance, matching being accomplished in the input of the intercarrier amplifier by a similar type of transformer, but this time with a low impedance primary.

In Fig. 23 the intercarrier signal is purposely allowed to get into the video amplifier stage, whereupon a 6 Mc/s transformer in the anode circuit extracts the signal and passes it back to the intercarrier amplifier. The transformer also acts as a rejector, preventing the 6 Mc/s signal from getting to the picture tube.

One advantage of passing the intercarrier signal through the video amplifier is that less subsequent gain is needed in the intercarrier amplifier, compared with taking the signal direct from the detector output. There are, however, several disadvantages in terms of linearity problems and beat effects which can spoil colour reception.

(To be continued)

## Building & Mast Contracts for BBC's Scarborough TV & VHF Sound Relay Station

The BBC has placed contracts with Messrs. Jaram & Son of Scarborough for the construction of the building, and with the Cornubian Construction Co. Ltd., of Danbury, Essex, for the erection of the 200ft aerial tower for the Scarborough television and v.h.f. sound relay station.

The new station, which is expected to be completed in early 1965, will be built at Rowbrow, about 2 miles west of Scarborough. It will radiate BBC-1 television and provide improved reception in the Scarborough and Filey areas, in parts of which reception is unsatisfactory and at times subject to interference from Continental television stations.

The new station will also radiate the BBC's three sound programmes on v.h.f. to the Scarborough area. The v.h.f. sound transmissions will provide reception which is much less susceptible to interference than are the medium and long wave services and, with suitable receivers, can give much better sound quality.

The BBC's site and mast at Rowbrow will also be used by the ITA for its projected television relay station to serve the same area.

# THE

## "SINGLE SPAN"

# MAINS DRIVEN RECEIVER

By Sir Douglas Hall, K.C.M.G., B.A. (Oxon)

*The ability to tune continuously from 150 to 2,100 metres without range switching is only one of the ingenious features of this unconventional receiver design. Also employed is an adaptation of the author's "Spontaflex" single-transistor reflex circuit, this feeding directly into a 4 watt audio output stage*

SOME CONSTRUCTORS MAY HAVE NOTICED THAT a coil which is designed to receive the long waveband with a ferrite rod as a core will cover the medium waveband if the core is removed. It occurred to the author that it should be possible to arrange a tuner which combined variation of inductance with variation of capacitance, thus bringing about a total variation of inductance multiplied by capacitance of well over 100 to 1.

This theory worked, and the tuner to be described will tune from 150 metres to 2,100 metres in a circuit in which stray capacitances are kept down to a reasonably low level.

### Tuning Assembly

Fig. 1 shows the arrangement. A 500pF variable capacitor is mounted on a bracket and has a drive

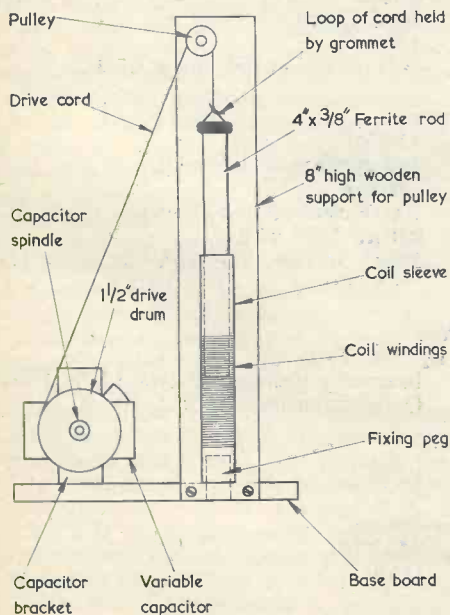

Fig. 1. The "single span" tuning assembly

drum of 1½ in diameter fixed to its spindle. Alongside this, the coil is mounted in a vertical position, being fixed to the tuner's baseboard by a small plug of wood which is cut to fit the coil sleeve and which is secured into a hole in the baseboard. A piece of ¾ in ferrite rod, 4 in long, has a loop of drive cord fixed to one end by means of a rubber grommet. A length of drive cord is tied to this loop and is passed over a pulley which is mounted above the coil at a height that allows all but about ½ in of the rod to be withdrawn from the coil. The other end of the cord passes round the drive drum and is fixed to it so that, with the tuning capacitor fully closed, the rod just rests on the peg which fixes the coil to the board. This peg is inserted ½ in into the coil former, at which point the winding starts. With the tuning capacitor at minimum capacitance position (all vanes out) the rod will have been lifted about 2½ in. As the winding is approximately 2 in long the rod will be ½ in clear of it, whilst still being held steady by the top of the sleeve. A terminal with a groove can be used as the pulley, it being bolted loosely to the 8 in length of wood behind the coil.

Details of the coil are shown in Fig. 2. The sleeve is made of a piece of contact or similar paper-backed adhesive plastic, 4 in by 3 in in size. The sleeve should be 4 in long and is made by wrapping the plastic round the rod. About half the paper-backing is left in place, and half cut away. The

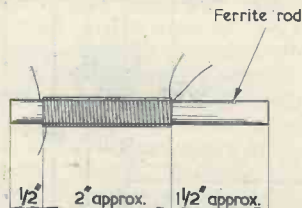

Fig. 2. Details of the coil. The inner coil has 225 turns of 38 s.w.g. enamelled wire close wound, and the outer coil has 40 turns of the same wire spaced to cover the inner coil. Details of winding are given in the text

paper-backed part is wrapped on first and the sleeve held together by the sticky half as the wrapping is completed. It should be made a nice easy sliding fit without being sloppy, since the rod has to be able to drop down it by its own weight and should not wobble in the process.

225 turns of 38 s.w.g. enamelled wire are close-wound on the sleeve, starting  $\frac{1}{2}$  in from one end. When this winding is completed it is covered with a further piece of adhesive plastic, which should be a tight, and not a sliding, fit, and should be about 2 in long. It is made in the same way as the first sleeve. On this second sleeve a coil is wound consisting of 40 turns of the same wire, wound in the same direction, and spaced out so as to cover the whole of the first winding. Sellotape can be used to secure this second winding.

It is necessary for the tuning capacitor to have a little natural stiffness in its movement so that it is not closed by the weight of the rod. The Jackson Bros. "Dilecon" component is very suitable.

A 6 to 1 reduction drive is useful, but tuning will not be found difficult despite the large span covered. It will be seen that for the lower (wavelength) part of the medium waveband, where stations are most crowded, inductance is constant and only capacitance varies. It will be found in practice that the first 50 degrees of swing will tune from about 150 to 300 metres. 300 to 550 metres will take a further 40 degrees. The next 30 degrees will be occupied by the intermediate section from 550 to 1,000 metres, and the long waveband will be covered by the last 60 degrees of movement.

### Receiver Circuit

The coil, with its two windings in ratio of about  $5\frac{1}{2}$  to 1, is suitable for use in a number of valve and

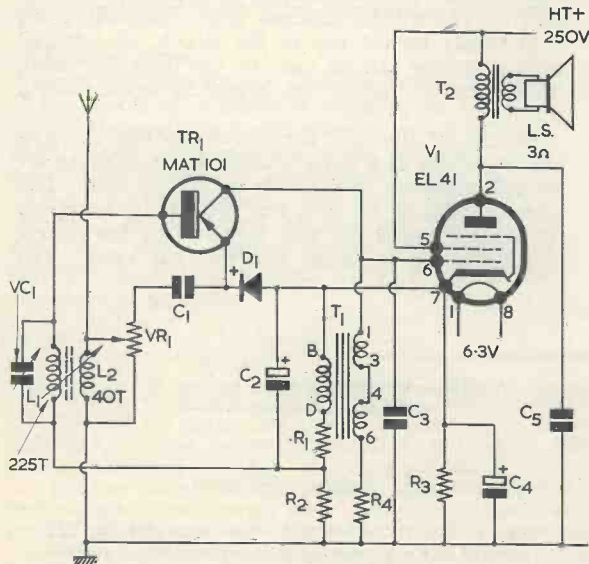

Fig. 3. Circuit of the receiver. This employs a MAT101 transistor in a "Spontaflex" circuit

transistor circuits. But the unit must be vertical in order to operate properly, and the coil will not therefore provide satisfactory pick-up without an aerial. In consequence, the unit is not suitable for a portable, as against a transportable receiver. If, as seems advisable, it is to be built into a static receiver, it would follow that the apparatus could be mains powered.

After trying out a number of circuits, using both valves and transistors, the author found that the most satisfactory and sensitive arrangement, bearing in mind the limitation of one tuned circuit, was to use a MAT101 transistor employing the "Spontaflex" principle, this feeding into a high slope output pentode, and deriving its modest power requirements from the "waste product" flowing in the bias resistor of the pentode.

The Spontaflex circuit has previously been described in this journal.\* In brief, it consists of a common collector radio frequency amplifier feeding into a crystal diode and followed by a common base audio frequency amplifier. As it is a voltage amplifier at audio frequencies it is very suitable as a driver for a pentode valve, which is a voltage operated amplifying device; and as the input of the

\* See the article by Sir Douglas Hall in the June 1964 issue, and our note on page 56 of the August 1964 issue.

### Components List (Fig. 3)

#### Resistors

(All fixed resistors  $\frac{1}{2}$  watt 10% unless otherwise specified)

- R<sub>1</sub> 22kΩ
- R<sub>2</sub> 470kΩ
- R<sub>3</sub> 180Ω 1 watt
- R<sub>4</sub> 470Ω
- VR<sub>1</sub> 5kΩ potentiometer, linear track

#### Capacitors

- C<sub>1</sub> 3,000pF
- C<sub>2</sub> 2μF electrolytic 12V wkg.
- C<sub>3</sub> 1,000pF
- C<sub>4</sub> 100μF electrolytic 12V wkg.
- C<sub>5</sub> 0.01μF 500V wkg.
- VC<sub>1</sub> 500pF variable "Dilecon" capacitor (Jackson Bros.)

#### Inductors

- L<sub>1</sub>, L<sub>2</sub> See Text
- T<sub>1</sub> Interval transformer type LF38 (Elstone)
- T<sub>2</sub> Output transformer, 50:1, 40mA

#### Valve

- V<sub>1</sub> EL41

#### Semiconductors

- TR<sub>1</sub> MAT101
- D<sub>1</sub> OA81

#### Loudspeaker

- 3Ω impedance



## Components List (Fig. 4)

### Capacitors

- C<sub>6</sub> 32 $\mu$ F electrolytic 275V wkg.  
C<sub>7</sub> 32 or 64 $\mu$ F electrolytic 275V wkg.

### Inductors

- L<sub>3</sub> Smoothing choke 10 henry 50mA  
T<sub>3</sub> Mains transformer. Primary: 200–250 volt.  
Secondaries: 250 volt at 50mA; 6.3 volt at 1.5 amp (0.7 amp minimum)

### Diode

- D<sub>2</sub> Metal rectifier 250 volt 50mA

### Switch

- S<sub>1</sub> 2-pole mains on-off switch (may be ganged with VR<sub>1</sub>)

### Note

The above power pack components may be obtained, as a kit from R.S.C. Ltd., 5 County Arcade, Leeds 1.

pentode has an impedance approaching infinity, the output load of the transistor is kept very high, which results in large amplification of voltage provided the collector circuit is supplied with a suitable load. In fact, with its high impedance input at radio frequencies, and its high impedance output at audio frequencies, the Spontaflex functions in a similar way to a pentode detector, except that the Spontaflex circuit provides true radio frequency amplification in addition to gain through regeneration.

Fig. 3 shows the circuit adopted. C<sub>1</sub> is reduced in value from the 0.01 $\mu$ F specified in previous versions, in order to slightly reduce reaction effects on the long waveband. With switched coils it can be arranged that the long wave reaction coil is smaller in relation to the main winding than is the case with the medium wave coils. But with the "single span" arrangement it has been necessary to adopt a compromise in the relationship between reaction and main windings.

The secondary (large winding) of T<sub>1</sub> is the collector load of TR<sub>1</sub>, and must have a very large inductance of several hundred henries to obtain maximum gain. There is virtually no damping of this inductance by the input of V<sub>1</sub>, and if a small inductance is used there will be a serious loss of bass. The author strongly advises the use of an Elstone transformer type LF38, to which connections are made as shown in Fig. 3. There will only be a small drop of less than 1 volt through the large winding, and direct coupling is therefore possible from the collector of TR<sub>1</sub> to the grid of V<sub>1</sub>. It will be noted that the voltage swing available for TR<sub>1</sub> is approximately the same as the grid bias available for V<sub>1</sub>, so that TR<sub>1</sub> can load V<sub>1</sub> fully before becoming overloaded itself. The value of R<sub>3</sub> is slightly larger than is normal for an EL41 to compensate for the fact that the grid is a little positive as regards chassis.

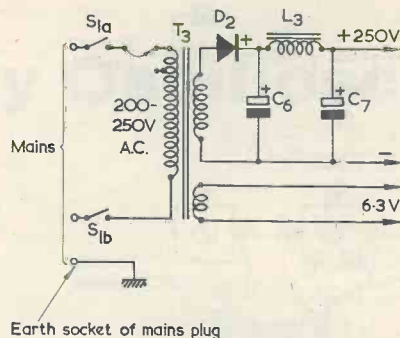

Fig. 4. A suitable power supply circuit

### Hum Cancellation

The small winding (primary) of T<sub>1</sub> is used to cancel out hum by negative feedback. The base of TR<sub>1</sub> should be at chassis potential but, due to the ferrite rod in L<sub>1</sub>, this coil picks up some hum from the mains transformer, especially when tuned to the longer wavelengths. The hum is amplified by TR<sub>1</sub>, acting as a very inefficient common emitter amplifier. As the base should be at earth potential, negative feedback can be applied to it without affecting the amplification of wanted signals. However, if R<sub>1</sub> is made too small in value in order to increase negative feedback of hum, there will be loss of amplification of wanted signals. This will occur not because of negative feedback but because R<sub>1</sub> is effectively in parallel with the primary of T<sub>1</sub> and consequently reduces, by reflection, the impedance of the secondary of T<sub>1</sub>, which is, of course, the collector load. For this reason R<sub>1</sub>, and consequently R<sub>2</sub>, are kept large. The value chosen for R<sub>1</sub> reflects a resistance of over 200k $\Omega$  across the secondary of T<sub>1</sub>, and this, together with a further small damping effect produced by R<sub>2</sub>, will only reduce amplification by a small and quite acceptable amount. At the same time, R<sub>1</sub>, in conjunction with C<sub>2</sub>, produces sufficient feedback to render hum nearly inaudible. Incidentally, C<sub>2</sub> cannot readily be reduced in value from the specified 2 $\mu$ F in an attempt to increase negative feedback of hum, because this would reduce the efficiency of TR<sub>1</sub> as a common base amplifier which, as already pointed out, requires the base to be at chassis potential.

C<sub>5</sub> is essential for the maintenance of stability as well as to compensate for a tendency in V<sub>1</sub> to over-emphasise the top notes. T<sub>2</sub> should have a ratio of about 50:1 and be capable of handling 40mA.

R<sub>4</sub> is necessary to prevent instability at the frequency at which the secondary of T<sub>1</sub> and C<sub>3</sub> form a tuned circuit. With R<sub>4</sub> in circuit there is a useful small bass boost, with complete stability.

The power pack can be quite simple and may be bought, very economically, as a kit. The circuit is shown in Fig. 4. The only precaution to be taken is to keep the axis of the mains transformer windings at right angles to the axis of L<sub>1</sub> and L<sub>2</sub>, and to keep these components as far from each other as possible.

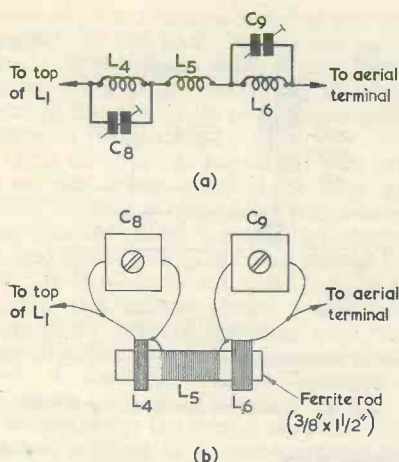

Fig. 5 (a). A coil assembly which counteracts interference on medium and long waves  
 (b). The practical appearance of the assembly. Winding details, together with suitable values for  $C_8$  and  $C_9$  are discussed in the text

### Performance

This receiver will give very good results on a few feet of wire as an aerial. Earthing is automatic, through the mains. If the receiver is used with a long outside aerial its sensitivity will outstrip its selectivity unless precautions are taken. Interference in these circumstances may be of three kinds. Firstly, the local medium wave station will be found to have a big spread. Secondly, other medium wave

stations may interfere with each other. Thirdly, there may be interference from powerful short wave stations at the low wavelength end of the tuning scale. The use of a series aerial capacitor, by itself, is not very satisfactory unless it is a variable panel control. This is because it will almost certainly provide too loose coupling for the long waveband and will have little effect on short wave stations.

A device which will do much to cure all three forms of interference is shown in Fig. 5.  $L_4$  consists of 50 turns of 38 s.w.g. enamelled wire, pile-wound, and tuned by a trimmer to suit the local station. Broadly speaking,  $C_8$  should be 100pF for wavelengths up to 290 metres, 250pF for stations between 290 and 400 metres, and 500pF for those above 400 metres. A wave trap is formed which is adjusted, once and for all, to tame the local station.  $L_5$ , which is close-wound with the same wire and in the same direction, has 40 turns, and will suppress all stations below 150 metres in wavelength.  $L_6$  has 200 turns of the same wire, pile-wound in the opposite direction from  $L_4$  and  $L_5$ . This coil offers a high impedance to all stations in the medium waveband, but very little to long wave stations. It is shunted by  $C_9$  which is adjusted to provide suitable selectivity on the medium waveband. All coils are wound on a  $1\frac{1}{2}$  in length of  $\frac{3}{8}$  in ferrite rod. The wave trap formed by  $L_6$  and  $C_9$  does not affect performance, as it will tune to a wavelength of about 800 to 900 metres, which is not required.

With this device in circuit the prototype gives excellent results from many stations on a long aerial in South Devon. About 4 watts output is available from the local station.

## Recent Publications . . .

**AMATEUR RADIO.** By F. G. Rayer. 192 pages,  $5\frac{1}{2} \times 8\frac{3}{4}$  in. Published by Arco Publications. Price 30s.

It is of interest to note that amateur radio has now become a sufficiently popular hobby to justify producing a book designed specifically to introduce the subject to those contemplating taking it up. Amateur radio has its own literature for those already participating but the interested "outsider" is not so well catered for and this book therefore more than fills his need.

The book covers both amateur radio transmitting and short wave listening. It explains the need for an examination prior to obtaining a transmitting licence and outlines the manner in which the necessary studies should be tackled. The morse code test is similarly dealt with and ideas and code practice oscillators for learning the code are described. Sufficient basic theory is given in Chapters 2 and 3. Chapter 4 deals with both t.r.f. and superhet receivers. Oscillators, c.w. transmitters, microphones, amplifiers and modulators, phone transmitters and power supplies are covered in Chapters 5 and 6, whilst Chapter 7 deals with aerials and their associated equipment. The final two chapters cover radio waves and their propagation, station operating, instruments, test equipment, etc.

This book is a very good introduction to the fascinating hobby of amateur radio and can be confidently recommended to those contemplating taking up this interest.

**SHORT WAVE AMATEUR RADIO.** By J. Schaap, PAØHH. 160 pages plus illustrations,  $5\frac{1}{2} \times 8$  in. Published by Philips Technical Library. Distributed in U.K. by Cleaver-Hume Press Ltd. Translated by G. du Cloux. Price 21s.

This book, originally published in Holland, is intended to cater for Dutch readers in a similar manner to that of F. G. Rayer's book, reviewed above, for English readers. The approach is somewhat different and it makes interesting reading particularly when compared with Rayer's *Amateur Radio*. The Preface explains that the book is not "an extensive practical manual", but is "to present the newcomer with a concise reference book which will introduce him to amateur radio". This the author does well. The treatment is comprehensive, covering components, receivers, transmitters, modulation systems, aerials, measuring equipment, station planning, building and operating. A number of useful appendices are included, such as bandspread calculations, coil calculations, countries lists, Q and amateur codes, and a comprehensive list for further reading in Appendix 12 entitled "For Those who Want to Know More". There are some excellent illustrations and fold-out circuit diagrams of typical amateur radio equipment.

Again—good reading for those about to take up amateur radio.

#####  
 #####  
 #####  
 #####  
 #####  
 #####

# Simple Quality Oscilloscope

#####  
**PART 1** ##  
 By ##  
**D. M. Williams** ##  
**B.Sc.** ##  
 #####

*This article, the first of a two-part series, introduces an efficient and carefully designed oscilloscope which has many attractions for the home constructor and experimenter. A particularly useful feature is the fact that the design offers two alternative amplifiers, one being a.c. coupled with a range of 5 c/s to 1 Mc/s and the other d.c. coupled with a bandwidth of 250 kc/s*

**T**HE AUTHOR HAS LONG FELT THE NEED FOR A versatile but not over-elaborate instrument for radio work and home experimentation. The instrument described in these articles was designed for such a purpose, and uses easily obtainable components.

## Design Considerations

The cathode ray tube used, the Mullard DG7-32, has comparatively low extra high tension requirements, and hence no special mains transformer is required. This tube is also highly sensitive, enabling low values of h.t. volts to be used. To minimise the problem of ripple volts in the supply a balanced cathode-coupled amplifier is used in the Y circuits, the gain being controlled by the application of negative feedback. A switched input attenuator is also fitted. Two alternative Y circuits are described, one being a.c. coupled and the other a hybrid d.c. coupled amplifier. In both cases the cathode ray tube is fed from cathode follower stages. The d.c. amplifier provides a gain of about 200, with a bandwidth of 250 kc/s, and the a.c. version a gain of 70 with a bandwidth of 5 c/s to 1 Mc/s.

The timebase is a straightforward Miller-Transitron designed around an EF91 valve, with an associated ECC81 providing the sync amplifier and phase inverter. The frequency of the timebase is continuously variable, from 12 c/s to 50 kc/s in four overlapping ranges. A method of calibrating the timebase at any point is included, although it must be remembered that this is only approximate as the sync control affects the repetition frequency.

The power supply is a simple tapped voltage doubler circuit using selenium rectifiers.

## The Timebase

Consider first the transitron relaxation oscillator shown in Fig. 1. It can be shown that the screen voltage in a transitron-connected pentode is in

phase with the suppressor voltage which produces it. If, therefore, the screen is RC coupled to the suppressor, any infinitesimal voltage change on the suppressor will precipitate a change in the screen and suppressor voltage in the same direction as the initial impulse. The eventual displacement of the electrodes is limited only when the valve has been forced into such a state that the suppressor has very little influence on the screen. The circuit, therefore, is unstable and will take up one of its two limiting conditions. These conditions are: (a) when the suppressor voltage is positive, so that the anode current is large and the screen current small; and (b) when the suppressor is negative, so that the anode current is small and the screen current large.

The switching of the circuit is extremely rapid, so that the charge on the capacitor  $C_1$  has no time to change. After the valve has switched, the voltage on this capacitor moves towards the value it would reach were the circuit stable. However, before it can reach this value the valve is again in the state

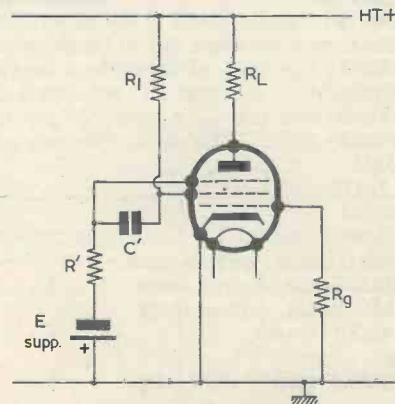

Fig. 1. The transitron relaxation oscillator

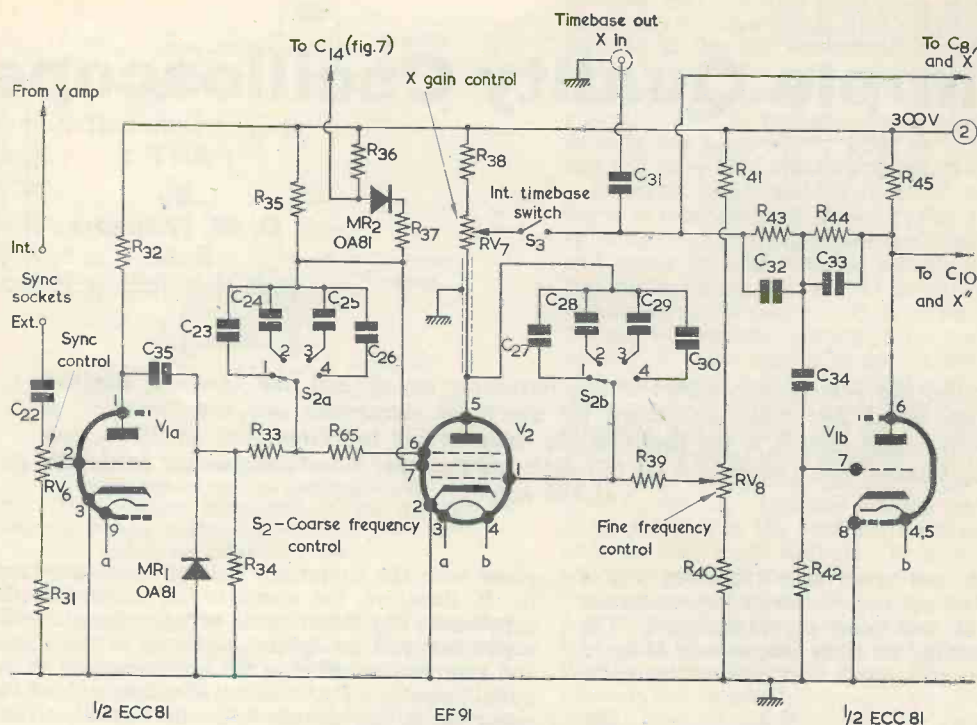

Fig. 2. The sync amplifier and timebase of the oscilloscope

### Components List (Fig. 2)

#### Resistors

(All fixed values 10% ½ watt)

R31	500kΩ
R32	82kΩ
R33	270kΩ
R34	10kΩ
R35	27kΩ
R36	12kΩ
R37	100kΩ
R38	10kΩ
R39	220kΩ
R40	68kΩ
R41	100kΩ
R42	10MΩ
R43	1MΩ
R44	1.2MΩ
R45	100kΩ
R65	47kΩ
RV6	250kΩ linear, carbon track
RV7	25kΩ linear, carbon track
RV8	1MΩ linear, carbon track

#### Capacitors

C22 0.002μF paper, 250V wkg.

C23	3,000pF silver mica
C24	470pF silver mica
C25	50pF silver mica
C26	20pF silver mica
C27	0.03μF paper, 250V wkg.
C28	0.005μF paper, 250V wkg.
C29	500pF silver mica
C30	56pF silver mica
C31	0.25μF paper, 250V wkg.
C32	33pF silver mica
C33	33pF silver mica
C34	0.05μF paper, 250V wkg.
C35	1,000pF paper, 350V wkg.

#### Valves and Diodes

V1	ECC81, 12AT7
V2	EF91, Z77
MR1	OA81
MR2	OA81

#### Switches

S2	2-pole, 4-way
S3	1-pole, 1-way toggle

where the suppressor controls the screen, and the circuit switches to its other limiting condition. Thus

the output across R1 is a square wave with a repetition frequency controlled by the time constant

of the coupling components.

Now, it can be shown that an external signal applied to the control grid can trigger the circuit from one state to the other at a faster rate than the natural repetition frequency. In the Miller-transitron timebase the charge across a capacitor is arranged to fulfill this function. It is also obvious that a signal applied to the suppressor grid can trigger the circuit, and this method is used to synchronise the timebase frequency with the work voltage frequency.

Assume that the transitron is in the condition where the screen current is very large, and the anode current very small. (See Fig. 2.) In this state one of the capacitors  $C_{27}$  to  $C_{30}$  charges via the anode load resistors,  $RV_7$  and  $R_{38}$ , until the transitron switches to its opposite limiting condition, i.e., small screen current and large anode current. However, in this case, when the anode current begins to flow the potential across  $RV_7$  and  $R_{38}$  is added to that already across the capacitors  $C_{27}$  to  $C_{30}$ , so that the voltage on the control grid becomes negative with respect to the cathode. This action limits the anode current, and as the valve is operating above the knee of its  $V_a-I_a$  characteristic with approximately constant screen potential, the anode current is substantially constant. The capacitor  $C_{27}$  to  $C_{30}$  discharges itself at constant current through the valve. Thus, the voltage at the anode runs down linearly from nearly full h.t. potential to the point where the anode potential is the same as that on the screen. The transitron then switches to cut off the anode current. The capacitor  $C_{27}$  to  $C_{30}$  begins to charge again via the anode load resistor and the above cycle repeats itself.

The potential divider chain including  $RV_8$  places a known positive voltage on the control grid, which the sum of the voltages across the capacitor  $C_{27}$ — $C_{30}$  and the anode load resistor  $RV_7$ ,  $R_{38}$ , minus the h.t. voltage (i.e.,  $V_{C_{27} \text{ to } C_{30}} + V_{RV_7, R_{38}} - V_{h.t.}$ ) must exceed, in order that the control grid shall become negative. This voltage ( $V_{C_{27} \text{ to } C_{30}} + V_{RV_7, R_{38}} - V_{h.t.} - V_{RV_8}$ ) determines the anode current during run down, and hence the rate of discharge of the capacitor. It is therefore obvious that  $RV_8$  controls the repetition frequency of the timebase.

In practice, as shown in Fig. 2, various values of the capacitor are switched into the circuit to give an extended frequency range. The capacitor  $C_{23}$  to  $C_{26}$  is also altered to give constant drive on each range.

Table I gives frequency ranges for each position of  $S_2$ .

#### Trace Blanking

The various waveforms obtainable from the device are shown in Fig. 3. From these it can be seen that a negative-going pulse, with a width equal to the flyback time, can be obtained from the screen. This pulse is used (as will be shown in Fig. 7, to be published in Part 2) to obtain flyback suppression by its application to the grid of the cathode ray tube, thus cutting off the trace for the

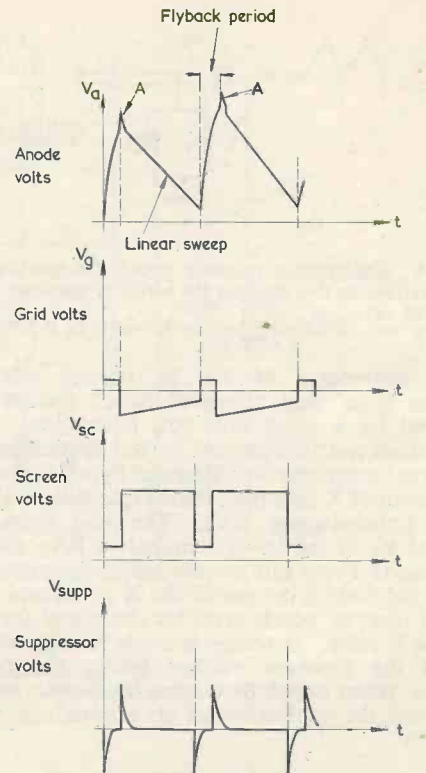

Fig. 3. The timebase waveforms given by  $V_2$

duration of the flyback. The grid of the c.r.t. is coupled to the transitron screen by two  $0.25\mu\text{F}$  capacitors in series ( $C_{13}$  and  $C_{14}$  in Fig. 7). This is a precaution against damaging the tube. If a single capacitor were employed and it short-circuited, a large positive voltage would be applied to the grid which could completely destroy the c.r.t. The diode  $MR_2$  (Fig. 2) ensures that only negative-going pulses are applied to the tube grid.

#### Synchronisation

Synchronisation is accomplished by the injection of a sync signal to the suppressor of the transitron. The signal is obtained by feeding a pulse amplifier,  $V_{1(a)}$ , from the Y amplifier, differentiating the output via capacitor  $C_{35}$ , and selecting a positive-going pulse with diode  $MR_1$ . This pulse is applied

TABLE I

Position of $S_2$	Timebase Frequency
1	12 c/s–140 c/s
2	80 c/s–1 kc/s
3	800 c/s–12 kc/s
4	10 kc/s–55 kc/s

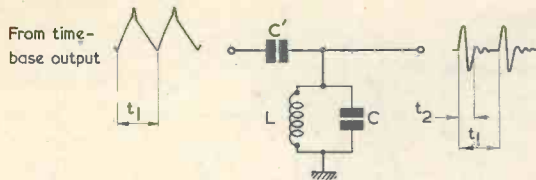

Fig. 4. Employing a resonant circuit for timebase calibration. In this diagram the period of the wave is

$$t_2 = \frac{10^6}{f} \mu\text{s}. \text{ But } f = \frac{1}{2\pi\sqrt{CL}}, \text{ so } t_2 = 2\pi\sqrt{CL} \times 10^6 \mu\text{s}$$

to the suppressor of  $V_2$ . In normal use the "Internal Sync" and "External Sync" sockets are connected by a short link but, if required, synchronisation can be obtained by the application of an external source to the "External Sync" socket.

A control of X gain (i.e., trace expansion) is given by the potentiometer  $RV_7$ . The lead from the anode of  $V_2$  to the lower terminal of  $RV_7$  should be screened. From this potentiometer the sawtooth wave is fed directly to one of the X plates and into a phase inverter which provides the signal for the opposite X plate. Provision is made for the extraction of the timebase voltage before the phase inverter. When switch  $S_3$  is open the output socket also allows the application of an external signal to

the X plates. This signal must, however, be of the order of 20 volts for a readable deflection, as the phase inverter has unity gain.

A method of timebase calibration can be incorporated whereby the sharp pulse A (Fig. 3) on the timebase anode waveform is used to shock-excite a tuned circuit. The damped wave train thus produced (an example is shown in Fig. 4) is fed to the input of the oscilloscope. Since the tuned circuit is excited each time the timebase fires, a stationary picture of the wave train appears on the screen. The frequency of these oscillations is determined only by the resonant frequency of the tuned circuit, when coupled to the oscilloscope input. Hence the period of the oscillations can be used as a time standard. In actual fact, this method is only approximate since the work voltage applied to the synchronising circuits has a slight effect on the timebase frequency. Nevertheless, this method of calibration has proved very satisfactory, provided large values of capacitor relative to the oscilloscope input capacitance are used in the tuned circuit.

Any reader who is especially interested in an analysis of the above or more sophisticated timebase circuits is referred to Ref. 1.

#### Reference

1. Puckle, O. S., *Time Bases*. Chapman and Hall.

(To be concluded)

## TRANSISTOR MAINS INTERCOM

By I. M. REES

THE NEED AROSE IN THE WRITER'S HOUSEHOLD FOR a general purpose intercommunications amplifier which would also be suitable for use as a baby alarm or call set at the sick bed. It had to meet the following specifications:

- (1) It should have sufficient sensitivity and output to ensure that normal breathing could be heard with the microphone several feet from the subject.
- (2) Building cost should be low.
- (3) It should provide economical and reliable running over long periods.
- (4) Both installation and operation should be simple.
- (5) Two-way communication should be provided.
- (6) The equipment should be compact and portable.

The intercom amplifier system described in this article meets all these requirements.

#### Circuit

Although transistor operation was chosen it was not thought desirable to work from batteries.

Higher quiescent currents can be tolerated in the output stage when battery economy is of no concern. This naturally leads to the use of the cheaper and very much simpler circuitry given by a single-ended output stage working in Class A. In the present circuit an output of approximately 100mW is obtained.

By reference to Fig. 1 it can be seen that the amplifier employs a straightforward resistance-capacitance coupled circuit. Partial stabilisation of  $TR_1$  and  $TR_2$  is given by obtaining their respective bias currents via their collector circuits, while  $TR_3$  has the more conventional potential divider network.

The input matching transformer,  $T_1$ , enables cheap unscreened twin flex to provide the connection between master and slave stations. The use of this transformer avoids the capacitance losses given by long lengths of screened lead, as would be used on a high impedance line, with the inherent top-cut effects.

The power requirements of this amplifier, at approximately 20mA, are very small by valve standards, with the result that a simple half-wave

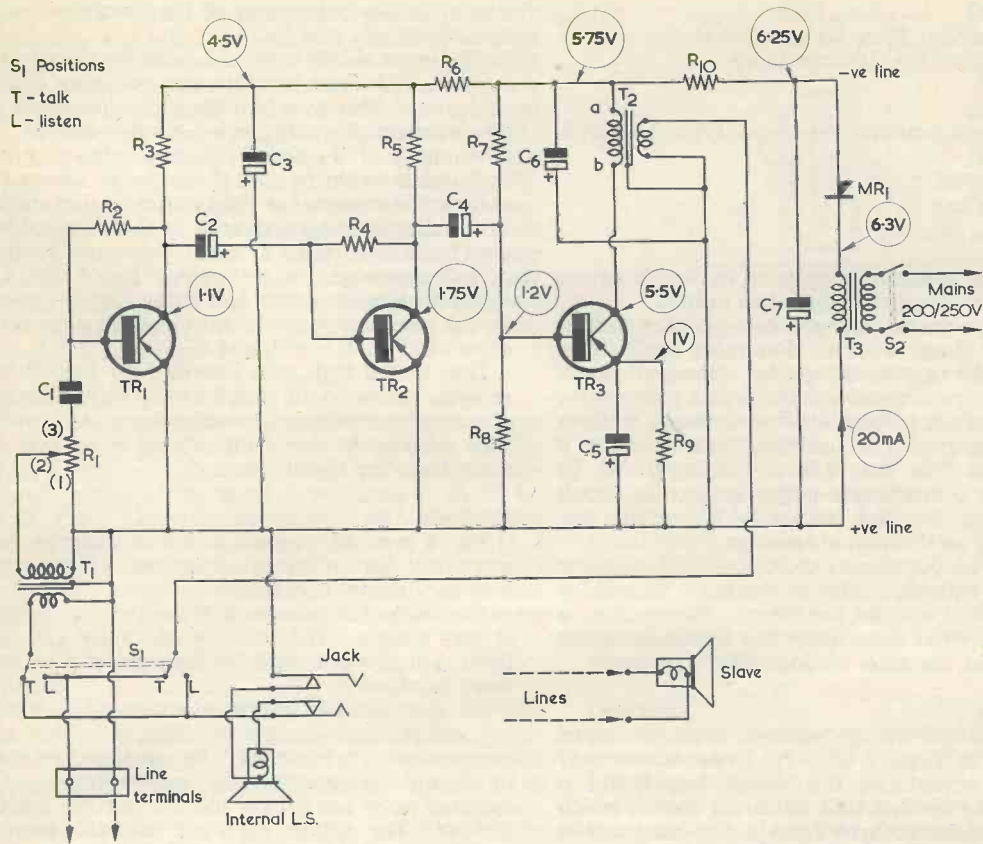

Fig. 1. The circuit of the transistorised intercom.  $T_1$  is connected such that its primary (the high resistance winding) couples to  $R_1$

### Components List

#### Resistors

(All fixed resistors  $\frac{1}{4}$  watt 20%)

$R_1$	5k $\Omega$ potentiometer, log track
$R_2$	390k $\Omega$
$R_3$	10k $\Omega$
$R_4$	220k $\Omega$
$R_5$	4.7k $\Omega$
$R_6$	1k $\Omega$
$R_7$	3.3k $\Omega$
$R_8$	1k $\Omega$
$R_9$	68 $\Omega$
$R_{10}$	22 $\Omega$

#### Capacitors

$C_1$	0.1 $\mu$ F, paper
$C_2$	10 $\mu$ F, electrolytic, 6V wkg.
$C_3$	50 $\mu$ F, electrolytic, 10V wkg.
$C_4$	10 $\mu$ F, electrolytic, 6V wkg.
$C_5$	50 $\mu$ F, electrolytic, 6V wkg.
$C_6$	1,000 $\mu$ F, electrolytic, 12V wkg.
$C_7$	1,000 $\mu$ F, electrolytic, 12V wkg.

#### Transformers

$T_1$	Input transformer, 18:1, type D167 (Ardente)
$T_2$	Output transformer, 18:1, type D167 (Ardente)
$T_3$	Mains transformer, 6.3 volts 50mA minimum. (Heater or bell transformer)

#### Transistors

$TR_1$	OC71
$TR_2$	OC71
$TR_3$	OC72 with heat sink. (See Fig. 3)

#### Switches

$S_1$	d.p.d.t. toggle switch
$S_2$	d.p.s.t. toggle switch

#### Rectifier

$MR_1$	L.T. rectifier, 50mA minimum. (Prototype employed Sen-Ter-Cel rectifier type H440)
--------	--

### Loudspeakers

Master station: 2½in, 3Ω impedance

Slave station: 6in, 3Ω impedance

### Miscellaneous

Jack. Closed-circuit type—see Figs. 1 and 2.  
(Igranic)

Paxolin panel

Line terminals

Grommet, etc., etc.

mains supply is used. In spite of its simple nature this gives an adequately ripple-free output.

For compactness, a small 2½in speaker unit is used in the master station. For most applications this is found to be adequate. However, extra volume as a speaker and sensitivity as a microphone (the loudspeakers at both slave and master stations double as microphones according to whether  $S_1$  is in the "Talk" or the "Listen" position) can be obtained by connecting a larger speaker in circuit by means of the jack socket. This action disconnects the small internal speaker.

The slave station simply consists of a 6in speaker fitted to a suitable baffle or cabinet. A smaller speaker should not be used here. Connection is taken direct from the master line terminals to the speech coil at the slave station.

### Construction

The layout and wiring employed in the prototype are shown in Figs. 2 and 3. Constructors may attempt to miniaturise this design layout, but it should be pointed out that an earlier model, which was very similar suffered from numerous troubles which were only successfully resolved by re-designing the layout to its present form.

The main trouble associated with the amplifier

unit is in the positioning of the unscreened transformers  $T_1$ ,  $T_2$  and  $T_3$ .

The input transformer,  $T_1$ , must be placed as far from  $T_2$  and  $T_3$  as possible, the minimum distance being 6in. This avoids both audio instability and 50 c/s hum pick-up due to inductive couplings. The positioning of  $T_2$  and  $T_3$  is not quite so critical although it might be wise if the design allows their cores to be mounted at right angles to one another. The writer employed screens in the form of mild steel brackets fitted to  $T_1$  and  $T_2$ , although Mumetal or soft iron might be preferable. Fig. 4 shows the method of construction and fixing. In the case of  $T_2$  the screening bracket also serves as a mount (as shown in Fig. 4) for  $C_6$  and  $C_7$ .

Due to the high gain provided by the circuit a separate mains on-off switch had to be fitted instead of using a combined potentiometer and switch. This enables the live mains wiring to be kept well away from the signal circuits.

### Cabinet

Fig. 2 is merely a guide to the constructor as far as cabinet dimensions are concerned. Components may vary in size and fixings.

The method of construction used in the prototype is very simple. Top, bottom and sides are made from ½in plywood, and the front panel is of single faced hardboard.

All the materials are cut to the required sizes as approximately indicated in Fig. 2. The main components are mounted later on the front panel by means of countersunk screw fixings. The required holes are drilled and the speaker aperture cut out. The cabinet parts are then all assembled together and held with glue and panel pins. Components  $T_3$ ,  $T_2$ ,  $T_1$  and the speaker are fitted to the front panel, the loudspeaker having an expanded

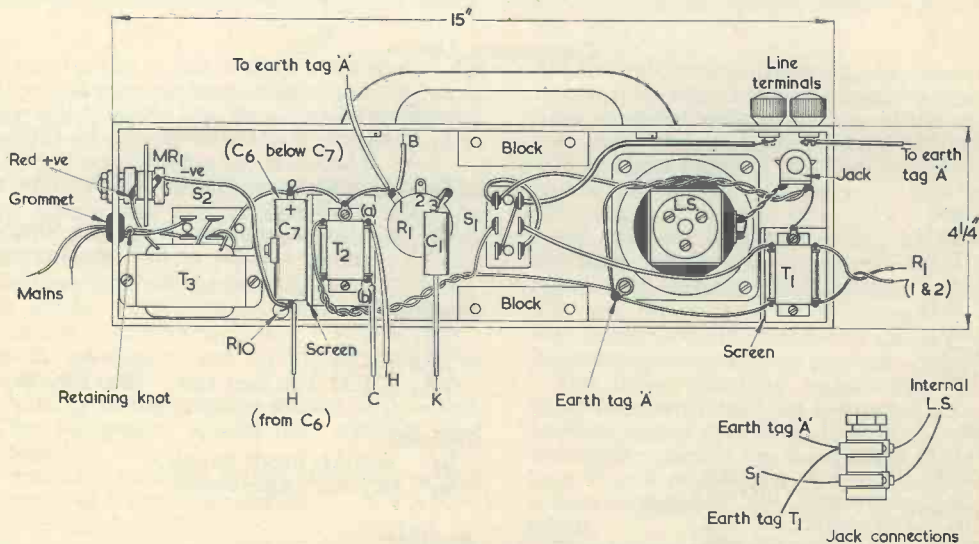

Fig. 2. The wiring and components fitted to the master station cabinet. Cabinet depth is 2½in



metal grille behind its aperture. Suitable holes are drilled to take MR<sub>1</sub>, the grommet, the line terminals and the handle (if required). All countersunk screw holes are filled with putty or wood filler and made flush with sandpaper. The edges of the cabinet are then smoothed and rounded with the sandpaper. If desired, the whole case can now be covered carefully with a suitable covering material. S<sub>1</sub>, S<sub>2</sub>, R<sub>1</sub>, MR<sub>1</sub>, the grommet, the jack, the handle and the line terminals may next be assembled in their appropriate positions. Finally the two wooden blocks which support the component panel are glued inside the cabinet. These blocks should have just sufficient height to allow the component board, when fitted, to clear S<sub>1</sub> and R<sub>1</sub>.

### Component Panel

The component panel employed in the prototype is a piece of  $\frac{1}{16}$  in Paxolin cut to  $2\frac{1}{2}$  by  $3\frac{1}{2}$  in. Twelve 6BA clearance holes are drilled at the points indicated in Fig. 3. To those in positions C, D, F, G, J, K, L and M are assembled eight 6BA single ended solder tags. The remaining 6BA tags at B, H, I and N are secured by means of the wood screws fixing the panel to the spacing blocks. Note that the heat sink for TR<sub>3</sub> is secured, along with an extra tag, at B.

### Wiring

All the usual precautions must be observed with regard to transistor circuit wiring. Just sufficient heat must be applied, and for the shortest possible time, to the miniature component lead-outs. The

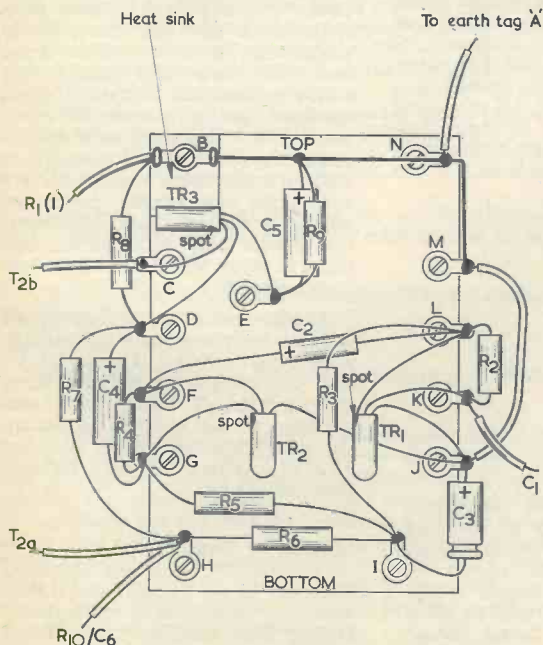

Fig. 3. Components on the Paxolin component board. This is  $\frac{1}{16}$  in thick and measures  $2\frac{1}{2}$  by  $3\frac{1}{2}$  in. It is secured to the wooden blocks shown in Fig. 2.

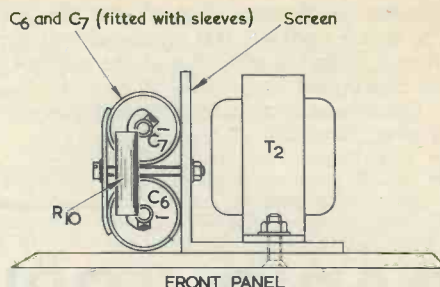

Fig. 4. Detail showing the manner in which C<sub>6</sub> and C<sub>7</sub> are fitted to the screen for T<sub>2</sub>. T<sub>1</sub> has a similar screen, but no components are fitted to it

three transistors should have a heat shunt on their leads during soldering.

Before soldering up a point ensure that no other connection has to be made there.

After the wiring and assembly is completed a visual check against the circuit in Fig. 1 should be made. Special attention should be given to the polarity of the electrolytic capacitors and transistor connections. It should also be noted that widespread circuit damage would result from a wrongly connected rectifier.

### Operation

After the constructor has satisfied himself that the circuit is wired correctly the unit may be given a functional test.

Connect the slave station to the master via the line terminals. If violent acoustical feedback is to be avoided the slave loudspeakers should be positioned some distance from the master, preferably outside the room.

Connect the unit to the mains supply and switch on. With the volume control set half-way, and the function switch in the "Talk" position, tap on the master speaker grille. This should be loudly reproduced at the slave end. In the "Listen" position the reverse will apply. With volume set at a suitable level the voice should be clearly reproduced free from hum.

As an aid to the constructor Fig. 1 shows the voltage readings obtained on the prototype. These will be found a great help in the case of a unit which, although wired correctly, refuses to work due to a faulty component. All readings are

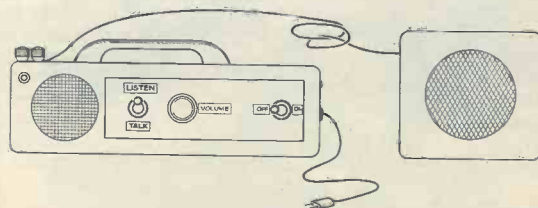

Fig. 5. A general view of the complete intercom equipment

between the points indicated and the positive line. The writer used a 1,000 ohms-per-volt meter on its 20 volt range to ensure that the current drawn by the instrument was small.

The system is capable of working on cable lengths of over 50 yards.

One last word of warning. This unit is of no use to those who are of weak constitution. If in the still of the night the infant decides to make his or her presence known, the 100mW of power available seems like a public address amplifier, and will jangle you out of the deepest sleep into violent action!

## RADIO TOPICS . . . by Recorder

ONE OF THE INCIDENTAL ADVANTAGES of 625 line TV reception is that the line frequency is 15,625 c/s instead of the 10,125 c/s which occurs with 405 lines. Self-generated line output transformer whistle is, therefore, removed to a frequency at which the ear is less sensitive, and should be less irritating in the television receivers of the future.

### Another Form of Whistle

There is, however, another form of line output stage interference which also results in a whistle—only, in this case, the whistle is reproduced by another receiver. If, like me, you live in an area where the B.B.C. Light Programme transmission on 200 kc/s (1,500 metres) is fairly weak, you are quite liable to hear a continual background whistle, particularly in the evenings. This whistle is the result of r.f. radiation

from the line output stages of neighbouring TV sets. The 20th harmonic of 10,125 c/s is 202.5 kc/s, with the result that a 2.5 kc/s beat is formed with the 200 kc/s Light Programme carrier. The effect is usually worst if a wire aerial (offering a capacitive pick-up) is used with the radio receiver, and it appears to be less evident when a ferrite frame is employed.

How troublesome is r.f. radiation from line output stages likely to be on 625 lines? The line frequency here is 15,625 c/s, whereupon the 13th harmonic turns up at 203.125 kc/s. So any possible whistle which may occur with the Light Programme will have a frequency of 3.125 kc/s. As the 625 line interfering signal is a 13th instead of a 20th harmonic it may, all else being equal, be somewhat stronger than that given by a 405 line timebase.

One incidental point is that, if you

see your next-door neighbour adding a u.h.f. aerial to his collection on the chimney, you may be able to tell whether he is viewing B.B.C.-2 by tuning in to the Light Programme on your radio. If the whistle stays at 2.5 kc/s all the evening you will know that his new aerial is just for show, and that he's still using the same old TV that he's had for the past decade!

In practice, it is extremely difficult to *entirely* eliminate r.f. radiation from a television chassis, although manufacturers go to great lengths to keep such radiation to a very low level. For complete freedom from radiation it isn't only necessary to screen the line output transformer and the valves and components which immediately connect to it, as has been standard practice for many years now. It is also necessary to screen the deflector coil assembly as well, an undertaking which, with very wide-angle components, is by no means as simple. And, of course, the whistle only becomes troublesome in areas where the Light Programme signal is at low level.

Another point that occurs to me is that if your neighbour on one side is switched to B.B.C.-1 or to I.T.V., and your neighbour on the other side to B.B.C.-2, Light Programme reception on 200 kc/s will be accompanied by whistles on 2.5 kc/s and 3.125 kc/s. Plus a beat note, between them, of 625 c/s!

### Moment of Truth

Occasionally, family commitments force me to sit through the B.B.C. television programme "Compact". During these sessions I find it impossible to concentrate on the plot as I am so completely fascinated by the incredibly large number of people who are needed to publish



At the Dagenham factory of the Ford Motor Company, an engineer checks the open circuit voltage of a regulator on a Ford Consul Corsair using an AvoMeter Model 12. Avo is a member of the M.I. Group.

one small magazine. Until very recently, this single fact has caused me to assume that the world of "Compact" is one of pure fantasy.

A few days ago, however, I chanced to look at the index page of the latest issue of *Which?*, the monthly journal published by Consumers' Association, to find that its executive staff numbers at least eight, and that they are backed up by no less than twelve Honorary Vice-Presidents of the Association together with fourteen Members of

the Council, making a grand total of thirty-four.

It was at that moment that the truth dawned upon me. The programme "Compact" is based on *Which?* magazine.

#### Two Equals One

Finally, a word about the "proof" I gave last month that 2 equals 1. You may recall that we started off by assuming that x is equal to y. The "proof" then proceeded in the following manner.

$$\begin{aligned} x &= y \\ \therefore x^2 &= xy \\ \therefore x^2 - y^2 &= xy - y^2 \\ \therefore (x+y)(x-y) &= y(x-y) \\ \therefore x+y &= y \\ \therefore 2x &= x \\ \therefore 2 &= 1 \end{aligned}$$

The error, as most of you will probably have spotted, lies in the third line, because subtracting  $y^2$  makes both sides equal to zero. All the third line says is that zero is equal to zero, after which everything else that follows is just nonsense!

## SHELL FIND MANY USES FOR

## CLOSED-CIRCUIT TV

Members of the staff of Shell International Petroleum Company Limited, at all levels, can now be coached for speaking on television. A closed-circuit TV studio at Shell Centre, London, has recently been designed for this and other purposes and the cameras and associated equipment were supplied by EMI Electronics Ltd.

When it becomes apparent that some subject in which the company is interested—a new oil refinery, or pesticides, for example—is coming into the news, specialists in the subject are trained in television techniques. Then, should the BBC or ITV ask for an interview or for a speaker to take part in a discussion, there is an expert ready who can face the cameras with confidence. Public relations executives from Shell companies overseas are also TV-trained while attending general courses in London.

Two EMI type 6 cameras are used in the studio for live programmes. In the control room, a third camera televises titles and captions, while a fourth forms part of a simple telecine arrangement for transmitting 16mm and 35mm films. Fades, super-impositions and other facilities are available. A battery of monitors gives the production team complete control of all camera outputs, and an off-line receiver indicates the quality of picture and sound being received throughout the Shell Centre offices, conference rooms, lecture halls, theatre and lounges.

There are many other ways in which members of Shell's public relations department propose to use this versatile installation—for instance, trying out TV scripts before sending them to overseas companies for use on local television programmes. A script that may look good on paper will not always make a good programme, but a trial run on the closed-circuit will help to evaluate the script and indicate any necessary amendments.

They can also mock up part of a film without entailing heavy production costs, to see if the treatment is on the right lines. It is always useful, too, to see how a colour film, which might be used on TV, comes over in black and white. Shell Film Unit uses the TV system to check the visual content and perspective of film sets.

Other departments are finding uses for it too. Language teaching, secretarial and supervisory courses are increasingly finding it an invaluable aid in their programmes.

**Queries.** We regret that we are unable to answer queries other than those arising from articles appearing in this magazine nor can we advise on modifications to equipment described. Queries should be submitted in writing.

**Correspondence** should be addressed to the Editor, Advertising Manager, Subscription Manager or the Publishers, as appropriate.

**Opinions** expressed by contributors are not necessarily those of the Editor or proprietors.

**Contributions** on constructional matters are invited, especially when they describe the building of particular items of equipment. Articles should be written on one side of the sheet only and should preferably be typewritten, diagrams being on separate sheets. Typewritten articles should have maximum spacing between lines. In handwritten articles, lines should be double-spaced. Diagrams need not be large or perfectly drawn, as our draughtsmen will re-draw in most cases, but all relevant information should be included. Sharp and clear photographs are helpful, where applicable. If negatives are sent, we usually work from these rather than from prints. Colour transparencies normally reproduce badly—black and white photographs are very much better. Details of topical ideas and techniques are also welcomed and, if the contributor so wishes, will be re-written by our staff into article form. All contributions must be accompanied by a stamped addressed envelope for return, if necessary, and should bear the sender's name and address. Payment is made for all material published.

**Production.**—Letterpress/contact litho.

Published in Great Britain by the Proprietors and Publishers Data Publications Ltd. 57 Maida Vale London W9

Printed by A. Quick & Co. (Printers) Ltd. Oxford Road Clacton-on-Sea England

Obtainable abroad through the following Collets Subscription Service Continental Publishers & Distributors Ltd. William Dawson & Sons Ltd. Australia and New Zealand Gordon & Gotch Ltd. Electronics Publications (Australia) South Africa Central News Agency Holland "Radio electronica"



## A NEW-PRACTICAL WAY of UNDERSTANDING

### RADIO · TELEVISION · ELECTRONICS

Including: Transistors; VHF/FM; Hi-Fi Equipment; Computers; Servo-Mechs. Test Instruments; Photo-electrics; Nucleonics; etc.

Radiostructor—an organisation specialising in electronic training systems—offers a new self-instructional method using specially designed equipment on a “do-it-yourself” basis. You learn by building actual equipment with the big kits of components which we send you. You advance by simple steps, performing a whole series of interesting and instructive experiments—with no complicated mathematics! Instructional manuals employ the latest techniques for showing the full story of electronics in a practical and interesting way—in fact, you really have fun whilst learning!

# RADIOSTRUCTOR

LEADS THE WORLD  
IN ELECTRONICS TRAINING

## POST NOW

To RADIOSTRUCTOR (Dept. G149), READING, BERKS.  
Please send brochure, without obligation, to:

\*Name .....

\*Address .....

(We do not employ representatives) 10/64  
\*Block Caps Please

## SMALL ADVERTISEMENTS

Use this form for your small advertisement

To: The Advertisement Manager, Data Publications Ltd., 57 Maida Vale, London, W.9  
Please insert the following advertisement in the ..... issue of THE RADIO CONSTRUCTOR

16 words at 9d.  
= 12/-

ALL WORDING  
IN  
BLOCK LETTERS  
PLEASE

I enclose remittance of ..... being payment at 9d. a word. MINIMUM 12/-.  
Box Number, if required, 2/- extra.

NAME .....

ADDRESS .....

Copy to be received four weeks prior to publication. Published on the 1st of every month

## SMALL ADVERTISEMENTS

Rate: 9d. per word.

Minimum charge 12/-.

Box No. 2/- extra.

Advertisements must be prepaid and all copy must be received by the 4th of the month for insertion in the following month's issue. The Publishers cannot be held liable in any way for printing errors or omissions, nor can they accept responsibility for the *bona fides* of advertisers. (Replies to Box numbers should be addressed to: Box No. —, *The Radio Constructor*, 57 Maida Vale, London, W.9.)

**DIRECT TV REPLACEMENTS LTD.** Largest stockists of TV components in the U.K. Line output transformers, Frame output transformers, Deflector coils for most makes. Official sole suppliers for many set makers. Same day despatch service. Terms C.O.D. or C.W.O. Send S.A.E. for quotes. Day and night telephone: Gipsy Hill 6166.—126 Hamilton Road, West Norwood, London, S.E.27.

**THE INCORPORATED PRACTITIONERS IN RADIO AND ELECTRONICS (I.P.R.E.) LTD.** Membership conditions booklet 1s. Sample copy of I.P.R.E. Official Journal 2s. post free.—Dept. D, Secretary, 32 Kidmore Road, Caversham, Reading, Berkshire.

**SERVICE SHEETS, 1925-1964.** From 1s. Catalogue 6,000 models, 1s. 6d. S.A.E. enquiries.—Hamilton Radio, 13 Western Road, St. Leonards, Sussex.

**CATALOGUE No. 15.** Government surplus electrical and radio equipment. Hundreds of items at bargain prices for the experimenter and research engineer, 2s. 6d. post free. Catalogue cost refunded on purchase of 50s.—Arthur Sallis Radio Control Ltd., 93 North Road, Brighton.

**HIGH QUALITY "BRAND FIVE" RECORDING TAPE** at reduced prices. Acetate. 5in, 900ft, 13s.; 5½in, 1,200ft, 16s. 6d.; 7in, 1,800ft, 24s. 6d.; Mylar 5in, 1,200ft, 26s. All new. Money back guarantee. All enquiries S.A.E.—Spectron, 6 Bingham Road, Radcliffe-on-Trent, Nottingham.

**S.E.S. SERVICE SHEETS** for all Television, Radio, etc. Lists 1s. 6d. plus S.A.E.—Sun Electrical Services, 38 St. George's Road, Hastings, Sussex.

**METALWORK.** All types cabinets, chassis, racks, etc., to your specifications.—Philpott's Metalworks Ltd., Chapman Street, Loughborough.

**FIND TV SET TROUBLES IN MINUTES** from that great book *The Principles of TV Receiver Servicing*, 10s. 6d., all book houses and radio wholesalers. If not in stock, from—Dept. D, Secretary, 32 Kidmore Road, Caversham, Reading, Berkshire.

**HAMMER FINISH PAINT.** The modern finish for electronics. Can be brushed or sprayed. Blue or silver. 2½ oz. tins 3s. 6d., ½ pint 7s. 6d., 1 pint 15s. Post 6d. on any order. Trade supplied.—Finnigan Speciality Paints, (RC), Mickley Square, Stocksfield, Northumberland.

continued on page 213

## BENTLEY ACOUSTIC CORPORATION LTD

38 CHALCOT ROAD CHALK FARM LONDON NW1  
THE VALVE SPECIALISTS Telephone PRIMROSE 9090

1L4	2/3	9BW6	9/6	DK40	15/6	ECH84	9/6	EY88	8/9	PY88	7/9
1R5	4/-	10C1	8/9	DK92	6/9	ECL80	6/-	EZ40	5/3	PY800	6/-
1S4	5/-	10C2	12/3	DK96	6/3	ECL82	7/-	EZ41	6/-	PY801	6/3
1S5	3/6	10F1	10/-	DL96	5/9	ECL83	9/6	EZ80	3/9	TY86F	11/8
1T4	2/3	10F18	9/9	DY70	5/-	ECL36	8/9	EZ81	4/-	U24	12/6
2D21	5/6	10LD11	9/6	DY86	7/6	EF37A	6/-	HABC80	9/3	U25	8/6
3D6	3/9	10P13	8/3	DY87	8/-	EF40	8/9	KT61	6/9	U26	7/6
3Q4	5/3	10P14	11/6	E80F	24/-	EF41	6/9	KT66	12/3	U191	9/6
3Q5	7/-	12AH8	10/9	E83F	24/-	EF80	3/9	N339	15/-	U282	12/3
3S4	4/6	12AT6	4/6	E88CC	10/-	EF83	9/9	PABC80	6/9	U301	11/3
3V4	5/3	12AU6	5/9	E180F	19/6	EF85	4/6	PC86	10/3	U329	9/-
5Y3	4/3	12AV6	6/6	EABC80	5/6	EF86	6/-	PC88	14/7	U404	6/-
5Z4	7/-	12BA6	5/9	EAC91	3/3	EF89	4/-	PC95	11/8	U801	16/3
6AQ5	5/9	12BE6	4/9	EAF42	7/6	EF91	3/-	PC97	7/3	UABC80	5/-
6AT6	3/9	12BH7	6/-	EB41	4/9	EF92	2/6	PCC84	5/6	UAF42	7/-
6AU6	5/3	19AQ5	7/3	EB91	2/3	EF97	11/8	PCC85	6/9	UBC41	6/3
6AV6	5/6	20D1	10/-	EBC41	6/6	EF98	10/-	PCC88	10/6	UBC81	6/3
6BA6	4/6	20F2	7/6	EBC81	5/9	EF183	7/-	PCC89	7/9	UBF80	5/9
6BE6	4/9	20L1	12/6	EBF80	5/6	EF184	7/-	PCC189	10/6	UBF89	6/9
6BH6	5/3	20P1	12/6	EBF83	7/3	EL33	6/9	PCF80	5/6	UC92	6/3
6BJ6	5/6	20P3	12/-	EBF89	6/3	EL34	8/6	PCF82	6/3	UCC84	8/9
6BQ7A	7/6	20P4	13/6	EC70	4/9	EL36	8/9	PCF84	8/6	UCC85	5/6
6BR7	8/3	20P5	12/3	ECC1	27/6	EL41	7/3	PCF86	7/9	UCF80	8/9
6BR8	8/-	30C15	9/-	ECC2	6/6	EL42	7/6	PCL82	6/6	UCH42	7/-
6BW6	6/9	30C18	10/6	ECC40	7/-	EL83	6/9	PCL83	7/9	UCH81	6/6
6CD6G	18/-	30F5	5/9	ECC81	3/6	EL84	4/6	PCL84	7/-	UCL82	7/9
6CH6	5/-	30L15	9/3	ECC82	4/6	EL85	7/6	PCL85	7/6	UCL83	8/6
6F1	9/6	30P4	12/3	ECC83	4/6	EL86	7/3	PCL86	8/9	UF41	6/9
6F13	4/9	30P12	7/6	ECC84	5/9	EL95	5/6	PL36	8/-	UF42	4/6
6J7G	4/6	30P19	12/3	ECC85	6/3	EM34	11/6	PL38	16/-	UF80	6/3
6K7G	1/3	30PL1	8/6	ECC88	8/9	EM71	13/6	PL81	6/9	UF85	6/9
6K8G	3/3	30PL13	9/6	ECC189	11/6	EM80	6/3	PL82	5/3	UF86	9/-
6L1	10/-	35W4	4/9	ECC804	16/4	EM81	7/-	PL83	5/3	UF89	6/9
6L18	10/-	85A2	6/6	ECC80	6/-	EM84	6/9	PL84	5/-	UL41	6/-
6LD20	3/6	5763	7/6	ECC82	6/3	EM85	8/5	PM84	9/3	UL46	8/6
6Q7G	4/-	AZ41	6/6	ECC86	11/6	EM87	7/6	PY33	8/9	UL84	6/-
6V6G	3/9	AZ41	6/6	ECH35	6/3	EY51	3/6	PY80	5/-	UM80	8/3
6X4	3/9	DAF96	5/9	ECH42	7/6	EY83	9/3	PY81	4/9	UY41	4/6
6X5	4/6	DF96	5/9	ECH81	5/9	EY84	9/6	PY82	4/9	UY85	5/-
6/30L2	8/3	DF97	10/-	ECH83	6/6	EY86	5/6	PY83	5/9	YX8	20/6

Terms of business: Cash with order or C.O.D. only. Post/packing 6d. per item. Orders over £3 post free. C.O.D. 3/6 extra. All orders despatched same day. C.O.D. orders by telephone accepted for immediate despatch until 3.30 p.m. Any parcel insured against damage in transit for 6d. extra. We are open for personal shoppers 8.30-5.30. Saturdays 8.30 a.m.-1 p.m.

## pitman

### AN ELECTRONIC ORGAN FOR THE HOME CONSTRUCTOR

Alan Douglas, Sen. Mem. I.E.E.E.

A very popular "how to make it" book. Shows exactly what is involved in work and materials (a list of sources of supply is included) in constructing an inexpensive instrument for use in the home. For this new edition, an alternative arrangement of continuous tuning has been added to a revised and up-to-date text.

Second edition 20s net

from all booksellers

Pitman Parker St London WC2

**RADIO SOCIETY OF GREAT BRITAIN**

**International**



**RADIO  
COMMUNICATIONS  
EXHIBITION**

**SEYMOUR HALL, SEYMOUR PLACE  
MARBLE ARCH W.1**

**OCTOBER 28th to 31st  
(WEDNESDAY TO SATURDAY)**

**10 a.m. to 9 p.m.**

**FIFTH ANNIVERSARY FLEET AIR ARM DISPLAY OF  
AIRCRAFT CARRIER RADIO CONTROL ROOM  
DISPLAY & DEMONSTRATIONS BY ROYAL AIR FORCE, ARMY  
AND POST OFFICE ENGINEERING  
COMPETITIONS OF HOME CONSTRUCTION EQUIPMENT  
LATEST RECEIVING & TRANSMITTING SETS  
NEW TV & V.H.F. AERIALS and MASTS  
EDUCATIONAL & BOOKSHOPS DISPLAY. MOBILE EQUIPMENT**

**Win £140 Hammarlund HQ 170A  
Latest Communication Receiver**

*(EXCHANGE THIS ADVERTISEMENT FOR ENTRY FORM AT DOOR)*

**ADMISSION 3/-**

## SMALL ADVERTISEMENTS

continued from page 211

**CONVERT ANY TV SET INTO AN OSCILLOSCOPE.** Instructions and diagrams, 12s. 6d.—Redmond, 26 St. John's Road, Hove, Sussex.

**NEW, UNOPENED CRATES.** 5BKP31 oscilloscope tubes. Data available. Cost over £25. Few at £4. 19s. 6d., carriage paid. Also lists, valves, tubes, etc.—Bearman, 43 Leicester Road, New Barnet, Herts. Telephone: BARNET 1934.

**SUB-ASSEMBLY,** wiring, testing and inspection. Small unit service work. Layout of components, parts, etc. Collection and delivery if necessary. Write or telephone: Mersea Marine Services Co., High Street, Burnham-on-Crouch, Essex. Telephone: 3335.

**FOR SALE.** Heathkit valve voltmeter model AV-3U. Unused. £15 o.n.o.—Box No. F212.

**MID-FI DISPOSAL.** Jason F.M., record player, 10 watt amp., loudspeaker £10. Tape deck and pre-amp., ribbon mike, 6,000 ft. tape £15.—10 Overstone Gardens, Shirley, Surrey.

**OFFERS for Philips 3-speed playing deck with auto change and 5 watt amplifier.**—Box No. F216.

**WANTED.** October 1961 to March 1962 copies of *The Radio Constructor*.—Sear, Lovatts Cottage, The Green, Croxley Green, Herts.

**U.S.A.F. SURPLUS.** 400 c.p.s. 3kVA regulated £50. 0-50V d.c. 150 amps. £60. 6 ft. racks £5. 24V relays. —Box No. F219.

**FOR SALE.** Newnes *Radio & Television Servicing* 7 volumes, 1955-1961. Heathkit R.C. Bridge, model C-3U as new. Offers?—Box No. F220.

**FOR SALE.** Commando II S.S.B. transmitter. New. Owner going v.h.f. £110.—Box No. F221.

**TELEPRINTERS.** Creeds No. 3 £10. Matching rectifiers, Westinghouse full voltage control for motor supply £5. New spares for machines available. Carriage paid. Limited supply.—Box No. F222.

**COLLECTOR** interested in purchasing really early wireless valves—First World War or earlier. Has for disposal numerous mid-1920s types. Also for sale several early crystal detectors.—Enquiries to Box No. F223.

**FOR SALE.** Decca "1000" projection model, complete with custom built triple speaker enclosure housing separate amplifier and retractable 4' x 3' projection screen. Nearest £50.—8 Melville Street, Wombwell, Barnsley, Yorks. Telephone: Wombwell 2391.

continued on page 215

## RETURN - OF - POST

ON CASH OR C.O.D. ORDERS

LATEST TEST METERS	Cash Price		Hire Purchase	
	Deposit	Mthly Pmts.	Deposit	Mthly Pmts.
AVO Model 8, Mark III	£24. 0.0	£4. 16.0	12 of	£1. 15. 2
AVO Model 7, Mark II	£21. 0.0	£4. 4.0	12 of	£1. 10. 10
AVO Multiminor Mark IV	£9. 10.0	£1. 18.0	12 of	14/4
T.M.K. TP10	£3. 19. 6	£1. 3. 6	3 of	£1. 2. 0
T.M.K. TP55	£5. 19. 6	£1. 15. 6	3 of	£1. 11. 4
T.M.K. Model 500	£8. 19. 6	£1. 15. 6	12 of	13/8
TAYLOR Model 127A	£10. 10.0	£2. 2. 0	12 of	15/8

Full details of any of the above supplied free on request. The AVO Models 7 and 8 are both latest models from current production—not to be confused with Government surplus.

### GRAMOPHONE EQUIPMENT

ALL LATEST MODELS ALL POST FREE	Cash Price		Hire Purchase	
	Deposit	Mthly Pmts.	Deposit	Mthly Pmts.

RECORD CHANGERS				
GARRARD AUTOSLIM (Mono PU plug in head)	£7. 19. 6	£1. 10. 6	6 of	£1. 4. 0
GARRARD AT5 (Mono PU plug in head)	£10. 8. 2	£2. 4. 2	12 of	15/4
GARRARD AUTOSLIM (Mono PU)	£6. 17. 6	£1. 12. 6	6 of	£1. 0. 0
GARRARD AUTOSLIM De-luxe AT6 (Mono PU)	£11. 9. 0	£2. 6. 0	12 of	16/11
GARRARD AUTOSLIM AT6 (Stereo/Mono PU)	£12. 5. 4	£2. 9. 4	12 of	18/-
B.S.R. UA15 (TC8 Mono PU)	£7. 15. 0	£1. 18. 0	6 of	£1. 2. 0
B.S.R. UA15 (TC8 Stereo/LP/78)	£8. 15. 0	£2. 6. 0	6 of	£1. 4. 0

Many of the above can be supplied for stereo working. See our Gramophone Equipment List for details.

### AMPLIFIER KITS

We have full stocks of all components for the Mullard 510, Mullard 3-3, Mullard 2 and 3 Valve Pre-Amp, Mullard Stereo, Mullard Mixer. Fully detailed list on any of these sent upon request. Instruction Manual: All Mullard Audio Circuits in "Circuits for Audio Amplifiers", 9/5. Post Free.

### ILLUSTRATED LISTS

Illustrated lists are available on LOUDSPEAKERS, TAPE DECKS, TEST GEAR, GRAMOPHONE EQUIPMENT, AMPLIFIERS. Any will be sent free upon request.

## WATTS RADIO (MAIL ORDER) LTD

54 CHURCH STREET WEYBRIDGE SURREY

Telephone Weybridge 47556

Please note: Postal business only from this address  
Callers welcome by appointment

## MODERN CAR RADIO RECEIVERS

No. 13 in our Data Book Series. This book contains three designs, covering Medium and Long Waves, and each being fully described with point-to-point wiring. The Jason-designed "Everest 6" and "Everest 7" employ transistors throughout and both now contain the latest modifications, together with extra illustrations and step-by-step instructions. A complete section, "Tackling Car Radio Interference" is also included.

Fully illustrated with photographs and circuit diagrams, this Data Book should prove of interest to all car owners requiring a car radio.

48 pages, with varnished board cover

Price 3/6 postage 4d.

Available from your usual supplier, or direct from

**DATA PUBLICATIONS LTD**  
57 Maida Vale London W9

## THE MODERN BOOK CO

**Guide to Broadcasting Stations.** Compiled by "WW". 5s. Postage 6d.

**A Beginner's Guide to Radio.** Pub. by Newnes. 8s .6d. Postage 9d.

**Worked Radio Calculations.** By A. T. Witts. 15s. Postage 9d.

**Radio and Line Transmission.** By G. L. Denielson. Vol. 1 21s. Vol. 2 22s. 6d. Postage 1s. each.

**Television Servicing Handbook.** By G. J. King. 35s. Postage 1s. 3d.

**Telecommunications.** By W. Fraser. 65s. Postage 1s. 6d.

**Telecommunications Principles in M.K.S. Units.** By R. N. Renton. 45s. Postage 1s. 6d.

**Radio Servicing Problems.** By W. A. L. Smith. 5s. Postage 6d.

**Hi Fi Year Book, 1964.** 10s. 6d. Postage 1s.

**Test Gear for Amateurs.** Illustrated. 3s. 6d. Postage 6d.

**The A.R.R.L. Antenna Book.** 18s. Postage 1s.

**Frequency Divider Organs for the Constructor.** By A. Douglas. 25s. Postage 1s.

**Radio, Television and Electrical Repair.** By R. C. Norris. 50s. Postage 2s.

**Radio Servicing.** By G. N. Patchett and B. Fozard. 1 vol. ed. 27s. 6d. Postage 1s.

**Practice Problems in Electronics Calculations.** By A. Andrews. 30s. Postage 1s.

**Radio and Television Reference Data.** Compiled by J. P. Hawker. 10s. 6d. Postage 1s.

Complete Catalogue 1s.

We have the Finest Selection of British and American Radio Books in the Country

**19-21 PRAED STREET (Dept RC) LONDON W2**

Telephone PADDington 4185



Patron: His Royal Highness The Prince Philip, Duke of Edinburgh, K.G.

**THE SAIL TRAINING ASSOCIATION**

48 WELBECK STREET, LONDON, W.1 Tel. WELbeck 2634

*Special Appeal Committee for The Sail Training Ship*

Chairman: The Earl St. Aldwyn, P.C., T.D.

The Sail Training Association was founded in 1955 to help bring together the youth of different nations in friendly competition and character training. These aims have been achieved by such events as the "Tall Ships Race" in which half of each of the crews must be youths with little experience of the sea.

A National appeal was recently launched to build a three-masted top-sail schooner, which will give character training to about six hundred boys a year. This 300 ton vessel has been designed by Camper and Nicholson's and her keel is to be laid in November, her builders being Richard Dunston of Hessele on the Humber.

The Association has relied on voluntary subscriptions to date, but the Council of the Association has now decided to offer Ordinary Membership to anyone who is interested enough to subscribe two guineas or more per year. Also Cadet Membership is offered to young people between 15-21 years of age who subscribe 7/6 per year. All such members, are entitled to wear the S.T.A.'s lapel badge and will receive S.T.A. literature as it is published.

Earl St. Aldwyn, President of the Special Appeal Committee announced recently that the keel of the 300 ton topsail schooner will be laid on November 21st next.

*Donations should be sent to The Sail Training Association, c/o Hoare & Co., Bankers, 37 Fleet Street, London, E.C.4, and information about the activities of the S.T.A. and the endowment of berths can be obtained from Lt.-Commander P. S. Boyle, R.N.R., The Sail Training Association, 48 Welbeck Street, London, W.1.*



## SMALL ADVERTISEMENTS

continued from page 213

**FOR SALE.** Quantity of new accumulators. Willard Radio-20-2, 2 volt. Size: 5in high x 3½in x 2½in., 5s. each plus carriage.—Box No. F224.

**INTERESTED IN AMATEUR RADIO TELEPRINTING?** Then join the British Amateur Radio Teleprinter Group. Details from Hon. Sec., G2UK, East Keal, Romany Road, Oulton Broad, Suffolk.

**JOIN THE INTERNATIONAL S.W. LEAGUE.** Free Services to members including Q.S.L. Bureau. Amateur and Broadcast Translation. Technical and Identification Dept.—both Broadcast and Fixed Stations, DX Certificates, contests and activities for the SWL and transmitting members. Monthly magazine, *Monitor*, containing articles of general interest to Broadcast and Amateur SWLs, Transmitter Section and League affairs, etc. League supplies such as badges, headed notepaper and envelopes. QSL cards, etc., are available at reasonable cost. Send for League particulars. Membership including monthly magazine, etc., 21s. per annum.—Secretary, ISWL, 12 Gladwell Road, London, N.8.

**THE INTERNATIONAL HAM HOP CLUB** is a non-profit-making organisation open to RADIO AMATEURS AND SHORT WAVE LISTENERS. OBJECT: to improve international relationships through an organised system of hospitality. MEMBERS offer overnight hospitality to visiting members, subscription 10s. per annum. ASSOCIATE MEMBERS invite radio amateurs to visit their stations. Associate membership 5s. per annum. FAMILY EXCHANGE holidays arranged, also FRIENDSHIP LINKS between radio clubs. The Club's official journal is free to both Full and Associate Members.—Hon. Gen. Secretary: G. A. Partridge, G3CED, 17 Ethel Road, Broadstairs, Kent.

### SITUATIONS VACANT

**YOUNG MAN** required over 18 years, to work in busy radio shop and mail order dept. Some previous experience necessary. For appointment telephone Paddington 1008. Henry's Radio Ltd., 303 Edgware Road, London, W.2.

### ELECTRONIC TECHNICIANS

Cambridge Works Limited, a member of the Pye (Cambridge) Limited Group of Companies, require technical staff for their Test Engineering Department. If you are seeking an interesting job covering a wide field in electronics this may be it. The work consists of the construction and maintenance of special test equipment for telecommunications also the repair of standard items of test equipment made by top line manufacturers.

Basic knowledge of AC and DC theory, ability to read circuit diagrams, plus common sense in good measure are the qualifications required.

These are staff appointments for technicians wishing to expand their experience and progress to design and development.

Please apply to Personnel Manager, Cambridge Works Limited, Haig Road, Cambridge.

TO DESIGNERS & CHIEF ENGINEERS

# OSMOR

SPECIALISES IN WINDING MINIATURE COILS AND TRANSFORMERS OF INTEREST TO BULK MANUFACTURERS IN THE INDUSTRIAL FIELD.

MANUFACTURERS USING UP TO 50 S.W.G. WOULD FIND OUR SERVICE ECONOMICAL AND RELIABLE. ENQUIRIES APPRECIATED.

## LARGE CAPACITY AVAILABLE

PLEASE TELEPHONE CRO 5148  
FOR SWIFT ACTION

## OSMOR RADIO PRODUCTS

540 PURLEY WAY (PARKING FACILITIES)  
CROYDON  
CRO 5148/9

## TESTED TRANSISTORS

1/- each Red or White Spots. OA81, OA202.

2/- each XA101, XA102, XA111, XA112, XB103, NKT122, OA90, OC430.

3/- each OC44, OC45, OC81, OC81D, OC200, GET16.

4/- each AF114, AF115, AF117, OC170, OC171 SX658, XV611.

5/- each OC72, OC139 OC140, OC204, GET8, ORP60, BY100.

10/- each OC35, OC26, OC28, AFY19, 2S013, ORP12, GET571.

ZENER DIODES 4.7 volt to 33 volt ¼ watt, 3/6 each, 1.5 watt, 5/- each, 7 watt, 6/- each.

Send 3d. stamp for Full Price List, and Free Equivalent Chart

## B. W. CURSONS

78 BROAD STREET, CANTERBURY, KENT

# CHASSIS and CASES by



287/9 Edgware Road  
London W2  
TELEPHONE  
PADdington 5891/7595

**BLANK CHASSIS—Same Day Service**  
Of over 20 different forms made up to YOUR SIZE.  
Order EXACT SIZE you require to nearest 1/16th.  
(Maximum length 35", depth 4".)  
Specials dealt with promptly.

**SEND FOR ILLUSTRATED LEAFLETS**  
or order straight away, working out total area of material required and referring to table below which is for four-sided chassis in 18 s.w.g. (for 16 s.w.g. add 1/16th).  
48 sq. in. 4/- 176 sq. in. 8/- 304 sq. in. 12/-  
80 sq. in. 5/- 208 sq. in. 9/- 336 sq. in. 13/-  
112 sq. in. 6/- 240 sq. in. 10/- 368 sq. in. 14/-  
144 sq. in. 7/- 272 sq. in. 11/- and pro rata  
P. & P. 2/6 P. & P. 2/9 P. & P. 3/-  
Discounts for quantities. Finishes arranged for quantities of 25 or over.

**CASES**  
ALUMINIUM, SILVER HAMMERED FINISH Type W

Type	Size	Price	Type	Size	Price
U	4 x 4 x 4"	9/6	Y	8 x 6 x 6"	25/-
U	5 1/2 x 4 1/2 x 4 1/2"	14/6	Y	12 x 7 x 7"	39/-
U	8 x 6 x 6"	20/-	Y	13 x 7 x 9"	44/-
U	15 x 9 x 9"	42/6	Y	15 x 9 x 9"	46/-
W	8 x 6 x 6"	19/6	Z	17 x 10 x 9"	63/-
W	12 x 7 x 7"	32/6	Z	19 x 10 x 8 1/2"	67/6
W	15 x 9 x 8"	42/-		* Height	

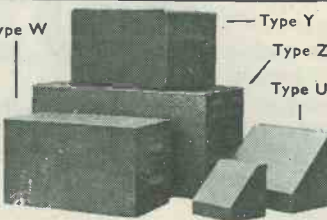

Type Z has removable back and front panels.  
Type Y all-screwed construction.

**FLANGES** (1/2" or 3/4"), 6d. per bend.  
**STRENGTHENED CORNERS**, 1/- each corner.  
**PANELS**  
Any size up to 3ft at 4/6 sq. ft. 18 s.w.g. (16 s.w.g. 5/3).  
Plus postage and packing (orders over £2 Post Free).

## BRASS · COPPER · DURAL · ALUMINIUM · BRONZE STAINLESS STEEL

ROD, BAR, SHEET, TUBE, STRIP, WIRE. 3,000 STANDARD STOCK SIZES  
No Quantity too small List on application

**H. ROLLET & CO LTD**  
**HOWIE ST. LONDON SW11 BATTERSEA 7872**  
Also at Liverpool, Birmingham, Manchester, Leeds, Glasgow

the unique **PANL** black crackle paint

4/-d. per 1/8 pt. Can  
(We regret we can only supply on cash with order basis)

**BRUCE MILLER LTD.,**  
249 Coastal Chambers,  
Buckingham Palace Road, S.W.1.

## 20 SUGGESTED CIRCUITS

by G. A. FRENCH

No. 15 in our Data Book Series. This book contains the first 20 circuits to be published in the very popular series of the same name appearing in *The Radio Constructor*.

The contents include: simple and inexpensive two-valve capacity bridge, short wave regeneration preselector, one-valve speech operated switching circuit, transformer ratio analyser, series noise limiter, receiver remote mains on-off control, and many others; covering subjects ranging from electronic laboratory equipment to a simple 2-Stage Gram Amplifier.

PRICE 3s. 6d. Postage 4d. 48 pages.

Available from your usual supplier, or direct from

**DATA PUBLICATIONS LTD**  
57 Maida Vale London W9

## For Discerning Enthusiasts Quality Transistors and Components

**UHF Amplifier Transistors** (BBC.2, etc.): AF139, 36/9; T208 (2N2398), 53/9; GMO290, 31/6. **Tunnel Diodes**: 1N3712 (TD-1) 1mA, Ipk 2,300 Mc/s, 50/3; 1N3720 (TD-5) 22mA, Ipk 1,600 Mc/s, 25/-.

**VHF Power Transistors**: 2N3053 60V, 5W, ft=100 Mc/s, silicon planar, 15/-; AU110 70V, 4.5W, ft=120 Mc/s, germanium alloy-diffused, 53/-; BUY10, silicon npn epitaxial planar, 40V, 10W, ft=90 Mc/s (typ.), 45/-.

**Audio Transistors, matched pairs**: OC81Z, 16/- pr.; AD140, 50/- pr.; OC35, 36/- pr.

**Pi-mode Amplifier**—printed circuit boards, 12/6 mono, 21/- stereo. Mains transformers and all components available. Also circuit (6d. stamp). Low noise metal oxide resistors from 2/3 each.

PROMPT SERVICE. C.W.O. PLEASE. POSTAGE 6d.  
PLEASE SEND 1/- (STAMPS) FOR REFERENCE CATALOGUE

**J. WILLIAMS & CO. (C.)** 208 HAGLEY ROAD  
BIRMINGHAM 16

## YOUR CAREER IN RADIO?

Big opportunities and big money await the qualified man in every field of Electronics today—both in the U.K. and throughout the world. We offer the finest home study training for all subjects in radio, television, etc., especially for the **CITY & GUILDS EXAMS**. (Technicians' Certificates); the Grad. Brit. I.R.E. Exam.; the **RADIO AMATEUR'S LICENCE**; P.M.G. Certificates; the R.T.E.B. Servicing Certificates; etc. Also courses in Television; Transistors; Radar; Computers; Servo-mechanisms; Mathematics and Practical Transistor Radio course with equipment. We have **OVER 20 YEARS'** experience in teaching radio subjects and an unbroken record of exam. successes. We are the only privately run British home study Institute specialising in electronic subjects only. Fullest details will be gladly sent without any obligation.

SEND FOR FREE BROCHURE TO:

**BRITISH NATIONAL RADIO SCHOOL**  
DEPT 4, RADIO HOUSE · READING · BERKSHIRE

## THE RADIO CONSTRUCTOR—BOUND VOLUMES

Now available

Volume 17, August 1963 to July 1964 Price £1 10s 0d Postage 3s 0d

Where all issues are returned: Price £1 Postage 3s 0d

Limited number also available of:—

Volume 13, August 1959 to July 1960 Price £1 5s 0d Postage 2s 6d

Volume 16, August 1962 to July 1963 Price £1 10s 0d Postage 3s 0d

Where all issues are returned: Price £1 Postage 3s 0d

We regret Volumes 14 and 15 are now sold out

Send for latest brochure containing details of our other publications

**DATA PUBLICATIONS LTD 57 MAIDA VALE LONDON W9**

### MULTI-METERS



Multi-range test meters featuring easy to read scales and provided with full operating instructions, lead and batteries. Suitable for amateurs, designers, repair shops, all domestic uses. Full details and specifications in our catalogue.

- ★ PT34, 1kΩ/V ... .. £1.19.6
- ★ M1, 2kΩ/V ... .. £2. 9.6
- ★ THL33, 2kΩ/V (illus) ... .. £3.15.0
- ★ EP10K, 10kΩ/V\* ... .. £3.19.6
- ★ ITI-2, 20kΩ/V ... .. £4. 2.6
- ★ TP55, 20kΩ/V\* ... .. £5.19.6
- ★ EP30K, 30kΩ/V\* ... .. £5.10.0
- ★ 500, 30kΩ/V\* ... .. £8.19.6
- ★ EP50K, 50kΩ/V\* ... .. £8.10.0
- ★ EP100K, 100kΩ/V ... .. £9.19.6

(\*Leather Cases Available)

### BUILD A QUALITY TAPE RECORDER

- ★ Pre-Built Equipment—6
- Valves—Collaro
- Studio Decks—
- Portable
- Cabinets with
- 8" x 5" Speakers



**TWO TRACK** Total Cost **£26**  
P.P. 8/6

OR Deck 10 gns. P.P. 5/-; Amplifier 11 gns. P.P. 3/6. Cabinet with Speaker 5 gns. P.P. 3/6.

**FOUR TRACK** Total Cost **£30**  
P.P. 8/6

OR Deck £13.19.6. P.P. 5/-; Amplifier 12 gns. P.P. 5/6. And Cabinet with Speaker 5 gns. P.P. 3/6. All complete in every detail. Illustrated leaflets on request. Ideal for portable or domestic equipment.

### GARRARD 2-TRACK BATTERY TAPE DECK



9V operated, 2 track, 2 speed. Brand new, fitted heads, etc. Supplied complete with cassette. Brand New. £11.15.0 P.P. 3/6

### FM VHF TUNING HEART

Printed circuit construction, fully tunable 85 to 105 Mc/s. Completely screened. Requires UCC85 (8/6), R.F. stage and osc./mixer stage. With circuit. Brand new in maker's cartons 15/- P.P. 1/-

### TRANSISTOR SUPERHET TUNER



9V medium wave 3-transistor and diode superhet radio tuner. Ideal for all amplifiers. Price with circuit 67/6. P.P. 1/6. Also mW/sW 4-transistor £7.9.6.

## TRANSISTORS, CRYSTALS, VALVES AND COMPONENTS

### THE LARGEST RANGE OF THE ABOVE ITEMS IN THE COUNTRY

We stock far too many types to list here. See our Catalogue for full range

★ New 8-page Transistor, Rectifier, Valve and Quartz Crystal List Free on request  
LET US QUOTE FOR PARTS FOR YOU  
RETURN OF POST SERVICE

### A SELECTION FROM OUR STOCKS

See Catalogue for full details

- Sinclair Micro-6 (to build) ... .. 59/6
- Sinclair TR750 Amplifier (to build) ... .. 39/6
- Sinclair Micro Injector (to build) ... .. 27/6
- Tape Jack Tuner (Full Med. Wave) ... .. 29/6
- 10-Watt Horn Tweeter ... .. 27/6
- 20-Watt Super Tweeter ... .. 69/6
- Two-channel Mixer for Mics/Pu's ... .. 15/-
- 1 to 200 Mc/s Field/str. Meter ... .. 59/6
- 5-hole Chassis Punch Kit ... .. 49/6
- Headphones 2kΩ 12/6; 4kΩ ... .. 14/6
- Stereo Stethoscope Headset, 8+8 arm ... .. 25/-
- Resistor Substitution Box ... .. 32/6
- Crystal Mono Stethoscope Headset ... .. 10/6
- Magnetic Mono Stethoscope Headset... .. 12/6
- Transistor Signal Injector ... .. 35/-
- Fully Disappearing Car Aerial ... .. 35/-
- Test Lead Kit with Pouch ... .. 8/6
- Capacitor Substitution Box ... .. 22/6
- De Luxe Stereo Headsets with junction box ... .. £6
- PP3 9V Batt. Eliminator ... .. 18/6
- Transistor Telephone Amplifier ... .. 59/6
- 8+8Ω Stereo Headphones ... .. 62/6
- Crystal Lapel Microphone ... .. 12/6
- 2kΩ Magnetic Lapel Microphone ... .. 8/6
- Crystal Contact Microphone ... .. 12/6
- 2kΩ 1/2 track Tape Head ... .. 15/-
- 2kΩ 1" diam. Mag. Mic. Insert... .. 15/-
- MCI Crystal Mic. ... .. 5/-
- Earphones, Crystal or Magnetic Complete with Jack and Socket. Telephone Recording Attachment ... .. 9/6
- 50-0-50μA Edgewise Meter ... .. 25/-
- 6/12V Min. 212W Relay ... .. 12/6
- Transistor Coil Set With Tuner, Ferrite Aerial and Circuit ... .. 20/-
- Complete Test Lead Kit ... .. 8/6
- 30W Pocket Mains Solder Iron ... .. 14/6
- 8" Hi-Fi 15/16 ohm Speaker ... .. 69/6
- 100 kc/s Quartz Crystal ... .. 15/-
- Twin Crystal 1 Mc/s and 100 kc/s ... .. 22/6

### RECORD/REPLAY/ERASE TAPE HEADS

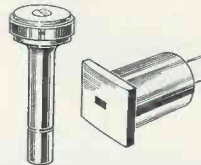

Marriot Type R/RP/3 1/2 track record-replay head and Mullard type TS erase head with mounting post. Ideal for transistor circuits. Bargain Offer 15/- Pair. P.P. 1/-

★ 700Ω IMPEDANCE ★

### CRYSTAL MICROPHONES



- (See Catalogue for details and for Dynamic Mics)
- Acos 39-1 Stick Microphone ... .. 32/6
  - Acos 40 Desk Microphone ... .. 15/-
  - Acos 45 Hand Microphone ... .. 19/6
  - Lapel/Hand Microphone ... .. 12/6
  - Acos Stick Microphone ... .. 15/-
  - 100C Stick with Stand ... .. 32/6
  - BM3 Stick with Stand ... .. 49/6
  - Lapel/Hand Magnetic ... .. 8/6
  - MM71 2k Mag. Mic ... .. 12/6

Trade and Export Enquiries Invited

### NOMBREX TEST EQUIPMENT



LEAFLETS ON REQUEST  
FULLY GUARANTEED

All transistor portable units supplied with full instructions.

- ★ 150 kc/s to 350 Mc/s generator. RF Mod., AF, 8 ranges. Leads, batt., instructions, £9.10.0.
- ★ Resistance/Capacitance Bridge, £8.5.0.
- ★ Transistorised Power Supply, £6.10.0.
- ★ Audio Generator, £16.15.0.
- ★ Inductance Bridge, £18.

### 4-CHANNEL TRANSISTOR MIXER

4-inputs, suitable for Mics, Pick-Ups, Tuners, etc. Built-in Battery. 49/6. P.P. 1/6



### TRANSISTOR PORTABLE WALKIE-TALKIES

9-Transistor Portable Trans-receivers. Supplied complete with leather cases, batteries, aerials, etc., in presentation case. Range up to 5 miles in favourable conditions. Sizes 6 1/2" x 3" x 1 1/2". Superhet crystal controlled on transmit and receive. Price £21 Per Pair. P.P. 3/6

### POCKET RADIOS

All complete with battery, earphone, carry case and fully guaranteed. 6 and 7 transistor superhet designs.



- ★ 6-Transistor Med. Wave, 69/6. P.P. 2/-
- ★ 7-Transistor Med. Wave, 79/6. P.P. 2/-
- ★ 6-Transistor Med./Long Wave, 5 gns. P.P. 2/6
- ★ 7-Transistor MW/LW/SW, £12 P.P. 3/6

### MAINS AND BATTERY RECORD DECKS

ALL COMPLETE with ARM and CARTRIDGE

- ★ BSR UA14 4-speed ... .. £5.19.6
- ★ BSR UA15 4-speed ... .. £6.19.6
- ★ Garrard Autoslim 4-speed ... .. £6.10.0
- ★ Unpluggable Head Version ... .. £6.19.6
- ★ Stereo Version ... .. £7.19.6
- ★ 6-9 volt version ... .. £8.19.6
- ★ SRP10 4-speed or BSRGU7... .. £5. 0.0
- ★ Garrard AT6 with Stereo Cartridge, 4-speed ... .. £10.19.6
- ★ AT6 with Mono Head ... .. £10.10.0
- P. & P. 3/6 any type above
- ★ AT6 with EV26 or Sonotone ... .. £11.19.6
- ★ 9V Star, 45 r.p.m. ... .. £1.19.6
- ★ 45 and 33 r.p.m. Star, 9V ... .. £4.12.6
- ★ 45 r.p.m. Garrard 6V ... .. £1.15.0
- ★ 4-speed B.S.R., 9V or S.R.P.10 9V ... .. £5. 5.0
- P. & P. 2/6 any of above

## HENRY'S RADIO LTD

303 EDGWARE ROAD LONDON W2

PADDINGTON 1008/9

Open Monday to Sat. 9-6. Thurs. 1 o'clock

PLEASE TURN TO BACK PAGE

# Components and Equipment Specialists for more than 20 years

## Transistor High Fidelity Equipment FOR MAINS OR BATTERY OPERATION

### ● MONO FULL FUNCTION PRE-AMPLIFIER/CONTROL UNIT

PRICE **£5.10.0** P.P. 2/-  
OR KIT 99/9 P.P. 2/-

★ Dark brown and gold front panel plate 8/6

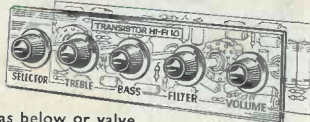

For use with one or two transistor power amplifiers as below or valve amplifiers—hum free—high sensitivity—8 inputs between 1.5mV and 300mV, with full equalisation. For all pick-ups—microphones, tuners—tape replay. Separate treble and bass with cut and boost—4 position low pass filter. Volume, 40 c/s and 20 kc/s, etc. Output 250mV. Overall size 9" x 2½" x 2". Battery operated (2½mA) or from power supply. Signal to noise ratio 70dB at 10 watts with power amplifier. 20 watts output when used with two power amplifiers. Supplied built and ready to use.

### ● INTEGRATED STEREO PRE-AMPLIFIER



For use with Valve or Transistor Equipment

Two channel version of above with addition of balance and mono/stereo controls. Overall size 9" x 3½" x 1½" deep. Designed to feed two 10 watt power amplifiers as below. Supplied built and ready to use. 5mA current. Battery operated (5mA) or from mains unit.

PRICE **£10.19.6** P.P. 3/6 ★ Dark brown and gold front panel plate 12/6

### ● MULTI-INPUT PRE-AMPLIFIER

For use with one or two transistor power amplifiers or as a general purpose pre-amplifier. A simplified version of the full function pre-amp. 8 inputs from 1.5mV to 300mV. Input selector, tone and volume controls. Size 5" x 2½" x 2". Ideal for public address systems, for microphones and pick-ups.



PRICE **65/-** P.P. 1/6

★ Dark brown and gold front panel plate, 6/6

### ● 10 WATT POWER AMPLIFIERS

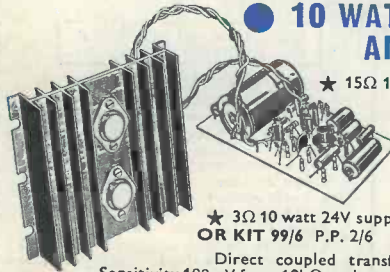

★ 15Ω 10 watt 40V supply.  
**£5.19.6**  
P.P. 2/6

OR KIT  
£5.10.0 P.P. 2/6

★ 3Ω 10 watt 24V supply.  
**£5.10.0**  
OR KIT 99/6 P.P. 2/6 P.P. 2/6

Direct coupled transformerless design. Sensitivity 100mV from 10kΩ or less source for 10 watts output. Response ±1dB 40 c/s to 10 c/s. 0.25% total distortion at 10 watts. Push-pull class B output. 60dB feedback. Two versions available for 3Ω to 4Ω and 15Ω to 16Ω output. Battery or mains supply operation. For use with mono or stereo preamplifiers as above. Supplied built and ready to use. The 24V version is suitable for 12V operation with an output of 3/4 watts. Also 4/5/8 or 15 ohm speakers.

DETAILS WITH CIRCUITS OF ABOVE UNITS  
FREE ON REQUEST

PLEASE  
TURN  
PAGE

We can supply from stock most of the components and items specified on circuits published in this and other magazines. Quality parts at realistic prices. Let us quote for your circuit.

## HENRY'S RADIO LTD

303 EDGWARE ROAD LONDON W2

PADDINGTON 1008/9

Open Monday to Sat. 9-6. Thurs. 1 o'clock

## CONVAIR PUSH-BUTTON PORTABLE/CAR RADIO



- ★ New printed circuit 6-transistor superhet design. Over 700mW push-pull output.
- ★ Push-button selection of MW and LW with full tuning on both wavebands.
- ★ A new design with amazing performance at a realistic price.
- ★ New attractively designed portable cabinet with horizontal tuning and all stations marked. Size: 10" x 7" x 3½"

Total Cost of **£7.19.6** P.P. (Batteries 6/- extra)

ALL PARTS SOLD SEPARATELY

FOLLOWING A LINE OF QUALITY AND VALUE IN PORTABLES

### ● VHF FM TRANSISTOR TUNER

- ★ Mullard 5-Transistor.
- ★ 4 Diodes.
- ★ Full coverage 87 to 105 Mc/s.
- ★ AFC and AVC.
- ★ Over 1V output.



Printed circuit superhet design of high sensitivity and quality. Output for valve or transistor amplifiers. Size 3½" x 2½" x 3". Simplified building instructions. Operates from 9V 9-10mA. All parts sold separately. Complete with dark brown and gold panel plate.

TOTAL **£7.19.6** P.P. 2/6  
COST (Cabinet assembly 20/- extra)

Detailed Circuit Book on Request

### Minigram Transistor Portable Record Player



★ Made by well known British manufacturer. Features ready built 4 transistor printed circuit, 1 watt amplifier, elliptical speaker and volume control. Low current Starr constant speed 45 r.p.m. turntable with crystal pick-up. Strong moulded two-colour cabinet with handle. Plays anywhere on

long life 9 volt battery. Requires less than half an hour's work to connect up using ready built units and easy instructions.

TOTAL **79/6** P.P. 5/- (Battery 3/9)

Or Amplifier with volume control and 5" x 3" Speaker, 4-Transistor, 35/-, P.P. 2/-  
9V Starr Player with Pick-up 39/6, P.P. 2/6  
And Two-Tone Case 5/-, P.P. 2/-

### ½ WATT 4-TRANSISTOR AMPLIFIER

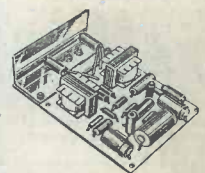

1½ watt peak output.  
±3dB 70 c/s to 12 kc/s.

Built **49/6**  
P.P. 1/6

Output to 3 ohm speaker 9V operated.

Or Kit **39/6**  
P.P. 1/6

Details on request.

- ★ 4 watt peak output
- ★ Full Treble and Bass boost and cut
- ★ 40 c/s to 20 kc/s ±3dB
- ★ Inputs for Pick-ups, Radio Tuners, Microphones, Mixers
- ★ 9-12V mains or battery operation for 3-5Ω speakers (mains unit 49/6 extra)
- ★ Size only 6" x 2½" x 2".

Ideal for mains or battery, portable or domestic record player, grams, etc., or car.

### 7-TRANSISTOR RECORD PLAYER PORTABLE AMPLIFIER

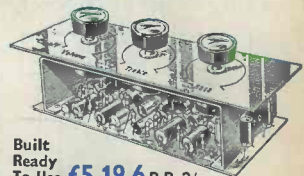

Built Ready To Use **£5.19.6** P.P. 2/-

★ New Improved High Gain Version ★

### LATEST CATALOGUE

86 PAGES, 10" x 7½"  
Now with new valve, transistor and crystal supplement.  
Fully detailed and illustrated.  
Price 2/6 post paid.