

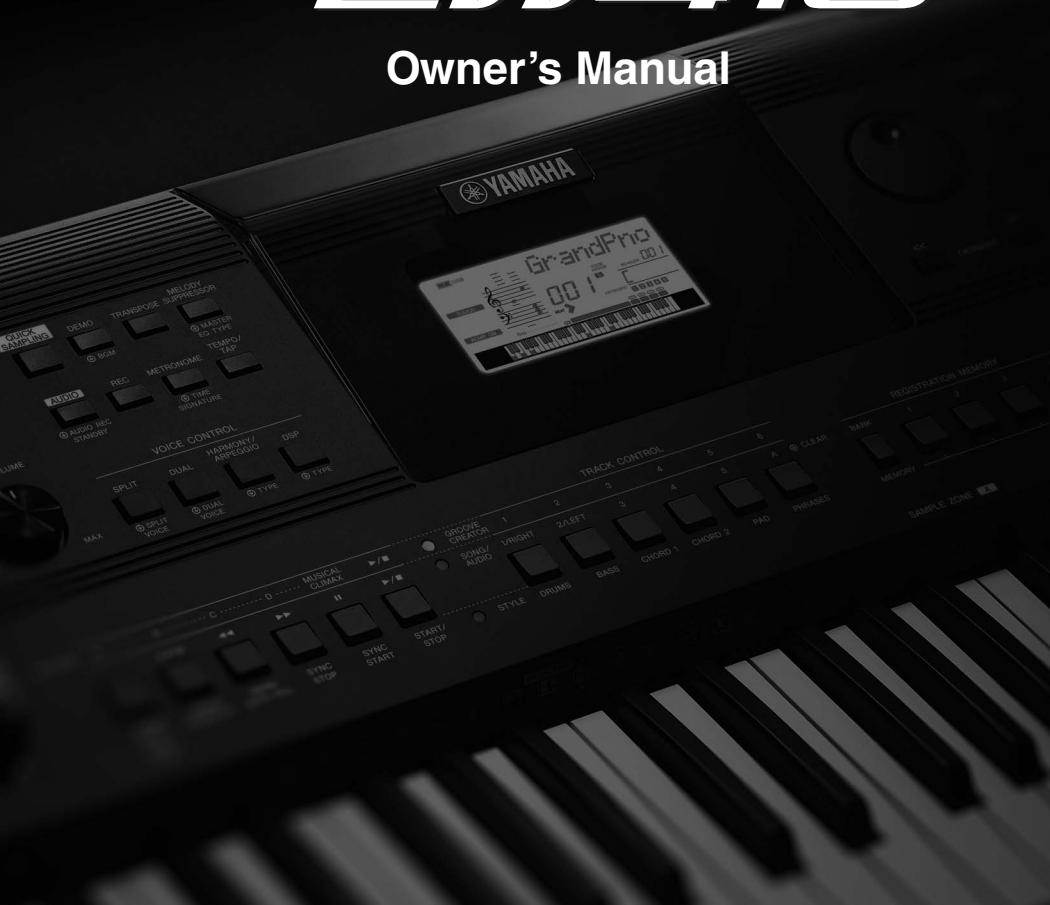

DIGITAL KEYBOARD

# PSR-E463 PSR-EW410

## Owner's Manual



Setting Up

Quick Guide

Reference

Appendix

Thank you for purchasing this Yamaha Digital Keyboard!  
The instrument is a portable keyboard with featuring a wide variety of sounds and functions.  
We recommend that you read this manual carefully so that you can fully take advantage of the advanced and convenient functions of the instrument. We also recommend that you keep this manual in a safe and handy place for future reference.

Before using the instrument, be sure to read "PRECAUTIONS" on pages 5-7.



## SPECIAL MESSAGE SECTION

This product utilizes batteries or an external power supply (adapter). DO NOT connect this product to any power supply or adapter other than one described in the manual, on the name plate, or specifically recommended by Yamaha.

**WARNING:** Do not place this product in a position where anyone could walk on, trip over, or roll anything over power or connecting cords of any kind. The use of an extension cord is not recommended! If you must use an extension cord, the minimum wire size for a 25' cord (or less) is 18 AWG. NOTE: The smaller the AWG number, the larger the current handling capacity. For longer extension cords, consult a local electrician.

This product should be used only with the components supplied or: a cart, rack, or stand that is recommended by Yamaha. If a cart, etc., is used, please observe all safety markings and instructions that accompany the accessory product.

### SPECIFICATIONS SUBJECT TO CHANGE:

The information contained in this manual is believed to be correct at the time of printing. However, Yamaha reserves the right to change or modify any of the specifications without notice or obligation to update existing units.

This product, either alone or in combination with an amplifier and headphones or speaker/s, may be capable of producing sound levels that could cause permanent hearing loss. DO NOT operate for long periods of time at a high volume level or at a level that is uncomfortable. If you experience any hearing loss or ringing in the ears, you should consult an audiologist. IMPORTANT: The louder the sound, the shorter the time period before damage occurs.

Some Yamaha products may have benches and / or accessory mounting fixtures that are either supplied with the product or as optional accessories. Some of these items are designed to be dealer assembled or installed. Please make sure that benches are stable and any optional fixtures (where applicable) are well secured BEFORE using.

Benches supplied by Yamaha are designed for seating only. No other uses are recommended.

### NOTICE:

Service charges incurred due to a lack of knowledge relating to how a function or effect works (when the unit is operating as designed) are not covered by the manufacturer's warranty, and are therefore the owners responsibility. Please study this manual carefully and consult your dealer before requesting service.

### ENVIRONMENTAL ISSUES:

Yamaha strives to produce products that are both user safe and environmentally friendly. We sincerely believe that our products and the production methods used to produce them, meet these goals. In keeping with both the letter and the spirit of the law, we want you to be aware of the following:

### Battery Notice:

This product MAY contain a small non-rechargeable battery which (if applicable) is soldered in place. The average life span of this type of battery is approximately five years. When replacement becomes necessary, contact a qualified service representative to perform the replacement.

This product may also use "household" type batteries. Some of these may be rechargeable. Make sure that the battery being charged is a rechargeable type and that the charger is intended for the battery being charged.

When installing batteries, never mix old batteries with new ones, and never mix different types of batteries. Batteries MUST be installed correctly. Mismatches or incorrect installation may result in overheating and battery case rupture.

### Warning:

Do not attempt to disassemble, or incinerate any battery. Keep all batteries away from children. Dispose of used batteries promptly and as regulated by the laws in your area. Note: Check with any retailer of household type batteries in your area for battery disposal information.

### Disposal Notice:

Should this product become damaged beyond repair, or for some reason its useful life is considered to be at an end, please observe all local, state, and federal regulations that relate to the disposal of products that contain lead, batteries, plastics, etc. If your dealer is unable to assist you, please contact Yamaha directly.

### NAME PLATE LOCATION:

The name plate is located on the bottom of the product. The model number, serial number, power requirements, etc., are located on this plate. You should record the model number, serial number, and the date of purchase in the spaces provided below and retain this manual as a permanent record of your purchase.

Model

---

Serial No.

---

Purchase Date

---

## PLEASE KEEP THIS MANUAL

92-BP (bottom)

### COMPLIANCE INFORMATION STATEMENT (DECLARATION OF CONFORMITY PROCEDURE)

Responsible Party : Yamaha Corporation of America  
Address : 6600 Orangethorpe Ave., Buena Park, Calif. 90620  
Telephone : 714-522-9011  
Type of Equipment : Digital Keyboard  
Model Name : PSR-E463/PSR-EW410

This device complies with Part 15 of the FCC Rules.

Operation is subject to the following two conditions:

- 1) this device may not cause harmful interference, and
- 2) this device must accept any interference received including interference that may cause undesired operation.

See user manual instructions if interference to radio reception is suspected.

\* This applies only to products distributed by YAMAHA CORPORATION OF AMERICA. (FCC DoC)

## FCC INFORMATION (U.S.A.)

**1. IMPORTANT NOTICE: DO NOT MODIFY THIS UNIT!**

This product, when installed as indicated in the instructions contained in this manual, meets FCC requirements. Modifications not expressly approved by Yamaha may void your authority, granted by the FCC, to use the product.

**2. IMPORTANT:** When connecting this product to accessories and/or another product use only high quality shielded cables. Cable/s supplied with this product **MUST** be used. Follow all installation instructions. Failure to follow instructions could void your FCC authorization to use this product in the USA.

**3. NOTE:** This product has been tested and found to comply with the requirements listed in FCC Regulations, Part 15 for Class "B" digital devices. Compliance with these requirements provides a reasonable level of assurance that your use of this product in a residential environment will not result in harmful interference with other electronic devices. This equipment generates/uses radio frequencies and, if not installed and used according to the instructions found in the users manual, may cause interference harmful to the operation of other electronic devices. Compliance with FCC regulations does not guarantee

that interference will not occur in all installations. If this product is found to be the source of interference, which can be determined by turning the unit "OFF" and "ON", please try to eliminate the problem by using one of the following measures:

Relocate either this product or the device that is being affected by the interference.

Utilize power outlets that are on different branch (circuit breaker or fuse) circuits or install AC line filter/s.

In the case of radio or TV interference, relocate/reorient the antenna. If the antenna lead-in is 300 ohm ribbon lead, change the lead-in to co-axial type cable.

If these corrective measures do not produce satisfactory results, please contact the local retailer authorized to distribute this type of product. If you can not locate the appropriate retailer, please contact Yamaha Corporation of America, Electronic Service Division, 6600 Orangethorpe Ave, Buena Park, CA90620

The above statements apply **ONLY** to those products distributed by Yamaha Corporation of America or its subsidiaries.

\* This applies only to products distributed by YAMAHA CORPORATION OF AMERICA.

(class B)

The model number, serial number, power requirements, etc., may be found on or near the name plate, which is at the bottom of the unit. You should note this serial number in the space provided below and retain this manual as a permanent record of your purchase to aid identification in the event of theft.

**Model No.**

---

**Serial No.**

---

(bottom\_en\_01)

## For AC adaptor

This device complies with Part 15 of the FCC Rules. Operation is subject to the following two conditions: (1) this device may not cause harmful interference, and (2) this device must accept any interference received, including interference that may cause undesired operation.

CAN ICES-3 (B)/NMB-3(B)

(can\_b\_02)

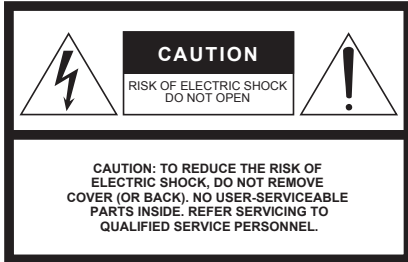

### Explanation of Graphical Symbols



The lightning flash with arrowhead symbol within an equilateral triangle is intended to alert the user to the presence of uninsulated “dangerous voltage” within the product’s enclosure that may be of sufficient magnitude to constitute a risk of electric shock to persons.



The exclamation point within an equilateral triangle is intended to alert the user to the presence of important operating and maintenance (servicing) instructions in the literature accompanying the product.

# IMPORTANT SAFETY INSTRUCTIONS

- 1 Read these instructions.
- 2 Keep these instructions.
- 3 Heed all warnings.
- 4 Follow all instructions.
- 5 Do not use this apparatus near water.
- 6 Clean only with dry cloth.
- 7 Do not block any ventilation openings. Install in accordance with the manufacturer’s instructions.
- 8 Do not install near any heat sources such as radiators, heat registers, stoves, or other apparatus (including amplifiers) that produce heat.
- 9 Do not defeat the safety purpose of the polarized or grounding-type plug. A polarized plug has two blades with one wider than the other. A grounding type plug has two blades and a third grounding prong. The wide blade or the third prong are provided for your safety. If the provided plug does not fit into your outlet, consult an electrician for replacement of the obsolete outlet.
- 10 Protect the power cord from being walked on or pinched particularly at plugs, convenience receptacles, and the point where they exit from the apparatus.
- 11 Only use attachments/accessories specified by the manufacturer.
- 12 Use only with the cart, stand, tripod, bracket, or table specified by the manufacturer, or sold with the apparatus. When a cart is used, use caution when moving the cart/apparatus combination to avoid injury from tip-over.
- 13 Unplug this apparatus during lightning storms or when unused for long periods of time.
- 14 Refer all servicing to qualified service personnel. Servicing is required when the apparatus has been damaged in any way, such as power-supply cord or plug is damaged, liquid has been spilled or objects have fallen into the apparatus, the apparatus has been exposed to rain or moisture, does not operate normally, or has been dropped.



### WARNING

TO REDUCE THE RISK OF FIRE OR ELECTRIC SHOCK, DO NOT EXPOSE THIS APPARATUS TO RAIN OR MOISTURE.

(UL60065\_03)

# PRECAUTIONS

## PLEASE READ CAREFULLY BEFORE PROCEEDING

Please keep this manual in a safe and handy place for future reference.

### For AC adaptor



#### **WARNING**

- This AC adaptor is designed for use with only Yamaha electronic instruments. Do not use for any other purpose.
- Indoor use only. Do not use in any wet environments.



#### **CAUTION**

- When setting up, make sure that the AC outlet is easily accessible. If some trouble or malfunction occurs, immediately turn off the power switch of the instrument and disconnect the AC adaptor from the outlet. When the AC adaptor is connected to the AC outlet, keep in mind that electricity is flowing at the minimum level, even if the power switch is turned off. When you are not using the instrument for a long time, make sure to unplug the power cord from the wall AC outlet.

### For PSR-E463/PSR-EW410



#### **WARNING**

**Always follow the basic precautions listed below to avoid the possibility of serious injury or even death from electrical shock, short-circuiting, damages, fire or other hazards. These precautions include, but are not limited to, the following:**

#### **Power supply/AC adaptor**

- Do not place the power cord near heat sources such as heaters or radiators. Also, do not excessively bend or otherwise damage the cord, or place heavy objects on it.
- Only use the voltage specified as correct for the instrument. The required voltage is printed on the name plate of the instrument.
- Use the specified adaptor (page 80) only. Using the wrong adaptor can result in damage to the instrument or overheating.
- Use only the supplied power cord/plug.
- Check the electric plug periodically and remove any dirt or dust which may have accumulated on it.

#### **Do not open**

- This instrument contains no user-serviceable parts. Do not attempt to disassemble or modify the internal components in any way. If it should appear to be malfunctioning, discontinue use immediately and have it inspected by qualified Yamaha service personnel.

#### **Water warning**

- Do not expose the instrument to rain, use it near water or in damp or wet conditions, or place on it any containers (such as vases, bottles or glasses) containing liquids which might spill into any openings. If any liquid such as water seeps into the instrument, turn off the power immediately and unplug the power cord from the AC outlet. Then have the instrument inspected by qualified Yamaha service personnel.
- Never insert or remove an electric plug with wet hands.

#### **Fire warning**

- Do not put burning items, such as candles, on the unit. A burning item may fall over and cause a fire.

## Battery

- Follow the precautions below. Failure to do so might result in explosion, fire, overheating or battery fluid leakage.
  - Do not tamper with or disassemble batteries.
  - Do not dispose of batteries in fire.
  - Do not attempt to recharge batteries that are not designed to be charged.
  - Keep the batteries separate from metallic objects such as necklaces, hairpins, coins, and keys.
  - Use the specified battery type (page 80) only.
  - Use new batteries, all of which are the same type, same model, and made by the same manufacturer.
  - Always make sure all batteries are inserted in conformity with the +/- polarity markings.
  - When the batteries run out, or if the instrument is not to be used for a long time, remove the batteries from the instrument.
  - When using Ni-MH batteries, follow the instructions that came with the batteries. Use only the specified charger device when charging.

- Keep batteries away from small children who might accidentally swallow them.
- If the batteries do leak, avoid contact with the leaked fluid. If the battery fluid should come in contact with your eyes, mouth, or skin, wash immediately with water and consult a doctor. Battery fluid is corrosive and may possibly cause loss of sight or chemical burns.

## If you notice any abnormality

- When one of the following problems occur, immediately turn off the power switch and disconnect the electric plug from the outlet. (If you are using batteries, remove all batteries from the instrument.) Then have the device inspected by Yamaha service personnel.
  - The power cord or plug becomes frayed or damaged.
  - It emits unusual smells or smoke.
  - Some object has been dropped into the instrument.
  - There is a sudden loss of sound during use of the instrument.



## CAUTION

**Always follow the basic precautions listed below to avoid the possibility of physical injury to you or others, or damage to the instrument or other property. These precautions include, but are not limited to, the following:**

### Power supply/AC adaptor

- Do not connect the instrument to an electrical outlet using a multiple-connector. Doing so can result in lower sound quality, or possibly cause overheating in the outlet.
- When removing the electric plug from the instrument or an outlet, always hold the plug itself and not the cord. Pulling by the cord can damage it.
- Remove the electric plug from the outlet when the instrument is not to be used for extended periods of time, or during electrical storms.

### Location

- Do not place the instrument in an unstable position where it might accidentally fall over.
- Before moving the instrument, remove all connected cables, to prevent damage to the cables or injury to anyone who might trip over them.
- When setting up the product, make sure that the AC outlet you are using is easily accessible. If some trouble or malfunction occurs, immediately turn off the power switch and disconnect the plug from the outlet. Even when the power switch is turned off, electricity is still flowing to the product at the minimum level. When you are not using the product for a long time, make sure to unplug the power cord from the wall AC outlet.

- Use only the stand/rack specified for the instrument. When attaching it, use the provided screws only. Failure to do so could cause damage to the internal components or result in the instrument falling over.

## Connections

- Before connecting the instrument to other electronic components, turn off the power for all components. Before turning the power on or off for all components, set all volume levels to minimum.
- Be sure to set the volumes of all components at their minimum levels and gradually raise the volume controls while playing the instrument to set the desired listening level.

## Handling caution

- Do not insert a finger or hand in any gaps on the instrument.
- Never insert or drop paper, metallic, or other objects into the gaps on the panel or keyboard. This could cause physical injury to you or others, damage to the instrument or other property, or operational failure.
- Do not rest your weight on, or place heavy objects on the instrument, and do not use excessive force on the buttons, switches or connectors.

- Do not use the instrument/device or headphones for a long period of time at a high or uncomfortable volume level, since this can cause permanent hearing loss. If you experience any hearing loss or ringing in the ears, consult a physician.

Yamaha cannot be held responsible for damage caused by improper use or modifications to the instrument, or data that is lost or destroyed.

Always turn the power off when the instrument is not in use.

Even when the [  ] (Standby/On) switch is in standby status (display is off), electricity is still flowing to the instrument at the minimum level.

When you are not using the instrument for a long time, make sure you unplug the power cord from the wall AC outlet.

Make sure to discard used batteries according to local regulations.

## DMI-5 3/3

### **NOTICE**

To avoid the possibility of malfunction/ damage to the product, damage to data, or damage to other property, follow the notices below.

#### ■ Handling

- Do not use the instrument in the vicinity of a TV, radio, stereo equipment, mobile phone, or other electric devices. Otherwise, the instrument, TV, or radio may generate noise. When you use the instrument along with an application on your iPad, iPhone or iPod touch, we recommend that you set “Airplane Mode” to “ON” on that device in order to avoid noise caused by communication.
- Do not expose the instrument to excessive dust or vibrations, or extreme cold or heat (such as in direct sunlight, near a heater, or in a car during the day) to prevent the possibility of panel discoloration, damage to the internal components or unstable operation. (Verified operating temperature range: 5° – 40°C, or 41° – 104°F.)
- Do not place vinyl, plastic or rubber objects on the instrument, since this might discolor the panel or keyboard.

#### ■ Maintenance

- When cleaning the instrument, use a soft cloth. Do not use paint thinners, solvents, alcohol, cleaning fluids, or chemical-impregnated wiping cloths.

#### ■ Saving data

- Some of the data of this instrument (page 49) are retained when the power is turned off. However, the saved data may be lost due to some failure, an operation mistake, etc. Save your important data onto USB flash drive/an external device such as a computer (pages 47, 72). Before using a USB flash drive, make sure to refer to page 78.
- To protect against data loss through USB flash drive damage, we recommend that you save your important data onto spare USB flash drive or an external device such as a computer as backup data.

### **Information**

#### ■ About copyrights

- Copying of the commercially available musical data including but not limited to MIDI data and/or audio data is strictly prohibited except for your personal use.
- This product incorporates and bundles contents in which Yamaha owns copyrights or with respect to which Yamaha has license to use others' copyrights. Due to copyright laws and other relevant laws, you are NOT allowed to distribute media in which these contents are saved or recorded and remain virtually the same or very similar to those in the product.
  - \* The contents described above include a computer program, Accompaniment Style data, MIDI data, WAVE data, voice recording data, a score, score data, etc.
  - \* You are allowed to distribute medium in which your performance or music production using these contents is recorded, and the permission of Yamaha Corporation is not required in such cases.

#### ■ About functions/data bundled with the instrument

- Some of the preset songs and the songs that can be downloaded from the Yamaha website have been edited for length or arrangement, and may not be exactly the same as the original.

#### ■ About this manual

- The illustrations and LCD screens as shown in this manual are for instructional purposes only, and may appear somewhat different from those on your instrument.
- Windows is a registered trademark of Microsoft® Corporation in the United States and other countries.
- iPhone, iPad, iPod touch and macOS are trademarks of Apple Inc., registered in the U.S. and other countries.
- IOS is a trademark or registered trademark of Cisco in the U.S. and other countries and is used under license.
- The company names and product names in this manual are the trademarks or registered trademarks of their respective companies.

# Table of Contents

Special Features .....	8
Compatible Format and Functions .....	10
Included Accessories .....	10
About the Manuals .....	11

## Setting Up

<b>Panel Controls and Terminals</b> .....	<b>12</b>
<b>Setting Up</b> .....	<b>14</b>
Power Requirements .....	14
Turning the Power On/Off .....	16
Adjusting the Master Volume .....	16
Using a Keyboard Stand .....	17

## Quick Guide

<b>Basic Operation and Display Items</b> .....	<b>18</b>
Basic Operation .....	18
Display Items .....	19
<b>Try Playing a Variety of Instrument Voices</b> .....	<b>20</b>
Selecting a Main Voice .....	20
Playing the "Grand Piano" .....	20
Layering a Dual Voice .....	20
Playing a Split Voice in the Left Hand area .....	21
Using the Metronome .....	21
Adding Harmony/Triggering Arpeggios .....	22
Changing the Harmony and Arpeggio types .....	23
Adding DSP Effects .....	24
<b>Creating Original Sounds via the Knobs</b> .....	<b>25</b>
Assigning Functions to the Knobs .....	25
Switching the Target .....	25
Using the Knobs .....	25
<b>Playing Styles</b> .....	<b>26</b>
<b>Playing Songs</b> .....	<b>27</b>
Listening to a Demo Song .....	28

Selecting and Playing Back a Song .....	28
Song Fast Forward, Fast Reverse, and Pause .....	28
Playing a Specified Section of a Song Repeatedly (A-B Repeat) ..	29
Turning Each Track On/Off .....	29
<b>Playing with Groove Creator</b> .....	<b>30</b>
<b>Playing with Quick Sampling</b> .....	<b>31</b>
Playing back the Samples .....	31
Getting Ready for Sampling .....	31
Sampling External Audio Sound .....	32
Restoring the Default Samples .....	34
Saving a Sample to a USB Flash Drive .....	34
Loading a Sample from a USB Flash Drive .....	35
Deleting a Sample in the USB Flash Drive .....	35
<b>Playing Like a DJ!</b> .....	<b>36</b>
Creating an Intro Part with the Track On/Off Controls ...	36
Building Excitement and Interest by Changing Sections ...	36
Adding Effects to the Groove with the Live Control Knobs ...	36
Creating Greater Excitement with the Retrigger Function ...	37
Switching to Another Groove with Musical Climax .....	37
<b>Recording Your Performance</b> .....	<b>38</b>
Track Structure of a Song .....	38
Quick Recording .....	38
Recording to a Specified Track .....	39
Clearing a User Song .....	40
Clearing a Specified Track from a User Song .....	40
<b>Audio Playback and Recording</b> .....	<b>41</b>
Playing back an Audio File in a USB Flash Drive .....	41
Recording/Saving Audio Files to a USB Flash Drive .....	42
Deleting Audio Files from the USB Flash Drive .....	43
<b>Memorizing Your Favorite Settings (Registration Memory)</b> .....	<b>44</b>
Memorizing Panel Settings to the Registration Memory ...	44
Recalling Panel Settings from the Registration Memory ...	44
<b>Connecting to Other Devices</b> .....	<b>45</b>
Connecting Headphones or an External Device .....	45
Using a Pedal (Sustain) .....	45
Playing an External Audio Device with the Built-in Speakers ...	46
Using the Melody Suppressor .....	46

## Special Features



Play the keyboard with any one of the amazing rich and wide-ranging 758 voices. (▶ Page 20)



Take your performance to new levels—whatever music you play—with 235 auto accompaniment Styles. (▶ Page 26)



The 10 DSP (Digital Signal Processor) effects provide powerful ways to enhance and totally change the sound. (▶ Page 24)



The two Live Control Knobs let you add dynamic sound variations—including classic filter effects, distortion and reverb—giving you the tools to completely transform the sound. (▶ Page 25)

## Groove Creator

▶ Page 30

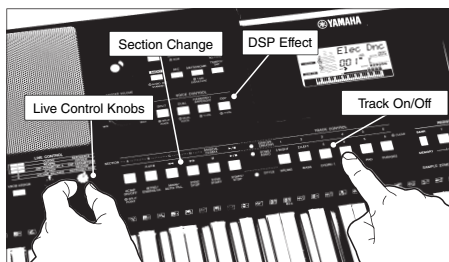

Groove Creator gives you a full selection of powerful dance rhythms—plus amazing real-time controls and DSP effects to help you sound and perform like a pro DJ.



Using with Computer or Smart Device..... 47  
 Using an External Stereo System for Playback  
 (OUTPUT [L/L+R]/[R] jacks) (PSR-EW410) ..... 48  
 Speaker Mute On/Off Setting (PSR-EW410)..... 48  
**Backup and Initialization** ..... **49**  
 Backup Parameters ..... 49  
 Initializing the Instrument..... 49

**Reference**

**Handy Performance Features** ..... **50**  
 Selecting a Reverb Type ..... 50  
 Selecting a Chorus Type ..... 50  
 Pitch Controls—Transpose..... 51  
 Pitch Controls—Fine Tuning..... 51  
 Pitch Controls—the [PITCH BEND] wheel..... 51  
 Calling Up Optimum Panel Settings—One Touch Setting (OTS) .. 51  
 Changing the Touch Response of the Keyboard..... 52  
 Selecting an EQ Setting for the Best Sound..... 52  
**Scale Tuning** ..... **53**  
 Selecting a Scale..... 53  
 Setting the Base Note for Each Scale ..... 53  
 Tuning Each Note to Create an Original Scale..... 54  
**Voice Settings** ..... **55**  
 Selecting a Dual Voice..... 55  
 Selecting a Split Voice..... 55  
 Voice Editing..... 55  
**Arpeggio Settings** ..... **56**  
 Synchronizing an Arpeggio to Song/Style/Groove  
 Playback—Arpeggio Quantize..... 56  
 Holding the Arpeggio Playback via the Footswitch..... 56  
**Parameters Assigned to the Knobs** ..... **57**  
**Style and Groove Settings** ..... **59**  
 Style Variations—Sections ..... 59  
 Style Synchro Stop ..... 60

Turning Each Style Track On/Off..... 60  
 Groove Variations—Sections..... 61  
 Groove Retrigger Function ..... 61  
 Changing the Tempo ..... 61  
 Tap Start ..... 61  
 Adjusting the Volume of the Style or Groove ..... 62  
 Setting the Split Point ..... 62  
 Playing Chords Without Style Playback (Stop Accompaniment) .. 62  
 Chord Types for Style Playback ..... 63

**Song Settings** ..... **64**  
 Background Music Playback..... 64  
 Random Song Playback ..... 64  
 Tempo Setting of the Song ..... 65  
 Tap Start..... 65  
 Song Volume ..... 65  
 Melody Voice Setting of the Preset Song ..... 65  
**The Functions** ..... **66**  
 Basic Procedure in the Function BEND Display ..... 66

**USB Flash Drive Operations** ..... **70**  
 Connecting a USB Flash Drive ..... 71  
 Formatting a USB Flash Drive ..... 72  
 Saving User Data to a USB Flash Drive ..... 72  
 Saving a User Song as SMF to a USB Flash Drive ..... 73  
 Loading User Data from a USB Flash Drive ..... 74  
 Loading a Style File ..... 75  
 Deleting a User File in the USB Flash Drive ..... 76  
 Deleting an SMF File in the USB Flash Drive..... 76  
 Exiting from a File Control Display..... 77  
 Message List..... 77

**Appendix**  
 Troubleshooting..... 78  
 Specifications ..... 79  
 Index..... 81

Setting Up  
 Quick Guide  
 Reference  
 Appendix

**Quick Sampling** ▶ Page 31

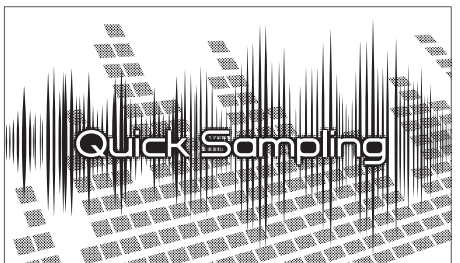

The Quick Sampling feature lets you sample short sounds from an external device, and play them from the keyboard—as rhythm loops, melodies or sound effects—giving you even greater creative expressive tools for your performance.

**USB Audio Recording** ▶ Page 41

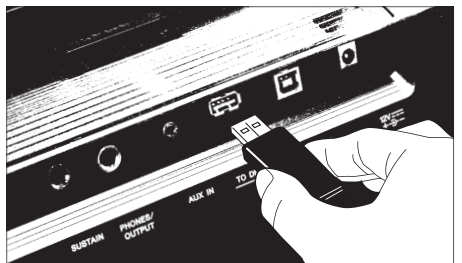

This convenient feature lets you record your performances to a USB flash drive. Since the recorded data is saved as an audio file, you can easily play it back on a computer or portable audio player.

## Compatible Format and Functions



### GM System Level 1

“GM System Level 1” is an addition to the MIDI standard which ensures that any GM-compatible music data can be accurately played by any GM-compatible tone generator, regardless of manufacturer. The GM mark is affixed to all software and hardware products that support GM System Level.



### XGlite

As its name implies, “XGlite” is a simplified version of Yamaha’s high-quality XG tone generation format. Naturally, you can play back any XG song data using an XGlite tone generator. However, keep in mind that some songs may play back differently compared to the original data, due to the reduced set of control parameters and effects.



### USB

USB is an abbreviation for Universal Serial Bus. It is a serial interface for connecting a computer with peripheral Devices. It allows “hot swapping” (connecting peripheral devices while the power to the computer is on).



### STYLE FILE FORMAT (SFF)

The Style File Format is Yamaha’s original style file format which uses a unique conversion system to provide high-quality automatic accompaniment based on a wide range of chord types.

## Included Accessories

- Owner’s Manual (this book)
- AC adaptor\*
- Power cord (PSR-EW410)
- Music rest
- Online Member Product Registration

\* May not be included depending on your area. Check with your Yamaha dealer.

### Attaching the Music Rest

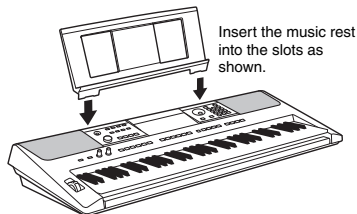

## About the Manuals

This instrument has the following documents and instructional materials.

### NOTE

- The illustrations and displays as shown in this manual are based on the PSR-E463.
- Please note that the PSR-E463 and PSR-EW410 have different numbers of keys: the PSR-E463 has 61 keys, and the PSR-EW410 has 76 keys.

### ■ Included Documents



#### Owner's Manual (this book)

- Setting Up Please read this section first.
- Quick Guide This section explains how to use the basic functions.
- Reference This section explains how to make detailed settings for the various functions of the instrument.
- Appendix This section includes troubleshooting and specifications.

### ■ Online Materials (PDF)



#### Data List

Contains various important preset content lists such as those of Voices, Styles, Grooves and Effects.



#### MIDI Reference

Contains MIDI-related information for this instrument.



#### MIDI Basics (only in English, French, German and Spanish)

Contains basic explanations about MIDI.



#### Computer-related Operations

Includes instructions on connecting this instrument to a computer, and operations related to transmitting/receiving the data.



#### iPhone/iPad Connection Manual

Explains how to connect the instrument to smart devices, such iPhone, iPad, etc.

To see the above materials, access the Yamaha website. Open the following website, enter the model name and search them.

**Yamaha Downloads** <https://download.yamaha.com/>

### ■ Song Book/Song Data

To obtain these materials, access the Yamaha website at "Download" tab below the model name.



#### Song Book (only in English, French, German, Spanish and Japanese)

Contains music scores for the preset Songs (excluding the Demo Songs) of this instrument and the optional Songs.



#### Song Data

Contains the data of 70 Songs that can be played back with this instrument.

### NOTE

- The downloaded Song data can be played back by transferring data from the computer to the instrument or saving data to the USB flash drive (page 27).

# Panel Controls and Terminals

## Front Panel

The illustration is of the PSR-E463.

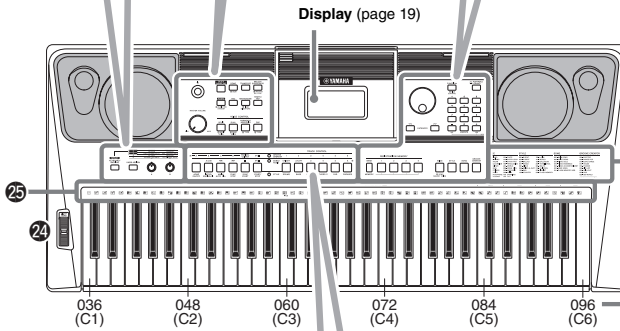
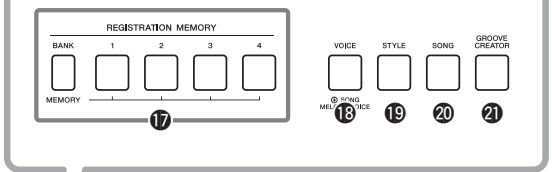
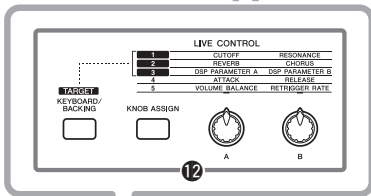
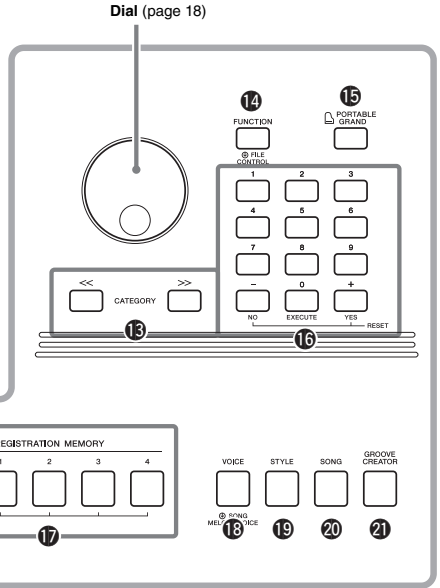
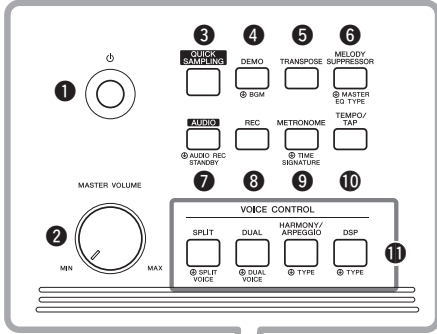

Display (page 19)

- Voice List (Data List)
- Style List (Data List)
- Song List (Data List)
- Groove List (Data List)

As illustrated, each note of the keyboard has a specific note number and name (e.g., 036/C1), which is used in making various settings, such as Split Point (page 62).  
 PSR-E463: 036 (C1) – 096 (C6)  
 PSR-EW410: 028 (E0) – 103 (G6)

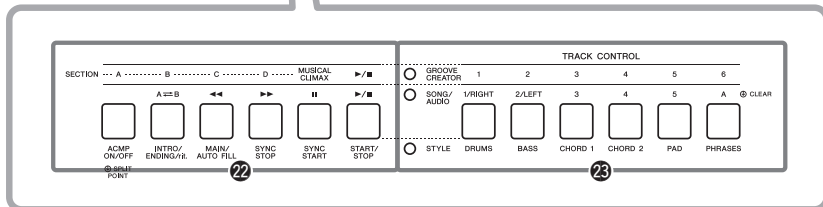

- ❶ [ ⏻ ] (Standby/On) switch ..... page 16
- ❷ [MASTER VOLUME] control ..... page 16
- ❸ [QUICK SAMPLING] button ..... page 20
- ❹ [DEMO] button ..... page 28
- ❺ [TRANPOSE] button ..... page 51
- ❻ [MELODY SUPPRESSOR] button ..... page 46
- ❼ [AUDIO] button ..... page 41
- ❽ [REC] button ..... page 38
- ❾ [METRONOME] button ..... page 21
- ❿ [TEMPO/TAP] button ..... page 61
- ⓫ VOICE CONTROL section
  - [SPLIT] button ..... page 21
  - [DUAL] button ..... page 20
  - [HARMONY/ARPEGGIO] button ..... page 22
  - [DSP] button ..... page 24
- ⓬ LIVE CONTROL section
  - [KNOB ASSIGN] button ..... page 25
  - [A] and [B] knobs ..... page 25
  - [TARGET] button ..... pages 24, 25
- ⓭ CATEGORY buttons ..... page 18
- ⓮ [FUNCTION] button ..... page 66
- ⓯ [PORTABLE GRAND] button ..... page 20
- ⓰ Number buttons [1]–[9], [–/NO], [0/EXECUTE] and [+ /YES] buttons ..... page 18
- ⓱ REGISTRATION MEMORY buttons
  - [BANK/MEMORY] buttons ..... page 44
  - [1]–[4] buttons ..... page 44
- ⓲ [VOICE] button ..... page 20
- ⓳ [STYLE] button ..... page 26
- ⓴ [SONG] button ..... page 28
- ⓵ [GROOVE CREATOR] button ..... page 30
- ⓶ GROOVE CREATOR/SONG/STYLE Control buttons
  - When the [GROOVE CREATOR] lamp is on: ..... pages 30 and 61
  - When the [SONG/AUDIO] lamp is on: ..... page 28
  - When the [STYLE] lamp is on: ..... pages 26, 59, and 60
- ⓷ TRACK CONTROL buttons
  - When the [GROOVE CREATOR] lamp is on: ..... page 30
  - When the [SONG/AUDIO] lamp is on: ..... pages 29, 38
  - When the [STYLE] lamp is on: ..... page 60
- ⓸ [PITCH BEND] wheel ..... page 51
- ⓹ Drum illustrations for the Drum Kit ..... page 20
 

These indicate the drum or percussion instrument assigned to the corresponding keys (in the case of “Standard Kit 1,” shown in the Drum/SFX Kit List of the online material Data List).

Rear Panel

PSR-E463

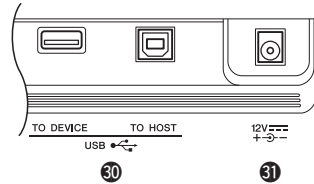
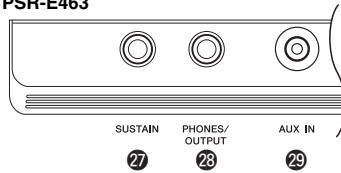

PSR-EW410

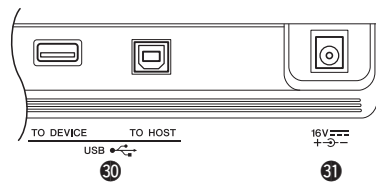
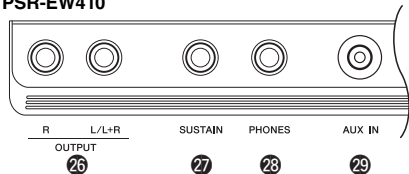

- ❷ OUTPUT [L/L+R]/[R] jacks (PSR-EW410) ..... page 48
- ❸ [SUSTAIN] jack ..... page 45
- ❹ [PHONES/OUTPUT] jack (PSR-E463), [PHONES] jack (PSR-EW410) ..... page 45
- ❺ [AUX IN] jack ..... page 46
- ❻ [USB TO DEVICE] terminal ..... page 70
- ❼ [USB TO HOST] terminal ..... page 47
- ❽ DC IN jack ..... page 14

Panel Setup (Panel Settings)

By using the controls on the panel, you can make various settings as described here. These settings of the instrument are together referred to as “panel setup” or “panel settings” in this manual.

# Setting Up

## Power Requirements

Although the instrument will run either from an AC adaptor or batteries, Yamaha recommends use of an AC adaptor whenever possible. An AC adaptor is more environmentally friendly than batteries and does not deplete resources.

### NOTICE

- You should use an AC adaptor when executing USB flash drive operations, since battery power may not be reliable enough to last through these crucial operations.

## Using an AC Adaptor

Connect the AC adaptor in the order shown in the illustration.

### PSR-E463

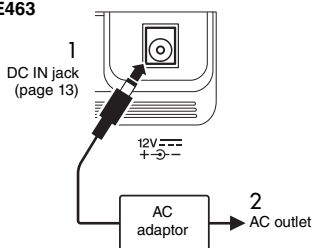

### PSR-EW410

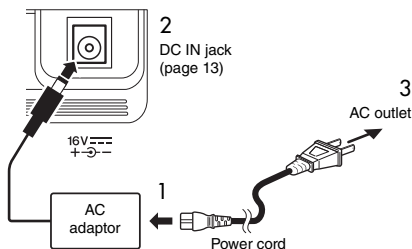

The shape of the plug differs depending on your area.

### WARNING

- Use the specified AC adaptor (page 80) only. Using the wrong AC adaptor can result in damage to the instrument or overheating.

### WARNING (PSR-E463)

- When using the AC adaptor with a removable plug, make sure to keep the plug attached to the AC adaptor. Using the plug alone can cause electric shock or fire.
- Never touch the metallic section when attaching the plug. To avoid electric shock, short circuit or damage, also be careful that there is no dust between the AC adaptor and plug.

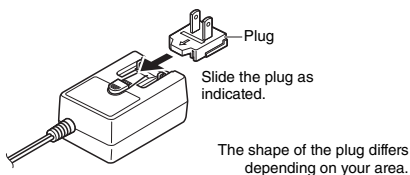

### CAUTION

- When setting up the product, make sure that the AC outlet you are using is easily accessible. If some trouble or malfunction occurs, immediately turn the power off and disconnect the plug from the outlet.

### NOTE

- Follow this procedure in reverse order when disconnecting the AC adaptor.

## Using Batteries

This instrument requires the following batteries.

- **PSR-E463:** Six "AA" size alkaline (LR6), manganese (R6) or Ni-MH rechargeable batteries.
- **PSR-EW410:** Six "D" size alkaline (LR20), manganese (R20) or Ni-MH rechargeable batteries.

The Alkaline batteries or rechargeable Ni-MH batteries are recommended for this instrument, since other types may result in poorer battery performance.

### NOTICE

- When using Ni-MH batteries, follow the instructions that came with the batteries.

- 1 Make sure that the power of the instrument is off.
- 2 Open the battery compartment cover located on the instrument's bottom panel.

### PSR-E463

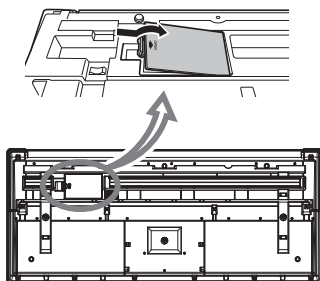

**PSR-EW410**

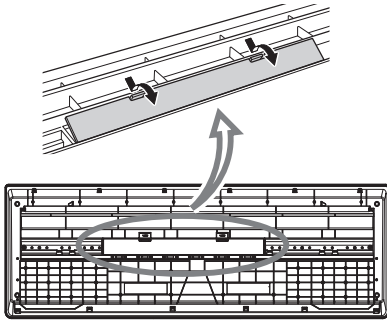

- 3 Insert the six new batteries, putting them in the correct direction according to the illustration.

**PSR-E463**

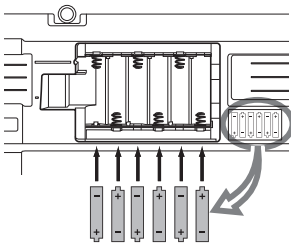

**PSR-EW410**

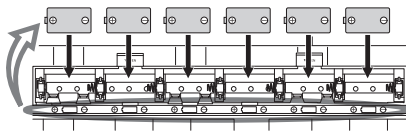

- 4 Replace the compartment cover, making sure that it locks firmly in place.

**NOTICE**

- Connecting or disconnecting the AC adaptor with batteries installed may turn the power off, resulting in loss of data being recorded or transferred at the time.
- Make sure to set the battery type correctly (page 15).
- When battery power becomes too low for proper operation, the volume may be reduced, the sound may be distorted, and other problems may occur. When this happens, make sure to replace all batteries with new ones or already-recharged ones.

**NOTE**

- This instrument cannot charge the batteries. Use only the specified charger device when charging.
- Power will be automatically drawn from the AC adaptor if an AC adaptor is connected while batteries are installed in the instrument.

**Setting the battery type**

Depending on the battery type to be used, you may need to change the battery type setting on this instrument. To change the setting, first turn on the power to the instrument, then choose the battery type you would like to use. Alkaline (and manganese) batteries are chosen by default. For details, refer to page 69, Function 064 (PSR-E463)/Function 065 (PSR-EW410).

**NOTICE**

- Failure to set the battery type may shorten the amount of the battery life. Make sure to set the battery type correctly.

**Checking the power status**

You can confirm the power source at the left corner of the display.

Only one of these is shown.



- ☐ : The power is supplied from the AC adaptor.
- : The power is supplied from the batteries.

**NOTE**

- When the AC adaptor is plugged in to the AC outlet, the battery icon does not appear even when batteries are inserted. In this case, the power is supplied from the AC adaptor.

**Remaining battery power indication**

	Indicates that the power will be turned off immediately. When rechargeable batteries are used, this icon flashes before the power is turned off.
	Indicates that remaining power is insufficient for operation. Before the power runs out, replace all the batteries with new ones, or fully recharged ones (when using rechargeable types). Note that the instrument may not work properly, including unusually soft volume and poor sound quality when remaining power becomes low.
	Indicates that the remaining power is sufficient.

## Turning the Power On/Off

- 1 Turn down the [MASTER VOLUME] control to “MIN”.

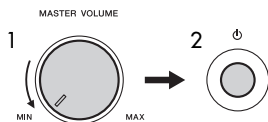

- 2 Press the [⏻] (Standby/On) switch to turn the power on.
- 3 Press and hold the [⏻] (Standby/On) switch for about a second to turn the power off.

### CAUTION

- Even when the power is off, a small amount of electricity is still being consumed by the instrument. When you are not using the instrument for a long time, make sure to unplug the AC adaptor from the wall AC outlet.

### NOTICE

- Press only the [⏻] (Standby/On) switch when turning the power on. Any other operations such as pressing keys, buttons or the pedal are not allowed. Doing so may cause the instrument to malfunction.

## Setting the Auto Power Off function

To prevent unnecessary power consumption, this instrument features an Auto Power Off function that automatically turns the power off if the instrument is not operated for a specified period of time. The amount of time that elapses before the power is automatically turned off is 30 minutes by default; however, you can change the setting. For details, refer to page 69, Function 063 (PSR-E463)/Function 064 (PSR-EW410).

### ■ Disabling Auto Power Off (simple method)

Turn the power on while holding down the lowest key on the keyboard. This starts the instrument with the Auto Power Off function disabled.

#### PSR-E463



The lowest key

+

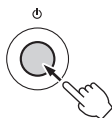

#### PSR-EW410



### NOTICE

- When the instrument is not operated for a specified period of time while connected to an external device such as an amplifier, speaker or computer, make sure to follow the instructions in the Owner's Manual to turn off the power to the instrument and the connected devices, in order to protect the devices from damage. If you do not want the power to turn off automatically when a device is connected, disable Auto Power Off.

### NOTE

- Generally, the data and settings are maintained even when the power is turned off. For details, see page 49.

## Adjusting the Master Volume

To adjust the volume of the entire keyboard sound, use the [MASTER VOLUME] control while playing the keyboard.

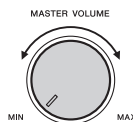

### CAUTION

- Do not use the instrument for a long period of time at a high or uncomfortable volume level, since this can cause permanent hearing loss.



## Using a Keyboard Stand

The following keyboard stands (sold separately) can be used.

- **PSR-E463:** L-2C
- **PSR-EW410:** L-6

### When using the L-6 Keyboard Stand (PSR-EW410)

The exterior size of PSR-EW410 exceeds the limits as described in the L-6 Assembly Instructions. However, we have determined through tests that the stand can be safely used for the instrument. When setting the instrument, place it on the center of the stand as shown in the illustration.

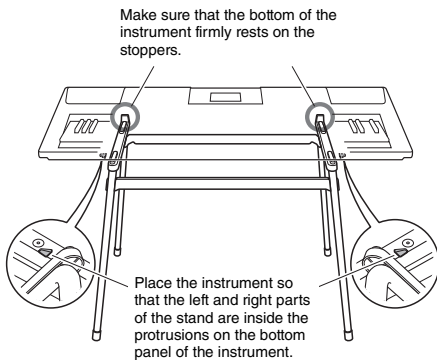

#### CAUTION

- *Do not place the instrument in an unstable position where it might accidentally slip down. This could cause physical injury to you or others, as well as damage to the instrument or other property.*

# Basic Operation and Display Items

## Basic Operation

This instrument features four basic functions: Voice, Style, Song and Groove Creator. To use this instrument, select a basic function first, and then make various settings.

**1** Select a basic function.

**2** Select an item or value.

**3** Start a function or play the keyboard.

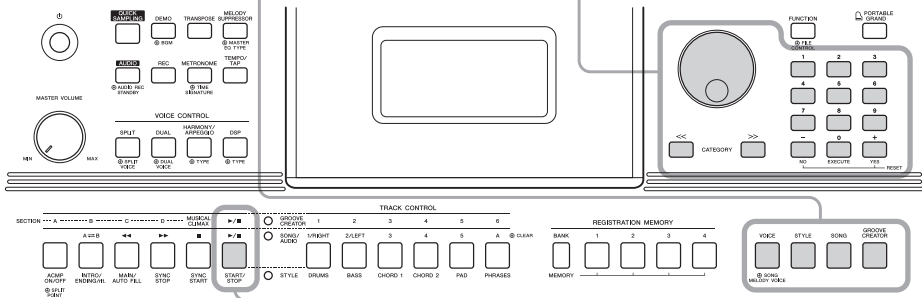

Quick Guide

### Dial

Rotate the dial clockwise to increase the value of the selected item, or counter-clockwise to decrease its value.

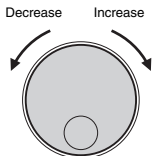

\* In most procedures described throughout this manual, the dial is used for selecting items or changing values. Note however, that in most cases in which the dial can be used to change values, the [+ / YES] and [- / NO] buttons can also be used.

### CATEGORY [<<], [>>] buttons

When selecting a Voice, Style, Groove, Song, etc., you can use these buttons to jump to the first item in the next or previous category. These buttons can also be used to select function items sequentially after pressing the [FUNCTION] button.

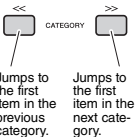

### Number buttons [0]–[9]

Use these buttons to directly enter the desired Style/Voice number etc, or a parameter value.

**Example:**  
Selecting Voice 003,  
Bright Piano.

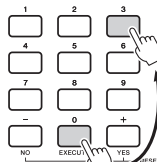

Press number buttons [0], [0], [3].

### [+ / YES], [- / NO] buttons

Press the [+ / YES] button briefly to increase the value by 1, or press the [- / NO] button briefly to decrease the value by 1. Press and hold either button to continuously increase or decrease the value in the corresponding direction.

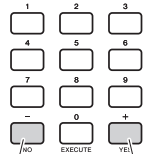

Press briefly to decrease. Press briefly to increase.

Pressing both buttons simultaneously lets you reset a parameter to the default value.

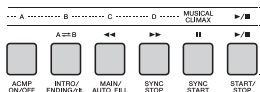

Depending on the basic function selected in step 1, you can use the different functions as printed on the panel. Song functions are printed above the buttons, Groove Creator functions are printed further above, and Style functions are printed below.



### The "Press & Hold" Symbol

Buttons having this indication can be used to call up an alternate function when the relevant button is pressed and held. Hold down this button until the function calls up.

# Display Items

The display shows all the current settings of the Song, Style, Groove, Voice and other related functions.

The illustration is from the PSR-E463.

### Power source status

Indicates the source from which this instrument obtains power: AC adaptor or batteries (page 15).



### USB connection status

Appears when a USB flash drive is connected to this instrument (page 71).

**USB**

### Notation

Normally this indicates the notes you play.

**NOTE**

- Any notes occurring below or above the staff are indicated by "8va."
- For a few specific chords, not all notes may be shown, due to space limitations in the display.



### Mode

**AUDIO**

Indicates that Audio Mode is enabled, allowing you to play back or record audio files from/to a USB flash drive (pages 41, 42).

**SAMPLING**

Indicates that the Quick Sampling mode is enabled, allowing you to sample sounds from an external audio device (page 31).

### Sample Zone status

Indicates the assign status of the Sample feature. When a Sample type is set to Loop, (↻) is displayed.



### On/off status

This area indicates the on/off status of each function. Each indication is shown when the corresponding function is turned on.

- SPLIT** page 21
- DUAL** page 20
- HARMONY** page 22
- ARPEGGIO** page 22
- TOUCH** page 52
- DSP** page 24
- SCALE** page 53
- MELODY SUPPRESSOR** page 46
- ACMP ON** page 26
- SYNC STOP** page 60

### Beat

Indicates the current beat of playback (page 28).

BEAT 

### Knob assignment

Indicates the parameters and target currently assigned to the knobs (page 25).



### FUNCTION and MEASURE

Indicates the Function number when the [FUNCTION] button is pressed, or the current Measure number during playback of a Song, Style or Groove.

FUNCTION MEASURE **001**

### Chord

Indicates the chord which is being played in the Auto Accompaniment range (page 26) or specified via Song playback.

**F**

### Track status

Indicates the on/off status of the current Song, Style or Groove (pages 29, 38, 60).

**1 2 3 4 5 6 A**

Quick Guide

# Try Playing a Variety of Instrument Voices

This instrument features various instrumental Voices including piano. Not only can you play just one single Voice (Main Voice), but you can also layer a different Voice (Dual Voice) to the Main Voice, or play a different Voice (Split Voice) in the left-hand area of the keyboard from the right-hand area.

## Selecting a Main Voice

### 1 Press the [VOICE] button.

The Voice number and name will be shown. For a list of available Voices, refer to the Voice List in the separate Data List.

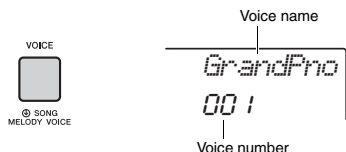

#### NOTE

- Voice number 001 on the PSR-EW410 is "Live! Grand Piano."

### 2 Use the dial to select the desired Voice.

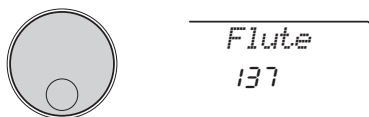

### 3 Play the keyboard.



## Preset Voice Types

001–237	Instrument Voices.
238–261 (Drum/SFX Kit)	Various drum/percussion or SFX sounds are assigned to individual keys. Details on assigning instruments to keys are provided in the Drum/SFX Kit List of the separate Data List.
262–301	Used for Arpeggio performance (page 22).
302–758	XGlite Voices.
759	Sample Voice.
000	Selecting this automatically calls up the most suitable Voice and panel setups for the current Style, Song or Groove. This function is called OTS (page 51).

## Playing the "Grand Piano"

When you want to reset various settings to their defaults and simply play a Piano sound, press the [PORTABLE GRAND] button.



The Voice for the entire keyboard will be set to 001 "Grand Piano" (PSR-E463) or "Live! Grand Piano" (PSR-EW410).

## Layering a Dual Voice

In addition to the Main Voice, you can layer a second, different Voice over the entire keyboard as a "Dual Voice."

### 1 Press the [DUAL] button to turn Dual on.

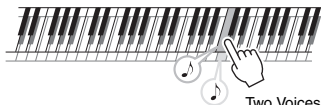

Two Voices will sound at the same time.

### 2 Press the [DUAL] button again to exit from Dual.

Although turning on Dual will select a Dual Voice suitable for the current Main Voice, you can also select a different Dual Voice (page 55).

## Playing a Split Voice in the Left Hand area

By dividing the keyboard into the two separate areas, you can play a different Voice between the Left hand and Right hand areas.

- 1 Press the [SPLIT] button to turn Split on.



The keyboard is divided into left and right hand area at the Split Point. You can play a Split Voice on the left hand area while playing a Main Voice and Dual Voice on the right hand area of the keyboard.

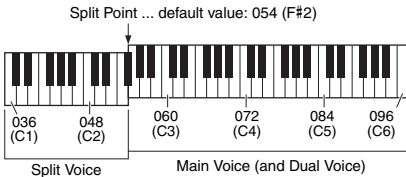

The Split Voice (page 55) and the Split Point can be changed as desired (page 62).

- 2 Press the [SPLIT] button again to exit from Split.

## Using the Metronome

This instrument features a built-in metronome which can be used when practicing.

- 1 Press the [METRONOME] button to start the metronome.



- 2 Press the [METRONOME] button again to stop the metronome.

## Adjusting the Metronome Tempo

This operation lets you adjust not only the metronome tempo, but also the tempo of Style, Song and Groove.

- 1 Press the [TEMPO/TAP] button to call up "Tempo."

The current tempo is shown on the display.

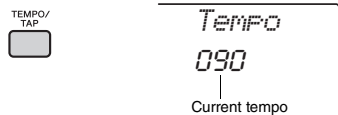

- 2 Adjust the tempo by rotating the dial.

## Setting the Time Signature

This operation lets you change the time signature from the default value. In this example, we'll set a time signature of 6/8.

- 1 Hold down the [METRONOME] button for longer than a second to call up "Time-Sign" (Time Signature Numerator).

The number of beats per measure is shown on the display.

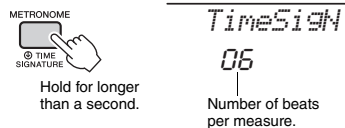

## 2 Rotate the dial to select the number of beats per measure.

A chime will sound on the first beat of each measure while a click sounds the other beats. If “0” is selected, a click sounds for all beats with no chime accent. Select 6 for this example.

**NOTE**

- This parameter cannot be set during playback of a Style, Song or Groove.

## 3 Press the CATEGORY [ >> ] button once to call up “TimeSigD” (Time Signature Denominator).

The length of one beat is shown on the display.

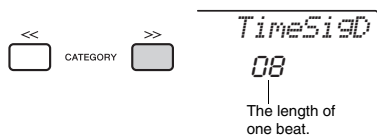

## 4 Rotate the dial to select the length of one beat, from 2<sup>nd</sup>, 4<sup>th</sup>, 8<sup>th</sup> and 16<sup>th</sup> note values.

Select “08” (8<sup>th</sup> note) for this example.

## 5 Confirm the setting by playing the Metronome.

### Setting the Metronome Volume

#### 1 Press the [FUNCTION] button.



## 2 Use the CATEGORY [ << ] and [ >> ] buttons to call up “MtrVol” (Function 060).

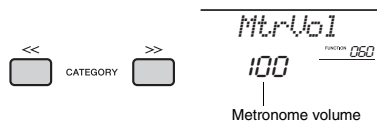

## 3 Rotate the dial to set the volume.

## Adding Harmony/Triggering Arpeggios

You can add effects such as Harmony, Tremolo and Echo to the Main Voice. For a list of the effects, refer to the Harmony Type List in the online material Data List.

### 1 Press the [HARMONY/ARPEGGIO] button to turn Harmony or Arpeggios on.

The HARMONY or ARPEGGIO icon appears on the display and the Harmony effect or the Arpeggio function are turn on.

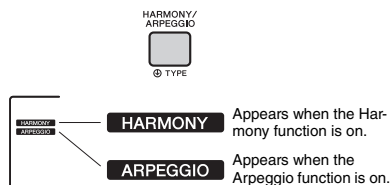

Although turning on the Harmony or the Arpeggio will select a Harmony type or an Arpeggio type suitable for the current Main Voice, you can select a different Harmony type or Arpeggio type (page 23).

### 2 Press a note or notes to add a Harmony or trigger an Arpeggio.

The operation differs depending on the Harmony type. Try playing the keyboard by referring to “Playing each Harmony Type” (see next page), and the Harmony Type List on online material Data List.

The Arpeggio phrase differs depending on the number of pressed notes and the area of the keyboard.

### 3 Press the [HARMONY/ARPEGGIO] button again to turn the Harmony or Arpeggio off.

**NOTE**

- When Split (page 21) is on, Arpeggio is applied only to the Split Voice. When Split is off, Arpeggio is applied to the Main and Dual Voices. Arpeggio cannot be applied to the Split and Main/Dual Voices simultaneously.
- Selecting a Voice number between 292 and 301 will turn on Split automatically, as well as Arpeggio. When one of those Voices is selected, Arpeggio is applied only to the Split Voice and is triggered only by playing a key to the left of the Split Point.
- By assigning the Arpeggio Hold function to the foot-switch, the Arpeggio will continue to play after the note is released (page 68).

**Playing each Harmony Type**

- Harmony types 01 to 05



Press the right-hand keys while playing chords in the Auto Accompaniment area of the keyboard when ACMP is on (page 26).

- Harmony types 06 to 12 (Trill)



Hold down two keys.

- Harmony types 13 to 19 (Tremolo)



Keep holding down the keys.

- Harmony types 20 to 26 (Echo)



Play the keys.

## Changing the Harmony and Arpeggio types

- 1 Hold down the [HARMONY/ARPEGGIO] button for longer than a second.

After “Harm/Arp” (Function 041) appears on the display, the current Harmony type or Arpeggio type appears.

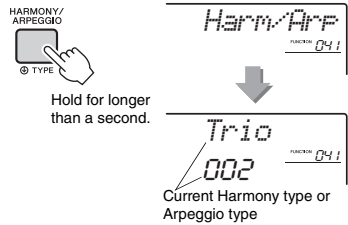

- 2 Rotate the dial to select the desired Harmony type or Arpeggio type.

**NOTE**

- 001 to 026 are Harmony types. 027 to 176 are Arpeggio types. Refer to the Harmony Type List / Arpeggio Type List on web material Data List.
- When playing one of the Arpeggio types 143 or later, select a Drum Kit (Voice No.238–261) as the Main Voice.

### Adjusting the Harmony Volume

You can adjust the Harmony volume in the Function Settings (page 68, Function 042).

### Adjusting the Arpeggio Velocity

You can adjust the Arpeggio velocity in the Function Setting (page 68, Function 043).

## Adding DSP Effects

DSP is an abbreviation for Digital Signal Processor, and provides effects that enhance the sound. DSP effects are applied only to a specified target as described below.

### Parts to which DSP effects are applied

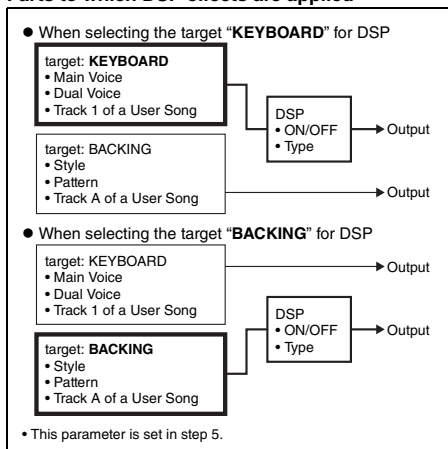

### 1 Press the [DSP] button to turn DSP on.



Although turning on DSP will select a DSP type suitable for the current panel setting, you can select a different DSP type as described in the following steps.

### 2 Hold down the [DSP] button for longer than a second to call up "DSP Type" (Function 040).

After a few seconds, the current DSP type appears.

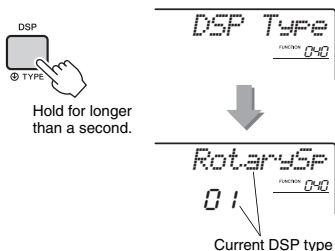

### 3 Rotate the dial to select a DSP type.

For information about the available DSP types, refer to the Effect Type List in the Data List.

### 4 Press [KNOB ASSING] button to select 3.

### 5 Press the [TARGET] button and select the target.

When KEYBOARD is selected, the DSP affects the Main Voice, Dual Voice or track 1 of a User Song. When BACKING is selected, it affects the Style, Groove Creator or track A of a User Song.

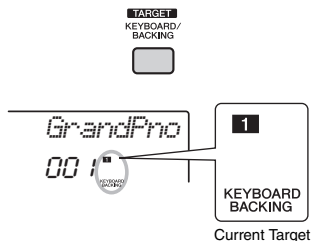

### 6 Press the [DSP] button again to turn DSP off.

#### Limitations when recording a Song

- DSP effects can be recorded only to Tracks 1 and A.
- The DSP type and target cannot be changed while recording.
- When recording to an existing User Song, if the target to which the DSP effects are applied differs from the recording tracks, DSP related setting data (DSP target, type, parameter A/B) will not be recorded or overwritten.
- The DSP effects may not be applied as expected when a User Song is being played back. This is because the DSP effects are affected by the data recorded to the User Song.



# Creating Original Sounds via the Knobs

The two knobs can be used to add variations to the sound being played, transforming the sound in a variety of musical ways. Select the desired pre-programmed function combination printed above the knobs, then rotate the knobs as you play, for an expressive, dynamic performance.

## Assigning Functions to the Knobs

Repeatedly press the [KNOB ASSIGN] button to sequentially assign the function combinations provided: **1** → **2** → **3** → **4** → **5** → **1** ... etc. The current combination is shown in the display.

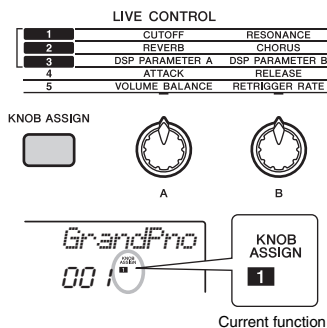

The target differs depending on the selected number.

Function	Target
1 CUTOFF/RESONANCE	Main Voice, Dual Voice, Style and Groove
2 REVERB/CHORUS	Main Voice, Dual Voice, Style, Groove and User Song
3 DSP	Main Voice and Dual Voice
4 ATTACK/RELEASE	Knob A: Audio input from the external device, and Style/ Groove/Song Knob B: Groove

For details about each function, refer to page 57.

### NOTE

- Only selecting a function combination will not affect the sound even if the knob arrow is not at the center position. The selected function only works when the knob is moved.
- Depending on the panel settings or how you move the knob, you may not notice any change to the parameter value, or you may hear a noise, or the knob may not work properly, even if you rotate it.

## Switching the Target

Press the [TARGET] button to switch the target controlled with the knobs. The current target is shown in the display.

- KEYBOARD:** Main Voice, Dual Voice and User Song (only Function 3)
- BACKING:** Style, Groove and User Song (only Function 3)

### NOTE

- The target differs depending on the selected function.
- The target is memorized for each function.

## Using the Knobs

Here is an example of how to use the knobs. For some other ideas for using the knobs, refer to page 58.

- Select the desired Main Voice (page 20).** Here, select Voice No.156 "SquareLD" (Square Lead) as a synth-lead type Voice.
- Press the [KNOB ASSIGN] button several times until **1** appears in the display.**
- Press the [TARGET] button to switch the target to KEYBOARD.**
- Rotate knob B all the way to the right (maximum), then play the keyboard with your right hand while operating the knob A with your left.**

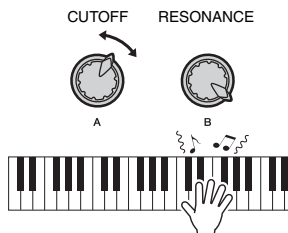

### NOTICE

- After selecting **1**, **2** or **3** by pressing the [KNOB ASSIGN] button, changing the Voice will replace the settings created via the knobs with the default settings of the new Voice. If you want to keep the settings you have created, make sure to memorize it to Registration Memory (page 44) before selecting a different Voice.

### NOTE

- Rotating a knob to the right while the volume is set to a high level may result in distortion. If this occurs, reduce the volume level.

# Playing Styles

This instrument includes an Auto Accompaniment feature that plays appropriate “Styles” (rhythm + bass + chord accompaniment). You can select from a huge variety of Styles covering a wide range of musical genres.

## 1 Press the [STYLE] button, then use the dial to select the desired Style.

For the Style List, refer to the online material Data List.

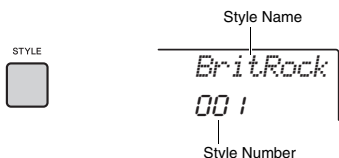

### NOTE

- Press the CATEGORY [ $\ll$ ][ $\gg$ ] button to change the musical genre. Refer to the Style List at the top of the panel.

STYLE	
001-B BEAT	128-LATIN
024-16 BEAT	161-WORLD
034-BALLAD	189-BALLROOM
047-DANCE	200-TRADITIONAL
081-DISCO	209-WALTZ
089-SWING & JAZZ	218-CHILDREN
105-R&B	223-PIANIST
120-COUNTRY	236-FLASH MEMORY

## 2 Press the [ACMP ON/OFF] button to turn on the Auto Accompaniment (ACMP).

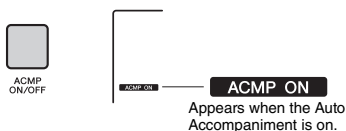

Appears when the Auto Accompaniment is on.

With this operation, the area of the keyboard to the left of the Split Point becomes the “Auto Accompaniment area” and is used only for specifying the chords. The rhythm part as well as the bass and chord accompaniment play back when you play chords.

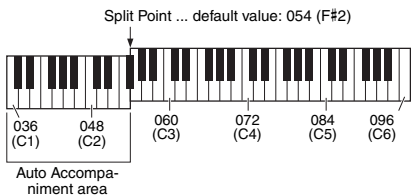

The Split Point can be changed as desired (page 62).

## 3 Press the [SYNC START] button to turn Synchro Start on.

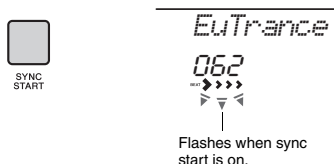

This puts the Style playback in “standby” and Style starts playing back when you play the keyboard.

## 4 Play a chord in the Auto Accompaniment area to start playback.

Play a melody with the right hand and chords with the left hand.

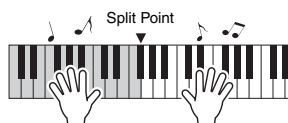

### NOTE

- For information about how to play chords, refer to page 63.

## 5 Press the [START/STOP] button to stop playback.



You can easily add variations to your performance by changing the section of the Style. For details, refer to page 59.

# Playing Songs

This instrument can play **Preset Songs, Songs you recorded on this instrument, or commercially available Songs.** In addition to listening to these Songs, you can play the keyboard along with the Song as it plays back.

## MIDI Data

A MIDI Song is comprised of your keyboard performance information and is not a recording of the actual sound itself. The performance information refers to which keys are played, at what timing, and at what strength—just as in a musical score. Based on the recorded performance information, the tone generator (of the Clavinova, etc.) outputs the corresponding sound. A MIDI Song uses a small amount of data capacity in comparison to an Audio song, and allows you to easily change aspects of the sound, such as Voices used, etc.

### NOTE

- For details on Audio playback and recording, refer to page 42.

## ● Song Category

The Songs are organized by category as listed below.

### SONG

- |                           |  |
|---------------------------|--|
| 001 - MAIN DEMO           | • Gives you an idea of the advanced capabilities of this instrument.             |
| 004 - VOICE DEMO          | • Demonstrates many useful Voices of this instrument.                            |
| 012 - PIANO SOLO          | • Enjoyable piano solo performances.   |
| 016 - PIANO ENSEMBLE      | • These songs are piano ensemble pieces. Enjoy the sound of piano and orchestra. |
| 021 - PIANO ACCOMPANIMENT | • Enjoyable piano accompaniment in a variety of genres.                          |
| 031 - USER SONG           | • Songs you've record yourself (page 38).  |
| 041 - FLASH MEMORY/USB    | • FLASH MEMORY: Songs transferred from a computer (page 47).                     |
|                           | • USB: Songs in the USB flash drive (page 70).                                   |

### NOTE

- In addition to the 30 preset Songs in this instrument, you can enjoy extra Songs downloadable from the Yamaha website. For details, refer to page 11.
- For instructions on transferring Songs from a computer to this instrument, refer to the online PDF manual (page 11) "Computer-related Operations."  
The numbers are generally assigned to the Songs in the following sequence: Songs transferred from a computer; Songs in the USB flash drive. When you transfer a Song from a computer while the USB flash drive is connected to the instrument, the transferred Song will be inserted before the first USB Song number, moving all USB Song numbers later in sequence.

## Listening to a Demo Song

Press the [DEMO] button to play Demo Songs 001–003 in sequence. Playback will repeat continuously, starting again from the first Song (001).



To stop playback, press the [DEMO] or [▶/■] (Start/Stop) button.

Hold down the [DEMO] button for longer than a second to use the instrument as a background music source (page 64).

## Selecting and Playing Back a Song

1 Press the [SONG] button, then rotate the dial to select the desired Song.

For a list of available Songs, refer to the Song List in the separate Data List.

You can select User Songs, Songs transferred from a computer, and Songs in the USB flash drive in the same way as above.

**NOTE**

- The selectable Songs are number 4 and later. When selecting the number 1 to 3, press [DEMO] button.

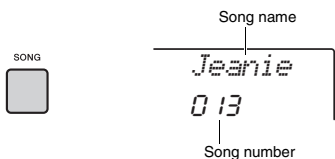

2 Press the [▶/■] (Start/Stop) button to start playback.

To stop playback, press the [▶/■] (Start/Stop) button again.

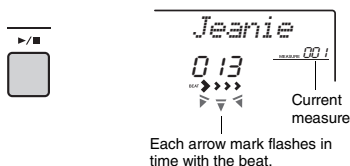

**NOTE**

- External MIDI Songs containing Portamento Control and Scale Tune settings may not be played correctly.
- If playback of a Song in the USB flash drive or a Song transferred from a computer produces distorted sound, decrease the Song volume (page 65) to reduce the distortion, and then adjust the master volume (page 16).

## Song Fast Forward, Fast Reverse, and Pause

**[▶▶] Fast Forward**

During playback, press this button to rapidly skip ahead to a later point in the Song.



**[◀◀] Fast Reverse**

During playback, press this button to rapidly return to an earlier point in the Song.



**[||] Pause**

During playback, press this button to pause playback, and press again to start from that point.



**NOTE**

- When the A-B repeat is specified, the Fast Reverse and Fast Forward will only work within the range between A and B.
- The [◀◀], [▶▶] and [||] buttons cannot be used for Demo Song playback started by using the [DEMO] button.

## Playing a Specified Section of a Song Repeatedly (A-B Repeat)

You can play back only a specific section of a Song repeatedly by setting the A point (start point) and B point (end point) in one-measure increments.

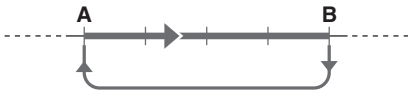

- 1 Start playback of the Song (page 28).
- 2 When playback reaches to the point you want to specify as the start point, press the [ A ⇌ B ] (A-B REPEAT) button to set the A point.



- 3 When playback reaches to the point you want to specify as the end point, press the [ A ⇌ B ] (A-B REPEAT) button again to set the B point.

The specified A-B section of the Song will now play repeatedly.

- 4 To cancel repeat playback, press the [ A ⇌ B ] (A-B REPEAT) button again. To stop playback, press the [ ▶/■ ] (Start/Stop) button.

**NOTE**

- If you want to set start point "A" to the top of the Song, press the [ A ⇌ B ] (A-B REPEAT) button before starting playback.
- If you want to set end point "B" to the end of the Song, specify only the A point and play back the Song to the end.

## Turning Each Track On/Off

Each "track" of a Song plays a different part—melody, percussion, accompaniment, etc. Each of the tracks can be muted so that you can play the muted part yourself. Pressing the desired Track button repeatedly will toggle the on/off status.

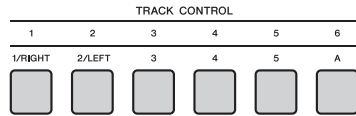

The status of each track is shown in the display.

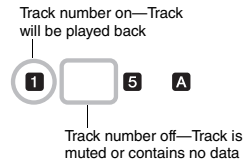

**NOTE**

- Up to two Track buttons can be pressed simultaneously for turning on or off.

# Playing with Groove Creator

The Groove Creator function lets you repeatedly play back various rhythm patterns and phrases (each called a Groove) in various genres, including Hip Hop, House, etc.—for dynamic, powerful performances. Try out the expressive performance features, such as changing keys in the left-hand area of the keyboard and rotating the knobs for dynamic sound variations.

## 1 Press the [GROOVE CREATOR] button, and use the dial to select the desired Groove.

ACMP is automatically turned on, and the keyboard is divided into the Auto Accompaniment area (page 26) and melody area.

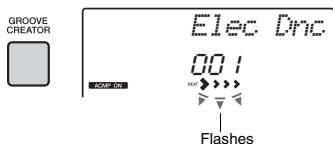

### NOTE

- To select a genre, use the CATEGORY [←>] buttons. Refer to the right side at the top of the panel.
- Refer to online material Data List.

### GROOVE CREATOR

001-ELECTRO  
005-DANCE POP  
010-EURO DANCE  
013-HOUSE  
019-TRANCE  
023-HIP HOP  
025-CHILLOUT  
027-DUB  
029-035 WORLD

## 2 Press the [▶/■] (Start/Stop) button to start Groove playback.

You can also start playback by pressing any note in the Auto Accompaniment area (page 26).



During Groove playback, enjoy creating sound variations via the following operations.

### • Turning on/off individual tracks via the [TRACK CONTROL] buttons

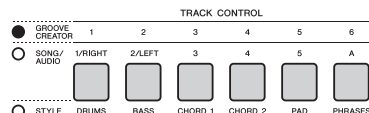

1 2 3 4 5 6 — On/off status is shown in the display (page 19)

### NOTE

- Up to two track buttons can be pressed simultaneously for turning on or off.

### • Changing the Section via the [A]–[D] buttons

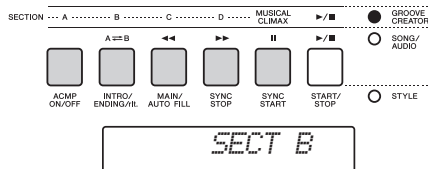

### • Using the [MUSICAL CLIMAX] button

When you press the button, a negative count (indicating a lead-in) appears on the display. As the lead-in approaches 0, the Groove builds in intensity and variation. When the count reaches 0, it comes to a musical climax. You can use this as professional sounding build-up, switching to another section or another Groove when the count reaches 0 (or even before, if you want). Moreover, this can also be used as an Ending; the Groove stops after the count reaches 0 and an Ending phrase is played.

### • Using the Retrigger function

Groove Retrigger is a function which repeats the first part of the current Groove, for a rhythmic break effect. For details, refer to page 61.

### • Transposing playback by pressing any note in the Auto Accompaniment area (page 26).



### • Changing the sound via the Knobs

Press the [KNOB ASSIGN] button several times to select the function. Press [TARGET] button and BACKING icon appears on the display, then rotate knobs A and B. Refer to page 25.

### • Playing Arpeggios in the right-hand area

Press the [ARPEGGIO] button to turn it on, and then play the notes in the right-hand area of the keyboard.

### NOTE

- When you select a Voice between 292 and 301, Arpeggio is applied only to the Split Voice. Playing a key to the left of the Split Point turns Arpeggio on as well as specifies the key for Groove playback.

## 3 Press the [▶/■] (Start/Stop) button to stop playback.

# Playing with Quick Sampling

This instrument features an extremely convenient and powerful Quick Sampling function. It allows you to sample sounds from an external audio device (such as a computer, smartphone, portable music player, etc.) via the [AUX IN] jack, and then assign the sampled sound to the keyboard for playing back as part of your performance.

## Sampling

Sampling is a technology that lets you record a short portion of a song or a sound, and use the sound (called a “sample”) as part of your performance. Unlike Audio Recording, the samples can be used in various ways: to play a melody, to play in a loop for a repeating rhythm pattern, or to add a special sound effect.

## Playing back the Samples

A wide variety of samples are already built into this instrument as presets. Try playing them and see how powerful the sampling features are!

- 1 Press the [VOICE] button.
- 2 Use the dial to select the Voice number 759 “Sampling” for the Main Voice.

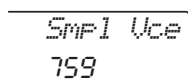

- 3 Press the keys in the Sample Zone to which the default samples are assigned to play back the samples.

### Sample Zone

The keyboards of the two instruments are divided into five or seven Sample Zones and each Zone has one assigned sample.

#### PSR-E463

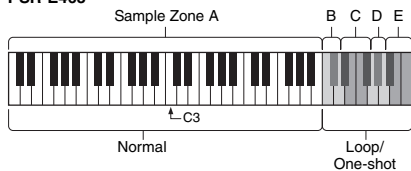

#### PSR-EW410

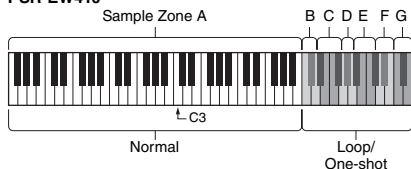

### Sample Type

By default, a “Normal” type sample is assigned to Sample Zone A, “Loop” types are assigned to B and C, and “One-shot” types are assigned to D–G. However, when you sample by yourself, you can freely choose “Loop” or “One-shot” types for Sample Zones B–G.

- **Normal:** The pitch of the sound varies depending on the key you play. The default pitch is assigned to the note C3.
- **Loop:** The sample is played in a loop without changing the pitch. Pressing a white key in the Sample Zone plays the sample as long as you are holding it, while pressing a black key plays the sample continuously until you press a black key in the same Sample Zone to stop it. When the type is “Loop,”  appears on the display for the corresponding Sample Zone.
- **One-shot:** The sample is played only once without changing the pitch. The sample is played continuously as long as you hold any key in the Sample Zone.

## Getting Ready for Sampling

- 1 Set the volume levels to minimum for both this instrument and the external device.

### NOTICE

- Connecting an external device to the instrument without turning down the volume may result in damage to the device.

- 2 Connect the headphone jack of an external device to the instrument’s [AUX IN] jack by using an audio cable.

### NOTICE

- To avoid damage to the devices, first turn on the power to the external device, and then to the instrument. When turning off the power, first turn off the power to the instrument, and then to the external device.

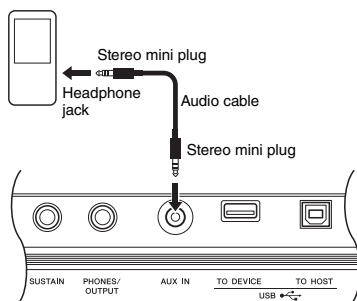

### 3 Start playback on the external device, and then adjust the volume balance between the device and the instrument.

3-1 Set the volume of the external device to maximum.

3-2 Adjust the volume you hear from the instrument by rotating the [MASTER VOLUME] control.

**NOTE**

- When the sound is too low even though the external device's volume is set to maximum, adjust the "AuxIn Vol" in the Function Settings (page 66, Function 004). If you increase the volume to more than 50, the audio device sound may be distorted. In this case, turn down the volume level on the external device.

## Sampling External Audio Sound

Up to five (on the PSR-E463) or seven (on the PSR-EW410) samples can be assigned to the keyboard of this instrument. The samples can also be saved to a USB flash drive (page 34).

Before you start sampling, make sure that the external device's volume is set to maximum. If the volume is too low, the instrument cannot sample the sound.

**NOTICE**

- The sampling operation will overwrite and erase previously existing samples. Save important data you want to keep to a USB flash drive (page 34).

**NOTE**

- The sampling format is two-channel stereo, 16-bit with a rate of 44.1 kHz.
- If you want to use the metronome or Melody Suppressor when sampling, set these functions beforehand. The Metronome click is not sampled.

### 1 Press the [QUICK SAMPLING] button to enter the Quick Sampling mode.

The SAMPLING icon and "PressKey" appear on the display.

**NOTE**

- To cancel and exit from the Quick Sampling mode, press the [QUICK SAMPLING] button again.

### 2 Press a key in the desired Sample Zone to which the sample is to be assigned.

Pressing the key will sound the default sample or previously assigned sample.

• To sample a "Normal" type:

2-1 Press one of the keys in Sample Zone A.

**PSR-E463**

Sample Zone A: C1-B4

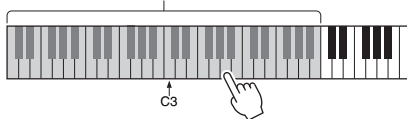

**PSR-EW410**

Sample Zone A: E0-B4

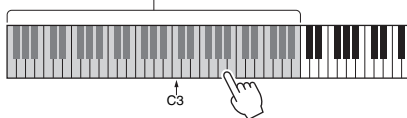

When "PressREC" appears on the display, go on to step 3.

• To sample a "Loop" or "One-shot" type:

2-1 Press one of the keys in the desired Sample Zone (B-E on the PSR-E463, and B-G on the PSR-EW410).

**PSR-E463**

Sample Zone  
B C D E

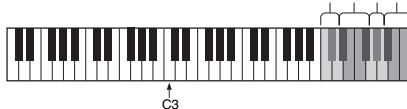

- Sample Zone B: C5-D5
- Sample Zone C: D#5-F#5
- Sample Zone D: G5-A5
- Sample Zone E: A#5-C6
- Sample Zone F: D6-E6
- Sample Zone G: F6-G6

**PSR-EW410**

Sample Zone  
B C D E F G

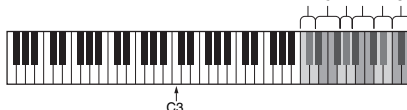



2-2 When “Loop?Y/N” appears on the display, press the [+ / YES] button to select “Loop” sampling, or press [- / NO] to select “One-shot” sampling. You cannot change the type after sampling.  
When “PressREC” appears on the display, go on to step 3.

### 3 Pause playback on the external device at the beginning of the sound or phrase you want to sample.

### 4 Press the [REC] button, and then start playback on the external device to start sampling.

While sampling the sound, “REC” appears and glowing icon of selected the Sample Zone on the display.



Do not disconnect the USB flash drive during the sampling operation. The operation may become unstable, and sampling may not be performed properly.

### 5 Stop playback on the external device at the end of the sound or phrase you want to sample.

### 6 Press the [REC] button to stop sampling. “Writing!” appears briefly on the display, and then the sample is stored to the instrument.

#### NOTE

- If the input volume from the external device is too low, “LowInput” appears on the display and cannot sample the sound. Raise the external device’s volume to maximum, and then adjust the output volume on this instrument by rotating the [MASTER VOLUME] control. After that, try sampling again from step 3.
- Sampling time is limited to a maximum of 9.6 seconds. When the time limit is reached, sampling stops automatically and the recorded sample (up to that point) is stored to the instrument.

### 7 Check if the sample is assigned successfully.

For “Normal” types, press the C3 key. For “Loop” and “One-shot” types, press any one key in the Sample Zone to which you assigned the sample. Any silence at the beginning and end of the sam-

ple can be automatically cut by the Blank Cut function (page 69).

If you are not satisfied with the sample, return to step 2 and try sampling again.  
To sample and assign to another Sample Zone, go on to step 2 again.

### 8 Press the [QUICK SAMPLING] button to exit from the Quick Sampling mode.

### 9 Try playing the samples.

Exiting from the Quick Sampling mode automatically selects the Voice number 759 “Smpl Vce” for the Main Voice. Try playing it on the keyboard.

#### NOTICE

To avoid damage to the external device, disconnect the device in this way:

- 1 Set the volume levels to minimum for both this instrument and the external device.
- 2 Disconnect the audio cable from the instrument, and then from the external device.

#### To sample during audio playback

Once you are familiar with the sampling operation, try starting and stopping sampling while the sound of the external device is playing back.

1. Execute steps 1–2 in “Sampling the External Audio Sound” on page 32.
2. Pause playback on the external device at a few measures before the sound or phrase you want to sample.
3. Start playback on the external device.
4. Press the [REC] button at the desired point to start sampling.
5. Press the [REC] button again at the desired point to stop sampling.
6. Stop playback on the external device, and then check what you have just sampled.

#### NOTE

- If there is silence in the audio that is cut automatically but you want to keep it, turn off the Blank Cut function (page 69).

## Restoring the Default Samples

This operation lets you restore the default samples. However, keep in mind that this deletes the samples you've assigned to each Sample Zone. If you want to save your samples before restoring the default ones, see the next section ("Saving Samples to a USB Flash Drive").

- 1 Press the [QUICK SAMPLING] button to enter the Quick Sampling mode.
- 2 Press the appropriate key in the Sample Zone to which the sample to be cleared has been assigned.
- 3 Hold down the TRACK CONTROL [STYLE] button for longer than a second.

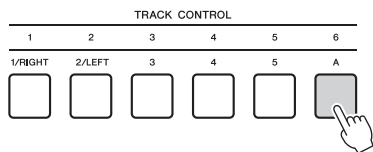

A confirmation message will appear on the display.



- 4 Press the [+ / YES] button. A confirmation message will appear on the display. To cancel this operation, press the [-] button.
- 5 Press the [+ / YES] button to clear the Sample. An in-progress message will appear briefly on the display.

## Saving a Sample to a USB Flash Drive

### IMPORTANT

- If the instrument is in the Quick Sampling mode, press the [QUICK SAMPLING] button to exit from the mode, and then follow the steps below.

- 1 Confirm the Sample Zone containing the sample you intend to save.
  - 1-1 Press the [VOICE] button.
  - 1-2 Select the Voice number 759 "Sampling" for the Main Voice.
  - 1-3 Press the key to confirm that the desired sample sounds.
- 2 Connect a USB flash drive to the [USB TO DEVICE] terminal. For details, refer to "Connecting a USB Flash Drive" on page 71.
- 3 Hold the [FUNCTION] button for longer than a second to call up the File Control display. To cancel the operation, press the [FUNCTION] button again to exit from the File Control display.
- 4 Use the CATEGORY [ << ] and [ >> ] buttons to call up "SaveSMPL."

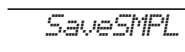

- 5 Press the [0 / EXECUTE] button. "PressKey" appears on the display.
  - 6 Press the appropriate key in the Sample Zone (the key to which the desired sample is assigned).
  - 7 Use the [+ / YES] and [- / NO] buttons to select the file name for saving.
    - Normal/One-shot: SMPL001–SMPL250
    - Loop: SMPLL001–SMPLL250
- NOTE**

  - If the file name already exists in the USB flash drive, "Overwr?" appears on the display. To overwrite, press the [+ / YES] button; to select another name, press the [- / NO] button.
- 8 Press the [0 / EXECUTE] button. "SaveOK?" appears on the display.
  - 9 Press the [0 / EXECUTE] button again. "Saving" appears on the display and the sample will be saved to the USB flash drive.
  - 10 Press the [FUNCTION] button to exit from the File Control display.

## Loading a Sample from a USB Flash Drive

### IMPORTANT

- If the instrument is in the Quick Sampling mode, press the [QUICK SAMPLING] button to exit from the mode, and then follow the steps below.

### NOTICE

- The loading operation will overwrite and erase previously existing samples. Save important data you want to keep to a USB flash drive (page 34).

- 1 Connect a USB flash drive to the [USB TO DEVICE] terminal.  
For details, refer to “Connecting a USB Flash Drive” on page 71.
- 2 Hold the [FUNCTION] button for longer than a second to call up the File Control display.  
To cancel the operation, press the [FUNCTION] button again to exit from the File Control display.
- 3 Use the CATEGORY [<<] and [>>] buttons to call up “LoadSMPL.”



- 4 Press the [0/EXECUTE] button.  
“PressKey” appears on the display.
- 5 Press the appropriate key in the Sample Zone to which you want to assign the sample.
- 6 Use the [+ /YES] and [- /NO] buttons to select the file name to load.  
You cannot select a sample that loops (SMPLL001–SMPLL250) for assigning to Sample Zone A.
- 7 Press the [0/EXECUTE] button.  
“LoadOK?” appears on the display.
- 8 Press the [0/EXECUTE] or [+ /YES] button again.  
“Loading” appears on the display and the sample will be saved to the USB flash drive.
- 9 Press the [FUNCTION] button to exit from the File Control display.

- 10 Try playing with the loaded samples.

Press the [VOICE] button and select the Voice number 759 “Smpl Vce” for the Main Voice. Pressing the appropriate key in the Sample Zone (to which you assigned the sample) to play the sound.

## Deleting a Sample in the USB Flash Drive

### IMPORTANT

- If the instrument is in the Quick Sampling mode, press the [QUICK SAMPLING] button to exit from the mode, and then follow the steps below.

- 1 Connect a USB flash drive to the [USB TO DEVICE] terminal.  
For details, refer to “Connecting a USB Flash Drive” on page 71.
- 2 Hold the [FUNCTION] button for longer than a second to call up the File Control display.  
To cancel the operation, press the [FUNCTION] button again to exit from the File Control display.
- 3 Use the CATEGORY [<<] and [>>] buttons to call up “Del SMPL.”



- 4 Press the [0/EXECUTE] button.
- 5 Use the [+ /YES] and [- /NO] buttons to select the file name to delete.
- 6 Press the [0/EXECUTE] button.  
“Del OK?” appears on the display.
- 7 Press the [0/EXECUTE] or [+ /YES] button again.  
“Deleting” appears on the display and the sample is deleted from the USB flash drive.
- 8 Press the [FUNCTION] button to exit from the File Control display.  
If the instrument is in the File Control display, no sound comes out even if you press the keyboard.

# Playing Like a DJ!

The dynamic Groove Creator function and Live Control Knobs give you powerful tools to sound just like a pro DJ! Since the Grooves and section variations change seamlessly without breaks in the rhythm, performing is truly easy. Still, a sense of rhythm is important. So, turn up the volume, feel the rhythm in your body, and work the buttons and knobs—as if you were in front of the dance floor!

In this example using Groove number 001 (Elec Dnc.), you'll learn how to take one Groove and transform it in a variety of ways.

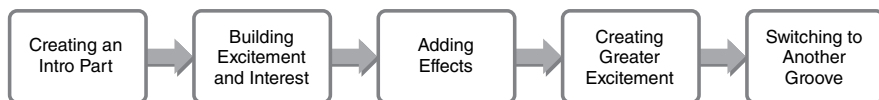

## Creating an Intro Part with the Track On/Off Controls

- 1 Press the [GROOVE CREATOR] button, and select Groove 001 with the dial or number buttons.
- 2 Use the [TRACK CONTROL] buttons to turn on tracks [1], [2] and [3], and turn off tracks [4], [5] and [6], so that only the rhythm plays back.



- 3 Press the section [A] button to play back Section A (shown as “SECT A” in the display).
- 4 Press the [▶/■] button to start playback.
- 5 While checking the Beat marks “▶▶▶▶” and Measure number as they change on the display, wait until the fourth beat of Measure 008 (just before Measure 001 starts again), and then press the track [6] button to turn on track [6].

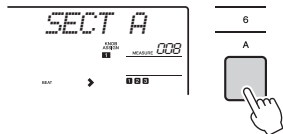

- 6 With the same timing as in step 5, simultaneously press the track [4] and [5] buttons to turn on tracks [4] and [5].

### NOTE

- Only up to two tracks can be turned on and off at the same time, so press only two buttons.

## Building Excitement and Interest by Changing Sections

- 1 While checking the Beat marks “▶▶▶▶” as they change on the display, press the section [B] button at a musically appropriate time to switch to Section B. Even if your timing is slightly off, the section will naturally change in time with the rhythm.
- 2 With the same timing as in step 1, press the section [C] or [D] button to build up the Groove.

## Adding Effects to the Groove with the Live Control Knobs

- 1 While checking the display, press the [KNOB ASSIGN] button several times (as needed) to select **1**.
- 2 While checking the display, press the [TARGET] button once or twice to select BACKING.

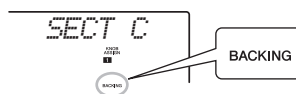

- 3 Rotate knob A fully to the right, and then rotate knob B fully to the left.



- 4 Rotate knob A slowly to the right to change the muffled sound to a clear, bright sound. Move it slowly in time with the rhythm.

- 5 Now try rotating knob A back and forth slowly with the rhythm. Notice that you can get a completely different sound and feel, even with the same rhythmic phrase.
- 6 As in the steps above, press the [KNOB ASSIGN] button and try using the second and third items. REVERB/CHORUS controls the acoustic ambience, or produces a rich and warm layered effect. DSP controls one of 10 different effects, such as rotary speaker and distortion. For details, refer to page 57.

**NOTE**

- When switching the [LIVE CONTROL] row, make sure to set the target to **BACKING**. The target is conveniently saved for each function.
- When using **5**, press the [DSP] button to turn on the DSP function. The DSP icon appears on the display.

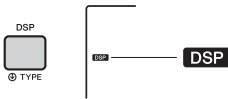

- Only selecting a function combination will not affect the sound even if the knob arrow is not at the center position. The selected function only works when the knob is moved.

## Creating Greater Excitement with the Retrigger Function

Press the section [C] button to switch to Section C and listen to the rhythm. The beats become increasingly more rapid after the Measure 005, and this effect creates intensity and excitement. You can raise the emotional level of your own performance with a similar “rapid-fire” effect with the Retrigger function and Live Control Knobs.

- 1 While checking the display, press the [KNOB ASSIGN] button several times to select **5**.

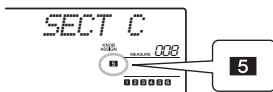

- 2 Rotate knob B about 90° to the left.



- 3 While checking the Beat marks “>>>>” and Measure number in the display, press and hold the section [C] button at the point just before the Measure count reaches 005.

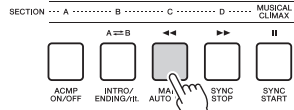

- 4 While holding down the section [C] button, rotate knob B according to the following illustration. The beats become more rapid according to the knob position.



- 5 Release the section [C] button at the dynamic peak to return to normal play-back of the Groove .

## Switching to Another Groove with Musical Climax

- 1 While checking the Beat marks “>>>>” on the display, press the [MUSICAL CLIMAX] button at an appropriate timing, just before when the Measure changes from 008 back to 001. The Groove starts building to a climax with an 8-measure lead-in (negative count).



- 2 Just as the lead-in approaches 0, use the number buttons to enter a different Groove number. The timing may be a little difficult, but with practice you can seamlessly switch to another Groove after the Musical Climax—just like a pro DJ!

**NOTE**

- By memorizing the next Groove to a Registration Memory setting, you can easily switch Grooves with just a single button press (page 44).

# Recording Your Performance

You can record up to 10 of your performances to the instrument as **User Songs**. The recorded **User Songs** can be played back in the same way as the preset **Songs**.

## NOTE

- For details on **Audio recording**, refer to page 42.
- This instrument records your performance and saves it in an original format. If you want to save it as **MIDI data**, convert it to **SMF** by saving it to the connected **USB flash drive** (page 73).

## Track Structure of a Song

A Song can be recorded to the six tracks. You can record without specifying tracks, but you can also record each track one by one (e.g., only the right-hand part or the left-hand part) to create a complete piece which may be difficult to play at once.

### ● Melody Tracks [1/RIGHT]–[5]

These are for recording melody or similar performances.

### ● Accompaniment Track [A]

This is for recording a chord progression (for the **Style**) or key changes (for the **Groove**) automatically.

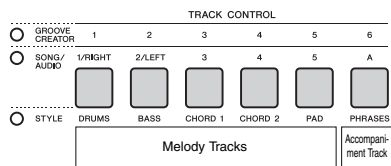

## Quick Recording

This section explains how to record without specifying a track. This is useful when recording a new Song from scratch.

### 1 Make the desired settings including the Main Voice selection.

### 2 Make the desired settings for recording your performance.

- If you want to record only the melody performance, press the **[SONG]** button.
- If you want to record the performance using a **Style**, press the **[STYLE]** button.
- If you want to record the performance using a **Groove**, press the **[GROOVE CREATOR]** button.

### 3 Press the **[REC]** button to enter the Record Ready mode.

This operation selects the lowest-numbered unrecorded **User Song** from 031–040 (**User 1–10**) as the recording target.

**Track 1** will be selected as recording target of the melody, and the **Track A** will be selected as recording target of the accompaniment part (the chord progression for the **Style** or the key change for the **Groove**) automatically. If a **User Song** was selected beforehand, recording data will overwrite **Tracks 1 and A** of the selected **Song**.

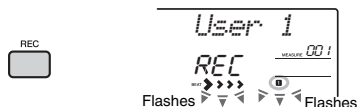

## NOTE

- The **ACMP on/off status** cannot be changed after the **[REC]** button is pressed.

To exit from this status, press the **[REC]** button again.

## 4 Start recording.

- When you press the **[SONG]** button in step 2, play any note to start recording.
- When you select a **Style** in step 2, play a chord in the **Auto Accompaniment** area to start recording with **Style playback**, or press the **[▶/■]** (**Start/Stop**) button to start recording with playback of only the **Rhythm** part of a **Style**.
- When you select a **Groove** in step 2, play a key in the **Accompaniment** area or press the **[▶/■]** (**Start/Stop**) button to start recording with **Groove playback**.

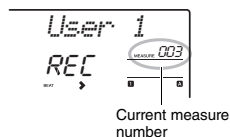

The current measure will be shown on the display while recording.

## 5 Press the [▶/■] (Start/Stop) or [REC] button to stop recording.

When using a Style or a Groove, you can stop recording also by pressing the [INTRO/ENDING/rit.] or [MUSICAL CLIMAX] button, and then waiting until playback ends.

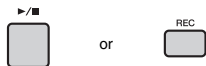

After recording finishes, "Writing!" appears indicating that the recorded data is being stored, and then the recorded track numbers in the display will light.

### NOTICE

- Never attempt to turn the power off when "Writing!" is shown in the display. Doing so can result in a loss of data.

## 6 To play back the recorded Song, press the [▶/■] (Start/Stop) button.

### NOTE

- When recording Groove playback with Retrigger, note that the beat indicator in the display, metronome and Arpeggio playback are not synchronized with playback of the recorded Song.
- When recording a performance with a Sample Voice, keep in mind that the Sample Voice itself is not recorded. For the performance to sound as you intended, you will need to assign that sample to the keyboard (the same as used when recording).
- If you fast forward or rewind during playback of a Song using Sample Voices, the playback sounds differ from the original recording.

### Limitations while recording

- The on/off status of ACMP cannot be changed.
- Playback cannot be changed between Style and Groove.
- The Groove number can be changed while the Style number cannot.
- When you use Style/Groove, the following parameters cannot be changed: Reverb Type, Chorus Type, Time Signature and Style/Groove Creator Volume.
- Performances with a Split Voice cannot be recorded.
- The audio input from an external device (playback sound on the connected computer or audio device) cannot be recorded.
- Performances using Sample Voices can be recorded on track 1 only.

## Recording to a Specified Track

This section explains how to record to a specified track. This is useful when you want to record additional performances to an already recorded Song, or re-record only one track of an already recorded Song.

### 1 Press the [SONG] button, and then select the desired User Song from 031–040 (User 1–10) as the recording target.

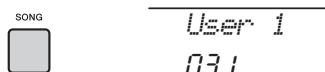

### 2 While holding down the [REC] button, press the desired Track button to enter the Record Ready mode.

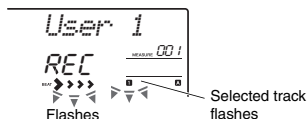

- If you want to record only the melody: While holding down the [REC] button, press one of the [1/RIGHT]–[5] buttons.

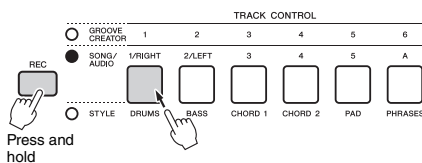

- If you want to record only the Style playback:

Press the [STYLE] button, select the desired Style, then simultaneously hold down the [REC] button and press the [A] button. ACMP is automatically turned on.

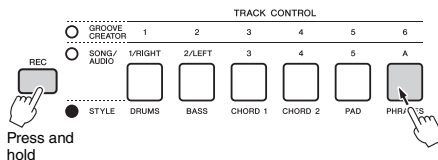

- If you want to record only the Groove play-back:

Press the [GROOVE CREATOR] button, and then select the desired Groove. While holding down the [REC] button, press the [A] button. ACMP is automatically turned on.

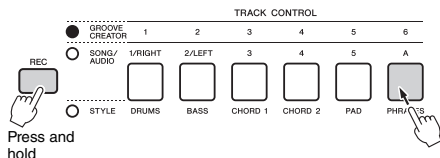

- 3 Same as in steps 4 to 6 (page 38) in “Quick Recording.”

**NOTE**

• If the memory becomes full while recording, an alert message will appear and recording will stop automatically. In this case, delete unnecessary data by using the Clear functions (below), and then execute the recording again.

## Clearing a User Song

You can clear all tracks of a User Song.

- 1 Press the [SONG] button, then select the User Song from 031–040 (User 1–10) to be cleared.
- 2 Hold down the track [1/RIGHT] and [A] buttons simultaneously for longer than a second.

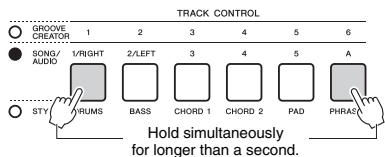

A confirmation message will appear on the display.



- 3 Press the [+YES] button. A confirmation message will appear on the display. To cancel this operation, press the [-] button.

- 4 Press the [+YES] button to clear the Song.

An in-progress message will appear briefly on the display.

## Clearing a Specified Track from a User Song

This lets you clear individual tracks from a User Song.

- 1 Press the [SONG] button, and then select the desired User Song from 031–040 (User 1–10).
- 2 From [1/RIGHT]–[5] and [A], press the Track button to be cleared for longer than a second.

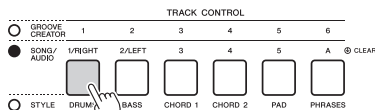

Hold for longer than a second.

A confirmation message will appear on the display.



- 3 Press the [+YES] button. A confirmation message will appear on the display. To cancel this operation, press the [-] button.
- 4 Press the [+YES] button to clear the track. An in-progress message will appear briefly on the display.



# Audio Playback and Recording

This instrument allows you to play back audio files and record your performances in audio format. The recorded performance can be saved to a USB flash memory as an audio file.

## Audio file

An audio file is a recording of the performed sound itself. This data is recorded in the same way as that used in recording with voice recorders, etc. This data can be played with a portable music player, etc., allowing you to easily let other people hear your performance.

### NOTE

- This instrument can record or play 44.1kHz/16-bit stereo WAV files.

## Playing back an Audio File in a USB Flash Drive

You can playback audio files in a USB flash drive in the Audio mode.

While in the Audio mode, some operations cannot be executed. When you are not playing back or recording audio files, exit from the Audio mode.

### NOTICE

- Do not disconnect the USB flash drive or turn off the power to the instrument during playback. Otherwise, damage to the data may occur.

### 1 Connect a USB flash drive to the [USB TO DEVICE] terminal.

For details, refer to “Connecting a USB Flash Drive” on page 71.

### 2 Press the [AUDIO] button to enter the Audio mode.

The audio file name, AUDIO icon and “PLY” appear on the display.



For example, the file named “AUDIO001.wav” in the USB flash drive is shown like this.

### NOTE

- To exit from the Audio mode, press the [AUDIO] button again.

### 3 Rotate the dial to select the desired audio file.

You can also use the CATEGORY [ << ] [ >> ] buttons, or the [+ / YES] [- / NO] buttons. To instantly

jump to the first audio file, press the [+ / YES] and [- / NO] buttons simultaneously.

### 4 Press the [▶ / ■] (Start/Stop) button to start playback of the audio file.

During playback, the time elapsed is shown on the display. To stop playback, press the [▶ / ■] (Start/Stop) button again.

### NOTE

The following operations cannot be executed for audio playback.

- Changing the Voice
- A-B Repeat
- Turning off “tracks” (page 60)
- Changing the tempo

### 5 Press the [AUDIO] button to exit from the Audio mode.

#### Message List

Message	Description
No USB	No USB flash drive is connected.
no file	There is no audio file in the USB flash drive.
Err Load	Cannot load the audio file because the format is not compatible with this instrument.
USB Err	The USB flash drive may have a problem. <ul style="list-style-type: none"><li>• Refer to “Compatible USB Device List for PSR-E463/EW410” on the Yamaha website.</li><li>• Format the USB Flash Drive.</li></ul>

## Recording/Saving Audio Files to a USB Flash Drive

You can record your performance and save it as an audio file to the USB flash drive.

### IMPORTANT

- Connect an AC adaptor to use this function.

### NOTICE

- Do not disconnect the USB flash drive or turn off the power to the instrument during recording. Otherwise, damage to the data may occur.

### 1 Connect a USB flash drive to the [USB TO DEVICE] terminal.

For details, refer to “Connecting a USB Flash Drive” on page 71.

### 2 Make the desired settings of your performance.

Depending on the selected function, the data that can be recorded differs as follows.

- **When a Style is selected:**  
Style, keyboard performance, audio input from the [AUX IN] jack
- **When a Song is selected:**  
Keyboard performance, audio input from the [AUX IN] jack
- **When a Groove Creator is selected:**  
Groove, keyboard performance, audio input from the [AUX IN] jack

### NOTE

- Data that cannot be recorded includes: the metronome click, Songs, and audio input from the [USB TO HOST] terminal.

### 3 Hold the [AUDIO] button for longer than a second to enter the Audio mode (recording standby).

“PressREC” and the AUDIO icon appear on the display.

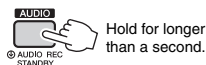

### NOTE

- To exit from the Audio mode, press the [AUDIO] button again.

### 4 Press the [REC] button to start recording.

The elapsed time is shown on the display during recording.

The maximum recording time is 80 minutes or until the memory of the USB flash drive becomes full.

When stopping Style or Groove, press the [▶/■] (Start/Stop) button.

### 5 Press the [REC] button to stop recording.

“Writing!” appears indicating that the recorded data is being stored. After storing, “Comple.” appears, and then the recorded audio file name will be shown as “AUDIO\*\*\*\*\*” (\*\*\*\*\*: number).

### NOTICE

- Never attempt to turn the power off when “Writing!” is shown in the display. Doing so can result in a loss of data.

### 6 Press the [▶/■] (Start/Stop) button to play back the recorded audio file.

### 7 Press the [AUDIO] button to exit from the Audio mode.

### Message List

Message	Description
No USB	No USB flash drive is connected.
UseAdpt	Power is now being drawn from batteries. Connect the AC adaptor.
File Ful	The total number of files in the USB flash drive exceeds the capacity. Delete unnecessary data or use another USB flash drive.
Unformat	The USB flash drive is unformatted. Format it (page 72).
Protect	The USB flash drive is protected. Set write-protect to off and try again.
Time Up	The recording time exceeds 80 minutes. The recording automatically stops and the audio file will be saved.
Disk Ful	Memory has become full. The recording is stopped and the audio file will be saved.
USB Err	The USB flash drive may have a problem. <ul style="list-style-type: none"> <li>• Refer to “Compatible USB Device List for PSR-E463/EW410” on the Yamaha website.</li> <li>• Format the USB Flash Drive.</li> </ul>

## Deleting Audio Files from the USB Flash Drive

- 1 Connect a USB flash drive to the [USB TO DEVICE] terminal.
- 2 Hold the [FUNCTION] button for longer than a second to call up the File Control display.  
If the instrument is in the Audio mode, press the [AUDIO] button to exit from the Audio mode, and then execute this operation.



- 3 Use the CATEGORY [<<] and [>>] buttons to call up “DeIAUDIO.”



- 4 Press the [0/EXECUTE] button.

Audio file names in the USB flash drive appear on the display as “AUDIO\*\*\*\*\*” (\*\*\*\*: number). Use the dial or the [+ /YES] [- /NO] button to select a different audio file.



- 5 Press the [0/EXECUTE] button again.

A confirmation message will appear. To cancel the operation, press the [- /NO] button.

- 6 Press the [0/EXECUTE] button again, or the [+ /YES] button to execute the Delete operation.

After a while, a message indicating completion of the operation appears.

### NOTICE

- The Delete operation cannot be cancelled during execution. Never turn off the power or disconnect the USB flash drive during the operation. Doing so may result in data loss.

- 7 Press the [FUNCTION] button to exit from the File Control display.

# Memorizing Your Favorite Settings (Registration Memory)

The Registration Memory function allows you to save (or “register”) panel settings such as Voice and Style to a Registration Memory button, and then instantly recall your custom panel settings by simply pressing a single button. The registered settings for four Registration Memory buttons will be saved as a single Bank.

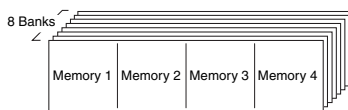

Up to 32 settings (eight banks of four each) can be memorized.

## Memorizing Panel Settings to the Registration Memory

- 1 Make the desired settings, such as those for Voice, Style, and Groove.

### NOTE

- Data cannot be saved to Registration Memory during Song playback.

- 2 Press the REGISTRATION MEMORY [BANK/MEMORY] button to call up a Bank number on the display.

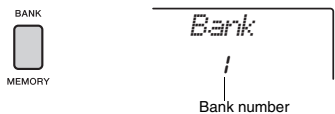

- 3 Use the dial or the [1]–[8] number buttons to select a Bank number.

- 4 While holding down the [BANK/MEMORY] button, press one of the [1]–[4] buttons to memorize the current panel settings.

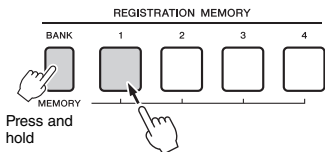

A “Mem OK” message appears indicating that the panel settings will be stored temporarily. The data is actually written to the memory when the power is turned off.

### NOTICE

- If you select a Registration Memory number that already contains data, the previous data is deleted and overwritten by the new data.
- Samples are not memorized. Save them to a USB Flash Drive (page 34).

## Recalling Panel Settings from the Registration Memory

- 1 Press and release the [BANK/MEMORY] button to call up a Bank number on the display.
- 2 Use the dial or the [1]–[8] number buttons to select a Bank number.
- 3 Press one of the REGISTRATION MEMORY [1]–[4] buttons to call up the panel settings you memorized.

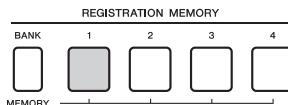

The recalled Registration Memory number appears in the display for a few seconds.

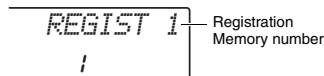

### NOTE

- When the [SONG] lamp is lit, the Style or Groove settings will not be recalled even if you press the [REGISTRATION MEMORY] button to which the Style or Groove settings are memorized. To recall Style/Groove settings, make sure to press the [STYLE] or [GROOVE CREATOR] button beforehand.

### Parameters that can be memorized to Registration Memory

- **Style settings:** Style number, ACMP on/off, Style volume, Track on/off, Main section A/B, Tempo
- **Groove settings:** Groove number, Groove volume, Section, Track on/off, Tempo
- **Voice settings:**
  - Main Voice settings:** Voice number and all settings of the related Functions (page 67)
  - Dual Voice settings:** Dual on/off and all settings of the related Functions
  - Split Voice settings:** Split on/off and all settings of the related Functions
- **Effect settings:** Reverb Type, Chorus Type
- **Harmony / Arpeggio settings:** Harmony/Arpeggio on/off and all settings of the related Functions
- **DSP:** DSP on/off, DSP type and parameter values of Knobs A/B.
- **Other settings:** Transpose, Pitch Bend Range, Knob Assign, Target, Split Point, Scale Tune

# Connecting to Other Devices

## CAUTION

- Before connecting the instrument to external devices, turn off the power of all the devices. Also, before turning the power on or off, make sure to set all volume levels to minimum. Otherwise, damage to the devices or electrical shock may occur.

## Connecting Headphones or an External Device

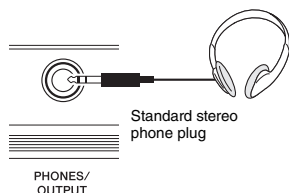

### Connecting Headphones

Connect a pair of headphones to the [PHONES/ OUTPUT]/[PHONES] jack on the rear panel. The built-in speakers are automatically shut off when a plug is inserted into this jack.

### Connecting an External Device

• **PSR-E463:** This jack also functions as an external output. By connecting to a computer, keyboard amplifier, recorder, or other audio device, you can output the audio signal of this instrument to that external device. The speakers of this instrument are automatically shut off when a plug is inserted into this jack.

- **PSR-EW410:** When connecting an external speaker, refer to page 48.

## CAUTION

- Do not use the headphones for a long period of time at a high or uncomfortable volume level, since this can cause permanent hearing loss.

## NOTICE

- To avoid possible damage to the external device, first turn on the power to the instrument, then to the external device. When turning off the power, do so in reverse order: first turn off the power to the external device, then to the instrument.

## Using a Pedal (Sustain)

You can produce a natural sustain as you play by pressing a footswitch (FC5 or FC4A; sold separately) plugged into the [SUSTAIN] jack.

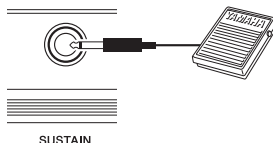

### NOTE

- Plug or unplug the footswitch while the power is off. Also, do not press the footswitch when turning the power on. Doing so changes the polarity of the footswitch, resulting in reversed operation.
- The sustain function does not affect Split Voices (page 21).
- Some Voices may sound continuously or have a long decay after the notes have been released while the footswitch is held.

## Playing an External Audio Device with the Built-in Speakers

By connecting an audio device such as a portable music player to the instrument's [AUX IN] jack, you can output the sound of the audio device through the built-in speakers of this instrument. This lets you play the keyboard along with the playback of your audio player, for practice or performance.

### NOTICE

- To avoid damage to the devices, first turn on the power to the external device, and then to the instrument. When turning off the power, first turn off the power to the instrument, and then to the external device.

### 1 Connect the headphone jack of an audio device to the instrument's [AUX IN] jack by using an audio cable.

Audio device (portable music player, etc.)

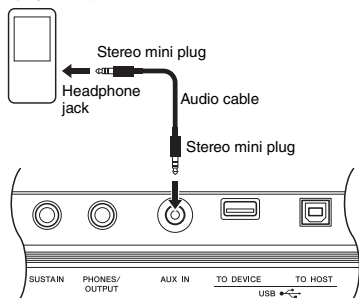

### NOTE

- If you are using a computer or a smart device such as an iPhone/iPad, you can also connect it to the [USB TO HOST] terminal (see "Using with Computer or Smart Device," at right).

### 2 Turn on the audio device, and then this instrument.

### 3 Start play back of the connected audio device.

The sound of the audio device is output through the speakers of this instrument.

### 4 Adjust the volume balance between the audio device and this instrument.

Adjust the audio playback volume on the audio device, then adjust the entire volume by rotating

the [MASTER VOLUME] control of the instrument.

### NOTE

- If you want to adjust the volume balance between the audio input from the external device and Style/Song/Groove Creator, use the [TARGET] button to select Function number 5, then turn Knob A (page 58). The audio input volume from the [AUX IN] jack can also be adjusted in the Function Settings (page 66, Function 004). If you increase the volume to more than 50, the audio device sound may be distorted.

### 5 Play the keyboard along with the sound of audio device.

### NOTE

- You can cancel or lower the volume of the melody part of audio playback. For details, refer to page 46.

### 6 After finishing your performance, stop playback of the audio device.

## Using the Melody Suppressor

When you output the audio sound of an external audio device or a computer connected to the [AUX IN] jack or the [USB TO DEVICE] or [USB TO HOST] terminal through this instrument, you can cancel or lower the volume of the melody part of audio playback. You can use the function to practice the melody part along with the audio playback.

### 1 Play back audio on the connected external device.

### 2 Press the [MELODY SUPPRESSOR] button to turn it on.

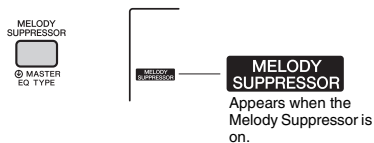

### NOTE

- Depending on the particular music source, the melody or vocal sound may not be cancelled as expected even when if the Melody Suppressor is turned on. In such a case, try adjusting the pan position to be cancelled in the Function Settings (page 68, Function 039).
- When the instrument is connected to the [USB TO HOST] terminal, and Audio Loop Back (page 69, Function 056) is set to OFF, the Melody Suppressor function cannot be used.

### 3 Press the [MELODY SUPPRESSOR] button again to turn it off.

## Using with Computer or Smart Device

Connecting the [USB TO HOST] terminal of this instrument and the computer or smart device allow you to use various function with just one USB cable, such as sending/receiving data with high sound quality, using the app of smart device, etc. The range of the instrument can do is extended. For details on using a computer or smart device, refer to the online PDF manual (page 11) “Computer-related Operations” or “iPhone/iPad Connection Manual.”

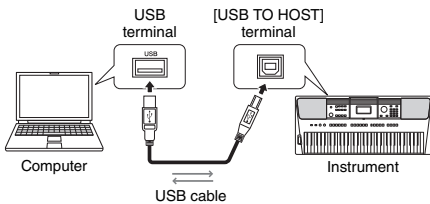

### NOTICE

- Use an AB type USB cable of less than 3 meters. USB 3.0 cables cannot be used.
- If you are using a DAW (digital audio workstation) with this instrument, set the Audio Loop Back (page 69) to OFF. Otherwise, a loud sound may occur, depending on the settings of the computer or the application software.

### NOTE

- When using the Windows computer, install the Yamaha Steinberg USB Driver on the computer. For details, refer to the online PDF manual (page 11) “Computer-related Operations.”

## Transmit/Receiving MIDI data

When transmitting/receiving MIDI data, you can do the following as examples.

- **Playbacking MIDI data**  
You can purchase data on the Yamaha website.
- **Recording the performance of the instrument as MIDI data**  
You can edit the data, such as sound, pitch, etc. on music production software.
- **Using the external sound like a software synthesizer with keyboard on this instrument.**  
You can performance with sounds other than built-in.

- **Using as a master keyboard to enter data on music production software or notation software.**

You can program on a music production software or enter notes on notation software.

### NOTE

- For details of MIDI, refer to the online PDF manual (page 11) “MIDI Reference.”

## Sending/Receiving Audio data (USB Audio Interface)

When sending/receiving audio data by digital signal, you can do the following as examples.

- **Playbacking audio data with high sound quality**  
You can enjoy clear sound that is less degradation of sound quality than connecting with [AUX IN] terminal.
- **Recording the performance of this instrument as audio data on recording software or music production software**  
You can playback the recorded data with computer or smart device.

### NOTE

- The volume can be adjusted on the computer or smart device, and also by using the instrument's [MASTER VOLUME] control.
- The audio data from computer or smart device cannot be played on the instrument in Quick Sampling mode or Audio mode.

## Using Smart Device Apps

Using the smart device apps that are compatible with the instrument, you can do the following as examples.

- **Piano Diary**  
You can leave the performance like diary.
- **Cloud Audio Recorder**  
You cannot only record the performance, but also upload data with one button on the music sharing service “Sound Cloud.”

For details of the corresponding smart device or apps, refer to the Yamaha website.

## Using an External Stereo System for Playback (OUTPUT [L/L+R]/[R] jacks) (PSR-EW410)

You can connect a stereo system to amplify the instrument's sound by using the OUTPUT [L/L+R]/[R] jacks.

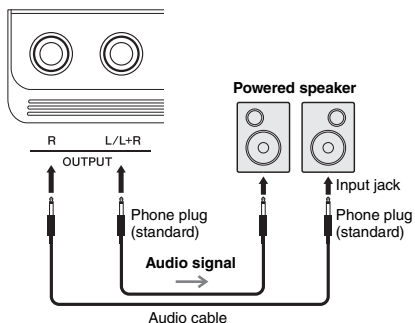

You can use the instrument's [MASTER VOLUME] dial to adjust the volume of the sound output to the external device.

### NOTE

- Use audio cables and adaptor plugs having no (zero) resistance.
- Use only the [L/L+R] jack for connection with a monaural device.

### NOTICE

- To avoid possible damage, first turn on the power to the instrument, then to the external device. When turning off the power, first turn off the power to the external device, then to the instrument. Since this instrument's power may automatically be turned off due to the Auto Power Off function (page 16), turn off the power to the external device, or disable Auto Power Off when you do not intend to operate the instrument.
- Do not route the output from the OUTPUT jacks to the [AUX IN] jack. If you make this connection, the signal input at the [AUX IN] jack is output from the [OUTPUT] jacks and then back again, creating a feedback loop that could make normal performance impossible, and may even damage the equipment.

## Speaker Mute On/Off Setting (PSR-EW410)

You can set whether the sound of this instrument is always output from its built-in speaker or not.

- 1 Press the [FUNCTION] button.



- 2 Use the CATEGORY [ << ] and [ >> ] buttons to call up "SP Mute" (Function 063).

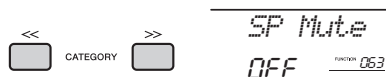

- 3 Use the dial to select the desired setting.

When Speaker Mute is set to "ON," the Speaker sound is off. You can only hear the instrument sound via the headphones or an external device connected to the [OUTPUT] jacks.

When Speaker Mute is set to "OFF," the speaker sound is always on as long as headphones are not connected.



# Backup and Initialization

## Backup Parameters

The following Backup parameters will be maintained even if the power is turned off.

### Backup parameters (each time)

- Use Songs (page 38)
- Style data transferred from a computer and loaded to Style numbers 221–230 (page 75)
- Assigned Sample to keyboards (page 35)

### Backup parameters when turning off the power

- Registration Memory (page 44)
- FUNCTION Settings: (page 66)
  - Style Volume, Song Volume, Groove Volume, Audio Input Volume, Tuning, Split Point, Touch Response, Master EQ Type, Audio Loop Back on/off, Blank Cut on/off, Metronome Volume, Demo Group, Demo Play Mode, Auto Power Off Time, Battery Type, Language

In addition to the Backup parameters above, all the data (including Style data that have not been loaded) transferred from the connected computer will be maintained, even if you turn off the power.

### NOTICE

*Backup is executed automatically when the power is turned off. When the power is turned off in the following cases, backup is not executed.*

- *Disconnected AC adaptor*
- *Power failure*
- *Low or no battery power*

## Initializing the Instrument

You can erase the backup parameter settings described above, and then restore all the default factory settings. The instrument can be initialized with the following two methods.

### Backup Clear

This operation initializes the backup parameters. While holding down the highest white key, press the [⏻] (Standby/On) switch to turn the power on.

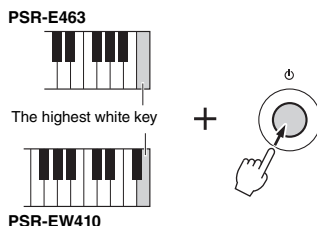

### Flash Clear

This operation deletes all the Songs and Styles that have been transferred from a computer. Note that Style data loaded to Style numbers 221–230 will be maintained. While simultaneously holding the highest white key and the three highest black keys, press the [⏻] (Standby/On) switch to turn the power on.

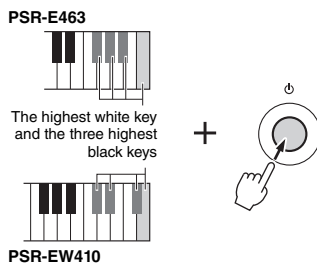

### NOTICE

- *Keep in mind that this operation also deletes any data you have purchased and loaded. Be sure to save important data to a computer. For details, refer to the online PDF manual (page 11) "Computer-related Operations."*

# Handy Performance Features

## Selecting a Reverb Type

The Reverb effect lets you play with a rich concert hall type ambience.

Although selecting a Style or Song will call up the optimum Reverb type for the entire sound, you can select a different Reverb type manually.

### 1 Press the [FUNCTION] button.



### 2 Use the CATEGORY [<<] and [>>] buttons to call up “Reverb” (Function 036).

After a few seconds, the current Reverb type appears.

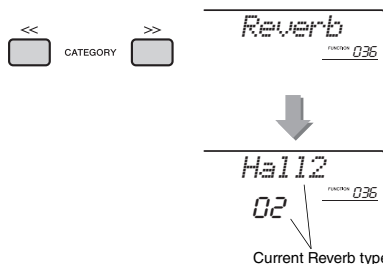

#### NOTE

- Some Songs and Styles use Reverb Types which cannot be selected via panel operation. If such a Song or Style is played back, “- -” is shown on the display.

### 3 Rotate the dial to select a Reverb type.

Play the keyboard to check the sound. For information about the available Reverb types, refer to the Effect Type List in the separate Data List.

#### Adjusting the Reverb depth

You can adjust the Reverb depth applied to the Main, Dual, and Split Voices individually via the same operations above. Regarding the item in step 2, refer to the Function List on page 68.

## Selecting a Chorus Type

The Chorus effect creates a thick sound that sounds like many of the same Voices being played in unison.

Although selecting a Style or Song will call up the optimum Chorus type for the entire sound, you can select a different Chorus type manually.

### 1 Press the [FUNCTION] button.



### 2 Use the CATEGORY [<<] and [>>] buttons to call up “Chorus” (Function 037).

After a few seconds, the current Chorus type appears.

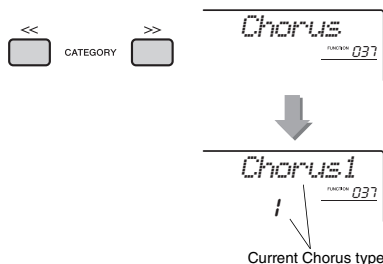

#### NOTE

- Some Songs and Styles use Chorus Types which cannot be selected via panel operation. If such a Song or Style is played back, “- -” is shown on the display.

### 3 Rotate the dial to select a Chorus type.

Play the keyboard to check the sound. For information about the available Chorus types, refer to the Effect Type List in the separate Data List.

#### Adjusting the Chorus depth

You can adjust the Chorus depth applied to the Main, Dual, and Split Voices individually via the same operations above. Regarding the item in step 2, refer to the Function List on page 68.

## Pitch Controls—Transpose

The overall pitch of the instrument (except for the Drum Kit Voices and Sample Voice) can be shifted up or down by a maximum of 1 octave in semitone increments.

- 1 Press the [TRANPOSE] button to call up “Transpose” (Function 006).

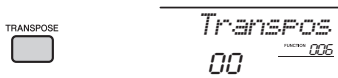

- 2 Use the dial to set the Transpose value between -12 and +12.

## Pitch Controls—Fine Tuning

The overall tuning of the instrument (except for the Drum Kit Voices) can be shifted up or down between 427.0 Hz and 453.0 Hz in approximately 0.2 Hz increments. The default value is 440.0 Hz.

- 1 Press the [FUNCTION] button.



- 2 Use the CATEGORY [<<] and [>>] buttons to call up “Tuning” (Function 007).

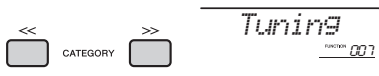

- 3 Use the dial to set the Tuning value.

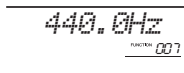

## Pitch Controls—the [PITCH BEND] wheel

The [PITCH BEND] wheel can be used to add smooth pitch variations to notes you play on the keyboard. Roll the wheel upward to raise the pitch, or downward to lower the pitch.

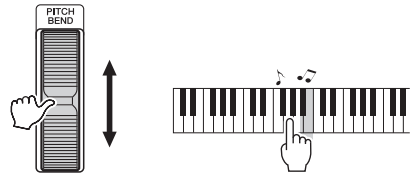

You can change the amount of pitch bend produced by the wheel in the Function Settings (page 66, Function 008).

## Calling Up Optimum Panel Settings—One Touch Setting (OTS)

Select a Song, Style or Groove by pressing the [SONG], [STYLE] or [GROOVE CREATOR] button, and then select Voice number 000 OTS (page 20). This lets you automatically call up the optimum panel settings such as Voice and tempo for the current Song, Style or Groove.

## Changing the Touch Response of the Keyboard

The keyboard of this instrument is equipped with a Touch Response feature that lets you dynamically and expressively control the level of the Voices according to your playing strength.

### 1 Press the [FUNCTION] button.



### 2 Use the CATEGORY [<<] and [>>] buttons to call up “TouchRes” (Function 010).

After a few seconds, the current Touch Response appears.

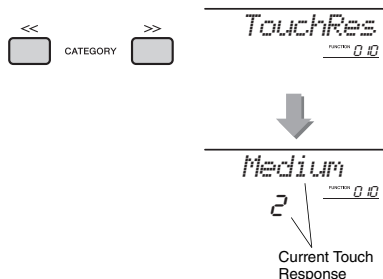

### 3 Use the dial to select a Touch Response setting between 1 and 4.

#### Touch Response

1	Soft	Allows maximum loudness to be produced with relatively light key pressure.
2	Medium	Produces a fairly “standard” keyboard response.
3	Hard	Requires strong playing to produce high volume.
4	Fixed	All notes are produced at the same volume no matter how hard the keyboard is played.

## Selecting an EQ Setting for the Best Sound

Six different master equalizer (EQ) settings give you the best possible sound when listening through different reproduction systems—the instrument’s internal speakers, headphones, or an external speaker system.

### 1 Hold down the [MELODY SUPPRESSOR] button for longer than a second to call up “Master EQ” (Function 038).

After a few seconds, the current Master EQ type appears.

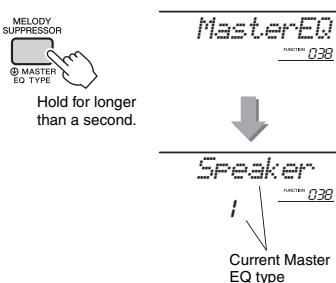

### 2 Rotate the dial to select the desired Master EQ type.

#### Master EQ types

1	Speaker	Optimum for listening via the instrument’s built-in speakers.
2	Headphone	Optimum for headphones, or for listening via external speakers.
3	Boost	Results in more powerful sound. Depending on the selected Voice and Style, etc., the sound may be more subject to distortion than other EQ types.
4	Piano	Optimum for piano solo performance.
5	Bright	Lowers the mid range for a brighter sound.
6	Mild	Lowers the high range for a softer sound.

# Scale Tuning

By default, the scale of this keyboard is set to Equal Temperament — the same tuning as with any acoustic piano. However, the setting can be changed to any other scale according to the music genre or style in which you want to play.

## Selecting a Scale

You can select a desired scale among the various preset scales.

- 1 Press the [FUNCTION] button.



- 2 Use the CATEGORY [ << ] and [ >> ] button to call up “Scale” (Function 046).

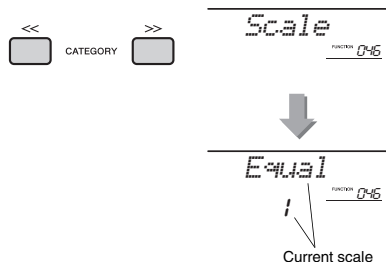

- 3 Rotate the dial to select a scale.

The default setting is “1 Equal.”

### Preset Scale types

1	Equal
2	Pure Major
3	Pure Minor
4	Bayat (Arabic)
5	Rast (Arabic)

## Setting the Base Note for Each Scale

Make sure to specify the appropriate base note, if you select a scale other than Equal Temperament, or create an original scale via Scale Tune function.

- 1 Press the [FUNCTION] button.



- 2 Use the CATEGORY [ << ] and [ >> ] button to call up “BaseNote” (Function 047).

After a few seconds, the current base note appears.

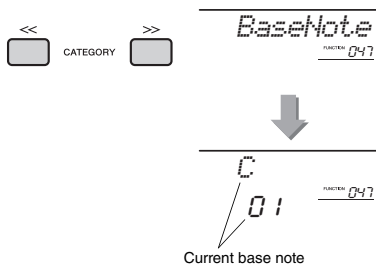

- 3 Rotate the dial to select a base note from C, C#, D, E♭, E, F, F#, G, A♭, A, B♭ and B.

The default setting is “C.”

## Tuning Each Note to Create an Original Scale

You can tune the individual notes in cents (a “cent” is 1/100th of a semitone) to create your own original scale.

### 1 Press the [FUNCTION] button.



### 2 Use the CATEGORY [<<] and [>>] buttons to call up “TuneNote” (Function 048).

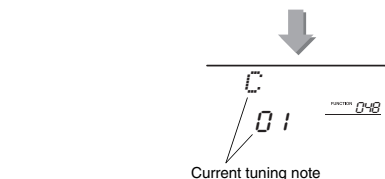
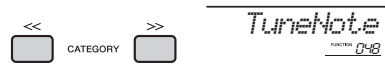

### 3 Rotate the dial to select the note to be tuned from C, C#, D, E♭, E, F, F#, G, A♭, A, B♭, B.

### 4 Press the CATEGORY [>>] button to call up “Tune” (Function 049).

After a few seconds, the tuning value of the note selected in step 3 appears.

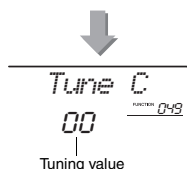
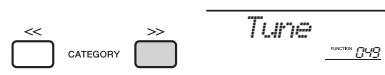

### 5 Rotate the dial to tune the note over a range of -64 to +63.

The setting can be reset to the initial default value by pressing the [+ / YES] and [- / NO] buttons simultaneously.

### 6 Repeat steps 2–5 as desired.

### 7 Memorize the settings here to a Registration Memory as desired (page 44).

#### NOTE

- When pressing the [+ / YES] and [- / NO] buttons simultaneously after recalling an original scale memorized to Registration Memory, the scale will return to the original scale registered to Registration Memory, not to the default tune value.
- When calling up “Scale” (Function 046) after using individual note scale tuning, “(Edited)” will be shown in the display. However, the edited scale settings will be erased by calling up another scale. For this reason, the edited settings should be memorized to Registration Memory.

# Voice Settings

## Selecting a Dual Voice

- 1 Hold down the [DUAL] button for longer than a second to call up “D.Voice” (Function 020).

After a few seconds, the current Dual Voice appears.

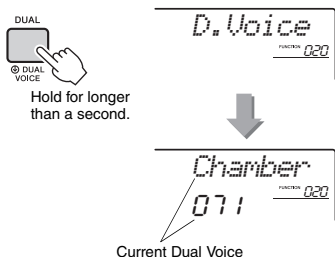

- 2 Rotate the dial to select the desired Dual Voice.

## Selecting a Split Voice

- 1 Hold down the [SPLIT] button for longer than a second to call up “S.Voice” (Function 030).

After a few seconds, the current Split Voice appears.

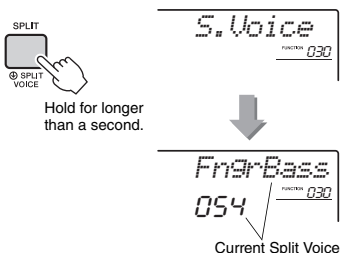

- 2 Rotate the dial to select the desired Split Voice.

## Voice Editing

Each of the Main, Dual and Split Voices can be edited, with available parameters including volume, octave and Reverb/Chorus depth—allowing you to create new, custom sounds to best suit your own musical preferences.

- 1 Press the [FUNCTION] button.



- 2 Use the CATEGORY [<<] and [>>] buttons to call up the desired item.

Voice parameters are indicated as below.

- Main Voice parameters: M.\*\*\*\*\* (Function 011–019)
- Dual Voice parameters: D.\*\*\*\*\* (Function 020–029)
- Split Voice parameters: S.\*\*\*\*\* (Function 030–035)

For details on each parameter, refer to the Function List on page 67.

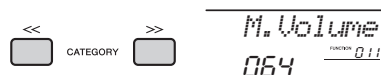

- 3 Rotate the dial to set the value.

Check the sound by playing the keyboard.

- 4 Repeat steps 2–3 above to edit various parameters.

- 5 If necessary, memorize the settings to a Registration Memory (page 44).

The Voice-related settings are reset when a different Voice is selected. If you want to store the created sound for future recall, memorize the settings to a Registration Memory.

# Arpeggio Settings

## Synchronizing an Arpeggio to Song/Style/Groove Playback—Arpeggio Quantize

When you play the keyboard to trigger an Arpeggio (page 22) along with Song/Style/Groove playback, you'll need to play the notes with correct timing to keep the Arpeggio in synchronization with the other playback tracks. However, your actual timing may be slightly ahead of or behind the beat (or both). The "Arpeggio Quantize" function of this instrument will correct any slight imperfections in the timing (according to settings below), and then play back the Arpeggio appropriately.

- No synchronization
- Synchronizing to 8th notes
- Synchronizing to quarter notes

Although the Arpeggio Quantize value is pre-programmed for each Arpeggio Type, you can change the value manually.

### 1 Press the [FUNCTION] button.



### 2 Use the CATEGORY [<<] and [>>] buttons to call up the "Quantize" (Function 044).

After a few seconds, the current Arpeggio Quantize value appears.

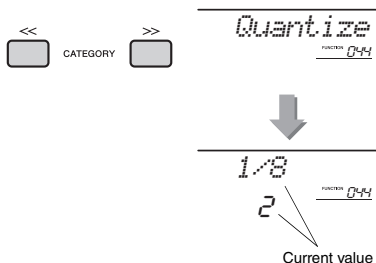

### 3 Rotate the dial to select a value from "OFF," "1/8" and "1/16."

- OFF No synchronization
- 1/16 Synchronizing to 8th notes
- 1/8 Synchronizing to quarter notes

## Holding the Arpeggio Playback via the Footswitch

You can set the instrument so that Arpeggio playback continues even after the note has been released, by pressing the footswitch connected to the [SUSTAIN] jack.

### 1 Press the [FUNCTION] button.



### 2 Use the CATEGORY [<<] and [>>] buttons to call up "Pd1 Func" (Function 045).

After a few seconds, the current pedal setting appears.

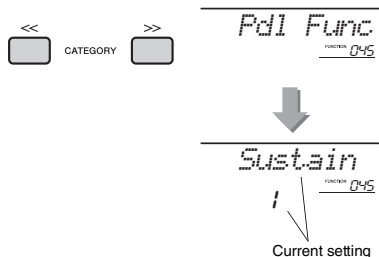

### 3 Rotate the dial to select "Arp Hold."

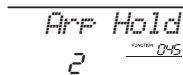

If you want to restore the footswitch function to sustain, select "Sustain." If you want to use both hold and sustain functions, select "Hold+Sus."

### 4 Try playing the Arpeggio with the footswitch.

Press the notes to trigger the Arpeggio, then press the footswitch. Even if you release the notes, Arpeggio playback will continue. To stop Arpeggio playback, release the footswitch.



# Parameters Assigned to the Knobs

This section describes each of the parameters which can be assigned to the Knobs (page 25).

## 1 CUTOFF/RESONANCE

These effects shape the sound by allowing only a specified range of frequencies to pass and/or by producing a resonance peak at the “cutoff” frequency. These effects can be used to create a range of synthesizer-like sounds.

### NOTE

- When the target is **KEYBOARD**, these effects are applied to the **Main/Dual Voices**. When the target is **BACKING**, these effects are applied to the **Styles and Grooves**.
- These effects can sometimes cause distortion, especially in the bass frequencies.

### ● Knob A: CUTOFF

Adjusts the cutoff frequency, and therefore the brightness of the sound. Turning the knob to the left makes the sound more muffled or darker, while turning the knob A to the right makes the sound brighter.

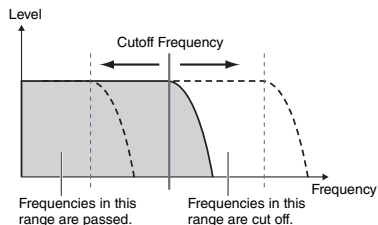

### ● Knob B: RESONANCE

Adjusts the amount of Resonance applied at the cutoff frequency. Turning the knob to the right increases the Resonance to emphasize the frequencies at the cutoff frequency, resulting in an exaggerated peak.

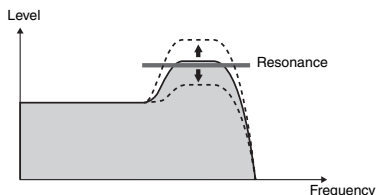

## 2 REVERB/CHORUS

### ● Knob A: REVERB

Reproduces the acoustic ambience of a concert hall or club. Turning the knob to the right increases the Reverb depth.

### ● Knob B: CHORUS

Produces a rich and warm layered effect. Turning the knob to the right increases the Chorus depth.

### NOTE

- When the target is **KEYBOARD**, these effects are applied to the **Main/Dual Voices**. When the target is **BACKING**, these effects are applied to the **Styles and Grooves**.

## 3 DSP

### ● Knob A/B: DSP PARAMETER A/B

With the digital effects built into the instrument, you can add DSP effects to your keyboard performance and the playback sound of Style, etc. (page 24). Each effect has two parameters which are assigned to Knobs A and B. By turning the knobs in real-time, you can alter the music in various dynamic ways, such as changing the rotating speed (slow/fast) of the rotary speaker or changing the degree of the Distortion.

## 4 ATTACK/RELEASE

These effects determine how the level of the sound varies over time. You can make the attack faster for a more percussive sound or slower for a violin-like sound, for example. Or you can lengthen or shorten the sustain to best match the music you're playing.

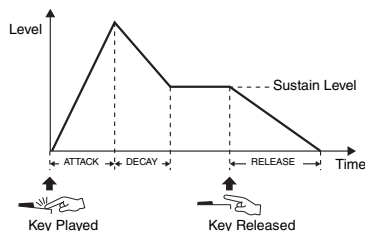

### ● Knob A: ATTACK

Adjusts the Attack Time (the amount of time it takes the sound to reach maximum level when a key is played). Turning the knob to the right increases the Attack Time, thus slowing down the attack rate.

### ● Knob B: RELEASE

Adjusts the Release Time (the amount of time it takes for the sound to decay to silence after a key is released). Turning the knob to the right increases the Release Time, thus making a longer sustain.

### NOTE

- These effects are applied only **KEYBOARD**. The target cannot be switched to **BACKING**.

**5 VOLUME BALANCE/RETRIGGER RATE****● Knob A: VOLUME BALANCE**

Adjusts the volume balance between the audio playback volume from the connected audio device (page 46) or the computer (page 47) and the Song/Style/Groove. Turning the knob to the left decreases the external audio volume, while turning it to the right decreases the instrument volume. Even when there is no audio input from an external device, the volume of Song, Style and Groove can be adjusted by using the knob. The volume of Voices played on the keyboard cannot be adjusted.

**NOTE**

- When the instrument is connected to the [USB TO HOST] terminal, and Audio Loop Back (page 69, Function 056) is set to OFF, you cannot adjust the volume of audio playback input from the external device.

**● Knob B: RETRIGGER RATE**

Adjusts the Retrigger Rate (the length of the part to be repeated) of the Groove Retrigger function (page 61). Turning this knob to the right decreases it, and turning the knob to the left increases it.

**NOTE**

- When setting the tempo of the Groove playback to more than 200, turning the knob to the right cannot change the length to be repeated.

The chart below lists some interesting ways to use the various effects that can be assigned to the knobs.

**Some Ideas for Using the Knobs**

Number/Effect		Try This
<b>1</b>	CUTOFF/RESONANCE	Select "143 Gemini" (a synth-lead type Voice) or "170 Noise." Select <b>1</b> with [KNOB ASSIGN] button, and then switch the target to KEYBOARD. Turning Knobs A or B while playing gives you the dynamic filter-sweep effects of an analog synthesizer.
<b>2</b>	REVERB/CHORUS	Select the Voice "008 CP80." Select <b>2</b> with [KNOB ASSIGN] button, and then switch the target to KEYBOARD. Turn Knobs A and B all the way down to hear the direct, unprocessed sound of the Voice. As you turn Knob B toward the right, a Chorus effect with modulation is gradually applied to the sound. Turning Knob A to the right adds a Reverb effect that makes you sound like you are playing in a concert hall.
<b>3</b>	DSP	Select the Voice, "019 Cool!Org." Select <b>3</b> with [KNOB ASSIGN] button, and then switch the target to KEYBOARD. Press the [DSP] button to turn the DSP on, then set the DSP type (Function 040) to "01 RotarySp." Use Knob A to change the rotating speed of the rotary speaker while playing the keyboard. When you move it slowly, you can create gradual speed changes like on a real rotary speaker. Use Knob B to control the distortion.
<b>4</b>	ATTACK/RELEASE	Select the Voice "173 RSAnPad." Turning Knob A all the way down makes the attack faster, and lets you hear the crisp, clear sound of the original Voice. Turning Knob B all the way down shortens the amount of time for the sound to decay to silence after a key is released. These knobs let you finely adjust the Voice to create the appropriate sound for the particular song you're playing.
<b>5</b>	VOLUME BALANCE/ RETRIGGER RATE	<p><b>Knob A:</b> Connect an audio device or a computer (page 46), then turn this knob while playing audio on the external device. You can adjust the volume balance between the performance on this instrument and the audio input.</p> <p><b>Knob B:</b> Select the Section C of the Groove "008 FrenchDJ" and start Groove playback. Turn this knob to the right while holding down the Section button C, and you can progressively shorten the Retrigger rate like a DJ would in performance.</p>

# Style and Groove Settings

## Style Variations—Sections

Each Style consists of “Sections” that allow you to vary the arrangement of the accompaniment to match the song you are playing.

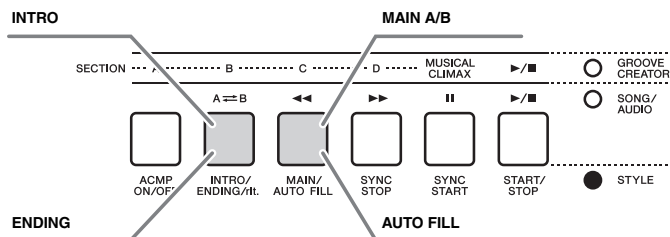

### INTRO

This is used for the beginning of the Song. When the Intro finishes, Style playback shifts to the Main section. The length of the Intro (in measures) differs depending on the selected Style.

### MAIN

This is used for playing the main part of the Song. Playback of the Main section repeats indefinitely until another Section's button is pressed. There are two variations (A and B), and the Style playback sound changes harmonically in response on the chords you play with your left hand.

### AUTO FILL

This is automatically added before changing to Main A or B.

### ENDING

This is used for the ending of the Song. When the Ending finishes, the Style playback stops automatically. The length of the Ending (in measures) differs depending on the selected Style.

1 Press the [STYLE] button, then rotate the dial to select a Style.

2 Press the [ACMP ON/OFF] button to turn ACMP on.

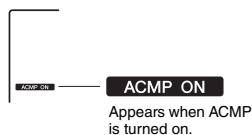

Appears when ACMP is turned on.

3 Press the [SYNC START] button to turn Synchro Start on.



To turn off Synchro Start, press the [SYNC START] button.

### Synchro Start

When Synchro Start is on, Style playback will begin as soon as you play a chord in the Auto Accompaniment area of the keyboard.

4 Press the [MAIN/AUTO FILL] button to select Main A or Main B.

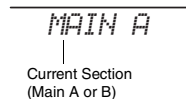

Current Section (Main A or B)

### 5 Press the [INTRO/ENDING/rit.] button.

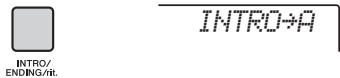

Now, you're ready to start Style playback of the Intro and then the Main A (or B) section.

### 6 Play a chord with your left hand to start playback of the Intro.

For information on how to play chords, see "Chords" on page 63.

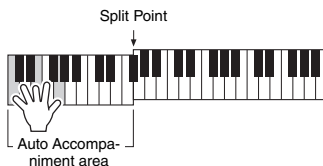

### 7 After the Intro finishes, play the keyboard according to the progression of the Song you are playing.

Play chords with your right hand, and press the [MAIN/AUTO FILL] button as necessary. The Section will change to Fill-in then Main A or B.



### 8 Press the [INTRO/ENDING/rit.] button.

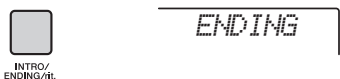

The Section switches to the Ending. When the Ending is finished, Style playback stops automatically. You can have the Ending gradually slow down (ritardando) by pressing the [INTRO/ENDING/rit.] button again while the Ending is playing back.

**NOTE**

- Style numbers 211, 223–235 have no rhythm parts, so no rhythm will play. When one of these Styles is selected, turn ACMP on, then specify the chord in the Auto Accompaniment area to play Style parts other than the Rhythm part.

## Style Synchro Stop

When you press the [SYNC STOP] button to turn on this function, the Style will only play while pressing chords in the Auto Accompaniment area of the keyboard. Releasing all the notes will stop Style playback.

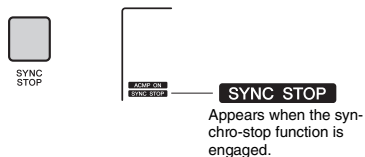

**NOTE**

- This function can be used when ACMP is turned on.

## Turning Each Style Track On/Off

As printed on the front panel, a Style consists of six tracks. Turn on/off each track via the TRACK CONTROL buttons. Each of the tracks can be muted so that you can play the muted part yourself. Pressing the desired Track button repeatedly will toggle the on/off status.

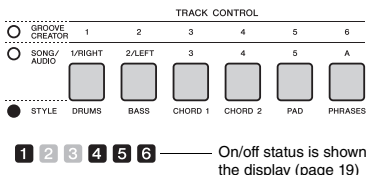

**NOTE**

- Up to two Track buttons can be pressed simultaneously for turning Tracks on or off.

## Groove Variations—Sections

Like the Styles, each Groove features several Sections, allowing you to add dynamic variations to the performance. Five Sections (A–D, MUSICAL CLIMAX) are available.

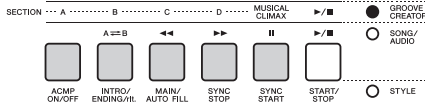

Unlike the Styles, however, Groove do not have Sections dedicated to the beginning or ending of the Song, such as Intro and Ending. All Sections A–D will play back repeatedly until stopped manually.

## Groove Retrigger Function

This function restarts Groove playback from the beginning.

- 1 Press the [GROOVE CREATOR] button, then rotate the dial to select the desired Groove.
- 2 Press the [START/STOP] button or press any key in the Auto Accompaniment area to start Groove playback (page 30).
- 3 By pressing the button of the currently playing Section, you can restart playback from the beginning. Holding down the button lets loop-play only the top portion of the Section.

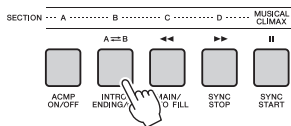

The top portion length (Retrigger Rate) can be changed by using the knob (page 58).

**NOTE**

- When recording Groove playback with the Retrigger function, note that the beat indicator in the display, metronome and Arpeggio playback is not synchronized with playback of the recorded Song.

## Changing the Tempo

A Style or Groove can be played at any tempo you desire—fast or slow—and the tempo can be changed precisely.

- 1 Press the [TEMPO/TAP] button to call up the Tempo value in the display.

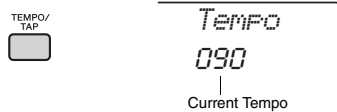

- 2 Rotate the dial to set a tempo from 011 to 280.

Pressing the [+ / YES] and [- / NO] buttons simultaneously can instantly reset the value to the default tempo of the current Style or Groove. You can change the tempo during playback by pressing the [TEMPO/TAP] button just twice at the required tempo.

**NOTE**

- The above operation applies also to Song or Arpeggio playback tempo.

## Tap Start

You can start play back of the Style, Groove or Song by simply tapping the [TEMPO/TAP] button at the required tempo—four times for time signatures in 4 (4/4, etc.), and three times for time signatures in 3 (3/4, etc.).

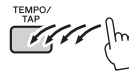

**NOTE**

- Tap tempo setting range: 32–280

## Adjusting the Volume of the Style or Groove

You can adjust the volume balance between Style or Groove playback and your keyboard performance.

- 1 Press the [FUNCTION] button.



- 2 Use the CATEGORY [<<] and [>>] buttons to call up “StyleVol” (Function 001) or “GroovVol” (Function 003).

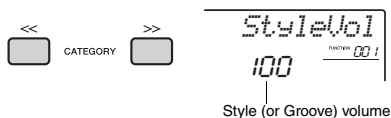

- 3 Rotate the dial to set the volume between 000 and 127.

## Setting the Split Point

The point on the keyboard that separates the left-hand area and the right-hand area of the keyboard is called the “Split Point.” The left-hand area is used to specify the chord for Style playback, to specify the key for Groove playback, or to play the Split Voice. The default Split Point is key number 054 (the F#2 key), but you can change it to another key.

- 1 Press the [FUNCTION] button.



- 2 Use the CATEGORY [<<] and [>>] buttons to call up “SplitPnt” (Function 009).

You can call up this display also by pressing the [STYLE] then holding the [ACMP] button for longer than a second.

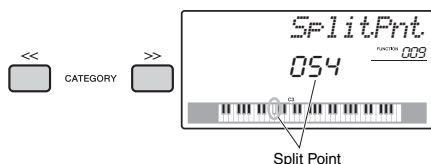

- 3 Rotate the dial to set the Split Point between 036 (C1) and 096 (C6) (on the PSR-E463) or 028 (E0) and 103 (G6) (on the PSR-EW410).

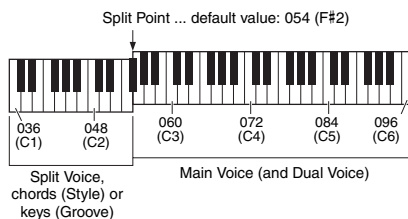

## Playing Chords Without Style Playback (Stop Accompaniment)

If you press the [STYLE] button, press the [ACMP ON/OFF] button to turn ACMP on (the ACMP ON icon appears), and play the chord in the Auto Accompaniment area of the keyboard (with SYNC START off), the chord sound will be heard without Style playback. This is referred to as “Stop Accompaniment.” The specified chord will be shown in the display, and affects the Harmony function (page 22).

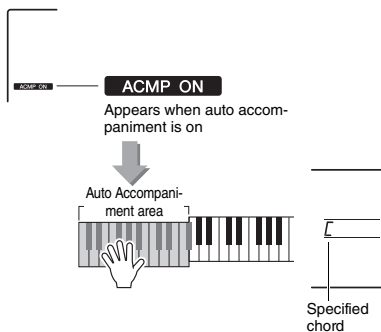

## Chord Types for Style Playback

For users who are new to chords, this chart features common chords. Since there are many useful chords and many different ways to use them musically, refer to commercially available chord books for further details.

★ indicates the root note.

Major	Minor	Seventh	Minor Seventh	Major Seventh
<b>C</b> 	<b>Cm</b> 	<b>C7</b> 	<b>Cm7</b> 	<b>CM7</b> 
<b>D</b> 	<b>Dm</b> 	<b>D7</b> 	<b>Dm7</b> 	<b>DM7</b> 
<b>E</b> 	<b>Em</b> 	<b>E7</b> 	<b>Em7</b> 	<b>EM7</b> 
<b>F</b> 	<b>Fm</b> 	<b>F7</b> 	<b>Fm7</b> 	<b>FM7</b> 
<b>G</b> 	<b>Gm</b> 	<b>G7</b> 	<b>Gm7</b> 	<b>GM7</b> 
<b>A</b> 	<b>Am</b> 	<b>A7</b> 	<b>Am7</b> 	<b>AM7</b> 
<b>B</b> 	<b>Bm</b> 	<b>B7</b> 	<b>Bm7</b> 	<b>BM7</b> 

- Inversions can be used as well as in "root" position—with the following exceptions: m7, m7♭5, m7(11), 6, m6, sus4, aug, dim7, 7♭5, 6(9), sus2
- Inversion of the 7sus4 chords are not recognized if the notes are omitted.
- When playing a chord which cannot be recognized by this instrument, nothing is shown on the display. In such a case, only the rhythm and bass parts will be played.

### Easy Chords

This method lets you easily play chords in the Auto Accompaniment area of the keyboard using only one, two, or three fingers.

#### For root "C"



**To play a major chord**  
Press the root note (★) of the chord.



**To play a minor chord**  
Press the root note together with the nearest black key to the left of it.



**To play a seventh chord**  
Press the root note together with the nearest white key to the left of it.



**To play a minor seventh chord**  
Press the root note together with the nearest white and black keys to the left of it (three keys altogether).

# Song Settings

## Background Music Playback

With the default setting, pressing the [DEMO] button will play back only a few of the internal Songs repeatedly. This setting can be changed so that, for example, all internal Songs are played, or all Songs transferred to the instrument from a computer are played back, letting you use the instrument as a background music source. Six playback group settings are provided for your listening pleasure.

### 1 Hold down the [DEMO] button for longer than a second to call up “DemoGrp.”

After a few seconds, the current repeat playback group appears.

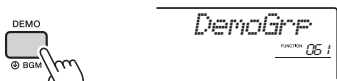

Hold for longer than a second.

### 2 Rotate the dial to select a repeat playback group from the table below.

Demo	Preset Songs 001–003
Preset	All preset Songs
User	All User Songs
Download	All Songs transferred from a computer
USB	All Songs (MIDI files) in the connected USB flash drive
AUDIO	All audio Songs in the connected USB flash drive

#### NOTE

- When there are no existing User Songs, Download Songs or USB Songs in the data, the Demo Songs are played back.

### 3 Press the [DEMO] button to start playback.

To stop playback, press the [DEMO] button again.

## Random Song Playback

The order of Song repeat playback via the [DEMO] button can be changed between numerical order and random order.

### 1 Press the [FUNCTION] button.



### 2 Use the CATEGORY [<<] and [>>] buttons to call up “PlayMode” (Function 062).

After a few seconds, the current playback mode appears.

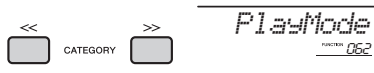

When the DemoGrp is set to “Demo,” this parameter cannot be set.

### 3 Rotate the dial to select “Random.”

To return to the numerical order, select “Normal.”

### 4 Press the [DEMO] button to start playback.

To stop playback, press the [DEMO] button again.



## Tempo Setting of the Song

This operation is same as that of the Style and Groove. Refer to page 61.

### NOTE

- Tempo of audio Song cannot be changed.

## Tap Start

This operation is same as that of the Style and Groove. Refer to page 61.

## Song Volume

- 1 Press the [FUNCTION] button.



- 2 Use the CATEGORY [<<] and [>>] buttons to call up "SongVol" (Function 002).

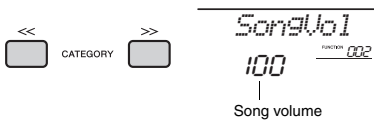

- 3 Rotate the dial to set the Song volume between 000 and 127.

### NOTE

- Song volume can be adjusted while in the Song mode.

## Melody Voice Setting of the Preset Song

You can change the Melody Voice of the current Preset Song and Song from the external device temporarily to any other desired Voice.

- 1 Press the [SONG] button, select the desired Preset Song, and then start playback (page 28).
- 2 Press the [VOICE] button, then rotate the dial to select the desired Voice.

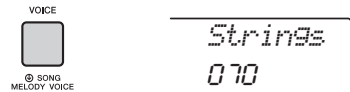

- 3 Hold down the [VOICE] button for longer than a second to call up "SONG MELODY VOICE."

After a few seconds, the Melody Voice of the Song will be changed to that selected in step 2.

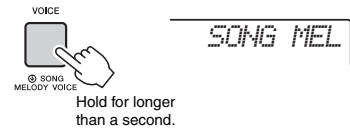

### NOTE

- Selecting another Song will cancel the changed Melody Voice.
- You cannot change the Melody Voice of a User Song.
- Other Voice will be changed depending on Song.
- You cannot change the Voice of an audio data.

# The Functions

The “Functions” provide access to a range of detailed instrument parameters such as Tuning, Split Point, Voices and Effects. Find the desired item in the Function List on pages 66–69, and then follow the instructions below.

## Basic Procedure in the Function Display

1 Press the [FUNCTION] button.



2 Press the CATEGORY [ << ] and [ >> ] button several times until the desired item appears.

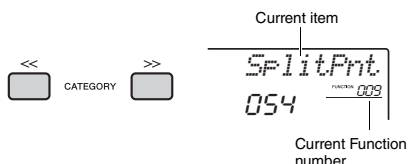

3 Use the dial, the [+ / YES] and [- / NO] buttons, or the [0]–[9] number buttons to set the value of the selected function.

To restore the default value, press the [+ / YES] and [- / NO] buttons simultaneously. The one exception to

this is the MIDI Initial Send function (Function 055), which is an operation and not a parameter. For this function, pressing the [+ / YES] button executes the operation while pressing [- / NO] cancels it.

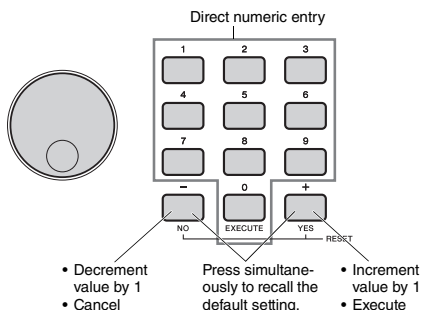

Some Function settings are maintained even if you turn off the power, and can be transferred to a computer as Backup Data (page 49).

### NOTE

- To exit from a Function display, press the [VOICE], [STYLE], [SONG] or [GROOVE CREATOR] button.

## Function List

Function Number	Function	Display	Range/Settings	Default Value	Description	
PSR-E463	PSR-EW410					
<b>Volume</b>						
001	001	Style Volume	<i>StyleVol</i>	000–127	100	Refer to page 62.
002	002	Song Volume	<i>SongVol</i>	000–127	100	Refer to page 65.
003	003	Groove Volume	<i>GrooveVol</i>	000–127	100	Refer to page 62.
004	004	[AUX IN] Audio Volume	<i>AuxInVol</i>	000–127	50	Adjusts the volume of audio playback that is input from the [AUX IN] jack (pages 32, 46).
005	005	[USB TO DEVICE] [USB TO HOST] Audio Volume	<i>USBInVol</i>	000–127	100	Adjusts the volume of audio playback that is input from the [USB TO DEVICE] and [USB TO HOST] terminal (pages 32, 46).
<b>Overall</b>						
006	006	Transpose	<i>TransPos</i>	-12–12	00	Refer to page 51.
007	007	Tuning	<i>Tuning</i>	427.0Hz–453.0Hz	440.0Hz	Refer to page 51.
008	008	Pitch Bend Range	<i>PBRange</i>	01–12	02	Sets the range over which you can control pitch by using the [PITCH BEND] wheel (page 51), in semitone increments.
009	009	Split Point	<i>SPlitPnt</i>	036–096 (C1–C6; PSR-E463) / 028–103 (E0–G6; PSR-EW410)	054 (F#2)	Refer to page 62.
010	010	Touch Response	<i>TouchRes</i>	1 (Soft), 2 (Medium), 3 (Hard), 4 (Fixed)	2 (Medium)	Refer to page 52.

Function Number		Function	Display	Range/Settings	Default Value	Description
PSR-E463	PSR-EW410					
<b>Main Voice (page 20)</b>						
011	011	Volume	<i>M. Volume</i>	000–127	*	Determines the volume of the Main Voice.
012	012	Octave	<i>M. Octave</i>	-2 – +2	*	Determines the octave range for the Main Voice.
013	013	Pan	<i>M. Pan</i>	000 (left)– 064 (center)– 127 (right)	*	Determines the stereo pan position of the Main Voice. A value of "0" results in the sound being panned full left, while a value of "127" results in the sound being panned full right.
014	014	Reverb Depth	<i>M. Reverb</i>	000–127	*	Determines how much of the Main Voice's signal is sent to the Reverb effect.
015	015	Chorus Depth	<i>M. Chorus</i>	000–127	*	Determines how much of the Main Voice's signal is sent to the Chorus effect.
016	016	Attack Time	<i>M. Attack</i>	000–127	064	Determines how fast the volume of the Main Voice reaches the Attack level when the note is pressed. The larger the value, the slower the attack rate. The smaller the value, the faster the attack rate.
017	017	Release Time	<i>M. Releas</i>	000–127	064	Determines how fast the volume of the Main Voice falls to 0 when the note is released. The larger the value, the longer the sustain. The smaller the value, the shorter the sustain.
018	018	Filter Cutoff	<i>M. Cutoff</i>	000–127	064	Determines the Filter Cutoff Frequency (page 57) of the Main Voice.
019	019	Filter Resonance	<i>M. Reso.</i>	000–127	064	Determines the Filter Resonance (page 57) of the Main Voice.
<b>Dual Voice (page 20)</b>						
020	020	Dual Voice	<i>D. Voice</i>	001–758	*	Selects a Dual Voice.
021	021	Volume	<i>D. Volume</i>	000–127	*	Determines the volume of the Dual Voice.
022	022	Octave	<i>D. Octave</i>	-2 – +2	*	Determines the octave range for the Dual Voice.
023	023	Pan	<i>D. Pan</i>	000 (left)– 064 (center)– 127 (right)	*	Determines the stereo pan position of the Dual Voice. A value of "0" results in the sound being panned full left; a value of "127" results in the sound being panned full right.
024	024	Reverb Depth	<i>D. Reverb</i>	000–127	*	Determines how much of the Dual Voice's signal is sent to the Reverb effect.
025	025	Chorus Depth	<i>D. Chorus</i>	000–127	*	Determines how much of the Dual Voice's signal is sent to the Chorus effect.
026	026	Attack Time	<i>D. Attack</i>	000–127	064	Determines how fast the volume of the Dual Voice reaches the Attack level when the note is pressed. The larger the value, the slower the attack rate. The smaller the value, the faster the attack rate.
027	027	Release Time	<i>D. Releas</i>	000–127	064	Determines how fast the volume of the Dual Voice falls to 0 when the note is released. The larger the value, the longer the sustain. The smaller the value, the shorter the sustain.
028	028	Filter Cutoff	<i>D. Cutoff</i>	000–127	064	Determines the Filter Cutoff Frequency (page 57) of the Dual Voice.
029	029	Filter Resonance	<i>D. Reso.</i>	000–127	064	Determines the Filter Resonance (page 57) of the Dual Voice.
<b>Split Voice (page 21)</b>						
030	030	Split Voice	<i>S. Voice</i>	001–758	054 (FngrBass)	Selects a Split Voice.
031	031	Volume	<i>S. Volume</i>	000–127	080	Determines the volume of the Split Voice.
032	032	Octave	<i>S. Octave</i>	-2 – +2	-1	Determines the octave range for the Split Voice.
033	033	Pan	<i>S. Pan</i>	000 (left)– 064 (center)– 127 (right)	064	Determines the stereo pan position of the Split Voice. A value of "0" results in the sound being panned full left; a value of "127" results in the sound being panned full right.
034	034	Reverb Depth	<i>S. Reverb</i>	000–127	008	Determines how much of the Split Voice's signal is sent to the Reverb effect.
035	035	Chorus Depth	<i>S. Chorus</i>	000–127	000	Determines how much of the Split Voice's signal is sent to the Chorus effect.

Function Number		Function	Display	Range/Settings	Default Value	Description
PSR-E463	PSR-EW410					
<b>Effects</b>						
036	036	Reverb Type	<i>Reverb</i>	01–13	**	Refer to page 50.
037	037	Chorus Type	<i>Chorus</i>	1–6	**	Refer to page 50.
038	038	Master EQ Type	<i>MasterEQ</i>	1 (Speaker), 2 (Headphone), 3 (Boost), 4 (Piano), 5 (Bright), 6 (Mild)	1 (Speaker)	Refer to page 52.
039	039	Melody Suppressor	<i>SUPPRPan</i>	L63–C–R63	C	Determines the pan position to be cancelled when the Melody Suppressor (page 46) is turned on.
<b>DSP (page 24)</b>						
040	040	DSP Type	<i>DSP Type</i>	01–10	01	Refer to page 24.
<b>Harmony/Arpeggio (page 22)</b>						
041	041	Harmony Type/ Arpeggio Type	<i>Harf/Arp</i>	01–26	*	Determines the Harmony type or Arpeggio type.
042	042	Harmony Volume	<i>HarmonVol</i>	000–127	*	Determines the volume of the Harmony effect.
043	043	Arpeggio Velocity	<i>ARP Velo</i>	1 (Original), 2 (Key)	Depends on the Arpeggio type	When “Key” is selected, the velocities of Arpeggio playback are determined by your playing strength. When “Original” is selected, the velocities of Arpeggio playback are determined by the original setting regardless of your playing strength.
044	044	Arpeggio Quantize	<i>Quantize</i>	1 (OFF), 2 (1/8), 3 (1/16)	Depends on the Arpeggio type	Refer to page 56.
045	045	Pedal Function	<i>Pd1 Func</i>	1 (Sustain) / 2 (Arp Hold) / 3 (Hold+Sus)	*	Refer to page 56.
<b>Scale Tuning (page 53)</b>						
046	046	Scale	<i>Scale</i>	1 (Equal), 2 (Pure Maj), 3 (Pure min), 4 (Bayat), 5 (Rast)	1 (Equal)	Refer to page 53.
047	047	Base Note	<i>BaseNote</i>	01 (C), 02 (C#), 03 (D), 04 (E $\flat$ ), 05 (E), 06 (F), 07 (F#), 08 (G), 09 (A $\flat$ ), 10 (A), 11 (B $\flat$ ), 12(B)	01 (C)	Refer to page 53.
048	048	Tuning Note	<i>TuneNote</i>	01 (C), 02 (C#), 03 (D), 04 (E $\flat$ ), 05 (E), 06 (F), 07 (F#), 08 (G), 09 (A $\flat$ ), 10 (A), 11 (B $\flat$ ), 12(B)	01 (C)	Refer to page 54.
049	049	Tuning	<i>Tune</i>	-64–63	Depends on the Scale	
<b>MIDI</b>						
050	050	Local Control	<i>Local</i>	ON/OFF	ON	Determines whether the instrument’s keyboard controls the internal tone generator (ON) or not (OFF). When you record your keyboard performance to a computer app via MIDI, set this parameter to OFF.
051	051	External Clock	<i>ExtClock</i>	ON/OFF	OFF	Determines whether the instrument synchronizes to the internal clock (OFF) or an external clock (ON). When you record your keyboard performance to a computer app via MIDI, set this parameter to ON.
052	052	Keyboard Out	<i>KbdOut</i>	ON/OFF	ON	Determines whether MIDI messages generated via keyboard performance are transmitted (ON) or not (OFF) from the [USB TO HOST] terminal. When selecting Sampling Voice, it is not generated regardless of setting.

Function Number		Function	Display	Range/Settings	Default Value	Description
PSR-E463	PSR-EW410					
053	053	Style Out	<i>StyleOut</i>	ON/OFF	OFF	Determines whether MIDI messages generated via Style playback are transmitted (ON) or not (OFF) from the [USB TO HOST] terminal.
054	054	Song Out	<i>SongOut</i>	ON/OFF	OFF	Determines whether MIDI messages generated via Song playback are transmitted (ON) or not (OFF) from the [USB TO HOST] terminal.
055	055	Initial Send	<i>InitSend</i>	YES/NO	-	Allows you to send the data of the panel settings to a computer. Press [+YES] to send, or press [-NO] to cancel. When recording a song to computer, perform this operation first before recording any notes, so that this instrument will be properly set during playback.
<b>Audio (page 46)</b>						
056	056	Audio Loop Back	<i>LoopBack</i>	ON/OFF	ON	Determines whether Audio sound input from the [USB TO HOST] terminal is returned to the computer or not with the performance played on the instrument. If you want to output only the sound played on this instrument to the computer, set this parameter to OFF.
<b>Sampling (page 33)</b>						
057	057	Blank Cut	<i>BlankCut</i>	ON/OFF	ON	Determines whether the blank is cut automatically before and after Sample.
<b>Metronome (page 21)</b>						
058	058	Time Signature Numerator	<i>Timesign</i>	00-60	**	Determines the time signature of the Metronome.
059	059	Time Signature Denominator	<i>TimesignD</i>	Half note, Quarter note, Eighth note, Sixteenth note	**	Determines the length of each metronome beat.
060	060	Metronome Volume	<i>MtrVol</i>	000-127	100	Determines the volume of the Metronome.
<b>Demo (page 28)</b>						
061	061	Demo Group	<i>DemoGrp</i>	1 (Demo) / 2 (Preset) / 3 (User) / 4 (Download) / 5 (USB)	1 (Demo)	Refer to page 64.
062	062	Demo Play Mode	<i>PlayMode</i>	1 (Normal) / 2 (Random)	1 (Normal)	Refer to page 64.
<b>Speaker Mute (page 48)</b>						
-	063	Speaker Mute	<i>SP Mute</i>	ON/OFF	OFF	Refer to page 48.
<b>Auto Power Off (page 16)</b>						
063	064	Auto Power Off Time	<i>AutoOff</i>	OFF, 5/10/15/30/60/120 (min.)	30 minutes	Specifies the time that will elapse before the instrument's power is automatically turned off.
<b>Battery (page 14)</b>						
064	065	Battery Type	<i>Battery Type</i>	1 (Alkaline) / 2 (Ni-MH)	1 (Alkaline)	Selects the type of batteries you have installed to this instrument.
<b>Language (page 71)</b>						
065	066	Language	<i>Language</i>	English/Japanese	English	Determines the language for the Song file names. Determines the language for the name of the files in the USB flash drive or the files loaded from a computer.

\* The appropriate value is automatically set for each Voice.

\*\* The appropriate value is automatically set for each Style, Song and Groove Creator.

**NOTE 1**

- The MIDI and Audio settings are designed specifically for convenient use for when an external device such as a computer is connected to the [USB TO HOST] terminal (page 47).

# USB Flash Drive Operations

By connecting a USB flash drive (sold separately) to the [USB TO DEVICE] terminal, you can save the data created on this instrument, such as User Song and parameter settings. The saved data can be recalled to this instrument again for future use.

## IMPORTANT

- You should use an AC adaptor when executing USB flash drive operations, since battery power may not be reliable enough to last through these crucial operations. When you try executing certain functions, the "UseAdpt" indication may appear and the selected function cannot be executed.

## Precautions when using the [USB TO DEVICE] terminal

This instrument features a built-in [USB TO DEVICE] terminal. When connecting a USB device to the terminal, be sure to handle the USB device with care. Follow the important precautions below.

### NOTE

- For more information about the handling of USB devices, refer to the owner's manual of the USB device.

### ● Compatible USB devices

#### ● USB flash drive

Other USB devices such as a USB hub, computer keyboard or mouse cannot be used.

The instrument does not necessarily support all commercially available USB devices. Yamaha cannot guarantee operation of USB devices that you purchase. Before purchasing a USB device for use with this instrument, please visit the following web page:

<https://download.yamaha.com/>

Although USB devices 1.1 to 3.0 can be used on this instrument, the amount of time for saving to or loading from the USB device may differ depending on the type of data or the status of the instrument.

### NOTE

- The rating of the [USB TO DEVICE] terminal is a maximum of 5V/500mA. Do not connect USB devices having a rating above this, since this can cause damage to the instrument itself.

### ● Connecting a USB device

When connecting a USB device to the [USB TO DEVICE] terminal, make sure that the connector on the device is appropriate and that it is connected in the proper direction.

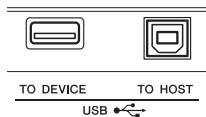

## NOTICE

- Avoid connecting or disconnecting the USB device while executing playback/recording and file management operations (such as Save, Delete and Format), or when accessing the USB device. Failure to observe this may result in "freezing" of the operation of the instrument or corruption of the USB device and the data.
- When connecting then disconnecting the USB device (and vice versa), make sure to wait a few seconds between the two operations.

### NOTE

- When connecting a USB cable, make sure that the length is less than 3 meters. Do not connect an extension cable.

## Using a USB Flash Drive

By connecting the instrument to a USB flash drive, you can save data you've created to the connected device, as well as read data from the connected device.

### ● Number of USB flash drives that can be used

Only one USB flash drive can be connected to the [USB TO DEVICE] terminal.

### ● Formatting a USB flash drive

You should format the USB flash drive only with this instrument (page 72). A USB flash drive formatted on another device may not operate properly.

## NOTICE

- The format operation overwrites any previously existing data. Make sure that the USB flash drive you are formatting does not contain important data.

### ● To protect your data (write-protect)

To prevent important data from being inadvertently erased, apply the write-protect provided with each USB flash drive. If you are saving data to the USB flash drive, make sure to disable write-protect.

### ● Turning off the instrument

When turning off the instrument, make sure that the instrument is NOT accessing the USB flash drive by playback/recording or file management (such as during Save, Delete and Format operations). Failure to do so may corrupt the USB flash drive and the data.

## Connecting a USB Flash Drive

**NOTE**

- Before using a USB flash drive, be sure to read "Precautions when using the [USB TO DEVICE] terminal" on page 70.
- Messages may appear on the display during File Control procedures to aid in operation. Refer to the Message List on page 77 for details.

### 1 Connect a USB flash drive to the [USB TO DEVICE] terminal, and wait until "USB" appears on the left corner of the display.

The "USB" indication confirms that the connected USB flash drive has been mounted or recognized.

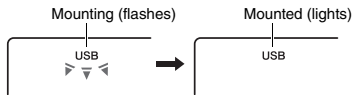

### 2 Hold down the [FUNCTION] button for longer than a second to call up the File Control display.

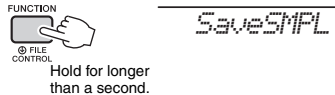

Hold for longer than a second.

● If "UnFormat" followed by "Format?" appears:

This indicates that the connected USB flash drive requires formatting. Execute the Format operation by following the instructions starting with step 2 on page 72.

**NOTE**

The File Control display cannot be called up in the following situations.

- During playback of Style, Groove, Song, Quick Sampling Mode, or Audio mode.
- When "USB" does not appear even if you have connected a USB flash drive to the [USB TO DEVICE] terminal.
- No sound will be produced if the keyboard is played while the File Control display is showing, and only buttons related to File Control operations will be active.

### 3 Use the CATEGORY [<<] and [>>] buttons to call up the desired File Control function, then execute it.

For details, refer to the table on the right.

## File Control Display List

Display	File Control function	Page
SaveSMPL	Saving a Sample to a USB Flash Drive	34
LoadSMPL	Loading a Sample from a USB Flash Drive	35
Del SMPL	Deleting a Sample in a USB Flash Drive	35
DelAUDIO	Deleting an Audio Song in a USB Flash Drive	35
Save SMF	Saving a User Song as SMF to a USB Flash Drive	73
Del SMF	Deleting a SMF in a USB Flash Drive	76
SaveUSR	Saving a User Data to a USB Flash Drive	72
LoadUSR	Loading a User Data from a USB Flash Drive	74
DelUSR	Deleting a User Data from a USB Flash Drive	76
LoadSTY	Loading a Style File	75
Format?	Formatting a USB Flash Drive	72
Exit?	Exiting from a File Control Display	77

**NOTE**

- You can also exit from a File Control display simply by pressing the [FUNCTION] button.

### Valid file locations in the USB flash drive for Song playback (page 28)

**IMPORTANT**

- If you manage the Song files in the USB flash drive by using a computer, etc., make sure to store the data either in the USB flash drive's root directory or a first-level/second-level folder in the root directory. Data stored in third-level folders created inside a second-level folder cannot be selected and played by this instrument.

USB flash drive (Root)

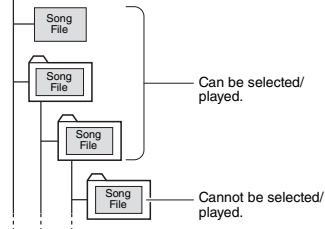

### Song title display language

File names containing Japanese katakana characters will only be properly displayed if the instrument's display language is set to "Japanese." All display information other than file names will be displayed in English even if "Japanese" is selected. For details, refer to page 69 Function 065 (PSR-E463)/Function 066 (PSR-EW410).

## Formatting a USB Flash Drive

The Format operation lets you prepare commercially available USB flash drives for use with this instrument.

### NOTICE

- The format operation overwrites any previously existing data. Make sure that the USB flash drive you are formatting does not contain important data.

1 Hold the [FUNCTION] button for longer than a second to call up the File Control display.

2 Use the CATEGORY [<<] and [>>] buttons to call up the “Format?” message.



3 Press the [0/EXECUTE] button.

A confirmation message will appear. To cancel the operation, press the [-/NO] button.

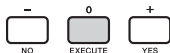

4 Press the [0/EXECUTE] button again or the [+ /YES] button to execute the Format operation.

After a while, a message indicating completion of the operation appears, and the “USER FILES” folder will be created in the USB flash drive.

### NOTICE

- The Format operation cannot be cancelled during execution. Never turn off the power or disconnect the USB flash drive during the operation. Doing so may result in data loss.

5 Press the [FUNCTION] button to exit from the File Control display.

## Saving User Data to a USB Flash Drive

User data is comprised of the following items.

- All 10 User Songs (page 38)
- Styles which have been transferred from a computer and then loaded to Style numbers 221–230 (page 75).
- All Registration Memory settings (page 44)

The User data can be saved as a single “User File” (.usr) to a USB flash drive.

### NOTE

- For detail on saving Sample, refer to page 34.
- The extension (.usr) of the User File will not be shown on the display of this instrument. Confirm the extension on the computer display when connecting the USB flash drive to a computer.

1 Hold the [FUNCTION] button for longer than a second to call up the File Control display.

2 Use the CATEGORY [<<] and [>>] buttons to call up “Save USR.”



3 Press the [0/EXECUTE] button.

Target User file names appear on the display as “USER\*\*\*” (\*\*\*: number). If desired, rotate the dial to select a different file name from “USER001”–“USER100.”

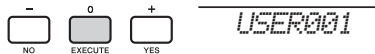

4 Press the [0/EXECUTE] button again.

A confirmation message will appear. To cancel the operation, press the [-/NO] button.

### Overwriting existing files

If a file that already contains data is selected as the target user file, “OverWr?” will appear on the display.



**5 Press the [0/EXECUTE] button again, or the [+ /YES] button to execute the Save operation.**

After a while, a message indicating completion of the operation appears, and a User file (.usr) will be saved in a "USER FILES" folder which will automatically be created on the USB flash drive.

**NOTICE**

- The Save operation cannot be cancelled during execution. Never turn off the power or disconnect the USB flash drive during the operation. Doing so may result in data loss.

**NOTE**

- The amount of time required for this operation may vary depending on the condition of the USB flash drive.

**6 Press the [FUNCTION] button to exit from the File Control display.**

**NOTE**

- If you want to recall the User file (.usr) to this instrument again, execute the Load operation (page 74).

**Saving a User Song as SMF to a USB Flash Drive**

A User Song can be converted to SMF (Standard MIDI File) format 0 and saved to a USB flash drive.

**SMF (Standard MIDI File) format**

With this format, various events via the keyboard performance such as note on/off and Voice selection will be recorded as MIDI data. The SMF Format 0 and Format 1 are available. A large number of MIDI devices are compatible with SMF Format 0, and most commercially available Song files (MIDI files) are provided in SMF Format 0.

**NOTE**

- If the size of a converted SMF is too large, such as a User Song recorded with Groove data, it cannot be played back on this instrument. We recommend using Audio recording.
- The DSP effect (page 24) cannot be converted to SMF format.
- The Transpose setting on this instrument is not included in the data.

**1 Hold the [FUNCTION] button for longer than a second to call up the File Control display.**

**2 Use the CATEGORY [ << ] and [ >> ] buttons to call up "Save SMF:"**

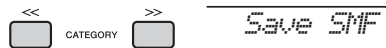

**3 Press the [0/EXECUTE] button.**

Target User Song names appear on the display as "USER\*\*" (\*\*: number 1–10). If desired, rotate the dial to select a different User Song from "USER01"–"USER10".



**4 Press the [0/EXECUTE] button again.**

Target file names on the USB flash drive appear on the display as "USER\*\*\*" (\*\*\*: number 1–100). If desired, rotate the dial to select the different file.



### 5 Press the [0/EXECUTE] button again.

A confirmation message will appear. To cancel the operation, press the [-/NO] button.

#### Overwriting existing files

If a file that already contains data is selected, an overwrite confirmation message will appear.

### 6 Press the [0/EXECUTE] button again, or the [+ /YES] button to execute the Save operation.

After a while, a message indicating completion of the operation appears, and a User Song will be saved (in SMF format 0) to a "USER FILES" folder, automatically created on the USB flash drive.

#### NOTICE

- The Save operation cannot be cancelled during execution. Never turn off the power or disconnect the USB flash drive during the operation. Doing so may result in data loss.

#### NOTE

- The amount of time required for this operation may vary depending on the condition of the USB flash drive.
- If a Groove has been recorded to the User Song, the Save operation cannot be executed by pressing the [0/EXECUTE] button or the [+ /YES] button, and "Can'tUse" appears on the display.

### 7 Press the [FUNCTION] button to exit from the File Control display.

## Loading User Data from a USB Flash Drive

A User data (page 72) saved as a User file (.usr) to the USB flash drive can be loaded to this instrument.

#### NOTICE

- Loading a User file will overwrite and erase the existing data, including all 10 User Songs, Style data loaded to the Style numbers 236–245, and all the Registration Memory settings. Save important data you want to keep to a separate USB flash drive before loading a User file.

#### IMPORTANT

- Note that User files should be saved in the "USER FILES" folder on the USB flash drive. Files saved outside this folder cannot be recognized.

#### NOTE

- About loading Sample, refer to page 35.

### 1 Hold the [FUNCTION] button for longer than a second to call up the File Control display.

### 2 Use the CATEGORY [ << ] and [ >> ] buttons to call up "Load USR."



### 3 Press the [0/EXECUTE] button.

User file names on the USB flash drive appear on the display as "USER\*\*\*" (\*\*\*: number). As desired, rotate the dial to select a different User file.



### 4 Press the [0/EXECUTE] button again.

A confirmation message will appear. To cancel the operation, press the [-/NO] button.

### 5 Press the [0/EXECUTE] button again, or the [+ /YES] button to execute the Load operation.

After a while, a message indicating completion of the operation appears.

#### NOTICE

- The Load operation cannot be cancelled during execution. Never turn off the power or disconnect the USB flash drive during the operation. Doing so may result in data loss.

**6** Press the [FUNCTION] button to exit from the File Control display.

**7** Confirm that the data has been properly loaded by calling up the User Song, one of the Styles 236–245, and/or the Registration Memory settings.

## Loading a Style File

Style data created on another instrument or a computer can be loaded to the Style numbers 236–245, and you can play them in the same way as the internal preset Styles. The following two Load operations are available.

- Loading of a Style file (.sty) saved on the root directory on the USB flash drive
- Loading of a Style file (.sty) transferred from a computer via the Musicsoft Downloader and stored in the internal memory of this instrument

### NOTE

- For instructions on transferring a Style file from a computer via the Musicsoft Downloader, refer to the online PDF manual (page 11) “Computer-related Operations.” After data transfer, load the Style data to one of the Style numbers 236–245 to enable playback.

### NOTICE

- Loading a Style file will overwrite and erase the existing data of the destination number. Save important data you want to keep to a separate USB flash drive before loading.

**1** Hold the [FUNCTION] button for longer than a second to call up the File Control display.

**2** Use the CATEGORY [<<] and [>>] buttons to call up the “Load STY” message.



**3** Press the [0/EXECUTE] button.

The name of a Style file in the USB flash drive or internal memory of this instrument will appear on

the display. If desired, rotate the dial to select a different Style file.



**4** Press the [0/EXECUTE] button again.

“Load To? \*\*\*” (\*\*\*) appears on the display as the Load destination. If desired, rotate the dial to select a different number.



**5** Press the [0/EXECUTE] button again.

A confirmation message will appear. To cancel the operation, press the [-/NO] button.

**6** Press the [0/EXECUTE] button again, or the [+ /YES] button to execute the Load operation.

After a while, a message indicating completion of the operation appears.

### NOTICE

- The Load operation cannot be cancelled during execution. Never turn off the power or disconnect the USB flash drive during the operation. Doing so may result in data loss.

**7** Press the [STYLE] button, rotate the dial to select a Style from 236–245, and then try playing it back.

## Deleting a User File in the USB Flash Drive

User Files (.usr) in the root directory of the USB flash drive can be deleted.

**IMPORTANT**

- Only User files (.usr) saved in the “USER FILES” folder on the USB flash drive can be deleted. Files outside this folder cannot be recognized.

- 1 Hold the [FUNCTION] button for longer than a second to call up the File Control display.
- 2 Use the CATEGORY [ << ] and [ >> ] buttons to call up the “Del USB” message.



- 3 Press the [0/EXECUTE] button. User file names in the USB flash drive appear on the display as “USER\*\*\*\*\*” (\*\*\*\*, number). If desired, rotate the dial to select a different User file.

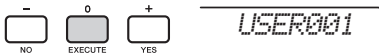

- 4 Press the [0/EXECUTE] button again. A confirmation message will appear. To cancel the operation, press the [-/NO] button.
- 5 Press the [0/EXECUTE] button again, or the [+ /YES] button to execute the Delete operation. After a while, a message indicating completion of the operation appears.

**NOTICE**

- The Delete operation cannot be cancelled during execution. Never turn off the power or disconnect the USB flash drive during the operation. Doing so may result in data loss.

- 6 Press the [FUNCTION] button to exit from the File Control display.

## Deleting an SMF File in the USB Flash Drive

You can delete a SMF file that has been saved in the USB flash drive via the Save SMF operation (page 73).

**IMPORTANT**

- Only SMF files (.mid) saved in the “USER FILES” folder on the USB flash drive can be deleted. Files outside this folder cannot be recognized. This operation applies only to file names having the format “SONG\*\*\*\*\*” (\*\*\*\*: 001–100).

- 1 Hold the [FUNCTION] button for longer than a second to call up the File Control display.
- 2 Use the CATEGORY [ << ] and [ >> ] buttons to call up “Del SMF”:

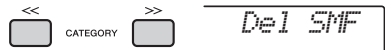

- 3 Press the [0/EXECUTE] button. SMF file names in the USB flash drive appear on the display as “SONG\*\*\*\*\*” (\*\*\*\*: number). If desired, rotate the dial to select a different SMF file.



- 4 Press the [0/EXECUTE] button again. A confirmation message will appear. To cancel the operation, press the [-/NO] button.
- 5 Press the [0/EXECUTE] button again, or the [+ /YES] button to execute the Delete operation. After a while, a message indicating completion of the operation appears.

**NOTICE**

- The Delete operation cannot be cancelled during execution. Never turn off the power or disconnect the USB flash drive during the operation. Doing so may result in data loss.

- 6 Press the [FUNCTION] button to exit from the File Control display.

## Exiting from a File Control Display

To exit from the File Control display, press the [FUNCTION], [VOICE], [STYLE], [SONG] or [GROOVE CREATOR] button.

You can also exit from the File Control function mode as follows:

- Use the CATEGORY [ << ] and [ >> ] buttons to call up the “Exit?” message.

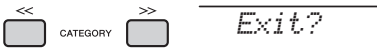

- Press the [0/EXECUTE] button to exit from the File Control display.



## Message List

Message	Comment
Can'tUse	Indicates that the file control function is currently unavailable since the USB flash drive is being accessed.
Compleat.	Indicates completion of the corresponding operation, such as data saving or transmission.
Data Err	Displayed when the user song contains invalid data.
Disk Ful	Displayed when saving data cannot be executed since the memory has become full. Delete any unnecessary data or use another USB flash drive.
Error	Displayed when a file error or operational error occurs.
File Ful	Displayed when saving of data cannot be executed because the total number of files exceeds the capacity. Delete any unnecessary data or use another USB flash drive.
no data	There is no data in the memory.
no file	There is no file in the memory.
Ovr (Flashes)	Communication with the USB flash drive has been shut down because of overcurrent to the USB flash drive. Disconnect the USB flash drive from the [USB TO DEVICE] terminal, then turn on the power of the instrument.
Protect	Displayed when trying to save or delete data on a protected USB flash drive, or formatting a protected USB flash drive. Set protect to off and try again.
UnFormat	Displayed when connecting an unformatted USB flash drive.
UseAdpt	USB flash drive save, delete, and format operations cannot be performed when the instrument is being powered from battery. Use an AC adaptor.

# Troubleshooting

Problem	Possible Cause and Solution
When the instrument is turned on or off, a popping sound is temporarily produced.	This is normal and indicates that the instrument is receiving electrical power.
When the instrument is turned on, power is turned off suddenly and unexpectedly.	This is normal. If an AC adaptor other than the one specified is used, power may be turned off suddenly and unexpectedly.
When using a mobile phone, noise is produced	Using a mobile phone in close proximity to the instrument may produce interference. To prevent this, turn off the mobile phone or use it further away from the instrument
The instrument is automatically turned off even if no operation is done.	This is normal. This occurs due to the Auto Power Off function (page 16).
<ul style="list-style-type: none"> <li>• The volume is too soft.</li> <li>• The sound quality is poor.</li> <li>• The Style/Groove/Song/Arpeggio stops unexpectedly or will not play.</li> <li>• The recorded data of the song, etc. does not play correctly.</li> <li>• The LCD display suddenly goes dark, and all panel settings are reset.</li> <li>• The instrument turns off when a USB flash drive is connected.</li> </ul>	The batteries are low or dead. Replace all six batteries with completely new ones or completely recharged ones, or use the AC adaptor.
No sound is produced even when the keyboard is played, or a Song, Style, or Groove is being played back.	Check whether a set of headphones or an audio cable is connected to the [PHONES/OUTPUT], or not. When such a connection is made, no sound is output from the speaker of this instrument.
	(PSR-EW410) Check the on/off status of the Speaker Mute setting (page 48). Make sure to set to OFF.
	Check the on/off status of the Local Control (page 68). Normally, set this parameter to ON.
The footswitch (for sustain) seems to produce the opposite effect. For example, pressing the footswitch cuts off the sound and releasing it sustains the sounds.	The polarity of the footswitch is reversed. Make sure that the footswitch plug is properly connected to the SUSTAIN jack before turning on the power.
Not all of the Voices seem to sound, or the sound seems to be cut off, when playing the keyboard, Arpeggio, Style or Song or Groove Creator.	You have exceeded 48 simultaneous notes, which is the maximum polyphony (the maximum amount of notes that can be played simultaneously) of this instrument. If the Main, Dual, and Split Voices are being used along with playback of Arpeggio, Style, Groove or Song, some notes/sounds may be omitted (or "stolen").
The sound of the Voice changes from note to note.	This is normal. The tone generation method uses multiple recordings (samples) of an instrument across the range of the keyboard; thus, the actual sound of the Voice may be slightly different from note to note.
The keyboard performance and playback of Style/Song/Groove Creator produces an unexpected or inappropriate sound, and cannot be restored to the normal status.	Using the Knobs can produce dramatic changes in the sound, but may also produce unexpected or undesired sounds. If you want to restore the original, normal sound before being changed by the Knobs, press the [DSP] button to turn DSP off, change the Voice, Style, Groove or Song, or press the [PORTABLE GRAND] button to reset the panel settings.
The Style, Song or Groove Creator does not start even when the [START/STOP] button is pressed. The Arpeggio does not start even when the note is pressed with the Arpeggio turned on.	Check the on/off status of the External Clock (page 68). Normally, set this parameter to OFF.
The volume of the Style, Song or Groove Creator is too low.	Check the volume setting in the Functions (pages 62 and 65).
The chords played in the left hand area cannot be recognized even when ACMP is turned on.	Check the Split Point setting (page 62). Set this to an appropriate value.
Style parts other than the Rhythm part produce no sound.	Check the on/off status of the ACMP (page 26). Make sure to turn ACMP on.
The ACMP indicator does not appear on the display when the [ACMP ON/OFF] button is pressed.	Check the on/off status of the [STYLE] lamp. When using a Style, press the [STYLE] button to turn on the [STYLE] lamp.

Refer to the "Message List" on pages 42, 77 as required.

# Specifications

Product Name		PSR-E463	PSR-EW410	
		Digital Keyboard		
Size/Weight	Dimensions (W x D x H)	946mm x 404mm x 139mm (37-1/4" x 15-7/8" x 5-1/2")	1179mm x 413mm x 138mm (46-7/16" x 16-1/4" x 5-7/16")	
	Weight	6.6 kg (14 lbs., 9 oz.) (not including batteries)	8.4 kg (18 lbs., 8 oz.) (not including batteries)	
Control Interface	Keyboard	Number of Keys	61	
		Touch Response	Soft, Medium, Hard, Fixed	
	Other Controllers	Pitch Bend Wheel	Yes	
		Knobs	Yes	
Panel	Language	English		
Voices	Tone Generation	AWM Stereo Sampling		
	Polyphony (max.)	48		
	Preset	Number of Voices	758 (237 Panel Voices + 24 Drum/SFX kits + 40 Arpeggio + 457 XGlite voices)	
	Compatibility	GM, XGlite		
Effects	Types	Reverb	12	
		Chorus	5	
		Master EQ	6	
		DSP	10	
	Functions	Dual	Yes	
		Split	Yes	
		Harmony	26	
		Arpeggio	150	
		Melody Suppressor	Yes	
		Crossfade	Yes	
Accompaniment Styles	Preset	Number of Styles	235	
		Fingering	Multi finger	
		Style Control	ACMP ON/OFF, SYNC START, SYNC STOP, START/STOP, INTRO/ENDING/rit., MAIN/AUTO FILL, TRACK ON/OFF	
	External Styles	10		
	Other Features	One Touch Setting (OTS)	Yes	
Compatibility	Style File Format (SFF)			
Groove Creator	Preset	Number of Grooves	35	
		Number of Sections	5 (4 Sections + 1 Musical Climax/Ending)	
Songs (MIDI)	Preset	Number of Preset Songs	30	
	Download	Number of Songs	70	
		Recording	Number of Songs	10
	Format	Number of Tracks	6 (5 Melody + 1 Style/Groove Creator)	
		Data Capacity	Approx. 19,000 notes (when only "melody" tracks are recorded)	
	Recording	Playback	SMF (Formats 0 & 1)	
USB Audio Recorder	Recording Time (max.)	80 minutes (approx. 0.9 GB) per Song		
	Format	Playback	WAV(44.1 kHz, 16 bit, stereo)	
		Recording	WAV(44.1 kHz, 16 bit, stereo)	
Quick Sampling	Sampling Type	Normal, Oneshot, Loop		
	Samples (Preset/User)	5	7	
	Sampling Time	Approx. 9.6sec.		
	Sampling Sources	AUX IN		
	Sampling Format	Original File Format (16 bit, stereo)		
	Sampling Rate	44.1 kHz		
Functions	USB audio interface		44.1 kHz, 16 bit, stereo	
	Registration Memory	Number of Buttons	4 (x 8 banks)	
		Metronome	Yes	
	Overall Controls	Tempo Range	11 – 280	
		Transpose	-12 to 0, 0 to +12	
		Tuning	427.0 – 440.0 – 453.0 Hz (approx. 0.2Hz increments)	
		Scale Type	5 types	
	Miscellaneous	PIANO Button	Yes	

# Specifications

		PSR-E463		PSR-EW410	
<b>Storage and Connectivity</b>	Storage	Internal Memory	Approx. 1.73 MB		
		External Drives	USB flash drive		
	Connectivity	USB TO HOST, USB TO DEVICE, DC IN 12V, Headphones/Output, Sustain Pedal, AUX IN (Stereo-mini)		USB TO HOST, USB TO DEVICE, DC IN 16V, Headphones, Sustain Pedal, AUX IN (Stereo-mini), OUTPUT (L/L+R, R)	
<b>Sound System</b>	Amplifiers	6W+6W		12W+12W	
	Speakers	12cm x 2			
<b>Power Supply</b>	AC Adaptor	PA-150 or an equivalent recommended by Yamaha		PA-300C or an equivalent recommended by Yamaha	
	Batteries	Six "AA" size alkaline (LR6), manganese (R6) or Ni-MH rechargeable (HR6) batteries		Six "D" size alkaline (LR20), manganese (R20) or Ni-MH rechargeable (HR20) batteries	
	Power Consumption	8 W (When using PA-150 AC adaptor)		11 W (When using PA-300C AC adaptor)	
	Auto Power Off	Yes			
<b>Included Accessories</b>		<ul style="list-style-type: none"> <li>• Owner's Manual</li> <li>• AC adaptor* (PA-150 or an equivalent recommended by Yamaha)</li> <li>* May not be included depending on your area. Check with your Yamaha dealer.</li> <li>• Music Rest</li> <li>• Online Member Product Registration</li> </ul>		<ul style="list-style-type: none"> <li>• Owner's Manual</li> <li>• Power cord/AC adaptor* (PA-300C or an equivalent recommended by Yamaha)</li> <li>* May not be included depending on your area. Check with your Yamaha dealer.</li> <li>• Music Rest</li> <li>• Online Member Product Registration</li> </ul>	
<b>Separately Sold Accessories (May not be available depending on your area.)</b>		<ul style="list-style-type: none"> <li>• AC adaptor: PA-150 or an equivalent recommended by Yamaha</li> <li>• Keyboard Stand: L-2C</li> <li>• Headphones: HPH-150/HPH-100/HPH-50</li> <li>• Footswitch: FC4A/FC5</li> <li>• Wireless MIDI adaptor: UD-BT01</li> </ul>		<ul style="list-style-type: none"> <li>• AC adaptor: PA-300C or an equivalent recommended by Yamaha</li> <li>• Keyboard Stand: L-6</li> <li>• Headphones: HPH-150/HPH-100/HPH-50</li> <li>• Subwoofer: KS-SW100</li> <li>• Footswitch: FC4A/FC5</li> <li>• Wireless MIDI adaptor: UD-BT01</li> </ul>	

\*The contents of this manual apply to the latest specifications as of the publishing date. To obtain the latest manual, access the Yamaha website then download the manual file. Since specifications, equipment or separately sold accessories may not be the same in every locale, please check with your Yamaha dealer.



# Index

<b>A</b>			
A-B Repeat .....	29	<b>G</b>	
AC adaptor .....	14	Groove.....	59
Accessories .....	10	Groove Creator .....	30
ACMP .....	26	<b>H</b>	
Arpeggio .....	22, 56	Harmony .....	22
Arpeggio Quantize.....	56	Harmony Type.....	23
Arpeggio Type .....	23	Headphones.....	45
Arpeggio Velocity.....	23	<b>I</b>	
Attack.....	57	Initial Send .....	69
Audio Device .....	46	Initialization .....	49
Audio Loop Back .....	69	INTRO.....	59
Auto Accompaniment.....	26	iPhone/iPad Connection Manual ..	11
Auto Accompaniment area .....	26	<b>K</b>	
Auto Power Off.....	16, 69	Keyboard Out.....	68
AUX IN.....	31, 46	Keyboard Stand.....	17
<b>B</b>		Knobs .....	25, 57
Background Music .....	64	<b>L</b>	
Backup.....	49	Language .....	69, 71
Backup Clear.....	49	Load STY .....	71
Base Note.....	53	Load USR.....	71
Battery .....	14	LoadSMPL .....	71
Battery Type.....	15	Local Control .....	68
Blank Cut.....	69	Loop .....	31
<b>C</b>		<b>M</b>	
Chord Type .....	63	MAIN .....	59
Chorus.....	57	Main Voice.....	20
Chorus Type .....	50	Master Volume .....	16
Computer .....	47	Melody Suppressor .....	46
Computer-related Operations ..	11	Melody Voice.....	65
Connection .....	45	Message List.....	41, 42, 77
Cutoff .....	57	Metronome .....	21
<b>D</b>		MIDI.....	27
Data List .....	11	MIDI Basics.....	11
Del SMF .....	71	MIDI Reference .....	11
Del SMPL .....	71	Music Rest .....	10
Del USR .....	71	MUSICAL CLIMAX .....	30
DelAUDIO.....	71	<b>N</b>	
Demo Song .....	28	Normal .....	31
Display.....	12, 19	<b>O</b>	
DSP .....	24, 57	Octave.....	67
DSP Type.....	24	One Touch Setting (OTS) ..	20, 51
Dual Voice .....	20, 55	One-shot .....	31
<b>E</b>		Output .....	48
ENDING .....	59	<b>P</b>	
EQ (Equalizer).....	52	Pan.....	67
External Clock .....	68	Pause .....	28
<b>F</b>		Pedal .....	45
Fast Forward.....	28	Pitch .....	51
Fast Reverse.....	28	Pitch Bend Range .....	66
File Control display .....	71	Power .....	16
FILL .....	59	<b>Q</b>	
Fine Tuning.....	51	Quick Sampling.....	31
Flash Clear .....	49	<b>R</b>	
Footswitch.....	45, 56	Random.....	64
Formatting .....	70, 72	Recording.....	38, 41
Function .....	66	Registration Memory.....	44
		Release.....	57
		Repeat .....	29
		Resonance.....	57
		Retrigger .....	61
		Retrigger Rate.....	58
		Reverb .....	57
		Reverb Type .....	50
		<b>S</b>	
		Sample Type .....	31
		Sample Zone .....	31
		Sampling.....	31
		Save SMF .....	71
		Save USR .....	71
		SaveSMPL .....	71
		Scale.....	53
		Sections.....	59, 61
		Smart Device .....	47
		Song .....	27, 64
		Song Book .....	11
		Song Out.....	69
		Speaker .....	48
		Specifications.....	79
		Split Point.....	21, 62
		Split Voice .....	21, 55
		Stop Accompaniment.....	62
		Style.....	26, 59
		Style Out.....	69
		Sustain.....	45
		Syncho Stop .....	60
		<b>T</b>	
		Tap Start .....	61, 65
		Tempo.....	21, 61, 65
		Time Signature.....	21
		Touch Response.....	52
		Track .....	29, 38, 39, 60
		Transpose .....	51
		Troubleshooting.....	78
		Tuning .....	51, 54
		<b>U</b>	
		USB Flash Drive .....	70
		USB TO DEVICE.....	70
		USB TO HOST.....	47
		<b>V</b>	
		Voice .....	20, 55
		Volume .....	16
		Volume (AUX IN).....	66
		Volume (Groove Creator) .....	62
		Volume (Harmony).....	23
		Volume (Metronome).....	22
		Volume (Song).....	65
		Volume (Style) .....	62
		Volume (USB TO DEVICE).....	66
		Volume (USB TO HOST) .....	66
		Volume (Voice).....	67
		Volume Balance.....	58

## OBSERVERA!

Apparaten kopplas inte ur växelströmskällan (nätet) så länge som den är ansluten till vägguttaget, även om själva apparaten har stängts av.

**ADVARSEL:** Netspændingen til dette apparat er IKKE afbrudt, så længe netledningen sidder i en stikkontakt, som er tændt — også selvom der er slukket på apparatets afbryder.

**VAROITUS:** Laitteen toisiopiiriin kytketty käyttökytin ei irroita koko laitetta verkosta.

(standby)

## Entsorgung leerer Batterien (nur innerhalb Deutschlands)

Leisten Sie einen Beitrag zum Umweltschutz. Verbrauchte Batterien oder Akkumulatoren dürfen nicht in den Hausmüll. Sie können bei einer Sammelstelle für Altbatterien bzw. Sondermüll abgegeben werden. Informieren Sie sich bei Ihrer Kommune.

(battery)

### Information for users on collection and disposal of old equipment and used batteries:



These symbols on the products, packaging, and/or accompanying documents mean that used electrical and electronic products and batteries should not be mixed with general household waste. For proper treatment, recovery and recycling of old products and used batteries, please take them to applicable collection points, in accordance with your national legislation.



By disposing of these products and batteries correctly, you will help to save valuable resources and prevent any potential negative effects on human health and the environment which could otherwise arise from inappropriate waste handling.



For more information about collection and recycling of old products and batteries, please contact your local municipality, your waste disposal service or the point of sale where you purchased the items.

#### For business users in the European Union:

If you wish to discard electrical and electronic equipment, please contact your dealer or supplier for further information.



#### Information on Disposal in other Countries outside the European Union:

These symbols are only valid in the European Union. If you wish to discard these items, please contact your local authorities or dealer and ask for the correct method of disposal.



#### Note for the battery symbol (bottom two symbol examples):

This symbol might be used in combination with a chemical symbol. In this case it complies with the requirement set by the EU Battery Directive for the chemical involved.

Cd

(weee\_battery\_eu\_en\_02)



## LIMITED 1-YEAR WARRANTY ON PORTABLE KEYBOARDS

### (NP, PSRE, PSREW, PSRF, EZ, DGX230, DGX530, YPG AND YPT SERIES)

Thank you for selecting a Yamaha product. Yamaha products are designed and manufactured to provide a high level of defect-free performance. Yamaha Corporation of America ("Yamaha") is proud of the experience and craftsmanship that goes into each and every Yamaha product. Yamaha sells its products through a network of reputable, specially authorized dealers and is pleased to offer you, the Original Owner, the following Limited Warranty, which applies only to products that have been (1) directly purchased from Yamaha's authorized dealers in the fifty states of the USA and District of Columbia (the "Warranted Area") and (2) used exclusively in the Warranted Area. Yamaha suggests that you read the Limited Warranty thoroughly, and invites you to contact your authorized Yamaha dealer or Yamaha Customer Service if you have any questions.

**Coverage:** Yamaha will, at its option, repair or replace the product covered by this warranty if it becomes defective, malfunctions or otherwise fails to conform with this warranty under normal use and service during the term of this warranty, without charge for labor or materials. Repairs may be performed using new or refurbished parts that meet or exceed Yamaha specifications for new parts. If Yamaha elects to replace the product, the replacement may be a reconditioned unit. You will be responsible for any installation or removal charges and for any initial shipping charges if the product(s) must be shipped for warranty service. However, Yamaha will pay the return shipping charges to any destination within the USA if the repairs are covered by the warranty. This warranty does not cover (a) damage, deterioration or malfunction resulting from accident, negligence, misuse, abuse, improper installation or operation or failure to follow instructions according to the Owner's Manual for this product; any shipment of the product (claims must be presented to the carrier); repair or attempted repair by anyone other than Yamaha or an authorized Yamaha Service Center; (b) any unit which has been altered or on which the serial number has been defaced, modified or removed; (c) normal wear and any periodic maintenance; (d) deterioration due to perspiration, corrosive atmosphere or other external causes such as extremes in temperature or humidity; (e) damages attributable to power line surge or related electrical abnormalities, lightning damage or acts of God; or (f) RFI/EMI (Interference/noise) caused by improper grounding or the improper use of either certified or uncertified equipment, if applicable. Any evidence of alteration, erasing or forgery of proof-of-purchase documents will cause this warranty to be void. This warranty covers only the Original Owner and is not transferable.

**In Order to Obtain Warranty Service:** Warranty service will only be provided for defective products within the Warranted Area. Contact your local authorized Yamaha dealer who will advise you of the procedures to be followed. If this is not successful, contact Yamaha at the address, telephone number or website shown below. Yamaha may request that you send the defective product to a local authorized Yamaha Servicer or authorize return of the defective product to Yamaha for repair. If you are uncertain as to whether a dealer has been authorized by Yamaha, please contact Yamaha's Service Department at the number shown below, or check Yamaha's website at [www.Yamaha.com](http://www.Yamaha.com). Product(s) shipped for service should be packed securely and must be accompanied by a detailed explanation of the problem(s) requiring service, together with the original or a machine reproduction of the bill of sale or other dated, proof-of-purchase document describing the product, as evidence of warranty coverage. Should any product submitted for warranty service be found ineligible therefore, an estimate of repair cost will be furnished and the repair will be accomplished only if requested by you and upon receipt of payment or acceptable arrangement for payment.

**Limitation of Implied Warranties and Exclusion of Damages:** ANY IMPLIED WARRANTIES, INCLUDING WARRANTIES OF MERCHANTABILITY AND FITNESS FOR A PARTICULAR PURPOSE SHALL BE LIMITED IN DURATION TO THE APPLICABLE PERIOD OF TIME SET FORTH ABOVE. YAMAHA SHALL NOT BE RESPONSIBLE FOR INCIDENTAL OR CONSEQUENTIAL DAMAGES OR FOR DAMAGES BASED UPON INCONVENIENCE, LOSS OF USE, DAMAGE TO ANY OTHER EQUIPMENT OR OTHER ITEMS AT THE SITE OF USE OR INTERRUPTION OF PERFORMANCES OR ANY CONSEQUENCES. YAMAHA'S LIABILITY FOR ANY DEFECTIVE PRODUCT IS LIMITED TO REPAIR OR REPLACEMENT OF THE PRODUCT, AT YAMAHA'S OPTION. SOME STATES DO NOT ALLOW LIMITATIONS ON HOW LONG AN IMPLIED WARRANTY LASTS OR THE EXCLUSION OR LIMITATION OF INCIDENTAL OR CONSEQUENTIAL DAMAGES, SO THE ABOVE LIMITATION OR EXCLUSION MAY NOT APPLY TO YOU. This Warranty gives you specific legal rights, and you may also have other rights which vary from state to state. This is the only express warranty applicable to the product specified herein; Yamaha neither assumes nor authorizes anyone to assume for it any other express warranty.

If you have any questions about service received or if you need assistance in locating an authorized Yamaha Servicer, please contact:



CUSTOMER SERVICE  
Yamaha Corporation of America  
6600 Orangethorpe Avenue, Buena Park, California 90620-1373  
Telephone: 800-854-1569  
[www.yamaha.com](http://www.yamaha.com)

**Do not return any product to the above address without a written Return Authorization issued by YAMAHA.**

© 2017 Yamaha Corporation of America.

# Important Notice: Guarantee Information for customers in Europe, Economic Area (EEA) and Switzerland

<b>Important Notice: Guarantee Information for customers in EEA* and Switzerland</b> For detailed guarantee information about this Yamaha product, and Pan-EEA* and Switzerland warranty service, please either visit the website address below (Printable file is available at our website) or contact the Yamaha representative office for your country. * EEA: European Economic Area	<b>English</b>
<b>Wichtiger Hinweis: Garantie-Information für Kunden in der EMW*, und der Schweiz</b> Für wichtige Garantie-Information über dieses Produkt von Yamaha, sowie über den Pan-EMW* und Schweizer Garantieservice, besuchen Sie bitte entweder die folgende angegebene Internetadresse (eine druckfähige Version befindet sich auch auf unserer Webseite), oder wenden Sie sich an den für Ihr Land zuständigen Yamaha-Vertrieb. *EMW: Europäischer Wirtschaftsraum	<b>Deutsch</b>
<b>Remarque importante: informations de garantie pour les clients de l'EEE et la Suisse</b> Pour des informations plus détaillées sur la garantie de ce produit Yamaha et sur le service de garantie applicable dans l'ensemble de l'EEE ainsi qu'en Suisse, consultez notre site Web à l'adresse ci-dessous (le fichier imprimable est disponible sur notre site Web) ou contactez directement Yamaha dans votre pays de résidence. * EEE : Espace Economique Européen	<b>Français</b>
<b>Belangrijke mededeling: garantie-informatie voor klanten in de EER* en Zwitserland</b> Voor gedetailleerde garantie-informatie over dit Yamaha-product en de garantieservice in heel de EER* en Zwitserland, gaat u naar de onderstaande website (u vindt een afdrukbare versie op onze website) of neemt u contact op met de vertegenwoordiging van Yamaha in uw land. * EER: Europese Economische Ruimte	<b>Nederlands</b>
<b>Aviso importante: información sobre la garantía para los clientes del EEE* y Suiza</b> Para una información detallada sobre este producto Yamaha y sobre el soporte de garantía en la zona EEE* y Suiza, visite la página web que aparece a continuación (se encuentra una versión imprimible en nuestro sitio web) o póngase en contacto con el representante de Yamaha en su país. * EEE: Espacio Económico Europeo	<b>Español</b>
<b>Aviso importante: informazioni sulla garanzia per i clienti residenti nell'EEA* e in Svizzera</b> Per informazioni dettagliate sulla garanzia relativa a questo prodotto Yamaha e l'assistenza in garanzia nei paesi EEA* e in Svizzera, potete consultare il sito Web all'indirizzo riportato di seguito (è disponibile il file in formato stampabile) oppure contattare l'ufficio di rappresentanza locale della Yamaha. * EEA: Area Economica Europea	<b>italiano</b>
<b>Aviso importante: informações sobre as garantias para clientes da AEE* e da Suíça</b> Para obter uma informação pormenorizada sobre este produto da Yamaha e sobre o serviço de garantia na AEE* e na Suíça, visite o site a seguir (o arquivo para impressão está disponível no nosso site) ou entre em contato com o escritório de representação da Yamaha no seu país. * AEE: Área Econômica Europeia	<b>Português</b>
<b>Значливиј информациони: Гарантиски информации за нашите клиенти од EEO* и Швајцарија</b> За детални информации за оваа гаранција и сервисот за гаранција на територијата на EEO* и Швајцарија, посетете ја следната интернет-адреса (печатлива верзија е достапна на нашата веб-страница) или контактирајте ја нашата локална застапувачка фирма. * EEO: Европски Економски Простор	<b>Македонски</b>
<b>Viktig informasjon: Garantioplysninger til kunder i EEO* og Sveits</b> De kan finne detaljerte garantioplysninger om dette Yamaha-produktet og garantiservice for hele EEO-området i vår nettside eller ved å kontakte vår lokale representant i ditt land. * EEO: Det europeiske økonomiske samarbeidsområdet	<b>Norsk</b>
<b>Viktig merknad: Garantierinformation för kunder i EEO* och Sveits</b> De kan finna detaljerad garantiinformation om detta Yamaha-produktet och garantiservice för hela EEO-området i vår hemsida eller genom att kontakta vår lokala representant i ditt land. * EEO: Det europeiska ekonomiska samarbetsområdet	<b>Svenska</b>
<b>Viktig oplysning: Garantioplysninger til kunder i EEO* og Schweiz</b> De kan finne detaljerte garantioplysninger om dette Yamaha-produktet og garantiservice for hele EEO-området i vår nettside eller ved å kontakte vår lokale representant i ditt land. * EEO: Det europeiske økonomiske samarbeidsområdet	<b>Dansk</b>

<b>Tärkeä ilmoitus: Takuutiedot Euroopan talousalueen (ETA*) ja Sveitsin asiakkaille</b> Tämän Yamaha-tuotteen sekä ETA-talouden ja Sveitsin takuuta koskevat yksityiskohtaiset tiedot saatte alla olevasta nettiliittolainasta. (Tulostettava tiedosto saatavissa sivustollamme.) Voitte myös ottaa yhteyttä paikalliseen Yamaha-edustajaan. *ETA: Euroopan talousalue	<b>Suomi</b>
<b>Ważne: Warunki gwarancji i obowiązujące w EEO* i Szwajcarii</b> Aby dowiedzieć się więcej o warunkach gwarancyjnych tego produktu firmy Yamaha i serwisu gwarancyjnym w całym EEO* i Szwajcarii, należy odwiedzić poniższą stronę internetową (plik gotowy do wydruku znajduje się na naszej stronie internetowej) lub skontaktować się z przedstawicielstwem firmy Yamaha w swoim kraju. * EEO — Europejski Obszar Gospodarczy	<b>Polski</b>
<b>Důležitá oznámení: Záruční informace pro zákazníky v EHS* a ve Švýcarsku</b> Podrobné záruční informace o tomto produktu Yamaha a záručním servisu v celém EHS* a ve Švýcarsku naleznete na níže uvedené webové adrese (soubor k tisku je dostupný na našich webových stránkách) nebo se můžete obrátit na zastoupení firmy Yamaha ve své zemi. * EHS: Evropský hospodářský prostor	<b>Česky</b>
<b>Fontos figyelemzvetés: Garancia-információk az EGT* területén és Svájcban élő vásárlók számára</b> A jelen Yamaha termékre vonatkozó részletes garancia-információk, valamint az EGT*-es és Svájcra kiterjedő garanciális szolgáltatás technikai részleteit keresse fel webhelyünkön az alábbi címen (a webhelyen nyomtatható fájllal is találja), vagy pedig lépjen kapcsolatba az országában működő Yamaha képviselői rovással. * EGT: Európai Gazdasági Térség	<b>Magyar</b>
<b>Öluline märkus: Garantiteave Euroopa Majanduspiirkonna (EMP) ja Šveitsi klientidele</b> Täpsemat teabe saamiseks sellel Yamaha toote garantii ning Euroopa Majanduspiirkonnaja Šveitsi garantiteeninduse kohta, küsige meie veebilehel või saadaval printida val) või pöörduge Teile riigis asuvas esinduse poole. * EMP: Euroopa Majanduspiirkond	<b>Eesti keel</b>
<b>Svarstus paziņojums: garantijas informācija klientiem EEZ* un Šveicā</b> Lai saņemtu detaļāku garantijas informāciju par šo Yamaha produktu, kā arī garantijas apkalpošanu EEZ* un Šveicā, lūdzam apmeklētjiet zemāk norādīto tīmekļa vietnes adresi (tīmekļa vietnē ir pieejams drukājams fails) vai sazināties ar jūsu valstī apkalpošo Yamaha pārstāvētību. * EEZ: Eiropas Ekonomikas zona	<b>Latviešu</b>
<b>Düsmesio: informācija dēl garantijas pirkšanas EEE* ir Šveicarijole</b> Jei reikia išsamios informacijos apie šį „Yamaha“ produktą ir jo techninę priežiūrą visoje EEE* ir Šveicarijole, apalankykite mūsų svetainę toliau nurodytą adresu (svetainėje yra spausdinamas failas) arba kreipkitės į „Yamaha“ atstovybę savo šalyje. *EEE – Europos ekonominė erdvė	<b>Lietuvių kalba</b>
<b>Dôležitú upozornenie: Informácie o záruke pre zákazníkov v EHP* a Švajčiarsku</b> Podrobné informácie o záruke týkajúcej sa tohto produktu od spoločnosti Yamaha a garancijnom servise v EHP* a Švajčiarsku nájdete na našej webovej stránke (všetchny súbor na tlač je dostupný) alebo sa obráťte na zastúpenie spoločnosti Yamaha vo svojom regióne. * EHP: Európsky hospodársky priestor	<b>Slovenčina</b>
<b>Pomembno obavestilo: Informacije o garanciji za kupce v EEP* in Švicari</b> Za podrobnejše informacije o tem Yamaha izdelkih ter garancijskem servisu v celotnem EEP in Švicari, obiščite spodnje mesto, ki je navedeno spodaj (našljajljiva datoteka je na voljo na našem spletnem mestu), ali se obrnite na Yamahinega predstavništva v svoji državi. * EEP: Evropski gospodarski prostor	<b>Slovenščina</b>
<b>Важно съобщение: Информация за гаранцията за клиентите в ЕИП* и Швейцария</b> За подробна информация за гаранцията за този продукт на Yamaha и гаранционното обслужване в палеоевропейската зона на ЕИП* и Швейцария или посетете посочения уеб сайт (на нашия уеб сайт има файл за печат), или се свържете с представителния офис на Yamaha във вашата страна. * ЕИП: Европейско икономическо пространство	<b>Български език</b>
<b>Notificare importantă: Informații despre garanție pentru clienții din SEE* și Elveția</b> Pentru informații detaliate privind acest produs Yamaha și serviciul de garanție Pan-SEE* și Elveția, vizitați site-ul la adresa de mai jos (fișierul imprimabil este disponibil pe site-ul nostru) sau contactați biroul reprezentanții Yamaha din țara dumneavoastră. * SEE: Spațiul Economic European	<b>Limba română</b>

<http://europe.yamaha.com/warranty/>

MEMO

MEMO

For details of products, please contact your nearest Yamaha representative or the authorized distributor listed below.

## NORTH AMERICA

### CANADA

**Yamaha Canada Music Ltd.**  
135 Milner Avenue, Toronto, Ontario M1S 3R1,  
Canada  
Tel: +1-416-298-1311

### U.S.A.

**Yamaha Corporation of America**  
6600 Orangethorpe Avenue, Buena Park, CA 90620,  
U.S.A.  
Tel: +1-714-522-9011

## CENTRAL & SOUTH AMERICA

### MEXICO

**Yamaha de México, S.A. de C.V.**  
Av. Insurgentes Sur 1647 Piso 9, Col. San José  
Insurgentes, Delegación Benito Juárez, México,  
D.F., C.P. 03900, México  
Tel: +52-55-5804-0600

### BRAZIL

**Yamaha Musical do Brasil Ltda.**  
Praça Professor José Lannes, 40, Cjs 21 e 22, Brooklin  
Paulista Novo CEP 04571-100 - São Paulo - SP,  
Brazil  
Tel: +55-11-3704-1377

### ARGENTINA

**Yamaha Music Latin America, S.A.,  
Sucursal Argentina**  
Olga Cossetini 1553, Piso 4 Norte,  
Madero Este-C1107CEK,  
Buenos Aires, Argentina  
Tel: +54-11-4119-7000

### PANAMA AND OTHER LATIN

#### AMERICAN REGIONS/ CARIBBEAN REGIONS

**Yamaha Music Latin America, S.A.**  
Edificio Torre Davivienda, Piso: 20  
Avenida Balboa, Marbella, Corregimiento de Bella  
Vista, Ciudad de Panamá, Rep. de Panamá  
Tel: +507-269-5311

## EUROPE

### THE UNITED KINGDOM/IRELAND

**Yamaha Music Europe GmbH (UK)**  
Sherbourne Drive, Tilbrook, Milton Keynes,  
MK7 8BL, U.K.  
Tel: +44-1908-366700

### GERMANY

**Yamaha Music Europe GmbH**  
Siemensstrasse 22-34, 25462 Rellingen, Germany  
Tel: +49-4101-303-0

### SWITZERLAND/LIECHTENSTEIN

**Yamaha Music Europe GmbH, Branch  
Switzerland in Thalwil**  
Seestrasse 18a, 8800 Thalwil, Switzerland  
Tel: +41-44-3878080

### AUSTRIA/CROATIA/CZECH REPUBLIC/ HUNGARY/ROMANIA/SLOVAKIA/ SLOVENIA

**Yamaha Music Europe GmbH, Branch Austria**  
Schlierergasse 20, 1100 Wien, Austria  
Tel: +43-1-60203900

### POLAND

**Yamaha Music Europe**  
Sp.z o.o. Oddział w Polsce  
ul. Wielicka 52, 02-657 Warszawa, Poland  
Tel: +48-22-880-08-88

### BULGARIA

**Dinacord Bulgaria LTD.**  
Bul. Iskarsko Schose 7 Targoviski Zentar Evropa  
1528 Sofia, Bulgaria  
Tel: +359-2-978-20-25

### MALTA

**Olimpus Music Ltd.**  
Valletta Road, Mosta MST9010, Malta  
Tel: +356-2133-2093

### NETHERLANDS/BELGIUM/ LUXEMBOURG

**Yamaha Music Europe, Branch Benelux**  
Clarissenhof 5b, 4133 AB Vianen, The Netherlands  
Tel: +31-347-358040

### FRANCE

**Yamaha Music Europe**  
7 rue Ambroise Croizat, Zone d'activités de Pariest,  
77183 Croissy-Beaubourg, France  
Tel: +33-1-6461-4000

### ITALY

**Yamaha Music Europe GmbH, Branch Italy**  
Via Tinelli N.67/69 20855 Gerno di Lesmo (MB),  
Italy  
Tel: +39-039-9065-1

### SPAIN/PORTUGAL

**Yamaha Music Europe GmbH Ibérica, Sucursal  
en España**  
Ctra. de la Coruña km. 17,200, 28231  
Las Rozas de Madrid, Spain  
Tel: +34-91-639-88-88

### GREECE

**Philippos Nakas S.A. The Music House**  
19th km. Leof. Lavriou 190 02 Peania - Attiki,  
Greece  
Tel: +52-580-210-6686260

### SWEDEN

**Yamaha Music Europe GmbH Germany filial  
Scandinavica**  
JA Wettergöngsgata 1, 400 43 Göteborg, Sweden  
Tel: +46-31-89-34-00

### DENMARK

**Yamaha Music Denmark,  
Filial of Yamaha Music Europe GmbH, Tyskland**  
Generatorvej 8C, ST. TH., 2860 Soborg, Denmark  
Tel: +45-44-92-49-00

### FINLAND

**F-Musiikki Oy**  
Antaksentie 4  
FI-01510 Vantaa, Finland  
Tel: +358 (0)96185111

### NORWAY

**Yamaha Music Europe GmbH Germany -  
Norwegian Branch**  
Grini Næringspark 1, 1332 Østerås, Norway  
Tel: +47-6716-7800

### ICELAND

**Hjódfaeruhsid Ehf.**  
Sidumula 20  
IS-108 Reykjavik, Iceland  
Tel: +354-525-5050

### CYPRUS

**Nakas Music Cyprus Ltd.**  
Nikis Ave 2k  
1086 Nicosia  
Tel: + 357-22-511080  
**Major Music Center**  
21 Ali Riza Ave. Ortakoy  
P.O.Box 475 Lefkosa, Cyprus  
Tel: (392) 227 9213

### RUSSIA

**Yamaha Music (Russia) LLC.**  
Room 37, entrance 7, bld. 7, Kievskaya street,  
Moscow, 121059, Russia  
Tel: +7-495-626-5005

### OTHER EUROPEAN REGIONS

**Yamaha Music Europe GmbH**  
Siemensstrasse 22-34, 25462 Rellingen, Germany  
Tel: +49-4101-303-0

## AFRICA

**Yamaha Music Gulf FZE**  
JAFZA-16, Office 512, P.O.Box 17328,  
Jebel Ali FZE, Dubai, UAE  
Tel: +971-4-801-1500

## MIDDLE EAST

### TURKEY

**Yamaha Music Europe GmbH**  
Merkezi Alanya Türkiye İstanbul Şubesi  
Mor Sumbul Sokak Varyap Meridian Business  
1.Blok No:1 113-114-115  
Bati Atasehir İstanbul, Turkey  
Tel: +90-216-275-7960

### ISRAEL

**RBX International Co., Ltd.**  
P.O.Box 10245, Petach-Tikva, 49002  
Tel: (972) 3-925-6900

### OTHER REGIONS

**Yamaha Music Gulf FZE**  
JAFZA-16, Office 512, P.O.Box 17328,  
Jebel Ali FZE, Dubai, UAE  
Tel: +971-4-801-1500

## ASIA

### THE PEOPLE'S REPUBLIC OF CHINA

**Yamaha Music & Electronics (China) Co., Ltd.**  
2F, Yunhedasha, 1818 Xinzha-lu, Jingan-qu,  
Shanghai, China  
Tel: +86-400-051-7700

### HONG KONG

**Tom Lee Music Co., Ltd.**  
11/F, Silvercord Tower 1, 30 Canton Road,  
Tsimshatsui, Kowloon, Hong Kong  
Tel: +852-2737-7688

### INDIA

**Yamaha Music India Private Limited**  
P-401, JMD Megapolis, Sector-48, Sohna Road,  
Gurgaon-122018, Haryana, India  
Tel: +91-124-485-3300

### INDONESIA

**PT. Yamaha Musik Indonesia (Distributor)**  
Yamaha Music Center Bldg. Jalan Jend. Gatot  
Subroto Kav. 4, Jakarta 12930, Indonesia  
Tel: +62-21-520-2577

### KOREA

**Yamaha Music Korea Ltd.**  
11F, Prudential Tower, 298, Gangnam-daero,  
Gangnam-gu, Seoul, 06253, Korea  
Tel: +82-2-3467-3300

### MALAYSIA

**Yamaha Music (Malaysia) Sdn. Bhd.**  
No.8, Jalan Perbandaran, Kelana Jaya, 47301  
Petaling Jaya, Selangor, Malaysia  
Tel: +60-3-78030900

### SINGAPORE

**Yamaha Music (Asia) Private Limited**  
Block 202 Hougang Street 21, #02-00,  
Singapore 530202, Singapore  
Tel: +65-6740-9200

### TAIWAN

**Yamaha Music & Electronics Taiwan Co., Ltd.**  
2F, No.1, Yuandong Rd., Banqiao Dist.,  
New Taipei City 22063, Taiwan (R.O.C.)  
Tel: +886-2-7741-8888

### THAILAND

**Siam Music Yamaha Co., Ltd.**  
3, 4, 15, 16th Fl., Siam Motors Building,  
891/1 Rama 1 Road, Wangmai,  
Pathumwan, Bangkok 10330, Thailand  
Tel: +66-2215-2622

### VIETNAM

**Yamaha Music Vietnam Company Limited**  
15th Floor, Nam A Bank Tower, 201-203 Cach  
Mang Thang Tam St., Ward 4, Dist.3,  
Ho Chi Minh City, Vietnam  
Tel: +84-28-3818-1122

### OTHER ASIAN REGIONS

[https://asia-latinamerica-mea.yamaha.com/  
index.html](https://asia-latinamerica-mea.yamaha.com/index.html)

## OCEANIA

### AUSTRALIA

**Yamaha Music Australia Pty. Ltd.**  
Level 1, 80 Market Street, South Melbourne,  
VIC 3205 Australia  
Tel: +61-3-9693-5111

### NEW ZEALAND

**Music Works LTD**  
P.O. BOX 6246 Wellesley, Auckland 4680,  
New Zealand  
Tel: +64-9-634-0099

### REGIONS AND TRUST

#### TERRITORIES IN PACIFIC OCEAN

[https://asia-latinamerica-mea.yamaha.com/  
index.html](https://asia-latinamerica-mea.yamaha.com/index.html)

Yamaha Global Site  
<https://www.yamaha.com/>

Yamaha Downloads  
<https://download.yamaha.com/>

Manual Development Group  
© 2017 Yamaha Corporation

Published 10/2020 POES-B0

VEW2890