

SOUTH BEND LATHE

*Anniversary
Catalog*

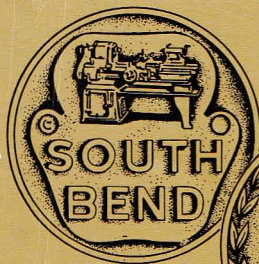

1906
1956

50th Anniversary

It was in the fall of 1906 that twin brothers John J. and Miles W. O'Brien set up shop in a small building at South Bend, Indiana and began to design and build precision machine tools. Although bringing with them a rich heritage of Yankee ingenuity, their products were a success only after years of hard, painstaking effort and financial hardship. Both brothers had served toolmaker apprenticeships in some of the finest of the old New England shops. Later they supplemented their practical training with engineering courses at Purdue University and gained wide business experience with several well established machine tool manufacturers and distributors.

Recognizing the advantage of specialization, one of the first and most important decisions of the O'Brien brothers was to restrict their products to precision machine tools. It was this policy that enabled them to produce a better machine at a better price. Through half a century there has been no deviation from this policy. Today, as in 1906, the entire resources and facilities of South Bend Lathe are devoted exclusively to the production of precision machine tools.

Operated first as a partnership and incorporated in 1914, the South Bend Lathe Works remained a closely held corporation until 1936 when its stock was first listed on the Chicago Stock Exchange, now the Midwest Stock Exchange of Chicago. The stock is now owned by a diversified group of shareholders residing in all parts of the United States and several outside this country.

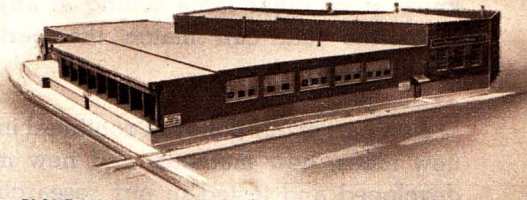

PLANT NO. 3

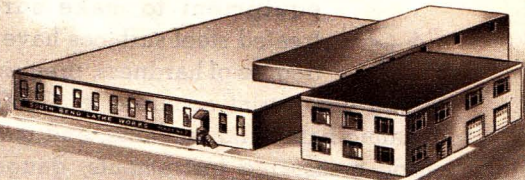

PLANT NO. 2

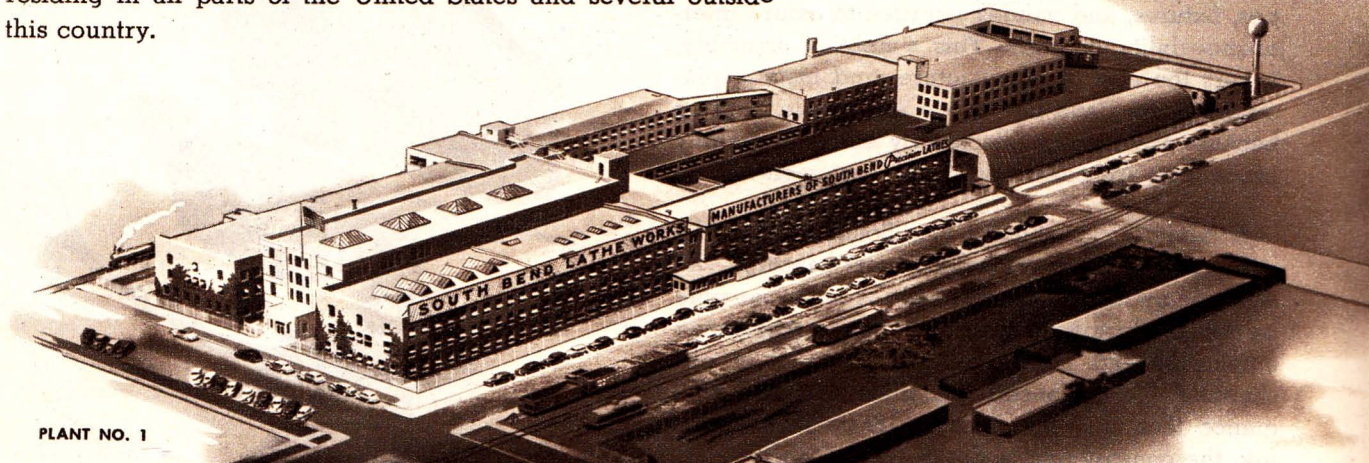

PLANT NO. 1

SOUTH BEND LATHE WORKS

Building Better Tools Since 1906

Cable address "TWINS" South Bend, South Bend 22, Indiana, U.S.A.



Careful design and conscientious workmanship are combined in South Bend Lathes to give you a machine tool that you can depend on for years of satisfactory service. Continual research has resulted in many improvements and refinements which contribute to their accuracy, durability, and ease of operation. We know of no other lathe selling at anywhere near the price that can match the performance of South Bend.



As a part of our policy of continual improvement, new ideas, new methods, and new materials are developed and tested in our research laboratory. The equipment of this laboratory includes precision gauge blocks accurate to five-millionths of an inch, an optical comparator for testing the form and lead of screw threads, a profilometer for checking the smoothness of surface finishes, hardness testing equipment to make sure that heat-treated steel surfaces have just the right degree of hardness, precision lead screw testing equipment accurate to .00005" in 30", a dynamic balancing machine, and many other precision measuring instruments, gauges, and tools. See page 3.



Parts for South Bend Lathes are economically produced in our modern factory equipped with efficient production machinery. Measuring instruments and tools are constantly checked to maintain uniform accuracy. Hundreds of special machines, jigs, fixtures, and gauges are used to assure interchangeability of parts. This simplifies assembly, lowers the cost of manufacture, and insures precision. South Bend Lathes are reasonable in price because the savings effected by efficient quantity production are passed on to the customer.

A careful inspection of any South Bend Lathe will disclose the most expert workmanship. The superior quality of workmanship is made possible by the highly specialized skills of our experienced employees and the excellent equipment of our shops. An experienced machinist can see at a glance that only the finest craftsmanship enters into the construction of South Bend Lathes.

The best materials available are used in building South Bend Lathes. That is why they last a lifetime if given the proper care. The headstock spindles

are made from a special quality of alloy steel manufactured to exacting specifications of analysis and heat treatment. The spindle bearings are the best quality phosphor bronze. The lathe beds are of a special grade of hard, close-grained iron having unusual tensile strength and wearing qualities.

The lead screws on South Bend Lathes are made of a special grade of steel that has proved to be most satisfactory for this purpose. The compound rest top, carriage, headstock, and other units of the lathe are made of the specific grades of iron that are the most suitable for the respective parts. Even the gray enamel used in finishing South Bend Lathes is made exclusively for us to our specifications.

The scientifically correct design, the generous proportions of bearing surfaces and the excellent facilities for oiling on South Bend Lathes assure permanent accuracy. We invite comparison with any other make of lathe, made either in this country or abroad. We are confident that you will find South Bend Lathes to be more accurate, and that they will retain their precision through years of service.

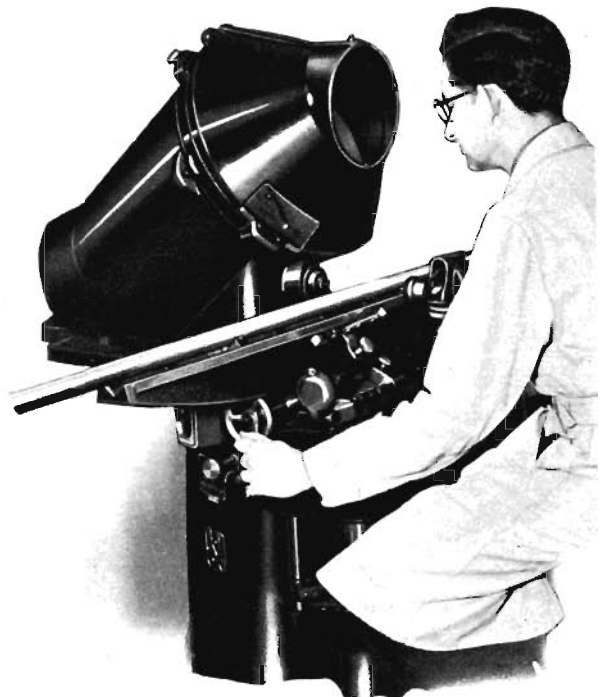

Fig. 1. Inspecting a Screw Thread with an Optical Comparator

Underneath Motor Drive

PROVIDES SMOOTH POWER

The patented South Bend Underneath Belt Motor Drive is unique and exclusive. This fully enclosed drive is unusually compact, silent in operation, powerful, and economical. Although several attempts have been made to imitate it, in our opinion no competitive drive has approached it in excellence of design or quality of construction.

The motor and driving mechanism are mounted in the cabinet leg under the lathe headstock. There are no exposed moving parts. This contributes to the neat appearance of the lathe, and is also noteworthy as a safety feature. V-belts transmit the power from the motor to the lower cone pulley. An endless flat leather belt running over the cone pulleys passes up through the lathe bed. Both the V-belts and the flat leather belt have convenient belt tension adjustments, "B" and "C", Figs. 10, 11, and 12.



The advantage of the smooth direct belt drive to the spindle for high speeds, combined with the powerful back-gear drive for slow speeds are almost too obvious to require explanation. The belt drive back-gear headstock construction has fewer parts and is, therefore, more rugged and durable than the geared head design. The few gears used for slow spindle speeds are of ample proportion to stand the shock of a heavy, interrupted cut; an operation that has proved the Waterloo of many geared head lathes. The noise and vibration of high speed gears (principal defect of the geared head design) are totally absent, thus eliminating the possibility of chatter marks on the work caused by headstock gear vibration. The speed range of a geared head lathe is limited by the gearing, but the belt drive operates smoothly at all speeds.



The quick acting belt tension release "A", Figs. 10, 11, and 12, and convenient headstock back gear change lever permit changing spindle speeds quickly, usually in five to ten seconds. The cover over the headstock cone pulley is hinged and may be raised for easy access to the cone pulley belt. The belt tension can be easily adjusted to transmit just the required amount of power. This feature can be used as a safety factor to prevent damage to the lathe by careless or inexperienced operators who often take too heavy a cut or otherwise stall the motor. When the full power of the motor is required for taking heavy cuts, the belt tension can be tightened quickly and easily to transmit full power. The lower cone pulley shaft assembly is mounted on prelubricated and sealed ball bearings which

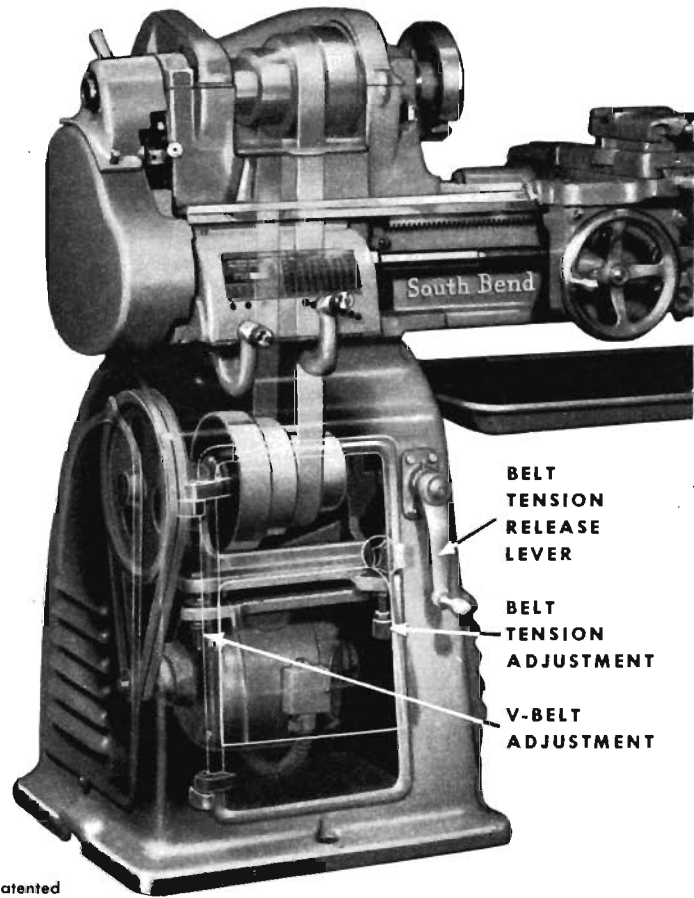
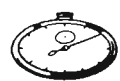

Patented

Fig. 9. Phantom View Showing Construction of South Bend Underneath Belt Motor Drive

require no oiling. Pulleys are carefully balanced for smooth operation at all speeds.

The control switch is conveniently located to permit the operator to start or stop the rotation of the lathe spindle from an easy working position. Wiring between the motor and the switch is enclosed in a flexible metal conduit. Pushbutton operated motor controls can be supplied for all 1/2 h.p. and larger motors. Drum type across-the-line reversing switch is optional for 230 volts or less. See pages 62 and 63 for more complete information on motors and controls.

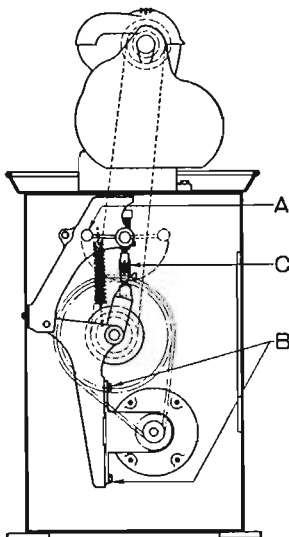

Fig. 10. Underneath Motor Drive Arrangement for 9" and Light Ten South Bend Lathes

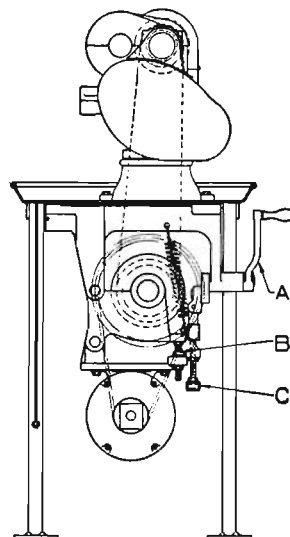

Fig. 11. Underneath Motor Drive Arrangement for 10"-1" Collet Bench Lathes

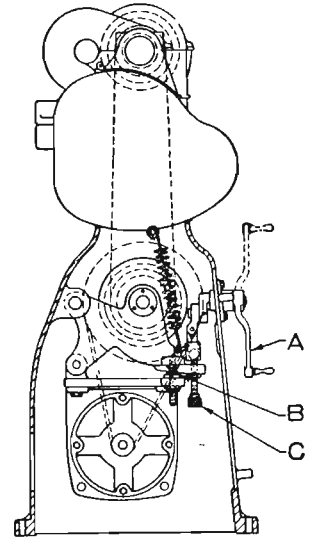

Fig. 12. Underneath Motor Drive Arrangement for 10" and Larger Floor Type Lathes



Fig. 13. Improved Quick Change Box for South Bend Lathes

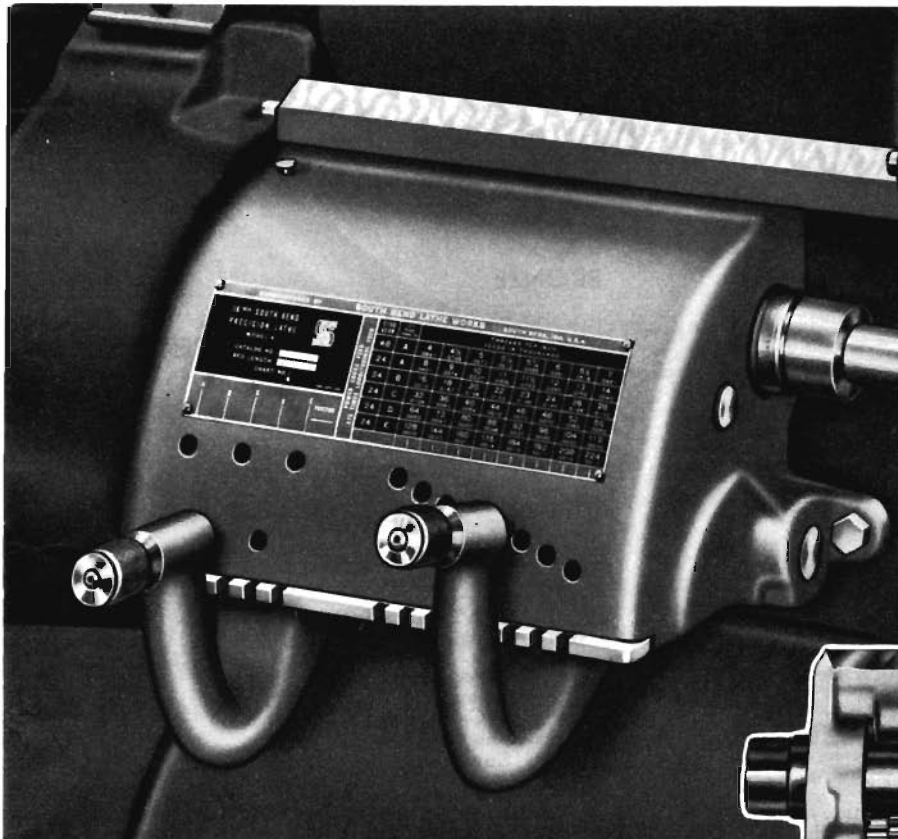
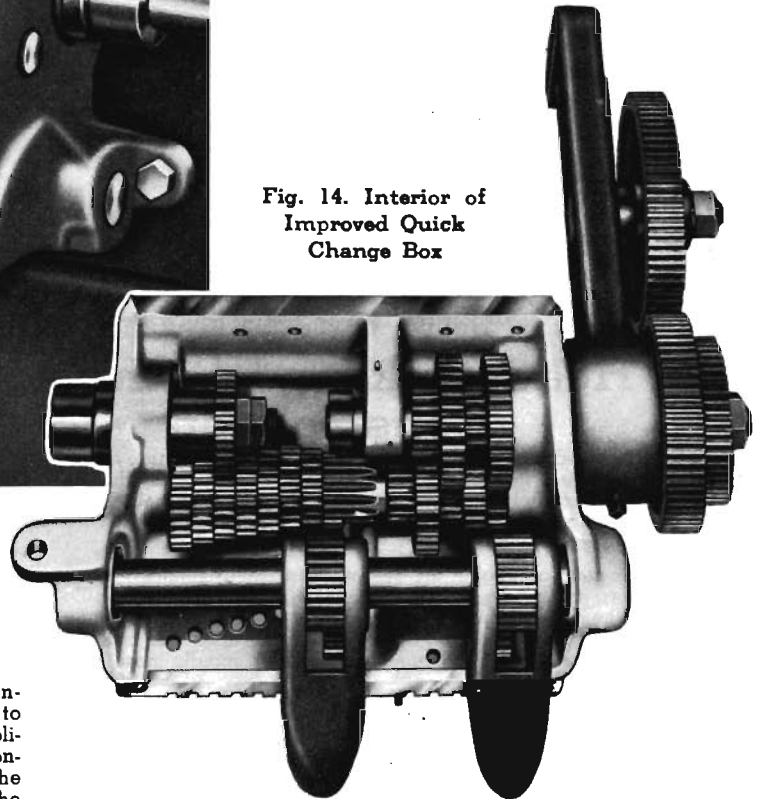

Fig. 14. Interior of Improved Quick Change Box



The Much Imitated Quick Change Box

No sooner had this improved quick change mechanism been placed on the market than imitations began to appear. A number of manufacturers have attempted to duplicate it—and have succeeded as far as appearance is concerned. But only genuine South Bend equipment has the quality of design, workmanship, and materials to give you the convenience, ease of operation, and the long, dependable service you have a right to expect. It took years of research and testing—actual use on tough jobs in our own shop—to develop a rugged fool-proof mechanism entirely satisfactory from the operators' standpoint.

A direct reading index chart shows positions in which the two conveniently located tumbler levers are placed for each of 48 screw thread pitches, 48 power longitudinal feeds, and 48 power cross-feeds.* There are no sliding clutches or sliding primary end gears to change. Shifting a single lever changes feed instantly from coarse to fine, for roughing or finishing cuts.

Standard screw threads from 8 to 224 per inch are obtained by shifting the two tumbler levers on the gear box. The stud gear is changed for an additional series of coarse pitches rang-

ing from 4 to 7 threads per inch. Provision is made for the use of special stud and intermediate gearing needed to cut metric screw threads, diametral pitch worm threads, or other special screw threads. Metric transposing gears are listed on page 61. Prices of extra stud gears for special threads will be quoted on request. State pitches of threads to be cut.

The main frame of the gear box consists of a heavy one-piece casting which is attached to the lathe bed near the headstock. Special quality alloy steel is used for all gears and shafts. Gears are precision-cut for maximum accuracy and quiet operation. Shafts are carefully ground and fitted. The lead screw shaft revolves in an annular ball bearing and has a precision thrust bearing to eliminate end play and cam action. Tumbler gears are fitted with needle bearings.

*10"-1" Collet Lathes have 70 changes, cut 70 screw threads 4 to 480 per inch. See page 19.

MANUFACTURED BY		SOUTH BEND LATHE WORKS		SOUTH BEND, IND. U.S.A.							
14½ & 16 INCH SOUTH BEND PRECISION LATHE MODEL A				CATALOG NO. _____ BED LENGTH _____ CHART NO. 1							
POWER CROSS FEED 37.5 TIMES LONGITUDINAL FEED	STUD GEAR	THREADS PER INCH FEEDS IN THOUSANDTHS									
	LEFT HAND TUMBLER	48	A	4 0841	4 0748	5 0673	5 0612	5 0585	6 0561	6 0518	7 0481
	24	A	8 0421	9 0374	10 0337	11 0306	11 0293	12 0280	13 0259	14 0240	
	24	B	16 0210	18 0187	20 0168	22 0153	23 0146	24 0140	26 0129	28 0120	
	24	C	32 0105	36 0093	40 0084	44 0076	46 0073	48 0070	52 0065	56 0060	
	24	D	64 0053	72 0047	80 0042	88 0038	92 0037	96 0035	104 0032	112 0030	
	24	E	128 0026	144 0023	160 0021	176 0019	184 0018	192 0017	208 0016	224 0015	
				↓	↓	↑	↑	↓	↓	↑	

Fig. 15. Direct Reading Index Chart Showing Threads and Feeds Provided by Quick Change Mechanism on 16-inch Swing Lathe

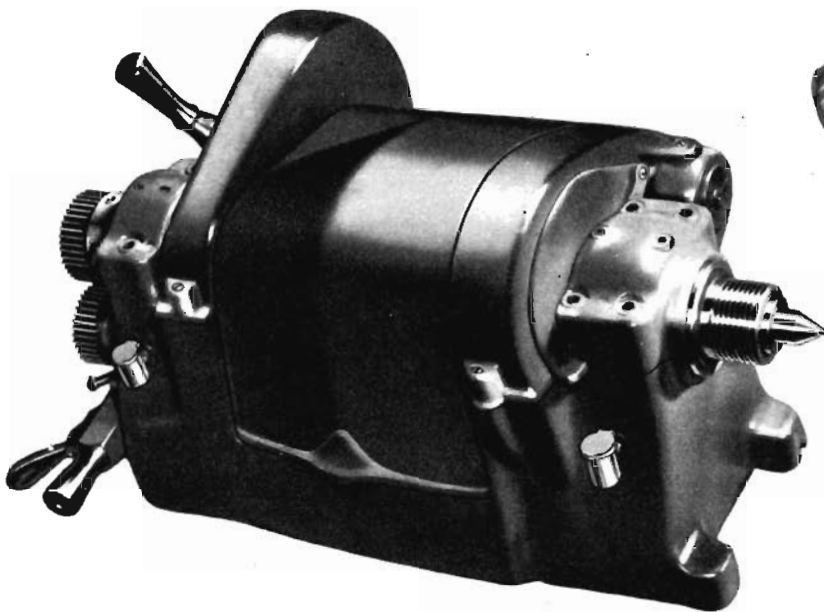

Fig. 16. Headstock for 16-inch Swing South Bend Lathe

Headstock and Spindle Construction

The headstock is the most important unit of the lathe, and it might be said that the life of the lathe is determined by the life of the headstock. Sturdy design, high quality materials, large bearings and excellent oiling facilities assure unusual life for South Bend Headstocks.

The main casting for the headstock is heavily reinforced and webbed for rigidity and permanent alignment of the spindle with the V-ways of the bed. The headstock base has unusually long bearings which are carefully hand-scraped and fitted to the bed ways. All moving parts (except spindle nose) are fully enclosed.

Direct belt drive to the spindle for high speeds assures smooth operation at high speed on small diameter work. Slow speeds for heavy cuts on large diameters are driven through the back gears. The threaded spindle nose shown is regularly supplied, but type L Long Key Drive or type D1 Cam Lock Spindle can be supplied to order. See page 32.

The wrenchless bull gear lock permits engaging the headstock back gears without the use of a wrench. A quick acting spring latch reverse on the left end of the headstock enables the operator to change from right-hand to left-hand feeds or threads instantly. These two convenient features will appeal to any busy mechanic for they save a lot of time.

Much time, thought and care have gone into the design and development of the headstock spindle and bearings for South Bend Lathes. Hundreds of different designs have been tested, including many with ball and roller bearings.

Two plain bearing designs were selected as the most satisfactory. For underneath motor drive lathes, a heat-treated spindle and replaceable bronze sleeve bearings were adopted. Preliminary research and testing of this bearing construction were so thorough that during the five years following its introduction not one spindle bearing was replaced because of wear. Bearing construction for the 9" horizontal drive lathe is similar, except that the spindle runs in integral cast-iron bearings.

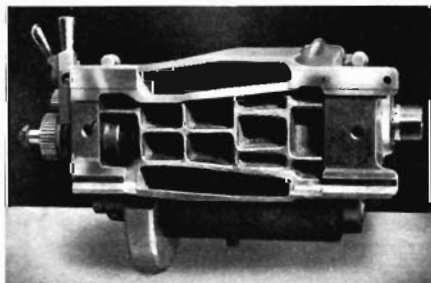

Fig. 20. Bottom View of Headstock Showing Rigid Cross-Ribbed Construction



Fig. 17. Headstock Spindle and Bearings

Fig. 18. Ball Thrust Bearing and Take-up Nut

Fig. 19. Cross Section of Spindle Showing Thickness ($\frac{3}{4}$ ") of Carburized and Hardened Bearing Surfaces

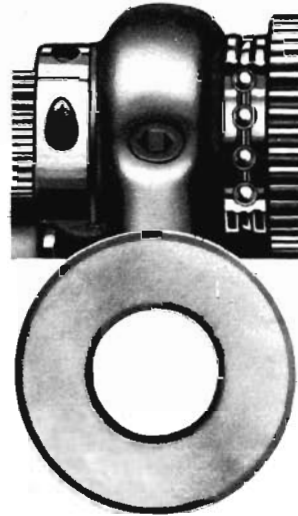

The bearing surfaces on the spindle are carburized, hardened to Rockwell C 56 to 61, ground and superfinished to a smoothness of 5 microinches (.000005") r.m.s. The extreme smoothness and accuracy of the superfinished spindle bearing surface eliminates wear, reduces friction, permits higher spindle speeds and assures precision.

The bearings in which the spindle revolves are unusually large, and are precision bored and burnished to a smoothness of ten microinches (.000010") r.m.s. by the bearingizing process. The design permits using a large diameter spindle providing extreme rigidity and reducing the possibility of chatter. The bearings are accurately adjusted at the factory and should require no further adjustment for years. Provision is made for take-up when required.

Large oil reservoirs and an improved circulating capillary oiling system provide a complete film of clean filtered oil which separates the rotating spindle from the bearings. As long as sufficient oil is supplied to maintain an adequate oil film, there can be no metal to metal contact in this bearing, no wear and no friction other than the fluid friction of the lubricant. An efficient oil return system retains the oil so that only an occasional replenishing is required.

There is prevalent much misunderstanding and misinformation relative to the respective merits of so-called anti-friction bearings. Certainly they are unequalled for certain applications where low cost or low starting torque are of greater importance than precision and durability. However, it has been our experience that for the spindles of precision lathes such as we manufacture, properly designed and fitted plain bearings are superior, and even though more costly than other types of bearings, their performance justifies the added expense.

The principal advantages of the plain bearing are that it provides better support for the spindle, permits using a larger diameter spindle, eliminates the possibility of chatter marks in the work due to vibration set up by balls or rollers, runs more smoothly and quietly, wears longer, and is adjustable.

On the other hand, a spindle revolving in a ball bearing can only run as true as the combined eccentricity of the outer and inner surfaces of both the outer and inner races, and is supported only by the point of contact between the ball or roller and the bearing race. A slight pit, worn spot, or other imperfection in the bearing race will cause vibrations which result in the familiar chatter marks so often encountered on lathes with ball or roller bearings. The frequent replacement of ball or roller bearings is an annoyance to say nothing of the expense.

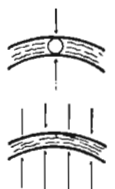

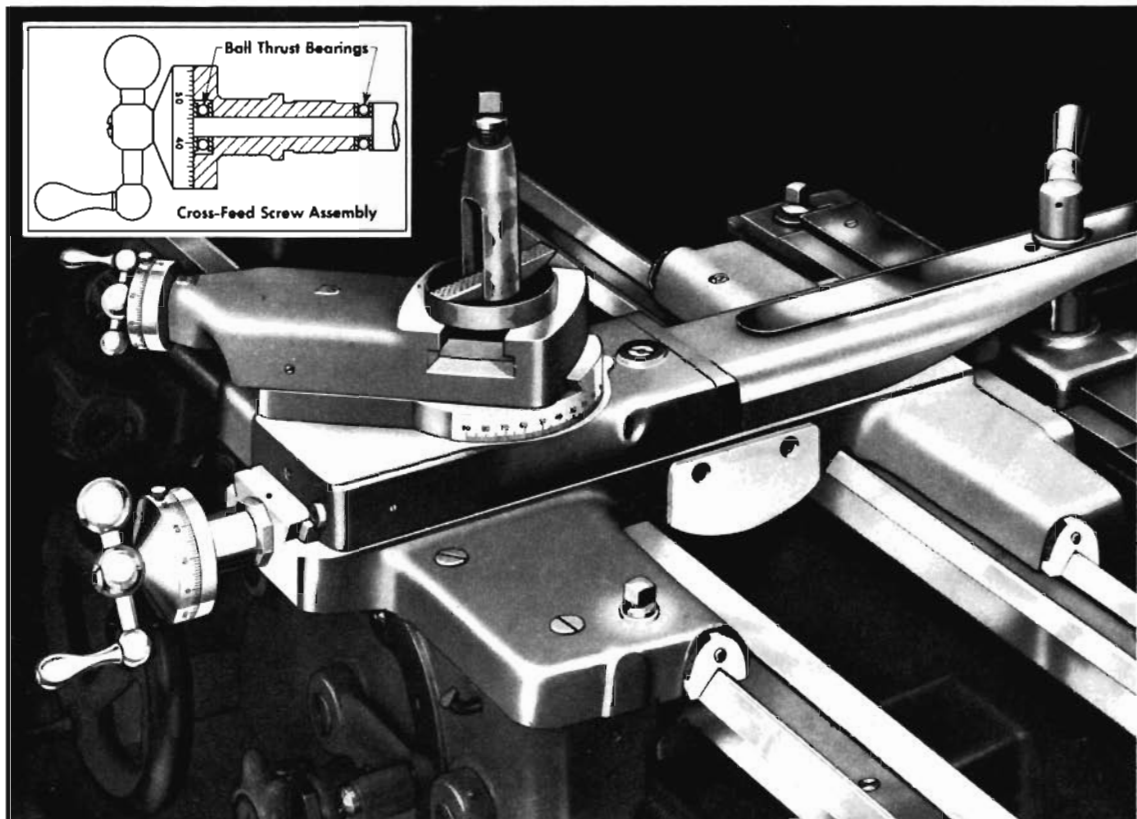

Fig. 21. Improved Saddle and Compound Rest for South Bend Lathes

Improved Saddle and Compound Rest



Saddles for South Bend Lathes have unusually long bearings carefully hand-scraped to conform with the outer V-ways of the lathe bed. Felt pad wipers are attached to each end of the saddle to clean and oil the V-ways of the bed. The cross slide bridge

is wide and deep, providing a rigid support for the tool rest. The cross slide dovetail is hand-scraped square with the V-ways of the saddle.

The back of the saddle is machined to receive the taper attachment and the saddle bridge is machined for the follower rest. (See pages 39 and 40.) A carriage lock screw, conveniently located on the right-hand front wing of the saddle, is provided for locking the carriage securely to the lathe bed for cutting-off and for precision facing operations.

Both the compound rest base and the compound rest top dovetails are hand-scraped, and on 10-inch 1" collet lathes and larger sizes, the dovetails have adjustable tapered gibs. Dovetails on 9-inch and Light Ten Lathes have flat gibs with screw adjustment. The compound rest base is drilled and tapped for the thread cutting stop screw. The compound rest swivel bearing is accurately ground and fitted. The swivel is graduated 180-degrees and may be set at any angle for turning and boring bevels and tapers. Full 360° graduation can be supplied to order if desired.

The cross-feed screw and compound rest screw have large diameter easy reading micrometer collars which are accurately graduated to read in thousandths of an inch advance of the cutting tool. Graduations reading in thousandths of an inch on the diameter of the work or in the metric system can be supplied to order. (See page 65.)

The graduated collars are adjustable and may be set at zero whenever desired. Crank handles for both the compound rest screw and cross-feed screw are nicely balanced and are made of polished steel. Cross-feed screw has ball thrust bearing and crank has swivel machine handle on 10"-1" Collet and larger lathes.

The tool post, tool post ring, and tool post rocker are made of steel, heat-treated and hardened. Rocker adjustment is provided for adjusting the cutting edge of the tool to the desired height. A forged steel heat-treated tool post wrench is supplied as regular equipment. Wrench has box opening on one end and fits the carriage lock screw as well as the tool post screw.

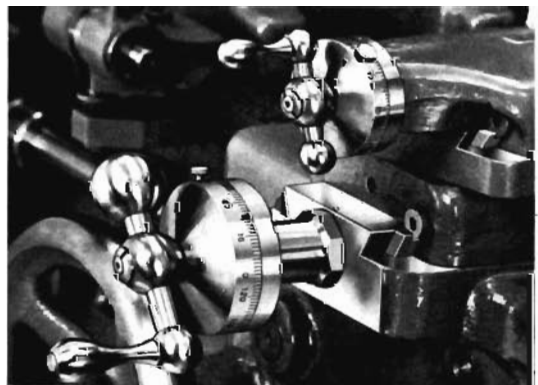

Fig. 22. Easy-reading Graduated Dials, Swivel Machine Handle, and Taper Gibs used on 10"-1" Collet and larger South Bend Lathes

METRIC GRADUATIONS—Any South Bend Lathe can be supplied with metric graduations throughout in lieu of English graduations. Write for information.

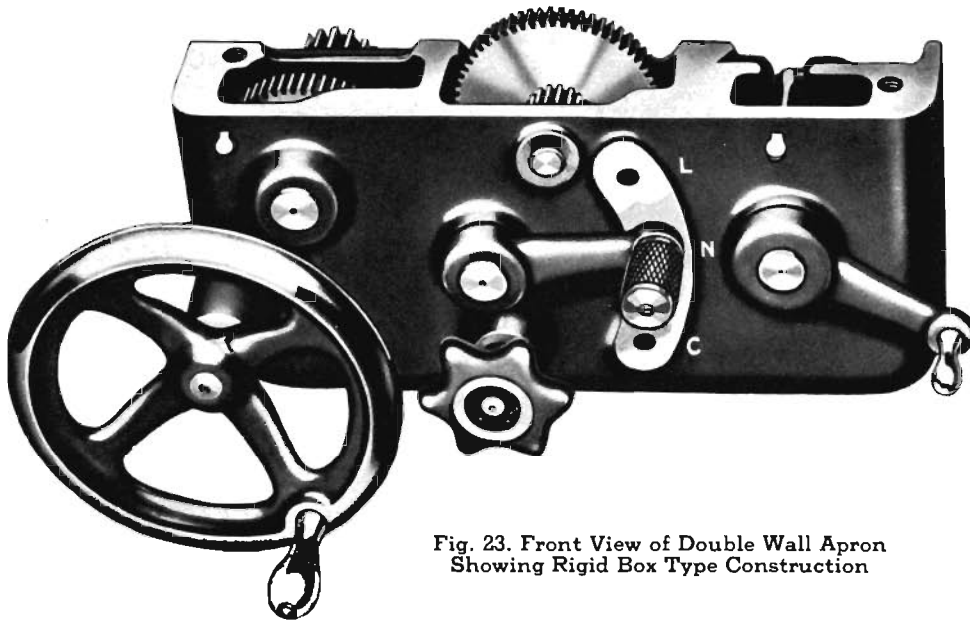
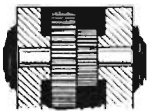

Fig. 23. Front View of Double Wall Apron Showing Rigid Box Type Construction

Fig. 23A. Close-up of Swivel Machine Handle on Apron Handwheel



One-Piece Double Wall Apron For 10"—1" Collet and Larger South Bend Lathes



The one-piece double wall apron supplied on all 10"—1" Collet and larger lathes is rigidly constructed and provides substantial support for both ends of the gear shafts. Gears in the apron are made of steel and have reservoir and felt wick oiling system.

A large diameter handwheel and swivel machine handle contribute to ease of operation.

The multiple disc friction clutch used for operating both the power cross-feeds and the power longitudinal feeds is shown in Fig. 25. Alternate steel discs precision ground on both sides to close tolerances for flatness and thickness are keyed to the clutch shaft and worm wheel respectively. A slight turn of the clutch knob will engage the clutch, placing the power carriage feed in operation. Clutch will engage or release instantly, is smooth in operation and will not stick or slip under heavy cuts.

The rack pinion, shown at right end of apron, Fig. 24, is rigidly supported by substantial bearings in both the front wall and back wall of the apron.

The half-nuts for thread cutting are close-coupled and are dovetailed into the back wall of the apron, as shown in Fig. 24. The half-nuts and threads of the lead screw are used only when cutting screw threads. A spline in the lead screw drives the worm which operates the power carriage feeds.

An automatic built-in safety device makes it impossible to engage the worm driven power feeds and half-nut feeds at the same time. When the feed lever is in either position "L" or "C", Fig. 23, the half-nuts are locked and cannot be engaged with the lead screw. To engage the half-nuts with the lead screw, the feed lever must be in the "N" or neutral position. A tumbler gear shift is used to change from power cross-feed to power longitudinal feed.

Fig. 24. (Below) Back View of New Double Wall Apron

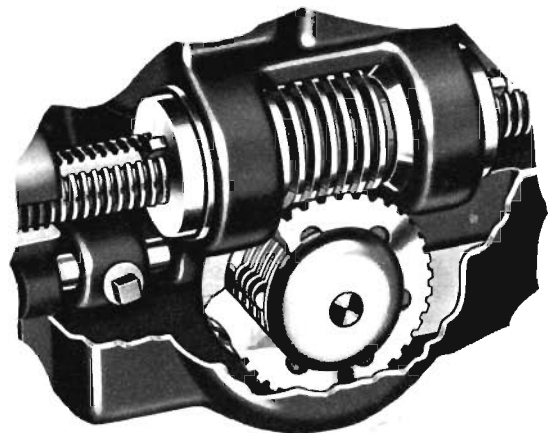
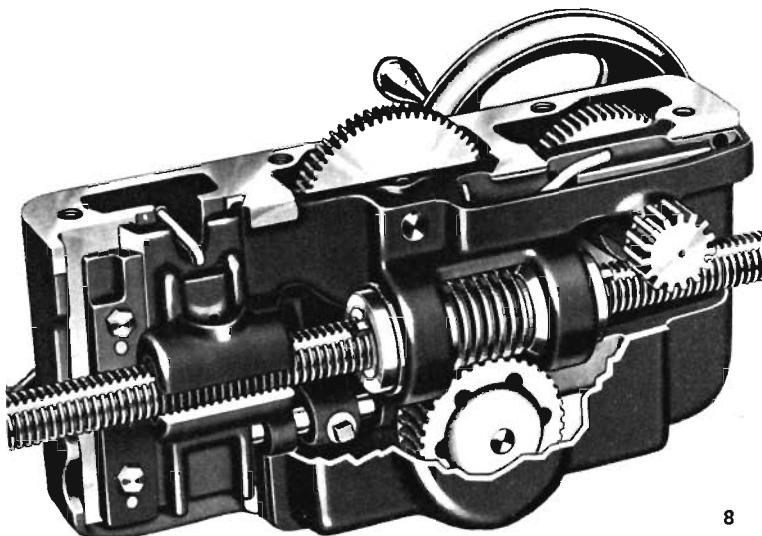

Fig. 25. (Above) Cut-away View Showing the Multiple Disc Friction Feed Clutch

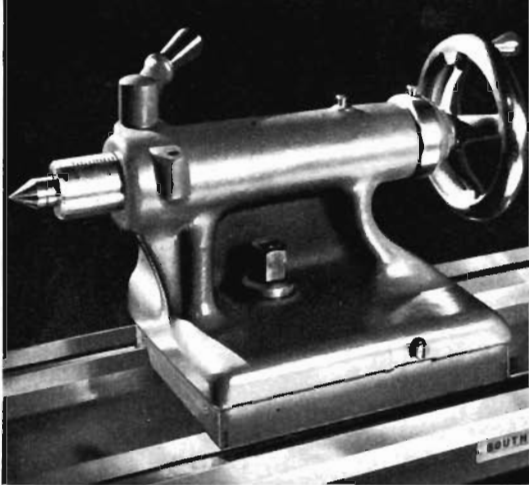

Fig. 26. Tailstock Design Used on 13" and Larger Lathes

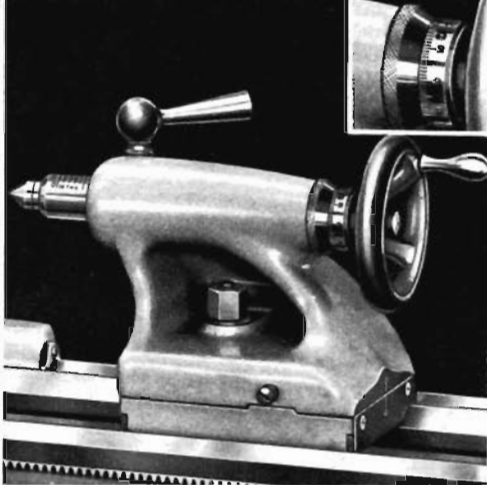

Fig. 27. Tailstock Design Used on 10" Swing Lathes

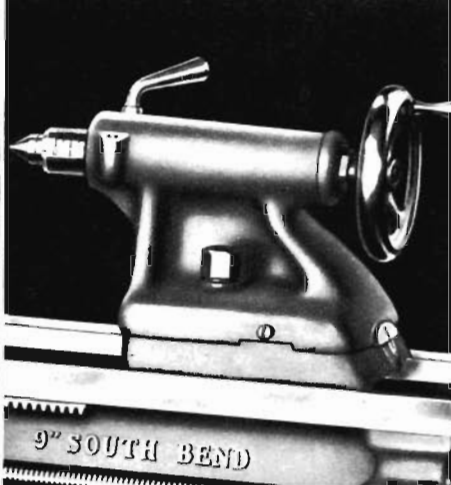

Fig. 28. Tailstock Design Used on 9" Swing Lathes

Tailstocks for South Bend Lathes

Tailstocks for all South Bend Lathes are rigidly constructed to provide solid support for the work. Generous bearing surfaces are carefully fitted to assure precision alignment of the tailstock spindle with the bed ways and the headstock spindle. On all 10" and larger lathes, felt wipers are attached to both ends of the tailstock base to clean and oil the bed ways. A substantial clamp and bolt with convenient box type wrench are provided for locking the tailstock securely at any point along the length of the lathe bed.

The tailstock top is offset to allow the compound rest to swivel over the tailstock base, parallel with the lathe bed. A sensitive screw adjustment is provided to set over the tailstock top for taper turning. Witness marks indicating the position of the tailstock top are conveniently placed on the right end of the tailstock where they can be seen with ease.

The tailstock screw has long wearing Acme thread and a large diameter handwheel which assure smooth and easy operation, especially important for drilling and reaming jobs. Graduations on the tailstock spindle indicate its movement for drilling to accurate depths and similar operations. Graduations read in sixteenths of an inch, except for the 10" swing lathes which have graduations reading in tenths of an inch. Metric graduations can be supplied to order. Tailstock screws for 10" lathes are fitted with graduated collars reading in thousandths of an inch advancement of the spindle. Handwheels on 10"-1" collet and larger lathes have swivel machine handles.

Tailstocks for 10" swing and larger lathes have an improved internal clutch device which securely locks the spindle without altering the alignment of the centers. Tailstocks for 9" swing lathes have split barrel and binding lever for locking tailstock spindle. A witness mark is scribed on the tailstock spindle at center height for adjusting height of cutter bit. The tailstock center is made of tool steel, is hardened and precision ground all over, and is automatically ejected as the spindle is retracted. See page 47 for hardened taper in spindle.

Rigid Lathe Bed

Three V-ways Assure Precision Alignment of Headstock, Tailstock, and Carriage

Beds for South Bend Lathes are heavily constructed with large braces cast in at short intervals. The beds are made of a special grade of iron with 30 to 70 per cent steel (depending on size) which produces a hard close-grained casting having unusual strength and long wearing qualities. See page 34 for hardened and ground bed ways.



Three large V-ways and one flat way on the bed assure permanent precision alignment of the headstock, carriage, and tailstock. Being cast integral with the bed, there is no possibility of the bed ways working loose and shifting in service. The carriage slides on the two outside V-ways and the headstock and tailstock are aligned by the inside V-way. The ways are carefully precision finished the entire length of the bed.

Careful inspection is made to be sure that a uniform bearing is obtained the full length of the bed and that all ways are straight and parallel. The serial number is stamped between the front ways at the tailstock end as shown. A record of each lathe is kept and is filed under this number. When attachments or parts are ordered, the serial number of the lathe should always be stated.

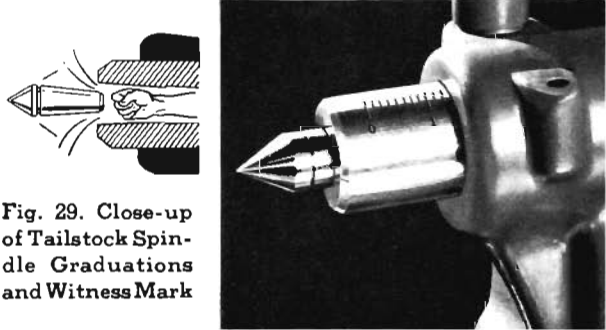
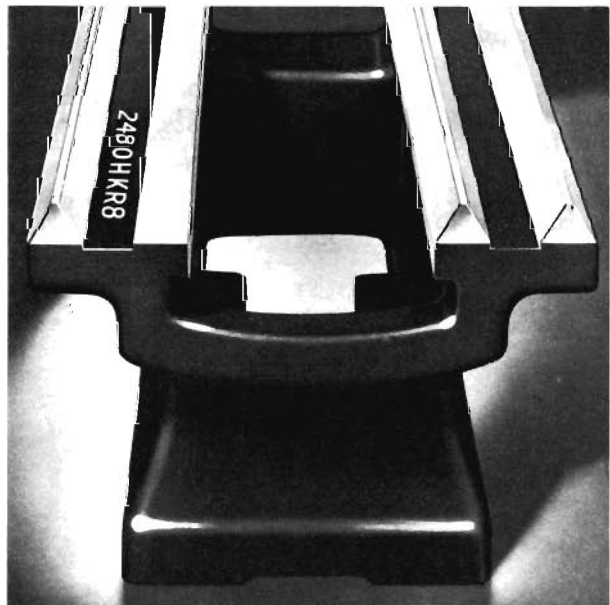
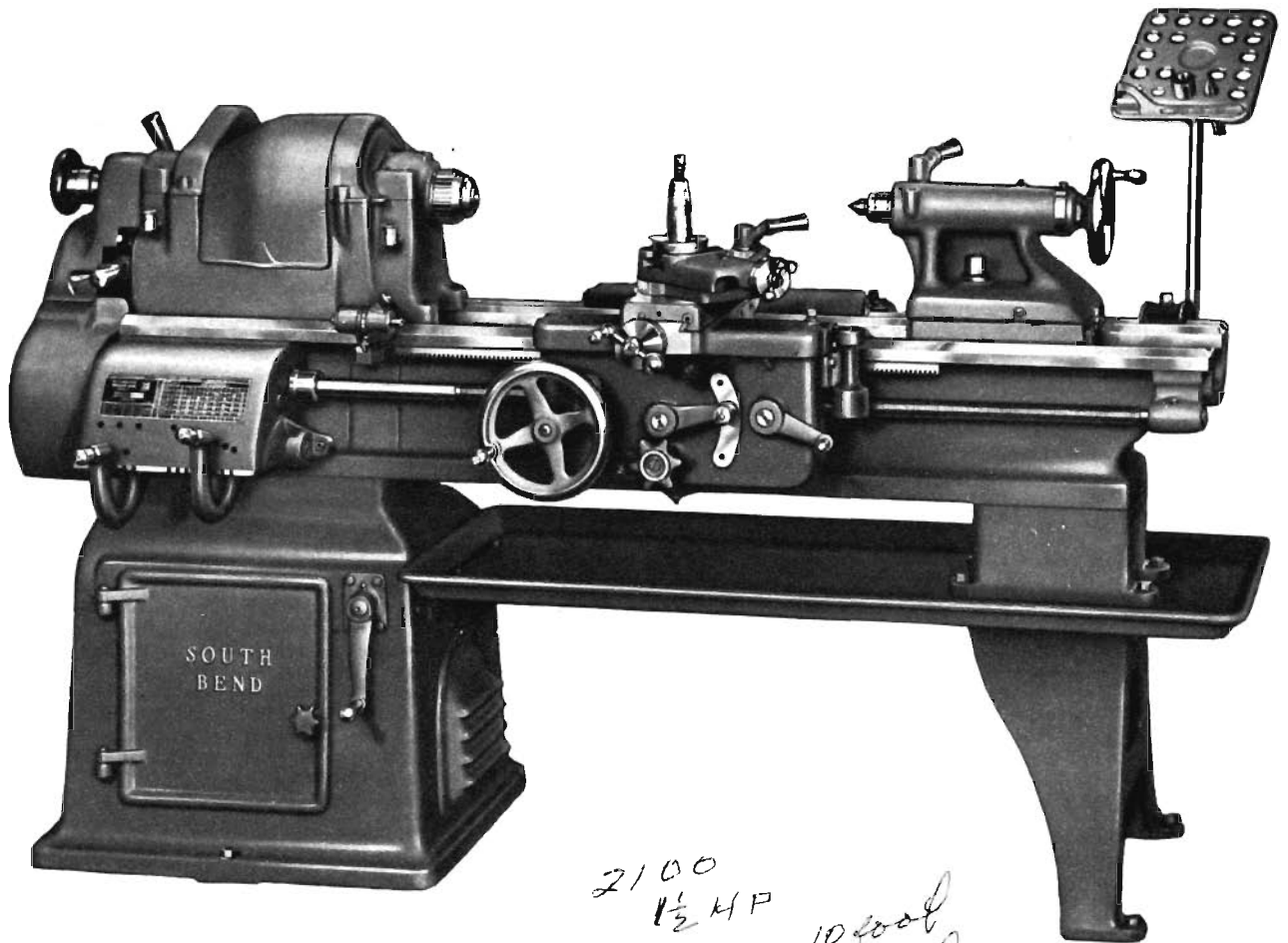

Fig. 29. Close-up of Tailstock Spindle Graduations and Witness Mark



Use a mixture of red lead and machine oil to lubricate the tailstock center point.



16" Swing South Bend Precision Toolroom Lathe

2100
1 1/2 HP
10 foot Bed
taper atts

16" South Bend Precision Lathes

TOOLROOM and ENGINE LATHE MODELS

Five Bed Lengths—33" to 105" Between Centers

We sincerely believe that this is the finest lathe of this size and type that you can buy at anywhere near the price. Capable of the most exacting operations, it has ample power and capacity for most toolroom and production jobs. Special accuracy tests are made on each lathe during the assembling and testing to assure utmost precision. Husky castings and large, carefully fitted bearings provide the rigidity so essential to smooth operation and a durability that assures long life.

Made in both toolroom and engine lathe models, you have a choice of five bed lengths providing 33" to 105" between centers. Hardened and ground bed ways, cam lock spindle nose, or long taper key drive spindle nose can be supplied in lieu of regular equipment at small extra cost. See pages 32 and 34.

TWO TYPES OF HEADSTOCKS

Six to Sixteen Spindle Speeds

Headstocks for 16" swing South Bend Lathes are made in two types: 4-step cone pulley and wide belt 3-step cone pulley. The 4-step cone pulley headstock provides either eight or sixteen spindle speeds depending on whether a single-speed or a two-speed motor is used. With the wide belt 3-step cone pulley you have either six or twelve spindle speeds.

The 4-step cone pulley design is well adapted to toolroom work and finishing operations as it provides a greater selection of spindle speeds.

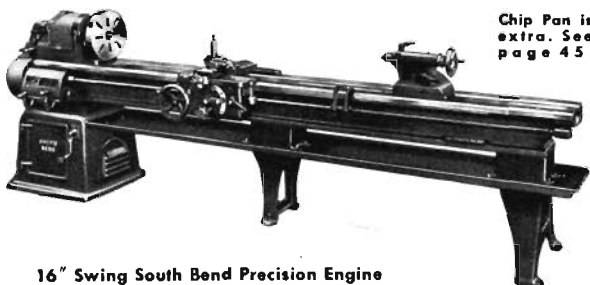

16" Swing South Bend Precision Engine Lathe with Center Leg

Chip Pan is extra. See page 45.

The wide belt 3-step cone pulley headstock assures maximum power transmission for heavy roughing cuts and rapid production. It is especially recommended for use with a two-speed motor.

Quick Change from High to Low-Speeds

When a two-speed motor is used it doubles the number of spindle speeds, providing sixteen speeds with the 4-step cone pulley or twelve speeds with the 3-step cone pulley headstock. This not only increases the speed range but with push button control it provides instantaneous changes between corresponding high speeds and low speeds. This feature saves time on multiple operations requiring frequent speed changes such as drilling and tapping, boring and reaming, or turning and facing. The low spindle speeds are approximately one-half the corresponding high speeds. See page 62 for information on motors and controls.

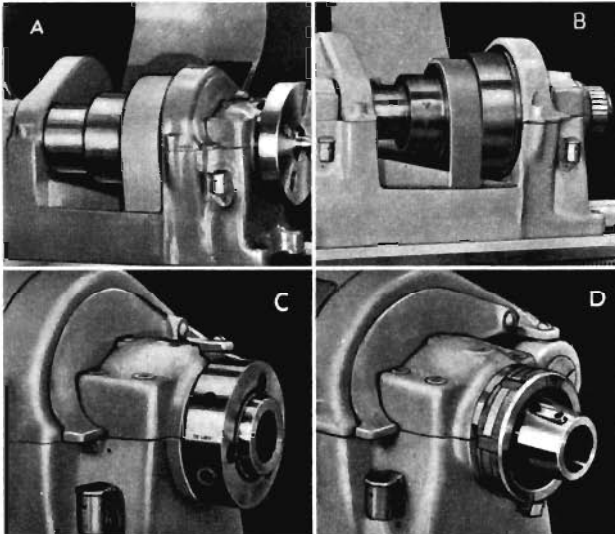

A. Three-step cone pulley headstock, each step 3" wide
 B. Four-step cone pulley headstock, each step 2 1/4" wide
 C. Cam lock spindle. See page 32
 D. Long taper key drive spindle. See page 32

ENGINE LATHES

Regular equipment included in price of each 16" Engine Lathe consists of: 4 V-belts; flat leather belt; thread indicator dial; small face plate; heat-treated steel tool post; adjustable thread cutting stop; tool steel centers for headstock and tailstock spindles; headstock spindle sleeve; wrenches; quick change box; installation plan; and book "How to Run a Lathe". Electrical equipment is not included in price of lathe. See page 62 for information on motors and controls.

Catalog Number	Bed Length Feet	Between Centers Inches	Cubic Feet Boxed	Boxed Weight Pounds	Crated Weight Pounds	Factory Price
16" Engine Lathes with THREE-STEP Pulley Headstock						
CL155C	6	33	89	2775	2375	\$2259
CL155D	7	45	96	3025	2455	2314
CL155E	8	57	105	3225	2535	2369
CL155G	10*	81	123	3625	2875	2527
CL155H	12*	105	141	3975	3050	2685
16" Engine Lathes with FOUR-STEP Pulley Headstock						
CL117C	6	33	89	2700	2300	\$2259
CL117D	7	45	96	2950	2380	2314
CL117E	8	57	105	3150	2460	2369
CL117G	10*	81	123	3550	2800	2527
CL117H	12*	105	141	3900	2975	2685

*Center leg is supplied with 10' and 12' beds.

TOOLROOM LATHES

Regular equipment included in price of each 16" Toolroom Lathe is the same as listed above for the Engine Lathe. In addition, the following toolroom attachments are supplied: precision lead screw; handwheel type draw-in collet attachment (without collets); collet rack; telescopic taper attachment; large face plate; chip pan; and micrometer carriage stop. Electrical equipment is not included in price of lathe. See page 62.

Catalog Number	Bed Length Feet	Between Centers Inches	Cubic Feet Boxed	Boxed Weight Pounds	Crated Weight Pounds	Factory Price
16" Toolroom Lathes with THREE-STEP Pulley Headstock						
CL8155C	6	33	100	3000	2600	\$2806
CL8155D	7	45	106	3250	2680	2869
CL8155E	8	57	117	3450	2760	2932
16" Toolroom Lathes with FOUR-STEP Pulley Headstock						
CL8117C	6	33	100	2925	2525	\$2806
CL8117D	7	45	106	3175	2605	2869
CL8117E	8	57	117	3375	2685	2932

SPECIFICATIONS

CAPACITY OF LATHE		
Swing over bed and saddle wings.....	16 1/2"	
Swing over saddle cross slide.....	9 3/4"	
Swing over cross slide without chip guard, engine lathe model only.....	11 1/2"	
SPINDLE SPEEDS (approximate, not exact)		
	Direct Drive	Back-Geared
With 4-Step Cone Pulley Headstock		
High speeds, r.p.m.....	980, 610, 390, 240	125, 80, 50, 30
Low speeds, available only with 2-speed motor, r.p.m.....	490, 305, 195, 120	62, 40, 25, 15
With 3-step cone pulley headstock		
High speeds, r.p.m.....	945, 550, 300	118, 70, 32
Low speeds, available only with 2-speed motor, r.p.m.....	475, 278, 150	60, 33, 20
HEADSTOCK		
Hole through spindle.....	1 1/2"	
Maximum collet capacity.....	1"	
Spindle nose diameter and threads.....	2 3/8"-6	
Size of center, Morse taper.....	No. 3	
Width, each step of 4-step cone pulley.....	2 1/2"	
Width, each step of 3-step cone pulley.....	3"	
Large face plate diameter.....	13 1/2"	
Small face plate diameter.....	8 1/2"	
Front spindle bearing diameter.....	2 3/8"	

TAILSTOCK	
Size of center, Morse taper.....	No. 3
Spindle travel.....	5 3/4"
Each graduation on tailstock spindle.....	1/4"
Tailstock top set-over for taper turning.....	1"
COMPOUND REST	
Cross slide travel, engine lathe model.....	10 1/2"
Cross slide travel, toolroom model.....	10 1/4"
Angular hand feed of compound rest top slide.....	3 3/4"
THREADS and FEEDS	
Thread cutting range—48 pitches R.H. or L.H.....	4 to 224 per inch
Longitudinal feeds through friction clutch—48 feeds R.H. or L.H.....	.0015" to .0841"
Cross-feeds through friction clutch—48 feeds.....	.0006" to .0315"
Lead screw, 29° Acme thread.....	1 1/2" dia.—6 thds.
TOOL POST	
Size of tool holder shank opening will take.....	3/8" x 1 1/2"
Size of cutter bit tool holder will take.....	3/8" sq.
MOTOR (recommended size)	
Four-step cone pulley, one-speed motor.....	1 1/2 h.p.
Three-step cone pulley, one-speed motor.....	2 h.p.
Three- or four-step cone pulley, two-speed motor.....	2-1 h.p.

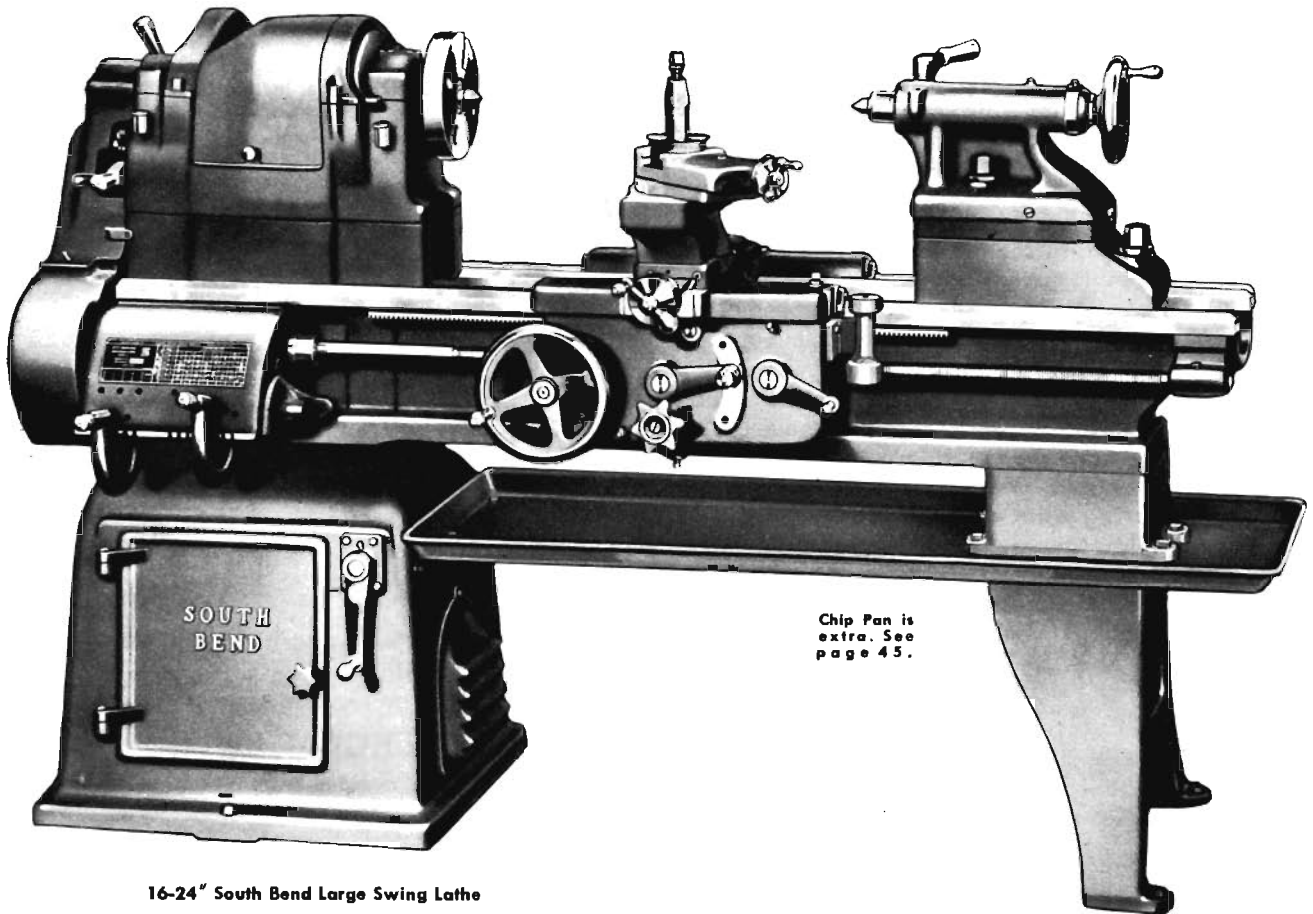

16-24" South Bend Large Swing Lathe

Chip Pan is extra. See page 45.

16-24" South Bend LARGE SWING Lathes

25 $\frac{1}{8}$ " Swing Over Bed—18 $\frac{3}{4}$ " Swing Over Saddle Cross Slide
Five Bed Lengths—30" to 102" Between Centers

The 16-24-inch Large Swing Lathe is a practical tool for machining large diameter work that is not excessively heavy. It is the same as the 16-inch Engine Lathe except that the height of the centers is increased to take work up to 25 $\frac{1}{8}$ " in diameter over the bed and 18 $\frac{3}{4}$ " in diameter over the saddle cross slide.

The large capacity of this lathe makes it a valuable tool for the shop requiring a general purpose precision lathe for large diameter jobs such as boring jig plates, turning and boring wheels, machining pulleys, turning brake drums, and similar work. Although this lathe has ample

capacity for large awkward jobs, it is not too heavy and cumbersome for efficient operation on small parts.

TWO TYPES OF HEADSTOCKS Six to Sixteen Spindle Speeds

Headstocks for 16-24" South Bend Lathes are made in two types: 4-step cone pulley and wide belt 3-step cone pulley. The 4-step cone pulley headstock provides either eight or sixteen spindle speeds depending on whether a single-speed or a two-speed motor is used. With the wide belt 3-step cone pulley you have either six or twelve spindle speeds.

The 4-step cone pulley design is well adapted to toolroom work and finishing operations as it provides a greater selection of spindle speeds. The wide belt 3-step cone pulley headstock assures maximum power transmission for heavy roughing cuts and rapid production. It is especially recommended for use with a two-speed motor.

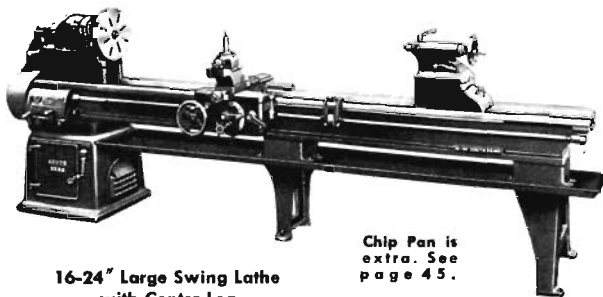

16-24" Large Swing Lathe with Center Leg

Chip Pan is extra. See page 45.

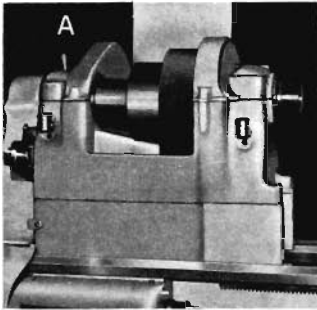

Three-step cone pulley headstock, each step 3" wide

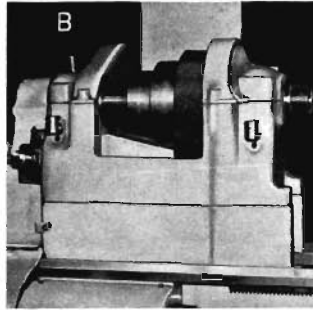

Four-step cone pulley headstock, each step 2 1/4" wide

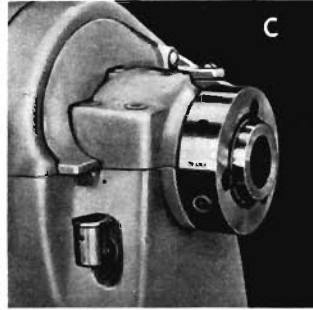

Cam lock spindle. See page 32

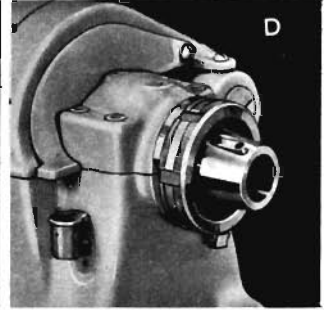

Long taper key drive spindle. See page 32

Quick Change from High to Low Speeds

When a two-speed motor is used it doubles the number of spindle speeds, providing sixteen speeds with the 4-step cone pulley or twelve speeds with the 3-step cone pulley headstock. This not only increases the speed range but, with push button control, it provides instantaneous changes between corresponding high speeds and low speeds. This feature saves time on multiple operations requiring frequent speed changes such as drilling and tapping, boring and reaming, or turning and facing. The low spindle speeds are approximately one-half the corresponding high speeds. See page 62 for information on motors and controls.

Choice of Spindle Nose Design

The regular threaded spindle nose is standard equipment for 16-24" South Bend Lathes. However, at small extra cost, either the Cam Lock or Long Taper Key Drive spindle nose construction may be had, the same as on other sizes of South Bend Lathes. Type of spindle nose design wanted should be specified when lathe is ordered. See page 32 for additional information.

Equipment Supplied with Lathes

Regular equipment included in price of lathe consists of: 4 V-belts; flat leather belt; thread indicator dial; small face plate; heat-treated steel tool post; adjustable thread cutting stop; tool steel centers for headstock and tailstock spindles; headstock

spindle sleeve; wrenches; quick change box; installation plan; and book "How to Run a Lathe". Electrical equipment is not included in price of lathe. See page 62 for motors and controls.

Catalog Number	Bed Length Feet	Between Centers Inches	Cubic Feet Boxed	Boxed Weight Pounds	Crated Weight Pounds	Factory Price
16-24" Large Swing Lathe with Six-Speed Drive THREE-STEP Cone Pulleys for 1-Speed Motor						
CL176C	6	30	98	3100	2480	\$2559
CL176D	7	42	104	3200	2560	2614
CL178E	8	54	114	3300	2640	2669
CL176G	10*	78	134	3700	2980	2827
CL176H	12*	102	153	3900	3155	2985

Catalog Number	Bed Length Feet	Between Centers Inches	Cubic Feet Boxed	Boxed Weight Pounds	Crated Weight Pounds	Factory Price
16-24" Large Swing Lathe with Twelve-Speed Drive THREE-STEP Cone Pulleys for 2-Speed Motor						
CL195C	6	30	98	3175	2555	\$2559
CL195D	7	42	104	3275	2635	2614
CL195E	8	54	114	3375	2715	2669
CL195G	10*	78	134	3775	3055	2827
CL195H	12*	102	153	3975	3230	2985

Catalog Number	Bed Length Feet	Between Centers Inches	Cubic Feet Boxed	Boxed Weight Pounds	Crated Weight Pounds	Factory Price
16-24" Large Swing Lathes with Eight-Speed Drive FOUR-STEP Cone Pulleys for 1-Speed Motor						
CL198C	6	30	98	3100	2480	\$2559
CL198D	7	42	104	3200	2560	2614
CL198E	8	54	114	3300	2640	2669
CL198G	10*	78	134	3700	2980	2827
CL198H	12*	102	153	3900	3155	2985

Catalog Number	Bed Length Feet	Between Centers Inches	Cubic Feet Boxed	Boxed Weight Pounds	Crated Weight Pounds	Factory Price
16-24" Large Swing Lathes with Sixteen-Speed Drive FOUR-STEP Cone Pulleys for 2-Speed Motor						
CL179C	6	30	98	3175	2555	\$2559
CL179D	7	42	104	3275	2635	2614
CL179E	8	54	114	3375	2715	2669
CL179G	10*	78	134	3775	3055	2827
CL179H	12*	102	153	3975	3230	2985

*Center leg is supplied with 10' and 12' bed lengths.

SPECIFICATIONS

CAPACITY OF LATHE

Swing over bed.....	25 1/4"
Swing over saddle wings.....	24 3/8"
Swing over saddle cross slide.....	18 3/4"
Swing over cross slide without chip guard.....	19 1/4"

HEADSTOCK

Hole through spindle.....	1 3/8"
Maximum collet capacity.....	1"
Spindle nose diameter and threads.....	2 3/8"-6
Size of center, Morse taper.....	No. 3
Width, each step of 4-step cone pulley.....	2 1/4"
Width, each step of 3-step cone pulley.....	3"
Large face plate diameter.....	13 1/2"
Small face plate diameter.....	8 1/16"
Front spindle bearing diameter.....	2 3/8"

SPINDLE SPEEDS (approximate, not exact)

	Direct Drive	Back-Geared
6-speed drive.....	405, 235, 130	50, 30, 14
8-speed drive.....	470, 280, 175, 105	60, 35, 22, 15
12-speed drive, high speeds.....	790, 460, 250	100, 60, 27
low speeds.....	400, 230, 125	50, 29, 15
16-speed drive, high speeds.....	900, 550, 340, 203	116, 70, 45, 30
low speeds.....	455, 274, 170, 104	60, 34, 24, 15

TAILSTOCK

Size of center, Morse taper.....	No. 3
Spindle travel.....	5 3/4"
Each graduation on tailstock spindle.....	10 1/4"
Tailstock top set-over for taper turning.....	1"

COMPOUND REST

Cross slide travel without taper attachment.....	10 1/2"
Cross slide travel with taper attachment.....	10 1/4"
Angular hand feed of compound rest top slide.....	3 3/4"

THREADS and FEEDS

Thread cutting range—48 pitches R.H. or L.H.....	.4 to 224 per inch
Longitudinal feeds through friction clutch—	
48 feeds R.H. or L.H.....	.0015" to .0841"
Cross-feeds through friction clutch—48 feeds.....	.0006" to .0315"
Lead screw, 29° Acme thread.....	1 1/8" dia.—6 threds.

TOOL POST

Size of tool holder shank.....	3/8" x 1 3/8"
Size of cutter bit for tool holder.....	3/8" sq.

MOTOR (recommended size)

Four-step cone pulley, one-speed motor.....	1 1/2 h.p.
Three-step cone pulley, one-speed motor.....	2 h.p.
Three- or four-step cone pulley, two-speed motor.....	2-1 h.p.

Why do others copy South Bend's design and features?

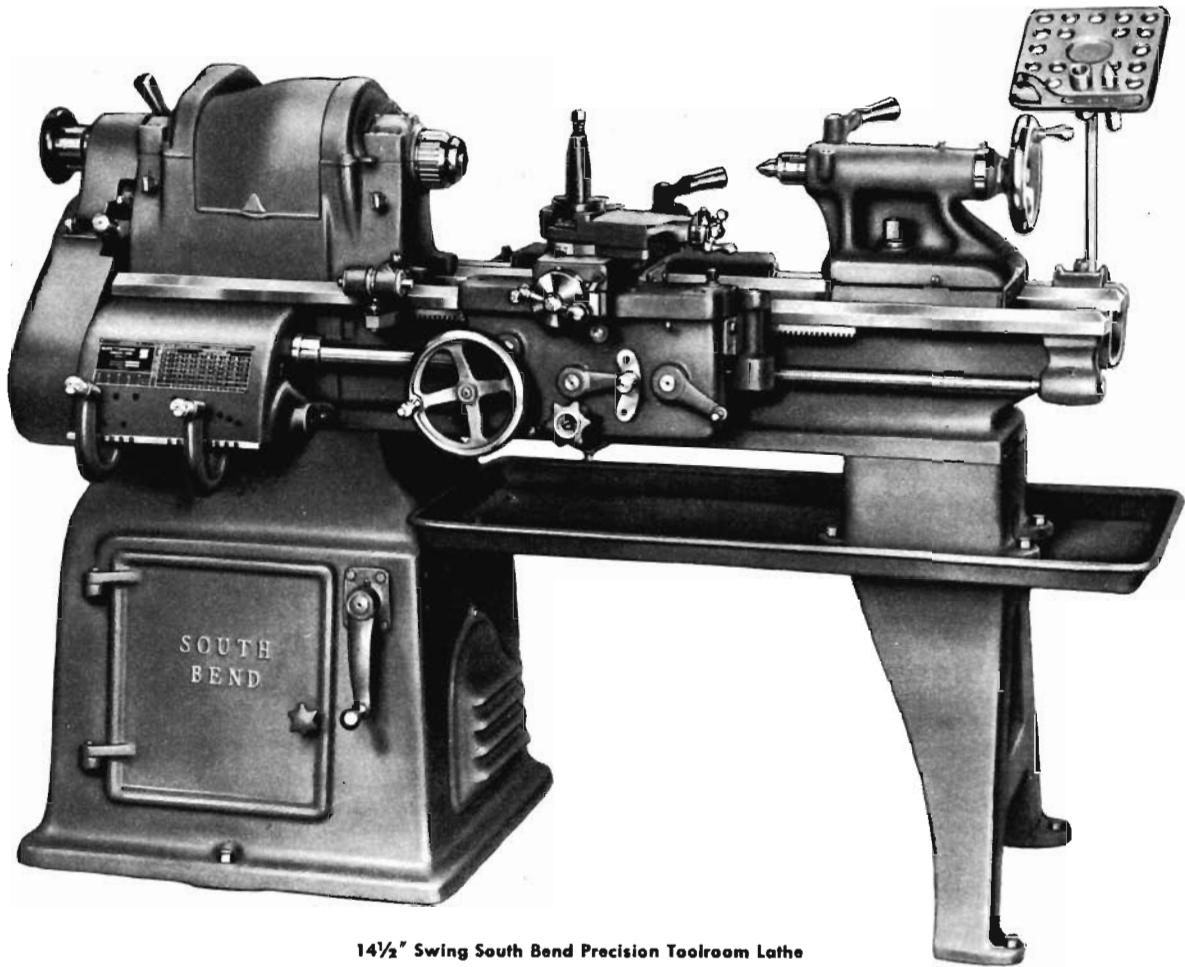

14½" Swing South Bend Precision Toolroom Lathe

14½" South Bend *Precision* Lathes

TOOLROOM and ENGINE LATHE MODELS

Four Bed Lengths—24" to 60" Between Centers

Careful design and conscientious workmanship are combined in South Bend 14½" Lathes to give you a machine tool that you can depend on for years of satisfactory service. Continual research has resulted in many improvements and refinements which contribute to accuracy, durability, and ease of operation. This superbly engineered model will appeal to the most discriminating technician. We know of no other lathe selling at a competitive price that can match its performance.

Made in both toolroom and engine lathe models, you have a choice of four bed lengths providing 24" to 60" between centers. Hardened and ground bed ways, cam lock spindle nose, or long taper key drive spindle nose can be supplied in lieu of regular equipment at small extra cost. See pages 32 and 34.

TWO TYPES OF HEADSTOCKS

Six to Sixteen Spindle Speeds

Headstocks for 14½" swing South Bend Lathes are made in two types: 4-step cone pulley and wide belt 3-step cone pulley. The 4-step cone pulley headstock provides either eight or sixteen spindle speeds depending on whether a single-speed or a two-speed motor is used. With the wide belt 3-step cone pulley you have either six or twelve spindle speeds.

The 4-step cone pulley design is well adapted to toolroom work and finishing operations as it provides a greater selection of spindle speeds. The

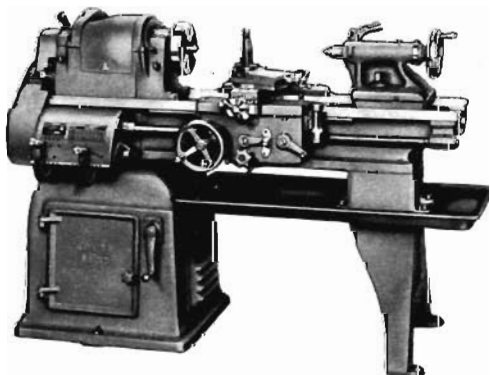

14½" Swing South Bend Precision Engine Lathe. Chip Pan is extra. See page 45.

Turn, bore, face, chase threads—the four basic operations.

wide belt 3-step cone pulley headstock assures maximum power transmission for heavy roughing cuts and rapid production. It is especially recommended for use with a two-speed motor.

Quick Change from High to Low Speeds

When a two-speed motor is used it doubles the number of spindle speeds, providing sixteen speeds with the 4-step cone pulley or twelve speeds with the 3-step cone pulley headstock. This not only increases the speed range but, with push button control, it provides instantaneous changes between corresponding high speeds and low speeds. This feature saves time on multiple operations requiring frequent speed changes such as drilling and tapping, boring and reaming, or turning and facing. The low spindle speeds are approximately one-half the corresponding high speeds. See page 62 for information on motors and controls.

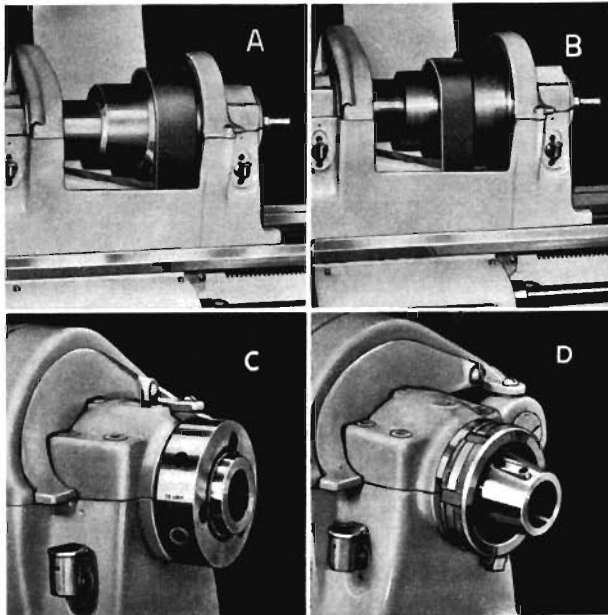

A. Three-step cone pulley headstock, each step 2-25/32" wide
 B. Four-step cone pulley headstock, each step 2-1/16" wide
 C. Cam lock spindle. See page 32
 D. Long taper key drive spindle. See page 32

ENGINE LATHES

Regular equipment included in price of each 14 1/2" engine lathe consists of: 4 V-belts; flat leather belt; thread indicator dial; small face plate; heat-treated steel tool post; adjustable thread cutting stop; tool steel centers for headstock and tailstock spindles; headstock spindle sleeve; wrenches; quick change box; installation plan; and book "How to Run a Lathe". Electrical equipment is not included in price of lathe. See page 62.

Catalog Number	Bed Length Feet	Between Centers Inches	Cubic Feet Boxed	Boxed Weight Pounds	Crated Weight Pounds	Factory Price
14 1/2" Engine Lathes with THREE-STEP Pulley Headstock						
CL129B	5	24	82	2500	1995	\$1899
CL129C	6	36	89	2600	2070	1954
CL129D	7	48	96	2750	2145	2009
CL129E	8	60	105	2900	2225	2064
14 1/2" Engine Lathes with FOUR-STEP Pulley Headstock						
CL185B	5	24	82	2500	1995	\$1899
CL185C	6	36	89	2600	2070	1954
CL185D	7	48	96	2750	2145	2009
CL185E	8	60	105	2900	2225	2064

TOOLROOM LATHES

Regular equipment included in price of each 14 1/2" toolroom lathe is the same as listed above for the engine lathe model. In addition, the following toolroom attachments are supplied: precision lead screw; handwheel type draw-in collet attachment (without collets); collet rack; telescopic taper attachment; large face plate; chip pan; and micrometer carriage stop. Electrical equipment is not included in price of lathe. See page 62.

Catalog Number	Bed Length Feet	Between Centers Inches	Cubic Feet Boxed	Boxed Weight Pounds	Crated Weight Pounds	Factory Price
14 1/2" Toolroom Lathes with THREE-STEP Pulley Headstock						
CL8129B	5	24	92	2685	2180	\$2399
CL8129C	6	36	100	2785	2255	2460
CL8129D	7	48	106	2935	2330	2522
CL8129E	8	60	117	3085	2405	2584
14 1/2" Toolroom Lathes with FOUR-STEP Pulley Headstock						
CL8185B	5	24	92	2685	2180	\$2399
CL8185C	6	36	100	2785	2255	2460
CL8185D	7	48	106	2935	2330	2522
CL8185E	8	60	117	3085	2405	2584

SPECIFICATIONS

CAPACITY OF LATHE

Swing over bed and saddle wings.....	14 1/2"
Swing over saddle cross slide, toolroom model.....	8 1/2"
Swing over saddle cross slide, engine lathe model.....	8 3/4"
Swing over cross slide without chip guard, engine lathe model only.....	10 1/4"

SPINDLE SPEEDS (approximate, not exact)

	Direct Drive	Back-Geared
With 4-Step Cone Pulley Headstock		
High speeds, r.p.m.....	875, 545, 350, 215	130, 80, 50, 30
Low speeds, available only with 2-speed motor, r.p.m.....	437, 272, 175, 107	65, 40, 25, 15
With 3-Step Cone Pulley Headstock		
High speeds, r.p.m.....	875, 428, 215	130, 61, 30
Low speeds, available only with 2-speed motor, r.p.m.....	437, 214, 107	65, 30, 15

HEADSTOCK

Hole through spindle.....	1 1/2"
Maximum collet capacity.....	1"
Spindle nose diameter and threads.....	2 5/8"-6
Size of center, Morse taper.....	No. 3
Width, each step of 4-step cone pulley.....	2 1/2"
Width, each step of 3-step cone pulley.....	2 3/8"
Large face plate diameter.....	13 1/4"

Small face plate diameter.....	8 1/2"
Front spindle bearing, diameter.....	2 5/8"

TAILSTOCK

Size of center, Morse taper.....	No. 3
Spindle travel.....	5 1/2"
Each graduation on tailstock spindle.....	1/6"
Tailstock top set-over for taper turning.....	1/8"

COMPOUND REST

Cross slide travel, engine lathe model.....	10"
Cross slide travel, toolroom model.....	9 1/2"
Angular hand feed of compound rest top slide.....	3 1/8"

THREADS AND FEEDS

Thread cutting range—48 pitches R.H. or L.H.....	.4 to 224 per inch
Longitudinal feeds through friction clutch—48 feeds R.H. or L.H.....	.0015" to .0841"
Cross-feeds through friction clutch—48 feeds.....	.0006" to .0315"
Lead screw, 29° Acme thread.....	1 1/2" dia.-6 threds.

TOOL POST

Size of tool holder shank.....	5/8" x 1 1/8"
Size of cutter bit for tool holder.....	3/8" sq.

MOTOR (recommended size)

One-speed motor.....	1 1/2 h.p.
Two-speed motor.....	2-1 h.p.

Infinite are the variations of the four basic operations.

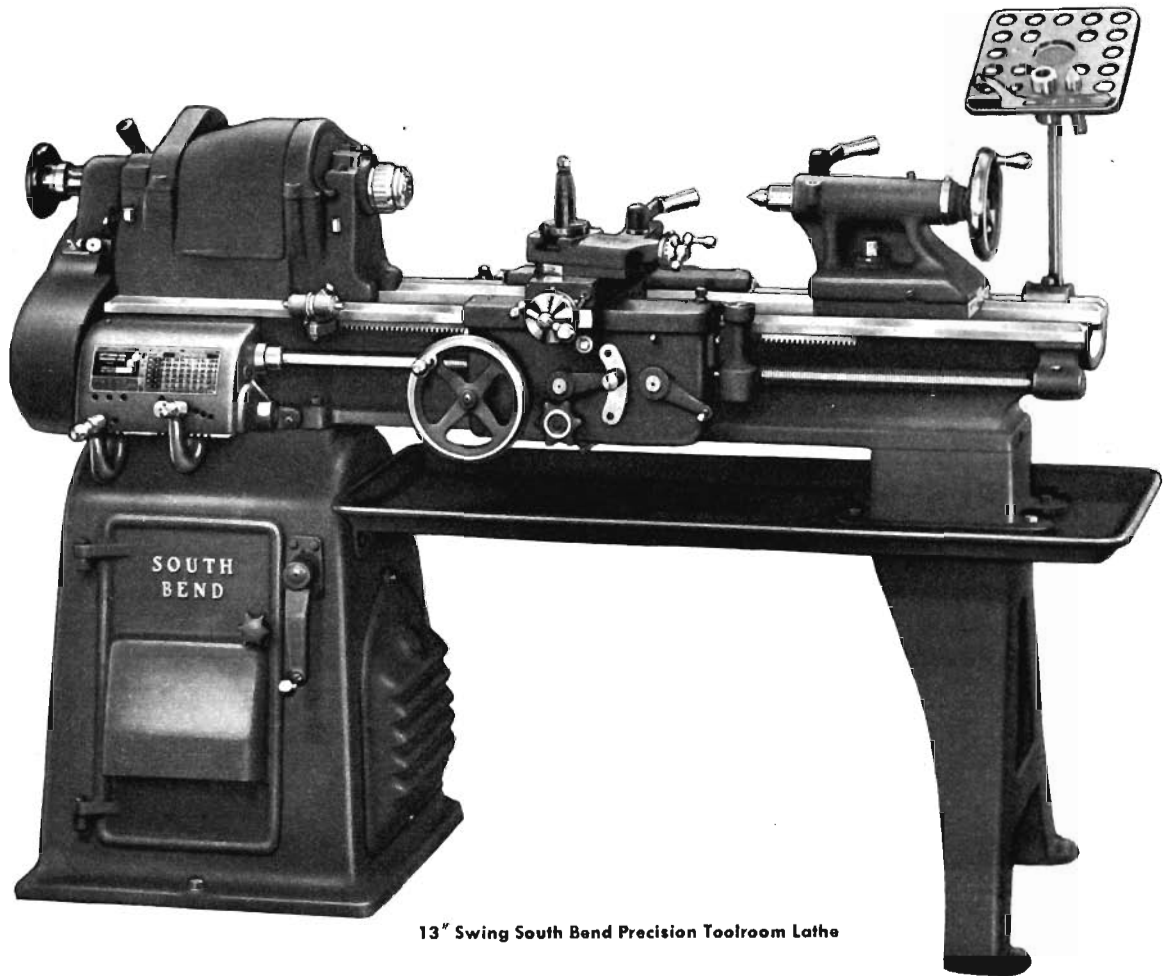

13" Swing South Bend Precision Toolroom Lathe

13" South Bend *Precision* Lathes

TOOLROOM and ENGINE LATHE MODELS

Four Bed Lengths—16" to 52" Between Centers

The South Bend 13-inch Lathe is especially popular for small and medium sized jobs requiring speed and accuracy. Conveniently placed controls make for ease of operation that reduces fatigue to a minimum. Special accuracy tests are made during assembling and testing to assure extreme precision. Having greater sensitivity and speed than larger lathes, this lathe will save you time and effort on all work within its capacity.

Made in both toolroom and engine lathe models, you have a choice of four bed lengths providing 16" to 52" between centers. Hardened and ground bed ways, cam lock spindle nose, or long taper key drive spindle nose can be supplied in lieu of regular equipment at small extra cost. See pages 32 and 34 for additional information.

TWO TYPES OF HEADSTOCKS

Six to Sixteen Spindle Speeds

Headstocks for 13" Swing South Bend Lathes are made in two types: 4-step cone pulley and wide belt 3-step cone pulley. The 4-step cone pulley headstock provides either eight or sixteen spindle speeds depending on whether a single-speed or a two-speed motor is used. With the wide belt 3-step cone pulley you have either six or twelve spindle speeds.

The 4-step cone pulley design is well adapted to toolroom work and finishing operations as it provides a greater selection of spindle speeds. The

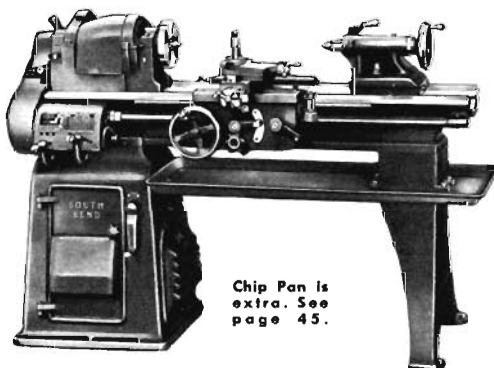

Chip Pan is extra. See page 45.

13" Swing South Bend Precision Engine Lathe

wide belt 3-step cone pulley headstock assures maximum power transmission for heavy roughing cuts and rapid production. It is especially recommended for use with a two-speed motor.

Quick Change from High to Low Speeds

When a two-speed motor is used it doubles the number of spindle speeds, providing sixteen speeds with the 4-step cone pulley or twelve speeds with the 3-step cone pulley headstock. This not only increases the speed range but, with push button control, it provides instantaneous changes between corresponding high speeds and low speeds. This feature saves time on multiple operations requiring frequent speed changes such as drilling and tapping, boring and reaming, or turning and facing. The low spindle speeds are approximately one-half the corresponding high speeds. See page 62 for information on motors and controls.

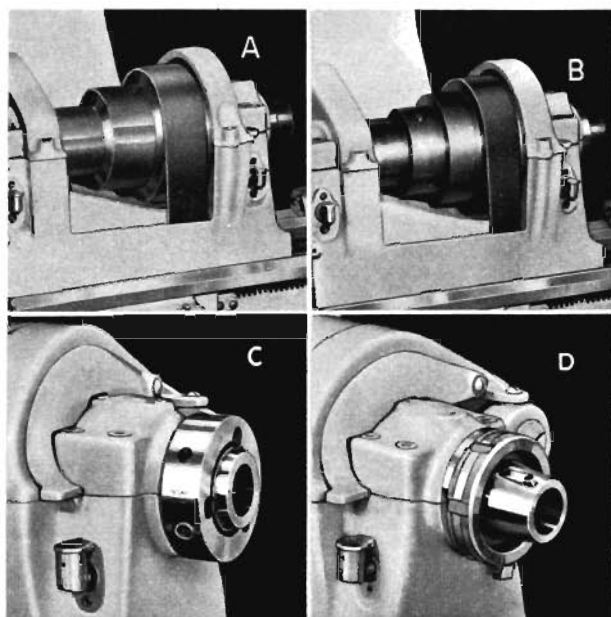

A. Three-step cone pulley headstock, each step 2-3/8" wide
 B. Four-step cone pulley headstock, each step 1-3/4" wide
 C. Cam lock spindle. See page 32
 D. Long taper key drive spindle. See page 32

SPECIFICATIONS

CAPACITY OF LATHE

Swing over bed and saddle wings.....	13 3/8"
Swing over saddle cross slide, toolroom model.....	8"
Swing over saddle cross slide, engine lathe model.....	7 3/4"
Swing over cross slide without chip guard, engine lathe model only.....	8 3/4"

SPINDLE SPEEDS (approximate, not exact)

	Direct Drive	Back-Geared
With 4-Step Cone Pulley Headstock		
High speeds, r.p.m.....	940, 628, 418, 270	135, 90, 60, 40
Low speeds, available only with 2-speed motor, r.p.m.....	470, 314, 209, 135	67, 45, 30, 20
With 3-Step Cone Pulley Headstock		
High speeds, r.p.m.....	940, 497, 270	135, 71, 40
Low speeds, available only with 2-speed motor, r.p.m.....	470, 248, 135	67, 35, 20

HEADSTOCK

Hole through spindle.....	1 1/2"
Maximum collet capacity.....	1"
Spindle nose diameter and threads.....	2 1/2" x 8
Size of center, Morse taper.....	No. 3
Width, each step of 4-step cone pulley.....	1 3/4"
Width, each step of 3-step cone pulley.....	2 3/4"
Large face plate diameter.....	10 3/4"

ENGINE LATHES

Regular equipment included in price of each 13" engine lathe consists of: 2 V-belts; flat leather belt; thread indicator dial; small face plate; heat-treated steel tool post; adjustable thread cutting stop; tool steel centers for headstock and tailstock spindles; headstock spindle sleeve; wrenches; quick change box; installation plan; and book "How to Run a Lathe". Electrical equipment is not included in price of lathe. See page 62.

Catalog Number	Bed Length Feet	Between Centers Inches	Cubic Feet Boxed	Boxed Weight Pounds	Crated Weight Pounds	Factory Price
13" Engine Lathes with THREE-STEP Pulley Headstock						
CL175A	4	16	63	1835	1460	\$1633
CL175B	5	28	73	1940	1510	1586
CL175C	6	40	77	2045	1560	1639
CL175D	7	52	82	2150	1615	1692
13" Engine Lathes with FOUR-STEP Pulley Headstock						
CL145A	4	16	63	1835	1460	\$1633
CL145B	5	28	73	1940	1510	1586
CL145C	6	40	77	2045	1560	1639
CL145D	7	52	82	2150	1615	1692

TOOLROOM LATHES

Regular equipment included in price of each 13" toolroom lathe is the same as listed above for the engine lathe. In addition, the following toolroom attachments are supplied: precision lead screw; handwheel type draw-in collet attachment (without collets); collet rack; telescopic taper attachment; large face plate; chip pan; and micrometer carriage stop. Electrical equipment is not included in price of lathe. See page 62.

Catalog Number	Bed Length Feet	Between Centers Inches	Cubic Feet Boxed	Boxed Weight Pounds	Crated Weight Pounds	Factory Price
13" Toolroom Lathes with THREE-STEP Pulley Headstock						
CL8175B	5	28	84	1995	1665	\$2049
CL8175C	6	40	89	2150	1715	2104
CL8175D	7	52	96	2305	1770	2180
13" Toolroom Lathes with FOUR-STEP Pulley Headstock						
CL8145B	5	28	84	1995	1665	\$2049
CL8145C	6	40	89	2150	1715	2104
CL8145D	7	52	96	2305	1770	2180

Small face plate diameter.....	6 5/8"
Front spindle bearing diameter.....	2 3/4"

TAILSTOCK

Size of center, Morse taper.....	No. 3
Spindle travel.....	4 1/2"
Each graduation on tailstock spindle.....	1/6"
Tailstock top set-over for taper turning.....	1 1/2"

COMPOUND REST

Cross slide travel, engine lathe model.....	8 3/4"
Cross slide travel, toolroom model.....	8 1/2"
Angular hand feed of compound rest top slide.....	3 3/8"

THREADS and FEEDS

Thread cutting range—48 pitches R.H. or L.H.....	.4 to 224 per inch
Longitudinal feeds through friction clutch—48 feeds R.H. or L.H.....	.0015" to .0841"
Cross-feeds through friction clutch—48 feeds.....	.0006" to .0315"
Lead screw, 29° Acme thread.....	1" dia.-6 thrs.

TOOL POST

Size of tool holder shank.....	1/2" x 1 1/8"
Size of cutter bit for tool holder.....	3/8" sq.

MOTOR (recommended size)

One-speed motor.....	1 h.p.
Two-speed motor.....	1 1/2-3/4 h.p.

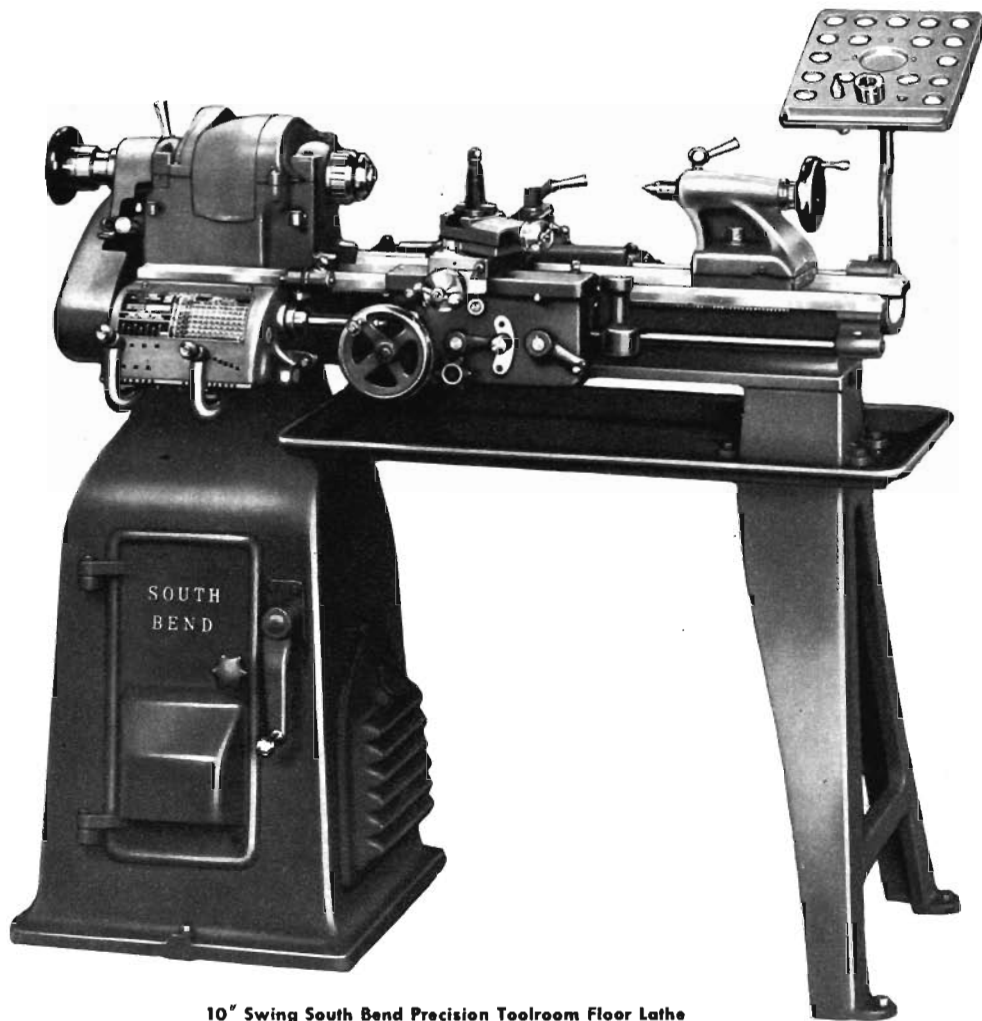

10" Swing South Bend Precision Toolroom Floor Lathe

10" South Bend *Precision* Lathes

Toolroom and Engine Lathe Models

Modern in design and built with extreme care, the South Bend 10" Engine and Toolroom Lathes are fast, accurate, and versatile. They have the high spindle speeds and rigidity required for efficient machining with carbide or diamond tipped tools, and plenty of power for heavy roughing cuts. They are capable of finish turning and boring with such precision that subsequent grinding, honing, or lapping operations can often be eliminated.

Bench or Floor Mounting

Either bench or floor mounting can be supplied. Bench lathes are mounted on a substantial welded steel bench with built-in chip pan and three roomy drawers. Motor and driving mechanism are fully enclosed in cabinet beneath lathe headstock. Floor lathes have a large cabinet leg under lathe headstock in which motor and driving mechanism are enclosed. See page 4.

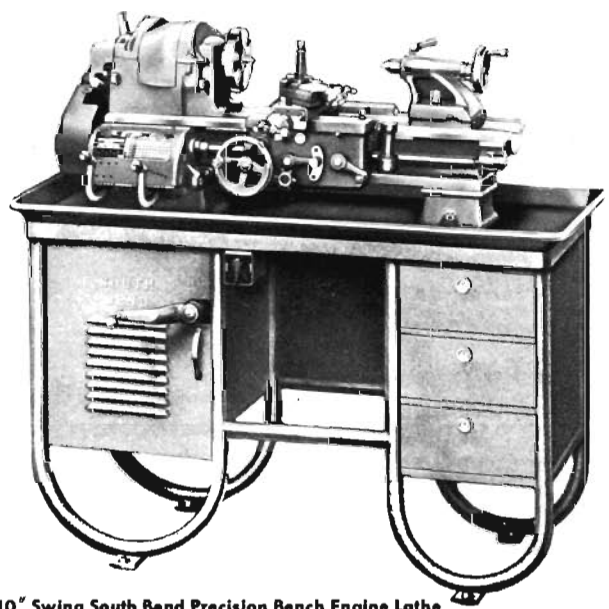

10" Swing South Bend Precision Bench Engine Lathe

Imitation may be the sincerest form of flattery, but just because a machine tool looks like South Bend is no indication that it has comparable quality.

Wide Range Quick Change Box

With the improved full quick change mechanism supplied on South Bend 10" Lathes you have at your finger tips 70 pitches of screw threads, 70 changes for power longitudinal feeds, and 70 power cross-feeds. Threads cut range from 4 to 480 per inch as shown on the index chart. Included are all standard pitches 4 to 80 as listed in the National Bureau of Standard Handbook H 28, "Screw Thread Standards". You can also cut many important pitches such as 1 1/2 and 27 pipe thread, 4, 6, and 7 1/2 fire hose coupling thread, 30 instrument thread and fine pitches up to 480 per inch used in watch and instrument work.

All pitches shown on the index chart are obtained by shifting the two tumbler levers on the gear box. No pick-off gears are used and no stud gear or primary gear changes are required. However, the stud gear can be easily changed if desired for cutting diametral pitch worm thread or other unusual pitches. Transposing gears can be supplied for cutting metric screw threads. See page 61.

ENGINE LATHES

Regular equipment included in price of each 10" Engine Lathe consists of: V-belt; flat leather belt; thread indicator dial; small face plate; heat-treated steel tool post; adjustable thread cutting stop; tool steel centers; spindle sleeve; wrenches; quick change box; installation plan; and book "How to Run a Lathe". Steel bench with built-in chip pan and three drawers is also supplied with each bench lathe. Electrical equipment is not included in price. See page 62.

Catalog Number	Bed Length Feet	Between Centers Inches	Cubic Feet Boxed	Boxed Weight Pounds	Crated Weight Pounds	Factory Price
10-inch 1" Collet Engine Lathes with FLOOR Legs						
CL187Y	3	14	50	1230	930	\$1174
CL187Z	3 1/2	20	50	1250	950	1198
CL187A	4	27	50	1270	970	1222
CL187R	4 1/2	34	54	1290	990	1256
10-inch 1" Collet BENCH Engine Lathes						
CL187YB	3	14	56	1200	850	\$1268
CL187ZB	3 1/2	20	56	1250	880	1292
CL187AB	4	27	68	1300	950	1329
CL187RB	4 1/2	34	68	1350	980	1383

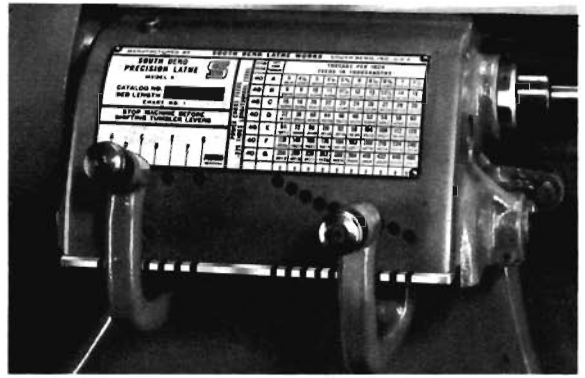

SOUTH BEND PRECISION LATHE MODEL A		THREADS PER INCH FEEDS IN THOUSANDS									
40 A	4%	5	5%	5%	6	6%	6%	7	7%	7%	7%
40 B	8	8	10	11	11%	12	12	14	15	15	15
40 C	18	18	20	22	23	24	26	27	28	29	30
40 D	32	36	40	44	48	48	52	54	58	60	60
40 E	64	72	80	88	92	96	104	108	112	120	120
40 F	128	144	160	176	184	192	208	216	224	240	240
40 G	256	288	320	352	368	384	416	432	448	480	480

TOOLROOM LATHES

Regular equipment included in price of each South Bend 10" Toolroom Lathe is the same as listed at left for the Engine Lathe model. In addition, the following toolroom attachments are supplied: precision lead screw; handwheel draw-in collet attachment (without collets); collet rack; telescopic taper attachment; large face plate; chip pan; and micrometer carriage stop. Electrical equipment is not included in price of lathe. See page 62.

Catalog Number	Bed Length Feet	Between Centers Inches	Cubic Feet Boxed	Boxed Weight Pounds	Crated Weight Pounds	Factory Price
10-inch 1" Collet Toolroom Lathes with FLOOR Legs						
CL8187Y	3	14	54	1290	990	\$1560
CL8187Z	3 1/2	20	54	1310	1010	1586
CL8187A	4	27	54	1330	1030	1611
10-inch 1" Collet Toolroom BENCH Lathes						
CL8187YB	3	14	56	1310	960	\$1617
CL8187ZB	3 1/2	20	56	1360	990	1641
CL8187AB	4	27	68	1410	1060	1678

SPECIFICATIONS

CAPACITY OF LATHE

Swing over bed and saddle wings.....	10 1/4"
Swing over saddle cross slide (engine lathe).....	5 1/2"
Swing over cross slide without chip guard (engine lathe only).....	6 3/4"
Swing over cross slide (toolroom lathe).....	5 3/4"

SPINDLE SPEEDS (approximate, not exact)

	Direct Drive	Back-Geared
With one-speed motor		
High speeds, r.p.m.....	1400, 898, 585	250, 160, 105
Low speeds, r.p.m.....	740, 470, 304	130, 85, 55
With two-speed motor		
High speeds, r.p.m.....	1400, 898, 585	250, 160, 105
Low speeds, r.p.m.....	740, 470, 304	130, 85, 55
Low speeds, r.p.m.....	700, 449, 292	125, 80, 52
	370, 235, 152	65, 42, 27

HEADSTOCK

Collet capacity, maximum.....	1"
Headstock spindle hole.....	1 3/8"
Headstock spindle nose threads.....	2 1/4"-8
Size of center, Morse taper.....	No. 2
Width of cone pulley step for belt.....	1 1/16"
Large face plate diameter.....	8 3/8"
Small face plate diameter.....	5 3/8"

Front spindle bearing diameter..... 2 1/4"

COMPOUND REST

Cross slide travel, (engine lathe).....	6 1/4"
Cross slide travel, (toolroom lathe).....	5 3/8"
Angular hand feed of compound rest top slide.....	2°

TOOL POST

Size of tool holder shank.....	3/8" x 1 5/16"
Size of cutter bit for tool holder.....	1/4" sq.

TAILSTOCK

Size of center, Morse taper.....	No. 2
Spindle travel.....	2 1/4"
Each graduation on tailstock spindle.....	1/10"
Tailstock top set-over for taper turning.....	1 1/16"

THREADS and FEEDS

Thread cutting range—70 pitches R.H. or L.H.....	4 to 480 per inch
Longitudinal feeds through friction clutch—70 feeds	
R.H. or L.H.....	.0007" to .0836"
Cross-feeds through friction clutch—70 feeds.....	.0003" to .0303"
Lead screw, 29° Acme thread.....	3/4" dia.—8 threds

MOTOR (recommended size)

One-speed.....	3/4 h.p.
Two-speed.....	1 1/2 h.p.

Collets used on the 10" Lathes shown above are interchangeable with those used on all larger sizes of South Bend Lathes.

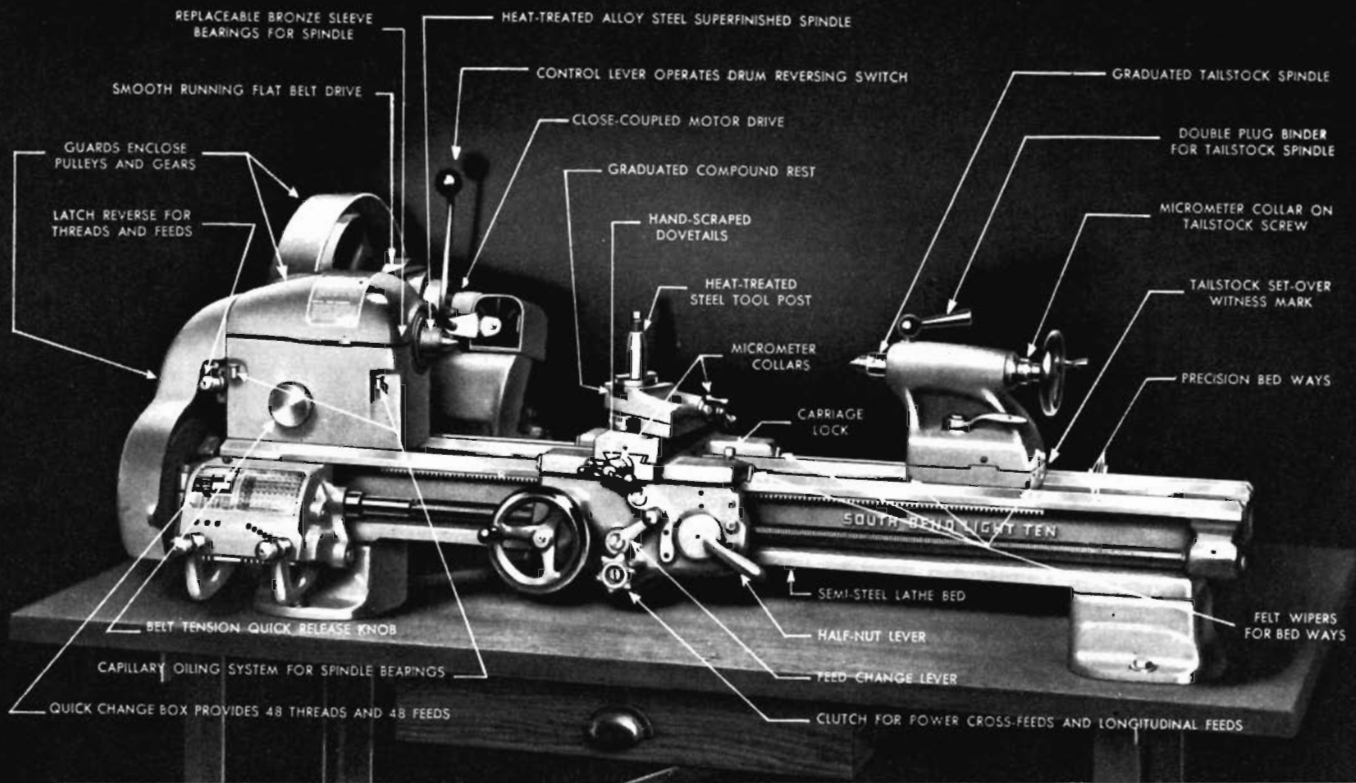

Model A South Bend Light Ten Precision Bench Lathe

South Bend Light Ten *Precision* Bench Lathes

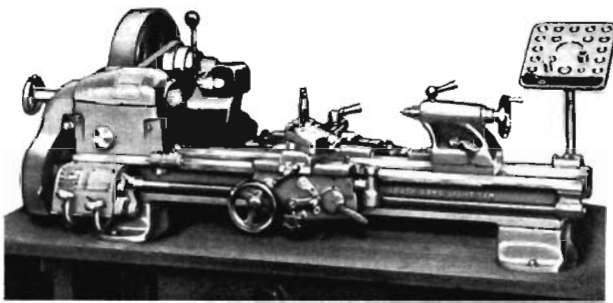

South Bend Light Ten Toolroom Bench Lathe

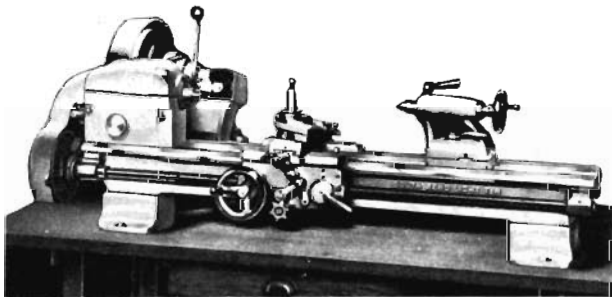

Model B South Bend Light Ten Bench Lathe

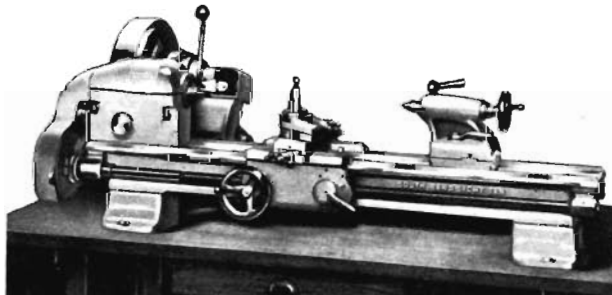

Model C South Bend Light Ten Bench Lathe

The Light Ten is a very fine precision lathe for small work in the toolroom, manufacturing plant, maintenance department or repair shop. Although it is competitively priced, it has the same precision and many of the features and refinements usually found only on larger and much more expensive lathes. These include precision finished V-ways on lathe bed, heat-treated and superfinished spindle, replaceable bronze sleeve bearings for spindle with oil reservoir and capillary oiling system, and graduated tailstock spindle with micrometer graduated collar on feed screw.

Four Models

South Bend Light Ten Bench Lathes are made in four models: Model A, Model B, Model C, and Toolroom.

MODEL A Light Ten Bench Lathes have full quick change box and patented worm drive apron with friction clutch which provide a wide range of thread cutting feeds, power cross-feeds and power longitudinal feeds. See specifications.

Regular equipment included in price of Model A Lathe consists of: horizontal motor drive unit (patented); motor pulley with $\frac{3}{4}$ " hole; necessary belting; worm drive friction clutch power feed apron (patented); graduated compound rest; small face plate; heat-treated steel tool post; two 60-degree hardened tool steel centers; spindle sleeve; wrenches; quick change box; installation plan; and book "How to Run a Lathe". Bench and electrical equipment are not included. See pages 62 and 65.

MODEL B Light Ten Bench Lathes are the same as Model A Lathes, except that instead of the quick change box a set of independent change gears is supplied for cutting screw threads and for power longitudinal feeds and power cross-feeds. Lathe equipment is the same except that the change gears are supplied instead of the gear box. Bench and electrical equipment are not included. See pages 62 and 65.

MODEL C Light Ten Bench Lathes are the same as Model B Lathes, except that they do not have the worm drive and clutch in the apron for operating the power feeds. Lead screw and half-nuts are used for power longitudinal feeds and the cross-feeds

South Bend Lathes are easier to operate.

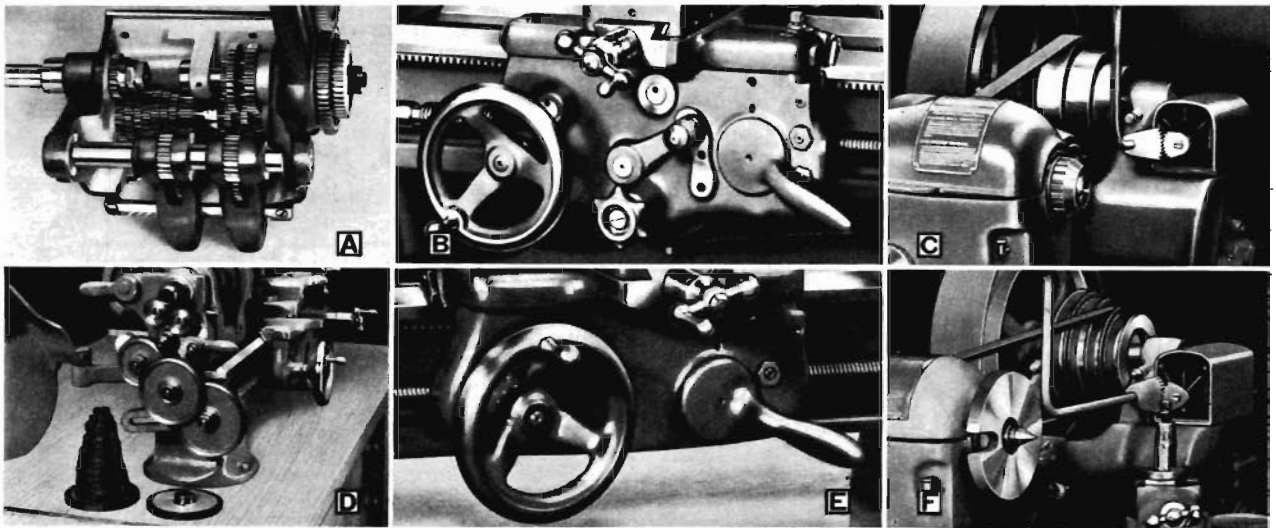

A. Interior of Quick Change Box for Model A and Toolroom Lathes
 B. Patented Apron used on Toolroom, Model A and Model B Lathes
 C. Patented Twelve-speed Flat Belt Horizontal Motor Drive

D. Change Gears Supplied for Models B and C
 E. Apron supplied on Model C Lathe
 F. Patented Sixteen-speed V-belt Horizontal Motor Drive

are hand-operated. Otherwise the equipment is the same. Bench and electrical equipment are not included. See pages 62 and 65.

TOOLROOM Light Ten Bench Lathes are the same as Model A Lathes, and have the same regular equipment. In addition, the following toolroom attachments are supplied: precision lead screw; handwheel type draw-in collet attachment (without collets); collet rack; plain taper attachment; thread indicator; thread cutting stop; large face plate; and micrometer carriage stop. Bench and electrical equipment are not included. See pages 62 and 65.

TWO TYPES OF DRIVES Twelve or Sixteen Spindle Speeds

All models of Light Ten Horizontal Motor Drive Bench Lathes can be supplied with either flat belt or V-belt cone pulleys for the headstock. The flat belt drive provides twelve spindle speeds. Power is transmitted with extreme smoothness at all speeds making this drive popular with those who require high precision and a fine finish. The sixteen-speed V-belt drive is well adapted to production work, especially for heavy roughing cuts at slow speeds. To replace the endless V-belt, it is necessary to disassemble both the lathe headstock and the drive unit.

Light Ten South Bend Bench Lathes

Model	Bed Length Feet	Between Centers Inches	Cubic Feet Boxed	Boxed Weight Pounds	Crated Weight Pounds	With 16-Speed V-Belt Horizontal Motor Drive		With 12-Speed Flat Belt Horizontal Motor Drive	
						Cat. No.	Price	Cat. No.	Price
Toolroom	3	16	26	650	520	CL8770Y	\$746.00	CL8670Y	\$731.00
	3½	22	26	665	535	CL8770Z	788.00	CL8670Z	753.00
	4	28	29	690	550	CL8770A	789.00	CL8670A	774.00
Model A	3	16	22	600	490	CL770Y	515.00	CL670Y	500.00
	3½	22	22	615	505	CL770Z	537.00	CL670Z	522.00
	4	28	25	640	520	CL770A	558.00	CL670A	543.00
Model B	3	16	22	585	475	CL787Y	439.00	CL667Y	424.00
	3½	22	22	600	490	CL787Z	461.00	CL667Z	446.00
	4	28	25	625	505	CL787A	481.00	CL667A	468.00
Model C	3	16	22	575	465	CL753Y	389.00	CL653Y	354.00
	3½	22	22	590	480	CL753Z	390.00	CL653Z	375.00
	4	28	25	615	495	CL753A	411.00	CL653A	396.00
	4½	34	29	645	510	CL753R	441.00	CL653R	426.00

SPECIFICATIONS

CAPACITY OF LATHE

Swing over bed, maximum.....10"
 Swing over saddle wings.....9½"
 Swing over cross slide, (models A, B, C).....6¼"
 Swing over cross slide, (toolroom lathe).....5¾"

TAILSTOCK

Size of center, Morse taper.....No. 2
 Spindle travel.....2¼"
 Each graduation on tailstock spindle......10"
 Tailstock top set-over for taper turning......3/8"

COMPOUND REST

Cross slide travel (models A, B, C)......5¼"
 Cross slide travel (toolroom lathe)......5¾"
 Angular hand feed of compound rest top slide......2¼"

TOOL POST

Size of tool holder shank......3/8" x 13/16"
 Size of cutter bit for tool holder......1/4" sq.

SPINDLE SPEEDS (approximate, not exact)

	Direct Drive	Back-Geared
With Flat Belt		
High, r.p.m.	1435, 844, 502	276, 165, 96
Low, r.p.m.	706, 415, 244	137, 80, 48
With V-belt		
High, r.p.m.	1365, 1010, 760, 570	265, 195, 150, 112
Low, r.p.m.	670, 495, 370, 285	130, 95, 75, 52

HEADSTOCK

Hole through spindle......27/64"
 Maximum collet capacity......5/8"
 Spindle nose diameter and threads per inch.....1½"-8
 Size of center, Morse taper.....No. 2
 Width of cone pulley step for flat belt......1"
 Small face plate diameter......5½"
 Front spindle bearing diameter......1½"

THREAD CUTTING RANGE

Toolroom and Model A—48 pitches, R.H. or L.H......4 to 224 per inch
 Models B and C—45 pitches, R.H. or L.H......4 to 160 per inch
 Lead screw, 29° Acme thread......3/4" dia.—8 thrs.

POWER LONGITUDINAL FEEDS

Toolroom and Model A—48 feeds......0015" to .0853"
 Model B—26 feeds......0021" to .0155"
 Model C—14 feeds......0021" to .0156"

POWER CROSS-FEEDS

Toolroom and Model A—48 feeds......0004" to .0255"
 Model B—23 feeds......0009" to .0046"

MOTOR

Standard size of motor recommended......1½ h.p.

South Bend Lathes are simpler to maintain.

South Bend
Light Ten
Precision
Floor Lathes
with
Metal Column Base
Underneath
Motor Drive



Design patented

South Bend Light Ten Precision Toolroom Lathe with Metal Column Base

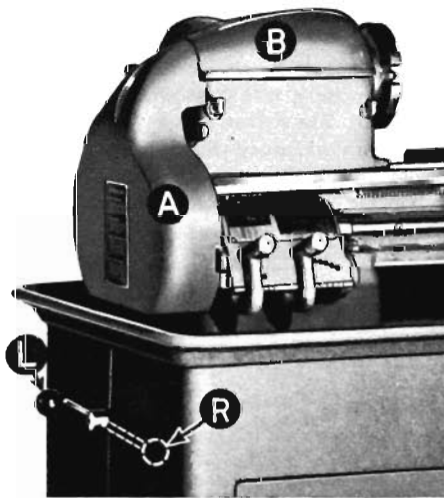

These lathes are the same as corresponding models of Light Ten Bench Lathes, except for the underneath motor drive and the necessary alterations in the headstock. Fully enclosed in the metal column base, the motor and driving mechanism are protected from dust, dirt, and chips. Base is available with three drawers, 10 $\frac{3}{4}$ " x 5 $\frac{1}{2}$ " x 14" as shown in illustration, or without drawers. A built-in chip pan with $\frac{5}{8}$ " bead around the edge forms the top of the metal column base. Equipment included in price of lathe is same as for corresponding models of bench lathes listed on preceding pages. Electrical equipment is not included in price of lathe. See page 62.

Unusual Safety Features

South Bend Light Ten Underneath Motor Drive Lathes have an automatic safety interlock which makes it impossible to open the end gear guard, "A", or the cone pulley cover, "B", until the belt tension lever, "L", is placed in position "R", disconnecting power.

Model	Catalog Number	Bed Length Feet	Between Centers Inches	Cubic Feet Boxed	Boxed Weight Pounds	Crated Weight Pounds	Factory Price
Toolroom	CL8370ZD	3 $\frac{1}{2}$	22	52	940	750	\$1052
Model A	CL370ZD	3 $\frac{1}{2}$	22	52	910	720	821
Model B	CL367ZD	3 $\frac{1}{2}$	22	52	895	705	744
Model C	CL363ZD	3 $\frac{1}{2}$	22	52	885	695	675

Note: For prices of above lathes on metal column base without drawers deduct \$35.00 from prices shown.

SPECIFICATIONS

CAPACITY OF LATHE

Swing over bed, maximum.....10"
Swing over saddle wings.....9 $\frac{15}{16}$ "
Swing over cross slide, (models A, B, C).....6 $\frac{1}{2}$ "
Swing over cross slide (toolroom lathe).....5 $\frac{7}{8}$ "

SPINDLE SPEEDS (approximate, not exact)

	Direct Drive	Back-Geared
High speeds, r.p.m.....	1365, 780, 460	265, 155, 90
Low speeds, r.p.m.....	715, 410, 240	135, 78, 50

TAILSTOCK

Size of center, Morse taper.....No. 2
Spindle travel.....2 $\frac{1}{2}$ "
Each graduation on tailstock spindle..... $\frac{1}{16}$ "
Tailstock top set-over for taper turning..... $\frac{5}{8}$ "

HEADSTOCK

Hole through spindle.....2 $\frac{1}{2}$ "
Maximum collet capacity..... $\frac{5}{8}$ "
Spindle nose diameter and threads per inch.....1 $\frac{1}{2}$ "-8
Size of center, Morse taper.....No. 2
Width of cone pulley step for belt.....1"
Small face plate diameter.....5 $\frac{1}{2}$ "
Front spindle bearing, diameter.....1 $\frac{13}{16}$ "

COMPOUND REST

Cross slide travel (models A, B, C).....5 $\frac{7}{8}$ "
Cross slide travel (toolroom lathe).....5 $\frac{5}{8}$ "
Angular hand feed of compound rest top slide.....2 $\frac{1}{4}$ "

TOOL POST

Size of tool holder shank..... $\frac{3}{8}$ " x $\frac{13}{16}$ "
Size of cutter bit for tool holder..... $\frac{1}{4}$ " sq.

THREAD CUTTING RANGE

Toolroom and Model A—48 pitches. .4 to 224 per inch
Models B and C—45 pitches. .4 to 160 per inch
Lead screw, 29° Acme thread..... $\frac{3}{4}$ " dia.—8 thds.

POWER LONGITUDINAL FEEDS

Toolroom and Model A—48 feeds......0015" to .0853"
Model B—26 feeds......0021" to .0155"
Model C—14 feeds......0021" to .0156"

POWER CROSS-FEEDS

Toolroom and Model A—48 feeds......0004" to .0255"
Model B—23 feeds......0009" to .0046"

MOTOR

Standard size of motor recommended..... $\frac{1}{2}$ h.p.

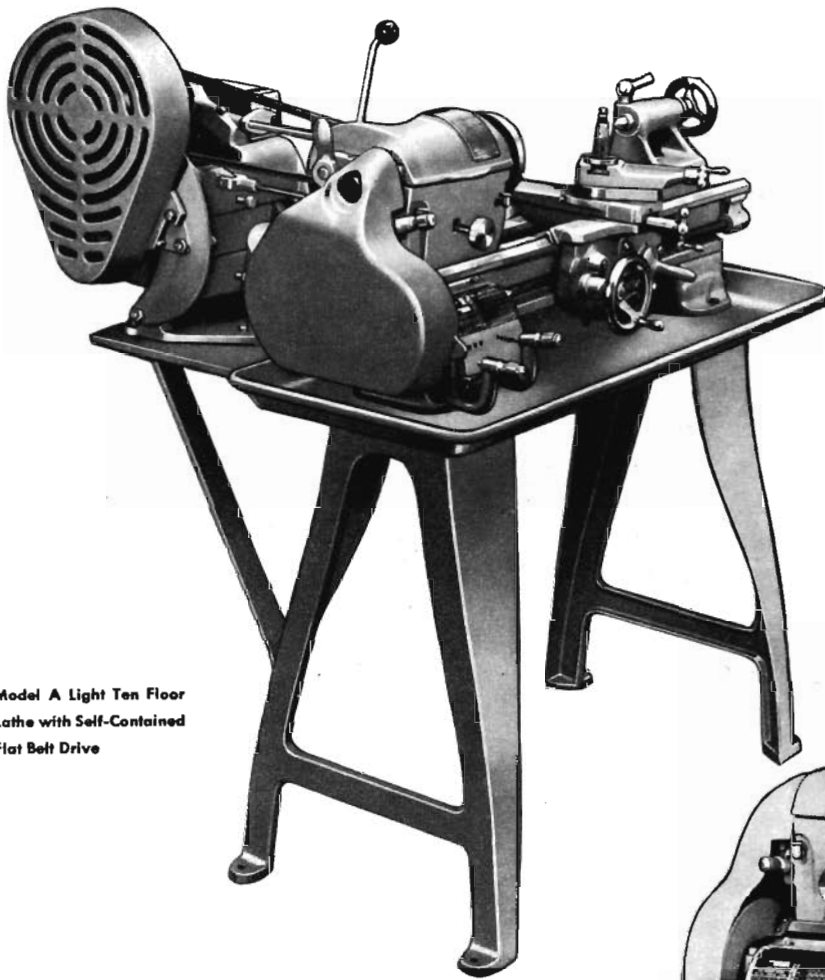

Model A Light Ten Floor Lathe with Self-Contained Flat Belt Drive

South Bend
Light Ten
Self-Contained
Motor Drive
Precision
Floor
Lathes

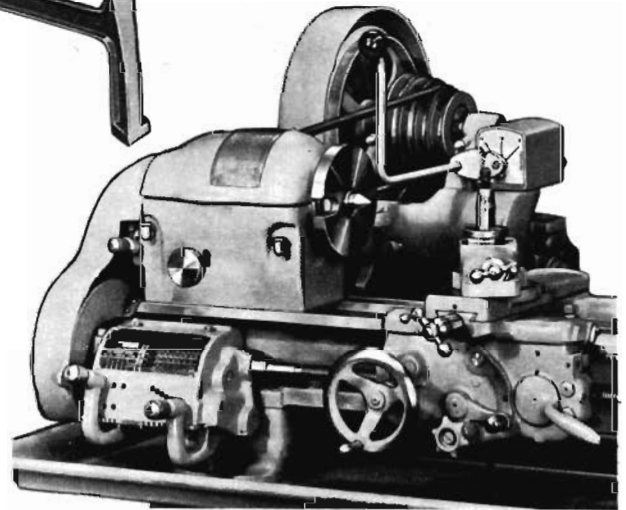

Close-up Showing V-belt Drive

The Light Ten Model A Self-Contained Motor Drive Floor Lathe is illustrated above. The Model B, Model C, and Toolroom Lathes are also made with this drive. Except for the self-contained drive equipment, chip pan, and floor legs, these lathes are the same and have the same equipment as corresponding models of Light Ten Bench Lathes described on the preceding pages 20 and 21. Specifications are also the same except for shipping weights and cubic feet boxed.

The self-contained drive equipment is permanently mounted back of the lathe headstock and consists of the self-contained motor drive unit (patented) for 1/2 h.p. motor; motor pulley with 3/4" hole; belt guard for motor belt; and necessary belting.

Either flat belt or V-belt cone pulleys are supplied for the

headstock. The flat belt drive transmits power with extreme smoothness required for high precision and fine finish. The V-belt drive is well adapted to production work, especially for heavy roughing cuts at slow speeds. To replace the endless V-belt, it is necessary to disassemble both the lathe headstock and the drive unit.

Light Ten South Bend Self-Contained Motor Drive Floor Lathes

Model	Bed Length Feet	Between Centers Inches	Cubic Feet Boxed	Boxed Weight Pounds	Crated Weight Pounds	With 16-Speed V-Belt Self-Contained Drive		With 12-Speed Flat Belt Self-Contained Drive	
						Cat. No.	Price	Cat. No.	Price
Toolroom	3	16	33	875	700	CL8270Y	\$849.00	CL8970Y	\$834.00
	3 1/2	22	33	900	725	CL8270Z	878.00	CL8970Z	861.00
	4	28	37	925	750	CL8270A	901.00	CL8970A	886.00
Model A	3	16	33	825	650	CL270Y	618.00	CL970Y	603.00
	3 1/2	22	33	850	675	CL270Z	645.00	CL970Z	630.00
	4	28	37	875	700	CL270A	670.00	CL970A	655.00
	4 1/2	34	37	900	725	CL270R	709.00	CL970R	694.00
Model B	3	16	33	805	630	CL267Y	542.00	CL967Y	527.00
	3 1/2	22	33	830	655	CL267Z	569.00	CL967Z	554.00
	4	28	37	855	680	CL267A	593.00	CL967A	578.00
	4 1/2	34	37	880	705	CL267R	632.00	CL967R	617.00
Model C	3	16	33	795	620	CL253Y	472.00	CL953Y	457.00
	3 1/2	22	33	820	645	CL253Z	498.00	CL953Z	483.00
	4	28	37	845	670	CL253A	523.00	CL953A	508.00
	4 1/2	34	37	870	695	CL253R	561.00	CL953R	546.00



9" South Bend Toolroom Bench Lathe

9" South Bend *Precision* Bench Lathes

We sincerely believe that South Bend 9" Lathes are superior in quality to any other lathe of similar size available at anywhere near the same price. They are precision tools capable of machining work to the exacting tolerances demanded in modern industry. Features include precision finished V-ways on lathe bed, heat-treated and super-finished spindle, precision bored integral bearings for spindle with oil reservoir and capillary oiling system, and graduated tailstock spindle.

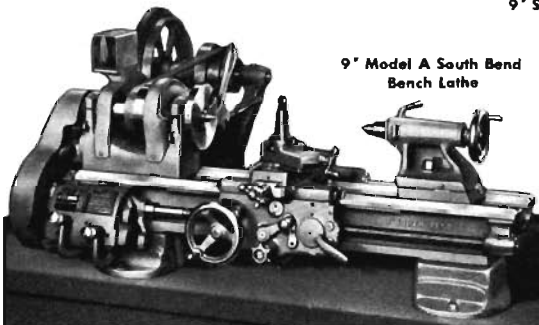

9" Model A South Bend Bench Lathe

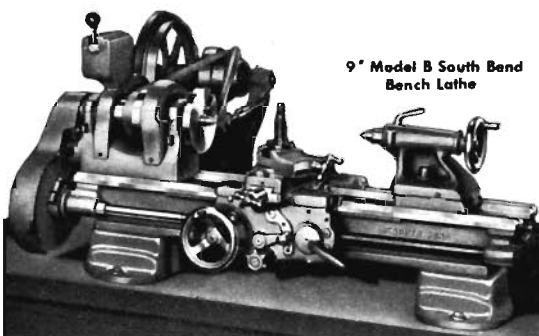

9" Model B South Bend Bench Lathe

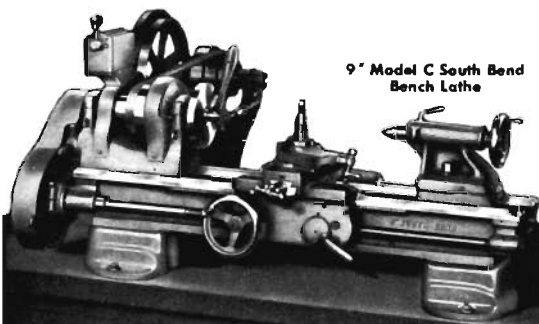

9" Model C South Bend Bench Lathe

Four Models

South Bend 9" Bench Lathes are made in four models: Model A, Model B, Model C, and Toolroom.

MODEL A 9" Bench Lathes have quick change box and patented worm drive apron with friction clutch which provide a wide range of thread cutting feeds, power cross-feeds and power longitudinal feeds. See specifications for threads and feeds.

Regular equipment included in price of Model A Lathe consists of: horizontal motor drive unit (patented); motor pulley with $\frac{5}{8}$ " hole; necessary belting; worm drive friction clutch power feed apron (patented); graduated compound rest; small face plate; heat-treated steel tool post; two 60-degree hardened tool steel centers; spindle sleeve; wrenches; quick change box; installation plan; and book "How to Run a Lathe". Bench and electrical equipment are not included. See pages 62 and 65.

MODEL B 9" Bench Lathes are the same as Model A Lathes, except that instead of the quick change box a set of independent change gears is supplied for cutting screw threads and for power longitudinal feeds and power cross-feeds. Lathe equipment is the same except that the change gears are supplied instead of the quick change box. Bench and electrical equipment are not included. See pages 62 and 65.

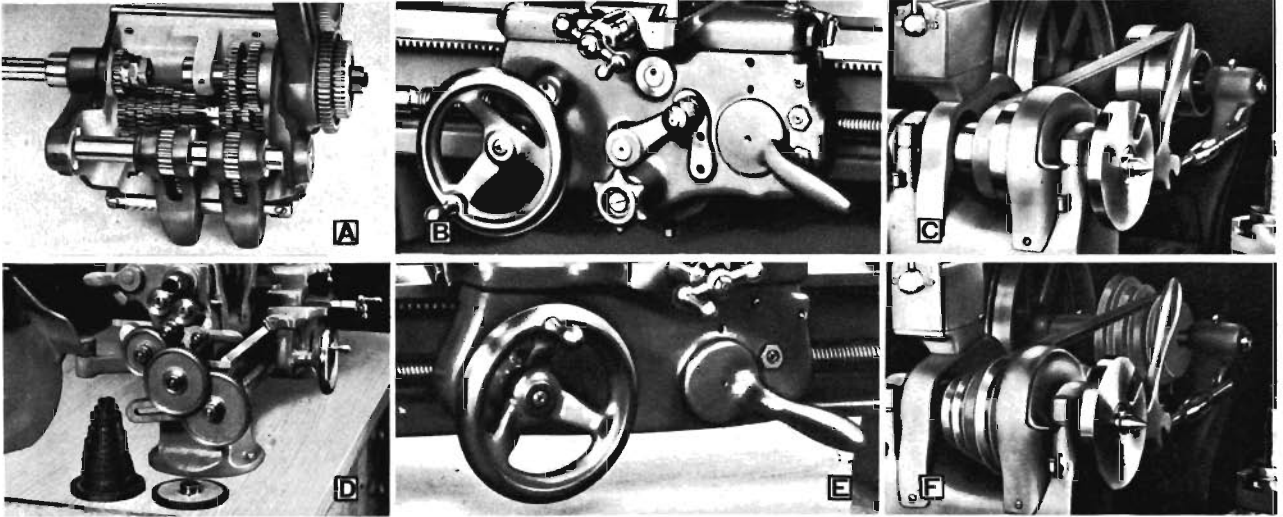

A. Interior of Quick Change Box for Model A and Toolroom Lathes
 B. Patented Apron used on Toolroom, Model A, and Model B Lathes
 C. Patented Twelve-speed Flat Belt Horizontal Motor Drive

D. Change Gears Supplied for Model B and C Lathes
 E. Apron supplied on Model C Lathe
 F. Patented Sixteen-speed V-belt Horizontal Motor Drive

MODEL C 9" Bench Lathes are the same as the Model B Lathes, except that they do not have the worm drive and clutch in the apron for operating the power feeds. Lead screw and half-nuts are used for power longitudinal feeds and the cross-feeds are hand-operated. Otherwise the equipment is the same. Bench and electrical equipment are not included. See pages 62 and 65.

TOOLROOM 9" Bench Lathes are the same as Model A Lathes, and have the same regular equipment. In addition, the following toolroom attachments are supplied: precision lead screw; handwheel type draw-in collet attachment (without collets); collet rack; plain taper attachment; thread indicator dial; thread cutting stop; large face plate; and micrometer carriage stop. Bench and electrical equipment are not included in price of lathe. See pages 62 and 65.

TWO TYPES OF DRIVES

Twelve or Sixteen Spindle Speeds

All models of 9" Horizontal Motor Drive Bench Lathes can be supplied with either flat belt or V-belt cone pulleys for the headstock. The flat belt drive provides twelve spindle speeds. Power is transmitted with extreme smoothness at all speeds making this drive popular with those who require high precision and a fine finish. The sixteen-speed V-belt drive is well adapted to production work, especially for heavy roughing cuts at slow speeds. To replace the endless V-belt, it is necessary to disassemble both the lathe headstock and the drive unit.

9-inch South Bend Bench Lathes

Model	Bed Length Feet	Between Centers Inches	Cubic Feet Boxed	Boxed Weight Pounds	Crated Weight Pounds	With 16-Speed V-Belt Drive		With 12-Speed Flat Belt Drive	
						Cat. No.	Price	Cat. No.	Price
Toolroom	3	16	21	550	440	CL8744Y	\$669.00	CL8644Y	\$653.00
	3½	22	21	565	455	CL8744Z	691.00	CL8644Z	675.00
	4	28	23	580	470	CL8744A	713.00	CL8644A	697.00
Model A	3	16	20	500	390	CL744Y	443.00	CL644Y	427.00
	3½	22	20	515	404	CL744Z	465.00	CL644Z	449.00
	4	28	21	530	420	CL744A	487.00	CL644A	471.00
	4½	34	24	545	435	CL744R	518.00	CL644R	502.00
Model B	3	16	20	485	375	CL777Y	359.00	CL677Y	343.00
	3½	22	20	500	390	CL777Z	381.00	CL677Z	365.00
	4	28	21	515	405	CL777A	403.00	CL677A	387.00
	4½	34	24	530	420	CL777R	434.00	CL677R	418.00
Model C	3	16	20	475	365	CL715Y	281.00	CL615Y	265.00
	3½	22	20	490	380	CL715Z	303.00	CL615Z	287.00
	4	28	21	505	395	CL715A	325.00	CL615A	309.00
	4½	34	24	520	410	CL715R	356.00	CL615R	340.00

Note: Above lathes can be supplied with six-speed flat belt or eight-speed V-belt drive unit for ¼ h.p. motor. Deduct \$31.00 from prices.
 Above lathes can be supplied with six-speed flat belt or eight-speed V-belt drive unit for ½ h.p. motor. Deduct \$10.00 from prices.

SPECIFICATIONS

CAPACITY OF LATHE

- Swing over bed and saddle wings.....9¼"
- Swing over saddle cross slide, (models A, B, C).....5½"
- Swing over saddle cross slide, (toolroom lathe).....5"

TAILSTOCK

- Size of center, Morse taper.....No. 2
- Spindle travel.....2½"
- Each graduation on tailstock spindle.....¼"
- Tailstock top set-over for taper turning.....½"

COMPOUND REST

- Cross slide travel (models A, B, C).....5¼"
- Cross slide travel (toolroom lathe).....5"
- Angular hand feed of compound rest top slide.....2¼"

TOOL POST

- Size of tool holder shank.....¾" x 1¼"
- Size of cutter bit for tool holder.....¼" sq.

SPINDLE SPEEDS (approximate, not exact)

	Direct Drive		Back-Geared	
With flat belt				
High, r.p.m.	1270	750, 446	250, 145,	86
Low, r.p.m.	692	410, 244	134,	81, 50
With V-belt				
High, r.p.m.	1200,	900, 662, 505	235, 179,	130, 100
Low, r.p.m.	640,	490, 362, 272	130,	95, 70, 54

HEADSTOCK

- Hole through spindle.....¾"
- Maximum collet capacity.....1½"
- Spindle nose diameter and threads per inch.....1½" - 8
- Size of center, Morse taper.....No. 2
- Width of cone pulley step for belt.....1"
- Small face plate diameter.....5¼"
- Front spindle bearing diameter.....1⅞"

THREAD CUTTING RANGE

- Toolroom and Model A—48 pitches, R.H. or L.H.....4 to 224 per inch
- Models B and C—45 pitches, R.H. or L.H.....4 to 160 per inch
- Lead screw, 29° Acme thread.....¾" dia.—8 threds.

POWER LONGITUDINAL FEEDS

- Toolroom and Model A—48 feeds......0015" to .0853"
- Model B—26 feeds......0021" to .0155"
- Model C—14 feeds......0021" to .0156"

POWER CROSS-FEEDS

- Toolroom and Model A—48 feeds......0004" to .0255"
- Model B—23 feeds......0009" to .0046"

MOTOR

- Standard size of motor recommended.....½ h.p.

South Bend
9-inch
Precision
Floor Lathes
with
Metal Column Base
Underneath
Motor Drive

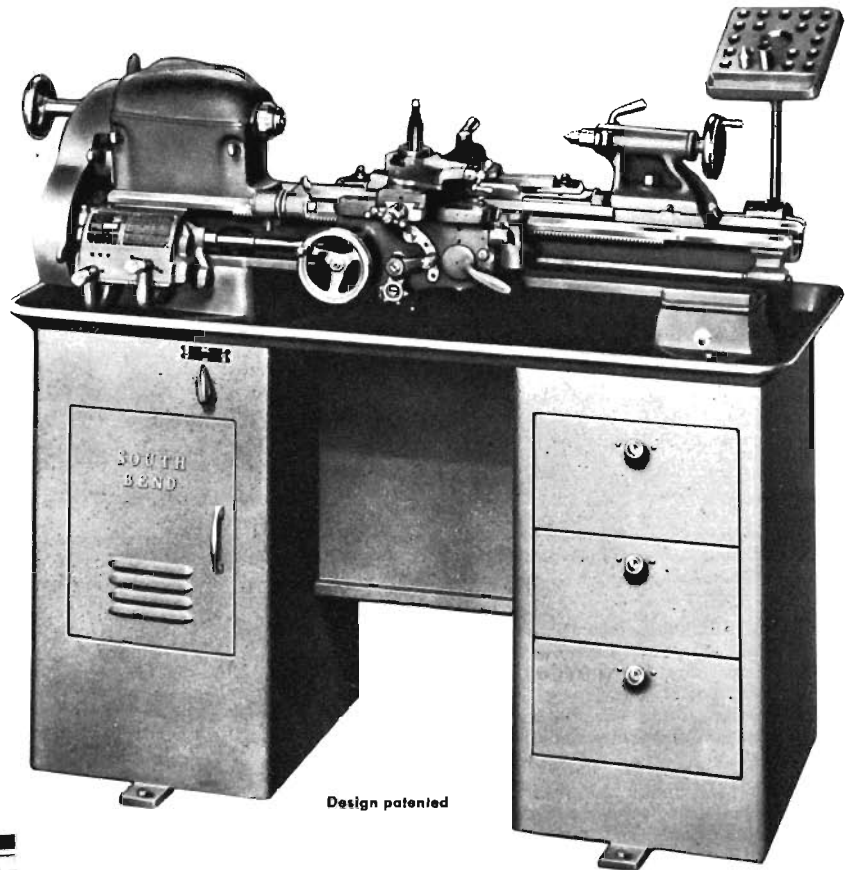

Design patented

South Bend 9-inch Precision Toolroom
Lathe with Metal Column Base

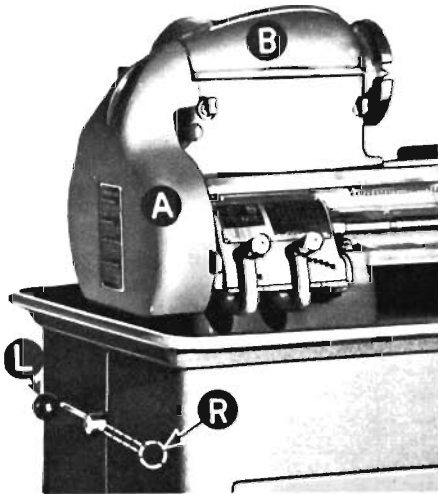

Unusual Safety Features

South Bend 9-inch Underneath Motor Driven Lathes have an automatic safety interlock which makes it impossible to open the end gear guard, "A", or the cone pulley cover, "B", until the belt tension lever, "L" is placed in position "R", disconnecting power.

These lathes are the same as corresponding models of 9-inch Bench Lathes, except for the underneath motor drive and the necessary alterations in the headstock. Fully enclosed in the metal column base, the motor and driving mechanism are protected from dust, dirt, and chips. Base is available with three drawers, 10 $\frac{3}{4}$ " x 5 $\frac{1}{2}$ " x 14" as shown in illustration, or without drawers. A built-in chip pan with $\frac{5}{8}$ " bead around the edge forms the top of the metal column base. Regular equipment included in price of lathe is same as for corresponding models of bench lathes listed on preceding pages. Electrical equipment is not included in price of lathe. See page 62.

Model	Catalog Number	Bed Length Feet	Between Centers Inches	Cubic Feet Boxed	Boxed Weight Pounds	Crated Weight Pounds	Factory Price
Toolroom	CL8344ZD	3 $\frac{1}{2}$	22	52	1090	820	\$933
Model A	CL344ZD	3 $\frac{1}{2}$	22	52	1030	700	707
Model B	CL377ZD	3 $\frac{1}{2}$	22	52	1020	685	623
Model C	CL315ZD	3 $\frac{1}{2}$	22	52	1010	675	545

Note: For prices of above lathes on metal column base without drawers deduct \$34.00 from prices shown.

S P E C I F I C A T I O N S

CAPACITY OF LATHE

- Swing over bed and saddle wings.....9 $\frac{1}{4}$ "
- Swing over cross slide (models A, B, and C).....5 $\frac{1}{2}$ "
- Swing over saddle cross slide (toolroom lathe).....5"

SPINDLE SPEEDS (approximate, not exact)

- | | | |
|-------------------------|----------------|--------------|
| | Direct Drive | Back-Gearod |
| High speeds, r.p.m..... | 1365, 780, 460 | 265, 155, 90 |
| Low speeds, r.p.m..... | 715, 410, 240 | 135, 78, 50 |

TAILSTOCK

- Size of center, Morse taper.....No. 2
- Spindle travel.....2 $\frac{1}{8}$ "
- Each graduation on tailstock spindle..... $\frac{1}{16}$ "
- Tailstock top set-over for taper turning..... $\frac{3}{8}$ "

HEADSTOCK

- Hole through spindle..... $\frac{3}{4}$ "
- Maximum collet capacity..... $\frac{1}{2}$ "
- Spindle nose diameter and threads per inch.....1 $\frac{1}{2}$ "-8
- Size of center, Morse taper.....No. 2
- Width of cone pulley step for belt.....1"
- Small face plate diameter.....5 $\frac{1}{8}$ "
- Front spindle bearing diameter.....1 $\frac{11}{16}$ "

COMPOUND REST

- Cross slide travel, (models A, B, and C).....5 $\frac{1}{8}$ "
- Cross slide travel, (toolroom lathe).....5 $\frac{1}{8}$ "
- Angular hand feed of compound rest top slide.....2 $\frac{1}{4}$ "

TOOL POST

- Size of tool holder shank..... $\frac{3}{8}$ " x 1 $\frac{13}{16}$ "
- Size of cutter bit for tool holder..... $\frac{1}{4}$ " sq.

THREAD CUTTING RANGE

- Toolroom and Model A—48 pitches..... $\frac{1}{4}$ to 224 per inch
- Models B and C—45 pitches..... $\frac{1}{4}$ to 160 per inch
- Lead screw, 29° Acme thread..... $\frac{3}{4}$ " dia.—8 thrs.

POWER LONGITUDINAL FEEDS

- Toolroom and Model A—48 feeds......0015" to .0853"
- Model B—26 feeds......0021" to .0155"
- Model C—14 feeds......0021" to .0156"

POWER CROSS-FEEDS

- Toolroom and Model A—48 feeds......0004" to .0255"
- Model B—23 feeds......0009" to .0046"

MOTOR

- Standard size of motor recommended..... $\frac{1}{2}$ h.p.

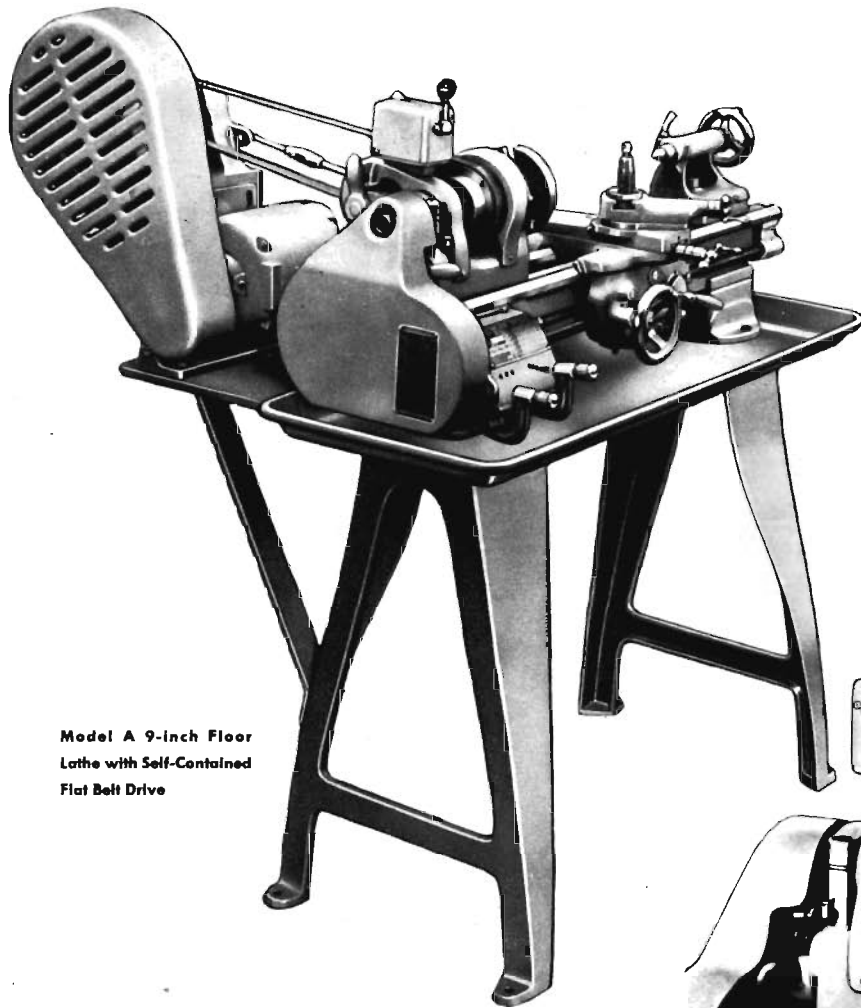

Model A 9-inch Floor Lathe with Self-Contained Flat Belt Drive

South Bend
9-inch
Self-Contained
Motor Drive
Precision
Floor
Lathes

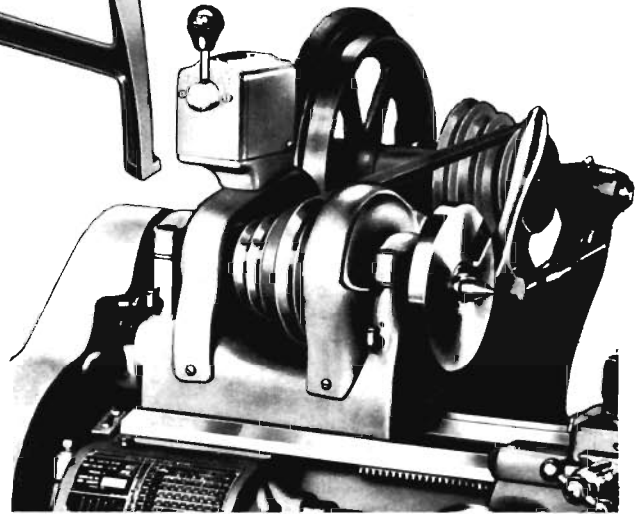

Close-up Showing V-belt Drive

The 9-inch Model A Self-Contained Motor Drive Floor Lathe is illustrated above. The Model B, Model C, and Tool-room Lathes are also made with this drive. Except for the self-contained drive equipment, chip pan, and floor legs, these lathes are the same and have the same equipment as corresponding models of 9-inch Bench Lathes described on the preceding pages. Specifications are also the same, except for shipping weights. See pages 24 and 25.

The self-contained drive equipment is permanently mounted back of the lathe headstock and consists of the self-contained motor drive unit (patented) for 1/2 h.p. motor; motor pulley with 3/4" hole; belt guard for motor belt; and necessary belting.

Either flat belt or V-belt cone pulleys are supplied for the headstock. The flat belt drive transmits power with the extreme smoothness required for high precision and fine finish. The V-belt drive is well adapted to production work, especially for heavy roughing cuts at slow speeds. To replace the endless V-belt, it is necessary to disassemble both the lathe headstock and the drive unit.

Self-Contained Motor Drive 9-inch South Bend Floor Lathes

Model	Bed Length Feet	Between Centers Inches	Cubic Feet Boxed	Boxed Weight Pounds	Crated Weight Pounds	With 16-Speed V-belt Self-Contained Drive		With 12-Speed Flat Belt Self-Contained Drive	
						Cat. No.	Price	Cat. No.	Price
Toolroom	3	16	30	835	660	CL8244Y	\$759.00	CL8944Y	\$743.00
	3 1/2	22	30	860	685	CL8244Z	782.00	CL8944Z	766.00
	4	28	34	885	710	CL8244A	805.00	CL8944A	789.00
Model A	3	16	30	775	600	CL244Y	533.00	CL944Y	517.00
	3 1/2	22	30	800	625	CL244Z	556.00	CL944Z	540.00
	4	28	34	825	650	CL244A	579.00	CL944A	563.00
	4 1/2	34	34	850	675	CL244R	611.00	CL944R	595.00
Model B	3	16	30	760	585	CL277Y	450.00	CL977Y	433.00
	3 1/2	22	30	785	615	CL277Z	473.00	CL977Z	456.00
	4	28	34	815	635	CL277A	496.00	CL977A	479.00
	4 1/2	34	34	835	660	CL277R	528.00	CL977R	511.00
Model C	3	16	30	740	575	CL215Y	372.00	CL915Y	355.00
	3 1/2	22	30	775	605	CL215Z	395.00	CL915Z	378.00
	4	28	34	805	625	CL215A	418.00	CL915A	401.00
	4 1/2	34	34	825	659	CL215R	450.00	CL915R	433.00

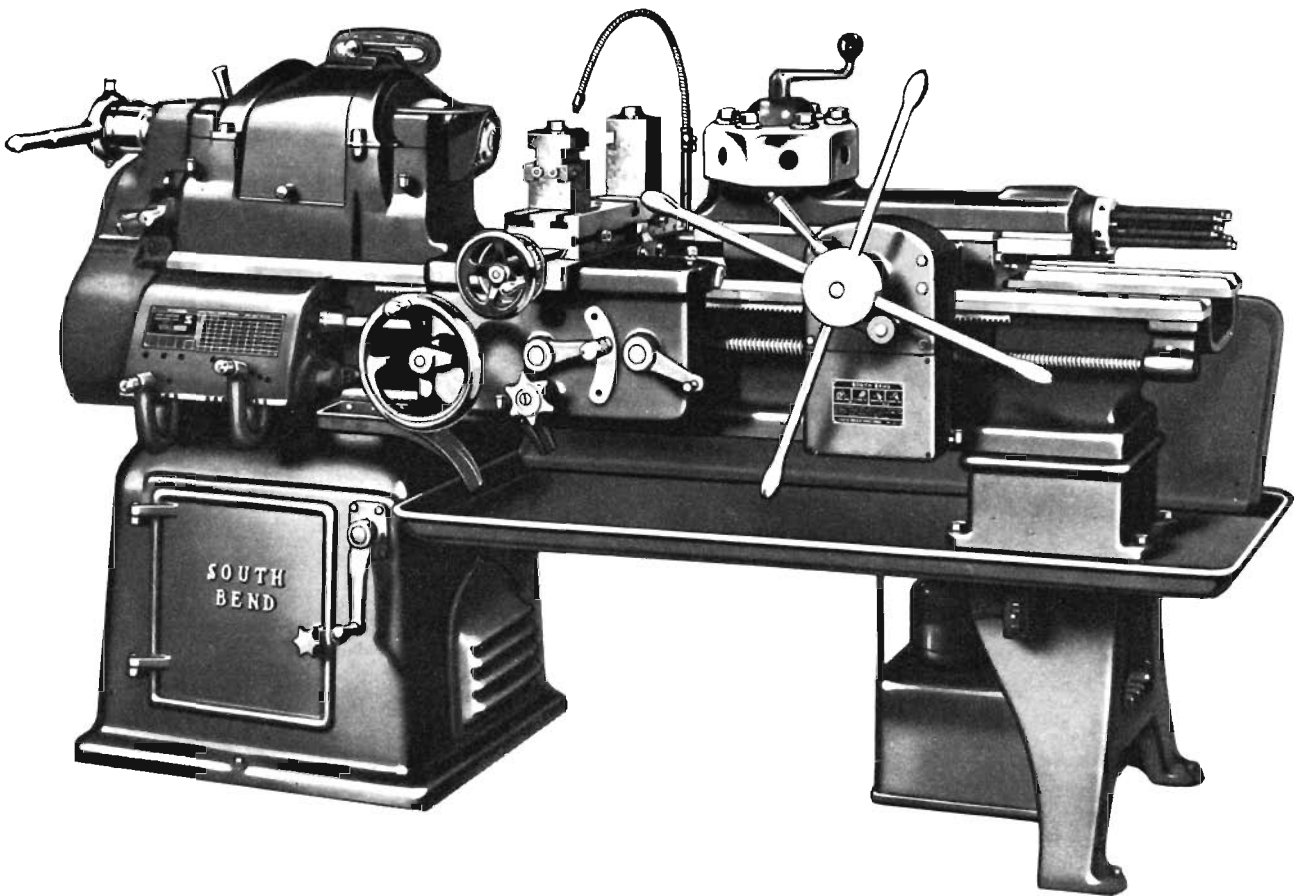

Collet attachment, electrical equipment, splash pan, coolant reservoir, and pump shown in illustration are not included in price of lathe.

No. 2-H Precision Turret Lathe

Designed for the efficient production of duplicate parts, the South Bend No. 2-H Turret Lathe has the precision for exacting close-tolerance operations, smooth power for producing a fine finish, and versatility that reduces set-up time to a minimum.

The universal carriage has 48 power cross-feeds, 48 power longitudinal feeds, and 48 thread cutting feeds ranging from 4 to 224 per inch. All changes are made through the quick change box at the headstock end of the lathe. Front and back tool blocks are supplied on the screw feed cross slide and a 4-way turret tool block is available to order. The large diameter micrometer graduated collar on the cross slide hand-wheel permits adjusting the cutting tools with extreme accuracy.

The ram-type turret has both power feed and hand feed, with an adjustable feed trip and stop for each of the six turret faces. The turret head indexes automatically on the return stroke of the turret slide. The quick change box provides 48 changes for power turret feeds. Change gears in the turret apron provide an additional change for turret power feed, independent of the universal carriage feeds in both rate of feed and direction of feed. Turret ram lock is provided.

Full advantage may be taken of the higher cutting speeds of tungsten carbide tools as the result of the wide range of

speeds and feeds available. The use of a two-speed motor permits quick change from high speeds to low speeds for reaming and tapping operations.

Equipment included in the price of lathe consists of: universal carriage with screw feed double tool slide having front and rear square tool blocks; power feed ram-type turret; quick change box; oil pan; coolant return assembly; wrenches; and installation plan. Electrical equipment, handlever collet attachment, collet splash guard, coolant reservoir, coolant pump, splash pan, and piping are not included in price of lathe. See page 62 for motors and controls.

No. 2-H Turret Lathes with Power Feed Carriage and Turret

Catalog Number	Bed Length Feet	Cubic Feet Boxed	Boxed Weight Pounds	Crated Weight Pounds	Factory Price
CL2CT	6	115	3175	2810	\$3350
CL2DT	7	130	3300	2900	3413

Note—These lathes can be supplied with hand feed only for the turret if desired. Write for information.

Specifications of No. 2-H Turret Lathes

CAPACITY OF LATHE

Hole through spindle.....	1 3/8"
Swing over double tool cross slide.....	8 3/8"
Swing over bed and saddle wings.....	18 1/2"
Width of lathe bed.....	11 1/2"
Spindle nose diameter and threads per inch.....	2 3/8"-8
Maximum collet capacity through handlever collet chuck.....	1"

SPINDLE SPEEDS (Standard spindle speeds with two-speed motor, approximate, not exact)

High spindle speeds	
r.p.m. of spindle, direct belt drive.....	945, 550, 300
r.p.m. of spindle, back-gear drive.....	118, 70, 32

Low spindle speeds (Not available with 1-speed motor)

r.p.m. of spindle, direct belt drive.....	475, 278, 150
r.p.m. of spindle, back-gear drive.....	60, 33, 20

TURRET

Diameter of holes in turret faces.....	1 1/2"
Center of turret hole to top of turret slide.....	2 1/2"
Effective feed of turret slide.....	5 3/8"
Distance between opposite flats.....	9 3/8"
Maximum distance between spindle nose and turret face at beginning of indexing movement.....	6 ft. bed 28 1/4", 7 ft. bed 40 1/4"

UNIVERSAL CARRIAGE

Thread cutting range.....	4 to 224 per inch
Power longitudinal feeds.....	.0015" to .0841"
Maximum longitudinal travel.....	6 ft. bed 22 1/2", 7 ft. bed 34 1/2"
Power cross-feeds, 48.....	.0006" to .0315"
Cross travel of cross slide.....	.9 3/4"
Tool block openings for cutter bits.....	3/8" x 3/8"

MOTOR

For operating on	
3-phase A.C. 2-speed, 1800-900 r.p.m., 2 h.p.-1 h.p.	
For operating on	
1-phase A.C. or D.C. 1-speed, 1800 r.p.m., 1 1/2 h.p.	

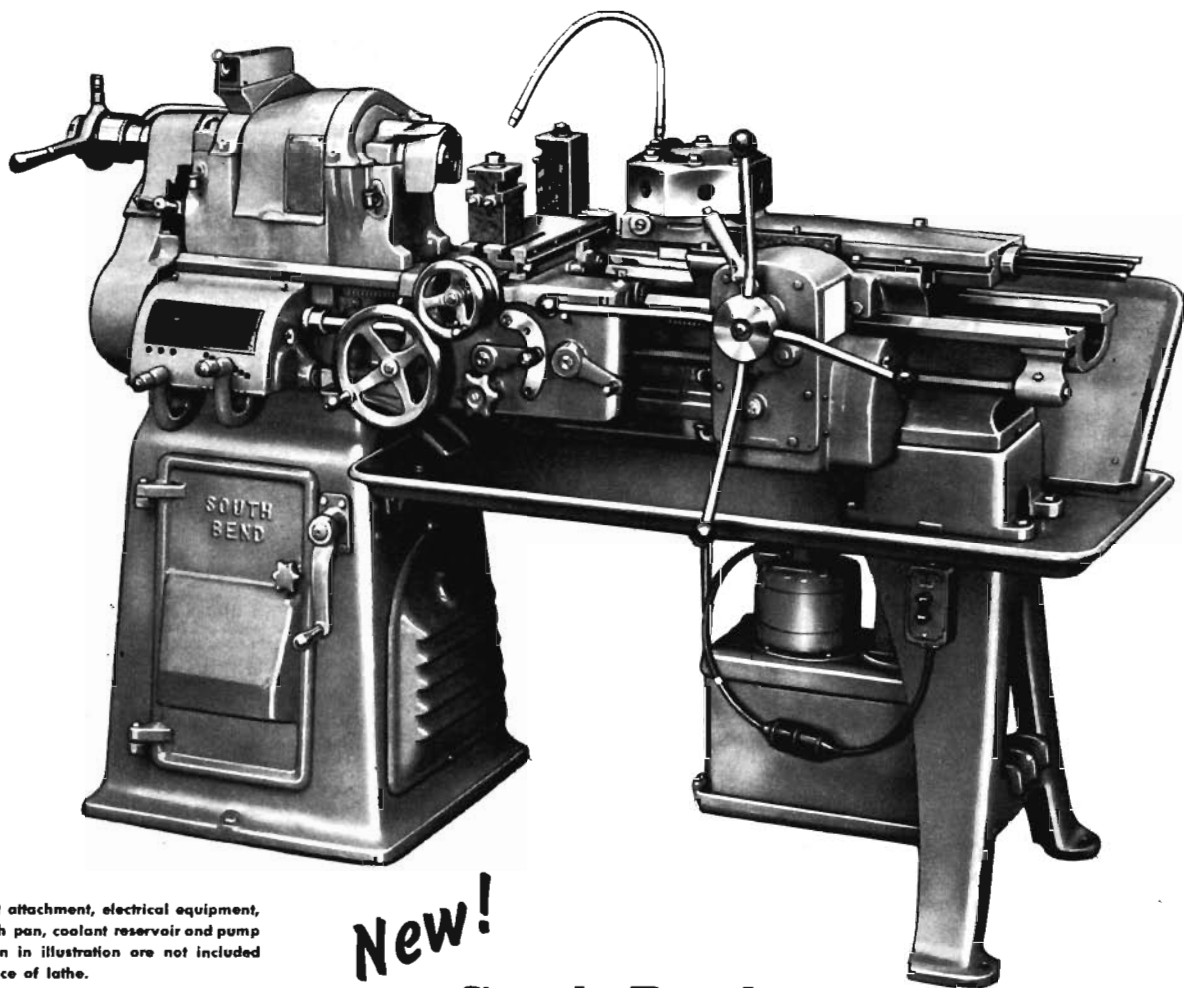

Collet attachment, electrical equipment, splash pan, coolant reservoir and pump shown in illustration are not included in price of lathe.

New!

South Bend 13" Precision Turret Lathe

The South Bend 13" Turret Lathe is a dependable tool for the manufacture of duplicate parts. It has the stamina for exacting close-tolerance work, ample power for smooth performance, and the rigidity for producing a fine finish.

The turret head indexes and locks automatically when the turret slide is returned to the starting position. An individual feed trip and stop for each face of the turret accurately regulates the length of the cut with either the power feed or the hand feed. The turret head may be back-indexed or spun when it is desired to skip tool positions. Turret slide has tapered gibs on both sides which provide adjustment for wear and alignment. Power feeds for the turret slide are driven by lever operated friction clutch, permitting instant engagement and disengagement. Lever shift gears in turret apron provide three changes for fast, slow and intermediate feeds. The power feed is reversible to permit feeding the turret toward the headstock

regardless of direction of universal carriage feed. A large turnstile operates the hand feed. Turret ram lock is provided.

Equipment includes: universal carriage; double tool slide; front and rear tool blocks; power feed turret; quick change box; oil pan; coolant return assembly; wrenches; and installation plan. Electrical equipment, handlever collet attachment, collet splash guard, coolant reservoir, coolant pump, splash pan, and piping are not included in price.

Catalog Number	Bed Length Feet	Cubic Feet Boxed	Boxed Weight Pounds	Crated Weight Pounds	Factory Price
CL1BT	5	88	1875	1570	\$2344
CL1CT	6	103	1950	1620	2397
CL1DT	7	117	2025	1670	2450

Note: These lathes can be supplied with hand feed turret if desired. Write for information.

SPECIFICATIONS

CAPACITY OF LATHE

Hole through spindle.....	1 3/8"
Swing over double tool cross slide.....	3 1/2"
Swing over bed and saddle wings.....	13 1/2"
Spindle nose diameter and threads per inch.....	2 1/4"-8
Maximum collet capacity through handlever collet chuck.....	1"

SPINDLE SPEEDS (standard spindle speeds with two-speed motor, approximate, not exact)

High spindle speeds	
r.p.m. of spindle, direct belt drive.....	940, 497, 270
r.p.m. of spindle, back-gear drive.....	135, 71, 40

Low spindle speeds (not available with 1-speed motor)
r.p.m. of spindle, direct belt drive.... 470, 248, 135
r.p.m. of spindle, back-gear drive.... 67, 35, 20

TURRET

Diameter of holes in turret faces.....	1"
Center of turret hole to top of turret slide.....	1 1/2"
Effective feed of turret slide.....	6 1/2"
Distance between opposite flats.....	8"
Maximum distance between spindle nose and turret face at beginning of indexing movement....	.6 ft. bed 35 3/8"

UNIVERSAL CARRIAGE

Thread cutting range.....	.4 to 224 per inch
Power longitudinal feeds.....	.0015" to .0841"
Maximum longitudinal travel.....	.6 ft. bed 3 1/4"
Power cross-feeds, 48.....	.0006" to .0315"
Cross travel of cross slide.....	9 3/4"
Tool block openings for cutter bits.....	1/8" x 1/8"

MOTOR

For operating on 1-phase A.C. or D.C.—1-speed, 1800 r.p.m.....	1 h.p.
For operating on 3-ph. A.C.—2-speed, 1800-900 r.p.m.....	1 1/2-3/4 h.p.

All important lead feed screws are single point chased.

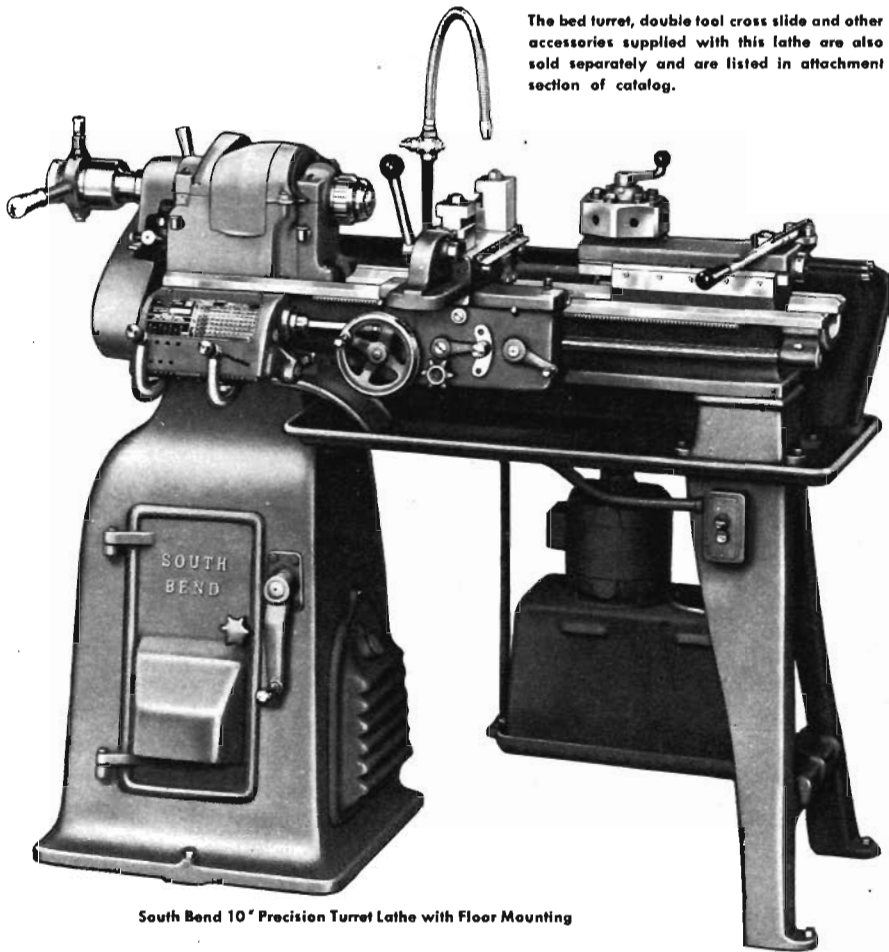

South Bend 10" Precision Turret Lathe with Floor Mounting

The bed turret, double tool cross slide and other accessories supplied with this lathe are also sold separately and are listed in attachment section of catalog.

SPECIFICATIONS

CAPACITY OF LATHE

Hole through spindle	1 3/8"
Swing over bed and saddle wings	10 1/8"
Width of lathe bed	7 1/16"
Spindle nose diameter and threads per inch	2 1/4"-8
Maximum collet capacity through handlever collet chuck	1"
Maximum capacity through universal lathe chuck	1 1/8"

TURRET

Diameter of holes in turret faces*	5/8"
Center of turret hole to top of turret slide	1 1/2"
Effective feed of turret slide	4"
Distance between opposite flats	4 3/8"
Maximum distance between spindle nose and turret face at beginning of indexing movement	19 3/8"

SPINDLE SPEEDS (approximate, not exact)

	Direct Drive		Back-Geared	
With one-speed motor				
High speeds, r.p.m.	1400, 898, 585	250, 160, 105		
Low speeds, r.p.m.	740, 470, 304	130, 85, 55		
With two-speed motor				
High speeds, r.p.m.	1400, 898, 585	250, 160, 105		
Low speeds, r.p.m.	740, 470, 304	130, 85, 55		
	700, 449, 292	125, 80, 52		
	370, 235, 152	65, 42, 27		

UNIVERSAL CARRIAGE

Thread cutting range	4 to 480 per inch
Power longitudinal feeds	.0007" to .0836"
Maximum longitudinal travel of universal carriage, hand or power feed	16"

DOUBLE TOOL CROSS SLIDE

Swing over double tool cross slide	3 1/4"
Cross travel of cross slide	3 3/8"
Maximum size cutter bit tool block opening will take	3/16" x 1/16"
Power cross-feeds	.0003" to .0303"

MOTOR (recommended size)

One-speed	3/4 h.p.
Two-speed	1/2-1 h.p.

*Can be supplied to order with 3/4" holes in turret head. No extra charge.

South Bend 10" Precision Turret Lathes

South Bend 10" Turret Lathes are made with 3 1/2" bed length and with either bench or floor mounting, as illustrated. They are precision tools capable of fast, efficient production and are easily adaptable to a wide variety of work. There is no excessive weight in moving parts to slow down operation and cause fatigue. These lathes can be equipped with a one-speed motor or a two-speed motor to provide twelve or twenty-four spindle speeds as listed in the specifications.

The turret is mounted on the inside bed ways and can be locked in position at any point along the length of the bed. The turret base can be placed close to the headstock to eliminate excessive overhang of the work or the turret tools. Turret head indexes automatically when the lever is moved to the extreme right, and has individual stops for each of the six turret faces. The turret head will index within plus or minus .0005"; measured 4" from turret face and it may be back indexed or spun to skip tool positions. Turret ram slide can be locked for mounting work between centers if desired.

Equipped with front and rear tool blocks the hand-lever cross slide has adjustable stops which limit the movement of the cross-feed in either direction, in or out. The hand-lever can be removed and the cross-feed screw attached, permitting use of all power cross-feeds and longitudinal feeds with the double tool cross slide. See small illustration at right.

Equipment included in the price of turret lathe consists of: underneath motor drive unit (patented); universal carriage with combination hand-lever and screw

feed double tool slide having front and rear square tool blocks; hand-lever bed turret; quick change box; oil pan; coolant return assembly; splash guards; wrenches; and installation plan. Bench turret lathes also include rigid tubular steel bench with three roomy drawers.

Catalog Number	Type of Mounting	Cubic Feet Boxed	Boxed Weight Pounds	Crated Weight Pounds	Factory Price
CL1006Z	Floor	59	1350	1050	\$1601
CL1005Z	Bench	56	1250	950	1641

NOTE: Splash pan, tailstock, compound rest, centers, spindle sleeve, face plates, draw-in collet chuck attachment, lathe chuck, thread cutting stop, coolant equipment, and electrical equipment are not included in price of lathe. See attachment section of catalog for these accessories.

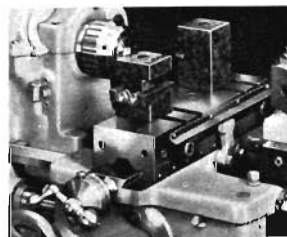

Double Tool Slide with Screw Feed

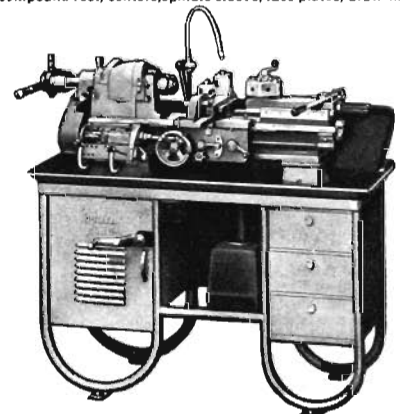

South Bend 10" Bench Turret Lathe

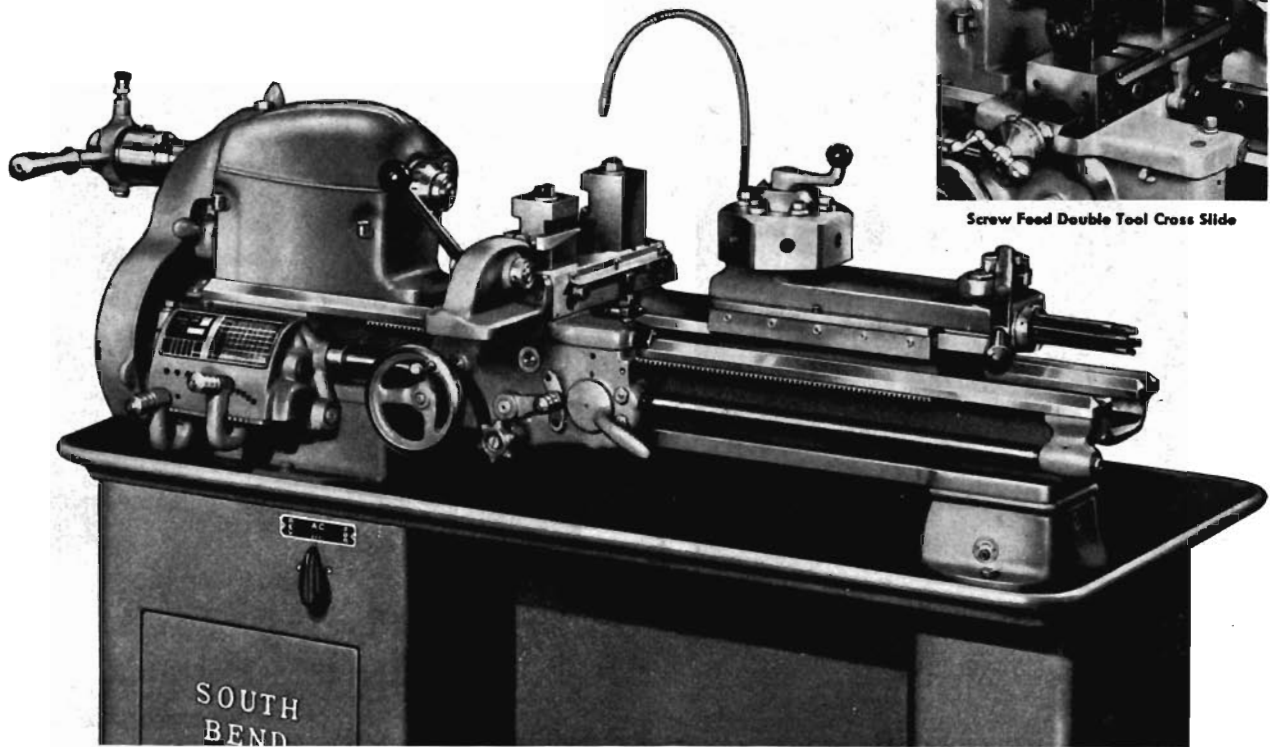

Screw Feed Double Tool Cross Slide

Turret Lathe Conversion Units for All 9" and Light Ten South Bend Lathes

Any South Bend 9" or Light Ten Lathe, either bench or floor type, can be supplied as a turret lathe with handlever bed turret and combination handlever or screw feed double tool cross slide in lieu of the regular tailstock and compound rest assemblies. When this equipment is wanted, Turret Lathe Conversion Units as listed below must be specified when the lathe is ordered.

Handlever Bed Turret

The handlever Bed Turret mounts on the inside bed ways and can be locked in position at any point along the length of the bed. The turret head indexes automatically when the feed lever is pushed to the extreme right. Each face of the turret has an independently adjustable feed stop screw which accurately regulates the length of the cut.

Accurate indexing of the turret head (within plus or minus .0005" measured 4" from turret face) is assured by the use of hardened, ground and superfinished index pin which operates in heat-treated steel bushings.

The effective feed of the turret slide is 4". Turret ram slide lock is provided. Center of turret hole to top of turret slide 1 1/2". Turret holes take standard turret tools with 5/8" diameter shank. If specified when lathe is ordered, turret head can be bored to order to take tools with 3/4" diameter shank, no extra charge. Distance between opposite flats on turret head is 4 7/8".

Combination Double Tool Slide

The combination Handlever and Screw Feed Double Tool Cross Slide is mounted on the saddle cross slide dovetail in place of the compound rest assembly. The handlever can be used on either side of the cross slide. Adjustable stops limit the movement of the cross slide in either direction, in or out. Power longitudinal carriage feeds can be used with either the hand-lever cross-feed or screw cross-feed. The handlever feed is easily removed and replaced with the screw operated cross-

feed. Power cross-feeds are available with the screw cross-feed. Cross-feed screw and nut can be supplied with either English or metric thread and graduations.

This cross slide has front and back square tool blocks in which 1/8" square cutter bits can be mounted for multiple turning, forming, facing and cutting-off operations. The front tool block takes two cutter bits and the back tool block takes one cutter bit. Tapered wedges and thumb screws provide adjustment for the height of cutter bits. Maximum swing over Double Tool Cross Slide is 3 5/16", maximum travel of cross slide 3 5/8". T-slots in the cross slide base permit adjusting the positions of the tool blocks.

Turret Lathe Conversion Units

Prices for Turret Lathe Conversion Units listed below are for handlever bed turret and combination handlever and screw-feed double tool cross slide in lieu of compound rest, tailstock, centers, spindle sleeve, tool post and small face plate. These prices apply only when Turret Lathe Conversion Units are specified when lathe is ordered. See attachment section of catalog if turret equipment is wanted for lathes now in service.

Turret Lathe Conversion Units for 9" and Light Ten Lathes

Catalog Number	Size Lathe	Type of Drive	Factory Price
CL3815N	9"	Horizontal Motor Drive, V-belt or flat belt	\$377
CL3816N	9"	Self-Contained Drive, V-belt or flat belt	377
CL3817N	9"	Underneath Motor Drive	367
CL3815K	Lt. Ten	Horizontal Motor Drive, V-belt or flat belt	382
CL3816K	Lt. Ten	Self-Contained Drive, V-belt or flat belt	382
CL3817K	Lt. Ten	Underneath Motor Drive	371

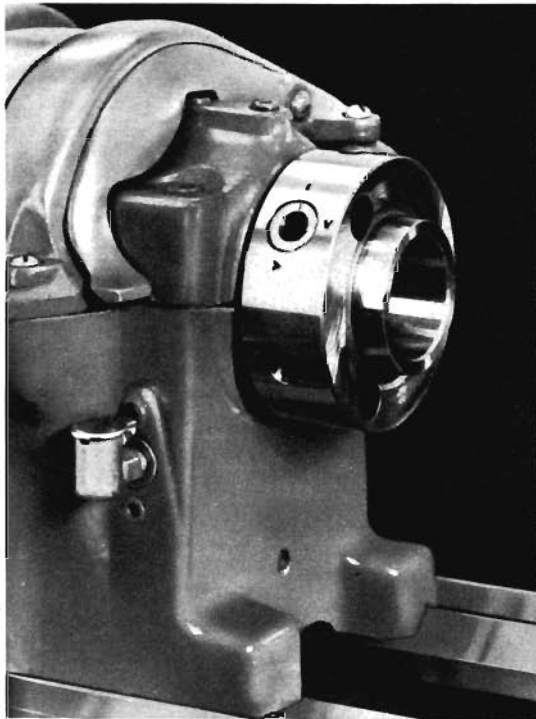

4" Type D1 Cam Lock Spindle



Size 00 Long Taper Key Drive Spindle

South Bend Lathes Equipped With Cam Lock and Long Taper Key Drive Spindles

All South Bend Lathes, 10"-1" Collet and larger, can be supplied with 4" Type D1 Cam Lock Spindles or Size 00 Type L Long Taper Key Drive Spindles, in lieu of the regular threaded spindles at extra cost. Price includes small face plate which is supplied with the lathe, but does not include large face plate, chucks, draw-in collet attachments, or other accessories. Spindle nose dimensions conform with ASA standards, but spindle bore and inside taper are larger to accommodate South Bend collet equipment, spindle sleeves, and centers. See attachment section of catalog for descriptions of chucks, collet equipment, and other accessories for these lathes.

Size of Lathe	Size 00 Long Taper Key Drive Spindle Nose in Lieu of Regular Threaded Spindle Nose		4" Cam Lock Spindle Nose in Lieu of Regular Threaded Spindle Nose	
	Cat. No.	Price	Cat. No.	Price
10"	CA8050L	\$25.00	CB8050L	\$33.00
13"	CA8050T	38.00	CB8050T	38.00
14 1/2"	CA8050F	46.00	CB8050F	46.00
16", 16-24", & 2-H	CA8050H	52.00	CB8050H	52.00

Distances Between Centers for Lathes with 4" Type D1 Cam Lock Spindles

Size of Lathes	Distance Between Centers									
	3' bed	3 1/2' bed	4' bed	4 1/2' bed	5' bed	6' bed	7' bed	8' bed	10' bed	12' bed
10"	13"	19"	26"	33"
13"	15"	...	27"	39"	51"
14 1/2"	23"	35"	47"	59"
16"	32"	44"	56"	80"	104"
16-24"	29"	41"	53"	77"	101"

Distances Between Centers for Lathes with Type L Long Taper Key Drive Spindles

Size of Lathes	Distance Between Centers									
	3' bed	3 1/2' bed	4' bed	4 1/2' bed	5' bed	6' bed	7' bed	8' bed	10' bed	12' bed
10"	13"	19"	25"	33"
13"	15"	...	27"	39"	51"
14 1/2"	23"	35"	47"	59"
16"	32"	44"	56"	80"	104"
16-24"	29"	41"	53"	77"	101"

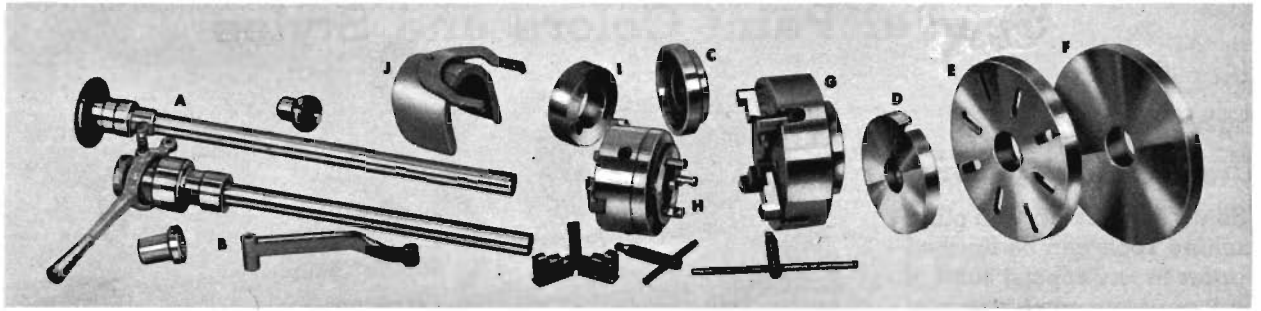

Accessories for Lathes With 4" Type D1 Cam Lock Spindles

Description	For 10" Lathe		For 13" Lathe		For 14 1/2" Lathe		For 16", 16-24", 2-H	
	Catalog Number	Fac. Price	Catalog Number	Fac. Price	Catalog Number	Fac. Price	Catalog Number	Fac. Price
A Handwheel Collet Attachment.....	CB4306L	\$ 61.00	CB4306T	\$ 66.00	CB4306F	\$ 70.00	CB4306H	\$ 73.00
B Handlever Collet Attachment.....	CB5206L	129.50	CB5206T	143.00	CB5206F	156.00	CB5206H	169.00
C Closer for Step Chucks 3" and 4" maximum capacity.....	CB6309LH	13.25	CB6309LH	13.25	CB6309LH	13.25	CB6309LH	13.25
C Closer for Step Chucks 5" and 6" maximum capacity.....	CB6311LH	17.50	CB6311LH	17.50	CB6311LH	17.50	CB6311LH	17.50
D Small Face Plate.....	CB2175LT	18.50	CB2175LT	18.50	CB2175FH	27.50	CB2175FH	27.50
E Large Face Plate.....	CB2180L	25.25	CB2180T	27.50	CB2180FH	37.25	CB2180FH	37.25
F Fixture Plate.....	CB46L	17.50	CB46T	19.00	CB46FH	20.50	CB46FH	20.50
G 6" 4-Jaw Independent Chuck.....	CB4006	50.00
6" 4-Jaw Independent Chuck.....	CB4206	84.00	CB4206	84.00
7 1/2" 4-Jaw Independent Chuck.....	CB4207	98.00	CB4207	98.00	CB4207	98.00	CB4207	98.00
9" 4-Jaw Independent Chuck.....	CB4209	112.00	CB4209	112.00	CB4209	112.00
10" 4-Jaw Independent Chuck.....	CB4210	122.00	CB4210	122.00
12" 4-Jaw Independent Chuck.....	CB4212	158.00
5" 3-Jaw Universal Chuck with two sets of jaws—1 pinion.....	CB3005	69.00	CB3005	69.00
5" 3-Jaw Universal Chuck with two sets of jaws—3 pinions.....	CB3505	113.00	CB3505	113.00	CB3505	113.00	CB3505	113.00
H 6" 3-Jaw Universal Chuck with two sets of jaws.....	CB3506	121.00	CB3506	121.00	CB3506	121.00	CB3506	121.00
7 1/2" 3-Jaw Universal Chuck with two sets of jaws.....	CB3507	137.00	CB3507	137.00	CB3507	137.00
9" 3-Jaw Universal Chuck with two sets of jaws.....	CB3509	184.00	CB3509	184.00
Chuck Plate fitted to chuck.....	CB2935	27.50	CB2935	27.50	CB2935	27.50	CB2935	27.50
I Semi-Machined Chuck Plate—5".....	CB2704RH	17.50	CB2704RH	17.50	CB2704RH	17.50	CB2704RH	17.50
Semi-Machined Chuck Plate—6 1/4".....	CB2707RH	18.50	CB2707RH	18.50	CB2707RH	18.50	CB2707RH	18.50
Semi-Machined Chuck Plate—9".....	CB2709RH	19.50	CB2709RH	19.50	CB2709RH	19.50	CB2709RH	19.50
J Collet Splash Guard.....	CB5223L	4.50	CB5223T	4.75	CB5223F	5.50	CB5223H	7.00

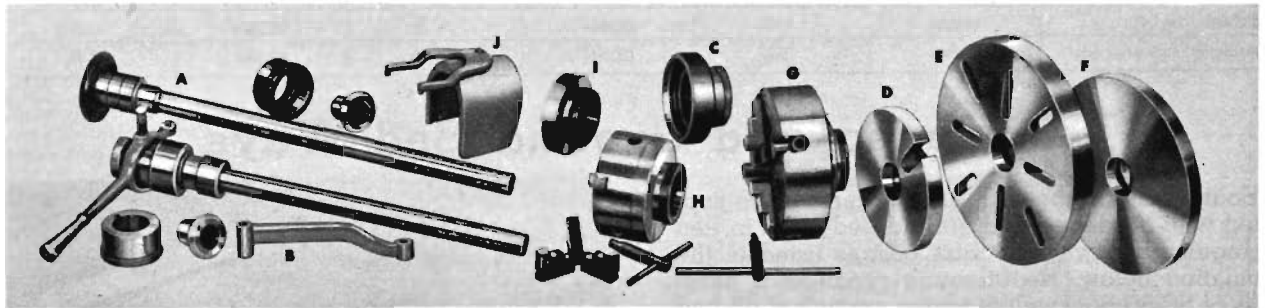

Accessories for Lathes With Type L Long Taper Key Drive Spindles

Description	For 10" Lathe		For 13" Lathe		For 14 1/2" Lathe		For 16", 16-24", 2-H	
	Catalog Number	Fac. Price	Catalog Number	Fac. Price	Catalog Number	Fac. Price	Catalog Number	Fac. Price
A Handwheel Collet Attachment.....	CA4306L	\$ 61.00	CA4306T	\$ 66.00	CA4306F	\$ 70.00	CA4306H	\$ 73.00
B Handlever Collet Attachment.....	CA5206L	129.50	CA5206T	143.00	CA5206F	156.00	CA5206H	169.00
C Closer for Step Chucks 3" and 4" maximum capacity.....	CA6309LH	13.25	CA6309LH	13.25	CA6309LH	13.25	CA6309LH	13.25
C Closer for Step Chucks 5" and 6" maximum capacity.....	CA6311LH	17.50	CA6311LH	17.50	CA6311LH	17.50	CA6311LH	17.50
D Small Face Plate.....	CA2175L	18.50	CA2175T	18.50	CA2175FH	27.50	CA2175FH	27.50
E Large Face Plate.....	CA2180L	25.25	CA2180T	27.50	CA2180FH	37.25	CA2180FH	37.25
F Fixture Plate.....	CA46L	17.50	CA46T	19.00	CA46FH	20.50	CA46FH	20.50
G 6" 4-Jaw Independent Chuck.....	CA4006	50.00
6" 4-Jaw Independent Chuck.....	CA4206	84.00	CA4206	84.00
7 1/2" 4-Jaw Independent Chuck.....	CA4207	98.00	CA4207	98.00	CA4207	98.00	CA4207	98.00
9" 4-Jaw Independent Chuck.....	CA4209	112.00	CA4209	112.00	CA4209	112.00
10" 4-Jaw Independent Chuck.....	CA4210	122.00	CA4210	122.00
12" 4-Jaw Independent Chuck.....	CA4212	158.00
5" 3-Jaw Universal Chuck with two sets of jaws—1 pinion.....	CA3005	69.00	CA3005	69.00
5" 3-Jaw Universal Chuck with two sets of jaws—3 pinions.....	CA3505	113.00	CA3505	113.00	CA3505	113.00	CA3505	113.00
H 6" 3-Jaw Universal Chuck with two sets of jaws.....	CA3506	121.00	CA3506	121.00	CA3506	121.00	CA3506	121.00
7 1/2" 3-Jaw Universal Chuck with two sets of jaws.....	CA3507	137.00	CA3507	137.00	CA3507	137.00
9" 3-Jaw Universal Chuck with two sets of jaws.....	CA3509	184.00	CA3509	184.00
Chuck Plate fitted to chuck.....	CA2935	27.50	CA2935	27.50	CA2935	27.50	CA2935	27.50
I Semi-Machined Chuck Plate—5".....	CA2704RH	17.50	CA2704RH	17.50	CA2704RH	17.50	CA2704RH	17.50
Semi-Machined Chuck Plate—6 1/4".....	CA2707RH	18.50	CA2707RH	18.50	CA2707RH	18.50	CA2707RH	18.50
Semi-Machined Chuck Plate—9".....	CA2709RH	19.50	CA2709RH	19.50	CA2709RH	19.50	CA2709RH	19.50
J Collet Splash Guard.....	CA5223L	4.50	CA5223T	4.75	CA5223F	5.50	CA5223H	7.00

Special Paint Colors and Styles

Color Code

Highlighting

Single or Multicolor

South Bend Lathes and other Machine Tools can be finished to order in any special color of paint, or in any combination of two or more colors to conform with your own color code or specifications. When special colors are wanted, color samples for matching must be supplied. If certain portions of the machinery are to be finished in different colors, clear and specific instructions indicating the exact portions for each color must be supplied. Finish enamel may be supplied by purchaser if desired, but no allowance or deduction for it can be made.

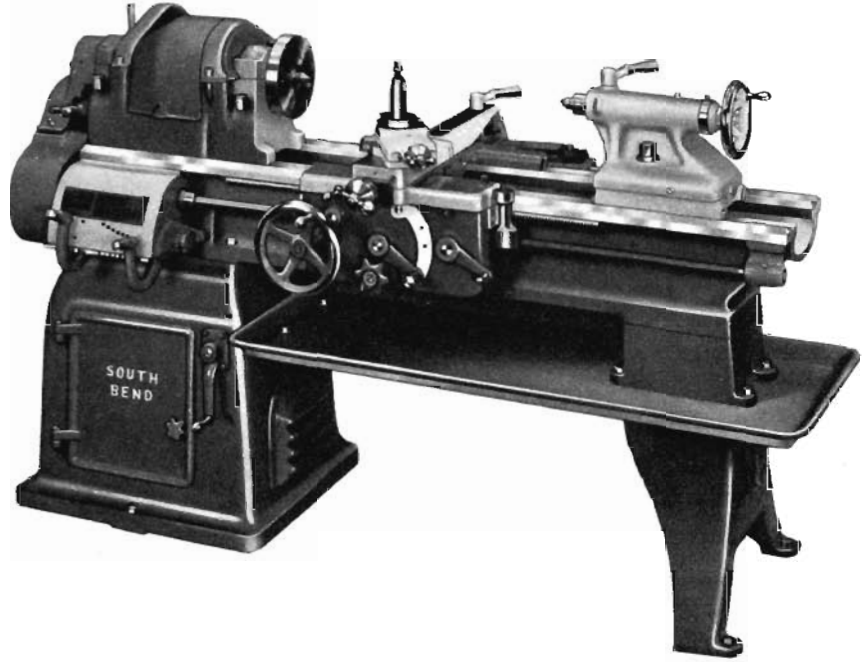

Size and Type of Machine	2-H, 16-24", 18", 14½" & 13" Lathes Milling Machine		10" Bench & Floor, 9" & Light Ten UMD and Self-Cont. Drive Floor Lathes, 3 & 4 Spindle Drill Presses		9" & Light Ten HMD Bench Lathes, Shaper, Pedestal Grinder, 1 & 2 Spindle Drill Presses	
	Cat. No.	Fac. Price	Cat. No.	Fac. Price	Cat. No.	Fac. Price
One Special Solid Color	CE2860	\$37.50	CE2861	\$25.50	CE2862	\$13.00
Multicolor 1st Color	CE2863	37.50	CE2864	25.50	CE2865	13.00
Multicolor, each extra color	CE2866	26.75	CE2867	21.50	CE2868	8.50

Hardened and Ground Bed Ways

South Bend Lathes 10" and larger can be supplied with hardened and ground bed ways in lieu of regular bed ways at extra cost as listed in the tabulation below. Heat-treating produces a hardness of 50-55 Rockwell C on the surface of all bed ways throughout the wearing area of the bed. After a period of seasoning, the bed ways are finished by precision grinding on equipment especially designed and built for the purpose.

Hardened bed ways resist wear and scoring. They are especially recommended for lathes that are to be used for machining rubber, plastics or other abrasive materials, also for machining tool steel or other materials which may produce sharp work hardened chips.

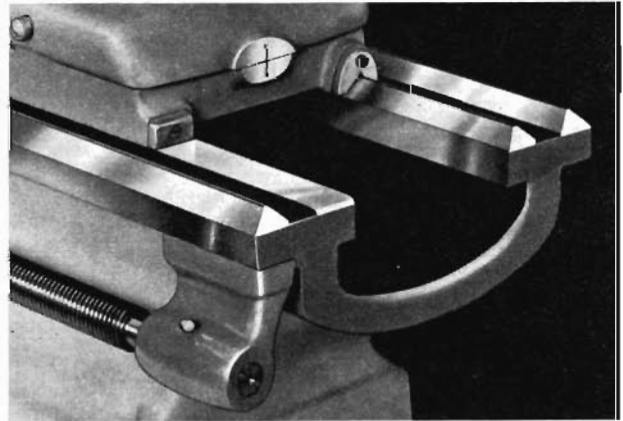

Catalog Number	Size	Bed Length Feet	Factory Price
CL4955Y	10"	3	\$145
CL4955Z	10"	3½	150
CL4955A	10"	4	155
CL4955R	10"	4½	160
CL4956A	13"	4	175
CL4956B	13"	5	186
CL4956C	13"	6	197
CL4956D	13"	7	208

Catalog Number	Size	Bed Length Feet	Factory Price
CL4957B	14½"	5	\$200
CL4957C	14½"	6	212
CL4957D	14½"	7	224
CL4957E	14½"	8	236
CL4958C	16", 16-24" & 2-H	6	225
CL4958D	16", 16-24" & 2-H	7	239
CL4958E	16", 16-24"	8	253
CL4958G	16", 16-24"	10	281
CL4958H	16", 16-24"	12	309

Attachments and Accessories for South Bend Lathes

A complete assortment of attachments and accessories greatly increases the adaptability of any lathe. Often a careful selection of equipment will save much loss of time and the expense of making special tools or fixtures. It is recommended that attachments and accessories be ordered with the lathe so that any fitting that may be required can be done at the factory.

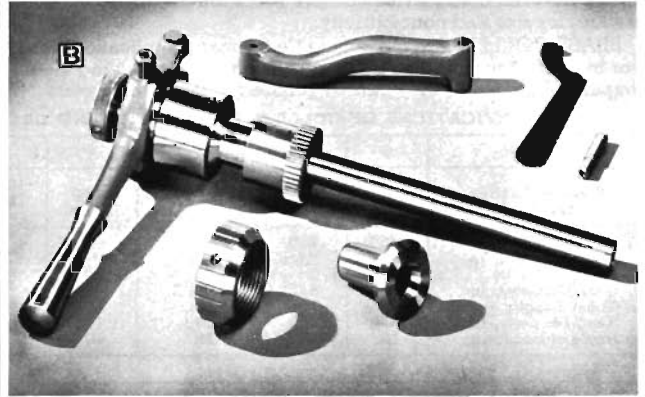
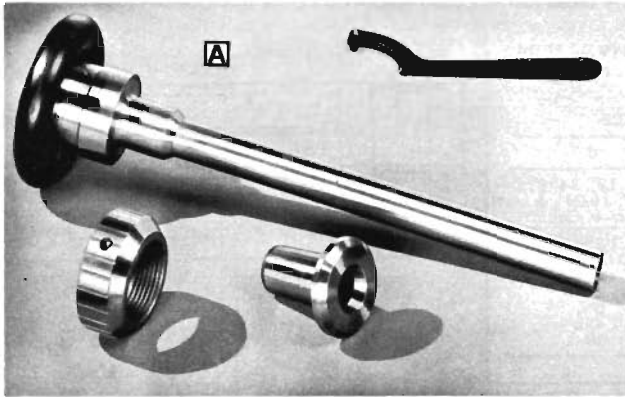

A Handwheel Collet Attachment

This attachment is a great time-saver in mounting small work in the lathe for production, toolroom, and maintenance operations, especially when extremely accurate centering is required. Bar and tube stock can be fed through the hollow draw-bar which operates the collet. When the handwheel is tightened, the collet automatically grips and centers the work. Equipment includes steel draw-bar with handwheel, spindle nose cap, spanner wrench, and heat-treated steel closing sleeve if required. Collets are not included. See page 36.

Catalog Number	Size of Lathe	Collet Used	Max. Collet Cap.	Shipping Weight	Factory Price
CL4306N	9"	No. 3	1/2"	5 lbs.	\$19.75
CL4306K	Light Ten	No. 6K	3/8"	5 lbs.	22.50
CL4306L	10"	No. 5	1"	10 lbs.	55.00
CL4306Q	13"	No. 5	1"	14 lbs.	60.00
CL4306M	14 1/2"	No. 5	1"	14 lbs.	64.00
CL4306H	16", 16-24", & 2-H	No. 5	1"	15 lbs.	67.00

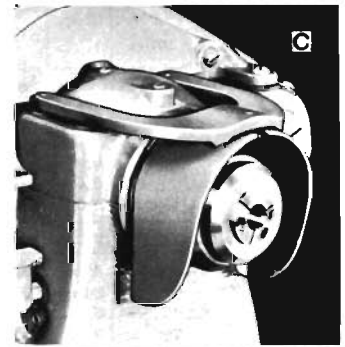

B Handlever Collet Attachment

Speed and accuracy are combined in the Handlever Collet Attachment. Without stopping the lathe spindle, the collet can be released, bar stock fed through the spindle, and the collet tightened again. Equipment includes adjustable chuck closing mechanism and hollow draw-bar, spindle nose cap, spanner wrench and heat-treated steel closing sleeve if required. Collets are not included. See page 36.

Catalog Number	Size of Lathe	Collet Used	Max. Collet Cap.	Shipping Weight	Factory Price
CLS206N	9"	No. 3	1/2"	10 lbs.	\$ 78.50
CLS206K	Light Ten	No. 6K	3/8"	10 lbs.	92.50
CLS206L	10"	No. 5	1"	20 lbs.	123.50
CLS206Q	13"	No. 5	1"	25 lbs.	137.00
CLS206M	14 1/2"	No. 5	1"	31 lbs.	150.00
CLS206H	16", 16-24", & 2-H	No. 5	1"	32 lbs.	163.00

This attachment should be ordered with the lathe so that it can be properly fitted at the factory.



C Collet Splash Guard

To prevent chips or coolant from flying off of lathe spindle, the collet splash guard is attached to the lathe headstock as shown above. Guard hooks into socket head cap screws and fits snugly around spindle nose and collet, but does not interfere with use of collet attachment. All lathes fitted with both collet attachment and coolant equipment should also be equipped with one of these guards.

Cat. No.	Size and Type of Lathe	Ship. Wt.	Price
CLS223NK	9" Underneath M.D.	2 lbs.	\$2.95
CLS200N	9" Horizontal M.D.	2 lbs.	3.00
CLS200K	Light Ten H.M.D.	2 lbs.	3.25
CLS223R	10" Underneath M.D.	2 lbs.	3.50
CLS223T	13" Underneath M.D.	2 lbs.	3.80
CLS223F	14 1/2" Underneath M.D.	3 lbs.	4.65
CLS223H	16", 16-24", & 2-H U.M.D.	3 lbs.	5.75

D Collet Rack

This collet rack provides a convenient place for keeping collets, centers, spindle sleeve, and draw-bar. Tray along lower edge of collet rack is provided for holding spanner wrench. Clamp for attaching to back V-way of lathe bed is supplied. Price does not include collets or collet attachment.

Catalog Number	Size of Lathe	Rack Holds	Ship. Wt.	Factory Price
CE1770N	9"	19 Collets	9 lbs.	\$17.25
CE1770K	Light Ten	17 Collets	10 lbs.	18.50
CE1770L	10"-1" Collet	17 Collets	10 lbs.	23.50
CE1770Q	13"-1" Collet	17 Collets	12 lbs.	23.50
CE1770M	14 1/2"-1" Collet	17 Collets	14 lbs.	23.50
CE1770H	16", 16-24", and No. 2-H	17 Collets	15 lbs.	23.50

A Three Collets to Choose From

South Bend Collets are manufactured with exacting care to deliver long, dependable service on precision work. Each collet is carefully inspected and tested, and packed in a substantial plastic box with transparent lid through which the size can be read for quick and easy selection.

←R-S-B← (South Bend Red Arrow) STEEL COLLETS. Threads are ground from solid steel after hardening to give you the utmost in precision, durability and smooth, easy operation.

STEEL COLLETS are carefully heat-treated inside and outside, including thread for maximum service and are precision ground to exceedingly close tolerances for size and concentricity.

BRASS COLLETS are indispensable for many applications and have no superior in their accuracy. Can be readily machined for holding tapered or irregular shapes. When worn, they can be rebored to larger diameters.

SPECIFICATIONS OF COLLETS FOR SOUTH BEND LATHES

Collet No.	3	6K	2	4	5
Sizes of Lathes Used on	9"	Light Ten	10"-11 1/8" Col. 13"-11 1/8" Col.	14 1/2" 3/4" Col.	10", 13", 14 1/2", 16", 16-24", & 2-H-1" Col.
A, Thread Diameter, in.650	.775	.865	.950	1.250
B, Thread Length, in.	3/4	2 1/2	1 1/2	1 1/2	3/4
C, Threads per in.	26	26	20	20	20
D, Body Diameter, in.6495	.8425	.8595	.9495	1.2495
E, Collet Length, in.	2 1/8	3	3 3/8	3	3 3/8
F, Head Diameter, in.852	1.160	1.095	1.150	1.452
G, Angle of Head, deg.	12	15	15	10	10

Collet No.	Collet Capacity in 64ths for Round Work	Ship. Wt.	Brass Collets		Steel Collets		←R-S-B← Collets	
			Cat. No.	Fac. Price	Cat. No.	Fac. Price	Cat. No.	Fac. Price

Collets With Standard Hole Sizes for Round Work

3	1/16" to 1/2"	6 ozs.	CE2825	\$1.75	CE2830	\$4.15	CE3050	\$4.40
6K	1/16" to 3/8"	8 ozs.	CE2826	2.10	CE2831	4.30	CE3051	4.55
2	1/16" to 11/16"	8 ozs.	CE2827	2.35	CE2832	4.40	CE3052	4.60
4	1/16" to 3/4"	8 ozs.	CE2829	2.50	CE2834	4.70	CE3053	4.95
5	1/16" to 1"	1 lb.	CE2828	2.90	CE2833	5.25	CE3054	5.50

Collets With Decimal Hole Sizes for Round Work

3	.0625" to .500"	6 ozs.	CE2835	\$1.90	CE2841	\$4.40	CE3055	\$4.65
6K	.0625" to .625"	8 ozs.	CE2836	2.40	CE2842	4.55	CE3056	4.80
2	.0625" to .6875"	8 ozs.	CE2837	2.50	CE2843	4.70	CE3057	4.90
4	.0625" to .750"	8 ozs.	CE2839	2.70	CE2845	4.95	CE3058	5.25
5	.0625" to 1.000"	1 lb.	CE2838	3.10	CE2844	5.50	CE3059	5.75

Collets With Metric Hole Sizes for Round Work

3	1.5 mm to 12.5 mm	6 ozs.	CE2850	\$1.90	CE2855	\$4.40	CE3060	\$4.65
6K	1.5 mm to 15.5 mm	8 ozs.	CE2851	2.40	CE2856	4.55	CE3061	4.80
2	1.5 mm to 17.0 mm	8 ozs.	CE2852	2.50	CE2857	4.70	CE3062	4.90
4	1.5 mm to 19.0 mm	8 ozs.	CE2854	2.70	CE2859	4.95	CE3063	5.25
5	1.5 mm to 25.0 mm	1 lb.	CE2853	3.10	CE2858	5.50	CE3064	5.75

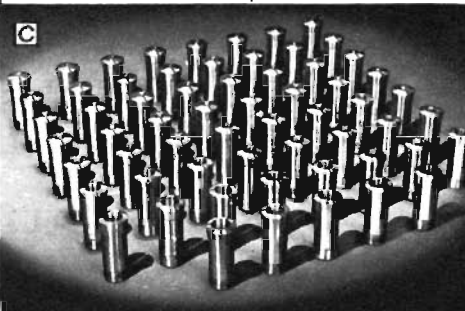
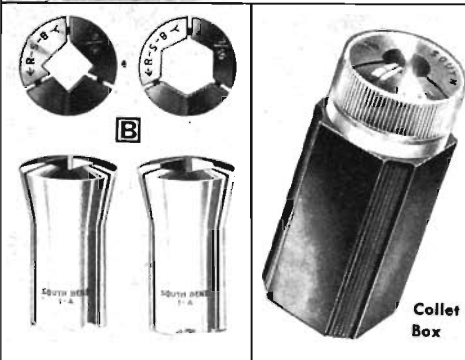
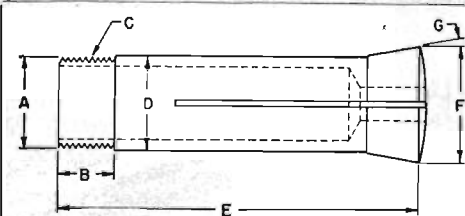
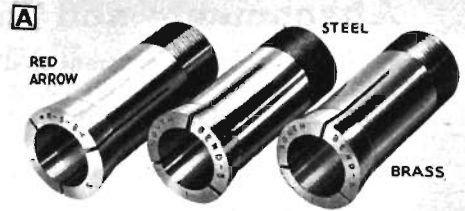

B Collets for Square and Hexagon Work

Collets for holding square and hexagon stock can be supplied in either ←R-S-B← Steel or Brass. Standard sizes of collets are made in sixteenths from 1/8" across flats up to maximum capacity shown in table. Write for information on other sizes.

Collet No.	Ship. Wt.	Collets for Square Work						Collets for Hexagon Work			
		Max. Cap.	Brass		←R-S-B← Steel		Max. Cap.	Brass		←R-S-B← Steel	
			Cat. No.	Fac. Price	Cat. No.	Fac. Price		Cat. No.	Fac. Price	Cat. No.	Fac. Price
3	6 ozs.	5/16"	CE2891	\$4.00	CE3080	\$7.25	7/16"	CE2971	\$4.00	CE3085	\$7.25
6K	8 ozs.	7/16"	CE2892	4.25	CE3081	7.40	1/2"	CE2972	4.25	CE3086	7.40
2	8 ozs.	15/32"	CE2893	4.45	CE3082	7.50	19/32"	CE2973	4.45	CE3087	7.50
4	8 ozs.	17/32"	CE2894	4.70	CE3083	8.00	21/32"	CE2974	4.70	CE3088	8.00
5	1 lb.	11/16"	CE2895	5.00	CE3084	8.50	7/8"	CE2975	5.00	CE3089	8.50

C Collets in Sets

Collets for South Bend Lathes can be supplied in sets as listed in the tabulation. A complete set of collets is especially helpful for toolroom and maintenance work. Often the time saved in getting out a single rush job without having to wait for a collet to come from the factory will more than compensate for the cost of a full set of collets. Each collet is individually packed in a plastic box with transparent lid.

Collet No.	Collets in Set	Ship. Wt. Lbs.	Sizes of Collets	Brass Collets		Steel Collets		←R-S-B← Collets	
				Catalog No.	Fac. Price	Catalog No.	Fac. Price	Catalog No.	Fac. Price
3	8	3	1/16" to 1/2" in 16ths	CE2235	\$13.25	CE2047	\$29.70	CE3065	\$33.95
	7	3	3/32" to 15/32" in odd 32nds	CE2534	11.50	CE2476	26.40	CE3066	29.75
	14	6	5/64" to 31/64" in odd 64ths	CE2535	22.00	CE2477	50.60	CE3067	59.25
6K	10	7	1/16" to 3/8" in 16ths	CE2485	18.50	CE2441	38.45	CE3068	43.75
	9	7	3/32" to 19/32" in odd 32nds	CE2486	16.75	CE2442	34.95	CE3069	39.50
	18	12	5/64" to 35/64" in odd 64ths	CE2487	33.00	CE2443	68.70	CE3070	78.50
2	11	6	1/16" to 11/16" in 16ths	CE2238	24.25	CE2432	42.90	CE3071	48.75
	10	6	3/32" to 21/32" in odd 32nds	CE2536	22.00	CE2478	39.60	CE3072	44.50
	20	12	5/64" to 37/64" in odd 64ths	CE2537	42.00	CE2479	78.10	CE3073	88.50
4	12	7	1/16" to 3/4" in 16ths	CE2244	28.00	CE2438	50.60	CE3074	57.25
	11	7	3/32" to 33/32" in odd 32nds	CE2538	26.00	CE2480	46.20	CE3075	52.50
	22	12	5/64" to 39/64" in odd 64ths	CE2539	48.75	CE2481	89.10	CE3076	104.50
5	16	11	1/16" to 1" in 16ths	CE2241	42.75	CE2435	74.80	CE3077	85.00
	15	11	3/32" to 31/32" in odd 32nds	CE2540	40.50	CE2482	70.40	CE3078	80.00
	30	20	5/64" to 63/64" in odd 64ths	CE2541	75.00	CE2483	139.70	CE3079	159.00

A Handwheel Collet Attachment Complete With Collets

You can save time and money by ordering your collet attachment complete with collets as listed below. Price includes Handwheel Collet Attachment with complete set of Steel Collets or **←R-S-B←** Collets in sixteenths, in sizes from $\frac{1}{16}$ " capacity up to the maximum capacity shown in table. Each collet packed in individual plastic case. Additional collet sets in 32nds and 64ths may be selected from page 36.

Size of Lathe	Number of Collets	Max. Collet Cap.	Shipping Weight	Steel Collets		←R-S-B← Collets	
				Catalog Number	Factory Price	Catalog Number	Factory Price
9"	8	$\frac{1}{2}$ "	9 lbs.	CL5415N	\$ 48.50	CL5417N	\$ 52.50
Light Ten	10	$\frac{3}{8}$ "	10 lbs.	CL5416K	59.50	CL5417K	64.50
10"	16	1"	28 lbs.	CL5416L	128.00	CL5417L	138.00
13"	16	1"	33 lbs.	CL5416Q	133.00	CL5417Q	143.00
14 $\frac{1}{2}$ "	16	1"	35 lbs.	CL5415M	137.00	CL5417M	147.00
16", 16-24", & 2-H	16	1"	35 lbs.	CL5416H	140.00	CL5417H	150.00

B Handlever Collet Attachment Complete With Collets

To be complete, your collet equipment should include a set of collets in sixteenths. Delay caused by waiting for a missing collet size can be more costly than the complete equipment. Price includes handlever collet attachment with a complete set of Steel Collets or **←R-S-B←** Collets in sixteenths, in sizes from $\frac{1}{16}$ " capacity up to the maximum capacity shown in table. Each collet packed in individual plastic case. Additional collet sets in 32nds and 64ths may be selected from page 36. Also collets for square and hexagonal work.

Size of Lathe	Number of Collets	Max. Collet Cap.	Shipping Weight	Steel Collets		←R-S-B← Collets	
				Catalog Number	Factory Price	Catalog Number	Factory Price
9"	8	$\frac{1}{2}$ "	14 lbs.	CL5416N	\$107.50	CL5418N	\$111.50
Light Ten	10	$\frac{3}{8}$ "	15 lbs.	CL5416K	129.50	CL5418K	134.50
10"	16	1"	35 lbs.	CL5416L	197.00	CL5418L	207.00
13"	16	1"	44 lbs.	CL5416Q	210.00	CL5418Q	220.00
14 $\frac{1}{2}$ "	16	1"	51 lbs.	CL5416M	223.00	CL5418M	233.00
16", 16-24" & 2-H	16	1"	52 lbs.	CL5416H	236.00	CL5418H	246.00

C Plastic Collet Boxes

Collets will retain their accuracy indefinitely if protected from accidental damage, dirt, abrasive dust, and corrosion. Keep each collet in one of these substantial plastic boxes with time-saving transparent lid through which the collet size can easily be read. Boxes are square and can be stacked neatly on shelf as shown in illustration. Can also be used for other makes not larger than No. 5 South Bend. See diagram on page 36. These boxes are $1\frac{1}{4}$ " x $2\frac{3}{4}$ " on inside and are ideal for keeping small tools and parts of all kinds.

Cat. No.	Description	Ship. Wt.	Price
CE2190	One Collet Box	1 lb.	\$.25
CE2191	Lot of 10 Collet Boxes	3 lbs.	2.25
CE2192	Lot of 20 Collet Boxes	5 lbs.	4.25
CE2193	Lot of 50 Collet Boxes	14 lbs.	8.75

D Special Combination Sets

Collet Chest With Collet Attachment and Collets

The Collet Chest illustrated and described at right can be supplied fitted with the handwheel type collet attachment for the 9-inch South Bend Lathe and various assortments of steel or brass collets. Space is provided for a full set of 29 collets, regardless of the number of collets included in the price of each of the smaller assortments. This permits adding collets as desired until a full set is acquired.

Cat. No.	Description	Ship. Wt. Lbs.	Factory Price
CE2220	Collet chest, 9" handwheel collet attachment, 29 Steel Collets for round work, $\frac{1}{16}$ " to $\frac{1}{2}$ " in 64ths.....	14	\$135.00
CE2233	Collet chest, 9" handwheel collet attachment, 29 ←R-S-B← Collets for round work, $\frac{1}{16}$ " to $\frac{1}{2}$ " in 64ths.....	14	151.00
CE2228	Collet chest, 9" handwheel collet attachment, 8 Steel Collets for round work, $\frac{1}{16}$ " to $\frac{1}{2}$ " in 16ths.....	12	58.00
CE2234	Collet chest, 9" handwheel collet attachment, 8 ←R-S-B← Collets for round work, $\frac{1}{16}$ " to $\frac{1}{2}$ " in 16ths.....	12	62.00
CE2290	Collet chest, 9" handwheel collet attachment, 29 Brass Collets for round work, $\frac{1}{16}$ " to $\frac{1}{2}$ " in 64ths.....	14	75.00
CE2293	Collet chest, 9" handwheel collet attachment, 8 Brass Collets for round work, $\frac{1}{16}$ " to $\frac{1}{2}$ " in 16ths.....	12	42.00

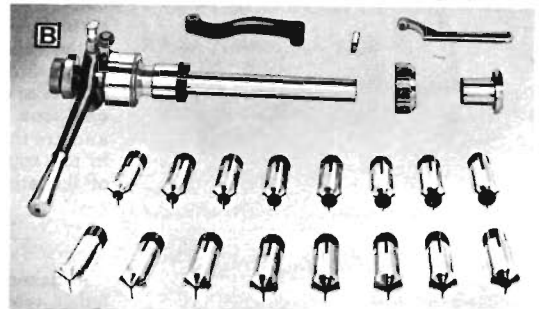
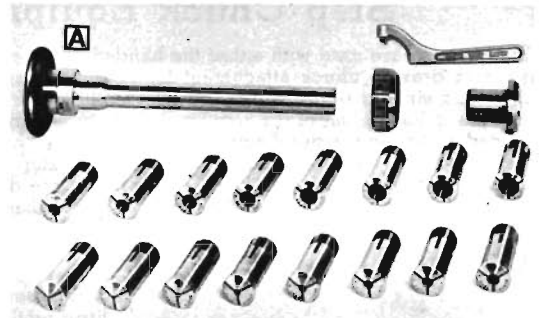

Protects Collets from Damage



Collet Chest

For Holding 9" Collets and Collet Attachment

This is a well-constructed wooden chest for holding the handwheel collet attachment and up to 29 Collets for a 9-inch South Bend Lathe. Hinged lid protects the collets and collet attachment from dust and dirt when not in use. Price does not include collet attachment or collets.

Cat. No. CE2225. Shipping weight 7 lbs. Price \$8.75

Step Chuck Equipment for South Bend Lathes

Step Chucks are used with either the handwheel type or the handlever draw-in chuck attachment for holding discs, gear blanks, and similar round work. The construction of the step chuck is similar to that of the regular collets, except that it is designed for holding larger diameters. A closer screws onto the threaded end of the lathe spindle nose and the step chuck screws into the threaded hole in the draw bar of the draw-in collet chuck attachment. As the step chuck is drawn back into

the closer by the draw-bar of the collet attachment, the three jaws of the step chuck are tightened on the work by the taper inside the step chuck closer.

The work is rigidly supported and can be chucked quickly and accurately. The large gripping surface prevents distortion of thin walled parts such as tubing, and also prevents marring the work.

A Closers for Step Chucks

A closer is required for each size of step chuck, with exception of the 2" size which fits directly into the collet sleeve included in the equipment of the collet attachment. Step chuck closers are made of cast iron or steel, and are threaded to fit the spindle nose of the lathe.

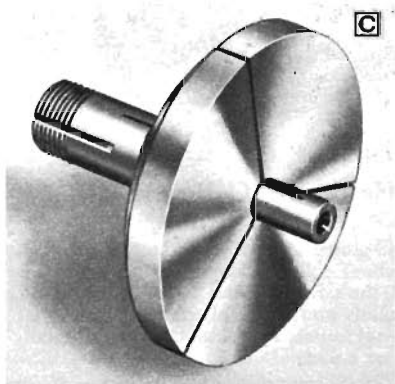
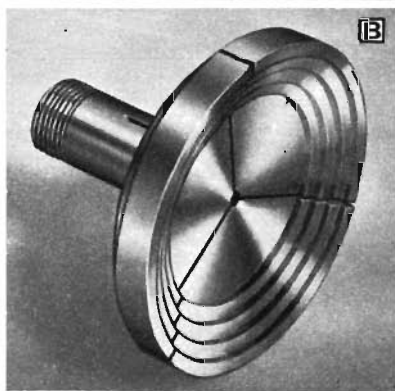
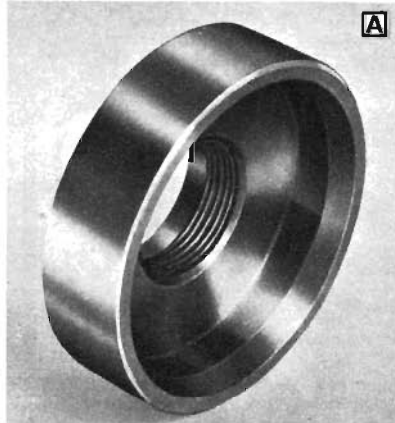
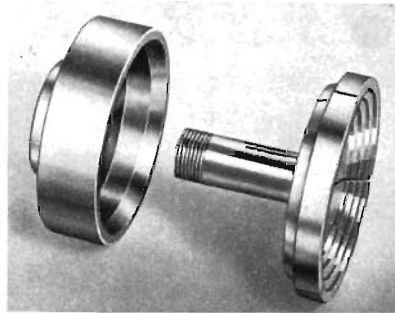

Catalog Number	Size Lathe	Takes Step Chuck Sizes	Shipping Weight	Factory Price
CL6309NK CL6311NK	9" & Light Ten	3" and 4" 5" and 6"	3 lbs. 5 lbs.	\$ 5.75 9.00
CL6309LQ CL6311LQ	10" and 13"	3" and 4" 5" and 6"	4 lbs. 6 lbs.	8.50 11.50
CL6309MH CL6311MH	14 1/2", 16", 16-24" & 2-H	3" and 4" 5" and 6"	5 lbs. 7 lbs.	9.50 13.25

B Finished Step Chucks

Finished step chucks have 4 to 6 steps which are finished to the diameters indicated in table below. Steps are 1/16" deep, and may be remachined as required to any larger diameter up to the maximum capacity of the step chuck.

Size Lathe	Nominal Size	Diameters of Steps	Ship. Wt.	Cat. No.	Factory Price
9"	2"	2", 1 3/4", 1 1/2", 1"	2 lbs.	CE5960*	\$11.00
	3"	3", 2 3/4", 2 1/2", 2 1/4", 2", 1 1/2"	3 lbs.	CE5961	15.75
	4"	4", 3 1/2", 3 1/4", 3", 2 3/4", 2 1/2"	5 lbs.	CE5962	17.25
	5"	5", 4 1/2", 4", 3 1/2", 3 1/4", 3"	8 lbs.	CE5963	19.00
	6"	6", 5 1/2", 5", 4 1/2", 4 1/4", 4"	12 lbs.	CE5964	21.50
Light ten	2"	2", 1 3/4", 1 1/2", 1"	3 lbs.	CE5965*	11.50
	3"	3", 2 3/4", 2 1/2", 2 1/4", 2", 1 1/2"	4 lbs.	CE5966	15.75
	4"	4", 3 1/2", 3 1/4", 3", 2 3/4", 2 1/2"	6 lbs.	CE5967	17.50
	5"	5", 4 1/2", 4", 3 1/2", 3 1/4", 3"	8 lbs.	CE5968	19.50
	6"	6", 5 1/2", 5", 4 1/2", 4 1/4", 4"	12 lbs.	CE5969	22.25
10", 13", 14 1/2", 16", 16-24", & 2-H	2"	2", 1 3/4", 1 1/2", 1"	4 lbs.	CE5975*	12.25
	3"	3", 2 3/4", 2 1/2", 2 1/4", 2", 1 1/2"	4 lbs.	CE5976	17.00
	4"	4", 3 1/2", 3 1/4", 3", 2 3/4", 2 1/2"	5 lbs.	CE5977	19.00
	5"	5", 4 1/2", 4", 3 1/2", 3 1/4", 3"	9 lbs.	CE5978	21.25
	6"	6", 5 1/2", 5", 4 1/2", 4 1/4", 4"	13 lbs.	CE5979	22.75

*This step chuck fits directly into collet sleeve and does not require a closer.

C Step Chuck Blanks

Extreme precision can be attained by mounting a step chuck blank in the closer of the lathe on which it is to be used and machining either multiple steps or a single cavity to receive the work. The cavity obviously will run dead true and should chuck the work to be machined with perfect concentricity.

Step chuck blanks are made in various sizes having a maximum capacity of 2", 3", 4", 5", and 6" respectively. The 2" size fits directly into the collet sleeve and does not require a closer, but all other sizes must be used with a closer of required size.

Size Lathe	Nominal Size	Max. Cap.	Shipping Weight	Catalog Number	Factory Price
9"	2"	2"	2 lbs.	CE5916*	\$ 8.25
	3"	3"	3 lbs.	CE5917	11.25
	4"	4"	5 lbs.	CE5918	12.75
	5"	5"	8 lbs.	CE5919	14.50
	6"	6"	12 lbs.	CE5920	17.25
Light Ten	2"	2"	3 lbs.	CE5936*	8.75
	3"	3"	4 lbs.	CE5937	11.50
	4"	4"	6 lbs.	CE5938	13.25
	5"	5"	8 lbs.	CE5939	15.25
	6"	6"	12 lbs.	CE5940	17.75
10", 13", 14 1/2", 16", 16-24", & 2-H	2"	2"	4 lbs.	CE5926*	9.50
	3"	3"	4 lbs.	CE5927	12.50
	4"	4"	5 lbs.	CE5928	14.50
	5"	5"	9 lbs.	CE5929	16.75
	6"	6"	13 lbs.	CE5930	18.50

*This step chuck fits directly into collet sleeve and does not require a closer.

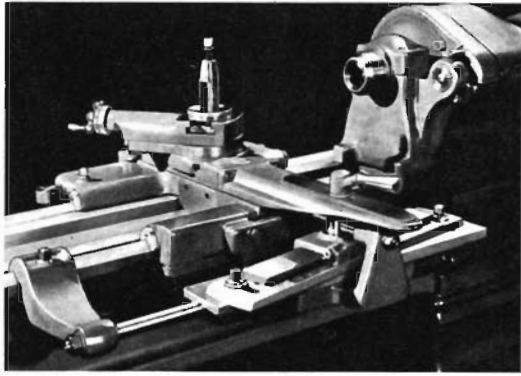

Taper Attachment

Taper turning and boring are as easily accomplished as straight turning on lathes equipped with the South Bend Telescopic Taper Attachment. The taper attachment swivel bar is graduated in degrees on one end and taper in inches per foot on the other end.

The telescopic taper attachment is supplied on 10"-1" Collet and larger lathes. A telescopic cross-feed screw eliminates the necessity of disconnecting the cross-feed nut when the tapers are machined. The cross-feed screw may be used to adjust the lathe tool for the required diameter. When the binding lever is tightened, the cross slide base is rigidly locked to the taper attachment swivel slide, and the thrust is removed from the cross-feed screw.

A plain taper attachment is supplied for the 9-inch and Light Ten lathes. This taper attachment has plain cross-feed screw and straight gibs. The cross-feed screw and nut must be disconnected before the taper attachment can be engaged for taper turning and boring.

The taper attachment is permanently mounted on the lathe carriage and is always ready for use. It does not in any way interfere with straight turning and boring, and only a few seconds are required to change over from straight to taper work. Accuracy and smooth operation are assured by the practical design and rugged construction of this attachment.

The taper attachment must be fitted to lathe at factory.

Taper Attachment With English Graduations

Cat. No.	Size of Lathe	Swing Over Cross Slide	Maximum Taper			Approx. Ship. Wt.	Factory Price
			At One Setting	Per Foot	In Degrees		
CL428NK	9"	5"	7"	3 1/2"	16 1/2	35 lbs.	\$105.50
CL428NK	Lt. 10"	5 7/8"	7"	3 1/2"	16 1/2	35 lbs.	105.50
CL1545R	10"	5 3/4"	8 1/2"	3 1/2"	16 1/2	40 lbs.	188.00
CL1545T	13"	8"	9 1/2"	3 1/2"	16 1/2	65 lbs.	214.00
CL1545F	14 1/2"	8 1/2"	9 1/2"	3 1/2"	16 1/2	80 lbs.	230.00
CL1545H	16"	9 5/8"	11 1/2"	3 1/2"	16 1/2	100 lbs.	257.00
CL1545H	16-24"	18 3/4"	11 1/2"	3 1/2"	16 1/2	100 lbs.	257.00

METRIC TAPER ATTACHMENT with metric graduations can be supplied for any size of type of South Bend Lathe. Write for information.

Extra Tool Posts

Machining time can often be saved by using two tool posts simultaneously. Tool posts may be mounted close together by grinding off sides of tool post rings. Made of heat-treated steel. Price includes tool post assembly complete.



Catalog Number	Size Lathe	Dimensions In Inches			Ship. Wt.	Factory Price
		Dia.	Opening	Block		
CE2450NK	9" & Lt. Ten	1 1/2	1 1/2 x 1 1/2	1 1/2 x 1 1/2 x 1 1/2	2 lbs.	\$ 7.25
CE2450R	10"	1 1/2	1 1/2 x 1 1/2	1 1/2 x 1 1/2 x 1 1/2	2 lbs.	8.75
CE2450T	13"	1 1/2	1 1/2 x 1 1/2	1 1/2 x 1 1/2 x 1 1/2	3 lbs.	11.00
CE2450F	14 1/2"	1 1/2	1 1/2 x 1 1/2	1 1/2 x 2 x 2 1/2	4 lbs.	14.25
CE2450H	16"	1 1/2	1 1/2 x 1 1/2	1 1/2 x 2 1/4 x 2 1/2	5 lbs.	15.25

Costly finishing operations can often be eliminated by precision turning and boring in the lathe.

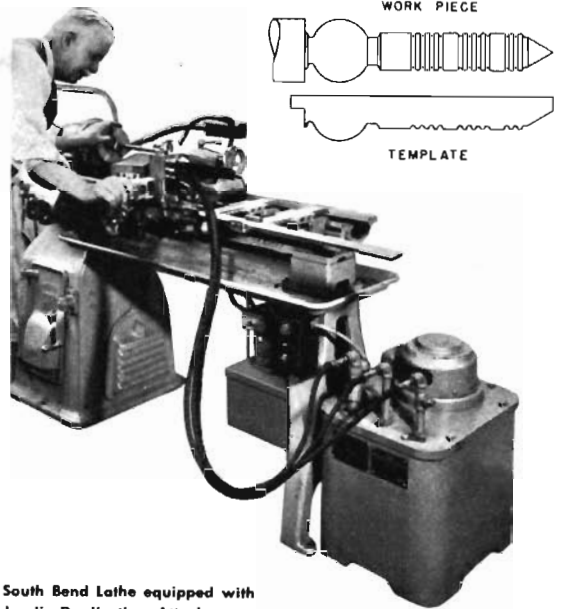

10" South Bend Lathe equipped with Hydraulic Duplicating Attachment

Duplicating Attachment

Any size or type of South Bend Lathe can be supplied to order with a tracer controlled hydraulic duplicating attachment for turning and boring irregular shapes as well as simple straight and tapered shafts with any number of steps.

With this equipment, a simple single point tool controlled by a template is used instead of complicated multiple-tool set-ups or forming tools. Duplicate parts may be produced without effort and a high degree of accuracy maintained. No measurements need to be made during operation and possibility of human error is thus reduced. High cutting speeds may be employed as the single point tool causes less vibration than multiple tool or forming tool setups.

Only one template and one cutting tool are required for each job. Either the easily made round master workpiece, or the more conveniently stored flat template may be used. The tracer tool slide replaces the regular compound rest of the lathe. A sensitive tracer follows the template to control movement of the cutting tool through a hydraulic cylinder. Work may be mounted either between centers or in the lathe chuck.

Write for complete information on any size or type of South Bend Lathe equipped with tracer controlled hydraulic duplicating attachment.

FAST Tapping Attachment for LATHES

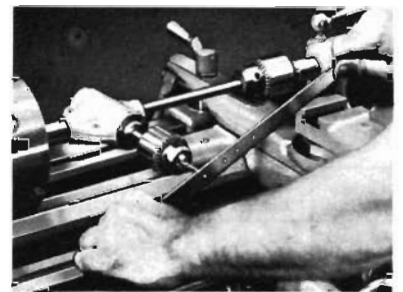

This new design attachment is chucked at the headstock for driving and anchored at the tailstock in the drill chuck. Taps up to 1/4"-20 TPI in steel up to 1/4" in thickness. Chuck for holding taps is furnished with the attachment. Bevel gears drive the tap forward or reverse. Work piece is held in hands of operator. Thread is tapped when work piece is "pushed" against tap. Slightest "pull" at end of thread reverses tap for withdrawing. Lathe spindle rotates constantly. Mounts and demounts in seconds. A versatile and ingenious device that every shop should have.

Cat. No. CE3145. Fast Tapping Attachment. \$24.50

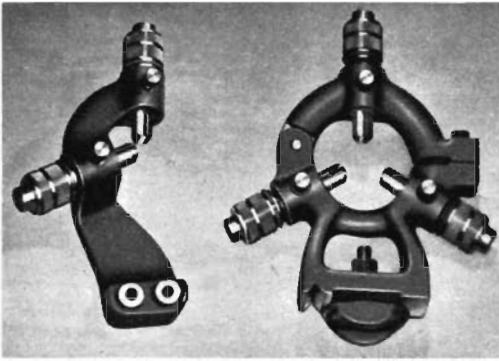

Telescoping Jaw Steady Rest and Follower Rest

To provide quicker and more efficient operation, the Telescoping Jaw Follower Rest and Steady Rest have been developed. Principal features of both the Follower Rest and Steady Rest are wrenchless adjustment and locking of the telescoping jaws. Each jaw has a large knurled knob for adjusting the jaw position, and a thumb screw for locking. An ingeniously designed double acting compound screw thread provides approximately 3/16" jaw movement for each revolution of the adjusting knob.

The jaws are made of brass and slide through precision steel sleeves which are pressed into the supporting frame. Manufactured to close tolerances throughout, the jaws and other parts are replaceable.

Steady Rest

The Steady Rest is clamped to the inside bed ways, and is used to support long, slender shafts mounted between the lathe centers. It is also used to support the outer end of a bar or shaft in such a way that it may be drilled, bored, reamed, etc., with tools mounted in the tailstock or in the tool post of the lathe. The top of the steady rest is hinged to facilitate inserting and removing shafts.

Telescoping Jaw Steady Rest

Catalog Number	Size Lathe	Maximum Capacity	Minimum Capacity	Shipping Weight	Factory Price
CL2400N	9 inch	3 in.	3/8 in.	11 lbs.	\$ 14.50
CL2400K	Light Ten	3 in.	3/8 in.	11 lbs.	15.75
CL2400R	10 inch	3 in.	3/8 in.	13 lbs.	18.00
CL2400T	13 inch	3 3/4 in.	3/8 in.	21 lbs.	22.00
CL2400F	14 1/2 inch	4 3/4 in.	3/8 in.	28 lbs.	25.75
CL2400H	16" & 2-H	4 3/4 in.	3/8 in.	30 lbs.	28.50
CL2400V	16-24"	4 3/4 in.	3/8 in.	47 lbs.	37.50

Follower Rest

The Follower Rest is attached to the lathe carriage and travels with the carriage. The follower rest is used to support long, slender shafts while being machined between the lathe centers.

Telescoping Jaw Follower Rest

Catalog Number	Size Lathe	Maximum Capacity	Minimum Capacity	Shipping Weight	Factory Price
CL2395N	9 inch	2 in.	3/8 in.	7 lbs.	\$ 9.25
CL2395K	Light Ten	2 in.	3/8 in.	7 lbs.	10.50
CL2395R	10 inch	2 1/2 in.	3/8 in.	9 lbs.	11.50
CL2395T	13 inch	3 1/4 in.	3/8 in.	11 lbs.	13.00
CL2395F	14 1/2 inch	4 1/4 in.	3/8 in.	15 lbs.	15.50
CL2395H	16" & 2-H	4 1/4 in.	3/8 in.	17 lbs.	17.00
CL2395V	16-24"	4 1/4 in.	3/8 in.	21 lbs.	23.25

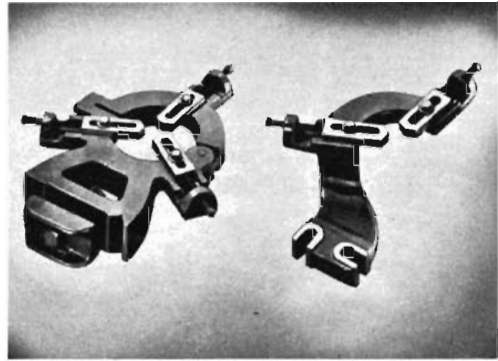

Regular Steady Rest and Follower Rest

The Regular Steady Rest and Follower Rest are ruggedly designed to provide a rigid support for the work. The jaws are made of cast iron, are machined all over and have adjusting screws and lock screws for setting and securing them in the desired position.

Steady Rest

The Steady Rest clamps onto the inside ways of the lathe bed and is used for supporting long shafts, boring spindles, etc. The top of the steady rest is hinged to facilitate inserting and removing shafts.

Regular Steady Rest

Catalog Number	Size Lathe	Maximum Capacity	Minimum Capacity	Shipping Weight	Factory Price
CL1177N	9 in.	3 in.	1/4 in.	10 lbs.	\$ 9.75
.....	Light Ten	Not Made
CL1177R	10 in.	3 in.	1/4 in.	11 lbs.	14.25
CL1177T	13 in.	3 3/4 in.	3/8 in.	19 lbs.	18.00
CL1177F	14 1/2 in.	4 3/4 in.	3/8 in.	27 lbs.	22.00
CL1177H	16" & 2-H	4 3/4 in.	3/8 in.	29 lbs.	24.75
CL1177V	16-24 in.	4 3/4 in.	3/8 in.	47 lbs.	33.75

Follower Rest

The Follower Rest is attached to the lathe carriage and travels with the carriage. The Follower Rest is used to support long, slender shafts while being machined between the lathe centers. Slots used for attaching follower rest to carriage permit attaching or removing quickly as it is not necessary to remove the screws from the saddle.

Regular Follower Rest

Catalog Number	Size Lathe	Maximum Capacity	Minimum Capacity	Shipping Weight	Factory Price
CL1353N	9 in.	2 in.	3/8 in.	4 lbs.	\$ 6.50
.....	Light Ten	Not Made
CL1353R	10 in.	2 1/2 in.	3/8 in.	6 lbs.	9.75
CL1353T	13 in.	3 1/2 in.	3/8 in.	9 lbs.	11.00
CL1353F	14 1/2 in.	4 1/4 in.	3/8 in.	12 lbs.	13.00
CL1353H	16" & 2-H	4 1/4 in.	3/8 in.	13 lbs.	14.25
CL1353V	16-24 in.	4 1/4 in.	3/8 in.	18 lbs.	20.50

Extra Large Steady Rest

Similar to steady rests described above, but with capacity for large diameter work. Takes from 4-3/4" diameter to 10-3/4" diameter.



Cat. No.	Lathe	Ship. Wt.	Price
Telescoping Jaw Extra Large Steady Rest			
CL2266H	16" & No. 2-H	65 lbs.	\$56.25
CL2266V	16-24"	85 lbs.	64.75
Regular Style Extra Large Steady Rest			
CL2258H	16" & No. 2-H	75 lbs.	42.00
CL2258V	16-24"	95 lbs.	50.75

PRICES IN THIS CATALOG are net f.o.b. South Bend, Indiana unless otherwise stated. In accordance with our established policy prices are subject to change without notice and accordingly prices herein are not necessarily those at which deliveries will be made at any future date because we reserve the right to invoice future deliveries at prices in effect at that time.

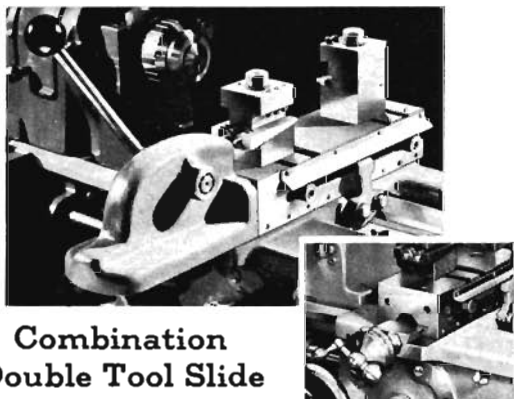

Combination Double Tool Slide

This combination Handlever and Screw Feed Double Tool Cross Slide is mounted on the saddle dovetail in place of the compound rest assembly. It does not interfere with the power longitudinal carriage feeds. The power cross-feed can be used by removing the handlever and replacing it with the cross-feed screw. Cross-feed nut is supplied for either English or metric pitch thread. Adjustable stops limit the movement of the cross slide in either direction, in or out. Handlever can be used on either side.

This cross slide has front and back square tool blocks in which $\frac{7}{16}$ " square cutter bits can be mounted. T-slots in the cross slide base permit adjusting the positions of the tool blocks. The front tool block takes two cutter bits, and the back tool block takes one cutter bit. Tapered wedges and thumb screws provide adjustment for the height of cutter bits.

Cat. No.	Size Lathe	Cross-Feed	Ship. Wt.	Price*
CL2030N	9"	ENGLISH	36 lbs.	\$104.00
CL2030K	Light Ten		37 lbs.	110.00
CL2030R	10"		45 lbs.	123.00
CL2030NME	9"	METRIC	36 lbs.	104.00
CL2030KME	Light Ten		37 lbs.	110.00
CL2030RME	10"		45 lbs.	123.00

*Can be supplied less handlever at lower prices. Write for information.

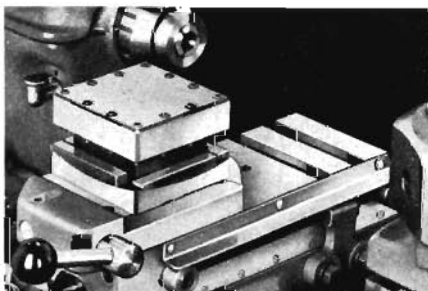

Patented

Square Turret Tool Block for Double Tool Cross Slide

The Square Turret Tool Block shown above is designed for use on the screw feed double tool cross slide. It cannot be used on the compound rest cross slide.

Four cutting tools can be mounted in the turret tool block. The turret indexes accurately, permitting each tool to be used in sequence for rough turning, finish turning, facing, boring, cutting-off, or other operations as required. A quick acting lever locks the turret securely in each of the four positions. Rocker adjustment is provided for adjusting the height of the cutting edge of each tool.

Square Turret Tool Block for Double Tool Slide

Catalog Number	Size of Lathe	Size Square	Takes Tools	Ship. Weight	Factory Price
CL3376NR	9" and 10"	3"	$\frac{3}{8}$ " x $\frac{3}{8}$ "	10 lbs.	\$41.50
CL3376K	Light Ten	3"	$\frac{3}{8}$ " x $\frac{3}{8}$ "	11 lbs.	41.50
CL3376T	13"	3"	$\frac{3}{8}$ " x $\frac{3}{8}$ "	20 lbs.	57.00
CL3376H	16" & No. 2-H	4"	$\frac{3}{8}$ " x $\frac{3}{8}$ "	28 lbs.	85.00

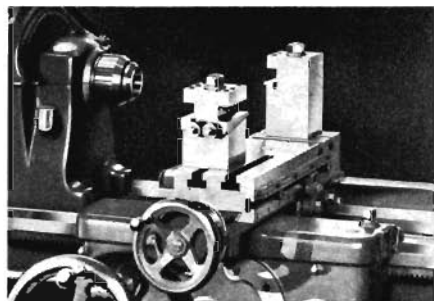

Screw Feed Double Tool Cross Slide for 13" and 16" South Bend Lathes

This cross slide fits on the saddle dovetail in place of the compound rest assembly. The cross-feed may be operated by power through the friction clutch in the apron, as well as by the cross-feed handwheel. A large diameter micrometer graduated collar permits adjusting the cutting tools with extreme precision. Cross-feed screw and graduations are supplied in either English or metric system.

Adjustable stops are provided for locating the position of the front and rear tools for repetitive operations. See page 50 for four-position stop. The front tool block takes two square cutter bits and the back tool block takes one square cutter bit. Tapered wedges are provided for adjusting the height of the cutter bits. T-slots in the cross slide base are provided for adjusting the position of the tool blocks. Should be ordered with the lathe.

Catalog Number	Size Lathe	Cross-Feed	Size Bit	Shipping Weight	Factory Price
CL2027T	13"	ENGLISH	$\frac{7}{16}$ " sq.	60 lbs.	\$157.00
CL2027H	16"		$\frac{9}{16}$ " sq.	95 lbs.	170.00
CL2027TME	13"	METRIC	$\frac{7}{16}$ " sq.	60 lbs.	157.00
CL2027HME	16"		$\frac{9}{16}$ " sq.	95 lbs.	170.00



Patented

Square Turret Tool Block for Compound Cross Slide

The Square Turret Tool Block shown above is designed for use on the base of the compound cross slide. It cannot be used on the double tool cross slide.

Four cutting tools can be mounted in the turret tool block. The turret indexes accurately, permitting each tool to be used in sequence for rough turning, finish turning, facing, boring, cutting-off, or other operations as required. A quick acting lever locks the turret securely in each of the four positions. Rocker adjustment is provided for adjusting the height of the cutting edge of each tool.

Square Turret Tool Block for Compound Cross Slide

Catalog Number	Size of Lathe	Size Square	Takes Tools	Shipping Weight	Factory Price
CL3375N	9"	3"	$\frac{3}{8}$ " x $\frac{3}{8}$ "	13 lbs.	\$46.00
CL3375K	Light Ten	3"	$\frac{3}{8}$ " x $\frac{3}{8}$ "	14 lbs.	48.50
CL3375T	10"	3"	$\frac{3}{8}$ " x $\frac{3}{8}$ "	15 lbs.	52.00
CL3375R	13"	3"	$\frac{3}{8}$ " x $\frac{3}{8}$ "	24 lbs.	58.50
CL3375F	14 $\frac{1}{2}$ "	4"	$\frac{3}{8}$ " x $\frac{3}{8}$ "	36 lbs.	84.00
CL3375H	16" and 16-24"	4"	$\frac{3}{8}$ " x $\frac{3}{8}$ "	40 lbs.	91.00

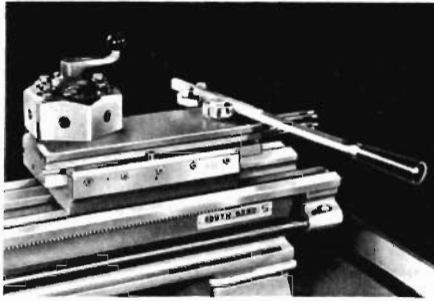

Handlever Bed Turret for 9", 10", and 13" South Bend Lathes

The Handlever Bed Turret mounts on the inside bed ways and can be locked in position at any point along the length of the bed. The turret head indexes automatically when the feed lever is pushed to the extreme right. Each face of the turret has an independently adjustable feed stop screw which accurately regulates the length of the cut. Ram lock is provided.

Accurate indexing of the turret head (within plus or minus .0005" measured 4" from turret face) is assured by the use of hardened, ground, and superfinished index pin which operates in heat-treated steel bushings.

The effective feed of the turret slide is 4". Center of turret hole to top of turret slide 1 1/2". Takes standard turret tools with 5/8" diameter shank*. Distance between opposite flats on turret head is 4 7/8". When turret is ordered separate from lathe, the purchaser must assume the responsibility of fitting turret to lathe and boring turret head.

Catalog Number	Size Lathe	Shipping Weight	Factory Price
CL1611N	9"	76 lbs.	\$273.00
CL1611K	Light Ten	76 lbs.	280.00
CL1611R	10"	83 lbs.	286.00
CL1611T	13"	130 lbs.	308.00

*Can be supplied to order with 3/4" holes in turret face. No extra charge.

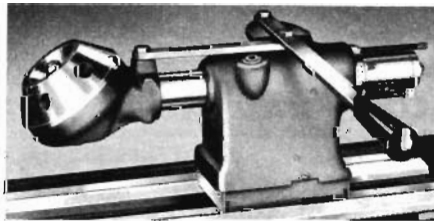

Handlever Turret (Tailstock Type) for 9", 10", and 13" South Bend Lathes

This handlever turret is mounted on the lathe bed in place of the tailstock. The turret head has six holes for tools with 5/8" diameter shanks. Adjustable stops are provided for each of the six turret holes. The turret head is geared to the stop roll so that the stop is brought in line with each stop screw as the corresponding tool in the turret head is revolved to the working position. The indexing mechanism is of high carbon heat-treated steel. Index lock releases automatically at the end of the return movement of the turret slide. The turret head is revolved by hand. The maximum length of stroke is 3 3/4 inches. When ordered separate from lathe, purchaser must assume the responsibility of fitting and boring.

Cat. No.	Size Lathe	Shipping Weight	Price
CL2045N	9"	50 lbs.	\$116.00
CL2045K	Light Ten	50 lbs.	123.00
CL2045R	10"	60 lbs.	134.00
CL2045T	13"	90 lbs.	161.00

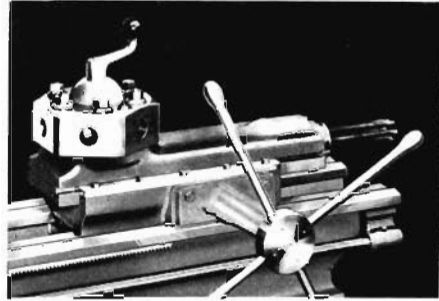

Bed Turret for 16" Lathe

The Hand Feed Turnstile Bed Turret is mounted on the inside bed ways of the lathe. The large turnstile is provided for hand operated turret slide feeds. No power feed is available.

The turret head is hexagonal in shape, having six accurately machined faces. It indexes automatically when the turret slide is returned to the starting position. An individual feed stop is provided for each face of the turret. The stop accurately regulates the length of the cut. The turret head may be back indexed or spun when it is desired to skip tool positions.

Accurate indexing (within plus or minus .0005" measured 4" from turret face) is assured by the use of a hardened, ground, and superfinished index pin which operates in heat-treated steel bushings. The indexing bushings are replaceable. The main central bearing is tapered for adjustment. The turret head is locked securely in position by a substantial binder. The turret slide has tapered gibs on both sides which provide adjustment for wear and alignment. Ram lock is provided.

Effective feed of turret slide 5 7/8". Center of turret hole to top of turret slide 2 1/2". Takes standard turret tools with 1 1/2" diameter shank. Distance between opposite turret flats is 9 3/8". When turret is ordered separate from lathe, the purchaser must assume the responsibility of fitting and boring.

Cat. No. CL1917H. Hand Feed Turnstile Bed Turret for 16" South Bend Lathe. Ship. wt. 505 lbs. Price.....\$683.00

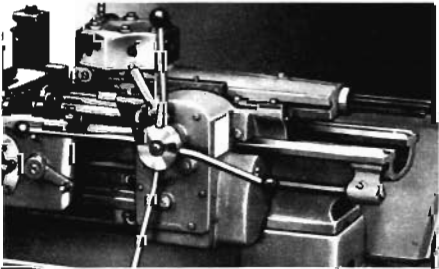

Bed Turrets for 13" Lathe

This turret for 13" lathe can be supplied with power and hand feed or with turnstile hand feed only. It has independent feed trip and stop for each of the six turret faces. Effective feed of turret slide is 6 1/2". Quick change box of lathe provides 144 power turret feeds .0006" to .1093". Lever shift gears in turret apron provide quick selection of fast, intermediate or slow feeds. Direction of feed is reversed by changing gears in turret apron. Turret head revolves on a precision ball bearing and has six 1" diameter holes for tools. Turret head indexes and locks automatically on the return stroke of the turret slide. Turret ram lock is provided. Clearance from center of tool hole to top of turret slide is 1 1/2". When ordered separate from lathe, customer must assume responsibility of fitting and boring, however the design of this turret is such that relatively little fitting is required for either the power feed type or hand feed type. Mounting instructions furnished with each turret.

Cat. No. CL1917T. Hand Feed Turnstile Bed Turret for 13" South Bend Lathe. Approx ship. wt. 346 lbs. Price.....\$495

Cat. No. CL2620T. Power Feed Turnstile Bed Turret for 13" South Bend Lathe. Approx. ship. wt. 414 lbs. Price.....\$698

Duplex Turret Tool Holder

With this Duplex Turret Tool Holder, two tools can be mounted on one face of the turret head. Shank of tool holder fits into turret head and tools are mounted in two holes in holder. Lever on holder is used to turn each tool into operating position as required. Adjustable stops position tool with sufficient accuracy for most drilling, reaming, or tapping operations.



Cat. No.	Shank Size		Hole Size		Ship. Wt. Pounds	Factory Price
	Dia.	Length	Dia.	Length		
CE2666	5/8"	1 1/2"	3/8"	3/4"	4	\$29.00
CE2667	3/4"	1 1/2"	3/8"	3/4"	6	30.00
CE2668	1"	1 1/2"	3/8"	3/4"	8	31.00
CE2669	1 1/2"	2 3/8"	1"	1 1/4"	10	42.00

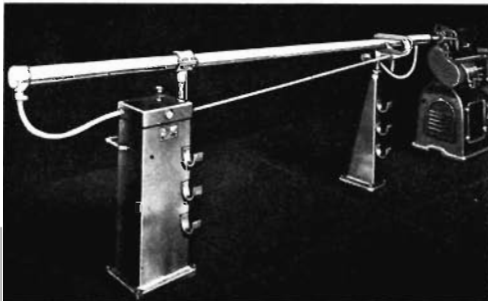

Pneumatic Bar Feed

This Pneumatic Bar Feed unit takes a twelve foot bar of stock, any shape or size, up to the maximum capacity through the bar feed cylinder, provided the bar is no larger than the hole through the lathe spindle or collet. Air pressure forces the stock forward instantly when the collet or chuck is opened. The stock is held firmly against the stop until the collet is closed.

Low air pressure is required for operating the pneumatic bar feed unit. (Price does not include air compressor). Shipped direct from factory in New York.

Cat. No. CE1881. Lipe Pneumatic Bar Feed Unit, 1" maximum bar capacity. Ship. wt. 385 lbs. Price..... \$285.00

Cat. No. CE1882. Lipe Pneumatic Bar Feed Unit, 2" maximum bar capacity. Ship. wt. 410 lbs. Price..... \$295.00

Indexing Attachment for 10" Lathe Headstock

With this attachment the lathe spindle can be accurately indexed for fluting, splining, graduating, cross-drilling, and similar operations. Changeable index wheels are attached to the left end of the spindle, leaving the spindle nose free for mounting chucks, face plates, or other work holding fixtures. The index wheels do not interfere with work passed through the headstock. A spring latch index pin is rigidly attached to the headstock and engages the index wheel to position the spindle. The equipment includes eight index wheels having 45, 56, 60, 64, 72, 80, 84, and 100 divisions respectively. This attachment should be ordered with the lathe and fitted at the factory. It cannot be used with a collet attachment.

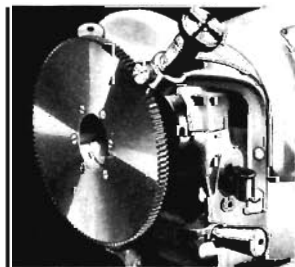

CL2505L, Indexing Attachment for 10"-1" Collet Lathe. Shipping weight 30 lbs. Factory Price..... \$115.00

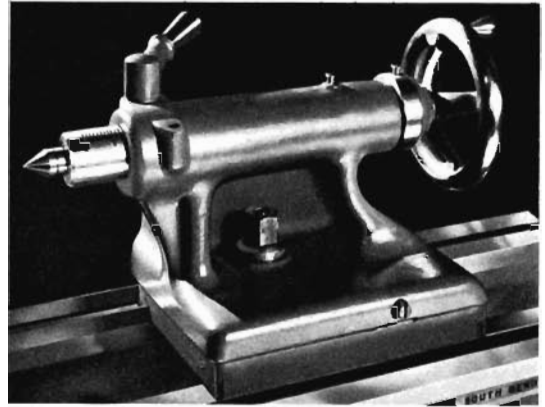

Tailstocks for South Bend Turret Lathes

Prices of South Bend Turret Lathes do not include tailstock. Standard set-over type tailstock illustrated above can be supplied to order. Tailstock mounts on the lathe bed, in place of the turret, for machining work between centers. Spindle is graduated and is fitted with a 60° hardened center. Tailstock has set-over for taper turning. This unit should be ordered with the lathe and fitted at the factory.

Catalog No.	Size Lathe	Size Center	Shipping Weight	Factory Price
CL2036N	9"	No. 2 M.T.	22 lbs.	\$ 43.50
CL2036K	Light Ten	No. 2 M.T.	22 lbs.	60.00
CL2036R	10"	No. 2 M.T.	42 lbs.	76.00
CL2036T	13"	No. 3 M.T.	90 lbs.	137.00
CL2036P	No. 2-H	No. 3 M.T.	133 lbs.	171.00

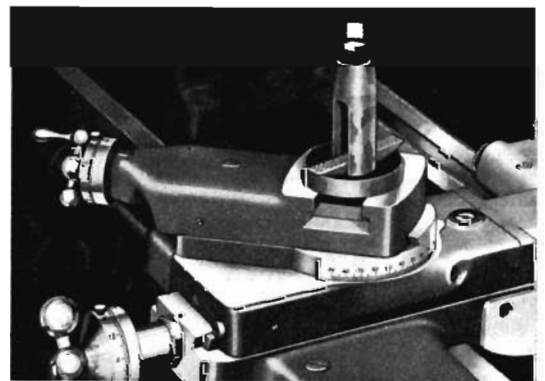

Compound Rest Cross Slides for South Bend Turret Lathes

The compound rest type cross slide can be supplied for use on the saddle cross slide dovetail of any South Bend Turret Lathe in place of the double tool cross slide. This compound rest is the same as is regularly supplied with the corresponding size of lathe.

Price includes compound rest top, swivel, and base assembly complete with tool post. Cannot be used with double tool slide. When this unit is required, it should be ordered with the lathe and fitted at the factory.

Cat. No.	Size Lathe	Ship. Wt.	Factory Price
CL2200N	9"	13 lbs.	\$ 38.50
CL2200K	Light Ten	14 lbs.	39.50
CL2200R	10"	15 lbs.	63.00
CL2200T	13"	30 lbs.	98.00
CL2200P	2-H	50 lbs.	125.00

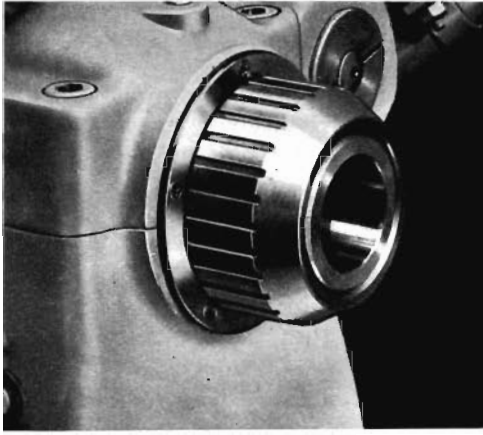

Spindle Nose Thread Protector

The threads of the lathe spindle nose should be protected against accidental damage at all times. When a lathe chuck or face plate is not in use, the Spindle Nose Thread Protector shown above should be used. Price includes spanner wrench for removing thread protector from spindle nose thread.

Catalog Number	Thread Size	Size Lathe	Shipping Weight	Factory Price
CL3S1SNK	1 1/2"-8	9" & Light Ten	2 lbs.	\$4.75
CL3S1SLT	2 1/4"-8	10" & 13"	3 lbs.	5.95
CL3S1SFH	2 3/8"-6	14 1/2", 16", 16-24" & 2-H	4 lbs.	8.95

Swiveling Machine Handles

Swivel type machine handles are standard equipment on 10"-1" collet and larger South Bend Lathes. They can be supplied in lieu of the regular solid machine handles for the 9" and Light Ten Lathes. The swivel handle is made in two parts, having an outer sleeve which revolves on a spindle. When swivel machine handles are wanted in lieu of the solid machine handles, they must be specified when lathe is ordered.



CL2605NK. Swiveling Machine Handles for apron handwheel, cross-feed knob, and tailstock handwheel in lieu of regular machine handles on 9" or Light Ten Lathes. Price \$1.95

Motor Belt Guard for 9" Bench Lathe

This guard is designed to enclose the motor pulley, motor V-belt, and countershaft drive pulley of 9-inch Horizontal Motor Driven Bench Lathes. It can be used with any 9-inch Horizontal Motor Drive Unit made since Feb. 1940. Guard is attached to the motor drive frame by a cap screw or bolt and a dowel pin. Frame must be drilled for pin and bolt or tapped for screw.

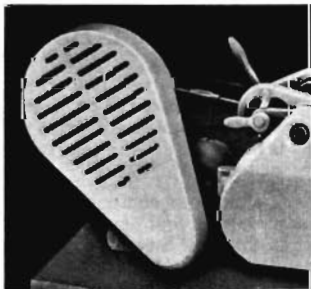

CL2885. Motor Belt Guard for 9" Horizontal Motor Drive with 1/3 h.p. or 1/4 h.p. motor. Ship. wt. 26 lbs. Price . . . \$12.00

CL2886. Motor Belt Guard for 9" Horizontal Motor Drive with 1/2 h.p. motor. Ship. wt. 27 lbs. Price \$14.25



Lathe Mandrels

For machining work mounted between lathe centers. Made of steel and properly carburized, hardened and ground for maximum durability. Large center holes provide substantial bearings on centers. Mandrels taper .006" per foot and are slightly undersize at small end for easy starting in standard holes. Flat for lathe dog is milled on each end. Nominal size of each mandrel is stamped on large end.

Catalog Number	Diameter Inches	Total Length, In.	Ship. Wt. Pounds	Factory Price
CE3620	1/4	3 3/4	1	\$2.65
CE3621	5/16	4	1	2.90
CE3622	3/8	4 1/4	1	3.15
CE3623	7/16	4 1/2	1	3.45
CE3624	1/2	5	1	3.65
CE3625	5/8	5 1/4	1	3.70
CE3626	3/4	5 1/2	1	3.80
CE3627	11/16	5 3/4	2	4.00
CE3628	3/4	6	2	4.15
CE3629	1 1/16	6 1/4	2	4.30
CE3630	7/8	6 1/2	2	4.45
CE3631	1 1/16	6 3/4	3	4.60
CE3632	1	7	3	4.75



Hardened and Ground Thread Screws for Compound Rest Cross Slides

Cross-feed Screws and Compound Rest Screws with hardened and ground English pitch threads can be supplied in lieu of regular screws on 10" and larger South Bend Lathes. Principal advantages of the hardened and ground thread screws are smoother operation and longer life. Prices below apply only when hardened and ground thread screws are specified when lathe is ordered and they can be supplied in lieu of regular screws when lathe is assembled at the factory.

Cross-Feed and Compound Rest Screws with Hardened and Ground Thread in Lieu of Regular Screws

Regular Cross-Feed			Taper Attachment Cross-Feed		
Cat. No.	Size Lathe	Price	Cat. No.	Size Lathe	Price
CL2032L	10"	\$12.75	CL2198L	10"	\$14.55
CL2032T	13"	21.75	CL2198T	13"	24.50
CL2032F	14 1/2"	23.75	CL2198F	14 1/2"	26.75
CL2032H	16" & 16-24"	24.50	CL2198H	16" & 16-24"	27.35

CL2222T. Hardened and ground thread cross-feed screw in lieu of regular screw for 13" lathe screw feed double tool cross slide \$17.00

CL2222H. Hardened and ground thread cross-feed screw in lieu of regular screw for 16" lathe or 2-H turret lathe screw feed double tool cross slide \$19.00



Center Knock-out Bar

For removing headstock center and sleeve from spindle. Made of steel, with knurled handle and brass bushing.

Catalog Number	Size Lathe	Outside Dia.	Total Length	Ship. Weight	Factory Price
CE1475NK	9" & Lt. Ten	3/4"	16"	4 lbs.	\$1.50
CE1475L	10"-1" Col.	1 1/8"	17 1/16"	7 lbs.	2.25
CE1475QH	13", 14 1/2", 16", 16-24", & 2-H	1 3/8"	28 1/16"	7 lbs.	3.50



Coolant Pump and Reservoir

The coolant equipment listed below is for use with South Bend Lathes equipped with oil pans. The oil pump is self-priming as it is below the oil level. Equipment includes coolant pump, tubing, reservoir, 1/4 h.p. motor, and switch. Price includes fitting to lathe at factory.

Coolant Pump and Reservoir Fitted to 10"-1" Collet or Larger Floor Leg Lathes, No. 2-H, or 10" Floor Leg Turret Lathes

Cat. No.	Current	Phase	Cycle	Voltage	Price
CL503C	A.C.	3	50	220	\$183.50
CL503D	A.C.	3	60	220	183.50
CL503E	A.C.	3	50	440	183.50
CL503F	A.C.	3	60	440	183.50
CL503G	A.C.	3	50	550	183.50
CL503H	A.C.	3	60	550	183.50
CL502C	A.C.	2	50	220	183.50
CL502D	A.C.	2	60	220	183.50
CL501A	A.C.	1	50	115	166.50
CL501B	A.C.	1	60	115	164.00
CL501C	A.C.	1	50	230	168.00
CL501D	A.C.	1	60	230	166.50
CL500K	D.C.	115	199.00
CL500L	D.C.	230	199.00

Coolant Pump and Reservoir Fitted to 9", or Light Ten U.M.D. Lathes, or 10" Bench Lathes on Tubular Steel Bench

Cat. No.	Current	Phase	Cycle	Voltage	Price
CL513C	A.C.	3	50	220	\$183.50
CL513D	A.C.	3	60	220	183.50
CL513E	A.C.	3	50	440	183.50
CL513F	A.C.	3	60	440	183.50
CL513G	A.C.	3	50	550	183.50
CL513H	A.C.	3	60	550	183.50
CL512C	A.C.	2	50	220	183.50
CL512D	A.C.	2	60	220	183.50
CL511A	A.C.	1	50	115	166.50
CL511B	A.C.	1	60	115	164.00
CL511C	A.C.	1	50	230	168.00
CL511D	A.C.	1	60	230	166.50
CL510K	D.C.	115	199.00
CL510L	D.C.	230	199.00

When ordered for 9" or Light Ten U.M.D. Lathes or 10-inch U.M.D. Lathes on steel bench, there is an additional charge for making chip pan oil tight and installing necessary drain pipes, splash guards, and oil tight seal. This does not apply to turret lathes.

Cat. No. CL2195NK—Making chip pan oil tight on 9" or Light Ten Lathe. Factory Price.....\$32.50

Cat. No. CL2195R—Making chip pan oil tight on 10" Lathe. Price...\$32.50

Universal Coolant Pump Equipment

The above coolant equipment may be ordered for application to lathes, drill presses, or other machine tools. Reservoir may be set on floor or attached to machine. Equipment consists of: coolant pump, tubing, reservoir, tray, 1/4 h.p. motor, switch, and wire for connecting motor and switch, but does not include equipment for fitting to South Bend Lathes. Ship. wt. 110 lbs.

Cat. No.	Current	Phase	Cycle	Voltage	Price
CE2003C	A.C.	3	50	220	\$160.00
CE2003D	A.C.	3	60	220	160.00
CE2003E	A.C.	3	50	440	160.00
CE2003F	A.C.	3	60	440	160.00
CE2003G	A.C.	3	50	550	160.00
CE2003H	A.C.	3	60	550	160.00
CE2002C	A.C.	2	50	220	160.00
CE2002D	A.C.	2	60	220	160.00
CE2001A	A.C.	1	50	115	144.50
CE2001B	A.C.	1	60	115	142.00
CE2001C	A.C.	1	50	230	146.00
CE2001D	A.C.	1	60	230	144.50
CE2000K	D.C.	115	175.50
CE2000L	D.C.	230	175.50

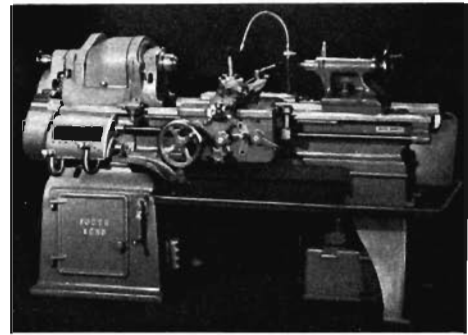

Oil Pans, Splash Pans, and Chip Pans

Oil Pans, Splash Pans, and Chip Pans for South Bend Lathes are made of heavy gauge sheet steel with welded corners and roll rim. Pans should be specified at the time the lathe is ordered so that they can be properly fitted at the factory.

Oil Pans are designed for collecting both oil and chips and are oil tight. Oil pans extend from the headstock leg to the tailstock end of bed as shown. Oil return troughs are provided at the headstock end of the lathes.

Splash Pans are an essential addition to the oil pans for all lathes that are equipped with taper attachments and for all turret lathes. The splash pans are attached to the back of the oil pans, as shown in the illustration above.

Chip Pans are intended for collecting chips only and are not necessarily oil tight. Chip pans extend from the headstock leg to the tailstock end of bed.

See page 35 for collet splash guard.

Pans for Floor Leg South Bend Lathes

Size Lathe	Oil Pan		Chip Pan		Splash Pan	
	Cat. No.	Price	Cat. No.	Price	Cat. No.	Price
9" and Light Ten U.M.D.					CL2057Z	18.00
10" x 3"	CL2020Y	\$ 82.00	CL1987Y	\$ 37.50	CL2059Z	22.00
10" x 3 1/2"	CL2020Z	84.50	CL1987Z	39.00	CL2059Z	22.00
10" Turret					CL2059R	27.00
10" x 4"	CL2020A	85.75	CL1987A	40.25	CL2059R	27.00
10" x 4 1/2"	CL2020R	87.00	CL1987R	41.50	CL2060A	29.75
13" x 4"	CL2022A	100.00	CL1989A	50.75	CL2060B	32.50
13" x 5"	CL2022B	102.50	CL1989B	53.25	CL2060C	33.75
13" x 6"	CL2022C	105.25	CL1989C	56.00	CL2060D	35.00
13" x 7"	CL2022D	110.50	CL1989D	58.50	CL2062B	32.50
14 1/2" x 5"	CL2023B	109.25	CL1990B	53.25	CL2062C	37.50
14 1/2" x 6"	CL2023C	115.75	CL1990C	59.50	CL2062D	37.50
14 1/2" x 7"	CL2023D	121.00	CL1990D	66.25	CL2062H	45.50
14 1/2" x 8"	CL2023E	127.25	CL1990E	72.75	CL2062C	37.50
16" x 6"	CL2024C	117.00	CL1991C	61.00	CL2062D	37.50
16" x 7"	CL2024D	125.00	CL1991D	68.75	CL2062H	45.50
16" x 8"	CL2024E	132.75	CL1991E	76.50	CL2062H	45.50
16" x 10"	CL2024G	148.25	CL1991G	92.50	CL2062H	45.50
16" x 12"	CL2024H	171.75	CL1991H	117.00	CL2062H	45.50
16-24" x 6"	CL2064C	135.00	CL1991C	61.00	CL2062C	37.50
16-24" x 7"	CL2064D	143.00	CL1991D	68.75	CL2062D	37.50
16-24" x 8"	CL2064E	150.75	CL1991E	76.50	CL2062H	45.50
16-24" x 10"	CL2064G	166.25	CL1991G	92.50	CL2062H	45.50
16-24" x 12"	CL2064H	189.75	CL1991H	117.00	CL2062H	45.50
2-H x 6"					CL2062C	37.50
2-H x 7"					CL2062D	37.50

Pans for South Bend Bench Lathes

Size Lathe	Chip Pan		Splash Pan	
	Cat. No.	Price	Cat. No.	Price
9" and Lt. Ten x 3"	CL1297Y	\$29.75	CL2056Y	\$15.50
9" and Lt. Ten x 3 1/2"	CL1297Z	32.50	CL2057Z	18.00
9" and Lt. Ten x 4"	CL1297A	35.00	CL2057Z	18.00
9" and Lt. Ten x 4 1/2"	CL1297R	36.25	CL2057R	18.00
10" x 3"	CL1377Z	32.50	CL2057Z	18.00
10" x 3 1/2"	CL1377Y	35.00	CL2057Z	18.00
10" Turret			CL2057Z	18.00
10" x 4"	CL1377A	37.50	CL2057R	18.00
10" x 4 1/2"	CL1377R	39.00	CL2057R	18.00

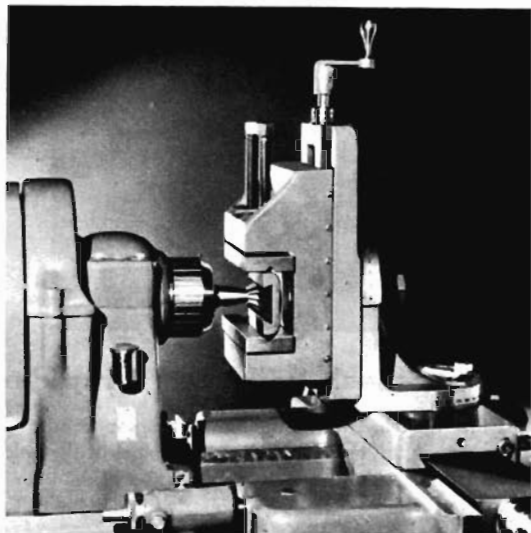

Milling and Keyway Cutting Attachment

The Milling and Keyway Cutting Attachment is excellent equipment for the shop that does not have a milling machine. It is mounted on the compound rest base of the lathe, permitting the power cross-feeds and power longitudinal feeds to be employed for milling and boring operations on work held in the milling attachment vise.

The angle plate to which the vertical slide is attached is graduated 180° in both the horizontal plane and vertical plane, permitting the vise to be swiveled in any direction. The vertical slide adjusting screw is equipped with a micrometer graduated collar.

The equipment included consists of: milling and keyway cutting attachment, two V-blocks for holding round work, one crank handle for feed screw, one double end wrench, and necessary bolts and nuts for installing attachment on lathe. Milling cutters and arbors are not included.

Milling and Keyway Cutting Attachment

Cat. No.	Size Lathe Ins.	Vert. Feed Ins.	Cross-Feed Ins.	Vise Holds Ins.	Jaw Depth Ins.	Jaw Width Ins.	Ship. Wt. Lbs.	Factory Price
CL2680NK	9-Lt. 10	3	5 7/8	1 1/2	1 5/8	3	13	\$49.00
CL2680R	10	3	5 7/8	1 3/4	1 5/8	3 1/2	25	61.00
CL2680T	13	4 1/4	8 1/2	2 1/2	1 11/8	4 7/8	40	75.50
CL2680F	14 1/2	6	10	4	2	5 3/4	50	88.50
CL2680H	16	6	10 1/2	4	2	5 3/4	65	102.50
CL2680H	16-24	6	10 1/2	4	2	5 3/4	65	102.50

Metric Milling Attachment

The milling and keyway cutting attachments shown above can be supplied with metric graduations in lieu of English graduations. Prices and specifications are same as for corresponding sizes with English graduations. Specify catalog numbers listed below for milling attachments with metric graduations.

Catalog Number	Size Lathe	Catalog Number	Size Lathe
CL2680NKME	9" & Lt. Ten	CL2680FME	14 1/2"
CL2680RME	10"	CL2680HME	16" & 16-24"
CL2680TME	13"		

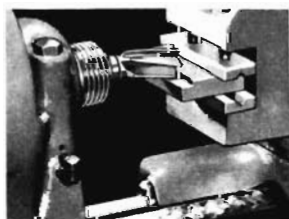

Off-set Base for Milling Attachment

To increase the capacity of the milling attachment for the 9" and Light Ten lathes, the off-set base illustrated right is used. The base consists of a metal plate which is mounted between the compound rest base of the lathe and the milling attachment base. When the off-set base is used, the position of the milling attachment is 1 1/4" farther away from the center line of the lathe spindle. This permits milling parts that might otherwise be too large for machining. See illustration at right. Price of off-set base includes necessary screws for mounting.

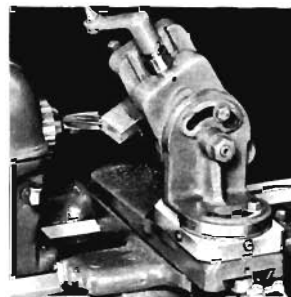

CL2408NK. Off-set Base for milling attachment. Fits 9" and Light Ten lathes only. Ship. weight 5 lbs. Price...\$3.75

Milling Attachment Chest

This substantially constructed wooden chest holds the 9" and Light Ten milling attachment, milling attachment crank, and milling attachment wrench. This protects the attachment from dirt, dust, and other abuse, when it is not in use. Price does not include milling attachment.

CL2224. Hinged Wooden Chest for No. CL2680NK Milling and Keyway Cutting Attachment. Shipping wt. 4 lbs. Price...\$6.00

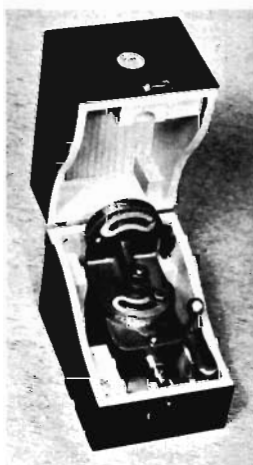

Small Diameter Double-end End Mills

Made of high speed steel with right-hand cut and right-hand spiral.

Cat. No.	Dia. of Mill	Dia. of Shank	Length of Flutes	No. of Flutes	Whole Length	Fac. Price
MIL7031	3/8"	3/8"	3/8"	4	2 1/4"	\$2.58
MIL7032	1/2"	3/8"	3/8"	4	2 1/4"	2.58
MIL7033	5/8"	3/8"	7/8"	4	2 1/4"	2.58
MIL7034	3/4"	3/8"	1 1/2"	4	2 1/4"	2.58



Straight Shank Single-end End Mills

Made of high speed steel with right-hand cut and right-hand spiral.

Cat. No.	Dia. of Mill	Dia. of Shank	Length of Flutes	No. of Flutes	Whole Length	Fac. Price
MIL7023	1/8"	3/8"	3/8"	4	2 1/2"	\$2.03
MIL7024	3/16"	3/8"	3/8"	4	2 1/2"	2.03
MIL7025	1/4"	3/8"	3/8"	4	2 1/2"	2.03
MIL7026	5/16"	3/8"	1 1/4"	4	3 1/2"	2.64
MIL7027	3/8"	3/8"	1 3/8"	4	3 3/4"	3.52
MIL7028	1/2"	3/8"	1 3/8"	4	3 3/4"	3.96
MIL7029	5/8"	3/8"	1 3/8"	4	4 1/2"	4.95
MIL7030	1"	1"	2"	4	4 1/2"	5.88

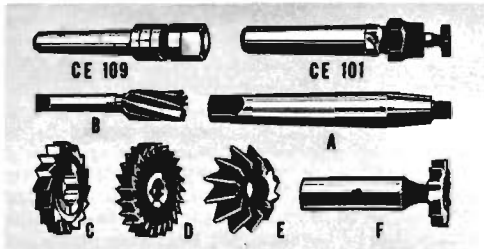

Milling Arbors and Cutters

Milling Arbors CE109, CE101, and A

All arbors and chucks listed below have No. 3 Morse taper shanks and fit all South Bend Lathes excepting the 10"-1" Collet Lathe which requires Spindle Sleeve CL205H to take No. 3 M. T. shanks.

CE109. Plain Arbor for milling cutters with 1-inch hole. Shipping weight 3 lbs. Factory Price \$9.75
 CE329. Screw Arbor (A) for Angular cutters (E) with right-hand thread. Shipping weight 2 lbs. Factory Price \$4.50
 CE330. Screw Arbor (A) for angular cutters (E) with left-hand thread. Shipping weight 2 lbs. Factory Price \$4.50
 CE101. Collet Chuck for Woodruff Cutters (F) with 1/2" diameter shank. Shipping weight 2 lbs. Factory Price \$5.50

Spiral End Mills (B)

High Speed Steel, Right-hand Cut, Right-hand Spiral

Cat. No.	Dia. Mill	Morse Taper	Factory Price	Cat. No.	Dia. Mill	Morse Taper	Factory Price
CE3893	1/2"	No. 2	\$5.80	CE3808	3/4"	No. 3	\$ 8.47
CE3894	3/8"	No. 2	5.92	CE3809	7/8"	No. 3	8.47
CE3895	3/4"	No. 2	5.92	CE3810	1"	No. 3	8.83
CE3896	7/8"	No. 2	6.89	CE3811	1 1/8"	No. 3	10.16
CE3897	1"	No. 2	7.98	CE3812	1 1/4"	No. 3	11.61

Plain Milling Cutters (C)

High Speed Steel With 1" Hole. Cut on Face Only

Cat. No.	Face Width	O.D.	Factory Price	Cat. No.	Face Width	O.D.	Factory Price
CE3920	3/16"	2 1/2"	\$3.75	CE3924	7/16"	2 1/2"	\$ 5.92
CE3921	1/4"	2 1/2"	4.96	CE3925	1/2"	2 1/2"	6.17
CE3922	3/8"	2 1/2"	5.20	CE3926	5/8"	2 1/2"	6.77
CE3923	1/2"	2 1/2"	5.56	CE3927	3/4"	2 1/2"	7.26

Side Milling Cutters (D)

High Speed Steel With 1" Hole. Cut on Face and Sides

Cat. No.	Face Width	O.D.	Factory Price	Cat. No.	Face Width	O.D.	Factory Price
CE3930	1/4"	3"	\$ 7.86	CE3934	1/2"	3"	\$ 9.68
CE3931	3/8"	3"	8.34	CE3935	3/4"	4"	16.09
CE3932	1/2"	3"	8.71	CE3936	5/8"	4"	17.30
CE3933	3/4"	3"	9.19				

Angular Cutters (E)

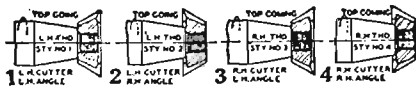

High Speed Steel With Threaded Hole
 1 1/4" O.D., 1/16" Face, 60° Included Angle

Cat. No.	Style	Description	Factory Price
CE667S1	1	L.H. thread, L.H. angle.....	\$6.82
CE667S2	2	L.H. thread, R.H. angle.....	6.82
CE667S3	3	R.H. thread, L.H. angle.....	6.82
CE667S4	4	R.H. thread, R.H. angle.....	6.82

Woodruff Keyseat Cutters (F)

High Speed Steel With 1/2" Diameter Straight Shanks
 Right-hand Cutters

Cat. No.	Cutter Dia.	Cutter Face	Factory Price	Cat. No.	Cutter Dia.	Cutter Face	Factory Price
CE3940	1/2"	1/16"	\$3.21	CE3948	1"	1/16"	\$4.36
CE3941	3/8"	1/16"	3.21	CE3949	1 1/8"	1/16"	4.59
CE3942	5/8"	1/16"	3.21	CE3950	1 1/4"	1/16"	4.81
CE3943	3/4"	1/16"	3.55	CE3951	1 3/8"	1/16"	4.81
CE3944	7/8"	1/16"	3.55	CE3952	1 1/2"	1/16"	5.04
CE3945	1"	1/16"	3.90	CE3953	1 5/8"	1/16"	5.28
CE3946	1 1/8"	1/16"	3.90	CE3954	1 3/4"	1/16"	5.28
CE3947	1 1/4"	1/16"	4.36	CE3955	1 7/8"	1/16"	5.63

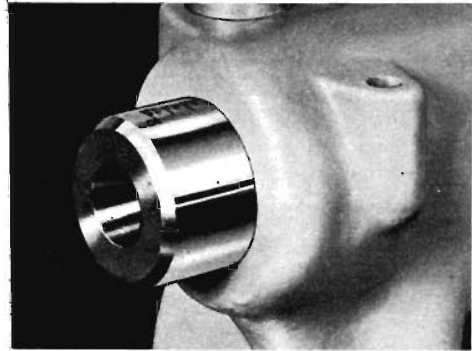

Hardened and Ground Taper Tailstock Spindles

Tailstock spindles with hardened and ground taper hole can be supplied for 10" and larger South Bend Lathes, either as an extra or in lieu of regular spindle. They are especially recommended for lathes that are to be used with taper shank tools in tailstock for drilling, reaming, and similar operations. Except that the taper hole is hardened and ground, these are the same as the regular tailstock spindles. If wanted in lieu of regular tailstock spindle, the spindle with hardened and ground taper must be specified when lathe is ordered.

Size Lathe	In Lieu of Regular Tailstock Spindle		As an Extra		
	Cat. No.	Price	Cat. No.	Ship. Wt.	Price
10"	CL3870R	\$5.25	CL3875R	2 lbs.	\$13.75
13"	CL3870T	5.65	CL3875T	4 lbs.	15.95
14 1/2"	CL3870F	6.75	CL3875F	5 lbs.	18.50
16" & 16-24"	CL3870H	7.50	CL3875H	7 lbs.	21.00

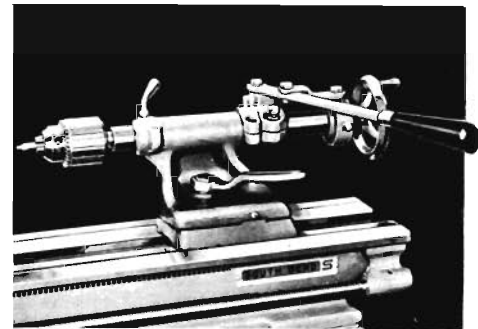

Handlever Tailstock

The Handlever Tailstock is a practical attachment for drilling, reaming, tapping, and centering operations. The convenient lever operation of the spindle saves much time on production work. The spindle may be set for drilling to any depth up to maximum length of feed. This tailstock is similar to the regular tailstock, except for the spindle construction. The tailstock top may be set over for taper turning. The spindle may be operated by the handlever or by turning the tailstock handwheel. This tailstock is interchangeable with the regular tailstock, and can be used for machining work between centers as well as for drilling, reaming, and tapping.

Handlever Tailstock for South Bend Lathes

Size Lathe	Lgth. of Feed Inches	Ship. Weight Lbs.	In Lieu of Regular Tailstock		In Addition to Regular Tailstock	
			Cat. No.	Price	Cat. No.	Price
9"			CL519N	\$60.00	CL1197N	\$80.00
Light Ten	2 3/8"	25	CL519K	66.50	CL1197K	90.00
10"	2 3/8"	33	CL519R	71.00	CL1197R	95.00

External Grinding Attachments for South Bend Lathes

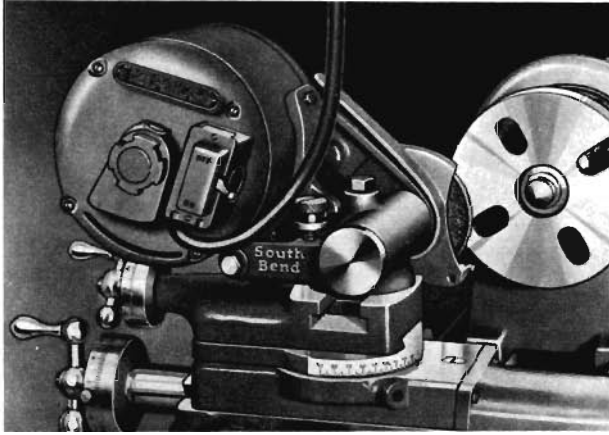

External Grinding Attachment Mounted on 16-inch South Bend Lathe

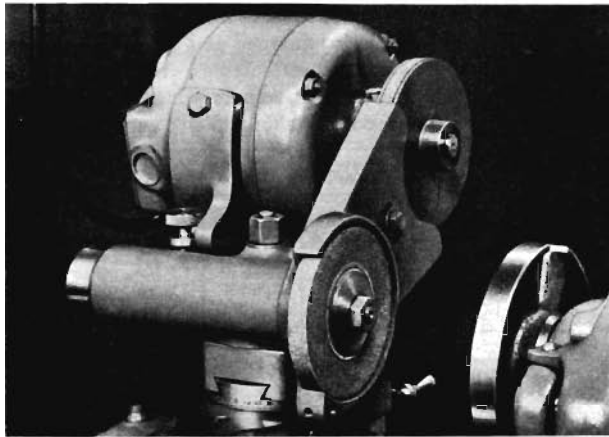

External Grinding Attachment Mounted on 9-inch South Bend Lathe

This powerful and efficient grinding attachment is recommended for grinding bushings, sharpening reamers and cutters, and other external grinding. Designed especially for South Bend Lathes, it is easily adaptable for use on other makes of lathes. The spindle revolves in prelubricated, precision ball bearings which are sealed to protect them from damage by dust, grit, and metal particles produced when grinding. Supplied with $\frac{1}{4}$ h.p., constant speed continuous duty motor, and 4" x $\frac{1}{2}$ " No. CE2759 general purpose grinding wheel. Spindle speed is approximately 5275 r.p.m.

Clamp bolt equipment is not included as it varies in design to conform with the various sizes of South Bend Lathes. When ordering the grinding attachment, be sure to include the clamp bolt equipment needed to mount the grinding attachment on the compound rest top of your lathe. See description and tabulation of clamp bolt equipment below.

Catalog Number	Motor Specifications			Shipping Weight	Factory Price
	Phase	Cycle	Volts		
CE301B	1	60	115	43 lbs.	\$64.50
CE301BA	1	60	150	43 lbs.	68.50
CE301D	1	60	230	43 lbs.	68.50
CE301A	1	50	115	43 lbs.	66.00
CE301C	1	50	230	43 lbs.	70.00
CE301Y	1	40	115	43 lbs.	68.50
CE301Z	1	40	230	43 lbs.	71.00
CE301K	1	25	230	43 lbs.	71.00
CE303D	3	60	220	43 lbs.	75.00
CE303F	3	60	440	43 lbs.	75.00
CE303C	3	50	220	43 lbs.	75.00
CE303E	3	50	440	43 lbs.	75.00
CE300K	D.C.	..	115	43 lbs.	92.00
CE300L	D.C.	..	230	43 lbs.	92.00

Clamp Bolt Equipment

Required for Mounting Grinding Attachment on Lathe

The equipment supplied with each External Grinding Attachment does not include the clamp bolt and other fittings necessary for mounting the grinding attachment on the lathe. The Clamp Bolt Equipment required for various sizes of South Bend Lathes is listed in the table. Be sure to include the required Clamp Bolt Equipment when ordering an External Grinding Attachment.

Catalog Number	Lathe Size	Shipping Weight	Factory Price
CE307NK	9" & Lt. Ten	1 lb.	\$2.00
CE307R	10"	1 lb.	2.50
CE307T	13"	3 lbs.	3.00
CE307F	14 $\frac{1}{2}$ "	3 lbs.	3.50
CE307H	16" & 16-24"	4 lbs.	3.50

Tailstock Diamond Holding Fixture

Clamps to tailstock spindle of lathe for holding the No. CE406 diamond dresser (shown in inset) for truing grinding wheel. Cannot be used while work is mounted between the lathe centers. Prices shown in table do not include diamond dresser which is listed below.

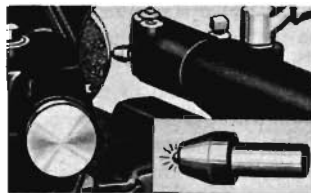

Cat. No.	Size Lathe	Ship. Wt.	Factory Price
CE91NK	9" & Lt. Ten	3 lbs.	\$8.50
CE91R	10"	3 lbs.	8.50
CE91T	13"	4 lbs.	9.75
CE91F	14 $\frac{1}{2}$ "	4 lbs.	9.75
CE91H	16" & 16-24"	5 lbs.	11.00

No. CE406. Diamond Dresser. Ship wt. $\frac{1}{2}$ lb. Price.....\$7.85

Extra Grinding Wheels For External Grinding Attachment



For rapid grinding and smooth finish, the correct grade of grinding wheel should be selected. The grinding wheels listed cover the more important classes of work. Wheels listed in table are 4" in diameter with $\frac{1}{2}$ " face and $\frac{1}{2}$ " hole, to fit external grinding attachment. Shipping weight 2 lbs.

Cat. No.	Type of Work	Class of Work	Price
CE2759	General Work.....	Rough or Finish	\$2.35
CE2758	Cutting Tools.....	Rough or Finish	2.35
CE2774	Automobile Valves.....	Rough or Finish	2.35
CE2757	Cast Iron.....	Finish Grinding	2.80
CE2769	Soft Steel.....	Finish Grinding	2.35

No. CE3236. Cup Grinding Wheel, 3 $\frac{1}{4}$ " O.D., 1 $\frac{1}{4}$ " face, $\frac{1}{2}$ " hole for sharpening reamers and cutters. Price...\$3.60

Reamer Grinding Stops

For sharpening reamers, milling cutters, etc., having either straight or spiral flutes. Also used for holding the No. CE18 Diamond Dresser listed below.

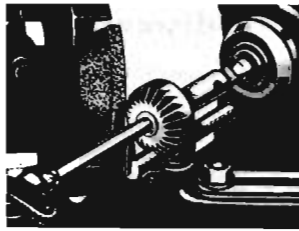

Cat. No.	Size Lathe	Ship. Wt.	Factory Price
CE1512N	9"	7 lbs.	\$20.75
CE1512K	Lt. Ten	8 lbs.	21.25
CE1512R	10"	9 lbs.	22.00
CE1512T	13"	14 lbs.	24.75
CE1512F	14 1/2"	20 lbs.	27.25
CE1512H	16"	24 lbs.	27.25
CE1512V	16-24"	30 lbs.	40.00

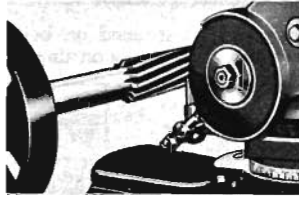

Diamond Dresser



For satisfactory operation, the grinding wheel should be trued frequently with a diamond dresser. This dresser must be mounted in the Reamer Grinding Stop fixture, listed above. Price does not include the fixture.

No. CE18. Diamond Dresser only. Shipping weight 1 lb. Price \$9.25

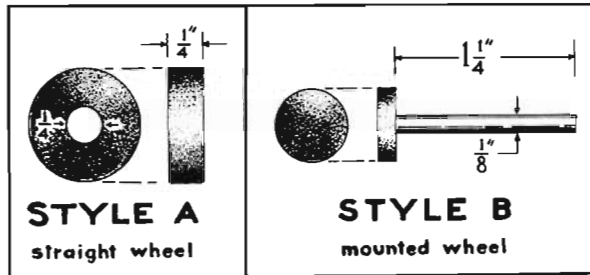

Grinding Wheels for Internal Grinding Attachment

Grinding wheels listed below are for use with the South Bend Internal Grinding Attachment or other grinder of similar size and speed. Grit and grain are suitable for general purpose grinding on bushings, tools, etc. Shipping weight approximately 4 oz. each wheel.

Catalog Number	Style	Diameter	Face	Factory Price
CE2925	A	3/8"	1/4"	.50
CE2926	A	3/4"	1/4"	.50
CE2927	A	3/8"	1/4"	.50
CE2928	A	1"	1/4"	.50
CE3035	B	1/4"	1/8"	.55
CE3036	B	1/2"	1/8"	.55
CE3037	B	3/4"	1/8"	.60
CE3038	B	1"	1/8"	.65
CE3039	B	3/2"	1/4"	.55
CE3040	B	1/2"	1/4"	.55
CE3041	B	3/8"	1/4"	.55
CE3042	B	1/4"	1/4"	.55
CE3043	B	3/8"	1/4"	.55
CE3044	B	3/8"	1/4"	.55
CE3045	B	1/2"	1/4"	.55
CE3046	B	3/8"	1/4"	.60
CE3047	B	3/4"	1/4"	.60
CE3048	B	3/8"	1/4"	.65
CE3049	B	1"	1/4"	.65

Right—Compound Belting Drives Grinding Wheel at 30,000 r.p.m.

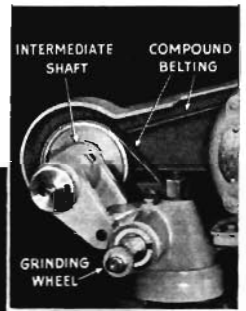

Below—Internal Grinding Attachment on 10" Lathe.

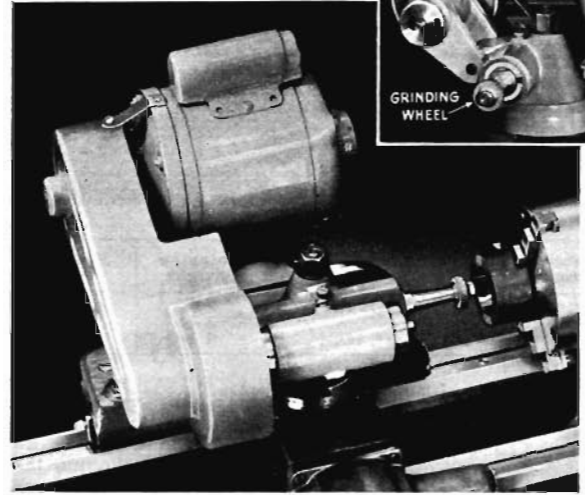

Internal Grinding Attachment

This new South Bend Constant Speed Precision Grinder has been developed to meet the long felt need for an internal grinding attachment having sufficient power to maintain a more constant wheel speed under varying loads and to prevent stalling under comparatively heavy cuts.

The grinder is powered by a standard type, constant speed, continuous duty 1/6 h.p., 3450 r.p.m., A.C. motor which has proved to be far superior to the universal type A.C.-D.C. motors ordinarily used. The motor is compound belted, through an intermediate shaft to obtain a quill spindle speed of 30,000 r.p.m. Tests have shown that less than 1000 r.p.m. drop in spindle speed occurs when taking cuts as heavy as .003" on a side in hardened steel. Power loss is negligible.

The grinding wheel and intermediate shaft spindle run on high precision, high speed ball bearings which require no adjustment. Lubricant is supplied from built-in oil wells. Oil is effectively sealed in the spindle units, and dust sealed out in such a way that the bearings will retain their precision indefinitely. The compound belting and the three pulleys are enclosed by a one-piece guard.

This grinder can be easily adapted for use on other makes of lathes or on other machine tools. Grinders have 1 ph., 60 cy., 115 v., A.C. motor, and accessories as listed below under specifications. Shipping weight 51 lbs.

Specifications

Grinding wheel speed 30,000 r.p.m.
Maximum depth of ground hole with 1-inch wheel 3/8 inches
Maximum wheel diameter recommended 1 inch

Accessories supplied:
Four 1/4" wheel arbors; lengths 2 1/8", 2 1/4", 3 1/8", and 4 1/8".
Four grinding wheels: 1/2" bore; 1/4" face; 5/8", 3/4", 7/8", and 1" diameters.
One chuck for mounted wheels 1/8" capacity
Eight-foot extension cord, plug, and switch.

No. CE601B. Internal Grinding Attachment with 1 ph., 60 cy., 115 v., A.C. motor and accessories listed above, but without clamp bolt equipment. Price f.o.b. factory . . . \$167.50

Write for information and prices of grinders equipped with motors for other current characteristics.

Clamp Bolt Equipment

Required for mounting Internal Grinding Attachment on Lathe.

Catalog Number	Lathe Size	Shipping Weight	Factory Price
CE307NK	9" & Lt. Ten	1 lb.	\$2.00
CE307R	10"	1 lb.	2.50
CE307T	13"	3 lbs.	3.00
CE307F	14 1/2"	3 lbs.	3.50
CE307H	16" & 16-24"	4 lbs.	3.50

Thread Indicator

Eliminates reversing of lathe spindle when cutting threads. Dial is numbered and graduated to show when to close half-nuts on lead screw to catch the thread on each successive cut, after returning carriage to the starting point. For English pitches only. See page 61 for metric thread indicator dial.

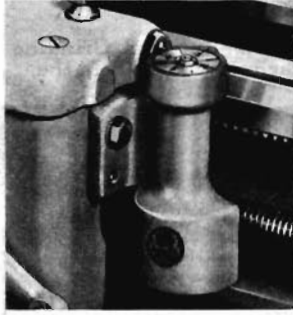

Catalog Number	Size Lathe	Shipping Weight	Factory Price
CL810NK	9" & Light Ten	2 lbs.	\$11.75
CL810R	10"	3 lbs.	18.00
CL810TH	13", 14 1/2", 16", 16-24", & 2-H	5 lbs.	20.75

Four Position Carriage Stop

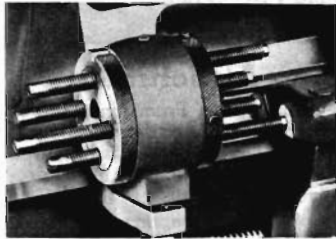

Much time can be saved in positioning the cutting tool for repetitive operations by using this four position carriage stop. Each of the four adjustable stops may be set for a different tool position and may be revolved into position to locate the carriage for each of four successive cuts. This attachment is especially

desirable for spacing shoulders in shafts and similar operations.

Catalog Number	Size Lathe	Shipping Weight	Factory Price
CL2185NK	9" & Light Ten	6 lbs.	\$23.75
CL2185RT	10" & 13"	6 lbs.	25.75
CL2185FH	14 1/2", 16", 16-24", & 2-H	10 lbs.	28.50

Dial Indicator Carriage Stop

Repetitive facing, shouldering or grooving operations can be performed with speed and precision on lathes equipped with a dial indicator type carriage stop. Position of carriage is clearly shown on face of dial which has 100 graduations reading in thousandths of an inch. Dial indicator hand will make 2 1/2 revolutions indicating a total movement of .250".

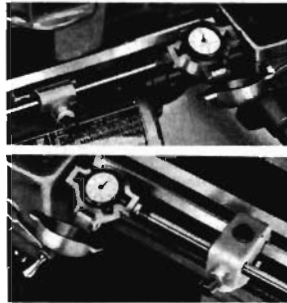

Enclosed in heavy metal case with hinged lid, the indicator is well protected at all times. Case is so constructed that indicator is protected from accidental damage by excessive pressure of carriage against indicator.

Two mounting brackets are supplied, one for work close to headstock as shown in upper illustration and the other for any position along length of bed. Indicator support bar has 5 1/2" adjustment in bracket. Price includes one dial indicator, indicator case with hinged lid, and two mounting brackets.

CL2795RT. Dial Indicator Carriage Stop for 10" or 13" Lathe. Shipping wt. 10 lbs. Price.....\$37.50

CL2795FH. Dial Indicator Carriage Stop for 14 1/2", 16", 16-24" or 2-H Lathe. Ship. wt. 12 lbs. Price.....\$41.00

Micrometer Carriage Stop

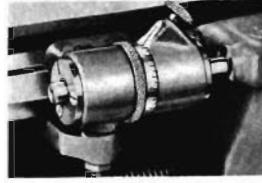

This attachment is useful for accurate facing, turning, boring, etc. It is used for locating the carriage at any point along lathe bed. Can be used on either side of carriage. Has accurately graduated micrometer collar. Either English or metric graduations can be supplied.

The stop is hardened on both ends and may be locked for repetitive operations on duplicate work.

Size Lathe	Ship Wt.	English Graduations		Metric Graduations	
		Cat. No.	Price	Cat. No.	Price
9" & Light Ten	2 lbs.	CL968NK	\$20.95	CL968NKME	\$20.95
	4 lbs.	CL968R	22.00	CL968RME	22.00
	4 lbs.	CL968T	24.75	CL968TME	24.75
14 1/2", 16", 16-24", & 2-H	7 lbs.	CL968FH	25.75	CL968FHME	25.75

Plain Carriage Stop



This stop may be clamped onto the front V-way of the lathe bed, on either side of the saddle, to locate the position of the cutting tool for facing, necking, cutting shoulders, machining grooves, and similar operations.

Catalog Number	Size Lathe	Shipping Weight	Factory Price
CL788NK	9" & Light Ten	2 lbs.	\$4.75
CL788R	10"	4 lbs.	5.00
CL788T	13"	4 lbs.	6.00
CL788FH	14 1/2", 16", 16-24", & 2-H	7 lbs.	7.50

Thread Cutting Stop



The Thread Cutting Stop is clamped onto the saddle cross-slide dovetail and is used for regulating the depth of cut for each successive chip when cutting screw threads. Price includes stop complete with clamp and knurled thumb screw.

Catalog Number	Size Lathe	Shipping Weight	Factory Price
CL2250NK	9" & Light Ten	1/2 lb.	\$5.25
CL2250R	10"	1/2 lb.	5.50
CL2250T	13"	1 lb.	6.25
CL2250F	14 1/2"	1 lb.	7.00
CL2250H	16" & 16-24"	2 lbs.	7.75

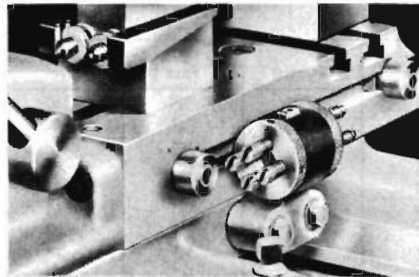

Four Position Cross Slide Stop

This stop fits onto the saddle and is used with the double tool cross slide in place of the regular cross slide stop. See page 41. It has four adjustable stops for locating the position of the cutting tools for each of four successive operations.

Cat. No.	Size Lathe	Ship. Wt.	Price
CL2154NR	9" and 10"	2 lbs.	\$15.50
CL2154T	13"	3 lbs.	16.00
CL2154H	16" and No. 2-H	3 lbs.	19.25

Mica Undercutting Attachment

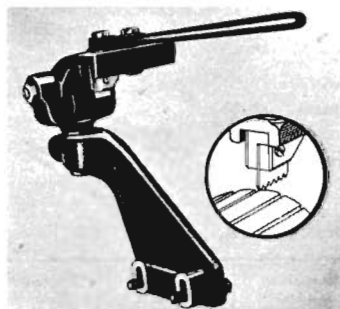

PATENTED

This prevents cutting into copper and throwing up burrs. A screw adjustment is provided for regulating the depth of the cut. Maximum length of stroke is 3". When not in use, the undercutter may be tilted back out of the way. Price includes one cutter blade .020" thick.

Any shop that repairs armatures for motors, generators or starters will have a lot of use for this practical attachment. It attaches to the saddle of the lathe for undercutting armature commutators. Hand operated, easy to use, and efficient. Cutter blade can be aligned with commutator segments, even though they are not parallel with the armature shaft.

Catalog No.	Size Lathe	Ship. Weight	Price
CL675N	9"	7 lbs.	\$24.75
CL675KR	Lt. Ten & 10"	10 lbs.	24.75
CL675T	13"	12 lbs.	25.75
CL675F	14 1/2"	15 lbs.	27.00
CL675H	16"	17 lbs.	28.50

CE2028. Extra cutter .015" thick. Ship. wt. 1/2 lb. Price..\$0.25

CE2029. Extra cutter .020" thick. Ship. wt. 1/2 lb. Price.. 0.35

Armature Service Equipment Kit

Consisting of mica undercutting attachment with two cutter blades; adjustable collet bushing chuck with set of three collets; drill chuck, 3/16" to 3/4" capacity for driving armatures; taper shank arbor with No. 3 shank for drill chuck; straight shank turning tool with cutter bit and wrench; and cutter bit ground for truing commutators.

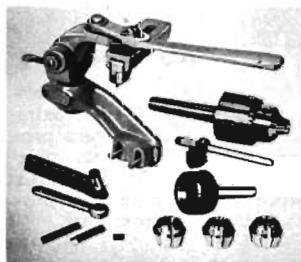

Catalog No.	Size Lathe	Shipping Weight	Factory Price
CL2330N	9"	20 lbs.	\$ 53.50
CL2330K	Light Ten	22 lbs.	53.50
CL2330R	10"	22 lbs.	53.50
CL2330T	13"	26 lbs.	59.00
CL2330F	14 1/2"	28 lbs.	62.00
CL2330H	16"	30 lbs.	63.00

Adjustable Collet Bushing Chuck

The adjustable Collet Bushing Chuck provides extremely accurate, but inexpensive equipment for mounting centerless armature shafts, and similar parts in the lathe. Can be used in either head or tail spindle of lathe. Collets are made of brass, and may be adjusted for either running fit or driving fit on shaft.

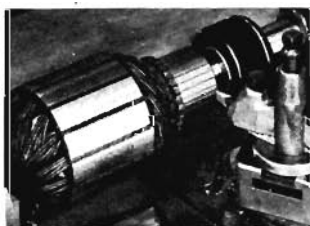

Description	Cat. No.	Shank	Shipping Weight	Factory Price
Adjustable Collet Bushing Chuck only.....	CE1615NR	No. 2	2 lbs.	\$ 8.50
	CE1615TH	No. 3	2 lbs.	9.25
Adjustable Collet Bushing Chuck with set of 3 collets, 3/16", 5/16", and .637" capacity for popular armatures..	CE1608NR	No. 2	3 lbs.	12.25
	CE1608TH	No. 3	4 lbs.	12.95

Cat. No. CE1659. Extra Collets for round work, any capacity 1/8" to 1" round by 16ths, ship. wt. 1 lb. Price.....\$1.35

Lubricating Oil

Nothing is more important to the satisfactory operation and life of fine machinery than correct lubrication. The lubricating oils listed below have been thoroughly tested in our research laboratory and are highly recommended. It is essential that the correct type of oil be used for the lathe spindle, apron and shaper oil reservoirs and general lubrication. A supply of each kind of oil should be kept on hand and used as needed. The Saybolt viscosity of the various oils is indicated in seconds at 100° F.



Cat. No.	Viscosity	Quantity	Ship. Wt.	Price
Oil for General Lubrication of Lathes and Other Machinery				
CE1603	240-500	1 quart	3 lbs.	\$0.85
CE1906	240-500	12 quarts	31 lbs.	9.10
CE2019	240-500	Gal. can	9 lbs.	2.45

Oil for Spindle Bearings of South Bend Lathes				
CE1600	100	1 quart	3 lbs.	\$0.85
CE1905	100	12 quarts	31 lbs.	9.10
CE2017	100	Gal. can	9 lbs.	2.45

Oil for Lathe Apron Oil Reservoir and Shaper Oil Reservoir				
CE1602	150-240	1 quart	3 lbs.	\$0.85
CE1904	150-240	12 quarts	31 lbs.	9.10
CE2018	150-240	Gal. can	9 lbs.	2.45

Pump Oil Can

Suitable for lubricating all types of machinery. Has large non-clogging pump tube, no leathers to crimp or dry out. Lower half of body is in one piece with no seam to open up or wear through. Cone tipped spout seats in oil hole, forces oil into bearings and prevents it from spilling. Hook on tip is provided for opening spring cap oil cups. Holds 1/8 pint and has 6" spout with twin-tipped vent.



CE3575. Pump Oil Can. Shipping weight 1 pound. Factory price.....\$2.10

Jacobs Valve Chuck

Chuck has 1 1/2"—8 thread to fit spindle nose of 9" and Light Ten lathes only. Has hollow body for holding automobile engine valves for refacing. Also used for holding small rods, bars, and tubes for machining. 5/8" chuck can be used in tailstock of lathe when fitted with solid arbor No. CE2304 or CE2305. Price and weight includes pinion key.

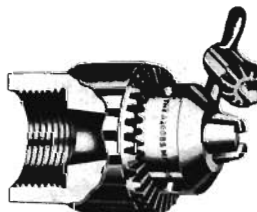

Cat. No.	Capacity	Ship. Wt.	Price
CE907	1/8" to 3/8"	3 3/4 lbs.	\$ 17.65
CE925	3/8" to 1/2"	4 1/4 lbs.	21.13

Ground Cutter Bits for Truing Commutators



Size of Bit	Single Bit			Lot of Six Bits		
	Cat. No.	Ship. Wt.	Fact. Price	Cat. No.	Ship. Wt.	Fact. Price
1/4" sq.	CE1363	4 ozs.	\$0.50	CE1744	10 ozs.	\$2.50
3/8" sq.	CE1365	5 ozs.	0.60	CE1746	10 1/2 ozs.	3.30
3/8" sq.	CE1366	5 ozs.	0.85	CE1747	11 ozs.	5.00

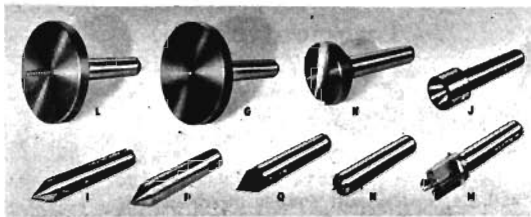

Lathe Centers and Drill Pads

G—Drill Pad, used in tailstock to support flat work for drilling.
 H—Crotch Center, used in tailstock for drilling round work.
 I—60° Center made of tool steel, heat-treated, hardened, and ground all over. For use in headstock or tailstock.
 J—60° Hollow Center for supporting centerless armature shafts, etc.
 L—Screw Center for wood turning.
 M—Spur Center for wood turning.
 N—Cup Center for wood turning.
 P—Carbide Tipped Center for heavy duty use in tailstock.
 Q—Half Center, used in tailstock for facing ends of shafts.

Catalog Number	Description	Morse Taper	Ship. Wt.	Factory Price
CE2396	G—Drill Pad.....	No. 2	3 lbs.	\$ 3.20
CE2397	G—Drill Pad.....	No. 3	4 lbs.	3.50
CE2398	H—Crotch Center.....	No. 2	2 lbs.	3.20
CE2399	H—Crotch Center.....	No. 3	3 lbs.	4.20
CE2401	I—60° Center.....	No. 2	1 lb.	2.90
CE2402	I—60° Center.....	No. 3	2 lbs.	3.80
CE1896	J—Hollow Center.....	No. 2	2 lbs.	3.20
CE1897	J—Hollow Center.....	No. 3	2 lbs.	4.10
CE2413	L—Screw Center.....	No. 2	3 lbs.	3.80
CE2414	L—Screw Center.....	No. 3	4 lbs.	4.20
CE2416	M—Spur Center.....	No. 2	2 lbs.	3.80
CE2417	M—Spur Center.....	No. 3	5 lbs.	4.20
CE2422	N—Cup Center.....	No. 2	1 lb.	2.80
CE2423	N—Cup Center.....	No. 3	2 lbs.	3.50
CE1889	P—Carbide Center.....	No. 2	1 lb.	5.75
CE1890	P—Carbide Center.....	No. 3	2 lbs.	10.25
CE2424	Q—Half Center.....	No. 2	1 lb.	2.90
CE2425	Q—Half Center.....	No. 3	2 lbs.	3.80

Ball Bearing Live Centers

Designed for maximum precision, strength and rigidity, the Ball Bearing Live Centers are recommended for high speeds and heavy roughing cuts. Concentricity of center point is guaranteed within $\pm .00015"$. Two styles are available, one having a 60° external point as shown above at right, and one having a 60° hollow as shown in the lower illustration. Both styles are made with No. 2 and No. 3 Morse standard tapers. Ball bearing is easily replaceable.

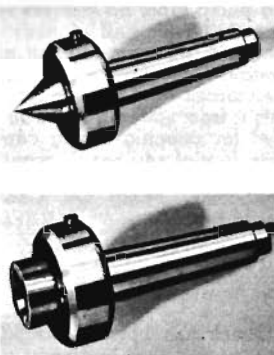

Catalog Number	Style of Center	Morse Taper	Shipping Weight	Factory Price
CE3900	60° Point	No. 2	3 lbs.	\$ 16.65
CE3901	60° Point	No. 3	5 lbs.	19.65
CE3903	60° Hollow	No. 2	3 lbs.	16.65
CE3904	60° Hollow	No. 3	5 lbs.	19.65

Combination Center Drill and Countersink



For drilling center hole and countersinking 60° angle for lathe center. Made of high speed tool steel.

Dia. of Drill	Dia. of Body	Single Drill			Lot of Twelve		
		Cat. No.	Ship. Wt.	Factory Price	Cat. No.	Ship. Wt.	Factory Price
$\frac{3}{16}"$	$\frac{1}{8}"$	CE2087	4 ozs.	\$.98	CE2555	8 ozs.	\$11.75
$\frac{3}{16}"$	$\frac{1}{8}"$	CE3021	4 ozs.	.98	CE3025	8 ozs.	11.75
$\frac{3}{16}"$	$\frac{1}{8}"$	CE3022	4 ozs.	.98	CE3026	8 ozs.	11.75
$\frac{1}{2}"$	$\frac{3}{16}"$	CE3023	4 ozs.	.98	CE3027	1 lb.	11.75
$\frac{3}{8}"$	$\frac{1}{4}"$	CE3024	6 ozs.	1.48	CE3028	2 lbs.	17.75

Cat. No. CE3020. Set of 5 Combination Center Drills and Countersinks, one each of above. Factory Price \$5.40

Pipe Centers

For mounting tubing, pipe, etc., between the lathe centers for machining. Centers have accurately ground 90° cone, and revolve on steel shanks with plain bearings.

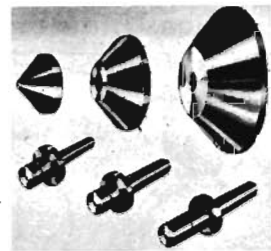

Pipe Centers

Cat. No.	Takes Pipe	Requires Shank	Shipping Weight	Factory Price
CE2160	$\frac{1}{2}"$ to 3"	CE2172 or CE2174	4 lbs.	\$ 5.75
CE2161	3" to 5"	CE2174	6 lbs.	7.85
CE2162	5" to 8"	CE2173	17 lbs.	11.80

Pipe Center Shanks

Cat. No.	Shank Taper	Take Centers	Shipping Weight	Factory Price
CE2172	No. 2	CE2160 & CE2161	2 lbs.	\$ 4.95
CE2174	No. 3	CE2160 & CE2161	3 lbs.	5.70
CE2173	No. 3	CE2162	4 lbs.	9.65

Hardened Pipe Center

CE2163. Takes pipe $\frac{1}{2}"$ to 3". Same as CE2160, but made of heat-treated and hardened steel. \$6.70



Ball Bearing Pipe Centers

Fitted with large, double row ball bearings, these extra large precision centers provide rigid support for pipe and other large diameter work. Tight fitting seal protects bearings from dust.

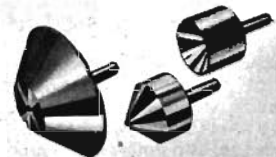

Catalog Number	Style of Center	Capacity	Morse Taper	Shipping Weight	Factory Price
CE2445	90° Point	$\frac{1}{2}"$ to 3 $\frac{1}{8}"$	No. 2	9 lbs.	\$37.50
CE2446	90° Point	$\frac{1}{2}"$ to 3 $\frac{1}{8}"$	No. 3	9 lbs.	39.50
CE2449	90° Point	3 $\frac{1}{8}"$ to 8 $\frac{3}{8}"$	No. 3	20 lbs.	54.50
CE2447	90° Hollow	$\frac{1}{8}"$ to 3 $\frac{1}{8}"$	No. 2	8 lbs.	37.50
CE2448	90° Hollow	$\frac{1}{8}"$ to 3 $\frac{1}{8}"$	No. 3	8 lbs.	39.50

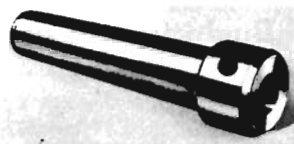

Center Drill Holder

The Center Drill Holder is designed for greater accuracy in center drilling. Holds drill rigidly.

Catalog Number	Taper Shank	Diameter Will Hold	Shipping Weight	Factory Price
CE2338	No. 2	$\frac{1}{8}"$	1 lb.	\$3.20
CE3029	No. 2	$\frac{3}{16}"$	1 lb.	3.20
CE2340	No. 2	$\frac{13}{64}"$	1 lb.	3.20
CE2339	No. 2	$\frac{13}{64}"$	1 lb.	3.20
CE3030	No. 2	$\frac{1}{4}"$	1 lb.	3.20
CE2341	No. 2	.302"	1 lb.	3.20
CE3031	No. 2	$\frac{3}{16}"$	1 lb.	3.20
CE2342	No. 2	$\frac{1}{8}"$	1 lb.	3.20
CE2346	No. 3	$\frac{1}{8}"$	2 lbs.	4.10
CE3032	No. 3	$\frac{3}{16}"$	2 lbs.	4.10
CE2343	No. 3	$\frac{13}{64}"$	2 lbs.	4.10
CE2347	No. 3	$\frac{13}{64}"$	2 lbs.	4.10
CE3033	No. 3	$\frac{1}{4}"$	2 lbs.	4.10
CE2344	No. 3	.302"	2 lbs.	4.10
CE3034	No. 3	$\frac{3}{16}"$	2 lbs.	4.10
CE2345	No. 3	$\frac{1}{8}"$	2 lbs.	4.10

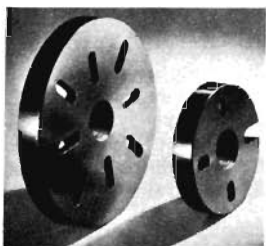

Face Plates

Face Plates are heavily constructed and ribbed on the back. Threaded to fit spindle nose of the lathe. Large Face Plates have slots for clamping work or special face plate fixtures. Small Face Plates have slots for driving lathe dog.

Small Face Plates for South Bend Lathes

Catalog Number	Size Lathe	Out-side Dia.	Thread	No. of Slots	Ship-ping Weight	Fac-tory Price
CL217SNK	9" and Light Ten	5 1/4"	1 1/2"-8	1	4 lbs.	\$ 7.00
CL217SL	10"-1" Collet	5 3/4"	2 1/2"-8	1	5 lbs.	12.25
CL217SQ	13"	6 3/8"	2 1/4"-8	4	8 lbs.	12.25
CL217SMH	14 1/2", 16", 16-24", & No. 2-H	8 1/8"	2 3/8"-6	4	13 lbs.	18.00

Large Face Plates for South Bend Lathes

Catalog Number	Size Lathe	Out-side Dia.	Thread	No. of Slots	Ship-ping Weight	Fac-tory Price
CL2180NK	9" and Light Ten	7 3/4"	1 1/2"-8	6	8 lbs.	\$ 9.75
CL2180L	10"-1" Collet	8 1/4"	2 1/2"-8	6	10 lbs.	17.00
CL2180Q	13"	10 3/4"	2 1/4"-8	8	19 lbs.	18.00
CL2180MH	14 1/2", 16", 16-24", & 2-H	13 1/4"	2 3/8"-6	8	38 lbs.	24.75
CL2180V*	16-24"	22 3/4"	2 3/8"-6	12	96 1/2 lbs.	54.50

*This is an extra large face plate for mounting large diameter work in 16-24" lathes only.



Multi-Tapped Face Plate

This heavily constructed face plate has six slots and thirty tapped holes for clamping work or special work holding fixtures. The cored slots are 1/16" wide, and the tapped holes have 5/16"-18 threads. The face plate is made of cast iron, and is accurately machined all over. It has a precision milled thread for the spindle nose of the lathe, and is 1/8" thick.

Catalog Number	Size Lathe	Out-side Dia.	Spindle Thread	Ship-ping Weight	Fac-tory Price
CL1483NK	9" & Lt. Ten	8 1/2"	1 1/2"-8	13 lbs.	\$12.50
CL1483LQ	10"-1" Collet & 13"	8 1/2"	2 1/4"-8	13 lbs.	19.25

Spindle Sleeves for Lathes



Catalog Number	Size Lathe	Taper Inside	Ship. Wt.	Factory Price
CL205NK	9" and Light Ten	No. 2	1 lb.	\$2.50
CL205L	10"-1" C., 13", 14 1/2", 16", 16-24" and 2-H	No. 2	2 lbs.	3.50
CL205H	10"-1" C., 13", 14 1/2", 16", 16-24", and 2-H	No. 3	2 lbs.	4.75

Taper Reducing Sleeve

Standard Morse Taper Reducing Sleeves for fitting drills, reamers, and other taper shank tools to spindle taper of lathe or other machine.



Catalog No.	Morse Taper		Shipping Weight	Factory Price
	Outside	Inside		
CE2525	2	1	8 ozs.	\$.95
CE2526	3	1	12 ozs.	1.20
CE2527	3	2	12 ozs.	1.20



Fixture Plate

This Fixture Plate is used for mounting special fixtures, jigs, holding devices, and tools on the spindle nose of the lathe. Being accurately machined all over, and threaded to fit the spindle nose of the lathe, its use will save much time and expense when tooling up a lathe for a production operation which calls for a special holding fixture fitted to the spindle nose.

Catalog Number	Size Lathe	Out-side Dia.	Spindle Thread	Ship-ping Weight	Fac-tory Price
CL46NK	9" & Lt. Ten	7 1/2"	1 1/2"-8	9 lbs.	\$ 4.95
CL46L	10"-1" Col.	9"	2 1/4"-8	14 lbs.	12.00
CL46Q	13"	10 1/4"	2 1/4"-8	22 lbs.	13.00
CL46MH	14 1/2", 16", 16-24", & No. 2-H	11 3/4"	2 3/8"-6	29 lbs.	14.00

Threaded Chuck Plate

Semi-machined threaded chuck plates are supplied for those who wish to fit their own chucks to South Bend Lathes. These are heavily constructed cast-iron plates, accurately threaded to fit the spindle nose of the lathe. The back of the plate is finished, and the outside diameter and face are rough machined. When ordering, be sure to specify the correct plate to fit the diameter of the recess in back of chuck. Stock is allowed for finishing to diameter shown in the table.



Catalog Number	Size Lathe	Spindle Nose Th'd	O.D. of Plate	Shipping Weight	Factory Price
CE2703NK	9" and Lt. Ten	1 1/2"-8	3 1/2"	3 lbs.	\$ 4.25
CE2704NK			5"	4 lbs.	4.25
CE2709NK			7 1/2"	10 lbs.	4.25
CE2703LQ	10"-1" Col. & 13"	2 1/4"-8	4 lbs.	4 lbs.	11.25
CE2704LQ			5"	5 lbs.	11.25
CE2705LQ			5 1/2"	6 lbs.	11.25
CE2707LQ			6 1/4"	7 lbs.	11.25
CE2708LQ			7 1/2"	11 lbs.	11.25
CE2709LQ			9"	13 lbs.	11.25
CE2710LQ			10 1/4"	18 lbs.	11.25
CE2704MH	14 1/2", 16", 16-24", & 2-H	2 3/8"-6	5"	8 lbs.	13.00
CE2705MH			5 1/2"	8 lbs.	13.00
CE2706MH			6"	9 lbs.	13.00
CE2707MH			6 1/4"	9 lbs.	13.00
CE2708MH			7 1/2"	13 lbs.	13.00
CE2710MH			10 1/4"	20 lbs.	13.00
CE2711MH			11 3/4"	24 lbs.	13.00

Chuck Plates Fitted to Chucks

Catalog numbers listed below cover fitting charges when chucks are shipped to us to be fitted with chuck plates threaded to fit South Bend Lathes. Fitting charges do not include transportation costs.



Catalog Number	Size Lathe	Factory Price
CE2935NK	9" & Light Ten	\$ 6.75
CE2935LQ	10"-1" Collet & 13"-1" Collet	14.50
CE2935MH	14 1/2", 16", 16-24", & 2-H	15.75

4-Jaw Independent Lathe Chucks

These chucks have four reversible jaws with individual screw adjustment. Chuck body is ground and chuck jaws are hardened and ground.

Price includes wrench, and chuck plate fitted to lathe spindle and chuck. Size chuck recommended for each size lathe is shown in bold face type.



Catalog Number	Size of Chuck	Size of Lathe	Ship. Wt.	Factory Price
CL4006NK	6"	9" and Light Ten	13 lbs.	\$ 42.00
CL4206NK	6"	9" and Light Ten	18 lbs.	76.00
CL4006L	6"	10"-1" Collet	13 lbs.	46.00
CL4206LQ	6"	10"-1" Collet	18 lbs.	78.00
CL4207LQ	7½"	10"-1" Collet	38 lbs.	94.00
CL4206LQ	6"	13"-1" Collet	18 lbs.	78.00
CL4207LQ	7½"	13"-1" Collet	38 lbs.	94.00
CL4209Q	9"	13"-1" Collet	46 lbs.	107.00
CL4207MH	7½"	14½"-1" Collet	38 lbs.	95.00
CL4209MH	9"	14½"-1" Collet	46 lbs.	108.00
CL4210MH	10"	14½"-1" Collet	57 lbs.	117.00
CL4207MH	7½"	16", 16-24", & 2-H	38 lbs.	95.00
CL4209MH	9"	16", 16-24", & 2-H	46 lbs.	108.00
CL4210MH	10"	16", 16-24", & 2-H	57 lbs.	117.00
CL4212H	12"	16", 16-24", & 2-H	96 lbs.	153.00

3-Jaw Universal Lathe Chucks

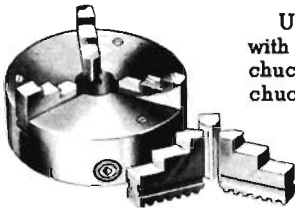

Universal Chucks are supplied with two sets of jaws, one set for chucking externally and the other for chucking internally. Chuck body is ground and jaws are hardened. Chuck jaws are moved simultaneously by a scroll, and work is automatically centered.

Price includes wrench and threaded chuck plate fitted to lathe spindle. Size of chuck recommended for each size lathe is shown in bold face type.

Universal Chucks With Two Sets of Jaws

Catalog Number	Size of Chuck	Size of Lathe	Ship. Wt.	Factory Price
CL3005NK	5"	9" and Light Ten	13 lbs.	\$ 62.00
CL3505NK	5"	9" and Light Ten	19 lbs.	107.00
CL3506NK	6"	9" and Light Ten	28 lbs.	113.00
CL3005L	5"	10"-1" Collet	13 lbs.	65.00
CL3505LQ	5"	10"-1" Collet	19 lbs.	109.00
CL3506LQ	6"	10"-1" Collet	28 lbs.	117.00
CL3505LQ	5"	13"-1" Collet	19 lbs.	109.00
CL3506LQ	6"	13"-1" Collet	28 lbs.	117.00
CL3507Q	7½"	13"-1" Collet	47 lbs.	132.00
CL3505MH	5"	14½"-1" Collet	19 lbs.	110.00
CL3506MH	6"	14½"-1" Collet	28 lbs.	118.00
CL3507MH	7½"	14½"-1" Collet	47 lbs.	133.00
CL3509MH	9"	14½"-1" Collet	59 lbs.	176.00
CL3505MH	5"	16", 16-24", & 2-H	19 lbs.	110.00
CL3506MH	6"	16", 16-24", & 2-H	28 lbs.	118.00
CL3507MH	7½"	16", 16-24", & 2-H	47 lbs.	133.00
CL3509MH	9"	16", 16-24", & 2-H	59 lbs.	176.00

Precision Boring Bar for Chuck

Designed especially for boring holes in turret head with extreme precision, this boring bar can be used for any similar operation in which the work is mounted on the lathe carriage or turret and the boring bar is held in the lathe chuck. Cutter bit has a very fine adjustment of .010" obtained by revolving the eccentric bushing. Minimum diameter of bore is ⅝". Maximum depth of bore is 2½".

CE3420. Precision Boring Bar for Chuck. Shipping weight 1 lb. Factory price.....\$2.50



Face Plate Chuck

This inexpensive Face Plate Chuck can be used for holding round, square, or irregular work. Maximum capacity for round work is 7½" in diameter. Face plate is 8" in diameter, with annular lines to aid in centering.

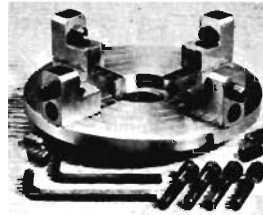

Catalog Number	Size of Lathe	Spindle Thread	Shipping Weight	Factory Price
CL2155NK	9" and Lt. Ten	1½"-8	14 lbs.	\$20.50
CL2155L	10"-1" Collet	2¼"-8	16 lbs.	25.75

3-Jaw Drill Chucks

These drill chucks are so constructed that they will hold the drill securely and accurately. Jaws are tempered steel. Price includes pinior key, but does not include arbor.



Cat. No.	Make of Chuck	Capacity of Chuck	Net Wt. Lbs.	Ship. Wt. Lbs.	Factory Price
CE1200	Jacobs	0 to ⅜ in.	1½	1½	\$ 6.96
CE1201	Jacobs	0 to ½ in.	1¾	2¾	8.56
CE1202	Jacobs	⅜ to ¾ in.	3¾	3½	12.84
CE1206	Jacobs	¾ to 1 in.	6¾	7½	28.00

Taper Arbors for Drill Chucks

For fitting drill chuck to taper of lathe headstock spindle or tailstock spindle.



For Drill Chuck	No. 2 Morse Taper			No. 3 Morse Taper		
	Cat. No.	Ship. Wt.	Price	Cat. No.	Ship. Wt.	Price
CE1200	CE2300	⅜ lb.	\$1.15	CE2301	⅜ lb.	\$1.70
CE1201	CE2302	½ lb.	1.15	CE2303	⅜ lb.	1.70
CE1202	CE2304	⅜ lb.	1.15	CE2305	¾ lb.	1.70
CE1206	CE2306	1 ¼ lbs.	1.15	CE2307	1 ¼ lbs.	1.70

Straight Arbors for Drill Chucks

For Fitting Drill Chuck to Hole in Turret Head

For Drill Chucks	⅝" Diameter		¾" Diameter		1 ¼" Diameter	
	Cat. No.	Price	Cat. No.	Price	Cat. No.	Price
CE1200	CE2360	\$1.15	CE2361	\$1.15	CE2377	\$2.50
CE1201	CE2362	1.15	CE2363	1.15	CE2378	2.50
CE1202	CE2364	1.15	CE2365	1.15	CE2379	2.50
CE1206	CE2366	1.15	CE2367	1.15	CE2380	2.50

Semi-Machined Drill Chuck Arbors

For fitting drill chucks and other tools to lathe spindle or turret head. Must be machined to fit drill chuck or other tool.



Cat. No.	Shank	Ship. Wt.	Price
CE1500	No. 2 Morse Taper	1 lb.	\$1.15
CE1501	No. 3 Morse Taper	2 lbs.	1.70
CE2325	⅝" Diameter Straight	1 lb.	1.55
CE2326	¾" Diameter Straight	1 lb.	1.60

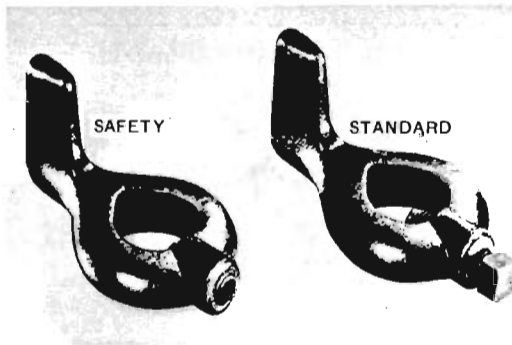

Standard and Safety Lathe Dogs

Lathe dogs should correspond in capacity to the diameter of the work if the work is to be held securely. These lathe dogs are made of heavy malleable iron and are properly designed for maximum strength and long service. Tail of dog is shaped to fit slot in drive plate. The Standard Lathe Dog has square head alloy steel set screw. The Safety Lathe Dog has a headless alloy steel set screw. Wrenches required for headless set screws are listed in right-hand columns.

Lathe Dogs for 13" and Larger Lathes

Cap. In.	Ship. Wt.	STANDARD		SAFETY		Wrenches for Safety Dogs	
		Cat. No.	Price	Cat. No.	Price	Cat. No.	Price
1/2	1 lb.	CE3843	\$1.05	CE3826	\$1.10	CE2385	\$0.07
3/4	1 lb.	CE3844	1.25	CE3827	1.25	CE2386	0.08
1	2 lbs.	CE3845	1.35	CE3828	1.35	CE2387	0.09
1 1/4	2 lbs.	CE3846	1.60	CE3829	1.60	CE2388	0.10
1 1/2	3 lbs.	CE3847	1.90	CE3830	1.90	CE2389	0.14
1 3/4	3 lbs.	CE3848	2.05	CE3831	2.05	CE2389	0.14
2	4 lbs.	CE3849	2.30	CE3832	2.30	CE2389	0.14
2 1/2	5 lbs.	CE3850	2.60	CE3833	2.60	CE2390	0.22
3	6 lbs.	CE3851	2.95	CE3834	2.95	CE2390	0.22
3 1/2	7 lbs.	CE3852	4.05	CE3835	4.05	CE2390	0.22
4	9 lbs.	CE3853	5.45	CE3836	5.45	CE2390	0.22

Lathe Dogs for 9" and 10" Lathes

Cap. In.	Ship. Wt.	STANDARD		SAFETY		Wrenches for Safety Dogs	
		Cat. No.	Price	Cat. No.	Price	Cat. No.	Price
3/8	1 lb.	CE3837	\$0.95	CE3820	\$0.95	CE2385	\$0.07
1/2	1 lb.	CE3838	1.00	CE3821	1.00	CE2385	0.07
3/4	2 lbs.	CE3839	1.20	CE3822	1.20	CE2386	0.08
1	2 lbs.	CE3840	1.30	CE3823	1.30	CE2387	0.09
1 1/4	3 lbs.	CE3841	1.45	CE3824	1.45	CE2388	0.10
1 1/2	3 lbs.	CE3842	1.85	CE3825	1.85	CE2388	0.10

Clamp Lathe Dog

Made of heavy drop-forged steel, carefully machined and hardened. Practical for holding round, hexagonal or rectangular work. Screws have U. S. Standard thread and are hardened and tempered. The nuts permit adjusting screws for minimum projection of screw heads beyond body of lathe dog. Each clamp lathe dog is boxed separately.



Clamp Lathe Dogs

Catalog Number	Capacity		Size Lathe Used With	Shipping Weight	Factory Price
	Maximum Opening	Distance Between Screws			
CE160	1 3/8"	1 3/4"	9" & larger	1 lb.	\$4.59
CE161	1 7/8"	2 1/4"	13" & larger	2 lbs.	6.11
CE162	2 1/2"	2 3/4"	13" & larger	3 lbs.	7.66
CE163	3 1/4"	3 1/2"	14 1/2" & larger	4 lbs.	10.70

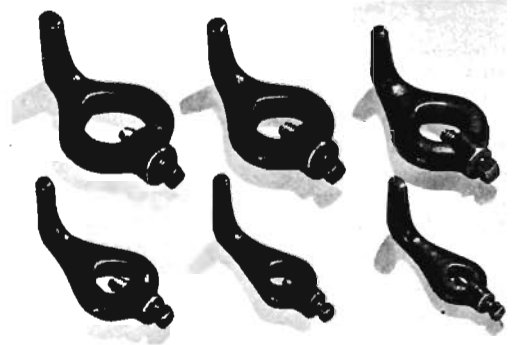

Sets of Lathe Dogs

A complete set of dogs for each lathe will save time and contribute to efficient operation. Having the correct size of lathe dog at hand for any job will more than compensate for the cost of a full set. Two or more dogs of each size will often save time on production work, as this permits changing one dog while the other is in use.

Cat. No. CE2102. Set of 11 Standard Lathe Dogs, 1/2" to 4" capacity for 13" and larger lathes. Ship. wt. 36 lbs. . . . \$26.50

Cat. No. CE2103. Set of 11 Safety Lathe Dogs, 1/2" to 4" capacity for 13" and larger lathes. Ship. wt. 36 lbs. . . . \$26.50

Cat. No. CE2105. Set of 6 Standard Lathe Dogs, 3/8" to 1 1/2" capacity for 9" and 10" lathes. Ship. wt. 6 lbs. . . . \$7.75

Cat. No. CE2107. Set of 6 Safety Lathe Dogs, 3/8" to 1 1/2" capacity for 9" and 10" lathes. Ship. wt. 6 lbs. Price. . . . \$7.75

Center Gauge



The center gauge is a useful tool for the lathe operator. The 60° included angle is used for checking the angle of the lathe center point. The two small 60° notches in the side of the tool are used for grinding and setting the point of the lathe tool for cutting screw threads. Engine divided graduations in each corner are in 32nds, 24ths, 20ths, and 14ths respectively. Made of good quality tool steel, hardened and tempered. Accurately ground on all faces, and lapped in the notches to a light tight fit with a standard.

No. CE650. Center Gauge. Shipping weight 2 ozs. . . \$0.80

Screw Thread Pitch Gauges

With one of these handy gauges you can check the pitches of internal and external screw threads quickly and accurately. Made of steel, with each blade marked to indicate threads per inch. Each blade has standard 60° U. S. thread form accurately milled and held well within commercial tolerances. Can be used for checking V, American National, and U. S. Standard threads.

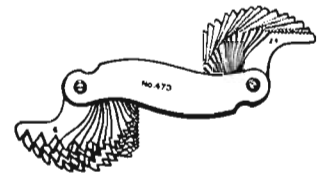

CE2188. Ace screw pitch gauge with 14 blades for 10, 11, 12, 13, 14, 16, 18, 20, 24, 27, 28, 32, 36, and 40 threads per inch. Shipping weight 4 ozs. Factory Price. . . . \$0.70

CE2171. Starrett screw pitch gauge with 30 blades for 6, 7, 8, 9, 10, 11, 11 1/2, 12, 13, 14, 15, 16, 18, 20, 22, 24, 26, 27, 28, 30, 32, 34, 36, 38, 40, 42, 48, 50, 56, and 60 threads per inch. Shipping weight 5 ozs. Factory Price. . . \$3.70

Turning Tool Holders

Drop-forged steel, heat-treated and hardened lathe tool holders. Supplied in three styles: straight, right-hand, and left-hand as illustrated.

Price includes: tool holder with hardened steel set screw, one unground hardened high-speed steel cutter bit, and a hardened drop-forged steel wrench.

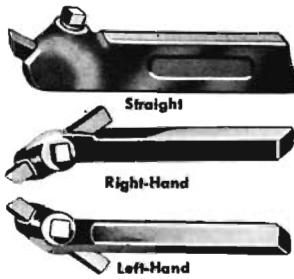

Cat. No.	Size Lathe	Size Shank	Size Cutter	Ship. Wt.	Fact. Price
Straight Shank Turning Tool Holders					
CE8478	9", Lt. Ten. & 10"	3/8" x 1 1/8"	1/4" x 1/4"	1 lb.	\$2.44
CE8468	9", Lt. Ten. & 10"	3/8" x 1 1/8"	1/2" x 1/2"	2 lbs.	5.61
CE8528	13"	1/2" x 1 1/8"	5/8" x 5/8"	3 lbs.	6.42
CE8538	14 1/2", 16" & 16-24"	5/8" x 1 3/8"	3/8" x 3/8"	3 lbs.	7.88

Cat. No.	Size Lathe	Size Shank	Size Cutter	Ship. Wt.	Fact. Price
Right-Hand Turning Tool Holders					
CE847R	9", Lt. Ten. & 10"	3/8" x 1 1/8"	1/4" x 1/4"	1 lb.	\$2.44
CE846R	9", Lt. Ten. & 10"	3/8" x 1 1/8"	1/2" x 1/2"	2 lbs.	5.61
CE852R	13"	1/2" x 1 1/8"	5/8" x 5/8"	3 lbs.	6.42
CE853R	14 1/2", 16" & 16-24"	5/8" x 1 3/8"	3/8" x 3/8"	3 lbs.	7.88

Cat. No.	Size Lathe	Size Shank	Size Cutter	Ship. Wt.	Fact. Price
Left-Hand Turning Tool Holders					
CE847L	9", Lt. Ten. & 10"	3/8" x 1 1/8"	1/4" x 1/4"	1 lb.	\$2.44
CE846L	9", Lt. Ten. & 10"	3/8" x 1 1/8"	1/2" x 1/2"	2 lbs.	5.61
CE852L	13"	1/2" x 1 1/8"	5/8" x 5/8"	3 lbs.	6.42
CE853L	14 1/2", 16" & 16-24"	5/8" x 1 3/8"	3/8" x 3/8"	3 lbs.	7.88

Cutting-off Tool Holders

Cutting-off tool holders are made of drop-forged steel, heat-treated and hardened. Supplied in three styles: straight, right-hand, and left-hand as illustrated.

Price includes: tool holder, one cutter blade, and wrench.

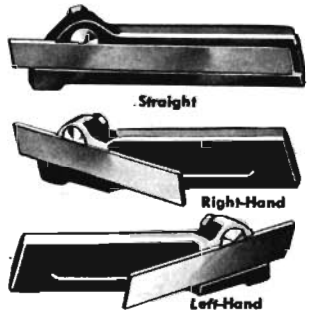

Cat. No.	Size Lathe	Size Shank	Size Cutter	Ship. Wt.	Fact. Price
Straight Shank Cutting-off Tool Holders					
CE833S	9", Lt. Ten. & 10"	3/8" x 1 1/8"	1/2" x .595"	1 lb.	\$2.89
CE736S	9", Lt. Ten. & 10"	3/8" x 1 1/8"	1/2" x .475"	2 lbs.	5.61
CE883S	13"	1/2" x 1 1/8"	1/2" x .735"	3 lbs.	7.06
CE884S	14 1/2", 16" & 16-24"	5/8" x 1 3/8"	1/2" x .870"	3 lbs.	8.86

Cat. No.	Size Lathe	Size Shank	Size Cutter	Ship. Wt.	Fact. Price
Right-Hand Cutting-off Tool Holders					
CE833R	9", Lt. Ten. & 10"	3/8" x 1 1/8"	1/2" x .595"	1 lb.	\$2.89
CE736R	9", Lt. Ten. & 10"	3/8" x 1 1/8"	1/2" x .475"	2 lbs.	5.61
CE883R	13"	1/2" x 1 1/8"	1/2" x .735"	3 lbs.	7.06
CE884R	14 1/2", 16" & 16-24"	5/8" x 1 3/8"	1/2" x .870"	3 lbs.	8.86

Cat. No.	Size Lathe	Size Shank	Size Cutter	Ship. Wt.	Fact. Price
Left-Hand Cutting-off Tool Holders					
CE736L	9", Lt. Ten. & 10"	3/8" x 1 1/8"	1/2" x .475"	2 lbs.	\$5.61
CE883L	13"	1/2" x 1 1/8"	1/2" x .735"	3 lbs.	7.06
CE884L	14 1/2", 16" & 16-24"	5/8" x 1 3/8"	1/2" x .870"	3 lbs.	8.86

Blades for Cutting-off Tool Holders

Made from high-speed steel, heat-treated, hardened, ground on the edges, ready to use in tool holders or 10 in 1 Tool Holder.

Cat. No.	Size of Blade	Ship. Wt.	Price
CE876	1/2" x .595" x 5"	5 ozs.	\$1.36
CE1192	3/8" x .475" x 4 1/2"	5 ozs.	1.12
CE878	3/8" x .735" x 5"	6 ozs.	1.48
CE879	3/8" x .870" x 6"	8 ozs.	1.94

Ground Cutter Bits for Forged Turning Tool Holders

These cutter bits are made of good quality high speed steel and are heat-treated and hardened.

When ordering, be sure to specify the catalog numbers and the letters designating shapes of bits wanted.

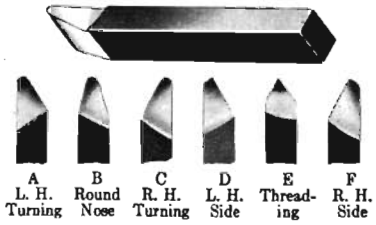

Size Square Inch	Length Cutter Inches	Single Bit			Set of 6 Bits		
		Cat. No.	Ship. Wt.	Price	Cat. No.	Ship. Wt.	Fact. Price
1/4"	2	CE1306	4 ozs.	\$0.45	CE1779	10 ozs.	\$2.40
3/8"	2 1/2	CE1313	5 ozs.	0.60	CE1777	10 1/2 ozs.	3.30
1/2"	3	CE1316	5 ozs.	0.85	CE1778	11 ozs.	4.70

Ground Cutter Bits for 10 in 1 Tool Holders

High speed steel cutter bits ground for use in 10 in 1 tool holder listed on page 58. Made in four shapes: T for turning, H for threading, R for facing on right side of work, and L for facing on left side of work. When ordering single bits be sure to specify shape wanted.

Size Square Inch	Length Cutter Inches	Single Bit			Set of 4 Bits		
		Cat. No.	Ship. Wt.	Price	Cat. No.	Ship. Wt.	Fact. Price
3/8"	3	CE2267	5 ozs.	\$0.85	CE2776	1 lb.	\$3.20
1/2"	4	CE2268	8 ozs.	1.75	CE2777	2 lbs.	6.75
3/4"	4 1/2	CE2269	1 lb.	3.40	CE2778	3 lbs.	12.95

Unground Cutter Bits

These cutter bits are the same quality as those listed above but they are not ground. They are heat-treated and hardened and are ready for use when sharpened. Specify catalog number and size when ordering cutter bits.

Catalog Number	Size Square	Length Cutter	Shipping Weight	Factory Price
CE3531	3/8"	1"	3 ozs.	\$0.14
CE3532	3/8"	1 1/2"	3 ozs.	0.17
CE3533	3/8"	2"	4 ozs.	0.38
CE3534	3/8"	2 1/2"	5 ozs.	0.48
CE3535	3/8"	3"	5 ozs.	0.70
CE3536	1/2"	3 1/2"	7 ozs.	1.00
CE3537	1/2"	4"	12 ozs.	1.35
CE3538	3/4"	4 3/8"	1 lb.	2.00

Unground High Speed Steel Cutter Bits in Lots

Size Square Inch	Length Cutter Inches	Lot of 6 Bits			Lot of 24 Bits		
		Cat. No.	Ship. Wt.	Price	Cat. No.	Ship. Wt.	Price
3/8"	1	CE2370	1 lb.	\$ 3.10
1/2"	1 1/2	CE2371	1 lb.	3.75
3/4"	2	CE2372	2 lbs.	7.50
1"	2 1/2	CE1628	10 ozs.	\$ 1.95	CE2373	3 lbs.	10.25
1 1/4"	3	CE1632	10 1/2 ozs.	2.70	CE2374	4 lbs.	14.50
1 1/2"	3 1/2	CE1633	11 ozs.	3.75	CE2375	6 lbs.	21.50
1 3/4"	4	CE2801	2 lbs.	8.50	CE2393	13 lbs.	29.00
2"	4 1/2	CE2802	3 lbs.	7.50	CE2376	15 lbs.	43.00
2 1/4"	5	CE2803	4 lbs.	10.95			

Cutter Bit Grinding Gauge

For grinding the correct front clearance, side clearance, front rake, and side rake on lathe tool cutter bits for machining iron and steel. Made of stainless steel. Instructions for using are packed with each gauge.

No. CE2169. Shipping weight 1/2 lb. Factory Price..... \$0.60



Style "B" Boring Tool

Made of drop-forged steel. Cutter can be set either straight or at a 45-degree angle. Price includes: drop-forged steel boring tool holder with hardened steel set screws, sleeve bar, end cap, two wrenches, and two unground high speed steel cutter bits. Will take the following sizes of boring bars: No. CE423, 1/8" to 1/2"; No. CE431, 1/4" to 3/4"; No. CE432, 3/8" to 1".



Cat. No.	Size of Lathe	Size of Shank, Inches	Size Bar Inches	Size of Cutter, Inch	Ship. Wt. Lbs.	Factory Price
CE423	9", Lt. 10, & 10"	3/16 x 3/4	1/2 x 7 7/8	3/16 x 3/16	2	\$ 9.67
CE431	13"	1/2 x 1 1/2	3/4 x 11	3/4 x 1 1/4	5	11.47
CE432	14 1/2", 16", 16-24"	3/8 x 1 3/8	1 1/16 x 13 1/4	3/8 x 3/8	8	15.11

Style "D" Boring Tool

For boring or threading work of small internal diameter. Price includes drop-forged steel boring tool holder, one boring bar, and wrench. Will take the following sizes of boring bars: No. CE3175, 1/8" to 1/2"; No. CE3176, 1/4" to 3/4"; No. CE3177, 3/8" to 1".



Cat. No.	Size of Lathe	Size of Shank, Inches	Size Bar, Inches	Ship. Wt. Lbs.	Factory Price
CE3175	9", Lt. 10, & 10"	3/16 x 3/4	1/4 x 5	2	\$6.17
CE3176	13"	1/2 x 1 1/2	3/8 x 7	4	7.09
CE3177	14 1/2", 16", 16-24"	3/8 x 1 3/8	3/8 x 8	6	8.03

Solid Boring Bar

For use with Style "B" and "D" Boring Tools and in the 10 in 1 Tool Holder. High speed steel tip welded onto carbon steel shank. Can be ground for either boring or internal thread cutting operations.



Cat. No.	Bar Inches	Ship. Wt.	Fact. Price
CE3856	1 3/16 x 4	3 ozs.	\$0.67
CE3857	1 1/4 x 4 1/2	4 ozs.	0.88
CE3858	1 1/2 x 5	5 ozs.	1.13
CE3859	1 3/8 x 6	5 ozs.	1.30
CE3860	1 1/2 x 7	8 ozs.	1.77
CE3861	1 3/8 x 8	1 lb.	2.44

Sleeve Boring Bar

For use with Style "B" and "D" Boring Tools, and in the 10 in 1 Tool Holder. Sleeve can be adjusted to hold square high speed steel cutter bit at 45° and 90° angles for boring and inside thread cutting operations. Price includes two cutter bits and wrench.



Cat. No.	Size of Bar	Size of Cutter Bit	Ship. Wt.	Factory Price
CE2419	1/2" x 7 7/8"	3/16" x 3/16"	1 lb.	\$5.93
CE2420	3/4" x 11"	1/4" x 1/4"	2 lbs.	7.41
CE2421	1 1/16" x 13 1/4"	5/16" x 5/16"	4 lbs.	10.66

Plain Boring Bars

For use with 10 in 1 Tool Holder and Boring Tool Holders. Bars will hold cutter bit at 45° and 90° angles. Price includes cutter bit and wrench.



Cat. No.	Bar Size	Cutter Bit	Ship. Wt.	Price
CE2943	3/4" x 12"	1/4" x 1/4"	3 lbs.	\$ 6.00
CE2944	1" x 16"	3/8" x 3/8"	5 lbs.	10.50
CE2945	1 1/8" x 18"	3/8" x 3/8"	7 lbs.	13.50

Knurling Tool

Knurling tool holder is made of drop-forged steel, heat-treated and hardened. Knurls are made of tool steel, hardened and tempered. Price includes: holder with choice of knurls in coarse, medium, or fine; straight, or diamond shape. When ordering specify pattern of knurls wanted; otherwise medium diamond knurls will be supplied.



Cat. No.	Size Lathe	Shank Size	Ship. Wt.	Price
CE820	9", Lt. 10, & 10"	3/8" x 3/4"	2 lbs.	\$ 5.79
CE665	9", Lt. 10, & 10"	1/2" x 3/4"	2 lbs.	11.12
CE893	13"	1/2" x 1 1/8"	2 lbs.	13.30
CE894	14 1/2", 16", & 16-24"	5/8" x 1 3/8"	3 lbs.	15.74

Revolving Head Knurling Tool

Revolving head carries three sets of knurls for fine, medium and coarse diamond patterns.



Cat. No.	Size Lathe	Shank Size	Ship. Wt.	Price
CE3615	9", Lt. 10, & 10"	3/8" x 3/4"	2 lbs.	\$15.78
CE3616	13"	1/2" x 1 1/8"	2 lbs.	17.76
CE3617	14 1/2", 16", & 16-24"	5/8" x 1 3/8"	3 lbs.	20.68

Extra Knurls for Knurling Tool



Diamond Pattern Straight Pattern

For use with Knurling Tools listed below, and with 10 in 1 Tool Holder listed on page 58. Illustrations above show actual size of knurling produced. Supplied in pairs.

Cat. No.	Pattern	Size	Fits Knurling Tools	Ship. Wt.	Factory Price
CE3150†	Fine Diamond	3/8" x 3/4"	CE820 & CE665	4 ozs.	\$1.97
CE3151†	Med. Diamond	3/8" x 3/4"	CE820 & CE665	4 ozs.	1.97
CE3152†	Coarse Diamond	3/8" x 3/4"	CE820 & CE665	4 ozs.	1.97
CE3153†	Fine Straight	3/8" x 3/4"	CE820 & CE665	4 ozs.	1.97
CE3154†	Med. Straight	3/8" x 3/4"	CE820 & CE665	4 ozs.	1.97
CE3155†	Coarse Straight	3/8" x 3/4"	CE820 & CE665	4 ozs.	1.97
CE3156†	Fine Diamond	3/8" x 3/4"	CE893 & CE894	5 ozs.	2.29
CE3157†	Med. Diamond	3/8" x 3/4"	CE893 & CE894	5 ozs.	2.29
CE3158†	Coarse Diamond	3/8" x 3/4"	CE893 & CE894	5 ozs.	2.29
CE3159†	Fine Straight	3/8" x 3/4"	CE893 & CE894	5 ozs.	2.29
CE3160†	Med. Straight	3/8" x 3/4"	CE893 & CE894	5 ozs.	2.29
CE3161†	Coarse Straight	3/8" x 3/4"	CE893 & CE894	5 ozs.	2.29

†Fits all sizes of 10 in 1 Tool Holders.

Threading Tool

Made of drop-forged steel. Cutter requires grinding on top edge only to sharpen. Price includes: threading tool holder with hardened steel set screw; wrench; and one high speed steel single point cutter. Choice of 60° cutter for U.S. Standard, V, or metric thread; or 55° cutter for Whitworth Standard thread. The 60° cutter will be furnished unless otherwise specified.



Cat. No.	Size of Lathe	Size of Shank	Ship. Wt.	Factory Price
CE845	9" Lt. 10, & 10"	3/8" x 3/4"	2 lbs.	\$ 4.88
CE848	9" Lt. 10, & 10"	1/2" x 3/4"	2 lbs.	8.19
CE867	13"	1/2" x 1 1/8"	3 lbs.	9.88
CE868	14 1/2", 16", & 16-24"	5/8" x 1 3/8"	4 lbs.	12.64

Extra Cutters for Threading Tool

Catalog Number		Fits Thread Tools	Shipping Weight	Factory Price
60° Angle	55° Angle			
CE3480	CE3483	CE845 & CE648	3 ozs.	\$3.18
CE3481	CE3484			
CE3482	CE3485			
		CE867	4 ozs.	6.18
		CE868	5 ozs.	8.22

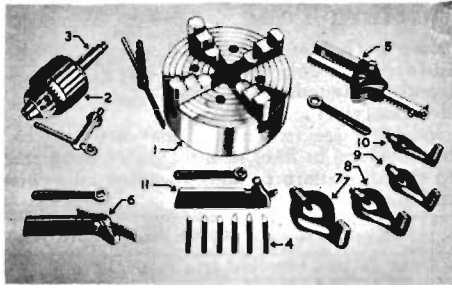

Chuck and Tool Assortments

The chucks and tools in the assortments listed are recommended for use with the various sizes of South Bend Lathes. They include the basic equipment required for the average shop for general machine work, such as turning, boring, drilling, cutting-off, chucking, etc.

11-Tool Assortment with Independent Lathe Chuck

Item	Description
1	4-Jaw Independent Lathe Chuck fitted to lathe. Sizes: 6 in. on 9' and 10' Lathes; 7 1/2 in. on 13" Lathe; 9 in. on 14 1/2" Lathe; 10" on 16" and 16-24" Lathes.
2	Jacobs 3-Jaw Drill Chuck. Sizes: 1/2 in. on 9' and 10' Lathes; 3/4 in. on 13" and 14 1/2" Lathes; 1 in. on 16" and 16-24" Lathes.
3	Arbor Fitted to above Drill Chuck.
4	6 Ground Cutter Bits for Tool Holder.
5	Boring Tool Holder, Style "B". 9' and Light Ten Lathes take Style "D".
6	Cutting-off Tool Holder, Right-Hand.
7-10	4 Malleable Lathe Dogs. Sizes: 1/2", 3/4", 1" and 1 1/2".
11	Straight Shank Tool Holder.

Complete Assortments as Listed Above

Cat. No.	Size Lathe	Ship. Wt.	Factory Price
CL2890NK	9' & Light Ten	28 lbs.	\$ 69.50
CL2890L	10"	35 lbs.	115.00
CL2890O	13"	70 lbs.	140.00
CL2890M	14 1/2"	75 lbs.	163.00
CL2890H	16" & 16-24"	80 lbs.	186.00

10 in 1 Tool Holder

The 10 in 1 Tool Holder replaces the conventional tool post and various tool holders ordinarily used for general lathe work. It provides rigid support for turning, boring, threading, and cut-off tool bits. In addition, it is equipped with a self-aligning knurling head having No. CE3151 medium diameter knurls. Screw adjustments for tool height are easily made, and they stay put. No readjustment is required when replacing tools. This tool block can be adapted to fit other makes of lathes. See pages 56, 57 and 59 for cutter bits, boring bars, cut-off blades, and extra knurls.

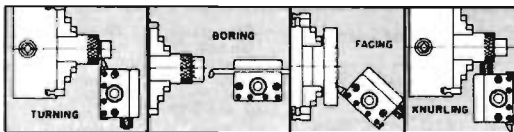
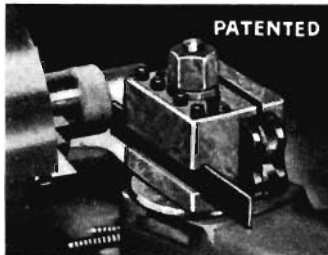

Catalog Number	Size Lathe Inches	Holds Cutter Bits Inch	Holds Boring Bars Inches	Holds Cut-off Blades Inch	Ship. Wt. Lbs.	Factory Price
CE1413NK	9 & Lt. Ten	3/8 x 3/8	3/8 to 3/4	3/8 x .595	5	\$13.50
CE1413R	10	3/8 x 3/8	3/8 to 3/4	3/8 x .595	5	14.50
CE1413T	13	1/2 x 1/2	1/2 to 1 1/4	1/2 x .735	7	17.25
CE1413F	14 1/2	5/8 x 3/8	1/2 to 1 1/4	1/2 x .870	10	20.00
CE1413H	16 & 16-24	3/4 x 3/8	1/2 to 1 1/4	1/2 x .870	10	20.75

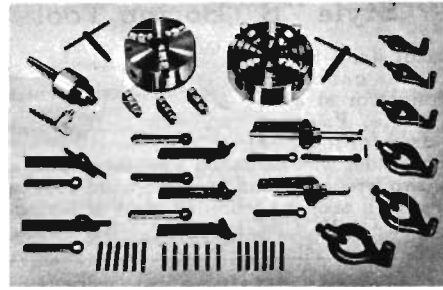

20-Tool Assortment for 9' and Light Ten Lathes

This is a more complete assortment than those listed at left, and consists of the following equipment:

Item	Cat. No.	Description
1	CL4006NK	6" Four-Jaw Independent Lathe Chuck, fitted.
2	CL3005NK	5" Three-Jaw Universal Lathe Chuck, fitted.
3	CE1201	Jacob's Three-Jaw Drill Chuck, 1/2" capacity.
4	CE2302	Taper Shank Arbor (No. 2 M.T.), fitted to Drill Chuck.
5	CE847S	Straight Shank Turning Tool Holder.
6	CE847R	Right-Hand Turning Tool Holder.
7	CE847L	Left-Hand Turning Tool Holder.
8	CE833R	Right-Hand Cutting-off Tool Holder.
9	CE833S	Straight Shank Cutting-off Tool Holder.
10	CE1779	Set (6) Ground Cutter Bits for Turning Tools.
11-12	CE1629	Two Sets (6) Unground Cutter Bits for Turning Tools.
13	CE317S	Style "D" Boring Tool Holder.
14	CE423	Style "B" Boring Tool Holder.
15	CE3837	1/2" Standard Malleable Lathe Dog.
16	CE3838	3/4" Standard Malleable Lathe Dog.
17	CE3839	1" Standard Malleable Lathe Dog.
18	CE3840	1 1/4" Standard Malleable Lathe Dog.
19	CE3841	1" Standard Malleable Lathe Dog.
20	CE3842	1 1/2" Standard Malleable Lathe Dog.

CL2970NK. Twenty Tool Assortment as listed above for 9' or Light Ten Lathes. Shipping weight 52 lbs. \$152.50

11-Tool Assortment With Universal Chuck For 9-inch and Light Ten Lathes Only

This assortment is exactly the same as the No. CL2890NK assortment listed at left, except that a No. CL3005NK, 5" 3-jaw Universal chuck is supplied in lieu of the 6" 4-jaw Independent chuck.

CL2960NK. Eleven Tool Assortment with Universal Chuck for 9-inch and Light Ten Lathes. Ship. wt. 20 lbs. Price. . \$89.50

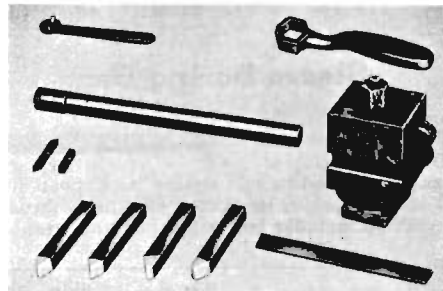

10 in 1 Tool Holder Kit

You can save money by purchasing this 10 in 1 Tool Holder Kit complete with boring bar, cut-off blade, and set of four ground high speed steel cutter bits. Price also includes knurling head, bolt clamp, and all other equipment regularly supplied with the 10 in 1 tool holder.

For specifications of tool holder see column at left. Descriptions and illustrations of cutter bits, boring bars, cut-off blades, and extra knurls, see pages 56, 57 and 59.

Catalog No. of Kit	Size of Lathe	Items Included in Kit			Ship. Weight	Factory Price
		Cutter Bits	Boring Bar	Cut-off Blade		
CE2930NK	9' & Lt. Ten	CE2778	CE2419	CE878	7 lbs.	\$23.00
CE2930R	10"	CE2778	CE2419	CE878	7 lbs.	24.00
CE2930T	13"	CE2778	CE2420	CE878	12 lbs.	32.00
CE2930F	14 1/2"	CE2778	CE2421	CE879	18 lbs.	44.00
CE2930H	16" & 16-24"	CE2778	CE2421	CE879	18 lbs.	45.00

Carbide Tipped Cutter Bits



Style AL (Left-Hand)

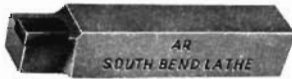

Style AR (Right-Hand)



Style BL (Left-Hand)

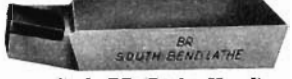

Style BR (Right-Hand)



Style D (Pointed Nose 80° Included Angle)

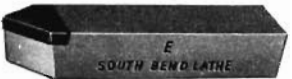

Style E (60° Thread Cutting Tool)

These Carbide Tipped Cutter Bits are intended for use in the 10 in 1 Tool Holder (page 58), Double Tool Cross Slide, and Square Turret Tool Block (page 41). They are not recommended for use in the Forged Tool Holders (page 56).

Carbide tipped cutting tools are used for manufacturing operations where long tool life and maximum cutting speeds are desirable. They are highly efficient for machining alloy steel, alloy cast iron, bronze, aluminum and abrasive non-metallic materials such as fibre, rubber, and plastics. Two grades of tools are supplied, one for machining steel and the other for machining cast iron and all other materials.

A special grinding wheel (preferably diamond impregnated) is required for grinding carbide as it cannot be satisfactorily ground on the ordinary grinding wheel. Because of its extreme hardness, the carbide tip is very brittle and must be carefully handled to avoid accidental damage. The cutting edge must be well supported and should have just enough clearance to permit it to cut freely.

Style AL Left-Hand Cutter Bits

Shank Size	Ship. Weight	Machining Steel		Other Materials	
		Cat. No.	Price	Cat. No.	Price
$\frac{3}{8}$ " x $\frac{3}{8}$ " x $2\frac{1}{2}$ "	5 ozs.	CE3320	\$1.32	CE3325	\$1.25
$\frac{1}{2}$ " x $\frac{1}{2}$ " x 3"	7 ozs.	CE3321	1.57	CE3326	1.50
$\frac{1}{2}$ " x $\frac{1}{2}$ " x $3\frac{1}{2}$ "	12 ozs.	CE3322	1.83	CE3327	1.74
$\frac{3}{8}$ " x $\frac{3}{8}$ " x 4"	1 lb.	CE3323	2.26	CE3328	2.15

Style AR Right-Hand Cutter Bits

Shank Size	Ship. Weight	Machining Steel		Other Materials	
		Cat. No.	Price	Cat. No.	Price
$\frac{3}{8}$ " x $\frac{3}{8}$ " x $2\frac{1}{2}$ "	5 ozs.	CE3330	\$1.32	CE3335	\$1.25
$\frac{1}{2}$ " x $\frac{1}{2}$ " x 3"	7 ozs.	CE3331	1.57	CE3336	1.50
$\frac{1}{2}$ " x $\frac{1}{2}$ " x $3\frac{1}{2}$ "	12 ozs.	CE3332	1.83	CE3337	1.74
$\frac{3}{8}$ " x $\frac{3}{8}$ " x 4"	1 lb.	CE3333	2.26	CE3338	2.15

Style BL Left-Hand Cutter Bits

Shank Size	Ship. Weight	Machining Steel		Other Materials	
		Cat. No.	Price	Cat. No.	Price
$\frac{3}{8}$ " x $\frac{3}{8}$ " x $2\frac{1}{2}$ "	5 ozs.	CE3590	\$1.32	CE3595	\$1.25
$\frac{1}{2}$ " x $\frac{1}{2}$ " x 3"	7 ozs.	CE3591	1.57	CE3596	1.50
$\frac{1}{2}$ " x $\frac{1}{2}$ " x $3\frac{1}{2}$ "	12 ozs.	CE3592	1.83	CE3597	1.74
$\frac{3}{8}$ " x $\frac{3}{8}$ " x 4"	1 lb.	CE3593	2.26	CE3598	2.15

Style BR Right-Hand Cutter Bits

Shank Size	Ship. Weight	Machining Steel		Other Materials	
		Cat. No.	Price	Cat. No.	Price
$\frac{3}{8}$ " x $\frac{3}{8}$ " x $2\frac{1}{2}$ "	5 ozs.	CE3550	\$1.32	CE3555	\$1.25
$\frac{1}{2}$ " x $\frac{1}{2}$ " x 3"	7 ozs.	CE3551	1.57	CE3556	1.50
$\frac{1}{2}$ " x $\frac{1}{2}$ " x $3\frac{1}{2}$ "	12 ozs.	CE3552	1.83	CE3557	1.74
$\frac{3}{8}$ " x $\frac{3}{8}$ " x 4"	1 lb.	CE3553	2.26	CE3558	2.15

Style D 80-deg. Included Angle Cutter Bits

Shank Size	Ship. Weight	Machining Steel		Other Materials	
		Cat. No.	Price	Cat. No.	Price
$\frac{3}{8}$ " x $\frac{3}{8}$ " x $2\frac{1}{2}$ "	5 ozs.	CE3340	\$1.52	CE3345	\$1.44
$\frac{1}{2}$ " x $\frac{1}{2}$ " x 3"	7 ozs.	CE3341	1.83	CE3346	1.73
$\frac{1}{2}$ " x $\frac{1}{2}$ " x $3\frac{1}{2}$ "	12 ozs.	CE3342	1.88	CE3347	1.79
$\frac{3}{8}$ " x $\frac{3}{8}$ " x 4"	1 lb.	CE3343	2.41	CE3348	2.30

Style E 60-deg. Thread Tool Cutter Bits

Shank Size	Ship. Weight	Machining Steel		Other Materials	
		Cat. No.	Price	Cat. No.	Price
$\frac{3}{8}$ " x $\frac{3}{8}$ " x $2\frac{1}{2}$ "	5 ozs.	CE3390	\$1.44	CE3394	\$1.38
$\frac{1}{2}$ " x $\frac{1}{2}$ " x 3"	7 ozs.	CE3391	1.65	CE3395	1.57
$\frac{1}{2}$ " x $\frac{1}{2}$ " x $3\frac{1}{2}$ "	12 ozs.	CE3392	1.76	CE3396	1.67
$\frac{3}{8}$ " x $\frac{3}{8}$ " x 4"	1 lb.	CE3393	2.30	CE3397	2.19

Work Light for Lathe

For clear vision without eyestrain, equip all your lathes (and other machine tools) with this new South Bend Work Light. It has a clamp for attaching to the lathe bed, or may be permanently installed by drilling and tapping the saddle for the threaded end of the flexible support, as shown in illustration. When attached to the lathe carriage in this way it travels with the cutting tool. When ordered with the lathe, the saddle will be drilled and tapped for the work light at no extra charge.

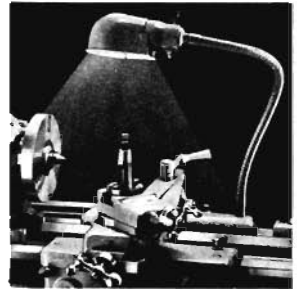

CE2815. Work Light for lathe, including clamp for attaching to lathe bed. Shipping weight 5 lbs. Price.....\$12.95

Waterproof Service Covers For Lathes

Use these durable waterproof oil resistant plastic machine tool service covers to protect your equipment overnight or whenever it is not in use. Effectively prevents dust and dirt from accumulating. See also pages 70, 73.



Catalog Number	Size, Inches			Suggested for	Ship. Wt.	Fac. Price
	Wdth.	Leqth.	Ht.			
CE2895	32	48	17	9' & 10' Lathe, 3' & 3 1/2' Bed	2 lbs.	\$2.95
CE2896	32	60	17	9' & 10' Lathe 4' & 4 1/2' Bed	3 lbs.	3.25
CE2897	38	72	25	13' & 14 1/2' Lathe, 4' & 5' Bed	3 lbs.	5.25
CE2898	38	96	25	13', 14 1/2', 16', 16-24' & 2-H Lathe, 6' & 7' Bed	3 lbs.	7.50

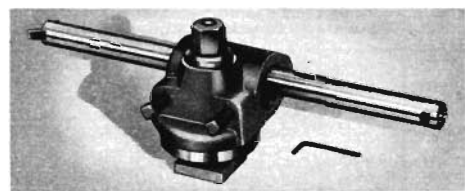

Heavy Duty Boring and Turning Tool

This is a very rigid combination tool for boring, turning, and facing operations. Holder takes bars from $\frac{3}{8}$ " up to maximum capacity listed in tabulation. Tool may be swiveled to any angle and holder may be reversed for turning extra large diameters. Bar has slots for holding bit at 90° and 45°. Supplied either with or without boring bar, as indicated in table. See page 57 for extra bars.

Size Lathe	9' & Lt. Ten	10'	13'	14 1/2'	16' & 16-24'
Max. Bar Cap.	$\frac{3}{4}$ "	$\frac{3}{4}$ "	$1\frac{1}{4}$ "	$1\frac{1}{2}$ "	$1\frac{1}{2}$ "
Size Boring Bar	$\frac{3}{4}$ " x 12"	$\frac{3}{4}$ " x 12"	1" x 16"	$1\frac{1}{2}$ " x 18"	$1\frac{1}{2}$ " x 18"
Size Cutter Bit	$\frac{1}{4}$ " x $\frac{1}{4}$ "	$\frac{1}{4}$ " x $\frac{1}{4}$ "	$\frac{3}{16}$ " x $\frac{3}{16}$ "	$\frac{3}{8}$ " x $\frac{3}{8}$ "	$\frac{3}{8}$ " x $\frac{3}{8}$ "
Holder Only					
Cat. No.	CE3677NK	CE3677R	CE3677T	CE3677F	CE3677H
Ship. Wt. Lbs.	3	3	5	7	7
Fac. Price	\$8.75	\$10.25	\$12.25	\$13.75	\$15.25
Holder and Bar					
Cat. No.	CE469NK	CE469R	CE469T	CE469F	CE469H
Ship. Wt. Lbs.	8	8	14	15	18
Fac. Price	\$14.75	\$16.25	\$22.75	\$27.25	\$28.75

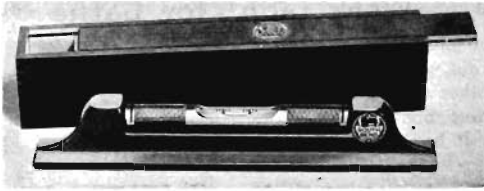

12" Precision Level

Precision tolerances can be maintained only when the lathe is properly leveled. With this 12" sensitive precision level, a lathe or other machine can be properly installed and leveled. The level has a ground and graduated vial mounted in a twelve inch cast iron frame with machined base having a V-way for leveling shafts. It has been carefully designed to provide just the right degree of sensitivity for quick and accurate leveling. Can be used only in horizontal position. We recommend that every shop be equipped with one of these levels.

Cat. No. CE2218. Precision Level. Packed in wooden case. Shipping weight 5 lbs. Factory Price..... \$12.50

Chuck Wrenches

Catalog Number	Size Square	Shipping Weight	Factory Price
CE2748	.277"	2 lbs.	\$1.90
CE2742	.297"	1 lb.	1.65
CE2743	.375"	2 lbs.	1.90
CE2749	.400"	2 lbs.	1.90
CE2744	.420"	2 lbs.	2.50
CE2746	.570"	2 lbs.	2.50

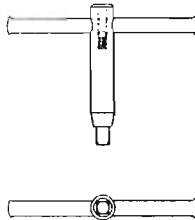

Sizes of Wrenches Required for Various Sizes of Chucks

Cat. No. of Chuck	Size of Chuck	Type of Chuck	Size Square	Cat. No. of Required Wrench
CL4006NK	6"	Independent	.297"	CE2742
CL4206NK	6"	Independent	.297"	CE2742
CL4006L	6"	Independent	.297"	CE2742
CL4206LO	6"	Independent	.297"	CE2742
CL4207LO	7 1/2"	Independent	.420"	CE2744
CL4209O	9"	Independent	.420"	CE2744
CL4207MH	7 1/2"	Independent	.420"	CE2744
CL4209MH	9"	Independent	.420"	CE2744
CL4210MH	10"	Independent	.420"	CE2744
CL4212H	12"	Independent	.420"	CE2744
CL3005NK	5"	Universal	.277"	CE2748
CL3505NK	5"	Universal	.375"	CE2743
CL3506NK	6"	Universal	.400"	CE2749
CL3005L	5"	Universal	.277"	CE2748
CL3505LO	5"	Universal	.375"	CE2743
CL3506LO	6"	Universal	.400"	CE2749
CL3507O	7 1/2"	Universal	.400"	CE2749
CL3505MH	5"	Universal	.375"	CE2743
CL3506MH	6"	Universal	.400"	CE2749
CL3507MH	7 1/2"	Universal	.400"	CE2749
CL3509MH	9"	Universal	.570"	CE2746

Single End Wrenches

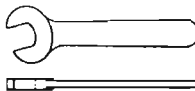

Catalog Number	Opening	Length	Thickness	Shipping Weight	Factory Price
CE2657	3/8"	5 1/2"	2 1/4"	7 ozs.	\$0.80
CE2658	1/2"	5 1/2"	2 1/4"	8 ozs.	0.80
CE2670	3/8"	6 1/2"	1 1/4"	1 lb.	1.36
CE2671	1 1/8"	8 1/2"	3/8"	1 lb.	1.92

Tool Post Wrenches

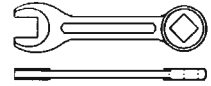

Catalog Number	Size Lathe	Open End	Closed End	Lgth.	Thick-ness	Ship. Wt.	Fact. Price
CE2650NK	9"	3 1/2"	3 1/2"	4"	3/8"	4 ozs.	\$0.80
CE2650R	10"	7/8"	1 1/8"	4"	3/8"	6 ozs.	0.95
CE2650T	13"	1 1/2"	1 1/2"	6"	3/8"	1 lb.	2.20
CE2650FH	14 1/2", 16", & 16-24"	3/4"	3/4"	6"	3/8"	1 lb.	2.20

Tailstock Wrenches

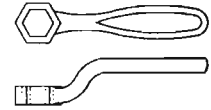

Catalog Number	Size Lathe	Open- ing	Ex- trem- e Lgth.	Thick- ness	Ship. Wt.	Fac- tory Price
CE2653NK	9"	1 1/8"	5 1/4"	7/8"	6 ozs.	\$0.65
CE2653R	10"	2 1/8"	6 1/2"	3/4"	1 lb.	0.75
CE2653T	13"	1 1/2"	7 1/2"	1 1/8"	2 lbs.	1.10
CE2653FH	14 1/2", 16", & 16-24"	1 1/2"	9 1/2"	1"	2 lbs.	1.35

Spanner Wrenches

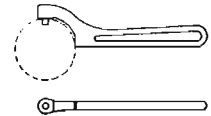

Catalog No.	Circle Diameter	Extreme Length	Pin Size	Shipping Weight	Factory Price
CE2739	1 1/2"	4"	3/8"	5 ozs.	\$0.80
CE2740	1 3/8"	5"	5"	6 ozs.	1.10
CE2734	2 1/2"	6 1/2"	1 1/2"	1 lb.	.80
CE2735	2 3/4"	7 1/2"	1 1/2"	1 lb.	1.10
CE2738	3"	8"	3/4"	1 lb.	1.25
CE2737	3 1/4"	8 1/2"	3/4"	1 lb.	1.30
CE2738	3 3/8"	9"	1 1/2"	2 lbs.	1.55

Hollow Hexagon Head Set Screw Wrenches

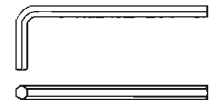

Catalog Number	Size Hex.	Extreme Length	Extreme Height	Shipping Weight	Factory Price
CE2391	3/8"	3 1/2"	3/8"	3 ozs.	\$0.07
CE2392	1/2"	2 11/16"	7/8"	3 ozs.	0.07
CE2385	5/8"	2 11/16"	1"	3 ozs.	0.07
CE2386	3/4"	2 3/8"	1 1/4"	4 ozs.	0.08
CE2387	7/8"	2 3/8"	1 1/2"	4 ozs.	0.09
CE2388	1 1/8"	3 1/2"	1 3/4"	4 ozs.	0.10
CE2389	1 1/4"	4 1/8"	1 3/4"	4 ozs.	0.14
CE2390	3/8"	4 1/8"	1 11/16"	6 ozs.	0.22

Double End Wrenches

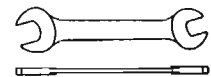

Catalog No.	Large Opening	Small Opening	Length	Thick-ness	Shipping Weight	Factory Price
CE2655	1 1/2"	3/8"	4 7/8"	1/4"	8 ozs.	\$0.72
CE2656	2 1/2"	1/2"	6 1/2"	1/2"	1 lb.	1.94

Socket Wrench

CE2750. Socket Wrench for nut 1/2" square. Fits stroke adjustment nut on South Bend 7" Shaper. Ship. wt. 1 1/2 lbs. Factory Price.....\$2.05

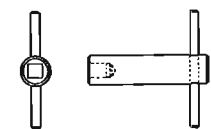

Open End Box Wrench

CE2675. Open End Box Wrench. 1/8" opening, 1/8" close, 1/2" thick, 10 1/2" long. Ship. wt. 1 lb. Factory Price.....\$2.82

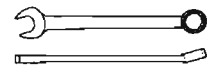

Right—Index Chart Showing English Screw Threads Cut with English Transposing Gears

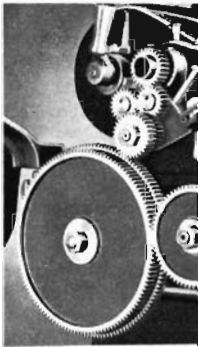

TRANSPOSING GEAR CHART ENGLISH SCREW THREADS Metric Pitch Lead Screw			
Threads per Inch	Lead	Pinion	Spindle Gear
4	1/4	24	24
5	1/5	20	20
6	1/6	18	18
8	1/8	15	15
10	1/10	12	12
12	1/12	10	10
14	1/14	9	9
16	1/16	8	8
18	1/18	7	7
20	1/20	6	6
24	1/24	5	5
28	1/28	4	4
32	1/32	3	3
36	1/36	3	3
40	1/40	2	2
48	1/48	2	2
56	1/56	2	2
64	1/64	2	2
72	1/72	2	2
80	1/80	2	2

Left—South Bend Lathe Equipped with English Transposing Gears

English Transposing Gears

For Cutting English Screw Threads

Right-hand and left-hand English screw threads ranging from 4 to 80 threads per inch, as listed in the index chart above, can be cut (in addition to the regular metric pitches) on any size or type of South Bend Lathe having a metric lead screw, when equipped with a set of English transposing gears.

When lathes are ordered with English transposing gears, the graduated collars on the tailstock spindle, the cross-feed screw, and the compound rest screw can be supplied to read in the English system, or in the metric system, as desired.

English Transposing Gears Ordered With Lathe

Size of Lathe	With English Graduations		With Metric Graduations	
	Cat. No.	Price	Cat. No.	Price
9" Model A	CL2288NK	\$13.50	CL2284NK	\$13.50
9" Model B	CL2253N	16.00	CL2255N	16.00
9" Model C	CL2254N	16.00	CL2256N	16.00
Light Ten Model A	CL2288NK	13.50	CL2284NK	13.50
Light Ten Model B	CL2253K	17.00	CL2255K	17.00
Light Ten Model C	CL2254K	17.00	CL2256K	17.00
10" Quick Change	CL2288R	46.00	CL2284R	46.00
13" Quick Change	CL2288T	50.85	CL2284T	50.85
14 1/2" Quick Change	CL2288F	58.15	CL2284F	58.15
16", 16-24", & 2-H Q.C.	CL2288H	63.00	CL2284H	63.00

English Transposing Gears Ordered Separate From Lathe

Size of Lathe	Ship. Wt.	Cat. No.	Price
9" Model A	8 lbs.	CL2289NK	\$13.50
9" Model B	21 lbs.	CL1283N	21.75
9" Model C	21 lbs.	CL1284N	21.75
Light Ten Model A	8 lbs.	CL2289NK	13.50
Light Ten Model B	21 lbs.	CL1283K	23.00
Light Ten Model C	21 lbs.	CL1284K	23.00
10" Quick Change	51 lbs.	CL2289R	63.55
13" Quick Change	73 lbs.	CL2289T	69.70
14 1/2" Quick Change	121 lbs.	CL2289F	78.90
16", 16-24", & 2-H Q.C.	65 lbs.	CL2289H	91.20

Metric Thread Dial

This attachment saves much time when cutting long screw threads. Instead of reversing the lathe to return the cutting tool to the starting point, the half-nuts may be opened and the carriage moved quickly by hand. The graduated dial shows when to engage the half-nuts so the cutting tool will follow the original cut.

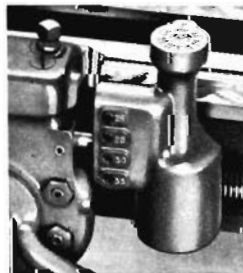

Cat. No. CL2265NK. Metric Thread Dial for 9" and Light Ten South Bend Lathes with metric lead screw. Shipping weight 3 lbs. Factory Price \$18.25
Note: See page 50 for English thread dials.

For long, trouble-free service, lubricate your machinery regularly with the correct grade of oil. See page 51.

METRIC LATHES

All South Bend Lathes can be supplied in the metric system, with metric lead screw and gearing for cutting standard pitches of metric screw threads, and metric cross-feed and compound rest feed screws having micro-meter collars with metric graduations. The tailstock spindles and taper attachment are graduated in both the English and metric systems. Except for these features, the metric lathes are identical with corresponding models having English gearing and graduations. Write for complete information.

Right—Index Chart Showing Metric Screw Threads Cut with Metric Transposing Gears

METRIC TRANSPOSING GEAR CHART Metric Pitch Lead Screw & Thread			
Threads per Inch	Lead	Pinion	Spindle Gear
1.25	1/8	24	24
1.50	3/16	20	20
2.00	1/4	18	18
2.50	5/16	15	15
3.00	3/8	12	12
3.50	7/16	10	10
4.00	1/2	9	9
4.50	9/16	8	8
5.00	5/8	7	7
5.50	11/16	6	6
6.00	3/4	5	5
6.50	13/16	4	4
7.00	7/8	3	3
7.50	15/16	3	3
8.00	1	2	2
8.50	1 1/16	2	2
9.00	1 1/8	2	2
9.50	1 1/4	2	2
10.00	1 1/2	2	2
10.50	1 5/8	2	2
11.00	1 3/4	2	2
11.50	1 7/8	2	2
12.00	2	2	2

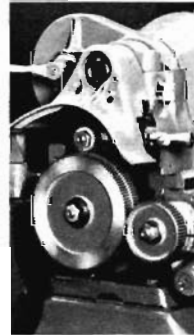

Left—South Bend Lathe Equipped with Metric Transposing Gears

Metric Transposing Gears

For Cutting Metric Screw Threads

Right-hand and left-hand metric screw threads ranging from 6 mm pitch to 0.20 mm pitch, as listed in the index chart above, can be cut (in addition to the regular English pitches) on any size or type of South Bend Lathe having an English lead screw, when equipped with set of metric transposing gears.

When lathes are ordered with metric transposing gears, the graduations on the tailstock spindle, the cross-feed screw, and the compound rest screw can be supplied to read in the metric system, or in the English system, as desired. Catalog numbers listed below apply to equipment for current models of lathes only.

Metric Transposing Gears Ordered With Lathe

Size of Lathe	With English Graduations		With Metric Graduations	
	Cat. No.	Price	Cat. No.	Price
9" Model A	CL1955NK	\$13.50	CL1941NK	\$13.50
9" Model B	CL2248N	16.00	CL2247N	16.00
9" Model C	CL2261N	16.00	CL2263N	16.00
Light Ten Model A	CL1955NK	13.50	CL1941NK	13.50
Light Ten Model B	CL2248K	17.00	CL2247K	17.00
Light Ten Model C	CL2261K	17.00	CL2263K	17.00
10" Quick Change	CL1955R	50.75	CL1941R	50.75
13" Quick Change	CL1955T	56.75	CL1941T	56.75
14 1/2" Quick Change	CL1955F	64.00	CL1941F	64.00
16", 16-24", & 2-H Q.C.	CL1955H	69.50	CL1941H	69.50

Metric Transposing Gears Ordered Separate From Lathe

Size of Lathe	Ship. Wt.	Cat. No.	Price
9" Model A	8 lbs.	CL1957NK	\$13.50
9" Model B	21 lbs.	CL1962N	21.75
9" Model C	21 lbs.	CL1961N	21.75
Light Ten Model A	8 lbs.	CL1957NK	13.50
Light Ten Model B	21 lbs.	CL1962K	23.00
Light Ten Model C	21 lbs.	CL1961K	23.00
10" Quick Change	51 lbs.	CL1957R	64.00
13" Quick Change	73 lbs.	CL1957T	70.25
14 1/2" Quick Change	121 lbs.	CL1957F	78.75
16", 16-24", & 2-H Q.C.	65 lbs.	CL1957H	91.00

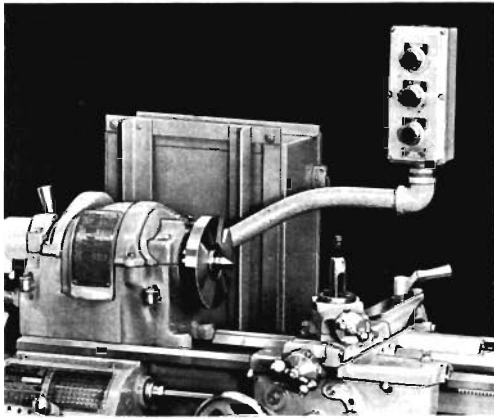

J. I. C. Electrical Equipment

South Bend Lathes 10" swing and larger can be supplied with electrical equipment manufactured to Joint Industry Committee of Automotive Industry standards as listed below.

Totally Enclosed Single-Speed Motors To Meet J. I. C. Standards

Cat. No.	H.P.	Phase	Cycle	Volts	Factory Price
CE6150	¾	3	60	220/440	\$ 60.00
CE6151	1	3	60	220/440	93.00
CE6152	1½	3	60	220/440	109.00
CE6153	2	3	60	220/440	131.00

Non-Fusible Control Equipment

Consisting of one combination magnetic reversing line-starter, size 1, with fused dual voltage transformer for low voltage control, overload protection and non-fusible disconnect, all in NEMA type 12 enclosure. Also one pushbutton station, forward, reverse, stop, in oil tight enclosure for surface mounting.

CE6154. Non-fusible Electrical Control Equipment to J. I. C. standards. Price..... \$186.00

Fusible Control Equipment

Consisting of one combination magnetic reversing line-starter, size 1, with fused dual voltage transformer for low voltage control, with overload protection and with fusible disconnect, all in NEMA type 12 enclosure. Also one pushbutton station, forward, reverse, stop, in oil tight enclosure for surface mounting.

CE6155. Fusible Electrical Control Equipment to J. I. C. standards. Price..... \$198.00

Circuit Breaker Control Equipment

Consisting of one combination magnetic reversing line-starter, size 1, with fused dual voltage transformer for low voltage control, overload protection and circuit breaker, all in NEMA type 12 enclosure. Also one pushbutton station, forward, reverse, stop, in oil tight enclosure for surface mounting.

CE6156. Circuit Breaker Electrical Control Equipment to J. I. C. standards. Price..... \$219.00

Fitting and Connecting Equipment

Labor and material for fitting and connecting J. I. C. electrical equipment to lathe, including special stand for mounting line-starter to J. I. C. standards are extra and will be supplied as follows:

CE6157. Mounting J. I. C. Electrical Equipment on 10" Underneath Motor Drive Bench Lathe. Price..... \$53.00

CE6158. Mounting J. I. C. Electrical Equipment on 10" Underneath Motor Drive Floor Lathe. Price..... \$51.00

CE6159. Mounting J. I. C. Electrical Equipment on 13" Underneath Motor Drive Lathe. Price..... \$51.00

CE6160. Mounting J. I. C. Electrical Equipment on 14½" or 16" Underneath Motor Drive Lathe. Price..... \$52.00

CE6161. Mounting J. I. C. Electrical Equipment on 16-24" Underneath Motor Drive Lathe. Price..... \$53.00

Motors and Controls

Motors are listed in tabulation No. 1, page 63. Controls are listed in tabulations Nos. 2, 3, and 4. The control equipment required for each size and type of motor is listed on the same line with the motor.

Two-speed motors are listed for 10-inch and larger lathes only. These motors have two forward speeds and two reverse speeds which with the cone pulley and back gears of the lathe, provide 12 to 24 spindle speeds.

Drum switch controls listed in Table No. 2 are optional for ½ h.p. and larger motors operating on 230 volts or less. Resistance panels are included in the prices of controls for D.C. motors ¾ h.p. and larger.

Pushbutton operated line-starter controls listed in Table No. 3 are required for all motors operating on currents higher than 230 volts. These controls are optional for all other motors ½ h.p. and larger. Pushbutton controls provide overload and low voltage protection. For currents above 230 v., transformer reduces pushbutton current to 110 volts. Necessary resistance panels are supplied for D.C. motors ¾ h.p. and larger.

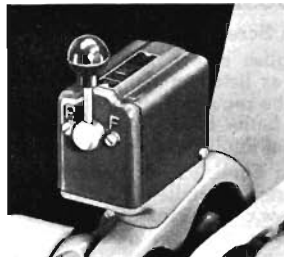

CE789 Drum Control Switch as mounted on 9" Bench Lathe



CE790 Drum Control Switch as mounted on 10" and larger Floor Lathes

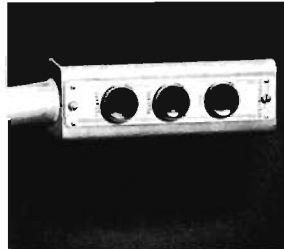

Pushbutton Control Switch for single speed reversing motor



Pushbutton Control Switch for two-speed single winding motor



Pushbutton Control Switch for two-speed double winding motor



Line-starter Control Equipment for two-speed motor

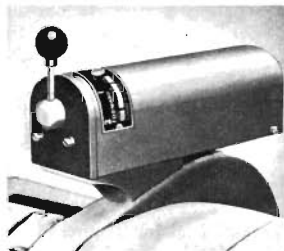

Drum Switch Control for 13" Turret Lathe

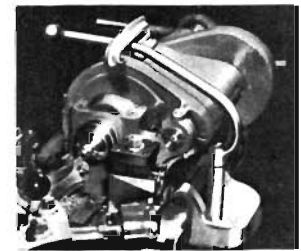

Control Equipment for 2-H Turret Lathe

Motors and Controls for Lathes

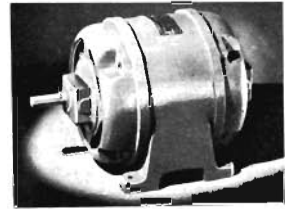

Reversing motors are recommended for South Bend Lathes because they permit reversing the lathe spindle for tapping, thread cutting, and similar operations. All motors listed below are of the instant reversing type with the exception of Cat. No. CE3256B, which is a start-stop reversing motor. Single

phase A.C. motors are capacitor type with the exception of CE3256B, which is a split-phase start-stop reversing type motor. For additional information on motors and controls, see page 62. Prices of motors and controls for current characteristics not listed will be quoted on request.

Size of Lathe	Current Characteristics				MOTORS				CONTROLS FOR MOTORS							
	Type of Current	Phase	Cycle	Voltage	Table 1				Table 2		Table 3		Table 4			
					Catalog Number	h.p.	Speeds	Price f.o.b. Factory	DRUM SWITCH CONTROLS Not required if equipment in Table No. 3 is ordered		PUSH BUTTON LINE-STARTER CONTROLS Not used with No. 2-H or 13" Turret Lathes		CONTROLS FOR TURRET LATHES			
								Catalog Number	Factory Price	Catalog Number	Factory Price	Catalog Number	Factory Price			
14½-Inch 16-Inch 16-24-Inch and 2-H	A.C.	3	60	220	CE2130††	2-1	Tree-Speed	\$182.00			CE2567	\$188.00	CE1217	\$199.00		
	A.C.	3	50	220	CE2147†	2-1	Tree-Speed	162.00			CE2568	198.00	CE1285	208.00		
	A.C.	3	50	440	CE2148†	2-1	Tree-Speed	141.00			CE2565	208.00	CE1209	233.00		
	A.C.	3	60	550	CE3372††	2-1	Tree-Speed	182.00			CE2566	216.00	CE1219	243.00		
16-Inch, 16-24-Inch and 2-H	A.C.	3	50	220	CE2543C	2	One-Speed	99.50	CE790	\$ 10.00	CE2573	98.00	CE1263	10.00		
	A.C.	3	50	440	CE2543D	2	One-Speed	99.50	CE790	10.00	CE2573	98.00	CE1263	10.00		
	A.C.	3	60	440	CE2543E	2	One-Speed	99.50			CE2574	107.00	CE1299	113.00		
	A.C.	3	50	550	CE2552G	2	One-Speed	99.50			CE2574	107.00	CE1299	113.00		
14½-Inch 16-Inch and 2-H	A.C.	3	50	220	CE2545C	1½	One-Speed	85.50	CE790	10.00	CE2573	98.00	CE1263	10.00		
	A.C.	3	60	220	CE2545D	1½	One-Speed	85.50	CE790	10.00	CE2573	98.00	CE1263	10.00		
	A.C.	3	50	440	CE2545E	1½	One-Speed	85.50			CE2574	107.00	CE1299	113.00		
	A.C.	3	60	440	CE2545F	1½	One-Speed	85.50			CE2574	107.00	CE1299	113.00		
	A.C.	3	50	550	CE2547G	1½	One-Speed	85.50			CE2579	114.00	CE1196	120.00		
	A.C.	3	60	550	CE2547H	1½	One-Speed	85.50			CE2579	114.00	CE1196	120.00		
	A.C.	1	50	115	CE2548A	1½	One-Speed	132.00	CE790	10.00	CE2577	109.00	CE1263	10.00		
	A.C.	1	60	115	CE2548B	1½	One-Speed	127.00	CE790	10.00	CE2577	109.00	CE1263	10.00		
	A.C.	1	50	230	CE2548C	1½	One-Speed	132.00	CE790	10.00	CE2573	98.00	CE1263	10.00		
	A.C.	1	60	230	CE2548D	1½	One-Speed	127.00	CE790	10.00	CE2573	98.00	CE1263	10.00		
13-Inch	D.C.	1	115	230	CE2549	1½	One-Speed	241.00	CE2564	69.00	CE2575	168.00	CE1242	69.00		
	D.C.	1	230	230	CE2550	1½	One-Speed	241.00	CE2563	69.00	CE2576	168.00	CE1245	69.00		
	A.C.	3	50	220	CE2625C	1	One-Speed	72.50	CE790	10.00	CE2569	81.00	CE790	10.00		
	A.C.	3	60	220	CE2625D	1	One-Speed	72.50	CE790	10.00	CE2569	81.00	CE790	10.00		
	A.C.	3	50	440	CE2625E	1	One-Speed	72.50			CE2570	90.00	CE1411	90.00		
	A.C.	3	60	440	CE2625F	1	One-Speed	72.50			CE2570	90.00	CE1411	90.00		
	A.C.	3	50	550	CE2627G	1	One-Speed	72.50			CE2580	98.00				
	A.C.	3	60	550	CE2627H	1	One-Speed	72.50			CE2580	98.00				
	A.C.	1	50	115	CE2628A	1	One-Speed	101.00	CE790	10.00	CE2573	98.00	CE790	10.00		
	A.C.	1	60	115	CE2628B	1	One-Speed	97.00	CE790	10.00	CE2573	98.00	CE790	10.00		
13-Inch	A.C.	1	50	230	CE2628C	1	One-Speed	101.00	CE790	10.00	CE2573	98.00	CE790	10.00		
	A.C.	1	60	230	CE2628D	1	One-Speed	97.00	CE790	10.00	CE2573	98.00	CE790	10.00		
	D.C.	1	115	230	CE2629	1	One-Speed	212.00	CE2564	69.00	CE2571	154.00				
	D.C.	1	230	230	CE2630	1	One-Speed	212.00	CE2563	69.00	CE2572	154.00				
	A.C.	3	60	220	CE3380††	¾-1½	Two	173.00	CE2685	61.00	CE2686	167.00	CE1403	40.00		
	A.C.	3	60	440	CE3381††	¾-1½	Two	173.00			CE2689	177.00	CE1407	189.00		
	10-Inch	A.C.	3	50	220	CE2801C	¾	One-Speed	54.00	CE790	10.00	CE2569	81.00			
		A.C.	3	60	220	CE2801D	¾	One-Speed	54.00	CE790	10.00	CE2569	81.00			
		A.C.	3	50	440	CE2801E	¾	One-Speed	54.00			CE2570	90.00			
		A.C.	3	60	440	CE2801F	¾	One-Speed	54.00			CE2570	90.00			
A.C.		3	50	550	CE2803G	¾	One-Speed	54.00			CE2580	98.00				
A.C.		3	60	550	CE2803H	¾	One-Speed	54.00			CE2580	98.00				
A.C.		1	60	115	CE2804	¾	One-Speed	61.50	CE790	10.00	CE2573	98.00				
A.C.		1	60	230	CE2805	¾	One-Speed	61.50	CE790	10.00	CE2569	81.00				
A.C.		1	50	115	CE2806A	¾	One-Speed	65.00	CE790	10.00	CE2573	98.00				
A.C.		1	50	230	CE2806B	¾	One-Speed	65.00	CE790	10.00	CE2569	81.00				
10-Inch Floor	D.C.	1	115	230	CE2807	¾	One-Speed	103.00	CE2564	69.00	CE2571	154.00				
	D.C.	1	230	230	CE2808	¾	One-Speed	106.00	CE2563	69.00	CE2572	154.00				
	A.C.	3	60	220	CE3385††	½-1	Two	164.00	CE2685	61.00	CE2686	167.00				
	A.C.	3	60	440	CE3386††	½-1	Two	164.00			CE2689	177.00				
	10-Inch Bench	A.C.	3	60	220	CE3385††	½-1	Two	164.00	CE2685	61.00	CE2686	167.00			
		A.C.	3	60	440	CE3386††	½-1	Two	164.00			CE2689	177.00			
		Light Ten, and 9-Inch with Under- neath Motor Drive	A.C.	3	50	220	CE3227C	½	One-Speed	40.50	CE790	10.00	CE2569	81.00		
			A.C.	3	60	220	CE3227D	½	One-Speed	40.50	CE790	10.00	CE2569	81.00		
			A.C.	3	50	440	CE3227E	½	One-Speed	40.50			CE2570	90.00		
			A.C.	3	60	440	CE3227F	½	One-Speed	40.50			CE2570	90.00		
A.C.			3	50	550	CE4927G	½	One-Speed	43.00			CE2580	98.00			
A.C.			3	60	550	CE4927H	½	One-Speed	43.00			CE2580	98.00			
A.C.			1	60	115	CE3583B*	½	One-Speed	47.50	CE790	10.00	CE2569	81.00			
A.C.			1	60	230	CE3584C	½	One-Speed	47.50	CE790	10.00	CE2569	81.00			
A.C.	1		50	230	CE3582C	½	One-Speed	51.00	CE790	10.00	CE2569	81.00				
A.C.	1		50	115	CE3581A*	½	One-Speed	51.00	CE790	10.00	CE2569	81.00				
Horizontal Motor Drive	D.C.	1	115	230	CE4930	½	One-Speed	91.00	CE790	10.00	CE2553	102.00				
	D.C.	1	230	230	CE4931	½	One-Speed	94.00	CE790	10.00	CE2553	102.00				
	A.C.	1	60	115	CE3228*	½	One-Speed	47.50	CE790	10.00	CE2569NF	65.00				
	A.C.	1	50	115	CE3240*	½	One-Speed	51.00	CE790	10.00	CE2569NF	65.00				
	A.C.	1	60	115	CE3228*	½	One-Speed	47.50	CE789	6.50	CE2569NF	65.00				
	A.C.	1	50	115	CE3240*	½	One-Speed	51.00	CE789	6.50	CE2569NF	65.00				
	A.C.	1	60	230	CE3229	½	One-Speed	47.50	CE790	10.00	CE2569NF	65.00				
	A.C.	1	50	230	CE3230	½	One-Speed	51.00	CE790	10.00	CE2569NF	65.00				
	A.C.	3	50	220	CE3227C	½	One-Speed	40.50	CE790	10.00	CE2569NF	65.00				
	A.C.	3	60	220	CE3227D	½	One-Speed	40.50	CE790	10.00	CE2569NF	65.00				
9-Inch with Horizontal Motor Drive	A.C.	3	50	440	CE3227E	½	One-Speed	40.50			CE2570NF	74.00				
	A.C.	3	50	550	CE4927G	½	One-Speed	43.00			CE2580NF	82.00				
	A.C.	3	60	550	CE4927H	½	One-Speed	43.00			CE2580NF	82.00				
	D.C.	1	115	230	CE4930	½	One-Speed	91.00	CE790	10.00	CE2553NF	86.00				
	D.C.	1	230	230	CE4931	½	One-Speed	94.00	CE790	10.00	CE2553NF	86.00				
	A.C.	3	50	220	CE3250C	¼	One-Speed	26.00	CE790	10.00						
	A.C.	3	60	220	CE3250D	¼	One-Speed	26.00	CE790	10.00						
	A.C.	1	60	115	CE3256B	¼	One-Speed	16.50	CE789	6.50						
	A.C.	1	60	115	CE3252*	¼	One-Speed	28.00	CE789	6.50						
	A.C.	1	60	330	CE3250	¼	One-Speed	30.00	CE790	10.00						

* Equipped with 6-ft. extension cord and plug when ordered with lathe.

† Single winding motor. †† Double winding motor.

Flat Leather Belts

Vim-Oak double ply leather belts and oak tan single ply belts listed below may be joined by cementing or lacing. Belt lace and lacing instructions are supplied with each belt. Cord reinforced belts must be joined by cementing and cement is supplied with each belt. Cord reinforced belts are recommended to those who desire a belt with minimum stretch due to variations in temperature and humidity. Shipping weight each, approximately 1/2 lb.



Size of Lathe and Type of Drive	Vim-Oak Belts		Cord Reinforced Belts			
	Cat. No.	Fac. Price	In Lieu of Reg. Belt		As an Extra	
			Cat. No.	Price	Cat. No.	Price
9" H.M.D.	CE2323N*	\$ 1.90	CE3185N	\$ 6.50	CE3190N	\$ 8.50
9" H.M.D.	CE2312N	7.00				
Light Ten H.M.D.	CE2313K	6.50	CE3186K	1.50	CE3191K	8.00
9" U.M.D.	CE2315N	8.00	CE3187N	2.00	CE3192N	10.00
Light Ten U.M.D.	CE2315K	8.00	CE3187K	2.00	CE3192K	10.00
10" U.M.D. Bench	CE2315R	8.50	CE3187R	2.00	CE3192R	11.50
10" U.M.D. Floor	CE2316R	10.00	CE3186R	2.00	CE3193R	12.00
13" U.M.D. 4-Step	CE2316T	14.00	CE3188T	2.75	CE3193T	16.75
13" U.M.D. 3-Step	CE2317T	17.75	CE3189T	4.00	CE3194T	21.75
14 1/2" U.M.D. 4-Step	CE2316F	16.50	CE3188F	2.75	CE3193F	19.25
14 1/2" U.M.D. 3-Step	CE2317F	18.50	CE3189F	4.00	CE3194F	22.50
16" U.M.D. 4-Step	CE2316H	19.50	CE3188H	3.00	CE3193H	22.50
16" U.M.D. 3-Step or 2-H	CE2317H	28.00	CE3189H	4.75	CE3194H	32.75
16-24" U.M.D. 4-Step	CE2316V	21.50	CE3188V	4.00	CE3193V	25.50
16-24" U.M.D. 3-Step	CE2317V	31.00	CE3189V	5.00	CE3194V	36.00

*This is regular oak tan single ply belt, all other belts in this column are Vim-Oak double ply.

Belt Splicing Cement

Waterproof belt splicing cement for gluing endless leather belts with lapped joint. Four ounce can. Cannot be shipped by parcel post. CE1433. Ship. wt. 6 oz. Factory Price. . . . \$0.60



Independent Power Feed Attachment For 10" Lathe

This attachment is especially desirable for manufacturing dental amalgam, diamond turning and diamond boring operations, and other work requiring extremely smooth, fine feeds, or high spindle speeds. The rate of feed is determined by the speed of the lathe spindle. For example, when the spindle revolves at 2400 r.p.m., the power longitudinal feeds range from .00015" to .018" per revolution of the spindle, approximately. This attachment should be ordered with the lathe and fitted at the factory.

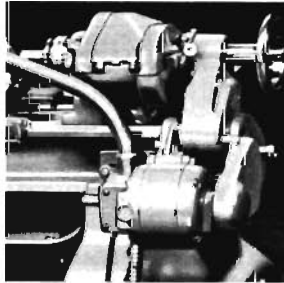

Independent Power Feed Attachment for 10-Inch Lathe

Catalog Number	Motor Specifications				Factory Price
	Current	Phase	Cycle	Voltage	
CL333DR	A.C.	3	60	220	\$214.75
CL333FR	A.C.	3	60	440	218.00
CL331BR	A.C.	1	60	115	203.75
CL331DR	A.C.	1	60	230	207.00

Die Holder

For holding standard 1" or 1 1/2" diameter button dies in tailstock spindle of lathe for cutting screw threads on work held in lathe chuck. Die holder has 1/2" hole, 3" deep for stock clearance. Made of a single piece of steel.



Catalog Number	Takes Dies	Taper Shank	Shipping Weight	Factory Price
CE1829	1" diameter	No. 2	2 lbs.	\$5.10
CE1834	1" diameter	No. 3	3 lbs.	5.75
CE1838	1 1/2" diameter	No. 2	2 lbs.	5.10
CE1839	1 1/2" diameter	No. 3	3 lbs.	5.75

V-Belts

Rubber V-Belts for use with South Bend Lathes and other power driven machinery. Specify catalog number, maximum width, and outside circumference when ordering. Ship. wt. each, approximately 1/2 lb.

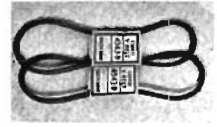

Catalog Number	Maximum Width	Outside Circumference	Factory Price
CE4521A	1 3/8 in.	21 in.	\$1.15
CE4522A	1 3/8 in.	22 in.	1.15
CE4523A	1 3/8 in.	23 in.	1.15
CE4527A	1 3/8 in.	27 in.	1.18
CE4527B	1 3/8 in.	27 in.	1.24
CE4528B	1 3/8 in.	28 in.	1.28
CE4529B	1 3/8 in.	29 in.	1.28
CE4530B	1 3/8 in.	30 in.	1.30
CE4531B	1 3/8 in.	31 in.	1.32
CE4532B	1 3/8 in.	32 in.	1.34
CE4535C	1 3/8 in.	35 in.	1.83
CE4537C	1 3/8 in.	37 in.	1.94
CE4538C	1 3/8 in.	38 in.	1.94
CE4540C	1 3/8 in.	40 in.	2.08
CE4541C	1 3/8 in.	41 in.	2.13
CE4542C	1 3/8 in.	42 in.	2.18
CE4543C	1 3/8 in.	43 in.	2.23
CE4544B	1 3/8 in.	44 in.	1.67
CE4544C	1 3/8 in.	44 in.	2.28
CE4545B	1 3/8 in.	45 in.	1.70
CE4545C	1 3/8 in.	45 in.	2.33
CE4546B	1 3/8 in.	46 in.	1.72
CE4546C	1 3/8 in.	46 in.	2.38
CE4547B	1 3/8 in.	47 in.	1.74
CE4548B	1 3/8 in.	48 in.	1.75
CE4549B	1 3/8 in.	49 in.	1.76
CE4549C	1 3/8 in.	49 in.	2.52
CE4550C	1 3/8 in.	50 in.	2.56
CE4551C	1 3/8 in.	51 in.	2.60
CE4552C	1 3/8 in.	52 in.	2.64
CE4553B	1 3/8 in.	53 in.	1.84
CE4554B	1 3/8 in.	54 in.	1.86
CE4554C	1 3/8 in.	54 in.	2.72
CE4555C	1 3/8 in.	55 in.	2.74
CE4556B	1 3/8 in.	56 in.	1.91
CE4558B	1 3/8 in.	58 in.	1.95
CE4559C	1 3/8 in.	59 in.	2.83
CE4560B	1 3/8 in.	60 in.	2.00
CE4564B	1 3/8 in.	64 in.	2.09
CE4568B	1 3/8 in.	68 in.	2.18
CE4570B	1 3/8 in.	70 in.	2.23
CE4571B	1 3/8 in.	71 in.	2.28
CE4578B	1 3/8 in.	78 in.	2.46
CE4580B	1 3/8 in.	80 in.	2.54
CE4598B	1 3/8 in.	98 in.	3.20

Motor Pulleys for V-Belts

These motor pulleys are machined all over and have accurately reamed holes so that they will fit standard sizes of motor shafts properly and will run true. They are made of cast iron or aluminum, depending on size. Pulleys having 1/2" bore have a set screw for locking to motor shaft, all others have standard keyways.



Cat. No.	Dia.	Bore	Price	Cat. No.	Dia.	Bore	Price
1-Groove Pulleys for 1 1/8" V-Belts							
Approx. ship. wts., 2 1/2" and 2 3/4" pulleys 1/2 lb., 3" and 3 1/4" pulleys 1 1/4 lbs.							
CE6342	2 1/2"	1/2"	\$1.00	CE6348	3"	1/2"	\$1.25
CE6343	2 3/4"	1/2"	1.00	CE6349	3"	3/4"	1.25
CE6344	2 3/4"	3/4"	1.00	CE6350	3"	3/4"	1.25
CE6345	2 1/2"	1/2"	1.15	CE6351	3 1/4"	1/2"	1.35
CE6346	2 1/2"	3/4"	1.15	CE6352	3 1/4"	3/4"	1.35
CE6347	2 1/2"	3/4"	1.15	CE6353	3 1/4"	3/4"	1.35

2-Groove Pulleys for 1 1/2" V-Belts							
Approx. ship. wts., 2 1/2" pulleys 1 1/2 lbs., 2 3/4" pulleys 2 lbs.							
CE6354	2 1/2"	3/4"	\$1.95	CE6357	2 3/4"	3/4"	\$2.35
CE6355	2 1/2"	1"	1.95	CE6358	2 3/4"	1"	2.35
CE6356	2 1/2"	1"	1.95	CE6359	2 3/4"	1"	2.35

4-Groove Pulleys for 1 1/2" V-Belts							
Approx. ship. wts., 2 1/2" and 2 3/4" pulleys 2 lbs., 3 1/4" and 3 3/4" pulleys 4 lbs.							
CE6360	2 1/2"	3/4"	\$4.30	CE6366	3 3/4"	3/4"	\$5.10
CE6361	2 1/2"	1"	4.30	CE6367	3 3/4"	1"	5.10
CE6362	2 1/2"	1"	4.30	CE6368	3 3/4"	1"	5.10
CE6363	2 3/4"	3/4"	4.95	CE6369	3 3/4"	3/4"	5.35
CE6364	2 3/4"	1"	4.95	CE6370	3 3/4"	1"	5.35
CE6365	2 3/4"	1"	4.95	CE6371	3 3/4"	1"	5.35

Special Micrometer Collars

Graduated collars on South Bend Lathes follow U.S. custom and are graduated in thousandths of an inch to measure the advance of the tool itself. Obviously, if the tool advances 1/1000 inch the work diameter is being reduced 2/1000 inch. European custom is to graduate the collar to read in thousandths the amount the work piece is being reduced. Such collars are known as DIRECT READING and can be supplied in lieu of standard collars at prices shown below.

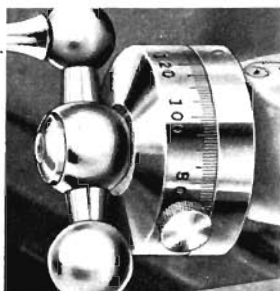

LARGE DIAMETER easy reading graduated collars with regular graduations are regular equipment on 10" and larger lathes and can be supplied at extra cost for 9" and Light Ten Lathes as listed below.

METRIC graduated collars can be supplied for any South Bend Lathe if ordered with lathe, no extra cost.

Size Lathe	Large Dia. Reg. Grad.		Direct Reading	
	Cat. No.	Price	Cat. No.	Price
9" & Light Ten	CL2117NK	\$4.75	CL2S20NK	\$2.95
10"	CL2S20R	3.50
13", 14 1/4", 16", 16-24"	CL2S20TH	4.25
No. 2-H	CL2S20P	4.50

How to Run a Lathe

A Practical Handbook on Lathe Operation

"How to Run a Lathe" is a complete reference book and manual on the care and operation of the back-geared screw-cutting lathe. It is a practical handbook for the machinist, lathe operator, apprentice, or shop man. Clearly written in simple, non-technical language, the instruction material is easy for the beginner to understand. Printed in English, Spanish, and Portuguese, languages.

Now in its 53rd edition, this book has been improved and perfected by suggestions, criticisms, and ideas that have been submitted by hundreds of practical shop men. The latest shop practices and methods used in modern industry are accurately described. Contains 128 pages 5 1/8" x 7 7/8" and more than 360 illustrations.



Partial List of Contents

History of the Lathe	Machining Work Between Centers
Erecting and Leveling the Lathe	Chuck Work
Operation of Lathe Controls	Taper Turning and Boring
Lathe Tools and Their Application	Drilling, Reaming, and Tapping
How to Take Accurate Measurements	Cutting Screw Threads
	Special Classes of Work

Catalog Number	Description	Price Postpaid
CE3450	"How to Run a Lathe", English (paper).....	\$0.50
CE3451	"How to Run a Lathe", English (leatherette)....	1.50
CE3452	"How to Run a Lathe", Spanish.....	.50
CE3454	"How to Run a Lathe", Portuguese.....	.50



Machinery's Handbook

An engineering reference book for machinists, students, designers, engineers, and executives. It is a practical guide for use in conjunction with engineering and vocational courses. Has 1911 pages, 1310 illustrations.

Cat. No. CE700. Machinery's Handbook. Price f.o.b. factory.....\$9.00



Patented Design

Tubular Steel Benches

Designed especially for our 9" and Light Ten Bench Lathes with horizontal motor drive, this sturdily constructed all steel bench will give your lathe the rigid support it needs for the most satisfactory operation. Bench is 32" high, 32" wide and 51 1/2" long, large enough for lathes having beds up to 3 1/2' long. May also be used for many other purposes.

Heavy gauge sheet metal panels are securely welded into the tubular frame. A built-in chip pan with 5/8" bead around the edge forms the top of the bench. This permits using a coolant if desired, and prevents chips from falling to the floor. Six drawers 10 1/2" wide, 15" long, 5 1/2" deep (inside dimensions) provide ample storage space for chucks, tools, lathe accessories, etc. Bench is nicely finished in gray wrinkle enamel.

CE1737. Tubular Steel Bench, 32" high, 32" wide, 51 1/2" long, for 9" and Light Ten Horizontal Motor Driven Bench Lathes with 3' or 3 1/2' bed lengths. Ship. wt. 336 lbs...\$185.00



Angle Steel Bench With Wood Top

Heavy angle steel construction, 29 3/16" or 34" high, with hardwood top 26" x 60" x 1 3/16" thick. For 9" and Light Ten Horizontal Motor Driven Bench Lathes, any bed length. This also makes an ideal work bench for general shop use. Bench top is edge glued and has oil finish. Price does not include drawer, which is listed separately below.

Bench is shipped knocked down with all necessary bolts for assembling. Metal parts are finished with gray enamel. The sturdy construction of this bench makes it ideal for mounting a vise, surface plate, drill press, grinder, shaper, or other substantial equipment as well as the lathe.

CE1780. Steel Bench 29 3/16" high with wood top (less drawer). Shipping weight, 84 lbs. Factory Price.....\$42.50

CE1849. Same as above but 34" high.....\$44.50

Drawer for Bench

CE1780D. Drawer for above bench, 20 1/8" wide, 14" long, 3 3/16" deep. Shipping weight 9 lbs. Factory Price.....\$8.25

New South Bend Vertical Spindle *Precision* Milling Machine

The new South Bend Vertical Spindle Precision Milling Machine is designed for maximum convenience and ease of operation. It is highly efficient for a wide variety of exacting toolroom and production work. Heavily constructed column with 3-point bearing on floor provides rigid support for the head and table assemblies. Massive knee has wide dovetail bearings and long, tapered gibs for both column and table.

The universal type head swivels full 360° for milling, drilling or boring at any angle. Worm gearing and precision graduations permit quick and easy adjustment of head angle. Rack and pinion ram adjustment provides 15" movement of keyed overarm for positioning head assembly.

Fairbanks Morse Axial Air-Gap Motor designed for operating in any position is mounted on milling machine head. Motor housing swivels around spindle for maximum flexibility in setting up work. A compound V-belt and timing belt "Lo-Loss" drive transmits power to the spindle with extreme smoothness. Aluminum pulleys are accurately machined and balanced.

Convenient belt tension release permits changing speeds quickly and easily. Eight spindle speeds are available. Reversing switch controls direction of spindle rotation, permitting right or left-hand milling.

Spindle is made of hardened and ground alloy steel and runs in precision bearings. The ten-spline spindle has 4" of travel with lever for rapid movement and handwheel for slow feed. A dependable micrometer depth stop is graduated in thousandths and positive quill lock is provided. Spindle has No. 30 milling machine taper and takes collets up to 3/4" capacity. Individual tool holders have up to 1" capacity.

The table is 9" wide and is available in 32" or 42" length, providing 20" or 30" longitudinal travel respectively. Movement of table is controlled by 1 1/4"-5 thread Acme feed screws, each equipped with large easy-reading micrometer collars. Adjustable stops are provided for regulating the length of the table feed. Three T-slots for clamping work or fixtures extend full length of table. Table has dual controls for operating from either end.

COMPARE THESE FEATURES

- Keyed overarm with 4 1/2" diameter flanged ram has tapered gibs and permanently mounted rack and pinion adjustment for positioning head. This feature increases the cross milling capacity and assures accurate movement for change in set-ups.
- Eight spindle speeds with convenient belt tension release for quick and easy speed changes.
- "Lo-Loss" drive to spindle at all speeds transmits full h.p. through timing belt.
- Head is semi-steel casting honed to a perfect precision fit to quill—360° rotation of head by worm and gear.
- Quill is ground and precision fitted to bored and honed head. Has lever operated fast feed and handwheel operated slow feed. (Manual feed standard. Automatic feed available at extra cost on deferred delivery basis.) Turnstile lever for rapid hand feed, disengages when worm and worm gear fine feed is used.
- Spindle has dependable micrometer depth stop graduated in thousandths, and positive quill lock.
- Spindle is made of hardened and ground alloy steel, has 1 1/4" ten-spline drive, takes No. 30 MM quick change individual holders.
- Spindle face has four 3/8"-16 bolt holes for mounting face mills, etc.
- Large diameter easy reading graduated collars provided for positioning table.
- Lever locks for table, knee and saddle conveniently located on front of machine.
- Adjustable stops in T-slot provided for regulating length of table travel.
- Manual longitudinal and cross-feeds to table are standard equipment. Power longitudinal feeds available at extra cost on deferred delivery basis.
- Troughs and precision measuring bars with dial indicator stops are available at extra cost on deferred delivery basis.

EQUIPMENT

Equipment included in price of milling machine consists of: three-phase A.C. motor; reversing switch; master collet holder; wrench; and four collets having 3/8", 1/2", 5/8" and 3/4" capacities.

PRICES OF SOUTH BEND VERTICAL SPINDLE MILLING MACHINES WITH 3 ph., 60 cy., 220/440 v., A.C. Motors

Catalog Number	Table Length	Motor		Factory Price
		R.P.M.	H.P.	
MIL3212	32"	1200	3/4	\$1675
MIL3218	32"	1800	1	1675
MIL4212	42"	1200	3/4	1750
MIL4218	42"	1800	1	1750

Note: Write for price of milling machine with single-phase motor in lieu of 3-phase motor.



SPECIFICATIONS

Table width.....	9'
Table lengths.....	32"-42"
Table travel, longitudinal.....	20"-30"
Table travel, cross.....	9 1/4"
Table travel, vertical.....	18"
Table feed screws, Acme thread.....	1 1/4"-5
Table to spindle, maximum.....	20"
Spindle to column, maximum.....	20"
Overarm ram travel by rack and pinion.....	15"
Overarm ram diameter.....	4 1/2"
Spindle taper.....	#30 MM
Spindle speeds.....	8
r.p.m. with 1 h.p., 1800 r.p.m. motor	
135, 220, 350, 560, 900, 1450, 2330, 3750	
r.p.m. with 3/4 h.p., 1200 r.p.m. motor	
90, 150, 230, 375, 600, 965, 1550, 2500	
Quill travel.....	4"
Collet capacity, maximum.....	3/4"
Quill diameter.....	3 1/4"
Head rotates.....	360°
Net weight, approx.....	1600 lbs.
Shipping weight crated, approx.....	1725 lbs.
Shipping weight boxed, approx.....	1900 lbs.
Cubic feet boxed, 32" table.....	116
Cubic feet boxed, 42" table.....	136



Milling Cutter Arbor

This arbor is designed to hold standard side milling cutters and dovetail cutters from 3" to 6" diameter with 1/8" to 3/4" face and having either a 1" or 1 1/4" diameter arbor hole. Cutter is securely held by a split expansion taper bushing and flush tightening screw. Cutters are driven by a key which fits standard size key slots. Spacing collars are provided to accommodate various face widths. Shipping weight 3 lbs.

MIL7035. Side Milling Cutter Arbor. Price.....\$38.00

See page 47 for milling cutters.

Extra Collets

Fit into master collet holder (standard equipment) to take straight shank milling cutters, boring tools, etc. Shipping weight 1 lb. each.



Cat. No.	Capacity	Price	Cat. No.	Capacity	Price
MIL7001	1/4"	\$8.95	MIL7007	1/4"	\$3.00
MIL7002	1/8"	8.95	MIL7008	1/8"	3.00
MIL7003	3/8"	3.25	MIL7009	3/8"	3.00
MIL7004	1/2"	3.25	MIL7010	1/2"	3.00
MIL7005	5/8"	3.25	MIL7011	1 1/8"	3.00
MIL7006	3/4"	3.00	MIL7012	3/4"	3.00

Quick Change Holders

Fit into No. 30 MM taper to hold single or double end straight shank end mills or other straight shank tools. Shipping weight 4 lbs. each.



Cat. No.	Capacity	Price	Cat. No.	Capacity	Price
MIL7016	3/16"	\$14.60	MIL7020	3/8"	\$15.65
MIL7017	3/8"	12.80	MIL7021	1/2"	19.30
MIL7018	1/2"	12.25	MIL7022	1"	19.45
MIL7019	5/8"	11.70			

See pages 46 and 47 for milling cutters.

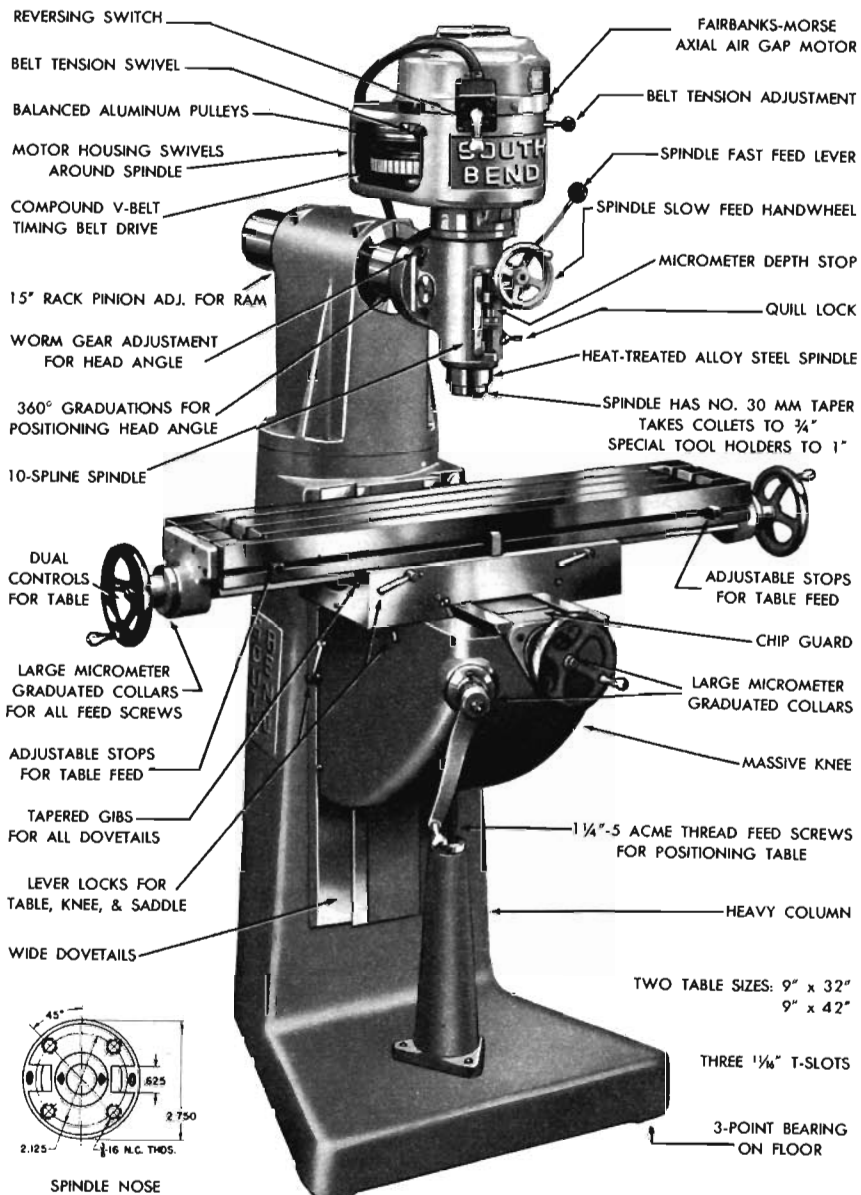

6" Swivel Vise

Vise has flanges for clamping to machine table and may be used with or without the 360° swivel base. Base has two 1 1/16" T-slot bolts and two 1 1/16" keys to fit machine table slots. Ground steel jaw plates are removable. Vise jaws are 6" wide, 2" deep and open 6". Shipping weight 95 lbs.

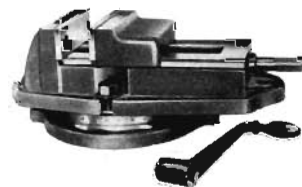

MIL7014. 6" Swivel Milling Machine Vise.....\$89.95
MIL7036. Crank Handle for above vise, extra.....\$7.10

Quick-Acting Vise

Vise has quick-acting self-aligning jaw. Vise jaws are 5 1/2" wide, 2 1/16" deep and open 6 1/2". Shipping weight 40 lbs.

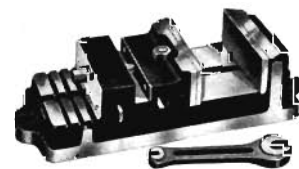

MIL7013. 5 1/2" Quick-acting Milling Machine Vise.....\$69.50

South Bend 7-inch *Precision* Bench Shaper

The South Bend 7" Shaper has been developed to meet tool-room and industrial demands for an accurate, compact bench shaper that is precision engineered and sturdily constructed. It has the built-in accuracy and versatility for rapid machining on small parts. The stroke rate per minute is higher than on larger shapers, permitting greater production on work within its capacity. The ease of setting up work in the bench shaper, its high operating speeds, and the low power consumption of the fractional h.p. motor, keep costs to a minimum. Built to the same high standards that have made South Bend Lathes famous for their precision and durability, this shaper is capable of the most exacting work on precision parts of all kinds.

Ram has long dovetail bearings which provide rigid support for the cutting tool, even in the extreme forward position. Gib adjustment is provided, and dovetail ways are fitted with felt wipers on both ends of column. Length of stroke is regulated by crank gear eccentric adjustment, and rocker arm is graduated to indicate length of stroke in inches. A large handwheel is provided for adjusting the ram which is locked in position by a conveniently located binding lever. The crank gear is precision made for quiet operation. Oil impregnated bearings are used for both the crank gear and the countershaft.

Pressure lubrication is provided by an automatic pump which circulates lubricating oil from a large reservoir in the base of the shaper to the ram dovetail, bull gear and pinion, pinion shaft and rocker arm shaft.

Tool head swivels to any angle, and has 3 1/2" diameter mounting with accurately cut graduations 0 to 90° right and left. The tool slide screw has a clear cut graduated collar reading in thousandths of an inch. The clapper box swivels on the tool slide and may be adjusted for clearance, regardless of the tool slide angle. A tool slide lock is provided so that extreme accuracy and flatness can be maintained.

Table has holes and slots on top and on each side for clamping work. A V-groove is also provided on one side of the table. The cross-feed screw has a clear cut graduated collar reading in thousandths of an inch. The cross rail on which table slides is substantially constructed with large widely spaced bearing ways. Gib adjustment is provided for take-up. Provision is made for locking the vertical adjustment. For safety, the cross-feed screw is so constructed that the nut will run off the thread when it has traveled the maximum distance in either direction. An adjustable front end support shoe travels with the table and provides extreme rigidity for heavy cuts regardless of table position.

Vise swivels to any angle, with base graduated 0 to 90° right and left, and can be mounted on the top or right side of the table. Vise jaw inserts are made of heat-treated steel.

Motor required is 1/3 or 1/2 h.p., 1725 r.p.m., and is mounted on a cradle at the back of the shaper. Power is transmitted by V-belts. A quick acting belt tension release is provided for easy shifting of the belt to change speeds. All V-belts and pulleys are enclosed in substantial metal guards. If shaper is ordered without motor, specify voltage, phase, and cycle of motor to be used so that correct wiring can be supplied.

CS100. South Bend 7" Precision Bench Shaper with vise, drive unit for 1/3 h.p. motor, motor pulley, V-belts, guards, work light, and built-in pushbutton type across-the-line manual starter for motor, but without motor, steel stand, or tool holder. (See pages 70 and 71.) Shipping weight crated 330 lbs. Boxed weight 400 lbs., cubic feet boxed 12. *Price\$551.00

CS100M. South Bend 7" Shaper, same as above but with metric graduations. Price f.o.b. factory\$551.00
*Cubic feet boxed with steel stand 38.

Specifications of South Bend 7" Precision Shaper

Ram	
Length of Ram Stroke	0 to 7"
Strokes Per Minute, approximate	42-75-120-195
Cutting Speeds	3 to 114 feet per minute
Tool Head	
Length of Vertical Feed	3"
Tool Post Takes Tool Holder Shank	3/8" x 1 1/16"
Swivels	360°
Vise	
Width of Jaws	4"
Depth of Jaws	1"
Maximum Opening	4"

Table	
Length of Top	6 1/16"
Width of Top	5"
Depth of Table	5 3/8"
Horizontal Travel	9 1/2"
Vertical Travel	5"
Distance from Ram	1/2" to 5 1/2"
Power Cross-Feeds (reversible)002" to .012"
Width of Slots	3/16"
Holes for Clamp Bolts	3/8"
Motor	
Size Recommended	1/3 or 1/2 h.p.

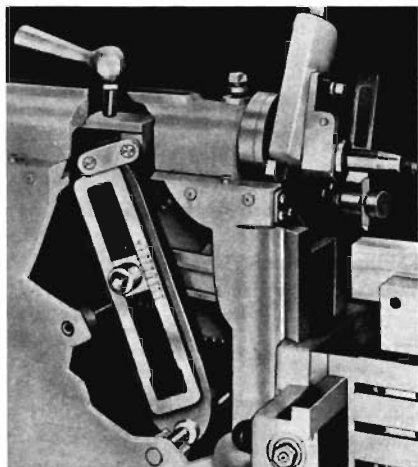

Rocker and crank with graduated eccentric adjustment for stroke

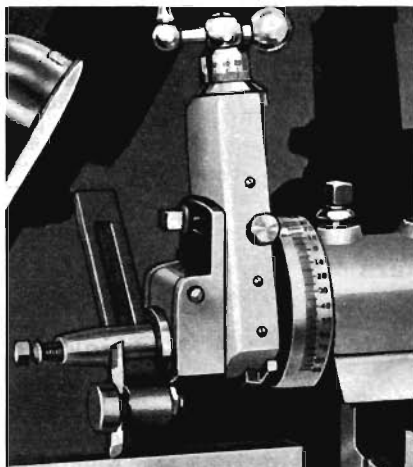

Tool head locks in any position. Rugged clapper box also adjustable



Guards on all belts and pulleys. Quick-acting belt tension release

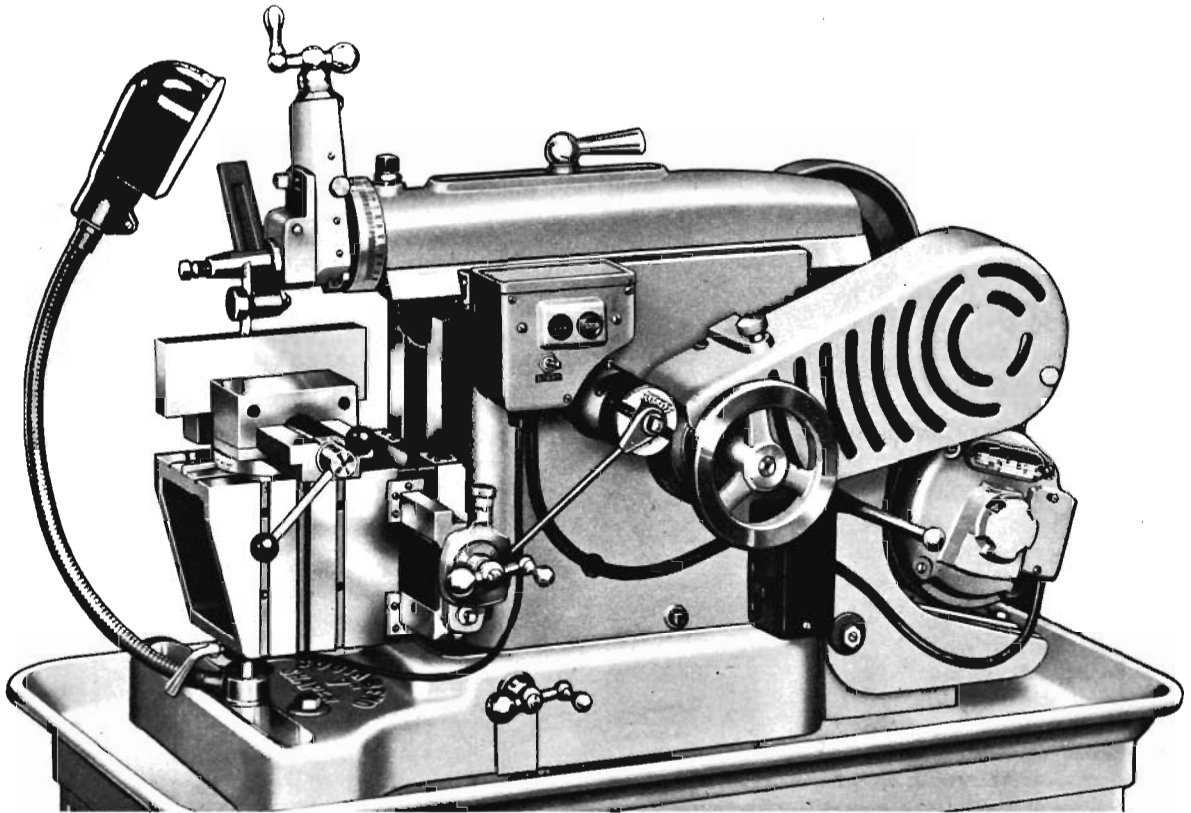

FEATURES

- Built-in work light prevents eye strain.
- Reversible power cross-feeds .002" to .012".
- Built-in motor drive with quick acting belt tension release for changing speeds.
- Swivel vise graduated in degrees.
- Swivel tool head graduated in degrees.
- Convenient stroke adjustment 0 to 7".
- Pressure lubrication to important bearings including ram dovetail.

Note: Motor, tool holder, and steel stand are not included in regular equipment of shaper.

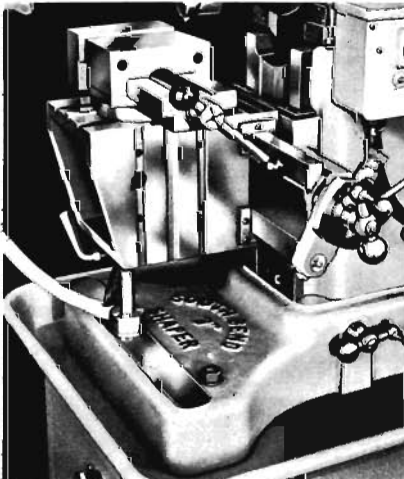
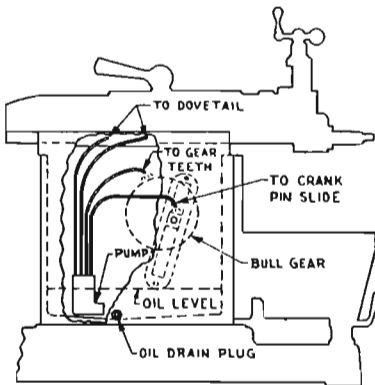

Close-up showing bearing on base for adjustable table support

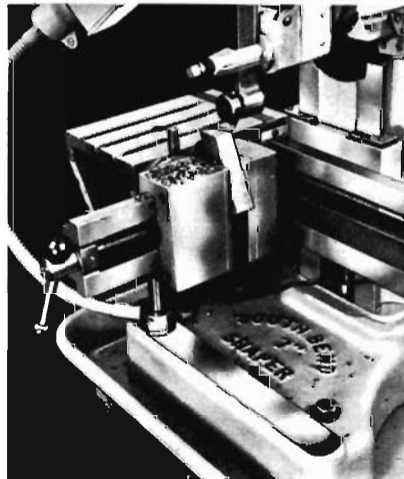
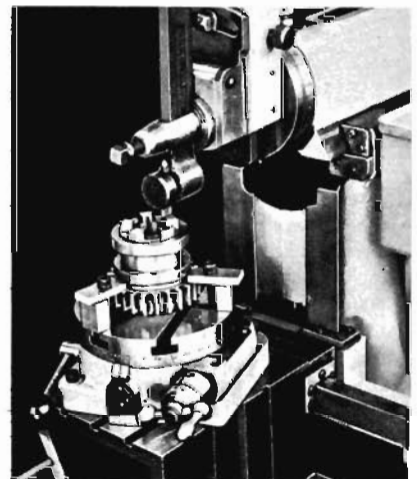

Table support travels with table across bearing surface on base



Machining clutch teeth with aid of rotary indexing table

The only bench shaper with force feed lubrication to ram dovetail.

Steel Machine Stand for Shaper

This sturdy, welded steel stand provides rigid support for a bench shaper, drill press, vise, jig saw, or other machine. Top has bolt holes punched for mounting shaper. A built-in chip pan forms the top of the stand permitting the use of coolant if desired. Three drawers 10½" x 5½" x 15¾" inside, with key locks provide plenty of storage space for work, tools and accessories. Nicely finished with gray wrinkle enamel. Width 19", depth 36", height 28⅝". Shipping weight 150 pounds.



CS9600. Steel Stand for Shaper. Price f.o.b. factory... \$120.00

Indexing Table

You will find this rotary indexing table a great convenience for mounting small work on the milling machine, drill press, or shaper. Used for accurately spacing bolt holes, indexing clutch teeth, machining square, hexagonal or octagonal shapes, milling circular grooves or T-slots, etc. Table is 4½" in diameter and has three T-slots for clamping work. Edge of table is graduated 360°. Table is turned by worm gearing having graduated collar and ball crank. Thumb screw on front of ball crank locks graduated collar in any position. Each graduation indicates a table movement of 3 minutes. One complete revolution of the ball crank turns the table 5 degrees. Clamping device is provided for locking table in any position. Top of table is precision ground. Base has two bolt holes for clamping to machine table. Price includes eight clamping bolts with nuts and washers.

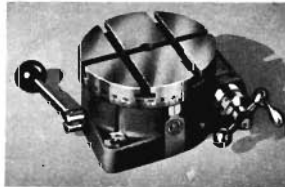

PATENTED

CE9144. Indexing Table. Ship. wt. 14 lbs. Price..... \$53.95

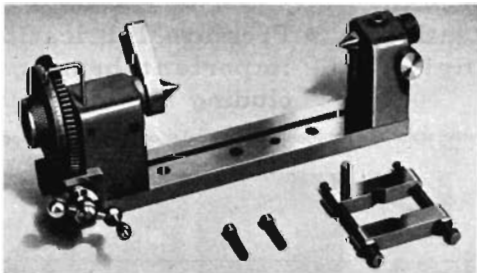

PATENT APPLIED FOR

Indexing Centers

This is an indispensable device for cutting splines or flutes in shafts, laying out work, accurate cross drilling, gear cutting, milling or shaping hexagons, squares, etc. Base has bolt holes for clamping on table of drill press, milling machine or shaper. Takes work between centers up to 5" in diameter, 6" long. Revolving center has large dial graduated 360°. Center is turned by worm gearing having graduated collar and ball crank. Each graduation indicates a center movement of 3 minutes. One complete revolution of the ball crank turns the center 5°. Worm gear can be disengaged for quick positioning of indexing center. Clamping device is provided for locking center in any position. Base has two bolt holes for clamping to machine table. Price includes two clamping bolts.

CE9635. Indexing Centers. Ship. wt. 12 lbs. Price..... \$67.00

Motors for South Bend Shapers

Motors listed below are recommended for use with South Bend 7" Shapers. These are all ball-bearing motors with the exception of No. CS3256B, which is a sleeve bearing motor. All single phase motors are capacitor type with the exception of the No. CS3256B, which is split-phase. Prices of ½ h.p. motors include special mounting base, when required. Prices of 230 V., single phase and D.C. motors include 230 V. lamp in lieu of 115 V. lamp which is regularly supplied with shaper.



Information on motors for current characteristics not listed will be supplied on request. Approximate ship. wts.: ½ h.p. motors 40 lbs., ¼ h.p. motors 50 lbs.

Motors for South Bend 7" Bench Shapers

Cat. No.	H.P.	Current	Volts	Phase	Cycle	Price
CS4910B	½	A.C.	115	1	60	\$ 38.00
CS3256B	½	A.C.	115	1	60	19.50
CS4910D	½	A.C.	230	1	60	38.00
CS4911A	½	A.C.	115	1	50	42.00
CS4911C	½	A.C.	230	1	50	42.00
CS4912D	½	A.C.	208-220	3	60	42.00
CS4912C	½	A.C.	208-220	3	50	42.00
CS4913S	½	A.C.	380	3	50	50.00
CS4913F	½	A.C.	440	3	60	45.00
CS4913E	½	A.C.	440	3	50	45.00
CS4920B	½	A.C.	115	1	60	46.00
CS4920D	½	A.C.	230	1	60	46.00
CS4921A	½	A.C.	115	1	50	62.00
CS4921C	½	A.C.	230	1	50	62.00
CS4916R	½	A.C.	125	1	50	67.00
CS4915O	½	A.C.	250	1	50	67.00
CS4922Y	½	A.C.	115	1	40	95.00
CS4922Z	½	A.C.	230	1	40	95.00
CS4914D	½	A.C.	208-220	2	60	50.00
CS4914C	½	A.C.	208-220	2	50	50.00
CS4914F	½	A.C.	440	2	60	50.00
CS4914E	½	A.C.	440	2	50	50.00
CS4924D	½	A.C.	208-220	3	60	50.00
CS4924C	½	A.C.	208-220	3	50	50.00
CS4924S	½	A.C.	380	3	50	55.00
CS4924F	½	A.C.	440	3	60	50.00
CS4924E	½	A.C.	440	3	50	50.00
CS4930	½	D.C.	115	111.00
CS4931	½	D.C.	230	114.00

Optional Low Voltage Controls for Two and Three Phase Motors

Low voltage remote control equipment is optional (not required) for two and three phase motors. This equipment includes step-down transformer and relays which reduce current to operating switch to 110 v., and provide overload protection and low voltage release. Transformer is dual voltage rated type and may be connected for use with either 220 v. or 440 v. line current. Price of shaper includes the manual type across-the-line motor control switch.

CE9609E. Remote Control for three phase or two phase three wire 208-220/440 v., 50 cy. A.C. motors. Ship. wt. 14 lbs. Price..... \$74.00

CE9609F. Remote control for three phase or two phase three wire 208-220/440 v., 60 cycle A.C. motors. Shipping weight 14 lbs. Price..... \$74.00

CE9609S. Remote control for three phase 380 v. A.C. motors. Shipping weight 14 lbs. Price f.o.b. factory..... \$77.00

Plastic Cover for Shaper

Keep your shaper clean and in good condition by protecting it overnight and whenever not in use with this waterproof oil resistant service cover. Attractive maroon color. Size 21" wide, 37" long, 24" high, large enough to cover the entire shaper.

CE2694. Waterproof Service Cover for Shaper, shipping weight 2 lbs. Price f.o.b. factory..... \$2.75



Shaper Tool Holder

An extremely rigid forged steel tool holder for $\frac{1}{4}$ " square cutter bits. Adjustable to work at all angles. Head can be swiveled and locked at eight different positions for machining many odd shapes and for cutting various angles without shifting the work. Shipping weight 1 lb.



CS9630. Adjustable Shaper Tool Holder. Price.....\$7.88

Extension Shaper Tool

A rigid forged steel tool holder for internal work. Adapted for die work, internal keyways or for any work on the shaper in which extra clearance is needed. Size of bar is $\frac{1}{2}$ " x $7\frac{1}{2}$ ". Takes cutter bit $\frac{3}{16}$ " x $\frac{3}{16}$ ". Shipping weight 2 pounds.

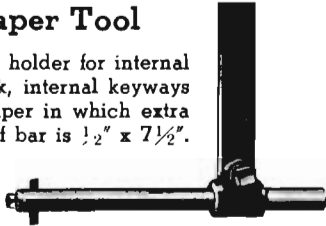

CS9631. Extension Shaper Tool. Price f.o.b. factory.... \$7.88

Swiveling Machine Handles

Swiveling machine handles for the shaper can be supplied in lieu of the solid machine handles, provided they are specified when the shaper is ordered.

CS9636. Swiveling Machine Handles for tool head feed screw, table cross-feed screw, and table vertical feed screw, in lieu of solid machine handles. Price f.o.b. factory when ordered with shaper...\$2.30



Angle Plate

A heavy cast iron angle plate for clamping work on shaper, drill press, milling machine, face plate of lathe, etc. Size $4\frac{1}{2}$ " x 3" x 2".

CE9640. Ship. wt. 4 lbs. Price....\$10.95



WARRANTY

South Bend Lathe Works warrants its products to conform to or excel the specifications set forth in its catalogs in use at the time of sale and reserves the right, at its own discretion, without notice and without making similar changes in articles previously manufactured, to make changes in materials, design, finish, or specifications. South Bend Lathe Works warrants products of its own factory against defects of material or workmanship for a period of one year from date of sale. Liability of South Bend Lathe Works under this warranty shall be limited to replacing, free of charge, f.o.b. South Bend, Indiana, any such parts proving defective within the period of this warranty but South Bend Lathe Works will not be responsible for transportation charges or consequential damages.

The warranty of South Bend Lathe Works is not made for products manufactured by others which are illustrated and described in "South Bend" catalogs or incorporated in "South Bend" products in essentially the same form as supplied by the original manufacturer. With respect to all such products, the warranties of the original manufacturers supplant the warranty of South Bend Lathe Works but, in applicable instances, the latter agrees to use its best efforts to have original suppliers make good their warranties.

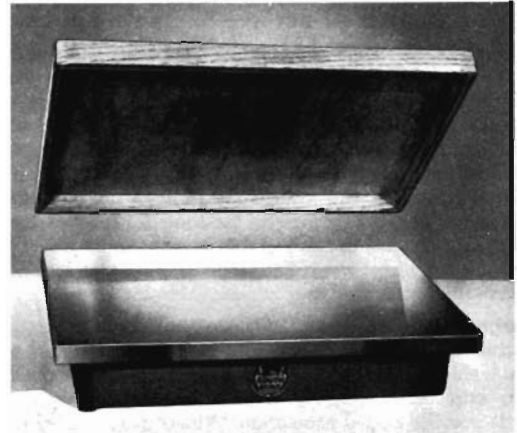

Surface Plate

This is a heavy surface plate for laying out work, testing and inspecting, surfacing, checking flat surfaces, and general toolroom and shop use. Made of close-grained cast iron, properly heat-treated to normalize casting and machining strains and prevent distortion.

Top surface is precision ground and is well supported by heavy ribs on back. Wooden cover is supplied to protect ground surface. Edges are machined and under side of edges is finished all around. Size 12" x 17" x 3" with top $\frac{3}{4}$ " thick. Approximate net weight 64 pounds.

CE2215. Surface Plate. Shipping weight 75 lbs Factory Price.....\$47.00

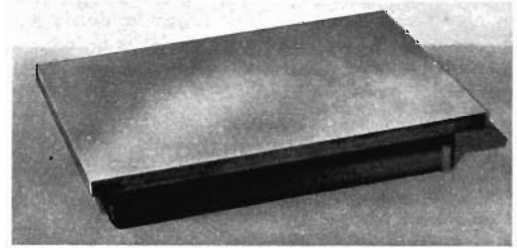

Bench Plate

This is a substantial, economically priced bench plate intended for work that does not require the true flat surface of the precision ground surface plate described above. Size 12" x 17" x 3" with top $\frac{3}{4}$ " thick. Top surface has commercial ground finish. Edges are unfinished.

CE2219. Bench Plate. Shipping weight 75 lbs. Factory Price.....\$32.50

South Bend Standard Gray Finish Enamel

For refinishing and touching up South Bend Lathes, Drill Presses, Shapers, and other machine tools. Made in two shades, light gray for current models and dark gray to match older models of lathes. Cannot be shipped by parcel post.



Catalog Number		Size Can	Number of Cans	Ship. Wt.	Factory Price
Light Gray	Dark Gray				
CE2640	CE2455	Pint	1	2 lbs.	\$ 1.35
CE2641	CE2456	Quart	1	4 lbs.	2.00
CE2642	CE2457	Gallon	1	12 lbs.	7.25
CE2643	CE2470	Pint	6	10 lbs.	7.50
CE2644	CE2471	Pint	12	19 lbs.	13.75
CE2645	CE2472	Quart	6	19 lbs.	11.50
CE2646	CE2473	Quart	12	39 lbs.	20.75
CE2647	CE2474	Gallon	2	24 lbs.	13.25
CE2648	CE2475	Gallon	4	50 lbs.	23.90

South Bend Pedestal Grinder

For Better—Faster—Easier Grinding

A great deal of careful research has gone into the design of the South Bend Pedestal Tool Grinder. To provide ample work clearance the grinding wheels are widely separated and the motor is mounted in the pedestal instead of between the wheels. Additional clearance for the work is obtained by mounting the grinding wheel spindle toward the front of the pedestal. This construction also provides extra toe room for the operator. The U-shaped tool rests are adjustable to any angle and are also adjustable for wheel wear. The large water pot for cooling work is conveniently located and is removable for cleaning.

Large safety glass eye shields are hinged and are easily adjusted to three positions. Two light bulbs enclosed in the frame of each shield throw ample light directly onto the work. Close-fitting adjustable spark guards built into the heavy wheel guards provide added protection. Wheel guards have removable end plates and large dust outlets for connecting with dust collector or exhaust ducts.

A pushbutton motor control is conveniently mounted at waist level on the front of the grinder frame. The motor is fully enclosed in the pedestal. A V-belt drives the grinding wheel spindle which revolves on sealed ball bearings. This construction practically eliminates vibration, removes the weight of the grinding wheels from the motor bearings and protects the motor from the abrasive dust of the grinding wheels.

The grinder is made with either 8" grinding wheels or with 10" wheels. A 1/2 h.p. motor is required with 8" wheels and a 3/4 h.p. motor with 10" wheels. Any N.E.M.A. standard 3450 or 2875 r.p.m. motor may be used. Equipment includes one coarse and one fine wheel for general work; tool rests; wheel guards; eye shields with wiring, sockets, and 110 v. lamps; V-belt and pulleys; and built-in pushbutton type across-the-line manual starter for motor. Price of grinder does not include motor. See page 73 for motors. If grinder is ordered without motor specify voltage, phase and cycle of motor to be used so correct wiring can be supplied.

CE2725. Pedestal Grinder with 8" wheels and equipment as listed above, but without motor.....\$257.

CE2726. Pedestal Grinder with 10" wheels and equipment as listed above, but without motor.....\$260.

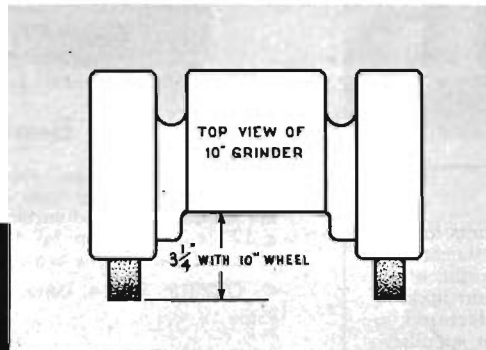
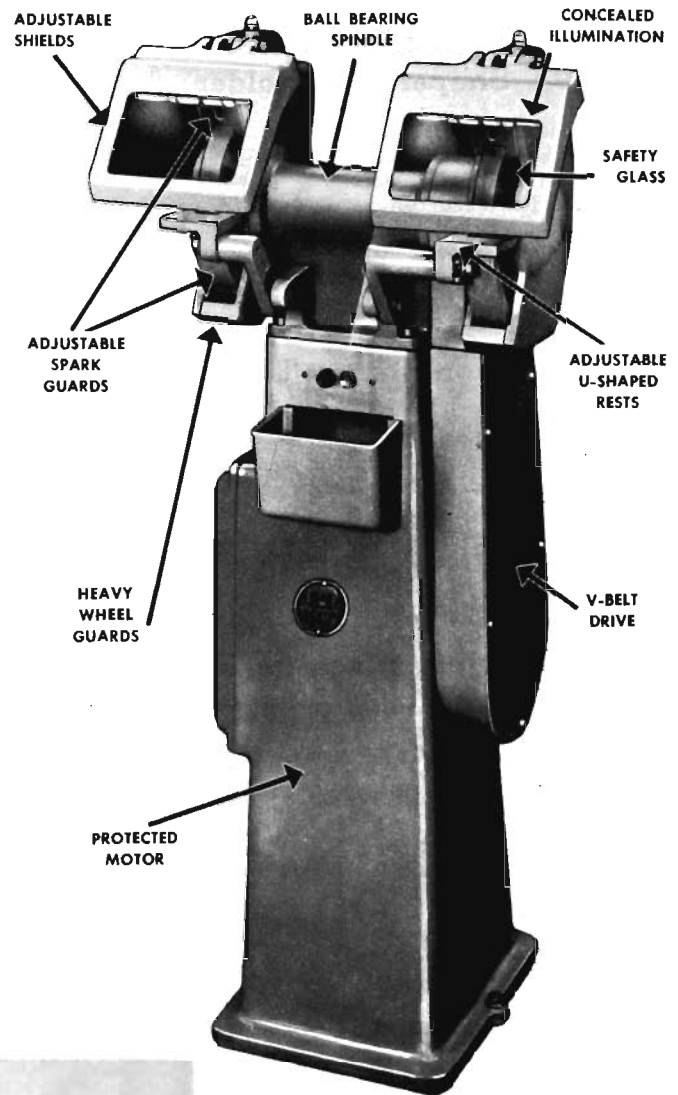

Knuckle Room To Spare

To give you plenty of room for both the work and your hands, the motor is mounted inside the pedestal instead of between the grinding wheels. Spaced 12" apart, the peripheries of the 10" wheels extend 3 1/4" beyond the spindle housing between them.

SPECIFICATIONS

- Wheel Size:** For 3/4 h.p. motor, 10" dia., 1" face, 3/4" hole.
For 1/2 h.p. motor, 8" dia., 1" face, 3/4" hole.
- Spindle:** Sealed ball bearings. Approximate speed 2450 r.p.m.
- Motor:** Standard 2875 r.p.m. 50 cycle or 3450 r.p.m. 60 cycle and D.C., 1/2 h.p. or 3/4 h.p.
- Over-all Dimensions:** 10" — 49 1/2" high, 20 3/4" wide, 22 3/4" deep.
8" — 49 1/2" high, 20 3/4" wide, 20 1/2" deep.
- Shipping Weight:** 10" grinder 377 lbs. crated for rail shipment, 437 lbs. boxed for export.
8" grinder 360 lbs. crated for rail shipment, 420 lbs. boxed for export.
- Export Space:** 24 cubic feet boxed.



Motors for Pedestal Grinders

South Bend Pedestal Grinders require N.E. M.A. standard frame 3450 r.p.m. or 2875 r.p.m. motors as listed below. A 1/2 h.p. motor is required for the grinder with 8" wheels, and a 3/4 h.p. motor is required with 10" grinding wheels. Approximate shipping weight of 1/2 h.p. motor is 40 lbs., 3/4 h.p. motor 50 lbs. Write for information on motors for currents not listed.



Optional Controls for Pedestal Grinders

Prices of South Bend Pedestal Grinders include a push-button type across-the-line manual starting switch for the motor. Remote control equipment is optional for two and three phase motors. This equipment includes step-down transformers and relays which reduce the current to the operating switch to 110 volts, and provide overload protection and low voltage release. Shipping weight 23 lbs.



1/2 h.p. Motors for 8" Grinder		3/4 h.p. Motors for 10" Grinder		Current Characteristics			
Cat. No.	Price	Cat. No.	Price	Current	Volts	Phase	Cycle
CE3431A	\$ 39.00	CE3441A	\$ 45.00	A.C.	115	1	50
CE3431R	42.00	CE3441R	50.00	A.C.	125	1	50
CE3461B	39.00	CE3471B	45.00	A.C.	115	1	60
CE3431C	39.00	CE3441C	45.00	A.C.	230	1	50
CE3461D	39.00	CE3471D	45.00	A.C.	230	1	60
CE3431Q	42.00	CE3441Q	50.00	A.C.	250	1	50
CE3463P	44.00	CE3443P	45.00	A.C.	208	3	60
CE3463C	44.00	CE3443C	45.00	A.C.	208-220	3	50
CE3463D	44.00	CE3443D	45.00	A.C.	220	3	60
CE3433S	44.00	CE3443S	50.00	A.C.	380	3	50
CE3433E	39.00	CE3443E	45.00	A.C.	440	3	50
CE3433F	39.00	CE3443F	45.00	A.C.	440	3	60
CE3462D	44.00	CE3442D	45.00	A.C.	208-220	2	60
CE3462C	44.00	CE3442C	45.00	A.C.	208-220	2	50
CE3432F	39.00	CE3442F	45.00	A.C.	440	2	60
CE3432E	39.00	CE3442E	45.00	A.C.	440	2	50
CE3430K	65.00	CE3440K	120.00	D.C.	115
CE3460L	67.00	CE3470L	123.00	D.C.	230

Cat. No.	Volts	Phase	Cycle	Factory Price
CE2636	208-220	2-3 3-wire	50	\$74.00
	440			
CE2637	208-220	2-3 3-wire	60	74.00
	440			
CE2638	380	3	50	77.00
CE2664	208-220	2 4-wire	50	74.00
	440			
CE2665	208-220	2 4-wire	60	74.00
	440			

Service Covers for Pedestal Grinders

This waterproof oil resistant service cover will protect your grinder from dust and dirt at night or whenever the grinder is not being used. Attractive maroon color, 12" wide, 28" long, 28" high.



CE2693. Waterproof Service Cover for Pedestal Grinder. Shipping weight 2 lbs. Factory Price..... \$1.95

How to Get Prompt Delivery

You can get almost any South Bend product quickly, either from stock carried by our distributors in all principal cities or direct from the factory at South Bend. No priority is required. To avoid delay, select the equipment you need and order immediately. Here are three ways to place your order:

1. See or telephone nearest distributor.
2. Order by mail from your distributor.
3. If no distributor is nearby, order direct from factory.

See classified section of telephone directory for name and address of South Bend Lathe distributor.

Protect Your Drill Press With This Waterproof Service Cover

Use this durable waterproof oil resistant plastic service cover to protect your drill press overnight or whenever it is not in use. Effectively prevents dust and dirt from accumulating. Attractive maroon color with South Bend emblem printed in metallic ink. Size 12" wide, 28" long, 28" high, large enough for any South Bend single spindle drill press. Folds compactly to small package for easy storing when not in use. Use two or more on multiple spindle drill presses.



CE2693. Waterproof Service Cover for Drill Press, Ship. wt. 2 lbs. Price..... \$1.95

Tapping Attachment for Drill Press

Jarvis Torqomatic Tapping Heads convert South Bend 14" Drill Presses into high speed, highly accurate tapping machines. Automatic reverse speed is twice forward speed. Quill mounting and No. 2 Morse taper spindle types shipped complete ready for use.

CE9145. Tapping head No. 0 to No. 10 tap capacity with No. 2 Morse taper arbor. Shipping weight 6 lbs. Price.. \$70.00

CE9146. Tapping head No. 10 to 3/16" tap capacity with No. 2 Morse taper arbor. Ship. wt. 7 1/2 lbs. Price.... \$85.00

CD9147. Tapping head No. 0 to No. 10 tap capacity, quill mounting. Shipping weight 6 lbs. Price \$70.00

CD9148. Tapping head No. 10 to 3/16" tap capacity, quill mounting. Ship. wt. 7 1/2 lbs. Price... \$85.00



14-inch South Bend Precision Model Drill Press

The South Bend 14-inch Precision Model Drill Press is the result of several years of careful research and thorough testing. Designed by the same engineering staff and produced with the same excellent manufacturing facilities employed in the production of South Bend Precision Lathes, this drill press is a superior tool unsurpassed for accuracy, ease of operation, versatility, and dependable performance. It is ruggedly constructed, and will maintain its precision accuracy indefinitely under severe industrial service.

Being a completely new design, the Precision Model Drill Press introduces several original features which add to its convenience and ease of operation. A built-in light with independent switch provides shadowless illumination on the work area, eliminating the necessity of installing a separate lighting fixture. A quick-acting belt tension release lever simplifies speed changes and returns the vertical mounted motor to its original position after each change, thus maintaining the same belt tension for each of the four cone pulley steps.

SPECIFICATIONS

Maximum drill size in iron or steel.....	1/2"
Drills to center of.....	14 1/4" circle
Net weight, bench type, less motor.....	130 lbs.
Net weight, floor type, less motor.....	165 lbs.
Chuck capacity.....	0 to 1/2"
Spindle speeds, four, approx. r.p.m.	720, 1335, 2025, 4325
Spindle travel, maximum.....	4"
Spindle run out, maximum.....	.001"
Spindle, square with table within.....	.002" in 5"
Chuck to base, maximum, bench type.....	16"
Chuck to base, maximum, floor type.....	45 1/4"
Chuck to table, maximum, bench type.....	11 3/8"
Chuck to table, maximum, floor type.....	40 3/4"
Base, work surface, bench type.....	7" x 10"
Base, work surface, floor type.....	8" x 12"
Table, work surface.....	10" x 10"
Table tilt.....	Any angle
Column diameter.....	2.730"
Motor, size recommended.....	1/3 or 1/2 h.p.
Motor, speed recommended.....	1725 r.p.m.

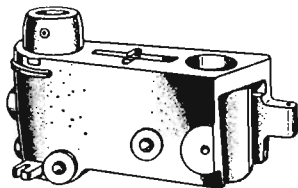

ONE-PIECE HEAD CASTING

Insures accurate alignment. Heavy, rigid construction. Internal clutch locks the head to column. Column bearing is NOT split.

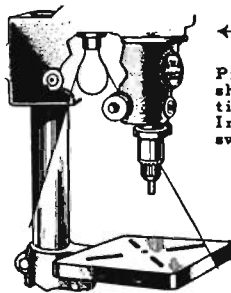

BUILT-IN LIGHT
Provides shielded, shadowless illumination on work area. Independent on-off switch is built-in.

ADJUSTABLE FEED LEVER
Feed lever is adjustable and can be centered or extended as desired for increased leverage or for greater convenience.

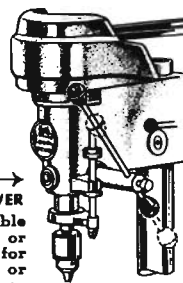

INTERCHANGEABLE SPINDLES

Spindles available to take No. 2 Morse taper shank tools, and for 1/2" straight shank tools, router bits, shaper cutters.

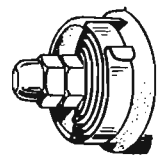

ADJUSTABLE QUILL RETURN SPRING

Retracts quill instantly upon release of feed lever. Tension of spring adjustable.

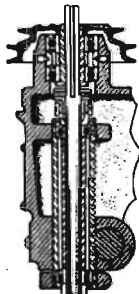

FOUR PRECISION BALL BEARINGS

Two on spindle, two on drive sleeve. Prelubricated and sealed precision type, no oiling required.

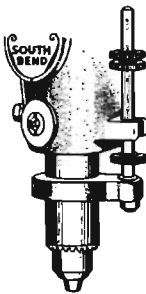

DEPTH GAUGE

Controls feed depth, length of return stroke, or locks spindle in any position. 16th graduations.

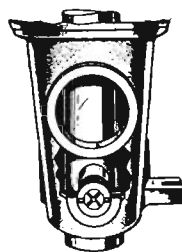

QUILL BEARING ADJUSTMENT

Shoe-type take-up provides feather-touch tension and secure locking. Quill bearing is NOT split.

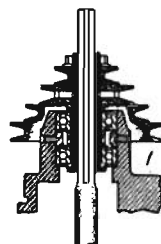

FREE-FLOATING SPINDLE

Design prevents misalignment, side thrust and whip. Precision splines in spindle and sleeve.

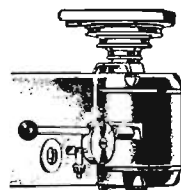

BELT TENSION RELEASE

Flip of lever removes tension from belt for easy speed changes. Proper belt tension maintained.

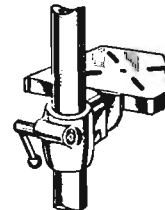
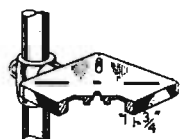

TABLE LOCK

Internal clutch securely locks table to column. Eliminates misalignment. Column bearing is NOT split.



PRECISION TABLE HAS WIDE CLAMPING RIB

Table has accurately ground work surface. Heavy rib 3/4" wide strengthens table and provides flat surface underneath for clamping work securely to table.

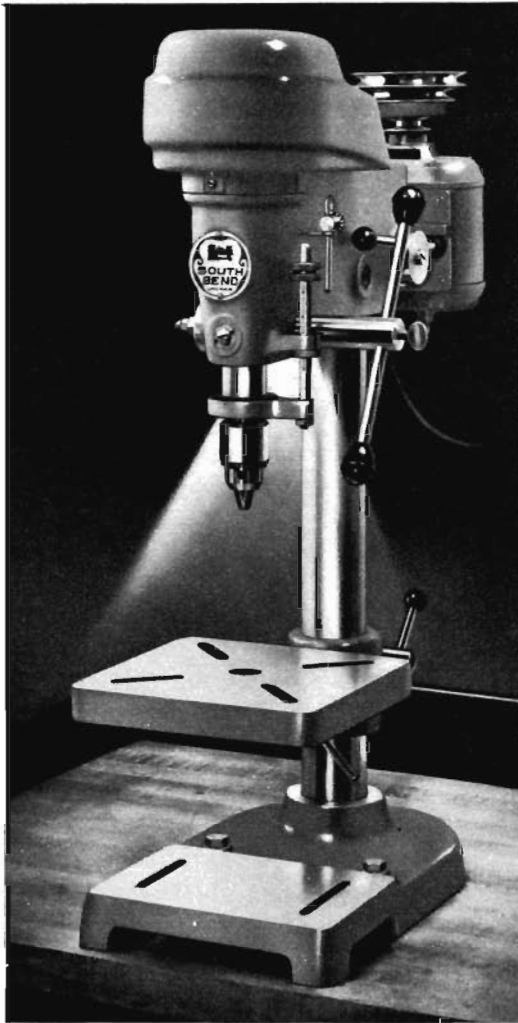

Precision Model 14-inch Bench Drill Press

Perfectly proportioned for mounting on any substantial work bench, table, or machine stand, this is one of our most popular drill presses. Base has bolt holes for securing to bench, and precision ground work surface with two slots for clamping. Maximum distance between base and chuck is 16" and between table and chuck is 11 $\frac{3}{8}$ ". See preceding page for other specifications and features.

The free-floating spindle design prevents misalignment, side thrust, and whip. Two precision ball bearings carry the drive sleeve and two additional ball bearings carry the spindle, which is spline driven. All ball bearings, being prelubricated and sealed, require no oiling. Quill bearing adjustment provides feather touch tension and secure locking.

Regular equipment supplied with each Precision Model Bench Drill Press includes motor base, balanced motor pulley, balanced spindle pulley, V-belt, built-in work light, wiring in drill press head, spindle equipment as indicated in table, and toggle switches for work light and motor, but does not include motor. See page 78 for drill press motors.

Precision Model Bench Drill Presses

Catalog Number	Spindle Equipment	Cubic Feet Boxed	Boxed Weight Pounds	Crated Weight Pounds	Factory Price
CD400B	$\frac{1}{2}$ " Jacobs Key Chuck	9	255	190	\$122
CD414B	No. 2 Morse Taper Socket	9	255	190	117

Note: If ordered less motor, specify voltage, phase, and cycle of motor to be used.

Give your shop equipment that new look with South Bend standard finish enamel. See page 71.



Precision Model 14-inch Floor Drill Press

Except for the tall column and large base for floor mounting, this is the same as the bench drill press shown at the left. Base is heavily constructed and of ample size to provide substantial support. Precision ground work surface on base has two slots for clamp bolts. Maximum distance between base and chuck is 45 $\frac{1}{4}$ " and between table and chuck is 40 $\frac{3}{4}$ ". For other specifications and features see preceding page.

The full tilt type table, with 10" x 10" precision ground top surface, has slots for clamping fixtures or work. An improved type of internal clutch binder is provided for locking the table quickly in any position on the column. The edge of the table has a heavy flange with a $\frac{3}{4}$ " flat underneath for clamping.

Regular equipment supplied with each Precision Model Floor Drill Press includes motor base, balanced motor pulley, balanced spindle pulley, V-belt, built-in work light, wiring in drill press head, spindle equipment as indicated in table, and switches for work light and motor, but does not include motor. See page 78 for drill press motors.

Precision Model Floor Drill Presses

Catalog Number	Spindle Equipment	Cubic Feet Boxed	Boxed Weight Pounds	Crated Weight Pounds	Factory Price
CD400F	$\frac{1}{2}$ " Jacobs Key Chuck	19	365	235	\$141
CD414F	No. 2 Morse Taper Socket	19	365	235	136

Precision Model Single and Multiple Spindle Drill Presses for Production Operations

Much time can be saved on production drill press work by using one of these multiple spindle models so that two or more operations can be performed in rapid sequence. Each spindle can be adjusted independently to the correct position and speed for most convenient and efficient operation.

These drill presses consist of our standard 14" Precision Model drill press heads mounted on heavy, accurately machined work tables having large coolant return grooves. Either bench mounting (not illustrated) or heavy cast legs for floor installation as illustrated, can be supplied. The open leg construction facilitates cleaning and permits the operator to sit comfortably if desired.

The drill press spindles can be supplied with either $\frac{1}{2}$ " Jacobs key type chucks or with taper sockets to receive tools with No. 2 Morse taper shanks. Coolant pump and reservoir, multi-speed attachment, and other attachments and accessories can be supplied and are illustrated and described on pages 77 to 79 inclusive.

Regular equipment supplied with each drill press head includes: head positioning mechanism, spindle equipment as indicated in table below, motor base, motor pulley, V-belt, built-in work light, wiring and toggle switches. Motors and remote control equipment are not included. (See page 78.) If drill press is ordered without motors, specify voltage, phase and cycle of motors to be used so correct wiring can be supplied in drill press head.

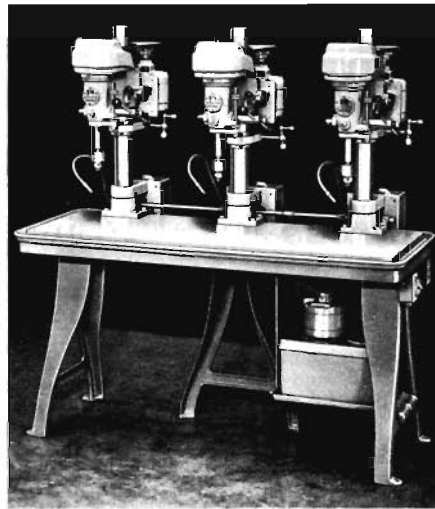
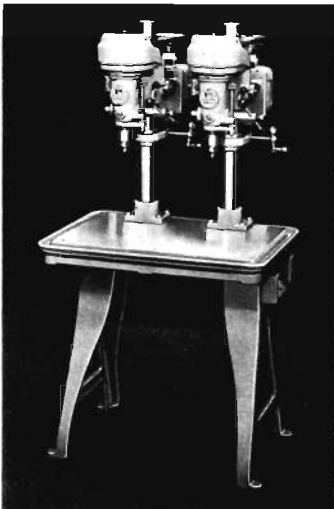
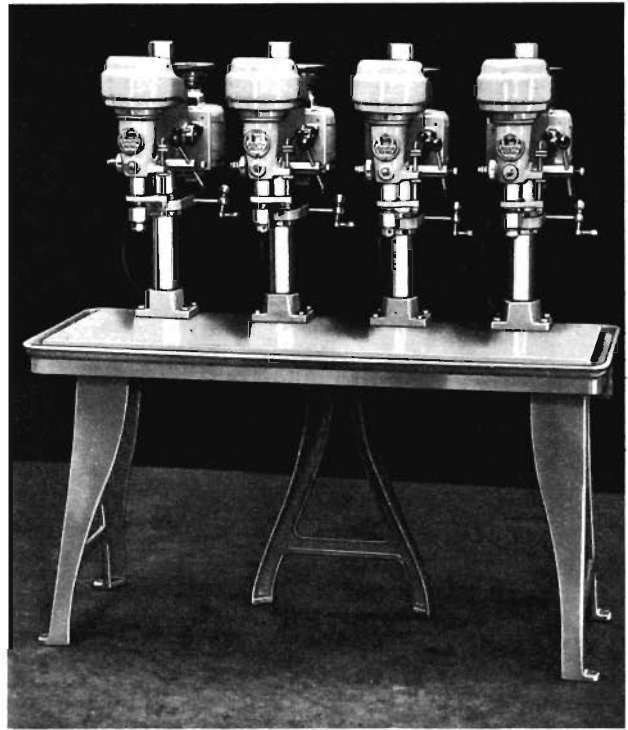

With $\frac{1}{2}$ " Jacobs Chucks		With No. 2 M. T. Sockets		Number of Spindles	Table Work Surface	Between Column Centers	Over-all Size			Cubic Feet Boxed	Boxed Weight Pounds	Crated Weight Pounds
Cat. No.	Factory Price	Cat. No.	Factory Price				Width	Depth	Height			

Floor Model Drill Presses for Production Operations

CD451F	\$241.00	CD491F	\$236.00	1	13 $\frac{3}{8}$ " x 15 $\frac{3}{4}$ "	20"	33"	66 $\frac{15}{16}$ "	22	475	375
CD452F	464.00	CD492F	454.00	2	14" x 28 $\frac{3}{4}$ "	13"	33 $\frac{1}{8}$ "	69 $\frac{13}{16}$ "	34	725	828
CD453F	720.00	CD493F	705.00	3	14" x 55"	19"	59 $\frac{1}{2}$ "	70 $\frac{1}{16}$ "	57	1185	1085
CD454F	828.00	CD494F	808.00	4	14" x 55"	13"	59 $\frac{1}{2}$ "	70 $\frac{1}{16}$ "	57	1320	1200

Bench Model Drill Presses for Production Operations

CD451B	\$182.00	CD491B	\$177.00	1	13 $\frac{3}{8}$ " x 15 $\frac{3}{4}$ "	20"	33"	37 $\frac{3}{8}$ "	22	393	293
CD452B	405.00	CD492B	395.00	2	14" x 28 $\frac{3}{4}$ "	13"	33 $\frac{1}{8}$ "	38 $\frac{7}{8}$ "	34	845	548
CD453B	599.00	CD493B	584.00	3	14" x 55"	19"	59 $\frac{1}{2}$ "	38 $\frac{1}{4}$ "	57	1085	902
CD454B	739.00	CD494B	719.00	4	14" x 55"	13"	59 $\frac{1}{2}$ "	38 $\frac{1}{4}$ "	57	1200	1035

Multi-Speed Attachment

The Multi-Speed Attachment for South Bend 14" Precision Model Drill Presses provides twelve spindle speeds 380, 605, 650, 1040, 1040, 1120, 2870, 3025, 3070, 4900, 5170, and 8010 r.p.m.



when used with 1725 r.p.m. motor. The attachment consists of an eccentric spindle, which is mounted in the drill press column to support a 4-step auxiliary cone pulley with two V-belts.

This attachment cannot be used with split phase motor No. CE3256B. Price includes eccentric spindle, 4-step cone pulley and two V-belts. Shipping weight 8 lbs.

CD9135A. For 1/2 h.p. motor. Factory Price.....\$16.25

CD9135B. For 3/4 h.p. motor. Factory Price.....\$16.25

Note: This attachment cannot be used with Head Positioning Attachment.

Belt Guard

This belt guard provides complete enclosure for V-belt. Guard is hinged and may be raised for changing spindle speeds. May be used with or without Multi-Speed Attachment.



CD9136. Belt Guard for use with Precision Model Drill Press only. Shipping weight 16 lbs. Factory Price.....\$13.50

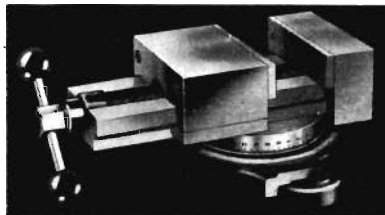

Swivel Machine Vise

For holding work on drill press table, milling machine, shaper, etc. Swivel is graduated 180° to permit setting vise at any angle with slots in table. Jaws are hardened and are replaceable. Jaws are 4" wide and 1" deep. Maximum jaw opening is 4".

CE9100 Swivel Drill Press Vise. Shipping weight 18 pounds. Factory price.....\$26.00

Extra Spindles for Drill Presses

Extra spindles are interchangeable with regular drill press spindles supplied with either the Single or Multiple Spindle Precision Model Drill Presses.

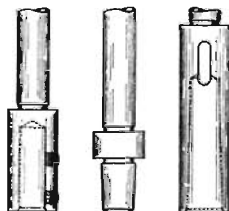

CD9125. Spindle with No. 2 Morse taper hole for holding taper shank tools. Drift included. Shipping weight 3 lbs. Factory Price.....\$6.85

CD9126. Utility spindle with 1/2" x 1 1/8" deep straight hole for holding routing tools, etc. Shipping weight 3 lbs. Factory Price.....\$5.00

CD9127. Spindle with short taper for 1/2" Drill Chuck No. CE1201. (Jacobs No. 34). Shipping weight 2 lbs. Factory Price.....\$4.20

CD9128. Spindle with No. 3 Morse taper hole for holding taper shank tools. Drift included. Shipping weight 5 lbs. Factory Price.....\$10.50

Chuck and Arbor for Drill Press

This drill chuck and arbor are recommended for use with drill presses having spindles with No. 2 Morse taper.



CE1201. Jacobs 3-jaw smooth body drill chuck, 0 to 1/2" capacity with pinion key. Shipping weight 2 1/2 pounds. Factory Price.....\$8.56

CE9110. No. 2 Morse taper shank arbor with tang, for fitting above chuck to drill press spindle No. CD9125. Ship. wt. 1/4 lb. Factory Price \$1.20

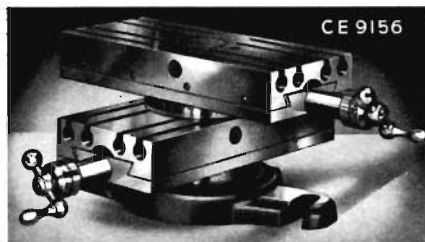

Universal Table

Both upper and lower slides have graduated swivels and may be turned through full 360° Slides can be used without graduated swivels to reduce height if desired. They can be positioned at any angle with each other and may be turned individually or together. Each slide has feed screw with micrometer collar reading in thousandths of an inch. Dovetails are equipped with full length gibs for take-up.

The precision ground work surface is 4" x 8 7/8" and maximum travel is 4" for either slide. Table has four slots for clamping work. Clamp bolts fit snugly into round slots in such a way that there is little danger of breaking out or otherwise damaging the slots. Supplied with base for use on drill press, milling machines, etc., also with a specially designed base for mounting on the South Bend 7" Shaper. Slides and bases may be purchased separately if desired.



CE9156. Universal Table complete with base for South Bend Drill Press or other machine tools, two slides, two graduated swivels, and eight clamp bolts with nuts. Ship. weight 43 lbs. Factory Price.....\$101.95

CE9150. Universal Table complete with base for South Bend 7" Shaper, two slides, two graduated swivels, and eight clamp bolts with nuts. Ship. wt. 37 lbs. Factory Price.....\$102.95

CE9157. Single Table with one graduated swivel and four clamp bolts with nuts. Ship. wt. 19 lbs. Factory Price....\$48.50

CE9158. Base only for adapting single table to South Bend 7" Shaper. Ship. wt. 3 lbs. Factory Price.....\$4.00

CE9159. Base only for adapting single table to South Bend Drill Press or other machine tool. Ship. wt. 8 lbs. Price....\$4.40

Wood Top Machine Stand

This is a heavily constructed angle steel stand 29 3/8" high for mounting the bench shaper, drill press, or for other small machines. The glued wood top is 20" x 32" and is 1 3/8" thick. Steel parts are finished in gray enamel. Shipping weight 52 lbs.



CE9141. Wood Top Machine Stand (less drawer). Factory Price.....\$24.95

Drawer for Machine Stand

Handy for keeping small tools, wrenches, etc. Finished to match stand CE9141. Drawer is 20 1/8" wide, 14" long, 3 3/8" deep. Price includes metal pull and wood slides. Shipping weight 9 lbs.

CE1780D. Drawer for use with Machine Stand. Price \$8.25

Motors for South Bend Drill Presses

Motors listed below are recommended for use with South Bend 14" Drill Presses. These are all vertical mounting ball-bearing motors with the exception of No. CE3256B, which is a sleeve bearing motor. All single phase motors are capacitor type with the exception of No. CE3256B which is split-phase. Prices of 230 v. single phase and D.C. motors include 230 v. lamp in lieu of 115 v. lamp regularly supplied with drill press.



Motors operating on two or three phase A.C. require either remote control or across-the-line manual starter equipment described below the motor table.

Wiring and switches for single phase or D.C. motors are supplied with Precision Model Drill Presses, and need not be ordered as extras. Information on motors for current characteristics not listed will be supplied on request.

Motors for South Bend 14" Drill Presses

Cat. No.	H.P.	Current	Volts	Phase	Cycle	Fact. Price
CE4910B	1/3	A.C.	115	1	60	\$35.00
CE3256B	1/3	A.C.	115	1	60	16.50
CE4910D	1/3	A.C.	230	1	60	35.00
CE4911A	1/3	A.C.	115	1	50	39.00
CE4911C	1/3	A.C.	230	1	50	39.00
CE4912D	1/3	A.C.	208-220	3	60	35.00
CE4912C	1/3	A.C.	208-220	3	50	35.00
CE4913S	1/3	A.C.	380	3	50	43.25
CE4913F	1/3	A.C.	440	3	60	38.00
CE4913E	1/3	A.C.	440	3	50	38.00
CE4920B	1/2	A.C.	115	1	60	43.00
CE4920D	1/2	A.C.	230	1	60	43.00
CE4921A	1/2	A.C.	115	1	50	46.00
CE4921C	1/2	A.C.	230	1	50	46.00
CE4916R	1/2	A.C.	125	1	50	51.00
CE4915Q	1/2	A.C.	250	1	50	51.00
CE4922Y	1/2	A.C.	115	1	40	79.00
CE4922Z	1/2	A.C.	230	1	40	79.00
CE4914D	1/2	A.C.	208-220	2	60	43.00
CE4914C	1/2	A.C.	208-220	2	50	43.00
CE4914F	1/2	A.C.	440	2	60	43.00
CE4914E	1/2	A.C.	440	2	50	43.00
CE4924D	1/2	A.C.	208-220	3	60	43.00
CE4924C	1/2	A.C.	208-220	3	50	43.00
CE4924S	1/2	A.C.	380	3	50	48.25
CE4924F	1/2	A.C.	440	3	60	43.00
CE4924E	1/2	A.C.	440	3	50	43.00
CE4930	1/2	D.C.	115	91.00
CE4931	1/2	D.C.	230	94.00

Controls for Two and Three Phase Motors

All two and three phase motors for drill presses require either remote control or across-the-line manual starter equipment. Remote control equipment includes step-down transformers and relays which reduce current to operating switch to 110 volts, and provide overload protection and low voltage release.

CE4901. Across-the-line Manual Starter for three phase or two phase three wire 208-220/440 v., 50/60 cycle A.C. motors. Ship. weight 5 lbs. Price f.o.b. factory... \$10.95

CE4909E. Remote Control for three phase or two phase three wire 208-220/440 v., 50 cycle A.C. motors. Ship. weight 23 lbs. Price f.o.b. factory... \$74.00

CE4909F. Remote Control for two phase or three phase, 208-220/440 v., 60 cy. A.C. motors. Ship. wt. 23 lbs. Price... \$74.00

CE4909S. Remote Control for three phase 380 v. A.C. motors. Shipping weight 23 lbs. Price f.o.b. factory... \$77.00

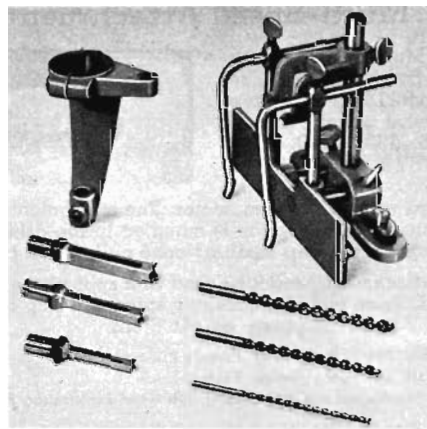

Mortising Attachment

This new South Bend Mortising Attachment converts any South Bend 14" Drill Press equipped with a 1/2" drill chuck into an efficient mortising machine. The improved fence assembly adjusts quickly and accurately for different thickness stock. The base clamps to the table and the fence adjusts on two steel posts. This design aids in eliminating alignment errors in the work. Two guide arms mount directly on the fence and are separately adjustable. A forked work hold down also adjusts on a vertical steel post mounted on the base. This fence assembly has many uses for guiding work other than mortising. It may be purchased separately.

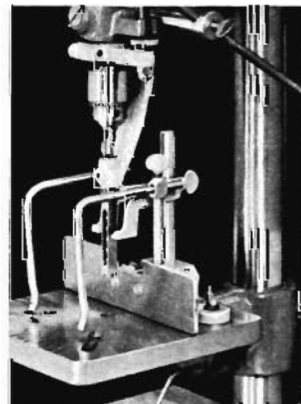

The mortising chisel holder clamps on the drill press quill taking the place of the depth stop clamp.

Specifications

Capacity under work hold down, maximum.....	5 1/16"
Capacity guide rods to fence, maximum.....	4 1/16"
Distance fence adjusts without moving base on table.....	1"
Working depth of chisels:	
1 1/4".....	2 1/16"
3/4".....	2 3/8"
1/2".....	3 3/8"

Cat. No.	Description	Ship. Wt.	Price
CE9151	Mortising Attachment Fence Assembly	10 lbs.	\$11.45
CD9152	Mortising Chisel Holder	3 lbs.	4.20
CE9153	1/4" Mortising Chisel and Bit	1/2 lb.	8.40
CE9154	3/8" Mortising Chisel and Bit	3/4 lb.	8.40
CE9155	1/2" Mortising Chisel and Bit	1 lb.	9.70

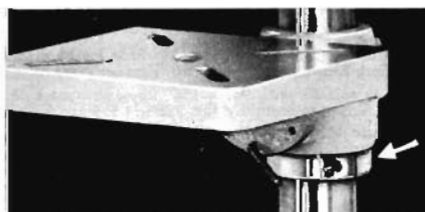

Table Support Ring

Clamped on the column beneath the drill press table, this support ring permits releasing the table clamp and swinging the table around the column to any position without danger of the table dropping down. Very convenient for surface grinding with cup wheel mounted in drill press spindle, and similar surfacing operations on wood or metal parts. Can also be used under drill press head.

CE9140. Table Support Ring. Ship. wt. 1 1/2 lbs. Price... \$1.60

Turnstile Feed Lever Attachment

This attachment adds two spokes to the regular feed lever to provide a four spoke turnstile feed for the drill press spindle. It consists of two levers of equal length mounted in a collar which slips over the quill feed shaft. The regular feed lever passes through the collar and locks it in position. The use of this attachment does not interfere with the adjustable feature of the regular feed lever, which can be set in central position or extended for additional leverage or convenience as desired. Made with knobs to match Precision Model Drill Press.

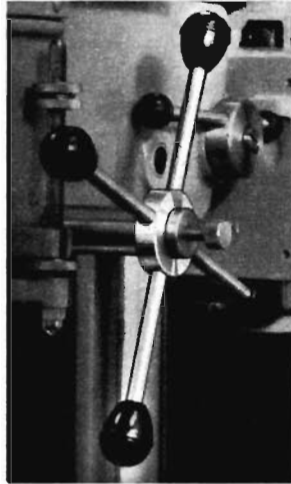

CD9170. Turnstile Feed Lever Attachment. Ship. wt. 3 lbs.
Price f.o.b. factory.....\$3.00

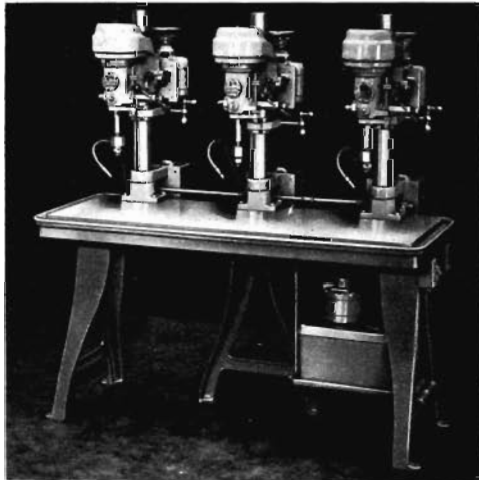

Coolant Pump Equipment for Production Type Drill Presses

This coolant pump equipment is designed for use with the production type drill presses. It includes a self priming coolant pump driven by a 1/4 h.p. motor, toggle switch, coolant reservoir, necessary piping, and individual nozzle with shut off valve for each spindle of the drill press. Price includes fitting coolant equipment to drill press at factory. Shipping weight approximately 154 lbs.

Table Positioning Attachment

This Table Positioning Attachment raises or lowers the drill press table. The attachment consists of a vertical screw operated by a steel ball crank through worm gearing. It is positioned on column by adjusting two lock rings and provides 4" of adjustment without resetting when the table is in the normal horizontal position. The adjustment is reduced to 3 1/2" when the table is set at 45°, which is the maximum angle for the table when the positioning adjustment is used. Swivels around column with table. Designed for use with South Bend Drill Presses which have column 2.730" in diameter.

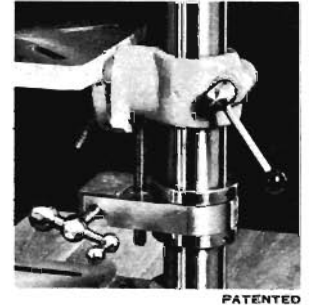

CE9130. Table Positioning Attachment. Ship. wt. 10 lbs.
Price f.o.b. factory.....\$17.40

Head Positioning Attachment

The Head Positioning Attachment provides a quick and convenient means for adjusting the position of the drill press head on the column. The attachment can be used at any point on the column, and provides four inches of vertical adjustment at one setting. Enclosed worm gearing operated by a steel ball crank assures smooth, easy operation. The head positioning attachment swivels around the column with the head to any desired angle. Designed for use with South Bend 14" Drill Presses which have columns 2.730" in diameter. The head positioning attachment and the multi-speed attachment cannot be used at the same time.

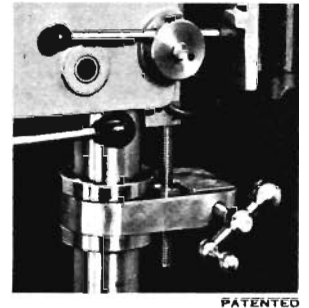

CE9131. Head Positioning Attachment. Ship. wt. 10 lbs.
Price f.o.b. factory.....\$17.40

Universal Coolant Pump Equipment

This coolant equipment may be ordered for drill presses, or other machine tools for which specially designed coolant equipment is not available. Reservoir may be set on floor or attached to machine. Equipment consists of: coolant pump, tubing, reservoir, tray, 1/4 h.p. motor, switch, and wire for connecting motor and switch. See page 45.



Coolant Pump Equipment for Production Type Drill Presses

CURRENT				One Spindle Drill Press		Two Spindle Drill Press		Three Spindle Drill Press		Four Spindle Drill Press	
Type	Phase	Cycle	Volts	Cat. No.	Price	Cat. No.	Price	Cat. No.	Price	Cat. No.	Price
A.C.	3	50	220	CD9103C	\$197.00	CD9203C	\$203.00	CD9303C	\$210.00	CD9403C	\$216.00
A.C.	3	60	220	CD9103D	197.00	CD9203D	203.00	CD9303D	210.00	CD9403D	216.00
A.C.	3	50	440	CD9103E	201.00	CD9203E	207.00	CD9303E	214.00	CD9403E	220.00
A.C.	3	60	440	CD9103F	201.00	CD9203F	207.00	CD9303F	214.00	CD9403F	220.00
A.C.	3	50	550	CD9103G	201.00	CD9203G	207.00	CD9303G	214.00	CD9403G	220.00
A.C.	3	60	550	CD9103H	201.00	CD9203H	207.00	CD9303H	214.00	CD9403H	220.00
A.C.	2	50	220	CD9102C	197.00	CD9202C	203.00	CD9302C	210.00	CD9402C	216.00
A.C.	2	60	220	CD9102D	197.00	CD9202D	203.00	CD9302D	210.00	CD9402D	216.00
A.C.	1	50	115	CD9101A	182.00	CD9201A	188.00	CD9301A	195.00	CD9401A	201.00
A.C.	1	60	115	CD9101B	178.00	CD9201B	185.00	CD9301B	191.00	CD9401B	198.00
A.C.	1	50	230	CD9101C	185.00	CD9201C	191.00	CD9301C	198.00	CD9401C	204.00
A.C.	1	60	230	CD9101D	181.00	CD9201D	187.00	CD9301D	194.00	CD9401D	200.00
D.C.	115	CD9100K	227.00	CD9200K	233.00	CD9300K	240.00	CD9400K	246.00
D.C.	230	CD9100L	230.00	CD9200L	237.00	CD9300L	243.00	CD9400L	249.00

Floor Space Required for South Bend Machine Tools

Dimensions A to G given in tables below are in inches

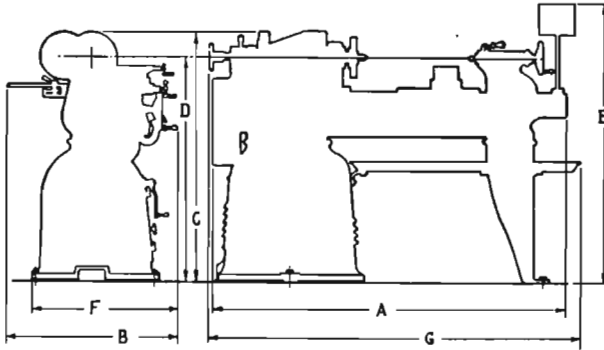

Underneath Motor Driven Floor Lathes

Size Lathe	Bed Length	A	B	C	D	E	F	G
10"	3'	44	27 3/4	44 1/2	41 1/2	50 1/2	24	46
13"	5'	65 3/4	34 1/2	45 1/2	41 1/2	52 1/2	26 1/4	70
14 1/2"	6'	78 1/2	36 3/4	46 1/2	41 1/2	50 1/2	27 1/2	84
16"	8'	102 1/2	41 3/4	46 3/4	42 1/2	54 1/2	28 3/4	106 3/4
16-24"	10'	126 1/2		51 1/2	46 3/4		28 3/4	

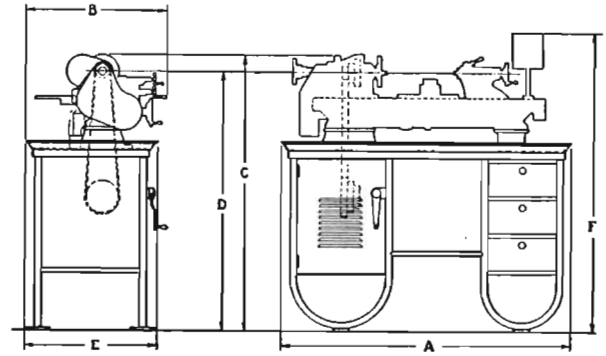

Underneath Motor Driven Bench Lathes

Size Lathe	Bed Length	A	B	C	D	E	F
10"	3 1/2'	51 1/2	26 3/8	47 1/2	44 1/2	22	52 1/2

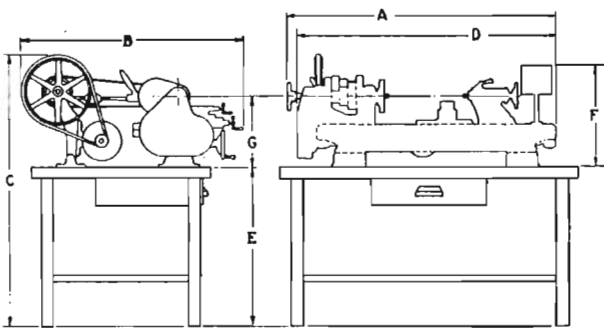

Horizontal Motor Driven Bench Lathes

Size Lathe	Bed Length	A	B	C	D	E	F	G
9"	3'	41 1/2	37	49 3/8	39 3/8	29 3/8	19 1/2	12 1/2
Lt. Ten	3'	41 1/2	38 1/2	49 1/4	39 3/8	29 3/8	19 1/2	12 17/32

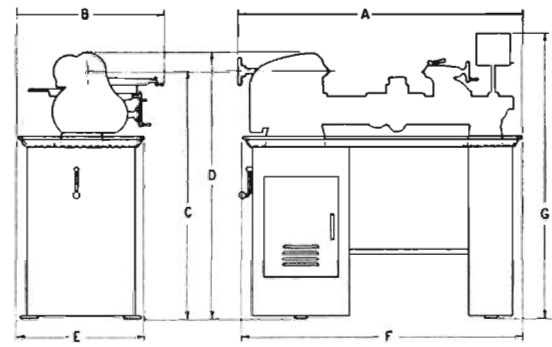

Underneath Motor Driven Metal Column Base Lathes

Size Lathe	Bed Length	A	B	C	D	E	F	G
9"	3 1/2'	49 3/8	25 1/4	41 3/8	44 3/8	21 1/2	48 1/4	48 15/16
Lt. Ten	3 1/2'	49 3/8	25 1/4	42 1/8	45 3/8	21 1/2	48 1/4	49 1/16

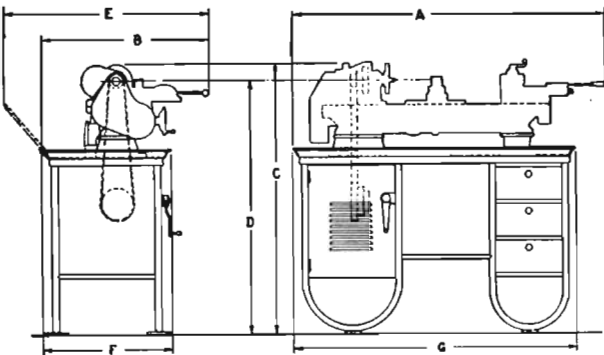

10" Bench Turret Lathe

Size Lathe	Bed Length	A	B	C	D	E	F	G
10"	3 1/2'	63 1/4	30 3/8	47 1/2	44 1/2	40 1/2	22	51 1/2

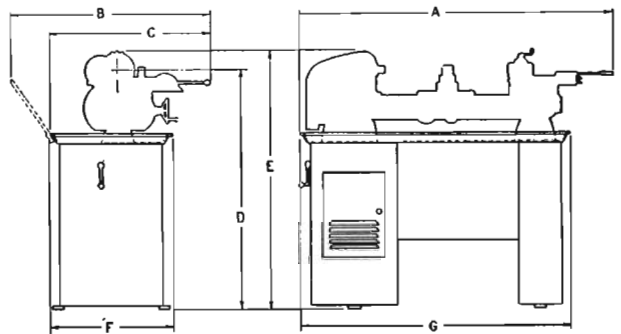

9" Metal Column Base Turret Lathes

Size Lathe	Bed Length	A	B	C	D	E	F	G
9"	3 1/2'	60	36 1/4	28 1/4	41 3/8	44 3/8	21 1/2	48 1/4

Floor Space Required for South Bend Machine Tools

Dimensions A to H in tables below are in inches

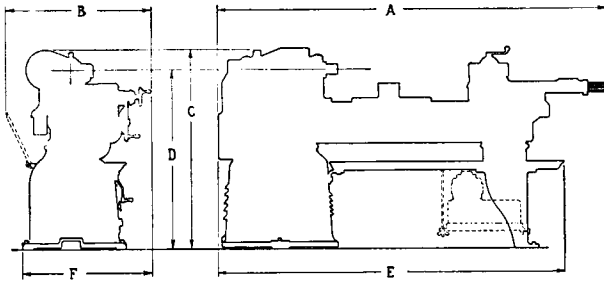

13" and No. 2-H Turret Lathes

Size Lathe	Bed Length	A	B	C	D	E	F
13"	5'	72 1/4	39 1/4	45 3/4	41 1/2	68 1/2	30 3/4
2-H	6'	93 1/2	37	46 3/4	42 1/2	81 1/2	28 3/4

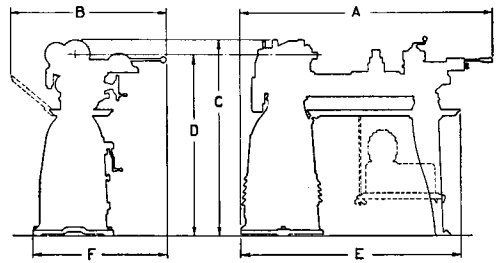

10" Turret Lathe

Size Lathe	Bed Length	A	B	C	D	E	F
10	3 1/2'	62 1/4	35 1/4	44 23/32	41 13/32	51	29 1/4

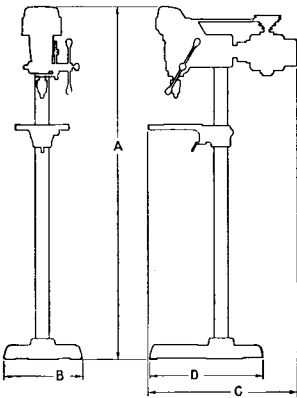

Floor Type Drill Presses

A	B	C		D
		1/2 h.p.	1/2 h.p.	
65 9/16"	15	27 3/4	29	21

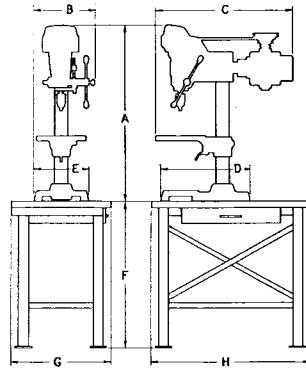

14" Bench Drill Presses

A—35 9/16"	D—17 3/4"
B—12 1/4"	E—10 3/4"
C—1/2 h.p. motor—27 3/4"	F—29 3/4"
C—1/2 h.p. motor—29"	G—20"
	H—32"

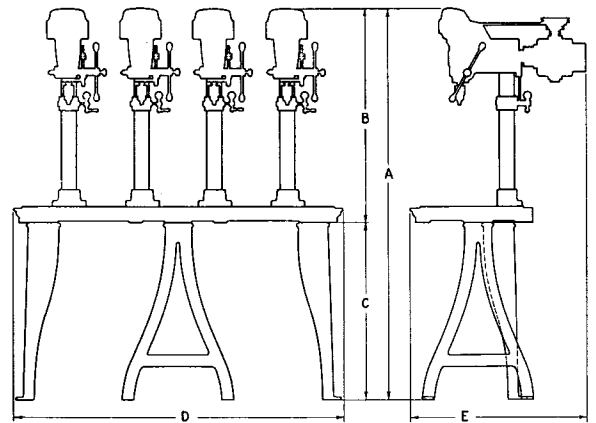

Drill Presses for Production Operations

Spindles	A	B	C	D	E	
					1/2 h.p.	1/2 h.p.
1	68 15/16	37 9/16	31 3/8	19 15/16	31 11/32	32 29/32
2	69 13/16	38 7/16	31 3/8	32 15/16	31 11/32	32 29/32
3	70 1/16	38 11/16	31 3/8	58 15/16	31 11/32	32 29/32
4	70 1/16	38 11/16	31 3/8	58 15/16	31 11/32	32 29/32

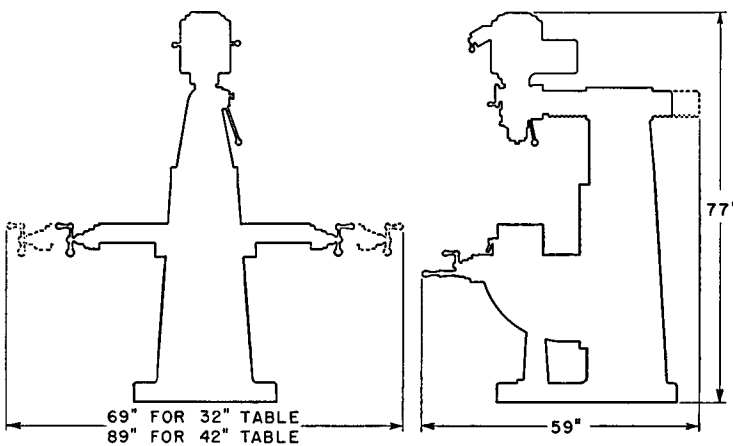

Milling Machine

Good light on the work prevents scrap—equip each lathe with South Bend work light. See page 59.

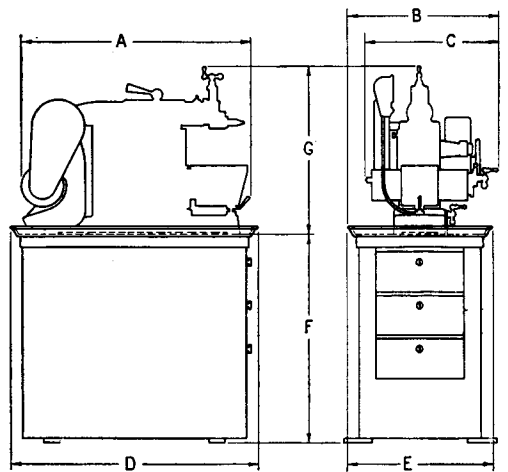

7" Shaper and Stand

1/2 h.p.	1/2 h.p.	A					
		B	C	D	E	F	G
31 3/4	35 1/4	20 1/2	19	36	19	28 3/4	26

