

# Dell™ OptiPlex™ GX400 System User's Guide

## [Safety Instructions](#)

- [Safety First—For You and Your Computer](#)
- [Protecting Against Electrostatic Discharge](#)
- [Ergonomic Computing Habits](#)

## [About Your Computer](#)

- [Front View of Your Computer](#)
- [Back View of Your Computer](#)
- [Inside Your Computer](#)

## [Advanced Features](#)

- [System Settings](#)
- [Manageability](#)
- [Security](#)
- [Password Protection](#)
- [Jumper Settings](#)
- [Installing and Configuring Software](#)
- [TAPI](#)
- [Power Management](#)

## [Installing Upgrades](#)

- [Computer Cover](#)
- [Power Supply](#)
- [Front Panel](#)
- [System Memory](#)
- [Disk Drives and Media](#)
- [AGP Card Brace](#)
- [Expansion Cards](#)
- [Microprocessor](#)
- [VRM](#)
- [System Battery](#)

## [Technical Specifications](#)

### [Solving Problems](#)

- [Before You Begin](#)
- [Dell Diagnostics](#)
- [Messages and Codes](#)
- [Software Problems](#)

### [Getting Help](#)



- [Help Overview](#)
- [Dell Contact Numbers](#)

### [Additional Information](#)

- [Regulatory Notices](#)
- [ENERGY STAR® Compliance](#)
- [Limited Warranty and Return Policy](#)
- [Microsoft® Windows® XP Features](#)

---

## Notes, Notices, and Cautions

-  **NOTE:** A NOTE indicates important information that helps you make better use of your computer.
-  **NOTICE:** A NOTICE indicates either potential damage to hardware or loss of data and tells you how to avoid the problem.
-  **CAUTION:** A CAUTION indicates a potential for property damage, personal injury, or death.

---

Information in this document is subject to change without notice.  
© 2001 Dell Computer Corporation. All rights reserved.

Reproduction in any manner whatsoever without the written permission of Dell Computer Corporation is strictly forbidden.

Trademarks used in this text: *Dell*, *OptiPlex*, *Dell OpenManage*, *Dimension*, *Inspiron*, *Latitude*, *DellWare*, and the *DELL* logo are trademarks of Dell Computer Corporation; *Microsoft*, *Windows*, *MS-DOS*, and *Windows NT* are registered trademarks of Microsoft Corporation; *Intel* and *Pentium* are registered trademarks of Intel Corporation; *3Com* is a registered trademark of 3Com Corporation. As an ENERGY STAR Partner, Dell Computer Corporation has determined that this product meets the ENERGY STAR guidelines for energy efficiency.

Other trademarks and trade names may be used in this document to refer to either the entities claiming the marks and names or their products. Dell Computer Corporation disclaims any proprietary interest in trademarks and trade names other than its own.

September 2001 P/N 66CUJ Rev. A01

## About Your Computer

### Dell™ OptiPlex™ GX400 System User's Guide

- [Front View of Your Computer](#)
- [Back View of Your Computer](#)
- [Inside Your Computer](#)

---

## Front View of Your Computer

The following illustration shows the controls and indicators located on the front panel of your computer.

### Front View

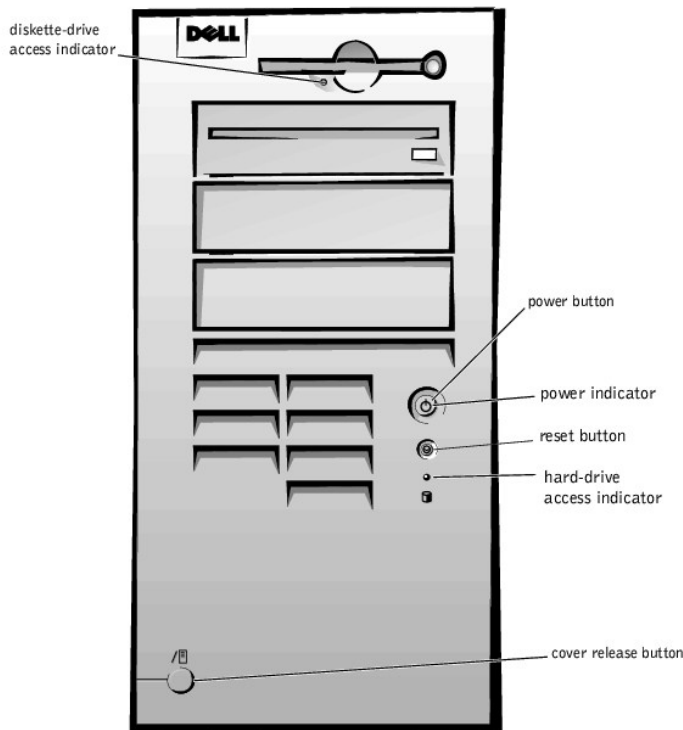

## Controls and Indicators

- 1 Reset button — reboots (restarts) the system in a way that reduces stress on system components. Before you push this button, save and close all open files and application programs to avoid losing data. Then perform an orderly shutdown of the operating system.

If your computer is not responding, you can press the reset button to reboot the system. For more information, see "[Recover From a Program That Is Not Responding](#)" and "[Restart a Computer That Is Not Responding](#)."

- **NOTICE:** If your computer is not responding, turning off power or unplugging the power cord should be done only as a last resort. Doing so can cause problems with system settings and configuration.

- 1 Power button — controls the system's AC input power. See the following table for power button functions on systems running Microsoft® Windows® 98 Second Edition (SE), Windows 2000, Windows XP, or Windows NT®.

Power Button Functions	
Computer Status	Power Button Functions
Off	Push and release to turn the computer on
On	Push and hold for more than 6 seconds to immediately turn the computer off
On	Push and release to attempt an orderly system shutdown
Suspended state	Push and release to bring the system out of the suspended state

- 1 Power indicator — contains a light that illuminates in two colors and blinks or remains solid to indicate different states.
- 1 Diskette-drive access indicator — lights when the drive is reading data from, or writing data to, a diskette. Wait until this indicator turns off before you remove a diskette from the drive.
- 1 Hard-drive access indicator — lights when a hard drive or CD drive is reading data from, or writing data to, the drive.
- 1 Cover release button — releases the computer cover; located on back of chassis.

## Back View of Your Computer

The following illustration shows the connectors and indicators on the back of your computer for attaching external devices.

### Back-Panel Connectors and Indicators

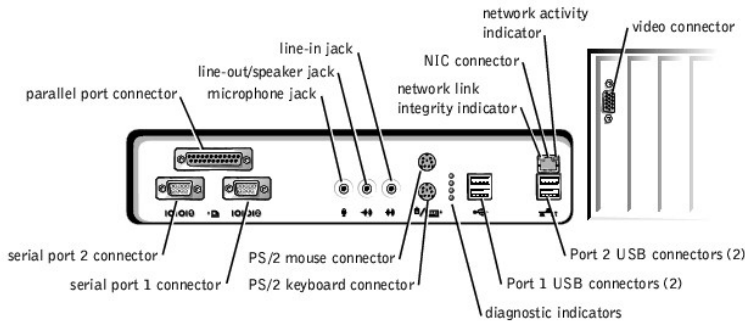

## Connecting Devices

When you connect external devices to your computer's back panel, follow these guidelines:

- 1 Check the documentation that accompanied the device for specific installation and configuration instructions.  
For example, you must connect most devices to a particular input/output (I/O) port or connector to operate properly. Also, external devices like a printer usually require you to load device drivers before they will work.
- 1 When connecting a Universal Serial Bus (USB) mouse or keyboard, make sure you connect to one of the Port 1 USB connectors.
- 1 Always attach external devices *while your computer is turned off*. Then turn on the computer *before* turning on any external devices, unless the documentation for the device specifies otherwise.

**NOTICE:** When you disconnect external devices from the back of the computer, wait 5 seconds after turning off the computer before you reconnect any devices to avoid possible damage to the system board.

### Serial Port Connectors

Default port designations: COM1 for serial port 1 and COM2 for serial port 2. You can reassign the serial port's designation in [system setup](#) if you add an expansion card containing a serial port using this designation.

If you set the system's serial ports to **Auto** in [system setup](#) and add an expansion card containing a serial port configured to a specific designation, the computer automatically maps (assigns) the integrated ports to the appropriate COM setting as necessary.

Before you add a card with a serial port, check the documentation that accompanied your software to make sure that the software can be mapped to the new COM port designation.

### Parallel Port Connector

Used to connect printers. Default designation: LPT1.

**NOTE:** The integrated parallel port is automatically disabled if the system detects an installed expansion card containing a parallel port configured to the same address as specified in the **Parallel Port** option in [system setup](#).

### Microphone Jack

Used to attach a standard personal computer microphone. Connect the audio cable from the microphone to the microphone jack.

### Line-Out/Speaker Jack

Used to attach computer speakers. This jack is amplified, so speakers with integrated amplifiers are not required. Connect the audio cable from the speakers to this jack.

### Line-In Jack

Used to attach record/playback devices such as cassette players, CD players, and VCRs. Connect the line-out cable from any of these devices to the line-in jack.

### PS/2 Mouse Connector

Attach the Personal System/2 (PS/2) mouse cable to the 6-pin mouse connector on the back panel. If your system uses Microsoft Windows 2000, Windows XP, or Windows NT, Dell installed the necessary mouse drivers on your hard drive.

 **NOTE:** This connector is similar to the keyboard connector. Make sure you correctly identify the mouse connector before you connect the device.

 **NOTE:** Do not attempt to operate a PS/2 mouse and a USB mouse simultaneously.

### PS/2 Keyboard Connector

Attach the PS/2 keyboard cable to the 6-pin keyboard connector on the back panel.

 **NOTE:** This connector is similar to the mouse connector. Make sure you correctly identify the keyboard connector before you connect the device.

### USB Connectors

Used to attach USB-compliant devices such as keyboards, mice, printers, and computer speakers to your system.

 **NOTE:** When connecting a USB mouse or keyboard, make sure you connect to one of the Port 1 USB connectors.

 **NOTE:** Do not attempt to operate a PS/2 mouse and a USB mouse simultaneously.

 **NOTICE:** USB devices do not operate with Microsoft Windows NT.

### NIC Connector

The network interface controller (NIC), which includes a Remote Wake Up feature, has the following indicators:

- 1 A yellow network *activity indicator* flashes when the system is transmitting or receiving network data. (A high volume of network traffic may make this indicator appear to be in a steady "on" state.)
- 1 A dual-colored network *link integrity and speed indicator*, which is green when a good connection exists between a 10-megabits per second (Mbps) network and the NIC, or is orange when a good connection exists between a 100-Mbps network and the NIC. When the orange or green indicator is off, the computer is not detecting a physical connection to the network.

### Network Cable Requirements

The NIC connector attaches an unshielded twisted pair (UTP) Ethernet cable to your system. Press one end of the UTP cable into the NIC connector until the cable snaps securely into place. Connect the other end to an RJ45 jack wall plate or to an RJ45 port on a UTP concentrator or hub, depending on your network configuration.

A 100-Mbps network requires Category 5 wiring and connectors. A 10-Mbps network requires Category 3 or Category 5 wiring and connectors.

### Video Connector

Used to attach a video graphics array (VGA)-compatible monitor to your system.

---

## Inside Your Computer

The following illustration shows your computer with the covers removed.

### Inside the Chassis

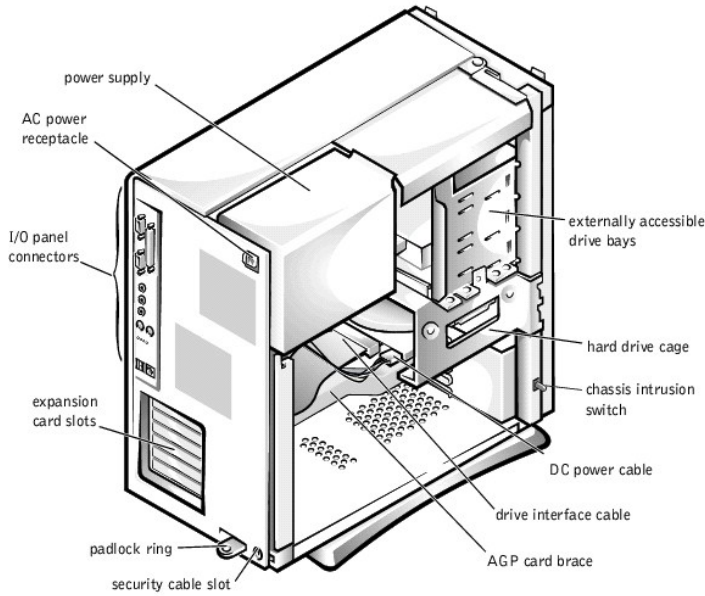

## System Board Components

The following illustration shows the system board and the location of its principal connectors and components.

### System Board Components

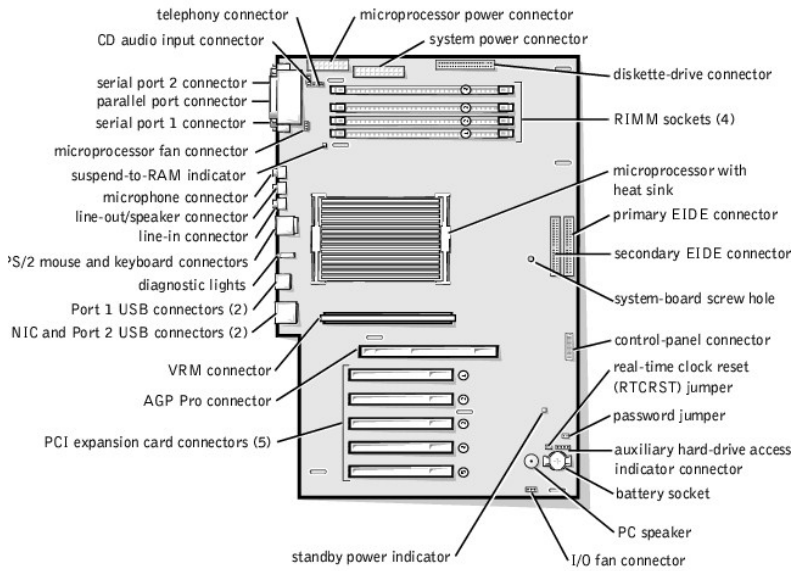

[Back to Contents Page](#)

## Advanced Features

### Dell™ OptiPlex™ GX400 System User's Guide

- [System Settings](#)
- [Manageability](#)
- [Security](#)
- [Password Protection](#)
- [Jumper Settings](#)
- [Installing and Configuring Software](#)
- [TAPI](#)
- [Power Management](#)

---

## System Settings

Each time you start your computer, it compares the installed hardware with the system configuration information stored in nonvolatile random-access memory (NVRAM). If the system detects a discrepancy, it generates an error message for each incorrect configuration setting.

You can use system settings as follows:

- 1 To set user-selectable options such as date and time or system password
- 1 To set the current configuration information such as the amount of memory or type of hard drive installed

You can view the current settings at any time. Dell recommends that you record the information for future reference. If you have a line printer connected to the parallel port on your computer, you can print the system setup screens by pressing <Print Screen>.

Before you use system setup, you need to know the kind of diskette drive(s) and hard drive(s) installed in your computer. If you are unsure of this information, see the Manufacturing Test Report that came with your system and is located in the **Dell Accessories** folder.

## Entering System Setup

1. Turn on your system.
2. If your system is already on, restart it.
3. When **F2 = Setup** appears in the upper-right corner of the screen, press <F2>.

If you wait too long and your operating system begins to load into memory, *let the system complete the load operation*; then restart the system and try again.

 **NOTE:** To ensure an orderly system shutdown, consult the documentation that accompanied your operating system.

## System Setup Screens

The system setup screens display the current configuration information for your computer. Information on the screen is organized into four areas:

- 1 Title — the box at the top of all screens that lists the computer system name.
- 1 Computer data — two boxes below the title box that display your system processor, level 2 (L2) cache, service tag, and the version number of the basic input/output system (BIOS).
- 1 Options — a scrollable box listing options that define the configuration of your computer, including installed hardware, power conservation, and security features.



Fields to the right of the option titles contain settings or values. Those that you can change appear bright on the screen. Those that you cannot change (because they are set by the computer) appear less bright. When <Enter> appears to the right of an option title, press <Enter> to access a pop-up menu of additional options.

















- 1 Key functions — a line of boxes across the bottom of all screens that lists keys and their functions within system setup.
- 1 Help — press <F1> for information in the currently highlighted option.

## System Setup Navigation Keys

The following table lists the keys you use to view or change information in system setup and to exit setup.

### System Setup Navigation Keys

Keys	Action
 or 	Moves to the next field.

  OR 	Moves to the previous field.
 OR 	Cycles through the options in a field. In many fields, you can also type the appropriate value.
 OR 	Scrolls through help information.
	Enters the selected field's pop-up options menu.
spacebar or  OR 	In the selected field's pop-up options menu, cycles through the options in a field.
 	Exits system setup without rebooting the system and returns the system to the boot routine.
 	Exits system setup and reboots the system, implementing any changes you have made.
 	Resets the selected option to its default setting.

 **NOTE:** For most of the options, any changes you make are recorded but do not take effect until the next time you boot the computer. For a few options (as noted in the help area), the changes take effect immediately.

## Changing the Boot Sequence

The boot sequence allows you to specify the order of the devices from which the system attempts to boot.

1. Press <Enter> to access the **Boot Sequence** option's pop-up menu.

 **NOTE:** Write down your current boot sequence in case you want to restore it.

2. Press the up- and down-arrow keys to move through the list of devices.
3. Press the spacebar to enable or disable a device (enabled devices appear with a check mark).
4. Press plus (+) or minus (-) to move a selected device up or down the list.

Option settings:

- 1 **Diskette Drive A:** — The system attempts to boot from the diskette drive. If the system finds a diskette in the drive that is not bootable, an error message appears. If no diskette is in the drive, the system attempts to boot from the next device in the list.
- 1 **Hard Drive** — The system attempts to boot from the primary hard drive. If the system does not find an operating system on the drive, it attempts to boot from the next device in the list.
- 1 **CD-ROM Device** — The system attempts to boot from the CD drive. If the system does not find a CD in the drive or if there is not an operating system on the CD, the system attempts to boot from the next device in the list.
- 1 **MBA (Onboard NIC)** — The system prompts you to press <Ctrl><Alt><b> at the Dell logo screen during boot. A menu appears that allows you to select a method for booting from a network server. If a boot routine is not available from the network server, the system attempts to boot from the next device in the list.

## Manageability

- 1 [Dell OpenManage™ IT Assistant](#)
- 1 [Dell OpenManage Client Instrumentation](#)

### Dell OpenManage IT Assistant

Dell OpenManage IT Assistant is the premier Dell™ systems management application for configuring, managing, and monitoring computers and other devices on a corporate network. IT Assistant employs the latest remote management technology to provide asset management, configuration management, event (alert) management, and security management for systems equipped with industry-standard management software. Software of this type is called system management *instrumentation*.

IT Assistant supports instrumentation that conforms to the following industry standards:

- 1 Simple Network Management Protocol (SNMP)

- 1 Desktop Management Interface (DMI)
- 1 Common Information Model (CIM)

The instrumentation available for your computer is Dell OpenManage Client instrumentation, which is based on DMI and CIM. For more information on IT Assistant, see the *Dell OpenManage IT Assistant User's Guide* available on the Dell website.

## Dell OpenManage Client Instrumentation

Dell OpenManage Client Instrumentation is software that enables remote management application programs such as IT Assistant to do the following:

- 1 Access information about your computer, such as how many processors it has and what operating system it is running
- 1 Monitor the status of your computer, such as listening for thermal alerts from temperature probes or hard drive failure alerts from storage devices
- 1 Change the state of your computer, such as updating its BIOS or shutting it down remotely

Dell OpenManage Client Instrumentation can be installed on computers like yours, which, when set up on a network with IT Assistant, are called *managed systems*. For more information about Dell OpenManage Client Instrumentation, see the *Dell OpenManage Client Instrumentation User's Guide* available on the Dell website.

---

## Security

The computer provides the following methods of physically securing the chassis:

- 1 [Chassis intrusion detection](#)
- 1 [Security cable slot and padlock ring](#)

### Chassis Intrusion Detection

The chassis intrusion monitor can detect whether the chassis is opened. The **Chassis Intrusion** option in [system setup](#) displays the status of the monitor.

1. Enter [system setup](#).
2. Press the down-arrow key to move to the **System Security** option.
3. Press <Enter> to access the **System Security** option's pop-up menu.
4. Press the down-arrow key to move to the **Chassis Intrusion** option.
5. Press the spacebar to select an option setting.

Option settings:

- 1 **Enabled (the default)** — When the computer cover is removed with this setting, a DMI event is generated, the setting changes to **Detected**, and the following message appears during the boot routine at the next system start-up:

Alert! Cover was previously removed.

To reset the **Detected** setting, enter [system setup](#) during the system's power-on self-test (POST). In the **Chassis Intrusion** option, press the left- or right-arrow key to select **Reset**, and then choose **Enabled**, **Enabled-Silent**, or **Disabled**.

- 1 **Enabled-Silent** — When the computer cover is removed with this setting, a DMI event is generated and the setting changes to **Detected**, but the alert message does not appear during the boot sequence at the next system start-up.
- 1 **Disabled** — No intrusion monitoring occurs and no messages appear.

 **NOTE:** When the [setup password](#) is enabled, you must know the setup password before you can reset the **Chassis Intrusion** option.

### Security Cable Slot and Padlock Ring

These features allow you to attach commercially available anti-theft devices (see the following figure). To prevent unauthorized removal of your computer, loop the galvanized security cable around an immovable object, insert the attached locking device into the security cable slot on the back of your computer, and lock the device with the key provided.

 **NOTE:** Before you purchase an anti-theft device, make sure it works with the cable slot on your computer.

#### Security Features on the Computer Chassis



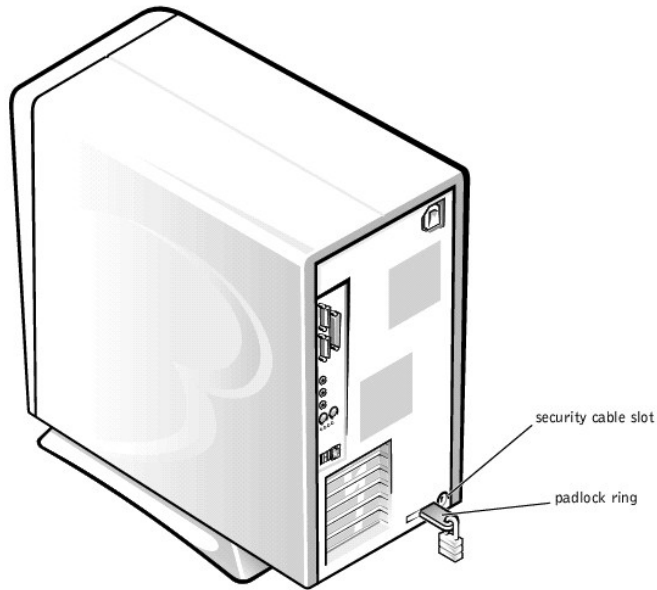

---

## Password Protection

The computer provides the following types of password protection:

- 1 [System password](#)
- 1 [Setup password](#)

## System Password

System passwords allow only those who know the password to have full use of the system. Your Dell system does not have the system password feature enabled when you receive it.

- ➔ **NOTE:** Although passwords provide security for the data on your system, they are not foolproof. If your data requires more security, it is your responsibility to obtain and use additional forms of protection, such as data encryption programs.
- ➔ **NOTE:** If you leave your system running and unattended without having a system password assigned, or if you leave your computer unlocked so that someone can disable the password by changing a jumper setting, anyone can access the data stored on your hard drive.

**System Password** settings in [system setup](#):

- 🔍 **NOTE:** You cannot change or enter a new system password if either of the following two options is displayed.

- 1 **Enabled — a system password is assigned**
- 1 **Disabled —** system password feature is disabled by a jumper setting on the system board

- 🔍 **NOTE:** You can only assign a system password when **System Password** is set to **Not Enabled**.

- 1 **Not Enabled —** no system password is assigned and the password jumper on the system board is in the enabled position (its default setting)

## Assigning a System Password

1. Verify that **Password Status** is set to **Unlocked in** system setup.
2. Highlight **System Password** and then press the left- or right-arrow key.

The option heading changes to **Enter Password**, followed by an empty 32-character field in square brackets.

3. Type your new system password.

You can use up to 32 characters.

As you press each character key (or the spacebar for a blank space), a placeholder appears in the field. The password assignment operation recognizes keys by their location on the keyboard, without distinguishing between lowercase and uppercase characters. For example, if you have an *M* in your password, the system recognizes either *M* or *m* as correct.

Certain key combinations are not valid. If you enter one of these combinations, the speaker emits a beep.

To erase a character when entering your password, press <Backspace> or the left-arrow key.

 **NOTE:** To escape from the field without assigning a system password, press <Tab> or the <Shift><Tab> combination to move to another field, or press <Esc> at any time before completing [step 5](#).

4. Press <Enter>.

If the new system password is less than 32 characters, the whole field fills with placeholders. Then the option heading changes to **Verify Password**, followed by another empty 32-character field in square brackets.

5. To confirm your password, type it a second time and press <Enter>.

The password setting changes to **Enabled**. Your system password is now set; you can exit [system setup](#) and begin using your system. Password protection takes effect when you reboot the system by pressing the reset button or by turning the system off and then on again.

## Using Your System Password

When you turn on your system or press the reset button, or when you reboot the system by pressing the <Ctrl><Alt><Del> combination, the following prompt appears on the screen when **Password Status** is set to **Unlocked**:

```
Type in the password and
- press <ENTER> to leave password security enabled.
- press <CTRL><ENTER> to disable password security.
Enter password:
```

If **Password Status** is set to **Locked**, the following prompt appears:

```
Type the password and press <Enter>.
```

 **NOTE:** If you have assigned a [setup password](#), the system accepts your setup password as an alternate system password.

If you enter a wrong or incomplete system password, the following message appears on the screen:

```
** Incorrect password. **
```

```
Enter password:
```

If you again enter an incorrect or incomplete system password, the same message appears on the screen. The third and subsequent times you enter an incorrect or incomplete system password, the system displays the following message:

```
** Incorrect password. **
Number of unsuccessful password attempts: 3
System halted! Must power down.
```

Even after your system is turned off and on, the previous message is displayed each time an incorrect or incomplete system password is entered.

 **NOTE:** You can use **Password Status** in conjunction with [System Password](#) and [Setup Password](#) to further protect your system from unauthorized changes.

## Deleting or Changing an Existing System Password

To delete or change an existing system password, perform the following steps:

1. Enter [system setup](#), and verify that **Password Status** is set to **Unlocked**.
2. Reboot your system to force it to prompt you for a system password.
3. When prompted, type the system password.
4. Press <Ctrl><Enter> to disable the existing system password, instead of pressing <Enter> to continue with the normal operation of your system.
5. Confirm that **Not Enabled** is displayed for the **System Password** option.

If **Not Enabled** appears in the **System Password** option, the system password has been deleted. If you want to assign a new password, continue to step 6. If **Not Enabled** is not displayed for the **System Password** option, press <Alt><B> to reboot the system, and then repeat steps 3 through 5.

6. To assign a new password, follow the procedure in "[Assigning a System Password](#)."

## Setup Password

Setup passwords allow only those who know the password to have full use of [system setup](#). Your Dell system does not have the setup password feature enabled when you receive it.

**Setup Password** options in system setup:

- 1 **Enabled** — does not allow assignment of setup passwords; users must enter a setup password to make changes to system setup
- 1 **Not Enabled** — allows assignment of setup passwords; password feature is enabled but no password is assigned

## Assigning a Setup Password

1. Enter [system setup](#), and verify that **Setup Password** is set to **Not Enabled**.
2. Highlight **Setup Password** and press the left- or right-arrow key.

The system prompts you to enter and verify the password. If a character is illegal for password use, the system emits a beep.

3. Type in and then verify the password.

After you verify the password, the **Setup Password** setting changes to **Enabled**. The next time you attempt to enter [system setup](#), the system prompts you for the setup password.

 **NOTE:** The [setup password](#) can be the same as the [system password](#).

 **NOTE:** If the two passwords are different, the setup password can be used as an alternate system password. However, the system password cannot be used in place of the setup password.

A change to **Setup Password** becomes effective immediately (rebooting the system is not required).

## Operating Your System With a Setup Password Enabled

When you start [system setup](#), the **Setup Password** option is highlighted, prompting you to type the password.

If you do not enter the correct password, the system lets you view, but not modify, [system setup](#) options.

 **NOTE:** You can use **Password Status** in conjunction with **System Password** and **Setup Password** to further protect your system from unauthorized changes.

## Deleting or Changing an Existing Setup Password

[To change an existing setup password, you must know the setup password.](#)

1. Enter [system setup](#).
2. If you have already assigned a setup password, type it at the prompt.
3. Highlight **Setup Password** and press the left- or right-arrow key to delete the existing setup password.

The setting changes to **Not Enabled**.

4. If you want to assign a new setup password, perform the steps in "[Assigning a System Password](#)."

## Disabling a Forgotten Password

 **NOTICE:** This process erases both the system and setup passwords.

 **CAUTION:** Before you remove the computer cover, see "[Safety First—For You and Your Computer](#)."

1. Turn off the computer and peripherals, disconnect them from their electrical outlets, wait at least 5 seconds, and then [remove the computer cover](#).
2. Remove the jumper plug from the PSWD jumper to disable the password feature.

See "[Jumper Settings](#)" to locate the password jumper (labeled "PSWD") on the system board.

3. Replace the computer cover.
4. Reconnect your computer and peripherals to an electrical outlet, and then turn them on.

This erases the existing password(s).

5. Enter [system setup](#) and verify that the password is disabled. Proceed to step 6 if you want to assign a new password.

 **NOTE:** Before you assign a new system and/or setup password, you must replace the PSWD jumper plug to reenables the password feature.

 **CAUTION:** Before you remove the computer cover, see "[Safety First—For You and Your Computer](#)."

6. Remove the computer cover.
7. Replace the PSWD jumper plug.
8. Replace the computer cover and reconnect the computer and peripherals to an electrical outlet and turn them on.

Booting your system with the PSWD jumper installed reenables the password feature. When you enter [system setup](#), both password options appear as **Not Enabled**, meaning that the password feature is enabled but that no password is assigned.

9. Assign a new system and/or setup password.

---

## Jumper Settings

The following figure shows the location of the jumpers on the system board.

### System Board Jumpers

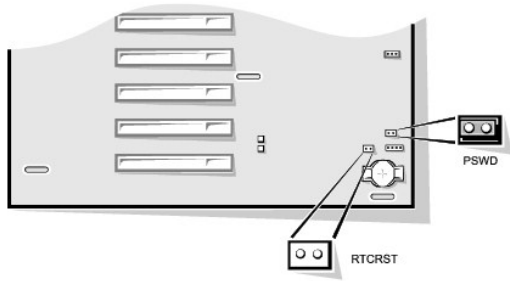





**NOTICE:** Make sure your system is turned off before you change a jumper setting. Otherwise, damage to your system or unpredictable results may occur.

To change a jumper setting, pull the plug off its pin(s) and carefully fit it down onto the pin(s) indicated

The following table lists the system board jumpers and their settings.

### System-Board Jumper Settings

Jumper	Setting	Description
PSWD	 (default)	Password features are enabled.
		Password features are disabled.
RTCRST		Real-time clock reset. Can be used for troubleshooting purposes.
 <i>jumpered</i>  <i>unjumpered</i>		

## Installing and Configuring Software

When you obtain software, check it for viruses with virus-scanning software before installing it on your computer's hard drive. Viruses, which are pieces of code that can replicate themselves, can quickly use all available system memory, damage or destroy data stored on the hard drive, and permanently affect the performance of the programs they infect. Several commercial virus-scanning programs are available for purchase, and most bulletin board services (BBSs) archive freely distributed virus-scanning programs that you can download with a modem.

Before you install a program, read its documentation to learn how the program works, what hardware it requires, and what its defaults are. A program usually includes installation instructions in its accompanying documentation and a software installation routine on its program diskette(s) or CD(s).

The software installation routine assists you in transferring the appropriate program files to your computer's hard drive. Installation instructions may provide details about how to configure your operating system to successfully run the program. Always read the installation instructions before running a program's installation routine. You may be instructed to modify some operating system start-up files, such as **config.sys** and **autoexec.bat**, or the installation routine may modify start-up files automatically.

When you run the installation routine, be prepared to respond to prompts for information about how your computer's operating system is configured, what type of computer you have, and what peripherals are connected to your computer.

## TAPI

Telephony Application Programming Interface (TAPI) enables Windows-based applications to operate with a wide variety of telephony devices, including voice, data, fax, video, and so forth. TAPI applications require a TAPI service provider (TSP), which is a software driver that allows TAPI applications to communicate with different types of TAPI hardware.

Microsoft® Windows® 2000, Windows XP, and Windows NT® provide a TSP called Unimodem, which is a "universal" modem service provider that supports a wide range of commonly used modems. For more information on Unimodem, see your Windows documentation. When using a TAPI device other than a modem, such as a Private Branch Exchange (PBX) or a voice processing card, you will need a TSP provided by the manufacturer of the device.

The TAPI system board connector uses a 4-pin cable to interface your internal TAPI-compliant expansion card with the audio system in your computer. To locate the TAPI system board connector, see "[System Board Components](#)." TAPI-compliant cards using the standard TAPI connector are supported. For example, you can connect your modem to the TAPI connector and then use your audio speakers and microphone as a speakerphone. The microphone carries your voice into the computer and then through the TAPI system board connector to your modem card. The caller's voice enters through the modem card to the TAPI system board connector and then out to the speakers. You can also use this configuration to record and play sound files over the phone.

### Installing a TAPI Device

**CAUTION:** Before you perform this procedure, see "[Safety First— For You and Your Computer](#)."

1. Turn off the computer and peripherals, disconnect them from their electrical outlets, wait at least 5 seconds, and then [remove the computer cover](#).

2. [Install the TAPI-compliant expansion card.](#)

See the manufacturer's documentation for more information.

3. [Rotate the power supply](#) away from the system board.
4. Connect the 4-pin TAPI cable to the TAPI system board connector.

To locate the TAPI connector on the system board, see "[System Board Components](#)."

5. Connect the 4-pin TAPI cable to the TAPI expansion card connector.

To locate the TAPI connector on the expansion card, see the manufacturer's documentation.

6. Rotate the power supply back into position, making sure that the securing tab snaps into place.
7. Replace the computer cover.
8. Reconnect your computer and peripherals to an electrical outlet, and then turn them on.
9. Install the appropriate TSP for the TAPI device.

See the manufacturer's documentation and your Windows documentation for more information.

## Installing a TAPI Sound Card

You can install a TAPI-compliant sound card that has a standard TAPI connector. For example, you can connect your modem to the TAPI sound card connector and then use the audio capabilities as a speakerphone.

 **CAUTION:** Before you perform this procedure, see "[Safety First— For You and Your Computer](#)."

1. Turn off the computer and peripherals, disconnect them from their electrical outlets, wait at least 5 seconds, and then [remove the computer cover](#).
2. [Install the TAPI-compliant sound card.](#)

See the manufacturer's documentation for more information.

3. Enter [system setup](#), select **Integrated Devices** and change the setting for **Sound** to **Off**.
4. Connect external audio devices to the sound card's connectors. Do not connect external audio devices to the microphone, line-out, or line-in connectors on the system back panel (see "[Back-Panel Connectors and Indicators](#)").

5. Connect the 4-pin TAPI cable to the TAPI sound card connector.

To locate the TAPI connector on the sound card, see the manufacturer's documentation.

6. Connect the 4-pin TAPI cable to the TAPI expansion card connector.

To locate the TAPI connector on the expansion card, see the manufacturer's documentation.

7. Replace the computer cover.
8. Reconnect your computer and peripherals to an electrical outlet, and then turn them on.
9. Install the appropriate TSP for the TAPI devices.

See the manufacturer's documentation and your Windows documentation for more information.

---

## Power Management

Your computer can be set to use less power when you are not working. You control the power usage through the operating system (OS) installed on your computer and certain option settings in [system setup](#). These periods of reduced power are called "sleep states."

- 1 **Standby.** In this sleep state, power to most components is reduced or turned off. However, system memory remains active.

This state is not supported by Windows NT 4.0.

- 1 **Hibernate.** This sleep state reduces power consumption to a minimum by writing all data in system memory to a hard drive and then removing system power. Waking up from this state restarts the computer, and the memory contents are restored. Operation then resumes where the system left off when it entered the hibernation state.

This state is supported by Windows 2000 and Windows XP only.

 **NOTE:** All components installed in the computer must support this feature and have the appropriate drivers loaded to enter hibernation. For more information, see the manufacturer's documentation for each component.

- 1 **Shutdown.** This sleep state removes all power from the system except a small auxiliary amount. As long as the computer remains connected to an electrical outlet, it can be automatically or remotely started. For example, the Auto Power On feature allows the computer to automatically start at a time you specify in [system setup](#). Also, your network administrator can remotely start your computer using a power management event (PME) such as access through a network connection (Wakeup On LAN).

The following table lists the sleep states available for each operating system as well as the methods you can use to "wake up" from each state.

## Power Management

Sleep State	Wake-Up Methods	
	Windows 2000 and XP	Windows NT 4.0
Standby	<ul style="list-style-type: none"><li>1 Press the power button</li><li>1 Auto power on</li><li>1 PME</li><li>1 Move or click the PS/2 mouse</li><li>1 Move or click the USB mouse</li><li>1 Type on the PS/2 keyboard</li><li>1 Type on the USB keyboard</li><li>1 USB device activity</li></ul>	Not supported
Hibernate	<ul style="list-style-type: none"><li>1 Press the power button</li><li>1 Auto power on</li><li>1 PME</li></ul>	Not supported
Shutdown	<ul style="list-style-type: none"><li>1 Press the power button</li><li>1 Auto power on</li><li>1 PME</li></ul>	<ul style="list-style-type: none"><li>1 Press the power button</li><li>1 Auto power on</li><li>1 PME</li></ul>

 **NOTE:** For more information on power management, see your operating system documentation.

---

[Back to Contents Page](#)

## Installing Upgrades

### Dell™ OptiPlex™ GX400 System User's Guide

- [Computer Cover](#)
- [Power Supply](#)
- [Front Panel](#)
- [System Memory](#)
- [Disk Drives and Media](#)
- [AGP Card Brace](#)
- [Expansion Cards](#)
- [Microprocessor](#)
- [VRM](#)
- [System Battery](#)

---

## Computer Cover

### Removing the Computer Cover

**CAUTION:** Before you perform this procedure, see "[Safety First— For You and Your Computer.](#)"

1. Turn off the computer and peripherals, and disconnect them from their electrical outlets.
2. If installed, remove the padlock from the padlock ring on the back panel.
3. Remove the computer cover.

Perform the following steps:

- a. Face the back of the computer and slide the outer padlock ring to the left to unlock the cover release mechanism (see the following figure).

#### Chassis Cover Release Mechanism

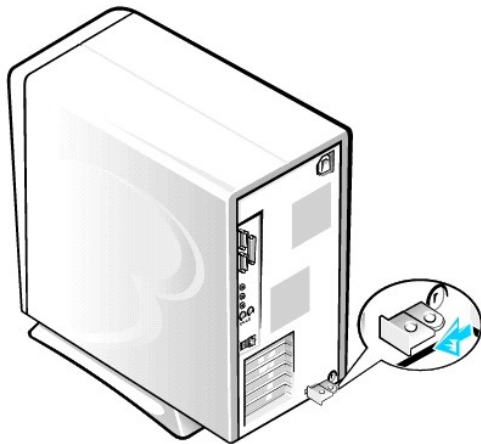

- b. Press the cover release button located at the bottom-left corner of the front panel (see the following figure).
- c. Rotate the bottom of the cover outward, away from the chassis.

#### Removing the Chassis Cover

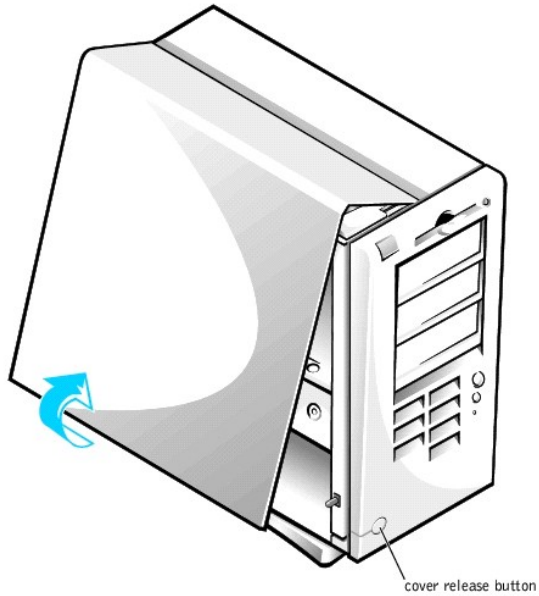

- d. Lift the cover away from the chassis.
- e. Turn the computer on its right side before you begin working inside the chassis.

### Replacing the Computer Cover

1. Check all cable connections and fold cables out of the way so that they do not catch on the computer cover. Ensure that cables are not routed over the drive cage—they will prevent the cover from closing properly.
2. Ensure that no tools or extra parts (including screws) are left inside the computer chassis.
3. Replace the computer cover.

Perform the following steps:

- a. Hold the cover at a slight angle as shown in the following figure. While aligning the top of the cover with the top of the chassis, insert the three hooks on the cover into the three recessed slots on the computer chassis.

### Replacing the Computer Cover

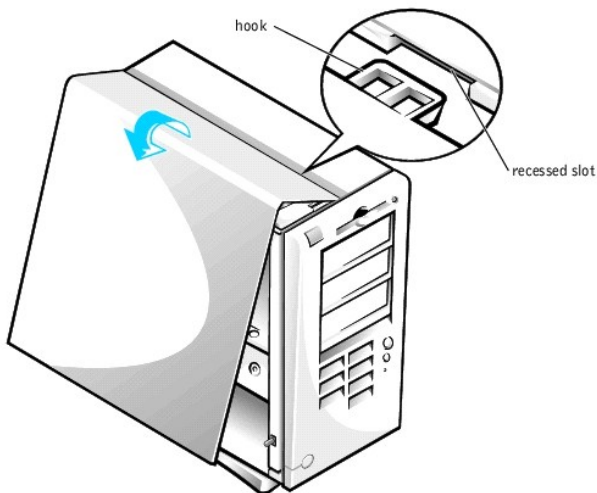

- b. Rotate the cover downward toward the bottom of the chassis. With both hands, press against the bottom edge of the cover to ensure that the securing hooks at the bottom of the cover click into place.
  - c. Slide the two parts of the padlock ring together to lock the cover release mechanism.
-



## Power Supply

To access some of the components on the system board, you may need to rotate the system power supply out of the way.

**⚠ CAUTION:** Before you perform this procedure, see "[Safety First—For You and Your Computer.](#)"

1. Turn off the computer and peripherals, disconnect them from their electrical outlets, wait at least 5 seconds, and then [remove the computer cover](#).
2. Make sure the AC power cable is disconnected from the AC power receptacle on the back of the power supply (see the following figure).

### Rotating the Power Supply in a Chassis

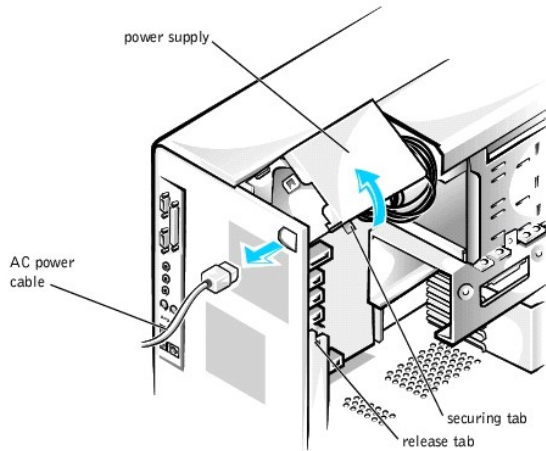

3. Free the power supply from the securing tab by pressing the tab labeled "RELEASE." Then rotate the power supply upward until it locks in its extended position.

When you have finished accessing components on the system board, rotate the power supply back to its original position until the release tab snaps into the securing tab.

---

## Front Panel

**⚠ CAUTION:** Before you perform this procedure, see "[Safety First— For You and Your Computer.](#)"

To remove the front panel, you first must [remove the computer cover](#). With the cover removed, release the front panel by pressing the green front-panel release button marked with the icon (see the following figure).

### Removing the Front Panel

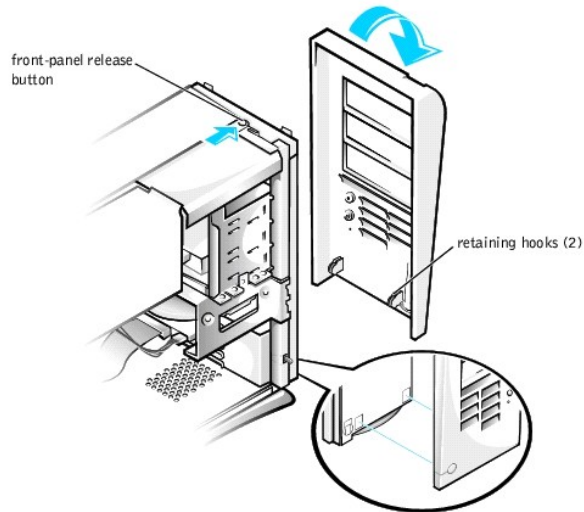

While pressing the front-panel release button, rotate the top of the panel outward, away from the chassis. Lift the panel away from the chassis.

To replace the front panel, fit the two front-panel retaining hooks into the recessed slots at the bottom of the chassis (see "[Removing the Front Panel](#)"). Then rotate the top of the panel toward the chassis until the front-panel latches snap into the tabs on the front panel.

## System Memory

- 👉 **NOTICE:** Before you install new memory modules, download the most recent BIOS for your computer from the Dell Support website at [support.dell.com](http://support.dell.com).

Your computer supports Rambus dynamic random-access memory (RDRAM) Rambus in-line memory modules (RIMMs) in 64-, 128-, 256-, and 512-megabyte (MB) capacities (see "[Sample Memory Module Configurations](#)"). "[System Board Components](#)" in "About Your Computer" shows the location of the four RIMM sockets on the system board. Sockets that do not contain a RIMM must contain Rambus continuity RIMMs (CRIMMs).

- 📌 **NOTE:** To reach the maximum 2-gigabyte (GB) memory total, you must install four 512-MB RIMMs that each have a maximum of 16 memory devices. The system supports no more than a total of 64 memory devices on all installed RIMMs. See "[RIMM Label Showing Number of Memory Devices](#)" for the location of the label on the RIMM that identifies the number of memory devices it contains. You can also determine the number of memory devices installed through the **System Memory** option in [system setup](#).
- 📌 **NOTE:** The system does not support RIMMs with six memory devices.
- 📌 **NOTE:** All four RIMM slots must be occupied either by a RIMM or a CRIMM and must be upgraded in matched pairs of identical capacity in slots 1 and 2 or slots 3 and 4. Mixed RIMM pairs provide a capacity equal to the sum of the four RIMMs; mixed pairs of RIMMs that provide error checking and correction (ECC) and non-ECC will all function as non-ECC.

- 👉 **NOTICE:** Be sure to install a RIMM in socket 1 first (closest to the processor) before installing a RIMM in socket 2.

Sample Memory Module Configurations				
Total Memory	Socket 1	Socket 2	Socket 3	Socket 4
128 MB	64 MB	64 MB	CRIMM	CRIMM
256 MB	64 MB	64 MB	64 MB	64 MB
256 MB	128 MB	128 MB	CRIMM	CRIMM
512 MB*	128 MB	128 MB	128 MB	128 MB
512 MB*	256 MB	256 MB	CRIMM	CRIMM
1024 MB	256 MB	256 MB	256 MB	256 MB

\*512-MB RIMM technology will be supported when it is available.

### RIMM Label Showing Number of Memory Devices

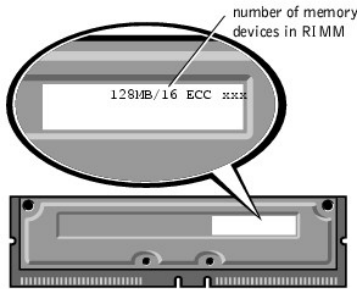

## Upgrading System Memory

**CAUTION:** Before you perform this procedure, see "[Safety First— For You and Your Computer.](#)"

**CAUTION:** RIMMs can get very hot during system operation. Be sure that the RIMMs have had sufficient time to cool before you touch them.

1. Turn off the computer and peripherals, disconnect them from their electrical outlets, wait at least 5 seconds, and then [remove the computer cover.](#)
2. Rotate the power supply away from the system board.
3. If necessary, remove any modules (RIMMs or CRIMMs) that occupy sockets in which you plan to install the upgrade modules.

**NOTE:** The system supports no more than a total of 64 memory devices on all installed RIMMs. See "[RIMM Label Showing Number of Memory Devices](#)" for the location of the label on the RIMM that identifies the number of memory devices it contains. You can also determine the number of memory devices installed through the **System Memory** option in [system setup.](#)

4. Install the upgrade RIMMs.
5. Rotate the power supply back into position, making sure that the securing tab snaps into place.
6. Replace the computer cover, reconnect the computer and peripherals to their electrical outlets, and turn them on.

**NOTE:** If enabled, the [Chassis Intrusion](#) option will cause the following message to be displayed at the next system start-up:

ALERT! Cover was previously removed.

The system detects that the new memory does not match the existing system configuration information and generates the following message:

The amount of system memory has changed.  
Strike the F1 key to continue, F2 to run the setup utility

7. Enter [system setup.](#) and check the value for **System Memory.** The system should have already changed the value of **System Memory** to reflect the newly installed memory. If the new total is correct, skip to [step 9.](#)
8. If the memory total is incorrect, repeat [step 1](#) and [step 2.](#) Check the installed modules to ensure that they are seated properly in their sockets. Then repeat [step 5](#) through [step 7.](#)
9. When the **System Memory** total is correct, exit [system setup.](#)
10. Run the [Dell Diagnostics](#) to verify that the memory modules are operating properly.

## Removing a Memory Module

1. Press the securing clips at each end of the socket outward simultaneously until the module pops out slightly from the socket (see the following figure).

### Removing a Memory Module

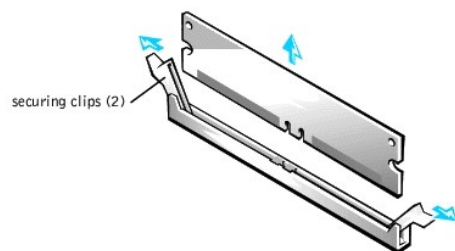

2. Lift the module away from the socket.

**NOTE:** If you remove a module (RIMM or CRIMM), you must install another module in the empty socket before turning on the computer.

## Installing a Memory Module

1. Press the securing clips at each end of the socket outward until they snap open (see the following figure).

### Installing a Memory Module

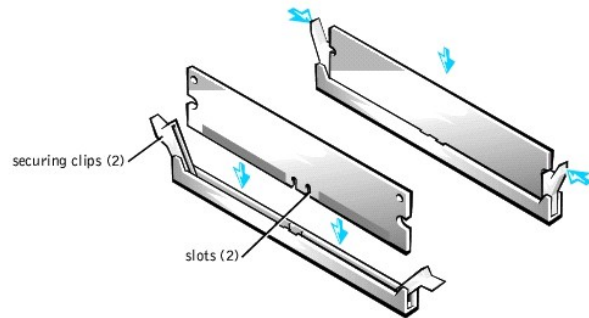

2. Align the slots on the bottom of the module with the two ridges inside the socket.
3. Press the module straight down into the socket until the securing clips snap into place at the ends of the module.

---

## Disk Drives and Media

### Installing a CD, ZIP, or Other Externally Accessible Drive in the Chassis

**⚠ CAUTION:** Before you perform this procedure, see "[Safety First— For You and Your Computer.](#)"

1. Turn off the computer and peripherals, disconnect them from their electrical outlets, wait at least 5 seconds, and then [remove the computer cover.](#)
2. Rotate the power supply away from the system board.
3. Remove the front panel.
4. Remove the drive bracket from the chassis drive bay you want to use.

Squeeze together the metal tabs that extend from each side of the drive bracket, and pull the bracket out of the bay (see the following figure).

### Removing the Drive Bracket

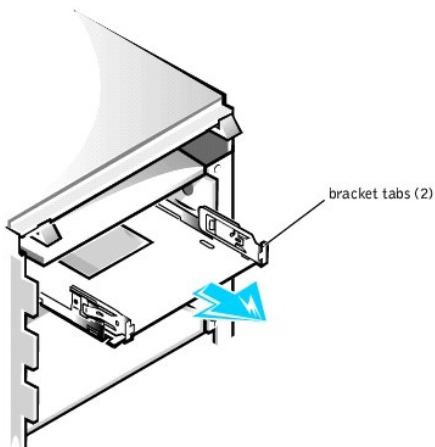

If a drive is already installed in the bay and you are replacing it, disconnect the DC power cable and interface cable from the back of the drive before removing the bracket from the bay. To remove the old drive from the bracket, turn the drive/bracket assembly upside down and remove the four screws that secure the drive to the bracket (see "[Attaching the Drive Bracket to the New Drive](#)").

5. Unpack the drive and prepare it for installation.

**⚡ NOTICE:** Ground yourself by touching an unpainted metal surface on the back of the computer.

See the documentation that accompanied the drive to verify that the drive is configured for your computer. Change any settings necessary for your

configuration.

6. Attach the new drive to the drive bracket.

Turn the drive upside down, and fit the bracket on the drive so that the screw holes align. To ensure proper installation, all screw holes should be aligned and the tabs on the front of the bracket should be flush with the front of the drive (see the following figure).

#### Attaching the Drive Bracket to the New Drive

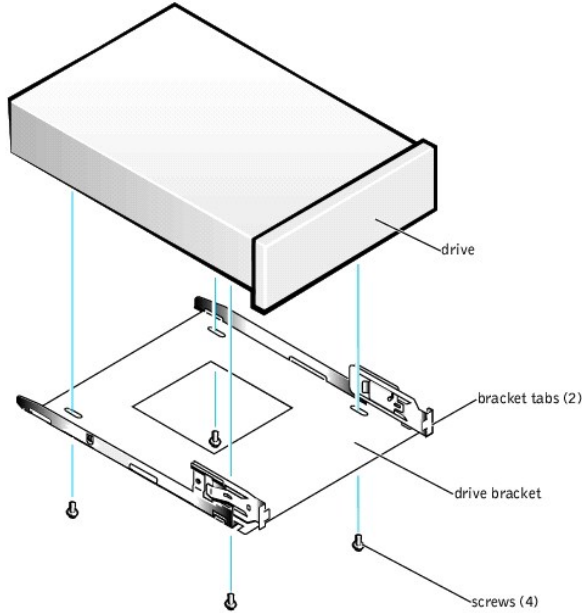

To further ensure proper positioning of the drive in the chassis, insert and tighten all four screws *in the order in which the holes are numbered* (the holes are marked "1" through "4").

7. Slide the new drive/bracket assembly into the drive bay until both drive bracket tabs snap securely into place (see the following figure).

#### Installing the Drive Bracket in the Chassis

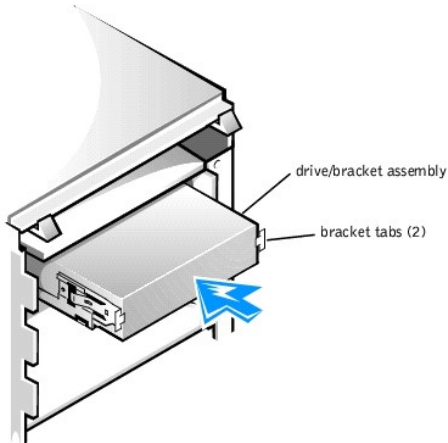

8. Connect the interface cable for the drive (see ["Attaching Drive Cables in the Chassis"](#)).

**NOTICE:** To avoid possible damage, you must match the colored strip on the interface cable with pin 1 on both the drive and system board connectors.

- a. If you are installing an enhanced integrated drive electronics (EIDE) device, make sure that the interface cable is properly connected to the EIDE connector on the system board. For more information, see ["EIDE Device Installation Guidelines."](#)
  - b. If you are installing a small computer system interface (SCSI) device, make sure that the SCSI interface cable is properly connected to the interface connector on the SCSI controller board. For more information, see ["SCSI Device Installation Guidelines."](#)
9. Connect a DC power cable to the power input connector on the back of the drive (see the following figure).

## Attaching Drive Cables in the Chassis

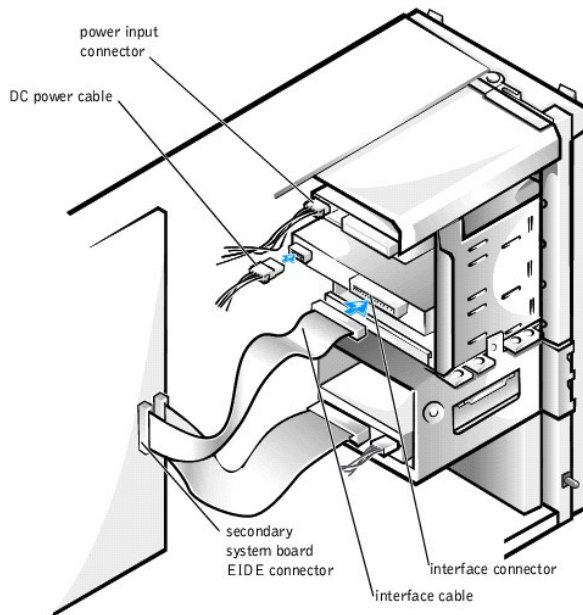

10. Ensure that all cables are firmly connected. Fold cables out of the way to provide airflow for the fan and cooling vents.
11. If the chassis drive bay was previously empty, remove the corresponding insert from the front panel.

Hold the front panel with the outside facing you. Press the ends of the insert with your thumbs until the insert snaps free of the front panel.

12. Replace the front panel.
13. Replace the computer cover, reconnect the computer and peripherals to their electrical outlets, and turn them on.

**NOTE:** If enabled, the [Chassis Intrusion](#) option will cause the following message to be displayed at the next system start-up:

ALERT! Cover was previously removed.

14. If the drive you installed is a hard drive, enter [system setup](#), and update the drive settings.  
After you update the system settings, exit system setup and reboot the computer.
15. If the device you installed is a hard drive, partition and logically format the drive before proceeding to the next step.  
See the operating system's documentation for instructions.
16. Test the drive to verify that it is operating properly.
  1. If the drive you installed is a hard drive, run the [Dell Diagnostics](#) to test the drive.
  1. For other types of drives, see the drive's documentation for information on testing the drive.
17. If the drive you installed is the primary hard drive, install the operating system on the drive.  
See the operating system's documentation for instructions.

**NOTE:** Tape drives sold by Dell come with their own operating software and documentation. After you install a tape drive, refer to the documentation that came with the drive for instructions on installing and using the tape drive software.

## Installing a Hard Drive in the Chassis

**NOTE:** If you are replacing a hard drive that contains data you want to keep, be sure to back up your files before you begin this procedure.

**CAUTION:** Before you perform this procedure, see "[Safety First— For You and Your Computer.](#)"

1. Turn off the computer and peripherals, disconnect them from their electrical outlets, wait at least 5 seconds, and then [remove the computer cover](#).
2. Rotate the power supply away from the system board.
3. Remove the front panel.
4. Remove the drive bracket from the chassis.

Pull the drive door forward and down until the hard-drive bracket is ejected halfway out of the chassis (see the following figure). Then grasp the bracket

and lift it up off the bracket hooks and away from the chassis.

### Removing the Hard Drive Bracket From the Chassis

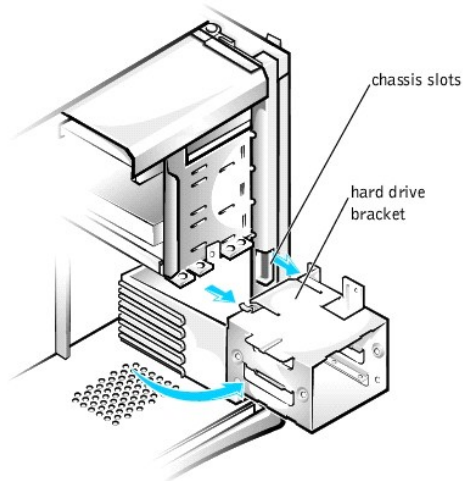

If a drive is already installed in the bracket, disconnect the DC power cable and interface cable from the back of the drive before removing the bracket from the chassis. To remove the old drive from the bracket, remove the four screws that secure the drive in the bracket (see "[Installing a Hard Drive in the Bracket](#)").

5. Unpack the drive and prepare it for installation.

**NOTICE:** Ground yourself by touching an unpainted metal surface on the back of the computer.

See the documentation that accompanied the drive to verify that the drive is configured for your computer. Change any settings necessary for your configuration.

6. Slide the drive into one of the bracket bays, oriented so the connectors on the back of the drive will face the interior of the chassis when the bracket is reinstalled (see "[Installing a Hard Drive in the Bracket](#)").
7. Align the screw holes of the drive and bracket, and secure the drive in the bracket using the screws that came with the upgrade kit (see the following figure).

### Installing a Hard Drive in the Bracket

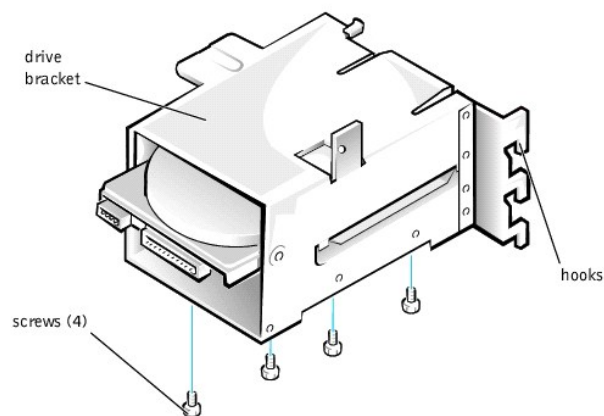

8. Reinstall the hard drive bracket in the chassis (see "[Installing the Hard-Drive Bracket in the Chassis](#)").

**NOTE:** Orient the drive in the bracket so that its bottom will face the left side of the chassis when the bracket is installed in the chassis.

Insert the drive bracket into the chassis, sliding it in until the tabs snap into place. Rotate the drive door upward to the chassis until it snaps securely into place.

**NOTE:** When you rotate the drive door back into place, ensure that the tabs on the drive door are inserted between the drive bracket and the drive cage.

**NOTE:** Be sure to fold down the drive door handle so that the front panel can be replaced on the chassis.

## Installing the Hard-Drive Bracket in the Chassis

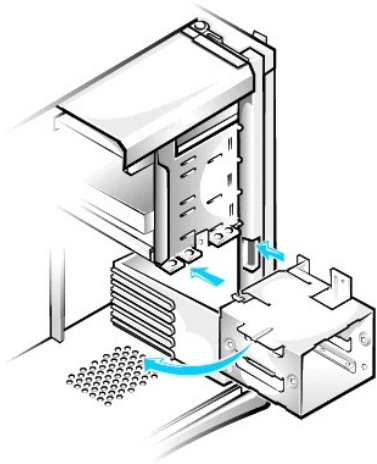

9. Connect the interface cable for the drive (see "[Attaching Hard Drive Cables in the Chassis](#)").

- NOTICE:** To avoid possible damage, you must match the colored strip on the interface cable with pin 1 on both the drive and system board connectors.
- a. If you are installing an EIDE device, ensure that the IDE interface cable is properly connected to the EIDE connector on the system board. For more information, see "[EIDE Device Installation Guidelines](#)."
  - b. If you are installing a SCSI device, ensure that the SCSI interface cable is properly connected to the interface connector on the SCSI controller board. For more information, see "[SCSI Device Installation Guidelines](#)."

10. Connect a DC power cable to the power input connector on the back of the drive (see the following figure).

## Attaching Hard Drive Cables in the Chassis

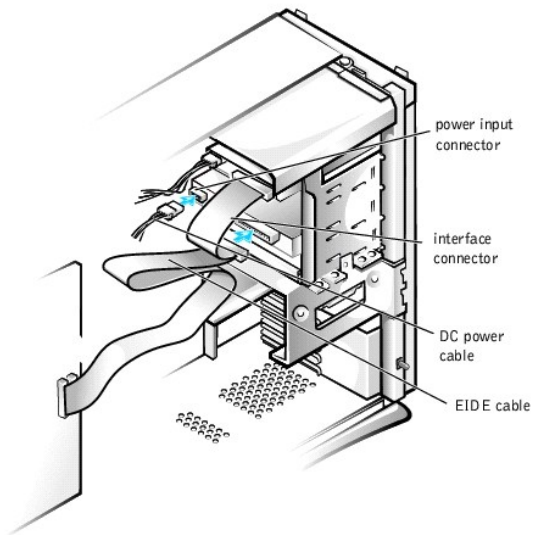

11. Ensure that all cables are firmly connected. Fold cables out of the way to provide airflow for the fan and cooling vents.
12. Ensure that the control panel cable is firmly connected to the system board.

The control panel contains the hard-drive activity indicator. To locate the control panel system board connector, see "[System Board Components](#)."

13. Replace the front panel.
14. Replace the computer cover, reconnect the computer and peripherals to their electrical outlets, and turn them on.

**NOTE:** If enabled, the **Chassis Intrusion** option will cause the following message to be displayed at the next system start-up:

ALERT! Cover was previously removed.



15. Enter [system setup](#), and update the drive settings.  
After you update the system settings, exit system setup and reboot the computer.
16. Partition and logically format the drive before proceeding to the next step.  
See the operating system's documentation for instructions.
17. Run the [Dell Diagnostics](#) to test the drive.
18. If the hard drive you installed is the primary drive, install the operating system on the drive.  
See the operating system's documentation for instructions.

## EIDE Device Installation Guidelines

### Jumper Settings

All EIDE drives should be configured for the Cable Select jumper position, which assigns master and slave status to drives by their position on the interface cable. When two EIDE drives are connected to a single EIDE interface cable and are configured for the Cable Select jumper position, the drive attached to the last connector on the interface cable is the master, or boot device (drive 0), and the device attached to the middle connector on the interface cable is the slave device (drive 1). Refer to the documentation in your drive upgrade kit for information on setting devices to the Cable Select jumper position.

### General Guidelines

With the two EIDE interface connectors on the input/output (I/O) board, your system can support up to four EIDE drives:

- 1 The primary EIDE connector, labeled "IDE PRI," should be cabled to EIDE hard drives
- 1 The secondary EIDE connector, labeled "IDE SEC," should be cabled to EIDE CD, DVD, tape, SuperDisk, and Zip drives

 **NOTE:** A SuperDisk drive is typically installed as the master device on the secondary EIDE system-board connector.

To locate the EIDE interface connectors on the system board, see "[System Board Components](#)." Each EIDE interface connector on the I/O board supports the following:

- 1 Two channels, master and slave
- 1 Logical block addressing (LBA)
- 1 Programmed I/O (PIO) Mode 3 and Mode 4
- 1 Ultra Advanced Technology Attachment (ATA)/100, ATA/66, or ATA/33

### EIDE Cables

Ultra ATA/66 and ATA/100 hard drives require an 80-conductor cable to transfer data at full speed. The 80-conductor cable has a 40-pin connector like the ATA/33 cable, but it has twice as many wires within the cable. If you use an ATA/33 cable with Ultra ATA/100 hard drives, the drives will operate properly, but data will transfer at ATA/33 speeds.

 **NOTICE:** Dell recommends that you use only EIDE cables purchased from Dell. Cables purchased elsewhere are not guaranteed to work with Dell™ systems.

## SCSI Device Installation Guidelines

This section describes how to configure and install SCSI devices in your system. To install a SCSI device, you must have a SCSI controller card installed in your system.

### SCSI ID Numbers

Internal SCSI devices must have a unique SCSI ID number from 0 to 15.

When SCSI devices are shipped from Dell, the default SCSI ID numbers for the primary and secondary controllers are assigned as follows:

- 1 SCSI controller: SCSI ID 7
- 1 Boot SCSI hard drive: SCSI ID 0
- 1 SCSI CD drive: SCSI ID 5
- 1 SCSI tape or digital audio tape (DAT) drive: SCSI ID 6

 **NOTE:** There is no requirement that SCSI ID numbers be assigned sequentially or that devices be attached to the cable in order by ID number.

SCSI devices installed by Dell are configured correctly during the manufacturing process. You do not need to set the SCSI ID for these SCSI devices.

If you attach additional optional SCSI devices, refer to the documentation for each device for information about setting the appropriate SCSI ID number.

 **NOTICE:** Dell recommends that you use only SCSI cables purchased from Dell. Cables purchased elsewhere are not guaranteed to work with Dell systems.

### Device Termination

SCSI logic requires that termination be enabled for the two devices at opposite ends of the SCSI chain and disabled for all devices in between.

Dell recommends that you use terminated cables and that you disable termination on all devices. See the documentation provided with any optional SCSI device you purchase for information on disabling termination on the device.

## General Guidelines

Follow these general guidelines when installing SCSI devices in your computer:

- 1 Although you install SCSI devices essentially the same way as other devices, their configuration requirements are different. For details on configuring your particular SCSI subsystem, refer to the documentation for your SCSI devices and/or your host adapter card.
- 1 Configure the device for a SCSI ID number and disable termination, if necessary.
- 1 If you are installing an external SCSI device, connect one end of the external SCSI cable to the bus connector on the back of the device. Attach the other end of the external SCSI cable to the connector on the controller installed in the computer.
- 1 After installing a SCSI hard drive, **Primary Drive 0** and **Primary Drive 1** should be set to **None** in [system setup](#). If you have any EIDE devices on the second EIDE channel, such as a CD or tape drive, **Secondary Drive 0** and/or **Secondary Drive 1** should be set to **Auto**. If you have any SCSI devices on the second EIDE channel, **Secondary Drive 0** and/or **Secondary Drive 1** should be set to **None**.
- 1 You may need to use programs other than those provided with the operating system to partition and format SCSI hard drives. Refer to the documentation that came with your SCSI software drivers for information on installing the appropriate drivers and preparing your SCSI hard drive for use.

## SCSI Cables

Ultra2/Wide low-voltage differential (LVD) drives (typically hard drives) use a 68-pin cable. One end of this cable attaches to the SCSI controller card. The remaining connectors on the cable attach to the various LVD drives.

Narrow SCSI drives (tape drives, CD drives, and some hard drives) use a 50-pin cable. One end of this cable attaches to the SCSI controller card. The remaining connectors on the cable attach to the various Narrow SCSI devices.

 **NOTICE:** Dell recommends that you use only SCSI cables purchased from Dell. Cables purchased elsewhere are not guaranteed to work with Dell systems.

---

## AGP Card Brace

To access some components on the system board in the chassis, you may need to remove the accelerated graphics port (AGP) card brace.

 **CAUTION:** Before you perform this procedure, see "[Safety First— For You and Your Computer.](#)"

1. Turn off the computer and peripherals, disconnect them from their electrical outlets, wait at least 5 seconds, and then [remove the computer cover](#).
2. Lay the computer on its right side.
3. Remove the screw that secures the AGP card brace to the chassis (see the following figure).

### Removing the AGP Card Brace

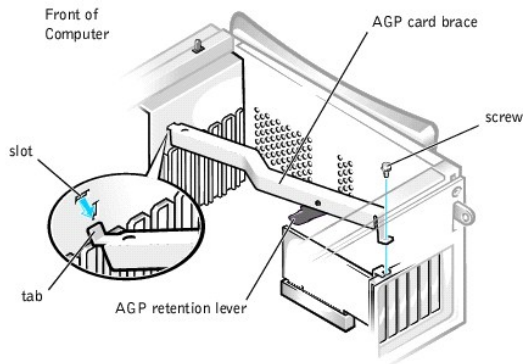

4. Rotate the brace up until it disengages from the card guide at the front of the chassis. Then lift the brace away from the chassis.

To replace the AGP card brace, perform the following steps:

1. Insert the tab on one end of the brace into the slot on the card guide at the front of the chassis (see the preceding figure).
  2. Lower the brace, ensuring that the AGP retention lever on the bottom of the brace is aligned with the top of the AGP card.
  3. Replace the screw that secures the brace to the chassis.
- 

## Expansion Cards

The system provides expansion slots for the following cards:

- 1 Up to five 32-bit, 33-megahertz (MHz) Peripheral Component Interconnect (PCI) expansion cards.
- 1 One 32-bit AGP card. The expansion slot supports AGP 4x or 2x modes operating at 1.5-volts (V).

See "[Expansion Cards](#)" for examples of these cards.

 **NOTE:** To meet PC99 system requirements, your Dell computer uses only PCI expansion slots. Industry-Standard Architecture (ISA) expansion cards are not supported. This is an industry standard for ease-of-use.

 **NOTICE:** Before disconnecting a peripheral device from the computer, wait 10 to 20 seconds after disconnecting the computer from its electrical outlet. Before removing a component from the system board, verify that the standby power light on the system board has turned off. To locate this light, see "[System Board Components](#)."

### Expansion Cards

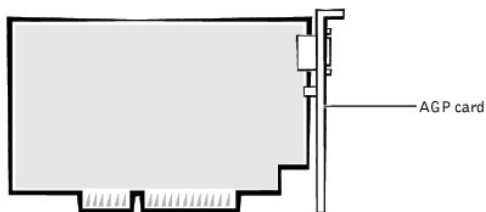
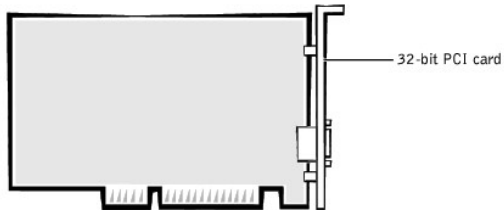

## Installing an Expansion Card

 **CAUTION:** Before you perform this procedure, see "[Safety First— For You and Your Computer](#)."

1. Turn off the computer and peripherals, disconnect them from their electrical outlets, wait at least 5 seconds, and then [remove the computer cover](#).
2. Lay the computer on its right side.
3. Prepare the expansion card for installation.

See the documentation that came with the expansion card for information on configuring the card, making internal connections, or otherwise customizing it for your system.

4. If you are installing an AGP card, [remove the AGP card brace](#).
5. Remove the screw that secures the expansion slot filler bracket to the chassis, and remove the bracket from the chassis (see the following figure).

Save the screw to use when installing the expansion card later in this procedure.

### Removing the Filler Bracket

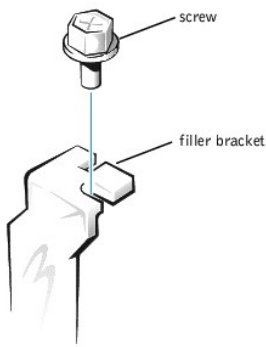

**CAUTION:** Some network interface controllers (NICs) automatically start up the system when they are connected to a network. To guard against electrical shock, be sure to unplug your computer from its electrical outlet before installing any expansion cards. Verify that the standby power indicator on the system board is off. To locate this indicator, see "[System Board Components](#)."

6. Insert the expansion card into the expansion-card connector.

If the expansion card is full-length, insert the end of the card into the expansion card guide bracket as you lower the card toward its connector on the system board. Insert the card firmly into the expansion-card connector on the system board (see the following figure).

### Installing an Expansion Card

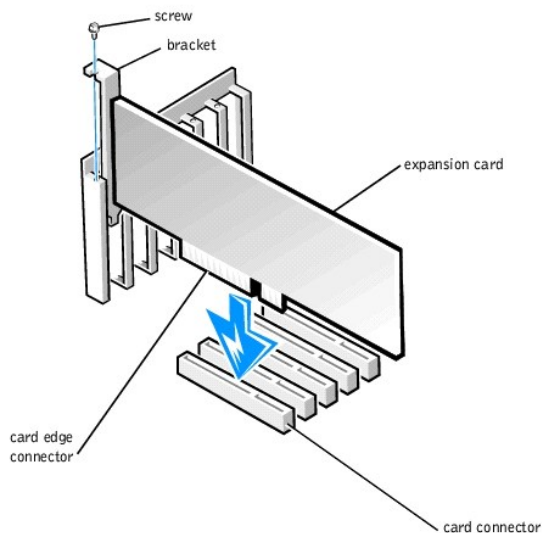

**NOTICE:** An AGP Pro50 card may use multiple screws on its bracket. Install all screws on the expansion card's bracket.

7. Secure the card's bracket to the chassis with the screw you removed in [step 5](#).
8. Connect any cables that should be attached to the card.

See the documentation for the card for information about the card's cable connections.

9. If you removed the AGP brace, replace it.
10. Stand the computer upright.
11. Replace the computer cover, reconnect the computer and peripherals to their electrical outlets, and turn them on.

**NOTE:** If enabled, the **Chassis Intrusion** option will cause the following message to be displayed at the next system start-up:

ALERT! Cover was previously removed.

12. If you installed a sound card, perform the following steps:
  - a. Enter [system setup](#), select **Integrated Devices** and change the setting for **Sound** to **Off**.
  - b. Connect external audio devices to the sound card's connectors. Do not connect external audio devices to the microphone, line- out, or line-in connectors on the system back panel (see "[Back- Panel Connectors and Indicators](#)").

13. If you installed an add-in NIC, perform the following steps:
  - a. Enter [system setup](#), select **Integrated Devices** and change the setting for **Network Interface Card** to **Off**.
  - b. Connect the network cable to the add-in NIC's connectors. Do not connect the network cable to the integrated NIC connector on the system back panel (see "[Back-Panel Connectors and Indicators](#)").

## Removing an Expansion Card

 **CAUTION:** Before you perform this procedure, see "[Safety First— For You and Your Computer](#)."

1. Turn off the computer and peripherals, disconnect them from their electrical outlets, wait at least 5 seconds, and then [remove the computer cover](#).
2. If you are removing an AGP card, [remove the AGP card brace](#).
3. If necessary, disconnect any cables connected to the card.
4. Remove the screw that secures the expansion card bracket to the chassis.

Save the screw to use when installing the expansion card or filler bracket later in this procedure.

5. Grasp the card by its top corners, and ease it out of its connector.
6. If you are removing the card permanently, install a filler bracket in the empty card-slot opening, using the screw you removed in [step 4](#).

If you need a filler bracket, [contact Dell](#) and order part number 81808.

 **NOTE:** Installing filler brackets over empty card-slot openings is necessary to maintain Federal Communications Commission (FCC) certification of the system. The brackets also keep dust and dirt out of your computer.

7. If you removed the AGP brace, replace it.
8. Replace the computer cover, reconnect the computer and peripherals to their electrical outlets, and turn them on.

 **NOTE:** If enabled, the **Chassis Intrusion** option will cause the following message to be displayed at the next system start-up:

ALERT! Cover was previously removed.

9. If you removed a sound card, perform the following:
    - a. Enter [system setup](#), select **Integrated Devices** and change the setting for **Sound** to **On**.
    - b. Connect external audio devices to the audio connectors on the system back panel (see "[Back-Panel Connectors and Indicators](#)").
  10. If you installed an add-in NIC, perform the following:
    - a. Enter [system setup](#), select **Integrated Devices** and change the setting for **Network Interface Card** to **On**.
    - b. Connect the network cable to the integrated NIC connector on the system back panel (see "[Back-Panel Connectors and Indicators](#)").
- 

## Microprocessor

### Upgrading the Microprocessor

 **NOTE:** Dell recommends that only a technically knowledgeable person perform this procedure.

 **CAUTION:** The processor can get very hot during system operation. Be sure that the processor has had sufficient time to cool before you touch it.

 **CAUTION:** Before you perform this procedure, see "[Safety First— For You and Your Computer](#)."

1. Turn off the computer and peripherals, disconnect them from their electrical outlets, wait at least 5 seconds, and then [remove the computer cover](#).
2. Rotate the power supply away from the system board.
3. Remove the airflow shroud
  - a. Pull back the release tabs on top of the shroud and lift the shroud up until the anchor tabs disengage from the chassis frame (see "[Removing the Microprocessor Airflow Shroud From the Chassis](#)").
  - b. Lift the airflow shroud out of the chassis.

#### Removing the Microprocessor Airflow Shroud From the Chassis

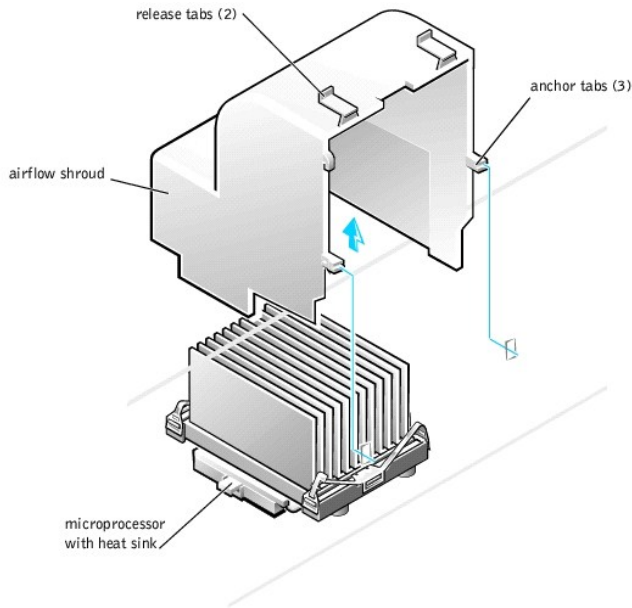

4. Remove the microprocessor heat sink:
  - a. For each of the metal clips that secure the heat sink to the microprocessor, press down on the clip's latch to release it from the heat-sink retention base. Then lift the clip away from the heat sink (see "[Removing the Microprocessor Heat Sink](#)").
  - b. Lift the heat sink away from the microprocessor.
5. Discard the original microprocessor heat sink and securing clips.

**NOTE:** The bottom of the heat sink is covered with thermal grease that conducts heat from the processor to the heat sink. Some of this lubricant will remain on the bottom of the heat sink when you remove it.

**NOTICE:** Do not discard the original microprocessor heat sink or securing clips unless you are installing a microprocessor upgrade kit from Dell. If you are *not* installing a microprocessor upgrade kit from Dell, reuse the original heat sink and securing clips when replacing the microprocessor.

#### Removing the Microprocessor Heat Sink

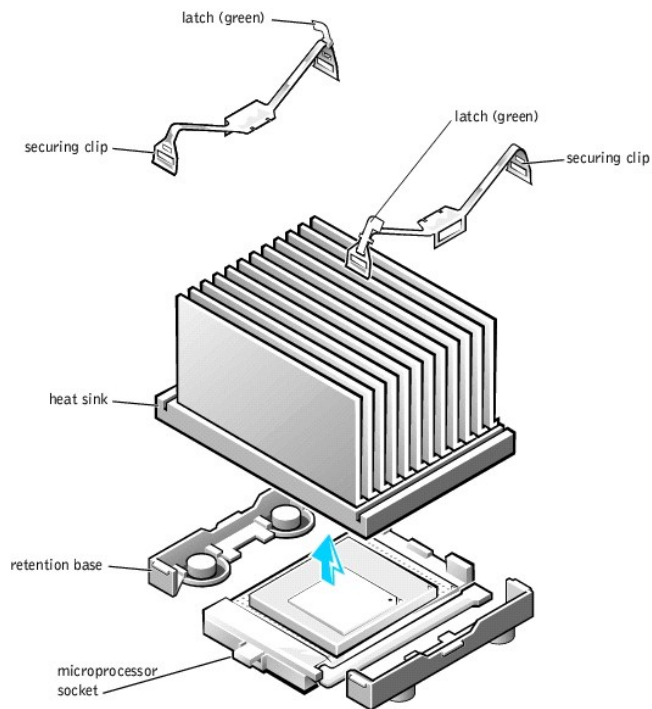

6. Remove the microprocessor from its connector.

Your microprocessor uses a zero insertion force (ZIF) socket with a lever-type handle that secures or releases the microprocessor.

To remove the microprocessor, pull the socket lever straight up until the microprocessor is released. Then remove the microprocessor from the socket (see the following figure).

### Removing the Microprocessor

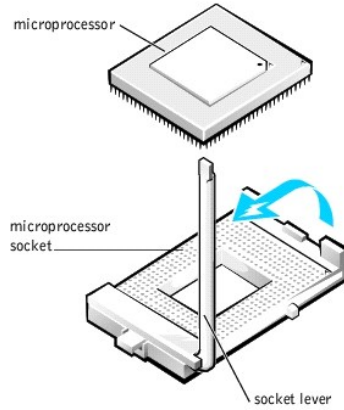

7. Install the new microprocessor in the socket:

- a. Ensure that the lever on the microprocessor socket is fully extended to the release position.

**NOTICE:** When you place the microprocessor in the socket, ensure that the microprocessor aligns properly with the socket. You must position the microprocessor correctly in the socket to avoid damage.

- b. Align pin 1 of the new microprocessor with pin 1 of the socket.

**NOTE:** Pin 1 of the microprocessor is indicated by a small dot or a triangle in one corner of the microprocessor. Pin 1 of the socket is indicated by a small triangle in one corner of the socket. See ["Replacing the Microprocessor."](#)

- c. Carefully set the microprocessor in the socket and press it down lightly to seat it.
- d. Rotate the socket lever back toward the socket until it snaps into place, securing the microprocessor.

### Replacing the Microprocessor

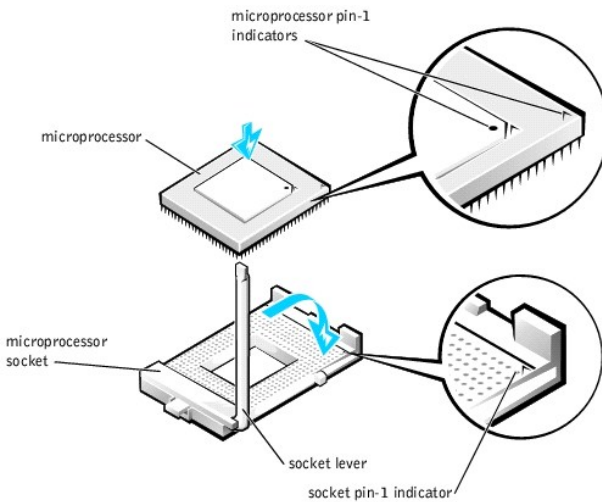

8. Install the microprocessor heat sink:

**NOTICE:** If you are *not* installing a microprocessor upgrade kit from Dell, reuse the original heat sink and securing clips when replacing the microprocessor.

- a. Remove the film covering the thermal grease on the bottom of the heat sink.
  - b. Lower the heat sink to the microprocessor so that the heat sink fits in the heat sink retention base.
  - c. For each of the replacement metal clips that secure the heat sink to the microprocessor, fit the end of the clip that does not have the latch to the heat sink retention base. Then press down on the clip's latch to secure the clip to the heat sink retention base (see "[Removing the Microprocessor Heat Sink](#)").
9. Replace the airflow shroud.
  10. Rotate the power supply back into position, making sure that the securing tab snaps into place.
  11. Replace the computer cover, reconnect the computer and peripherals to their electrical outlets, and turn them on.

 **NOTE:** If enabled, the **Chassis Intrusion** option will cause the following message to be displayed at the next system start-up:

ALERT! Cover was previously removed.

12. Enter [system setup](#), and confirm that the top line in the **System Data** area correctly identifies the new microprocessor. Also, confirm that the values under the **CPU Information** menu are correct for the new microprocessor.
13. Exit system setup, and then run the [Dell Diagnostics](#) to verify that the new microprocessor is operating properly.

## VRM

The voltage regulator module (VRM) senses the microprocessor's voltage requirements and ensures that the correct voltage is maintained.

### Removing the VRM

 **CAUTION:** Before you perform this procedure, see "[Safety First— For You and Your Computer](#)."

 **NOTICE:** Before disconnecting a peripheral device from the computer, wait 10 to 20 seconds after disconnecting the computer from its electrical outlet. Before removing a component from the system board, verify that the standby power light on the system board has turned off. To locate this light, see "[System Board Components](#)."

1. Turn off the computer and peripherals, disconnect them from their electrical outlets, wait at least 5 seconds, and then [remove the computer cover](#).
2. [Rotate the power supply](#) away from the system board.
3. Remove the VRM securing clip:
  - a. Press down on the two raised points of the clip's top surface to release it from the VRM connector.
  - b. Lift the clip away from the VRM (see the following figure).

#### Removing the VRM

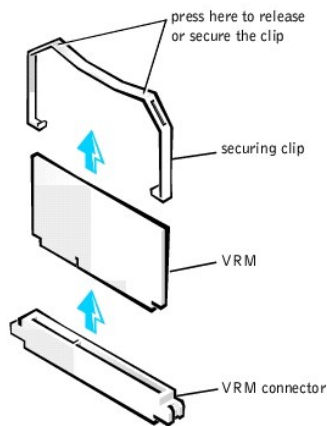

4. Grasp the VRM by its top corners, and ease it out of its connector.

### Replacing the VRM

1. Align the slot on the bottom of the new VRM with the ridge inside the connector.
2. Press the VRM straight into the connector.
3. Replace the VRM securing clip:
  - a. Lower the clip onto the VRM so that the top corners of the VRM go through the slots in the clip.
  - b. Press down on the two raised points of the clip's top surface to secure it to the VRM connector (see "[Removing the VRM](#)").



4. Rotate the power supply back into position until the securing tab snaps into the release latch.
5. Replace the computer cover and restart the system.

---

## System Battery

The 3.0-V CR2032 coin-cell battery installed on the system board provides power to retain the configuration, date, and time information when the system is turned off. The system battery is designed to provide years of service without being replaced. However, you may need to replace the battery if configuration or clock-related inconsistencies occur or if one of the following messages is displayed during the boot routine:

Time-of-day not set - please run SETUP program

or

Invalid configuration information -  
please run SETUP program

or

Strike the F1 key to continue,  
F2 to run the setup utility

**⚠ CAUTION:** There is a danger of the new battery exploding if it is installed incorrectly. Replace the battery only with the same or equivalent type recommended by the manufacturer. Discard used batteries according to the manufacturer's instructions.

**⚠ CAUTION:** Before you perform this procedure, see "[Safety First— For You and Your Computer.](#)"

1. If you have not already done so, make a copy of your system configuration information in [system setup](#).

If the settings are lost while you are replacing the battery, you can refer to your copy of the system configuration information to restore the correct settings.

2. Turn off the computer and peripherals, disconnect them from their electrical outlets, wait at least 5 seconds, and then [remove the computer cover](#).
3. Remove the battery.

See "[System Board Components](#)" in "About Your Computer" to locate the battery on the system board.

**🔍 NOTICE:** If you use a blunt, nonconductive object to pry the battery out of its socket, be careful not to touch the system board with the object. Be sure that the object is inserted between the battery and the socket before you attempt to pry out the battery. Otherwise, you may damage the system board.

Pry the battery out of its socket with your fingers or with a blunt, nonconductive object, such as a plastic screwdriver.

4. Install the new battery.

Orient the battery with the side labeled "+" facing up (see the following figure). Then insert the battery into the socket, and snap it into place.

### Replacing the System Battery

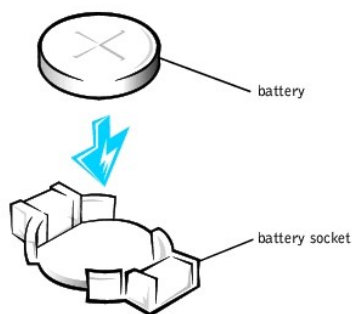

5. Replace the computer cover, reconnect the computer and peripherals to their electrical outlets, and turn them on.

**🔍 NOTE:** If enabled, the **Chassis Intrusion** option will cause the following message to be displayed at the next system start-up:

ALERT! Cover was previously removed.

6. Enter [system setup](#) and enter the current time and date. Then exit system setup and save the information.
7. Turn off your computer and disconnect it from its electrical outlet. Leave the computer off for at least 10 minutes.
8. Reconnect the computer to its electrical outlet and turn it on.
9. Enter [system setup](#) and check the date and time.

10. If the time and date are still incorrect, see "[Getting Help](#)" for instructions on obtaining technical assistance.

---

[Back to Contents Page](#)

## Technical Specifications

Dell™ OptiPlex™ GX400 System User's Guide

### Technical Specifications

Processor	
Microprocessor type	Intel® Pentium® 4 microprocessor. Design provides for future Dell-supported upgrades. A slower compatibility speed can be set through <a href="#">system setup</a> .
Internal cache	8-kilobyte (KB) first-level
L2 cache memory	256-KB pipelined-burst, eight-way set-associative, write-back static random-access memory (SRAM)
Math coprocessor	internal to microprocessor
Memory	
Architecture	Rambus dynamic random access memory (RDRAM)
Rambus in-line memory module (RIMM) sockets	four
RIMM capacities	64-, 128-, 256-, and 512-megabyte (MB) RDRAM
Standard RAM	128 MB minimum
Maximum RAM	2 gigabyte (GB)
Basic input/output system (BIOS) address	F8000h
System Information	
Chip set	Intel 850 Peripheral Component Interconnect (PCI)/accelerated graphics port (AGP)
Data bus width	64 bits
Address bus width	32 bits
Direct memory access (DMA) channels	eight
Interrupt levels	15
BIOS chip	4 megabits (Mb)
System bus speed	100 megahertz (MHz) clock, 400 MHz data rate
Video	
Video type	AGP 4X or PCI graphics card (see manufacturer's specifications)
Bus speed	66 MHz
AGP expansion-card connectors	one
AGP expansion-card connector size	172 pins
AGP expansion-card connector data width (maximum)	32 bits
AGP bus protocols	4x/2x modes at 1.5 volts (V) (3.3 volt AGP cards are not supported.)
Audio	
Audio type	Soundblaster emulation
Audio controller	Analog Devices AD1885 AC97 Codec
Stereo conversion	16 bits (analog-to-digital and digital-to-analog)
Interfaces:	
Internal	PCI bus/AC97 CDROM Telephony applications programming interface (TAPI)
External	line-in jack; microphone jack; line-out jack
Expansion Bus	
Bus types	PCI
Bus speed	PCI: 33 MHz
PCI expansion-card connectors	five
PCI expansion-card connector size	120 pins
PCI expansion-card connector data width (maximum)	32 bits
Drives	
Externally accessible bays	three 5.25-inch bays for diskette, tape, or CD drives; one 3.5-inch bay for a diskette drive
Internally accessible bays	two 3.5-inch bays for two 1-inch high hard drives or one 1-inch high hard drive and one 1.6-inch-high hard drive
Ports	
Externally accessible:	

Serial (DTE)	two 9-pin connectors; 16550-compatible
Parallel	one 25-hole connector (bidirectional)
Video	one 15-hole connector (on video card)
Network interface controller (NIC)	RJ45 connector
Personal System/2 (PS/2)-style keyboard	6-pin mini-Deutsche Industrie Norm (DIN)
PS/2-compatible mouse	6-pin mini-DIN
Universal Serial Bus (USB)	four USB-compliant connectors
Audio	one microphone jack; one line-in jack; one line-out jack
Internally accessible:	
Primary enhanced integrated drive electronics (EIDE) hard drive	40-pin connector on PCI local bus
Secondary EIDE hard drive	40-pin connector
Diskette drive	34-pin connector
CD drive audio interface	4-pin connector
Fan	3-pin connector
Telephony (TAPI)	4-pin connector
<b>Key Combinations</b>	
<Ctrl><Alt><Del>	restarts (reboots) the system
<F2>	starts <a href="#">system setup</a> during power-on self-test (POST) only
<Ctrl><Alt><\>	toggles microprocessor speeds on 101-key keyboard (in MS-DOS® real mode only)
<Ctrl><Alt><#>	toggles microprocessor speeds on 102-key keyboard (in MS-DOS real mode only)
<Ctrl><Enter>	disables the system password at start-up
<b>Controls and Indicators</b>	
Reset control	push button
Power control	push button
Power indicators	green light blinking green in sleep state; dual-color light on front panel—green for power, yellow for diagnostics
Hard-drive access indicator	green light
Link integrity and speed indicator (on integrated NIC connector)	green light for 10-Mb operation; orange light for 100-Mb operation
Activity indicator (on NIC connector)	yellow light
<b>Power</b>	
DC power supply:	
Wattage	250 Watts (W)
Heat dissipation	913 British thermal units (BTU) (fully loaded system without monitor)
Voltage	90 to 135 V at 60 hertz (Hz); 180 to 265 V at 50 Hz
Backup battery	3-V CR2032 coin cell
<b>Physical</b>	
Height	44.5 centimeters (cm) (17.5 inches)
Width	20.6 cm (8.1 inches)
Depth	43.7 cm (17.2 inches)
Weight	15 kilograms (kg) (33.0 pounds [lb]) or more, depending on options installed
<b>Environmental</b>	
Temperature:	
Operating	10° to 35°C (50° to 95°F)
Storage	-40° to 65°C (-40° to 149°F)
Relative humidity	20% to 80% (noncondensing)
Maximum vibration:	
Operating	0.25 gravities (G) at 3 to 200 Hz at 0.5 octave/minute (min)
Storage	0.5 G at 3 to 200 Hz at 1 octave/min
Maximum shock:	
Operating	bottom half-sine pulse with a change in velocity of 20 inches/second (sec) (50.8 cm/sec)
Storage	27-G faired square wave with a velocity change of 200 inches/sec (508 cm/sec)
Altitude:	
Operating	-16 to 3048 meters (m) (-50 to 10,000 feet [ft])
Storage	-16 to 10,600 m (-50 to 35,000 ft)

[Back to Contents Page](#)

## Solving Problems

### Dell™ OptiPlex™ GX400 System User's Guide

- [Before You Begin](#)
- [Dell Diagnostics](#)
- [Messages and Codes](#)
- [Software Problems](#)

---

## Before You Begin

This section describes system and software problems, offers corrective actions, describes the [Dell Diagnostics](#) utility, and provides system messages and codes. Before you call Dell for technical assistance, complete the following tasks to help you resolve computer problems:

- 1 Read "[About Your Computer](#)" and "[Safety First—For You and Your Computer](#)."
- 1 Take the problem-solving action listed in the following table for the component or equipment that is not working properly.

Solving Problems	
Problem	Action
Power indicator does not light	See " <a href="#">Power Problems</a> "
Monitor power indicator does not light	See " <a href="#">Monitor Problems</a> "
No sound	See " <a href="#">Sound and Speaker Problems</a> "
Printer not working	See " <a href="#">Printer Problems</a> "
Serial or other parallel devices not working	See " <a href="#">Serial or Parallel Device Problems</a> "
Mouse not working	See " <a href="#">Mouse Problems</a> "
Keyboard not working	See " <a href="#">Keyboard Problems</a> "
Diskette drive or hard drive: indicators not lit, scraping or unusual noises, no noise	See " <a href="#">Diskette Drive Problems</a> " or " <a href="#">Hard Drive Problems</a> "
System battery not working	See " <a href="#">Battery Problems</a> "
Expansion card errors or malfunction	See " <a href="#">Expansion-Card Problems</a> "
A program locks up	See " <a href="#">Recover From a Program That Is Not Responding</a> "
Computer locks up	See " <a href="#">Restart a Computer That Is Not Responding</a> "
Computer gets wet	See " <a href="#">Repairing a Wet Computer</a> "
Computer is dropped or damaged	See " <a href="#">Repairing a Dropped or Damaged Computer</a> "
Hardware devices conflict	See " <a href="#">Hardware Conflicts</a> "
System memory amount is not correct	See " <a href="#">System Memory Problems</a> "
System board malfunctions	See " <a href="#">System Board Problems</a> "
System board is damaged	See " <a href="#">Resetting a Damaged System Board</a> "
An error message	See " <a href="#">Messages and Codes</a> "
A series of beeps on system startup	See " <a href="#">Messages and Codes</a> "

## Power Problems

The power indicator on the [front panel](#) communicates codes that can help you determine whether there is a problem with your computer. The following table lists the codes for the power indicator. For more information, see "[Diagnostic Indicators](#)."

Power Indicator Codes	
Power Indicator Code	Cause
Solid green	Power is on, and the computer is operating normally.
Blinking green	The computer is in the suspended state (Microsoft® Windows® 2000 only).
Solid yellow	The <a href="#">Dell Diagnostics</a> is running a test, or a device on the system board may be faulty or incorrectly installed.
Blinking yellow	There is a system board or power supply failure.

Basic Checks:

- 1 Test the electrical outlet: ensure that the electrical outlet is working by testing it with a different device such as a lamp.
- 1 Connect the computer power cable directly to an electrical outlet to ensure that the computer turns on. Do not connect it to a power protection device, uninterruptible power supply (UPS), power strip, or extension cord.
- 1 Ensure that all power cables are firmly connected, verifying that each power cable is adequately connected at the computer device and to the electrical outlet.
- 1 Check for interference: electrical appliances on the same circuit or operating in close proximity to the computer can cause interference.

- 1 Swap the power cables between the computer and the monitor to see whether the problem symptoms change.

If the problem still exists after you complete the basic checks, fill out the [Diagnostics Checklist](#) as you perform the following steps:

1. Turn off the computer and peripherals, and disconnect them from their electrical outlets.
2. Wait approximately 30 seconds, and reconnect the computer and peripherals to their electrical outlets.
3. Turn on the computer.

Does the power indicator on the front of the computer light up?

**Yes.** The problem is resolved.

**No.** The computer may be defective. [Contact Dell](#) for technical assistance.

## Monitor Problems

The power indicator on the monitor communicates codes that can help you determine whether there is a problem. The following table lists the codes for the monitor power indicator. For more information, see the documentation that came with your monitor.

Monitor Indicator Codes	
Monitor Indicator Code	Cause
Solid green	Power is on, and the monitor is receiving video input from the computer. The system is operating normally.
Solid yellow	Power is on, but the monitor is not receiving video input from the computer.

### Basic Checks:

- 1 Run the monitor self-test as instructed in the monitor user's guide.
- 1 Connect the monitor power cable directly to an electrical outlet to ensure that the monitor turns on. Do not connect it to a power protection device, UPS, power strip, or extension cord.
- 1 Ensure that the monitor power cable is firmly connected, verifying that the power cable is adequately connected at the monitor and to the electrical outlet.
- 1 Swap the power cables between the computer and the monitor to see whether the problem symptoms change.
- 1 If the monitor display is blank, the computer may be in suspended, or hibernate, state. Push and release the power button, move the mouse, or press a key on the keyboard to bring the computer out of the suspended state.
- 1 Disconnect the monitor interface cable from the computer and check the cable connector for bent or broken pins. Check for damaged or frayed cables.
- 1 If the monitor interface cable is not damaged, ensure that it is firmly connected to the computer.
- 1 Adjust brightness and contrast settings on the monitor.

If the problem still exists after you complete the basic checks, fill out the [Diagnostics Checklist](#) as you perform the following steps:

1. Turn off the computer, wait at least 30 seconds, and then turn the computer back on.
2. Allow 1 minute for the computer to initialize its components, and then adjust the monitor's brightness and contrast controls.

Is the monitor readable?

**Yes.** The problem is resolved.

**No.** Go to [step 3](#).

3. Turn off nearby fans, lights, lamps, or other electrical devices.

Is the monitor readable?

**Yes.** One or more of those devices was causing interference. The problem is resolved.

**No.** Go to the next question.

Do you have another monitor that is working properly?

**Yes.** Go to [step 4](#).

**No.** [Contact Dell](#) for technical assistance.

4. Turn off the computer and the monitor, wait at least 30 seconds, and disconnect the monitor. Connect a different monitor to the computer and then turn them on.
5. Allow 1 minute for the computer to initialize its components, and then adjust the monitor's brightness and contrast controls.

Is the monitor readable?

**Yes.** The original monitor is defective. The problem is resolved.

**No.** [Contact Dell](#) for technical assistance.

## Video Problems

#### Basic Checks:

- 1 Run the monitor self-test as instructed in the monitor user's guide.
- 1 Check the [monitor power indicator](#).
- 1 Listen for [system beep codes](#) that may indicate a display problem.
- 1 Connect the monitor power cable directly to an electrical outlet to verify that the monitor turns on. Do not connect it to a power protection device, UPS, power strip, or extension cord.
- 1 If the monitor display is blank, the computer may be in suspended, or hibernate, state. Push and release the power button, move the mouse, or press a key on the keyboard to bring the computer out of the suspended state.
- 1 Disconnect the monitor interface cable from the computer and check the cable connector for bent or broken pins. Check for damaged or frayed cables.
- 1 If the monitor interface cable is not damaged, ensure that it is firmly connected to the computer.
- 1 Adjust brightness and contrast settings on the monitor.
- 1 Check for interference:
  - o Electrical appliances on the same circuit or operating in close proximity to the computer can cause interference.
  - o Audio equipment and certain types of lamps operating in immediate proximity to the computer can cause interference.
- 1 Restart the computer.
- 1 Enter [system setup](#) and ensure that **Primary Video Controller** under the **Integrated Devices** option is set correctly. An advanced graphics port (AGP) or peripheral component interconnect (PCI) expansion card will operate with **Primary Video Controller** set to either **Auto** or the default setting **AGP**.  
 **NOTE:** If your computer has both an AGP and a PCI expansion card installed, set **Primary Video Controller** to **AGP** to use the AGP expansion card. Set **Primary Video Controller** to **Auto** to use the PCI expansion card.

If the problem still exists after you complete the basic checks, fill out the [Diagnostics Checklist](#) as you perform the following steps:

1. Perform the procedure in "[Monitor Problems](#)."  
Is the computer working properly?  
**Yes.** The problem is resolved.  
**No.** Go to the next question.  
Do you have another computer that is working properly?  
**Yes.** Go to [step 2](#).  
**No.** Go to [step 6](#).
2. Turn off the original computer and monitor, wait at least 30 seconds, and disconnect the monitor.
3. Turn off your other computer, wait at least 30 seconds, and disconnect its monitor. Connect the monitor from the original computer, and then turn them on.
4. Allow 1 minute for the computer to initialize its components, and then adjust the monitor's brightness and contrast controls.  
Is the monitor readable?  
**Yes.** The monitor is working properly. There may be a problem with the video card in the original computer. Go to [step 5](#).  
**No.** The monitor may be defective. See "[Monitor Problems](#)."
5. Turn off the computer and monitor, wait at least 30 seconds, and disconnect the monitor. Connect the monitor back to the original computer, and then turn them on.
6. Turn off nearby fans, lights, lamps, or other electrical devices.  
Is the monitor readable?  
**Yes.** One or more of those devices was causing interference. The problem is resolved.  
**No.** Go to [step 7](#).
7. Run the VESA/VGA Interface tests in the [Dell Diagnostics](#).  
Did any of the tests fail?  
**Yes.** The video controller on the system board may be defective. [Contact Dell](#) for technical assistance.  
**No.** [Contact Dell](#) for technical assistance.

## Sound and Speaker Problems

#### Basic Checks:

- 1 If using external speakers:
  - o Ensure that external audio devices are connected to the microphone, line-out/speaker, or line-in connectors on the system [back panel](#).



- o Ensure that the speaker cable is firmly connected to the computer.
  - o Test the electrical outlet. Verify that the speakers are connected to a working electrical outlet.
  - o Ensure that the speakers are turned on.
- 1 If using a sound card, ensure that external audio devices are connected to the sound card's connectors and not to the microphone, line- out/speaker, or line-in connectors on the system back panel (see ["Back- Panel Connectors and Indicators"](#)).
  - 1 Ensure that audio is not muted in the operating system (OS) settings. See the OS documentation for more information.
  - 1 Adjust the volume control on the speakers, if it is provided.
  - 1 Adjust the volume control in the audio software. For more information, see the documentation for either your OS or your audio software.
  - 1 If you are trying to listen to an audio CD, try different CDs.
  - 1 Reinstall the audio driver for your operating system.
  - 1 Check for interference: electrical appliances on the same circuit or operating in close proximity to the computer can cause interference.

If the problem still exists after you complete the basic checks, fill out the [Diagnostics Checklist](#) as you perform the following steps:

1. Turn off nearby fans, lights, lamps, or other electrical devices.
 

Are the external speakers functioning properly?

**Yes.** One or more of those electrical devices was causing interference. The problem is resolved.

**No.** Go to [step 2](#).
2. Enter [system setup](#) and make sure that **Sound** under the **Integrated Devices** option is set to **On**. Then exit system setup properly to save the information, and reboot the system.
 

Is the device working properly?

**Yes.** The problem is resolved.

**No.** Go to [step 3](#).
3. Run the **Misc. PCI Devices** tests in the [Dell Diagnostics](#).
 

Did the tests complete successfully?

**Yes.** The controller is working properly. Go to the next question.

Do you have a set of headphones?

**Yes.** Go to [step 4](#).

**No.** [Contact Dell](#) for technical assistance.
4. Connect the headphones to the line-out/speaker jack.
 

Can you hear sound through the headphones?

**Yes.** The speakers are defective. The problem is resolved.

**No.** [Contact Dell](#) for technical assistance.

## Printer Problems

### Basic Checks:

- 1 Disconnect the cable from the computer and check the cable connector for bent or broken pins. Check for damaged or frayed cables.
- 1 If the cable is not damaged, ensure that it is firmly connected to the computer.
- 1 Test the electrical outlet. Verify that the printer is connected to a working electrical outlet.
- 1 Ensure that the printer is turned on.
- 1 Check for interference: electrical appliances on the same circuit or operating in close proximity to the computer can cause interference.

If the problem still exists after you complete the basic checks, fill out the [Diagnostics Checklist](#) as you perform the following steps:

1. Perform the procedure in ["Serial or Parallel Device Problems."](#)

Is the device working properly?

**Yes.** The problem is resolved.

**No.** Go to [step 2](#).
2. Run the printer's self-test.
 

Does the self-test complete successfully?

**Yes.** Go to [step 3](#).

**No.** The printer is probably defective. If you bought the printer from Dell, [contact Dell](#) for technical assistance. If you did not, take it to an authorized service center for repair.

3. Try to print again.

Does the print operation complete successfully?

**Yes.** The problem is resolved.

**No.** [Contact Dell](#) for technical assistance.

## Serial or Parallel Device Problems

 **NOTE:** If you are having a problem with a printer, see "[Printer Problems](#)."

If a system error message indicates a port problem or if equipment connected to a port seems to perform incorrectly or not at all, the source of the problem can be any of the following:

- 1 A faulty connection between the input/output (I/O) port and the device
- 1 Incorrect settings for [system setup](#) options
- 1 Incorrect settings in the operating system's configuration files
- 1 A faulty cable between the I/O port and the device
- 1 A faulty device
- 1 Faulty I/O port logic on the system board
- 1 Conflicting COM port settings
- 1 Lack of drivers

### Basic Checks:

- 1 Disconnect the cable from the computer and check the cable connector for bent or broken pins. Check for damaged or frayed cables.
- 1 If the cable is not damaged, ensure that it is firmly connected to the computer.
- 1 Test the electrical outlet. Verify that the device is connected to a working electrical outlet.
- 1 Verify that the device is turned on.
- 1 Check for interference: electrical appliances on the same circuit or operating in close proximity to the computer can cause interference.

If the problem still exists after you complete the basic checks, fill out the [Diagnostics Checklist](#) as you perform the following steps:

1. Enter [system setup](#) and check the **Integrated Devices** option settings. Then exit system setup properly to save the information, and reboot the system.

For a serial device, check the **Serial Port** options; for a parallel device, check the **Parallel Port** options. See the device's documentation for additional information on port settings and configuration requirements.

Is the device working properly?

**Yes.** The problem is resolved.

**No.** Go to [step 2](#).

2. Run the **Serial Ports** device group and/or the **Parallel Ports** device group in the [Dell Diagnostics](#).

These device groups check the basic functions of the system board's I/O port logic. If a printer is connected to the parallel port, the Parallel Ports device group tests the communication link between the system board's I/O port logic and the printer.

Do the tests complete successfully?

**Yes.** Go to [step 3](#).

**No.** [Contact Dell](#) for technical assistance.

3. If the problem is confined to a particular application program, see the application program's documentation for specific port configuration requirements.

Is the device working properly?

**Yes.** The problem is resolved.

**No.** Go to [step 4](#).

4. Turn off the computer and the device, swap the device's cable with a known working cable, and then turn on the computer and the device.

Is the device working properly?

**Yes.** You need a new device cable. [Contact Dell](#) for technical assistance.

**No.** Go to [step 5](#).

5. Turn off the computer and the device, swap the device with a comparable working device, and then turn on the computer and the device.

Is the device working properly?

**Yes.** You need a new device. [Contact Dell](#) for technical assistance.

**No.** [Contact Dell](#) for technical assistance.

## Mouse Problems

### Basic Checks:

- 1 Disconnect the cable from the computer and check the cable connector for bent or broken pins. Check for damaged or frayed cables.
- 1 Ensure that the cable is firmly connected to the computer.
- 1 If you are using a USB mouse, ensure that you connect to one of the Port 1 USB connectors on the system back panel (see "[Back-Panel Connectors and Indicators](#)").
- 1 Reinstall the mouse driver for your operating system.
- 1 Restart the computer.

If the problem still exists after you complete the basic checks, fill out the [Diagnostics Checklist](#) as you perform the following steps:

1. Turn off the computer, wait at least 30 seconds, and disconnect the mouse. Reconnect the mouse to the computer, and then turn the computer on.

Is the device working properly?

**Yes.** The problem is resolved.

**No.** Go to [step 2](#).

2. If you are using a Personal System/2 (PS/2) mouse, enter [system setup](#) and make sure that **Mouse Port** under the **Integrated Devices** option is set to **On**. Then exit system setup properly to save the information, and reboot the system.

Is the device working properly?

**Yes.** The problem is resolved.

**No.** Go to [step 3](#).

3. If you are using a PS/2 mouse, run the **Mouse** test in the **Pointing Devices** device group in the [Dell Diagnostics](#).

Did the tests complete successfully?

**Yes.** Go to the next question.

**No.** [Contact Dell](#) for technical assistance.

Do you have another computer that is working properly?

**Yes.** Go to [step 4](#).

**No.** Go to the next question.

Do you have another mouse that is working properly?

**Yes.** Turn off the computer, wait at least 30 seconds, and disconnect the mouse. Then go to [step 6](#).

**No.** [Contact Dell](#) for technical assistance.

4. Turn off the original computer, wait at least 30 seconds, and disconnect the mouse.
5. Turn off your other computer, wait at least 30 seconds, and disconnect its mouse. Connect the mouse from the original computer, and then turn the computer on.

Is the mouse working properly?

**Yes.** There is a problem with the original computer. [Contact Dell](#) for technical assistance.

**No.** The mouse may be defective. [Contact Dell](#) for technical assistance.

6. Connect a different mouse to the computer, and then turn the computer on.

Is the mouse working properly?

**Yes.** The original mouse is defective. The problem is resolved.

**No.** [Contact Dell](#) for technical assistance.

## Keyboard Problems

### Basic Checks:

- 1 Disconnect the cable from the computer and check the cable connector for bent or broken pins. Check for damaged or frayed cables.
- 1 Ensure that the cable is firmly connected to the computer.

- 1 If you are using a USB keyboard, ensure that you connect to one of the Port 1 USB connectors on the system back panel (see "[Back-Panel Connectors and Indicators](#)").
- 1 If you are using a PS/2 keyboard that can be configured with various switch settings, ensure that the switch is set to PS/2, Enhanced XT/AT, or PC/AT. The switch settings are usually on the bottom of the keyboard, sometimes behind a panel. Refer to the documentation that came with the keyboard for more information.
- 1 Check for interference. Keyboard extension cables can cause problems.
- 1 Restart the computer.

If the problem still exists after you complete the basic checks, fill out the [Diagnostics Checklist](#) as you perform the following steps:

1. Turn off the computer, and then disconnect the keyboard cable and check it for bent or broken pins.
 

Do you see bent pins?

**Yes.** If they can be straightened, straighten them and go to [step 2](#). If they cannot be straightened or are broken, you must replace the keyboard.

**No.** Go to step 2.
2. Reconnect the keyboard to the computer.
 

Make sure the keyboard cable is firmly connected to computer.
3. Turn on the computer.
4. If you are using a keyboard that can be configured with various switch settings, make sure the switch is set to PS/2, Enhanced XT/AT, or PC/AT.
 

The switch settings are usually on the bottom of the keyboard, sometimes behind a panel. Refer to the documentation that came with the keyboard for more information.
5. Turn off the computer, wait 30 seconds, and turn it on again.
 

During the boot routine, do the Num Lock, Caps Lock, and Scroll Lock lights on the keyboard blink momentarily?

**Yes.** Go to [step 6](#).

**No.** Go to [step 7](#).
6. Use the keyboard to type some characters.
 

Do the characters appear on the screen?

**Yes.** The problem is resolved.

**No.** [Contact Dell](#) for technical assistance.
7. Run the **PC-AT Compatible Keyboards** tests in the [Dell Diagnostics](#).
 

Did any of the diagnostics tests fail?

**Yes.** The original keyboard may be defective. Go to [step 8](#).

**No.** Go to the next question.

Do you have another computer that is working properly?

**Yes.** Go to [step 8](#).

**No.** Go to the next question.

Do you have another keyboard that is working properly?

**Yes.** Turn off the computer, wait at least 30 seconds, and disconnect the keyboard. Go to [step 9](#).

**No.** [Contact Dell](#) for technical assistance.
8. Turn off the original computer, wait at least 30 seconds, and disconnect the keyboard.
9. Turn off your other computer, wait at least 30 seconds, and disconnect its keyboard. Connect the keyboard from the original computer, and then turn the computer on.
 

Is the keyboard working properly?

**Yes.** The original keyboard is defective. The problem is resolved.

**No.** [Contact Dell](#) for technical assistance.

## Diskette Drive Problems

During the power-on self-test (POST), the computer checks the diskette drive, comparing its characteristics with the system configuration information. The diskette-drive access light blinks as the computer performs this check.

Basic Checks:

- 1 If you hear an unfamiliar scraping or grinding sound when a drive is accessed, there could be a hardware malfunction. [Contact Dell](#) for technical

assistance.

- 1 When you turn on the computer, you can hear drive activity during the boot routine. If your computer does not boot, [contact Dell](#) for technical assistance.
- 1 If you are trying to copy data to the diskette, ensure that it is not write-protected.
- 1 Try a different diskette in the drive. If the new diskette works, the original one may be defective.
- 1 Test the diskette drive access indicator by using one of the following methods:
  - o Using MS-DOS®, insert a diskette into the drive, type `dir a:` at the prompt, and press <Enter>.
  - o Using Microsoft Windows or Windows NT®, insert a diskette into the drive, open **My Computer** from the desktop, and double-click the diskette drive icon.
- 1 Check the settings in [system setup](#).
- 1 Clean the drive using a commercially available cleaning kit.

 **NOTICE:** Do not attempt to clean drive heads with a swab. You may accidentally misalign the heads, rendering the drive inoperable.

If the problem still exists after you complete the basic checks, fill out the [Diagnostics Checklist](#) as you perform the following steps.

 **CAUTION:** Before you perform this procedure, see "[Safety First— For You and Your Computer.](#)"

1. Run the Diskette device group in the [Dell Diagnostics](#).  
  
Did any of the tests fail?  
  
**Yes.** [Contact Dell](#) for technical assistance.  
  
**No.** Go to [step 2](#).
2. Turn off the computer and peripherals, disconnect them from their electrical outlets, wait at least 5 seconds, and then [remove the computer cover](#).
3. Remove and reinstall the diskette drive.
4. Replace the computer cover, reconnect the computer and peripherals to their electrical outlets, and turn them on.

Does the diskette-drive access light blink during the boot routine?

**Yes.** Go to the next question.

**No.** [Contact Dell](#) for technical assistance.

Does the computer display a drive error message?

**Yes.** See "[System Messages](#)" for an explanation of the message, and then go to [step 5](#).

**No.** The problem is resolved.

5. Insert a bootable diskette into the diskette drive and reboot the computer.

Does the drive boot the operating system?

**Yes.** The problem is probably resolved. If you continue to experience trouble, [contact Dell](#) for technical assistance.

**No.** [Contact Dell](#) for technical assistance.

## Hard Drive Problems

Basic Checks:

- 1 If you hear an unfamiliar scraping or grinding sound when a drive is accessed, there could be a hardware malfunction. [Contact Dell](#) for technical assistance.
- 1 When you turn on the computer, you can hear drive activity during the boot routine. If your computer does not boot, [contact Dell](#) for technical assistance.
- 1 Test the hard drive by using one of the following methods:
  - o For Windows XP and Windows 2000, run the `chkdsk` utility by clicking the **Start** button, selecting **Run**, and then typing `cmd` in the dialog box. At the `c:` prompt, type `chkdsk` and press <Enter>.  
  
This utility creates and displays a status report, and lists and corrects errors on the disk.
  - o For Windows NT, run the error-checking utility by double-clicking **My Computer** and selecting the hard drive that you want to check. Click the right mouse button, select **Properties**, then click **Tools**, and select **Check Now** in the **Error Checking** section.
  - o For Windows 98 SE and Windows 98, run the ScanDisk utility by clicking the **Start** button, pointing to **Run**, typing `scandisk` in the dialog box, selecting the type of test to run, and then clicking **Start**.
  - o For MS-DOS, type `scandisk x:` at an MS-DOS prompt, where `x` is the hard drive letter, and press <Enter>.

If the problem still exists after you complete the basic checks, fill out the Diagnostic Checklist as you perform the following steps:

 **CAUTION:** Before you perform this procedure, see "[Safety First— For You and Your Computer.](#)"

1. Enter [system setup](#) and make sure the problem drive is configured correctly. Make any necessary changes, and reboot the system.

Is the drive operating properly?

**Yes.** The problem is resolved.

**No.** Go to [step 2](#).

2. Test the hard drive by using one of the following methods:

1. Test the hard drive by using one of the following methods:

- o For Windows XP and Windows 2000, run the chkdsk utility by clicking the **Start** button, selecting **Run**, and then typing `cmd` in the dialog box. At the `C:` prompt, type `chkdsk` and press `<Enter>`.

This utility creates and displays a status report, and lists and corrects errors on the disk.

- o For Windows NT, run the error-checking utility by double-clicking **My Computer** and selecting the hard drive that you want to check. Click the right mouse button, select **Properties**, then click **Tools**, and select **Check Now** in the **Error Checking** section.

- o For Windows 98 SE and Windows 98, run the ScanDisk utility by clicking the **Start** button, pointing to **Run**, typing `scandisk` in the dialog box, selecting the type of test to run, and then clicking **Start**.

- o For MS-DOS, type `scandisk x:` at an MS-DOS prompt, where `x` is the hard drive letter, and press `<Enter>`.

Is the drive operating properly?

**Yes.** The problem is resolved.

**No.** Go to [step 3](#).

3. Run the appropriate test group in the [Dell Diagnostics](#):

1. For an integrated drive electronics (IDE) hard drive, run the **IDE Devices** device group.
1. For a small computer system interface (SCSI) hard drive, run the **SCSI Devices** device group.

Did any of the diagnostics tests fail?

**Yes.** Go to the next question.

**No.** Go to [step 4](#).

Did any of the diagnostics tests indicate a faulty drive?

**Yes.** The hard drive may be faulty. [Contact Dell](#) for technical assistance.

**No.** Go to the next question.

Did any of the diagnostics tests indicate a faulty drive controller?

**Yes.** The system board may be faulty. [Contact Dell](#) for technical assistance.

**No.** Go to [step 4](#).

4. Turn off the computer and peripherals, disconnect them from their electrical outlets, wait at least 5 seconds, and then [remove the computer cover](#).
5. Make sure the DC power cables from the power supply are firmly connected to the connectors on each drive. Also verify that the interface cable for each drive is firmly connected to the drive and to the system board.
6. Make sure the control panel cable is firmly connected to the system board. The control panel contains the hard drive activity indicator. To locate the control panel system board connector, see "[System Board Components](#)."
7. Replace the computer cover, reconnect the computer and peripherals to their electrical outlets, and turn them on.

Does the hard drive activity light blink during the boot routine?

**Yes.** Go to the next question.

**No.** The system board may be faulty. [Contact Dell](#) for technical assistance.

Does the computer display a drive error message?

**Yes.** See "[System Messages](#)" for an explanation of the message. If you cannot correct the problem by performing the action described in the table, then [contact Dell](#) for technical assistance.

**No.** Go to the next question.

Is this the primary hard drive that contains the operating system?

**Yes.** Go to the next question.

**No.** [Contact Dell](#) for technical assistance.

Does the drive boot the operating system?

**Yes.** Go to the next question.

**No.** Files in the operating system may be corrupt. See your operating system documentation.

Is the drive operating properly?

**Yes.** The problem is resolved.

**No.** [Contact Dell](#) for technical assistance.

## Battery Problems

If an error message indicates a problem with the battery or if configuration information is lost from [system setup](#) when the computer is turned off, the battery may be defective.

 **CAUTION:** There is a danger of a new battery exploding if it is incorrectly installed. Replace the battery only with the same or equivalent type recommended by the manufacturer. Discard used batteries according to the manufacturer's instructions.

 **CAUTION:** Before you perform this procedure, see "[Safety First— For You and Your Computer.](#)"

1. Turn off the computer and peripherals, disconnect them from their electrical outlets, wait at least 5 seconds, and then [remove the computer cover](#).
2. Reseat the battery in its socket with the side labeled "+" facing up.
3. Replace the computer cover, reconnect the computer and peripherals to their electrical outlets, and turn them on.
4. Enter [system setup](#) and reenter the current time and date. Then exit system setup properly to save the information.
5. Turn off your computer and disconnect it from its electrical outlet. Leave the computer off for at least 10 minutes.
6. Reconnect the computer to its electrical outlet and turn it on.
7. Enter [system setup](#), and check the date and time.

Are the date and time correct?

**Yes.** The problem is resolved.

**No.** The battery may be defective. Go to [step 8](#).

8. [Replace the battery](#).

Is the battery working properly?

**Yes.** The problem is resolved.

**No.** You may have a faulty system board. [Contact Dell](#) for technical assistance.

## Expansion-Card Problems

If an error message indicates an expansion-card problem or if an expansion card seems to perform incorrectly or not at all, the problem could be a faulty connection, a conflict with software or other hardware, or a faulty expansion card.

Fill out the [Diagnostics Checklist](#) as you perform the following steps.

 **CAUTION:** Before you perform this procedure, see "[Safety First— For You and Your Computer.](#)"

1. Run the diagnostics provided by the manufacturers of all expansion cards installed in your computer.

 **NOTE:** The manufacturers of many expansion cards, such as video, network interface, and sound cards, provide diagnostics programs. If you do not have any diagnostics for your cards, go to [step 2](#).

2. Turn off the computer and peripherals, disconnect them from their electrical outlets, wait at least 5 seconds, and then [remove the computer cover](#).
3. [Remove the AGP card brace](#).
4. Make sure each expansion card is firmly seated in its connector. If any expansion cards are loose, reseat them.
5. Make sure all cables are firmly connected to their corresponding connectors on the expansion cards. If any cables appear loose, reconnect them.

For instructions on which cables should be attached to specific connectors on an expansion card, see the expansion card's documentation.

6. Replace the AGP card brace.
7. Replace the computer cover, reconnect the computer and peripherals to their electrical outlets, and turn them on.

Is the system working properly?

**Yes.** The problem is resolved.

**No.** You may have a faulty expansion card. Go to [step 8](#).

8. Turn off the computer and peripherals, disconnect them from their electrical outlets, wait at least 5 seconds, and then remove the computer cover.

- Remove all expansion cards except the video card.

 **NOTE:** If your primary hard drive is connected to a drive controller card and not one of the system board enhanced integrated drive electronics (EIDE) connectors, leave the drive controller card installed in the computer.

- Replace the computer cover, reconnect the computer and peripherals to their electrical outlets, and turn them on.
- Run the **RAM** test group in the [Dell Diagnostics](#).

Did any of the diagnostics tests fail?

**Yes.** [Contact Dell](#) for technical assistance.

**No.** Go to [step 12](#).

- Turn off the computer and peripherals, disconnect them from their electrical outlets, wait at least 5 seconds, and then remove the computer cover.
- Reinstall one of the expansion cards that you removed previously, and repeat [step 10](#) and [step 11](#).

Did any of the diagnostics tests fail?

**Yes.** The expansion card you just reinstalled is faulty and needs to be replaced.

**No.** Repeat [step 12](#) and [step 13](#) with another expansion card. Go to step 13.

- If you have replaced all the expansion cards and the problem is not resolved, [contact Dell](#) for technical assistance.

## Recover From a Program That Is Not Responding

- Press <Ctrl><Alt><Delete>.

Did the **Close Program** window appear?

**Yes.** Go to [step 2](#).

**No.** Skip to [step 4](#).

- Click the program that no longer responds.
- Click **End Task**.

Is the computer operating properly?

**Yes.** The problem is resolved.

**No.** Go to step 4.

- Press the reset button to reboot the computer.

## Restart a Computer That Is Not Responding

- Press the reset button to reboot the system.

Did the computer reboot?

**Yes.** Skip to [step 4](#).

**No.** Go to [step 2](#).

- Press and hold the power button until the computer turns off.

Did the computer reboot?

**Yes.** Skip to [step 4](#).

**No.** Go to [step 3](#).

- Unplug the AC power cable from the computer, wait approximately 30 seconds, and plug in the AC power cable.
- Press the power button to turn on the computer.

 **NOTICE:** If your computer is not responding, turning off power or unplugging the power cord should be done only as a last resort. Doing so can cause problems with system settings and configuration.

## Repairing a Wet Computer

Spills, splashes, and excessive humidity can cause damage to the system. If an external device, such as a printer or modem, gets wet, contact the manufacturer of the device for instructions.

 **CAUTION:** Before you perform this procedure, see "[Safety First— For You and Your Computer.](#)"

Fill out the [Diagnostics Checklist](#) as you perform the following steps:



1. Turn off the computer and peripherals, disconnect them from their electrical outlets, wait at least 5 seconds, and then [remove the computer cover](#).
2. Let the computer dry for at least 24 hours. Make sure that it is thoroughly dry before you proceed.
3. [Remove the AGP card brace](#).
4. [Remove all expansion cards](#) installed in the computer except a video expansion card.

 **NOTE:** If your primary hard drive is connected to a drive controller card and not one of the system board EIDE connectors, leave the drive controller card installed in the computer.

5. Replace the computer cover, reconnect the computer and peripherals to their electrical outlets, and turn them on.

Does the system have power?

**Yes.** Go to [step 6](#).

**No.** [Contact Dell](#) for technical assistance.

6. Turn off the computer and peripherals, disconnect them from their electrical outlets, wait at least 5 seconds, and then remove the computer cover.
7. Reinstall all expansion cards.
8. Replace the AGP card brace.
9. Replace the computer cover, reconnect the computer and peripherals to their electrical outlets, and turn them on.
10. Run the **System Board Devices** test group in the [Dell Diagnostics](#).

Did any of the diagnostics tests fail?

**Yes.** [Contact Dell](#) for technical assistance.

**No.** The problem is resolved.

## Repairing a Dropped or Damaged Computer

 **CAUTION:** Before you perform this procedure, see "[Safety First— For You and Your Computer](#)."

Fill out the [Diagnostics Checklist](#) as you perform the following steps:

1. Turn off the computer and peripherals, disconnect them from their electrical outlets, wait at least 5 seconds, and then [remove the computer cover](#).
2. Check all the expansion-card connections in the computer, and reseat any loose expansion cards.
3. Make sure that all cables are properly connected and that all components are properly seated in their connectors and sockets.
4. Replace the computer cover, reconnect the computer and peripherals to their electrical outlets, and turn them on.
5. Run the **System Board Devices** test group in the [Dell Diagnostics](#).

Did any of the diagnostics tests fail?

**Yes.** [Contact Dell](#) for technical assistance.

**No.** The problem is resolved.

## Hardware Conflicts

Hardware conflicts occur when the operating system detects multiple devices that are attempting to operate on the same system resources when those resources cannot be shared between the devices.

### Symptoms:

- 1 System hangs or locks up, particularly while using a specific device.
- 1 Memory parity errors occur on parity-enabled systems.
- 1 Noise or other problems from sound cards.
- 1 Unintelligible characters printed on the printer.
- 1 Mouse pointer hangs and will not move or moves in a stuttering fashion.
- 1 Messages stating that the computer is not operating at maximum performance.
- 1 Errors and crashes of applications for no apparent reason.
- 1 Nothing displays on the video monitor.

### To resolve hardware conflicts:

- 1 Make sure the conflict is not a [software problem](#).
- 1 Remove any newly added hardware and contact the hardware manufacturer.
- 1 See your operating system documentation.

## System Memory Problems

During POST, the computer checks the computer's memory, determines the amount of installed memory, and then writes to and reads from the number of available bytes to ensure proper operation.

### Basic Checks:

- 1 If an insufficient memory message appears, save and close any open files and exit any open application programs not in use.
- 1 Consider installing additional system memory.
- 1 Run the **System Memory** test in the [Dell Diagnostics](#).
- 1 Reseat the memory modules.
- 1 Restart the computer.

If the problem still exists after you complete the basic checks, fill out the [Diagnostics Checklist](#) as you perform the following steps.

 **CAUTION:** Before you perform this procedure, see "[Safety First— For You and Your Computer.](#)"

1. Reboot the computer.

Does the random access memory (RAM) count displayed correctly match the actual amount of memory installed in the computer?

**Yes.** The computer needed to update the memory count. The problem is resolved.

**No.** Go to [step 2](#).

2. Run the System Memory test group in the [Dell Diagnostics](#).

Did any of the diagnostics tests fail?

**Yes.** [Contact Dell](#) for technical assistance.

**No.** Go to [step 3](#).

3. Turn off the computer and peripherals, disconnect them from their electrical outlets, wait at least 5 seconds, and then [remove the computer cover](#).
4. [Rotate the power supply](#) away from the system board.
5. [Replace the memory module\(s\)](#).
6. Replace the computer cover, reconnect the computer and peripherals to their electrical outlets, and turn them on.

Does the RAM count displayed correctly match the actual amount of memory installed in the computer?

**Yes.** The memory module(s) were defective. The problem is resolved.

**No.** [Contact Dell](#) for technical assistance.

## Microprocessor Problems

During POST, the computer checks the computer's microprocessor and determines its operational specifications. This information is stored in [system setup](#).

### Basic Checks:

- 1 Run the System Board Devices and Processor Cache test groups in the [Dell Diagnostics](#).
- 1 Enter [system setup](#) and ensure that values for the microprocessor under the **CPU Information** option are accurate.
- 1 Reseat the microprocessor.
- 1 Reconnect the microprocessor cooling fan.
- 1 Restart the computer.

If the problem still exists after you complete the basic checks, fill out the [Diagnostics Checklist](#) as you perform the following steps.

 **CAUTION:** Before you perform this procedure, see "[Safety First— For You and Your Computer.](#)"

 **NOTICE:** Before disconnecting a peripheral device from the computer, wait 10 to 20 seconds after disconnecting the computer from its electrical outlet. Before removing a component from the system board, verify that the standby power light on the system board has turned off. To locate this light, see "[System Board Components.](#)"

1. Run the System Board Devices and Processor Cache test groups in the [Dell Diagnostics](#).

Did any of the diagnostics tests fail?

**Yes.** [Contact Dell](#) for technical assistance.

**No.** Go to [step 2](#).

2. Turn off the computer and peripherals, disconnect them from their electrical outlets, and wait 10 to 20 seconds.
3. Lay the computer down on its right side.

4. [Remove the computer cover.](#)
5. [Remove and install the microprocessor.](#)
6. Ensure that the microprocessor fan cable is firmly connected to the connector on the system board.
7. [Replace the computer cover.](#)
8. Stand the computer upright.
9. Reconnect the computer and peripherals to their electrical outlets, and turn them on.

Is the computer working properly?

**Yes.** The problem is resolved.

**No.** [Contact Dell](#) for technical assistance.

## System Board Problems

A system board problem can result from a defective system board component, a faulty power supply, or a defective component connected to the system board. If an error message indicates a system board problem, fill out the [Diagnostics Checklist](#) as you perform the following steps.

 **CAUTION:** Before you perform this procedure, see "[Safety First— For You and Your Computer.](#)"

1. Reboot the system and run the **System Board Devices** test group in the [Dell Diagnostics](#).

Did any of the tests fail?

**Yes.** [Contact Dell](#) for technical assistance.

**No.** Go to [step 2](#).

2. Turn off the computer and peripherals, disconnect them from their electrical outlets, wait at least 5 seconds, and then [remove the computer cover](#).
3. Make sure the power cables from the power supply are firmly connected to the connectors on the system board.
4. Replace the computer cover, reconnect the computer and peripherals to their electrical outlets, and turn them on.

Is the computer working properly?

**Yes.** The problem is resolved.

**No.** Go to [step 5](#).

5. Perform the procedure in "[Expansion-Card Problems.](#)"

Is the computer working properly?

**Yes.** The problem is resolved.

**No.** Go to [step 6](#).

6. Perform the procedure in "[Keyboard Problems.](#)"

Is the computer working properly?

**Yes.** The problem is resolved.

**No.** Go to [step 7](#).

7. Perform the procedure in "[Resetting a Damaged System Board.](#)"

Is the computer working properly?

**Yes.** The problem is resolved.

**No.** [Contact Dell](#) for technical assistance.

## Resetting a Damaged System Board

If the system cannot boot and you have exhausted all other troubleshooting options, perform the following steps.

 **CAUTION:** Before you perform this procedure, see "[Safety First— For You and Your Computer.](#)"

1. Turn off the computer and peripherals, disconnect them from their electrical outlets, wait at least 5 seconds, and then [remove the computer cover](#).
2. Install a jumper plug on the RTCRST jumper pins and then remove it.

See "[Jumper Settings](#)" to locate the real-time clock reset jumper (labeled "RTCRST") on the system board.

3. Replace the computer cover, reconnect the computer and peripherals to their electrical outlets, and turn them on.

Is the computer working properly?

**Yes.** The problem is resolved.

**No.** [Contact Dell](#) for technical assistance.

---

## Dell Diagnostics

### When to Use the Dell Diagnostics

If you experience a problem with your computer, run the Dell Diagnostics before you call Dell for technical assistance. The Dell Diagnostics tests check your computer's hardware without additional equipment and without the risk of destroying data. When the diagnostics tests complete without indicating any problems, you can have confidence in your computer's operation. If the tests indicate a problem you cannot solve by yourself, the test results provide important information you will need when talking to Dell's service and support personnel.

 **NOTICE:** Only use the Dell Diagnostics to test your Dell™ computer. Using this program with other computers may cause incorrect computer responses or result in error messages.

### Features

The diagnostic test groups features allow you to take the following actions:

- 1 Perform quick checks or extensive tests on one or all devices
- 1 Choose the number of times a test group or subtest is repeated
- 1 Display or print test results or save them in a file
- 1 Suspend testing if an error is detected or terminate testing when an adjustable error limit is reached
- 1 Access online Help screens that describe the tests and tell how to run them
- 1 Read status messages that inform you whether test groups or subtests completed successfully
- 1 Receive error messages that appear if problems are detected

### Before You Start Testing

- 1 Read "[Safety First—For You and Your Computer](#)" and the safety instructions in your *System Information Guide*.
- 1 Turn on your printer if one is attached, and make sure it is online.
- 1 Enter [system setup](#), confirm your computer's system configuration information, and enable all of its components and devices, such as ports.

### Running the Dell Diagnostics

 **NOTE:** Dell recommends that you print these procedures before you begin. For additional information, refer to the Dell OptiPlex User's Guide, located on the Dell ResourceCD.

1. Insert the *Dell ResourceCD* into the CD drive.

 **NOTE:** Some of the diagnostics tests allow you to print the results. If you want to print test results, turn on your printer, if one is attached, and make sure that it is online.

2. Shut down and restart the computer.
3. Enter [system setup](#).
4. Change the [Boot Sequence](#) to use the CD drive as the first device in the boot sequence.

 **NOTE:** Write down your current boot sequence in case you want to restore it after running the Dell Diagnostics.

5. Press <Alt><b> to exit system setup and save your changes.

The computer reboots and the Dell logo screen appears followed by a list of the available languages.

 **NOTE:** If you are starting the ResourceCD for the first time on this computer, the **ResourceCD Installation** window opens to inform you that the ResourceCD is about to begin installation. Click **OK** to continue. To complete the installation, respond to the prompts offered by the installation program. If the **Welcome Dell System Owner** screen opens, click **Next** to continue.

6. Select **Start computer to run Dell Diagnostics**.
7. Select the number for the language that you want.
8. A numbered list displays the following options:
  - 1 **Option 1– Dell Diagnostics** — Loads the Dell Diagnostics that run computer tests
  - 1 **Option 2– Exit** — Exits the main menu and returns to an MS-DOS prompt
9. Select **Option 1– Dell Diagnostics**.

After the diagnostics initialize, the Dell Diagnostics main menu appears:

## Dell Diagnostics Main Menu

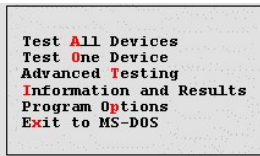



- 1 **Test All Devices:** Performs quick or extensive tests on all devices.
  - 1 **Test One Device:** Performs quick or extensive tests on a single device after you select it from a list of device groups. After you select **Test One Device**, press <F1> for more information about a test.
  - 1 **Advanced Testing:** Allows you to modify the parameters of a test, select a group of tests to perform, and access additional information about [Advanced Testing](#).
  - 1 **Information and Results:** Provides test results, test errors, version numbers of subtests, and additional information on the Dell Diagnostics.
  - 1 **Program Options:** Allows you to change the settings of the Dell Diagnostics.
  - 1 **Exit to MS-DOS:** Exits to the MS-DOS prompt.
10. Select the type of tests to perform:
- 1 To perform a quick check of your computer or a specific device, select **Quick Tests** from the **Test All Devices** or **Test One Device** option.  
**Quick Tests** runs only the tests that run fast and do not require user interaction. Dell recommends that you choose **Quick Tests** first to increase the odds of tracing the source of the problem quickly.
  - 1 For a thorough check of your computer or to check a particular area of your computer, select **Extended Tests** from the **Test All Devices** or **Test One Device** option.
  - 1 To customize your test(s), select the **Advanced Testing** option.
11. Remove the *ResourceCD* from the CD drive when you finish running the Dell Diagnostics.
12. Enter [system setup](#) and change the [Boot Sequence](#) to your original configuration.

## Advanced Testing

When you select **Advanced Testing** from the Diagnostics Menu, the following screen appears:

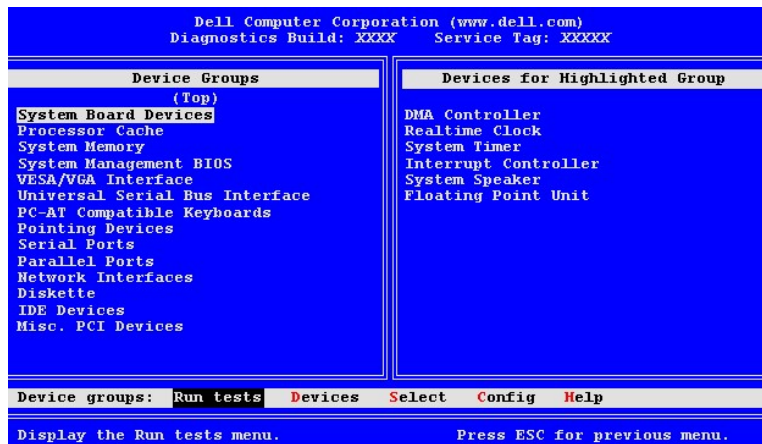
### Advanced Testing Screen



 **NOTE:** The groups and devices listed in your screen can vary somewhat based on the components installed in your computer.

Information in the **Advanced Testing** screen is presented as follows:

- 1 **Device Groups** — lists the diagnostic test groups in the order they will run if you select **All** from the **Run tests** menu option.

To select a test device group, press the up- or down-arrow key to highlight the group.

 **NOTE:** The diagnostics may not list in the **Device Groups** area the names of all components or devices that are part of your computer system. For example, it may not list a printer even though it is connected to your computer. However, the parallel port to which the printer is connected appears in the **Device Groups** list. You can test your printer connection in the **Parallel Ports** tests.

- 1 **Devices for Highlighted Group** — lists the computer's current hardware.
- 1 **Device groups menu bar** — contains the options **Run tests**, **Devices**, **Select**, **Config**, and **Help**

To select a menu option, press the left- or right-arrow key to highlight the option and press <Enter>, or press the key that corresponds to the highlighted letter in the category title.

 **NOTE:** The options displayed on your screen should reflect the hardware configuration of your computer.

## Advanced Testing Help Menu

The **Help** options and a description of their functions are presented in the following table:

Advanced Testing Help Categories	
Help Option	Description
Menu	Describes the <a href="#">Advanced Testing</a> screen, the <b>Device Groups</b> , and the diagnostic menus and commands, and gives instructions on how to use them
Keys	Explains the functions of all keystrokes that can be used in Dell Diagnostics
Device Group	Describes the highlighted group in the <b>Device Groups</b> list on the main menu and provides reasons for using certain tests
Device	Describes the highlighted device in the <b>Device Groups</b> list on the <a href="#">Advanced Testing</a> screen
Test	Describes the test procedure for each highlighted test group subtest
Versions	Lists the version numbers of the subtests

## Messages and Codes

Your application programs, operating system, and computer can identify problems and alert you to them. When a problem occurs, a message may appear on your monitor screen or a beep code may sound. The following two subsections present information about each message or beep code.

### System Messages

If you receive a system message, see the following table for suggestions on resolving problems indicated by the message. The system messages are listed alphabetically.

 **NOTE:** If the system message you received is not listed in the table, check the documentation for the application program that you were running at the time the message appeared and/or the operating system documentation for an explanation of the message and a recommended action.

System Messages		
Message	Cause	Action
Address mark not found	The basic input/output system (BIOS) found a faulty disk sector or could not find a particular disk sector.	See " <a href="#">Hard Drive Problems</a> ."
Alert! Cover was previously removed.	The computer cover was removed.	Reset <b>Chassis Intrusion</b> in <a href="#">system setup</a> .
Alert! Hard drive thermal probe not detected.	No hard-drive thermal probe is installed; computer has a defective thermal probe; thermal probe cable is not connected to the control panel.	Ensure that an operational hard-drive thermal probe is installed and connected to the control panel.
Alert! Previous attempts at booting this system have failed at checkpoint [nnnn]. For help in resolving this problem, please note this checkpoint and contact Dell Technical Support.	The system failed to complete the boot routine three consecutive times for the same error.	<a href="#">Contact Dell</a> for technical assistance, and report the checkpoint code (nnnn) to the support technician.
Alert! Previous hard drive thermal failure.	One of the hard drives overheated the last time you started the computer.	Make sure that nothing is blocking the vents on the back of the computer and that all fans inside the computer are working.
Alert! Previous shutdown due to thermal event.	Microprocessor(s) or hard drive(s) overheated the last time you started the computer. Computer was shut down to protect the components.	Make sure that nothing is blocking the vents on the back of the computer and that all fans inside the computer are working.
Alert! System battery voltage is low.	System battery is providing inadequate voltage.	See " <a href="#">Battery Problems</a> ."
Alert! System fan not detected.	No system fan is installed; system fan has failed; system fan is not connected to the system board.	Ensure that an operational system fan is installed and connected to the system board.
Alert! Uncorrectable memory error previously detected in XXXXh.	Faulty or improperly seated Rambus in-line memory modules (RIMMs) or defective system board.	See " <a href="#">System Memory Problems</a> " and " <a href="#">System Board Problems</a> ."
Alert! Unsupported AGP adapter card installed. System halted!	A high-power AGP Pro110 graphics card is installed in a desktop computer.	Replace the AGP Pro110 graphics card with an AGP Pro50 graphics card.
Attachment failed to respond	The diskette drive or hard drive controller cannot send data to the associated drive.	See " <a href="#">Diskette Drive Problems</a> " and " <a href="#">Hard Drive Problems</a> ."
Bad command or file name	The command you entered does not exist or the file name you specified is faulty.	Make sure you have spelled the command correctly, put spaces in the proper place, and used the correct pathname.
Bad error-correction code (ECC) on disk read	The diskette drive or hard drive controller detected an uncorrectable	See " <a href="#">Hard Drive Problems</a> ."

	read error.	
Controller has failed	The hard drive or the associated controller is defective.	See " <a href="#">Hard Drive Problems.</a> "
Data error	The diskette or hard drive cannot read the data.	Run the ScanDisk utility in the Microsoft Windows operating system to check the file structure of the diskette or hard drive. See your operating system documentation for more information.  If you are using another operating system, run the appropriate utility to check the file structure of the diskette or hard drive. See your operating system documentation.
Decreasing available memory	One or more RIMMs may be faulty or improperly seated.	See " <a href="#">System Memory Problems.</a> "
Diskette drive 0 seek failure Diskette drive 1 seek failure	A cable may be loose, or the system configuration information may not match the hardware configuration.	See " <a href="#">Diskette Drive Problems.</a> "
Diskette read failure	A cable may be loose, or the diskette may be faulty.	See " <a href="#">Diskette Drive Problems.</a> "
Diskette subsystem reset failed	The diskette drive controller may be faulty.	Run the <b>Diskette</b> tests in the <a href="#">Dell Diagnostics</a> .
Diskette write protected	The diskette write-protect feature is activated.	Remove the diskette from drive A and move the write-protect tab to the unlocked position.
Drive not ready	No diskette is in the drive. The operation requires a diskette in the drive before it can continue.	Put a diskette in the drive or close the drive latch.
Error! The previous boot failed to complete. Last reported checkpoint was nmmn.	The system could not complete the boot routine.	Restart the system. If the error recurs, listen for a beep code and refer to " <a href="#">System Beep Codes.</a> " If no beep code is emitted, run the <b>System Board Devices</b> tests in the <a href="#">Dell Diagnostics</a> .
Gate A20 failure	One or more RIMMs may be loose.	See " <a href="#">System Memory Problems.</a> "
General failure	The operating system is unable to carry out the command.	This message is usually followed by specific information—for example, PRINTER OUT OF PAPER. Respond by taking the appropriate action.
Hard disk configuration error	The hard drive failed initialization.	See " <a href="#">Hard Drive Problems.</a> "
Hard disk controller failure Hard disk failure Hard drive read failure	The hard drive failed initialization.	See " <a href="#">Hard Drive Problems.</a> "
Invalid configuration information - please run SETUP program	The system configuration information does not match the hardware configuration.	Enter <a href="#">system setup</a> and correct the system configuration information.
Keyboard clock line failure Keyboard controller failure Keyboard data line failure Keyboard failure Keyboard stuck key failure	A cable or connector may be loose, or the keyboard or keyboard/mouse controller may be faulty.	See " <a href="#">Keyboard Problems.</a> "
Memory address line failure at <i>address</i> , read value expecting value	One or more RIMMs may be faulty or improperly seated.	See " <a href="#">System Memory Problems.</a> "
Memory allocation error	The software you are attempting to run is conflicting with the operating system or another application program or utility.	Turn off the computer, wait 30 seconds, and turn it on. Try to run the program again. If the problem persists, contact the software company.
Memory data line failure at <i>address</i> , read value expecting value Memory double word logic failure at <i>address</i> , read value expecting value Memory odd/even logic failure at <i>address</i> , read value expecting value Memory write/read failure at <i>address</i> , read value expecting value	One or more RIMMs may be faulty or improperly seated.	See " <a href="#">System Memory Problems.</a> "
Memory size in CMOS invalid	The amount of memory recorded in the system configuration information does not match the memory installed in the computer.	Reboot the computer. If the error appears again, <a href="#">contact Dell</a> for technical assistance.
No boot device available	The computer cannot find the diskette or hard drive.	Enter <a href="#">system setup</a> , check the system configuration information for the diskette and hard drive, and if necessary, correct the information.
No boot sector on hard drive	The system configuration information in system setup may be incorrect, or the operating system may be corrupted.	Enter <a href="#">system setup</a> , check the system configuration information for the hard drive, and if necessary, correct the information.

		If the message persists, reinstall your operating system. See the documentation that came with your operating system.
No timer tick interrupt	A chip on the system board might be malfunctioning.	Run the <b>System Board Devices</b> tests in the <a href="#">Dell Diagnostics</a> .
Non-system disk or disk error	The diskette in drive A or your hard drive does not have a bootable operating system installed.	A nonbootable diskette is in drive A. Either replace the diskette with one that has a bootable operating system, or remove the diskette from drive A and restart the computer.
Not a boot diskette	There is no operating system on the diskette.	Boot the computer with a diskette that contains an operating system.
Please connect USB Keyboard/Mouse to USB port 1 on the back of the computer.	The USB keyboard and/or mouse must be connected to the port 1 USB connectors.	Turn your system off, connect the USB keyboard and/or mouse to one of the <b>Port 1 USB connectors</b> , and restart your system. See " <a href="#">Back-Panel Connectors and Indicators</a> ."
Plug and Play Configuration Error	The system has encountered a problem in trying to configure one or more expansion cards.	Turn your system off and unplug it. Remove all but one of the cards. Plug in your system and reboot it. If the message persists, the expansion card may be malfunctioning. If the message does not appear, turn off the power and reinsert one of the other cards. Repeat this process until you identify the malfunctioning card.
Read fault Requested sector not found	The operating system cannot read from the diskette or hard drive.  The system could not find a particular sector on the disk, or the requested sector is defective.	See " <a href="#">Diskette Drive Problems</a> " and " <a href="#">Hard Drive Problems</a> ."
Reset failed	The disk reset operation failed.	See " <a href="#">Diskette Drive Problems</a> " and " <a href="#">Hard Drive Problems</a> ."
Sector not found	The operating system is unable to locate a sector on the diskette or hard drive.	See " <a href="#">Diskette Drive Problems</a> " and " <a href="#">Hard Drive Problems</a> ."
Seek error	The operating system is unable to find a specific track on the diskette or hard drive.	If the error is on the diskette drive, try another diskette in the drive.
Shutdown failure	A chip on the system board might be malfunctioning.	Run the <b>System Board Devices</b> tests in the <a href="#">Dell Diagnostics</a> .
Time-of-day clock stopped	The battery may be dead.	Enter <a href="#">system setup</a> and correct the date or time.  If the problem persists, see " <a href="#">Battery Problems</a> ."
Time-of-day not set	The time or date displayed in the system configuration information does not match the system clock.	Enter <a href="#">system setup</a> and correct the date or time.
Timer chip counter 2 failed	A chip on the system board might be malfunctioning.	Run the <b>System Board Devices</b> tests in the <a href="#">Dell Diagnostics</a> .
Unexpected interrupt in protected mode	The keyboard controller may be malfunctioning, or one or more RIMMs may be loose.	Run the <b>System Memory</b> and the <b>Keyboard</b> tests in the <a href="#">Dell Diagnostics</a> .
WARNING: Dell's Disk Monitoring System has detected that drive [0/1] on the [primary/secondary] EIDE controller is operating outside of normal specifications. It is advisable to immediately back up your data and replace your hard drive by calling your support desk or Dell Computer Corporation.	POST has queried the EIDE drive for status information. The drive has returned a parameter from the call that indicates it has detected possible error conditions for its operating specifications.	When your computer finishes booting, immediately back up your data and replace your hard drive. Restore the data to the replaced drive.  Back up the data on your hard drive. If a replacement drive is not immediately available and the drive is not the only bootable drive, enter <a href="#">system setup</a> and change the appropriate drive setting to <b>None</b> . Remove the drive from the system.
Write fault Write fault on selected drive	The operating system cannot write to the diskette or hard drive.	See " <a href="#">Diskette Drive Problems</a> " and " <a href="#">Hard Drive Problems</a> ."

## System Beep Codes

When errors occur during a boot routine that cannot be reported on the monitor, your computer may emit a beep code that identifies the problem. The beep code is a pattern of sounds: for example, one beep, followed by a second beep, and then a burst of three beeps (code 1-1-3) means that the computer was unable to read the data in nonvolatile random-access memory (NVRAM). This information is invaluable to the Dell support staff if you need to call for technical assistance.

When a beep code is emitted, write it down on a copy of the [Diagnostics Checklist](#), and look it up in the following table. If you are unable to resolve the problem by looking up the meaning of the beep code, use the [Dell Diagnostics](#) to identify a more serious cause. If you are still unable to resolve the problem, [contact Dell](#) for technical assistance.

If the system loses power and beeps constantly when you turn it back on, the BIOS is probably corrupted. See "[BIOS Recovery Utility](#)" for information on restoring the BIOS.

System Beep Codes		
Code	Cause	Action
1-1-2	Microprocessor register failure	<a href="#">Contact Dell</a> for technical assistance.
1-1-3	NVRAM	Run the <b>System Board Devices</b> tests in the <a href="#">Dell Diagnostics</a> .
1-1-4	ROM BIOS checksum failure	Run the <b>System Board Devices</b> tests in the <a href="#">Dell Diagnostics</a> , if possible.



1-2-1	Programmable interval timer	Run the <b>System Board Devices</b> tests in the <a href="#">Dell Diagnostics</a> , if possible.
1-2-2	Direct memory access (DMA) initialization failure	Run the <b>System Board Devices</b> tests in the <a href="#">Dell Diagnostics</a> , if possible.
1-2-3	DMA page register read/write failure	Run the <b>System Board Devices</b> tests in the <a href="#">Dell Diagnostics</a> , if possible.
1-3	Video Memory Test failure	Run the <b>VESA/VGA Interface</b> tests in the <a href="#">Dell Diagnostics</a> .
1-3-1 through 2-4-4	RIMMs not being properly identified or used	See " <a href="#">System Memory Problems</a> ."
3-1-1	Slave DMA register failure	Run the <b>System Board Devices</b> tests in the <a href="#">Dell Diagnostics</a> , if possible.
3-1-2	Master DMA register failure	Run the <b>System Board Devices</b> tests in the <a href="#">Dell Diagnostics</a> , if possible.
3-1-3	Master interrupt mask register failure	<a href="#">Contact Dell</a> for technical assistance.
3-1-4	Slave interrupt mask register failure	<a href="#">Contact Dell</a> for technical assistance.
3-2-2	Interrupt vector loading failure	<a href="#">Contact Dell</a> for technical assistance.
3-2-4	Keyboard Controller Test failure	Run the <b>Keyboard</b> tests in the <a href="#">Dell Diagnostics</a> . Otherwise, <a href="#">contact Dell</a> for technical assistance.
3-3-1	NVRAM power loss	Run the <b>System Board Devices</b> tests in the <a href="#">Dell Diagnostics</a> , if possible.
3-3-2	NVRAM configuration	Run the <b>System Board Devices</b> tests in the <a href="#">Dell Diagnostics</a> , if possible.
3-3-4	Video Memory Test failure	Run the <b>VESA/VGA Interface</b> tests in the <a href="#">Dell Diagnostics</a> .
3-4-1	Screen initialization failure	Run the <b>VESA/VGA Interface</b> tests in the <a href="#">Dell Diagnostics</a> .
3-4-2	Screen retrace failure	Run the <b>VESA/VGA Interface</b> tests in the <a href="#">Dell Diagnostics</a> .
3-4-3	Search for video ROM failure	Run the <b>VESA/VGA Interface</b> tests in the <a href="#">Dell Diagnostics</a> .
4-2-1	No timer tick	<a href="#">Contact Dell</a> for technical assistance.
4-2-2	Shutdown failure	<a href="#">Contact Dell</a> for technical assistance.
4-2-3	Gate A20 failure	<a href="#">Contact Dell</a> for technical assistance.
4-2-4	Unexpected interrupt in protected mode	<a href="#">Contact Dell</a> for technical assistance.
4-3-1	Memory failure above address 0FFFFh	Run the <b>System Memory</b> tests in the <a href="#">Dell Diagnostics</a> .
4-3-3	Timer-chip counter 2 failure	<a href="#">Contact Dell</a> for technical assistance.
4-3-4	Time-of-day clock stopped	<a href="#">Contact Dell</a> for technical assistance.
4-4-1	Serial or parallel port test failure	Run the <b>Serial Ports</b> and the <b>Parallel Ports</b> tests in the <a href="#">Dell Diagnostics</a> .
4-4-2	Failure to decompress code to shadowed memory	Run the <b>System Board Devices</b> tests in the <a href="#">Dell Diagnostics</a> .
5-2-2-1	Mismatch Rambus dynamic random-access memory (RDRAM) device count; unsupported RIMM device count or technology	Verify that both RIMM sockets contain a RIMM or Rambus continuity module (RCM). If the problem recurs, replace the RIMM in socket B (if any), then the RIMM in socket A. If the problem is still not resolved, <a href="#">contact Dell</a> for technical assistance.
5-2-2-2	Mismatch channel pair	See " <a href="#">System Memory Problems</a> ."
5-2-2-3	RDRAM levelization failure	Verify that both RIMM sockets contain a RIMM or RCM. If the problem recurs, replace the RIMM in socket B (if any), then the RIMM in socket A. If the problem is still not resolved, <a href="#">contact Dell</a> for technical assistance.

## Warning Messages

Your application programs or operating system generate warning messages to alert you to a possible problem and ask you to take an action before you continue. For example, before you format a diskette, a message may warn you that you can lose all data on the diskette as a way to protect against inadvertently erasing or writing over the data. These warning messages usually interrupt the procedure and require you to respond by typing a y (yes) or n (no).

## Diagnostics Messages

When you run a test group or subtest in the [Dell Diagnostics](#), an error message may result. These error messages are not covered in this section. Record the message on a copy of your [Diagnostics Checklist](#) and [contact Dell](#) for technical assistance.

## Diagnostic Indicators

Indicators are located on the [front panel](#) and [back panel](#) of the chassis. These indicators communicate diagnostic codes that can help you solve problems with your system.

 **CAUTION:** Before servicing any components inside your computer, see "[Safety First—For You and Your Computer](#)."

### Front-Panel Indicators

The following table lists the codes for the front panel diagnostic indicators, gives probable causes, and suggests corrective actions.

Front-Panel Diagnostic Indicator Codes			
Power Indicator Code	Hard Drive Indicator Code	Cause	Action
Solid green	N/A	Power is on, and the computer is operating normally.	No corrective action is required.
Blinking green	Blank	The computer is in the suspended state (Windows 2000 only).	Push and release the power button, move the mouse, or press a key on the keyboard to bring the computer out of the suspended state.

Solid yellow	N/A	The <a href="#">Dell Diagnostics</a> is running a test, or a device on the system board may be faulty or incorrectly installed.	If the <a href="#">Dell Diagnostics</a> is running, allow the testing to complete. Otherwise, see " <a href="#">System Board Problems.</a> " If the system does not boot, <a href="#">contact Dell</a> for technical assistance.
Blinking yellow	Blank	There is a system power supply failure.	<a href="#">Contact Dell</a> for technical assistance.
Blinking yellow	Solid green	Voltage regulator failure on the system board.	<a href="#">Contact Dell</a> for technical assistance.
Solid green and a beep code during POST	N/A	A problem was detected while the BIOS was executing.	See " <a href="#">System Beep Codes</a> " for instructions on diagnosing the beep code.
Solid green power indicator and no beep code and no video during POST	N/A	The monitor or the graphics card may be faulty or incorrectly installed.	See " <a href="#">Video Problems.</a> "
Solid green power indicator and no beep code but the system locks up during POST	N/A	An integrated system board device may be faulty.	<a href="#">Contact Dell</a> for technical assistance.

## Back-Panel Indicators





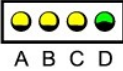
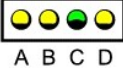
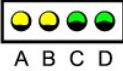
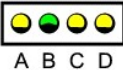
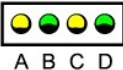
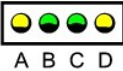

When you turn on your system, it performs a POST, which is a series of self-diagnostic checks. A successful POST ends with a single beep that signifies the start of normal operation. If the system fails to emit the single beep or appears to stop responding during POST, a series of indicators located at the rear of the computer can help you understand which POST test failed or why the system stopped responding. These indicators communicate problems encountered during POST only, not during normal operation.

**CAUTION:** Before servicing any components inside your computer, see "[Safety First—For You and Your Computer.](#)"

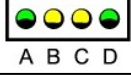
The indicator patterns described in the following table can help you determine what to do to resolve the problem. If a problem resolution requires you to remove the computer cover, refer to "[Installing Upgrades](#)" for procedures you must complete before performing the suggested resolution. If the problem persists after you perform the suggested resolution, [contact Dell](#) for technical assistance.

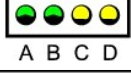
The following table lists the codes for the back panel diagnostic indicators, gives probable causes, and suggests corrective actions. The indicator patterns are shown as they appear on the back of your computer. The indicators are labeled to help you match the pattern on your computer with one of the patterns shown in the table.

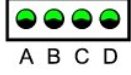
Back-Panel Diagnostic Indicator Codes		
Indicator Pattern	Cause	Action
	Normal off condition or start up default	Ensure that the <a href="#">front-panel power indicator</a> is on. If the power indicator is off, ensure that the computer is connected to a working electrical outlet.  If the problem is still not resolved, <a href="#">contact Dell</a> for technical assistance.
	Possible BIOS failure, and the system is in the recovery mode	Run the <a href="#">BIOS Recovery Utility</a> , and restart the system to retest.  If the problem is still not resolved, perform the procedure in " <a href="#">Resetting a Damaged System Board.</a> "
	Possible microprocessor failure	Reseat the microprocessor and restart the system to retest. For instructions on removing and replacing the microprocessor, see " <a href="#">Upgrading the Microprocessor.</a> "  If the problem is still not resolved, <a href="#">contact Dell</a> for technical assistance.
	Possible memory failure	Perform the procedure in " <a href="#">System Memory Problems.</a> "
	Possible expansion card failure or conflict	Perform the procedure in " <a href="#">Expansion-Card Problems</a> " and see " <a href="#">Hardware Conflicts.</a> "
	Possible video card failure	Reseat the video card, and restart the system to retest. For instructions on removing and replacing an expansion card, see " <a href="#">Removing an Expansion Card.</a> "  If the problem is still not resolved, <a href="#">contact Dell</a> for technical assistance.
	Possible diskette drive or hard drive failure	Perform the procedures in " <a href="#">Diskette Drive Problems</a> " and " <a href="#">Hard Drive Problems.</a> "
	Possible USB failure	Disconnect all USB devices and cables, and restart the system to retest. Then reconnect all USB devices and cables, and restart the system to retest.

		If the problem is still not resolved, <a href="#">contact Dell</a> for technical assistance.
	Possible system board resource and/or hardware failure	Perform the procedure in " <a href="#">System Board Problems</a> " and see " <a href="#">Hardware Conflicts</a> ."
	Possible system board resource and/or hardware failure	Perform the procedure in " <a href="#">System Board Problems</a> " and see " <a href="#">Hardware Conflicts</a> ."
	Possible expansion card failure or conflict	Perform the procedure in " <a href="#">Expansion-Card Problems</a> " and see " <a href="#">Hardware Conflicts</a> ."
	Possible system board resource and/or hardware failure	Perform the procedure in " <a href="#">System Board Problems</a> " and see " <a href="#">Hardware Conflicts</a> ."
	Normal operating condition after POST	No action is necessary.
 <p>● = yellow ● = green ○ = off</p>		

## SNMP Platform Event Traps

Your system generates simple network management protocol (SNMP) platform event trap (PET) messages that are sent to network management software to inform the network manager that specific events have occurred on your system.

The following table lists the SNMP platform event traps your system generates.

SNMP Platform Event Traps	
Description	Code
BIOS boot failure	02 03 23 6f 00
Chassis intrusion	02 03 05 6f 00
Temperature failure	02 03 01 06 01
Invalid password	02 03 06 6f 01
Voltage failure	02 03 02 06 01
SOS enable / PC presence	02 03 25 6f 00

## Software Problems

This section provides general guidelines for analyzing software problems. For detailed troubleshooting information on a particular program, see the documentation that accompanied the software or consult the support service for the software.

If your system is behaving erratically, back up your files immediately. If your system has a tape drive installed, see the documentation that came with the tape backup software for instructions on performing a backup operation. Otherwise, see your operating system documentation for information on backing up data files.

### Basic Checks:

- 1 Ensure that the application program is compatible with the operating system installed in your computer and that your computer meets the minimum hardware requirements needed to run the software.
- 1 Ensure that you properly installed and configured the application program. Reinstall the program if necessary.

Consult the software documentation or contact the software manufacturer for detailed troubleshooting information on a particular application program.

- 1 Ensure that you have not made an error while entering data.

- 1 Make sure that problems are not caused by a virus — use a virus-scanning application program to check the software installation diskettes or CDs before using them.
- 1 After you have checked the software installation diskettes or CDs with a virus-scanning application program, you should disable the virus-scanning application program before installing the software. You should also disable any other application programs that are "hidden," or operate in the background.
- 1 Verify that the program's device drivers do not conflict with certain application programs.
- 1 Confirm that a problem is software-related by running the **System Board Devices** tests in the [Dell Diagnostics](#). If all tests run successfully, the error condition may be related to a software problem.
- 1 Ensure that the use of terminate-and-stay-resident (TSR) programs has not resulted in a memory conflict.
- 1 Remove or confirm the possibility of a program conflict by rebooting your computer system.
- 1 Make sure that a [hardware conflict](#) does not exist between devices.

## Operating System Compatibility

Make sure the computer's operating environment is set up to accommodate the application programs you use. Whenever you change the operating environment parameters, you may also affect the successful operation of the application programs. Sometimes, after modifying the operating environment, you may need to reinstall a program that no longer runs properly.

## Input Errors

If a specific key or set of keys is pressed at the wrong time, a program may give you unexpected results. See the documentation that came with your application program to make sure the values or characters you are entering are valid.

## Error Messages

Error messages are produced by the operating system, an application program, or the computer. "[Messages and Codes](#)" discusses error messages that are generated by the operating system. If you receive an error message that is not listed in "[Messages and Codes](#)," check your computer or application program documentation.

## Device Drivers

Programs that use specialized subroutines called *device drivers* can also cause problems with your system. For example, a variation in the way the data is sent to the monitor may require a special screen driver program that expects a certain kind of video mode or monitor. In such cases, you may have to develop an alternative method of running that particular program—the creation of a boot file made especially for that program, for example. Call the support service for the software you are using to help you with this problem.

## Memory-Resident Programs

Many utilities and supplementary programs load either when the computer boots or from an operating system prompt. These programs are designed to stay resident in system memory and thus always be available for use. Because they remain in the computer's memory, memory conflicts and errors can result when other programs require use of all or part of the memory already occupied by these TSR programs.

Typically, your operating system's start-up files (such as **config.sys** and **autoexec.bat**) contain commands to start TSR programs when you boot your system. If you suspect that one of these TSR programs is causing a memory conflict, remove the commands that start them from the start-up file. If the problem you were experiencing does not recur, one of the TSR programs probably created the conflict. Add the TSR commands back into the start-up files one at a time until you identify which TSR program is creating the conflict.

## Program Conflicts

Some programs may leave portions of their setup information behind, even though you have exited from them. As a result, other programs cannot run. Rebooting your system can confirm whether these programs are causing the problem.

## Memory Address Conflicts

Memory address conflicts occur when two or more devices try to access the same address in the upper memory blocks (UMB). For example, if a network expansion card and an expanded-memory page frame are assigned an overlapping block of addresses, a memory address conflict arises. As a result, when you try to log in to the network, the operation fails.

To resolve this type of conflict, you can change the address of one of the devices. For example, in the case of the network expansion card and expanded-memory page-frame address conflict, you can move the network card to an address block in the range of C000h through D000h. To reassign the expansion card's address block, refer to the documentation for the card.

## Interrupt Assignment Conflicts

Problems can arise if two devices attempt to use the same interrupt request (IRQ) line. To avoid this type of conflict, check the documentation for the default IRQ-line setting for each installed expansion card. Then consult the following table to configure the card for one of the available IRQ lines.

 **NOTE:** The following table lists *default* IRQ settings. In systems with Plug and Play capabilities, you can modify the defaults. If you install a Plug and Play card in a Plug and Play computer, the computer automatically selects an open IRQ line if any are available. If you install a non-Plug and Play card, you may need to run the ISA Configuration Utility to determine the current IRQ settings and to find an available IRQ line.

Default IRQ Line Assignments	
IRQ Line	Used/Available
IRQ0	Used by the system timer
IRQ1	Used by the keyboard to signal that the output buffer is full

IRQ2	Used by interrupt controller 1 to enable IRQ8 through IRQ15
IRQ3	Used by serial port 2
IRQ4	Used by serial port 1
IRQ5	Available
IRQ6	Used by the diskette/tape drive controller
IRQ7	Used by the parallel port
IRQ8	Used by the real-time clock (RTC)
IRQ9	Used by the advanced configuration and power interface (ACPI)
IRQ10	Available
IRQ11	Used by the USB controllers
IRQ12	Used by the mouse port
IRQ13	Used by the math coprocessor (if applicable)
IRQ14	Used by the primary IDE controller
IRQ15	Used by the secondary IDE controller

## BIOS Recovery Utility

If your system loses power and beeps constantly but does not boot when power is restored, the basic input/output system (BIOS) is probably corrupted. To restore the BIOS, perform the following steps:

1. Disconnect the system from its power source.
2. Go to another working system, and download the BIOS flash executable utility for the system from the **File Library** located on the Dell support website at <http://support.dell.com>.
3. On the working system, go to an MS-DOS prompt and type the command `xxxxxx -writehdrfile` (where `xxxxxx` is the name of the BIOS flash executable utility you downloaded).

Running this utility generates a file with an **.hdr** extension.

4. Copy the **.hdr** file to a diskette.
5. Insert the diskette into the diskette drive of the corrupted system and turn it on.

The system automatically flashes the BIOS from the diskette.

6. When the system begins to restart and the Dell logo screen appears, remove the diskette from the diskette drive so that the system does not boot from the diskette again.

---

[Back to Contents Page](#)

[Back to Contents Page](#)

## Getting Help

### Dell™ OptiPlex™ GX400 System User's Guide

- [Help Overview](#)
  - [Dell Contact Numbers](#)
- 

## Help Overview

This section describes the tools Dell provides to help you when you have a problem with your computer. It also tells you when and how to contact Dell for technical or customer assistance.

### Technical Assistance

If you need assistance with a technical problem, perform the following steps:

1. Complete the procedures in "[Solving Problems](#)."
2. Run the [Dell Diagnostics](#).
3. Make a copy of the [Diagnostics Checklist](#), and fill it out.
4. Use Dell's extensive suite of online services available at Dell's website (<http://www.dell.com>) for help with installation and troubleshooting procedures.

For more information, see "[World Wide Web](#)."

5. If the preceding steps have not resolved the problem, call Dell for technical assistance.

When prompted by Dell's automated telephone system, enter your *Express Service Code* to route the call directly to the proper support personnel. If you do not have an Express Service Code, open the **Dell Accessories** folder, double-click the **Express Service Code** icon, and follow the directions.

 **NOTE:** Dell's *Express Service Code* system may not be available in all countries.

For instructions on using the technical support service, see "[Technical Support Service](#)" and "[Before You Call](#)."

## Help Tools

Dell provides a number of tools to assist you. These tools are described in the following sections.

 **NOTE:** Some of the following tools are not always available in all locations outside the continental U.S. Please call your local Dell representative for information on availability.

### World Wide Web

The Internet is your most powerful tool for obtaining information about your computer and other Dell products. Through the Internet, you can access most of the services described in this section, including AutoTech, TechFax, order status, technical support, and product information.

You can access Dell's support Web site at <http://support.dell.com>. To select your country, click the map that appears. The **Welcome to support.dell.com** page opens. Enter your system information to access help tools and information.

Dell can be accessed electronically using the following addresses:

- 1 World Wide Web

<http://www.dell.com/>

<http://www.dell.com/ap/> (for Asian/Pacific countries only)

<http://www.euro.dell.com> (for Europe only)

<http://www.dell.com/la> (for Latin American countries)

- 1 Anonymous file transfer protocol (FTP)

<ftp.dell.com/>

Log in as user: anonymous, and use your e-mail address as your password.

- 1 Electronic Support Service

[support@us.dell.com](mailto:support@us.dell.com)

[apsupport@dell.com](mailto:apsupport@dell.com) (for Asian/Pacific countries only)

[support.euro.dell.com](mailto:support.euro.dell.com) (for Europe only)

- 1 Electronic Quote Service

[sales@dell.com](mailto:sales@dell.com)

[apmarketing@dell.com](mailto:apmarketing@dell.com) (for Asian/Pacific countries only)

- 1 Electronic Information Service

[info@dell.com](mailto:info@dell.com)

## AutoTech Service

Dell's automated technical support service—AutoTech—provides recorded answers to the questions most frequently asked by Dell customers about their portable and desktop computer systems.

When you call AutoTech, you use your touch-tone telephone to select the subjects that correspond to your questions.

The AutoTech service is available 24 hours a day, seven days a week. You can also access this service through the technical support service. For the telephone number to call, see "[Dell Contact Numbers](#)."

## TechFax Service

Dell takes full advantage of fax technology to serve you better. Twenty-four hours a day, seven days a week, you can call the Dell TechFax line toll-free for all kinds of technical information.

Using a touch-tone phone, you can select from a full directory of topics. The technical information you request is sent within minutes to the fax number you designate. For the TechFax telephone number to call, see "[Dell Contact Numbers](#)."

## Automated Order-Status System

You can call this automated service to check on the status of any Dell products that you have ordered. A recording prompts you for the information needed to locate and report on your order. For the telephone number to call, see "[Dell Contact Numbers](#)."

## Technical Support Service

Dell's industry-leading hardware technical-support service is available 24 hours a day, seven days a week, to answer your questions about Dell hardware.

Our technical support staff pride themselves on their track record: more than 90 percent of all problems and questions are taken care of in just one toll-free call, usually in less than 10 minutes. When you call, our experts can refer to records kept on your Dell system to better understand your particular question. Our technical support staff use computer-based diagnostics to provide fast, accurate answers to questions.

To contact Dell's technical support service, see "[Before You Call](#)" and then call the number for your country as listed in "[Dell Contact Numbers](#)."

## Problems With Your Order

If you have a problem with your order, such as missing parts, wrong parts, or incorrect billing, contact Dell for customer assistance. Have your invoice or packing slip handy when you call. For the telephone number to call, see "[Dell Contact Numbers](#)."

## Product Information

If you need information about additional products available from Dell, or if you would like to place an order, visit Dell's website at <http://www.dell.com/>. For the telephone number to call to speak to a sales specialist, see "[Dell Contact Numbers](#)."

## Returning Items for Warranty Repair or Credit

Prepare all items being returned, whether for repair or credit, as follows:

1. Call Dell to obtain an authorization number, and write it clearly and prominently on the outside of the box.  
For the telephone number to call, see "[Dell Contact Numbers](#)."
2. Include a copy of the invoice and a letter describing the reason for the return.
3. Include a copy of the [Diagnostics Checklist](#) indicating the tests you have run and any error messages reported by the [Dell Diagnostics](#).
4. Include any accessories that belong with the item(s) being returned (such as power cables, software diskettes, and guides) if the return is for credit.
5. Pack the equipment to be returned in the original (or equivalent) packing materials.

You are responsible for paying shipping expenses. You are also responsible for insuring any product returned, and you assume the risk of loss during shipment to Dell. Collect-on-delivery (C.O.D.) packages are not accepted.

Returns that are missing any of the preceding requirements will be refused at our receiving dock and returned to you.

## Before You Call

 **NOTE:** Have your Express Service Code ready when you call. The code helps Dell's automated-support telephone system direct your call more efficiently.

Remember to fill out the [Diagnostics Checklist](#). If possible, turn on your system before you call Dell for technical assistance and call from a telephone at or near the computer. You may be asked to type some commands at the keyboard, relay detailed information during operations, or try other troubleshooting steps possible only at the computer system itself. Make sure that the system documentation is available.

 **CAUTION:** Before servicing any components inside your computer, see "[Safety First—For You and Your Computer](#)."

<b>Diagnostics Checklist</b>	
Name: _____	Date: _____
Address: _____	Phone number: _____
Service tag (bar code on the back of the computer): _____	
Express Service Code: _____	
Return Material Authorization Number (if provided by Dell support technician): _____	
Operating system and version: _____	
Peripherals: _____	
_____	
_____	
Expansion cards: _____	
_____	
_____	
Are you connected to a network?    yes <input type="checkbox"/> no <input type="checkbox"/>	
Network, version, and network card: _____	
Programs and versions: _____	
_____	
_____	
See your operating system documentation to determine the contents of the system's startup files. Print each file if possible. Otherwise, record the contents of each file before calling Dell.	
Error message, beep code, or diagnostic code: _____	
Description of problem and troubleshooting procedures you performed: _____	
_____	
_____	
_____	

## Dell Contact Numbers

The following table provides country-specific access codes and telephone numbers, websites, and e-mail addresses that you can use to contact Dell.

The codes required depend on where you are calling from as well as the destination of your call; in addition, each country has a different dialing protocol. If you need assistance in determining which codes to use, contact a local or an international operator.

 **NOTE:** Toll-free numbers are for use only within the country for which they are listed. Area codes are most often used to call long distance within your own country (not internationally)—in other words, when your call originates in the same country you are calling.

Country (City) International Access Code Country Code City Code	Department Name or Service Area, Website and E-mail Address	Area Codes, Local Numbers, and Toll Free Numbers
<b>Antigua and Barbuda</b>	General Support	1-800-805-5924
<b>Australia (Sydney)</b>  International Access Code: <b>0011</b>  Country Code: <b>61</b>  City Code: <b>2</b>	Home and Small Business	1-300-65-55-33
	Government and Business	toll free: 1-800-633-559
	Preferred Accounts Division (PAD)	toll free: 1-800-060-889
	Customer Care	toll free: 1-800-819-339
	Corporate Sales	toll free: 1-800-808-385
	Transaction Sales	toll free: 1-800-808-312
	Fax	toll free: 1-800-818-341
<b>Austria (Vienna)</b>  International Access Code: <b>900</b>  Country Code: <b>43</b>  City Code: <b>1</b>	Home/Small Business Sales	01 795 67602
	Home/Small Business Fax	01 795 67605
	Home/Small Business Customer Care	01 795 67603
	Preferred Accounts/Corporate Customer Care	0660 8056
	Home/Small Business Technical Support	01 795 67604
	Preferred Accounts/Corporate Technical Support	0660 8779



	Switchboard	01 491 04 0
	Website: <a href="http://support.euro.dell.com">http://support.euro.dell.com</a>	
	E-mail: tech_support_central_europe@dell.com	
<b>Barbados</b>	General Support	1-800-534-3066
<b>Belgium (Brussels)</b>	Technical Support	02 481 92 88
International Access Code: 00	Customer Care	02 481 91 19
Country Code: 32	Home/Small Business Sales	toll free: 0800 16884
City Code: 2	Corporate Sales	02 481 91 00
	Fax	02 481 92 99
	Switchboard	02 481 91 00
	Website: <a href="http://support.euro.dell.com">http://support.euro.dell.com</a>	
	E-mail: tech_be@dell.com	
	E-mail for French Speaking Customers: <a href="http://support.euro.dell.com/be/fr/emaildell/">http://support.euro.dell.com/be/fr/emaildell/</a>	
<b>Bermuda</b>	General Support	1-800-342-0671
<b>Brazil</b>	Customer Support, Technical Support	0800 90 3355
International Access Code: 0021	Tech Support Fax	55 51 481 5470
Country Code: 55	Sales	0800 90 3366
City Code: 51	Website: <a href="http://www.dell.com/br">http://www.dell.com/br</a>	
<b>Brunei</b>	Customer Technical Support (Penang, Malaysia)	604 633 4966
Country Code: 673	Customer Service (Penang, Malaysia)	604 633 4949
	Transaction Sales (Penang, Malaysia)	604 633 4955
<b>Canada (North York, Ontario)</b>	Automated Order-Status System	toll free: 1-800-433-9014
International Access Code: 011	AutoTech (Automated technical support)	toll free: 1-800-247-9362
	Customer Care (From outside Toronto)	toll free: 1-800-387-5759
	Customer Care (From within Toronto)	416 758-2400
	Customer Technical Support	toll free: 1-800-847-4096
	Sales (Direct Sales—from outside Toronto)	toll free: 1-800-387-5752
	Sales (Direct Sales—from within Toronto)	416 758-2200
	Sales (Federal government, education, and medical)	toll free: 1-800-567-7542
	Sales (Major Accounts)	toll free: 1-800-387-5755
	TechFax	toll free: 1-800-950-1329
<b>Cayman Islands</b>	General Support	1-800-805-7541
<b>Chile (Santiago)</b>	Sales, Customer Support, and Technical Support	toll free: 1230-020-4823
Country Code: 56		
City Code: 2		
<b>China (Xiamen)</b>	Home and Small Business Technical Support	toll free: 800 858 2437
Country Code: 86	Corporate Accounts Technical Support	toll free: 800 858 2333
City Code: 592	Customer Experience	toll free: 800 858 2060
	Home and Small Business	toll free: 800 858 2222
	Preferred Accounts Division	toll free: 800 858 2062
	Large Corporate Accounts North	toll free: 800 858 2999
	Large Corporate Accounts East	toll free: 800 858 2020
	Large Corporate Accounts South	toll free: 800 858 2355
	Large Corporate Accounts GCP	toll free: 800 858 2055
	Large Corporate Accounts HK	toll free: 800 964108
	Large Corporate Accounts GCP HK	toll free: 800 907308
<b>Colombia</b>	General Support	980-9-15-3978
<b>Costa Rica</b>	General Support	0800-012-0435
<b>Czech Republic (Prague)</b>	Technical Support	02 22 83 27 27
International Access Code: 00	Customer Care	02 22 83 27 11
Country Code: 420	Fax	02 22 83 27 14
City Code: 2	TechFax	02 22 83 27 28
	Switchboard	02 22 83 27 11
	Website: <a href="http://support.euro.dell.com">http://support.euro.dell.com</a>	
	E-mail: czech_dell@dell.com	
<b>Denmark (Horsholm)</b>	Technical Support	45170182

International Access Code: <b>00</b> Country Code: <b>45</b>	Relational Customer Care	45170184
	Home/Small Business Customer Care	32875505
	Switchboard	45170100
	Fax Technical Support (Upplands Vasby, Sweden)	46 0 859005594
	Fax Switchboard	45170117
	Website: <a href="http://support.euro.dell.com">http://support.euro.dell.com</a>	
	E-mail: den_support@dell.com E-mail Support for Servers: Nordic_server_support@dell.com	
<b>Dominican Republic</b>	General Support	1-800-148-0530
El Salvador	General Support	01-899-753-0777
<b>Finland (Helsinki)</b> International Access Code: <b>990</b> Country Code: <b>358</b> City Code: <b>9</b>	Technical Support	09 253 313 60
	Technical Support Fax	09 253 313 81
	Relational Customer Care	09 253 313 38
	Home/Small Business Customer Care	09 693 791 94
	Fax	09 253 313 99
	Switchboard	09 253 313 00
	Website: <a href="http://support.euro.dell.com">http://support.euro.dell.com</a> E-mail: fin_support@dell.com	
<b>France (Paris/Montpellier)</b> International Access Code: <b>00</b> Country Code: <b>33</b> City Code: <b>(1) (4)</b>	<b>Home and Small Business</b>	
	Technical Support	0825 387 270
	Customer Care	0825 823 833
	Switchboard	0825 004 700
	Switchboard (Alternative)	04 99 75 40 00
	Sales	0825 004 700
	Fax	0825 004 701
	Fax (Alternative)	04 99 75 40 01
	Website: <a href="http://support.euro.dell.com">http://support.euro.dell.com</a> E-mail: <a href="http://support.euro.dell.com/fr/fr/emaildell/">http://support.euro.dell.com/fr/fr/emaildell/</a>	
	<b>Corporate</b>	
	Technical Support	0825 004 719
	Customer Care	0825 338 339
	Switchboard	01 55 94 71 00
	Sales	01 55 94 71 00
	Fax	01 55 94 71 01
	Website: <a href="http://support.euro.dell.com">http://support.euro.dell.com</a> E-mail: <a href="http://support.euro.dell.com/fr/fr/emaildell/">http://support.euro.dell.com/fr/fr/emaildell/</a>	
	<b>Germany (Langen)</b> International Access Code: <b>00</b> Country Code: <b>49</b> City Code: <b>6103</b>	Technical Support
Home/Small Business Customer Care		0180-5-224400
Global Segment Customer Care		06103 766-9570
Preferred Accounts Customer Care		06103 766-9420
Large Accounts Customer Care		06103 766-9560
Public Accounts Customer Care		06103 766-9555
Switchboard		06103 766-7000
Website: <a href="http://support.euro.dell.com">http://support.euro.dell.com</a> E-mail: tech_support_central_europe@dell.com		
<b>Guatemala</b>		General Support
<b>Hong Kong</b> International Access Code: <b>001</b> Country Code: <b>852</b>	Technical Support	toll free: 800 96 4107
	Customer Service (Penang, Malaysia)	604 633 4949
	Transaction Sales	toll free: 800 96 4109
	Corporate Sales	toll free: 800 96 4108
<b>Ireland (Cherrywood)</b> International Access Code: <b>16</b> Country Code: <b>353</b> City Code: <b>1</b>	Technical Support	1850 543 543
	Home User Customer Care	01 204 4095
	Small Business Customer Care	01 204 4026
	Corporate Customer Care	01 279 5011
	Sales	01 204 4444
	SalesFax	01 204 0144
	Fax	204 5960
	Switchboard	01 204 4444

	Website: <a href="http://support.euro.dell.com">http://support.euro.dell.com</a>	
	E-mail: dell_direct_support@dell.com	
<b>Italy (Milan)</b>	<b>Home and Small Business</b>	
International Access Code: <b>00</b>	Technical Support	02 577 826 90
Country Code: <b>39</b>	Customer Care	02 696 821 14
City Code: <b>02</b>	Fax	02 696 821 13
	Switchboard	02 696 821 12
	Website: <a href="http://support.euro.dell.com">http://support.euro.dell.com</a>	
	E-mail: <a href="http://support.euro.dell.com/it/it/emaildell/">http://support.euro.dell.com/it/it/emaildell/</a>	
	<b>Corporate</b>	
	Technical Support	02 577 826 90
	Customer Care	02 577 825 55
	Fax	02 575 035 30
	Switchboard	02 577 821
	Website: <a href="http://support.euro.dell.com">http://support.euro.dell.com</a>	
	E-mail: <a href="http://support.euro.dell.com/it/it/emaildell/">http://support.euro.dell.com/it/it/emaildell/</a>	
<b>Jamaica</b>	General Support	1-800-682-3639
<b>Japan (Kawasaki)</b>	Technical Support (Server)	toll free: 0120-1984-35
International Access Code: <b>001</b>	Technical Support Outside of Japan (Server)	81-44-556-4152
Country Code: <b>81</b>	Technical Support (Dimension™ and Inspiron™)	toll free: 0120-1982-26
City Code: <b>44</b>	Technical Support Outside of Japan (Dimension and Inspiron)	81-44-520-1435
	Technical Support (Dell Precision™, OptiPlex™ and Latitude™)	toll free: 0120-1984-33
	Technical Support Outside of Japan (Dell Precision, OptiPlex, and Latitude)	81-44-556-3894
	24-Hour Automated Order Service	044 556-3801
	Customer Care	044 556-4240
	Business Sales Division (up to 400 employees)	044 556 3494
	Preferred Accounts Division Sales (over 400 employees)	044 556-3433
	Large Corporate Accounts Sales (over 3500 employees)	044 556-3440
	Public Sales (Government Agencies, Educational Institutions, and Medical Institutions)	044 556 3440
	Global Segment Japan	044 556 3469
	Individual User	044 556 1657
	Faxbox Service	044 556-3490
	Switchboard	044 556-4300
	Website: <a href="http://support.jp.dell.com">http://support.jp.dell.com</a>	
<b>Korea (Seoul)</b>	Technical Support	toll free: 080-200-3800
International Access Code: <b>001</b>	Sales	toll free: 080-200-3600
Country Code: <b>82</b>	Customer Service (Seoul, Korea)	toll free: 080-200-3800
City Code: <b>2</b>	Customer Service (Penang, Malaysia)	604 633 4949
	Fax	2194-6202
	Switchboard	2194-6000
<b>Latin America</b>	Customer Technical Support (Austin, Texas, U.S.A.)	512 728-4093
	Customer Service (Austin, Texas, U.S.A.)	512 728-3619
	Fax (Technical Support and Customer Service)(Austin, Texas, U.S.A.)	512 728-3883
	Sales (Austin, Texas, U.S.A.)	512 728-4397
	SalesFax (Austin, Texas, U.S.A.)	512 728-4600
		or 512 728-3772
<b>Luxembourg</b>	Technical Support (Brussels, Belgium)	02 481 92 88
International Access Code: <b>00</b>	Home/Small Business Sales (Brussels, Belgium)	toll free: 080016884
Country Code: <b>352</b>	Corporate Sales (Brussels, Belgium)	02 481 91 00
	Customer Care (Brussels, Belgium)	02 481 91 19
	Fax (Brussels, Belgium)	02 481 92 99
	Switchboard (Brussels, Belgium)	02 481 91 00
	Website: <a href="http://support.euro.dell.com">http://support.euro.dell.com</a>	
	E-mail: tech_be@dell.com	
<b>Macau</b>	Technical Support	toll free: 0800 582

Country Code: <b>853</b>	Customer Service (Penang, Malaysia)	604 633 4949
	Transaction Sales	toll free: 0800 581
<b>Malaysia (Penang)</b>	Technical Support	toll free: 1 800 888 298
International Access Code: <b>00</b>	Customer Service	04 633 4949
Country Code: <b>60</b>	Transaction Sales	toll free: 1 800 888 202
City Code: <b>4</b>	Corporate Sales	toll free: 1 800 888 213
<b>Mexico</b>	Customer Technical Support	001-877-384-8979 or 001-877-269-3383
International Access Code: <b>00</b>		
Country Code: <b>52</b>	Sales	50-81-8800 or 01-800-888-3355
	Customer Service	001-877-384-8979 or 001-877-269-3383
	Main	50-81-8800 or 01-800-888-3355
Netherlands Antilles	General Support	001-800-882-1519
<b>Netherlands (Amsterdam)</b>	Technical Support	020 581 8838
International Access Code: <b>00</b>	Customer Care	020 581 8740
Country Code: <b>31</b>	Home/Small Business Sales	toll free: 0800-0663
	Home/Small Business Sales Fax	020 682 7171
	Corporate Sales	020 581 8818
	Corporate Sales Fax	020 686 8003
	Fax	020 686 8003
	Switchboard	020 581 8818
	Website: <a href="http://support.euro.dell.com">http://support.euro.dell.com</a>	
	E-mail: tech_nl@dell.com	
<b>New Zealand</b>	Home and Small Business	0800 446 255
International Access Code: <b>00</b>	Government and Business	0800 444 617
Country Code: <b>64</b>	Sales	0800 441 567
	Fax	0800 441 566
<b>Nicaragua</b>	General Support	001-800-220-1006
<b>Norway (Lysaker)</b>	Technical Support	671 16882
International Access Code: <b>00</b>	Relational Customer Care	671 17514
Country Code: <b>47</b>	Home/Small Business Customer Care	23162298
	Switchboard	671 16800
	Fax Technical Support (Upplands Vasby, Sweden)	46 0 85 590 05 594
	Fax Switchboard	671 16865
	Website: <a href="http://support.euro.dell.com">http://support.euro.dell.com</a>	
	E-mail: nor_support@dell.com	
	E-mail Support for Servers: Nordic_server_support@dell.com	
<b>Panama</b>	General Support	001-800-507-0962
Peru	General Support	0800-50-669
<b>Poland (Warsaw)</b>	Customer Service Phone	57 95 700
International Access Code: <b>011</b>	Customer Care	57 95 999
Country Code: <b>48</b>	Sales	57 95 999
	Customer Service Fax	57 95 806
	Reception Desk Fax	57 95 998
City Code: <b>22</b>	Switchboard	57 95 999
	Website: <a href="http://support.euro.dell.com">http://support.euro.dell.com</a>	
	E-mail: pl_support@dell.com	
<b>Portugal</b>	Technical Support	35 800 834 077
International Access Code: <b>00</b>	Customer Care	800 300 415 or 35 800 834 075
Country Code: <b>35</b>	Sales	800 300 410 or 800 300 411 or 800 300 412 or
		351 214 220 710
	Fax	35 121 424 01 12

	E-mail: <a href="http://support.euro.dell.com/es/es/emaildell/">http://support.euro.dell.com/es/es/emaildell/</a>	
<b>Puerto Rico</b>	General Support	1-800-805-7545
<b>St. Lucia</b>	General Support	1-800-882-1521
<b>Singapore (Singapore)</b>	Technical Support	toll free: 800 6011 051
International Access Code: 005	Customer Service (Penang, Malaysia)	604 633 4949
	Transaction Sales	toll free: 800 6011 054
Country Code: 65	Corporate Sales	toll free: 800 6011 053
<b>South Africa (Johannesburg)</b>	Technical Support	011 709 7710
International Access Code: 09/091	Customer Care	011 709 7707
	Sales	011 709 7700
Country Code: 27	Fax	011 706 0495
	Switchboard	011 709 7700
City Code: 11	Website: <a href="http://support.euro.dell.com">http://support.euro.dell.com</a>	
	E-mail: dell_za_support@dell.com	
<b>Southeast Asian and Pacific Countries</b>	Customer Technical Support, Customer Service, and Sales (Penang, Malaysia)	604 633 4810
<b>Spain (Madrid)</b>	<b>Home and Small Business</b>	
International Access Code: 00	Technical Support	902 100 130
	Customer Care	902 118 540
Country Code: 34	Sales	902 118 541
	Switchboard	902 118 541
City Code: 91	Fax	902 118 539
	Website: <a href="http://support.euro.dell.com">http://support.euro.dell.com</a>	
	E-mail: <a href="http://support.euro.dell.com/es/es/emaildell/">http://support.euro.dell.com/es/es/emaildell/</a>	
	<b>Corporate</b>	
	Technical Support	902 100 130
	Customer Care	902 118 546
	Switchboard	91 722 92 00
	Fax	91 722 95 83
	Website: <a href="http://support.euro.dell.com">http://support.euro.dell.com</a>	
	E-mail: <a href="http://support.euro.dell.com/es/es/emaildell/">http://support.euro.dell.com/es/es/emaildell/</a>	
<b>Sweden (Upplands Vasby)</b>	Technical Support	08 590 05 199
International Access Code: 00	Relational Customer Care	08 590 05 642
	Home/Small Business Customer Care	08 587 70 527
Country Code: 46	Fax Technical Support	08 590 05 594
	Sales	08 590 05 185
City Code: 8	Website: <a href="http://support.euro.dell.com">http://support.euro.dell.com</a>	
	E-mail: swe_support@dell.com	
	E-mail Support for Latitude and Inspiron: Swe-nbk_kats@dell.com	
	E-mail Support for OptiPlex: Swe_kats@dell.com	
	E-mail Support for Servers: Nordic_server_support@dell.com	
<b>Switzerland (Geneva)</b>	Technical Support (Home and Small Business)	0844 811 411
International Access Code: 00	Technical Support (Corporate)	0844 822 844
	Customer Care (Home and Small Business)	0848 802 202
Country Code: 41	Customer Care (Corporate)	0848 821 721
	Fax	022 799 01 90
City Code: 22	Switchboard	022 799 01 01
	Website: <a href="http://support.euro.dell.com">http://support.euro.dell.com</a>	
	E-mail: swisstech@dell.com	
	E-mail for French Speaking HSB and Corporate Customers: <a href="http://support.euro.dell.com/ch/fr/emaildell/">http://support.euro.dell.com/ch/fr/emaildell/</a>	
<b>Taiwan</b>	Technical Support	toll free: 0080 60 1255
International Access Code: 002	Technical Support (Servers)	toll free: 0080 60 1256
	Transaction Sales	toll free: 0080 651 228
Country Code: 886		or 0800 33 556
	Corporate Sales	toll free: 0080 651 227
		or 0800 33 555

<b>Thailand</b>	Technical Support	toll free: 0880 060 07
International Access Code: <b>001</b>	Customer Service (Penang, Malaysia)	604 633 4949
Country Code: <b>66</b>	Sales	toll free: 0880 060 09
<b>Trinidad/Tobago</b>	General Support	1-800-805-8035
<b>U.K. (Bracknell)</b>	Technical Support (Corporate/Preferred Accounts/PAD [1000+ employees])	0870 908 0500
International Access Code: <b>010</b>	Technical Support (Direct/PAD and General)	0870 908 0800
Country Code: <b>44</b>	Global Accounts Customer Care	01344 723186
City Code: <b>1344</b>	Home and Small Business Customer Care	0870 906 0010
	Corporate Customer Care	01344 72 3185
	Preferred Accounts (500-5000 employees) Customer Care	01344 723196
	Central Government Customer Care	01344 723193
	Local Government Customer Care	01344 723194
	Home/Small Business Sales	0870 907 4000
	Corporate/Public Sector Sales	01344 860456
	Website: <a href="http://support.euro.dell.com">http://support.euro.dell.com</a>	
	E-mail: dell_direct_support@dell.com	
<b>U.S.A. (Austin, Texas)</b>	Automated Order-Status System	toll free: 1-800-433-9014
International Access Code: <b>011</b>	AutoTech (for portable and desktop computers)	toll free: 1-800-247-9362
Country Code: <b>1</b>	<b>Dell Home and Small Business Group</b> (for portable and desktop computers):	
	Customer Technical Support (Return Material Authorization Numbers)	toll free: 1-800-624-9896
	Customer Technical Support (Home sales purchased via <a href="http://www.dell.com">http://www.dell.com</a> )	toll free: 1-877-576-3355
	Customer Service (Credit Return Authorization Numbers)	toll free: 1-800-624-9897
	<b>National Accounts</b> (systems purchased by established Dell national accounts [have your account number handy], medical institutions, or value-added resellers [VARs]):	
	Customer Service and Technical Support (Return Material Authorization Numbers)	toll free: 1-800-822-8965
	<b>Public Americas International</b> (systems purchased by governmental agencies [local, state, or federal] or educational institutions):	
	Customer Service and Technical Support (Return Material Authorization Numbers)	toll free: 1-800-234-1490
	Dell Sales	toll free: 1-800-289-3355 or toll free: 1-800-879-3355
	Spare Parts Sales	toll free: 1-800-357-3355
	DellWare™	toll free: 1-800-753-7201
	Desktop and Portable Fee-Based Technical Support	toll free: 1-800-433-9005
	Sales (Catalogs)	toll free: 1-800-426-5150
	Fax	toll free: 1-800-727-8320
	TechFax	toll free: 1-800-950-1329
	Dell Services for the Deaf, Hard-of-Hearing, or Speech-Impaired	toll free: 1-877-DELLTTY (1-877-335-5889)
	Switchboard	512 338-4400
	Dellnet Technical Support	toll free: 1-877-Dellnet (1-877-335-5638)
US Virgin Islands	General Support	1-877-673-3355
Venezuela	General Support	8001-3605

[Back to Contents Page](#)

## Additional Information

### Dell™ OptiPlex™ GX400 System User's Guide

- [Regulatory Notices](#)
  - [ENERGY STAR® Compliance](#)
  - [Limited Warranty and Return Policy](#)
- 

## Regulatory Notices

Electromagnetic Interference (EMI) is any signal or emission, radiated in free space or conducted along power or signal leads, that endangers the functioning of a radio navigation or other safety service or seriously degrades, obstructs, or repeatedly interrupts a licensed radio communications service. Radio communications services include but are not limited to AM/FM commercial broadcast, television, cellular services, radar, air-traffic control, pager, and Personal Communication Services (PCS). These licensed services, along with unintentional radiators such as digital devices, including computer systems, contribute to the electromagnetic environment.

Electromagnetic Compatibility (EMC) is the ability of items of electronic equipment to function properly together in the electronic environment. While this computer system has been designed and determined to be compliant with regulatory agency limits for EMI, there is no guarantee that interference will not occur in a particular installation. If this equipment does cause interference with radio communications services, which can be determined by turning the equipment off and on, you are encouraged to try to correct the interference by one or more of the following measures:

- 1 Reorient the receiving antenna.
- 1 Relocate the computer with respect to the receiver.
- 1 Move the computer away from the receiver.
- 1 Plug the computer into a different outlet so that the computer and the receiver are on different branch circuits.

If necessary, consult a Technical Support representative of Dell or an experienced radio/television technician for additional suggestions.

Dell computer systems are designed, tested, and classified for their intended electromagnetic environment. These electromagnetic environment classifications generally refer to the following harmonized definitions:

- 1 Class A is typically for business or industrial environments.
- 1 Class B is typically for residential environments.

Information Technology Equipment (ITE), including peripherals, expansion cards, printers, input/output (I/O) devices, monitors, and so on, that are integrated into or connected to the system should match the electromagnetic environment classification of the computer system.

**A Notice About Shielded Signal Cables: Use only shielded cables for connecting peripherals to any Dell device to reduce the possibility of interference with radio communications services. Using shielded cables ensures that you maintain the appropriate EMC classification for the intended environment. For parallel printers, a cable is available from Dell. If you prefer, you can order a cable from Dell on the World Wide Web at <http://www.dell.com/products/dellware/index.htm>.**

Most Dell computer systems are classified for Class B environments. To determine the electromagnetic classification for your system or device, refer to the following sections specific for each regulatory agency. Each section provides country-specific EMC/EMI or product safety information.

## FCC Notices (U.S. Only)

Most Dell computer systems are classified by the Federal Communications Commission (FCC) as Class B digital devices. However, the inclusion of certain options can change the rating of some configurations to Class A. To determine which classification applies to your computer system, examine all FCC registration labels located on the bottom or back panel of your computer, on card-mounting brackets, and on the cards themselves. If any one of the labels carries a Class A rating, your entire system is considered to be a Class A digital device. If *all* labels carry an FCC Class B rating as distinguished by either an FCC ID number or the FCC logo, (FCC), your system is considered to be a Class B digital device.

Once you have determined your system's FCC classification, read the appropriate FCC notice. Note that FCC regulations provide that changes or modifications not expressly approved by Dell could void your authority to operate this equipment.

This device complies with Part 15 of the FCC Rules. Operation is subject to the following two conditions:

- 1 This device may not cause harmful interference.
- 1 This device must accept any interference received, including interference that may cause undesired operation.

### Class A

This equipment has been tested and found to comply with the limits for a Class A digital device pursuant to Part 15 of the FCC Rules. These limits are designed to provide reasonable protection against harmful interference when the equipment is operated in a commercial environment. This equipment generates, uses, and can radiate radio frequency energy and, if not installed and used in accordance with the manufacturer's instruction manual, may cause interference with radio communications. Operation of this equipment in a residential area is likely to cause harmful interference, in which case you will be required to correct the interference at your own expense.

### Class B

This equipment has been tested and found to comply with the limits for a Class B digital device pursuant to Part 15 of the FCC Rules. These limits are designed to provide reasonable protection against harmful interference in a residential installation. This equipment generates, uses, and can radiate radio frequency energy and, if not installed and used in accordance with the manufacturer's instruction manual, may cause interference with radio communications. However, there is no guarantee that interference will not occur in a particular installation. If this equipment does cause harmful interference to radio or television reception, which can be determined by turning the equipment off and on, you are encouraged to try to correct the interference by one or more of the following measures:

- 1 Reorient or relocate the receiving antenna.
- 1 Increase the separation between the equipment and the receiver.
- 1 Connect the equipment into an outlet on a circuit different from that to which the receiver is connected.
- 1 Consult the dealer or an experienced radio/television technician for help.

The following information is provided on the device or devices covered in this document in compliance with FCC regulations:

- 1 Model number: MMP
- 1 Company name: Dell Computer Corporation  
EMC Engineering Department  
One Dell Way  
Round Rock, Texas 78682 USA  
512-338-4400

## IC Notice (Canada Only)

Most Dell computer systems (and other Dell digital apparatus) are classified by the Industry Canada (IC) Interference-Causing Equipment Standard #3 (ICES-003) as Class B digital devices. To determine which classification (Class A or B) applies to your computer system (or other Dell digital apparatus), examine all registration labels located on the bottom or the back panel of your computer (or other digital apparatus). A statement in the form of "IC Class A ICES-003" or "IC Class B ICES-003" will be located on one of these labels. Note that Industry Canada regulations provide that changes or modifications not expressly approved by Dell could void your authority to operate this equipment.

This Class B (or Class A, if so indicated on the registration label) digital apparatus meets the requirements of the Canadian Interference-Causing Equipment Regulations.

Cet appareil numérique de la Classe B (ou Classe A, si ainsi indiqué sur l'étiquette d'enregistrement) respecte toutes les exigences du Règlement sur le Matériel Brouilleur du Canada.

## CE Notice (European Union)

Marking by the symbol **CE** indicates compliance of this Dell system to the EMC Directive and the Low Voltage Directive of the European Union. Such marking is indicative that this Dell system meets the following technical standards:

- 1 EN 55022 — "Limits and Methods of Measurement of Radio Interference Characteristics of Information Technology Equipment."
- 1 EN 50082-1: 1992 — "Electromagnetic compatibility—Generic immunity standard Part 1: Residential, commercial, and light industry."
- 1 EN 60950 — "Safety of Information Technology Equipment."

 **NOTE:** EN 55022 emissions requirements provide for two classifications:

- 1 *Class A is for typical commercial areas.*
- 1 *Class B is for typical domestic areas.*

**RF INTERFERENCE WARNING: This is a Class A product. In a domestic environment this product may cause radio frequency (RF) interference, in which case the user may be required to take adequate measures.**

This Dell device is classified for use in a typical Class B domestic environment.

A "Declaration of Conformity" in accordance with the preceding directives and standards has been made and is on file at Dell Computer Corporation Products Europe BV, Limerick, Ireland.

## Battery Disposal



Your computer system uses a lithium battery. The lithium is a long-life battery, and it is very possible that you will never need to replace it. However, should you need to replace it, refer to the section about replacing the battery in your Dell system documentation for instructions.

Do not dispose of the battery along with household waste. Contact your local waste disposal agency for the address of the nearest battery deposit site.

## EN 55022 Compliance (Czech Republic Only)



This device belongs to Class B devices as described in EN 55022, unless it is specifically stated that it is a Class A device on the specification label. The following applies to devices in Class A of EN 55022 (radius of protection up to 30 meters). The user of the device is obliged to take all steps necessary to remove sources of interference to telecommunication or other devices.

Pokud není na typovém štítku počítače uvedeno, že spadá do třídy A podle EN 55022, spadá automaticky do třídy B podle EN 55022. Pro zařízení zařazená do třídy A (ochranné pásmo 30m) podle EN 55022 platí následující. Dojde-li k rušení telekomunikačních nebo jiných zařízení, je uživatel povinen provést taková opatření, aby rušení odstranil.

## VCCI Notice (Japan Only)

Most Dell computer systems are classified by the Voluntary Control Council for Interference (VCCI) as Class B information technology equipment (ITE). However, the inclusion of certain options can change the rating of some configurations to Class A. ITE, including peripherals, expansion cards, printers, input/output (I/O) devices, monitors, and so on, integrated into or connected to the system, should match the electromagnetic environment classification (Class A or B) of the computer system.

To determine which classification applies to your computer system, examine the regulatory labels/markings (see "[VCCI Class A ITE Regulatory Mark](#)" and "[VCCI Class B ITE Regulatory Mark](#)") located on the bottom or back panel of your computer. Once you have determined your system's VCCI classification, read the appropriate VCCI notice.

### Class A ITE

この装置は、情報処理装置等電波障害自主規制協議会（VCCI）の基準に基づくクラス A 情報技術装置です。この装置を家庭環境で使用すると電波妨害を引き起こすことがあります。この場合には使用者が適切な対策を講ずるよう要求されることがあります。

This is a Class A product based on the standard of the Voluntary Control Council for Interference (VCCI) for information technology equipment. If this equipment is used in a domestic environment, radio disturbance may arise. When such trouble occurs, the user may be required to take corrective actions.

### VCCI Class A ITE Regulatory Mark

## VCCI-A

### Class B ITE

この装置は、情報処理装置等電波障害自主規制協議会（VCCI）の基準に基づくクラス B 情報技術装置です。この装置は家庭環境で使用することを目的としています。ラジオやテレビジョン受信機に近接して使用されると、受信障害を引き起こすことがあります。取扱説明書に従って正しい取り扱いをしてください。

This is a Class B product based on the standard of the Voluntary Control Council for Interference (VCCI) for information technology equipment. If this equipment is used near a radio or television receiver in a domestic environment, it may cause radio interference. Install and use the equipment according to the instruction manual.

### VCCI Class B ITE Regulatory Mark



## MIC Notice (Republic of Korea Only)

To determine which classification (Class A or B) applies to your computer system (or other Dell digital device), examine the Republic of Korean Ministry of Information and Communications (MIC) registration labels located on your computer (or other Dell digital device). The MIC label may be located separately from the other regulatory marking applied to your product. Line three of the label identifies the emissions class for the product—"A" for Class A products or "B" for Class B products.

 **NOTE:** MIC emissions requirements provide for two classifications:

- 1 Class A devices are for business purposes.
- 1 Class B devices are for nonbusiness purposes.

### Class A Device

기종별	사용자안내문
A급 기기 (업무용 정보통신기기)	이 기기는 업무용으로 전자파적합등록을 한 기기이오니 판매자 또는 사용자는 이 점을 주의하시기 바라며 만약 잘못 판매 또는 구입하였을 때에는 가정용으로 교환하시기 바랍니다.

Please note that this device has been approved for business purposes with regard to electromagnetic interference. If you find that this device is not suitable for your use, you may exchange it for a nonbusiness-purpose device.

#### MIC Class A Regulatory Mark



1. 기기의 명칭(모델명):
2. 인증번호:
3. 인증받은 자의 상호: (A)
4. 제조년월일:
5. 제조자/제조국가:

#### Class B Device

기종별	사용자 안내문
B급 기기 (가정용 정보통신기기)	이 기기는 가정용으로 전자파적합등록을 한 기기로서 주거지역에서는 물론 모든 지역에서 사용할 수 있습니다.

Please note that this device has been approved for nonbusiness purposes and may be used in any environment, including residential areas.

#### MIC Class B Regulatory Mark



1. 기기의 명칭(모델명):
2. 인증번호:
3. 인증받은 자의 상호: (B)
4. 제조년월일:
5. 제조자/제조국가:

### Polish Center for Testing and Certification Notice

The equipment should draw power from a socket with an attached protection circuit (a three-prong socket). All equipment that works together (computer, monitor, printer, and so on) should have the same power supply source.

The phasing conductor of the room's electrical installation should have a reserve short-circuit protection device in the form of a fuse with a nominal value no larger than 16 amperes (A).

To completely switch off the equipment, the power supply cable must be removed from the power supply socket, which should be located near the equipment and easily accessible.

A protection mark "B" confirms that the equipment is in compliance with the protection usage requirements of standards PN-93/T-42107 and PN-EN 55022:1996.

Urządzenie powinno być zasilane z gniazda z przyłączonym obwodem ochronnym (gniazdo z kolkiem). Współpracujące ze sobą urządzenia (komputer, monitor, drukarka) powinny być zasilane z tego samego źródła.

Instalacja elektryczna pomieszczenia powinna zawierać w przewodzie fazowym rezerwową ochronę przed zwarciami, w postaci bezpiecznika o wartości znamionowej nie większej niż 16A (amperów).

W celu całkowitego wyłączenia urządzenia z sieci zasilania, należy wyjąć wtyczkę kabla zasilającego z gniazdka, które powinno znajdować się w pobliżu urządzenia i być łatwo dostępne.

Znak bezpieczeństwa "B" potwierdza zgodność urządzenia z wymaganiami bezpieczeństwa użytkownika zawartymi w PN-93/T-42107 i PN-EN 55022:1996.

Jeżeli na tabliczce znamionowej umieszczono informację, że urządzenie jest klasy A, to oznacza to, że urządzenie w środowisku mieszkalnym może powodować zakłócenia radioelektryczne. W takich przypadkach można żądać od jego użytkownika zastosowania odpowiednich środków zaradczych.

#### **Wymagania Polskiego Centrum Badań i Certyfikacji**

- Nie należy używać wtyczek adapterowych lub usuwać kolka obwodu ochronnego z wtyczki. Jeżeli konieczne jest użycie przedłużacza to należy użyć przedłużacza 3-żyłowego z prawidłowo połączonym przewodem ochronnym.
- System komputerowy należy zabezpieczyć przed nagłymi, chwilowymi wzrostami lub spadkami napięcia, używając eliminatora przepięć, urządzenia dopasowującego lub bezzakłócenowego źródła zasilania.
- Należy upewnić się, aby nic nie leżało na kablach systemu komputerowego, oraz aby kable nie były umieszczone w miejscu, gdzie można byłoby na nie nadeptywać lub potykać się o nie.
- Nie należy rozlewać napojów ani innych płynów na system komputerowy.
- Nie należy wpychać żadnych przedmiotów do otworów systemu komputerowego, gdyż może to spowodować pożar lub porażenie prądem, poprzez zwarcie elementów wewnętrznych.
- System komputerowy powinien znajdować się z dala od grzejników i źródeł ciepła. Ponadto, nie należy blokować otworów wentylacyjnych. Należy unikać kładzenia luźnych papierów pod komputer oraz umieszczania komputera w ciasnym miejscu bez możliwości cyrkulacji powietrza wokół niego.

#### **Pozostałe instrukcje bezpieczeństwa**

#### **BSMI Notice (Taiwan Only)**

## BSMI通告(僅限於台灣)

大多數的Dell電腦系統被BSMI(經濟部標準檢驗局)劃分為乙類數位裝置。但是，使用某些選件會使有些組態的等級變成甲類。若要確定您的電腦系統適用等級，請檢查所有位於電腦底部或背面板、擴充卡安裝托架，以及擴充卡上的BSMI註冊標籤。如果其中有一甲類標籤，即表示您的系統為甲類數位裝置。如果只有BSMI的檢驗號碼標籤，則表示您的系統為乙類數位裝置。

一旦確定了系統的BSMI等級，請閱讀相關的BSMI通告。請注意，BSMI通告規定凡是未經Dell Computer Corporation 明確批准的擅自變更或修改，將導致您失去此設備的使用權。

此裝置符合BSMI(經濟部標準檢驗局)的規定，使用時須符合以下兩項條件：

- 此裝置不會產生有害干擾。
- 此裝置必須能接受所接收到的干擾，包括可能導致無法正常作業的干擾。

## 甲類

此設備經測試證明符合BSMI(經濟部標準檢驗局)之甲類數位裝置的限制規定。這些限制的目的是為了在商業環境中使用此設備時，能提供合理的保護以防止有害的干擾。此設備會產生、使用並散發射頻能量；如果未遵照製造廠商的指導手冊來安裝和使用，可能會干擾無線電通訊。請勿在住宅區使用此設備。

### 警告使用者：

這是甲類的資訊產品，在居住的環境中使用時，可能會造成射頻干擾，在這種情況下，使用者會被要求採取某些適當的對策。

## 乙類

此設備經測試證明符合BSMI(經濟部標準檢驗局)之乙類數位裝置的限制規定。這些限制的目的是為了在住宅區安裝時，能防止有害的干擾，提供合理的保護。此設備會產生、使用並散發射頻能量；如果未遵照製造廠商的指導手冊來安裝和使用，可能會干擾無線電通訊。但是，這並不保證在個別的安装中不會產生干擾。您可以透過關閉和開啓此設備來判斷它是否會對廣播和電視收訊造成干擾；如果確實如此，我們建議您嘗試以下列一種或多種方法來排除干擾：

- 重新調整天線的接收方向或重新放置接收天線。
- 增加設備與接收器的距離。
- 將設備連接至不同的插座，使設備與接收器連接在不同的電路上。
- 請向經銷商或有經驗的無線電/電視技術人員查詢，以獲得幫助。

---

## ENERGY STAR® Compliance

Certain configurations of Dell computer systems comply with the requirements set forth by the Environmental Protection Agency (EPA) for energy-efficient computers. If the front panel of your computer bears the [ENERGY STAR® Emblem](#), your original configuration complies with these requirements and all ENERGY STAR® power management features of the computer are enabled.

 **NOTE:** As an ENERGY STAR® Partner, Dell Computer Corporation has determined that this product meets the ENERGY STAR® guidelines for energy efficiency.

 **NOTE:** Any Dell computer bearing the ENERGY STAR® Emblem is certified to comply with EPA ENERGY STAR® requirements as configured when shipped by Dell. Any changes you make to this configuration (such as installing additional expansion cards or drives) may increase the system's power consumption beyond the limits set by the EPA's ENERGY STAR® Computers program.

### ENERGY STAR® Emblem



The EPA's ENERGY STAR® Computers program is a joint effort between the EPA and computer manufacturers to reduce air pollution by promoting energy-efficient computer products. The EPA estimates that use of ENERGY STAR® computer products can save computer users up to two billion dollars annually in electricity costs. In turn, this reduction in electricity usage can reduce emissions of carbon dioxide, the gas primarily responsible for the greenhouse effect, and sulfur dioxide and nitrogen oxides, which are the two primary causes of acid rain.

Computer users can also help to reduce electricity usage and its side effects by turning off their computer systems when they are not in use for extended periods of time—particularly at night and on weekends.

---

## Limited Warranty and Return Policy

### Three-Year Limited Warranty (U.S. Only)

Dell Computer Corporation ("Dell") manufactures its hardware products from parts and components that are new or equivalent to new in accordance with industry-standard practices. Dell warrants that the hardware products it manufactures will be free from defects in materials and workmanship. The limited warranty term is three years beginning on the date of invoice, as described in the following text.

Damage due to shipping the products to you is covered under this limited warranty. Otherwise, this limited warranty does not cover damage due to external causes, including accident, abuse, misuse, problems with electrical power, servicing not authorized by Dell, usage not in accordance with product instructions, failure to perform required preventive maintenance, and problems caused by use of parts and components not supplied by Dell.

This limited warranty does not cover any items that are in one or more of the following categories: software; external devices (except as specifically noted); accessories or parts added to a Dell system after the system is shipped from Dell; accessories or parts added to a Dell system through Dell's system integration department; accessories or parts that are not installed in the Dell factory; or DellWare™ products. Monitors, keyboards, and mice that are Dell-branded or that are included on Dell's standard price list are covered under this limited warranty; all other monitors, keyboards, and mice (including those sold through the DellWare program) are not covered. Batteries for portable computers are covered only during the initial one-year period of this limited warranty.

#### Coverage During Year One

During the one-year period beginning on the invoice date, Dell will repair or replace products covered under this limited warranty that are returned to Dell's facility. To request warranty service, you must call Dell's Customer Technical Support within the warranty period. See "[Getting Help](#)" to obtain customer assistance. If warranty service is required, Dell will issue a Return Material Authorization Number. You must ship the products back to Dell in their original or equivalent packaging, prepay shipping charges, and insure the shipment or accept the risk of loss or damage during shipment. Dell will ship the repaired or replacement products to you freight prepaid if you use an address in the continental U.S., where applicable. Shipments to other locations will be made freight collect.

**NOTE:** Before you ship the product(s) to Dell, back up the data on the hard drive(s) and any other storage device(s) in the product(s). Remove any removable media, such as diskettes, CDs, or PC Cards. Dell does not accept liability for lost data or software.

Dell owns all parts removed from repaired products. Dell uses new and reconditioned parts made by various manufacturers in performing warranty repairs and building replacement products. If Dell repairs or replaces a product, its warranty term is not extended.

#### Coverage During Years Two and Three

During the second and third years of this limited warranty, Dell will provide, on an exchange basis and subject to Dell's Exchange Policy in effect on the date of the exchange, replacement parts for the Dell hardware product(s) covered under this limited warranty when a part requires replacement. You must report each instance of hardware failure to Dell's Customer Technical Support in advance to obtain Dell's concurrence that a part should be replaced and to have Dell ship the replacement part. Dell will ship parts (freight prepaid) if you use an address in the continental U.S., where applicable. Shipments to other locations will be made freight collect. Dell will include a prepaid shipping container with each replacement part for your use in returning the replaced part to Dell. Replacement parts are new or reconditioned. Dell may provide replacement parts made by various manufacturers when supplying parts to you. The warranty term for a replacement part is the remainder of the limited warranty term.

You will pay Dell for replacement parts if the replaced part is not returned to Dell. The process for returning replaced parts, and your obligation to pay for replacement parts if you do not return the replaced parts to Dell, will be in accordance with Dell's Exchange Policy in effect on the date of the exchange.

You accept full responsibility for your software and data. Dell is not required to advise or remind you of appropriate backup and other procedures.

#### General Provisions

THIS LIMITED WARRANTY GIVES YOU SPECIFIC LEGAL RIGHTS WHICH VARY FROM STATE TO STATE (OR JURISDICTION TO JURISDICTION). DELL'S RESPONSIBILITY FOR MALFUNCTIONS AND DEFECTS IN HARDWARE IS LIMITED TO REPAIR AND REPLACEMENT AS SET FORTH IN THIS LIMITED WARRANTY STATEMENT. ALL EXPRESS AND IMPLIED WARRANTIES FOR THE PRODUCT, INCLUDING BUT NOT LIMITED TO ANY IMPLIED WARRANTIES OF AND CONDITIONS OF MERCHANTABILITY AND FITNESS FOR A PARTICULAR PURPOSE, ARE LIMITED IN DURATION TO THE WARRANTY PERIOD SET FORTH ABOVE AND NO WARRANTIES, WHETHER EXPRESS OR IMPLIED, WILL APPLY AFTER SUCH PERIOD.

SOME STATES (OR JURISDICTIONS) DO NOT ALLOW LIMITATIONS ON HOW LONG AN IMPLIED WARRANTY LASTS, SO THE PRECEDING LIMITATION MAY NOT APPLY TO YOU.

DELL DOES NOT ACCEPT LIABILITY BEYOND THE REMEDIES SET FORTH IN THIS LIMITED WARRANTY STATEMENT OR LIABILITY FOR INCIDENTAL OR CONSEQUENTIAL DAMAGES, INCLUDING WITHOUT LIMITATION ANY LIABILITY FOR PRODUCTS NOT BEING AVAILABLE FOR USE OR FOR LOST DATA OR SOFTWARE.

SOME STATES (OR JURISDICTIONS) DO NOT ALLOW THE EXCLUSION OR LIMITATION OF INCIDENTAL OR CONSEQUENTIAL DAMAGES, SO THE PRECEDING EXCLUSION OR LIMITATION MAY NOT APPLY TO YOU.

These provisions apply to Dell's three-year limited warranty only. For provisions of any service contract covering your system, refer to your invoice or the separate service contract that you will receive.

If Dell elects to exchange a system or component, the exchange will be made in accordance with Dell's Exchange Policy in effect on the date of the exchange. In any instance in which Dell issues a Return Material Authorization Number, Dell must receive the product(s) for repair prior to the expiration of the warranty period in order for the repair(s) to be covered by the limited warranty.

**NOTE:** If you chose one of the available warranty and service options in place of the standard three-year limited warranty described in the preceding text, the option you chose will be listed on your invoice.

### Three-Year Limited Warranty (Canada Only)

Dell Computer Corporation ("Dell") manufactures its hardware products from parts and components that are new or equivalent to new in accordance with industry-standard practices. Dell warrants that the hardware products it manufactures will be free from defects in materials and workmanship. The warranty term is three years beginning on the date of invoice, as described in the following text.

Damage due to shipping the products to you is covered under this limited warranty. Otherwise, this limited warranty does not cover damage due to external causes, including accident, abuse, misuse, problems with electrical power, servicing not authorized by Dell, usage not in accordance with product instructions,

failure to perform required preventive maintenance, and problems caused by use of parts and components not supplied by Dell.

This limited warranty does not cover any items that are in one or more of the following categories: software; external devices (except as specifically noted); accessories or parts added to a Dell system after the system is shipped from Dell; accessories or parts added to a Dell system through Dell's system integration department; accessories or parts that are not installed in the Dell factory; or DellWare products. Monitors, keyboards, and mice that are Dell-branded or that are included on Dell's standard price list are covered under this limited warranty; all other monitors, keyboards, and mice (including those sold through the DellWare program) are not covered. Batteries for portable computers are covered only during the initial one-year period of this limited warranty.

## Coverage During Year One

During the one-year period beginning on the invoice date, Dell will repair or replace products covered under this limited warranty that are returned to Dell's facility. To request warranty service, you must call Dell's Customer Technical Support within the warranty period. See "[Getting Help](#)" to obtain customer assistance. If warranty service is required, Dell will issue a Return Material Authorization Number. You must ship the products back to Dell in their original or equivalent packaging, prepay shipping charges, and insure the shipment or accept the risk of loss or damage during shipment. Dell will ship the repaired or replacement products to you freight prepaid if you use an address in Canada, where applicable. Shipments to other locations will be made freight collect.

**NOTE:** Before you ship the product(s) to Dell, back up the data on the hard drive(s) and any other storage device(s) in the product(s). Remove any removable media, such as diskettes, CDs, or PC Cards. Dell does not accept liability for lost data or software.

Dell owns all parts removed from repaired products. Dell uses new and reconditioned parts made by various manufacturers in performing warranty repairs and building replacement products. If Dell repairs or replaces a product, its warranty term is not extended.

## Coverage During Years Two and Three

During the second and third years of this limited warranty, Dell will provide, on an exchange basis and subject to Dell's Exchange Policy in effect on the date of the exchange, replacement parts for the Dell hardware product(s) covered under this limited warranty when a part requires replacement. You must report each instance of hardware failure to Dell's Customer Technical Support in advance to obtain Dell's concurrence that a part should be replaced and to have Dell ship the replacement part. Dell will ship parts (freight prepaid) if you use an address in Canada, where applicable. Shipments to other locations will be made freight collect. Dell will include a prepaid shipping container with each replacement part for your use in returning the replaced part to Dell. Replacement parts are new or reconditioned. Dell may provide replacement parts made by various manufacturers when supplying parts to you. The warranty term for a replacement part is the remainder of the limited warranty term.

You will pay Dell for replacement parts if the replaced part is not returned to Dell. The process for returning replaced parts, and your obligation to pay for replacement parts if you do not return the replaced parts to Dell, will be in accordance with Dell's Exchange Policy in effect on the date of the exchange.

You accept full responsibility for your software and data. Dell is not required to advise or remind you of appropriate backup and other procedures.

## General Provisions

DELL MAKES NO EXPRESS WARRANTIES OR CONDITIONS BEYOND THOSE STATED IN THIS LIMITED WARRANTY STATEMENT. DELL DISCLAIMS ALL OTHER WARRANTIES AND CONDITIONS, EXPRESS OR IMPLIED, INCLUDING WITHOUT LIMITATION IMPLIED WARRANTIES AND CONDITIONS OF MERCHANTABILITY AND FITNESS FOR A PARTICULAR PURPOSE. SOME STATES (OR JURISDICTIONS) DO NOT ALLOW LIMITATIONS ON IMPLIED WARRANTIES OR CONDITIONS, SO THIS LIMITATION MAY NOT APPLY TO YOU.

DELL'S RESPONSIBILITY FOR MALFUNCTIONS AND DEFECTS IN HARDWARE IS LIMITED TO REPAIR AND REPLACEMENT AS SET FORTH IN THIS LIMITED WARRANTY STATEMENT. THESE WARRANTIES GIVE YOU SPECIFIC LEGAL RIGHTS, AND YOU MAY ALSO HAVE OTHER RIGHTS, WHICH VARY FROM STATE TO STATE (OR JURISDICTION TO JURISDICTION).

DELL DOES NOT ACCEPT LIABILITY BEYOND THE REMEDIES SET FORTH IN THIS LIMITED WARRANTY STATEMENT OR LIABILITY FOR INCIDENTAL OR CONSEQUENTIAL DAMAGES, INCLUDING WITHOUT LIMITATION ANY LIABILITY FOR PRODUCTS NOT BEING AVAILABLE FOR USE OR FOR LOST DATA OR SOFTWARE.

SOME STATES (OR JURISDICTIONS) DO NOT ALLOW THE EXCLUSION OR LIMITATION OF INCIDENTAL OR CONSEQUENTIAL DAMAGES, SO THE PRECEDING EXCLUSION OR LIMITATION MAY NOT APPLY TO YOU.

These provisions apply to Dell's three-year limited warranty only. For provisions of any service contract covering your system, refer to your invoice or the separate service contract that you will receive.

If Dell elects to exchange a system or component, the exchange will be made in accordance with Dell's Exchange Policy in effect on the date of the exchange. In any instance in which Dell issues a Return Material Authorization Number, Dell must receive the product(s) for repair prior to the expiration of the warranty period in order for the repair(s) to be covered by the limited warranty.

**NOTE:** If you chose one of the available warranty and service options in place of the standard three-year limited warranty described in the preceding text, the option you chose will be listed on your invoice.

## One-Year End-User Manufacturer Guarantee (Latin America and the Caribbean Only)

### Guarantee

Dell Computer Corporation ("Dell") warrants to the end user in accordance with the following provisions that its branded hardware products, purchased by the end user from a Dell company or an authorized Dell distributor in Latin America or the Caribbean, will be free from defects in materials, workmanship, and design affecting normal use, for a period of one year from the original purchase date. Products for which proper claims are made will, at Dell's option, be repaired or replaced at Dell's expense. Dell owns all parts removed from repaired products. Dell uses new and reconditioned parts made by various manufacturers in performing repairs and building replacement products.

### Exclusions

This Guarantee does not apply to defects resulting from: improper or inadequate installation, use, or maintenance; actions or modifications by unauthorized third parties or the end user; accidental or willful damage; or normal wear and tear.

### Making a Claim

Claims must be made in Latin America or the Caribbean by contacting the Dell point of sale within the guarantee period. The end user must always supply proof of purchase, indicating name and address of the seller, date of purchase, model and serial number, name and address of the customer, and details of symptoms and configuration at the time of malfunction, including peripherals and software used. Otherwise, Dell may refuse the guarantee claim. Upon diagnosis of a warranted defect, Dell will make arrangements and pay for ground freight and insurance to and from Dell's repair/replacement center. The end

user must ensure that the defective product is available for collection properly packed in original or equally protective packaging together with the details listed above and the return number provided to the end user by Dell.

### Limitation and Statutory Rights

Dell makes no other warranty, guarantee or like statement other than as explicitly stated above, and this Guarantee is given in place of all other guarantees whatsoever, to the fullest extent permitted by law. In the absence of applicable legislation, this Guarantee will be the end user's sole and exclusive remedy against Dell or any of its affiliates, and neither Dell nor any of its affiliates shall be liable for loss of profit or contracts, or any other indirect or consequential loss arising from negligence, breach of contract, or howsoever.

**This Guarantee does not impair or affect mandatory statutory rights of the end user against and/or any rights resulting from other contracts concluded by the end user with Dell and/or any other seller.**

**Dell World Trade LP**  
One Dell Way, Round Rock, TX 78682, USA

**Dell Computadores do Brasil Ltda (CNPJ No. 72.381.189/0001-10) /  
Dell Commercial do Brasil Ltda (CNPJ No. 03 405 822/0001-40)**  
Avenida Industrial Belgraf, 400  
92990-000 - Eldorado do Sul - RS - Brasil

**Dell Computer de Chile Ltda**  
Coyancura 2283, Piso 3- Of.302,  
Providencia, Santiago - Chile

**Dell Computer de Colombia Corporation**  
Carrera 7 # 115-33 Oficina 603  
Bogota, Colombia

**Dell Computer de Mexico SA de CV**  
Rio Lerma # 302- 4 Piso  
Col. Cuauhtemoc, Mexico, D.F. 06500

### "Total Satisfaction" Return Policy (U.S. and Canada Only)

If you are an end-user customer who bought new products directly from a Dell company, you may return them to Dell within 30 days of the date of invoice for a refund or credit of the product purchase price. If you are an end-user customer who bought reconditioned or refurbished products from a Dell company, you may return them to Dell within 14 days of the date of invoice for a refund or credit of the product purchase price. In either case, the refund or credit will not include any shipping and handling charges shown on your invoice. If you are an organization that bought the products under a written agreement with Dell, the agreement may contain different terms for the return of products than specified by this policy.

To return products, you must call Dell Customer Service to receive a Credit Return Authorization Number. See "[Getting Help](#)" to obtain customer assistance. To expedite the processing of your refund or credit, Dell expects you to return the products to Dell in their original packaging within five days of the date that Dell issues the Credit Return Authorization Number. You must also prepay shipping charges and insure the shipment or accept the risk of loss or damage during shipment. You may return software for refund or credit only if the sealed package containing the diskette(s) or CD(s) is unopened. Returned products must be in as-new condition, and all of the manuals, diskette(s), CD(s), power cables, and other items included with a product must be returned with it. For customers who want to return, for refund or credit only, either applications software or an operating system that has been installed by Dell, the whole system must be returned, along with any media and documentation that may have been included in the original shipment.

This "Total Satisfaction" Return Policy does not apply to DellWare products, which may be returned under DellWare's then-current return policy. In addition, reconditioned parts purchased through Dell Spare Parts Sales in Canada are nonreturnable.

---

[Back to Contents Page](#)

## Safety Instructions

### Dell™ OptiPlex™ GX400 System User's Guide

- [Safety First—For You and Your Computer](#)
  - [Protecting Against Electrostatic Discharge](#)
  - [Ergonomic Computing Habits](#)
- 

## Safety First—For You and Your Computer

Before you remove the computer cover, perform the following steps in the sequence indicated.

 **NOTICE:** Do not attempt to service the computer yourself, except as explained in your online Dell™ documentation or otherwise provided to you. Always follow installation and service instructions closely.

 **CAUTION:** There is a danger of a new battery exploding if it is incorrectly installed. Replace the battery only with the same or equivalent type recommended by the manufacturer. Discard used batteries according to the manufacturer's instructions.

1. Turn off your computer and any peripherals.
2. Ground yourself by touching an unpainted metal surface on the chassis, such as the metal around the card-slot openings at the back of the computer, before touching anything inside your computer.

While you work, periodically touch an unpainted metal surface on the computer chassis to dissipate any static electricity that might harm internal components.

3. Disconnect your computer and peripherals from their power sources. Also, disconnect any telephone or telecommunication lines from the computer.

Doing so reduces the potential for personal injury or shock.

In addition, take note of these safety guidelines when appropriate:

- 1 When you disconnect a cable, pull on its connector or on its strain-relief loop, not on the cable itself. Some cables have a connector with locking tabs; if you are disconnecting this type of cable, press in on the locking tabs before disconnecting the cable. As you pull connectors apart, keep them evenly aligned to avoid bending any connector pins. Also, before you connect a cable, make sure both connectors are correctly oriented and aligned.
- 1 Handle components and cards with care. Do not touch the components or contacts on a card. Hold a card by its edges or by its metal mounting bracket. Hold a component such as a microprocessor chip by its edges, not by its pins.

Also see "[Protecting Against Electrostatic Discharge](#)." In addition, Dell recommends that you periodically review the safety instructions in your *System Information Guide*.

---

## Protecting Against Electrostatic Discharge

Static electricity can harm delicate components inside your computer. To prevent static damage, discharge static electricity from your body before you touch any of your computer's electronic components, such as the microprocessor. You can do so by touching an unpainted metal surface on the computer chassis.

As you continue to work inside the computer, periodically touch an unpainted metal surface to remove any static charge your body may have accumulated.

You can also take the following steps to prevent damage from electrostatic discharge (ESD):

- 1 When unpacking a static-sensitive component from its shipping carton, do not remove the component from the antistatic packing material until you are ready to install the component in your computer. Just before unwrapping the antistatic packaging, be sure to discharge static electricity from your body.
  - 1 When transporting a sensitive component, first place it in an antistatic container or packaging.
  - 1 Handle all sensitive components in a static-safe area. If possible, use antistatic floor pads and workbench pads.
- 

## Ergonomic Computing Habits

 **CAUTION:** Improper or prolonged keyboard use may result in injury.

 **CAUTION:** Viewing the monitor screen for extended periods of time may result in eye strain.

For comfort and efficiency, observe the following ergonomic guidelines when setting up and using your computer system:

- 1 Position your system so that the monitor and keyboard are directly in front of you as you work. Special shelves are available (from Dell and other sources) to help you correctly position your keyboard.
- 1 Set the monitor at a comfortable viewing distance (usually 510 to 610 millimeters [20 to 24 inches] from your eyes).
- 1 Make sure the monitor screen is at eye level or slightly lower when you are sitting in front of the monitor.
- 1 Adjust the tilt of the monitor, its contrast and brightness settings, and the lighting around you (such as overhead lights, desk lamps, and the curtains or blinds on nearby windows) to minimize reflections and glare on the monitor screen.



- 1 Use a chair that provides good lower back support.
- 1 Keep your forearms horizontal with your wrists in a neutral, comfortable position while using the keyboard or mouse.
- 1 Always leave space to rest your hands while using the keyboard or mouse.
- 1 Let your upper arms hang naturally at your sides.
- 1 Sit erect, with your feet resting on the floor and your thighs level.
- 1 When sitting, make sure the weight of your legs is on your feet and not on the front of your chair seat. Adjust your chair's height or use a footrest, if necessary, to maintain proper posture.
- 1 Vary your work activities. Try to organize your work so that you do not have to type for extended periods of time. When you stop typing, try to do things that use both hands.

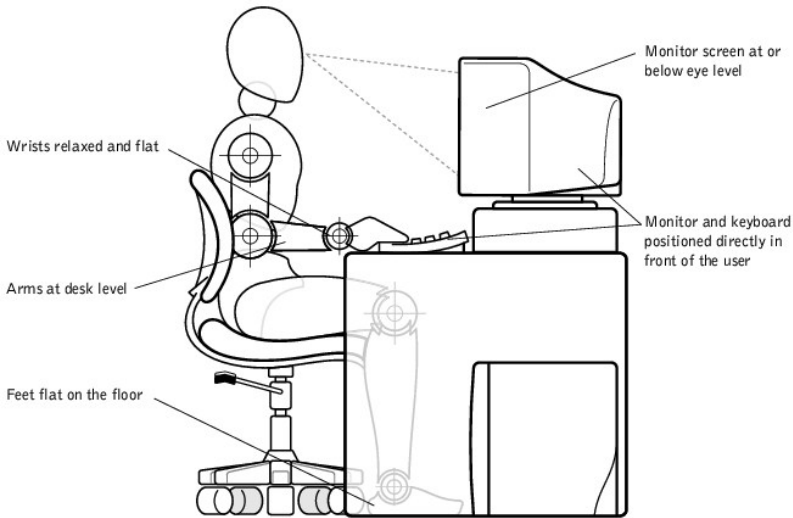

[Back to Contents Page](#)

## Microsoft® Windows® XP Features

- [Overview](#)
  - [New User Interface](#)
  - [Files and Settings Transfer Wizard](#)
  - [Application and Device Compatibility](#)
  - [System Restore](#)
  - [User Accounts and Fast User Switching](#)
  - [Home and Small Office Networking](#)
  - [Internet Connection Firewall](#)
- 

### Overview

Based on an enhanced version of the Windows 2000 operating system, Windows XP is available in consumer and business editions: Windows XP Home Edition and Windows XP Professional. The features discussed are available in both editions, but the Professional version, designed for business environments, includes additional productivity, security, networking, and management features important in business environments.

For home users, Windows XP brings the significantly increased stability and security inherent in the Windows 2000/Windows NT® operating systems. It also provides better support for portable computers. Key new Windows XP features include:

- 1 An improved desktop and user interface
- 1 Files and Settings Transfer Wizard
- 1 Application program compatibility enhancements
- 1 System Restore
- 1 Fast User Switching\*
- 1 Expanded home and small office networking functions\*
- 1 A personal firewall for always-on Internet connections\*

\*Home and small office features

### Help and Support Center

The Help and Support Center, introduced with Microsoft Windows Millennium Edition (Me), replaces Windows Help from earlier operating systems. The Help and Support Center provides an integrated resource center for information and assistance in using, configuring, and troubleshooting your computer and installed hardware devices and software. For Windows XP, the Help and Support Center features expanded search capabilities, including full-text search and the capability to search across multiple remote sites in addition to files resident on the hard drive. You can use a single print command to print an entire chapter of help content.

To open Help and Support Center, click the **Start** button, and then click **Help and Support**. From the home page, you can conduct a search or select categories of information, leading to task and information topics covering the use of your computer. Click **User and System Guides for information on using your Dell™** computer, including installed hardware devices and software.

---

### New User Interface

Windows XP features a redesigned user interface with a new visual style, a less cluttered desktop, and built-in desktop cleanup features. Window layout has also been changed for Windows XP and, as in the Control Panel, emphasizes task presentation. The **Start** menu has been redesigned. The left half of the new **Start** menu includes the most frequently used icons. As you use your computer, the icons in this area are changed and rearranged depending on your computer usage patterns. If you wish to keep one of the icons permanently in its location, right-click the icon and click **Pin to Start menu**.

To access all the programs installed on the computer, click **All Programs** at the bottom of the **Start** menu. The right half of the new **Start** menu contains useful icons for accessing your files, configuring the computer, and finding information and assistance. The **Dell Solution Center** icon opens a portal to services and application programs installed on your Dell computer.

### Switching to Classic View

If you wish, you may change the appearance of the **Start** menu, desktop and windows, or **Control Panel** layout to that of earlier Windows operating systems. These classic view options are independent of each other.

You can easily switch back and forth between the new Control Panel category view and the classic icon view by clicking **Switch to Classic View** or **Switch to Category View** in the upper left area of the **Control Panel** window. This can be handy if you would like to take advantage of the new, task-oriented features of the Windows XP Control Panel, but you are accustomed to performing a particular task with the icon-oriented classic Control Panel.

To change the appearance of the **Start** menu to the classic view:

1. Right-click the empty area on the task bar.
2. Click **Properties**.
3. Click the **Start Menu** tab.
4. Select **Classic Start Menu** and click **OK**.

If you prefer the classic window and button appearance, perform the following steps:

1. Right-click anywhere on the main desktop screen and click **Properties**.
2. Click the **Appearance** tab.
3. From the **Windows and buttons** dropdown box, select **Windows Classic style**.
4. To customize color, font, and other classic desktop options, click **Advanced**.
5. When you have completed your appearance selections, click **OK**.

## Clean Desktop Wizard

Another feature of Windows XP is the Desktop Cleanup Wizard. The wizard runs 7 days after you first start your computer and every 60 days after that. The Desktop Cleanup Wizard first opens a dialog box informing you that there are unused icons on the desktop and asking whether you want to run the wizard. If you elect to run the wizard, it places unused desktop icons in the folder **C:\Desktop Icons**.

The default for the Desktop Cleanup Wizard is on. To turn the wizard off:

1. Right-click anywhere on the main desktop screen and click **Properties**.
2. Select the **Desktop** tab and click **Customize Desktop**.
3. In the **Desktop cleanup** options make sure that the **Run Desktop Cleanup Wizard every 60 days** box is not checked.

You can run the Desktop Cleanup Wizard anytime by following these steps:

1. Right-click anywhere on the main desktop screen and select **Properties**.
2. Click the **Desktop** tab and click **Customize Desktop**.
3. Click **Clean Desktop Now**.
4. When the **Desktop Cleanup Wizard** appears, click **Next>**.
5. In the **Shortcuts** list, deselect any shortcuts you want to leave on the desktop, and then click **Next>**.
6. Click **Finish** to remove the shortcuts and close the wizard.

The shortcuts are moved to the folder **C:\Desktop Icons**.

To access desktop icons removed by Windows XP, click the **Start** button, and then click **Dell Solution Center**.

## Taskbar Grouping

The Windows taskbar is a row of buttons that typically displays across the bottom of the screen. The taskbar includes the **Start** button and a button for each open application. (The taskbar also includes the Quick Launch icons and the notification area.) Windows XP groups multiple instances of the same application on the taskbar. For example, if six instances of Internet Explorer are open, each displaying a button on the taskbar, Windows XP groups the buttons next to one another on the taskbar. If space becomes an issue on the taskbar, Windows XP consolidates all the Internet Explorer buttons into a single button. When clicked, that button expands to a menu of the six Internet Explorer active sessions.

## Notification Area Cleanup

Over time, software icons tend to proliferate in the notification area, the area in the bottom right corner of the Windows desktop. Windows XP detects when icons in the notification area are not being accessed and hides them. A caret, or chevron, button indicates that there are hidden icons that can be viewed by selecting the button. You can also configure the notification area manually by right-clicking the taskbar, selecting **Properties**, and then clicking **Customize...** in the **Taskbar and Start Menu Properties** window. For example, you may choose to hide the antivirus program icon because it is rarely accessed, but display the audio volume icon because it is used frequently. The notification area cleanup feature is automatically enabled when the operating system is installed, but you may disable it by unchecking **Hide inactive icons** in the **Taskbar and Start Menu Properties** window.

---

## Files and Settings Transfer Wizard

The Files and Settings Transfer Wizard is used to migrate personal files and settings from one computer to another (for instance, when upgrading to a new computer). Personal files include the documents, images, spreadsheets, presentations, and e-mail messages on your computer. User settings include display properties, window sizes, toolbar settings, dial-up connections, Internet bookmarks, and so forth on your computer. The Files and Settings Transfer Wizard is run on a source (old) computer to collect the data and is run again on the destination (new) computer to import the data. If the old computer is using an earlier operating system, the wizard can be launched either from the Windows XP CD or from a diskette created on the new Windows XP computer. You transfer the data to the new computer over a network or direct serial connection, or store it on a removable medium such as a floppy disk, Zip disk, or writable CD.

To use the Files and Settings Transfer Wizard:

1. On the new Windows XP computer, click the **Start** button, point to **All Programs—> Accessories—> System Tools**, and click **Files and Settings Transfer Wizard**.
2. On the **Files and Settings Transfer Wizard** welcome screen, click **Next>**.
3. On the **Which computer is this?** screen, select **New Computer**, and then click **Next>**.

The **Do you have a Windows XP CD?** screen appears.

The Files and Settings Transfer Wizard guides you through the steps necessary to transfer user settings, personal files, or both to the new computer. If a CD drive is not available, the wizard allows you to create a wizard diskette to run on your old computer.

 **NOTE:** The time required to collect and transfer data depends on the amount of data collected. Times can vary from just a few minutes to several hours.

---

## Application and Device Compatibility

Although Windows XP is designed to be compatible with a wide range of application programs and hardware devices, some older programs and devices may not be usable. Check the Microsoft Web site at [www.microsoft.com](http://www.microsoft.com) for application programs and hardware devices known to be compatible. When buying new software and devices, look for those that are labeled as ready for Windows XP. If you encounter problems using an application program designed for an earlier Windows operating system, Windows XP provides a compatibility mode feature (see "[Program Compatibility Wizard](#)"). If you are unsuccessful at installing application programs or hardware devices designed to operate on earlier Windows operating systems, contact the manufacturer of the product for information or updates for Windows XP.

Windows XP also includes a new technology that addresses the problems sometimes encountered on previous operating systems with Windows application programs that, when installed, replace current versions of certain Windows files with older versions. This situation can cause problems with the newer application programs, which rely on the replaced files. To eliminate this problem and improve operating system stability, Windows XP manages multiple versions of files and invokes the correct version required by a program.

 **NOTE:** If you experience problems with your operating system or other applications after performing an installation, you can use [System Restore](#) to return your computer to a previous stable condition.

## Program Compatibility Wizard

A program compatibility feature is provided in Windows XP that solves some issues that may be encountered when attempting to run older application programs. Using the Program Compatibility Wizard, you can configure a program to run in an environment closer to Windows 95, Windows 98/Me, Windows NT 4.0 with Service Pack 5, or Windows 2000.

To use the Program Compatibility Wizard:

1. Click the **Start** button, point to **All Programs**—> **Accessories**, and click **Program Compatibility Wizard**.
2. When the Program Compatibility Wizard appears, click **Next**>.
3. Select how you want to locate the program to run with compatibility settings: from a list, available on a CD, or manually located. Then click **Next**>.
4. Select the type of operating system for which the program was designed or on which it ran successfully, and then click **Next**>.
5. If necessary, as for some games, select display settings for the program.
6. Click **Next**>.
7. To test the compatibility settings for the program, click **Next**>.

After you have determined whether the program is running correctly, return to the **Program Compatibility Wizard** window.

8. Select **Yes** if the program ran correctly, **No, try different compatibility settings**, or **No, I am finished trying compatibility settings** and click **Next**>.
9. Select either **Yes** to send information about the settings you used and whether they fixed the problem, or select **No**, and then click **Next**>.
10. Click **Finish** to close the wizard.

---

## System Restore

The System Restore feature of Windows XP provides the capability to restore the operating system, in the event of a problem, to a previous state without losing personal data files (such as Word documents, drawings, or e-mail).

System Restore actively monitors system file changes and some application file changes to record or store previous versions before the changes occurred. System Restore maintains a rolling record of restore points: to limit the amount of space used, older restore points are purged to make room for newer ones.

In the event of a serious operating system problem, System Restore can be used from Safe Mode or Normal Mode to go back to a previous system state, restoring optimal system functionality.

 **NOTE:** System Restore does not revert user data or document files, so restoring does not cause loss of work, mail, or browsing history and favorites.

 **NOTE:** Dell recommends that you make regular backups of your data files. System Restore does not monitor changes to or recover your data files. In the event the original data on the hard drive is accidentally erased or overwritten or becomes inaccessible because of a hard-drive malfunction, backup files are required to recover lost or damaged data.

## Using System Restore

System Restore monitors a core set of system and application program files, recording and sometimes copying states of these files before changes are made. System Restore automatically creates restore points: no user intervention is required. In addition, you can create restore points manually, if desired.

Restore points are created to allow you to choose previous system states. Each restore point gathers the necessary information needed to restore to a precisely chosen system state. There are three types of restore points:

- 1 System (automatically created) restore points (scheduled by your computer)
- 1 Installation (event-triggered) restore points (when a program is installed)
- 1 Manual restore points (created by you as needed)

### Scheduled Automatic Restore Points

By default, System Restore creates a restore point every day that the computer is running. If your computer is off for more than a day, a new restore point is created the next time you turn the computer on.

## Event-Triggered Restore Points

Event-triggered restore points are created before key changes are made to the system. System Restore automatically creates a restore point before the following events:

- 1 *Application installations* — System Restore creates a restore point before you install an application program designed for Windows XP. You may wish to create a manual restore point before attempting to install an older program.
- 1 *AutoUpdate installation* — When you choose to install the update, System Restore creates a restore point before the actual installation of the update begins.
- 1 *Restore operation* — The restore operation itself also creates a restore point for undo purposes.
- 1 *Microsoft Backup Utility recovery* — Before Microsoft Backup Utility (only available in Windows XP Professional) performs a backup recovery, System Restore creates a restore point.
- 1 *Unsigned driver installation* — The INF installer of Windows detects unsigned device-driver installations. Drivers that are signed (electronically certified by the device manufacturer) do not generate a restore point.

## Manual Restore Points

If you are logged on to the computer as computer administrator or as a user with administrator rights, you may create and name an on-demand restore point. (For information on types of user accounts, see "[How to Add Users](#).") This is useful to create a checkpoint to return to before making a particularly risky change, before leaving a shared system to other users, or at a particular state you believe is optimal.

To create a restore point, perform the following steps:

1. Click the **Start** button, point to **All Programs—> Accessories—> System Tools**, and then click **System Restore**.
2. Select **Create a restore point** and click **Next>**.
3. Type a description of the restore point and click **Create**.

The date and time are automatically added to the description of the new restore point.

## Restore Process

As the computer is used over time, restore points are collected in the archive without any management or intervention. If you encounter operating system problems, you can use the System Restore feature to select any of the restore points presented through the System Restore Wizard.

If problems occur after installing a device driver, you should first attempt to use [Driver Rollback](#). If that is unsuccessful, then use System Restore.

To return your computer to a previous, stable condition, perform the following steps:

1. Click the **Start** button, point to **All Programs—> Accessories—> System Tools**, and then click **System Restore**.
2. Select **Restore my computer to an earlier time** and click **Next>**.

The **Select a Restore Point** screen appears. The calendar on the left indicates in bold the dates on which restore points were created.

3. Click a date, click a restore point for that date, and click **Next>**.
4. Click **Next>** to confirm the restore point selection and complete the restore process.

After System Restore finishes collecting data, the computer automatically restarts and the **Restoration Complete** screen appears.

5. Click **OK**.

If you are not satisfied with the results of the restoration, you can repeat the preceding steps, using a different restore point, or you can undo the restoration.

To undo a restoration, perform the following steps:

1. Click the **Start** button, point to **All Programs—> Accessories—> System Tools**, and then click **System Restore**.
2. Select **Undo my last restoration** and click **Next>**.
3. Click **Next>** to confirm the restoration undo.

After System Restore finishes collecting data, the computer automatically restarts and the **Undo Complete** screen appears.

4. Click **OK**.

## Driver Rollback

Windows XP device Driver Rollback can replace a device driver with the previously installed version. When you install a new device driver that causes system instability, use Driver Rollback to reinstall the previous drivers. In the event that Driver Rollback cannot reinstall your previous driver, you can use System Restore to return your operating system to its state before the new device driver installation.

To use Driver Rollback, perform the following steps:

1. Click the **Start** button, and then right-click **My Computer**.
2. Click **Properties**.
3. Click the **Hardware** tab, and then click **Device Manager**.
4. In the **Device Manager** window, right-click the device for which the new driver was installed, and then click **Properties**.
5. Click the **Drivers** tab, and then click **Roll Back Driver**.

---

## User Accounts and Fast User Switching

 **NOTE:** Fast User Switching is the default user screen for both Home and Professional editions, but is disabled in Windows XP Professional when the computer is a member of a computer domain.

Microsoft Windows XP includes a new feature that provides multiuser access to a single computer. Fast User Switching, which is available in both the Home and Professional editions, allows users to access the computer with their specific settings, including the desktop and various applications, without requiring the previous user to log off. New users log on and switch from the original user's session to their own. New users can run their desktop and applications without interfering with the original user. When the original user returns, that user can switch back to the desktop and applications with the original settings. All of this is accomplished without the delay of each individual user logging off the computer.

During setup, the computer administrator creates all the accounts that will be used on the computer. (For information on types of accounts and adding new accounts, see "[How to Add Users.](#)") When the computer starts, the main user screen appears with all of the user names. From this screen you select an account and log in to that session.

### How to Use Fast User Switching

To access Fast User Switching, perform the following steps:

1. Click the **Start** button and click **Log Off**.
2. When the **Log Off Windows** screen appears, click either **Switch User** or **Log Off**.

When you select **Switch User**, the main user screen appears. You can then select your account name and log in. Your personal desktop appears.

### What Happens When a Fast User Switch Occurs?

When a fast user switch occurs, the original user is not logged off the computer as previously happened on other Microsoft operating systems. On Windows XP, the user's logon remains active, but is replaced by the new user. Users can switch between login IDs as often as they want.

However, user applications active during a user switch remain active and running in the background while the new user is working; this can result in a slower computer until the process finishes. For example, if one user is downloading a large file from the Internet and another user logs on to the computer, the file download continues in the background until it is complete.

While most applications continue to run in the background during a fast user switch, multimedia applications do not. Because multimedia applications use resources that cannot easily be shared between different users on a single computer, those applications terminate during the user switch, allowing the new user to take full advantage of the multimedia capabilities.

### Special Considerations With Fast User Switching

Considerations when using Fast User Switching include:

- 1 Some older Windows games may not operate with a fast user switch.
- 1 Multimedia games may shut down on a fast user switch.
- 1 DVD software shuts down and requires a restart when the user comes back.
- 1 Computers with low memory configurations can experience problems. The computer uses memory to keep the first user's programs running in the background while the second user is logged on. On computers with limited memory, this can cause the entire computer to run slowly. **Fast User Switching is off by default on computers with less than 128 megabytes (MB) of random-access memory (RAM).**

Fast User Switching is unavailable if the computer has Windows XP Professional installed and is a member of a computer domain.

### How to Turn Off Fast User Switching

You must have a computer administrator account on the computer to turn off Fast User Switching. (For information on types of accounts, see "[How to Add Users.](#)")

To disable Fast User Switching, perform the following steps:

1. Click the **Start** button, and click **Control Panel**.
2. In the **Control Panel** window, click **User Accounts**.
3. Under **Pick a task**, click **Change the way users log on or off** and do one of the following:
  - 1 Select the **Use Fast User Switching to log off** check box to enable Fast User Switching.
  - 1 Deselect the **Use Fast User Switching to log off** check box to disable Fast User Switching.
4. Click **Apply Options**.

### How to Add Users

Only a computer administrator or a user with administrator rights can create multiple user accounts. The individual who performs the initial operating system setup creates a computer administrator account and can add any number of users during the initial setup. All user accounts created during setup have administrator rights.

After initial operating system setup, the computer administrator or a user with administrator rights can create additional user accounts.

 **NOTE:** Different account options are available when a Windows XP Professional computer is connected to a domain.

To add users, perform the following steps:

1. Click the **Start** button, and click **Control Panel**.
2. In the **Control Panel** window, click **User Accounts**.
3. In the **User Accounts** window under **Pick a Task**, click **Create a new account**.
4. In the box under **Name the new account**, type the name of the new user. Click **Next>**.
5. Under **Pick an account type**, click the bullet next to the type of account you are going to create — **Computer administrator** or **Limited**.
  - 1 Computer administrators can change all computer settings.
  - 1 Limited account users can change only a few settings such as their own passwords.
6. Click **Create Account**.

After the accounts are created, each shows up on the main user screen.

---

## Home and Small Office Networking

The Network Setup Wizard includes a checklist and steps to guide you through the process of sharing resources, such as files, printers, or an Internet connection, between computers in a home or small office. In Windows XP, Microsoft has improved the online documentation and usability of operating-system tools for setting up a home or small office network. New features in the operating system include support for the Point-to-Point Protocol over Ethernet (PPPoE) and a built-in firewall.

### Network Setup Wizard

The Home Network Wizard first appeared in Windows Me. To make setting up a home or small office network easier, Microsoft developed an enhanced Network Setup Wizard for Windows XP. This version provides more complete online documentation and support for setting up a home or small office network. The new wizard automatically enables the personal firewall discussed later in this section (see "[Internet Connection Firewall](#)").

To use the wizard, perform the following steps:

1. Click the **Start** button, point to **All Programs**—> **Accessories**—> **Communications**, and click **Network Setup Wizard**.
2. When the Network Setup Wizard appears, click **Next>**.
3. Click **checklist for creating a network**.

The checklist leads you through the steps necessary to set up a home or small office network and provides extensive references for each step. When you have completed the necessary connections and preparations, return to the **Network Setup Wizard**.

4. Select the Internet connection method and click **Next>**.
  5. Select the desired Internet connection if required, and click **Next>**.
  6. Type a description of the computer and a computer name, and then click **Next>**.
  7. Review the network settings and click **Next>** to finish the setup.
  8. When the setup process is complete, click **Finish** to close the wizard.
- 

## Internet Connection Firewall

Today's always-on cable modem and DSL Internet access connections offer unprecedented bandwidth to the home, but also leave the connected computer or home network vulnerable to hacker attacks. The nature of these attacks varies, but the goal is to gain access to individual computers attached to the Internet. With this access, a hacker can browse the hard drive and add or delete files, discover passwords and credit card numbers, and set the system up to launch attacks on other systems or websites. As a result, firewall protection from these attacks is increasingly required on computers. Recognizing this need, Microsoft provides an integrated firewall in Windows XP to provide immediate protection from outside access attempts. When enabled, the Internet Connection Firewall provides basic protection suitable for most home and small office users. The Internet Connection Firewall is disabled when the computer is connected to a domain.



**NOTE:** Enabling the Internet Connection Firewall does not reduce the need for virus-checking software.

The firewall is automatically enabled when you run the Network Setup Wizard. When the firewall is enabled for a network connection, its icon appears with a red background in the **Network Connections** portion of the Control Panel. The Internet Connection Firewall can be applied to each Internet connection on the computer. The firewall also provides basic logging capabilities. Not all events that appear in the log are hacker attacks. Many different types of harmless events can appear in the log, such as routine checks by an Internet Service Provider to verify the presence of your computer (pings).

The firewall is configured using the **Properties** dialog box associated with each Internet connection in the Control Panel. The firewall can be enabled or disabled. Additional configuration options are available for more advanced users. These advanced options include the ability to open or close specific Transmission Control Protocol (TCP) or User Datagram Protocol (UDP) ports or to enable port redirection. Port redirection allows access requests to a specific port on the firewall (such as port 80, the Web server port) to be automatically redirected to another computer on the local network. This capability allows a Web server on a home network to be protected by an edge firewall.

---

[Back to Contents Page](#)

