



www.mortara.com

REF 70-00297-01 Rev D1

TM55/TM65

STRESS TREADMILLS
USER MANUAL



Manufactured by Mortara Instrument, Inc., Milwaukee, Wisconsin U.S.A.



CAUTION: *Federal law restricts this device to sale by or on the order of a physician.*



Copyright © 2015
by Mortara Instrument, Inc.
7865 N. 86th Street
Milwaukee, Wisconsin 53224

This document contains confidential information that belongs to Mortara Instrument, Inc. No part of this document may be transmitted, reproduced, used, or disclosed outside of the receiving organization without the express written consent of Mortara Instrument, Inc. Mortara, Burdick, Quinton, Quest, and Q-Stress are registered trademarks of Mortara Instrument, Inc. HeartStride is a trademark of Mortara Instrument, Inc. 2015-11

TABLE OF CONTENTS

1. GENERAL STATEMENTS	1
TECHNICAL SUPPORT AND SERVICE	1
2. NOTICES	2
MANUFACTURER’S RESPONSIBILITY	2
RESPONSIBILITY OF THE CUSTOMER	2
EQUIPMENT IDENTIFICATION	2
COPYRIGHT AND TRADEMARK NOTICES	2
OTHER IMPORTANT INFORMATION	2
3. WARRANTY INFORMATION	3
YOUR MORTARA WARRANTY	3
4. USER SAFETY INFORMATION	5
WARNING(S)	5
CAUTION(S)	5
NOTE(S)	7
5. EQUIPMENT SYMBOLS AND MARKINGS	9
SYMBOL DELINEATION	9
6. GENERAL CARE	11
DISINFECTION	11
DAILY	11
WEEKLY	11
PERIODIC	11
7. ELECTROMAGNETIC COMPATABILITY (EMC)	13
8. INTRODUCTION	17
OVERVIEW	17
TREADMILL CONFIGURATION	17
TREADMILL CONTROLS	18
<i>Power</i>	18
OPERATION	18
EMERGENCY STOP BUTTON	19
INDICATORS	19
ACCESSORIES AND OPTIONS	19
9. OPERATING THE TREADMILL	21
GUIDELINES FOR SAFE OPERATION	21
INSTRUCTING THE PATIENT	21
STARTING THE EXERCISE	22
EMERGENCY STOP BUTTON (OPTION)	22
ENDING THE EXERCISE	22
10. MAINTENANCE/TROUBLESHOOTING	23
DAILY VISUAL INSPECTION	23
CLEANING	23
<i>Exterior</i>	23

<i>Interior</i>	23
DISINFECTION	24
ADJUSTMENTS	24
<i>Belt Tension</i>	24
<i>Belt Tracking</i>	25
REAR ROLLERS GUARDS	26
ELECTRICAL TESTING	26
MOVING THE TREADMILL	27
STORING THE TREADMILL	27
TROUBLESHOOTING.....	27
TROUBLESHOOTING GUIDE	29
11. SPECIFICATIONS.....	31
CARDIAC STRESS TREADMILLS	31
POWER REQUIREMENTS.....	31
SPEED VS WEIGHT RANGE	32
% GRADE VS ANGLE RELATIONSHIP	33
12. RECEIVING AND INSTALLATION.....	35
RECEIVING.....	35
INSTALLATION NOTICE	35
SITE REQUIREMENTS	35
INSTALLATION	36
<i>Tools</i>	36
<i>Procedure</i>	36
CONNECTING TO THE MONITORING SYSTEM	38
TESTING THE TREADMILL	39

TABLE OF FIGURES

Figure 1 Example of a Treadmill.....	17
Figure 2 Example of Hood Configuration Plate for Treadmill.....	18
Figure 3 Example of Emergency Stop Button.....	22
Figure 4 Adjustment bolts.....	24
Figure 5 Roller Guard.....	26
Figure 6 Speed vs. Weight graph.....	32
Figure 7 %Grade vs. Angle Graph.....	33
Figure 8 Example of Treadmill front.....	36
Figure 9 Example of Monitoring System Connections.....	38

1. GENERAL STATEMENTS

Technical Support and Service

Headquarters

Mortara Instrument, Inc.

7865 North 86th Street
Milwaukee, WI 53224
U.S.A.

Tel: 414.354.1600
Tel: 800.231.7437
Fax: 414.354.4760
Internet: <http://www.mortara.com>

European Union

Mortara Instrument Europe s.r.l.

(European Headquarters)
Via Cimarosa 103/105
40033 Casalecchio di Reno (BO)
Italy

Tel: +39.051.298.7811
Fax: +39.051.613.3582

Service/Technical Support Group

Mortara Instrument, Inc.

7865 North 86th Street
Milwaukee, WI 53224
U.S.A.

Tel: 414.354.1600
Service: 888.MORTARA
(888.667.8272)
Fax: 414.354.4760
E-mail: techsupport@mortara.com

Sales Support/ Supplies & Accessories

Mortara Instrument, Inc.

7865 North 86th Street
Milwaukee, WI 53224
U.S.A.

Tel: 414.354.1600
Fax: 414.354.4760

Hospital Customers: orders.us@mortara.com
Physician Practice: orderspc.us@mortara.com
U.S. Distribution: orderspc.us@mortara.com

Mortara Instrument Germany

Bonifaciusring 15
45309 Essen
Germany

Tel: +49.201.18 55 69 70
Fax: +49.201.18 55 69 77

Mortara Instrument Netherlands

Postbus 324
5680 AH Best
Industrieweg 160b
5683 CG Best
Netherlands

Tel: +31.499.377310
Fax: +31.499.377908

Mortara Instrument Australia

PO Box 7568
Baulkham Hills NSW 2153
Unit 28, 9 Hoyle Avenue
Castle Hill NSW 2154
Australia

Tel: +61 2 8070 9303
Fax: +61 2 9899 9478

Mortara Instrument UK Ltd

Units 11 & 12, Scion House
Stirling University Innovation Park
Stirling FK9 4NF
Scotland

Tel: +44.1786.444980
Fax: +44.1786.446630

2. NOTICES

Manufacturer's Responsibility

Mortara Instrument, Inc. is responsible for the effects on safety and performance only if:

- Assembly operations, extensions, readjustments, modifications, or repairs are carried out by persons authorized by Mortara Instrument, Inc.
- The device is used in accordance with the instructions for use.
- The electrical installation of the relevant room complies with the requirements of appropriate regulations.

Responsibility of the Customer

The user of this device is responsible for ensuring the implementation of a satisfactory maintenance schedule. Failure to do so may cause undue failure and possible health hazards.

Equipment Identification

Mortara Instrument, Inc. equipment is identified by a serial and reference number on the back of the device. Care should be taken so that these numbers are not defaced.

Copyright and Trademark Notices

This document contains information that is protected by copyright. All rights are reserved. No part of this document may be photocopied, reproduced, or translated to another language without prior written consent of Mortara Instrument, Inc.

Other Important Information

The information in this document is subject to change without notice.

Mortara Instrument, Inc. makes no warranty of any kind with regard to this material including, but not limited to, implied warranties of merchantability and fitness for a particular purpose. Mortara Instrument, Inc. assumes no responsibility for any errors or omissions that may appear in this document. Mortara Instrument, Inc. makes no commitment to update or to keep current the information contained in this document.

3. WARRANTY INFORMATION

Your Mortara Warranty

MORTARA INSTRUMENT, INC. (hereafter referred to as “Mortara”) warrants that components within Mortara products (hereafter referred to as “Product/s”) will be free from defects in workmanship and materials for the number of years specified on documentation accompanying the product, or previously agreed to by the purchaser and Mortara, or if not otherwise noted, for a period of thirteen (13) months from the date of shipment.

Consumable, disposable or single use products such as, but not limited to, PAPER or ELECTRODES are warranted to be free from defects in workmanship and materials for a period of 90 days from the date of shipment or the date of first use, whichever is sooner.

Reusable product such as, but not limited to, BATTERIES, BLOOD PRESSURE CUFFS, BLOOD PRESSURE HOSES, TRANSDUCER CABLES, Y-CABLES, PATIENT CABLES, LEAD WIRES, MAGNETIC STORAGE MEDIUMS, CARRY CASES or MOUNTS, are warranted to be free from defects in workmanship and materials for a period of 90 days. This warranty does not apply to damage to the Product/s caused by any or all of the following circumstances or conditions:

- a) Freight damage;
- b) Supplies, accessories and internal parts NOT approved by Mortara;
- c) Misapplication, misuse, abuse, and/or failure to follow the Product/s instruction sheets and/or information guides;
- d) Accident;
- e) A disaster affecting the Product/s;
- f) Alterations and/or modifications to the Product/s not authorized by Mortara;
- g) Other events outside of Mortara’s reasonable control or not arising under normal operating conditions.

THE REMEDY UNDER THIS WARRANTY IS LIMITED TO THE REPAIR OR REPLACEMENT WITHOUT CHARGE FOR LABOR OR MATERIALS, OR ANY PRODUCT/S FOUND UPON EXAMINATION BY MORTARA TO HAVE BEEN DEFECTIVE. This remedy shall be conditioned upon receipt of notice by Mortara of any alleged defects promptly after discovery thereof within the warranty period. Mortara’s obligations under the foregoing warranty will further be conditioned upon the assumption by the purchaser of the Product/s (i) of all carrier charges with respect to any Product/s returned to Mortara’s principal place or any other place as specifically designated by Mortara or an authorized distributor or representative of Mortara, and (ii) all risk of loss in transit. It is expressly agreed that the liability of Mortara is limited and that Mortara does not function as an insurer. A purchaser of a Product/s, by its acceptance and purchase thereof, acknowledges and agrees that Mortara is not liable for loss, harm, or damage due directly or indirectly to an occurrence or consequence there from relating to the Product/s. If Mortara should be found liable to anyone under any theory (except the expressed warranty set forth herein) for loss, harm, or damage, the liability of Mortara shall be limited to the lesser of the actual loss, harm, or damage, or the original purchase price of the Product/s when sold.

EXCEPT AS SET FORTH HEREIN WITH RESPECT TO REIMBURSEMENT OF LABOR CHARGES, A PURCHASER'S SOLE EXCLUSIVE REMEDY AGAINST MORTARA FOR CLAIMS RELATING TO THE PRODUCT/S FOR ANY AND ALL LOSSES AND DAMAGES RESULTING FROM ANY CAUSE SHALL BE THE REPAIR OR REPLACEMENT OF DEFECTIVE PRODUCT/S TO THE EXTENT THAT THE DEFECT IS NOTICED AND MORTARA IS NOTIFIED WITHIN THE WARRANTY PERIOD. IN NO EVENT, INCLUDING THE CLAIM FOR NEGLIGENCE, SHALL MORTARA BE LIABLE FOR INCIDENTAL, SPECIAL, OR CONSEQUENTIAL DAMAGES, OR FOR ANY OTHER LOSS, DAMAGE, OR EXPENSE OF ANY KIND, INCLUDING LOSS OF PROFITS, WHETHER UNDER TORT, NEGLIGENCE OR STRICT LIABILITY THEORIES OF LAW, OR OTHERWISE. THIS WARRANTY IS EXPRESSLY IN LIEU OF ANY OTHER WARRANTIES, EXPRESS OR IMPLIED, INCLUDING, BUT NOT LIMITED TO THE IMPLIED WARRANTY OF MERCHANTABILITY AND THE WARRANTY OF FITNESS FOR A PARTICULAR PURPOSE.

4. USER SAFETY INFORMATION



Warning:

This alert identifies hazards that may cause serious personal injury or death.



Caution:

This alert identifies hazards that may cause minor personal injury, product damage, or property damage.

Note:

Provides information to further assist in the use of the device.

***NOTE:** This manual may contain screen shots and pictures. Any screen shots and pictures are provided for reference only and are not intended to convey actual operating techniques. Consult the actual screen in the host language for specific wording.*



Warning(s)

- This user guide contains the user and patient safety requirements, operating instructions and maintenance requirements for the Cardiac Stress treadmills, models TM55, and TM65. The user guide is intended for use by trained clinicians working in a clinical setting. It is expected that the clinician will instruct the patient in the proper use of the treadmill and its accessories. Before using the treadmill, read the user guide carefully, noting the safety requirements in this chapter.
- There are no user-serviceable parts in the treadmill. Any attempt by non-authorized personnel to service the equipment may void the warranty. Upon request, we will provide a technical document containing block-level theory of operation, troubleshooting, removal and replacement instructions (by module), maintenance, and other information that will assist appropriately-trained personnel to repair those parts of the equipment designated as repairable.
- The treadmill must be on an appropriate, dedicated electrical circuit with a power rating that meets the electrical specification on the treadmill serial number label. Nothing else should be connected to the circuit.
- As long as the treadmill is plugged into a powered outlet and the treadmill circuit breaker is set to ON, the treadmill is receiving power, even when the monitoring system is turned off. Do not place hands beneath the treadmill while it is plugged in.



Caution(s)

- Use only approved equipment. Accessory equipment connected to analog, digital, or power interfaces must be either equipment offered for sale by Mortara Instrument or equipment that, when connected to such interfaces, maintains the safety and specified performance of the overall system and the individual devices. For example, such safety is maintained if the individual equipment and overall system complies with relevant safety requirements found in International Electrotechnical Commission (IEC) standards.
- Read this manual in full before operating the treadmill.
- Before each use of this equipment, check the power receptacle for signs of damage. Do not operate the equipment if the integrity of these items is in question.
- Be sure the connection for the optional Emergency Off switch is secure. Test the switch to verify proper operation. Do not operate the equipment if the integrity of these items is in question.

- Keep the treadmill area clear. Maintain a minimum open space of 1.5 feet (0.5 meter) on each side and 6 feet (2 meters) at the rear.
- The Cardiac Stress Treadmill should not be used adjacent to or stacked with other equipment. If adjacent or stacked use is necessary, the Cardiac Stress Treadmill should be observed to verify normal operation in the configuration in which it will be used.
- Do not operate this equipment in the presence of flammable anesthetic mixtures.
- Regularly inspect cables and treadmill belts for wear or damage. Do not operate the equipment if the integrity of these items is in question.
- Increased risk due to leakage current can result if this equipment is not grounded properly.
- To avoid potential safety and electrical problems, use parts and accessories that meet specifications as noted in this user guide and the user guide for your stress monitor.
- When connecting auxiliary equipment approved for use with the monitoring system, be certain the summation leakage current does not exceed local or provincial standards.
- Failure to follow these guidelines can produce a serious or possibly fatal electrical shock hazard. Consult a qualified electrician as required.
- Patients and clinicians should secure long hair and loose clothing before using and/or operating the treadmill.
- Do not start the treadmill when someone is standing on the belt.
- Keep speed and grade at the lowest settings when getting on and off the treadmill belt.
- Never place chairs or other objects on treadmills.
- Be aware of a moving treadmill belt.
- Allow sufficient room for patients to maneuver around the system and to safely mount and dismount the treadmill.
- Patients should wear shoes when using the treadmill.
- This treadmill may be equipped with the rapid deceleration profile (optional); if so, it is specifically designed to come to a rapid stop. This feature requires that attendant(s) are available to support and assist the patient user. Attendants **MUST** be in a position to support and assist the patient when the belt stops





















Note(s)

- This equipment is classified Class I, Type B, ordinary equipment, not protected against fluid ingress. It is rated for continuous operation.
- Use of accessories or cables other than those specified, with the exception of accessories or cables sold by the manufacturer as replacement parts for internal components, may result in increased emissions or decreased immunity of the treadmill.
- Keep the area underneath and around the treadmill clear. Make sure cables are clear of the treadmill.
- The following are safety guidelines for operating the treadmill. Ensure the patient understands the proper treadmill mount and dismount procedure. Properly train new staff.



5. EQUIPMENT SYMBOLS AND MARKINGS

Symbol Delineation

Your treadmill may display one or more of the following symbols and warning labels for your protection. No single product displays all.

<p>Caution</p>  <p>Attention: Consult accompanying documents</p>	 <p>Earth ground (protective)</p>
 <p>Off (power disconnected from mains)</p>	 <p>Type B equipment – provides adequate protection against electric shock, particularly regarding allowable leakage current; reliability of the protective earth connection (when present)</p>
 <p>On (power connected to mains)</p>	 <p>Type BF equipment – contains an F-type isolated patient applied part providing a high degree of protection against electric shock</p>
 <p>Alternating current</p>	 <p>Type BF equipment with defibrillation protection</p>
 <p>High voltage</p>	 <p>Type CF equipment – contains an F-type isolated patient applied part and provides a degree of protection against electric shock higher than that for type BF equipment regarding allowable leakage currents</p>
 <p>Earth ground (functional)</p>	 <p>Type CF equipment with defibrillation protection</p>
 <p>Replace fuse only as marked</p>	 <p>Fuse</p>
 <p>Mains power</p>	 <p>Equipotentiality</p>
 <p>Down</p>	 <p>Up</p>
 <p>Faster</p>	 <p>Slower</p>
<p>Warning</p>  <p>Warning</p>	<p>T</p> <p>Timed fuse (slo-blo)</p>

EQUIPMENT SYMBOLS AND MARKINGS

 <p>USB Connector</p>	 <p>Fragile: Do not lift in this location</p>
<p>Hz Hertz</p>	<p>V Volts</p>
<p>A Amperes</p>	<p>VA Volt Amperes</p>
 <p>Do not dispose as unsorted municipal waste. Per European Union Directive 2002/96, requires separate handling for waste disposal according to national requirements</p>	

6. GENERAL CARE

Never wipe the deck beneath the belt, even when changing the belt. Wiping can damage the wax finish.

Do not use detergents or cleaning agents on any part of the deck.

Disinfection

If it is necessary to disinfect the treadmill, follow the procedures established by your institution.

Do not use liquids on the deck surface.

Daily

Keep the treadmill free of dust and debris. Clean the exterior and walking belt with a damp sponge; do not soak surfaces. Dry all surfaces thoroughly.

Weekly

Elevate the treadmill to maximum grade and vacuum the floor under it to prevent excess dust and dirt from interfering with operation.

Periodic

Depending upon the treadmill environment, dust and or lint can accumulate under the hood. Period internal cleaning by an authorized technician is recommended (see Service Manual).



Cautions

Turn off the treadmill and unplug the power cord from the wall outlet before cleaning.

Do not let liquid enter the interior of the treadmill. If it does, the equipment must be inspected and tested for safety by an approved technician before it can be used again.

7. ELECTROMAGNETIC COMPATABILITY (EMC)

This section lists EMC Declaration Tables.

The Cardiac Stress Treadmill requires special precautions regarding EMC and must be installed and put into service according to the guidelines of the EMC declaration tables.

Portable and mobile RF communications equipment may affect the Cardiac Stress Treadmill and the recommended separation distances in the EMC declaration tables should be observed.

Guidance and Manufacturer's Declaration: Electromagnetic Emissions

The equipment is intended for use in the electromagnetic environment specified in the table below. The customer or the user of the equipment should ensure that it is used in such an environment.

Emissions Test	Compliance	Electromagnetic Environment: Guidance
RF Emissions CISPR 11	Group 1	The Cardiac Stress Treadmills use RF energy only for its internal function. Therefore, its RF emissions are very low and are not likely to cause any interference in nearby electronic equipment. The Cardiac Stress Treadmills are suitable for use in all establishments other than domestic and those directly connected to the public low-voltage power supply network that supplies buildings used for domestic purposes.
RF Emissions CISPR 11	Class A	
Harmonic Emissions IEC 61000-3-2	Class A	
Voltage Fluctuations/ Flicker Emissions IEC 61000-3-3	Complies	
NOTE: Tests verified with shielded input/output cables only.		

Guidance and Manufacturer's Declaration: Electromagnetic Immunity

The equipment is intended for use in the electromagnetic environment specified in the table below. The customer or the user of the equipment should ensure that it is used in such an environment.

Immunity Test	IEC 60601 Test Level	Compliance Level	Electromagnetic Environment: Guidance
Electrostatic discharge (ESD) IEC 61000-4-2	+/- 6 kV contact +/- 8 kV air	+/- 6 kV contact +/- 8 kV air	Floors should be wood, concrete, or ceramic tile. If floors are covered with synthetic material, the relative humidity should be at least 30%.
Electrical fast transient/burst IEC 61000-4-4	+/- 2 kV for power supply lines +/- 1 kV for input/output lines	+/- 2 kV for power supply lines +/- 1 kV for input/output lines	Mains power quality should be that of a typical commercial or hospital environment.
Surge IEC 61000-4-5	+/- 1 kV differential mode +/- 2 kV common mode	+/- 1 kV differential mode +/- 2 kV common mode	Mains power quality should be that of a typical commercial or hospital environment.
Voltage dips, short interruptions and voltage variations on power supply input lines IEC 61000-4-11	<5% UT (>95% dip in UT) for 0.5 cycles <40% UT (>60% dip in UT) for 5 cycles <70% UT (>30% dip in UT) for 25 cycles <5% UT (>95% dip in UT) for 5 sec	<5% UT (>95% dip in UT) for 0.5 cycles <40% UT (>60% dip in UT) for 5 cycles <70% UT (>30% dip in UT) for 25 cycles <5% UT (>95% dip in UT) for 5 sec	Mains power quality should be that of a typical commercial or hospital environment. If the user of the equipment requires continued operation during power mains interruptions, it is recommended that the equipment be powered from an uninterruptible power supply or a battery.
Power frequency (50/60 Hz) magnetic field IEC 61000-4-8	3 A/m	3 A/m	Power frequency magnetic fields should be at levels characteristic of a typical location in a typical commercial or hospital environment.

NOTE: UT is the AC Mains voltage prior to application of the test level.

NOTE: Tests verified with shielded input/output cables only.

Guidance and Manufacturer's Declaration: Electromagnetic Immunity

The equipment is intended for use in the electromagnetic environment specified in the table below. The customer or the user of the equipment should ensure that it is used in such an environment.

Immunity Test	IEC 60601 Test Level	Compliance Level	Electromagnetic Environment: Guidance
Conducted RF EN 61000-4-6	3 Vrms 150 kHz to 80 MHz	3 Vrms 150 kHz to 80 MHz	<p>Portable and mobile RF communications equipment should be used no closer to any part of the equipment, including cables, than the recommended separation distance calculated from the equation applicable to the frequency of the transmitter.</p> <p>Recommended separation distance</p> <p>$d = 1.2 \sqrt{P}$ 150 kHz to 80 MHz</p> <p>$d = 1.2 \sqrt{P}$ 80 MHz to 800 MHz</p> <p>$d = 2.3 \sqrt{P}$ 800 MHz to 2.5 GHz</p> <p>Where P is the maximum output power rating of the transmitter in watts (W) according to the transmitter manufacturer and d is the recommended separation distance in meters (m).</p> <p>Field strengths from fixed RF transmitters, as determined by an electromagnetic site survey^a, should be less than the compliance level in each frequency range^b.</p> <p>Interference may occur in the vicinity of equipment marked with the following symbol:</p> 
Radiated RF IEC 61000-4-3	3 V/m 80 MHz to 2.5 GHz	3 V/m 80 MHz to 2.5 GHz	

NOTE: At 80 MHz and 800 MHz, the higher frequency range applies.

NOTE: These guidelines may not apply in all situations. Electromagnetic propagation is affected by absorption and reflection from structures, objects and people.

NOTE: Tests were verified with shielded input/output cables only.

- Field strengths from fixed transmitters, such as base stations for radio (cellular/cordless) telephones and land mobile radios, amateur radios, AM and FM radio broadcast, and TV broadcast cannot be predicted theoretically with accuracy. To assess the electromagnetic environment due to fixed RF transmitters, an electromagnetic site survey should be considered. If the measured field strength in the location in which the equipment is used exceeds the applicable RF compliance level above, the equipment should be observed to verify normal operation. If abnormal performance is observed, additional measures may be necessary, such as reorienting or relocating the equipment.
- Over the frequency range 150 kHz to 80 MHz, field strengths should be less than [3] V/m.

Recommended Separation Distances Between Portable and Mobile RF Communications Equipment and the Equipment

The equipment is intended for use in an electromagnetic environment in which radiated RF disturbances are controlled. The customer or the user of the equipment can help to prevent electromagnetic interference by maintaining a minimum distance between portable and mobile RF communications equipment (transmitters) and the equipment as recommended in the table below, according to the maximum output power of the communications equipment.

Rated Maximum Output Power of Transmitter (W)	Separation Distance According to Frequency of Transmitter (m)		
	150 KHz to 80 MHz	80 MHz to 800 MHz	800 MHz to 2.5 GHz
	$d = 1.2 \sqrt{P}$	$d = 1.2 \sqrt{P}$	$d = 2.3 \sqrt{P}$
0.01	0.12 m	0.12 m	0.23 m
0.1	0.38 m	0.38 m	0.73 m
1	1.2 m	1.2 m	2.3 m
10	3.8 m	3.8 m	7.3 m
100	12.0 m	12.0 m	23.0 m

For transmitters rated at a maximum output power not listed above, the recommended separation distance d in meters (m) can be estimated using the equation applicable to the frequency of the transmitter, where P is the maximum output power rating of the transmitter in watts (W) according to the transmitter manufacturer.

NOTE: At 80 MHz and 800 MHz, the separation distance for the higher frequency range applies.

NOTE: These guidelines may not apply in all situations. Electromagnetic propagation is affected by absorption and reflection from structures, objects, and people.

NOTE: Tests were verified with shielded input/output cables only.

8. INTRODUCTION

Overview

The Cardiac Stress Treadmills are heavy-duty medical treadmills designed specifically for stress test applications. Two models (TM55 and TM65) are available and can be used with the following cardiac stress testing systems:

- Quinton® Q-Stress® Cardiac Stress System
- Burdick® CareCenter MD Stress System

All models feature variable speed and grade and a 20-inch-wide walking surface.

Treadmill Configuration

The following illustration shows a typical treadmill configuration.

Figure 1 Example of a Treadmill

1. Handle bar
2. Front of hood
3. Walking belt
4. Rear of treadmill

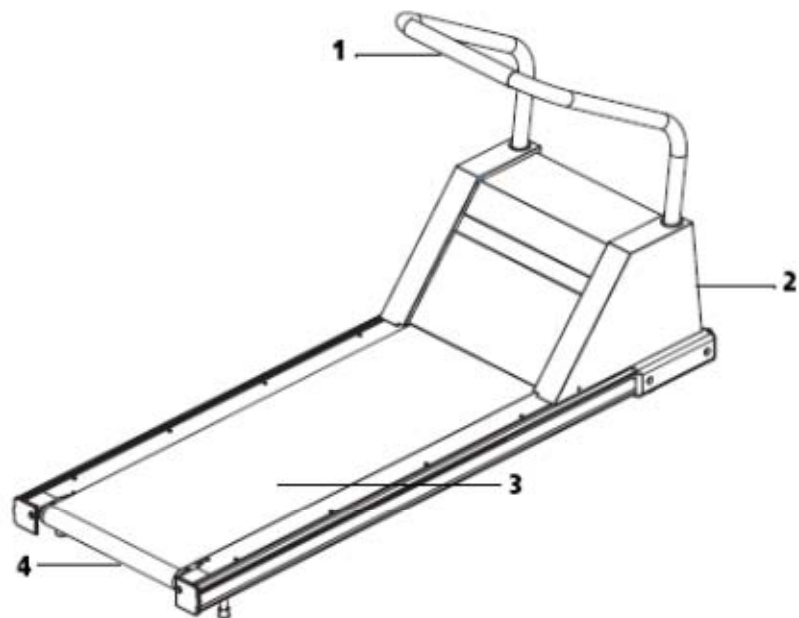

Treadmill Controls

Power

The circuit breaker located on the front of the treadmill hood, controls the power to the treadmill (see item 1 in Figure 2). The circuit breaker must be set to **ON** for the treadmill to run. As long as the treadmill is plugged into a powered socket and the circuit breaker is set to **ON**, the treadmill is receiving power, even when the monitoring system power is turned off.



WARNING! Danger of electric shock.

Turn off the treadmill circuit breaker before connecting or disconnecting the treadmill from the power outlet.

Figure 2 Example of Hood Configuration Plate for Treadmill

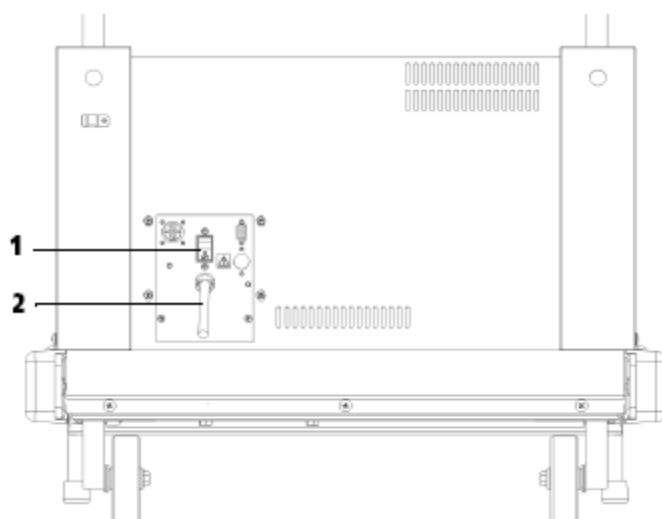

- 1 Circuit breaker**
- 2 Power cord**

Operation

All patient data displays on the monitoring system screen. Use the operator manual supplied with the monitoring system for instructions on how to control the treadmill.

Emergency Stop Button

If the treadmill is equipped with an optional emergency stop button, it is located on the front handle bar. Pressing the emergency stop button causes the treadmill to stop sending power to the belt drive motor and the grade motor.

Note: The emergency stop button is intended only for emergency use. You may have to restart the stress test if the emergency stop button is pressed.



WARNING! Connect Emergency Stop Button.

If your treadmill is equipped with the Emergency Stop Button feature, the treadmill will not run unless the emergency button cable is plugged into the connector on the front of the hood. Once installed, this cable should not be removed except by an authorized technician.

Indicators

There are no visual indicators on the treadmill. All patient responses and warnings for low power, motor overload, and other responses appear on the stress test monitoring system screen.

Accessories and Options

Part No.	Description
60-00130-01	Hand grip, Vinyl, Gray, Short
60-00131-01	Hand grip, Vinyl, Gray, Long
60-00132-01	Hand grip, vinyl, gray, short, cutout
10-00312-01	Side Handrail Kit, Short, TM55 and TM65
10-00314-01	Side Handrail Kit, Long TM55 and TM65
10-00255-01	Low Handrail Kit
10-00309-01	Emergency Stop Button Kit

9. OPERATING THE TREADMILL

The stress test monitor controls all treadmill operation. Please read the following treadmill-specific information, then refer to the operator manual supplied with your stress test monitor for operational procedures.

Guidelines for Safe Operation

- Keep the treadmill area clear. Maintain a minimum open space of 1.5 feet (0.5 meter) on each side and 6 feet (2 meters) at the rear.
- Before using the treadmill, verify that the correct cable connects the treadmill to the monitoring system.
- Do not start the treadmill when someone is standing on the belt.
- Never place chairs or other objects on treadmills.
- Do not leave a patient unattended on the treadmill.
- Patients and clinicians should secure long hair and loose clothing before using and operating the treadmill.
- Keep speed and grade at minimum settings when patients are getting on and off the treadmill.
- Use the optional emergency stop button only for emergency.

Instructing the Patient

1. Before each test, describe the complete procedure to the patient:
 - Remind the patient to not use the handrail for support during the exercise unless absolutely necessary. Explain that gripping the handrail can affect the accuracy of the test measurements.
 - Describe how you will change the belt speed and treadmill grade during the test.
2. Demonstrate how to get on and off the moving belt:
 - a. Stand next to the treadmill belt, facing the front of the treadmill.
 - b. Place both hands on the handrail.
 - c. Step onto the side of the deck or straddle the belt.
 - d. (Optional) Place one foot forward on the belt and let it move backwards, as though walking with one foot. Repeat until comfortable.
 - e. Carefully step onto the belt and begin walking.
 - f. When able to walk unassisted, let go of the handrail.
 - g. While walking on the treadmill:
 - Face forward; avoid looking down.
 - Maintain speed by keeping a constant distance from the handrail.

Starting the Exercise

To start the exercise:

1. Start the treadmill walking belt while the patient stands on the side of the deck or straddles the walking belt.



WARNING! Risk of injury.

Do not start the belt while someone is on the treadmill belt.

2. Set the speed and grade to the minimum settings.
3. Have the patient step onto the treadmill as previously instructed.
4. Before changing speed or grade, inform the patient of the change.

Emergency Stop Button (option)

If the treadmill is equipped with an optional emergency stop button, pressing this button causes the treadmill to stop sending power to the belt drive motor and the grade motor. The belt stops moving and the grade cannot change. The button locks into place and the treadmill does not function until the button is unlocked. To unlock the button, turn it counter-clockwise.

Note: The emergency stop button is intended only for emergency use. You may have to restart the stress test if the emergency stop button is pressed.

Figure 3 Example of Emergency Stop Button

- 1 Emergency Stop Button

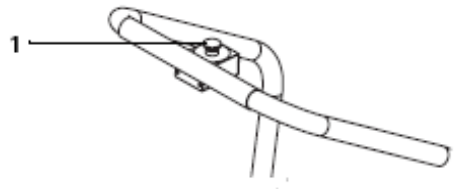

Ending the Exercise

1. Tell the patient when the test is about to end.
2. Decrease the speed and grade gradually to minimum settings.
3. Before stopping the walking belt, tell the patient to grasp the handrail for balance.
4. Stop the walking belt.
5. Tell the patient to hold the handrail and step off to the side.



WARNING! Unsteady patient.

The patient may be slightly unsteady for several seconds after stepping off the walking belt.

10. MAINTENANCE/TROUBLESHOOTING

Daily Visual Inspection

Check the following items daily:

- Inspect the treadmill power cord and walking belt for wear.
- Check the position of the walking belt; be sure it is not rubbing against the frame. It should be centered on the deck within 0.25 inch of the sides. Adjust if necessary.
- Check the handle bar and optional attachments to be sure they are fastened securely.
- Remove potential hazards from the treadmill area.

Cleaning

Exterior



WARNING! Electric shock hazard.

Turn off the treadmill and unplug the power cord from the wall outlet before cleaning.

Daily

Keep the treadmill free of dust and debris. Clean the exterior and walking belt with a damp sponge; do not soak surfaces. Dry all surfaces thoroughly.



Caution. Damage to exterior.

Never wipe the deck beneath the belt, even when changing the belt. Wiping can damage the wax finish.

Do not use detergents or cleaning agents on any part of the deck.

Weekly

Elevate the treadmill to maximum grade and vacuum the floor under it to prevent excess dust and dirt from interfering with operation.



Caution.

Do not let liquid enter the interior of the treadmill. If it does, the equipment must be inspected and tested for safety by an approved technician before it can be used again.

Interior

Depending upon the treadmill environment, dust and or lint can accumulate under the hood. Periodic internal cleaning by an authorized technician is recommended (see Service Manual).

Disinfection

If it is necessary to disinfect the treadmill, follow the procedures established by your institution.

- ◆ Do not use liquids on the deck surface.

Adjustments

Tools required: Hex wrenches
Phillips screwdriver
Torque wrench



WARNING! Catching of clothing.

Secure long hair and loose clothing before using the treadmill or working near the treadmill walking surface or pulleys.

Belt Tension

Adjust the belt tension whenever the belt slips or moves unsteadily during operation:

1. Use the controls on the monitoring system to start the treadmill at minimum speed and grade, then increase the speed to 2.5 mph.
2. Hold onto the handrail for balance and walk heavily on the treadmill by marching flat-footed.
 - a. If the belt hesitates or lags noticeably, tighten the belt as in steps 3 and 4.

Note: Do not use all your weight to resist the belt movement. Too much resistance applied too long (more than two seconds) will shut down the system. If this should occur, recycle power to resume normal operation.

- b. Increase the speed to 4.5 mph (7.1 km/h) and jog on the treadmill. If the belt hesitates or lags noticeably, tighten the belt as in steps 3 and 4.
 - c. Increase the speed to 6.5 mph (10.3 km/h) and run on the treadmill. If the belt hesitates or lags noticeably, tighten the belt as in steps 3 and 4.
3. Locate the two adjustment bolts at the rear of the treadmill (see Figure 4).

Figure 4 Adjustment bolts

- 1 Adjustment bolts

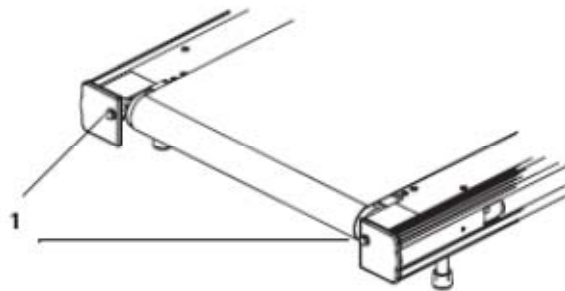

4. Rotate both adjustment bolts clockwise $\frac{1}{4}$ turn. Test the belt tension as in Step 2. Repeat if necessary until the belt runs smoothly without slipping. If more than three adjustments are necessary, call an authorized technician.

**Caution. Belt damage.**

Do not overtighten the walking belt. Overtightening can damage the belt and rollers. Do not torque adjustment screws beyond 80 in/lb (9 Nm) maximum..

5. Stop the treadmill.
6. Check the position of the rear roller guards and adjust if necessary (see Figure 5).

Belt Tracking

Perform this procedure whenever the belt moves to one side or the other.

**WARNING! Falling hazard.**

Stay off the belt when adjusting the tracking. Do not touch or grab the walking belt while it is moving.

To adjust the belt tracking:

1. Use the controls on the monitoring system to start the treadmill at minimum speed and grade.
2. Increase speed to 6 mph (9.5 km/h) and make the following adjustment (See Figure 4 for the location of the bolts):
 - If the belt moves to the right, rotate the right tension bolt clockwise $\frac{1}{4}$ turn.
 - If the belt moves to the left, rotate the left tension bolt clockwise $\frac{1}{4}$ turn.
3. After making an initial adjustment, run the treadmill for several minutes and observe how the belt tracks; adjustments to belt tracking take several minutes to become apparent. If the belt continues to move off center, adjust accordingly until it is properly centered.

If more than three adjustments are necessary, call an authorized technician.

**Caution. Damage to belt and rollers.**

Do not overtighten the walking belt. Overtightening can damage the belt and rollers. Do not torque adjustment screws beyond 80 in/lb (9N/m) maximum.

4. Stop the treadmill.
5. Check the position of the rear roller guards and adjust if necessary (see Figure 5).

Rear Rollers Guards

Check the position of the rear roller guards each time you readjust the belt tracking or the belt tension. The roller guards are located at the rear of the treadmill between the rear roller and the deck (see Figure 5).

Figure 5 Roller Guard

- 1 Adjustment Screws
- 2 Roller Guard

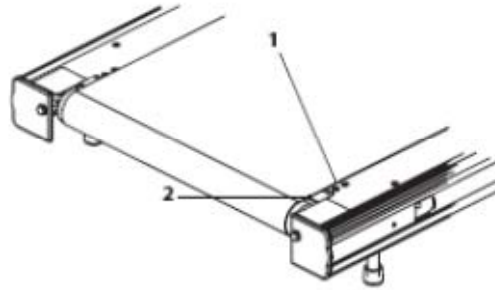

Adjust the guards when the gap between the roller and the guard exceeds $\frac{3}{8}$ (0.375) inch (9.5 mm).

1. Disconnect the treadmill power cord from the power source.
2. Loosen, but do not remove, the two screws attaching the rear roller guard to the deck (hold the wing nuts on the underside with your finger).
3. Slide the rear roller guard towards the rear roller until the gap between the two is approximately 0.1 inch (2.5 mm or the thickness of two quarters).
4. Tighten the mounting screws loosened in Step 2.
5. Connect the power cord.
6. Use the controls on the monitoring system to start the treadmill belt. If there is a scraping noise by the rear roller guards, redo steps 1 through 6.

Electrical Testing

Electrical testing is to be done by the facility's biomedical department as required. Check the leakage current of the treadmill periodically—at least every nine months—to be sure it does not exceed local or provincial standards.

Moving the Treadmill

**WARNING!**

Moving the treadmill requires two people.

To move the treadmill:

1. Set the treadmill to 3 to 5% grade.
2. To avoid electric shock, turn off the treadmill circuit breaker and the monitoring system, then remove the power cord from the power source.
3. Disconnect all cables that are attached to the treadmill or any other equipment which is attached to the treadmill.

**WARNING! Pinch hazard.**

As long as the treadmill is plugged into a powered outlet and the treadmill circuit breaker is set to ON, the treadmill is receiving power, even when the monitoring system is turned off. Do not place hands beneath the treadmill while it is plugged in.

4. Together, lift the rear of the treadmill, then roll it to the new site using the wheels on the front of the treadmill.

Note: You may stand the treadmill on end to maneuver around corners.

Storing the Treadmill

When storing for prolonged periods, cover the treadmill with a dust cover. Do not store in damp areas.

**WARNING! Falling hazard.**

Do not store the treadmill on its end as it could fall on someone.

Before using the treadmill again after moving or storage, check the power cord and all attachments to be sure they are undamaged and securely connected, then test the system for proper operation.

Troubleshooting

If the walking belt does not run, check the monitoring system for an error code. Record the code, if present, then call an authorized technician. If no error message is present, recycle the power by powering the monitoring system off and on again. If this does not eliminate the fault, check the interface cables for proper connection.

If problems persist, refer to the Troubleshooting Guide. Problems beyond the scope of this table may require service assistance to isolate and correct. Contact an authorized technician or call 888-667-8272.



WARNING! Electric shock hazard.

Do not remove the treadmill hood: Dangerous voltages are present. There are no operator-serviceable components.



Caution. Authorized service only.

Servicing should be done only by an authorized technician who should consult the service manual before attempting any in-depth troubleshooting..

Troubleshooting Guide

Problem	Possible Cause	Remedy
Treadmill will not run.	Treadmill or monitoring system power cord is not plugged in.	Plug in power cords.
	Interface cable disconnected or damaged.	Plug in and secure interface cable. Replace if damaged.
	Monitoring system power off.	Turn on power. Check AC power, if necessary.
	Circuit breaker on treadmill hood reads OFF.	Set the circuit breaker switch on the treadmill to ON.
	1. Start key not selected. 2. Not in proper menu.	Press proper key on monitoring system control panel. Consult stress test system user guide.
	No power at outlet	Check building circuit breaker.
	Voltage below nominal.	Provide dedicated line for treadmill.
	Emergency Stop button has been unplugged.	Plug into connector on front of hood.
	Emergency Stop button activated.	Turn emergency stop button counter-clockwise to deactivate.
Internal problem.	Service required. Contact an authorized technician.	
Walking belt too far left or right.	Improper belt tracking.	Adjust tracking (see "Belt Tracking" in this section). If problem persists, contact an authorized technician.
Walking belt slips, but front roller turns.	Improper belt tension.	Adjust belt tension (see "Belt Tension" in this section). If problem persists, contact an authorized technician.
Walking belt hesitates; adjusting walking belt tension is ineffective.	Internal drive belt slipping.	Service required. Contact an authorized technician.
Treadmill will not change grade.	Excess weight on treadmill.	See the <i>Specifications</i> section for maximum load.
	Internal problem.	Service required. Contact an authorized technician.
Circuit breaker trips during normal operation.	Power fault.	Service required. Contact an authorized technician.
Error messages on stress test monitor.	Refer to monitoring system user guide.	Refer to monitoring system user guide.
	Internal problem.	Service required. Contact an authorized technician.

11. SPECIFICATIONS

Cardiac Stress Treadmills

Cardiac Stress Treadmills have the following specifications:

Performance	
Maximum Rated Load	500 lb (227.3 kg) (with restrictions – see Speed Vs. Weight graph in this section).
Belt Speed Range \pm 0.2 mph (continuously adjustable)	0.8 to 9.6 mph (1.3 to 15.4 km/h)
Grade Range \pm 0.5%	0 to 25%

Physical	
Weight	TM55: 352 lb (160 kg) TM65: 375 lb (170 kg)
Nominal Walking Surface	TM55: 20 x 55 in. (51 x 140 cm) TM65: 20 x 65 in. (51 x 165 cm)
Treadmill Area	TM55: 29.9 x 80.2 in. (76 x 204 cm) TM65: 29.9 x 90.2 in. (76 x 229 cm)
Walking Surface Height	7.0 in. (18 cm) from floor
Handrail Height	47.2 in. (120 cm) from floor

Environmental	
Temperature	Operating: 50 to 104 °F (10 to 40 °C) Storage: -40 to 158 °F (-40 to 70 °C)
Humidity (non-condensing)	Operating: 15 to 95% relative Storage: 5 to 95% relative

Power Requirements

Listed below are the power requirements for your treadmill.

Nominal Voltage Range (min – max) / Hertz*	Current Draw (Amps)	Min. Branch Circuit Amps
100-120 V, 50/60 Hz	20**	20
200-240 V, 50/60 Hz	10**	10

* The nominal voltage range is listed on the serial number name plate, which can be found on the hood under the circuit breaker switch.

** Full-load current is computed as described in section 430-24 of the National Electrical Code.

Speed vs Weight Range

The following graph illustrates the relationship between speed and weight for the treadmills.

Figure 6 Speed vs. Weight graph

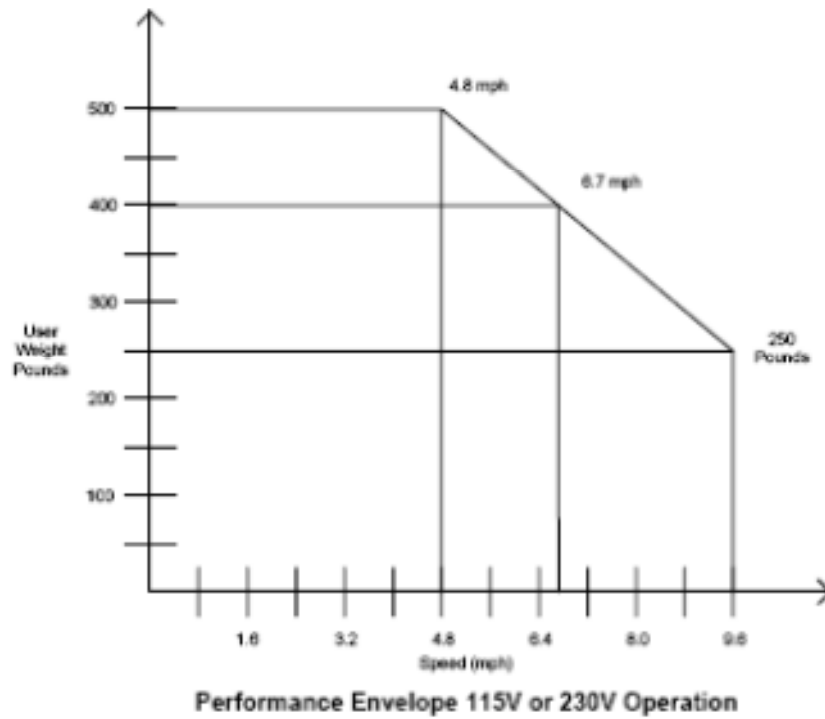

% Grade vs Angle Relationship



$$\text{Grade} = \frac{\text{rise}}{\text{run}} \quad \tan \theta = \frac{\text{rise}}{\text{run}}$$

$$\text{Grade} = \tan \theta$$

$$\theta = \arctan (\text{Grade})$$

Note: 15% grade = grade = 0.15

Figure 7 %Grade vs. Angle Graph

Grade (%)	Angle (°)	Grade (%)	Angle (°)	Grade (%)	Angle (°)	Grade (%)	Angle (°)	Grade (%)	Angle (°)
0.0	0.00	5.0	2.86	10.0	5.71	15.0	8.53	20.0	11.31
0.5	0.29	5.5	3.15	10.5	5.99	15.5	8.81	20.5	11.59
1.0	0.57	6.0	3.43	11.0	6.28	16.0	9.09	21.0	11.86
1.5	0.86	6.5	3.72	11.5	6.56	16.5	9.37	21.5	12.13
2.0	1.15	7.0	4.00	12.0	6.84	17.0	9.65	22.0	12.41
2.5	1.43	7.5	4.29	12.5	7.13	17.5	9.93	22.5	12.68
3.0	1.72	8.0	4.57	13.0	7.41	18.0	10.20	23.0	12.95
3.5	2.00	8.5	4.86	13.5	7.69	18.5	10.48	23.5	13.22
4.0	2.29	9.0	5.14	14.0	7.97	19.0	10.76	24.0	13.50
4.5	2.58	9.5	5.43	14.5	8.25	19.5	11.03	24.5	13.77
5.0	2.86	10.0	5.71	15.0	8.53	20.0	11.31	25.0	14.04

12. RECEIVING AND INSTALLATION

Receiving

When the carrier delivers your order, verify that the number of items received equals the number listed on the freight bill or express receipt.

Inspect the containers for damage. Itemize discrepancies and damage on the waybill and have the agent sign it. Failure to describe external evidence of loss adequately may result in the carrier refusing to honor your claim. Do not discard the packing materials until you have verified physical condition and proper operation.

Installation Notice

The treadmill and controller must be installed correctly before being used. We recommend that you contact your treadmill dealer or representative when your equipment arrives. The representative will help unpack, install, and demonstrate it, to ensure that:

- equipment is free from shipping damage.
- the treadmill is connected correctly to the appropriate AC power source.
- installation and operation are in accordance with standards stated in this manual.

Incorrect installation by unauthorized personnel can lead to equipment damage and may void the warranty.



WARNING! Dedicated circuit.

The treadmill must be on a dedicated branch circuit. No other device should be connected to that circuit.

Excessive risk current (leakage) can result if the equipment is not properly grounded.

Failure to follow these guidelines will produce a serious or possibly fatal electrical shock hazard. Consult a qualified electrician as required.

Site Requirements

The treadmill requires a dedicated AC power line (refer to “Power Requirements” in the *Specifications* section). To ensure electrical safety, the treadmill is equipped with a three-wire power cord and three-pronged plug. To maintain ground reliability, the plug must be connected to an equivalent receptacle.



Caution. Operate in conditioned environment.

The treadmill is designed to operate in a typical clinical environment with adequate heat dissipation (1850 Watts maximum).

Place the treadmill on a flat surface, free of moisture and debris. Maintain a minimum clearance of 1.5 feet (0.5 m) on each side and 6 feet at the rear.

If the preamp for the Q-Stress system is to be attached to the handrail, maintain a clearance of 1.5 feet (0.5 m) at the front of the treadmill.

Installation

If you choose to install your treadmill without the assistance of your representative, follow the procedure given below:

Tools

- hex wrench (supplied in kit)

Procedure

1. Ensure that the handrail gaskets have been placed in their proper location (see Figure 8).
2. Insert the front handrail into the holes on each side of the hood.
3. Use the two hex-head socket screws recessed within the front of the hood to secure the handrail:
 - a. Using the hex wrench supplied in the ship kit, turn the socket screws clockwise.
 - b. Cover the screws with the caps supplied in the ship kit.

Figure 8 Example of Treadmill front

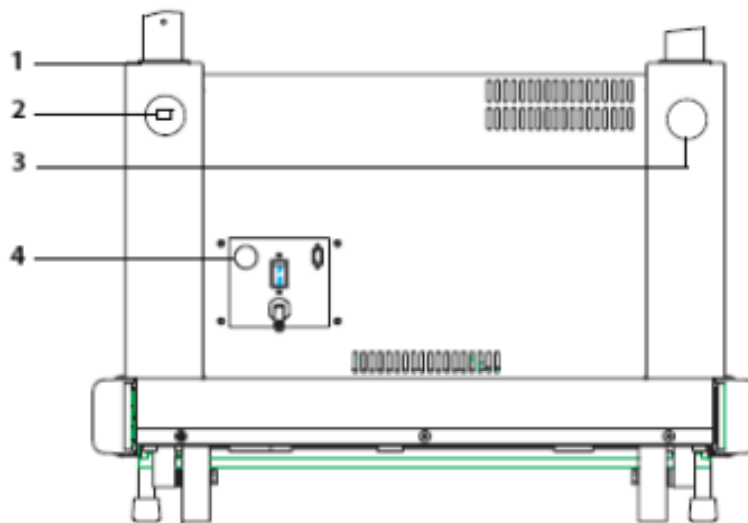

- 1 Handle bar gasket
- 2 Socket screw
- 3 Cap in place
- 4 Emergency Stop switch Connector (optional)

4. Plug the cable for the optional Emergency Stop Button, if present, into the connector on the front of the hood (see Figure 8).

Note: If the optional Emergency Stop Button is present, it must remain connected and secured at all times. It should be disconnected only by an authorized technician.

5. (High Voltage units only.) Plug the female end of the power cord into the connector on the front of the treadmill hood. Be sure the plug is connected securely, then tighten the clamp using the hex wrench provided.
6. If you want to attach the Q-Stress preamp to the handrail, follow the installation instructions included with the preamp.

Connecting to the Monitoring System

1. Be sure the treadmill and the monitoring system are disconnected from the power source.
2. Inspect the monitoring system interface cable connector, located on the front of the hood (see Figure 9). If it appears damaged, contact an authorized technician before continuing this installation.

If the connector is undamaged, plug the male end of the monitoring system interface cable into the connector. Tighten the connector thumb screws until finger tight.

3. Plug the female end into the treadmill connector on the back panel of the monitoring system.
4. Verify that the outlet voltage matches the voltage on the nameplate located on the front of the treadmill hood.
5. If the voltage is adequate, plug in the power cord. Do not use this outlet if the voltage is not adequate.

Figure 9 Example of Monitoring System Connections

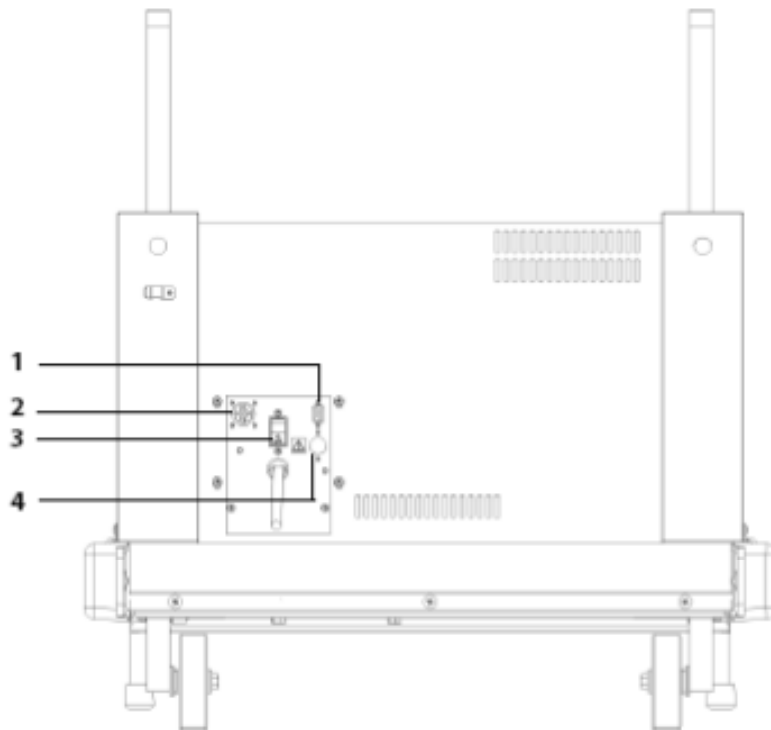

- 1 Monitoring System Interface Cable Connector
- 2 Emergency Stop Switch Connector
- 3 Circuit Breaker Switch
- 4 USB Monitoring System Interface Cable Connector

6. Check the circuit breaker switch on the treadmill hood to be sure it is set to ON.
7. Test the treadmill as described (see *Testing the Treadmill* in this section) by using the controls on the monitoring system.

Testing the Treadmill



WARNING! Falling hazard.

DO NOT permit anyone to stand on the treadmill when it is started.

1. Connect the treadmill power cord to the correct power outlet. Turn on treadmill power..
2. Start the walking belt from the monitoring system: the treadmill starts running immediately at low speed..
3. Set the treadmill to minimum speed and zero grade and confirm that the treadmill meets these values.
4. Set the treadmill to maximum speed and confirm that the treadmill meets that value.
5. Set the treadmill to maximum grade and confirm that the treadmill meets that value.
6. Let the treadmill run for at least 15 minutes.
 - a. Watch the walking belt carefully to ensure that it does not drift left or right. Adjust if necessary using the adjustment procedures described in *Adjustments* (see Maintenance/Troubleshooting section).
 - b. List for unusual noises, such as squeals or squeaks. The treadmill should run quietly.
 - c. Reduce speed and grade until the treadmill belt is moving at a reasonable speed for walking.
 - d. Walk on the moving belt and verify proper operation at representative speeds and grades. If the walking belt slips, but the front roller turns, adjust the walking belt tension.
7. When the test is finished:
 - a. Set the treadmill to zero grade.
 - b. Stop the walking belt.
 - c. Turn off the monitoring system.

If the treadmill is not running smoothly, contact an authorized technician before using it.

