

VISUAL COMFORT
& Co. Est. 1987



20th

At Visual Comfort we greet our twentieth anniversary
with our broadest collection ever.



Visual Comfort is the premier American resource for signature designer lighting.

Over the past twenty years we have produced lighting with some of the most influential names in design.

We will continue to partner with noteworthy talents moving forward, to enrich our extensive and creative selection of products.

We employ exceptional craftsmanship and skillful engineering in every piece we make. We remain committed to creating lighting products that are useful as well as inspired. And, we are proud to offer you extraordinary quality in fine lighting at a remarkable value.





We constantly pursue lighting craft with defining design innovation.

Together with our Chart House and Studio collections, under Chief Designer, lighting legend

Earle F. (Sandy) Chapman, the Visual Comfort offerings span from traditional to contemporary styles.

Our “living” finishes make the difference for lighting choices that are unique in personality and collectible in appeal. We use authentic and natural materials to give our products their

custom character: brass, bronze, nickel, silver and chrome in antique and polished lusters; classic enamels, ceramic and porcelain; forged irons and honed woods; handblown glass; rock crystal and alabaster; elegant parchment papers, silks and linens.





Our selection is suitable for all types of contract and residential projects, and for every decorating philosophy. Whether you are looking for the work of a particular designer or a general type of light, this catalog will help you survey and compare the range of products we proudly offer. See how the art of lighting can work for you.

CONTENTS

Table	12
Floor	100
Ceiling	148
Wall	225
Outdoor	296
Finish Codes	315
Index	316



TABLE

Chart House	16
Studio	56
Thomas O'Brien	70
Bill Blass	92
Eric Cohler	95
Clodagh	98





CHA8935CG-NP
Square Stacked Table Lamp
in Crystal with
Natural Paper Shade
Height: 34"
Width: 19"
Base: 6½" Square

Available Finishes:
ALB, CG
Shade Treatment: NP
Shade Details:
16" x 19" x 14" Square

Socket: Hi-Lo
Wattage: 150 A
©EFC DESIGNS



CHA8934CG-NP
Oval Stacked Buffet Lamp
in Crystal with
Natural Paper Shade
Height: 34"
Width: 18"
Base: 7¾" Oval

Shade Treatment: NP
Shade Details:
8½"/15" x 12"/18" x 12" Oval

Socket: Hi-Lo
Wattage: 150 A
©EFC DESIGNS



CHA8933CG-NP
Oval Stacked Bedside Lamp
in Crystal with
Natural Paper Shade
Height: 25"
Width: 14"
Base: 6½" Oval

Shade Treatment: NP
Shade Details:
8"/12" x 10"/14" x 9" Oval

Socket: Hi-Lo
Wattage: 100 A
©EFC DESIGNS



CHA8927CG-S
Mini Column Lamp
in Crystal with Silk Shade
Height: 13½"
Width: 7¼"
Base: 3½" Square

Available Finishes: ALB, CG, Q
Shade Treatments: L, S
Shade Details: 4½" x 7¼" x 5¼"

Socket: Hi-Lo Nordy
Wattage: 60 A
French Wired
©EFC DESIGNS



CHA8940CG-NP
Scored Column Bedside Lamp
in Crystal with
Natural Paper Shade

Height: 22"
 Width: 11"
 Base: 5" Square

Available Finishes: ALB, CG
Shade Treatments: NP, SBP

Shade Details:
 8" x 11" x 7" NP or
 8" x 11½" x 7½" SBP

Socket: 2-Pull Chain
Wattage: 2-40 B
 French Wired
 ©EFC DESIGNS



CHA8941CG-NP
Scored Column Table Lamp
in Crystal with
Natural Paper Shade

Height: 27"
 Width: 15"
 Base: 5¼"

Available Finishes: ALB, CG
Shade Treatments: NP, SBP

Shade Details:
 12" x 15" x 9" NP or
 12" x 15½" x 9½" SBP

Socket: 2-Pull Chain
Wattage: 2-60 A
 French Wired
 ©EFC DESIGNS



CHA8937CG-NP
Chubby Column Bedside Lamp
in Crystal with
Natural Paper Shade

Height: 23½"
 Width: 13½"
 Base: 5" Square

Available Finishes: ALB, CG, Q
Shade Treatments: NP, SBP

Shade Details:
 11" x 13½" x 9" NP or
 11" x 14" x 9½" SBP

Socket: Hi-Lo
Wattage: 100 A
 French Wired
 ©EFC DESIGNS



CHA8931CG-NP
Chubby Column Table Lamp
in Crystal with
Natural Paper Shade

Height: 30¾"
 Width: 19"
 Base: 6½" Square

Available Finishes:
 ALB, CG, Q

Shade Treatments:
 NP, SBP
Shade Details:
 15" x 19" x 12" NP or
 15" x 19" x 13" SBP

Socket: Hi-Lo
Wattage: 150 A
 French Wired
 ©EFC DESIGNS



CHA8926CG-NP
Crystal Column Lamp
on Low Plinth with
Natural Paper Shade
Height: 30"
Width: 17"
Base: 6" Square

Shade Treatments:
NP, SBP
Shade Details:
13" x 17" x 10" NP or
13" x 17" x 11" SBP

Socket: Hi-Lo
Wattage: 100 A
French Wired
©EFC DESIGNS



CHA8938CG-NP
Slender Column Bedside Lamp
in Crystal with
Natural Paper Shade
Height: 24"
Width: 14"
Base: 5½" Square

Available Finishes: ALB, CG
Shade Treatments: NP, SBP
Shade Details:
10" x 13" x 8½" NP or
10" x 12" x 9" SBP

Socket: Hi-Lo
Wattage: 100 A
French Wired
©EFC DESIGNS



CHA8932CG-NP
Crystal Octagonal Column
Candlestick Lamp with Natural
Paper Shade
Height: 27¾"
Width: 17"
Base: 7½" Octagonal

Shade Treatments: NP, SBP
Shade Details:
13" x 17" x 10" NP or
13" x 17" x 11" SBP

Socket: Hi-Lo
Wattage: 100 A
French Wired
©EFC DESIGNS



CHA8910CG-S
Large Octagonal Crystal
Column Lamp with Silk Shade
Height: 34"
Width: 19"
Base: 8" Square

Shade Treatment: S
Shade Details: 12" x 19" x 12"

Socket: Hi - Lo
Wattage: 100 A
French Wired
©EFC DESIGNS



CHA8920CG-S

Tall Crystal Column Lamp with Capital on Stepped Base with Silk Shade

Height: 29½"
Width: 17"
Base: 6¼" Square

Available Finishes: CG, Q

Shade Treatments:

NP, S

Shade Details:

9" x 17" x 11"

Socket: Hi-Lo

Wattage: 100 A

French Wired

©EFC DESIGNS



CHA8920Q-S

CHA8921CG-S

Crystal Column Lamp with Capital on Scalloped Base with Silk Shade

Height: 21"
Width: 11"
Base: 5" Scalloped

Shade Treatment: S

Shade Details: 7" x 11" x 8½"

Socket: Hi-Lo

Wattage: 100 A

French Wired

©EFC DESIGNS



CHA8922CG-S

Octagonal Crystal Column Lamp with Silk Shade

Height: 32"
Width: 19"
Base: 9" Octagonal

Shade Treatment: S

Shade Details:

10" x 19" x 12" Octagonal

Socket: Hi-Lo

Wattage: 100 A

French Wired

©EFC DESIGNS



CHA8925CG-NP

Crystal Column on Brass Mount with Natural Paper Shade

Height: 32"
Width: 18"
Base: 6¼" Square

Shade Treatment: NP

Shade Details: 11" x 18" x 12½"

Socket: Hi-Lo

Wattage: 100 A

French Wired

©EFC DESIGNS



CHA8924CG-NP
Balustrade Table Lamp in Crystal
with Natural Paper Shade

Height: 27"
Width: 17"
Base: 5½" Square

Available Finishes: ALB, CG, Q
Shade Treatments: NP, SBP
Shade Details:
13" x 17" x 10" NP or
13" x 17" x 11" SBP

Socket: Hi-Lo
Wattage: 150 A
French Wired
©EFC DESIGNS



CHA8939CG-NP
Balustrade Bedside Lamp
in Crystal with
Natural Paper Shade

Height: 23¼"
Width: 13"
Base: 4¾" Square

Available Finishes: ALB, CG, Q
Shade Treatments: NP, SBP
Shade Details:
11" x 13½" x 9" NP or
11" x 14" x 9½" SBP

Socket: Hi-Lo
Wattage: 100 A
French Wired
©EFC DESIGNS



CHA8950CG-NP
Medium Octagonal Spire Table
Lamp in Crystal with Natural
Paper Shade

Height: 25"
Width: 13½"
Base: 3½" Octagonal

Available Finishes: BM, CG,
WM
Shade Treatments: NP, SBP
Shade Details:
11" x 13½" x 9" NP or
11" x 14" x 9½" SBP

Socket: Dimmer
Wattage: 100 A
French Wired
©EFC DESIGNS



CHA8951CG-NP
Large Octagonal Spire Table
Lamp in Crystal with
Natural Paper Shade

Height: 31½"
Width: 17"
Base: 4½" Octagonal

Available Finishes: BM, CG,
WM
Shade Treatments: NP, SBP
Shade Details:
13" x 17" x 10" NP or
13" x 17" x 11" SBP

Socket: Dimmer
Wattage: 150 A
French Wired
©EFC DESIGNS



CHA8936CG-NP
Bowed Pot Form Lamp
in Crystal with
Natural Paper Shade
 Height: 17"
 Width: 9½"
 Base: 5" Square

Shade Treatment: NP
Shade Details:
 8" x 9½" x 7" Square

Socket: Hi-Lo Nordy
Wattage: 100 A
 French Wired
 ©EFC DESIGNS



CHA8942CG-S
Banded Pot Lamp
in Crystal with Silk Shade
 Height: 14½"
 Width: 10"
 Base: 5¼" Round

Shade Treatment: S
Shade Details: 8" x 10" x 7"

Socket: Hi-Lo Nordy
Wattage: 75 A
 ©EFC DESIGNS



CHA8928CG-S
Mini Urn Form Lamp
in Crystal with Silk Shade
 Height: 13"
 Width: 7¼"
 Base: 3½" Square

Available Finishes: ALB, CG
Shade Treatments: L, S
Shade Details: 4½" x 7¼" x 5¼"

Socket: Hi-Lo Nordy
Wattage: 60 A
 French Wired
 ©EFC DESIGNS



CHA8929CG-S
Mini Balustrade Form Lamp
in Crystal with Silk Shade
 Height: 13½"
 Width: 7¼"
 Base: 3½" Square

Available Finishes: ALB, CG
Shade Treatments: L, S
Shade Size: 4½" x 7¼" x 5¼"

Socket: Hi-Lo Nordy
Wattage: 60 A
 French Wired
 ©EFC DESIGNS



CHA8923CG-S
Cut Corner Rectangular
Crystal Urn Form Lamp with
Silk Shade
 Height: 24"
 Width: 16"
 Base: 4½" x 6"

Shade Treatment: S
Shade Details:
 6" / 8" x 8" / 13" x 9"

Socket: Hi-Lo
Wattage: 100 A
 French Wired
 ©EFC DESIGNS



CHA8946FLU-NP
Square Chunky Stacked
Bedside Lamp in Fluorite with
Natural Paper Shade
Height: 24"
Width: 13"
Base: 3½" Square

Available Finishes: ALB, FLU,
Q, RQ
Shade Treatment: NP
Shade Details:
11½" x 13" x 10" Square
Socket: Dimmer
Wattage: 150 A
©EFC DESIGNS



CHA8946Q-NP

CHA8947ALB-NP
Square Chunky Stacked Table
Lamp in Alabaster with
Natural Paper Shade
Height: 31"
Width: 16"
Base: 5" Square

Shade Treatment: NP
Shade Details:
14" x 16" x 12" Square
Socket: Dimmer
Wattage: 150 A
©EFC DESIGNS



CHA8960ALB-NP
Rectangular Form Table Lamp
in Alabaster with
Natural Paper Shade
Height: 24"
Width: 13½"
Base: 5" x 6½"

Shade Treatment: NP
Shade Details:
8½" x 13½" x 9" Rectangle
Socket: Hi-Lo
Wattage: 100 A
©EFC DESIGNS



CHA8945ALB-NP
Round Chunky Stacked Table
Lamp in Alabaster with
Natural Paper Shade
Height: 29½"
Width: 16"
Base: 5" Round

Shade Treatment: NP
Shade Details:
14" x 16" x 12"
Socket: Dimmer
Wattage: 150 A
©EFC DESIGNS



CHA8949RQ-NP
Round Stacked Bedside Lamp
 in Rose Quartz with
 Natural Paper Shade
 Height: 23½"
 Width: 11"
 Base: 4½" Round

Available Finishes:
 FLU, O, RQ
Shade Treatment: NP
Shade Details:
 9½" x 11" x 8½"

Socket: Dimmer
Wattage: 100 A
 ©EFC DESIGNS



CHA8949Q-NP

CHA8948ALB-NP
Round Stacked Table Lamp
 in Alabaster with
 Natural Paper Shade
 Height: 34"
 Width: 16"
 Base: 5" Round

Shade Treatment: NP
Shade Details: 14" x 16" x 12"

Socket: Dimmer
Wattage: 150 A
 ©EFC DESIGNS



CHA8940ALB-NP
Scored Column Bedside Lamp
 in Alabaster with
 Natural Paper Shade
 Height: 22"
 Width: 11"
 Base: 5" Square

Available Finishes: ALB, CG
Shade Treatments: NP, SBP
Shade Details:
 8" x 11" x 7" NP or
 8" x 11½" x 7½" SBP

Socket: 2-Pull Chain
Wattage: 2-40 B
 ©EFC DESIGNS



CHA8941ALB-NP
Scored Column Table Lamp
 in Alabaster with
 Natural Paper Shade
 Height: 27"
 Width: 15"
 Base: 5¼" Square

Available Finishes: ALB, CG
Shade Treatments: NP, SBP
Shade Details:
 12" x 15" x 9" NP or
 12" x 15½" x 9½" SBP

Socket: 2-Pull Chain
Wattage: 2-60 A
 ©EFC DESIGNS



CHA8938ALB-NP

Slender Column Bedside Lamp in Alabaster with Natural Paper Shade

Height: 24"
Width: 14"
Base: 5 1/2" Square

Available Finishes: ALB, CG
Shade Treatments: NP, SBP
Shade Details: 10" x 13" x 8 1/2" NP or 10" x 12" x 9" SBP

Socket: Hi-Lo
Wattage: 100 A
©EFC DESIGNS



CHA8937ALB-NP

Chubby Column Bedside Lamp in Alabaster with Natural Paper Shade

Height: 23 1/2"
Width: 13 1/2"
Base: 5" Square

Available Finishes: ALB, CG, Q
Shade Treatments: NP, SBP
Shade Details: 11" x 13 1/2" x 11" NP or 11" x 14" x 9 1/2" SBP

Socket: Hi-Lo
Wattage: 100 A
©EFC DESIGNS



CHA8937Q-NP

CHA8931ALB-NP

Chubby Column Table Lamp in Alabaster with Natural Paper Shade

Height: 30 1/2"
Width: 19"
Base: 6 1/2" Square

Available Finishes: ALB, CG, Q
Shade Treatments: NP, SBP
Shade Details: 15" x 19" x 12" NP or 15" x 19" x 13" SBP

Socket: Hi-Lo
Wattage: 150 A
©EFC DESIGNS



CHA8931Q-NP

CHA8524ALB-NP

Etruscan Urn with Handles in Alabaster with Natural Paper Shade

Height: 25"
Width: 17"
Base: 6" Square

Shade Treatment: NP
Shade Details: 13" x 17" x 10"

Socket: Hi-Lo
Wattage: 150 A
©EFC DESIGNS



CHA8939ALB-NP
Balustrade Bedside Lamp in Alabaster with Natural Paper Shade
 Height: 23 3/4"
 Width: 13"
 Base: 4 1/2" Square

Available Finishes: ALB, CG, Q
Shade Treatments: NP, SBP
Shade Details:
 11" x 13 1/2" x 9" NP or
 11" x 14" x 9 1/2" SBP

Socket: Hi-Lo
Wattage: 100 A
 ©EFC DESIGNS



CHA8939Q-NP

CHA8924ALB-NP
Balustrade Table Lamp in Alabaster with Natural Paper Shade
 Height: 27"
 Width: 17"
 Base: 5 1/2" Square

Available Finishes: ALB, CG, Q
Shade Treatments: NP, SBP
Shade Details:
 13" x 17" x 10" NP or
 13" x 17" x 11" SBP

Socket: Hi-Lo
Wattage: 150 A
 ©EFC DESIGNS



CHA8924Q-NP

CHA8927ALB-L
Mini Column Lamp in Alabaster with Linen Shade
 Height: 13 1/2"
 Width: 7 1/4"
 Base: 3 1/2" Square

Available Finishes: ALB, CG, Q
Shade Treatments: L, S
Shade Details: 4 1/2" x 7 1/4" x 5 1/4"

Socket: Hi-Lo Nordy
Wattage: 60 A
 ©EFC DESIGNS



CHA8927Q-S

CHA8928ALB-L
Mini Urn Form Lamp in Alabaster with Linen Shade
 Height: 13"
 Width: 7 1/4"
 Base: 3 1/2" Square

Available Finishes: ALB, CG
Shade Treatments: L, S
Shade Details: 4 1/2" x 7 1/4" x 5 1/4"

Socket: Hi-Lo Nordy
Wattage: 60 A
 ©EFC DESIGNS



CHA8929ALB-L
Mini Balustrade Form Lamp in Alabaster with Linen Shade
 Height: 13 1/2"
 Width: 7 1/4"
 Base: 3 1/2" Square

Available Finishes: ALB, CG
Shade Treatments: L, S
Shade Details: 4 1/2" x 7 1/4" x 5 1/4"

Socket: Hi-Lo Nordy
Wattage: 60 A
 ©EFC DESIGNS



CHA8970ALB-NP

Large Ring Table Lamp in Alabaster with Natural Paper Shade

Height: 27¼"
Width: 18"
Base: 7½" Square

Available Finishes:

AB, ALB, BZ, PS

Shade Treatment: NP

Shade Details:

8" x 14" x 10" / 18" x 11"
Rectangle

Socket: Hi – Lo

Wattage: 100 A

French Wired

Fabric Cord not UL Listed

©EFC DESIGNS



CHA8905WM-NP

Medium Fluted Spire Table Lamp in White Marble with Natural Paper Shade

Height: 25½"
Width: 13½"
Base: 3¼" Scalloped

Available Finishes:

AB, BZ, PS, WM

Shade Treatment:

NP

Shade Details:

11" x 13½" x 9"

Socket: Dimmer

Wattage: 100 A

©EFC DESIGNS

CHA8905BZ-NP



CHA8906BZ-NP

Large Fluted Spire Table Lamp in Bronze with Natural Paper Shade

Height: 31½"
Width: 17"
Base: 4¼" Scalloped

Available Finishes:

AB, BZ, PS, WM

Shade Treatment: NP

Shade Size:

13" x 17" x 10"

Socket: Dimmer

Wattage: 150 A

©EFC DESIGNS



CHA8950BM-NP

Medium Octagonal Spire Table Lamp in Black Marble with Natural Paper Shade

Height: 25"
Width: 13½"
Base: 3½" Octagonal

Available Finishes: BM, CG

Shade Treatments: NP, SBP

Shade Details:

11" x 13½" x 9" NP or

11" x 14" x 9½" SBP

Socket: Dimmer

Wattage: 100 A

©EFC DESIGNS



CHA8252AN-B
Large Classic Column Lamp in
Antique Nickel with Black Shade

Height: 31½"
 Width: 17"
 Base: 6" Square

Available Finishes:
 AB, AN, OAK, SN
Shade Treatments: B, NP, S
Shade Details:
 11" x 17" x 11¾" Square

Socket: Hi-Lo
Wattage: 150 A
 ©EFC DESIGNS



CHA8251AB-B
Large Classic Balustrade Lamp
in Antique-Burnished Brass
with Black Shade

Height: 31½"
 Width: 19"
 Base: 6½" Square

Available Finishes:
 AB, AN, OAK, SB
Shade Treatments: B, NP
Shade Details: 12" x 19" x 12"

Socket: Hi-Lo
Wattage: 150 A
 ©EFC DESIGNS



CHA8511ABV-NP
Large Twisted Column Lamp in
Antique-Burnished Brass with
Verdigris Accents with Natural
Paper Shade

Height: 42"
 Width: 20"
 Base: 6" Square

Available Finishes: ABV, BZV
Shade Treatment: NP
Shade Details:
 11" x 20" x 13"

Socket: Hi-Lo
Wattage: 100 A
 ©EFC DESIGNS



CHA8510ABV-NP
Twisted Column Lamp in
Antique-Burnished Brass with
Verdigris Accents with
Natural Paper Shade

Height: 34"
 Width: 19"
 Base: 6" Square

Available Finishes: ABV, BZV
Shade Treatment: NP
Shade Details:
 11" x 19" x 12"

Socket: Hi-Lo
Wattage: 100 A
 ©EFC DESIGNS



CHA8513ABV-NP

**Classic English Column Lamp
in Antique-Burnished Brass
with Verdigris Accents with
Natural Paper Shade**

Height: 28½"
Width: 15"
Base: 6¼" Square

Available Finishes: ABV, PS
Shade Treatments: NP, SBP

Shade Details:
8" x 15" x 11" NP or
13" x 17" x 11" SBP

Socket: Hi-Lo
Wattage: 100 A

©EFC DESIGNS



CHA8512OAK-NP

**Large Classic English Column Lamp
in Oak with Natural Paper Shade**

Height: 36½"
Width: 19"
Base: 7¾" Square

Available Finishes:
ABV, OAK, PS

Shade Treatments: NP, S, SBP

Shade Details:
14" x 19" x 12" NP or
15" x 19" x 13" S, SBP

Socket: Hi-Lo
Wattage: 150 A
©EFC DESIGNS



CHA8166AB-B

**Lion Passant Column Lamp
in Antique-Burnished Brass
with Black Shade**

Height: 31½"
Width: 17"
Base: 7½"

Shade Treatments: B, S
Shade Details: 8" x 17" x 9"

Socket: Hi-Lo
Wattage: 100 A

©EFC DESIGNS



CHA8155AB-B

**Trionne Burner Lamp
in Antique-Burnished Brass
with Black Shade**

Height: 27"
Width: 17"
Base: 7½"

Available Finishes: AB, AN
Shade Treatment: B, S
Shade Details: 8" x 17" x 9"

Socket: Hi-Lo
Wattage: 100 A
©EFC DESIGNS



CHA8512ABV-S
Large Classic English Column Lamp
in Antique-Burnished Brass with
Verdigris Accents with Silk Shade

Height: 36½"
 Width: 19"
 Base: 7¾" Square

Available Finishes:
 ABV, OAK, PS
Shade Treatments: NP, S
Shade Details:
 14" x 19" x 12" NP, S or
 15" x 19" x 13" SBP

Socket: Hi-Lo
Wattage: 150 A
 ©EFC DESIGNS



CHA8137AB-B
Lion Passant Two-Light Table Lamp
in Antique-Burnished Brass
with Black Shades

Height: 19"
 Width: 13"
 Base: 7" Round

Shade Treatment: B
Shade Details: 4" x 6" x 5"

Socket: 2-Candelabra/
 Line Switch
Wattage: 2-60 C
 ©EFC DESIGNS



CHA8157AB-B
Lion Passant Single Light Desk
Lamp in Antique-Burnished
Brass with Black Shade

Height: 19"
 Width: 13"
 Base: 4½" x 6"

Shade Treatment: B
Shade Details: 9" x 13" x 6"

Socket: 2-Keyless/
 Line Switch
Wattage: 2-60 A
 ©EFC DESIGNS



CHA8167AB-B
Lion Passant Buffet Lamp in
Antique-Burnished Brass with
Black Shade

Height: 32"
 Width: 10"
 Base: 4½" x 6"

Shade Treatment: B
Shade Details: 4" x 10" x 7½"

Socket: Candelabra
 with Hi-Lo Line Switch
Wattage: 60 C
 ©EFC DESIGNS



CHA8132AB-B
18th Century English Single
Candle Tray Lamp in
Antique-Burnished Brass with
Black Shade

Height: 18½"
 Width: 7"
 Base: 6" Round

Available Finishes: AB, AN
Shade Details: 2½" x 7" x 4"

Socket: Candelabra
Wattage: 60 C
 ©EFC DESIGNS



CHA8134AB-B
Two-Arm Bouillotte with
Balustrade Form Support in
Antique-Burnished Brass with
Black Shade

Height: 24"
 Width: 11"
 Base: 4¼" Hexagonal
 Candles not Included

Available Finishes: AB
Shade Treatments: B
Shade Details:
 4¾"/8¼" x 7⅞"/11"
 x 4¼" Oval

Socket: 2-Keyless
Wattage: 2-60 A
 ©EFC DESIGNS



CHA8135AN-B
Three-Arm Bouillotte with
Urn Form Support on
Saucer Base in Antique Nickel
with Black Shade

Height: 23"
 Width: 11"
 Base: 7" Round

Available Finishes: AB, AN
Shade Treatments: B, RD
Shade Details: 8½" x 11" x 7½"
 Candles not Included

Socket: 2-Keyless
Wattage: 2-60 A
 ©EFC DESIGNS



CHA8135AB-RD

CHA8117BZ-MP
Regency Bouillotte in Bronze
with Monte Patina Shade

Height: 28"
 Width: 14"
 Base: 7" Round

Available Finishes: AB, BZ
Shade Treatments: G, MP
Shade Details: 11" x 14" x 8"
 Candles not Included

Socket: 2-Candelabra
Wattage: 2-60 C



CHA8117AB-G

CHA8138SN-SN
Four-Arm Column Motif
Bouillotte on Saucer Base
in Sheffield Nickel with
Sheffield Nickel Shade

Height: 35"
 Width: 19"
 Base: 10" Round
 Candles not Included

Available Finishes: AB, SN
Shade Treatments: G, SN
Shade Details:
 13" x 19" x 7 1/2"

Socket: 2-Keyless/Line Switch
Wattage: 2-60 A
 ©EFC DESIGNS



CHA8139PS-B
Large Four-Arm Bouillotte
in Polished Silver

Height: 35"
 Width: 19"
 Base: 9" Round
 Candles not Included

Shade Treatments: B
Shade Details: 13" x 19" x 7 1/2"

Socket: 2-Keyless/Line Switch
Wattage: 2-60 A
 ©EFC DESIGNS



CHA8124ABC-B
Overseas Adjustable Table Lamp in
Antique-Burnished Brass and Faux
Cordovan with Black Shade

Height: 20"-29"
 Width: 13"
 Base: 6 1/2" Round

Shade Treatment: B
Shade Details: 8" x 13" x 6"

Socket: 2-Pull Chain
Wattage: 2-60 A
 ©EFC DESIGNS



CHA8125PS-S
Overseas Adjustable Console Lamp
in Polished Silver with Silk Shade

Height: 26"-35"
 Width: 15"
 Base: 6 1/2" Round

Available Finishes: AB, PS
Shade Treatments: B, S
Shade Details:
 6" x 15" x 8" B or
 9" x 14" x 8 1/2" Silk Hex

Socket: 2-Pull Chain
Wattage: 2-60 A
 ©EFC DESIGNS



CHA8133AB-B
Edwardian Column Table Lamp
in Antique-Burnished Brass
with Black Shade

Height: 20"
Width: 10½"
Base: 7" Round

Available Finishes: AB, AN
Shade Treatments: B
Shade Details: 6" x 10½" x 7"

Socket: Hi-Lo/Line Switch
Wattage: 75 A
©EFC DESIGNS



CHA8164AB-B
Edwardian Column Console
Lamp in Antique-Burnished
Brass with Black Shade

Height: 31½"
Width: 10½"
Base: 7" Round

Shade Treatment: B
Shade Details: 6" x 10½" x 7"

Socket: Hi-Lo/Line Switch
Wattage: 75 A
©EFC DESIGNS



CHA8133AB-WG
Edwardian Column Table Lamp
in Antique-Burnished Brass
with White Glass Shade

Height: 21¼"
Width: 13¼"
Base: 7" Round

Shade Treatments: WG
Shade Details: 6¾" x 13¼"

Socket: Hi-Lo/Line Switch
Wattage: 100 A
©EFC DESIGNS



CHA8152AN/AB-B
King's Road Column Lamp in
Antique Nickel and
Antique-Burnished Brass
with Black Shade

Height: 30"
Width: 17"
Base: 6" Round

Shade Treatment: B
Shade Details:
8" x 17" x 9"

Socket: Hi-Lo
Wattage: 100 A



CHA8501AB-SC
Essex Accent Lamp in Antique-Burnished
Brass with Silk Collar Shade

Height: 24"
 Width: 10"
 Base: 5½" Square

Available Finishes: AB, PN
Shade Treatment: SC
Shade Details: 6" x 10" x 8"

Socket: Hi-Lo
Wattage: 75 A
 ©EFC DESIGNS



CHA8500AB-SC
Essex Adjustable Table Lamp in Antique-Burnished Brass
with Silk Collar Shade

Height: 23"-26"
 Width: 10"
 Base: 4½" Square

Available Finishes: AB, AN, PN
Shade Treatment: SC
Shade Details: 6" x 10" x 8"

Socket: Hi-Lo
Wattage: 75 A
 ©EFC DESIGNS



CHA8500PN-SC

CHA8178AB-B
Dorchester Adjustable
Swing-Arm Desk Lamp in
Antique-Burnished Brass
with Black Shade

Height: 27"-33"
 Width: 10"
 Extension: 16"
 Base: 7" Round

Available Finishes: AB, AN
Shade Treatments: B, S, SC
Shade Details: 5" x 10" x 8"

Socket: Hi-Lo
Wattage: 60 A
 ©EFC DESIGNS



CHA8188AB-B
Dorchester Club Table Lamp in
Antique-Burnished Brass with
Black Shade

Height: 22"-32"
 Width: 13"
 Base: 7" Round

Available Finishes:
 AB, AN
Shade Treatments: B, NP, S
Shade Details: 8" x 13" x 7"

Socket: Hi-Lo
Wattage: 100 A
 ©EFC DESIGNS



CHA8190AN/AB-B

**Twist Column Design Lamp in
Antique Nickel and
Antique-Burnished Brass
with Black Shade**

Height: 35"
Width: 15½"
Base: 8" Round

Shade Treatment: B

Shade Details: 7" x 15½" x 9"

Socket: Hi-Lo

Wattage: 75 A

©EFC DESIGNS



CHA8450WI-L

**Windsor Iron Twist Table Lamp in
Weathered Iron and Distressed Brass
with Linen Shade**

Height: 40"
Width: 18"
Base: 8" Round

Shade Treatment: L

Shade Details: 11" x 18" x 11½"

Socket: Hi-Lo

Wattage: 100 A

©EFC DESIGNS



CHA8457AB-NP

**Spiral Table Lamp
in Antique-Burnished Brass
with Natural Paper Shade**

Height: 32½"
Width: 14"
Base: 6½" Round

Available Finishes:

AB, BZ, BZV, PS

Shade Treatment: NP

Shade Details: 9" x 14" x 8½"

Socket: Dimmer

Wattage: 100 A

©EFC DESIGNS



CHA8458AB-NP

**Spiral Buffet Lamp in
Antique-Burnished Brass
with Natural Paper Shade**

Height: 36½"
Width: 14"
Base: 6½" Round

Available Finishes: AB, BZ, BZV, PS

Shade Treatment: NP

Shade Details: 9" x 14" x 8½"

Socket: Dimmer

Wattage: 100 A

©EFC DESIGNS



CHA8123ABR-GL
Console Candle Lamp in Antique-Burnished Brass and Rust with Gold Leaf Shade

Height: 34"
 Width: 12½"
 Base: 6" Round

Shade Treatment: GL
Shade Details: 4½" x 12½" x 8½"

Socket: Hi-Lo
Wattage: 60 A
 ©EFC DESIGNS



CHA8112ABT-B
English Foyer Candle Lamp in Antique-Burnished Brass and Tortoise with Black Shade

Height: 35"
 Width: 15"
 Base: 7" Round

Shade Treatment: B
Shade Details: 6" x 15" x 8"

Socket: 2-Pull Chain
Wattage: 2-40 A



CHA8110ABR-B
French Stemmed Candle Lamp in Antique-Burnished Brass and Rust with Black Shade

Height: 39"
 Width: 15"
 Base: 6" Round

Shade Treatment: B
Shade Details: 6" x 15" x 8"

Socket: 2-Pull Chain
Wattage: 2-40 A



CHA8111ABR-B
French Urn Candlestick in Antique-Burnished Brass and Rust with Black Shade

Height: 38"
 Width: 15"
 Base: 7" Round

Shade Treatment: B
Shade Details: 6" x 15" x 8"

Socket: 2-Pull Chain
Wattage: 2-40 A



CHA8130AB-S

**Chinoiserie Styled Candle Lamp
in Antique-Burnished Brass on
Faux Marble Mount with Silk Shade**

Height: 26"
Width: 10"
Base: 5" Hexagonal

Shade Treatment: S
Shade Details: 5" x 10" x 6½"

Socket: Candelabra
Wattage: 60 C



CHA8113ABR-B

**English Stemmed Font in
Antique-Burnished Brass and
Rust with Black Shade**

Height: 29"
Width: 15"
Base: 6½" Round

Shade Treatments: B, L
Shade Details: 6" x 15" x 8"

Socket: 2-Pull Chain
Wattage: 2-40 A



CHA8122AB-B

**English Urn Candle Lamp in
Antique-Burnished Brass on
Antiqued Faux Marble Base
with Black Shade**

Height: 25½"
Width: 13"
Base: 6" Square

Shade Treatment: B
Shade Details:
9" x 13" x 6"

Socket: 2-Pull Chain
Wattage: 2-40 A



CHA8156SN-B

**Trophy Urn on Faux Marble
Mount in Sheffield Nickel with
Black Shade**

Height: 25½"
Width: 15"
Base: 6½" Round

Shade Treatment: B
Shade Details: 6" x 15" x 8"

Socket: 2-Pull Chain
Wattage: 2-40 A



CHA8522AS-S

**Antique Urn Form
in Antique Silver with
Silk Shade**

Height: 28"
Width: 18"
Base: 6" Square

Available Finishes: AB, AS

Shade Treatment: BS, S

Shade Details:

10" x 18" x 12" Flat Pleat

Socket: Hi-Lo

Wattage: 100 A

©EFC DESIGNS



CHA8521AB-S

**Florentine Urn
in Antique-Burnished Brass
with Black Shade**

Height: 27½"
Width: 17"
Base: 5½" Round

Available Finishes: AB, SP

Shade Treatment: NP, S

Shade Details:

13" x 17" x 11" Flat Pleat

Socket: Hi-Lo

Wattage: 150 A

©EFC DESIGNS



CHA8173PS-NP

**Medium Chunky Urn
in Polished Silver with
Natural Paper Shade**

Height: 31"
Width: 19"
Base: 6¾" Square

Available Finishes: AB, BZV, PS

Shade Treatment: NP, S

Shade Details:

12" x 18" x 13" NP or
12" x 18" x 13" Silk Square

Socket: Dimmer

Wattage: 150 A

©EFC DESIGNS



CHA8174AB-NP

**Large Chunky Urn
in Antique-Burnished Brass
with Natural Paper Shade**

Height: 37½"
Width: 21"
Base: 8¾" Square

Available Finishes:

AB, BZV, PS

Shade Treatment: NP

Shade Details:

19" x 21" x 14"

Socket: Dimmer

Wattage: 150 A

©EFC DESIGNS



CHA8162AB-B

Large Classical Urn Form on Cast Brass Mount in Antique-Burnished Brass with Black Shade

Height: 35"
Width: 20"
Base: 9" Round

Finishes: AB, PS, SN
Shade Treatment: B, S

Shade Details:
11" x 20" x 13" B or
12" x 18" x 13"
Silk Pleated Square

Socket: Hi-Lo
Wattage: 150 A
©EFC DESIGNS



CHA8162SN-B



CHA8162AB-S



CHA8172AB-B

Medium Classical Urn Form on Cast Brass Mount in Antique-Burnished Brass with Black Shade

Height: 24"
Width: 15"
Base: 6" Round

Available Finishes:
AB, AN, BZ, PS, SN
Shade Treatment: B
Shade Details:
6" x 15" x 8"

Socket: 2-Pull Chain
Wattage: 2-40 A
©EFC DESIGNS



CHA8172AN-B

CHA8970AB-NP

Large Ring Table Lamp in Antique-Burnished Brass with Natural Paper Shade

Height: 27 1/4"
Width: 18"
Base: 7 1/2" Square

Available Finishes:
AB, ALB, BZ, PS
Shade Treatment: NP
Shade Details:
8" / 14" x 10" / 18" x 11"
Rectangle

Socket: Hi - Lo
Wattage: 100 A
©EFC DESIGNS



CHA8198AB
Earle's Art Deco Table Lamp in
Antique-Burnished Brass

Height: 22"
 Width: 17"
 Base: 9" Round

Available Finishes: AB, PN/PB
Shade Details: 4" x 17"

Socket: Hi-Lo
Wattage: 100 A
 ©EFC DESIGNS



CHA8198PN/PB

CHA8196AN
Earle's Draftsman Lamp in
Antique Nickel

Height: 22"-45"
 Width: 6½"
 Extension: 10"-28"
 Base: 6½" Round

Available Finishes: AB, AN, BZ
Shade Details: 4" x 6"

Socket: Hi-Lo
Wattage: 60 A
 ©EFC DESIGNS



CHA8195AB
Earle's Double Arm Functional Lamp
in Antique-Burnished Brass

Height: 14"-20"
 Extension: 9"-17"
 Base: 6" Round

Available Finishes: AB, AN, BZ
Shade Details: 2¾" x 5¼" x 4¼"

Socket: Hi-Lo
Wattage: 60 A
 ©EFC DESIGNS



CHA8192AB-B
Engraver's Adjustable Desk
Lamp in Antique-Burnished
Brass with Black Shade

Height: 26"-48"
 Extension: 23"-36"
 Base: 5½" x 8"

Shade Treatment: B
Shade Details:
 4" x 6½" x 5"

Socket: Hi-Lo
Wattage: 60 A
 ©EFC DESIGNS



CHA8159AB
Pimlico Boom-Arm Pharmacy
Desk Lamp in Antique-
Burnished Brass
 Height: 12½"-19"
 Width: 7"
 Extension: 21"-28"
 Base: 7" Round

Available Finishes: AB, BZ, PN
Shade Details: 3½" x 7"

Socket: Hi-Lo
Wattage: 60 A
 ©EFC DESIGNS



CHA8150PN-PN
Pimlico Adjustable Table Lamp
in Polished Nickel with
Polished Nickel Shade
 Height: 25"-32½"
 Extension: 20½"
 Base: 6" Round

Available Finishes:
 AB, AN, BZ, PN
Shade Treatments:
 AB, BZ, AN, PN

Socket: Hi-Lo
Wattage: 60 A
 ©EFC DESIGNS



CHA8150AB-LCF
Pimlico Adjustable Table Lamp
in Antique-Burnished Brass
with Linen Collar Frill Shade
 Height: 25"-32½"
 Extension: 20½"
 Base: 6" Round

Available Finishes:
 AB, AN, BZ, PN
Shade Treatments:
 LC, LCF
Shade Details:
 5" x 9" x 7½"

Socket: Hi-Lo
Wattage: 60 A
 ©EFC DESIGNS



CHA8150AB-LC

CHA8106AB-NP
Chunky Adjustable Swing-Arm
Table Lamp in Antique-Burnished
Brass with Natural Paper Shade
 Height: 27"-30"
 Width: 12"
 Extension: 24"
 Base: 8" Round

Available Finishes:
 AB, AN, BZ, PN
Shade Treatments: L, NP
Shade Details: 10" x 12" x 7½"

Socket: Dimmer
Wattage: 100 A
 ©EFC DESIGNS



CHA8308AWG-B
Italian Finial Form in Antique White Tole
and Gold Leaf with Black Shade

Height: 29"
 Width: 18"
 Base: 6¼" Square

Shade Treatment: B
Shade Details: 6" x 18" x 11"

Socket: Hi-Lo
Wattage: 75 A



CHA8336WW-NP
Ionic Fluted Column Table
Lamp in Waxed Wood with
Natural Paper Shade

Height: 42"
 Width: 19"
 Base: 5" x 8¾"

Available Finishes:
 OW, TB, WW
Shade Treatment: NP
Shade Details:
 8"/17" x 10"/19" x 12"
 Rectangle

Socket: Dimmer
Wattage: 150 A
 ©EFC DESIGNS



CHA8309WGL-GL
English Barley Twist Candle
Lamp in Gold Leaf and White
Over Waxed Wood with Gold
Leaf Shade

Height: 33"
 Width: 12½"
 Base: 6" Round

Shade Treatment: GL
Shade Details:
 4½" x 12½" x 8½"

Socket: Hi-Lo
Wattage: 60 A



CHA8390WGL-L
Italian Candle Buffet Lamp in
Wood with Distressed Gold
Leaf Finish with Linen Shade

Height: 42"
 Width: 17"
 Base: 10"

Shade Treatment: L
Shade Details: 11" x 17" x 10"

Socket: Hi-Lo
Wattage: 100 A



CHA8391SP-NP

**Carved Balustrade Candle Lamp
in Scrubbed Pine Finish with
Natural Paper Shade**

Height: 35"
Width: 17"
Base: 6 3/4" Round

Shade Treatment: NP

Shade Details:
13" x 17" x 10" Natural Paper

Socket: Hi-Lo

Wattage: 150 A

©EFC DESIGNS



CHA8523SP-L

**Rectangular Urn Form in
Scrubbed Pine with Linen
Shade**

Height: 24"
Width: 13 1/2"
Base: 4 3/4" x 5 3/4"

Shade Treatment: L

Shade Details:
8 1/4" / 6 1/4" x 13 1/2" / 8 1/2" x 9"
Rectangle

Socket: Hi-Lo

Wattage: 100 A

©EFC DESIGNS



CHA8353OGW-L

**Cortina Urn with Handles on
Mount in Old Garden White
with Linen Shade**

Height: 31"
Width: 18"
Base: 7 1/2" Square

Shade Treatment: L

Shade Details: 10" x 18" x 12"

Socket: Hi-Lo

Wattage: 100 A

©EFC DESIGNS



CHA8362AW-S

**Althorp Urn Form on Mount
in Antique White Tole with
Silk Pleated Shade**

Height: 24"
Width: 14"
Base: 5" Round

Shade Treatments: B, NP, S

Shade Details: 10" x 14" x 9"

Socket: Hi-Lo

Wattage: 100 A

©EFC DESIGNS



CHA8363B-S

**Large Urn Form Lamp
in Black and Gold Finish
with Silk Shade**

Height: 35"
Width: 20"
Base: 8" Round

Available Finishes:

B, M

Shade Treatments:

L, NP, S

Shade Details:

14" x 20" x 13"

Box Pleat

Socket: Hi-Lo

Wattage: 150 A

©EFC DESIGNS

CHA8363M-NP



CHA8223G-B

**Nathan Road Reproduction of
an Early 18th Century Tea
Caddy in Tones of Green and
Gold with Black Shade**

Height: 28"
Width: 18"
Base: 9" Round

Shade Treatments: B, NP

Shade Details:

8" x 18" x 13"

Socket: Hi-Lo

Wattage: 100 A

©EFC DESIGNS



CHA8228BLK-S

**Tole Urn Form Lamp
with Double Cornucopia
Design on Amber Brown
Ground with Silk Shade**

Height: 24"
Width: 15"
Base: 6" Round

Shade Treatment: S

Shade Details: 7" x 15" x 9½"

Socket: Hi-Lo

Wattage: 75 A



CHA8224BLK-S

**Numeral Tea Caddy Lamp in
Black with Silk Shade**

Height: 26"
Width: 16"
Base: 9" Round

Available Finishes: BLK, RD

Shade Treatment:

B, I, S

Shade Details:

9" x 16" x 10½"

Socket: Hi-Lo

Wattage: 60 A



CHA8230G-L

**No.15 Tea Caddy Lamp
in Green with Gold Design
with Linen Shade**

Height: 29"
Width: 19"
Base: 10 1/4" Round

Shade Treatment: L

Shade Details:
12" x 19" x 13"

Socket: Hi-Lo
Wattage: 150 A
©EFC DESIGNS



CHA8229CHI-L

**Tole Tea Caddy Lamp
in Chinoiserie Design
with Linen Shade**

Height: 31"
Width: 19"
Base: 10 1/4" Round

Shade Treatment: L

Shade Details:
12" x 19" x 13"

Socket: Hi-Lo
Wattage: 150 A
©EFC DESIGNS



CHA8341CM-B

**Chinese Marquetry Lamp
with Black Shade**

Height: 27"
Width: 17"
Base: 7 1/2" x 9 1/2" Octagonal

Shade Treatment: B

Shade Details:
5 7/8" x 11"/17" x 12 1/2" Rectangle

Socket: Hi-Lo
Wattage: 100 A
©EFC DESIGNS



CHA8226FL-S

**Chinoiserie Lamp on Hex
Mount in Heavily Distressed
Black with Floral and Bird
Designs with Silk Shade**

Height: 28"
Width: 16"
Base: 9 1/2" Hexagonal

Shade Treatment: S

Shade Details: 13" x 16" x 11"

Socket: Hi-Lo
Wattage: 150 A



CHA8805AGL-B
Cantonese Melon Form in
Antique and
Distressed Gold Leaf over
Ceramic with Black Shade
 Height: 27½"
 Width: 21"
 Base: 7½" Square

Shade Treatment: B
Shade Details: 6" x 21" x 12"

Socket: Hi-Lo
Wattage: 75 A



CHA8831AMB-B
Ceramic Water Vessel Form on
Wooden Mount in Amber Tone
with Black Shade
 Height: 32"
 Width: 19"
 Base: 8" Square

Shade Treatment: B, L, NP
Shade Details: 12" x 19" x 13"

Socket: Hi-Lo
Wattage: 100 A
 ©EFC DESIGNS



CHA8351WGL-S
Harp Form Table Lamp in
Heavily Distressed Antique
White and Gold with Silk
Shade
 Height: 30½"
 Width: 16"
 Base: 8" Square

Shade Treatment: S
Shade Details: 10" x 16" x 12"

Socket: Hi-Lo
Wattage: 100 A



CHA8350RD-S
Melon Form Table Lamp in
Heavily Distressed Tones of
Red, Black, and Gold with Silk
Shade
 Height: 33½"
 Width: 16"
 Base: 6" Square

Shade Treatment: S
Shade Details: 9" x 16" x 10"

Socket: Hi-Lo
Wattage: 100 A



CHA8505AT-ABP

Umbrian Garden Urn in Terracotta with Natural Patina and Antique Black Parchment Shade

Height: 29"
Width: 20"
Base: 7" Square

Shade Treatment: ABP, L
Shade Details: 7" x 20" x 12½"

Socket: Hi-Lo
Wattage: 100 A



CHA8507CT-L

Garden Urn in Cracked Terracotta on Footed Mount with Linen Shade

Height: 30"
Width: 19"
Base: 6" Square

Shade Treatment: L
Shade Details: 12" x 19" x 13"

Socket: Hi-Lo
Wattage: 150 A



CHA8403R-S

Greens Park Urn Lamp in Rusty Iron on Antique Wooden Mount with Silk Shade

Height: 26"
Width: 15"
Base: 6" Square

Available Finishes: GW, R
Shade Treatment: S
Shade Details: 10" x 15" x 9"

Socket: Hi-Lo
Wattage: 100 A



CHA8403GW-S

CHA8227BLK-S

Peninsula Tole Lamp in Black on Footed Mount with Silk Shade

Height: 27½"
Width: 10"
Base: 9" Round

Shade Treatment: S
Shade Details: 5" x 10" x 7"

Socket: Line Switch
Wattage: 60 A
©EFC DESIGNS



CHA8452BZ-L
Large Ring Handled Pot
in Bronze with Linen Shade

Height: 31"
 Width: 19"
 Base: 8" Round

Available Finishes: BZ
Shade Treatments: B, L, NP
Shade Details: 12" x 19" x 12"

Socket: Dimmer
Wattage: 150 A
 ©EFC DESIGNS



CHA8814WHT-B
Ceramic Ring Handle Oil Jar in
Off White Crackle on Incised Wooden
Mount with with Black Shade

Height: 28"
 Width: 18"
 Base: 7"

Shade Treatments: B, NP
Shade Details: 11" x 18" x 11½"

Socket: Hi-Lo
Wattage: 100 A



CHA8811WHT-S
Italian Potter's Urn
in Terracotta with Off White
Distressed Glaze on Mount
with Silk Shade

Height: 26"
 Width: 15"
 Base: 6" Round

Shade Treatment: S
Shade Details: 7" x 15" x 9½"

Socket: Hi-Lo
Wattage: 100 A



CHA8809WHT-ABP
Italian Potter's Vase
in Terracotta with Off White
Distressed Glaze on
Mount with Antique Black
Parchment Shade

Height: 29½"
 Width: 20"
 Base: 6" Round

Shade Treatment: ABP
Shade Details: 7" x 20" x 12½"

Socket: Hi-Lo
Wattage: 100 A



CHA8802WHT-TSC

Chinese Female Figurine in Antiqued White Italian Ceramic on Wooden Base with Tea-Stained Silk Shade

Height: 28"
Width: 14"
Base: 5½" x 7¾"

Shade Treatment: TSC

Shade Details:
7" / 9" x 10" / 14" x 10¾"

Socket: Hi-Lo

Wattage: 100 A

©EFC DESIGNS



CHA8801WHT-TSC

Chinese Male Figurine in Antiqued White Italian Ceramic on Wooden Base with Tea-Stained Silk Shade

Height: 28"
Width: 14"
Base: 5½" x 7¾"

Shade Treatment: TSC

Shade Details:
7" / 9" x 10" / 14" x 10¾"

Socket: Hi-Lo

Wattage: 100 A

©EFC DESIGNS



CHA8844WHT-NP

French Balustrade Table Lamp in White Ceramic with Natural Paper Shade

Height: 32½"
Width: 19"
Base: 6" Square

Shade Treatment: NP

Shade Details: 10" x 19" x 13"

Socket: Dimmer

Wattage: 100 A

©EFC DESIGNS



CHA8845WHT-NP

French Balustrade Bedside Lamp in White Ceramic with Natural Paper Shade

Height: 27"
Width: 14"
Base: 4¾" Square

Shade Treatment: NP

Shade Details: 10" x 14" x 11"

Socket: Dimmer

Wattage: 100 A

©EFC DESIGNS



CHA8620CC-NP
Small Bowed Jar Form
in Celadon Crackle on Antique
Brass Footed Base
with Natural Paper Shade
 Height: 20"
 Width: 12½"
 Base: 7" Square

Available Finishes: CC, IC
Shade Treatment: NP
Shade Details:
 8½" x 12½" x 9½" Square

Socket: Dimmer
Wattage: 100 A
 ©EFC DESIGNS



CHA8621CC-NP
Double Bowed Jar Form
in Celadon Crackle on
Antique Brass Footed Base
with Natural Paper Shade
 Height: 30¾"
 Width: 18"
 Base: 7" Square

Available Finishes: CC, IC
Shade Treatment: NP
Shade Details: 13" x 18" x 13"
 Square

Socket: Dimmer
Wattage: 150 A
 ©EFC DESIGNS



CHA8622IC-NP
Large Bowed Jar Form in
Ivory Crackle on Bronze
Museum Mounting with
Natural Paper Shade
 Height: 29¾"
 Width: 19"
 Base: 10¾" Square

Available Finishes: CC, IC
Shade Treatment: NP
Shade Details:
 14" x 19" x 14" Square

Socket: Dimmer
Wattage: 150 A
 ©EFC DESIGNS



CHA8623IC-NP
Square Column Vase in
Ivory Crackle on Bronze
Museum Mounting with
Natural Paper Shade
 Height: 32"
 Width: 19"
 Base: 7"

Available Finishes: CC, IC
Shade Treatment: NP
Shade Details:
 14" x 19" x 12" Square

Socket: Dimmer
Wattage: 150 A
 ©EFC DESIGNS



CHA8610I-NP
Elongated Square Vase Form
in Ivory Porcelain on
Antique Brass with
Natural Paper Shade
Height: 34½"
Width: 19"
Base: 7¼" Square

Shade Treatments: NP
Shade Details:
14" x 19" x 14" Square

Socket: Dimmer
Wattage: 150 A
©EFC DESIGNS



CHA8626IC-NP
Medium Square Kuan Form
Lamp in Ivory Crackle Glaze
with Natural Paper Shade
Height: 30"
Width: 18"
Base: 8" Square

Shade Treatment: NP
Shade Details:
13" x 18" x 13" Square

Socket: Dimmer
Wattage: 150 A
©EFC DESIGNS



CHA8617I-NP
Large Narrow Neck Vase Form
in Ivory Glaze with Natural
Paper Shade
Height: 32"
Width: 19"
Base: 7½" Round

Available Finishes: CC, I
Shade Treatment: NP
Shade Details: 14" x 19" x 13"

Socket: Dimmer
Wattage: 150 A
©EFC DESIGNS



CHA8618CC-NP
Large Baluster Vase Form
in Celadon Crackle Glaze
with Natural Paper Shade
Height: 33"
Width: 19"
Base: 7½" Round

Available Finishes: CC, I
Shade Treatment: NP
Shade Details: 14" x 19" x 13"

Socket: Dimmer
Wattage: 150 A
©EFC DESIGNS



CHA8614I-NP
Small Hexagonal Vase Form
Lamp in Ivory Glaze with
Natural Paper Shade
 Height: 28"
 Width: 17"
 Base: 6" Hexagonal

Available Finishes: CC, I
Shade Treatment: NP
Shade Details: 12" x 17" x 12"

Socket: Dimmer
Wattage: 100 A
 ©EFC DESIGNS



CHA8612I-NP
Large Hexagonal Vase Form
Lamp in Ivory Glaze with
Natural Paper Shade
 Height: 32½"
 Width: 19"
 Base: 7½" Hexagonal

Available Finishes: CC, I
Shade Treatment: NP
Shade Details: 14" x 19" x 14"

Socket: Dimmer
Wattage: 150 A
 ©EFC DESIGNS



CHA8619IC-NP
Octagonal Narrow Neck Gourd
in Ivory Crackle on
Antique Brass with
Natural Paper Shade
 Height: 32¾"
 Width: 19"
 Base: 7" Hexagonal

Available Finishes: CC, IC
Shade Treatment: NP
Shade Details: 14" x 19" x 13"

Socket: Dimmer
Wattage: 150 A
 ©EFC DESIGNS



CHA8627AB-NP
Fang Gourd Lamp in Antique
Brass with Natural Paper Shade
 Height: 27"
 Width: 18"
 Base: 6¼" Square

Available Finishes:
 AB, IC
Shade Treatment: NP
Shade Details:
 8"/14" x 10"/18" x 11"
 Square

Socket: Dimmer
Wattage: 150 A
 ©EFC DESIGNS



CHA8627IC-NP

CHA8615I-NP

**Large Gourd Form Lamp
in Ivory Glaze with Natural
Paper Shade**

Height: 34½"
Width: 20"
Base: 7½" Square

Available Finishes: CC, I
Shade Treatment: NP
Shade Details: 15" x 20" x 14"

Socket: Dimmer
Wattage: 150 A
©EFC DESIGNS



CHA8613CC-NP

**Small Gourd Form Lamp
in Celadon Crackle Glaze
with Natural Paper Shade**

Height: 26"
Width: 16"
Base: 6" Square

Available Finishes: CC, I
Shade Treatment: NP
Shade Details: 11" x 16" x 11"

Socket: Dimmer
Wattage: 100 A
©EFC DESIGNS



CHA8613I-NP

CHA8611I-NP

**Large Mokko Form Gourd
Lamp in Ivory Glaze with
Natural Paper Shade**

Height: 36½"
Width: 20"
Base: 7½" Square

Available Finishes: CC, I
Shade Treatment: NP
Shade Details: 15" x 20" x 14"

Socket: Dimmer
Wattage: 150 A
©EFC DESIGNS



CHA8616I-NP

**Medium Mokko Form Gourd
Lamp in Ivory Glaze with
Natural Paper Shade**

Height: 30"
Width: 17"
Base: 6" Square

Available Finishes: CC, I
Shade Treatment: NP
Shade Details: 12" x 17" x 12"

Socket: Dimmer
Wattage: 100 A
©EFC DESIGNS



CHA8405ST-NP
Corinthian Column Fragment
Table Lamp on Museum Mount
with Natural Paper Shade
 Height: 21"-26½"
 Width: 17"
 Base: 8" x 6"

Shade Treatments: NP
Shade Details:
 6"/12½" x 8"/17" x 11" Half Shade

Socket: Dimmer
Wattage: 100 A
 ©EFC DESIGNS



CHA8406ST-NP
Flame Finial Fragment Table
Lamp on Museum Mount
with Natural Paper Shade
 Height: 25½"-31½"
 Width: 16"
 Base: 5½" x 8"

Shade Treatment: NP
Shade Details:
 6"/11½" x 8"/16" x 12" Half Shade

Socket: Dimmer
Wattage: 100 A
 ©EFC DESIGNS



CHA8455BR-L
Gate Fragment Adjustable
Table Lamp on
Museum Mount with
Linen Shade
 Height: 22½"-27½"
 Width: 15"
 Base: 6" x 10¾"

Shade Treatments: L
Shade Details:
 5½"/13" x 6½"/15" x 9" Half Shade

Socket: Dimmer
Wattage: 100 A
 ©EFC DESIGNS



CHA3109AB
Rolled Lip Hurricane
in Antique-Burnished Brass
Height: 19½"
Width: 8"
Base: 9½"

Available Finishes: AB, PS



CHA3109PS



CHA3121AB
Large English Hurricane on
Fluted Column Mount in
Antique-Burnished Brass
Height: 20"
Width: 10"
Base: 8¼"

Available Finishes: AB, BZ, PS



CHA3121PS



CHA8451WI
Windsor Iron Twist Candlestick
in Weathered Iron
with Antique Brass Fittings
Height: 29"
Width: 16"
Base: 8"
Candles Not Included



SL3032HAB

**Mini Architect's Draftsman
Table Lamp in Hand-Rubbed**

Antique Brass

Height: 18"-24"

Width: 6 1/4"

Extension: 24"

Base: 6 1/4" Square

Available Finishes:

BZ, HAB, PS

Shade Details: 2" x 6 1/4" x 4 1/2"

Hexagonal

Socket: Hi-Lo

Wattage: 40 B

©EFC DESIGNS



SL3025AN

**The Pixie Adjustable Desk Lamp
in Antique Nickel**

Height: 13"-18 1/2"

Width: 5 1/2"

Extension: 16"

Base: 5 1/2" Round

Available Finishes:

AN, BZ, HAB, PN

Shade Details: 2 1/4" x 4 3/4"

Socket: Hi-Lo

Wattage: 25C

©EFC DESIGNS

SL3025HAB



S3064CH

Angle Draftsman's Lamp in Chrome

Height: 14"-32"

Width: 6 3/4"

Extension: 17"-27"

Base: 6" Square

Available Finishes: CH, HAB

Shade Details: 2" x 5 3/4" x 6 3/4"

Socket: Keyless with

Hi-Lo Line Switch

Wattage: 40 A

©EFC DESIGNS

S3064HAB



SL3BHAB

**Adjustable Photographer's Lamp in
Hand-Rubbed Antique Brass**

Height: 15" - 21"

Width: 5"

Extension: 7"

Base: 5" Round

Available Finishes: AN, HAB

Shade Details: 4" x 4" x 7"

Socket: Keyless/

Hi-Lo Line Switch

Wattage: 50 R20

©EFC DESIGNS

SL3BAN



S3061PN**Bauhaus Single-Arm Architect's Lamp in Polished Nickel**

Height: 18"-28"

Extension: 27"

Base: 6" Round

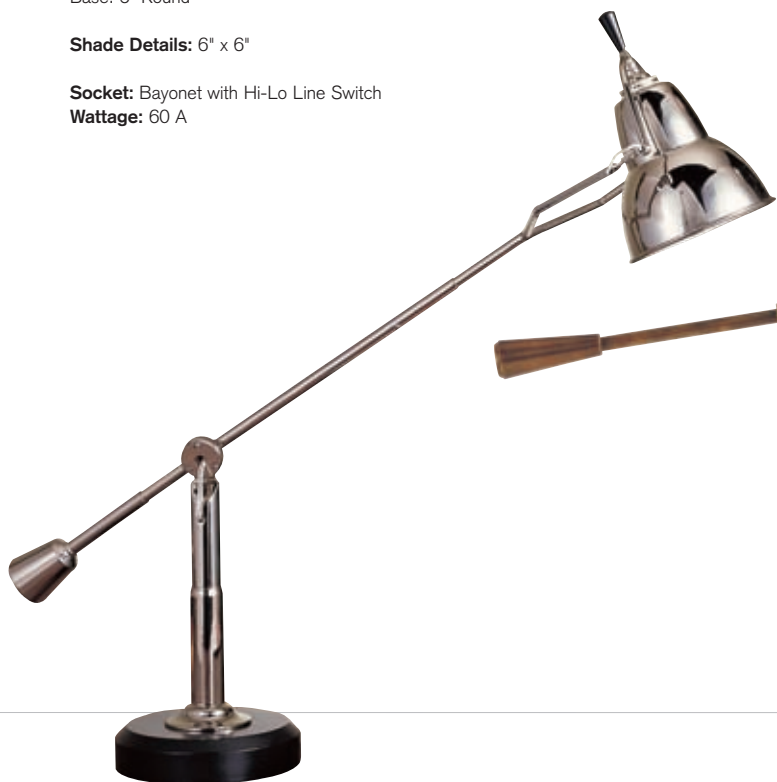
Shade Details: 6" x 6"**Socket:** Bayonet with Hi-Lo Line Switch**Wattage:** 60 A**SL3975HAB****Boom-Arm Table Lamp in Hand-Rubbed Antique Brass**

Height: 15"-26½"

Extension: 34"

Base: 8" Round

Available Finishes:

BZ, HAB, PN

Shade Details: 7" Round**Socket:** Hi-Lo**Wattage:** 60 A

©EFC DESIGNS

**S3060PN****Bauhaus Architect's Lamp in Polished Nickel**

Height: 15"-45"

Extension: 41"

Base: 6" Round

Shade Details: 6" x 6"**Socket:** Bayonet w/ Hi-Lo Line Switch**Wattage:** 60 A

SL3910AN/SLJG-WG

**Boston Adjustable Desk Lamp
in Antique Nickel with
White Glass SLJG Shade**

Height: 10½"-20"

Extension: 17"

Base: 6" Round

Available Finishes: AN, BZ, HAB

Shade Treatment: SLJG-WG

See Shade Schedule for
Additional Shade Options

Socket: Hi-Lo

Wattage: 60 A

©EFC DESIGNS



SL3910AN/SLG-AN

**Boston Adjustable Desk Lamp
in Antique Nickel with
Antique Nickel SLG Shade**

Height: 10½"-20"

Extension: 17"

Base: 6" Round

Available Finishes: AN, BZ, HAB

Shade Treatment: SLG-AN

See Shade Schedule for
Additional Shade Options

Socket: Hi-Lo

Wattage: 60 A

©EFC DESIGNS



SL3910AN/SLE-AW

**Boston Adjustable Desk Lamp
in Antique Nickel with
Antique White SLE Shade**

Height: 10½"-20"

Extension: 17"

Base: 6" Round

Available Finishes: AN, BZ, HAB

Shade Treatment: SLE-AW

See Shade Schedule for
Additional Shade Options

Socket: Hi-Lo

Wattage: 60 A

©EFC DESIGNS



SL3905HAB

**Boston Functional Bookkeeper's Lamp
in Hand-Rubbed Antique Brass**

Height: 20" - 26"

Width: 15½"

Base: 8" Round

Available Finishes: HAB, PN

Shade Details: 15½" x 4¼"

Socket: 2 - Candelabra

Wattage: 2 - 60 C

©EFC DESIGNS



SL3992PN-PN

**Boston Double-Arm Down Bridge
Table Lamp in Polished Nickel**

Height: 26" - 31½"
Width: 35"
Base: 9½" Round

Available Finishes: BZ, HAB, PN
Shade Details: 4" x 7½" x 5½" Metal

Socket: 2 - Hi-Lo
Wattage: 2 - 60 A
©EFC DESIGNS

**SL3980HAB-WG2**

**Boston Swing-Arm Table Lamp
in Hand-Rubbed Antique Brass**

Height: 26"-31½"
Extension: 31"
Base: 7" Round

Available Finishes:
BZ, HAB, PN
Shade Details: 7" Round

Socket: Hi-Lo
Wattage: 60 A
©EFC DESIGNS

**SL2BHAB-S**

**Adjustable Photographer's Lamp
in Hand-Rubbed Antique Brass
with Silk Shade**

Height: 17"-22"
Width: 10"
Base: 5" Round

Available Finishes: AN, HAB, PS
Shade Treatments: S, TSC
Shade Details: 6" x 10" x 7¾"

Socket: Hi-Lo
Wattage: 75 A
©EFC DESIGNS

**SL2BAN-S****SL30BHAB-S**

**Adjustable Photographer's
Console Lamp in Hand-Rubbed
Antique Brass with Silk Shade**

Height: 27½"-37"
Width: 10"
Base: 6" Round

Available Finishes: AN, HAB, PS
Shade Treatments: S, SBP, TSC
Shade Details: 6" x 10" x 7¾"
Silk / Tea - Stained Silk Bell or
11½" x 15" x 10" Silk Box Pleat

Socket: Hi-Lo
Wattage: 75 A
©EFC DESIGNS

SL30BAN-S

S3200BZ-WG

Ian's Reading Lamp in Bronze with White Glass Shade

Height: 21¼"
Width: 9¾"
Base: 8½" Round

Available Finishes: BZ, HAB, PN
Shade Treatment: WG
Shade Details: 9" x 9¾" x 6¾"

Socket: Dimmer
Wattage: 100 A



SL30BPS-SBP

Photographer's Console Lamp in Polished Silver with Silk Shade

Height: 27¾"-37½"
Width: 15"
Base: 6" Round

Available Finishes: AN, HAB, PS
Shade Treatments: S, SBP, TSC
Shade Details: 6" x 10" x 7¾"
Silk / Tea - Stained Silk Bell or
11½" x 15" x 10" Silk Box Pleat

Socket: Hi-Lo
Wattage: 75 A
©EFC DESIGNS



SL3804CHC-NP

Stacked Four-Ball Lamp in Chocolate Wood with Bronze Accent with Natural Paper Shade

Height: 33¾"
Width: 20"
Base: 7½" Square

Available Finishes: CHC, HAB, PS
Shade Treatment: NP
Shade Details: 15" x 20" x 14"

Socket: Hi-Lo
Wattage: 150 A
©EFC DESIGNS



SL3804HAB-NP

SL3811WG-NP

MOUTH BLOWN GOURD LAMP IN WHITE GLASS WITH NATURAL PAPER SHADE

Height: 30"
Width: 19"
Base: 6" Round

Available Finishes: CG, WG
Shade Treatment: NP
Shade Details: 15" x 19" x 12"

Socket: Hi-Lo
Wattage: 150 A
©EFC DESIGNS



SL3811CG-NP

SL3805HAB-NP
Stacked Three-Ball Lamp in
Hand-Rubbed Antique Brass
on Chocolate Wood with
Natural Paper Shade
 Height: 24"
 Width: 14"
 Base: 6½" Square

Available Finishes:
 CHC, HAB, PS, Q
Shade Treatments: NP
Shade Size: 10" x 14" x 10"

Socket: Hi-Lo
Wattage: 100 A
 ©EFC DESIGNS

SL3805PS-NP

SL3805Q-NP



SL3801WG-NP
Gourd Lamp in White Glass
with Natural Paper Shade
 Height: 33"
 Width: 20"
 Base: 8½" Square

Available Finishes:
 AGL, ASL, EG, WG
Shade Treatment:
 L, NP, S
Shade Details:
 15" x 20" x 14"

Socket: Hi-Lo
Wattage: 150 A
 ©EFC DESIGNS

SL3801EG-NP

SL3801ASL-L

SL3801AGL-S



SL3802CG-NP
Conical Crystal Bedside Lamp
on Faceted Base with Natural
Paper Shade

Height: 21½"
Width: 13"
Base: 4¾" Octagonal

Shade Treatment: NP
Shade Size: 10" x 13" x 8"

Socket: Hi-Lo
Wattage: 100 A
French Wired
©EFC DESIGNS



SL3803CG-NP
Large Conical Crystal Bedside
Lamp on Faceted Base with
Natural Paper Shade

Height: 27½"
Width: 17"
Base: 8" Octagonal

Shade Treatment: NP
Shade Size: 13" x 17" x 10"

Socket: Hi-Lo
Wattage: 150 A
French Wired
©EFC DESIGNS



SL3806CG-NP
Variable Cube Stacked Bedside in
Crystal with Natural Paper Shade

Height: 25½"
Width: 12"
Base: 5½" Square

Available Finishes: CG, Q
Shade Treatment: NP
Shade Details:
11" x 12" x 8¼"
Square

Socket: Hi-Lo
Wattage: 150 A
©EFC DESIGNS



SL3806Q-NP

SL3807CG-NP
Variable Cube Stacked
Buffet in Crystal with
Natural Paper Shade

Height: 36"
Width: 12"
Base: 6" Square

Shade Treatment: NP
Shade Size: 11" x 12" x 8¼"
Square

Socket: Hi-Lo
Wattage: 150 A
©EFC DESIGNS



SL3338CG-S**Square Balustrade Table Lamp
in Crystal with Silk Shade**

Height: 27½"
Width: 16"
Base: 5¼" Square

Available Finishes:

CG, OW, R

Shade Treatment:

L, NP, S

Shade Details:

11" x 16" x 10" Square

Socket: Hi-Lo**Wattage:** 150 A

French Wired

©EFC DESIGNS

**SL3339CG-SBP****Square Balustrade Table Lamp
in Crystal with Silk Shade**

Height: 27¼"
Width: 16"
Base: 5¼" Square

Available Finishes: CG, OW

Shade Treatment: NP, SBP

Shade Details:

13' x 17" x 10" NP or

13' x 17" x 11" SBP

Socket: Hi-Lo**Wattage:** 150 A

French Wired

©EFC DESIGNS

**SL3944CG-NP****French Balustrade Table Lamp in
Crystal with Natural Paper Shade**

Height: 32½"
Width: 19"
Base: 6" Square

Available Finishes: CG, ALB

Shade Treatment: NP

Shade Details:

10" x 19" x 13"

Socket: Dimmer**Wattage:** 100 A

French Wired (CG)

©EFC DESIGNS

**SL3944ALB-NP****SL3945CG-NP****French Balustrade Bedside Lamp in
Crystal with Natural Paper Shade**

Height: 27"
Width: 14"
Base: 4¾" Square

Available Finishes: CG, ALB

Shade Treatment: NP

Shade Size:

10" x 14" x 11"

Socket: Dimmer**Wattage:** 100 A

French Wired (CG)

©EFC DESIGNS

**SL3945ALB-NP**

SL3948IP-L
Surrey Table Lamp in Irish Pine with Linen Shade

Height: 35"
Width: 21½"
Base: 9" Octagonal

Available Finishes: IP, OW
Shade Treatment: L
Shade Details:
17½" x 21" x 12"

Socket: Dimmer
Wattage: 150 A
©EFC DESIGNS



SL3941FPW-NP
Balustrade Table Lamp in Fence Post Wash on Bronze Museum Mount with Natural Paper Shade

Height: 28"-35"
Width: 17"
Base: 7½" Square

Available Finishes: AWG, FPW
Shade Treatments: B, L, NP
Shade Details: 13" x 17" x 10"

Socket: 2-Pull Chain
Wattage: 2-60 A
©EFC DESIGNS



SL3943IP-NP
Wood Balustrade Table Lamp in Irish Pine with Natural Paper Shade

Height: 33"
Width: 17"
Base: 5½" Square

Available Finishes:
IP, OS
Shade Treatment:
NP
Shade Size:
13" x 17" x 10"

Socket: Hi-Lo
Wattage: 150 A
©EFC DESIGNS



SL3943OS-NP

SL3338OW-L
Square Balustrade Table Lamp in Old White with Linen Shade

Height: 26"
Width: 16"
Base: 5¾" Square

Available Finishes: CG, OW, R
Shade Treatment:
L, NP, S
Shade Size:
11" x 16" x 10" Square

Socket: Hi-Lo
Wattage: 150 A
©EFC DESIGNS



SL3338R-NP

SL3339OW-NP

**Round Balustrade Table Lamp
in Old White with
Natural Paper Shade**

Height: 29¼"
Width: 16"
Base: 5¾" Square

Available Finishes: CG, OW
Shade Treatment: NP, SBP
Shade Details: 11" x 16" x 10"

Socket: Hi-Lo
Wattage: 150 A
©EFC DESIGNS

**SL3336TB-NP**

**Balustrade Candlestick Table
Lamp in Tudor Brown
with Natural Paper Shade**

Height: 31"
Width: 14"
Base: 10" Round

Available Finishes: FW, TB
Shade Treatment: B, L, NP
Shade Details: 10" x 14" x 11"

Socket: Hi-Lo
Wattage: 100 A
©EFC DESIGNS

**SL3324FW-B**

**Tudor Twist Desk Lamp
in French Wax Finish
with Black Shade**

Height: 23"
Width: 13"
Base: 7½" Round

Available Finishes: FW, TB
Shade Treatment: B
Shade Size: 9" x 13" x 6"

Socket: 2-Keyless with
Hi-Lo Line Switch
Wattage: 2-60 A
©EFC DESIGNS

**SL3325TB-B**

**Tudor Twist Table Lamp in
Tudor Brown with Black Shade**

Height: 35½"
Width: 15"
Base: 8" Round

Available Finishes: FW, TB
Shade Treatment: B
Shade Size: 6" x 15" x 8"

Socket: 2-Keyless with
Hi-Lo Line Switch
Wattage: 2-40 A
©EFC DESIGNS



SL3326FW-NP

Tudor Twist Adjustable Table Lamp in French Wax with Natural Paper Shade

Height: 35"-45½"
Width: 16"
Base: 7½" Round

Available Finishes: FW, WA
Shade Treatments: L, NP
Shade Details:
10" x 16" x 10"

Socket: Hi-Lo
Wattage: 100 A
©EFC DESIGNS



SL3326WA-NP

SL3940FPW-NP

Twist Column Adjustable Lamp in Fence Post Wash on Bronze Museum Mount with Natural Paper Shade

Height: 39½"-42½"
Width: 11"
Base: 5½" Square

Available Finishes: AWG, FPW
Shade Treatments: B, L, NP
Shade Details: 8" x 11" x 9"

Socket: Hi-Lo
Wattage: 100 A
©EFC DESIGNS



SL3940AWG-NP

S312BB-NP

Bamboo Desk Lamp with Natural Paper Shade

Height: 18½"
Width: 10½"
Base: 6" Round

Shade Treatment: NP
Shade Details: 9½" x 10½" x 6¾"

Socket: Hi-Lo
Wattage: 100 A



S311BB-NP

Bamboo Table Lamp with Natural Paper Shade

Height: 27"
Width: 12"
Base: 7" Round

Shade Treatment: NP
Shade Details: 11" x 12" x 8"

Socket: Hi-Lo
Wattage: 150 A



S310EB-NP
Tribal Form Table Lamp
 in Ebony with
 Natural Paper Shade
 Height: 26"
 Width: 13"
 Base: 6¼" Round

Shade Treatment: NP
Shade Details:
 12" x 13" x 9"

Socket: Hi-Lo
Wattage: 150 A



SL3700FW-NP
Tripod Table Lamp
 in French Wax
 with Natural Paper Shade
 Height: 27"
 Width: 12"
 Base: 9" Tripod

Shade Treatment: NP
Shade Details: 12" x 12" x 8"

Socket: Hi-Lo
Wattage: 150 A
 ©EFC DESIGNS



S301AN-NP
Small Oval Lamp in Antique
Nickel with Natural Paper Shade
 Height: 17"
 Width: 11"
 Base: 3¾" x 5½" Oval

Available Finishes: AN, HAB
Shade Treatment: NP
Shade Details:
 6" / 9" x 8½" / 11" x 7"

Socket: Keyless with
 Hi-Lo Line Switch
Wattage: 60 A



S302HAB-NP
Tall Oval Lamp in Hand-Rubbed
Antique Brass
 Height: 26"
 Width: 14½"
 Base: 3¾" x 5" Oval

Available Finishes: AN, HAB
Shade Treatment: NP
Shade Details:
 9" / 12" x 11½" / 14½" x 10"

Socket: Hi-Lo
Wattage: 100 A



SL3103PS-S

Hex Bedside Lamp in Polished Silver with Silk Shade

Height: 24"
Width: 11"
Base: 4 3/4" Hexagonal

Available Finishes: HAB, PS
Shade Treatment: S
Shade Details: 8" x 11" x 8 1/2"

Socket: Hi-Lo
Wattage: 100 A
©EFC DESIGNS



SL3102HAB-S

Hex Table Lamp in Hand-Rubbed Antique Brass with Silk Shade

Height: 27"
Width: 13 1/2"
Base: 6 1/2" Hexagonal

Available Finishes: HAB, PS
Shade Treatment: S
Shade Details: 9 1/2" x 13 1/2" x 10"

Socket: Hi-Lo
Wattage: 100 A
©EFC DESIGNS



SL3101PS-S

Tall Hex Candlestick Lamp in Polished Silver with Silk Shade

Height: 34"
Width: 11"
Base: 5 1/2" Hexagonal

Available Finishes: HAB, PS
Shade Treatment: S
Shade Details: 8" x 11" x 8 1/2"

Socket: Hi-Lo
Wattage: 100 A
©EFC DESIGNS



SL3100HAB-S

Hex Urn Lamp in Hand-Rubbed Antique Brass with Silk Shade

Height: 26 1/2"
Width: 15"
Base: 6 1/2" Hexagonal

Available Finishes: AN, HAB, PS
Shade Treatment: S
Shade Details: 11" x 15" x 11"

Socket: Hi-Lo
Wattage: 100 A
©EFC DESIGNS



PT3000BZ-S

Peter Talbot Table Lamp in Bronze with Silk Shade

Height: 34 1/2"
Width: 10"
Base: 6 1/2" Square

Available Finishes: BC, BZ, HAB
Shade Treatment: S
Shade Details: 10" x 10" x 12"

Socket: Dimmer
Wattage: 100 A



S30HAB-NP
Architectural Table Lamp in
Hand-Rubbed Antique Brass
with Natural Paper Shade

Height: 23"
 Width: 14"
 Base: 6" Square

Available Finishes:

BS, HAB

Shade Treatment:

NP, NPS

Shade Details:

7" x 14" x 10"

Socket: Hi-Lo

Wattage: 75 A



S3030BR-NP
Iron Table Lamp
with Natural Paper Shade

Height: 24¼"-31¾"
 Width: 6¼"
 Extension: 19¾"
 Base: 6¼" x 8¾"

Shade Treatment: NP

Shade Details: 6" x 6" x 4½"

Socket: Candelabra /

Hi-Lo Line Switch

Wattage: 60 C



S3050BR-NP
Aspen Table Lamp
with Natural Paper Shade

Height: 25"
 Width: 14"
 Base: 6½" Round

Shade Treatment: NP

Shade Details:

13½" x 14½" x 9"

Socket: Hi-Lo

Wattage: 150 A



S3051BR-NP
Aspen Console Lamp
with Natural Paper Shade

Height: 22½"
 Width: 16"
 Base: 4½" x 9"

Shade Treatment: NP

Shade Details:

7" / 15" x 8" / 16" x 8"

Rectangle

Socket: 2-Candelabra /

Hi-Lo Switch

Wattage: 2-60 C



TOB3039BZ/HAB-NP
Ryan Puzzle Lamp in Bronze and Hand-Rubbed Antique Brass with Natural Paper Shade
 Height: 15"
 Width: 9 1/4"
 Base: 5" x 9 1/4"

Shade Treatment: NP
Shade Details: 5 1/2" x 6 1/2" x 6 1/2"

Socket: Pull Chain
Wattage: 60 A



TOB3038BZ
Eclipse Table Lamp in Bronze with Half Shade
 Height: 9"
 Width: 6 1/2"
 Base: 6 1/2" Round

Available Finishes: BZ, BZ/PN, HAB, PN, PS

Socket: Keyless/Hi-Lo Switch
Wattage: 60 A

TOB3038HAB

TOB3038PN



TOB3043PN
Small David Table Lamp in Polished Nickel with Wood Tray
 Height: 10"
 Width: 10 1/4"
 Base: 3" x 10 1/4"

Available Finishes: BZ, HAB, PN

Socket: Keyless/Hi-Lo Switch
Wattage: 40 T

TOB3043HAB

TOB3042PS
David Mantel Light in Polished Silver
 Height: 4 1/4"
 Width: 3"
 Base: 3" x 8 3/4"

Available Finishes: BZ, HAB, PN, PS

Socket: Hi-Lo
Wattage: 40 T

TOB3042BZ

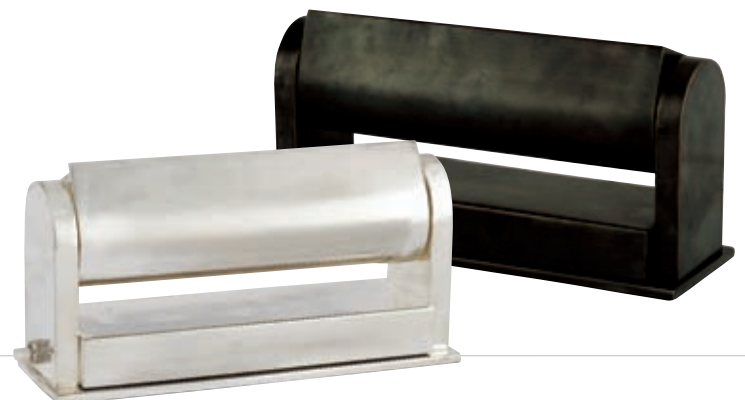

TOB3040BZ
Trent Lamp in Bronze
 Height: 8"
 Width: 17 1/4"
 Extension: 5 1/2"
 Base: 5 1/2" x 17 1/4"

Available Finishes: BZ, HAB, PN

Socket: 2-Candelabra/
 Line Switch
Wattage: 2 - 40 C



TOB3052PN
Tommy Task Lamp
in Polished Nickel
 Height: 5 1/4"-9 1/2"
 Extension: 10 1/2"
 Base: 3 1/4" Round

TOB3052BZ

TOB3052HAB

Available Finishes: AN, BZ, HAB, PN

Socket: Push
Wattage: 25 B



Wall "Pin-Up" Feature

TOB3009BC
Greenwich Desk Lamp
in Brushed Chrome
 Height: 23"
 Extension: 15"
 Base: 10" Round

Available Finishes: BC, BZ, HAB, PN
Shade Details: 13"

Socket: Dimmer
Wattage: 60 T



TOB3037PN-BZ
Vernon Task Lamp in Polished Nickel and Bronze
 Height: 14 1/2"
 Width: 8 1/4"
 Extension: 14"
 Base: 8 1/4" Round

TOB3037BZ

Available Finishes: BZ, BZ-HAB, HAB, PN-BZ

Socket: Hi-Lo
Wattage: 60 T



TOB3036PS-NP
Ziyi Pivoting Table Lamp
in Polished Silver with
Natural Paper Shade

Height: 27 $\frac{3}{4}$ "
Width: 8"
Extension: 13"
Base: 8" Round

Available Finishes:
BZ, HAB, PN, PS
Shade Treatment: NP
Shade Details: 5" x 5" x 9"

Socket: Hi-Lo
Wattage: 60 A

TOB3036BZ-NP



TOB3005CH
Thurston Pivoting
Desk Lamp in Chrome

Height: 14"
Width: 14 $\frac{1}{2}$ "
Extension: 22"
Base: 9 $\frac{1}{4}$ " Square

Available Finishes:
AN, BZ, CH, HAB
Shade Details: 14 $\frac{1}{2}$ " Round

Socket: Dimmer
Wattage: 75 A



TOB3061BLK/HAB
Selecta Task Lamp in Black
and Hand-Rubbed Antique
Brass with Black Shade

Height: 25 $\frac{3}{4}$ "
Width: 8 $\frac{1}{4}$ "
Extension: 14 $\frac{1}{2}$ "
Base: 8 $\frac{1}{4}$ " Round

Available Finishes:
BLK/HAB, HAB, PN/AW

Socket: Keyless/
Hi-Lo Switch
Wattage: 60 A



TOB3060BZ/HAB
Selecta Desk Lamp in Bronze
with Hand-Rubbed Antique Brass
Accents with Bronze Shade

Height: 30 $\frac{3}{4}$ "
Width: 11 $\frac{1}{2}$ "
Extension: 20 $\frac{1}{2}$ "
Base: 8 $\frac{1}{4}$ " Round

Available Finishes:
BZ/HAB, HAB, PN,
PN/AW

Socket: 2-Keyless/
Hi-Lo Switch
Wattage: 2-40 B



TOB3065PN**Elkins Pivoting Task Lamp
in Polished Nickel**

Height: 19½"-36½"

Width: 8"

Extension: 45¼"

Base: 8" Round

Available Finishes: BZ, BZ/PN, HAB, PN**Socket:** Keyless with Hi-Lo Switch**Wattage:** 60 A**TOB3065BZ****TOB3066BZ****Elkins Clamp On Desk Lamp
in Bronze**

Height: 36"

Width: 7¼"

Extension: 31"

Clamp On: ¼" Round

Available Finishes:
BZ, BZ/PN, HAB, PN**Socket:** Keyless/
Hi-Lo Line Switch**Wattage:** 60 A

TOB3081AN/PN-NP

**Alton Pivoting Accent Lamp in
Antique Nickel and Polished
Nickel with Natural Paper Shade**

Height: 12½"
Width: 6"
Extension: 10½"
Base: 4½" x 5½" Oval

Available Finishes: AN/PN, BZ,
BZ/HAB, HAB, PN
Shade Treatments: NP, NP/BT
Shade Details: 4" x 6" x 6½"

Socket: Hi-Lo
Wattage: 60 A



TOB3018HAB/BZ-NP/BT
**Jack Table Lamp in Hand-Rubbed
Antique Brass and Bronze with
Natural Paper Shade**

Height: 18½"
Width: 12"
Base: 3" Round

Available Finishes:
HAB/BZ, PS
Shade Treatments:
NP/BT, NP/ST
Shade Details: 9" x 12" x 9"

Socket: Pull Chain
Wattage: 100 A



TOB3018PS-NP/ST

TOB3025HAB-C

**Nina Table Lamp in
Hand-Rubbed Antique Brass
with Cotton Shade**

Height: 27½"
Width: 8"
Base: 8" Round

Available Finishes:
AN, BZ, HAB, PS, R
Shade Treatments:
C, C/BT, C/RT
Shade Details:
4½" x 6" x 8"

Socket: Hi-Lo
Wattage: 60 A



TOB3026BZ-C/BT

**Nina Tapered Table Lamp
in Bronze with Cotton Shade**

Height: 31"
Width: 15"
Base: 12" Round

Available Finishes:
AN, BZ, HAB, PS, R
Shade Treatments:
C, C/BT, C/RT
Shade Details:
14" x 15" x 9½"

Socket: Hi-Lo
Wattage: 150 A



TOB3019HAB-C
Jackie Table Lamp in
Hand-Rubbed Antique Brass
with Cotton Shade
 Height: 26½"-28"
 Width: 16"
 Base: 13½" Round

Available Finishes:
 AN, HAB, PS, R
Shade Treatment: C
Shade Details:
 12½" x 16" x 10"

Socket: 2-Pull Chain
Wattage: 2-75 A



TOB3019PS-C



TOB3076BZ-NP
Stanford Bedside Lamp in
Bronze with Natural Paper
Shade
 Height: 20"-21"
 Width: 11"
 Base: 4½" Round

Available Finishes:
 ALB, AN, BZ, HAB, PS
Shade Treatment: NP
Shade Details:
 11" x 11" x 7½"

Socket: 2-Pull Chain
Wattage: 2-40 B



TOB3076ALB-NP

TOB3077HAB-NP
Stanford Table Lamp in Hand-
Rubbed Antique Brass with
Natural Paper Shade
 Height: 26½"-28¾"
 Width: 14"
 Base: 6½" Round

Available Finishes:
 ALB, AN, BZ, HAB, PS
Shade Treatment: NP
Shade Details:
 14" x 14" x 9½"

Socket: 2-Pull Chain
Wattage: 2-60 A



TOB3077ALB-NP

TOB3072ROP-NP

Watson Table Lamp in Rope with Natural Paper Shade

Height: 26¼"

Width: 15"

Base: 5½" Square

Shade Treatments: CP, NP

Shade Details: 14" x 15" x 10"

Socket: 2-Pull Chain

Wattage: 2-75 A



TOB3012CHC-NP

Nelson Table Lamp in Chocolate with Natural Paper Shade

Height: 34¼"

Width: 19"

Base: 7" Square

Available Finishes:

CAR, CHC

Shade Treatment: NP

Shade Details:
9" x 19½" x 15½"

Socket: 2-Pull Chain

Wattage: 2-60 A



TOB3074DBS-S

Maison Accent Lamp in Dark Brown Shagreen with Silk Shade

Height: 23"

Width: 11"

Base: 4¾" x 5¼" Oval

Available Finishes:

DBS, WS

Shade Treatment: S

Shade Details:

10½" x 11" x 11½"

Socket: Hi-Lo

Wattage: 100 A



TOB3006HAB-NP

Porter Table Lamp in Hand-Rubbed Antique Brass with Natural Paper Shade

Height: 26"

Width: 14"

Base: 3½" x 4½"

Available Finishes:

BC, BZ, HAB

Shade Treatment: NP

Shade Details:

10" x 14" x 10¾"

Socket: 2-Pull Chain

Wattage: 2-60 A



TOB3000HAB-NP
Longacre Small Table Lamp
in Hand-rubbed Antique Brass
with Natural Paper Shade
 Height: 16"
 Width: 9"
 Base: 5" Round

Available Finishes: BZ, HAB,
 PN, PS
Shade Treatment: NP
Shade Details: 9" x 9" x 6"

Socket: 2-Pull Chain
Wattage: 2-25 B



TOB3000PN-NP

TOB3001BZ-NP/BT
Longacre Tall Table Lamp in Bronze
with Natural Paper Shade
 Height: 32½"
 Width: 20"
 Base: 10¼" Round

Available Finishes:
 BZ, HAB, PN, PS
Shade Treatments:
 NP, NP/BT
Shade Details:
 20" x 20" x 7½"

Socket: 2-Pull Chain
Wattage: 2-60 B



TOB3008BZ-WP
Beekman Table Lamp in Acrylic
with White Paper Shade
 Height: 17½"
 Width: 8"
 Base: 6" Round

Shade Treatment: WP
Shade Details: 7" x 8" x 8½"

Socket: Hi-Lo
Wattage: 75 A



TOB3073CG-NP
Zoe Table Lamp in Crystal
with Natural Paper Shade
 Height: 31¼"
 Width: 15"
 Base: 6" Square

Available Finishes: CG, CHC
Shade Treatment: NP
Shade Details: 12" x 15" x 14"

Socket: Hi-Lo
Wattage: 150 A



TOB3016SDL-L

**Palin Table Lamp in Saddle
Leather with Linen Shade**

Height: 31¾"
Width: 18"
Base: 10½" Square

Available Finishes: SDL, BLK
Shade Treatment: L
Shade Details: 11" x 18" x 13"

Socket: Pull Chain
Wattage: 150 A



TOB3017CG-L

**Palin Crystal Table Lamp with
Polished Nickel Accents with
Linen Shade**

Height: 31¾"
Width: 18½"
Base: 10½" Square

Shade Treatment: L
Shade Details: 11" x 18" x 13"

Socket: Pull Chain
Wattage: 150 A



TOB3031CG-C

**Small Crystal Block Table
Lamp with Cotton Shade**

Height: 18"-19½"
Width: 11½"
Base: 4" x 6"

Shade Treatment: C
Shade Details:
11½" x 11½" x 8"

Socket: 2-Pull Chain
Wattage: 2-40 B



TOB3030CG-C

**Large Crystal Block Table
Lamp with Cotton Shade**

Height: 24"-26"
Width: 16¾"
Base: 6" x 9"

Shade Treatment: C
Shade Details:
9½"/15" x 11"/16¾" x
10½" Oval

Socket: 2-Pull Chain
Wattage: 2-60 B



TOB3082CG-S
Luca Etched Crystal Lamp
 with Silk Shade
 Height: 25"-27½"
 Width: 14"
 Base: 6¾" x 11½"

Shade Treatment: S
Shade Details: 14" x 14" x 10"

Socket: 2-Pull Chain
Wattage: 2-40 B



TOB3083CG-S
Daphne Etched Crystal Lamp
 with Silk Shade
 Height: 26"-28½"
 Width: 16½"
 Base: 6¾" x 13½"

Shade Treatment: S
Shade Details:
 9½"/15" x 11"/16½" x 10½"
 Oval

Socket: 2-Pull Chain
Wattage: 2-60 B



TOB3084CG-S
Cynthia Etched Crystal Lamp
 with Silk Shade
 Height: 26½"-29½"
 Width: 16½"
 Base: 6¾" x 14"

Shade Treatments: S
Shade Details:
 9½"/15" x 11"/16½" x 10½"
 Oval

Socket: 2-Pull Chain
Wattage: 2-60 B



TOB3075GS-S
Val Accent Lamp in Gray
 Shagreen with Silk Shade
 Height: 16½"
 Width: 7"
 Base: 6¾" Square

Available Finishes: GS, RS
Shade Treatment: S
Shade Details: 7" x 7" x 7¾"
 Hardback Square

Socket: Pull Chain
Wattage: 75 A

TOB3075RS-S



TOB3003BZ-NP

Soho Lamp in Bronze with Natural Paper Shade

Height: 28"
Width: 16"
Base: 11" Square

Available Finishes:

AN, BZ, HAB

Shade Treatment: NP

Shade Details:

16" x 16" x 13" NPS

Socket: 2-Pull Chain

Wattage: 2-60 A with 60 A in Base



TOB3002GBC-NP

Spring Street Table Lamp in Grey Book Cloth with Saddle Leather with Natural Paper Shade

Height: 27"
Width: 16"
Base: 11" Square

Available Finishes: GBC, SBC

Shade Treatment: NP

Shade Details:

16" x 16" x 13" NPS

Socket: 2-Pull Chain

Wattage: 2-60 A



TOB3032GBC/AN-GBC
Small Dixon Table Lamp in Grey Book Cloth and Antique Nickel with Grey Book Cloth Shade

Height: 20½"
Width: 13½"
Base: 6¾" x 4½"

Available Finishes:

AN/PN, BL/BZ, BZ/HAB, HAB/BZ, GBC/AN, SBC/HAB

Shade Treatments:

BZ, GBC, NP, PN, SBC

Shade Details:

8½"/13¼" x 8½"/13¼" x 9"

Socket: 2-Pull Chain

Wattage: 2-60 A



TOB3032SBC/HAB-NP



TOB3032BZ/HAB-BZ
Small Dixon Table Lamp in
Bronze and Hand-Rubbed
Antique Brass with Bronze
Shade

Height: 21"
 Width: 13¼"
 Base: 4½" x 6¾"

Available Finishes:

AN/PN, BL/BZ, BZ/HAB,
 HAB/BZ, GBC/AN, SBC/HAB

Shade Treatments: BZ, GBC,
 NP, PN, SBC

Shade Details:

8½"/13¼" x 8½"/13¼" x 9"

Socket: 2-Pull Chain

Wattage: 2-60 A



TOB3032AN/PN-PN



TOB3033HAB/BZ-BZ
Tall Dixon Table Lamp
in Hand-Rubbed
Antique Brass and Bronze
with Bronze Shade

Height: 30½"
 Width: 18"
 Base: 7¾" x 9½"

Available Finishes:

AN/PN, BL/BZ, BZ/HAB,
 HAB/BZ, GBC/AN, SBC/HAB

Shade Treatments:
 BZ, GBC, NP, PN, SBC

Shade Details:

13½"/18" x 13½"/18" x 11½"

Socket: 2-Pull Chain

Wattage: 2-60 A



TOB3033BL/BZ-BZ



TOB3011ALB-NP
London Column Lamp
in Alabaster with
Natural Paper Shade

Height: 38 1/4"
Width: 19"
Base: 7" Round

Shade Treatment: NP
Shade Details:
9" x 19 1/2" x 15 1/2"

Socket: 2-Pull Chain
Wattage: 2-75 A



TOB3013ALB-NP
Leland Table Lamp
in Alabaster with
Natural Paper Shade

Height: 38 1/2"
Width: 21"
Base: 8 1/2" Round

Shade Treatment: NP
Shade Details:
9 1/2" x 21" x 15"

Socket: 2-Pull Chain
Wattage: 2-75 A



TOB3020ALB-NP
Terri Cube Lamp in Alabaster
with Natural Paper Shade

Height: 12 1/2"
Width: 6"
Base: 4 1/2" Square

Available Finishes: ALB, CG, Q
Shade Treatment: NP
Shade Details: 4" x 6" x 6"

Socket: Hi-Lo
Wattage: 60 A



TOB3020CG-NP
French Wired



TOB3022ALB-NP
Terri Pyramid Lamp
in Alabaster with
Natural Paper Shade

Height: 12 1/2"
Width: 6 1/2"
Base: 6 1/2" Square

Available Finishes: ALB, CG, Q
Shade Treatment: NP
Shade Details: 4" x 6" x 6"

Socket: Hi-Lo
Wattage: 60 A



TOB3022CG-NP
French Wired



TOB3021ALB-NP
Terri Cone Lamp in Alabaster
 with Natural Paper Shade
 Height: 16"
 Width: 6"
 Base: 4½" Round

Available Finishes: ALB, CG
Shade Treatment: NP
Shade Details: 4" x 6" x 6"

Socket: Hi-Lo
Wattage: 60 A



TOB3021CG-NP
 French Wired

TOB3023ALB-NP
Terri Large in Alabaster
 with Natural Paper Shade
 Height: 15"
 Width: 8"
 Base: 3" Round

Available Finishes: ALB, CG
Shade Treatment: NP
Shade Details: 5" x 8" x 8"

Socket: Hi-Lo
Wattage: 75 A



TOB3023CG-NP
 French Wired

TOB3051PS-NP
Tiny Terri Lamp in
 Polished Silver with
 Natural Paper Shade
 Height: 10¼"
 Width: 5"
 Base: 2¼"

Available Finishes:
 ALB, CG, HAB, PS
Shade Treatment: NP
Shade Details: 3" x 5" x 5½"

Socket: Candelabra with
 Hi-Lo Line Switch
Wattage: 40 C
 French Wired

TOB3051HAB-NP

TOB3051ALB-NP

TOB3051CG-NP

TOB3014CG-NP
Terri Crystal Accent Lamp
 with Natural Paper Shade
 Height: 12½"
 Width: 6"
 Base: 3" Round

Shade Treatment: NP
Shade Details: 4" x 6" x 6"

Socket: Hi-Lo
Wattage: 60 A
 French Wired



TOB3070CHC-NP/BT
Gladding Table Lamp in
Chocolate Wood and Crystal
with Natural Paper Shade

Height: 23¼"
Width: 15"
Base: 9¼" Square

Shade Treatment: NP/BT
Shade Details: 11½" x 15" x 11"

Socket: 2-Pull Chain
Wattage: 2-60 A



TOB3069PN/CAR-NP/RT
Morgan Table Lamp in Polished
Nickel and Caramel Wood
with Natural Paper Shade

Height: 27½"
Width: 16"
Base: 9¼" Square

Shade Treatment: NP/RT
Shade Details: 12" x 16" x 13"

Socket: 2-Pull Chain
Wattage: 2-60 A



TOB3024ALB-NP/BT
Terri Tall in Alabaster with
Natural Paper Shade

Height: 24"
Width: 16"
Base: 8" Round

Shade Treatments: NP/BT
Shade Details:
14" x 16" x 5"

Socket: 2-Hi-Lo
Wattage: 2-40 B



TOB3067PN/BZ-NP/BT
Elkins Table Lamp in Polished
Nickel and Bronze with Natural
Paper Shade

Height: 25"-27½"
Width: 13½"
Base: 9¼" Round

Available Finishes:
HAB, PN/BZ, PS
Shade Treatments: NP, NP/BT
Shade Details:
8¼" x 13½" x 10½"

Socket: 2-Pull Chain
Wattage: 2-40 A



TOB3068PN/CHC-NP
Ryder Table Lamp in Polished Nickel and Chocolate Wood with Natural Paper Shade
 Height: 28¾"
 Width: 6¼"
 Base: 6¾" Round

Available Finishes:
 BZ, HAB, PN/CHC, PS/CG
Shade Treatment: NP
Shade Details:
 4½" x 6" x 7½"

Socket: Hi-Lo
Wattage: 60 A

TOB3068PS/CG-NP

TOB3068HAB-NP

TOB3010ALB-NP
Jacqueline Lamp in Alabaster on Chocolate Wood Base with Natural Paper Shade
 Height: 32½"
 Width: 16"
 Base: 5¼" Square

Available Finishes:
 ALB, CAR
Shade Treatment: NP
Shade Details:
 10" x 16" x 13½"

Socket: 2-Pull Chain
Wattage: 2-75 A

TOB3010CAR-NP



TOB3141GS-WG
Brandt Accent Lamp in Grey Shagreen with White Glass Shade
 Height: 14½"
 Width: 7"
 Base: 6" Round

Available Finishes: BL, BZ, DBS, GS, HAB, HAB/BZ, PN, RS, WS
Shade Treatment: WG
Shade Details: 4¾" x 6¾"

Socket: Pull Chain
Wattage: 60 A

TOB3141WS-WG

TOB3141HAB/BZ-WG

TOB3041HAB-WG
Brandt Round Lamp in Hand-Rubbed Antique Brass with White Glass Shade
 Height: 21¾"
 Width: 11¼"
 Base: 8½" Round

Available Finishes:
 BZ, HAB, PN
Shade Treatment: WG
Shade Details: 11¼" Round

Socket: Pull Chain
Wattage: 100 A



TOB3071CHC-NP

Xavier Table Lamp in Chocolate Wood with Natural Paper Shade

Height: 29¾"
Width: 15½"
Base: 7¾"

Shade Treatment: NP

Shade Details: 13" x 15½" x 11½"

Socket: Hi-Lo

Wattage: 150 A



TOB3015BZ-NP

Jackson Lamp in Bronze with Natural Paper Shade

Height: 33¾"
Width: 13½"
Base: 7" Round

Available Finishes:

BZ, HAB, PS

Shade Treatment: NP

Shade Details: 7½" x 13½" x 12"

Socket: Hi-Lo

Wattage: 100 A



TOB3090BR-NP/BT

Hugo Accent Lamp in Black Rust and Hand-Rubbed Antique Brass with Natural Paper Shade

Height: 22"
Width: 10½"
Base: 8¼" Round

Shade Treatment: NP/BT

Shade Details: 6¼" x 10½" x 8½"

Socket: Hi-Lo

Wattage: 75 A



TOB3091BR-NP/BT

Hugo Table Lamp in Black Rust and Hand-Rubbed Antique Brass with Natural Paper Shade

Height: 26"-28½"
Width: 11½"
Base: 10" Round

Shade Treatment: NP/BT

Shade Details: 8¼" x 13½" x 11½"

Socket: 2-Pull Chain

Wattage: 2-40 A



TOB3004BC-WP/ST
Academy Pivoting Desk Lamp in
Brushed Chrome with
White Paper Shade

Height: 24"
 Width: 19"
 Extension: 32¼"
 Base: 14½" Round

Available Finishes:
 BC, BZ, CH

Shade Treatment:
 WP/ST, NP/BT

Shade Details:
 19" x 19" x 7"

Socket: 2-Keyless
 with Hi-Lo Line Switch
Wattage: 2-60 A



TOB3080HAB-NP
Studio Tripod Table Adjustable Lamp
in Hand-Rubbed Antique Brass
with Natural Paper Shade

Height: 32"-75"
 Width: 20"
 Base: 11"-20" Tripod

Available Finishes:
 BZ, HAB, PN

Shade Treatment: NP

Shade Details:
 15" x 20" x 13½"

Socket: 2-Pull Chain
Wattage: 2-75 A



TOB3080BZ-NP



TOB3007PS-NP
Bryant Table Lamp in Polished Silver with Natural Paper Shade
 Height: 24½"-30½"
 Width: 6"
 Base: 4¼" Round

Available Finishes:
 AS, BZ, HAB, PS
Shade Treatment: NP
Shade Size: 4" x 6" x 6½"

Socket: Keyless with Hi-Lo Line Switch
Wattage: 60 A



TOB3007HAB-NP



TOB3088OAK-NP
Nicky Candlestick in Oak with Natural Paper Shade
 Height: 44¾"
 Width: 10½"
 Base: 10½" Round

Shade Treatment: NP
Shade Size: 4" x 6" x 6½"

Socket: Pull Chain
Wattage: 60 A



TOB3049BZ-CP
Olivia Candlestick Lamp in Bronze with Chocolate Paper Shade
 Height: 43¾"
 Width: 10"
 Base: 10" Round

Available Finishes:
 AN, BZ, CHC
Shade Treatments: CP, NP
Shade Details: 9" x 10" x 12"

Socket: Pull Chain
Wattage: 100 A



TOB3049CHC-NP



TOB3050AN-NP
Oliver Candlestick Lamp in Antique Nickel with Natural Paper Shade
 Height: 49¾"
 Width: 10"
 Base: 10" Round

Available Finishes:
 AN, BZ, CHC
Shade Treatments: CP, NP
Shade Details: 9" x 10" x 12"

Socket: Pull Chain
Wattage: 100 A



TOB3050CHC-CP



TOB3028WG-NP
Chloe Table Lamp
 in White Glass with
 Natural Paper Shade
 Height: 31½"-33"
 Width: 15"
 Base: 6½" Round

Available Finishes:
 BG, EG, WG
Shade Treatment: NP
Shade Size: 9" x 15" x 12½"

Socket: 2-Pull Chain
Wattage: 2-60 A



TOB3028BG-NP

TOB3027SG-NP
Miro Table Lamp
 in Clear-Seeded Glass with
 Natural Paper Shade
 Height: 32"-34"
 Width: 20"
 Base: 8½" Square

Available Finishes:
 BG, SG, WG
Shade Treatment: NP
Shade Details:
 12" x 20" x 15½"

Socket: 2-Pull Chain
Wattage: 2-75 A



TOB3047WG-NP
Small Emily Table Lamp
 in Clear-Seeded Glass with
 Natural Paper Shade
 Height: 19"
 Width: 11"
 Base: 3¼" Round

Available Finishes: BG, SG, WG
Shade Treatment: NP
Shade Details: 9" x 11" x 8"

Socket: Hi-Lo
Wattage: 100 A



TOB3048BG-NP
Large Emily Table Lamp
 in Blue Glass with
 Natural Paper Shade
 Height: 26½"
 Width: 15½"
 Base: 5" Round

Available Finishes:
 BG, SG, WG
Shade Treatment:
 NP
Shade Details:
 12½" x 15½" x 12¼"

Socket: Hi-Lo
Wattage: 150 A



TOB3046LB-NP
Elcy Ceramic Table Lamp
 in Light Blue with
 Natural Paper Shade
 Height: 22¼"
 Width: 14"
 Base: 4¾" Round

Available Finishes: I, LB, LC
Shade Treatment: NP
Shade Size:
 8"/12" x 10"/14" x 9½" Oval

Socket: Pull Chain
Wattage: 100 A



TOB3112AN-CG

**Austin Hurricane
in Antique Nickel
with Clear Glass**

Height: 17¾"

Width: 11¾"

Base: 11¾" Round

Available Finishes:

AN-CG, BZ-CG, CHC-CG



TOB3114AN-BG

**Andre Hurricane
in Antique Nickel
with Blue Glass**

Height: 19½"

Width: 9½"

Base: 9½" Round

Available Finishes:

AN-BG, AN-CG,
BZ-CG, CHC-CG



TOB3113CHC-CG

**Augusta Hurricane
in Chocolate Wood
with Clear Glass**

Height: 20¼"

Width: 10¼"

Base: 8" Round

Available Finishes:

AN-CG, BZ-CG, CHC-CG



TOB3111CHC-CG
Atwood Hurricane
in Chocolate Wood
with Clear Glass

Height: 18"
Width: 8 1/4"
Base: 8 1/4" Round

Available Finishes:
AN-CG, BZ-CG, CHC-CG



TOB3110AN-BG
Adam Hurricane
in Antique Nickel
with Blue Glass

Height: 16 1/4"
Width: 8 1/4"
Base: 8 1/4" Round

Available Finishes:
AN-BG, AN-CG, BZ-CG, CHC-CG

TOB3110CHC-BG



BB3102BZV-HAB

**Columnar Candlestick Table Lamp
in Bronze Verdigris with
Hand-Rubbed Antique Brass Shade**

Height: 32"
Width: 15"
Base: 7½" Square

Shade Details:
8½" x 14" x 10½"

Socket: Hi-Lo
Wattage: 100 A



NYPL2

**New York Public Library
Mini Table Lamp in Bronze
with Hand-Rubbed Antique
Brass Shade**

Height: 24"
Width: 12½"
Base: 6¾" Round

Shade Treatment: HAB
Shade Details:
7" x 12½" x 8½"

Socket: 2-Pull Chain
Wattage: 2-60 A



NYPL1

**New York Public Library
Reading Room Lamp in Bronze
with Hand-Rubbed Antique
Brass Shade**

Height: 31"
Width: 15"
Base: 8" Round

Shade Treatment: HAB
Shade Details:
8" x 15" x 10½"

Socket: 2-Pull Chain
Wattage: 2-60 A



BB3101HAB-S

**Small Trophy Lamp in
Hand-Rubbed Antique Brass
with Silk Shade**

Height: 23"
Width: 11½"
Base: 7" Round

Available Finishes:

AN, HAB

Shade Treatments:

B, NP, S

Shade Details:

8" x 11" x 8½"

Socket: Hi-Lo
Wattage: 100 A



BB3100HAB-B

**Classic Trophy Lamp in
Hand-Rubbed Antique Brass
with Black Shade**

Height: 25¼"
Width: 15"
Base: 6" Round

Available Finishes:

AN, HAB, PB

Shade Treatments:

B, NP

Shade Details:

6" x 15" x 10"

Socket: Dimmer
Wattage: 75 A



BB3821BLK-B
31" Candlestick Lamp
in Black with Black Shade

Height: 31"
 Width: 15"
 Base: 7 1/4" Round

Available Finishes:
 BLK, OX
Shade Treatments:
 B, L, NP
Shade Details:
 5" x 15" x 9 1/2"

Socket: Keyless with
 Hi-Lo Line Switch
Wattage: 60 A



BB3820OX-NP
24" Candlestick Lamp
in Oxblood with
Natural Paper Shade

Height: 24"
 Width: 10"
 Base: 6" Round

Available Finishes:
 BLK, OX
Shade Treatments:
 B, L, NP
Shade Details:
 4" x 10" x 7"

Socket: Keyless with
 Hi-Lo Line Switch
Wattage: 60 A



BB3002HAB-MP
Large Bouillotte Lamp
in Hand-Rubbed Antique Brass
with Monte Patina Shade

Height: 24"
 Width: 17 1/2"
 Base: 4" x 9"

Available Finishes: HAB, PB
Shade Treatments: MP, OX
Shade Details: 8" x 17 1/2"

Socket: 2-Candelabra with
 Hi-Lo Line Switch
Wattage: 2-60 C



BB3002HAB-OX

BB3040HAB-NP
Hobbs Table Lamp
in Hand-Rubbed Antique Brass
with Natural Paper Shade

Height: 31"
 Width: 12 1/2"
 Extension: 7 1/4"
 Base: 5" Round

Available Finishes:
 AN, BZ, HAB, PN
Shade Treatment: NP
Shade Details:
 9 1/2" x 12 1/2" x 9 3/4"

Socket: Hi-Lo
Wattage: 100 A



BB3110HAB-NP

**French Candlestick Buffet Lamp
in Hand-Rubbed Antique Brass
with Natural Paper Shade**

Height: 35"
Width: 11"
Base: 6" Round

Available Finishes:
AN, BZ, HAB, PB, PN
Shade Treatments:
L, NP, T
Shade Details:
5" x 11" x 8¼"

Socket: Dimmer
Wattage: 75 A



BB3510HABL2-NP

**Adjustable Miniature Library Lamp
in Antique Brass with Braided
Leather with Natural Paper Shade**

Height: 19"-29"
Width: 7"
Base: 5" Round

Available Finishes:
AN, BZ, HAB, HABL2
Shade Treatments:
B, NP
Shade Details:
3½" x 7" x 6"

Socket: Candelabra with
Hi-Lo Line Switch
Wattage: 40 C



BB3500HABL2-NP

**Adjustable French Library Lamp
in Antique Brass with Braided
Leather with Natural Paper Shade**

Height: 27" - 38"
Width: 11"
Base: 6½" Round

Available Finishes:
AN, BZ, HAB, HABL2
Shade Treatments:
B, NP
Shade Details:
9" x 11" x 8¾"

Socket: Hi-Lo
Wattage: 100 A



BB3510BZ-NP

**Adjustable Miniature Library
Lamp in Bronze with Natural
Paper Shade**

Height: 19"-29"
Width: 9"
Base: 5" Round

Available Finishes:
AN, BZ, HAB, HABL2
Shade Treatments:
B, NP
Shade Details: 3" x 9" x 6½"

Socket: Candelabra with
Hi-Lo Line Switch
Wattage: 40 C



BB3500BZ-NP

**Adjustable French Library
Lamp in Bronze with Natural
Paper Shade**

Height: 27"-38"
Width: 15"
Base: 6½" Round

Available Finishes:
AN, BZ, HAB, HABL2
Shade Treatments: B, NP
Shade Details:
4" x 15" x 9"

Socket: Hi-Lo
Wattage: 60 A



SC3008IC-NP
Small Tang Lamp in Ivory Crackle with Natural Paper Shade

Height: 18½"
 Width: 14"
 Base: 4¼" Round

Available Finishes: BLK, IC
Shade Treatment: NP
Shade Details: 6" x 14" x 9"

Socket: Dimmer
Wattage: 75 A



SC3009IC-NP
Medium Tang Lamp in Ivory Crackle with Natural Paper Shade

Height: 26"
 Width: 21"
 Base: 8½" Round

Available Finishes: BLK, IC
Shade Treatment: NP
Shade Details: 12" x 21" x 13½"

Socket: Dimmer
Wattage: 150 A



SC3002IC-NP
Tang Lamp in White with Natural Paper Shade

Height: 34"
 Width: 27½"
 Base: 8½" Round

Available Finishes: BLK, IC
Shade Treatment: NP
Shade Details: 11½" x 27½" x 17"

Socket: Dimmer
Wattage: 150 A



SC3002BLK-NP



SC3004CRC-NP

**Geige Double Lamp in Cream Crackle Finish
with Natural Paper Shade**

Height: 30"

Width: 15"

Base: 7½" Round

Shade Treatment: NP

Shade Details: 9" x 15" x 11½"

Socket: Dimmer

Wattage: 100 A



SC3012HAB-S

**"U-Fill It" Table Lamp in Hand-Rubbed
Antique Brass with Silk Shade**

Height: 33"

Width: 18"

Base: 11½" Square

Available Finishes: AN, HAB

Shade Treatment: S

Shade Details:
12¼" x 18" x 11¼"

Socket: Hi-Lo

Wattage: 150 A



SC3000BW-NP
Small Shore Line Lamp
with Natural Paper Shade

Height: 25"
Width: 21"
Base: 9" Round

Shade Treatment: NP

Shade Details:
8½" x 21" x 11¾"

Socket: Hi-Lo

Wattage: 100 A



SC3001BW-NP
Tall Shore Line Lamp
with Natural Paper Shade

Height: 31"
Width: 21"
Base: 8" Round

Shade Treatment: NP

Shade Details:
8½" x 21" x 11¾"

Socket: Hi-Lo

Wattage: 100 A



CL3170BZ

**Noho Double-Yoke Accent Lamp
in Bronze**

Height: 12"-13½"

Width: 7"

Base: 5" x 7"

Available Finishes: BC, BZ

Shade Details: 4" x 6"

Socket: Keyless with
Hi-Lo Line Switch

Wattage: 60 A



CL3100BZ-WP

**Tribeca Table Lamp in Bronze
with White Paper Shade**

Height: 24"

Width: 8"

Base: 8" Square

Available Finishes: BS, BZ

Shade Treatments: FG, WP

Shade Details: 7½" x 7½" x 9"
Square

Socket: Pull Chain

Wattage: 100 A



CL3001BZ-L

**Chelsea Mini Table Lamp
in Bronze with Linen Shade**

Height: 15"

Width: 5"

Base: 4" Square

Shade Treatment: L

Shade Details: 5"⁄5" x 5"⁄5" x 11½"

Socket: Keyless with
Hi-Lo Line Switch

Wattage: 60 A



CL3005BZ-L

**Chelsea Horizontal Table Lamp
in Bronze with Linen Shade**

Height: 9"

Width: 13"

Base: 11½" x 3½"

Shade Treatment: L

Shade Details:

13"⁄5" x 13"⁄5" x 5"

Socket: 4-Candelabra with
Hi-Lo Line Switch

Wattage: 4-40 C



CL3004BZ-L
Chelsea Rectangle Table Lamp
in Bronze with Linen Shade

Height: 24"
 Width: 16"
 Base: 7" x 13"

Shade Treatment: L
Shade Details:
 16"/11½" x 16"/11½" x 9"

Socket: 2-Keyless with
 Hi-Lo Line Switch
Wattage: 2-60 A



CL3002BZ-L
Chelsea Small Square Table Lamp
in Bronze with Linen Shade

Height: 25"
 Width: 9"
 Base: 7" Square

Shade Treatment: L
Shade Details:
 9"/9" x 9"/9" x 11½"

Socket: Keyless with
 Hi-Lo Line Switch
Wattage: 60 A

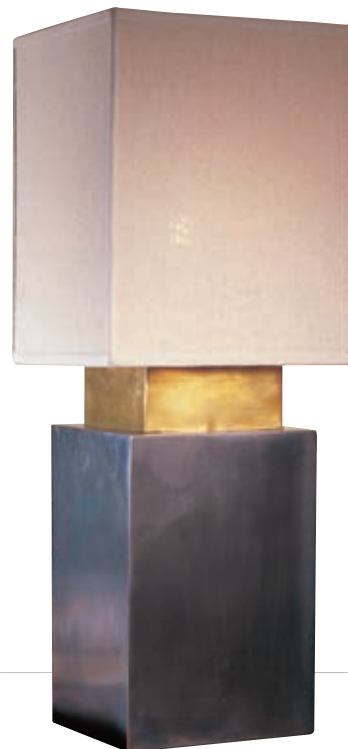

CL3003BZ-L
Chelsea Large Square Table Lamp
in Bronze with Linen Shade

Height: 28"
 Width: 12½"
 Base: 9" Square

Shade Treatment: L
Shade Details:
 12½"/12½" x 12½"/12½" x 16"

Socket: Keyless with
 Hi-Lo Line Switch
Wattage: 60 A





FLOOR

Chart House	104
Studio	122
Thomas O'Brien	132
Bill Blass	141
Clodagh	145
Eric Cohler	146





CHA9153AB
Edwardian Boom Arm Floor
Lamp in Antique-Burnished Brass
Height: 50"-56"
Extension: 58"
Base: 11" Round

Available Finishes: AB, AN, BZ
Shade Details: 11" X 6"

Socket: Hi-Lo
Wattage: 75 A
©EFC DESIGNS

CHA9151AB
Pimlico Tripod Boom-Arm
Pharmacy Floor Lamp in
Antique-Burnished Brass
Height: 55"
Extension: 38"
Base: 22" Tripod

Available Finishes: AB, BZ, PN
Shade Details: 3½" x 7"

Socket: Hi-Lo
Wattage: 60 A
©EFC DESIGNS



CHA9134AB-S
Overseas Adjustable Height
Downbridge Lamp in Antique-
Burnished Brass with Silk
Shade

Height: 51"-62"
Extension: 33"
Base: 9" Round

Shade Treatment: S
Shade Details: 7½" x 12" x 8"

Socket: Hi-Lo
Wattage: 100 A
©EFC DESIGNS

CHA9150AB-LC
Pimlico Adjustable Floor Lamp
in Antique-Burnished Brass
with Linen Collar Shade

Height: 47"-60"
Extension: 29½"
Base: 9" Round

Finishes: AB, AN, BZ, PN
Shade Treatment: LC
Shade Details: 7" x 12" x 9"

Socket: Hi-Lo
Wattage: 100 A
©EFC DESIGNS



CHA9152AB-TSF

**Pimlico Two-Arm Adjustable Chair Lamp
in Antique-Burnished Brass
with Tissue Silk Shades**

Height: 54"-64"

Extension: 31"-38"

Base: 9" Round

Shade Treatment: TSF

Shade Details: 7" x 12" x 9"

Socket: 2-Hi-Lo

Wattage: 2-100 A



CHA9132AB-WG

**Edwardian Torchiere Floor
Lamp in Antique-Burnished
Brass with White Glass Shade**

Height: 74"

Base: 11" Round

Available Finishes:

AB, AN, BZ, PN

Shade Treatment:

AB, AN, BZ, PN, WG

Socket: Hi-Lo

Wattage: 100 A

©EFC DESIGNS

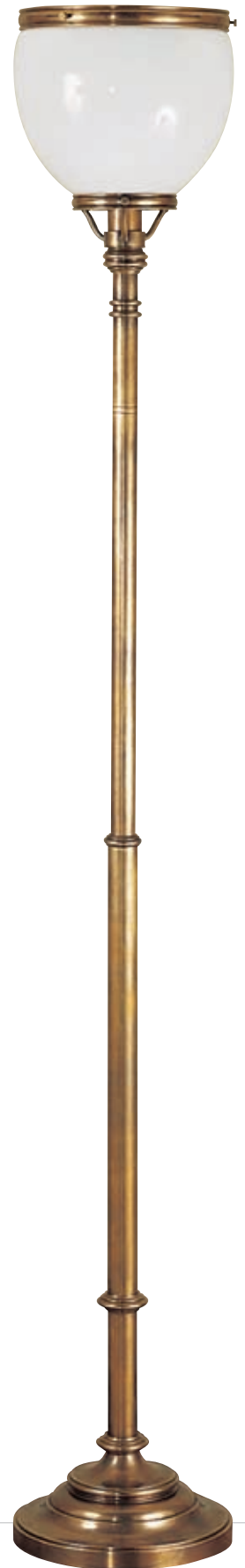

CHA9154AN/AB-S

**Star Motif Boom-Arm Floor Lamp
in Antique-Burnished Brass with
Antique Nickel Accents with Silk Shade**

Height: 41"-74"
Width: 10"
Extension: 22"-26 3/4"
Base: 10" Round

Available Finishes: AB/AN, AN/AB
Shade Treatment: L, S
Shade Details: 7" x 10" x 9"

Socket: Hi-Lo Nordy
Wattage: 100 A
©EFC DESIGNS

CHA9154AB/AN-S

CHA9155AB/AN-NP

**Adjustable Star Motif Club Floor Lamp
in Antique-Burnished Brass with
Antique Nickel Trim with Natural Paper Shade**

Height: 55"-72"
Width: 19"
Base: 10" Round

Shade Treatment: NP
Shade Details:
14" x 19" x 12"

Socket:
2-Pull Chain
Wattage: 2-75 A
©EFC DESIGNS



CHA9450WI-L
Windsor Iron Twist Adjustable
Floor Lamp in Weathered Iron
with Linen Shade

Height: 57½"-66"

Width: 19"

Base: 11" Round

Shade Treatment: L

Shade Details: 14" x 19" x 12"

Socket: Hi-Lo

Wattage: 150 A

©EFC DESIGNS



CHA9451WI-L
Windsor Iron Twist Candlestick
Floor Lamp in Weathered Iron
with Linen Shade

Height: 63"

Width: 23"

Base: 11" Round

Shade Treatment: L

Shade Details:
17" x 23" x 13" Rectangle

Socket: 2-Pull Chain

Wattage: 2-75 A

©EFC DESIGNS



CHA9452AB/AN-L
**Castle Floor Lamp in Antique-
Burnished Brass with Antique
Nickel Accents with Linen
Shade**
Height: 63"
Width: 21"
Base: 17"

Available Finishes: AB/AN, WI
Shade Treatment: L
Shade Details: 15" x 21" x 12"

Socket: 2-Pull Chain
Wattage: 2-75 A
©EFC DESIGNS

CHA9452WI-L



CHA9135ABL-L
Edwardian Club Floor Lamp
in Natural Leather Wrapped
Antique-Burnished Brass
Height: 60½" - 83"
Width: 19"
Base: 11"

Available Finishes: ABL, ANL
Shade Treatments: B, L
Shade Details: 14" x 19" x 12"

Socket: 2-Pull Chain
Wattage: 2-75 A
©EFC DESIGNS



CHA9124ABC-B
Overseas Adjustable Club Floor Lamp
in Antique-Burnished Brass and
Faux Cordovan with Black Shade
Height: 40"-64½"
Width: 15"
Base: 9" Round

Available Finishes: ABC, PS
Shade Treatment: B, S
Shade Details: 9" x 15" x 9"

Socket: 2-Pull Chain
Wattage: 2-60 A
©EFC DESIGNS



CHA9125AB-B
Overseas Adjustable Height Floor Lamp
with Glass Tray in Antique-Burnished Brass
with Black Shade
Height: 40"-65"
Width: 15"
Base: 9" Round

Available Finishes: AB, PS
Shade Treatment: B, S
Shade Details: 9" x 15" x 9"

Socket: 2-Pull Chain
Wattage: 2-60 A
©EFC DESIGNS



CHA9140AB-S
Earle's Adjustable Tray Floor Lamp
in Antique Burnished-Brass
with Silk Shade
Height: 59"-72"
Width: 18"
Base: 14" Tripod

Shade Treatment: S
Shade Details: 14" x 18" x 11"

Socket: Hi-Lo
Wattage: 150 A
©EFC DESIGNS



CHA9314BLK-SC

**Adjustable Tray Floor Lamp
in Black and Gold Tole
with Silk Collar Shade**

Height: 55"-63"

Width: 18"

Tray: 15½" Round

Base: 11½"

Shade Treatment: SC

Shade Size: 12" x 18" x 12"

Socket: Hi-Lo

Wattage: 150 A

©EFC DESIGNS



CHA9315BLK-L

**Column Form Floor Lamp
in Black with Linen Shade**

Height: 56½"

Width: 16"

Base: 10" Square

Available Finishes: BLK, OAK

Shade Treatments: L, NP

Shade Details: 12" x 16" x 11"

Socket: Hi-Lo

Wattage: 150 A

©EFC DESIGNS



CHA9313BLK-S
Candle Floor Lamp in Black and Gold with Silk Shade

Height: 60"
Width: 18"
Base: 12" Round

Available Finishes: ASL, BLK
Shade Treatment: S

Shade Details:
12" x 18" x 13" Silk Pleat Square or
12" x 19" x 13" Silk Bell

Socket: Hi-Lo
Wattage: 150 A
©EFC DESIGNS

CHA9313ASL-S

CHA9312CHI-NP
Turned Wood Floor Lamp in Black with Gold Chinoiserie Floral Designs with Natural Paper Shade

Height: 67½"
Width: 20"
Base: 12" Round

Shade Treatment: NP

Shade Details:
13½" x 20" x 12½"

Socket: Hi-Lo
Wattage: 150 A
©EFC DESIGNS



CHA9316AB-NP

**Torned Adjustable Floor Lamp with
Lion Feet in Antique-Burnished Brass
with Natural Paper Shade**

Height: 60"-69"

Width: 23"

Base: 15" Round

Available Finishes: AB, BZ, PS, TB

Shade Treatment: NP

Shade Details: 9¼" x 23" x 12½"

Socket: Dimmer

Wattage: 150 A

CHA9316TB-NP

CHA9122AB-S

**English Candlestand Floor
Lamp in Antique-Burnished
Brass with Silk Shade**

Height: 58½"

Width: 18"

Base: 9"

Available Finishes: AB, PS

Shade Treatments: B, L, NP, S

Shade Details:
11" X 18" X 11½"

Socket: Hi-Lo

Wattage: 150 A

©EFC DESIGNS



CHA9310WGL-B
Large Italian Wood Candle
Floor Lamp in Distressed White
and Gold with Black Shade
Height: 60"
Width: 19"

Shade Treatment: B
Shade Details:
10" x 19" x 11½"

Socket: Hi-Lo
Wattage: 100 A



CHA9160AB-L
Sloane Street Floor Lamp
in Antique-Burnished Brass
with Linen Shade
Height: 62"
Width: 15½"
Base: 12"

Available Finishes: AB, BR
Shade Treatment: L
Shade Details:
11½" x 15½" x 10"

Socket: 2-Pull Chain
Wattage: 2-60 A
©EFC DESIGNS



CHA9402NR-NP

**Large Mediterranean
Candlestick Floor Lamp in Rust
with Natural Paper Shade**

Height: 62"

Width: 19"

Base: 12½"

Shade Treatments: B, NP
Shade Details: 14" x 19" x 12"

Socket: Hi-Lo
Wattage: 150 A

©EFC DESIGNS



CHA9401WI-B

**Etruscan Floor Lamp in
Weathered Iron with Black Shade**

Height: 68"

Width: 20"

Base: 20" Tripod

Shade Treatment: B
Shade Details: 7" x 20" x 12½"

Socket: Hi-Lo
Wattage: 75 A
©EFC DESIGNS



CHA9131AB-NP
Dorchester Floor Lamp in
Antique-Burnished Brass with
Natural Paper Shade
Height: 51"-64"
Width 14"
Base: 9" Round

Available Finishes: AB, ABC
Shade Treatment: B, NP, S
Shade Details: 9" x 14" x 8½"

Socket: Hi-Lo
Wattage: 100 A
©EFC DESIGNS

CHA9131ABC-B

CHA9128ABV-TSBC
Adjustable Reeded Club Lamp in
Antique-Burnished Brass Verdigris
with Tissue Silk Bell Shade
Height: 60"-70"
Width: 18"
Base: 10" Round

Shade Treatment: TSBC
Shade Details: 12" x 18" x 12"

Socket: Hi-Lo
Wattage: 150 A
©EFC DESIGNS



CHA9455AB-NP
Spiral Floor Lamp
in Antique-Burnished Brass
with Natural Paper Shade

Height: 62"
Width: 16"
Base: 9" Round

Available Finishes: AB, BZV, PS
Shade Treatment: NP
Shade Details: 10" x 16" x 10"

Socket: Dimmer
Wattage: 100 A



CHA9102ABT-B
Chelsea Floor Lamp
in Antique-Burnished Brass and
Tortoise Shell with Black Shade

Height: 58"
Width: 17"
Base: 10" Round

Shade Treatment: B
Shade Details: 8" x 17" x 9"

Socket: 2-Pull Chain
Wattage: 2-60 A
©EFC DESIGNS



CHA9103ABC-B
Kensington Library Floor Lamp
in Antique-Burnished Brass
and Faux Cordovan Leather
with Black Shade

Height: 58"
Extension: 17"
Base: 10" Round

Shade Treatment: B
Shade Details: 5½" x 15" x 9"

Socket: Hi-Lo
Wattage: 75 A
©EFC DESIGNS



CHA9105AN-B
Sloane Club Swing Arm Floor Lamp
in Antique Nickel with Black Shade
Height: 52"-65"
Extension: 21"
Base: 10½" Round

Available Finishes: AB, AN
Shade Treatment: B, NP
Shade Details: 9" x 13" x 8½"

Socket: Hi-Lo
Wattage: 100 A

CHA9121AB-B
Dorchester Swing-Arm Floor Lamp
in Antique-Burnished Brass
with Black Shade
Height: 51"-64"
Extension: 21"
Base: 9" Round

Available Finishes: AB, BZ, PN
Shade Treatment: B, S
Shade Details: 6" x 12" x 8½"

Socket: Hi-Lo
Wattage: 75 A
©EFC DESIGNS

CHA9106AB-NP
Chunky Swing-Arm Floor Lamp
in Antique-Burnished Brass
with Natural Paper Shade
Height: 54½"-70½"
Extension: 26"
Base: 12½" Round

Available Finishes:
AB, AN, BZ, PN
Shade Treatment: L, NP
Shade Details: 10" x 12" x 7½"

Socket: Dimmer
Wattage: 100 A
©EFC DESIGNS



CHA9107AB

**Dorchester Swing-Arm Floor Lamp
with Pharmacy Shade in
Antique-Burnished Brass**

Height: 37"-63"

Extension: 22"

Base: 9" Round

Finishes: AB, AN, BZ, PN

Shade Details: 8 $\frac{3}{4}$ " x 3 $\frac{1}{8}$ " x 2"

Socket: Hi-Lo

Wattage: 60 T

©EFC DESIGNS

CHA9127ABV

**Adjustable Reeded Floor Lamp in
Antique-Burnished Brass Verdigris**

Height: 39 $\frac{1}{2}$ "-63"

Extension: 20"

Base: 10" Round

Shade Details: 5 $\frac{1}{2}$ " x 9 $\frac{3}{4}$ "

Socket: Hi-Lo

Wattage: 50 R20

©EFC DESIGNS

CHA9161AN

**Apothecary Floor Lamp in
Antique Nickel on Black Mount**

Height: 40"-54"

Extension: 14 $\frac{1}{2}$ "

Base: 10" Round

Available Finishes: AB, AN, BZ, SN

Shade Details: 6 $\frac{1}{2}$ " Round

Socket: Hi-Lo

Wattage: 60 A

©EFC DESIGNS

CHA9161AB



CHA9336TB-NP
Ionic-Fluted Column Floor Lamp in
Tudor Brown with Natural Paper Shade

Height: 60"
Width: 20"
Base: 6" X 9½"

Available Finishes: OW, TB, WW
Shade Treatment: NP
Shade Details: 8"/18" x 10"/20" x 13"
Rectangle

Socket: Dimmer
Wattage: 150 A
©EFC DESIGNS



CHA9461AB-NP
Fluted Spire Floor Lamp in
Antique-Burnished Brass with
Natural Paper Shade

Height: 60½"
Width: 19"
Base: 6½" Fluted

Available Finishes: AB, BZ, BZV
Shade Treatment: NP
Shade Details: 14" x 19" x 12"

Socket: Dimmer
Wattage: 150 A
©EFC DESIGNS



SL1975BZ

**Boom-Arm Floor Lamp
in Bronze**

Height: 39½"-50"

Extension: 35"

Base: 11" Round

Available Finishes: AN, BZ,
HAB, PN

Shade Details: 7" Round

Socket: Hi-Lo

Wattage: 60 A

©EFC DESIGNS

SL1031HAB

**Mini Architect's Boom-Arm
Floor Lamp in Hand-Rubbed
Antique Brass**

Height: 35"-64½"

Width: 8"

Extension: 28"

Base: 8" Square

Available Finishes: BZ, HAB,
PS

Shade Details: 2" x 6¼" x 4½"

Socket: Hi-Lo

Wattage: 40 B

©EFC DESIGNS



SL1702AN-B
New York Functional Floor
Lamp in Antique Nickel with
Black Shades
Height: 45½"
Extension: 27"
Base: 9½" Square

Shade Details: 3" x 7"

Socket: 2-Hi-Lo
Wattage: 2-60 A
©EFC DESIGNS



SL1950HAB
Big Boston Pharmacy Floor
Lamp in Hand-Rubbed
Antique Brass
Height: 63"-68½"
Extension: 25½"
Base: 11" Round

Available Finishes: AN, BZ,
HAB, PN
Shade Details: 5" x 11"

Socket: Hi-Lo
Wattage: 100 A
©EFC DESIGNS

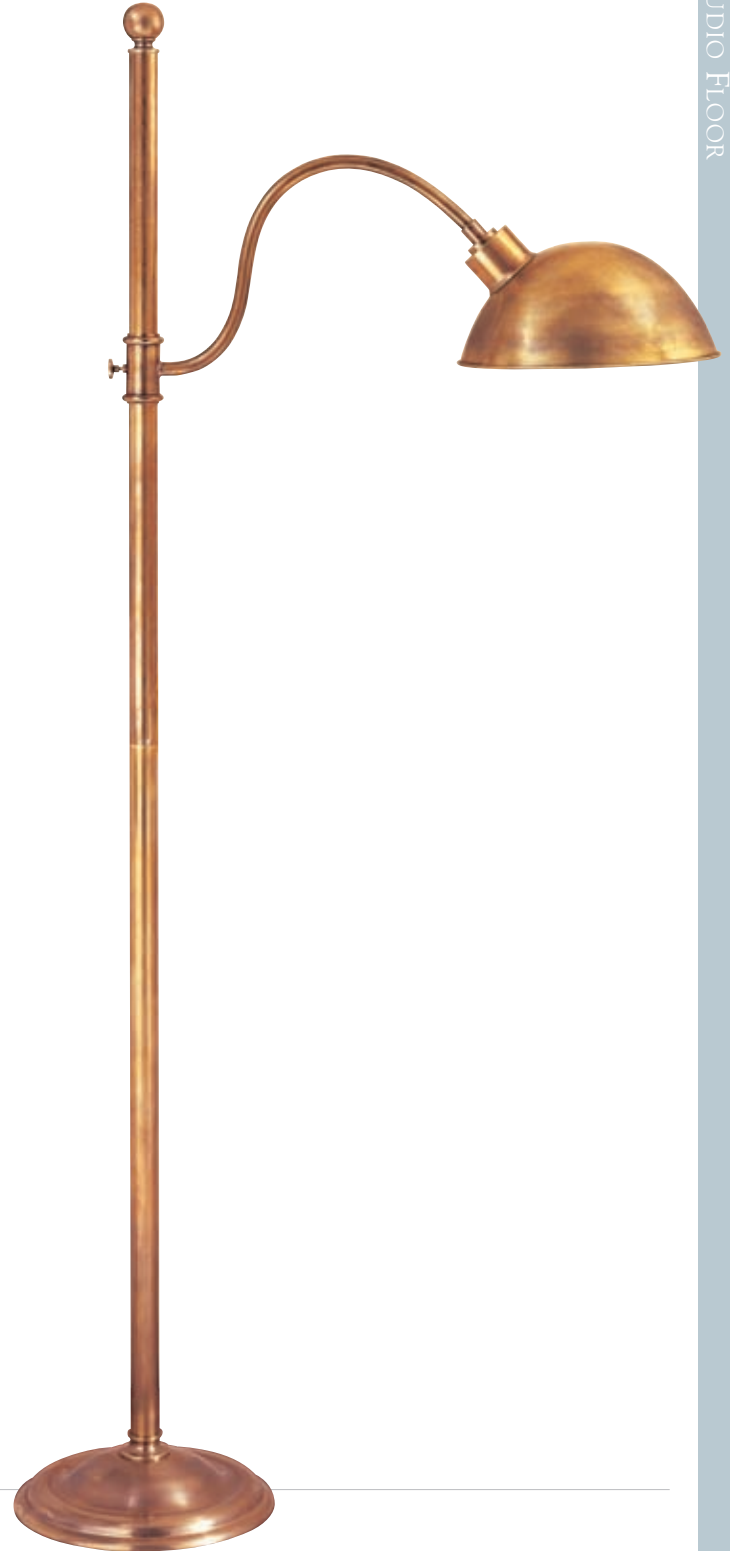

SL1900BZ/SLG-BZ

**Boston Adjustable Floor Lamp
in Bronze with
Bronze SLG Shade**

Height: 35"-57"

Extension: 17"

Base: 10" Round

Available Finishes: AN, BZ,
HAB, SN

Shade Treatment: SLG-BZ

See Shade Schedule for
Additional Shade Options

Shade Details: 2½" x 5¼" x 5½"

Socket: Hi-Lo

Wattage: 60 A

©EFC DESIGNS

SL1900HAB/SLB-AW

**Boston Adjustable Floor Lamp
in Hand-Rubbed Antique Brass
with Antique White SLB Shade**

Height: 35"-57"

Extension: 17"

Base: 10" Round

Available Finishes: AN, BZ,
HAB, SN

Shade Treatment: SLB-AW

See Shade Schedule for
Additional Shade Options

Shade Details: 2½" x 5¼" x 5½"

Socket: Hi-Lo

Wattage: 60 A

©EFC DESIGNS

SL1930BZ/SLE-BZ

**Boston Adjustable Downbridge
Floor Lamp in Bronze
with Bronze SLE Shade**

Height: 35"-57"

Extension: 17"

Base: 10" Round

Shade Treatment: SLE-BZ

See Shade Schedule for
Additional Shade Options

Shade Details: 2¼" x 5¾" x 4½"

Socket: Hi-Lo

Wattage: 60 A

©EFC DESIGNS



81134HAB
Adjustable Floor Lamp in
Hand-Rubbed Antique Brass
Height: 43"-57"
Extension: 20"
Base: 6" x 9"

Available Finishes:
AN, BLK, BZ, CH, HAB, PB
Shade Details: 5½" x 3¼" x 2"

Socket: Dimmer
Wattage: 60 T

91025AN
Adjustable Floor Lamp in
Hand-Rubbed Antique Nickel
Height: 34"-45"
Width: 13"
Base: 6" x 9"

Available Finishes: AN, BLK,
BZ, CH, HAB, PB, WHT
Shade Details: 3½" x 6" x 2"

Socket: Dimmer
Wattage: 60 T

91025HAB



SL1126WA-NP

**Tudor Twist Adjustable Floor
Lamp in Walnut with Natural
Paper Shade**

Height: 54"-74"

Width: 15"

Base: 9½" Round

Available Finishes: FW, WA
Shade Treatments: B, L, NP
Shade Details: 9" x 15" x 9"

Socket: Hi-Lo
Wattage: 100 A

©EFC DESIGNS



SL1125FW-B

**Tudor Twist Floor Lamp in
French Wax with Black Shade**

Height: 53½"

Width: 15"

Base: 10" Round

Available Finishes: FW, TB
Shade Treatments: B, L, NP
Shade Details: 9" x 15" x 9"

Socket: Hi-Lo
Wattage: 100 A

©EFC DESIGNS



SL1143IP-NP
Entasis Floor Lamp in Irish Pine
on Museum Mount with
Natural Paper Shade
Height: 58"-64"
Width: 17"
Base: 10 3/4" Square

Shade Treatment: NP
Shade Details: 13" x 17" x 10"

Socket: Hi-Lo
Wattage: 150 A
©EFC DESIGNS



SL1142FPW-NP
Twist Balustrade Floor Lamp in
Fence Post Wash on Bronze Museum Mount
with Natural Paper Shade
Height: 57 1/2"-71"
Width: 17"
Base: 9" Square

Available Finishes: AWG, FPW
Shade Treatments: B, L, NP
Shade Details: 13" x 17" x 10"

Socket: Hi-Lo
Wattage: 150 A
©EFC DESIGNS



SL1135FW-NP

**Balustrade Candle Floor Lamp
in French Wax with Natural
Paper Shade**

Height: 59"
Width: 19"
Base: 12" Round

Available Finishes: FW, OW, TB
Shade Treatments: B, L, NP
Shade Details: 14" x 19" x 12"

Socket: Hi-Lo
Wattage: 150 A
©EFC DESIGNS



SL1137FW-L

**Sussex Floor Lamp in French
Wax with Linen Shade**

Height: 62"
Width: 19"
Base: 12" Round

Available Finishes: FW, TB
Shade Treatments: B, L, NP
Shade Details: 14" x 19" x 12"

Socket: Hi-Lo
Wattage: 150 A
©EFC DESIGNS



SL1138OW-L
Surrey Tray Table Floor Lamp
in Old White with Linen Shade
Height: 63"
Width: 21"
Tray: 21" Round, 24" to Tray
Base: 9½" Octagonal

Available Finishes: IP, OW
Shade Treatment: L
Shade Details: 14" x 20" x 12½"

Socket: Hi-Lo
Wattage: 150 A
©EFC DESIGNS

SL1138IP-L

SL1920HAB-L
Boston Adjustable Library Floor Lamp
in Hand-Rubbed Antique Brass
with Linen Shade
Height: 51"-61"
Width: 13"
Base: 10" Round

Available Finishes: AN, BZ, HAB
Shade Treatment: L
Shade Details: 9" x 13" x 8½"

Socket: Hi-Lo
Wattage: 100 A
©EFC DESIGNS



S111BB-NP

**Bamboo Floor Lamp with
Natural Paper Shade**

Height: 52½"

Width: 17"

Base: 9½" Round

Shade Treatment: NP

Shade Details: 13" x 17" x 11"

Socket: Hi-Lo

Wattage: 150 A

©EFC DESIGNS

S110EB-NP

**Tribal Form Floor Lamp in Ebony
with Natural Paper Shade**

Height: 52"

Width: 19"

Base: 7½" Round

Shade Treatment: NP

Shade Details: 14" x 19" x 12"

Socket: 3-Way

Wattage: 150 A



SL1700FW-NP
Wood Tripod Floor Lamp in French
Wax with Natural Paper Shade
Height: 61"
Width: 21"
Base: 21" Tripod

Shade Treatment: NP
Shade Details: 20" x 20" x 11"

Socket: Hi-Lo
Wattage: 150 A



S1001BZ-L
Stage Floor Lamp in Bronze with
Linen Shade
Height: 53"-75"
Width: 22"
Base: 24½"

Available Finishes: BC, BZ
Shade Treatment: L
Shade Details: 22" x 22" x 6½"

Socket: 2-Keyless/Foot Switch
Wattage: 2-60 A



TOB1007PS-NP

**Parke Floor Lamp in Polished Silver
with Natural Paper Shade**

Height: 69"

Width: 19"

Base: 20 3/4" Tripod

Available Finishes: AN, BZ, HAB, PS

Shade Treatment: NP

Shade Details: 12" x 19" x 15 1/2"

Socket: 2-Pull Chain

Wattage: 2 - 75 A

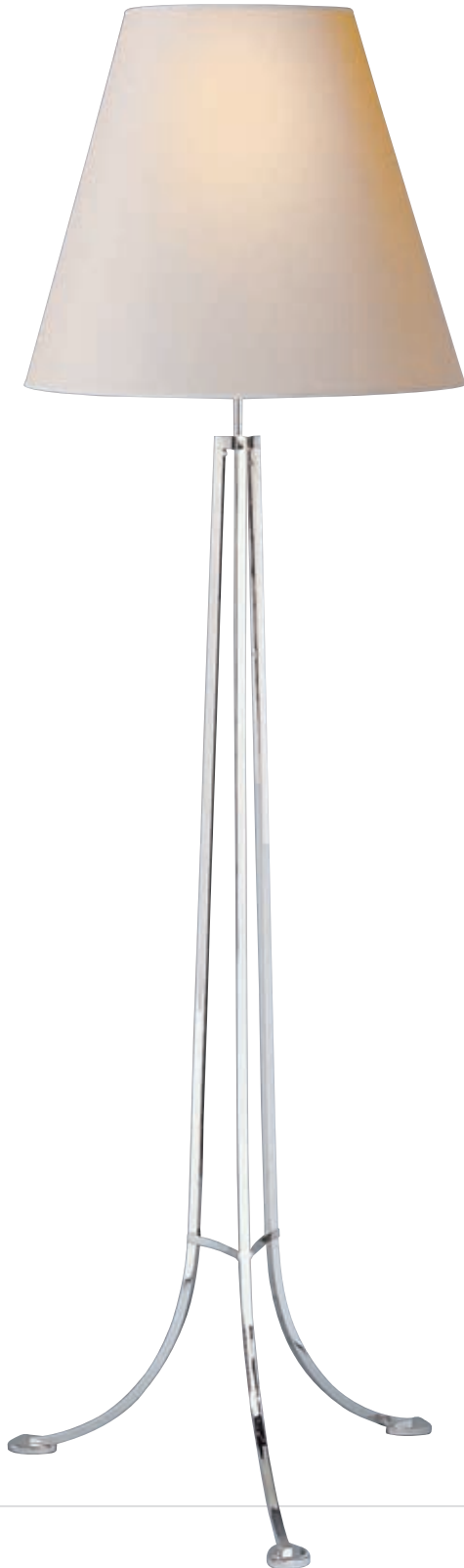

TOB1009CAR-NP

**Linden Floor Lamp in
Caramel Wood Finish**

Height: 69"

Width: 19"

Base: 23 1/2" Tripod

Available Finishes: CAR, CHC

Shade Treatment: NP

Shade Details: 12" x 19" x 15 1/2"

Socket: 2 - Pull Chain

Wattage: 2 - 75 A



TOB1090BR-NP/BT
Hugo Floor Lamp in Black Rust
with Natural Paper Shade
Height: 66"-69"
Width: 21"
Base: 14½" Round

Shade Treatment: NP/BT
Shade Details: 12" x 21" x 16½"

Socket: 2 - Pull Chain
Wattage: 2 - 75 A



TOB1000PN-NP
Longacre Floor Lamp in Polished Nickel
with Natural Paper Shade
Height: 64½"
Width: 22"
Base: 15" Round

Available Finishes: BZ, HAB, PN, PS
Shade Treatment: NP
Shade Details: 22" x 22" x 12½"

Socket: 2 - Pull Chain
Wattage: 2 - 75 A



TOB1006BL-NP

**Essex Floor Lamp in Black Leather
with Natural Paper Shade**

Height: 70"
Width: 21"
Base: 14" Square

Available Finishes: BL, SL
Shade Treatment: NP
Shade Details: 11" x 21" x 16"

Socket: Hi-Lo
Wattage: 100 A

TOB1006SL-NP

TOB1016CHC-NP

**Highland Floor Lamp in Chocolate Wood
with Natural Paper Shade**

Height: 71"
Width: 21½"
Base: 18" Round

Shade Treatment: NP
Shade Details: 14½" x 21½" x 19½"

Socket: 2 - Pull Chain
Wattage: 2 - 75 A



TOB1004AN-WP/ST
Hudson Floor Lamp in Antique Nickel
with White Paper Shade

Height: 60"
Width: 22"
Base: 15 1/4"

Available Finishes: AN, BZ, HAB, PN
Shade Treatments: NP/BT, WP/ST
Shade Details: 22" x 22" x 6 1/4"

Socket: 2-Keyless / Hi-Lo Pull Chain
Wattage: 2-60 A

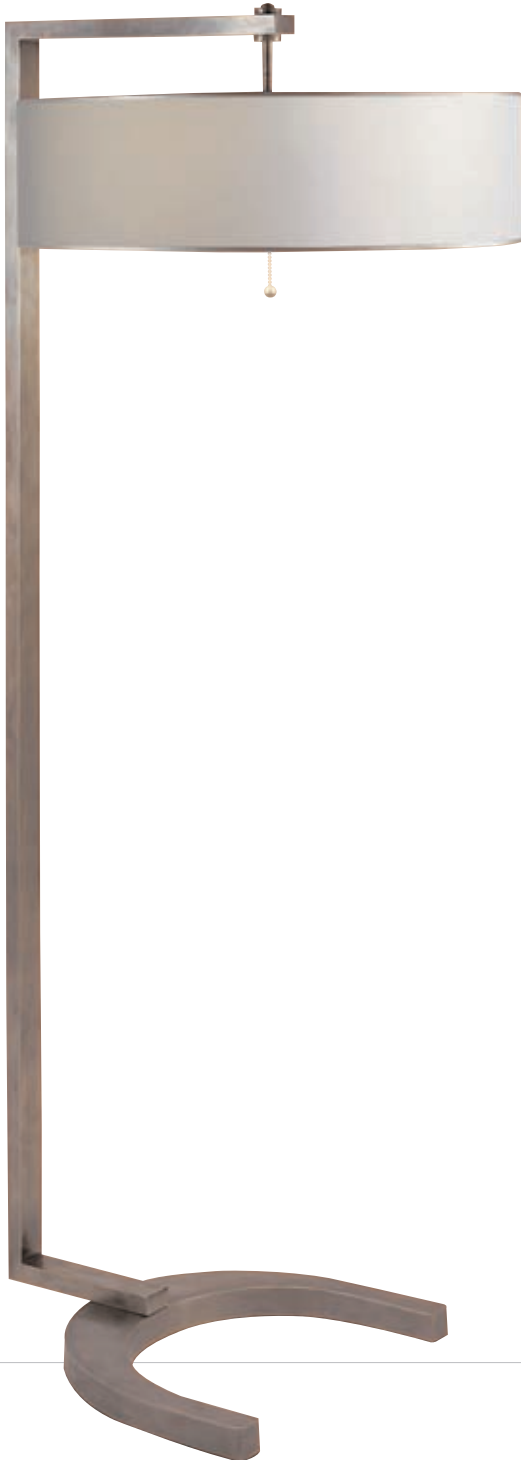

TOB1011BZ-C/BT
Nina Floor Lamp in Bronze
with Cotton Shade

Height: 54 3/4"
Width: 8"
Extension: 22"
Base: 12" Round

Available Finishes:
AN, BZ, HAB
Shade Treatments:
C, C/BT, C/RT
Shade Details: 6" x 8" x 9"

Socket: Pull Chain
Wattage: 75 A

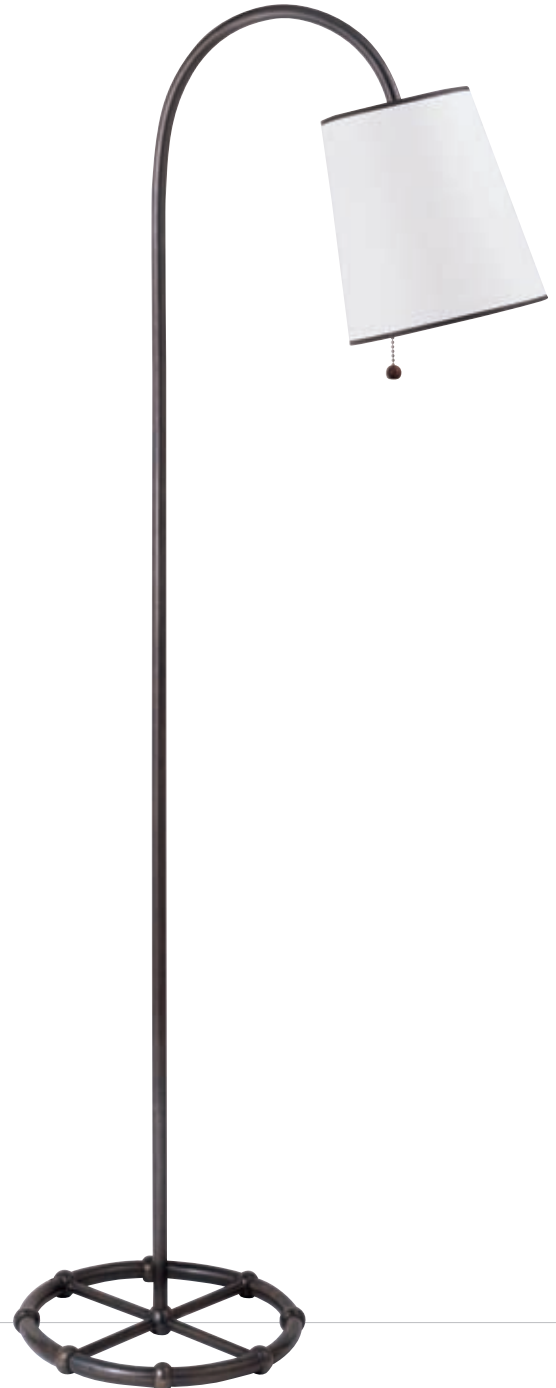

TOB1068PN/CHC-NP
Jones Floor Lamp in Polished Nickel
and Chocolate Wood with
Natural Paper Shade
Height: 63"
Width: 19"
Base: 11" Round

Shade Treatment: NP
Shade Details: 10" x 19" x 15½"

Socket: Hi-Lo
Wattage: 150 A



TOB1002HAB-NP
Bryant Adjustable Floor Lamp
in Hand-Rubbed Antique Brass
with Natural Paper Shade
Height: 44"-60"
Width: 12"
Base: 10½" Round

Available Finishes:
AS, BZ, HAB, PN
Shade Treatment: NP
Shade Details: 11" x 12" x 12"

Socket: Hi-Lo
Wattage: 100 A



TOB1008AN-NP

**Giorgio Floor Lamp in Acrylic and
Antique Nickel with Natural Paper Shade**

Height: 74"

Width: 16"

Base: 13½" Round

Available Finishes: AN, BZ

Shade Treatments: NP

Shade Details: 15" x 16" x 14"

Socket: Hi-Lo

Wattage: 150 A



TOB1012BZ-NP

**Ziyi Pivoting Floor Lamp in Bronze
with Natural Paper Shade**

Height: 58"

Width: 10½"

Extension: 10½"

Base: 10½" Round

Available Finishes:

BZ, HAB, PN

Shade Treatment: NP

Shade Details: 7½" x 8½" x 11"

Socket: Hi-Lo

Wattage: 75 A



TOB1001BZ
Greenwich Adjustable Floor Lamp
in Bronze

Height: 42"-54"
Extension: 17"
Base: 12" Round

Available Finishes:
BC, BZ, HAB, PN

Socket: Dimmer
Wattage: 60 T

TOB1014HAB
Studio Arc Task Lamp in
Hand-Rubbed Antique Brass

Height: 48"-77½"
Extension: 31"
Base: 20" Tripod

Available Finishes:
AN, BZ, HAB, PN

Socket: Keyless/Floor Dimmer
Wattage: 75 A

TOB1014PN



TOB1015AN
Studio Pivoting Task Lamp
in Antique Nickel
Height: 43½"-86"
Extension: 53"
Base: 20" Tripod

Available Finishes:
AN, BZ, HAB, PN

Socket: Keyless/Floor Dimmer
Wattage: 75 A



TOB1013BZ/HAB-NP
Ziyi Tension Pole Lamp in Bronze with
Hand-Rubbed Antique Brass Accents
with Natural Paper Shade
Height: 8"-10"
Extension: 14½"
Base: 2" Round

Available Finishes: BZ/HAB, PN
Shade Treatments: NP
Shade Details: 4" x 5" x 6½"

Socket: 3 - Hi-Lo
Wattage: 3 - 60 A



TOB1010HAB-NP
Studio Adjustable Floor Lamp
in Hand-Rubbed Antique Brass

Height: 53"-122"
Width: 28"
Base: 20" - 34"

Available Finishes:
BZ, HAB, PN

Shade Treatment:
NP, NP2
Shade Details:
25" x 28" x 22" NP
17" x 20" X 17" NP2

Socket: 2-Pull Chain
Wattage: 2-100 A



TOB3080BZ-NP
Studio Tripod Adjustable Floor/Table Lamp
in Bronze with Natural Paper Shade

Height: 32"-75"
Width: 20"
Base: 11" - 20"

Available Finishes:
BZ, HAB, PN
Shade Treatment: NP, NP2
Shade Details: 15" x 20" x 13½"

Socket: Dimmer
Wattage: 150 A



NYPL3

**New York Public Library Reading
Room Lamp in Bronze with
Hand-Rubbed Antique Brass Shade**

Height: 50"-60"

Width: 15"

Base: 11" Round

Shade Treatment: HAB

Shade Details: 8" x 15" x 10½"

Socket: 2-Pull Chain

Wattage: 2-60 A



BB1230HAB-NP

**Downbridge Loop Adjustable Floor Lamp
in Hand-Rubbed Antique Brass
with Natural Paper Shade**

Height: 47"-71"

Extension: 16"

Base: 10" Round

Available Finishes: BZ, HAB

Shade Treatments: NP, T

Shade Details: 7½" x 12" x 8"

Socket: Hi-Lo

Wattage: 100 A



BB1040HAB-NP
Hobbs Floor Lamp in
Hand-Rubbed Antique Brass
with Natural Paper Shade

Height: 64"
Width: 20"
Extension: 20"
Base: 11" Round

Available Finishes:
AN, BZ, HAB, PN
Shade Treatment: NP
Shade Details:
10½" x 16¼" x 11"

Socket: Hi-Lo
Wattage: 100 A



BB1200HAB-T
Triple Swing-Arm Adjustable Floor Lamp
in Hand-Rubbed Antique Brass
with Tissue Silk Shade

Height: 47"-71"
Extension: 22"
Base: 10" Round

Available Finishes: AN, BZ, HAB, PB
Shade Treatment: L, S, T
Shade Details: 7" x 11" x 8½"

Socket: Dimmer
Wattage: 100 A



BB1010HAB-NP
Candlestick Floor Lamp in
Hand-Rubbed Antique Brass
with Natural Paper Shade
Height: 57½"
Width: 12"
Base: 8" Round

Available Finishes: AN, BZ, HAB, PN
Shade Treatment: L, NP, S, T
Shade Details:
5" x 13" x 9" L, NP, T or
8" x 11" x 8¼" S

Socket: Dimmer
Wattage: 100 A

BB1010AN-T

BB1500HABL2-NP
Adjustable Floor Lamp in
Hand-Rubbed Antique Brass
with Braided Leather Accents
with Natural Paper Shade
Height: 41"-56"
Width: 14"
Base: 8" Round

Finishes: AN, BZ, HAB, HABL2
Shade Treatment: B, K, NP
Shade Details:
10" x 14" x 11" on HABL2 or
5" x 19" x 11" on AN, BZ, HAB

Socket: Hi-Lo
Wattage: 100 A

BB1500HAB-NP



BB1600HAB
Adjustable Floor Lamp in
Hand-Rubbed Antique Brass
Height: 40½"-57"
Width: 10"
Extension: 18"
Base: 10" Round

Available Finishes: AN, BZ, HAB, PN
Shade Details: 5¼" x 5¼"

Socket: Floor Dimmer
Wattage: 50 R20

BB1100HAB
Adjustable Old Pharmacy Lamp in
Hand-Rubbed Antique Brass
Height: 36"-54"
Width: 10"
Extension: 15"
Base: 10" Round

Available Finishes: AN, BZ, HAB, PN
Shade Details: 6" Round

Socket: Hi-Lo
Wattage: 60 A

BB1101HAB
Adjustable Shell Pharmacy
Floor Lamp in Hand-Rubbed
Antique Brass
Height: 40"-51"
Width: 10"
Extension: 14"
Base: 10" Round

Available Finishes: AN, HAB
Shade Details: 7" Long Shell

Socket: Hi-Lo
Wattage: 60 A

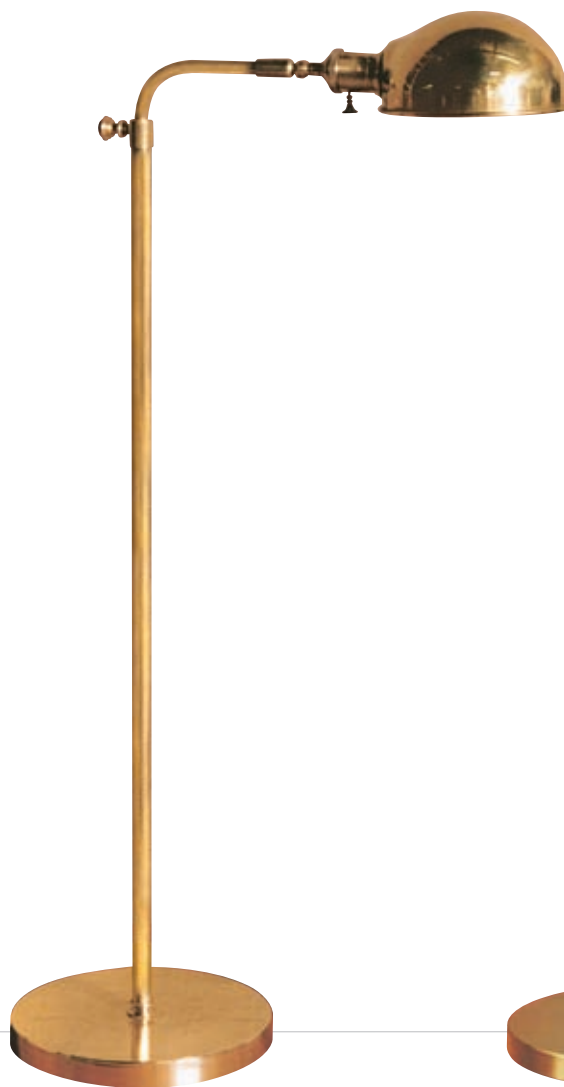

CL1001BZ-WP
Tribeca Floor Lamp in Bronze
with White Paper Shade

Height: 70"
Width: 15"
Base: 15" Square

Available Finishes: BS, BZ
Shade Treatment: WP
Shade Details: 15" x 15" x 13½"

Socket: 2-Pull Chain
Wattage: 2-75 A



CL1002BZ-WP
Small Tribeca Floor Lamp in Bronze
with White Paper Shade

Height: 53"
Width: 8"
Base: 8" Square

Available Finishes: BS, BZ
Shade Treatment: FG, WP
Shade Details: 7½" x 7½" x 9"

Socket: Pull Chain
Wattage: 100 A



CL1100BZ
Noho Torchiere Floor Lamp
with Casters in Bronze

Height: 75½"
Width: 15"
Base: 15"

Available Finishes: BS, BZ
Shade Details: 9" x 10"

Socket: Keyless with Foot Switch
Wattage: 100 A



SC1102BZ-S

**Adjustable Puzzle Floor Lamp
in Bronze with Silk Shade**

Height: 54"-68"
Width: 12"
Extension: 12"
Base: 8½" x 10½"

Shade Treatment: S

Shade Details:
11" x 12" x 12" Silk

Socket: Hi-Lo
Wattage: 100 A

SC1106BZ-NP

**Rope Floor Lamp in Bronze
with Natural Paper Shade**

Height: 76"
Width: 17"
Base: 17" Tripod

Available Finishes: BZ, HAB, PN

Shade Treatments: NP
Shade Details: 16" x 16" x 16"

Socket: Dimmer
Wattage: 150 A

SC1101HAB-L

**Paris Floor Lamp in
Hand-Rubbed Antique Brass and
Mahogany with Linen Shade**

Height: 58" - 77½"
Width: 20"
Base: 14"

Available Finishes: HAB, PN

Shade Treatment: L
Shade Details:
10"/20" x 10"/20" x 11" Oval

Socket: 2-Pull Chain
Wattage: 2-75 A



SC1105BZ-NP
Rome Floor Lamp in Bronze
with Natural Paper Shade
Height: 79½"
Width: 24½"
Base: 16½" Round

Shade Treatment: NP
Shade Details:
15½" x 24½" x 18"

Socket: Pull Chain
Wattage: 150 A



SC1100BZ
Socrates Floor Lamp in Bronze
Height: 70"
Width 16"
Base: 12" Round

Shade Details: 4" x 16"

Socket: Keyless/Floor Dimmer
Wattage: 150 A





CEILING

Chart House	152
Studio	196
Thomas O'Brien	208
Bill Blass	219
Eric Cohler	220





CHC1154CG
Large Faceted George II
Chandelier in Crystal

Height: 31"
Width: 30"
Canopy: 5½" Round

Available Finishes:
AB, AN, CG, PS, Q

Socket: 6-Candelabra
Wattage: 6-60 C
©EFC DESIGNS



CHC1155CG
Small George II Chandelier
in Crystal

Height: 23½"
Width: 22"
Canopy: 5½" Round

Available Finishes:
AB, AN, CG, PS, Q

Socket: 6-Candelabra
Wattage: 6-60 C
©EFC DESIGNS



CHC1154AB
Large George II Chandelier
in Antique Burnished Brass

Height: 31"
Width: 30"
Canopy: 5½" Round

Available Finishes:
AB, AN, CG, PS, Q

Socket: 6-Candelabra
Wattage: 6-60 C
©EFC DESIGNS



CHC1155AN
Small George II Chandelier
in Antique Nickel

Height: 23½"
Width: 22"
Canopy: 5½" Round

Available Finishes:
AB, AN, CG, PS, Q

Socket: 6-Candelabra
Wattage: 6-60 C
©EFC DESIGNS



CHC1152CG
Large Faceted George II
Chandelier in Crystal
Height: 31"
Width: 30"
Canopy: 5½" Round

Available Finishes:
AB, CG, PS

Socket: 6-Candelabra
Wattage: 6-60 C
©EFC DESIGNS



CHC1152PS



CHC1153PS
Small Faceted George II
Chandelier in Polished Silver
Height: 23½"
Width: 22"
Canopy: 5½" Round

Available Finishes:
AB, CG, PS

Socket: 6-Candelabra
Wattage: 6-60 C
©EFC DESIGNS



CHC1153AB



CHC1173AB

**Large Two-Tier Twelve-Light
Sussex Chandelier in
Antique-Burnished Brass**

Height: 44½"

Width: 44"

Canopy: 5¾" Round

Available Finishes:

AB, AB/AN, AN, BZ, PS

Shade Treatment: CHS-114NP

Shade Sold Separately

Shade Details: 4" x 6" x 5"

Socket: 12-Medium Candle

Wattage: 12-60 B

©EFC DESIGNS



CHC1171AN

**Large Eight-Light Sussex
Chandelier in Antique Nickel**

Height: 32½"

Width: 44"

Canopy: 5¾" Round

Available Finishes:

AB, AB/AN, AN, BZ, PS

Shade Treatment: CHS-114NP

Shade Sold Separately

Shade Details: 4" x 6" x 5"

Socket: 8-Medium Candle

Wattage: 8-60 B

©EFC DESIGNS



CHC1172AB
Medium Two-Tier Nine-Light
Sussex Chandelier in
Antique Brass
Height: 33¼"
Width: 35"
Canopy: 5¾" Round

Available Finishes:
AB, AB/AN, AN, BZ, PS
Shade Treatment: CHS-114NP
Shade Sold Separately
Shade Details: 4" x 6" x 5"

Socket: 9-Medium Candle
Wattage: 9-60 B
©EFC DESIGNS



CHC1170AB/AN
Medium Six-Light Sussex
Chandelier in Antique Brass
and Antique Nickel
Height: 39"
Width: 35"
Canopy: 5¾" Round

Available Finishes:
AB, AB/AN, AN, BZ, PS
Shade Treatment: CHS-114NP
Shade Sold Separately
Shade Details: 4" x 6" x 5"

Socket: 6-Medium Candle
Wattage: 6-60 B
©EFC DESIGNS



CHC1166BZ
Single Tier Six-Light Sussex
Chandelier in Bronze

Height: 33"
Width: 26"
Canopy: 6" Round

Available Finishes:
AB, AN, BZ, PS

Socket: 6-Candelabra
Wattage: 6-60 C
©EFC DESIGNS



CHC1169AB
Double Tier Nine-Light
Sussex Chandelier in
Antique-Burnished Brass

Height: 33"
Width: 26"
Canopy: 6" Round

Available Finishes:
AB, AN, BZ, PS

Socket: 9-Candelabra
Wattage: 9-60 C
©EFC DESIGNS



CHC1126PS
Chelsea Six-Light Chandelier
in Polished Silver

Height: 34"
Width: 39½"
Canopy: 6" Round

Available Finishes:
AB, BZ, PS

Socket: 6-Candelabra
Wattage: 6-60 C
©EFC DESIGNS



CHC1118AN
18th Century Twelve-Light
Chandelier in
Antique Burnished Nickel
Height: 38¼"
Width: 39"
Canopy: 5¾" Round

Available Finishes: AB, AN

Socket: 12-Candelabra
Wattage: 12-60 C
©EFC DESIGNS



CHC1112AN
Large 18th Century
Eight-Light Chandelier in
Antique Burnished Nickel
Height: 29"
Width: 38"
Canopy: 5¾" Round

Available Finishes: AB, AN

Socket: 8-Candelabra
Wattage: 8-60 C



CHC1114AB
18th Century Eight-Light
Chandelier in
Antique-Burnished Brass
Height: 24"
Width: 28"
Canopy: 5¾" Round

Available Finishes: AB, AN

Socket: 8-Candelabra
Wattage: 8-60 C
©EFC DESIGNS



CHC1117AB
18th Century Two-Tier
Eight-Light Chandelier in
Antique-Burnished Brass
Height: 33"
Width: 28"
Canopy: 5½" Round

Available Finishes: AB, AN

Socket: 8-Candelabra
Wattage: 8-60 C
©EFC DESIGNS



CHC1113AB
18th Century Six-Light Chandelier in
Antique-Burnished Brass
Height: 24"
Width: 28"
Canopy: 5½" Round

Available Finishes:
AB, AN

Socket: 6-Candelabra
Wattage: 6-60 C
©EFC DESIGNS



CHC1115AB
18th Century Four-Light Chandelier in
Antique-Burnished Brass
Height: 19"
Width: 18"
Canopy: 5½" Round

Available Finishes: AB, AN
Shade Treatment: CHS-104B
Shade Sold Separately
Shade Details: 3" x 4" x 4"

Socket: 4-Candelabra
Wattage: 4-60 C
©EFC DESIGNS



CHC1116AB
18th Century Six-Light Chandelier in
Antique-Burnished Brass
Height: 19"
Width: 18"
Canopy: 5½" Round

Available Finishes: AB, AN
Shade Treatment: CHS-109S
Shade Sold Separately
Shade Details: 2½" x 5" x 4½"

Socket: 6-Candelabra
Wattage: 6-60 C
©EFC DESIGNS



CHC1168AB
Balustrade Form Four-Light
English Chandelier in
Antique Burnished Brass
 Height: 32"
 Width: 15"
 Canopy: 5 7/8" Round

Available Finishes: AB, AN
Shade Treatment: CHS-104B
 Shade Sold Separately
Shade Details: 3" x 4" x 4"

Socket: 4-Candelabra
Wattage: 4-60 C
 ©EFC DESIGNS



CHC2150AB
Four-Light Pimlico Chandelier
in Antique-Burnished Brass
 Height: 13"
 Width: 13 1/2"
 Canopy: 5 7/8" Round

Available Finishes:
 AB, AN, PN
Shade Treatment: CHS-104S
 Shade Sold Separately
Shade Details: 3" x 4" x 4"

Socket: 4-Candelabra
Wattage: 4-60 C
 ©EFC DESIGNS



CHC1120AB
English Four-Light Chandelier
in Antique-Burnished Brass
 Height: 12"
 Width: 13"
 Canopy: 5 7/8" Round

Available Finishes: AB, AN, BZ

Socket: 4-Candelabra
Wattage: 4-60 C
 ©EFC DESIGNS



CHC1138AB-G
Balustrade Form Four-Light
English Chandelier in
Antique Burnished Brass
with Tole Shade
 Height: 36"
 Width: 19"
 Canopy: 5 7/8" Round

Available Finishes: AB, SN

Socket: 4-Candelabra
Wattage: 4-60 C



CHC1138SN-SN

CHC1150ABV
Large Eaton Eight-Light Chandelier in
Antique-Burnished Brass Verdigris

Height: 32"
Width: 46"
Canopy: 5 3/4" Round

Shade Treatment: CHS-112S

Shade Sold Separately

Shade Details: 4" x 5" x 5"

Socket: 8-Candelabra

Wattage: 8-60 C

©EFC DESIGNS



CHC1151ABV
Eaton Eight-Light Chandelier in
Antique-Burnished Brass Verdigris

Height: 23"
Width: 31"
Canopy: 5 3/4" Round

Socket: 8-Candelabra

Wattage: 8-60 C

©EFC DESIGNS



CHC1111AN
Georgian Six-Light Chandelier
in Antique Nickel

Height: 24"
Width: 39"
Canopy: 5 3/4" Round

Available Finishes: AB, AN, BZ, PS

Shade Treatment: CHS-101B

Shade Sold Separately

Shade Details: 3" x 6" x 4"

Socket: 6-Candelabra

Wattage: 6-60 C

©EFC DESIGNS



CHC1131AB
Small Georgian Six-Light Chandelier
in Antique-Burnished Brass

Height: 19"
Width: 28"
Canopy: 5 3/4" Round

Available Finishes: AB, AN, BZ, PS

Shade Treatment: CHS-104B

Shade sold separately

Shade Details: 3" x 4" x 4"

Socket: 6-Candelabra

Wattage: 6-60 C

©EFC DESIGNS



CHC1408AB-SG
Large Paris Flea Market Chandelier
in Antique-Burnished Brass
with Seeded Glass Trim
Height: 33"
Width 32"
Canopy: 5 3/4" Round

Socket: 8 - Candelabra
Wattage: 8 - 60 C
©EFC DESIGNS



CHC1426AB-SG
Medium Paris Flea Market Chandelier
in Antique-Burnished Brass
with Seeded Glass Trim
Height: 26"
Width: 24"
Canopy: 5 3/4" Round

Socket: 8-Candelabra
Wattage: 8-60 C
©EFC DESIGNS



CHC1407AB-SG
Petite Paris Flea Market Chandelier
in Antique-Burnished Brass
with Seeded Glass Trim
Height: 17 1/2"
Width: 16 1/4"
Canopy: 5 3/4" Round

Socket: 6 - Candelabra
Wattage: 6 - 60 C
©EFC DESIGNS



CHC1424BR-SG

La Cour Chandelier in Black Rust and Tudor Brown Wood with Seeded Glass Trim

Height: 33¼"
Width: 33¾"
Canopy: 5½" Round

Available Finishes:

AB-SG, BR-SG

Socket: 6-Candelabra

Wattage: 6-60 C

©EFC DESIGNS



CHC1425BZ-Q

St. Helier Six-Light Chandelier in Bronze with Quartz Trim

Height: 32¼"
Width: 33¾"
Canopy: 5½" Round

Available Finishes:

AN-Q, BZ-Q, PS-Q

Socket: 6-Candelabra

Wattage: 6-60 C

©EFC DESIGNS



CHC1420AN

Piedmont Six-Light Chandelier in Antique Burnished Nickel

Height: 33"
Width: 32"
Canopy: 5¾" Round

Available Finishes: AB, AN, R

Shade Treatment: CHS-104NP

Shade Sold Separately

Shade Details: 3" x 4" x 4"

Socket: 6-Candelabra

Wattage: 6-60 C

©EFC DESIGNS



CHC1420R



CHC1415R
Marigot Six-Light Chandelier in
Rusted Iron and Distressed Brass
with Tudor Brown Wooden Beads
Height: 30"
Width: 33"
Canopy: 5½" Round

Available Finishes: AB, OW, R

Socket: 6-Candelabra
Wattage: 6-60 C
©EFC DESIGNS



CHC1413R
Marigot Eight-Light Chandelier in
Rusted Iron and Distressed Brass
with Tudor Brown Wooden Beads
Height: 36"
Width: 44"
Canopy: 5½" Round

Available Finishes: OW, R
Shade Treatment: CHS-104NP
Shade Sold Separately
Shade Details: 3" x 4" x 4"

Socket: 8-Candelabra
Wattage: 8-60 C
©EFC DESIGNS



CHC1419OW
Bead and Tassel Chandelier in
Old White
Height: 37"
Width: 31"
Canopy: 5½" Round

Socket: 6-Candelabra
Wattage: 6-60 C
©EFC DESIGNS



CHC1423AB-SG
Venetian Chandelier in
Antique-Burnished Brass
and French Wax Wood
with Seeded Glass Trim
Height: 41"
Width: 32"
Canopy: 5½"

Available Finishes:
AB-SG, AN-SG, OW
Shade Treatment: CHS-104NP
Shade Sold Separately
Shade Details: 3" x 4" x 4"

Socket: 6-Candelabra
Wattage: 6-60 B
©EFC DESIGNS



CHC142R
Sans Crystal Eight-Light Chandelier
in Rusted Iron
Height: 28"
Width: 30"
Canopy: 5 3/4" Round

Available Finishes: AB, R

Socket: 6-Candelabra
Wattage: 6-60 C
©EFC DESIGNS



CHC142AB



CHC1421AB
Brettonne Six-Light Chandelier
in Antique-Burnished Brass
Height: 44"
Width: 32"
Canopy: 5 3/4" Round

Available Finishes: AB, AN, BZ, R
Shade Treatment: CHS-104NP
Shade Sold Separately
Shade Details: 3" x 4" x 4"

Socket: 6-Candelabra
Wattage: 6-60 C
©EFC DESIGNS



CHC1421R



CHC1411R
"La Cage" Eight-Light French
Chinoiserie Chandelier in
Rusty Iron with Heavily
Antiqued Brass Accents
Height: 32"
Width: 32"
Canopy: 5½" Round

Socket: 8-Candelabra
Wattage: 8-60 C
©EFC DESIGNS



CHC1415AB-SG
Marigot Six-Light Chandelier in
Antique-Burnished Brass and
Seeded Glass
Height: 30"
Width: 33"
Canopy: 5½" Round

Available Finishes:
AB, OW, R

Socket: 6-Candelabra
Wattage: 6-60 C
©EFC DESIGNS



CHC1409R
Louis XVI De-Provence
Eight-Light Chandelier in
Rusted Iron with Heavily
Antiqued Brass Accents
Height: 32"
Width: 32"
Canopy: 5½" Round

Shade Treatment: CHS-104NP
Shade Sold Separately
Shade Details: 3" x 4" x 4"

Socket: 8-Candelabra
Wattage: 8-60 C
©EFC DESIGNS



CHC1410R
"Petite Trianon" Eight-Light
Plume and Crown Motif Chandelier
in Rusted Iron with Heavily
Antiqued Brass Accents
Height: 30"
Width: 28"
Canopy: 5½" Round

Shade Treatment: CHS-104NP
Shade Sold Separately
Shade Details: 3" x 4" x 4"

Socket: 8-Candelabra
Wattage: 8-60 C
©EFC DESIGNS



CHC1432BR
**Windsor Iron Two-Tier
Twelve-Light Chandelier
in Black Rust**
Height: 42"
Width: 41"
Canopy: 5 3/4" Round

Socket: 12-Candelabra
Wattage: 12-60 C
©EFC DESIGNS



CHC1435BR
**Windsor Iron Two-Tier
Eight-Light Chandelier
in Black Rust**
Height: 24"
Width: 21"
Canopy: 5 3/4" Round

Socket: 8-Candelabra
Wattage: 8-60 C
©EFC DESIGNS



CHC1436BR
**Six-Light J Arm Chandelier in Black Rust
with Wrapped Leather Accents**
Height: 31"
Width: 31"
Canopy: 5 3/4" Round

Shade Treatment: CHS-101NP
Shade Sold Separately
Shade Details:
3" x 6" x 4"

Socket: 6-Candelabra
Wattage: 6-60 C
©EFC DESIGNS



CHC1437BR
**Four-Light J Arm Chandelier in Black Rust
with Wrapped Leather Accents**
Height: 15"
Width: 21"
Canopy: 5 3/4" Round

Shade Treatment: CHS-101NP
Shade Sold Separately
Shade Details:
3" x 6" x 4"

Socket: 4-Candelabra
Wattage: 4-60 C
©EFC DESIGNS



CHC3108R
Grande Diego Classical French Lantern
with Perching Birds in Rust
with Light Verdi Accents
Height: 25"
Width: 16"
Canopy: 5 3/4" Round

Socket: 4-Candelabra
Wattage: 4-60 C
©EFC DESIGNS



CHC3109R
Petite Diego Classical French Lantern
with Perching Birds in Rust
with Light Verdi Accents
Height: 14"
Width: 8"
Canopy: 5 3/4" Round

Socket: 3-Candelabra
Wattage: 3-60 C
©EFC DESIGNS



CHC1158R
Classical French Perching Birds Chandelier
in Rust with Light Verdi Accents
Height: 23"
Width: 20"
Canopy: 5 3/4" Round

Socket: 5-Candelabra
Wattage: 5-60 C
©EFC DESIGNS



CHC1472RG
Fifteen-Light Crystal Petal Chandelier
in Rust and Antique Gold Leaf

Height: 45"
Width: 44"
Canopy: 5" Round

Available Finishes: AWG, R, RG

Socket: 15-Candelabra
Wattage: 15-60 C

©EFC DESIGNS



CHC1471RG
Nine-Light Crystal Petal Chandelier
in Rust and Antique Gold Leaf

Height: 36"
Width: 29"
Canopy: 5" Round

Available Finishes:
AWG, R, RG

Socket: 9-Candelabra
Wattage: 9-60 C

©EFC DESIGNS



CHC1470RG
Eight-Light Crystal Petal Chandelier
in Rust and Antique Gold Leaf

Height: 26"
Width: 29"
Canopy: 5" Round

Available Finishes: AWG, R, RG
Shade Treatment: CHS-104TSC
Shade Sold Separately
Shade Details: 3" x 4" x 4"

Socket: 8-Candelabra
Wattage: 8-60 C
©EFC DESIGNS



CHC1405NR
De Provence Six-Light Fixture
in Natural Rust
Height: 41"
Width: 44"
Canopy: 5" Round

Socket: 6-Candelabra
Wattage: 6-60 C
©EFC DESIGNS



CHC1401NR
Large French Country Inn Chandelier
in Natural Rust
Height: 40"
Width: 36"
Canopy: 5" Round

Socket: 6-Candelabra
Wattage: 6-60 C
©EFC DESIGNS



CHC1402NR
Small French Country Inn Chandelier
in Natural Rust
Height: 32"
Width: 28½"
Canopy: 5" Round

Socket: 6-Candelabra
Wattage: 6-60 C
©EFC DESIGNS



CHC1451WI
Windsor Iron Six-Light Ring Chandelier
in Weathered Iron with
Heavily Antiqued Brass Accents

Height: 28"
Width: 28"
Canopy: 5 $\frac{3}{4}$ " Round

Shade Treatment: FG

Shade Details:
4 $\frac{3}{4}$ " x 4 $\frac{3}{4}$ " x 5 $\frac{3}{4}$ "

Socket: 6-Keyless

Wattage: 6-60 A

©EFC DESIGNS



CHC1450WI
Windsor Iron Twist Chandelier
in Weathered Iron with
Heavily Antiqued Brass Accents

Height: 62"
Width: 25 $\frac{1}{2}$ " x 37 $\frac{1}{2}$ "
Canopy: 5 $\frac{3}{4}$ " Round

Shade Treatment: FG

Shade Details: 4 $\frac{3}{4}$ " x 4 $\frac{3}{4}$ " x 5 $\frac{3}{4}$ "

Socket: 6-Keyless

Wattage: 6-60 A

©EFC DESIGNS



CHC1414WI
Oval Ring Torch Chandelier
in Weathered Iron
Height: 41"
Width: 31½" x 45½" Oval
Canopy: 6½" Round

Shade Treatment: CHS-112NP
Shade Sold Separately
Shade Size: 4" x 9" x 6"

Socket: 6-Keyless
Wattage: 6-60 A
©EFC DESIGNS



CHC1416BR
Large French Country Iron Chandelier
in Black Rust
Height: 39"
Width: 35"
Canopy: 5½" Round

Shade Treatment: CHS-112NP
Shade Sold Separately
Shade Details: 4" x 9" x 6"

Socket: 4-Candelabra
Wattage: 4-60 C
©EFC DESIGNS



CHC1406BR
Small French Country Iron Chandelier
in Black Rust
Height: 24"
Width: 21"
Canopy: 5½" Round

Shade Treatment: CHS-101NP
Shade Sold Separately
Shade Details: 3" x 6" x 4"

Socket: 4-Candelabra
Wattage: 4-60 C
©EFC DESIGNS



CHC1461BR
Dorset Two-Tier Nine-Light Chandelier
in Black Rust

Height: 43"
Width: 47"
Canopy: 5 $\frac{3}{4}$ " Round

Shade Treatment: CHS-114NP
Shade Sold Separately
Shade Details: 4" x 6" x 5"

Socket: 9-Candelabra
Wattage: 9-60 C
©EFC DESIGNS



CHC1463BR
Small Nine-Light Two-Tier Chandelier
in Black Rust

Height: 43"
Width: 42"
Canopy: 5 $\frac{3}{4}$ " Round

Shade Treatment: CHS-114NP
Shade Sold Separately
Shade Details: 4" x 6" x 5"

Socket: 9-Candelabra
Wattage: 9-60 C
©EFC DESIGNS



CHC1462WI
Dorset Two-Tier Chandelier with
Torch Arms in Weathered Iron
Height: 49"
Width: 57"
Canopy: 6½" Round

Shade Treatment: SH5X8X6NP
Shades Sold Separately
Shade Details: 5" x 8" x 6"

Socket: 9-Keyless
Wattage: 9-60 A
©EFC DESIGNS



CHC1460BR
Six-Light Scroll Chandelier
in Black Rust
Height: 28"
Width: 35"
Canopy: 5¾" Round

Shade Treatment: CHS-106NP
Shade Sold Separately
Shade Details: 3" x 6" x 4¼"

Socket: 6-Candelabra
Wattage: 6-60 C
©EFC DESIGNS



CHC1443AB
Round Flatline Chandelier in
Antique-Burnished Brass

Height: 35"
Width: 32"
Canopy: 5 $\frac{3}{4}$ " Round

Available Finishes: AB, AN, BZ, PN
Shade Treatment: CHS-106NP
Shade Sold Separately
Shade Details: 3" x 6" x 4 $\frac{1}{4}$ "

Socket: 6-Candelabra
Wattage: 6-60 C
©EFC DESIGNS



CHC1442BZ
Rectangular Flatline Chandelier in Bronze

Height: 35"
Width: 38"
Depth: 18"
Canopy: 5 $\frac{3}{4}$ " Square

Available Finishes: AB, AN, BZ, PN
Shade Treatment: CHS-106L
Shade Sold Separately
Shade Details: 3" x 6" x 4 $\frac{1}{4}$ "

Socket: 8-Candelabra
Wattage: 8-60 C
©EFC DESIGNS



CHC1444AB
Oval Flatline Chandelier in
Antique-Burnished Brass
Height: 35"
Width: 36"
Canopy: 5 3/4" Round

Available Finishes: AB, AN, BZ, PN
Shade Treatment: CHS-106NP
Shade Sold Separately
Shade Details: 3" x 6" x 4 1/4"

Socket: 6-Candelabra
Wattage: 6-60 C
©EFC DESIGNS



CHC1441BZ
Linear Flatline Fixture in Bronze
Height: 33"
Width: 48"
Depth: 3"
Canopy: 5 3/4" Square

Available Finishes: AB, AN, BZ, PN
Shade Treatment: CHS-106LS
Shade Sold Separately
Shade Details: 3" x 6" x 4 1/4"

Socket: 5-Candelabra
Wattage: 5-60 C
©EFC DESIGNS



CHC5106AB-AB

**Large Chelsea Linear Chandelier in
Antique-Burnished Brass with
Antique Brass Shades**

Height: 32"

Width: 62"

Canopy: 5½" Round

24" Stem or 6' Chain Included

Available Finishes: AB, AN, BZ

Shade Treatments: AB, AN, BZ

Shade Details: 12" x 15" x 7"

Socket: 6-Candelabra

Wattage: 6-60 C

©EFC DESIGNS



CHC5107BZ-BZ

**Medium Chelsea Linear Chandelier in
Bronze with Bronze Shades**

Height: 32"

Width: 47"

Canopy: 5½" Round

24" Stem or 6' Chain Included

Available Finishes: AB, AN, BZ

Shade Treatments: AB, AN, BZ

Shade Details: 12" x 15" x 7"

Socket: 6-Candelabra

Wattage: 6-60 C

©EFC DESIGNS



CHC5102AB-L
Double Sloane Street
Shop Light Ceiling
Mounted Fixture in
Antique Burnished Brass

Height: 57"
Width: 54"
Canopy: 5 3/4" Round
Custom Height Available

Available Finishes:

AB, AN, BZ

Shade Treatment:

AB, AN, BZ, L

Shade Details:

11 1/2" x 15 1/2" x 10"

Socket: 4-Keyless

Wattage: 4-60 A

©EFC DESIGNS

CHC5101AB-L
Sloane Street
Shop Light Fixture in
Antique-Burnished Brass
with Linen Shade

Height: 49"
Width: 15 1/2"
Canopy: 5 3/4" Round
Custom Height Available

Available Finishes: AB, AN, BZ

Shade Treatment:

AB, AN, BZ, L

Shade Details:

11 1/2" x 15 1/2" x 10"

Socket: 2-Keyless

Wattage: 2-60 A

©EFC DESIGNS



CHC5102AB-AB
Sloane Street Two-Light
Ceiling Mounted Fixture in
Antique Burnished Brass with
Antique-Burnished Brass Shades

Height: 57"
Width: 54"
Canopy: 5 3/4" Round
Custom Height Available

Available Finishes:

AB, AN, BZ

Shade Treatment:

AB, AN, BZ, L

Shade Details:

11 1/2" x 15 1/2" x 10"

Socket: 4-Keyless

Wattage: 4-60 A

©EFC DESIGNS

CHC5101AB-AB
Sloane Street Shop Light Fixture in
Antique-Burnished Brass with
Antique-Burnished Brass Shade

Height: 49"
Width: 15 1/2"
Canopy: 5 3/4" Round
Custom Height Available

Available Finishes: AB, AN, BZ

Shade Treatment:

AB, AN, BZ, L

Shade Details:

11 1/2" x 15 1/2" x 10"

Socket: 2-Keyless

Wattage: 2-60 A

©EFC DESIGNS



CHC1480BZ-L
Grosvenor One-Light in
Bronze with Linen Shade
Height: 54½"
Width: 17½"
Canopy: 6" Round
Custom Height Available

Available Finishes:
AB, AN, BZ, PN
Shade Treatment: L
Shade Details:
14" x 17½" x 10½"

Socket: 2-Keyless
Wattage: 2-75 A
©EFC DESIGNS



CHC1481PN-L
Grosvenor Two-Light in
Polished Nickel with Linen
Shades
Height: 42½"
Width: 51"
Canopy: 6" Round
Custom Height Available

Available Finishes:
AB, AN, BZ, PN
Shade Treatment : L
Shade Details: 12" x 15" x 10½"

Socket: 4-Keyless
Wattage: 4-75 A

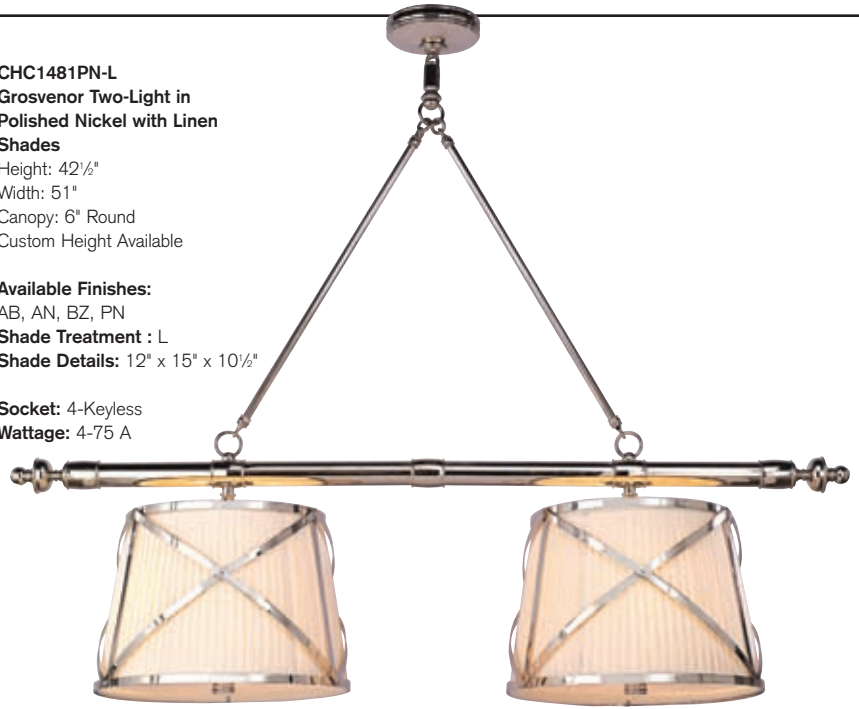

CHC1482AB-L
Grosvenor Three-Light
in Antique-Burnished Brass
with Linen Shades
Height: 42½"
Width: 74½"
Canopy: 6" Round
Custom Height Available

Available Finishes: AB, AN, BZ, PN
Shade Treatment: L
Shade Details: 12" x 15" x 10½"

Socket: 6-Keyless
Wattage: 6-75 A
©EFC DESIGNS

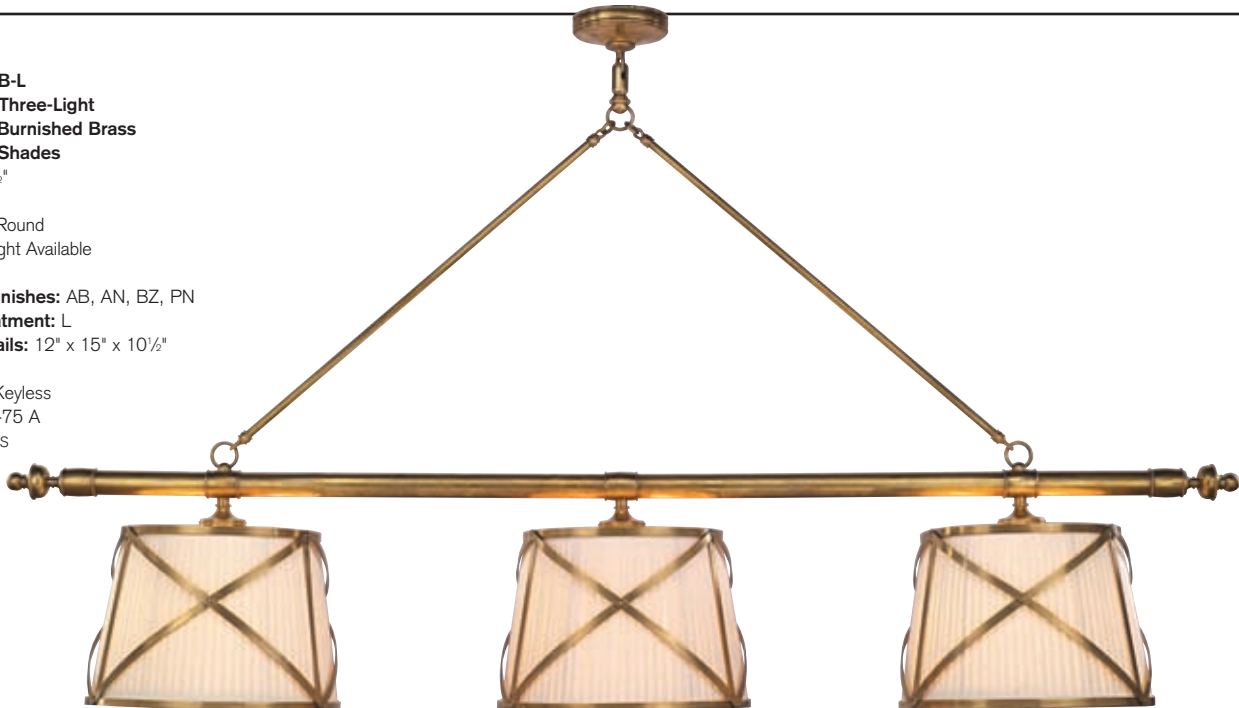

CHC5104AB
Sloane Street Two-Light
Fixture in Antique-Burnished
Brass

Height: 71"
Width: 48"
Canopy: 5 1/4" Round
Custom Height Available

Available Finishes: AB, AN
Shade Treatments: AB, AN
Shade Details: 10" x 13" x 8"

Socket: 2-Keyless
Wattage: 2-100 A
©EFC DESIGNS



CHC1440BR
Windsor Iron Island
Fixture in Rust

Height: 55"
Width: 62"
Canopy: 5 1/4" Round
Custom Height Available

Shade Treatment: R
Shade Details: 10" x 15 1/2" x 8 1/4"

Socket: 2-Keyless
Wattage: 2-100 A
©EFC DESIGNS



CHC5132AN-WG
Edwardian Single
Pendant in Antique
Burnished Nickel with
White Glass Shade
Height: 44"
Width: 10"
Canopy: 5 3/4"
Custom Height Available

Available Finishes:
AB, AN, BZ, PN
Shade Treatment:
AB, AN, BZ, PN, WG
Shade Details: 5" x 10" x 9"

Socket: Keyless
Wattage: 100 A
©EFC DESIGNS



CHC5132AB-AB



CHC5105AB-WG
Triple Sloane Street
Shop Light in Antique-
Burnished Brass with
White Glass Shade
Height: 76"
Width: 58"
Canopy: 5 3/4" Round
Custom Height Available

Available Finishes:
AB, AN, BZ, PN
Shade Treatment:
AB, AN, BZ, PN, WG
Shade Size:
5" x 10" x 9"

Socket: 3-Keyless
Wattage: 3-100 A
©EFC DESIGNS



CHC5150AN-SCC
Three-Light Pimlico Chandelier
in Polished Nickel
Height: 65"
Width: 47"
Canopy: 5 3/4" Round
Custom Height Available

Available Finishes: AB, AN, PN
Shade Treatment: SCC
Shade Details: 6" x 11" x 9"

Socket: 3-Keyless
Wattage: 3-100 A
©EFC DESIGNS



CHC5121AB
Cornice Double Tier
Rectangular Hanging Light in
Antique-Burnished Brass with
White Dressage Glass

Height: 55"
Cage Height: 16"
Width: 36"
Depth: 16"
Canopy: 5½" Square,
24" On Center
Custom Height Available

Available Finishes:
AB, AN, BZ, PN

Socket: 3-Keyless
Wattage: 3-75 A
©EFC DESIGNS



CHC5120BZ
Cornice Single Tier Rectangular
Hanging Light in Bronze with
White Dressage Glass

Height: 49"
Cage Height: 10"
Width: 36"
Depth: 16"
Canopy: 5½" Square,
24" On Center
Custom Height Available

Available Finishes:
AB, AN, BZ, PN

Socket: 3-Keyless
Wattage: 3-75 A
©EFC DESIGNS



CHC2112AB-WG
Zodiac Pendant in
Antique-Burnished Brass
with White Glass
Height: 46½"
Width: 23½"
Canopy: 5½" Round

Socket: 2-Keyless
Wattage: 2-100 A
©EFC DESIGNS



CHC2111BR-WG
Crown Top Banded
Globe Fixture in Black Rust
with White Glass
Height: 21"
Width: 15"
Canopy: 5½" Round

Available Finishes:
AB, AW, BR, BZ/AB
Glass Options:
CG, WG

Socket: 3-Candelabra
Wattage: 3-60 C
©EFC DESIGNS



CHC2111AB-CG



CHC2111AW-CG



CHC1447AB
Arrow Chandelier in
Antique-Burnished Brass
Height: 21"
Width: 34½"
Canopy: 5¾" Round

Available Finishes:
AB, AB/AN, BZ, BZ/AB, PS
Shade Treatment: CHS-104NP
Shade Sold Separately
Shade Size: 3" x 4" x 4"

Socket: 8-Candelabra
Wattage: 8-60 C
©EFC DESIGNS



CHC1446AB
Twelve-Arm Normandy
Chandelier in Antique Brass
Height: 28"
Width: 28"
Canopy: 6" Round

Available Finishes: AB, AN, BZ
Shade Treatment: CHS-104NP
Shade Sold Separately
Shade Details:
3" x 4" x 4"

Socket: 12-Candelabra
Wattage: 12-60 C
©EFC DESIGNS



CHC1500PN-NP
Manhattan Eight-Light
Chandelier in Polished Nickel
with Natural Paper Shades
Height: 44"
Width: 32½"
Canopy: 6" Round

Available Finishes:
AB, AN, BZ, PN
Shade Treatment: NP
Shade Details: 3¾" x 5" x 6"

Socket: 8-Candelabra
Wattage: 8-60 B
©EFC DESIGNS



CHC5133AB-WG
Country Industrial Pendant
in Antique-Burnished Brass
with White Glass Shade

Height: 59"
Width: 14"
Canopy: 5½" Round
Custom Height Available

Available Finishes:
AB, AC, AN, BZ, PN
Shade Treatments:
AB, AC, AN, BZ, PN, WG
Shade Details: 14" x 10"

Socket: Keyless
Wattage: 100 A

©EFC DESIGNS

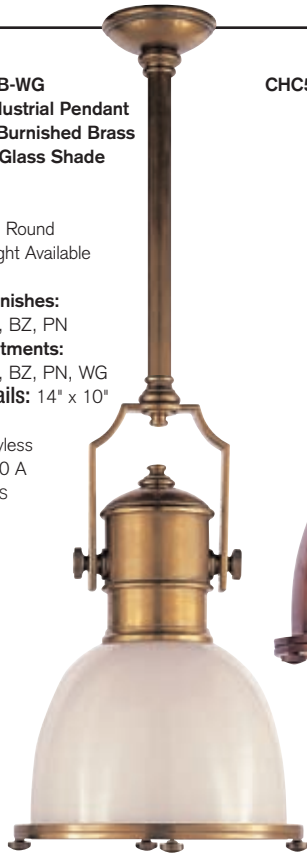

CHC5133AC-AC



CHC5136BZ-BZ
Large Country Industrial
Pendant in Bronze with Bronze
Shade

Height: 59"
Width: 19½"
Canopy: 5½" Round
Custom Height Available

Available Finishes:
AB, AC, AN, BZ, PN
Shade Treatments:
AB, AC, AN, BZ, PN, WG
Shade Details: 19½" x 10"

Socket: Keyless
Wattage: 100 A

©EFC DESIGNS



CHC5137BZ
French Basin
Pendant in Bronze

Height: 48"
Width: 15"
Canopy: 5½" Round
Custom Height Available

Available Finishes:
AB, BZ, CH, PN
Shade Details: 15" x 9"

Socket: Keyless
Wattage: 100 A

©EFC DESIGNS

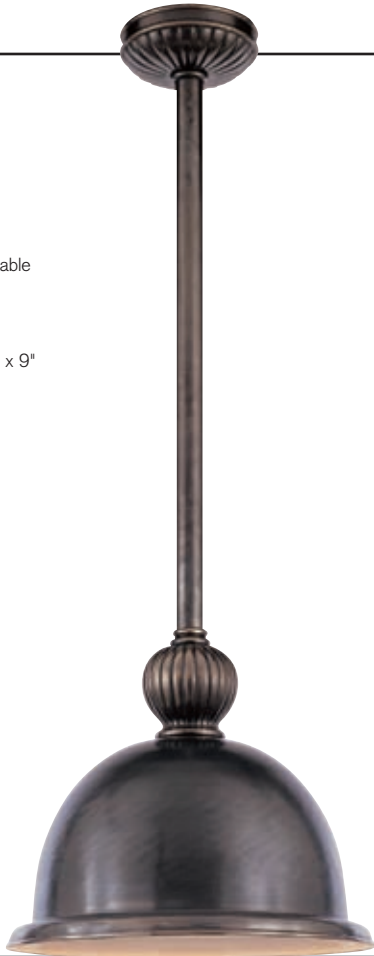

CHC5160AB-AB
Pimlico Street Lamp in
Antique-Burnished Brass
with Antique Brass Shade

Height: 26"
Width: 17½"
(10" without shade)
Canopy: 5½" Round

Available Finishes:
AB, AN, PN, SB, SN
Shade Treatments:
AB, AN, PN, SB, SN
Shade Sold Separately
Shade Details:
17½" Round

Socket: Keyless
Wattage: 100 A

©EFC DESIGNS



CHC5160AN



CHC2103AN
Georgian Four-Light
Hanging Globe
with Smoke Bell
in Antique Nickel
Height: 35"
Width: 13½"
Canopy: 5½" Round

Available Finishes:
AB, AN, BZ, PS

Socket: 3 - Candelabra
Wattage: 3 - 60 C
©EFC DESIGNS



CHC2103AB



CHC5135AB-WG
Edwardian Lantern
in Antique Burnished Brass
Height: 26"
Width: 10"
Canopy: 5½" Round

Available Finishes:
AB, AN, BZ, PN

Socket: 3 - Candelabra
Wattage: 3 - 60 C
©EFC DESIGNS



CHC2101PS
Classic Smoke Bell
in Polished Silver
Height: 29"
Width: 15"
Canopy: 5½" Round

Available Finishes:
AB, AN, BZ, PS

Socket: 3 - Candelabra
Wattage: 3 - 60 C
©EFC DESIGNS



CHC2102AB
Rolled Lip Smoke Bell in
Antique-Burnished Brass
Height: 23½"
Width: 11½"
Canopy: 5½" Round

Available Finishes:
AB, AN, BZ, PS

Socket: 2 - Candelabra
Wattage: 2 - 60 C
©EFC DESIGNS



CHC2104BZ
Chelsea Smoke Bell
in Bronze
Height: 31½"
Width: 15"
Canopy: 6" Round

Available Finishes:
AB, AN, BZ, PS

Socket: 4-Candelabra
Wattage: 4-60 C
©EFC DESIGNS



CHC2110AB
Large Country Bell Jar
Lantern with Antique-
Burnished Brass Trim
Height: 25¾"
Width: 21"
Canopy: 6" Round

Available Finishes:
AB, AN, BZ, PS

Socket: 6-Candelabra
Wattage: 6-60 C
©EFC DESIGNS



CHC2109AB
Country Semi-Flush
Bell Jar Lantern with
Antique-Burnished
Brass Trim
Height: 14½"
Width: 13"
Canopy: 6" Round

Available Finishes:
AB, AN, BZ, PS

Socket: 3-Candelabra
Wattage: 3-60 C
©EFC DESIGNS

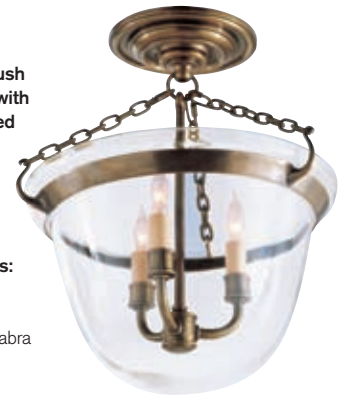

CHC3423PN
Medium-Round Edwardian
Entry Lantern in Polished
Nickel
Height: 29½"
Width: 18"
Canopy: 5¾" Round

Available Finishes:
AB, AN, BZ, PN

Socket: 5-Candelabra
Wattage: 5-60 C
©EFC DESIGNS



CHC3441AB
Large Tapered Arch Top
Lantern in
Antique-Burnished Brass
Height: 43½"
Width: 25"
Canopy: 5½" Round

Available Finishes:
AB, AN, BZ, PN

Socket: 5-Candelabra
Wattage: 5-60 C
©EFC DESIGNS



CHC3425AN
Large Arch Top Lantern
in Antique Nickel
Height: 34½"
Width: 20¼"
Canopy: 5¾" Round

Available Finishes:
AB, AN, BZ, PN

Socket: 5-Candelabra
Wattage: 5-60 C
©EFC DESIGNS



CHC3422AB
Medium Arch Top Lantern
in Antique-Burnished Brass
Height: 29½"
Width: 17½"
Canopy: 5¾" Round

Available Finishes:
AB, AN, BZ, PN

Socket: 4-Candelabra
Wattage: 4-60 C
©EFC DESIGNS



CHC3421BZ
Small Arch Top Lantern
in Bronze
Height: 24"
Width: 14½"
Canopy: 5¾" Round

Available Finishes:
AB, AN, BZ, PN

Sockets: 4-Candelabra
Wattage: 4-60C
©EFC DESIGNS



CHC3420AB
Mini Arch Top Lantern
in Antique-Burnished Brass
Height: 16¾"
Width: 8¼"
Canopy: 5¾" Round

Available Finishes:
AB, AN, BZ, PN

Socket: 3-Candelabra
Wattage: 3-60 C
©EFC DESIGNS



CHC2200AB
Crown Top Hanging Lantern
in Antique-Burnished Brass

Height: 30 3/4"
Width: 16 1/2"
Canopy: 5 1/2" Round

Available Finishes:
AB, AW, GP

Socket: 3-Candelabra
Wattage: 3-60 C
©EFC DESIGNS



CHC2200GP

CHC2106AB
Tall English Hall Lantern
in Antique-Burnished Brass

Height: 49"
Width: 20 1/2"
Canopy: 5 1/2" Round

Available Finishes:
AB, AN, BZ, PN

Socket: 6-Candelabra
Wattage: 6-60 C
©EFC DESIGNS



CHC2113AB
St. Honore Entry Lantern
in Antique-Burnished Brass

Height: 27 1/2"
Width: 16 1/4"
Canopy: 5 3/4" Round

Available Finishes:
AB, AB-Q

Socket: 6-Candelabra
Wattage: 6-60 C
©EFC DESIGNS



CHC2105AN
English Hall Lantern
in Antique Nickel

Height: 26"
Width: 12"
Canopy: 5 3/4" Round

Available Finishes:
AB, AN, BZ, PN

Socket: 3-Candelabra
Wattage: 3-60 C
©EFC DESIGNS



CHC2108AB
Small Scroll Motif
Pendant Lantern in
Antique-Burnished Brass
Height: 15½"
Width: 8"
Canopy: 5½" Round

Available Finishes:
AB, BR

Socket: 3-Candelabra
Wattage: 3-60 C
©EFC DESIGNS



CHC2108BR



CHC2107AB
Large Scroll Motif
Pendant Lantern in
Antique-Burnished Brass
Height: 27¼"
Width: 16"
Canopy: 5½" Round

Available Finishes: AB, BR

Socket: 4-Candelabra
Wattage: 4-60 C
©EFC DESIGNS



CHC3411BR
Provencal French Hanging Lantern
in Black Rust
Height: 24"
Width: 15"
Canopy: 5¾" Round

Socket: 2-Candelabra
Wattage: 2-60 C



CHC3414BR
Three-Light French Market
Lantern in Black Rust
Height: 30½"
Width: 16½"
Canopy: 5¾" Round

Socket: 3-Candelabra
Wattage: 3-60 C
©EFC DESIGNS



CHC3415NR
Gothic Four-Light Hanging Lantern
in Natural Rust
Height: 31½"
Width: 20"
Canopy: 5" Round

Available Finishes: BLK, NR

Socket: 4-Candelabra
Wattage: 4-60 C
©EFC DESIGNS



CHC3405NR
Gothic Three-Light Hanging Lantern
in Natural Rust
Height: 26"
Width: 15"
Canopy: 5" Round

Available Finishes: BLK, NR

Socket: 3-Candelabra
Wattage: 3-60 C
©EFC DESIGNS



CHC3406NR
Breton Four-Light Hanging Lantern
in Natural Rust
Height: 38"
Width: 29½"
Canopy: 5" Round

Available Finishes: BLK, NR

Socket: 4-Candelabra
Wattage: 4-60 C
©EFC DESIGNS



CHC3409NR
Breton Three-Light Hanging Lantern
in Natural Rust
Height: 24"
Width: 18"
Canopy: 5" Round

Available Finishes: BLK, NR

Socket: 3-Candelabra
Wattage: 3-60 C
©EFC DESIGNS



CHC3407NR
Large French Provencal Lantern
in Natural Rust
Height: 28"
Width: 19"
Canopy: 5" Round

Available Finishes: BLK, NR

Socket: 3-Candelabra
Wattage: 3-60 C



CHC3401NR
Medium French Provencal Lantern
in Natural Rust
Height: 24"
Width: 19"
Canopy: 5" Round

Available Finishes: BLK, NR

Socket: 6-Candelabra
Wattage: 6-60 C
©EFC DESIGNS



CHC3408NR
Small French Provencal Lantern
in Natural Rust
Height: 20 1/4"
Width: 14"
Canopy: 5" Round

Available Finishes: BLK, NR

Socket: 3-Candelabra
Wattage: 3-60 C
©EFC DESIGNS



CHC4140PN
Cornice Hexagonal
Flush Mount in
Polished Nickel with
White Dessage Glass
Height: 7"
Width: 18½"

Available Finishes:
AB, AN, BZ, PN
Available Glass: WG

Socket: 2-Keyless
Wattage: 2-60 A
©EFC DESIGNS



CHC4170AB
Cornice Tiered
Flush Mount in
Antique-Burnished Brass
with White Dessage Glass
Height: 12½"
Width: 18½"

Available Finishes:
AB, AN, BZ, PN
Available Glass: WG

Socket: 2-Keyless
Wattage: 2-60 A
©EFC DESIGNS



CHC5180AB
Cornice Hanging Prism Form in
Antique-Burnished Brass with
White Dessage Glass
Overall Height: 23¼" to Center Chain
Cage Height: 11½"
Width: 24"
Canopy: 5½" Hexagonal

Available Finishes:
AB, AN, BZ, PN
Available Glass: WG

Socket: 2-Keyless
Wattage: 2-100 A
©EFC DESIGNS



CHC5170PN
Cornice Hanging Tiered Form
in Polished Nickel with
White Dessage Glass
Overall Height: 24½" to Center Chain
Cage Height: 12½"
Width: 18½"
Canopy: 5½" Hexagonal

Available Finishes:
AB, AN, BZ, PN
Available Glass: WG

Socket: 2-Keyless
Wattage: 2-100 A
©EFC DESIGNS



CHC4128PN-FG
Small Club Square Flush Mount
in Polished Nickel with
Frosted Glass
Height: 8½"
Width: 9"

Available Finishes:
AB, AN, BZ, PN
Available Glass: CG, FG

Socket: 3-Candelabra
Wattage: 3-60 C



CHC4129AB-CG
Large Club Square Flush Mount
in Antique-Burnished Brass
with **Clear Glass**
Height: 9"
Width: 13"

Available Finishes:
AB, AN, BZ, PN
Available Glasses: CG, FG

Socket: 3-Candelabra
Wattage: 3-60 C



CHC4120PN
Cornice Square Flush Mount
in Polished Nickel with
White Message Glass
Height: 10¼"
Width: 16"

Available Finishes:
AB, AN, BZ, PN
Available Glass: WG

Socket: 2-Keyless
Wattage: 2-60 A
©EFC DESIGNS



CHC4215AB
Square Flush Mount in
Antique-Burnished Brass
Height: 6¼"
Width: 14"
Canopy: 14" Square

Available Finishes:
AB, AN, BZ, PN

Socket: 2-Keyless
Wattage: 2-60 A
©EFC DESIGNS



CHC4125BZ-FG
Small Club Hexagonal
Flush Mount in Bronze
with **Frosted Glass**
Height: 8¼"
Width: 10"

Available Finishes:
AB, AN, BZ, PN
Available Glass: CG, FG

Socket: 3-Candelabra
Wattage: 3-60 C



CHC4126PN-CG
Large Club Hexagonal
Flush Mount in
Polished Nickel with
Clear Glass
Height: 9"
Width: 10½"

Available Finishes:
AB, AN, BZ, PN
Available Glass: CG, FG

Socket: 3-Candelabra
Wattage: 3-60 C
©EFC DESIGNS



CHC4134AB
Edwardian Flush Mount
in Antique Burnished Brass

Height: 16"
Width: 13"

Available Finishes:
AB, AN, BZ, PN
Available Glass: WG

Socket: 2-Keyless
Wattage: 2-60 A
©EFC DESIGNS



CHC4132AN-WG
Edwardian Open-Bottom Flush Mount
in Antique-Burnished Nickel

Height: 11½"
Width: 10"
Canopy: 8" Round

Available Finishes:
AB, AN, BZ, PN
Shade Treatment:
AB, AN, BZ, PN, WG
Shade Details: 5" x 10" x 9"

Socket: Keyless
Wattage: 60 A
©EFC DESIGNS



CHC4107AB
Small English Hall Flush Mount
in Antique-Burnished Brass

Height: 6¼"
Width: 10"

Available Finishes:
AB, AN, BZ, PN

Socket: Keyless
Wattage: 60 A
©EFC DESIGNS



CHC4105AB
English Hall Flush Mount
in Antique-Burnished Brass

Height: 12"
Width: 14½"

Available Finishes:
AB, AN, BZ, PN

Socket: 3-Candelabra
Wattage: 3-60 C
©EFC DESIGNS



CHC4106AB
Large English Hall Flush Mount
in Antique-Burnished Brass

Height: 8"
Width: 17"

Available Finishes:
AB, AN, BZ, PN

Socket: 2-Keyless
Wattage: 2-60 A
©EFC DESIGNS



CHC4211PN
Small Bolection Molding
Flush Mount in
Polished Nickel
Height: 8½"
Width: 12"



Available Finishes:
AB, AN, BZ, PN
Available Glass: WG

Socket: Keyless
Wattage: 60 A
©EFC DESIGNS

CHC4212AB
Bolection Molding
Flush Mount in
Antique-Burnished Brass
Height: 8½"
Width: 16¾"



Available Finishes:
AB, AN, BZ, PN
Available Glass: WG

Socket: Keyless
Wattage: 60 A
©EFC DESIGNS

CHC4201AB
Small Crown Flush Mount in
Antique-Burnished Brass
Height: 4¾"
Width: 7"



Available Finishes:
AB, AN, BZ, PN
Available Glass: WG

Socket: Keyless
Wattage: 60 A
©EFC DESIGNS

CHC4202PN
Crown Flush Mount in
Polished Nickel
Height: 7"
Width: 12"



Available Finishes:
AB, AN, BZ, PN
Available Glass: WG

Socket: 2-Keyless
Wattage: 2-60 A
©EFC DESIGNS

CHC4203AB
Large Crown
Flush Mount in
Antique-Burnished Brass
Height: 7½"
Width: 15½"



Available Finishes:
AB, AN, BZ, PN
Available Glass: WG

Socket: 2-Keyless
Wattage: 2-60 A
©EFC DESIGNS

CHC4213BZ
Large Bolection
Molding Flush
Mount in Bronze
Height: 8½"
Width: 19½"



Finishes: AB, AN, BZ, PN
Available Glass: WG

Socket: 2-Keyless
Wattage: 2-60 A
©EFC DESIGNS

SL5811BZ-NP

Classic Linear Chandelier in Bronze

Height: 37½"

Width: 45¼"

Canopy: 5¾" Round

Available Finishes:

AN, BZ, HAB, PN

Shade Treatment: NP

Shade Details: 3" x 6½" x 5"

Socket: 5-Candelabra

Wattage: 5-40 C

©EFC DESIGNS



SL5812HAB-NP

**Classic Ring Chandelier
in Hand-Rubbed Antique Brass**

Height: 24"

Width: 33¼"

Canopy: 5¾" Round

Available Finishes:

AN, BZ, HAB, PN

Shade Treatment: NP

Shade Details: 3" x 6½" x 5"

Socket: 6-Candelabra

Wattage: 6-40 C

©EFC DESIGNS



SL5870HAB
Semi-Flush Cornice Lantern in Hand-Rubbed Antique Brass

Overall Height: 14½"
Width: 9½"
Canopy: 6" Round

Available Finishes:
BR, BZ, HAB, PN

Socket: 3-Candelabra

Wattage: 3-40 C
©EFC DESIGNS



SL5871PN
Small Cornice Hanging Lantern in Polished Nickel

Height: 23"
Width: 14½"
Canopy: 6" Round

Available Finishes:
BR, BZ, HAB, PN

Socket: 4-Candelabra
Wattage: 4-60 C
©EFC DESIGNS



SL5872BR
Large Cornice Hanging Lantern in Black Rust

Height: 30½"
Width: 20"
Canopy: 6" Round

Available Finishes:
BR, BZ, HAB, PN

Socket: 4-Candelabra
Wattage: 4-60 C
©EFC DESIGNS



SL5863HAB
TT Linear Branched Ten-Light Chandelier in Hand-Rubbed Antique Brass

Height: 52"
Width: 36"
Canopy: 5¼" Round
Custom Height Available

Available Finishes:
AN, BZ, HAB, PN
Shade Treatment: CHS-104NP
Shade Sold Separately
Shade Details: 3" x 4" x 4"

Socket: 10-Candelabra
Wattage: 10-60 C
©EFC DESIGNS



SL5830BZ-NP
Nine-Light Retro Chandelier in Bronze with Natural Paper Shades

Height: 23¼"
Width: 37"
Canopy: 6" Round

Available Finishes:
AN, BZ, HAB, PN
Shade Treatment: NP
Shade Details:
4" x 6" x 5"

Socket: 9-Candelabra
Wattage: 9-60 C
©EFC DESIGNS



SL5130AN-AN
Mini Cornice Pendant in
Antique Nickel with
Antique Nickel Shade
Height: 55"
Width: 10½"
Canopy: 6" Round
Custom Height Available

Available Finishes:
AN, BZ, HAB, PN
Shade Treatments:
AN, BZ, HAB, NP, PN
Shade Details:
9½" x 10½" x 7" Square

Socket: 3-Candelabra
Wattage: 3-60 C
©EFC DESIGNS



SL5131PN-PN
Small Cornice Pendant in
Polished Nickel with Polished
Nickel Shade
Height: 55"
Width: 16¼"
Canopy: 6" Round
Custom Height Available

Available Finishes:
AN, BZ, HAB, PN
Shade Treatments:
AN, BZ, HAB, NP, PN
Shade Details:
14½" x 16¼" x 11½" Square

Socket: 2-Keyless
Wattage: 2-100 A
©EFC DESIGNS



SL5132BZ-BZ
Medium Cornice Pendant in
Bronze with Bronze Shade
Height: 55"
Width: 19½"
Canopy: 6" Round
Custom Height Available

Available Finishes:
AN, BZ, HAB, PN
Shade Treatments:
AN, BZ, HAB, NP, PN
Shade Details:
17" x 19½" x 14¼" Square

Socket: 2-Keyless
Wattage: 2-100 A
©EFC DESIGNS



SL5133HAB-NP
Large Cornice Pendant in
Hand-Rubbed Antique Brass
with Natural Paper Shade
Height: 55"
Width: 24"
Canopy: 6" Round
Custom Height Available

Available Finishes:
AN, BZ, HAB, PN
Shade Treatments:
AN, BZ, HAB, NP, PN
Shade Details:
20" x 24" x 16¼" Square

Socket: 2-Keyless
Wattage: 2-100 A
©EFC DESIGNS



SL5820PN-NP
Six-Light Square Tube
Chandelier in Polished Nickel
with Natural Paper Shade
 Height: 19"
 Width: 24"
 Canopy: 5 3/4" Square

Available Finishes:
 AN, BZ, HAB, PN
Shade Treatment: NP
Shade Details:
 20" x 24" x 11"

Socket: 6-Candelabra
Wattage: 6-60 C
 ©EFC DESIGNS



S5031BR-NP
Iron Ceiling Light
in Black Rust with
Natural Paper Shade
 Height: 11 1/2"
 Width: 8 1/2"
 Canopy: 6" Round

Available Finishes: BR
Shade Treatment: NP
Shade Details:
 7 1/2" x 8 1/4" x 7"

Socket: Candelabra
Wattage: 60 C
 ©EFC DESIGNS



S5030BR-NP
Iron Ceiling Light
in Black Rust with
Natural Paper Shade
 Height: 20 3/4"
 Width: 19 1/4"
 Canopy: 6" Round

Available Finishes: BR
Shade Treatment: NP
Shade Details:
 19" x 19 1/2" x 10 1/4"

Socket: 4 - Candelabra
Wattage: 4 - 60 C
 ©EFC DESIGNS

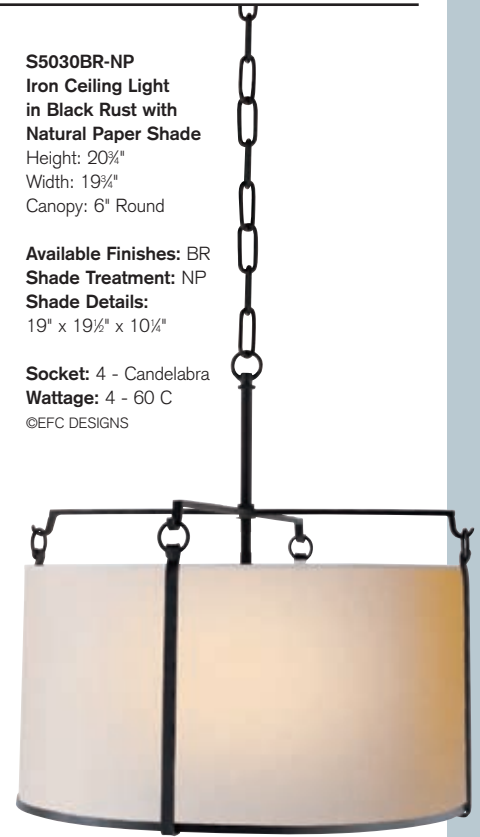

SL5175HAB-HAB1
Yoke Pendant in Hand-Rubbed
Antique Brass with Large Shade
 Height: 56 3/4"
 Width: 18"
 Canopy: 5 1/2" Round
 Custom Height Available

Available Finishes:
 AN, BC, BZ, HAB, PN
Shade Treatments:
 AN1, BC1, BZ1, HAB1, PN1
Shade Details: 10 1/4" x 17 1/2"

Socket: Keyless
Wattage: 150 A
 ©EFC DESIGNS



SL5175BC-BC2
Yoke Pendant in Brushed Chrome
with Small Shade
 Height: 55 3/4"
 Width: 11"
 Canopy: 5 1/2" Round
 Custom Height Available

Available Finishes:
 AN, BC, BZ, HAB, PN
Shade Treatments:
 AN2, BC2, BZ2, HAB2, PN2
Shade Details: 9 1/4" x 11"

Socket: Keyless
Wattage: 150 A
 ©EFC DESIGNS



SL5175BZ-BZ2



SL5851HAB-HABH
Flanders Double Pendant in Hand-Rubbed Antique Brass with Hammered Hand-Rubbed Antique Brass Shades

Height: 50½"
Width: 32"
Canopy: 5½" Round
Custom Height Available
Slope Mount Included

Available Finishes:

AN, BZ, HAB, PN

Shade Treatments:

AN, BZ, HAB, PN

Hammered or Non-Hammered

Shade Details: 3¼" x 8" x 8½"

Socket: 2-Keyless

Wattage: 2-100 A

©EFC DESIGNS



SL5850HAB-BZH
Flanders Single Pendant in Hand-Rubbed Antique Brass with Hammered Bronze Shade

Height: 50½"
Width: 8"
Canopy: 5½" Round
Custom Height Available
Slope Mount Included

Available Finishes:

AN, BZ, HAB, PN

Shade Treatments:

AN, BZ, HAB, PN

Hammered or Non-Hammered

Shade Details: 3¼" x 8" x 8½"

Socket: Keyless

Wattage: 100 A

©EFC DESIGNS



S5103AN/HAB-AN
Houston Industrial Triple Hanging Light in Antique Nickel and Hand-Rubbed Antique Brass with Antique Nickel Shades

Height: 36"-60"
Width: 36"
Canopy: 6" Round
Custom Height Available
Slope Mount Included

Available Finishes:

AN, AN/HAB, BZ, HAB, PN

Shade Treatments:

AN, BZ, HAB, PN

Shade Details:

3" x 7¼" x 9¼"

Socket: 3-Keyless

Wattage: 3-75 A



S5101PN-PN
Houston Industrial Pendant in Polished Nickel with Polished Nickel Shade

Height: 28"-52"
Width: 7¼"
Canopy: 6" Round
Custom Height Available
Slope Mount Included

Available Finishes:

AN, AN/HAB, BZ, HAB, PN

Shade Treatments:

AN, BZ, HAB, PN

Shade Details:

3" x 7¼" x 9¼"

Socket: Keyless

Wattage: 75 A



SS5002HAB-WG
Siena Four-Light Pendant
in Hand-Rubbed
Antique Brass with
White Glass Shade

Height: 12½"
Width: 15"
Canopy: 5" Square
Custom Height Available

Available Finishes:
HAB, PN
Shade Treatment: WG
Shade Details:
4¾" x 2½" x 5½"

Socket: 4-Keyless
Wattage: 4-60 A



SS5005HAB-WG
Siena One-Light Pendant
in Hand-Rubbed Antique Brass
with White Glass Shade

Height: 58"
Width: 5"
Canopy: 5" Square
Custom Height Available

Available Finishes: HAB, PN
Shade Treatment: WG
Shade Details:
4¾" x 2½" x 5½"

Socket: Keyless
Wattage: 60 A



SL5151HAB-WG
NY Subway Flush Mount
in Hand-Rubbed Antique Brass
with White Glass Shade

Height: 10½"
Width: 5"
Canopy: 4½" Square

Available Finishes:
AN, BZ, CH, HAB
Shade Treatment: WG
Shade Details: 3" x 5" x 5"

Socket: Keyless
Wattage: 60 A
©EFC DESIGNS



SL5150HAB-WG
NY Subway One-Light Pendant
in Hand-Rubbed Antique Brass
with White Glass Shade

Height: 49"
Width: 5"
Canopy: 4½" Square
Custom Height Available

Available Finishes:
AN, BZ, CH, HAB
Shade Treatment: WG
Shade Details: 3" x 5" x 5"

Socket: Keyless
Wattage: 60 A
©EFC DESIGNS



SL5156HAB-WG

**NY Subway Four-Arm Up Light
in Hand Rubbed Antique Brass
with White Glass Shades**

Height: 45"
Width: 28½"
Canopy: 4½" Square
Custom Height Available

Available Finishes:

AN, BZ, CH, HAB

Shade Treatment: WG

Shade Details: 3" x 5" x 5"

Socket: 4-Keyless

Wattage: 4-60 A

©EFC DESIGNS



SL5154BZ-WG

**NY Subway Four Light Linear Fixture
in Bronze with White Glass Shades**

Height: 49"
Width: 28½"
Canopy: 4½" Square
Custom Height Available

Available Finishes: AN, BZ, CH, HAB

Shade Treatment: WG

Shade Details: 3" x 5" x 5"

Socket: 4-Keyless

Wattage: 4-60 A

©EFC DESIGNS



SL5153CH-WG
NY Subway Two-Arm Up Light
 in Chrome with
White Glass Shades
 Height: 45"
 Width: 17"
 Canopy: 4½" Square
 Custom Height Available

Available Finishes:
 AN, BZ, CH, HAB
Shade Treatment: WG
Shade Details: 3" x 5" x 5"

Socket: 2-Keyless
Wattage: 2-60 A
 ©EFC DESIGNS



SL5152HAB-WG
NY Subway Two-Arm Down Light
 in Hand Rubbed Antique Brass
 with **White Glass Shades**
 Height: 49"
 Width: 17"
 Canopy: 4½" Square
 Custom Height Available

Available Finishes: AN, BZ, CH, HAB
Shade Treatment: WG
Shade Details: 3" x 5" x 5"

Socket: 2-Keyless
Wattage: 2-60 A
 ©EFC DESIGNS



SL5003HAB/SLEG-WG
Boston Double Down-Light
 in **Hand-Rubbed Antique Brass**
 with **White Glass SLEG Shade**
 Height: 14"
 Width: 15½"
 Canopy: 4½" Round
 Custom Height Available

Available Finishes:
 AN, BZ, CH, HAB, PN, SN
Shade Treatment:
 SLEG-WG
 See Shade Schedule for
 Additional Shade Options
Shade Details:
 2¼" x 5¾" x 4½"

Socket: 2-Keyless
Wattage: 2-60 A
 ©EFC DESIGNS



SL5002BZ/SLEG-WG
Boston Double Up-Light
 in **Bronze** with
White Glass SLEG Shade
 Height: 15½"
 Width: 15½"
 Canopy: 4½" Round
 Custom Height Available

Available Finishes:
 AN, BZ, CH,
 HAB, PN, SN
Shade Treatment:
 SLEG-WG
 See Shade Schedule for
 Additional Shade Options
Shade Details:
 2¼" x 5¾" x 4½"

Socket: 2-Keyless
Wattage: 2-60 A
 ©EFC DESIGNS



SL5001HAB/SLEG-WG
Boston Single Flush Mount in Hand-Rubbed Antique Brass with White Glass SLEG Shade
Height: 8½"
Width: 5¼"
Canopy: 5" Round



Available Finishes:
AN, BZ, CH, HAB, PN, SN
Shade Treatment:
SLEG-WG
See Shade Schedule for Additional Shade Options
Shade Details:
2¼" x 5¾" x 4½"
Socket: Keyless
Wattage: 60 A
©EFC DESIGNS

SL4128BZ-WG
Bronze Industrial Fitter Flush Mount with Amphora Shaped White Glass
Height: 11½"
Width: 8"



Available Finishes:
AN, BZ, HAB
Shade Treatment: WG
Shade Details:
8" x 9", 4" Fitter
Socket: Keyless
Wattage: 60 A
©EFC DESIGNS

SL4000HAB-WG
Small Marine Flush Mount Fixture in Hand-Rubbed Antique Brass with White Drop Glass
Height: 8"
Width: 5"



Available Finishes:
AN, BZ, CH, HAB
Shade Treatment: WG
Socket: Keyless
Wattage: 60 A
©EFC DESIGNS

SL5125HAB/SLE-AW
Boston Functional Single Pendant in Hand-Rubbed Antique Brass with Antique White SLE Shade
Height: 44½"
Width: 5¾"
Canopy: 4½" Round
Custom Height Available



Available Finishes:
AN, BZ, CH, HAB, PN, SN
Shade Treatments:
SLD, SLE, SLEG, SLF, WG1, WG2, WG3
Shade Details:
SLE: 2¼" x 5¾" x 4½"
Socket: Keyless
Wattage: 100 A
©EFC DESIGNS

SL5125HAB/SLF-HAB
Boston Functional Single Pendant in Hand-Rubbed Antique Brass with Hand-Rubbed Antique Brass SLF Shade
Height: 47"
Width: 12¾"
Canopy: 4½" Round
Custom Height Available

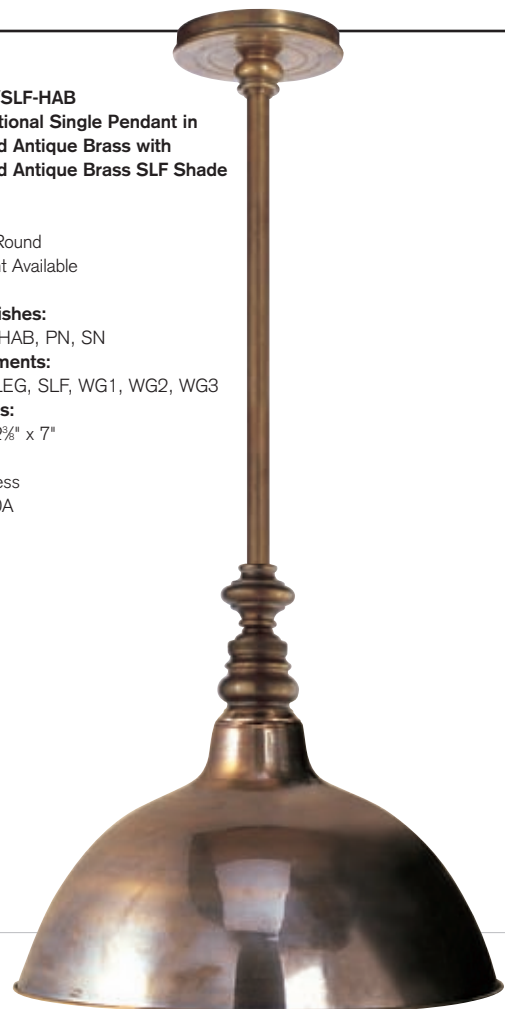

Available Finishes:
AN, BZ, CH, HAB, PN, SN
Shade Treatments:
SLD, SLE, SLEG, SLF, WG1, WG2, WG3
Shade Details:
SLF: 2¼" x 12¾" x 7"
Socket: Keyless
Wattage: 100A
©EFC DESIGNS

SL5125AN/SLEG-WG
Boston Functional Single Pendant
in Antique Nickel with
White SLEG Shade
 Height: 44½"
 Width: 5¼"
 Canopy: 4½" Round
 Custom Height Available

Available Finishes:
 AN, BZ, CH, HAB, PN, SN
Shade Treatments:
 SLD, SLE, SLEG, SLF, WG1, WG2, WG3
Shade Details:
 SLEG: 2¼" x 5¾" x 4½"

Socket: Keyless
Wattage: 100 A
 ©EFC DESIGNS



SL5125HAB/SLD-HAB
Boston Functional Single Pendant in
Hand-Rubbed Antique Brass with
Hand-Rubbed Antique Brass SLD Shade
 Height: 45"
 Width: 7¼"
 Canopy: 4½" Round
 Custom Height Available

Available Finishes:
 AN, BZ, CH, HAB, PN, SN
Shade Treatments:
 SLD, SLE, SLEG, SLF, WG1, WG2, WG3
Shade Details:
 SLD: 2" x 7¼" x 6"

Socket: Keyless
Wattage: 100 A
 ©EFC DESIGNS



SL5125BZ-WG1
Boston Functional Single
Pendant with Fitter in Bronze
with White Glass Shade
 Height: 47"
 Width: 10"
 Canopy: 4½" Round
 Custom Height Available

Available Finishes:
 AN, BZ, CH, HAB, SN
Shade Treatments:
 SLD, SLE, SLEG, SLF,
 WG1, WG2, WG3
Shade Details:
 WG1: 2¼" x 10" x 7"

Socket: Keyless
Wattage: 100A

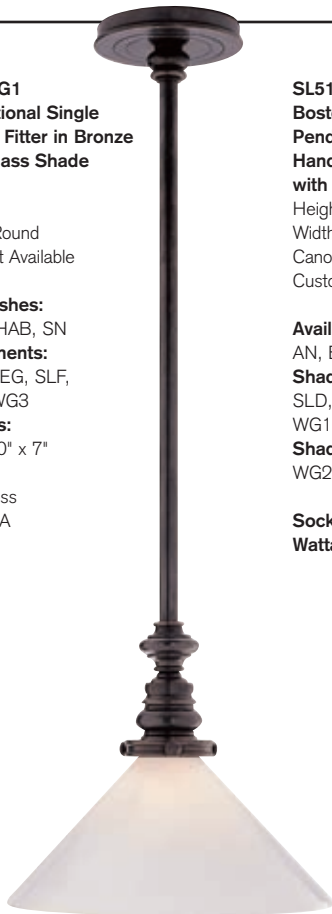

SL5125HAB-WG2
Boston Functional Single
Pendant with Fitter in
Hand-Rubbed Antique Brass
with Small Dish Glass
 Height: 45"
 Width: 10½"
 Canopy: 4½" Round
 Custom Height Available

Available Finishes:
 AN, BZ, CH, HAB, SN
Shade Treatments:
 SLD, SLE, SLEG, SLF,
 WG1, WG2, WG3
Shade Details:
 WG2: 2¼" x 10½" x 3"

Socket: Keyless
Wattage: 100A

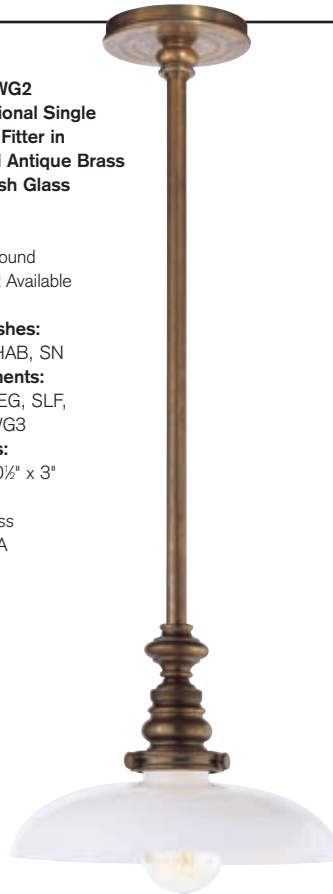

SL5125BZ-WG3
Boston Functional Single
Pendant with Fitter in Bronze
with Large Dish Glass
 Height: 45"
 Width: 15¾"
 Canopy: 4½" Round
 Custom Height Available

Available Finishes:
 AN, BZ, CH, HAB, SN
Shade Treatments:
 SLD, SLE, SLEG, SLF,
 WG1, WG2, WG3
Shade Details:
 WG3: 2¼" x 16" x 3"

Socket: Keyless
Wattage: 100A

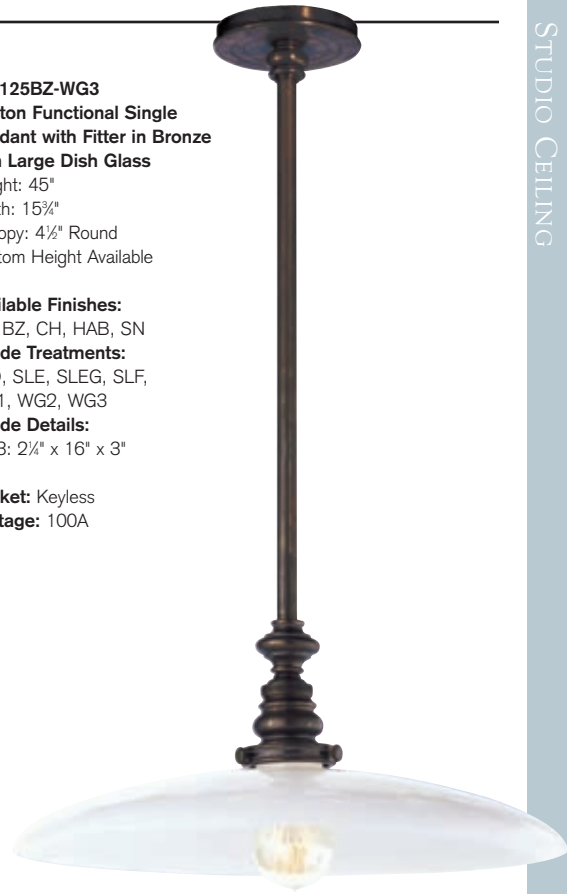

SL4120HAB-WG
Round School House Flush
Mount in Hand-Rubbed
Antique Brass with
White Glass Shade
Height: 21½"
Width: 13"
Canopy: 5¾" Round

Available Finishes:
AN, BZ, HAB, PN
Shade Treatment:
WG

Socket: Keyless
Wattage: 100 A
©EFC DESIGNS



SL4122HAB-WG
Long School House Flush
Mount in Hand-Rubbed
Antique Brass with
White Glass Shade
Height: 23"
Width: 15½"
Canopy: 5¾" Round

Available Finishes:
AN, BZ, HAB, PN
Shade Treatment:
WG
Shade Details:
15½" x 15½"

Socket: Keyless
Wattage: 100 A
©EFC DESIGNS

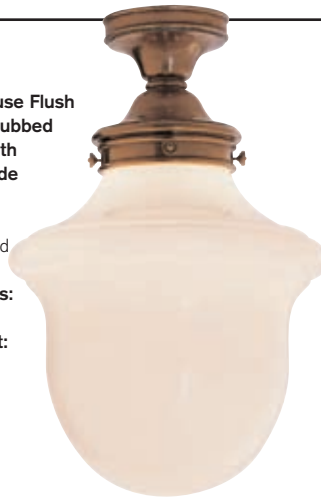

SL4121HAB-WG
Short School House Flush
Mount in Hand-Rubbed
Antique Brass with
White Glass Shade
Height: 16"
Width: 14½"
Canopy: 5¾" Round

Available Finishes:
AN, BZ, HAB, PN
Shade Treatment:
WG

Socket: Keyless
Wattage: 100 A
©EFC DESIGNS



SL5120PN-WG
Round School House
Pendant in Polished Nickel
with White Glass Shade
Height: 46½"
Width: 13"
Canopy: 5¾" Round
Custom Height Available

Available Finishes:
AN, BZ, HAB, PN
Shade Treatment: WG

Socket: Keyless
Wattage: 100 A
©EFC DESIGNS



SL5122HAB-WG
Long School House
Pendant in Hand-Rubbed
Antique Brass with
White Glass Shade
Height: 49"
Width: 15½"
Canopy: 5¾" Round
Custom Height Available

Available Finishes:
AN, BZ, HAB, PN
Shade Treatment: WG
Shade Details: 15½" x 15½"

Socket: Keyless
Wattage: 100 A
©EFC DESIGNS



SL5121BZ-WG
Short School House
Pendant in Bronze with
White Glass Shade
Height: 43"
Width: 14½"
Canopy: 5¾" Round
Custom Height Available

Available Finishes:
AN, BZ, HAB, PN
Shade Treatment: WG

Socket: Keyless
Wattage: 100 A
©EFC DESIGNS



SS4010BZ-FG
Openwork Small Flush Mount
Fixture in Bronze with
Frosted Drop Glass
Height: 4"
Width: 10"



Available Finishes:
AN, BZ, CH, HAB, PN
Shade Treatment: FG

Socket: 2-Candelabra
Wattage: 2-60 C

SS4011CH-FG
Openwork Large Flush Mount
Fixture in Chrome with
Frosted Drop Glass
Height: 5"
Width: 13½"



Available Finishes:
AN, BZ, CH, HAB, PN
Shade Treatment: FG

Socket: 2-Candelabra
Wattage: 2-60 C

SL4001CH-WG
Medium Marine Flush Mount
in Chrome with
White Drop Glass
Height: 4¾"
Width: 8¾"



Available Finishes:
AN, BZ, CH, HAB, PN
Shade Treatment: WG

Socket: Keyless
Wattage: 60 A
©EFC DESIGNS

SL4002HAB-WG
Large Marine Flush Mount
in Hand-Rubbed Antique Brass
with White Drop Glass
Height: 6¾"
Width: 12½"



Available Finishes:
AN, BZ, CH, HAB, PN
Shade Treatment: WG

Socket: 2 - Keyless
Wattage: 2 - 60 A
©EFC DESIGNS

SS4012HAB-FG
Small Siena Flush Mount
in Hand-Rubbed Antique Brass
with Frosted Drop Glass
Height: 5"
Width: 11¾"



Available Finishes:
BZ, CH, HAB, PN
Shade Treatment: FG

Socket: 2-Candelabra
Wattage: 2-60 C

SS4013CH-FG
Large Siena Flush Mount
in Chrome with
Frosted Drop Glass
Height: 5"
Width: 14"



Available Finishes:
BZ, CH, HAB, PN
Shade Treatment: FG

Socket: 2-Candelabra
Wattage: 2-60 C

SS4015BZ-WG
Small Bronze Siena Flush Mount
with Flat Panel Glass
Height: 4¾"
Width: 11¾"



Available Finishes:
AN, BZ, CH, HAB, PN
Shade Treatment: WG

Socket: 2-Keyless
Wattage: 2-40 A

SS4016CH-WG
Large Chrome Siena Flush Mount
with Flat Panel Glass
Height: 4¾"
Width: 14"



Available Finishes:
AN, BZ, CH, HAB, PN
Shade Treatment: WG

Socket: 2-Keyless
Wattage: 2-40 A

TOB5008BZ-NP

**Vendome Large Chandelier in
Bronze with Natural Paper Shades**

Height: 44"
Width: 36"
Canopy: 5¼" Round
Custom Height Available
Slope Mount Included

Available Finishes:

AS, BZ, HAB, PS, R

Shade Treatment:

NP, NP/BT, NP/ST

Shade Details: 4" x 5½" x 6"

Socket: 8-Candelabra

Wattage: 8-60 C



TOB5007HAB-NP/BT

**Vendome Small Chandelier
in Hand-Rubbed Antique Brass
with Natural Paper Shades**

Height: 44"
Width: 26"
Canopy: 5¼" Round
Custom Height Available
Slope Mount Included

Available Finishes:

AS, BZ, HAB, PS, R

Shade Treatment:

NP, NP/BT, NP/ST

Shade Details: 4" x 5½" x 6"

Socket: 4-Candelabra

Wattage: 4-60 C



TOB5010PS-NP
Reed Eight-Light Chandelier in
Polished Silver with Natural
Paper Shades

Height: 37 $\frac{3}{4}$ "
Width: 26 $\frac{1}{2}$ "
Canopy: 5 $\frac{1}{4}$ " Round
Custom Height Available

Available Finishes: AN, BZ,
HAB, PS

Shade Treatment: NP

Shade Details: 4" x 5" x 5 $\frac{1}{2}$ "

Socket: 8-Candelabra

Wattage: 8-60 C



TOB5009HAB-NP
Reed Small Chandelier in
Hand-Rubbed Antique Brass
with Natural Paper Shades

Height: 30"
Width: 20"
Canopy: 5 $\frac{1}{4}$ " Round
Custom Height Available

Available Finishes: AN, BZ,
HAB, PS

Shade Treatment: NP

Shade Details: 4" x 5" x 6"

Socket: 3-Candelabra

Wattage: 3-60 C



TOB5003BZ-NP
Bryant Large Chandelier in
Bronze with Natural Paper Shades
Height: 48"
Width: 36"
Canopy: 7" Round
Custom Height Available
Slope Mount Included

Available Finishes:
AN, BZ, HAB, PS
Shade Treatments:
NP, NP/BT, NP/ST
Shade Details: 4" x 5½" x 6"

Socket: 4-Keyless
Wattage: 4-60 A



TOB5002HAB-NP
Bryant Small Chandelier
in Hand-Rubbed Antique Brass
with Natural Paper Shades
Height: 48"
Width: 26"
Canopy: 7" Round
Custom Height Available
Slope Mount Included

Available Finishes:
AN, BZ, HAB, PS
Shade Treatments:
NP, NP/BT, NP/ST
Shade Details: 4" x 5½" x 6"

Socket: 4-Keyless
Wattage: 4-60 A



TOB5017BZ/HAB-NP
Farlane Chandelier in Bronze
with Hand-Rubbed Antique
Brass Accents and Natural
Paper Shades

Height: 42"-60"
Width: 48"
Canopy: 5 $\frac{3}{4}$ " Round
Custom Height Available
Slope Mount Included

Available Finishes:
AN, BZ/HAB, HAB, PS
Shade Treatments: NP, NP/RT
Shade Details: 3" x 5" x 7"

Socket: 12-Candelabra
Wattage: 12-40 C



TOB5018HAB-NP
Small Farlane Chandelier
in Hand-Rubbed Antique Brass
with Natural Paper Shades

Height: 42"-60"
Width: 34"
Canopy: 5 $\frac{3}{4}$ " Round
Custom Height Available
Slope Mount Included

Available Finishes:
AN, BZ/HAB, HAB, PS
Shade Treatments: NP, NP/RT
Shade Details: 3" x 5" x 7"

Socket: 6-Candelabra
Wattage: 6-40 C



TOB5016HAB-NP
Ziyi Large Chandelier in
Hand-Rubbed Antique Brass
with Natural Paper Shades
Height: 44½"
Width: 33½"
Canopy: 4¼" Round
Custom Height Available

Available Finishes:
BZ, HAB, PN
Shade Treatment: NP
Shade Details:
4" x 4" x 9½"

Socket: 8-Candelabra
Wattage: 8-40 C



TOB5015PS-NP
Ziyi Small Chandelier in
Polished Silver with
Natural Paper Shades
Height: 44½"
Width: 24"
Canopy: 4¼" Round
Custom Height Available

Available Finishes:
BZ, HAB, PN, PS
Shade Treatment: NP
Shade Details:
4" x 4" x 9½"

Socket: 4-Candelabra
Wattage: 4-40 C



TOB5020HAB/CHC-NP
Julia Chandelier in
Hand-Rubbed Antique Brass
and Chocolate Wood Accents
with Natural Paper Shades
Height: 29"-54"
Width: 29¼"
Canopy: 5¾" Round
Custom Height Available
Slope Mount Included

Available Finishes:
BZ, BZ/HAB, HAB/CHC, PS
Shade Treatment: NP
Shade Details: 3½" x 5" x 6½"

Socket: 10-Candelabra
Wattage: 10-40 C



TOB5005BZ-NP
Bryant Large Billiard Light in Bronze
with Natural Paper Shades

Height: 32"
Width: 60"
Custom Height Available

Available Finishes:
AN, BZ, HAB
Shade Treatment: NP
Shade Details:
10½" x 12" x 7½"

Socket: 3-Keyless
Wattage: 3-75 A



TOB5004AN-NP
Bryant Small Billiard Light
in Antique Nickel with
Natural Paper Shades

Height: 32"
Width: 36"
Custom Height Available

Available Finishes:
AN, BZ, HAB
Shade Treatment: NP
Shade Details:
6½" x 8" x 7½"

Socket: 3-Keyless
Wattage: 3-75 A



TOB5011BZ-NP/BT
Reed Hanging Light in Bronze
with Natural Paper Shade

Height: 29½"
Width: 22"
Canopy: 5¼" Round
Custom Height Available

Available Finishes: AN, BZ, HAB, PS
Shade Treatment: NP, NP/BT
Shade Details: 22" x 22" x 7½"

Socket: 2-Keyless
Wattage: 2-100 A



TOB5014BZ/HAB-NP/BT
Goodman Hanging Lamp
in Bronze and Hand-Rubbed
Antique Brass with
Natural Paper Shade

Height: 48½"
Width: 24½"
Canopy: 5¼" Round
Custom Height Available

Available Finishes:
AN, BZ, BZ/HAB, HAB
Shade Treatments:
AN, AW, BZ, HAB, NP, NP/BT
Shade Details:
7½" x 24" x 22½"

Socket: 2-Keyless
Wattage: 2 -100 A



TOB5014HAB-AW



TOB5061PN-AW
Large Selecta Ceiling Light
in Polished Nickel
with Antique White Shade
Height: 48"
Width: 18 1/4"
Canopy: 5 1/2" Round
Custom Height Available
Slope Mount Included

Available Finishes:
AN-AW, HAB-BZ, HAB-HAB,
PN-AW, PN-PN

Socket: 3-Keyless
Wattage: 3-75 A



TOB5060PN-PN
Small Selecta Ceiling Light
in Polished Nickel with
Polished Nickel Shade
Height: 48"
Width: 14 1/4"
Canopy: 5 1/2" Round
Custom Height Available
Slope Mount Included

Available Finishes:
AN-AW, HAB-BZ, HAB-HAB,
PN-AW, PN-PN

Socket: 2-Keyless
Wattage: 2-75 A



TOB5063BZ/HAB-WG
Large Hicks Pendant
in Bronze with Hand-Rubbed
Antique Brass Accents
with White Glass Shade
Height: 16 3/4"
Width: 12 1/2"
Canopy: 4 3/4" Round

Available Finishes:
AN, AW/HAB, BZ/HAB,
HAB, PN

Socket: 2 - Porcelain
Wattage: 2 - 75 A



TOB5062AN-WG
Small Hicks Pendant Light
in Antique Nickel with White
Glass Shade
Height: 11 3/4"
Width: 8 1/2"
Canopy: 4 3/4" Round

Available Finishes:
AN, AW/HAB, BZ/HAB,
HAB, PN

Socket: Porcelain
Wattage: 75 A

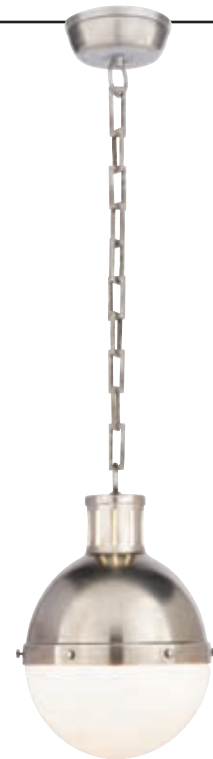

TOB5000AW
Eugene Pendant in
Antique White
Height: 49"
Width: 21"
Canopy: 4" Round

Available Finishes:
AN, AW, BZ, HAB
Shade Details: 11" x 21"

Socket: Keyless
Wattage: 150 A



TOB5013AN
Eugene Medium Hanging Light
in Antique Nickel
Height: 24" - 12'
Width: 15½"
Canopy: 4" Round

Available Finishes:
AN, AW, BZ, HAB

Socket: Keyless
Wattage: 150 A



TOB5012BZ
Eugene Small Hanging Light
in Bronze
Height: 24" - 12'
Width: 12"
Canopy: 4" Round

Available Finishes:
AN, AW, BZ, HAB

Socket: Keyless
Wattage: 150 A



TOB4003CH
Ted Ceiling Light in
Chrome with
White Dessage Glass
Height: 4"
Width: 14"

Available Finishes:
BZ, CH, HAB, PN
Shade Treatment: WG

Socket: 2-Keyless
Wattage: 2-60 A



TOB4005AN-WG
Grove Ceiling Light
in Antique Nickel with
White Glass Shade
Height: 12½"
Width: 11"
Canopy: 9½" Round

Available Finishes:
AN, AW, BZ, HAB, PN

Socket: Porcelain
Wattage: 75 A



TOB4002PN
Emma Ceiling Light
in Polished Nickel with
White Glass
Height: 6¼"
Width: 9"

Available Finishes:
AN, AW, BZ, HAB, PN
Shade Treatment: WG

Socket: Keyless
Wattage: 75 A



TOB4000HAB
Perry Ceiling Light in
Hand-Rubbed Antique Brass
with **White Glass**
Height: 9"
Width: 9½"
Canopy: 7½" Round

Available Finishes:
AN, AW, BZ, HAB, PN
Shade Treatment: WG

Socket: Keyless
Wattage: 60 A



TOB4001HAB
Greene Street Ceiling Light in
Hand-Rubbed Antique Brass
with **White Glass**
Height: 8"
Width: 8⅜"

Available Finishes:
AN, AW, BZ, HAB, PN
Shade Treatment: WG

Socket: Keyless
Wattage: 60 A



TOB4004AN-WG
Alden Ceiling Light
in Antique Nickel
with White Glass
Height: 7½"
Width: 8½"



TOB4004PN-WG



TOB4004AW-WG



Available Finishes:
AN, AW, BZ, HAB, PN

Socket: Porcelain
Wattage: 75 A

TOB4006HAB-WG
Clark Ceiling Light
in Hand-Rubbed
Antique Brass with
White Glass Shade
Height: 12¾"
Width: 7½"



TOB4006BZ-WG



TOB4006PN-WG



Available Finishes:
AN, AW, BZ, HAB, PN

Socket: Porcelain
Wattage: 75 A

BB5300HAB-NP
Hobbs Six-Light Chandelier
in Hand-Rubbed Antique Brass
with Natural Paper Shades
Height: 19¾"
Width: 21½"
Canopy: 5¾" Round

Available Finishes: AN, BZ,
HAB, PN
Shade Treatment: NP
Shade Details: 4" x 5" x 5"

Socket: 6-Candelabra
Wattage: 6-60 C



SC5003BZ
Venetian Sixteen-Light
Chandelier
in Bronze

Height: 33½"

Width: 38"

Canopy: 14½" Star

Available Finishes:

AS, BZ, HAB

Socket: 16 - Candelabra

Wattage: 16 - 60 C



SC5002HAB
Venetian Nine-Light
Two-Tier Chandelier in
Hand-Rubbed Antique
Brass

Height: 23"

Width: 28"

Canopy: 14½" Star

Available Finishes:

AS, BZ, HAB

Socket: 9-Candelabra

Wattage: 9-60 C



SC4000BZ
Star Flush Mount in Bronze
Height: 4"
Width: 14½"
FerroWatt Bulb Shown

Available Finishes:
AS, BZ, HAB

Socket: Keyless
Wattage: 60 A



SC5001AS
Venetian Six-Light Chandelier in Antique Silver
Height: 23"
Width: 28"
Canopy: 14½" Star

Available Finishes:
AS, BZ, HAB

Socket: 6-Candelabra
Wattage: 6-60 C



SC5005HAB
Double Twist Five-Light Chandelier in Hand-Rubbed Antique Brass
Height: 29¾"
Width: 36"
Canopy: 5¾" Round

Available Finishes:
AS, BZ, HAB, PN

Socket: 5 - Candelabra
Wattage: 5 - 60 C



SC5155BR
Twisted Sunburst Chandelier
in Black Rust
Height: 46"
Width: 38"
Canopy: 7¼" Round

Socket: 8-Candelabra
Wattage: 8-60 C



SC5008BR
Hudson Six-Arm Chandelier
in Black Rust
Height: 20"
Width: 24½"
Canopy: 6" Round

Socket: 6-Candelabra
Wattage: 6-60 C



SC5007BR
Hudson Two-Tier Twelve-Light Chandelier
in Black Rust
Height: 29½"
Width: 35"
Canopy: 5¾" Round

Socket: 12-Candelabra
Wattage: 12-60 C



SC5102HAB
Armillary Sphere
Chandelier in Hand-
Rubbed Antique Brass
Height: 24¾"
Width: 35"
Canopy: 5½" Round

Available Finishes:
BZ, HAB, PN

Socket: 6-Candelabra
Wattage: 6-60 C



SC5120PN
Sasson Hanging Light
in Polished Nickel with
Silk Shade
Height: 28¾"
Width: 10¼"
Canopy: 4½" Square

Available Finishes: BZ, PN
Shade Treatments: S
Shade Details:
2¼" x 4" x 3⅞" Hardback

Socket: Candelabra
Wattage: 40 C



SC5004BZ
Tyler Three-Light
Chandelier in Bronze
Height: 30"
Width: 8"
Canopy: 5" Round
Custom Height Available

Available Finishes:
AS, BZ, HAB, PN
Shade Treatments:
CHS-104S
Shade Sold Separately
Shade Details:
3" x 4" x 4"

Socket: 3-Candelabra
Wattage: 3-60 C



SC5150PN
Square Link Chandelier in
Polished Nickel
Height: 19"
Width: 27 1/2"
Canopy: 8 3/4" Hexagonal

Available Finishes:
AS, BZ, HAB, PN

Socket: 6-Candelabra
Wattage: 6-60 C



SC5100BZ
Socrates Pendant in Bronze
Height: 29"
Width: 16"
Canopy: 12" Round
Custom Height Available

Socket: 2-Keyless
Wattage: 2-75 A





WALL

Chart House	230
Studio	252
Thomas O'Brien	274
Bill Blass	285
Eric Cohler	289
Clodagh	294





CHD1167AM/AB
Large Kensington Single Sconce
in Antique Mirror and
Antique-Burnished Brass

Height: 23¼"
Width: 9"
Extension: 8⅝"
Backplate: 9" x 23¼"

Available Finishes:
AB, AM/AB, AM/SN

Socket: Candelabra
Wattage: 60 C
©EFC DESIGNS



CHD1167AB

CHD1173AM/AB
Large Kensington Double Sconce
in Antique Mirror and
Antique-Burnished Brass

Height: 23¼"
Width: 9"
Extension: 5"
Backplate: 9" x 23¼"

Available Finishes:
AB, AM/AB, AM/SN
Shade Treatment: CHS-104S
Shade Sold Separately
Shade Details: 3" x 4" x 4"

Socket: 2 – Candelabra
Wattage: 2 – 60 C
©EFC DESIGNS



CHD1171AM/AB
Small Kensington Single Sconce
in Antique Mirror and
Antique-Burnished Brass

Height: 12"
Width: 4¾"
Extension: 8⅝"
Backplate: 4¾" x 12"

Available Finishes:
AB, AM/AB, AM/SN

Socket: Candelabra
Wattage: 60 C
©EFC DESIGNS



CHD1172AM/AB
Medium Kensington Single Sconce
in Antique Mirror and
Antique-Burnished Brass

Height: 16"
Width: 6¼"
Extension: 8⅝"
Backplate: 6¼" x 16"

Available Finishes:
AB, AM/AB, AM/SN

Socket: Candelabra
Wattage: 60 C
©EFC DESIGNS



CHD1175AB

Library Wall Sconce in Antique-Burnished Brass

Height: 13¾"
Width: 7"
Extension: 6½"
Backplate: 3" x 5"

Available Finishes:
AB, AN, BZ, PN, PS

Shade Treatment: CHS104NP
Shade Sold Separately
Shade Details: 3" x 4" x 4"

Socket: Candelabra
Wattage: 60 C
©EFC DESIGNS



CHD1175PS



CHD1165AB

Cut Corner Sconce in Antique-Burnished Brass

Height: 9"
Width: 3½"
Extension: 6¼"
Backplate: 3½" x 6¼"

Available Finishes: AB, PN
Shade Treatment: CHS-111S
Shade Sold Separately
Shade Details: 4" x 5½"

Socket: Candelabra
Wattage: 60 C
©EFC DESIGNS



CHD1166PN

Double Cut Corner Sconce in Polished Nickel

Height: 9"
Width: 9"
Extension: 5½"
Backplate: 3½" x 6¼"

Available Finishes: AB, PN
Shade Treatment: CHS-111S
Shade Sold Separately
Shade Details: 4" x 5½"

Socket: 2-Candelabra
Wattage: 2-60 C
©EFC DESIGNS



CHD1140AB-B

18th Century English Swing Arm Sconce in Antique-Burnished Brass

Height: 17"
Extension: 15"
Backplate: 4" x 6¼" Oval

Available Finishes: AB, AN
Shade Treatment: B
Shade Details: 4½" x 8" x 5"

Socket: Candelabra

Wattage: 60 C

©EFC DESIGNS



CHD1150AB-B

18th Century English Swing arm Wall Lamp in Antique-Burnished Brass with Black Shade

Height: 20"
Extension: 17"
Backplate: 4" x 6¼" Oval
Cord Cover Included

Available Finishes: AB, AN
Shade Treatment: B, S
Shade Details: 5" x 10" x 8"

Socket: Hi-Lo

Wattage: 100 A

©EFC DESIGNS



CHD1120AN

English One-Light Sconce in Antique Nickel

Height: 13¼"
Width: 4½"
Extension: 9"
Backplate: 4½" Round

Available Finishes: AB, AN, BZ
Shade Treatment: CHS-104B
Shade Sold Separately
Shade Details: 3" x 4" x 4"

Socket: Candelabra

Wattage: 60 C

©EFC DESIGNS



CHD1122BZ

English Two-Light Sconce in Bronze

Height: 13¼"
Width: 10"
Extension: 7"
Backplate: 4½" Round

Available Finishes: AB, AN, BZ
Shade Treatment: CHS-104NP Shade
Sold Separately
Shade Details: 3" x 4" x 4"

Socket: 2-Candelabra

Wattage: 2-60 C

©EFC DESIGNS



CHD1138AB

**Grosvenor House Double Arm Sconce
in Antique-Burnished Brass**

Height: 10½"
Width: 4½"
Extension: 8"
Backplate: 4½" x 6¼" Oval

Available Finishes:

AB, AN, BZ, PS, SN

Shade Treatment:

CHS-109S or CHS-101B

Shade Sold Separately

Shade Details:

2½" x 5" x 4½" (CHS-109) or

3" x 6" x 4" (CHS-101)

Socket: Candelabra

Wattage: 60 C

©EFC DESIGNS



CHD1138AN



CHD1139AB

**Grosvenor House Double Arm Sconce
in Antique-Burnished Brass**

Height: 10½"
Width: 10½"
Extension: 8"
Backplate: 4½" x 6¼" Oval

Available Finishes:

AB, AN, BZ, PS, SN

Shade Treatment:

CHS-109S or CHS-104B

Shade Sold Separately

Shade Details:

2½" x 5" x 4½" (CHS-109) or

3" x 4" x 4" (CHS-104)

Socket: 2-Candelabra

Wattage: 2-60 C

©EFC DESIGNS



CHD1139SN



CHD1115AB
18th Century One-Light Sconce in
Antique-Burnished Brass
Height: 20"
Width: 6"
Backplate: 6" Round

Available Finishes: AB, AN, BZ, PS
Shade Treatment: CHS-101B
Shade Sold Separately
Shade Details: 3" x 6" x 4"

Socket: Candelabra
Wattage: 60 C
©EFC DESIGNS



CHD1116AN
18th Century Two-Light Sconce
in Antique Nickel
Height: 20"
Width: 10½"
Backplate: 6" Round

Available Finishes:
AB, AN, BZ, PS
Shade Treatment:
CHS-101B
Shade Sold Separately
Shade Details: 3" x 6" x 4"

Socket: 2-Candelabra
Wattage: 2-60 C
©EFC DESIGNS



CHD1117AB
18th Century Three-Light Sconce in
Antique-Burnished Brass
Height: 20"
Width: 13½"
Extension: 9½"
Backplate: 6" Round

Available Finishes: AB, AN, BZ, PS

Socket: 3-Candelabra
Wattage: 3-60 C
©EFC DESIGNS



CHD1409AB-SG
Petite Paris Flea Market
Sconce in Antique-Burnished
Brass with Antique Mirror and
Seeded Glass

Height: 12"
Width: 7"
Extension: 6½"
Backplate: 7" x 12"

Socket: 3-Candelabra
Wattage: 3-60 C
©EFC DESIGNS



CHD1408AB-SG
Paris Flea Market Sconce
in Antique-Burnished Brass
with Antique Mirror and
Seeded Glass

Height: 16½"
Width: 12½"
Extension: 8¼"
Backplate: 10" x 16½"

Socket: 3-Candelabra
Wattage: 3-60 C
©EFC DESIGNS



CHD1470AWG
Crystal Petal Three-Light
Sconce in Antique White Gold

Height: 26½"
Width: 23"
Extension: 14½"
Backplate: 4¾" Round

Available Finishes: AWG, R, RG

Socket: 3-Candelabra
Wattage: 3-60 C
©EFC DESIGNS



CHD1168AN
Normandy Two-Light Sconce
in Antique Nickel

Height: 12½"
Width: 7¾"
Extension: 5½"
Backplate: 4¾" x 5"

Available Finishes:

AB, AN, BZ, PN

Shade Treatment: CHS-104NP

Shade Sold Separately

Shade Details: 3" x 4" x 4"

Socket: 2 – Candelabra

Wattage: 2 – 60 C

©EFC DESIGNS



CHD1169BZ
Normandy Three-Light Sconce
in Bronze

Height: 20"
Width: 7¾"
Extension: 5½"
Backplate: 4¾" x 5"

Available Finishes:

AB, AN, BZ, PN

Shade Treatment: CHS-104NP

Shade Sold Separately

Shade Details: 3" x 4" x 4"

Socket: 3 – Candelabra

Wattage: 3 – 60 C

©EFC DESIGNS



CHD4132AB
Edwardian Wall Wash in
Antique-Burnished Brass

Height: 13½"
Width: 9½"
Extension: 6¼"
Backplate: 9¼" x 9¼"

Available Finishes: AB, AN

Shade Treatment: WG

Socket: Keyless

Wattage: 60 A

©EFC DESIGNS



CHD4133AB-B
Edwardian Wall Wash in
Antique-Burnished Brass

Height: 13½"
Width: 9½"
Extension: 6"
Backplate: 4" Round

Shade Treatment: B

Socket: Keyless

Wattage: 60 A

©EFC DESIGNS



CHD1112AB
Dorchester Swing Arm Sconce
in Antique-Burnished Brass

Height: 10½"
Extension: 7"
Backplate: 2" x 4¼"

Available Finishes: AB, AN
Shade Treatment: CHS-109
Shade Sold Separately
Shade Details: 2½" x 5" x 4½"

Socket: Candelabra
Wattage: 60 C
©EFC DESIGNS



CHD5101AB-B
Dorchester Swing-Arm Wall
Lamp in Antique-Burnished
Brass with Black Shade

Height: 15"
Extension: 22"
Backplate: 2¼" x 4½"
Cord Cover Included

Available Finishes:
AB, AN, PS
Shade Treatments: B, S
Shade Details:
5" x 10" x 8"

Socket: Hi-Lo
Wattage: 100 A
©EFC DESIGNS



CHD5102AB-NP
Dorchester Double Backplate
Swing-Arm Wall Lamp in
Antique-Burnished Brass with
Natural Paper Shade

Height: 24"
Extension: 24"
Backplates: 2½" x 4"
Cord Cover Included

Available Finishes: AB, AN
Shade Treatment: B, NP
Shade Details: 6" x 10" x 7"

Socket: Hi-Lo
Wattage: 100 A
©EFC DESIGNS



CHD1502AB-SC
Essex Pivoting Swing-Arm Wall
Lamp in Antique-Burnished Brass
with Silk Collar Shade

Height: 14"
Extension: 21"
Backplate: 4½" Square
Cord Cover Included

Available Finishes: AB, AN, PN
Shade Treatment: SC
Shade Details: 6" x 10" x 8"

Socket: Hi-Lo
Wattage: 100 A
©EFC DESIGNS



CHD1161PN

Horn Sconce in Polished Nickel

Height: 12½"

Width: 2½"

Extension: 5¾"

Backplate: 2½" x 6½"

Available Finishes: AB, PN

Shade Treatment: CHS-111S

Shade Sold Separately

Shade Details: 4" x 5½"

Socket: Candelabra

Wattage: 60 C

©EFC DESIGNS

CHD1161AB



CHD1162AB

Double Horn Sconce in

Antique-Burnished Brass

Height: 12½"

Width: 8"

Extension: 5¾"

Backplate: 2½" x 6½"

Available Finishes: AB, PN

Shade Treatment: CHS-111S

Shade Sold Separately

Shade Details: 4" x 5½"

Socket: 2-Candelabra

Wattage: 2-60 C

©EFC DESIGNS



CHD1176AB

Horn Sconce with Oval Backplate in

Antique-Burnished Brass

Height: 17½"

Width: 4½"

Extension: 8"

Backplate: 4½" x 6½" Oval

Available Finishes:

AB, AN, BZ, PS

Shade Treatment: CHS-112S

Shade Sold Separately

Shade Details: 4" x 5" x 5"

Socket: Candelabra

Wattage: 60 C

©EFC DESIGNS



CHD1170AB

Sussex Sconce with Cove

Corner Backplate in

Antique-Burnished Brass

Height: 11½"

Width: 4½"

Extension: 10¼"

Backplate: 4½" x 6¾"

Available Finishes:

AB, AN, BZ, PS

Shade Treatment: CHS-112S

Shade Sold Separately

Shade Details: 4" x 5" x 5"

Socket: Candelabra

Wattage: 60 C

©EFC DESIGNS



CHD1500AB
Essex Library Sconce in
Antique-Burnished Brass

Height: 14"
Width: 5"
Extension: 4½"
Backplate: 4½" Square

Available Finishes: AB, AN, PN
Shade Treatment: CHS-104S
Shade Sold Separately
Shade Details: 3" x 4" x 4"

Socket: Candelabra
Wattage: 60 C
©EFC DESIGNS



CHD1501AB
Essex Pivoting Wall Sconce in
Antique-Burnished Brass

Height: 10½"
Width: 5"
Extension: 11½"
Backplate: 4½" Square

Available Finishes: AB, AN, PN
Shade Treatment: CHS-112S
Shade Sold Separately
Shade Details: 4" x 5" x 5"

Socket: Candelabra
Wattage: 60 C
©EFC DESIGNS



CHD1163ABV
Scallop Sconce in
Antique-Burnished Brass Verdigris

Height: 12"
Width: 6"
Extension: 7"
Backplate: 6" Round

Available Finishes: ABV, PN
Shade Treatment: CHS-112S
Shade Sold Separately
Shade Details: 4" x 5" x 5"

Socket: Candelabra
Wattage: 60 C
©EFC DESIGNS



CHD1164ABV
Double Scallop Sconce in
Antique-Burnished Brass Verdigris

Height: 13"
Width: 8"
Extension: 6½"
Backplate: 6" Round

Available Finishes: ABV, PN
Shade Treatment: CHS-104S
Shade Sold Separately
Shade Details: 3" x 4" x 4"

Socket: 2-Candelabra
Wattage: 2-60 C
©EFC DESIGNS



CHD147AB
Shield Sconce in
Antique-Burnished Brass

Height: 13"
Width: 4½"
Extension: 7"
Backplate: 4½"

Available Finishes: AB, AN, SN
Shade Treatment: CHS-104B
Shade Sold Separately
Shade Details: 3" x 4" x 4"

Socket: Candelabra
Wattage: 60 C
©EFC DESIGNS



CHD148AN
Ribbon Sconce in
Antique Nickel

Height: 19"
Width: 9½"
Extension: 3¾"
Backplate: 4½" Round

Available Finishes:
AB, AN, SN
Shade Treatment:
CHS-104B
Shade Sold Separately
Shade Details: 3" x 4" x 4"

Socket: 2 – Candelabra
Wattage: 2 – 60 C
©EFC DESIGNS



CHD1137AB-B
Lion Passant Wall Lamp in
Antique-Burnished Brass
with Black Shades

Height: 23"
Width: 14½"
Extension: 10½"
Backplate: 4" x 6½"
Cord Cover Included

Shade Treatment: B, S
Shade Details: 3" x 6" x 4"

Socket: 2 – Candelabra
Wattage: 2 – 60 C
©EFC DESIGNS



CHD1448AB
Arrow Wall Sconce
Antique-Burnished Brass

Height: 12"
Width: 12"
Extension: 6¼"
Backplate: 4½" Round

Available Finishes:
AB, AB/AN, BZ,
BZ/AB, PS
Shade Treatment:
CHS-104NP
Shade Sold Separately
Shade Details:
3" x 4" x 4"

Socket: 2 – Candelabra
Wattage: 2 – 60 C
©EFC DESIGNS



CHD113ABV
Plume Motif Wall Sconce in
Antique-Burnished Brass Verdigris

Height: 16½"
Width: 11"
Extension: 6½"
Backplate: 4¾" Round

Shade Treatment:
CHS-108
Shade Sold Separately
Shade Details: 3" x 5" x 4"

Socket: 2 – Candelabra
Wattage: 2 – 60 C
©EFC DESIGNS



CHD146ABV
French Pierced Back Country Sconce in
Antique-Burnished Brass Verdigris

Height: 15½"
Width: 13"
Extension: 9½"
Backplate: 5"

Shade Treatment:
CHS-109
Shade Sold Separately
Shade Details:
2½" x 5" x 4½"

Socket: 2 – Candelabra
Wattage: 2 – 60 C
©EFC DESIGNS



CHD1110R
Petite Fleur-de-Lis Two-Light
Sconce in Rust

Height: 15½"
Width: 8"
Extension: 5"
Backplate: 5"

Shade Treatment:
CHS-104B
Shade Sold Separately
Shade Details: 3" x 4" x 4"

Socket: 2 – Candelabra
Wattage: 2 – 60 C
©EFC DESIGNS



CHD1109R
Fleur-de-Lis Two-Light
Sconce in Rust

Height: 17"
Width: 13"
Extension: 6"
Backplate: 5"

Shade Treatment:
CHS-104B
Shade Sold Separately
Shade Details: 3" x 4" x 4"

Socket: 2 – Candelabra
Wattage: 2 – 60 C
©EFC DESIGNS



CHD1406BR

Two-Light Iron Shield in Black Rust

Height: 15"
Width: 15"
Extension: 6"
Backplate: 5" x 7½"

Available Finishes:

BR, BRG

Shade Treatment:

CHS-104NP

Shade Sold Separately

Shade Details: 3" x 4" x 4"

Socket: 2 – Candelabra

Wattage: 2 – 60 C

©EFC DESIGNS



CHD1402BR

Two-Light Fleur-de-Lis Hand Forged Iron Sconce in Black Rust

Height: 12"
Width: 11½"
Extension: 6"
Backplate: 4½" Round

Shade Treatment:

CHS-104B

Shade Sold Separately

Shade Details:

3" x 4" x 4"

Socket: 2 – Candelabra

Wattage: 2 – 60 C

©EFC DESIGNS



CHD1401BR

One-Light Hand Forged Sconce in Black Rust

Height: 8¾"
Width: 4½"
Extension: 5½"
Backplate: 4½" Round

Shade Treatment:

CHS-104NP

Shade Sold Separately

Shade Details: 3" x 4" x 4"

Socket: 2 – Candelabra

Wattage: 2 – 60 C

©EFC DESIGNS



CHD1403BR

Two-Light Hand Forged Iron Sconce in Black Rust

Height: 11½"
Width: 11"
Extension: 6"
Backplate: 4½" Round

Shade Treatment:

CHS-104NP

Shade Sold Separately

Shade Details:

3" x 4" x 4"

Socket: 2 – Candelabra

Wattage: 2 – 60 C

©EFC DESIGNS



CHD1404BR-NP
Iron Torch Sconce in Black Rust
with Natural Paper Shade

Height: 18"
Width: 8"
Extension: 9"
Backplate: 5½" Round

Shade Treatment: NP
Shade Details: 5" x 8" x 6"

Socket: Keyless
Wattage: 75 A
©EFC DESIGNS



CHD1437BR
Two-Light J-Arm Wall Sconce in
Black Rust with Wrapped Leather Accents

Height: 16"
Width: 15"
Extension: 8"
Backplate: 4½" Round

Shade Treatment:
CHS-104NP
Shade Sold Separately
Shade Details:
3" x 4" x 4"

Socket: 2 – Candelabra
Wattage: 2 – 60 C
©EFC DESIGNS



CHD1405BR
Iron Plume Two-Light Sconce
in Black Rust

Height: 18½"
Width: 15¼"
Extension: 7¼"
Backplate: 4½" Round

Shade Treatment:
CHS-104NP
Shade Sold Separately
Shade Details: 3" x 4" x 4"

Socket: 2 – Candelabra
Wattage: 2 – 60 C
©EFC DESIGNS



CHD1455BR-L
Gate Fragment Adjustable Wall Mount
Fixture in Black Rust with Linen Shade

Height: 21½"-26"
Width: 15"
Extension: 7¾"
Backplate: 2¾" x 4¼"

Shade Treatment: L
Shade Details:
6½"/13" x 7 ½"/15" x 9"
Half Shade

Socket: Hi-Lo
Wattage: 60 A
©EFC DESIGNS



CHD1158R

Single Light Perching Bird Sconce in Rust with Light Verdis Accents

Height: 14"
Width: 5"
Extension: 7"
Backplate: 7½" Oval

Shade Treatment: CHS-104B

Shade Sold Separately

Shade Details: 3" x 4" x 4"

Socket: Candelabra

Wattage: 60 C

©EFC DESIGNS



CHD1103ABV

Graceful Loop Candle Sconce in Antique Brass Verdigris

Height: 19½"
Width: 5½"
Extension: 9½"
Backplate: 4¾" Round

Shade Details: 5" x 3" x 9"

Socket: Candelabra

Wattage: 60 C

©EFC DESIGNS



CHD1106AB-B

Regency Hand Motif Sconce in Antique-Burnished Brass (Hand Faces Right)

Height: 12½"
Width: 6¾"
Extension: 12"
Backplate: 6" Round

Shade Treatment: B

Shade Details: 4" x 8" x 5"

Socket: Keyless

Wattage: 60 A

©EFC DESIGNS



CHD1107AB-B

Regency Hand Motif Sconce in Antique-Burnished Brass (Hand Faces Left)

Height: 12½"
Width: 6¾"
Extension: 12"
Backplate: 6" Round

Shade Treatment: B

Shade Details: 4" x 8" x 5"

Socket: Keyless

Wattage: 60 A

©EFC DESIGNS



CHD1450WI-NP
Windsor Iron Twist Sconce
in Weathered Iron and
Heavily Distressed Brass
with Natural Paper Shade

Height: 24"
Width: 10"
Extension: 10"
Backplate: 4½" Round

Shade Treatment: NP
Shade Details: 7" x 10" x 7½"

Socket: Keyless
Wattage: 100 A
©EFC DESIGNS



CHD1435BR
Four-Light Twisted Iron
Sconce in Black Rust
Height: 23"
Width: 15"
Extension: 10½"
Backplate: 4½" Round

Shade Treatment:
CHS-104NP
Shade Sold Separately
Shade Details:
3" x 4" x 4"

Socket: 4-Candelabra
Wattage: 4-60 C
©EFC DESIGNS



CHD1460WI
Small Castle Torch Sconce
in Weathered Iron and Heavily
Distressed Brass with Frosted Glass

Height: 14"
Width: 5½"
Extension: 6½"
Backplate: 4¾" x 6¼"

Shade Treatment: FG
Shade Details: 4¾" x 4¾" x 5¾"

Socket: Keyless
Wattage: 100 A
©EFC DESIGNS



CHD1461WI
Large Castle Torch Sconce
in Weathered Iron and Heavily
Distressed Brass with Frosted Glass

Height: 25¼"
Width: 5½"
Extension: 9½"
Backplate: 4¾" x 6¼"

Shade Treatment: FG
Shade Details: 4¾" x 4¾" x 5¾"

Socket: Keyless
Wattage: 100 A
©EFC DESIGNS



CHD2154PN-LCC

**Pimlico Swing-Arm Wall Lamp
in Polished Nickel with Linen
Collar Shade**

Height: 17"
Width: 11"
Extension: 27"
Backplate: 3" x 6½"
Cord Cover Included

Available Finishes: AB, AN, PN
Shade Treatment: LCC
Shade Details: 7" x 12" x 9"
Nordy Fitter

Socket: Hi-Lo
Wattage: 100 A
©EFC DESIGNS



CHD2151PN-SC

**Pimlico Swing-Arm Wall Lamp
in Polished Nickel with Silk
Collar Shade**

Height: 20"
Extension: 19"
Backplate: 3" x 6½"
Cord Cover Included

Available Finishes: AB, AN, PN
Shade Treatment:
AB, AN, PN, SC, WG
Shade Details: 6" x 10" x 8"

Socket: Hi-Lo
Wattage: 60 A
©EFC DESIGNS



CHD2150AB-AB

**Pimlico Double Swing-Arm
Wall Lamp in Antique-
Burnished Brass with Antique
Brass Shade**

Height: 16"
Extension: 24"
Backplate: 3" x 6½"
Cord Cover Included

Available Finishes:
AB, AN, PN
Shade Treatment:
AB, AN, PN, SCF, WG
Shade Details: 6" x 6½"

Socket: Hi-Lo
Wattage: 60 A
©EFC DESIGNS



CHD2153PN-WG

**Pimlico Adjustable Single Light
Sconce in Polished Nickel with
White Glass Shade**

Height: 11"
Width: 6"
Extension: 12¾"
Backplate: 3" x 6½"
Cord Cover Included

Available Finishes: AB, AN, PN
Shade Treatment: WG
Shade Details: 2¼" x 6" x 6½"

Socket: Hi-Lo
Wattage: 60 A
©EFC DESIGNS



CHD5106BZ-NP
Chunky Swing-Arm Wall Lamp in
Bronze with Natural Paper Shade

Height: 18 1/4"
Width: 12"
Extension: 25 1/2"
Backplate: 4" x 5"
Cord Cover Included

Available Finishes:
AB, AN, BZ, PN
Shade Treatments:
L, NP
Shade Details:
10" x 12" x 7 1/2"

Socket: Dimmer
Wattage: 100 A
©EFC DESIGNS



CHD5105AN-B
Sloane Swing-Arm Club Wall Lamp in
Antique Nickel with Black Shade

Height: 16"
Extension: 18"
Backplate: 4 1/2" Square
Cord Cover Included

Available Finishes: AB, AN
Shade Treatments: B, L, NP
Shade Details: 8" x 12" x 7"

Socket: Dimmer
Wattage: 100 A



CHD2155PN
Pimlico One-Light Sconce in
Polished Nickel

Height: 9 1/2"
Width: 3 1/4"
Extension: 7 1/2"
Backplate: 3" x 6 1/2"

Available Finishes:
AB, AN, BZ, PN
Shade Treatment: CHS-112S
Shade Sold Separately
Shade Details: 4" x 5" x 5"

Socket: Candelabra
Wattage: 60 C
©EFC DESIGNS



CHD2156AB
Pimlico Two-Light Sconce in
Antique-Burnished Brass

Height: 9 1/2"
Width: 9"
Extension: 8 1/2"
Backplate: 3" x 6 1/2"

Available Finishes:
AB, AN, BZ, PN
Shade Treatment: CHS-104S
Shade Sold Separately
Shade Details: 3" x 4" x 4"

Socket: 2- Candelabra
Wattage: 2-60 C
©EFC DESIGNS



CHD5117AB
8" Dorchester Picture Light in
Antique-Burnished Brass

Height: 4½"
Width: 8"
Extension: 10½"
Backplate: 2½" x 4½"

Available Finishes:

AB, AN, BZ, PN

Shade Details: 8" x 3½" x 2"

Socket: Keyless/Line Switch

Wattage: 60 T

©EFC DESIGNS



CHD5107BZ
Dorchester Loop Arm
Picture Light in Bronze

Height: 7½"
Width: 8¾"
Extension: 11½"
Backplate: 2¾" x 4½"

Available Finishes:

AB, AN, BZ, PN

Shade Details: 8¾" x 3½" x 2"

Socket: Keyless/Line Switch

Wattage: 60 T

©EFC DESIGNS



CHD5137AN
18" Dorchester Picture Light in
Antique Nickel

Height: 4½"
Width: 18"
Extension: 9½"
Backplate: 4½" x 14"

Available Finishes:

AB, AN, BZ, PN

Shade Details: 18" x 3½" x 2"

Socket: 2-Keyless/Line Switch

Wattage: 2-60 T

©EFC DESIGNS

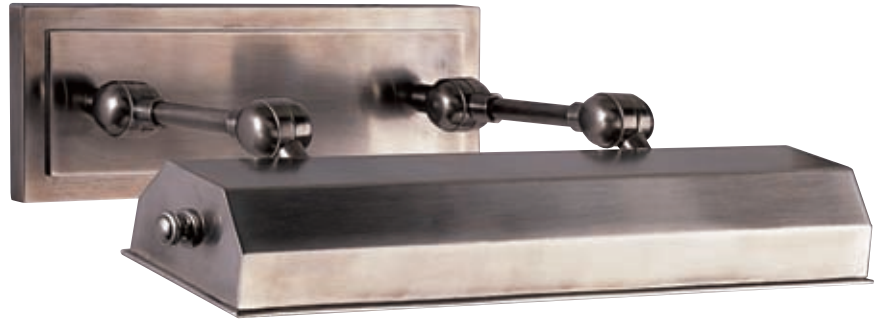

CHD5147AB
24" Dorchester Picture Light in
Antique-Burnished Brass

Height: 4½"
Width: 24"
Extension: 9½"
Backplate: 4½" x 18½"

Available Finishes:

AB, AN, BZ, PN

Shade Details: 24" x 3½" x 2"

Socket: 2-Keyless/Line Switch

Wattage: 2-60 T

©EFC DESIGNS

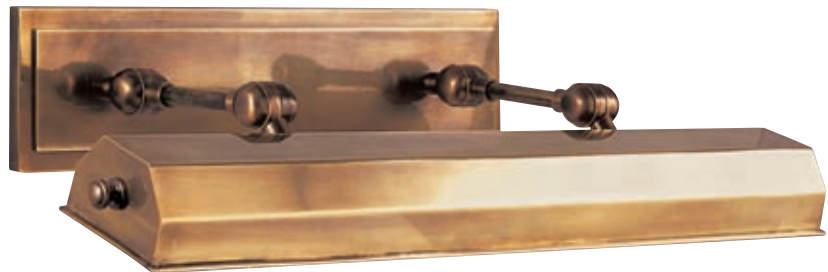

CHD1550PN-FG
Oxford Short Linear Wall
Sconce in Polished Nickel
with Frosted Glass

Height: 8½"
Width: 3"
Extension: 4"
Backplate: 3" x 8½"

Available Finishes:
AB, AN, BZ, CH, PN

Socket: Keyless
Wattage: 60 T
©EFC DESIGNS



CHD1551CH-FG
Oxford Medium Linear Wall
Light in Chrome
with Frosted Glass

Height: 12"
Width: 3¾"
Extension: 4"
Backplate: 3¾" x 12"

Available Finishes:
AB, AN, BZ, CH, PN

Socket: Keyless
Wattage: 60 T



CHD1552AB-FG
Oxford Tall Linear Wall Light
in Antique-Burnished Brass
with Frosted Glass

Height: 18"
Width: 4¼"
Extension: 4"
Backplate: 4¼" x 18"

Available Finishes:
AB, AN, BZ, CH, PN

Socket: 2-Keyless
Wattage: 2-60 T



CHD1541PN-FG

**Normandie Faceted One-Light
Sconce in Polished Nickel with
Frosted Glass Shade**

Height: 10½"
Width: 5"
Extension: 9"
Backplate: 4½" x 5½"

Available Finishes: AB, AN, PN
Shade Treatment: FG
Shade Details: 2¾" x 5½" x 4¾"

Socket: Hi-Lo
Wattage: 60 A
©EFC DESIGNS



CHD1541AB-FG



CHD1542AN-FG

**Normandie Faceted Two-Light
Sconce in Antique Nickel with
Frosted Glass Shades**

Height: 10½"
Width: 14"
Extension: 9"
Backplate: 4½" x 5½"

Available Finishes: AB, AN, PN
Shade Treatment: FG
Shade Details: 2¾" x 5½" x 4¾"

Socket: 2-Hi-Lo
Wattage: 2-60 A
©EFC DESIGNS



CHD1543AB-FG

**Normandie Faceted Three-Light
Sconce in Antique-Burnished
Brass with Frosted Glass Shades**

Height: 10½"
Width: 23"
Extension: 9"
Backplate: 4½" x 5½"

Available Finishes: AB, AN, PN
Shade Treatment: FG
Shade Details: 2¾" x 5½" x 4¾"

Socket: 3-Hi-Lo
Wattage: 3-60 A
©EFC DESIGNS



CHD1510PN-WG
Belgrania Bath Light in Polished Nickel with White Glass Shade

Height: 9½"
Width: 5¼"
Extension: 7"
Backplate: 5" Square

Available Finishes:
AB, AN, BZ, CH, PN
Shade Treatment: WG
Shade Details: 3" x 5¼" x 5½"

Socket: Keyless
Wattage: 60 A
©EFC DESIGNS



CHD1510AB-WG



CHD1521AB-FG
Essex Single Wall Fixture in Antique-Burnished Brass with Frosted Glass Shade

Height: 10½"
Width: 6"
Extension: 7½"
Backplate: 4½" Square

Available Finishes:
AB, AN, PN
Shade Treatment: FG

Socket: Hi-Lo
Wattage: 60 A
©EFC DESIGNS



CHD1522PN-FG
Essex Double Wall Fixture in Polished Nickel with Frosted Glass Shades

Height: 10½"
Width: 14"
Extension: 7½"
Backplate: 4½" Square

Available Finishes:
AB, AN, PN
Shade Treatment: FG

Socket: 2- Hi-Lo
Wattage: 2-60 A
©EFC DESIGNS



CHD1531AB-FG
Essex Single Formal Sconce in Polished Nickel with Frosted Glass Shade

Height: 10"
Width: 6"
Extension: 9½"
Backplate: 4½" Square

Available Finishes:
AB, AN, PN
Shade Treatment: FG
Shade Details:
3½" x 6" x 6"

Socket: Keyless
Wattage: 60 A
©EFC DESIGNS



CHD1532AN-FG
Essex Double Formal Sconce in Antique Nickel with Frosted Glass Shades

Height: 10"
Width: 15"
Extension: 9½"
Backplate: 4½" Square

Available Finishes:
AB, AN, PN
Shade Treatment: FG
Shade Details:
3½" x 6" x 6"

Socket: 2-Keyless
Wattage: 2-60 A
©EFC DESIGNS



CHD2908PN
Short Linear Lantern
in Polished Nickel

Height: 15"
Width: 9"
Extension: 5"

Available Finishes:
AB, AN, BZ, PN

Socket: 2-Candelabra
Wattage: 2-60 C
©EFC DESIGNS



CHD2910AN
Tall Linear Lantern
in Antique Nickel

Height: 22½"
Width: 9"
Extension: 5"

Available Finishes:
AB, AN, BZ, PN

Socket: 2-Candelabra
Wattage: 2-60 C
©EFC DESIGNS



CHD2103AB
Georgian Hurricane Candle Sconce in
Hand-rubbed Antique Brass
Height: 33½"
Width: 11¼"
Extension: 12¾"
Candle Not Included
Electrification Available

Available Finishes: AB, AN, BZ, PS
©EFC DESIGNS



SL2500HAB/SLT-SC

Boston Hi-Lo Wall Lamp in Hand-Rubbed Antique Brass with SLT Shade

Height: 20½"
Extension: 19"
Backplate: 3" Round
Cord Cover Included

Available Finishes:

AN, BZ, HAB, SN

Shade Treatment:

SLT-SC

See Shade Schedule for Additional Shade Options

Shade Details:

6" x 10" x 8"

Socket: Hi-Lo

Wattage: 60 A

©EFC DESIGNS



SL2921HAB/SLE-HAB

Boston Single-Arm Wall Lamp in Hand-Rubbed Antique Brass with Antique Brass SLE Shade

Height: 9"
Extension: 17"
Backplate: 5" Round
Cord Cover Included

Available Finishes:

AN, BZ, HAB, SN

Shade Treatment: SLE-HAB

See Shade Schedule for Additional Shade Options

Shade Details: 2¼" x 5½" x 4¼"

Socket: Hi-Lo

Wattage: 60 A

©EFC DESIGNS



SL2922HAB

Boston Functional Library Wall Light in Hand-Rubbed Antique Brass

Height: 25"
Extension: 25"
Backplate: 4¾" Round
Cord Cover Included

Available Finishes: AN, BZ, HAB, PN

Shade Details: 2" x 7" x 5"

Socket: Hi-Lo

Wattage: 60 A

©EFC DESIGNS



SL2923BZ

Boston Functional Library Two-Arm Wall Light in Bronze

Height: 35½"
Extension: 35½"
Backplate: 4¾" Round
Cord Cover Included

Available Finishes:

AN, BZ, HAB, PN

Shade Details: 2" x 7" x 5"

Socket: Hi-Lo

Wattage: 60 A

©EFC DESIGNS



SL2920HAB-L
Boston Swing-Arm Wall Lamp
in Hand-Rubbed Antique Brass
with Linen Shade

Height: 13"
Extension: 19"
Backplate: 5" Round
Cord Cover Included

Available Finishes:
AN, BZ, HAB, SN
Shade Treatment: L
See Shade Schedule for
Additional Shade Options
Shade Details:
8" x 12" x 7"

Socket: Hi-Lo
Wattage: 60 A
©EFC DESIGNS



SL2920HAB/SLJ-HAB
Boston Swing-Arm Wall Lamp
in Hand-Rubbed Antique Brass
with Antique Brass SLJ Shade

Height: 5"
Extension: 19"
Backplate: 5" Round
Cord Cover Included

Available Finishes:
AN, BZ, HAB, SN
Shade Treatment: SLJ-HAB
See Shade Schedule for
Additional Shade Options
Shade Details: 3 3/4" x 6"

Socket: Hi-Lo
Wattage: 60 A
©EFC DESIGNS



SL2920HAB/SLE-AW
Boston Swing-Arm Wall Lamp
in Hand-Rubbed Antique Brass
with Antique White SLE Shade

Height: 13"
Extension: 13"
Backplate: 5" Round
Cord Cover Included

Available Finishes:
AN, BZ, HAB, SN
Shade Treatment: SLE-AW
See Shade Schedule for
Additional Shade Options
Shade Size: 2 1/4" x 5 3/4" x 4 1/2"

Socket: Hi-Lo
Wattage: 60 A
©EFC DESIGNS



SL2800HAB-S

**Classic Swing-Arm Wall Lamp
in Hand-Rubbed Antique Brass
with Silk Bell Shade**

Height: 17 1/4"
Width: 11"
Extension: 19"
Backplate: 4 1/4" Round
Cord Cover Included

Available Finishes:
AN, BZ, HAB, PN
Shade Treatment: S
Shade Details:
8" x 11" x 8 1/2"

Socket: Dimmer
Wattage: 100 A
©EFC DESIGNS



SL2815BZ

**Classic Round Back Wall Sconce
in Bronze with Natural Paper Shade**

Height: 8"
Width: 4 1/2"
Extension: 7"
Backplate: 4 1/2" Round

Available Finishes:
AN, BZ, HAB, PN
Shade Treatments:
CHS-104NP
Shade Sold Separately
Shade Details:
3" x 4" x 4"

Socket: Candelabra
Wattage: 60 C
©EFC DESIGNS



SL2815PN

SL2813HAB

**One-Light Classic Wall Sconce
in Hand-Rubbed Antique Brass
with Natural Paper Shade**

Height: 8 1/4"
Width: 3 1/2"
Extension: 6"
Backplate: 2 3/4" x 4 1/2"

Available Finishes:
AN, BZ, HAB, PN
Shade Treatments:
CHS-104NP Shade
Sold Separately
Shade Details:
3" x 4" x 4"

Socket: Candelabra
Wattage: 60 C
©EFC DESIGNS



SL2814BZ

**Two-Light Classic Wall Sconce in
Bronze with Natural Paper Shade**

Height: 8 1/4"
Width: 10 1/4"
Extension: 6"
Backplate: 2 3/4" x 4 1/2"

Available Finishes:
AN, BZ, HAB, PN
Shade Treatments:
CHS-104NP Shade
Sold Separately
Shade Details:
3" x 4" x 4"

Socket: 2-Candelabra
Wattage: 2-60 C
©EFC DESIGNS



SL2817PN-NP
Double Classic Wall Light in Polished Nickel with Natural Paper Shade
Height: 17"
Width: 13"
Extension: 8½"
Backplate: 4½" Round
Cord Cover Included

Available Finishes:
AN, BZ, HAB, PN
Shade Treatments: NP
Shade Details:
5½"/11" x 7"/13" x 7½" Oval

Socket: 2-Candelabra/
Hi-Lo Switch
Wattage: 2-60 C
©EFC DESIGNS



SL2816AN
Two Light Classic Round Back Wall Sconce in Antique Nickel
Height: 8"
Width: 11"
Extension: 7"
Backplate: 4½" Round

Available Finishes:
AN, BZ, HAB, PN

Socket: 2-Candelabra
Wattage: 2-60 C
©EFC DESIGNS



S2020BZ-L
French Deco Horn Wall Lamp in Bronze with Linen Shade
Height: 23½"
Width: 5"
Extension: 7"
Backplate: 3" x 7"

Available Finishes:
BZ, HAB, PN
Shade Treatment: L
Shade Details:
5" x 5" x 6"

Socket: Candelabra
Wattage: 60 C



S2020HAB-L



92000DBZ-L
Classic Swing Arm Wall Lamp
in Bronze with Linen Shade

Height: 11"
Extension: 25"
Backplate: 4½" Square
Cord Cover Included

Available Finishes:

AN, BLK, BZ, CH,
HAB, PB, WHT

Shade Treatment: L, PL, NP

Shade Details: 6" x 12" x 7"

Socket: Dimmer

Wattage: 75 A



82034HAB
Swing-Arm Wall Lamp in
Hand-Rubbed Antique Brass

Height: 4½"
Extension: 24"
Backplate: 4½" Square
Cord Cover Included

Available Finishes:

AN, BLK, BZ, CH,
HAB, PB, WHT

Shade Details: 3¼" x 5½" x 2"

Socket: Dimmer

Wattage: 60 T



92025BZ
Swing-Arm Wall Lamp in
Bronze

Height: 4½"
Extension: 25"
Backplate: 4½" Square
Cord Cover Included

Available Finishes:

AN, BLK, BZ, CH,
HAB, PB, WHT

Shade Details: 3½" x 6" x 2"

Socket: Dimmer

Wattage: 60 T



SL2701HAB
Frame Makers 8" Picture Light in
Hand-Rubbed Antique Brass

Height: 1½"
Width: 8"
Extension: 8"
Frame Mounted

Available Finishes:
AN, BZ, HAB, PN

Socket: Keyless/
Hi-Lo Line Switch
Wattage: 25 T



SL3971HAB
Frame Makers Cabinet Light in
Hand-Rubbed Antique Brass

Height: 3½"
Width: 8"
Extension: 9½"
Backplate: 3" Round
Cabinet Mounted

Available Finishes:
AN, BZ, HAB, PN

Socket: Keyless /
Hi-Lo Line Switch
Wattage: 25 T



SL2702AN
Frame Makers 18" Picture Light
in Antique Nickel

Height: 1½"
Width: 18"
Extension: 8"
Frame Mounted

Available Finishes:
AN, BZ, HAB, PN

Socket: 2-Keyless/
Hi-Lo Line Switch
Wattage: 2- 25 T

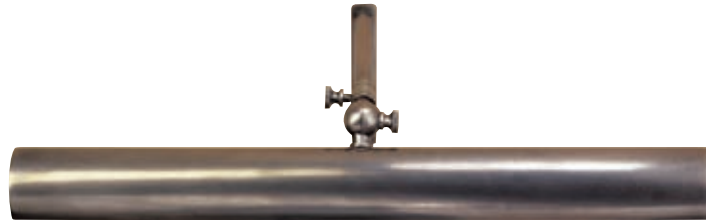

SL2703HAB
Frame Makers 24" Picture Light in
Hand-Rubbed Antique Brass

Height: 1½"
Width: 24"
Extension: 8"
Frame Mounted

Available Finishes:
AN, BZ, HAB, PN

Socket: 2-Keyless/
Hi-Lo Line Switch
Wattage: 2-25 T



SL2975HAB-AN

**Yoke-Style Sconce in
Hand-Rubbed Antiqued Brass
with Antique Nickel Shade**

Height: 10¼"

Width: 5"

Extension: 9½"

Backplate: 4½" Round

Available Finishes:

AN, BZ, CH, HAB, PN, SN

Shade Treatments:

AN, BZ, CH, HAB, PN, WG

Shade Details: 2¼" x 4¾" x 5"

Socket: Keyless

Wattage: 60 A

©EFC DESIGNS



SL2975BZ-HAB



SL2975HAB-WG

**Yoke-Style Sconce in
Hand-Rubbed Antique Brass
with White Glass Shade**

Height: 10¼"

Width: 5"

Extension: 9½"

Backplate: 4½" Round

Available Finishes:

AN, BZ, CH, HAB, PN, SN

Shade Treatments:

AN, BZ, CH, HAB, PN, WG

Shade Details: 2¼" x 4¾" x 5"

Socket: Keyless

Wattage: 60 A

©EFC DESIGNS



SL2975AN-WG



SL2711BZ
Haberdasher One-Light Sconce
in Bronze

Height: 11"
Width: 2¾"
Extension: 6"
Backplate: 2¾" x 4½"

Available Finishes:
AN, BZ, HAB, PN
Shade Treatment: CHS-104L
Shade Sold Separately
Shade Details: 3" x 4" x 4"

Socket: Candelabra
Wattage: 60 C
©EFC DESIGNS



SL2712PN
Haberdasher Two-Light Sconce
in Polished Nickel

Height: 11"
Width: 8"
Extension: 6"
Backplate: 2¾" x 4½"

Available Finishes:
AN, BZ, HAB, PN
Socket: 2-Candelabra
Wattage: 2-60 C
©EFC DESIGNS



SL2811AN
Haberdasher Round One Light Sconce
in Antique-Burnished Nickel

Height: 11"
Width: 5"
Extension: 6"
Backplate: 5" Round

Available Finishes:
AN, BZ, HAB, PN
Shade Treatment: CHS-104L
Shade Sold Separately
Shade Details: 3" x 4" x 4"

Socket: Candelabra
Wattage: 60 C
©EFC DESIGNS



SL2812BZ
Haberdasher Round Two-Light
Sconce in Bronze

Height: 11"
Width: 8"
Extension: 6"
Backplate: 5" Round

Available Finishes:
AN, BZ, HAB, PN
Socket: 2-Candelabra
Wattage: 2-60 C
©EFC DESIGNS



SL2865HAB
RA Single Wall Light Sconce
in Hand-Rubbed Antique Brass

Height: 18"
Width: 4"
Extension: 7"
Backplate: 4" x 6"

Available Finishes:

AN, BZ, HAB, PN

Shade Treatment:

CHS-104NP

Shade Sold Separately

Shade Details: 3" x 4" x 4"

Socket: Candelabra

Wattage: 60 C



SL2866AN
RA Double Wall Light Sconce
in Antique Nickel

Height: 18"
Width: 10"
Extension: 7"
Backplate: 4" x 6"

Available Finishes:

AN, BZ, HAB, PN

Shade Treatment:

CHS-104NP

Shade Sold Separately

Shade Details: 3" x 4" x 4"

Socket: 2 – Candelabra

Wattage: 2 – 60 C



SL2860PN
TT Single Wall Light Sconce in
Polished Nickel

Height: 18"
Width: 4"
Extension: 7"
Backplate: 4" x 6"

Available Finishes:

AN, BZ, HAB, PN

Shade Treatment: CHS-104NP

Shade Sold Separately

Shade Details: 3" x 4" x 4"

Socket: Candelabra

Wattage: 60 C



SL2861BZ
TT Double Wall Light Sconce
in Bronze

Height: 18"
Width: 10"
Extension: 7"
Backplate: 4" x 6"

Available Finishes:

AN, BZ, HAB, PN

Shade Treatment: CHS-104NP

Shade Sold Separately

Shade Details: 3" x 4" x 4"

Socket: 2 – Candelabra

Wattage: 2 – 60 C



SL2845PN-NP
Wilton Single Sconce in Polished Nickel with Natural Paper Shade
 Height: 13¾"
 Width: 5"
 Extension: 8"
 Backplate: 5" Round

Available Finishes:
 AN, BZ, CH, HAB, PN
Shade Treatment: NP
Shade Details:
 4¼" x 4½" x 5½"

Socket: Candelabra
Wattage: 60 C
 ©EFC DESIGNS



SL2845BZ-NP



SL2846HAB-NP
Wilton Double Double Sconce in Hand-Rubbed Antique Brass with Natural Paper Shades
 Height: 13¾"
 Width: 12½"
 Extension: 8"
 Backplate: 5" Round

Available Finishes:
 AN, BZ, CH, HAB, PN
Shade Treatment: NP
Shade Details:
 4¼" x 4½" x 5½"

Socket: 2 - Candelabra
Wattage: 2 - 60 C
 ©EFC DESIGNS



PT2000HAB-S
Architect's Swing Arm in Hand-Rubbed Antique Brass with Silk Shade
 Height: 13"
 Width: 8"
 Extension: 21½"
 Backplate: 3" x 4½"
 Cord Cover Included

Available Finishes:
 BC, BZ, HAB
Shade Treatment: S
Shade Details: 8" x 8" x 8"

Socket: Dimmer
Wattage: 100 A



PT2001BC-S
Architect's Wall Sconce in Brushed Chrome with Silk Shade
 Height: 12"
 Width: 4½"
 Extension: 5½"
 Backplate: 3" x 4½"

Available Finishes:
 BC, BZ, HAB
Shade Treatment: S
Shade Details: 4½" x 4½" x 6¼"

Socket: Nurdy Keyless
Wattage: 60 A



S20BS-NPS

**Architectural Wall Sconce in
Brushed Steel with
Natural Paper Shade**

Height: 13½"
Extension: 7"
Backplate: 4½" Square

Available Finishes: BS, HAB
Shade Treatments: NP, NPS
Shade Details:
4" x 7" x 6½" Square

Socket: Candelabra
Wattage: 60 C



SS2031PN-NP

**Box Sconce in Polished Nickel
with Natural Paper Shade**

Height: 11"
Width: 7½"
Extension: 7¼"
Backplate: 4½" x 11"
Cord Cover Included

Available Finishes:
BZ, HAB, PN
Shade Treatment: NP
Shade Details:
5" x 7½" x 6½"

Socket: Keyless/
Hi-Lo Line Switch
Wattage: 60 A



SL2820BZ-NP

**Two-Light Square Tube Sconce in
Bronze with Natural Paper Shades**

Height: 14"
Width: 15"
Extension: 7¼"
Backplate: 4" x 4½"

Available Finishes:
AN, BZ, HAB, PN
Shade Treatment: NP
Shade Details: 4½" x 6¼" x 6¼"

Socket: 2-Candelabra
Wattage: 2-60 C
©EFC DESIGNS



SS2030BZ-FG

Mission Bracket Sconce in Bronze with Frosted Glass

Height: 14"
Width: 6½"
Extension: 5½"
Backplate: 4¾" x 6¾"

Available Finishes:

BZ, HAB, PN

Shade Details: 4" x 4" x 6½"

Socket: Keyless

Wattage: 60 A



S2030BR-NP

Aspen Iron Wall Lamp in Black Rust with Natural Paper Shade

Height: 15½"
Width: 7½"
Extension: 9½"
Backplate: 4¾" x 12¾"

Shade Treatment: NP

Shade Details: 7½" x 7½" x 6"

Socket: Candelabra

Wattage: 60 C

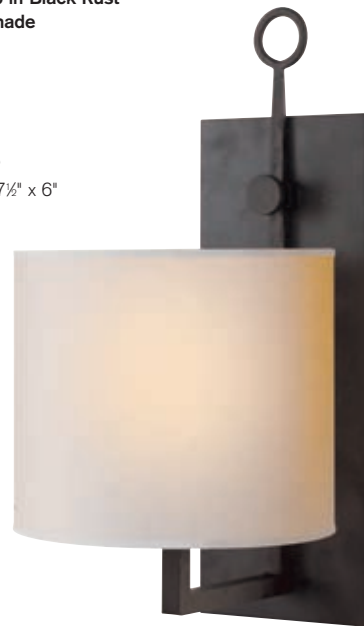

S2050BR-NP

Aspen Sconce in Black Rust with Natural Paper Shade

Height: 18½"
Width: 9"
Extension: 4½"
Backplate: 5" Round

Shade Treatment: NP

Shade Details: 4" x 9" x 5¾"

Socket: Candelabra

Wattage: 60 C



SL2151BZ-WG

**New York Subway One-Light Sconce
in Bronze with White Glass Shade**

Height: 9 3/4"
Width: 5"
Extension: 8"
Backplate: 4 1/2" Square

Available Finishes

AN, BZ, CH, HAB, PN

Shade Treatment: WG

Shade Details: 3" x 5" x 5"

Socket: Keyless

Wattage: 60 A

©EFC DESIGNS



SL2151CH-WG



SL2152HAB-WG

**New York Subway Two-Light Sconce
in Hand-Rubbed Antique Brass
with White Glass Shades**

Height: 9 3/4"
Width: 14"
Extension: 8"
Backplate: 4 1/2" Square

Available Finishes:

AN, BZ, CH, HAB, PN

Shade Treatment: WG

Shade Details: 3" x 5" x 5"

Socket: 2-Keyless

Wattage: 2-60 A

©EFC DESIGNS



SL2153BZ-WG

**New York Subway Three-Light Sconce
in Bronze with White Glass Shades**

Height: 9 3/4"
Width: 22 3/4"
Extension: 8"
Backplate: 4 1/2" Square

Available Finishes:

AN, BZ, CH, HAB, PN

Shade Treatment: WG

Shade Details: 3" x 5" x 5"

Socket: 3-Keyless

Wattage: 3-60 A

©EFC DESIGNS



SS2001PN-WG
Siena One-Light Sconce
in Polished Nickel
with White Glass Shade

Height: 8¼"
Width: 4¾"
Extension: 6½"
Backplate: 4¾" Square

Available Finishes: BZ, HAB, PN
Shade Treatment: WG
Shade Details: 4¾" x 2½" x 5½"

Socket: Keyless
Wattage: 60 A
©EFC DESIGNS



SS2001HAB-WG



SS2002HAB-WG
Siena Two-Light Sconce
in Hand-Rubbed Antique Brass
with White Glass Shades

Height: 8½"
Width: 15"
Extension: 6"
Backplate: 4¾" Square

Available Finishes: BZ, HAB, PN
Shade Treatment: WG
Shade Details: 4¾" x 2½" x 5½"

Socket: 2-Keyless
Wattage: 2-60 A
©EFC DESIGNS



SS2003PN-WG
Siena Three-Light Sconce
in Polished Nickel
with White Glass Shade

Height: 8¼"
Width: 23"
Extension: 10¼"
Backplate: 4¾" Square

Available Finishes: BZ, HAB, PN
Shade Treatment: WG
Shade Details: 4¾" x 2½" x 5½"

Socket: 3-Keyless
Wattage: 3-60 A
©EFC DESIGNS



SL2941HAB-FG

Boston Square One-Light Sconce in Hand-Rubbed Antique Brass with Frosted Glass Shade

Height: 11"
Width: 5"
Extension: 8½"
Backplate: 4½" x 5"

Available Finishes:
AN, BZ, CH, HAB, PN
Shade Treatment: FG
Shade Details:
2¼" x 4¼" x 5¼"

Socket: Hi-Lo
Wattage: 60 A
©EFC DESIGNS



SL2944CH-FG

Boston Square Up and Down Sconce in Chrome with Frosted Glass Shades

Height: 16½"
Width: 5"
Extension: 8½"
Backplate: 4½" x 5"

Available Finishes:
AN, BZ, CH, HAB, PN
Shade Treatment: FG
Shade Details:
2¼" x 4¼" x 5¼"

Socket: 2-Hi-Lo
Wattage: 2-60 A
©EFC DESIGNS



SL2942BZ-FG

Boston Square Two-Light Sconce in Bronze with Frosted Glass Shades

Height: 11"
Width: 14"
Extension: 8½"
Backplate: 4½" x 5"

Available Finishes:
AN, BZ, CH, HAB, PN
Shade Treatment: FG
Shade Details: 2¼" x 4¼" x 5¼"

Socket: 2-Hi-Lo
Wattage: 2-60 A
©EFC DESIGNS



SL2943HAB-FG

Boston Square Three-Light Sconce in Hand-Rubbed Antique Brass with Frosted Glass Shades

Height: 11"
Width: 22"
Extension: 8½"
Backplate: 4½" x 5"

Available Finishes:
AN, BZ, CH, HAB, PN
Shade Treatment: FG
Shade Details: 2¼" x 4¼" x 5¼"

Socket: 3-Hi-Lo
Wattage: 3-60 A



SL2841BZ-WG
Wilton Single Bath Light
in Bronze with
White Glass Shade

Height: 10"
Width: 5"
Extension: 8½"
Backplate: 5" Round

Available Finishes:
AN, BZ, CH, HAB, PN
Shade Treatment: WG
Shade Details: 1¾" x 5" x 5½"

Socket: Keyless
Wattage: 60 A
©EFC DESIGNS



SL2841CH-WG



SL2842HAB-WG
Wilton Double Bath Light in
Hand-Rubbed Antique Brass
with White Glass Shades

Height: 10"
Width: 13"
Extension: 8½"
Backplate: 5" Round

Available Finishes:
AN, BZ, CH, HAB, PN
Shade Treatment: WG
Shade Details: 1¾" x 5" x 5½"

Socket: 2-Keyless
Wattage: 2-60 A
©EFC DESIGNS



SL2843PN-WG
Wilton Triple Bath Light
in Polished Nickel
with White Glass Shades

Height: 10"
Width: 21"
Extension: 8½"
Backplate: 5" Round

Available Finishes:
AN, BZ, CH, HAB, PN
Shade Treatment: WG
Shade Details: 1¾" x 5" x 5½"

Socket: 3-Keyless
Wattage: 3-60 A
©EFC DESIGNS



SL2931SN/SLEG-WG

**Boston Functional Single Sconce
in Sheffield Nickel
with White Glass SLEG Shade**

Height: 9"
Width: 5 3/4"
Extension: 9 1/2"
Backplate: 4 1/2" Round

Available Finishes:

AN, BZ, CH, HAB, PN, SN

Shade Treatment: SLEG-WG

See Shade Schedule for
Additional Shade Options

Shade Details: 2 1/4" x 5 3/4" x 4 1/2"

Socket: Hi-Lo

Wattage: 60 A

©EFC DESIGNS



SL2931BZ/SLEG-WG



SL2932CH/SLEG-WG

**Boston Functional Double Sconce
in Chrome with White Glass SLEG Shade**

Height: 9"
Width: 14 1/2"
Extension: 9 1/2"
Backplate: 4 1/2" Round

Available Finishes:

AN, BZ, CH, HAB, PN, SN

Shade Treatment: SLEG-WG

See Shade Schedule for Additional Shade Options

Shade Details: 2 1/4" x 5 3/4" x 4 1/2"

Socket: 2-Hi-Lo

Wattage: 2-60 A

©EFC DESIGNS



SL2933HAB/SLEG-WG

**Boston Functional Triple Sconce
in Hand-Rubbed Antique Brass
with White Glass SLEG Shade**

Height: 9"
Width: 23"
Extension: 9 1/2"
Backplate: 4 1/2" Round

Available Finishes:

AN, BZ, CH, HAB, PN, SN

Shade Treatment: SLEG-WG

See Shade Schedule for Additional
Shade Options

Shade Details: 2 1/4" x 5 3/4" x 4 1/2"

Socket: 3-Hi-Lo

Wattage: 3-60 A

©EFC DESIGNS



SL2935HAB-WG
Boston Diffuser Wall Sconce in Hand-Rubbed Antique Brass

Height: 11½"
Width: 6"
Extension: 6¼"
Backplate: 4¾" Round

Available Finishes:
AN, BZ, CH, HAB, PN
Shade Treatment: WG
Shade Details: 6" Round

Socket: Hi-Lo
Wattage: 60 A
©EFC DESIGNS



SL2934HAB-WG
Boston Loop Arm Wall Sconce in Hand-Rubbed Antique Brass with White Glass Shade

Height: 12½"
Width: 4¾"
Extension: 7½"
Backplate: 4¾" Round

Available Finishes:
AN, BZ, CH, HAB, PN
Shade Treatment: WG

Socket: Hi-Lo
Wattage: 60 A
©EFC DESIGNS



SL2000BZ-WG
Marine Wall Light in Bronze and White Glass

Height: 10½"
Width: 4½"
Extension: 7¾"
Backplate: 4¾" x 6½"

Available Finishes:
AN, BZ, CH, HAB, PN
Shade Treatment: WG
Shade Details:
3½" x 6½"

Socket: Keyless
Wattage: 60 A
©EFC DESIGNS



SL2000CH-WG



SLO2001BZ-SG
Indoor/Outdoor Marine Wall Light in Bronze and Seeded Glass

Height: 10½"
Width: 8½"
Extension: 10"
Backplate: 4¾" x 6½"

Available Finishes:
BZ, CH, HAB
Shade Treatments: CG, SG
Shade Details:
3½" x 6½"

Socket: Keyless
Wattage: 60 A
©EFC DESIGNS



SL2111BZ-FG
Edwardian Articulating Wall Light in Bronze with Frosted Glass Shade

Height: 7¾"-10¼"
Width: 4"
Extension: 5½"-10½"
Backplate: 2½" x 4¾"

Available Finishes: BZ, CH, HAB
Shade Treatment: FG
Shade Details: 3" x 4" x 5¼"

Socket: Keyless
Wattage: 60 A
©EFC DESIGNS



SL2111CH-FG



SS2014PN-FG

**Openwork Over-the-Mirror
Bath Fixture in Polished Nickel
with Frosted Glass Shade**

Height: 4 $\frac{3}{4}$ "
Width: 24"
Extension: 5"
Backplate: 4 $\frac{3}{4}$ " Square

Available Finishes:
AN, BZ, CH, HAB, PN
Shade Treatment: FG

Socket: 2-Keyless
Wattage: 2-60 A



SS2011BZ-FG

**Openwork Single Wall Sconce
in Bronze with
Frosted Glass Shade**

Height: 9"
Width: 4 $\frac{3}{4}$ "
Extension: 5"
Backplate: 4 $\frac{3}{4}$ " Square

Available Finishes:
AN, BZ, CH, HAB, PN
Shade Treatment: FG

Socket: Keyless
Wattage: 60 A



SS2012PN-FG

**Openwork Double Wall Sconce
in Polished Nickel
with Frosted Glass Shades**

Height: 9"
Width: 8 $\frac{3}{4}$ "
Extension: 5"
Backplate: 4 $\frac{3}{4}$ " Square

Available Finishes:
AN, BZ, CH, HAB, PN
Shade Treatment: FG

Socket: 2-Keyless
Wattage: 2-60 A



SS2015BZ-WG

**Faceted Glass Sconce
in Bronze with
White Glass Shade**

Height: 9 $\frac{1}{2}$ "
Width: 4 $\frac{3}{4}$ "
Extension: 6"
Backplate: 4 $\frac{3}{4}$ " Square

Available Finishes:
AN, BZ, CH, HAB, PN
Shade Treatment: WG
Shade Details: 3 $\frac{3}{8}$ " x 6"

Socket: Keyless
Wattage: 60 A



SS2015CH-WG



S2003BZ-WG
Square Glass Shield Sconce
in Bronze with White Glass
Diffuser Height: 13"
 Width: 7"
 Extension: 4 1/4"
 Backplate: 5 1/2" Round

Available Finishes:
 BZ, HAB, PN
Shade Details: 4 1/4" x 8"
 Flat Glass Panel (No Sides)

Socket: Candelabra
Wattage: 60 C



S2003PN-WG



S2006PN-WG
One-Light Cylinder Sconce
in Polished Nickel
with White Glass Shade
 Height: 13"
 Width: 5 1/2"
 Extension: 5 1/2"
 Backplate: 5 1/2" Round

Available Finishes:
 BZ, HAB, PN
Shade Details: 4 1/4" x 8" Cylinder

Socket: Keyless
Wattage: 60 A



S2007BZ-WG
Two-Light Cylinder Sconce
in Bronze with
White Glass Shades
 Height: 12"
 Width: 14 1/2"
 Extension: 6 3/4"
 Backplate: 5 1/2" Round

Available Finishes:
 BZ, HAB, PN
Shade Details:
 8" x 4 1/4" Cylinder

Socket: 2-Keyless
Wattage: 2-60 A



S2001PN-WG
One-Light Deco Sconce
in Polished Nickel
with White Glass Shade
 Height: 9 1/2"
 Width: 6 1/4"
 Extension: 7 1/2"
 Backplate: 4 3/4" x 6 1/2" Oval

Available Finishes:
 BZ, HAB, PN
Shade Details: 6 1/4" Oval

Socket: Keyless
Wattage: 60 A



S2002BZ-WG
Two-Light Deco Sconce
in Bronze with
White Glass Shades
 Height: 9 1/2"
 Width: 15 1/2"
 Extension: 7 1/2"
 Backplate: 6 1/2" x 4 3/4" Oval

Available Finishes:
 BZ, HAB, PN
Shade Details: 6 1/4" Oval

Socket: 2-Keyless
Wattage: 2-60 A



TOB2010PS-NP

Longacre Sconce in Polished Silver with Natural Paper Shade

Height: 14"
Width: 6"
Extension: 7"
Backplate: 5" Round

Available Finishes:

BZ, HAB, PN, PS

Shade Treatment: NP

Shade Details: 4" x 6" x 6"

Socket: Hi-Lo

Wattage: 60 A



TOB2011HAB-NP

Metropolitan Sconce in Hand-Rubbed Antique Brass with Natural Paper Shade

Height: 11"
Width: 5"
Extension: 6 1/4"
Backplate: 4 1/2" Round

Available Finishes:

AW, BZ, CH, HAB, PN

Shade Treatments:

NP, NP/BT, NP/ST

Shade Details:

5" x 5" x 5 1/2"

Socket: Keyless

Wattage: 60 A



TOB2011BZ-NP/BT



TOB2011CH-WG

Metropolitan Sconce in Chrome with White Glass Shade

Height: 11"
Width: 5"
Extension: 6 1/4"
Backplate: 4 1/2" Round

Available Finishes:

AW, BZ, CH, HAB, PN

Shade Details: 2 7/8" x 6"

Socket: Keyless

Wattage: 60 A



TOB2011HAB-WG



TOB2012AN-C/RT

Nina Sconce in Antique Nickel with Cotton Shade

Height: 14"
Width: 5 1/2"
Extension: 8"
Backplate: 4" x 8"

Available Finishes:

AN, BZ, HAB, PS, R

Shade Treatments:

C, C/BT, C/RT

Shade Details:

3 1/2" x 5 1/2" x 7"

Socket: Keyless

Wattage: 60 A



TOB2012BZ-C/BT



TOB2067AN/PN-NP
Elkins Sconce in Antique Nickel and Polished Nickel with Natural Paper Shade
 Height: 12¾"
 Width: 5½"
 Extension: 7"
 Backplate: 5½" Round

Available Finishes:
 AN/PN, BZ/HAB, HAB/CHC, PS
Shade Treatments:
 FS, NP, NP/BT
Shade Details: 3½" x 4" x 6"

Socket: Candelabra
Wattage: 40 C



TOB2068BZ/HAB-NP/BT
Elkins Double Sconce in Bronze and Hand-Rubbed Antique Brass with Natural Paper Shades
 Height: 13¾"
 Width: 9½"
 Extension: 8¾"
 Backplate: 5½" Round

Available Finishes:
 AN/PN, BZ/HAB, HAB/CHC, PS
Shade Treatments:
 FS, NP, NP/BT
Shade Details:
 3½" x 4" x 6"

Socket:
 2 – Candelabra
Wattage: 2 – 40 C



TOB2035BZ/HAB
Selecta Sconce in Bronze with Hand-Rubbed Antique Brass Accents with Bronze Shade
 Height: 15½"
 Width: 4½"
 Extension: 9"
 Backplate: 4½" x 9½" Oval

Available Finishes:
 BLK/HAB, BZ/HAB, HAB, PN, PN/AW

Socket: Candelabra
Wattage: 60 C



TOB2035HAB



TOB2064PS-NP
Selecta Sconce in Polished Silver with Natural Paper Shade
 Height: 16"
 Width: 5"
 Extension: 8¾"
 Backplate: 4¾" x 9¾" Oval

Available Finishes:
 AN, BZ/HAB, HAB, PN, PS
Shade Treatments:
 NP, NP/BT, NP/RT
Shade Details: 3½" x 5" x 8"

Socket: Candelabra
Wattage: 60 C



TOB2013CH-WG

**Jamie Sconce in Chrome
on Chocolate Wood Mount
with White Glass Shade**

Height: 13"
Width: 5"
Extension: 12½"
Backplate: 5¾" Round

Available Finishes:

AS, BZ, CH, HAB

Shade Treatment: WG

Shade Details: 2" x 5" x 7"

Socket: Pull Chain

Wattage: 60 A



TOB2013HAB-WG



TOB2002BZ-NP/BT

**Bryant Sconce in Bronze with
Natural Paper Shade**

Height: 14¼"
Width: 5½"
Extension: 8¾"
Backplate: 4½" Round

Available Finishes:

AN, BZ, HAB, PN, PS

Shade Treatment:

NP, NP/BT, NP/ST

Shade Size:

4" x 5½" x 6"

Socket: Keyless

Wattage: 60 A



TOB2002PN-NP/ST



TOB2081AN/PN-NP
Alton Pivoting Sconce in
Antique Nickel and Polished Nickel
with Natural Paper Shade
 Height: 16½"
 Width: 5"
 Extension: 8"
 Backplate: 4½" x 5¾" Oval

Available Finishes:
 AN/PN, BZ, BZ/HAB, HAB, PN
Shade Treatments:
 NP, NP/BT, NP/RT
Shade Details:
 4" x 6" x 6½"

Socket: Hi – Lo
Wattage: 60 A



TOB2081HAB-NP



TOB2081PN-NP



TOB2046PS-NP
Farlane Double Sconce
in Polished Silver
with Natural Paper Shades
 Height: 12"
 Width: 12½"
 Extension: 8"
 Backplate: 3½" x 8¼"

Available Finishes:
 AN, BZ, BZ/HAB, HAB, PS
Shade Treatments:
 NP, NP/BT, NP/RT
Shade Details: 3" x 5" x 7"

Socket: 2-Candelabra
Wattage: 2-40 C



TOB2045HAB-NP
Farlane Sconce in
Hand-Rubbed Antique Brass
with Natural Paper Shade
 Height: 12"
 Width: 5"
 Extension: 8"
 Backplate: 3½" x 8¼"

Available Finishes:
 AN, BZ, BZ/HAB, HAB, PS
Shade Treatments:
 NP, NP/BT, NP/RT
Shade Details: 3" x 5" x 7"

Socket: Candelabra
Wattage: 40 C



TOB2017BZ-NP

Ziyi Sconce in Bronze with Natural Paper Shade

Height: 13 3/4"
Width: 4 1/4"
Extension: 5 1/2"
Backplate: 4 1/4" Round

Available Finishes:
BZ, HAB, PN, PS
Shade Treatment: NP
Shade Details:
3" x 3 1/2" x 7 1/4"

Socket: Candelabra
Wattage: 25 C



TOB2017PS-NP



TOB2017HAB-NP



TOB2018HAB-NP

Ziyi Pivoting Sconce in Hand-Rubbed Antique Brass with Natural Paper Shade

Height: 22"
Width: 4 1/4"
Extension: 7 1/2"
Backplate: 4 1/4" Round

Available Finishes:
BZ, HAB, PN, PS
Shade Treatment: NP
Shade Details: 3 1/2" x 4" x 7 1/4"

Socket: Candelabra
Wattage: 40 C



TOB2018BZ-NP



TOB2029PS-NP

Ziyi Five-Light Sconce in Polished Silver with Natural Paper Shades

Height: 20 3/4"
Width: 17"
Extension: 12"
Backplate: 4" Round

Available Finishes:
BZ, HAB, PN, PS
Shade Treatment: NP
Shade Details:
3 1/2" x 4" x 7 1/4"

Socket: 5-Candelabra
Wattage: 5-40 C



TOB2027BZ-NP

Ziyi Two-Light Sconce in Bronze with Natural Paper Shades

Height: 19"
Width: 10 1/2"
Extension: 8"
Backplate: 4" Round

Available Finishes:
BZ, HAB, PN, PS
Shade Treatments: NP
Shade Details:
3 1/2" x 4" x 7 1/4"

Socket: 2-Candelabra
Wattage: 2-40 C



TOB2300PN
Eclipse Wall Light
in Polished Nickel
Height: 21"
Width: 4"
Extension: 8½"
Backplate: 4" x 21"

Available Finishes:
AN, BZ, HAB, PN

Socket: Keyless
Wattage: 60 T



TOB2301BZ
Tall Eclipse Wall Light
in Bronze
Height: 32½"
Width: 4"
Extension: 8½"
Backplate: 4" x 32½"

Available Finishes:
AN, BZ, HAB, PN

Socket: 3 – Keyless
Wattage: 3 – 25 T



TOB2000PN
Academy Map Light in
Polished Nickel
Height: 4"
Width: 9"
Extension: 12¾"-16½"
Backplate: 4" Square
With Cord and Plug

Available Finishes:
BZ, HAB, PN
Shade Details: 2" x 5¾"

Socket: Keyless/Line Switch
Wattage: 40 T



TOB2000BZ

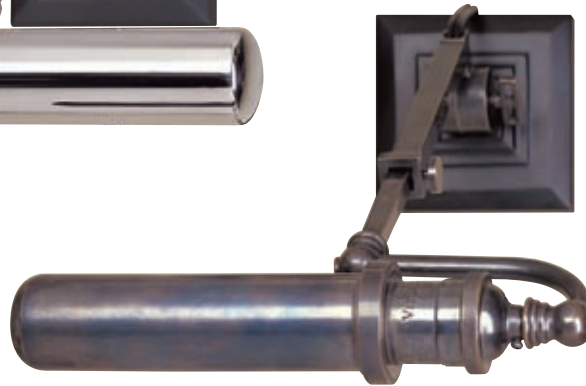

TOB2007HAB-NP
Vendome Single Light Sconce
in Hand-Rubbed Antique Brass
with Natural Paper Shade

Height: 14"
Width: 5½"
Extension: 8½"
Backplate: 5¼" Round

Available Finishes:

AS, BZ, HAB, PS

Shade Treatment:

NP, NP/BT, NP/ST

Shade Details: 4" x 5½" x 6"

Socket: Keyless

Wattage: 60 A



TOB2007PS-NP/ST



TOB2008BZ-NP
Vendome Two-Light Sconce
in Bronze with
Natural Paper Shades

Height: 14"
Width: 18"
Extension: 9"
Backplate: 5¼" Round

Available Finishes:

AS, BZ, HAB, PS

Shade Treatment:

NP, NP/BT, NP/ST

Shade Details: 4" x 5½" x 6"

Socket: 2-Keyless

Wattage: 2-60 A



TOB2009HAB-NP
Vendome Three-Light Sconce
in Hand-Rubbed Antique Brass
with Natural Paper Shades

Height: 14"
Width: 22"
Extension: 11"
Backplate: 5¼" Round

Available Finishes:

AS, BZ, HAB, PS

Shade Treatment:

NP, NP/BT, NP/ST

Shade Details: 4" x 5½" x 6"

Socket: 3-Keyless

Wattage: 3-60 A



TOB2020PN
Small David Sconce
in Polished Nickel

Height: 7"
Width: 3¾"
Extension: 5¾"
Backplate: 3" x 3¾"

Available Finishes:
BZ, BZ-HAB, HAB, HAB-BZ, PN

Socket: Keyless
Wattage: 40 T



TOB2021HAB
Medium David Sconce in
Hand-Rubbed Antique Brass

Height: 12"
Width: 3¾"
Extension: 5¾"
Backplate: 3¾" x 6"

Available Finishes:
BZ, BZ-HAB, HAB, HAB-BZ, PN

Socket: Keyless
Wattage: 40 T



TOB2021HAB-BZ



TOB2019BZ-HAB
David Pivoting Wall Sconce
in Bronze with Hand-Rubbed
Antique Brass Shade

Height: 18"
Width: 4"
Extension: 6"
Backplate: 4" x 6"

Available Finishes:
BZ-HAB, HAB, HAB-BZ, PN

Socket: 2-Keyless
Wattage: 2 40 T



TOB2014BC
Greenwich Sconce
 in Brushed Chrome
 Height: 17½"
 Width: 4"
 Extension: 4¼"
 Backplate: 3½" x 6¾"

Available Finishes:
 AN, BC, BZ, HAB, PN

Socket: Keyless/
 Hi-Lo Switch

Wattage: 60 T



TOB2014HAB



TOB2016HAB/BZ
Greenwich Glass Sconce
 in Hand-Rubbed Antique Brass
 and Bronze
 Height: 10½"
 Width: 4¼"
 Extension: 4"
 Backplate: 3" x 8"

Available Finishes:
 AN, BZ, BZ/HAB,
 HAB, HAB/BZ, PN

Socket: Keyless
Wattage: 60 T



TOB2016AN



TOB2006CH
Ted Sconce in Chrome
 Height: 14¾"
 Width: 3¾"
 Extension: 3¾"
 Backplate: 3¾" x 14¾"

Available Finishes:
 BZ, CH, HAB, PN

Socket: 2-Keyless
Wattage: 2-40 A-15



TOB2001BZ
Bellport Sconce
 in Bronze
 Height: 10"
 Width: 4½"
 Extension: 4"
 Backplate: 4½" Round

Available Finishes: BZ, CH
Shade Treatment: WG

Socket: Candelabra /
 Hi-Lo Switch
Wattage: 60 C



TOB2030PN-WG
Keeley Pivoting Bath Light
in Polished Nickel
with White Glass

Height: 12"
Width: 3½"
Extension: 6½"
Backplate: 3½" x 5½"

Available Finishes: BZ, CH,
HAB, HAB/AN, PN

Socket: Keyless
Wattage: 60 T



TOB2030HAB/AN-WG



TOB2031PN-WG
Tall Keeley Pivoting
Bath Light in Polished Nickel
with White Glass

Height: 20¾"
Width: 3½"
Extension: 6½"
Backplate: 3½" x 20¾"

Available Finishes:
BZ, CH, HAB, HAB/AN, PN

Socket: 2-Keyless
Wattage: 2-60 T



TOB2061PN-WG
Selecta Glass Bath Light in
Polished Nickel with White
Glass

Height: 4¼"
Width: 11"
Extension: 3"
Backplate: 4¾" x 11" Oval

Available Finishes:
BZ, BZ/HAB, CH, HAB, PN

Socket: Keyless
Wattage: 60 T



TOB2062BZ/HAB-WG
Selecta Long Glass Bath Light
in Bronze with Hand-Rubbed
Antique Brass Accents with
White Glass

Height: 4¾"
Width: 21¾"
Extension: 3¼"
Backplate: 4¾" x 21¾" Oval

Available Finishes:
BZ, BZ/HAB, CH, HAB, PN

Socket: 2-Keyless
Wattage: 2-60 T



TOB2003PN
Mercer Box Light Sconce in Polished Nickel

Height: 9½"
Width: 5½"
Extension: 4"
Backplate: 5½" x 9½"

Available Finishes:
BZ, CH, HAB, PN

Socket: Keyless
Wattage: 60 T



TOB2004PN
Mercer Square Box Light Sconce in Polished Nickel

Height: 12"
Width: 12"
Extension: 4"
Backplate: 12" Square

Available Finishes:
BZ, CH, HAB, PN

Socket: 2-Keyless
Wattage: 2-60 T



TOB2103PN
Mercer Medium Box Light Sconce in Polished Nickel

Height: 15"
Width: 5½"
Extension: 4"
Backplate: 5½" x 15"

Available Finishes:
BZ, CH, HAB, PN

Socket: 2-Keyless
Wattage: 2-60 T



TOB2005HAB
Mercer Long Box Light Sconce in Hand-Rubbed Antique Brass

Height: 24"
Width: 5½"
Extension: 4"
Backplate: 5½" x 24"

Available Finishes:
BZ, CH, HAB, PN

Socket: 3-Keyless
Wattage: 3-60 T



BB2010HAB-S
Swing Arm Candlestick Wall Lamp in Hand-Rubbed Antique Brass with Silk Shade
 Height: 16"
 Extension: 19"
 Backplate: 5" Round
 Cord Cover Included

Available Finishes:
 AN, BZ, HAB, PB, PN
Shade Treatments:
 B, L, NP, S, T
Shade Details:
 5" x 11" x 8 1/4" B, L, NP, T or
 8" x 11" x 8 3/8" Silk Box Pleat

Socket: Dimmer
Wattage: 100 A



BB2040HAB-NP
Hobbs Wall Sconce in Hand-Rubbed Antique Brass with Natural Paper Shade
 Height: 17 1/4"
 Width: 9"
 Extension: 10"
 Backplate: 6 1/2" Round

Available Finishes:
 AN, BZ, HAB, PN
Shade Treatment: NP
Shade Details: 6 1/2" x 9" x 7"

Socket: Candelabra
Wattage: 60 C



BB2000HAB-S
Triple Swing Arm Wall Lamp in Hand-Rubbed Antique Brass
 Height: 13"
 Extension: 18 1/2"
 Backplate: 3 1/2" x 4 1/2"
 Cord Cover Included

Available Finishes:
 AN, BZ, HAB, PB, PN
Shade Treatments:
 B, L, NP, S, T
Shade Details:
 5" x 11" x 8 1/4" B, L, NP, T or
 8" x 11" x 8 3/8" Silk Box Pleat

Socket: Dimmer
Wattage: 100 A



BB2500AN-NP
Primitive Swing Arm Wall Lamp in Antique Nickel with Natural Paper Shade
 Height: 14"
 Extension: 18 1/4"
 Backplate: 3 1/2" x 5"
 Cord Cover Included

Available Finishes:
 AN, HAB
Shade Treatments:
 L, NP
Shade Details:
 5" x 12" x 8 3/4"

Socket: Hi-Lo
Wattage: 100 A



BB2005HAB-L
Single Swing-Arm Sconce
in Hand-Rubbed Antique Brass
with Linen Shade

Height: 12"
Extension: 7"
Backplate: 3½" x 5"

Available Finishes:
AN, BZ, HAB, PB, PN
Shade Treatments:
B, L, NP, T
Shade Details: 3" x 6" x 5"

Socket: Candelabra
Wattage: 60 C



BB2007HAB-L
Double Swing-Arm Sconce
in Hand-Rubbed Antique Brass
with Linen Shade

Height: 12"
Extension: 11½"
Backplate: 3½" x 5"

Available Finishes:
AN, BZ, HAB, PB, PN
Shade Treatments:
B, L, NP, T
Shade Details: 3" x 6" x 5"

Socket: Candelabra
Wattage: 60 C



BB2001PB-T
Classic Single Sconce
in Polished Brass
with Tissue Silk Shade

Height: 12"
Width: 6"
Extension: 9¼"
Backplate: 5" Round

Available Finishes:
AN, BZ, HAB, PB, PN
Shade Treatments:
B, L, NP, T
Shade Details: 3" x 6" x 5"

Socket: Candelabra
Wattage: 60 C



BB2002BZ-NP
Classic Double Wall Sconce
in Bronze with
Natural Paper Shades

Height: 12"
Width: 15"
Extension: 9¼"
Backplate: 5" Round

Available Finishes:
AN, BZ, HAB, PB, PN
Shade Treatments:
B, L, NP, T
Shade Details:
3" x 6" x 5"

Socket: 2-Candelabra
Wattage: 2-60 C



BB2210HAB-L
Single French Library Sconce
in Hand-Rubbed Antique Brass
with Linen Shade

Height: 12"
Extension: 8 3/4"
Backplate: 2 1/2" x 4 1/2"

Available Finishes:
AN, BZ, HAB, PB, PN
Shade Treatments:
B, L, NP, T
Shade Details: 3" x 6" x 5"

Socket: Candelabra
Wattage: 60 C



BB2212PN-B
Double French
Library Sconce
in Polished Nickel
with Black Shades

Height: 12"
Extension: 6 1/4"
Backplate: 2 1/2" x 4 1/2"

Available Finishes:
AN, BZ, HAB, PB, PN
Shade Treatments:
B, L, NP, T
Shade Details:
3" x 5" x 4"

Socket: 2-Candelabra
Wattage: 2-60 C



BB2110PB-B
Single French Sconce
in Polished Brass
with Black Shade

Height: 12"
Width: 6"
Extension: 8 3/4"
Backplate: 4 1/2" Round

Available Finishes:
AN, BZ, HAB, PB, PN,
Shade Treatments:
B, L, NP, T
Shade Details: 3" x 6" x 5"

Socket: Candelabra
Wattage: 60 C



BB2112PB-B
Double French Sconce
in Polished Brass
with Black Shades

Height: 12"
Width: 12 1/2"
Extension: 8 3/4"
Backplate: 4 1/2" Round

Available Finishes:
AN, BZ, HAB, PB, PN,
Shade Treatments:
B, L, NP, T
Shade Details:
3" x 6" x 5"

Socket: 2-Candelabra
Wattage: 2-60 C



BB2650HAB-HAB
Swivel Head Wall Lamp in
Hand-Rubbed Antique Brass

Height: 14"
Width: 8"
Extension: 9½"
Backplate: 4" Square
Cord Cover Included

Available Finishes:
AN, BZ, HAB, PN
Shade Details: 4" x 8" x 5"

Socket: Hi-Lo
Wattage: 60 A



BB2650AN-AN



BB2602HAB
Adjustable Library Wall Lamp in
Hand-Rubbed Antique Brass

Extension: 16"-31"
Backplate: 3½" x 4½"
Cord Cover Included

Available Finishes: AN, BZ, HAB
Shade Details: 5¼" x 5¼"

Socket: Keyless/Hi-Lo Switch
Wattage: 50 R 20



SC2100HAB
Savoy One-Light Sconce in Hand-Rubbed Antique Brass and Antique Mirror
Height: 12"
Width: 5½"
Extension: 5"
Backplate: 5¾" x 8" Oval

Available Finishes: HAB, SL
Shade Option:
4" x 4" x 5" Silk Pleat

Socket: Candelabra
Wattage: 60 C



SC2102AS
Venetian Two-Light Sconce in Antique Silver and Antique Mirror
Height: 15½"
Width: 9¼"
Extension: 6½"
Backplate: 5¾" x 8" Oval

Available Finishes:
AS, BZ, HAB

Socket: 2-Candelabra
Wattage: 2-60 C



SC2104HAB
Double-Twist Sconce in Hand-Rubbed Antique Brass
Height: 15½"
Width: 12"
Extension: 5"
Backplate: 4½" Diamond

Available Finishes:
AS, BZ, HAB, PN

Socket: Candelabra
Wattage: 60 C



SC2103HAB
Three-Light Double-Twist Sconce in Hand-Rubbed Antique Brass
Height: 14½"
Width: 22¼"
Extension: 5"
Backplate: 4½" Diamond

Available Finishes:
AS, BZ, HAB, PN

Socket: 3-Candelabra
Wattage: 3-60 C



SC2105AS

**Two-Light Double-Twist Sconce
in Antique Silver**

Height: 11¼"
Width: 18¾"
Extension: 4½"
Backplate: 4½" Diamond

Available Finishes:

AS, BZ, HAB, PN

Socket: 2-Candelabra

Wattage: 2-60 C



SC2160HAB-NP

**Catherine Sconce in
Hand-Rubbed Antique
Brass with
Natural Paper Shades**

Height: 20"
Width: 13"
Extension: 5"
Backplate: 3" x 5¼"

Available Finishes:

AS, BZ, HAB, PN, R

Shade Treatment: NP

Shade Details:

4½" x 4½" x 5¼"

Socket: 2-Candelabra

Wattage: 2-60 C



SC2166HAB-NP

**Troy Four-Light Sconce
in Hand-Rubbed Antique Brass
with Natural Paper Shades**

Height: 24½"
Width: 17"
Extension: 8"
Backplate: 5" x 12½"

Available Finishes:

AS, BZ, HAB, PN

Shade Treatment: NP

Shade Details:

4½" x 4½" x 5¼"

Socket: 4-Candelabra

Wattage: 4-60 C



SC2165PN-NP

**Troy Two-Light Sconce
in Polished Nickel with
Natural Paper Shades**

Height: 20"
Width: 15"
Extension: 5"
Backplate: 5" x 12½"

Available Finishes:

AS, BZ, HAB, PN

Shade Treatment: NP

Shade Details:

4½" x 4½" x 5¼"

Socket: 2-Candelabra

Wattage: 2-60 C



SC2126BR
Hudson One-Arm Sconce
in Black Rust

Height: 13¼"
Width: 4½"
Extension: 9"
Backplate: 4½" Square

Socket: Candelabra
Wattage: 60 C



SC2127BR
Hudson Sconce
in Black Rust

Height: 13¼"
Width: 19¼"
Extension: 5"
Backplate: 4½" Square

Shade Details:
CHS-104NP
Shade Sold Separately

Socket: 2-Candelabra
Wattage: 2-60 C



SC2120BZ
Sasson Wall Light in Bronze

Height: 24¾"
Width: 10¼"
Extension: 6½"
Backplate: 4½" Square

Available Finishes: BZ, PN
Shade Details:
2¼" x 4" x 3⅞" Hardback

Socket: Candelabra
Wattage: 40 C



SC2155BR
Twisted Sunburst Sconce
in Black Rust

Height: 36½"
Width: 19¼"
Extension: 5½"
Backplate: 6¼" Round

Socket: 2-Candelabra
Wattage: 2-60 C



SC2107BZ

**Tyler Two-Light Sconce
in Bronze**

Height: 12½"
Width: 9"
Extension: 5½"
Backplate: 3½" x 5½"

Available Finishes:

AS, BZ, HAB, PN

Shade Treatment: CHS-104S

Shade Sold Separately

Shade Details: 3" x 4" x 4"

Socket: 2-Candelabra

Wattage: 2-60 C



SC2106PN

Tyler Sconce in Polished Nickel

Height: 12½"
Width: 3½"
Extension: 5"
Backplate: 3½" x 5½"

Available Finishes:

AS, BZ, HAB, PN

Shade Treatment: CHS-104S

Shade Sold Separately

Shade Details: 3" x 4" x 4"

Socket: Candelabra

Wattage: 60 C



SC2116AM/HAB

**Tyler Swing-Arm Sconce in
Antique Mirror and Hand-
Rubbed Antique Brass**

Height: 13½"
Width: 6"
Extension: 20"
Backplate: 6" x 13½"

Available Finishes:

AM/AN, AM/HAB, AM/PN

Shade Details: CHS-108S

Shade Sold Separately

Socket: Candelabra

Wattage: 60 C



SC2108PN

**Reflections Sconce
in Polished Nickel
and Antique Mirror**

Height: 9"
Width: 9"
Extension: 5¼"
Backplate: 4½"

Socket: Candelabra

Wattage: 40 B



SC2109CH-WG
Luxe Sconce in Chrome
with White Glass Shade
Height: 10¼"
Width: 4⅞"
Extension: 5"
Backplate: 4⅞" Square

Available Finishes:
BZ, CH, HAB, PN
Shade Treatment: WG
Shade Details: 3¼" x 1½" x 7½"

Socket: Candelabra
Wattage: 40 C



SC2109HAB-WG



SC2110PN-WG
Double Luxe Sconce in
Polished Nickel with
White Glass Shades
Height: 17"
Width: 4⅞"
Extension: 4⅞"
Backplate: 4⅞" Square

Available Finishes:
BZ, CH, HAB, PN
Shade Treatment: WG
Shade Details: 3¼" x 1½" x 7½"

Socket: 2-Candelabra
Wattage: 2-40 C



SC2111BZ-WG
Triple Luxe Sconce in Bronze
with White Glass Shades
Height: 10"
Width: 21"
Extension: 4"
Backplate: 4⅞" Square

Available Finishes:
BZ, CH, HAB, PN
Shade Treatment: WG
Shade Details: 3¼" x 1½" x 7½"

Socket: 3-Candelabra
Wattage: 3-40 C



CL2170BZ

**Noho Double-Yoke Torchiere
Sconce in Bronze**

Height: 5½"
Width: 5½"
Extension: 7"-14"
Backplate: 3½" x 5½"
Cord Cover Included

Available Finishes: BC, BZ
Shade Details: 4" x 6"

Socket: Keyless/Hi-Lo Switch
on Backplate
Wattage: 60 A



CL2174BZ

**Soho Single Sconce
in Bronze**

Height: 9"
Width: 5¼"
Extension: 4"
Backplate: 5¼" x 9"
Bottom Vented

Available Finishes: BS, BZ

Socket: Porcelain
Wattage: 60 A



CL2172BZ

**Soho Double Sconce
in Bronze**

Height: 9"
Width: 11"
Extension: 4"
Backplate: 9" x 11"
Bottom Vented

Available Finishes: BS, BZ

Socket: 2-Porcelain
Wattage: 2-60 A



CL2001BZ-L
Small Square Sconce in
Bronze with Linen Shade

Height: 9½"
Extension: 4⅞"
Backplate: 2½" x 4"

Shade Treatment: L
Shade Details:
4" / 5¼" x 4" / 5¼" x 6¼"

Socket: Keyless
Wattage: 60 A



CL2002BZ-L
Small Rectangle Sconce in
Bronze with Linen Shade

Height: 11½"
Extension: 5⅞"
Backplate: 2½" x 4"

Shade Treatment: L
Shade Details:
5" / 5¼" x 5" / 5¼" x 8½"

Socket: Keyless
Wattage: 60 A





OUTDOOR

Chart House	300
Studio	312



CHO2024AB

Small 3/4 Wall Leaf Lantern in Antique-Burnished Brass

Height: 20½"
Width: 9¾"
Extension: 8½"
Backplate: 8" x 7¾"

Available Finishes:
AB, BZ

Socket: 3-Candelabra
Wattage: 3-60 C

©EFC DESIGNS



CHO2025BZ

Medium 3/4 Wall Leaf Lantern in Bronze

Height: 25"
Width: 12½"
Extension: 10¼"
Backplate: 10½" x 10"

Available Finishes:
AB, BZ

Socket: 3-Candelabra
Wattage: 3-60 C

©EFC DESIGNS



CHO2026BZ

Large 3/4 Wall Leaf Lantern in Bronze

Height: 32"
Width: 16½"
Extension: 14"
Backplate: 13½" x 13"

Available Finishes:
AB, BZ

Socket: 3-Candelabra
Wattage: 3-60 C

©EFC DESIGNS



CHO2020AB

Small Bracket Leaf Lantern in Antique-Burnished Brass

Height: 22½"
Width: 10"
Extension: 13"
Backplate: 5½" square

Available Finishes:
AB, BZ

Socket: 3-Candelabra
Wattage: 3-60 C

©EFC DESIGNS



CHO2021AB

Medium Leaf Lantern in Antique-Burnished Brass

Height: 28½"
Width: 12½"
Extension: 14"
Backplate: 5½" square

Available Finishes:
AB, BZ

Socket: 3-Candelabra
Wattage: 3-60 C

©EFC DESIGNS



CHO2022AB

Large Bracket Leaf Lantern in Antique-Burnished Brass

Height: 38"
Width: 17"
Extension: 18"
Backplate: 6½" x 5¼"

Available Finishes:
AB, BZ

Socket: 3-Candelabra
Wattage: 3-60 C

©EFC DESIGNS



CHO2034BZ
Small 3/4 Wall Sussex Lantern
in Bronze

Height: 19"
Width: 9½"
Extension: 8¼"
Backplate: 8¾" x 8"

Available Finishes:
AB, BZ

Socket: 3-Candelabra
Wattage: 3-60 C
©EFC DESIGNS



CHO2035AB
Medium 3/4 Wall Sussex Lantern
in Antique-Burnished Brass

Height: 24"
Width: 12"
Extension: 11"
Backplate: 11" x 10¼"

Available Finishes:
AB, BZ

Socket: 3-Candelabra
Wattage: 3-60 C
©EFC DESIGNS



CHO2036AB
Large 3/4 Wall Sussex Lantern
in Antique-Burnished Brass

Height: 31"
Width: 16"
Extension: 14½"
Backplate: 13½" x 13"

Available Finishes:
AB, BZ

Socket: 3-Candelabra
Wattage: 3-60 C
©EFC DESIGNS



CHO2031AB
Small Sussex Bracket
Lantern in Antique-
Burnished Brass

Height: 22¼"
Width: 9½"
Extension: 11½"
Backplate: 5" x 4½"

Available Finishes:
AB, BZ

Socket: 3-Candelabra
Wattage: 3-60 C
©EFC DESIGNS



CHO2032BZ
Medium Sussex Bracket
Lantern in Bronze

Height: 26½"
Width: 12¼"
Extension: 16½"
Backplate: 5¼" x 4½"

Available Finishes:
AB, BZ

Socket: 3-Candelabra
Wattage: 3-60 C
©EFC DESIGNS



CHO2033AB
Large Sussex Bracket Lantern
in Antique-Burnished Brass

Height: 36"
Width: 16"
Extension: 17"
Backplate: 7" x 5"

Available Finishes:
AB, BZ

Socket: 3-Candelabra
Wattage: 3-60 C
©EFC DESIGNS



CHO2110AB
Small Chelsea Lantern in
Antique-Burnished Brass

Height: 18½"
Width: 7"
Extension: 11¼"
Backplate: 5¼" x 4"

Available Finishes:
AB, BZ

Socket: Candelabra
Wattage: 60 C
©EFC DESIGNS



CHO2111AB
Medium Chelsea Lantern in
Antique-Burnished Brass

Height: 24½"
Width: 9"
Extension: 15"
Backplate: 4" x 6"

Available Finishes:
AB, BZ

Socket: 3-Candelabra
Wattage: 3-60 C
©EFC DESIGNS



CHO2112AB
Large Chelsea Lantern in
Antique-Burnished Brass

Height: 31½"
Width: 12"
Extension: 18½"
Backplate: 7" x 5½"

Available Finishes:
AB, BZ

Socket: 3-Candelabra
Wattage: 3-60 C
©EFC DESIGNS



CHO2113AB
Chelsea Lantern on
Suspension Bracket in
Antique-Burnished Brass

Height: 31"
Width: 9¼"
Extension: 13¼"
Backplate: 9" x 4¾" x 1"

Available Finishes:
AB, BZ

Socket: 3-Candelabra
Wattage: 3-60 C
©EFC DESIGNS



CHO2001AB
French Railroad Station
Lantern, All Glass in
Antique-Burnished Brass

Height: 33½"
Width: 12"
Extension: 13"
Backplate: 5" X 8¼"

Available Finishes:
AB, BZ

Socket: Keyless
Wattage: 100 A
©EFC DESIGNS



CHO2401BZ
Small Club Door Lantern
in Bronze

Height: 14"
Width: 6½"
Extension: 4½"
Backplate: 4¾" x 9"

Available Finishes:
AB, BZ

Socket: 2-Candelabra
Wattage: 2-40 C
©EFC DESIGNS



CHO2401AB



CHO2400AB
Large Club Door Lantern in
Antique-Burnished Brass

Height: 24½"
Width: 8¾"
Extension: 5½"
Backplate: 4" Round

Available Finishes:
AB, BZ

Socket: 2-Candelabra
Wattage: 2-60 C
©EFC DESIGNS



CHO2500AB
Club Door Lantern in
Antique-Burnished Brass

Height: 18½"
Width: 10"
Extension: 5½"
Backplate: 4" Round

Available Finishes:
AB, BZ, BZV

Socket: 2-Candelabra
Wattage: 2-60 C
©EFC DESIGNS



CHO2500BZV



CHO2908BZ
Short Linear Lantern
in Bronze

Height: 15"
Width: 9"
Extension: 5"

Available Finishes: AB, BZ

Socket: 2-Candelabra
Wattage: 2-60 C

©EFC DESIGNS



CHO2910AB
Long Linear Lantern in
Antique-Burnished Brass

Height: 22½"
Width: 9"
Extension: 5"

Available Finishes: AB, BZ

Socket: 2-Candelabra
Wattage: 2-60 C
©EFC DESIGNS



CHO2701AB
Small Bistro Lantern

Height: 14¼"
Width: 9¾"
Extension: 6¼"

Available Finishes:
AB, BZ

Socket: 2-Candelabra
Wattage: 2-60 C
©EFC DESIGNS



CHO2700AB
Large Bistro Lantern in
Antique-Burnished Brass

Height: 28"
Width: 14½"
Extension: 9½"
Backplate: 4" x 6"

Available Finishes:
AB, BZ

Socket: 3-Candelabra
Wattage: 3-60 C
©EFC DESIGNS



CHO2300BZ
Small Arch Top Wall Lantern
in Bronze

Height: 13½"
Width: 8¼"
Extension: 6¼"
Backplate: 9" x 6"

Available Finishes:
AB, BZ, VG

Socket: 2-Candelabra
Wattage: 2-60 C
©EFC DESIGNS



CHO2300VG

CHO2310AB
Medium Arch Top Wall Lantern
in Antique-Burnished Brass

Height: 24"
Width: 8¼"
Extension: 7½"
Backplate: 18" x 7"

Available Finishes:
AB, BZ, VG

Socket: Keyless
Wattage: 100 A
©EFC DESIGNS



CHO2100AB
French Conductor Lantern in
Antique-Burnished Brass

Height: 21"
Width: 12½"
Extension: 8½"
Backplate: 4" Round

Available Finishes:
AB, BZ

Socket: Keyless
Wattage: 100 A
©EFC DESIGNS



CHO2900AB
Cargo Lantern in
Antique-Burnished Brass

Height: 22"
Width: 10¼"
Extension: 7¼"

Available Finishes:
AB, BZ

Socket: Keyless
Wattage: 100 A
©EFC DESIGNS



CHO2610AB
Coach Lamp in
Antique-Burnished Brass

Height: 30"
Width: 8"
Extension: 9 1/4"
Backplate: 5 1/4" x 8"

Available Finishes:
AB, BZ

Socket: 2-Candelabra

Wattage: 2-40 C

©EFC DESIGNS



CHO2602AB
Medium Coach Lamp in
Antique-Burnished Brass

Height: 22"
Width: 6 1/2"
Extension: 6 1/8"
Backplate: 4" Round

Available Finishes:
AB, BZ

Socket: 2-Candelabra

Wattage: 2-40 C

©EFC DESIGNS



CHO2601AB
Small Carriage Lantern in
Antique-Burnished Brass

Height: 14 1/2"
Width: 6 1/4"
Extension: 4"

Available Finishes:
AB, BZ

Socket: 2-Candelabra

Wattage: 2-40 C

©EFC DESIGNS



CHO2600AB
Large Carriage Lantern in
Antique-Burnished Brass

Height: 22"
Width: 7 3/4"
Extension: 4 1/2"
Backplate: 4" Round

Available Finishes:
AB, BZ

Socket: 2-Candelabra

Wattage: 2-40 C

©EFC DESIGNS



CHO4110BZ-FG
Small Club Hexagonal
Flush Mount in Bronze
with Frosted Glass

Height: 8 1/4"
Width: 10"

Available Finishes: AB, BZ
Available Glass: CG, FG

Socket: 3-Candelabra
Wattage: 3-60 C

©EFC DESIGNS



CHO4111BZ-CG
Large Club Hexagonal
Flush Mount in Polished
Nickel with Clear Glass

Height: 9"
Width: 14 1/2"

Available Finishes: AB, BZ
Available Glass: CG, FG

Socket: 3-Candelabra
Wattage: 3-60 C

©EFC DESIGNS



CHO4310AB-FG
Small Club Square Flush Mount
in Polished Nickel
with Frosted Glass

Height: 8 1/4"
Width: 9"

Available Finishes: AB, BZ
Available Glass: CG, FG

Socket: 3-Candelabra
Wattage: 3-60 C

©EFC DESIGNS



CHO4311AB-CG
Large Club Square Flush Mount
in Antique-Burnished Brass
with Clear Glass

Height: 9"
Width: 13"

Available Finishes: AB, BZ
Available Glass: CG, FG

Socket: 3-Candelabra
Wattage: 3-60 C

©EFC DESIGNS



CHO5018BZ
Small Hanging Leaf Lantern in Bronze
Height: 21"
Width: 9 3/4"
Canopy: 5 1/2" Round

Available Finishes:
AB, BZ

Socket: 3-Candelabra
Wattage: 3-60 C
©EFC DESIGNS



CHO5019AB
Medium Hanging Leaf Lantern in Antique-Burnished Brass
Height: 25"
Width: 12 1/2"
Canopy: 5 1/2" Round

Available Finishes:
AB, BZ

Socket: 3-Candelabra
Wattage: 3-60 C
©EFC DESIGNS



CHO5020AB
Medium Hanging Leaf Lantern in Antique-Burnished Brass
Height: 34"
Width: 16 1/2"
Canopy: 5 1/2" Round

Available Finishes:
AB, BZ

Socket: 3-Candelabra
Wattage: 3-60 C
©EFC DESIGNS



CHO5031AB
Small Sussex Hanging Lantern in Antique-Burnished Brass
Height: 20 1/2"
Width: 9 1/2"
Canopy: 5 1/2" Round

Available Finishes:
AB, BZ

Socket: 3-Candelabra
Wattage: 3-60 C
©EFC DESIGNS



CHO5032BZ
Medium Sussex Hanging Lantern in Bronze
Height: 26"
Width: 12 1/4"
Canopy: 5 1/2" Round

Available Finishes:
AB, BZ

Socket: 3-Candelabra
Wattage: 3-60 C
©EFC DESIGNS



CHO5033AB
Large Sussex Hanging Lantern in Antique-Burnished Brass
Height: 32 1/4"
Width: 13"
Canopy: 5 1/2" Round

Available Finishes: AB, BZ

Socket: 3-Candelabra
Wattage: 3-60 C



CHO5002AB
Chelsea Stem-Mounted Lantern
in Antique-Burnished Brass
Height: 33" - 68"
Width: 16"

Available Finishes: AB, BZ

Socket: 3-Candelabra
Wattage: 3-60 C
©EFC DESIGNS



CHO5000AB
French Hanging Lantern in
Antique Burnished Brass
Height: 27"
Width: 15"

Available Finishes:
AB, BZ

Socket: 3-Candelabra
Wattage: 3-60 C
©EFC DESIGNS



CHO5300BZ
Small Hanging Arch Top Lantern
in Bronze

Height: 16½"
Width: 7¾"
Canopy: 5½" Round

Available Finishes:
AB, BZ, VG

Socket: 3-Candelabra
Wattage: 3-60 C
©EFC DESIGNS



CHO7018BZ
Small Post Leaf Lantern
in Bronze

Height: 25"
Width: 9 3/4"
Post: 3 1/2" Round

Available Finishes:
AB, BZ

Socket: 3-Candelabra
Wattage: 3-60 C
©EFC DESIGNS



CHO7019BZ
Medium Post Leaf Lantern
in Bronze

Height: 31"
Width: 12 1/4"
Post: 3 1/2" Round

Available Finishes:
AB, BZ

Socket: 3-Candelabra
Wattage: 3-60 C
©EFC DESIGNS



CHO7020AB
Large Post Leaf Lantern in
Antique-Burnished Brass

Height: 33"
Width: 16 1/2"
Post: 3 1/2" Round

Available Finishes: AB, BZ

Socket: 3-Candelabra
Wattage: 3-60 C
©EFC DESIGNS



CHO7031AB
Small Post Sussex Lantern
in Antique-Burnished Brass

Height: 23 1/2"
Width: 9 1/2"
Post: 3" Round

Available Finishes:
AB, BZ

Socket: 3-Candelabra
Wattage: 3-60 C
©EFC DESIGNS



CHO7032AB
Medium Post Sussex Lantern
in Antique-Burnished Brass

Height: 30 1/4"
Width: 12 1/4"
Post: 3" Round

Available Finishes:
AB, BZ

Socket: 3-Candelabra
Wattage: 3-60 C
©EFC DESIGNS



CHO7033AB
Large Post Sussex Lantern in
Antique-Burnished Brass

Height: 37 1/4"
Width: 18"
Post: 3" Round

Available Finishes:
AB, BZ

Socket: 3-Candelabra
Wattage: 3-60 C
©EFC DESIGNS



CHO7111AB
Large Chelsea Post Lantern in
Antique Burnished Brass

Height: 29½"

Width: 12"

Post Cap: 3"

Available Finishes:

AB, BZ

Socket: 3-Candelabra

Wattage: 3-60 C

©EFC DESIGNS



CHO7300BZ
Small Post Arch Top Lantern
in Bronze

Height: 18¾"

Width: 7¾"

Post: 3" Round

Available Finishes:

AB, BZ, VG

Socket: 3-Candelabra

Wattage: 3-60 C

©EFC DESIGNS



SLO2001BZ-SG
Indoor/Outdoor Marine
Wall Light in Bronze

Height: 10½"
Width: 8½"
Extension: 10"
Backplate: 4¾" x 6½"

Available Finishes:
BZ, CH, HAB

Shade Size: 3½" x 6½"
Shade Treatments: CG, SG

Socket: Keyless
Wattage: 60 A
©EFC DESIGNS



FINISH CODES AND PRODUCT INDEX

SHADE OPTIONS

CHS101
Black, Natural Paper
3" x 6" x 4"



CHS104
Black, Linen, Natural Paper, Silk, Tea-stained Silk
3" x 4" x 4"



CHS106
Linen,
Natural Paper
3" x 6" x 4 1/4"



CHS106LSQ
Linen Square
3" x 6" x 4 1/4"



CHS108S
Off White Mesh Pleat
3" x 5" x 4"



CHS109S
Silk Bell
2 1/2" x 5" x 4 1/2"



CHS110
Linen Collar, Silk Collar
3 1/2" x 6" x 4 1/2"



CHS111S
Silk Pleated Shield
4" x 5 1/2"



CHS112NP
Natural Paper
4" x 9" x 6"



CHS112S
Silk Pleat
4" x 5" x 5"



CHS113S
Silk Square
3 1/2" x 5" x 5"



CHS114NP
Natural Paper
4" x 6" x 5"



BOSTON FUNCTIONAL SHADE OPTIONS

SLB
Finishes:
AN, AW, BZ, HAB, SN



SLEG
Finishes:
GG, WG



SLE
Finishes:
AN, AW, BZ, HAB, SN



SLJ
Finishes:
AN, AW, BZ, HAB, SN



SLG
Finishes:
AN, AW, BZ, HAB, PN, SN



SLJG
Finishes:
GG, WG



LAMP AND FIXTURE FINISH CODES

AB	Antique-Burnished Brass	FPW	Fence Post Wash
ABAN	Antique-Burnished Brass with Antique Nickel	FW	French Wax on Wood
ABC	Antique-Burnished Brass with Faux Cordovan Leather	GBC	Grey Book Cloth
ABL	Antique-Burnished Brass with Leather	GP	Green Patina Painted Metal
ABR	Antique-Burnished Brass with Rust Accents	GS	Grey Shagreen
ABT	Antique-Burnished Brass with Faux Tortoise	GW	Garden White on Iron
ABV	Antique Brass Verdigris	HAB	Hand-Rubbed Antique Brass
AC	Antique Copper	HABL2	Hand-Rubbed Antique Brass with Braided Leather
AGL	Antique Gold Leaf	I	Ivory Ceramic
ALB	Alabaster Natural Stone	IC	Ivory Crackle Ceramic
AM	Antique Mirror	IP	Irish Pine on Wood
AN	Antique Nickel	LB	Light Blue Ceramic
ANL	Antique Nickel with Black Leather	LC	Light Celadon Ceramic
AS	Antique Silver	M	Marbleized Tole
ASL	Antique Silver Leaf	MHG	Mahogany Wood Finish
AT	Antiqued Terracotta	NR	Natural Rusted Iron
AW	Antique White	OAK	Natural American White Oak
AWG	Antique White with Gold Leaf	OS	Old Stone on Wood
BB	Bamboo	OGW	Old Garden White on Wood
BC	Brushed Chrome	OW	Old White on Wood
BG	Blue Glass	OX	Oxblood Tole on Wood
BL	Black Leather	PB	Polished Brass
BLK	Black	PN	Polished Nickel
BM	Black Crema Marble	PS	Polished Silver
BR	Blackened Rust Painted Finish	Q	Natural Quartz Stone
BRG	Burnished Rust and Gold	R	Painted Rust
BS	Brushed Steel	RD	Red
BW	Blue and White Porcelain	RG	Rust with Gold
BZ	Bronze	ROP	Rope Wrapped Wood
BZV	Bronze with Verdigris Highlights	RQ	Rose Quartz Natural Stone
C	Celadon Porcelain	RS	Red Shagreen
CAR	Caramel Wood Finish	SB	Sheffield Brass
CC	Celadon Crackle	SBC	Sage Book Cloth
CG	Crystal or Clear Glass	SDL	Saddle Leather
CH	Chrome	SL	Silver Leaf
CHC	Chocolate Wood Finish	SN	Sheffield Nickel
CHI	Chinoiserie	SP	Scrubbed Pine
CM	Chinese Marquetry	TB	Tudor Brown on Wood
CRC	Crackle Beige Ceramic	VG	Verdis
CT	Crackled Terracotta	WA	Walnut Wood Finish
DBS	Dark Brown Shagreen	WG	Weathered Gold or White Glass
EG	Eggplant (Black) Glass	WGL	Weathered White and Gold
FL	Floral	WHT	White Ceramic or Paint
FLU	Fluorite (Natural Green Stone)	WI	Weathered Iron
		WM	White Marble
		WS	White Shagreen
		WW	Waxed Wood

METAL AND GLASS SHADE FINISH CODES

AB	Antique-Burnished Brass
AC	Antique Copper
AN	Antique Nickel
ANH	Antique Nickel (Hammered)
AW	Antique White
BG	Blue Glass
BZ	Bronze
BZH	Bronze (Hammered)
FG	Frosted Glass
GG	Green Glass
HAB	Hand-Rubbed Antique Brass
HABH	Hand-Rubbed Antique Brass (Hammered)
OX	Oxblood Crackle Painted Metal
PN	Polished Nickel
PNH	Polished Nickel (Hammered)
PS	Polished Silver
SN	Sheffield Nickel
SNH	Sheffield Nickel (Hammered)
WG	White Glass
MP	Monte Patina painted Metal

FABRIC SHADE FINISH CODES

B	Black Paper (Tortoise Lining)
BS	Black Silk Pleated
CP	Chocolate Paper
FS	Fawn Silk
G	Green Painted Metal
GBC	Grey Book Cloth
GL	Gold Leaf on Paper
L	Linen (Hardback, Stretched, or Pleated)
LC	Pleated Linen (Collar Top)
LCC	Pleated Linen (Collar Top and Bottom)
LCF	Pleated Linen (Collar Top) with Frill
NP	Natural Paper
S	Silk (Stretched or Pleated)
SBC	Silk Bell with Collar or Sage Book Cloth
SBP	Silk Box Pleat
SC	Pleated Silk (Collar Top)
SCC	Pleated Silk (Collar Top and Bottom)
SCF	Pleated Silk (Collar Top) with Frill
SF	Silk Frill
T	Tissue
TS	Tea Stained Silk
TSBC	Tissue Silk Bell (Collar Top)
TSC	Tissue Silk (Collar Top)
TSF	Tissue Silk Frill
WP	White Paper

SHADE TRIM CODES

BT	Brown/Black Tape
RT	Rust Tape
ST	Silver Tape

PRODUCT INDEX

Product	Page	Product	Page	Product	Page	Product	Page	Product	Page	Product	Page
81134	125	CHA8195	39	CHA8923	21	CHC1126	156	CHC2150	159	CHD1163	239
82034	258	CHA8196	39	CHA8924	20, 25	CHC1131	160	CHC2200	188	CHD1164	239
91025	125	CHA8198	39	CHA8925	19	CHC1138	159	CHC3108	167	CHD1165	231
92000	258	CHA8223	43	CHA8926	18	CHC1150	160	CHC3109	167	CHD1166	231
92025	258	CHA8224	43	CHA8927	16, 25	CHC1151	160	CHC3401	191	CHD1167	230
BB1010	143	CHA8226	44	CHA8928	21, 25	CHC1152	153	CHC3405	190	CHD1168	236
BB1040	142	CHA8227	46	CHA8929	21, 25	CHC1153	153	CHC3406	190	CHD1169	236
BB1100	144	CHA8228	43	CHA8931	17, 24	CHC1154	152	CHC3407	191	CHD1170	238
BB1101	144	CHA8229	44	CHA8932	18	CHC1155	152	CHC3408	191	CHD1171	230
BB1200	142	CHA8230	44	CHA8933	16	CHC1158	167	CHC3409	190	CHD1172	230
BB1230	141	CHA8251	27	CHA8934	16	CHC1166	156	CHC3411	189	CHD1173	230
BB1500	143	CHA8252	27	CHA8935	16	CHC1168	159	CHC3414	189	CHD1175	231
BB1600	144	CHA8308	41	CHA8936	21	CHC1169	156	CHC3415	190	CHD1176	238
BB2000	285	CHA8309	41	CHA8937	17, 24	CHC1170	155	CHC3420	187	CHD1401	242
BB2001	286	CHA8336	41	CHA8938	18, 24	CHC1171	154	CHC3421	187	CHD1402	242
BB2002	286	CHA8341	44	CHA8939	20, 25	CHC1172	155	CHC3422	187	CHD1403	242
BB2005	286	CHA8350	45	CHA8940	17, 23	CHC1173	154	CHC3423	186	CHD1404	243
BB2007	286	CHA8351	45	CHA8941	17, 23	CHC1401	169	CHC3425	187	CHD1405	243
BB2010	285	CHA8353	42	CHA8942	21	CHC1402	169	CHC3441	186	CHD1406	242
BB2040	285	CHA8362	42	CHA8945	22	CHC1405	169	CHC4105	194	CHD1408	235
BB2110	287	CHA8363	43	CHA8946	22	CHC1406	171	CHC4106	194	CHD1409	235
BB2112	287	CHA8390	41	CHA8947	22	CHC1407	161	CHC4107	194	CHD1435	245
BB2210	287	CHA8391	42	CHA8948	23	CHC1408	161	CHC4120	193	CHD1437	243
BB2212	287	CHA8403	46	CHA8949	23	CHC1409	165	CHC4125	193	CHD1448	240
BB2500	285	CHA8405	53	CHA8950	20, 26	CHC1410	165	CHC4126	193	CHD1450	245
BB2602	288	CHA8406	53	CHA8951	20	CHC1411	165	CHC4128	193	CHD1455	243
BB2650	288	CHA8450	34	CHA8960	22	CHC1413	163	CHC4129	193	CHD146	241
BB3002	93	CHA8451	55	CHA8970	26, 38	CHC1414	171	CHC4132	194	CHD1460	245
BB3040	93	CHA8452	47	CHA9102	118	CHC1415	163, 165	CHC4134	194	CHD1461	245
BB3100	92	CHA8455	53	CHA9103	118	CHC1416	171	CHC4140	192	CHD147	240
BB3101	92	CHA8457	34	CHA9105	119	CHC1419	163	CHC4170	192	CHD1470	235
BB3102	92	CHA8458	34	CHA9106	119	CHC142	164	CHC4201	195	CHD148	240
BB3110	94	CHA8500	33	CHA9107	120	CHC1420	162	CHC4202	195	CHD1500	239
BB3500	94	CHA8501	33	CHA9121	119	CHC1421	164	CHC4203	195	CHD1501	239
BB3510	94	CHA8505	46	CHA9122	114	CHC1423	163	CHC4211	195	CHD1502	237
BB3820	93	CHA8507	46	CHA9124	110	CHC1424	162	CHC4212	195	CHD1510	251
BB3821	93	CHA8510	27	CHA9125	111	CHC1425	162	CHC4213	195	CHD1521	251
BB5300	219	CHA8511	27	CHA9127	120	CHC1426	161	CHC4215	193	CHD1522	251
CHA3109	54	CHA8512	28, 29	CHA9128	117	CHC1432	166	CHC5101	177	CHD1531	251
CHA3121	54	CHA8513	28	CHA9131	117	CHC1435	166	CHC5102	177	CHD1532	251
CHA8106	40	CHA8521	37	CHA9132	106	CHC1436	166	CHC5104	179	CHD1541	250
CHA8110	35	CHA8522	37	CHA9134	105	CHC1437	166	CHC5105	180	CHD1542	250
CHA8111	35	CHA8523	42	CHA9135	110	CHC1440	179	CHC5106	176	CHD1543	250
CHA8112	35	CHA8524	24	CHA9140	111	CHC1441	175	CHC5107	176	CHD1550	249
CHA8113	36	CHA8610	50	CHA9150	105	CHC1442	174	CHC5120	181	CHD1551	249
CHA8117	30	CHA8611	52	CHA9151	104	CHC1443	174	CHC5121	181	CHD1552	249
CHA8122	36	CHA8612	51	CHA9152	106	CHC1444	175	CHC5132	180	CHD2103	253
CHA8123	35	CHA8613	52	CHA9153	104	CHC1446	183	CHC5133	184	CHD2150	246
CHA8124	31	CHA8614	51	CHA9154	107	CHC1447	183	CHC5135	185	CHD2151	246
CHA8125	31	CHA8615	52	CHA9155	107	CHC1450	170	CHC5136	184	CHD2153	246
CHA8130	36	CHA8616	52	CHA9160	115	CHC1451	170	CHC5137	184	CHD2154	246
CHA8132	30	CHA8617	50	CHA9161	120	CHC1460	173	CHC5150	180	CHD2155	247
CHA8133	32	CHA8618	50	CHA9310	115	CHC1461	172	CHC5160	184	CHD2156	247
CHA8134	30	CHA8619	51	CHA9312	113	CHC1462	173	CHC5170	192	CHD2908	252
CHA8135	30	CHA8620	49	CHA9313	113	CHC1463	172	CHC5180	192	CHD2910	252
CHA8137	29	CHA8621	49	CHA9314	112	CHC1470	168	CHD1103	244	CHD4132	236
CHA8138	31	CHA8622	49	CHA9315	112	CHC1471	168	CHD1106	244	CHD4133	236
CHA8139	31	CHA8623	49	CHA9316	114	CHC1472	168	CHD1107	244	CHD5101	237
CHA8150	40	CHA8626	50	CHA9336	121	CHC1480	178	CHD1109	241	CHD5102	237
CHA8152	32	CHA8627	51	CHA9401	116	CHC1481	178	CHD1110	241	CHD5105	247
CHA8155	28	CHA8801	48	CHA9402	116	CHC1482	178	CHD1112	237	CHD5106	247
CHA8156	36	CHA8802	48	CHA9450	108	CHC1500	183	CHD1115	234	CHD5107	248
CHA8157	29	CHA8805	45	CHA9451	108	CHC2101	185	CHD1116	234	CHD5117	248
CHA8159	40	CHA8809	47	CHA9452	109	CHC2102	185	CHD1117	234	CHD5137	248
CHA8162	38	CHA8811	47	CHA9455	118	CHC2103	185	CHD1120	232	CHD5147	248
CHA8164	32	CHA8814	47	CHA9461	121	CHC2104	186	CHD1122	232	CHO2001	302
CHA8166	28	CHA8831	45	CHC1111	160	CHC2105	188	CHD113	241	CHO2020	300
CHA8167	29	CHA8844	48	CHC1112	157	CHC2106	188	CHD1137	240	CHO2021	300
CHA8172	38	CHA8845	48	CHC1113	158	CHC2107	189	CHD1138	233	CHO2022	300
CHA8173	37	CHA8905	26	CHC1114	157	CHC2108	189	CHD1139	233	CHO2024	300
CHA8174	37	CHA8906	26	CHC1115	158	CHC2109	186	CHD1140	232	CHO2025	300
CHA8178	33	CHA8910	18	CHC1116	158	CHC2110	186	CHD1150	232	CHO2026	300
CHA8188	33	CHA8920	19	CHC1117	158	CHC2111	182	CHD1158	244	CHO2031	301
CHA8190	34	CHA8921	19	CHC1118	157	CHC2112	182	CHD1161	238	CHO2032	301
CHA8192	39	CHA8922	19	CHC1120	159	CHC2113	188	CHD1162	238	CHO2033	301

PRODUCT INDEX

Product	Page	Product	Page	Product	Page	Product	Page	Product	Page	Product	Page
CHO2034	301	S20B	264	SL1950	123	SL3948	64	TOB1090	133	TOB3040	71
CHO2035	301	S30	69	SL1975	122	SL3971	259	TOB2000	279	TOB3041	85
CHO2036	301	S301	67	SL2000	271	SL3975	57	TOB2001	282	TOB3042	70
CHO2100	305	S302	67	SL2111	271	SL3980	59	TOB2002	276	TOB3043	70
CHO2110	302	S3030	69	SL2151	266	SL3992	59	TOB2003	284	TOB3046	89
CHO2111	302	S3050	69	SL2152	266	SL3B	56	TOB2004	284	TOB3047	89
CHO2112	302	S3051	69	SL2153	266	SL4000	204	TOB2005	284	TOB3048	89
CHO2113	302	S3060	57	SL2500	254	SL4001	207	TOB2006	282	TOB3049	88
CHO2300	305	S3061	57	SL2701	259	SL4002	207	TOB2007	280	TOB3050	88
CHO2310	305	S3064	56	SL2702	259	SL4120	206	TOB2008	280	TOB3051	83
CHO2400	303	S310	67	SL2703	259	SL4121	206	TOB2009	280	TOB3052	71
CHO2401	303	S311	66	SL2711	261	SL4122	206	TOB2010	274	TOB3060	72
CHO2500	303	S312	66	SL2712	261	SL4128	204	TOB2011	274	TOB3061	72
CHO2600	306	S3200	60	SL2800	256	SL5001	204	TOB2012	274	TOB3065	73
CHO2601	306	S5030	199	SL2811	261	SL5002	203	TOB2013	276	TOB3066	73
CHO2602	306	S5031	199	SL2812	261	SL5003	203	TOB2014	282	TOB3067	84
CHO2610	306	S5101	200	SL2813	256	SL5120	206	TOB2016	282	TOB3068	85
CHO2700	304	S3103	200	SL2814	256	SL5121	206	TOB2017	278	TOB3069	84
CHO2701	304	SC1100	147	SL2815	256	SL5122	206	TOB2018	278	TOB3070	84
CHO2900	305	SC1101	146	SL2816	257	SL5125	204, 205	TOB2019	281	TOB3071	86
CHO2908	304	SC1102	146	SL2817	257	SL5130	198	TOB2020	281	TOB3072	76
CHO2910	304	SC1105	147	SL2820	264	SL5131	198	TOB2021	281	TOB3073	77
CHO4110	307	SC1106	146	SL2841	269	SL5132	198	TOB2027	278	TOB3074	76
CHO4111	307	SC2100	289	SL2842	269	SL5133	198	TOB2029	278	TOB3075	79
CHO4310	307	SC2102	289	SL2843	269	SL5150	201	TOB2030	283	TOB3076	75
CHO4311	307	SC2103	289	SL2845	263	SL5151	201	TOB2031	283	TOB3077	75
CHO5000	309	SC2104	289	SL2846	263	SL5152	203	TOB2035	275	TOB3080	87, 140
CHO5002	309	SC2105	290	SL2860	262	SL5153	203	TOB2045	277	TOB3081	74
CHO5018	308	SC2106	292	SL2861	262	SL5154	202	TOB2046	277	TOB3082	79
CHO5019	308	SC2107	292	SL2865	262	SL5156	202	TOB2061	283	TOB3083	79
CHO5020	308	SC2108	292	SL2866	262	SL5175	199	TOB2062	283	TOB3084	79
CHO5031	308	SC2109	293	SL2920	255	SL5811	196	TOB2064	275	TOB3088	88
CHO5032	308	SC2110	293	SL2921	254	SL5812	196	TOB2067	275	TOB3090	86
CHO5033	308	SC2111	293	SL2922	254	SL5820	199	TOB2068	275	TOB3091	86
CHO5300	309	SC2116	292	SL2923	254	SL5830	197	TOB2081	277	TOB3110	91
CHO7018	310	SC2120	291	SL2931	270	SL5850	200	TOB2103	284	TOB3111	91
CHO7019	310	SC2126	291	SL2932	270	SL5851	200	TOB2300	279	TOB3112	90
CHO7020	310	SC2127	291	SL2933	270	SL5863	197	TOB2301	279	TOB3113	90
CHO7031	310	SC2155	291	SL2934	271	SL5870	197	TOB3000	77	TOB3114	90
CHO7032	310	SC2160	290	SL2935	271	SL5871	197	TOB3001	77	TOB3141	85
CHO7033	310	SC2165	290	SL2941	268	SL5872	197	TOB3002	80	TOB4000	217
CHO7111	311	SC2166	290	SL2942	268	SLO2001	271, 312	TOB3003	80	TOB4001	217
CHO7300	311	SC3000	97	SL2943	268	SS2001	267	TOB3004	87	TOB4002	217
CL1001	145	SC3001	97	SL2944	268	SS2002	267	TOB3005	72	TOB4003	216
CL1002	145	SC3002	95	SL2975	260	SS2003	267	TOB3006	76	TOB4004	218
CL1100	145	SC3004	96	SL2B	59	SS2011	272	TOB3007	88	TOB4005	217
CL2001	295	SC3008	95	SL3025	56	SS2012	272	TOB3008	77	TOB4006	218
CL2002	295	SC3009	95	SL3032	56	SS2014	272	TOB3009	71	TOB5000	216
CL2170	294	SC3012	96	SL30B	59, 60	SS2015	272	TOB3010	85	TOB5002	210
CL2172	294	SC4000	221	SL3100	68	SS2030	265	TOB3011	82	TOB5003	210
CL2174	294	SC5001	221	SL3101	68	SS2031	264	TOB3012	76	TOB5004	213
CL3001	98	SC5002	220	SL3102	68	SS4010	207	TOB3013	82	TOB5005	213
CL3002	99	SC5003	220	SL3103	68	SS4011	207	TOB3014	83	TOB5007	208
CL3003	99	SC5004	224	SL3324	65	SS4012	207	TOB3015	86	TOB5008	208
CL3004	99	SC5005	221	SL3325	65	SS4013	207	TOB3016	78	TOB5009	209
CL3005	98	SC5007	223	SL3326	66	SS4015	207	TOB3017	78	TOB5010	209
CL3100	98	SC5008	223	SL3336	65	SS4016	207	TOB3018	74	TOB5011	214
CL3170	98	SC5100	225	SL3338	63, 64	SS5002	201	TOB3019	75	TOB5012	216
NYPL1	92	SC5102	224	SL3339	63, 65	SS5005	201	TOB3020	82	TOB5013	216
NYPL2	92	SC5120	224	SL3700	67	TOB1000	133	TOB3021	83	TOB5014	214
NYPL3	141	SC5150	225	SL3801	61	TOB1001	138	TOB3022	82	TOB5015	212
PT2000	263	SC5155	222	SL3802	62	TOB1002	136	TOB3023	83	TOB5016	212
PT2001	263	SL1031	122	SL3803	62	TOB1004	135	TOB3024	84	TOB5017	211
PT3000	68	SL1125	126	SL3804	60	TOB1006	134	TOB3025	74	TOB5018	211
S1001	131	SL1126	126	SL3805	61	TOB1007	132	TOB3026	74	TOB5020	212
S110	130	SL1135	128	SL3806	62	TOB1008	137	TOB3027	89	TOB5060	215
S111	130	SL1137	128	SL3807	62	TOB1009	132	TOB3028	89	TOB5061	215
S2001	273	SL1138	129	SL3811	60	TOB1010	140	TOB3030	78	TOB5062	215
S2002	273	SL1142	127	SL3905	58	TOB1011	135	TOB3031	78	TOB5063	215
S2003	273	SL1143	127	SL3910	58	TOB1012	137	TOB3032	80, 81		
S2006	273	SL1700	131	SL3940	66	TOB1013	139	TOB3033	81		
S2007	273	SL1702	123	SL3941	64	TOB1014	138	TOB3036	72		
S2020	257	SL1900	124	SL3943	64	TOB1015	139	TOB3037	71		
S2030	265	SL1920	129	SL3944	63	TOB1016	134	TOB3038	70		
S2050	265	SL1930	124	SL3945	63	TOB1068	136	TOB3039	70		

Visual Comfort & Co.
2021 Bingle Road
Houston, TX 77055

713 686 5999