



MODELS

P36A4

PACKAGED AIR CONDITIONER INSTALLATION INSTRUCTIONS

**FOR RESIDENTIAL AND COMMERCIAL
HEATING / COOLING APPLICATIONS**

BARD MANUFACTURING CO. • BRYAN, OHIO 43506

Dependable quality home equipment . . . since 1914

SPECIFICATIONS

MODEL	P24A1	P30A1	P36A4	P36A4-3	P36A4-3	P48A4	P48A4-3	P48A4-3	P60A4	P60A4-3	P60A4-3
Cooling Capacity BTUH	22,000	25,000	*36,000	*35,000	35,000	**46,000	**46,000	46,000	†55,000	†55,000	55,000
Heating Capacity BTUH	SEE ELECTRIC HEAT TABLE NO. 1 and NO. 2										
Electrical Rating — 60 Hz	230-1	230-1	230/208-1	230/208-3	460-3	230/208-1	230/208-3	460-3	230/208-1	230/208-3	460-3
Operating Voltage Range	197-253	207-253	197-253	187-253	414-406	197-253	187-253	414-506	197-253	187-253	414-506
Minimum Circuit Ampacity	21	25	27	21	15	34	24	15	44	33	17
**Field Wire Supply	(2)#12AWG	(2)#10AWG	(2)#10AWG	(3)#10AWG	(3)#14AWG	(2) #8AWG	(3)#10AWG	(3)#14AWG	(2) #6AWG	(3) #6AWG	(3)#12AWG
Delay Fuse/Max. Amps	30	40	40	30	15	50	35	20	60	50	25
Total Unit Amps	17.4	20.9	21.7	16.7	9.7	28	20	11	36.5	27.5	13.8
Compressor — Circuit A											
Volts	230/208	230	230/208	230/200	460	230/208	230/200	460	230/208	230/200	460
Rated Load Amps	13	16.5	18	13	7.0	22	14	8.0	29	20	10
Lock Rotor Amps	64	76	91	66	35	95.4	82	41	132	103	54
Fan Motor & Condenser											
Fan Motor — HP/RPM	1/2/1075	1/2/1075	1/5/1075	1/5/1075	1/3/1075	1/3/825	1/3/825	1/3/825	1/2/1075	1/2/1075	1/2/1075
Fan Motor — Amps	4.4	4.4	1.6	1.6	1.4	2.8	2.8	2.8	4.3	4.3	4.3
Fan Dia. — CFM	18"/1600	18"/1600	20"/2340	20"/2340	20"/2340	24"/2800	24"/2800	24"/2800	24"/3530	24"/3530	24"/3530
Face Area Sq. Ft./Row/Fins per in.	3.75/2/15	3.75/2/15	5.04/3/16	5.04/3/16	5.04/3/16	7.7/3/15	7.7/3/15	7.7/3/15	7.7/3/15	7.7/3/15	7.7/3/15
Motor & Evaporator	DD10-6	DD10-6	DD10-8	DD10-8	DD10-8	DD10-10	DD10-10	DD10-10	DD10-10	DD10-10	DD10-10
Blower Motor — HP/RPM	Common	Common	1/3/1075	1/3/1075	1/3/1075	1/2/1075	1/2/1075	1/2/1075	1/2/1075	1/2/1075	1/2/1075
Blower Motor — Amps	w/Fan	w/Fan	2.1	2.1	1.3	3.2	3.2	3.2	3.2	3.2	3.2
CFM Cooling w/Filter (Rated)	825 @ 20	900 @ 15	1275 @ 15	1275 @ 15	1275 @ 15	1700 @ 20	1700 @ 20	1700 @ 20	1700 @ 20	1700 @ 20	1700 @ 20
Face Area Sq. Ft./Row/Fins per in.	2.08/3/12	2.08/3/12	3.21/3/13	3.21/3/13	3.21/3/13	4.62/4/14	4.62/4/14	4.62/4/14	4.62/4/14	4.62/4/14	4.62/4/14
Refrigerant 22 (oz.)	41	39	68	68	68	136	136	136	123	123	123
Shipping Weight Lbs.	300	300	365	365	365	485	485	485	510	510	510

MODEL	@240V	
	KW	RATED BTUH
P24A1	5	19,000
P30A1	10	36,000
P36A4	5	18,000
	10	35,000
	15	52,000
P36A4-3	9	32,000
	15	52,000
P48A4	10	37,000
P60A4	15	55,000
	20	71,000
P48A4-3	9	33,000
P60A4-3	15	55,000
	18	64,000

CFM — DRY COIL WITH FILTER			
E.S.P. in H ₂ O	P24A1 P30A1	P36A4	P48A4 P60A4
.0	975	1420	1850
.10	925	1370	1785
.20	870	1320	1735
.30	820	1270	1710
.40	765	1200	1640
.50		1130	1565

Deduct 600 Btuh for 208 volt operation. *Deduct 1500 Btuh for 208 volt operation.
 Deduct 1000 Btuh for 208 volt operation. †60°C Copper wire size, basic unit only. See Electrical Data for models with Electric heat.

MODEL	Rated Volts & Ph.	Heater Kw @ 240V	Max. Unit Amps	No. Field Power Circuits	*Req'd. Maximum External Fuses Circuit A	Min. Circuit Ampacity Circuit A	**Field Power Wiring Circuit A	**Ground Wire Size Circuit A
P24A1	230	5	25.2	1	35	32	8	10
	1	10	46.0	1	60	57	4	10
P30A1	230	5	25.2	1	40	32	8	10
	1	10	46.0	1	60	57	4	10
P36A4	230/208	10	43.7	1	60	56	4	10
	1	15	64.6	1	*90	82	2	8
P36A4	230/208	9	23.8	1	35	31	8	10
	3	15	38.3	1	*50	50	6	10
P36A4	460	9	12.1	1	20	16	12	12
	3	15	19.3	1	25	25	10	10
P48A4 and P60A4	230/208	10	44.8	1	60	56	4	10
	1	15	65.7	1	*90	83	2	8
	20	86.5	1	*110	108	1	6	
P48A4	230/208	9	24.9	1	35	32	8	10
	3	15	39.4	1	50	50	6	10
	18	46.5	1	60	59	4	10	
P48A4	460	9	12.4	1	20	16	12	12
	3	15	19.6	1	25	25	10	10
	18	23.3	1	30	30	10	10	
P60A4	230/208	9	27.5	1	50	33	8	10
	3	15	39.4	1	50	50	6	10
	18	46.5	1	60	59	4	10	
P60A4	460	9	13.8	1	25	17	12	12
	3	15	19.6	1	25	25	10	10
	18	23.3	1	30	30	10	10	

*May be fuse or circuit breaker. **Based on 60°C copper wire. †Must be time delay type fuse.

MODEL NUMBER	EER 82°F		EER 95°F		SEER 82°F	
	230V	208V	230V	208V	230V	208V
	P24A1	7.4		6.8		6.50
P30A1	6.8		6.0		6.00	
P36A4	9.1	9.1	8.0	8.0	8.00	8.00
P36A4-3	9.1	9.1	8.0*	8.0		
P48A4	9.2	9.1	8.1	8.0	8.10	8.00
P48A4-3	9.5	9.4	8.4*	8.3		
P60A4	9.1	8.9	7.9	7.7	8.00	7.80
P60A4-3	9.2	9.0	8.0*	7.8		

*EER rating at 460V same as 230V

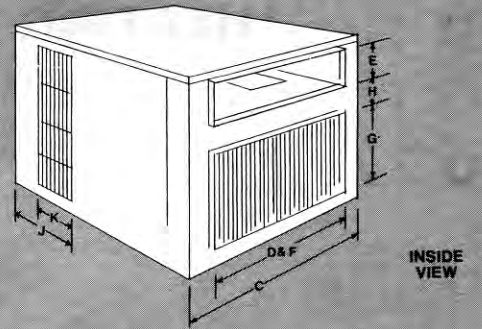
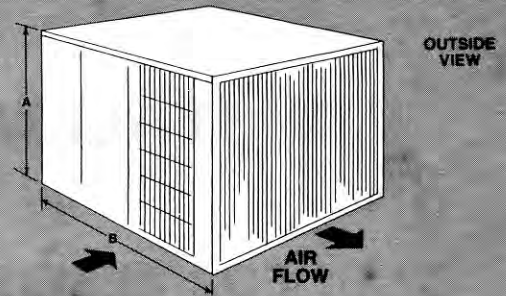

Specifications subject to change without notice.



IMPORTANT
 While this electrical data is presented as a guide, it is important to electrically connect, properly size fuses and conductor wires in accordance with the National Electrical Code and all existing local codes.
Underwriters' Listed for outdoor installation.

Before purchasing this appliance, read important energy cost and efficiency information available from your retailer.

Model	NOMINAL CABINET DIMENSIONS (Inches)						DUCT OPENINGS (Inches)			
	A	B	C	H	J	K	Discharge	Return Air		
P24A1, P30A1	23 3/4	40	32	1 7/8	21 1/8	11	D	E	F	G
P36A4	24 1/4	48 3/16	38 3/8	7/8	26 1/8	17 1/4	33	6	33	14
P48A4, P60A4	31 1/4	50	42	1 3/8	22 7/8	16 1/4	38	10	38	16



BARD MANUFACTURING COMPANY • BRYAN, OHIO 43506

APPLICATION AND INSTALLATION INSTRUCTIONS
FOR SINGLE PACKAGE AIR CONDITIONERS

IMPORTANT

The equipment covered in this manual is to be installed by trained, experienced service and installation technicians. Any heat pump is more critical of proper operating charge and an adequate duct system than a straight air conditioning unit. All duct work, supply and return, must be properly sized for the design air flow requirement of the equipment. NESCA is an excellent guide to proper sizing. All duct work or portions thereof not in the conditioned space should be properly insulated in order to both conserve energy and prevent condensation or moisture damage.

SHIPPING DAMAGE

Upon receipt of equipment, the carton should be checked for external signs of shipping damage. If damage is found, the receiving party must contact the last carrier immediately, preferably in writing, requesting inspection by the carrier's agent.

GENERAL

The refrigerant system is completely assembled and charged. All internal wiring is complete.

The unit is designed for use with or without duct work. Flanges are provided for attaching the supply and return ducts.

These instructions explain the recommended method to install the air cooled self-contained unit and the electrical wiring connections to the unit.

These instructions and any instructions packaged with any separate equipment required to make up the entire air conditioning system should be carefully read before beginning the installation. Note particularly "Starting Procedure" and any tags and/or labels attached to the equipment.

While these instructions are intended as a general recommended guide, they do not supersede any national and/or local codes in any way. Authorities having jurisdiction should be consulted before the installation is made.

PRESSURE SERVICE PORTS

High and low pressure service ports are installed on all units so that the system operating pressures can be observed. Pressure curves can be found later in the manual covering all models on both cooling and heating cycles. It is imperative to match the correct pressure curve to the unit by model number.

LOCATION

The unit must be located outside, or in a well ventilated area. It must not be in the space being heated or cooled. A sound absorbing material should be considered if the unit is to be installed in such a position or location that might cause transmission of sound or vibration to the living area or adjacent buildings.

TYPICAL INSTALLATIONS

1. Roof-Mounted - The unit is mounted on a sturdy base on the roof of the building. Return air to the unit is brought through a single return grille (grilles with built-in filters are best, since they enable easy access for filter changing). Return air ducts are attached to the lower section of the front panel. Supply air is brought from the unit to attic duct work or to a furred down hall. Supply air duct is attached to the top of the front panel. CAUTION: All outdoor duct work must be thoroughly insulated and weatherproofed. All attic duct work must be thoroughly insulated. Two inch thick insulation with suitable vapor barrier is recommended for both outdoor and attic runs. In roof-top installation, as in all installations, the heat pump must be level from side to side. However, the unit should have a pitch along the length to assure complete external drainage of precipitation and of defrost condensate.
2. Crawl Space - Duct work installed in crawl space must be well insulated and provided with a vapor barrier. In addition, the crawl space must be thoroughly ventilated and provided with a good vapor barrier as a ground cover. It is most desirable to install the unit outdoors, rather than inside the crawl space, so that it will be readily accessible for service. In addition, it is necessary to dispose of the condensate from the outdoor coil on the heating cycle, and this is virtually impossible with the unit installed inside the crawl space.
3. Slab Mounted at Ground Level - This type installation is ideal for homes with slab floor construction, where a roof-mounted unit is not desired. The supply and return duct work can be run through a furred closet space.
4. Thru-The-Wall - This type installation requires a suitable framework to be fabricated, capable of withstanding the unit weight. Normally the unit will be installed so as to minimize supply and return duct work.
5. Other Installations - Many other installations are possible with the packaged air conditioner. No matter what the installation, always consider the following facts:
 - a. Insure that the discharge air is not obstructed in any way so as to cause operation difficulties.
 - b. The indoor coil drain pan is equipped with a coupling that must be piped through a condensate drain trap to a suitable drain.
 - c. Always mount the unit in such a position that it may be easily reached for servicing and maintenance.
 - d. Insure that the unit is clear so that proper air flow over the outdoor coil will be maintained.

WIRING - MAIN POWER

Refer to the unit rating plate for wiring sizing information and maximum fuse size. Each outdoor unit is marked with a "Minimum Circuit Ampacity." This means that the field wiring used must be sized to carry that amount of current. Depending on the installed Kw of electric heat, there may be two field power circuits required. If this is the case, the unit serial plate will so indicate. Some models are suitable only for connection with copper wire, while others can be wired with either copper or aluminum wire. Each unit and/or wiring diagram will be marked "Use Copper Conductors Only" or "Use Copper or Aluminum Conductors." These instructions MUST BE adhered to. Refer to the National Electrical Code for complete current carrying capacity data on the various insulation grades of wiring material.

The electrical specifications on page 18 lists fuse and wire sizes (60°F copper) for all models, including the most commonly used heater sizes. Also shown are the number of field power circuits required for the various models with heaters.

The unit rating plate lists a "Maximum Time Delay Fuse" that is to be used with the equipment. The correct size fuse must be used for proper circuit protection and also to assure that there will be no nuisance tripping due to the momentary high starting current of the compressor motor.

WIRING - CONTROL CIRCUIT

All units are provided with a 24 volt terminal board which is marked C, G, R, Y, W1 and W1. DO NOT wire to terminal C. This will cause transformer burnout. Refer to specific unit wiring diagram for details.

SEQUENCE OF OPERATION

Cooling - R-Y at thermostat pulls in the compressor contactor starting the compressor and outdoor fan. The same R-Y also feeds G, which pulls in the fan relay for blower operation. The reversing valve is not energized, so the system is in the cooling cycle.

Heating - R-W1 (and W2 on higher Kw models) energize the installed electric heat contactors. The indoor motor circuit is completed through the normally closed contact on the blower relay when the first electric heat contactor pulls in.

In most cases, a two-stage heating thermostat is desirable whenever there are more than one electric heat contactors. There is a nominal 1-1/2 degree differential between stages of the thermostat to allow better operating efficiency.

FILTERS

PRIOR THOUGHT SHOULD BE GIVEN TO RETURN AIR LOCATION AND PLACEMENT OF THE AIR FILTERS(S). The air filter(s) must be of adequate size and readily accessible to the homeowner. Filters must be adequate in size and properly maintained for proper operation. If this is not done, excessive energy use and multiple service problems will result. IT IS IMPOSSIBLE TO OVERSIZE AIR FILTERS. Generous sizing will result in cleaner air and coils, as well as lower operating costs and extend time between required changes. The following is minimum recommended filter sizes, suggested total static and expected air flows with dry coil.

MODEL	P24A1	P30A1	P36A4	P48A4	P60A4
Total Static	.25"	.10"	.15"	.30"	.20"
CFM	860	900	1275	1700	1700
Air Filter	2.18 sq.ft. 314 sq.in.	2.25 sq.ft. 324 sq.in.	3.56 sq.ft. 513 sq.in.	4.5 sq.ft. 648 sq.in.	5 sq.ft. 720 sq.in.
Approx. Size Example	16x20	16x20	20x25	(2) 16x20	(2) 20x20

INSTALLER NOTE: Optimum unit performance will occur with a refrigerant charge resulting in a suction line temperature (near the compressor) of 53° to 58°F with 95°F outdoor temperature and 80°F dry bulb/67°F wet bulb (50% R.H.) indoor temperatures and rated air flow across the indoor coil.



ROOF HOOD ACCESSORY FOR SINGLE PACKAGE HEAT Pumps AND AIR CONDITIONERS

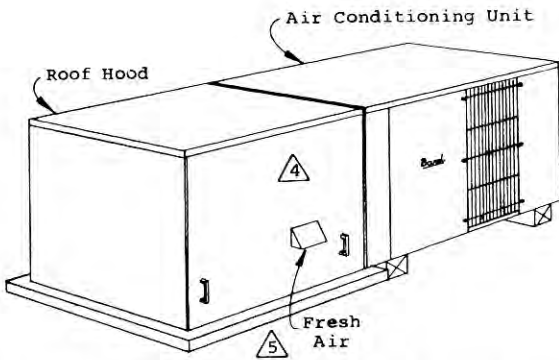

FIG. 1 - TYPICAL ROOFTOP INSTALLATION

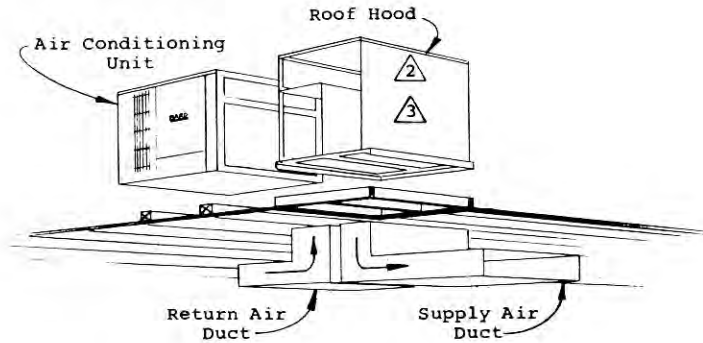

FIG. 2 - TYPICAL DUCT INSTALLATION

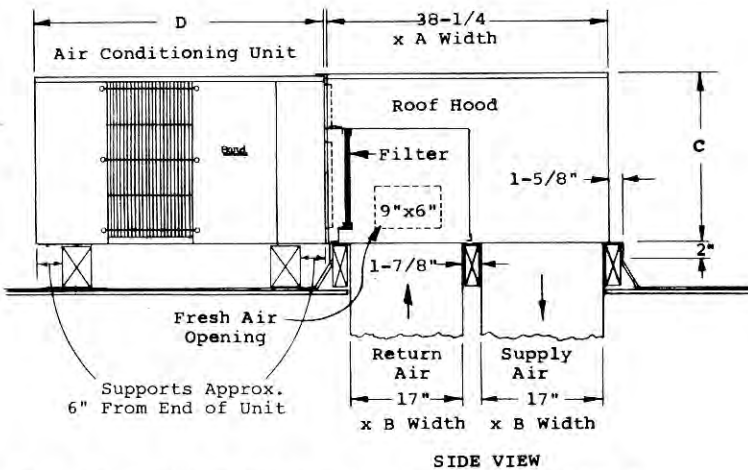
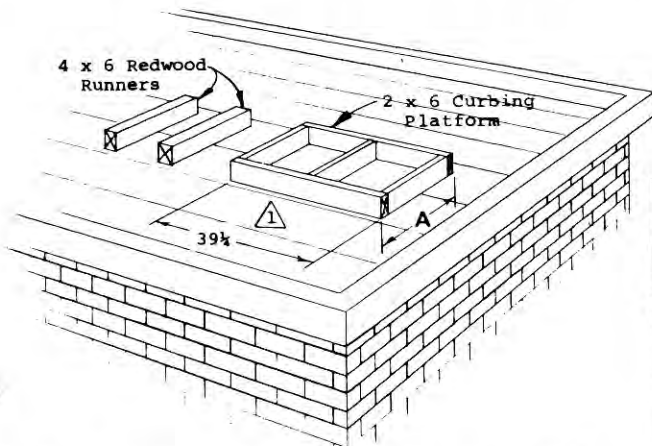

FIG. 3 - UNIT AND ROOF HOOD DETAILS

UNIT DIMENSIONS					
MODEL	A	B	C	D	1" Filter
P24A1	32	31-1/2	23-1/8	40	15 x 30-5/8
PH24	32	31-1/2	23-1/8	40	15 x 30-5/8
P30A1	32	31-1/2	23-1/8	40	15 x 30-5/8
PH30	32	31-1/2	23-1/8	40	15 x 30-5/8
PH31-1	38-1/8	37-1/2	24	48-3/16	(1) 16x16 &
P36A4	38-1/8	37-1/2	24	48-3/16	(1) 16x20
PH36-2	38-1/8	37-1/2	24	48-3/16	(1) 16x20
P48A4	42	41-1/2	31-1/8	50	(2) 16 x 20
PH48-1	42	41-1/2	31-1/8	50	(2) 16 x 20
P60A4	42	41-1/2	31-1/8	50	(2) 16 x 20
PH60-1	42	41-1/2	31-1/8	50	(2) 16 x 20



MODEL	A
P24A1	34-7/8
PH24	34-7/8
P30A1	34-7/8
PH30	34-7/8
PH31-1	41
P36A4	41
PH36-2	41
P48A4	44-7/8
PH48-1	44-7/8
P60A4	44-7/8
PH60-1	44-7/8

FIG. 4 - CURBING DETAILS (FIELD FABRICATED)

- 1 A separate metal flashing should be installed around wood curbing. Caulk and seal all joints and weatherproof.
- 2 Galvannealed cabinets painted to match basic unit design - heavy 1" insulation - built-in filter included.
- 3 Roof hood to be assembled in field. (See FIG. 5 on back side)
- 4 Remove this side to gain access to air filter.
- 5 Provides 15% fresh air.

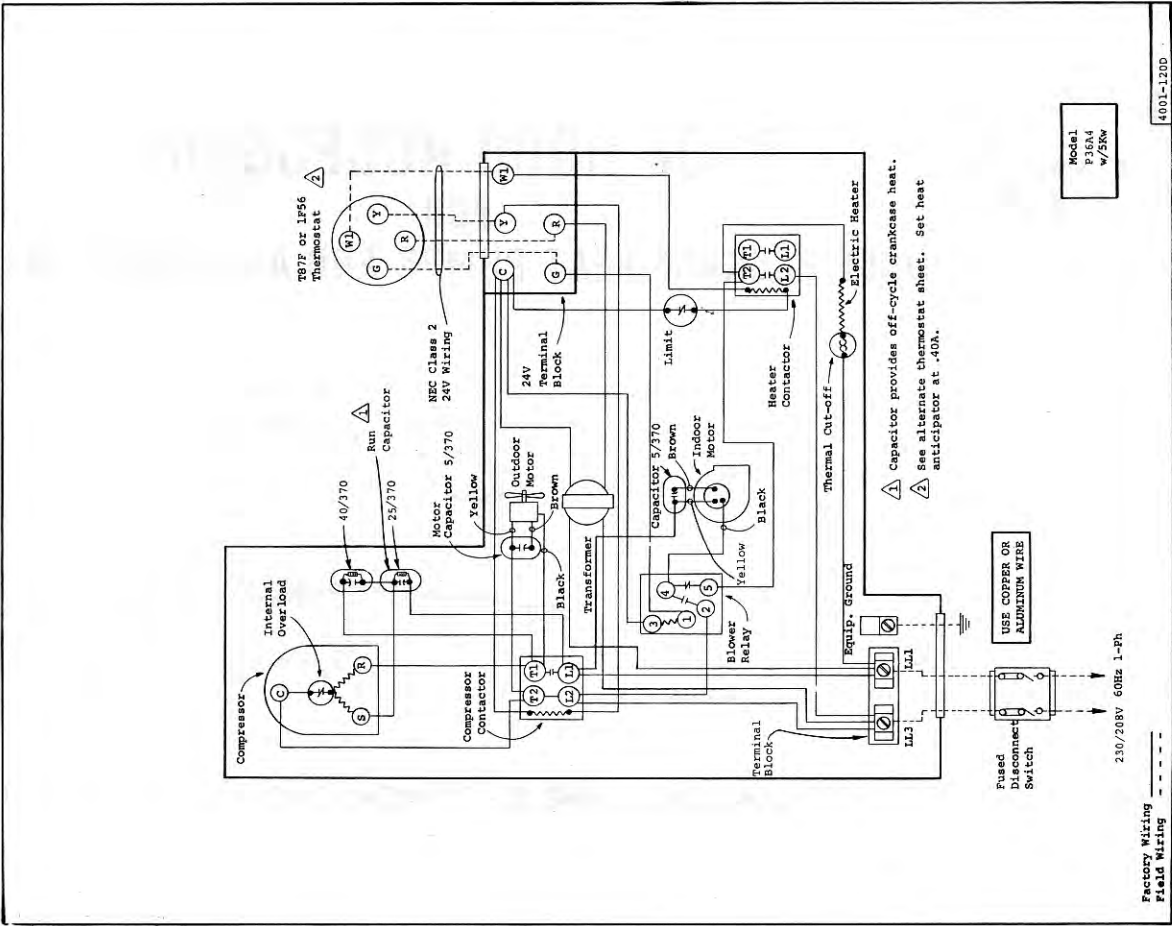
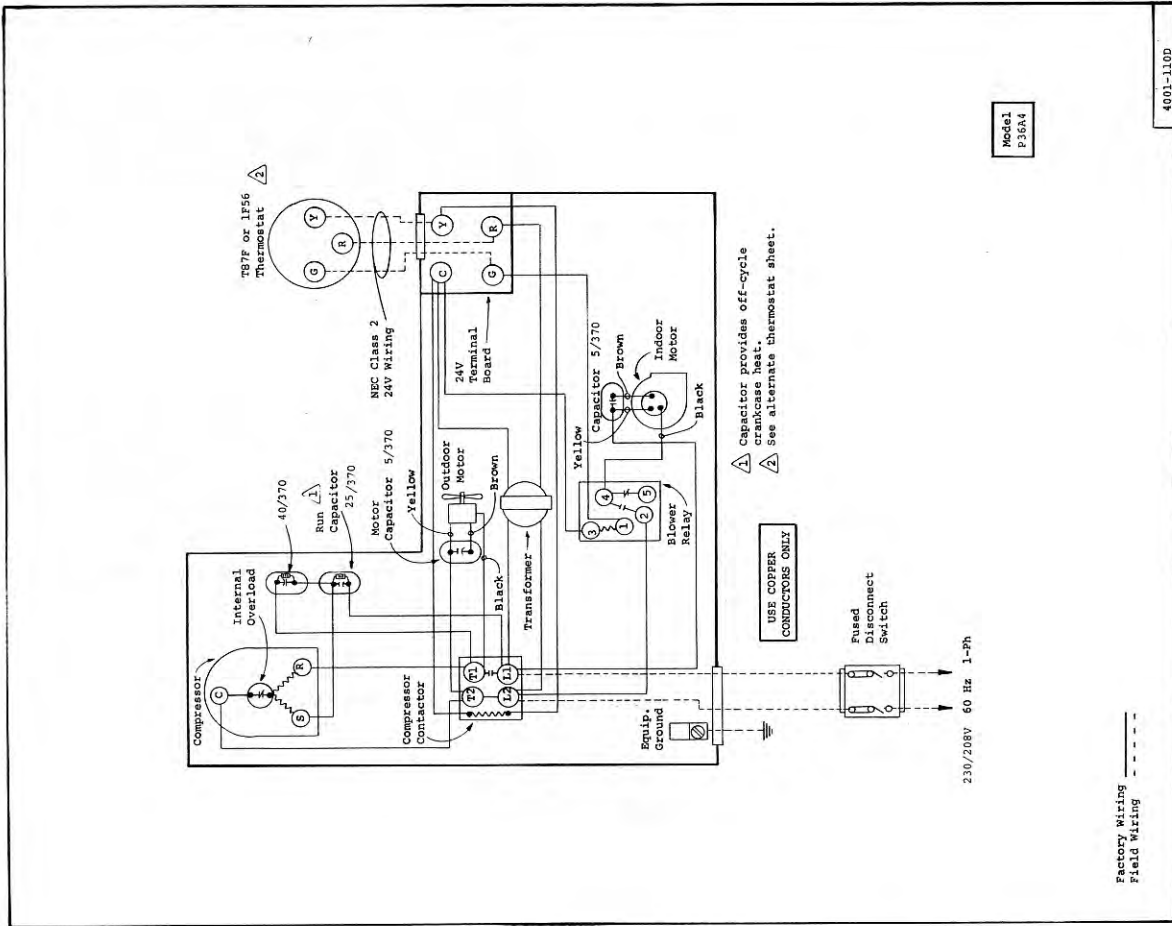

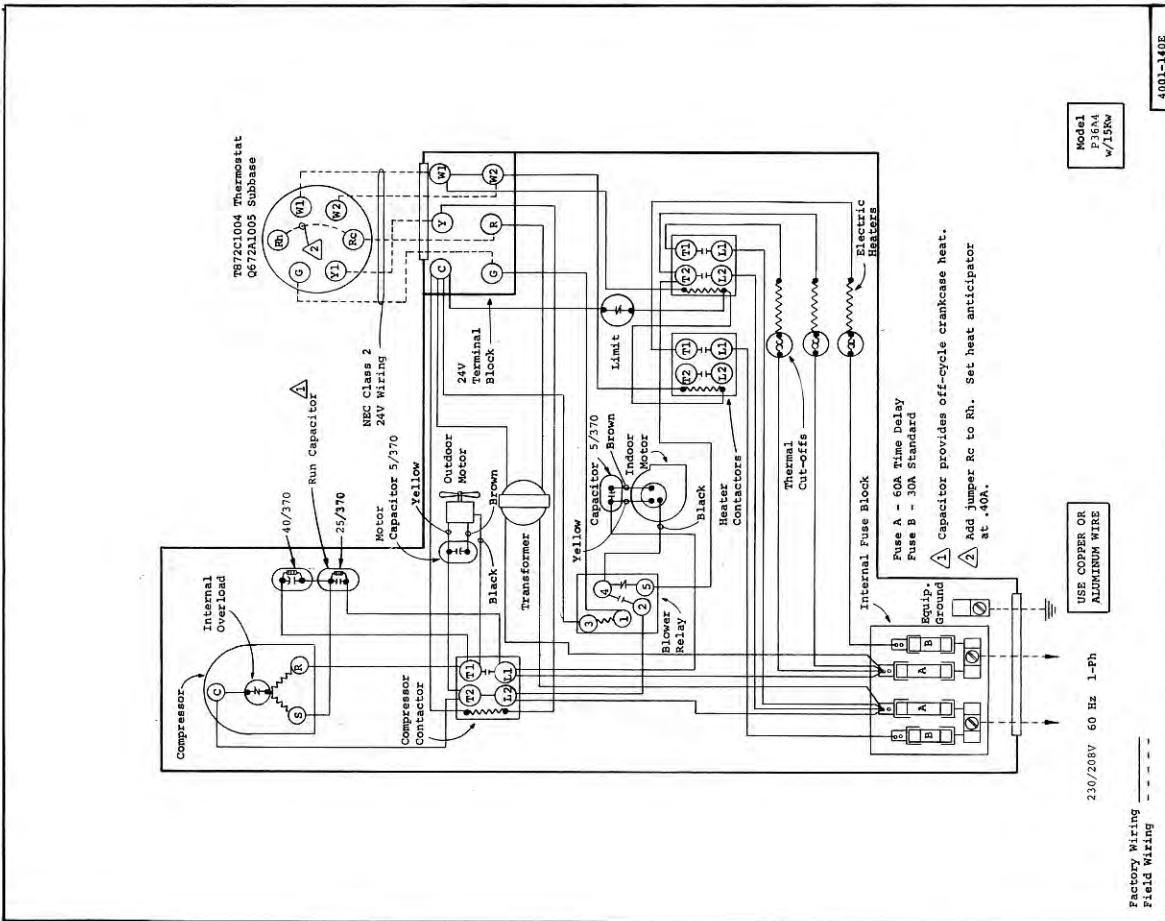
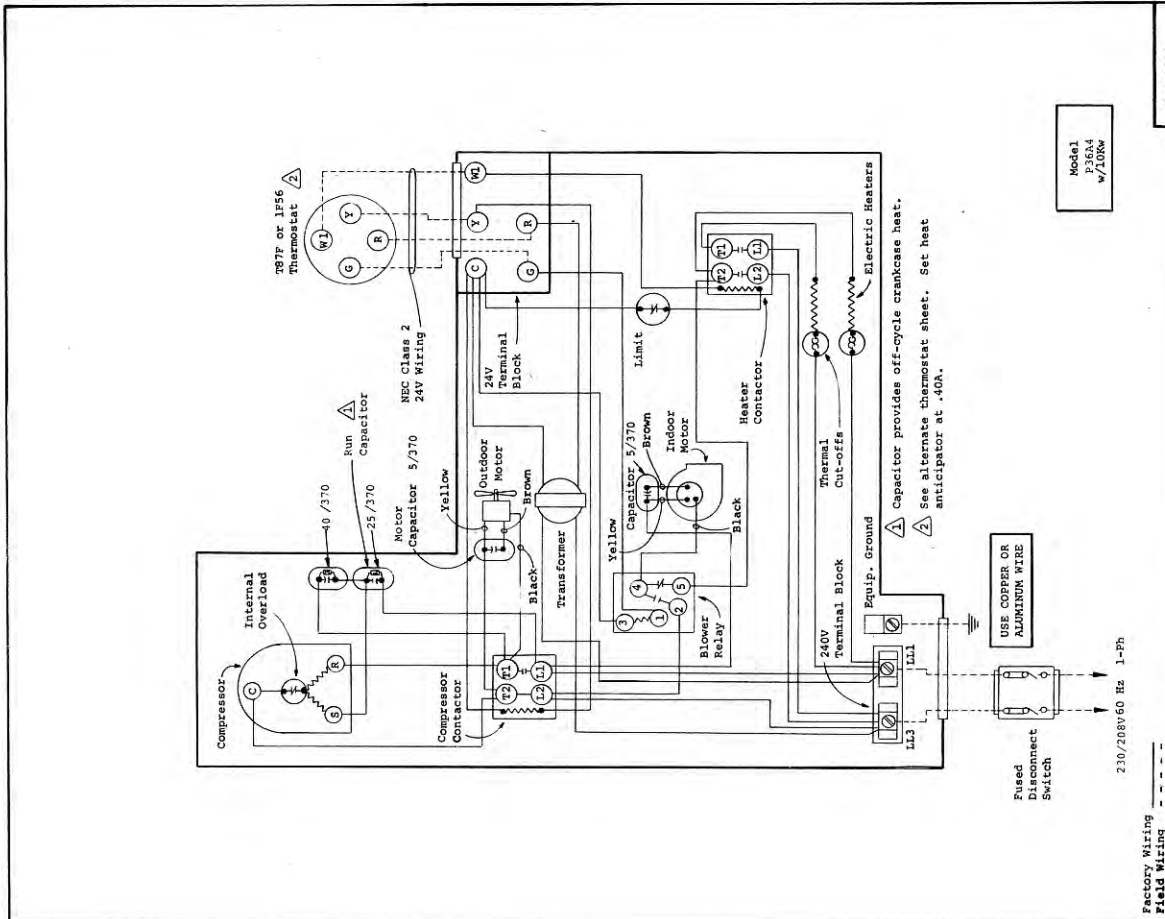

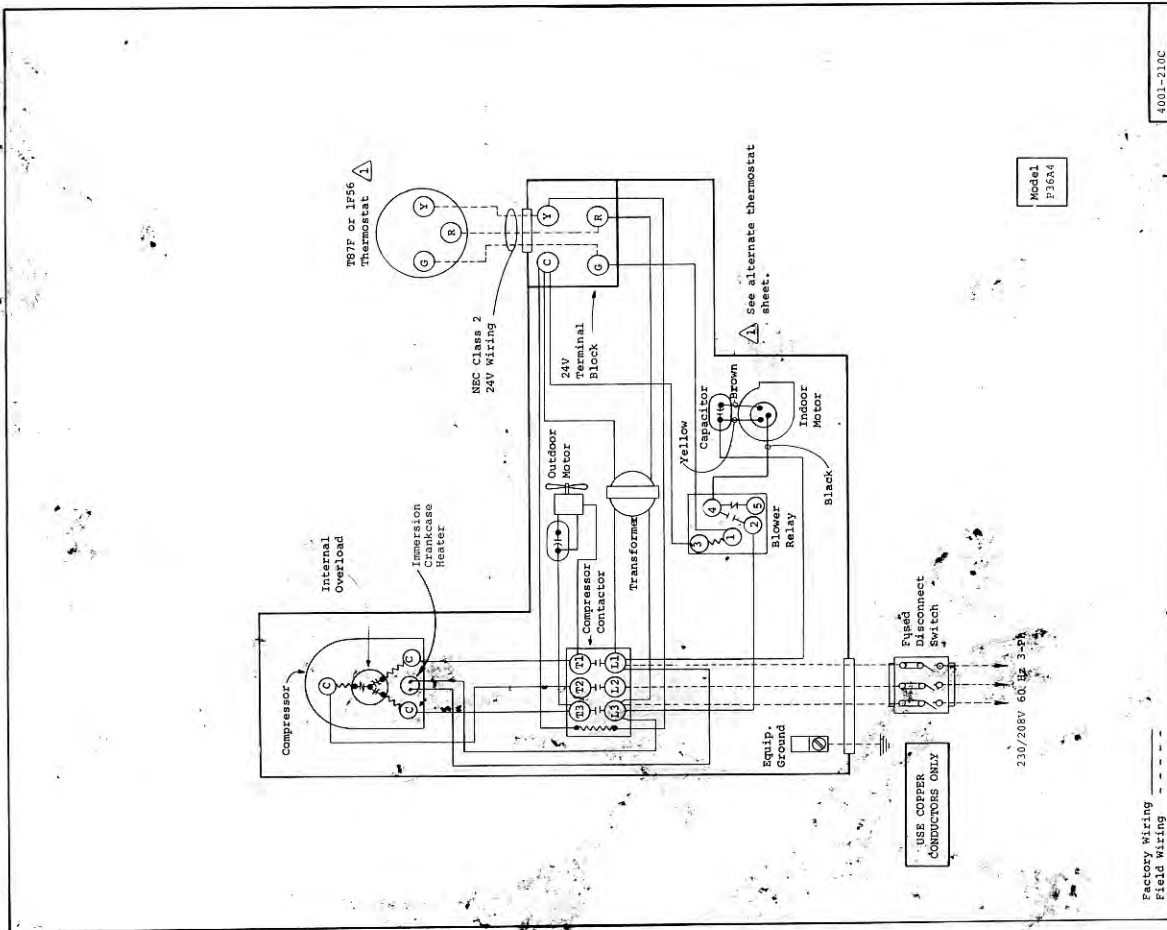

Factory Wiring
Field Wiring

4001-210C

Model
P36A4

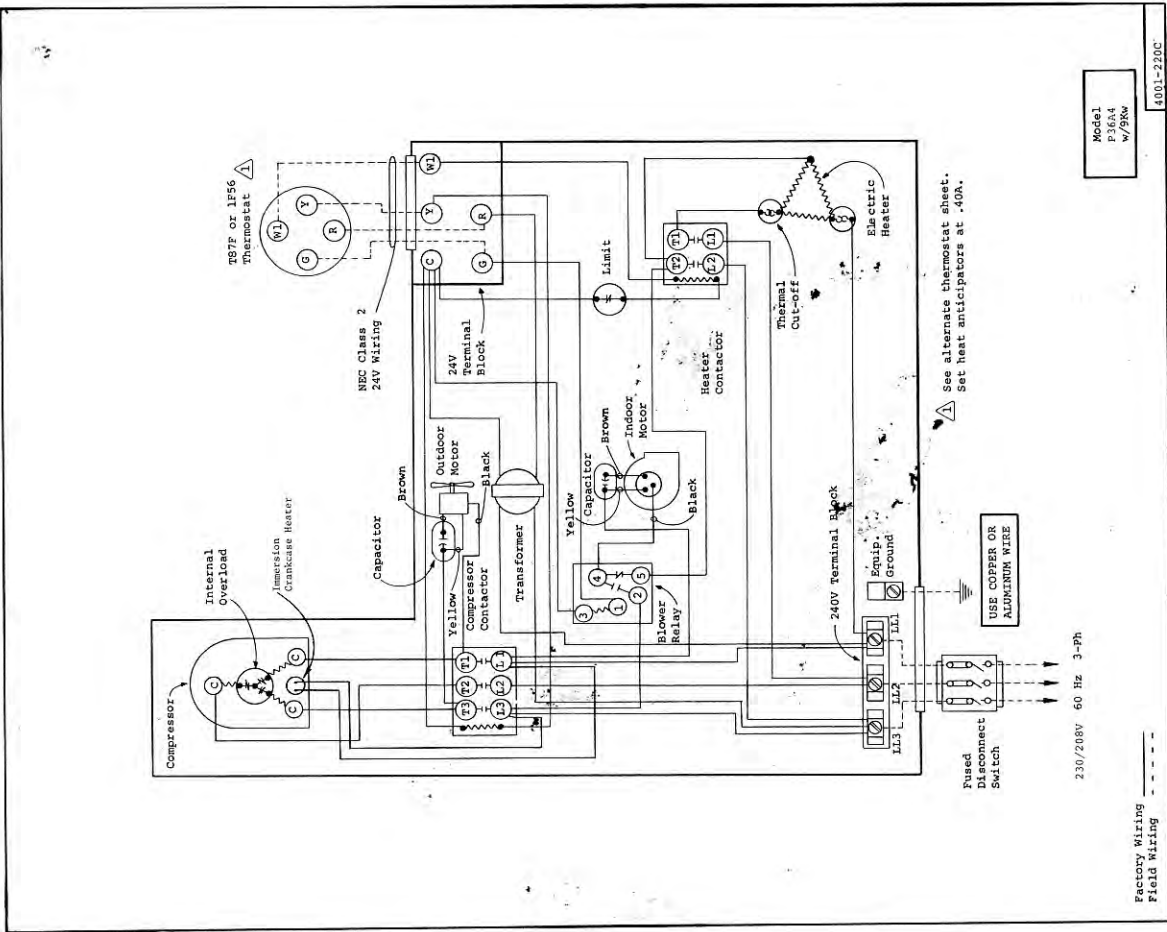

Factory Wiring
Field Wiring

4001-220C

Model
P36A4
w/9RW

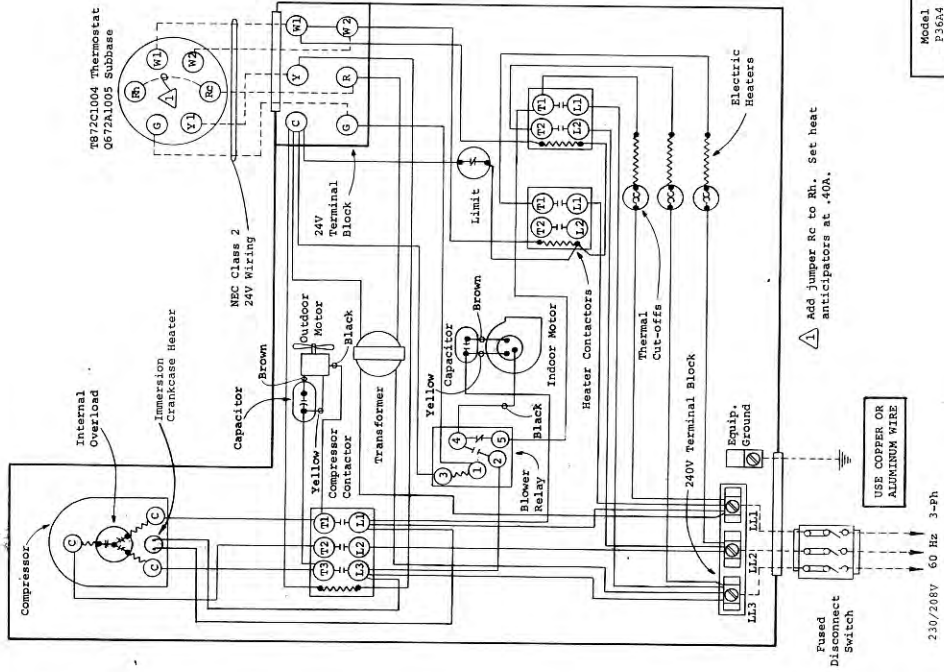

Factory Wiring
Field Wiring

4001-230C

Model
P36A4
w/12 or 15Rw

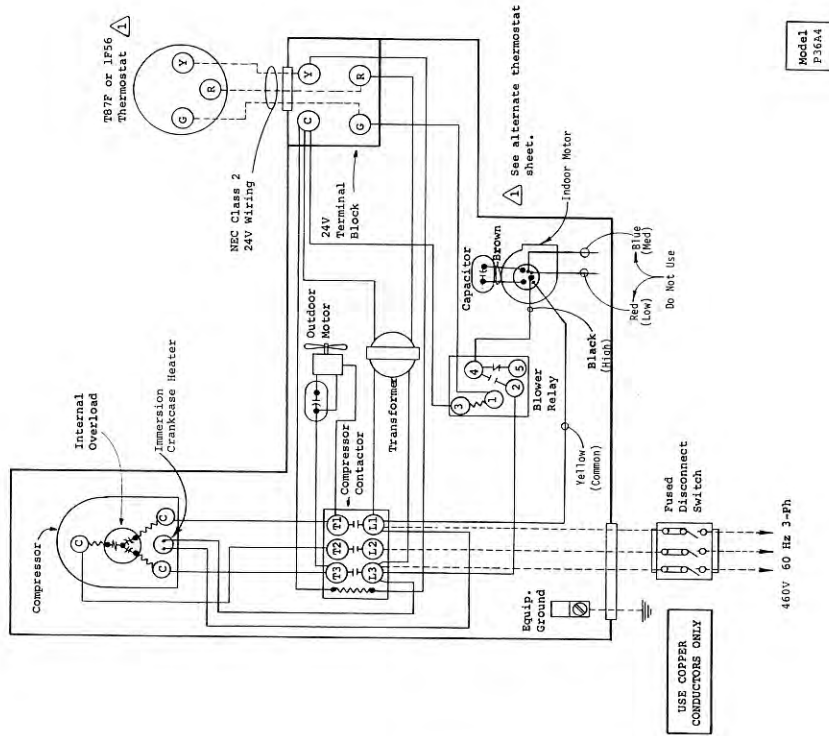

Factory Wiring
Field Wiring

4001-310C

Model
P36A4

BARD MANUFACTURING COMPANY
SINGLE PACKAGE AIR CONDITIONER - MODEL P36A4

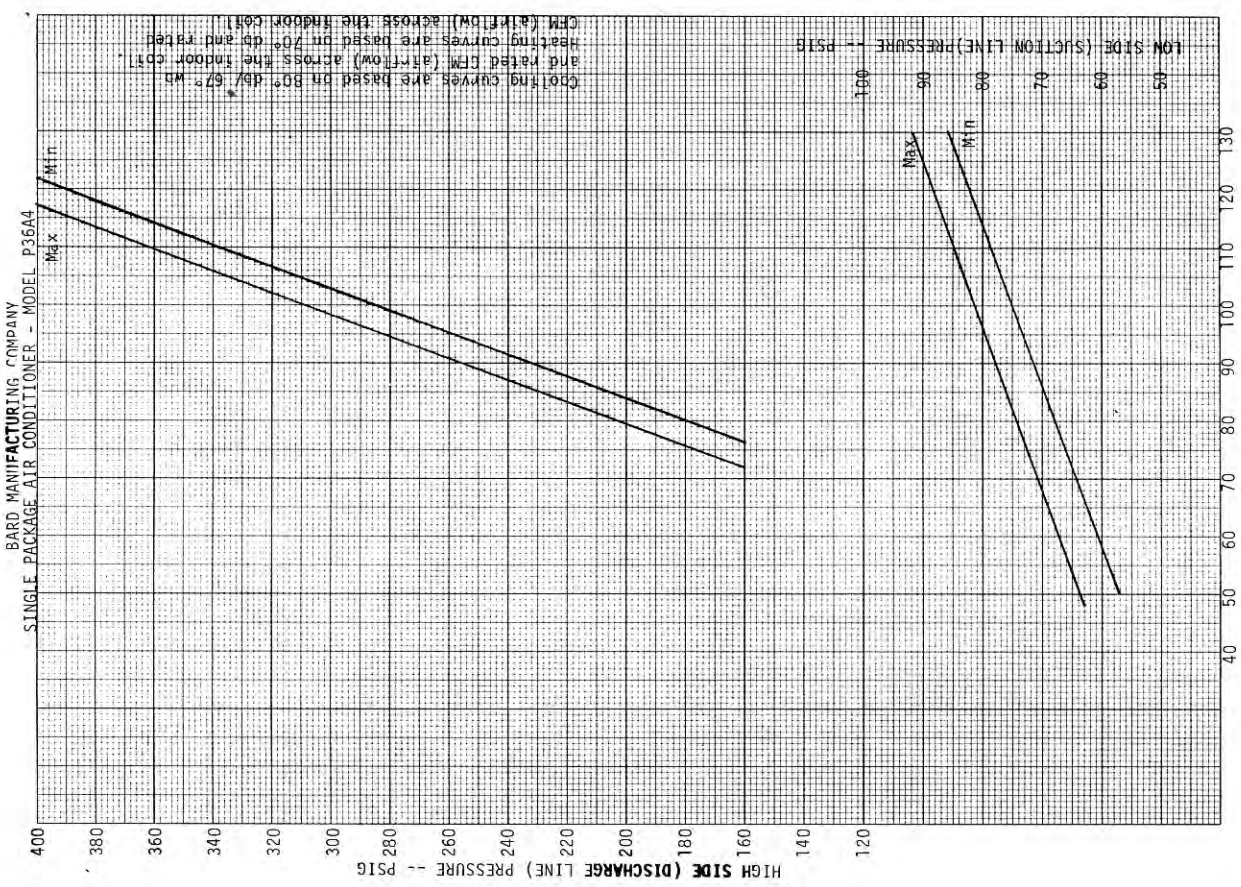
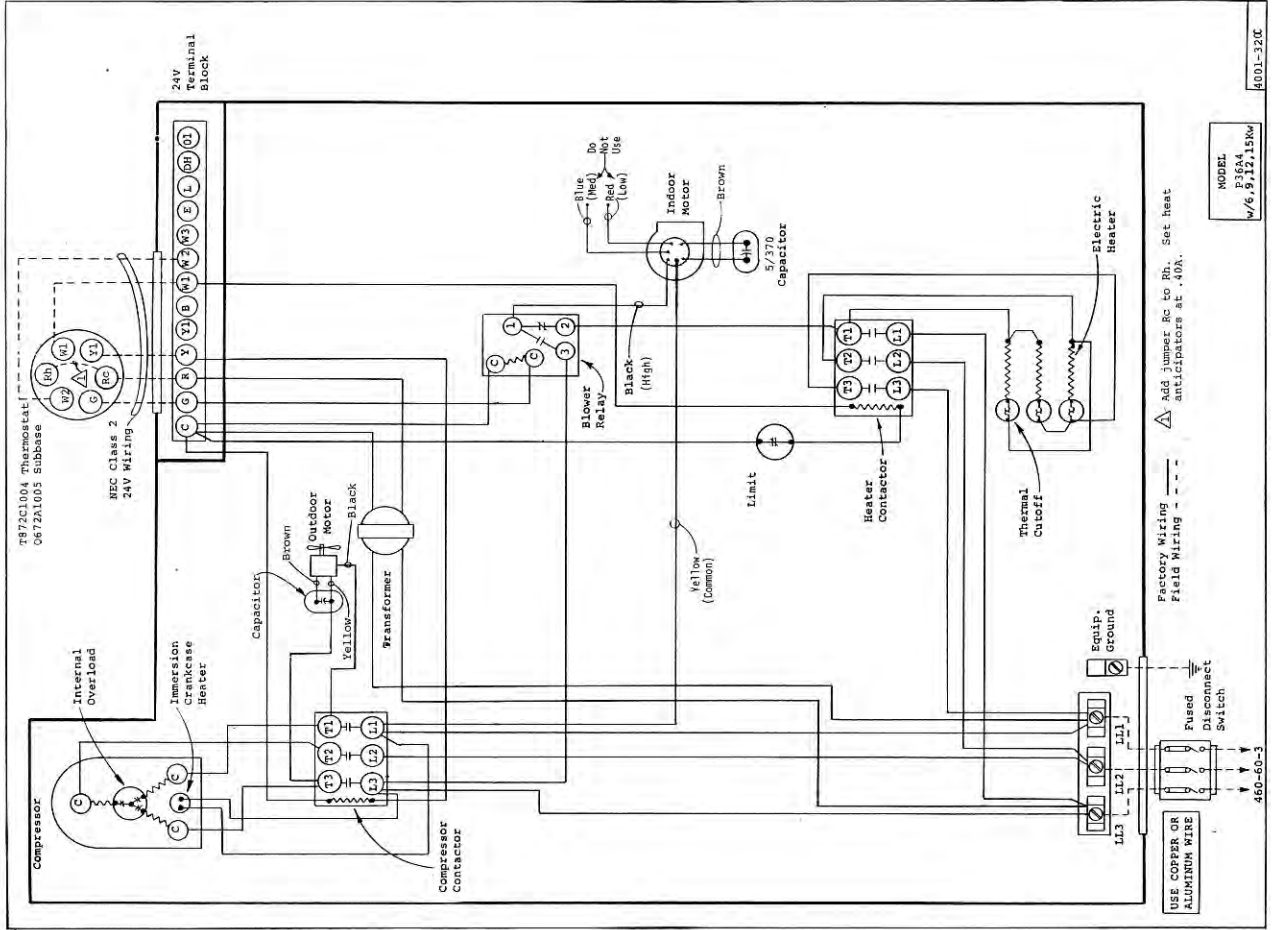

PARTS LIST
SINGLE PACKAGE AIR CONDITIONERS

PART NO.	DESCRIPTION	P36A4	P36A4-3	P36A4-3 460V
*	Blower Housing S1110-6	x	x	x
5152-013	Blower Wheel DD10-8A	x	x	x
8552-024	Capacitor - Compressor 40/370V	x		
8552-015	Capacitor - Compressor 25/370V	x		
8552-002	Capacitor - Fan & Blower 5/370V	x	x	x
5811-033	Capillary Tube - Cool	(2)	(2)	(2)
8000-051	Compressor H2EA363AB	x		
8000-056	Compressor CRH1-0275-TF5-270		x	
8000-057	Compressor CRH1-0275-TFD-270			x
5051-023	Condenser Coil	x	x	x
8401-007	Contactator - Comp. 1P25A	x		
8401-002	Contactator - Comp. 3P25A		x	x
8401-006	Contactator - Heater 2P20	x	x	
5060-023	Evaporator Coil	x	x	x
5151-004	Fan Blade TP2026 ccw	x	x	
5151-025	Fan Blade F10H08-2027 cw			x
8614-017	Fuse Block 15Kw	x		
8614-022	Fuse 60A	x		
8614-006	Fuse 30A	x		
8604-042	Heat Strip 5Kw	x		
8604-044	Heat Strip 10Kw	x		
8604-047	Heat Strip 15Kw	x	x	
8604-048	Heat Strip 9Kw		x	
8604-046	Heat Strip 12Kw		x	
8604-050	Heat Strip 9Kw			x
8604-052	Heat Strip 15Kw			x
8402-012	Limit Switch 130°	x	x	x
8105-020	Motor - Blower 1/3 hp ccw	x	x	
8105-018	Motor - Blower 1/3 hp ccw			x
8103-009	Motor - Fan 1/5 hp cw	x	x	
8105-016	Motor - Fan 1/3 hp ccw			x
8200-003	Motor Mount - Blower	x	x	x
8200-001	Motor Mount - Fan	x	x	x
5451-011	Motor Mounting Parts	x	x	x
8201-009	Relay - Blower	x	x	
8201-032	Relay - Blower			x
5210-004	Strainer	x	x	x
8607-006	Terminal Board 24V	x	x	x
8607-001	Terminal Block 230V	x		
8607-002	Terminal Block 230V		x	x
8402-026	Thermal Cutoff	x	x	x
8407-007	Transformer 40VA	x		
8407-015	Transformer 55VA		x	
8407-027	Transformer 48VA			x

*Please order by model number

IMPORTANT

PURCHASER'S RESPONSIBILITIES

Below are the responsibilities of the purchaser and these items cannot be considered as defects in workmanship or material.

1. Air filter cleaning or replacement.
2. Failure to operate due to improper air distribution over indoor and outdoor equipment sections.
3. Failure to start due to voltage conditions, blown fuses or other damage due to inadequacy or interruption of electrical service.
4. Damage caused directly or indirectly by improper installation.
5. Damage due to lack of proper and periodic maintenance.
6. Damage resulting from transportation, moving or storage of unit.
7. Unit must be readily accessible for servicing and/or repair at all times.
8. Any adjustment or service to the unit should be made by qualified service personnel.
9. Misapplication of product.

MODEL NO. _____ SERIAL NO. _____ DATE
INSTALLED _____

INSTALLER: Please fill in above blanks and leave
this manual with equipment owner/operator.