

Operating Instructions

Accutorr® V

mindray

Operating Instructions

Accutorr[®] V

mindray

Accutorr[®] is a registered trademark of Mindray DS USA, Inc.

Masimo SET[®] is a U.S. registered trademark of Masimo Corp.

Mindray[®] is a trademark or a registered trademark of Shenzhen Mindray Bio-Medical Electronics Co., Ltd.

Nellcor[®] is a U.S. registered trademark of Nellcor Puritan Bennett LLC.

SmarTemp[™] is a trademark of Shenzhen Mindray Bio-Medical Electronics Co., Ltd.

Copyright © Mindray DS USA, Inc., 2009. All rights reserved. Contents of this publication may not be reproduced in any form without permission of Mindray DS USA, Inc.

| | |
|--|--------------|
| Foreword | v |
| Warnings, Cautions, and Notes..... | vi |
| Warnings..... | vi |
| Cautions | vii |
| Notes | ix |
| Safety Designations | ix |
| Indications For Use..... | x |
| Product Limitations..... | x |
| Unpacking..... | xi |
| Symbols and Descriptions..... | xi |
| General Description | 1 - 1 |
| General Product Description | 1 - 2 |
| Product Features..... | 1 - 4 |
| Recommended Test and Calibration Frequency | 1 - 5 |
| Controls and Indicators | 2 - 1 |
| Introduction | 2 - 2 |
| Front Panel | 2 - 3 |
| Rear Panel..... | 2 - 7 |
| Recorder Module | 2 - 8 |
| Operation..... | 3 - 1 |
| Introduction | 3 - 2 |
| Operator Position | 3 - 2 |
| Setting-up and Turning Power On | 3 - 2 |
| Standby and Power OFF | 3 - 4 |
| Entering Standby | 3 - 4 |
| Exiting Standby | 3 - 4 |
| Turning Power Off..... | 3 - 4 |
| Selecting a Configuration | 3 - 4 |
| Patient Setup..... | 3 - 6 |
| Entering Patient Information..... | 3 - 6 |
| Quick Admit | 3 - 7 |
| Selecting the Patient Size | 3 - 7 |
| Setting Initial Cuff Inflation Pressure | 3 - 8 |
| Manual NIBP Measurements..... | 3 - 11 |
| NIBP Pressure Limit Fail Safe | 3 - 13 |
| Cuff Inflation Time..... | 3 - 13 |
| Automatic Retry | 3 - 13 |
| Automatic NIBP Measurements (Interval Mode) | 3 - 14 |
| Starting an Automatic Measurement | 3 - 14 |
| Canceling an Automatic NIBP Measurement | 3 - 14 |
| Changing the Interval Setting | 3 - 15 |
| START and DEFLATE Functions..... | 3 - 15 |
| Automatic Adjustment of Cuff Inflation Pressure (Adaptive Inflation) | 3 - 15 |
| Automatic Retry | 3 - 16 |
| Alarms | 3 - 17 |

| | |
|--|--------|
| Setting Alarm Limits | 3 - 17 |
| Alarm Violations | 3 - 19 |
| Pausing and Silencing Alarms | 3 - 20 |
| Viewing and Deleting Stored Trend Data | 3 - 21 |
| Storing Measurements | 3 - 21 |
| Viewing Stored/Trend Data | 3 - 21 |
| Reviewing and Deleting Stored/Trend Data | 3 - 22 |
| Selecting a Patient ID | 3 - 22 |
| Reviewing Trend Data | 3 - 22 |
| Deleting Trend Data | 3 - 23 |
| Exiting the REVIEW SETUP Dialog | 3 - 23 |
| Common Setup | 3 - 24 |
| Setting the Alarm Volume, Key Volume, and Pulse Volume, and NIBP End Tone Volume | 3 - 24 |
| Setting the LCD Brightness and Contrast | 3 - 24 |
| SpO ₂ Measurements | 3 - 26 |
| Pulse Oximetry Sensors | 3 - 26 |
| Sequence for Establishing SpO ₂ with Nellcor® Pulse Oximetry | 3 - 28 |
| NELLCOR® Sensors | 3 - 29 |
| Sequence for Establishing SpO ₂ with Masimo® Pulse Oximetry | 3 - 29 |
| MASIMO® Sensors and Patient Cable | 3 - 31 |
| DPM SpO ₂ | 3 - 31 |
| Temperature Measurement | 3 - 34 |
| Setting Temperature Properties | 3 - 34 |
| Applying a Probe Cover (SmarTemp) | 3 - 35 |
| Taking an Oral Temperature Measurement | 3 - 35 |
| Taking an Axillary Temperature Measurement | 3 - 36 |
| Measuring Rectal Temperature | 3 - 37 |
| Recorder | 3 - 39 |
| Setting The Clock (Date and Time) | 3 - 40 |
| Battery Operation | 3 - 41 |
| Creating a User Configuration | 3 - 42 |
| Turning Barcode Power On or Off | 3 - 43 |
| Selecting a Language | 3 - 43 |
| Turning Alarm Tones Off | 3 - 44 |
| SpO ₂ Sensor Off | 3 - 44 |
| Saving a user configuration | 3 - 44 |
| Setting a Default Power-on Configuration | 3 - 45 |
| Status and Error Codes | 3 - 47 |
| Physiological Alarm Messages | 3 - 47 |
| Technical Alarm Messages | 3 - 47 |
| General Alarm Messages of Parameter Modules | 3 - 48 |
| NIBP Module Alarm Messages | 3 - 48 |
| Masimo SpO ₂ Module Alarm Messages | 3 - 50 |
| Nellcor SpO ₂ Module Alarm Messages | 3 - 51 |
| DPM SpO ₂ Module Alarm Messages | 3 - 51 |
| SmarTemp™ TEMP Module Alarm Messages | 3 - 53 |
| Recorder Module Alarm Messages | 3 - 53 |

| | |
|--|--------------|
| System Alarm Messages | 3 - 55 |
| Prompt Messages | 3 - 55 |
| User Maintenance | 4 - 1 |
| Introduction | 4 - 2 |
| Cleaning and Disinfection of the Accutorr V Monitor | 4 - 3 |
| Decontamination of the Optional SmarTemp™ TEMP Probe | 4 - 4 |
| Sterilization and Cleaning of Reusable Cuffs | 4 - 5 |
| Battery Maintenance and Replacement | 4 - 6 |
| Battery Maintenance | 4 - 6 |
| Battery Replacement | 4 - 6 |
| Recorder Maintenance | 4 - 7 |
| Recorder Paper Replacement | 4 - 7 |
| Care and Storage of Thermal Paper | 4 - 9 |
| Resetting the NIBP | 4 - 10 |
| Nurse Call Set-up | 4 - 12 |
| Accutorr V Accessories | 5 - 1 |
| Accessories | 5 - 2 |
| Hoses, Non Invasive Blood Pressure | 5 - 2 |
| Oximetry Sensors and Accessories | 5 - 3 |
| Pulse Oximetry DPM SpO ₂ | 5 - 3 |
| Pulse Oximetry-Masimo SET® LNOP® SpO ₂ | 5 - 4 |
| Pulse Oximetry-Masimo SET® LNCS® SpO ₂ | 5 - 5 |
| Pulse Oximetry-Nellcor® SpO ₂ | 5 - 5 |
| SmarTemp Temperature Accessories | 5 - 5 |
| Welch Allyn SureTemp® Plus Thermometer Accessories | 5 - 6 |
| Nurse Call Connector | 5 - 6 |
| Recorder Paper | 5 - 6 |
| Barcode Scanner | 5 - 6 |
| Battery and Power Cords | 5 - 6 |
| Mounting Assemblies | 5 - 6 |
| Appendix | 6 - 1 |
| How To Get Assistance | 6 - 2 |
| Specifications | 6 - 3 |
| Systolic Pressure Readout | 6 - 3 |
| Diastolic Pressure Readout | 6 - 3 |
| Mean Pressure Readout | 6 - 3 |
| NIBP Measurement Cycle Time | 6 - 3 |
| Pulse Rate | 6 - 4 |
| Maximum Cuff Pressure | 6 - 4 |
| Temperature | 6 - 5 |
| Nellcor® Performance Specifications | 6 - 5 |
| Masimo Performance Specifications | 6 - 6 |
| DPM Performance Specifications | 6 - 8 |
| Battery | 6 - 8 |
| Real Time Clock | 6 - 10 |
| Physical Characteristics | 6 - 10 |

| | |
|--|--------|
| Recovery from Power Loss | 6 - 11 |
| Alarm Restoration from Power Loss | 6 - 11 |
| Data Logging after Power Loss | 6 - 11 |
| Environmental Characteristics | 6 - 12 |
| Electrical Ratings..... | 6 - 13 |
| Agency Compliance | 6 - 14 |
| Electromagnetic Compatibility..... | 6 - 15 |
| Indirect Blood Pressure Measurements and Associated Errors..... | 6 - 19 |
| Precautions With Using Automatically Cycled Blood Pressure Cuffs | 6 - 20 |
| Cuff Size | 6 - 20 |
| Other Factors | 6 - 20 |
| User Verification Of The Accutorr V NIBP Measurements..... | 6 - 21 |
| Warranty | 6 - 22 |
| Manufacturer's Responsibility | 6 - 23 |

Foreword

These operating instructions are intended to provide information for the proper operation of the Mindray DS USA, Inc./Shenzhen Mindray Bio-Medical Electronics Co., Ltd Accutorr V.

The Accutorr V configurations are:

- **Accutorr V with Nellcor® Pulse Oximetry**— includes NIBP, Nellcor SpO₂, a Trend Display, and Recorder
- **Accutorr V with Nellcor® Pulse Oximetry and SmarTemp™**— includes NIBP, Nellcor SpO₂, SmarTemp, a Trend Display, and Recorder
- **Accutorr V with Masimo SET® Pulse Oximetry**— includes NIBP, Masimo SpO₂, a Trend Display, and Recorder
- **Accutorr V with Masimo SET® Pulse Oximetry and SmarTemp™**— includes NIBP, Masimo SpO₂, SmarTemp, a Trend Display, and Recorder
- **Accutorr V with DPM Pulse Oximetry**— includes NIBP, DPM SpO₂, a Liquid Crystal Display (LCD), and Recorder
- **Accutorr V with DPM Pulse Oximetry and SmarTemp™**— includes NIBP, DPM SpO₂, SmarTemp, a Liquid Crystal Display (LCD), and Recorder
- **Accutorr V with DPM NIBP and SmarTemp™**— includes NIBP, SmarTemp, a Trend Display, and Recorder
- **Accutorr V with DPM NIBP only**— includes NIBP, a Trend Display, and Recorder

All Accutorr V configurations can be upgraded with a barcode scanner.

In this manual, when a described feature refers to a particular Accutorr V configuration, it will be noted. When the name Accutorr V is used, it refers to all configurations.

General knowledge of monitoring and an understanding of the features and functions of the Accutorr V are prerequisites for its proper use.

DO NOT OPERATE THIS UNIT BEFORE READING ALL INSTRUCTIONS.

Refer to the Accutorr V Service Manual: P/N 0070-00-0702 for information for servicing this instrument. For additional information or assistance, contact an authorized representative.

U.S. Federal Law restricts this device to sale by or on the order of a physician or other practitioner licensed by state law to use or order the use of this device.

Mindray maintains a policy of continual product improvement and reserves the right to change materials and specifications without notice.

Masimo Patents: This device (MASIMO SpO₂ Module) is covered under one or more of the following U.S. Patents 5,758,644, 5,823,950, 6,011,986, 6,157,850, 6,263,222, 6,501,975, and other applicable patents listed at: www.masimo.com/patents.htm. Possession or purchase of this device does not convey any express or implied license to use the device with replacement parts which would, alone, or in combination with this device, fall within the scope of one or more of the patents relating to this device.

Nellcor Patents: This device (Nellcor SpO₂ Module) is covered under one or more of the following U.S. Patents Patent No. 5,485,847, 5,676,141, 5,743,263, 6,035,223, 6,226,539, 6,411,833, 6,463,310, 6,591,123, 6,708,049, 7,016,715, 7,039,538, 7,120,479, 7,120,480, 7,142,142, 7,162,288, 7,190,985, 7,194,293, 7,209,774, 7,212,847, and 7,400,919. Possession or purchase of this device does not convey any express or implied license to use the device with replacement parts which would, alone, or in combination with this device, fall within the scope of one or more of the patents relating to this device.

Warnings, Cautions, and Notes

Read and adhere to all of the warnings and cautions listed throughout this manual.

A **WARNING** is provided to alert the user to potentially serious outcomes (death, injury or serious adverse events) to the patient or the user.

A **CAUTION** is provided to alert the user that special care should be taken for the safe and effective use of the device. They will include actions to be taken to avoid effects on patients or users that will not be potentially life threatening or result in serious injury, but about which the user should be aware.

A **NOTE** is provided when additional general information is available.

Warnings

WARNING: Internal Electrical Shock Hazard - This unit does not contain any user-serviceable parts. Do not remove instrument covers. Refer servicing to qualified personnel. When the integrity of the protective earth conductor, in the installation or its arrangement, is in doubt, the equipment should be operated from its internal battery. Observe all CAUTION and WARNING labels on the unit.

WARNING: Possible explosion hazard. Do not operate machine near flammable anesthetic agents or other flammable substances. Do not use flammable anesthetic agents (i.e., ether or cyclopropane.)

WARNING: Continued use of the STAT NIBP mode or short term automatic mode may result in surface vessel rupture (petechia).

WARNING: Always place the unit on a flat, rigid surface or onto a Mindray approved stable mounting bracket.

WARNING: To ensure proper performance and safety and to prevent the voiding of the warranty, only use authorized parts and accessories with the Accutorr V. Use of unauthorized accessories may result in erroneous readings.

WARNING: Use only cuffs with approved quick connect type connectors.

WARNING: The Accutorr V is not intended for use in a magnetic resonance imaging (MRI) environment and may interfere with MRI procedures.

- WARNING:** Danger of explosion if battery is incorrectly replaced. Replace only with the same or equivalent type recommended by the manufacturer. Dispose of used batteries according to the manufacturers instructions and local regulations. Batteries used in this device may present a risk of fire or chemical burn if mistreated. Do not incinerate battery, possible explosion may occur.
- WARNING:** Do not use a damaged or broken unit or accessory.
- WARNING:** Operation of the Accutorr V below the minimum amplitude or value of patient physiological signal may cause inaccurate results.
- WARNING:** Use of accessories, transducers, and cables other than those specified in the manual may result in increased Electromagnetic Emissions or decreased Electromagnetic Immunity of the Accutorr V. It can also cause delayed recovery after the discharge of a cardiac defibrillator.
- WARNING:** Perform the decontamination or cleaning process with the unit powered down and power cord removed.
- WARNING:** Use only authorized single use disposable probe covers when taking temperature measurements. Use of any other probe cover may result in erroneous readings or damage to the probe.

Cautions

- CAUTION:** Observe extreme caution when a defibrillator is in use. Do not touch any part of the patient, table, or monitor when a defibrillator is in use. The Accutorr V should not be used adjacent to or stacked with other equipment. If adjacent or stacked use is necessary, the Accutorr V should be observed to verify normal operation in the configuration in which it will be used.
- CAUTION:** The unit should be checked periodically for obstructed vents. If an obstruction is found, refer the unit to qualified service personnel.
- CAUTION:** At the end of their life, dispose of the Accutorr V, accessories, and single use supplies in accordance with local regulations. Dispose of packaging waste in accordance with local regulations.
- CAUTION:** Wrapping the cuffs too tightly may cause a hazard to the patient.
- CAUTION:** When equipped with Nellcor[®] SpO₂, use only Nellcor[®] oxygen transducers including Nellcor[®] Oxisensor[®] patient dedicated adhesive sensors. Use of other oxygen transducers may cause improper oximeter performance.
- CAUTION:** When equipped with MASIMO[®] SpO₂, use only MASIMO[®] oxygen transducers including MASIMO LNOP[®], MASIMO LNCS[®] patient dedicated adhesive sensors and MASIMO PC Series Patient Cable. Use of other oxygen transducers may cause improper oximetry performance.

- CAUTION:** When equipped with DPM SpO₂, use only DPM oxygen sensors and cables. Use of other oxygen sensors may cause improper oximeter performance.
- CAUTION:** Excessive ambient light may cause inaccurate SpO₂ measurements. Cover the sensor with opaque materials.
- CAUTION:** Inaccurate readings may be caused by incorrect sensor application or use; significant levels of dysfunctional hemoglobins (i.e. carbohemoglobins or methemoglobin); or intra-vascular dyes such as indocyanine green or methylene blue; exposure to excessive illumination, such as surgical lamps (especially ones with a Xenon light source), bilirubin lamps, fluorescent lights, infrared heating lamps, or direct sunlight; excessive patient movement; venous pulsations; electro-surgical interference; and placement of a sensor on an extremity that has a blood pressure cuff, arterial catheter, or intra-vascular line.
- CAUTION:** Route cables neatly. Ensure cables, hoses, and wires are kept away from patient's neck to avoid strangulation. Keep floors and walkways free of cables to reduce risk to hospital personnel, patients, and visitors. If the sensor or patient cable is damaged in any way, discontinue use immediately.
- CAUTION:** When cleaning sensors, do not use excessive amounts of liquid. Wipe the sensor surface with a soft cloth, dampened with the cleaning solution. To prevent damage, do not soak or immerse the sensor in any liquid solution. **DO NOT ATTEMPT TO STERILIZE.**
- CAUTION:** Prolonged and continuous monitoring may increase the risk of skin erosion and pressure necrosis at the site of the sensor. Check the SpO₂ sensor site frequently to ensure proper positioning, alignment, and skin integrity at least every eight (8) hours; with the Adult and Pediatric re-usable finger sensor, check every four (4) hours; for neonates and patients of poor perfusion or with skin sensitive to light, check every 2 - 3 hours; more frequent examinations may be required for different patients. Change the sensor site if signs of circulatory compromise occur. Ensure proper adhesion, skin integrity, and proper alignment. Exercise extreme caution with poorly perfused patients. When sensors are not frequently monitored, skin erosion and pressure necrosis can occur. Assess the site every two (2) hours with poorly perfused patients and neonates.
- CAUTION:** Recharge the Lithium ion battery while in the unit at room temperature. If using the Accutorr V in a hot environment, the Lithium ion battery may not charge when the unit is connected to the AC mains.
- CAUTION:** Remove the battery if the Accutorr V is not likely to be used for an extended period of time.
- CAUTION:** The Communications Connectors on the Accutorr V are only for use with IEC 60601-1-1 compliant equipment.
- CAUTION:** Never place fluids on top of this monitor. If fluid spills on the unit, wipe clean immediately and refer the unit to qualified service personnel.

Notes

- NOTE:** The Accutorr V should be operated only by trained and qualified personnel.
- NOTE:** Use disposable and single use accessories only once.
- NOTE:** Place the equipment in a location where the screen can easily be seen and the operating controls can easily be accessed.
- NOTE:** In certain situations in which perfusion and signal strength are low, such as in patients with thick or pigmented skin, inaccurately low SpO₂ readings will result. Verification of oxygenation should be made, especially in preterm infants and patients with chronic lung disease, before instituting any therapy or intervention.
- NOTE:** The instructions in this manual are based on the maximum configuration.
- NOTE:** The optional Temperature module kit must be installed only by trained personnel, and proper ESD prevention methods must be followed.
- NOTE:** Only devices specified by Mindray DS USA, Inc./Shenzhen Mindray Bio-Medical Electronics Co., Ltd shall be connected the RS-232 port.
- NOTE:** When the RS-232 connector is used for DIAP, barcode power must be set to OFF.
- NOTE:** Disconnect the Accutorr V from the mains to isolate it from the mains power during an emergency.

Safety Designations

Safety designations per IEC 60601-1 Standard:

| | |
|---|---|
| Type of protection against electric shock | Class 1 with internal electric power source. Where the integrity of the external protective earth (ground) in the installation or its conductors is in doubt, the equipment shall be operated from its internal electric power source. |
| Degree of protection against electric shock | Monitor - Type B applied part. NIBP - Type BF defibrillation protected applied part. SpO ₂ - Type BF protected applied part. Temp - Type BF protected applied part. |
| Supply Connection | 100 – 240 VAC 50/60 Hz 0.85 – 0.5 A |

| | |
|---|--|
| Mode of Operation | Continuous |
| Protection Against Hazard of Explosion | Not Protected (Ordinary) |
| Protection Against Ingress of Liquids | IPX1 |
| Degree of Electrical Connection Between Equipment and Patient | Equipment designed for direct electrical and non-electrical connection to the patient. |
| Degree of Mobility | Portable |

Indications For Use

The Accutorr V is intended for intra-hospital use under the direct supervision of a licensed healthcare practitioner. The Indications for Use for the Accutorr V include the monitoring of the following human physiological parameters:

- Noninvasive blood pressure (NIBP)
- Pulse oximetry (SpO₂)
- Heart Rate
- Temperature

Product Limitations

Non-invasive blood pressure (NIBP) accuracy depends on the application of the proper cuff size. See Chapter 3.0 for detailed information.

The Accutorr V will not operate effectively on patients who are experiencing convulsions or tremors.

The Accutorr V is a portable device intended for intra-hospital use.

If the pressure cuff is not placed at the patient's heart level, the NIBP measurement may be subject to error, due to the hydrostatic effect.

The pulse rate data displayed on the Accutorr V is computed from the measurement of peripheral pulses (peripheral pulses taken only during a measurement cycle). The rate measured by the Accutorr V may differ from the rate of an ECG monitor. This is because the ECG is an electrical signal that may not always result in a peripheral pulse.

Administration of certain vasoconstrictor drugs (for example, norepinephrine), may reduce peripheral perfusion to a level that prevents the Accutorr V from taking pulse rate measurements.

Arterial compression, tricuspid regurgitation, or other conditions may reduce perfusion to a level that prevents the Accutorr V from taking pulse rate measurements.

The presence of arrhythmias may increase the time required to complete a measurement and may extend this time so that a measurement cannot complete.

















The Accutorr V is not intended for use during CPR. The monitor uses an oscillometric technique based on normal peripheral circulation to compute blood pressure.



















Unpacking

Remove the instrument from the shipping carton and examine it for signs of shipping damage. Save all packing materials, invoice, and bill of lading. These may be required to process a claim with the carrier. Check all materials against the packing list. Contact the Customer Service Department (800) 288-2121 or (201) 265-8800 for prompt assistance in resolving shipping problems.

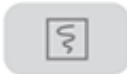
NOTE: **The Accutorr V should only be shipped in its original packing materials to avoid shipping damage.**

Symbols and Descriptions

| SYMBOL | DESCRIPTION | SYMBOL | DESCRIPTION |
|---|---|--|--|
|  | Attention, Consult Accompanying Documents / Refer to Manual |  | Type BF Equipment |
|  | Equipotentiality Equipotential grounding |  | Defibrillator-proof Type BF Equipment |
|  | Alternating Current (AC) |  | Adult |
| T1 | Predictive Thermometer Connector |  | Pediatric/Child |
| SpO₂ | SpO ₂ Connector |  | Neonate |
|  | Operating on battery power |  | Manufacturer |
|  | Connected to AC mains |  | NIBP Connector |
|  | Power On/Off – Standby |  | Recycle |
|  | Serial number |  | Up key |

| SYMBOL | DESCRIPTION | SYMBOL | DESCRIPTION |
|---|--|---|--|
|  | Part Number |  | Confirm key |
|  | Patient Information key |  | Down key |
|  | Main menu key |  | Deflate Cuff key |
|  | Set alarms key |  | Patient Size key |
|  | Start NIBP key |  | Alarm Silence key |
|  | Display Tabular Trends/Pleth Wave | NC1 | Nurse Call connector |
|  | NIBP interval key | SP1 | RS-232 connector (Serial Port 1) |
|  | Print key (front panel) | CS1 | Network connector |
|  | Print key (recorder) |  | Alarm Disabled indicator on LCD display |
|  | Alarm Silenced indicator on LCD display |  | Audio Alarm Off indicator on LCD display |
|  | Classified by Underwriters Laboratories Inc. with respect to electric shock, fire and mechanical hazards, only in accordance with UL 60601-1, CAN/CSA C22.2 NO.601-1, IEC 60601-1-1, IEC 60601-2-30, IEC 60601-2-49. | | |

1.0 *General Description*

| | |
|---|-----|
| General Product Description | 1-2 |
| Product Features | 1-4 |
| Recommended Test and Calibration Frequency..... | 1-5 |

1.1 General Product Description

The Accutorr V monitors vital signs non-invasive blood pressure (NIBP), pulse oxygen saturation (SpO₂), pulse rate (PR), and temperature (Temp) for a single adult, pediatric, or neonatal patient. Temperature is measured using the optional Temperature Module.



FIGURE 1-1 View of Accutorr V Front Panel

An Accutorr V contains an NIBP module, SpO₂ module, a rechargeable Lithium ion battery, and an internal printer.

Product Configurations:

| NIBP MODULE | SPO₂ MODULE | PREDICTIVE TEMPERATURE MODULE | BATTERY | RECORDER |
|--------------------|---|--------------------------------------|----------------|-----------------|
| DPM NIBP | DPM SpO ₂ | — | Lithium ion | Recorder |
| DPM NIBP | DPM SpO ₂ | SmarTemp™ | Lithium ion | Recorder |
| DPM NIBP | Masimo SET® SpO ₂ (MS-2013) | — | Lithium ion | Recorder |
| DPM NIBP | Masimo SET® SpO ₂ (MS-2013) | SmarTemp™ | Lithium ion | Recorder |
| DPM NIBP | Nellcor Oximax® SpO ₂ (NELL-3) | — | Lithium ion | Recorder |
| DPM NIBP | Nellcor Oximax® SpO ₂ (NELL-3) | SmarTemp™ | Lithium ion | Recorder |
| DPM NIBP | — | SmarTemp™ | Lithium ion | Recorder |
| DPM NIBP | — | — | Lithium ion | Recorder |

NOTE: For any of these configurations, the Barcode Scanner is optional.

All configurations measure NIBP, pulse rate, and SpO₂ (optional). The Accutorr V features front panel digital displays for Mean Arterial Pressures, Temperature, and Interval Mode Timer. It has extra large displays for the Systolic, Diastolic, Pulse Rate, optional Temperature, and SpO₂ with a choice of Nellcor, Masimo, or DPM. The Accutorr V incorporates a Liquid Crystal Display (LCD) to view stored measurements and to access system setting menus.

On all units, temperature can be measured with the optional Predictive Thermometer Module (SmarTemp). All units are equipped with a recorder module for documenting NIBP, pulse rate, SpO₂, and temperature information. Each printout includes the time and date of each measurement.

The Accutorr V stores a maximum of 1,200 groups of measurement data in memory. These 1,200 groups of measurement data are shared by the number of patients that are monitored (one patient at a time) by the Accutorr V. When only one patient is monitored, the Accutorr V can store up to 1,200 groups of measurement data for that one patient. When more than one patient is monitored, the Accutorr V can store any number of measurements for each patient provided the total number of stored groups of measurement data for all patients equals 1,200 or less.

The Accutorr V has an Interval Mode that enables the unit to take automatic NIBP measurements at timed intervals.

Alarm limits can be set for Accutorr V parameters. All alarm violations are indicated by an audible alarm tone, flashing front panel displays, parenthesis around the violated parameter on the recorder printouts, and reverse video on the Trend display.

The Accutorr V can operate from a battery.

1.2 Product Features

Some key features of the Accutorr V are:

- Non-Invasive Blood Pressure (NIBP)
- Pulse Rate
- Nellcor, Masimo, or DPM SpO₂
- Alarms
- Interval Mode
- Large Light Emitting Diode (LED) Displays
- Trend Memory—Up to 1,200 Measurements
- Communications—Improved ASCII Protocol (DIAP) using straight serial cable
- Nurse Call function
- Universal Power Supply
- User Configured Settings
- Optional Predictive Thermometer Module (SmarTemp)
- Recorder
- High Contrast LCD
- Customer Replaceable Lithium ion Battery
- Universal mounting adapter for rolling stands and wall mounts
- Barcode ready

1.3 Recommended Test and Calibration Frequency

| CHECK/MAINTENANCE ITEM | | FREQUENCY |
|-------------------------|--------------------------------|---|
| Visual test | | When first installing or after reinstalling. |
| Power on test | | 1. When first installing or after reinstalling. 2. Following any maintenance or replacement of any main unit part. |
| NIBP tests | Accuracy test | 1. If the user suspects that the measurement is incorrect. 2. Following any repairs or replacement of the NIBP module. 3. At least once per year. |
| | Leakage test | |
| | Calibration | |
| SpO ₂ test | | |
| Temperature test | | |
| Analog output test | | If the user suspects that analog output is abnormal. |
| Bar code scanner test | | If the user suspects that bar code scan is incorrect. |
| Electrical safety tests | Enclosure leakage current test | 1. Following any repair or replacement of the power module. 2. At least once every two years. |
| | Earth leakage current test | |
| | Patient leakage current test | |
| | Patient auxiliary current test | |
| Recorder check | | Following any repair or replacement of the recorder. |

This page intentionally left blank.

2.0 *Controls and Indicators*

| | |
|----------------------|-----|
| Introduction..... | 2-2 |
| Front Panel | 2-3 |
| Rear Panel..... | 2-7 |
| Recorder Module..... | 2-8 |

2.1 Introduction

This section of the Operating Instructions identifies and describes each control and display of the Accutorr V. For step-by-step operating instructions, see Chapter 3.0.

The following is a list of all controls, connectors, and indicators, their item numbers and the page numbers. The item number refers to the call-outs on the drawings within this chapter. The page number refers to the page where the item description is found.

| FRONT PANEL | PAGE | FRONT PANEL | PAGE |
|---|-------------|--|-------------|
| 1. Alarm lamp | 2-3 | 25. DEFLATE key | 2-5 |
| 2. Systolic pressure (SYS) | 2-4 | 26. INTERVAL key | 2-6 |
| 3. Mean pressure (MAP) | 2-4 | 27. NIBP Interval indicator | 2-6 |
| 4. Diastolic pressure (DIA) | 2-4 | 28. Pulse strength indicator | 2-6 |
| 5. Pulse Rate (PR) Source indicator | 2-4 | 29. SILENCE key | 2-6 |
| 6. Pulse rate (PR) | 2-4 | 30. Silence indicator | 2-6 |
| 7. Oxygen saturation (SpO ₂) | 2-4 | 31. Temperature site | 2-6 |
| 8. Temperature (Temp) | 2-4 | 32. Temperature Unit indicator | 2-6 |
| 9. PATIENT INFO key | 2-4 | 33. PRINT key | 2-6 |
| 10. SET ALARMS key | 2-4 | 34. NIBP connector | 2-6 |
| 11. DISPLAY key | 2-4 | REAR PANEL | |
| 12. MENU key | 2-4 | 35. TEMP probe sheath | 2-7 |
| 13. ON/STANDBY key/indicator | 2-4 | 36. TEMP probe covers | 2-7 |
| 14. AC power indicator | 2-4 | 37. TEMP probe connector | 2-7 |
| 15. Battery status indicator | 2-5 | 38. RS-232 connector | 2-7 |
| 16. UP ARROW key | 2-5 | 39. Nurse call connector | 2-7 |
| 17. LCD Display | 2-5 | 40. Network connector | 2-8 |
| 18. OK key | 2-5 | 41. Equipotential grounding connector | 2-8 |
| 19. DOWN Arrow key | 2-5 | 42. AC power input connector | 2-8 |
| 20. SpO ₂ Connector | 2-5 | RECORDER MODULE | |
| 21. Patient size indicator | 2-5 | 43. Paper outlet | 2-8 |
| 22. NIBP status indicator | 2-5 | 44. Recorder door | 2-8 |
| 23. PATIENT SIZE key | 2-5 | 45. Power indicator | 2-8 |
| 24. START NIBP key | 2-5 | 46. Recorder door latch | 2-8 |

2.2 Front Panel

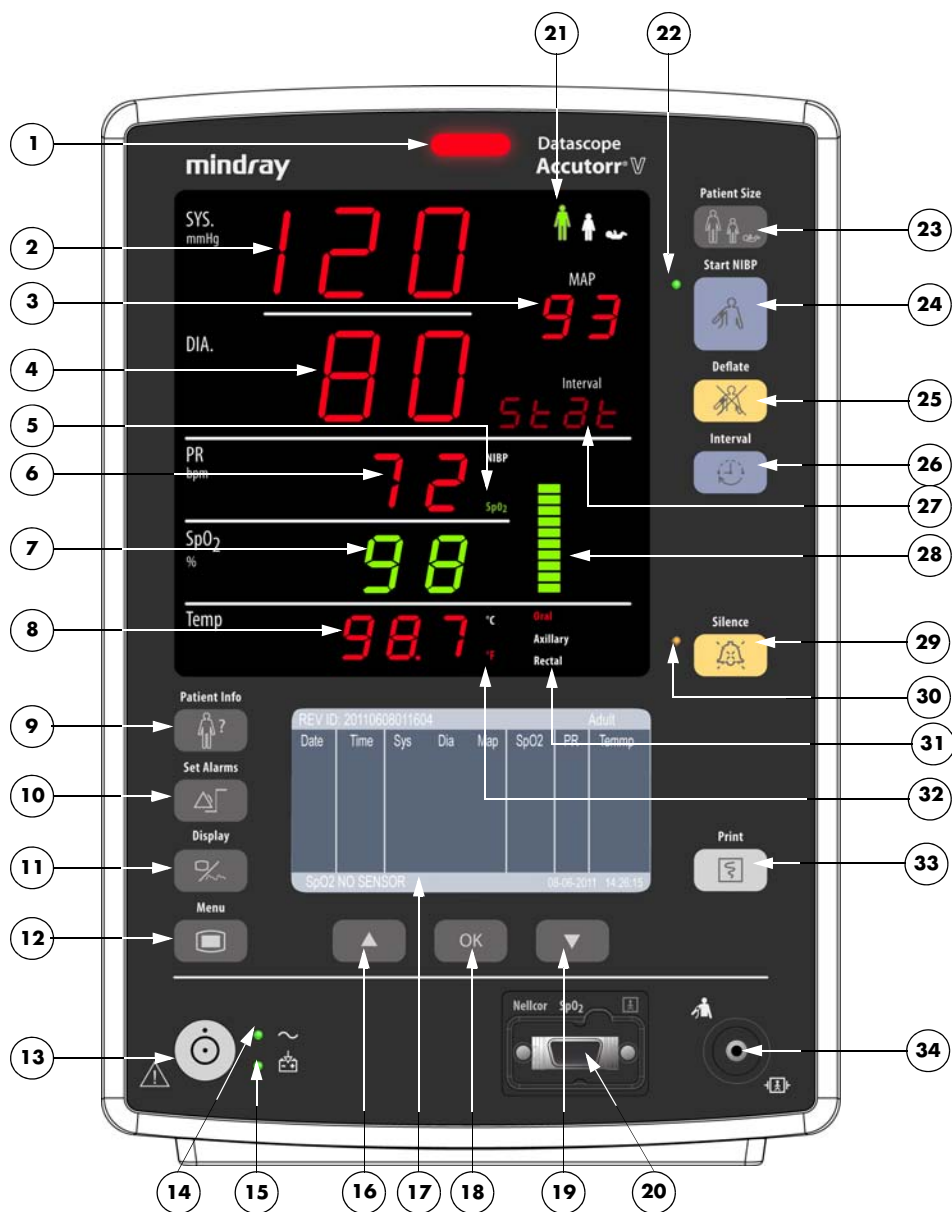

FIGURE 2-1 Accutorr V Front Panel

NOTE: The numbers in parentheses () refer to the items described as follows and shown in Figures 2-1 through 2-3.

1. Alarm lamp

Flashes red for a high priority alarm and shows continuous yellow for a low priority alarm.

NOTE: In the event that a high alarm and a low alarm occur simultaneously, only the high priority red lamp flashes.

2. Systolic pressure (SYS)

The value of systolic pressure is obtained by the NIBP module. When no other LEDs illuminate and the SYS LED displays three (3) flashing dashes and the LCD display (17) is blank, the Accutorr V is in the standby state.

3. Mean pressure (MAP)

The value of mean pressure is obtained by the NIBP module.

4. Diastolic pressure (DIA)

The value of diastolic pressure is obtained by the NIBP module.

5. Pulse Rate (PR) Source indicator

The PR source is either SpO₂ or NIBP.

6. Pulse rate (PR)

The value of the pulse rate is obtained by the NIBP module or SpO₂ module. The PR unit is beats per minute (bpm).

7. Oxygen saturation (SpO₂)

The monitor displays the SpO₂ value in %.

8. Temperature (Temp)

The monitor displays the temperature value in degrees C or degrees F, selectable in the Temp SETUP dialog. The currently applied unit is illuminated as shown in callout (32).

9. PATIENT INFO key

Press to switch to the PATIENT INFORMATION dialog and automatically create a patient ID.

10. SET ALARMS key

Press to switch between the SET ALARMS dialog and the Trend display.

11. DISPLAY key

Press to switch between the PLETH display and Trend display.

12. MENU key

Press to switch between the SYSTEM SETUP dialog and the Trend display.

13. ON/STANDBY key/indicator

Press to turn the monitor on or off or to enter/exit the standby state. In the operating state, press and hold for less than 1 second to switch the device to standby. To turn off the monitor, press and hold for more than 2 seconds.

Inside this key there is a working status indicator:

- Illuminated: Indicates the monitor is powered on.
- Dark: Indicates the monitor is powered off.

14. AC power indicator

- Illuminated: Indicates the AC power is connected.

- Dark: Indicates the AC power is not connected.

15. Battery status indicator

- Illuminated: Indicates the unit is on and the battery is inserted.
- Flashes: Indicates the system is on and in low battery status.
- Dark: Indicates the battery is not inserted. The battery indicator also remains dark when monitor power is off.

16. UP ARROW key

Moves the cursor up within the LCD display (17).

17. LCD Display

Displays startup screen, menus, trend data, PLETH waveforms, and current date and time.

18. OK key

Selects the highlighted option. In the trend view, pressing this key displays the REVIEW SETUP dialog.

19. DOWN Arrow key

Moves the cursor down within the LCD display (17).

20. SpO₂ Connector

Used to attach an SpO₂ sensor to the Accutorr V.

21. Patient size indicator

Patient sizes include adult, pediatric, or neonate from left to right.

22. NIBP status indicator

- Illuminated: Indicates the monitor is ready to perform an NIBP measurement.
- Dark: Indicates that interval NIBP measurement is in progress or device not ready to perform an NIBP measurement.

23. PATIENT SIZE key

Changes the patient size by cycling through adult, pediatric, and neonate. Patient size changes only when this key is pressed and held for one second.

24. START NIBP key

Starts an NIBP measurement.

25. DEFLATE key

Stops an NIBP measurement that is in progress and deflates the cuff. Pressing this key while in the interval mode suspends the interval mode operation until the Start NIBP key is pressed again.

NOTE: Interval display flashes between pressing the Deflate key and pressing the Start NIBP key.

26. INTERVAL key

Changes the NIBP measuring mode and interval by cycling through the modes and intervals displayed in the NIBP Interval indicator (27), as follows:

OFF (manual), STAT, or 1, 2, 3, 5, 10, 15, 20, 30, 60, 120, 240 minutes

Pressing and holding the Interval key for 3 seconds directly goes to OFF, i.e. the manual mode.

27. NIBP Interval indicator

Indicates the current NIBP measuring mode or interval.

28. Pulse strength indicator

Indicates the patient's relative pulse strength by the number of stacked bars.

29. SILENCE key

A quick press of this key pauses the current alarm for two (2) minutes, after which alarm tone resumes if alarm limits are still violated. If a new alarm condition occurs during the two (2) minutes, a new alarm tone sounds. Pressing and holding this key for more than two (2) seconds disables alarm tones indefinitely. If a new alarm condition occurs while in this state, the monitor automatically exits the alarm silenced state.

30. Silence indicator

- **Dark** (Normal state): when an alarm occurs, the monitor presents an alarm tone, visual indication, and message according to the alarm level.
- **Illuminated**: Alarm silenced state: when an alarm occurs, the monitor presents a visible alarm and alarm message, but no alarm tone is given. If a new alarm condition occurs, the monitor automatically exits the alarm silenced state.
- **Flash** (Alarm paused status): when an alarm occurs, the monitor displays a visible alarm and alarm message, but no alarm tone is given. The alarm paused time is 120 seconds, after which the alarm tone sounds again if alarm limits are still violated. The unit counts down the 120 seconds on the LCD Display (17) in place of the date and time. If a new alarm occurs during this period, the monitor automatically exits the alarm paused state.

31. Temperature site

The temperature measuring position and monitoring mode, oral, auxiliary, and rectal selection illuminates.

32. Temperature Unit indicator

The current temperature unit.

33. PRINT key

Starts or stops the recorder.

34. NIBP connector

Used to attach the specified NIBP hose to the Accutorr V.

2.3 Rear Panel

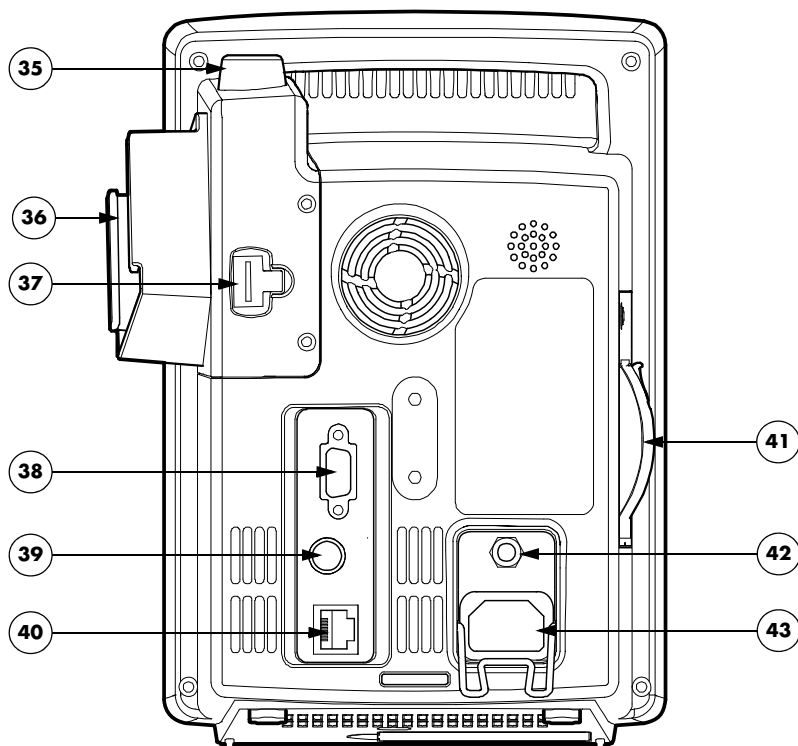

FIGURE 2-2 Accutorr V — Rear Panel

35. TEMP probe sheath

Holds the temperature probe when not in use.

36. TEMP probe covers

Holds the temperature probe covers for easy access.

37. TEMP probe connector

Used to attach a temperature probe to the Accutorr V.

NOTE: The Temperature Module is an optional kit.

38. RS-232 connector

Used to attach a bar code scanner or DIAP.

NOTE: When the RS-232 connector is used for DIAP, barcode power must be set to OFF. Refer to Section 3.16.1 for turning BARCODE POWER to OFF.

39. Nurse call connector

Provides compatible communication from the Accutorr V to the hospital's nurse call system.

NOTE: All equipment attached to the communications ports on the Accutorr V must meet the requirements as specified in EN 60601-1-1.

40. Network connector

For software updates only.

41. Recorder

Recorder for printing trend data and PLETH waveform.

42. Equipotential grounding connector

Used to connect the equipotential grounding connectors of other devices.

43. AC power input connector

Connects the monitor to the AC power through a 3-core power cable.

2.4 Recorder Module

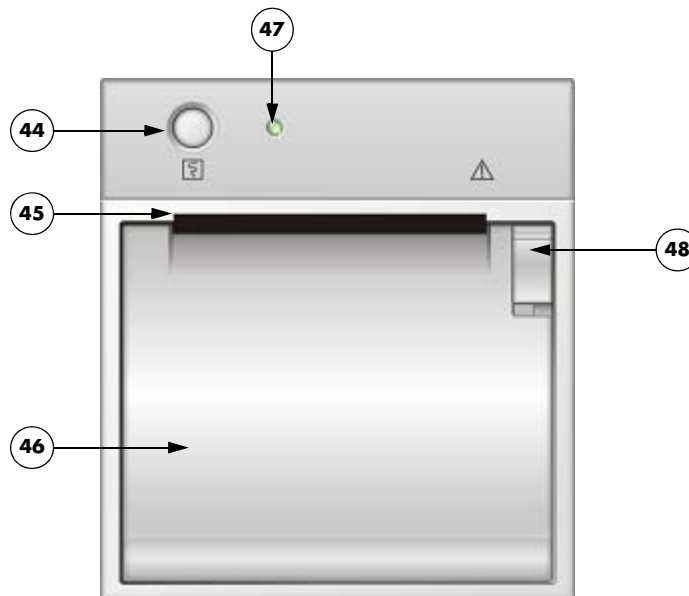

FIGURE 2-3 Accutorr V — Recorder Module

44. Print button

Prints the PLETH curve or the trend data on the current display.

45. Paper outlet

Recorder feeds paper out of slot.

46. Recorder door

Access to paper roll.

47. Power indicator

Indicates power to the recorder.

48. Recorder door latch

Secures the recorder door.

Operation

| | |
|---|------|
| Introduction..... | 3-2 |
| Operator Position | 3-2 |
| Setting-up and Turning Power On | 3-2 |
| Standby and Power OFF | 3-4 |
| Patient Setup..... | 3-6 |
| Manual NIBP Measurements | 3-11 |
| Automatic NIBP Measurements (Interval Mode) | 3-14 |
| Alarms | 3-17 |
| Viewing and Deleting Stored Trend Data | 3-21 |
| Common Setup | 3-24 |
| SpO2 Measurements | 3-26 |
| Temperature Measurement | 3-34 |
| Recorder | 3-39 |
| Setting The Clock (Date and Time) | 3-40 |
| Battery Operation..... | 3-41 |
| Creating a User Configuration | 3-42 |
| Status and Error Codes | 3-47 |

3.1 Introduction

This section of the Operating Instructions provides guidelines and step-by-step instructions for proper operation of the Accutorr V. The numbers in parentheses () refer to the items described in Chapter 2.0 , "Controls and Indicators" and shown in Figures 2-1 through 2-3.

3.2 Operator Position

The operator of the device should be positioned in front of the Accutorr V Patient Monitoring Display at a distance of no more than 1m.

3.3 Setting-up and Turning Power On

1. Before turning the power on, check the rear panel for voltage requirements. Confirm proper voltage is available and install the battery.
2. Optional – Attach a serial cable to the 9-pin rear panel RS-232 connector (38).

CAUTION: The Communications Connectors on the Accutorr V are only for use with IEC 60601-1-1 compliant equipment.

3. Attach the AC power cord into the rear panel AC power input connector (43) and into a grounded (3-prong) hospital grade AC receptacle. Do not use an adapter to defeat the ground. The AC power indicator (14) illuminates, indicating AC power has been applied. The internal battery charges automatically when AC power is applied. The Accutorr V operates from the AC mains and can be operated from its internal battery.
4. Press  (13) to activate the unit.
 - The system beeps indicating the software has loaded.
 - All the LEDs on the front panel light up.
 - The technical alarm lamp turns yellow, red, then turns off to indicate the self test related to alarm lamps passed.
 - After the Accutorr V initializes, the start-up screen clears, and the Trend display shows in the LCD Display (17) (see FIGURE 3-1).

NOTE: If an error occurs during the power-up sequence, see Section 3.17.3.



| Patient ID | | Patient Size | | | | | |
|------------------------|------|---------------|-----------|-----|---------------------|----|------|
| REV ID: 20081216153412 | | Adult | | | | | |
| Date | Time | Sys | Dia | Map | SpO2 | PR | Temp |
| 12-16 | 1539 | - / - / - | - / - / - | - | 96 | 66 | - |
| 12-16 | 1539 | 123 / 69 / 91 | | | 97 | 65 | - |
| 12-16 | 1538 | - / - / - | - / - / - | - | 97 | 65 | - |
| 12-16 | 1538 | - / - / - | - / - / - | - | 96 | 65 | - |
| 12-16 | 1538 | - / - / - | - / - / - | - | 97 | 65 | 36.2 |
| ALARM DISABLED! | | | | | 01-16-2009 14:50:35 | | |
| Message Area | | | | | Date and Time | | |

FIGURE 3-1 Example LCD Display (17)

5. Optional – To set the time and date, refer to section 3.14 for instructions.
6. Optional – To adjust the contrast on the LCD, refer to section 3.10.2, “Setting the LCD Brightness and Contrast”.
7. Test the recorder by pressing  (33). The recorder prints a real time waveform to verify proper function.
8. If the optional Temperature module kit is installed, test the predictive thermometer by removing the probe from its holder.
9. Verify that the message “Temp Warming Up” displays, followed by the message “Predictive Temp Ready” and a double beep.

3.4 Standby and Power OFF

3.4.1 Entering Standby

1. Press  (13) for less than 1 second to put the monitor in standby mode.
2. In the dialog on the LCD Display (17), confirm entering standby by pressing  (18).

3.4.2 Exiting Standby

1. Press any key on the device.
2. In the dialog on the LCD Display (17), confirm exiting standby by pressing  (18).

NOTE: **The monitor exits standby mode when it receives SpO₂ physiological signals or the temp probe is removed from the sheath.**

Once the monitor exits Standby mode, it enables alarms, restores all functions, restores communication, and starts to save trend data.

3.4.3 Turning Power Off

Press  (13) for two (2) seconds or more to turn off the monitor.

NOTE: **Disconnect the Accutorr V from the mains to isolate it from the mains power during an emergency.**

3.4.4 Selecting a Configuration

When power to the Accutorr V is turned on, it automatically loads one of three configurations.

- The **FACTORY DEFAULT** (or **FACTORY CONFIG**) is installed by the factory and cannot be modified.
- The **USER CONFIG** is created by following the steps in Section 3.16.5.
- The **LAST CONFIG** consists of the parameter settings in use before the unit was powered off.

To select a configuration to be loaded at power-on, follow the steps in Section 3.16.6.

To load a user configuration or factory default configuration after the Accutorr V is powered on:

1. Press  (12) to display the SYSTEM SETUP dialog as shown in FIGURE 3-2.

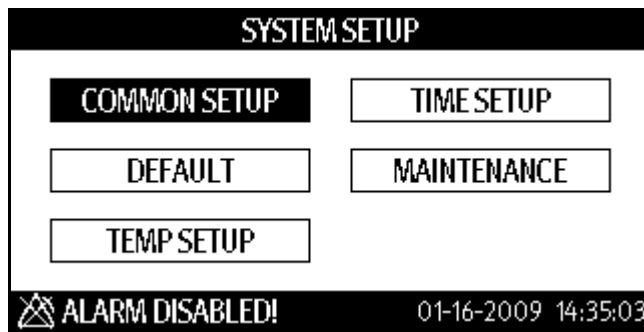

FIGURE 3-2 SYSTEM SETUP Dialog

2. Press  (16) or  (19) to highlight **DEFAULT** to display the DEFAULT dialog as shown in FIGURE 3-3.

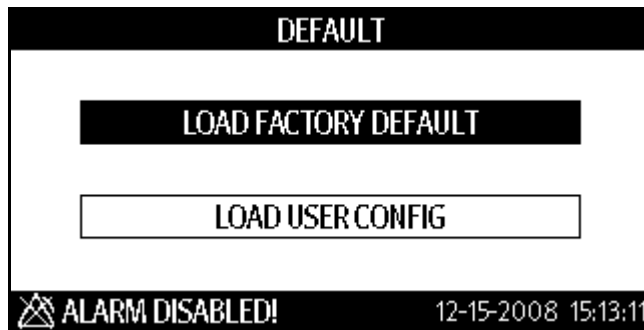







FIGURE 3-3 DEFAULT Configuration Load Dialog

3. Press  (16) or  (19) to highlight a configuration to load.
4. Once the choice is highlighted, press  (18) to select it.
5. Press  (12) to display the SYSTEM SETUP dialog.
6. Press  (12) again to display the main screen.

3.5 Patient Setup

3.5.1 Entering Patient Information



Patient information in the Accutorr V monitor consists of the PATIENT ID and the PATIENT TYPE as shown in FIGURE 3-4.











FIGURE 3-4 Example PATIENT INFORMATION Dialog

To enter patient information:

1. Press  (9) to display the PATIENT INFORMATION dialog.
2. Scan the patient ID barcode to enter the PATIENT ID.





NOTE: After connecting the barcode scanner to the Accutorr V, follow the steps in Section 3.16.1 to turn BARCODE POWER on.

NOTE: Each time the monitor is turned on, it generates a new PATIENT ID. If Quick Admit is on and  (9) is pressed, the monitor generates a new PATIENT ID. Scanning the patient ID barcode replaces the generated PATIENT ID. If Quick Admit is off and  (9) is pressed, the monitor does not generate a new PATIENT ID. To turn Quick Admit on or off, see Section 3.5.1.1.

3. Press  (16) or  (19) to select the PATIENT TYPE (patient size) field. See Section 3.5.2 to select a patient size without using the PATIENT INFORMATION dialog.
4. Once the field is highlighted, press  (18) to select it.
5. Press  (16) or  (19) to select the PATIENT TYPE (patient size).
6. Once the choice is highlighted, press  (18) to select it.
7. Press  (16) or  (19) to highlight OK.
8. Press  (18) to return to the Trend display mode.
 - The patient size indicator (21) displays the new patient size.
 - Select CANCEL and then press  (18) to cancel the patient type change.

3.5.1.1 Quick Admit

To turn Quick Admit on or off:

1. Press  (12) to display the SYSTEM SETUP dialog as shown in FIGURE 3-2.
2. Press  (16) or  (19) to highlight **MAINTENANCE**.
3. Once **MAINTENANCE** is highlighted, press  (18) to display the MAINTENANCE dialog as shown in FIGURE 3-5.

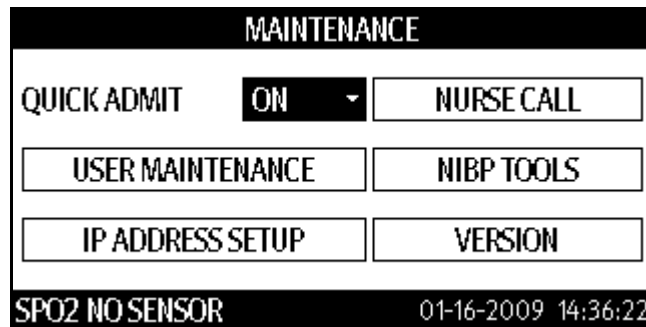









FIGURE 3-5 MAINTENANCE dialog

NOTE: The **VERSION** and **IP ADDRESS SETUP** selections in the **MAINTENANCE** dialog (**FIGURE 3-5**) are used by service. See the **Service Manual**, part number **0070-10-0702**.

4. Press  (16) or  (19) to highlight the QUICK ADMIT field.
5. Once the QUICK ADMIT field is highlighted, press  (18) to enable the QUICK ADMIT field.
6. Press  (16) or  (19) to turn Quick Admit on or off.
7. Press  (18) to keep the new setting.
8. Press  (12) to display the SYSTEM SETUP dialog.
9. Press  (12) again to return to the Trend display mode.

3.5.2 Selecting the Patient Size

Select patient size using one of the two methods:

- Press  (9) to display the PATIENT INFORMATION dialog (see Section 3.5.1).
- Press  (23) as follows.

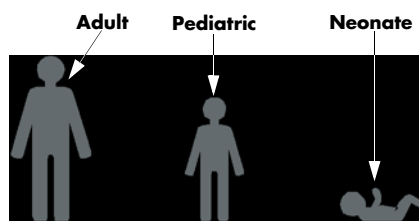



FIGURE 3-6 Patient Size Graphics and Indicators (21)

To select the Patient Size, press  (23). Three choices are available: Adult, Pediatric, and Neonate. The patient size changes with each key press.

The Patient size indicator (21) illuminates to indicate the selected size as shown in FIGURE 3-6. The factory default Patient Size setting is Adult.

NOTE: **Selecting Neonate patient size changes Temperature site (31) to Axillary. The temperature site will default to oral when Adult patient size is selected.**



3.5.3 Setting Initial Cuff Inflation Pressure

The initial cuff inflation pressure depends on the Patient Size setting. The initial cuff inflation pressures are listed in the following table.

| PATIENT SIZE SETTING | FACTORY DEFAULT INITIAL CUFF INFLATION VALUES | LOWEST SELECTABLE PRESSURE | HIGHEST SELECTABLE PRESSURE | INCREMENT |
|----------------------|---|----------------------------|-----------------------------|-----------|
| Adult | 180 mmHg | 100 mmHg | 280 mmHg | 5 mmHg |
| Pediatric | 140 mmHg | 60 mmHg | 180 mmHg | 5 mmHg |
| Neonate | 100 mmHg | 40 mmHg | 120 mmHg | 5 mmHg |

NOTE: **The default patient size and initial cuff inflation pressure can be customized.**

To modify the initial cuff inflation pressure:

1. Press  (12) to display the SYSTEM SETUP dialog as shown in FIGURE 3-7.
2. Press  (16) or  (19) to highlight **MAINTENANCE**.

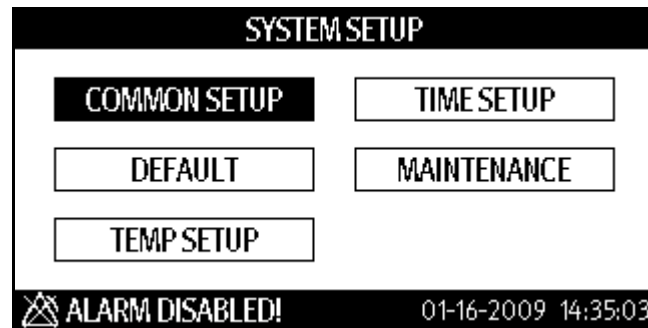



FIGURE 3-7 SYSTEM SETUP Dialog

3. Once **MAINTENANCE** is highlighted, press  (18) to display the MAINTENANCE dialog as shown in FIGURE 3-8.

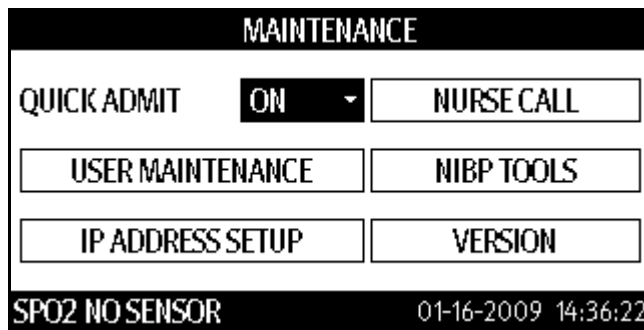

FIGURE 3-8 MAINTENANCE dialog

4. Press (16) or (19) to highlight **NIBP TOOLS** to display the NIBP TOOLS dialog as shown in FIGURE 3-9.
5. Once **NIBP TOOLS** is highlighted, press (18) to display the NIBP TOOLS dialog.

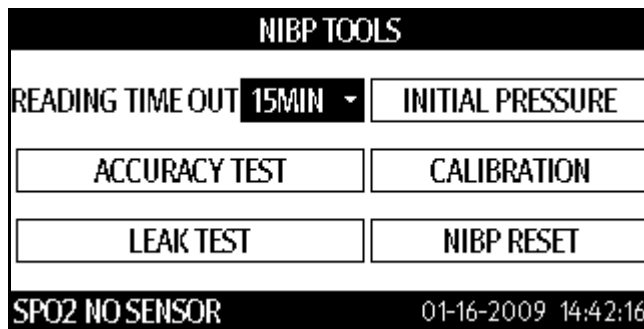

FIGURE 3-9 NIBP TOOLS Dialog

NOTE: The **ACCURACY TEST**, **LEAK TEST**, and **CALIBRATION** selection shown the NIBP TOOLS dialog (FIGURE 3-9) are explained in the Service Manual, part number 0070-10-0702. Calibration should be carried out by qualified personnel only.

6. Press (16) or (19) to highlight **INITIAL PRESSURE** to display the INITIAL PRESSURE dialog as shown in FIGURE 3-10.
7. Once **INITIAL PRESSURE** is highlighted, press (18) select it.

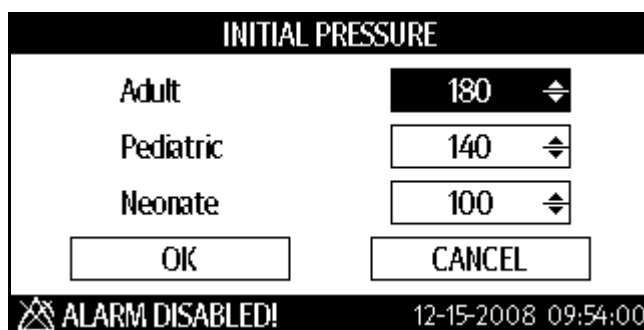











FIGURE 3-10 Example NIBP Cuff Initial Pressure Dialog

8. Press  (16) or  (19) to highlight an initial cuff pressure to change.
9. Once the initial cuff pressure is highlighted, press  (18) to select it.
10. Press  (16) or  (19) to change the initial cuff pressure value.
11. Once the desired pressure is displayed, press  (18) to set it.
12. Repeat steps 8 through 11 as needed.
13. Once the initial cuff pressure values are set, press  (16) or  (19) until **OK** is selected.
14. Once **OK** is selected, press  (18) to accept the new cuff pressure values and exit the INITIAL PRESSURE dialog to the NIBP TOOLS dialog.

NOTE: Select **CANCEL** and then press  (18) to cancel the operation and exit the INITIAL PRESSURE dialog without changing the initial pressure values.

3.6 Manual NIBP Measurements

The Accutorr V calculates NIBP values using the oscillometric method of noninvasive blood pressure measurement. These measurements correspond to comparisons with auscultatory values, measured using the fifth Korotkoff sound within ANSI/AAMI SP10 standards for accuracy.

1. Select a pressure cuff that is appropriate for the patient size. Use the following chart as a guideline.

| LIMB CIRCUMFERENCE* | DESCRIPTION / CUFF NAME | PART NUMBER |
|---|-------------------------|-----------------------------|
| REUSABLE CUFFS – QUICK CONNECT- LATEX FREE* | | |
| 10 – 19 cm | Small Child | 0683-15-0001-01 |
| 18 – 26 cm | Small Adult | 0683-15-0002-01 |
| 25 – 35 cm | Adult | 0683-15-0003-01 |
| 33 – 47 cm | Large Adult | 0683-15-0004-01 |
| 46 – 66 cm | Adult Thigh | 0683-15-0005-01 |
| 25 – 35 cm | Adult Long | 0683-15-0006-01 |
| 33 – 47 cm | Large Adult Long | 0683-15-0007-01 |
| SINGLE PATIENT USE CUFFS – QUICK CONNECT- LATEX FREE** | | |
| 10 – 19 cm | Small Child | 0683-14-0001-01 (box of 10) |
| 18 – 26 cm | Small Adult | 0683-14-0002-01 (box of 10) |
| 25 – 35 cm | Adult | 0683-14-0003-01 (box of 10) |
| 33 – 47 cm | Large Adult | 0683-14-0004-01 (box of 10) |
| 46 – 66 cm | Adult Thigh | 0683-14-0005-01 (box of 5) |
| 25 – 35 cm | Adult Long | 0683-14-0006-01 (box of 10) |
| 33 – 47 cm | Large Adult Long | 0683-14-0007-01 (box of 10) |
| SINGLE PATIENT USE CUFFS – QUICK CONNECT- LATEX FREE** (REQUIRES HOSE P/N 0683-04-0003) | | |
| 3 – 6 cm | Neonatal, Size 1 | 0683-23-0001 (box of 10) |
| 5 – 8 cm | Neonatal, Size 2 | 0683-23-0002 (box of 10) |
| 7 – 10 cm | Neonatal, Size 3 | 0683-23-0003 (box of 10) |
| 9 – 13 cm | Neonatal, Size 4 | 0683-23-0004 (box of 10) |
| 12 – 17 cm | Neonatal, Size 5 | 0683-23-0005 (box of 10) |

* The limb circumferences of cuffs adhere to the American Heart Association (AHA) guidelines for size. They also incorporate index and range lines to assist in cuff selection.

** Do not reuse single patient use cuffs.

NOTE: The Accutorr V cuffs have special quick connect connectors.

WARNING: To ensure proper performance and safety and to prevent the voiding of the warranty, only use authorized parts and accessories with the Accutorr V. Use of unauthorized accessories may result in erroneous readings.



The limb pressure may not fall to zero between measurements if the cuff is wrapped too tightly. Therefore, assure that the cuff is properly applied.

The skin is sometimes fragile (i.e., on pediatrics, geriatrics, etc.). In these cases, consider a longer timer interval to decrease the number of cuff inflations over a period of time.

NOTE: In extreme cases, a thin layer of soft roll or webril cotton padding may be applied to the limb in order to cushion the skin when the cuff is inflated. This measure may affect NIBP performance and should be used with caution.

2. Attach the cuff hose to the NIBP connector (34) by holding the hose behind the knurled pressure fitting (female). Push onto the male connector until a “click” is heard. To remove, hold the knurled female fitting and pull firmly to release.
3. Apply the cuff to the patient. To reduce errors, the cuff should fit snugly, but with enough room for two fingers to be placed between the cuff and the patient’s arm (on adults), and with little or no air present within the cuff. The cuff should fit loosely on neonates. Apply the cuff so that the center of the inflation bag (bladder) is over the brachial artery. Be sure that the INDEX line on the cuff falls between the two RANGE lines. If not, a larger or smaller cuff is required. Be sure the cuff lies directly against the patient’s skin. For best results, the cuff should be placed on the arm at heart level, and no clothing should come between the patient and the cuff.

NOTE: Avoid compression or restriction of the pressure hose. Do not place the NIBP cuff on a limb that is being utilized for any other medical procedure. For example, an I.V. Catheter.

4. If required, select the Patient Size with  (23). On initial power up, the configurable default setting is used. Otherwise, the last selected patient size is used. Initial default cuff inflation pressure depends on the Patient Size setting. See section 3.5.3 for details on changing the initial cuff inflation pressure.
5. Press  (24) to begin an NIBP measurement. During inflation and deflation of the cuff, the Accutorr V displays the bladder pressure in the MAP display.

NOTE: Inflate the cuff only after proper application to the patient’s limb. Cuff damage can result if the cuff is left unwrapped and then inflated.

The cuff begins to inflate to the selected cuff pressure. After reaching the selected pressure, the cuff begins to slowly deflate, and the Accutorr V collects oscillometric pulsations.

If the unit detects inadequate initial cuff inflation, the unit retries with a higher inflation pressure (+50 mmHg in the adult and pediatric modes; +40 mmHg in the neonate mode).

Have the patient remain still to avoid unnecessary motion artifact. After the cuff pressure drops below the diastolic pressure, the results of the measurement are displayed, and the cuff deflates.

NOTE: When required, press  (25) to interrupt a measurement and deflate the cuff.

NOTE: Once the initial measurement is taken, the Accutorr V continues to use the selected patient size.

NOTE: Check the patient’s limb for any indications of circulation impairment.

3.6.1 NIBP Pressure Limit Fail Safe

If the cuff is over-pressurized, it will automatically deflate, and "OVER PRESSURE" displays as an error message on the LCD Display (17).

Before taking a new measurement, press  (24) to clear an over-pressure message.

3.6.2 Cuff Inflation Time

If the cuff pressure does not attain 15 mmHg within 20 seconds for adult and pediatric patients or 15 mmHg within 10 seconds for neonate patients from the start of inflation or if the target pressure is not reached within another 60 seconds, the cuff is deflated, and status codes display. See Section 3.17 for a list of error and status codes.

3.6.3 Automatic Retry

If an NIBP measurement fails, the Accutorr V retries measuring up to three times. The message "NIBP RETRY" is displayed after the cuff deflates. If the measurement fails all three retries, the LCD Display (17) shows the Sys, Dia, and Map values as "XXX" and PR as "-" if SpO₂ not providing the pulse rate.



3.7 Automatic NIBP Measurements (Interval Mode)

The Accutorr V can be set to automatically take NIBP measurements. When first placed in service and powered up, the interval setting defaults to OFF. Use the User Configuration mode to set custom defaults for the Interval Mode. See section 3.16, 'Creating a User Configuration' for details. In this mode, adaptive inflation is always enabled.

WARNING: Continued use of the STAT NIBP mode or short term automatic mode may result in surface vessel rupture (petechia).

3.7.1 Starting an Automatic Measurement

Follow steps 1 through 4 in the manual NIBP measurement procedure, section 3.6, to select the cuff, attach and apply the cuff, and to adjust the initial cuff inflation pressure. Then do the following:



1. Press  (26) to display the current selection in the NIBP Interval indicator (27).
2. Press  (26) to scroll through the interval selections.

The selections are OFF, STAT, 1, 2, 3, 5, 10, 15, 20, 30, 60, 120, 240 minutes.



3. Press  (24) to take a measurement and to activate the interval mode.

NOTE: When the NIBP STAT interval is chosen, the Accutorr V takes back to back (one right after the other) blood pressure readings. As a safety precaution, there is a five minute or 10 measurement limit for continuous NIBP measurements. After 5 minutes or 10 measurements, the NIBP module automatically switches to the mode in use before NIBP STAT was selected. This reduces the chance of surface vessel rupture (petechia).

3.7.2 Canceling an Automatic NIBP Measurement

To cancel a scheduled measurement, press  (25), which suspends the timed NIBP measurements until  (24) is pressed. The interval indicator flashes. See section 3.7.4 for more details on the start and deflate function.

NOTE: Pressing  (25) also ends a measurement cycle that is already in progress.

To take an immediate measurement and to reactivate the Interval mode, press  (24). The Accutorr V continues the interval mode. For example, if the interval was set to 30 minutes, the next timed measurement will be 30 minutes after pressing .

NOTE: If the Interval mode is no longer required, set the interval to OFF prior to pressing  (24). See section 3.7 for details on changing the interval mode.

NOTE: If  (25) is pressed, there is a 1 – 2 second delay before another measurement can be taken. The Accutorr V illuminates the NIBP status indicator (22) when ready.

3.7.3 Changing the Interval Setting

If the INTERVAL mode is active and the interval time is changed (follow steps 1 through 3 in section 3.7.1), the measurement cycle is reset with the new interval. Measurement resumes after the new interval time elapses.

For example: The interval time is set to 60 minutes. Thirty minutes have elapsed since the last timed automatic measurement and the interval time is changed to 10 minutes. Once the interval time is entered, the Accutorr V will take an automatic NIBP measurement in 10 minutes and then once every 10 minutes.

3.7.4 START and DEFLATE Functions

The START NIBP and DEFLATE functions have the following effects on the timed measurement sequence.



START NIBP key
(24)

If the INTERVAL mode is active, the NIBP module instantly begins a measurement. Taking this unscheduled measurement does not affect the timing of the interval cycle, therefore, the scheduled measurements will still be taken as if there were no interruptions. Only one measurement is taken for each measurement cycle - even if the unscheduled measurement coincides with the scheduled measurement.





DEFLATE key (25)

If a measurement is in progress, the measurement is suspended and the cuff deflates. If the INTERVAL mode is active with a measurement in progress, no additional measurements are taken until the **START NIBP** key (24) is pressed.

3.7.5 Automatic Adjustment of Cuff Inflation Pressure (Adaptive Inflation)

The Accutorr V adjusts the inflation pressure according to the previous reading of the systolic pressure. After the first successful measurement, the inflation pressure is the previous systolic +50 mmHg in the adult and pediatric modes, or +40 mmHg in the neonate mode. If a manual measurement is taken between interval readings, the manual measurement uses Adaptive Inflation because the unit is in Interval Mode.

NOTE: When not in Interval mode, Adaptive Inflation is disabled.

To view the current initial inflation pressure, follow the steps in Section 3.5.3. Press  (16) or  (19) to change the inflation pressure.

3.7.6 Automatic Retry

If an NIBP measurement fails, the Accutorr V retries measuring up to three times. The message "NIBP RETRY" is displayed after the cuff deflates. If the measurement fails all three retries, the LCD Display (17) shows the Sys, Dia, and Map values as "XXX" and PR as "-" if SpO₂ not providing the pulse rate.

3.8 Alarms

The Accutorr V provides HI (high) and LO (low) alarm limit settings for systolic, diastolic, MAP, pulse rate, and SpO₂. An alarm violation occurs when one or more patient parameters equals or exceed the specified alarm limits.

NOTE: The audio alarm complies with the requirements of IEC60601-1-8.

The measured sound pressure level for the high audio alarm is 75.4 dB.

The measured sound pressure level for the low audio alarm is 47 dB.







3.8.1 Setting Alarm Limits

The factory and custom defaults for alarms can be changed as required to accommodate the needs of individual patients.



Pressing  (10) toggles between the Trend display and the SET ALARMS dialog shown in FIGURE 3-11.

| SET ALARMS | | | | | |
|----------------|----|-----|---------------------|----|----|
| SYS ALM | HI | 160 | ⇅ | LO | 90 |
| DIA ALM | HI | 90 | ⇅ | LO | 50 |
| MAP ALM | HI | 110 | ⇅ | LO | 60 |
| SPO2 ALM | HI | OFF | ⇅ | LO | 85 |
| PR ALM | HI | 120 | ⇅ | LO | 50 |
| SPO2 NO SENSOR | | | 01-16-2009 14:40:36 | | |

FIGURE 3-11 Example SET ALARMS Dialog

1. Press  (10) to display the SET ALARMS dialog.
2. Press  (16) or  (19) to highlight a HI or LO alarm limit.
3. Once the alarm limit is highlighted, press  (18) to select it.
4. Press  (16) or  (19) to change the alarm limit values.

NOTE: The high end of a HI (high) alarm limit is OFF, and the low end of a LO (low) alarm limit is OFF.

5. Once the desired value is displayed, press  (18) to set it.
6. Repeat steps 2 to 5 as needed.
7. Once the alarm values are set, press  (10) to exit the SET ALARMS dialog.

NOTE: If the patient size is changed and it is the first time that patient size is selected, the alarm settings change to the factory default settings.

Alarm Limit Table

| PARAMETER | RANGE | UNITS | FACTORY DEFAULT | UNITS OF INCREMENT |
|--|-------------|-------------------|-----------------|--------------------|
| Systolic High | | | | |
| Adult | Off, 60–235 | mmHg | Off | 5 |
| Pediatric | Off, 60–160 | | Off | |
| Neonate | Off, 50–120 | | Off | |
| Systolic Low | | | | |
| Adult | Off, 55–230 | mmHg | Off | 5 |
| Pediatric | Off, 55–155 | | Off | |
| Neonate | Off, 45–115 | | Off | |
| Diastolic High | | | | |
| Adult | Off, 35–200 | mmHg | Off | 5 |
| Pediatric | Off, 35–150 | | Off | |
| Neonate | Off, 25–100 | | Off | |
| Diastolic Low | | | | |
| Adult | Off, 30–195 | mmHg | Off | 5 |
| Pediatric | Off, 30–145 | | Off | |
| Neonate | Off, 20–95 | | Off | |
| MAP High | | | | |
| Adult | Off, 35–235 | mmHg | Off | 5 |
| Pediatric | Off, 30–160 | | Off | |
| Neonate | Off, 25–120 | | Off | |
| MAP Low | | | | |
| Adult | Off, 30–230 | mmHg | Off | 5 |
| Pediatric | Off, 30–155 | | Off | |
| Neonate | Off, 20–115 | | Off | |
| NIBP Pulse Rate High | | | | |
| Adult | Off, 37–245 | bpm | Off | 1 |
| Pediatric | Off, 37–245 | | Off | |
| Neonate | Off, 72–245 | | Off | |
| NIBP Pulse Rate Low | | | | |
| Adult | Off, 35–243 | bpm | Off | 1 |
| Pediatric | Off, 35–243 | | Off | |
| Neonate | Off, 70–243 | | Off | |
| DPM SpO₂ High | | | | |
| Adult | Off, 51–100 | %SpO ₂ | Off | 1 |
| Pediatric | Off, 51–100 | | Off | |
| Neonate | Off, 51–100 | | Off | |
| DPM SpO₂ Low | | | | |
| Adult | 50–99 | %SpO ₂ | 85 | 1 |
| Pediatric | 50–99 | | 90 | |
| Neonate | 50–99 | | 92 | |
| DPM SpO₂ Pulse Rate High | | | | |
| Adult | Off, 2–254 | bpm | Off | 1 |
| Pediatric | | | | |
| Neonate | | | | |
| DPM SpO₂ Pulse Rate Low | | | | |
| Adult | Off, 0–252 | bpm | Off | 1 |
| Pediatric | | | | |
| Neonate | | | | |

Alarm Limit Table

| PARAMETER | RANGE | UNITS | FACTORY DEFAULT | UNITS OF INCREMENT |
|--|-------------|-------|-----------------|--------------------|
| Masimo SpO₂ Pulse Rate High | | | | |
| Adult | Off, 27–240 | bpm | Off | 1 |
| Pediatric | | | Off | |
| Neonate | | | Off | |
| Masimo SpO₂ Pulse Rate Low | | | | |
| Adult | Off, 25–238 | bpm | Off | 1 |
| Pediatric | | | Off | |
| Neonate | | | Off | |
| Nellcor SpO₂ Pulse Rate High | | | | |
| Adult | Off, 22–250 | bpm | Off | 1 |
| Pediatric | | | Off | |
| Neonate | | | Off | |
| Nellcor SpO₂ Pulse Rate Low | | | | |
| Adult | Off, 20–248 | bpm | Off | 1 |
| Pediatric | | | Off | |
| Neonate | | | Off | |

NOTE: If the SpO₂ alarm high is set to OFF, the alarm OFF symbol will display in the SpO₂ parameter tile.

Alarms occurring during the process of SpO₂ measurement include two (2) types: physiological alarms and technical alarms. Physiological alarms occur when the patient's pulse rate or oxygen saturation level is equal to or exceeds set alarm limits. Technical alarms are any SpO₂-related alarms, which are not physiological, such as functional failures.

3.8.2 Alarm Violations

An alarm condition exists if the physiological parameter is equal to or exceeds the high/low alarm limit. An alarm limit violation causes the following to occur:

- The alarm lamp flashes red for high priority alarms, and shows continuous yellow for low priority alarms.
- The LEDs for the alarming parameter condition flash.
- The parameter in an alarm condition is in reverse video on the LCD Display (17).
- The alarmed parameters displayed in red on color display.
- The alarm tone sounds (unless silenced with  (29)).
- The alarming parameter prints in parenthesis () when printed on the recorder.

NOTE: If the message "ALARM DISABLED!" is shown on the LCD Display (17), one or more alarms is OFF as shown for the SPO₂ ALM HI in FIGURE 3-11. To view the alarm settings, press  (10).

3.8.3 Pausing and Silencing Alarms



When an NIBP alarm exists:

- Press  (29) for less than two (2) seconds to pause the alarm tone for two (2) minutes. The alarm tone returns if the next measurement value violates the selected limits.



NOTE: **The Accutorr V counts down time remaining for the alarm pause in the Trend display.**

- Press  (29) for two (2) seconds or more to silence the alarm. The alarm tone returns after the next measurement value that violates the selected limits.

When in the paused state:

- Press  (29) for less than two (2) seconds to return to the normal state.
- Press  (29) for two (2) seconds or more to silence the alarm. The alarm tone returns after the next measurement value that violates the selected limits.

When in the silenced state:

- Press  (29) for less than two (2) seconds to enter the paused state.
- Press  (29) for two (2) seconds or more to return to the normal state.

3.9 Viewing and Deleting Stored Trend Data

The Accutorr V displays trend data for configured parameters. The displayed contents of a full configuration include data in trend tables for all working parameters: systolic pressure, diastolic pressure, mean pressure, SpO₂, pulse rate, temperature, measurement time, patient ID, and patient type.

3.9.1 Storing Measurements

The Accutorr V automatically stores measurements in trend memory. It stores a maximum of 1,200 rows of data. When the trend memory is full, the Accutorr V automatically deletes the oldest data for the currently displayed patient.

The Accutorr V stores SpO₂ and monitor mode Temp values once every 30 seconds and when an NIBP measurement is acquired. It stores NIBP and predictive mode temperature values when the measurements are acquired.

Referring to the example trend display in FIGURE 3-12, the TEMP module was in PREDICTIVE mode, and the temperature measurement was stored with the current SpO₂ and PR measurements when it was acquired. A minute later the NIBP module acquired and stored a blood pressure measurement with the current SpO₂ and PR measurements. The SpO₂ module stored measurements every 30 seconds and when temperature and blood pressure measurements were acquired.

3.9.2 Viewing Stored/Trend Data

The LCD screen displays trend data by default as shown in FIGURE 3-12. If it is not displayed, press  (11) to change the screen to display trend data.

| REV ID: 20081216153412 | | | | | | | Adult | |
|------------------------|------|---------------|-----------|-----|------|----|-------|--|
| Date | Time | Sys | Dia | Map | SpO2 | PR | Temp | |
| 12-16 | 1539 | - / - / - | - / - / - | - | 96 | 66 | - | |
| 12-16 | 1539 | 123 / 69 / 91 | | | 97 | 65 | - | |
| 12-16 | 1538 | - / - / - | - / - / - | - | 97 | 65 | - | |
| 12-16 | 1538 | - / - / - | - / - / - | - | 96 | 65 | - | |
| 12-16 | 1538 | - / - / - | - / - / - | - | 97 | 65 | 36.2 | |

 ALARM DISABLED! 01-16-2009 14:50:35

FIGURE 3-12 Example Trend Display

NOTE: If measured data is not saved, the LCD does not show trend data.

If a measurement is invalid or not available, the LCD Display (17) shows a “-” in its place. If an NIBP measurement was interrupted, “XXX” shows under Sys, Dia, and Map.

NOTE: When the time or date settings in the Accutorr V are changed, the monitor saves the new data with the new time and/or date, and trend data displays according to the actual saved time sequence.

3.9.3 Reviewing and Deleting Stored/Trend Data

To display the Review Setup dialog, press  (18) while the LCD Display (17) shows Trend List data.

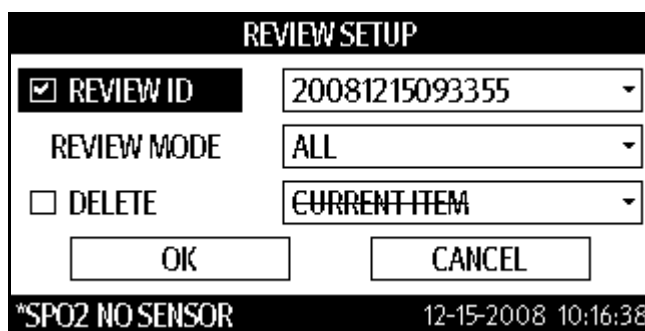







FIGURE 3-13 Example REVIEW SETUP Dialog

3.9.3.1 Selecting a Patient ID

The REVIEW ID check box is checked, and the field to the right shows the Patient ID to review. To select a Patient ID for review:



1. Press  (16) or  (19) to highlight the PATIENT ID field.
2. Once the Patient ID field is highlighted, press  (18) to select it.
3. Press  (16) or  (19) to view the Patient IDs.
4. Once the Patient ID shows in the field, press  (18) to select it.





3.9.3.2 Reviewing Trend Data

The trend mode determines which data is displayed in the Trend List. The REVIEW MODE field selections are:

- | | |
|-----------------------|--|
| ALL | View all data based on the time of each measurement. |
| NIBP (default) | View all data based on the time of the NIBP measurement. If SpO ₂ or temperature is acquired within 2 minutes of the NIBP measurement, then SpO ₂ , PR, and temperature will be displayed on the same line as the NIBP measurement. |
| TEMP | View only data that includes temperature measurements. |



To select a review mode:

1. Press  (16) or  (19) to highlight the REVIEW MODE field.

2. Once the REVIEW MODE field is highlighted, press  (18) to select it.
3. Press  (16) or  (19) to view the review modes.
4. Once the REVIEW MODE shows in the field, press  (18) to select it.







3.9.3.3 Deleting Trend Data

To delete stored trend data:

1. Press  (16) or  (19) to highlight the DELETE check box.
2. Once the DELETE check box is highlighted, press  (18) to place a check in it.



The delete items selection field becomes active. The selections are:

| | |
|----------------------------|---|
| ITEMS OF ALL ID | Deletes all stored trend data. |
| ITEMS OF CURRENT ID | Delete all items from the current ID's stored trend data |
| CURRENT ITEM | Delete only the item selected in the LIST Display when the REVIEW SETUP dialog was entered. |

3. Press  (16) or  (19) to highlight a delete field.
4. Once the field is highlighted, press  (18) to view the delete item list.
5. Press  (16) or  (19) to view the delete item selections.
6. Once the delete item shows in the field, press  (18) to select it.
7. Exit the REVIEW SETUP dialog as show in Section 3.9.3.4 to complete the deletions.

3.9.3.4 Exiting the REVIEW SETUP Dialog





To exit the REVIEW SETUP dialog:

1. Press  (16) or  (19) to highlight **OK**.
2. Once **OK** is highlighted, press  (18) to accept the selections and return to the Trend List Display.

NOTE: Select **CANCEL** and then press  (18) to cancel the any changes or deletions.

3.10 Common Setup

Set volumes and display visuals using the COMMON SETUP dialog.

1. Press  (12) to display the SYSTEM SETUP dialog as shown in FIGURE 3-7.
2. Press  (16) or  (19) to highlight COMMON SETUP.
3. Once the COMMON SETUP has been highlighted, press  (18) to display the COMMON SETUP dialog as shown in FIGURE 3-14.

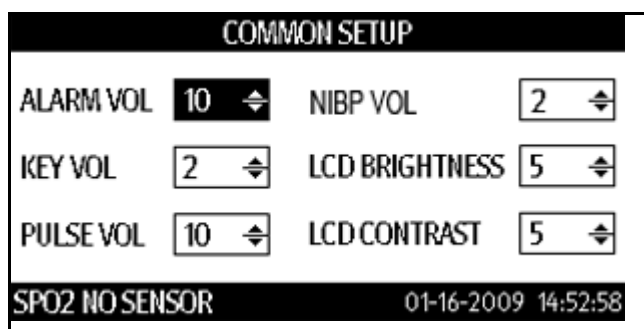









FIGURE 3-14 Example COMMON SETUP Dialog (Black-and- White LCD display)

NOTE: The monitor with color LCD DOES NOT have the setting item LCD CONTRAST in the COMMON SETUP.





3.10.1 Setting the Alarm Volume, Key Volume, and Pulse Volume, and NIBP End Tone Volume



To set alarm, key, pulse volume, or NIBP end tone volume:

1. Press  (16) or  (19) to highlight the ALARM VOL selection field.
2. Once the selection field has been highlighted, press  (18) to activate it.
3. Press  (16) or  (19) to change the ALARM VOL value.
4. Once the desired value is displayed, press  (18) to set it.
5. Repeat steps 1 through 4 as needed.
6. Once the volume values are set, either:
 -  (12) to exit the COMMON SETUP dialog.
 - Set the LCD contrast and brightness (refer to Section 3.10.2).

3.10.2 Setting the LCD Brightness and Contrast

To adjust the brightness or contrast on the Accutorr V LCD Display (17) for optimum viewing:

1. Press  (16) or  (19) to highlight the contrast or brightness selection field.
2. Once the selection field has been highlighted, press  (18) activate it.
3. Press  (16) or  (19) to change the value.

4. Once the desired value is displayed, press  (18) to set it
5. Repeat steps 1 through 4 as needed.
6. Once the contrast or brightness values are set, either:
 -  (12) to exit the COMMON SETUP dialog.
 - Set the alarm, key, or pulse volume (refer to Section 3.10.1).

NOTE: Any changes made to LCD BRIGHT and LCD CONTRAST remain when the monitor is turned off and then on again.

NOTE: There is no setting item "LCD CONTRAST" on the color LCD display.

3.11 SpO₂ Measurements

To obtain SpO₂ measurements and SpO₂ Heart Rate from the Accutorr V with an optional SpO₂ module, see: section 3.11.2 for units with Nellcor SpO₂, section 3.11.3 for units with Masimo SpO₂, and section 3.11.4 for units with DPM SpO₂.

The LCD Display (17) can display a normalized PLETH waveform from SpO₂ data. To view the waveform when the LCD shows any other display, press the DISPLAY key (11).

CAUTION: Route cables neatly. Ensure cables, hoses, and wires are kept away from patient's neck to avoid strangulation. Keep floors and walkways free of cables to reduce risk to hospital personnel, patients, and visitors. If the sensor or patient cable is damaged in any way, discontinue use immediately.

NOTE: If a reading cannot be obtained, or the reading is inaccurate, check the patients vital signs by alternate means and consider the following:

- If the patient is poorly perfused, try applying the sensor to another site (i.e., a different finger or toe).
- Check that the sensor is properly aligned.
- In electrosurgery, verify the sensor is not too close to ESU devices or cables.
- Verify the site area is clean / non-greasy. Clean the site and sensor if needed. Remove nail polish and fungus.

NOTE: The pulse tone frequency increases as oxygen saturation increases.

NOTE: SpO₂ modules on the Accutorr V have a typical response time of 15 seconds.

NOTE: Information specific to the technical design of Nellcor and Masimo SpO₂ modules should be obtained from the manufacturer.

3.11.1 Pulse Oximetry Sensors

A. Sensor Selection and Application

Selection of a specific sensor is based on the patient's size, physical condition, and expected monitoring duration. Sensor application instructions are provided in each sensor package. For optimal placement, ensure that the cable side is placed in the correct position (see FIGURE 3-15 and FIGURE 3-16).

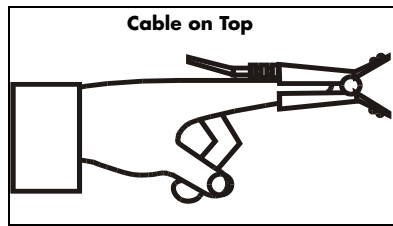

FIGURE 3-15 Typical reusable sensor placement

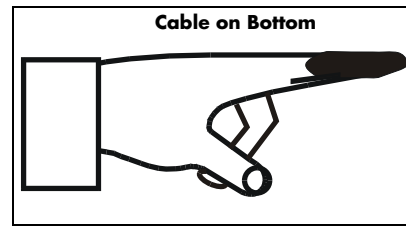

FIGURE 3-16 Typical disposable sensor placement

B. Connect a sensor to the Accutorr V:

1. Align the cable connector on the sensor assembly with the SpO₂ Connector (20) on the Accutorr V.
2. Push the cable connector into the SpO₂ Connector (20). Confirm that the cable connector is securely in place.
3. The digital SpO₂ values and SpO₂ pulse rate display in the SpO₂ and Pulse Rate LED windows.
4. If desired, adjust the beep volume. See section 3.10.1, Setting the Alarm Volume, Key Volume, and Pulse Volume, and NIBP End Tone Volume, for details on adjusting the beep volume.

C. Inspect the Sensor

Before use, always inspect sensors, cables, and connectors for damage, i.e., cuts and abrasions. Do not use a sensor, cable, or connector if damaged. Replace it with a good working sensor if needed.

For long sensor life:

- Do not drop on the floor, or jolt the sensor(s). Between use, store the sensors in the accessory pouch, or coil the sensor cable and store on the side of the Accutorr V rolling stand using the optional cable retainer. For accessory part number information see section 5.0, "Accutorr V Accessories".
- Avoid running any cart, bed, or any piece of equipment over the sensor cable.
- Avoid yanking the sensor cable.
- Watch for cracks in the housing.
- Watch for cracks, cuts, rips, fogging, or signs of moisture accumulation.

D. For the best sensor performance:

- DO NOT PLACE any sensor on an extremity with an arterial catheter or blood pressure cuff in place. Placement of an arterial catheter or blood pressure cuff on an extremity may obstruct normal blood flow. False pulse rate information may result if the sensor is placed on that same extremity. Place the sensor on the limb opposite the site of the arterial catheter or blood pressure cuff.
- Encourage the patient to remain still. Patient motion may affect the sensor's performance. If it is not possible for the patient to remain still, replace the sensor bandage on the sensor to assure good adhesion, or change the site of the sensor.
- Check the reusable sensor site every 2 hours and check the disposable sensor site every 8 hours for indications of skin abrasions, sensor displacement, sensor damage, or circulation impairment. Check the sensor site every 4 hours if the ear clip is used. If

necessary, remove and reapply the sensor. If any of the above mentioned indications occur, immediately remove the sensor and find an alternate site.

NOTE: Check the sensor site more frequently on neonate and active patients.

- Incorrect placement can also reduce the acquired sensor signal, and therefore compromise performance. Select an alternate site (toe) if the sensor can not be placed on the patient's finger correctly or if the fingernails interfere with the acquisition of a reliable signal.
- Use of the reusable sensor is not recommended for long-term monitoring (4 to 6 hours). For monitoring situations exceeding 4 to 6 hours, either reposition the reusable sensor every 2 to 4 hours to a different site (finger/toe) or use a disposable sensor with its appropriate bandage.

CAUTION: Prolonged and continuous monitoring may increase the risk of skin erosion and pressure necrosis at the site of the sensor. Check the SpO₂ sensor site frequently to ensure proper positioning, alignment, and skin integrity at least every eight (8) hours; with the Adult and Pediatric re-usable finger sensor, check every four (4) hours; for neonates and patients of poor perfusion or with skin sensitive to light, check every 2 - 3 hours; more frequent examinations may be required for different patients. Change the sensor site if signs of circulatory compromise occur. Ensure proper adhesion, skin integrity, and proper alignment. Exercise extreme caution with poorly perfused patients. When sensors are not frequently monitored, skin erosion and pressure necrosis can occur. Assess the site every two (2) hours with poorly perfused patients and neonates.

- Do not over-tighten the sensor bandages. Excessive pressure on the monitoring site can affect SpO₂ readings and may reduce readings below true SpO₂. Excessive pressure can also result in pressure necrosis and other skin damage.

3.11.2 Sequence for Establishing SpO₂ with Nellcor[®] Pulse Oximetry

This is an optional feature.

1. Plug the sensor directly into the SpO₂ Connector (20) or if necessary, use a Nellcor[®] DOC-10 extension cable.
2. See package insert(s) for use and care instructions. Additional information is available from Nellcor Puritan Bennett Inc. at www.nellcor.com.

CAUTION: When equipped with Nellcor[®] SpO₂, use only Nellcor[®] oxygen transducers including Nellcor[®] Oxisensor[®] patient dedicated adhesive sensors. Use of other oxygen transducers may cause improper oximeter performance.

CAUTION: Excessive ambient light may cause inaccurate SpO₂ measurements. Cover the sensor with opaque materials.

- CAUTION:** Inaccurate readings may be caused by incorrect sensor application or use; significant levels of dysfunctional hemoglobins (i.e. carbohemoglobins or methemoglobin); or intra-vascular dyes such as indocyanine green or methylene blue; exposure to excessive illumination, such as surgical lamps (especially ones with a Xenon light source), bilirubin lamps, fluorescent lights, infrared heating lamps, or direct sunlight; excessive patient movement; venous pulsations; electro-surgical interference; and placement of a sensor on an extremity that has a blood pressure cuff, arterial catheter, or intra-vascular line.
- CAUTION:** Route cables neatly. Ensure cables, hoses, and wires are kept away from patient's neck to avoid strangulation. Keep floors and walkways free of cables to reduce risk to hospital personnel, patients, and visitors. If the sensor or patient cable is damaged in any way, discontinue use immediately.
- NOTE:** Do not place the sensor on an extremity with an invasive catheter or blood pressure cuff in place.
- NOTE:** In certain situations in which perfusion and signal strength are low, such as in patients with thick or pigmented skin, inaccurately low SpO₂ readings will result. Verification of oxygenation should be made, especially in preterm infants and patients with chronic lung disease, before instituting any therapy or intervention.

The digital SpO₂ value displays on the SpO₂ LED (7), and the SpO₂ Pulse Rate displays on the Pulse Rate LED (6).

3. If desired, adjust the beep volume. See section 3.10.1, "Setting the Alarm Volume, Key Volume, and Pulse Volume, and NIBP End Tone Volume", for details on adjusting the beep volume.

3.11.2.1 NELLCOR[®] Sensors

NELLCOR[®] provides a family of sensors suitable for a wide variety of clinical settings and patients. See package insert(s) for use and care instructions. Additional information is available from Nellcor Puritan Bennett Inc. at www.nellcor.com.

3.11.3 Sequence for Establishing SpO₂ with Masimo[®] Pulse Oximetry

This is an optional feature.

1. Select the appropriate sensor for the patient from the list of accessories in Chapter 5.0 .
2. Attach the appropriate corresponding Patient Cable (P/N 0012-00-1099-02, 0012-00-1652, 0012-00-1599, or 0012-00-1653) to the sensor and plug the other end of the patient cable into the SpO₂ connector (20).

CAUTION: When equipped with MASIMO[®] SpO₂, use only MASIMO[®] oxygen transducers including MASIMO LNOP[®], MASIMO LNCS[®] patient dedicated adhesive sensors and MASIMO PC Series Patient Cable. Use of other oxygen transducers may cause improper oximetry performance.

CAUTION: Excessive ambient light may cause inaccurate SpO₂ measurements. Cover the sensor with opaque materials.

- CAUTION:** Inaccurate readings may be caused by incorrect sensor application or use; significant levels of dysfunctional hemoglobins (i.e. carbohemoglobins or methemoglobin); or intra-vascular dyes such as indocyanine green or methylene blue; exposure to excessive illumination, such as surgical lamps (especially ones with a Xenon light source), bilirubin lamps, fluorescent lights, infrared heating lamps, or direct sunlight; excessive patient movement; venous pulsations; electro-surgical interference; and placement of a sensor on an extremity that has a blood pressure cuff, arterial catheter, or intra-vascular line.
- CAUTION:** In certain situations in which perfusion and signal strength are low, such as in patients with thick or pigmented skin, inaccurately low SpO₂ readings will result. Verification of oxygenation should be made, especially in preterm infants and patients with chronic lung disease, before instituting any therapy or intervention.
- CAUTION:** Prolonged and continuous monitoring may increase the risk of skin erosion and pressure necrosis at the site of the sensor. Check the SpO₂ sensor site frequently to ensure proper positioning, alignment, and skin integrity at least every eight (8) hours; with the Adult and Pediatric re-usable finger sensor, check every four (4) hours; for neonates and patients of poor perfusion or with skin sensitive to light, check every 2 - 3 hours; more frequent examinations may be required for different patients. Change the sensor site if signs of circulatory compromise occur. Ensure proper adhesion, skin integrity, and proper alignment. Exercise extreme caution with poorly perfused patients. When sensors are not frequently monitored, skin erosion and pressure necrosis can occur. Assess the site every two (2) hours with poorly perfused patients and neonates.
- CAUTION:** Route cables neatly. Ensure cables, hoses, and wires are kept away from patient's neck to avoid strangulation. Keep floors and walkways free of cables to reduce risk to hospital personnel, patients, and visitors. If the sensor or patient cable is damaged in any way, discontinue use immediately.
- NOTE:** The PC Series Patient Cable is not used with the LNOP®•DCSC Sensors.
- NOTE:** Do not place the sensor on an extremity with an invasive catheter or blood pressure cuff in place.

The digital SpO₂ value displays on the SpO₂ LED (7), and the SpO₂ Pulse Rate displays on the Pulse Rate LED (6).

3. If needed, adjust the beep volume. See Section 3.10.1, "Setting the Alarm Volume, Key Volume, and Pulse Volume, and NIBP End Tone Volume", for details on adjusting the beep volume.

3.11.3.1 MASIMO[®] Sensors and Patient Cable

MASIMO[®] provides a family of sensors suitable for a wide variety of clinical settings and patients. There are specific sensors for each patient size. All sensors are indicated for continuous non-invasive monitoring of arterial oxygen saturation (SpO₂) and pulse rate. All sensors are intended for "single-patient use only" unless indicated as "reusable".

A. Selecting a Sensor

To select the appropriate sensor, consider the patient's weight, level of activity, adequacy of perfusion, available sensor sites, and the anticipated duration of monitoring.

B. Cleaning and Re-use

The sensor may be reattached to the same patient if the emitter and detector windows are clear and the adhesive still adheres to the skin. The adhesive can be partially rejuvenated by wiping with an alcohol wipe and allowing the sensor to thoroughly air dry prior to replacement on the patient.

C. Performance Considerations

To insure optimal performance, use an appropriate sensor, apply it as directed, and observe all warnings and cautions.

If excessive ambient light is present, cover the sensor site with opaque material. Failure to do so may result in inaccurate measurements. Light sources that can affect performance include surgical lights, especially those with a xenon light source, bilirubin lamps, fluorescent lights, infrared heating lamps, and direct sunlight.

Special Features

D. Automatic Calibration

The oximetry subsystem incorporates automatic calibration mechanisms. It is automatically calibrated each time it is turned on, at periodic intervals thereafter, and whenever a new sensor is connected. Also, the intensity of the sensor's LEDs is adjusted automatically to compensate for differences in tissue thickness.

Each sensor is calibrated when manufactured; the effective mean wavelength of the red LED is determined and encoded into a calibration resistor in the sensor plug. The instrument's software reads this calibration resistor to determine the appropriate calibration coefficients for the measurements obtained by that sensor.

E. Oximetry Sensitivity Mode and Post Averaging Time

The Accutorr V sensitivity mode for SpO₂ is set to normal and the averaging of the saturation, pulse rate, and signal strength measurements for SpO₂ is set to 8 seconds.

3.11.4 DPM SpO₂

The DPM SpO₂ module accuracy has been validated in human studies against arterial blood sample reference measured with a co-oximeter. Pulse oximeter measurements are statistically distributed, and about two-thirds of the measurements can be expected to fall within the specified accuracy compared to the co-oximeter measurements.

Two (2) sensors are available with DPM SpO₂. They are an adult reusable finger sensor and a reusable Y sensor for adult and pediatric patients.

The digital SpO₂ value displays on the SpO₂ LED (7), and the SpO₂ Pulse Rate displays on the Pulse Rate LED (6).

CAUTION: When equipped with DPM SpO₂, use only DPM oxygen sensors and cables. Use of other oxygen sensors may cause improper oximeter performance.

NOTE: Refer to instructions included with each SpO₂ sensor and cable for proper placement and use.

1. Select an SpO₂ sensor that is appropriate for the patient size.
2. Attach the connector of the SpO₂ sensor to the SpO₂ extension cable.
3. Attach the SpO₂ sensor to the patient's finger (or other appropriate site).
4. Align the key slot on the connector on the end of the SpO₂ extension cable with the SpO₂ receptacle on the right side panel of the Accutorr V. Push the connector into the SpO₂ receptacle until a "click" is heard. The SpO₂ measurement displays when the Accutorr V detects that the sensor is connected to the patient. A plethysmogram displays on the LCD.

NOTE: To disconnect the cable from the Accutorr V, pull straight out on the collar of the connector marked with two arrows.

Monitoring with a Reusable Y Sensor (Adult and Pediatric)

The reusable Y SpO₂ sensor consists of the sensor and its sheath. One side of the sensor has an LED with an infrared detector and the other side has a pulse detector.

1. Insert the LED and pulse detector ends of the Y SpO₂ sensor into the respective grooves of the sheath (see FIGURE 3-17 and FIGURE 3-18).

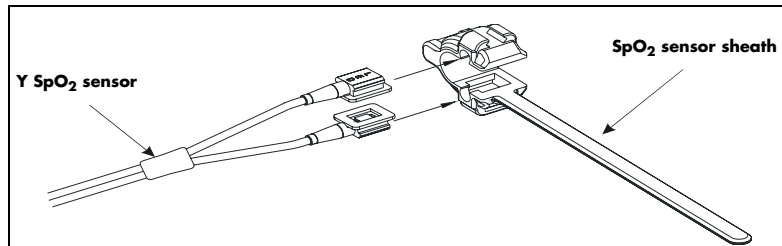

FIGURE 3-17 Inserting the Y SpO₂ sensor into the sheath

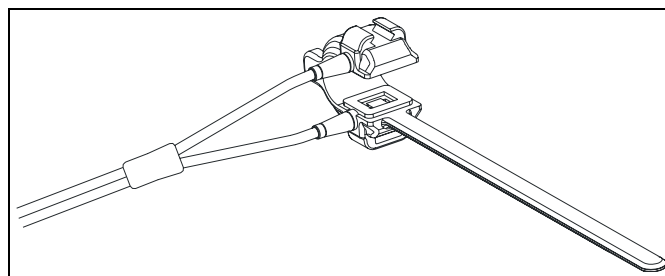

FIGURE 3-18 The Y SpO₂ sensor inserted in the sheath

2. Once inserted, place the sensor on the patient's finger, hand or foot. Check sensor position before securing it to the patient.
3. To secure the sensor, place the side of the sensor belt with V edge into the V groove on the corresponding side of the sheath. Repeat with the other side, ensuring the belt is secure, but comfortably placed on the patient. If necessary, adjust the belt using the second lock bar.
4. Ensure the sensor's LED and pulse detector sides are opposite each other.
5. Check sensor site frequently. If the sensor is too tight it may cause venous pulsation and therefore result in inaccurate measurement. Perform frequent site checks to verify skin integrity is not compromised.

CAUTION: When using the Accutorr V equipped with SpO₂, use only Mindray supplied oxygen transducers and patient cables. Use of other oxygen transducers may cause improper oximeter performance.

3.12 Temperature Measurement

The optional SmarTemp™ TEMP module is intended for monitoring oral, auxiliary, and rectal temperature of adult and pediatric patients and auxiliary temperature of neonatal patients. TEMP TYPE can be set to PREDICTIVE or MONITOR (see Section 3.12.1). The default TEMP TYPE is PREDICTIVE.

NOTE: If the patient size is adult or pediatric, the Accutorr V automatically selects oral as the measurement site if the oral/axillary temperature probe is in use. You can change the measurement site in the TEMP SETUP dialog.

NOTE: If the patient size is neonatal, the Accutorr V automatically selects axillary as the measurement site if the oral temperature probe is in use. In this case, you cannot change measurement site.

PREDICTIVE MODE: In PREDICTIVE mode, the TEMP probe warms up automatically as the probe is withdrawn from the probe sheath. Warming takes approximately 10 seconds, and the monitor beeps twice when the probe is up to temperature. The monitor beeps once when the patient's temperature is obtained, which takes approximately 10 to 12 seconds. The temperature reading remains on the display until the probe is removed from the sheath again.

CAUTION: In PREDICTIVE mode, place the temperature probe in the measurement site when probe warm-up is completed or an inaccurate temperature reading may result.

The Accutorr V automatically enters the predict mode when the probe is replaced in the probe sheath.





MONITOR MODE: In MONITOR mode, the patient's temperature is obtained in 3 to 5 minutes and the temperature reading is continuously shown as long as the probe is kept at the measurement position and the patient's temperature is within the measuring range. In this mode, the monitor does not beep when the final temperature is obtained.

The monitor automatically enters the MONITOR mode when an accurate temperature is not reached in the PREDICTIVE mode.

NOTE: After a measurement, allow 60 seconds for the tip to cool before proceeding with the next measurement.

3.12.1 Setting Temperature Properties

To configure the TEMP properties:

1. Press  (12) to display the SYSTEM SETUP dialog as shown in FIGURE 3-7.
2. Press  (16) or  (19) to highlight TEMP SETUP.
3. Once TEMP SETUP is highlighted, press  (18) to display the TEMP SETUP dialog as shown in FIGURE 3-19.

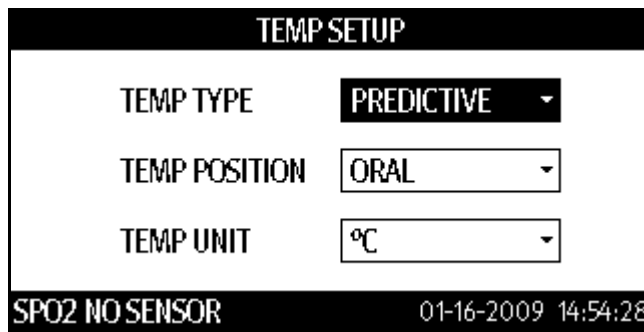

FIGURE 3-19 Example TEMP SETUP dialog

4. Press (16) or (19) to highlight a property.
5. Once the property is highlighted, press (18) to select it.
6. Press (16) or (19) to change the choice in the field.
7. Once the desired choice is displayed, press (18) to set it.
8. Repeat steps 4 to 7 as needed.
9. Once the choices are set, press (12) to exit the TEMP SETUP dialog.

CAUTION: Selecting the incorrect PATIENT SIZE (see Section 3.5.2) and/or TEMP POSITION may result in an inaccurate temperature measurement.

3.12.2 Applying a Probe Cover (SmarTemp)

1. To open the probe cover box, remove the “tear out” tab on the end of the box top.
2. Place the box of probe covers into the thermometer module holder with the opening to the bottom.
3. Remove the probe from the sheath. This turns on the thermometer.
4. Insert the probe into a probe cover in the box, and push firmly on the cap of the probe handle until the probe cover snaps into place.

WARNING: Use only authorized single use disposable probe covers when taking temperature measurements. Use of any other probe cover may result in erroneous readings or damage to the probe.

The two types of TEMP probe are: oral/axillary probe (blue) and rectal probe (red). Use the blue oral/axillary probe only with the blue probe sheath. Use the red rectal probe only with red probe sheath.

3.12.3 Taking an Oral Temperature Measurement

To measure Oral Temperature.

1. Verify that the oral/axillary probe is connected to the probe connector, and the indicator lamp illuminates to indicate that TEMP module is operating.

2. Select the temperature type (see Section 3.12.1).
3. Set TEMP POSITION to ORAL (see Section 3.12.1).
4. Remove the probe from the probe sheath and insert it into a cover in the probe cover box. Press the probe handle down firmly until the probe engages the cover.
5. After probe warms, apply the probe under the patient's tongue from either side of the mouth (see FIGURE 3-20). Verify that the probe reaches the rear sublingual pocket. Have the patient close his/her lips to hold the probe.

NOTE: Obtain accurate temperatures in the heat pocket at this location. Temperatures in other locations in the mouth may vary by two degrees F (one degree C) or more. Hold the probe steady in this location. The patient's mouth must be closed for the measurement. The thermometer reading begins to flash, and then indicates the rising temperature as the measurement proceeds.

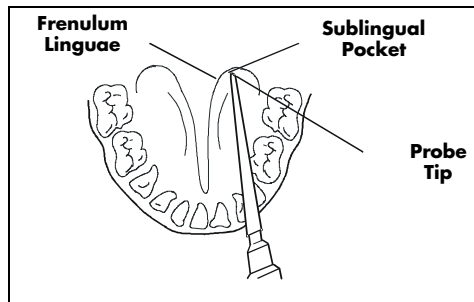

FIGURE 3-20 Probe Placement for Oral Temperatures

6. The monitor beeps when the temperature measurement is complete.
7. Withdraw the probe from the patient's mouth.
8. Press the ejection button on the top of the probe to eject the probe cover.
9. Return the probe to the sheath.

3.12.4 Taking an Axillary Temperature Measurement

1. Verify that the oral/axillary probe is connected to the probe connector, and the indicator lamp illuminates to indicate that TEMP module is operating.
2. Select the temperature type.
3. Set TEMP POSITION to AXILLARY (see Section 3.12.1).
4. Remove the probe from the probe sheath and insert it into a cover in the probe cover box. Press the probe handle down firmly until the probe engages the cover.
5. After the probe warms, lift the patient's arm to show the entire armpit. Apply the probe as high as possible in the armpit. Check that the probe tip is completely surrounded by the axillary tissue. Lower the patient's arm so that it is tightly placed at the patient side. Keep the patient's arm and the probe in place throughout the measurement.

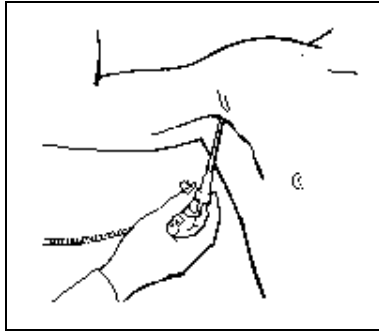

FIGURE 3-21 Probe Placement for Axillary Temperatures

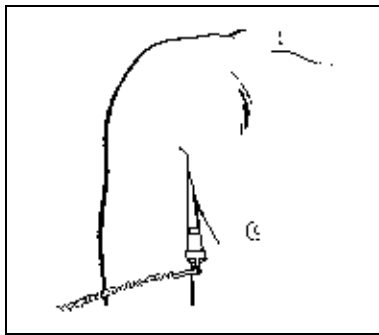

FIGURE 3-22 Probe Placement for Axillary Temperatures

6. The monitor beeps when the temperature measurement is complete.
7. Withdraw the probe from the patient's armpit.
8. Press the ejection button on the top of the probe to eject the probe cover.
9. Return the probe to the sheath.

3.12.5 Measuring Rectal Temperature

1. Verify that the rectal probe is connected to the probe connector, and the indicator lamp illuminates to indicate that TEMP module is operating.
2. Select the temperature type.
3. Set TEMP POSITION to RECTAL (see Section 3.12.1).
4. Remove the probe from the probe sheath and insert it into a cover in the probe cover box. Press the probe handle down firmly until the probe engages the cover.
5. After probe warms, insert the probe into the patient's rectum. To insure proper tissue contact, angle the probes lightly after insertion. Insertion depth is recommended at 1/2" to 3/4" (1.25 to 2 cm) for adults and 1/4" to 1/2" (0.5 to 1.25 cm) for children. A lubricant may be used if desired. The measurement will proceed similarly to the oral measurement, and the final reading will be displayed when the display stops flashing.

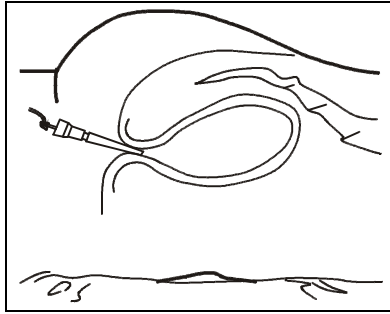

FIGURE 3-23 .Probe Placement for Rectal Temperatures

6. The monitor beeps when the temperature measurement is complete.
7. Withdraw the probe from the patient's rectum.
8. Press the ejection button on the top of the probe to eject the probe cover.
9. Return the probe into the sheath.



NOTE: The tip of the probe should not come in contact with a heat source (i.e., hands or finger) prior to taking a temperature. If this happens, allow at least 5 seconds for the tip to cool before proceeding with the reading.

NOTE: The thermometer turns itself off about 3 minutes after turning it on, or when the probe is returned to the probe sheath. Always store in the sheath for the protection of the probe and to reset the temperature module.

NOTE: The thermometer will not take a reading if the patient's temperature is less than 6°F (3.3°C) above the ambient temperature.

3.13 Recorder

The Accutorr V provides a permanent record of patient data using the recorder.

- To print the data on the current display (5 lines of data), press  (33) for less than 2 seconds (1 beep tone).
- To print all the trend data for the current patient (up to 11 lines of data per block.), press  (33) for more than 2 seconds (1 beep tone) in trend data review mode.
- To stop printing while in progress, press  (33) (1 beep tone).

An interrupted NIBP measurement prints as XXX for Sys, Dia, and Map. **If the temperature is shown in every time slot, the temperature parameter is in continuous mode.**

When no information is available for a particular parameter, a dash prints. **Parenthesis print around measurements that caused an alarm violation.**

| | Time | Sys (mmHg) | Dia (mmHg) | Map (mmHg) | SpO2 (%) | PR (BPM) | Temp (°F) |
|-------------|---------------|------------|------------|------------|----------|----------|-----------|
| | 12 - 10 11:19 | XXX | XXX | XXX | | | 97.2 |
| Trend Table | 12 - 10 11:19 | — | — | — | 94 | 80 | 96.8 |
| (ALL) | 12 - 10 11:18 | — | — | — | (85) | (122) | 95.7 |
| | 12 - 10 11:18 | — | — | — | 92 | 110 | 93.4 |
| | 12 - 10 11:17 | 120 | 80 | 93 | — | 72 | 83.5 |

PATIENT ID: 20081210095209 Record Time: 12-10-2008 11:19:29 Mindray DS USA, Inc.

FIGURE 3-24 Example Recorder Strip of Data on the Current Display

- Whenever SpO₂ is active, it is used to measure Pulse Rate.
- If data is invalid or not available for any given parameter, “—” prints under that parameter.
- If an NIBP measurement was interrupted, “XXX” is printed under Sys, Dia, and Map.
- Parenthesis () indicate a parameter value that violated alarm limits.

3.14 Setting The Clock (Date and Time)

Set the clock during normal operation or in the User Configuration. See section 3.16, for details on entering the User Configuration. There are six (6) properties to set in the clock dialog: DATE FORMAT, YEAR, MONTH, DAY, HOUR, and MINUTE.

NOTE: The Accutorr V always displays time in a 24-hour format.

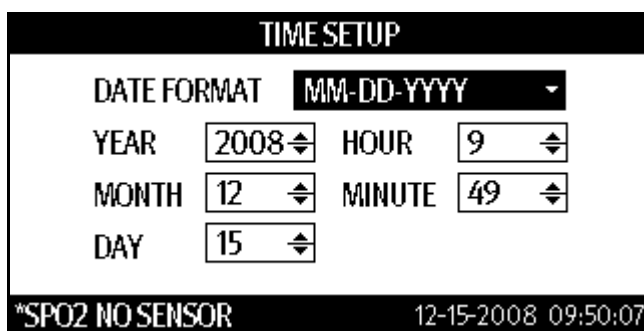













FIGURE 3-25 Example TIME SETUP Dialog

To set the time and date:

1. Press  (12) to display the SYSTEM SETUP dialog as shown in FIGURE 3-7.
2. Press  (16) or  (19) to select **TIME SETUP**.
3. Once **TIME SETUP** is highlighted, press  (18) to display the TIME SETUP dialog as shown in FIGURE 3-25.
4. Press  (16) or  (19) to highlight a property to set.
5. Once the property is highlighted, press  (18) to select it.
6. Press  (16) or  (19) to change the value in the selection.
7. Once the desired value is displayed, press  (18) to set it.
8. Repeat steps 4 to 7 as needed.
9. Once the values are set, press  (12) to exit to the SYSTEM SETUP dialog.
10. Press  (12) to exit to the Trend display.

3.15 Battery Operation

When the Accutorr V is powered from the battery and switched on, the Battery status indicator (15) illuminates, and the AC power indicator (14) remains dark.

When the battery charge is low, but not below the cutoff voltage, the battery indicator flashes. When the LED begins to flash, at least 5 minutes of low battery warning time remain.

Battery run time for the Accutorr V is approximately 540 minutes for a new Lithium ion battery, fully charged, at an ambient temperature of 25°C, with one automatic NIBP measurement taken every 15 minutes, continuous SpO₂ measurement, and the recorder not in use.





The Accutorr V automatically recharges the battery, when required, if the monitor is plugged into an AC receptacle. When the unit is plugged into an AC receptacle, the Battery status indicator (15) is always illuminated. Maximum battery recharge time is 4.5 hours for Lithium ion with the Accutorr V in standby mode or off, and 6 hours in normal running mode (not in Standby mode).

NOTE: Replace the Lithium ion battery with new battery if its run time is diminished.

3.16 Creating a User Configuration

The operator can set custom default settings. Each time the Accutorr V is turned on, it will use the User Configuration (custom default settings).

To create a User Configuration:

1. Press  (12) to display the SYSTEM SETUP dialog FIGURE 3-7.
2. Press  (16) or  (19) to select **MAINTENANCE**.
3. Once the **MAINTENANCE** is highlighted, press  (18) to display the MAINTENANCE dialog as shown in FIGURE 3-26.

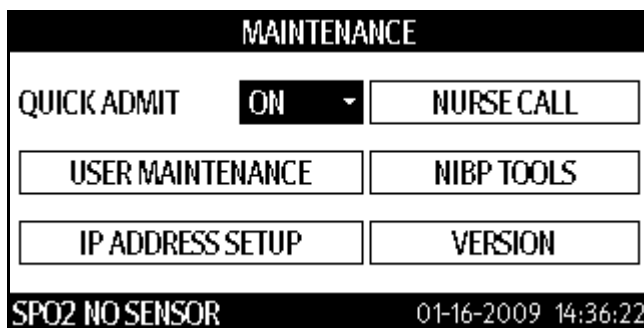





FIGURE 3-26 MAINTENANCE Dialog

4. Press  (16) or  (19) to select **USER MAINTENANCE**.
5. Once **USER MAINTENANCE** is highlighted, press  (18) to display the Enter Password dialog, as shown in FIGURE 3-27.

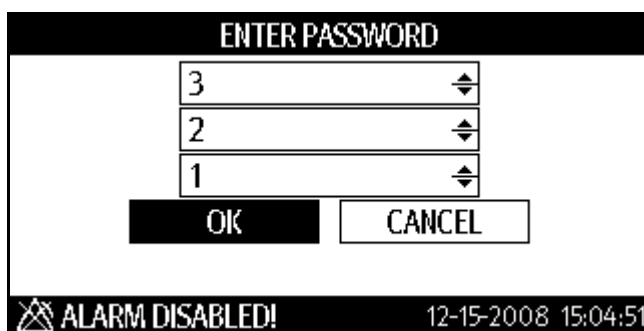

FIGURE 3-27 ENTER PASSWORD Dialog

6. In the Enter Password dialog, press **OK** (18).
7. Press **▲** (16) or **▼** (19) to set the first password digit to 3.
8. Press **OK** (18).
9. Press **▲** (16) or **▼** (19) to highlight the second password digit.
10. Press **OK** (18).
11. Press **▲** (16) or **▼** (19) to set the second password digit to 2.
12. Press **OK** (18).
13. Press **▲** (16) or **▼** (19) to highlight the third password digit.
14. Press **OK** (18).
15. Press **▲** (16) or **▼** (19) to set the third password digit to 1.
16. Press **OK** (18).
17. Press **▲** (16) or **▼** (19) to highlight **OK**.
18. Press **OK** (18) to display the USER MAINTENANCE dialog as shown in FIGURE 3-28.

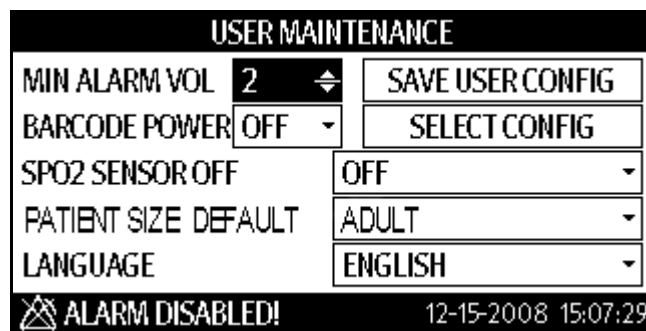

FIGURE 3-28 Example USER MAINTENANCE Dialog

NOTE: Press **ESC** (12) to exit to the MAINTENANCE dialog.







3.16.1 Turning Barcode Power On or Off

1. Follow steps 1 to 18 above to access the USER MAINTENANCE dialog as shown in FIGURE 3-28.
2. Press **▲** (16) or **▼** (19) to highlight the BARCODE POWER selection field.
3. Once the selection field is highlighted, press **OK** (18) select it.
4. Press **▲** (16) or **▼** (19) to select ON or OFF.
5. Once the selection is highlighted, press **OK** (18) select it.

NOTE: When the RS-232 connector is used for DIAP, barcode power must be set to OFF.

3.16.2 Selecting a Language











1. Follow steps 1 to 18 above to access the USER MAINTENANCE dialog as shown in FIGURE 3-28.

2. Press  (16) or  (19) to highlight the LANGUAGE selection field.
3. Once the selection field is highlighted, press  (18) select it.
4. Press  (16) or  (19) to highlight a language.
5. Once the selection is highlighted, press  (18) select it.

NOTE: The new language becomes effective once the Accutorr V is restarted.

3.16.3 Turning Alarm Tones Off





To turn off the alarm tones, in the USER MAINTENANCE dialog do the following:

1. Follow steps 1 to 18 above to access the USER MAINTENANCE dialog as shown in FIGURE 3-28.
2. Press  (16) or  (19) to highlight the MIN ALARM VOL selection field.
3. Once the selection field is highlighted, press  (18) select it.
4. Press  (16) or  (19) to change the value to 0.
5. Once 0 is displayed, press  to set it.
6. Press  (12) again to exit to the SYSTEM SETUP dialog.
7. Press  (16) or  (19) to highlight **COMMON SETUP**.
8. Once the COMMON SETUP has been highlighted, press  (18) to display the COMMON SETUP dialog as shown in FIGURE 3-14.
9. In steps 1 through 4 of Section 3.10.1, set the ALARM VOL to 0.

3.16.4 SpO₂ Sensor Off

When SPO2 SENSOR OFF is set to OFF, the Accutorr V disables all alarm indications related to the SpO₂ sensor off alarm.

To set the SpO₂ sensor alarm:



1. Follow steps 1 to 18 above to access the USER MAINTENANCE dialog as shown in FIGURE 3-28.
2. Press  (16) or  (19) to highlight the SPO2 SENSOR OFF selection field.
3. Once the selection field is highlighted, press  (18) to select it.
4. Press  (16) or  (19) to change it to OFF.



NOTE: The SPO2 SENSOR OFF selections are HIGH priority, LOW priority, and OFF.

5. Once OFF is displayed, press  to set it.

3.16.5 Saving a user configuration

To save a newly created configuration:





























1. Press  (16) or  (19) to highlight SAVE USER CONFIG.

2. Once SAVE USER CONFIG is highlighted, press  to save the new user configuration.
3. When the confirmation request is displayed, press  to confirm saving the new configuration.

3.16.6 Setting a Default Power-on Configuration

The operator can select the default power-on configuration. Each time the Accutorr V is turned on, it will use that default configuration.

To select a default power-on configuration:

1. Press  (12) to display the SYSTEM SETUP dialog FIGURE 3-7.
2. Press  (16) or  (19) to select **MAINTENANCE**.
3. Once the **MAINTENANCE** is highlighted, press  (18) to display the MAINTENANCE dialog as shown in FIGURE 3-26.
4. Press  (16) or  (19) to select **USER MAINTENANCE**.
5. Once **USER MAINTENANCE** is highlighted, press  (18) to display the Enter Password dialog, as shown in FIGURE 3-27.
6. In the Enter Password dialog, press  (18).
7. Press  (16) or  (19) to set the first password digit to 3.
8. Press  (18).
9. Press  (16) or  (19) to highlight the second password digit.
10. Press  (18).
11. Press  (16) or  (19) to set the second password digit to 2.
12. Press  (18).
13. Press  (16) or  (19) to highlight the third password digit.
14. Press  (18).
15. Press  (16) or  (19) to set the third password digit to 1.
16. Press  (18).
17. Press  (16) or  (19) to highlight **OK**.
18. Press  (18) to display the USER MAINTENANCE dialog as shown in FIGURE 3-28.
19. Press  (16) or  (19) to highlight **SELECT CONFIG**.
20. Once **SELECT CONFIG** is highlighted, press  (18) to display the SELECT CONFIG dialog as shown in FIGURE 3-29.

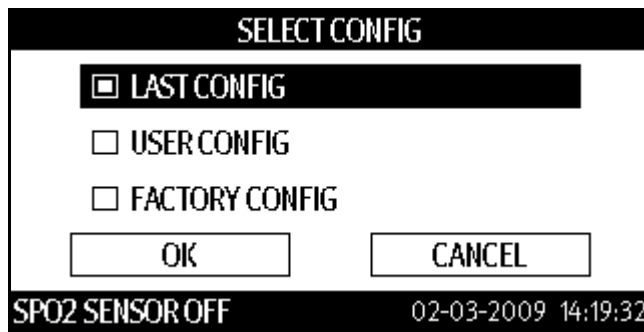







FIGURE 3-29 Default Power-on Configuration Selection Dialog (SELECT CONFIG)

- 21.** Press  (16) or  (19) to highlight a default power-on configuration to load.
- 22.** Once the configuration is highlighted, press  (18) select it.
- 23.** Press  (16) or  (19) to highlight **OK** or **CANCEL**.
- 24.** Once the **OK** or **CANCEL** is highlighted, press  (18) select it and return to the USER MAINTENANCE dialog.

3.17 Status and Error Codes

3.17.1 Physiological Alarm Messages

| ALARM MESSAGE | LEVEL | CAUSE | ACTION |
|-----------------------|--------------|--|--|
| HIGH PR | H | PR value exceeds the upper alarm limit. | Make sure the alarm limits are appropriate for the patient, and check the patient's condition. |
| LOW PR | H | PR value is lower than the lower alarm limit. | Make sure the alarm limits are appropriate for the patient, and check the patient's condition. |
| HIGH SPO ₂ | H | SpO ₂ value exceeds the upper alarm limit. | Make sure the alarm limits are appropriate for the patient, and check the patient's condition. |
| LOW SPO ₂ | H | SpO ₂ value is lower than the lower alarm limit. | Make sure the alarm limits are appropriate for the patient, and check the patient's condition. |
| HIGH SYS | H | SYS value exceeds the upper alarm limit. | Make sure the alarm limits are appropriate for the patient, and check the patient's condition. |
| LOW SYS | H | SYS value is lower than the lower alarm limit. | Make sure the alarm limits are appropriate for the patient, and check the patient's condition. |
| HIGH DIA | H | DIA value exceeds the upper alarm limit. | Make sure the alarm limits are appropriate for the patient, and check the patient's condition. |
| LOW DIA | H | DIA value is lower than the lower alarm limit. | Make sure the alarm limits are appropriate for the patient, and check the patient's condition. |
| HIGH MAP | H | MAP value exceeds the upper alarm limit. | Make sure the alarm limits are appropriate for the patient, and check the patient's condition. |
| LOW MAP | H | MAP value is lower than the lower alarm limit. | Make sure the alarm limits are appropriate for the patient, and check the patient's condition. |
| NO PULSE | H | The pulse signal of the patient is so weak that the monitor cannot perform pulse analysis. | Check the connection of the sensor and the patient's condition. |

The alarm levels are H = high and L = low.

3.17.2 Technical Alarm Messages

In the following tables, XX represents a parameter module such as NIBP or SpO₂, or a parameter label, such as PR and SpO₂, but not RECORDER (for RECORDER, see Section 3.17.9). ## stands for patient category, i.e., adult, pediatric, or neonate. The "Level" field indicates the alarm level: H means high and L means low.

3.17.3 General Alarm Messages of Parameter Modules

| ALARM MESSAGE | A | B | LEVEL | CAUSE | ACTION |
|---|-----|----|-------|--|---|
| XX INIT ERR N | Yes | No | H | An error occurs to the XX module during initialization. | Restart the monitor. If the problem persists, contact service personnel for repair. |
| NOTE: Note: N stands for error code. | | | | | |
| XX COMM STOP | No | No | H | Failure in communication between XX module and the main board. | |
| XX COMM ERROR | No | No | H | Failure in communication between XX module and the main board. | |
| XX ALM LMT ERR | No | No | H | The alarm limit of the XX parameter is changed inadvertently. | If the problem persists, contact service personnel for repair. |
| XX OUT OF RANGE | No | No | H | The measured XX value exceeds the measurement range. | |

The "A" field indicates whether all alarm indications can be cleared or not, and the "B" field indicates whether all alarm indications except the alarm message can be cleared or not. The alarm levels are H = high and L = low.

3.17.4 NIBP Module Alarm Messages

| ALARM MESSAGE | A | B | LEVEL | CAUSE | ACTION |
|--------------------|----|----|-------|--|--|
| NIBP SELFTEST ERR | No | No | L | An error occurs during NIBP module initialization. | Select NIBP RESET in the MAINTAIN menu. If the problem still exists, contact service personnel for repair. See Section 4.8. |
| NIBP INIT ERR | No | No | L | An error occurs during NIBP module initialization. | Restart the monitor. If the problem still exists, contact service personnel for repair. |
| NIBP COMM ERR | No | No | L | Communication between NIBP module and the host fails. | |
| LOOSE CUFF | No | No | L | The NIBP cuff is not properly connected. | Reconnect the NIBP cuff. |
| AIR LEAK | No | No | L | The NIBP cuff is not properly connected or there is leak in the airway. | Check the connections or use a new cuff. If the problem persists, contact our service personnel for repair. |
| AIR PRESSURE ERROR | No | No | L | Failures occur in the pulse measurement. The monitor cannot perform measurement, analysis, or calculation. | Check the connections between the cuff, the monitor and the patient. or use a new cuff. If the problem persists, contact our service personnel for repair. |

The "A" field indicates whether all alarm indications can be cleared or not, and the "B" field indicates whether all alarm indications except the alarm message can be cleared or not. The alarm levels are H = high and L = low.

| ALARM MESSAGE | A | B | LEVEL | CAUSE | ACTION |
|----------------------|----------|----------|--------------|--|--|
| NIBP WEAK SIGNAL | No | No | L | Failures occur in the pulse measurement. The monitor cannot perform measurement, analysis, or calculation. | Check the patient's condition and verify patient type. Replace with an appropriate cuff and connect it correctly. If the problem still exists, contact service personnel for repair. |
| NIBP OVERRANGE | No | No | L | Failures occurred in the pulse measurement. The monitor cannot perform measurement, analysis, or calculation. | |
| EXCESSIVE MOTION | No | No | L | Excessive motion of the patient's arms | |
| OVER PRESSURE | No | No | L | The airway might be blocked. | |
| SIGNAL SATURATED | No | No | L | A failure occurred during pulse measurement. The monitor cannot perform measurement, analysis, or calculation. | |
| PNEUMATIC LEAK | No | No | L | Leak in the airway. | |
| NIBP SYSTEM FAILURE | No | No | L | Failures occur in the pulse measurement. The monitor cannot perform measurement, analysis, or calculation. | |
| NIBP TIME OUT | No | No | L | | |
| CUFF TYPE ERR | No | No | L | The cuff used does not correspond to selected patient type. | |
| NIBP RESET ERROR | No | No | L | Illegal reset during NIBP measurement. | Check the airway and take measurements again. If the problem still exists, contact service personnel for repair. |

The "A" field indicates whether all alarm indications can be cleared or not, and the "B" field indicates whether all alarm indications except the alarm message can be cleared or not. The alarm levels are H = high and L = low.

3.17.5 Masimo SpO₂ Module Alarm Messages

| ALARM MESSAGE | A | B | LEVEL | CAUSE | ACTION |
|---------------------|----|-----|-------|---|---|
| SPO2 SENSOR OFF | No | Yes | * | The sensor is disconnected from the patient or the monitor. | Make sure that the sensor is placed at an appropriate position and the monitor is connected to cables correctly. |
| SPO2 PULSE SEARCH | No | No | L | The monitor is searching for the patient's pulse signal. | If the pulse reading is not displayed after 30 seconds, check if the sensor is properly connected to the patient. Change the sensor site for better signals if necessary. |
| SPO2 INTERFERENCE | No | No | L | The pulse signals are subject to great external interference. | Reduce or remove external interference. |
| SPO2 LOW PERFUSION | No | No | L | The pulse signal is too weak. | Move the sensor to a site with better perfusion. |
| SPO2 TOO MUCH LIGHT | No | No | L | Too much light on the sensor. | Turn down or off the lighting, move the sensor to a place of weaker light or cover the sensor. |
| UNKNOWN SPO2 SENSOR | No | No | L | The monitor cannot recognize the SpO ₂ sensor type. | Check whether the type of the sensor is correct. |
| SPO2 BOARD FAULT | No | No | L | The SpO ₂ board malfunctions and might not be able to measure the pulse signals correctly. | Stop using the SpO ₂ module, and contact biomedical engineers or service for maintenance. |
| SPO2 SENSOR FAULT | No | No | L | The sensor is damaged. | Stop using the sensor. |
| SPO2 NO SENSOR | No | Yes | L | The sensor is disconnected from the patient or the monitor, or the sensor is not properly connected. | Disconnect and reconnect the sensor as directed by the instructions. If the alarm remains, the sensor or the cable might have been damaged. |
| | | | | SpO ₂ sensor is reversed. | Disconnect and reconnect the sensor as directed by the instructions. Pay attention to the mark on the sensor. |
| SPO2 WEAK SIGNAL | No | No | L | The pulse signals detected by the monitor are of poor quality. | Move the sensor to a site with better signals. |
| SPO2 SENSOR CHECK | No | No | L | | |
| WRONG SPO2 SENSOR | No | No | L | The SpO ₂ sensor is incompatible to the monitor, or is damaged. | Stop using the sensor. |

The "A" field indicates whether all alarm indications can be cleared or not, and the "B" field indicates whether all alarm indications except the alarm message can be cleared or not. The alarm levels are H = high and L = low.

** The alarm level is user-adjustable.*

3.17.6 Nellcor SpO₂ Module Alarm Messages

| ALARM MESSAGE | A | B | LEVEL | CAUSE | ACTION |
|----------------------|----------|----------|--------------|--|---|
| SPO2 SENSOR OFF | No | Yes | * | The sensor is disconnected from the patient or the monitor. | Make sure that the sensor is placed at an appropriate position and the monitor is connected to cables correctly. |
| SPO2 NO SENSOR | No | Yes | L | The sensor is disconnected from the patient or the monitor, or the sensor is not connected properly. | Disconnect and reconnect the sensor as directed by the instructions. If the alarm remains, the sensor or the cable might have been damaged. |
| | | | | SpO ₂ sensor is reversed. | Disconnect and reconnect the sensor as directed by the instructions. Pay attention to the mark on the sensor. |
| SPO2 INTERFERENCE | No | No | L | The pulse signals are subject to great external interference. | Reduce or remove external interference. |
| SPO2 BOARD FAULT | No | No | L | The SpO ₂ board malfunctions and might be unable to measure the pulse signals correctly. | Stop using the SpO ₂ module, and contact biomedical engineers or us for maintenance. |
| SPO2 SENSOR CHECK | No | No | L | | |
| SPO2 SENSOR FAULT | No | No | L | The sensor is damaged. | Stop using the sensor. |
| SPO2 WEAK SIGNAL | No | No | L | The SpO ₂ signal is weak. | Change the sensor site for better signals. |

The "A" field indicates whether all alarm indications can be cleared or not, and the "B" field indicates whether all alarm indications except the alarm message can be cleared or not. The alarm levels are H = high and L = low.

** The alarm level is user-adjustable.*

3.17.7 DPM SpO₂ Module Alarm Messages

| MESSAGE/ISSUE | REASON | SOLUTION |
|----------------------|---|--|
| SPO2 SENSOR OFF | SpO ₂ sensor may be disconnected from the patient or the monitor | Plug the sensor into the monitor or the sensor into the cable. Place the sensor on the patient |
| SPO2 INIT ERR 1 | SpO ₂ module failure | Notify hospital technician or service personnel |
| SPO2 COMM STOP | SpO ₂ module failure or communication error | Notify hospital technician or service personnel |
| SPO2 COMM ERR | SpO ₂ module failure or communication error | Notify hospital technician or service personnel |
| SPO2 ALM LMT ERR | Functional failure | Notify hospital technician or service personnel |
| PR ALM LMT ERR | Functional failure | Notify hospital technician or service personnel |
| SPO2 EXCEED | SpO ₂ value exceeds the measurement range | Check patient, notify physician |

| MESSAGE/ISSUE | REASON | SOLUTION |
|-------------------------------|---|---|
| PR EXCEED | PR value exceeds the measurement range | Check patient, notify physician |
| SEARCH PULSE | SpO ₂ module is searching for pulse | Change sensor sites, ensure site is not on a limb with vasoconstriction or other conditions which would contra-indicate use. Change or readjust sensor if loose or disconnected |
| Unable to obtain SPO2 reading | Patient has poor perfusion Sensor not applied properly Cables loose / not connected Ambient light detected | Move sensor to limb with better perfusion, notify physician Reapply sensor Check connections, switch cables Switch limbs and cover sensor with an opaque material |
| No SPO2 waveform | Cable or sensor not plugged in | Check connections and sensor Replace as necessary |
| Low amplitude SPO2 signal | SpO ₂ sensor on same limb as blood pressure cuff Patient has poor perfusion | Check sensor placement, move as necessary Move sensor to limb with better perfusion, notify physician |

3.17.8 SmarTemp™ TEMP Module Alarm Messages

| ALARM MESSAGE | A | B | LEVEL | CAUSE | ACTION |
|----------------------|----------|----------|--------------|---|--|
| WARMUP TIMED OUT | Yes | Yes | L | TEMP probe initial temperature is too high. | Cool the TEMP probe before taking measurement. |
| WARMING RESISTOR ERR | No | No | L | The warming resistor in the TEMP probe fails. | Replace the TEMP probe. |
| TEMP PROBE MISPLACED | Yes | No | L | TEMP probe is not placed in the sheath or the probe sheath is not in place. | 1. Check that the probe sheath is in place. 2. Replace the TEMP probe in the sheath properly. |
| ENV TEMP OVERRANGE | No | Yes | L | The ambient temperature is beyond the measuring range. | Take measurement in proper working condition. |
| TEMP VOLTAGE ERR | No | Yes | L | Supply voltage is too high or too low. | Check the power supply. |
| TEMP NO PROBE | No | Yes | L | The TEMP probe is disconnected from the TEMP module. | Reconnect the probe with the TEMP module. |
| TEMP PREDICTION ERR | Yes | Yes | L | Improper temperature measurement | Take TEMP measurement again correctly. |
| TEMP SELFTEST ERR | No | No | L | An error occurs during the TEMP module initialization | Replace the TEMP module. |
| TEMP PROBE OFF | No | Yes | L | TEMP probe does not contact with the patient. | Take measurement again after the probe warms up. |
| TEMP OVER HIGH LIMIT | No | No | L | The temperature measured is too high or measurement error | Lower the measured temperature or replace the TEMP module. |
| TEMP OVER LOW LIMIT | No | No | L | The temperature measured is too low or measurement error | Raise the measured temperature or replace the TEMP module. |
| TEMP WRONG PROBE | No | No | L | A TEMP probe not supplied by Mindray DS USA, Inc./ Shenzhen Mindray Bio-Medical Electronics Co., Ltd is used. | Replace with a TEMP probe Mindray DS USA, Inc./Shenzhen Mindray Bio-Medical Electronics Co., Ltd supplies. |
| TEMP COMM ERR | No | No | L | TEMP module is not available or TEMP module fails | Check if a TEMP module is available. If yes, replace the TEMP module. |

The "A" field indicates whether all alarm indications can be cleared or not, and the "B" field indicates whether all alarm indications except the alarm message can be cleared or not. The alarm levels are H = high and L = low.

3.17.9 Recorder Module Alarm Messages

| ALARM MESSAGE | A | B | LEVEL | CAUSE | ACTION |
|----------------------|----------|----------|--------------|---|---|
| RECORDER INIT ERR N | Yes | No | L | An error occurs during the recorder initialization. | Contact the hospital's engineers or Customer Service. |
| REC SELFTEST ERR | Yes | No | L | An error might occur to the RAM, ROM and CPU watchdog. | Restart the recorder. If the error remains, contact service personnel for repair. |
| RECORDER HEAD HOT | No | No | L | The thermal head of the recorder is too hot. | Resume the recording after the recorder cools down completely. If the problem still exists, contact service personnel for repair. |
| REC HEAD WRONG POS. | Yes | Yes | L | The thermal head of the recorder is in wrong position. | Restore the control lever of the recorder to its previous position. |
| REC OUT OF PAPER | Yes | Yes | L | The recorder paper is used up. | Replace with a new paper roll. |
| RECORDER PAPER JAM | No | No | L | The recorder has recorded data on paper for 30m long or more. | Place the recorder correctly and try again. |
| RECORDER COMM ERR | Yes | No | L | Error in recorder communication. | Clear recording tasks and restart the monitor. If the problem remains, contact service personnel for repair. |
| TOO MANY REC TASKS | No | No | L | Too many alarm events occur at the same time. | Clear recording tasks and restart the monitor. If the problem remains, contact service personnel for repair. |
| RECORDER PAPER W.P. | Yes | Yes | L | The paper roll of the recorder is not placed in the correct position. | Place the paper roll correctly. |
| REC S. COMM ERR | Yes | No | L | Error in recorder communication. | Clear recording tasks and restart the monitor. If the problem remains, contact service personnel for repair. |
| REC NOT AVAILABLE | No | No | L | Error in the recorder work mode. | Clear recording tasks and restart the monitor. If the problem remains, contact service personnel for repair. |





The "A" field indicates whether all alarm indications can be cleared or not, and the "B" field indicates whether all alarm indications except the alarm message can be cleared or not. The alarm levels are H = high and L = low.

3.17.10 System Alarm Messages

| ALARM MESSAGE | A | B | LEVEL | CAUSE | ACTION |
|---------------------|-----|----|-------|--|--|
| REAL CLOCK NEED SET | No | No | L | The system time is incorrect. | Reset the system time and then restart the monitor. |
| REAL CLK NOT EXIST | No | No | L | There is no button battery, or the battery power is depleted. | Install a button battery or replace with a new one. |
| NET INIT ERR (G.) | No | No | L | The monitor cannot be connected to the network due to network problem. | Contact service personnel for repair. |
| NET INIT ERR (RAM) | No | No | L | | |
| NET INIT ERR (REG) | No | No | L | | |
| NET INIT ERR (MII) | No | No | L | | |
| NET INIT ERR (LOOP) | No | No | L | | |
| NET ERR (RUN 1) | No | No | L | | |
| NET ERR (RUN 2) | No | No | L | | |
| NET ERR (RUN 3) | No | No | L | | |
| 12V TOO HIGH | No | No | L | A problem occurs to the system's power supply. | If this alarm message occurs frequently, contact service personnel for repair. |
| 12V TOO LOW | No | No | L | | |
| BATTERY TOO LOW | No | No | H | The battery voltage is too low. | Connect the monitor to AC mains to charge the battery. |
| NET ERROR | Yes | No | L | The monitor is not connected to the network. | Check the network links. |

The "A" field indicates whether all alarm indications can be cleared or not, and the "B" field indicates whether all alarm indications except the alarm message can be cleared or not. The alarm levels are H = high and L = low.

3.17.11 Prompt Messages

| PROMPT MESSAGE | CAUSE | ACTION |
|------------------------|--|--|
| PULSE SEARCH | The SpO ₂ module is searching the pulse. | Wait till the end of the search. |
| REC INITIALIZING | The recorder is initializing | Wait until initialization complete before printing. |
| NIBP MEASURING... | NIBP measurement in process | Wait until measurement complete or press  (25) to interrupt a measurement and deflate the cuff. |
| PRESS START NIBP | Interval NIBP measurement has been stopped by pressing  (25). | Press  (24) to restart NIBP interval mode measurements. |
| PNEUM TESTING... | Pneumatic testing in process. | Wait until testing complete. |
| MEASUREMENT COMPLETE | A measurement has finished. | None |
| NIBP RETRY | NIBP measurement failed and is retrying. | Wait until measurement complete or |
| NIBP RETRY PUMP HIGHER | NIBP measurement failed and is retrying with a higher pressure. | press  (25) to interrupt a measurement and deflate the cuff. |
| BARCODE FAILED | The barcode reader failed to read the patient's barcode. | Use another barcode reader. If failure continues, contact service personnel. |

| PROMPT MESSAGE | CAUSE | ACTION |
|------------------------------|---|---|
| STANDBY FAILED | The unit failed to enter the standby mode. | Following instructions in Section 3.4.1 again. If standby fails again, restart unit. If failure continues, contact service personnel. |
| SPO2 WEAK PULSE | The SpO ₂ signal is weak. | Change the sensor site for better signals. |
| SPO2 MOTION | SpO ₂ sensor is moving. | Eliminate sensor movement. |
| ALARM DISABLED! | One or more alarms are switched off. | Switch on alarm(s). |
| RECORDER BUSY | The recorder is recording data. | Wait till the end of the recording. |
| RESETTING... | Module is resetting. | Wait till resetting is finished. |
| CALIBRATING... | The NIBP module is being calibrated. | Wait till the end of the calibration. |
| CALIBRATION COMPLETE | The calibration is finished. | None |
| PNEUM TEST COMPLETE | The test for air leakage is finished. | None |
| RESET FAILED | The NIBP module fails to be reset. | None |
| TEMP WARMING UP | TEMP module is warming up. | Wait till TEMP module completes warm-up. |
| PREDICTIVE TEMP READY | TEMP module completes warming up and predictive measurement can be performed now. | Perform predictive TEMP measurement. |
| PREDICTIVE TEMP COMPLETE | TEMP predictive measurement is finished. | Check TEMP reading. |
| TEMP MEASURE COMPLETE | TEMP monitoring is over | Remove the TEMP probe from patient and insert it in the probe sheath. |
| SERVER NOT EXIST | Sever is not installed. | Install the server. |
| CONFIGURATION RESTORED | Last configuration is loaded successfully. | None |
| FAC ADULT CONFIG LOADED | ADULT factory configuration is loaded successfully. | None |
| FAC PEDIATRIC CONFIG LOADED | PEDIATRIC factory configuration is loaded successfully. | None |
| FAC NEONATAL CONFIG LOADED | NEONATAL factory configuration is loaded successfully. | None |
| USER ADULT CONFIG LOADED | ADULT user configuration is loaded successfully. | None |
| USER PEDIATRIC CONFIG LOADED | PEDIATRIC user configuration is loaded successfully. | None |
| USER NEONATAL CONFIG LOADED | NEONATAL user configuration is loaded successfully. | None |

NOTE: The prompt message **PULSE SEARCH** is for the **DPM** and **Nellcor SpO₂** modules only.

NOTE: The prompt message **SPO2 MOTION** is for the **Nellcor SpO₂** module only.

4.0 *User Maintenance*

| | |
|--|------|
| Introduction..... | 4-2 |
| Cleaning and Disinfection of the Accutorr V Monitor..... | 4-3 |
| Sterilization and Cleaning of Reusable Cuffs..... | 4-5 |
| Battery Maintenance and Replacement..... | 4-6 |
| Recorder Maintenance..... | 4-7 |
| Care and Storage of Thermal Paper..... | 4-9 |
| Resetting the NIBP..... | 4-10 |
| Nurse Call Set-up..... | 4-12 |

4.1 Introduction

This section of the manual outlines routine user maintenance care.

The Accutorr V is stable for operation over long periods of time and under normal circumstances should not require technical maintenance beyond that described in this section. However, routine maintenance, calibration, and safety checks are recommended at least once a year, or more often as required by local statutory or hospital administration practice. For details about maintenance and testing frequency, see the Accutorr V Service Manual Part Number 0070-10-0702.

4.2 Cleaning and Disinfection of the Accutorr V Monitor

WARNING: Be sure to shut down the monitor and disconnect all power cords from the outlet before cleaning.

The equipment should be cleaned regularly. Please consult your hospital's policy for the recommended frequency for cleaning and disinfecting equipment.

The exterior surfaces of the equipment may be cleaned with a clean and soft cloth, sponge or cotton ball, dampened with either of the following cleaning solutions:

- Mild soap (Diluted)
- Quaternary ammonia (Diluted)
- Sodium hypochlorite bleach (10%)
- Hydrogen peroxide (3%)
- Ethyl alcohol (70%)
- Isopropyl alcohol (70%)
- Super sani-cloth (0.5% quaternary ammonia + 55% Isopropyl alcohol)

To avoid damage to the equipment:

- ALWAYS use solutions in accordance with the manufacturer's instructions.
- ALWAYS wipe off the excess cleaning solution with a dry cloth after cleaning.
- NEVER submerge the equipment into water or any cleaning solution, or pour or spray water or any cleaning solution on the equipment.
- NEVER permit fluids run into the casing, switches, connectors, or any ventilation openings in the equipment.

4.3 Decontamination of the Optional SmarTemp™ TEMP Probe

WARNING: Perform the decontamination or cleaning process with the unit powered down and power cord removed.

Use LpH SE Germicidal detergent to decontaminate a probe that has come in contact with a biological material. Apply a small amount of detergent to a disposable wipe (paper based) and wipe down the outside of the probe. Discard the wipe appropriately. After waiting 10 minutes, use a clean dry wipe to dry the probe.

4.4 Sterilization and Cleaning of Reusable Cuffs

Take out the bladder before cleaning and disinfecting the cuff.

NOTE: Some disinfectants may cause skin irritation. Rinse cuff thoroughly with water to remove any residual disinfectants.

NOTE: Using dark colored soaks may stain the cuffs. Test a single cuff to ensure that no damage occurs.

NOTE: When cleaning cuffs do not use excessive amounts of liquid. Wipe the cuff surface with a soft cloth, dampened with the cleaning solution.

Cleaning

Hand wash or machine wash the cuff in warm water or with mild detergent. Clean the bladder with a damp cloth. Air dry the cuff thoroughly after washing.

NOTE: Machine washing may shorten the service life of the cuff.

Disinfection

Disinfect the cuff with a damp cloth with 70% ethanol or 70% isopropanol or with ultraviolet. Disinfect the bladder only with ultraviolet.

NOTE: Prolonged use of disinfectant may cause discoloration of the cuff.

Replace the bladder after cleaning and disinfecting the cuff, as follows:

1. Place the bladder on the top of the cuff, as the figure shows.
2. Roll the bladder lengthwise and insert it into the large opening. See the FIGURE 4-1.
3. Hold the hose and the cuff and shake the complete cuff until the bladder is in position.
4. Thread the hose from inside the cuff, and out through the small hole under the internal flap.

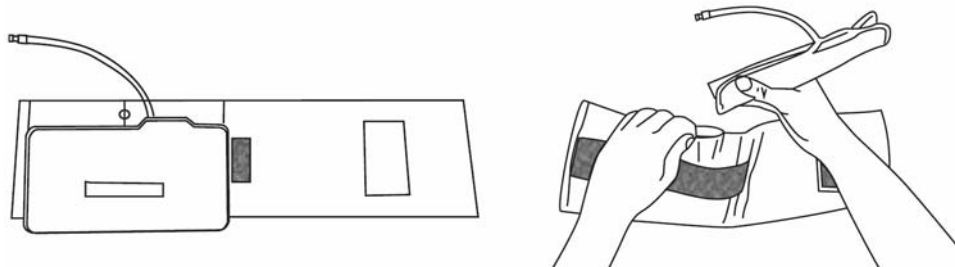

FIGURE 4-1 Cuffs with Bladders

- Do not dry clean the cuff.
- Do not use detergent and disinfectant other than 70% ethanol or 70% isopropanol.
- Clean and disinfect the cuff according to the instructions.

4.5 Battery Maintenance and Replacement

4.5.1 Battery Maintenance

The Accutorr V uses a lithium ion battery. This battery type may be subject to local regulations regarding disposal. At the end of the battery life, dispose of the battery in accordance with any local regulations.

CAUTION: Recharge the Lithium ion battery while in the unit at room temperature. If using the Accutorr V in a hot environment, the Lithium ion battery may not charge when the unit is connected to AC.

CAUTION: Remove the battery if the Accutorr V is not likely to be used for an extended period of time.

CAUTION: Replace the Lithium ion battery with new battery if its run time is seriously diminished.

4.5.2 Battery Replacement

Use only the battery specified in Section 5.1.8.

1. Open battery compartment door, located on the bottom of the unit, by pressing the release tab.
2. Rotate the battery retaining clip away from the battery.
3. Slide out the old battery by pulling on the fabric tab attached to the battery.
4. With the main label facing the back of the Accutorr V, slide the replacement battery in until it clicks into place.
5. Rotate the battery retaining clip back over the battery.
6. Close the battery compartment door.
7. Batteries are shipped partially charged and require fully charging prior to use. Charge the Lithium ion battery the Accutorr V for 4.5 hours minimum prior to use.

NOTE: If the Accutorr V is plugged into the AC mains, the Battery Status Indicator (15) illuminates if a battery is inserted. The Battery Status Indicator also (15) illuminates if the Accutorr V is turned on with a battery inserted and the AC mains unplugged.

4.6 Recorder Maintenance

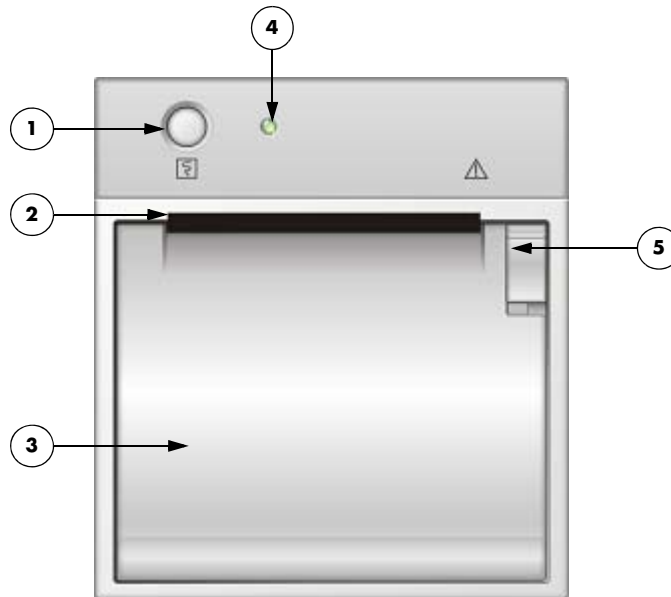

FIGURE 4-2 Accutorr V — Recorder Module

- 1. Print button**
- 2. Paper outlet**
- 3. Recorder door**

Open this door to access the recorder paper.

- 4. Power indicator**
- 5. Recorder door latch**

Gently pull down on this latch to open the recorder door.

4.6.1 Recorder Paper Replacement

The instructions below describe the replacement of recorder paper. Use only recommended recorder paper (P/N 0683-00-0505-02.) This ensures that the print quality is acceptable and reduces printer head wear.

1. Open the recorder door, located on the left side panel, by pulling down on the recorder door latch, located on the upper right side of the recorder door.

NOTE: **If the recorder door does not open completely, carefully pull the door until it is completely open.**

2. Remove empty paper spool.

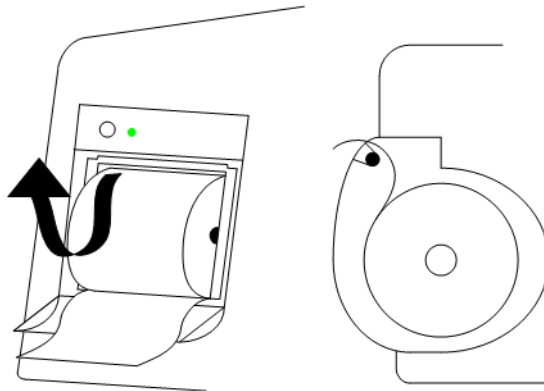

FIGURE 4-3 Paper Loading

3. Replace the paper roll in the holder with the sensitive (shiny) side of the paper facing upward as shown in FIGURE 4-3.
4. Unroll approximately six (6) inches (15 cm.) of paper.
5. Close the recorder door.

4.7 Care and Storage of Thermal Paper



Thermal chart paper is chemically treated and the permanency of the printout can be affected by storage and handling conditions.

Conditions which may affect the integrity of the paper and printouts are:

- **Ultraviolet Light**
We recommend storing the printouts in a filing cabinet within a few days of printing. Long term exposure to natural or artificial UV sources may be detrimental
- **Storage Temperature and Humidity**
Keep the printouts in a cool and dry area for a longer lasting image. Extreme temperature and humidity (above 80 °F/26 °C and 80% humidity) should be avoided
- **Solvent Reactions**
Do not store the printouts in plastic bags, acetate sheet protectors and similar items made from petroleum products. These products emit a small amount of vapor which will, over a period of time, deteriorate the image on the chart paper
- **Adhesive Tape**
Never place adhesive tape over printouts. The reaction between adhesive compound and the chemical/thermal paper can destroy the image within hours
- **Archives**
We recommend that if long term archives are required, make a photocopy of the printouts as a back-up. Under normal office filing conditions the printouts should retain acceptable image quality for about five (5) years

4.8 Resetting the NIBP

To reset the NIBP:

1. Press  (12) to display the SYSTEM SETUP dialog as shown in FIGURE 4-4.
2. Press  (16) or  (19) to highlight **MAINTENANCE**.

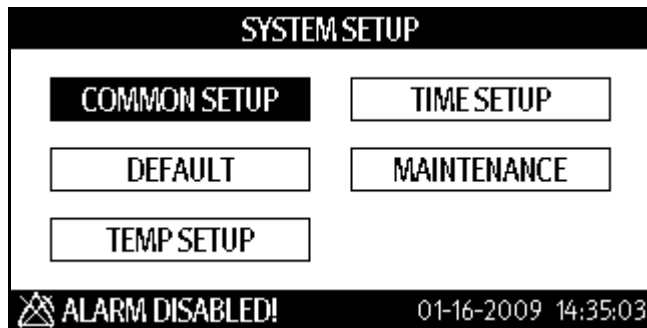



FIGURE 4-4 SYSTEM SETUP Dialog

3. Once **MAINTENANCE** is highlighted, press  (18) to display the MAINTENANCE dialog as shown in FIGURE 4-5.

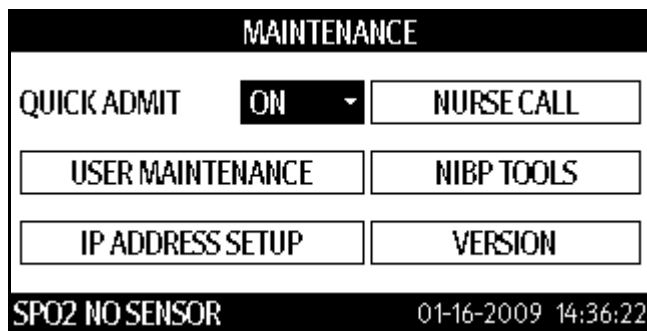



FIGURE 4-5 MAINTENANCE dialog

4. Press  (16) or  (19) to highlight **NIBP TOOLS** to display the NIBP TOOLS dialog as shown in FIGURE 4-6.
5. Once **NIBP TOOLS** is highlighted, press  (18) to display the NIBP TOOLS dialog.

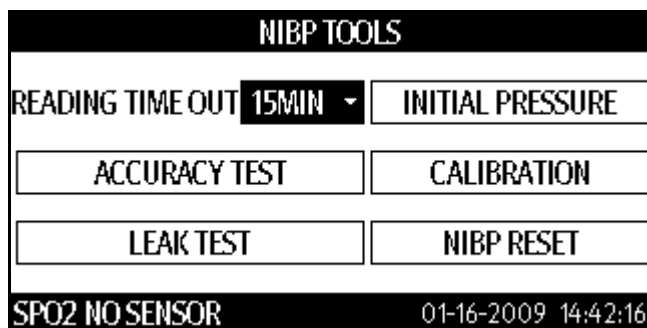













FIGURE 4-6 NIBP TOOLS Dialog

NOTE: The **ACCURACY TEST**, **LEAK TEST**, and **CALIBRATION** selections shown the **NIBP TOOLS** dialog (**FIGURE 4-6**) are explained in the **Service Manual**, part number **0070-10-0702**. **Calibration should be carried out by qualified personnel only.**

- 6.** Press  (16) or  (19) to highlight **NIBP RESET** to display the INITIAL PRESSURE dialog as shown in **FIGURE 4-6**.

- 7.** Once **NIBP RESET** is highlighted, press  (18) reset the NIBP. While the NIBP is setting, the prompt message "RESETTING..." displays.

4.9 Nurse Call Set-up

1. If needed, press  to return to the Normal display.
2. Press  to display the SYSTEM SETUP dialog.
3. Press  or  to highlight **MAINTENANCE**.
4. Once **MAINTENANCE** is highlighted, press  to display the MAINTENANCE dialog shown in FIGURE 4-5.
5. Press  or  to highlight **NURSE CALL**.
6. Once **NURSE CALL** is highlighted, press  to display the NURSE CALL SETUP dialog shown in FIGURE 4-7.

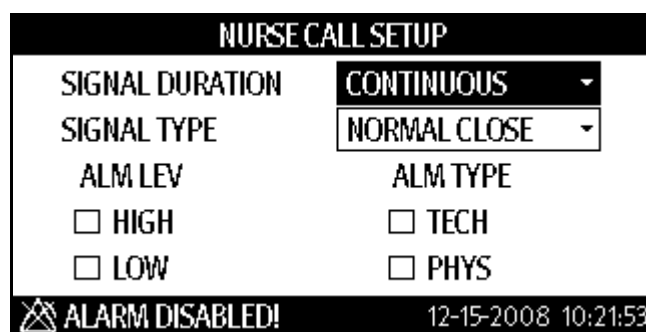



















FIGURE 4-7 NURSE CALL SETUP Dialog

7. Press  or  to highlight the **SIGNAL DURATION** pull-down list.
8. Once the **SIGNAL DURATION** pull-down list is highlighted, press  to select it.
9. Press  or  to highlight **CONTINUOUS** or **PULSE**.
 - CONTINUOUS sets the nurse call signal duration to the same as the alarm duration.
 - PULSE sets the nurse call signal to a one (1) second pulse. When multiple alarms occur, the monitor outputs only one pulse signal. If another alarm occurs before the current alarm is cleared, the monitor will output another pulse signal.
10. Once the selection is highlighted, press  to select it.
11. Press  or  to highlight the **SIGNAL TYPE** pull-down list.
12. Once the **SIGNAL TYPE** pull-down list is highlighted, press  to select it.
13. Press  or  to highlight **NORMAL OPEN** or **NORMAL CLOSE**.

NOTE: **SIGNAL TYPE is determined by the hospital nurse call system.**

14. Once the selection is highlighted, press  to select it.
15. Press  or  to highlight either **HIGH** or **LOW** for ALM LEV.
16. Once an ALM LEV is highlighted, press  to select it.
17. Press  or  to highlight either **TECH** or **PHYS** for ALM TYPE.
18. Once an ALM TYPE is highlighted, press  to select it.

5.0 *Accutorr V Accessories*

Accessories..... 5-2

5.1 Accessories

5.1.1 Hoses, Non Invasive Blood Pressure

| DESCRIPTION | PART NUMBER |
|---|--------------|
| Hose, quick connect to quick connect (1.5 m.) | 0683-04-0003 |
| Hose, quick connect to quick connect (3.5 m.) | 0683-04-0004 |

Reusable Cuffs - Quick-Connect

| DESCRIPTION | PART NUMBERS |
|--|-----------------|
| Starter Kit: (1) child, (1) small adult, (1) adult, (1) large adult, (1) thigh | 0020-00-0184-01 |
| Child, 10 – 19 cm (limb circumference), latex free | 0683-15-0001-01 |
| Small Adult, 18 – 26 cm (limb circumference), latex free | 0683-15-0002-01 |
| Adult, 25 – 35 cm (limb circumference), latex free | 0683-15-0003-01 |
| Large Adult, 33 – 47 cm (limb circumference), latex free | 0683-15-0004-01 |
| Thigh, 46 – 66 cm (limb circumference), latex free | 0683-15-0005-01 |
| Adult Long, 25 – 35 cm (limb circumference), latex free | 0683-15-0006-01 |
| Large Adult Long, 33 – 47 cm (limb circumference), latex free | 0683-15-0007-01 |

Single Patient Use - Quick-Connect

| DESCRIPTION | PART NUMBERS |
|--|-----------------|
| Child, 10 – 19 cm (limb circumference), latex free, box of 10 | 0683-14-0001-01 |
| Small Adult, 18 – 26 cm (limb circumference), latex free, box of 10 | 0683-14-0002-01 |
| Adult, 25 – 35 cm (limb circumference), latex free, box of 10 | 0683-14-0003-01 |
| Large Adult, 33 – 47 cm (limb circumference), latex free, box of 10 | 0683-14-0004-01 |
| Thigh, 46 – 66 cm (limb circumference), latex free, box of 5 | 0683-14-0005-01 |
| Adult Long, 25 – 35 cm (limb circumference), latex free, box of 10 | 0683-14-0006-01 |
| Large Adult Long, 33 – 47 cm (limb circumference), latex free, box of 10 | 0683-14-0007-01 |

Single Patient Use Cuffs - Quick-Connect (Neonatal)*

| DESCRIPTION | PART NUMBERS |
|---------------------------------|--------------|
| APPROXIMATE LIMB CIRCUMFERENCE: | BOX OF 10 |
| Size 1: 3 – 6 cm, box of 10 | 0683-23-0001 |
| Size 2: 5 – 8 cm, box of 10 | 0683-23-0002 |
| Size 3: 7 – 10 cm, box of 10 | 0683-23-0003 |
| Size 4: 9 – 13 cm, box of 10 | 0683-23-0004 |
| Size 5: 12 – 17 cm, box of 10 | 0683-23-0005 |

* Hose P/N 0683-04-0003 is required.

5.1.2 Oximetry Sensors and Accessories

5.1.2.1 Pulse Oximetry DPM SpO₂

| DESCRIPTION | PART NUMBER |
|---|--------------------|
| Extension cable, 2.5 m, 6 pins | 0010-20-42594 |
| 520A Adult (>30 kg) single patient/disposable Wrap type with 0.5m. cable | 520A-30-64101 |
| 520P Pediatric (10 to 50 kg) single patient/disposable Wrap type with 0.5m. cable | 520P-30-64201 |
| 520I Infant (3 to 20 kg) single patient/disposable Wrap type with 0.5m. cable | 520I-30-64301 |
| 520N Neonate (<3 kg), Adult (>40 kg) single patient/disposable Wrap type with 0.5m. cable | 520N-30-64401 |
| 518B Adult, pediatric, neonate (multi-sites) reusable Wrap type with 1.1m. cable | 518B-30-72107 |
| 512F Adult reusable Finger Clip type with 1.1m. cable | 512F-30-28263 |
| 512H Pediatric reusable Finger Clip type with 1.1m. cable | 512H-30-79061 |
| Envitec DPM SpO ₂ , Adult Ear Sensor | 0010-10-12392 |

5.1.2.2 Pulse Oximetry-Masimo SET[®] LNOP[®] SpO₂

| DESCRIPTION | PART NUMBER |
|---|-----------------|
| Masimo SET [®] AC-1 LNCS [®] adapter cable | 0012-00-1656 |
| LNOP [®] DCI-Adult reusable finger sensor (with added "flaps" for ambient light shielding and 3' cable) | 0600-00-0047 |
| LNOP [®] DCIP-Pediatric/slender digit reusable finger sensor | 0600-00-0063 |
| LNOP [®] TCI Tip Clip Ear Sensor | 0600-00-0110 |
| Ear Clip | 0600-00-0086 |
| Ear Hanger (pkg of 5) | 0600-00-0087 |
| LNOP [®] YI-Multisite reusable sensor | 0600-00-0078 |
| Multisite wrap (box of 100) | 0600-00-0081 |
| Multisite wrap, foam (pkg of 12) | 0600-00-0083 |
| LNOP [®] DCSC-Adult spot check reusable sensor | 0600-00-0077 |
| PC08-SpO ₂ cable (2.44 m.) | 0012-00-1099-01 |
| PC12-SpO ₂ cable (3.66 m.) | 0012-00-1099-02 |
| LNOP [®] Adt-Adult single patient adhesive sensors for patients more than 30 kgs. (pkg of 20) | 0600-00-0043-01 |
| LNOP [®] Pdt-Pediatric/slender digit single patient sensors for patients more than 10 kgs. and less than 50 kgs. (pkg of 20) | 0600-00-0044-01 |
| LNOP [®] II Inf-L-Infant L single patient adhesive sensors for patients more than 3 kgs. and less than 10 kgs. (pkg of 20) | 0600-00-0100 |
| Replacement Tape for LNOP [®] II Inf-L-Infant L single patient adhesive sensors (pkg of 100) | 0600-00-0108 |
| Adhesive tapes for Neonatal Y single patient adhesive sensors (pkg of 100) | 0600-00-0065 |
| LNOP [®] II Neo-Neonatal L single patient adhesive sensors for patients more than 1 kg. and less than 10 kgs. (pkg of 20) | 0600-00-0099 |
| Adhesive tapes for Neonatal L single patient adhesive sensors (pkg of 100) | 0600-00-0096 |
| LNOP [®] NeoPt-Preterm Neonatal Y single patient adhesive sensors-for patients more than 3 kg. and less than 10 kgs. (pkg of 20) | 0600-00-0045-01 |
| LNOP [®] NeoPt-Preterm Neonatal Y single patient adhesive sensors-for patients less than 1 kg. (pkg of 20) | 0600-00-0046-01 |
| Posey wraps for Preterm Neonatal Y single patient adhesive sensors (pkg of 12) | 0600-00-0064 |
| LNOP [®] II NeoPt-L-Preterm Neonatal L single patient adhesive sensors-for patients less than 1 kg. (pkg of 20) | 0600-00-0098 |
| Posey wraps for Preterm Neonatal L single patient adhesive sensors (pkg of 12) | 0600-00-0097 |
| Clothing clips (pkg of 5) | 0600-00-0084 |

5.1.2.3 Pulse Oximetry-Masimo SET[®] LNCS[®] SpO₂

| DESCRIPTION | PART NUMBER |
|--|--------------|
| LNCS [®] Adult/Pediatric starter kit (1 reusable adult sensor, 1 adult and 1 pediatric single patient adhesive sensor, and one 3.1m. cable) | 0020-00-0154 |
| LNCS [®] DC-I Adult finger reusable sensor - for patients more than 30 kg. | 0600-00-0126 |
| LNCS [®] DC-IP Pediatric finger reusable sensor - for patients from 10 kg. to 50 kg. | 0600-00-0127 |
| LNCS TC-I, Reusable Adult Ear Sensor - for patients more than 30 kg. | 0600-00-0128 |
| LNCS [®] ADTX Adult single patient adhesive sensors - for patients more than 30 kg. (box of 20) | 0600-00-0121 |
| LNCS [®] PDTX Pediatric single patient adhesive sensors (20/Box) - for patient weight range from 10 kg to 50 kg | 0600-00-0122 |
| LNCS [®] INF-L Infant single patient adhesive sensors (box of 20) - for patient weight range from 3 kg to 20 kg | 0600-00-0158 |
| LNCS [®] NEO-L Neonatal single patient adhesive sensors - for patients more than 3 kg. and less than 40 kgs. (box of 20) | 0600-00-0157 |
| LNCS [®] NEO PT-L Neonatal preterm single patient adhesive sensors - for patients less than 1 kg.(box of 20) | 0600-00-0125 |
| LNC-4 SpO ₂ Patient cable, 1.2m. | 0012-00-1652 |
| LNC-10 SpO ₂ Patient cable, 3.1m. | 0012-00-1599 |
| LNC-14 SpO ₂ Patient cable, 4.3m. | 0012-00-1653 |
| LNCS [®] to LNOP [®] PC series adapter | 0012-00-1651 |

5.1.2.4 Pulse Oximetry-Nellcor[®] SpO₂

NOTE: Oximetry-Nellcor[®] OxiMax[®] SpO₂ Replacement sensors are available from Covidien. Phone: 1 800 NELLCOR or WWW.NELLCOR.COM

| DESCRIPTION | PART NUMBER |
|---|--------------|
| SpO ₂ cable, DOC-10, OxiMax [®] | 0012-00-1464 |

5.1.3 SmarTemp Temperature Accessories

| DESCRIPTION | PART NUMBER |
|-----------------------------------|-------------------|
| TEMP sheath (oral/auxiliary) | M09A-20-62062 |
| TEMP sheath (rectal) | M09A-20-62062-51 |
| TEMP probe (oral/auxiliary) | 801-6006-00009-00 |
| TEMP probe (rectal) | 6006-30-39599 |
| Disposable probe cover (20 pcs) | M09A-20-62124 |
| Disposable probe cover (2000 pcs) | M09A-30-62128 |

5.1.4 Welch Allyn SureTemp[®] Plus Thermometer Accessories

| DESCRIPTION | PART NUMBER |
|---|-----------------|
| Welch Allyn SureTemp Plus thermometer module (without mounting bracket kit) | 0992-00-0198 |
| SureTemp Plus oral probe, 2.7m. cable and well | 0992-00-0213-02 |
| SureTemp Plus rectal probe, 2.7m. cable and well | 0992-00-0212-02 |
| Probe covers (box of 1000) | 0198-00-0044 |
| Welch Allyn locking bracket | 6101-30-46633 |

5.1.5 Nurse Call Connector

| DESCRIPTION | PART NUMBER |
|-----------------------------|---------------|
| Nurse Call connecting cable | 8000-21-10361 |

5.1.6 Recorder Paper

| DESCRIPTION | PART NUMBER |
|---------------------------|-----------------|
| Recorder paper (12 rolls) | 0683-00-0505-02 |

5.1.7 Barcode Scanner

| DESCRIPTION | PART NUMBER |
|------------------|---------------|
| Scanner, barcode | 0000-10-10767 |

5.1.8 Battery and Power Cords

| DESCRIPTION | PART NUMBER |
|-------------------------------|---------------|
| Battery, Lithium-Ion | 0146-00-0099 |
| Power Cord, 110 Volt | 0012-25-0001 |
| Power Cord, 220 Volt | 0012-25-0002 |
| Power Cord, 240 Volt (UK) | 0012-25-0003 |
| Power Cord, 250 Volt (Brazil) | 009-001075-00 |

5.1.9 Mounting Assemblies

| DESCRIPTION | PART NUMBER |
|---|---------------|
| Mounting kit for Accutorr V to rolling stand (Includes mounting head kit, and mounting bracket) | 6101-30-46696 |
| Mounting head kit (For rolling stand) | 115-002451-00 |
| Mounting bracket (For wall mount or rolling stand) | 6101-30-46669 |
| Wall mount kit and bracket | ACTVWALLMT |
| Rolling stand with mounting bracket | ACTVROLLSTD |
| Genius Temperature bracket kit | 115-007728-00 |

| DESCRIPTION | PART NUMBER |
|--|---------------|
| Rolling Stand Bin | 115-004084-00 |
| Rolling Stand casters, set of 5 | CASTERKIT |
| Spare Latch assembly for rolling stand | 115-009638-00 |

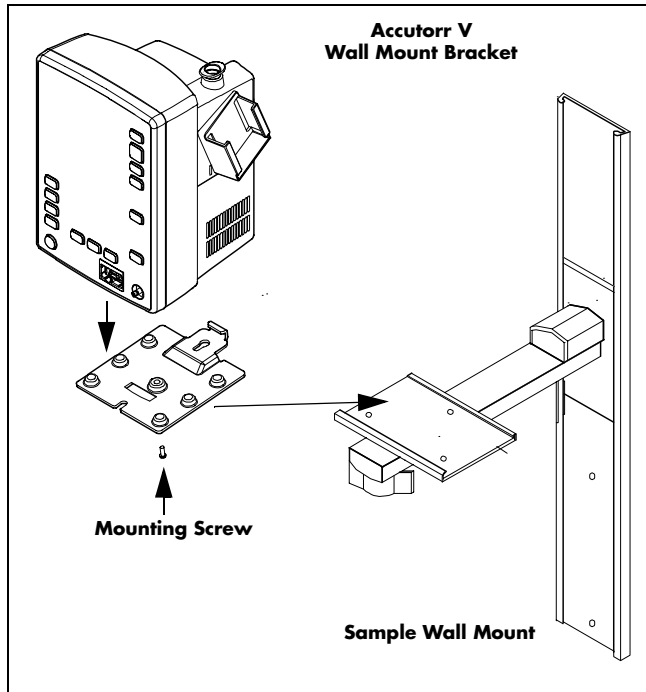

FIGURE 5-1 Accutorr V Wall Mount Kit (P/N: ACTVWALLMT)

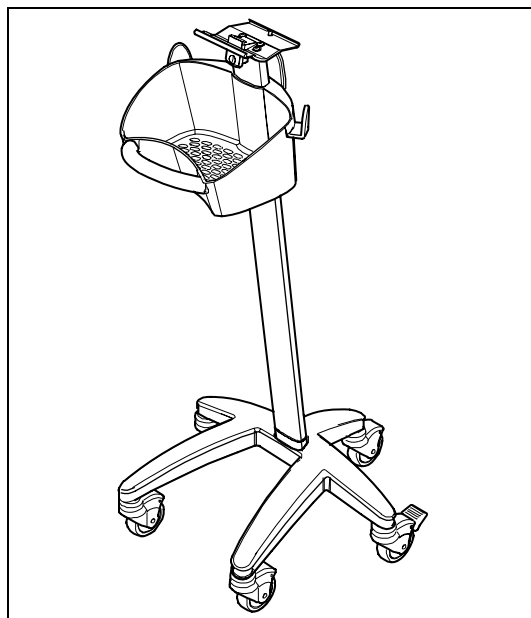

FIGURE 5-2 Rolling Stand with Mounting Bracket (P/N: ACTVROLLSTD)

This page intentionally left blank.

Appendix

| | |
|---|------|
| How To Get Assistance..... | 6-2 |
| Specifications..... | 6-3 |
| Recovery from Power Loss..... | 6-11 |
| Environmental Characteristics..... | 6-12 |
| Electrical Ratings | 6-13 |
| Agency Compliance | 6-14 |
| Electromagnetic Compatibility | 6-15 |
| Indirect Blood Pressure Measurements and Associated Errors | 6-19 |
| Precautions With Using Automatically Cycled Blood Pressure Cuffs..... | 6-20 |
| User Verification Of The Accutorr V NIBP Measurements | 6-21 |
| Warranty..... | 6-22 |
| Manufacturer's Responsibility | 6-23 |

6.1 How To Get Assistance

A network of service representatives and factory-trained distributors is available. Prior to requesting service, perform a complete operational check of the instrument to verify proper control settings. If operational problems continue to exist, contact the Service Department at (800) 288-2121 or (201) 995-8116 for assistance in determining the nearest field service location.

Please include the instrument model number, the serial number, and a description of the problem with all requests for service.

Warranty questions should be directed to a local representative. A list of offices, along with their phone numbers, is provided at the end of this manual.

6.2 Specifications

6.2.1 Systolic Pressure Readout

| | |
|-------------------|--|
| Number of Digits: | 3 |
| Accuracy: | Mean error: within ± 5 mmHg Standard deviation: within ± 8 mmHg |
| Range: | Adult Mode: 55 – 235 mmHg Pediatric Mode: 55 – 160 mmHg Neonatal Mode: 45 – 120 mmHg |

Measurements outside of the stated ranges are not guaranteed to be accurate.

6.2.2 Diastolic Pressure Readout

| | |
|-------------------|--|
| Number of Digits: | 3 |
| Accuracy: | Mean error: within ± 5 mmHg Standard deviation: within ± 8 mmHg |
| Range: | Adult Mode: 30 – 200 mmHg Pediatric Mode: 30 – 150 mmHg Neonatal Mode: 20 – 100 mmHg |

Measurements outside of the stated ranges are not guaranteed to be accurate.

6.2.3 Mean Pressure Readout

| | |
|-------------------|--|
| Number of Digits: | 3 |
| Accuracy: | Mean error: $< \pm 5$ mmHg Standard deviation: $< \pm 8$ mmHg |
| Range: | 30 – 235 mmHg for Adult 30 – 160 mmHg for Pediatric 20 – 120 mmHg for Neonates |

Measurements outside of the stated ranges are not guaranteed to be accurate.

6.2.4 NIBP Measurement Cycle Time

Less than 40 seconds average at 80 BPM with 180mmHg pump up pressure, without retries, motion artifact or arrhythmia with standard adult cuff on a healthy individual. Cycle time is affected by arm size and wrapping technique.

6.2.5 Pulse Rate

Range: 35 – 245 BPM for Adult and Pediatric
70 – 245 BPM for Neonates

Display Resolution: 1 BPM

Accuracy: ± 3 BPM or $\pm 3\%$, whichever is greater

Measurements outside of the stated ranges are not guaranteed to be accurate.

6.2.6 Maximum Cuff Pressure

Hardware controls the cuff deflation to prevent cuff pressure from exceeding the following maximum pressures:

Maximum Normal Operating Pressure:

Adult: 300 mmHg

Pediatric: 200 mmHg

Neonate: 150 mmHg

Maximum Single Fault Over Pressure:

Adult: 330 mmHg

Pediatric: 220 mmHg

Neonate: 165 mmHg

Inflation Source

This inflation source is capable of supplying sufficient air to bring a volume of 200cc's to a pressure of 300 mmHg in no more than 10 seconds. If the cuff is not inflated to the desired pressure within 60 seconds, the cuff is vented and a retry cycle is initiated.

Leak Rate

With the bleed valve closed, the maximum pressure drop shall be 1 mmHg in 10 seconds measured with a 200cc volume at a differential pressure of 250 mmHg, 150 mmHg, and 50 mmHg.

Cuff Vent Rate

When the unit is vented in adult mode, a volume of at least 500 cc's is reduced from a pressure of 260 mmHg to a pressure of 15 mmHg in a maximum of 10 seconds. When the unit is vented in neonate mode, a volume of at least 500 cc's is reduced from a pressure of 150 mmHg to a pressure of 5 mmHg in a maximum of 5 seconds.

6.2.7 Temperature

Monitor

| | |
|---------------------|----------------------------------|
| Range: | 77 – 111.2°F, 25 – 44°C |
| Display Resolution: | 0.1°F, 0.1°C |
| Accuracy: | Meets ASTM E1112-86 for accuracy |

Predictive

| | |
|---------------------|-------------------------|
| Range: | 95 – 109.4°F, 35 – 43°C |
| Display Resolution: | 0.1°F, 0.1°C |

6.2.8 Nellcor[®] Performance Specifications

SpO₂

| | |
|--|--|
| Range: | 70 – 100% SpO ₂ |
| Display Resolution: | 1% SpO ₂ |
| Averaging Time | 4–6 seconds |
| Typical response Time | 15 seconds |
| Alarm Condition delay plus alarm generation | <1 second |
| Calibration: | Factory Calibrated to Functional Saturation |
| Accuracy - Nellcor [®] : ¹ | <p>Sensors: MAX-A, MAX-AL, MAX-N, MAX-P, MAX-I, & MAX-FAST: ± 2% from 70 to 100%</p> <p>Sensors: OxiCliq A, OxiCliq N, OxiCliq P, OxiCliq I: ± 2.5% from 70 – 100%</p> <p>Sensors: D-YS, DS-100A, OXI-A/N, OXI-P/I: ± 3% from 70 – 100%</p> <p>Sensors: MAX-R, D-YSE, D-YSPD: ± 3% from 70 – 100%</p> <p><70% unspecified</p> |

Pulse Rate

¹ When sensors are used on neonatal subjects as recommended, the specified accuracy range is increased by ±1 digit, to account for the theoretical effect on oximeter measurements of fetal hemoglobin in neonatal blood.

| | |
|--|---|
| Pulse Rate Range | 20 – 300 BPM |
| Accuracy Pulse Rate | 20 – 250 BPM: ± 3 BPM 251 – 300 BPM: Undefined |
| Update Rate: | 1 second |
| Wavelength of light emitted by the sensors | red: 660 nm infrared 890 nm |

1 When sensors are used on neonatal subjects as recommended, the specified accuracy range is increased by ± 1 digit, to account for the theoretical effect on oximeter measurements of fetal hemoglobin in neonatal blood.

6.2.9 Masimo Performance Specifications

SpO₂

| | |
|---|---|
| Range: | 1 to 100% |
| Display Resolution: | 1% |
| Display Update: | 1 second |
| Averaging Time | 4–6 seconds |
| Typical response Time | 15 seconds |
| Alarm Condition delay plus alarm generation | <1 second |
| SpO ₂ Accuracy Saturation during No Motion Conditions ¹ : | |
| Adults / Pediatrics: | 70% – 100% $\pm 2^5$ <70% unspecified |
| Neonates (LNOP/LNCS): | 70% – 100% ± 3 |
| SpO ₂ Accuracy Saturation during Motion Conditions ^{2,3} : | |
| Adults / Pediatrics ² / Neonates ³ : | 70% – 100% ± 3 <70% unspecified |
| Low Perfusion Performance ⁴ : | >0.02% Pulse Amplitude and %Transmission >5% %SpO ₂ Accuracy: ± 2 digits Pulse Accuracy: ± 3 digits |

Pulse Rate

Pulse Rate During No Motion
Conditions¹:

Adult/Pediatric/Neonates: 25 – 240 BPM \pm 3 digits

Pulse Rate During Motion
Conditions^{2,3}:

Adult/Pediatric/Neonates: 25 – 240 BPM \pm 5 digits

Update Rate: 1 second

| | | |
|--|----------|--------|
| Wavelength of light emitted by the sensors | red: | 660 nm |
| | infrared | 940 nm |

- 1 *The Masimo MS-2013 pulse oximeter with LNOP-Adt sensors have been validated for no motion accuracy in human blood studies on healthy adult volunteers in induced hypoxia studies in the range of 70% to 100% SpO₂ against a laboratory co-oximeter and ECG monitor. This variation equals plus or minus one standard deviation. Plus or minus one standard deviation encompasses 68% of the population.*
- 2 *The Masimo MS-2013 pulse oximeter with LNOP-Adt sensors has been validated for motion accuracy in human blood studies on healthy adult volunteers in induced hypoxia studies while performing rubbing and tapping motions at 2 to 4 Hz. At an amplitude of 1 to 2 cm and non-repetitive motion between 1 to 5 Hz. At an amplitude of 2 to 3cm in induced hypoxia studies in the range of 70% to 100% SpO₂ against a laboratory co-oximeter and ECG monitor. This variation equals plus or minus one standard deviation. Plus or minus one standard deviation encompasses 68% of the population.*
- 3 *The Masimo MS-13 pulse oximeter with LNOP-Neo and Neo Pt sensors have been validated for neonatal motion accuracy in human blood studies on neonates while moving the neonate's foot at 2 to 4 Hz at an amplitude of 1 to 2 cm against a laboratory co-oximeter and ECG monitor. This variation equals plus or minus one standard deviation. Plus or minus one standard deviation encompasses 68% of the population*
- 4 *The Masimo MS-13 pulse oximeter has been validated for low perfusion accuracy in bench top testing against a Biotek Index 2 simulator and Masimo's simulator with signal strengths of greater than 0.02% and a % transmission of greater than 5% for saturation's ranging from 70 to 100%. This variation equals plus or minus one standard deviation. Plus or minus one standard deviation encompasses 68% of the population.*

6.2.10 DPM Performance Specifications

SpO₂

| | |
|---|--|
| Range: | 0 – 100% |
| Display Resolution: | 1% |
| Averaging Time | 8 seconds |
| Typical response Time | 15 seconds |
| Alarm Condition delay plus alarm generation | <1 second |
| Calibration: | Factory Calibrated to Functional Saturation |
| Accuracy: | Adult and Pediatric: 70% – 100% ±2 digits Adult and Pediatric: 0% – 69%, Undefined Neonate: 70% – 100% ±3 digits Neonate: 0% – 69%, Undefined |

Pulse Rate

| | |
|--|---|
| Pulse Rate Range | 20 – 254 BPM |
| Display Resolution: | 1 BPM |
| Accuracy: | Adult / Pediatric / Neonate: 20 – 254 BPM ±3 digits |
| Update Rate: | 1 second |
| Wavelength of light emitted by the sensors | red: 660 nm infrared 905 nm |

6.2.11 Battery

| | |
|----------------------|------------------|
| Battery Type: | Lithium ion |
| Number of Batteries: | 1 |
| Battery Voltage: | 11.1 VDC nominal |
| Battery Capacity: | 4.6 Amp-Hour |

Battery Run Time:

Battery run time for the Accutorr V is approximately 540 minutes with a new Lithium ion battery, fully charged, at an ambient temperature of 25°C, with one automatic NIBP measurement taken every 15 minutes, continuous SpO₂ measurement, and the recorder not in use.

Recharge Time:

Maximum battery recharge time is 4.5 hours for Lithium ion with the Accutorr V in standby mode or off, and 6 hours in normal running mode (not in Standby mode).

6.2.12 Real Time Clock

| | |
|-----------------|--|
| Resolution: | 1 second |
| Accuracy: | ±1 minute/month |
| Display Format: | 24 hours |
| Power: | The real time clock maintains the time and date when the instrument is On or in the Standby mode, connected to AC mains or running from internal battery for at least ten years from original assembly. The real time clock will maintain time and date even if the instrument's main battery is disconnected. |

6.2.13 Physical Characteristics

- Size (maximum):

| | |
|-------------|------------------------------|
| Dimensions: | Width 168 mm (6.614 inches) |
| | Height 246 mm (9.685 inches) |
| | Depth 166 mm (6.535 inches) |

| | |
|---|----------------|
| Weight (full configuration, including battery): | <3.5 kilograms |
| | <7.71 pounds |

6.3 Recovery from Power Loss

6.3.1 Alarm Restoration from Power Loss

If the Accutorr V is turned off or loses power for less than 60 seconds, the alarm settings in use at that time are restored when it is turned on.

If the Accutorr V is turned off or loses power for more than 60 seconds, the default power-on configuration is restored (see Section 3.16.6, "Setting a Default Power-on Configuration").

6.3.2 Data Logging after Power Loss

The patient database will be restored following a power loss of any duration.

6.4 Environmental Characteristics

- Operating:

| | |
|----------------------|--|
| Temperature: | 0°C to 40°C, 32°F to 104°F (Accutorr V & Recorder) 10°C to 40°C, 50°F to 104°F (Predictive Thermometer) |
| Humidity: | 15 to 95% max, non-condensing. |
| Altitude: | -1,250 to 10,000 feet (-381 to 3048 meters, 70.0 kPa to 106 kPa) |
| Shock and Vibration: | <p>Meets IEC 60068-2-27 for shock with peak acceleration of 15.3g, 11 mSec duration, half sine.</p> <p>Meets EN 60068-2-64 for random vibration with frequencies of 10 to 2000 Hz, resolution of 10Hz, 10 minutes per axis, acceleration spectral density of:</p> <p>10 Hz to 100 Hz: 1.0 (m/s²)²/Hz 100 Hz to 200 Hz: -3 dB per octave 200 Hz to 2000 Hz: 0.5 (m/s²)²/Hz</p> <p>Meets IEC 60068-2-6 for sinusoidal vibration with Displacement / acceleration of 0.07 mm or 1g, 58 – 62 Hz crossover frequency 10 Hz to 500 Hz with 5 frequency sweep cycles at each axial direction.</p> |

- Storage and Transportation:

| | |
|--------------|--|
| Shipping: | Meets ISTA Test Procedure 2A (less than 100 lbs) |
| Temperature: | -20°C to +60°C, -4°F to 140°F |
| Humidity: | 10 to 95%, non-condensing |

NOTE: The Accutorr V may not meet its performance specifications if stored outside these temperature and humidity specifications.

| | |
|-----------|--|
| Altitude: | -1,250 to 20,000 feet (-381 to 6096 meters, 46.6 kPa to 106 kPa) |
|-----------|--|

6.5 Electrical Ratings

| | |
|--------------------|---------------|
| Voltage: | 100 – 240 VAC |
| Current: | 0.85 – 0.5 A |
| Frequency: | 60 / 50 Hz |
| Power Consumption: | 40 W, maximum |

6.6 Agency Compliance

This monitor is designed to comply with the following agency standards:

| | |
|--|---|
| Safety, IEC | EN 60601-1:1990 +A1:1993 + A2:1995 +A13:1996 / IEC 60601-1:1988 +A1:1991 +A2:1995 |
| Safety, UL | UL 60601-1:2003 |
| Safety, Canada | CAN/CSA C22.2 No. 601.1-M90 (R2005) |
| Safety, collateral | EN 60601-1-1:2001 / IEC 60601-1-1:2000 |
| Multifunction | EN 60601-2-49:2001 / IEC 60601-2-49:2001 |
| SpO ₂ particular | ISO 9919:2005 |
| NIBP, particular | EN 60601-2-30:2000 / IEC 60601-2-30:1999 |
| NIBP, IEC | EN 1060-1:1995 +A1:2002 |
| NIBP, supplementary | EN 1060-3:1997 +A1:2005 |
| NIBP, USA | ANSI/ AAMI SP-10:1992 + A1:1996 |
| Programmable | EN 60601-1-4:1996 +A1:1999 IEC 60601-1-4:1996 +A1:1999 |
| Temperature | ASTM E1112-00:2006 |
| Biological | ISO 10993-1:2003 |
| Risk | EN 14971:2000 +A1:2007 |
| Acoustics | EN 60601-1-8:2006 |
| Random Vibe | EN 60068-2-64:1994 / IEC 60068-2-64:1993 +Corr.1:1993 |
| Shock | EN 60068-2-27:1993 /IEC 60068-2-27:1987 |
| Ingress | EN 60529:1991 +A1:2000 |
| Shipping | ISTA Procedure 2A:2008 |
| Drop and Impact | ECRI PB 296892:1979 |
| EMC | EN 60601-1-2:2001 +A1:2004/IEC 60601-1- 2:2007 +A1:2004 |
| Radiated and Conducted Emissions | EN 55011:2007 +A2:2007 |
| Sinusoidal Vibration | IEC 60068-2-6:1995 |
| Usability | IEC 60601-1-6:2004 |
| Clinical Thermometers Part 3: Performance of Compact Electrical Thermometers (non- predictive and predictive) with maximum device | EN 12470-3:2000 |

6.7 Electromagnetic Compatibility

Electromagnetic Compatibility

NOTE: The Accutorr V needs special precautions regarding EMC and needs to be installed and put into service according to the EMC information provided in the following tables.

NOTE: Portable and mobile RF communications equipment can affect the Accutorr V. See TABLE 6-1 through TABLE 6-4.

TABLE 6-1

GUIDANCE AND DECLARATION - ELECTROMAGNETIC EMISSIONS

The Accutorr V is intended for use in the electromagnetic environment specified in the table. The customer or the user of the Accutorr V should assure that it is used in such an environment.

| EMISSIONS TEST | COMPLIANCE | ELECTROMAGNETIC ENVIRONMENT - GUIDANCE |
|---|-------------------|--|
| RF emissions CISPR 11 | Group 1 | The Accutorr V uses RF energy only for its internal function. Therefore, its RF emissions are very low and are not likely to cause any interference in nearby electronic equipment. |
| RF emissions CISPR 11 | Class A | The Accutorr V is suitable for use in all establishments other than domestic establishments and those directly connected to the public low-voltage power supply network that supplies buildings used for domestic purposes |
| Harmonic emissions IEC 61000-3-2 | Class A | |
| Voltage fluctuations/ Flicker emissions IEC 61000-3-3 | Complies | |

TABLE 6-2**GUIDANCE AND DECLARATION - ELECTROMAGNETIC IMMUNITY**

The **Accutorr V** is intended for use in the electromagnetic environment specified in the table. The customer or the user of the **Accutorr V** should assure that it is used in such an environment.

| IMMUNITY TEST | IEC 60601 TEST LEVEL | COMPLIANCE LEVEL | ELECTROMAGNETIC ENVIRONMENT - GUIDANCE |
|---|---|---|--|
| Electrostatic discharge (ESD) IEC 61000-4-2 | ±6 kV contact ±8 kV air | ±6 kV contact ±8 kV air | Floors should be wood, concrete or ceramic tile. If floors are covered with synthetic material, the relative humidity should be at least 30%. |
| Electrical fast transient/burst IEC 61000-4-4 | ±2 kV for power supply lines ±1 kV for input/output lines | ±2 kV for power supply lines ±1 kV for input/output lines | Mains power quality should be that of a typical commercial or hospital environment. |
| Surge IEC 61000-4-5 | ±1 kV differential mode ±2 kV common mode | ±1 kV differential mode ±2 kV common mode | Mains power quality should be that of a typical commercial or hospital environment. |
| Voltage dips, short interruptions and voltage variations on power supply input lines IEC 61000-4-11 | <5% U_T (>95% dip in U_T) for 0.5 cycle | <5% U_T (>95% dip in U_T) for 0.5 cycle | Mains power quality should be that of a typical commercial or hospital environment. If the user of the Accutorr V requires continued operation during power mains interruptions, it is recommended that the Accutorr V be powered from an uninterruptible power supply or a battery. |
| | 40% U_T (60% dip in U_T) for 5 cycles | 40% U_T (60% dip in U_T) for 5 cycles | |
| | 70% U_T (30% dip in U_T) for 25 cycles | 70% U_T (30% dip in U_T) for 25 cycles | |
| | <5% U_T (>95% dip in U_T) for 5 sec. | <5% U_T (>95% dip in U_T) for 5 sec. | |
| Power frequency (50/60 Hz) magnetic field IEC 61000-4-8 | 3 A/m | 3 A/m | Power frequency magnetic fields should be at levels characteristic of a typical location in a typical commercial or hospital environment. |

U_T is the A.C. mains voltage prior to application of the test level.

TABLE 6-3

GUIDANCE AND DECLARATION - ELECTROMAGNETIC IMMUNITY

The **Accutorr V** is intended for use in the electromagnetic environment specified in the table. The customer or the user of the **Accutorr V** should assure that it is used in such an environment.

| IMMUNITY TEST | IEC 60601 TEST LEVEL | COMPLIANCE LEVEL | ELECTROMAGNETIC ENVIRONMENT - GUIDANCE |
|-------------------------------|-----------------------------|------------------|---|
| | | | Portable and mobile RF communications equipment should be used no closer to any part of the Accutorr V , including cables, than the recommended separation distance calculated from the equation applicable to the frequency of the transmitter. |
| | | | Recommended separation distance |
| Conducted RF IEC 61000-4-6 | 3 Vrms 150 kHz to 80 MHz | 3 Vrms | $d = 1.2 \times \sqrt{P}$ |
| Radiated RF IEC 61000-4-3 | 3 V/m 80 MHz to 2.5 GHz | 3 V/m | $d = 1.2 \times \sqrt{P}$ 80 MHz to 800 MHz $d = 2.3 \times \sqrt{P}$ 800 MHz to 2.5 GHz where P is the maximum output power rating of the transmitter in watts (W) according to the transmitter manufacturer and d is the recommended separation distance in meters (m). Field strengths from fixed RF transmitters, as determined by an electromagnetic site survey, ^a should be less than the compliance level in each frequency range. ^b Interference may occur in the vicinity of equipment marked with this symbol:  |

NOTE: At 80 MHz and 800 MHz, the separation distance for the higher frequency range applies.

NOTE: These guidelines may not apply in all situations. Electromagnetic propagation is affected by absorption and reflection from structures, objects and people.

a Field strengths from fixed transmitters, such as base stations for radio (cellular/cordless) telephones and land mobile radios, amateur radio, AM and FM radio broadcast and TV broadcast cannot be predicted theoretically with accuracy. To assess the electromagnetic environment due to fixed RF transmitters, an electromagnetic site survey should be considered. If the measured field strength in the location in which the Accutorr V is used exceeds the applicable RF compliance level above, the Accutorr V should be observed to verify normal operation. If abnormal performance is observed, additional measures may be necessary, such as reorienting or relocating the Accutorr V.

b Over the frequency range 80 MHz to 2.5 GHz, field strengths should be less than 3 V/m.

TABLE 6-4**RECOMMENDED SEPARATION DISTANCES BETWEEN PORTABLE AND MOBILE RF COMMUNICATIONS EQUIPMENT AND THE ACCUTORR V**

The Accutorr V is intended for use in an electromagnetic environment in which radiated RF disturbances are controlled. The customer or the user of the Accutorr V can help prevent electromagnetic interference by maintaining a minimum distance between portable and mobile RF communications equipment (transmitters) and the Accutorr V as recommended in the table, according to the maximum output power of the communications equipment.

| RATED MAXIMUM OUTPUT POWER OF TRANSMITTER W (WATTS) | SEPARATION DISTANCE ACCORDING TO FREQUENCY OF TRANSMITTER M (METERS) | | |
|---|---|---------------------------|---------------------------|
| | 150 kHz to 80 MHz | 80 MHz to 800 MHz | 800 MHz to 2.5 GHz |
| | $D = 1.2 \times \sqrt{P}$ | $D = 1.2 \times \sqrt{P}$ | $D = 2.3 \times \sqrt{P}$ |
| 0.01 | 0.12 | 0.12 | 0.23 |
| 0.1 | 0.38 | 0.38 | 0.73 |
| 1 | 1.2 | 1.2 | 2.3 |
| 10 | 3.8 | 3.8 | 7.3 |
| 100 | 12 | 12 | 23 |

For transmitters rated at a maximum output power not listed above, the recommended separation distance d in meters (m) can be determined using the equation applicable to the frequency of the transmitter, where P is the maximum output power rating of the transmitter in watts (W) according to the transmitter manufacturer.

NOTE: At 80 MHz and 800 MHz, the separation distance for the higher frequency range applies.

NOTE: These guidelines may not apply in all situations. Electromagnetic propagation is affected by absorption and reflection from structures, objects and people.

NOTE: The Accutorr V is intended for use in the electromagnetic environment specified. The customer or the user of the Accutorr V should assure that it is used in such an environment.

6.8 Indirect Blood Pressure Measurements and Associated Errors

Place the patient in a supine position to obtain true physiological pressure. If the cuff is not at the patient's heart level, the pressure values obtained will not reflect the true physiological pressure. Instead, the readings will be decreased by 1.86 mmHg for every inch (0.73 mmHg for every centimeter) the cuff is placed above the heart level and increased by 1.86 mmHg for every inch (0.73 mmHg for every centimeter) the cuff is placed below the heart level. This effect is due to hydrostatic pressure.

Blood has weight and it is this weight that influences these blood pressure readings. The value of the weight of blood depends on where the measurement is taken with respect to the heart. When the patient is supine, on a flat surface, the arm is near enough to the heart level so no adjustment of the NIBP readings will be necessary.

6.9 Precautions With Using Automatically Cycled Blood Pressure Cuffs

Reports have been made of nerve injury occurring during use of automatically cycled blood pressure cuffs. Mindray recommends the following practices when using automatically cycled blood pressure cuffs:

- Position and support the limb in such a way as to minimize stretching of and weight exertion on affected nerves.
- Avoid cuff placement that applies pressure on the ulnar nerve. Cuff tubing should not exit the cuff over the course of the ulnar nerve at the elbow.
- Select a measurement interval that provides adequate venous drainage during cuff deflation.
- Periodically inspect the limb bearing the cuff in order to detect venostasis.

6.9.1 Cuff Size

Using a narrow cuff gives erroneously high pressure readings. If a standard cuff is applied to an obese patient or a patient with large biceps, the extra tissue and fat will dissipate the applied pressure, requiring an additional pressure increase to collapse the artery. On the other hand, over-wrapping a slender arm gives erroneously low pressure readings. Too much force per unit area is exerted. This requires less pressure to collapse the artery.

6.9.2 Other Factors

An accurate determination of blood pressure by the Accutorr V can be difficult if cardiac rhythm is very irregular. Irregular cardiac rhythm changes the stroke volume from beat to beat. This changing stroke volume may increase the time it takes the Accutorr V to make a measurement. The Accutorr V system will take up to four successive attempts to obtain a measurement. If a measurement cannot be made an error code will be displayed.

6.10 User Verification Of The Accutorr V NIBP Measurements

Regular service to blood pressure equipment will help ensure accurate measurements.

Consult the service manual for appropriate information.

If the accuracy of the Accutorr V is questionable, check it (the Accutorr V) with a manometer. See the Calibration Section of the Accutorr V Service Manual.

Auscultatory verification can be made at the same time the Accutorr V is taking a measurement. Apply a bell stethoscope over the brachial artery. Do not allow the stethoscope to touch either the patient's clothing or the pressure cuff.

6.11 Warranty

Mindray DS USA Inc./Shenzhen Mindray Bio-Medical Electronics Co., Ltd warrants that components within its products will be free from defects in workmanship and materials for a period of three years from the date of purchase except that disposable or one-time use products are warranted to be free from defects in workmanship and materials up to a date one year from the date of purchase or the date of first use, whichever is sooner. This warranty does not cover consumable items such as, but not limited to, batteries, external cables, and sensors.

Mindray DS USA Inc./Shenzhen Mindray Bio-Medical Electronics Co., Ltd shall not be liable for any incidental, special, or consequential loss, damage, or expense directly or indirectly arising from the use of its products, liability under this warranty and the buyer's exclusive remedy under this warranty is limited to servicing or replacing at Mindray DS USA Inc./Shenzhen Mindray Bio-Medical Electronics Co., Ltd's option at the factory or at an authorized distributor, any product which shall under normal use and service appear to the Company to have been defective in material or workmanship. Recommended preventative maintenance, as prescribed in the service manual, is the responsibility of the user and is not covered by this warranty.

No agent, employee, or representative of Mindray DS USA Inc./Shenzhen Mindray Bio-Medical Electronics Co., Ltd has any authority to bind Mindray DS USA Inc./Shenzhen Mindray Bio-Medical Electronics Co., Ltd to any affirmation, representation, or warranty concerning its products, and any affirmation, representation or warranty made by any agent, employee, or representative shall not be enforceable by buyer.

This warranty is expressly in lieu of any other express or implied warranties, including any implied warranty or merchantability or fitness, and of any other obligation on the part of the seller.

Damage to any product or parts through misuse, neglect, accident, or by affixing any non-standard accessory attachments or by any customer modification voids this warranty. Mindray DS USA Inc./Shenzhen Mindray Bio-Medical Electronics Co., Ltd makes no warranty whatever in regard to trade accessories, such being subject to the warranty of their respective manufacturers.

A condition of this warranty is that this equipment or any accessories which are claimed to be defective be returned when authorized, freight prepaid to Mindray DS USA Inc./Shenzhen Mindray Bio-Medical Electronics Co., Ltd or its authorized representative. Mindray DS USA Inc./Shenzhen Mindray Bio-Medical Electronics Co., Ltd shall not have any responsibility in the event of loss or damage in transit.

6.12 Manufacturer's Responsibility

The effects on safety, reliability, and performance of the equipment are the manufacturer's responsibility only if:

- assembly operations, extensions, readjustments, modifications, or repairs are carried out by authorized personnel; and
- the electrical installation of the relevant room complies with the appropriate requirements; and
- the equipment is used in accordance with the Instructions for use.

*Mindray DS USA, Inc. • 800 MacArthur Boulevard • Mahwah, NJ 07430 • USA •
Dom. Customer Service: 1.800.288.2121 • Intl. Customer Service: +1.201.995.8000 •
Dom. Fax: 1.800.926.4275 • Intl. Fax: +1.201.995.8680 • www.mindray.com*

*Mindray Medical Netherlands B.V. • Drs. W. van Royenstraat 8 • P.O. Box 26 • 3870 CA
Hoevelaken • The Netherlands • Tel: +31 33 25 44 911 • Fax: +31 33 25 37 621*

*Mindray (UK) Limited • 3 Percy Road • St. John's Park • Huntingdon • Cambridgeshire PE29 6SZ •
United Kingdom • Tel: 01480 416840 • Fax: 01480 436588*

*Mindray Medical France SARL • Europarc Créteil • 123, Chemin des Bassins •
94035 Créteil Cedex • France • Tel: (0)1.45.13.91.50 • Fax: (0)1.45.13.91.51*

*Mindray Medical Germany GmbH • Zwischen den Bächen 4 • 64625 Bensheim • Deutschland •
Tel: +49.6251.17524-0 • Fax: +49.6251.17524-20*

*Mindray Medical International Ltd. • 2813 Office Tower, Convention Plaza • No 1 Harbour Road •
Wanchai • Hong Kong • Tel: +852 2793 5596 • Fax: +852 2344 8824*

*Medstar Importação e Exportação Ltda • Av. Vereador José Diniz, 3300 • São Paulo, SP • CEP
04804-000 • Brazil • Tel: 55 11 2872-3385 • Fax: 55 11 2872-3385*