

# DASHER<sup>®</sup> D210 and D211 DISPLAY TERMINALS USER'S MANUAL



Ordering No. 014-000746

 Data General

# TECHNICAL SPECIFICATIONS

## Functional:

<b>Display Unit</b>	Tabletop, tiltable mounting; 305-mm (12-in.) diagonal screen with 212-mm (8.35-in.) by 137-mm (5.4-in.) viewing area; 24 lines by 81 characters per line
<b>Keyboard</b>	Low-profile, independent tabletop mounting with sculptured keys; n-key rollover; typematic and manual repeat; 5 basic keypad groups; on-line, alpha-lock, and hold lamps
<b>Screen Phosphor</b>	P31 green
<b>Screen Refresh Rate</b>	60 frames/second (domestic 60 Hz) 50 frames/second (foreign 50 Hz)
<b>Display Technique</b>	Non-interlaced raster
<b>Characters</b>	10 × 12 dot matrix character cell
<b>Character Sets</b>	U.S., (D211 Only - U.K., French, German, Swedish/Finnish, Spanish, Danish/Norwegian, Swiss)
<b>Display Scrolling</b>	One-row increments ("jump" scrolling)
<b>Self-Test</b>	On power-up, program verifies terminal is operational

## Communication:

<b>Interface Types</b>	Asynchronous serial, full-duplex; RS-232C; (D210 and 211) RS-422A or 20-mA current loop (D211 only); XON/XOFF protocol
<b>Baud Rates</b>	50, 75, 110, 134.5, 150, 300, 600, 1200, 1800, 2400, 3600, 4800, 7200, 9600, and 19200 baud (EIA RS-232C and RS-422A; 110-9600 (20-mA))
<b>Data Format</b>	ASCII; 7- or (D211) 8-bit characters; even, odd, or no parity; one stop bit DG or ANSI (switch selectable)
<b>Printer/Port (D211)</b>	7-/8-bit; serial; EIA RS-232C (D211 only)

## Physical:

<b>Display Unit Dimensions</b>	Height: 34 cm (13.1 in.) Depth: 32.7 cm (12.8 in.) Width: 32.7 cm (12.8 in.)
<b>Keyboard Dimensions</b>	Height: 4.4 cm (2.4 in.) Depth: 19.6 cm (7.5 in.) Width: 51.9 cm (20 in.)
<b>Display Unit Weight</b>	7.3 kg (16.1 lb)
<b>Keyboard Weight</b>	2.6 kg (5.8 lb)
<b>Cable Lengths:</b>	
<b>Keyboard Cable (extended)</b>	1.2 m (4 ft)
<b>Display Unit Power Cord</b>	2.25 m (7.5 ft)
<b>EIA, Modem, 20-mA Current Loop</b>	6.1 m (25 ft) standard for all three cable types

## Power:

<b>0 or 1 Power Suffix: Voltage</b>	90-132 VAC
<b>Frequency</b>	50 or 60 Hz ± 1%
<b>Current</b>	2.4 Amps peak at 90 VAC
<b>Start-up Surge</b>	22 Amps at 120 VAC for 1/2 cycle
<b>2 or 4 Power Suffix: Voltage</b>	187-264 VAC
<b>Frequency</b>	50 or 60 Hz ± 1%
<b>Current</b>	2.0 Amps peak at 187 VAC
<b>Start-up Surge</b>	11 Amps at 240 VAC for 1/2 cycle

## Environmental:

<b>Temperature Range</b>	Operating: 10 to 38°C (50 to 100°F) Storage: -40 to 65°C (-40 to 149°F)
<b>Humidity Range</b>	Operating: 20 to 80% Non-condensing Storage: 10 to 90% Non-condensing
<b>Altitude</b>	Operating: Maximum 2438 m (8000 ft) Storage: Maximum 7620 m (25000 ft)
<b>Radiation</b>	Below 0.5 milliroentgens per hour (complies with FCC regulation Part 15, Subpart J, and CISPRE Part 16 for Class "A" computing devices)

# **DASHER<sup>®</sup> D210 and D211 DISPLAY TERMINALS USER'S MANUAL**

## **Warning:**

This equipment generates, uses, and can radiate radio frequency energy and if not installed and used in accordance with the instruction manual, may cause interference to radio communications. It has been tested and found to comply with the limits for Class A computing devices pursuant to Subpart J of Part 15 of FCC Rules, which are designed to provide reasonable protection against such interference when operated in a commercial environment. Operation of this equipment in a residential area is likely to cause interference, in which case the user, at his own expense, will be required to take whatever measures may be required to correct the interference.

## NOTICE

Data General Corporation (DGC) has prepared this document for use by DGC personnel, customers, and prospective customers. The information contained herein shall not be reproduced in whole or in part without DGC prior written approval.

DGC reserves the right to make changes in specifications and other information contained in this document without prior notice, and the reader should in all cases consult DGC to determine whether any such changes have been made.

THE TERMS AND CONDITIONS GOVERNING THE SALE OF DGC HARDWARE PRODUCTS AND THE LICENSING OF DGC SOFTWARE CONSIST SOLELY OF THOSE SET FORTH IN THE WRITTEN CONTRACTS BETWEEN DGC AND ITS CUSTOMERS. NO REPRESENTATION OR OTHER AFFIRMATION OF FACT CONTAINED IN THIS DOCUMENT INCLUDING BUT NOT LIMITED TO STATEMENTS REGARDING CAPACITY, RESPONSE-TIME PERFORMANCE, SUITABILITY FOR USE OR PERFORMANCE OF PRODUCTS DESCRIBED HEREIN SHALL BE DEEMED TO BE A WARRANTY BY DGC FOR ANY PURPOSE, OR GIVE RISE TO ANY LIABILITY OF DGC WHATSOEVER.

IN NO EVENT SHALL DGC BE LIABLE FOR ANY INCIDENTAL, INDIRECT, SPECIAL OR CONSEQUENTIAL DAMAGES WHATSOEVER (INCLUDING BUT NOT LIMITED TO LOST PROFITS) ARISING OUT OF OR RELATED TO THIS DOCUMENT OR THE INFORMATION CONTAINED IN IT, EVEN IF DGC HAS BEEN ADVISED, KNEW OR SHOULD HAVE KNOWN OF THE POSSIBILITY OF SUCH DAMAGES.

DASHER, microNOVA, and ECLIPSE are U.S. registered trademarks of Data General Corporation.

## FIRST EDITION

*(First Printing July 1983)*

Ordering No. 014-000746  
Copyright © Data General Corporation, 1983  
All Rights Reserved  
Printed in Hong Kong  
Rev. 00, July 1983

## PREFACE

*This DASHER D210 and D211 Display Terminal User's Manual provides an overview of the terminal's features and contains operating, programming, and installation instructions. Throughout this manual the term "D210/211 terminal" is used whenever the current topic is common to both the D210 and D211 display terminals. This manual is divided into chapters and appendices as follows:*

*Chapter/  
Appendix*

- 1 Product Overview — Introduces features of both models of the terminal and briefly describes terminal operation when connected to a host computer.*
  - 2 Operation — Describes the terminal controls and indicators with emphasis on the keyboard, includes terminal operating procedures that are independent of the host computer, and closes with a short paragraph on operator maintenance.*
  - 3 Programming — This chapter is for the programmer interested in writing host-resident software that interfaces directly with the terminal. All of the programming commands are described in detail in this chapter.*
  - 4 Installation — Provides the site requirement, unpacking, installation, and checkout instructions for the terminal.*
  - A ASCII D210/211 Control Codes*
  - B ASCII D210/211 Display Codes*
  - C ASCII D210/211 Code Sequences*
  - D U.S., European, and Alternate Character Fonts*
  - E Summary of D210/211 Commands*
  - F European Keyboards*
- Glossary  
Index*

## RELATED PUBLICATIONS

*The following documentation contains additional information on the DASHER D210 and D211 Display Terminals:*

- DASHER D210 and D211 Display Terminals Field Engineers Maintenance Series, part number 015-000136*
- DASHER D210 and D211 Display Terminals Programmer's Reference Card, part number 014-000763*



# CONTENTS

	Page		Page
<b>PREFACE</b>		General Overview .....	3-1
<b>CHAPTER 1</b>		Modes of Terminal Operation .....	3-2
<b>PRODUCT OVERVIEW</b>		<b>PRINTER COMMUNICATIONS (D211 Only)</b> .....	3-3
INTRODUCTION .....	1-1	<b>KEYBOARD CODES</b> .....	3-3
<b>PRODUCT FEATURES</b> .....	1-2	<b>DISPLAY UNIT PROGRAMMING</b> .....	3-3
Display Screen Management .....	1-2	Display Screen Organization .....	3-4
Editing Functions .....	1-2	Command Set Overview .....	3-4
Character Attributes .....	1-2	Command Descriptions .....	3-6
Terminal Operating Modes .....	1-2	Command Descriptions (Data General Mode) .....	3-6
Character Sets .....	1-3	Command Descriptions (ANSI Standard Mode) .....	3-11
Printer Operations (D211 Only) .....	1-3	<b>CHAPTER 4</b>	
<b>PRODUCT DESCRIPTION</b> .....	1-3	<b>INSTALLATION</b>	
Display Unit .....	1-4	GENERAL .....	4-1
Keyboard .....	1-5	SITE REQUIREMENTS .....	4-1
<b>SYSTEM OPERATION OVERVIEW</b> .....	1-6	UNPACKING .....	4-2
On-Line Operation .....	1-6	INSTALLATION .....	4-2
Off-line Operation .....	1-7	<b>OPERATIONAL CHECKOUT</b> .....	4-9
<b>PRODUCT SPECIFICATIONS</b> .....	1-7	Self-Test and Off-Line Checkout .....	4-9
<b>CHAPTER 2</b>		On-Line Checkout .....	4-11
<b>OPERATION</b>		Off-Line Printer Checkout (D211 Only) .....	4-11
GENERAL .....	2-1	<b>APPENDIX A</b>	
<b>DISPLAY UNIT CONTROLS AND INDICATORS</b> .....	2-1	ASCII D210/211 CONTROL CODES .....	A-1
<b>KEYBOARD CONTROL AND INDICATORS</b> .....	2-2	<b>APPENDIX B</b>	
Main Keypad .....	2-3	ASCII D210/211 DISPLAY CODES .....	B-1
Screen Management Keypad .....	2-4	<b>APPENDIX C</b>	
Numeric Keypad .....	2-5	ASCII D210/211 CODE SEQUENCES .....	C-1
User Function Keys .....	2-5	<b>APPENDIX D</b>	
Local Print Key (D211 Only) .....	2-5	U.S., EUROPEAN, AND ALTERNATE	
Terminal Power-Up/Power-Down Procedures .....	2-7	CHARACTER SETS .....	D-1
Power-Up Procedure .....	2-7	<b>APPENDIX E</b>	
Power-Down Procedure .....	2-7	SUMMARY OF D210/211 COMMANDS .....	E-1
Operating Procedures .....	2-7	<b>APPENDIX F</b>	
On-Line Operation .....	2-7	EUROPEAN KEYBOARDS .....	F-1
Off-Line Operation .....	2-8	<b>GLOSSARY</b>	
<b>USER MAINTENANCE</b> .....	2-8	<b>INDEX</b>	
<b>CHAPTER 3</b>			
<b>PROGRAMMING</b>			
GENERAL .....	3-1		
HOST/TERMINAL COMMUNICATIONS .....	3-1		





# CHAPTER 1

## PRODUCT OVERVIEW



Figure 1-1. DASHER D210/211 Display Terminal

### INTRODUCTION

The DASHER D210 and D211 display terminals are ASCII-based, soft-copy devices that support the full upper/lower case, alphanumeric, printing character set. The D210/211 display terminal is a desk-top unit with a 12-inch screen and tilt base mounting (Figure 1-1). The unit is designed for information entry, interaction and display in a wide range of operating environments. A significant new feature of the D210/211 terminal is its ability to operate in either the Data General mode of operation used exclusively in the past or in the newly implemented ANSI standard mode of operation.

The D211 is an enhanced version of the D210 with two significant added features. First, both 7- and 8-bit operations are supported by the D211. This means that the D211 can offer extended communications capabilities as well as the choice of several character sets.

Second, the D211 supports a slave printer device via an EIA RS-232C compatible printer port. The D210 offers only 7-bit operation, one character set, and no provision for local printing.

Both the D210 and D211 terminals are intended to be connected to any host computer system that supports full-duplex communications with an EIA RS-232C compatible interface and uses XON/XOFF protocol. In addition, the D211 offers both RS-422 and 20-mA current loop communication interfaces. For host/terminal transmission distances up to 1500 meters, the RS-422 interface may be used. The terminal's EIA interface can be used at remote sites in conjunction with Bell 103, 113, or 212A compatible modems and an available telephone system.

Throughout this manual, the term "D210/211 terminal" is used whenever the current topic is common to both the D210 and D211 terminals.

## PRODUCT FEATURES

The basic D210/211 terminal consists of a CRT display unit, a keyboard, and an input/output cable as shown in Figure 1-1. The display unit, mounted on a tilt base, and the detached, sculptured keyboard combine to provide maximum flexibility in viewing and keyboard access for the operator.

The D211 terminal supports the United States ASCII character set and eight foreign character sets. The D210 supports only the standard ASCII U.S. character set. When the terminal is powered up, the display unit senses the nationality of the attached keyboard and automatically displays the matching character set.

The next few sections highlight the more important features of the D210/211 terminal. The D210/211 terminal includes significant advances over the D100/200 terminal series, yet it is still compatible with the earlier DASHER D100/200 Display Terminal. That is, a D100 or D200 terminal can be disconnected and replaced with the D210/211 without making significant hardware or software changes. The added features of the D210/211 terminal can then be taken advantage of as existing software is modified or replaced.

All of the features described in the next few pages are programmable. A programmable feature is one that can be exercised on command from a host computer. The D210/211 terminal command set is both versatile and easy to use, simplifying the process of implementing the terminal features in various applications. Some of the features can be controlled directly by the user from the keyboard. These features will be pointed out as they are discussed.

### Display Screen Management

The D210/211 terminal provides essentially the same screen management capabilities as the earlier D200 series. The display unit of both terminals displays 1920 characters using a non-interlaced video monitor with a 12-inch diagonal screen. The screen's active area is 8.3 by 6.0 inches, formatted as 24 lines by 80 characters per line.

All printing characters sent to the display are stored in memory and displayed on the screen in a 7- by 9-character font within a 10- by 12-character cell. The non-destructive cursor is displayed as a non-blinking, reverse video block.

Scrolling is performed on the D210/211 in one row increments ("jump" scrolling). The scroll rate depends upon the set baud rate of the terminal.

### Editing Functions

The D210/211 terminal includes several built-in editing features. These features allow for convenient erasing

of characters in line or for erasing the entire display screen or portions thereof.

### Character Attributes

The D210/211 offers visual attributes on a character-by-character basis. Each character displayed on the screen can be underscored, dimmed, made to blink, or displayed in reverse video independent from all other characters. These four attributes can be applied in all combinations. In addition, the underscore attribute may be combined with other visual attributes such that underscores may be dim, blinking, dim-blinking, etc. There is no provision, however, for dim reverse video characters.

### Terminal Operating Modes

The D210/211 terminal offers the user two basic operating modes: Data General (DG) and ANSI standard.

The DG mode of operation preserves software compatibility with previous Data General products and systems. When the terminal is in DG mode, private Data General control sequences are recognized and interpreted as commands. Previous DG customers who wish to operate the D210/211 in a Data General environment should use the DG mode of operation.

The newly implemented ANSI operating mode of the D210/211 terminal allows DG users to integrate this terminal with other ANSI-based systems, or to use the terminal for remote entry with systems and equipment that are based on ANSI standards. Users who have a large base of ANSI-compatible code, for example, may now use the D210/211 terminal without penalty by selecting the ANSI mode of operation.

**NOTE:** *When the D210/211 is in ANSI mode, compatibility does NOT exist with previous Data General systems or equipment.*

The choice of operating modes (DG or ANSI) may be made via a hardware switch at the back of the terminal or with a software command.

The D211 terminal offers the user the choice of 7- or 8-bit operation. Previous DG systems have used the 7-bit mode of operation exclusively. When the terminal is in 8-bit mode, full compatibility exists with previous DG 7-bit operations. Users may wish to operate the terminal in 8-bit mode for easier access to the different character sets that are supported by the D211. The choice of 7- or 8-bit operation is made via a hardware switch at the back of the D211 terminal. In addition, the user/host may select 7/8-bit operation using a software command if and only if the hardware switch is set for 8-bit mode. If the hardware switch is set for 7-bit operation, then the software command to select 7/8-bit operation is disabled.

These modes of operation (DG, ANSI, 7/8-bit) are explained in greater detail in Chapter 3.

## Character Sets

The D210 terminal supports only the basic United States ASCII character set. The character sets available for the D211 terminal are:

- United States
- Spanish
- United Kingdom
- Danish/Norwegian
- French
- Swiss
- German
- DG International
- Swedish/Finnish

Appendix D shows the characters in each of these sets. When the terminal is powered up, the display unit senses the nationality of the keyboard and automatically selects the matching character set for display. Any of the other character sets listed can be chosen for display on the D211 terminal as the need arises.

## Printer Operations (D211 Only)

The D211 terminal supports local, RS-232C serial printers. The data format for the print operations may be either 7 or 8 data bits. For 7-bit communications, the printer UART uses even parity, 7 data bits, and one stop bit. For 8-bit communications, the printer UART uses no parity, 8 data bits, and 2 stop bits. Both 7- and 8-bit communications support baud rates up to 19200 baud.

When the printer is selected for 7-bit operations, only 94 printable characters (plus the space and delete characters) are allowed in the character set. The terminal assumes that the printer 7-bit character set matches the keyboard nationality. If the printer is selected for 8-bit operations, the terminal assumes the Data General International character set is present in the printer. The chief difference between 7- and 8-bit printer operations is that a 7-bit printer can print only the primary character set (94 characters), whereas the 8-bit printer can print both primary and secondary language sets (188 characters).

The printing capabilities available with the D211 are compatible with the D200. This includes the ability to print all the characters on the screen from the first character of the current cursor's row to the end of the screen, and a selective print which transmits only non-dimmed characters on the screen to the printer.

## PRODUCT DESCRIPTION

The basic D210/211 terminal system consists of the following major components:

- Display Unit
- Host/Terminal Interface Cable
- Keyboard (and Cable)
- Display Unit Power Cord

The model numbers for the D210/211 terminal components are listed in Table 1-1. The display unit model number includes a suffix which defines the power configuration. The keyboard model number includes a suffix character which defines the primary nationality. Notice that Table 1-1 shows numerous keyboard nationalities but no display unit nationality. When the D211 terminal is powered up, the display unit senses the nationality of the keyboard and automatically displays the matching character set.

**Table 1-1. D210/211 Terminal Component Model Numbers**

Component	Model No./ Suffix	Description
Display Unit (D210)	6242/Num	D210 display unit, RS-232-C, DG/ANSI mode, 7-bit operation only.
Display Unit (D211)	6243/Num	D211 display unit with printer port, RS-232C/RS-422A/20-mA, DG/ANSI mode, 7- or 8-bit operation and international character sets.
(Display Unit Power Suffix)	Num = 0	100 Vac; 50/60 Hz (switch selectable)
	= 1	120 Vac; 50/60 Hz (switch selectable)
	= 2	220 Vac (Model 6243 only); 50/60 Hz (switch selectable)
	= 4	240 Vac (Model 6243 only); 50/60 Hz (switch selectable)
	Keyboard	6245/Alpha
	Alpha = A	United States
	= B	United Kingdom (D211 only)
	= C	French (D211 only)
	= D	German (D211 only)
	= E	Reserved
	= F	Reserved
	= G	Spanish (D211 only)
	= H	Danish/Norwegian (D211 only)
	= I	Italian
	= J	Swiss/German (D211 only)
	= K	Swiss/French (D211 only)
	= L	English/Canadian (D211 only)
	= M	French/Canadian (D211 only)
	= N	Swedish/Finnish (D211 only)

## Display Unit

Figure 1-2 shows the configuration of a D210/211 terminal connected to a host computer system. The display unit is the center of activity for the D210/211 terminal and houses the electronic hardware and firmware that provide the D210/211 terminal with its ability to function.

The CRT mounted inside the display unit housing is a 12-inch, green phosphor, monochrome unit. The display unit housing has external cable connections, dual-inline-package (DIP) switches, and a power on/off switch at the rear. A display screen brightness control is located on the lower-right front of the display unit. The housing sits on a base that permits the operator to tilt the display unit for optimum viewing.

The host computer, keyboard, host cable, and optional printer cable connections (for the D211) and the DIP switches at the rear of the display unit are also shown in Figure 1-2. The D210 has only one set of DIP switches. The D211 has two sets of DIP switches. The DIP switches must be set as required by the installation configuration.

Both the D210 and D211 have a host switch to the right of the keyboard connector. This switch is used to select the baud rate, parity type for host computer communications, and default (power-up) terminal operating mode (DG or ANSI and 7/8-bit operation for the D211 only). The D211 also has a set of DIP switches to the right of the host switch. This switch is used to select the printer baud rate (110 to 19200) and 7/8-bit printer data communications operations.

**NOTE:** See Chapter 4 for details on switch settings.

When power to the display unit is turned on, a built-in self-test automatically verifies that the display unit and attached keyboard are in good working condition. The self-test checks out the key elements inside the display unit, such as the read-only memory (ROM), read/write memory, etc. The cable connection to the keyboard is checked along with the lamps and bell on the keyboard. If a failure is noted during the self-test, an error message is displayed across the top of the display screen identifying the failing element.

When the terminal is turned on, the DIP switch settings at the rear of the display unit are read to

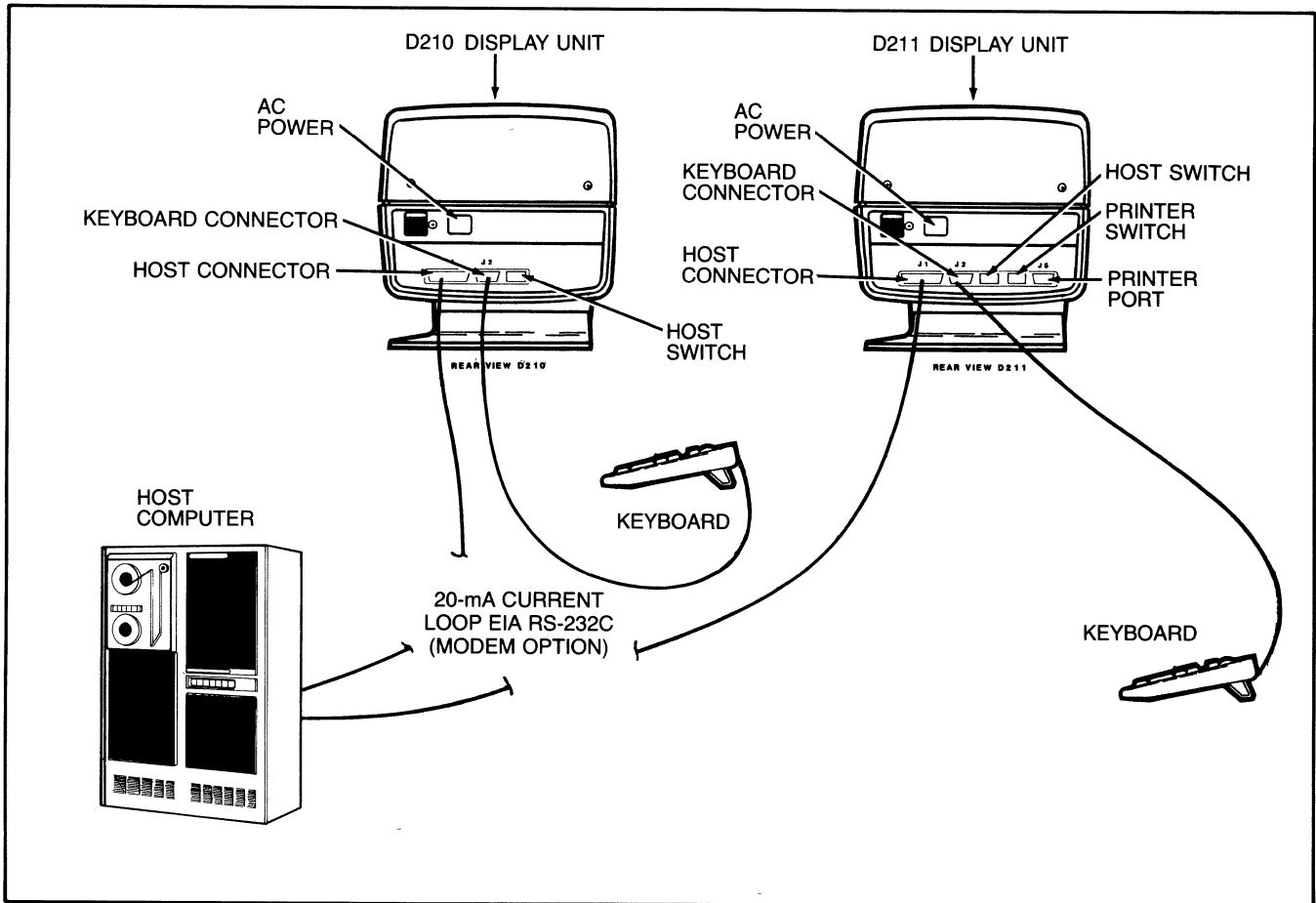

Figure 1-2. D210/211 Terminal System Configuration

program the baud rates and parity of the host computer and printer interfaces and mode of operation (DG or ANSI, 7- or 8-bit). In addition, the keyboard language is set to the nationality of the keyboard.

**NOTE:** *The keyboard language and the display language may be different.*

Operation of the D210/211 terminal is controlled by command sequences or control codes and is dependent upon the mode in effect (i.e., Data General or ANSI). Chapter 3 describes in detail how these commands can be used to manipulate all of the features described earlier in this chapter. Commands and characters for display originate from one of two sources: when the terminal is on-line, the host computer is the source; when the terminal is off-line, the keyboard is the source. See the system operation overview paragraph later in this chapter for additional details for on-line and off-line operation.

### Keyboard

Figure 1-3 shows the layout of the D210/211 terminal keyboard.

The D210 terminal supports only the standard domestic keyboard layout. The D211 supports the various keyboard layouts as shown in Table 1-2. The only differences between the D210 and D211 keyboards is that the D211 makes use of a main keyboard key called SPCL and a local print key called Local Print. (On the

D210, these keys do not perform any function when depressed.) The SPCL or "special" key provides overstriking and accenting capabilities when the terminal is set for 8-bit Data General or ANSI operation or for 7-bit ANSI operation. (The SPCL key has no effect for 7-bit Data General operation.) The Local Print key allows local print functions when a printer is connected to the D211 terminal. (See Chapter 2 for additional details on the SPCL and Local Print keys).

The keyboard connects to the rear of the display unit with a 1.2-meter (4-foot) cable.

Each of the D211 keyboard nationalities works with the display unit to generate ASCII character codes. The ASCII codes include the full set of 95 displayable characters, a delete code, control characters, and special user function code sequences.

**Table 1-2. Keyboard Layouts Supported by the D211 Terminal**

United States	Swiss/German
United Kingdom	Swiss/French
French	Danish/Norwegian
German	English/Canadian
Spanish	French/Canadian
Swedish/Finnish	

Appendices A, B, and C list all of the ASCII codes and code sequences and identify the keys used to produce them.

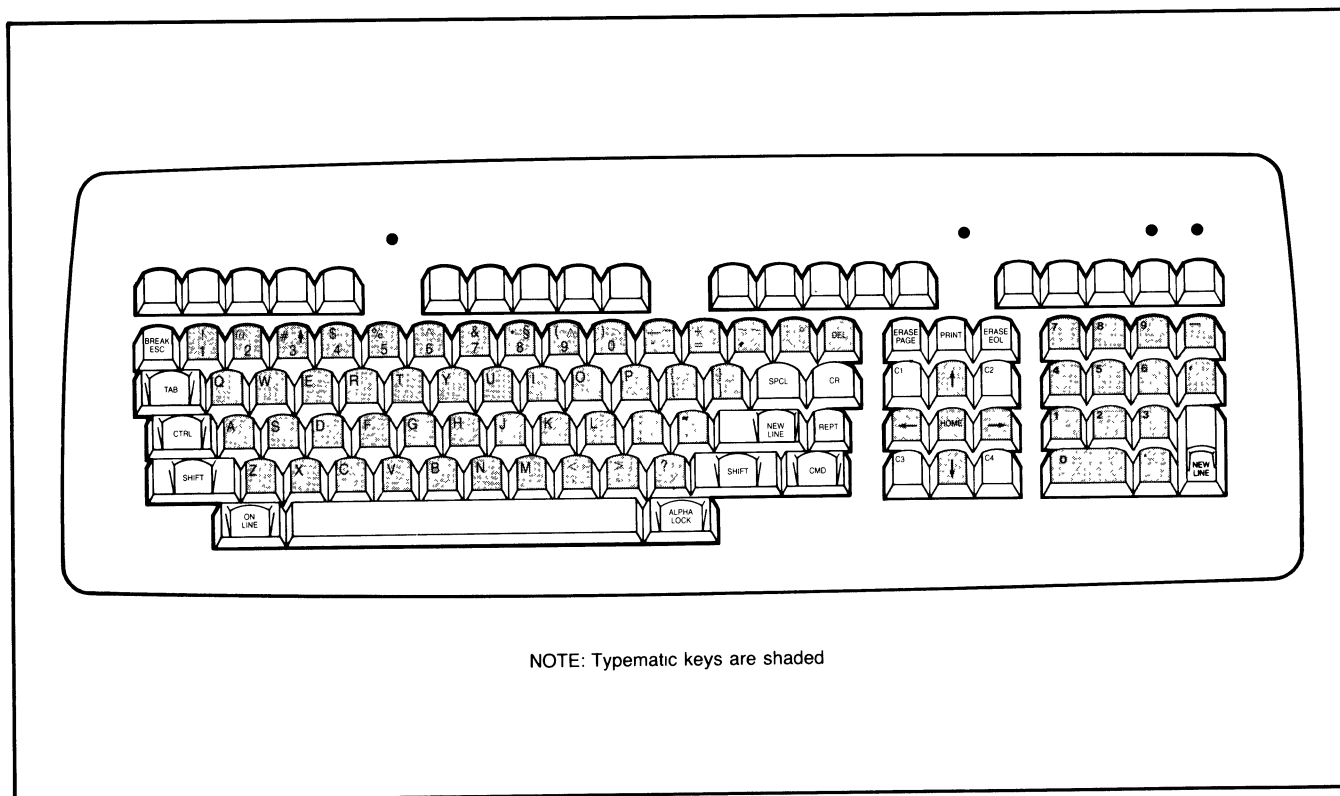

NOTE: Typematic keys are shaded

**Figure 1-3. D210/211 Terminal Keyboard Layout**

As shown in Figure 1-3, the keyboard is organized functionally into the following groups:

- Main keypad
- Screen management keypad
- Numeric keypad
- User function keys
- Local print key (D211)

The difference between the nationalities of keyboards lies with the main keypad. Appendix F shows the main keypads of the supported keyboards. Chapter 2 provides a detailed description of the keypads.

The main keypad is similar to a standard typewriter keyboard with a few additional functions. All of the displayable ASCII characters can be entered from the main keypad. The 12-key screen management keypad is used for cursor control, screen erase, and special user functions (keys C1 through C4). The 14-key numeric keypad duplicates some of the main keypad functions, but the keys are arranged in a calculator fashion to make entering numerical data easier. The user function keys (F1 through F15) and the CTRL and SHIFT keys on the main keypad combine to produce most of the special code sequences. The code sequences are often used to invoke special user functions in the host software servicing the D210/211 terminal. The local function key (“Local Print”) controls print operations from the D211 terminal.

The user has two features available when a key needs to be depressed repeatedly. First, and slowest, is “typematic” repeat. When any one of the character display keys is depressed and held down for more than three-quarters of a second, the character corresponding to that key is displayed at the rate of 15 characters per second until the key is released. In general, the typematic feature applies to the alphanumeric keys on the main keypad, the numeric keypad, and the cursor control keys on the screen management keypad. The second, and fastest method of repeating a keystroke, is through use of the REPT (repeat) key on the main keypad. REPT can be used in conjunction with any code-generating key to increase the code repetition rate to 30 per second.

The bell for the terminal is located inside the keyboard and is controlled from the display like the keyboard lamps. The bell is rung on command for 128 ms at 2 kHz.

## SYSTEM OPERATION OVERVIEW

The D210/211 terminal can be used in two basic operating states: on-line and off-line. The difference between the two states depends on whether or not the terminal is part of a host computer system. “On-line” means the

terminal is communicating with the host computer (see Figure 1-4A). “Off-line” means no communication occurs between the host computer and the terminal (see Figure 1-4B). The on-line state will prove more valuable in most environments because, in addition to the terminal itself, the host computer system and its resources are accessible to the operator. These resources often include development and application software plus hardcopy output devices, such as printers and plotters. The off-line state is somewhat restricted because the terminal keyboard, display unit, and an optional printer (for the D211 only) comprise the complete system.

**NOTE:** *If the terminal is taken off-line while connected to a host system, any data transmitted to the terminal by the host system is lost.*

When the D210/211 terminal is turned on, the terminal automatically performs a self-test, as described earlier in this chapter. As the self-test completes, but before the user can begin operating the terminal, an automatic check is made to see if a complete connection exists between the rear of the display unit and a host computer. If a host connection is found, the ON LINE lamp on the keyboard turns on and the terminal enters the on-line state. If no host connection exists, the ON LINE lamp will blink. Depressing the CMD and ON LINE keys simultaneously with the ON LINE lamp blinking causes the terminal to enter the off-line state and turns the ON LINE lamp off.

## On-Line Operation

In the on-line state, the D210/211 terminal communicates with the host computer system as shown in Figure 1-4A. Data entered at the keyboard is first routed to the display unit and then transmitted to the host computer in the form of ASCII characters. The character format, along with the default mode of operation, parity and the baud rate used to communicate with the host computer, are all selected with the DIP switches at the rear of the display unit. (Chapter 4 contains complete details for setting these DIP switches.) If a match does not exist between the terminal and host computer communication characteristics, a transmission error character in the form of a parity error (a block smaller than the cursor) will appear on the display screen.

The software in the host computer servicing the D210/211 terminal checks each incoming character from the terminal. If the character is a display character, such as a letter, number, or symbol, the character is often echoed back to the display unit without modification so that it appears on the display screen. If the incoming character or character sequence includes a control character, the host software often performs one or more special functions before sending anything back to the terminal. The special functions typically result in the transmission of commands and/or display characters to the terminal.

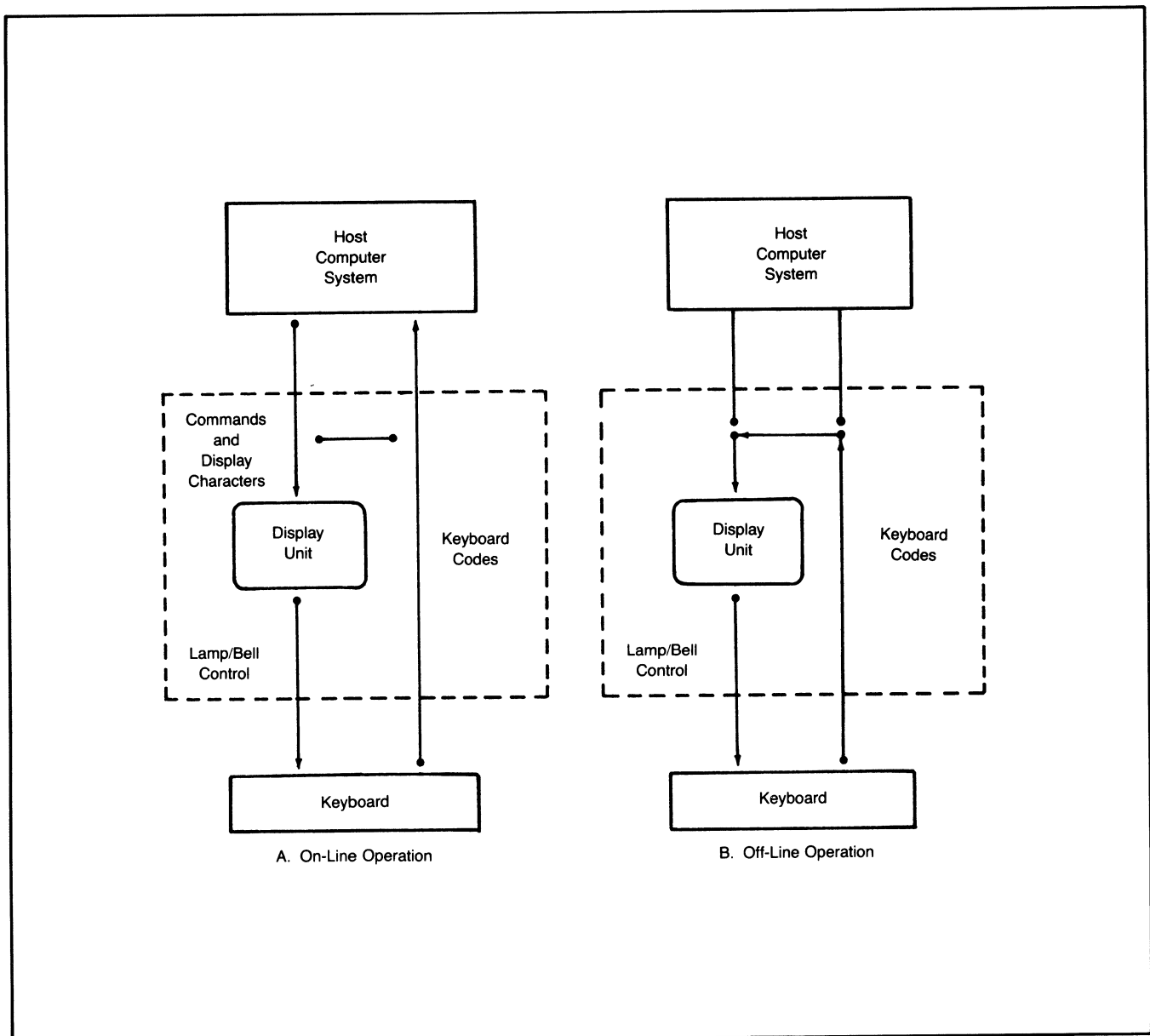

Figure 1-4. D210/211 Terminal and Host Computer Operation

The Local Print key for the D211 sends no code at all to the host computer; when the Local Print key is depressed, the display unit performs the printing operation independent of the host.

### Off-line Operation

In the off-line state no logical connection exists between the terminal and the host computer (see Figure 1-4B). If a communications link to the host does exist and the terminal is on-line, a switch to off-line operation can be made by depressing the ON LINE key while holding down the CMD key.

The terminal can perform all functions off-line, but the user must enter all display characters and commands by hand at the keyboard. With the terminal off-line,

data entered at the keyboard is converted to ASCII character form and interpreted directly by the display unit with no buffering by the host software. All display characters entered at the keyboard are displayed on the screen and all single control characters are interpreted as listed in Appendix A. Appendix E lists the control codes and code sequences for all D210/211 commands.

## PRODUCT SPECIFICATIONS

The Technical Specifications table (Table 1-3) which follows contains the functional and communication specifications for the D210/211 terminal. Physical, environmental, and power specifications are provided in Chapter 4.

**Table 1-3. D210/211 Terminal Functional and Communication Specifications**

Item	Specification
<b>FUNCTIONAL:</b>	
Display Unit	Tabletop, tiltable mounting; 305-mm(12-in.) diagonal screen with 212- by 137-mm (8.35- by 5.4-in.) viewing area; 24 lines by 80 characters per line.
Keyboard	Low-profile, independent mounting with sculptured keys; n-key rollover; typematic and manual repeat; 5 basic keyboard groups; on-line, alpha-lock, and hold lamps.
Screen Phosphor	P31 green
Screen Refresh Rate	60 frames/second(domestic 60 Hz) 50 frames/second(foreign 50 Hz).
Display Technique	Non-interlaced raster.
Characters	10- X 12-dot matrix character cell.
Character Sets	U.S. (D211 Only - U.K., French, German, Swedish/Finnish, Spanish, Danish/Norwegian, Swiss).
Display Scrolling	One-row increments ("jump" scrolling).
Self-test	On power-up, program verifies terminal is operational.
<b>COMMUNICATION:</b>	
Interface Types	Full duplex; serial asynchronous; RS-232-C (D210 and D211); RS-422A or 20-mA current loop (D211 only); XON/XOFF protocol.
Baud Rates	50, 75, 110, 134.5, 150, 300, 600, 1200, 1800, 2400, 3600, 4800, 7200, 9600, and 19200 (EIA RS-232C and RS422A; 110-9600 (20 mA) ).
Data Format	ASCII; 7- or (D211) 8-bit characters; odd, even, or no parity; one stop bit; DG or ANSI (switch selectable).
Printer Port (D211)	7/8-bit; serial; EIA RS-232C; (D211 only)



# CHAPTER 2

## OPERATION

### GENERAL

This chapter contains the following operation information about the D210/211 terminal:

- Display unit controls and indicators
- Keyboard controls and indicators
- Power-up and power-down procedures
- Operating procedures
- Operator maintenance procedures

The terminal operating procedures in this chapter are limited in scope because most on-line operation details are controlled by the software in the host computer. Chapter 1 helps clarify this point and includes a discussion of terminal on-line and off-line operation. Off-line operating procedures receive most of the attention in

this chapter because they depend only on the characteristics of the D210/211 terminal.

Those users who have a printer configured with their D211 terminal should see the printer manual(s) for printer operating instructions.

### DISPLAY UNIT CONTROLS AND INDICATORS

The display unit has one control on the front of the display screen, a power on/off switch, and connectors and miniature DIP switches at the rear. Chapter 4 contains detailed instructions for completing the cable and power cord connections and setting the DIP switches at the rear of the terminal.

The power on/off switch is located on the rear of the display unit.

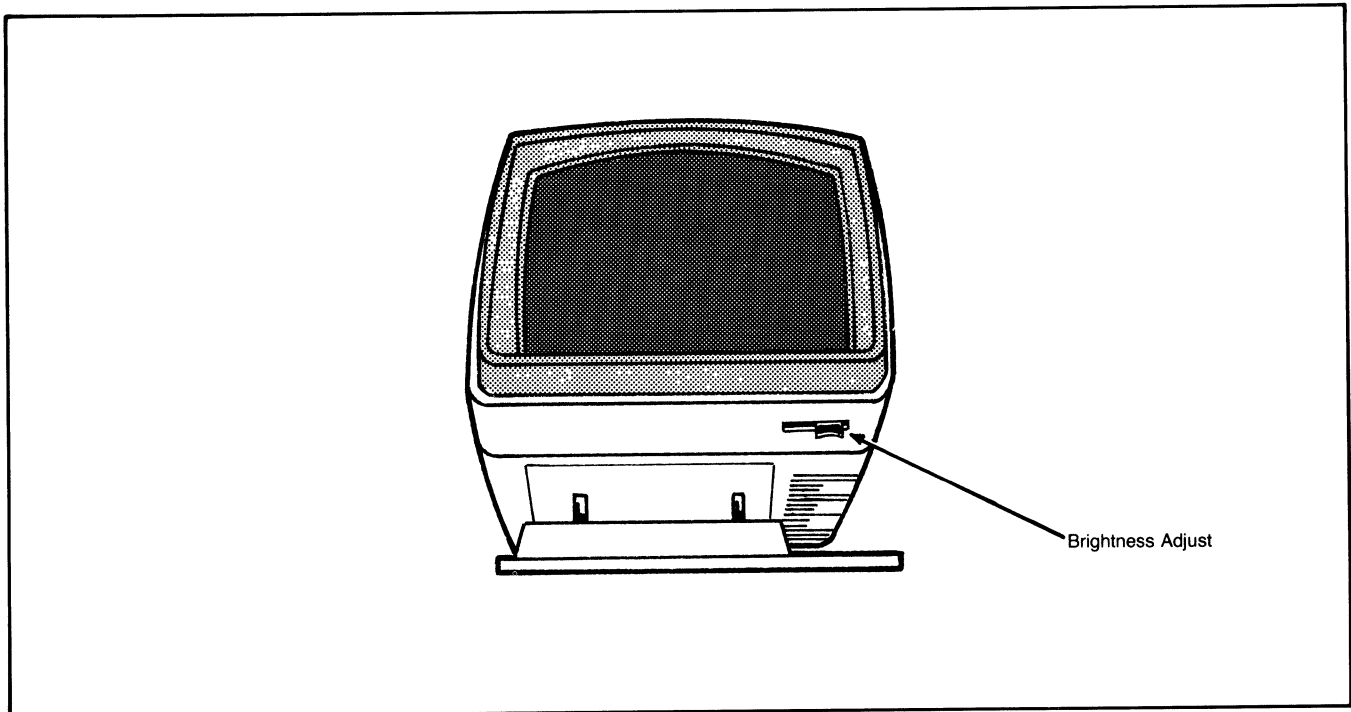

Figure 2-1. Display Unit Brightness Control

A slide switch control located on the lower right front of the display unit, as shown in Figure 2-1, changes display screen brightness. Slide the control to the right to increase brightness, to the left to decrease brightness.

The terminal bell rings once when the terminal is first turned on and a second time when the automatic self-test is completed. The bell can be sounded off-line from the keyboard (depress CTRL-G) or on-line by the host computer.

**NOTE:** *Except where specified, the operation characteristics of the D210/211 terminal described in this chapter apply to both the Data General and ANSI modes of terminal operation.*

## KEYBOARD CONTROL AND INDICATORS

The United States keyboard (see Figure 2-2) contains a typewriter-style, 61-key main keypad, a 12-key screen management keypad, a 14-key numeric keypad, 15 user function keys, and for the D211, one operational local function key (the Local Print key). Appendix F shows how the main keypads of the European keyboards differ from the U.S. main keypad.

With the keyboard, the operator can generate all 95 displayable ASCII characters, the delete character,

control characters, and numerous special character sequences. Appendices A, B, and C list all of these characters and character sequences.

Two separate keyboard features are provided to speed up the entry of repeated characters. The first feature, typematic repeat, applies only to the alphanumeric keys, the numeric keypad keys, and the cursor movement keys. When one of these shaded keys is depressed for more than three-quarters of a second, the associated character is generated at a rate of 15 per second until the key is released. The second feature to speed up entry is the REPT key. When this key is depressed and held down along with any other character-generating key or key combination, the associated character repeats at the rate of 30 characters per second. The characters repeat at this rate until either the REPT key is released (in which case the rules for typematic repeat apply) or until the other key or combination is released (in which case the repetition ceases). The REPT feature also works for the CTRL functions and NEW LINE key, but does not affect the operation of the SHIFT, ON LINE, ALPHA LOCK, and CMD key sequences.

**NOTE:** *The functions performed by code-generating keys in the on-line mode are controlled by software servicing the D210/211 terminal in the host computer. The following paragraphs describe off-line operation of the code-generating keys and operation of the keys that do not generate codes for the host computer. See the host*

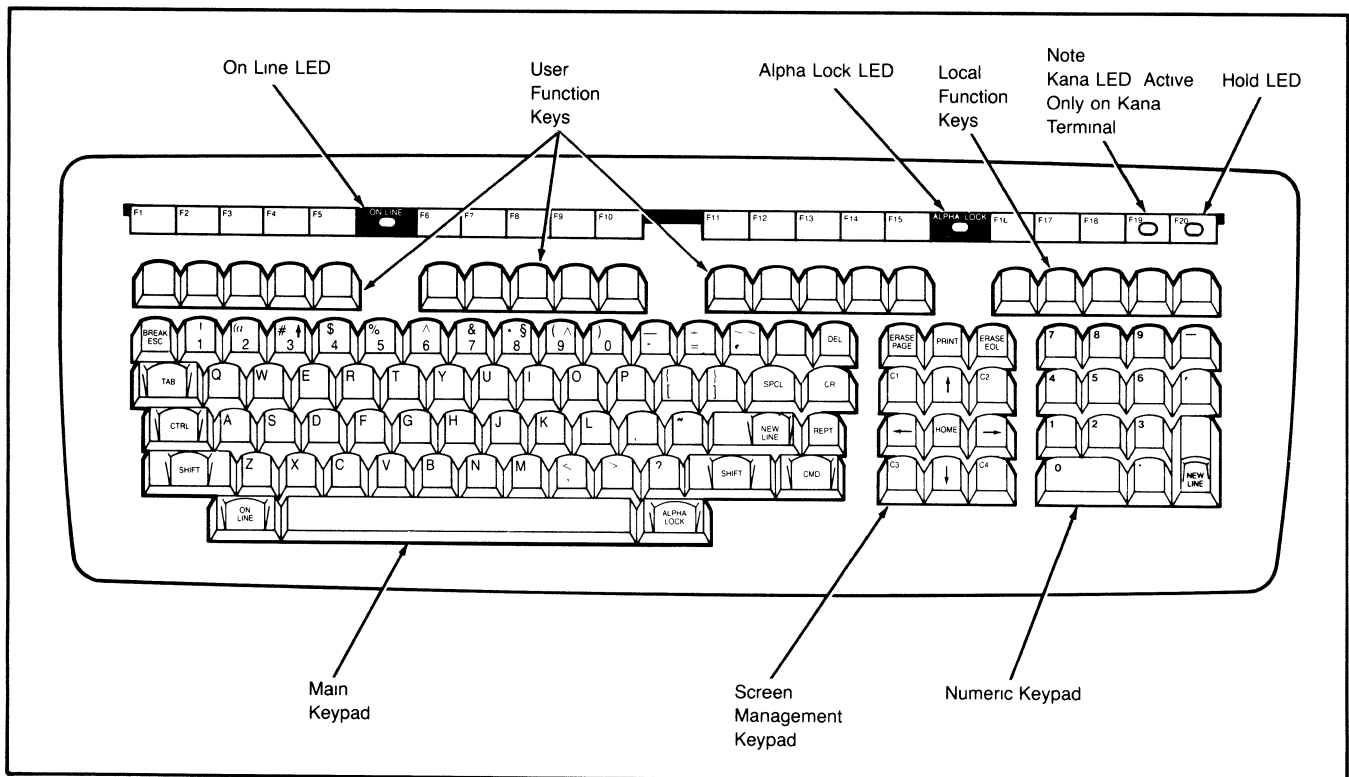

Figure 2-2. D210/211 Terminal Keyboard

system or application documentation for a description of on-line operation of the code-generating keys.

## Main Keypad

The main keypad is shown in Figure 2-3. The alphanumeric keys on the main keypad form the standard typewriter-style keyboard. Off-line, these keys produce the displayable characters shown on their keycaps.

**NOTE:** When the space bar or a display character key is depressed, a space or display character is written to the alphanumeric cursor location, deleting any previously displayed character in that location. Spacing over characters already typed will erase those characters. The cursor control keys can be used to move the cursor without the erasing action.

The functions of the other keys on the main keypad in the off-line mode are:

- **BREAK ESC** — Depressing this key alone has no effect. When the CMD key is depressed and held down while BREAK ESC is depressed (CMD-BREAK ESC), the ASCII control code <036> is generated. (The <036> control code is used in programming the terminal when it is operating in

Data General mode and cannot be generated from the keyboard when the terminal is on-line.)

**NOTE:** In this manual, an octal-based number is enclosed in angle brackets (e.g., <007> = octal 7).

- **TAB** — Depressing this key has no effect.
- **CTRL** — Depressing this key alone has no effect. When CTRL is depressed and held down while another key is depressed, the control code of the other key is generated.
- **SHIFT** — Depressing this key alone has no effect. When SHIFT is depressed and held down while another key is depressed, the shift code of the other key is generated (uppercase functions on dark blue keys of main keypad). If the ALPHA LOCK mode is on, this key has no effect on the alphabetic keys.
- **ON LINE** — Depressing this key alone has no effect. When CMD is depressed and held down while ON LINE is depressed (CMD-ON LINE), the terminal will switch between the on-line and off-line states. The ON LINE lamp will light when the terminal is on-line, blink when the terminal is waiting to go on-line due to an incomplete connection to the host computer, and turn off when the terminal is off-line. When the terminal is powered up, it will

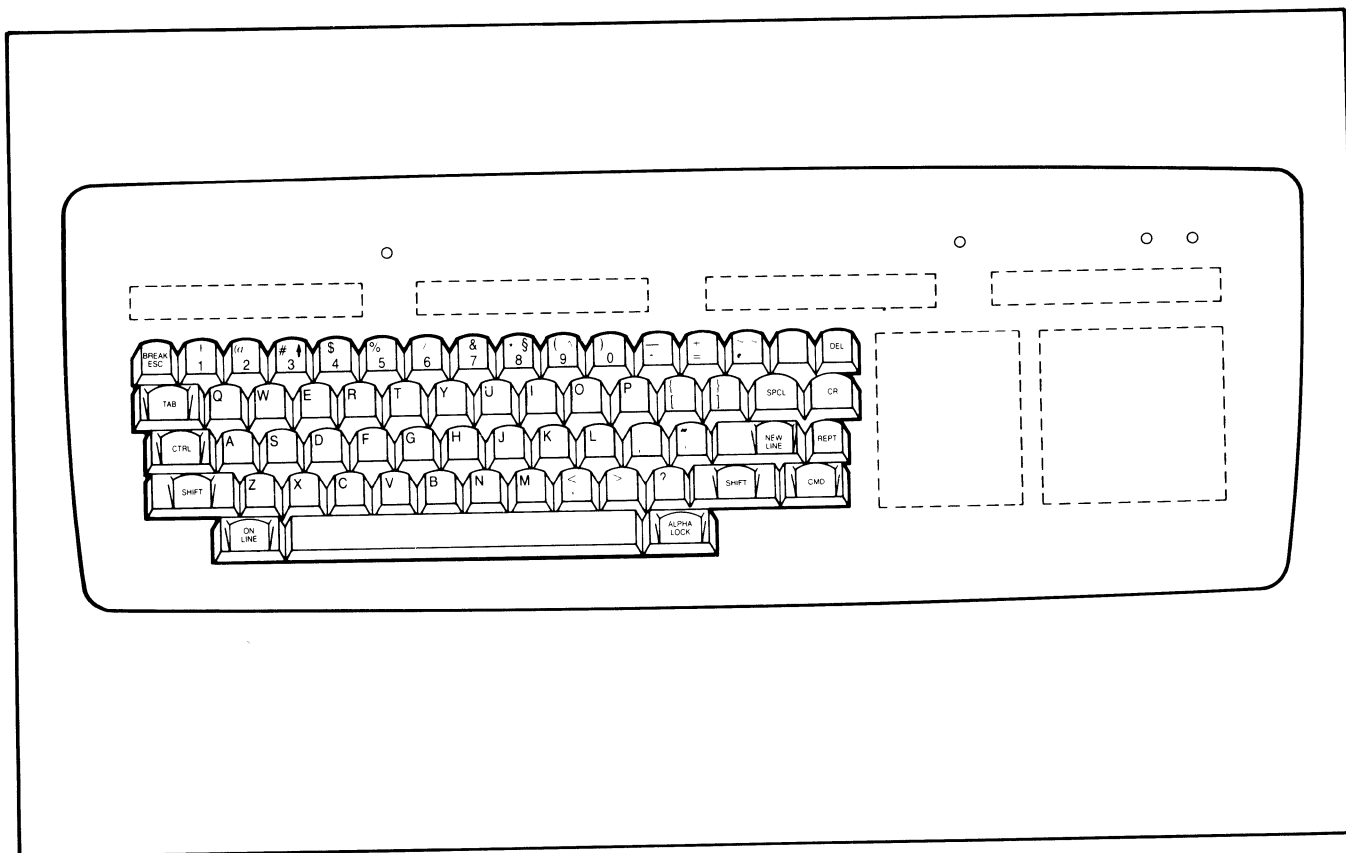

Figure 2-3. Main Keypad

attempt to go on-line automatically. As a result, the ON LINE lamp will either be on or blinking after power-up.

- **ALPHA LOCK** — This is an alternate action key that places all alphabetic keys in the uppercase mode the same way a shift-lock key does on a typewriter. ALPHA LOCK does not affect numeric or special symbol keys. The ALPHA LOCK lamp will light when the uppercase mode is in effect.
- **CMD** — Depressing this key alone has no effect. When CMD is depressed and held down while another key is depressed, the command code of the other key is generated.
- **REPT** — Depressing this key alone has no effect. When REPT is depressed along with another code-generating key or key combination, the code is repeated at a rate of 30 times a second. This key will override the normal typematic feature of the keyboard. When the terminal is on-line and set to operate at less than 300 baud, the repeat rate is limited by the baud rate.
- **NEW LINE** — Depressing this key moves the cursor to the beginning of the next line (row).
- **CR** — Depressing this key moves the cursor to the beginning of the current line.
- **DEL** — Depressing this key has no effect off-line.
- **SPCL** — Depressing this key and then depressing certain sequences of other keys, as shown in Table 2-1, results in one of 45 possible DG International characters being displayed on the screen. Since only the D211 uses the international character set, this key is not in use on the D210 keyboard.

**NOTE:** *The SPCL key has no effect when the D211 terminal is operating in Data General 7-bit mode. It may only be used for 8-bit Data General operations and for both 7- and 8-bit ANSI operations.*

The SPCL key provides limited “overstrike” capability for the D211 terminal. When the SPCL key is pressed, the terminal combines the next two keyboard strokes into one of the appropriate international accented characters as shown in Table 2-1. (The SPCL key does not need to be held while pressing the next key.) If the combination of keyboard strokes following the SPCL key does not produce a valid accented character, then the cursor remains in place and no character is displayed.

The particular characters shown in Table 2-1 produced by the SPCL key combination sequences will only be displayed if the secondary character set for the D211 is the default DG International set.

**NOTE:** *See Appendix B for the octal codes produced by each SPCL key combination*

**Table 2-1. SPCL Key Sequences**

Depress SPCL Key		Character Displayed
Then Depress	Then Depress	
A	^	â (Â)
A	..	à (À)
A	/	á (Á)
A	~	á (Á)
A	o	ã (Ã)
A	o	ã (Ã)
e	^	ê (Ê)
e	..	è (È)
e	/	é (É)
e	~	é (É)
i	^	î (Î)
i	..	ì (Ì)
i	/	í (Í)
i	~	í (Í)
o	^	ô (Ô)
o	..	ò (Ò)
o	/	ó (Ó)
o	~	ó (Ó)
u	^	û (Û)
u	..	ù (Ù)
u	/	ú (Ú)
u	~	ú (Ú)
n		ñ (Ñ)
L	—	£
	(?)	(¿)
	(!)	(¡)
	↑	↑
	§	§
	X	⌘
o	^	ˆ
space	..	˙
space	/	˘
space	~	˜
space	o	o
a	e	æ (Æ)
c	,	ç (Ç)
o	e	œ (Œ)
s	s	ß
o	~	ô (Ô)
c	/	ç
o	/	ø (Ø)

**NOTE:** Parentheses ( ) indicate the character displayed when the Shift Key is depressed and held down while the character is depressed.  
 Keys that produce special character accents such as “ˆ” are identified by the symbols printed in the upper right corner of certain numeric key faces.  
 Once the SPCL Key has been depressed, the order in which the other keys are pressed does not matter.

### Screen Management Keypad

The screen management keypad is shown in Figure 2-4. The four keys labeled C1, C2, C3, and C4 are user function keys and may be re-defined by the user. The remaining keys on the screen management keypad perform the following off-line functions:

- **ERASE PAGE** — Depressing this key clears the screen and moves the cursor to the first column of the top row of the screen (cursor home position).

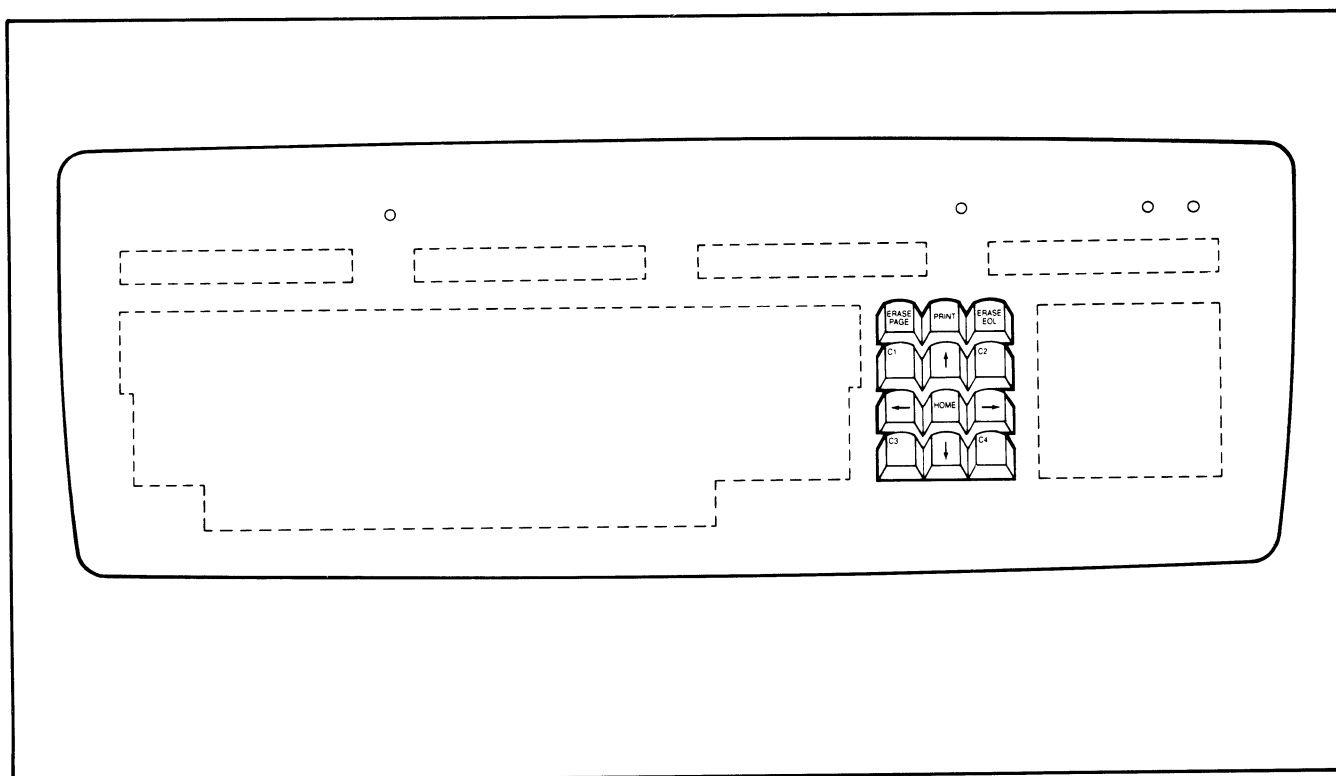

Figure 2-4. Screen Management Keypad

- **PRINT** — Depressing this key has no effect.
- **ERASE EOL** — Depressing this key erases characters from the current cursor position to the end of the current row. The cursor position is not changed with this key.
- **Cursor Up** — Depressing this key moves the cursor up one row. If the cursor is on the top row of the screen, it moves to the bottom row of the screen in the same column.
- **Cursor Down** — Depressing this key moves the cursor down one row in the current column. If the cursor is on the bottom row of the screen, it moves to the top row of the screen in the same column.
- **Cursor Left** — Depressing this key moves the cursor one column position to the left on the current row. If the cursor is at the first column of a row, it moves to the last column of the previous row.
- **Cursor Right** — Depressing this key moves the cursor one column position to the right on the current row. If the cursor is at the last column of the row, it moves to the first column of the next row. If the cursor is at the last column of the last row of the screen, the screen is normally scrolled up one line and the cursor moves to the first column of the new bottom row. The roll enable/disable programming commands determine whether or not the screen image will scroll up or the cursor is moved to the first column of the first row.
- **HOME** — Depressing this key moves the cursor to the first column of the first row.

## Numeric Keypad

The numeric keypad is shown in Figure 2-5. All of the keys on the numeric keypad are duplicated on the main keypad; their arrangement on the numeric keypad makes the entry of numerical data easier.

## User Function Keys

The user function keys are shown in Figure 2-5 also. In addition to keys F1 through F15, the keys C1 through C4, PRINT, and the cursor positioning keys can all be considered user function keys when used as shown in Appendix C. Appendix C lists the code sequences generated by the user function keys. User function keys have no effect in the off-line mode and are intended for on-line use with the host software.

## Local Print Key (D211 Only)

The Local Print key is shown in Figure 2-6. This key should not be confused with the PRINT key that is on the screen management keypad. The Local Print key has the same effect whether the D211 terminal is on-line or off-line. (The other four local function keys are reserved.)

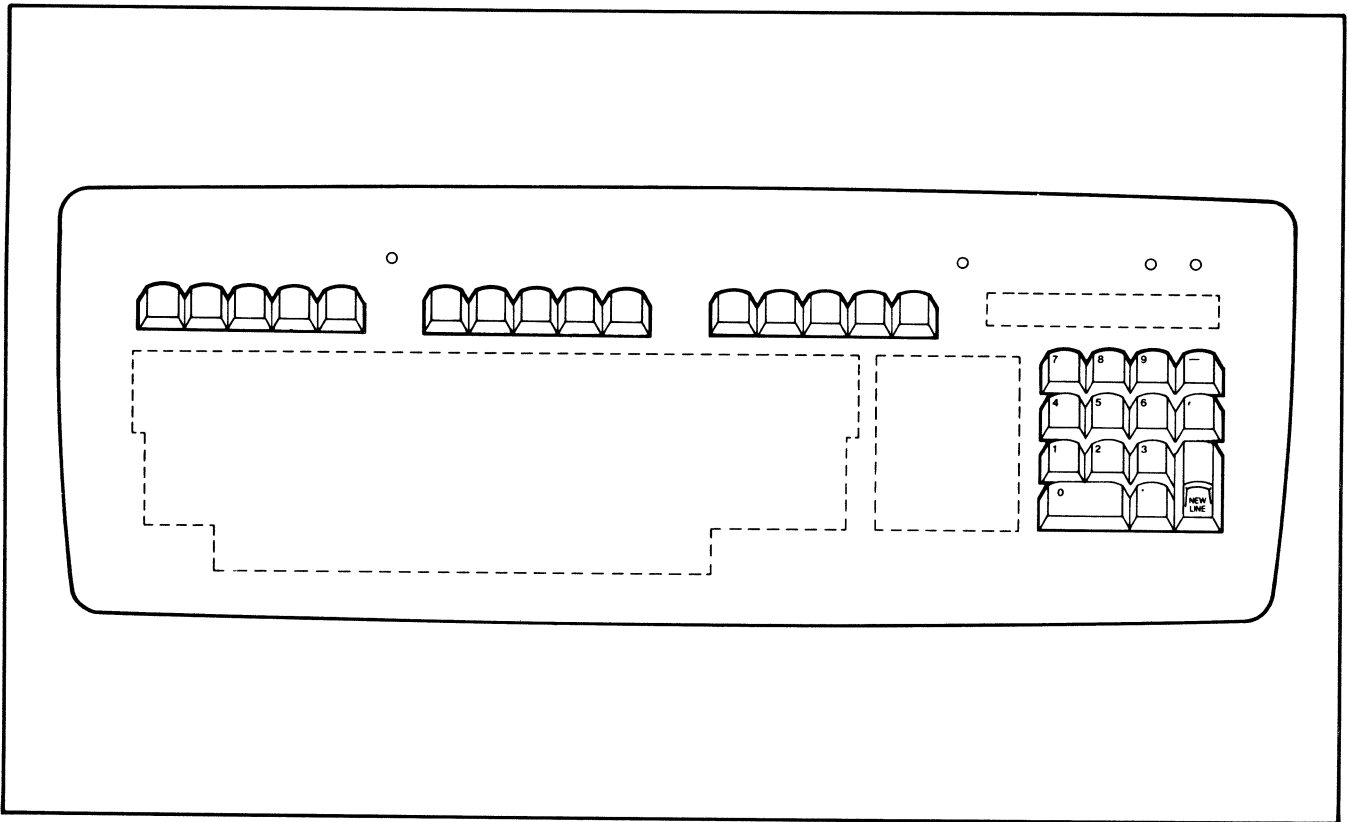

Figure 2-5. Numeric Keypad and User Function Keys

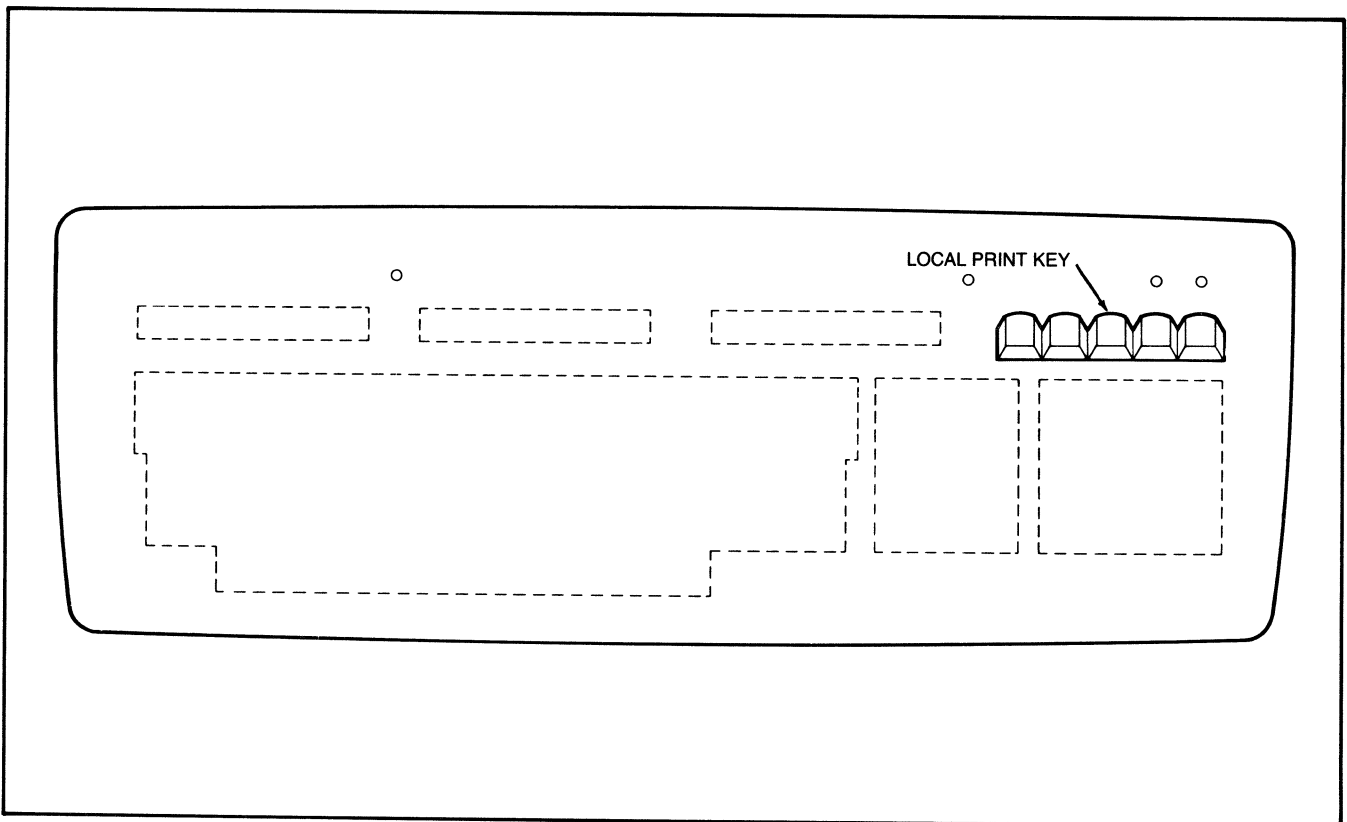

Figure 2-6. Local Function Keys and Lamp

The Local Print key has no effect unless an operating printer is connected to the terminal. This key may be used alone or with the SHIFT key to produce two different printing operations:

- When Local Print is depressed alone, the contents of the current terminal screen, beginning with the row containing the cursor, are transmitted to the printer. During printing, data entered at the keyboard is ignored and lost. The printing can be aborted before the complete screen has been printed by depressing Local Print a second time (or CMD-CR).
- When SHIFT is depressed and held down while Local Print is depressed, only characters appearing at full intensity on the screen are printed. Dimmed text is transmitted as space characters and reverse video spaces are output as non-reverse video characters.

## Terminal Power-Up/Power-Down Procedures

The power on/off control is located on the left rear of the display unit.

### Power-Up Procedure

Before applying power, verify that the terminal has been installed in accordance with the procedures in Chapter 4. The power application steps in the following procedure will work whether or not a host computer is connected to the terminal:

1. Apply power to the terminal by setting the power control to the “on” position.
2. When first turned on, the terminal executes a self-test to verify terminal operation. (The self-test takes less than one second.) The following sequence of events occurs during the self-test:
  - a. Immediately after power is applied, the bell rings and the ON LINE and ALPHA LOCK lamps on the keyboard turn on.
  - b. The keyboard lamps remain on as the circuitry inside the terminal is automatically checked to verify everything is in good working condition.
  - c. As the self-test completes, the terminal bell rings a second time and the ALPHA LOCK lamp turns off. The ON LINE lamp will remain lighted if the terminal is connected correctly to a host computer. If no host connection exists, or if modems are used for communications with the host, the ON LINE lamp blinks. If modems are used, the ON LINE lamp will stop blinking and remain on when the modem is ready for communications with the remote host.

- d. The reverse video block cursor appears in the screen home (upper-left corner) character position, along with a self-test diagnostic message.

**NOTE:** *When the terminal is not connected to a host computer, the ON LINE lamp will blink until CMD is depressed and held down while ON LINE is depressed (CMD-ON LINE). Then the ON LINE lamp will turn off to indicate the terminal is off-line.*

3. If the terminal is to be operated on-line, log on the host computer in accordance with the host software requirements. The details of this step should be found in the host system software documentation.

The descriptions of keyboard controls and indicators earlier in this chapter summarize off-line operation of the terminal. On-line operation is defined by the host software as well as the terminal itself.

### Power-Down Procedure

During normal use, the D210/211 terminal should be turned off only when it is not expected to be used for several hours.

If the terminal is not connected to a host computer system, turn off power by setting the power control on the rear of the display unit to “off”.

If the terminal is connected to a host computer system, first log off the host software before shutting off the power. To log off the host software, the terminal must be on-line (ON LINE lamp on). The CMD-ON LINE key sequence is used to switch the terminal between the on-line and off-line modes.

## Operating Procedures

The operating characteristics of the D210/211 terminal depend on whether the terminal is being used off-line by itself or on-line with a host computer.

On-line operation is controlled by the host. Read host system and application documentation for detailed operating instructions pertaining to the host-resident software. Off-line operation receives more attention in this user’s manual because the user can exercise the same terminal features (and commands) off-line that the host computer can when the terminal is on-line.

### On-Line Operation

Before D210/211 terminal can be operated on-line, the steps of the Power-up Procedure described above must be followed.

With these initial steps completed, the terminal is ready for communications with the host computer and its software. As discussed earlier in this chapter, the

## Operation

performance of the terminal is under control of the operating system and any other host software used. The host software documentation is the primary source of terminal operating instructions when the terminal is on-line.

To switch the terminal off-line, depress CMD-ON LINE and the ON LINE lamp will turn off.

### Off-Line Operation

Off-line, the D210/211 terminal can be used as a training and software debugging tool. The user can manually (from the keyboard) exercise the same terminal features and commands that the host computer can exercise under on-line conditions. The following paragraphs provide general guidelines to off-line operation.

As mentioned earlier, the descriptions of keyboard controls and indicators in this chapter define how the terminal responds off-line when the various keys are depressed. Chapter 3 and Appendix E contain all of the D210/211 terminal commands. These commands can be entered from the keyboard by keying in the appropriate ASCII control codes or character sequences for the associated commands.

When the terminal is operating in Data General mode, some of the commands use special ASCII control code characters that do not have a corresponding key on the keyboard. These characters fall in the range of <000> to <037>. Appendix A shows how to produce these characters from the keyboard. The <036> code is used occasionally in the Data General commands and can only be produced from the keyboard by depressing and holding down CMD while depressing BREAK ESC (CMD-BREAK ESC) with the terminal off-line.

When the terminal is operating in ANSI mode, some of the terminal commands also use characters that do not have corresponding keys on the keyboard (also falling in the <000> to <037> range). However, these characters may generally be produced by using the CTRL key in conjunction with one of the main keypad keys. Appendix A also shows how to produce each of these characters.

The command execution procedure that follows can be used to execute the terminal commands off-line. Off-line operation can be aborted in favor of on-line operation by depressing CMD-ON LINE at any point in the procedure. However, the terminal environment established off-line (character attributes, etc.) will remain in effect until reestablished by the host software.

#### Command Execution Procedure:

1. With the terminal off-line and using the Programming Chapter or Appendix E as a reference, enter a command on the keyboard. (The command will not be displayed.)

2. The command will be executed as soon as it is completely entered at the keyboard.
3. Repeat steps 1 and 2 for each command to be executed.

**NOTE:** *If an error is made entering a command, the command will be ignored. Retype the command correctly.*

For a thorough example demonstrating the entry of terminal commands off-line, read the terminal off-line checkout and demonstration procedure in Chapter 4.

## USER MAINTENANCE

User maintenance can be divided into two categories: preventive maintenance and problem diagnosis.

Preventive maintenance for the D210/211 terminal primarily involves maintaining a clean, dust-free environment that conforms to the specifications listed in the site requirements portion of Chapter 4. If dust or dirt accumulates on any of the terminal equipment, wipe the equipment with a clean, dry, dust-free cloth. Also, be careful not to obstruct the cooling vent area on top of the display unit.

If a problem appears to develop with the terminal, the user can take a few steps to solve the problem before calling on Data General Field Service for help. See Table 2-2 for a list of failure symptoms and the corresponding solutions. If the suggested solution does not fix the failure, or if an obviously serious problem occurs, contact the nearest Data General Field Service Office for help.

**Table 2-2. Terminal Problem Diagnosis**

Failure Symptom	Solution
Nothing happens when terminal is turned on.	Check terminal power cord connection and verify ac power source to cord is turned on.
Bell does not ring or keyboard lamps do not light when terminal is turned on.	Verify keyboard cable connection to rear of display unit is secure.
Cursor is not displayed on screen within 10 to 15 seconds after power to terminal is turned on.	Adjust power/brightness control slide on display unit to the right to ensure that screen brightness is not turned too far down for viewing.
Error message displayed when terminal is turned on.	Contact local Data General Office for help. Try using the terminal even though error message appears; the failure may not be fatal to terminal operation.
Terminal will not go on-line (ON LINE lamp blinking or off).	Verify cable connection from host to terminal is secure; if a user-supplied cable is installed, verify terminal end of cable is wired as shown in Chapter 4.



**Table 2-2. Terminal Problem Diagnosis (continued)**

Failure Symptom	Solution
Data entered at keyboard is not displayed when on-line.	Depress CTRL-Q to unfreeze screen.
UART error character displayed (reverse video block).	Verify baud rate and parity DIP switches at rear of display unit are set as intended. If switches must be reset, go off-line and then back on-line to reprogram UART with new settings.
Data entered at keyboard is not the same as data displayed.	Verify that all DIP switches are set as intended. Turn the power off and then on again to reset the terminal and ensure that the display character set matches keyboard nationality.



# CHAPTER 3

## PROGRAMMING

### GENERAL

This chapter contains the following information for the user who intends to write host-resident software for the D210/211 terminal:

- Description of host/terminal communications and requirements that must be met by the host-resident software
- Description of printer operations and communications
- Definition of all ASCII codes generated by the keyboard
- Conceptual overview of the programmable features of the terminal coupled with an introduction to D210/211 commands
- Detailed description of all D210/211 commands

The D210/211 terminal is compatible with earlier model D100/200 display terminals, such as the Dasher D200. Host software written to run with the D200 will do the same for the D210/211. In addition, the D210/211 provides some of the functionality of the D400/450 terminal and the new D410/460 series.

A significant new feature of the D210/211 terminal is that it may be operated in either the standard Data General mode used in past DG terminal products or in the newly implemented ANSI mode. In addition, the D211 supports both 7- and 8-bit operations which allows for an extended range of character selection. These various modes of operation are described in the next section, "Host/Terminal Communications."

Appendix E lists the command codes and code sequences for all D210/211 commands in a more compact format than presented in this chapter.

### HOST/TERMINAL COMMUNICATIONS

This section describes the host/terminal communications (terminal input/output) for the D210/211 terminals. The first part gives a general overview of

host/terminal communications strategy. The second section describes the various modes of terminal operation and how the selection of one of these modes affects host-to-terminal communications.

### General Overview

For the programmer planning to develop host-resident software for the D210/211 terminal, the basic terminal consists of two independent devices when on-line with the host computer. First is the keyboard, which serves primarily as an input device that generates ASCII characters for interpretation by the host. Second is the display unit, the primary output device that interprets the commands from the host to control the appearance of the display screen image. Communications between the keyboard and display unit is provided by the host computer software.

Input from the keyboard consists of characters for display on the screen, control codes, and command sequences. Characters entered at the keyboard for display must be echoed back to the display unit screen by the host. Control codes and command sequences from the keyboard may be echoed back to the display unit or used to invoke special functions in the host software. The keyboard serves as an output device in the sense that it contains the terminal bell. To ring the bell, the host must issue a "bell" command to the display unit, which in turn rings the bell in the keyboard.

The display unit functions primarily as an output device that responds to the ASCII display and control/command sequences from the host/keyboard combination. A few of the ASCII character sequences (commands) do request status/configuration information from the display unit; in these cases the display unit functions as an input device. The display unit is capable of interpreting many character sequences that cannot be generated on-line from the keyboard, and therefore must originate from the host. This chapter describes in detail all of the characters and control/command sequences that the display unit can interpret.

The D210/211 terminal is a serial device. The host computer and the optional printer device (for the D211 only) communicate with the terminal through two separate serial interfaces. The terminal transmit and re-

ceive baud rates and serial character format are selected with dual-inline-package (DIP) switches at the rear of the terminal. These switch settings are sampled and used to control terminal communications when the terminal is powered up or switched from off-line to on-line operation. Even though the bit transmission rate is set with the baud rate switches, compatibility with DGC operating systems requires that the D210/211 terminal transmit characters to the host at a maximum rate of 60 characters per second (the rate falls below 60 with baud rates of less than 600).

The D210/211 terminal processes all display characters and most commands within the time it takes to receive them (within 2 ms) when the baud rate is 4800 or less. The terminal makes use of a 256-byte input buffer to hold accumulated ASCII characters.

As the input buffer approaches its capacity, the terminal automatically issues a CTRL-S (ASCII DC3 or <023>) to signal the host to stop transmitting characters. After receipt of the CTRL-S, the host must send no more than 64 characters before halting the character flow to the terminal. If the host does not react to the CTRL-S quickly enough, the terminal input buffer will fill and additional characters from the host will be lost. As characters are removed from the input buffer for processing, the terminal sends a CTRL-Q (ASCII DC1 or <021>) to the host to resume transmission when 64 characters remain in the buffer. The host must respond before the input buffer is emptied to avoid a stuttering effect on the display screen.

## Modes of Terminal Operation

The D210 terminal can operate in one of the following two modes:

- Data General 7-bit
- ANSI Standard 7-bit

The D211 terminal can operate in one of the following four modes:

- Data General 7-bit
- Data General 8-bit
- ANSI Standard 7-bit
- ANSI Standard 8-bit

An overview of each of these modes of operation follows.

### Data General Mode

When the terminal operates in Data General (DG) mode, software compatibility exists between the D210/211 series and the Data General D100/200 series (and, to a certain extent, with the D400 series as well). Data General customers may continue to use software developed for the Data General family by operating the terminal in DG mode.

### ANSI Standard Mode

When the terminal operates in ANSI Standard mode, compatibility exists with other ANSI terminals and systems. The D210/211 terminal may be easily integrated into a system using ANSI standards by simply selecting the ANSI mode of operation. When in ANSI mode, the terminal operation conforms to the following ANSI standards: ANSI X3.4-1977 (Definition of the ASCII Character Set and Associated Controls), ANSI X3.41-1974 (Methods of Extending the Seven Bit ASCII Set and the Structure of an Eight Bit Character Set), and ANSI X3.64-1979 (Additional Controls For Character Imaging Devices). Not all of these ANSI standards are implemented; only those necessary to cover the functionality of the D210/211 are included in the command set.

### Seven-Bit Operation Mode

The D210/211 terminals support 7-bit operation in both Data General and ANSI operating modes. Previous Data General terminals operated in 7-bit mode exclusively. The 7-bit implementation in the D210/211 is fully compatible with existing DG terminals which use a 7-bit command stream.

### Eight-Bit Operation Mode

Only the D211 supports 8-bit operations. The D210 must be operated in 7-bit mode exclusively. The 8-bit operation mode for the D211 allows for easier access to character sets. Data General 8-bit mode is downward compatible with DG-7 bit operations; that is, the SPCL key and a few of the DG commands function only (or differently) when the 8-bit mode is in effect. In contrast, ANSI 8-bit operations are fully compatible with ANSI 7-bit operations.

### Mode Selection

The selection of either ANSI or DG mode and either 7- or 8-bit operations is initially made with a hardware switch at the back of the terminal. Following power-up, these modes may be changed (under certain conditions) with software commands.

For the D211 terminal, there are two switches on the back of the terminal which select the communication and operating mode on power-up. One of these switches selects the number of data bits for the Host UART as either 7 or 8, and the other switch selects the operating mode as Data General (DG) or ANSI. Since the D210 has a fixed 7-bit operation, it has only one switch which is used to select either Data General or ANSI mode. A software command also exists for the D210/211 which allows for selection of either Data General or ANSI operating modes.

Selection of the 7/8-bit mode for the D211 is made by the 7/8-bit switch setting on the back of the terminal. If the terminal is set for 8-bit operations, a software command may be used to alternate between 7- and 8-

bit operations. If the hardware switch is set for 7-bit operations, the software command to select data bit operations is disabled, and the hardware switch must then be used to select 8-bit operations.

## PRINTER COMMUNICATIONS (D211 Only)

The D211 supports an optional 7/8-bit serial printer. The printer is a slave output device controlled by the host or the display unit with two dedicated commands. The contents of the display screen may be printed on command from the host or by a user request with a dedicated Local Print key. A carriage return (CR) and line feed (LF) sequence are output at the beginning of a print operation and at the end of each character row output to the printer. The display unit acknowledges the normal completion or abnormal termination of a printing operation initiated by the host by returning an ACK ((006)) to the host computer. A print operation in progress can be terminated from the keyboard by depressing the Local Print key or the CMD-CR keys.

Communications protocol between the printer and display unit is implemented via a hardware busy line that runs from the printer to the display unit) and/or by a software busy (XON/XOFF protocol).

Printer baud rates available are from 110 to 19200. The data format for the print operations may be either 7 or 8 bits. A DIP switch on the back of the D211 selects either 7- or 8-bit printer operations. For 7-bit communications, the printer UART uses even parity, 7 data bits, and 1 stop bit. For 8-bit communications, the printer UART uses no parity, 8 data bits, and 2 stop bits.

When the printer is selected for 7-bit operations, only 94 printable characters (plus the space and delete characters) are allowed in the character set. The terminal assumes the character set in the printer matches the terminal display language. When the printer is selected for 8-bit operations, the terminal assumes that the U.S. ASCII and the Data General International character sets are present in the printer. The chief difference between 7- and 8-bit printer operations is that for a 7-bit printer, only the primary character set can be printed. For the 8-bit printer, both primary and secondary language sets may be printed.

## KEYBOARD CODES

The D210/211 keyboard can generate the full set of 95 displayable ASCII character codes, the delete code, and 30 of the 32 ASCII control codes when the terminal is on-line. These codes and the keys used to generate them are listed in Appendices A and B. Those control codes in Appendix A that do not have dedicated control functions in the terminal and are not used by the host operating system may be used by the programmer to initiate special "user functions" in the host software.

The two ASCII control codes that cannot be generated separately from the keyboard when the terminal is on-line are (036) and (037). When the terminal is operating in Data General mode (as opposed to ANSI mode), a few of the terminal commands use the command header code (036). The (037) code is used in only one case: as a header to the terminal's response to a read cursor location command (DG mode only) from the host.

The (036) command header code can be generated from the keyboard when the terminal is off-line by depressing and holding the CMD key and then pressing the BREAK ESC keys simultaneously (CMD-BREAK ESC).

**NOTE:** *The notation "CMD-BREAK ESC" or "CTRL-A" and so forth used in this manual to denote a pair of key sequences means that the first key specified is to be depressed and held while the second key is then depressed simultaneously.*

Because the (036) code is used by the terminal when it is operating in DG mode, this makes the off-line mode valuable to the programmer as a learning and debugging tool. All command sequences (in both DG and ANSI modes) that the D210/211 terminal is capable of recognizing while on-line can be generated from the keyboard in the off-line mode.

Appendix C lists the two-code sequences that can be generated from the D210/211 keyboard. None of these two-code sequences invoke dedicated control functions in the terminal. These sequences, therefore, can be used by the programmer to initiate special "user functions" in the host software, similar to the unused single control codes in Appendix A.

## DISPLAY UNIT PROGRAMMING

The following paragraphs describe how the D210/211 display unit responds to ASCII character codes and code sequences (commands) from either the keyboard (off-line operation) or host computer (on-line operation). The programming coverage is divided into the following major topics:

1. Display screen organization
2. Command set overview
3. Command descriptions (Data General operations)
4. Command descriptions (ANSI Standard operations)

The first section describes the display screen memory and how it is affected by scrolling. The second section introduces the D210/211 commands and describes in general terms how they can be manipulated to exercise the features of the terminal. The last two sections

describe the D210/211 programming commands in detail; the third section covers the terminal when it is operating in Data General mode, while the fourth section covers the ANSI mode of operation.

### Display Screen Organization

The display screen memory for the D210/211 terminal consists of 24 rows of 80 columns each for a total of 1920 character positions. Since the D100/200 terminals have the same size screen, compatibility is retained with the D210/211 command set.

Vertical scrolling operations on the screen occur in single increments ("jump" scrolling). When a New Line command is received with the cursor on the bottom line of the screen and the screen roll is enabled, the screen contents roll up one row. The terminal scroll rate is baud-dependent.

### Command Set Overview

The D210/211 command set for a terminal operating in Data General mode includes 27 commands common to both the D210 and D211 terminals with 7 additional commands unique to the D211. The total of 34 commands can be divided functionally into 8 groups, as listed in Table 3-1. The following paragraphs provide an overview of the terminal capabilities by describing the highlights of each command group.

Table 3-1. D210/211 Data General Commands by Category

<p><b>SCREEN ROLL COMMANDS</b></p> <ul style="list-style-type: none"> <li>• Roll Disable</li> <li>• Roll Enable</li> </ul>	<p><b>CHARACTER ATTRIBUTE COMMANDS</b></p> <ul style="list-style-type: none"> <li>• Blink Disable</li> <li>• Blink Enable</li> <li>• Blink Off</li> <li>• Blink On</li> <li>• Dim Off</li> <li>• Dim On</li> <li>• Reverse Video Off</li> <li>• Reverse Video On</li> <li>• Underscore Off</li> <li>• Underscore On</li> </ul>
<p><b>CURSOR COMMANDS</b></p> <ul style="list-style-type: none"> <li>• Carriage Return</li> <li>• Cursor Home</li> <li>• Cursor Down</li> <li>• Cursor Left</li> <li>• Cursor Right</li> <li>• Cursor Up</li> <li>• New Line</li> <li>• Read Cursor Address</li> <li>• Write Cursor Address</li> </ul>	<p><b>OPERATION MODE COMMANDS</b></p> <ul style="list-style-type: none"> <li>• Select ANSI/DG Mode</li> <li>• Select 7/8-Bit Operation (D211 Only)</li> </ul>
<p><b>SCREEN ERASE COMMANDS</b></p> <ul style="list-style-type: none"> <li>• Erase End-Of-Line</li> <li>• Erase End-Of-Screen</li> <li>• Erase Screen</li> </ul>	<p><b>PRINTER COMMANDS (D211 Only)</b></p> <ul style="list-style-type: none"> <li>• Print Screen</li> <li>• Print Screen Form</li> </ul>
<p><b>TERMINAL DEVICE COMMANDS</b></p> <ul style="list-style-type: none"> <li>• Bell</li> <li>• Read Model Identification</li> </ul>	<p><b>CHARACTER SET COMMANDS (D211 Only)</b></p> <ul style="list-style-type: none"> <li>• Primary Character Set Enable</li> <li>• Secondary Character Set Enable</li> <li>• Select Character Set</li> <li>• Set Keyboard Language</li> </ul>

**NOTE:** *The following overview covers the command set when the terminal is in Data General mode. Although the DG and ANSI command sets do not have a strict one-to-one correspondence, the following section provides a general description of the D210/211 function when operating in either DG or ANSI mode.*

#### Screen Roll Commands

The screen roll command group is used to enable or disable vertical scrolling.

Screen roll is enabled at power-up. This means that an automatic scroll up occurs when the cursor is on the bottom row of the screen and a New Line command is issued. Screen roll can be disabled or enabled on command (Roll Disable or Roll Enable).

#### Cursor Commands

The cursor command group is used to position the cursor on the screen and to read the cursor's location.

The Cursor Up, Down, Left, Right, New Line, and Carriage Return commands are all cursor-relative positioning commands. The destination location is relative to the current location. The Cursor Home command is an absolute cursor positioning command and moves the cursor to the first column of the top row on the screen (the "home" position). Another absolute cursor positioning command is Write Cursor Address which moves the cursor to an explicitly specified row and column.

The host computer may read the current row and column position of the cursor with the Read Cursor Address command.

#### Character Attribute Commands

The character attribute command group is used to control the four character attributes: blink, dim, underscore, and reverse video.

Character attributes are on a character by character basis and may be used one at a time or in any combination. When used, the blink, dim, underscore, and reverse video attributes affect the appearance of the displayed characters. Character blinking can be enabled or disabled for all of display screen memory with the Blink Enable and Blink Disable commands. When the terminal is powered up, blinking is automatically enabled.

#### Screen Erase Commands

The screen erase command group is used to perform erase operations. The entire terminal screen can be completely erased with the Erase Screen command or it may be selectively erased with the Erase To End-Of-Screen command. In addition, the Erase To End-Of-Line command permits erasing of a complete line or portions of a line.

## Terminal Device Commands

There are two commands in the terminal device command group: Bell and Read Model ID. The Bell command rings the bell in the keyboard once. The Read Model ID command returns such information as the terminal type, the hardware status (printer ready, 7/8-bit setting), the firmware revision level, and the current keyboard language.

## Operation Mode Select Commands

The D210/211 terminal may be operated in either Data General or ANSI mode. When operating in DG mode, the command Select ANSI Mode may be issued to switch the terminal operation to ANSI mode. When operating in ANSI mode, the command Reset Mode may be issued to switch the terminal operation to the standard Data General mode.

The D211 terminal may be operated in either 7- or 8-bit mode. When the hardware switch at the back of the terminal is set to 8-bit mode, the command Select 7/8 Bit Operations may be issued to alternate between 7- and 8-bit data operations. If the hardware switch is set to 7-bit mode, 8-bit selection via a software command is not possible.

The operating mode of the D210/211 terminal is initially set by a hardware switch at the back of the terminal. This set of commands allows software selection of the terminal's operating mode(s).

## Printer Commands (D211 Only)

The printer command group is used to control two print modes: print screen and print screen form. The Print Screen and Print Screen Form commands perform the same function as the Local Print and SHIFT-Local Print key sequences, respectively. These commands allow an entire terminal screen, or portions thereof, to be transmitted to a serial printer connected to the terminal.

## Character Set Select Commands (D211 Only)

The character set select command group is used to select the character set for display on the screen. Display character sets are referred to as "primary" or "secondary" character sets. The D210 terminal version uses only a primary character set while the D211 version allows both a primary and secondary character set.

The primary character set is the set initially displayed, and may be reassigned to any of the available character sets with the Select Character Set command. The primary set remains the display set until the secondary set is enabled with the Secondary Character Set Enable command. Once the secondary set is enabled, it too may be reassigned to any of the available sets without affecting the previously chosen primary character set. The character set select commands, there-

fore, allow switching between character sets and the assignment of any available set as primary or secondary.

## Character Sets Available

The standard ASCII United States character set (only) is furnished in the D210 terminal. The character sets available for the D211 terminal (only) are shown in Table 3-2.

Table 3-2. D211 Character Sets

Keyboard Nationality	Type of Character Set
• United States	(ASCII standard)
• United Kingdom	(ISO standard)
• French	(ISO standard)
• German	(ISO standard)
• Swedish/Finnish	(ISO standard)
• Spanish	(DG private)
• Danish/Norwegian	(DG private)
• Swiss	(DG private)
• DG International	(DG private)

The primary display language for the D210 terminal (operating in either Data General or ANSI mode) is the standard U.S. ASCII character set. (Note that the D210 version does not have a secondary character set.)

For the D211 terminal, primary and secondary character sets are available for both Data General and ANSI modes of operation. Below are the default (power-up) primary and secondary display languages for the D211:

Terminal Mode	Primary	Secondary
Data General 7-bit	KYBD	DG INT
Data General 8-bit	U.S.	DG INT
ANSI Standard 7-bit	U.S.	DG INT
ANSI Standard 8-bit	U.S.	DG INT

**To Summarize:** At any one time, the D211 terminal maintains both a primary character set and a secondary character set. These two sets may be the same or different; both sets are selected from the composite list of 9 sets as shown in Table 3-2 with the Select Character Set command. Only the primary or secondary character set may be in effect at any one time. The Primary Character Set Enable command causes the primary character set to be used and displayed. The Secondary Character Set Enable command causes the secondary character set to be the one in current use. When the terminal is turned on, the character set matching the keyboard nationality is assigned as the primary character set and the Data General International character set is assigned as the secondary set.

Finally, when the terminal is operating in 8-bit mode, the user has immediate and direct access to both primary and secondary character sets without having to use the character set enable commands. To retain compatibility between 7- and 8-bit operations, however, the character set select commands will work the same for 8-bit operations as they do for 7-bit operations.

## Command Descriptions

The D210/211 terminal recognizes two modes of command operation: the standard Data General operating mode and the newly implemented ANSI operating mode. Data General customers may continue to use software designed for the Data General family of terminals by operating the D210/211 terminal in the Data General mode of operation. The terminal may also be set to ANSI operation mode (via software selection or hardware switch configuration). This mode allows D210/211 commands to be invoked with standard ANSI control sequences.

When the terminal is powered on, a hardware switch setting determines the initial mode of operation. The switch may be set to either Data General Mode or to ANSI Mode. Once the switch is set, however, the hardware mode selection may be overridden by issuing a command to the terminal.

If the terminal is operating in Data General mode, it may be set to ANSI mode by invoking the Select ANSI Mode control code sequence (`<036><106><100>`). If the terminal is in ANSI mode, it may be set to Data General mode by issuing the Reset Mode control code sequence (`<<CSI><074><063><154>`). These commands are described in the appropriate Data General Commands and ANSI Commands sections which follow.

In ANSI operation mode, the terminal will not respond to standardized Data General control sequences. The D210/211, however, does provide the same functional features found in Data General mode while operating in ANSI mode. ANSI Standards X3.4-1977, X3.41-1974, and X3.64-1979 were used in the implementation of the ANSI operating mode, and references are made to these documents in the description of the ANSI command control code sequences.

In Data General operation mode, compatibility exists with the the Data General D100/200 terminal series, as well as downward compatibility with the D400 terminal family (D400, D410, D450, D460). Throughout this chapter, references will be made to Data General mode or to ANSI Standard mode. These two terms refer to software compatibility while operating in one of these two modes.

Since the control code sequences for invoking commands are completely different for Data General and ANSI operation modes, the D210/211 command set is described in two sections: Data General Operation Mode and ANSI Standard Operation Mode. Control code sequences **cannot** be mixed between modes. The terminal must either be in a "Data General state" or an "ANSI state," and only one of the following two command sets will be in effect at any one time.

The first command section describes command control sequences and functionality for the terminal when op-

erating in **Data General** mode. The second command section covers the command set available while in **ANSI** operating mode. Although command function is similar for both modes of operation, a few differences do exist and command names do not always match one to one.

The format for describing each command is the same for both modes, as follows:

<b>COMMAND NAME</b>	(Command Mode)
(octal command form)	ASCII/keyboard form

Detailed description of command function and any arguments required.

These format fields specify the following information:

**COMMAND NAME** — General name of the command.

(Command Mode) — The specific mode of operation in effect for the command described. Two modes exist: Data General and ANSI Standard.

(octal command form) — The sequence of octal codes required to invoke the command.

ASCII/keyboard form — The sequence of ASCII characters that may be issued from the keyboard with the terminal off-line to invoke the command.

The Data General command set for the D210/211 is described first and then the ANSI Standard command set is presented.

**NOTE:** *Only one command set (either DG or ANSI) is in effect at any one time. Programmers that use only the Data General mode of operation may safely ignore the ANSI command descriptions. Similarly, those users who operate exclusively in ANSI mode may skip the Data General command descriptions.*

## Command Descriptions (Data General Mode)

This section describes all the commands available to the user when the terminal is in Data General mode. When operating in DG mode, the D210/211 command set is compatible with the earlier D100/200 command set.

Command sequences in DG mode which are composed of two characters begin with the ASCII code `<036>`. Command sequences comprised of three characters begin with the ASCII codes `<036><106>`. The remaining command sequence characters following an `<036>` are



always printable ASCII codes from <101> through <145>.

**NOTE:** *The header code <036> is generated off-line by typing CMD-BREAK ESC.*

Command sequences that have no meaning to the terminal are ignored. Also note that function key sequences (all of which begin with an <036> header) that are not valid D210/211 command sequences are also ignored.

The following commands are described in alphabetical order, as shown in Table 3-3.

**Table 3-3. D210/211 Data General Commands in Alphabetical Order**

Command Name	Command Name
Bell	Primary Character Set Enable*
Blink Disable	Print Screen*
Blink Enable	Print Screen Form*
Blink Off	
Blink On	
	Read Model ID
Carriage Return	Read Cursor Address
Cursor Down	Reverse Video Off
Cursor Home	Reverse Video On
Cursor Left	Roll Disable
Cursor Right	Roll Enable
Cursor Up	
	Secondary Character Set Enable*
Dim Off	Select ANSI Mode
Dim On	Select Character Set*
	Select 7/8 Bit Operation*
Erase End-of-Line	Set Keyboard Language *
Erase End-of-Screen	
Erase Screen	Underscore Off
	Underscore On
New Line	
	Write Cursor Address

\*Indicates D211 command only.

### D210/211 Data General Command Descriptions

**BELL** (Data General Mode)  
<007> CTRL-G

The terminal bell rings once.

**BLINK DISABLE** (Data General Mode)  
<004> CTRL-D

All character blinking is disabled, regardless of the state of the blink attributes assigned to display characters.

**BLINK ENABLE** (Data General Mode)  
<003> CTRL-C

Enables the blinking of any character whose blink attribute is turned on. When the terminal is powered up, the Blink Enable command is automatically executed.

**BLINK OFF** (Data General Mode)  
<017> CTRL-O

The blink attribute for each successive character following this command is turned off. This command is

issued automatically with the Erase Screen command or when the terminal is powered up.

**BLINK ON** (Data General Mode)  
<016> CTRL-N

The blink attribute for each successive character following this command is turned on. Blinking occurs for those characters with their blink attribute on if blinking has been enabled with the Blink Enable command.

**CARRIAGE RETURN** (Data General Mode)  
<015> CR or CTRL-M

The cursor is moved to the first column of the current row.

**CURSOR DOWN** (Data General Mode)  
<032> CTRL-Z

The cursor is moved down one row in the current column. If the cursor is on the bottom row of the screen, it moves to the top row (same column) of the screen.

**CURSOR HOME** (Data General Mode)  
<010> CTRL-H

The cursor is moved to the first column of the top row of the screen. This command is issued automatically with the Erase Screen command.

**CURSOR LEFT** (Data General Mode)  
<031> CTRL-Y

The cursor is moved one column to the left on the current row. If the cursor is at the first column of a row, it moves to the last column of the previous row. If the cursor is at the first column of the first row (the home position), it moves to the last column of the last row.

**CURSOR RIGHT** (Data General Mode)  
<030> CTRL-X

The cursor is moved one column to the right on the current row. If the cursor is at the last column of a row, it moves to the first column of the next row down. If the cursor is at the last column of the last row on the screen, cursor movement depends on whether or not screen roll is enabled. If screen roll is enabled, the screen contents scroll up one row and the cursor moves to the first column of the new bottom row; if screen roll is disabled, the cursor moves to the first column of the first row on the screen ("home" position).

**CURSOR UP** (Data General Mode)  
<027> CTRL-W

The cursor is moved up one row in the current column. If the cursor is on the top row of the screen, it moves to the bottom row of the screen.

**DIM OFF** (Data General Mode)  
<035> CTRL-]

The dim attribute for each successive character following this command is turned off. This command is issued automatically with the Erase Screen command or when the terminal is powered up.

**DIM ON** (Data General Mode)  
 {034} CTRL-\  
 The dim attribute for each successive character following this command is turned on. Characters that follow this command and precede the next Dim Off command will be dimmed on the display screen.

**ERASE END-OF-LINE** (Data General Mode)  
 {013} CTRL-K  
 All character positions from the cursor through the last column in the current row are erased. The cursor position is unchanged.

**ERASE END-OF-SCREEN** (Data General Mode)  
 {036}{106}{106} {036}FF  
 All characters from the cursor location to the end of the screen are erased. The cursor position is unchanged. All attributes remain in effect.

**ERASE SCREEN** (Data General Mode)  
 {014} CTRL-L  
 All characters on the screen are erased. The cursor is moved to the first column of the top row ("home" position). The blink, dim, underscore, and reverse video attributes are all turned off. All other modes remain in their current state.

**NEW LINE** (Data General Mode)  
 {012} CTRL-J  
 The cursor is moved to the first column of the next row down on the screen. If the cursor is on the last row of the screen before the command is issued, cursor movement depends on whether or not screen roll is enabled. If screen roll is enabled, the screen contents scroll up one row and the cursor is moved to the first column of the new (blank) bottom row. If screen roll is disabled, the cursor moves to the first column of the top row on the screen ("home" position)

**PRIMARY CHARACTER SET ENABLE (SHIFT IN)** (Data General Mode)  
 {036}{117} {036}O  
 D211 Only:  
 The primary character set (versus the secondary character set) is enabled for display on the screen. This command is a member of the character set select command group. This command group is used to select and switch between character sets for display on the screen as described under the command set overview paragraph. The Select Character Set command description says more about this Primary Character Set Enable command.

**NOTE:** *Only the D211 terminal responds to this command sequence; the D210 terminal version has only one character set.*

**PRINT SCREEN** (Data General Mode)  
 {021} CTRL-Q or Local Print  
 D211 Only:  
 All characters on the screen, beginning with the row

containing the cursor, are transmitted to a slave serial printer. Initiation of a print causes the terminal to transmit a {CR}{LF} sequence to the printer. An ACK {006} is returned to the host when the printing operation is completed/terminated. The print operation can be terminated before completion by depressing CMD-CR at the keyboard or by pressing the Local Print key again. Available printer baud rates are 110 to 19200 baud.

**NOTE:** *Only the D211 provides support for a slave printer device; the D210 will not respond to this command.*

**PRINT SCREEN FORM** (Data General Mode)  
 {001} CTRL-A or SHIFT-Local Print  
 D211 Only:

All full-intensity characters on the screen, beginning with the row containing the cursor, are transmitted to a slave serial printer. Dimmed text is transmitted as null characters (spaces in ASCII text mode). Reverse video spaces are output as non-reverse video characters. Initiation of a print causes the terminal to transmit a {CR}{LF} sequence to the printer. An ACK {006} is returned to the host when the printing operation is completed/terminated. The print operation can be terminated before completion by depressing CMD-CR at the keyboard or by pressing the Local Print key again. Available printer baud rates are 110 to 19200 baud.

**NOTE:** *Only the D211 provides support for a slave printer device; the D210 will not respond to this command.*

**READ MODEL ID** (Data General Mode)  
 {036}{103} {036}C  
 The terminal responds to this command by returning a 6-byte sequence to the host computer. The sequence is:

- {036} — Header Code
- {157} — Header Code
- {043} — Indicates model report data follows
- {050} — Indicates a D210/211 terminal
- {xxx} — Status 1
- {yyy} — Status 2

where xxx and yyy are variables.

The Status 1 code {xxx} contains information specifying the current state of terminal operation. This byte includes data on printer readiness (D211 only), self-test passage or failure, 7/8-bit operation, and 3 bits which indicate the current firmware revision.

The Status 2 code {yyy} contains information specifying the current keyboard language and identification as either a D210 or D211 unit.

For Status 1 byte (bit 7 = MSB, bit 0 = LSB):

Bit	Meaning	
7	Always 0 (not used)	
6	Always 1	
5	0 = Self-test OK 1 = Self-test failure	
4	0 = 7-bit mode 1 = 8-bit mode	
3	0 = Printer not ready 1 = Printer ready	(Always 0 For D210 Terminal)
2	Bits 2, 1, and 0	
1	indicate the current	
0	firmware revision (0-7)	

For Status 2 byte (bit 7 = MSB, bit 0 = LSB):

Bit	Meaning
7	Always 0 (not used)
6	Always 1
5	0 = D210 1 = D211
4	These five bits indicate the current keyboard language, as follows:
3	
2	
1	
0	

Bits	4	3	2	1	0	Language
	0	0	0	0	0	No keyboard
	1	0	0	1	1	Swiss/French
	1	0	1	0	0	Swiss/German
	1	0	1	0	1	Canadian/English
	1	1	0	0	0	Canadian/French
	1	1	0	0	1	United States
	1	1	0	1	0	United Kingdom
	1	1	0	1	1	French
	1	1	1	0	0	German
	1	1	1	0	1	Swedish/Finnish
	1	1	1	1	0	Spanish
	1	1	1	1	1	Danish/Norwegian

For example, if the following sequence is returned:

<036><157><043><050><130><171> (octal)

or:

<036>o#(Xy) (ASCII)

then the meaning of the status codes is as follows: Self-test of terminal ok, 8-bit mode, printer ready, revision level 0, D211 model with U.S. keyboard.

**READ CURSOR ADDRESS** (Data General Mode)  
<005> CTRL-E

The column and row of the cursor location relative to the first column of the top row of the screen ("home" position) are returned to the host computer in the following form:

<037><column><row>

where: <column> = <000> to <117>, for columns  
0 to 79  
<row> = <000> to <027>, for rows  
0 to 23

Notice that the value of the <row> byte will always be an ASCII control code and the value of the <column> byte could be an ASCII control code. As a result, a binary read command/statement should be used to read the relative column and row bytes.

**Example:**

If the terminal responds to the command "<005>" with "<037>H<010>", the cursor is located at column 72 (ASCII H = <110> or 72 decimal), row 8 relative to the screen "home" position.

**REVERSE VIDEO OFF** (Data General Mode)  
<036><105> or: <036>E or:  
<002> CTRL-B

The reverse video attribute for each successive character following this command is turned off. This command is issued automatically with the Erase Screen command or when the terminal is powered up.

**REVERSE VIDEO ON** (Data General Mode)  
<036><104> or: <036>D or:  
<026> CTRL-V

The reverse video attribute for each successive character following this command is turned on. Characters that follow this command and precede the next Reverse Video Off command will be displayed in reverse video form.

**ROLL DISABLE** (Data General Mode)  
<023> CTRL-S

The screen contents are disabled from scrolling up when the cursor is commanded to move beyond the bottom row. The cursor moves to the top row of the screen from the bottom row with screen roll disabled.

**ROLL ENABLE** (Data General Mode)  
<022> CTRL-R

Screen scrolling is enabled so that scrolling occurs when the cursor is commanded to move beyond the bottom row of the screen. When the screen contents scroll up, the cursor moves to the new bottom row while the top row on the screen disappears from view. When the terminal is powered up, the Roll Enable command is automatically executed.

**SECONDARY CHARACTER SET ENABLE**  
(SHIFT OUT) (Data General Mode)  
<036><116> <036>N  
D211 Only:

The secondary character set (versus the primary character set) is enabled for display on the screen. This command is a member of the character set select command group. This command group is used to select and switch between character sets for display on the screen as described under the command set overview

paragraph. The Select Character Set command description says more about this Secondary Character Set Enable command.

**NOTE:** *Only the D211 terminal responds to this command sequence; the D210 has only one character set.*

**SELECT ANSI MODE** (Data General Mode)

`<036><106><100>` (036)F@

The ANSI mode is selected for all further commands which are received. After this command is issued, the terminal operates as a standard ANSI terminal in accordance with ANSI standards 3.4, 3.41, and 3.64. Data General command sequences are not recognized by the terminal when in ANSI mode. The ANSI command sequences recognized by the terminal in ANSI mode are described in the next section of this chapter. To switch back to the standard Data General operating mode, issue the Reset Mode command as described in the ANSI command section. For a discussion of ANSI and Data General modes of operation, see the section “Modes of Terminal Operation” at the beginning of this chapter.

**SELECT CHARACTER SET** (Data General Mode)

`<036><106><123><set>` (036)FS...

D211 Only:

The character set specified by argument `<set>` is selected for display on the screen. This command is one of three in the character set select command group. These commands are used to select and switch between character sets for display on the screen as described in the command set overview paragraph.

**NOTE:** *Only the D211 terminal recognizes this command sequence; the D210 does not allow character set selection.*

The terminal keeps track of a “primary” character set and a “secondary” character set. When the terminal is turned on, the character set matching the keyboard nationality is assigned as the primary character set if the terminal is set for 7-bit operations. If the terminal is set to 8-bit operations, the U.S. ASCII character set is assigned as the primary character set. The primary character set is the active set (used on the screen). The secondary character set is assigned the Data General International set when the terminal is turned on.

The Primary and Secondary Character Set Enable commands are used to select the active character set. The Select Character Set command described here is used to select a character set for display after the primary or secondary set has been selected as active. The intent of this set of commands is as follows: select the two most frequently used character sets as primary and secondary, and then use the primary/secondary character set enable commands to switch between the two sets. In this way, host/terminal character traffic can be kept to a minimum when selecting character sets.

The command argument `<set>` may either be an ASCII string specified from the keyboard or a sequence of octal constants if the command was issued by the host. The `<set>` argument may have one of the following values:

Set Argument		Character Set
(octal)	(ASCII)	
(060)(060)	00	Keyboard nationality
(060)(061)	01	U.S.
(060)(062)	02	United Kingdom
(060)(063)	03	French
(060)(064)	04	German
(060)(065)	05	Swedish/Finnish
(060)(066)	06	Spanish
(060)(067)	07	Danish/Norwegian
(060)(070)	08	Swiss
(060)(076)	0>	DG International

As an example, to select the Swiss character set, issue either the ASCII representation of the command `<036>FS08` or use the octal command sequence `<036><106><123><060><070>`.

Appendix D shows the character codes and details of each character for all of these character sets. Only those characters in Appendix D are supported by the D210/211 terminals.

**SELECT 7/8 BIT OPERATION** (Data General Mode)

`<036><106><125><mode>` (036)FU ...

D211 Only:

This command sets the 7/8-bit operations for the D211 terminal. The `<mode>` specifies which data bit operation (either 7- or 8-bit) is to be set for the D211 terminal, as follows:

- `<mode>` = `<060>` — select 7-bit operations for the terminal.
- = `<061>` — select 8-bit operations for the terminal.

**NOTE:** *The D211 terminal will respond to this command ONLY if the switch at the back of the terminal is set for “8 Bit” operations. If the hardware switch on the D211 is set for “7 Bit” operations, this command has NO effect when issued.*

**SET KEYBOARD LANGUAGE** (Data General Mode)

`<036><106><146><parameter>` (036)Ff ...

D211 Only:

This command sets the keyboard language for the D211 terminal. The `<parameter>` specifies which keyboard language is to be set for the D211 terminal. The `<parameter>` may either specify the default keyboard language in use or the U.S. ASCII keyboard language. Valid parameters are as follows:

- `<parameter>` = `<060>` — set keyboard language to the default set.

= <061> — set keyboard language to U.S. ASCII

**NOTE:** Only the D211 terminal when operating in 8-bit mode may be set to different keyboard languages. The D210 and D211 terminals in 7-bit mode do not respond to this command.

**WARNING:**

The keyboard language is always reset to its default value any time the mode is changed (either from 8- to 7-bit or DG to ANSI). This occurs if the mode was changed either with a hardware switch or with a software command (e.g., Select 7/8 Bit Operation or Select ANSI Mode).

**UNDERSCORE OFF** (Data General Mode)  
<025> CTRL-U

The underscore attribute for each successive character following this command is turned off. This command is issued automatically with the Erase Screen command or when the terminal is powered up.

**UNDERSCORE ON** (Data General Mode)  
<024> CTRL-T

The underscore attribute for each successive character following this command is turned on. Characters that follow this command and precede the next Underscore Off command will be underscored on the display screen.

**WRITE CURSOR ADDRESS** (Data General Mode)  
<020><column><row> CTRL-P...

The cursor is moved to the specified row and column on the screen. The command arguments are relative to the “home” location on the screen. If an attempt is made to position the cursor past the last row on the screen (row 23), the cursor pegs at the bottom row. If an attempt is made to position past the last column, the cursor pegs at the last column. The command arguments are as follows:

<column> = <000> to <117> or <177>

which is the destination column number in the range of 0 to 79 (decimal) relative to the “home” position on the screen; <177> is a special case where the destination column remains the same as its value before this command.

<row> = <000> to <027> or <177>

which is the destination row number in the range of 0 to 23 relative to the “home” position on the screen; <177> is a special case where the destination row remains the same as its value before this command.

**NOTE:** Both “column” and “row” are passed in binary format to the terminal (D100/D200 compatible).

## Command Descriptions (ANSI Standard Mode)

This section describes all the commands available to the user when the terminal is in ANSI Standard mode. When operating in ANSI mode, the terminal does not respond to Data General command control sequences and is not compatible with previous Data General terminals.

Command sequences are composed of ASCII characters (7-bit quantities only for the D210 terminal; 7- or 8-bit quantities for the D211). The character sequences that compose ANSI standard commands often use the mnemonic CSI (Control Sequence Introducer) as the first character in the sequence as a “lead-in” code.

The CSI mnemonic may be represented in either 7- or 8-bit quantities for the D211 terminal (7-bit quantity only for D210). If the D211 is operating in an 8-bit mode, then the octal string for 8-bit quantities should be used; otherwise, the 7-bit octal string representation is used to generate the CSI mnemonic.

Mnemonic	Quantity	Octal Constants
<CSI>	7-bit	<033><133>
<CSI>	8-bit	<233>

**NOTE:** The header code <CSI> is generated off-line by typing ESC-[; that is, press the ESC key and then press the [ key.

Command sequences that have no meaning to the terminal are ignored. Also note that function key sequences that are not valid D210/211 command sequences are also ignored.

### ANSI Modes Of Operation

When the D210/211 is used as an ANSI standard terminal, several modes of operation may be in effect. These modes affect how the D210/211 will respond to several of the commands. All of the ANSI modes are described in the ANSI standard X3.64 (1977). Only modes that are directly applicable to the D210/211 are discussed in this manual.

An ANSI mode of operation may be in one of two states: set or reset. Several of the D210/211 ANSI modes are fixed in one of these states and cannot be altered by the programmer. Other modes, however, may be placed in either the set or reset state by using the Set Mode and Reset Mode commands.

Table 3-4 shows the fixed ANSI modes of operation that pertain to the D210/211.

### Selectable ANSI Modes

Four of the D210/211 ANSI modes of operation may be set or reset by the programmer with the Set Mode and

**Table 3-4. D210/211 Fixed ANSI Modes Of Operation**

Mode	(Code)	Fixed State	Effects on D210/211 Operations
Guarded Area Transfer	(061)	Set	All data may be transmitted or transferred (except for certain print operations; see FORMS mode in next section.
Keyboard Action	(062)	Reset	The host cannot disable the keyboard via control codes.
Control Representation	(063)	Reset	Control codes have no graphic representation.
Status Reporting Transfer	(065)	Reset	Terminal status information sent only when requested by the host
Erasure Mode	(066)	Set	Erase functions affect characters regardless of their attributes.
Positioning Unit	(061)(061)	Reset	All paramaters specifying screen positioning are specified in character units.
Send-Receive Mode	(061)(062)	Set	The keyboard is disconnected from the display screen, except when in local mode.
Format Effector Action	(061)(063)	Reset	Format effectors (New Line, Form Feed, etc.) are performed immediatly when received in a data stream.
Format Effector Transfer	(061)(063)	Reset	Format effectors are included in the data stream when transferred to an auxilliary device.
Multiple Area Transfer	(061)(065)	Set	When printing, all selected areas are transferred in the data stream.
Line Feed New Line	(062)(060)	Set	A New Line command moves the cursor to the first character position of the next line down.
Margins Mode (DG Defined)	(074)(065)	Reset	Editing operations operate irrespective of margins. (NOTE: The D210/211 does not implement definable margins.)

**Table 3-5. D210/211 Selectable ANSI Modes Of Operation**

Mode	State	Effect
Roll Mode	Set Reset	Roll Disabled Roll Enabled
Blink Mode	Set Reset	Blink Disabled Blink Enabled
DG/ANSI Mode	Set Reset	ANSI Mode DG Mode
Forms Mode	Set Reset	Only full intensity characters printed All characters printed

Reset Mode commands. Table 3-5 outlines the selectable ANSI modes of operation for the D210/211 terminal.

For additional information on the effects of these selectable modes, see the Set Mode and Reset Mode command descriptions in the ANSI Commands Description section which follows.

The following ANSI commands (Table 3-6) are described in alphabetical order:

**Table 3-6. D210/211 Command Set (ANSI Mode)**

Command Name	Command Name
Bell	Read Terminal Configuration
Carriage Return	Reset Mode
Cursor Backward	Select Character Set*
Cursor Down	Select Graphic Rendition
Cursor Forward	Set Mode
Cursor Position	Set Parameters
Cursor Up	Shift In*
Device Status Report	Shift Out*
Erase In Display	Single Shift Two*
Erase In Line	Single Shift Three*
Form Feed	XOFF
Media Copy*	XON
New Line	

\*Note: D211 Only

**NOTE:** *The formal command name used in the ANSI specifications is shown in parentheses after the given DG name; for example, CURSOR DOWN (CUD).*

**D210/211 ANSI Command Descriptions**

**BELL (BEL)** (ANSI Standard Mode)  
(007) CTRL-G  
The terminal bell rings once. (ANSI X3.4, 5.2)

**CARRIAGE RETURN (CR)** (ANSI Standard Mode)  
(015) CR or CTRL-M  
The cursor is moved to the first character position on the current row. (ANSI X3.4, 5.2)

**CURSOR BACKWARD (CUB)** (ANSI Standard Mode)

(CSI)(# of columns)(104) (CSI)...D  
The cursor is moved one or more column positions to the left on the current row. If the cursor is in the first column position of a row prior to issuing the command, then the cursor moves to the last column position, and a CURSOR UP operation is performed. A parameter supplied with the command specifies how many columns to move the cursor; the default value when no parameter is present is one ((061)). The maximum parameter value is 255 for the D210/211, or:

(# of columns) = (061) to (062)(065)(065) (octal)  
= 1 to 255 (ASCII)

Note that this command sequence is also sent to the host when the Cursor Left key on the keyboard is depressed (see Chapter 2). (ANSI X3.64, 5.13)

**CURSOR DOWN (CUD)** (ANSI Standard Mode)  
 ⟨CSI⟩⟨# of rows⟩⟨102⟩ (CSI)...B  
 The cursor is moved down one or more rows while maintaining the same column position. A parameter supplied with the command specifies how many rows to move the cursor; the default value when no parameter is present is one (⟨061⟩). The maximum parameter value is 255 for the D210/211, or:

⟨# of rows⟩ = ⟨061⟩ to ⟨062⟩⟨065⟩⟨065⟩ (octal)  
 = 1 to 255 (ASCII)

Note that this command sequence is also sent to the host when the Cursor Down key on the keyboard is depressed (see Chapter 2). (ANSI X3.64, 5.14)

**CURSOR FORWARD (CUF)**(ANSI Standard Mode)  
 ⟨CSI⟩⟨# of columns⟩⟨103⟩ (CSI)...C  
 The cursor is moved one or more column positions to the right on the current row. If the cursor is at the end of the current line prior to issuing the command, a NEW LINE operation is performed. A parameter supplied with the command specifies how many columns to move the cursor; the default value when no parameter is present is one (⟨061⟩). The maximum parameter value is 255 for the D210/211, or:

⟨# of columns⟩ = ⟨061⟩ to ⟨062⟩⟨065⟩⟨065⟩ (octal)  
 = 1 to 255 (ASCII)

Note that this command sequence is also sent to the host when the Cursor Right on the keyboard is depressed (see Chapter 2). (ANSI X3.64, 5.15)

**CURSOR POSITION (CUP)** (ANSI Standard Mode)  
 ⟨CSI⟩⟨row⟩⟨073⟩⟨column⟩⟨110⟩ (CSI)...;...H  
 The cursor is moved to the position indicated by the parameter pair. The first parameter specifies the row position (numbered from the top row); the second specifies the column position (numbered from the left-most column). Valid parameter ranges are as follows:

⟨row⟩ = ⟨061⟩ to ⟨062⟩⟨064⟩ (octal)  
 = 1 to 24 (ASCII)

⟨column⟩ = ⟨061⟩ to ⟨070⟩⟨060⟩ (octal)  
 = 1 to 80 (ASCII)

If both parameter values are missing, then both row and column values are assumed to be one, i.e.; the cursor “homes”.

Note that this command sequence is also sent to the host when the Home key on the keyboard is depressed. (ANSI X3.64, 5.16)

**CURSOR UP (CUU)** (ANSI Standard Mode)  
 ⟨CSI⟩⟨# of rows⟩⟨101⟩ (CSI)...A  
 The cursor is moved up one or more rows while maintaining the same column position. If the cursor is on the top row prior to issuing the command, then the cursor moves to the 24th line of the display. A parameter supplied with the command specifies how many

rows to move the cursor; the default value when no parameter is present is one (⟨061⟩). The maximum parameter value is 255 for the D210/211, or:

⟨# of rows⟩ = ⟨061⟩ to ⟨062⟩⟨065⟩⟨065⟩ (octal)  
 = 1 to 255 (ASCII)

Note that this command sequence is also sent to the host when the Cursor Up on the keyboard is depressed (see Chapter 2). (ANSI X3.64, 5.17)

**DEVICE STATUS REPORT (DSR)**  
 (ANSI Standard Mode)

⟨CSI⟩⟨066⟩⟨156⟩ (CSI)6n  
 This command queries the terminal for the current cursor position. The current cursor position is sent to the host in the following form (status information is returned in the form of a “CPR” string, see ANSI X3.64, section 5.9):

⟨CSI⟩⟨row⟩⟨073⟩⟨column⟩⟨122⟩

⟨row⟩ = row position, in range ⟨060⟩⟨060⟩ to  
 ⟨062⟩⟨063⟩ (00 to 23)

⟨column⟩ = column position, in range ⟨060⟩⟨060⟩  
 to ⟨067⟩⟨071⟩ (00 to 79)

(ANSI X3.64, 5.25)

**ERASE IN DISPLAY (ED)** (ANSI Standard Mode)  
 ⟨CSI⟩⟨parameter⟩⟨112⟩ (CSI)...J  
 The displayed characters on the screen are erased according to the parameters. Parameter values are:

⟨060⟩ — Erase from the cursor to the end of the display; cursor position is unaffected; ⟨060⟩ is the default value when no parameter is supplied with the command.

⟨061⟩ — Erase from the start of the display to the cursor; cursor position is unaffected.

⟨062⟩ — Erase the entire display; all visual attributes in effect are canceled; the cursor moves to the home position.

(ANSI X3.64, 5.29)

**ERASE IN LINE (EL)** (ANSI Standard Mode)  
 ⟨CSI⟩⟨parameter⟩⟨113⟩ (CSI)...K  
 The displayed characters on the current row are erased according to the parameters. Parameter values are:

⟨060⟩ — Erase from the cursor position to the end of the row; ⟨060⟩ is the default value when no parameter is supplied with the command. Cursor stays in original position.

⟨061⟩ — Erase from the start of the row to the cursor position, inclusive. Cursor stays in original position.

**<062>** — Erase the entire row on which the cursor resides. The cursor moves to the first column of the current row.

(ANSI X3.64, 5.31)

**FORM FEED (FF)** (ANSI Standard Mode)  
**<014>** **FF**

The cursor is moved to the first character position on the next row. This control operates the same as the New Line control. (ANSI X3.4, 5.2)

**MEDIA COPY (MC)** (ANSI Standard Mode)  
**<CSI><parameter><151>** **<CSI>...i**

D211 Only:

The information appearing on the display screen is transmitted to the printer, starting with the row on which the cursor is located. If the FORMS MODE is in a set state, only those characters at full intensity will be transmitted. A parameter value of **<060>** indicates to print on a local printer; other parameter values have not been implemented; the default value when no parameter is supplied is **<060>**. (ANSI X3.64, 5.57)

**NOTE:** *Only the D211 supports a slave printer; the D210 terminal does not respond to this command.*

**NEW LINE (LF)** (ANSI Standard Mode)  
**<012>** **NL**

The cursor is moved to the first character position on the next row. (ANSI X3.4, 5.2)

**READ TERMINAL CONFIGURATION**  
**(DG PRIVATE)** (ANSI Standard Mode)  
**<CSI><170>** **<CSI> x**

This command queries for terminal configuration information, such as model ID, keyboard type, etc.

Terminal configuration information is sent back in the following form:

**<CSI><model ID><073><status><073><revision><073>**  
**<keyboard><170>**

where:

**<model ID>** = **<065><060>** (for D210/211 terminals)

**<status>** = **<060><060>** to **<061><066>**, the last four bits reflect terminal status information:

Bit	Value	Meaning
3	0	D210
	1	D211
2	0	Self-test ok
	1	Self-test failed
1	0	7-bit operation
	1	8-bit operation
0	1	Printer ready
	0	Printer not ready

**<revision>** = firmware revision; bits 0-2 indicate revision level.

**<keyboard>** = keyboard language in use, shipped as a pair of binary coded digits with the following meanings:

Code	Keyboard Language
<b>&lt;060&gt;&lt;060&gt;</b>	No keyboard
<b>&lt;061&gt;&lt;071&gt;</b>	Swiss/French
<b>&lt;062&gt;&lt;060&gt;</b>	Swiss/German
<b>&lt;062&gt;&lt;061&gt;</b>	Canadian/English
<b>&lt;062&gt;&lt;064&gt;</b>	Canadian/French
<b>&lt;062&gt;&lt;065&gt;</b>	United States
<b>&lt;062&gt;&lt;066&gt;</b>	United Kingdom
<b>&lt;062&gt;&lt;067&gt;</b>	French
<b>&lt;062&gt;&lt;070&gt;</b>	German
<b>&lt;062&gt;&lt;071&gt;</b>	Swedish/Finnish
<b>&lt;063&gt;&lt;060&gt;</b>	Spanish
<b>&lt;063&gt;&lt;061&gt;</b>	Danish/Norwegian

**RESET MODE (RM)** (ANSI Standard Mode)  
**<CSI><mode><073><mode><073>...<mode>** **<CSI>...;...1**  
**<154>**

This command resets one or more terminal modes of operation according to the parameters supplied; only those modes whose parameters are supplied will be affected (ANSI X3.64, 5.73). The modes (whose states can be altered), their corresponding parameter values, and the effects of resetting these modes are shown in Table 3-7.

**Table 3-7. Effects of Reset Mode**

Mode	<Code>	Effects of Reset Mode
Roll	<b>&lt;074&gt;&lt;060&gt;</b>	All windows are enabled so that they will scroll up when the cursor is commanded to move beyond the bottom row. When the terminal is powered up, the Roll mode is automatically reset, and screen roll is enabled.
Blink	<b>&lt;074&gt;&lt;061&gt;</b>	All characters with their blink attribute set will indeed blink. When the terminal is powered up, the Blink mode is automatically reset, and character blinking is enabled.
DG-ANSI	<b>&lt;074&gt;&lt;063&gt;</b>	When this mode is reset, the terminal operates with private Data General sequences only. ANSI mode is disabled and the D210/211 will not respond to ANSI control sequences. When the terminal is powered up, this mode is set according to the hardware switch setting on the back of the terminal. After power-up, the mode may be selected via a software command such as this one.
Forms	<b>&lt;074&gt;&lt;064&gt;</b>	A Local Print command (D211 only) causes all characters on the display screen to be printed, regardless of their visual attributes.

**SELECT CHARACTER SET (DG PRIVATE)**  
(ANSI Standard Mode)

**<033><level><set>** **ESC (...)**  
D211 Only:

A character set specified by the parameter **<set>** is assigned as either the primary, secondary, or auxiliary character set, according to the **<level>** specified.



<level> may be:

- <050> for the primary character set (ANSI: G0)
- <051> for the secondary character set (ANSI: G1)
- <052> for the first auxiliary character set (ANSI: G2)
- <053> for the second auxiliary character set (ANSI: G3)

<set> may be:

- <102> U.S. ASCII
- <101> United Kingdom
- <122> French
- <113> German
- <110> Swedish/Finnish
- <060> Terminal keyboard language
- <061> Spanish
- <062> Danish/Norwegian
- <063> Swiss
- <070> Canadian
- <065> Data General International

At any one time, the D211 terminal maintains a primary and a secondary character set. These two sets may be the same or different; both are selected from the composite list of the sets above. When the terminal is turned on, the character set matching the keyboard nationality is assigned as the primary character set and the Data General International character set is assigned as the secondary character set.

The primary character set is the one initially displayed. It may be reassigned to any of the available character sets with this command. The primary set remains the display set until the secondary set is enabled with the Shift Out command. Once the secondary set is enabled, it too may be reassigned to any of the available sets without affecting the previously chosen primary character set. The Shift In and Shift Out commands, therefore, allow switching between the primary and secondary character sets with minimum character traffic.

In addition, the D211 terminal may also maintain two background character sets called the first and second auxiliary sets. These sets may also be assigned with this command. The first auxiliary character set is accessed with the Single Shift Two command, and the

second auxiliary is accessed with the Single Shift Three command. The first and second auxiliary character sets are described in greater detail in the Single Shift Two and Single Shift Three command descriptions, respectively.

The default character sets for the D211 terminal are as follows:

Character Set Level	Default Character Set
Primary (G0 in ANSI documentation)	U.S. ASCII
Secondary (G1)	DG International
First Auxiliary (G2)	DG International
Second Auxiliary (G3)	DG International

**NOTE:** Only the D211 handles more than one character set; the D210 terminal does not respond to this command.

### SELECT GRAPHIC RENDITION (SGR)

(ANSI Standard Mode)

<CSI><parm><073><parm><073>...<parm> <CSI>...;...m  
<155>

One or more visual attributes are turned on for successive characters in the data stream according to the parameter values. Visual attributes not specified in the parameter string supplied with the command are turned off. If no parameters are supplied with the command or if a parameter with a value of zero is supplied, then all attributes for subsequent characters are turned off (ANSI X3.64, 5.77). Valid parameter values are as follows:

- <parm> = <060> — turn off all visual attributes
- = <062> — turn dim on
- = <064> — turn underscore on
- = <065> — turn blink on
- = <067> — turn reverse video on

### SET MODE (SM) (ANSI Standard Mode)

<CSI><mode><073><mode><073> ... <CSI>...;...h  
<mode><150>

One or more terminal modes of operation are set according to the parameters supplied (ANSI X3.64, 5.79). Table 3-8 lists the modes (whose states can be altered), their corresponding parameter values and the effects these modes have in the set state:

**Table 3-8. Effect of Modes in Set State**

Mode	<Code>	Effects of Set Mode
Roll	<074><060>	The screen roll is disabled. Each time a command is issued that would move the cursor beyond the bottom row, the cursor moves to the top line.
Blink	<074><061>	Characters will not blink, regardless of their blink attribute setting.

**Table 3-8. Effect of Modes in Set State (continued)**

Mode	(Code)	Effects of Set Mode
DG-ANSI	(074)(063)	The terminal functions as a standard ANSI terminal. ANSI standard command sequences are recognized; private DG control sequences are ignored.
Forms	(074)(064)	In response to a Local Print command (D211 only) only those characters that are displayed at full intensity will be printed.

For additional information on the Set Mode command, see the Reset Mode command in this section.

**SET PARAMETERS (DG PRIVATE)**

ANSI Standard Mode)

(CSI)(parm)(073)(value)(073)(parm)... (CSI)...;...v (166)

D211 Only:

This command sets the keyboard language and/or 7/8-bit operations for the D211 terminal. The (parm) specifies which parameter (keyboard language or 7/8-bit operation) is to be set for the D211 terminal. The (value) is the value that the parameter is to be set to. Valid parameters are as follows:

- (parm) = (060) — select default values for keyboard language. This is the default parameter if none is supplied.
- = (061) — set keyboard language (default U.S. ASCII)
- = (062) — set 7/8-bit operation (default current setting)

The (value)s for the above two parameters may be as follows:

**Keyboard Language:**

- (value) = (060) — keyboard set in use  
= (061) — DG International set

**7/8 Bit Operation:**

- (value) = (060) — 7-bit operation  
= (061) — 8-bit operation

This is a DG private command whose syntax conforms to ANSI standards as outlined in section 10 of the ANSI document X3.64.

**NOTE:** *Only the D211 has 7- and 8-bit operations and more than one keyboard language; the D210 does not respond to this command.*

**SHIFT IN (SI)** (ANSI Standard Mode)  
(017) CTRL-O

D211 Only:

This command sets the selected primary character set as the active character set. See the Select Character Set command for additional details.

When the D211 operates in an 8-bit mode, the upper half of the active character set is, by default, the sec-

ondary set. Thus, the use of the Shift In/Shift Out command pair is somewhat superfluous for 8-bit operations. The Shift In and Shift Out commands are used primarily in 7-bit environments, although compatibility does exist if the commands are invoked for 8-bit operations. (ANSI X3.41, 5.2)

**SHIFT OUT (SO)** (ANSI Standard Mode)  
(016) CTRL-N

D211 Only:

This command sets the selected secondary character set as the active character set. See the Select Character Set command for additional details.

When the D211 operates in an 8-bit mode, the upper half of the active character set is, by default, the secondary set. Thus, the use of the Shift In/Shift Out command pair is somewhat superfluous for 8-bit operations. The Shift In and Shift Out commands are used primarily in 7-bit environments, although compatibility does exist if the commands are invoked for 8-bit operations. (ANSI X3.41, 5.2)

**SINGLE SHIFT TWO (SS2)** (ANSI Standard Mode)  
(SS2) BREAK ESC-N

D211 Only:

This command causes the next character typed to be selected from the first auxiliary character set (also known as G2 in the ANSI documentation). The first auxiliary set is the DG International character set by default. This set may be changed to any of the allowable character sets with the Select Character Set command. Only the first character typed after this command is issued will be taken from the first auxiliary set; after that, the character set in effect (either primary or secondary) when the command is issued will be used. See the Select Character Set command for additional details.

**NOTE:** *Only the D211 supports auxiliary character sets; the D210 terminal does not respond to this command.*

**SINGLE SHIFT THREE (SS3)** (ANSI Standard Mode)  
(SS3) BREAK ESC-O

D211 Only:

This command causes the next character typed to be selected from the second auxiliary character set (also known as G3 in the ANSI documentation). The second auxiliary set is the DG International character set by default. This set may be changed to any of the allowable character sets with the Select Character Set command. Only the first character typed after this command is issued will be taken from the second auxiliary set; after that, the character set in effect (either primary or secondary) when the command is issued will be used. See the Select Character Set command for additional details.

**NOTE:** *Only the D211 supports auxiliary character sets; the D210 terminal does not respond to this command.*

**XOFF** (DC3) (ANSI Standard Mode)  
<023> CTRL-S  
This command signals the terminal that host buffer overflow is imminent; the terminal is to stop transmitting characters until further notified. The reverse protocol also applies, that is, the terminal may also send this character when its buffer is about to overflow. (ANSI X3.4, 5.2)

**XON** (DC1) (ANSI Standard Mode)  
<021> CTRL-Q  
This command alerts the terminal/host that it may resume character transmission. (ANSI X3.4, 5.2)



# CHAPTER 4

## INSTALLATION

### GENERAL

This chapter covers all of the steps required to install and check the operation of the D210/211 terminal. The information in this chapter is organized as follows:

- Site requirements
- Unpacking instructions
- Installation instructions
- Operational checkout instructions

The installation and operational checkout instructions include steps for the D211 terminal configurations that involve a printer. The instructions in this chapter must be followed carefully to ensure a successful installation.

### SITE REQUIREMENTS

Before the D210/211 terminal can be installed, an installation site must be found that meets the space, environmental, power, and communications requirements of the terminal.

Ideally, the D210/211 terminal will be located on a desk or table in a normal office environment with the temperature at or near 24° C (75° F) and the relative humidity at or near 50%. All terminal cables and power cords must reach their connection points, and the ac power source must match the voltage and frequency requirements of the terminal (and optional printer). If the terminal is to be connected to a host computer over telephone lines, a terminal-compatible modem must be installed. Otherwise, a Current Loop or an EIA cable must be installed from the host computer to the terminal site.

The dimensions of the terminal are shown in Figure 4-1. Verify that the work surface intended to hold the terminal has the necessary space available. Make sure the chosen site meets the cable length, environmental, and power needs of the terminal listed in Table 4-1.

The selection of a communications line from the host computer to the terminal depends on the cable length

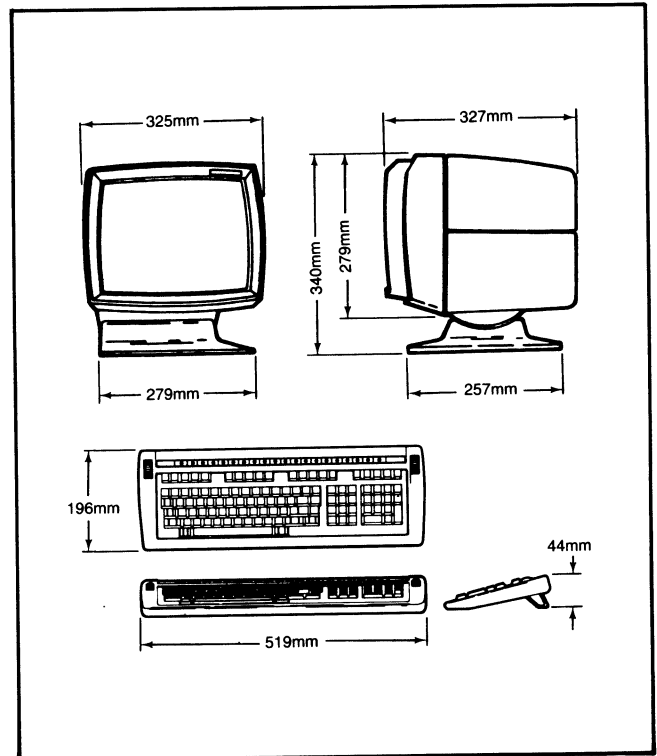

Figure 4-1. D210/211 Terminal Dimensions

required, whether or not a modem is to be used, and the configuration of the host system.

The D210 terminal permits only the RS-232C interface to be used. The D211, on the other hand, may also use a 20-mA Current Loop and an EIA RS-422A line.

For the D211, the Current Loop line and EIA RS-422 line are intended for relatively long cable lengths when a direct connection between the host and terminal is made. The 20-mA Current Loop supports transmission rates up to 9600 baud; EIA RS-422A cabling supports rates up to 19200 baud. When a short (15 meters (50 feet) or less) direct connection is required, or the terminal is to interface with a Bell 103, 113, or 212A compatible modem, the EIA RS-232 communications line should be used for the D211. Detailed cabling information is provided in the installation instructions later in this chapter; available cable lengths are contained in Table 4-1.

**NOTE:** *If the D210/211 terminal is to be connected to the host over the telephone lines with a Bell 103, 113, or 212 compatible modem, make sure the modem installation is scheduled early enough so the D210/211 terminal installation is not delayed for lack of a modem.*

**Table 4-1. D210/211 Terminal Physical, Environmental, and Power Specifications**

Item	Specification
<b>PHYSICAL:</b>	
Display Unit and Keyboard Dimensions	See Figure 4-1
Display Unit Weight	7.3 kg (16.1 lb)
Keyboard Weight	2.6 kg (5.8 lb)
Cable Lengths:	
Keyboard Cable (extended)	1.2 m (4 ft)
Display Unit Power Cord	2.25 m (7.5 ft)
EIA, Modem, 20-mA Current Loop	6.1 m (25 ft) standard for all three cable types
<b>POWER:</b>	
0 or 1 Power Suffix: Voltage	90-132 VAC
Frequency	50 or 60 Hz ± 1%
Current	2.4 Amps peak at 90 VAC
Start-up Surge	22 Amps at 120 VAC for ½ cycle
2 or 4 Power Suffix: Voltage	187-264 VAC
Frequency	50 or 60 Hz ± 1%
Current	2.0 Amps peak at 187 VAC
Start-up Surge	11 Amps at 240 VAC for ½ cycle
<b>ENVIRONMENTAL:</b>	
Temperature Range	Operating: 10 to 38°C (50 to 100°F) Storage: -40 to 65°C (-40 to 149°)
Humidity Range	Operating: 20 to 80% Non-condensing Storage: 10 to 90% Non-condensing
Attitude	Operating: Maximum 2438 m (8000 ft) Storage: Maximum 7620 m (25000 ft)
Radiation	Below 0.5 milliroentgens per hour (complies with FCC regulation Part 15, Subpart J, and CISPRE Part 16 for Class "A" computing devices)

## UNPACKING

The D210/211 terminal display unit and keyboard are packed as shown in Figure 4-2. Perform the following steps to unpack and inventory the terminal equipment:

1. Inspect the shipping containers for damage. If obvious damage to the equipment has occurred, notify the shipping carrier as soon as possible.
2. Move the shipping containers to the installation site.
3. Using Figure 4-2 as a guide, unpack the display unit, keyboard, communications cables, and documentation.
4. As each item is unpacked, inspect for damage and verify that the item received is the one ordered. Verify that all items ordered have been received.

**NOTE:** *Save the packing material in case reshipment of the terminal becomes necessary. Otherwise, Figure 4-2 must be used as a guide in replacing packing material for shipping purposes.*

## INSTALLATION

After an installation site has been selected that meets all the requirements specified earlier in this chapter and the D210/211 terminal has been unpacked and all parts accounted for, the terminal can be installed. Perform the following steps to complete the installation:

1. Move the terminal equipment to its intended work surface and position the display unit so the rear of the unit is accessible.
2. Locate the terminal configuration label on the rear of the display unit as shown in Figure 4-3. Verify that the model number on the unpacked unit matches the number ordered. In particular, verify that the power configuration of the unpacked unit matches the power source. The display unit model numbers are explained in Chapter 1.
3. Using Figure 4-3 as a guide, set the DIP switches at the rear of the display unit. The D210 terminal has only one set of DIP switches (the HOST switch set). The D211 has two sets of DIP switches (the HOST set and the PRINTER switch set). Figure 4-3A shows the switch settings for the D210 terminal; Figure 4-3B shows the switch settings for the D211 terminal. Both terminals have the HOST communications port DIP switch. The D211 also has a PRINTER port DIP switch to the right of the HOST switch as you face the rear of the terminal. Depending upon if you have a D210 or D211 terminal, set the switches as follows:

For BOTH the D210 and D211 Terminals:

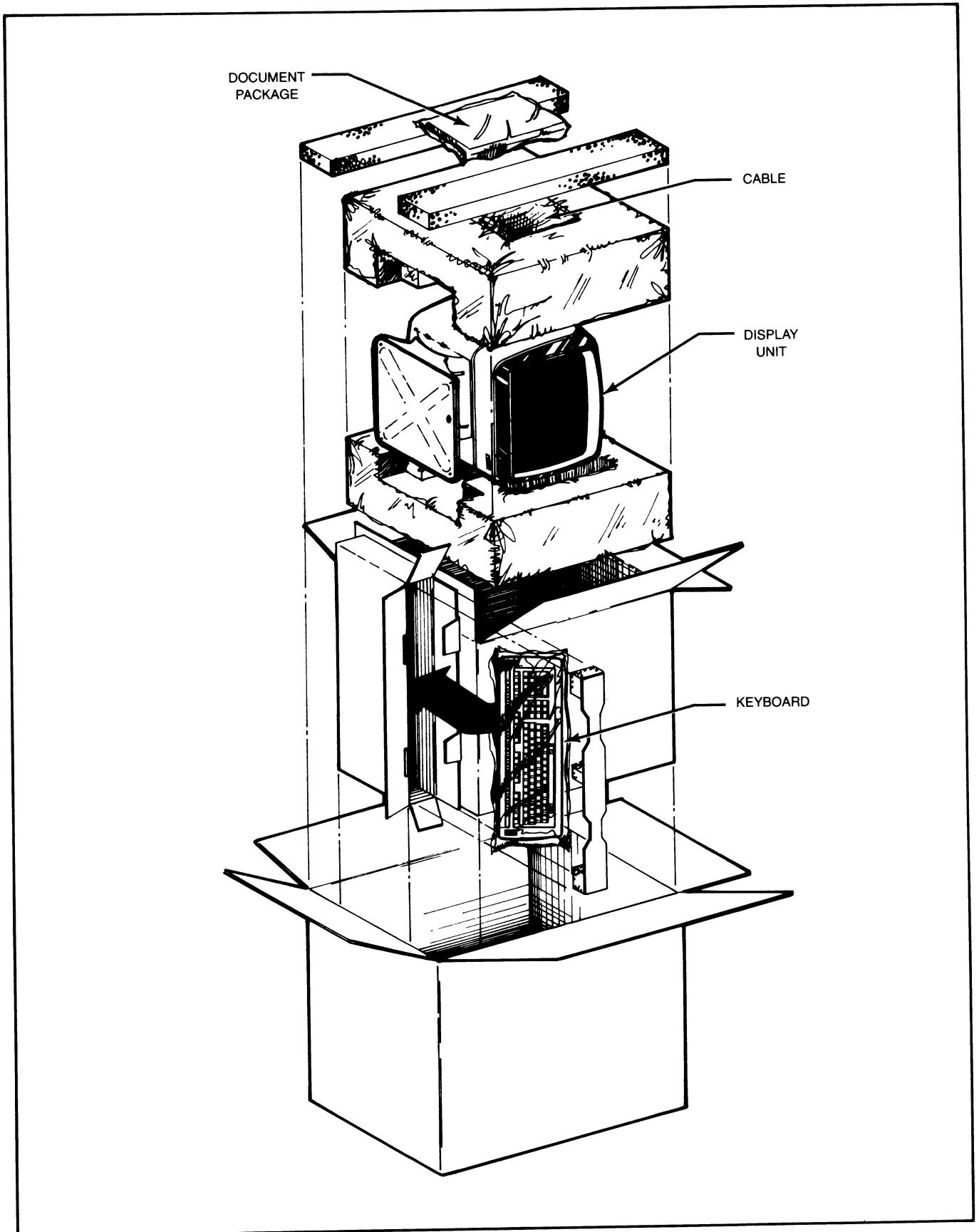

Figure 4-2. Display Unit and Keyboard Packing/Unpacking

- a. Set the HOST baud rate DIP switches (1 through 4) to match the baud rate selections at the host computer.
- b. Set the HOST parity rate DIP switches (5 and 6) to match the parity selections of the host computer.
- c. Set the HOST terminal operating mode DIP switch (8) to either "Data General" or "ANSI" mode of operation.

For the D210 Terminal ONLY:

- a. Verify that DIP switch 7 (50/60 Hz) is set to match the frequency of the power source and the terminal model number. If the switch is set incorrectly, the screen image will flicker and be the wrong size.

For the D211 Terminal ONLY:

- a. Select either 7- or 8-bit data operations for the terminal with HOST port switch 7.
- b. On the PRINTER port DIP switch (the switch to the right of the HOST port DIP switch), verify that DIP switch 8 (50/60 Hz) is set to match the frequency of the power source and the terminal model number. If the switch is set incorrectly, the screen image will flicker and be the wrong size.
- c. If a printer is to be used with the D211 terminal, select the printer baud rate with PRINTER port switches 1, 2, 3, and 4 (baud 110 through 19200). Now select either 7- or 8-bit data operations for the printer with PRINTER port switch 5. (Note that switches 6 and 7 are not used on the PRINTER port DIP switch.)

### WARNING

*If the terminal switches are set for 7-bit mode and no parity, then baud rates above 110 are NOT supported. Baud rates above 110 are supported for operations in 7-bit mode for even, odd, and marked parity.*

4. Connect the cable attached to the keyboard to the keyboard connector at the rear of the display unit (see Figure 4-7A and B for the display unit keyboard connector location).

**NOTE:** *Guidelines for selecting host-to-terminal interface cabling are provided in the site requirements paragraph of this chapter. The following step assumes the correct cabling is available as determined by the host computer and the selected communications system.*

5. Connect the communications cabling between the host or modem and the rear of the display unit. Secure the display unit connection with the two

screws provided with the 25-pin Cannon connector that plugs into the rear of the display unit.

**NOTE:** *Figure 4-4 shows the EIA cables available from Data General for Data General host systems; when not using a Data General EIA cable for an EIA connection, wire the terminal end of the 25-pin Cannon connector as shown in Figure 4-5. Figure 4-6 shows the 20-mA current loop cables from Data General. Data General 20-mA current loop cables are all wired for a passive connection where the host system supplies the power to drive the terminals interface. When a Data General Current Loop cable is not used for a 20-mA current loop connection, wire the 25-pin Cannon connector for a passive connection.*

### WARNING

*The display unit comes equipped with a three-conductor ac power cord. The power cord must be plugged into a grounded three-contact electrical outlet.*

6. If a printer is to be installed with the D211 terminal (such as a DASHER TP1/TP2 receive only (RO) printer or a 340 CPS Serial Matrix Printer) consult the printer documentation for unpacking instructions, parts inventory, etc. Proceed as follows when the printer is ready for installation:
  - a. Verify that the ac power source matches the requirements of the printer model.
  - b. Set the printer data bit communications to either 7 bits or 8 bits via switch 5 of the PRINTER port DIP switch. For 7-bit printer operations, the terminal will be set to 7-bit, even parity, 1 stop bit mode. For 8-bit printer operations, the terminal will be set to 8-bit, no parity, 2 stop bit mode. Finally, set the baud rate on the installed printer to match the terminal printer port parity and stop bits selected earlier in this installation procedure.
  - c. Connect the printer interface cable between the printer and the printer connector at the rear of the display unit. The printer cables are shown in Figure 4-8.
  - d. With the printer power switch set to OFF, plug in the printer power cord and get the printer ready to print by following instructions in the printer manual for loading paper, etc.
7. Make sure the terminal power control switch on rear of the display unit is set to the power-off position. Plug the display unit power cord into the ac power source, and position the terminal equipment for normal operation.

The D210/211 terminal hardware is now installed and ready for checkout.



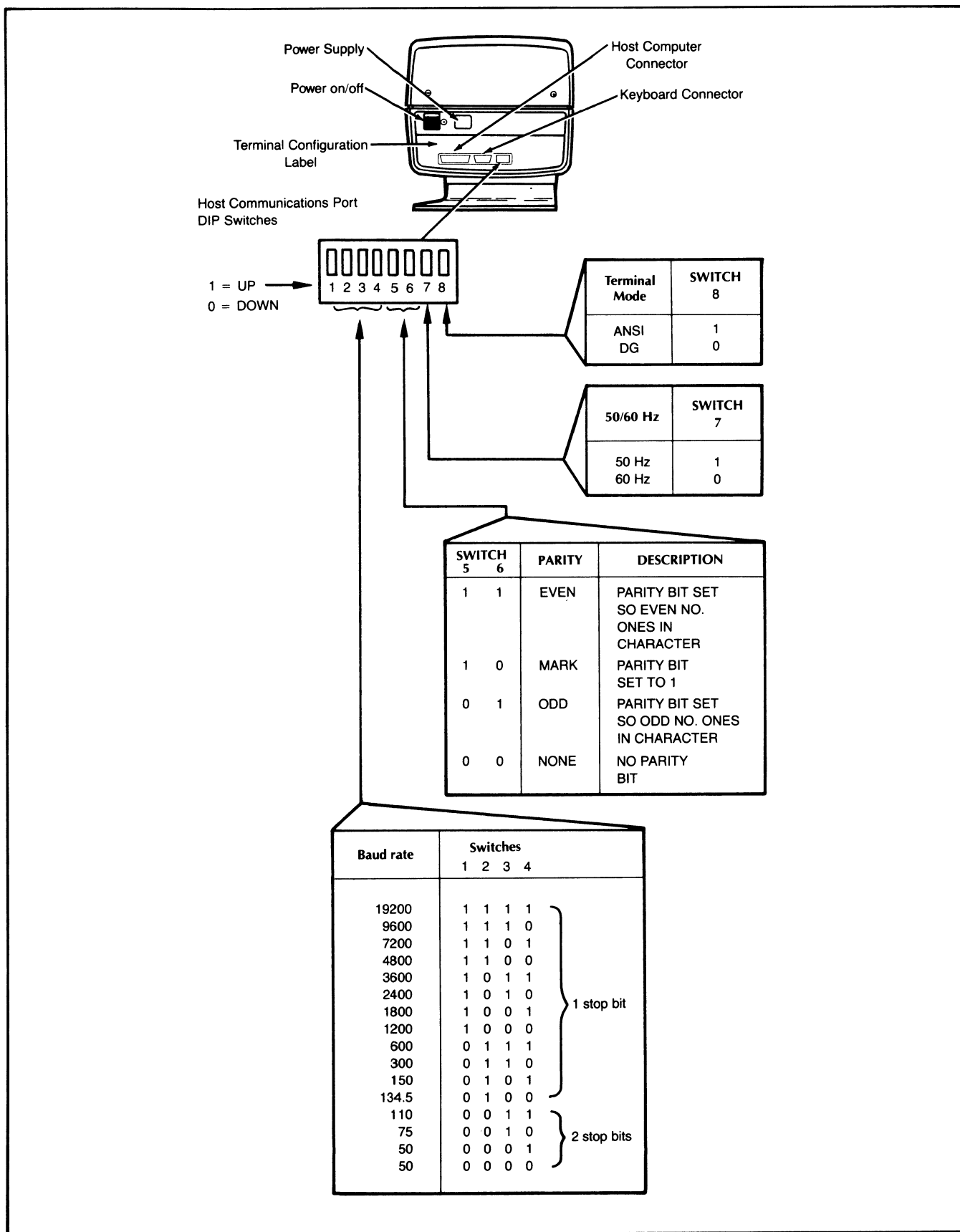

Figure 4-3 A. Rear of Display Unit: D210

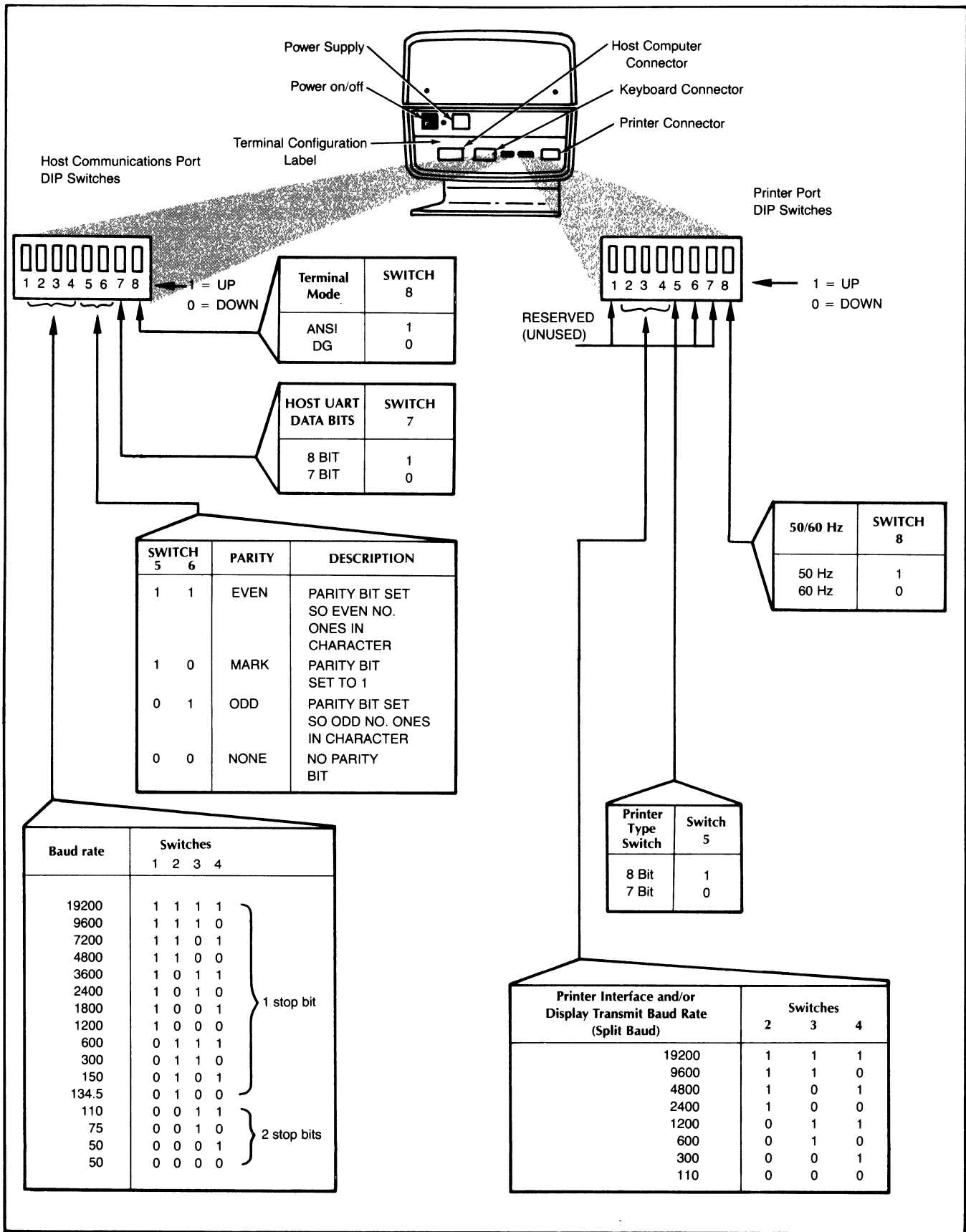
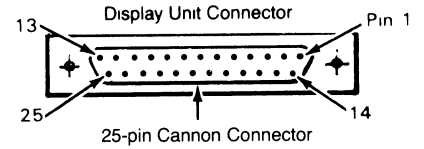

Figure 4-3 B. Rear of Display Unit: D211

EIA RS-232C

HOST/CONTROLLER	CABLES REQUIRED MODEL # (ASSEMBLY)	CABLE MODEL # LENGTH SUFFIXES
CONVENIENCE PANEL SYSTEMS WITH 25-PIN CONNECTORS	1340 (005-13258)	MODEL 1340 CABLE (EIA RS-232C) IS 25' LONG.  MODEL 1340-A IS 60' LONG. 1340-A MAY BE USED IN PLACE OF MODEL 1340.  MODELS 1241, 1243, 1244, AND ARE ADAPTOR CABLES. EACH IS 18' LONG.
ALM-8 SYSTEMS WITH BACKPANEL CONNECTION	1340 (005-13258) AND 1241 (005-13270)	
ULM, microNOVA 422x, OR microNOVA CONSOLE INTERFACE	1340 (005-13258) AND 1243 (005-13271)	
ALM-18 WITH BACKPANEL CONNECTION	1340 (005-13258) AND 1244 (005-13273)	
PRIMARY CONSOLE INTERFACE WITH BACKPANEL CONNECTION	1340 (005-13258) AND 1257 (005-13389)	
MODEM	1338 (005-13268)	



MODEM CABLE  
MODEL 1338  
005-13268

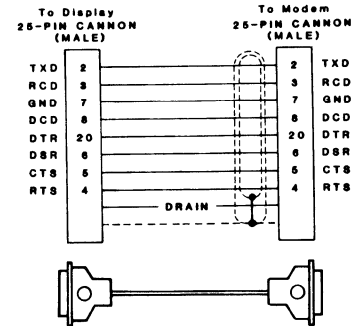

RS-232C HOST-END ADAPTER CABLES

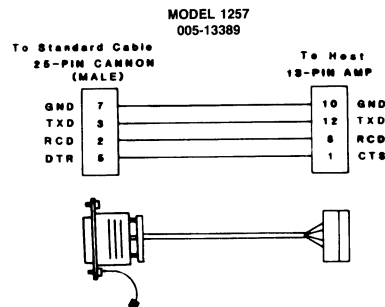
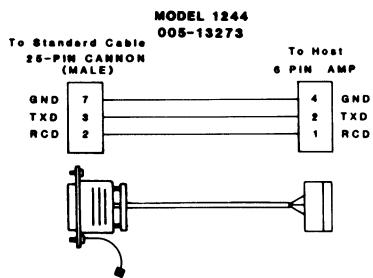
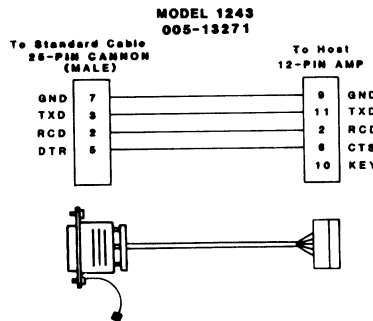
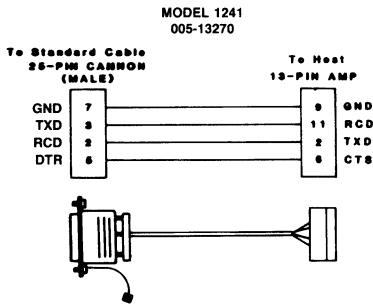

STANDARD EIA RS-232C CABLE  
MODEL 1340  
005-13258

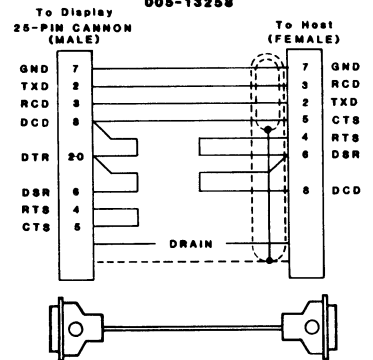

Figure 4-4. Data General EIA Host/Terminal Interface Cables

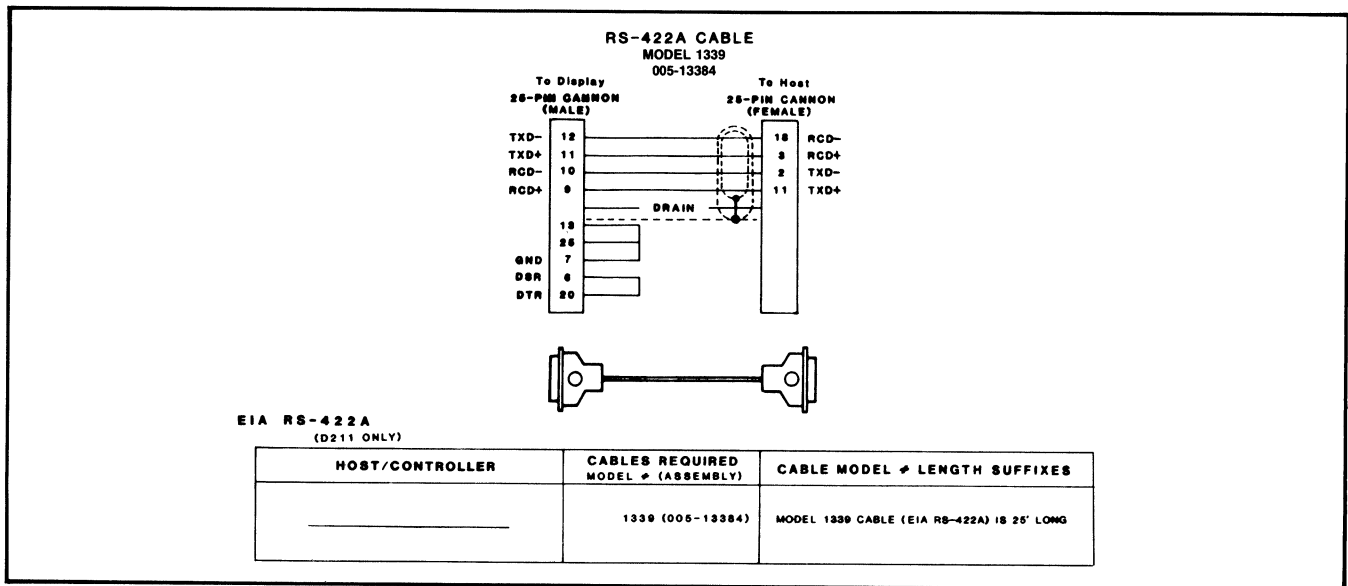

Figure 4-5. RS-422A Host/Controller Cable (D211 Only)

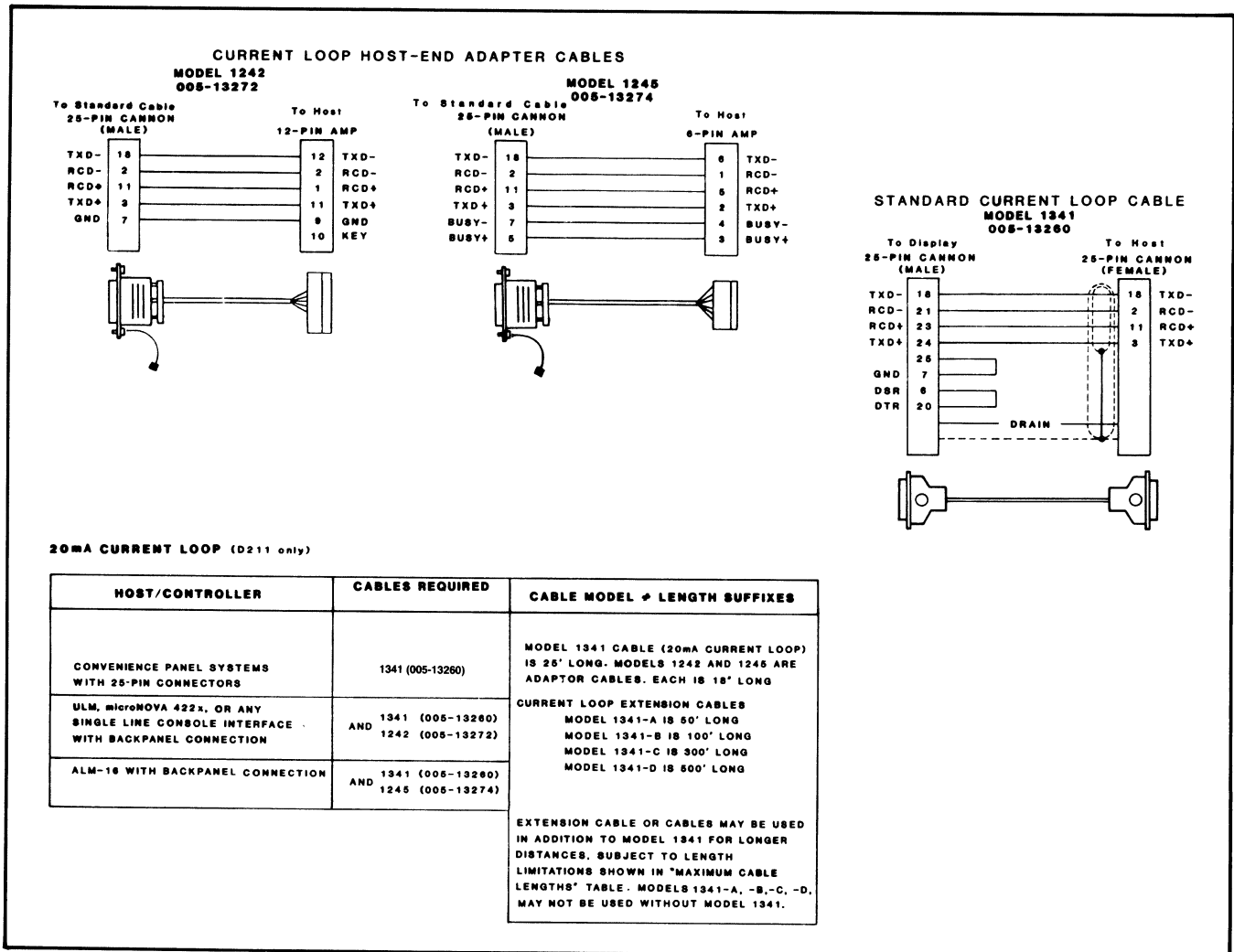
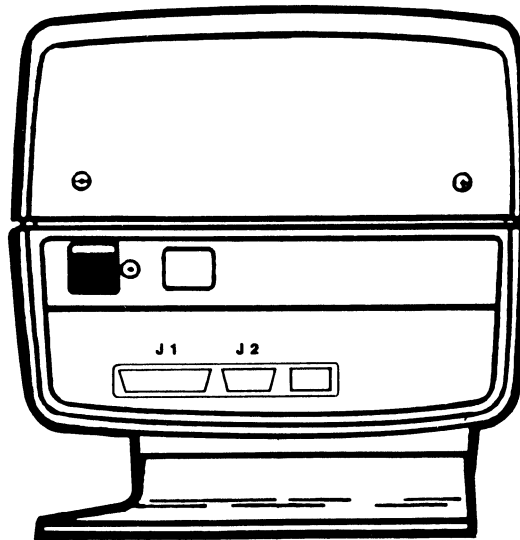

Figure 4-6. Data General 20-mA Current Loop Host/Terminal Interface Cables



REAR VIEW D210

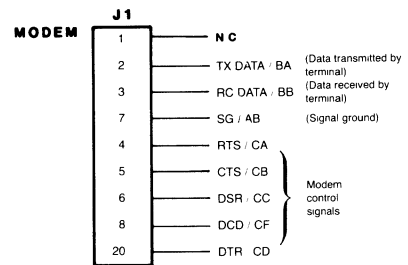
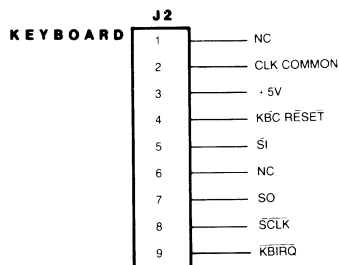
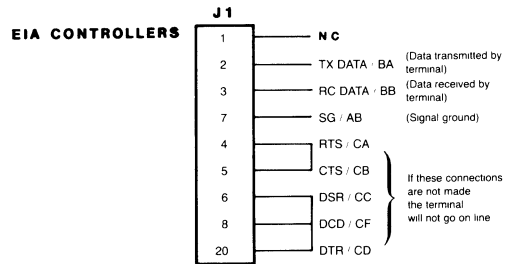
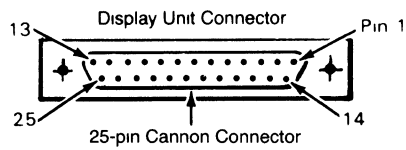
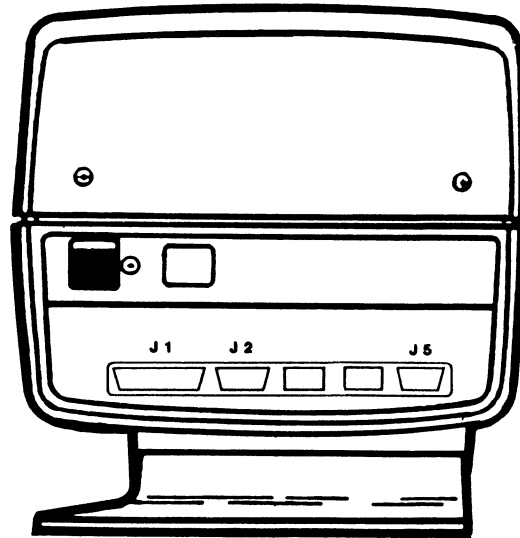

Figure 4-7 A. Rear View and Connectors of the D210



REAR VIEW D211

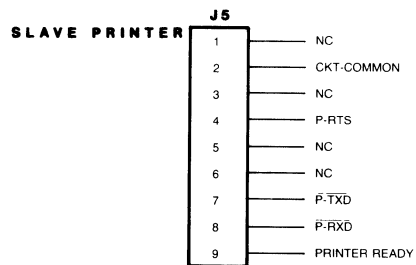
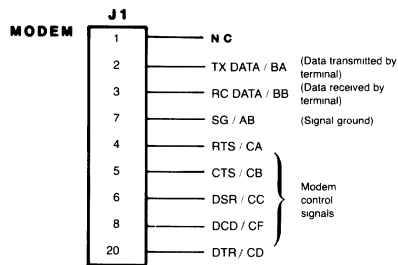
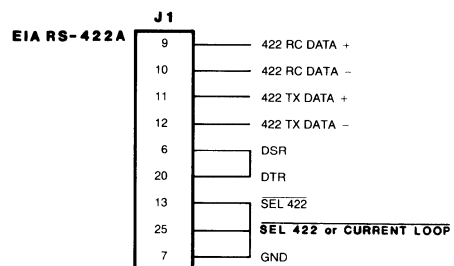
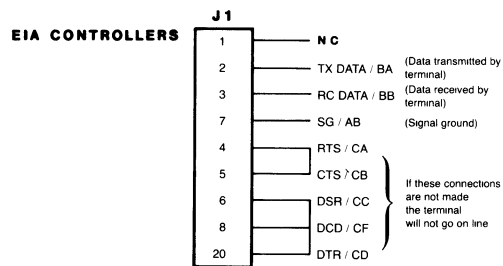
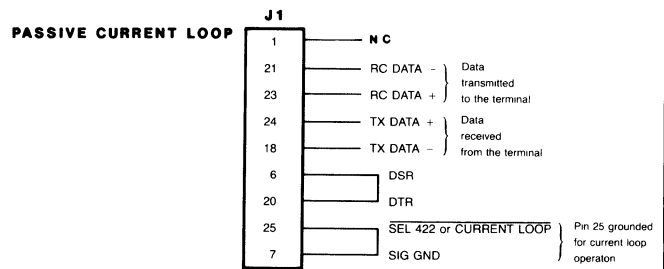
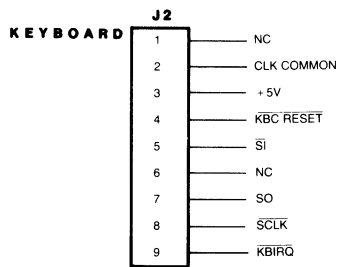
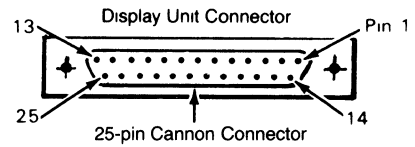

Figure 4-7 B. Rear View and Connectors of the D211

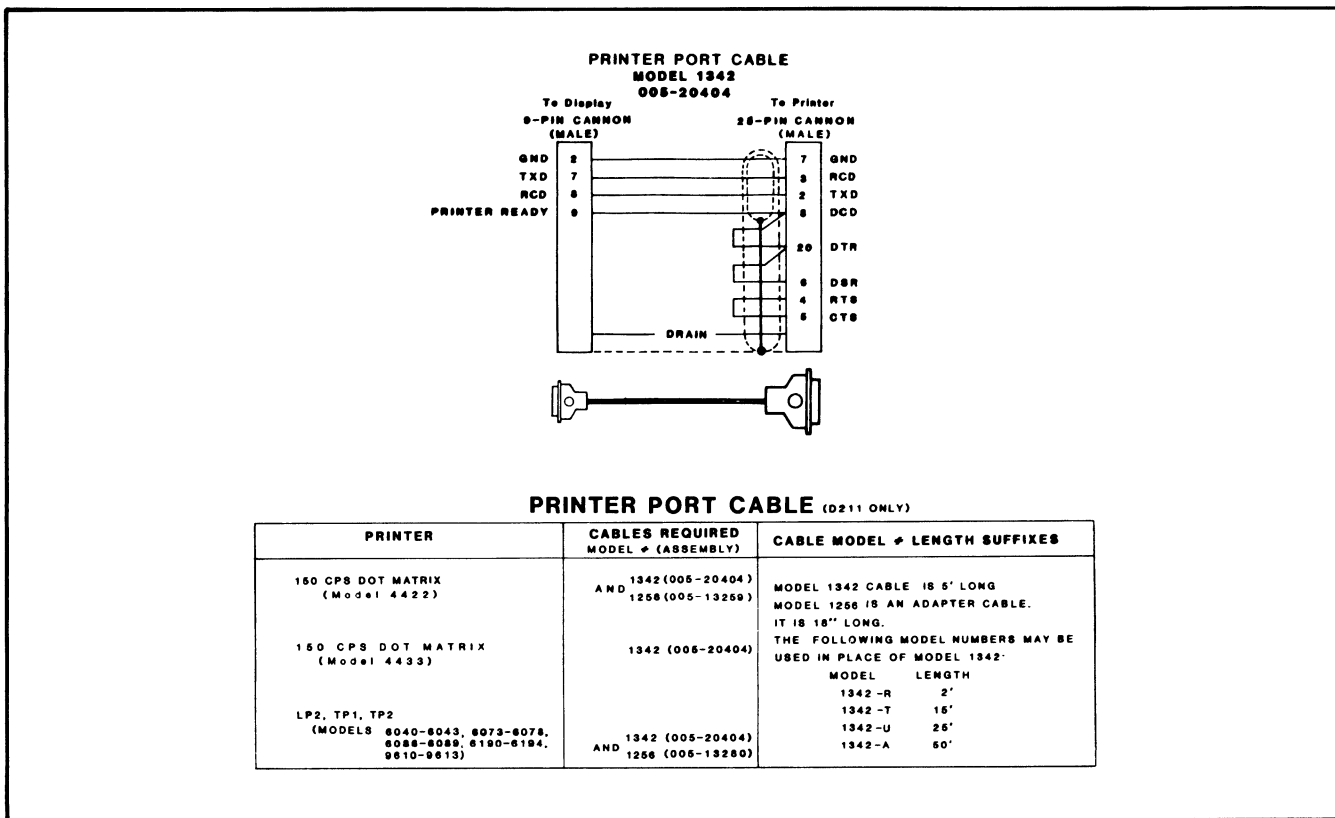

Figure 4-8. Terminal/Printer Interface Cables (D211 Only)

## OPERATIONAL CHECKOUT

Before beginning normal use of the D210/211 terminal, the self-test and off-line checkout procedures should be performed and the communications link to the host tested (on-line checkout). These checkouts for the terminal are followed by a separate checkout procedure for those D211 terminal configurations that include a printer. If any of the checkout procedures produce results other than those indicated, read through the terminal problem diagnosis information in the user maintenance section of Chapter 2.

### Self-Test and Off-Line Checkout

The self-test and off-line checks verify that the terminal display unit and keyboard work properly when separate from a host computer:

1. Make certain the terminal has been installed as described in the installation paragraph of this chapter.
2. Turn on power to the terminal with the on/off switch located on the rear of the display unit.

When first turned on, the terminal executes a self-test to verify that everything is working. The following events should occur during the self-test:

- a. The terminal bell rings and two lamps on the keyboard (ON LINE and ALPHA LOCK) turn on.
- b. The keyboard lamps remain on as the self-test checks ROM, RAM, UARTs, etc. (This takes about one second.)
- c. The terminal bell rings and the ALPHA LOCK lamp turns off. The ON LINE lamp remains on if the terminal is connected directly (modems not used) to the host; otherwise, it blinks. If modems are used, the ON LINE lamp blinks until the modems are ready for communications, then stays on.
- d. The reverse video block cursor appears in the screen home (upper-left corner) position along with the message "D210 (or D211) Self Test OK."

3. If the ON LINE lamp on the keyboard is on steady or blinking, depress and hold down the CMD key while depressing the ON LINE key (CMD-ON LINE). The ON LINE lamp should turn off indicating the terminal is off-line.

**NOTE:** The terminal must be set to Data General operating mode (switch 8 of the HOST switch) before performing the following checkout procedure.

**Table 4-2. Terminal Off-Line Checkout and Demonstration Procedure**

Procedure	Expected Results
Check ON LINE lamp	ON LINE lamp is off.
Depress ALPHA LOCK key	ALPHA LOCK lamp goes on.
Enter some text on keyboard	Text entered appears in uppercase.
Depress ALPHA LOCK key	ALPHA LOCK lamp goes off.
Enter more text	Text appears in lowercase unless SHIFT key is depressed.
Depress and hold down CTRL and then depress G (CTRL-G)	Terminal bell emits a beep.
Depress CTRL-T and enter some text	Text appears underscored.
Depress CTRL-\ and enter some text	Text appears dimmed and underscored.
Depress CTRL-N and enter some text	Text blinks, is dimmed, and is underscored.
Depress CTRL-U and enter some text	Underscore does not appear under new text but remains under old text.
Depress CTRL-] and enter some text	New text is brightly displayed but old text remains dim.
Depress CTRL-O and enter some text	New text does not blink but old text continues blinking.
Depress CTRL-D	All text stops blinking.
Depress each of four cursor control keys marked with arrow on keycaps	Cursor moves in direction of arrows.
Depress HOME	Cursor moves to upper-left corner of screen.
Depress CTRL-S, enter some text, and repeatedly depress NEW LINE until cursor moves past bottom of screen	Cursor moves to bottom of screen then jumps to top and continues moving downward; text is not affected.

Procedure	Expected Results
Depress CTRL-R and repeatedly depress NEW LINE until cursor moves past bottom of screen	Cursor moves to bottom of screen then text moves up one line with each depression of NEW LINE.
Depress CTRL-T; CTRL-\;CTRL-C; CTRL-N and enter some text	Text is underscored, dimmed, and blinking.
Depress CTRL-L and enter some text	Screen clears and new text is not underscored, dimmed, or blinking.
Move cursor to middle of previously entered line of text and depress ERASE EOL	Characters from cursor position to end-of-line are erased.
Enter some text in lower part of screen and repeatedly depress NEW LINE until cursor moves past bottom of screen	Cursor moves to bottom of screen then text moves up in one-line increments.
Enter some text and depress and hold down NEW LINE and REPT	Text moves quickly up and off screen (if NEW LINE and REPT are held down long enough).
NOTE: In the remainder of this checkout, command sequences begin with <036>. The <036> value is generated from the keyboard by typing CMD-BREAK ESC. That is, first depress and hold down CMD, and then press the BREAK ESC key. The characters following the <036> must be entered exactly as shown, upper case with no embedded spaces.	
Enter <036>D and type some text	Text appears in reverse video form.
Enter <036>E and enter some text	Text appears normal without reverse video
Position cursor to beginning of first string and then enter <036>FF	All text is erased after the cursor.



## On-Line Checkout

Following a successful self-test and off-line checkout, communications with the host computer should be tested.

**NOTE:** *Before proceeding, make sure the host computer system is operational and equipped with the software needed to communicate with the terminal.*

Proceed to test communications with the host:

1. If the terminal is off-line (ON LINE lamp on keyboard is off), depress CMD-ON LINE. The ON LINE lamp should come on indicating that the terminal is on-line with the host.
2. Log on the host-resident software to verify that the host/terminal communications link is working.

## Off-Line Printer Checkout (D211 Only)

This check verifies that the printer connected to the rear of the D211 terminal will produce hardcopy as directed from the keyboard of the terminal.

Before proceeding with the checkout steps, make certain the printer has been installed with the terminal as described earlier in this chapter. Be sure that the

available power source is in accord with the printer model number.

Configure the printer to receive characters with 7 data bits, even parity, and 1 stop bit; and set the printer baud rate to match the terminal printer port baud rate.

The printer interface cable should be connected between the printer and the printer connector at the rear of the display unit. The printer power cord should be plugged in, and the printer on-line and loaded with paper; i.e., ready to print.

Proceed with the checkout steps:

1. With the terminal off-line, use the keyboard to enter both full intensity and dim characters on the display screen. To begin a string of dim characters, first enter CTRL-\`&`; to end a string of dim characters, enter CTRL-]`&`.
2. Move the cursor to the screen "home" location and depress the Local Print key. All characters on the screen should print. In order for the printer to print all characters on the D211 screen, the printer line length must be equal to or greater than 80 columns.
3. With the cursor at "home", depress SHIFT-Local Print. Only the full intensity characters on the screen should print.



# APPENDIX A

## ASCII D210/211 CONTROL CODES

This appendix lists ASCII control codes (000) through (037), the function each code has on the D210/211 terminal in Data General mode, and the keys that must be depressed on the keyboard to generate each of the

codes in DG mode and in ANSI mode. Note that several of the codes have specific functions listed for ANSI mode; where no function is listed for ANSI mode, that function is undefined.

Table A-1. ASCII D210/211 Control Codes

Code (octal)	Keyboard in DG Mode	Function in DG Mode	Keyboard in ANSI Mode	Function in ANSI Mode
000	CTRL-SHIFT-2 (CTRL- @)	—		
001	CTRL-A	Print screen form	CTRL-A	
002	CTRL-SHIFT-A			
002	CTRL-B	Reserved	CTRL-B	
003	CTRL-SHIFT-B			
003	CTRL-C	Enable blink	CTRL-C	
004	CTRL-SHIFT-C			
004	CTRL-D	Disable blink	CTRL-D	
005	CTRL-SHIFT-D			
005	CTRL-E	Read cursor address	CTRL-E	
006	CTRL-SHIFT-E			
006	CTRL-F	—	CTRL-F	
007	CTRL-SHIFT-F			
007	CTRL-G	Bell	CTRL-G	Bell
010	CTRL-SHIFT-G			
010	CTRL-H	Cursor home	CTRL-H	
011	CTRL-SHIFT-H			
011	HOME CTRL-HOME			
011	CTRL-I	—	CTRL-I	
012	CTRL-SHIFT-I			
012	TAB			
012	SHIFT-TAB			
012	CTRL-TAB			
012	CTRL-SHIFT-TAB			
012	CTRL-J	New line	CTRL-J	New line
013	CTRL-SHIFT-J			
013	NEW LINE			
013	CTRL-NEW LINE			
013	SHIFT-NEW LINE			
013	CTRL-SHIFT-NEW LINE			
013	CTRL-K	Erase to end-of-line	CTRL-K	Erase end-of-line
014	CTRL-SHIFT-K			
014	ERASE EOL			
014	SHIFT-EOL			
014	CTRL-EOL			
014	CTRL-SHIFT-EOL			
014	CTRL-L	Erase page	CTRL-L	New line
015	ERASE PAGE			
015	SHIFT-ERASE PAGE			
015	CTRL-ERASE PAGE			
015	CTRL-SHIFT-ERASE PAGE			
015	CTRL-M	Carriage return	CTRL-M	Carriage return
016	CTRL-SHIFT-M			
016	CR			
016	CTRL-CR			
016	SHIFT-CR			
016	CTRL-SHIFT-CR			
016	CTRL-N	Start blink	CTRL-N	Shift-out
017	CTRL-SHIFT-N			
017	CTRL-O	End blink	CTRL-O	Shift-in
020	CTRL-SHIFT-O			
020	CTRL-P	Write cursor address	CTRL-P	
020	CTRL-SHIFT-P			

Table A-1. ASCII D210/211 Control Codes (continued)

Code (octal)	Keyboard in DG Mode	Function in DG Mode	Keyboard in ANSI Mode	Function in ANSI Mode
021	CTRL-Q	Print screen	CTRL-Q	X-ON
022	CTRL-SHIFT-Q CTRL-R	Roll enable	CTRL-R	
023	CTRL-SHIFT-R CTRL-S	Roll disable	CTRL-S	X-OFF
024	CTRL-SHIFT-S CTRL-T	Start underscore	CTRL-T	
025	CTRL-SHIFT-T CTRL-U	End underscore	CTRL-U	
026	CTRL-SHIFT-U CTRL-V	Reserved	CTRL-V	
027	CTRL-SHIFT-V CTRL-W	Cursor up	CTRL-W	
030	CTRL-SHIFT-W ↑,CTRL-↑	Cursor right	CTRL-X	
031	CTRL-X CTRL-SHIFT-X →,CTRL-→	Cursor left	CTRL-Y	
032	CTRL-Y CTRL-SHIFT-Y ←,CTRL-←	Cursor down	CTRL-Z	
033	CTRL-Z CTRL-SHIFT-Z ↓,CTRL-↓	—	BREAK ESC	Command header
034	ESC SHIFT-ESC CTRL-ESC CTRL-SHIFT-ESC CTRL-[			
035	CTRL-\	Start dim	CTRL-\	
036	CTRL-]	End dim	CTRL-]	
037	CMD-BREAK ESC —	Function header code Read cursor address code prefix	CTRL-^ CTRL-—	



# **APPENDIX B**

## **ASCII D210/211 DISPLAY CODES**

This appendix identifies the U.S. and European ASCII characters displayed by the D210/211 terminal, the octal codes for the characters, and the keys that must be depressed to produce the characters.

Table B-1. ASCII D210/211 Display Codes

Name	Symbol Display	Octal Code	Keypad *	
			Main Keypad	Numeric Keypad
Space	Blank space	040	Space Bar	-
Exclamation Mark	!	041	SH 1	-
Quotation Marks	"	042	SH '	-
Number Sign	#	043	SH 3	-
Dollar Sign	\$	044	SH 4	-
Percent	%	045	SH 5	-
Ampersand	&	046	SH 7	-
Apostrophe (Single Closing Quotation Mark)	'	047	'	-
Opening Parenthesis	(	050	SH 9	-
Closing Parenthesis	)	051	SH 0	-
Asterisk	*	052	SH 8	-
Plus	+	053	SH =	-
Comma	,	054	,	-
Hyphen (Minus)	-	055	-	-
Period (Decimal Point)	.	056	.	-
Slant	/	057	/	-
Zero	0	060	0	0
One	1	061	1	1
Two	2	062	2	2
Three	3	063	3	3
Four	4	064	4	4
Five	5	065	5	5
Six	6	066	6	6
Seven	7	067	7	7
Eight	8	070	8	8
Nine	9	071	9	9
Colon	:	072	SH ,	-
Semicolon	;	073	;	-
Less Than	<	074	SH .	-
Equals	=	075	=	-
Greater Than	>	076	SH	-
Question Mark	?	077	SH /	-
Commercial At	@	100	SH 2	-
A	A	101	SH A	-
B	B	102	SH B	-
C	C	103	SH C	-
D	D	104	SH D	-
E	E	105	SH E	-
F	F	106	SH F	-
G	G	107	SH G	-
H	H	110	SH H	-
I	I	111	SH I	-
J	J	112	SH J	-
K	K	113	SH K	-
L	L	114	SH L	-
M	M	115	SH M	-
N	N	116	SH N	-
O	O	117	SH O	-
P	P	120	SH P	-
Q	Q	121	SH Q	-
R	R	122	SH R	-



Table B-1. ASCII D210/211 Display Codes (continued)

Name	Symbol Display	Octal Code	Keypad	
			Main Keypad	Numeric Keypad
S	S	123	SH S	-
T	T	124	SH T	-
U	U	125	SH U	-
V	V	126	SH V	-
W	W	127	SH W	-
X	X	130	SH X	-
Y	Y	131	SH Y	-
Z	Z	132	SH Z	-
Opening Bracket	[	133	[	-
Reverse Slant	\	134	\	-
Closing Bracket	]	135	]	-
Circumflex	^	136	SH 6	-
Underline	—	137	SH -	-
Single Opening Quotation Mark	·	140	·	-
a	a	141	A	-
b	b	142	B	-
c	c	143	C	-
d	d	144	D	-
e	e	145	E	-
f	f	146	F	-
g	g	147	G	-
h	h	150	H	-
i	i	151	I	-
J	J	152	J	-
k	k	153	K	-
l	l	154	L	-
m	m	155	M	-
n	n	156	N	-
o	o	157	O	-
p	p	160	P	-
q	q	161	Q	-
r	r	162	R	-
s	s	163	S	-
t	t	164	T	-
u	u	165	U	-
v	v	166	V	-
w	w	167	W	-
x	x	170	X	-
y	y	171	Y	-
z	z	172	Z	-
Open Brace	{	173	SH [	-
Vertical Line		174	SH \	-
Closing Brace	}	175	SH ]	-
Tilde	~	176	SH `	-
Delete*	Non-printing	177	DEL	-

\* Not a displayable character

Table B-1. ASCII D210/211 Display Codes (continued)

Keypad					
	Name	Symbol Display	Octal Code	Main Keypad	Numeric Keypad
UNITED KINGDOM	Pound Sign	£	043	SH 3	-
	Up Arrow	↑	136	SH 6	-
	Over Bar	—	176	SH	-
FRENCH	Pound Sign	£	043	£	-
	a grave	à	100	à	-
	Degree	°	133	SH )	-
	C Cedilla	ç	134	ç	-
	Paragraph Sign	§	135	SH !	-
	e aigue	é	173	é	-
	u grave	ù	174	ù	-
e grave	è	175	è	-	
GERMAN	Paragraph Sign	§	100	SH 3	-
	A umlaut	Ä	133	SH Ä	-
	O umlaut	Ö	134	SH Ö	-
	U umlaut	Ü	135	SH U	-
	a umlaut	ä	173	Ä	-
	o umlaut	ö	174	O	-
	u umlaut	ü	175	U	-
Schaffe	ß	176	B	-	
SPANISH	N tilde	Ñ	134	SH Ñ	-
	n tilde	ñ	174	Ñ	-
SWEDISH/ FINNISH	Crown	Ɔ	044	SH 4	-
	E acute	É	100	SH É	-
	A umlaut	Ä	133	SH A	-
	O umlaut	Ö	134	SH Ö	-
	A dot	Å	135	SH Å	-
	U umlaut	Ü	136	SH Ü	-
	e acute	é	140	É	-
	a umlaut	ä	173	Ä	-
	o umlaut	ö	174	Ö	-
	a dot	å	175	Å	-
u umlaut	u	176	U	-	
DANISH/ NORWEGIAN	Crown	Ɔ	044	SH 4	-
	0 (zero)	0	060	0	-
	A umlaut	Ä	100	SH A	-
	Æ	Æ	133	SH Æ	-
	Ø (uppercase)	Ø	134	SH Ø	-
	A dot	Å	135	SH Å	-
	U umlaut	Ü	136	SH U	-
	a umlaut	ä	140	Ä	-
	æ	æ	173	æ	-
	ø (lowercase)	ø	174	ø	-
a dot	å	175	Å	-	
u umlaut	u	176	U	-	
SWISS	u grave	ù	174	ù	-
	a grave	à	100	à	-
	e umlaut	è	133	e	-
	c cedilla	ç	134	ç	-
	e grave	è	135	è	-
	e circumflex	ê	136	ê	-
	o circumflex	ô	140	ô	-
	a umlaut	ä	173	ä	-
	o umlaut	ö	174	ö	-
	u umlaut	ü	175	ü	-
e acute	é	176	é	-	

Table B-1. ASCII D210/211 Display Codes (continued)

Name	Symbol Display	Octal Code
Buy	⌘	246
Cent sign	¢	247
British pound	£	250
Exclamation introducer	!	253
Question introducer	?	254
Accent grave	`	272
Degree	°	274
Umlaut	¨	275
Accent aigue	´	276
Circumflex	ˆ	136
a, (A) aigue	á (Á)	340 (300)
a, (A) grave	à (À)	341 (301)
a, (A) circumflex	â (Â)	342 (302)
a, (A) umlaut	ä (Ä)	343 (303)
a, (A) Tilde	ã (Ã)	344 (304)
a, (A) degree	â (Â)	345 (305)
æ (Æ)	æ (Æ)	346 (306)
c (C) cedilla	ç (Ç)	347 (307)
e (E) aigue	é (É)	350 (310)
e (E) grave	è (È)	351 (311)
e (E) circumflex	ê (Ê)	352 (312)
e (E) umlaut	ë (Ë)	353 (313)
i (I) aigue	í (Í)	354 (314)
i (I) grave	ì (Ì)	355 (315)
i (I) circumflex	î (Î)	356 (316)
i (I) umlaut	ï (Ï)	357 (317)
n (N) tilde	ñ (Ñ)	360 (320)
o (O) aigue	ó (Ó)	361 (321)
o (O) grave	ò (Ò)	362 (322)
o (O) circumflex	ô (Ô)	363 (323)
o (O) umlaut	ö (Ö)	364 (324)
o (O) tilde	õ (Õ)	365 (325)
o (O) slash	ø (Ø)	366 (326)
œ (Œ)	œ (Œ)	367 (327)
u (U) aigue	ú (Ú)	370 (330)
u (U) grave	ù (Ù)	371 (331)
u (U) circumflex	û (Û)	372 (332)
u (U) umlaut	ü (Ü)	373 (333)
Paragraph sign	¶	273
Up arrow	↑	277
Schaffe	β	374

Parenttheses indicate uppercase version of symbol



# APPENDIX C

## ASCII D210/211 CODE SEQUENCES

This appendix lists the ASCII code sequences that can be generated by the D210/211 terminal when operating in either Data General Mode or ANSI Mode, and the keys that must be depressed to produce these sequences.

Table C-1. ASCII D210/211 Code Sequences (DG Operations)

Code Sequence (octal)	D210/211 Keyboard	Code Sequence (octal)	D210/211 Keyboard
036,001	CMD-SHIFT-PRINT	036,131	SHIFT-C2
036,010	SHIFT-MODE-HOME	036,132	SHIFT-C3
036,021	CMD-PRINT	036,133	SHIFT-C4
036,027	SHIFT-	036,134	C1
036,030	SHIFT-—	036,135	C2
036,031	SHIFT-—	036,136	C3
036,032	SHIFT-	036,137	C4
036,040	CTRL-SHIFT-F15	036,140	SHIFT-F15
036,041	CTRL-SHIFT-F1	036,141	SHIFT-F1
036,042	CTRL-SHIFT-F2	036,142	SHIFT-F2
036,043	CTRL-SHIFT-F3	036,143	SHIFT-F3
036,044	CTRL-SHIFT-F4	036,144	SHIFT-F4
036,045	CTRL-SHIFT-F5	036,145	SHIFT-F5
036,046	CTRL-SHIFT-F6	036,146	SHIFT-F6
036,047	CTRL-SHIFT-F7	036,147	SHIFT-F7
036,050	CTRL-SHIFT-F8	036,150	SHIFT-F8
036,051	CTRL-SHIFT-F9	036,151	SHIFT-F9
036,052	CTRL-SHIFT-F10	036,152	SHIFT-F10
036,053	CTRL-SHIFT-F11	036,153	SHIFT-F11
036,054	CTRL-SHIFT-F12	036,154	SHIFT-F12
036,055	CTRL-SHIFT-F13	036,155	SHIFT-F13
036,056	CTRL-SHIFT-F14	036,156	SHIFT-F14
036,060	CTRL-F15	036,160	F15
036,061	CTRL-F1	036,161	F1
036,062	CTRL-F2	036,162	F2
036,063	CTRL-F3	036,163	F3
036,064	CTRL-F4	036,164	F4
036,065	CTRL-F5	036,165	F5
036,066	CTRL-F6	036,166	F6
036,067	CTRL-F7	036,167	F7
036,070	CTRL-F8	036,170	F8
036,071	CTRL-F9	036,171	F9
036,072	CTRL-F10	036,172	F10
036,073	CTRL-F11	036,173	F11
036,074	CTRL-F12	036,174	F12
036,075	CTRL-F13	036,175	F13
036,076	CTRL-F14	036,176	F14
036,130	SHIFT-C1		

# **APPENDIX D**

## **U.S., EUROPEAN, AND ALTERNATE CHARACTER SETS**

This appendix lists the available character sets for the D210/211 terminal. Note that the D210 terminal can be set in **ONLY** the U.S. character set. The other character sets listed apply to the D211 terminal **ONLY**.

AMERICAN USAGE

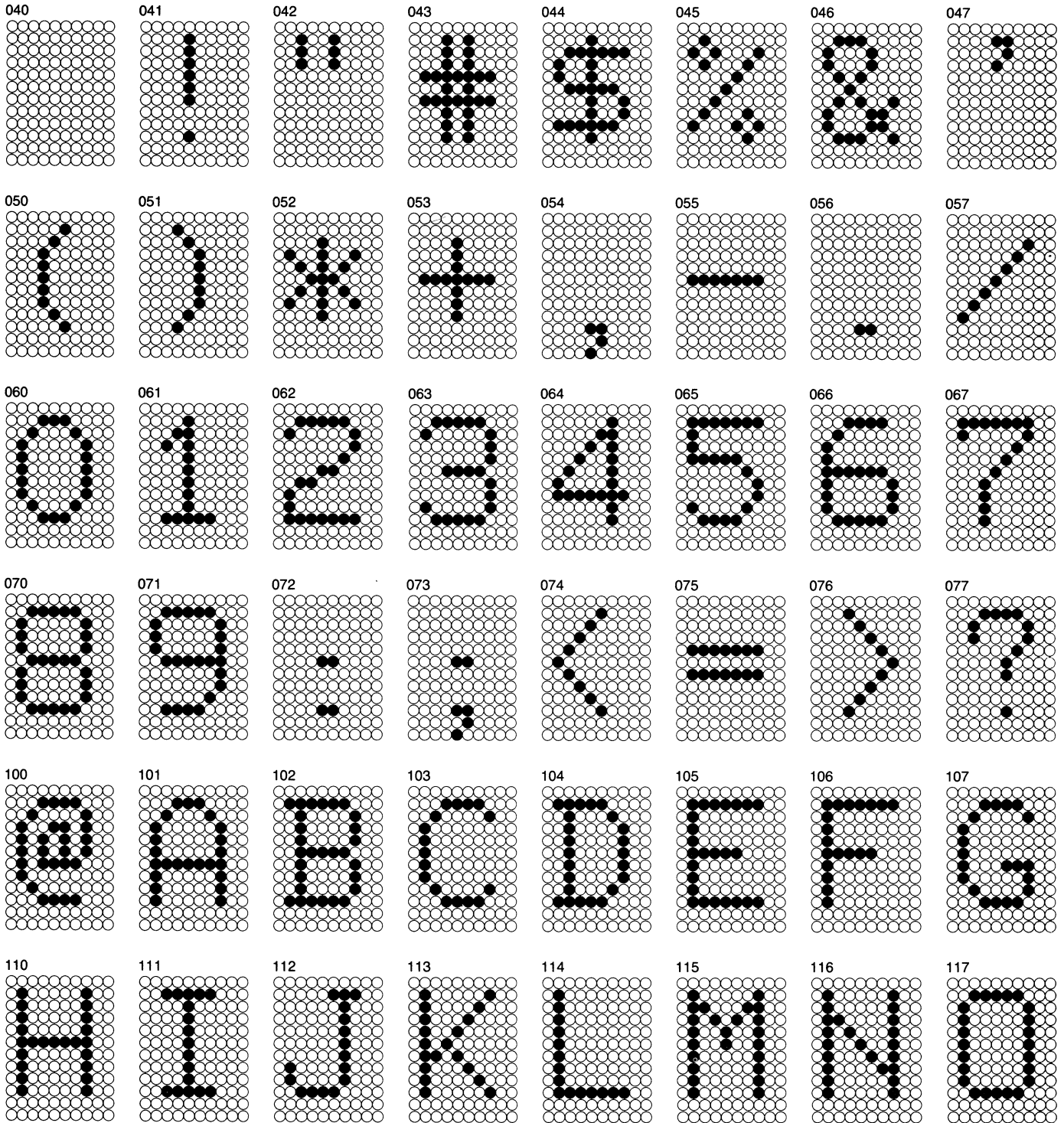



AMERICAN USAGE

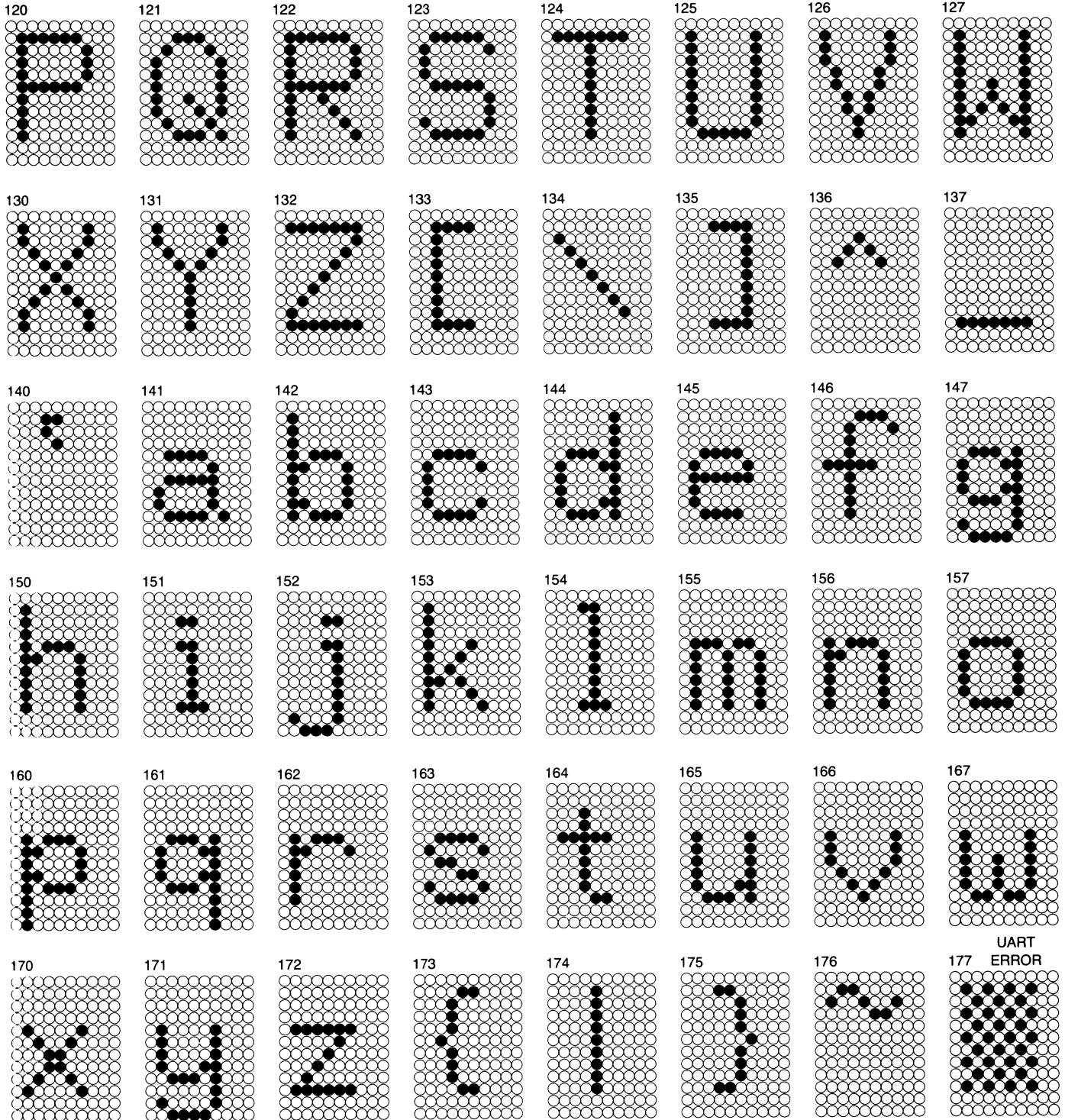

### UNITED KINGDOM USAGE

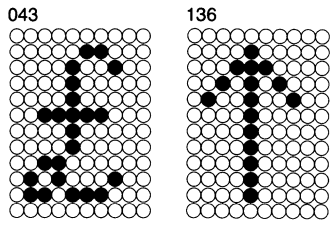

### FRENCH USAGE

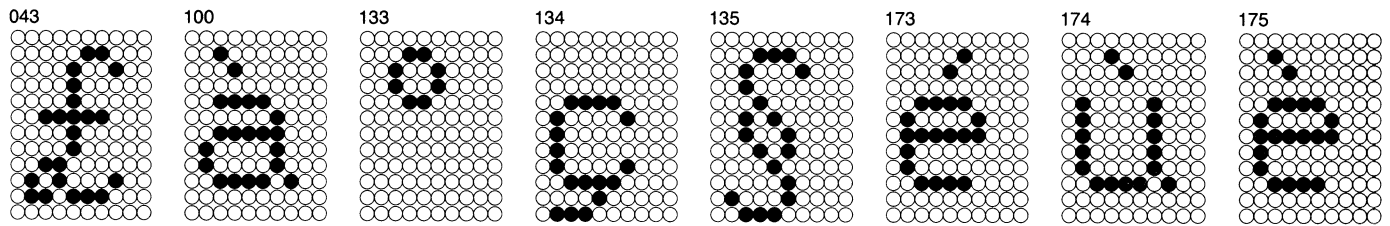

### GERMAN USAGE

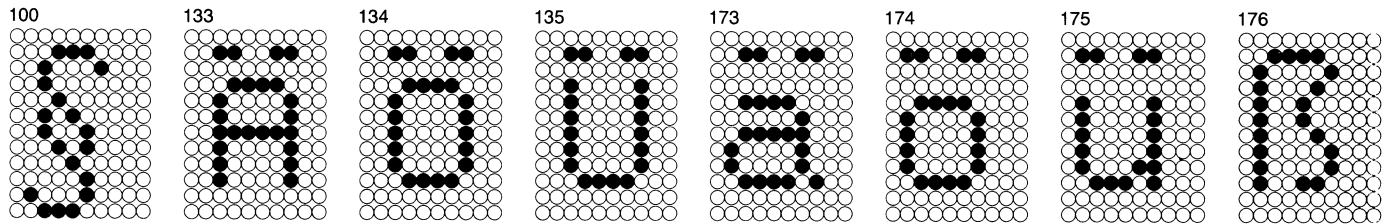

### SPANISH USAGE

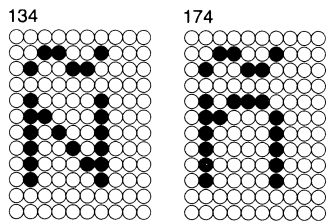

### SWEDISH/FINNISH USAGE

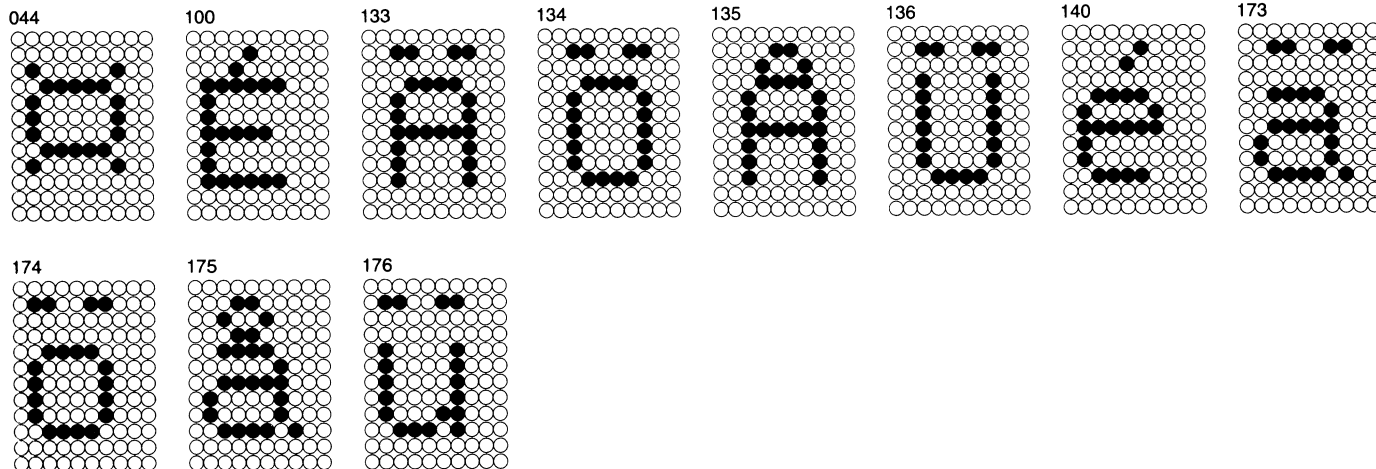

### DANISH/ NORWEGIAN USAGE

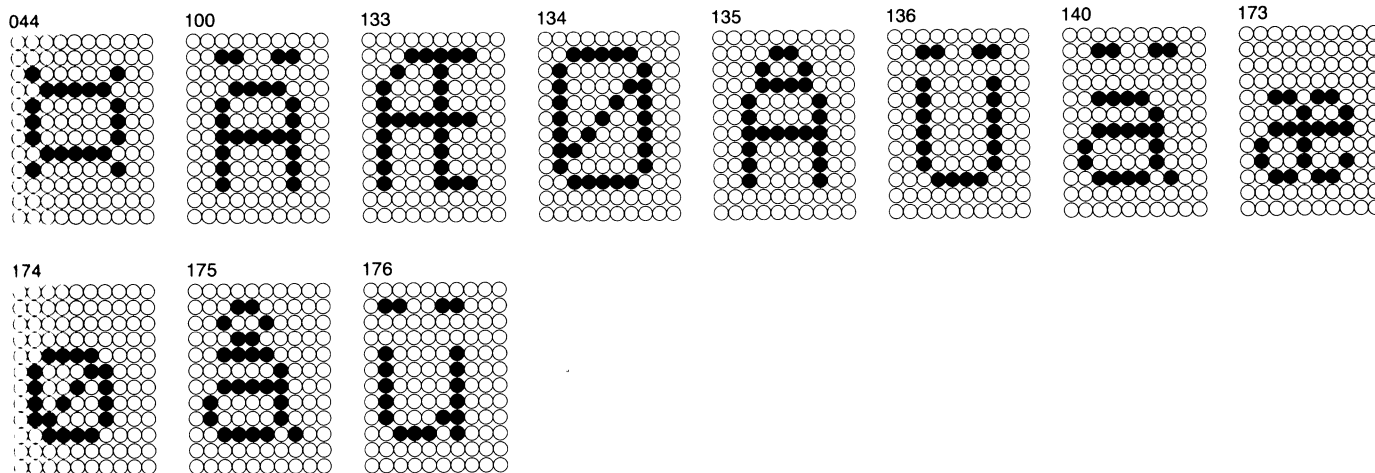

SWISS USAGE

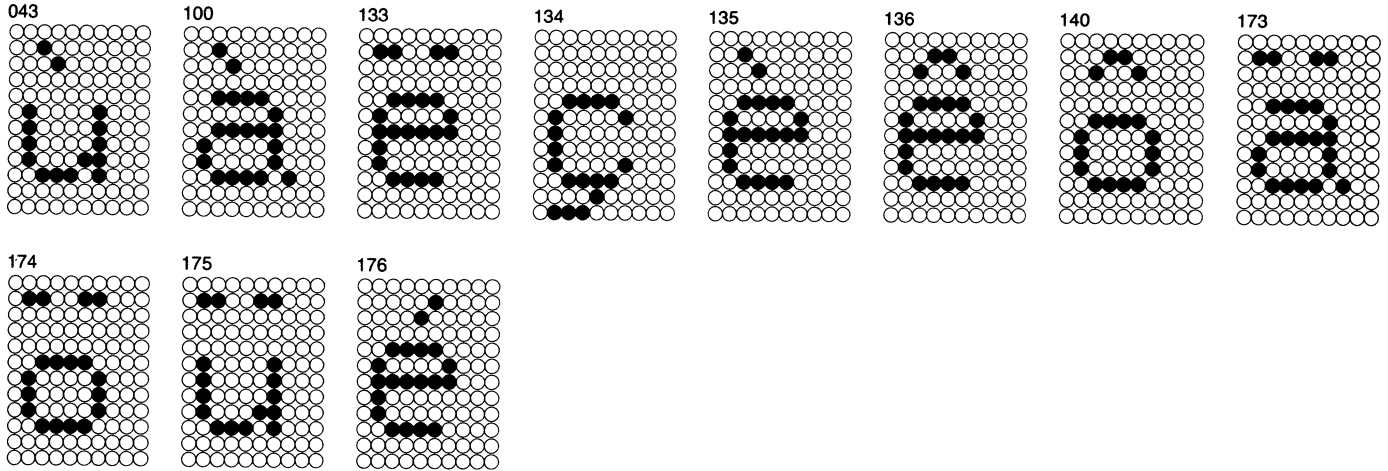

### D.G. INTERNATIONAL USAGE

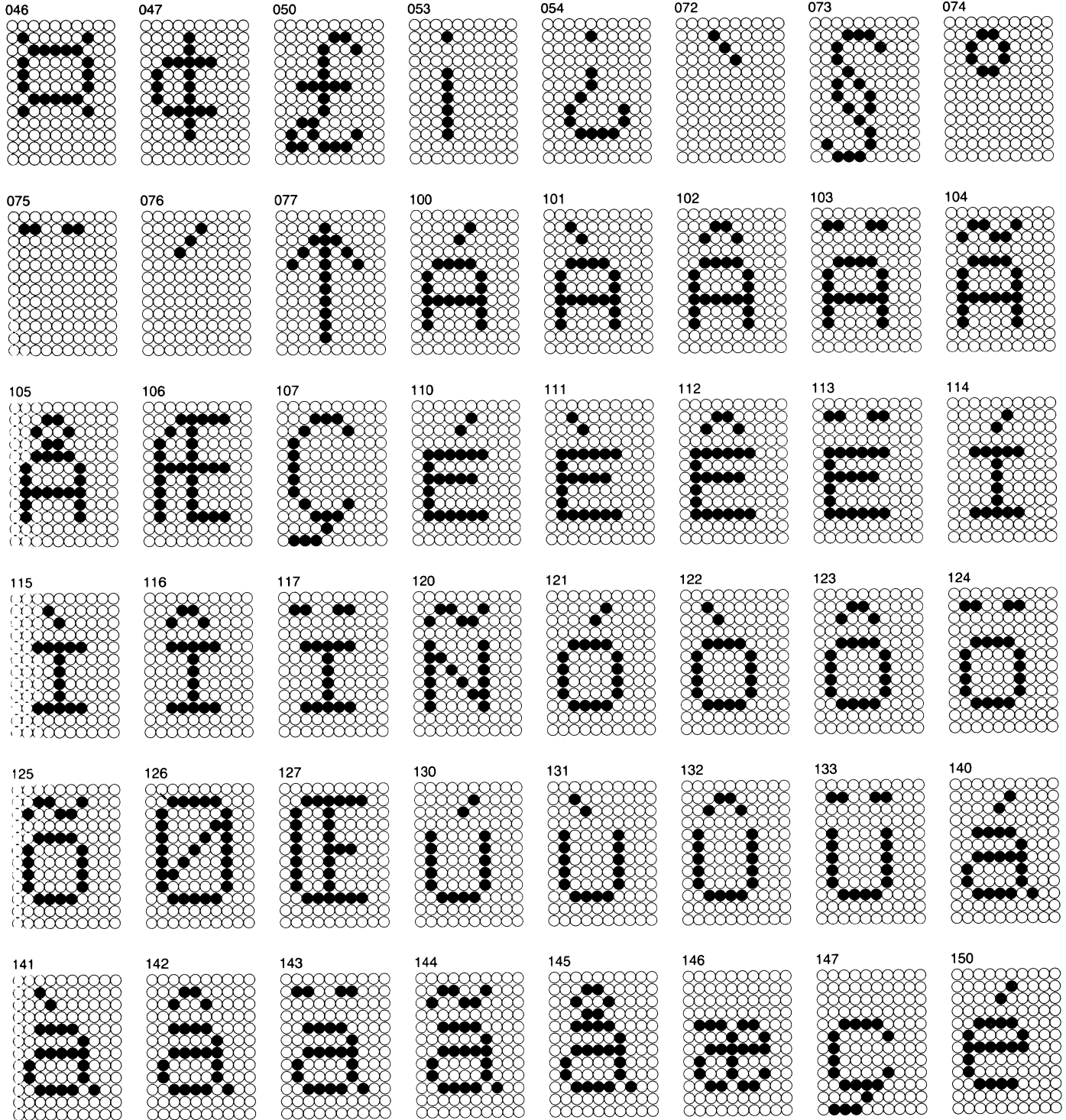

### D.G. INTERNATIONAL USAGE

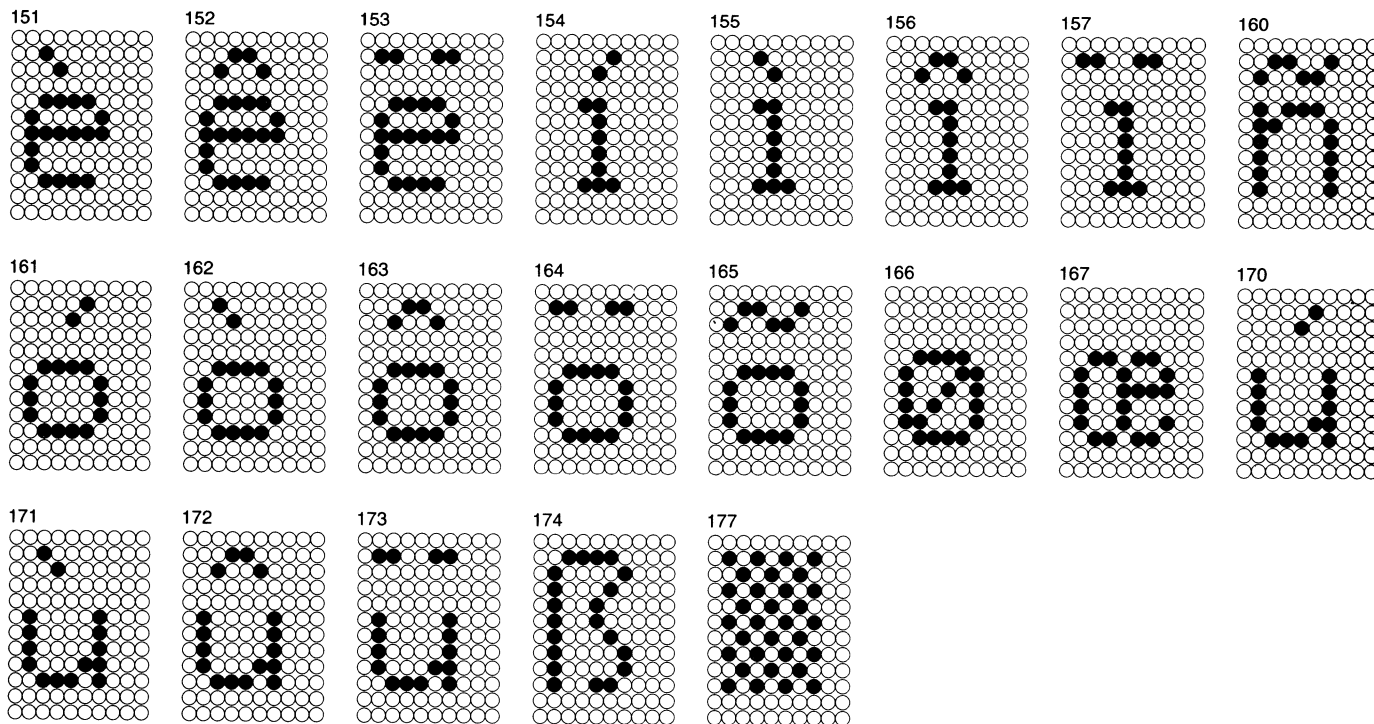

# **APPENDIX E**

## **SUMMARY OF D210/211 COMMANDS**

This appendix lists all of the D210/211 commands and their respective ASCII code or code sequences. The commands are divided into two sections: Data General Mode Commands and ANSI Mode Commands.

**Table E-1. D210/211 Commands (Data General Operations)**

Command Name	Octal Form	Keyboard
Bell	(007)	CTRL-G
Blink disable	(004)	CTRL-D
Blink enable	(003)	CTRL-C
Blink off	(017)	CTRL-O
Blink on	(016)	CTRL-N
Carriage return	(015)	CTRL-M
Cursor down	(032)	CTRL-Z
Cursor home	(010)	CTRL-H
Cursor left	(031)	CTRL-Y
Cursor right	(030)	CTRL-X
Cursor up	(027)	CTRL-W
Dim off	(035)	CTRL-]
Dim on	(034)	CTRL-\
Erase end-of-line	(013)	CTRL-K
Erase end-of-screen	(036)(106)(106)	(036)FF
Erase screen	(014)	CTRL-L
New line	(012)	CTRL-J
Primary character set enable*	(021)	(036)O
Print screen	(021)	CTRL-Q or Local Print
Print screen form*	(001)	CTRL-A or SHIFT-Local Print
Read model ID	(036)(103)	(036)C
Read cursor address	(005)	CTRL-E
Reverse video off	(036)(105)	(036)E
Reverse video on	(036)(104)	(036)D
Roll disable	(023)	CTRL-S
Roll enable	(022)	CTRL-R
Secondary character set enable*	(036)(116)	(036)N
Select ANSI mode	(036)(106)(100)	(036)F@
Select character set*	(036)(106)(123)(...)	(036)FS
Select 7/8-bit operation	(036)(106)(125)(...)	(036)FU
Set keyboard language	(036)(106)(146)(...)	(036)FF
Underscore off	(025)	CTRL-U
Underscore on	(024)	CTRL-T
Write cursor address	(020)(...)(..)	CTRL-P...

\*NOTE: D211 command only; D210 does not respond

**Table E-2. D210/211-Commands (ANSI Operations)**

Command Name	Octal Form	Keyboard
Bell	(007)	CTRL-G
Carriage Return	(015)	CTRL-M
Cursor Backward	(CSI)(col)(104)	(CSI).. D
Cursor Down	(CSI)(row)(102)	(CSI) B
Cursor Forward	(CSI)(col)(103)	(CSI) ..C
Cursor Position	(CSI)(row)(073)(col)(110)	(CSI)...;...H
Cursor Up	(CSI)(row)(101)	(CSI) . . A
Device Status Report	(CSI)(066)(156)	(CSI)6n
Erase In Display	(CSI)(...)(112)	(CSI) . . J
Erase In Line	(CSI)(...)(113)	(CSI) . K
Form Feed	(014)	FF
Media Copy*	(CSI)(.. )(151)	(CSI)...I
New Line	(012)	CTRL-J
Read Terminal Configuration	(CSI)(170)	(CSI)x

Command Name	Octal Form	Keyboard
Reset Mode	(CSI)(...)(073)(.. ) (154)	(CSI) . ;...I
Select Character Set*	(033)(...)( ..)	(ESC)... ..
Select Graphic Rendition	(CSI)( .. ) (073)(...)(155)	(CSI) . ;...m
Set Mode	(CSI)( . )(073) (...)(150)	(CSI)...;... h
Set Parameters*	(CSI)(...) (073)(. . )(166)	(CSI)...;...v
Shift In	(017)	CTRL-O
Shift Out	(016)	CTRL-N
Single Shift Two	(SS2)	(ESC)-N
Single Shift Three	(SS3)	(ESC)-O
XOFF	(023)	CTRL-S
XON	(021)	CTRL-Q

\*NOTE: D211 command only; D210 does not respond.



# APPENDIX F

## EUROPEAN KEYBOARDS

The D211 terminal can be equipped with a keyboard from one of eleven different countries (nationalities). The differences between the keyboards for the various nationalities lies within the keycaps on the main keypad. The United States keyboard is shown and described in the Operation Chapter of this manual. This appendix shows the main keycaps for the following ten European keyboards:

- Canadian/Bilingual
- Danish/Norwegian
- French
- German
- Italian
- Spanish
- Swedish/Finnish
- Swiss/French
- Swiss/German
- United Kingdom

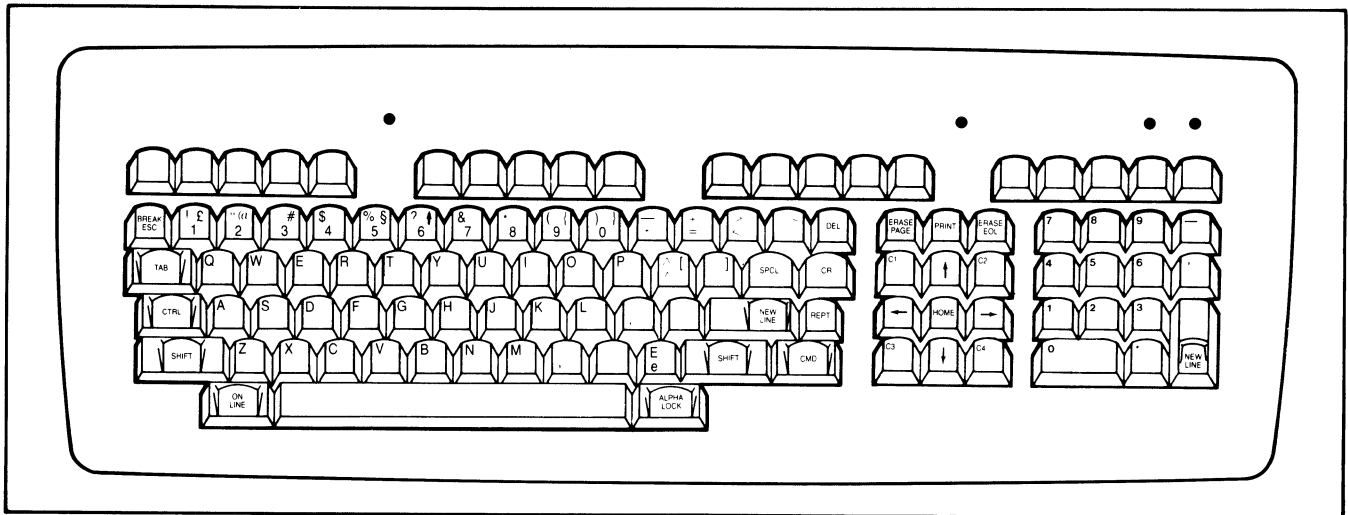

Figure F-1. Canadian Bilingual Main Keyboard

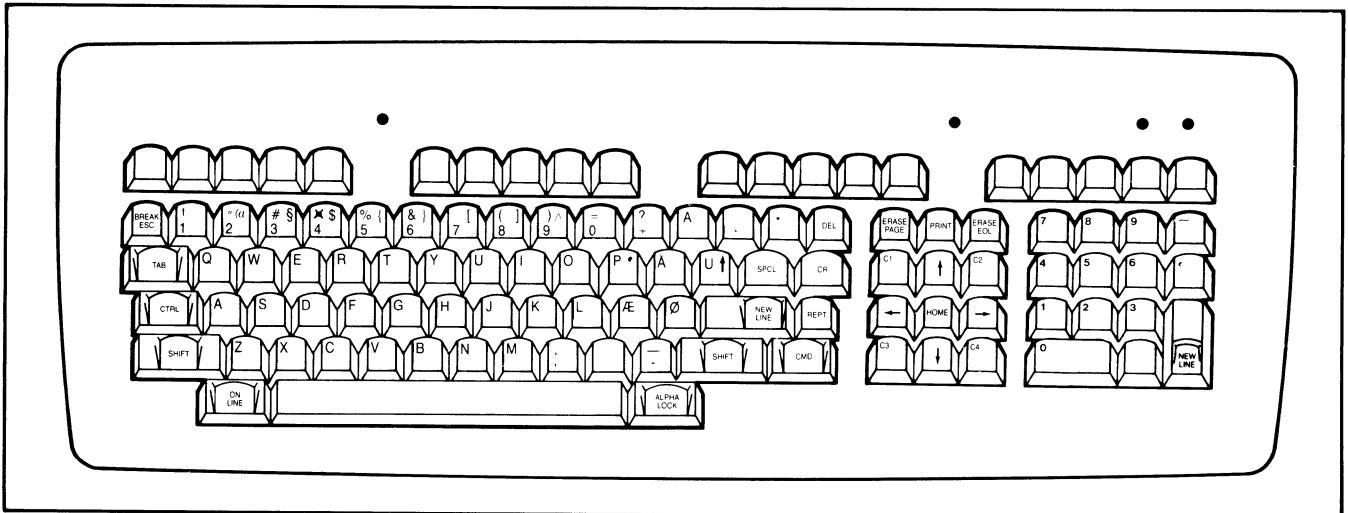

Figure F-2. Danish/Norwegian Main Keyboard

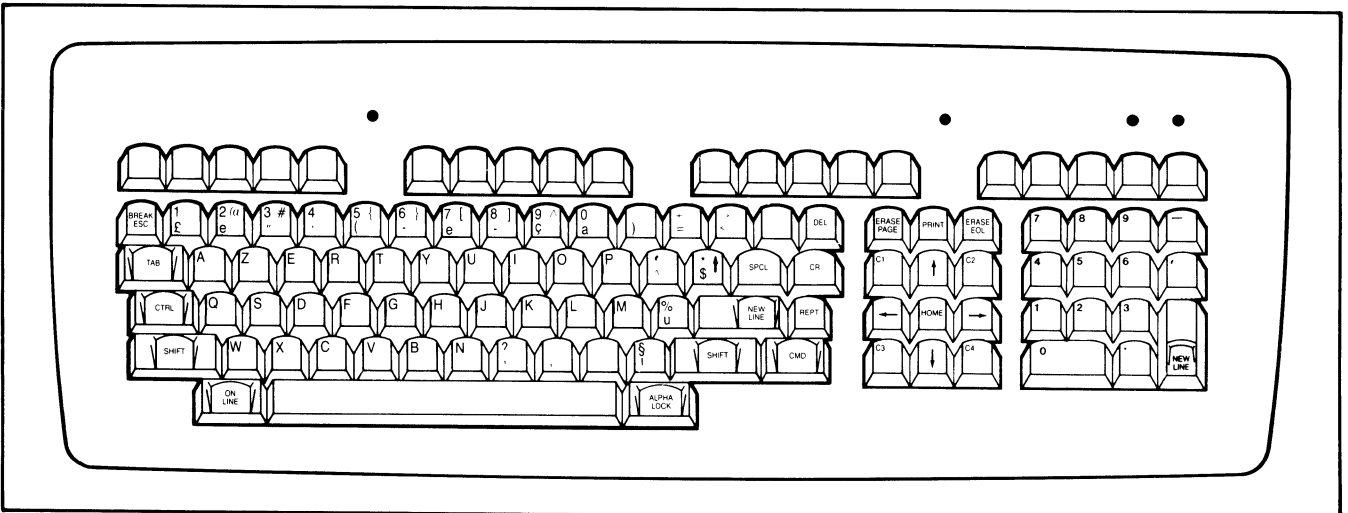

Figure F-3. French Main Keyboard

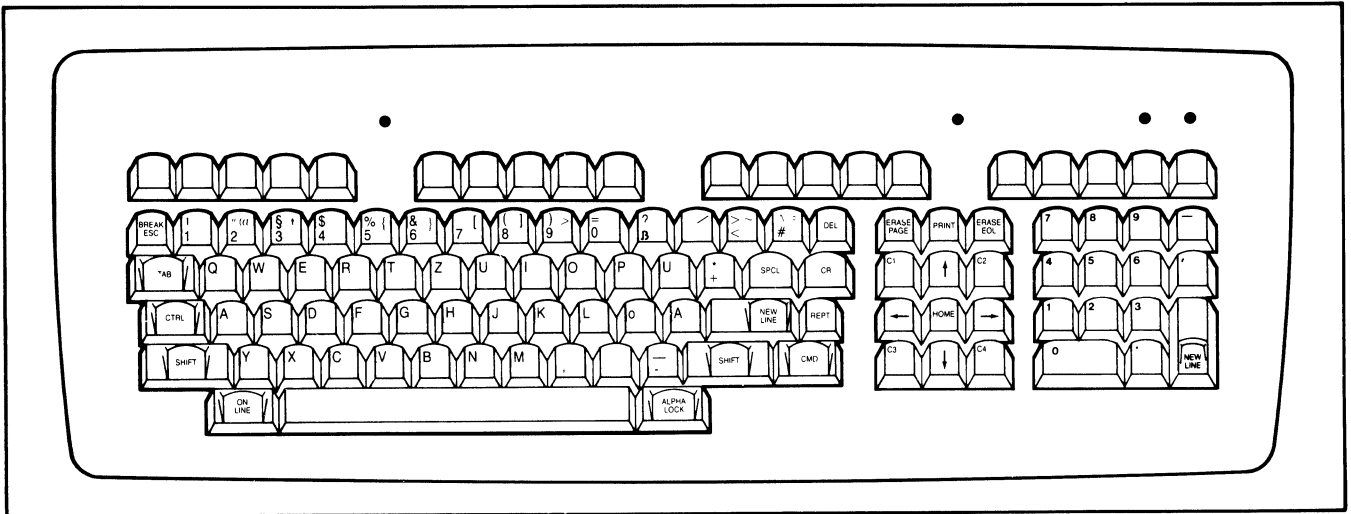

Figure F-4. German Main Keyboard

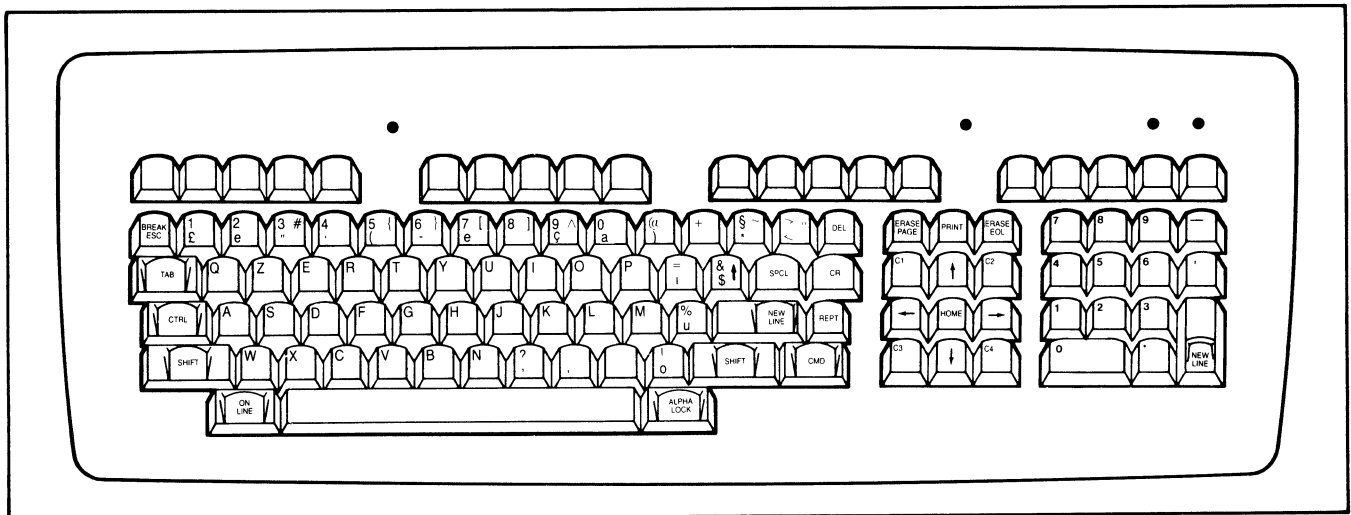

Figure F-5. Italian Main Keyboard

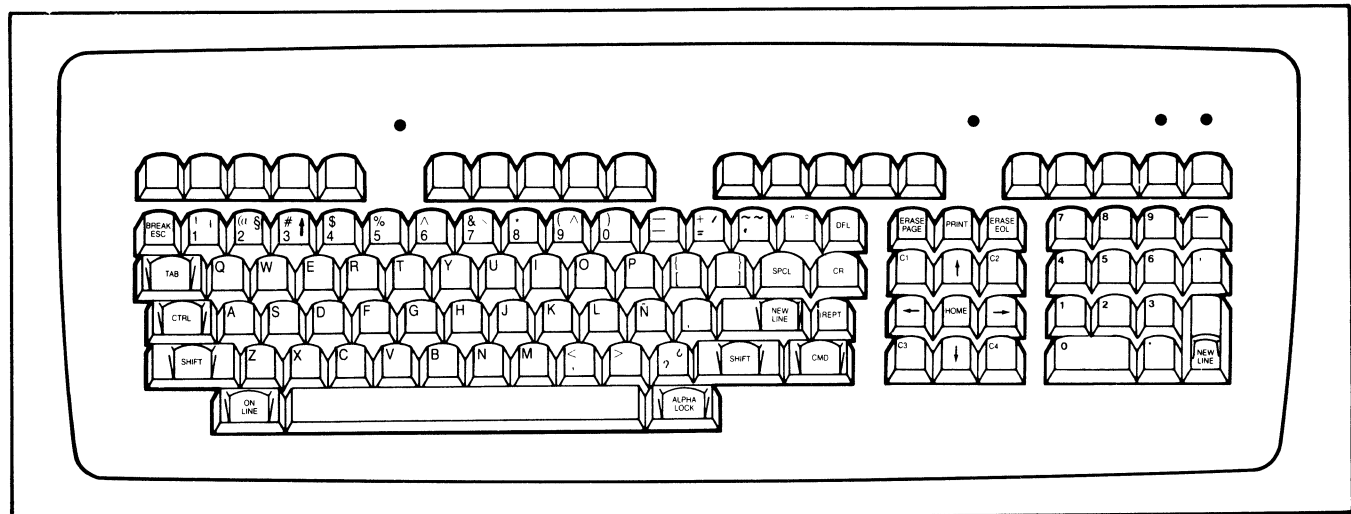

Figure F-6. Spanish Main Keyboard

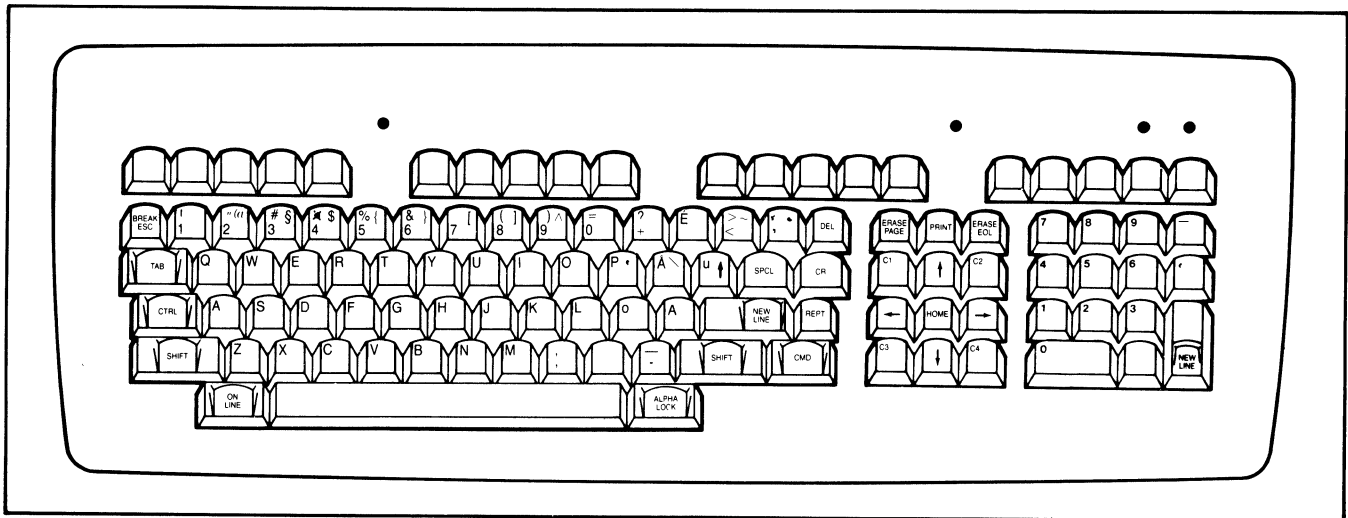

Figure F-7. Swedish/Finnish Main Keyboard

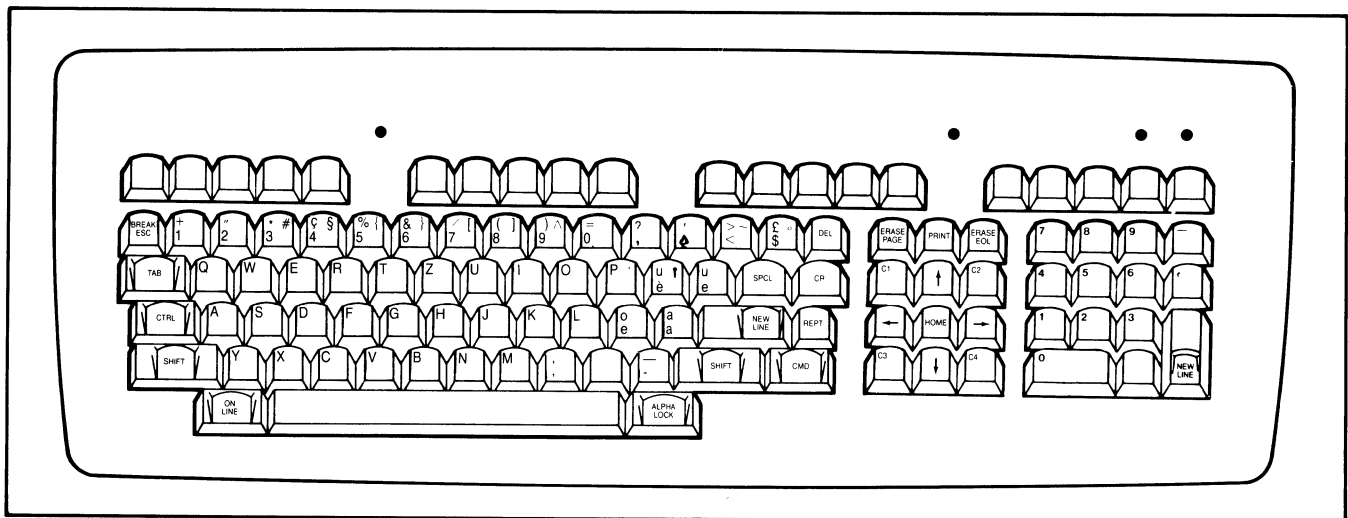

Figure F-8. Swiss/French Main Keyboard

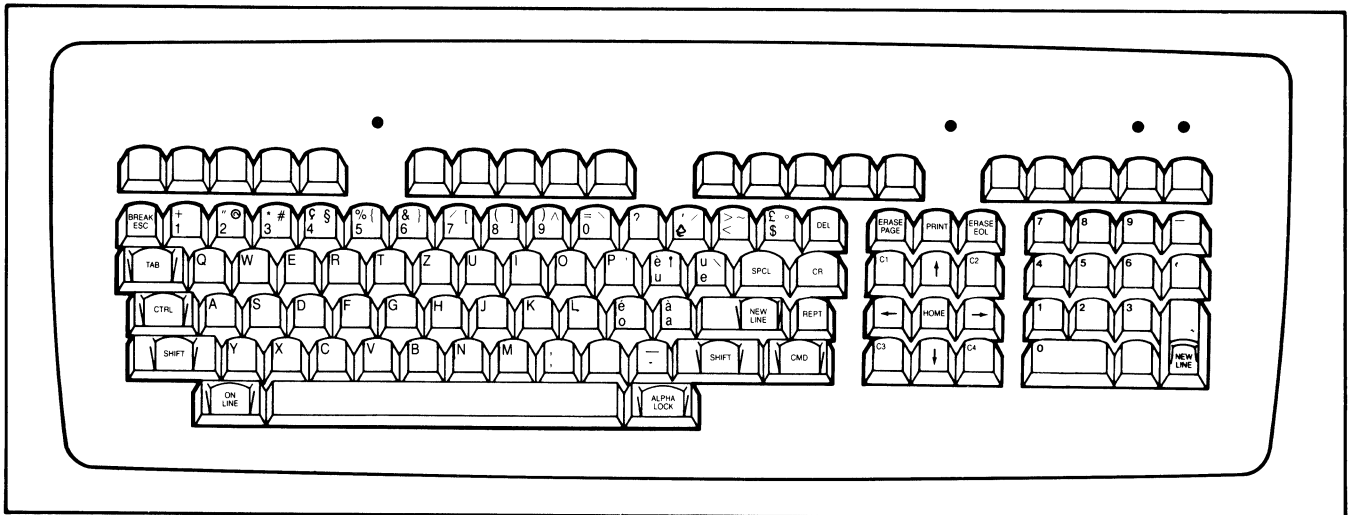

Figure F-9. Swiss/German Main Keyboard

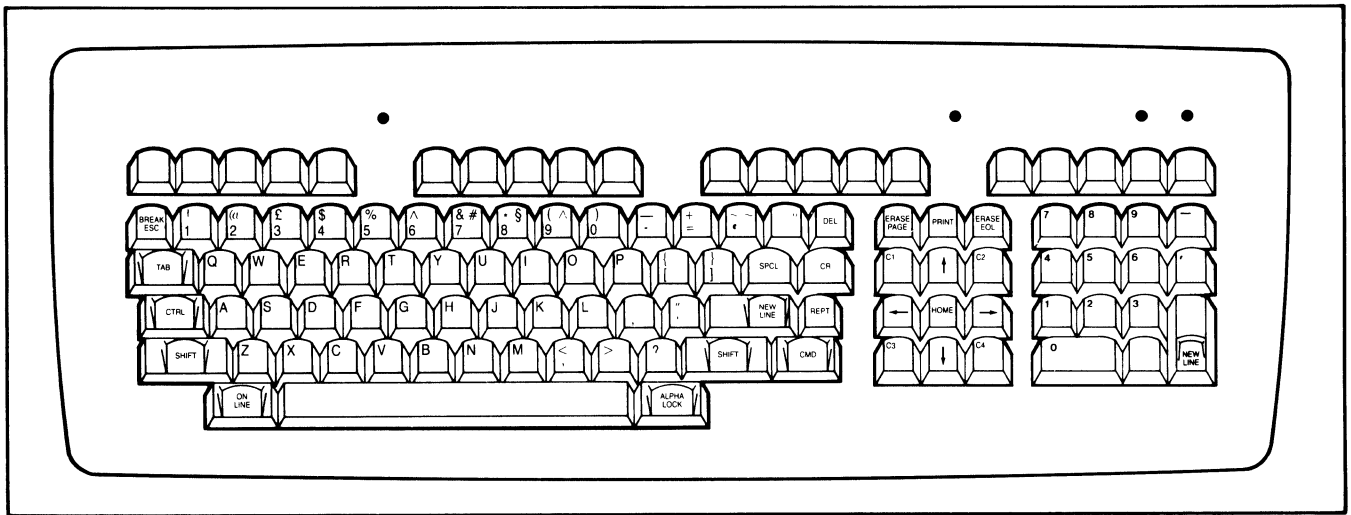

Figure F-10. U.K. Main Keyboard



# GLOSSARY

<b>ANSI</b>	American National Standards Institute, Inc., an organization that presents a standard coded character set used for information interchange among information processing systems, communications systems, and associated equipment.	<b>Cathode Ray Tube (CRT)</b>	A vacuum tube with a screen and a controlled beam of electrons often used as a display device.
<b>ASCII</b>	American Standard Code for Information Interchange, one of the standards used to translate alphanumeric and control characters into binary numbers. The ASCII code assigns a unique binary number to each symbol (letters, digits, punctuation marks, etc.) and control character.	<b>Character</b>	A member of a set of elements used to represent information. Characters are classified in groups, such as alphabetical characters, numeric characters, special sign and symbol characters, and control characters that direct device operations.
<b>Alphanumeric</b>	A set of alphabetic, numeric, and other character symbols.	<b>Character code</b>	A combination of bits that represent a character in a character set.
<b>Argument</b>	An independent variable upon whose value the execution of a command depends. Some D400/450 commands include one or more arguments that combine with the command to define an action to be taken by the terminal.	<b>Character set</b>	A collection of characters grouped together for a special purpose.
<b>Attribute</b>	For display terminals, an attribute is a characteristic associated with a character position on the display screen. For the D400/450 terminal, each character position can be programmed with five attributes: blink, dim, underscore, reverse video, and protect.	<b>Command</b>	A string of characters that combine to direct a device operation. All D410/460 terminal operations are controlled with the commands defined in the Programming Chapter.
<b>Baud</b>	The number of bits transmitted serially each second over a communication line.	<b>Cursor</b>	A visible marker on the display screen identifying the character position destined to hold the next character for display. For the D410/460 terminal, the cursor may appear as a solid block, blinking block, blinking underscore, or invisible.
<b>Binary</b>	A numbering system with a radix of two; the two numerals used are 0 and 1.	<b>Data</b>	A general expression for the information that moves through a computer system or device.
<b>Bit</b>	A binary digit with a value of either 0 or 1.	<b>Delimit</b>	To establish the limits or bounds of something; some of the D410/460 commands require delimiter characters to mark their end.
<b>Buffer</b>	A temporary storage area for data often used to compensate for the difference in data handling capacities between a transmitting device and a receiving device.	<b>Dot matrix</b>	A rectangular pattern of dots used to form characters for display, also called a character cell. The characters for the D410/460 terminal are all formed in a rectangular pattern that is 10 dots wide and 12 dots high (normal character spacing) or 12 dots wide and 12 dots high (compressed character spacing).
<b>Byte</b>	A group of 8 bits.	<b>Download</b>	The process whereby data is transmitted from a host device and retained in a receiving device. For the D410/460

	terminal, the custom character definitions can be transmitted from the host computer and retained in the terminal.		this manual, octal numbers are enclosed in angle brackets ((octal number)).
<b>EIA</b>	Electronic Industries Association, an organization that establishes standards for electronic equipment.	<b>Off-line</b>	The state of a device, such as the D410/460 terminal, when it is not in communications with a host device.
<b>Firmware</b>	Programming instructions retained in Read Only Memory (ROM) that can be executed by a computer just like software in Random Access Memory (RAM).	<b>On-line</b>	The state of a device when it is communicating with a host device.
<b>Full duplex</b>	A mode of serial data communication which takes place between two points in both directions simultaneously.	<b>Operating System</b>	The software resident in the host computer that controls the overall operation of the computer system.
<b>Graphics</b>	The science of communicating information with artwork, text, special symbols, etc. For the D410/460 terminal, graphics refers to the display of artwork and text symbols with the aid of a host computer (computer graphics).	<b>Parity</b>	An extra bit that is added to the code for each character and is used for error detection. When odd parity is used, the parity bit is set so the number of binary 1s in a character is odd; for even parity, the parity bit is set to maintain an even number of 1s. Errors can be detected by checking for the correct count of 1s in a character.
<b>Hardware</b>	The physical equipment comprising the devices in a computer system.	<b>Pixel</b>	A picture element or dot; the smallest element on the display screen that can be illuminated or darkened individually. For the D410/460 terminal with normal character spacing in effect, there are 810 pixels across the width of the display screen; with compressed spacing, there are 1215 pixels across the screen. In both cases there are 12 pixels for each character row (24 rows = 288 pixels).
<b>Hexadecimal</b>	A numbering system with a radix of 16; the characters used to represent a hexadecimal number range from 0 to 9 and A to F.	<b>Program</b>	A sequence of instructions or commands that are interpreted by a computer (or microprocessor) to control its operation and the operation of connected devices to perform a specific function.
<b>Host Computer</b>	The computer controlling operation of a device, such as the D410/460 terminal.	<b>Query</b>	A command issued by a device requesting selected information from another device. Several of the D410/460 commands allow the host computer to request various types of status information from the terminal.
<b>Margins</b>	For the D410/460 terminal, the margins define the columns between which the cursor is free to move. The margin settings (column numbers) are programmable and may define a column range running from 1 to 162.	<b>Read/write</b>	For the D410/460 terminal, a type of memory that retains data written into it until power is turned off (volatile) or until new data is written over the old data.
<b>Matrix</b>	A two-dimensional rectangular array organized into columns and rows.	<b>Raster scan</b>	A method of display information on a CRT. A raster scan consists of sweeping an electron beam across a display screen on a line-by-line basis, turning on pixels as required to create the desired image.
<b>Microprocessor</b>	An electronic component (or part) that contains all the circuits necessary to fetch and execute instructions in a program.		
<b>Monochrome</b>	A single color system; for the D410/460 terminal green is displayed on black.		
<b>Nibble</b>	A group of 4 bits.		
<b>Octal</b>	A numbering system with a radix of eight; the numerals used to represent an octal number range from 0 to 7. In		



<b>Read Only Memory (ROM)</b>	A type of computer memory that retains data written into it permanently. For the D410/460 terminal, ROM is used to hold firmware that must remain intact when power is turned off.	<b>Terminal</b>	An input/output device that an operator can use to communicate with a computer system, usually in an interactive mode. The D410/460 terminal displays output data on its screen and accepts operator inputs through its keyboard.
<b>Serial communication</b>	The process whereby bits are transmitted and received one at a time. On a communication line, a character consists of a string of bits, and is not recognized at the receiving end until all of the bits have been received.	<b>UART</b>	Universal Asynchronous Receiver Transmitter, used to transmit and receive data serially. The UARTs in the D410/460 terminal are responsible for communications with the host computer and optional printer.
<b>Software</b>	A collection of instructions (commands) and data that are interpreted and executed by a computer to control the hardware in a computer system. Software is a general term for all the binary data that can be manipulated in a computer system.	<b>Window</b>	For the D410/460 terminal, a window consists of one or more consecutive character rows on the display screen. A window may contain from 1 to 24 rows; there may be from 1 to 24 windows on the display screen. The active window contains the cursor and has all the features of a full display screen.



# INDEX

- ANSI mode, see Operating modes
- ANSI modes 3-11
  - Blink 3-12, 3-14, 3-15
  - Control representation 3-12
  - DG/ANSI 3-14, 3-16
  - DG/ANSI select 3-12
  - Erasure 3-12
  - Fixed 3-12
  - Format effector action 3-12
  - Format effector
    - transfer 3-12
  - Forms 3-12, 3-14, 3-16
  - Guarded area transfer 3-12
  - Keyboard action 3-12
  - Line feed new line 3-12
  - Margins mode 3-12
  - Multiple area transfer 3-12
  - Positioning unit 3-12
  - Roll 3-12, 3-14, 3-15
  - Selectable 3-12
  - Send-receive 3-12
  - Status reporting
    - transfer 3-12
- BELL 3-7, 3-12
- BLINK DISABLE 3-7
- BLINK ENABLE 3-7
- BLINK OFF 3-7
- BLINK ON 3-7
- Brightness control, see Display
  - unit control
- Cables, see Installation,
  - Cabling
- CARRIAGE RETURN 3-7, 3-12
- Character attributes 1-2
- Character sets 1-3, 3-5, 3-10
  - Auxiliary 3-15
  - Default 3-5
  - Primary 3-5, 3-8, 3-15
  - Secondary 3-5, 3-9, 3-15,
    - see Appendix D
- Code sequences, see Appendix C
- Command execution
  - procedure 2-8
- Command header code 3-3
- Command set
  - ANSI 3-12
  - Character attribute
    - commands 3-4
  - Character set selection
    - commands 3-5
  - Cursor commands 3-4
  - Data General 3-4
  - Operation mode select
    - commands 3-5
  - Printer commands 3-5
  - Screen erase commands 3-4
  - Screen roll commands 3-4
  - Terminal device
    - commands 3-5
- Command summary, see Appendix E
- Control codes, see Appendix A
- CURSOR BACKWARD 3-12
- CURSOR DOWN 3-7, 3-13
- CURSOR FOWARD 3-13
- CURSOR HOME 3-7
- CURSOR LEFT 3-7
- CURSOR POSITION 3-13
- CURSOR RIGHT 3-7
- CURSOR UP 3-7, 3-13
- DEVICE STATUS REPORT 3-13
- DG mode, see Operating modes
- DIM OFF 3-7
- DIM ON 3-8
- DIP switches, see Installation,
  - Switch settings
- Display codes, see Appendix B
- Display screen management 1-2
- Display screen
  - organization 3-4
- Display unit 1-4
- Display unit control 2-1
- Display unit programming 3-3
- Editing functions 1-2
- Eight-bit mode, see Operating
  - modes
- ERASE END-OF-LINE 3-8
- ERASE END-OF-SCREEN 3-8
- ERASE IN DISPLAY 3-13
- ERASE IN LINE 3-13
- ERASE SCREEN 3-8
- FORM FEED 3-14
- Header code 3-7
  - ANSI 3-10
- Host/terminal
  - communications 3-1

## Index

- Installation 4-2
  - Cabling 4-7, 4-8, 4-11,
  - Checkout 4-12, 4-13
  - Communications line 4-1
  - Printer 4-6
  - Site requirements 4-1
  - Switch settings 4-5, 4-6
  - Unpacking 4-2
- Keyboard codes 3-3
- Keyboard control 2-2
- Keyboard language 3-10
- Keyboard languages 1-5
- Keyboard layout 1-5
- Keyboard layouts, see Appendix F
- Keys
  - ALPHA LOCK 2-4
  - BREAK ESC 2-3
  - C1-C4 2-4
  - CMD 2-4
  - CR 2-4
  - CTRL 2-3
  - Cursor Down 2-5
  - Cursor Left 2-5
  - Cursor Right 2-5
  - Cursor Up 2-5
  - DEL 2-4
  - ERASE EOL 2-5
  - ERASE PAGE 2-4
  - HOME 2-5
  - Local Print 2-5
  - NEW LINE 2-4, 2-8
  - ON LINE 2-3
  - PRINT 2-5
  - REPT 2-4
  - SHIFT 2-3
  - SPCL 2-4
  - TAB 2-3
  - User function 2-5
- Main keypad 2-3
- MEDIA COPY 3-14
- Model numbers 1-3
- NEW LINE 3-8, 3-14
- Numeric keypad 2-5
- Off-Line 1-7
  - Operation 1-7, 2-8
- On-Line 1-6
  - Operation 1-6, 2-1, 2-7
- Operating modes 1-2, 3-2
  - ANSI mode 1-2, 3-2
  - DG mode 1-2, 3-2
  - Eight-bit 1-2, 3-2
  - Selection 3-2
  - Seven-bit 1-2, 3-2
- Power-down procedure 2-7
- Power-up procedure 2-7
- PRIMARY CHARACTER SET
  - ENABLE 3-8
- PRINT SCREEN 3-8
- PRINT SCREEN FORM 3-8
- Printer baud rates 1-3
- Printer communications 3-3
  - Eight-bit 3-3
  - Seven-bit 3-3
- Printer operations 1-3
  - Eight-bits 1-3
  - Seven-bits 1-3
- Product description 1-3
- Product features 1-2
- Product specifications 1-7
- READ CURSOR ADDRESS 3-9
- READ MODEL ID 3-8
- READ TERMINAL
  - CONFIGURATION 3-14
- RESET MODE 3-14
- REVERSE VIDEO OFF 3-9
- REVERSE VIDEO ON 3-9
- ROLL DISABLE 3-9
- ROLL ENABLE 3-9
- Screen management keypad 2-4
- SECONDARY CHARACTER SET
  - ENABLE 3-9
- SELECT 7/8 BIT OPERATION 3-10
- SELECT ANSI MODE 3-10
- SELECT CHARACTER SET 3-10,  
3-14
- SELECT GRAPHIC RENDITION 3-15
- Self-test 1-6, 4-11
- SET KEYBOARD LANGUAGE 3-10
- SET MODE 3-15
- SET PARAMETERS 3-16
- Seven-bit mode, see Operating  
modes
- SHIFT IN 3-16
- SHIFT OUT 3-16
- SINGLE SHIFT THREE 3-16
- SINGLE SHIFT TWO 3-16
- Terminal checkout, see  
Installation, Checkout
- Terminal dimensions 4-1
- Terminal input buffer 3-2
- Terminal problem  
diagnosis 2-8
- Terminal specifications
  - Environmental 4-2
  - Physical 4-2
  - Power 4-2
- Typematic repeat 1-5, 2-2
- UNDERSCORE OFF 3-11
- UNDERSCORE ON 3-11
- User maintenance 2-8
- WRITE CURSOR ADDRESS 3-11
- XOFF 3-17
- XON 3-17

# Data General Users group

## Installation Membership Form

Name \_\_\_\_\_ Position \_\_\_\_\_ Date \_\_\_\_\_  
 Company, Organization or School \_\_\_\_\_  
 Address \_\_\_\_\_ City \_\_\_\_\_ State \_\_\_\_\_ Zip \_\_\_\_\_  
 Telephone. Area Code \_\_\_\_\_ No. \_\_\_\_\_ Ext. \_\_\_\_\_

### 1. Account Category

- OEM  
 End User  
 System House  
 Government

### 5. Mode of Operation

- Batch (Central)  
 Batch (Via RJE)  
 On-Line Interactive

### 2. Hardware

Qty. Installed | Qty. On Order

M/600	_____	_____
C/350, C/330, C/300	_____	_____
S/250, S/230, S/200	_____	_____
S/130	_____	_____
AP/130	_____	_____
CS Series	_____	_____
N3/D	_____	_____
Other NOVA	_____	_____
microNOVA	_____	_____
Other _____	_____	_____
(Specify) _____	_____	_____
_____	_____	_____

### 6. Communications

- RSTCP       CAM  
 HASP       4025  
 RJE80       Other  
 SAM

Specify \_\_\_\_\_  
 \_\_\_\_\_

### 3. Software

- AOS       RDOS  
 DOS       RTOS  
 SOS       Other

Specify \_\_\_\_\_  
 \_\_\_\_\_

### 7. Application Description

\_\_\_\_\_  
 \_\_\_\_\_  
 \_\_\_\_\_  
 \_\_\_\_\_  
 \_\_\_\_\_

### 4. Languages

- Algol       Assembler  
 DG/L       Interactive  
 Cobol       Fortran  
 ECLIPSE Cobol       RPG II  
 Business BASIC       PL/1  
 BASIC       Other

Specify \_\_\_\_\_  
 \_\_\_\_\_

### 8. Purchase

From whom was your machine(s) purchased?

- Data General Corp.  
 Other  
 Specify \_\_\_\_\_  
 \_\_\_\_\_

### 9. Users Group

Are you interested in joining a special interest or regional Data General Users Group?

\_\_\_\_\_  
 \_\_\_\_\_



FOLD

FOLD

STAPLE

STAPLE

FOLD

FOLD

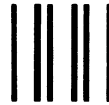

NO POSTAGE  
NECESSARY  
IF MAILED  
IN THE  
UNITED STATES

**BUSINESS REPLY MAIL**  
FIRST CLASS PERMIT NO. 26 SOUTHBORO, MA. 01772

Postage will be paid by addressee



ATTN: Users Group Coordinator  
4400 Computer Drive  
Westboro, MA 01581

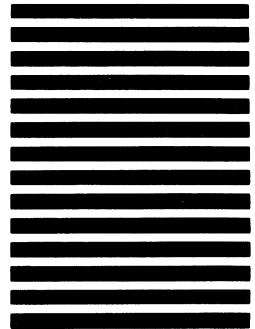

# Engineering Publications Comment Form

Please help us improve our future publications by answering the questions below. Use the space provided for your comments.

Title: \_\_\_\_\_

Document No. \_\_\_\_\_

Yes	No		
<input type="checkbox"/>	<input type="checkbox"/>	Is this manual easy to read?	<input type="radio"/> You (can, cannot) find things easily. <input type="radio"/> Other: <input type="radio"/> Language (is, is not) appropriate. <input type="radio"/> Technical terms (are, are not) defined as needed.
		In what ways do you find this manual useful?	<input type="radio"/> Learning to use the equipment <input type="radio"/> To instruct a class <input type="radio"/> As a reference <input type="radio"/> Other <input type="radio"/> As an introduction to the product
<input type="checkbox"/>	<input type="checkbox"/>	Do the illustrations help you?	<input type="radio"/> Visuals (are, are not) well designed. <input type="radio"/> Labels and captions (are, are not) clear. <input type="radio"/> Other:
<input type="checkbox"/>	<input type="checkbox"/>	Does the manual tell you all you need to know? What additional information would you like?	
<input type="checkbox"/>	<input type="checkbox"/>	Is the information accurate? (If not please specify with page number and paragraph.)	

Name: \_\_\_\_\_ Title: \_\_\_\_\_

Company: \_\_\_\_\_ Division: \_\_\_\_\_

Address: \_\_\_\_\_ City: \_\_\_\_\_

State: \_\_\_\_\_ Zip: \_\_\_\_\_ Telephone: \_\_\_\_\_ Date: \_\_\_\_\_

FOLD

FOLD

STAPLE

STAPLE

FOLD

FOLD



NO POSTAGE  
NECESSARY  
IF MAILED  
IN THE  
UNITED STATES

**BUSINESS REPLY MAIL**  
FIRST CLASS PERMIT NO. 26 SOUTHBORO, MA. 01772

Postage will be paid by addressee

 **Data General**

ATTN: ENGINEERING PUBLICATIONS

2706 Montopolis Drive  
Austin, TX 78741

