

Dilution

S O L U T I O N S

A Dosatron International, Inc. Company

Product Catalogue

Chemical Delivery Made Easy





Contents

DOSATRON

Dosatron Water Powered Injectors	2 - 3
Mobile Solutions	4 - 6
Proportioner	6
Installation Ready Systems	7 - 10
Service and Maintenance	11 - 12
Nutrient Delivery System (NDS)	13 - 17
Installation Accessories	18 - 24
Tools and Supplies	25

HM METERS/TESTERS	26
------------------------------------	----

ETATRON

Electric Metering Pump Series	27 - 34
Motor Pump Series	35 - 38
ePool Series	39
F & B Peristaltic Pump Series	40 - 42
eControl Series	43
eSelect Series	44
Replacement Pump Heads/ Injection Valves	45 - 46
Tubing	47
Miscellaneous Accessories	48 - 54
e128 Pre-Plumbed Accessories	55
Connect and Chat	56

Chemical Delivery Made Easy

At Dilution Solutions, we are excited to offer products and accessories that are designed to enhance your chemical delivery systems. This catalogue includes Dosatron water-powered chemical injectors starting on page 2, along with installation options and accessories. You can check out Dosatron's Nutrient Delivery System (NDS) with its customizable capabilities, kits, and accessories beginning with page 13. Learn about the Etatron electric metering pumps and accessories starting on page 26 along with much more.

We Are Here to Help

Call **1-800-451-6628** any time between 8:30 a.m. to 5:00 p.m. EST to speak directly with one of our knowledgeable customer service representatives.

Come Visit Us in Florida

We offer training to become a "Certified Dosatron and/or Etatron Technician" at our service center in Clearwater, Florida. We also offer on-site training and workshops at your facility. To sign up, or to learn more about our training options, call **1-800-451-6628**.

Need Maintenance? Send Us Your Injector or Pump

Dilution Solutions provides technical service and equipment maintenance at our repair center located in Clearwater, Florida. If your Dosatron or Etatron needs servicing, scan the QR code in the box to the right with your mobile device and complete the form, or call **1-800-451-6628** to receive a return authorization number and mailing instructions. We are always ready to help.

User Friendly Website

Visit www.dilutionsolutions.com to view all our products and accessories.

REPAIR CENTER



Service and repairs are easy at Dilution Solutions. Just scan the QR code to request a return authorization number or call 1-800-451-6628.



Become an Authorized
Service Center by calling
1-800-451-6628.

Dosatron Water-Powered Chemical Injectors

Dosatron non-electric technology has been trusted for more than 40 years!

Dosatron chemical injectors are water-powered, so no electricity is necessary. They automatically compensate for flow and pressure changes providing consistent, repeatable results. Dosatrons are simple to use, easy to adjust and provide infinitely adjustable dosage rates. They are easy to maintain, saving you time and effort.

How It Works

The Dosatron pulls up solution like a syringe, drawing in the concentrate with the plunger and displacing it into the body of the Dosatron, where it mixes with the incoming water. Then just the right amount of chemical is discharged into the water line.

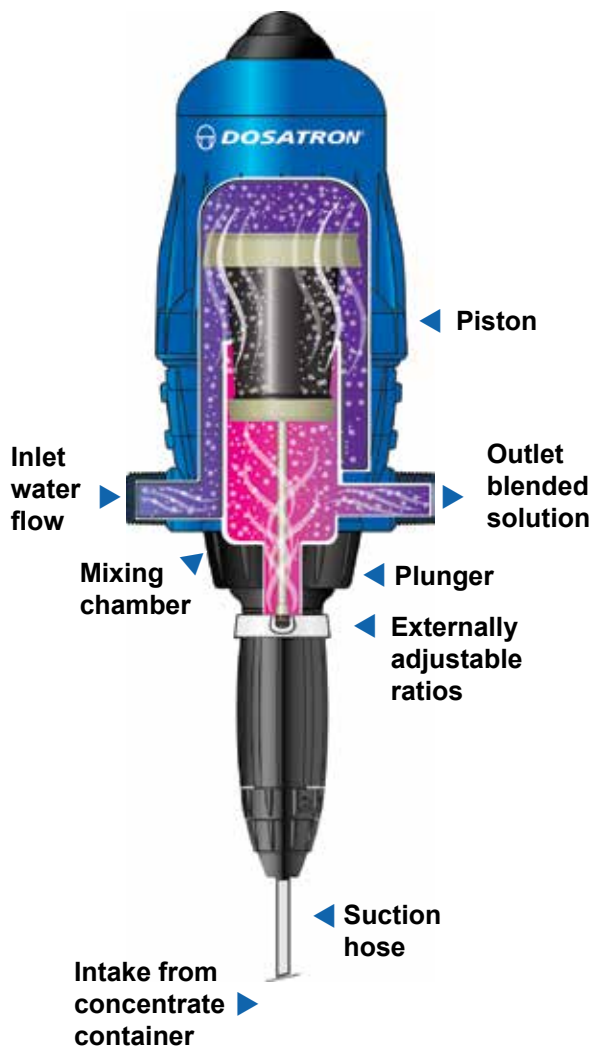

How to Choose the Right Dosatron for Your Application

Dosatron chemical injectors can be found in multiple industries, such as:











- Irrigation
- Animal Health
- Nutrient Delivery
- Vehicle Wash
- Drinking Water Treatment
- Food Safety & Sanitation
- Metal Processing
- Printing
- And many more!

To find the Dosatron injector that best fits your needs:

- First, name your industry and application _____
- Estimate your flow rate of water being treated in gallons per minute (GPM) or liters per minute (LPM) _____
- What dilution rate do you need in ratio, percentage or ounces per gallon? _____
- Which chemical are you injecting? _____
- Can you provide an SDS Sheet? _____

Once you have the information, give us a call at **1-800-451-6628**. Our trained customer service team members will help you choose the right Dosatron injector and answer any questions you might have. Or you may **CHAT by going to www.dilutionsolutions.com**.

Dosatron Injector Series

DOSATRON										
SERIES	D07	D128	D25	DM11	D14	D45	D8	D40	D20	D132
CONNECTION SIZE	3/4"	3/4"	3/4"	3/4"	3/4"	1"	1 1/2"	1 1/2"	2"	3"
GPM	0.02 to 3	0.09 to 7	0.05 to 11	0.02 to 11	0.05 to 14	0.4 to 20	2.2 to 40	2.2 to 40	5 to 100	35 to 132
INJECTION RATE	1:667 to 1:18	1:200 to 1:100	1:1000 to 1:10	1:128 to 1:32	1:3000 to 1:5	1:3000 to 1:12	1:3000 to 1:20	1:3000 to 1:20	1:500 to 1:50	1:30,000 to 1:100
PSI	4.3 to 85	7 to 70	4.3 to 85	1.5 to 85	4.3 to 85	7 to 70	2.2 to 116	2.2 to 116	2 to 120	7 to 87

Mobile Solutions

Proportional, on-demand dispensing for irrigation to sanitation and everything in between.

The carts are designed for maximum mobility and the Hook-Up Kit makes attaching your Dosatron injector a snap.

Our Carts are Perfect for Mobile Foaming

Sanitation

- Chemical application
- Foaming cleaners and disinfectants

Irrigation and Hydroponics

- Mobile spot treatments in greenhouses
- Easy-to-maneuver in garden centers
- Portable fertilizing for gardens, vegetables, and trees
- Low-pressure spray applications
- Soil and root drenches



Li'l Bud-D (5-gallon) Part #: HS15-5

The Li'l Bud-D cart is perfect for spot treatments and accommodates 11 and 14 GPM injectors. The cart features ergonomic design for extra maneuverability, no flat tires, and is constructed with high strength polypropylene. Dosatron injector and hook-up kit sold separately.

Cart Hook-Up Kit Part #: HSPK58LB.

Li'l Bud-D (5-gallon)





The Li'l Bud-D cart is perfect for a wide variety of portable needs and accommodates the 11 and 14 GPM Dosatron injectors. Made of polyethylene and includes cart and 5-gallon bucket with lid.

The Li'l Bud-D Hook-Up Kit makes cart set-up easy and protects it from tipping over. It includes a filter, stainless steel clamps, 5/8" hose, and adapters.

Product	Description	Part #
Li'l Bud-D	5-gallon (includes Cart and 5-Gallon Bucket with Lid)	HS15-5
Li'l Bud-D Hook-Up Kit	11 and 14 GPM (Hook-Up Kit only)	HSPK58LB
PAA DosaCart Hook-Up Kit	11 and 14 GPM (Hook-Up Kit only)	HSPK58-PAA



Dosatron injector and Cart Hook-Up Kit are sold separately.

DosaCart (15-gallon)

	<p>The 15-gallon DosaCart is the perfect, portable solution for garden centers and greenhouses. It has a translucent, polyethylene tank and accommodates the 11, 14, 20, and 40* GPM Dosatron injectors. Includes cart with clean-out valve, bracket, and crash bar.</p> <p>It's highly recommended to purchase a Hook-Up Kit for the 15-gallon DosaCart. The Hook-Up Kit makes cart setup easy and includes a filter, stainless steel clamps, 5/8" hose, and adapters.</p> <p>*Hook-Up Kit is not available for the 40 GPM.</p>		
	Product	Description	Part #
DosaCart	15-gallon (Cart only).	HS15-16	
	DosaCart Hook-Up Kit	11 and 14 GPM (Hook-Up Kit only).	HSPK58
	DosaCart Hook-Up Kit	20 GPM (Hook-Up Kit only).	HSPKD45

Dosatron Injector and Cart Hook-Up Kit are sold separately.

Mobile Coolant Fill System (25-gallon)

	<p>The Mobile Coolant Fill System conveniently allows the user to add and adjust coolant concentrations as needed. Mixed coolant is dispensed directly into the machine sump, eliminating sloppy bucket filling, spills, the danger of slipping, and back injuries from lifting heavy pails. No more spilled coolant creating a slip hazard.</p>		
	Product	Description	Part #
Mobile Coolant Fill System	25-gallon tank with 4 wheels for stability. No tilt ergonomic design and easy to maneuver. Stainless steel brackets. Integrated dosing pump. Easy to plumb Hook-Up Kit (see below).	HS25	
	Mobile Coolant Fill System Plumbing Hook-Up Kit	The Mobile Coolant Fill System Plumbing Hook-Up Kit features elbows, unions, nipples, hose clamps, strap, 10' delivery hose and gasoline style gun.	HSPK25COOLKIT



Eco-Cart - 11 GPM (5-gallon)

	This Eco-Cart is perfect for the home grower and garden center. It includes all you need to feed your flowers and plants. Designed with the 11 GPM-D25F1 (fixed 1:100), it includes cart, 5-gallon bucket with lid, D25F1 injector, and plumbing to connect the hose to inlet and outlet.		
	Product	Description	Part #
	Eco-Cart	5-gallon bucket with lid, D25F1 Injector, and plumbing.	HSECO-D25F1
Eco-Cart without injector	Already have a Dosatron? No problem. Our Eco-Cart is available without the injector and includes cart, 5-gallon bucket with lid, and plumbing.	HSECO	

Eco-Cart - 14 GPM (5-gallon)

	This Eco-Cart is perfect for the home grower and garden center. It includes all you need to feed your flowers and plants. Designed with the 14 GPM-D14M22 includes cart, 5-gallon bucket with lid, D14M22 injector, and plumbing to connect the hose to inlet and outlet.		
	Product	Description	Part #
	Eco-Cart	5-gallon bucket with lid, D14M22 Injector, and plumbing.	HSECO-D14M22
Eco-Cart without injector	Already have a Dosatron? No problem. Our Eco-Cart is available without the injector and includes cart, 5-gallon bucket with lid, and plumbing.	HSECO	

Proportioner

Water-powered proportional, on-demand dispensing for irrigation to sanitation and everything in between.

	Dosatron's self-cleaning polypropylene Venturi proportioner allows for flow rates up to 2 GPM at 58 psi in dosing mode and up to 13 GPM at 58 psi when in bypass/rinse mode. A simple one-quarter turn of the handle changes the function from dosing mode to bypass/rinse for simple operation. Turn the handle 180° for back-flush mode, making cleaning and maintenance hassle-free. Perfect for washing and disinfection of hard surfaces and floors. A system, with 12 color-coded tips, is provided to allow for an injection range of 1:100 (1%) to 1:2.3 (43.6%).		
	Product	Description	Part #
	Dosatron Proportioner	This polypropylene proportioner features a back flush and rinse mode.	DSA-VENTURI



Installation Ready Systems



Standard 3/4" Single Panel
Part #: PS6A130

- Ball valves
- Flow restrictor
- Pressure regulator
- Check valve
- Filter
- Sample port
- D14MZ2VFII
- Fittings
- Unions



We offer Custom installation options for your convenience.

These pre-plumbed, secured systems are water-powered and include all the necessary accessories. Delivered installation-ready, they eliminate the need to put your chemical management system together piece-by-piece. Just take the system out of the box, install to your water line (no electricity needed), and you are ready to go!

Panel Systems

Our panel systems are custom made, and factory tested prior to shipment. We offer two options: a black polyethylene panel or an aluminum diamond plate, your choice. If you don't see a panel that meets your specifications, give us a call at **1-800-451-6628** to discuss your specific installation needs.

Standard 3/4" Single - Diamond Plate Panel

	<p>Description</p> <p>17" w x 24" h panel includes ball valves, flow restrictor, pressure regulator, check valve, filter, test port, Dosatron model D14MZ2VFII, and fittings.</p> <p>Other injectors are available in the same configuration mounted on the diamond plate panel.</p>	<p>Part #</p> <p>PSD6A130</p>
---	---	--------------------------------------

Failsafe Dual Panel - with Backup Dosatron

	<p>Description</p> <p>36" w x 24" h panel provides a backup Dosatron that is ready to go if needed. The panel includes an inbound t-filter, pressure regulator with gauge, ball valves, unions for quick disconnect to service units, one-way check valves, flow restrictors, and fittings.</p>	<p>Part #</p> <p>Call 1-800-451-6628 for your specific part #.</p>
---	--	--

Triple Unit Panel - Perfect for Triple Foam Applications

	<p>Description</p> <p>The 48" w x 24" h foam, car care panel is mounted on a diamond plate and is perfect for triple foam or three independent chemicals. Ideal for new installations or retrofits.</p>	<p>Part #</p> <p>Call 1-800-451-6628 for your specific part #.</p>
---	--	--

Self Service Panel - Used in Car Wash for Presoaks and More

	<table border="1"> <thead> <tr> <th>Description</th> <th>Part #</th> </tr> </thead> <tbody> <tr> <td>The 17" w x 24" h panel for car care is mounted on a diamond plate and is perfect for presoaks, detergents/soaps, drying agents, bug remover, and waxes.</td> <td>Call 1-800-451-6628 for your specific part #.</td> </tr> </tbody> </table>	Description	Part #	The 17" w x 24" h panel for car care is mounted on a diamond plate and is perfect for presoaks, detergents/soaps, drying agents, bug remover, and waxes.	Call 1-800-451-6628 for your specific part #.
Description	Part #				
The 17" w x 24" h panel for car care is mounted on a diamond plate and is perfect for presoaks, detergents/soaps, drying agents, bug remover, and waxes.	Call 1-800-451-6628 for your specific part #.				

Coolant Mixing Panel - Control Your Coolant Management

	<table border="1"> <thead> <tr> <th>Description</th> <th>Part #</th> </tr> </thead> <tbody> <tr> <td>The 24" w x 36" h panel needs no external power. It can increase tool life, reduce reject rates, control bacterial growth, reduce skin/respiratory issues, reduce foaming to maximize tramp oil filter efficiency and chip collection. It includes a D14MZ10VVF, t-filter, ball valves, flow restrictor, pressure regulator with gauge, fittings, 10' injection hose, and water hammer arrestor. The Fill Accessory Kit sold separately (see below).</td> <td>PS4A150</td> </tr> </tbody> </table>	Description	Part #	The 24" w x 36" h panel needs no external power. It can increase tool life, reduce reject rates, control bacterial growth, reduce skin/respiratory issues, reduce foaming to maximize tramp oil filter efficiency and chip collection. It includes a D14MZ10VVF, t-filter, ball valves, flow restrictor, pressure regulator with gauge, fittings, 10' injection hose, and water hammer arrestor. The Fill Accessory Kit sold separately (see below).	PS4A150
Description	Part #				
The 24" w x 36" h panel needs no external power. It can increase tool life, reduce reject rates, control bacterial growth, reduce skin/respiratory issues, reduce foaming to maximize tramp oil filter efficiency and chip collection. It includes a D14MZ10VVF, t-filter, ball valves, flow restrictor, pressure regulator with gauge, fittings, 10' injection hose, and water hammer arrestor. The Fill Accessory Kit sold separately (see below).	PS4A150				

Coolant Mixing Panel - Fill Accessory Kit

	<table border="1"> <thead> <tr> <th>Description</th> <th>Part #</th> </tr> </thead> <tbody> <tr> <td>All you need for a quick installation is the Coolant Mixing System Fill Accessory Kit. The Kit includes polypropylene gas nozzle, 15' mixed coolant discharge hose, 2 barbs, and 2 hose clamps.</td> <td>HOSEKITGUN34</td> </tr> </tbody> </table>	Description	Part #	All you need for a quick installation is the Coolant Mixing System Fill Accessory Kit. The Kit includes polypropylene gas nozzle, 15' mixed coolant discharge hose, 2 barbs, and 2 hose clamps.	HOSEKITGUN34
Description	Part #				
All you need for a quick installation is the Coolant Mixing System Fill Accessory Kit. The Kit includes polypropylene gas nozzle, 15' mixed coolant discharge hose, 2 barbs, and 2 hose clamps.	HOSEKITGUN34				

Vibratory Panel - The Solution for Vibratory Finishing

	<table border="1"> <thead> <tr> <th>Description</th> <th>Part #</th> </tr> </thead> <tbody> <tr> <td>The 17" w x 24" h panel is the perfect solution for vibratory finishing. It includes the Dosatron D07RE5, adjustable flow meter, 200 mesh filter, ball valve, check valve, and rigid polypropylene panel.</td> <td>PS6VIB126</td> </tr> </tbody> </table>	Description	Part #	The 17" w x 24" h panel is the perfect solution for vibratory finishing. It includes the Dosatron D07RE5, adjustable flow meter, 200 mesh filter, ball valve, check valve, and rigid polypropylene panel.	PS6VIB126
Description	Part #				
The 17" w x 24" h panel is the perfect solution for vibratory finishing. It includes the Dosatron D07RE5, adjustable flow meter, 200 mesh filter, ball valve, check valve, and rigid polypropylene panel.	PS6VIB126				

Beer Line Cleaning Sanitation Panel

	<table border="1"> <thead> <tr> <th>Description</th> <th>Part #</th> </tr> </thead> <tbody> <tr> <td>This 17" w x 8" h panel provides you optimum cleaning of your beer lines. It includes mini panel, D25RE2VFBPII, filter, and check valve. Other models are available. For more information call 1-800-451-6628.</td> <td>PS8A136BLC</td> </tr> </tbody> </table>	Description	Part #	This 17" w x 8" h panel provides you optimum cleaning of your beer lines. It includes mini panel, D25RE2VFBPII, filter, and check valve. Other models are available. For more information call 1-800-451-6628 .	PS8A136BLC
Description	Part #				
This 17" w x 8" h panel provides you optimum cleaning of your beer lines. It includes mini panel, D25RE2VFBPII, filter, and check valve. Other models are available. For more information call 1-800-451-6628 .	PS8A136BLC				

Nutrient Delivery System Panel (NDS) - for more information see page 13

	<table border="1"> <thead> <tr> <th>Description</th> <th>Part #</th> </tr> </thead> <tbody> <tr> <td>The NDS is made up of 4 main panel sections which can be arranged to accommodate a wide variety of fertigation programs. It thrives anywhere, from greenhouse environments to outdoors, allowing installation in any application.</td> <td>Call 1-800-451-6628 for your specific part #.</td> </tr> </tbody> </table>	Description	Part #	The NDS is made up of 4 main panel sections which can be arranged to accommodate a wide variety of fertigation programs. It thrives anywhere, from greenhouse environments to outdoors, allowing installation in any application.	Call 1-800-451-6628 for your specific part #.
Description	Part #				
The NDS is made up of 4 main panel sections which can be arranged to accommodate a wide variety of fertigation programs. It thrives anywhere, from greenhouse environments to outdoors, allowing installation in any application.	Call 1-800-451-6628 for your specific part #.				

Floor Scrubbing Fill Station Panel

	<table border="1"> <thead> <tr> <th>Description</th> <th>Part #</th> </tr> </thead> <tbody> <tr> <td>24" w x 17" h panel with Dosatron D14MZ2VFII (14 GPM).</td> <td>PS6A130FS</td> </tr> <tr> <td>24" w x 17" h panel with Dosatron D45RE15VFII (20 GPM).</td> <td>PS4A081FS</td> </tr> <tr> <td>24" w x 17" h panel with Dosatron D8RE2VFII (40 GPM).</td> <td>PS4A190FS</td> </tr> <tr> <td colspan="2">The 24" w x 17" h panel will perfectly mix your chemicals without waste. It's easy to adjust by setting the desired dilution rate and easy to use, just grab the gas nozzle and fill.</td> </tr> </tbody> </table>	Description	Part #	24" w x 17" h panel with Dosatron D14MZ2VFII (14 GPM).	PS6A130FS	24" w x 17" h panel with Dosatron D45RE15VFII (20 GPM).	PS4A081FS	24" w x 17" h panel with Dosatron D8RE2VFII (40 GPM).	PS4A190FS	The 24" w x 17" h panel will perfectly mix your chemicals without waste. It's easy to adjust by setting the desired dilution rate and easy to use, just grab the gas nozzle and fill.	
Description	Part #										
24" w x 17" h panel with Dosatron D14MZ2VFII (14 GPM).	PS6A130FS										
24" w x 17" h panel with Dosatron D45RE15VFII (20 GPM).	PS4A081FS										
24" w x 17" h panel with Dosatron D8RE2VFII (40 GPM).	PS4A190FS										
The 24" w x 17" h panel will perfectly mix your chemicals without waste. It's easy to adjust by setting the desired dilution rate and easy to use, just grab the gas nozzle and fill.											

Cabinet Systems

Dosatron Cabinet Systems Are Custom Built For You!

Keep unauthorized personnel from disturbing your chemical management system along with physically protecting your injector. These attractive, locking, stainless steel cabinets can be plumbed to your exact specifications and be ready for installation. If you don't see the cabinet that meets your specifications, give us a call at **1-800-451-6628**.



Standard 3/4" Single Stainless Steel Locking Cabinet

	Description	Part #
	The 17" w x 24" h x 7 1/2" d, locking cabinet includes ball valves, flow restrictor, pressure regulator, check valve, filter, test port, D14MZ10VFII, and fittings.	SC1A151

Failsafe Dual Stainless Steel Locking Cabinet - With Backup Dosatron

	Description	Part #
	The 24" w x 31" h x 7 1/2" d cabinet provides a backup Dosatron that is ready to go if needed. Fitted with ball valves, pressure regulator with gauge, fittings, one-way check valve, inbound filter kit, and outlet connector with a ball valve.	Call 1-800-451-6628 for your specific part #.

Dual Cabinet in Series

	Description	Part #
	The 24" w x 31" h x 7 1/2" d cabinet is fitted with a pressure regulator, ball valve, unions for quick disconnect to service units, one-way check valve, inbound filter kit, and outlet connector with ball valve.	Call 1-800-451-6628 for your specific part #.

Coolant Mixing Cabinet - Control Your Coolant Management

	<table border="1"> <thead> <tr> <th>Description</th> <th>Part #</th> </tr> </thead> <tbody> <tr> <td>24" w x 31" h x 7 1/2" d, Dosatron's proportional coolant mixing cabinet is easily installed and requires no external power source. The Coolant Mixing Cabinet can increase tool life, reduce reject rates, control bacterial growth, reduce skin and respiratory issues, and reduces foaming to maximize tramp oil filter efficiency and chip collection. It includes the D14MZ10VVF, t-filter, ball valves, flow restrictor, pressure regulator with gauge, fittings, 10' suction hose, and water hammer arrestor. Accessory kit available, see below.</td> <td>SC2A150</td> </tr> </tbody> </table>	Description	Part #	24" w x 31" h x 7 1/2" d, Dosatron's proportional coolant mixing cabinet is easily installed and requires no external power source. The Coolant Mixing Cabinet can increase tool life, reduce reject rates, control bacterial growth, reduce skin and respiratory issues, and reduces foaming to maximize tramp oil filter efficiency and chip collection. It includes the D14MZ10VVF, t-filter, ball valves, flow restrictor, pressure regulator with gauge, fittings, 10' suction hose, and water hammer arrestor. Accessory kit available, see below.	SC2A150
Description	Part #				
24" w x 31" h x 7 1/2" d, Dosatron's proportional coolant mixing cabinet is easily installed and requires no external power source. The Coolant Mixing Cabinet can increase tool life, reduce reject rates, control bacterial growth, reduce skin and respiratory issues, and reduces foaming to maximize tramp oil filter efficiency and chip collection. It includes the D14MZ10VVF, t-filter, ball valves, flow restrictor, pressure regulator with gauge, fittings, 10' suction hose, and water hammer arrestor. Accessory kit available, see below.	SC2A150				

Coolant Mixing System - Fill Accessory Kit

	<table border="1"> <thead> <tr> <th>Description</th> <th>Part #</th> </tr> </thead> <tbody> <tr> <td>All you need for a quick installation is included in the Coolant Mixing System Fill Accessory Kit. It includes polypropylene gas nozzle, 15' mixed coolant discharge hose, barbs, and hose clamps.</td> <td>HOSEKITGUN34</td> </tr> </tbody> </table>	Description	Part #	All you need for a quick installation is included in the Coolant Mixing System Fill Accessory Kit. It includes polypropylene gas nozzle, 15' mixed coolant discharge hose, barbs, and hose clamps.	HOSEKITGUN34
Description	Part #				
All you need for a quick installation is included in the Coolant Mixing System Fill Accessory Kit. It includes polypropylene gas nozzle, 15' mixed coolant discharge hose, barbs, and hose clamps.	HOSEKITGUN34				

Mounting Bracket

3-Sided, Space Saver Mounting Bracket - For Those Tight Areas

	<table border="1"> <thead> <tr> <th>Description</th> <th>Part #</th> </tr> </thead> <tbody> <tr> <td>The Mounting Bracket is 12" w x 12" h x 12" d with 2" flanges and is the perfect fit for those tight areas. It uses less than 35% wall space versus a standard triple foam panel. The 3-sided bracket is made of rugged diamond plate. The finished size, with units attached, is 23" w x 24" h x 17" d. For a custom pre-plumbed system, call 1-800-451-6628. Dosatrons and hardware sold separately.</td> <td>PANEL3</td> </tr> </tbody> </table>	Description	Part #	The Mounting Bracket is 12" w x 12" h x 12" d with 2" flanges and is the perfect fit for those tight areas. It uses less than 35% wall space versus a standard triple foam panel. The 3-sided bracket is made of rugged diamond plate. The finished size, with units attached, is 23" w x 24" h x 17" d. For a custom pre-plumbed system, call 1-800-451-6628 . Dosatrons and hardware sold separately.	PANEL3
Description	Part #				
The Mounting Bracket is 12" w x 12" h x 12" d with 2" flanges and is the perfect fit for those tight areas. It uses less than 35% wall space versus a standard triple foam panel. The 3-sided bracket is made of rugged diamond plate. The finished size, with units attached, is 23" w x 24" h x 17" d. For a custom pre-plumbed system, call 1-800-451-6628 . Dosatrons and hardware sold separately.	PANEL3				



Service and Maintenance

Rebuild Kits

Extend the life of your water-powered Dosatron with our Rebuild Kits. Each kit includes two parts. Part one includes the piston contents, and part two includes items to replace three seals and the check valve assembly. To order, find your specific Dosatron 14 GPM model part number. If you need help, give us a call at **1-800-451-6628** or **CHAT** at www.dilutionsolutions.com.

Description	Part #	Description	Part #
D14MZ2VFII - 14 GPM	MKD14MZ2VF	D14MZ10AFII - 14 GPM	MKD14MZ10AF
D14MZ2VFIK - 14 GPM	MKD14MZ2K	D14MZ10VAFII - 14 GPM	MKD14MZ10VAF
D14MZ2AFII - 14 GPM	MKD14MZ2AF	D14MZ10VFII - 14 GPM	MKD14MZ10VF
D14MZ5AFII - 14 GPM	MKD14MZ5AF	D14MZ10VVFII - 14 GPM	MKD14MZ10VVF
D14MZ5VFII - 14 GPM	MKD14MZ5VF	D14MZ3000AFII - 14 GPM	MKD14MZ3000AF
D14MZ5VVFII - 14 GPM	MKD14MZ5VVF	D14MZ3000VFIK - 14 GPM	MKD14MZ3000K
D14MZ5VAFII - 14 GPM	MKD14MZ5VAF	D14MZ3000VFII - 14 GPM	MKD14MZ3000VF

Mini Maintenance Kits

These kits are the perfect, economical solution for Dosatron users who perform maintenance on a regular schedule. They can be used as often as necessary to ensure that your Dosatron injects accurately and runs smoothly.

Description	Industry	Part #
D25F1 - 11 GPM	Horticulture	PJ117MINI-H
D25RE09 - 11 GPM	Industrial/Hydroponics	PJ127MINI-H
DM11F - 11 GPM	Animal Health	PJD1900MINI-LS
D14MZ2 - 14 GPM	Horticulture/Hydroponics	PJD1116MINI-H
D14MZ10 - 14 GPM	Industrial	PJD1122MINI-H
D14MZ3000 - 14 GPM	Horticulture/Industrial/Hydroponics	PJD1139MINI
D45RE15 - 20 GPM	Horticulture	PJ096MINI-H
D45RE15 - 20 GPM	Animal Health	PJ096MINI-LS
D8R - 40 GPM	Horticulture	8PJ052MINI-H
D8RE2 - 40 GPM	Horticulture	PJD1120VMINI-H
D20S - 100 GPM	Horticulture	20PJ030MINI-H



Seal Kits

Keeping your water-powered Dosatron in tip-top shape is important. One of the best ways is by performing annual Seal Kit maintenance. The Seal Kits include maintenance parts and instructions. View service videos on our DosatronIntl YouTube Channel for Seal Kit installation, step-by-step. For help, call at **1-800-451-6628** or **CHAT at www.dilutionsolutions.com**.

Dosatron Injector	Part #
D07RE5 - 3 GPM	PJDI095
D07RE125 - 3 GPM	PJDI106 (for serial # >05370953)
D25RE10 - 8.8 GPM	PJ120
D14MZ520 - 9 GPM	PJDI135 for serial # <13400000) PJDI167 (for serial # >13400000)
D25F - 11 GPM	PJ117
D25F1 - 11 GPM	PJ117
D25RE2 - 11 GPM	PJ093
D25RE5 - 11 GPM	PJ119
D25RE09 - 11 GPM	PJ127
D14MZ2 - 14 GPM	PJDI116
D14MZ2-D - 14 GPM	PJDI116
D14MZ5 - 14 GPM	PJDI120 PJDI120V
D14MZ5-D - 14 GPM	PJDI120
D14MZ10 - 14 GPM	PJDI122 PJDI122V
D14MZ10-D - 14 GPM	PJDI122
D14MZ3000 - 14 GPM	PJDI139
D14MZ3000-D - 14 GPM	PJDI139
D45RE3 - 20 GPM	PJ084 PJ095 (side-inject)
D45RE8 - 20 GPM	PJ098 (for serial # <07141221) PJ151 (for serial # >07141221)
D45RE15 - 20 GPM	PJ096 PJ097 (side-inject)
D8R - 40 GPM	8PJ052
D8RE2 - 40 GPM	PJDI120V
D8RE5 - 40 GPM	PJDI122V
D8RE3000 - 40 GPM	8PJ075
D40WL3000NAF - 40 GPM	8PJ075NAF
D20S - 100 GPM	20PJ030

Nutrient Delivery System (NDS)



The NDS is a simple system made up of four main panel sections. You can arrange to accommodate a wide variety of fertigation programs. With total control in mind, customizing the entire panel is easy, based on your personal nutrient program!

The Nutrient Delivery System allows for the use of up to 8 different nutrients, additives, or supplements along with a pH adjuster — all in one well-blended solution. It thrives anywhere, from greenhouse environments to outdoors, allowing installation in any application. And, by automating the nutrient delivery process, it accurately dispenses the desired solution, making the time draining practice of “measure and pour” a thing of the past, saving you time and money!

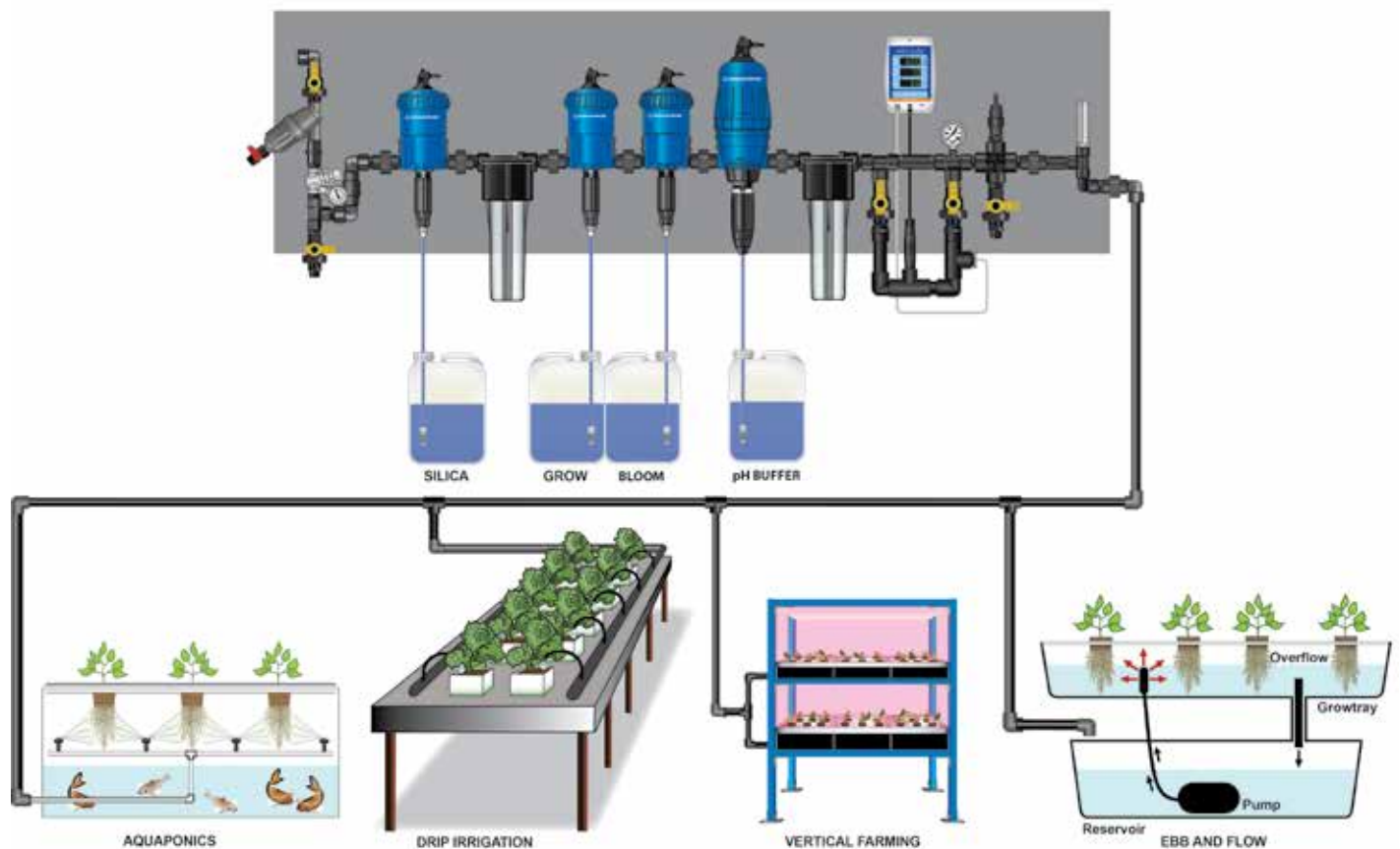

NOTE: Installation illustrations are to be used as a reference guide only.

DIY Nutrient Delivery Kits



Nutrient Delivery Systems Are Customized With The Number Of Dosers Needed.

Creating the right nutrient mix for your hydroponic growing operations is a delicate science. With Dosatron's full line of dosers, you can automate your process to create fine-tuned, multi-chemical mixes with repeatable results, every time!

They are water-powered so no electricity is needed and compared to other dosing products on the market, they are easy to maintain and keep in service — saving you time and money.

Kits available:

- Lo-Flo Series (11/14 GPM - 3/4" NPT)
- Hi-Flo Series (40 GPM - 1 1/2" NPT)

If you are hands-on and like to create your setup, these Kits are for you. Choose the Kits and Dosers to fit your specific requirements, then assemble. Questions? Call **1-800-451-6628**.



Applications

- Aquaponics
- Vertical Farming
- Drip Irrigation
- Ebb and Flow

Benefits of the Dosatron System

- Used to accurately fill reservoirs or in a drain to waste system — eliminating the need to measure and pour
- Easy to adjust the amount of nutrient dispensed — just turn the dial to set the necessary dosage rate
- Designed to perform in both indoor and outdoor environments
- Precise nutrient management, eliminating waste, increasing yields
- Simple and inexpensive to maintain — easy to use

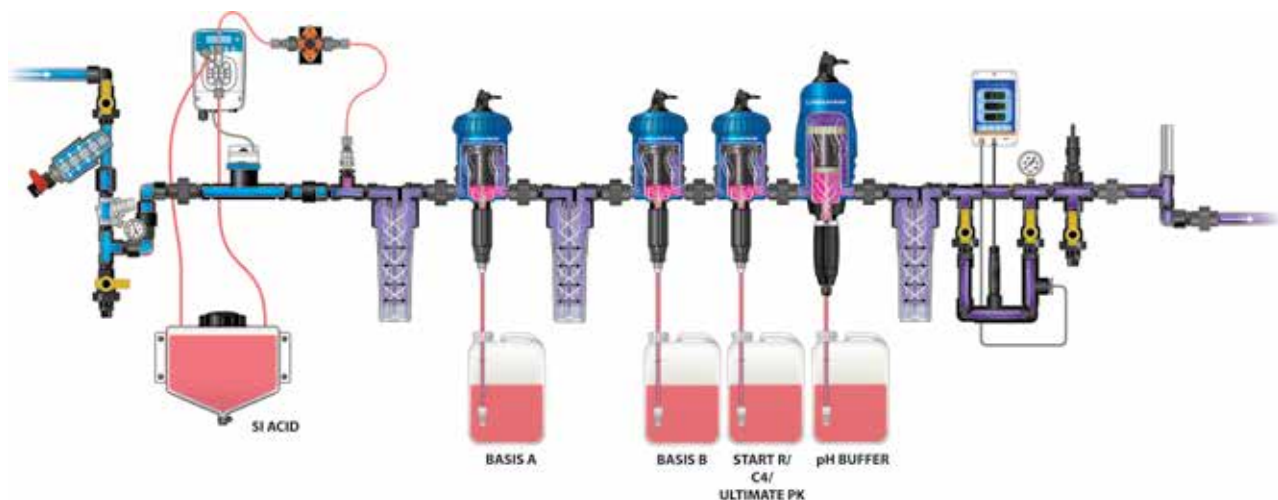

NOTE: Installation illustrations are to be used as a reference guide only.

Lo-Flo Series (11 and 14 GPM - 3/4")

Starter Kit

	<table border="1"> <thead> <tr> <th data-bbox="456 283 1247 321">Description</th> <th data-bbox="1247 283 1526 321">Part #</th> </tr> </thead> <tbody> <tr> <td data-bbox="456 321 1247 590">It includes all the parts you need to get started, from ball valves to Teflon® tape. Dosatron dosers sold separately.</td> <td data-bbox="1247 321 1526 590">HYKSTART</td> </tr> </tbody> </table>	Description	Part #	It includes all the parts you need to get started, from ball valves to Teflon® tape. Dosatron dosers sold separately.	HYKSTART
Description	Part #				
It includes all the parts you need to get started, from ball valves to Teflon® tape. Dosatron dosers sold separately.	HYKSTART				

Mixing Chamber Kit

	<table border="1"> <thead> <tr> <th data-bbox="456 663 1247 701">Description</th> <th data-bbox="1247 663 1526 701">Part #</th> </tr> </thead> <tbody> <tr> <td data-bbox="456 701 1247 917">Enhances blending as the solution passes through the Mixing Chamber.</td> <td data-bbox="1247 701 1526 917">HYKMC34</td> </tr> </tbody> </table>	Description	Part #	Enhances blending as the solution passes through the Mixing Chamber.	HYKMC34
Description	Part #				
Enhances blending as the solution passes through the Mixing Chamber.	HYKMC34				

Monitor Kit

	<table border="1"> <thead> <tr> <th data-bbox="456 982 1247 1020">Description</th> <th data-bbox="1247 982 1526 1020">Part #</th> </tr> </thead> <tbody> <tr> <td data-bbox="456 1020 1247 1289">Includes a unique in-line nutrient monitor that measures and displays your well-blended outgoing solution. No more guess work involved in feeding your plants!</td> <td data-bbox="1247 1020 1526 1289">HYKMON</td> </tr> </tbody> </table>	Description	Part #	Includes a unique in-line nutrient monitor that measures and displays your well-blended outgoing solution. No more guess work involved in feeding your plants!	HYKMON
Description	Part #				
Includes a unique in-line nutrient monitor that measures and displays your well-blended outgoing solution. No more guess work involved in feeding your plants!	HYKMON				

End Kit

	<table border="1"> <thead> <tr> <th data-bbox="456 1362 1247 1400">Description</th> <th data-bbox="1247 1362 1526 1400">Part #</th> </tr> </thead> <tbody> <tr> <td data-bbox="456 1400 1247 1583">An alternative to the Monitor Kit, the End Kit includes all the necessary plumbing parts to complete your NDS setup.</td> <td data-bbox="1247 1400 1526 1583">HYKEND</td> </tr> </tbody> </table>	Description	Part #	An alternative to the Monitor Kit, the End Kit includes all the necessary plumbing parts to complete your NDS setup.	HYKEND
Description	Part #				
An alternative to the Monitor Kit, the End Kit includes all the necessary plumbing parts to complete your NDS setup.	HYKEND				



NOTE: Installation illustrations are to be used as a reference guide only.

Hi-Flo Series (40 GPM - 1 1/2")

Starter Kit

	Description	Part #
	<p>It includes all the parts you need to get started, from ball valves to Teflon® tape. Dosatron dosers sold separately.</p>	<p>HYKSTART150</p>

Mixing Chamber Kit

	Description	Part #
	<p>Enhances blending as the solution passes through the Mixing Chamber.</p>	<p>HYKMC150</p>

Monitor Kit

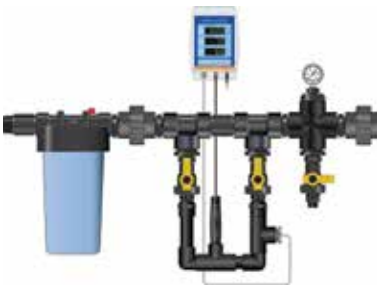
	Description	Part #
	<p>Includes a unique in-line nutrient monitor that measures and displays your well-blended outgoing solution. No more guess work involved in feeding your plants!</p>	<p>HYKMON150</p>

End Kit

	Description	Part #
	<p>An alternative to the Monitor Kit, the End Kit includes all the necessary plumbing parts to complete your NDS setup.</p>	<p>HYKEND150</p>



NOTE: Installation illustrations are to be used as a reference guide only.

NDS Micro Doser Panels

Ultimate Delivery with the Etatron eOne Micro-Doser System

The Etatron eOne Micro-Doser, combined with the Dosatron Lo- and Hi-Flo Dosers, make the perfect combination to customize a delivery system for your specific applications. The blending of these dosers brings the ultimate in reliability and functionality, in one system — The Nutrient Delivery System!

The Etatron eOne accurately doses super-concentrated products into an existing fertigation system. It hits the targets that many of the high-value products, on the market, demand.

- You can adjust the amount dispensed with every stroke
- Dial into micro-dose, down to 0.25 mL per gallon
- Allow for the ultimate in reliability and functionality in one system
- Designed to be in unison with the NDS

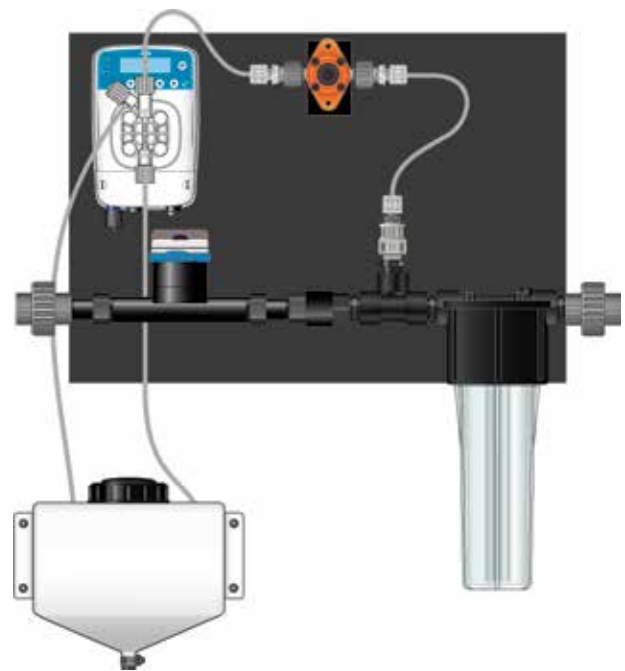

NDS Micro Doser Panel - Lo-Flo (3/4" NPT)



Description	Part #
<p>The NDS Lo-Flo Etatron eOne MF Micro-Doser includes:</p> <ul style="list-style-type: none"> • eOne MF 0110 pump • Polyethylene panel • PVC suction tube • Water meter • Check valve • Injection valve • PVC bleed-off tube • Polyethylene discharge tube • Pressure relief valve • Unions • Foot filter • Mixing chamber <p>NOTE: Installation illustrations are to be used as a reference guide only. Bucket not included.</p>	<p>Lo-Flo: PE0110MF.75INX1PR</p>

NDS Micro Doser Panel - Hi-Flo (1 1/2" NPT)

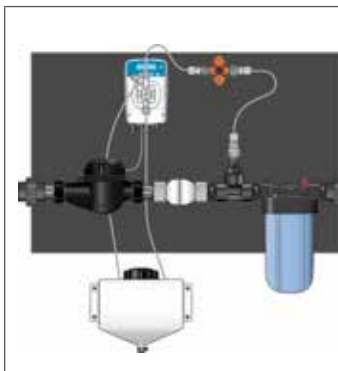

Description	Part #
<p>The NDS Hi-Flo Etatron eOne MF Micro-Doser includes:</p> <ul style="list-style-type: none"> • eOne MF 0110 pump • Polyethylene panel • PVC suction tube • Water meter • Check valve • Injection valve • PVC bleed-off tube • Polyethylene discharge tube • Pressure relief valve • Unions • Foot filter • Mixing chamber <p>NOTE: Installation illustrations are to be used as a reference guide only. Bucket not included.</p>	<p>Hi-Flo: PE0110MF1.5INX1PR</p>

Installation Accessories



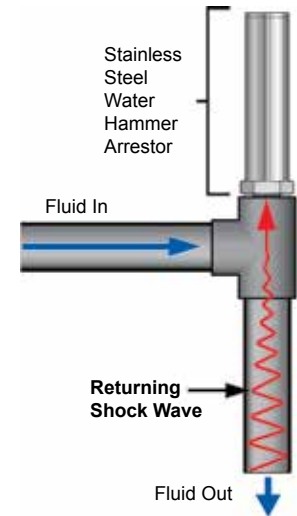

The accessories were specifically chosen to enhance your Dosatron set-up. If you have any questions, or can't find what you are looking for, give our customer service team a call at **1-800-451-6628**.

Water Hammer Arrestor Kits



Water hammer is a pressure surge, or wave caused when a fluid in motion is forced to stop or change directions suddenly. An example is if the flow control valve (on/off) is positioned downstream from the Dosatron. For this type of installation and others with strong water hammer potential, we recommend using a water hammer arrestor kit for easy and optimum installation.

Remember, arrestors should always be installed so the shock dead-ends into the arrestor. Arrestors should be placed as near to the source of shock as possible. The illustration shows proper positioning where the shock would be most effective.

	Description	Part #
	<p>Kit for 3/4" line: 3/4" MPT x 6 1/2" tall, stainless steel water hammer arrestor, nipple, tee, elbows, Teflon® tape, and union. Normal operating pressure 35 to 500 psi. Spike pressure not to exceed 2,000 psi.</p>	<p>WHA34-SS-KIT</p>
	<p>Kit for 1" line: 1" MPT x 6 1/2" tall, stainless steel water hammer arrestor, nipple, tee, elbows, Teflon® tape, and union. Normal operating pressure 35 to 500 psi. Spike pressure not to exceed 2,000 psi.</p>	<p>WHA100-SS-KIT</p>
	<p>Kit for 1 1/2" line: 3/4" MPT x 11 3/16" tall, stainless steel water hammer arrestor, nipple, tee, elbows, Teflon® tape, and union. Normal operating pressure 35 to 500 psi. Spike pressure not to exceed 2,000 psi.</p>	<p>WHA150-SS-KIT</p>
	<p>Kit for 2" line: 1" MPT x 11 3/16 tall, stainless steel water hammer arrestor, nipple, tee, elbows, Teflon® tape, and union. Normal operating pressure 35 to 500 psi. Spike pressure not to exceed 2,000 psi.</p>	<p>WHA200-SS-KIT</p>

Industrial Plumbing Kit (IPK)

Dosatron's IPKs are an all-in-one installation kit that includes what you need to install and protect your Dosatron chemical injector. They include:

- Ball valves - opens and closes the line
- 200 mesh filter - stops large particles from entering the Dosatron
- Pressure regulator with gauge - regulates incoming pressure
- Flow restrictor prevents excessive flow
- Check valve
- Unions - for easy injector removal
- Roll of Teflon® tape
- Instruction card
- Fittings

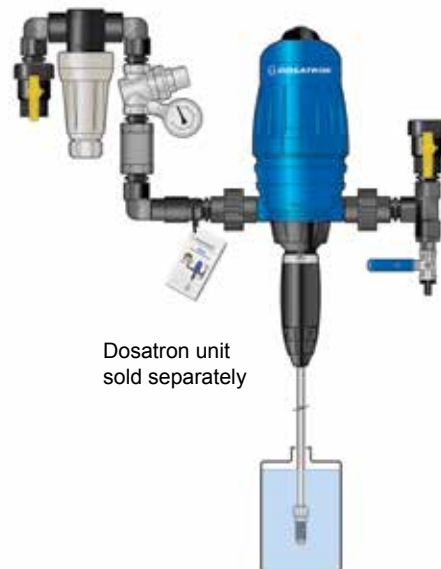

Industrial Plumbing Kits



Description	Part #
3 GPM Industrial Plumbing Kit, 3/4" connection.	IPK34-3GPM
3 GPM Industrial Plumbing Kit with mixing chamber, 3/4" connection.	IPK34MC-3GPM
7 GPM Industrial Plumbing Kit, 3/4" connection.	IPK34-7GPM
9 GPM Industrial Plumbing Kit, 3/4" connection.	IPK34-9GPM
10 GPM Industrial Plumbing Kit, 3/4" connection.	IPK34-10GPM
10 GPM Industrial Plumbing Kit with mixing chamber, 3/4" connection.	IPK34MC-10GPM
14 GPM Industrial Plumbing Kit, 3/4" connection.	IPK34-14GPM
14 GPM Industrial Plumbing Kit with mixing chamber, 3/4" connection.	IPK34MC-14GPM
20 GPM Industrial Plumbing Kit, 1" connection.	IPK100-20GPM

Kits may vary depending on IPK ordered.



Quick Priming and Sample Collection Instructions

Follow the easy step-by-step instructions below.

Quick Priming



- Shut off outlet ball valve
- Insert injection hose into the chemical container
- Turn on the discharge valve (collect discharged solution or send it to drain)
- Observe the injection hose and when full, count 10 clicks
- Shut off discharge valve
- Turn outlet ball valve on

Sample Collection

- Prime the unit
- Shut off outlet ball valve
- Turn on the discharge valve
- In a clean container, collect 2.5 gallons of diluted solution
- Turn off discharge valve
- Collect sample out of the 2.5 gallons and check concentration
- Turn on the outlet valve



NOTE: Make sure to use personal protective equipment (PPE) when disassembling injector or handling chemicals.

Dosa Lock

	Description	Part #
	Dosa Lock is an easy-to-install lockout device that protects unauthorized access to your injector and fits most Dosatron units. It is tamper resistant, controls chemical costs, fits injectors ranging from 11 GPM up to 40 GPM, made of high impact strength polypropylene, secures your settings, and is resistant to most chemicals. Dosa Lock comes with lock and key. Dosatron injector sold separately.	DOSA-LOCK
	Replacement Lock and Key set (keyed alike).	DOSA-PL
	Replacement Key only.	DOSA-PLKEY

Mixing Chamber

Enhance your chemical blending by using a mixing chamber.

	Description	Part #
	3/4" Mixing Chamber provides enhanced chemical blending, is excellent for extremely low flow applications, and low volume requirements (bottle fill), along with minute injection rates. Made of polycarbonate and polypropylene.	MC34
	Mixing chamber bracket for 3/4" clear mixing chamber.	MC34-BRACKET
	3/4" Mixing Chamber, is excellent in low flow applications. Made of polypropylene.	MC34-PP
	1" Mixing Chamber is excellent in low flow applications. Made of polypropylene.	MC100
	1 1/2" Mixing Chamber is excellent in low flow applications. Made of polypropylene.	MC150

Mixing Chamber Sunshade





	Description	Part #
	Light blocking mixing chamber sunshade for 3/4" mixing chamber. Prevents the light from impacting nutrient rich water, eliminating the potential for biofilm and algae growth in the chamber. Removable cover for the clear bowl portion of the mixing chamber.	MC34-SHADE
	Features: <ul style="list-style-type: none"> • Neoprene custom size cover • Black base and trim • Easily slips on and off for viewing 	

DAB Mini Booster Pump 2 HP

	Description	Part #
	Integrated, electronic water booster system for domestic and residential use that provides the comfort of constant water pressure, while saving energy.	X500-109-DAB2HP
	Features: <ul style="list-style-type: none"> <li style="width: 50%;">• Capacity up to 32 GPM, head up to 210' <li style="width: 50%;">• Self-priming double impeller pump <li style="width: 50%;">• Maximum pressure 115 psi <li style="width: 50%;">• Water cooled motor <li style="width: 50%;">• Dry run and antifreeze protections 	

Check Valve

Putting a Check Valve before the injection pump allows a one-way flow towards the unit. It can help prevent back flow if the fluid in the line reverses direction.



	Description	Part #
	3/4", 11 GPM Check Valve rated up to 200 psi. It includes extra 3/4" MPTX x 3/4" MGHT and is made of Schedule 40 PVC.	CV34-11GPM
	3/4" Check Valve rated up to 200 psi. Made of polypropylene and Hastelloy.	CV34-PH
	1", 20 GPM Check Valve rated up to 200 psi. Made of Schedule 40 PVC.	CV100
	1 1/2", 40 GPM Check Valve rated up to 200 psi. Made of Schedule 40 PVC.	CV112
	2", 100 GPM Check Valve rated up to 200 psi. Made of Schedule 40 PVC.	CV200

Water Meter

A Water Meter measures the flow through a specific portion of a system.

	Description	Part #
	3/4" Totalizer Water Meter with a pulse valve of 1/10 gallon (1 pulse per 10 gallons), lightweight analog reads gallons. Made of polypropylene.	WM34-1PP10G
	3/4" Totalizer Water Meter with a pulse valve of 1/1 gallon (1 pulse per 1 gallon), lightweight analog that reads gallons. Made of polypropylene.	WM34-1PPG

Flow Restrictor

	Description	Part #
	3/4" Flow Restrictor, 3 GPM maximum and made of nickel plated brass.	FR34-3GPM
	3/4" Flow Restrictor, 7 GPM maximum and made of nickel plated brass.	FR34-7GPM
	3/4" Flow Restrictor, 9 GPM maximum and made of nickel plated brass.	FR34-9GPM
	3/4" Flow Restrictor, 10 GPM maximum and made of nickel plated brass.	FR34-10GPM
	3/4" Flow Restrictor, 20 GPM maximum and made of nickel plated brass.	FR34-20GPM
	3/4" Flow Restrictor, 14 GPM maximum and made of PVC.	FRI-14GPM
	1 1/2" NPT Flow Restrictor assembly, 40 GPM maximum and made of Schedule 80 PVC.	FR200-40GPM







Vacuum Breaker Valve

This Valve will prevent the siphoning of chemicals when the unit is turned off. Siphoning will lead to a higher concentration of chemicals in the line and inaccurate readings when the unit is initialized.

	Description	Part #
	3/4" NPT connection.	VBV34
	1" NPT connection.	VBV100



Filters

All our filters include a cleanable, permanent, stainless steel filter. No replacement cartridges are necessary.

	Description	Part #
	3/4" Spin-Down Filter Kit with 200 mesh/80 micron and quick, clean-out valve. Made of polypropylene and includes Schedule 80 unions.	AKF5AP11KIT-A
	1" Spin-Down Filter Kit with 200 mesh/80 micron and quick, clean-out valve. Made of polypropylene and includes Schedule 80 unions.	AKF5AP20KIT-A
	1 1/2" Spin-Down Filter with 200 mesh/80 micron and quick, clean-out valve. Made of polypropylene.	AKF5AP40-A
	3/4" FNPT T-shaped, space saving Filter with 200 mesh/80 microns. Made of fiber charged polypropylene. The flush port is adaptable for clean-out of the 3/4" FPT ball valve.	AKF5AP11T
	3/4" T-shaped, space saving Filter with 200 mesh/80 microns. Made of industrial grade polypropylene. It is small and compact, perfect for tight installations.	AKF5AP11T-S
	1" T-shaped, space saving Filter with 200 mesh/80 microns. Made of fiber charged industrial polypropylene.	AKF5AP20T
	2" Filter with 200 mesh/80 microns. Made of polypropylene with spin down, quick clean-out valve.	AKF5AP100-A

Certified NSF Filters



These filters are NSF Certified, 42 Housing. Replaceable FDA approved, CFR Title 21 String Cartridge, NSF 42/61.

	Description	Part #
	3/4" NPT Filter. Head made out of polypropylene with SAN (Styrene-acrylonitrileplastic) bowl (clear).	AKF5AP11NSF
	1" NPT Filter. Made out of polypropylene (blue bowl).	AKF5AP20NSF
	1 1/2" NPT Filter. Made out of polypropylene (blue bowl).	AKF5AP40NSF



NOTE: Always follow the rules and regulations in your area in regards to water source protection. A different piece of equipment may be adapted to your specific situation.

Pressure Regulator

Pressure reducing valves are devices which, when installed on water systems, decrease the pressure from the incoming water line.

	Description	Part #
	3/4" NPT Pressure Regulator with female inlet and outlet. Working pressure is 15-87 psi, has a maximum incoming pressure of 230 psi, maximum temperature of 140°F, and is preset at 43.5 psi. It is a chrome plated, brass body with 2" face.	PR34
	1 1/2" MPT and/or 1" FPT Pressure Regulator comes with one 1" FPT union adapter for easy installation and maintenance. Set pressure is 50 psi, it is adjustable from 25 to 75 psi and designed to reduce pressures up to 400 psi. Made of brass.	PR100
	2" MPT or 1 1/2" FPT Pressure Regulator comes with one 1 1/2" FPT union adapter for easy installation and maintenance. Set pressure is 50 psi, it is adjustable from 25 to 75 psi and designed to reduce pressures up to 400 psi. Made of brass.	PR112

Pressure Gauge

	Description	Part #
	3/4" Pressure Gauge with 2" face. It has a bottom mount only with 1/4" MPT, 1 - 100 psi, and made of brass.	PG100
	This Pressure Gauge has an extra needle that remains at the maximum pressure reached. It has a 2 1/2" face with 160 psi and maximum pointer. Made of stainless steel.	PG160-MP-T

Pressure Gauge Kit

Kit includes a T-fitting and a reducer fitting for easy in-line installation. Has a 2" face and made of polypropylene.

	Description	Part #
	3/4" FPT with 0 - 100 psi.	PG100-34KIT
	1" FPT with 0 - 100 psi.	PG100-100KIT
	1 1/2" FPT with 0 - 100 psi.	PG100-150KIT



Foam Up Series

Airless Foam Wand

Our Foam Up Series creates foam without the need for compressed air! Use downstream from your Dosatron to create a wet or clinging foam that increases chemical contact time and effectiveness.

	Description	Part #
	The polypropylene Airless Foam Wand has a stainless steel ball valve, is pump fed with a 20' throw at 60 psi and a solution flow rate of 6.3 GPM at 40 psi.	X400-113

ChemStick Pick-Up Assembly

The ChemStick was designed to be used with either a barrel or tote and easily connects to existing pick-up tubes.

Features include:

- Chemical and acid resistant polypropylene construction
- Viton® seals
- Adjustable stopper for setting depth
- Rigid pipe
- Vented, so it doesn't allow debris in the container

Includes:

- 4 polypropylene hose barbs: 1/4", 3/8", 1/2", and 3/4"
- Foot spacer (1/2")
- Chemical check valve to prevent backflow
- Hastelloy strainer that is easy to clean



	Description	Part #
	33" long with bung adapter for a barrel.	CS33
	48" long with bung adapter for a barrel.	CS48
	54" long with bung adapter for a barrel.	CS54
	48" long with a tote plate cover.	CSP48
	54" long with a tote plate cover.	CSP54
	The ChemStick for 5-gallon bucket is easy-to-set-up and vented. 1/4" (6mm) in size with a universal fitting that can be used with any 5-gallon bucket with a spout. 5-gallon bucket not included.	CS12-6
	ChemStick for 5-gallon bucket. 5/16" (8 mm) in size.	CS12-8

Miscellaneous Accessories

	Product	Description	Part #
	Injector Tote Stand	Place the Injector Tote Stand on top of your barrel, drum, tote, or mini-bulk tank and thread a garden hose into either side for a quick and easy installation.	X500-103
	Bucket Stacker	Stacks two 5-gallon buckets in the footprint of one! Made of white PVC coated steel and built for stability. The lid holds up to a 3/4" suction hose, and it can hold up to 70 pounds of liquid. Tubing and buckets not included.	BS5
	5-Gallon Bucket	Translucent bucket has an expandable spout lid and graduated measurement sticker. Made of polypropylene.	PB5GAL

Tools and Supplies





Perfect for Maintenance

Dosa-Lube

Dosa-Lube is perfect for conditioning static seals and o-rings. It comes in a conveniently sized packet of 2.5-grams.

	Description	Part #
Dosa-Lube comes in a 2.5-gram packet. It includes silicone.		DOSA-LUBE

Repair Supplies

	Product	Description	Part #
	Universal Strap Wrench	Ideal for use on 7 - 40 GPM Dosatron bell housings. Can also be used to remove the sleeve on the Dosatron 100 GPM injector.	TOOL01
	Seal Remover Pick	Safely and quickly remove seals from their seat without damaging surrounding areas.	TOOL02
	Pressure Tester	2 1/2" face, 160 psi, brass Pressure Tester with maximum pointer. Helps to identify pressure spikes and pressure related issues.	PG160-MP
	Testing Station	Repair and testing station panel for 3/4" Dosatron injectors. It allows for quick and easy hook-up. Dosatron injector not included.	TBLD34



Check out our YouTube channel for installation tutorials, service videos and more.

youtube.com/DosatronIntl

HM Meters/Testers

Tools to Determine Specific Measurements



Pro HM Digital EC Meter

	<table border="1"> <thead> <tr> <th>Description</th> <th>Part #</th> </tr> </thead> <tbody> <tr> <td> Testing and monitor digital meters for receiving the desired results, they quickly measure conductivity, TDS, and temperature of water. Features: <ul style="list-style-type: none"> • Low battery warning • Professional model • Waterproof body. It floats too! • Pinpoint accuracy, highly versatile - 0.5 and 0.7 scale! • Easy digital calibration • Replaceable probe • Comes with lanyard • 1-year warranty • Measures EC/PPM/TEMP </td> <td>COM-100</td> </tr> </tbody> </table>	Description	Part #	Testing and monitor digital meters for receiving the desired results, they quickly measure conductivity, TDS, and temperature of water. Features: <ul style="list-style-type: none"> • Low battery warning • Professional model • Waterproof body. It floats too! • Pinpoint accuracy, highly versatile - 0.5 and 0.7 scale! • Easy digital calibration • Replaceable probe • Comes with lanyard • 1-year warranty • Measures EC/PPM/TEMP 	COM-100
Description	Part #				
Testing and monitor digital meters for receiving the desired results, they quickly measure conductivity, TDS, and temperature of water. Features: <ul style="list-style-type: none"> • Low battery warning • Professional model • Waterproof body. It floats too! • Pinpoint accuracy, highly versatile - 0.5 and 0.7 scale! • Easy digital calibration • Replaceable probe • Comes with lanyard • 1-year warranty • Measures EC/PPM/TEMP 	COM-100				



Pro HM Digital pH Meter

	<table border="1"> <thead> <tr> <th>Description</th> <th>Part #</th> </tr> </thead> <tbody> <tr> <td> Testing and monitor digital meters for receiving the desired results, they easily measure pH and temperature of water. Features: <ul style="list-style-type: none"> • Low battery warning • Professional model • Waterproof body. It floats too! • Easy, automatic digital calibration • Replaceable probe • Lanyard included • Rewettable tips • 1-year warranty • Measures 0.00 - 14.00 pH </td> <td>PH-200</td> </tr> </tbody> </table>	Description	Part #	Testing and monitor digital meters for receiving the desired results, they easily measure pH and temperature of water. Features: <ul style="list-style-type: none"> • Low battery warning • Professional model • Waterproof body. It floats too! • Easy, automatic digital calibration • Replaceable probe • Lanyard included • Rewettable tips • 1-year warranty • Measures 0.00 - 14.00 pH 	PH-200
Description	Part #				
Testing and monitor digital meters for receiving the desired results, they easily measure pH and temperature of water. Features: <ul style="list-style-type: none"> • Low battery warning • Professional model • Waterproof body. It floats too! • Easy, automatic digital calibration • Replaceable probe • Lanyard included • Rewettable tips • 1-year warranty • Measures 0.00 - 14.00 pH 	PH-200				

Calibration Solutions

Product	Description	Part #
	pH Storage Solution Keeps probe balanced. Contains fungicide and helps probe last longer.	PH-STOR
	EC Ready-to-use Liquid Calibration Packets 20 pack, TDS/EC solution. 20 mL packets of 1000 ppm/2 mS solution.	CP-1000
	pH Ready-to-use Liquid Calibration Packets 20 pack, pH-7 buffer solution, 20 mL packets of pH-7 solution.	PH-P7

Meter Protective Cases

Description	Part #
	Hard-sided, Plastic Protective Case for your pH Digital Meter. The case includes a PH-200 Meter, 2-pH buffer solutions, storage solution, and a lanyard.
	Hard-sided, Plastic Protective Case for your EC Digital Meter. The case includes a COM-100 Meter and a lanyard.
	Hard-sided, Polypropylene Protective Case for your EC or pH Digital Meter. The interior has a triple layer of pick and pluck foam for added protection. There are integrated, metal core rear hinges with snap locking front clasps. Case only, meters and solutions sold separately.

Etatron Electric Metering Pumps

The perfect answer for your water treatment plan.

Etatron is a leader in electric chemical metering pumps, providing electrical solenoid, peristaltic, and motor pumps along with controllers, for over 35 years.

Built with a broad range of chemical resistant materials and features:

- One-Piece Teflon® Diaphragm
- Manually Controlled
- Operated with a Water Meter or Flow Meter
- Control 4 - 20 mA
- pH, EC, and ORP Probes
- 2-Year Warranty

Etatron metering pumps are simple to use, highly reliable and are compact in size. They are available in:

- 12V
- 24V
- 115V
- 230V
- 50/60 Hertz

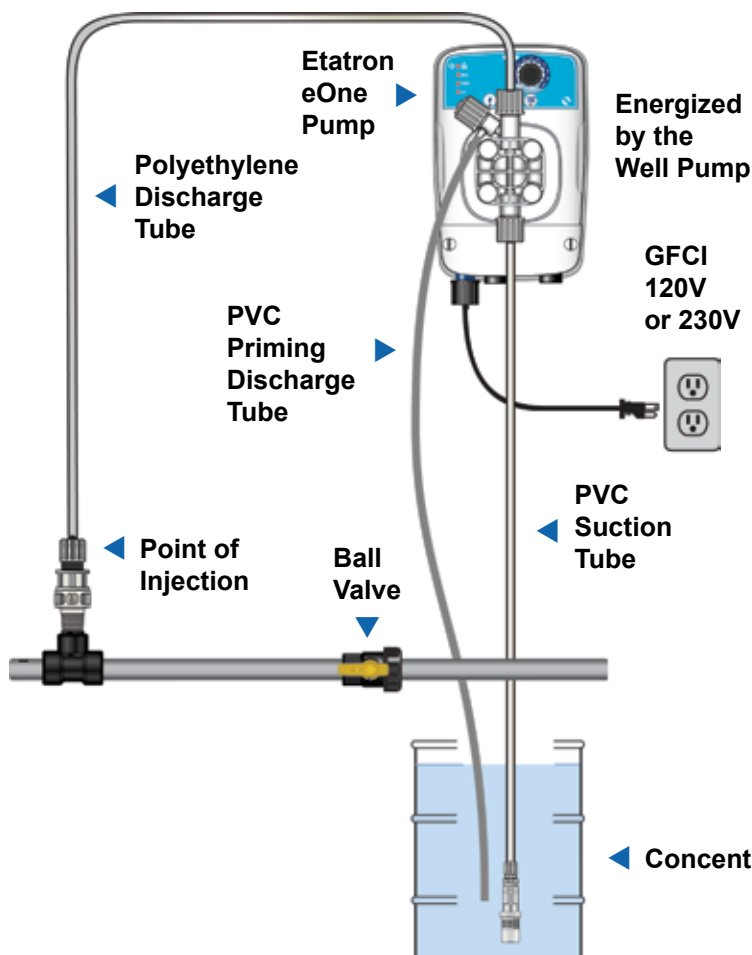

Etatron Pumps Include:

- eOne Series
- PKX Series
- DLX/DLXB Series
- Motor Pump Series
- ePool Series
- F/B Series



NOTE: Installation illustrations are to be used as a reference guide only.

How to Choose the Right Etatron Pump for Your Application

Etatron electric metering pumps can be found in multiple industries, such as:

- Irrigation
- Animal Health
- Nutrient Delivery
- Vehicle Wash
- Drinking Water Treatment
- Food Safety & Sanitation
- Metal Processing
- Printing
- and many more!

To find the Etatron pump that best fits your needs:

- How much chemical do you need to inject in an hour (liters or gallons)? _____
- What is the maximum pressure in the water line? _____
- What chemical are you injecting? _____
- How do you want to operate the pump for the best chemical delivery? _____

Once you have the information, give us a call at **1-800-451-6628**. Our trained customer service team members will help you choose the right Etatron pump and answer any questions you might have. Or you may **CHAT by going to www.dilutionsolutions.com**.

Etatron Pump Series Quick View

ETATRON							
SERIES	eOne	PKX	DLX/DLXB	Motor Pump (Diaphragm)	Motor Pump (Piston)	ePool	Series F/B
FLOW RATE (GPH)	0.26 to 7.93 GPH	0.26 to 2.64 GPH	0.26 to 5.28 GPH	2.64 to 151.6 GPH	1.59 to 271.3 GPH	0.40 to 0.79 GPH	0.13 to 3.17 GPH
FLOW RATE (LPH)	1 to 30 LPH	1 to 10 LPH	1 to 20 LPH	10 to 574 LPH	6 to 1.027 LPH	1 to 12 LPH	0.5 to 12 LPH
PRESSURE (PSI)	72 to 290 PSI	14 to 101 PSI	29 to 290 PSI	29 to 203 PSI	58 to 360 PSI	21 to 43 PSI	14 to 43 PSI
PRESSURE (BAR)	5 to 20 BAR	1 to 7 BAR	2 to 20 BAR	2 to 14 BAR	4 to 2	1.5 to 3 BAR	1 to 3 BAR
STROKES PER MINUTE	Up to 300	Up to 120	Up to 120	Up to 144	Up to 120	N/A	N/A
DETAILS PAGE	See pages 29 - 31	See page 32	See pages 33 - 34	See pages 35 -36	See pages 37 - 38	See page 39	See pages 40 - 42

eOne Series

eOne's technical characteristics deliver a reliable and effective solution.

- High stroke rate up to 300 impulses/minute
- Flow rate variation control in relation to pressure changes
- Energy efficient using absorbed power control in comparison to the real dosing conditions.
Advantages: constant dosing, energy saving, low operating temperatures
- eOne Metering pumps power supply range of 100 to 250VAC (50-60 Hz) voltage
- Proportional function, 1 to 1 on all manual pumps
- UNDERLOAD – Suction alarm in the event of low chemical level, blocked suction valve or damaged suction line
- OVERLOAD – Discharge alarm in the event of over pressure in pump head caused by an obstruction or increased operating system pressure beyond the pump specification
- Level control

Characteristics include: Maximum injection frequency equal to 300 impulses/minute, Power voltage supply range 100 - 250VAC (50/60 Hz), Maximum absorbed power 32 W to 4. Proportional function 1 to 1.

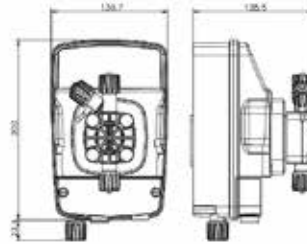

eOne Wetted Parts	
Pump Head	PVDF
Diaphragm	PTFE (Teflon®)
Seals	TFE/P (Aflas®)
Valves	Ceramic Ball
Discharge Tubing	PE (Polyethylene)
Suction Tubing	PVC

Version	Flow Rate		Pressure		Strokes Per Minute
e128	5.26 GPH	20 LPH	101 PSI	7 BAR	300
eMP	0.26 GPH	1 LPH	145 PSI	10 BAR	180

Version	Flow Rate		Pressure		Strokes Per Minute
Basic 0210	0.53 GPH	2 LPH	145 PSI	10 BAR	180
Basic 0507	1.32 GPH	5 LPH	101 PSI	7 BAR	180

Version	Flow Rate		Pressure		Strokes Per Minute
0110	0.26 GPH	1 LPH	145 PSI	10 BAR	180
0216	0.53 GPH	2 LPH	232 PSI	16 BAR	300
0420	1.06 GPH	4 LPH	290 PSI	20 BAR	300
0607	1.59 GPH	6 LPH	101 PSI	7 BAR	300
0710	1.84 GPH	7 LPH	145 PSI	10 BAR	300
1012	2.64 GPH	10 LPH	174 PSI	12 BAR	300
1505	3.96 GPH	15 LPH	72 PSI	5 BAR	300
2007	5.26 GPH	20 LPH	101 PSI	7 BAR	300
3005	7.92 GPH	30 LPH	72 PSI	5 BAR	300

e128 Livestock Medicator - a True 11 GPM Electric Medicator

Description
<div style="display: flex; align-items: center;">  <div> <p>The e128 Medicator is the perfect pump for both your medicating and water treatment needs. Etatron's operation is NOT affected by water quality and is simple to use, highly reliable, and compact. Features include:</p> <ul style="list-style-type: none"> • Fixed at 1:128 • Pump capacity is equivalent to an 11 GPM water-powered medicator • Pump automatically compensates injections for variations in flow • 120V, 60 Hz • IP65 acid resistance housing • Self-priming pump head with manual air bleed for fast self-priming • Suction alarm to detect when bucket is empty • PVDF solenoid head for enhanced chemical resistance • Long lasting unique one-piece Teflon® PTFE diaphragm design • Connects to 1 pulse per gallon (1PPG) or 1 pulse per 10-gallons (1PP10G) water meter • 2-year warranty </div> </div>

eMP



Description

The eMP Livestock Water Treatment metering pump is the perfect answer for your water treatment. It is simple to use, highly reliable, and compact in size. Features include:

- Flow — 0.26 GPH (1 LPH)
- Max pressure — 145 PSI (10 BAR)
- Weight — 6.7 lbs.
- Stroke output (mL) — 0.09 at 145 PSI (10 BAR)
- Max pulses per minute — 180
- Mount type — wall mount
- Voltage — 120V

eOne Basic



Description

The eOne Basic is an analog metering pump. It has manual flow control with dual scale adjustment from 0 to 100% or 1 to 20%. Other features include a volumetric proportional mode (1:1) via input from a reed switch water meter and a level alarm.

- Flow rate regulation, 0 to 100% and 0 to 20%
- Proportional mode 1 to 1 with water meter input
- Level control setting (supplied without probe)

eOne MA



Description

The eOne MA is an analog metering pump. It has manual flow control with dual scale adjustment from 0 to 100% of 0 to 20%. There is also a volumetric proportional mode (1:1) via input from a reed switch water meter. Features include:

- Underload suction alarm
- Overload discharge alarm
- Level alarm

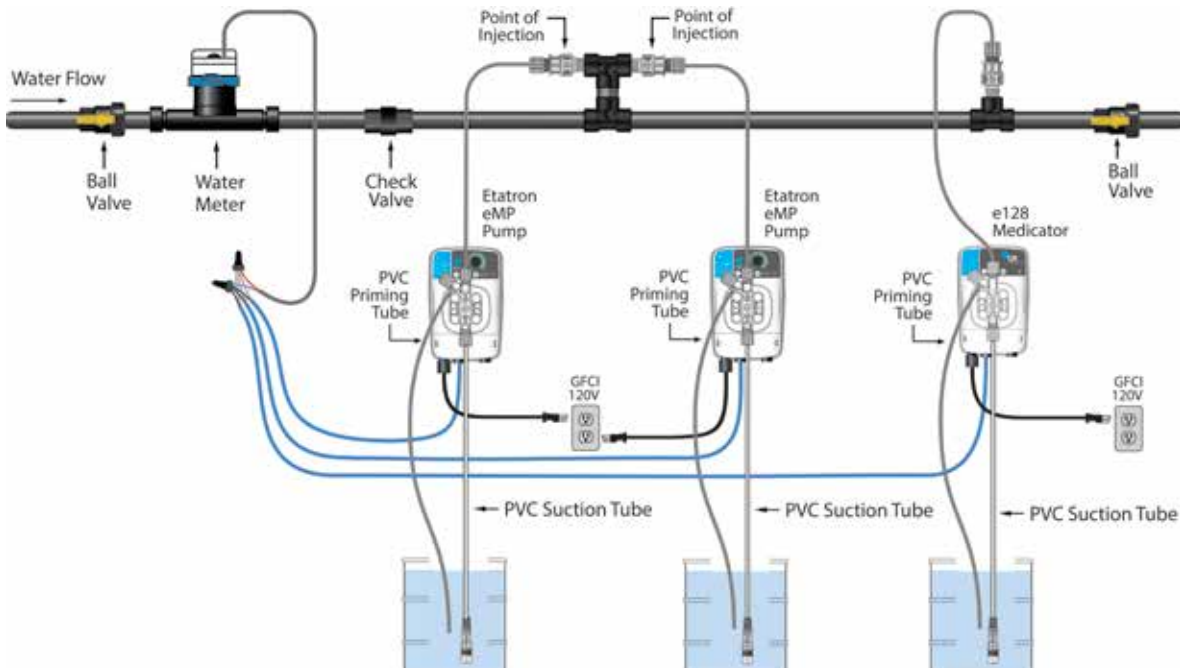

NOTE: Installation illustrations are to be used as a reference guide only.

eOne MF



Description

The eOne MF is a multifunction microprocessor metering pump, suitable for applications which require proportional dosing. The pump operates at a high dosing frequency (up to 300 impulses/minute) and is equipped with backlit graphic display for correct setting of the various programming parameters.

The eOne MF features are:

- Proportional dosing modes (1 x n; 1 : n; 1 x n M; ml x l; L x l; ml x m3; PPM)
- Digital manual control
- Level control
- Flow rates calibration
- Flow sensor input
- 4-20 mA control
- Pump output display
- Relay output
- Underload suction alarm
- Overload discharge alarm

eOne Plus



Description

The eOne Plus microprocessor controlled metering pump is suitable for proportional applications with built-in controller for pH, Redox, and Chlorine regulation. pH measuring range is 0 to 14 pH; Redox measuring range is -1000 to +1400 mV; and Chlorine measuring range is 0 to 2, 0 to 20, and 0 to 200 ppm.

The pump operates at high dosing frequency (up to 300 impulses/minute) and is equipped with backlit graphic display for correct setting of various programming parameters.

The eOne Plus features are:

- Proportional dosing modes (1 x n; 1 : n; 1 x n M; ml x l; L x l; ml x m3, PPM)
- Relay output
- Underload/overload alarms
- 4-20 mA output
- Proximity switch
- Integral pH, Rx, or chlorine control
- PT100 temperature input
- Digital manual control
- Level control
- Flow rate calibration
- Flow sensor input
- Pump output display

PKX Series

The PKX metering pump is compact and can be wall-mounted or foot-mounted.

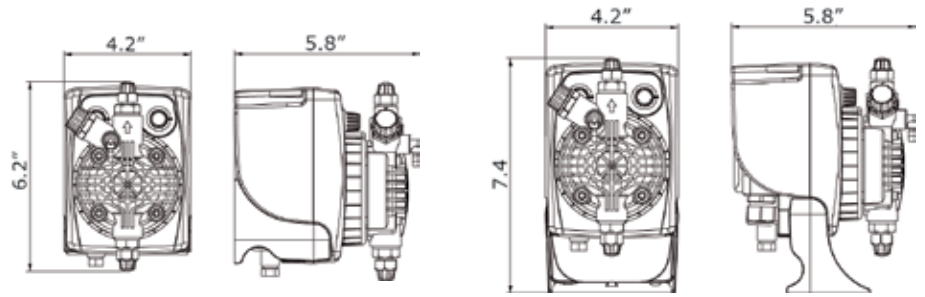

PKX Wetted Parts	
Pump Head	PP (Polypropylene)
Diaphragm	PTFE (Teflon®)
Seals	FPM (Viton®) or EPDM (Dutral®)
Valves	Duck Bill FPM (Viton®) or EPDM (Dutral®)
Discharge Tubing	PE (Polyethylene)
Suction Tubing	PVC

Version	Flow Rate		Pressure		Strokes Per Minute
0105	0.26 GPH	1 LPH	72 PSI	5 BAR	120
0206	0.53 GPH	2 LPH	87 PSI	6 BAR	120
0505	1.32 GPH	5 LPH	72 PSI	5 BAR	120
0507	1.32 GPH	5 LPH	101 PSI	7 BAR	120
0702	1.85 GPH	7 LPH	29 PSI	2 BAR	120
	2.64 GPH	10 LPH	14 PSI	1 BAR	120

MA/A

Description

The MA/A is an analogic metering pump with a manual control from 0 to 100%. Level alarm is available upon request. 230V and low voltage (12V and 24V) models are available upon request. 120V and 230V models are CSA certified.

The PKX dosing pump is compact and can be wall-mounted or foot-mounted.

FT/A

Description

The FT/A is an analog metering pump with manual flow control from 0 to 100%. It has two operating modes controlled by a reed switch water meter:

- Volumetric proportional mode — 1:1 (1 injection per 1 signal) as indicated by F mode
- Volumetric timer mode — 0 to 60 seconds of metering per signal

Level alarm is available upon request.

The PKX dosing pump is compact and can be wall-mounted or foot-mounted.

DLX/DLXB Series

The DLXB, foot-mounted pump and the DLX, wall-mounted pump offer analogic or digital versions with 120 to 230 Volts. Low voltage models are available.

Operating features include:

- Manual pumps
- Proportional with water meter or flow meter
- 4-20 mA
- Directly to pH/ORP/Cl probes
- Level control
- Relay or MA outputs available

DLX/DLXB Wetted Parts	
Pump Head	PP (Polypropylene)
Diaphragm	PTFE (Teflon®)
Seals	FPM (Viton®) or EPDM (Dutral®)
Valves	Duck Bill FPM (Viton®) or EPDM (Dutral®)
Discharge Tubing	PE (Polyethylene)
Suction Tubing	PVC

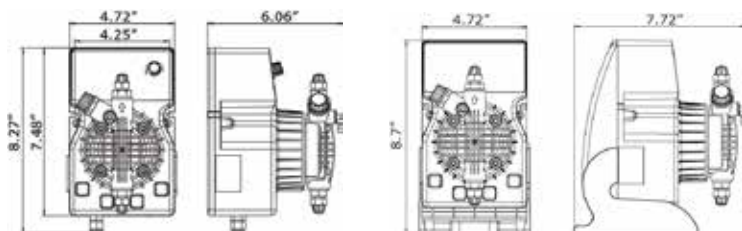

DLX Wall-Mounted

DLXB Foot-Mounted



Version	Flow Rate		Pressure		Strokes Per Minute
	GPH	LPH	PSI	BAR	
0115	0.26	1	217	15	120
	0.53	2	145	10	120
	0.78	3	72	5	120
0220	0.53	2	290	20	120
0507	1.32	5	101	7	120
	1.59	6	72	5	120
	2.11	8	29	2	120
0810	2.11	8	145	10	120
	2.64	10	101	7	120
	3.17	12	43	3	120
1504	3.96	15	58	4	120
2003	5.28	20	43	3	120

MA/AD

	<table border="1"> <thead> <tr> <th data-bbox="383 205 1515 247">Description</th> </tr> </thead> <tbody> <tr> <td data-bbox="383 247 1515 403"> <p>The MA/AD is an analog metering pump. It has manual flow control with dual-scale adjustment from 0 - 20% to 0 - 100%. Level alarm is available upon request. 230V and low voltage (12V and 24V) models are available upon request. 120V and 230V models are CSA certified. DLXB with stroke length adjustment is available upon request.</p> </td> </tr> </tbody> </table>	Description	<p>The MA/AD is an analog metering pump. It has manual flow control with dual-scale adjustment from 0 - 20% to 0 - 100%. Level alarm is available upon request. 230V and low voltage (12V and 24V) models are available upon request. 120V and 230V models are CSA certified. DLXB with stroke length adjustment is available upon request.</p>
Description			
<p>The MA/AD is an analog metering pump. It has manual flow control with dual-scale adjustment from 0 - 20% to 0 - 100%. Level alarm is available upon request. 230V and low voltage (12V and 24V) models are available upon request. 120V and 230V models are CSA certified. DLXB with stroke length adjustment is available upon request.</p>			

MA/MB

	<table border="1"> <thead> <tr> <th data-bbox="386 474 1523 516">Description</th> </tr> </thead> <tbody> <tr> <td data-bbox="386 516 1523 663"> <p>The MA/MB is a microprocessor controlled, digital metering pump. It has manual flow control from 0 to 100% with a 3-digit display, relay output, and level alarm. 230V models are available upon request. 120V and 230V models are CSA certified. DLXB with stroke length adjustment are available upon request.</p> </td> </tr> </tbody> </table>	Description	<p>The MA/MB is a microprocessor controlled, digital metering pump. It has manual flow control from 0 to 100% with a 3-digit display, relay output, and level alarm. 230V models are available upon request. 120V and 230V models are CSA certified. DLXB with stroke length adjustment are available upon request.</p>
Description			
<p>The MA/MB is a microprocessor controlled, digital metering pump. It has manual flow control from 0 to 100% with a 3-digit display, relay output, and level alarm. 230V models are available upon request. 120V and 230V models are CSA certified. DLXB with stroke length adjustment are available upon request.</p>			

VFT/MBB

	<table border="1"> <thead> <tr> <th data-bbox="386 737 1529 779">Description</th> </tr> </thead> <tbody> <tr> <td data-bbox="386 779 1529 924"> <p>The VFT/MBB is a microprocessor controlled metering pump with four operating modes: a digital manual mode and three proportional modes, signaled by a reed switch water meter. 230V models are available upon request. Other features include a level alarm and a relay output. DLXB with stroke length adjustment are available upon request.</p> </td> </tr> </tbody> </table>	Description	<p>The VFT/MBB is a microprocessor controlled metering pump with four operating modes: a digital manual mode and three proportional modes, signaled by a reed switch water meter. 230V models are available upon request. Other features include a level alarm and a relay output. DLXB with stroke length adjustment are available upon request.</p>
Description			
<p>The VFT/MBB is a microprocessor controlled metering pump with four operating modes: a digital manual mode and three proportional modes, signaled by a reed switch water meter. 230V models are available upon request. Other features include a level alarm and a relay output. DLXB with stroke length adjustment are available upon request.</p>			

MF/M

	<table border="1"> <thead> <tr> <th data-bbox="386 999 1529 1041">Description</th> </tr> </thead> <tbody> <tr> <td data-bbox="386 1041 1529 1186"> <p>The MF/M is a microprocessor controlled, multifunction metering pump. Operating modes include digital manual mode, four proportional modes, signaled by a reed switch water meter and a 4-20 mA input. 230V and low voltage (12V and 24V) models are available upon request. 120V and 230V models are CSA certified. Other features are: backlit LCD display, level alarm, relay output, flow alarm, buzzer, clock, remote control and timer. DLXB with stroke length adjustment are available upon request.</p> </td> </tr> </tbody> </table>	Description	<p>The MF/M is a microprocessor controlled, multifunction metering pump. Operating modes include digital manual mode, four proportional modes, signaled by a reed switch water meter and a 4-20 mA input. 230V and low voltage (12V and 24V) models are available upon request. 120V and 230V models are CSA certified. Other features are: backlit LCD display, level alarm, relay output, flow alarm, buzzer, clock, remote control and timer. DLXB with stroke length adjustment are available upon request.</p>
Description			
<p>The MF/M is a microprocessor controlled, multifunction metering pump. Operating modes include digital manual mode, four proportional modes, signaled by a reed switch water meter and a 4-20 mA input. 230V and low voltage (12V and 24V) models are available upon request. 120V and 230V models are CSA certified. Other features are: backlit LCD display, level alarm, relay output, flow alarm, buzzer, clock, remote control and timer. DLXB with stroke length adjustment are available upon request.</p>			

pH-Rx-CI/M

	<table border="1"> <thead> <tr> <th data-bbox="386 1260 1529 1302">Description</th> </tr> </thead> <tbody> <tr> <td data-bbox="386 1302 1529 1463"> <p>The pH-Rx-CI/M is a microprocessor controlled metering pump with pH, redox and chlorine regulating capabilities. pH measuring range is 0 to 14 pH; redox measuring range is -1000 to +1400 mV; and chlorine measuring range is 0 to 2, 0 to 20, and 0 to 200 ppm. 230V and low voltage (12V and 24V) models are available upon request. 120V and 230V models are CSA certified. Other features are: backlit LCD display, digital manual mode, on/off proportional mode, level alarm, 4-20 mA output, relay output, proximity switch, PT100 input, and manual/automatic temperature compensation - 32°F to 212°F (0°C to 100°C). DLXB with stroke length adjustment are available upon request.</p> </td> </tr> </tbody> </table>	Description	<p>The pH-Rx-CI/M is a microprocessor controlled metering pump with pH, redox and chlorine regulating capabilities. pH measuring range is 0 to 14 pH; redox measuring range is -1000 to +1400 mV; and chlorine measuring range is 0 to 2, 0 to 20, and 0 to 200 ppm. 230V and low voltage (12V and 24V) models are available upon request. 120V and 230V models are CSA certified. Other features are: backlit LCD display, digital manual mode, on/off proportional mode, level alarm, 4-20 mA output, relay output, proximity switch, PT100 input, and manual/automatic temperature compensation - 32°F to 212°F (0°C to 100°C). DLXB with stroke length adjustment are available upon request.</p>
Description			
<p>The pH-Rx-CI/M is a microprocessor controlled metering pump with pH, redox and chlorine regulating capabilities. pH measuring range is 0 to 14 pH; redox measuring range is -1000 to +1400 mV; and chlorine measuring range is 0 to 2, 0 to 20, and 0 to 200 ppm. 230V and low voltage (12V and 24V) models are available upon request. 120V and 230V models are CSA certified. Other features are: backlit LCD display, digital manual mode, on/off proportional mode, level alarm, 4-20 mA output, relay output, proximity switch, PT100 input, and manual/automatic temperature compensation - 32°F to 212°F (0°C to 100°C). DLXB with stroke length adjustment are available upon request.</p>			

pH-Rx/MBB

	<table border="1"> <thead> <tr> <th data-bbox="386 1545 1529 1587">Description</th> </tr> </thead> <tbody> <tr> <td data-bbox="386 1587 1529 1734"> <p>The pH-Rx/MBB is a microprocessor controlled metering pump with pH and redox control. pH measuring range is 0 to 14 pH; redox measuring range is -1000 to +1400 mV. 230V and low voltage (12V and 24V) models are available upon request. 120V and 230V models are CSA certified. Other features include a backlit LCD display, digital manual mode, on/off proportional mode, level alarm, and manual/automatic temperature compensation - 32°F to 212°F (0°C to 100°C). DLXB with stroke length adjustment are available upon request.</p> </td> </tr> </tbody> </table>	Description	<p>The pH-Rx/MBB is a microprocessor controlled metering pump with pH and redox control. pH measuring range is 0 to 14 pH; redox measuring range is -1000 to +1400 mV. 230V and low voltage (12V and 24V) models are available upon request. 120V and 230V models are CSA certified. Other features include a backlit LCD display, digital manual mode, on/off proportional mode, level alarm, and manual/automatic temperature compensation - 32°F to 212°F (0°C to 100°C). DLXB with stroke length adjustment are available upon request.</p>
Description			
<p>The pH-Rx/MBB is a microprocessor controlled metering pump with pH and redox control. pH measuring range is 0 to 14 pH; redox measuring range is -1000 to +1400 mV. 230V and low voltage (12V and 24V) models are available upon request. 120V and 230V models are CSA certified. Other features include a backlit LCD display, digital manual mode, on/off proportional mode, level alarm, and manual/automatic temperature compensation - 32°F to 212°F (0°C to 100°C). DLXB with stroke length adjustment are available upon request.</p>			

Motor Pump Series

Diaphragm Motor Pumps

The ST-D & D Series are spring return, motor-driven mechanical diaphragm pumps. Mechanical diaphragm motor pumps are suitable when pumped liquid is abrasive or contains suspended solid particles. The Diaphragm Motor Pumps have flow capacities of 2.64 to 141.40 GPH at 50 Hz, 3.17 to 151.60 GPH at 60 Hz, with pressures up to 203 psi. The standard power supply is 230 – 400V, 3 phase, at 50 Hz and 275 – 480V, 3 phase at 60 Hz. Standard pump head materials are Stainless Steel, PVC, and Polypropylene.

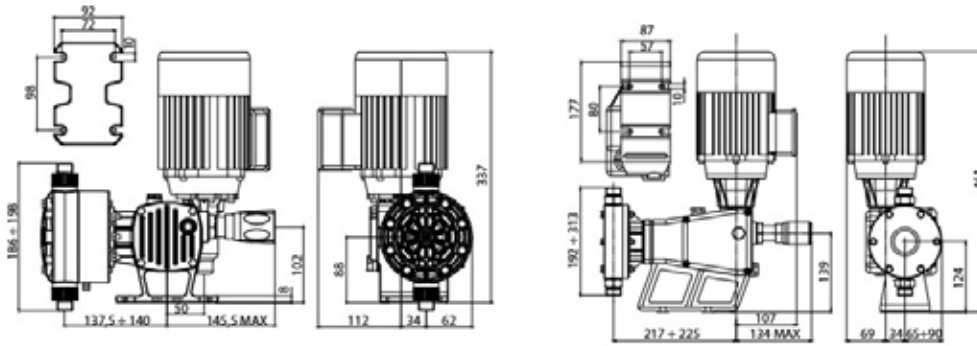

Series ST-D

Series D

Series	Flow Rate				Delivery Head AISI (Stainless Steel)				Delivery Head PP				Strokes	
	GPH	GPH	LPH	LPH	PSI	PSI	BAR	BAR	PSI	PSI	BAR	BAR	Per Minute	Per Minute
ST-D	50 Hz	60 Hz	50 Hz	60 Hz	50 Hz	60 Hz	50 Hz	60 Hz	50 Hz	60 Hz	50 Hz	60 Hz	50 Hz	60 Hz
Diaphragm														
AD0010	2.64	3.17	10	12	203	203	14	14	203	203	14	14	60	72
AD0016	4.23	5.07	16	19	203	203	14	14	203	203	14	14	60	72
AD0021	5.55	6.66	21	25	203	174	14	12	203	174	14	12	120	144
AD0027	7.13	8.56	27	32	203	174	14	12	203	174	14	12	120	144
AD0033	8.72	10.46	33	40	203	174	14	12	203	174	14	12	120	144
AD0019	5.02	6.02	19	23	160	160	11	11	160	160	11	11	60	72
AD0030	7.92	9.51	30	36	160	160	11	11	160	160	11	11	60	72
AD0039	10.30	12.42	30	47	160	145	11	10	160	145	11	10	120	144
AD0051	13.47	16.12	51	61	160	145	11	10	160	145	11	10	120	144
AD0060	15.85	19.02	60	72	160	145	11	10	160	145	11	10	120	144
AD0041	10.83	13.00	41	49	102	94	7	6.5	102	94	7	6.5	60	72
AD0061	16.12	19.34	61	73	102	94	7	6.5	102	94	7	6.5	60	72
Ad0084	22.19	26.63	84	101	87	72	6	5	87	72	6	5	120	144
AD0104	27.48	32.97	104	125	87	72	6	5	87	72	6	5	120	144
AD0123	32.50	39.00	123	148	87	72	6	5	87	72	6	5	120	144



Series	Flow Rate				Delivery Head AISI (Stainless Steel)				Delivery Head PVC				Strokes	
	D	GPH	GPH	LPH	LPH	PSI	PSI	BAR	BAR	PSI	PSI	BAR	BAR	Per Minute
Diaphragm	50 Hz	60 Hz	50 Hz	60 Hz	50 Hz	60 Hz	50 Hz	60 Hz	50 Hz	60 Hz	50 Hz	60 Hz	50 Hz	60 Hz
BD0056	14.80	17.75	56	67	174	160	12	11	145	145	10	10	60	72
BD0079	20.87	25.05	79	95	174	160	12	11	145	145	10	10	60	72
BD0113	29.85	35.83	113	137	145	116	10	8	145	116	10	8	103	122
BD0135	35.67	42.80	135	172	145	116	10	8	145	116	10	8	103	122
BD0158	41.74	-	159	-	116	-	8	-	116	-	8	-	120	-
BD0104	27.48	32.97	104	125	109	87	7.5	6	109	87	7.5	6	60	72
BD0150	39.63	48.57	150	180	109	87	7.5	6	109	87	7.5	6	60	72
BD0209	55.22	66.26	209	251	87	73	6	5	87	73	6	5	103	122
BD0257	67.90	81.48	257	308	87	73	6	5	87	73	6	5	103	122
BD0300	79.26	-	300	-	73	-	5	-	73	-	5	-	120	-
BD0188	49.67	59.60	188	226	51	44	3.5	3	51	44	3.5	3	60	72
BD0278	73.45	88.14	278	334	51	44	3.5	3	51	44	3.5	3	60	72
BD0420	111.0	133.2	420	504	36	29	2.5	2	36	29	2.5	2	103	122
BD0478	126.3	151.6	478	574	36	29	2.5	2	36	29	2.5	2	103	122
BD0535	141.4	-	535	-	29	-	2	-	29	-	2	-	120	-
BD0188	49.67	59.60	188	226	58	51	4	3.5	58	51	4	3.5	60	72
BD0278	73.45	88.14	278	334	58	51	4	3.5	58	51	4	3.5	60	72
BD0420	111.0	133.2	420	504	43	36	3	2.5	43	36	3	2.5	103	122
BD0478	126.3	151.6	478	574	43	36	3	2.5	43	36	3	2.5	103	122
BD0535	141.4	-	535	-	36	-	2.5	-	36	-	2.5	-	120	-



Piston Motor Pumps

The ST-P & P Series are spring return motor-driven mechanical piston pumps. Piston type pumps are suitable when pumped liquid is not abrasive and does not contain suspended solid particles. The Piston Motor Pumps have flow capacities of 1.59 to 221.38 GPH at 50 Hz, 1.85 to 265.20 GPH at 60 Hz, with pressure up to 360 psi. The standard power supply is 230 – 400V, 3 phase at 50 Hz and 275 – 480V, 3 phase at 60 Hz. Standard pump head materials Stainless Steel and PVC.

Series	Flow Rate				Delivery Head AISI (Stainless Steel)				Delivery Head PVC				Strokes	
	GPH	GPH	LPH	LPH	PSI	PSI	BAR	BAR	PSI	PSI	BAR	BAR	Per Minute	
ST-P	50 Hz	60 Hz	50 Hz	60 Hz	50 Hz	60 Hz	50 Hz	60 Hz	50 Hz	60 Hz	50 Hz	60 Hz	50 Hz	60 Hz
AP006	1.59	1.85	6	7	290	290	20	20	145	145	10	10	60	72
AP0011	2.91	3.49	11	13	290	290	20	20	145	145	10	10	60	72
AP0013	3.43	-	13	-	290	-	20	-	145	-	10	-	120	-
AP0018	4.76	-	18	-	290	-	20	-	145	-	10	-	120	-
AP0022	5.81	-	22	-	290	-	20	-	145	-	10	-	120	-
Ap0023	6.08	7.29	23	28	196	157	13.5	11	145	145	10	10	60	72
AP0039	10.30	12.36	39	47	196	157	13.5	11	145	145	10	10	60	72
AP0046	12.15	-	46	-	145	-	10	-	145	-	10	-	120	-
AP0064	16.91	-	64	-	145	-	10	-	145	-	10	-	120	-
AP0077	20.34	-	77	-	145	-	10	-	145	-	10	-	120	-
AP0058	15.32	18.39	58	70	65	58	4.5	4	65	58	4.5	4	60	72
AP0095	25.10	30.12	95	114	65	58	4.5	4	65	58	4.5	4	60	72
AP0116	30.65	-	116	-	51	-	3.5	-	51	-	3.5	-	120	-
AP0157	41.48	-	157	-	51	-	3.5	-	51	-	3.5	-	120	-
AP0190	50.20	-	190	-	51	-	3.5	-	51	-	3.5	-	120	-

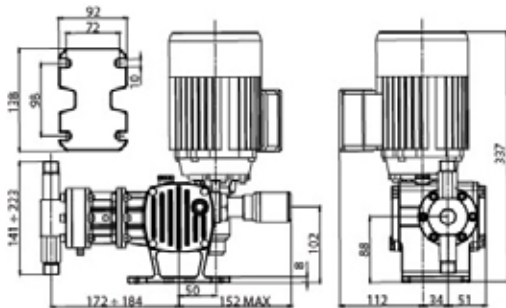

Series ST-P

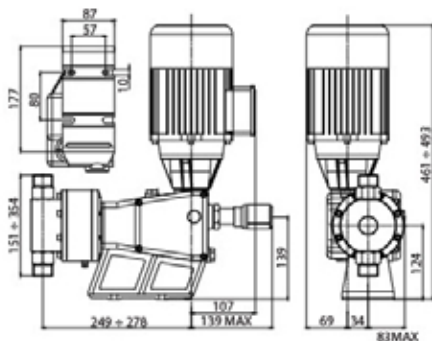

Series P



ETATRON / PUMPS

Series	Flow Rate				Delivery Head AISI (Stainless Steel)				Delivery Head PVC				Strokes		
	P	GPH	GPH	LPH	LPH	PSI	PSI	BAR	BAR	PSI	PSI	BAR	BAR	Per Minute	
	Piston	50 Hz	60 Hz	50 Hz	60 Hz	50 Hz	60 Hz	50 Hz	60 Hz	50 Hz	60 Hz	50 Hz	60 Hz	50 Hz	60 Hz
BP0014		3.69	4.49	14	17	360	360	25	25	-	-	-	-	60	72
BP0024		6.34	7.66	24	29	360	360	25	25	-	-	-	-	60	122
BP0029		7.66	-	29	-	360	-	25	-	-	-	-	-	120	-
BP0034		8.98	10.78	34	41	290	290	20	20	145	145	10	10	60	72
BP0052		13.74	16.64	52	63	290	290	20	20	145	145	10	10	60	72
BP0066		17.44	20.60	66	78	290	261	20	18	145	145	10	10	103	122
BP0088		23.25	28.00	88	106	290	261	20	18	145	145	10	10	103	122
BP0103		27.21	-	103	-	261	-	18	-	145	-	10	-	120	-
BP0083		21.93	26.31	83	100	174	138	12	9.5	145	138	10	9.5	60	72
BP0128		33.81	40.42	128	153	174	138	12	9.5	145	138	10	9.5	60	72
BP0158		41.72	49.66	158	188	131	109	9	7.5	131	109	9	7.5	103	122
BP0220		58.12	68.68	220	260	131	109	9	7.5	131	109	9	7.5	103	122
BP0256		67.63	-	256	-	103	-	7.5	-	109	-	7.5	-	120	-
BP0163		43.06	51.68	163	196	87	72	6	5	87	72	6	5	60	72
BP0251		66.31	79.78	251	302	87	72	6	5	87	72	6	5	60	72
BP0321		82.42	98.80	312	374	65	51	4.5	3.5	65	51	4.5	3.5	103	122
BP0431		113.86	135.26	431	512	65	51	4.5	3.5	65	51	4.5	3.5	103	122
BP0503		132.88	-	503	-	51	-	3.5	-	51	-	3.5	-	120	-
BP0083		21.83	25.31	83	100	262	210	18	14.5	145	145	10	10	60	72
BP0128		33.81	40.42	128	153	262	210	18	114.5	145	145	10	10	60	72
BP0158		41.74	49.66	158	188	232	189	16	13	145	145	10	10	103	122
BP0220		58.12	68.68	220	260	232	189	16	13	145	145	10	10	103	122
BP0256		67.63	-	256	-	189	-	13	-	145	-	10	-	120	-
BP0163		43.06	51.68	163	196	131	109	9	7.5	131	109	9	7.5	60	72
BP0251		66.31	79.78	251	302	131	109	9	7.5	131	109	9	7.5	60	72
BP0312		82.42	98.80	312	374	102	80	7	5.5	102	80	7	5.5	103	122
BP0431		113.86	135.26	431	512	102	80	7	5.5	102	80	7	5.5	103	122
BP0503		132.88	-	503	-	87	-	6	-	87	-	6	-	120	-
BP0251		66.30	79.78	251	302	160	138	11	9.5	145	138	10	9.5	60	72
BP0431		113.86	135.26	431	512	131	116	9	8	131	116	9	8	103	122
BP0503		132.9	-	503	-	131	-	8	-	131	-	8	-	120	-
BP0513		135.52	162.20	513	613	80	65	5.5	4.5	80	65	5.5	4.5	60	72
BP0838		221.38	256.2	838	1004	58	44	4	3	58	44	4	3	103	122
BP1027		271.3	-	1027	-	44	-	3	-	44	-	3	-	120	-
BP0251		66.30	79.78	251	302	276	254	19	17.5	145	145	10	10	60	72
BP0431		113.86	135.26	431	512	239	210	16.5	14.5	145	145	10	10	103	122
BP0503		132.9	-	503	-	210	-	14.5	-	145	-	10	-	120	-
BP0513		135.52	162.20	513	614	174	145	12	10	145	145	10	10	60	72
BP0838		221.38	265.2	838	1004	116	94	8	6.5	131	94	8	6.5	103	122
BP1027		271.3	-	1027	-	94	-	6.5	-	94	-	6.5	-	120	-

ePool Series

The ePool series is designed for home swimming pools and wellness centers. The ePool uses micro-electronic technology which monitors in real-time and activates the peristaltic pump for the correct liquid dosage.

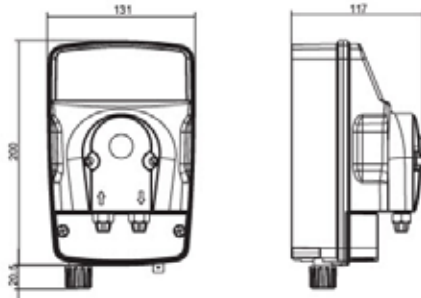

ePool Wall-Mounted



Version	Flow Rate		Pressure	
	GPH	LPH	PSI	BAR
0101	0.40	1.5	21	1
0301	0.79	3	21	1
0202	0.53	2	29	2
0303	0.79	3	43	3

ePool

Description	
	<p>The functions performed by the ePool are:</p> <ul style="list-style-type: none"> • Power supply – 110, 230VAC 50/60 Hz • Maximum power supply – 15 W • It has the possibility to measure two different types of electrochemical variables: pH or Rx in the ranges 5 to 9 “pH”, +300 to +900mV “Rx” • Set Point Selection • Type of intervention (direct or inverse) • Hysteresis • ON/OFF or proportional activation mode respect to the measure value • Delay time of the pump activation • Over alarm, indicates an overdose situation. This is activated when the defined set point value is not reached in a predetermined time • Relay output for signaled alarm status • Level switch input



F and B Peristaltic Pump Series

F Series Peristaltic Pump

The F Series is a fixed peristaltic pump that is small in size and quiet. It's easy to maintain and safe to use.

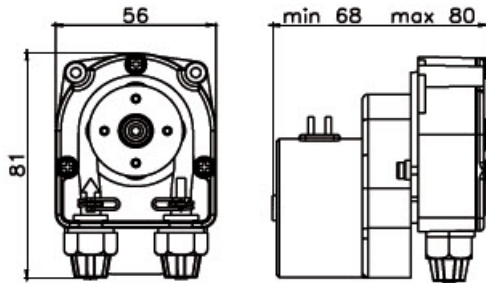

F Series Wall-Mounted



Version	Flow Rate		Pressure	
0001	0.13 GPH	0.5 LPH	14 PSI	1 BAR
0101	0.29 GPH	1.1 LPH	14 PSI	1 BAR
0201	0.58 GPH	2.2 LPH	14 PSI	1 BAR
0301	0.87 GPH	3.3 LPH	14 PSI	1 BAR
0601	1.59 GPH	6.0 LPH	14 PSI	1 BAR

F

Description
 <p>Peristaltic pump F series features:</p> <ul style="list-style-type: none"> • A constant flow rate • Available 0.5 to 1, 1 to 2, 2 to 3, 3 l/h at 120 - 230V with Santoprene® or silicone tubing • Model 6.0 l/h only 24VDC • Tube is coupled to the external fitting with stainless steel clamps • Cover is anchored on the casing with 3 screws, there's a groove for an additional shaft support • The hydraulic head is independent of the motor type and can be supplied separately • Inter-axis holes: 42 mm - 1.65" • Anchoring panel thickness measure from 1 to 4mm – 0.04 to 0.16" • Available NSF certified version

F-T

Description
 <p>Peristaltic pump F-T series features:</p> <ul style="list-style-type: none"> • A constant flow rate • Available 0.5 to 1, 1 to 2, 2 to 3, 3 l/h at 120 to 230V with Santoprene® or silicone tubing • Model 6.0 l/h only 24VDC • Tube is coupled to the external fitting with stainless steel clamps • Cover is anchored on the casing with 3 screws, there's a groove for an additional shaft support • The hydraulic head is independent of the motor type and can be supplied separately • Inter-axis holes: 42 mm - 1.65" • Anchoring panel thickness measure from 1 to 4mm – 0.04 to 0.16" • Available NSF certified version • Power supply with temporized flow control through potentiometer timer setting between 0 to 7 seconds

B Series Peristaltic Pump

The B Series is a peristaltic pump that is small in size and quiet. It's easy to maintain and safe to use.

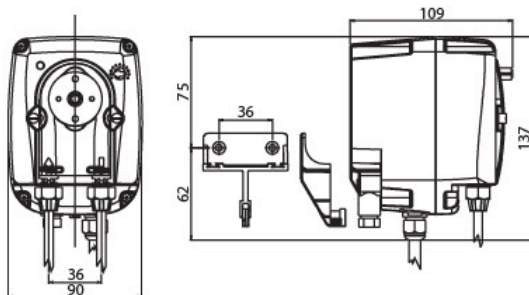

B Series Wall-Mounted



Version	Flow Rate		Pressure	
0103	0.26 GPH	1 LPH	43 PSI	3 BAR
0101	0.39 GPH	1.5 LPH	21 PSI	1 BAR
0303	0.79 GPH	3 LPH	43 PSI	3 BAR
0301	0.79 GPH	3 LPH	21 PSI	1 BAR
0403	1.06 GPH	4 LPH	43 PSI	3 BAR
0601	1.59 GPH	6 LPH	14 PSI	1 BAR
1001	2.60 GPH	10 LPH	14 PSI	1 BAR
1201	3.17 GPH	12 LPH	14 PSI	1 BAR

B3-V



Description

Peristaltic pump with flow adjustment from 0 to 100%. The flow is controlled adjusting the motor speed 90 to 260V by means of a potentiometer placed on the frontal part of the pump. Available with removable power cord.

B-F



Description

Peristaltic pump with flow fixed. Power supply 230V. Available with removable power cord.

B-FCD



Description

Peristaltic pump with integral CD meter to monitor detergent concentration in washing systems. The pump automatically maintains the desired detergent concentration in accordance with a set point selected by the user. Direct function and upon request, reverse function.

- Operating range 400 to 20,000 μ S
- LED pump ON indicator
- Max flow: 6 l/h
- Supplied with detergent accessories kit and conductivity probe
- Available with removable power cord

BH Series Peristaltic Pump

The BH is a peristaltic pump that is small in size and quiet. It's easy to maintain and safe to use.

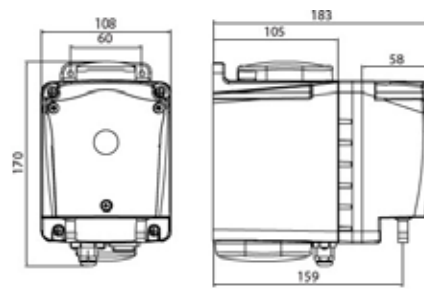

BH Series Wall-Mounted



Version	Flow Rate		Pressure		Hose
1001	26.41 GPH	10/100 LPH	21.7 PSI	1.	Norprene®
1001	26.41 GPH	10/100 LPH	21.7 PSI	1.	Santoprene®
1001	26.41 GPH	10/100 LPH	21.7 PSI	1.	Silicone
1001	26.41 GPH	10/100 LPH	21.7 PSI	1.	Tygon

BH3-V



Description

"ADJUSTABLE" flow rate peristaltic pump, discontinuous duty. Tubes available in Norprene®, Santoprene®, Silicone, and Tygon LFL. Pump supplied with 4 mt suction and delivery pipe, foot filter and injection valve not included. Universal multi-tension power supply 90 to 260VAC.

Bioclean Series Peristaltic Pump

The Bioclean is a peristaltic pump with timer.

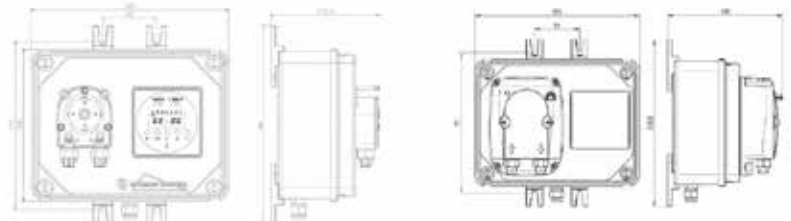

Bioclean Series Wall-Mounted

Version	Flow Rate		Pressure	
0101	29 GPH	1.1 LPH	14 PSI	1 BAR
0201	57 GPH	2.2 LPH	14 PSI	1 BAR
0103	26 GPH	1 LPH	43 PSI	3 BAR
0202	53 GPH	2 LPH	29 PSI	2 BAR
0303	79 GPM	3 LPH	43 PSI	3 BAR

Bioclean Control



Description

Peristaltic pump and electronic timer with day or week programs, 8 cycles with 1 minute minimum activation time. Santoprene® hose. Supplied with water treatment peristaltic pump accessories. Also available with electromechanical timer, activation time 15 minutes minimum.

Bioclean Control/B



Description

Peristaltic pump and electronic timer with day or week programs, 8 cycles with 1 minute minimum activation time. Santoprene® hose. Supplied with water treatment peristaltic pump accessories. Also available with electromechanical timer, activation time 15 minutes minimum.

Accessories

eControl Series

The eControl series of controllers have been designed and developed to be used in wellness centers, home and public swimming pools. The controllers use galvanic isolated micro-processors protecting the measured readings from the application environment. Optional is an eControl with double measurement ranges that are independently configurable.

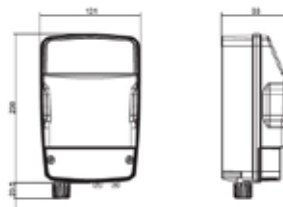

eControl Series Wall-Mounted



eControl

	Description	Part #
	<p>The Etatron eControl signal splitter receives a reed input signal from a water meter counter and divides it into four equal and synchronous reed output signals. It features:</p> <ul style="list-style-type: none"> • Signals multiple devices, independently, from a 1PPG or 1PP10G water meter • LED indicator lights up for each pulse • Prewired for up to four devices • 120V, 60 Hz • IP65 water resistant • Just plug into your power supply and connect communication wires 	<p>EPC-Pulse Control</p>

ePC (ePulse Control)

	Description	Part #
	<p>The Etatron ePulse Control receives a reed input signal from a water meter and divides it into four equal and synchronous reed output signals. Use with a 1 pulse per gallon (1PPG) or 1 pulse per 10 gallons (1PP10G) water meter to eliminate any possibility of communication problems between devices. The ePulse Control features:</p> <ul style="list-style-type: none"> • Signals multiple devices, independently, from a 1PPG to 1PP10G water meter • LED indicator lights up for each pulse • Prewired for up-to-four devices • Just plug into power supply and connect communication wires 	
	<p>1 measure - 100/250V</p>	<p>CXB 70001 01</p>
	<p>2 measures - 100/250V</p>	<p>CXB 70002 01</p>



eSelect Series

The eSelect controllers are high-tech microprocessor based devices to measure and control one electrochemical parameter among pH value, Rx (Redox potential), Chlorine concentration and other electrochemical parameter. These controllers are highly flexible and can be configured to measure any of the above mentioned parameters, using a sensor. There is no need to worry about power supply settings, since they are automatically detected by controller at power-up.

eSelect B2

	Description	Part #
	Features: <ul style="list-style-type: none"> • Color backlit 4" display • Galvanic Isolated Electronics • 4 - 20 mA output (dynamic 0..500Ω) No. 2 current output for each measurements • TTL 0 – 999 imp/min output. No. 2 TTL output for each measurements • Measure pH 0 ... 14 0,01 • Measure Rx (mV) - 1000 to +1400 ± 1mV • Chlorine measure 0 to 2, 0 to 20, 0 to 200, 0 to 2000 ppm • Temperature measure 32 to 212°F (0 to 100°C) • Weekly, Daily Timer for programmed dosing: flocculant cycle or probe cleaning • Internal memory data storage and USB output for downloading • Minimum and maximum measurement alarm function • Overdosing alarm function • Serial output for connecting to computer/network 	
	90 - 260VAC	CXB 50051 01
	12VDC - 24VAC/VDC	CXB 50051 11

eSelect B3

	Description	Part #
	Features: <ul style="list-style-type: none"> • Color backlit 4" display • Galvanic Isolated Electronics • 4 - 20 mA output (dynamic 0 to 500 Ω) No. 2 current output for each measurements • TTL 0 to 999 impulses/minute output. No. 2 TTL output for each measurements • Measure pH 0 to 14 0.01 • Measure Rx (mV) - 1000 to +1400 ± 1 mV • Chlorine measure 0 to 2, 0 to 20, 0 to 200, 0 to 2000 ppm • Temperature measure 32 to 212°F (0 to 100°C) • Weekly, Daily Timer for programmed dosing : flocculant cycle or probe cleaning • Internal memory data storage and USB output for downloading • Minimum and maximum measurement alarm function • Overdosing alarm function • Serial output for connecting to computer/network. 	
	90 - 260VAC	CXB 50101 01
	12VDC - 24VAC/VDC	CXB 50101 11

eSelect B4

	Description	Part #
	The eSelect B4 controller measures the main parameters in water treatment applications. It is possible to connect the new controller to an Ethernet LAN to control all parameters and storage all data. We have used a 7" colored display touch screen to improve the view, with user-friendly settings and displays. The main technical characteristic of the B4 are the following: <ul style="list-style-type: none"> • 3 measure channels (4 on request), settable separately by the user: pH, RX, Cl2, Cl tot • Temperature measure • Automatic filter washing output • No. 2 auxiliary outputs activating by a weekly/daily timer • No.1 input water meter • No.1 Ethernet RJ45 (LAN) connection • No.1 USB to update firmware or to download data • Power supply 100-250VAC or 12-30VDC 	
	3 measures and temps	CXB 60001 01
	4 measures and temps	CXB 60001 02

Complete line of replacement pump heads

eOne Series - standard pump head, PVDF, and manual air bleed.

	Description	Part #
	0.26 to 3.96 GPH (1 to 15 LPH), TFE/P (Aflas®) with ceramic ball valves, 4 x 6 and 6 x 8 mm tubing connections. For eMP, eOne Basic, eOnes excluding the 2007 and 3005 versions.	SCP8105471
	5.26 to 7.92 GPH (20 to 30 LPH), TFE/P (Aflas®) with ceramic ball valves, 4 x 6 and 6 x 8 mm tubing connections. For e128, eOne 2007 and 3005 versions.	SCP8006871

eOne Series - automatic air bleed pump head, PVDF.

	Description	Part #
	0.26 to 3.96 GPH (1 to 15 LPH) TFE/P (Aflas®) with ceramic ball valves, 4 x 6 and 6 x 8 mm tubing connections. This pump head enables the automatic bleed-off of gas generated by gaseous liquids. For eMP, eOne Basic, eOnes excluding the 2007 and 3005 versions.	SCP8015471

PKX and DLX/DLXB Series - standard pump head, polypropylene, manual air bleed. 0.26 to 3.96 GPH (1 to 15 LPH), 4 x 6 mm tubing connections.

	Description	Part #
	FPM (Viton®) with lip valves. Excludes DLX/DLXB 0220 and 2003 versions.	SCP0003002
	EPDM (Dutral®) with lip valves. Excludes DLX/DLXB 0220 and 2003 versions.	SCP0003006
	FPM (Viton®) with ceramic ball valves. Excludes DLX/DLXB 0220 and 2003 versions.	SCP0003082
	EPDM (Dutral®) with ceramic ball valves. Excludes DLX/DLXB 0220 and 2003 versions.	SCP0003084

PKX and DLX/DLXB Series - automatic air bleed pump head, PVDF, 4 x 6 and 6 x 8 mm tube connections.

	Description	Part #
	0.26 to 7.93 GPH (1 to 30 LPH) TFE/P (Aflas®) with ceramic ball valves. TFE/P (Aflas®) seals/o-rings. Includes eOne 2007 and 3005 versions.	SCP8016871
	0.26 to 7.93 GPH (1 to 30 LPH) TFE/P with ceramic ball valves. FPM (Viton®) seals/o-rings. Includes eOne 2007 and 3005 versions.	SCP8016851

Standard pump head (PP), 20 liters for DLX(B) 2003 versions - BT 20 l/h - 43.5 psi (3 bar) and 72 psi (5) with connection for 4 x 6 tube.

	Description	Part #
	FPM (Viton®) lip valve (without manual air bleed)	2083148
	EPDM (Dutral®) lip valve (without manual air bleed)	2083150
	FPM (Viton®) ceramic ball valve	2083160
	EPDM (Dutral®) ceramic ball valve	2083262

Standard pump head (PVC), 290 psi (20 bar) for DLX(B) 0220 versions - BT 2 + 5 l/h with connections for 4 x 6 tube.

	Description	Part #
	FPM (Viton®) lip valve	2083079
	EPDM (Dutral®) lip valve	2083085

Injection Valve Kit

eOne, eMP, and e128

	Description	Part #
	Injection valve kit, PVDF with TFE/P (Aflas®), 4 x 6, 6 x 8 and 10 x 14 mm. M10 tubing	SVA0030021

e128

	Description	Part #
	Injection valve kit, PVDF with TFE/P (Aflas®), Pre-cut 1/2" for 6 x 8 mm tubes	SVA0833021

Injection Valves

PKX and DLX/DLXB Series

	Description	Part #
	Injection valve, polypropylene with FPM (Viton®), 4 x 6 mm tubing	2144009
	Injection valve, polypropylene with EPDM (Dutral®), 4 x 6 mm tubing	2144015

Tubing Kits

eOne kits

	Description	Part #
	Injection valve and foot filter, PVDF with TFE/P (Aflas®) and 4 x 6 mm PVC and polyethylene tubing, 0.26 to 3.96 GPH (1 to 15 LPH). Excluding 2007 and 3005 versions.	SCO0030022
	Injection valve and foot filter, PVDF with TFE/P (Aflas®) and 6 x 8 mm PVC and polyethylene tubing, 5.26 to 7.92 GPH (20 to 30 LPH). For One eOne 2007 and 3005 versions.	SCO0031021

e128 kits

	Description	Part #
	e128 tubing kit includes injection valve and foot filter, PVDF with TFE/P (Aflas®), 6 x 8 mm polyethylene (PE) and PFC tubing, 4 x 6 mm PVC tubing for e128 Medicator.	SCO0131021

PKX and DLX/DLXB kits

	Description	Part #
	Injection valve and foot filter, polypropylene with FPM (Viton®) and 4 x 6 mm PVC and polyethylene tubing, 0.26 to 5.26 GPH (1 to 20 LPH) - standard (FPM).	2061002
	Injection valve and foot filter, polypropylene with EPDM (Dutral®) and 4 x 6 mm PVC and polyethylene tubing, 0.26 to 5.26 GPH (1 to 20 LPH) - standard (EPDM).	2061005

PKX and DLX/DLXB kits

	Description	Part #
	Injection valve and foot filter, polypropylene with FPM (Viton®) and 4 x 6 mm PVC and polyethylene tubing.	SCO0030002
	Injection valve and foot filter, polypropylene with EPDM (Dutral®) and 4 x 6 mm PVC and polyethylene tubing.	SCO0030012

Tubing

Delivery and suction tubes. For DLX, DLXB, PKX, and eOne up to and including the 15 LPH versions

	Description	Part #
	4 x 6 PE delivery tube - Sold by foot.	2003021
	4 x 6 PVC suction tube - Sold by foot.	DUT0000006
	4 x 6 Kynar® flex 2800 suction tube - Sold by foot.	DTU0010302
	6 x 8 PE delivery tube - Sold by foot.	ATU000603
	6 x 8 PVC suction tube - Sold by foot.	ATU0004202
	6 x 8 Kynar® flex 2800 suction tube - Sold by foot.	DTU0000901

Foot Filters

eOne series

	Description	Part #
	Foot filter with ceramic ball valve, PVDF with TFE/P (Aflas®). eOne and eMP versions.	SFT0030021

e128

	Description	Part #
	Foot filter with ceramic ball valve, PVDF with TFE/P (Aflas®) and connections for 6 x 8 mm tube. For e128 and eOne series, versions 2007 and 3005	SFT0832021



PKX and DLX/DLXB series

	Description	Part #
	Foot filter, polypropylene with FPM (Viton®), 4 x 6 mm tubing	2142001
	Foot filter, polypropylene with EPDM (Dutral®), 4 x 6 mm tubing	2142004

Pressure Relief Valves



	Description	Part #
	Relief valve, PVC with PTFE diaphragm, manual counter pressure adjustment, 3/8" threaded connections. All Etatron pumps.	AVA0010101
	Hose nipples kit, 4 x 6 mm, PVDF. All Etatron pumps except eOne 2007 and 3005 versions and the e128.	KRA0005311
	Hose nipples kit, 6 x 8 mm, PVDF. For e128, eOne versions 2007 and 3005.	KRA0006213

ePool Kits

	Description	Part #
	pH ePool pumps accessories includes pH plastic body electrode with 5 m cable, pH7 and pH9 buffer solutions in 55 mL containers, floating level switch complete with plastic support, 1/2" inline PP electrode holder, clamp 1/2" GF-DN50 saddle for electrode holder (2 pcs), PVC M/F 1/2" - 3/8" reduction nipple, PP tube nut (2 pieces).	SCO0003001
	Description	Part #
	Rx ePool pumps accessories include Rx plastic body electrode with 5 m cable, Rx 650 mV buffer solution in 55 mL container, floating level switch complete with plastic support, 1/2" inline PP electrode holder, clamp 1/2" GF-DN50 saddle for electrode holder (2 pieces), PVD M/F 1/2" - 3/8" reduction nipple, PP tube nut (2 pieces).	SCO0003002

Water Meters

Totalizer water meter. Lightweight, analog that reads in gallons. Made of polypropylene. For PKX FT-A, eOne, e128, eMP, DLX MF/M, and DLXB VFT/MBB.

	Description	Part #
	3/4" - 1 pulse per gallon	WM34-1PPG
	3/4" - 1 pulse per 10 gallons	WM34-1PP10G
	1" - 1 pulse per gallon	WM100-1PPG
	1" - 1 pulse per 10 gallons	WM100-1PP10G
	1 1/2" - 1 pulse per gallon	WM150-1PPG
	1 1/2" - 1 pulse per 10 gallons	WM150-1PP10G

Tanks

The vertical tanks are made of Polyethylene. They provide containment of toxic liquids and are suitable for prolonged exposure to UV, are weather resistant, and insensitive to aging. Compatible with all pumps.

	Description	Part #
	60 l tank	1SRB045
	108 l tank	1SRB002
	230 l tank	1SRB003
	315 l tank	1SRB004
	530 l tank	1SRB005
	1040 l tank	1SRB006

Syringe Kit

The Syringe Kit is a prime pump kit with 4 mm and 6 mm adapters.

	Description	Part #
	4 mm and 6 mm adapters	07944-KIT

Paddlewheel Flowmeter

The programmable Paddlewheel Flowmeter is made out of polypropylene and is pre-wired for dry contact signal. Features: 120 Volt, fits into pipe sizes 1/2" - 8", low flow capabilities down to 0.1 m/s (.3 ft/s), low power, high resolution. NOTE: Flowmeter must be used with flowmeter saddles. For PKX FT-A, eOne, eMF, eOne Plus, DLX MF/M, DLXB MF/M, DLX VFT, and DLXB VFT.

Description	Part #
Programmable Flow Sensor Paddlewheel, fits 1/2" to 4" pipe	PW-FLOW1/2-4
Programmable Flow Sensor Paddlewheel, fits 5" to 8" pipe	PW-FLOW5-8

Flowmeter Fitting Saddles

Fitting Saddle for the Paddlewheel Flowmeter. For PKX FT-A, eOne, eMF, eOne Plus, DLX MF/M, DLXB MF/M, DLX VFT, and DLXB VFT.

Description	Part #
2 1/2" PVC clamp on EPDM o-ring for PW-FLOW	SAD2.5INPVC
2" PVC clamp on EPDM o-ring for PW-FLOW	SAD2INPVC
3" PVC clamp on EPDM o-ring for PW-FLOW	SAD3INPVC
4" PVC clamp on EPDM o-ring for PW-FLOW	SAD4INPVC
6" PVC clamp on EPDM o-ring for PW-FLOW	SAD6INPVC
8" PVC clamp on EPDM o-ring for PW-FLOW	SAD8INPVC

Injection Fitting Saddles

Fitting Saddle for the Injection Valve. For PKX FT-A, eOne, eMF, eOne Plus, DLX MF/M, DLXB MF/M, DLX VFT, and DLXB VFT.

Description	Part #
2 1/2" PVC clamp on FKM o-ring for 1/2" injection	SAD2.5INPVC-INJ
2" PVC clamp on FKM o-ring for 1/2" injection	SAD2INPVC-INJ
3" PVC clamp on FKM o-ring for 1/2" injection	SAD3INPVC-INJ
4" PVC clamp on FKM o-ring for 1/2" injection	SAD4INPVC-INJ
6" PVC clamp on FKM o-ring for 1/2" injection	SAD6INPVC-INJ
8" PVC clamp on FKM o-ring for 1/2" injection	SAD8INPVC-INJ

Electrode Accessories

	Description pH electrode, polycarbonate, 0 - 14 pH with 16.4' (5 m) cable. For eOne Plus and DLX/DLXB pH versions.	Part # AEL0004921
	Description Rx electrode, polycarbonate, 1.000 mV with 16.4' (5 m) cable. For eOne Plus and DLX/DLXB pH versions.	Part # AEL0005021
	Description Glass body pH or Rx electrodes. Measuring range: pH - 0 to 14 pH, Rx - ± 1,000 mV. Glass body electrode with screw connector	Part #
	87 psi (6 bar) - 140°F (60°C), pH	AEL0003511
	87 psi (6 bar) - 140°F (60°C), Rx	AEL0004111
	145 psi (10 bar) - 176°F (80°C), pH	AEL0003601
	145 psi (10 bar) - 176°F (80°C), Rx	AEL0004201
	145 psi (10 bar) - 266°F (130°C) / 232 psi (16 bar) - 77°F (25°C), pH	AEL0004501
	145 psi (10 bar) - 266°F (130°C) / 232 psi (16 bar) - 77°F (25°C), Rx	AEL0004601
	Glass body electrode with cable	
	102 psi (7 bar), 212°F (100°C), pH - 16.4' (5 m)	AEL0002211
	102 psi (7 bar), 212°F (100°C), Rx - 16.4' (5 m)	AEL0002311
102 psi (7 bar), 140°F (60°C), pH - 1.6' (0.50 m)	AEL0002212	
102 psi (7 bar), 140°F (60°C), Rx - 1.6' (0.50 m)	AEL0002312	
	Description Inline electrode holder, PVC	Part # 2143001
	Description Inline PP electrode probe holder with o-ring. 1/2" conical fitting for pH and Rx electrodes. Maximum pressure - 73 psi ()	Part # KPS0002301
	Description Submersible electrode holder, PVC, 1 meter	Part # 2143003



Coaxial Cable For Electrode

	Description Coaxial cable for screw connector electrodes with BNC and connector. 16.4' (5 meters). Use on any electrode without a cable.	Part # 2105004
---	--	--------------------------



Temperature Probe Connection

	Description PT100 temperature probe with 1/2" connection in PVC. Tap type, 5 mt cable, 16.4 feet. Tmax 113°F (45°C), Pmax 72 psi. For DLX/DLXB pH-Rx-CI/M and eOne Plus versions.	Part # ASO0000302
---	---	-----------------------------

Temperature Probe

	Description	Part #
	Stainless steel, PT100 temperature probe measuring range 32 to 212°F (0 to 100°C), for electrode holder. For DLX/DLXB pH-Rx-CI/M and eOne Plus.	ASO0002601
	Glass, PT100 temperature probe measuring range 32 to 212°F (0 to 100°C), for electrode holder. For DLX/DLXB pH-Rx-CI/M and eOne Plus.	ASO0002501

Probe Holders

	Description	Part #
	<p>Double electrode probe holder for pH and Rx electrode (Plexiglas®/PP) with maximum pressure of 73 psi () and maximum temperature of 113°F (45°C).</p> <p>For eOne Plus, DLX/DLXB, both pH versions.</p>	SPS0001001
	<p>Double electrode holder with flow sensor for pH, Rx electrodes and temperature probe. Features Plexiglas®/PP, manual flow rate adjustment, 2 wires proximity switch, manual sampling, maximum pressure is 73 psi () and maximum temperature is 113°F (45°C).</p> <p>For eSelect, eControl, DLX(B) pH-Rx-CI/M, pH-Rx-CI/M, and eOne Plus.</p>	SPS0001201
	<p>Double electrode holder with flow sensor for pH, Rx electrodes and temperature probe. Features Plexiglas®/PP, manual flow rate adjustment, 2 wires proximity switch, manual sampling, maximum pressure is 73 psi () and maximum temperature is 113°F (45°C).</p> <p>For DLX(B) pH-Rx/MBB.</p>	SPS0001204

Buffer Solutions

Buffer solution in polyethylene container (55 mL) for calibration and control of pH meter, Rx (ORP) meter, and conductometer (500 mL).

	Description	Part #
	pH 4. For pH probes, eOne Plus, DLX/DLXB pH-Rx/MBB, pH-Rx-CI/M and any controller with pH compatibility.	ASZ0000101
	pH 7. For pH probes, eOne Plus, DLX/DLXB pH-Rx/MBB, pH-Rx-CI/M and any controller with pH compatibility.	ASZ0000201
	pH 9. For pH probes, eOne Plus, DLX/DLXB pH-Rx/MBB, pH-Rx-CI/M and any controller with pH compatibility.	ASZ0000301
	Rx 475 mV. For Rx probes, eOne Plus, DLX/DLXB pH-Rx/MBB, pH-RX-CI/M, and any controller with Rx capability.	ASZ0001101
	Rx 650 mV. For Rx probes, eOne Plus, DLX/DLXB pH-Rx/MBB, pH-RX-CI/M, and any controller with Rx capability.	ASZ0001501

Amperometric Sensors

Low pH dependence, compatible with presence of isocyanate acid, surfactants/flocculants, automatic temperature compensation, and pH working range of 4 to 14. Required constant flow rate of 30 to 40 l/h with maximum working pressure of 14.5 psi (1 bar) and maximum working temperature of 113°F (45°C). Cable not supplied.

For DLX/DLXB pH-Rx-Cl/M and eOne Plus versions.

	Description	Part #
	0 - 20 ppm (inorganic free and organic chlorine)	RSO0001701
	0 - 2 ppm (inorganic free and organic chlorine)	RSO0001702
	0 - 20 ppm (total chlorine)	ASO0001603
	0 - 2 ppm (total chlorine)	ASO0001604

Not compatible with presence of isocyanate acid, surfactants/flocculants, automatic temperature compensation, and pH working range: 4 to 8. Operative pH level must remain constant with a required constant flow rate of 30 to 40 l/h. Maximum working pressure of 14.5 psi (1 bar) and maximum working temperature of 113°F (45°C). Cable not supplied.

	Description	Part #
	0 - 200 ppm (inorganic free chlorine)	ASO0001605
	0 - 20 ppm (inorganic free chlorine)	ASO0001601
	0 - 2 ppm (inorganic free chlorine)	ASO0001602

High pH dependence. Not compatible with presence of isocyanate acid, surfactants, flocculants, iron and manganese. Automatic temperature compensation, required constant flow rate: 30 to 40 l/h with a maximum working pressure of 72.5 psi () and a maximum working temperature of 122°F (50°C). Requires dedicated probe holder on request. Cable not supplied.

	Description	Part #
	0 - 10 ppm (inorganic free chlorine for potable high pressure water)	ASO0002001

Compatible with presence of surfactants automatic temperature compensation pH working range of 2 to 11. Required constant flow rate of 30 to 40 l/h. Maximum working pressure of 72.5 psi () (with snap ring) and a maximum working temperature of 113°F (45°C). Cable not supplied.

	Description	Part #
	0 - 200 ppm	ASO0003301

Tensides and conductivity acids are tolerated, compatible with presence of surfactants, automatic temperature compensation, and pH working range of 2 to 11. Required constant flow rate: 30 to 40 l/h with a maximum working pressure of 14.5 psi (1 bar) and a maximum working temperature of 113°F (45°C). Cable not supplied.

	Description	Part #
	0 - 200 ppm (peracetic acid)	ASO0003201

Not compatible with presence of surfactants, automatic temperature compensation, pH working range of 1 to 14. Required constant flow rate of 30 to 40 l/h with a maximum working pressure of 14.5 psi (1 bar) and a maximum working temperature of 113°F (45°C). Cable not supplied.

	Description	Part #
	0 - 20 ppm (chlorine dioxide)	ASO0003101
	0 - 2 ppm (chlorine dioxide)	ASO0003102

Amperometric Sensors

Compatible with presence of surfactants, automatic temperature compensation, pH working range of 2 to 14. Required constant flow rate of 30 to 40 l/h with a maximum working pressure of 14.5 psi (1 bar) and a maximum working temperature of 113°F (45°C). Cable not supplied.

	Description	Part #
	0 - 20 ppm (chlorine dioxide with surfactants)	ASO0004301
	0 - 2 ppm (chlorine dioxide)	ASO0004302

Low pH dependence, automatic temperature compensation, pH working range of 2 to 11. Required constant flow rate of 30 to 40 l/h with a maximum working pressure of 14.5 psi (1 bar) and a maximum working temperature of 122°F (50°C). Analog output signal 0 - 2,000 mV. Cable not supplied.



	Description	Part #
	0.05 - 10.00 ppm (ozone)	ASO0005501
	0.05 - 5.00 ppm (ozone)	ASO0005502

Cable For Amperometric Sensors



Cable for membrane covered amperometric sensor with BNC connector for signal. Hirshmann connector for power supply.

	Description	Part #
	0.7 m - for DLX/Controllers	SCV0001003
	0.7 m - for eOne/eControl	SCV0001301
	0.7 m - for DLXB	SCV0001004
	2 m - for DLX/Controllers	SCV0001005
	2 m - for eOne/eControl	SCV0001302
	5 m - for DLX/Controllers	SCV0001006
	5 m - for eOne/eControl	SCV0001303
	15 m - for DLX/Controllers	SCV0001002
	15 m - for eOne/eControl	SCV0001304

Probe Holders For Amperometric Sensors

	<p>Double probe holder for amperometric ion-selective probes and either pH, Rx or temperature probes. Flow rate adjustment and 2 wires proximity switch with manual sampling, Plexiglas®/PP, maximum pressure of 72 psi () and maximum temperature 113°F (45°C).</p> <p>For DLX/DLXB pH-Rx-CI/M and eOne Plus versions.</p>	SPS0002001
	<p>Triple probe holder for pH, Rx, amperometric ion-selective and temperature probes. Flow rate adjustment, 2 wires proximity switch, Plexiglas®/PP, maximum pressure is 72 psi (), and maximum temperature is 113°F (45°C).</p> <p>For DLX/DLXB pH-Rx-CI/M and eOne Plus versions.</p>	SPS0001801

e128 Pre-Plumbed Accessories

	Description	Part #
 <p>The image shows a black rectangular panel with two white cylindrical components mounted on it. The component on the left is the Etatron e128 medicator, and the one on the right is the ePulse Control. A white tube connects the two units. The panel is mounted on a metal base with some wiring visible at the bottom.</p>	<p>e128 Medicator Panel with ePulse Control This simple to install, preassembled panel includes the Etatron e128 medicator and an ePulse Control. You can easily attach a 1 pulse per gallon (1PPG) or a 1 pulse per 10 gallons (1PP10G) water meter that is already hooked up to your existing house control.</p> <p>Specifications:</p> <ul style="list-style-type: none"> • Ships preassembled • Panel is 17" x 24" • Pre-plumbed, simply connect 3/4" FPT to your plumbing line or by garden hose connection • Includes ePulse Control 	<p>PE128.75IN1GPC</p>
 <p>The image shows a black rectangular panel with a single white cylindrical component (the Etatron e128 medicator) mounted on it. A white tube is connected to the top of the medicator. The panel is mounted on a metal base with some wiring visible at the bottom.</p>	<p>e128 Medicator Panel with Water Meter The Etatron e128 medicator, with a 3/4" 1 pulse per gallon water meter (1PPG), is built onto an easy-to-install panel.</p> <p>Specifications:</p> <ul style="list-style-type: none"> • Ships preassembled • Panel is 17" x 24" • Pre-plumbed, simply connect 3/4" FPT to your plumbing line or by garden hose connection • 3/4" 1 pulse per gallon water meter 	<p>PE128.75IN1G</p>



Connect



Need help? Give us a call at 1-800-451-6628 and a customer service representative will be glad to assist you.

Mailing Address:

Dilution Solutions, 2090 Sunnydale Blvd., Clearwater, FL 33765

Hours of Operation:

Monday - Friday, 8:30 am - 5:00 pm

Saturday - Sunday, Closed

CHAT



It's easy to CHAT at www.dilutionsolutions.com. Just enter your question and we will be glad to assist.

Call Now! 1-800-451-6628 or 1-727-451-1198



Dilution

SOLUTIONS

A Dosatron International, Inc. Company

2090 Sunnydale Blvd. • Clearwater, FL 33765
1-800-451-6628 • 1-727-451-1198 • www.dilutionsolutions.com