

Electronic Design 25

FOR ENGINEERS AND ENGINEERING MANAGERS

VOL. 18 NO.
DEC. 6, 1970

RECEIVED
DEC 08 1970
CALIFORNIA

Extract signals from noise with a simple, inexpensive voltage correlator. Costing as little as \$100, the circuit rejects noise, harmonics and quadrature components on input signals. With additional circuitry, the correlator measures phase-shift or becomes a complete spectrum analyzer. For the full details, see p. 66.

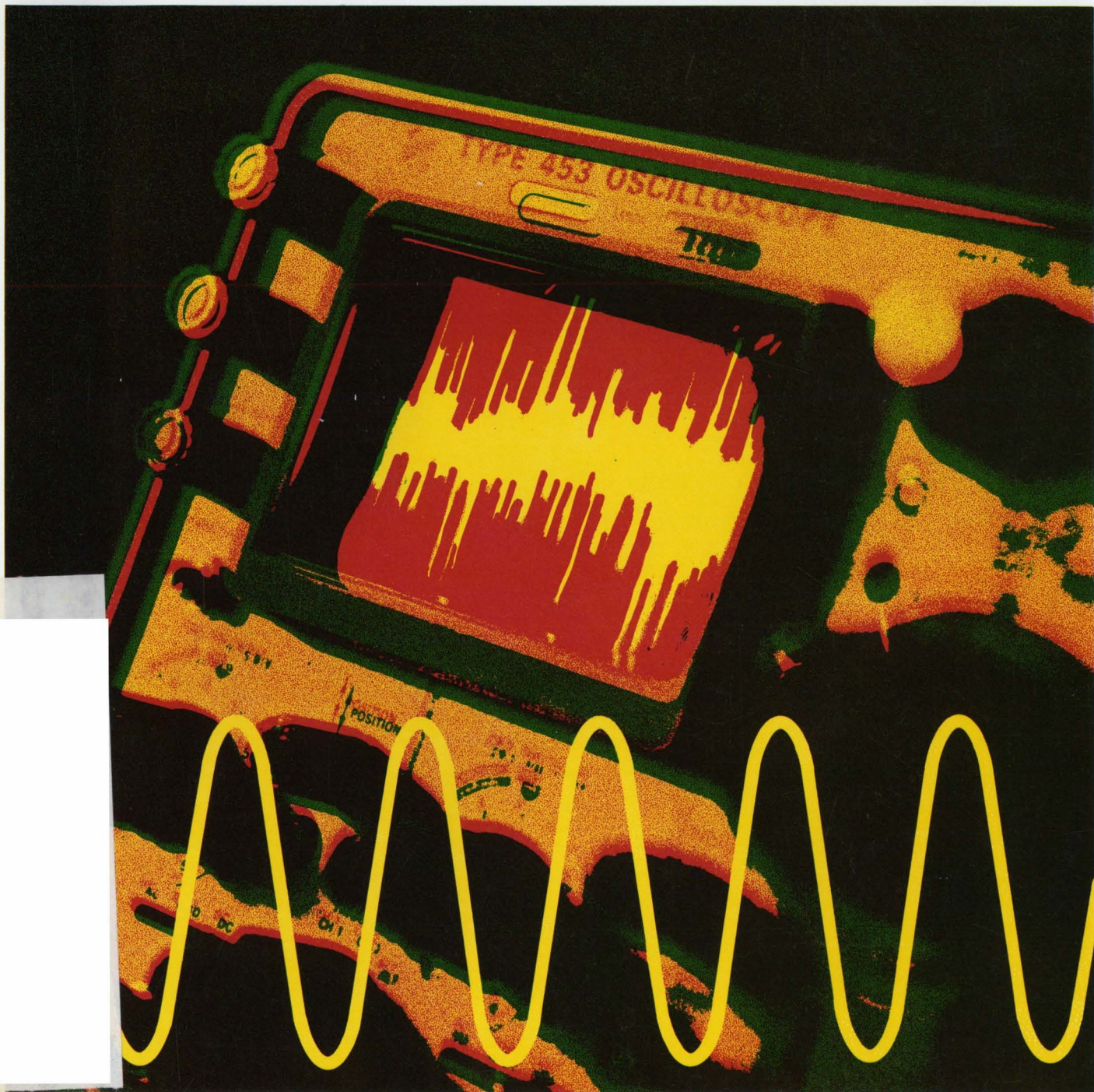

From Dale—the pots you don't ship back...



<1% customer rejection rate!

Less than 1% customer rejection for all causes. That's the record established by Dale T-Pots. Consider the savings this can bring you in time, paper work. Then consider the added efficiency of consolidating more of your buys at this versatile source. Almost 50% more models added in two years. Military (RT-10, 11, 12, 22, 24), Industrial, Commercial ... wirewound and film elements. All are very competitively priced. Check today and find out. We can deliver them quickly—and you won't have to send them back.

MILITARY GRADE T-POTS

600 Series: Mil. Equiv. RT-10; 10Ω to 100KΩ, ±5%; 1 watt at 70°C, derated to 0 at 175°C; .18 H x .32 W x 1.00 L.

1200 Series: Mil. Equiv. RT-11; 10Ω to 100KΩ, ±5%; 1 watt at 70°C, derated to 0 at 175°C; .28 H x .31 W x 1.25 L.

1600 Series: Mil. Equiv. RT-12; 10Ω to 100KΩ, ±5%; 1 watt at 70°C, derated to 0 at 175°C; .19 H x .32 W x 1.25 L.

5000 Series: Mil. Equiv. RT-22; 10Ω to 50KΩ, ±5%; 1 watt at 70°C, derated to 0 at 175°C; .19 or .22 H x .50 W x .50 L.

5800 Series: Mil. Equiv. RT-24; 10Ω to 50KΩ, ±5%; 1 watt at 70°C, derated to 0 at 175°C; .145 or .150 H x .375 W x .375 L.

COMMERCIAL GRADE ECONO-TRIM T-POTS

WIREWOUND ELEMENT

2300 Series: Sealed/Unsealed; 10Ω to 50KΩ, ±10%; 0.5 watt at 25°C, derated to 0 at 105°C; .36 H x .28 W x 1.00 L.

2400 Series: Sealed/Unsealed; 10Ω to 50KΩ, ±10%; 1 watt at 40°C, derated to 0 at 125°C; .31 H x .16 W x .75 L.

FILM ELEMENT

8300 Series: Sealed/Unsealed; 10Ω to 2 Meg., ±10% 100Ω thru 500K, ±20% all other values; .75 watt at 25°C, derated to 0 at 105°C; .36 H x .28 W x 1.00 L.

8400 Series: Sealed/Unsealed; 10Ω to 2 Meg., ±10% 100Ω thru 500K, ±20% all other values; .75 watt at 25°C, derated to 0 at 125°C; .31 H x .16 W x .75 L.

INDUSTRIAL GRADE T-POTS

WIREWOUND ELEMENT

100, 200, 300 Series: 10Ω to 100KΩ.

100 Series: ±5%; 0.8 watt at 70°C, derated to 0 at 135°C.

200 Series: ±10%; 0.5 watt at 70°C, derated to 0 at 105°C.

300 Series: ±15%; .25 watt at 70°C, derated to 0 at 85°C.

Dimensions: .22 H x .31 W x 1.25 L (also 1.32 L for 100, 200).

1100 Series: 10Ω to 100KΩ, ±10%; 1 watt at 70°C, derated to 0 at 175°C; .28 H x .31 W x 1.25 L.

2100 Series: Industrial counterpart RT-11; 10Ω to 100KΩ, ±10%; 1 watt at 70°C, derated to 0 at 125°C; .28 H x .31 W x 1.25 L.

2200 Series: Industrial counterpart RT-10; 10Ω to 100KΩ, ±10%; 1 watt at 70°C, derated to 0 at 125°C; .18 H x .32 W x 1.00 L.

FILM ELEMENT

8100 Series: Industrial counterpart RJ-11; 10Ω to 2 Meg., ±10% 100Ω to 500K, ±20% other values; .75 watt at 70°C, derated to 0 at 125°C; .28 H x .31 W x 1.25 L.

Call 402-564-3131 for complete information or write for Catalog B



DALE ELECTRONICS, INC., 1328 28th Ave., Columbus, Nebraska 68601
 In Canada, Dale Electronics Canada, Ltd. • A subsidiary of The Lionel Corporation
 INFORMATION RETRIEVAL NUMBER 181





**These are the
solid-state displays
you'll be
hearing about.**

Starting now!

HP's new solid-state monolithic numeric indicators are ready for you right now. They give solid-state reliability and long operating life to your information display. Their small size (5 digits in 0.750 inch width), low power requirements (200 fL at 5mA per segment) and low cost (\$7.05/digit in 1 K quantities) open up many new applications in the display of numeric data.

All characters are brilliant, easy-to-use, 7-segment figures, available in a standard DIP or flat-pack package. And lead connections are truly minimal — only 13 connections for 5 characters.

For more information on these 5082-7200 series of displays as well as our other numerics, alphanumerics and LED's, call your local HP field engineer. Or write: Hewlett-Packard, Palo Alto, California 94304; Europe: 1217 Meyrin-Geneva, Switzerland.

HEWLETT  PACKARD

COMPONENTS

Allen-Bradley cuts space requirements with new sealed type Z cermet trimmers

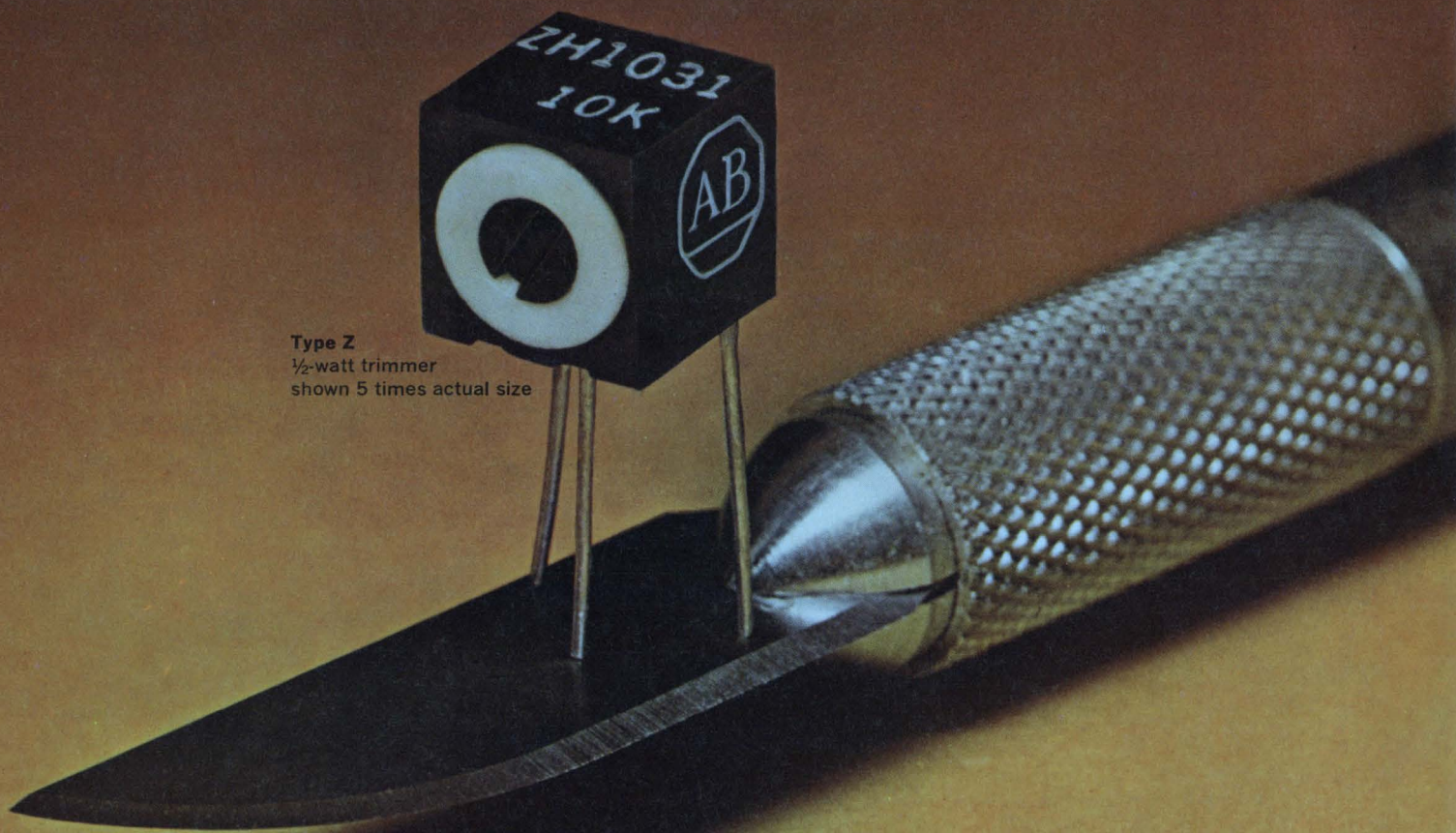

Type Z
1/2-watt trimmer
shown 5 times actual size

this latest addition to the Allen-Bradley line of cermet trimmers...the type Z...affords high performance in an especially compact package

The cermet material — an exclusive formulation developed by Allen-Bradley — provides superior load life, operating life, and electrical performance. For example, the full load operation (1/2 watt) for 1000 hours at 70°C produces less than 3% total resistance change. And the temperature coefficient is less than ± 250 PPM/°C for all resistance values and throughout the complete temperature range (-55°C to $+125^{\circ}\text{C}$).

The Type Z is ruggedly constructed to withstand shock and vibration. The unique rotor design ensures smooth adjustment and complete stability under severe environments. The leads are permanently anchored and bonded. The connection exceeds the lead strength — opens cannot occur. Leads are weldable.

The enclosure is *SEALED*. It is both dust-tight as well as watertight and can be potted. Mounting pads prevent moisture migration and also post-solder washout. You can get immediate delivery at factory prices from your authorized A-B industrial electronics distributor. Or write: Marketing Dept., Electronics Div., Allen-Bradley Co., 1201 S. Second St., Milwaukee, Wis. 53204. Export Office: 1293 Broad St., Bloomfield, N. J., U. S. A. 07003. In Canada: Allen-Bradley Canada Limited.

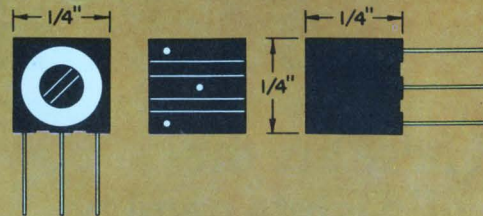

SPECIFICATIONS SUMMARY

- Adjustment:** Horizontal or vertical.
- Temperature Range:** -55°C to $+125^{\circ}\text{C}$.
- Resistances:** 50 ohms through 1 megohm. Lower resistances available.
- Tolerances:** $\pm 20\%$ standard, $\pm 10\%$ available.
- Resolution:** Essentially infinite.
- Rotational Life:** Less than 2% total resistance change after 200 cycles.
- Rotation:** 300° single turn.
- End Resistance:** Less than 3 ohms.



ALLEN-BRADLEY
QUALITY ELECTRONIC COMPONENTS

Electronic Design 25

VOL. 18 NO
FOR ENGINEERS AND ENGINEERING MANAGERS
DEC. 6, 1970

NEWS

- 7 Letters
- 21 News Scope
- 25 Surface-wave devices offer cheap signal processing
- 30 Phase locked loops plus ICs—and, presto, better circuitry!
- 36 Electronics to play by—tricky circuitry for toys
- 42 Technology Abroad
- 45 Washington Report

TECHNOLOGY

- 66 **Separate the signals from the noise** with this simple voltage correlator circuit. It costs only \$100 in parts—yet analyzes complex signals.
- 70 **Compute lead-lag network response.** This BASIC program gives precise results for a general feedback integrator-differentiator.
- 74 **Use this tan-lock demodulator** to get wide-range linear performance with no threshold or sideband problems.
- 78 **Solve interference problems painlessly.** Many noise sources can be eliminated with these design hints and nomographs.
- 86 **Puzzled by management responsibilities?** This refresher outlines your duties and guides you in techniques to lessen tensions.
- 92 **Ideas for Design**
- 104 **Product Source Directory:** Digital Panel Meters

PRODUCTS

- 117 **ICs & Semiconductors:** Hybrid op amp needs only 0.01 pA of bias current.
- 132 **Components:** Six-position switch comes in a dual-in-line package.
- 148 **Instrumentation:** Inexpensive 15-MHz counter kit costs just \$200.
- 122 Microwaves & Lasers
- 138 Modules & Subassemblies
- 152 Data Processing
- 153 Packaging & Materials
- 154 Tools & Engineering Aids
- 172 Product Index

Departments

- 65 **Editorial:** Air-pollution market? Caution required!
- 13 Designer's Calendar
- 156 Evaluation Samples
- 158 Design Aids
- 159 Application Notes
- 160 New Literature
- 167 Bulletin Board
- 170 Advertisers' Index

Information Retrieval Service Card inside back cover

Cover: Designed by Art Director Cliff Gardiner. Photo, courtesy of Dubner Computer Systems, Inc., New York City.

ELECTRONIC DESIGN is published biweekly by Hayden Publishing Company, Inc., 850 Third Avenue, New York, N.Y. 10022. James S. Mulholland, Jr., President. Printed at Brown Printing Co., Inc., Waseca, Minn. Controlled circulation postage paid at Waseca, Minn., and New York, N.Y. Copyright © 1970, Hayden Publishing Company, Inc. 82,501 copies this issue.

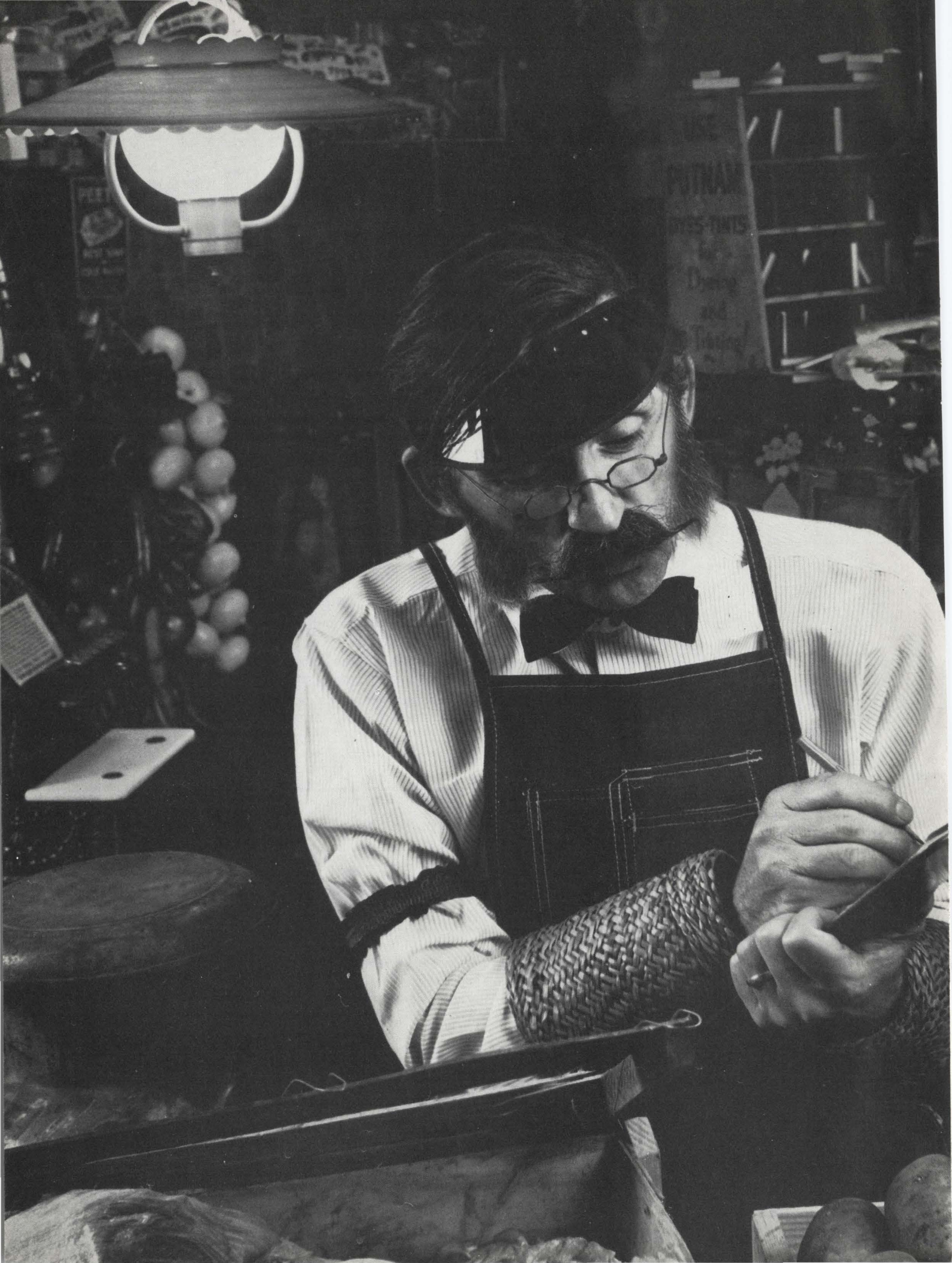



**Now there's
a better way.**

**Our new DOS brings
batch processing costs
down to
\$765 a month.**

If you've been hanging on to old-fashioned ways because you thought a computer was too expensive, think again. Our new Disc Operating System brings the cost of computation and general purpose processing right down to where your budget lives.

With our new DOS, you'll easily create, check out and run your own programs. Use it for scientific calculations, business-accounting functions, information retrieval, inventory control, school administration — in fact, problem-solving of all kinds.

Anyone who can poke a typewriter key or pencil-mark a card can use our DOS. Because the assembly (or compilation), loading and execution of your programs are under the control of a teleprinter keyboard or batch input device.

On the other hand, if you're already batch processing with another system, give this a thought. Our DOS can probably do everything you're doing now — for about half the cost.

Because both the software and the hardware are fully modular, our DOS accommodates the needs of many different applications. Lets you vary the number of input/output devices. Add more core memory. Use a card reader as well as teleprinter. Add a line printer, paper tape punch, photo reader and magnetic tape. Other advantages include software protection and program segmentation. Plus automatic program retention so your programs can be easily reused.

Our basic DOS includes an 8K computer with direct memory access, 2.4 million-character disc, one teleprinter and one high-speed paper tape reader. Price is just \$35,600. Or \$765 per month on a five-year lease. And it's upward expandable for your future needs.

Get the full story by calling your local HP computer specialist. Or write Hewlett-Packard, Palo Alto, California 94304; Europe: 1217 Meyrin-Geneva, Switzerland.

HEWLETT  PACKARD

DIGITAL COMPUTERS
INFORMATION RETRIEVAL NUMBER 4

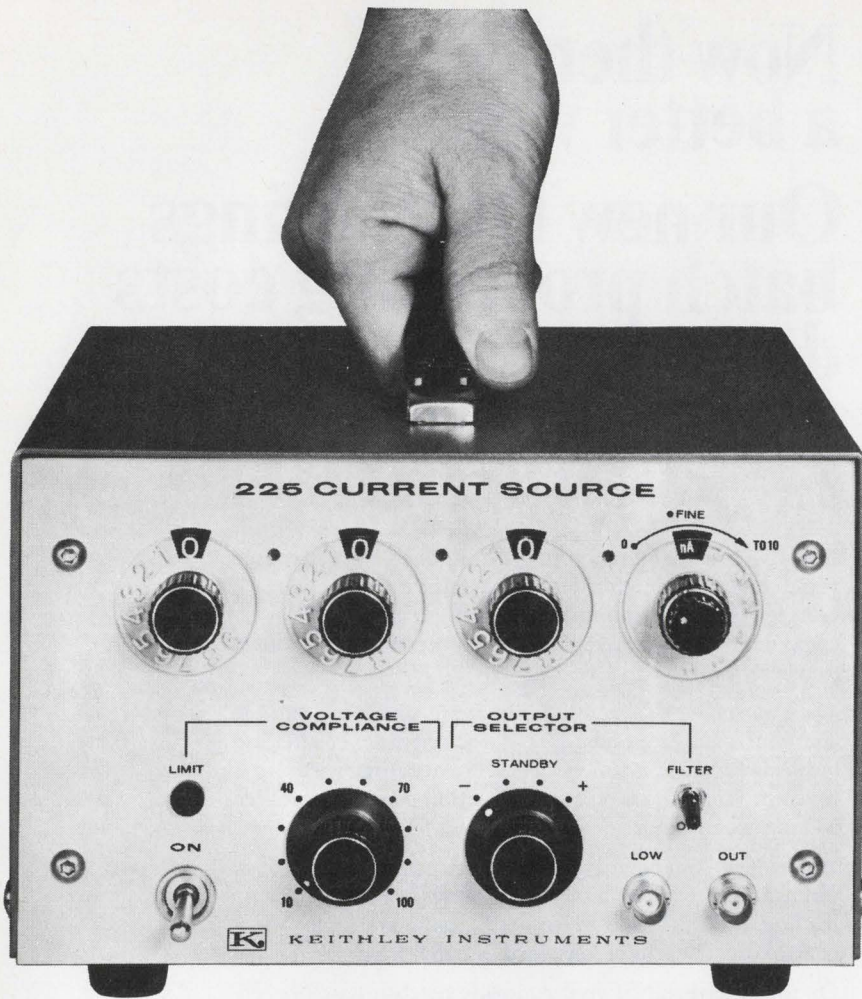

NEW WAY TO GET A HANDLE ON CONSTANT CURRENT ... 0.1 AMPERE TO 1 NANOAMPERE

Now you can keep tight rein on low level currents for materials research, semiconductor testing and for other areas in science and industry where a reliable current source is needed. The Keithley 225 delivers from 0.1 A to 100 nA full scale with 0.02% resolution on most ranges. It keeps them on target with 0.02% stability and low 0.01% rms noise. Variably selectable compliance voltages from 10 to 100 volts and 0.005% load regulation wrap-up this neat source for really constant currents.

Consider convenience features

like bipolar output, the ability to float 500 volts off ground, an output filter to deal with inductive loads. And, protection from overloads with automatic recovery. Now—can you afford to pass up such capability when it's yours for only \$595?

For technical literature and demonstration, contact your Keithley Sales Engineer. Or, Keithley Instruments, Inc., 28775 Aurora Road, Cleveland, Ohio 44139. Telephone: (216) 248-0400. In Europe: 14 Ave. Villardin, 1009 Pully, Suisse. Prices slightly higher outside the U.S.A.



KEITHLEY
INFORMATION RETRIEVAL NUMBER 5

Publisher

Hugh R. Roome

Editors

New York Office
850 Third Ave.
New York, N.Y., 10022
(212) 751-5530

Editor: Frank Egan
Managing Editor: Ralph Dobriner
Managing Editor: Raymond D. Speer
Microelectronics, Steven A. Erenburg
Computers, Milton J. Lowenstein
Microwaves, Michael J. Riezenman
Management, Richard L. Turmail
News, John N. Kessler
Military-Aerospace, John F. Mason
New Products, Roger Allan
New Products, Lucinda Mattera
Copy, Marion Allen

Field Editors

Massachusetts
Jim McDermott
P.O. Box 272
Easthampton, Mass. 01027
(413) 527-3632

San Francisco
Elizabeth de Atley
Suite 6, 95 Main St.
Los Altos, Calif. 94022
(415) 941-3087

Los Angeles
David Kaye
2930 Imperial Highway
Inglewood, Calif. 90303
(213) 757-0183

Washington
Don Byrne
1425 N St. NW
Washington, D.C. 20005
(202) 667-6568

Editorial Production

Dollie S. Viebig
Richard D. Grissom

Art

Art Director, Clifford M. Gardiner
Assistant, William Kelly
Rita Jendrzewski

Production

Manager, Thomas V. Sedita
Helen De Polo
Kathleen McConkey
Leslie Stein

Circulation

Manager, Nancy L. Merritt

Information Retrieval

Peggy Long

letters

We are playing a global ball game

Regarding the article, "How Do We Compete with 'Japan, Inc.'?" in the Sept. 13, 1970 issue (ED 19, p. 100) the basic difference between Japan and the U. S. A. seems to be that the former has found a way to unite government, industry and labor in a common goal, for the common good. This is unique in a world that operates as though these aims were incompatible under a free enterprise system. But in many respects, "free enterprise" in the U. S. is not as free as its mentors would have us believe.

Consider what would happen to any group of companies that united under the EIA banner—or any other banner—to discuss common economic problems or to compare R&D efforts. The moment a dollar sign appeared, U. S. antitrust forces would declare it a no-no—definitely out of bounds, and generally a substitute for price fixing. And wouldn't the company patent attorneys have a field day on the subject of what any engineer might disclose! After many years' service on both EIA and IEEE committees, I assure you this is no figment of my imagination.

What this country needs is to recognize that we are playing a global ball game. Federal policy must be changed to reflect this fact. We cannot have one set of rules for the Japanese, largely favorable to them, while we play under rules that are absurd, outdated, and severely restrictive. While Japanese companies have adopted a paternalistic approach to labor—including engineers—U. S. companies consider labor expendable and engineers an expensive commodity! Meanwhile, U. S. labor con-

siders its work-output of little importance, quality irrelevant, and loyalty nil. But in Japan, labor seeks a secure lifetime job, takes pride in its work and stays with the employer. The quality of products coming out of Japan today clearly reflects these differences.

What we certainly don't need in this country is more electronic businesses—unless one is ready to admit that the vast military-space complex cannot be successfully converted to peacetime, nonspace use. With thousands of companies retrenching, we need to use the existing plant more effectively. But if this cannot be done, then death and re-birth under new names do not really constitute "new" business. And while this is going on—what a tremendous latent advantage we are handing to the modern, fully geared plants of Japan that can move ahead without pause!

In short, while Japan has unified the objectives of government, industry and labor, we seem to be moving toward aimless self-interest. We must reverse this trend if we are to avoid trouble at home, let alone face a powerful market-ing adversary.

Such tangential ideas as developing "new" companies, or introducing "Picturephones" by "1980" are irrelevant. Moreover, they fail to recognize the growth problem which is taxing the telephone companies' ability to handle the new computer peripheral devices while maintaining adequate voice telephone service. A difficult domestic problem is not likely to provide the solution to an urgent international problem.

Charles A. Cady

Consulting Engineer
42 Shaw Drive
Wayland, Mass.

Electronic Design welcomes the opinions of its readers on the issues raised in the magazine's editorial columns. Address letters to Managing Editor, Electronic Design, 850 Third Ave., New York, N. Y. 10022. Try to keep letters under 200 words. Letters must be signed. Names will be withheld on request.

Select BULOVA/ATP oscillators to meet your frequency/ timing needs

- Computer Clocks
- Terminals
- Facsimile
- Timing Systems
- Data Transmission
- Peripherals I/O
- Security/Alarm Systems
- Process Control

ATP capability can provide oscillators to meet all your frequency needs — with many frequencies available from stock.

FEATURES

- Accuracies up to $\pm 0.0005\%$
- Low Cost, light weight & small size
- Low power drain down to $6\mu a$
- Reliability — Typically 90% for 200,000 hours
- Logic Circuit Compatibility

If you have a frequency/timing requirement, ATP has the oscillator you need — or can design what you need. Reliability, accuracy and size criteria can be quickly met, with appreciable savings in engineering time and production costs. Call American Time Products at 212-335-6000.



Electronics Division of Bulova Watch Co., Inc.
61-20 Woodside Ave., Woodside, N. Y. 11377
(212) 335-6000

INFORMATION RETRIEVAL NUMBER 6

Enroll now in the Magnetics Technology Center

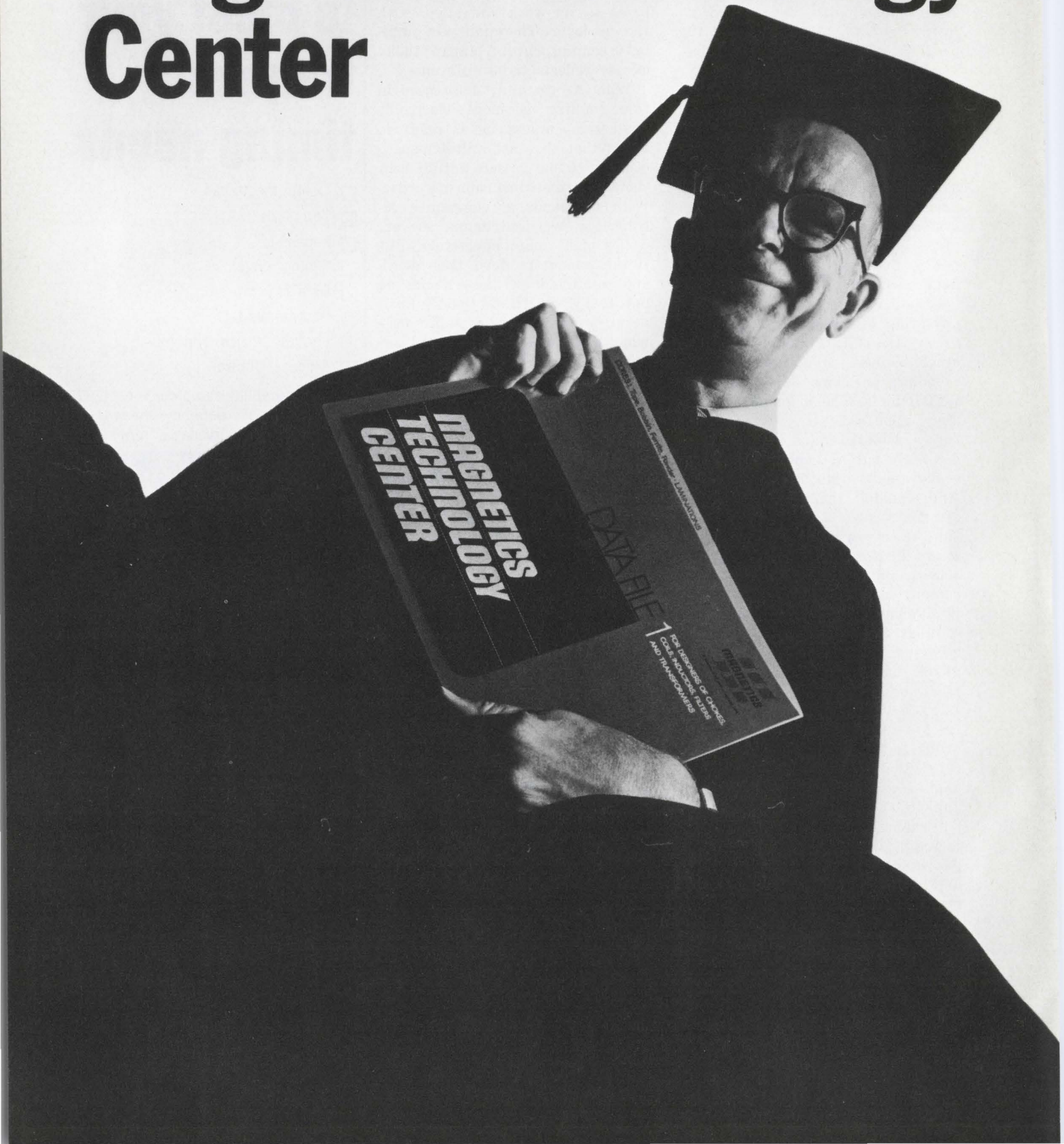

Magnetics introduces a post-grad center that keeps you up to date on the state of the art in magnetic materials. No campus; no fee; texts free. You learn on your own time.

We don't pretend to be scholars behind ivy-covered walls. We are a group of inquisitive specialists with interests in electronics, electrical engineering, physics, metallurgy and related fields. We work with low and high permeability magnetics, ferrites and photo-chemically machined metals. Some of us have spent over 20 years here at Magnetics developing theories and putting them to practical use.

Now we'd like to share with you what we've learned—through a curriculum that no undergraduate school to our knowledge now offers. (Sure, we have another purpose. We believe that as people learn what our products can do, the more these products will be used in future commercial applications. If today we give you the kind of information that will help you do a better job, it seems reasonable to assume you may give us an order someday.)

So we invite you to enroll now in our newly created Magnetics Technology Center. It exists as a repository of what is known about magnetic materials. It intends to spread this knowledge freely—and broadly. It seeks engineers interested in learning more about this field. It welcomes both recent graduates and those who have been involved in design and application for some time. We intend to gear

our programs to your needs.

As an enrollee in the Magnetics Technology Center you will receive without obligation a continuing flow of printed material. You may have received some of this in previous years, but the bulk will be new material developed especially for our Center. Among the items:

1) Magnetics Technology Center Study Courses on such subjects as:

- Ferrites versus magnetic materials
- Photo-chemically machined parts
- Reducing magnetic circuit size and response time
- Ferrites in transformer design
- Proper selection of cores for saturating transformers

2) Magnetics Technology Center Data Bank Files for designers of chokes, coils, inductors, filters, magnetic amplifiers, converter-inverter transformers and electronic transformers

3) Magnetics Technology Center news, at regular intervals, on advances in magnetic materials, applications, etc.

4) Magnetics Technology Center Annual Bibliography of important papers and articles on magnetic science technology

Enroll now. No tuition. No tests.

No campus. Merely fill out and mail the coupon.

MAGNETICS, Magnetics Technology Center, Dept. ED-106, Box 391, Butler, Pennsylvania 16001

How do we qualify to institute this Center?

- We developed the 550 Mu Flake Core, an industry first, that allows miniaturization without excessive circuit losses
- We tightened up industry inductance tolerances for powder cores. Twelve years ago the accepted tolerance was as high as $\pm 22\%$. We went to $\pm 8\%$ and others followed
- We established ourselves as the only approved source of bobbin cores for the Apollo program
- We patented a one-piece powder core die to increase production and help make a more uniform product
- We developed linear inductance-temperature characteristics in powder cores
- We stabilized miniature cores for inductance changes with temperature
- We developed a guaranteed voltage breakdown finish for tape and bobbin cores, eliminating the need for taping
- We developed our own powder metallurgy techniques and producing facilities to gain stricter control of magnetic core properties
- We tightened limits or standards on tape wound cores and set limits on other cores where no industrial standards were in place

To enroll, clip this and mail today.

MAGNETICS, Magnetics Technology Center, Dept. ED-106, Box 391, Butler, Pennsylvania 16001

Please enroll me in the Magnetics Technology Center and forward all curriculum materials, free of charge, to:

Name _____

Title or Function _____

Field of Interest and/or Product Now Working On _____

Specific Subjects You Would Like Us to Include in the Curriculum _____

Degree _____ School _____ Year _____

Firm Name _____

Address _____

City _____ State _____ Zip _____

Your associates may wish to enroll also. Have them furnish the above information on their company letterhead and send it to us. We need this data to assist us in selecting your curriculum.



A DIVISION OF SPANG INDUSTRIES INC.

INFORMATION RETRIEVAL NUMBER 7

AMP IC receptacles difference in panels

A different kind of IC receptacle.

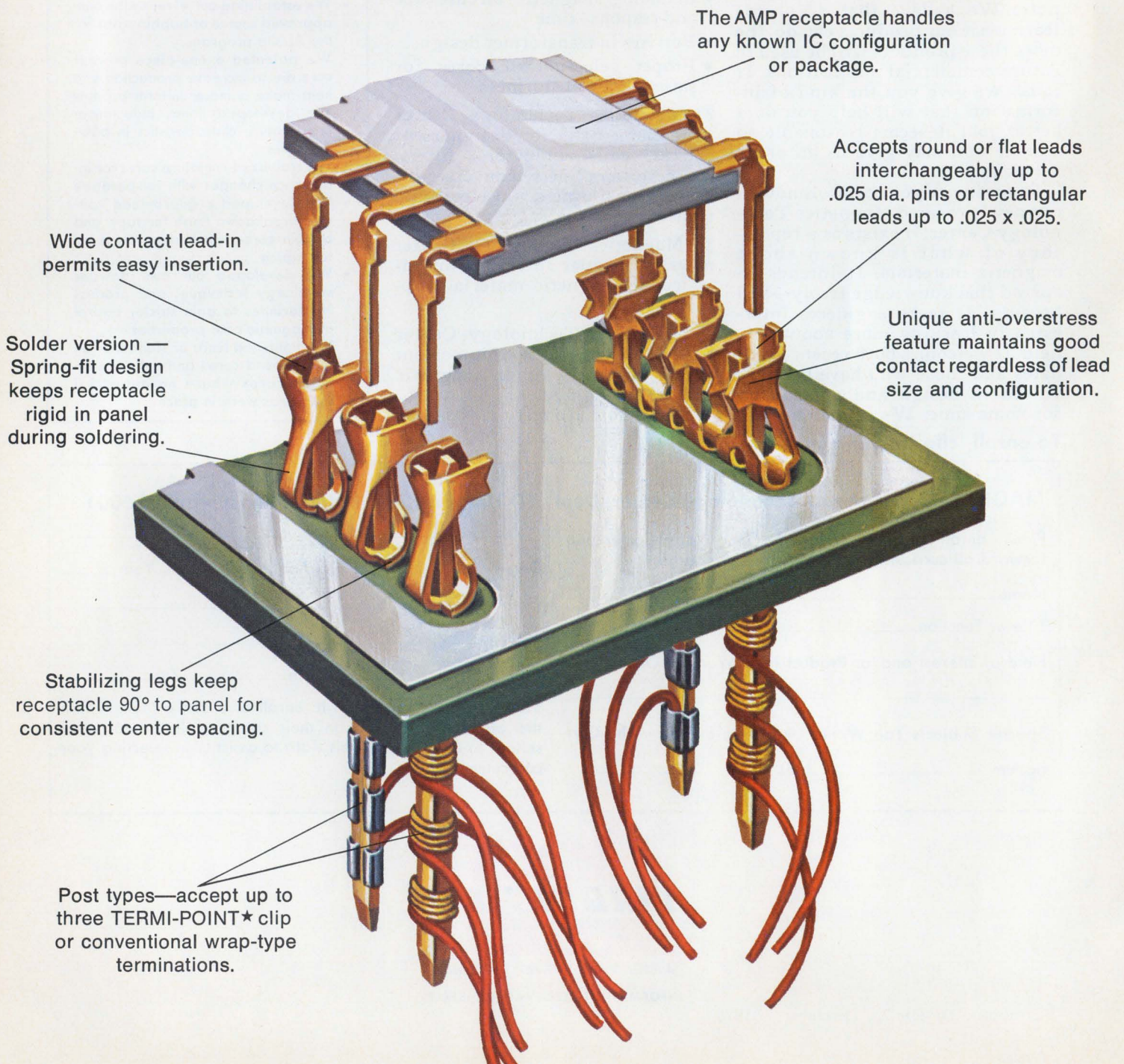

are where the starts.

We don't stop there.

We've designed greater reliability into the critical receptacle portion of your panel designs, but that's only *part* of the difference in AMP's complete packaging panel capabilities. No other company offers the flexibility that AMP does in panels. We offer a tried and tested panel building technique and AMP's one-house responsibility to back it up.

Tell us what you want.

1. You build the panel.

If your requirements dictate that you build the panels, we don't just supply you with loose receptacles and let you tackle your production problems alone. The AMP IC receptacles are supplied with a carrier strip and special insertion tooling for high speed assembly to the board or panel. We've lived with panel production problems and we'll share the resulting know-how with you.

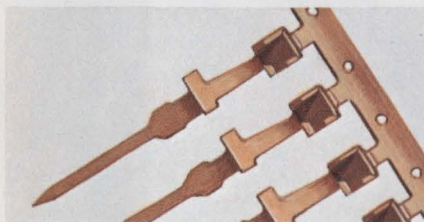

★Trademark of AMP Incorporated

2. We build the panel.

Obviously, the same time tested know-how can be put to work in our plant to build standard or custom panels for you. The placing of the IC receptacles can be as random or uniform as you need. Remember, our receptacle can handle any IC configuration or package. Pictured below are several of the panels produced for our customers.

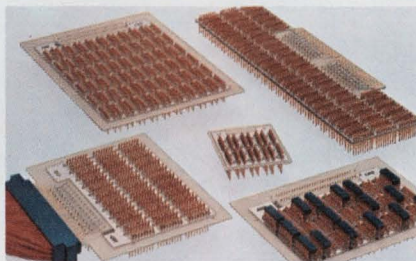

3. Either of us wire the panel.

For point-to-point wiring, AMP offers two basic types of panels. One for use with the versatile termi-point wiring technique and another for use with the conventional wrap-type techniques, for use in your plant or ours.



And the price is right.

Forget the usual claim that something better always costs more. The advantages of the AMP IC receptacle are available at a competitive, low per-unit cost, *plus* there are additional savings in our assembly technique.

For more information on the difference in AMP IC receptacles or our panel capability in general, write:

AMP Incorporated, Industrial Division, Harrisburg, Pa. 17105.

AMP
INCORPORATED

**Cut the Size of Your
Power Supply in Half with Fast, High-Voltage
Transistors from RCA.**

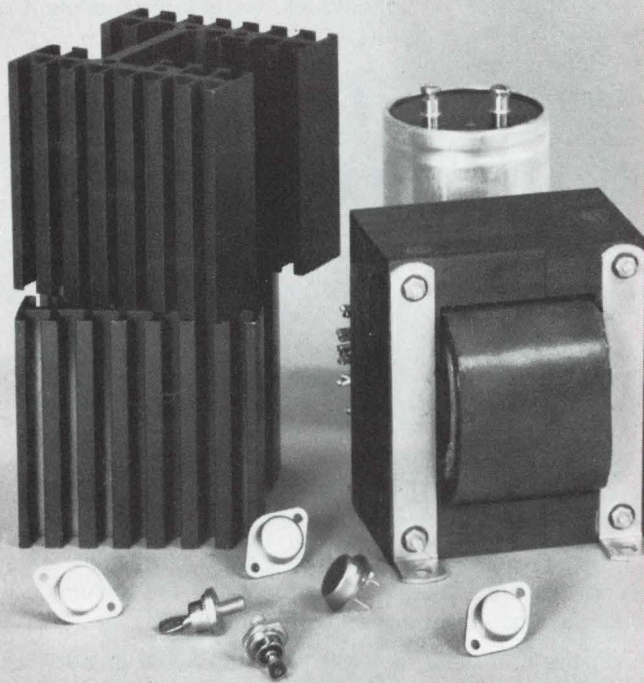

Conventional 5 V, 25 A Supply

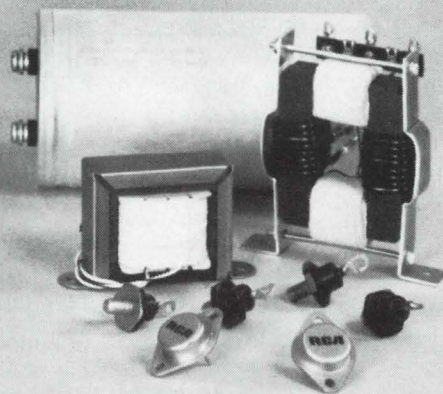

New 5 V, 50 A Supply

RCA

For details and application note, write: RCA, Commercial Engineering, Section 57L-6/UT14, Harrison, N.J. 07029
INFORMATION RETRIEVAL NUMBER 9

Designer's Calendar

JANUARY 1971						
S	M	T	W	T	F	S
					1	2
3	4	5	6	7	8	9
10	11	12	13	14	15	16
17	18	19	20	21	22	23
24	25	26	27	28	29	30
31						

Jan. 12-14
Symposium on Reliability (Washington, D. C.) Sponsors: IEEE et al. J. W. Thomas, Vitro Labs., 14000 Georgia Ave., Silver Spring, Md. 20910.

CIRCLE NO. 401

Jan. 25-26
Optics in Microelectronics Conference (Las Vegas, Nev.) Sponsor: Optical Society of America, Microelectronics Meeting, 2100 Pennsylvania Ave., N. W., Washington, D. C. 20037.

CIRCLE NO. 402

FEBRUARY 1971						
S	M	T	W	T	F	S
	1	2	3	4	5	6
7	8	9	10	11	12	13
14	15	16	17	18	19	20
21	22	23	24	25	26	27
28						

Feb. 9-11
Aerospace & Electronic Systems Winter Convention (WINCON), (Los Angeles). Sponsors: IEEE et al. William H. Herrman, Wincon '71, IEEE Los Angeles Council, 3600 Wilshire Blvd., Los Angeles, Calif. 90005.

CIRCLE NO. 403

Feb. 17-19
International Solid State Circuits Conference (Philadelphia, Pa.) Sponsors: IEEE et al. Lewis Winner, 152 W. 42nd St., New York, N. Y. 10036.

CIRCLE NO. 404

A Smart Way to Beat Your Power Supply Size Problem

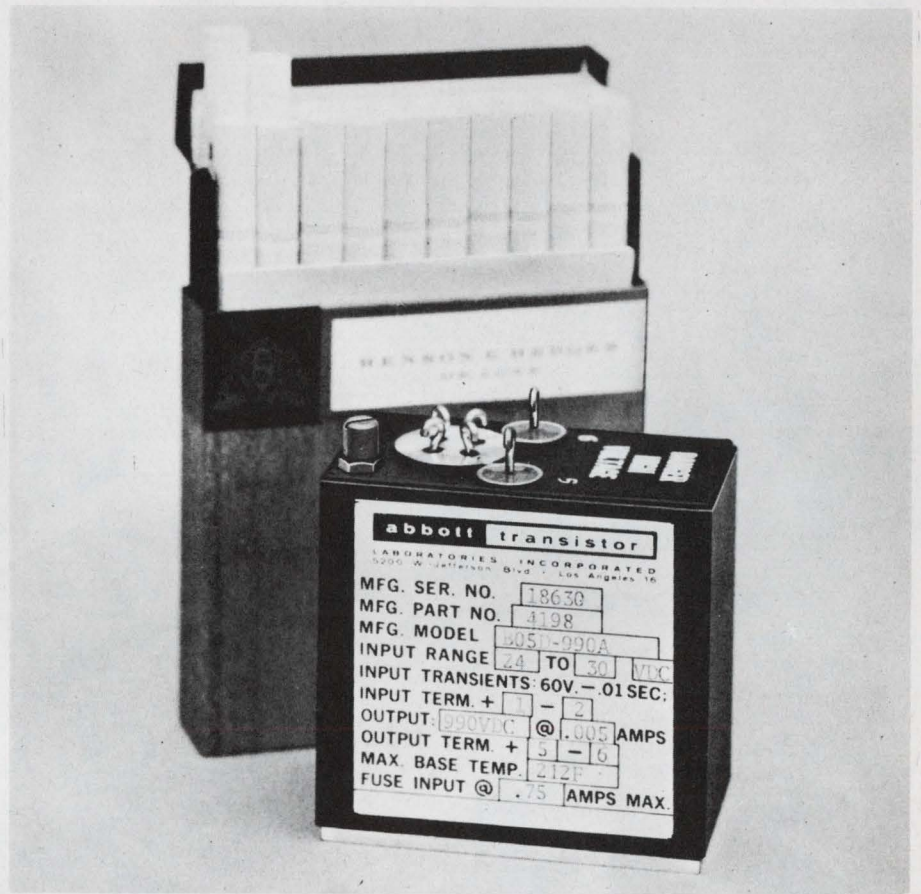

abbott

1½" thin, 2¾" short, yet this converter produces 1000 volts DC, regulated, from a battery input of 28 VDC! It weighs less than 15 ounces. This is only one of our wide variety of many small light weight converters, inverters and power supplies — there are over 3000 models listed in our newest catalog, including size, weight, and prices. If you have a size problem, why not send for an Abbott catalog?

MIL SPEC ENVIRONMENT — All of the power modules listed in our new catalog have been designed to meet the severe environmental conditions required by modern aerospace systems, including MIL-E-5272C and MIL-E-5400. They are hermetically sealed and encapsulated in heavy steel containers. New all silicon units will operate at 100°C.

Please write for your FREE copy of this new catalog or see EEM (1969-70 ELECTRONIC ENGINEERS MASTER Directory), Pages 1834-1851.

abbott transistor
 LABORATORIES, INCORPORATED
 5200 W. Jefferson Blvd./ Los Angeles 90016
 (213) WEBster 6-8185 Cable ABTLABS

RELIABLE — Highest quality components are used in Abbott power modules to yield the high MTBF (mean time between failure) as calculated in the MIL-HDBK-217 handbook. Typical power modules have over 100,000 hours MTBF — proving that the quality was built in from the beginning.

WIDE RANGE OF OUTPUTS — Any voltage from 5 volts DC to 10,000 VDC is available by selecting the correct model you need from our catalog with any of a variety of inputs including:

- 60 ϕ to DC, Regulated
- 400 ϕ to DC, Regulated
- 28 VDC to DC, Regulated
- 28 VDC to 400 ϕ , 1 ϕ or 3 ϕ
- 60 ϕ to 400 ϕ , 1 ϕ or 3 ϕ

TO: Abbott Transistor Labs., Inc., Dept. 57
 5200 West Jefferson Blvd.
 Los Angeles, California 90016

Sir:
 Please send me your latest catalog on power supply modules:

NAME _____ DEPT. _____

COMPANY _____

ADDRESS _____

CITY & STATE _____

INFORMATION RETRIEVAL NUMBER 10

**Reliability is six things we do
that nobody else does.**

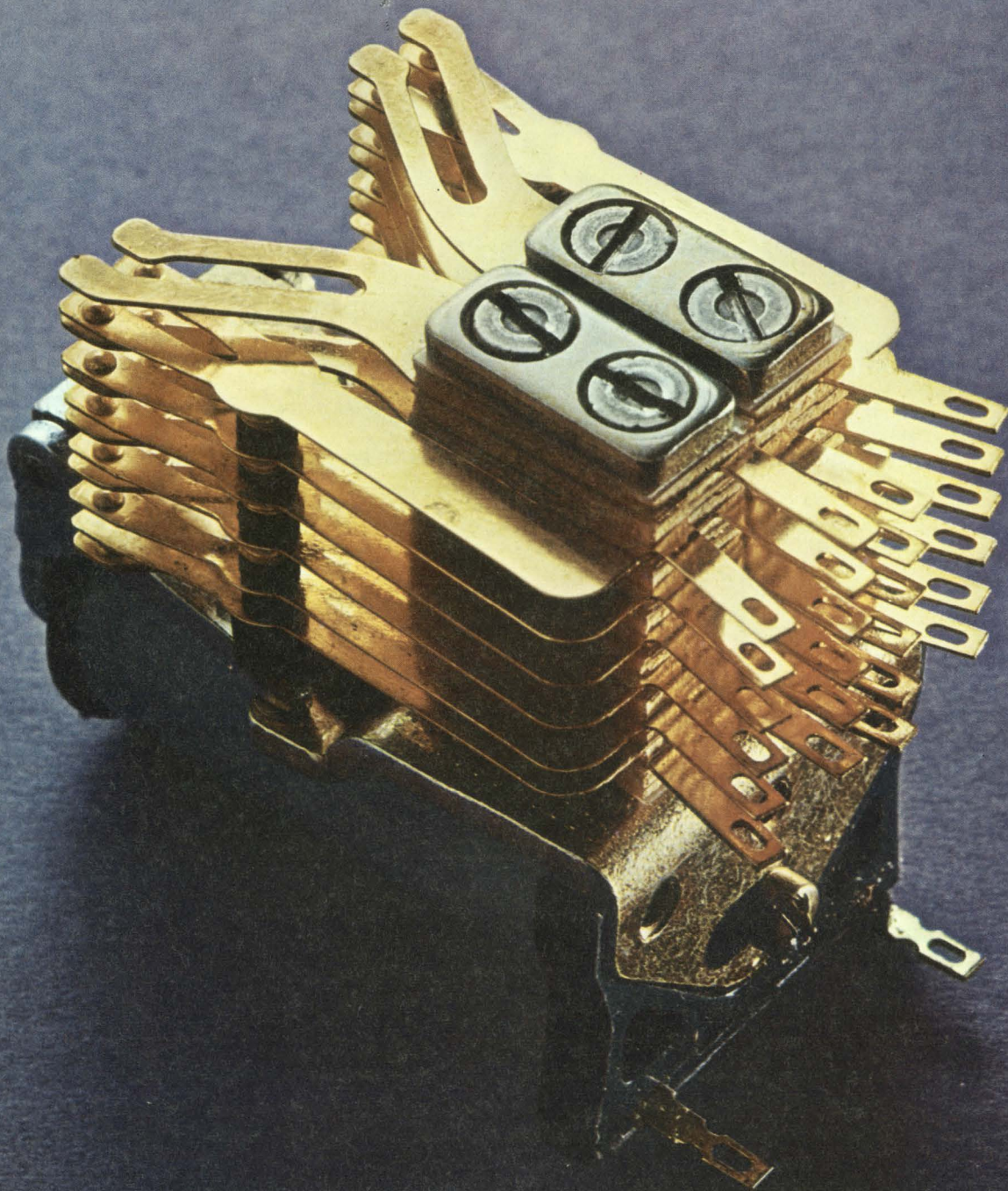

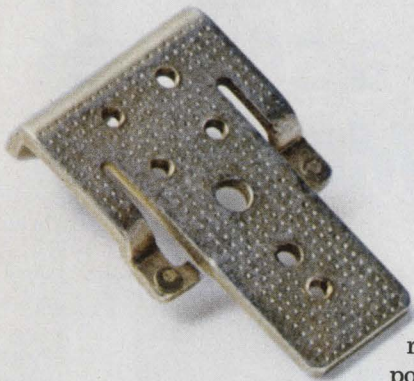

We're fanatics.

We build our relays stronger than we have to. That way, they last longer than they ever have to. Our Class E relay (shown on the opposite page) is a good example of our way of thinking.

The industry's strongest heelpiece.

We make the strongest heelpiece in the industry. A gigantic machine bangs them out extra fat and extra flat.

Extra fat to carry a maximum of flux. To handle big loads. Extra flat so that once an AE relay is adjusted, it stays adjusted.

Since our backstop is part of the heelpiece, it's just as thick and flat. But, tough as it is, the slightest wear here would throw the entire contact assembly out of whack. So, to be safe, we weld two tiny, non-magnetic pads where the armature arms meet the backstop. You might say we created the no-stop backstop.

Three parts that'll wear like crazy.

When you build a relay like a small tank, you have to think of everything. We try. Right down to the tiniest part. For example, we make our armature arms and bearing yoke extra thick.



Thicker than years of testing and use say they have to be. Then, to make sure they don't cause wear problems, we insert a hardened shim between the hinge pin and the frame. The pin rides on the shim, instead of wearing into the heelpiece. (You can forget the bearing, it's permanently lubricated.)

Buffers with lots of muscle.

We make our buffers of a special tough phenolic material that lasts. And lasts. And lasts. All without wear or distortion. Another reason why our relays stay in whack.

To make sure our buffers stay in place, we weld the buffer cups to the armature arms. We weld, instead of using rivets, because our lab found that rivets have a habit of falling out.

For the very same reason, we weld buffer cups to the contact springs. And also use the same special tough phenolic buffers.

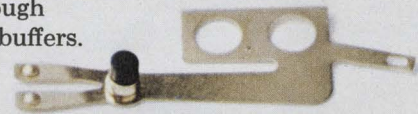

No, we didn't forget the contact springs.

We have some strong feelings as to what makes a contact spring reliable. Our sentiment is that two contacts are better than one. So, we bifurcate all the springs, not just the make and break. This slotting and the addition of another contact to each spring means you get a completed circuit every time.

We make each set of contact points self-cleaning. The bad stuff doesn't have a chance to build up.

Now, what's different about our bobbin?

Our bobbin is one piece—molded of glass-filled nylon. This provides the maximum in insulation resistance.

Because our bobbin is nylon, we don't have to impregnate with varnish. Moisture and humidity have no effect on the stubborn nylon material. No effect means no malfunctions for you to worry about.



What all this means to you.

What this all adds up to is reliability. The kind of toughness no one else can give you. It means an AE relay works when it's supposed to, longer than it has to.

Isn't this the kind of reliability you really need? Automatic Electric Company, Northlake, Ill. 60164.

AUTOMATIC ELECTRIC

SUBSIDIARY OF GENERAL TELEPHONE & ELECTRONICS

MSI/Complex-function:	Series 5400/7400	Series 4300/4000	Series 9300/8300	Series 8200/7200	TOTAL
COUNTERS:					11
Divide by 10	1	1			
Divide by 12	1	1			
Divide by 16	1				
Programmable Modulo-N		2			
Presetable			2	2*	

...including these most-used, Complex-function/MSI types:

Motorola made a commitment . . . one year ago . . . to become "one of the World's leading suppliers of series 54/74 T²L integrated circuits in 1970." The above lineup of complex-function/MSI circuits indicates that we've done that . . . and, then some! Here's the rest of the story:

In all, Motorola offers you the industry's most complete, interchangeable selection of T²L, for all of your design requirements. Seven (7) families, *plus* . . . Check the lineup:

- MTTL I — MC500/400 series (SUHL I)
- MTTL II — MC2100/2000 series (SUHL II)
- MTTL III — MC3100/3000 series (SN54H/74H)
- MC4300/4000 series complex functions
- MC5400/7400 series (SN54/74)
- MC8200/7200 series complex functions
- MC9300/8300 series complex functions

Plus, these additional capabilities:

- MTTL Beam Lead ICs and Chips.
- MDTL & MTTL Dielectrically-Isolated Circuits.
- The World's broadest line of system-compatible MDTL circuits.

For complete data, including high-light specifications and selection guides, write: P.O. Box 20912, Phoenix, Arizona 85036.

The Logical T²L Choice is yours.

DATA SELECTORS:					3
Dual 4-input		1	1		
8-input			1		
DECODERS/DATA DISTRIBUTORS:					20
BCD to Decimal	1		1		
Excess-3 to Decimal	1				
Excess-3 Gray to Decimal	1				
BCD to 7-segment	4	1			
Binary to 1-of-16	1**		1		
Binary to 2-of-8		1			
Binary to 1-of-8		1			
Binary to 1-of-8					
Invert/non-invert		1			
Dual Binary to 1-of-4 line		1			
BCD to Decimal/Driver	3				
Dual 1-of-4 line		1			
Dual 1-of-2 line		1			
ENCODERS:					2
Binary to BCD		1			
BCD to Binary		1			
ARITHMETIC FUNCTIONS:					12
Adders	1	6			
Dual Adders	2		1		
4-bit Adders	1				
Look-ahead-carry-lock		1			
SHIFT REGISTERS:					7
4-bit Universal	1	1	1	2*	
8-bit Serial	1				
Dual 8-bit Serial			1		
LATCHES and FLIP FLOPS:					6
4-bit Latch	2	2			
Dual 4-bit Latch			1		
Quad D Flip Flop		1			
MEMORIES:					4
16-bit RAM		1			
64-bit RAM		1*			
128-bit ROM		1			
256-bit ROM		1			
MULTIVIBRATORS:					3
One-shot	1				
Retriggerable 1-shot			1		
Voltage-controlled		1			
PARITY TREES:					3
8-bit		1			
Dual 4-bit		1			
Single-error Hamming-Code					
Detector and Generator		1			
COUNTER/LATCH, 7-SEGMENT DECODER / DRIVER		1*			1
FREQUENCY PHASE DETECTOR		1			1
	23	35	11	4	73

*To be introduced within 30-days.

**Functionally-replaceable by 9300 series type.



MOTOROLA TTL
— total capability . . . of course!

INFORMATION RETRIEVAL NUMBER 12

NEW!

QUAD POWER DRIVERS REDUCE PACKAGE COUNT

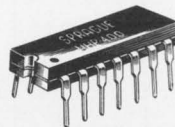
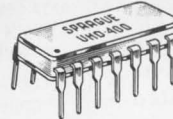
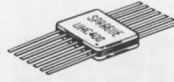

FIFTEEN NEW
DRIVERS INCORPORATE
MONOLITHIC LOGIC GATES
DRIVING HIGH-CURRENT
SWITCHING TRANSISTORS

Extremely versatile power devices designed for lamp driver, relay driver, level shifter, and a wide variety of similar applications. Operating at a standard V_{CC} voltage of 5 volts, each driver output transistor is capable of sustaining 40 volts in the OFF state while sinking 150 mA in the ON state. Special selection can guarantee even higher breakdown voltages and sink currents. Other features include inputs

Cat. No.	Description	Package	Temp. Range
UHC-400 UHC-402 UHC-420 UHC-451 UHC-459	Quad 2-input AND Quad 2-input OR Dual 4-input AND 2-wide, 2-input AND-OR 2-wide, 2-3-input AND-OR	14-lead flat pack	-55 C to +125 C
UHD-400 UHD-402 UHD-420 UHD-451 UHD-459	Quad 2-input AND Quad 2-input OR Dual 4-input AND 2-wide, 2-input AND-OR 2-wide, 2-3-input AND-OR	14-lead ceramic dual in-line	-55 C to +125 C
UHP-400 UHP-402 UHP-420 UHP-451 UHP-459	Quad 2-input AND Quad 2-input OR Dual 4-input AND 2-wide, 2-input AND-OR 2-wide, 2-3-input AND-OR	14-lead plastic dual in-line	0 C to +70 C

that are compatible with DTL/TTL logic devices, and pinning compatible with Series 54/74 networks.

For the name of your nearest stocking distributor, call or write to Bill Campbell or Bill O'Connor, Functional Electronic Circuits Operations, Sprague Electric Co., 115 Northeast Cutoff, Worcester, Mass. 01606. Telephone 617-853-5000, Ext. 314, 270, or 313.

For Engineering Bulletin 29300, write to Technical Literature Service, Sprague Electric Co., 347 Marshall St., North Adams, Mass. 01247.

THE BROAD-LINE PRODUCER OF ELECTRONIC PARTS



highlighting

THE ISSUE

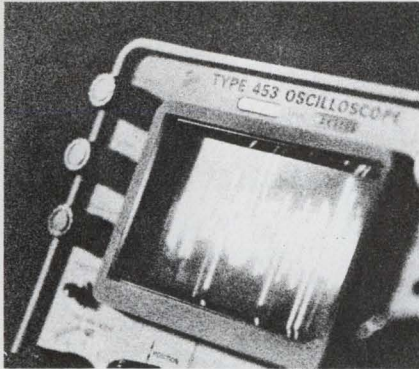

Correlation techniques offer a powerful means of extracting low-level signals from noise and for analyzing the frequency spectrum of complex ac signals. But too often correlation methods require expensive, sophisticated test equipment or general-purpose analog computers.

Not anymore! With today's low-cost amps and multipliers, many of these instrument and computer techniques are practical for use in system design.

A basic correlator circuit can be designed with a component cost of around \$100. The simple circuit described uses only two multipliers and two op amps.

Page 66



Electronics on a more intricate scale is invading the toy industry. Circuits that respond to a variety of input stimuli are turning up in playthings: They include sound, light, heat, touch and moisture (baby-doll wetting). The outputs activate small motors, solenoids, light bulbs or some combination of these elements. And between the inputs and outputs, circuits may be interposed to perform many kinds of logic or timing functions.

Present electronics are limited to small printed-circuit-board technology. But, as yet, no toy manufacturer is using integrated circuits.

Why not? The answer is cost—peripheral resistors and capacitors are needed. But predictions are that in the next year or two the costs of ICs will be low enough for general use by the toy industry.

Page 36

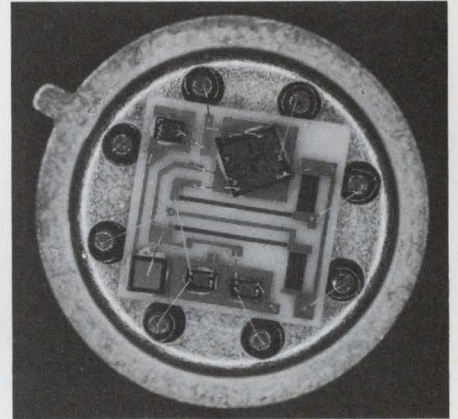

Constructed of monolithic and discrete components in a TO-5 can, a new low-cost hybrid operational amplifier features input bias currents of less than 0.01 pA.

These very low input currents are achieved by an isolation technique that allows the case to follow the applied input voltage. This prevents any leakage from the case to the input pin, which would result if the case were at ground or collector-supply voltage levels.

The new op amp is frequency compensated internally, has a 5-mV input offset voltage, an adjustable offset voltage range of ± 25 mV and common-mode rejection of 60:1.

Page 117

TRY TO MATCH THIS

for size and reliability

you can't!

For their size, Type BB resistors pack a tremendous power dissipating ability. Rated 1/8 watt at 70°C in a 0.0004375 cu. in. volume.

And miniaturization has not reduced reliability. Tests prove it. They satisfy the highest level—the S level—of the latest MIL-R-39008 Established Reliability Specifications in all resistance values.

The key is hot molding—the Allen-Bradley way. A-B developed and built the machines. Only A-B uses them. They're fully automatic. Built-in precision control. A high degree of uniformity. Predictable performance from resistor to resistor—year after year.

For immediate delivery at factory prices call your authorized A-B industrial electronics distributor. Or write Marketing Dept., Electronics Division, Allen-Bradley Co., 1201 South Second St., Milwaukee, Wis. 53204. Export Office: 1293 Broad St., Bloomfield, N.J., U.S.A. 07003. In Canada: Allen-Bradley Canada Limited.

© Allen-Bradley Company 1969



Exclusive

Only A-B Type BB
RCRO5 meets MIL-R-39008
ER (established reliability)
for 1/8-watt resistors
at the S level.
Shown actual size.



ALLEN-BRADLEY
QUALITY ELECTRONIC COMPONENTS

EC69-80

Where to go in MOS debated in 'Silicon Valley'

SUNNYVALE, CALIF.—Which of the proliferating MOS technologies will win out in the 70s? A panel of manufacturers including IBM, National Semiconductor, Intel, General Instrument, Mostek and American Microsystems debated this question last month in front of 500 of their competitors at a local chapter meeting of the IEEE in the heart of semiconductor land.

The technologies they considered were N-channel, high voltage P-channel, and four low-voltage P-channel types. The low-voltage types include silicon gate; metal-nitrous-oxide semiconductor; ion implantation; and crystal-orientation-100 aluminum-gate. Eventually every manufacturer will use his favorite combination of the newer technologies. Meanwhile, high-voltage P-channel, the first of the MOS technologies, will be around for awhile if only because it is well understood.

IBM's L. V. Gregor claimed considerable success making N-channel devices in the laboratory, but he declined to say when IBM will be using this technology. N-channel is considerable faster than P-channel, but also far trickier to make.

All the technologies, including high-voltage P-channel, can be passivated by placing a glass layer over the top, making it possible to package products in low-cost plastic.

The panel agreed that silicon gate can save area in random logic chips that contain a high ratio of interconnects to active devices. However, Floyd Kvamme of National Semiconductor argued that this is not an advantage in very regular structures such as ROMs, where the area eaten up by contacts between the two layers of interconnects is large.

L. J. Sevin, president of Mos-

tek, pointed out that the ion-implant technique (wherein the gate region is bombarded by boron ions to lower the threshold voltage) can also produce depletion-mode transistors. Their turn-off time is faster, and they consume less area.

Engineers make it easier for computers to talk

New techniques of analyzing speech sounds by engineers at Bell Telephone Laboratories have made it considerably easier for computers to talk. Previously, information based on samples of speech waveforms was stored in a computer and later synthesized to form speech.

The new method, in which vocal tract resonances are converted to numbers, takes between one-fiftieth and one-hundredth the amount of information normally required to produce computer speech. This makes it practical for the first time to store large vocabularies of synthetic speech in talking computers, according to

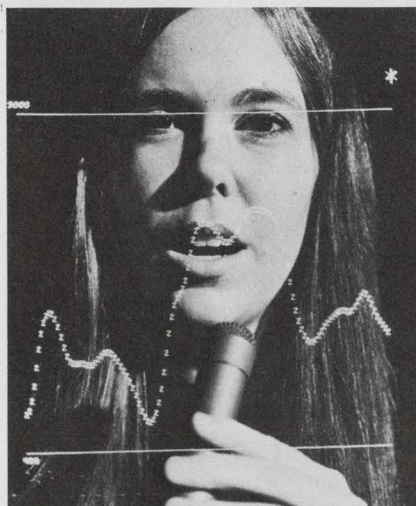

Words are turned to numbers and stored in one-hundredth the space previously required to make a computer talk.

Bell Labs.

The Murray Hill, N. J., research and development organization points to a range of telephone communication services that may be provided once computers can talk as easily as they print out information:

- A computer "librarian" could provide publication information in response to a telephone request.

- Computer "weather reporters" in aircraft or space vehicles could give verbal reports.

Super LSI predicted, along with 4-chip TV

Metal nitrous oxide semiconductor (MNOS) technology will give rise to 100,000 gate-per-chip devices, C. Lester Hogan, president of Fairchild Camera and Instrument Corp., told the 1970 Hybrid Microelectronics Symposium in Los Angeles.

In commenting on other progress in microelectronics, he noted that by the middle of 1971 Fairchild would be delivering to a Japanese company, on a single chip, the electronics for an entire desk-top calculator.

And speaking of linear circuits, Dr. Hogan predicted that by the middle of next year the circuitry for a complete black-and-white TV would be put on three or four chips. Color TV? That will require six chips, Dr. Hogan said.

Memory battle heightens at computer show

The long-heralded battle of the ferrite core vs semiconductor memories was finally joined at the 1970 Fall Joint Computer Conference as three manufacturers showed operating mainframes that use fast semiconductor storage. All these mainframes had previously been announced, but they were receiving their first public exposure at the Nov. 17-19 meeting in Houston, Tex.

The three computers were all minis, and two of the companies—Four-Phase Systems, Cupertino, Calif., and Data General Southboro, Mass.—were attracting a large share of the 20,000 registrants. The third minicomputer

with semiconductor storage—IBM's System/7—drew fewer visitors, possibly because it is being sold directly to end users, as opposed to OEMs, and few end users were in sight at the show.

Attendance was a sore point at this year's Fall Joint Computer Conference, being roughly 50% below last year's nearly 40,000 registrants. About 25% of the total paid the registration fee. The remainder were exhibitors or guests. Some booths were so poorly attended that their staffs kept themselves busy discussing the national economic downturn or visiting competitors' exhibits.

As for the semiconductor memories, proponents stressed their higher speed and better performance, while their detractors pointed to the higher costs with respect to core memories and the problem of volatility—loss of memory content in case of power failure. At least one major manufacturer—Digital Equipment Corp. of Maynard, Mass.—indicated that it was looking to their early application. Nick Mazzerese, vice president of Digital Equipment, said the company would introduce a computer with a semiconductor memory "as soon as it is cost-effective." The indication was that this goal might be reached by late 1971.

Educator sees growth in industrial R&D

Industry-supported research and development will grow at least as fast as the Gross National Product during the 70s, Dr. Frederick E. Terman, former dean of the Stanford School of Engineering, recently told a group of IEEE engineering managers in Palo Alto, Calif.

New EEs with graduate degrees will look to industry for jobs, now that universities are fully staffed and Government-supported R & D programs have dried up, Dr. Terman said. But, he warned, industry will not be able to absorb these men as rapidly as the schools are turning them out. Furthermore, he said, industry will look for more "flexible" men with broader training than the typical Ph.D. candidate offers today.

"This means we will have to

start training the students for where the market is," Dr. Terman said. "Ph.D. candidates should do research to find out how research is done, not to become experts in one speciality."

There will have to be less sharp specialization, the former engineering dean said, and more opportunities to pick up related training—such as computer programming.

Lasers ray of hope as electronics slumps

Sales of gas and solid-state lasers, equipment and systems are showing a continuing upward growth despite the current decline in other areas of the electronics field, according to a spokesman for RCA Components Operations, Harrison, N. J. Industry sales, RCA claims, have increased 40% in the first half of 1970 as compared to the first half of 1969. And the company believes this growth rate will continue to 1971.

"The unit volume of small gas lasers is up," says C. Harry Knowles, president of Metrologic Instruments, Bellmawr, N. J., which specializes in the production of small He-Ne gas lasers. "But the dollar volume is holding steady because of price deteriorations in this area during the last few months. We do anticipate a 30% to 40% increase in 1971.

A survey recently released by the Electronic Industries Association showed total sales of lasers for the first half of 1969 reaching \$43.6-million, up 40.6% over second half 1968 sales. Gas lasers recorded the greatest gain, with 78% of the sales, while solid-state lasers were up 16% over 1968.

Laser sales for R&D in the first six months of 1969 were placed at \$18.7-million, with the Government the largest buyer.

Atomic battery built, with 10-to-20-year life

A nuclear battery reported capable of supplying continuous power for 10 or 20 years has been developed at Resalab Scientific Div., Menlo Park, Calif. The battery consists of a small fuel cell

containing plutonium 238, which gives off heat that is converted to electric energy by an array of semiconductors.

Valvo Raag, director of the company's Energy Conversion Dept., says that the device is potentially cheap enough to compete with chemical batteries in such commercial applications as heart pacemakers and even flashlights.

NASA has developed similar devices that consume hundreds of watts for space work, Raag reports, but they require large fuel cells. Low-power devices—in the milliwatt or microwatt region—that use small cells have been in development for two or three years, primarily for pacemakers, he says. But these devices have very low output voltage—a few 10ths of a volt typically—and therefore require a dc/dc converter to step them up to the 4.5 V necessary to power a pacemaker. Since there is a power loss across the dc/dc converter itself, a larger fuel cell must be used to compensate for this, and thus the cost of the device goes up. Resalab says its device can put out the required voltage without using a dc/dc converter.

At present it is against the law to sell radioactive devices for commercial use, but Raag says the matter is under Government review.

Labor Dept. to bring job and engineer together

A national registry, comprising a central file of engineering job applications and job opportunities, has been set up by the U. S. Dept. of Labor, and went to work the first of November.

The registry, organized with the cooperation of the National Society of Professional Engineers and the California Dept. of Human Resources, is located at 800 Capitol Mall, Sacramento, Calif. 95814. Although located in California, the organization will provide specialized assistance to engineers throughout the country.

Applicants may secure forms from either the local office of their state employment service, or through the facilities of professional engineering societies.

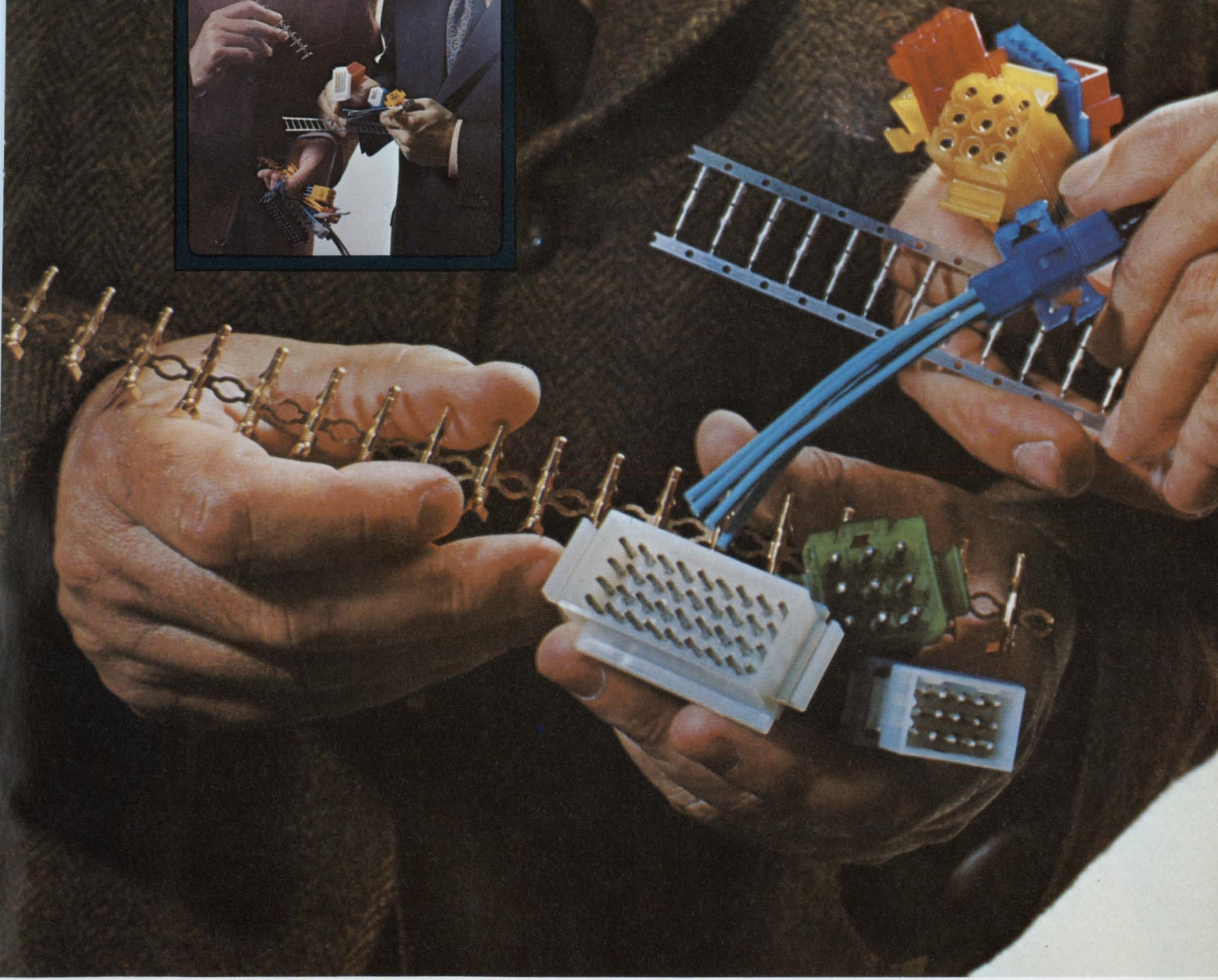

MAKE YOUR CONNECTIONS: FAST. With Molex standard and miniature connectors. They're easier to work with. Simplify wiring. Speed production. Save assembly steps. Make installation and servicing extra easy, too. This is why circuitry idea men everywhere are making connections with Molex. From one circuit to 104 or more. Production keyed and available in a variety of colors to meet design requirements. Molex has the

connector. Plus the design and engineering capability to solve the most complex wiring problems . . . fast. For a colorful free sample of the Molex connector write: Molex Incorporated, Downers Grove, Illinois 60515. Or you can make connections by calling (312) 969-4550.

... creating components that simplify circuitry



CELANESE NYLON. THE HEAD START MATERIAL.

Give your products a head start on top product design, performance and economics. With Celanese Nylon.

General Electric does. In GE hair dryers, for example, the resilience of Celanese Nylon gives coil bobbins the kind of snap-fit that holds parts together snugly. So assembly is simple, less expensive.

But of course there are lots of other reasons for choosing Celanese Nylon. Like the fact that it has U/L rating on electrical properties of 105° C. Or its great mechanical strength and toughness. Or its high dielectric properties,

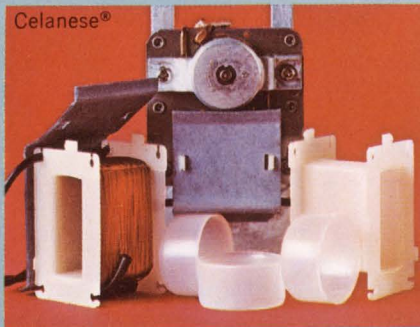

so you can design more compact units with thinner walls. Or the fact that Celanese Nylon is made in a totally continuous process. So it's whiter in the pellet. Whiter in your product. Whiter through successive regrinds. And more consistent from lot to lot.

Maybe that's why retainer rings in GE hair dryers are also molded in Celanese Nylon. And why GE uses Celanese Nylon for gears and bushings and bobbins in their broad line of oscillating fans and heaters.

Give your products a good head start by writing for a copy of our brochure on electrical applications of Celanese Nylon. And a U/L Yellow Card. Celanese Plastics Company, Dept. N-502, 550 Broad St., Newark, N.J. 07102.



Celanese Plastics Company is a division of Celanese Corporation. Canadian Affiliate: Chemcell Resources, Ltd. Export: Amcel Co., Inc., and Pan Amcel Co., Inc., 522 Fifth Avenue, New York 10036.



Surface-wave devices offer cheap signal processing

You press the "A" key on your terminal and send a pulse traveling down a fine metallic grating the size of an IC. At the other end of this grating, the pulse emerges as a unique analog or digital waveform that is broadcast to the mirror image of that grating thousands of miles away. There it is reconverted to a pulse that taps out the letter "A."

Cheap signal processing of all kinds—that's the promise of new surface-wave devices that can be mass-produced by the same photolithographic techniques that are used to make ICs. Probably the hottest new technology since MOS, surface waves can be used to make i-f delay lines, inexpensive TV filters that never need tuning, expanders and compressors, and encoders and decoders. They also show promise for making amplifiers, as well as nonlinear devices such as frequency multipliers, mixers and correlators.

The nonlinear characteristics of surface waves, however, are still being explored in the laboratory, whereas linear devices are actually being delivered to customers.

At the moment, surface-wave devices are used only for military applications, where the high cost of the materials is a negligible part of the total system cost. (For example, the favorite material—lithium niobate—costs \$50 or more per cubic centimeter, even in very

large quantities.) However, researchers are confident that lithium niobate will get cheaper as manufacturers learn to make it more efficiently, or that less ex-

ensive materials will be found that serve the purpose. Already Zenith Radio Corp. has built experimental i-f filters for color TV out of very low-cost lead zirconate titanate (PZT), a ceramic, and has tried them out in a TV set. According to Adrian DeVries, leader of the ultrasonic research group at Zenith's Radio Microcircuit Facility, Elk Grove, Ill., the picture was of good quality and contained no noticeable ghosts due to reflections or crosstalk.

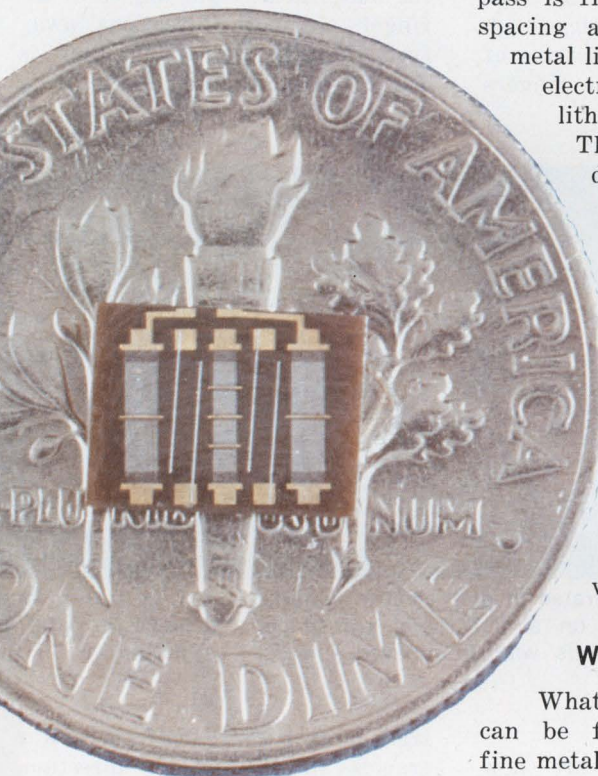

persive materials will be found that serve the purpose.

Already Zenith Radio Corp. has built experimental i-f filters for color TV out of very low-cost lead zirconate titanate (PZT), a ceramic, and has tried them out in a TV set. According to Adrian DeVries, leader of the ultrasonic research group at Zenith's Radio Microcircuit Facility, Elk Grove, Ill., the picture was of good quality and contained no noticeable ghosts due to reflections or crosstalk.

A typical color TV i-f strip contains about 10 LC-tuned circuits that must be precisely tuned

together to pass a particular frequency band. DeVries says that all these filters have been replaced in the experimental TV set by three surface-wave devices. Their bandpass is fixed permanently by the spacing and overlapping of fine metal lines deposited on a piezoelectric substrate by photolithographic techniques. Thus, once the master is designed, filters of the desired bandpass can be mass-produced.

Despite these inherent advantages, it's a question whether surface waves can undercut in price an established technology such as LC-tuned filters for a mass market right now. But the day will soon come, DeVries believes, when they can.

What are surface waves?

What are these waves that can be filtered and shaped by fine metal lines? They are acoustic waves that travel along the surface of a material, twisting and bending it like waves in water. They can be generated in any solid by hitting it, and they can be generated in a piezoelectric material by applying a voltage to its surface.

The advantage of converting electromagnetic waves into acoustic waves is the great reduction in speed and the consequent feasibility of making long delay lines in a small space. In single-crystal lithium niobate, for example, acoustic waves travel along the surface at about 3.4×10^5 cm per second—some five orders of magnitude slower than electromagnetic waves. Thus $1 \mu\text{s}$ of time

Elizabeth de Atley
West Coast Editor

delay can be achieved in 1/3 cm of lithium niobate, whereas it would take about 1000 feet of coaxial cable to delay an electromagnetic wave by the same amount.

Surface waves can be controlled

Acoustic waves can be made to travel through the interior of a material, as well as on the surface, and bulk-wave devices have been in development for several years. The reason for the excitement about surface waves is that, because they travel on the surface, they can be easily controlled. For example, the frequency bandpass and the shape of a surface-wave signal are determined by the geometry of the transducer, which normally consists of thin strips of metal interleaved like the fingers

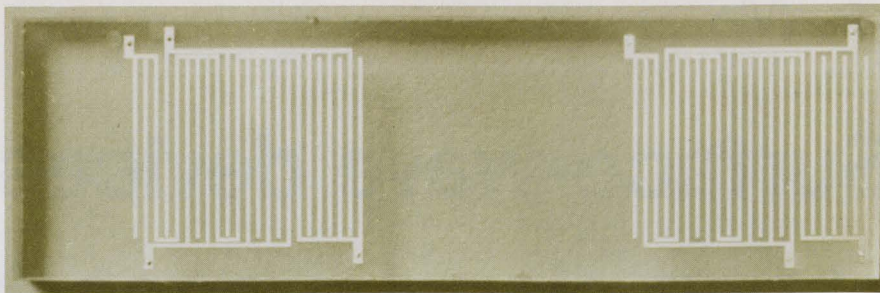

This filter can be used to encode or decode a digital signal. It was developed at MIT Lincoln Laboratory, Lexington, Mass.

“hands” of a transducer (see Fig. 1). This induces an electric field between adjacent fingers, which generates acoustic waves. These waves travel along the surface of the material at right angles to the fingers in both directions away from the transducer. Thus there is a 3-dB loss at the transmitting

adjacent fingers cancel. Thus for maximum power, the distance between finger centers must equal half the wavelength, λ_s , of the surface wave. The fingers themselves are $\lambda_s/2$ in width, and the distance between finger edges is $\lambda_s/4$. Since lithium niobate has an acoustic velocity of 3.4×10^5 , at

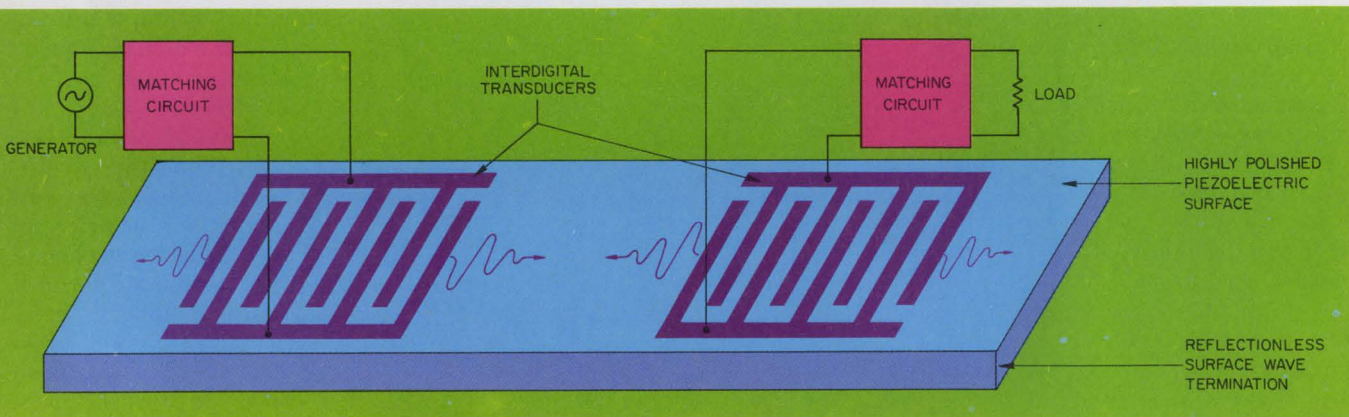

1. Surface waves are generated in piezoelectric material by impressing a voltage on a flat metal transducer shaped like a pair of hands with interleaved fingers.

They travel along the surface of the material, much like waves in water, and are coupled back out to an electrical output circuit through a similar transducer.

of two hands.

Surface-wave devices are new compared to bulk-wave devices because the state of the photolithographic art until recently did not allow the required precision of spacing between the transducer fingers. The higher the frequency, the smaller this spacing must be. Since surface waves travel at a velocity that is independent of frequency, the required spacing becomes infinitesimal at high frequencies. For example, at 1 GHz in lithium niobate, the finger separation must be about 0.8 micron. However, recent advances in IC technology make this degree of control possible.

Surface waves are induced by impressing a voltage across the

transducer because half the power travels in the wrong direction. There is a similar 3-dB loss at the receiving transducer, because a fourth of the power is reflected back to the input while a fourth travels through the transducer to the other side.

The frequency bandpass of a transducer with evenly spaced fingers is maximum at the frequency where half of the acoustic wavelength is equal to the distance from the center of one finger to that of its neighbor. At this frequency the wavelengths generated by each pair of adjacent fingers add to each other. The bandpass is zero at the frequency where that spacing equals a full wavelength, because here the wavelengths from

1 GHz the acoustic wavelength $\lambda_s = v_s/f = 3.4$ microns.

The fingers, therefore, must be about 1.7 microns from center to center and 0.8 microns apart for maximum power.

As the number of fingers in the transducer increases, the power at the center frequency increases also, since more and more waves that add in phase are being generated. At the same time, however, the bandwidth decreases because smaller and smaller changes away from the center frequency cause a phase mismatch somewhere along the row of fingers as the number increases. Thus for maximum bandwidth, a single pair of lines would be ideal—but the price would be high conversion loss due

Signetics makes interface IC's to meet the toughest standards.

COMPUTER PERIPHERALS EQUIPMENT

8T13 Dual Line Driver and 8T14 Triple Line Receiver. Interface with the IBM system I/O interface channel-to-control-unit.

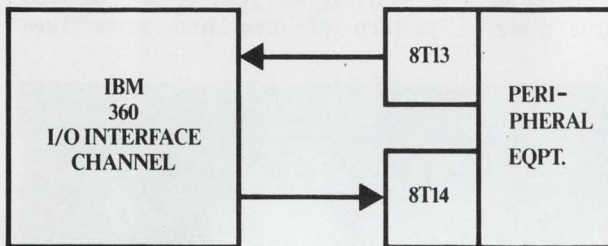

The 8T13 Driver/8T14 Receiver features:

1. Party-Line Multiplexing Operation.
2. Short Circuit Protection.
3. 8T13 High-Power Drive Capability: -75 mA at 2.8V ("1" level).
4. 8T14 Receiver Input Hysteresis of 0.5 Volt (typ) provides High Noise Immunity.

COMMUNICATIONS EQUIPMENT

The 8T15 Dual Line Driver and 8T16 Dual Line Receiver. For data transmission and reception between Data Communication and Terminal Equipment.

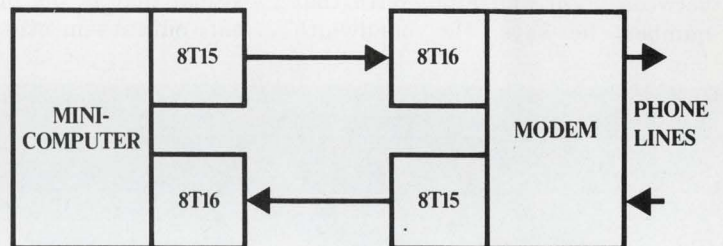

The 8T15 Driver/8T16 Receiver features:

1. Meet EIA Standard RS-232C and MIL-STD-188B and CCITT V24.
2. ± 25 Volt Output Short Circuit Protection.
3. 8T16 Dual Receiver accepts single (EIA) or double-ended (MIL) inputs and provides output strobing control.
4. 8T16 Dual Receiver Hysteresis:
EIA Hysteresis $\sim 4V$
MIL Hysteresis $\sim 1.2V$

Detailed data sheets, comprehensive application notes available.

Sample parts too—we've got the devices on the shelves ready to go. Contact your Signetics salesman, local distributor or Signetics Corporation, 811 E. Arques Avenue, Sunnyvale, California 94086. (408) 739-7700. A subsidiary of Corning Glass Works.

Signetics

to electrical mismatch.

The input transducer is an impedance in the electrical input circuit that must be matched for maximum power transfer. The fewer fingers the transducer contains, the smaller its capacitance, and therefore the lower the bandwidth of the electrical input circuit. The same is true of the output circuit. For a given material there is an optimum number of fingers at which the bandwidth of the electrical circuit and that of the transducer are both as large as possible.

Dr. Donald Armstrong, senior scientist, Litton Industries, Electron Tube Div., San Carlos, Calif., points out that for lithium niobate, the optimum number of fingers is between eight and nine. With that number, he says, the bandwidth

as to encode and decode them.

An analog expander/compressor (see Fig. 2) works this way: If a pulse containing many frequencies is applied to the input transducer, the frequencies sort themselves out in the pattern of the grating. The higher frequencies are coupled to the narrower spacings and the lower frequencies to the larger spacings. (Of course, the number of fingers spaced to pass a particular frequency must be fairly large so that the bandpass at that frequency will be small.)

The high frequencies reach the output transducer first and are coupled out as the leading edge of an expanded pulse. The same delay line can be used to compress a signal that is the mirror image of this output—in other words, a sig-

nal whose leading edge contains the low frequencies and whose trailing edge contains the high frequencies.

The low frequencies arrive at the input transducer first and are coupled into the delay line. By the time they arrive at the similarly spaced gratings at the right end of the output transducer, the high frequencies of the trailing edge have also arrived at the output transducer, and the result is a single sharp pulse.

An analog encoder or decoder can be made by varying the spacings according to the desired code.

A pulse can be similarly expanded, compressed or coded digitally by tapping a grating at various points and reversing the phase selectively to produce the desired pattern of ones and zeros (see

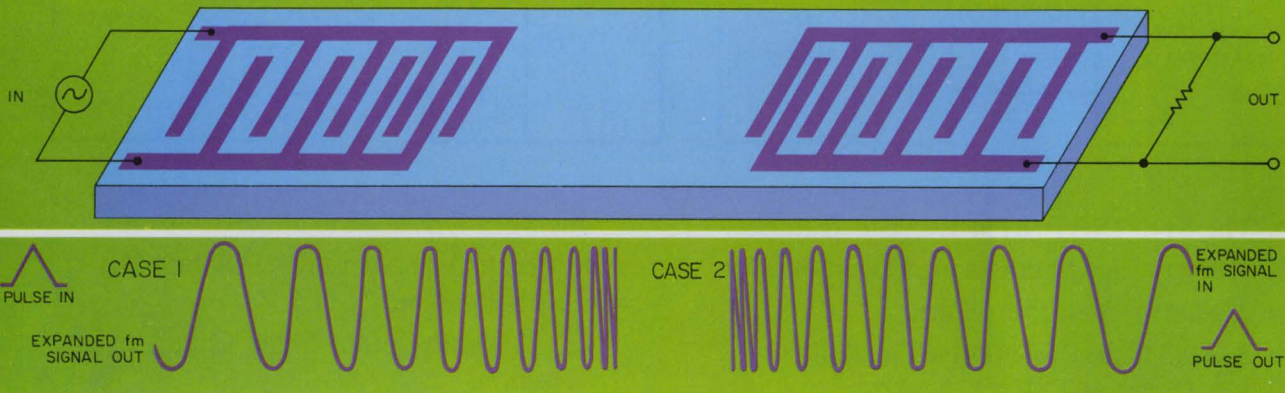

2. Surface-wave delay line with input and output transducers having graduated gratings that are mirror images of each other can be used as analog pulse expanders

and compressors. One such device produced by Hughes Aircraft Co., Culver City, Calif., can expand or compress a pulse by a ratio of 500:1.

percentage is about 20 to 25% using the simplest electrical matching circuit—an inductor to tune out transducer capacitance.

The very small finger spacings at high frequencies limit the upper frequency of surface-wave devices that can be made by photolithographic techniques to 1 GHz or less. Above this limit costly techniques such as the scanning electron microscope are required to obtain the fine finger spacings.

Output is frequency-modulated

By varying the finger spacings along the transducer, it is possible to frequency-modulate the output. This principle can be used to expand and compress pulses as well

A nonlinear device

A nonlinear surface-wave device developed at Stanford University by Prof. C. F. Quate, can correlate electronic signals with a bandwidth of 15 MHz at an input frequency of about 250 MHz and a maximum delay time of 6 μ s. Other researchers say that much larger bandwidths and delays of hundreds of microseconds are possible. Unlike linear surface-wave devices, which are frequency-limited to about 1 GHz, this device can be used over a range well up into the microwave region. Such a device could do real-time processing of very complex signals at GHz rates.

photo on page 26).

One difficulty with surface-wave devices is the attenuation of the waves as they travel through the substrate. This loss, added to the 6-dB insertion loss at the transducers, is appreciable.

In most applications, the insertion losses can be overcome by using an external transistor amplifier. But there are problems. If the amplifier is placed after the insertion loss, the noise figure will be bad because the signal will be reduced by the loss. On the other hand, if it is placed before the insertion loss, there is an upper limit to the amount of power that can be applied without driving the delay line into a nonlinear mode and finally into breakdown. ■■

TRY TO WRAP A BETTER CONNECTOR!

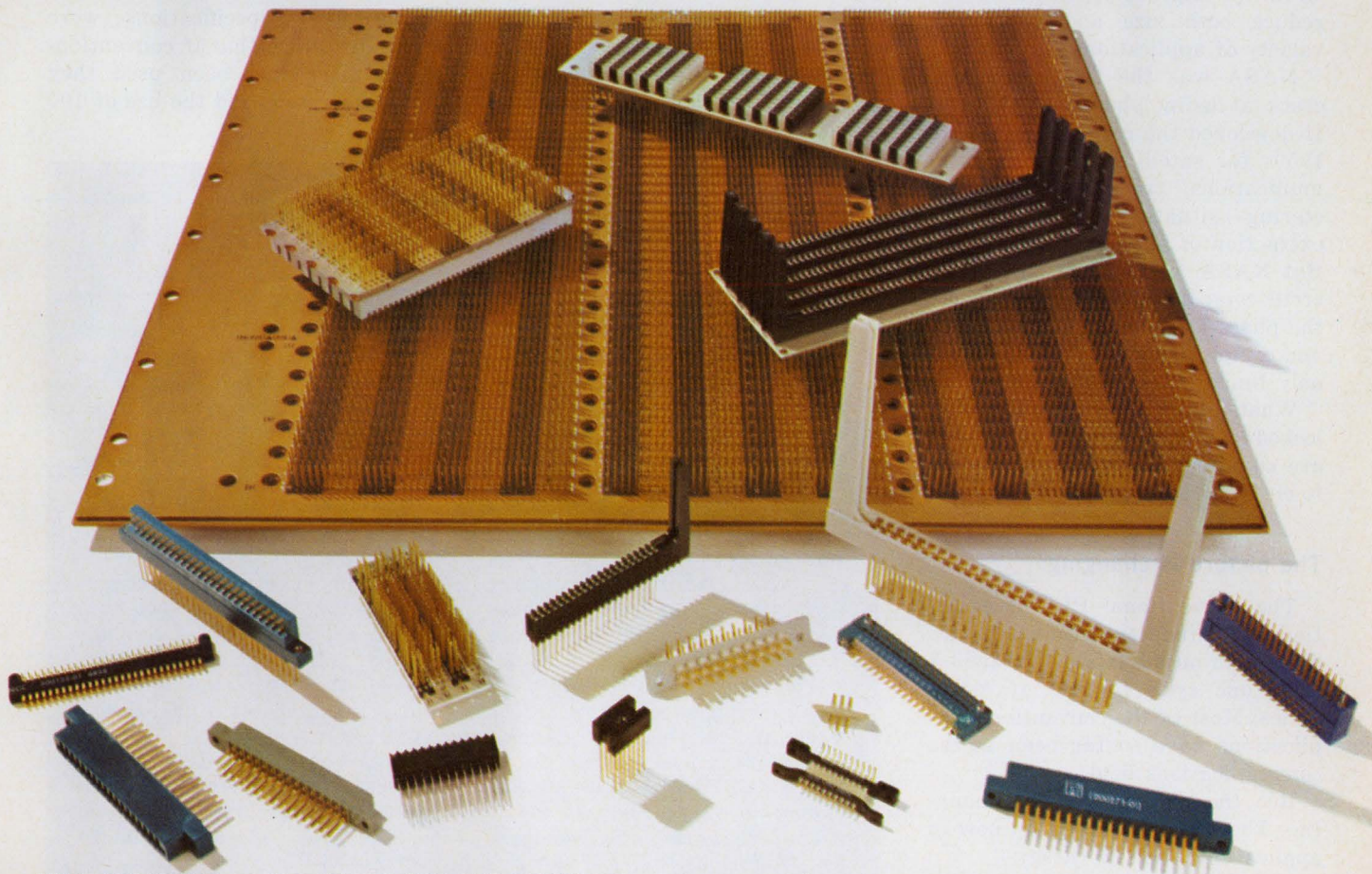

WIRE-WRAPPED CONNECTORS ARE OUR BUSINESS. Modular interconnection systems for wire-wrapping applications have been our business for over ten years. That's about as long as wire-wrapping has been around.

From the start we've concentrated on precision. Exclusive methods hold tail alignment within .010-in. radius of true position (.015-in. for .200 centers). The result: fast, accurate wrapping with no delays and no mistakes.

Our precision manufacturing assures good alignment for mating connectors too. We hold your tolerances on plates large or small, configurations standard or special. In-line or offset on .100, .125, .150, or .200 inch centers.

Stop worrying about wire-wrap connector problems.

We've already solved them. It's our business.



Write for our new connector design guide. Fabri-Tek, National Connector Division, 9210 Science Center Drive, Minneapolis, Minnesota 55428. Phone: (612) 533-5361, TWX: 910-576-2866.

FABRI-TEK[®] INC.
NATIONAL CONNECTOR DIVISION

INFORMATION RETRIEVAL NUMBER 18

Phase locked loops plus ICs— and, presto, better circuitry!

By dusting off an electronic concept known since the 1930s—the phase locked loop—and combining it with recently developed integrated circuits, designers are finding that they can substantially simplify circuitry, improve performance and reduce both size and cost in a variety of applications.

NASA was the first to take a crack at using phase locked loops. It developed the concept in the late 1950s for satellite and space communications, tracking and telemetering—situations requiring the extraction of signals deep in noise. But NASA was strapped with discrete components, and these made the phase locked loop (PLL) costly and complex. For years, PLL found only limited use in civilian design.

What a difference with phase-locked-loop ICs! In many cases they are changing historical approaches to circuit design.

The picture is changing

The conventional PLL is essentially a noninductive, tunable active filter with an adjustable bandwidth from one cycle to tens of megacycles. Most of the conventional applications have so far been in the communications field.

But the picture may be changing. The PLL is turning up now in applications such as these:

- Biomedical instrumentation for the analysis of multichannel data and brain waves.
- Precise control of studio motion-picture camera speeds.
- Low-cost computer terminal modems, as a frequency-shift keyed tone demodulator and modulator.
- Automatic direction finders, to improve bearing-pointing accuracy

Jim McDermott
East Coast Editor

and extend receiving range.

Donald Bloodworth, research associate at the Laboratory of Experimental Psychopathology in Atlanta, points to two examples to show how the use of ICs in PLLs has reduced complexity, cost, size and power requirements: a 100-channel monitor/receiver and a brain-wave monitoring system.

For the 100 channel system, the

channels lay between 300 and 500 kHz and were simultaneously transmitted on a coaxial cable. The channel sampling rate was 120 Hz. Bloodworth chose the PLLs to function as a channel-hunting selector and a narrow-band filter.

The filter specifications were tight enough so that if conventional circuitry had been used they would have required the use of 100

Phase locked loops and how they work

The phase locked loop, according to Garth Nash, section manager of systems analysis and development at Motorola Semiconductor Products, Phoenix, is essentially a closed-loop electronic frequency-controlled servo, whose output locks onto and tracks an input reference signal. A coherent phase lock is obtained by comparing the phase of the output signal with that of the reference, and any phase difference is converted to an error correction voltage that changes the output signal phase to make it track the input.

The servo has three basic parts: a phase detector, a loop filter and a voltage controlled oscillator (lower left figure). When the phase difference between the VCO and the reference signal is constant, the phase loop is locked. If either the ref-

erence or the VCO output changes in phase, the phase detector and filter produce a dc error voltage that is proportional in magnitude and polarity to the original phase change. This error voltage changes the VCO oscillator phase by altering its frequency, so that it again locks onto the reference signal.

The basic phase lock loop serves as an FM demodulator without tuned circuits, since the audio component can be extracted at output of the loop filter.

If a programmable frequency divider is inserted in the feedback path of the phase locked loop (lower right figure), the output can be made to be some multiple of the reference frequency, supplied by a crystal-controlled oscillator. This is used for multiple frequency generation, as with synthesizers.

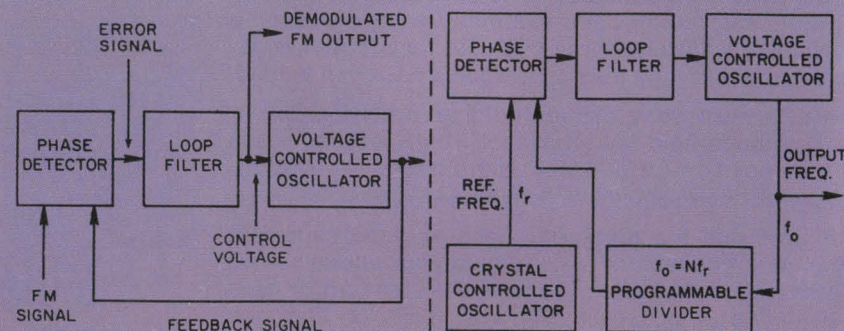

Φ-LINE SCRs 24¢



**moisture protection
doesn't
cost you more...**

and it's nice to know it's there.

Unitrode offers you hermetically sealed SCRs in metal packages at plastic prices. The bonus in reliability you'll get is performance protection in all types of environmental conditions, wherever your end products may be used. Electrically, these SCRs are equivalent to the most widely used plastic devices, but none in this price range offer the high reliability and parameter stability made possible by Unitrode's unique combination of oxide passivated junctions in hermetic packages. Unitrode SCRs range from low-voltage, low-current sensing models to high-voltage, medium current control types. All offer the versatility of lead-mounted design for easy interchangeability in hundreds of applications. The low-price, high reliability of Φ -line SCRs make them ideal for lamp or relay driving and as sensors, for use in pulse generators, timing circuits, motor controls and process controllers. (Sensing types are as low as 24¢ ea. in 100K lots.) They're in stock now, ready for immediate delivery. Can you afford not to use them? For fast action, call Sales Engineering collect at (617) 926-0404
Unitrode Corporation,
580 Pleasant Street, Watertown, Mass. 02172
Send for your free samples and complete specs today.

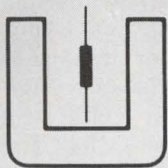

UNITRODE quality takes the worry out of paying less.

	ID 100 Series	ID 200 Series	ID 300 Series
Anode current rating	500mA @ 100°C Case	1.6A @ 70°C Case	1.6A @ 70°C Case
Voltage ratings	to 200V	to 200V	to 400V
Max. gate trigger current	200 μ a	200 μ a	200 μ a
Peak On-voltage	1.7V max. @ 1 Amp.	2.2V max. @ 4 Amps.	2.5V max. @ 4 Amps.
Package	TO-18 can, 0.5" leads	TO-5 can, 0.5" leads	TO-5 can, 1.5" leads

separate crystal filters. But Bloodworth pointed out, he used only one crystal for the basic reference signal, with digital programming of a single IC-PLL for channel scanning and selection.

In an application requiring the analysis of conventional electroencephalogram data—brain-wave recordings—Bloodworth utilized a PLL with an effective bandwidth of 2 cycles. The electroencephalogram, recorded between 4 to 25 Hz, is scanned by the PLL for signals of interest within 2 Hz bandpass.

While active filters utilizing operational amplifiers might have been used, Bloodworth noted that it would have been necessary to employ a large number and to switch the filters in discrete steps. With the PLL, the scan over the entire band was digitally controlled. And equally important, the signal search was successfully made at almost dc levels in the region of noise.

Camera speed good to 0.0001%

The improvement in speed regulation over conventional velocity

servos used to drive motion-picture cameras has been dramatic with the help of PLLs. Accuracy has jumped from 0.5% to 0.0001% in a new drive system designed by Techni-Craft Co., Pasadena, Calif.

The requirement was to synchronize several cameras taking the same scene in a studio, without connecting wires. Richard Mylius, president of Techni-Craft, says he used Motorola's MC 4404 phase and frequency detector, with feedback from the motor shaft derived from a digital electromagnetic pickup and a precisely machined gear. In this case, the motor itself acted as the VCO. The stable reference frequency for the motor drive was supplied by a crystal.

Data transmission improved

To combat the generally poor quality of data transmission over telephone networks, a Signetics 560 PLL is being used in a modem that converts frequency-shift-keyed tone signals with mark and space frequencies to and from digital data. The modem, a part of an automatic dialer and data terminal built by

Credex Corp. of Huntsville, Ala., is compatible with the Bell 301A Dataphone.

"We found," says Barry Duggan, vice president of Credex, "that the best way to combat cross-talk and distortion and to improve over-all noise rejection was to match the time constant of the PLL with the low-speed data characteristics."

The PLL replaced an earlier approach that used tuned circuits and an FM type of discriminator. While use of the PLL improved system performance, Duggan reports, it also eliminated the tuned circuits, thereby reducing the over-all cost and size of modems, and in addition eliminated magnetic interference picked up by inductors from the power supply.

Aircraft ADF made accurate

A fivefold increase in reliable bearing range and an improvement of 25 dB in the signal-to-noise threshold are only part of the success story that resulted from use of the PLL in a new aircraft automatic direction finder (ADF) receiver design, according to Joseph J. Battistelli, research engineer in the Ohio University Avionics Research Group at Athens, Ohio. The new circuitry also permits the receiver to home in reliably on ADF beacon stations only a few hertz apart in frequency. This contrasts with conventional receiver separations of up to 2 or 3 kHz. And where the bearing pointer usually swings toward lightning discharges in a thunderstorm area, the improved design eliminates this.

The new system, developed under contract to the Army Electronics Command at Fort Monmouth, N. J., improves performance by correlation of the signals from both the sense and loop antennas.

To accomplish this, a conventional ADF receiver was modified by adding a PLL (see figure) to phase-lock a voltage-controlled crystal oscillator (VXCO) signal to the i-f carrier frequency.

The reference signal is applied to the PLL phase detector and to a coherent detector in which phase coherence of both the VXCO output and the i-f carrier is maintained. The coherent detector output drives the ADF bearing-indicator. ■■

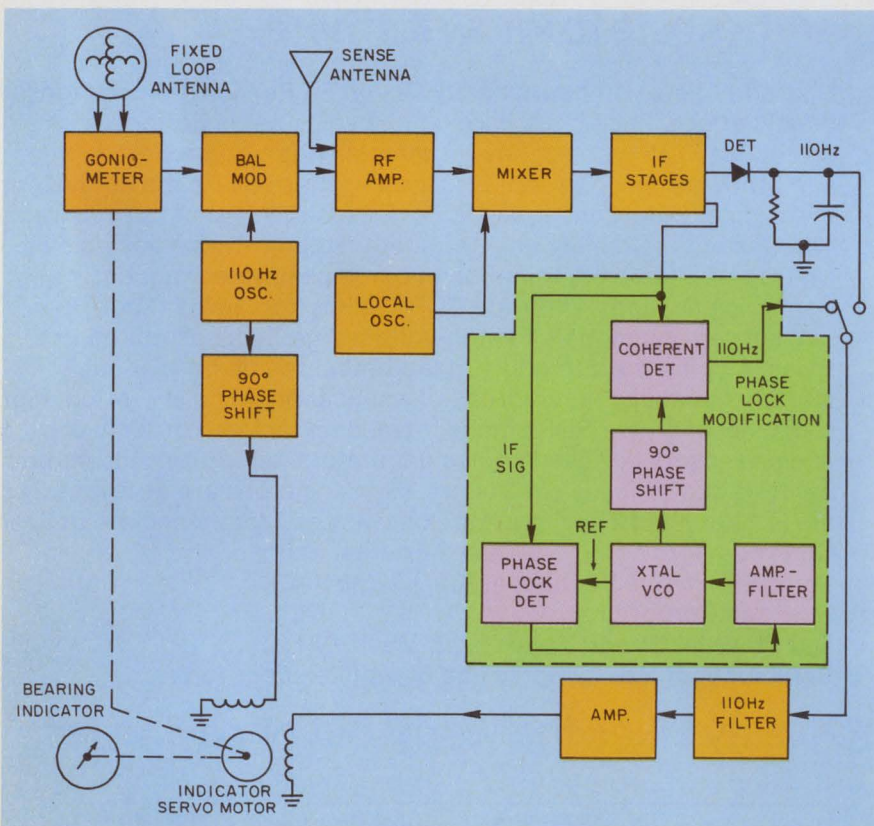

Modified ADF receiver uses a balanced ring modulator for the coherent detector. The PLL detector has a memory feature to hold the pointer steady during signal loss. The PLL modification output drives the bearing servo.

C-LINE POWER DARLINGTONS

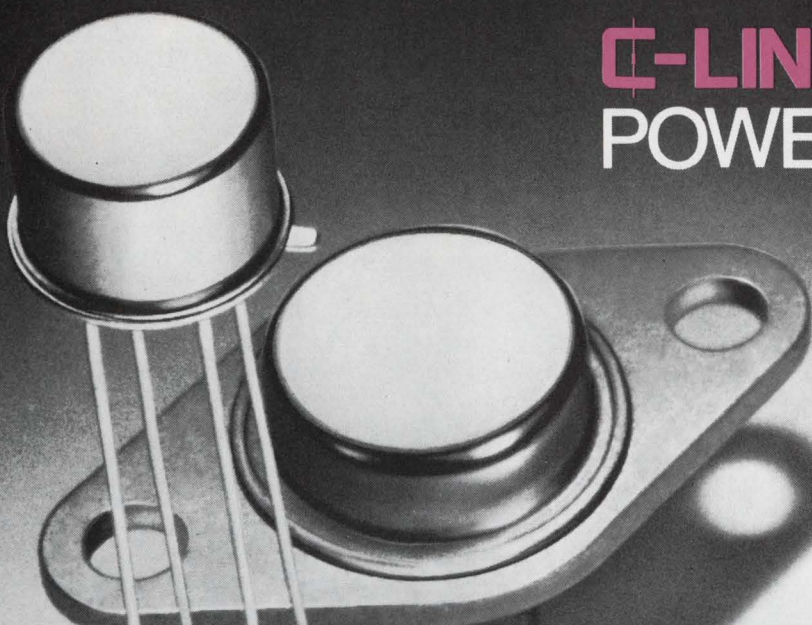

**integrated switching
circuits
cost you less...**

and make your work a lot easier.

Unitrode's new industrial 10 Amp silicon planar NPN Darlington transistors offer you the advantages of a monolithic two transistor circuit for less than the price of comparable discrete devices. They're ideal for high gain switching applications such as print hammer drivers, solenoid, servo and lamp drivers and for amplifying applications such as motor controls and linear amplifiers. They're available in two hermetically sealed metal packages — a lead-mounted TO-33 (U2T101) and a chassis-mounted TO-66 (U2T201). Both utilize overlay (multiple emitter) techniques on driver and output transistors. Saturation voltage is 1.5V max. @ 5A and current gain is 2000 min @ 5A. Collector-Emitter voltage ratings are available up to 150 volts. U2T201 has a power dissipation rating of 25W @ a case temperature of 100°C. For whatever Darlington application you have, Unitrode C-Line Darlington are more efficient and less expensive than any other method of performing the function. Why not make us prove it? (U2T101 is \$2.75 ea. in lots of 100.)

For fast action, call sales engineering collect at (617) 926-0404
Unitrode Corporation,
Dept.12B, 580 Pleasant St., Watertown, Mass. 02172

Free samples on request.



UNITRODE quality takes the worry out of paying less.

How to evaluate DEC and SYSTEMS and other small real-time computers.

Go to a company that makes a complete line for the OEM and end-user markets. Which leaves only DEC and SYSTEMS.

Forget everything you've heard. Take a hardnosed look for yourself. Compare dollars against performance—right down both lines.

If you need large memory, compare SYSTEMS 72 with the PDP-8 and PDP-11. You'll find the SYSTEMS 72 has a little more speed and a lot more memory (max. 65,000 words of programmable memory—almost twice as much as the other two). On many applications, this will cut cost as much as 40%.

If you need more speed, you'll find the SYSTEMS 82 is 4-5 times faster than the PDP-8 or 11. And because it's designed for real-time systems use, you can hang on a wide variety of analog front ends and peripheral equipment.

If you need even faster speeds and heavier software, check out SYSTEMS 810B—the fastest field-proven 16-bit machine in the business. It comes with a whole library of software including FORTRAN IV and a foreground-background-middleground programming system called Real-Time Executive.

SYSTEMS also makes some very large, very fast real-time computers. But that's another story.

As far as small real-time computers go, don't take our word for it. Send the coupons.

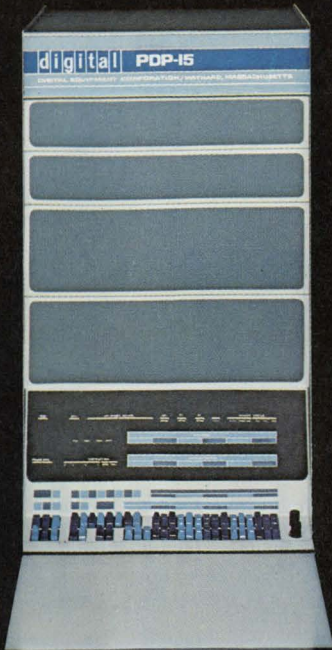

PDP-15

Word length—18-bit
Cycle time—800 nanosec.
Maximum core memory—131

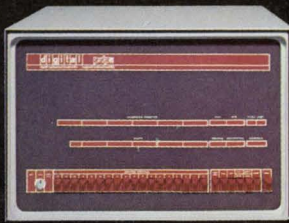

PDP-11

Word length—16-bit
Cycle time—1200 nanosec.
Maximum core memory—32

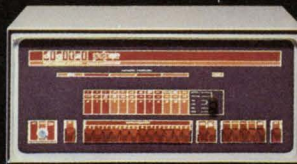

PDP-8 Series

Word length—12-bit
Cycle time—1200-1600 nanosec.
Maximum core memory—32

10

Digital Equipment Corp.

146 Main Street
Maynard, Mass. 01754

I'd like to compare the DEC and SYSTEMS lines of small real-time computers. Please send me more information.

Name _____

Title _____ Tel. _____

Company _____

Address _____

City _____ State _____ Zip _____

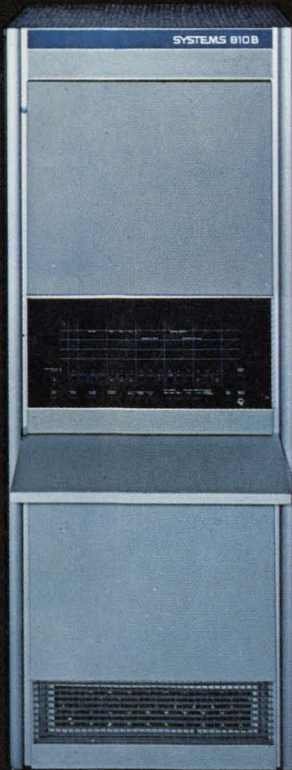

SYSTEMS 810B

Word length—16-bit
Cycle time—750 nanosec.
Maximum core memory—32

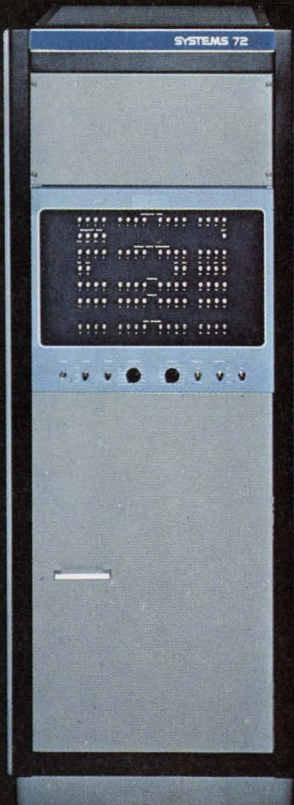

SYSTEMS 72

Word length—16-bit
Cycle time—880 nanosec.
Maximum core memory—65



SYSTEMS 82

Word length—16-bit
Cycle time—900 nanosec.
Maximum core memory—16

10

SYSTEMS Engineering Laboratories

6901 West Sunrise Blvd.
Ft. Lauderdale, Fla. 33313

I'd like to compare the SYSTEMS and DEC lines of small real-time computers. Please send me more information.

Name _____

Title _____ Tel. _____

Company _____

Address _____

City _____ State _____ Zip _____

ELECTRONICS TO PLAY BY

TRICKY CIRCUITRY FOR TOYS

Jim McDermott East Coast Editor

Not too long ago the kid with the greatest collection of Xmas toys wound them by hand to make them run. Then came toys that eliminated the wind-up; the youngsters flicked a switch, and the toys ran on batteries. This Xmas, junior chauffeurs will be playing with a school bus that closes its door and is off and running when somebody blows a whistle—no wind-up, no manual operation of a switch, just a whistle. Other young drivers will also be operating cars remotely, making them run ahead or turn left or right, by aiming a light at the tops of the cars.

The trend is unmistakable: Electronics on a more intricate scale is invading the toy industry. Circuits that respond to a variety of input stimuli are turning up in playthings: The stimuli include sound, light, heat, touch and moisture (baby doll wetting). The circuit outputs activate small motors, solenoids, light bulbs or some combination of these elements.

And between the inputs and outputs, other circuits may be interposed to produce time delays, to advance from one operating state to another, to repeat a desired sequence of events, or to perform many kinds of logic or timing functions.

Present electronics are limited to small printed-circuit board technology (see photos). An exception is the Light Beam Car, built by Kenner Products, Inc., Cincinnati, which has a ceramic substrate and thick-film resistors (Fig. 1). But, as yet, no toy manufacturer is using integrated circuits.

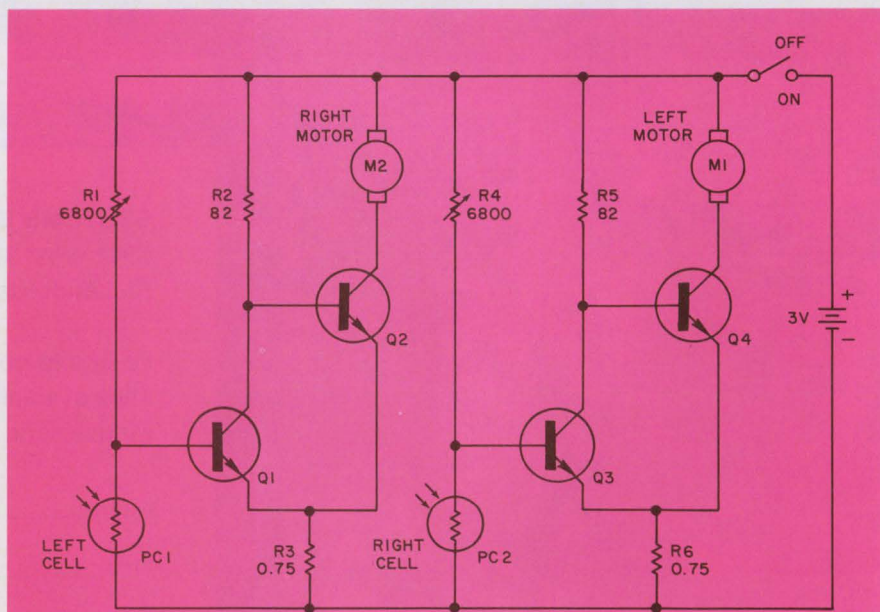
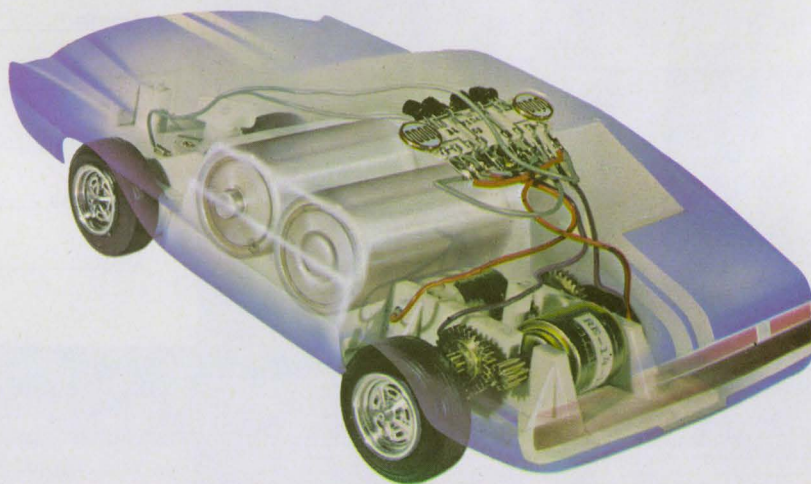

1. Photocells control motors on the rear wheels of Kenner Products' Light Beam Car. Illuminating a photocell turns the first transistor off and the second on, energizing the opposite motor. Resistors R1 and R4 serve to equalize the motor drives so that when both cells are illuminated the car goes straight ahead.

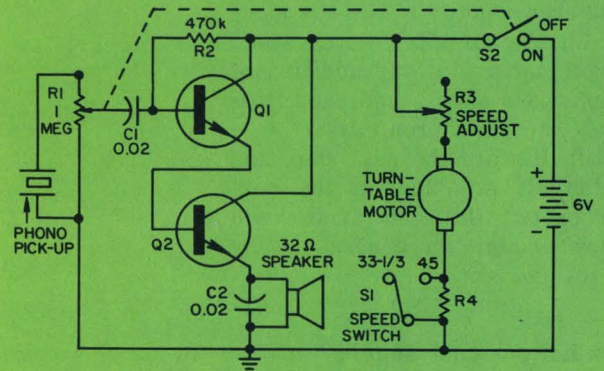
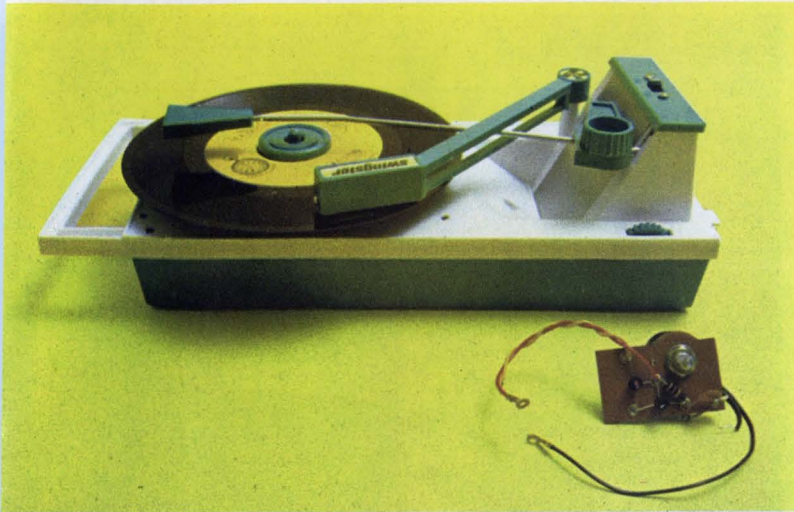

2. The Swingster phono, by Kenner Products, uses the Darlington circuit and PC board shown. Amplifier response is 70 Hz to 50 kHz.

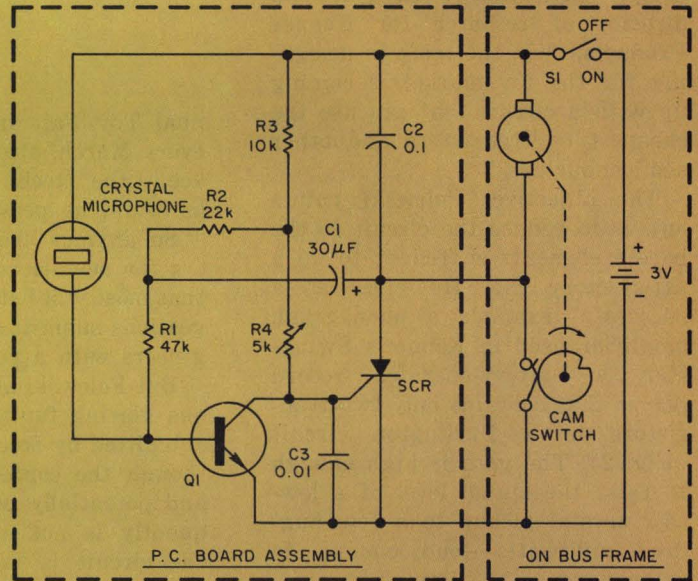

3. At the blast of a whistle, Remco's Tricky Busy School Bus closes its door and starts up. The PC board and circuit shown have an SCR that is triggered by the whistle-signal output of the microphone, amplified by transistor Q1. With the bus stopped, the cam switch is open, and starting motor current flows through the SCR. As the bus moves, the cam switch closes, shorting out the SCR and returning it to a nonconducting state. When the bus stops, the voltage across C1 holds Q1 off for 1.5 to 2.5 seconds.

Why not? The answer is the same everywhere: If the ICs alone had all the circuitry, costs would be acceptable. But the addition of peripheral resistors and capacitors makes the price prohibitive.

Still, ICs are the next step, and predictions are that in the next year or two the costs of ICs will be low enough for general use by the toy industry.

Rock-bottom cost sought

Designing electronic packages for battery-operated toys is tough because of the stress on rock-bottom cost.

"Practically anyone can 'cook-book' a circuit, such as an amplifier or Schmitt trigger or time delay," says Robert E. Polewski, director of research for Kenner Products, "but the trick in designing for the toy market is coming up with a circuit that can use the cheapest of transistors and other semiconductors."

The objective, Polewski points out, is to reduce the circuit to the barest elements sufficient to do a satisfactory job. He gives as a successful example a phonograph amplifier used in Kenner's Swinger, a battery-operated record player that contains only two transistors in a Darlington circuit (Fig. 2). The gain is high enough to raise the signal level of a low-cost crystal pickup to a few hundred milliwatts—loud enough to drive parents to distraction.

The school bus that operates at the sound of a whistle uses a crystal earphone for a microphone and only two semiconductors, a transistor and an SCR. The sound, amplified by the transistor triggers the SCR to start the bus motor. A cam and switch control the cycle time (Fig. 3). The bus is manufactured by Remco Industries, Inc., of Harrison, N. J., and is being marketed as the Remco Tricky Busy School Bus.

Development in secret stressed

The development of toys like these traditionally takes place in a super-secret atmosphere, with factory security as tight as that at the Pentagon. Competition is keen in the toy industry, and even when prototypes are unveiled at the an-

nual Toy Fair in New York City every March, attempts are made to keep the techniques of design as secret as possible.

So anxious are toy manufacturers for new, clever electronic ideas that most will listen eagerly to suggestions submitted by freelance engineers with a penchant for toys.

But Polewski also points out that one glaring fault with many ideas submitted by freelancers is that although the concept may be clever and potentially worthwhile, it frequently is not acceptable because the circuit is too complicated. It simply will be too expensive to manufacture. For the mass toy market, Polewski says, the OEM cost of an operating printed-circuit device should preferably be less than \$1 in large quantities.

Patrick Tomaro, senior vice president of research and engineering at Remco Industries, notes:

"A clever circuit by itself isn't generally useful. From a practical viewpoint, it's necessary first to create the concepts of what the toy is to do, then devise the electronics to make it feasible."

Safety can be a problem

There are other problems in design. While the designer of battery-operated toys is plagued by battery rundown, those designing toys that run on 110-V ac must consider safety factors. The design must

protect children against possible shock from biting the line cord, from sticking screwdrivers or metal rods through holes in the toy, or simply from tearing the toy apart and exposing live portions of the 110-V house circuits.

Underwriters Laboratories has issued safety guides for the designers of toys. These are found in "Standards for Safety, Electric Toys," Bulletin UL 696, third edition, October, 1966, plus revisions. Some of the more important UL suggestions include these:

- If hazardous voltages are present inside the toy, it must be assembled so that it can't be taken apart with pliers or screwdrivers (hammers excepted). The toy must be able to withstand a series of drops from three feet to a hard surface without breaking.

- The line cord must be fastened securely enough to withstand a one-minute pull of 35 pounds.

- Switches and lampholders must be mounted securely enough to prevent turning.

- Toys must be capable of withstanding a 60-Hz sine wave breakdown potential of 900 V, applied between live and dead metal parts.

- Should the toy use a low-voltage transformer, either in the form of a conventional transformer or as the insulated coil of a motor, it must withstand for one minute a 60-Hz breakdown potential of 1000-V plus twice the rated voltage



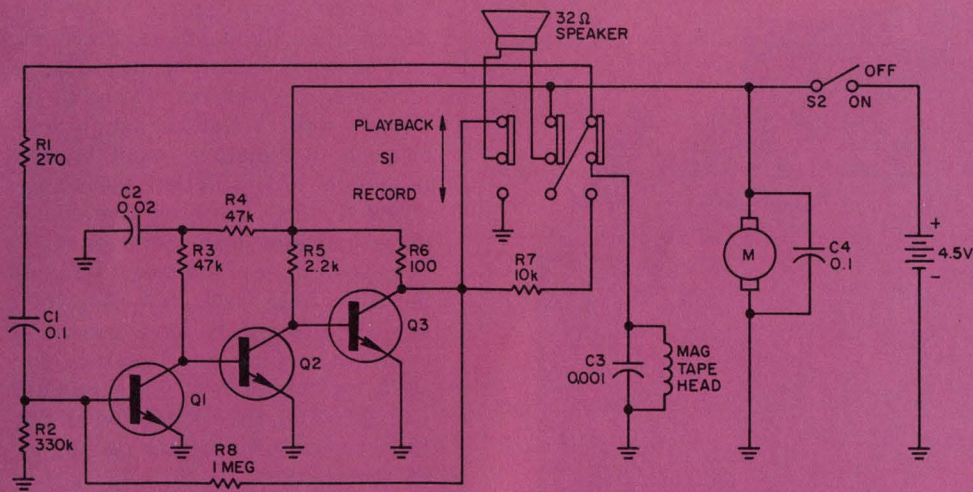

4. An endless-loop tape cartridge is used in this Say-It-Play-It tape recorder by Kenner. In the record mode, the speaker is the microphone, feeding the direct-coupled amplifier. The tape is erased with a small magnet.



Looking over their work are Richard Culbertson and Joan Klatil, designers for GE's Youth Electronic Section. Tivoli Tim the soldier, and Battery Barney the clown, are small radios. The Circus Wagon is a 110-V clock radio designed

for the child's safety. The case is fastened together with pins that must be drilled for disassembly, and the line cord is "chewproof". A transformer steps the line voltage down to 28 V for the transistor radio.

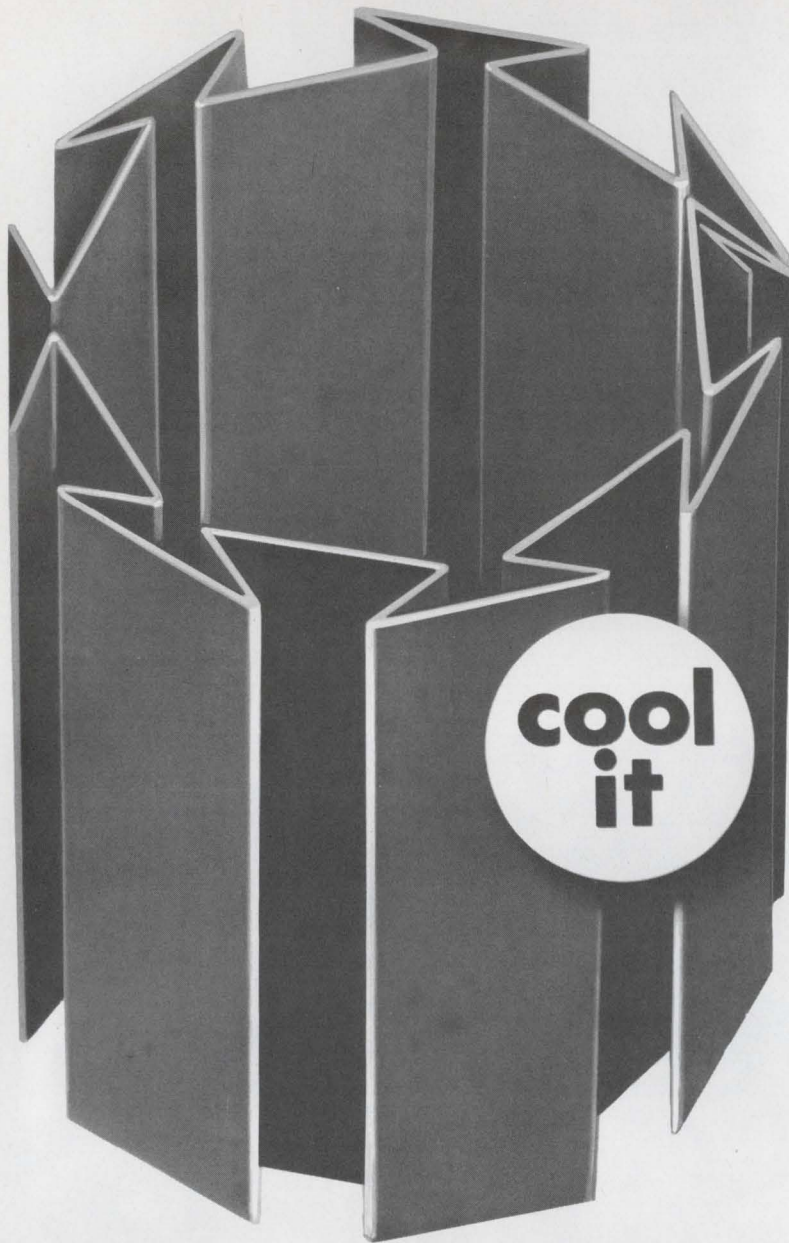

Atlee's delta-wave configuration keeps components 80°C cooler than other inserts.

Atlee has a complete line of full-contact heat dissipating inserts for cooling many types of electronic components. Made of beryllium copper to provide unexcelled heat conduction. Provide cooling when used inside cans or castings or are interlocked to form a circle and slid over the component.

Exclusive delta-wave design proves more effective

than that of any conventional insert because more than 80% of the surface contacts the flat area of the delta. Particularly effective when forced air systems are used. Available with or without finish, cut to any length, or in rolled uncut form. Write today for complete information and samples. Atlee Corporation, 2 Lowell Avenue, Winchester, Massachusetts 01890.



atlee corporation

INFORMATION RETRIEVAL NUMBER 22

of the high-voltage winding.

- After conditioning a toy for 24 hours in air at 32° C (89.6° F) and relative humidity of 85%, a hand-held toy, or one likely to be cleaned with a wet or damp cloth or used in moisture, must have a minimum of insulation resistance of 50-K ohms between live metal parts and any dead metal parts.

- Toy motor control switches must perform satisfactorily when subjected to an overload test of 50 cycles of making and breaking the stalled rotor current at maximum voltage. And the switch must not fail because of burning or pitting of the contacts.

- Heavy, "anti-chew" line cords must be used for ordinary room conditions. For elevated temperatures or wet conditions, jacketed cords are necessary.

Billions in sales reported

Does engineering for toys pay? The potential is great. Last year the toy industry shipped \$2.04-billion worth of products from its factories, and for the first half of this year, shipments rose by 14.8%, according to Edwin J. Nelson Jr., president of Toy Manufacturers of America, Inc., New York City, the industry's trade association. Nelson predicts that if sales continue at this level, the 1970 total of factory shipments will reach \$2.24-billion, a healthy increase.

At least one big manufacturer, General Electric, is convinced that higher-priced, high-quality toys are a growth market. GE has organized a new Youth Electronics Section in Utica, N. Y., dedicated to the design and marketing of children's audio-visual educational products, portable record players designed around Walt-Disney character motifs, clock and toy radios, and a line of quality children's walkie-talkies to compete with the Japanese deluge of these devices.

In addition GE's Semiconductor Products Dept. at Auburn, N. Y., has a special engineering group engaged in analyzing toy electronics and consulting with toy manufacturers and their designers.

So far as the toy industry is concerned, it isn't toying with electronics. Clever circuitry is becoming a mainstay of this highly competitive business. ■■

INFORMATION RETRIEVAL NUMBER 23 ►

You've met Skinny Mini II...

Now meet Skinny Mini IV.

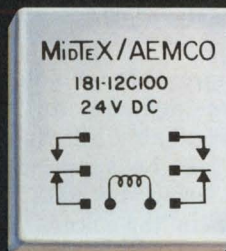
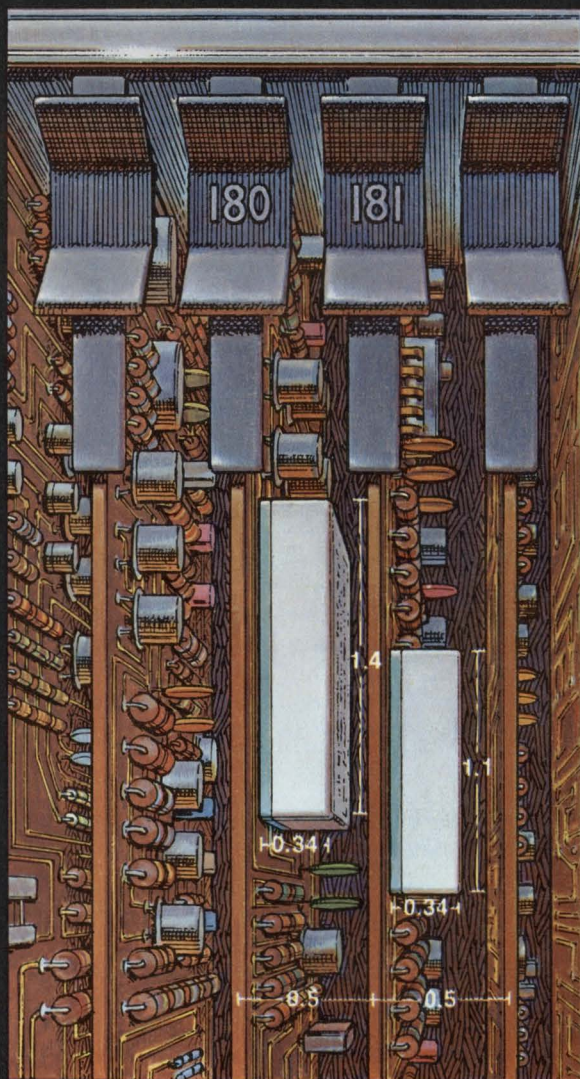

SKINNY MINI II, the first 2 amp 2PDT relay skinny enough to mount on 0.5 PCB centers, has an off the board height of just 0.340 inches. Cheaper than a crystal can, handles more power than a TO-5 relay, and provides true Form C switching which micro-reeds do not provide. Call her Midtex/AEMCO Type 181, if you wish.

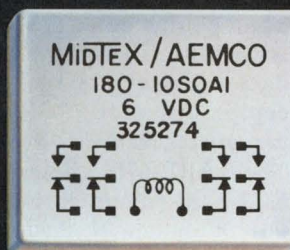

SKINNY MINI IV, the first 2 amp 4PDT relay skinny enough to mount on 0.5 PCB centers, has all the features of her sister, plus 2 more poles and a silly .3 inch increase in length. Affectionately called Midtex/AEMCO Type 180, Skinny Mini IV, like II, provides 1/16" clearance through air and 1/8" over surface. Terminals are 0.025"

pins. The relay mounts on four raised pads to permit proper PCB cleaning and soldering. Both Skinny Minis are smaller than any other 2 amp industrial relay, and they come with low-level gold, fine silver, or silver cadmium oxide contacts. For more information about either Skinny Mini II or Skinny Mini IV, write or call Midtex/AEMCO, 507 388-6286, or see a Midtex/AEMCO representative.

AEMCO DIVISION

MIDTEX 
INCORPORATED

10 STATE STREET
MANKATO, MINNESOTA 56001

NEW MICRO-MINIATURE CERAMIC TRIMMER CAPACITOR



now
available for
45¢ in quantities
of 1,000



We are pleased to introduce the 9300 series. You will find the unit is truly micro-miniature (.315 high with a .276 diameter and .200 pin spacing). Its rotary assembly is designed with special ceramic materials which provide longer life and complete environmental stability. Capacitance values are available up to 70 pf. For immediate delivery, please phone (201) 334-2676.

STOCK MODELS

MODEL	CAPACITY RANGE pF	TEMP. COEF. @ ±10MHZ	MIN. Q
9312	2.8 — 10	—350 PPM/°C	300
9313	3.2 — 18	—550 PPM/°C	300

MANUFACTURING CORPORATION

400 ROCKAWAY VALLEY ROAD
BOONTON, NEW JERSEY 07005

ELECTRONIC ACCURACY THROUGH
MECHANICAL PRECISION

technology abroad

A new telecommunication system to serve Europe, the Middle East and parts of Africa has been proposed for installation between a German and a French terminal, and then by undersea cable to Green Hill, N. J. The new system, will be built, owned and operated by the Deutsche Bundespost and the French Ministry of Posts, with AT&T as the American partner. It would handle 825 voice circuits and could increase service to the Indian Ocean area by a ground station-to-satellite link. The plan is now awaiting FCC approval. Communications traffic between Germany and the U. S. alone increased by 60% in May, June and July of 1970 as compared with the same period a year ago. For Europe as a whole, telecommunications with the U. S. has increased by 43% this year as compared with 1969.

To improve Japan's defense capabilities against air attacks, 32 ground-to-air communications links will be supplied to Hitachi Ltd., Tokyo, by RCA in cooperation with the Okura Trading Co. Ltd. They will be used in (JA)F-4E tactical aircraft to be built for the Japanese Self-Defense Force. The equipment, designated the ARR-670, will receive and process data necessary to vector an interceptor aircraft to an airborne target tracked by ground radar. The ARR-670, being built by RCA's Communications Systems Div., Camden, N. J., under a \$2.5-million contract, will use time-division multiplexing so that a ground control center can transmit vectoring data on many separate targets simultaneously to an equal number of interceptors.

New solid-state optical card, tape and character readers using hybrid packaging techniques have been developed by Integrated Photomatrix (IPL) Dorset, England. One device, a transparent, epoxy-encapsulated package with nine MOS light-activated switches reads standard tapes at speeds in

excess of 3000 characters per second. Each MOS switch is fabricated on a 0.04-inch-square MOS chip and mounted on 0.1-inch centers on a ceramic substrate. A more complex array by IPL has 50 in-line light sensors, together with a shift register. With this unit optical data is inserted simultaneously and read out serially.

A miniature, battery-powered, solid-state laser, capable of continuous operation at room temperatures, was announced by the Standard Telephone Laboratories of England within a few days of Bell Laboratories' announcement of the same device in the U. S. A. The English laser, slated for application in optical communication systems, is fabricated like the Bell laser and is mounted on a chip 1/2 by 1/3 mm in area. In a communications system, the output from the new laser would be directed into the ends of low-loss fiber optics cables carrying wide-band communications signals.

Electrical switching properties in a liquid tellurium-selenium alloy at temperatures ranging up to 200° above its melting point have been observed at the Swiss Federal Polytechnic, Zurich by researchers of the Physics in Solids Laboratory. The switching property was noticed when current-voltage traces were observed to contain sharp breaks. The physics of how the effect works—and whether or not it is related to solid state switching—is yet unknown.

Soviet scientists have successfully pumped a laser with neutrons while much of the world is speculating about the feasibility of triggering a nuclear reaction with lasers. A research team from Moscow State University bombarded a mixture of helium-3 and mercury vapor with high fluxes of neutrons (5 by 10⁶/cm²/s) and produced 10 mW of lasing light at 6150 Å. ■■

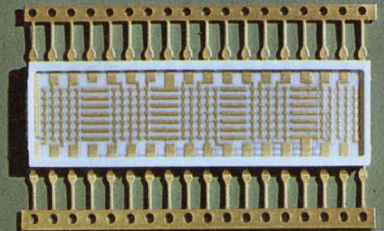
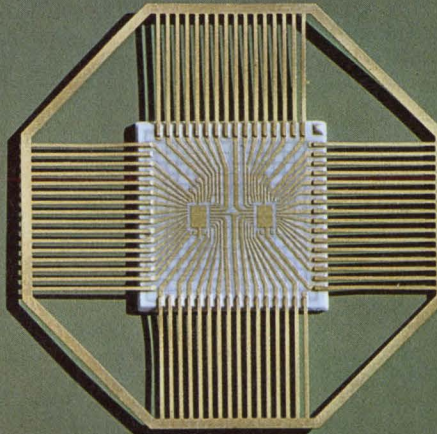
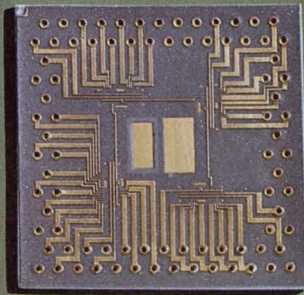
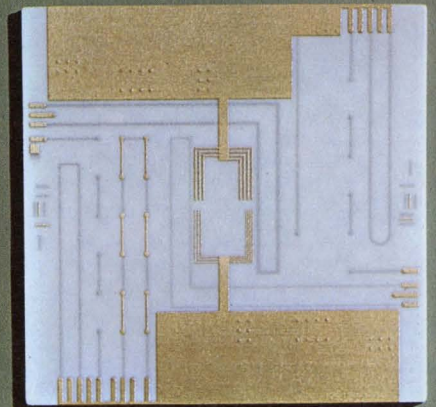
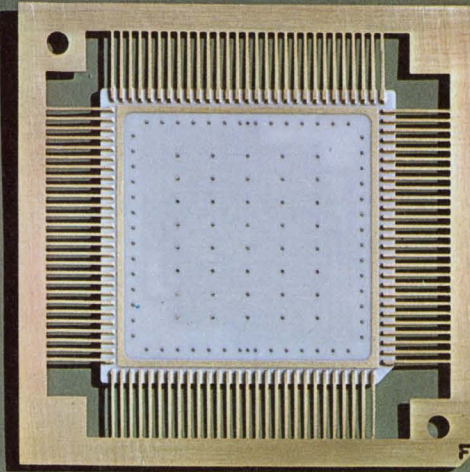
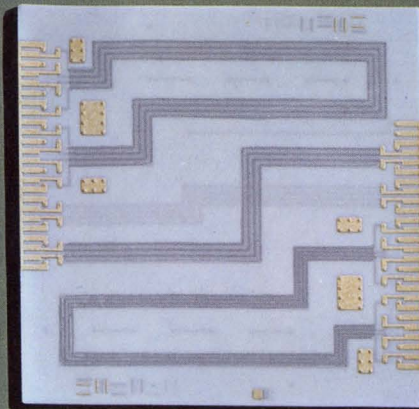
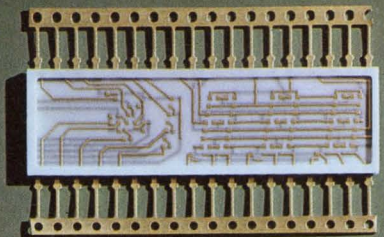
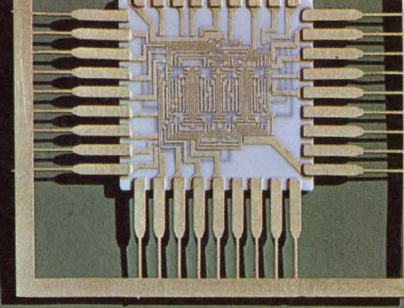
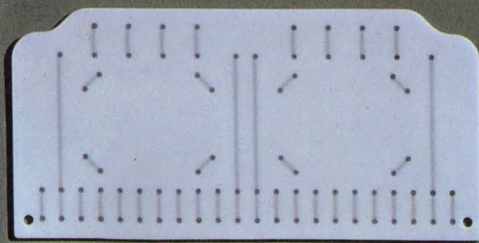

Illustration approximately actual size.

MULTI-LAYER

AlSiMag[®] Composite Substrates

Tremendous advances continue in these custom made, monolithic multilayered structures of electrically conductive patterns separated and insulated by planes of high-alumina ceramic (no glass). Prototypes frequently are the stepping stones to major ad-

vances. By getting together with people to see what we can work out, dramatic progress continues to be made. Best designs have evolved through head to head conversations. A folder giving present design parameters will be sent on request.

CONSIDER FOR:

MULTI-CHIP CIRCUITS

(Both Bi-polar and MOS)
Chip Attachment may be Flip Chip or Beam Lead.

CHIP CARRIERS

LIGHT EMITTING DIODE ARRAYS
Can be made in any number of layers.

COMPLEX THIN FILM, THICK FILM, or ETCH BACK CIRCUITS

(Standard buried conductor paths permit you to customize the top layer.)

CODE IDENT. NO. 70371

PHONE 615/265-3411 • CHATTANOOGA, TENNESSEE 37405, U.S.A. A SUBSIDIARY OF

American Lava Corporation 3M COMPANY

For service, contact American Lava representatives in Offices of Minnesota Mining and Manufacturing Company in these cities (see your local telephone directory): Boston: Needham Heights, Mass. • Chagrin Falls, O. • Chicago: Elmhurst, Ill. • Dallas, Tex. • Indianapolis, Ind. • Laurens, S. C. • Los Angeles, Calif. • Metropolitan New York: West Caldwell, N. J. • Up-State New York and Canada: Phoenix, N. Y. • Orange, Conn. • Philadelphia, Penn. • St. Louis: Lee's Summit, Mo. • Salem, Va. • S. San Francisco, Calif. • Tempe, Ariz. • International: c/o American Lava Corporation, Chattanooga, Tenn. 37405, U.S.A. TELEX 558432

69th
YEAR
OF
CERAMIC
LEADERSHIP



Bodine helps copiers/duplicators stay sharp, quick, reliable

Small. Quiet. Run reliably in long, hard, heavy-duty usage. Bodine fractional horsepower drive systems meet the needs of copier-duplicator operations. Bodine designs and builds exceptional performance and service-life into every drive and control unit. For they have a reputation to live up to: *Yours!* This means fewer callbacks. Fewer field service problems. Power that meets the dependability standards you've engineered into your product.

Whatever your product—copier, duplicator, business machine, instrumentation—specify Bodine fhp drives and controls. Over 3,500 standard specifications to choose from. Bodine also builds custom fhp drives and controls to meet design requirements. Our engineers will gladly help pinpoint the right one for your application. Write for bulletin. Bodine Electric Company, 2500 W. Bradley Place, Chicago, Ill. 60618.



Bodine Motors Wear Out—It Just Takes Longer

**BODINE MOTORS/GEARMOTORS
SPEED CONTROLS**

washington report

DON BYRNE, WASHINGTON BUREAU

A domestic satellite decision planned by 1971

A final decision on domestic satellites and who will operate them will probably be made by the Federal Communications Commission not more than six months to a year after the filing of the last application. And, right now, it appears that the final application will be in by next spring.

The FCC has an option on whether to hold hearings once all the applications have been filed, but such hearings have been known to run four or five years. FCC officials have told *ELECTRONIC DESIGN* that it's unlikely they will make the country wait that long for domestic satellite service. Present plans are to license a system without holding hearings.

Applications by Western Union and, jointly, AT&T and Comsat are pending before the commission. Microwave Communications, Inc., and its affiliates have also said they wish to file and have been granted an extension until Feb. 28. MCI said it wants to explore using the higher 12-GHz band, which is less crowded than the 4 and 6-GHz bands originally designated for domestic satellites. In addition the broadcasting networks have also been granted an open-end extension, so they can study a report on satellites made for them by Page Communications Engineers.

The networks' eventual decision is regarded as a key factor, because television transmission revenues will have a great economic impact on the company that wins the FCC nod to operate the satellite system. The networks must decide whether to operate their own system or to lease facilities from the satellite operator, as they now do from AT&T's terrestrial facilities.

NASA fighting to maintain present spending level

National Aeronautical and Space Administration brass are meeting with Budget Bureau officials in an attempt to head off budget cuts in the coming fiscal year. NASA feels that its budget request of last winter, \$3.3-billion, is the very minimum it can accept if the manned space flight program is to continue, and it is asking the Budget Bureau to approve a similar amount for the coming year. But there is little optimism in the space agency as it and other Government agencies are being told by the Administration to pare to the bone. NASA knows, too, that it faces a tough fight in Congress in the coming year, with manned-flight critics in a position to cite Russian successes in unmanned space exploration.

House committee will push for more Navy vessels

The House Armed Services Committee is quietly gearing for a battle in Congress to provide the Navy with more and better ships. Committee Chairman L. Mendel Rivers (D—S. C.) has been stumping for a more modern Navy and, in particular, for more nuclear-powered, Poseidon-carrying submarines. The feeling on Capitol Hill is that if the Navy does not request the ships, the House committee will add them to the

authorization bill anyway. No new carriers are expected; the emphasis will be on submarines, anti-submarine warfare vessels and missile-carrying surface ships.

Airlines continue attack on FAA's efforts in R&D

The Air Transport Association, continuing its assault on the Federal Aviation Administration's R&D efforts as largely irrelevant to airline needs, says now that while nearly all American airliners are equipped with code transponders and "perhaps half our fleet is transmitting automatic altitude reporting information, only two [FAA] operational facilities in the United States can use the altitude information." The rest of the time, the association says, "we transmit altitude data to nobody in particular."

Lockheed still heads Defense Dept. contract list

Despite all its financial problems with Government contracts in the last year, Lockheed, for the second year in a row, is the No. 1 defense contractor in the nation. It received \$1.84 billion in Defense Dept. procurement awards and \$526-million in R&D work in fiscal 1970. Ranked behind Lockheed are General Dynamics, General Electric, AT&T, American Rockwell, Grumman, Litton and Hughes Aircraft.

NASA to test uhf satellite for air traffic control

NASA's Applications Technology Satellite-F2, scheduled for launching in 1973, will carry, along with other equipment, a uhf transponder in the 1,500-to-1,700-MHz frequency band to test absolute and relative accuracy in fixing aircraft positions and the possibility of using satellites for two-way communications between the ground and multiple aircraft. The airlines and the Federal Aviation Administration want a hybrid satellite with vhf and uhf capability, since U. S. airlines use vhf equipment. NASA and European airlines and governments favor the uhf satellite.

Capital Capsules: The National Bureau of Standards has "cleared" a dozen or more makes of microwave ovens it has been testing for possible radiation hazards. The main cause of excessive radiation seems to be just plain old dirty ovens, with resultant improper sealing. . . . The Federal Aviation Administration has awarded a \$1.02-million contract to IBM's Federal Systems Div. for software modifications at 20 air traffic control centers. . . . Slowdowns and cutbacks in the Apollo program have led NASA to close down three ground tracking stations and to retire three tracking ships and four tracking aircraft in the last year. . . . Microwave Communications of America, Inc., says it hopes to begin microwave data communications service in February between St. Louis and Chicago. MCI wants to sign a contract with AT&T for local interconnections for its customers. . . . NASA is investigating an allegation by the General Accounting Office that Boeing overcharged NASA \$2.7-million on Apollo Saturn 5 booster work and thereby made a \$695,000 profit it shouldn't have. In another case, Boeing's \$321,000 contract with the Federal Water Pollution Control Administration for computer time-sharing is being protested by other bidders who contend Boeing is using its private company phone system to move the data in violation of FCC regulations.

Tektronix *expands* . . .

. the valued plug-in concept

The New Tektronix 7000-Series Oscilloscope System does more of what a plug-in oscilloscope is intended to do. With four-plug-in flexibility, and new operator convenience, you make more measurements with fewer errors and less effort.

Four-Plug-In Flexibility

Tektronix single and dual plug-in oscilloscopes proved the value of the modular approach to solving measurement problems. Now the added ability to *simultaneously* use multiple plug-ins—with similar or widely different features—makes the plug-in concept even more valuable. Tektronix 7000-Series Oscilloscopes offer bandwidths up to 150 MHz, four-plug-in flexibility, and mainframe versatility, to display more measurement data in a single setup than any other oscilloscope system. Multiple plug-ins minimize the loss of valuable time and the inconvenience caused by having to repeatedly interchange plug-ins to solve a measurement problem. If you wish, start with only one horizontal and one vertical plug-in and add more as your measurement requirements change.

Wider Performance Spectrum

Some features which widen the performance spectrum of the seventeen plug-ins currently available are: dual trace, 105 MHz at 5 mV/div (four trace, 105 MHz with two units) • differential, 100,000:1 CMRR at 10 μ V/div • differential comparator, 100 MHz at 1 mV/div • random or sequential sampling, 25 ps t. (depending upon the sampling head) • two new single-trace amplifiers, 150 MHz at 5 mV/div • current amplifier, 105 MHz at 1 mA/div • 500 MHz digital counter • and a digital multimeter that also measures temperature.

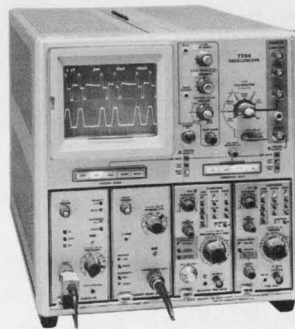

More Convenience

Convenience is another outstanding feature of the 7000-Series Oscilloscopes. Auto Scale-Factor Readout, a Tektronix exclusive, labels the CRT with time and frequency; volts, amps, ohms and temperature (C); invert and uncal symbols and corrects the readout for probes and magnifiers. Color-keyed panels, lighted push-button controls, peak-to-peak auto triggering, and trace-identify switches on probe tips and plug-in panels are just a few of the many convenience features which mean faster, easier measurements with fewer errors.

Your Tektronix Field Engineer will gladly discuss with you the complete FLEXIBILITY, VERSATILITY and CONVENIENCE of the NEW

7000-Series Oscilloscope System. Contact him locally or write: Tektronix, Inc., P. O. Box 500, Beaverton, Oregon 97005. See your 1970 Tektronix Catalog and Supplement for specifications and descriptions of the entire 7000-Series including the NEW 7514, DC-to 90 MHz, Storage Oscilloscope.

Prices of instruments shown:

7704 150-MHz Four-Plug-In Oscilloscope	\$2500
7A16 150-MHz Single-Trace Amplifier	\$ 600
7A14 105-MHz Current Amplifier	\$ 575
7B71 Delaying Sweep Time Base	\$ 685
7B70 Delayed Sweep Time Base	\$ 600
Blank Plug-In Panel, order 016-0155-00	\$ 6

U.S. Sales Prices FOB Beaverton, Oregon

Available in U.S. through the Tektronix lease plan



TEKTRONIX®

committed to
technical excellence

INFORMATION RETRIEVAL NUMBER 27

FOR A FLEETING MEMORY . . .

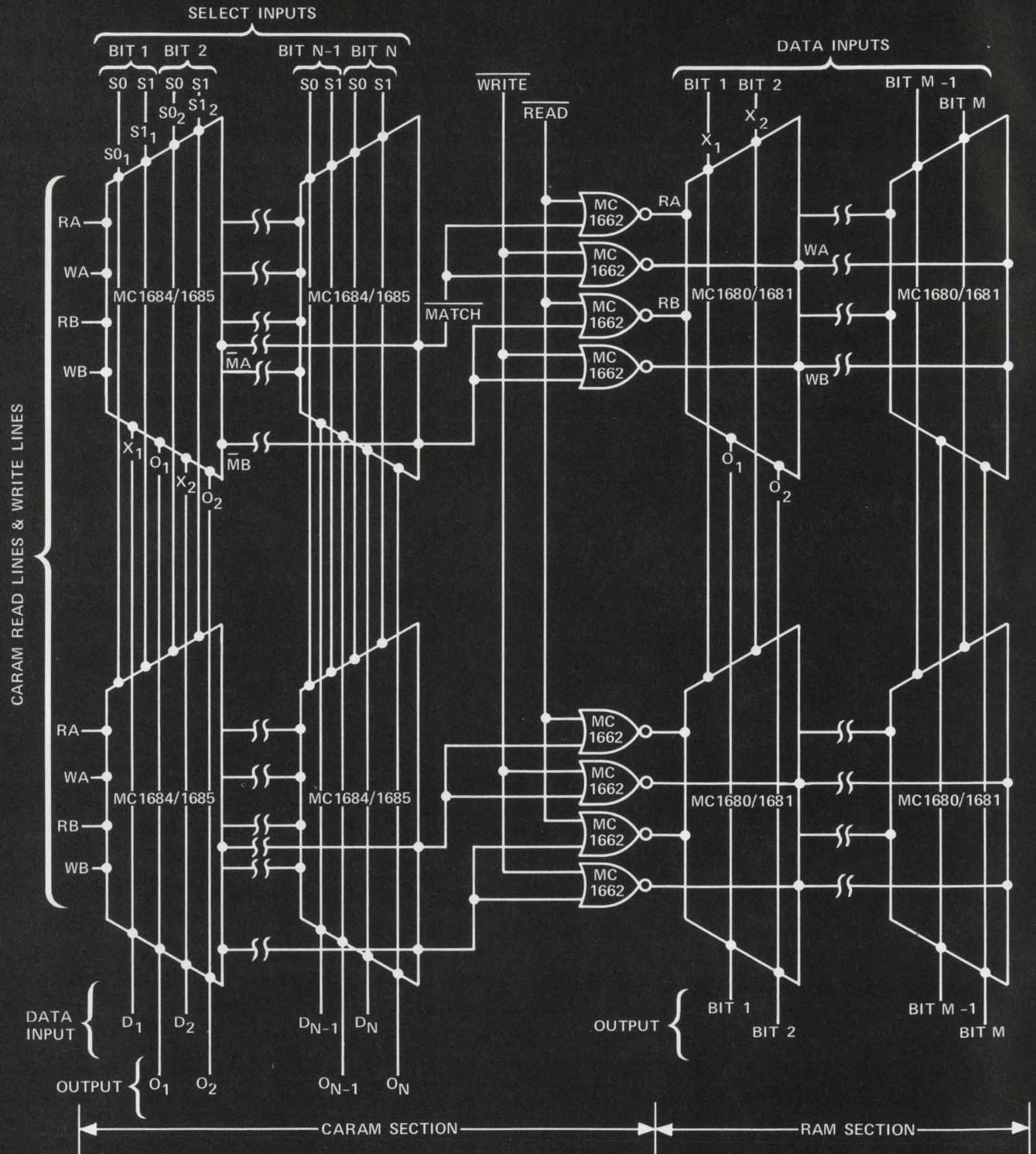

CAM/RAM BUFFER MEMORY

MECL III OFFERS THE FASTEST

Picture a computer with limitless storage capacity and instantaneous retrieval. Impossible? Today, yes — but new technologies are providing more rapid access to data, and performance of high-speed memory functions outside the main storage memory are paving the way to the ideal computer. MECL III now introduces three basic memories to meet state-of-art requirements for high-speed buffers and applications requiring rapid storage and transfer of data.

The MC1684 (High Z)/MC1685 (Low Z) Content Addressable Random Access Memory performs the read-write (scratch-pad) function *plus* the content addressable (interrogate-match) function. In other words, information may be written-in, read-out and the memory may be interrogated to check its contents. Typical read, write and search delays are 2.5-3 ns, 4 ns and 2.5-3 ns, respectively.

The MC1680 (High Z)/MC1681 (Low Z) Random Access Memory is sometimes called a decoded scratch-pad memory. Data can be entered or read out of the memory from either of two words simultaneously. Recommended for ultra-high performance applications, the MC1680/1681 features typical 2.5 ns access times and a write delay of 3 ns. Computer interrogation is speeded through application of the MC1682 (High Z)/MC1683 (Low Z) Content Addressable Memory. Sometimes called an associative memory, the MC1682/1683 features a search (interrogate) delay of 2.5-3 ns and a write delay of 4 ns, both typical values.

As illustrated, the MC1684/1685 CARAM and MC1680/81 combine to form a very high speed buffer memory. When a word is required from the mass storage memory, it is placed in the RAM portion of the buffer for future access. The word's address in mass storage is placed in a content addressable memory tied to the random access section thereby allowing words to be addressed by their mass storage location in one cycle time of the buffer memory.

As the address of the desired word is presented to the content addressable section, the CAM will indicate (in one cycle time) if the address is in the CAM and if the desired word is available in the buffer. If the word is present, the desired read and/or write function can be performed at buffer RAM speeds. If the word is not present it must be brought from the slow mass storage through 'push-down pop-up' techniques. Through the use of the CAM/RAM Buffer Memory, the effective access time is a function of the memory access sequencing and not the mass storage access time.

For further details on these high-speed memories write to Motorola Semiconductor Products Inc., P. O. Box 20912, Phoenix, Arizona 85036. Evaluation devices are available at your nearby Motorola distributor. MECL III provides the fastest memory functions available today. Design in and THINK FAST!



MOTOROLA MECL
the only way to go . . . FASTER

Our 5000 and 7500 permeability Ceramag[®] ferrite materials can pack a terrific amount of inductance into a small size.

And the higher the perm, the fewer turns required. Results. Lower distributed capacity. Material savings. Improved performance.

Ceramag[®] 24H offers the designer a true 5000 permeability. New, Ceramag[®] 24K is also a true 7500 permeability. Both materials hold their permeability over a wide range of sizes.

Ceramag[®] 24H and 24K are production materials, ready for immediate use in your design. Stock available in some sizes.

Precisely engineered, Stackpole ferrite materials are produced by exact processing, density checks, rigid kiln controls and accurate sintering. You get more out of Stackpole Ceramag[®] materials simply because we put more into them.

Study the characteristics of 24H

	$\frac{L}{N^2}$ (nh) TOROID SIZE: 0.230" O.D. 0.120" I.D. 0.060" L.	MAXIMUM PERMEABILITY	SATURATION FLUX DENSITY @ 1.5 OERSTED	RESIDUAL MAGNETISM	COERCIVE FORCE	CURIE POINT	TEMPERATURE COEFFICIENT OF μ_0	
							-25° to 25° C.	25° C. to 75° C.
CERAMAG [®] 24K	1485	9700	4100	700	0.05	175	+1.000	-0.450
CERAMAG [®] 24H	990	6900	3800	850	0.1	175	+0.700	-0.450
2500 PERM REFERENCE	495							

and 24K, then consider how you might use these ferrites.

For more information, samples and applications, contact:

Stackpole Carbon Company,
Electronic Components Division,
St. Marys, Pa. 15857. Ph: 814-834-1521. TWX: 510-693-4511.

Disaccommodation factor for both materials is 1.4×10^{-6} , typical.



STACKPOLE
Electronic Components Division

Producing high quality Ceramag[®] ferrite components for the home entertainment, industrial electronics and computer industries for over twenty-two years.



did you know?



General Electric **AC VOLTAGE STABILIZERS**
respond instantly* to give you voltage that is constant...
constant, constant, constant, constant, constant, constant, constant, constant, constant...

Send in this coupon for free bulletin giving complete details on GE AC Voltage Stabilizer features, ratings and application data; or see your GE sales representative today.

* Output voltage is stabilized in less than 2 cycles for transient line drop of 30%.

GENERAL  ELECTRIC

.....
• Section 413-35
• General Electric Company
• Schenectady, New York 12305
• Please send me free bulletin GEA-7376 on AC Line Voltage Stabilizers.
• NAME _____
• COMPANY _____
• TITLE _____
• ADDRESS _____
• CITY _____ STATE _____ ZIP _____
.....



DEFENCE

WITHIN THE ERIE ORBIT ...

Throughout the free world in airborne armaments, guidance, communications and navigational systems, there are more types and quantities of Erie components and assemblies than we can possibly enumerate.

An important addition to this range is the broad band filtering specifically developed for the protection of armament systems from electromagnetic R.F. interference in the HAWKER SIDDELEY "HARRIER" VTOL JET in service with the R.A.F. The filtering for this aircraft was custom designed by our Erie England engineering and manufacturing groups. Similar and equally important filtering against RFI is accomplished by our North American facilities for numerous USA type aircraft. Just another example of the filter devices used the world over in aircraft, spacecraft, ships, land vehicles and static installations. Would you like to find out why? We will gladly send you a brochure. Write to Sales Engineering Dept., Erie Technological Products, Inc., 644 West 12th Street, Erie, Pa. 16512.

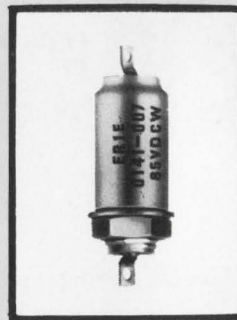

Erie Technological

ERIE

TECHNOLOGICAL

PRODUCTS, INC.



Erie, Pennsylvania

BREAKTHROUGH

in mercury wetted contact relays

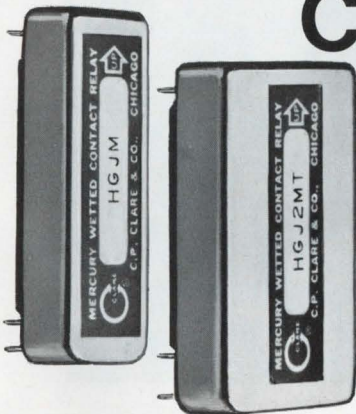
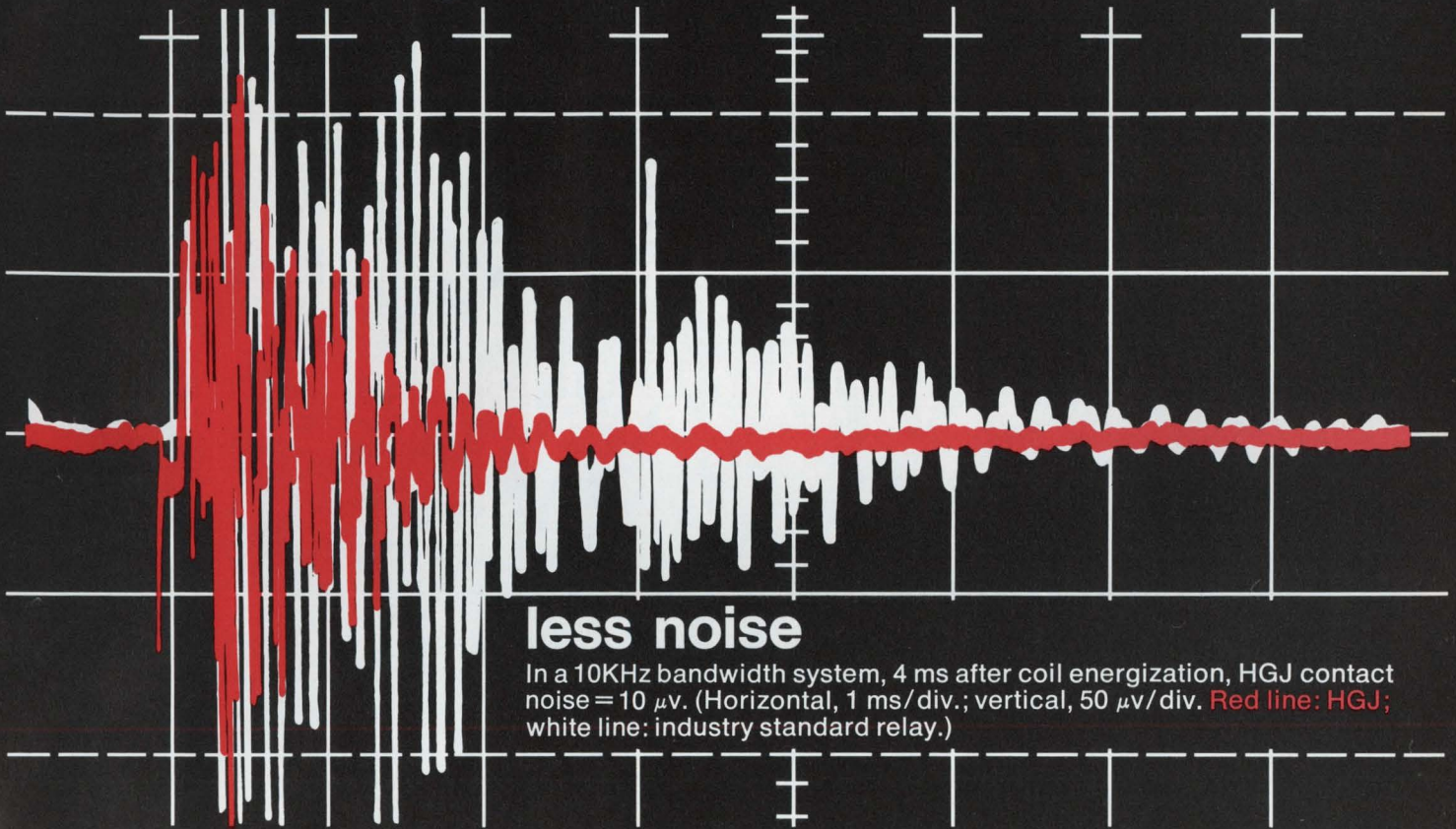

CLARE HGJ RELAYS

shatter industry standards

Compare the new Clare HGJ Relays with any other mercury-wetted contact relays. You'll get more speed, less noise, and less jitter — in less space than any other! Take your choice: 0.340" profile for true half-inch pcb spacing, 0.400" profile for higher sensitivity. Single-pole HGJM, two-pole HGJ2MT. Both are capable of switching low level to 2 amp max, 500 v max (100 va max, ac or dc).

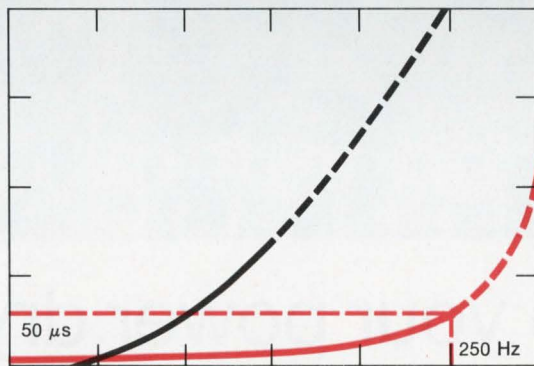

↑ less jitter

At drive frequency of 250 Hz, HGJ jitter = $50 \mu\text{s}$.

— HGJ — Industry standard

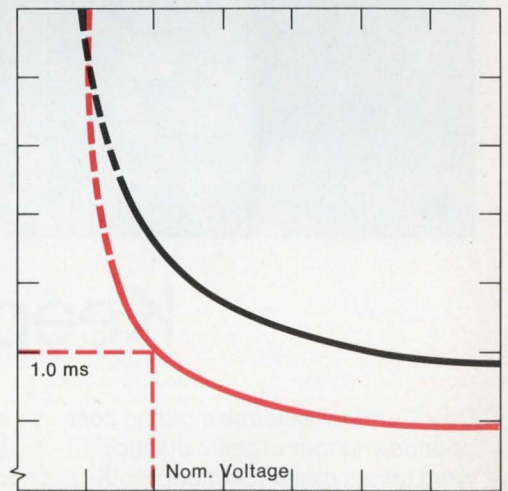

↑ faster response

At nominal voltage, HGJ response time = 1 ms.

For full information, circle the Reader Service Number.



C. P. CLARE & CO.
Chicago 60645 and worldwide.
A General Instrument company.

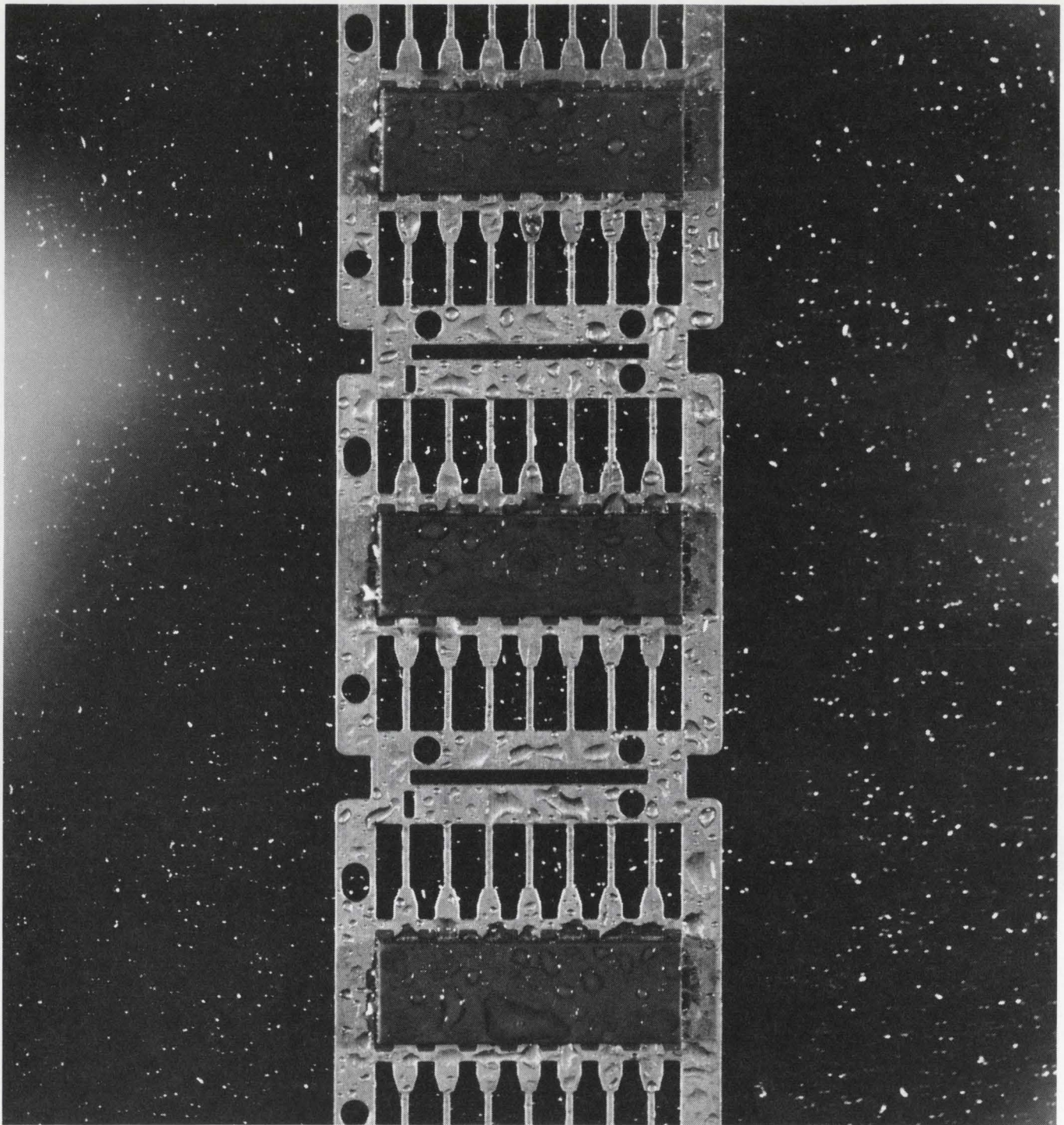

Keep your power dry

Dow Corning® silicone molding compounds and four organic plastics were tested under identical conditions—93% relative humidity at 70C for 5000 hours. The organic plastics absorbed nearly five times as much moisture as the silicones. Moral: silicones protect your power devices from galvanic corrosion. Other advantages of silicones include

superior resistance to thermal shock, cracking and burning. No derating is necessary, the initial cost is low, and you get faster production because of good mold release and minimum flash. Dow Corning silicone molding compounds are a genuine bargain that can improve your product and save you money. Our new booklet gives complete details on Dow Corning silicone

molding compounds. For your copy, write Dow Corning Corporation, Dept. A-9343, Midland, Michigan 48640.

Electrical / Electronic materials from

DOW CORNING

DOW CORNING

The compatible DATA-PAC family presents Analog Interface Modules.

Count on high precision in your data acquisition systems with Analog Interface Modules — AIMs. They offer a complete capability:

A-to-D, D-to-A, multiplexing, sample-and-hold buffering and compatibility with DATA-PAC core memories, logic modules, minicomputers and hardware. Eight, ten and thirteen-bit A-to-D and corresponding D-to-A converters, configured to your system needs and installed in a

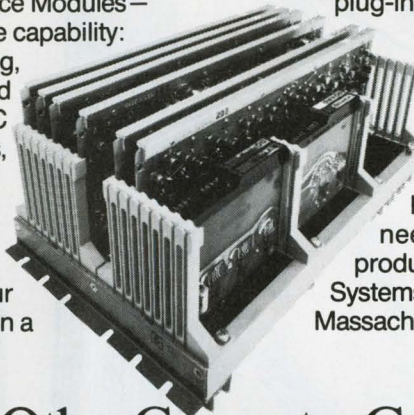

completely prewired connector plane, will "plug-in" to your data acquisition subsystem.

AIM products offer accuracies as high as $\pm 0.015\%$ at speeds as fast as eight microseconds, with up to 256 single-ended or 128 differential input channels. AIM products are supported by applications know-how. The ability to interface with your needs is here. Learn more about AIM products by writing Honeywell Information Systems, MS 261, 200 Smith Street, Waltham, Massachusetts 02154.

The Other Computer Company:
Honeywell

INFORMATION RETRIEVAL NUMBER 34

HONEYWELL INTERNATIONAL—Sales and Service offices in all principal cities of the world. Manufacturing in Australia, Canada, Finland, France, Germany, Japan, Mexico, Netherlands, Spain, Taiwan, U.K. and U.S.A.



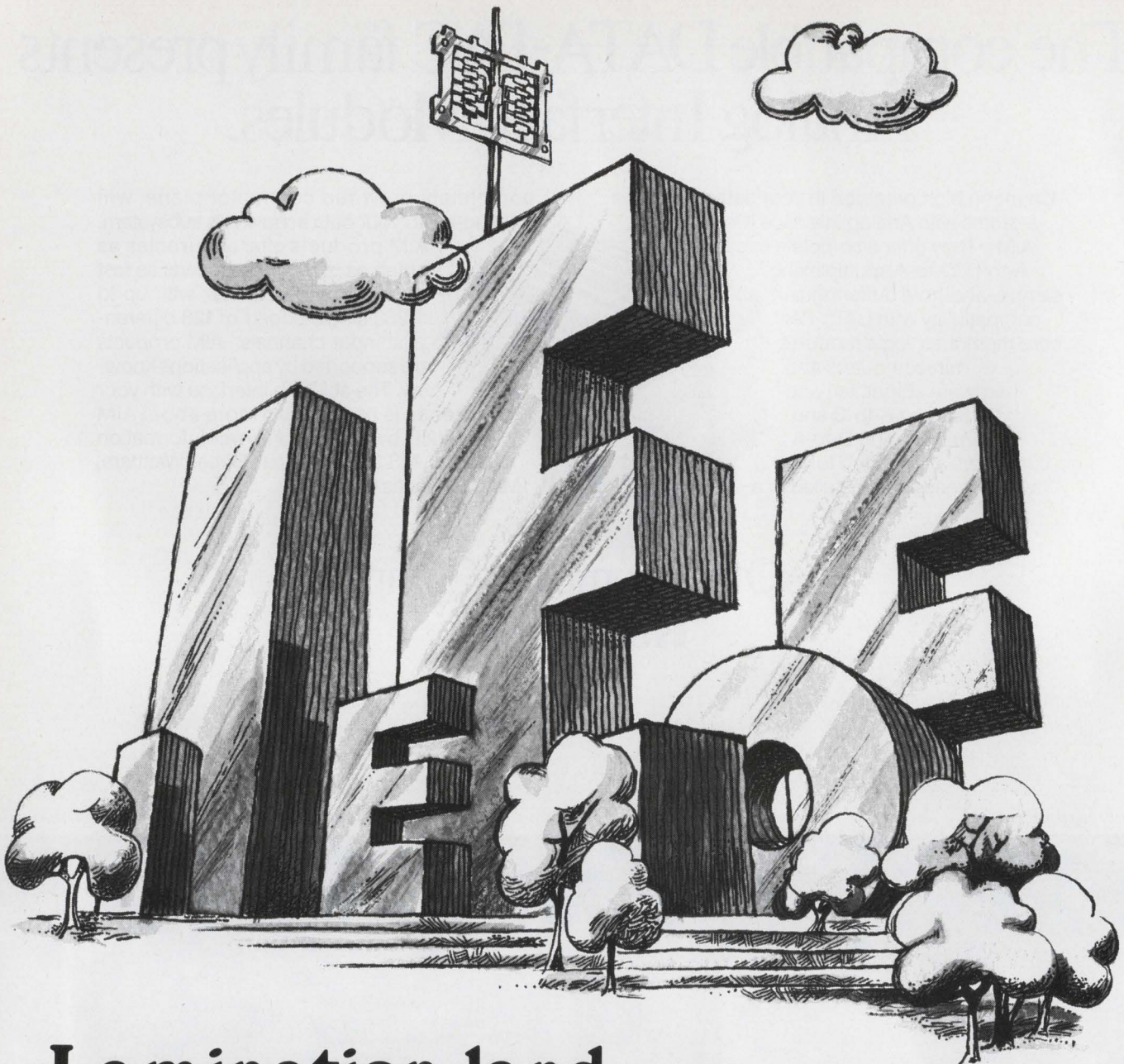

Lamination land.

Located at Arnold's Pacific Division. Where precision plus quality plus experience go into every lamination.

You've come to the right place when you come to us for precision-stamped or chemically etched laminations, lead frames, and other precision parts. Whether you want to use them in motors, transformers, recording heads, integrated circuits, or similar devices.

We maintain our own facilities for both stamping and photo-chemical fabrication. And our own tool-and-die shop. So we have total control

of quality—from melt to finished part—to keep dimensional tolerances to a minimum and develop magnetic properties to a maximum. In our standard laminations made from silicon steel, 4750 nickel-iron alloy, and 4-79 Mo-Permalloy. And in special lamination configurations and lead frames made from more exotic materials.

Tell us what you need. Call or write today.



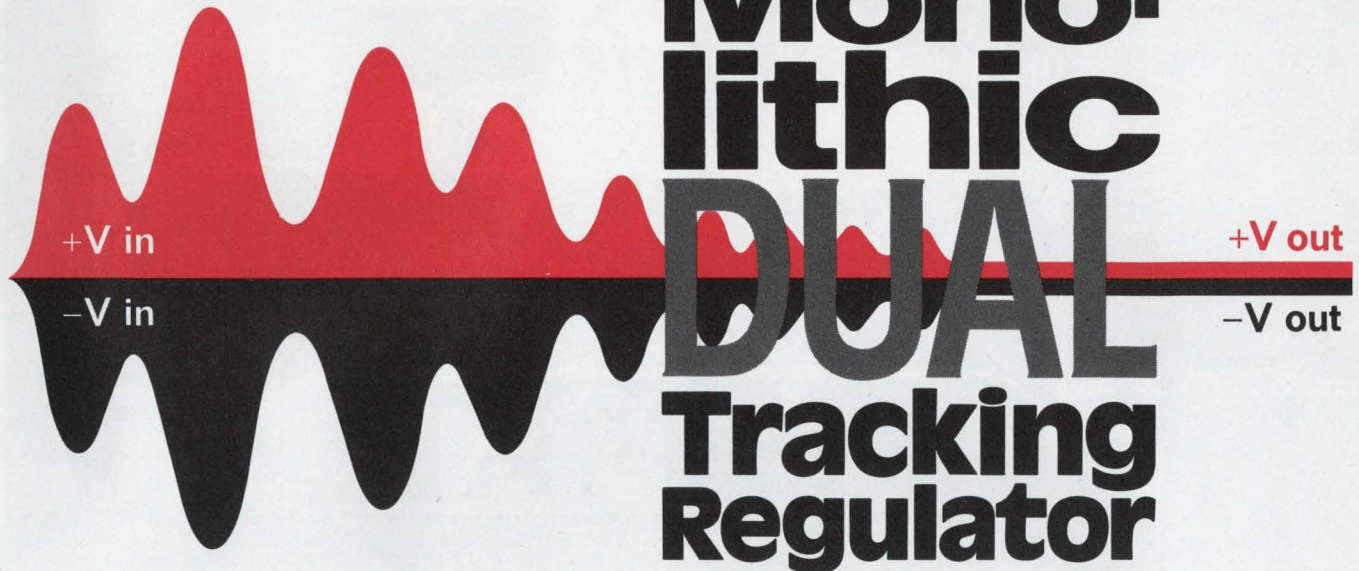

Hot News!

THE FIRST

Mono-

lithic

DUAL

Tracking

Regulator

OTHER 1501 FEATURES

- Input voltages to $\pm 30V$
- Output currents to 100mA (± 5 amps with external transistors)
- Adjustable current limiting
- Less than 1% temperature drift
- Single reference
- TO-100 and DIP versions in military and commercial grades

SG 1501 DUAL-POLARITY TRACKING REGULATOR

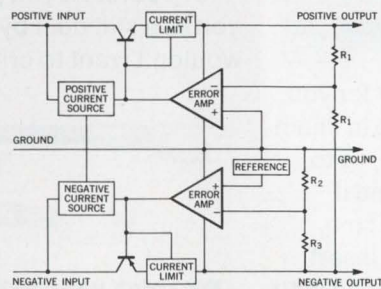

... the Silicon General 1501! That's right, positive and negative outputs from one regulator ... factory set at $\pm 15V$ or variable from $\pm 8V$ to $\pm 23V$ with a single external adjustment. ... balanced to within 1% (outputs typically track one another within 50mV!) ... line regulation of 3mV ... load regulation of 5mV.

The 1501 makes distributed, or on-card, regulation a practical reality by cutting component count and cost. This single device, priced from \$4.80 to \$9.80 (100 pcs.), will power over 25 op amps. Call or write for more data. Silicon General has all the good regulators: SG1501/2501/3501, SG100/200/300, SG723/723C, SG105/205/305 and coming soon: the SG109/209/309 and SG104/204/304.

**JUST ANNOUNCED
MORE NEW HOT LINES
FROM THE HOT SOURCE!**

SG110/210/310 SG1595/1495
SG102/202/302 SG1596/1496

FOR IMMEDIATE DELIVERY, CALL YOUR SILICON GENERAL DISTRIBUTOR

Silicon General



CALL COLLECT (714) 839-6200
Silicon General, Inc.
7382 Bolsa Avenue, Westminster, California 92683

SILICON GENERAL DISTRIBUTORS: ARROW ELECTRONICS, INC. — Ohio 216/464-2000, 513/253-9176, **RODELLE COMPANY, INC.** — Chicago, Ill. 312/468-1016, **INDUSTRIAL COMPONENTS, INC.** — Minneapolis, Minn. 612/927-9991, **INTERMARK ELECTRONICS** — San Carlos, Calif. 415/592-1641, San Diego, Calif. 714/279-5200, Denver, Colo. 303/936-8284, **KIERULFF ELECTRONICS** — Phoenix, Ariz. 602/273-7331, Albuquerque, N.M. 505/247-1055, Palo Alto, Calif. 415/968-6292, San Diego, Calif. 714/278-2112, Denver, Colo. 303/343-7090, Seattle, Wash. 206/763-1550, **K-TRONICS/WESCO** — Los Angeles, Calif. 213/685-9525, **GREENE-SHAW COMPANY, INC.** — Newton, Mass. 617/969-8900, **HARVEY RADIO COMPANY** — Woodbury, L.I., N.Y. 516/921-8700, N.Y., N.Y. 212/582-2590, Clifton, N.J. 201/473-8558, **OSSMANN COMPONENT SALES CORP.** — Rochester, N.Y. 716/422-3290, **PYTTRONIC INDUSTRIES, INC.** — Baltimore, Md. 301/539-6525, Cheverly, Md. 301/322-3740, Montgomeryville, Pa. 215/643-2850, Philadelphia, Pa. 215/242-6700, Pittsburgh, Pa. 412/931-0915, Harrisburg, Pa. 717/233-6591, Raleigh, N.C. 919/833-7552, **REPRESENTATIVES:** ALA 205/772-9237, ARIZ 602/253-6104, CALIF 213/945-2341, 415/349-1266, COLO 303/798-8439, CONN 203/239-0212, FLA 305/622-1468, 305/622-1730, ILL 312/286-1500, IND 317/359-9283, 219/432-5591, 317/453-6868, IOWA 319/362-8155, MD 301/825-0001, MASS 617/862-8230, MICH 313/342-3242, MINN 612/927-9991, N.M. 505/268-3941, N.Y. 716/442-3290, 914/338-5505, 315/454-4477, 607/785-9949, N Y CITY 516/741-8966, OHIO 216/241-4880, 513/298-0662, PA 215/248-3377, 412/922-3890, TENN 615/968-4195, WASH 206/767-4330, MONTREAL 514/735-5775, HASSELT Tel: 011-25467, COPENHAGEN Telex: 2771, PARIS Telex: 62.630 F, MUNICH Telex: 05-22-106, ATHENS Tel: 727-719, TEL-AVIV Telex: 033-638, MILAN Tel: 639-751, GENNEP Telex: 45239, STOCKHOLM Telex: 08/756-65-53, ZURICH Telex: 52028, LONDON Telex: 24443.

INFORMATION RETRIEVAL NUMBER 36

Malco Presents Auto-Mates, another great moment in mating



When it comes to mating, we don't take a back seat to anyone.

Maybe you're one of those designers for whom mating hasn't changed much these last few years. You really don't require any of that fancy, sophisticated stuff. For you, standard quick-connects are still the best.

We haven't forgotten you.

We know what you like. And we've got them. A whole line of quick, efficient, reliable mates. We call them AUTO-MATES. Because that's just what they do. Mate automatically.

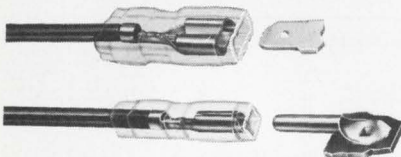

Malco Auto-Mates include quick-connect crimp-type wire connectors, flat blade receptacles (Tabons®), pin receptacles (Pinons), wrapost receptacles (Wrapons), rectangular wraptails,

solderless ring and spade terminals, strain reliefs and a complete array of printed circuit hardware like pins and wraposts.

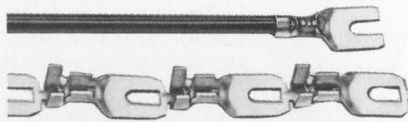

To make it even easier for you, Auto-Mates are available in chain form for automatic crimping to all types of lead wires. And if you're really pressed for time, Malco will automatically insert your P.C. wraposts or pins to your specifications. That's all part of the Auto-Mate package.

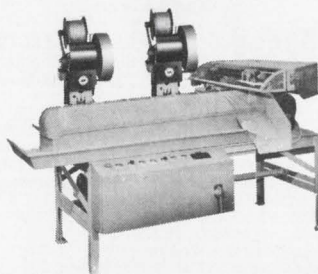

Malco also has a complete line of automatic crimping machines. They'll crimp receptacles, insulating sleeves, pins and connectors.

Of course, if you prefer, you can still do it by hand. We wouldn't want to crimp your style.

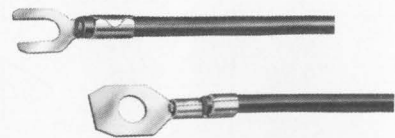

We solve your mating problems.



MALCO MFG COMPANY INC
5150 WEST ROOSEVELT ROAD
CHICAGO, ILLINOIS 60650
(312) 287-6700

Get the goods on Auto-Mates. Send for your free copy of Malco's book:

Auto-Mates.

A Guide To Good Old Quick-Connects.

NO CAPACITOR MANUFACTURER OFFERS EVERY CERAMIC STYLE IN MIL-C-11015D OR MIL-C-39014... BUT...

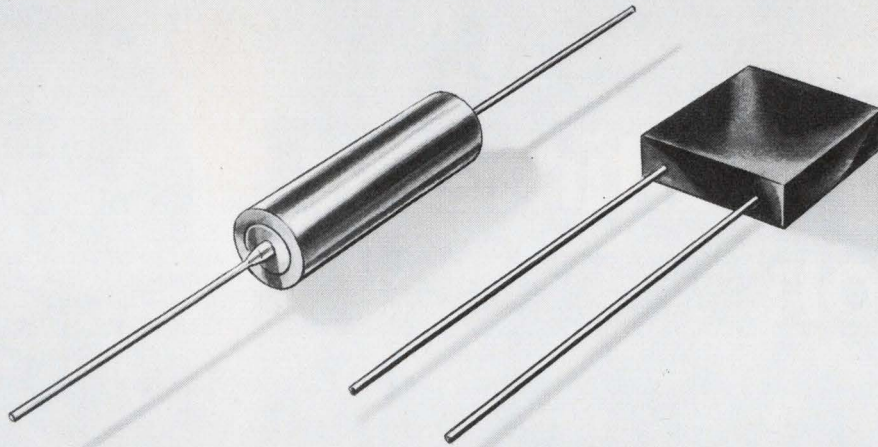

Aerovox has more QPL's than anyone else!

That's right... Aerovox is on the QPL for more approved ceramic capacitors than any other ceramic manufacturer in the industry. By way of comparison, Aerovox can supply over 76% of the parts approved to MIL-C-11015D while supplier number two can supply only 71%, and supplier number three can provide only 42% of the approved parts. Is it any wonder then that more and more manufacturers turn first to Aerovox when they have a requirement for ceramic capacitors to meet MIL-C-11015D and MIL-C-39014.

For Mil-C-39014 Aerovox is approved to "R" level and "S" level approval is expected in early 1971.

And if you are looking for firm delivery schedules and not promises, you've discovered a second good reason for making Aerovox your first call-out on prints and specs for ceramic capacitors. Fact of the matter is, no matter what your capacitor requirement is... check first with Aerovox... you'll be more than pleasantly surprised with our prices and delivery schedules.

AVOX Aerovox®

AEROVOX CORPORATION, NEW BEDFORD, MASSACHUSETTS 02741 • TEL. 617-994-9661
PLANTS IN: NEW BEDFORD, MA., OLEAN & FRANKLINVILLE, N.Y., MYRTLE BEACH, S.C. AND HAMILTON, ONT., CANADA

INFORMATION RETRIEVAL NUMBER 38

When the lights go out, the only really portable Digital Multimeter goes on



...and on.

Run the Fluke 8100A 0.02% digital multimeter anywhere, anytime up to 8 full hours off the rechargeable battery pack. Printer output now available.

There are twenty or thirty digital multimeters around that lay claim to portability. The only one you can move around easily and use without a nearby wall plug is ours. It's the only portable machine that works where you need a portable machine.

True portability is just part of the story. The Fluke 8100A, with an accuracy of 0.02% and a selling price of \$795, with rechargeable battery option, gives you nine times the accuracy of three digit instruments for half the price of comparable four digit multimeters. We've used a new A to D technique to give you an instrument with low power drain for eight-hour continuous battery operation without recharging. (line operation only \$695)

The Fluke 8100A measures ac and dc volts in four ranges to 1200 volts and ohms in five ranges to twelve megohms. Readout is four full digits plus "1" for 20% overranging. Features include an active 2-pole switchable filter and automatic polarity indicator. All functions are push-button selectable.

Also available are RF and high voltage probes, switched ac-dc current shunts, a ruggedized case, and data output (line operation only).

John Fluke Mfg. Co., Inc., P. O. Box 7428, Seattle, Washington 98133. Phone (206) 774-2211, TWX: 910-449-2850 / In Europe, address Fluke Nederland (N.V.), P.O. Box 5053, Tilburg, Holland. Phone: (04250) 70130. Telex: 884-50237 / In the U.K., address Fluke International Corp., Garnett Close, Watford, WD2 4TT. Phone: Watford, 27769. Telex: 934583.



OUR ANGLE: angle position indicators that do more and cost less

SHOULDN'T YOU TAKE A NEW READING ON THIS COST-PERFORMANCE ANGLE?

For better ways to measure synchro and resolver data, North Atlantic offers the best of both worlds: budget prices for the popular API-8025; superior performance and increased capability of the new 8525. • Both are interchangeable without any mechanical or wiring modifications. North Atlantic's solid-state 8525 offers an accuracy of 0.05° (3 minutes). Following a 180° step input, it synchronizes a five-digit NIXIE readout in 1/2 second flat. And it tracks at up to 1000° per second. Where cost can be traded against performance, the proven electromechanical API-8025 . . . a recognized indus-

MODEL 8525



MODEL 8025

try workhorse . . . is available with its 6 minute accuracy, 25°/second slew speed, and many options. • Input of the 8525 is any 60 or 400Hz resolver/synchro data from control instrumentation. The patented servo design eliminates all inertia and improves dynamic performance many times over. Its digital outputs are especially suited to the computer-oriented requirements of today's automatic test systems. The 8525 . . . priced at \$2475 . . . and the API-8025 priced at \$995 actually cost less because they perform more functions per dollar. And with greater reliability. ®

For complete information on the cost-performance angle, please write or phone now.

NORTH ATLANTIC
industries, inc.

200 TERMINAL DRIVE, PLAINVIEW, NEW YORK 11803
cable: noatlantic / twx: 510-221-1879 / phone: (516) 681-8600

INFORMATION RETRIEVAL NUMBER 40

REED SWITCH SPEEDS



¼ actual size.

WITH NO CONTACT BOUNCE.

Hamlin's miniature, mercury-wetted switches offer all the advantages of high-speed, reed switches with the low contact resistance and high-power capacities of mercury switches. Precise, "on-off" actuation makes mercury-wetted switches ideal for applications where contact bounce cannot be tolerated. Available in form A (100 VDC) and form C (28 VDC). Useable length as low as .835". Write for catalog. Hamlin, Inc., Lake Mills, Wis. 53551. Or call 414/648-2361.

HAMLIN

INCORPORATED

INFORMATION RETRIEVAL NUMBER 191

20 MILLIWATTS KEEP YOU IN CONTROL WITH CONTROL-PAK.TM

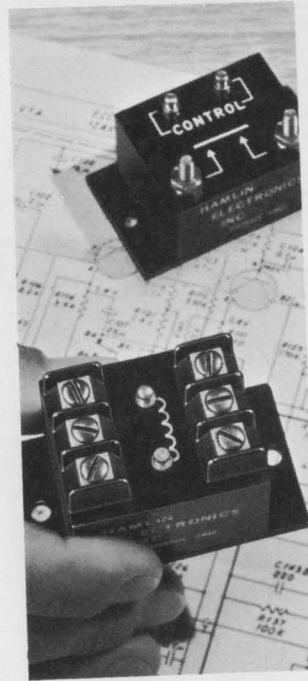

Solid state control handles up to 25 amps but can be controlled by I.C. logic input . . . without amplification. And it's fast—operates in a millisecond, releases within ½ cycle. No noise—electrical or acoustical. Zero switch-line for minimum EMI and RFI. It's completely encapsulated; immune to environment and shock-resistant. Controls all types of loads with reliable, arcless operation. Never needs maintenance. Write for catalog. Hamlin Electronics, Inc., 3066 West Clarendon, Phoenix, Arizona 85017. Or call, 602/277-4834.

HAMLIN

ELECTRONICS, INC.

INFORMATION RETRIEVAL NUMBER 192

YOU PAY FOR RELIABILITY IN HAMLIN REED SWITCHES. JUST ONCE.

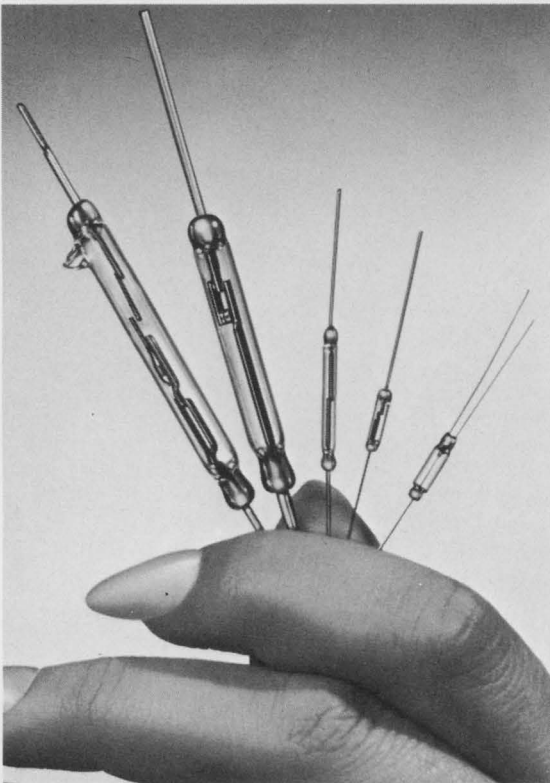

The cost difference between a Hamlin reed switch and another of comparable rating is pennies—sometimes just mills. And it pays off. A switch failure may go unnoticed until it's too late. Then the cost of a malfunction is probably hundreds of times the cost of Hamlin reliability. Rhodium contacts, for example, precision assembly in white room conditions, the industry's most effective hermetic seal, rigid electrical inspection on a 100% basis—these are the things that will make you glad you specified Hamlin reed switches, even after 50 million safe, dependable closures. And you can choose from nearly 2,000 models, from 660 watt capacity down to a 3/10 watt, "grain of wheat" size. You get Hamlin reliability in every one and you pay for it only once. Write for free evaluation samples and catalog. Hamlin, Inc., Lake Mills, Wisconsin 53551. Or call 414/648-2361.

HAMLIN

INCORPORATED

INFORMATION RETRIEVAL NUMBER 193

ELECTRONIC DESIGN 25, December 6, 1970

Varadyne D/A and A/D converters. In volume. In stock. Now.



(Single Quantity)

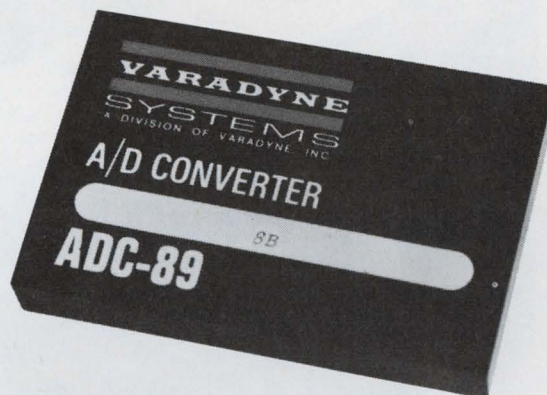

(Single Quantity)

\$29

\$89

SPECIFICATIONS

ELECTRICAL

Digital Inputs		Output current	±5 ma
Resolution	8 binary bits or 2 digit BCD	Output loading	2K ohms for 0 to +10V output or 1K ohms for ±5V output, in parallel with 1000 pf
Coding	Parallel data in the following formats: Straight binary (unipolar output) BCD (unipolar output) Two's complement (bipolar output)	Output setting time	20 µsec to ±0.2% of FS (typ.)
Data inputs	DTL or TTL compatible, positive logic. Loading: one standard TTL load IL max. = 1.6 ma @ VIN = 0.4V	Output voltage resolution	40 mV for eight binary bits 100 mV for 2 digit BCD
Update rate	5MHz typical, but voltage output limited by output amplifier setting time	Linearity	±½ LSB
Analog output (@25°C)		Temperature coefficient	± 50 pp m/°c of FS
Accuracy	±0.2% of FS ±½ LSB	Long term stability	±0.05%/YR
Output voltage	0 to +10V FS (connect Pin 15 to Pin 14) ±5V FS (connect Pin 15 to Pin 13)	Reference source	Internal
		Input power requirements	± 15VDC @ ±20 ma
		Operating temperature range	0°C to +70°C
		Storage temperature range	55°C to +85°C
		Size	2" L x 2" W x 0.4" H plug-in module
		Weight	2 oz.

**ORDERING INFORMATION: DAC-29-8B — 8 BINARY BITS
8D — 2 DIGIT BCD**

SPECIFICATIONS

ELECTRICAL

Inputs:		Performance:	
Analog input voltage range	0V to +10V FS, (Ground Pin #2) ±5V FS (Pin #2 floating) Binary only	Resolution	One part in 2 ⁿ (resolution 8 binary bits or 2 digit BCD) (n = number of binary bits)
Input impedance	5K ohms shunted by 10 pf	Accuracy	±0.2% of FS ±½ LSB
Outputs:		Long term stability	±0.05%/YR
Parallel output data	Up to 8 parallel lines of data held until next conversion command Vout ("0") < +0.8V Vout ("1") > +2.4V Each output capable of driving up to 6 TTL loads	Temperature coefficient	± 50 ppm/°c
Coding	Straight binary (unipolar input) 2 digit BCD (unipolar input) Offset binary (bipolar input)	Encoding time	8 binary bits — 200 µsec total 2 digit BCD — 100 µsec total
End of Conversion	Conversion status signal. Vout ("0") < +0.8V Conversion complete Vout ("1") > +2.4V during conversion Loading up to 6 TTL loads	Reading Rate	8 binary bits — 5000 samples/sec. max. 2 digit BCD — 10,000 samples/sec. max.
		Input Power Requirements	+15 VDC, ±0.5VDC @ 20 ma 15 VDC, ±0.5VDC @ 12 ma + 5 VDC, ±0.5VDC @ 75 ma
		Operating temperature range	0° to +70°C
		Storage temperature range	55°C to 85°C
		Size	2" W x 3" L x 0.4" H
		Weight	4 oz. max.

**ORDERING INFORMATION: ADC-89-8B — 8 BINARY BITS
8D — 2 DIGIT BCD**

36 OTHER A/D AND D/A MODELS TO CHOOSE FROM. WRITE FOR OUR FREE 24-PAGE CATALOG.



1020 TURNPIKE ST., CANTON, MASSACHUSETTS 02021 · (617) 828-6395

INFORMATION RETRIEVAL NUMBER 42

Solid state, for 1000x reliability.

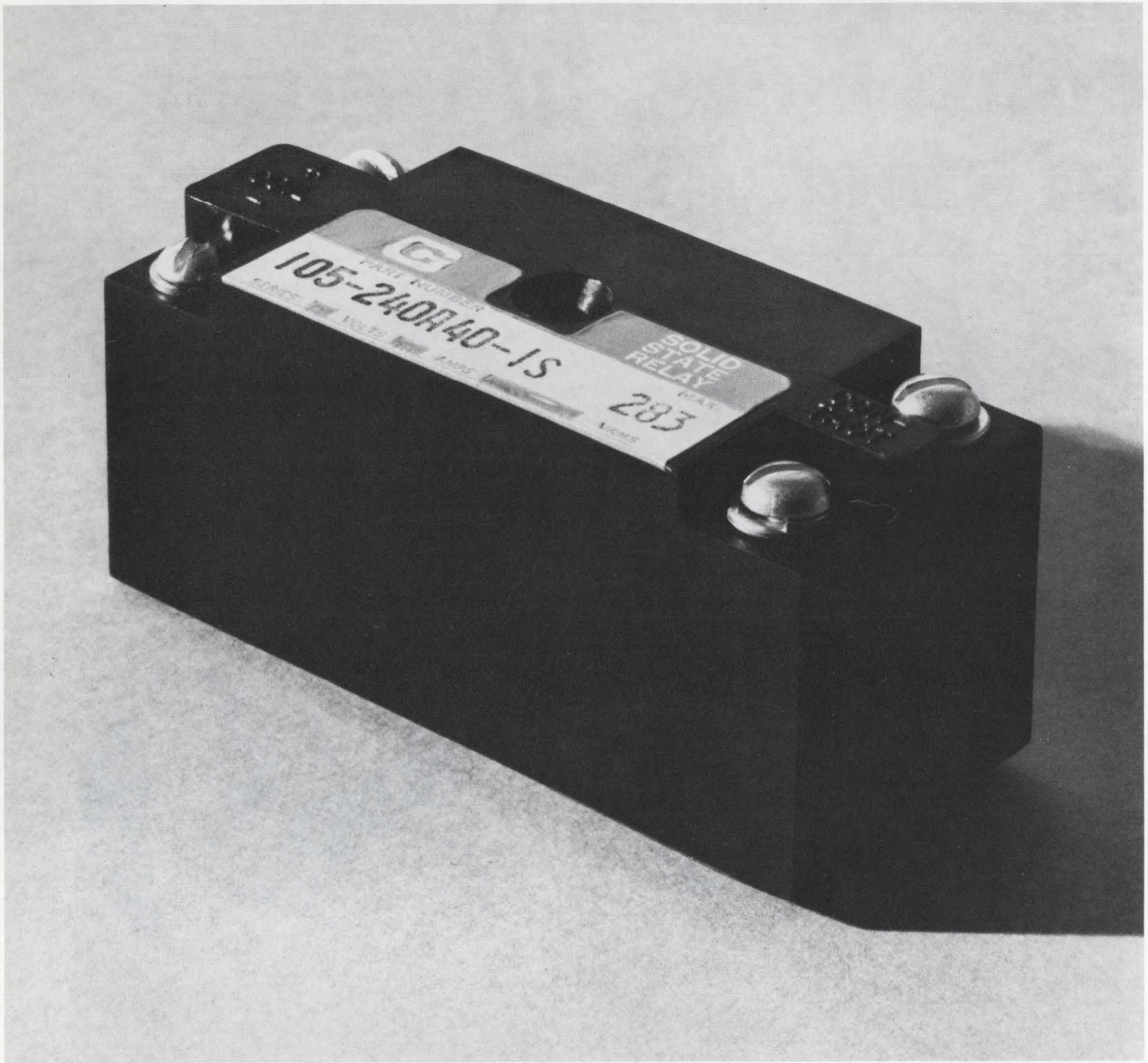

Genistron, for high-amp ratings.

Get it all. The whopping improvement in cycle life that solid state relays switch on: 100-million operations vs. 100,000 from horse-and-buggy EM. Plus the fullest range going in high-amp solid state. All the way to 40 amps—twenty more than the nearest competition.

Up through 240 Volts AC, 40 VDC, Genistron isolated SSR's are fully encapsulated for ruggedness. With barrier-strip screw-type terminals for easy connections. And our AC Syncroswitch Relay has zero-axis switching to eliminate RFI. (Just what you'd expect from the same people who bring you Genistron EMI filters.)

Catalog and specs, yours for the asking. Call or write Genistron Solid State Relays, Genisco Technology Corporation, 18435 Susana Road, Compton, California 90221. (213) 774-1850.

GENISTRON SOLID STATE RELAYS

Air-pollution market? Caution required.

The air-pollution market for electronics is small, but it's due to grow swiftly. Spending for air-pollution sensors alone should total \$500-million over the decade of the 70s, according to H. J. Hall, research associate with the Esso Research and Engineering Company. But this may not be the golden opportunity for the electronics industry that the raw figures indicate.

There are 15 classes and 48 subclasses of air pollutants that are of interest in antipollution studies, according to Esso's Government Research Laboratory. In the order of 50 new types of sensors will be needed, and this means perhaps 50 different design and development jobs.

If we divide the \$500-million total spending estimate by the number of years in the decade and then by the number of different instruments required, we arrive at a disappointing average yearly market of \$1-million for each type. Certainly, the spending for some types of sensors will far exceed this figure, but for many the markets just won't be large enough to justify the research, development and marketing costs. From the viewpoint of private industry, therefore, the air-pollution market must be approached with decidedly cautious optimism.

Government funding for necessary R&D will, of course, be available. The National Air Pollution Control Administration estimates its pollution abatement and control spending for 1970 at \$35-million, and plans to spend \$40-million in 1971. The contracts involved are a very real profit opportunity for companies with the required technical expertise.

But we mustn't be too optimistic here, either. A few Government contracts don't mean booming sales for the industry. Recall that the National Institutes of Health and the Department of Health, Education and Welfare have both funded work in medical electronics for years, and only a very few companies have developed significant sales volumes in the medical field.

Yes, the air-pollution-control market may use \$500-million worth of electronics in the 1970s. Opportunities exist, money will be spent, and the possibilities must be investigated. But the development costs in many instrument areas could eat up the potential profits and more. Approach with caution!

RAYMOND D. SPEER

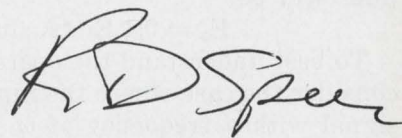

Separate the signals from the noise

with this simple voltage correlator circuit.

It costs only \$100 in parts—yet analyzes complex signals.

Correlation techniques offer a powerful means of extracting low-level signals from noise and for analyzing the frequency spectrum of complex ac signals. But too often correlation methods require expensive, sophisticated test equipment or general-purpose analog computers.

Not anymore! With today's low-cost amps and multipliers, many of these instrument and computer techniques are practical for use in system design.

A basic correlator circuit can be designed with a component cost of around \$100. The simple circuit described here uses only two multipliers and two op amps.

Here's how it works

The output of the correlator circuit shown in Fig. 1 is the in-phase component of the input signal. The circuit rejects the harmonics and quadrature components and is independent of the magnitude of the reference signal.

The output, E_o , can be determined from the closed-loop operation of the circuit. The first multiplier, M_1 , has an output of

$$E_2 = 0.1 (A \sin \omega_c t) (-E_1 + E_o)$$

Since most commercially available multipliers have a built-in gain of 0.1 this value is used for both multipliers in the correlator circuit.

If the integrator time-constant is large relative to the frequency range of interest, then the output of the integrator will be a dc level. The loop feedback will cause the output of the integrator, E_3 , to vary in dc level until the dc average of E_2 goes to zero. The output of the second multiplier will be

$$E_o = 0.1 E_3 (A \sin \omega_c t)$$

To best understand the operation of the circuit, consider the case where the input is some periodic signal with a frequency of ω_s and zero dc value. Then this periodic signal can easily be described by the simple Fourier series

$$E_1(t) = B \sum_{n=1}^{\infty} \left(a_n \cos \frac{2n\pi}{T} t + b_n \sin \frac{2n\pi}{T} t \right),$$

where

$$a_n = \frac{2}{T} \int_{-\frac{T}{2}}^{\frac{T}{2}} E_1(t) \cos \frac{2n\pi}{T} t dt,$$

and

$$b_n = \frac{2}{T} \int_{-\frac{T}{2}}^{\frac{T}{2}} E_1(t) \sin \frac{2n\pi}{T} t dt.$$

In another form,

$$E_1(t) = B \cos \theta \sin \omega_s t + B \sin \theta \cos \omega_s t + \text{Harmonics},$$

where $B \cos \theta \sin \omega_s t$ is the in-phase component, $B \sin \theta \cos \omega_s t$ is the quadrature component and $\omega_s = 2\pi/T$.

The reference input is $A \sin \omega_c t$. From the previous discussion,

$$E_2 = 0.1 (A \sin \omega_c t) (-E_1 + 0.1 E_3 A \sin \omega_c t).$$

In the steady-state condition the average value of E_2 , $\bar{E}_2 = 0$.

$$\bar{E}_2 = \left\{ - [0.1 A \sin \omega_c t] \left[\sum_{n=1}^{\infty} (a_n \cos n\omega_s t + b_n \sin n\omega_s t) \right] \right\}_{\text{AVG.}} + \left\{ 0.01 A^2 E_3 \sin^2 \omega_c t \right\}_{\text{AVG.}} = 0.$$

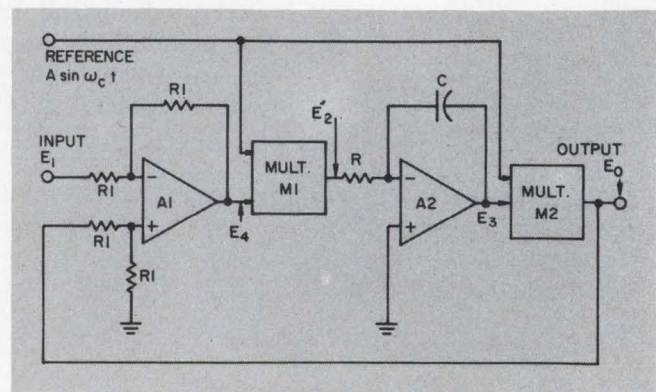

1. Only two op amps and two multipliers are required for this simple correlator circuit. Harmonics and quadrature components of the input are rejected; only the in-phase component appears as an output signal.

Edited by: **Steven A. Erenburg**, Microelectronics Editor

Tom Cate, Product Marketing Engineer, Burr-Brown Research Corp., International Airport Industrial Park, Tucson, Ariz. 85706.

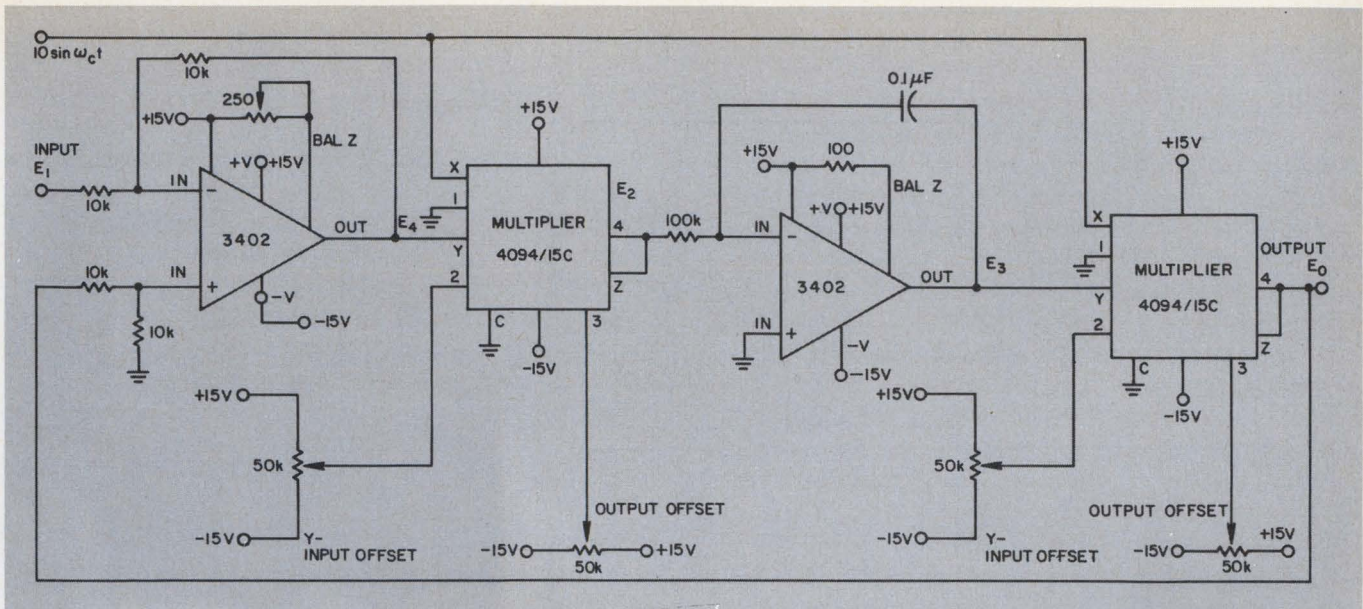

2. The input and feedback resistors of the first op amp must be closely matched for high loop accuracy. Lineari-

ty and offset characteristics of the multipliers are more important considerations than the gain accuracy.

The average value of the first term is zero for all ω_s except when $\omega_s = \omega_c$. Then the average value of the first term is

$$-\frac{A}{10} \left(\frac{b_1}{2} \right) = -\frac{A}{10} \left(\frac{B \cos \theta}{2} \right),$$

where $\omega_s = \omega_c$.

The average value of the second term is $(1/200) (A^2 E_3)$.

Now if \bar{E}_2 is to be zero, then we must have $-(1/20) AB \cos \theta + (1/200) A^2 E_3 = 0$. Solving for E_3 ,

$$E_3 = 10 \frac{B}{A} \cos \theta \text{ for } \omega_s = \omega_c.$$

The output of the second multiplier is

$$E_o = \left(\frac{B}{A} \cos \theta \right) (A \sin \omega_c t).$$

Note that $E_o = B \cos \theta \sin \omega_c t$ for $\omega_c = \omega_s$ and $E_o = 0$ for $\omega_c \neq \omega_s$.

In the design of the correlator circuit, any reasonable value of R_1 may be used. But it is very important that the R_1 s be accurately matched. A typical value for R_1 would be 10 k Ω , with a matching accuracy of $\pm 0.05\%$.

The gain accuracy of multiplier M_1 is not important, but the linearity and offsets are. A complete circuit is shown in Fig. 2. Linearity is typically $\pm 0.5\%$ for the 4094/15C multiplier, and the offsets may be easily trimmed externally.

Amplifier A_2 acts as an integrator. The integrator gain, $-1/RC$, directly affects the rate at which the circuit can follow amplitude changes in the fundamental of E_1 . A large RC means that the response will be sluggish, but the low-pass filtering effect will be better and distortion will be lower. On the other hand, a small RC means that rapid amplitude changes in E_1 can be followed and the loop-gain will be high, thereby improving gain accuracy. The best value of RC depends upon the particular application.

The output is not dependent upon the magnitude of the carrier, but the accuracy is best if the carrier is 10 sin $\omega_c t$ volts. This will use the full dynamic range of the multiplier.

Separate in-phase and quadrature

If the input signal is a clean sine wave, but shifted in phase from a reference signal, there will be both an in-phase component and a quadrature component.

If $E_1(t) = B \sin(\omega t + \theta)$

$$= B \cos \theta \sin \omega t + B \sin \theta \cos \omega t,$$

and the reference input is $A \sin \omega t$, then

$$E_o = \frac{10 B}{A} \cos \theta \text{ and}$$

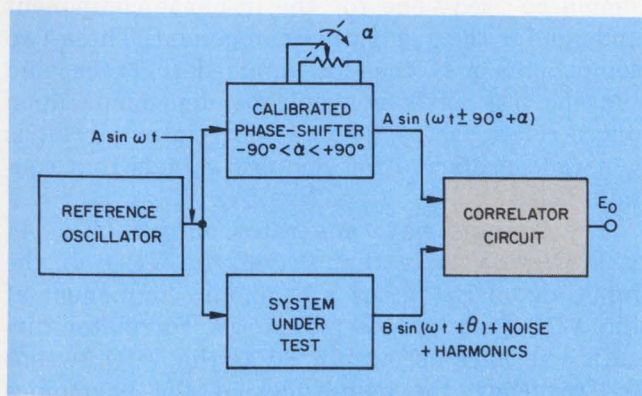

3. A simple phase shifter is all that is needed to measure phase angles. The output of the correlator is nulled when $\alpha = \theta$. The sensitivity of the nulling circuit, not accuracy, is affected by the amplitude B of the signal.

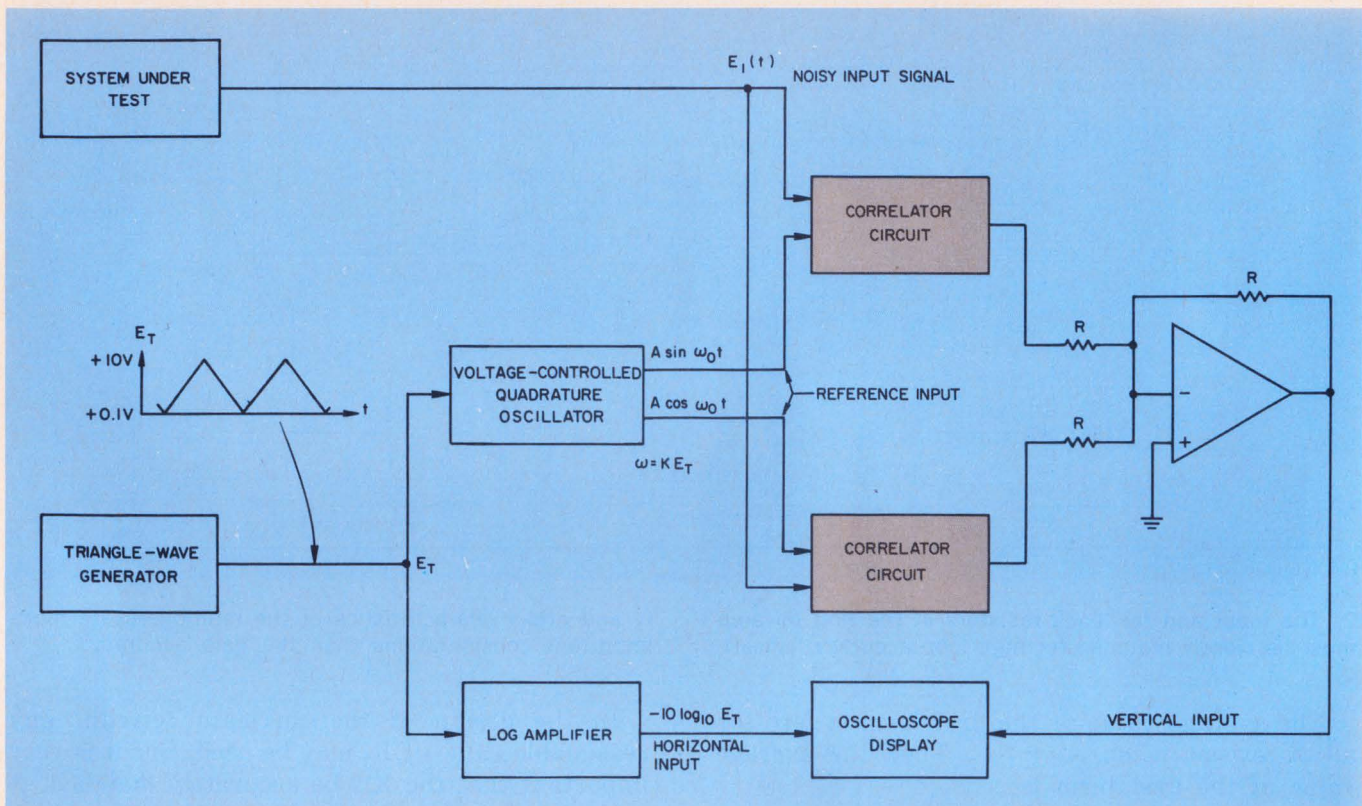

4. This two-correlator spectrum analyzer is useful for processing complex signals that contain noise. As the

VCO sweeps in frequency, the amplitudes of the input's harmonics are determined and displayed on the scope.

$$E_o = B \cos \Theta \sin \omega t.$$

In addition, $E_4 = E_o - E_1 = -B \sin \Theta \cos \omega t$.

So, in the steady-state condition, the output E_o is the in-phase component and the first amplifier output, E_4 , is the quadrature component, but with reversed polarity.

Since the output of the correlator circuit is $B \cos \Theta \sin \omega t$, the phase angle Θ can be determined. If the amplitude of the input is constant, then demodulating and computing the arc-cosine will provide a measure of phase angle. On the other hand, if the reference is shifted by Θ plus 90° , then $\cos \Theta$ will be zero.

Nulling the output by shifting the reference phase by a calibrated amount will also measure the phase shift Θ .

The reference oscillator (Fig. 3) sinusoidal output is applied to the system under test and to a phase-shifting circuit. The output of the correlator is

$$E_o = B \cos (\Theta \pm 90^\circ - \alpha) \sin \omega t.$$

Since the $\cos (\pm 90^\circ) = 0$, the output will be zero when $\Theta = \alpha$.

Manually adjusting the phase angle α for a null at E_o will make Θ and α equal.

The measurement accuracy is not dependent on the amplitude of the reference, so simple phase-shifting circuits may be used. The amplitude B affects sensitivity, but it also isn't critical.

The system under test may be nonlinear. This circuit measures the phase shift with respect to

only the fundamental—all harmonics are rejected. The accuracy depends almost entirely on the accuracy of the calibrated phase-shifting circuit.

Build a spectrum analyzer

The correlator circuit can be used as a spectrum analyzer by simply varying the reference input frequency. Harmonic content of a periodic waveform can then be determined.

For manual analysis, a single correlator circuit will generally suffice. But for more generalized spectral analysis, two correlator circuits should be used—one for the in-phase component and one for the quadrature component. These two components may then be summed together, and the spectral analysis won't be dependent upon phase relationships. The two-correlator circuit is generally preferred for complex signals that contain noise.

The triangle wave generator output (Fig. 4) is a sweep voltage that drives the VCO. If the input signal $E_1(t)$ has a harmonic component at the VCO frequency ω_o , then the correlator circuits will have an output. So as the VCO sweeps in frequency, the amplitudes of the harmonics are determined.

The log amplifier is optional, but is very convenient for display purposes. The horizontal axis is then the log of frequency. ■■

V CXOs

Get 'em straight from Damon!

Whether you're in a sweat on a VCXO prototype for a tough application – or need a production run in a hurry, you can get 'em straight from Damon. Speedy proficiency in design and production of VCXOs allows Damon to deliver all-silicon solid state devices with linearity to within 1% of best straight line and frequency deviation to $\pm 0.25\%$.

Just glance at the specification guide below for more good news on available characteristics. Computer-assisted designs are available, too. Ask Damon today for a quote on VCXOs tailored to your specifications – and deadlines. Call or write: Damon/Electronics Division, 115 Fourth Ave., Needham, Mass. 02194. Phone: (617) 449-0800.

SPECIFICATION GUIDE*

Parameter	Basic and Multiplier VCXOs	Mixer and Mixer-Multiplier VCXOs
Center Frequency	1 KHz to 300 MHz	100 Hz to 300 MHz
Frequency Deviation	$\pm 0.01\%$ to $\pm 0.25\%$ of C.F.	± 10 Hz to ± 1 MHz
Frequency Stability 24 hr. @ 25°C	± 1 to ± 10 ppm	$\pm 0.5\%$ of peak deviation
0 to 65°C (no oven)	± 10 to ± 50 ppm	$\pm 2\%$ of peak deviation
Linearity	to within 1% of best straight line	to within 1% of best straight line
Minimum Deviation Rate	0 (dc)	0 (dc)
Maximum Deviation Rate	0.2% of C.F. (100 KHz max.)	10 KHz to 100 KHz
Mod. Voltage (Typical)	± 5 V peak	± 5 V peak
Mod. Input Impedance	> 50 K ohms	> 50 K ohms
Output Power Available	0.5 mw to 20 mw	0.5 mw to 20 mw
Load Impedance	50 ohms to 10 K ohms	50 ohms to 10 K ohms
Power Requirements (Typical)	-25 V ± 1 V @ 30 ma	-25 V ± 1 V @ 40-50 ma
C.F. Manual Adjustment Range	$\pm 0.01\%$	$\pm 5\%$ of peak deviation

* Obviously, the limits are not absolute. The interrelationship of parameters for VCXOs are of such a nature as to permit optimization of any one or more characteristics to satisfy customer requirements.

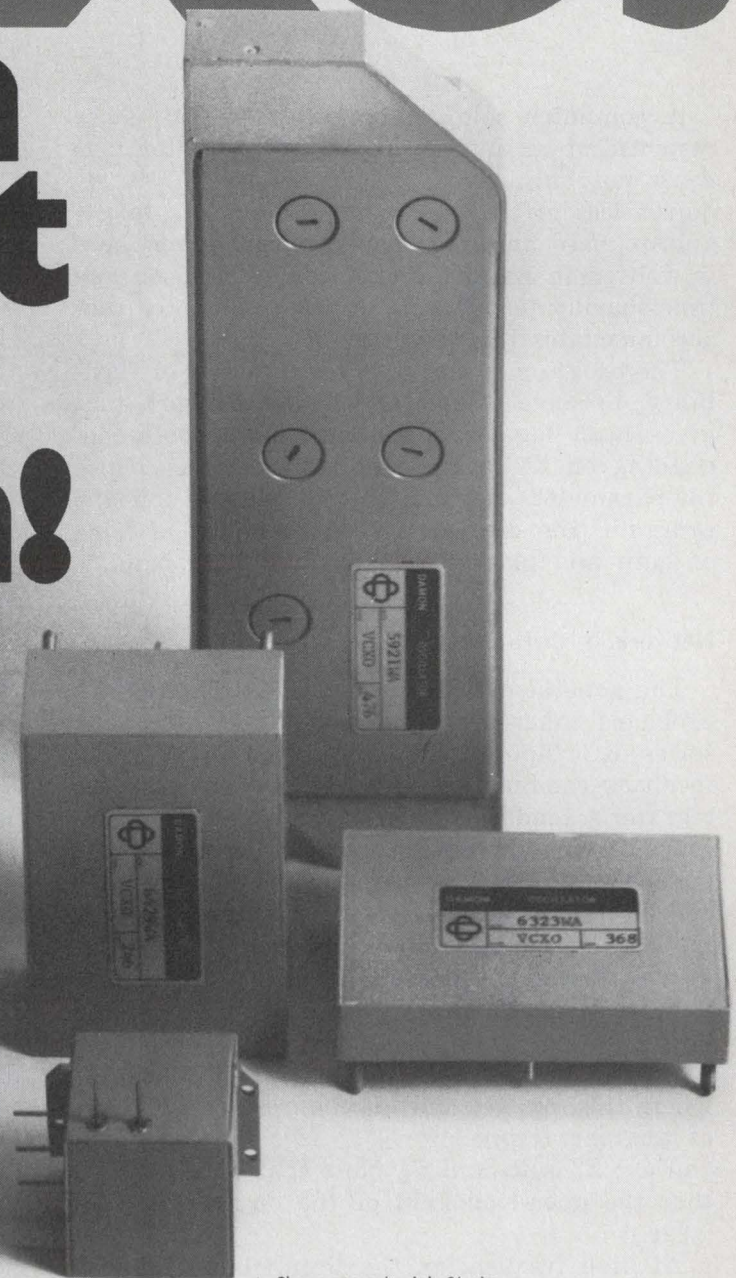

Shown approximately 3/4 size

 **DAMON**

Compute lead-lag network response.

This BASIC program gives precise results for a general feedback integrator-differentiator.

A computer solution of the gain and phase response of an integrator or differentiator network not only gives precise results but it requires less effort than using Bode plots to get approximate answers. The program given here is written in BASIC, and it can be used on any time-sharing terminal or in-house computer that accommodates this language.

The program is set up, in the interests of flexibility, to solve a general lead-lag network that gives lead, lag, or a combination of both, depending on the component values chosen. Once the parameters of the circuit are entered into the program, the computer yields a complete table of gain and phase over any frequency band.

Network is drift-free

The general network used avoids the stability problems inherent in the pure integrator. The series RC input network and the parallel RC feedback combination (Fig. 1) overcome the integrator's tendency to drift into saturation because of bias current or spurious dc inputs. The general network has two breakpoints, but they can be located in such a way as to provide only integration or only differentiation in the frequency range of interest.

From feedback theory, closed-loop gain is given by:

$$G(\omega) = e_o/e_i = -Z_f/Z_i$$

where the voltages and impedances are functions of angular frequency, ω . Z_f is composed of R_2 and C_2 ; Z_i is R_1 and C_1 . Note that it is assumed that the open-loop gain of the op amp is very large.

At high frequencies, the circuit is an integrator or lag network, at low frequencies it is a differentiator or lead network, in the midrange its gain is constant. A low-frequency breakpoint occurs when the reactance of C_2 equals R_2 , and

a high-frequency breakpoint occurs when the reactance of C_1 equals R_1 . This characteristic is plotted in Fig. 4, while the equivalent circuits of these operational ranges are shown in Fig. 1.

The program (Fig. 2) is interactive, and it makes no assumptions about the breakpoint locations. Once the program has been entered into the computer the values of R_1 , C_1 , R_2 , C_2 and the lowest and highest values of the frequency range are requested (Fig. 3). Plotting the results can be simplified if the two frequency values are powers of 10.

Lines 100 to 230 in the program request and accept the input data. Line 300 converts frequency to angular frequency, and 310 computes gain in decibels. Line 320 begins the phase computation, lines 330-350 decide whether the phase is leading or lagging and line 360, 380 or 400 print the results. The remainder of the program performs the frequency incrementing as the dummy variable I is stepped from 0 in line 290 to 7 in line 490. The actual incrementing of I takes place in line 420.

With minor variations in the lines that actually compute the circuit performance, this program can easily be adapted to other frequency sensitive networks. ■■

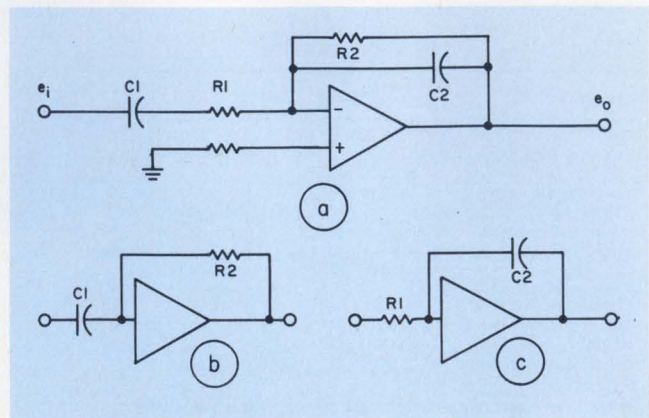

1. A general lead-lag network (a) has the low-frequency equivalent (b) and the high-frequency equivalent (c). In the low frequency end of the spectrum R_1 is negligible, and in the high range R_2 can be ignored.

```

100 PRINT"ENTER R1,OHMS"
110 INPUT R1
120 PRINT"ENTER C1,MICROFARADS"
130 INPUT C
140 LET C1=C/1000000
150 PRINT"ENTER R2,OHMS"
160 INPUT R2
170 PRINT"ENTER C2,MICROFARADS"
180 INPUT B
190 LET C2=B/1000000
200 PRINT"ENTER LOWEST FREQUENCY,HERTZ"
210 INPUT L
220 PRINT"ENTER HIGHEST FREQUENCY,HERTZ"
230 INPUT H
240 PRINT
250 PRINT
260 PRINT
270 PRINT"FREQUENCY,HZ","GAIN,DB"," PHASE,DEGREES"
280 PRINT
290 LET I=0
300 LET W=2*PI*L
310 LET K=20*CLG((W*R2*C1)/SQR((W*R1*C1+W*R2*C2)^2+(W*W*R1*C1*R2*C2-1)^2))
320 LET Y=90-(180/PI)*ATN(W*R2*C2)-(180/PI)*ATN(W*R1*C1)
330 IF Y>0 GOTO 360
340 IF Y<0 GOTO 380
350 IF Y<0 GOTO 400
360 PRINT L,K,(180-Y),"LAG"
370 GOTO 420
380 PRINT L,K,"180"
390 GOTO 420
400 PRINT L,K,(180+Y),"LEAD"
410 GOTO 420
420 LET I=I+1
430 IF I=1 GOTO 500
440 IF I=2 GOTO 520
450 IF I=3 GOTO 540
460 IF I=4 GOTO 560
470 IF I=5 GOTO 580
480 IF I=6 GOTO 600
490 IF I=7 GOTO 620
500 LET L=1.5*L
510 GOTO 300
520 LET L=2*L/1.5
530 GOTO 300
540 LET L=3*L/2
550 GOTO 300
560 LET L=4*L/3
570 GOTO 300
580 LET L=5*L/4
590 GOTO 300
600 LET L=7*L/5
610 GOTO 300
620 LET L=10*L/7
630 LET I=0
640 IF L>(H/10)GOTO 670
650 PRINT
660 GOTO 300
670 END

```

2. This frequency response program is written in BASIC and is interactive in lines 100-230 where circuit values are requested. Most of the computation takes place in lines 300-320. The remainder of the program provides for output of results.

RUN	FREQUENCY, HZ	GAIN, DB	PHASE, DEGREES	
ENTER R1, OHMS 739.2	.04	-8.4758	91.3576	LAG
ENTER C1, MICROFARADS 77.5	.05	-6.53896	91.6968	LAG
ENTER R2, OHMS 7200000	.07	-3.62003	92.3749	LAG
ENTER C2, MICROFARADS 7.47
ENTER LOWEST FREQUENCY, HERTZ 7.01	10.	23.935	171.448	LAG
ENTER HIGHEST FREQUENCY, HERTZ 71000000	15.	24.001	175.147	LAG
	20.	24.0223	177.277	LAG
	30.	24.0321	179.942	LAG
	40.	24.0278	178.198	LEAD
	50.	24.0174	176.662	LEAD
	70.	23.9847	174.018	LEAD

	100000.	-21.2714	90.3111	LEAD
	150000.	-24.7932	90.2074	LEAD
	200000.	-27.2919	90.1556	LEAD

3. Data entry (left) is followed by a printout of the results (right). Only part of the output is given here—the low and high-frequency ends of the spectrum and the phase crossover.

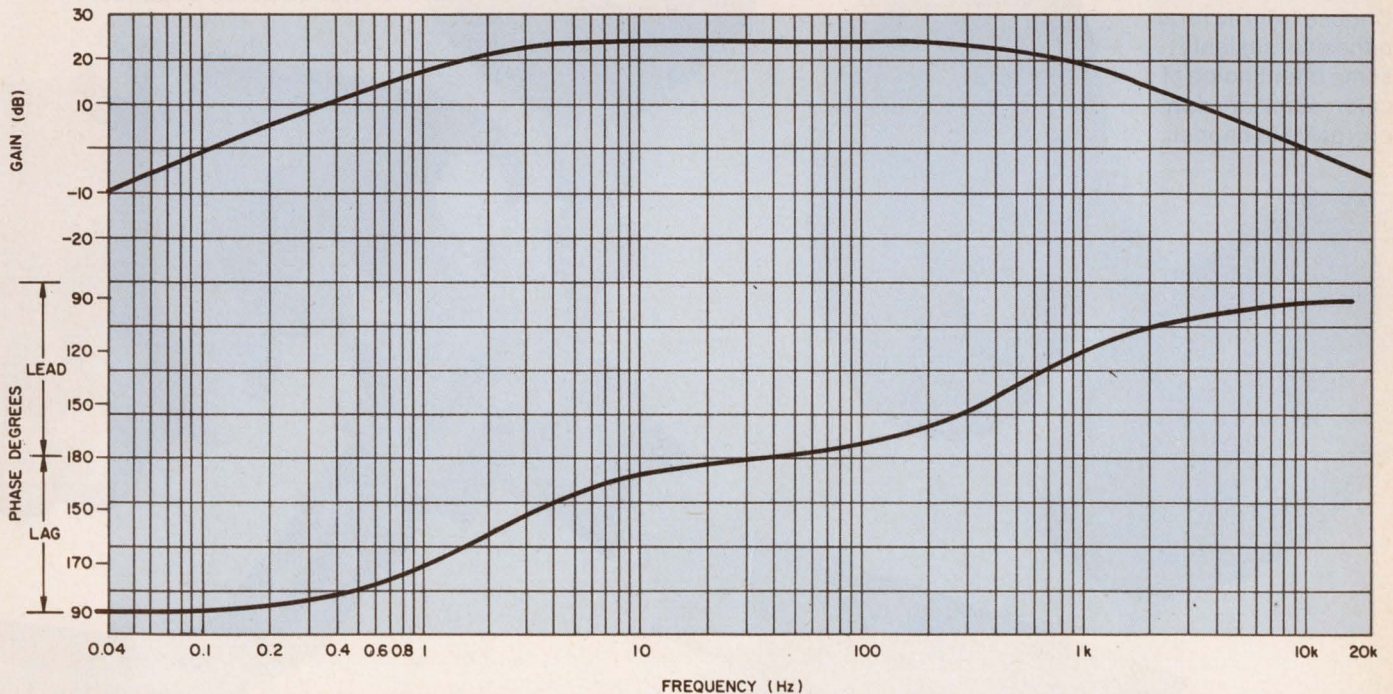

4. The frequency response of both gain and phase are plotted from the results of the computer run. Hand drawing of response curves can be avoided if an X-Y plotting terminal is used for data output.

If you make a product no matter what, we can

From space capsules to computers to consumer appliances . . . Dow Corning silicone materials add a critical measure of reliability to designs. They improve the performance and service life so vital to your product's function, be it aerospace, industrial or entertainment.

Dow Corning silicone rubber RTV adhesive/sealants bond, seal and insulate. Cured materials give excellent resistance to breakdown by harsh environments. An adhesive/sealant is shown here sealing feed-through wires where they enter a high-vacuum test chamber. Units remain leak free under severe vacuum, wide temperature changes and wire flexing. Choose from several adhesive/sealants . . . some offer choice of color; some are non-corrosive to copper.

Dow Corning® protective coatings cure at room temperature to form tough, noncorrosive coatings on components, subassemblies and circuit boards. Coatings have excellent resistance to moisture, dust, dirt, abrasive materials, ozone, radiation and many solvents and industrial chemicals. There are several to choose from . . . some are transparent, others opaque.



that's got to perform, protect it.

Effective heat transfer and protection from corrosion are properties of **Dow Corning heat sink compound**. Diodes, transistors and rectifiers last longer and are more stable in operation when nondrying silicone paste provides full contact with heat sink for optimum thermal conductivity. Other compounds prevent corrosion of connectors, lamp bases . . . lubricate gaskets.

Outstanding environmental protection for electronic components and assemblies—that's what **Dow Corning RTV encapsulants** provide. These materials cure to tough, yet flexible, silicone rubber that protects components from moisture, dirt, corona, weathering and corrosive atmospheres. Applications are almost endless, ranging from encapsulating printed circuit boards to encapsulating the glass-enclosed image-intensifier tubes of U.S. Army helicopters' night vision units. There's a variety to choose from . . . Some are transparent for easy visual inspection; others can be color coded . . . and they're adaptable to a wide variety of processing requirements.

When total reliability is essential in electronic parts and finished products, count on high-performance silicones from Dow Corning. Write for information, Dept. B-0321 Dow Corning Corporation, Midland, Michigan 48640.

Electrical / electronic materials from

DOW CORNING

DOW CORNING

INFORMATION RETRIEVAL NUMBER 45

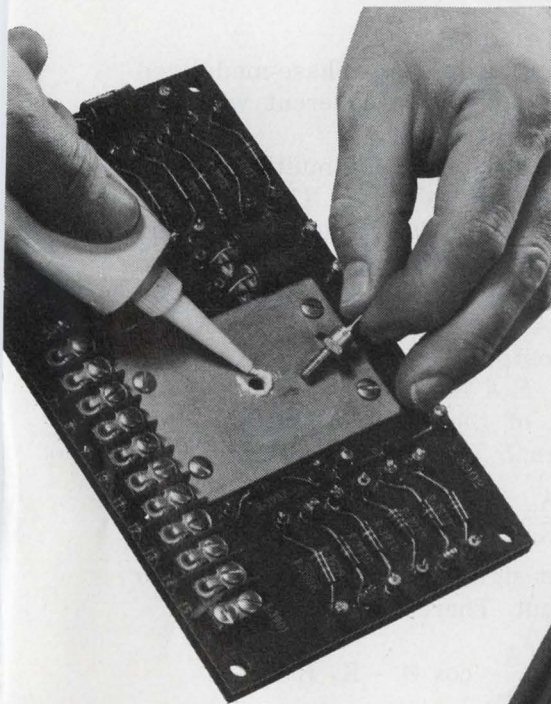

Use this tan-lock demodulator

to get wide-range linear performance with no threshold or sideband problems.

Trade-offs between linearity and signal-to-noise ratio (S/N) often determine the choice of phase demodulator used in a communication signal-processing system. The choice is usually made between two types, coherent and linear, but the field isn't that limited. There's another demodulator that can often be used—the tan-lock¹ type.

To review the field, coherent modulators have an output S/N which is linearly related to all values of the input S/N; consequently, for all practical purposes, they have no threshold. But at large input deviation, sidebands are produced that are not easily filtered and are present in the output as interference. Tan-lock demodulators don't have this disadvantage.

Linear demodulators do not have this sideband problem, either, but they do exhibit a threshold. This results in degraded performance at low-input S/N. Tan-lock demodulators have only a minor threshold effect, and they offer a possibility of extending the linear range.

Why use tan-lock demodulators?

The output voltage of the tan-lock demodulator has the form

$$E_o = \frac{C \sin \Theta}{1 + C \cos \Theta},$$

which can be shown to have a greater approximately linear range than $\sin \Theta$ for proper choice of "C." This output form gives the demodulator its name. The functions $\sin \Theta$ and $\cos \Theta$ are obtained from conventional phase detectors driven in quadrature. The greater linear range, of course, not only reduces distortion of the recovered modulation, but provides the demodulator with improvements in noise threshold, hold-in range, and pull-out frequency.

The tan-lock demodulator (Fig. 1), is used as a phase demodulator only. A separate loop is provided for carrier tracking. The signal from

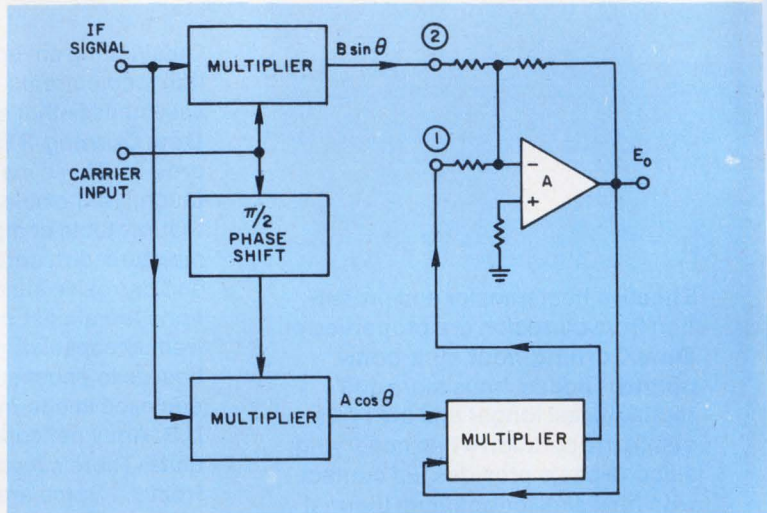

1. The basic loop configuration of the tan-lock demodulator uses a multiplier in the feedback loop to perform division. With the $\cos \Theta$ input set to zero, the loop acts as a coherent demodulator.

the carrier-tracking loop is a phase-modulated signal on a carrier, which is coherent with the i-f signal.

In the circuit shown, an analog multiplier with a transfer function of the form XY/K_o where $10 \leq K_o \leq 100$ is used.² The op amp in the circuit is connected as an inverting summer, whose gain to a signal at input 1 is $-K_1$ and at input 2 is $-K_2$.

The multiplier output

$$E_o A \cos \Theta / K_o$$

is fed to input 1 of the summer and added to the $(B \sin \Theta)$ signal. The summer output is

$$-K_1 E_o \frac{A}{K_o} \cos \Theta - K_2 B \sin \Theta.$$

This is the output signal E_o that is fed back to the multiplier input. Therefore,

$$E_o = -K_1 E_o \frac{A}{K_o} \cos \Theta - K_2 B \sin \Theta.$$

Solving for E_o yields

$$E_o = \frac{-K_2 B \sin \Theta}{1 + K_1 \frac{A}{K_o} \cos \Theta}.$$

Robert P. Hennick, Design Engineer, Communication Systems, Mail Zone C-62, Bell Aerospace Co., Division of Textron, Buffalo, N. Y. 14240

For the case where $-K_2B = \frac{K_1A}{K_o} = C$,

$$E_o = \frac{C \sin \theta}{1 + C \cos \theta}$$

The value of E_o is less than one for all values of C less than one. For linearity, the values for C should lie between 0.5 and 0.8.

The circuit shown in Fig. 2 uses an analog multiplier and an inverting summer. It is limited in frequency response to 100 kHz for full output current and to a maximum frequency of 25 kHz

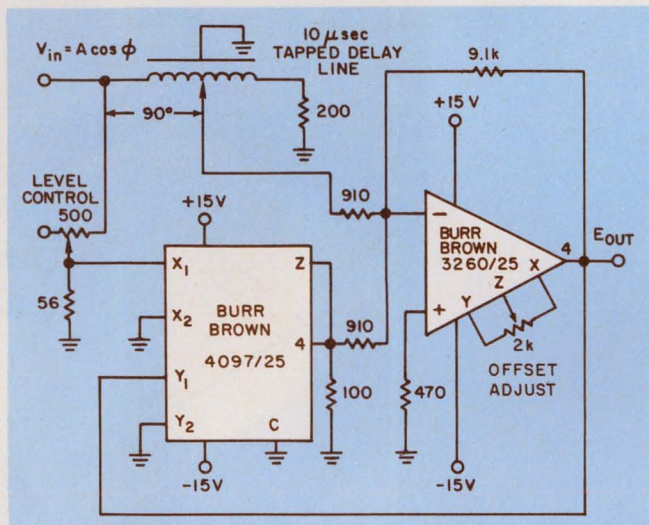

2. The characteristics of the tan-lock loop can be determined by breadboarding this circuit. Full output current is obtained at frequencies up to 100 kHz. The delay line adjusts phase quadrature.

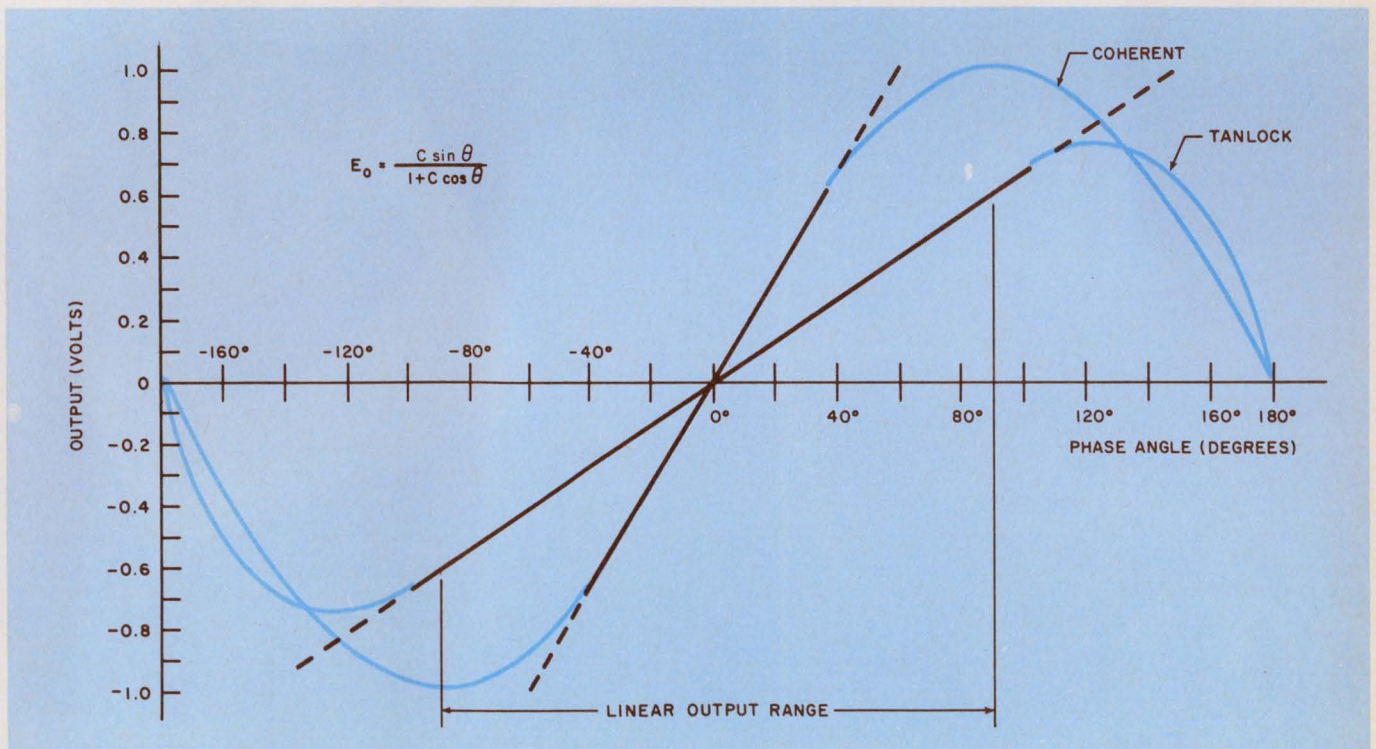

3. The output of the tan-lock loop is linear to phase angles of 2.0 radians when the control, C , is set to a

for a phase shift of 1° .

Sine and cosine inputs are provided with independently adjustable amplitudes. Phase quadrature is adjustable by means of a variable delay line. With a cw sine and cosine input the demodulator will repetitively generate all output values as θ varies from $-\pi$ to $+\pi$. Tests indicate little output response deterioration at 100 kHz (less than 1 dB).

The demodulator transfer function $C \sin \theta / (1 + C \cos \theta)$ for $C = 0.61$ is shown in Fig. 3 superimposed on the sine-wave input. This function is linear for approximately ± 2 radians.

Get coherent demodulation, too

One further feature of this demodulator is that if the amplitude of the $\cos \theta$ input (Fig. 1) is reduced to zero, the multiplier output is zero, and the phase demodulator becomes a coherent demodulator with the characteristic transfer function $B \sin \theta$.

When this is done, the summer becomes an inverting amplifier. The demodulator can easily be changed to a coherent demodulator, then, providing a means for experimentally testing both linear and coherent demodulation. ■■

References

1. Gardner, F. M., *Phaselock Techniques*, John Wiley & Sons, Inc., New York, 1967.
2. Lindenlaub, J. C., et al, "Threshold Study of Phase Lock, Interim Technical Report NASA-CR-80844," Purdue University, December, 1966.

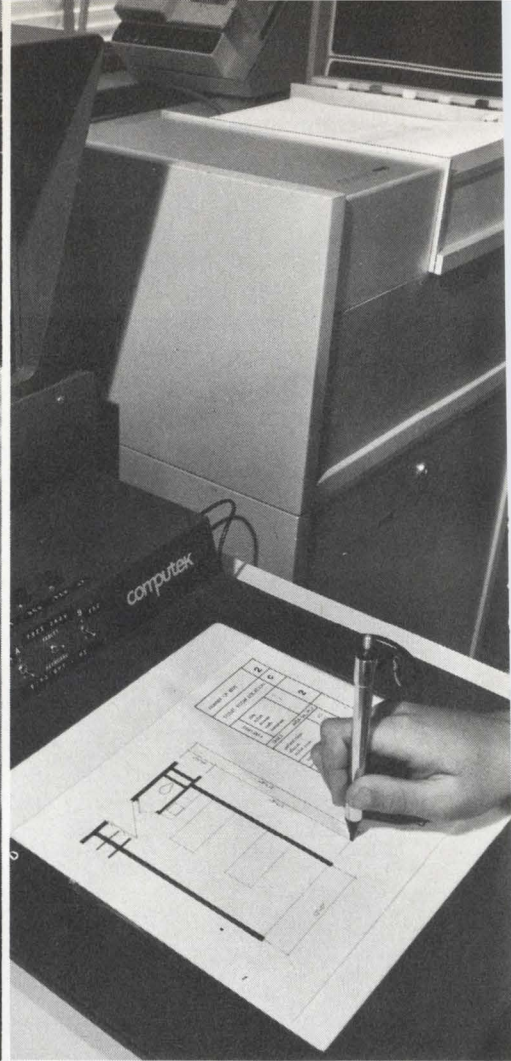

Gould 4800 meets architects' demanding requirements for hardcopy alphanumerics and graphics.

A Boston-based architectural firm, specializing in institutional projects, has made a high speed interactive computer system an integral part of their architectural design process. And to take full advantage of this capability, they use a Gould 4800 electrostatic printer to provide hardcopy alphanumerics and graphics.

The Gould 4800 provides printout for feasibility studies, area diagrams, alternate plans, perspectives, detail drawings, specifications and managerial reports. Where a plotter would take up to 30 minutes to produce a drawing, the Gould 4800 delivers one in seconds.

And where a dry-silver photographic process would produce muddy copies that can't be traced or used directly, Gould 4800 copy is sharp, clean and fully acceptable for client presentations.

The computer system, called the ARK/TWO was developed by Perry, Dean and Stewart Architects and Planners and programmed by Design Systems, Inc.

It includes an Autrotrol digitizer, a DEC PDP 15/20 (16K), 500K Disk, two Computek CRT's with a keyboard and tablet. Ultimately, it's felt this advanced system will reduce the critical path in large construction projects by 4 to 6 months. All kinds of companies are using the Gould 4800 to meet all kinds of hardcopy requirements. This smooth, quiet unit delivers up to 4800 lines per minute on an 8½" or 11" format. It has an optional character generator. Software and interfaces for major computers are available. And while the Gould 4800 has relatively few moving parts and little need for maintenance, there are service facilities nationwide.

Find out what the Gould 4800 can do for you.

Give us a call. Or write: Graphics Division,
Gould Inc., 3631 Perkins Avenue,
Cleveland, Ohio 44114.



 **GOULD**

Solve interference problems painlessly.

Many noise sources, from contact arcs to ground loops, can be eliminated with these design hints and nomographs.

Have you ever had a noise-interference problem and no realistic guide to its solution? You probably had to plow through a field-theory book or a number of articles to extract just that small bit of information needed to solve your problem. Or you may have thrown up your hands in disgust because of differences in presentation or disagreement among authors.

But you can reduce the drudgery of researching every problem you may come across. All interference problems are similar, and most can be solved quite simply. All it takes is a knowledge of the fundamentals.

Basically, two types of design action can be used to reduce interference: electrical and physical.

Good electrical design includes the incorporation of circuitry to suppress contact arcing and to reduce ringing.

Good physical design involves the appropriate use of cabling, grounding and shielding.

The main effect of good electrical design is to reduce the amount of interference at its source. Good physical design, on the other hand, is primarily concerned with protecting a circuit from noise that already exists.

Electrical design for low noise

Contact arcing is the most serious source of interference within electronic equipment. Even a well-designed circuit located near a relay can be drastically affected by the small arcs generated at the relay contacts.

The level of arcing across a pair of separating contacts is primarily determined by the ratio of inductance to resistance in series with the contacts. Additional factors that affect the amount of arcing are contact surface contamination and contact separation velocity.

Thin films of oil or grease can increase the field emission of the negative (cathode) contact. This is one of the reasons for having relays hermetically sealed.

Increasing the contact separation velocity reduces the duration of the arc, but at the same time it increases the maximum arc voltage, because the voltage is proportional to $L di/dt$.

To suppress arcing across separating contacts, a capacitor can be placed across them. Unfortunately, this can aggravate the arcing that occurs when the contacts are closing—leading to the additional problem of contact welding. A resistor in series with the capacitor can ease these problems, but the larger the resistance the less effective is the capacitor in suppressing the separation arc. Thus, a trade-off must be made.

The optimum combinations of resistor and capacitor, as obtained by solving the equation

$$R = \frac{E}{10 (3.16 \sqrt{C})^{1 + 50/E}}$$

are given in the nomographs of Fig. 1. For every value of circuit voltage, an infinite number of optimum combinations of R and C are possible. Thus, for example, if $E = 200$ Vdc, then a resistor of 100Ω in series with a capacitor of $0.0076 \mu\text{F}$ would be appropriate, as would a resistor of 10Ω in series with $0.3 \mu\text{F}$.

Ringing is another common type of interference generated within electronic equipment. This is an undesired oscillation that occurs as a by-product of the normal operation of a circuit. For example, a square pulse may be applied to a relay coil to actuate the relay. At the same time, the pulse may excite the L-C circuit formed by the coil inductance and, say, a coupling capacitor. If the oscillation serves no useful purpose, it should be suppressed.

The most common method of reducing ringing is to introduce resistance in series with the ringing inductance. To easily calculate the amount of resistance needed to suppress the ringing of a given L-C circuit, the nomograph of Fig. 2 may be used. The nomograph solves the equation $R = 2(L/C)^{1/2}$, which is the amount of resistance needed to critically damp the circuit. A value of resistance about 10% greater than the critical-damping resistance will provide enough overdamping to prevent ringing.

For example, with $L = 10 \mu\text{H}$ and $C = 200 \text{ pF}$,

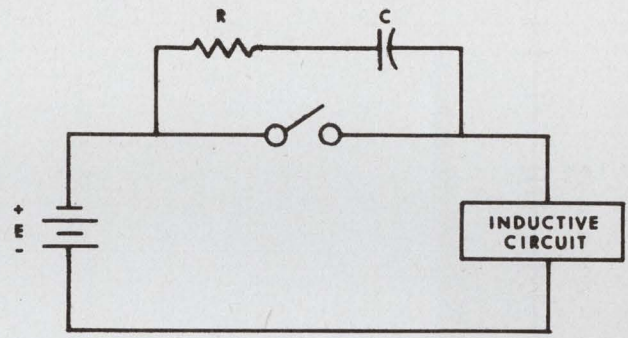
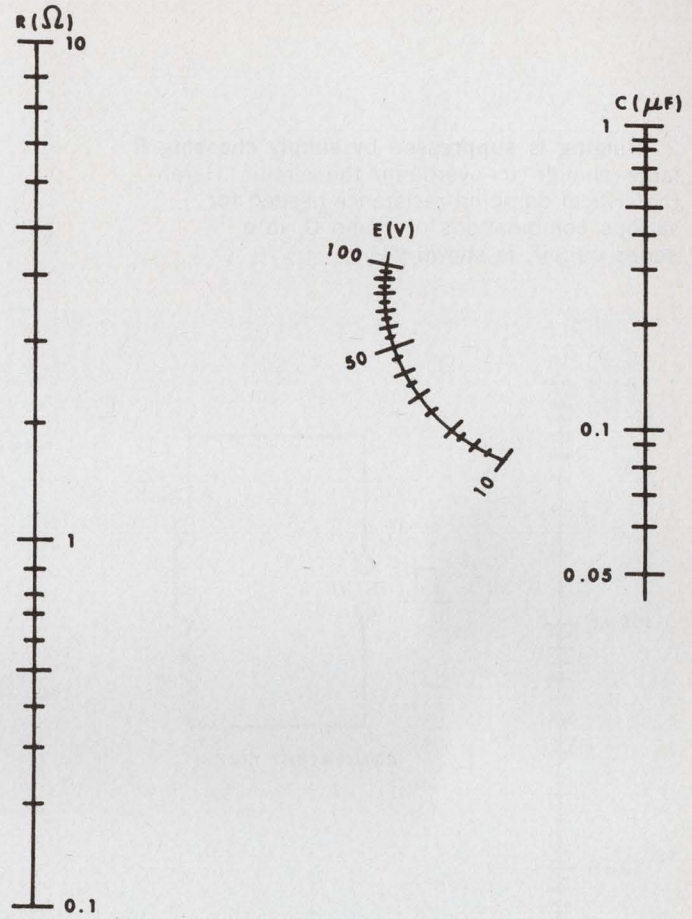
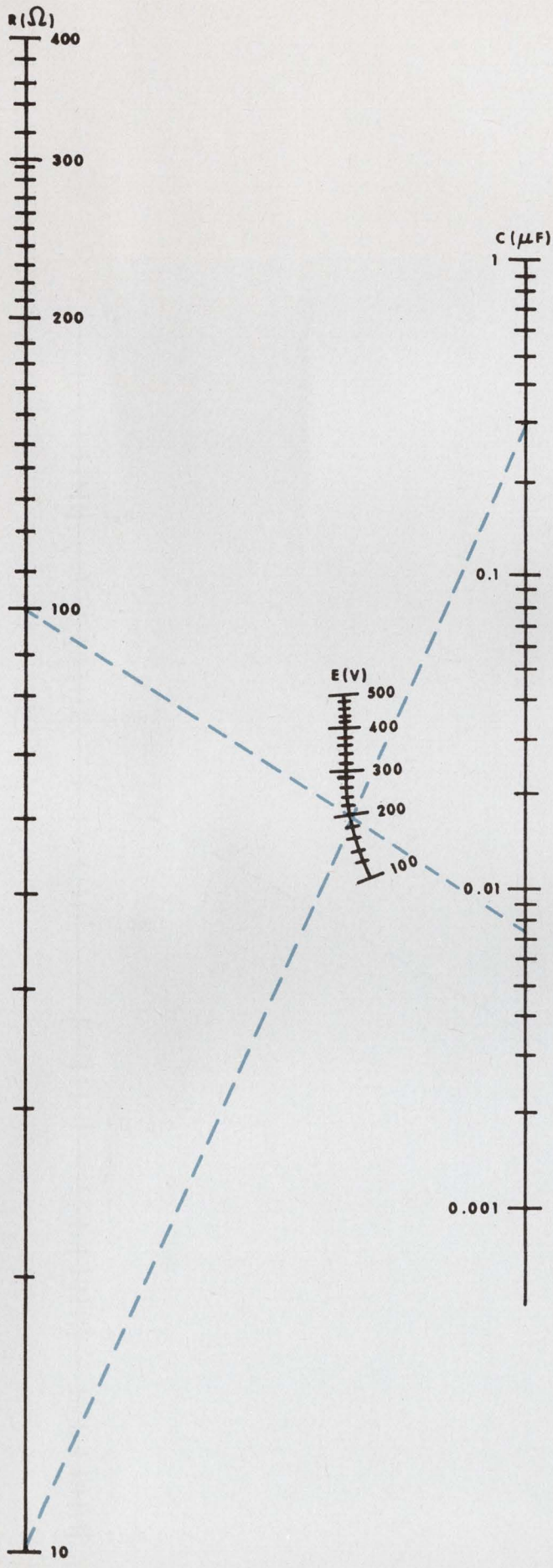

THIS NOMOGRAPH SOLVES THE EQUATION

$$R = \frac{E}{10 (3.16 \sqrt{C})^{1+50/E}}$$

1. Choose the optimum R-C combination to minimize contact arcing. This nomograph shows the best choices of R and C for different open-circuit voltages. The nomograph is broken into two sections: one covers 10 V to 100 V; the second covers 100 V to 500 V.

2. Ringing is suppressed by simply choosing R large enough to overdamp the circuit. Here, the critical damping resistance needed for various combinations of L and C, in a series circuit, is shown.

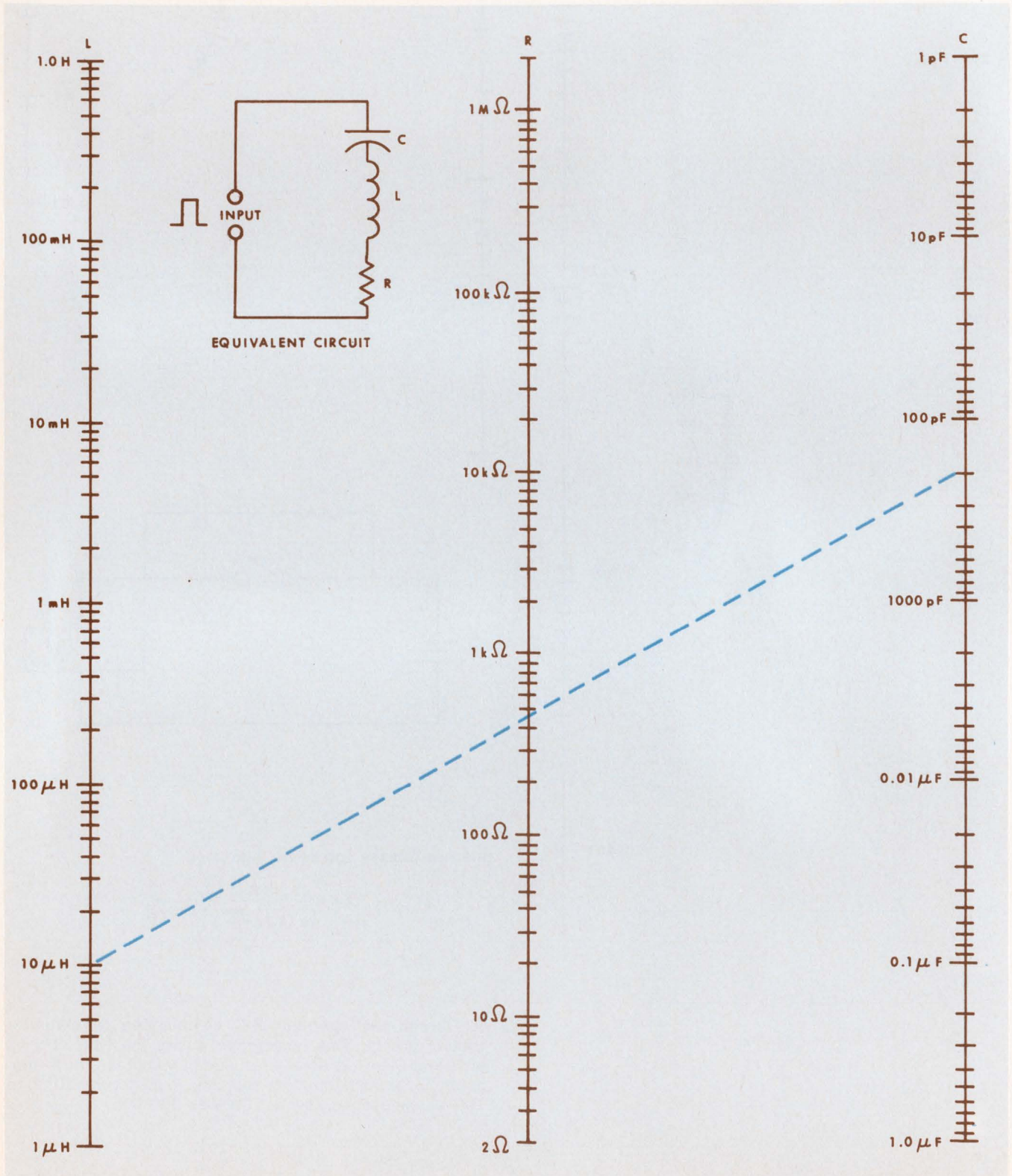

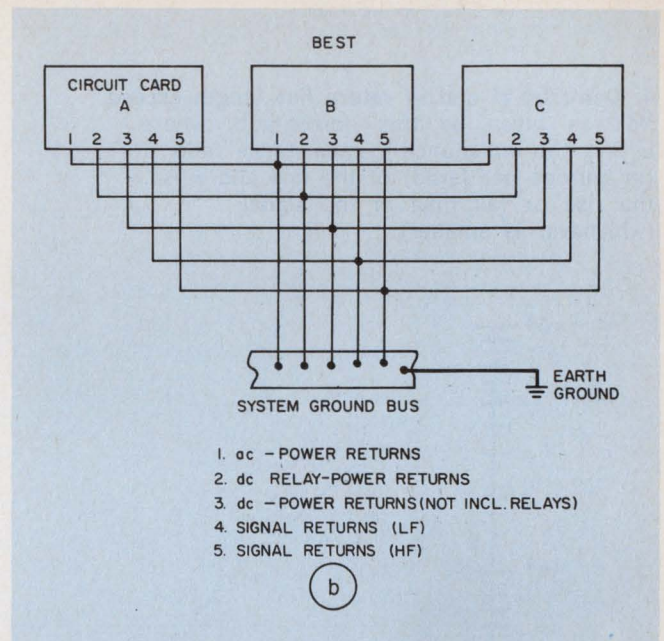
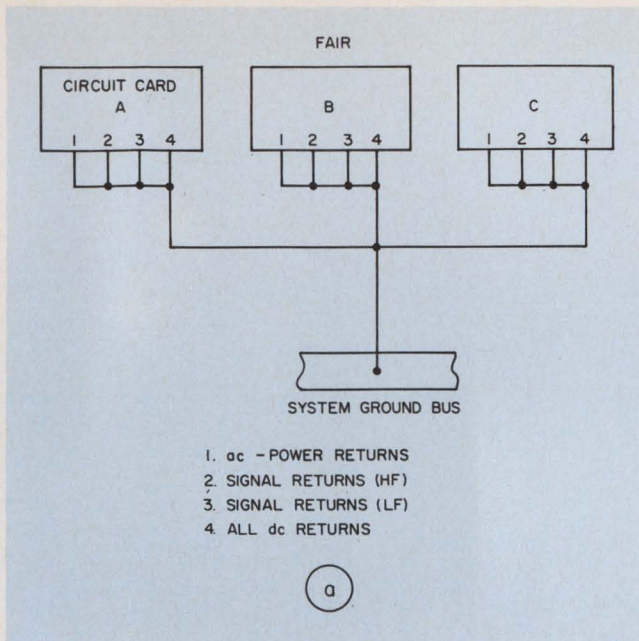

3. **Ground looping is minimized** by keeping all ground-return leads isolated from each other until they terminate at the system ground bus (b). Also, the bus is

earth-grounded with braided wire. This approach to grounding has been found to be better than the more common approach shown in "a."

the nomograph yields $R = 448 \Omega$. For good suppression, use $R \cong 500 \Omega$.

imum line length, d , as a function of τ and the inductance-to-capacitance ratio.

Physical design fights noise

The best-designed circuits may do all sorts of things except their intended functions if their grounding, interconnecting cabling and shielding are not also well designed. A short time spent planning these aspects of a system design can save many hours of frantic redesigning after the system is built.

In the example shown on the nomograph the line is assumed to have $L = 0.1 \mu\text{H}/\text{foot}$ and $C = 10 \text{ pF}/\text{foot}$. Thus $L/C = 10^4 \text{ H}/\text{F}$. For a risetime of $200 \mu\text{s}$, the nomograph indicates that the grounding-wire length should be less than one foot.

Note: For sinusoidal signals, the wire length should not exceed a quarter wavelength.

A list of hints in these three areas follows.

CABLING

GROUNDING

Shield all lines carrying signals above 50 kHz and ground the shields at both ends.

Prevent static charges from building up on the insulation of long cables because of vibration and longitudinal movement, by interposing a thin film of cable lubricant between insulators. Care must be taken to choose the correct lubricant for rubber insulators. Teflon insulation agrees well chemically with almost any lubricant. Or you can tightly bond cable bundles about every 3 inches for each 3/4 inch of bundle diameter.

Use twisted shielded wire for all power lines and ground the shields at the transmitting ends only.

Keep power lines, relay and other electromechanical-command signals in separate cable bundles (away from low-level signal wires) as far as is practical.

Make separate bus lines for dc-relay (and other electromechanical-device returns) and for ac-signal returns. Connect all bus lines to earth (chassis) ground with braided wire (Fig. 3).

Chassis-ground all control shafts by spring fingers to prevent interfering signals from reaching the device under control, such as a resolver.

Use twisted pairs for all signals in the audio range. The frequency of a nonsinusoidal signal can be calculated from the formula $f = 0.35/T$, where T is the rise or fall time of the signal, whichever is shorter, and f is the frequency of an equivalent sinusoid.

Ground returns for rf and i-f signals at their respective chassis with wire less than one-half the length of the product of the signal's minimum risetime, τ , and the line's propagation velocity, v — $d < \tau v/2$. The propagation velocity of a line is $v = (LC)^{-1/2}$ where L and C are the line's inductance and capacitance per unit length, respectively. The nomograph of Fig. 4 presents the max-

Always terminate a coaxial cable in its characteristic impedance to minimize reflections.

(continued on next page)

4. Don't let rf and i-f return line length exceed "d" as given by this nomograph, where L/C is the inductance-to-capacitance ratio (in henries per farad) of the line and τ is the rise or fall time of the signal (whichever is smaller).

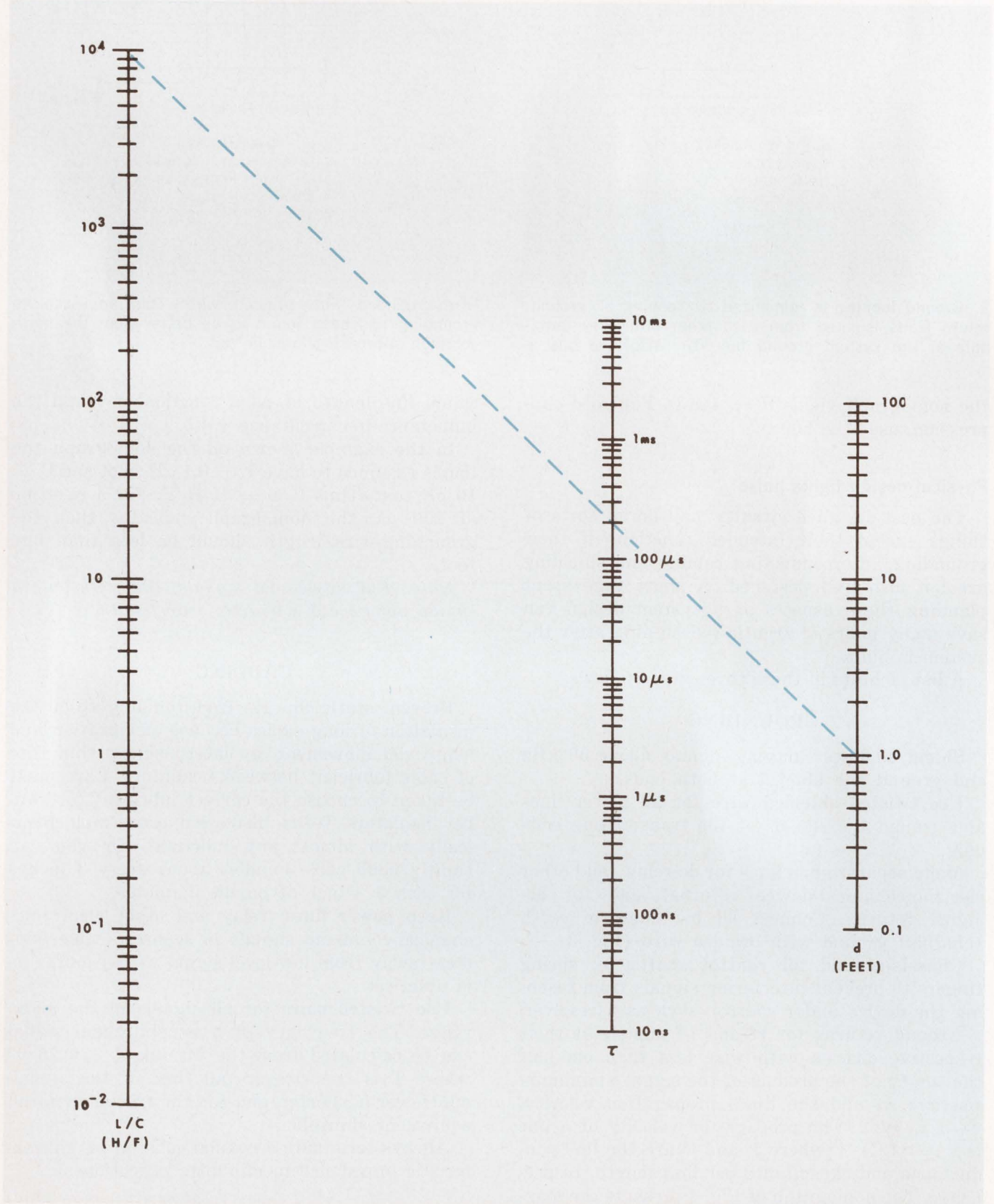

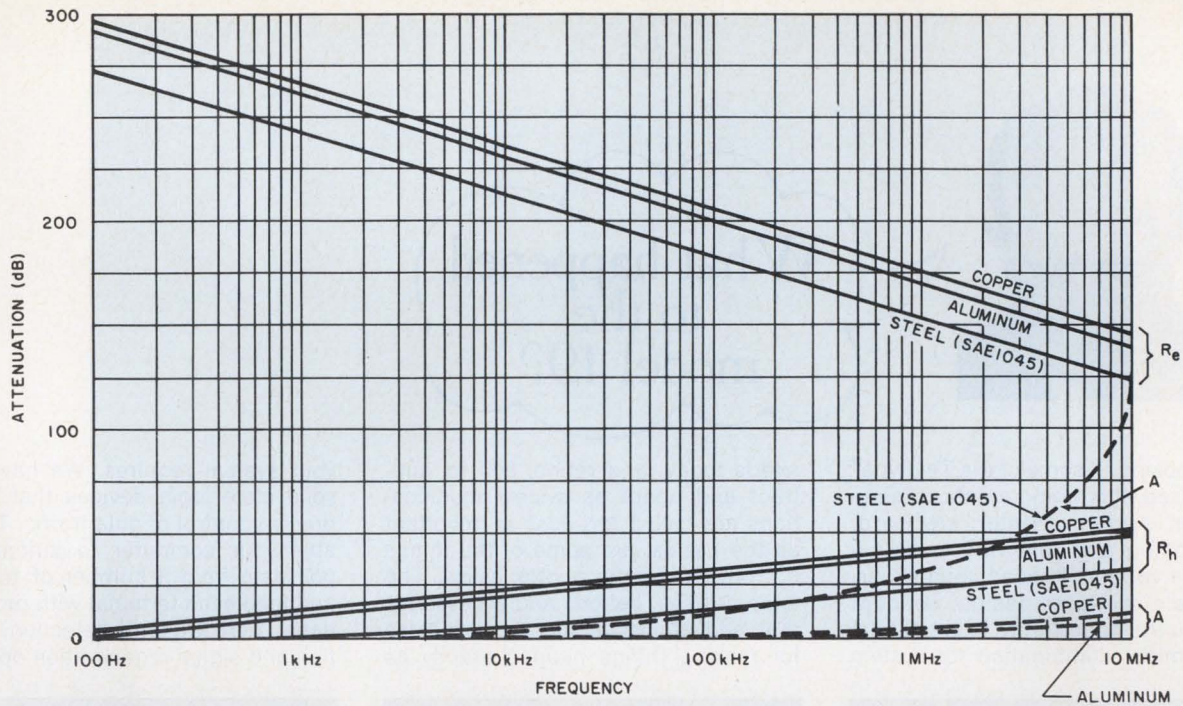

5. Compare the shielding effectiveness (S) of aluminum, copper and steel by checking their electric-field reflection losses, R_e ; magnetic-field reflection losses, R_h , and

absorption losses, A. $S(\text{dB}) \cong R_e + R_h + A$. The absorption losses are given for a one-mil thickness of material and can be scaled up for larger thicknesses.

SHIELDING

Shield your design with a material that can reflect and absorb external interference. A shield's effectiveness, S, is the sum (in dB) of all of the losses it imposes on a field that impinges upon it. S is approximately equal to the sum of the electric-field reflection losses, R_e , the magnetic-field reflection losses, R_h , and the losses resulting from absorption by the shield material, A.

The graph of Fig. 5 shows the reflection losses (both R_e and R_h) as a function of frequency for aluminum, copper and steel located one inch away from the source of interference. The graph can be used for larger distances by subtracting 1/2 dB per inch from R_e and adding 1 dB per inch to R_h .

Absorption losses for the same three materials are also shown in Fig. 5. The curves are all for a piece of material one mil (0.001 inch) thick. For thicker material, multiply the thickness, in mils, by the figures shown on the graph.

Assume for example, that a shield is required around a circuit to attenuate the interference radiated by a wideband transformer located eight inches away. Let's also assume that 320 dB of attenuation is needed and that the lowest frequency component in the interfering signal is 3 MHz. Furthermore, let's require that aluminum be used because no other materials are available.

From Fig. 5, at 3 MHz, we find:

$$R_e = 156 - (1/2) \times 8 = 152 \text{ dB}$$

and

$$R_h = 45 + 8 = 53 \text{ dB.}$$

Thus, $R_e + R_h = 205 \text{ dB}$. The remaining 115 dB must come from absorption losses. Since a one-mil thickness of aluminum provides 5 dB of absorption at 3 MHz, a thickness of 23 mils (0.023 inches) will be needed. ■■

Bibliography

ARCING

Bates, C. C., "Contact Protection for Electromagnetic Relays," *Electromechanical Design*, August, 1966.

Germer, L. M., and Daworth, F. E., "Erosion of Electrical Contacts on Make," *Journal of Applied Physics*, Vol. 20, November, 1959.

CABLING AND GROUNDING

Brenner, M., and Manzi, M., "Grounding Coax and Shielded Cable," *Electronic News and Engineering*, Vol. 62, No. 8, April, 1953.

Caso, L., "Approximating Cable Diameters," *Design News*, Jan. 5, 1970.

Hole, R. D., "Noise Generation by Coaxial Cables When Subjected to Vibrating," *Electronic Engineering*, December, 1960.

Mahr, R. J., "Interference Coupling—Attack It Early," *EDN*, July 1, 1969.

Manzi, M.; Marsman, J. M.; and Brenner, M., "Grounding Shielded Cable," *Electrical Manufacturing*, Vol. 18, May, 1945.

MIL SPECS

MIL-I-618D, *Interference Control Requirements*, Aircraft Equipment.

MIL-C-27072A, *Cable, Special Purpose, Electrical Multi-conductor*.

MIL-STD-285, *Method of Attenuation, Measurement for Enclosures, Electromagnetic Shielding for Electronic Test Purposes*.

SHIELDING

Ellwood, W. D., "Magnetic Shields," *Bell Laboratories Record*; November, 1938.

Fichie, R. H., *Electrical Interference*, Hayden Publishing Co., Inc., New York, 1964.

Jorgensen, C. M., "Shielding in Modern Computer Design," *Automatic Control*, Vol. 8, No. 6, December, 1958.

Robinson, J. G., "Fundamentals of EMI Shielding," *Electro Technology*, June, 1966.



What happened to the model 19?

You're looking at some of the Teletype® basics used in building a data communications system. Printer, keyboard, tape sending and receiving combinations in a variety of speed capabilities. Teletype's modular design concept gives you the opportunity to extract the best terminal combination for system

needs today, and refine, add to, subtract and adapt as system modifications are called for. Just as important as the basics, are some of the things not obvious in the photos below. The logic devices, options and accessories that add almost limitless possibilities for making things happen exactly as

your system requires. We have some solid state logic devices that provide precise control of data traffic. That enable your computer to automatically poll data from a number of terminals and feed each terminal with processed data. There are error detection, correction and signal regeneration options to

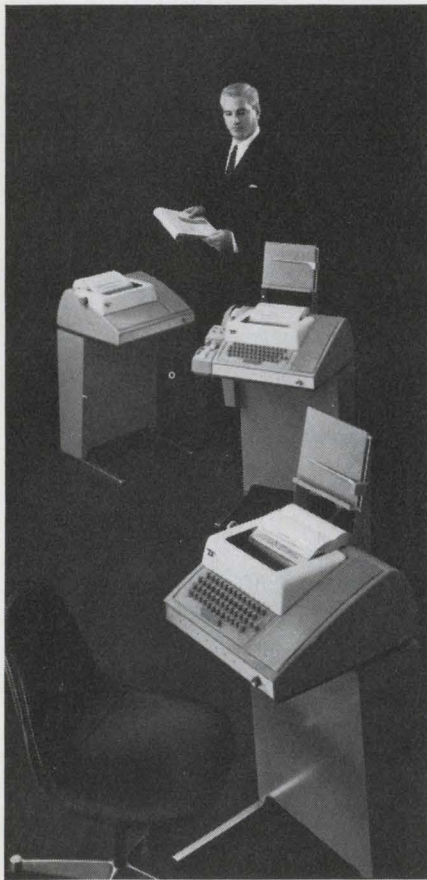

model 33 series: An extremely economical 100 wpm terminal line. Has 4-row keyboard, uses 8-level ASCII code. The most widely used terminal in time-sharing systems today.



model 35 series: A rugged, heavy-duty line of 100 wpm terminals. Uses ASCII. Units in foreground are self-contained paper tape punch and paper tape reader.

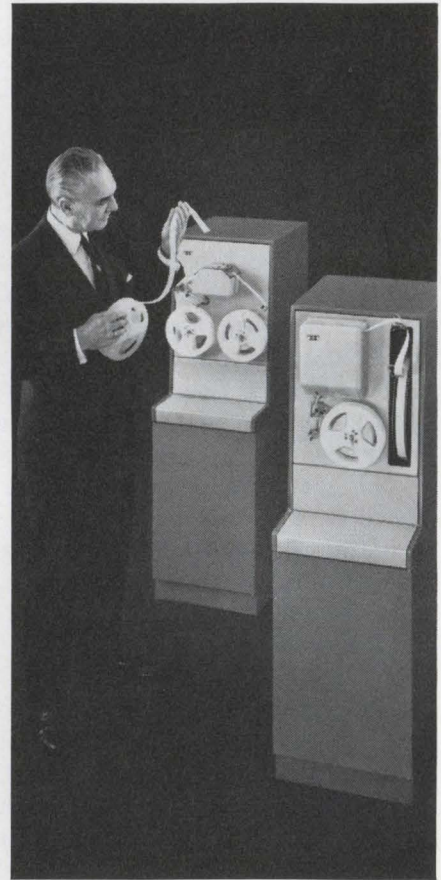

Telespeed™ equipment: A line of high-speed tape-to-tape terminals capable of sending and receiving at speeds of 750, 1050 (shown above), or 1200 words per minute.

DATA COMMUNICATIONS

equipment for on-line, real-time processing

keep data flowing faultlessly. Options such as pin-feed platens and form feed controls that make it possible to fill multiple copy business forms on-line. And many, many more. What did happen to the model 19? Believe it or not, there are still some of these old, die-hard terminals around. And that's

another advantage your data communications dollar buys when you specify Teletype equipment. It lasts. Moves data reliably, economically, for a long time. On a price/performance basis, Teletype equipment is in a class by itself.

Teletype data communications equipment is available in send-receive capabilities of up to 2400 words per minute. If you would like specific information about any of the equipment described here, write: Teletype Corporation, Dept. 89-17, 5555 Touhy Ave., Skokie, Ill. 60076.

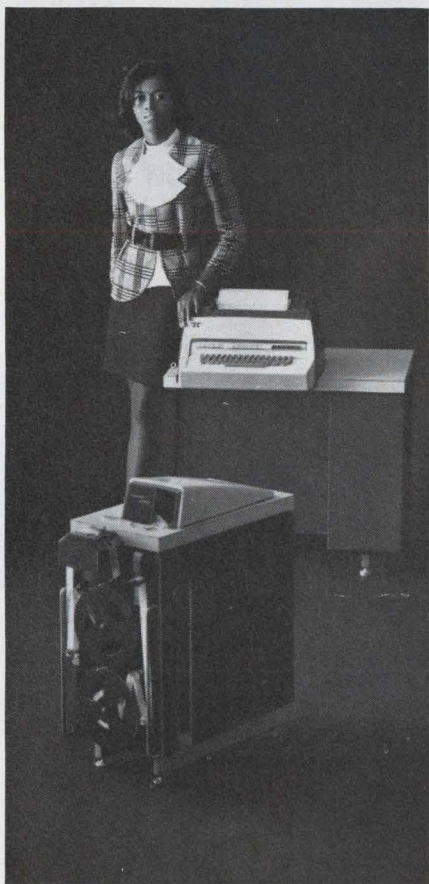

model 37 series: One of the most versatile heavy-duty terminal lines going. Generates all 128 characters of ASCII. Operates at 150 wpm. Prints in upper and lower case.



Inktronic® data terminals: A unique electronic, solid state terminal. Prints up to 1200 wpm. Forms characters through electrostatic deflection (no typebox). ASCII compatible.



magnetic tape data terminals: Use compact reusable tape cartridges. Operate on-line at up to 2400 wpm, and connect "locally" to lower speed Teletype terminals using ASCII code.

Teletype is a trademark registered in the U.S. Pat. Office

machines that make data move



INFORMATION RETRIEVAL NUMBER 47

Puzzled by management responsibilities?

This refresher gives you the complete picture of your duties, and guides you in the techniques that lessen inherent conflicts.

Engineers often find that the jump from the drawing board to the executive board is a longer one than they had anticipated. Many aspiring young men with technical ability have fallen short of the management mark because they've found it difficult or impossible to discharge the numerous, diverse, and conflicting responsibilities required of them. First-line or middle managers, for example, are responsible to four basic groups, including higher management; parallel organizations; subordinates; and customers.

So let's identify the supervisory responsibilities, examine their ramifications, and explore the inherent conflicts arising from them.

Responsibilities to top management

Depending on the company, the technical manager's responsibilities to higher management are determined either by executive management personnel, or jointly. The technical manager is expected to provide top management with what it wants, when and how it wants it. He's also expected to suggest or recommend changes, identify problems, and implement policy and directives from above. Beyond that he should:

- Ensure that the objectives of the technical activities are consistent with company objectives.
- Promote the growth and performance of the company, as well as the technical activity.
- Coordinate and direct large multidisciplinary project groups.

Technical managers often establish objectives that are not entirely consistent with those established by top management. They tend to emphasize understanding rather than utility, technical excellence rather than operating ease, and creativity rather than routine. The corporate group tends to emphasize financial soundness,

H. Burt Hiester, Advisory Marketing Representative, Avionics Systems Marketing, IBM Electronics Systems Center, Owego, N. Y. 13827.

The author's comments are not intended to reflect the management policies of any one company but are based on his experiences with a number of electronics firms.

growth in business volume, and utility. To ensure company compatibility, it is up to the line manager to remind top management to define the company objectives, communicate them to the technical managers, and periodically review them. If implementation of a company objective has an adverse effect on the subordinates of the technical manager, he should inform management of the situation, support the claim with facts, and suggest constructive solutions.

Since top management is principally concerned with over-all company performance and growth, it is reluctant to advocate the expansion of one activity at the expense of others unless it can be reasonably established that the company will benefit sufficiently. Technical managers, not unlike other managers, tend to become embroiled in their own activities to such an extent that they sometimes fail to keep abreast of their over-all

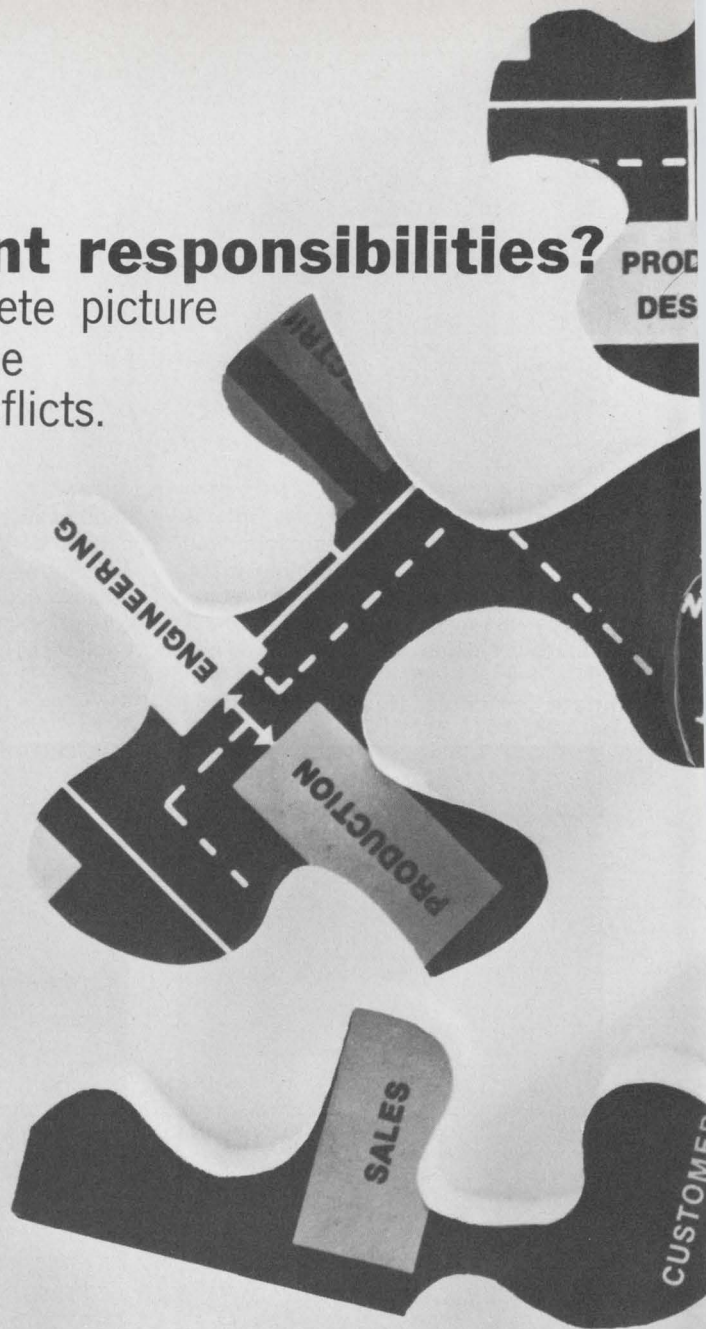

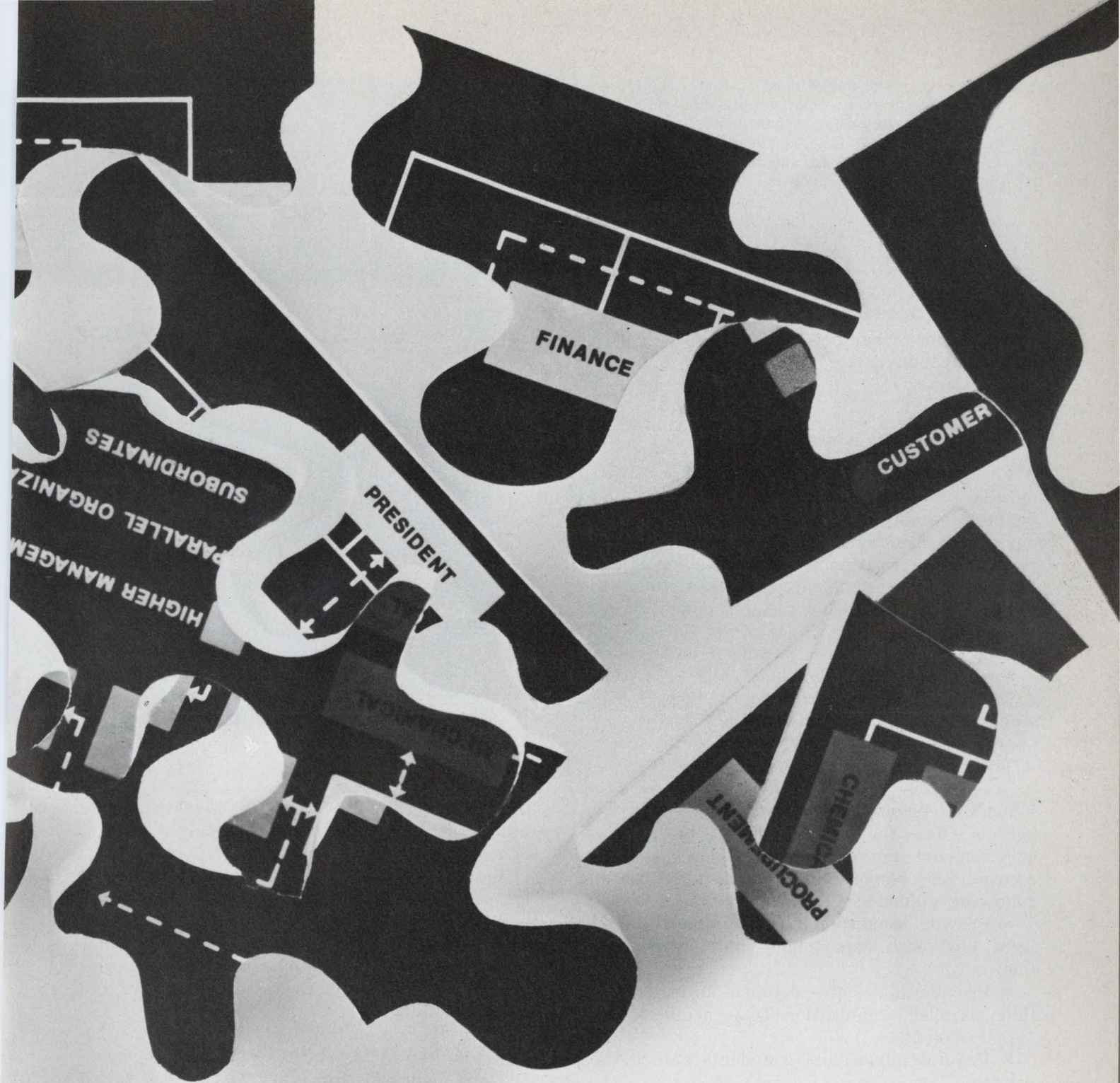

impact on the rest of the company. They must be constantly vigilant that balance is maintained.

A third responsibility to top management is to coordinate and direct large multidisciplinary groups that include representatives of different disciplines such as engineering, management, physics, chemistry, anthropology, and mathematics. Proper development and use of such a group can be accomplished, in part, by acquiring an understanding of a broader spectrum of disciplines with emphasis on how they relate to one another.

In addition, accountability is an inherent part of company activity. Every individual is accountable for his actions to someone else. Therefore, the technical manager is responsible for keeping his superiors informed through some reporting structure.

The schedule and type of report is generally determined by the supervisor, but the two principal types of written reports are those for control and those for planning purposes. Control reports include information that facilitate evaluation, show causes of variances from planned results, and provide the basis for performance measurement. Planning reports are those that keep executive levels of management advised of the

The dotted lines on this corporate organization chart point out the four primary sources of management responsibility the technical manager has. He fulfills his duties to top management, peer groups, subordinates, and the customer by, respectively, providing data; negotiating; delegating and satisfying.

latest technological developments and potential new-product areas for the business organization to consider.

When responsibility is negotiable

The responsibilities of technical managers to parallel organizations are sometimes difficult to define, especially when the functions of the various groups are vaguely described. The degree of responsibility then tends to become negotiable. In many instances one party will assume that the other party has taken the responsibility and tasks go unperformed. Since direct lines of control do not exist between parallel groups, coordination is essential. To solicit the support of parallel organizations, techniques of persuasion and cajolery—along with a sincere wish to help—are generally necessary.

The technical manager, more often than not, is a member of the engineering department, which may be only one of several parallel organizations within the company. To secure the necessary support, the technical manager should discharge his responsibilities according to the following guidelines:

- Provide background information and highlight how each department contributes to the final output.
- Provide sufficiently detailed information so that parallel organizations can perform their tasks efficiently.
- Request advice and comments rather than dictate.
- Avoid overcontrol, but insist on receiving progress and status reports on a regular basis.
- Do not blindly assume technical competence, but periodically check on quality of output.
- Recognize the achievements of these organizations.

A spirit of cooperation is essential among parallel organizations. Too often, well-conceived programs have floundered because of bickering and squabbling among the personnel.

Responsibilities to subordinates

In a broad concept, the primary responsibility of the technical manager to his subordinates is

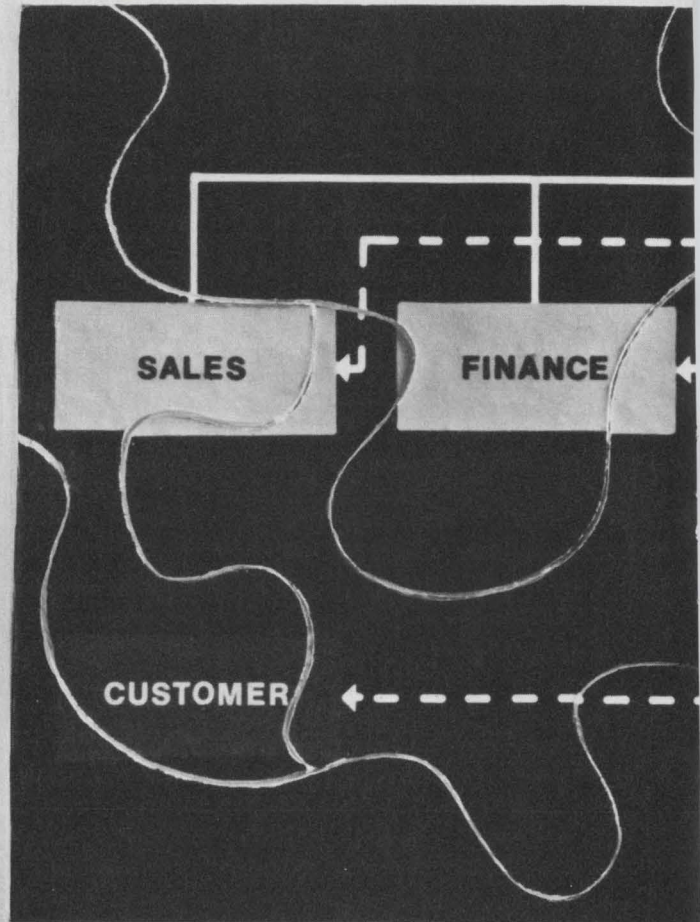

service. A well-known Biblical quotation exemplifies this concept of service: "Let him who would become great among you first become the servant of all."

Specifically, the supervisor's responsibilities to his subordinates include motivation, leadership, and the establishment of a proper work climate. Through the manager's leadership and guidance in a proper working atmosphere, his subordinates become as productive as their abilities and morale allow.

When the productivity of a subordinate becomes limited by his ability, the manager should attempt to provide him with tasks more suited to his abilities or with opportunities to increase them, such as encouraging him to take courses within the company and outside it.

When the technical manager sees fit to delegate responsibility to his subordinates, he should attempt to abide by the following three cardinal rules:

1. Keep an open mind.
2. When a subordinate makes an honest mistake, try to turn it to advantage.
3. Don't overdirect subordinates.

In addition to passing background and detailed assignment information down the line, the technical manager is responsible for forwarding pertinent information from his subordinates to

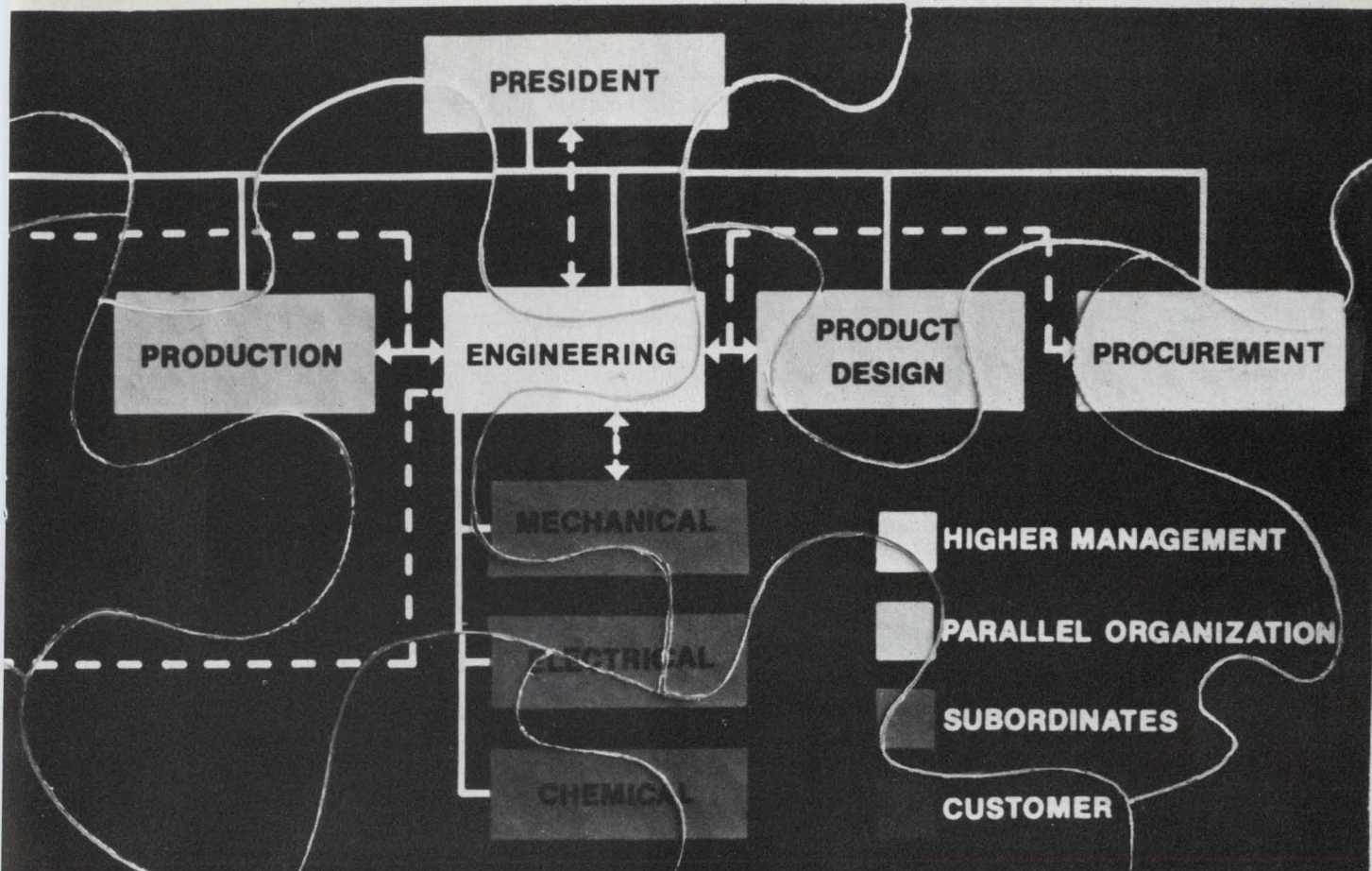

higher management. In the interests of maintaining high morale among his subordinates and providing top management with realistic information properly attributed to personnel, the technical manager should act more as an information relay center than as a converter or filter.

Technical managers have the additional responsibility of telling their subordinates the complete and honest story that applies to the over-all activities of the company and the technical group, as well as the areas covered by their performance appraisal. Most technical personnel want to know where they stand, how they're doing, and how they might improve. Here are some don'ts to aid technical managers to delegate responsibility:

- Don't use language that is vague in meaning.
 - Don't assume that the person to whom you delegate work automatically knows what you want done.
 - Don't talk down to employees or watch over their shoulders after you have delegated work.
- Some do's include:
- Select the proper employee for the task.
 - Use examples and demonstrations when applicable.
 - Limit the number of orders given at one time.

- Allow reasonable time for the job.
- Follow up in an orderly fashion.

Responsibilities to the customer

The three principal responsibilities to the customer are:

1. Be on schedule.
2. Meet technical specifications (performance).
3. Be within budget.

Being on schedule has assumed greater importance in recent times with the advent of the large complex space and weapon programs. The overall progress of these programs depends upon the accomplishment of a multitude of subprojects. For example, consider the space program in which the following major subprojects—just to list a few—had to be completed before astronauts could be launched into space (with a high degree of assurance that they would return safely):

- Develop and test launch vehicle.
- Develop and test propellents.
- Develop and test space vehicle.
- Develop and test electronic equipment.
- Select and train personnel.
- Develop and test ground tracking station network.
- Perfect rescue or retrieval operations.

■ Perform system marriage tests—equipment with equipment and personnel with equipment.

A delay in one or more of these projects resulted in the over-all program being delayed. In such situations the resulting expenses are greatly magnified when such a delay occurs, because the remaining subprojects still have to be financed during the delay period.

Meeting the technical specifications is an obvious responsibility of the technical manager since the final product, if it is hardware, must perform a task or do a job. There are also certain minimum performance standards (both electrical and environmental), dictated by the intended use or operation that must be achieved by the final product. In many cases the customer will request performance that is beyond the state of the art or performance that is really not required for the particular operation—such as overdesign. For these reasons the technical specifications are often relaxed during the course of the program.

Being within budget is probably the least important of the three responsibilities to the customer, nevertheless it is significant. In this era of technological advancement, especially related to research and development projects, it is almost impossible to predict budgets accurately. There is just too much virgin ground being plowed to program costs accurately, and the uncertainties simply overwhelm the certainties. For this reason, it might be more realistic to consider these budgets as tentative goals. However, the technical manager should strive to meet them.

Other responsibilities of the technical manager to the customer include: keeping the customer appraised of program status and progress as well as potential problem areas—there should be no surprises; maintaining cordial relations with the customer and making him an integral part of the project; and listening attentively to the suggestions of the customer in areas of concern to him.

The foremost responsibility of the technical manager is to keep the customer satisfied. And if the technical manager discharges all the previously mentioned responsibilities in an expeditious manner, he will have a satisfied customer.

Alleviating the conflicts

Now that several of the technical manager's responsibilities have been discussed and the sources from which they emanate identified, let's explore potential conflicts that arise from the diverse nature of these responsibilities and recommend a few techniques that should lessen their severity.

The general potential conflict arises from a variance in the perspectives of the technical and management groups. The technical group empha-

sizes creativity and contributions to man's knowledge, whereas the management group emphasizes financial soundness, growth in business volume, and return on investment.

More specifically, conflicts arise in the area of selection and scheduling of tasks. The technical manager finds himself in the middle of this clash.

As a partial solution to this problem, each summer about 50 key personnel from one company (representatives of both management and technology) gather at an old farm in Vermont. There they reflect, consider, and discuss these conflicts and other areas related to maintaining a high level of company efficiency and growth. Bringing the representatives of both groups together in a relaxed low-pressure atmosphere allows them to contribute much to the solution of their own and mutual problems.

A second potential conflict lies in the area of training personnel vs meeting current schedules and budgets. Some technical managers take the long-range view that it is necessary to provide their personnel with a variety of experiences, especially early in their careers, so that they will become more versatile and make more significant contributions in the future. To accomplish this, the technical manager must often use his personnel inefficiently. This, in turn, endangers the likelihood of meeting current schedules and staying within budgets.

In this situation the technical manager sometimes finds it difficult to satisfy simultaneously his responsibilities to management and the customer, on the one hand, and to his subordinates on the other. Long-term gains might not be sacrificed so regularly to short-term profits if the technical manager could find a way to prove to management that the company would profit more over the long haul, from long-term gains.

In the application of controls the technical manager is confronted with a difficult problem. Top management and the customer have a basic right to know the status and progress of the programs and to be advised of potential problem areas. To do this, technical managers must implement control procedures—which technical personnel appear to dislike intensely—because they claim that controls tend to: stifle creativity, create too much pressure, force-fit personnel to a schedule and measure the output only in terms of dollars.

If the technical managers were at liberty to select their own control procedures, they could possibly select procedures that would provide the necessary information and also be least objectionable to the technical personnel.

Though he may not solve all of his problems and create a utopian environment, by following these suggestions, the technical manager can do much toward lessening his dilemma. ■■

General Electric's new epoxy TO-18 transistors run hot and cold

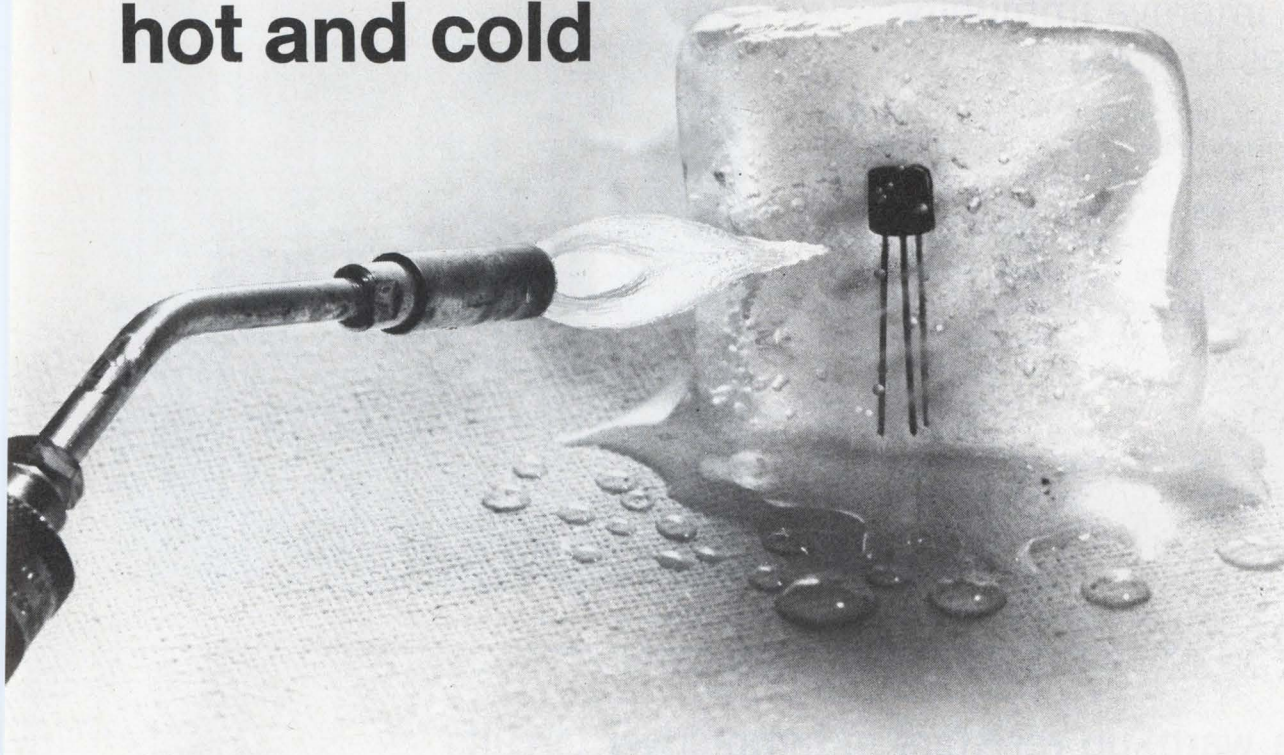

- ✓ **PASSED**
85C @ 85% R.H.

- ✓ **PASSED**
-65 to +150C
temperature cycling
MIL TEST

General Electric has just introduced 32 new TO-18 based epoxy transistors. And we know they're good. We've tested them over and over again. Tests like temperature cycling from -65C to +150C. Not just a few times . . . but 300 times. That's 30-times the normal MIL requirement for reliability.

We've subjected these new epoxy transistors to other tests, too, such as 85C at 85% relative humidity for up to 8000 hours just to find out how reliable they really are.

GE's epoxy TO-18 transistors can take the bumps, too. No need to worry about shock or vibration damage. Their solid epoxy encapsulant provides rigid mechanical stability . . . seals trouble out and performance in.

We've got 16 new JEDEC types and many new GET replacement devices that will substitute for common 2N types with no redesign at all. We're adding more new types every month. They're available in NPN's, PNP's, matched pairs and Darlington amps with breakdown ratings up to 60V and dissipation as high as 500 mw.

We've tested these transistors in every way possible. See the results for yourself in our new reliability

brochure (Pub. #95.28). We'll send the brochure along with specification sheets for GE's new epoxy TO-18 transistors.

Just write General Electric Company, Section 221-33, 1 River Road, Schenectady, N. Y. 12305. In Canada: Canadian General Electric, 189 Dufferin Street, Toronto, Ont. Export: International Sales Division, General Electric Co., 159 Madison Avenue, New York, N. Y. 10016.

PD mW	Ic mA	JEDEC Type	NPN				PNP				
			hrs			Noise fig. dB (max)	JEDEC Type	hrs			Noise fig. dB (max)
			Ic=1 Vce=1V	Ic=300 Vce=2V	Ic=800 Vce=5V			Ic=1 Vce=-1V	Ic=300 Vce=-2V	Ic=800 Vce=-5V	
400†	500	2N6000	50	40		3.0	2N6001	90	35		3.0
400†	500	2N6002	130	80		2.0	2N6003	210	50		1.5
400††	500	2N6004	50	40		3.0	2N6005	90	35		3.0
400††	500	2N6006	130	80		2.0	2N6007	210	50		1.5
500†††	800	2N6010	45	85	45	5.0	2N6011	70	65	45	3.0
500†††	800	2N6012	90	160	50	3.0	2N6013	180	135	70	2.0
500††††	800	2N6014	45	65	15	5.0	2N6015	70	60	35	3.0
500††††	800	2N6016	90	60	15	3.0	2N6017	180	125	55	2.0

† BV_{CEO}=25V; †† BV_{CEO}=40V; ††† BV_{CEO}=60V

GE Type	Replaces	GE Type	Replaces	GE Type	Replaces
GET706	2N706	GET2221A	2N2221A	GET3013	2N3013
GET708	2N708	GET2222	2N2222	GET3014	2N3014
GET914	2N914	GET2222A	2N2222A	GET3638	2N3638
GET929	2N929	GET2369	2N2369	GET3638A	2N3638A
GET930	2N930	GET2484	2N2484	GET3646	2N3646
GET2221	2N2221				

GENERAL ELECTRIC

INFORMATION RETRIEVAL NUMBER 48

ideas for design

Resistors improve immunity of flip-flops to noise

The noise immunity of a simple counting flip-flop can be greatly improved by the addition of two resistors. The diagram shows a conventional circuit with the two extra resistors, R_1 and R_8 .

Without these resistors the circuit has almost zero noise immunity and can easily be triggered by noise pulses in the ground lines.

With the two resistors added, the noise im-

munity is $\frac{R_2 V_{cc}}{R_1 + R_2}$.

R. Verrill, Industrial Systems Engineering Dept., G.E.C. Electrical Products Limited, Bough-ton Rd., Warwickshire, England.

VOTE FOR 311

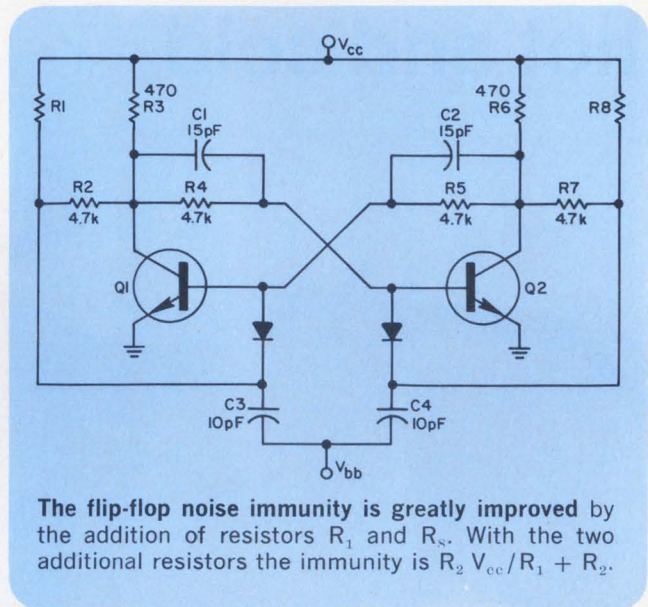

The flip-flop noise immunity is greatly improved by the addition of resistors R_1 and R_8 . With the two additional resistors the immunity is $R_2 V_{cc} / R_1 + R_2$.

Eliminate warm-up resistors in lamp-driver circuits

Conventional lamp-switching circuits waste power by using lamp warm-up resistors. The conventional warm-up resistor continually conducts current through the lamp to maintain the filament resistance while limiting the current enough to avoid lamp illumination. This prevents excessive turn-on current surges when the warm-up resistor is bypassed to produce full lamp illumination.

Cold lamp turn-on surge currents can range to 10 times steady-state lamp currents, and they play havoc with the power supply and surrounding circuits, but standby lamp warming power can be a large fraction of active power dissipation. Furthermore, this warming current reduces the life of the lamp.

The circuit shown does not require standby power dissipation, and it requires less surge current capability than conventional lamp-driver circuits. This circuit cannot be damaged by insertion of a cold lamp while the driver is turned on. The circuit uses the delay inherent in the lamp warm-up.

When the input logic level is ZERO, Q_1 is biased off, thus biasing off Q_2 . When the input logic level changes to ONE, resistor R_2 supplies constant current to Q_2 biasing Q_2 on and passes constant current through the lamp. Since the lamp has a very low resistance value initially, the

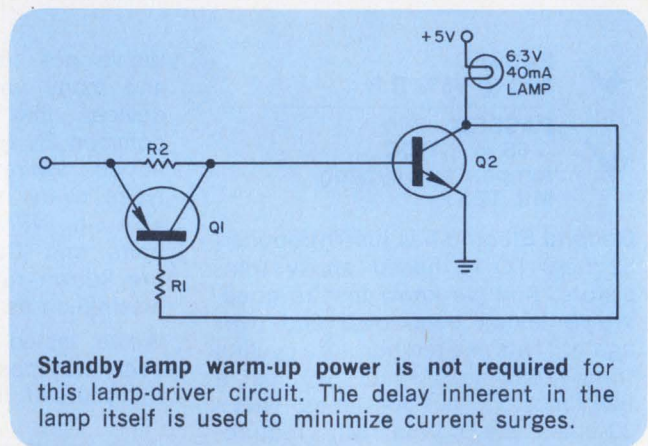

Standby lamp warm-up power is not required for this lamp-driver circuit. The delay inherent in the lamp itself is used to minimize current surges.

collector voltage of Q_2 is approximately 5 V and Q_1 remains biased off. As the current from R_2 and Q_2 warm the lamp and its internal resistance increases, the collector of Q_2 declines to less than the input logic level. Transistor Q_1 is biased to saturation as the internal resistance of the lamp increases to its steady-state value. If the input logic level returns to ZERO the circuit is, of course, biased off and the lamp is extinguished.

Alphonso H. Marsh, Jr., Sr. Engineer, Raytheon Company, 111 Horse Pond Rd., Sudbury, Mass. 01776.

VOTE FOR 312

If a thousand solid-state low-level switches won't turn you on, how about \$80 a switch?

You may not have 1024 signals at 2.5 millivolts that you want to run at 20kHz, but you can control that many if you want to by hooking eight of our solid-state differential multiplexer units together.

What's probably more important to you is that, even if you need only 128 switch channels, it'll still cost you less than \$110 per channel, including a 12-bit A-to-D converter, power supply, all multiplexer control circuitry, 13 levels of programmed gain and interconnecting cabling — all ready to interface with your computer.

Actually, the incremental price per

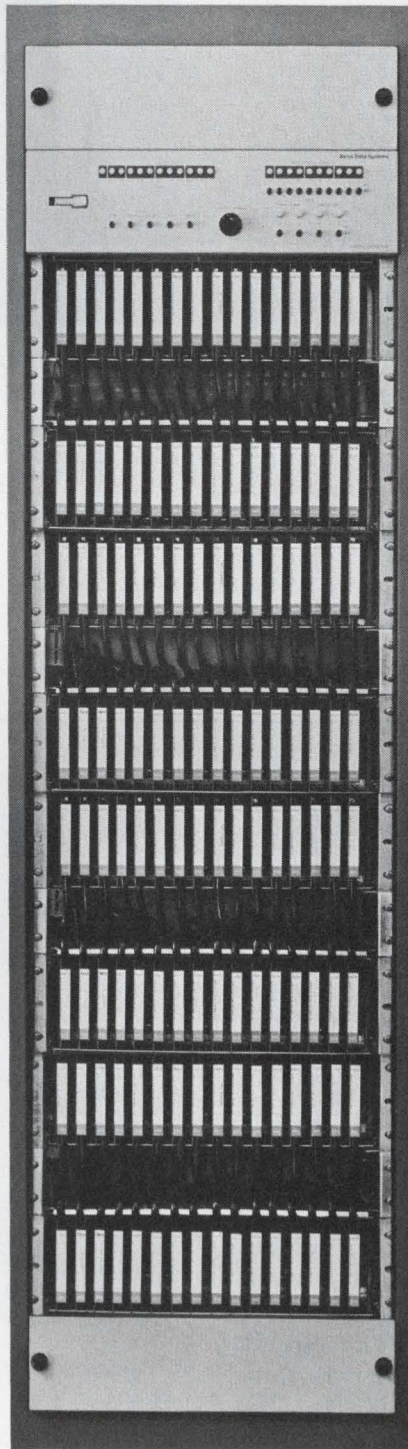

switch is only \$50. The other goodies make up the difference.

You'll also be relieved to know that our low-level multiplexer works. Over 40 systems are operating in the field with high reliability. User testimonials furnished on request.

If you're interested in low cost, flexibility and reliability in proven units that are available now, you ought to call us at (213) 679-4511, ext. 1139 or 3392.

If you're not in a hurry, write Xerox Data Systems, Dept. A, 701 South Aviation Blvd., El Segundo, Calif. 90245

XDS
Xerox Data Systems
El Segundo, California

Variable clock source operates to 4 MHz

This variable-rate clock source is operable to 4 MHz and at the same time is both inexpensive and DTL/TTL compatible. It will operate from supply voltages of 2 to 5 V, and its pulse output is directly compatible with the noise margins and rise or fall-time requirements of most DTL/TTL IC logic. With the values shown in Fig. 1, a range of 200 KHz to 4 MHz may be realized by varying the 20-K Ω variable portion of R_T . Other ranges may be obtained by changing the values of R_T and C_T . The frequency of oscillation may be approximated by the formula $F = 1/1.7 R_T C_T$.

The basic circuit is composed of an RC charging circuit (R_T and C_T) and a regeneratively coupled pair of complementary transistors, Q_1 and Q_2 . The threshold voltage for the regenerative transistors is set at approximately 3 V (plus V_{EB} of Q_2) by the voltage divider formed by R_1 and R_2 .

When power is applied to the circuit, C_T charges through R_T until Q_2 becomes forward-biased. As soon as Q_2 conducts, the regenerative coupling of Q_1 and Q_2 enables extremely rapid turn-on of both transistors. Once Q_1 and Q_2 turn on, C_T will discharge through Q_2 and Q_3 . Q_1 will go into saturation, limited only by diode D_1 , which turns off Q_1 and Q_2 as soon as Q_1 saturates. The cycle then begins again with C_T charging until

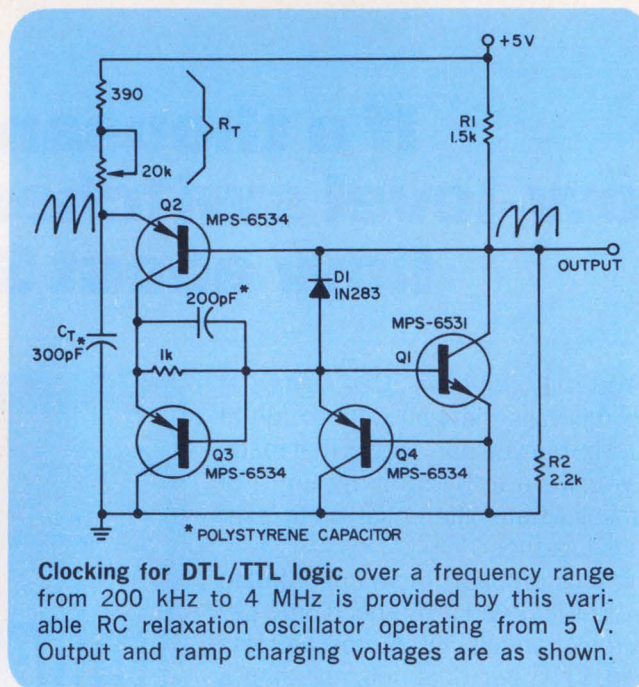

threshold voltage is reached.

Transistors Q_3 and Q_4 function to decrease the C_T discharge time and to limit positive excursions of Q_1 base drive.

Craig A. Kuechenmeister, Research Instrumentation Engineer, Department of Psychiatry, University of Alabama Medical School, Birmingham, Ala. 35233.

VOTE FOR 313

Zener adds offset capability to active filter

Many low-pass filter applications require an adjustment of the output dc level that is independent of the output gain setting. This design task is greatly simplified by taking advantage of the inherent low output impedance of the active amplifiers used in the filter design.

The offset adjustment potentiometer is connected across a zener diode at the output of the first active filter section. The zener current and, therefore, its dynamic impedance are controlled by the resistor connected to the supply voltage.

In the circuit shown, a negative voltage is used, but the opposite offset range could be provided by using a positive supply voltage. The circuit constants shown are for a fourth-order Butterworth filter having a 3-dB cutoff at 300 Hz. The offset range was selected for 6 V and introduced less than 1% gain change over this range.

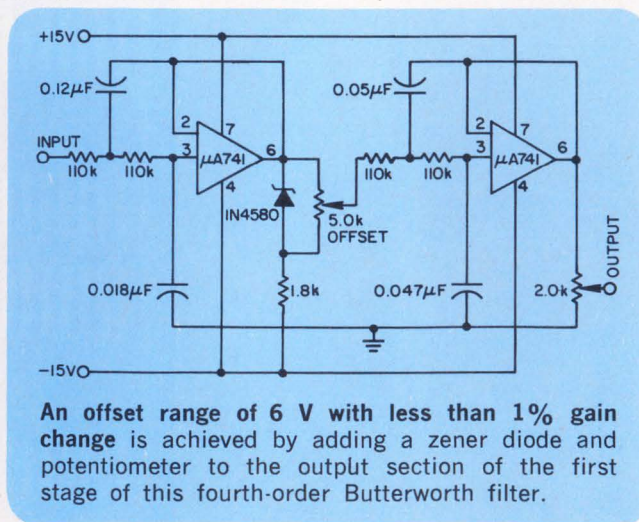

James Welch, Electronics Design Manager, Odetics, Inc., 1845 S. Manchester Ave., Anaheim, Calif. 92802.

VOTE FOR 314

how to keep your

COOL

Heat generated in an enclosed rack or cabinet tragically shortens the life of the contents and seriously impairs the operation. That's why it's so important to install a blower . . . a Bud Trans-aire Blower.

Available in six models, they all fit in standard 19" panel space and have the lowest silhouette height with the greatest CFM output in the industry. They are all guaranteed for 20,000 hours of continuous duty.

See the Trans-aire Blowers at your Bud Distributors and find out all about their advantages. Write us for catalog.

Trans-aire BLOWERS

for your cabinets and racks

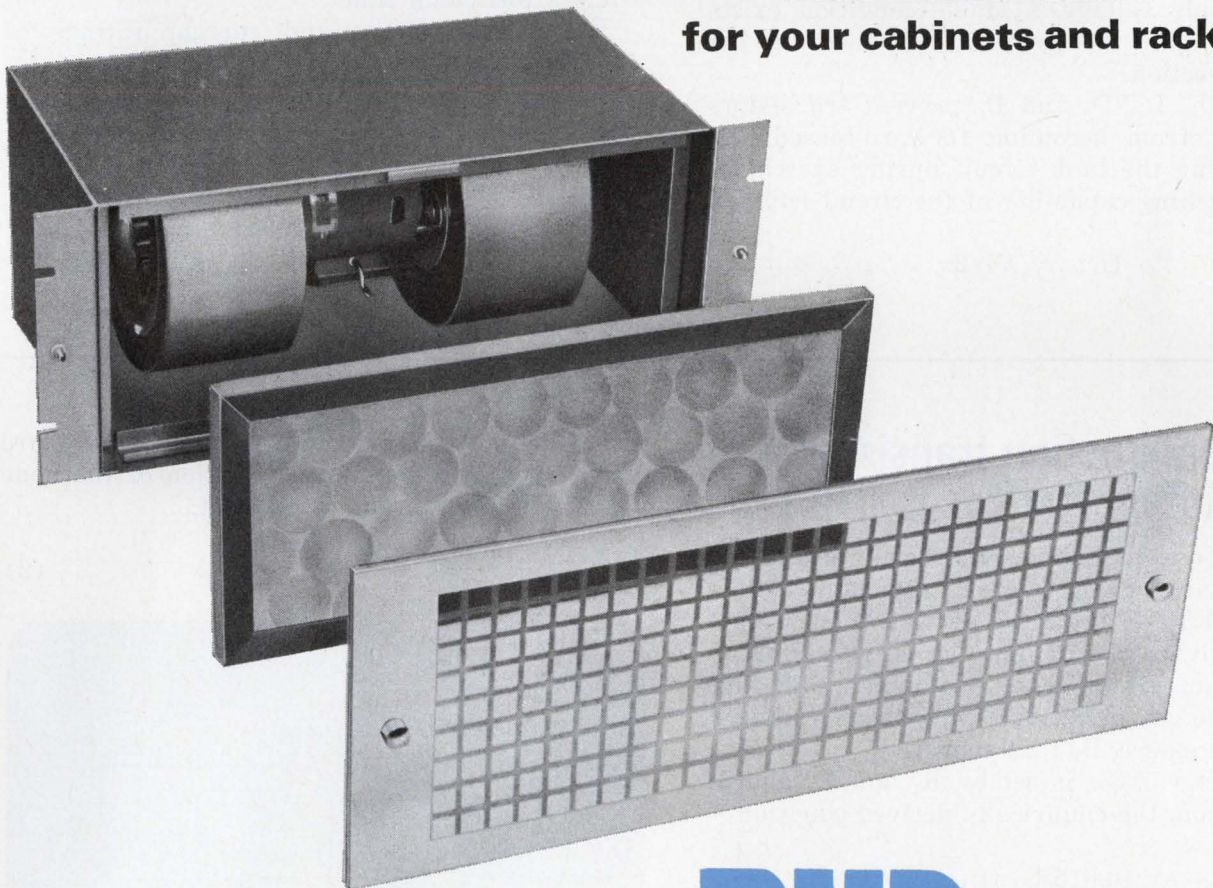

BUD

BUD RADIO INC.
Willoughby, Ohio 44094

INFORMATION RETRIEVAL NUMBER 50

High-speed switch reverses current in an inductor

The switch circuit shown in the figure is capable of quickly reversing the current through an inductor and maintaining that current for any desired time. It isolates the power supply while the energy in the inductor is transferred to a capacitor, and switches it back to the inductor with reverse polarity to get current flowing in the opposite direction. Voltage surges are neatly avoided. Polarized relays and electric motors often require this kind of switching.

Transistors Q_3 and Q_4 are driven fully on or fully off by complementary, and not necessarily symmetric, rectangular waves, $+E_1$ and $-E_1$. When Q_3 is on and Q_4 is cut off, current flows through Q_1 - L - R_2 - R_1 - D_2 - Q_3 . The voltage developed across D_2 cuts off Q_2 . Thus the source voltage appears across terminals A and B. This is a stable condition.

When the signal of Q_3 and Q_4 reverses, the current in L has only one open path and that is to charge the capacitor. Thus the parallel LC tank circuit is isolated from the power source and will start to oscillate. Just prior to the end of a half period when the voltage across C is equal to the supply voltage, a stable condition exists again—but now the current in L flows in the reverse direction.

Diodes D_3 , D_4 , D_5 and D_6 prevent transistors Q_1 and Q_2 from becoming forward-biased and thus shorting the tank circuit during switching.

The switching capability of the circuit is given by

$$U/t_0 = VI/2\pi$$

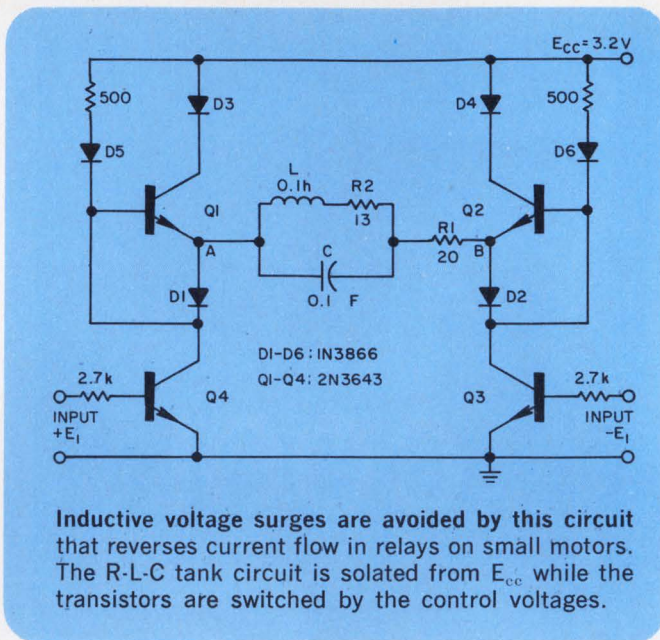

where the quantities in the equation are

U = total energy to be switched

t_0 = switching time

VI = peak voltage and current ratings of switching elements.

The circuit will also function with a resistive load.

Z. D. Farkas, Stanford University, Stanford Linear Accelerator Center, P.O. Box 4349, Stanford, Calif. 94305.

VOTE FOR 315

Use a unijunction transistor as an integrator reset

A common technique for resetting an integrator is to discharge an integrating capacitor with a relay or FET. To use these devices, a level sensing and driving circuit must be provided for an automatic integrator reset. A simple circuit that can provide an accurate temperature-stabilized reset point uses a UJT as shown.

The reset voltage is set by R_1 and R_3 and is obtained from the empirically derived equation:

$$\frac{R_1 R_3}{R_1 + R_3} = (0.015 R_{BB} \eta) \left(\frac{V_{CC} R_3}{R_1 + R_3} - V_{OM} \right), \quad (1)$$

where R_{BB} is the interbase resistance of UJT, η is the intrinsic standoff ratio of UJT, V_{CC} is the supply voltage and V_{OM} is the maximum inte-

grator output voltage before reset. R_1 and R_3 are determined by simultaneous solution of the node equation for V_{B2} at the reset point,

$$R_1 [R_3 (V_{B2} - V_{OM}) + R_{BB} V_{B2}] - R_3 R_{BB} (V_{CC} - V_{B2}) = 0. \quad (2)$$

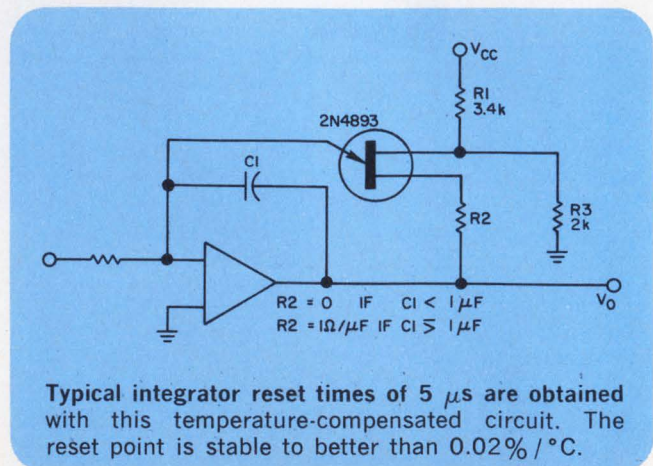

If you have problems to solve, these days you need all the help you can get. That's where we come in. We make tools that extend your capabilities. And once you have our tools we give you all the support you need to use them efficiently.

We make three different calculating systems and a time-sharing mini-computer. The one thing they all share is versatility. For instance any calculator we make is capable of doing very sophisticated scientific work but it will also work for a business man, to accommodate the merger of science and business. A lot of things come up during the technical man's day that have to do with dollars and cents.

Every system we make has the added versatility that it can be programmed and will keep records in numeric or graphic

form. The important thing is you can have as little or as much as you want. When you want it.

We had to think of everything. Because you never know what you'll be thinking of.

For information on any Wang system, call Mr. Courtney collect (617) 851-7211. Wang Laboratories, Inc., Dept. ED-12, 836 North Street, Tewksbury, Massachusetts 01876.

Thinking tools.



WANG

The value of V_{B2} is determined from the equation $\eta V_{B2} - \eta V_{OM} + V_{OM} + 0.4 = 0$. (3)

With the calculated resistor values used as initial values, a temperature coefficient of less than $0.02\%/^{\circ}\text{C}$ can be achieved by trimming R_1 and R_3 . The trimming is required because of variations in individual UJTs.

The time required for reset is typically less than $5 \mu\text{s}$, depending on the value of the integrating capacitor and the UJT used. For long-term integrators, the UJT parameters that would be of prime consideration are I_P and I_{E0} . These are, respectively, the minimum current to fire the UJT and the emitter leakage current that appears in parallel with the integrating capacitor.

A typical choice of UJT may be a 2N4893 whose maximum values are $I_P = 1 \mu\text{A}$ and

$I_{E0} = 0.01 \mu\text{A}$ at 30°C . The circuit shown works only for negative output limits, but the same technique can be used for a positive limit by using a complementary UJT, or both types of UJT can be used to provide both positive and negative limits.

The values of R_1 and R_3 are for an integrator whose output limit is -12 V with a V_{CC} of $+15 \text{ V}$. The UJT is a 2N4893 with a typical R_{BB} of $6 \text{ k}\Omega$ and η of 0.8 . R_2 has a value of zero if C_1 , the integrator feedback capacitor, is less than $1 \mu\text{F}$, and R_2 has a value of $1\Omega/\mu\text{F}$ if C_1 is greater than or equal to $1 \mu\text{F}$.

Larry G. Smeins, Development Engineer, Ball Brothers Research Corp., Box 1062, Mail Station TT-2, Boulder, Colo. 80302.

VOTE FOR 316

Wideband sawtooth generator controlled by tunnel diode

Six transistors and a tunnel diode connected as shown in the diagram make an excellent and inexpensive wideband sawtooth generator.

Capacitor C is charged by a constant-current generator, Q_4 . A current of 10-mA maximum which is large compared with leakage currents, is controlled by the base voltage of Q_4 . A precise integration (0.1%) is obtained in this manner over a wide current range.

The accurate switching level of 0.1% for a 10°C temperature change and the rapid voltage drop (within 1 ns) of tunnel diode D are used to discharge the integrating capacitor at a speci-

fied output voltage.

The discharge current passes through Q_3 . The switching time can be set by adjusting the current through R and Q_1 .

The discharge pulse drives Q_2 into conduction. The output voltage, 6 V pk-pk , is delivered by Q_5 and Q_6 . The minimum output frequency depends on leakage currents. The maximum frequency depends on the cutoff frequency of Q_3 .

Dr. J. A. van Best, Fysisch Laboratorium, Rijksuniversiteit Utrecht, Bijlhouwerstraat 6, Utrecht, The Netherlands.

VOTE FOR 317

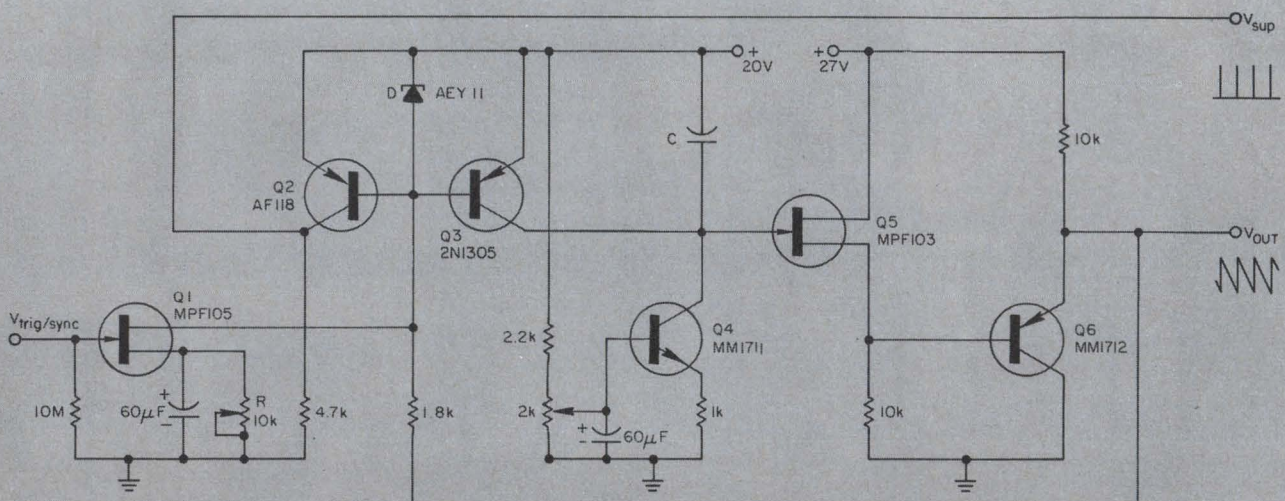

The accurate switching characteristics of a tunnel diode are used to control this wideband sawtooth

generator. This circuit will operate over a frequency range stretching from 0.001 Hz to 5 MHz .

Time to settle down



In only 300nsec. the new Model 1025 FET op amp reaches 0.01% of final value. Model 1019 takes just 200nsec. longer.

Both of these new FET op amps are ideal for high speed analog applications such as A/D conversion, peak detection, high speed integration, coaxial line driving and fast sample and hold circuits.

Model 1019 is a differential FET op amp featuring, in addition to its 500nsec. to 0.01% settling time, a 1000V/ μ sec. slew rate and a high gain-bandwidth product of 100 MHz. Other characteristics include: a full power frequency of 10 MHz, a CMRR or 100dB, and a low bias current of -50pA .

Model 1025 is a FET input op amp designed for inverting applications where very fast settling time and economy are desired. In addition to its 300nsec. to 0.01% settling time, the 1025 features a slew rate of 500V/ μ sec. and a high output current of 50mA at $\pm 10\text{V}$.

If you don't want to settle for less than the best, contact your local TPN representative or Teledyne Philbrick Nexus, Allied Drive at Route 128, Dedham, Mass. 02026. Tel. (617) 329-1600. Prices F.O.B. Factory U.S.A.



Send today for complete specs and new Product Guide.

 **TELEDYNE
PHILBRICK NEXUS**

Insure proper starting polarity of astable multivibrators

A simple RC circuit at a gate input can be used to insure an initial logic ONE output for the DTL astable multivibrator. This arrangement insures a high output at gate A when V_{cc} is applied. If a logic ZERO is required, the complementary output gate B, is used.

When V_{cc} is applied, the capacitor initially acts like a short circuit and takes current from the base of the output transistor, preventing it from saturating. The capacitor presents a logic ZERO to the input of gate A forcing a logic ONE at its output. The gate A output stays high long enough to force a logic ONE to the input of gate B. The output of gate B is then a logic ZERO, keeping the first gate at logic ONE. Usual astable action then takes over, the frequency being determined by the timing capacitors.

The value of the starting capacitor is determined from the peak charging current and the dv/dt value when the 5-V supply is switched on. The maximum charging current is limited by the monolithic resistance of approximately 3.75 k Ω and the voltage drop of the input diode. The maximum charging current is approximately 1.2 mA. Since $i = C (dv/dt)$, C should be selected

for a minimum value equal to $\frac{1.2 \text{ ma}}{dv/dt}$.

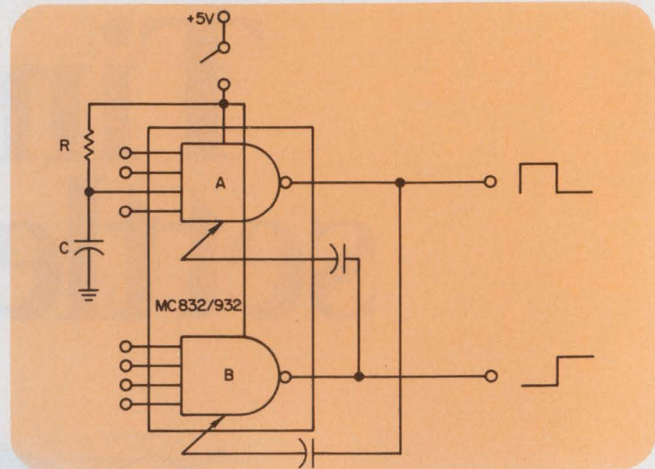

An initial logic ONE output of the DTL astable multivibrator is insured with the simple RC circuit at the input to the gate. The charged capacitor does not interfere with normal astable operation.

The pull-up resistor R allows C to discharge when V_{cc} is removed. Its value should be larger than 3.75 K to allow charging current to be supplied mainly through the gate. The charged capacitor at the input gate does not interfere with normal astable operation.

Wesley A. Vincent, *Electronic Engineer, Motorola Inc., Government Electronics Div., 8201 E. McDowell Rd., Scottsdale, Ariz. 85252.*

VOTE FOR 318

IFD Winner for September 1, 1970

J. Diggelmann, Design Engineer, Institut fur Technische Physik an der ETH, Zurich, Switzerland. His idea "Frequency Discriminator Generates Logical Output" has been voted the Most Valuable of Issue award. **Vote for the Best Idea in this Issue.**

IFD Winner for September 13, 1970

William Ress, Engineer, Zeta Laboratories, Inc., 616 National Ave., Mountain View, Calif. 94040. His idea "Proportional Oven Control Is Low-Cost And Precise" has been voted the Most Valuable of Issue award. **Vote for the Best Idea in this Issue.**

IFD Winner for August 16, 1970

J. R. Nielsen, Electrical Engineer, Idaho Nuclear Corp., Idaho Falls, Idaho. His Idea "Transformerless Modulator Operates From Dc to 1 MHz" has been voted the Most Valuable of Issue award.

Vote for the Best Idea in this Issue.

VOTE! Go through all Idea-for-Design entries, select the best, and circle the appropriate number on the Reader-Service-Card.

SEND US YOUR IDEAS FOR DESIGN. You may win a grand total of \$1050 (cash)! Here's how. Submit your IFD describing a new or important circuit or design technique, the clever use of a new component or test equipment, packaging tips, cost-saving ideas to our Ideas-for-Design editor. You will receive \$20 for each accepted idea, \$30 more if it is voted best-of-issue by our readers. The best-of-issue winners become eligible for the Idea Of the Year award of \$1000.

Centralab's PACERS

*PRIME'

*temperature-compensated reference diodes —
the most stable offered*

1N821
thru
1N829A
1N935
thru
1N939B
1N941
thru
1N945B
1N1735
thru
1N1742A
1N3154
thru
1N3157A
1N4565
thru
1N4569A
1N4570
thru
1N4574A
1N4575
thru
1N4579A
1N4580
thru
1N4584A
1N4765
thru
1N4769A
1N4770
thru
1N4774A
1N4775
thru
1N4779A
1N4780
thru
1N4784A
1N430, A
1N1530, A

- In our new **Pacers** near-perfect combination of planar reverse biased chip and proprietary-process forward-biased chips assures time stability of reference voltage previously available only at extreme price premium.
- Average long-term stability of reference voltage: 10 parts per million per thousand hours. Customer tests demonstrate exceptional short-term stability, minimal "warm-up" time (see actual plot of these voltage/time tests shown below).
- Our **Pacers** exhibit lower noise than products previously available — both low frequency and broad band.
- And the **Pacers** exhibit significantly lower dynamic impedance.

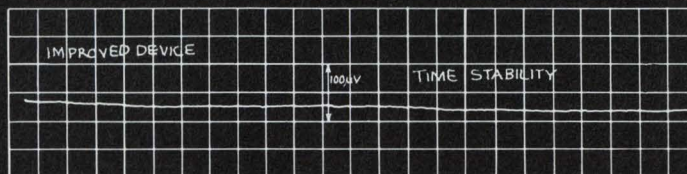
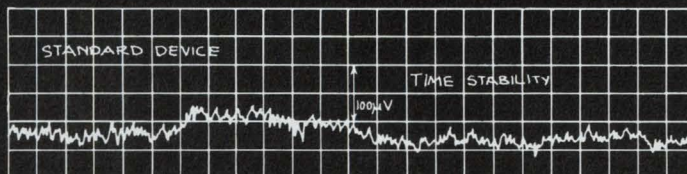

JAN devices available.
All JEDEC numbers competitively priced and ready for delivery.

*Centralab Semiconductor Program for Reliability, Integrity and Manufacturing Efficiency under which all our products—incorporating improved designs—are manufactured to JAN quality levels for inherent reliability. Special conditioning and selection provides products at four levels of reliability—at realistic prices to fit individual needs.

CONTACT US FOR A COMPREHENSIVE DATA PACKAGE AND A FULL DESCRIPTION OF THE PRIME' PROGRAM.



**CENTRALAB
SEMICONDUCTOR**

Division • GLOBE-UNION INC.
4501 NORTH ARDEN DRIVE
EL MONTE, CALIFORNIA 91734

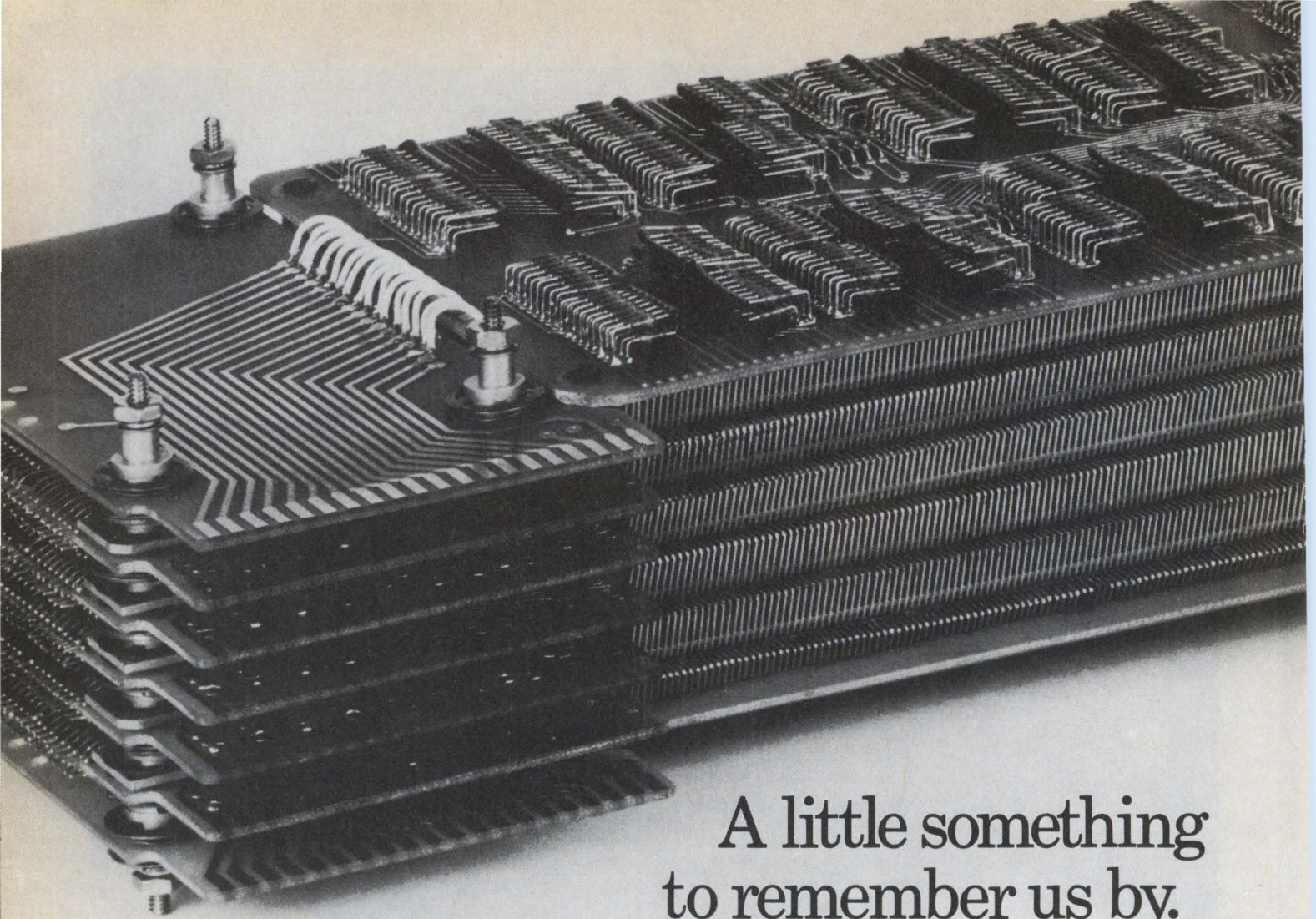

A little something
to remember us by.

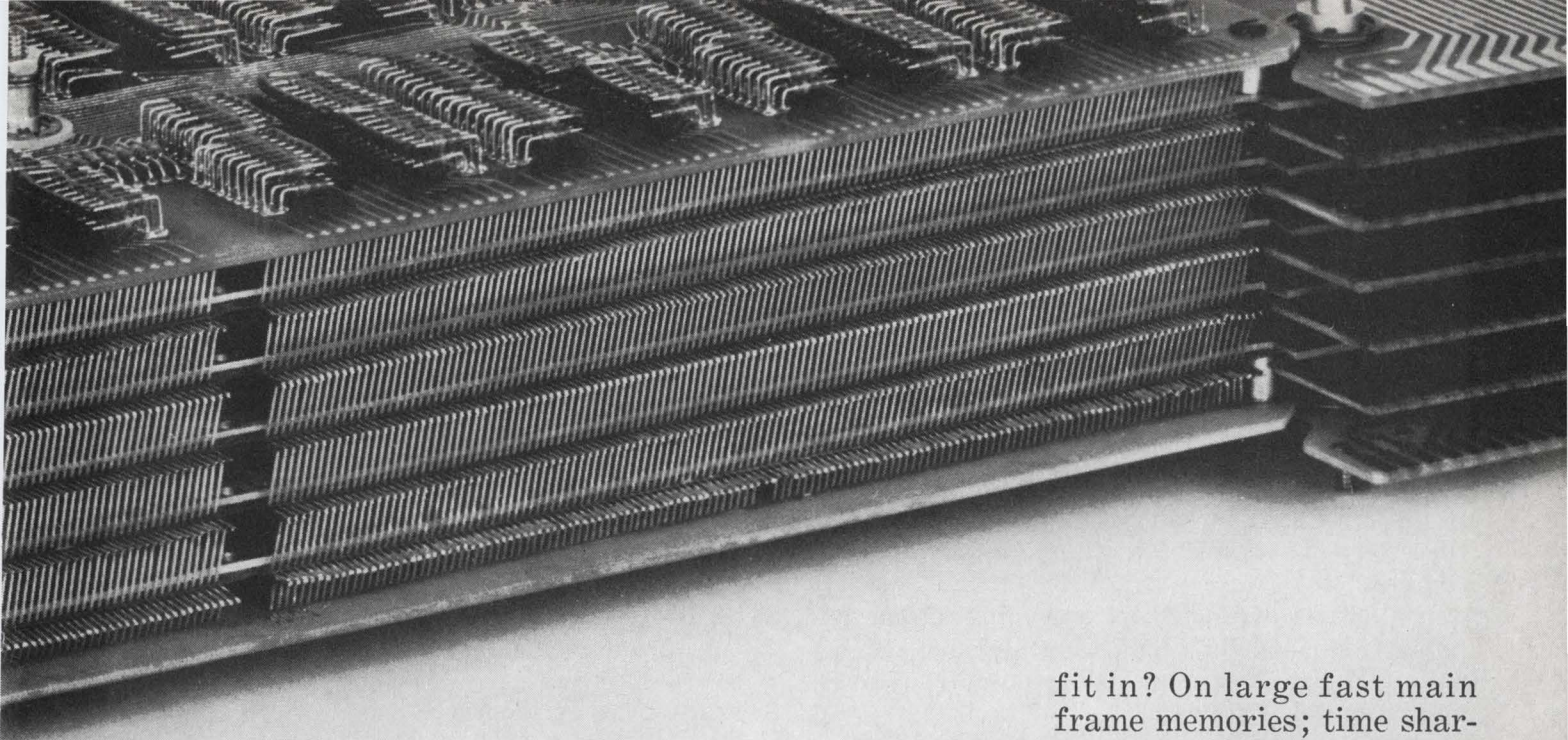

You're looking at an actual size photograph of the new Nanostak[®] NS-3020 commercial memory stack. Proof that big things come in small packages. This stack is so compact its volume is only 25% of competing planar designs.

But we didn't cut corners on performance.

Nanostak is a modular

2½D stack with full cycle times as fast as 700 nanoseconds. Its maximum capacities are 32,768 words by 20 bits, 16,384 words by 40 bits and 8,192 words by 40 bits.

And everything happens so easily.

We've designed Nanostak with printed circuit board edge connectors and mounting jack screws. Which gives you a simple plug-in unit for all NS-3020 configurations.

Just where does Nanostak

fit in? On large fast main frame memories; time sharing systems; electronic telephone exchanges and radar signal processors. We've built enough reliability into this stack for process control applications in the most severe industrial environments. Wide temperature range cores are even available as an option.

Nanostak. A little something you might want to talk over with us. Soon.



Electronic Memories. Worth remembering.

Solid-State Microwave Oscillators

The solid-state microwave oscillators covered in this Product Source Directory are divided into three groups—transistor, Gunn and avalanche sources.

Units are arranged in ascending order by upper-frequency limit and then alphabetized by manufacturer. Maximum device output power is approximately one watt.

Manufacturers are identified by the abbreviations shown in the Master Cross Index below. The following abbreviations are used in the tables:

- ina—information not available
- typ—typical
- mech—mechanical
- elec—electronic
- req—price on request

Abbrev.	Company	Information Retrieval No.
AEL	American Electronic Labs, Inc. P.O. Box 522 Lansdale, Pa. 19446 (215) 822-2929	428
Acrodyne	Acrodyne Industries 666 Davisville Rd. Willow Grove, Pa. 19090 (215) 657-1800	429
Airtron	Airtron Div. of Litton Industries 200 E. Hanover Ave. Morris Plains, N.J. 07950 (201) 539-5500	430
Applied Tech	Applied Technology Div. of Itek Corp. 3410 Hillview Ave. Palo Alto, Calif. 94304 (415) 321-5135	431
Avantek	Avantek, Inc. 2981 Copper Rd. Santa Clara, Calif. 95050 (418) 739-6170	432
Bradley/Edwin	G & E Bradley, Ltd. Edwin Industries 11961 Tech Rd. Silver Spring, Md. 20904 (301) 622-0700	433
Calif. Micro	California Microwave, Inc. 455 W. Maude Ave. Sunnyvale, Calif. 94086 (408) 732-4000	434
Cayuga	Cayuga Associates, Inc. Cornell Research Park Ithaca, N.Y. 14850 (607) 257-0555	435
Centilabs	Centilabs Corp. 2455 Old Middlefield Way Mountain View, Calif. 94040 (415) 969-0427	436

Abbrev.	Company	Information Retrieval No.
EMF	EMF Systems, Inc. P.O. Box 1009 State College, Pa. 16801 (814) 237-6022	437
Engelmann	Engelmann Microwave Co. Skyline Dr. Montville, N.J. 07045 (201) 334-5794	438
Fairchild	Fairchild Microwave & Optoelectronics 2513 Charleston Rd. Mountain View, Calif. 94040 (415) 961-1391	439
Freq. Sources	Frequency Sources, Inc. Kennedy Dr. North Chelmsford, Mass. 01863 (617) 251-4921	440
Greenray	Greenray Industries, Inc. 840 W. Church Rd. Mechanicsburg, Pa. 17055 (717) 766-0223	441
H-P	Hewlett-Packard 1501 Page Mill Rd. Palo Alto, Calif. 94304 (415) 326-7000	Contact local sales office
Hitachi	Hitachi Ltd. Marubeni-Iida (America), Inc. 200 Park Ave. New York, N.Y. 10017 (212) 973-6500	442
Hughes	Hughes Aircraft Electron Dynamics Div. 3100 W. Lomita Blvd. Torrance, Calif. 90509 (213) 534-2121	443
IMC	International Microwave Corp. 33 River Rd. Cos Cob, Conn. 06807 (203) 661-6277	444

Abbrev.	Company	Information Retrieval No.
Intradyne	Intradyne Systems, Inc. Sub. of Texscan Corp. 1261 Birchwood Dr. Sunnyvale, Calif. 94086 (405) 734-3504	445
M-O/MOSC	M-O Valve Co., Ltd. Metropolitan Overseas Supply Corp. 468 Park Ave. South New York, N.Y. 10016 (212) 686-2120	446
MA	Microwave Associates, Inc. South Ave. Burlington, Mass. 01803 (617) 272-3000	447
MPD	Microwave Power Devices, Inc. 556 Peninsula Blvd. Hempstead, N.Y. 11550 (516) 538-7520	448
MPG	Microwave Products Group, Inc. Sub. of Sage Laboratories, Inc. 3 Huron Dr. Natick, Mass. 01760 (617) 653-0844	449
Marconi	Marconi Instruments Ltd. 111 Cedar Lane Englewood, N.J. 07631 (201) 567-0607	450
Micro State	Micro State Operation Raytheon Co. 130 Second Ave. Waltham, Mass. 02154 (617) 899-8080	451
Micromega	Micromega Div. of Bunker-Ramp 12575 Beatrice St. Los Angeles, Calif. 90066 (213) 391-7137	452
Microphase	Microphase West Div. of Microphase Inc. River Rd. Cos Cob, Conn. 06807 (203) 661-6200	453
Miteq	Miteq, Inc. 100 Ricefield Lane Hauppauge, N.Y. 11787 (516) 543-8873	454
Monsanto	Monsanto Microwave Products 11636 Administration Dr. St. Louis, Mo. 63141 (314) 694-4816	455
Mullard	Mullard Inc. 100 Finn Court Farmingdale, N.Y. 11735 (516) 694-8989	456
Nippon	Nippon Electric New York, Inc. Pan Am Building, Suite 3721 200 Park Ave. New York, N.Y. 10017 (212) 661-3420	457
OKI	OKI Electronics of America, Inc. 500/506 S.E. 24th St. Fort Lauderdale, Fla. 33316 (305) 523-7202	458
Omni Spectra	Omni Spectra, Inc. 253 S. Hinton Ave. Scottsdale, Ariz. 85251 (602) 947-8400	459

Abbrev.	Company	Information Retrieval No.
PEL	Physical Electronics Laboratories 1185 O'Brien Dr. Menlo Park, Calif. 94025 (415) 326-9092	460
Philco	Philco-Ford Corp. Microelectronics Div. 500 S. Main St. Spring City, Pa. 19475 (215) 948-8400	461
RCA	RCA Electronic Components Harrison, N.J. 07029 (201) 485-3900	462
RFD	RFD, Inc. 5024 Nassau St. Tampa, Fla. 33607 (813) 872-1502	463
Sanders	Sanders Associates, Inc. Microwave Div. P.O. Box 907 Nashua, N.H. 03060 (603) 885-2445	464
Spectra	Spectra Microwave Sub. of Spectra Electronics 915 Linda Vista Ave. Mountain View, Calif. 94040 (415) 964-4170	465
Sylvania	Sylvania Electric Products Semiconductor Div. Microwave Components 100 Sylvan Rd. Woburn, Mass. 01801 (617) 933-3500	466
TI	Texas Instruments Inc. P.O. Box 5012 Dallas, Tex. 75222 (214) 238-2801	467
Texscan	Texscan Microwave Products 7707 N. Records St. Indianapolis, Ind. 46226 (317) 357-8781	468
Trak	Trak Microwave Corp. 4726 Eisenhower Blvd. Tampa, Fla. 33614 (813) 884-1411	469
Varian/Calif.	Varian Associates 611 Hansen Way Palo Alto, Calif. 94303 (415) 326-4000	470
Varian/Mass.	Varian Associates Salem Rd. Beverly, Mass. 01915 (617) 922-6000	471
W-J	Watkins-Johnson Co. 3333 Hillview Ave. Palo Alto, Calif. 94304 (415) 326-8830	472
Yig-Tek	Yig-Tek 1725 Delacruz Blvd. Sant Clara, Calif. 95050 (408) 244-3240	473
Zeta	Zeta Laboratories, Inc. 616 National Ave. Mountain View, Calif. 94040 (415) 961-9050	474

the QUIET ones

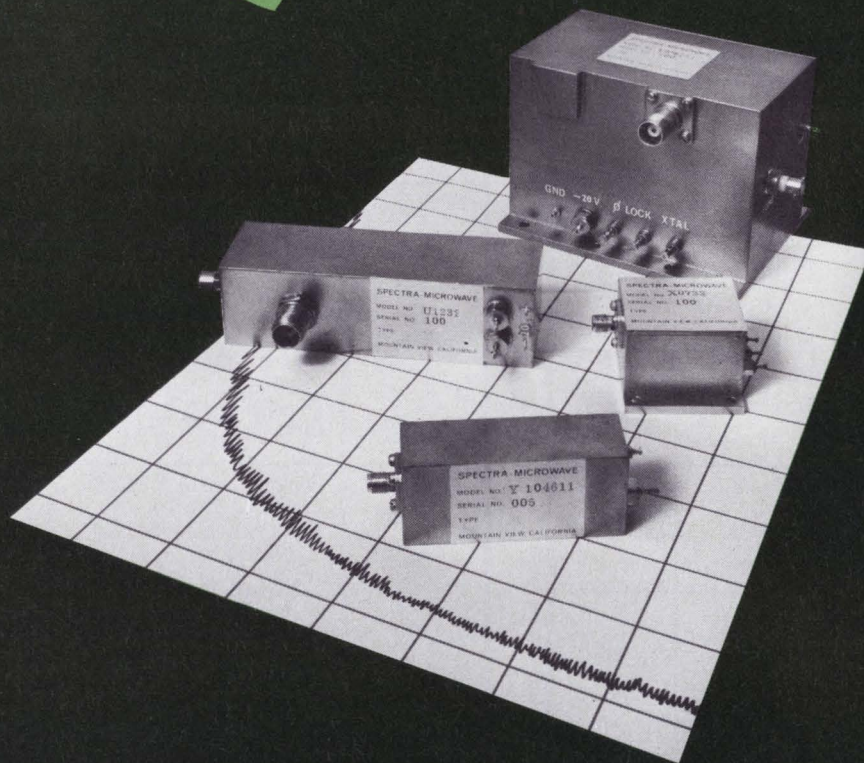

Octave Bandwidth Voltage Tuned Solid State Fundamental Oscillators

The ability to measure performance parameters of solid state sources is essential. For example, no one would consider building a source without using a power meter. Yet, it is common practice for source companies to guess the noise performance of their products.

Spectra Electronics has the capability of being able to measure AM & FM noise on their sources.

These units are also available in mechanically tuned versions, and both versions are obtainable through Ku band in narrower bandwidths.

Spectra Electronics also offers a line of high stability, phase locked sources for the telecommunications industry, wherein low noise is featured.

Watch For More On Our 'Quiet' Family!

Frequency (GHz)	Harmonic Rejection (dB)	Power (Mw) Min at $\pm 25^{\circ}\text{C}$	Pulling Into Phaseable 3:1 (%)	FM Noise 1 KHz Bandwidth / 10 KHz From Carrier
0.25-0.50	20	100	± 1	30 Hz RMS
0.5 -1.0	20	50	± 1	30 Hz RMS
1.0 -2.0	20	150	± 0.2	30 Hz RMS
2.0 -4.0	20	50	± 0.2	30 Hz RMS

 **spectra electronics inc.**

915 Linda Vista Avenue
Mountain View, California 94040
Telephone (415) 964-4170
TWX 910-379-6447

Manufacturer	Model	Operating Frequency Range (GHz)	Tuning Range (MHz)	Output Power Min-Max (mW)	Notes	Price (\$)
Omni Spectra	28671-51	0.010-0.020	octave	600 typ	q	req
Omni Spectra	28671-53	0.020-0.040	octave	600 typ	q	req
Omni Spectra	28651-10	0.056	40%	400 typ	hn	req
Omni Spectra	28671-54	0.030-0.060	octave	600 typ	q	req
Zeta	4208	0.05-0.12	p	10 min	ij	req
Omni Spectra	28671-56	0.060-0.120	octave	600 typ	q	req
MPD	SS100-150-1	0.1-0.15	50	1000 typ	(6)	req
Omni Spectra	28671-57	0.080-0.160	octave	600 typ	q	req
Miteq	OTM-1A-1218	0.12-0.18	60	300 min	nx	240
Omni Spectra	28651-16	0.180	40%	400 typ	hn	req
MPD	SS150-225-1	0.15-0.225	75	1000 typ	(6)	req
MPG	E-30-250	0.03-0.25	30	100 typ	a	230
MPG	M-30-250	0.03-0.25	30	100 typ	n	230
Freq. Sources	FS-21A	0.06-0.25	p	10-20	i	400
MPG	E-60-250	0.06-0.25	60	100 typ	a	230
MPG	M-60-250	0.06-0.25	60	100 typ	n	230
MPG	E-90-250	0.09-0.25	90	100 typ	a	230
MPG	M-90-250	0.09-0.25	90	100 typ	n	230
Miteq	OTV-3A-0125	0.125-0.25	125	100 min	q	370
Miteq	OTV-1A-0125	0.125-0.25	125	150 min	q	280
Miteq	OTV-2A-0125	0.125-0.25	125	100 min	q	350
Omni Spectra	28671-58	0.125-0.250	octave	600 typ	q	req
MPG	E-135-250	0.135-0.25	135	100 typ	a	230
MPG	M-135-250	0.135-0.25	135	100 typ	n	230
Miteq	OTM-1A-1725	0.17-0.25	80	300 min	nx	240
Omni Spectra	28651-18	0.270	40%	400 typ	hn	req
MPD	SS225-335-1	0.225-0.335	110	1000 typ	(6)	req
Miteq	OTM-1A-2335	0.23-0.35	120	300 min	nx	240
Freq. Sources	FS-21B	0.25-0.45	p	5-10	i	425
Omni Spectra	28651-21	0.470	40%	400 typ	hn	req
EMF	TS-10	0.010-0.5	25%	1-1000	h	140-170
EMF	TSO-10	0.01-0.5	octave	1-1000	h	150-250
EMF	VTN-1	0.01-0.5	10%	1-1000	h	140-225
EMF	VTO-1	0.01-0.5	octave	1-1000	h	220-375
EMF	VTW-1	0.01-0.5	25%	1-1000	h	150-250
Omni Spectra	2867105	0.010-0.500	10%	400 typ	hq	req
Omni Spectra	2867110	0.010-0.500	20%	300 typ	hq	req
Omni Spectra	2867120	0.010-0.500	40%	300 typ	hq	req
Engelmann	FF-500 series	0.100-0.500	ina	10-1000	ij	req
Microphase	VTS12550	0.250-0.500	250	50 typ	j	295-695
Miteq	OTV-1A-0250	0.25-0.50	250	150 min	q	280
Miteq	OTV-2A-0250	0.25-0.50	250	100 min	q	350
Miteq	OTV-3A-0250	0.25-0.50	250	100 min	q	370
Omni Spectra	28671-60	0.250-0.500	octave	500 typ	q	req
Spectra	VT-0452	0.25-0.50	octave	500 min	bq	req
Texscan	VTS-25	0.25-0.5	250	600 min	q	195
W-J	WJ-2811	0.25-0.5	250	100 min	q	req
MPD	SS 335-5	0.335-0.5	165	1000 typ	(6)	req
Miteq	OTM-1A-3450	0.34-0.50	160	200 min	nx	240
Omni Spectra	28652-22	0.560	40%	250 typ	hn	req
Applied Tech.	SFU series	0.3-0.6	0.1%	200 max	hij	req
Omni Spectra	28652-23	0.680	40%	250 typ	hn	req
Miteq	OTM-1A-4670	0.46-0.70	240	200 min	nx	270
Spectra	VT-0532	0.375-0.750	octave	300 min	bq	req
EMF	TS-11	0.5-0.75	250	1-1000	h	150-190
EMF	VTW-2	0.5-0.75	250	1-700	h	170-330
MPD	SS 500-750-1	0.5-0.75	250	1000 typ	(6)	req
Acrodyne	S1002-6	0.6-0.8	ina	1000 typ	i	625
Omni Spectra	28652-24	0.820	40%	250 typ	hn	req
W-J	WJ-571-10	0.75-0.87	120	60 min	d	req
EMF	TSO-11	0.5-1.0	500	1-1000	h	170-305
EMF	VTN-2	0.5-1.0	10%	1-900	h	150-250
EMF	VTO-2	0.5-1.0	500	1-500	h	180-200
Microphase	VTS 2510	0.5 to 1.0	500	50 typ	j	295-695
Miteq	OTV-1A-0500	0.5-1.0	500	100 min	q	320
Miteq	OTV-2A-0500	0.5-1.0	500	80 min	q	390
Miteq	OTV-3A-0500	0.5-1.0	500	100 min	q	395
Omni Spectra	28672-62	0.500-1.000	octave	250 typ	q	req
Omni Spectra	2867205	0.500-1.000	10%	200 typ	hq	req
Omni Spectra	2867210	0.500-1.000	20%	150 typ	hq	req
Omni Spectra	2867220	0.500-1.000	40%	150 typ	hq	req
PEL	OP-100	0.5-1.0	500	10 min	d	req
Spectra	VT-0712	0.50-1.0	octave	100 min	bq	req
Spectra	VT-0752	0.50-1.0	octave	500 min	bq	req
Texscan	VTS-50	0.5-1.0	500	400 min	q	195
W-J	WJ-571	0.5-1.0	500	20 min	d	req
W-J	WJ-571-1	0.5-1.0	500	100 min	d	req
W-J	WJ-2800	0.5-1.0	500	100 min	d	req
W-J	WJ-5077	0.5-1.0	500	20 min	d	req
Yig-Tek	300	0.5-1.0	500	10 min	d	1000

Manufacturer	Model	Operating Frequency Range (GHz)	Tuning Range (MHz)	Output Power Min-Max (mW)	Notes	Price (\$)
Zeta	4301	0.5-1.0	p	20 min	cij	req
EMF	TS-12	0.75-1.0	250	1-1000		150-195
EMF	VTW-3	0.75-1.0	250	1-700		175-190
Miteq	OTM-1A-6710	0.67-1.0	330	100 min	nx	270
Miteq	OTC-1A	0.7-1.0	14%	1400 min	jm	595
Miteq	OTC-1B	0.7-1.0	14%	600 min	jm	495
MPD	SS 750-1000-1	0.75-1.0	250	1000 typ	(6)	req
Acrodyne	S1002-8	0.8-1.0	ina	1000 typ	i	680
Omni Spectra	286523-25	1.000	20%	250 typ	hn	req
Airtron	6	0.95-1.05	100	800 min	ab	req
Calif. Micro.	PA11P	0.98-1.10	120	250-400	bf	req
Fairchild	MO(L)-102	0.980-1.100	120	250 min	i	req
Nippon	LD-905	1.140-1.180	p	10 min	i	req
Freq. Sources	FS-2M	0.2-1.2	12%	1000 typ	hqr	520
EMF	TSO-12	0.6-1.2	600	1-300		250-350
W-J	WJ-571-6	0.6-1.2	600	50 min	d	req
Acrodyne	S1002-10	1.0-1.2	ina	1000 typ	i	800
Calif. Micro.	PA12P	1.08-1.22	140	250-400	bf	req
Fairchild	MO(L) 104	1.080-1.220	140	250 min	j	req
Calif. Micro.	PA13P	1.20-1.32	120	250-400	bf	req
Fairchild	MO(L) 106	1.200-1.340	140	250 min	j	req
Nippon	LD-903	1.225-1.380	p	40 min	i	req
Freq. Sources	FS-2R	0.6-1.4	1%	1000 typ	ch	450
Miteq	OTM-1A-9414	0.94-1.4	460	50 min	nx	270
Airtron	5	1.25-1.35	100 elec.	400 min		req
		1.2-1.4	200 mech.			
Sanders	DG716	0.8-1.45	0.5	10 min	gjn	800
Zeta	4312	1.435-1.485	p	1000 typ	fj	req
Zeta	4602-00	1.435-1.485	50	500 min	m	req
Zeta	4602-01	1.435-1.485	50	1000 typ	m	req
Freq. Sources	FS-36	0.2-1.5	octave	10-250	q	360
Spectra	VT-1132	0.75-1.5	octave	300 min	bq	req
EMF	TS-13	1.0-1.5	500	1-300		225-240
EMF	VTN-3	1.0-1.5	10%	1-300	h	170-250
EMF	VTW-4	1.0-1.5	500	1-200		180-250
Freq. Sources	FS-26	1.2-1.5	300	10-40	m	200
Omni Spectra	28653-27	1.500	20%	100 typ	hn	req
Calif. Micro.	PA15P	1.30-1.52	220	200-300	bf	req
Fairchild	MO(L) 108	1.320-1.520	200	250 min	j	req
Zeta	4313	1.485-1.535	p	1000 typ	fj	req
Zeta	4601-00	1.485-1.535	40	500 min	m	req
Zeta	4601-01	1.485-1.535	40	1000 typ	m	req
Zeta	4315	1.535-1.540	p	1000 typ	fj	req
Zeta	4603-00	1.535-1.540	5	600 min	m	req
Zeta	4603-01	1.535-1.540	5	1000 typ	m	req
W-J	WJ-571-11	0.56-1.56	1000	20 min	d	req
Zeta	4600-00	1.65-1.67	20	600 min	m	req
Zeta	4600-01	1.65-1.67	20	1000 typ	m	req
Freq. Sources	FS-7	0.1-1.7	15%	50-200	ch	325
Calif. Micro.	PA17P	1.50-1.72	220	150-225	bf	req
Fairchild	MO(L) 110	1.500-1.720	220	100 min	j	req
Freq. Sources	FS-6	0.3-1.8	15%	25-100	hq	310
Freq. Sources	FS-5	0.5-1.8	15%	25 typ	ch	310
Engelmann	MT-107	0.90-1.8	200	500 typ	ajn	500
Omni Spectra	28653-28	1.800	20%	100 typ	hn	req
Calif. Micro.	PA19P	1.63-1.92	290	50 min	bf	req
Zeta	6508	1.85-1.99	140	10 typ	ij	req
Freq. Sources	FS-21C	0.45-2.0	p	5-1000	i	550
Applied Tech.	SFL series	1.0-2.0	0.1%	10-1000	hij	req
Applied Tech.	SML series	1.0-2.0	1%-15%	10-1000	hmn	req
EMF	TSO-13	1.0-2.0	1000	1-100		350-375
EMF	VTO-3	1.0-2.0	1000	1-50		420-450
Engelmann	ET-109	1.0-2.0	1000	250 min	a	req
Fairchild	MVL 2700	1.0-2.0	1000	50 min	q	req
Fairchild	MVL 2710	1.0-2.0	1000	75 min	q	req
MA	MA-86746	1.0-2.0	1000	10 typ	q	req
Microphase	VTS312	1.0-2.0	1000	50 typ	j	295-695
Miteq	OTC-2A	1.0-2.0	14%	1000 min	jm	675
Miteq	OTV-1A-1000	1.0-2.0	1000	150 min	q	450
Miteq	OTV-2A-1000	1.0-2.0	1000	50 min	q	450
Miteq	OTV-4A-1000	1.0-2.0	1000	100 min	q	695
Omni Spectra	28673-64	1.000-2.000	octave	150 typ	q	req
Omni Spectra	28773-64	1.0-2.0	octave	150 typ	q	req
Omni Spectra	2867305	1.000-2.000	10%	130 typ	hq	req
Omni Spectra	2867310	1.000-2.000	20%	100 typ	hq	req
Omni Spectra	2867320	1.000-2.000	40%	100 typ	hq	req
PEL	OL-103	1.0-2.0	1000	10 min	d	req
Spectra	VT-1522	1.0-2.0	octave	250 min	bq	req
Texscan	VTS-100	1.0-2.0	1000	200 min	q	275
W-J	WJ 569	1.0-2.0	1000	20 min	d	req

IN BALANCED MIXERS.. YOU GET MORE FROM RELCOM

Custom cans are put thru a proprietary burr removal and a polishing process; checked for size to assure proper fit, legibility and permanence of printing, and solderability before being placed in stock.

Core material is selected as optimum for the specified frequency range. Cores are checked for dimensions, physical imperfections, and electrical performance. Relcom processing then brings them to optimum shape and a permanent insulative coating is applied to identify type and process completion. After electrical test and a permanence of coating test, cores are ready for parts stock.

Specially made wire is inspected upon receipt for geometry, wire size, insulation type and thickness and bonding physical strength. Insulation is stripped and wires cleaned before soldering for reliability of solder joints. Wires are additionally bonded to prevent excessive splitting which would degrade performance.

This header has been designed with a can-mounting flange and nail-head pins for reliability of solder joints. Inspectors check glass-to-metal seals, plating, and dimensions.

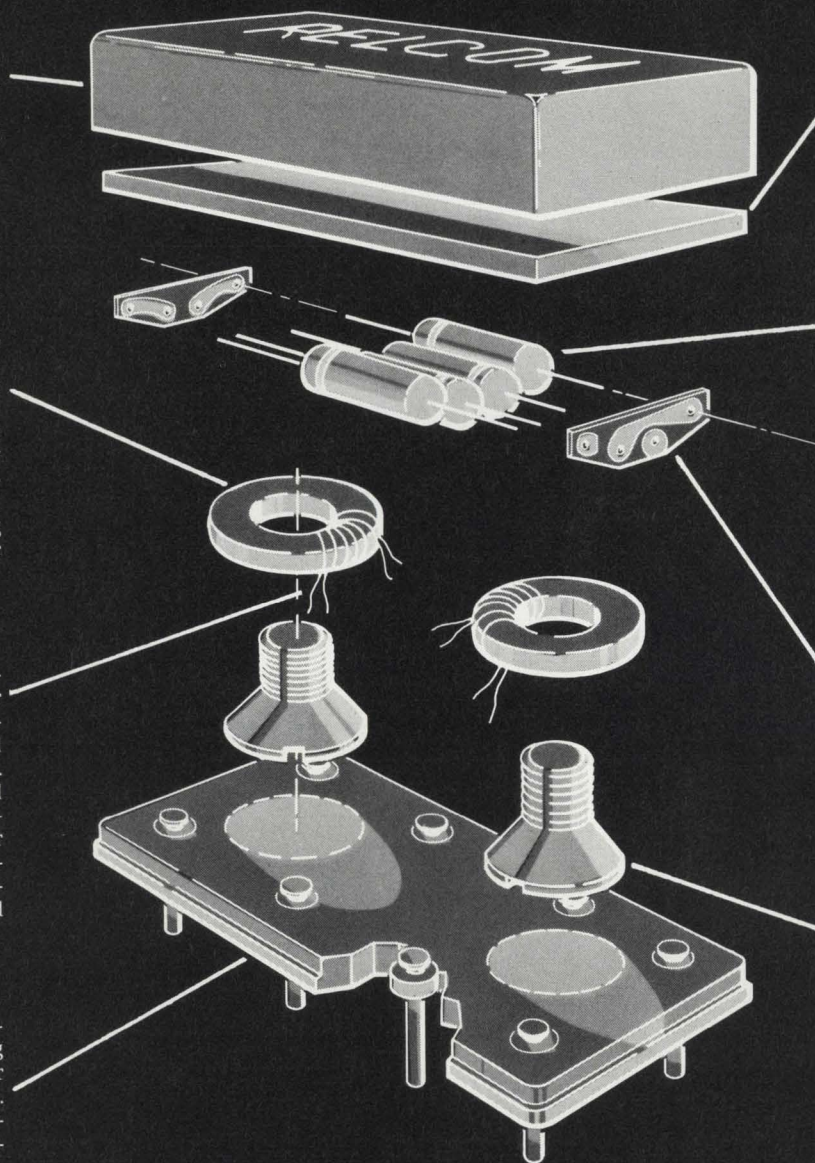

A cushion provides added insurance against electrical shorts to the can and extra protection against damage in a severe shock environment. Protective spraying of circuitry provides additional protection against electrical shorts.

Diode type has been carefully selected and specified to provide high reliability and a broad frequency range with low noise figure. As with other parts, vendors have been carefully qualified. Incoming diodes are temperature cycled to assure stability, checked for physical and electrical characteristics, and precisely matched to provide excellent mixer isolation and IMD performance.

For an extra measure of reliability, two circuit boards are used to interconnect the diode ring. These plated-thru boards are designed and inspected to avoid possible electrical shorts.

Plastic supports provide winding insulation from the header, maximum support for the transformers, and a means of holding the windings in place under any shock or vibration condition.

Bonding materials and application methods have been selected to provide reliable attachment of components without suffering electrical degradation or component damage.

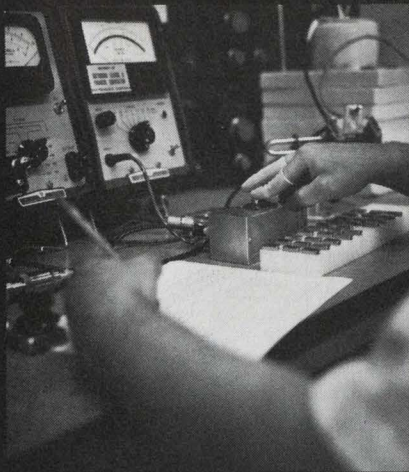

100% Electrically Tested

Now, here's how all this attention to detail can benefit you —

RELIABILITY: Relcom's mixers, transformers, reactive hybrids and switches are produced in accordance with MIL-I-45208A performance standards. They're GUARANTEED to meet our published specifications from -54°C to $+100^{\circ}\text{C}$, AFTER exposure to MIL-STD-202D environments. This is an unmatched reliability guarantee! And it's why you can use standard Relcom products, right off the shelf, in nearly any high-rel application.

CONFIDENCE: Relcom's products are 100% tested to electrical specifications (with guard-bands and recorded data). Units are serialized for performance and material traceability. Our one-year warranty experience shows less than 0.2% of units shipped need be replaced.

VALUE: Product losses, resulting from defective production parts, are unusually low. That's why our prices can match your in-house costs, and stay competitive with other outside sources.

DELIVERY: Our near absence of production problems means on-time delivery. During the past year, 95% of Relcom's shipments were made by the scheduled shipping date, and 97% were made within three days of that date.

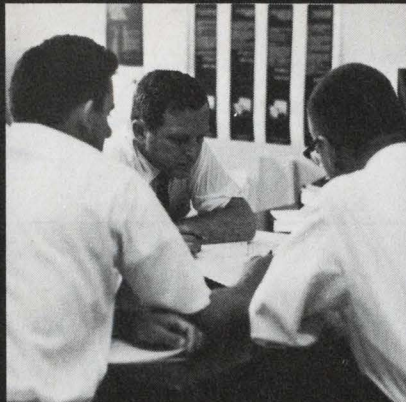

Qualified People

Another big factor in Relcom quality is our people, with their training, experience and dedication. Relcom engineers, for example, do nothing else but design signal-processing components. Their combined experience totals more than 56 years. You benefit by coming to experts who've designed a wide variety of signal-processing devices for a broad series of applications.

Relcom's production staff is another big contributor to product quality and reliability. Again, experience is a good part of it. Our assemblers average more than two years with the company. New personnel are trained in-house by production managers who've worked in several facets of the business. Turnover is low. Craftsmanship, continuity is maintained from product to product.

Relcom's Quality Assurance Department combines a 25-year electronics industry background with 11 years in quality control. Personnel update their skills in QA methodology with formal classwork. During product design, inspection procedures and production documentation are reviewed. From receiving and assembly inspection plans to final inspection audit, customers are assured of detail conformity on every aspect of the product they buy.



Delivery From Stock

Put all the elements of our QA program together — our people, procedures, and procurement techniques — you'll find you buy much more than a product when you buy from Relcom. Ask any of our 400 customers; instrument manufacturers, receiver designers, large-scale military and commercial systems producers, and builders of satellite transponders.

After all, when you make signal-processing components with the care we do, and make them for the customers we have, you have to provide the best product available.

Relcom products cover a frequency range from DC to 2.5 GHz. You can find out more about Relcom reliable signal-processing components and their applications by circling our reader service number. We'll send you detailed short-form catalogs describing our complete line of mixers, transformers, reactive hybrids and RF switches in coaxial connector models, or P.C. packages. Or better still, call a Relcom sales engineer at our Mountain View office for your own evaluation unit. The call's on us.

RELCOM

Reliable Signal Processing Components

2329 Charleston Road ● Mountain View ● California 94040 ● Telephone (415) 961-6265 ● TWX (910) 379-6979

Manufacturer	Model	Operating Frequency Range (GHz)	Tuning Range (MHz)	Output Power Min-Max (mW)	Notes	Price (\$)
W-J	WJ-569-1	1.0-2.0	1000	10 min	d	req
W-J	WJ-569-3	1.0-2.0	1000	50 min	d	req
W-J	WJ-2802	1.0-2.0	1000	30 min	q	req
W-J	WJ-2803	1.0-2.0	1000	100 min	q	req
W-J	WJ-5078	1.0-2.0	1000	15 min	d	req
Yig-Tek	310	1.0-2.0	1000	10 min	d	1000
Zeta	4302	1.0-2.0	p	20 min	cij	req
EMF	TS-14	1.5-2.0	500	1-200		250-395
EMF	VTN-3.1	1.5-2.0	100	1-200	h	170-290
EMF	VTW-5	1.5-2.0	500	1-100		250-310
Freq. Sources	FS-50	1.5-2.0	15%	200 max	bhq	req
Fairchild	MO(L)112	1.700-2.020	320	75 min	j	req
Calif. Micro.	PA20P	1.78-2.04	260	50 min	bf	req
Marconi	6055	0.85-2.15	1300	50 typ		945
W-J	WJ-569-2	1.0-2.2	1200	20 min	d	req
Omni Spectra	28654-29	2.200	20%	50 typ	hn	req
Nippon	LD-885	2.090-2.210	120	100 min	y	req
Calif. Micro.	PA22P	2.00-2.27	270	40 min	bf	req
Freq. Sources	FS-28	1.5-2.3	800	10-20	m	350
AEL	MIC3068-1	2.0-2.3	p	10 min		225
Micromega	28450-10 to 22	0.980-2.320	200-300	250-1000	jn	160-560
Fairchild	MO(S) 114	2.000-2.320	320	50 min	j	req
Sanders	DG715	1.0-2.4	2	180 min	n (2)	750
W-J	WJ-2810	1.4-2.4	1000	40 min	q	req
W-J	WJ-572-13	2.0-2.4	400	35 min	d	req
Nippon	LD-884	2.340-2.460	120	100 min	y	req
Freq. Sources	FS-25	1.8-2.5	200	40	q	450
EMF	TS-15	2.0-2.5	500	1-200		290-330
Freq. Sources	FS-30A	2.0-2.5	p	10-15	i	750
Trak	6000-1307	2.2-2.7	500	10 min		req
Fairchild	(S) 116	2.300-2.720	420	20 min	i	req
Nippon	LD-904	2.665-2.935	p	40 min	j	req
Acrodyne	S1007	1.0-3.0	ina	1000 typ	ij	2600
EMF	TSO-14	1.5-3.0	1500	1-50		410-475
Omni Spectra	287734-65	1.5-3.0	octave	150 typ	q	req
Spectra	VT-2212	1.5-3.0	octave	100 min	bq	req
EMF	VTN-4	2.0-3.0	10%	1-100	h	320-350
W-J	WJ-572-32	2.0-3.0	1000	30 min	d	req
EMF	TS-16	2.5-3.0	500	1-100		320-350
Trak	6000-1300	2.7-3.0	300	15 min		req
W-J	WJ-572-19	1.56-3.16	1500	10 min	d	req
Fairchild	(S)118	2.700-3.220	520	20 min	j	req
Trak	6000-1305	3.1-3.4	300	15 min		req
Centilabs	OLS2000	1.5-3.5	50	50-100		550
Freq. Sources	FS-14R	2.4-3.5	1%	500 typ	ch	600
Trak	6000-1306	3.2-3.6	400	8 min		req
Fairchild	MS(S) 42	3.600-3.900	300	10 min	g	req
Fairchild	MS(S) 420	3.600-3.900	300	50 min	g	req
Freq. Sources	FS-47	1.0-4.0	octave	15-150	q	650
Miteq	OTC-2B	1.0-4.0	±7%	40 min	jm	575
Sanders	DG 717	1.45-4.0	0.5	5 min	gjn	800
Applied Tech.	SFS series	2.0-4.0	0.1%	10-1000	hij	req
Applied Tech.	SMS series	2.0-4.0	1%-15%	10-500	hmn	req
Avantek	AV-7200M	2.0-4.0	2000	25 min	d	1200-1400
Avantek	AV-7202M	2.0-4.0	2000	30 min	d	800-900
Engelmann	ET-111	2.0-4.0	2000	50 min	a	1200
Fairchild	MVS 4700	2.0-4.0	2000	40 min	q	req
Fairchild	MVS 4710	2.0-4.0	2000	75 min	q	req
Freq. Sources	FS-4R	2.0-4.0	1%	7-15	ch	340
Freq. Sources	FS-31	2.0-4.0	800	10-20	m	380
Freq. Sources	FS-300	2.0-4.0	10%	50-200	bhq	req
H-P	35009A	2.0-4.0	2000-4000	10 min	adpt	715
H-P	35009B	2.0-4.0	2000-4000	10 min	adpst	765
Microphase	VTS 324	2.0-4.0	2000	50 typ	j	295-695
Miteq	OTV-5A-2000	2.0-4.0	2000	40 min	q	1150
Miteq	OTV-1A-2000	2.0-4.0	2000	40 min	q	900
Omni Spectra	28774-66	2.0-4.0	octave	100 typ	q	req
PEL	OS-100	2.0-4.0	2000	1 min	d	req
Spectra	VT-3051	2.0-4.0	octave	50 min	bq	req
Texscan	VTO-200	2.0-4.0	2000	100 min	q	600
W-J	WJ-572	2.0-4.0	2000	5 min	d	req
W-J	WJ-2804-20	2.0-4.0	2000	20 min	q	req
W-J	WJ-2804-40	2.0-4.0	2000	40 min	q	req
W-J	WJ-5079	2.0-4.0	2000	5 min	d	req
Yig-Tek	320	2.0-4.0	2000	10 min	d	1200
W-J	WJ-572-33	3.0-4.0	1000	15 min	d	req
Calif. Micro.	MT41P	3.63-4.13	500	10 min	bcg	req
Calif. Micro.	PA41P	3.63-4.13	500	10 min	bcf	req
Avantek	AV-7202M-08	1.7-4.2	2500	20 min	d	900-1000
Spectra	VT-3141	2.1-4.2	octave	40 min	bq	req

Manufacturer	Model	Operating Frequency Range (GHz)	Tuning Range (MHz)	Output Power Min-Max (mW)	Notes	Price (\$)
Fairchild	MS(S) 440	3.850-4.200	350	50 min	g	req
Fairchild	(S) 44	3.850-4.200	350	10 min	g	req
Texscan	VTO-300	3.0-4.3	1300	30 min	q	600
Fairchild	MS(C) A 480	4.330-4.630	300	50 min	g	req
Calif. Micro.	MT49P	4.33-4.93	600	10 min	bcg	req
Calif. Micro.	PA49P	4.33-4.93	600	10 min	bcf	req
Fairchild	MS(C) 48	4.330-4.930	600	10 min	g	req
Fairchild	MS(C) B 480	4.600-4.930	630	50 min	g	req
Engelmann	CC-1000 series	0.685-5.0	30%	20 min	jn	req
Engelmann	PL-1000 series	0.685-5.0	30%	20 min	fn	1300
Freq. Sources	FS-23	2.5-5.0	15%	10-15	hq	req
Freq. Sources	FS-30	2.5-5.0	p	5-15	i	690
Microphase	VTS 345	4.0-5.0	1000	50 typ	j	295-695
Omni Spectra	287703	1.000-5.200	6%	350 typ	hq	req
Omni Spectra	287705	1.000-5.200	10%	250 typ	hq	req
Omni Spectra	287710	1.000-5.200	20%	250 typ	hq	req
Omni Spectra	287720	1.000-5.200	40%	150 typ	hq	req
Microphase	VTS 22652	2.6-5.2	2600	50 typ	j	295-695
Omni Spectra	287745-67	2.6-5.2	octave	50 typ	q	req
Omni Spectra	28795-1	4.8-5.4	600	50 typ	q	req
Texscan	VTO-400	4.0-5.5	1500	25 min	q	600
Fairchild	MS(C) 52	5.400-5.900	500	10 min	g	req
Omni Spectra	28795-2	5.4-5.9	500	50 typ	q	req
Zeta	4408	5.4-5.9	500	1000 typ	cq	req
IMC	TOC-6000G	1.0-6.0	100-300	10-100		100-450
Zeta	4213	1.0-6.0	p	10 min	cij	req
Zeta	4303	2.0-6.0	p	10 min	cij	req
Freq. Sources	FS-14	2.3-6.0	10%	100-250	hqr	1190
Freq. Sources	FS-14L	3.5-6.0	1%	150-400	hq	700
Freq. Sources	FS-27H	3.6-6.0	500	20 typ	m	450
Engelmann	MT-230	4.0-6.0	100	10-100	acjn	880
Freq. Sources	FS-9R	4.0-6.0	1%	20 typ	ch	440
MA	86748	4.0-6.0	2000	1 typ		req
Sanders	DG718	4.0-6.0	0.5	5 min	gjn	1200
Freq. Sources	FS-53	4.5-6.0	10%	50 max	bhq	req
Zeta	4314-01	5.0-6.0	p	10 min	fj	req
Fairchild	MS(C) A540	5.855-6.105	250	50 min	g	req
Airtron	4	5.7-6.2	500	8-20	ac	req
MA	86C16	6.0-6.3	p	1000 typ		req
Fairchild	MS(C) B540	6.105-6.355	250	50 min	g	req
Fairchild	MS(C) 540	5.855-6.360	505	50 min	g	req
Calif. Micro.	MT64P	5.855-6.455	600	10 min	bcg	req
Calif. Micro.	PA64P	5.855-6.455	600	10 min	bcf	req
Fairchild	MS(C) 54	5.855-6.455	600	10 min	g	req
Freq. Sources	FS-1R	4.0-6.5	1%	4-7	ch	340
Texscan	VTO-500	5.0-6.6	1600	20 min	q	600
Micromega	28450-385-665	3.6-6.855	300-500	50 min	cjn	515-825
Fairchild	MS(C) 560	6.355-6.855	500	50 min	g	req
Calif. Micro.	MT69P	6.425-6.925	500	10 min	bcg	req
Calif. Micro.	PA69P	6.425-6.925	500	10 min	bcf	req
Fairchild	MS(C) 56	6.425-6.925	500	10 min	g	req
Calif. Micro.	MT72P	6.8-7.2	400	10 min	bcg	req
Calif. Micro.	PA72P	6.8-7.2	400	10 min	bcf	req
Fairchild	MS(C) 58	6.800-7.200	400	10 min	g	req
Freq. Sources	FS-37A	4.0-7.5	500	10 typ	m	600
Fairchild	MS(C)60	7.000-7.525	525	5 min	g	req
Calif. Micro.	MT75P	7.055-7.525	470	10 min	bcg	req
Calif. Micro.	PA77P	7.055-7.750	695	10 min	bcf	req
Applied Tech.	SFC series	4.0-8.0	0.1%	10-1000	hij	req
Applied Tech.	SMC series	4.0-8.0	1%-15%	10-250	hmn	req
Omni Spectra	28795-3	6.0-8.0	750	25 typ	q	req
Omni Spectra	28795-4	6.0-8.0	200	50 typ	q	req
Calif. Micro.	MT80P	7.5-8.0	500	10 min	bcg	req
Fairchild	MS(C) 62	7.500-8.000	1500	5 min	g	req
Zeta	6513	8.38-8.42	40	40 min	ciq	req
Calif. Micro.	PA84P	7.75-8.47	720	10 min	bcf	req
Micromega	28450-38 to -83	3.6-8.5	300-525	10 min	cjn	475-880
Calif. Micro.	MT85P	7.975-8.5	525	10 min	bcg	req
Fairchild	MS(X) 64	7.975-8.500	525	5 min	g	req
Engelmann	LD-240	6.0-9.0	150	10-100	acjn	925
Nippon	LD-956	8.940-9.220	p	15 min	i	req
Airtron	2	8.75-9.4	650	4-10	ac	req
Airtron	3	9.1-9.4	300	20-40	ac	req
Trak	5008-9904	9.25-9.55	300	50 min	cq	req
Calif. Micro.	MT96 P	9.0-9.6	600	10 min	bcg	req
Greenray	EL-101-EL-116	1.2-9.7	600	10 typ	n	600
Greenray	EP-101-EP-116	1.2-9.7	600	10 typ	q	650
Bradley/Edwin	438	8.5-9.7	400	20 max	a	506
Bradley/Edwin	444	8.5-9.7	400	20 max	a	567
Trak	6054-9901	9.2-9.72	520	8-60	a(3)	req

(tables continued on p. 112)

QUALIFIED TO MIL. C-55302.

Government Designation	Burndy Part Number
M55302/1-03	UPC2A17P4
M55302/1-04	UPC2A23P4
M55302/1-05	UPC2A28P4
M55302/2-03	UPC2A17R4
M55302/2-04	UPC2A23R4
M55302/2-05	UPC2A28R4
M55302/4-02	UPC2B17P4
M55302/4-03	UPC2B25P4
M55302/4-04	UPC2B33P4
M55302/4-05	UPC2B41P4
M55302/6-02	UPC2B17R4
M55302/6-03	UPC2B25R4
M55302/6-04	UPC2B33R4
M55302/6-05	UPC2B41R4
M55302/7-01	UPC3B13P4
M55302/7-02	UPC3B25P4
M55302/7-03	UPC3B37P4
M55302/7-04	UPC3B49P4
M55302/7-05	UPC3B61P4
M55302/8-01	UPC3B13R4
M55302/8-02	UPC3B25R4
M55302/8-03	UPC3B37R4
M55302/8-04	UPC3B49R4
M55302/8-05	UPC3B61R4
M55302/19-01	UPC2A41P-4
M55302/20-01	UPC2A41R-4
M55302/21-01	UPC3B92P4
M55302/22-01	UPC3B92R4

The current Mil E-5400L specifies the use of two-piece printed circuit type connectors for airborne military applications. At the same time, recent additions to Mil STD-454, requirement 10, specifically call out the Mil C-55302 connector series. Burndy has them in stock, ready for delivery. Just call your nearest Burndy electronic distributor or Burndy Sales Office.

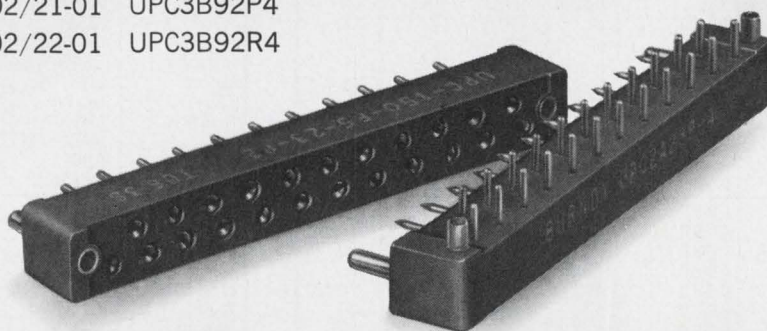

THE BURNDY UPC.

INTERNATIONAL SALES HEADQUARTERS & MANUFACTURING FACILITIES: CANADA / ENGLAND / BELGIUM / MEXICO / BRAZIL / JAPAN / Sales Offices in Major Cities

70-32

INFORMATION RETRIEVAL NUMBER 57

COMING JAN. 7

1971 TOP TEN CONTEST ISSUE

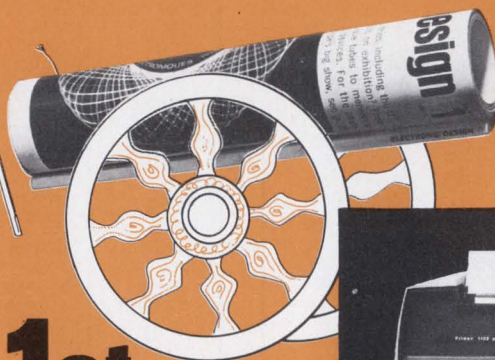

NEW PRIZES!
NEW RULES!

1st PRIZE
FRIDEN MODEL 1152
PROGRAMMABLE
PRINTING CALCULATOR



Frیدن Electronic Display Calculator

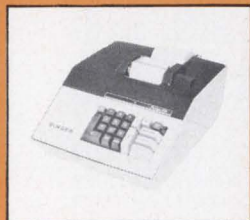

Frیدن Adding Machine

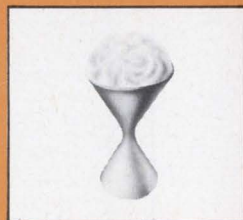

EICO "Light Fantastic"



Bulova Accutron® Timepiece



Std. Dictionary of Computers and Information Processing

HERE'S ALL YOU HAVE TO DO TO ENTER:

(1) Examine the January 7 issue of Electronic Design with extra care. (2) Pick the ten advertisements that you think will be best READ by your fellow engineer-subscribers. (3) List these advertisements (in the rank order you think our readers will select them) on the special entry form bound in the January 7 issue. Your Top Ten list will be compared with the ten ads ranking highest in the "Recall READ MOST" category of Reader Recall—Electronic Design's method of measuring readership.

CAUTION: In other years, your rankings were judged on the basis of "Recall Seen" scores. This year they will be judged on the basis of "Recall READ MOST" scores. This means that some striking ads will step back in favor of those offering greater content and usefulness to the reader.

Test your skill! See if you can pick the Top Ten . . . valuable prizes are waiting for the winners.

PRIZES—READER CONTEST

FIRST PRIZE:	FRIDEN MODEL 1152 PROGRAMMABLE PRINTING CALCULATOR	4th & 5th PRIZES:	EICO "LIGHT FANTASTIC" COLOR-IMAGE AUDIO LIGHTING SYSTEM
SECOND PRIZE:	FRIDEN MODEL 1114 ELECTRONIC DISPLAY CALCULATOR	6th through 13th PRIZES:	BULOVA ACCUTRON® "SPACEVIEW" ELECTRONIC WRIST TIMEPIECES
THIRD PRIZE:	FRIDEN MODEL 213 ADDING MACHINE (with automatic recall)	14th through 75th PRIZES:	COPIES OF THE "STANDARD DICTIONARY OF COMPUTERS AND INFORMATION PROCESSING." Martin H. Weik, 326 pp.

**COMPLETE INFORMATION, RULES, AND ENTRY BLANKS
WILL APPEAR IN ELECTRONIC DESIGN'S JAN. 7 ISSUE**

Motorola's Ponderous Pachyderm Syndrome

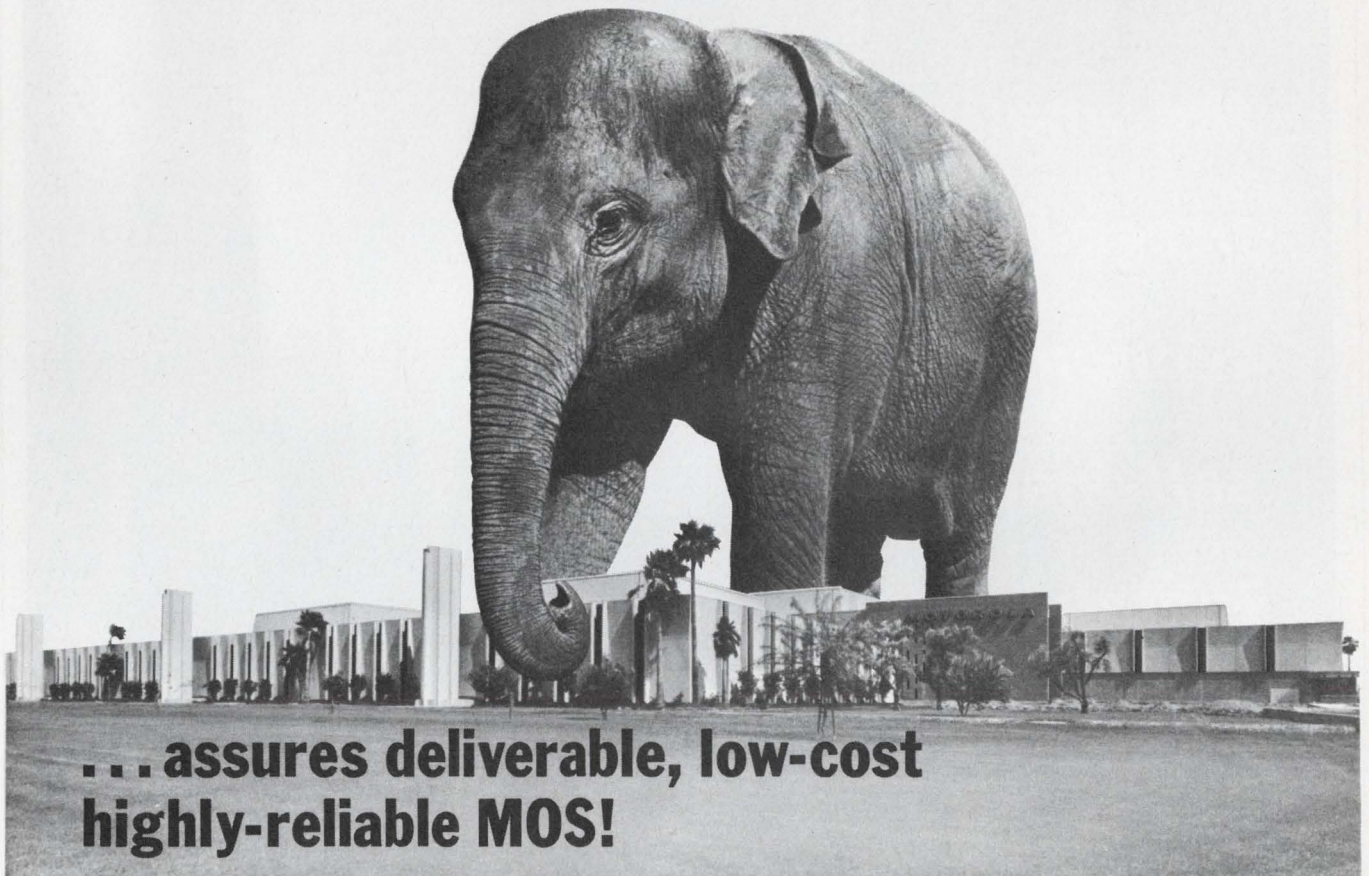

**... assures deliverable, low-cost
highly-reliable MOS!**

Why Ponderous Pachyderm?

Motorola typically moves slowly and carefully into new product categories, planning, examining, and developing sure, reproducible processes before total commitment. This has been our history, and we have applied the same approach to MOS.

Motorola already offers a selection of standard MOS devices in both high threshold and low threshold P-channel MOS, matched by a growing line of Complementary MOS types. Included are gates, flip-flops, multiplex switches, memories, counters, general purpose logic elements, and dynamic and static shift registers. These will be joined before the end of the year by several Silicon-Gate MOS shift register and memory introductions to launch our capability in this significant area. And our Polycell LSI program is in full swing for the design of custom MOS. For perspective,

what does the pachyderm syndrome indicate?

We were deliberate in entering the silicon transistor business. We made the commitment. Who has supplied more silicon transistors since!

We were slow with RTL and DTL. We made commitments. Who has supplied more RTL and DTL since!

We waited before committing to Linear circuits. We committed. Who has delivered more Linear circuits since!

We delayed on MOS. Then in the first six months of 1970 we increased our design capability, our production capacity, and our deliveries by 10 times. Now we are committed!

Ask us to back this up by telling us your MOS product interests. If you have a problem, we'll offer assistance. Write to Motorola Semiconductor Products Inc., P. O. Box 20912, Phoenix, Arizona 85036.



MOTOROLA MOS
— the broad line is our specialty

INFORMATION RETRIEVAL NUMBER 58

TRW presents

**the small,
precision,
economical,
self-insulated
tantalum
capacitor...**

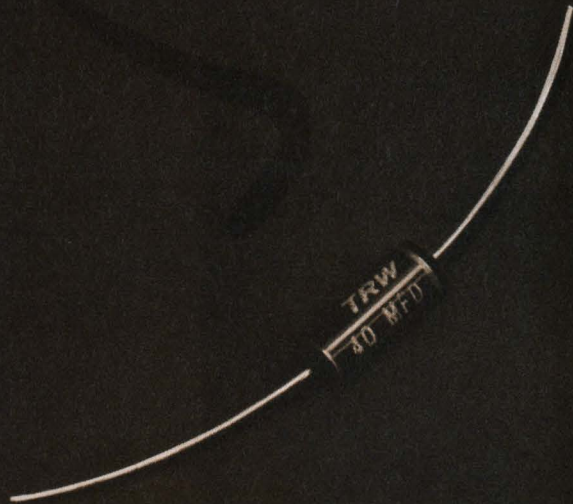

14-76

that laughs at shock and environment

Space savings of up to 40%. A one-piece dense epoxy resin case which is self-insulated and provides complete environmental protection. High shock and vibration resistance due to the elimination of all voids. Precision dimensioned for high-density packaging. Great flexibility in mounting positions and lead options, and ideal for automatic insertion.

These are just a few of the

advantages offered by the TRW Type 935 tantalum capacitor. In addition, they are remarkably inexpensive, due to the high speed molding techniques used in their production.

The versatile 935 is available from 6 through 50 volts, and from .0047 to 56 mfd. It is designed to operate from -55°C to $+85^{\circ}\text{C}$ at full rating, and up to $+125^{\circ}\text{C}$ with $\frac{1}{3}$ derating.

For complete information and

INFORMATION RETRIEVAL NUMBER 59

technical data, contact TRW Capacitor Division, Box 1000, Ogallala, Nebraska. Phone: (308) 284-3611. TWX: 910-620-0321.

TRW[®]

new products

Low-cost hybrid op amp lowers bias to 0.01 pA

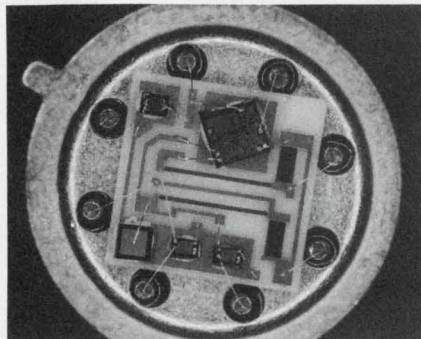

Intersil, Inc., 10900 N. Tantau Ave., Cupertino, Calif. Phone: (408) 257-5450. P&A: \$42.50, \$40.35; stock.

Constructed of monolithic and discrete components in a TO-5 can, the new low-cost hybrid ICH8500A operational amplifier features very low input bias currents of less than 0.01 pA.

The very low input currents are achieved by an isolation technique that allows the case to follow the applied input voltage. This prevents any leakage from the case to the input pin which would result if the case were at ground or collector-supply-voltage levels.

The ICH8500A is frequency compensated internally, has a 5-mV input offset voltage, an adjustable offset voltage range of ± 25 mV and a common-mode rejection ratio of 60:1.

Closed-loop frequency response of the new amplifier can be made flat to 100 kHz. Open-loop frequency response is flat to 20 Hz. Other characteristics include input offset-voltage null capability, short-circuit protection, 500-mW power consumption and pin-for-pin compatibility with popular type 741 operational amplifiers.

Large-signal voltage gain is 20,000 and output-voltage swing is ± 12 V. Slew rate is 0.5 V/ μ s and long-term stability for the input offset voltage is ± 3 mV.

A lower-priced version of the ICH8500A is the ICH8500 which is identical to the ICH8500A except for a bias current of 0.1 pA.

CIRCLE NO. 250

DIP 12-bit ladder tracks to 1 ppm/ $^{\circ}$ C

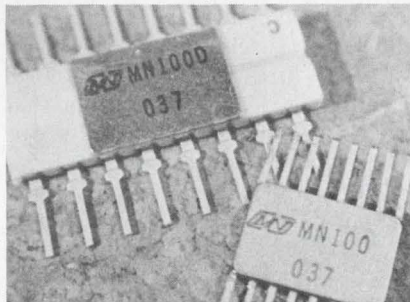

Micro Networks Corp., 5 Barbara Lane, Worcester, Mass. Phone: (617) 756-4635. P&A: \$69; stock.

The MN100 is a precision nickel-chromium ladder network in a 16-lead flatpack or a 16-pin DIP providing temperature tracking from -50 to $+125^{\circ}$ C of typically less than 1 ppm/ $^{\circ}$ C. Accuracy is 0.0122%, $\pm 1/2$ bit for 12 bits over the full temperature range of -50 to $+125^{\circ}$ C. The MN100 is designed to meet the requirements of MIL-STD-883.

CIRCLE NO. 251

Six MOS/LSI ICs comprise calculator logic

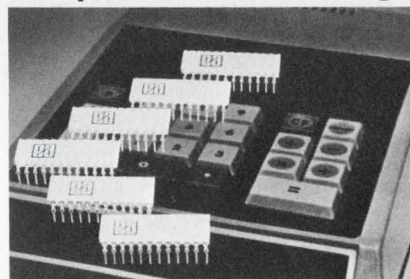

Electronic Arrays, Inc., 501 Ellis St., Mountain View, Calif. Phone: (415) 964-4321.

The S-100 set of six MOS/LSI circuits, provides the entire electronic logic required to build an eight-digit four-function calculator. The six MOS circuits packaged in 24-pin dual-in-line packages are an input chip, a register chip, an arithmetic chip, a read-only memory, a control logic chip and an output chip. Chip die sizes range from 82 by 88 to 90 by 100 mils.

CIRCLE NO. 252

IC sense amplifier cuts threshold to 4 mV

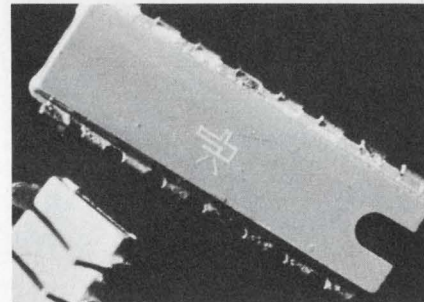

Nucleonic Products Co., 6660 Variel Ave., Canoga Park, Calif. Phone: (213) 887-1010. Availability: stock to 6 wks.

A new sense amplifier for read-only memories is the Sescosem SFC2003 with a low threshold voltage of just 4 mV. Other features of this 16-pin IC are dual channels with input selection, variable threshold from 4 to 12 mV, output register and DTL/TTL-compatible outputs. Propagation time is 25 ns.

CIRCLE NO. 253

Universal multiplexer ups versatility



General Instrument Corp., 600 W. John St., Hicksville, N. Y. Phone: (516) 681-8000. Price: \$32.

The AY-1-4016 is a flexible universal multiplexer composed of a 4-stage binary counter, a 4-by-16 decode matrix and 16 spdt switches. It permits current or voltage modes of operation and provides matching resistors to improve accuracy. Interface is available to TTL/DTL and MOS families. Random or sequential-access and single-ended or differential modes are possible.

CIRCLE NO. 254

Read-only memories access in 350 ns

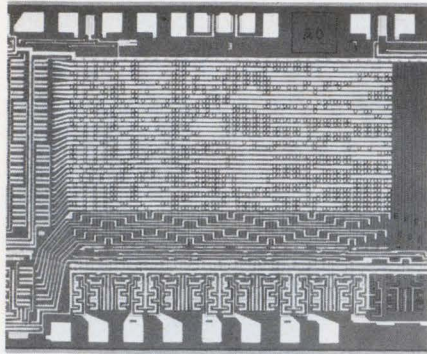

Intersil, Inc., 10900 N. Tantau Ave., Cupertino, Calif. Phone: (408) 257-5450. P&A: from \$1.14 to 2.6¢/bit; stock.

A new family of 1024, 2048 and 2560-bit fully decoded static MOS read-only memories with sense amplifier on the chip features a typical access time of 350 ns. The 7600 memories are p-channel units that are programmed by changing one mask during fabrication. Features include bipolar compatibility and low power consumption of 360 mW.

CIRCLE NO. 255

Thin-film chip resistors stabilize to ±50 ppm/°C

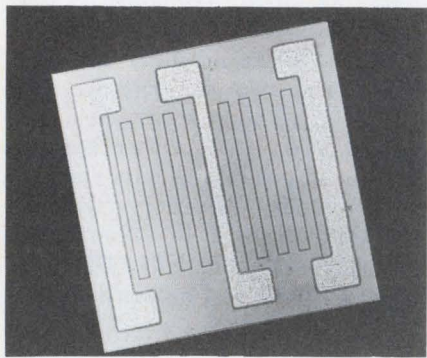

Sloan Microelectronics, Div. of Sloan Technology Corp., 139 Maryland St., El Segundo, Calif. Phone: (213) 322-9340.

Two new thin-film chip resistors feature stability of 0.05%/1000 hours and a temperature coefficient of ±50 ppm/°C. The resistors are 30-mils square and are available in 5-Ω to 500-kΩ values in two patterns: a center tap with two matched resistors and a pattern containing 12 bonding points permitting selection from 1 to 110 squares.

CIRCLE NO. 256

Flatpack diode quad is matched to 1 mV

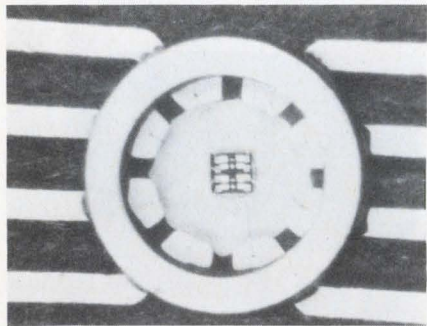

Mini-Systems, Inc., David Rd., N. Attleboro, Mass. Phone: (617) 695-0206. P&A: \$9.50; stock.

Four diodes matched to within a forward voltage of 1 mV make up the monolithic 0.175-in-dia MS214 sealed diode array flatpack. Each diode is dielectrically isolated and is rated for 100 mA maximum. Reverse voltage is 60 V minimum at 100 μA and reverse current is 25 nA maximum at 50 V. Reverse recovery time is 300 ns.

CIRCLE NO. 257

Miniature sealed diode handles 20 kV at 1 mA

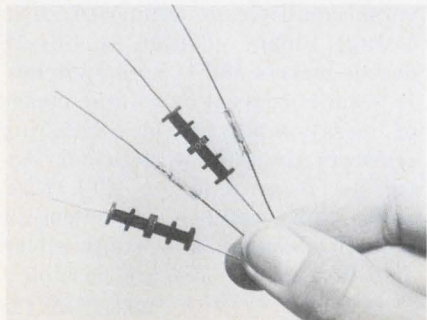

Codi Semiconductor Div., Computer Diode Corp., Pollitt Dr., Fairlawn, N. J. Phone: (201) 797-3900. Price: \$2 to \$9.50.

Featuring a maximum dia of 0.1 in. and a length of only 0.5 in., a new solid-state diode handles 20 kV at a 10-mA current rating. It meets or exceeds MIL-S-19500 specifications and can be designed into circuits which can later be epoxy-encapsulated. It has a recovery time ranging from 100 to 300 ns.

CIRCLE NO. 258

MOS 1024-bit memory accesses in 300 ns

Intel Corp., 365 Middlefield Rd., Mountain View, Calif. Phone: (415) 969-1670. P&A: \$60; stock.

Fully decoded on the chip, the low-cost 1103 MOS/LSI 1024-bit dynamic random-access memory has an access time of 300 ns and power dissipation of 400 mW. Its cycle time is 580 ns, it refreshes every 2 ms and operates over the temperature range of 0 to +70°C. The new memory is constructed as 1024 words by 1 bit and allows simple memory expansion with a chip enable lead. It is a low-threshold p-channel silicon-gate device.

CIRCLE NO. 259

Line driver/receivers meet three specs

Signetics Corp., 811 E. Arques Ave., Sunnyvale, Calif. Phone: (408) 739-7700. Price: \$3.75 (100-999).

Two new monolithic communication ICs, the 8T15 dual line driver and the 8T16 dual line receiver, meet specifications EIA RS-232, MIL STD 188 and international specification CC ITTV24. The 8T15 is a dual 4-input NAND driver that accepts TTL inputs and drives interface lines with ±6-V outputs. The 8T16 is a dual line receiver that accepts single or double-ended inputs and has a 6-V output.

CIRCLE NO. 260

Second-source ICs lower bias to 1 nA

Silicon General, Inc., 7382 Bolsa Ave., Westminster, Calif. Phone: (714) 839-6200. P&A: \$3.25 (SG310); stock.

Second-sourced model SG110/210/310 IC voltage followers are silicon monolithic amplifiers which exhibit a low 1-nA input bias current. They are internally connected as unity-gain non-inverting amplifiers and have input resistances of 10¹² Ω. Features include internal frequency compensation and offset balancing.

CIRCLE NO. 261

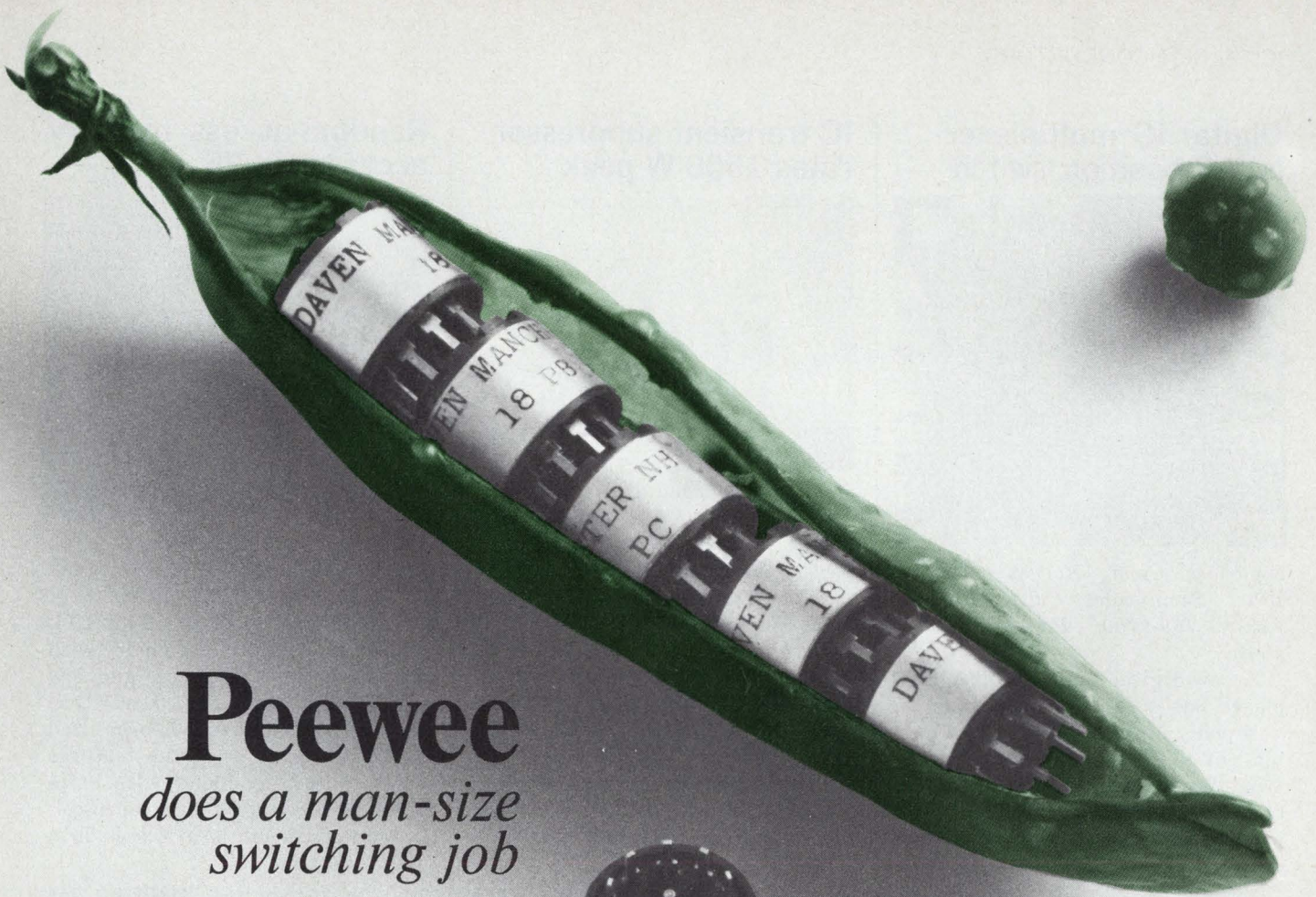

Peewee

*does a man-size
switching job*

Peewee may be pea-sized, but behind that low space-saving profile there's enormous switching capability. Daven's new printed circuit Series P switch has all the inherent features of the famous Series G (MIL-S-3786/20) packed into a miniature unit, solderable directly to PC boards. Exceptionally reliable.

Economical too. And versatile, with 36° spacing, shorting and non-shorting, one pole 2 through 10 positions, or 2 poles, 2 through 5 positions. Positive detent action.

Non-conductive, insulating surface. Completely sealed for immersion in cleaning solutions. Dry circuit conditions through 3 amps. carrying capacity, with low contact resistance. Positionable screw driver slot with clearly marked terminals. For samples and Bulletin P write to Daven Division, McGraw-Edison Company, Manchester, New Hampshire 03101.

(603) 669-0940. TWX 710-220-1747.



Digital IC multiplexer is a 3-position switch

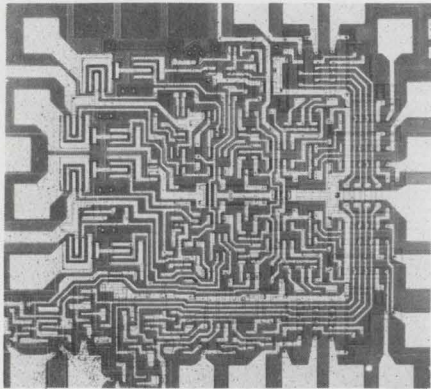

Signetics Corp., 811 E. Arques Ave., Sunnyvale, Calif. Phone: (408) 739-7700. P&A: \$15.95; stock.

A new digital 3-input 4-bit multiplexer has a function analogous to a 4-pole, 3-position switch. Four bits of digital data are selected from one of three inputs. Two versions are available: the 8263 with active pull-up outputs and the 8264 with bare-collector outputs.

CIRCLE NO. 262

IC transient suppressor rates 1500 W peak

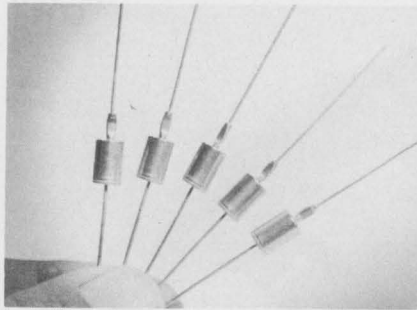

General Semiconductor Industries, Inc., 230 W. 5th St., Tempe, Ariz. Phone: (602) 966-7263. P&A: \$3.50; stock.

A new low-voltage silicon transient suppressor for 5-V ICs is rated for a peak pulse power of 1500 W for 1 ms and has a peak clamping time of 1×10^{-12} seconds. The ICT-5 protects TTL, ECL, DTL, MOS and MSI circuits. When properly used, it can replace crowbars and affords complete noise and voltage-surge immunity to logic circuits.

CIRCLE NO. 263

Random-access memory accesses in 75 ns

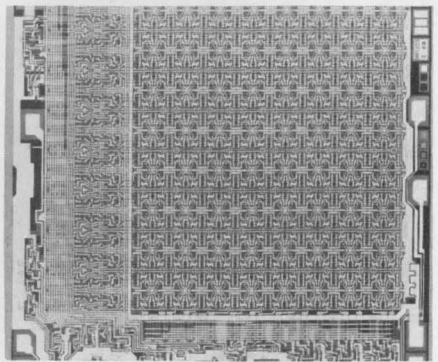

Intersil, 10900 N. Tantau Ave., Cupertino, Calif. Phone: (408) 257-5450. P&A: \$57; stock.

The IM5503 IC is a 256-bit TTL bipolar random-access memory with an access time of 75 ns, and low power dissipation of 1.5 mW/bit. This monolithic device is organized as 256 words by 1 bit and features on-chip decoding along with chip-select write-enable and open-collector outputs. It is available in a 16-pin ceramic DIP.

CIRCLE NO. 264

Remex is coming out of its shell.

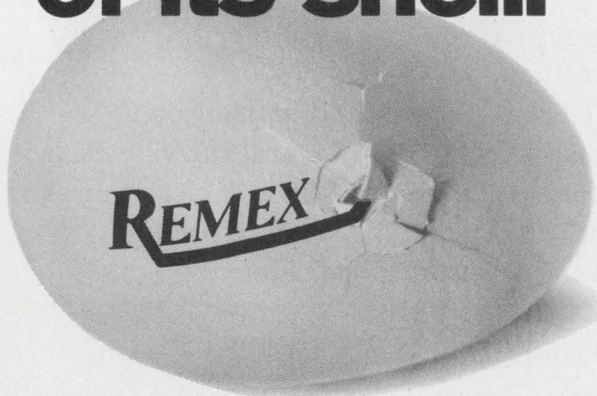

With an economy photoelectric punch tape reader. See pages 133 & 135.



EX-CELL-O CORPORATION

INFORMATION RETRIEVAL NUMBER 61

FOR EXCELLENCE IN TERMINATION HARDWARE SPECIFY GRAYHILL



Test Clips

Test Clips

Adjustable tension, threaded studs or plug in bases, various sizes.

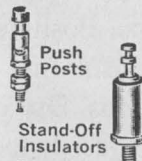

Push Posts

Stand-Off Insulators

Push Posts

Plunger action lets you connect and disconnect quickly and easily, assures positive contact.

Binding Posts

Screw type or spring loaded, banana plug or stud mounting, single or multiple units, with various colors for circuit identification.

Stand-Off Insulators

High dielectric strength, low loss insulation, low moisture absorption, various mounting styles.



Binding Posts

Sockets

Lamp or transistor, various colors, various mountings including printed circuit.



Sockets

Custom Molded Parts

Tight tolerances provide you with "assembly ready" units. Thermosetting plastics to meet most specifications.



Plastic Molded Parts



For your Grayhill Engineering Catalog offering complete technical data—contact

565 Hillgrove Avenue
LaGrange, Illinois 60525
Area Code 312, Phone 354-1040



... the Difference Between Excellent and Adequate

INFORMATION RETRIEVAL NUMBER 62

Our new
micropower
op amp
runs
off $\pm 1v$
with $20 \mu W$
power
consumption.

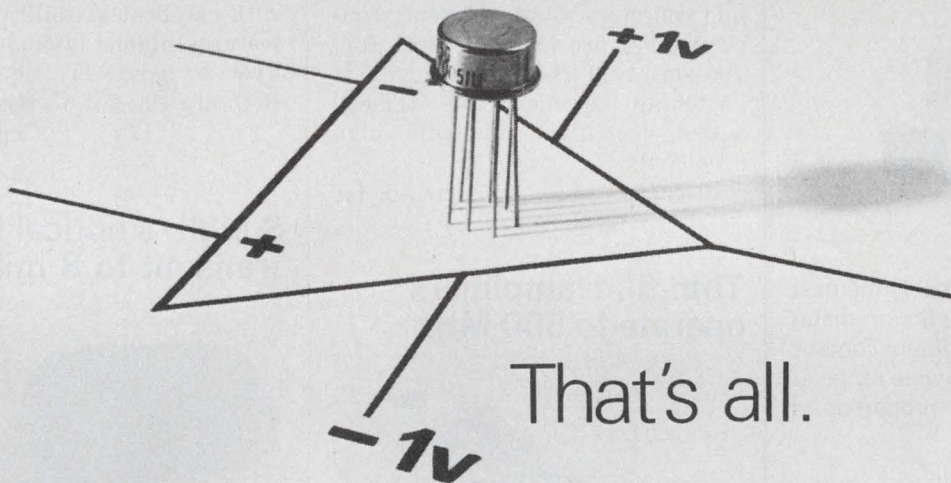

Solitron's UC4250 micropower op amp uses so little power that its batteries will last as long as their shelf life. It needs so little voltage that only two single cells are needed. (Although it can handle up to $\pm 18v$.)

The other specifications aren't so bad either. 3 nanoamps input bias current with tempera-

ture drift of zero nanoamps per degree C. 100 db gain into a 10K load. And it's available now. From (who else?) Solitron.

Solitron Devices, Inc., P.O. Box 1416,
San Diego, California 92112.
Telephone 714/278-8780.
TWX 910-335-1221.



For custom designs or standards, contact Solitron, leader in semiconductors:

SAN DIEGO, CAL.
8608 Balboa Avenue
FET & Dual FET Transistors
MOS/FET Devices
MOS Memory Arrays
Shift Registers
Monolithic IC's

RIVIERA BEACH, FLA.
1177 Blue Heron Blvd.
Hi Rel Power Transistors
Si & Ge. Power Transistors
RF & small Signal Transistors
PNP-NPN Industrial Transistors
PORT SALERNO, FLA.
Cove Road
Microwave Connectors

LONG ISLAND CITY, N.Y.
37-11 47th Ave.
Microwave Components
Bolometer Elements
Ferrite & Ferrite Devices
Microwave Semicond.
Plaxial (R) Cable
Precision RF Coax.

TAPPAN, N.Y.
256 Oak Tree Road
Diodes & Rectifiers
Zeners
High Voltage Assemblies
Power Rectifiers
Thick Film Hybrid Circuits

KENT, ENGLAND
Tubs Hill House
London Road, Sevenoaks
Solidev, Ltd.
Full line of
Solitron devices

BEN BAROQ, ISRAEL
51 Hayarkon Street
AEL Israel, Ltd.
Full line of
Solitron devices

TOKYO 105, JAPAN
NO. 5, 3-Chome
Shibahamamatsu-cho
Minato-ku
Matsushita Electric Trading
Full line of
Solitron devices

INFORMATION RETRIEVAL NUMBER 63



Iridium Platinum

Iridium Platinum is probably the best known alloy in the Platinum metal family. By varying the Iridium content from 5% to 40%, a very wide range of physical and electrical properties is obtained.

Diameters available range from rod sizes down to 0.0005" and, in some alloys, to 0.0002". With alloys high in Iridium, fantastic tensile strength can be obtained particularly in the smaller diameters. All of the alloys have excellent corrosion resistance and are not affected by any single acid.

Resistivity, temperature coefficient and tensile strength graphs are available. Write for complete data.

Sigmund Cohn Corp.

121 S. Columbus Ave.
Mount Vernon, N.Y. 10553
(914) 664-5300

INFORMATION RETRIEVAL NUMBER 64

MICROWAVES & LASERS

Phototransistor sensor is truly miniature

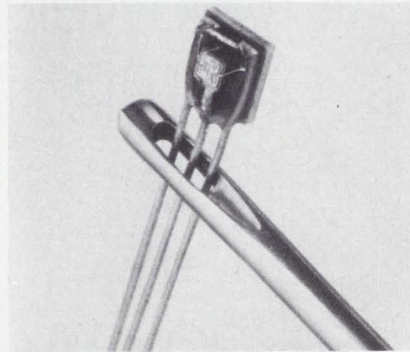

HEI, Inc., Jonathan Industrial Center, Chaska, Minn. Phone: (612) 448-3510. P&A: \$1.51, \$1.86; stock.

The new HT series Micro Sensor is an ultraminiature photosensor consisting of either a phototransistor or a photoDarlington sensor bonded to a ceramic substrate with three leads attached (emitter, base and collector). Two different semiconductors are available: the HT-700 series offers low cost and fast switching speeds; the HT-800 series has high gain and high sensitivity.

CIRCLE NO. 265

Thin-film amplifiers operate to 500 MHz

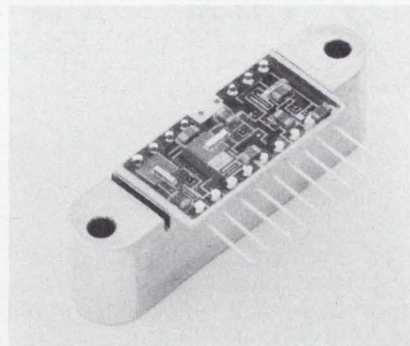

TRW, Inc., Semiconductor Div., 14520 Aviation Blvd., Lawndale, Calif. Phone: (213) 679-4561. Price: \$195, \$147.

Two new broadband thin-film IC amplifiers mounted on aluminum heatsinks provide high gains to 500 MHz. The CA800 50-Ω unit has a 5-to-500-MHz bandwidth with 25-dB gain. It uses a 28-V supply and achieves 400 mW of output power. The CA600 75-Ω CATV unit has a 40-to-300-MHz bandwidth with 28-dB gain.

CIRCLE NO. 266

Bright tiny GaP lamps use low drive currents

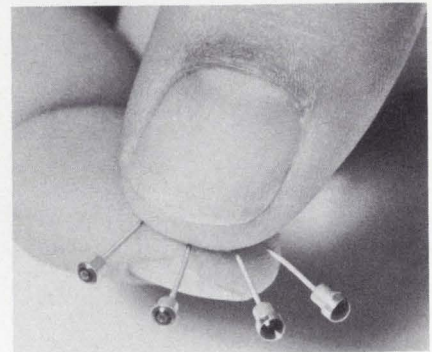

OPCOA, Inc., 330 Talmadge Rd., Edison, N. J. Phone: (201) 287-0355. Availability: stock.

The new tiny red GaP LED IC-compatible Solid-Lite lamps produce two millicandelas of luminous intensity at only 15 mA of drive current. Two models are available: OSL-1 provides 180-degree viewing with excellent visibility and OSL-2 features higher luminous intensity with a narrower viewing angle. Both are 100-mil-dia assemblies.

CIRCLE NO. 267

3-Mbit/s optical links transmit to 8 miles

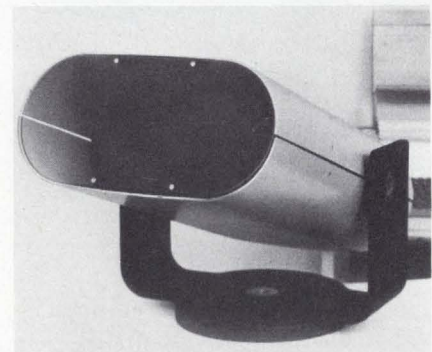

University Instruments Corp., 5541 Central Ave., Boulder, Colo. Phone: (303) 443-4210. Price: from \$6000.

Three high-speed optical communication links operate to 3 megabits/s and range up to 8 miles. All three have an error rate of less than 1 bit in 10⁸. Type OCL-300 operates synchronously from 20 to 50 kbits/s with an eight-mile range. OCL-310 works from 350 kbits/s to 3 megabits/s from 1/2 to 1 mile. OCL-400 has an analog bandwidth from 60 Hz to 4.5 MHz (3-dB points) with an eight-mile range.

CIRCLE NO. 268



What you hear about our new dry test bath is true.

The tape recorder is operating in a dry bath of Fluorinert® Brand Electronic Liquids. Just as your electronic and microelectronic units will.

Fluorinert Liquids give you an accurate method of temperature testing or testing for gross leaks. They keep their efficiency over a wide range of temperatures. They

do not react with even the most sensitive of materials. They won't deteriorate with use.

And you can ship or use parts directly out of the test bath without cleaning because Fluorinert Liquids evaporate, leaving no residue.

If you've been listening, you know that Fluorinert Electronic

Liquids are specified for Mil-Standard 883 and Mil-Standard 750A gross leak tests for microcircuits.

The coupon will bring you copies of both Mil-Standards and a lot of good solid information about test baths. Send it or call your local 3M man.

Fluorinert® Electronic Liquids 3M BRAND COMPANY

3M Company, Chemical Division, 3M Center
St. Paul, Minn. 55101

KAP 12-70

Send me all the details about Fluorinert Brand Electronic Liquids.

Name _____

Company _____ Title _____

Address _____

City _____ State _____ Zip _____

INFORMATION RETRIEVAL NUMBER 65

Hand-held rf detector spots 1-mW leaks

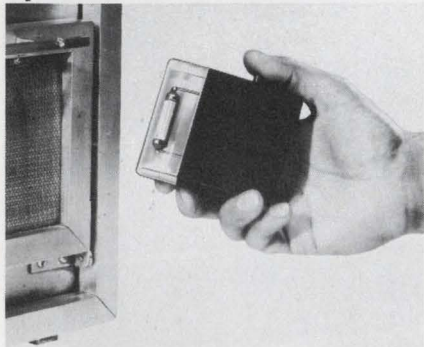

Reeve Electronics, Inc., 609 W. Lake St., Chicago, Ill. Phone: (312) 726-9755. P&A: \$50 (less battery); 2 wks.

Minute levels of rf leakage from microwave equipment can now be quickly and easily detected through the use of a portable hand-held inexpensive leakage detector. Sensitive to leakage levels of 1 mW or less per square centimeter, the LD-2 is ideal for ensuring that leakage levels are within the limits of newly proposed Federal standards.

CIRCLE NO. 269

50/93-Ω video switches operate in 70 ns

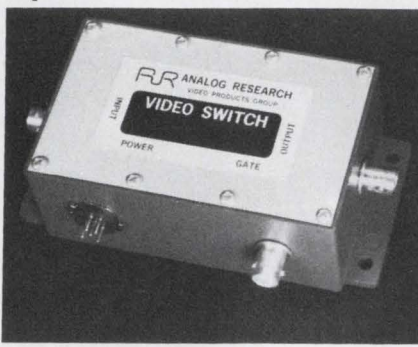

Analog Research, P.O. Box 22023, Dallas, Tex. Phone: (214) 521-7056. P&A: \$95; stock to 3 wks.

Designed for direct insertion in 50 or 93-Ω video lines, VS video switches with MOSFETs perform gating functions such as blanking or chopping in less than 70 ns. High isolation of 70 dB is achieved while insertion loss is only 0.4 dB. Switching pedestals are only 10 mV maximum. A built-in driver is compatible with all micrologic circuitry.

CIRCLE NO. 270

Thin-film hybrid unit is a tiny 50-Ω pulser

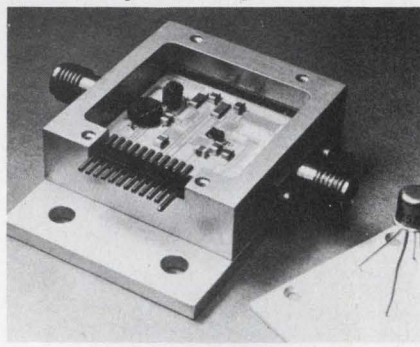

Syston Donner Corp., Datapulse Div., 10150 W. Jefferson Blvd., Culver City, Calif. Phone: (213) 871-0401. P&A: \$750; 90 days.

Designated the model 930 Pico-Pulser, a new 50-Ω thin-film hybrid circuit permits point-of-test pulse switching from a tiny package. It is used in conjunction with the model 330 controller. Repetition rates are a single shot to 0.5 GHz, transition time is less than 500 ps and upper level is -1 to +1 V. Lower level is -3 to +0.5 V.

CIRCLE NO. 271

Remex is coming out of its shell.



With a line of tape punches.
See page 135.



INFORMATION RETRIEVAL NUMBER 66

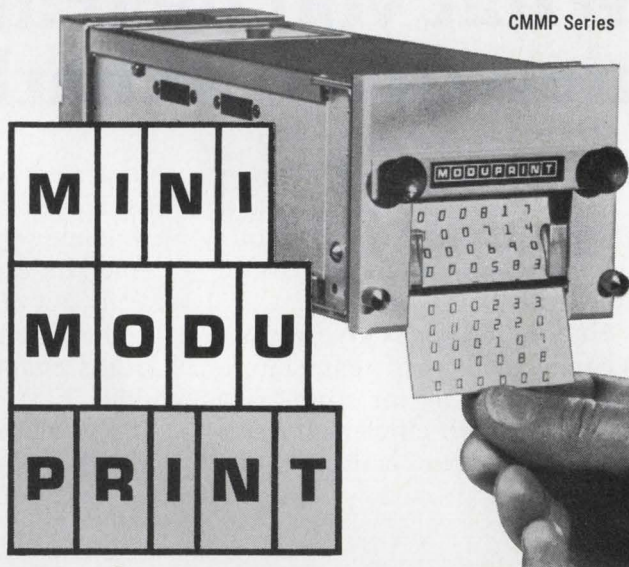

adds the necessary dimension to digital instruments

- 6 columns; 3 lines per second
- Full BCD T² L interface built-in, for IC instrument compatibility.
- Entire printer a plug-in
- Size: 3" x 3½" on panel
- Price: Only \$292.50* for full 6 columns

Send for catalog of the P. A. LINE of Printers, Counters and Digital Displays

*quantity 50

PRACTICAL AUTOMATION, INC.

Trap Falls Road, Shelton, Conn. 06484 • (203) 929-1495 • Telex 96-4217

INFORMATION RETRIEVAL NUMBER 67

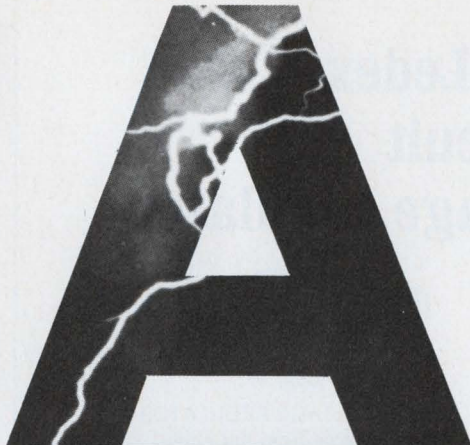
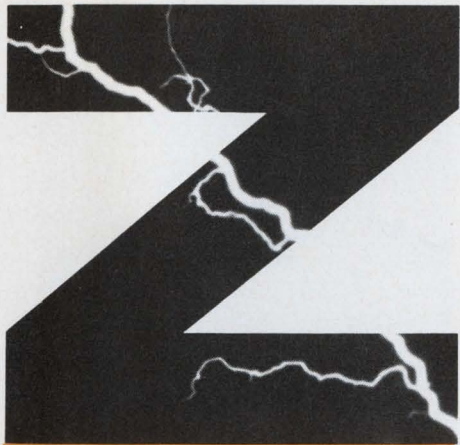

this



**protects
equipment
against
voltage
surges**

Electronic equipment is constantly running the risk of being "zapped" . . . by lightning, short circuits, switching of inductive components, etc. These ceramic gas filled arresters, from Signalite, offer maximum protection against voltage surges. They are low priced (under \$1.00) . . . reduce maintenance and down time . . . withstand shock and vibration. Some of the more vital statistics are listed, but for complete details, contact Signalite.

**Guaranteed 50
discharges . . .
200 typical**

**Fast response . . .
40 kv/nsec. wavefront**

**High temperature
capability with true
follow-on capability**

**Rugged ceramic
construction . . .
no glass**

Low cost . . . under \$1

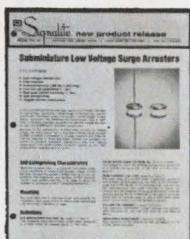

**AVAILABLE UPON
REQUEST**

Detailed Data Sheet . . .
on Signalite Subminiature
Low Voltage Ceramic Gas
Filled Surge Arresters.



**The Broadest Line of Spark Gaps In
The World . . .** are described in the
Signalite "300" Spark Gap brochure . . .
including definition of terms,
characteristics of gap operation and
application information.

Signalite



**DIVISION OF
GENERAL INSTRUMENT**

1933 HECK AVE., NEPTUNE, N.J. 07753
(201) 775-2490

Another new Ledex thick-film circuit 100 watt voltage regulator



LMR-3 VOLTAGE REGULATOR
now available from the shelf.

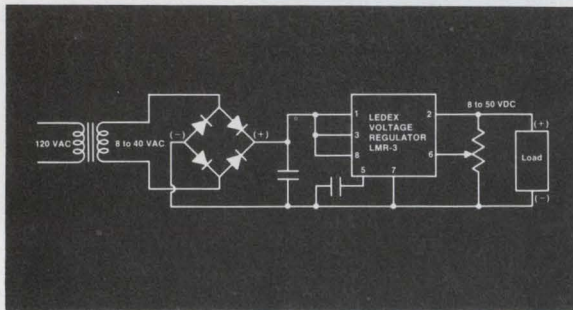

Typical Application and Connection Diagram

Typical Specifications (T_A = 25°C)

Parameter	Typ.	Max.
Input voltage	—	60V
Output voltage	8 to 50V	
Load current	1 Amp	2 Amp
Line regulation		
basic mode	0.3%	1.0%
Load regulation		
basic mode	0.5%	1.0%
Power dissipation	10 Watts	25 Watts

This thick-film voltage regulator consists of a series regulator and elements capable of regulating 8 to 50 volt DC power supplies, up to 100 watts. It will regulate your voltage supply to within less than 1% tolerance.

The LMR-3 is packaged in a low profile TO-3, .250" maximum. It can also be used as a driver for higher current regulators.

Fast Custom Design

We're equipped to give you fast design and prototype service on any custom hybrid microelectronics package. Our engineers will come to you, if that's what you need.

You'll find our delivery dependable and our production standards among the highest in the industry.

The circuit described above is now stocked. Ask for catalog sheet. Or, for the whole story on our capability, write for brochure, "Custom Hybrid Microcircuits."

Specialists in hybrid microelectronic circuits



LEDEX MICROELECTRONICS, LEDEX INC.
123 Webster Street, Dayton, Ohio 45401 phone (513) 222-6992

INFORMATION RETRIEVAL NUMBER 69

MICROWAVES & LASERS

Silicon p-i-n diodes switch rf in 5 ns

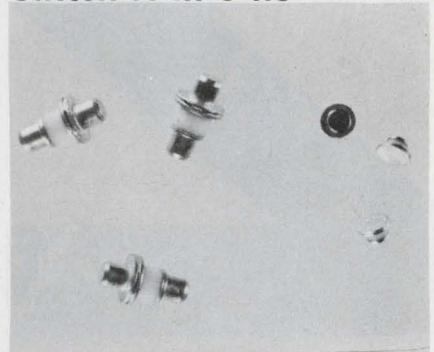

Aerotech Industries, 825 Stewart Dr., Sunnyvale, Calif. Phone: (408) 732-0880. P&A: \$3.50 to \$22; stock to 3 wks.

Silicon p-i-n diodes with 5-ns switching times and 300-W power dissipation are available. Series A5S110 diodes switch rf in 5 ns. Series A4S115 diodes have 5-ns risetimes, 1-Ω resistance and 70-V breakdown. The A5S100 diodes can handle 300 W of power and switch in 100 ns. Series A5S106 units provide 0.32 pF, 200-V breakdown and 1.5-Ω resistance.

CIRCLE NO. 272

28-V power transistors operate to 1 GHz

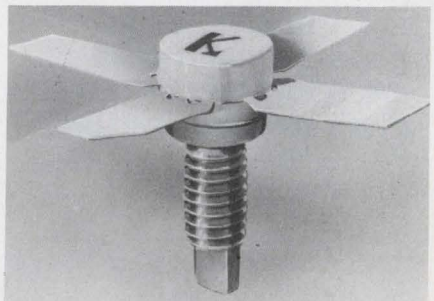

Kertron, Inc., 7516 Central Industrial Dr., Riviera Beach, Fla. Phone: (305) 848-9606. P&A: \$13, \$26; 2 wks.

The 3TX850 and 3TX851 transistors are for FM and cw requirements at 28-V operation up to 1 GHz. They are specified with 5.2 dB of power gain at 1 and 2.5 W, respectively, and have infinite VSWR. Both are packaged in a 1/4-in. ceramic stripline case with all leads isolated from the case. They are also available in 1/4-in. molded stripline cases.

CIRCLE NO. 273



The moment of truth.

There are times customer CG Capacitor specs demand better than the best. When this happens, we'll tell you like it is.

If a simple modification to your specs is all we need to supply you with one of our long-life production CG's, we'll suggest it. They're about the best you can buy. Or, if a special looks like the answer, we'll recommend that.

What we won't do is make up a special and sell it to you as a production CG. That's not telling it like it is.

Send for our capacitor-application information form to find out how we can help you . . . best. Standard items, of course, are available from your Mallory distributor.

MALLORY

MALLORY CAPACITOR COMPANY

a division of P. R. MALLORY & CO. INC.
3029 E. Washington St., Indianapolis, Indiana 46206; Telephone: 317-636-5353

Electrical and electronic components • sequence timers • metallurgical products • batteries

Wideband amplifier covers 1 to 100 MHz



Arvee Engineering Co., Inc., P.O. Box 3759, Torrance, Calif. Phone: (213) 373-1324. P&A: \$150; 1 wk.

The model 610 wideband amplifier covers the frequency range of 1 to 100 MHz. It has 20-dB gain and less than 15 μ V of equivalent input noise. The amplifier can drive a 1-V pk-pk signal into a 50- Ω load with less than 1 dB of gain compression. It employs sub-miniature coaxial connectors on a machined-aluminum housing measuring 1.75 by 1 by 0.6 in. Input impedance is 50 Ω .

CIRCLE NO. 274

IR GaAs emitters cost from \$2.18

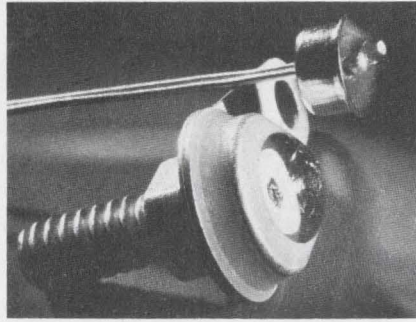

Texas Instruments, Inc., 13500 N. Central Expressway, Dallas, Tex. Phone: (214) 238-2011. P&A: \$2.18, \$16.50; stock.

Two new low-cost GaAs IR emitters, TIXL26 and TIXL27, are priced at \$2.18 and \$16.50 respectively. TIXL26 features 1-mW power output when biased at 35 mA. The TIXL27 features power output of 15 mW when biased at 300 mA. TIXL26 is encased in a glass-to-metal-seal header with an epoxy dome-shaped lens. TIXL27 is encapsulated in a TO-5 stud header.

CIRCLE NO. 275

Two element photocells are independent pairs

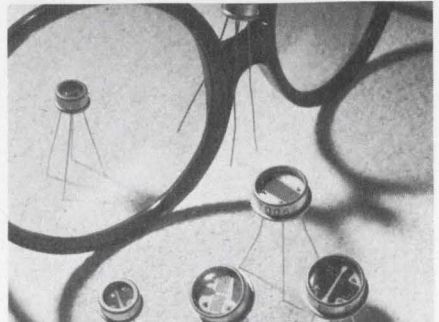

Raytheon Co., Industrial Components Operation, 465 Centre St., Quincy, Mass. Phone: (617) 479-5300. P&A: 90¢; stock to 4 wks.

A family of 10 new dual-element photocells contains two completely independent and isolated photo-sensitive elements on a common ceramic substrate. The units offer a range of applications where two or more photocells are used simultaneously in phase. Resistance balance is 90% and tracking error is 10% at irradiance levels of 100 to 10,000 μ W/cm².

CIRCLE NO. 276

Remex is coming out of its shell.



With a magnetic tape cassette series.
See page 133.



INFORMATION RETRIEVAL NUMBER 71

HOW CAN THIS LITTLE GIRL SAVE YOU MONEY?

WE'RE GLAD YOU ASKED.

Mona Devost is only 19. But she's smart, hard-working, intelligent and accurate...with extremely nimble fingers. Mona operates our 6-station 24 spindle turret coil winder—a machine capable of turning out 5000 completely wound coils every 8 hours.



In this case, we're producing 4 coils every 0.74 minutes, each with 5000 turns of No. 38 coated single polyurethane copper wire. Accuracy is ± 2 turns. Of the more than 250,000 coils produced in this run, there has not been a *single* reject!

With a capability like this, we can afford to pass the cost-saving along to our customers.

Delivery? We've been known to supply 10,000 coils in 2 days with only 24 hours lead time... assuming we have your bobbin size in stock.

Why not let us quote on your coil specifications. Call us at (203) 747-1213.

ELECTRONIC COIL CORPORATION
329 NEW BRITAIN AVENUE PLAINVILLE, CONN. 06062

INFORMATION RETRIEVAL NUMBER 72

For Capacitors with **GREATER RELIABILITY . . .**

Choose
EL-Menco

*The Capacitors You
Find Wherever
There's Electronics!*

EL-MENCO DUR-MICA CAPACITORS

Only 1 Failure Per 43,000,000 Unit-Hours!

- It has been computed that "debugged" DM30, 10,000 MMF units, when subjected to 257,000 hours of life at 85°C with 100% of the rated DC voltage applied, will yield only 1 FAILURE PER 43,000,000 UNIT-HOURS!
- DM15, DM16, DM19, DM20 . . . perfect for miniaturization and for new designs using printed wiring circuits. Also available in DM30, DM42 and DM43.
- New "hairpin" parallel leads insure easy application. Exceed all electrical requirements of military specification MIL-C-5A.

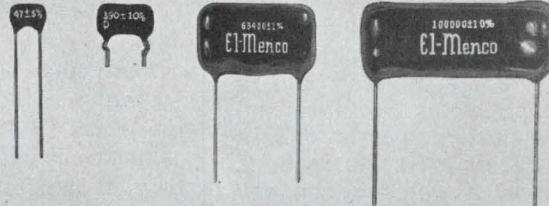

EL-MENCO TRIMMERS & PADDERS

Design Versatility!

- Available in 350 VDC and 500 VDC as well as other test voltages.
- All bases are of low-loss steatite.
- Special lugs are obtainable for printed circuitry.
- Miniature units are available.
- Solder Lugs can be bent in any position without affecting the capacity setting due to the rigid construction.
- Various types of mounting brackets are available for all trimmers.
- Units can be constructed for special applications.

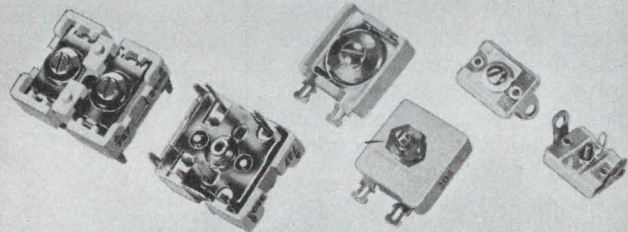

EL-MENCO *MYLAR-PAPER DIPPED CAPACITORS

Only 1 Failure in 14,336,000 Unit-Hours!

- Life tests at 105°C with rated voltage applied have yielded only 1 FAILURE PER 1,433,600 UNIT-HOURS for 1 MFD. Since the number of unit-hours for these capacitors is inversely proportional to the capacitance, 0.1 MFD Mylar-Paper Dipped capacitors will yield only 1 FAILURE PER 14,336,000 UNIT-HOURS!
- Working volts DC: 200, 400, 600, 1000 and 1600.
- Durez phenolic resin impregnated.
- Tolerances: $\pm 10\%$ and $\pm 20\%$ (closer tolerances available).
- Dielectric strength: 2 or 2½ times rated voltage, depending upon working voltage.
- Exceed all electrical requirements of E.I.A. specification RS-164 and military specifications MIL-C-91A and MIL-C-25A.

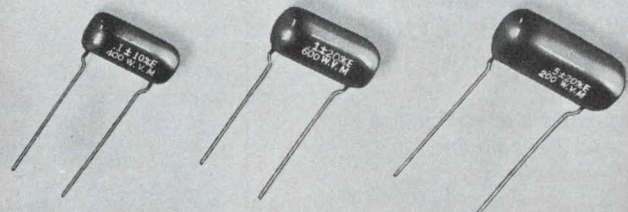

*Registered Trademark of DuPont Co.

EL-MENCO MOLDED MICA CAPACITORS

Superior Performance!

- Unmatched for excellent stability, dielectric strength, high insulation resistance, extremely high "Q" and correspondingly low power factor.
- Units can be subjected to a short "debugging" life test at elevated voltage and temperature for removal of early life failures and for improved reliability.

*Write for Free Samples and Booklets
on Any of The Above Capacitors*

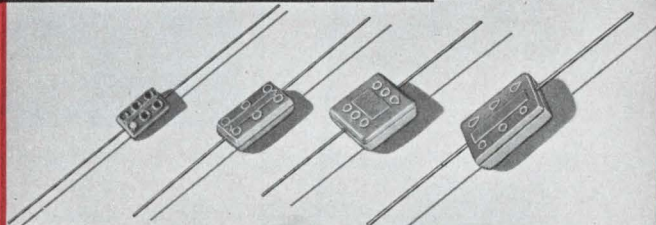

EL-MENCO OFFERS A COMPLETE LINE OF CAPACITORS . . . STANDS READY TO SERVE ALL YOUR CAPACITOR NEEDS

THE ELECTRO MOTIVE MFG. CO., INC.

WILLIMANTIC, CONNECTICUT 06226

Dipped Mica • Molded Mica • Silvered Mica Films • Mica Trimmers & Padders
Mylar-Paper Dipped • Paper Dipped • Mylar Dipped • Tubular Paper

West Coast Manufacturers contact: **COLLINS & HYDE CO.**, 900 N. San Antonio Rd., Los Altos, California 94022
5380 Whittier Blvd., Los Angeles, California 90022

ALSO SOLD NATIONALLY THROUGH ELECTRONIC PARTS DISTRIBUTORS

INFORMATION RETRIEVAL NUMBER 73

MANUFACTURERS OF
EL-Menco
Capacitors

Exactly your speed.

Servo-Tek's Speed Indicating System takes the precise rotational speed of your application and displays it on an easy-to-read meter. And it tells you repeatedly and accurately even on the most delicate machinery. A temperature-compensated low torque d-c generator and a taut-band meter movement assure a maximum error of less than 1% of full scale reading. Use it as a watchdog on any industrial application where sensitive speed indication is necessary. The attractive design of our Model ST-926 modernizes any application and comes in a standard version or tailor-made with bi-directional indication, special scales and ranges, and with color coding for multiple readouts.

SERVO-TEK PRODUCTS COMPANY
1086 Goffle Road, Hawthorne,
New Jersey 07506.

SERVO-TEK

PRODUCTS COMPANY

For complete specifications
write for our colorful
technical sheets.

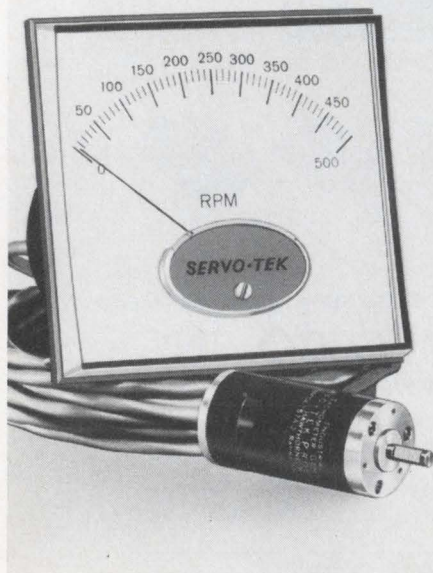

INFORMATION RETRIEVAL NUMBER 74

MICROWAVES & LASERS

Differential amplifier claims 1-GHz bandwidth

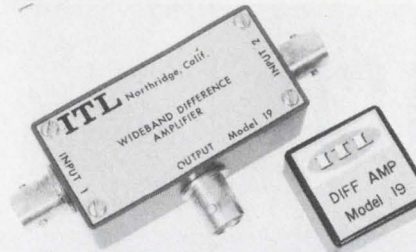

ITL Research Corp., 8955 Quartz Ave., Northridge, Calif. Phone: (213) 882-3500. P&A: \$495; 30 days.

Featuring a common-mode rejection ratio of more than 60 dB, the model 19 differential amplifier achieves a wide bandwidth of 1 GHz. It is offered in three configurations: as a 14-pin DIP, as a molded module and as a coaxial component. Rise time is up to 1 ns, propagation delay is 5 ns and input pulse widths range over 10 ns to 10 μ s. Maximum duty cycle is 0.1.

CIRCLE NO. 277

Avalanche silicon diode pulses at S band

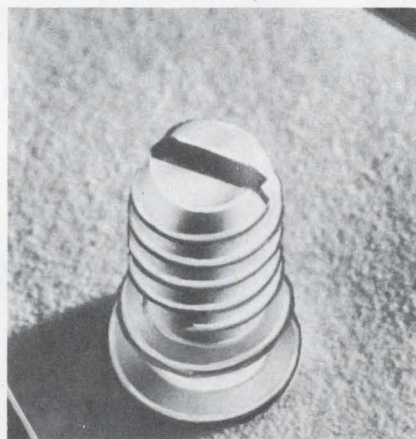

General Electric Tube Dept., 316 E. 9th St., Owensboro, Ky. Phone: (502) 683-2401.

The Y-2075 is an avalanche silicon mesa diode structure bonded to a copper heat sink for high-efficiency pulsed service at S band. It produces 20 to 40 W of pulsed output power at 3.7 GHz and has a 20% efficiency for 1- μ s pulses at a 10-kHz pulsing rate. It is available with the C-2076 S-band test circuit for testing and evaluating.

CIRCLE NO. 278

Injection laser diodes increase output power

Texas Instruments, Inc., 13500 N. Central Expressway, Dallas, Tex. Phone: (214) 238-2011. P&A: \$37.50, \$12.50, \$50; stock.

Three new injection laser diodes, TIXL28, TIXL29 and TIXL30, are for applications using pulsed light with high peak-power outputs. The TIXL28 is a three-layer diode with a threshold current to 15,000 A/cm² at 25°C. The economical TIXL29 is 4 by 10 mils in size and requires a threshold current of 25 to 40 A at 25°C. It features peak power of 4 W and lases at 50,000 A/cm². The TIXL30 is 15 by 15 mils in size and achieves power outputs of 10 to 15 W.

CIRCLE NO. 279

Photon detectors span uv to IR bands

Optoelectronics, Inc., 1309 Dynamic St., Petaluma, Calif. Phone: (707) 763-4181. Availability: stock.

The new KN-15 series of broad band quantum-measuring devices detect from the ultraviolet to the infrared spectrums. They provide high sensitivity throughout the spectral range from 2000 Å to 3 microns with a time constant of 500 μ s. Peak detectivity is typically 10¹¹ cm-Hz^{1/2}/W with a responsivity of 4 to 7 $\times 10^5$ V/W. Cell resistance is 0.5 to 1 M Ω /square. Standard sizes are 1 by 1 or 2 by 2 mm.

CIRCLE NO. 280

Small step attenuators cover dc to 12.4 GHz

Solitron/Microwave, Filmohm Div., 37-11 47th Ave., Long Island City, N. Y. Phone: (212) 937-0400. P&A: \$205 to \$270; 8 wks.

A new series of 1/2-W attenuators covers the range of dc to 12.4 GHz. Series TA1050 units measure 3/8-in. long and 1-1/2-in. in dia. One model, the TA1050-9B, is a 0-to-9-dB dc-to-8-GHz unit with 1-dB steps. Its maximum attenuation error is 1/2, its VSWR ranges over 1.2 to 1.4 and its insertion loss spans 0.2 to 0.5 dB.

CIRCLE NO. 281

Discrete or Microwave Integrated Circuit (MIC) – a Great, New Idea in RCA Low-Noise Transistors for UHF/Microwave Use.

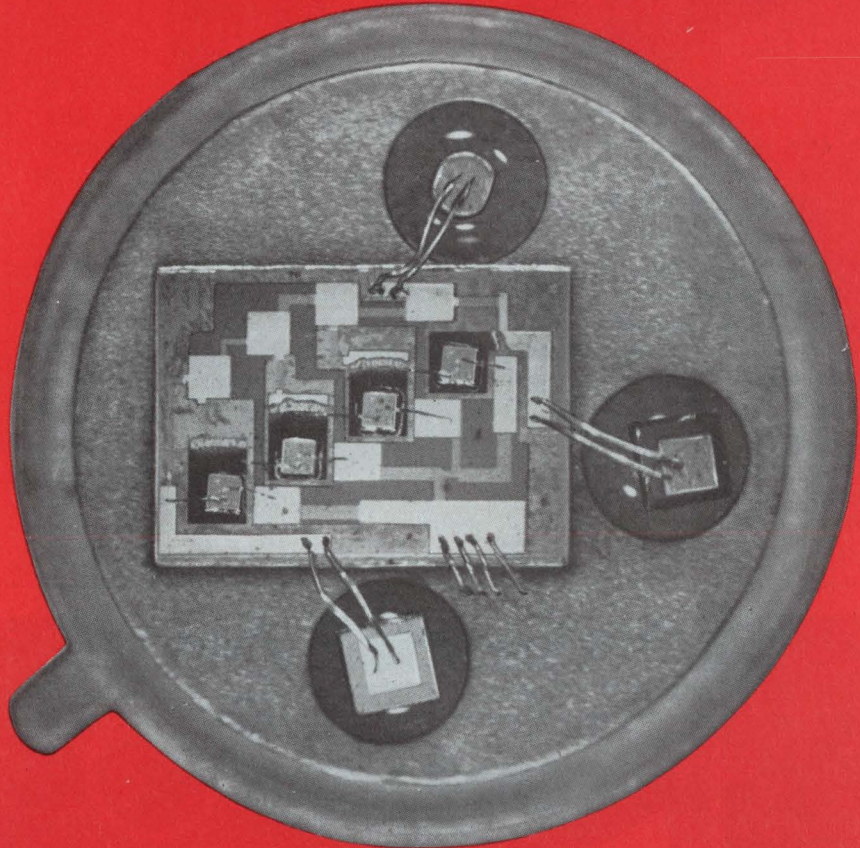

Actual microphotograph of a TA7701 in its package with top removed.

RCA today introduces to designers a great idea in three new devices — the discrete TA7486 and TA8104, and the 4-stage MIC broadband amplifier, TA7701. Useful in the 400 MHz to 2 GHz frequency range, these units offer improved low-noise performance at low cost.

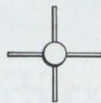

TA7486 is a miniature hermetic stripline-package transistor intended for use as a low-noise amplifier for receiver front ends. At 1 GHz, it has a 3 dB maximum noise figure and a power gain of 10 dB.

A similar unit, TA8104, is available in the TO-72 package.



TA7701, a thin-film hybrid integrated circuit, utilizes four low-noise n-p-n transistors similar to the TA7486 and TA8104, in a direct-coupled circuit. This device operates over the bandwidth of 50-700 MHz at a noise figure of 5 dB max. and a gain of 30 dB at 500 MHz. TA7701 comes in a low-profile TO-12 package.

For more information, including prices and delivery, see your local RCA Representative or your RCA Distributor. For technical data, write: RCA, Commercial Engineering, Section 57L-6/UF9, Harrison, N. J. 07029. International: RCA, 2-4 rue du Lievre, 1227 Geneva, Switzerland, or P.O. Box 112, Hong Kong.

RCA

INFORMATION RETRIEVAL NUMBER 75

Low-profile switch is a 14-pin DIP

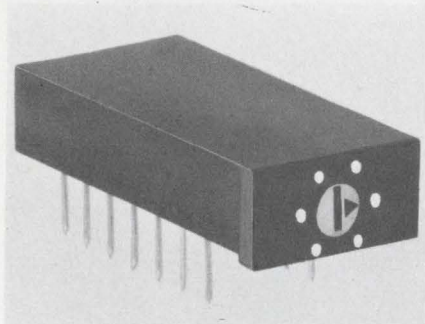

Daven Div. of Thomas A. Edison Industries, Grenier Field, Manchester, N. H. Phone: (603) 669-0940.

The Dipswitch is a low-profile (0.23 in.) 14-pin dual-in-line switch that is 100% IC compatible. It offers a piggy-back feature that allows any standard 14-pin device to be plugged directly into it. By means of a screwdriver slot, 6 positions can be selected, each position corresponding to a respective circuit.

CIRCLE NO. 282

Low-voltage readout shows 6k foot-lamberts

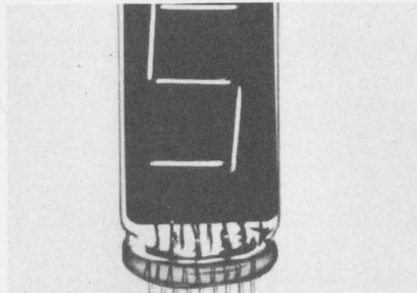

Apollo Corp. International Div., 5-1, Togoshi 6-Chome, Shanagawa-Ku, Tokyo, Japan. Availability: 60 days.

Utilizing a seven-segment display, type DA133 incandescent readout tube which operates on only 3.5 to 5 V projects adjustable brightness levels up to 6000 foot-lamberts. It is compatible with IC decoder/drivers and indicates alphabetical characters A, C, E, F, H, J, L, P and U. Readout is in a single plane at a viewing angle of 140 degrees.

CIRCLE NO. 283

Tiny surge protectors operate at 2000 V

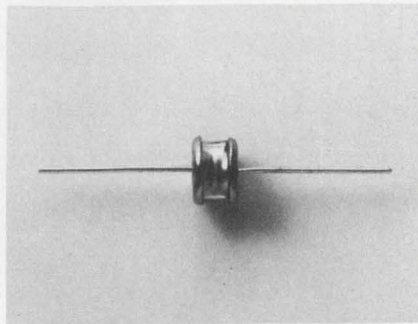

Siemens Corp., 186 Wood Ave. S., Iselin, N. J. Phone: (201) 494-1000. P&A: \$1; stock.

Two new miniature gas-filled surge-voltage protectors, type B2-H10 (0.28-in long) and B2-H25 (0.44-in long), provide protection with peak operating voltages up to 850 and 2000 V, respectively. The former has a dc striking voltage of 1 kV $\pm 15\%$, and the latter has a dc striking voltage of 2.5 kV $\pm 15\%$. Both have insulation resistance greater than $10^{10} \Omega$.

CIRCLE NO. 284

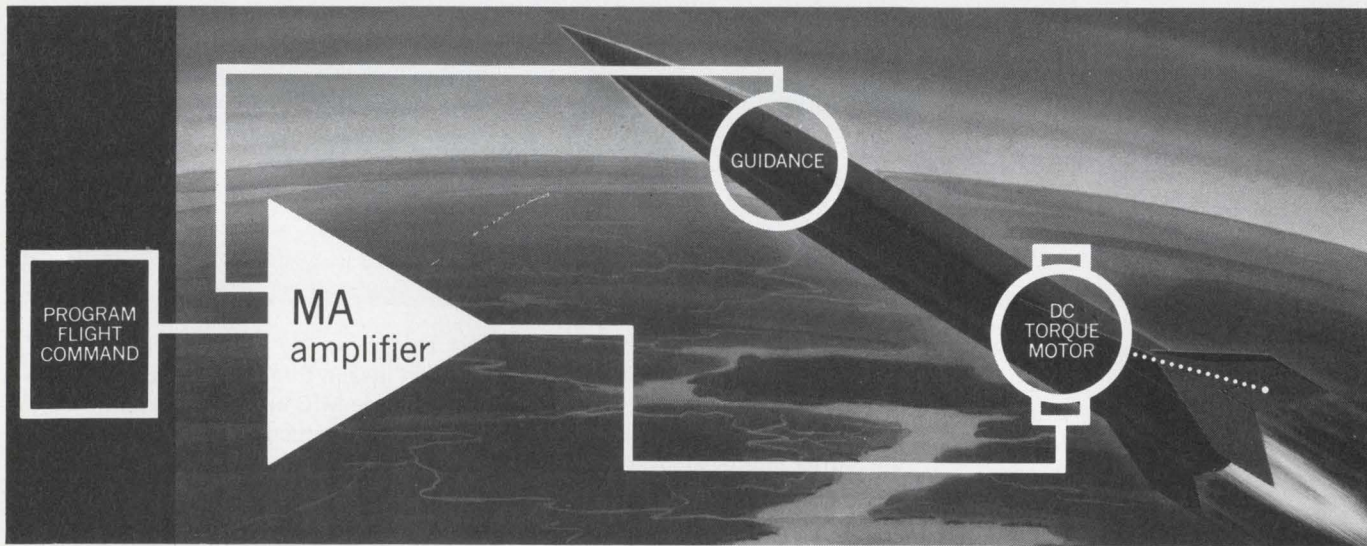

We sell more than amplifiers

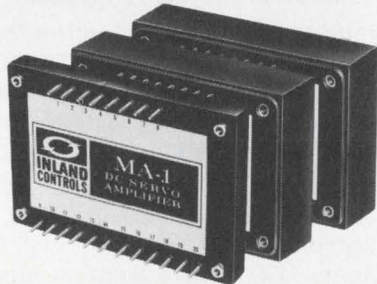

Sure . . . we can provide you with our DC servo power amplifiers ranging from 25 to 1,500 watts output. But complete system design is our forte. Working with our sister divisions that manufacture motors and tachs, we can coordinate the design of your system from command signal to primary driver and eliminate interface problems.

Fin control on missiles is just one example. Give us a call and let us show you how we debug your application before the bugs get in.



Inland Controls, Inc. 250 Alpha Drive, Pittsburgh, Pa. 15238 Tel: 412-782-3516 TWX 710-664-2082

INFORMATION RETRIEVAL NUMBER 76

**Remex is coming out
of its shell.**



With an economy photoelectric punch tape reader. With a line of tape punches. A magnetic tape cassette series. And this is just the beginning. All the quality that made ours the Grade A name in punch tape reader products--now in a whole line of peripheral equipment.

Welcome to the coming out party!

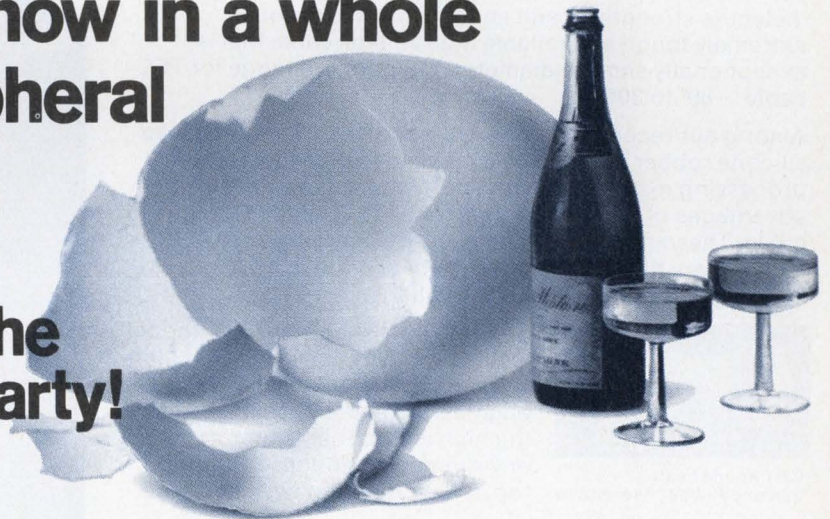

REMEX 5250 W. El Segundo Blvd., Hawthorne, California 90250

A UNIT OF
XLO
EX-CELL-O CORPORATION

INFORMATION RETRIEVAL NUMBER 77

Take a closer look at the results of high voltage cable experience!

BIW has 30 years of it.

Years of solid, down-to-earth experience have been essential ingredients in the development of BIW high voltage cable features. Our standard silicone rubber cable is a good example. A life versus voltage test series data sheet reflects the superior performance record of these cables. Voltage overload (60 cycle A-C) of 125% with cable life of at least 10,000 hours. A data sheet is yours for the asking. BIW offers eight basic KV voltage cables with voltage flexibility from 10 to 100 KV D-C in the above category.

Another interesting example is our exclusive process for our TFE cable. Thin TFE tapes are combined with high dielectric strength oil and an FEP jacket to produce extremely tough and reliable high voltage cable that is exceptionally small in diameter. Temperature range for TFE cable: -80° to 200° C.

Among our recent additions: UL-approved CRT anode lead silicone rubber assemblies with molded plugs for data processing read-out equipment. With them, you get all the advantages of our standard silicone rubber, high voltage cable. These new BIW assemblies are operable to 70,000 ft. altitude, are highly corona resistant and are rated to 30 KV D-C continuous working voltage.



CRT Anode Lead
Silicone Rubber Assemblies

Send for data sheets on CRT anode lead assemblies and other BIW high voltage products. Check BIW engineering experience in developing high voltage cable for difficult environments. No reason why you, too, shouldn't profit by experience.



Boston Insulated Wire & Cable Company

65 Bay Street, Boston, Mass. 02025 • Tel: 617-265-2104
El Segundo, California 90245; Hamilton, Canada;
Kingston-upon-Thames, U.K.; GEDEBIW, S.A. - Clichy, France

INFORMATION RETRIEVAL NUMBER 78

COMPONENTS

Tiny-30-in.³ delay line has 100:1 delay-to-rise

*ESC Electronics, 534 Bergen Blvd.,
Palisades Park, N. J. Phone: (201)
947-0400.*

The model 47-41 electromagnetic delay line features a high 100:1 delay-to-rise time ratio in a package measuring only 30 cubic in. The delay line is extremely stable with a temperature coefficient characteristic of 25 ppm/ $^{\circ}$ C. It also provides a choice of delay taps, each spaced every 1.28 μ s in delay apart. The total delay time of the 47-71 is 15.36 μ s. Its impedance is 250 Ω and it has a maximum attenuation of 10 dB.

CIRCLE NO. 285

Tiny chip resistors span 0.1 to 1 M Ω range

*Airco Speer Electronic Components,
Div. of Air Reduction Co., Inc.,
Niagara Falls, N. Y. Phone: (716)
285-9381.*

New chip resistors that feature 85-by-55-mil sizes span the resistance range of 100 Ω to 100 M Ω . The new chips have thick-film elements and palladium-gold terminations. Gold is also applied to the underside of each element. Their temperature coefficient of resistance is less than 200 ppm/ $^{\circ}$ C and their tolerances are ± 5 and ± 10 %. The new chip resistors are available in kits.

CIRCLE NO. 286

Small synchro bridge costs only \$100

*Theta Instrument Corp., Fairfield,
N. J. Phone: (201) 227-1700.
P&A: \$100; stock.*

Model SB-M-11 is a three-arm encapsulated synchro bridge device measuring 0.44 by 0.5 by 1.75 in. and costing only \$100. It accepts S1, S2 and S3 synchro outputs and converts them to a two-wire analog voltage representing synchro position. It mounts easily onto a printed circuit board. Its specifications include an accuracy of 20 seconds of arc.

CIRCLE NO. 287



In the beginning: The Remex Punch Tape Reader/Spoolers. Fast. Fast. Fast.

Maybe you've heard that Remex is breaking out of its shell. And breaking into new areas of peripheral data processing.

But we're not forgetting where we started.

Remex rules the roost with our reliable 3000/4001 series of punched tape reader/spoolers. We dominate the field because our units are the best around. Accurate, adaptable, and fast.

Fiber optics is one of our most famous features. This Remex patented innovation prevents signal confusion and assures you super sensing of data.

The system collimates light so that punched tapes of up to 70% transparency can be read. It's the most perceptive, most sensitive, and most reliable optical system available. Period.

We back it up with a self-cleaning, vibration-proof quartz iodine lamp. Another Remex innovation. These lamps give you 15,000 hours of even illumination—and that's a conservative estimate.

With integrated circuits, interfacing is easy.

The spooler smoothly handles a greater-than-normal tape capacity with better-than-

normal accuracy. And the unit's compact.

Speed may be the biggest plus of all. Remex has all you need for punched tape operation. Up to 1,000 characters per second.

And we have off-the-shelf delivery.

So that even though our reader/spoolers have been around for a long time, you can still get them fresh. Here's where. 5250 W. El Segundo Blvd., Hawthorne, California 90250.

In Europe and the U.K., contact S.p.A. Microtecnica, Torino, Italy.

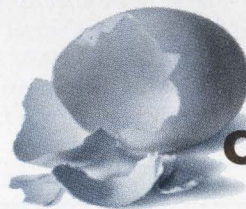

REMEX
**IS COMING OUT
OF ITS SHELL.**

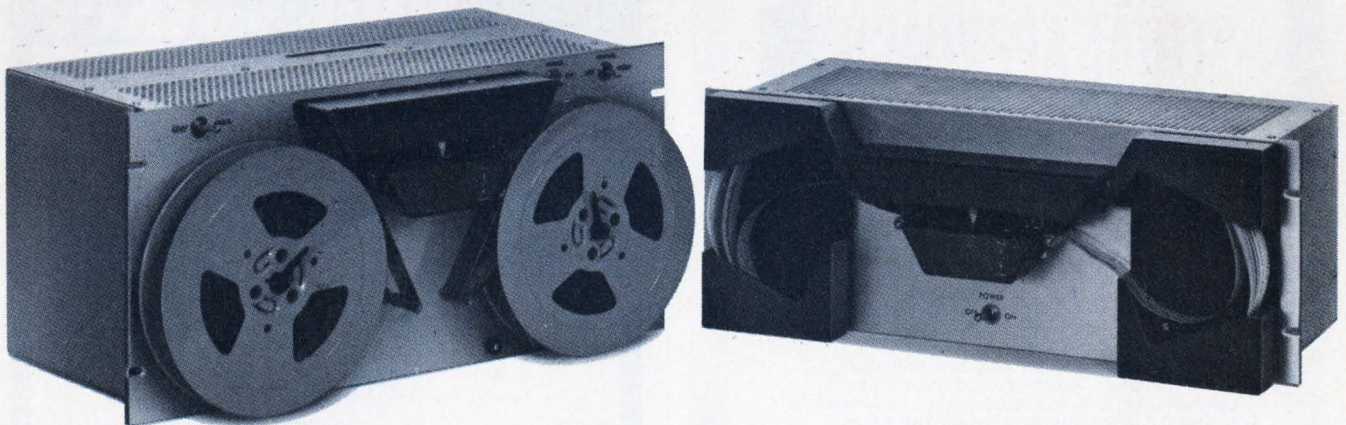

A UNIT OF



EX-CELL-O CORPORATION

INFORMATION RETRIEVAL NUMBER 79

Teflon chip capacitors reduce dielectric loss

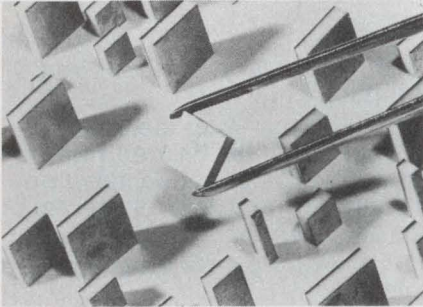

Polyflon Corp., 35 River St., New Rochelle, N. Y. Phone: (914) 636-7222.

New chip capacitors made of electroplated copper on pure Teflon substrates provide low-loss dielectrics and can be soldered with ease into circuits. Chips are made of 0.02 to 0.125-in.-thick Teflon and vary in capacitance from 0.5 to 5 pF. Units employing thin substrates can have their capacitances precisely determined by trimming the geometry of the Teflon.

CIRCLE NO. 288

Silicon resistors drift +7000 ppm/°C

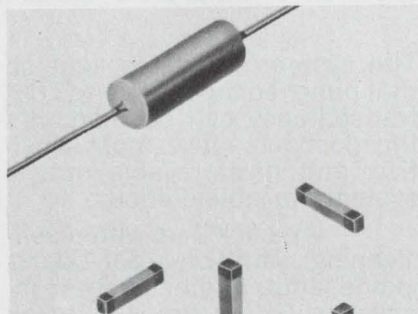

Angstrom Precision, Inc., sub. of Riker-Maxon Corp., 7811 Lemona Ave., Van Nuys, Calif. Phone: (213) 989-3064. Availability: stock.

A new line of silicon resistors caled Plus-R features a large temperature coefficient of +7000 ppm/°C. The line includes 1/8 and 1/4-W sizes, both encapsulated and in chip form. They meet requirements of MIL-T-23648A and have resistance values from 10 Ω to 10 KΩ with tolerances of ±5% and ±10%.

CIRCLE NO. 289

Transient suppressors work within 50 ns

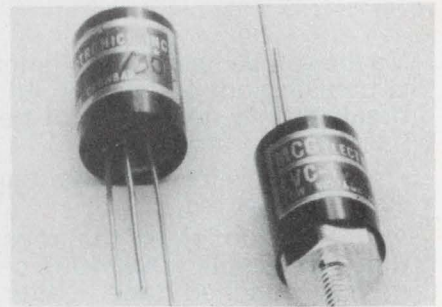

MCG Electronics, 279 Skidmore Rd., Deer Park, N. Y. Phone: (516) 586-5125. P&A: \$10; 3 wks.

The LVC-1Z line of miniature transient suppressors switch from an open-circuit to a clamping state within 50 ns whenever the clamping threshold is exceeded. They can handle 5 kW for 500 μs. In standby mode, leakage current is only a few microamperes. Units are available with trip voltages from 5 to 600 V and power capabilities from 100 to 5000 W.

CIRCLE NO. 290

JANCO OFFERS A "TOTAL APPROACH" TO YOUR SWITCHING PROBLEM!



Standard rotary selector switches, miniature, micro-miniature, power, push-button, solenoid operated, keylock, momentary, etc. . . . Janco has the total line for your every need! You'll find this same "total approach" in Janco's quality of design and materials. And if Janco's basic switches do not completely fill your needs . . . Janco engineers will design one!

JANCO CORPORATION
3111 Winona Ave., Burbank, California 91504
Phone 213-845-7473 • TWX 910-498-2701

INFORMATION RETRIEVAL NUMBER 80

who cares what a control knob looks like?

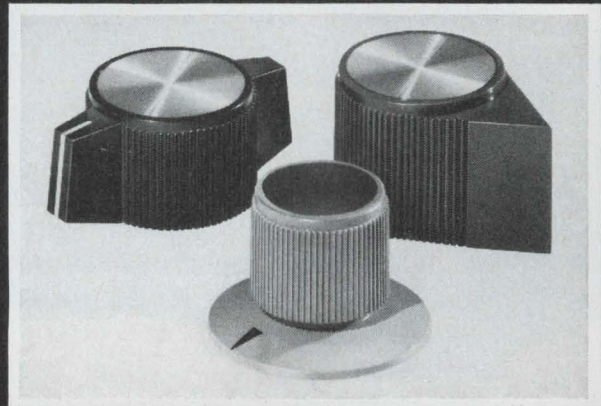

we do.

ROGAN
BROTHERS, INC.

Outline your requirements for quotation and free knob sample. Also write for free, full-color catalog.

8019 N. MONTICELLO AVE., SKOKIE, ILLINOIS 60076, PHONE: (312) 675-1234

INFORMATION RETRIEVAL NUMBER 81

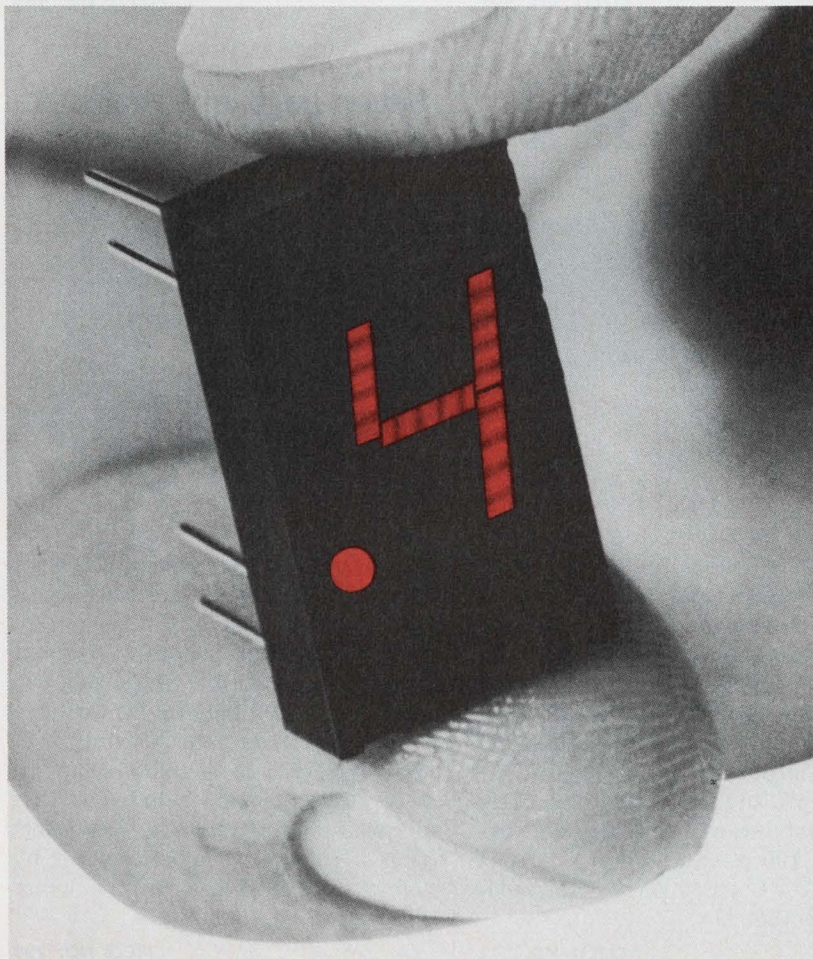
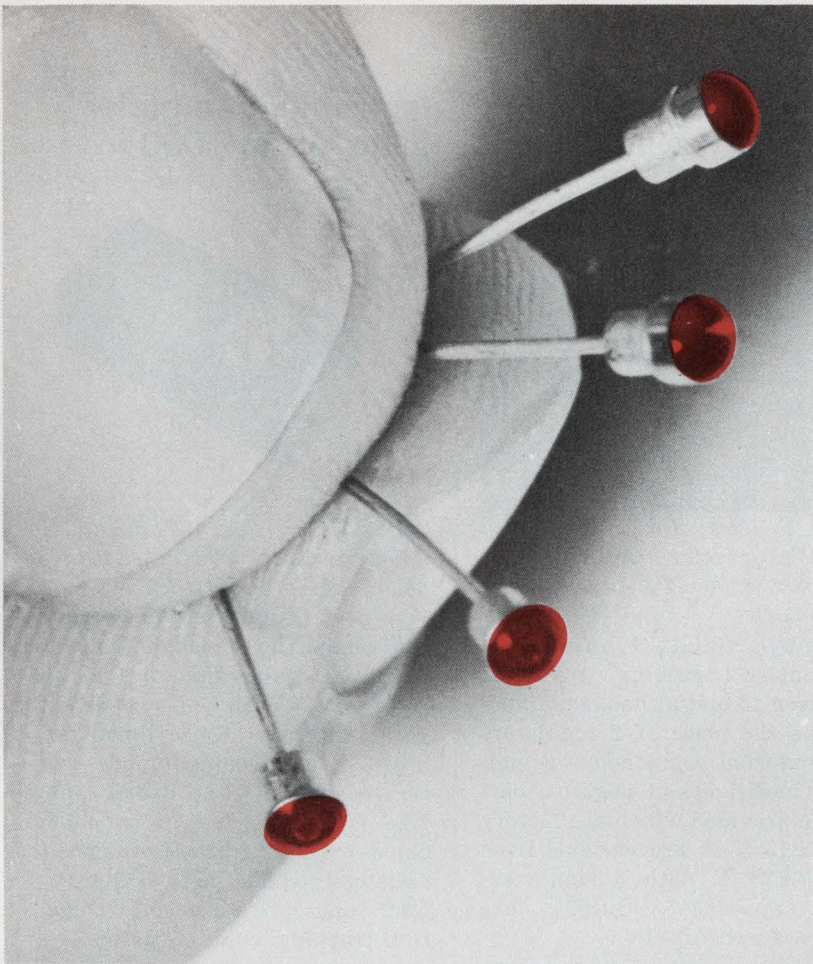

SOLID-LITE

SOLID STATE LAMPS AND NUMERIC INDICATORS

New Solid-Lite semiconductor display devices use gallium phosphide, the most efficient of all visible-light electroluminescent materials. You get bright light at lower current.

SOLID-LITE Solid State Lamps

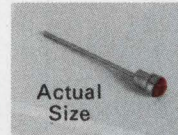

Provide an area source of light—not just a pinpoint. These IC-compatible light-emitting diodes produce a luminous intensity of 2 millicandelas at 15 mA and 2.1 volts with easy wide-angle viewing. They offer:

- Low power consumption
- Excellent shock and vibration resistance
- High reliability—long life
- Low cost

SOLID-LITE Solid State Numeric Indicators

Actual
Size



Low-cost, seven-segment numeric indicators in standard 14-pin dual in-line packages are compatible with TTL and DTL IC's. Large, bright numerals are pleasing to the eye. They offer:

- Low voltage operation at less than 1/4 watt total power
- Large character size—.33" x .21"
- Single-plane wide-angle viewing
- High reliability—long life
- Excellent shock and vibration resistance

For technical literature or applications assistance, write or call OPCOA, Inc., 330 Talmadge Road, Edison, New Jersey 08817; phone (201) 287-0355.

OPCOA INC.

IN A/D AND D/A CONVERTERS WHAT SETS ANALOGIC APART? SPECS.

More specifications than most other companies. Tighter specifications than most other companies. Specifications that are met on a continuing basis. Analogic's specifications are conservatively stated, never overstated, and are designed into the product not the result of test "fall ins".

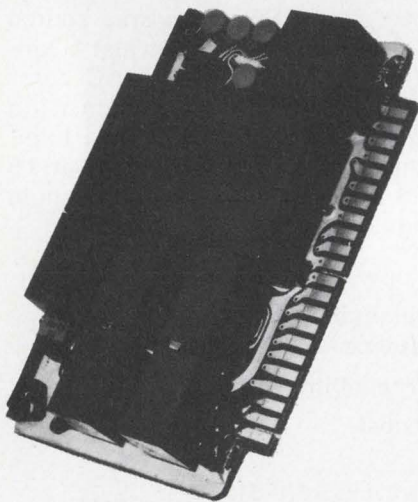

LOW COST, HIGH PERFORMANCE A/D CONVERTER

Analogic's low-cost, high-performance AN2800 series is a recent addition to what we believe to be the industry's most complete line of A/D and D/A converters.

- Available in 8, 10, or 12 binary bits and 2 or 3 BCD digit configurations
- DTL/T²L compatible
- Accuracy to 0.01%
- Speeds to 1 μ sec/bit
- Temperature coefficients are: 9ppm/°C (gain); 0.0015% F.S./°C (offset); and 2ppm/°C (differential interbit quantizing)
- Adjustable word lengths
- Unipolar and bipolar input ranges
- All standard output codes (including NRZ serial)

Contained on an easily repairable single 2-13/16" x 4-5/8" plug-in card, the AN 2800 has accessible built-in clock rate, offset and range adjustments.

Cost of the AN 2800 is \$275 to \$345, with substantial OEM discounts depending upon output resolution.

The most knowledgeable and available A/D and A/D application engineers in the industry are ready to assist you. For immediate information call Paul LaBrie, (617) 246-0300 or write for definitive data sheets and our comprehensive short form catalog. Analogic Corporation, Audubon Road, Wakefield, Massachusetts 01880.

ANALOGIC 

...The Digitizers

INFORMATION RETRIEVAL NUMBER 83

MODULES & SUBASSEMBLIES

Dual tracking regulator powers 25 op amps

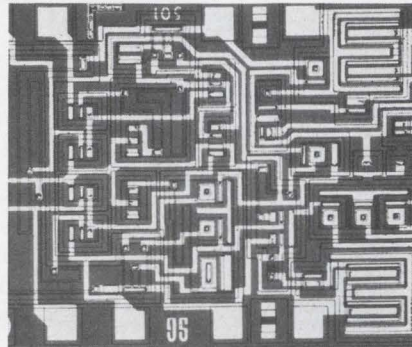

Silicon General, Inc., 7382 Bolsa Ave., Westminster, Calif. Phone: (714) 839-6200. P&A: \$4.80 to \$9.80; stock.

A single SG1501 monolithic dual-polarity tracking regulator will power 25 operational amplifiers and take the place of 2 regulators and 8 external components. Simultaneous positive and negative outputs are provided which are factory set at ± 15 V or are variable from ± 8 to ± 23 V with a single external adjustment. Outputs are balanced to within 1%.

CIRCLE NO. 291

1000-V/μs op amps settle to 1% in 200 ns

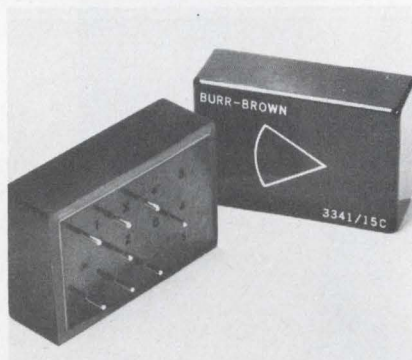

Burr-Brown Research Corp., International Airport Industrial Park, Tucson, Ariz. Phone: (602) 294-1431. P&A: \$69, \$59; stock.

The 3341-2/15C operational amplifiers have slew rates of 1000 V/μs and settle to 1% of final value in 200 ns. Bandwidth is 50 MHz, output rating is ± 10 V at ± 100 mA and ± 5 V up to 20 MHz when driving a 50-Ω line. Bias current is 100 pA and voltage drift is ± 25 μV/°C (± 50 μV/°C for model 3342/15C).

CIRCLE NO. 292

Instrument amplifier gains up to 1000

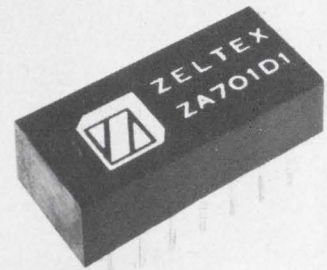

Zeltex Inc., 1000 Chalomar Rd., Concord, Calif. Phone: (415) 686-6660. P&A: \$52; stock.

A new 14-pin DIP instrumentation amplifier, model ZA701D1, features a gain range of 1 to 1000. Only one resistor is needed for gain selection. Gain linearity is $\pm 0.03\%$ and common-mode rejection is 110 dB. The hybrid amplifier is constructed of monolithic chips and uses thick-film deposited resistors which are trimmed to 0.1% and have excellent temperature-tracking characteristics.

CIRCLE NO. 293

Seven-segment readout mates edge connectors

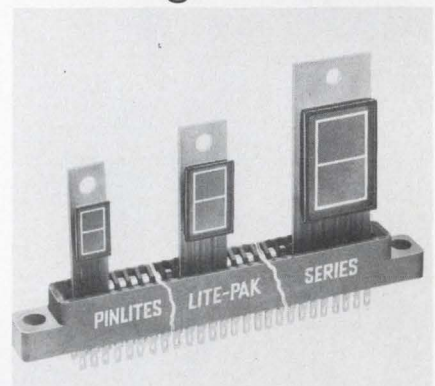

Pinlites Inc., 1275 Bloomfield Ave., Fairfield, N. J. Phone: (201) 226-7724.

The Lite-Pak is a 7-segment digital readout that plugs directly into a standard 0.05-in.-center edge connector. It operates on only 3 to 5 V at 8 mA. It is readable in direct sunlight and includes a 120-degree viewing angle. A wide selection of colors is available either by using colored glass or by using filters.

CIRCLE NO. 294



**Model 630-A
Laboratory V-O-M**

1. $\pm 1\frac{1}{2}\%$ DC, $\pm 3\%$ accuracy.
2. One selector switch minimizes chance of incorrect settings and burnouts.
3. Rugged $5\frac{1}{2}$ " suspension meter movement with $4\frac{1}{2}$ " mirrored scale. \$75 suggested USA user net price



**Model 630-APL
Laboratory V-O-M**

1. $\pm 1\frac{1}{2}\%$ DC, $\pm 3\%$ accuracy.
2. One selector switch minimizes chance of incorrect settings and burnouts. Polarity reversing for DC.
3. Suspension meter movement diode protected against instantaneous overloads. \$75 suggested USA user net price

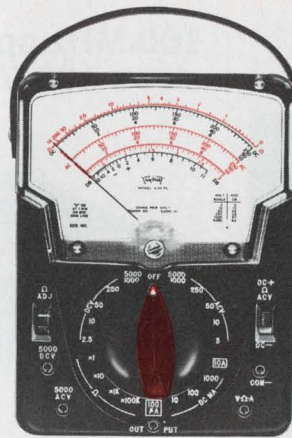

**General Purpose V-O-M
Model 630-PL**

1. One selector switch minimizes chance of incorrect settings and burnouts. Polarity reversing for DC.
2. 4.4 Ohms center scale, 0.1 ohm to 100 megohms resistance.
3. Meter movement diode protected against instantaneous overloads. \$64 suggested USA user net price



**General Purpose V-O-M
Model 630**

1. One selector switch minimizes chance of incorrect settings and burnouts.
2. 4.4 Ohm center scale, reads from 0.1 ohm up to 100 megohms resistance in 4 ranges.
3. 20,000 ohms per volt DC sensitivity; 5,000 AC. \$64 suggested USA user net price

Laboratory or General Purpose Triplett meets the need precisely

Products of Triplett's long experience in the design and manufacture of high-quality, high-performance V-O-Ms, these representatives of the great Model 630 series offer the most-wanted features combined as perfectly as the skills of dedicated craftsmen can guarantee.

See your Triplett representative or distributor for a free demonstration of any or all of these versatile instruments.



MANUFACTURERS OF THE WORLD'S MOST COMPLETE LINE OF V-O-Ms

INFORMATION RETRIEVAL NUMBER 84

Thick-film ladder matches to 25 ppm/°C

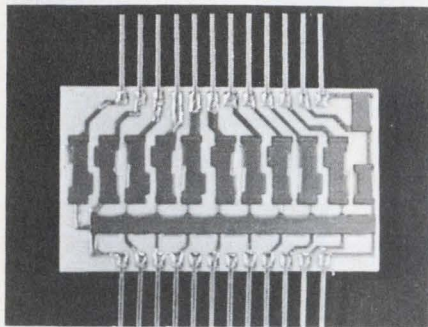

Microtek, a unit of Components, Inc., Smith St., Biddeford, Me. Phone: (207) 282-5111.

The LN128 is a high-performance thick-film 10-bit binary ladder network with resistor temperature coefficients of 25 ppm/°C over the temperature range of -55 to +125°C. Tracking between resistors is 2.5 ppm/°C and output voltage settling time to 0.1% is 100 ns. Resistance values to 50 kΩ are also available in 0.1-in.-high packages.

CIRCLE NO. 295

100-MHz op amp slews 100 V/μs min.

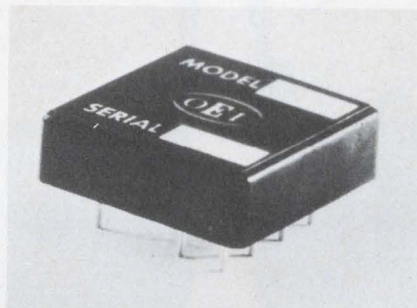

Optical Electronics, Inc., P. O. Box 11140, Tucson, Ariz. Phone: (602) 624-8358. P&A: \$82; stock.

Packaged in a 1-in.-square by 0.31-in.-high module, the 9697 operational amplifier provides a ±100-V/μs minimum slewing rate, 100-MHz minimum gain-bandwidth product and 500-ns settling time to 0.1%. Other features include a ±50-V common-mode voltage range and ±10 to ±75-V output supply voltage range.

CIRCLE NO. 296

DIP decoder/drivers work 7-segment displays

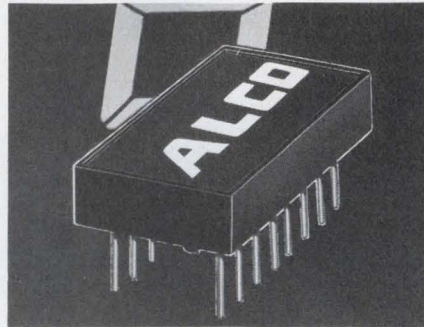

Alco Electronic Products, Inc., P.O. Box 1348, Lawrence, Mass. Phone: (617) 686-3887. Availability: stock.

The MSDD-320 series integrated hybrid decoder/drivers in 16 and 20-pin DIP configurations contains BCD-to-7-segment and count-to-1-segment units with or without quad latch memory. Current sinking per segment is 120 mA for incandescent displays. For cold-cathode displays, the MSDD-720 series features 200-V outputs. Inputs are TTL/DTL compatible.

CIRCLE NO. 297

COMPLETE PACKAGING CAPABILITY

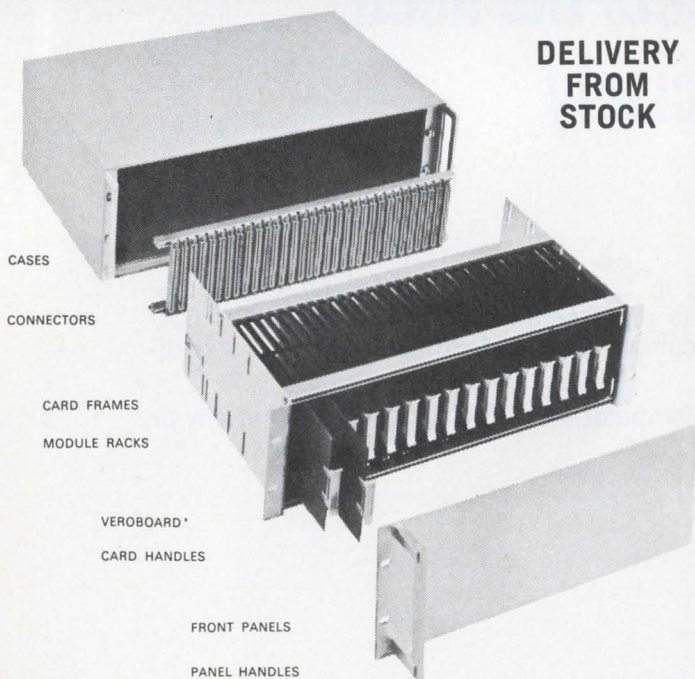

DELIVERY FROM STOCK

P.C. CARD HANDLES

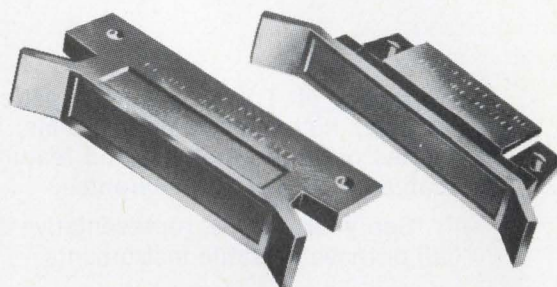

Molded of polycarbonate, these smartly styled handles mount without hardware in two styles, while the third may be riveted. The snap-in versions have molded lugs that snap into holes in the P.C. card and lock in place. This unique fixture saves time, labor and hardware costs while providing a positive attachment of handle to card, available from stock in black, white, red, green and blue.



VERO ELECTRONICS INC. TWX510-227-8890
171 BRIDGE ROAD, HAUPPAUGE, N. Y. 11787 TEL: 516-234-0400

H.E.L.P. Yourself!

Yes! I would like additional information on the following:

Leasing Renting Off-the-shelf Delivery

NAME _____ POSITION _____

FIRM _____

ADDRESS _____

CITY _____

STATE _____

ZIP _____

ED

H.E.L.P.:
A new way of not paying for the equipment you need!

H.E.L.P. is Honeywell's Equipment Leasing Plan. A new way we can help you help yourself.

With H.E.L.P., you can lease the Honeywell instrumentation you would ordinarily have to buy. But, without a large capital investment. Which means you can have state-of-the-art equipment now. When you need it. And pay for its use while you use it. Not before.

H.E.L.P. enables you to lease new equipment that's covered by standard warranties. As part of your lease plan, you may include an option to buy the leased equipment. It's up to you. Each lease plan is tailored to your particular needs.

H.E.L.P. is new. But, helping you isn't. We feel that's one of the big reasons we've grown large enough to offer an exciting, new program like H.E.L.P.



H.E.L.P.:
Off-the-shelf, 17-day delivery helps shelve your time problems!

Many times, you need instrumentation fast. So, we get it to you fast. Within days. Instead of weeks. In fact, we can promise 17-day delivery on all transducers, signal conditioning equipment, X-Y recorders and digital products.

Help yourself to any of our services. They're all designed to help you. Because helping you helps us. For additional information, simply fill out and mail the attached coupon to Honeywell, Test Instruments Division, P.O. Box 5227, Denver, Colorado 80217. Attention: M.S. 218

H.E.L.P.:
Short-term rental agreements to meet short-term needs!

If your instrumentation requirements are short-term, you may rent the equipment. Instead of leasing it. This way, if you need instrumentation for two weeks, you can rent it for two weeks. Or however long you need it.

And, of course, all rental agreements include service. Honeywell's nationwide staff of service specialists, using the latest test equipment and measuring standards, stand ready to serve you.

For many, renting equipment can also mean increased tax benefits. The exact amount, of course, will depend on the individual situation. And by renting, as with leasing, you don't tie up your capital. Or your time.

Renting . . . just another way we can be of H.E.L.P.

With
a little H.E.L.P.
from your
friends at

Honeywell

Project:

electronic tuning.

Solution:



If you're doing electronic tuning, you should be talking to us. We'll tell you about KEVICAPs™, our superior line of tuning diodes. We manufacture abrupt and hyperabrupt diodes, or custom make them to your specs. Anyway you want them, KEVICAPs have superb signal-handling capabilities. And they're hermetically sealed.

Our hyperabrupt diodes have a large capacitance swing. Superior tracking. Our ion implantation process allows endless reproducibility — no more matched sets. So no matter when you order, or what volume you order, you get the same product.

We have broad capabilities: abrupt junction; hyperabrupt; VVC's for HF, VHF or UHF tuning; VHF bandswitching diodes. Whatever your application: military, industrial, avionics, AM or FM broadcast, VHF or UHF TV, VCXO, TCXO or frequency synthesis.

Behind our product is our staff. They're your staff, too, anytime you need aid in systems design. And our prices are low.

We're here. We're better. We're competitive. Write or call us for specs. Today.

KEV ELECTRONICS CORP.

WILMINGTON INDUSTRIAL PARK
WILMINGTON, MASS. 01887
PHONE (617) 658-6970

"Pioneers in Ion Implantation"

MODULES & SUBASSEMBLIES

7-1/2-in.³ supplies sock out 50 watts

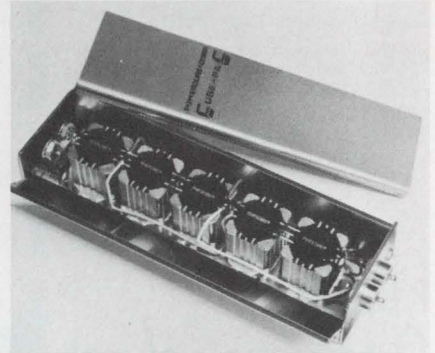

Powercube Corp., 214 Calvary St., Waltham, Mass. Phone: (617) 924-1758. Availability: stock.

Cube-Pac power supplies provide up to 50 W and 100 V of output power and voltage, all packed in 7-1/2-in.³ rfi/emi shielded enclosures. Their modular design allows flexibility of multiple-output combinations. Features include line and load regulation, input-output isolation, current limiting and high efficiency. Units meet MIL-S-19500 requirements.

CIRCLE NO. 298

Low-drift oscillator stabilizes to 2×10^{-7}

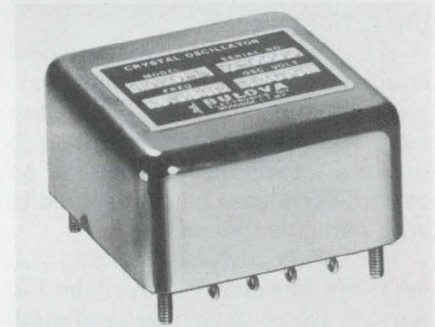

Bulova Watch Co., Inc., Electronics Div., 61-20 Woodside Ave., Woodside, N. Y. Phone: (212) 335-6000.

Containing a voltage regulator, the TCXO-2 temperature-compensated crystal oscillator features a frequency stability of $\pm 2 \times 10^{-7}$ over the temperature range of -40 to $+75^\circ\text{C}$. The new oscillator operates over the frequency range of 3 to 5 MHz and ages at a rate of $\pm 1 \times 10^{-8}$ /week. It is packaged in a four-cubic in. case and weighs only 5 oz.

CIRCLE NO. 299

Tips on cooling off hot semiconductors

See how other circuit designers use IERC heat sinks/dissipators to hold junction temperatures below rated maximums, improve circuit performance and reliability

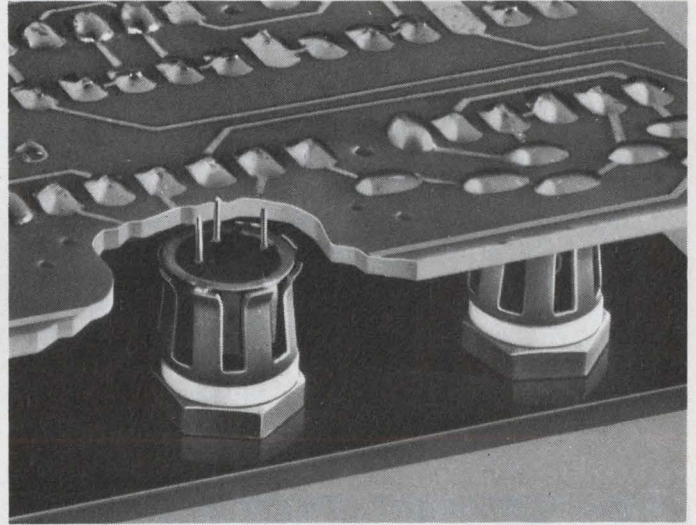
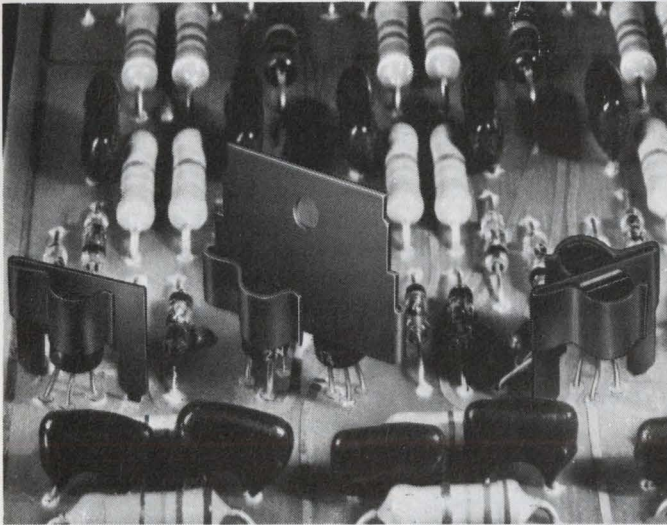

R097's, R097A's, X20's (D-Style) and other lead mounted, low power "plastic" transistors can be operated at up to 65% more power with IERC dissipators. They cost only pennies, provide excellent retention in severe environments, reduce failures from solder heat during assembly. 5 different styles; both single and dual models.

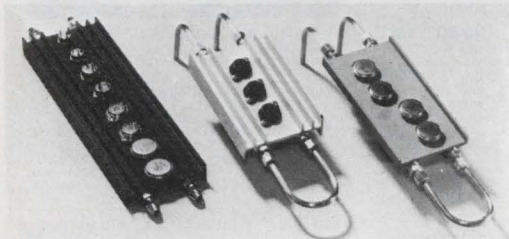

Replace elaborate forced air cooling systems for power devices. IERC fluid cooled systems provide up to 1,000 watts of dissipation in less than 45 cu. in. Parallel or series flow; open or closed loop systems. All standard mounting hole patterns; specials, too. Lengths from 6" to 3' standard.

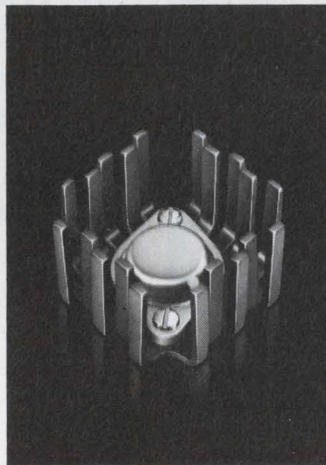

TO3's, TO66's, TO15's and other case-mounted devices can be operated with many times more power when mounted in UP's. In still air, the staggered fingers dissipate by radiation and convection. In forced air, turbulence moves the air around each finger. Efficient in any direction. Outperforms extrusions dramatically.

For low capacitance between transistor and chassis, use IERC Thermal Links with BeO washers. BeO has the thermal conductivity of aluminum, yet cuts capacitance up to 2/3rds. Excellent dissipators and retainers. Each size fits a complete JEDEC case diameter range for TO5's and TO18's. Dual and quad models also.

Is yours a special heat problem? Talk to the thermal specialists at IERC. They have the problem solving experience to come up with a practical, low cost solution.



Free 4-page Short Form Catalog. Complete ordering and pricing information on the world's broadest line of heat sinks/dissipators and retainers for lead and case mounted semiconductors.

Heat Sinks/Dissipators

IERC



7-bar-segment display retails at \$3.25

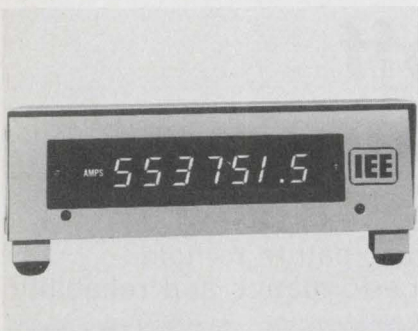

Industrial Electronic Engineers, Inc., 7720 Lemona Ave., Van Nuys, Calif. Phone: (213) 787-0311. P&A: \$3.25; 4 wks.

A new low-cost 7-bar-segment display costs only \$3.25. Its standard features include single-plane viewing, front or rear relamping, choice of red, blue, green, grey or amber screen colors and a plug-in package with no external hardware. Options include caption display of 3 or 6 messages and rear-projection 12-message display.

CIRCLE NO. 335

Compact GaAsP display has flat configuration

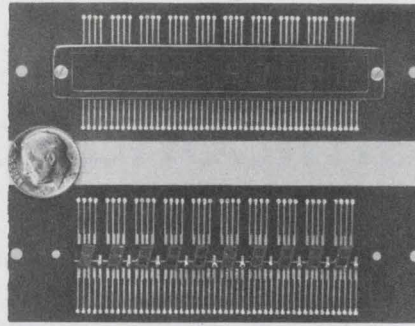

Bowmar/Canada Ltd., 1257 Algoma Rd., Ottawa, Ontario, Canada. Phone: (613) 746-3100.

A new monolithic multi-digit GaAsP display features 7-segment characters in a flat single-plane configuration. It can be custom designed in terms of numerals displayed and final packaging. Each numeral is affixed directly to a master PC board. Numeral character sizes of 0.07, 0.11, 0.19 and 0.25 in., each having eight leads (one is a common ground), are available.

CIRCLE NO. 336

Voltage-divider decades cost as low as \$5

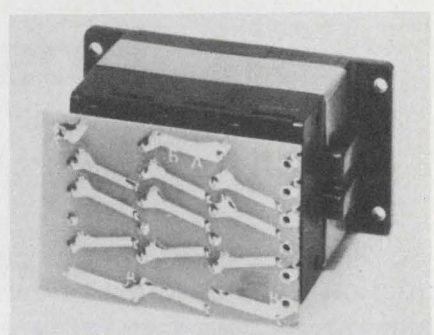

Electronic Engineering Co. of Calif., 1441 E. Chestnut Ave., Santa Ana, Calif. Phone: (714) 547-5651. P&A: \$5; stock.

Two series 1776 thumbwheel switches, a Wolff-Poggendorf voltage divider and a 1-2-3-6 resistor decade, retail for only \$5. The Wolff-Poggendorf circuit uses 9 resistors and presents a constant input resistance to a reference voltage. The 1-2-3-6 resistor decade requires 4 resistors to obtain 9 equal increments.

CIRCLE NO. 337

PUSH BUTTON MINIATURES

Exceptionally high current. 6A @ 125 VAC. Snap-action with fast make and break contacts. SPDT, DPDT & 4PDT, usable as either Norm. Open or Norm. Closed switch. Silver contacts & terminals.

ALCOSWITCH® or **MOMENTARY**

DIV. OF ALCO ELECTRONIC PRODUCTS, INC., LAWRENCE, MASS.

Information Retrieval Number 89

ROTARY SWITCH MINIATURES

Two series: MRA Series with adjustable stop & in 1-2-3-4 poles on a single deck with max. of 10 or 12 positions. MSRE waterproof series meet high reliability standards; non-adj. 1 to 4 poles. 500 mA @ 125 VAC.

ALCOSWITCH®

DIV. OF ALCO ELECTRONIC PRODUCTS, INC., LAWRENCE, MASS.

Information Retrieval Number 90

UNUSUAL BARGAINS ... MANY U.S. GOV'T SURPLUS

QUICK OCR "GO...NO-GO" TEST!
Detect problems before they occur. Two 27mm reticles with handy, pocket-sized 6X Comparator for checking ANSI size I & IV character set. Etched transparent ink. Quickly, easily check character size, shape, skew & spacing; stroke width, voids, smudges, peaks, valleys, extra marks. English & metric scales. No. 41,350DA \$34.50 Ppd.
RETICLES ONLY:
No. 30,642DA SIZE I \$11.00 Ppd.
No. 30,643DA SIZE II \$10.75 Ppd.

\$16.50 AIR POLLUTION TESTER!
1st low-cost survey-type instrument. Quickly provides quantitative results in threshold limit ranges set by Amer. Conf. of Gov't. Industrial Hygienists. Sensitive, accurate, wide measuring range. Includes 2 ampoules each to test CO₂, CO, H₂S, NO₂ and SO₂. Sufficient for 2 to 4 tests depending on concentration. Lightweight Kit includes sturdy vacuum pump, coupling tubes, complete instructions with scales to determine results. Sets (4) of replacement ampoules available separately for \$4.75. Stock No. 71,349DA \$16.50 Ppd.

4 1/4" ASTRONOMICAL TELESCOPE
See craters on moon, rings of Saturn, double stars. Up to 270x. New vibration-free equatorial mount. f/10 mirror corrected to better than 1/4 wave length. Gives theoretical limited resolution. Rack and pinion focusing. Aluminum tube, 6x finder telescope. 2 standard eyepieces and Barlow lens gives power up to 270x. Star Chart, Handbook & Instrs. Incl. Ship. wt. 42 lbs. Stock No. 85,105DA \$94.50 F.O.B.

EDMUND SCIENTIFIC CO. 300 EDSCORP BLDG., BARRINGTON, NEW JERSEY 08007
ORDER BY STOCK NUMBER • OPEN ACCOUNT TO RATED FIRMS • MONEY-BACK GUARANTEE

Information Retrieval Number 91

signal sources

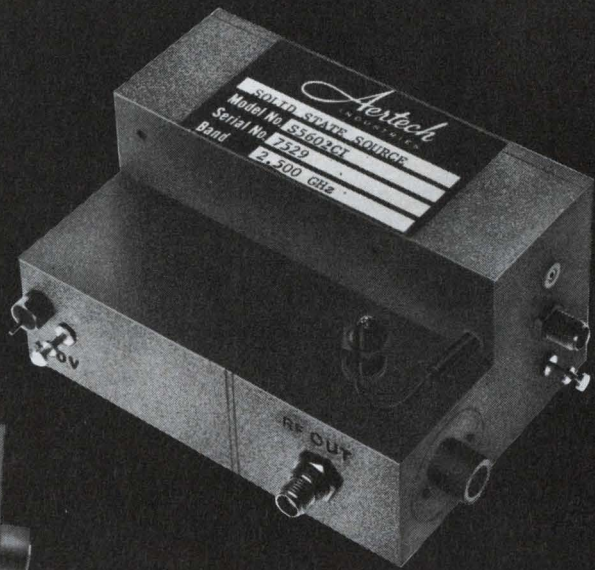
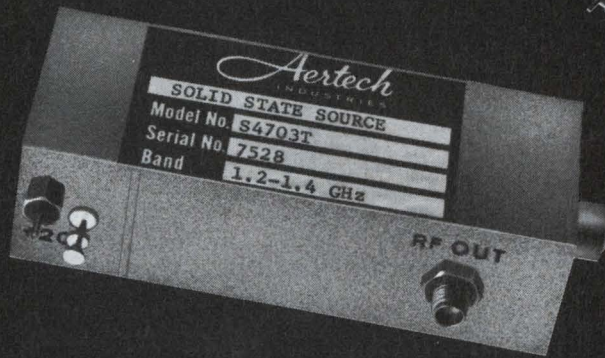

Delivery: 7 to 45 days ARO.

Aerotech Industries now offers a new series of high quality, low noise signal sources. These compact units were developed to complement Aerotech's capabilities in microwave components and subsystems.

Units are now available at selected bands from 850 MHz to 3 GHz, delivering an output power up to 1 watt. Designed to operate with any fixed voltage in the range of -15 VDC to -28 VDC or +15 VDC to +28 VDC with an operating temperature of -20°C to +60°C and a frequency stability of .05% to .000001%.

SPECIFICATIONS

AERTECH'S BASIC MODELS	FREQUENCY (GHZ)	POWER OUTPUT (MW)
S3601 (*)	.85-1.0	10-1000
S4612 (*)	1.0-1.2	10-1000
S4703 (*)	1.2-1.4	10-600
S4613 (*)	1.4-1.7	10-200
S4607 (*)	1.7-2.0	10-100
S5603 (*)	2.0-2.3	10-50
S5602 (*)	2.3-2.6	10-20
S5605 (*)	2.6-3.0	10

NOTE: (*) Suffixed with any one of the below
 (T)—Free Running Source
 (F)—Free Running Source with FM
 (FG)—Free Running Source with FM and Fine Tuning Capability
 (PL)—Phase Locked Source with external reference supplied by Customer
 (CI)—Phase Locked Source with internal reference supplied by Aerotech
 (CE)—Phase Locked Source with external reference supplied by Aerotech on common mounting plate.

FEATURES

- High reliability
- Low AM & FM Noise
- Small Size & Weight
- Many options available

APPLICATIONS

- Telecommunications
- Troposcatter
- Radar
- Instrumentation

Your local Aerotech Rep will assist you with any microwave signal source you may require. Also ask for our new signal source data sheet.

Aerotech
INDUSTRIES

825 STEWART DR. • SUNNYVALE • CALIF. 94086 • (408) 732-0880 • TWX 910-339-9207

WE'VE GOT A BETTER WAY TO MAKE PRINTED CIRCUITS!

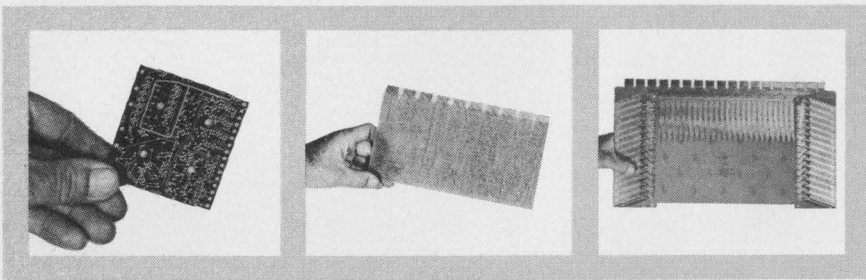
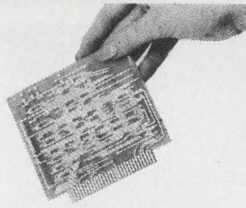

To avoid the necessity of a multi-layer circuit board for a process computer, we produced this high-density dual-inline double-sided board with a 6 mil line width and 8 mil line spacing. Ask us . . . we've got a better way to make printed circuits!

This 3-layer circuit board was designed to be as economical as most double-sided circuit boards . . . for the Control Data 7600 Computer. Ask us . . . we've got a better way to make printed circuits!

Not all multi-layer circuit boards are small. Although some of our circuits measure a fraction of an inch, double-sided circuit board produced for a memory system measures 18" x 22". Ask us . . . we've got a better way to make printed circuits!

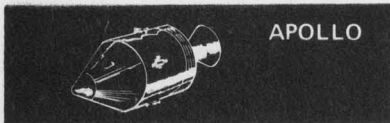

APOLLO

Our circuit boards were on Apollo, LEM, and seis. experiment. Sequential laminating, extra-fine line width and spacing, plated slots and edges.



GEMINI

Again, top reliability was required and delivery on-time was made to the customer.

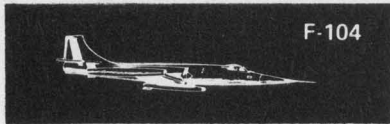

F-104

Developed new technique to produce circuit boards with more reliable plated-thru holes.

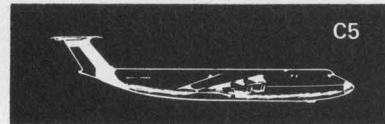

C5

We introduced circuit boards that had the highest density circuitry ever used before on a production basis.

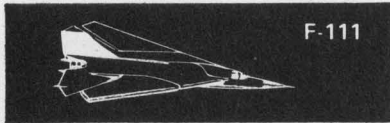

F-111

New industry technique was used to produce multilayer circuit boards with an internal heat sink.

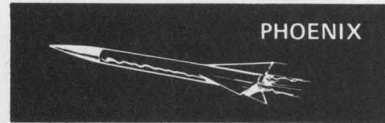

PHOENIX

Required new techniques for manufacturing heat sinks and insulation by chemical milling.



707

Reliable circuit boards in high volume at low cost were produced for this project.



POSEIDON

Developed new technology for sequential laminating multi-layer circuit boards with aluminum backbone.



This design and production experience can work for you . . . CALL US NOW.

**CONTROL DATA
CORPORATION**

CONTROL DATA CORPORATION
CIRCUITS DIVISION
7800 COMPUTER AVENUE
MINNEAPOLIS, MINN. 55435
PHONE: (612) 927-5681

MODULES & SUBASSEMBLIES

Hexidecimal driver operates three ways

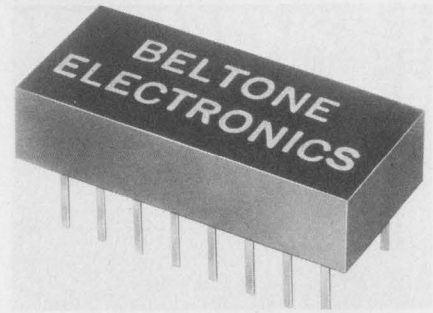

Beltone Electronics Corp., Components Div., 4201 W. Victoria St., Chicago, Ill. Phone: (312) 583-3600.

A new hexidecimal driver is designed to operate as either a level changer, lamp or relay driver from IC levels. It functions with six independent drivers or inverter circuits at a 28-V supply. When used as a driver, it drives six 28-V relays with an output of 180 mA. When used as an inverting level changer, it provides outputs of 14 V at 25 mA.

CIRCLE NO. 338

Keyboard switch module produces 1-ms closure

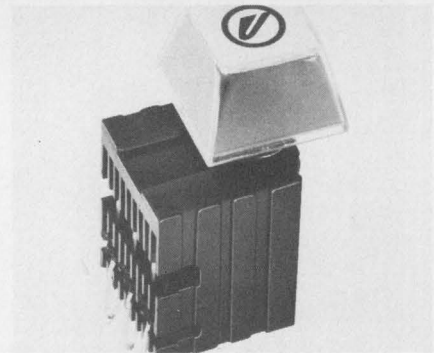

Unimax Switch Corp., sub. of Riker-Maxon, Ives, Rd., Wallingford, Conn. Phone: (203) 269-8701. P&A: \$1 to \$4; 1st quarter, 1971.

A new keyboard switch module features contact closure for 1 ms during plunger depression and allows no closure on its upstroke. The mechanical one-shot provides a tactile sensation and an audible click coincident with the contact closure. The switch module is designed for mounting on 3/4-in. keyboard centers.

CIRCLE NO. 339

Celco Yokes for CRT DISPLAYS



CELCO makes YOKES. They make them good. In fact, CELCO has been making the best CRT deflection yokes and focus coils in the industry for the past twenty years.

CELCO makes yokes for precision displays when you must have the highest performance available.

And CELCO makes yokes for computer terminal displays when you need reliable repetitive scan yokes for commercial purposes, at low cost. Not only does CELCO make good yokes, but they make sure you get the right yoke for your particular CRT display requirements.

Call CELCO on your present display problem. A CELCO yoke will solve it. (It might even be one of the standard CELCO yokes listed below:)

CELCO PRECISION DISPLAY YOKES:

- DNA702 "superfastDYNAYOKE"
(2 μ sec recovery time to 0.1%)
- HDN428 Low-Zero Approach
- HDQ428 Mini-Spot, (CRT/Yoke matched)

CELCO COMPUTER TERMINAL DISPLAY YOKES:

- PW Position-Write Yokes
- PWM Position-Write, with Pincushion Correction
- YA Resonant Drive, Hi-Q

CONSTANTINE ENGINEERING LABORATORIES COMPANY

MAHWAH, N. J. 07430 TEL. 201-327-1123 TWX: 710-988-1018

UPLAND, CAL. 91786 TEL. 714-982-0215 TWX: 910-581-3401

Go ahead and call CELCO. All you've got to lose are your yoke problems.

INFORMATION RETRIEVAL NUMBER 94

15-MHz counter kit has a \$200 price tag



Heath Co., Benton Harbor, Mich. Phone: (616) 983-3961. P&A: \$199.95; stock.

The new model IB-101 counter provides counting from 1 Hz to 15 MHz for only \$199.95, in kit form. An overrange indicator and five cold-cathode display tubes are included. Readings are made to the nearest kHz or Hz with a two-position range switch. Triggering is from 100 mV to 200 V and input impedance is 1 MΩ shunted by 20 pF. Assembly takes only 5 hours.

CIRCLE NO. 340

50-MHz pulse generator costs just \$555

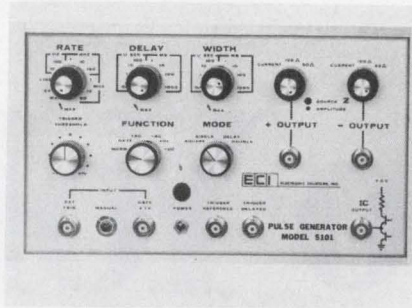

Data Dynamics Div. of Electronic Counters, Inc., 240 Humphrey St., Englewood, N. J. Phone: (201) 567-5300. P&A: \$555; stock.

Model 5101 19-in-rack-mountable pulse generator is capable of pulse repetition rates of 1 Hz to 50 MHz at a low cost of \$555. There are three separate active and simultaneous outputs: a positive pulse, a negative pulse and an IC-compatible output pulse for TTL, RTL and DTL ICs. Single and double pulses may be selected.

CIRCLE NO. 341

Tiny Wheatstone bridge spans 0.08Ω to 120 MΩ



Siemens Corp., 186 Wood Ave. S., Iselin, N. J. Phone: (201) 494-1000.

A new portable direct-reading Wheatstone bridge has 9 measurement ranges covering resistances from 0.08 Ω to 120 MΩ for voltages up to 500 V. The bridge is battery operated, has pushbutton controls and balances by means of a rotary knob with a scale on which resistance values can be read directly. A built-in shockproof galvanometer is of the taut-strip-suspension type. A battery check is also included.

CIRCLE NO. 342

ARITECH VOLTAGE CONTROLLED FILTERS

VCFs can help you

solve problems in radar, telemetry, voice coding, signal conditioning, data acquisition, plus many other areas.

VCFs allow you to electronically shift cut-off frequency without affecting the shape of the response. They are compact, stable, and extremely reliable.

Our standard VCFs — now in stock — are 4-pole Butterworth, 24 dB/octave, either high-pass, low-pass, or band-pass.

Cut-off Frequency Range	0.1 Hz to 20 kHz
Tuning Ratio	50:1
Tuning Voltage	0 to 5 VDC
Module Size	0.75" x 2.15" x 2.15"
Quantity prices for some versions	— under \$80.

See us also for custom active filters.

ARITECH CORP. 130 Lincoln St., Brighton, Mass. 02135
Telephone: (617) 254-2990

INFORMATION RETRIEVAL NUMBER 95

HV capacitors

built for your job requirements

Specialty capacitors for:

- **HVDC Power Supplies** — standard and special values
- **Energy Storage Capacitors** — minimum inductance & maximum current
- **Laser & Radar Applications** —
Line Type Modulators: pulse forming networks (self-contained for low & medium power); external coils & pulse capacitors (for high power modulators)

Hard Tube Modulators: storage capacitors (low, medium & high power, low inductance)
We will be pleased to quote on your particular requirements. Just write for specification order sheet. Or call 914-279-8091 and Don Corson will be glad to supply you with any information.



**CORSON DIVISION
HIPOTRONICS, INC.**
BREWSTER, NEW YORK 10509
(914) 279-8091
Telex: 710-574-2420

INFORMATION RETRIEVAL NUMBER 96

Here's the solution...

Philips' miniature

Plumbicon*

...now what's your problem?

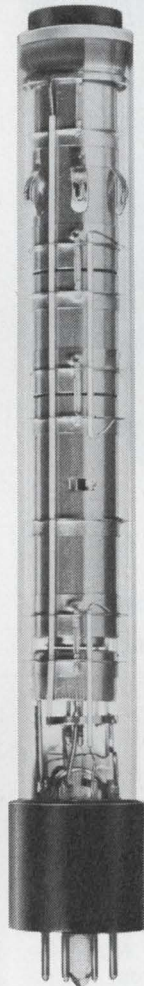

(actual size)

We'll tell you the truth. It took a lot of imagination to build this TV camera tube.
With a diameter of just 5/8", it's just about half the size of Philips' famous Plumbicon tube preferred all over the world for its speed of response, resolution and sensitivity.
Yet the performance of the mini-Plumbicon is comparable to that of its big brother.
Now it's your turn.
What could a half-sized Plumbicon mean to you?
A whole new range of miniature broadcast cameras?
A solution to a tricky CCTV application... maybe industrial... or military... or even in space? A new medical monitoring concept, perhaps? Or something to simplify outside broadcasting reportage?
Maybe it's the key to a new idea for a data transmission link... or the heart of an intelligence or security system.
What about colour microscopy?
But as we said it's your turn.

*** Registered trademark of N.V. Philips' Gloeilampenfabrieken for TV camera tubes.**

N.V. Philips' Gloeilampenfabrieken – Eindhoven, the Netherlands
Manufactured, distributed and sold in the U.S. by
Amperex Electronic Corporation, Electro-Optical Devices Division,
Slatersville R.I.



electronic components
and materials

PHILIPS

INFORMATION RETRIEVAL NUMBER 97

ADLAKE MERCURY DISPLACEMENT RELAYS

Rugged and critically demanding applications in all types of industrial and commercial equipment and systems have proven the inherent quality and reliability of Adlake's mercury displacement relays. Available in QUICK ACTING and TIME DELAY types, these relays are ideal for widely varying switching applications where reliability is paramount.

ELECTRICAL DETAILS

Contact Arrangements:

Time Delay SPST (N.O. or N.C.)
(Up to 3 poles) Quick Acting SPST
(N.O. or N.C.) (Up to 3 poles)

Contact Rating:

Time Delay* 0.1 to 15 amps
Quick Acting 30 to 100 amps

*Depending upon nature of load, voltage, length of time delay, and timing function.

Contact Resistance:

Time Delay 28 milliohms max.
Quick Acting 1 to 5 milliohms
max. depending on construction.

Life:

5 million operations minimum.

Time Delays:

Available up to 1800 seconds.

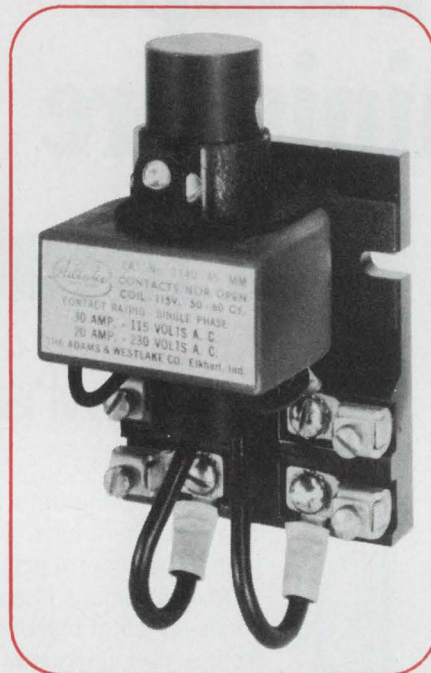

MECHANICAL DETAILS

Hermetically sealed contacts; stainless steel enclosed, all welded construction. Magnetic circuits finished black wrinkle enamel, cadmium plated and lacquered. Epoxy molded coils—guaranteed for life.

MERCURY WETTED CONTACT RELAYS

Low, stable contact resistance and "1-billion-operation" life qualify Sensitive Mercury Wetted Contact Relays for a wide array of switching applications, such as digital and analog computers, telecommunications systems, multiplex, industrial control equipment, power control devices. New Series MWK and AWK Sensitive Relays offer contact form K (SPST, center off)—ideal for multiple channel switching.

DRY REED RELAYS

Miniature, intermediate, and standard sizes offer A and B contact forms with from 1 to 4 poles of switching. Typical life is 20×10^6 operations (rated load) or 500×10^6 operations (dry circuit).

USE READER-SERVICE NUMBER FOR COMPLETE INFORMATION



THE ADAMS & WESTLAKE COMPANY

Elkhart, Indiana 46514 • (219) 264-1141 • TWX (219) 522-3102 • TELEX 25-8458 • Cable ADLAKE

A SUBSIDIARY OF  **ALLIED PRODUCTS CORPORATION**

INFORMATION RETRIEVAL NUMBER 98

Line monitor/booster handles 2 kW for \$245



R&B Instruments, Inc., P. O. Box 84, Glen Rock, N. J. Phone: (201) 445-2178. P&A: \$177, \$245.50; 6 to 8 wks.

The PLM-105 power line monitor and PLB-105 line booster which plugs into the monitor combine to offer a low-cost method of monitoring the line at 1% accuracy with 300 W (model A) or 2000 W (model B) of power. The monitor indicates conditions below 105 V ac with a blinking red light. A steady amber light, a memory which stays on until reset, indicates that previous undervoltages occurred.

CIRCLE NO. 333

Modular instruments form a complete system

Tektronix, Inc., P. O. Box 500, Beaverton, Ore. Phone: (503) 644-0161. P&A: \$495, \$430, \$300, \$485, \$280; 4 wks.

The 2600 series of modular instruments is designed to generate, condition, mix and amplify a variety of signals. They consist of the 2601 mainframe and four-plug-in modules: the 26G1 rate/ramp generator, the 26G2 ramp generator, the 26G3 pulse generator and the 26A1 operational amplifier. Inputs and outputs are all fully TTL compatible.

CIRCLE NO. 334



behind
every
successful
key

there's a coil

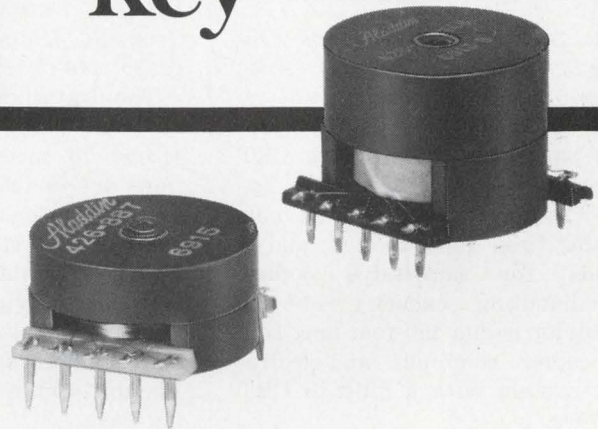

Data lovers, how do these frequencies grab you?

600Hz	1200Hz	2025Hz
697Hz	1209Hz	2050Hz
770Hz	1270Hz	2150Hz
852Hz	1336Hz	2200Hz
941Hz	1477Hz	2225Hz
1070Hz	1633Hz	2250Hz
1098Hz	1950Hz	2350Hz

Applications:

As fixed and adjustable inductors for low frequency filters. As transformers for tone frequencies used in push button telephone oscillator circuits and data sets; coupling and impedance matching applications.

Features:

High and low profile units, p/c mounting, fine tuning, tuning adjustment at least $\pm 3\%$ from nominal, TC matches polystyrene capacitors, high Q — custom designs, impregnated coils, for extreme environments.

data coils by **Aladdin**

AE

Transformers, Inductors, Filters, Pulse Transformers? We've got those too!

Aladdin Electronics shows you more than 20,000 different magnetic components in the new Aladdin *Encyclopedia of Capabilities*—a real Supermarket in Print for designers. Unique double binder shows Applications and Configurations . . . makes it easy for you to select components by telling us the performance characteristics you want. If you'll write on your letterhead (telling us a few things about yourself and your company please), we'll send you a FREE COPY of the Encyclopedia.

ALADDIN ELECTRONICS

A Division of Aladdin Industries, Inc.
703 Murfreesboro Road
Nashville, Tennessee 37210

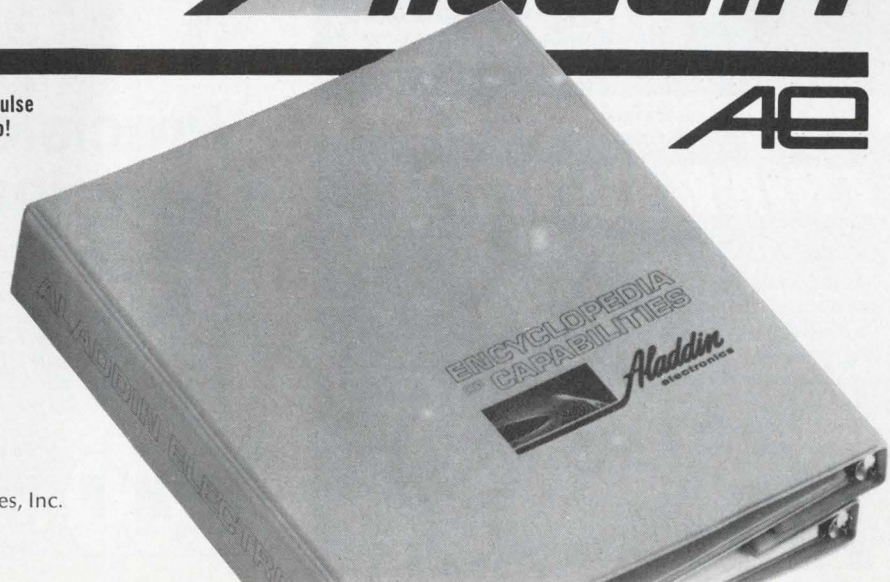

Desktop CRT copier lowers cost to 2¢/copy

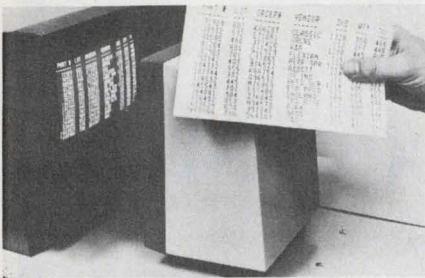

A. B. Dick Co., Videograph Operations, 5700 W. Touhy Ave., Chicago, Ill. Price: \$2500.

The 9750 desktop copier produces hard paper copies of a CRT display at a cost of less than 2¢/copy. Copying speed is 12 seconds for the first reproduction and 8 seconds for successive copies. Paper-handling capacity of the new copier is one 460-foot long roll. The copier combines an electrostatic system with a built-in CRT monitor.

CIRCLE NO. 345

9600-baud analyzer checks data distortion

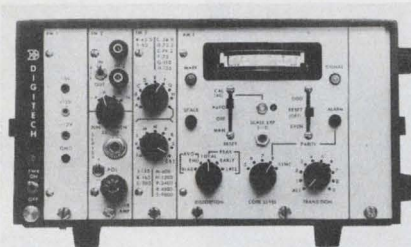

Digitech Data Industries, Inc., 66 Grove St., Ridgefield, Conn. Phone: (203) 438-3731.

The Datachek analyzer operates at baud rates up to 9600 bits/second to measure signal distortions due to telegraph and data set communications networks. It will display distortion percentage in 1% increments and it can check vertical parity on eight-level codes. Polar, neutral and low or high-level signals can be used as inputs. The unit comes in a portable carrying case.

CIRCLE NO. 346

15-digit calculator performs 253 steps



Sony Corp. of America, 47-47 Van Dam St., Long Island City, N. Y. Phone: (212) 361-8600. Price: \$2400.

The Sobax LCC 2700W is a 15-digit calculator with 253 steps and 12 memories. It also contains conditional or unconditional branching, as well as the insertion of separate programs. Debugging of programs is also another of its capabilities. All programs are produced from the calculator's keyboard and can be reproduced on magnetic cards.

CIRCLE NO. 347

THINK DIGITAL

NEON READOUT DRIVER MODULE

Factory assembled Elfin readout modules with built-in decoder-drivers are ready to plug into your systems. Choice of decoder-drivers or with memory, counter, Model DM-17G-721

USES ELFIN* 7-SEGMENT DISPLAY TUBE

13.62
IN 500 LOTS

ALCO
LAWRENCE, MASS.

* Manufactured Under a License By Burroughs Corp.

INFORMATION RETRIEVAL NUMBER 100

THINK DIGITAL

READOUTS WITH DRIVERS

Ultra-small 1/2" x 1" incandescent single plane numeric and symbol displays operate on 2.5V & 20 mA per segment. A mating plug-in module is available having a decimal input decoder-driver.

MS-250 READOUT

MTX-250 DECODER DRIVER

ALCO ELECTRONIC PRODUCTS, LAWRENCE, MASS.

INFORMATION RETRIEVAL NUMBER 101

Happy Endings...

Precision Metal Terminals

Whether you need terminals from stock or of special design — tell us your requirements. Our free engineering assistance in terminal selection or design will provide the happy ending. We precision-machine your specials, often with no tooling charge. Or select from over 500 stock items, the most complete line in the industry. You can look to PMP for precision-made mini-pins too, for use in connectors, micro modules and every mini purpose.

Send for our latest complete catalog.

PMP
PRECISION METAL PRODUCTS

PRECISION METAL PRODUCTS CO.
41 ELM ST., STONEHAM, MASS. 02180
Telephone: (Area Code 617) 438-3650

INFORMATION RETRIEVAL NUMBER 102

Ceramic substrates are 0.035-in. thick

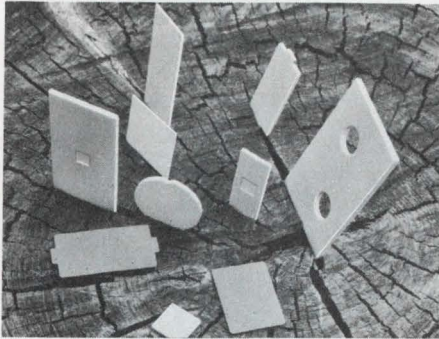

Diamonite Products Co., Div. of U. S. Ceramic Tile Co., Shreve, Ohio. Phone: (216) 567-4211.

Manufactured for LSI and hybrid packages, new multi-shaped alumina substrate ceramics are available in thicknesses greater than 0.035 in. They are produced by powder pressing to assure a high degree of uniformity. A wide range of sizes are offered with high mechanical strength, good thermal conductivity and electrical and thermal shock resistance.

CIRCLE NO. 348

Breadboarding card holds 20 14-pin DIPs

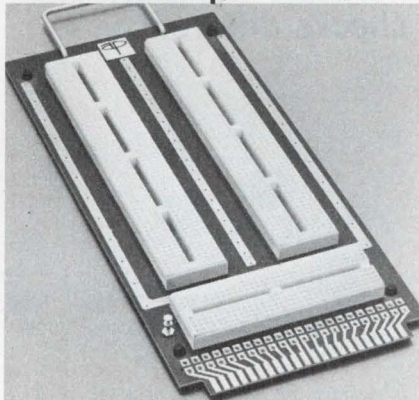

A P Inc., 72 Corwin Dr., Painesville, Ohio. Phone: (216) 357-5597. P&A: \$48.60; stock.

The Unicard II versatile breadboarding card can accommodate up to 20 14-pin DIPs, 17 16-pin DIPs or 12 20-pin DIPs in addition to TO-5 cans. It features a turret-post for convenient termination to the back-side ground plane, drilled-hole solder points on the power-distribution busses that accommodate AWG 20 wire sizes and rubber feet for sturdy bench work.

CIRCLE NO. 349

NEED A 10,000 VOLT ZENER DIODE?

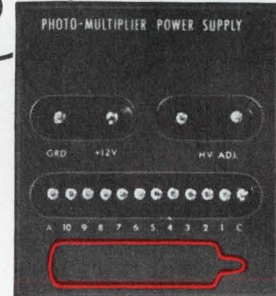
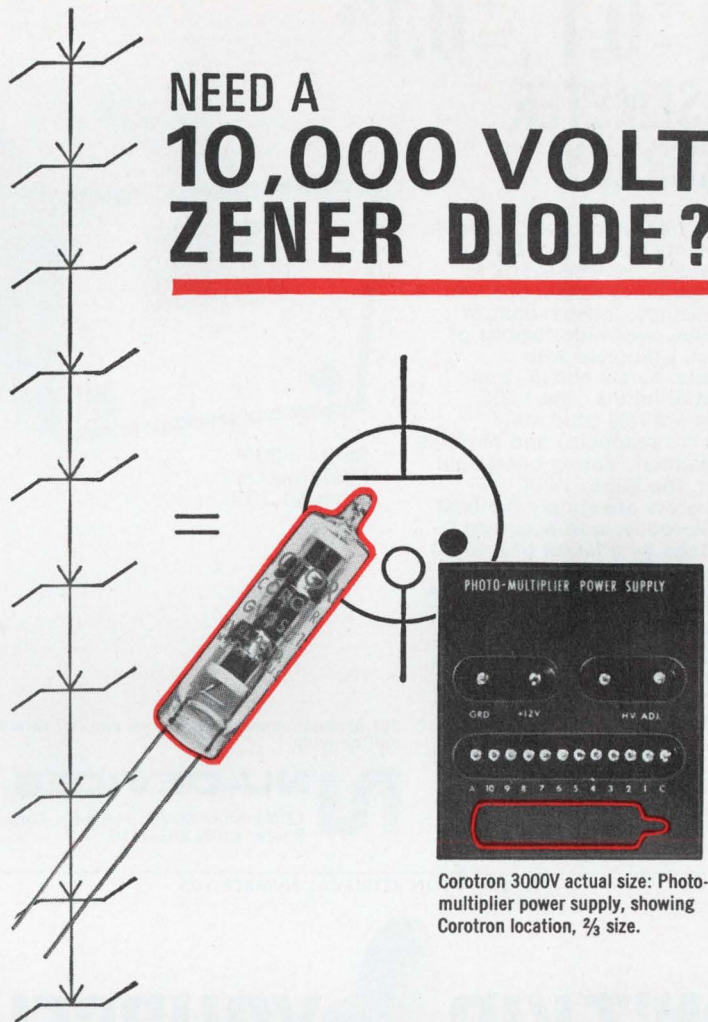

Corotron 3000V actual size: Photo-multiplier power supply, showing Corotron location, 1/3 size.

You could string together several hundred zeners. Or you could specify *one* Victoreen Corotron. It is the gaseous equivalent of the zener with all the advantages of an *ideal* HV zener diode.

For space research and other rugged applications requiring absolute power supply stability, GV3S Series, shown, provide the ideal reference voltage anywhere in the range of 400 to 3000 volts. They enable circuitry to maintain constant high voltage regardless of battery source voltage or load current variations. Cubage and weight (GV3S Corotron weighs only 4 gm.) are important considerations. So is temperature variation (Corotrons operate from 200°C down to -65°C). Ruggedized versions withstand shock to 2000 G, vibration 10 to 2000 cps.

If you're trying to simplify circuits . . . to cut cost, size and weight . . . to upgrade performance—you need Corotron high voltage regulators. Models are available now from 400 to 30,000 volts. A consultation with our Applications Engineering Dept. will speed up the countdown.

DMA 525



VICTOREEN INSTRUMENT DIV. of VLN
10101 WOODLAND AVENUE • CLEVELAND, OHIO 44104
 EUROPE: ARNDAL HOUSE, THE PRECINCT, EGHAM, SURREY, ENGLAND • TEL: EGHAM 4887

INFORMATION RETRIEVAL NUMBER 103

$\pm 0.1^\circ, \pm 0.1\%$ PHASEMETER ACCURACY

These highly accurate, versatile instruments not only measure phase angle over the 0.5Hz to 2MHz frequency range, but also offer readings, independent of amplitude, over wide regions of variation. Complete with selectable, single ended, true differential inputs, the I-200 series is entirely solid state (except for readouts) and requires no adjustment during operation. In short, the Series I-200 phasemeters are simply the best available today, with accuracy guaranteed by a factor of 3 to 20 times better than others.

Of particular interest are these critical "specs" for each of the 3 models in this product group . . .
Model I-220 — $\pm 0.1^\circ, \pm 0.1\%$ digital readout (50 Hz to 200 KHz)
Model I-210 — $\pm 0.1^\circ, \pm 0.2\%$ digital readout (50 Hz to 200 KHz)
Model I-200 — $\pm 0.1^\circ, \pm 0.1\%$ DC, not digital (50 Hz to 200 KHz)



Series I-200 Phasemeters From \$1,150.

For optional accessories, prices and full details call or write.

NU-DEVICES, INC.
 18 Marshall Street, Norwalk, Conn. 06854
 Phone: (203) 853-3410

INFORMATION RETRIEVAL NUMBER 105

PC-board probe system gauges coatings

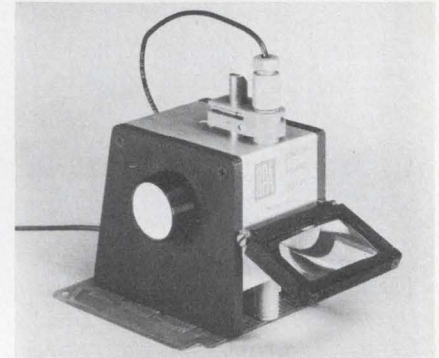

Unit Process Assemblies, Inc., 53-15 37 Ave., Woodside, N. Y. Phone: (212) 899-9090.

A new precision probe system measures printed-circuit board coatings instantly and accurately. The CB-3 can measure the smallest lines, tabs and isolated pads. Its positioning is aided by a magnifier and by cross hairs whose images lie directly on the area being measured. Different measuring probes can be instantly snapped into the system with relative ease.

CIRCLE NO. 350

DON'T KID YOURSELF!



This won't ward off heart disease. But a gift to the Heart Fund will help protect your heart and the hearts you love.



GIVE...
 so more will live
**HEART
 FUND**

Contributed by the Publisher

Portable comparator checks differences



Electrovert, Inc., 86 Hartford Ave., Mount Vernon, N. Y. Phone: (914) MO4-6090.

The Mini Flicka 58 is a portable optical comparator which visually magnifies and emphasizes the differences between two similar objects. In operation, the standard and the sample are placed on separate illuminated viewing stages and are visually superimposed through a set of optics. The two objects are alternately presented to the observer and differences appear as a visual flicker.

CIRCLE NO. 351

START

WITH A LENS-END LAMP

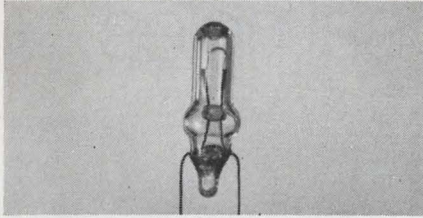

TEST

FOR SPOT SIZE AND
CANDLEPOWER

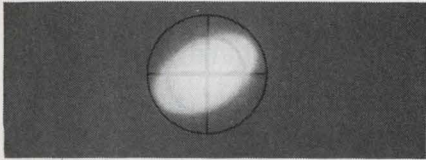

WELD

PINS TO END OF LEAD
WIRES

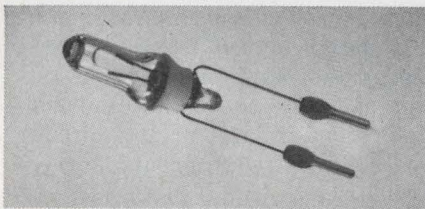

MOLD

TO MAKE A PLUG-IN LIGHT
MODULE THAT WILL ACTIVATE
PHOTO ELECTRIC SENSOR IN
A HIGH SPEED CHECK SORTER

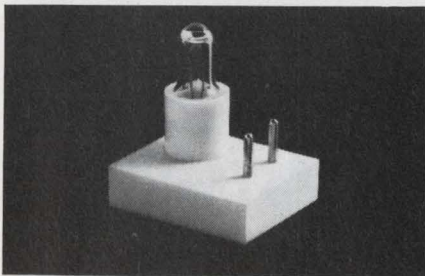

We specialize in finding practical solutions to small applications where cataloged items won't do. Write, describing your requirement. Tung-Sol Division, Wagner Electric Corporation, 630 W. Mt. Pleasant Avenue, Livingston, N.J. 07039. TWX: 710-994-4865. Phone: (201) 992-1100.

TUNG-SOL®

WHERE BIG THINGS ARE
DONE WITH SMALL LAMPS

® Reg. T.M. Wagner Electric Corporation

INFORMATION RETRIEVAL NUMBER 107

ELECTRONIC DESIGN 25, December 6, 1970

Precision lighthouse
drafts to 0.0005 in.

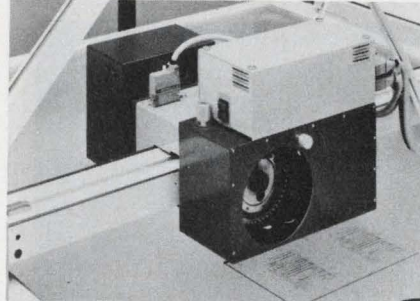

Faul-Coradi, Inc., 27 Fennell St.,
Skaneateles, N. Y. Phone: (315)
685-5761.

The MKII precision lighthouse for lightbeam drafting on photosensitive film using the Coradomat 21 plotter positions symbols to within ± 0.0005 in. It features a dual set of optics, one for line drafting and the other for flashing of images. Conversion from a cut-and-strip operation to a lightbeam drafting operation using the MKII takes just three minutes.

CIRCLE NO. 320

Plastic welding tools
heat up to 350°C

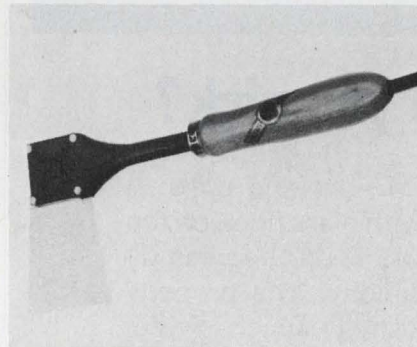

Caig Laboratories, Inc., 455A
Union Ave., Westbury, N. Y.
Phone: (516) 334-1940. P&A:
\$18.75, \$26; stock.

Two new welding tools for plastics, #611-001 and #611-005, deliver blade temperatures of 300 and 350°C, respectively. The former is rated for 200 W and measures 3-in. deep by 3-in. wide. The latter is rated for 300 W and measures 2-3/4-in. deep by 4-3/4-in. wide. Both use 110 V ac for operation and incorporate nickel-plated electrolytic copper blades.

CIRCLE NO. 321

SWITCH TO FRITCH®

FREQUENCY RESPONSIVE SWITCHES



HERE'S WHY:

- Broad Frequency Range . . . 20 HZ to 100 KHZ
- Low Signal Power . . . as low as 0.3 milliwatts
- Fast Response Time . . . up to 150 operations per second
- Solid State Reliability
- Shock and Vibration Resistant
- SPST to DPDT Outputs

Especially Recommended For:
"TOUCH-TONE"* Decoding •
Telemetry • Over and Under
Frequency Control •
Multi-Zone Alarm Detection
Over One Telephone Line.

Price in units of 100 . . . \$14.40
(Oscillators also available)

*Registered Service Mark of AT&T.

DOUGLAS RANDALL, INC.

6 Pawcatuck Ave.,
Westerly, R.I. 02891

A Division of
Walter Kidde & Company, Inc.



Kidde

Volume Resistance of Thermosetting Compounds at 160° F, 100% RH

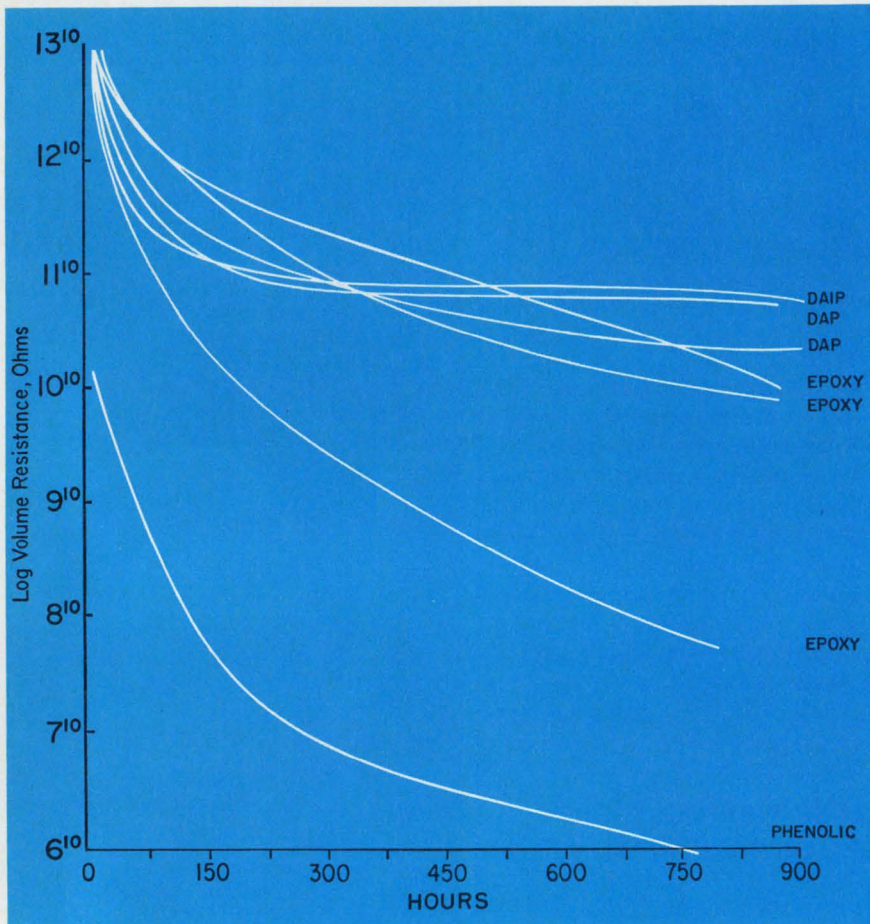

Which resin do you pick?

That's right! DAP. That's our DAPON® and DAPON M diallyl phthalate resins, filled with glass fiber, on top after 900 hours at 160 degrees F (70 degrees C) and 100 percent relative humidity. The property being measured is volume resistivity which is what an insulating plastic is all about.

The story is more involved than that, of course. Let us send you reprints of "Chemical and Thermal Resistance of Thermosetting Molding Materials" and "The Effects of Temperature and Humidity on Electrical Properties of Thermosetting Plastics" and get the complete story.



ORGANIC CHEMICALS DIVISION
FMC CORPORATION

633 Third Avenue, New York, N. Y. 10017

INFORMATION RETRIEVAL NUMBER 109

evaluation samples

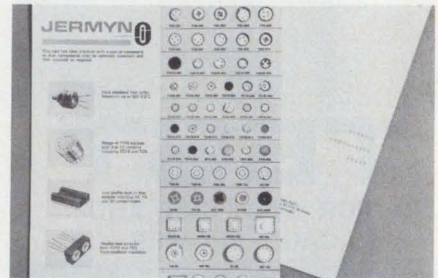

Component hardware

A new range of supplementary hardware for use with sub-miniature components is available on a sample card with sixty-seven samples, free of charge. Injection molded from nylon or polypropylene, the hardware items include panel washers, two sizes of anti-vibration clips for small capacitors, mounting pads designed for transistors, diodes and multi-lead ICs and special pads for converting-lead configurations to meet printed circuit-board layout requirements. Jermyn Industries.

CIRCLE NO. 352

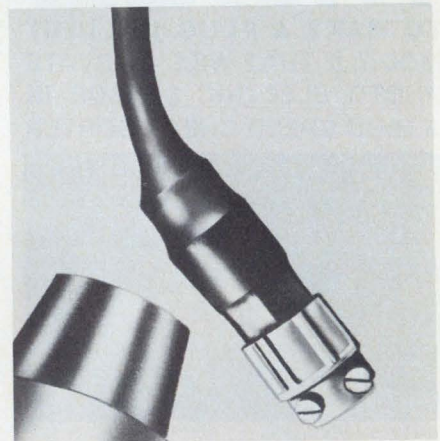

Heat-shrink tubing

Penntube VII-B is a new neoprene flame-retardent heat shrinkable tubing that reduces a full 50% in size upon application of heat in excess of 160° F. It can be used over sharp edges without cracking and provides resistance to corrosion and chemicals. It can also be shrunk down in hot water above 140° F. Free samples are available, Penntube Plastics Co., Inc.

CIRCLE NO. 353

Get low-cost transient protection in a microcircuit package.

Capable of deflecting overvoltage transients in 50 nano-seconds or less, the new TRANSTECTOR* Circuit Protector Hybrid Crowbar can operate in circuits carrying up to 10 Amps. Standard overvoltage trip points from 5 to 200 VDC.

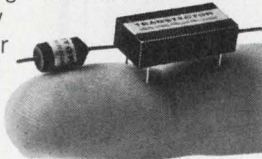

Conveniently packaged in standard dual in-line integrated circuit and DO-27 diode cases—it permits you to save space on your printed circuit or multi-layer boards by 3 to 1 over the old method of using discrete components.

Find out about Transtector Systems from M&T Chemicals Inc., 532 Monterey Pass Road, Monterey Park, Calif. 91754. Tel. (213) 283-9278.

*Trademark of M&T Chemicals Inc.

M&T Chemicals Inc. 
SUBSIDIARY OF AMERICAN CAN COMPANY

M&T can make you look good.

INFORMATION RETRIEVAL NUMBER 110

Soshin's One Finger Speciality Mica Capacitors

The only mica capacitors to pass evaluation testing by Japanese Government equivalent to **MIL-C-5D**

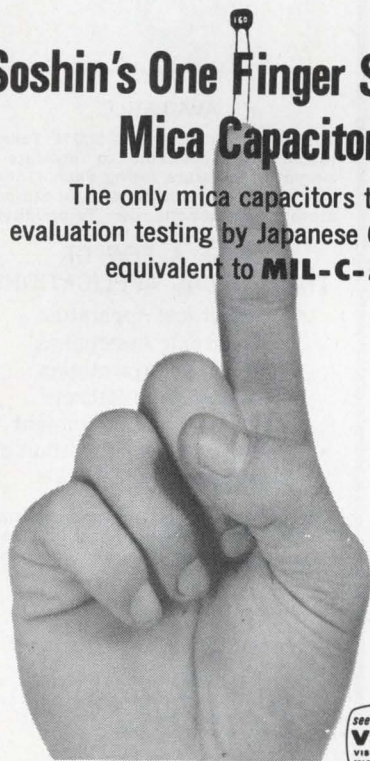

SOSHIN SOSHINELECTRIC CO., LTD.
Rm. 920, TOC Bldg. 22-17, Nishi-Gotanda 7-chome, Tokyo, Japan
Cables: SOSHINCAPACITOR Telex: 246-6501

INFORMATION RETRIEVAL NUMBER 111

ELECTRONIC DESIGN 25, December 6, 1970

Qwik-Ty* For Fast Strain Relief

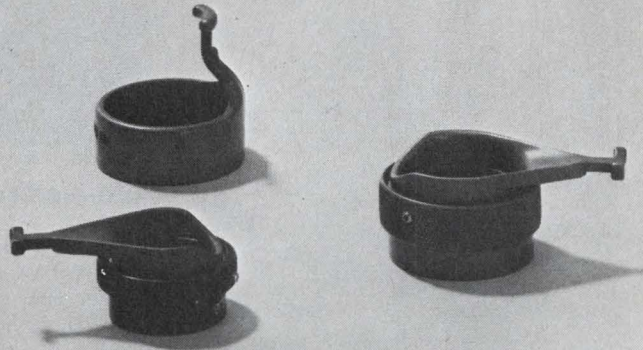

Qwik-Ty, New Connector-To-Cable Strain Relief

**THERE IS NOTHING LIKE IT
IN CABLE CLAMPS**

The new **LOW PROFILE 90°** and **Straight QWIK-TY's** are the first innovation in connector cable clamps in over 30 years! **QWIK-TY** relieves strain 6 times faster and weighs as much as 70% less than conventional cable clamps. Simply wrap a plastic tie strap or lacing tape around **QWIK-TY's** arm and wire bundles are captured and tightly secured . . . in seconds! It's that simple.

**INSTALLED COST — DOWN
WEIGHT SAVINGS — UP**

**AVAILABLE FOR ALL POPULAR
CYLINDRICAL CONNECTORS**

MIL-SPEC	Qwik-Ty SERIES	
	STRAIGHT	90°
MIL-C-5015	GTR05	GTR25
MIL-C-26482	GTR00	GTR20
MIL-C-26500/ 38300	GTR01	GTR21
MIL-C-38999	GTR84	GTR87
MIL-C-81511	GTR03	GTR23
MIL-C-83723 (threaded)	GTR86	GTR89
NAS-1599/ MIL-C-83723	GTR02	GTR22
DEUTSCH	GTR06	GTR26
MICRODOT	GTR08	GTR28
And Others		

For Fast Relief . . . call or write for demonstration and literature, today!

*U.S. and Foreign Patents Pending

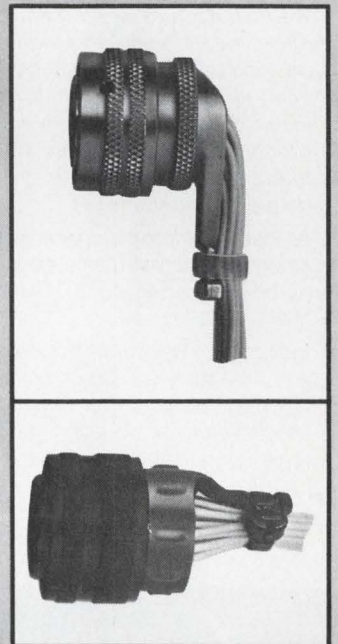

Glenair

GLENAIR, INC.
1211 AIR WAY / GLENDALE, CALIFORNIA 91201
PHONE (213) 247-6000 / TWX 910-497-2066
TELEX 67-3485

INFORMATION RETRIEVAL NUMBER 112

There is a difference in Heath Dynamics' Quartz Crystal Filters!

Heath Dynamics specializes in the design and manufacture of the highest quality Quartz Crystal Filters and Discriminators for the Communications Industry.

Our facility is completely new, inside and out, fully staffed and equipped with the most modern mechanical and electronic test measuring devices.

We employ the assistance of one of the largest time sharing computers available.

Heath Dynamics' area of specialization includes the manufacture of miniature and sub-miniature filters in the range of 10 thru 32 Mhz. Bandwidths may be from .025% thru .35% in the smallest packages and may range up to 2.0% in the larger ones.

We manufacture direct replacement filters for all the current monolithic designs using our half lattice configuration which yield lower insertion loss, lower ripple and greater ultimate rejection. Yet our filters cost less and faster delivery is guaranteed!

All Heath Dynamics' crystal filters designed and manufactured to your particular specifications meet Mil F. 18327.

In short, we want your business and we'll act like it. Do us both a favor and send us your print or specification for a quote. If you have any questions just write or call us...we're here to serve you.



**heath
dynamics, inc.**

6050 n. 52nd avenue
glendale, arizona 85301
(602) 934-5234

subsidiary of
Heath International, Inc., Richmond, Mich.

INFORMATION RETRIEVAL NUMBER 113

design aids

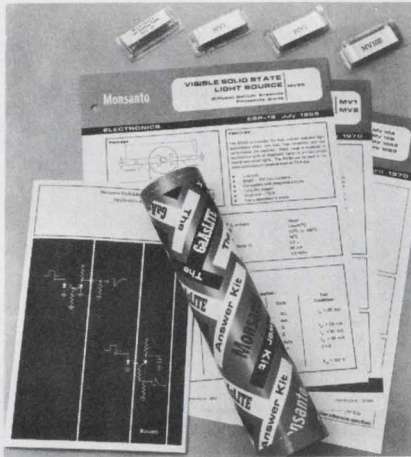

Opto-electronics kits

Two new design kits, the Interface Answer Kit and the GaAsLite Answer Kit, provide circuit designers with a wide variety of opto-electronic products with which to experiment. The former contains three different opto-isolators, each in a six-lead dual-in-line iso-dip package. They include the MCD2 photo-diode coupled pair with fast response, the MCT2 photo-transistor coupled pair with high gain and the MCS2 photo-SCR coupled pair for ac applications. The latter kit has four types of indicator lights: the green MV2, two amber MV1's, two red MV10B's and two red MV50's. These are packaged in TO-18 headers. Both design kits are available at a cost of only \$9.95 each. Monsanto Electronic Special Products.

CIRCLE NO. 354

LED selection chart

A complete chart for selecting GaAs LEDs is available. The selector guide provides a full description of LED characteristics that include wavelengths, brightness levels, forward voltage and current ratings, power output levels and manufacturer's names, to help the design engineer decide the best LED lamp for his application. Included with the selector guide is a semiconductor report which reviews the technology, products, pricing and economics of semiconductors. Semiconductor Specialists, Inc.

CIRCLE NO. 355

For a true record
of temperature
in service...

Tempilabel[®]

Easy to use . . .

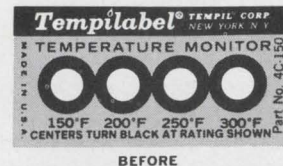

BEFORE

Easy to read



AFTER

Self-adhesive Tempilabels[®] assure dependable monitoring of attained temperatures. Heat-sensitive indicators, sealed under the little round windows, turn black and provide a permanent record of the temperature history. Tempilabel[®] can be removed easily to document a report.



AVAILABLE

Within the range 100° to 500°F Tempilabels[®] are available to indicate a single temperature rating each — and also in a wide choice of four-temperature combinations per Tempilabel[®].

JUST A FEW OF THE TYPICAL APPLICATIONS

- Electrical Apparatus
- Electronic Assemblies
- Appliance Warranties
- Aircraft and Rockets
- Machinery and Equipment
- Storage and Transportation of Heat Sensitive Materials.

For descriptive literature and a sample Tempilabel[®] for evaluation . . . (please state temperature range of interest).



132 WEST 22nd St., NEW YORK, N.Y. 10011
Phone: 212 • 675-6610 TWX: 212 • 640-5478

INFORMATION RETRIEVAL NUMBER 114

ELECTRONIC DESIGN 25, December 6, 1970

HYBRID MOS DIP MULTIPLEXER

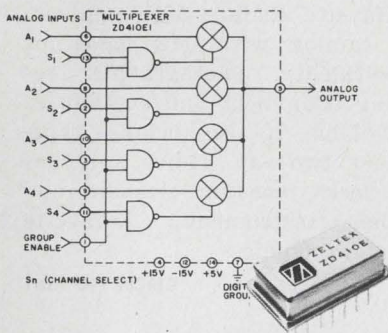

HYBRID/MONOLITHIC DESIGN

- DTL-TTL Compatible
- Power Off Isolation
- Hermetically-Sealed
- Operation -55 to 85°C

The ZD410E1 is a four-channel multiplexer featuring MOS switches and a patented "power off" isolation of 10 megohms. Channel "off" impedance is 100 megohms. The multiplexer is DTL and TTL compatible and offers excellent performance in both low and high level data applications.

Accuracy of the unit is specified at 0.01% with crosstalk less than 2 mV for 20V p-p input signal (1 kHz). The multiplexer accepts -5V to $+10\text{V}$ or $\pm 10\text{V}$ input signals with input capacitance of less than 25 pF for selected (ON) channel. Additional features include enable input, single-line control, and standard DIP pin spacing.

ZELTEX also offers a complete line of 8 to 15-bit conversion products; as well as operational amplifiers, function modules and power supplies. See our complete catalog in the 1970-71 EEM, Volume 2, pages 1344-1347 or call 415-686-6660, TWX 910-481-9477.

*The New Leaders in
Hybrid/Monolithic Products*

Zeltex INC.

A SUBSIDIARY OF REDCOR CORP.
1000 Chalamar Road - Concord, California 94520

INFORMATION RETRIEVAL NUMBER 115

application notes

110-degree TV design

A twenty-page booklet entitled "Single-stage circuit and equalisation of pincushion distortions for 110° colour TV sets" details circuit design requirements for color TV sets that use 110-degree deflection systems. It includes an abundance of sketches and schematic diagrams illustrating the topics covered. AEG-Telefunken Corp.

CIRCLE NO. 330

Microwave measurement

A swept-frequency microwave measurement system is explained in detail in an application note. It shows how fixed-frequency or octave-band swept measurements may be made over an 80-dB dynamic range over the frequency range of 100 MHz to 40 GHz. Some of the measurements described include insertion loss, bandpass-filter and directional-coupler characteristics, swept standing-wave ratios and attenuator and reflectometer characteristics. Scientific-Atlanta, Inc.

CIRCLE NO 331

D/a/d converters

The principles of d/a and a/d converters are explained in an eight-page technical application note. It begins with a description of principles of temperature compensation in quad switches which depend on a closed-loop current-forcing scheme and explains the inherent gain correction provided by the inclusion of amplifier feedback resistors within thin-film resistor packages. The practical design aspects of a typical 0.01%-accurate 12-bit d/a converter are also dealt with. Among the points further discussed are techniques for stamping out possible parasitic oscillations, temperature compensating tricks and cascading arrangements for binary and BCD operations. Analog Devices, Inc.

CIRCLE NO. 332

Now the famous 829 has a "G" for good measure!

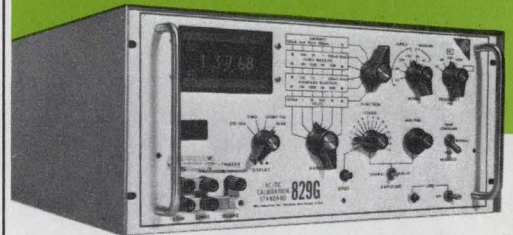

Calibrate or Measure
with the

RFL Model 829G

RFL's famous 829, for 15 years the industry calibration standard, now gives way to the new 829G — still the industry calibration standard, but now it's twice as useful. The 829G provides a precision source of AC and DC volts, amps and ohms — plus precision measurements of these parameters from external sources. It offers four-terminal sensing in both source and measurement modes, and high accuracy, resolution and regulation, with 5-digit readout. 5 ranges of AC or DC, 0.1 to 1000V. 6 ranges of current, 100 μA to 10A. 50, 60, 400, 1000 Hz AC plus EXT. And many other features — all for just \$3,350. Write for complete data today. RFL Industries, Inc., Instrumentation Div., Boonton, New Jersey 07005. Tel: (201) 334-3100 / TWX: 710-987-8352 / CABLE RADAIRCO, N. J.



RFL Industries, Inc.

NEW Mini-Module Regulated dc POWER SUPPLIES

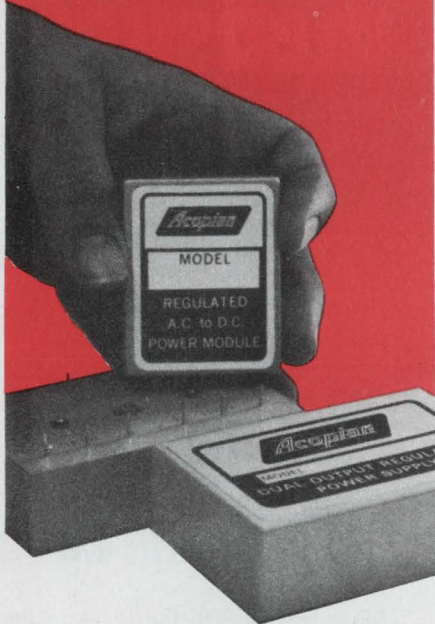

Now you can save space and improve reliability by mounting an Acopian mini-module power supply directly into a printed circuit board. Sizes start at 2.32" x 1.82" x 1". Both single and dual outputs are available. And the duals can be used to power op amps or for unbalanced loads. Other features include:

- Choice of 58 different single output modules ranging from 1 to 28 volts, 40 ma to 500 ma
- 406 combinations of dual output modules with electrically independent, like or different outputs in each section
- 0.02 to 0.1% load and line regulation, depending on model
- 0.5 mv RMS ripple
- Prices as low as \$39 for singles, \$58 for duals

Do you have the latest Acopian catalog? It lists over 82,000 AC to DC power modules for industrial or MIL-spec applications. For your copy, write Acopian Corp., Easton, Pa. 18042, or call (215) 258-5441. And remember, every Acopian power module is shipped with this tag...



INFORMATION RETRIEVAL NUMBER 117

new literature

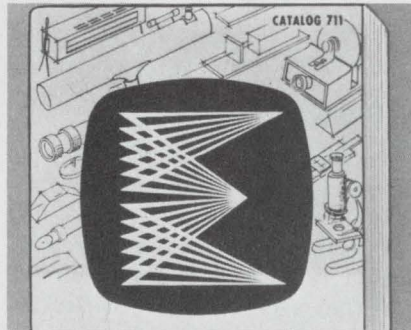

Edmund Scientific catalog

Just about any scientific and optical item from a 95¢ lens used in the Apollo mooncraft to a \$4210 laboratory lens can be found in the 1971 148-page Edmund Scientific catalog. Over 4000 unusual items are crammed between its covers. Edmund Scientific Co.

CIRCLE NO. 356

Analog instrumentation

A 48-page condensed product guide provides designers with a convenient reference manual for selection guidelines, application tips, and operating techniques for analog instrumentation. Teledyne Philbrick Nexus.

CIRCLE NO. 357

Potentiometers

Over 100 precision potentiometers are detailed in a 20-page brochure. Bourns, Inc., Trimpot Div.

CIRCLE NO. 358

Thermocouples

A six-page brochure on thermocouple assemblies includes standard, angle-type, and pipe-extended assemblies. Pyco, Inc.

CIRCLE NO. 359

Tubes and semiconductors

More than 23,000 types of electron tubes and semiconductors are covered in this 60-page price-list catalog. Sections include: industrial cathode-ray tubes, tube-replacement transistors and SCRs and ICs. JSH Electronics, Inc.

CIRCLE NO. 360

Lafayette catalog

Lafayette Radio's 50th anniversary catalog with 112 pages of stereo-fidelity, photographic, recording equipment and accessories is available. It also includes typewriters, two-way radios, watches and clocks, vacuum cleaners and weather instruments. Lafayette Radio Electronics.

CIRCLE NO. 361

Linear IC chips

Linear IC chips that include operational amplifiers, voltage regulators, video amplifiers, comparators, multipliers, transistor arrays and sense amplifiers are shown in a 12-page catalog. Silicon General, Inc.

CIRCLE NO. 362

Ultra-microfiche

A six-page folder explains and illustrates the new ultra-microfiche technology which makes it possible to place as many as 6000 images on a transparent plastic card measuring 3 by 5 or 4 by 6 in. Images Enterprises, Inc.

CIRCLE NO. 363

Cords and plugs

A twelve-page catalog lists a variety of patch, switchboard and test cords and test plugs. Lynn Electronics Corp.

CIRCLE NO. 364

Miniature inductors

A new brochure describes a line of miniature inductors for micro-circuit applications. Cambridge Thermionic Corp.

CIRCLE NO. 365

High-voltage devices

A new 32-page catalog includes electrical and mechanical specifications along with application and dimensional data for high-voltage lead assemblies, harnesses, receptacles and hermetically sealed connectors. Capitron Div. of AMP Inc.

CIRCLE NO. 366

Mini Bus by Rogers

For noise and
cost reduction

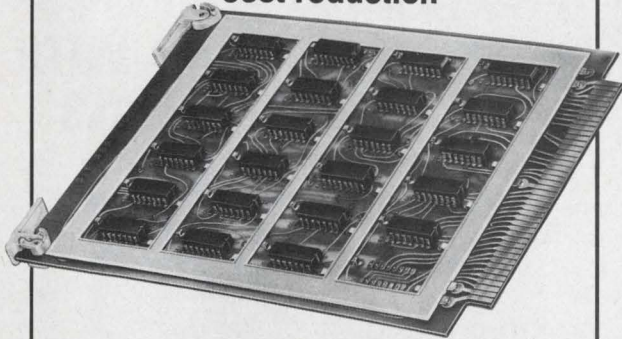

A small, voltage-distributing busbar for PC card application, each Mini/Bus gives you built-in capacitance . . . noise-cutting capacitance that means more reliable, compact circuit packaging at a fraction of multilayer prices. Write for data.



Rogers Corporation / Rogers, Conn. 06263

INFORMATION RETRIEVAL NUMBER 118

Last chance to get the new Alpha Catalog

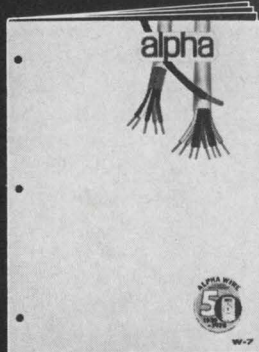

It's all here. Everything in wire, cable and tubing. Organized for quick and easy reference, fully illustrated, and with all applicable specs and buying information. Check the reader service card to assure your copy of the best read, most widely used catalog in the industry. Alpha Wire, 711 Lidgerwood Avenue, Elizabeth, New Jersey 07207.

FREE SAMPLE . . . Fit® soldering sleeves, a new concept in one-step insulating and soldering. Request on company letterhead.



Alpha Wire • Division of Lorain Corporation

INFORMATION RETRIEVAL NUMBER 119

ELECTRONIC DESIGN 25, December 6, 1970

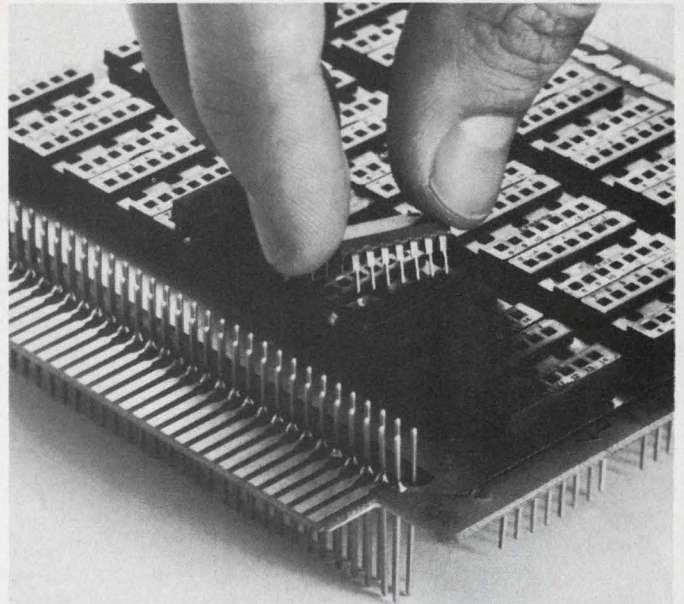

use our wire-wrap* combi-cards to keep your ic's in line

Matter of fact, we'll help you package whole IC sub-systems. Start with our 4.5 x 4.5 inch or 4.5 x 9.25 inch Cambi-Card® printed circuit boards with 70-pin input/output edge connectors, containing Wire-Wrap sockets for 14, 16 or 24-pin dual in-line IC's. Then our precision fabricated card files with 13 or 26 positions. Next our 13 or 26 position power planes.

And if you need 'em, our card extenders, Wire-Wrap card connectors, blank Cambi-Cards for discrettes, pluggable/patchable breadboards for 16, 32 or 64 DIPS, patch cord kits . . . even our super fast, economical wire-wrapping service.

For details, call us or write for Catalog 92, the latest word on IC accessories and wire-wrapping. Cambridge Thermionic Corporation, 445 Concord Avenue, Cambridge, Mass. 02138. Phone: (617) 491-5400. In Los Angeles, 8703 La Tijera Boulevard 90045. Phone: (213) 776-0472.

*Registered Mark of Gardner-Denver Co.

Standardize on

CAMBION®

The Guaranteed Electronic Components

INFORMATION RETRIEVAL NUMBER 120

SHIELDED BOXES

Take
your
pick.

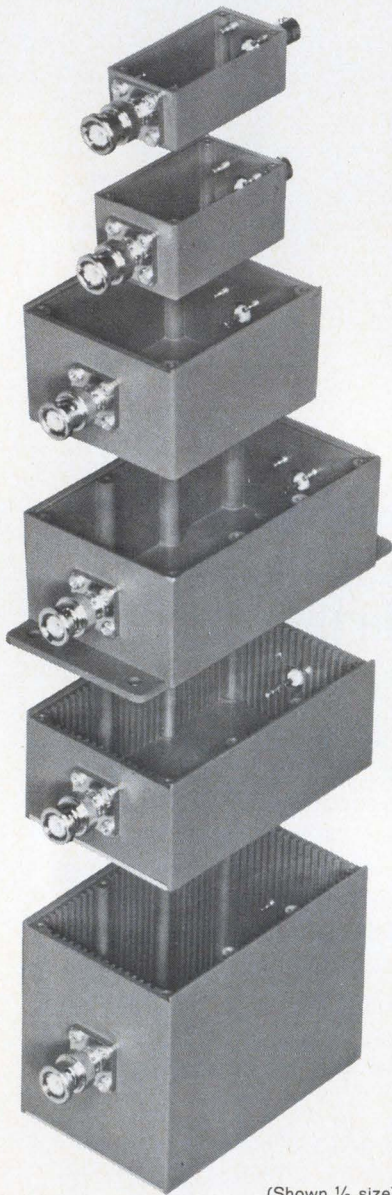

(Shown 1/3 size)

The newly expanded line of Pomona Shielded "Black Boxes" now comes in six different sizes; in cast or extruded aluminum; some slotted to accept circuit boards; in a broad choice of connector combinations or no connectors. There's bound to be one to meet your requirement. Write for complete information in our General Catalog.

**POMONA
ELECTRONICS**

1500 E. Ninth Street • Pomona, California 91766

NEW LITERATURE

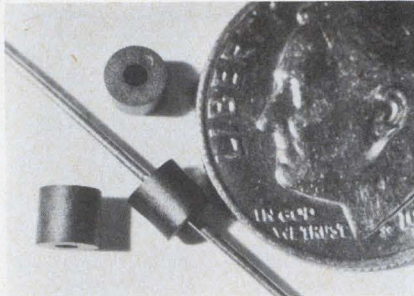

Ferrite beads

A four-page brochure describes several ferrite bead materials of standard sizes, and gives application notes. Ferronics Inc.

CIRCLE NO. 367

Dc power kits

An extensive catalog describes 450 professional dc power supply kits, regulated by the engineer and technician. Kits are available in choke or capacitor-input versions and with 0.15 or 0.01% regulation. Techni-kit Div., Universal Electronics Co.

CIRCLE NO. 368

IC sockets

A 38-page catalog lists IC sockets, systems, and accessories for dual-in-line, flat-pack, and TO-5 IC products. Robinson-Nugent, Inc.

CIRCLE NO. 369

Hardware

Catalog AM-1 lists captive panel screws, retainers, standoffs, handles, ferrules, washers, spacers, terminals and self-locking nuts. Electronic Hardware Corp.

CIRCLE NO. 370

Potentiometers

Specifications on a series of 10-turn precision potentiometers are contained in a new brochure. Beckman Instruments, Inc.

CIRCLE NO. 371

Dry reed relays

Seventeen pages of detailed specifications for 56 types of PC-board dry reed relays are included in a new catalog. C.P. Clare & Co.

CIRCLE NO. 372



A single pair of wires, or a leased telephone line, can carry the audio signals for a complete control system.



For inaccessible areas or mobile installations, a radio transmitter and receiver system can carry the signals.

REMOTE CONTROL SWITCHING WITH AUDIO SIGNALS

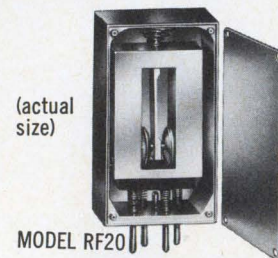

(actual size)

MODEL RF20
contactless resonant
reed encoder/decoder
.395 x .620 x 1.100

An audio tone can be generated by an electronic oscillator or resonant reed encoder circuit, then transmitted by wire or radio. The tone activates a resonant reed relay to perform a control function.

Bramco reeds permit over 100 selective control frequencies within the 67 to 3000 Hz. spectrum. This is assured by: (1) the narrow response band-width of about 1% for decoders and (2) the high accuracy of Bramco reed encoders (1/10 of 1% of design frequency).

A big advantage of reeds in control switching is that they are ideally suited for simultaneous and sequential coded tone systems. The actual number of control functions possible in such a system is virtually unlimited. For example, over 3300 individual control functions are possible with only 16 frequencies coded sequentially in groups of three.

Compared to other types of tone filters, resonant reeds are small and inexpensive. They give more control functions per spectrum, per size, per dollar.

If you work with controls that select, command, regulate, or indicate, you should know how it can be done with audio signals. We custom design and stock a broad line of encoder/decoder components and modules. Bramco also custom designs LC filters from 0 to 200 KHz.

For literature write Bramco Controls Division, Ledex Inc., College and South Streets, Piqua, Ohio, or call 513-773-8271.

LEDEX

**BRAMCO CONTROLS DIVISION
LEDEX INC.**

College and South Streets, Piqua, Ohio 45356

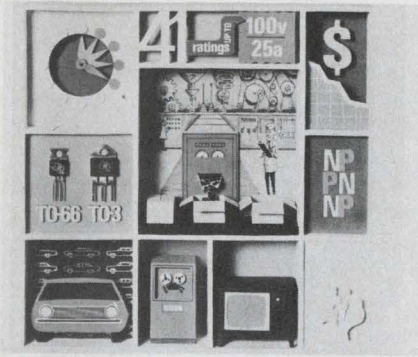

Transistors

A six-page economy transistor brochure covers an expanded line of 41 plastic-encapsulated silicon power transistors. An easy-to-read chart lists electrical parameters for each device. Texas Instruments, Inc.

CIRCLE NO. 373

Data transmission

New devices for data transmission in industrial monitoring and control systems are shown in a 12-page brochure. Larse Corp.

CIRCLE NO. 374

Toroids

A line of packaged toroids for pulse applications is featured in a catalog. The new line is available in core sizes from 1/16 to 1/2-in. inside dia. James Electronics Inc.

CIRCLE NO. 375

S/d converters

A variety of single and multi-channel synchro-to-digital converters are included in a brochure. Singer-General Precision, Inc., Kearfott Div.

CIRCLE NO. 376

Clock oscillators

A four-page brochure details crystal-controlled clock oscillators that are TTL/DTL compatible. Vectron, Laboratories, Inc.

CIRCLE NO. 377

Manual switches

A new 64-page catalog contains a variety of pushbuttons, indicators and toggle switches. Micro Switch Div. of Honeywell, Inc.

CIRCLE NO. 378

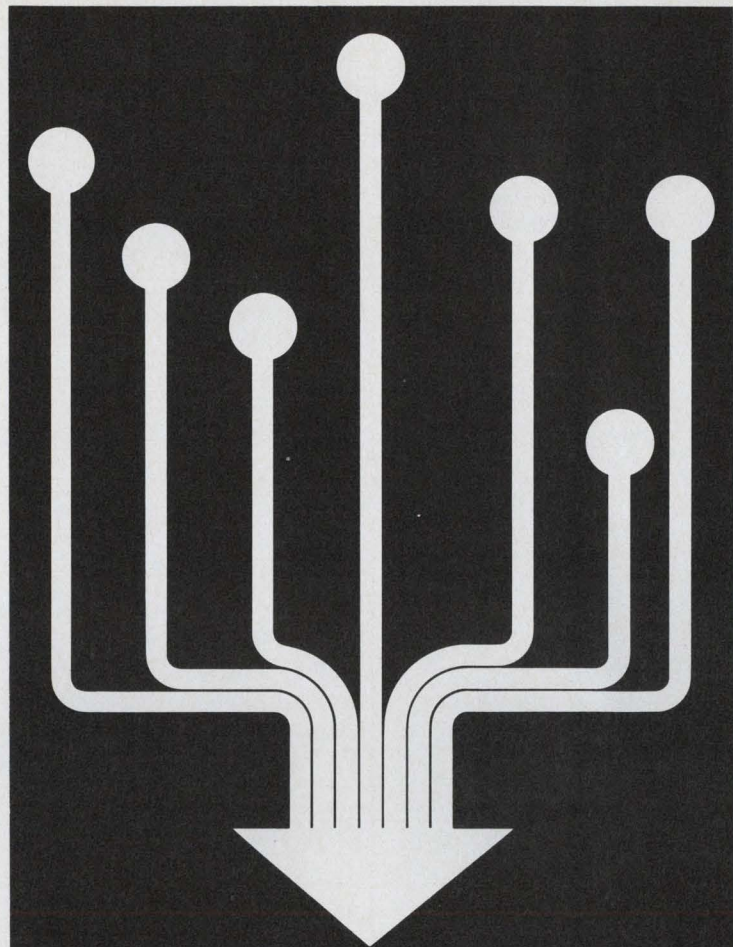

Buy only what you need for your signal scanning requirements.

You can now select the exact scanning equipment you need—no more, no less. The new Cunningham 2000 Series includes two addressable scanning switch modules—crossbar and reed. Also a universal control module which can be mated with either for a complete scanner (which can also be controlled remotely).

Buy these units complete, or their switch and control modules separately



Model 2400 Crossbar Scanner. Includes:
1. Crossbar Module (Model 2100) with capacity from 100 six-wire to 600 single-wire channels. Scans up to 60 channels/sec.
2. Control Module (Model 2300) can control more than one Crossbar Module.

Model 2500 Guarded Reed Scanner.

Includes: 1. Reed Switch Module (Model 2200) with 10 to 100 three-wire channels. Scans up to 250 channels/sec. 2. Control Module (Model 2300) can control up to 10 Reed Switch Modules (1000 channels).

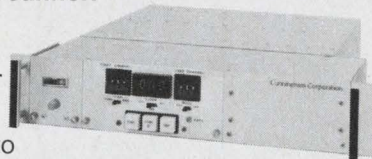

Both scanners and their switches are especially ideal for low-level and low thermal switching, accept BCD address (other optional), and are modular, expandable and 19" rack-mountable. Read the details on Model 2400 (Bulletin 324) and Model 2500 (Bulletin

325). Write Cunningham Corporation, 10 Carriage Street, Honeoye Falls, New York 14472.

Cunningham Corporation

SUBSIDIARY OF GLEASON WORKS

INFORMATION RETRIEVAL NUMBER 123

Avantek chip transistors now available for thin film circuitry!

Avantek, leading producer of thin film microwave amplifiers and microwave transistors, now offers a complete line of small-signal, VHF, UHF, L and S Band silicon chip transistors.

Ideal for companies desiring to build their own integrated circuits, Avantek chip transistors feature:

- 1) Low noise figure...VHF through S Band.
- 2) Gold metallization.
- 3) Wide selection of performance options.
- 4) Availability from stock to 30 days ARO.

Representative models include:

Freq. Band	Chip Type	Generic Avantek Model
VHF	CT-25 CT-25A	AT-25 AT-25A, AT-25B
UHF	CT-51 CT-50A CT-55	AT-51, AT-52 AT-50, AT-50A AT-55
L BAND	CT-24 CT-24A	AT-241, AT-242 AT-240, AT-240A
S BAND	CT-20A CT-20B CT-30 CT-22 CT-32	AT-201, AT-201A AT-201B AT-301, AT-301A AT-220 AT-320

In addition, every packet of Avantek chip transistors is guaranteed to be traceable to the same wafer.

For the finest in MIC designs and circuitry, specify Avantek chip transistors.

Avantek

Avantek, Inc. 2981 Copper Rd.,
Santa Clara, Ca. 95051
Phone: (408) 739-6170
Cable: AVANTEK

Advanced engineering opportunities are now available. Avantek is an equal opportunity employer.

NEW LITERATURE

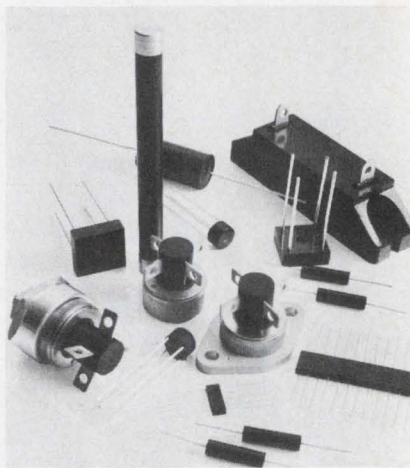

Silicon rectifiers

A 12-page catalog contains detailed information on integrated bridge, epoxy bridge and high-voltage diffused silicon rectifiers. Varo Semiconductor Div.

CIRCLE NO. 379

Stepper motors

An expanded line of stepper motors and controllers is contained in a new four-page bulletin. Clifton Div. of Litton Industries.

CIRCLE NO. 380

Function modules

A new eight-page short-form catalog lists specifications and applications of a/d and d/a converters, sample-hold modules, multiplexers and comparators. Analog Devices, Inc.

CIRCLE NO. 381

Hall effect devices

Hall effect devices such as gaussmeters, Hall multipliers, magnet processing systems, nondestructive testers and wattmeter transducers are shown in a short-form catalog. F. W. Bell, Inc.

CIRCLE NO. 382

Component ovens

Specifically designed for the engineer requiring a temperature-controlled environment, a new handbook/catalog provides useful definitions and illustrations of temperature-controlled component ovens. Oven Industries, Inc.

CIRCLE NO. 383



THIS IS A RELAY

A MERCURY-WETTED RELAY THAT OPERATES IN ANY POSITION

Don't be fooled by the dual-in-line package. It's a Logcell® mercury-film relay that is completely compatible with DTL/TTL power driver IC's. It operates in any mounting position without contact bounce. And you can mount it into DIP-drilled printed circuit boards or DIP sockets without special handling. Other features include:

- Long life—tested to billions of cycles
- 2.5 millisecond speed
- Thermal noise less than 1 microvolt
- AC noise below instrumentation levels
- 10^{-6} to 1 ampere load switching range
- Open circuit resistance in excess of 10,000 megohms
- 0.05 ohms maximum contact resistance
- Available in bi-stable or mono-stable configurations

Logcell DIP relays open new vistas of switching system operation and packaging. For more information, write Fifth Dimension Inc., Box 483, Princeton, New Jersey 08540 or call (609) 924-5990.

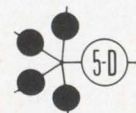

FIFTH DIMENSION INC.

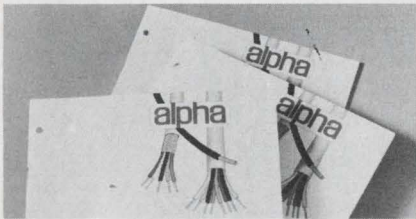

Wire products

A colorful 72-page illustrated publication describes more than 7000 wire, cable and tubing products. Included are descriptions and specifications for products ranging from hook-up wire and multi-conductor cable to coaxial cable and zipper tubing. Alpha Wire Corp.

CIRCLE NO. 384

Switches

Illustrated and described in a 16-page catalog are precision switches and typical switch assemblies with actuators. Haydon Switch & Instrument, Inc.

CIRCLE NO. 385

Electrolytic capacitors

A new four-page folder features axial-lead and upright radial-lead low-voltage aluminum electrolytic capacitors. International Electronics Corp., Capacitor Div.

CIRCLE NO. 386

Switches

140 models of precision electric switches are covered in a 40-page publication which gives a complete cross-reference to other manufacturers' products. Robertshaw Controls Co.

CIRCLE NO. 387

Thick-film hybrids

Low-power thick-film hybrid circuits that include flip-flops, buffers, gates, drivers, binary modules and encoders are shown in a catalog. Spacetac Inc.

CIRCLE NO. 388

Capacitance bridges

Automatic capacitance bridges and classifiers are described in a new brochure. Teradyne, Inc.

CIRCLE NO. 389

spark & noise eaters

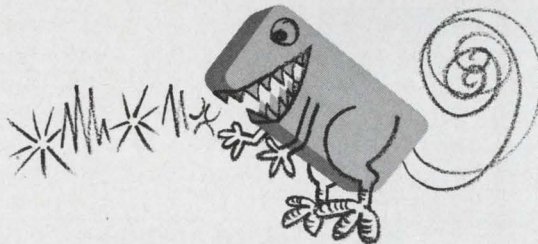

Electro Cube RC networks can chew and swallow at least 200,000,000 tough, jagged edge arcs, sparks and noise transients (when operated according to specifications). Standard molded units have 125 to 500 VAC, 200 to 2,000 VDC ratings. Custom metal or molded units, single or multicircuit, designed to your electrical, packaging and mounting requirements. Brochure on request. Call or write for engineering assistance. (213) 283-0511. 1710 South Del Mar Ave., San Gabriel, Calif. 91776.

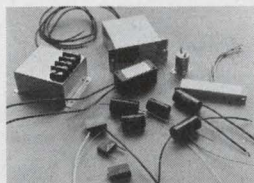

electro cube, inc.
Capacitors, RFI Filters, RC Networks

INFORMATION RETRIEVAL NUMBER 126

WesCo Aircraft and Industrial SOLENOIDS

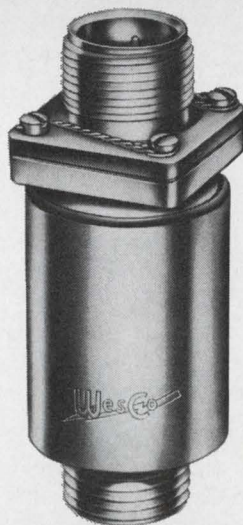

Let WesCo engineers help solve your aircraft or industrial solenoid problem. Hundreds of proven designs available, or WesCo will design to meet your specifications.

Here are some of the features available:

- High temp units exceed 500°F.
- Adjustable plunger travel
- Units pressure sealed to 10,000 p.s.i.
- Push or pull types
- Miniature, medium and heavy duty types
- All voltages available

Please write for our latest brochure and, remember, when you think of solenoids, think of WesCo!



The trademark on millions of solenoids since 1927

WEST COAST ELECTRICAL MFG. CO.

233 WEST 116TH PLACE, LOS ANGELES, CALIFORNIA 90061 · PHONE (213) 755-1138

INFORMATION RETRIEVAL NUMBER 127

10% OFF Call Now



Digital Panel Meters 3½ and 4½ digits

All of the high quality DPM's listed below are specially priced with a 10% discount in quantities of 1-9. If you call or write within 7 days as a result of this ad (you must mention this publication), you will receive a 10% discount card good for one month.

If you require specials for OEM applications such as ratiometers, comparators, or customs (mechanical/electrical) we would like to quote it and give you the best price.

**Take off 10% from these
Published 1-9 Prices**

3½ digit Model 510 Unipolar	\$195. Now \$175.50
3½ digit Model 520 Autopolarity	\$225. Now \$202.50
4½ digit Model 720 Autopolarity	\$370. Now \$333.00

I need complete specifications and information. Send literature!
 Send me a 10% discount card. No obligation. It's good for 30 days.

Model: 510 Quantity _____
 520 _____
 720 _____

Name _____

Title _____

Company _____

Address _____

City _____

State _____ Zip _____

Datascan Inc.

1111 Paulison Avenue, Clifton, New Jersey 07013
 (201) 478-2800

913

INFORMATION RETRIEVAL NUMBER 128

NEW LITERATURE

N/C equipment

A 32-page catalog describes a line of numerical controls plus auxiliary equipment. Covered are features and programming procedures of point-to-point positioning, point-to-point and straight-line milling, and continuous-path contouring controls. Superior Electric Co.

CIRCLE NO. 390

Wire strippers

A full line of hand and bench-mounted wire strippers is illustrated and described in an eight-page brochure. The brochure offers helpful suggestions on how to select the correct wire stripper for your specific requirements. Ideal Industries, Inc.

CIRCLE NO. 391

Reactive hybrid modules

Diagrams, specifications and performance curves for a line of reactive hybrid components are included in a five-page catalog. Relcom.

CIRCLE NO. 392

Resistors

Low-cost precision wire-wound resistors are described in an eight-page booklet which gives technical, price and availability information, specifications and power derating curves. General Resistance.

CIRCLE NO. 393

Connectors

A complete four-page test report on a series of connectors tested to MIL-STD-202, MIL-C-8384B, MIL-C-24308 (Navy) and MIL-C-24308 (modified) specifications is available. Microdot, Inc.

CIRCLE NO. 394

Microwave components

Broadband microwave components covering the frequency range of dc to 1 GHz are shown in a brochure. They include power dividers/combiners, couplers, mixers, baluns and rf impedance transformers. Olektron Corp.

CIRCLE NO. 395

Getting small components critically clean. Is it critical to your operation?



The Cobehn spray cleaning method gets small parts and assemblies critically clean. It's fast, efficient and easy. Just as important, it's been proven in hundreds of tough applications, both on an automated and manual basis.

This combination of versatility and critical cleanliness has made the Cobehn process ideal for cleaning a host of small components such as contacts in relays, switches, choppers and voltage regulators, as well as semiconductors, crystals, slip rings communicators, printed circuits, instrument and jewel bearings.

How does it work? In two ways. First, Cobehn Solvent, a fractionally distilled material of chemically pure composition, is power-sprayed against a component with a high velocity stream of filtered, heated air.

The solvent completely removes all traces of soluble materials such as oil, grease, silicone lubricants, resin flux and fingerprints. All without any trace of film or residue. The insolubles are then driven off the part by a blast of warm filtered air.

This combined liquid-scrubbing action leaves components totally free of contamination, critically clean and completely dry.

If you'd like more information, or a demonstration, write: Cobehn, Inc., 226 Passaic Avenue, Fairfield, N.J. 07006. Or call (201) 227-6675.

Cobehn

Proven parts cleaning.

INFORMATION RETRIEVAL NUMBER 129

ELECTRONIC DESIGN 25, December 6, 1970

bulletin board

of product news
and developments

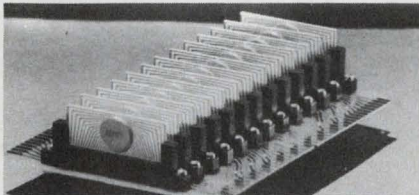

A new **leadless packaging system** for MOS LSI ICs that mounts on its edge has been jointly developed and produced by Texas Instruments, Attleboro, Mass., American Micro-Systems, Santa Clara, Calif. and Coors Porcelain, Golden, Colo. The system, which reportedly cuts LSI and IC packaging costs in half, uses a flat ceramic package with its leads metallized onto the ceramic substrate and an edgeboard connector.

CIRCLE NO. 396

To prove the uniformity, quality and reliability of its water-scribing equipment, Quantronix Corp., Smithtown, N.Y. is offering to **scribe a sample silicon wafer** to requested specifications, free of charge.

CIRCLE NO. 397

J. W. Microelectronics Corp., Philadelphia, Pa., has developed a 1-in.-square **hybrid circuit that incorporates both digital and linear circuits on one substrate**. The package houses thick-film and MOS ICs.

CIRCLE NO. 398

Ultra-high-speed LSI ICs having average propagation delays of 1.1 ns have been developed by Hitachi, Ltd. of Japan. Hitachi claims that the new ICs will cut computer sizes to one-tenth that of current models and increase computing speeds 20 times.

CIRCLE NO. 399

An experimental **silicon FET** with a 14-GHz cutoff frequency has been developed by scientists of IBM's Research Div., Yorktown Heights, N. Y.

ULTRA LOW DUAL-IN-LINE SOCKETS

PRECISION MACHINED CONTACTS

- Sockets available with 14 and 16 contacts in PC termination.
- Directly interchangeable! Terminal pattern and size identical to IC package.
- Molded glass filled nylon insulator with polarization notch.
- Raised numbers permit easy identification of contacts.
- .125 inch overall height.

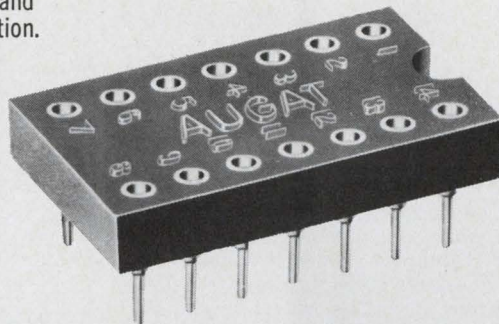

Request Data Sheet 166H



AUGAT INC.

TEL: 617/222-2202
31 PERRY AVE., ATTLEBORO, MASS. 02703

INFORMATION RETRIEVAL NUMBER 130

Where reliability really counts!

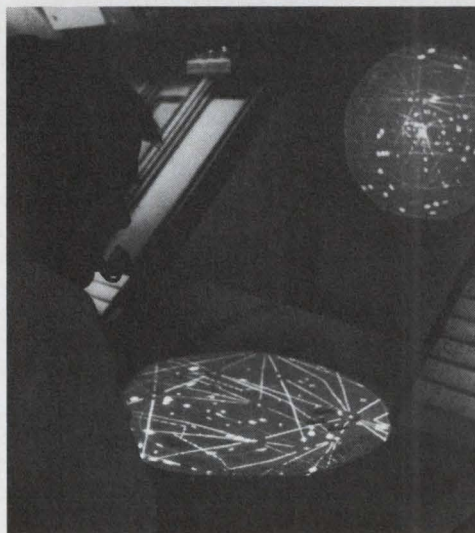

The reliability of Zenith Flat-Face Metal CRTs is demonstrated by their extensive use in enroute air traffic control centers and airports. When safety depends on reliability, Zenith is specified! Shouldn't you take advantage of Zenith CRT quality in your application? Write for details.

ZENITH ZENITH RADIO CORPORATION
THE RAULAND DIVISION

5616 W. JARVIS AVE. • CHICAGO, ILL. 60648 • 312-647-8000
INFORMATION RETRIEVAL NUMBER 131

ELECTRONIC DESIGN's function is:

- To aid progress in the electronics manufacturing industry by promoting good design.
- To give the electronic design engineer concepts and ideas that make his job easier and more productive.
- To provide a central source of timely electronics information.
- To promote two-way communication between manufacturer and engineer.

Want a subscription? ELECTRONIC DESIGN is sent free to qualified engineers and engineering managers doing design work, supervising design or setting standards in the United States and Western Europe. For a free subscription, use the postfree application form inside the back cover. If none is included, write to us direct for an application form.

If you do not qualify, you may take out a paid subscription for \$25 a year in the U.S.A., \$35 a year elsewhere. Single copies are \$1.50 each.

If you change your address, send us an old mailing label and your new address; there is generally a prepaid postcard for this inside the back cover. You will have to requalify to continue receiving ELECTRONIC DESIGN free.

The accuracy policy of ELECTRONIC DESIGN is:

- To make reasonable efforts to ensure the accuracy of editorial matter.
- To publish prompt corrections whenever inaccuracies are brought to our attention. Corrections appear at the end of the Letters column.
- To refuse any advertisement deemed to be misleading or fraudulent.

Microfilm copies are available of complete volumes of ELECTRONIC DESIGN at \$19.00 per volume, beginning with Volume 9, 1961. Work is now in process to complete the microfilm edition of Volumes 1-8. Reprints of individual articles may be obtained for \$2.00 each, prepaid (\$.50 for each additional copy of the same article) no matter how long the article. For further details and to place orders, contact the Customer Services Department, University Microfilms, 300 North Zeeb Road, Ann Arbor, Michigan 48106; telephone (313) 761-4700.

Want to contact us? If you have any comments or wish to submit a manuscript or article outline, address your correspondence to:

Editor
ELECTRONIC DESIGN,
850 Third Avenue,
New York, N.Y. 10022.

Crystal technology a mystery?



This free new 60-page illustrated ERIE Frequency Control Catalog will clear it up. Contains detailed information on . . . ERIE's complete line of crystals, crystal oscillators, crystal filters and ovens. Plus . . . the industry's most comprehensive refresher course in crystal, filter, oscillator and oven technology. Covers theory, production and design applications . . . MIL standards, environmental tests and mechanical hardware . . . all in understandable language. All you need to know to write specifications like an expert. Just off the press. Send for your copy now.

Erie Frequency Control
453 Lincoln Street, Carlisle, Pennsylvania 17013
(717) 249-2232 • Telex 084-2328

CIRCLE NO. 171

New PC Drafting Aids Catalog

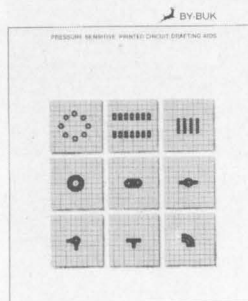

The By-Buk 1970-71 catalog of pressure sensitive printed circuit drafting aids is now available. With thousands of ideas to promote accuracy and efficiency in printed circuit master artwork layouts. Featured are new artwork patterns for: TO cans, multi-pads, dual in-lines and flat packs. Also the most comprehensive listings of conductor line tapes, pads, donuts, connector strips, elbows, corners, etc. Available in opaque black, transparent red and transparent blue materials. Send for your free catalog and samples.

By-Buk Company
4326 W. Pico Blvd.
Los Angeles, California 90019
(213) 937-3511

CIRCLE NO. 172

FUNDAMENTALS OF INTEGRATED CIRCUITS

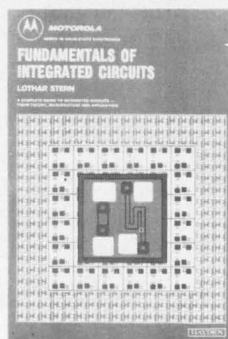

A practical guide to integrated circuits, their theory, manufacture, and applications. This new guide by Lothar Stern offers complete, highly readable coverage of the various techniques of circuit fabrication, and their effect on circuit design and performance. As to marketing considerations, it compares the characteristics of the numerous IC structures devised to date in terms of economics and logistics. A volume in the **Motorola Series in Solid-State Electronics**. 198 pages, 7 x 10, illustrated. \$8.95, clothbound. Circle the reader-service number below for 15-day examination copies.

Hayden Book Company, Inc.
116 West 14th Street
New York, N.Y. 10011

CIRCLE NO. 173

Manufacturers

Advertisements of booklets, brochures, catalogs and data sheets. To order use Reader-Service Card (Advertisement)

MINIATURE SOLID-STATE SERVO AMPLIFIERS



Send today for Bulova's 1970 Bulletin 100 on 400Hz Servo Amplifiers suitable for commercial, industrial and military applications. Listed servo amplifiers range from 2 to 40 watts output power. Includes complete electrical and physical spec information on an off-the-shelf line of Servo Amplifiers, with all related data necessary for the circuit designer. Easy-to-follow chart sets forth all related design guidelines from input to output characteristics. Design criteria of units described meet mil-spec requirements under MIL-E-5272, MIL-E-5400 and MIL-I-26600. Free copies of this 8-page bulletin available upon request.

Bulova Watch Company Inc.
Electronics Division
61-20 Woodside Avenue
Woodside, New York 11377

CIRCLE NO. 174

Improved 500-Line Analyzer Reads Peak Automatically

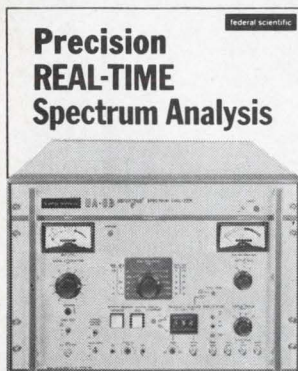

For on-line studies of noise, vibration, radar, underwater signals. The peak of a varying frequency component is automatically tracked by new UA-6B Ubiquitous® Real-Time Spectrum Analyzer — a constant readout can be produced regardless of frequency drift or variation; for direct plotting of amplitude vs rpm for a rotating machine, & long-term monitoring of single frequencies. Also 1000-line power spectral density analysis & improved hi-temp performance to 130°F. 40 kHz max. range, continuous input and output level monitoring, 5 mHz direct input, built-in capability for expansion into a real-time correlation & cross-PSD system. Send for catalog.

Federal Scientific Corporation
a subsidiary of Elgin National Industries, Inc.
615 West 131st Street, New York, N. Y. 10027

CIRCLE NO. 175

A guide to transducer design & operation

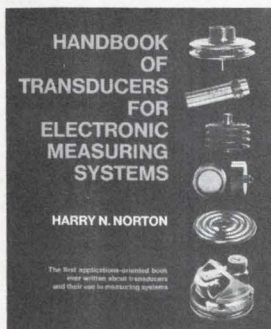

A practical guide describing virtually all existing transducers — their application, calibration, specification & testing. Cuts through the haze of trade names, telling all you need about the sensing end of test & data acquisition systems. 377 illustrations show low-cost uses & how to predict behavior under adverse conditions. Covers all physical measurands & helps save time, money & uncertainty in selecting & using transducers. Discusses devices such as photodiodes, shaft-angle encoders, contactless sensors, semiconductor nuclear-radiation sensors, & transducers with integral excitation. Pub. Oct. 1969, 704 pp., 377 illus., 7 x 9", \$27.95. Circle the reader service number below for a 15-day examination copy.

Prentice-Hall, Inc.
Englewood Cliffs, N. J. 07632

CIRCLE NO. 176

Electronic Design

Advertising Sales Staff
Keith Aldrich
Sales Manager

New York 10022
Robert W. Gascoigne
Samuel M. Deitch
Daniel J. Rowland
850 Third Avenue
(212) Plaza 1-5530
TWX: 867-7866

Philadelphia 19025
Mort Sullivan
P.O. Box 126
Dresher, Pa.
(215) 884-6880

Boston 02154
Joseph F. Palmer
1268 Main Street
Waltham, Mass.
(617) 894-2700

Chicago 60611
Thomas P. Kavooras
Berry Conner, Jr.
200 East Ontario
(312) 337-0588

Cleveland
Thomas P. Kavooras
(Chicago)
(312) 337-0588
(call collect)

Los Angeles 90303
Stanley I. Ehrenclou
Jerry D. Latta
2930 Imperial Highway
Inglewood, Calif.
(213) 757-0183

San Francisco 94022
Arthur R. Shields, Jr.
95 Main Street
Los Altos, Calif.
(415) 941-3084

London W. 1
For United Kingdom and Holland
Brayton C. Nichols
44 Conduit Street
Tel: REGent 4714

Verviers, Belgium
For Continental Europe
Andre Jamar
1, Rue Mallard, 1
(087) 253.83 Telex 41563

Tokyo
Haruki Hirayama
Electronic Media Service
5th Floor, Lila Bldg.,
4-9-8 Roppongi
Minato-ku
Phone: 402-4556
Cable: Electronicmedia, Tokyo



AMERICAN BUSINESS PRESS, INC.

advertiser's index

Advertiser	Page	Advertiser	Page	Advertiser	Page
AMP, Incorporated	10, 11	Erie Frequency Control	168	Philbrick/Nexus Research, A Teledyne Company	99
Abbott Transistor Laboratories Incorporated	13	Erie Technological Products, Inc.	52	Philips Electronic Measuring Instruments	149
Acopian Corp.	160	FMC Corporation	156	Pomona Electronics	162
Adams & Westlake Company, The.....	150	Fabri-Tek, Incorporated, National Connector Division	29	Practical Automation, Inc.	124
Aerovox Corporation	59	Federal Scientific Corporation	169	Precision Metal Products Co.	152
Aertech Industries, Inc.	145	Fifth Dimension, Inc.	164	Prentice-Hall, Inc.	169
Alco Electronic Products, Inc.	144, 152	Fluke Mfg. Co., Inc., John	60		
Allen-Bradley Co.	2, 20				
Aladdin Electronics, a Division of Aladdin Industries, Inc.	151	General Electric Company	51, 91	RCA Electronic Components and Devices	12, 131, Cover IV
Alpha Wire, a Division of Loral Corporation	161	Genisco Technology Corporation	64	RFL Industries, Inc.	159
American Lava Corporation	43	Glenaire, Inc.	157	Relcom	108, 109
Analogue Corporation	138	Gould, Inc., Graphics Division	76, 77	Remex Electronics Division of Ex-Cello Corporation.....	120, 124, 128, 133, 135
Aritech Corp.	148	Grayhill, Inc.	120	Rogan Brothers, Inc.	136
Arnold Engineering Company, The....	56			Rogers Corporation	161
Atlee Corporation	40	Hamlin, Inc.	62	Rohde & Schwarz	128B
Augat, Inc.	167	Hayden Book Company, Inc.	128B, 168, 171		
Automatic Electric Company	14, 15	Heath Dynamics, Inc.	158	Sercel	128C
Avantek, Inc.	164	Hewlett-Packard	1, 4, 5	Servo Tek Products Company	130
		Hipotronics, Inc.	148	Signalite Division of General Instruments	125
		Honeywell, Computer Control Division	55	Signetics Corporation	27
		Honeywell Test Instrument Division	141	Silicon General, Inc.	57
Bodine Electric Company	44			Solitron Devices, Inc.	121
Boston Insulated Wire and Cable Company	134	Inland Controls, A Division of Kollmorgen	132	Soshin Electric Co., Ltd.	157
Bramco Controls Division, Ledex, Inc.	162	International Electronic Research Corporation	143	Spectra Electronics, Inc.	106
Bud Radio, Inc.	95			Sprague Electric Company	18
Bulova Electronics Division of Bulova Watch Company	7	Janco Corporation	136	Stackpole Carbon Company	50
Bulova Servo Products Electronics Division of Bulova Watch Company	169	Johanson Manufacturing Corp.	42	Systems Engineering Laboratories 34, 35	
Burndy Corporation	111				
By-Buk Company	168	Keithley Instruments, Inc.	6	TRW, Inc., Capacitor Division	116
		KEV Electronics Corp.	142	Tektronix, Inc.	47
Cambridge Thermionic Corporation	161			Teletype Corporation	84, 85
CELCO (Constantine Engineering Laboratories Co.)	147	Ledex Microelectronics, Ledex, Inc.	126	Tempil Division of Big Three Industrial Gas and Equipment Co.	158
Celanese Plastics Company	24			Triplett Corporation	139
Centralab Semiconductor Division, Globe-Union, Inc.	101	3M Company, Chemical Division.....	123	Tung Sol Division, Wagner Electric Corporation	155
Clare & Co., C. P.	53	M & T Chemicals, Inc.	157		
Cobehn, Inc.	166	Magnetics, A Division of Spang Industries, Inc.	8, 9	Unitrode Corporation	31, 33
Cohn Corp., Sigmund	122	Malco Mfg. Company, Inc.	58		
Constantine Engineering Labs. Co. (CELCO)	147	Mallory Capacitor Company	127	Varadyne Systems, A Division of Varadyne, Inc.	63
Control Data Corporation	146	Midtex, Incorporated, Aemco Division	41	Vero Electronics, Inc.	140
Cunningham Corporation	163	Molex, Incorporated	23	Victoreen Instrument Division	153
		Monsanto Company	Cover III		
Dale Electronics, Inc.	Cover II	Motorola Semiconductor Products, Inc.	16, 17, 48, 49, 115		
Damon/Electronics Division	69			Wang Laboratories, Inc.	97
Datascan, Inc.	166	North Atlantic Industries, Inc.	61	West Coast Electric Mfg. Co.	165
Daven, Division of McGraw-Edison	119	Nu-Devices, Inc.	154		
Douglas Randall, Inc.	155			Xerox Data Systems	93
Dow Corning Corporation.....	54, 72, 73	OPCOA, Inc.	137		
				Zeltex, Inc.	159
Edmund Scientific Company	144			Zenith Radio Corporation	167
Electro Cube, Inc.	165				
Electro-Motive Mfg. Co., Inc., The....	129				
Electronic Coil Corporation	128				
Electronic Design	114				
Electronic Memories, Inc.	102, 103				
English Electric Valve Co., Ltd.....	128A				

Up-to-date and thorough PE Examination Guides

These two volumes offer the most convenient and economical coverage of the subject matter that must be mastered to successfully pass the preliminary examination (Engineer-in-Training) and the final examination for the professional license in electrical engineering.

Each concise, carefully organized volume presents problems from recent state examinations together with complete step-by-step solutions. Providing rapid access

to important topics, vital for "open book" examinations, each also includes numerous pertinent illustrations and lists of references for further study.

Prepared by practicing engineers, the books have been written on the premise that the reader is versed in engineering, and that he is approaching the time when his State Board of Examiners will consider him qualified for taking the examinations.

BASIC ENGINEERING SCIENCES AND STRUCTURAL ENGINEERING FOR ENGINEER-IN-TRAINING EXAMINATIONS

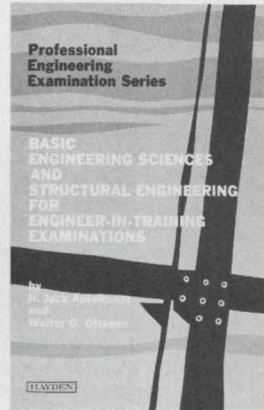

ELECTRICAL ENGINEERING AND ECONOMICS AND ETHICS FOR PROFESSIONAL ENGINEERING EXAMINATIONS

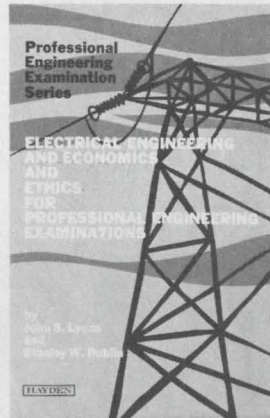

H. JACK APFELBAUM, P.E., Department of Mechanical Engineering, Lowell Technological Institute; and WALTER O. OTTESEN, P.E., Patent Counsel

JOHN S. LYONS, P.E.; and STANLEY W. DUBLIN, Institute of Environmental Medicine, New York University Medical Center

Comprehensive and well balanced in its coverage of the concepts and techniques fundamental to all areas of engineering practice, this volume presents nearly two-hundred problems carefully chosen from recent examinations given by the individual states. Typical of the material the reader is likely to encounter in Engineer-in-Training Examinations, these are conveniently arranged by subject, and cover three broad areas: background material in mathematics, physics, and chemistry; the basic engineering sciences: statics, dynamics, fluid mechanics, thermodynamics, electricity, and engineering economy; and seven chapters detailing topics in structural engineering. Introductory sections precede each subject area and its fully worked-out problems, providing background in the specific concepts, principles, and terminology. More than three-hundred detailed illustrations insure a complete grasp of problem-solving techniques. #5712, 408 pages, illustrated, \$13.95

Presenting a wide range of problems in electrical engineering, this book concentrates on the subjects and topics that form the basis for an ever-changing technology. The portion of the book devoted to economics and legal and ethical considerations is equally complete, providing in-depth understanding that will prove valuable in future engineering assignments.

Almost one-hundred problems in electrical engineering range from basic circuitry to the uncategorizable "bonus" problems frequently encountered in examinations. More than one-hundred-seventy illustrations illustrate the text. The section on economics features an unusual approach to such topics as interest, costs, valuation, and the like — the summarized use of formulas in solving nearly fifty typical problems. #5715, 320 pages, illustrated, \$12.95.

Hayden Professional Engineering Examination Series, LAWRENCE J. HOLLANDER, P.E., Editor-in-Chief. Subsequent volumes will focus on mechanical and civil engineering.

Send no money — clip or duplicate this coupon today!

15-DAY FREE EXAMINATION

Please send the book(s) checked below on a 15-day free examination basis. At the end of that time, I will remit payment, plus postage, or return the book(s) without further obligation.

- #5712, Basic Engineering Sciences and Structural Engineering for Engineer-in-Training Examinations, \$13.95
- 5715, Electrical Engineering and Economics and Ethics for Professional Engineering Examinations, \$12.95
- Further information on the Hayden Professional Engineering Examinations Series



HAYDEN BOOK COMPANY, INC.
116 W. 14 St., New York, N.Y. 10011

Name _____

Firm/Institution _____

Address _____

City/State _____

71-34 1

Payment enclosed (Hayden pays postage). Same return guarantee. On all overseas orders payment in U.S. dollars must be enclosed.

product index

Information Retrieval Service. New Products, Evaluation Samples (ES), Design Aids (DA), Application Notes (AN), and New Literature (NL) in this issue are listed here with page and Information Retrieval numbers. Reader requests will be promptly processed by computer and mailed to the manufacturer within three days.

Category	Page	IRN	Category	Page	IRN	Category	Page	IRN
Components			Modules & Subassemblies			tools, plastic welding 155 321		
bridge, sychro	134	287	amplifier, DIP	138	293	ultra-microfiche (NL)	180	363
capacitors (NL)	165	386	amplifier, operational	140	296	new literature		
capacitors, Teflon chip	136	288	amplifiers, operational	138	292	analog instrumentation	160	357
converters, s/d (AN)	159	332	converters, s/d (NL)	163	376	beads, ferrite	162	367
delay line	134	285	decoder/drivers	140	297	bridges, capacitance	165	389
inductors (NL)	160	365	display, GaAsP	144	336	capacitors	165	386
oscillators, clock (NL)	163	377	displays, 7-bar-segment	144	335	chips, linear IC	160	362
potentiometers (NL)	160	358	driver, hexadecimal	146	338	connectors	166	394
potentiometers (NL)	162	371	hybrids (NL)	165	388	converters, s/d	163	376
readout, incandescent	132	283	ladder, 10-bit	140	295	cords and plugs	160	364
relays, reed (NL)	162	372	ladder, 12-bit	117	251	Edmund Scientific		
resistors (NL)	166	393	modules, function (NL)	164	381	catalog	160	356
resistors, chip	134	286	modules, reactive (NL)	166	392	Hall effect devices	164	382
resistors, silicon	136	289	oscillator, crystal	142	299	hardware	162	370
suppressors, transient	136	290	power kits, dc (NL)	162	368	high-voltage devices	160	366
surge protectors	132	284	power supplies, modular	142	298	hybrids, thick-film	165	388
switch, 14-pin DIP	132	282	readout, digital	138	339	inductors	160	365
switches (NL)	163	378	switch module	146	339	Lafayette catalog	160	361
switches (NL)	165	385	switches, decade	144	337	microwave components	166	395
switches (NL)	165	387	Microwaves & Lasers			modules, function	164	381
thermocouples (NL)	160	359	amplifiers, differential	130	277	modules, reactive	166	392
toroids (NL)	163	375	amplifier, 100-mHz	128	274	motors, stepper	164	380
tubes (NL)	160	360	amplifiers, thin-film	122	266	N/C equipment	166	390
tubing (ES)	156	353	attenuators, step	130	281	oscillators, clock	163	377
Data Processing			components (NL)	166	395	ovens, component	164	383
analyzer, distortion	152	346	detector, photon	130	280	potentiometers	160	358
calculator, 15-digit	152	347	detector, rf leakage	124	269	potentiometers	162	371
copier, display	152	345	diode, avalanche	130	278	power kits, dc	162	368
transmission, data (NL)	163	374	diodes, laser	130	279	rectifiers, silicon	164	379
ultra-microfiche (NL)	160	363	diodes, p-i-n	126	272	relays, reed	162	372
ICs & Semiconductors			emitters, IR	128	275	resistors	166	393
amplifier, sense	117	253	lamps, GaP	122	267	semiconductors	160	360
array, quad diode	118	257	LED chart (DA)	158	355	sockets, IC	162	369
chips (NL)	160	362	links, optical	122	268	strippers, wire	166	391
diode, 20-kV	118	258	opto-electronics (DA)	158	354	switches	165	385
driver/receivers, line	118	260	photocells	128	276	switches	165	387
hardware (ES)	156	352	pulser, thin-film	124	271	switches, manual	163	378
IC sockets (NL)	162	369	sensors, photo	122	265	thermocouples	160	359
ICs, MOS/LSI	117	252	switches, video	124	270	toroids	163	375
memories, read-only	118	255	transistors, 1-GHz	126	273	transistors	163	373
memory, random-access	118	259	Packaging & Materials			transmission, data	163	374
memory, random-access	120	264	beads, ferrite (NL)	162	367	tubes	160	360
multiplexer	117	254	breadboard, PC	153	349	ultra-microfiche	160	363
multiplexer, IC	120	262	connectors (NL)	160	394	wire	165	384
op amp, hybrid	117	250	cords (NL)	160	364	evaluation samples		
rectifiers (NL)	164	379	hardware (ES)	156	352	converters, s/d	159	332
regulator, dual	138	291	hardware (NL)	162	370	deflection design, TV	159	330
resistors, thin-film	118	256	plugs (NL)	160	364	microwave measure-		
semiconductors (NL)	160	360	sockets (NL)	162	369	ments	159	332
suppressor, transient	120	263	substrates, ceramic	153	348	design aids		
transistors (NL)	163	373	tubing (ES)	156	353	LED chart	158	355
voltage followers	118	261	wire (NL)	165	384	opto-electronics kit	158	354
Instrumentation			Tools & Engineering Aids			application notes		
bridge, Wheatstone	148	342	chart, LED (DA)	158	355	hardware, component	156	352
bridges (NL)	165	389	comparator, optical	154	351	tubing, heat-shrink	156	353
counter, frequency	148	340	drafting lighthouse	155	320			
generator, pulse	148	341	opto-electronics (DA)	158	354			
instruments (NL)	160	357	ovens (NL)	164	383			
line monitor/booster	150	333	probe system, PC	154	350			
system, instrument	150	334	strippers, wire (NL)	166	391			

99¢

Hooray! Price reductions for both red and amber GaAsLITEs.

Effective immediately, prices (suggested resale in 1,000 quantities) on our red light-emitting diodes MV 50, MV 10B and our amber GaAsLITE MV 1, have been cut to 99¢. Smaller quantity prices have gone down, too. Get the details from your distributor.

If you've been considering GaAsLITEs in sockets where you need good brightness, low power drive, high reliability, and ready availability, it's time to stop thinking and send a P.O. Wow! 99¢.

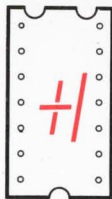

MAN 1001

New: Polarity and overflow display

Customers who have bought and used our MAN 1 displays asked us to build a ± 1 device to integrate into digital readout displays, cockpit instruments, and industrial controls.

Voila! the MAN 1001. Same size and package as the MAN 1 GaAsLITE display. Same high brightness (typ. 350 ft-L @ 20 mA) and IC-compatible power requirements (3.4V typ. forward voltage per segment @ $I_F = 20$ mA).

Suggested resale price, 100's: \$11.50 each.

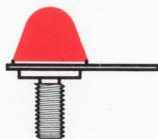

Meet Big Red, the MV 4

The GaAsLITE becomes an illuminator

Photography fans will be delighted to hear that we've developed the MV 4 series of light-emitting diodes. They put out 5,000 ft-L @ $I_F = 1.0$ A in the 6700 Å region, well above the sensitivity range of most photographic emulsions. Mounted in a TO-5 stud-type header, the MV 4 can take up to 1A continuous current in an efficient heat sink.

MV 4's will also serve well as high intensity locators and warning indicators when pulsed. They will handle peak currents of 25A at 1 μ sec, 300 pps limits.

Price: (resale, 100's) \$9.25.

Delivery: off the shelf.

GaAsLITE Update

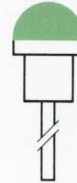

MV 2:

The green GaAsLITE is GO...

We are now in full production with our green solid-state light, the MV 2. Its active gallium phosphide puts out a very bright 300 ft-L in the 5600Å range @ 650 mA.

Packaged in a TO-18 header, the MV 2 completes the stop-wait-go color choices that display designers have been looking for.

Suggested resale price, 1,000's: \$3.75.

... and it's in our new GaAsLITE Answer Kit.

Creative display designers want new answers for panel indicator light problems. They'll find them, complete with applications ideas and design help, in our GaAsLITE Answer Kit, available from any Monsanto distributor worldwide for only \$9.95. Contains a volume of GaAsLITE Tips, two MV 50 and MV 10B red GaAsLITEs, two MV 1 amber solid-state lights, and one of our new green answers, the MV 2.

Get out a purchase req and start working with all kinds of GaAsLITEs now.

Monsanto

For additional technical information write
Monsanto Electronic Special Products
10131 Bubb Road, Cupertino, California 95014
(408) 257-2140

Take advantage of RCA's ability to supply superior SCR's and Triacs... when you need them.

Ask our solid-state specialists why RCA's broad line of industrial SCR's and triacs excel in quality, reliability, and performance. They'll tell you that RCA thyristors are subjected to some of the toughest quality assurance tests in the industry. Thus, they save design dollars by virtue of superior performance in critical applications.

Ask users of industrial thyristors why RCA is a key supplier and they'll tell you RCA services the industry! Whatever the application—area lighting to avionics, regulators to inverters, or power supplies to modulators—RCA has SCR's and triacs to meet your application requirements.

Use these SCR's and triacs in your control applications:

SCR Family	Rating		Triac Family	Rating	
	$I_{T(RMS)}$	V_{DROM}		$I_{T(RMS)}$	V_{DROM}
40740	10 A	600 V	40795	10 A	600 V
40752	20 A	600 V	40797	15 A	600 V
2N690	25 A	600 V	40671	30 A	600 V
2N3899	35 A	600 V	2N5443	40 A	600 V

NOTE: SCR ratings of 100, 200, & 400 volts and triac ratings of 200 & 400 volts are available in each family. Stud packages & isolated-stud packages are also available in each rating.

For further details and your copy of the latest thyristor catalog, THC-500, see your local RCA Representative or your RCA Distributor. Or write RCA Electronic Components, Commercial Engineering Section 57L-6/UR6, Harrison, N.J. 07029. International: RCA, 2-4 rue du Lièvre, 1227 Geneva, Switzerland, or Post Office Box 112, Hong Kong.

RCA
Thyristors

