



## CENTRIFUGAL LIQUID CHILLERS

OPERATIONS AND MAINTENANCE

Supersedes: 160.84-OM1 (214)

Form 160.84-OM1 (914)

### YMC<sup>2</sup> MODEL B WITH OPTIVIEW™ CONTROL CENTER



LD17500

**R-134a**

Issue Date:  
September 15, 2014



# IMPORTANT!

## READ BEFORE PROCEEDING!

### GENERAL SAFETY GUIDELINES

This equipment is a relatively complicated apparatus. During installation, operation maintenance or service, individuals may be exposed to certain components or conditions including, but not limited to: refrigerants, materials under pressure, rotating components, and both high and low voltage. Each of these items has the potential, if misused or handled improperly, to cause bodily injury or death. It is the obligation and responsibility of operating/service personnel to identify and recognize these inherent hazards, protect themselves, and proceed safely in completing their tasks. Failure to comply with any of these requirements could result in serious damage to the equipment and the property in

which it is situated, as well as severe personal injury or death to themselves and people at the site.

This document is intended for use by owner-authorized operating/service personnel. It is expected that these individuals possess independent training that will enable them to perform their assigned tasks properly and safely. It is essential that, prior to performing any task on this equipment, this individual shall have read and understood this document and any referenced materials. This individual shall also be familiar with and comply with all applicable governmental standards and regulations pertaining to the task in question.

---

### SAFETY SYMBOLS

The following symbols are used in this document to alert the reader to specific situations:



*Indicates a possible hazardous situation which will result in death or serious injury if proper care is not taken.*



*Identifies a hazard which could lead to damage to the machine, damage to other equipment and/or environmental pollution if proper care is not taken or instructions and are not followed.*



*Indicates a potentially hazardous situation which will result in possible injuries or damage to equipment if proper care is not taken.*

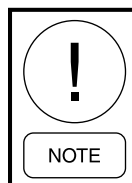

*Highlights additional information useful to the technician in completing the work being performed properly.*



*External wiring, unless specified as an optional connection in the manufacturer's product line, is not to be connected inside the OptiView cabinet. Devices such as relays, switches, transducers and controls and any external wiring must not be installed inside the micro panel. All wiring must be in accordance with Johnson Controls' published specifications and must be performed only by a qualified electrician. Johnson Controls will NOT be responsible for damage/problems resulting from improper connections to the controls or application of improper control signals. Failure to follow this warning will void the manufacturer's warranty and cause serious damage to property or personal injury.*



*Ensure power is removed from the input side of the VSD at all times when the chiller is under vacuum (less than atmospheric pressure). The VSD maintains voltage to ground on the motor when the chiller is off while voltage is available to the VSD. Insulating properties in the motor are reduced in vacuum and may not insulate this voltage sufficiently.*

## CHANGEABILITY OF THIS DOCUMENT

In complying with Johnson Controls' policy for continuous product improvement, the information contained in this document is subject to change without notice. Johnson Controls makes no commitment to update or provide current information automatically to the manual owner. Updated manuals, if applicable, can be obtained by contacting the nearest Johnson Controls Service office or accessing the Johnson Controls QuickLIT website at <http://cgproducts.johnsoncontrols.com>.

Operating/service personnel maintain responsibility for the applicability of these documents to the equipment. If there is any question regarding the applicability of

these documents, the technician should verify whether the equipment has been modified and if current literature is available from the owner of the equipment prior to performing any work on the chiller.

### CHANGE BARS

Revisions made to this document are indicated with a line along the left or right hand column in the area the revision was made. These revisions are to technical information and any other changes in spelling, grammar or formatting are not included.

---

## ASSOCIATED LITERATURE

MANUAL DESCRIPTION	FORM NUMBER
Installation and Reassembly	160.84-N1
Unit Installation Checklist and Request for Startup	160.84-CL1
Unit Startup Checklist	160.84-CL2
Field Connections Diagram	160.84-PW1
Field Control, Wiring and MBC Diagrams	160.84-PW2
Unit Replacement Parts	160.84-RP1
VSD Replacement Parts	160.84-RP3
Centrifugal Chiller Long Term Storage	50.20-NM5
All Products - Replacement Parts Electrical Connectors	50.20-RP1
All Products - Replacement Parts Fittings	50.20-RP2

## SYSTEM NOMENCLATURE

**Y M C 2 - S 0756 A B**

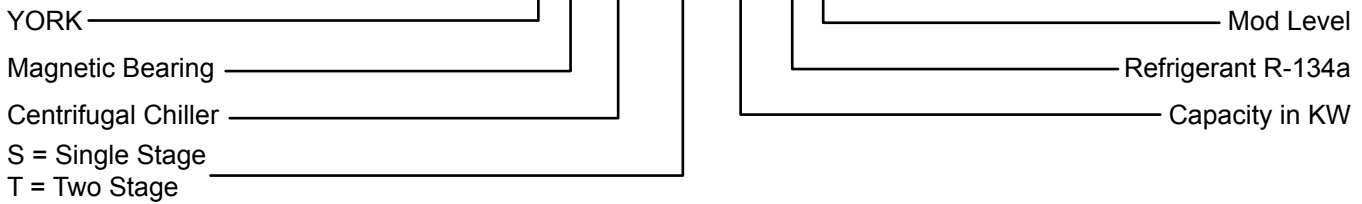

## COMPRESSOR NOMENCLATURE

**M2 B - 197 F A A**

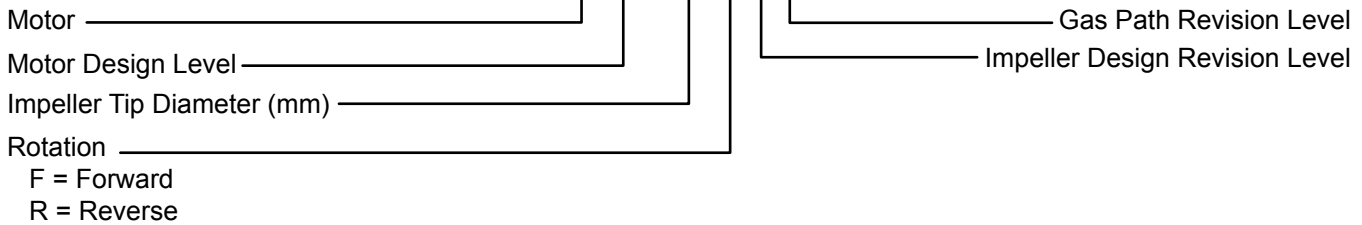

## VESSEL NOMENCLATURE

**E A 25 14 271 B R 1 1 F C R**

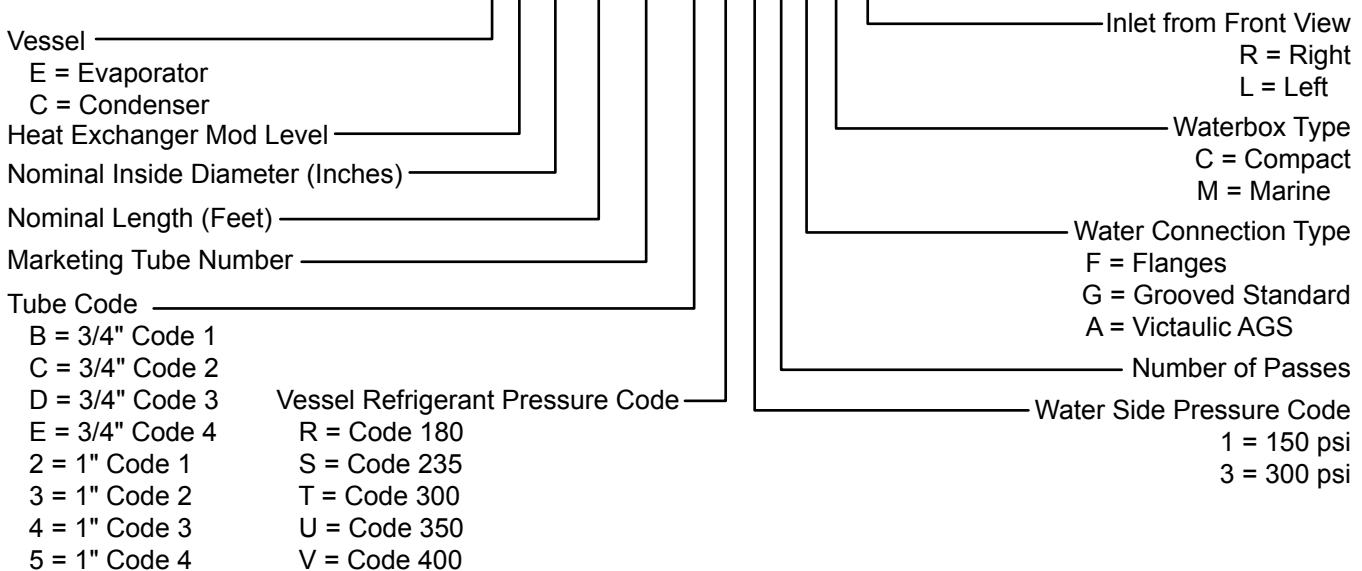

## VARIABLE SPEED DRIVE NOMENCLATURE

**HYP 0774 X H 15 D - 40**

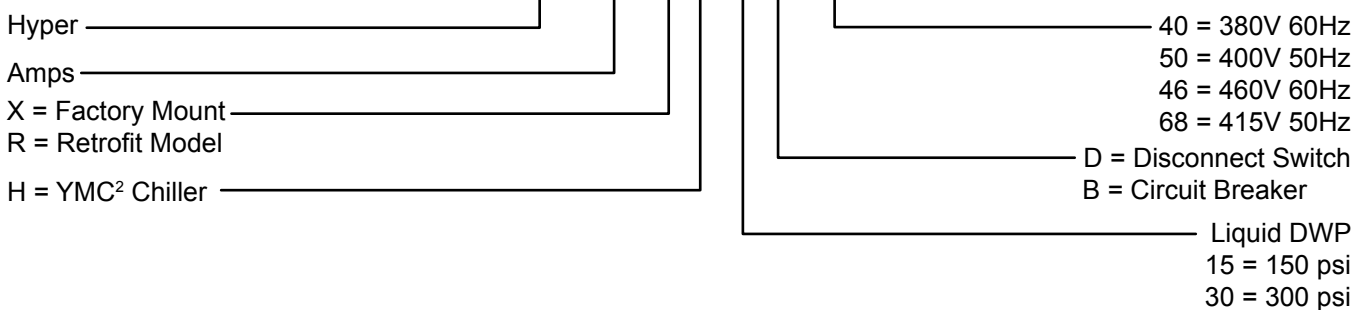

## TABLE OF CONTENTS

<b>SECTION 1 - SYSTEM FUNDAMENTALS.....</b>	<b>9</b>
System Components .....	9
System Operation Description.....	13
 <b>SECTION 2 - SYSTEM OPERATING PROCEDURES .....</b>	 <b>17</b>
Pre-Starting .....	17
Condenser Water Temperature Control.....	17
Start-Up .....	17
Chiller Operation .....	18
Chilled Liquid Control Settings .....	18
Operator Setpoints Quick Reference .....	19
Stopping The System .....	19
Safety Stop.....	20
Operating Logs.....	20
Need For Maintenance Or Service.....	20
Fault Shutdowns.....	21
Prolonged Shutdown .....	21
Restart After Prolonged Shutdown .....	21
 <b>SECTION 3 - OPTIVIEW™ CONTROL CENTER FUNCTIONS AND NAVIGATION .....</b>	 <b>23</b>
Interface Conventions .....	23
Analog Input Ranges.....	25
Home Screen .....	26
System Screen.....	28
Evaporator Screen .....	30
Condenser Screen .....	32
Compressor Screen .....	34
Magnetic Bearing Controller Screen .....	36
Magnetic Bearing Controller Details Screen .....	38
Surge Screen .....	40
Variable Geometry Diffuser Screen.....	42
Power Panel Screen.....	43
Capacity Control Screen .....	45
Variable Speed Drive Screen .....	47
Variable Speed Drive (VSD) Details Screen .....	49
Motor Details Screen.....	51
Setpoints Screen .....	53
Setup Screen.....	55
Schedule Screen .....	57
User Screen .....	59
COMMS Screen .....	60
Printer Screen .....	61
Sales Order Screen.....	62
Operations Screen .....	64
History Screen.....	65
History Details Screen.....	67
Custom Screen.....	68
Custom Setup Screen .....	69

## TABLE OF CONTENTS (CONT'D)

Trend Screen.....	70
Trend Setup Screen .....	72
Advanced Trend Setup Screen .....	74
Common Slots Screen .....	76
Master Slot Numbers List For Use With Trend Feature .....	77
Display Messages .....	80
<b>SECTION 4 - VSD OPERATION.....</b>	<b>103</b>
Optispeed Compressor Drive Overview .....	103
Optispeed Compressor Drive Features .....	103
Optispeed Compressor Drive Details (490 and 774 amp drives).....	104
Optispeed Compressor Drive Details (612 amp drive).....	105
Optispeed Compressor Drive And Chiller Operation (490 and 774 amp models).....	110
Optispeed Compressor Drive And Chiller Operation (612 amp model) .....	110
<b>SECTION 5 - MAINTENANCE.....</b>	<b>111</b>
Preventative Maintenance .....	111
Renewal Parts .....	112
Operating Inspections .....	112
Checking System For Leaks .....	112
Conduct Pressure Test .....	112
System Evacuation.....	113
Vacuum Dehydration .....	113
Conduct R-134a Pressure Test .....	115
Refrigerant Charging .....	116
Checking The Refrigerant Charge.....	116
Handling Refrigerant For Dismantling And Repairs.....	116
Compressor And Motor .....	116
Condensers And Evaporators .....	117
Electrical Controls .....	119
Automatic Battery Health Test – During Shutdown.....	119
<b>SECTION 6 - TROUBLESHOOTING.....</b>	<b>121</b>
<b>SECTION 7 - PRINTING .....</b>	<b>123</b>
Printing Overview .....	123
Acceptable Printers .....	123
Printer Connections.....	124
Printer Setup .....	124
Printer Connections.....	125
Control Center Setup.....	125
Downloading System Prints to a Laptop .....	126
Temperature .....	135

## LIST OF FIGURES

<b>FIGURE 1</b> - YMC <sup>2</sup> Chiller Components .....	9
<b>FIGURE 2</b> - Optiview™ Control Center .....	11
<b>FIGURE 3</b> - Refrigerant Flow-Thru Chiller.....	16
<b>FIGURE 4</b> - Liquid Chiller Log Sheets.....	20
<b>FIGURE 5</b> - Home Screen.....	26
<b>FIGURE 6</b> - System Screen .....	28
<b>FIGURE 7</b> - Evaporator Screen.....	30
<b>FIGURE 8</b> - Condenser Screen.....	32
<b>FIGURE 9</b> - Compressor Screen .....	34
<b>FIGURE 10</b> - Magnetic Bearing Controller Screen.....	36
<b>FIGURE 11</b> - Magnetic Bearing Controller Details Screen.....	38
<b>FIGURE 12</b> - Surge Screen.....	40
<b>FIGURE 13</b> - Variable Geometry Diffuser Screen .....	42
<b>FIGURE 14</b> - Power Panel Screen.....	43
<b>FIGURE 15</b> - Capacity Controls Screen.....	45
<b>FIGURE 16</b> - Variable Speed Drive Screen.....	47
<b>FIGURE 17</b> - Variable Speed Drive (VSD) Details Screen.....	49
<b>FIGURE 18</b> - Motor Details Screen .....	51
<b>FIGURE 19</b> - Setpoints Screen .....	53
<b>FIGURE 20</b> - Setup Screen.....	55
<b>FIGURE 21</b> - Schedule Screen .....	57
<b>FIGURE 22</b> - User Screen.....	59
<b>FIGURE 23</b> - COMMS Screen.....	60
<b>FIGURE 24</b> - Printer Screen.....	61
<b>FIGURE 25</b> - Sales Order Screen .....	62
<b>FIGURE 26</b> - Operations Screen.....	64
<b>FIGURE 27</b> - History Screen .....	65
<b>FIGURE 28</b> - History Details Screen .....	67
<b>FIGURE 29</b> - Custom Screen.....	68
<b>FIGURE 30</b> - Custom Setup Screen.....	69
<b>FIGURE 31</b> - Trend Screen .....	70
<b>FIGURE 32</b> - Trend Setup Screen.....	72
<b>FIGURE 33</b> - Advanced Trend Setup Screen.....	74
<b>FIGURE 34</b> - Common Slots Screen.....	76
<b>FIGURE 35</b> - Left Side Of Drive Cabinet (Typical For All Model Drives) .....	106
<b>FIGURE 36</b> - Right Side Of Drive Cabinet HYP0490 .....	107
<b>FIGURE 37</b> - Right Side Of Drive Cabinet HYP0612 .....	107
<b>FIGURE 38</b> - Right Side Of Drive Cabinet HYP0774 .....	108
<b>FIGURE 39</b> - Drive Logic Board .....	108
<b>FIGURE 40</b> - Rectifier Side Of The Power Unit HYP0490 and HYP0612.....	109
<b>FIGURE 41</b> - Rectifier Side Of The Power Unit HYP0774 .....	109
<b>FIGURE 42</b> - Evacuation of Chiller.....	114
<b>FIGURE 43</b> - Saturation Curve.....	115
<b>FIGURE 44</b> - OKIPOS Printer .....	124
<b>FIGURE 45</b> - Breckman Printer.....	125
<b>FIGURE 46</b> - Communications Block Diagram.....	127
<b>FIGURE 47</b> - OptiView Panel to PC Serial Cable.....	127
<b>FIGURE 48</b> - Sample Printout (Status or History) .....	128
<b>FIGURE 49</b> - Sample Printout (Setpoints).....	130
<b>FIGURE 50</b> - Sample Printout (Schedule).....	132
<b>FIGURE 51</b> - Sample Printout (Sales Order).....	132
<b>FIGURE 52</b> - Sample Printout (Security Log Report).....	134
<b>FIGURE 53</b> - Sample Printout (Trend Data New or Existing Points).....	134
<b>FIGURE 54</b> - Sample Printout (Custom Screen Report) .....	134

## LIST OF TABLES

<b>TABLE 1</b> - Input Current Limit Threshold .....	18
<b>TABLE 2</b> - Temperature Setpoint .....	18
<b>TABLE 3</b> - Water Flow Rate Limits In GPM (L/S) – Based Upon Standard Tubes @ Design Full Load Conditions .....	21
<b>TABLE 4</b> - Analog Input Ranges .....	25
<b>TABLE 5</b> - Status Messages .....	80
<b>TABLE 6</b> - Run Messages.....	81
<b>TABLE 7</b> - MBC Startup Messages.....	81
<b>TABLE 8</b> - Start Inhibit Messages .....	81
<b>TABLE 9</b> - Warning Messages .....	82
<b>TABLE 10</b> - Routine Shutdown Messages.....	84
<b>TABLE 11</b> - Cycling Shutdown Messages.....	85
<b>TABLE 12</b> - Safety Shutdown Messages .....	92
<b>TABLE 13</b> - Maintenance Requirements.....	111
<b>TABLE 14</b> - System Pressures .....	114
<b>TABLE 15</b> - Approximate Refrigerant and Water Weight .....	117
<b>TABLE 16</b> - Operation Analysis Chart.....	121
<b>TABLE 17</b> - OKIDATA OKIPOS 441.....	124
<b>TABLE 18</b> - Brecknell CP130.....	125
<b>TABLE 19</b> - SI Metric Conversion .....	135



## SECTION 1 - SYSTEM FUNDAMENTALS

### SYSTEM COMPONENTS

The YORK Model YMC<sup>2</sup> Centrifugal Liquid Chiller is completely factory-packaged including evaporator, condenser, compressor, motor, Variable Speed Drive, Battery Power Panel, OptiView™ Control Center, and all interconnecting unit piping and wiring (see *Figure 1*).

#### Compressor

The compressor is a single-stage centrifugal type powered by a hermetic electric motor, on a common shaft with a cast aluminum, fully shrouded impeller. The compressor has fixed inlet vanes and variable geometry diffuser.

#### Motor

The compressor motor is a hermetic permanent magnet high speed design with magnetic bearings. The compressor impeller is overhung from the end of the motor shaft and has no bearings of its own.

The motor includes angular contact ball bearings only engaged with the rotor shaft during shutdown after rotation is stopped or during shutdown due to loss of power to the magnetic bearings.

The bearing control center maintains proper shaft position in the magnetic bearings.

#### Heat Exchangers

Evaporator and condenser shells are fabricated from rolled carbon steel plates with fusion welded seams. Heat exchanger tubes are internally enhanced type.

#### Evaporator

The evaporator is a shell and tube, hybrid falling film, and flooded type heat exchanger. A distributor trough provides uniform distribution of refrigerant over tubes in the falling film section. Residual refrigerant floods the tubes in the lower section. Suction baffles are located above the tube bundle to prevent liquid refrigerant carryover into the compressor. A 2" liquid level sight

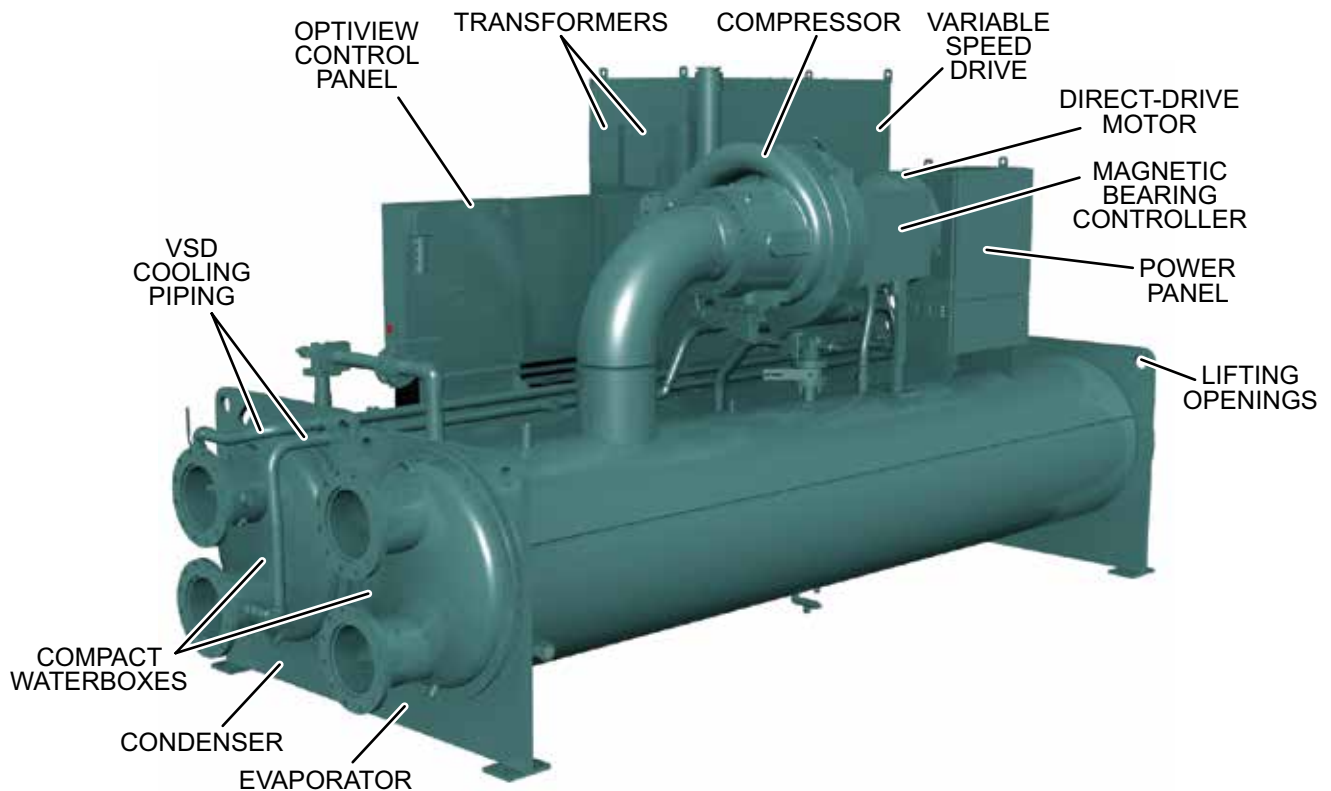

LD14022b

**FIGURE 1 - YMC<sup>2</sup> CHILLER COMPONENTS**

glass is located on the side of the shell. The evaporator shell contains dual refrigerant relief valves unless condenser isolation is installed.

### Condenser

The condenser is a shell and tube type, with a discharge gas baffle to prevent direct high velocity impingement on the tubes. A separate subcooler is located in the condenser to enhance performance. Dual refrigerant relief valves are located on condenser shells and optional refrigerant isolation valves are available.

### Water Boxes

The removable compact water boxes are fabricated of steel. The design working pressure is 150 PSIG (1034 kPa) and the boxes are tested at 225 PSIG (1551 kPa). Integral steel water baffles provide the required pass arrangements. Stub-out water nozzle connections with Victaulic grooves are welded to the water boxes. These nozzle connections are suitable for Victaulic couplings, welding or flanges, and are capped for shipment. Plugged 3/4" drain and vent connections are provided in each water box. Optional marine waterboxes and higher pressure ratings are available.

### Refrigerant Flow Control

Refrigerant flow to the evaporator is controlled by the liquid level control valve.

A level sensor senses the refrigerant level in the condenser and outputs an analog voltage to the control panel that represents this level (0% = empty; 100% = full). Under program control, the control panel modulates the liquid level control valve to control the condenser refrigerant level to a programmed setpoint. Other setpoints affect the control sensitivity and response. Only a qualified service technician may modify these settings. The level setpoint must be entered at chiller commissioning by a qualified service technician.

While the chiller is shut down, the level control valve will be pre positioned to anticipate run. When the chiller is started, if actual level is less than the level setpoint, a linearly increasing ramp is applied to the level setpoint. This ramp causes the setpoint to go from the initial refrigerant level to the programmed setpoint over a programmable period of time. If the actual level is greater than the setpoint upon run, it immediately begins to control to the programmed setpoint.

While the chiller is running, the refrigerant level is normally controlled to the level setpoint.

### Variable Speed Drive

A Variable Speed Drive will be factory packaged with the chiller. It is designed to vary the compressor motor speed by controlling the frequency and voltage of the electrical power to the motor. The control logic automatically adjusts motor speed as required to suit lift and capacity requirements.

### Power Panel

The power panel includes the uninterrupted power supply and power storage battery. These feed essential loads while the chiller shuts down upon loss of main chiller power.

### Optional Service Isolation Valves

If your chiller is equipped with optional service isolation valves on the discharge and liquid line, these valves must remain open during operation. These valves are used for isolating the refrigerant charge in either the evaporator or condenser to allow service access to the system. A refrigerant pump-out unit will be required to isolate the refrigerant.



***Isolation of the refrigerant in this system must be performed by a qualified service technician.***

### Optional Hot Gas Bypass

Hot gas bypass is optional and is used to provide greater turndown than otherwise available for load and head conditions. The OptiView™ Control Center will automatically modulate the hot gas valve open and closed as required. Adjustment of the hot gas control valve must only be performed by a qualified service technician.



LD18050

**FIGURE 2 - OPTIVIEW™ CONTROL CENTER**

### OptiView™ Control Center

The YORK OptiView™ control center LCD Graphic Display and keypad is the interface for starting, stopping, configuring, monitoring, and commanding the chiller controls. The control center is a microprocessor based system for R134a centrifugal chillers. It controls the leaving chilled liquid temperature and maintains safe operation. It is factory-mounted, wired and tested.

The graphic display allows the presentation of operating parameters in logical groups on screens and can trend data to present a graphical representation of present or historical operation of the chiller. The locations of various chiller parameters are clearly and intuitively marked. Instructions for specific operations are provided on many of the screens. The screens and navigation are shown in the OptiView™ Control Center Functions and Navigation section of this manual.

Eight buttons are available on the right side of the panel, and are primarily used for navigation between the system screens. At the base of the display are 5 additional buttons. The button functions are redefined based on the currently displayed screen. The area to the right of the keypad is used for data entry with a standard numeric keypad provided for entry of system setpoints and limits.

 The *Decimal* key provides accurate entry of setpoint values.

 A +/- key has also been provided to allow entry of negative values and AM/PM selection during time entry.

 In order to accept changes made to the chiller setpoints, the *Check* key is provided as a universal ‘Enter’ key or ‘Accept’ symbol.

 In order to reject entry of a setpoint or dismiss an entry form, the ‘X’ key is provided as a universal ‘Cancel’ symbol.

 *Cursor Arrow* keys are provided to allow movement on screens which contain a large amount of entry data. In addition, these keys can be used to scroll through history and event logs.

The graphic display also allows numerical information to be represented in both English (temperatures in °F and pressures in PSIG) and Metric (temperatures in °C and pressures in kPa) mode. It also has the ability to display many languages.

The control center continually monitors the system operation and records the cause of any shutdowns (Safety, Cycling or Normal). This information is recorded in memory and is preserved even through a power failure condition. The user may recall it for viewing at any time. During operation, the user is continually advised of the operating conditions by various status and warning messages. In addition, it may be configured to notify the user of certain conditions via alarms. A complete listing of shutdown, status, and warning messages is attached in the *Display Messages on page 80* of this manual.

The control center includes capabilities for remote control and communications. Common networking protocol through the Building Automation System (BAS) allows increased remote control of the chiller, as well as 24-hour performance monitoring via a remote site. An optional circuit board called the E-Link Gateway provides Johnson Controls and YORK mechanical equipment such as the YMC<sup>2</sup> chiller with building automation system (BAS) networking connectivity. It is designed with three active serial ports: Port 1 and Port 4 are used for BAS networking, Port 2 is reserved for connecting to the equipment, and Port 3 provides access for auxiliary monitoring and control.

Accessory mounting kits are used to mount the E-Link Gateway directly into OptiView™ panels. If installed in the OptiView™ Control Center; the E-Link Gateway is powered by +12VDC from the main microboard. The E-link is configured at purchase to the network protocol desired.

The chiller also maintains the standard digital remote capabilities as well. Both of these remote control capabilities allow for the following standard Energy Management System (EMS) interfaces. The actual connection details are in the Field Connections section of the *Wiring Diagram (Form 160.84-PW1)*:

- Remote Start
- Remote Stop
- Remote Leaving Chilled Liquid Temperature Setpoint adjustment: BAS coms, Analog signal, (0-10VDC, 2-10VDC, 0-20mA or 4-20mA) or Pulse Width Modulation
- Remote Current Limit Setpoint adjustment: BAS coms, Analog signal, (0-10VDC, 2-10VDC, 0-20mA or 4-20mA) or Pulse Width Modulation
- Remote “Ready to Start” Contacts
- Safety Shutdown Contacts
- Cycling Shutdown Contacts

The OptiView™ panel can be used to control the customer chilled and condenser liquid flow. A set of contacts exists to initiate flow for each shell. Details are in the Field Connections section of the *Wiring Diagram (Form 160.84-PW2)*. The chilled water pump contacts close immediately upon execution of a chiller start command. They open coincident with the receipt of a stop command or a fault other than those below:

- A. LEAVING CHILLED LIQUID - LOW TEMPERATURE cycling shutdown.
- B. MULTIUNIT CYCLING - CONTACTS OPEN or SYSTEM CYCLING - CONTACTS OPEN (Only if Chilled Liquid Pump Operation is set to ENHANCED)
- C. LEAVING CHILLED LIQUID FLOW SWITCH OPEN cycling shutdown

The Condenser Pump contacts close immediately upon execution of a chiller start command. They open coincident with receipt of a chiller stop command or fault other than CONDENSER-FLOW SWITCH OPEN cycling shutdown.

If the chiller is Stopped and the Condenser Pump contacts are open (flow off), the contacts close when Saturated Condenser Temperature is less than 35.0 °F. This helps mitigate condenser freeze due to plant issues in brine applications.

If the contacts are closed only due to the Saturated Condenser Temp, they are opened when Saturated Condenser Temperature returns above 40.0 °F. If the existing logic calls for them to be closed, they remain closed.

Some screens, displayed values, programmable setpoints and manual controls exist for Service Technician use only. They are only displayed when logged in at SERVICE access level or higher. The setpoints and parameters displayed on these screens are explained in detail in *YORK YMC<sup>2</sup> Service Manual (Form 160.84-M2)*. These parameters affect chiller operation and should never be modified by anyone other than a qualified Service Technician. The advanced diagnostics and troubleshooting information for Service Technicians are included in *YORK YMC<sup>2</sup> Service Manual (Form 160.84-M2)*. Also included in the Service manual are detailed descriptions of chiller features, such as Capacity Control, Refrigerant Level Control, Variable geometry diffuser, and Magnetic bearing controller.

The chiller operating program resides in the Opti-View Control Center microboard. Software versions (C.OPT.18.xx.yzz) are alpha-numeric codes that represent the application, language package and revision levels per below. Each time the controls portion or language section is revised, the respective revision level increments.

- C – Commercial chiller
- OPT - OptiView
- 18 – YMC<sup>2</sup> Mod B chiller
- xx - controls revision level (00, 01, etc)
- y – language package (0=English only, 1=NEMA, 2=CE, 3=NEMA/CE )
- zz – language package revision level (00, 01, etc)

Software upgrades should only be performed by a Service Technician.

## SYSTEM OPERATION DESCRIPTION

In operation, a liquid to be chilled (water or brine) flows through the evaporator tubes, where its heat is transferred to low pressure liquid refrigerant sprayed over and pooled outside the tubes, boiling the refrigerant. The chilled liquid is then piped to air conditioning or process terminal units, absorbing heat. The warmed liquid is then returned to the chiller to complete the chilled liquid circuit cycle.

The refrigerant vapor, which is produced by the boiling action in the evaporator, is drawn into the suction of the compressor where the rotating impeller increases its pressure and temperature and discharges it into the condenser. Cooling water (or other fluid) flowing through the condenser tubes absorbs heat from the refrigerant vapor, causing it to condense. The cooling water is supplied to the chiller from an external source, usually a cooling tower. The condensed refrigerant drains from the condenser into the subcooler section. There it is cooled by the entering condenser water and exits to into the liquid return line. The level control valve meters the flow of liquid refrigerant to the evaporator to complete the refrigerant circuit. The level control valve continually adjusts position as load changes to meet the changed mass flow rate of refrigerant required to keep the system balanced. It does this by maintaining a constant level in the condenser, enough to maintain a liquid seal to the outlet.

## Capacity Control

The major components of a chiller are selected to handle the required refrigerant flow at full load design conditions. However, most systems will be called upon to deliver full load capacity for only a relatively small part of the time the unit is in operation. A means exists to modulate capacity for other loads.

The speed at which the compressor rotates establishes the pressure differential that the chiller can operate against. This is referred to as ‘lift’. Speed must always be maintained above the minimum necessary to create the lift required for the pressure difference between the condenser and evaporator, regardless of load. Below that speed, gas surge occurs. That pressure difference is a function of the leaving chilled liquid temperature and the leaving condenser liquid temperature and the heat transfer between those liquids and the refrigerant.

Reduced speed also reduces the available capacity of the chiller, when speed reduction is possible. If speed is reduced, the chiller power use is reduced. Therefore, at reduced capacity requirements where condenser pressure is also reduced, the motor speed is reduced as much as possible while maintaining chilled liquid temperature and sufficient lift. When the speed cannot be further reduced due to lift required for the specified leaving chilled water temperature setting and available cooling to the condenser and capacity must be further reduced, a mechanism called Variable Geometry Diffuser (VGD) at the exit of the impeller is used to reduce refrigerant gas flow. The VGD not only controls capacity, but serves to mitigate “stall”. Stall is an effect caused by slow refrigerant gas passing through the compressor at reduced flow rates needed for low capacity operation.

A final optional means to reduce capacity called Hot Gas Bypass (HGBP) is available regardless of compressor model. When selected for an application, HGBP is used to re-circulate some refrigerant through the compressor without using it for cooling the chilled liquid. Although this does not reduce power consumption, it greatly reduces the capacity of the chiller for maximum turndown. The YMC<sup>2</sup> uses these mechanisms in a controlled order to maintain best efficiency.

The YMC<sup>2</sup> Chiller controls capacity by adjusting the compressor VGD position, the compressor motor Variable Speed Drive (VSD), and optional Hot Gas Bypass valve (HGBP) position (if equipped) in a specific sequence depending on whether loading or unloading is required to keep Leaving Chilled Liquid Temperature at setpoint. Motor speed is additionally and simultaneously adjusted as necessary to maintain the minimum compressor lift required to prevent surge. The sequence for operation of the control devices is as follows to achieve the best chiller efficiency:

- Conditions require capacity increase: HGBP (if present) is driven toward closed. Then when the HGBP is full closed, VGD is driven toward open. Then when the VGD is full open, VSD speed is increased.
- Conditions require capacity decrease: VSD speed is decreased. Then when VSD speed is at the minimum limit to avoid surge for the lift, the VGD is driven toward closed. Then when the VGD reaches closed, the HGBP (if present) is driven toward open.

Also, High Condenser Pressure, Low Evaporator Pressure, High Motor Current, and High Input Current limits and overrides limit or reduce the output to the appropriate devices (HGBP, VGD, or VSD) to mitigate the condition to keep the chiller online. As any of these physical thresholds are approached, the control will proportionally limit the amount of capacity increase permitted and if exceeded will issue unloading into the capacity control command.

### Anti-Surge Minimum Frequency

In order to maintain sufficient compressor lift to overcome condenser pressure and prevent surge throughout operation, the control maintains and continuously updates a minimum limit for VSD speed. This limit is the Active Anti-Surge Minimum Frequency. It is calculated and applied to the speed each cycle of the capacity control routine.

### Smart Freeze

The Smart Freeze feature prevents nuisance chiller shutdowns due to brief periods of chilled liquid flow fluctuations or other brief operating conditions that would normally cause Low Evaporator Pressure Safety shutdowns. With this feature enabled and activated, the chiller is permitted to ride through these tempo-

rary conditions. Also, this feature allows the Leaving Chilled Liquid Temperature Setpoint to be set as low as 36.0°F (2.2°C). Smart Freeze protection can be enabled or disabled at the Keypad, by a Service Technician. It cannot be used in Brine cooling mode.

Smart Freeze protection uses the Evaporator Refrigerant Temperature as one of the variables to determine when freezing is imminent. The basis of this feature is that the chilled liquid contains an amount of heat, which cannot be eliminated immediately. Therefore, it requires a certain amount of time for the liquid to change to a solid. During this period of time, those parameters that determine when solidification will occur are evaluated and the shutdown is based on accumulated time below the freeze temperature.

### Surge Protection

The surge protection feature detects surge events. It provides a running count of the surges detected over the lifetime of the chiller. It allows the user to define how many surges are excessive and how the control will react to an excess surge condition. When excessive surging is detected, this feature can shutdown the chiller.

Surge events are detected by monitoring the relationship between the Condenser pressure and Evaporator pressure while the chiller is running. An excess surge condition is detected by comparing the number of surge events that occur in a selectable time period to a selectable threshold.

If the number of surge events (Surge Window Count) detected in the time period programmed as the COUNT WINDOW setpoint (1 to 5 minutes; default 5) exceed the threshold programmed as the COUNT LIMIT setpoint (4 to 20; default 4) an excess surge condition has been detected.

Unless the SHUTDOWN features have been enabled, as explained below, the chiller will continue to run under the same conditions displaying WARNING – EXCESS SURGE DETECTED. This message will be displayed until manually reset with the Warning Reset key in Operator access level. If the SHUTDOWN setpoint is Enabled, when an excess surge condition has been detected a safety shutdown will be performed and SURGE PROTECTION - EXCESS SURGE is displayed.

## Head Pressure Control

The Head Pressure Control feature enables chiller control of a field-mounted facility condenser water temperature control means, if one is necessary for prolonged cold water startup as described in *SECTION 2 - SYSTEM OPERATING PROCEDURES* of this manual. YMC<sup>2</sup> chillers are capable of operation within a wide range of condenser water temperatures. However, a low minimum condenser water temperature, as specified in the *YMC<sup>2</sup> Engineering Guide (Form 160.84-EG1)*, is required to maintain sufficient pressure differential (head) between the condenser and evaporator for proper refrigerant management in the chiller. The head pressure control function provides an analog output control signal from the OptiView™ Control Center that responds to the programmed Head Pressure (condenser pressure minus evaporator pressure) Setpoint. The 0-10VDC or 4-20mA output is configurable from the Head Pressure Control screen when the feature is Enabled. Output wiring is described in the Field Connections section of the *Wiring Diagram (Form 160.84-PW2)*:

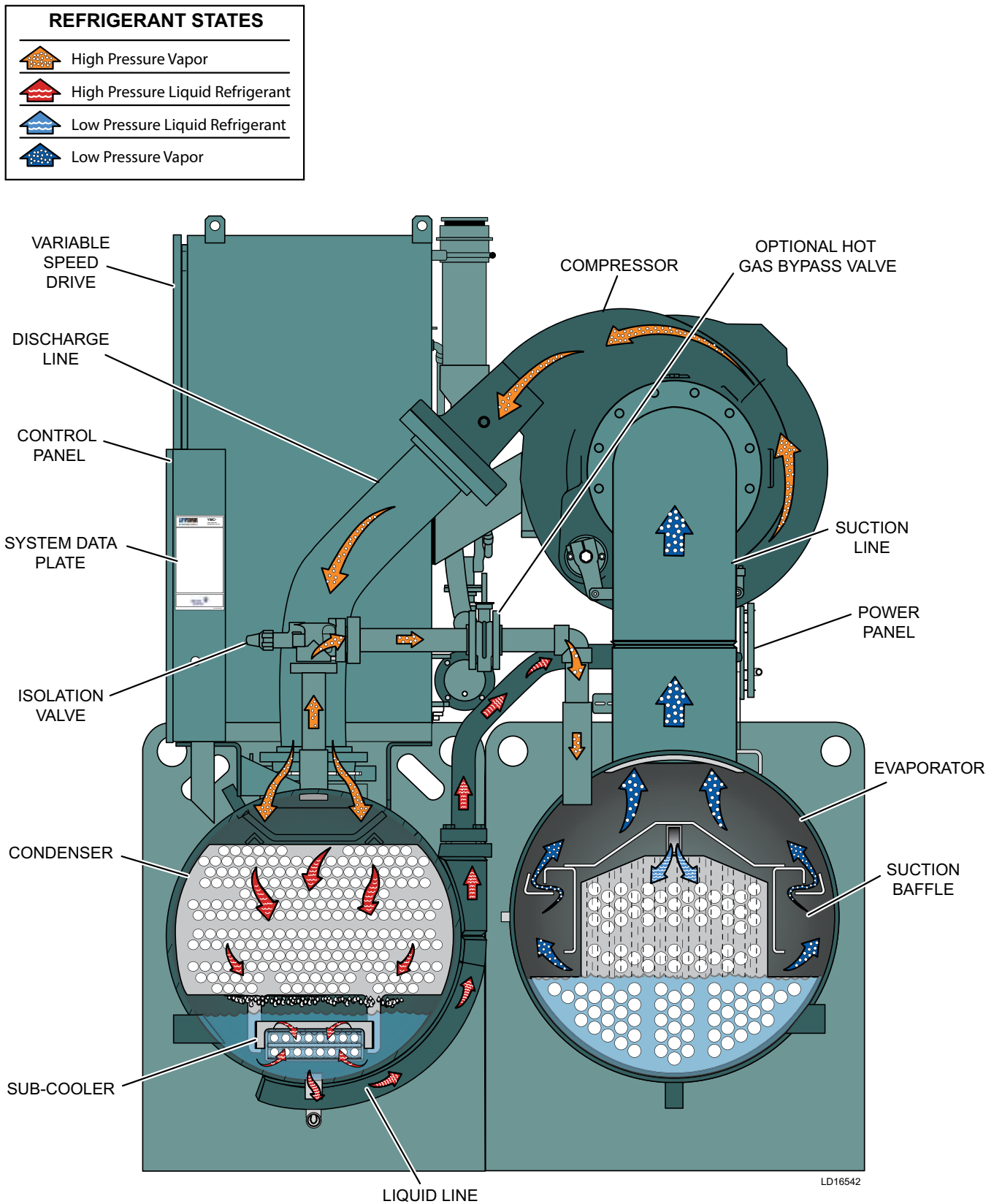

FIGURE 3 - REFRIGERANT FLOW-THRU CHILLER



## SECTION 2 - SYSTEM OPERATING PROCEDURES

### PRE-STARTING

Prior to starting the chiller, make sure the display reads "SYSTEM READY TO START".

The Panel can only boot up when line power is available to the VSD transformers and the UPS battery in the power panel is present and connected with its disconnect closed.

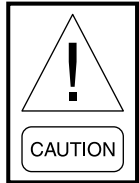

*After periods of waterside maintenance or prolonged shutdown, vent any air from the chiller water boxes prior to starting the water pumps. Failure to do so can result in pass baffle damage.*

### CONDENSER WATER TEMPERATURE CONTROL

The YORK YMC<sup>2</sup> chiller is designed to use less power by taking advantage of lower than design temperatures that are naturally produced by cooling towers throughout the operating year. Exact control of condenser water such as a cooling tower bypass, is not necessary for most installations. The minimum entering condenser water temperature for full and part load conditions is specified in the chiller engineering guide.

Where:

$$\text{Min. ECWT} = \text{LCWT} - \text{C RANGE} + 5^{\circ}\text{F} + 12 \left( \frac{\% \text{ Load}}{100} \right)$$

$$\text{Min. ECWT} = \text{LCWT} - \text{C RANGE} + 2.8^{\circ}\text{C} + 6.6 \left( \frac{\% \text{ Load}}{100} \right)$$

ECWT = Entering Condensing Water Temperature

LCWT = Leaving Chilled Water Temperature

C Range = Condensing water temperature range at the given load condition.

At start-up, the entering condenser water temperature may be as much as 25°F (14°C) colder than the standby return chilled water temperature. Cooling tower fan cycling will normally provide adequate control of the entering condenser water temperature on most installations.

### START-UP

If the chilled water and/or condenser water pumps are manually operated, start the pump. The Control Center will not allow the chiller to start unless chilled liquid flow is established through the unit. If the liquid pumps are wired to the Microcomputer Control Center pump run contacts, the pump will automatically start, therefore, this step is not necessary.

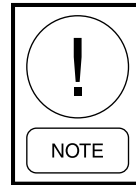

*The coolant temperature inside any JCI-supplied liquid-cooled motor starter must be maintained above the dewpoint temperature in the equipment room to prevent condensing water vapor inside the starter cabinet. Therefore, an additional temperature-controlled throttle valve is needed in the flow path for the starter heat exchanger to regulate cooling above the equipment room dewpoint for applications using cooling sources other than evaporative air-exchange methods, such as wells, bodies of water, and chilled water. The temperature control valve should be the type to open on increasing drive coolant temperature, fail-closed, and set for a temperature above dewpoint. It can be requested as factory-supplied on a chiller order by special quotation.*

The Start/Stop control depends whether the chiller Control Source is set to Local or one of the Remote types from the chiller Setup - Operations screen. Start is operated:

- Only the keypad when the chiller is set to local mode,
- remotely through digital inputs in digital or analog remote mode but local keypad start must be pressed initially to enable the run permissive, or
- by the E-Link Gateway in BAS (ISN) remote mode but local keypad start must be pressed initially to enable the run permissive.

To start the chiller press the START key on the Home Screen on the display panel. In LOCAL control source, the chiller then starts. In remote ISN, ANALOG, DIGITAL, or MODEM a remote start command must also be provided to the proper input connection.

When the control is changed to local mode from any other source, it will remain in RUN if already running or remain in STOP if already stopped. A hardware Safety Stop button is also located on the side of the panel.

The chiller will start if the following conditions are met:

- Leaving Chilled Liquid Temperature is above the setpoint
- Chilled liquid flow is established
- Condenser liquid flow is established
- No un-cleared faults or start inhibits exist

**CHILLER OPERATION**

Upon start request, the following occur in sequence:

1. Chiller's system pump run contacts close.
2. VSD pre-charges (~12 seconds)
3. VSD pre-regulates (~3 seconds)
4. Motor runs

The chiller will vary capacity to maintain the leaving chilled liquid temperature setpoint by a specific sequencing of optional hot gas bypass, variable geometry diffuser, and compressor speed.

Throughout capacity control, the compressor speed is maintained above the minimum required for the prevailing head condition, to avoid surge. Otherwise, the device maintaining capacity is controlled by a proportional-integral-derivative control based on leaving chiller liquid temperature. Pressure and motor current overrides also apply as necessary to maintain operating limits.

The Input Current limit threshold value is determined from several settings, depending on the chiller control source selected according to the Table 1.

**TABLE 1 - INPUT CURRENT LIMIT THRESHOLD**

CONTROL SOURCE	ACTIVE INPUT CURRENT LIMIT THRESHOLD
Local	Lowest of: Local Input Current Limit Setpoint (% Input Job FLA) Pulldown Input Current Limit (when active)
ISN	Remote Input Current Limit Setpoint (comms)
Analog Remote	Lowest of: Local Input Current Limit Setpoint (% Input Job FLA) Analog Remote Input Current Limit Setpoint Pulldown Input Current Limit (when active)
Digital Remote	Lowest of: Local Input Current Limit Setpoint (% Input Job FLA) Digital Remote Input Current Limit Setpoint Pulldown Input Current Limit (when active)

**CHILLED LIQUID CONTROL SETTINGS****Temperature Control Setpoint**

The temperature to which the chiller will control the chilled fluid leaving the evaporator must be set by the Operator. The way it is selected depends whether the Operator wants this value set locally or modulated by a remote input.

**TABLE 2 - TEMPERATURE SETPOINT**

CONTROL SOURCE	LEAVING CHILLED LIQUID TEMPERATURE SETPOINT
Local	Local Leaving Chilled Liquid Temperature Setpoint, entered from the panel. It is programmable over the range of 38.0°F to 70.0°F (water) or 10.0°F to 70.0°F (brine). If Smart Freeze (see previous) is enabled, the range is 36.0°F to 70.0°F (water). The default is 45 °F.
ISN (BAS)	Remote Leaving Chilled Liquid Temperature Setpoint value sent over communications. The setpoint entered from the panel is ignored. If nothing is written to the address, the default is 45 °F.
Analog Remote	Local Leaving Chilled Liquid Temperature Setpoint, entered from the panel plus the temperature offset defined by the remote analog input signal. A remote device can provide an analog signal (0-20mA, 4-20mA, 0-10VDC or 2-10VDC) that creates the temperature offset in Analog Remote mode. The span of the offset may be defined as 10, 20, 30, or 40°F using the Local Leaving Chilled Liquid Temperature Range setting from the panel. For example, if this Range Setpoint is programmed for 10°F and the Local Leaving Chilled Liquid Temperature Setpoint is 45°F, then the remote device can set the Leaving Chilled Liquid Temperature setpoint over the range 45.0 to 55.0°F as its voltage or current changes from minimum to maximum.
Digital Remote	Local Leaving Chilled Liquid Temperature Setpoint, entered from the panel plus the temperature offset defined by the remote pulse width signal. A remote device can provide a Pulse Width Modulation (PWM) signal in Digital Remote mode that creates the temperature offset in Digital Remote mode. The span of the offset may be defined as 10, 20, 30, or 40°F using the Local Leaving Chilled Liquid Temperature Range setting from the panel. For example, if this Range Setpoint is programmed for 10°F and the Local Leaving Chilled Liquid Temperature Setpoint is 45°F, then the remote device can set the Leaving Chilled Liquid Temperature setpoint over the range 45.0 to 55.0°F as its pulse duration changes from minimum to maximum. The PWM input is in the form of a 1 to 11 second relay contact closure that applies 115VAC to the I/O Board TB4-19 for 1 to 11 seconds. A contact closure time (pulse width) of 1 second produces a 0°F offset. An 11 second closure produces the maximum offset. The relay contacts should close for 1 to 11 seconds at least once every 30 minutes to maintain the setpoint to the desired value. If a 1 to 11 second closure is not received within 30 minutes of the last closure, the offset is defaulted to zero. A closure is only accepted at rates not to exceed once every 70 seconds. Offset (°F) = (pulse width in seconds – 1)( Local Leaving Chilled Liquid Temperature Range) divided by 10.

Regardless of which method is used to select the desired Leaving Chilled Liquid Temperature (LCHLT), the chiller controls to its own Active LCHLT Setpoint. The Active Setpoint is a target to the programmed setpoint. When the chiller is not running, the Active Setpoint is set to Entering Chilled Liquid Temperature minus a programmable offset (default 5°F), but not adjusted to less than the programmed LCHLT setpoint. When the compressor motor starts, the Active LCHLT Setpoint is ramped from this value to the programmed LCHLT Setpoint at the programmable LCHLT Setpoint Ramp Rate (default 0.1°F/second). This keeps the chiller from undershooting setpoint excessively during pulldown. Any time the programmed setpoint is changed during operation, the active setpoint is ramped to the new value at this rate.

**Automatic Temperature Shutdown**

The temperature below the LCHLT setpoint at which the chiller is desired to automatically cycle off when load is less than the chiller minimum capability is programmed from the panel as Leaving Chilled Liquid Temperature Cycling Offset; Shutdown. This setting defines the temperature offset below the LCHLT setpoint where shutdown is expected. It is programmable over a range of 1°F to 64°F. However the actual shutdown temperature will never be calculated to lower than 36°F (water), 34°F (water with Smart Freeze enabled) or 6°F (brine). Anytime the LCHLT setpoint is decreased, the shutdown threshold decreases to the new LCHLT active setpoint minus offset at a rate equal to the programmed LCHLT Setpoint Ramp Rate. Anytime the Leaving Chilled Liquid Temperature setpoint is increased, the shutdown threshold increases to the new LCHLT active setpoint minus offset at a rate = 1/2 the programmed LCHLT Setpoint Ramp Rate. This allows time for the chiller to change temperature without shutting down first.

**Automatic Temperature Restart:**

The temperature above the LCHLT setpoint at which the chiller is desired to automatically restart after a low LCHLT shutdown per above is programmed from the panel as Leaving Chilled Liquid Temperature Cycling Offset; Restart. This setting defines the temperature offset above the LCHLT setpoint where automatic restart is expected. It is programmable over a range of 0°F to 70°F. However, the restart temperature will never be calculated above 80°F. This setpoint can be used to reduce chiller cycling by delaying the chiller restart until the cooling load has increased sufficiently.

**OPERATOR SETPOINTS QUICK REFERENCE**

The most common Operator level setpoints can be found on the Setpoints screen or the following screens:

Leaving Chilled Liquid Temperature:	Evaporator Screen
Shutdown Temperature Offset:	Evaporator Screen
Restart Temperature Offset:	Evaporator Screen
Local Input Current Limit:	VSD Screen
Pulldown Demand Limit:	VSD Screen
Pulldown Demand Time:	VSD Screen
Control Source:	Setpoints - Setup - Operations Screen
Head Pressure Setpoint (When The Feature Is Enabled)	Condenser - Head Pressure Control Screen

**STOPPING THE SYSTEM**

To stop the chiller, proceed as follows:

1. Push the Soft Stop key on the home screen of the OptiView™ panel if in LOCAL control or send a stop command through the remote system if in REMOTE or BAS control. If the chiller is in a remote control source and the local Soft Stop key is used to stop the chiller, the Start key must be pressed before the chiller will again permit starts through the remote source. In the event of an unusual circumstance requiring immediate stoppage, a safety stop switch is located on the side of the control panel. Normal stop eases the driveline to stop and should always be used instead of the safety stop during regular operation.
2. Stop the chilled water and/or condenser water pumps if not wired into the Microcomputer Control Center, (in which case it will shut off automatically. The actual water pump contact timing operation is dependent upon the selection on the SETUP screen.)
3. Open the switch to the cooling tower fan motors, if used.

The OptiView™ Control Center can be programmed to start and stop automatically (maximum - once each day) whenever desired.

Refer to *Schedule Screen on page 57* in the *SECTION 3 - OPTIVIEW™ CONTROL CENTER FUNCTIONS AND NAVIGATION* of this manual.

**SAFETY STOP**

When depressed, the chiller will not run under any condition. For safety reasons, this position is required for many maintenance tasks to be completed. The safety stop button must be rotated clockwise to release the stop condition. The safety stop is not intended for normal shutdown of the chiller. If used an immediate stop occurs, which by passes the programmed controlled shutdown.

**OPERATING LOGS**

A permanent daily record of system operating conditions (temperatures and pressures) recorded at regular intervals throughout each 24-hour operating period should be kept. Automatic data logging is possible by connecting the optional printer and programming the DATA LOGGER function. An optional status printer is available for this purpose. *Figure 4 on page 20* shows an example log sheet used by Johnson Controls Personnel for recording test data on chiller systems. Log sheets are available in pads of 50 sheets and may be obtained through the nearest Johnson Controls office.

An accurate record of readings serves as a valuable reference for operating the system. Readings taken when a system is newly installed will establish normal conditions with which to compare later readings.

For example, an increase in condenser approach temperature (condenser temperature minus leaving condenser water temperature) may be an indication of dirty condenser tubes.

**NEED FOR MAINTENANCE OR SERVICE**

If the system is malfunctioning in any manner or the unit is stopped by one of the safety controls, refer to the Operation Analysis Chart shown on *Table 16 on page 121 (SECTION 6 - TROUBLESHOOTING)*. After consulting this chart, if you are unable to make the proper repairs or adjustments to start the compressor or the particular trouble continues to hinder the performance of the unit, please call the nearest Johnson Controls District Office. Failure to report constant troubles could damage the unit and increase the cost of repairs.



*Ensure power is removed from the input side of the VSD at all times when the chiller is under vacuum (less than atmospheric pressure). The VSD maintains voltage to ground on the motor when the chiller is off while voltage is available to the VSD. Insulating properties in the motor are reduced in vacuum and may not insulate this voltage sufficiently.*

LD16236a

\* **NOTE:** A pad of 50 log sheets can be ordered from your local Johnson Controls branch by requesting Form 160.84-MR1.

**FIGURE 4 - LIQUID CHILLER LOG SHEETS**

### FAULT SHUTDOWNS

The chiller is programmed to shut down on two kinds of fault conditions. A Cycling fault will allow the chiller to automatically restart when the condition clears. A Safety fault requires the cause for the condition be determined and resolved before restarting. Safety faults require the Clear Faults key on the panel Home screen be pressed to allow restart. When the condition is cleared and that key pressed, the chiller will restart unless the local stop key was pressed or the remote run command ceased.

### PROLONGED SHUTDOWN

If the chiller is to be shut down for an extended period of time (for example, over the winter season), the following procedure should be followed.

1. Test all system joints for refrigerant leaks with a leak detector. If any leaks are found, they should be repaired before allowing the system to stand for a long period of time.

During long idle periods, the tightness of the system should be checked periodically.

2. If freezing temperatures are encountered while the system is idle, carefully drain the cooling water from the cooling tower, condenser, condenser pump, and the chilled water system-chilled water pump and coils.

Open the drains on the evaporator and condenser liquid heads to assure complete drainage. Drain the Variable Speed Drive cooling system.

3. On the SETUP Screen, disable the clock. This conserves the battery.
4. Open the main disconnect switches to the VSD, condenser water pump and the chilled water pump. Open the disconnect on the side of the Power Panel to disconnect the storage battery. Ensure the control center is powered off.

### RESTART AFTER PROLONGED SHUTDOWN

The chiller has a start inhibit limit for storage battery minimum voltage below 12.8 VDC when charging. Ensure the chiller has line power and battery disconnect restored at least eight hours prior to first planned startup to charge the battery.

**TABLE 3 - WATER FLOW RATE LIMITS IN GPM (L/S) – BASED UPON STANDARD TUBES @ DESIGN FULL LOAD CONDITIONS**

M2 MOTOR EVAPORATOR MODEL	EVAPORATOR						M2 MOTOR CONDENSER MODEL	CONDENSER					
	1 PASS		2 PASS		3 PASS			1 PASS		2 PASS		3 PASS	
	MIN	MAX	MIN	MAX	MIN	MAX		MIN	MAX	MIN	MAX	MIN	MAX
EB2910-B	950 (60)	3790 (239)	470 (30)	1820 (115)	320 (20)	950 (60)	CB2914-B	1160 (73)	4170 (263)	580 (37)	1920 (121)	390 (25)	1290 (81)
EB2910-C	1040 (66)	4170 (263)	520 (33)	2000 (126)	350 (22)	1050 (66)	CB2914-C	1380 (87)	4980 (314)	690 (44)	2270 (143)	460 (29)	1530 (97)
EB2910-2	740 (47)	2950 (186)	370 (23)	1470 (93)	250 (16)	980 (62)	CB2914-D	1620 (102)	5840 (368)	810 (51)	2630 (166)	540 (34)	1790 (113)
EB2910-3	1000 (63)	3990 (252)	500 (32)	1990 (126)	330 (21)	1300 (82)	CB2914-E	1760 (111)	6330 (399)	880 (56)	2830 (179)	590 (37)	1930 (122)
EB2914-B	950 (60)	3790 (239)	470 (30)	1900 (120)	320 (20)	1010 (64)	CB2914-F	1950 (123)	7030 (444)	980 (62)	3100 (196)	650 (41)	2140 (135)
EB2914-C	1040 (66)	4170 (263)	520 (33)	2090 (132)	350 (22)	1110 (70)	CB2914-2	1420 (90)	5120 (323)	710 (45)	2560 (162)	470 (30)	1710 (108)
EB2914-2	740 (47)	2950 (186)	370 (23)	1470 (93)	250 (16)	980 (62)	CB2914-3	1740 (110)	6290 (397)	870 (55)	3140 (198)	580 (37)	2100 (132)
EB2914-3	1000 (63)	3990 (252)	500 (32)	1990 (126)	330 (21)	1330 (84)	CB2510-B	780 (49)	2810 (177)	390 (25)	1400 (88)	260 (16)	940 (59)
EB3310-B	1170 (74)	4690 (296)	590 (37)	2350 (148)	390 (25)	1280 (81)	CB2510-C	900 (57)	3230 (204)	450 (28)	1610 (102)	300 (19)	1080 (68)
EB3310-C	1500 (95)	6010 (379)	750 (47)	3010 (190)	500 (32)	1640 (103)	CB2510-D	1120 (71)	4030 (254)	560 (35)	2020 (127)	370 (23)	1340 (85)
EB3310-2	790 (50)	3140 (198)	390 (25)	1570 (99)	260 (16)	1050 (66)	CB2510-E	1400 (88)	5030 (317)	700 (44)	2520 (159)	470 (30)	1680 (106)

**TABLE 3 - WATER FLOW RATE LIMITS IN GPM (L/S) – BASED UPON STANDARD TUBES @ DESIGN FULL LOAD CONDITIONS**

M2 MOTOR EVAPORATOR MODEL	EVAPORATOR						M2 MOTOR CONDENSER MODEL	CONDENSER					
	1 PASS		2 PASS		3 PASS			1 PASS		2 PASS		3 PASS	
	MIN	MAX	MIN	MAX	MIN	MAX		MIN	MAX	MIN	MAX	MIN	MAX
EB3310-3	1400 (88)	5610 (354)	700 (44)	2800 (177)	470 (30)	1870 (118)	CB2510-2	910 (57)	3290 (208)	460 (29)	1640 (103)	300 (19)	1100 (69)
EB3314-B	1170 (74)	4690 (296)	590 (37)	2350 (148)	390 (25)	1340 (85)	CB2510-3	1320 (83)	4760 (300)	660 (42)	2380 (150)	440 (28)	1590 (100)
EB3314-C	1500 (95)	6010 (379)	750 (47)	3010 (190)	500 (32)	1710 (108)	CB2910-B	1160 (73)	4170 (263)	580 (37)	2090 (132)	390 (25)	1390 (88)
EB3314-2	790 (50)	3140 (198)	390 (25)	1570 (99)	260 (16)	1050 (66)	CB2910-C	1380 (87)	4980 (314)	690 (44)	2490 (157)	460 (29)	1660 (105)
EB3314-3	1400 (88)	5610 (354)	700 (44)	2800 (177)	470 (30)	1870 (118)	CB2910-D	1620 (102)	5840 (368)	810 (51)	2920 (184)	540 (34)	1950 (123)
							CB2910-E	1760 (111)	6330 (399)	880 (56)	3170 (200)	590 (37)	2110 (133)
							CB2910-F	1950 (123)	7030 (444)	980 (62)	3520 (222)	650 (41)	2340 (148)
							CB2910-2	1420 (90)	5120 (323)	710 (45)	2560 (162)	470 (30)	1710 (108)
							CB2910-3	1740 (110)	6290 (397)	870 (55)	3140 (198)	580 (37)	2100 (132)
							CB3310-B	1590 (100)	5720 (361)	790 (50)	2860 (180)	530 (33)	1910 (121)
							CB3310-C	1900 (120)	6830 (431)	950 (60)	3420 (216)	630 (40)	2280 (144)
							CB3310-D	2480 (156)	8940 (564)	1240 (78)	4370 (276)	830 (52)	2980 (188)
							CB3310-E	2760 (174)	9940 (627)	1380 (87)	4720 (298)	920 (58)	3310 (209)
							CB3310-2	1620 (102)	5840 (368)	810 (51)	2920 (184)	540 (34)	1950 (123)
							CB3310-3	1930 (122)	6960 (439)	970 (61)	3480 (220)	640 (40)	2320 (146)
							CB3310-4	2590 (163)	9320 (588)	1290 (81)	4660 (294)	860 (54)	3110 (196)
							CB3314-B	1590 (100)	5720 (361)	790 (50)	2580 (163)	530 (33)	1750 (110)
							CB3314-C	1900 (120)	6830 (431)	950 (60)	3020 (191)	630 (40)	2080 (131)
							CB3314-D	2480 (156)	8940 (564)	1240 (78)	3790 (239)	830 (52)	2690 (170)
							CB3314-E	2760 (174)	9940 (627)	1380 (87)	4120 (260)	920 (58)	2960 (187)
							CB3314-2	1620 (102)	5840 (368)	810 (51)	2920 (184)	540 (34)	1950 (123)
							CB3314-3	1930 (122)	6960 (439)	970 (61)	3480 (220)	640 (40)	2320 (146)
							CB3314-4	2590 (163)	9320 (588)	1290 (81)	4660 (294)	860 (54)	3110 (196)

## SECTION 3 - OPTIVIEW™ CONTROL CENTER FUNCTIONS AND NAVIGATION

### INTERFACE CONVENTIONS

Each screen description in this document will begin with a section entitled **Overview** which will describe the graphical elements on the screen and give a short summary of the functions available. Each element on the screen will then be categorized into three distinct groups: Display Only, Programmable, and Navigation. Below is a short description of what types of information are included in these groups.

The Programmable values and Navigation commands are also subject to access level restrictions as described below. For each of these elements, an indication is given to show the minimum access level required to program the value or navigate to the subscreen.

### DISPLAY ONLY

Values in this group are read-only parameters of information about the chiller operation. This type of information may be represented by a numerical value, a text string, or an LED image. For numerical values, if the monitored parameter is above the normal operating range, the high limit value will be displayed along with the '>' symbol; if it is below the normal operating range, the low limit value will be displayed along with the '<' symbol. In some cases, the value may be rendered invalid by other conditions and the display will use X's to indicate this.

### PROGRAMMABLE

Values in this group are available for change by the user. In order to program any setpoints on the system, the user must first be logged in with the appropriate access level. Each of the programmable values requires a specific Access Level which will be indicated beside the specified value. All of the programmable controls in the system fall into one of the categories described below:

#### Access Level

The OptiView™ Panel restricts certain operations based on password entry by the operator. Three different access levels are provided as follows: **VIEW**: The panel defaults to the lowest access level which is termed **VIEW**. In this mode, the chiller operating values and setpoints can be observed, but no changes can be made. **OPERATOR**: The second access level is termed **OPERATOR** and will allow the customer

to change all of the setpoints required to operate the chiller system. In order to gain standard **OPERATOR** level access, the Home Screen Login Password would be entered as 9 6 7 5, using the numeric keypad. **SERVICE**: In the event that advanced diagnostics are necessary, a **SERVICE** access level has been provided. Only qualified service personnel utilize this access level. This level provides advanced control over many of the chiller functions and allows calibration of many of the chiller controls. The access levels are listed above in hierarchical order beginning with the lowest level and proceeding to the highest level. Users logged in under higher access levels may perform any actions permitted by lower access levels.

The **OPERATOR** access level is accompanied by a 10-minute timeout. After ten (10) successive minutes without a keypress, the panel will revert to the **VIEW** access level. This prevents unauthorized changes to the chiller if a user was logged in at a higher access level and failed to logout. Proper procedure requires that after making necessary setpoint adjustments the user return to the Home Screen and logout.

### Change Setpoints

On screens containing setpoints programmable at the **OPERATOR** access level, a key with this label will be visible if the present access level is **VIEW**. This key brings up the Access Level prompt described above. It allows the user to login at a higher Access Level without returning to the Home Screen. After login, the user may then modify setpoints on that screen.

### Setpoints

The control center uses the setpoint values to control the chiller and other devices connected to the chiller system. Setpoints can fall into several categories. They could be numeric values (such as 45.0°F for the Leaving Chilled Liquid Temperature), or they could Enable or Disable a feature or function.

Regardless of which setpoint is being programmed, the following procedure applies:

1. Press the desired setpoint key. A dialog box appears displaying the present value, the upper and lower limits of the programmable range, and the default value.

- If the dialog box begins with the word “ENTER”, use the numeric keys to enter the desired value. Leading zeroes are not necessary. If a decimal point is necessary, press the ‘.’ key (i.e. 45.0).

Pressing the ▲ key, sets the entry value to the default for that setpoint. Pressing the ▼ key, clears the present entry. The ◀ key is a backspace key and causes the entry point to move back one space.

If the dialog box begins with “SELECT”, use the ◀ and ▶ keys to select the desired value.

If the previously defined setpoint is desired, press the "X" (Cancel) key to dismiss the dialog box.

- Press the "✓" (Enter) key.

If the value is within range, it is accepted and the dialog box disappears. The chiller will begin to operate based on the new programmed value. If out of range, the value will not be accepted and the user is prompted to try again.

## Manual Controls

Some keys are used to perform manual control functions. These may involve manual control of items such as the compressor speed or valve actuators. These are typically restricted to qualified technicians in Service access. Other keys in this category are used to initiate/terminate processes such as calibrations or reports.

## Free Cursor

On screens containing many setpoints, a specific “soft” key may not be assigned to each setpoint value. A soft key will be assigned to enable the cursor arrow keys below the numeric keypad which are used to “highlight” the desired setpoint field. At this point, the ‘✓’ key is pressed to bring up a dialog prompting the user to enter a new setpoint value. The ‘X’ key cancels cursor mode. (See the Schedule Screen for an example.)

## NAVIGATION

In order to maximize the amount of values which the panel can display to the user, and in order to place those values in context, multiple screens have been designed to describe the chiller operation. In order to move from one screen to the next, navigation keys have been defined. These keys allow the user to either move “forward” to a subscreen of the present screen, or move “backward” to the previous screen. Except for the Home Screen display, the upper-right “soft” key will always return the user to the Home Screen. Navigating with “soft” keys is as simple as pressing the key next to the label containing the name of the desired screen.

The system will immediately refresh the display with the graphics for that screen. Following is a layout of all the screens and how they are connected.

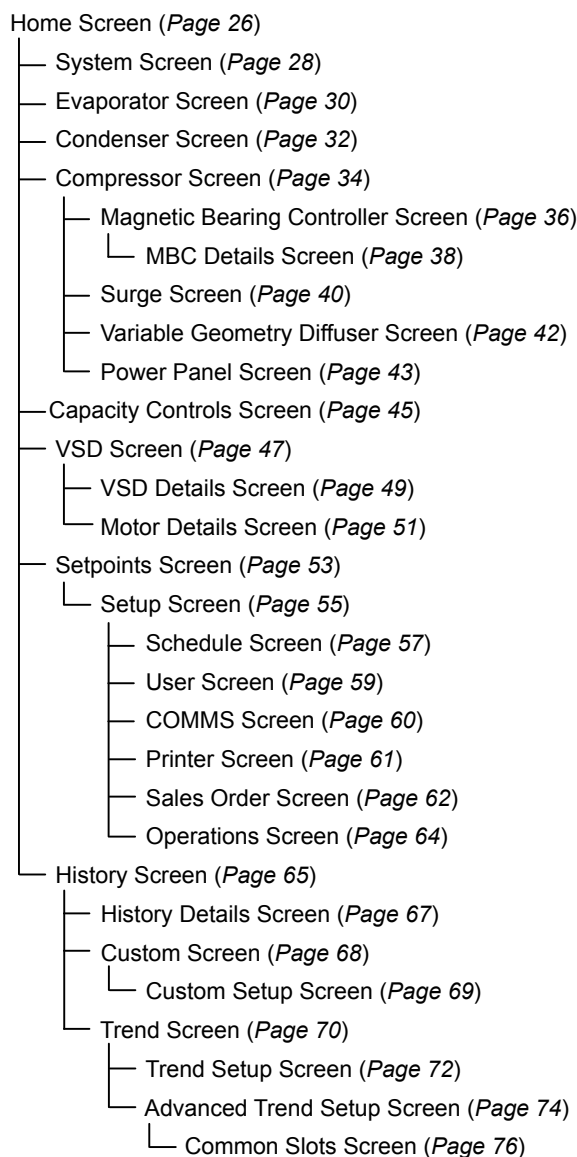



## LANGUAGES

The screens can be displayed in various languages. Language selection is done on the USER Screen. The desired language is selected from those available. Not all languages are available. English is the default lan-

guage. If a language other than English is being displayed, an English speaking person should navigate to the USER Screen (using the preceding Navigation chart) and select English.

## ANALOG INPUT RANGES

The following table indicates the valid display range for each of the analog input values. In the event that the input sensor is reading a value outside of these ranges,

the < or > symbols will be displayed beside the minimum or maximum value, respectively.

**TABLE 4 - ANALOG INPUT RANGES**

ANALOG INPUT	ENGLISH RANGE			METRIC RANGE		
	LOW	HIGH	UNITS	LOW	HIGH	UNITS
Leaving Chilled Liquid Temperature	0.0	82.0	°F	-17.7	27.7	°C
Return Chilled Liquid Temperature	0.0	94.1	°F	-17.7	34.5	°C
Leaving Condenser Liquid Temperature	8.0	133.5	°F	-13.3	56.3	°C
Return Condenser Liquid Temperature	8.0	133.5	°F	-13.3	56.3	°C
Evaporator Refrigerant Temperature (Optional)	0.0	126.1	°F	-17.7	52.3	°C
Discharge Temperature	31.8	226.3	°F	-0.1	107.9	°C
Condenser Pressure (R134a)	0.0	300.0	PSIG	0.0	2069	KPAG
Condenser Temperature (R134a)*	-98.7	160.1	°F	-72.6	71.7	°C
Evaporator Pressure (R134a)	0.0	125.0	PSIG	0	862	KPAG
Evaporator Temperature (R134a)*	-44.9	64.7	°F	-42.7	18.1	°C
Refrigerant Level	0.0	100.0	%	0.0	100.0	%
Drop Leg Refrigerant Temperature	0.0	121.7	°F	-17.7	49.8	°C
Motor Housing Temperature	31.8	226.3	°F	-0.1	107.9	°C

\*Saturation temperatures are calculated values. They will display XXX if the pressure used for the calculation is out of range.

## HOME SCREEN

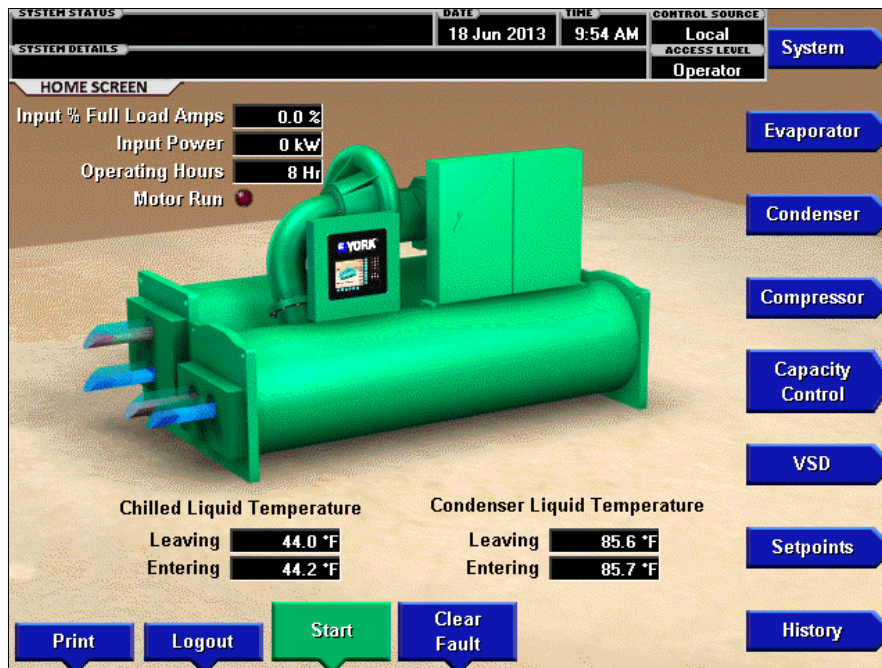

LD17916a

FIGURE 5 - HOME SCREEN

### OVERVIEW

When the chiller system is powered on, the above default display appears. The Home Screen display depicts a visual representation of the chiller itself. Animation indicates chilled liquid flow and/or condenser cooling liquid flow when the flow switch inputs are satisfied.

### DISPLAY ONLY

#### Chilled Liquid Temperature - Leaving

Displays the temperature of the liquid as it leaves the evaporator.

#### Chilled Liquid Temperature - Entering

Displays the temperature of the liquid as it enters the evaporator.

#### Condenser Liquid Temperature - Leaving

Displays the temperature of the liquid as it leaves the condenser.

#### Condenser Liquid Temperature - Entering

Displays the temperature of the liquid as it enters the condenser.

#### Input % Full Load Amps

This displays the percentage of full load amps utilized by the system.

#### Input Power (kW)

This displays the total input power used by the system.

#### Operating Hours

Displays the cumulative operating hours of the chiller.

#### Motor Run (LED)

Is ON when the digital output that gives the VSD a motor run command is on.

### PROGRAMMABLE

#### Login

*Access Level Required: VIEW*

This key allows the user to change Access Level when the proper password is entered at the prompt.

#### Logout

*Access Level Required: OPERATOR*

This key is displayed when a user is logged in at any level other than **VIEW**. Pressing it will return the access level to **VIEW**.

## Print

*Access Level Required: VIEW*

Use this key to generate a hard-copy report of the present system status. This provides a snapshot of the primary operating conditions at the time the key is pressed. The History page provides enhanced reporting capability. (See HISTORY Screen.) This option will not be present if the chiller is presently configured to print History, New Data, which continuously logs.

## Clear Fault

*Access Level Required: VIEW*

When safety conditions have been detected, the chiller is shutdown, and the main status display of the chiller will display a message indicating the cause of the shutdown. Using this key, the fault and message can be cleared once the condition has been removed. The key only shows when the condition can be cleared. If the chiller has a standing Local or Remote run command, it will start when the key is pressed.

## Warning Reset

*Access Level Required: OPERATOR*

Use of this key acknowledges a warning condition and resets the message display associated with it.

## Start

*Access Level Required: OPERATOR*

This key is only available when the chiller does not have a local run request. Pressing this key allows selection of enter to run or cancel to abort to stopped. Enter causes the chiller to start if control source is LOCAL, or permits run if control source is any remote.

## Soft Stop

*Access Level Required: OPERATOR*

This key is only available when the chiller is in local mode and has a local run request. It shows in place of the start key. Pressing this key allows selection of enter to stop or cancel to remain running. Enter causes the chiller to perform a soft shutdown and disables the remote run permissive.

## NAVIGATION

### System

Used to provide additional system information.

### Evaporator

A detailed view of all evaporator parameters, including the programmable Leaving Chilled Liquid Setpoints.

### Condenser

A detailed view of all condenser parameters, including control of the liquid level functions.

### Compressor

A detailed view of all the compressor parameters. This includes surge protection, Magnetic Bearing Control, Variable Geometry Diffuser, and calibration.

### Capacity Control

A detailed view of all the parameters associated with capacity control.

### VSD

A detailed view of the motor and VSD parameters. This allows programming of the Current Limit and the Pulldown Demand Limit values.

### Setpoints

This screen provides a single location to program the most common system setpoints. It is also the gateway to many of the general system setup parameters such as Date/Time, Display Units, Scheduling, Printer Setup, etc.

### History

This screen provides access to a snapshot of system data at each of the last 10 shutdown conditions, and provides for trending operating parameters.

## SYSTEM SCREEN

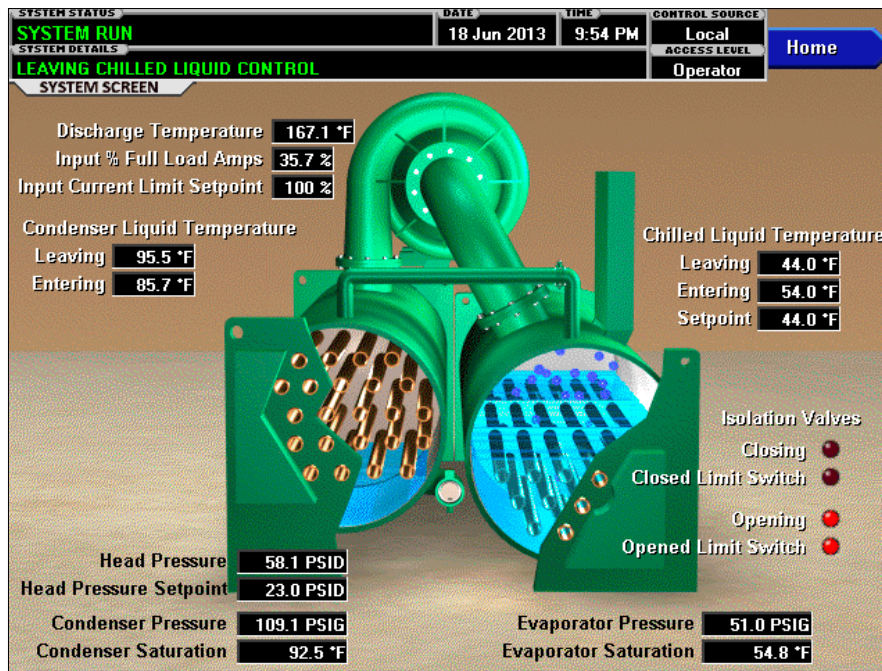

LD17917a

FIGURE 6 - SYSTEM SCREEN

### OVERVIEW

This screen gives a general overview of common chiller parameters for both shells.

### DISPLAY ONLY

#### Discharge Temperature

Displays the temperature of the refrigerant in its gaseous state at discharge of the compressor as it travels to the condenser.

#### Input % Full Load Amps

This displays the percentage of full load amps utilized by the system.

#### Input Current Limit Setpoint

Displays the current limit value in use. This value is percent of Input Full Load Amps.

#### Condenser Liquid Temperature - Leaving

Displays the temperature of the liquid as it leaves the condenser.

#### Condenser Liquid Temperature - Entering

Displays the temperature of the liquid as it enters the condenser.

#### Chilled Liquid Temperature - Leaving

Displays the temperature of the liquid as it leaves the evaporator.

#### Chilled Liquid Temperature - Entering

Displays the temperature of the liquid as it enters the evaporator.

#### Chilled Liquid Temperature - Setpoint

Displays the programmed temperature setpoint for leaving chilled liquid. It is the local value or remote reset value depending on control source.

#### Condenser Pressure

Displays the refrigerant pressure in the condenser.

#### Condenser Saturation Temperature

Displays the saturation temperature in the condenser calculated from condenser pressure.

### **Evaporator Pressure**

Displays the present refrigerant pressure in the evaporator.

### **Evaporator Saturation Temperature**

Displays the present saturation temperature in the evaporator calculated from evaporator pressure.

### **Head Pressure**

Displays the pressure difference between the condenser and evaporator (condenser minus evaporator). Only appears when Head Pressure Control is enabled.

### **Head Pressure Setpoint**

Displays the active Head Pressure Setpoint to which the head pressure is being controlled. Only appears when Head Pressure Control is enabled.

### **Isolation Valves (LEDs)**

Only show when optional brine isolation valve feature exists and enabled.

Closing - The control is commanding the valve close output on.

Closed Limit Switch - Feedback from the valve limit switch at the full closed position shows the switch made, indicating closed valve.

Opening - The control is commanding the valve open output on.

Opened Limit Switch - Feedback from the valve limit switch at the full open position shows the switch made, indicating open valve.

### **PROGRAMMABLE**

There are no programmable fields on this screen.

### **NAVIGATION**

#### **Home**

Causes an instant return to the Home Screen.



## EVAPORATOR SCREEN

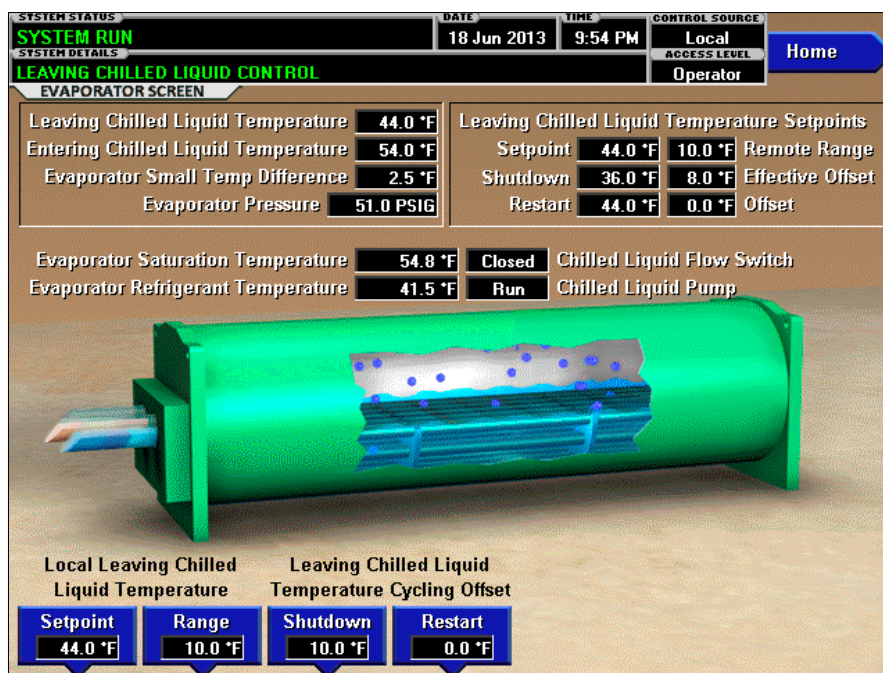

LD17918a

FIGURE 7 - EVAPORATOR SCREEN

### OVERVIEW

This screen displays a cutaway view of the chiller evaporator. All setpoints relating to the evaporator side of the chiller are maintained on this screen. Animation of the evaporation process indicates whether the chiller is presently in a **RUN** condition. Animation of the liquid flow indicates chilled liquid flow.

### DISPLAY ONLY

#### Leaving Chilled Liquid Temperature

Displays the temperature of the liquid as it leaves the evaporator.

#### Entering Chilled Liquid Temperature

Displays the temperature of the liquid as it enters the evaporator.

#### Evaporator Small Temperature Difference

Displays the difference between the Leaving Chilled Liquid temperature and the Evaporator Refrigerant temperature. The Evaporator Refrigerant temperature will be represented by the Refrigerant Temperature sensor input if the sensor is enabled, otherwise it will be represented by the Evaporator Saturation temperature.

#### Evaporator Pressure

Displays the present refrigerant pressure in the evaporator.

#### Leaving Chilled Liquid Temperature Setpoints – Setpoint

Displays the present setpoint to which the chiller is operating, whether controlled locally or remotely.

#### Leaving Chilled Liquid Temperature Setpoints - Shutdown

Displays the Leaving Chilled Liquid Temperature at which the chiller will shutdown on LEAVING CHILLED LIQUID – LOW TEMPERATURE cycling shutdown. It is calculated automatically from the temperature setpoint minus the shutdown offset setpoint and limited to chiller minimum.

#### Leaving Chilled Liquid Temperature Setpoints – Restart

Displays the Leaving Chilled Liquid Temperature at which the chiller will restart after it has shutdown on LEAVING CHILLED LIQUID – LOW TEMPERATURE cycling shutdown. This temperature is set as an offset using the LEAVING CHILLED LIQUID TEMPERATURE CYCLING OFFSET – RESTART setpoint.

### **Leaving Chilled Liquid Temperature Setpoints – Remote Range**

Displays the temperature range proportional to a remote analog input used to reset the Leaving Chilled Liquid temperature upward by this amount remotely.

### **Leaving Chilled Liquid Temperature Setpoints (Shutdown) – Effective Offset**

Displays the present value of the leaving chilled liquid temperature shutdown offset in effect limited by the chiller minimum temperature.

### **Leaving Chilled Liquid Temperature Setpoints (Restart) – Offset**

Displays the value set for leaving chilled liquid temperature restart offset.

### **Evaporator Saturation Temperature**

Displays the present saturation temperature in the evaporator, determined from evaporator pressure.

### **Chilled Liquid Flow Switch (Open/Closed)**

Displays whether the liquid flow switch input indicates flow is present in the evaporator.

### **Chilled Liquid Pump**

Displays the command presently sent by the control center to the Chilled Liquid Pump run contacts (**RUN** or **STOP**).

### **Evaporator Refrigerant Temperature**

Displays the temperature of the refrigerant in the evaporator.

## **PROGRAMMABLE**

### **Local Leaving Chilled Liquid Temperature - Setpoint**

*Access Level Required: OPERATOR*

This value allows the user to define the Leaving Chilled Liquid Temperature that is to be maintained by the chiller. It is programmable over the range of 38.0°F to 70.0°F (water) or 10.0°F to 70.0°F (brine). If Smart Freeze (see below) is enabled, the range is 36.0°F to 70.0°F (water).

When the chiller is running, performing capacity control, any change to the LCHLT setpoint results in a ramp from the old value to the new value at the programmed LCHLT setpoint ramp rate.

### **Local Leaving Chilled Liquid Temperature - Range**

*Access Level Required: OPERATOR*

This is the range over which an analog or a digital signal (PWM) can reset the Leaving Chilled Liquid Temperature setpoint above the operator programmed **Base Setpoint**.

### **Leaving Chilled Liquid Temperature Cycling Offset - Shutdown**

*Access Level Required: OPERATOR*

This value allows the user to specify the Leaving Chilled Liquid Temperature at which the chiller will shut down on a LEAVING CHILLED LIQUID – LOW TEMPERATURE cycling shutdown. This is done by defining an offset below the Leaving Chilled Liquid Temperature setpoint. It is programmable over a range of 1°F to 64°F.

### **Leaving Chilled Liquid Temperature Cycling Offset - Restart**

*Access Level Required: OPERATOR*

This value allows the user to specify the Leaving Chilled Liquid Temperature at which the chiller will restart after a shutdown on a LEAVING CHILLED LIQUID – LOW TEMPERATURE cycling shutdown. This is done by defining an offset above the Leaving Chilled Liquid Temperature setpoint. It is programmable over a range of 0°F to 70°F.

## **NAVIGATION**

### **Home**

Causes an instant return to the Home Screen.

## CONDENSER SCREEN

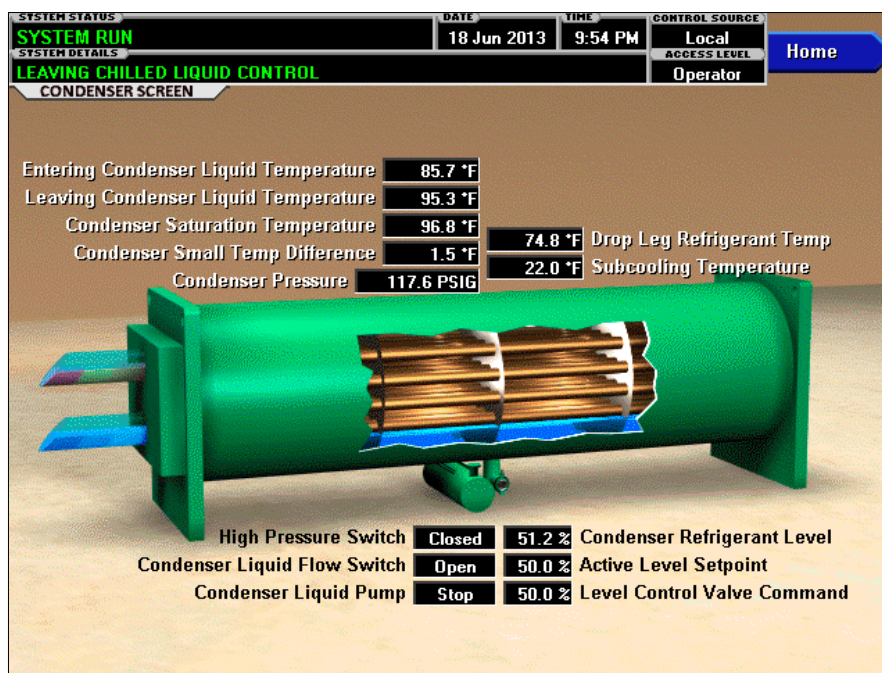

LD17919a

FIGURE 8 - CONDENSER SCREEN

### OVERVIEW

This screen displays a cutaway view of the chiller condenser. All setpoints relating to the condenser side of the chiller are maintained on this screen. Animation indicates condenser liquid flow. This screen also serves as a gateway to controlling the Refrigerant Level.

### DISPLAY ONLY

#### Entering Condenser Liquid Temperature

Displays the water temperature as it enters the condenser.

#### Leaving Condenser Liquid Temperature

Displays the water temperature as it leaves the condenser.

#### Condenser Saturation Temperature

Displays the saturation temperature in the condenser.

#### Condenser Small Temperature Difference

Displays the difference between the Condenser Refrigerant temperature and the Leaving Condenser Liquid temperature. The Condenser Refrigerant temperature will be represented by the Condenser Saturation temperature.

#### Condenser Pressure

Displays the refrigerant pressure in the condenser.

#### Drop Leg Refrigerant Temperature

Displays the temperature of the refrigerant in the drop leg between the condenser and evaporator shells.

#### Subcooling Temperature

Displays the difference between the Condenser Refrigerant temperature and the Drop Leg Refrigerant temperature. The Condenser Refrigerant temperature will be represented by the Condenser Saturation temperature.

#### High Pressure Switch (Open/Closed)

Displays the present position of the high pressure switch. This will indicate open when a High Pressure fault is present.



### **Condenser Liquid Flow Switch**

Indicates whether flow is present in the condenser.

### **Condenser Liquid Pump (Run/Stop)**

Displays the command presently sent by the control center to the Condenser Liquid Pump run contacts.

### **Refrigerant Level**

Displays the present position of the refrigerant level.

### **Active Level Setpoint**

Displays the setpoint to which the refrigerant level is being controlled.

### **Level Control Valve Command**

Displays the position command to the level control valve in percent of travel with 0% full closed to 100% full open.

## **NAVIGATION**

### **Home**

Causes an instant return to the Home Screen.

## COMPRESSOR SCREEN

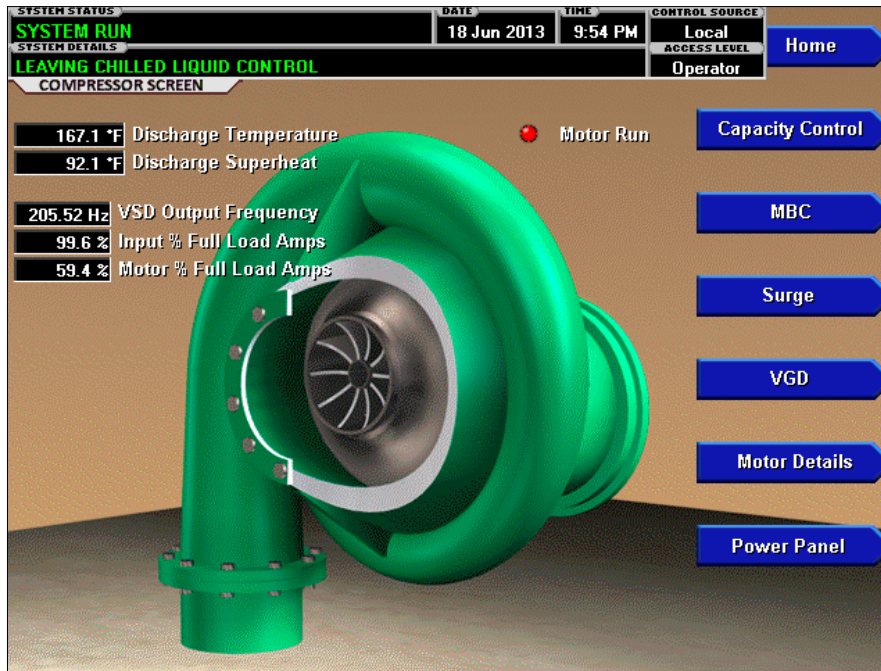

LD17922a

**FIGURE 9 - COMPRESSOR SCREEN**

### OVERVIEW

This screen displays a cutaway view of the chiller compressor, revealing the impeller, and shows all conditions associated with the compressor. Animation of the compressor impeller indicates whether the chiller is presently in a **RUN** condition. This screen also serves as a gateway to subscreens for jumping to capacity control and displaying MBC, Surge and VGD and Power Panel detail.

### DISPLAY ONLY

#### Discharge Temperature

Displays the temperature of the refrigerant in its gaseous state at discharge of the compressor as it travels to the condenser.

#### Discharge Superheat

Displays the Discharge superheat, calculated as (Discharge Temperature – Condenser Saturation temperature).

#### Motor Run (LED)

Indicates ON when the digital output run command to the VSD is on.

#### Input % Full Load Amps

Displays the chiller current as a percentage of the job input Full Load Amps (FLA) value.

#### Motor % Full Load Amps

Displays the current to the motor as a percentage of the motor maximum current.

#### VSD Output Frequency

Displays the VSD frequency.

### PROGRAMMABLE

There are no programmable fields on this screen.

### NAVIGATION

#### Home

Causes an instant return to the Home Screen.

#### Capacity Control

Causes an instant transfer to the Capacity Control Screen.

**MBC**

Moves to the subscreen allowing view of the Magnetic Bearing Controller parameters and event log.

**Surge**

Moves to the subscreen that allows viewing and programming of the Surge Protection feature.

**VGD**

Moves to the subscreen that allows viewing and calibrating the Variable Geometry Diffuser feature. Programming requires an access level of SERVICE.

**Motor Details**

Moves to the screen showing motor operating details.

**Power Panel**

Moves to the subscreen that allows viewing power panel status and parameters

## MAGNETIC BEARING CONTROLLER SCREEN

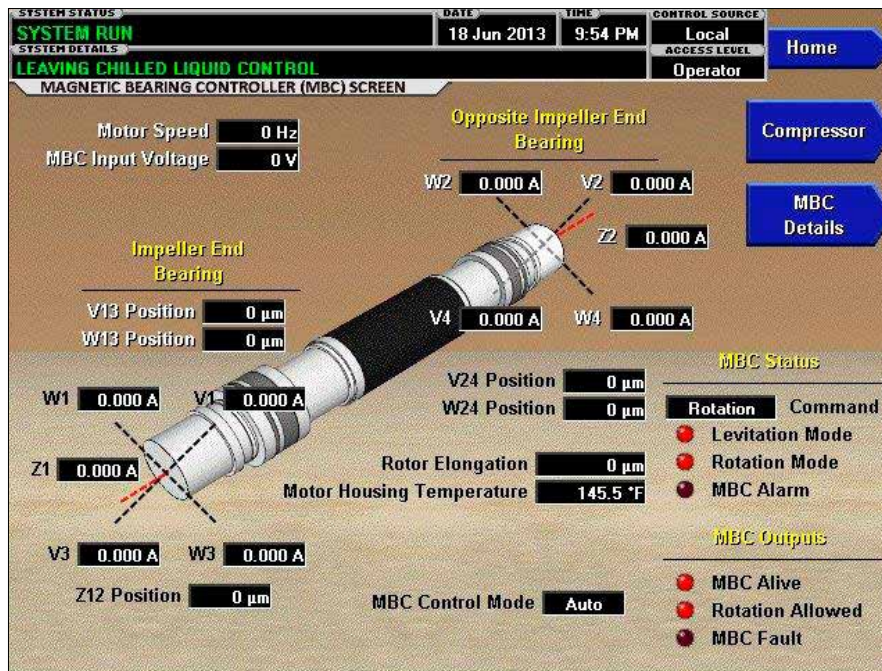

LD17923a

FIGURE 10 - MAGNETIC BEARING CONTROLLER SCREEN

### OVERVIEW

This screen displays the orientation of the magnetic bearing axes relative to the compressor driveline. Pertinent parameters transmitted to the control panel from the Magnetic Bearing Controller (MBC) are displayed on this screen. Many parameters are shown in the diagram in the locations they represent. The left end of the motor shaft graphic represents the low stage (single stage) Impeller End Bearing. The right end of the motor shaft graphic represents the Opposite End Bearing.

### DISPLAY ONLY

#### V13 Position

Displays the shaft position in micrometers from center along the radial axis designated “V” for the Impeller End Bearing.

#### W13 Position

Displays the shaft position in micrometers from center along the radial axis designated “W” for the Impeller End Bearing.

#### W1 (Current)

Displays the magnetizing current to the upper bearing on the radial axis designated “W” for the Impeller End.

#### W3 (Current)

Displays the magnetizing current to the lower bearing on the radial axis designated “W” for the Impeller End.

#### V1 (Current)

Displays the magnetizing current to the upper bearing on the radial axis designated “V” for the Impeller End.

#### V3 (Current)

Displays the magnetizing current to the lower bearing on the radial axis designated “V” for the Impeller End.

#### Z1 (Current)

Displays the magnetizing current to the axial bearing at the Impeller End.

#### Z12 Position

Displays the shaft position in micrometers from center along the axial axis.

#### V24 Position

Displays the shaft position in micrometers from center along the radial axis designated “V” for the Opposite Impeller End Bearing.

### **W24 Position**

Displays the shaft position in micrometers from center along the radial axis designated “W” for the Opposite Impeller End Bearing.

### **W2 (Current)**

Displays the magnetizing current to the upper bearing on the radial axis designated “W” for the Opposite Impeller End.

### **W4 (Current)**

Displays the magnetizing current to the lower bearing on the radial axis designated “W” for the Opposite Impeller End.

### **V2 (Current)**

Displays the magnetizing current to the upper bearing on the radial axis designated “V” for the Opposite Impeller End.

### **V4 (Current)**

Displays the magnetizing current to the lower bearing on the radial axis designated “V” for the Opposite Impeller End.

### **Z2 (Current)**

Displays the magnetizing current to the axial bearing at the Opposite Impeller End.

### **MBC Control Mode**

Displays whether the MBC is in Manual or Automatic Control.

### **Command**

Displays the OptiView state command to the MBC

### **[MBC Status] Levitation Mode (LED)**

Indicates the MBC is reporting itself in Levitated status via Modbus Data.

### **[MBC Status] Rotation Mode (LED)**

Indicates the MBC is reporting itself in Rotation mode via Modbus Data.

### **[MBC Status] MBC Alarm (LED)**

Indicates the MBC is reporting a shutdown fault via Modbus Data.

### **[MBC Outputs] MBC Alive (LED)**

Indicates the MBC alive allowed contacts are closed by the control Digital Input.

### **[MBC Outputs] Rotation Allowed (LED)**

Indicates the MBC rotation allowed contacts are closed by the control Digital Input.

### **[MBC Outputs] MBC Fault (LED)**

Indicates the MBC fault contacts are opened, indicating a fault, by the control Digital Input.

### **Motor Speed**

Indicates the compressor motor rotational speed.

### **MBC Input Voltage**

Indicates voltage supply to the MBC.

### **Rotor Elongation**

Indicates the thermal growth of the motor shaft as determined by the difference in the low stage impeller end position sensor and the opposite end position sensor.

### **Motor Housing Temperature**

Indicates the motor housing temperature measured from a thermistor inserted in the motor housing.

## **NAVIGATION**

### **Home**

Causes immediate return to the Home Screen.

### **Compressor**

Causes immediate transfer to the Compressor Screen.

### **MBC Details**

Moves to the subscreen showing additional detailed MBC parameters.

### **MBC Event Log**

Moves to the subscreen showing the MBC collection of event history logs.



## MAGNETIC BEARING CONTROLLER DETAILS SCREEN

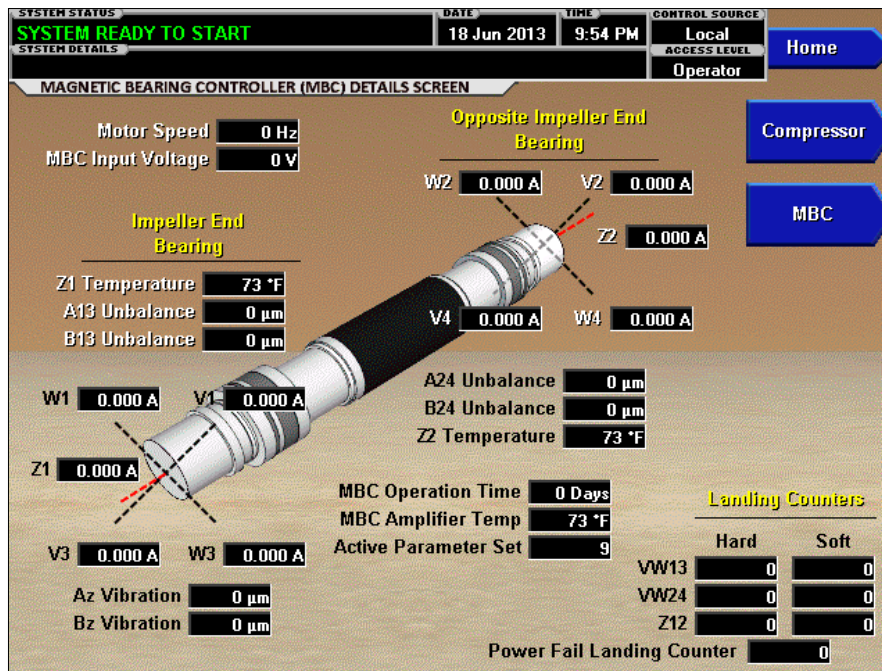

LD17924a

FIGURE 11 - MAGNETIC BEARING CONTROLLER DETAILS SCREEN

### OVERVIEW

This screen displays the orientation of the magnetic bearing axes relative to the compressor driveline similar to the MBC Screen. Additional pertinent parameters transmitted to the control panel from the Magnetic Bearing Controller (MBC) are displayed on this screen. Many parameters are shown in the diagram in the locations they represent. The left end of the motor shaft graphic represents the low stage (single stage) Impeller End Bearing. The right end of the motor shaft graphic represents the Opposite End Bearing.

### DISPLAY ONLY

#### Z1 Temperature

Displays the temperature measured at the impeller end bearing assembly.

#### A13 Unbalance / B13 Unbalance

Magnitude of motion at 1x rotation in each of two vectors at the 1-stage impeller end.

#### A24 Unbalance / B24 Unbalance

Magnitude of motion at 1x rotation in each of two vectors at the opposite 1-stage impeller end.

#### Z2 Temperature

Displays the temperature measured at the opposite impeller end bearing assembly.

#### Z12 Vibration

Displays the vibration amplitude for specific frequencies measured axially by the position sensors.

Magnetic bearing currents as described for the MBC Screen are repeated on this screen:

- W1 (Current)
- V1 (Current)
- Z1 (Current)
- V3 (Current)
- W3 (Current)
- W2 (Current)
- V2 (Current)
- Z2 (Current)
- V4 (Current)
- W4 (Current)

### **[MBC Status] AVR (LED)**

Indicates the MBC is reporting its automatic vibration reduction feature is active via Modbus Data.

### **[MBC Status] ABS (LED)**

Indicates the MBC is reporting its automatic balancing system feature is active via Modbus Data.

### **Motor Speed**

Indicates the compressor motor rotational speed.

### **DC Bus Voltage**

Indicates the voltage of the DC Bus, which supplies the MBC.

### **MBC Operation Time**

Indicates the cumulative time of operation of the MBC since initial power up.

### **MBC Amplifier Temp**

Displays the temperature measured at the MBC bearing current amplifier board.

### **Active Parameter Set**

Displays a code number for the bearing stiffness parameter set the MBC is using, as commanded by OptiView on power up. This is based on the compressor model number on the Sales Order Screen.

### **AZ Vibration / BZ Vibration**

Magnitude of runout motion in each of two vectors.

### **Landing Counters**

Display the number of time the MBC counted a displacement beyond 80% of the nominal bearing gap when running in each of the indicated directions or planes. Hard or Soft relates to dwell time.

### **Power Fail Landing Counter**

Indicates the number of times OptiView has determined upon power up that the last power down occurred while speed was still indicated from the MBC.

## **PROGRAMMABLE**

There are no programmable fields on this screen.

## **NAVIGATION**

### **Home**

Causes immediate return to the Home Screen.

### **Compressor**

Causes immediate transfer to the Compressor Screen.

### **MBC**

Causes immediate return to the MBC Screen.

## SURGE SCREEN

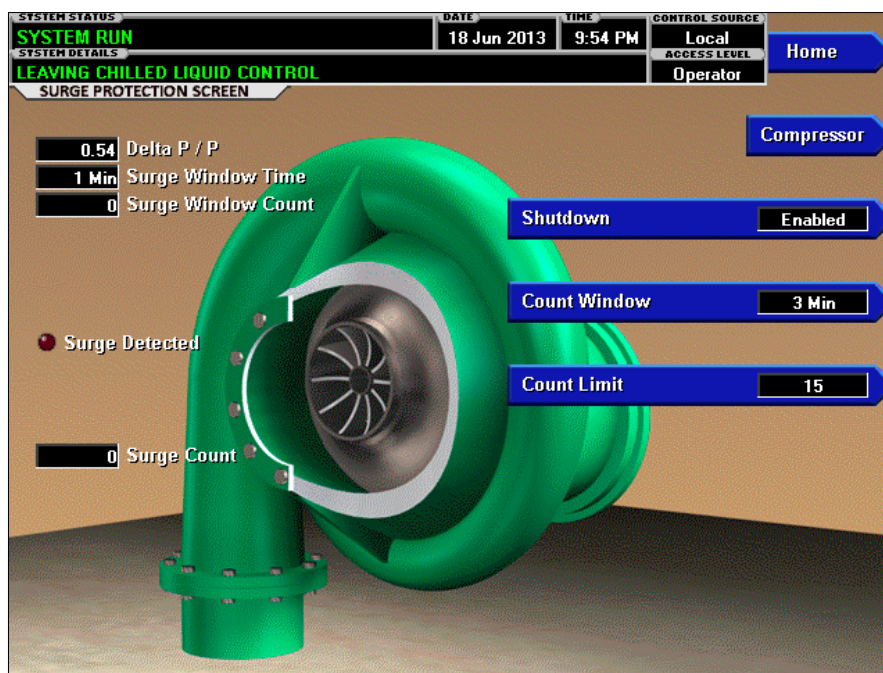

LD17927a

FIGURE 12 - SURGE SCREEN

### OVERVIEW

This screen displays the chiller compressor and all parameters relating to the Surge Protection feature. All setpoints relating to this screen are maintained on this screen.

The Surge Protection feature allows the user to define how many surges are excessive and how the control will react to an excess surge condition. When excess surging is detected, it can be configured to shutdown the chiller. The sensitivity of this surge detection is set by the Sensitivity Setpoint on this screen.

### DISPLAY ONLY

#### Delta P/P

A parameter that represents the system differential or HEAD PRESSURE. It is calculated as (condenser pressure – evaporator pressure) / evaporator pressure.

#### Surge Window Time

When the chiller enters run mode, this value counts up to the time programmed as the COUNT WINDOW setpoint. When it reaches the COUNT WINDOW minutes, the number of surge events in the oldest minute is

discarded and the number of surge events in the most recent minute is added, thus providing a rolling count of the total surge events that have occurred in the last COUNT WINDOW minutes. This value is reset when the chiller shuts down.

#### Surge Window Count

Displays the number of surge events that have occurred in the last 1 to 5 minutes as programmed with the COUNT WINDOW setpoint. If the chiller has been running for less than the COUNT WINDOW minutes, it is the number of surge events that have occurred within the last number of minutes displayed as the SURGE WINDOW TIME. The count is cleared when the chiller shuts down.

#### Surge Detected (LED)

Illuminates momentarily when a surge is detected by the Surge Protection feature.

#### Surge Count

This is the total number of surges accumulated by the Surge Protection feature.



## PROGRAMMABLE

### Shutdown (Enabled/Disabled)

*Access Level Required: OPERATOR*

Allows the user to select whether the chiller will shut-down or continue to run when an Excess Surge situation has been detected.

### Count Window

*Access Level Required: OPERATOR*

Allows the user to define the period of time (1 to 5 minutes; default 5; default 3 in which the number of surge events (SURGE WINDOW COUNT) are compared to the maximum allowed (COUNT LIMIT), for the purpose of detecting an excess surge situation.

### Count Limit

*Access Level Required: OPERATOR*

Allows the user to define the maximum number of surge events (4 to 20; default 4; default 15 that can occur within a defined period of time before an Excess Surge situation is detected. If the SURGE WINDOW COUNT exceeds the COUNT LIMIT, an Excess Surge situation has occurred.

When an Excess Surge situation is detected, and the SHUTDOWN setpoint is Enabled, the chiller will perform a safety shutdown and display SURGE PROTECTION – EXCESS SURGE.

## NAVIGATION

### Home

Causes an instant return to the Home Screen.

### Compressor

Causes an instant return to the Compressor Screen.

## VARIABLE GEOMETRY DIFFUSER SCREEN



LD17928a

FIGURE 13 - VARIABLE GEOMETRY DIFFUSER SCREEN

### OVERVIEW

This screen displays information pertinent to the VGD operation.

### DISPLAY ONLY

#### Active Stall Voltage

Displays the Stall Detector output voltage (x.xxVdc), as received by the Microboard, from the stall board.

#### Active Stall Voltage Type

Displays STANDARD or ENHANCED to indicate whether the Active Stall Voltage has enhanced filtering applied when necessary to normalize flow noise.

#### Mach Number

Displays the compressor calculated mach number, based on drive speed and suction conditions.

#### VGD Position

Displays the position of the VGD over the range of 0% (fully closed) to 100% (fully open). Displayed as XXX until calibration procedure is performed by a qualified Service technician.

### VGD Command

Displays the position command from the control to the VGD.

### Surge Detected (LED)

Illuminates for 5 seconds each time a surge is detected.

### Discharge Pressure

Displays the compressor discharge pressure as sensed by the transducer used for the stall signal determination.

### Condenser Pressure

Displays the condenser pressure sensed by the condenser shell transducer.

### Head Pressure

Displays the resultant of the Condenser Pressure minus the evaporator pressure.

### NAVIGATION

#### Home

Causes an instant return to the Home Screen.

#### Compressor

Causes an instant return to the Compressor Screen.

## POWER PANEL SCREEN

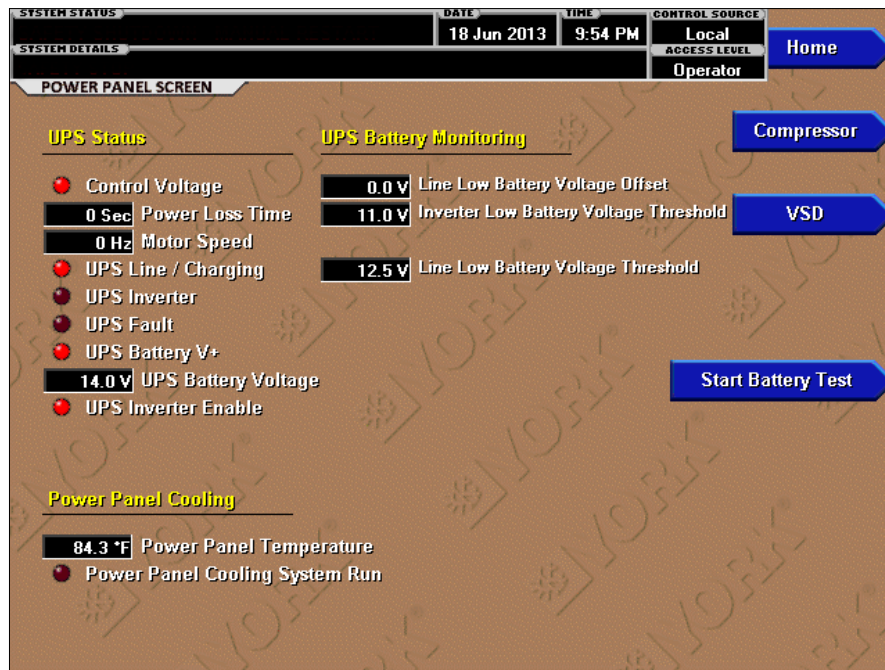

LD17930a

FIGURE 14 - POWER PANEL SCREEN

### OVERVIEW

This screen displays information pertaining to the power panel, which includes the uninterruptable power supply (UPS) and storage battery for essential loads necessary for shutdown during a line power loss.

### DISPLAY ONLY

#### Control Voltage (LED)

Indicates the OptiView control voltage digital input voltage is present, indicating line power is available.

#### Power Loss Time

Indicates the time in seconds while the OptiView control voltage digital input is low, indicating time without line power for the present outage.

#### Motor Speed

Indicates the motor speed as reported from the MBC.

#### UPS Line / Charging (LED)

Indicates the UPS is in charging mode, using line power to supply loads and any necessary current to the power storage battery.

#### UPS Inverter (LED)

Indicates the UPS is providing power from the storage battery.

#### UPS Fault (LED)

Indicates the UPS has faulted.

#### UPS Battery V+ (LED)

Indicates the UPS senses battery present

#### UPS Battery Voltage

Indicates the UPS battery voltage from available to the UPS input.

#### UPS Inverter Enable (LED)

Indicates the presence of the signal from OptiView to the UPS permitting the UPS to supply power from the battery as needed upon loss of line power.

#### Power Panel Temperature

Indicates the ambient temperature inside the power panel.

**Power Panel Cooling System Run (LED)**

Indicates the power panel coolant pump and coil fan are commanded to run.

**Line Low Battery Voltage Offset, Inverter Low Battery Voltage Threshold, Line Low Battery Voltage Threshold**

These are control setpoints for battery health fault logic.

**PROGRAMMABLE****Start Battery Test**

*Access Level Required: Operator*

Initiates a battery load test. Only applies when chiller is shutdown and manual operation of power supply to the chiller can be performed according to the process outlines in *YORK YMC<sup>2</sup> Service Manual (Form 160.84-M2)*.

**NAVIGATION****Home**

Causes an instant return to the Home Screen.

**Compressor**

Causes an instant return to the Compressor Screen.

**VSD**

Causes an instant return to the Variable Speed Drive Screen.

## CAPACITY CONTROL SCREEN

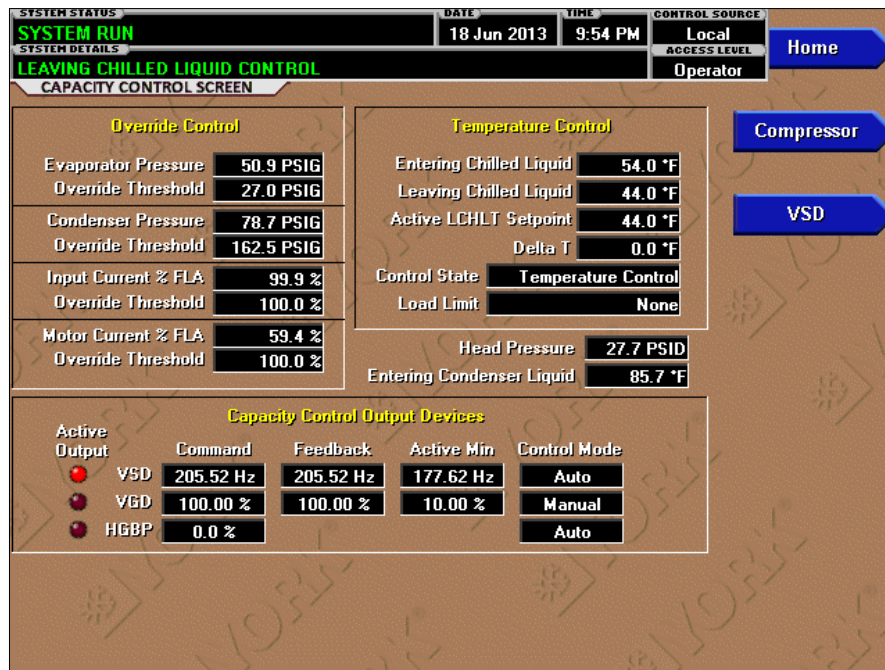

LD17931a

FIGURE 15 - CAPACITY CONTROLS SCREEN

### OVERVIEW

This screen displays the pertinent parameters associated with capacity control in relation to Leaving Chilled Liquid temperature, current and pressure overrides, and anti-surge control. This screen also provides a means for a Service Technician to control VGD, Speed, and Optional Hot Gas Bypass Valve manually for maintenance or service.

### DISPLAY ONLY

#### Evaporator Pressure

Displays the pressure in the evaporator.

#### [Evaporator Pressure] Override Threshold

Displays the evaporator pressure setpoint below which the low evaporator pressure capacity control override takes effect.

#### Condenser Pressure

Displays the pressure in the condenser.

#### [Condenser Pressure] Override Threshold

Displays the condenser pressure setpoint above which the high condenser pressure capacity control override takes effect.

#### Input Current % FLA

Displays the percent of useful job full load current presently supplied to the chiller, determined from the highest of the three phase Input Currents/(Input Job FLA setting/0.9).

#### [Input Current % FLA] Override Threshold

Displays the active input current percent limit, which is the minimum of Local Input Current Limit, Remote Input Current Limit, and Pulldown Current Limit or BAS (ISN) current limit.

#### Motor Current % FLA

Displays the percentage of maximum motor current delivered to the motor, determined from the highest of the three phase Motor Currents/Maximum Motor Current Limit.

#### [Motor Current % FLA] Override Threshold

Displays the active motor current percent limit, which is a percentage of the minimum of VSD and motor maximum current limits.

#### Entering Chilled Liquid

Displays the temperature of the chilled liquid as it enters the evaporator.



**Leaving Chilled Liquid**

Displays the temperature of the chilled liquid as it leaves the evaporator.

**Active LCHLT Setpoint**

Displays the active temperature setpoint to which the chiller is set to control liquid leaving the evaporator. The Active Setpoint is a target to the Local, Remote or BAS (ISN) LCHLT programmed setpoint, depending on the control source selected. When the chiller is not running, the Active Setpoint is set to Entering Chilled Liquid Temperature - LCHLT Setpoint Start Offset. When the VSD starts, the Active LCHLT Setpoint is ramped to the programmed LCHLT Setpoint at the programmable LCHLT Setpoint Ramp Rate. When the chiller is running, performing capacity control, any change to the programmed LCHLT setpoint results in a ramp from the old Active Setpoint value to the new LCHLT setpoint value at the programmed LCHLT Setpoint Ramp Rate.

**Delta T**

Displays the difference between the temperature of the chilled liquid leaving the evaporator and the Leaving Chilled Liquid Active Setpoint.

**Control State**

Displays the present source controlling the command to the capacity control devices, based on conditions as follows:

- Inactive- Capacity Control is not active
- Temperature Control – Capacity Control is active with no overrides acting
- Input Current- Input Current Override is in control
- Motor Current- Motor Current Override is in control
- Condenser Pressure – Condenser Pressure Override is in control
- Evaporator Pressure- Evaporator Pressure Override is in control
- Low LCHLT- LCHLT low temperature Override is in control

**Load Limit**

Displays if any load limiting control is acting on the temperature control output to the capacity control devices. The field indicates the following:

- Inactive - Capacity Control is not active
- None – No limit is in effect
- Input Current
- Motor Current
- Condenser Pressure
- Evaporator Pressure

**Head Pressure**

Displays the difference between condenser refrigerant pressure and evaporator refrigerant pressure.

**Entering Condenser Liquid Temperature**

Displays the temperature of the condenser liquid entering the condenser.

**Capacity Control Output Devices**

Displays the following for each of the devices that is available: VSD (Variable Speed Drive), VGD (Variable Geometry Diffuser) or HGBP (Hot Gas Bypass Valve)

- Active Output (LED): Indicates which device is currently selected by the control for manipulation.
- Command: Displays the output command from the control to the device in Hertz to the VSD or in percent of full open to the VGD or HGBP valve.
- Feedback: Displays the present speed feedback from the VSD or present position feedback from the VGD.
- Control Mode: Displays whether the device is under Automatic or Manual control.
- Active Min: Displays the prevailing minimum value to which the control to the device is limited, based upon surge controls or operating limits.

**NAVIGATION****Home**

Causes and instant return to the Home Screen.

**Compressor**

Causes an instant navigation to the Compressor Screen.

**VSD**

Causes an instant navigation to the VSD Screen.

## VARIABLE SPEED DRIVE SCREEN

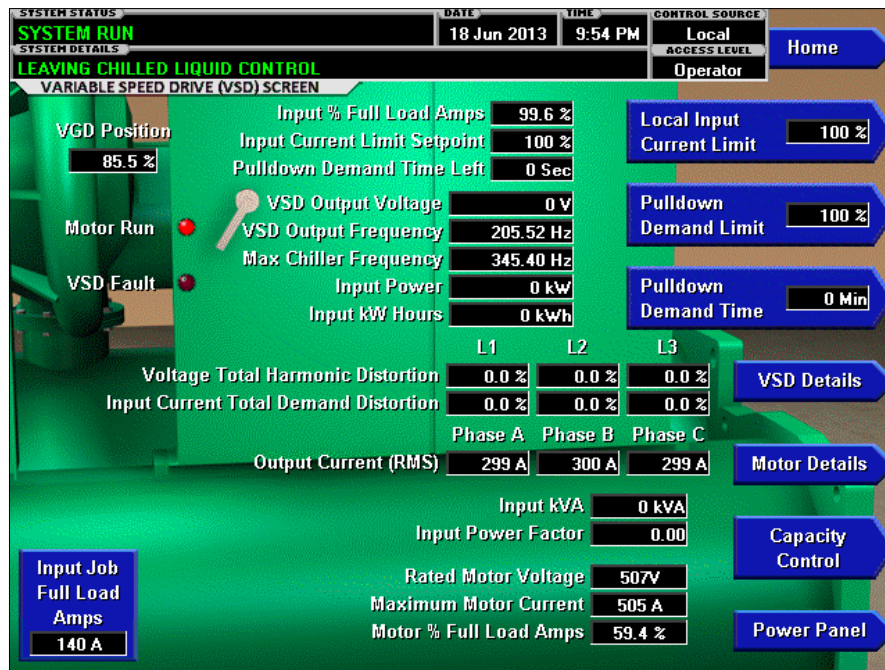

LD17932a

FIGURE 16 - VARIABLE SPEED DRIVE SCREEN

### OVERVIEW

This screen displays information pertaining to the Variable Speed Drive (VSD).

### DISPLAY ONLY

#### Motor Run (LED)

Indicates whether the digital output from the controls is commanding the motor to RUN.

#### VSD Fault (LED)

Indicates the VSD is reporting a fault over the communications link or by logic low at the hardwired digital input.

#### Input % Full Load Amps

Displays the input current as a percentage of the job Full Load Amps (FLA) value, based on the highest phase.

#### Input Current Limit Setpoint

Displays the input current limit value in use. This value could come from a 0-20mA, 4-20 mA, 0-10VDC or 2-10VDC input in Analog Remote mode, PWM signal

in Digital Remote mode, E-Link Gateway interface in BAS (ISN) mode, or a locally programmed value.

#### Pulldown Demand Time Left

Displays the time remaining in the programmed pulldown period if the value is nonzero.

#### VSD Output Voltage

Displays the output voltage measured to the motor.

#### VSD Output Frequency

Displays the present output frequency to the motor.

#### Max Chiller Frequency

Displays the maximum value that the Output frequency is limited to for the chiller, based on configuration.

#### Input Power

Displays the total input Kilowatts measured by the VSD.

#### Input kW Hours

Displays the cumulative amount of kilowatts used over time as the VSD motor controller operates.

**Output Current (RMS) - Phase A, B, C**

Displays the RMS current measured to the motor, per phase.

**VGD Position**

Displays the variable geometry diffuser position as a value between 0 and 100%.

**Input kVA**

Displays the supply kVA measured by the VSD.

**Input Power Factor**

Displays the relationship between the Input Power and the Supply kVA.

**Rated Motor Voltage**

Displays the motor voltage rating, based on configuration.

**Maximum Motor Current**

Displays the maximum motor current, based on configuration.

**Motor % Full Load Amps**

Displays the percentage of maximum motor current presently delivered, based on highest phase.

**Voltage Total Harmonic Distortion - (L1, L2, L3)**

Displays the Total Harmonic Distortion (THD) for each of the voltage lines as calculated by the VSD.

**Input Current Total Demand Distortion - (L1, L2, L3)**

Displays the Total Dynamic Distortion (TDD) for each of the supply current lines as calculated by the VSD.

**Input Job Full Load Amps**

Shows the job input full load amp limit within a range limited from 10% to 100% of the VSD nominal input current at nominal line voltage.

**PROGRAMMABLE****Local Input Current Limit**

*Access Level Required: OPERATOR*

Allows the user to specify the maximum allowed input current (as a percentage of job FLA). When the input current reaches this value, the input current override takes effect.

**Pulldown Demand Limit**

*Access Level Required: OPERATOR*

Allows the user to specify the current limit value (as a percentage of FLA) to which the chiller will be limited during the specified pulldown limit time. This value will override the input Current Limit value during this time period. This function is used to provide energy savings following chiller start-up. Pulldown demand limit is ignored in BAS (ISN) control source because the BAS system is expected to use its algorithms to reset current limit as required in that operating mode.

**Pulldown Demand Time**

*Access Level Required: OPERATOR*

Allows the user to set a period of time for which the pulldown demand limit will be in effect after the chiller starts.

**NAVIGATION****Home**

Causes an instant return to the Home Screen.

**VSD Details**

Moves to the subscreen which provides more information about the Variable Speed Drive.

**Capacity Control**

Moves to the Capacity Control Screen.

**Motor Details**

*Access Level Required: SERVICE*

Moves to a subscreen that provides information and setpoints pertinent to the Motor Monitoring feature.

**Power Panel**

Moves to the power Panel Screen.



## VARIABLE SPEED DRIVE (VSD) DETAILS SCREEN

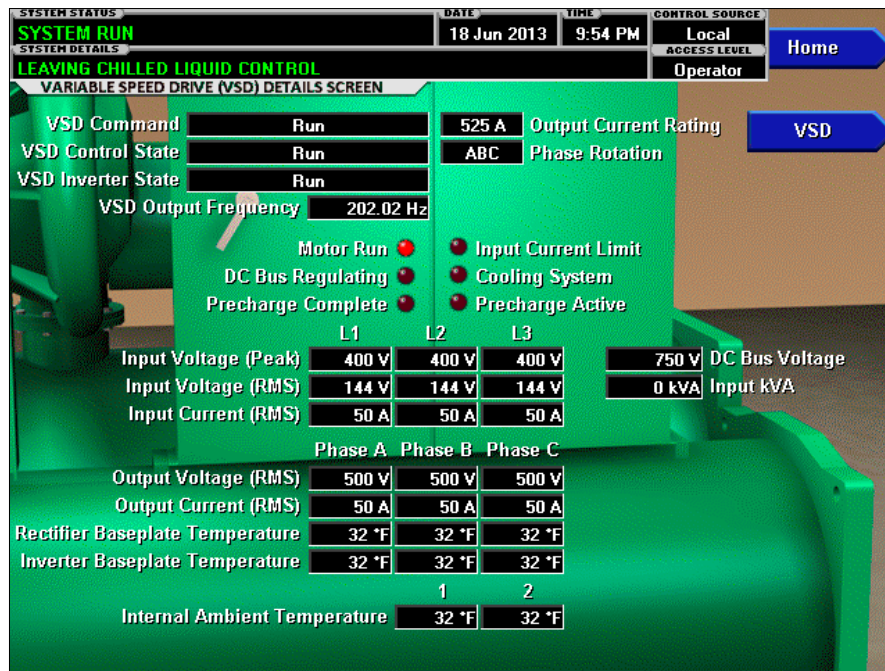

LD17933a

FIGURE 17 - VARIABLE SPEED DRIVE (VSD) DETAILS SCREEN

### OVERVIEW

This screen displays more detailed parameters associated with the Variable Speed Drive. This screen also provides a means for a Service Technician to access setpoints or control the DC Bus manually for maintenance or service.

### DISPLAY ONLY

#### VSD Command

The command from OptiView™ control to the VSD. Commands are as follows:

- 0 = Off
- 1 = Pre-Regulate
- 2 = Run
- 3 = Manual Precharge
- 4 = Manual Pre-Regulate
- 5 = Soft Shutdown

#### VSD Control State

Displays the control state of the VSD. States are as follows:

- 0 = Idle

- 1 = Precharge
- 2 = Pre-Regulate
- 3 = Waiting for Run
- 4 = Run
- 5 = Stop
- 6 = Unit trip
- 7 = Water Pump
- 8 = Test Mode
- 9 = Manual Precharge
- 10 = Man Pre-Regulate
- 11 = Soft Shutdown
- 12 = Precharge Re-init
- 13 = Check DCCT

#### VSD Inverter State

- 0 = Stop
- 1 = Dwell
- 2 = Run
- 3 = Run Voltage Control
- 4 = Test Mode
- 5 = Faulted
- 6 = Check DCCT

**VSD Output Frequency**

Displays the present output frequency to the motor.

**Phase Rotation**

Displays the phase rotation sequencing

**Output Current Rating**

Indicates VSD size reported from VSD.

**Motor Run (LED)**

Indicates the digital output from the controls is commanding the motor to RUN.

**DC Bus Regulating (LED)**

Indicates the VSD is regulating the DC bus.

**Precharge Complete (LED)**

Indicates the VSD DC bus has been pre-charged.

**Input Current Limit (LED)**

Indicates the chiller input current is at the Job FLA limit.

**Cooling System (LED)**

Indicates the relay controlling the VSD water pump output is energized.

**Precharge Active (LED)**

Indicates the VSD is pre-charging the DC bus.

**DC Bus Voltage**

Displays the DC Bus voltage.

**Total Supply kVA**

Displays the total kilovolt-Amps measured by the VSD.

**Input Voltage Peak (L1, L2, L3)**

Displays the three-phase input peak voltages measured by the VSD (Neutral to Line).

**Input Voltage RMS (L1, L2, L3)**

Displays the three-phase input RMS voltages across each line.

**Input Current RMS (L1, L2, L3)**

Displays the three-phase input current values measured by the VSD.

**Output Voltage RMS (Phase A, B, C)**

Displays the three-phase output RMS voltages across each line.

**Output Current RMS (Phase A, B, C)**

Displays the three-phase output current values measured by the VSD.

**Rectifier Baseplate Temperature (L1, L2, L3)**

Displays the VSD input rectifier baseplate temperatures at each phase.

**Inverter Baseplate Temperature (Phase A, B, C)**

Displays the VSD output inverter baseplate temperatures at each phase.

**Internal Ambient Temperature**

Displays the ambient temperature inside the VSD cabinet from two sensors as reported by the VSD.

**NAVIGATION****Home**

Causes an instant return to the Home screen.

**VSD**

Causes an instant return to the VSD screen.

## MOTOR DETAILS SCREEN

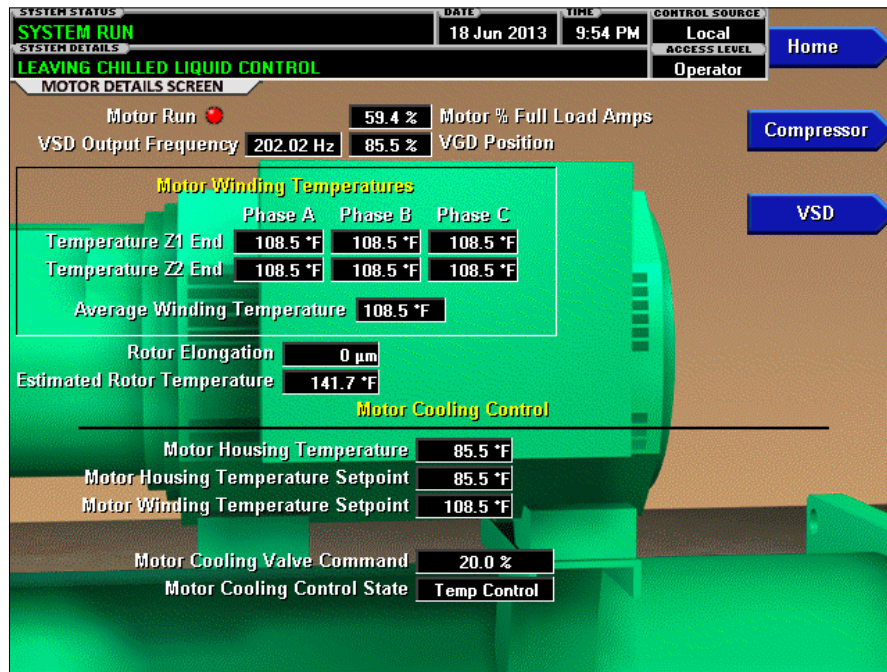

LD17934a

FIGURE 18 - MOTOR DETAILS SCREEN

### OVERVIEW

This screen displays information pertinent to the Motor Temperature Monitoring feature. The feature consists of motor winding temperature and motor housing temperature. Also, individual winding temperature sensors can be disabled on this screen.

### DISPLAY ONLY

#### Motor Run (LED)

Illuminates when the OptiView™ control center is commanding the motor to run.

#### %Input Full Load Amps

Displays the input current as a percentage of chiller full load amps.

#### Output Frequency

Displays the frequency at which the VSD is operating the motor. This value is returned from the VSD Logic Board.

### VGD Position

Displays the present variable geometry diffuser position as a value between 0% (closed) and 100% (full open).

### Motor Temperatures

Displays the enabled motor winding temperatures for phase A, B and C. Individual temperatures can be disabled using the TEMPERATURE DISABLE Setpoint. The software prevents more than 2 of the 3 sensors at either end of the motor to be disabled. When an individual temperature is disabled, the temperature data box does not appear. Any input that registers as open is considered invalid and displays as XXX.X.

### Average Winding Temperature

This value is calculated as the average of all enabled and valid motor winding temperatures. Any winding temperature that registers as open, out of range or disabled is not used in the calculation. A maximum of 6 temperatures is used to calculate the average.

**Rotor Elongation**

Displays the calculated change in distance from the two axial position sensors for the rotor shaft versus the shutdown baseline set at the factory. This indicates thermal growth and torque effect.

**Estimated Rotor Temperature**

Displays the temperature derived from physical parameters, elongation, and housing temperature.

**Motor Housing Temperature**

Display the temperature of the motor housing sensed at the thermistor on the motor externally.

**Motor Housing Temperature Setpoint**

Displays the target temperature for the motor cooling control. It is equal to entering condenser water temperature plus the programmable setpoint offset.

**Ambient Dew Point Temperature**

When the optional Ambient Dew Point Temperature sensor is Enabled, its reading is indicated here.

**Motor Cooling Valve Command**

Output to the motor cooling valve in percent from 0% (closed) to 100% Opened)

**Motor Cooling Control State**

Displays whether the motor cooling valve is in Auto or Manual control.

**NAVIGATION****Home**

Causes an instant return to the Home Screen.

**VSD**

Returns to the VSD Screen.

## SETPOINTS SCREEN

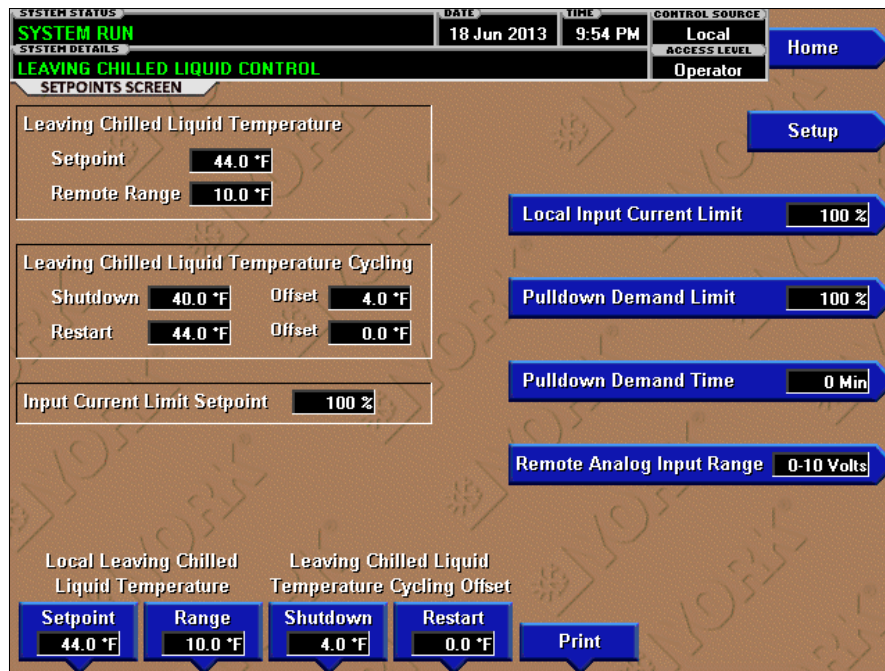

LD17935a

FIGURE 19 - SETPOINTS SCREEN

### OVERVIEW

This screen provides a convenient location for programming the most common setpoints involved in the chiller control. This screen also serves as a gateway to a subscreen for defining the setup of general system parameters.

### DISPLAY ONLY

#### Leaving Chilled Liquid Temperature - Setpoint

Displays the present Active setpoint to which the chiller is operating whether controlled remotely or locally.

#### Leaving Chilled Liquid Temperature Cycling - Shutdown

Displays the Leaving Chilled Liquid Temperature at which the chiller will shut down to avoid over-cooling LCHLT below setpoint in low load situations.

#### Leaving Chilled Liquid Temperature Cycling - Restart

Displays the Leaving Chilled Liquid Temperature at which the chiller will restart after it has shut down due to over-cooling temperature.

### Input Current Limit Setpoint

Displays the active Input Current Limit setpoint. This is the minimum of the locally or remote (received via 0-10VDC, 2-10VDC, 0-20mA or 4-20mA input or PWM) programmed Current Limit setpoint or pulldown limit. In BAS (ISN) remote mode, the remote setpoint is received from the E-Link Gateway interface.

### PROGRAMMABLE

#### Local Leaving Chilled Liquid Temperature - Range

*Access Level Required: OPERATOR*

This is the range over which an analog signal or a digital signal (PWM) can reset the Leaving Chilled Liquid Temperature setpoint above the operator programmed **Base** Setpoint. Programmable as either 10°F, 20°F, 30°F or 40°F, with a default of 10°F, it is added to the *BASE* value to create a range over which the remote device can reset the setpoint.

### Local Leaving Chilled Liquid Temperature - Setpoint

*Access Level Required: OPERATOR*

This value allows the user to define the Leaving Chilled Liquid Temperature that is to be maintained by the chiller. It is programmable over the range of 38.0°F to 70.0°F (water) or 10.0°F to 70.0°F (brine). If Smart Freeze is enabled, the range is 36.0°F to 70.0°F (water).

### Leaving Chilled Liquid Temperature Cycling Offset - Shutdown

*Access Level Required: OPERATOR*

This value allows the user to specify the Leaving Chilled Liquid Temperature at which the chiller will shut down on a **LEAVING CHILLED LIQUID – LOW TEMPERATURE** cycling shutdown. This is done by defining an offset below the Leaving Chilled Liquid Temperature setpoint. It is programmable over a range of 1°F to 64°F.

### Leaving Chilled Liquid Temperature Cycling Offset - Restart

*Access Level Required: OPERATOR*

This value allows the user to specify the Leaving Chilled Liquid Temperature at which the chiller will restart after a shutdown on a **LEAVING CHILLED LIQUID – LOW TEMPERATURE** cycling shutdown. This is done by defining an offset above the Leaving Chilled Liquid Temperature setpoint. It is programmable over a range of 0°F to 70°F.

### Remote Analog Input Range

*Access Level Required: OPERATOR*

This setpoint defines, for the control center, the remote signal range applied for remote reset of the Leaving Chilled Liquid temperature Setpoint and Current Limit Setpoint in ANALOG remote mode. If the remote signal is 0-10VDC or 0-20mA, this setpoint must be programmed for 0-10VDC. If the remote signal is 2-10VDC or 4-20mA, this setpoint must be programmed for 2-10VDC.

### Local Input Current Limit

*Access Level Required: OPERATOR*

Allows the user to specify the maximum allowed chiller input current (as a percentage of FLA). When the chiller input current reaches this value, the input current override takes effect.

### Pulldown Demand Limit

*Access Level Required: OPERATOR*

Allows the user to specify the current limit value (as a percentage of Full Load Amps) to which the chiller will be limited during the specified pulldown limit time. This value will override the Input Current Limit value during this time period. This function is used to provide energy savings following chiller start-up. Pulldown demand limit is ignored in BAS (ISN) control source because the BAS system is expected to use its algorithms to reset current limit as required in that operating mode.

### Pulldown Demand Time

*Access Level Required: OPERATOR*

Allows the user to set a period of time for which the pulldown demand limit will be in effect after the chiller starts.

### Print

Generates **Setpoints** print report.

## NAVIGATION

### Home

Causes an instant return to the Home Screen.

### Setup

Moves to the subscreen allowing setup of general system parameters.



## SETUP SCREEN

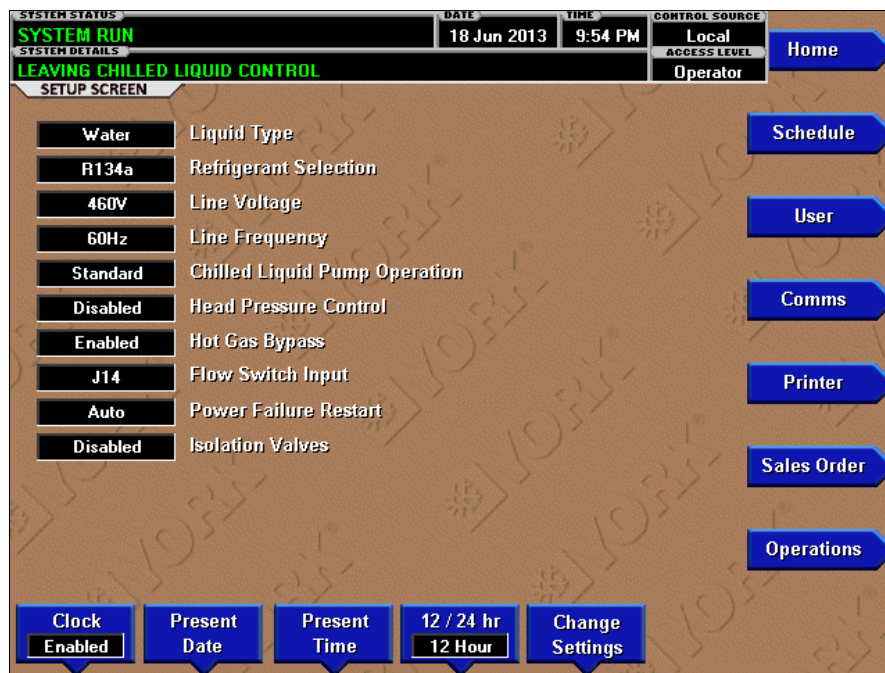

LD17936a

FIGURE 20 - SETUP SCREEN

### OVERVIEW

This screen is the top level of the general configuration parameters. It allows programming of the time and date, along with specifications as to how the time will be displayed (12 or 24 hour format). In addition, the chiller configuration, as determined by the state of the Microboard Program Jumpers and Program Switches is displayed. A qualified Service Technician, following instructions in *YORK YMC<sup>2</sup> Service Manual (Form 160.84-M2)*, establishes this configuration per the desired operation. This screen also serves as a gateway to more subscreens for defining general system parameters.

### DISPLAY ONLY

#### Liquid Type

Displays Water or Brine

#### Refrigerant Selection

Shows R134a selected at factory level.

### PROGRAMMABLE

#### Present Date

*Access Level Required: OPERATOR*

Allows the user to specify the present date. This value is critical to logging system shutdowns accurately and for utilizing the scheduling capabilities. When prompted to enter a date value, the user must enter the day, month, and four-digit year (using leading zeroes as necessary). If within range, the value will be accepted. If out of range, the user is prompted for the information again. At this point the user may retry the date entry, or cancel the programming attempt.

#### Present Time

*Access Level Required: OPERATOR*

Allows the user to specify the present time. This value is critical to logging system shutdowns accurately and for utilizing the scheduling capabilities. When prompted to enter a time value, the user must enter the hour and minute desired (using leading zeroes as necessary). If the chiller is presently set to 24-hour mode, the time must be entered in the 24-hour format. Otherwise, the user must also select AM or PM for the entered time. If out of range, the user is prompted for the information again. At this point the user may retry the time entry, or cancel the programming attempt.



**Clock (Enabled / Disabled)**

*Access Level Required: OPERATOR*

Allows the user to enable or disable the real-time clock in order to conserve battery life. The clock will be disabled during manufacturing and must be enabled at system commissioning. In addition, when preparing for prolonged shutdown the clock should once again be disabled.

**12/24 Hr**

*Access Level Required: OPERATOR*

Allows the user to specify the format in which the time will be presented. This setpoint affects the display of the time on the chiller panel and on all reports generated. The 12-Hour time format will include the **AM** and **PM** modifiers and show the range of time between 1:00 and 12:59, while the 24-Hour time format will show the range of time between 0:00 and 23:59.

**Change Settings**

*Access Level Required: OPERATOR or higher*

Used to enter the following setpoints. Pressing this key places a green selection box around the first changeable setpoint. The access level determines which setpoints can be changed. Use the ▲ and ▼ keys to place the selection box around the desired setpoint. With the setpoint selected, press the ENTER " ✓" key. A dialog box appears with the range of settings.

**Chilled Liquid Pump Operation**

*Access Level Required: SERVICE*

Allows a Service Technician to select chilled liquid pump control contacts (I/O Board TB2-44/45) operation as either Standard or Enhanced. Service Technicians refer to *YORK YMC<sup>2</sup> Service Manual (Form 160.84-M2)*.

**Line Voltage**

*Access level Required: SERVICE*

Allows a Service Technician to program the applicable supply line voltage

**Line Frequency**

*Access level Required: SERVICE*

Allows as Service technician to program the line frequency to 50 or 60hZ.

**Power Failure Restart**

*Access Level Required: OPERATOR*

Allows the user to select Manual or Automatic restart after power failure.

**Head Pressure Control**

*Access Level Required: SERVICE*

Allows the Service Technician to enable or disable the Head Pressure Control feature. Service Technicians refer to *YORK YMC<sup>2</sup> Service Manual (Form 160.84-M2)*.

**Hot Gas Control (Enabled/Disabled)**

*Access level required: SERVICE*

Enables and disables the optional Hot gas Bypass Control feature.

**Flow Switch**

*Access Level Required: SERVICE*

Used to enter the applicable Flow Switch type. YMC<sup>2</sup> chillers could be equipped with either Paddle-type or Thermal-Type Flow sensors. The actual type installed must be entered to allow the program to read the correct input.

**NAVIGATION****Home**

Causes an instant return to the Home Screen.

**Schedule**

Moves to the subscreen allowing definition of the chiller operation schedule.

**User**

Moves to the subscreen allowing configuration of user preferences.

**Comms**

Moves to the subscreen allowing configuration of system communications.

**Printer**

Moves to the subscreen allowing configuration and control of printer functions.

**Sales Order**

Moves to the subscreen displaying the Sales Order information for the chiller system.

**Operations**

Moves to the subscreen displaying operating parameters of the chiller system.

**Diagnostics**

*Access Level Required: SERVICE*

Moves to the subscreen allowing limited diagnostic capability while operating.

## SCHEDULE SCREEN

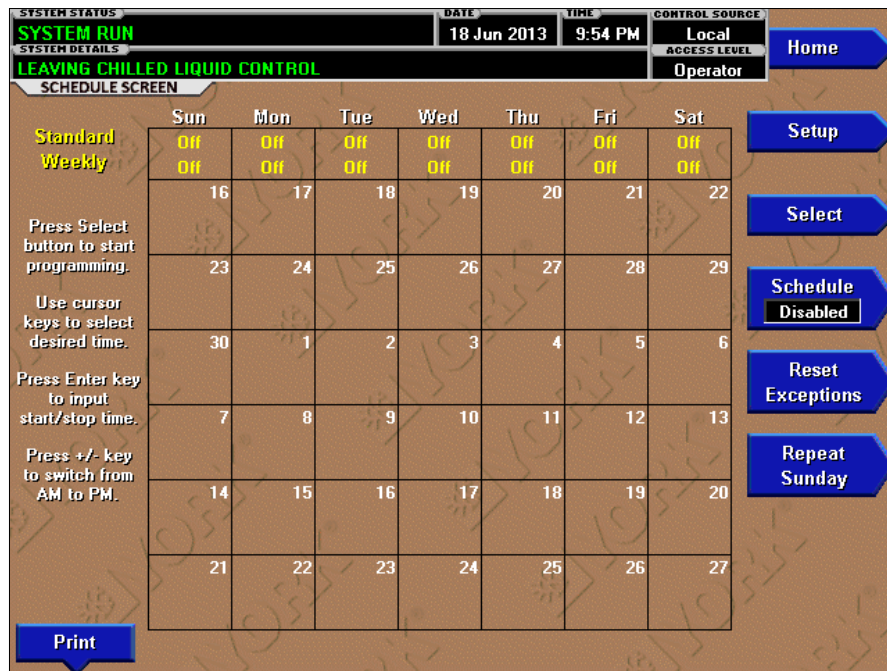

LD17937a

FIGURE 21 - SCHEDULE SCREEN

### OVERVIEW

The schedule screen contains more programmable values than a normal display screen. As such, each programmable value is not linked to a specific button. Instead the **Select** key is used to enable the cursor arrows which are used to highlight the day and the start or stop time the user wishes to modify. At this point the user may press the "✓" (**Check**) key to program the Start / Stop times for that day.

In order for the Start / Stop combination to be utilized, each Start time must have a corresponding Stop time which occurs later in the day. The presently programmed schedule for a given day can be cancelled by setting both the Start time and Stop time to 12:00 AM. If the Start time equals the Stop time (with any time other than 12:00 AM), the chiller is OFF for that day. If the user desires the chiller to operate continuously through several days, the Stop time of Day 1 can be set to 11:59 PM and the Start time of Day 2 can be set to 12:00 AM. The chiller will not stop but continue to operate until the stop of Day 2.

The user has the ability to define a standard set of Start / Stop times which are utilized every week. The user may then specify *exception* Start / Stop combinations for any day of the week up to 6 weeks in advance. At the end of each week the schedule for the next week is created by combining the standard week definition and the next defined exception week. The schedule is then updated as each of the exception weeks “shifts down”, leaving a new, blank exception week in the 6<sup>th</sup> week slot.

### DISPLAY ONLY

This screen displays the chiller schedule. There are no other display options.

### PROGRAMMABLE

#### Standard Week Start/Stop Times

*Access Level Required: OPERATOR*

For each day of the week, the user may specify a time for the chiller to start and a time for the chiller to stop. The times specified in this entry week will be used as the default for every week of chiller operation.

**Exception Start/Stop Times**

*Access Level Required: OPERATOR*

For each day of the week, the user may specify a time for the chiller to start and a time for the chiller to stop. These Start / Stop combinations may be scheduled up to five (5) weeks in advance and also for the present week. As each week goes by, the new schedule will be created for the present week using the Exception specification in combination with the Standard week definition, as described above.

**Schedule (Enabled / Disabled)**

*Access Level Required: OPERATOR*

Allows the user to enable or disable the monitoring function which enforces the scheduled starting and stopping of the chiller.

**Repeat Sunday Schedule**

*Access Level Required: OPERATOR*

Duplicates the schedule defined for Sunday for the remainder of the standard weekdays.

**Reset All Exception Days**

*Access Level Required: OPERATOR*

Deletes all programming for exception days within the next 6 weeks.

**Select**

*Access Level Required: OPERATOR*

Places a selection box around a start time for a given day. Use ◀, ▶, ▲ or ▼ cursor arrows to place the box around the desired start or stop time for a given day.

**Print**

Generates a **Schedule** print report.

**NAVIGATION****Home**

Causes an instant return to the Home Screen.

**Setup**

Return to the previous Setup Screen.

## USER SCREEN

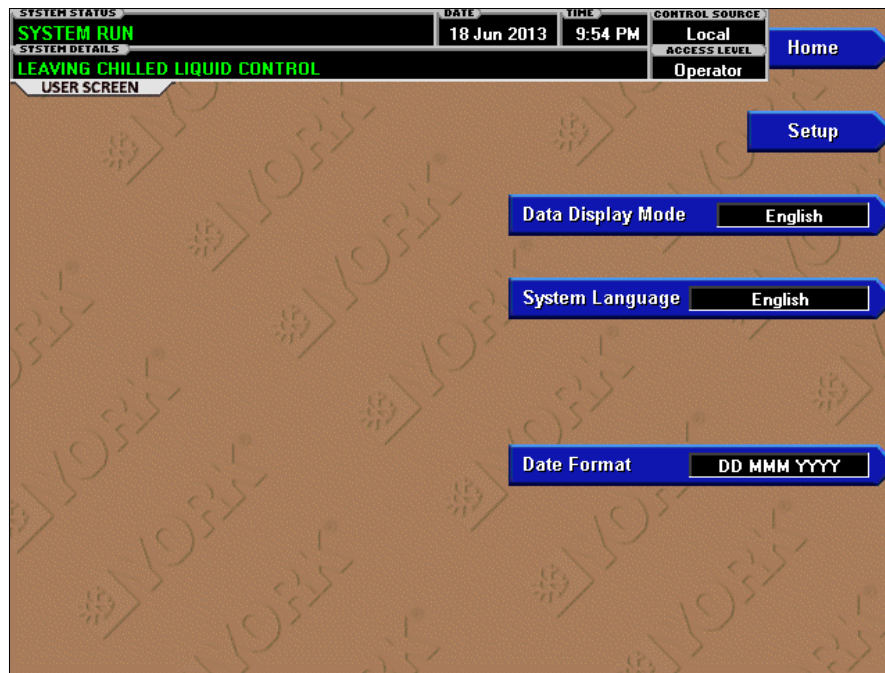

LD17938a

**FIGURE 22 - USER SCREEN**

### OVERVIEW

This screen allows definition of custom User ID's and matching passwords. This allows the building administrator to assign custom passwords to those who are authorized to maintain the chiller.

Each Custom User value is not linked to a specific button. Instead, the **Change** button is pressed which enables the cursor arrows which are used to highlight the Custom User parameter the user wishes to modify. At this point the "✓" (**ENTER**) key is pressed and the value may be entered.

### DISPLAY ONLY

This screen displays attributes assigned to User IDs. There are no other display options.

### PROGRAMMABLE

#### System Language

*Access Level Required: OPERATOR*

Allows the user to define the language for all Screens. The desired language is selected by scrolling through

the list of those available. English is the Default language and is selected by pressing the ▲ key when the dialog box appears during the selection process. The selected language will not be displayed until after the user navigates from the USER Screen to another Screen. The selections are: English, French, German, Hungarian, Italian, Japanese, Portuguese, Simplified Chinese, Spanish, and Traditional Chinese.

#### English / Metric Units

*Access Level Required: OPERATOR*

Define the unit system (English or Metric) used by the chiller display.

### NAVIGATION

#### Home

Causes an instant return to the Home Screen.

#### Setup

Return to the Setup Screen.

## COMMS SCREEN

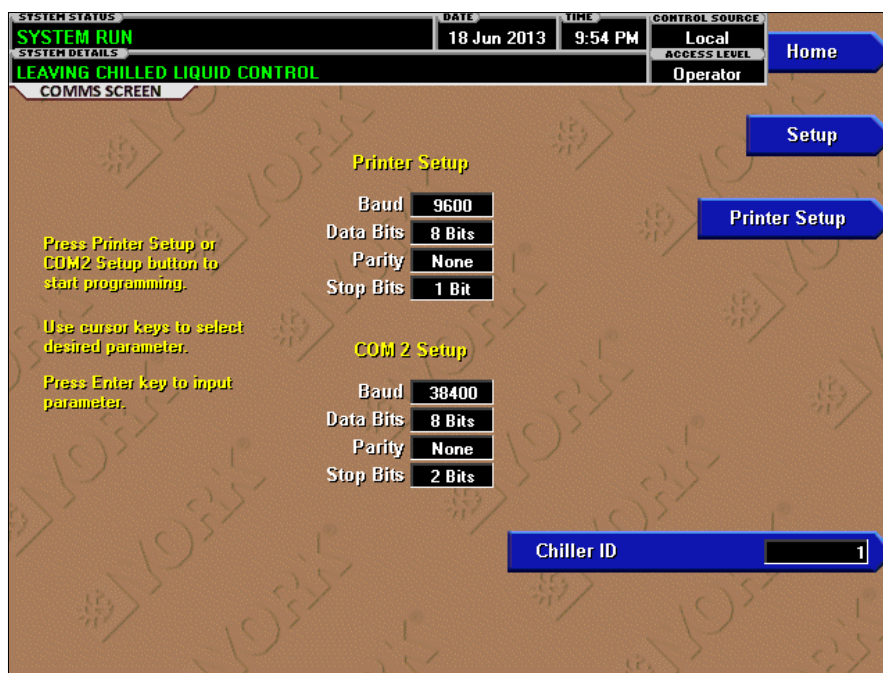

LD17939a

FIGURE 23 - COMMS SCREEN

### OVERVIEW

This screen allows definition of the necessary communications parameters. Refer to *SECTION 7 - PRINTING* of this manual for details on the Printer connections and setup. Presently, there are no COM 2 communications features available.

### DISPLAY ONLY

This screen displays attributes assigned to COMMS IDs. There are no other display options.

### PROGRAMMABLE

#### Chiller ID

*Access Level Required: OPERATOR*

Define the numeric chiller ID when used within an BAS network of chillers. This ID number is also printed at the top of reports obtained with a local printer.

#### Printer Setup

*Access Level Required: OPERATOR*

Pressing either key places a green selection box around the first changeable parameter. Use the ▲ and ▼ keys to place the selection box around the desired parameter

to be changed. With the selection box around the desired parameter, press the ENTER "✓" key. A dialog box is displayed permitting data entry.

#### Printer Baud Rate

Define the baud rate at which the panel shall communicate to the printer.

#### Printer Data Bit(s)

Define the number of data bits with which the panel shall communicate to the printer.

#### Printer Parity Bit(s)

Define the number of parity bits with which the panel shall communicate to the printer.

#### Printer Stop Bit(s)

Define the number of stop bits with which the panel shall communicate to the printer.

### NAVIGATION

#### Home

Causes an instant return to the Home Screen.

#### Setup

Return to the Setup Screen.



## PRINTER SCREEN



LD17940a

FIGURE 24 - PRINTER SCREEN

### OVERVIEW

This screen allows definition of the necessary communications parameters for the printer. Refer to *SECTION 7 - PRINTING* of this manual for details on Printer connections and setup.

### DISPLAY ONLY

#### Time Remaining Until Next Print

Displays the time until the next print log will occur, if the function is enabled.

### PROGRAMMABLE

#### Log Start Time

*Access Level Required: OPERATOR*

Set the time at which scheduled print logs will begin.

#### Output Interval

*Access Level Required: OPERATOR*

Define the interval at which log printing will occur.

#### Automatic Printer Logging (Enabled/Disabled)

*Access Level Required: OPERATOR*

Enable the printer to begin printing status reports beginning at the programmed start time and recurring at the interval defined above.

#### Printer Type

*Access Level Required: OPERATOR*

Define the printer type connected to the chiller system.

#### Print Report

*Access Level Required: OPERATOR*

Select the report type to print when the Print Report key is selected. This can vary from Status report (present system parameters), Setpoints report (present value of the system setpoints), Schedule report (present value of the system schedule times), or a Sales Order Data report (information provided on the Sales Order screen). A print report is generated upon completion of selection.

#### Print All Histories

*Access Level Required: OPERATOR*

Generate a report of the system data at the time of all stored shutdowns.

### NAVIGATION

#### Home

Causes an instant return to the Home Screen.

#### Setup

Return to the Setup Screen.

## SALES ORDER SCREEN

SYSTEM STATUS		DATE	TIME	CONTROL SOURCE	
SYSTEM RUN		18 Jun 2013	9:54 PM	Local	
SYSTEM DETAILS				ACCESS LEVEL	
LEAVING CHILLED LIQUID CONTROL				Operator	
SALES ORDER SCREEN					
<b>Order Information</b>			<b>Nameplate Information</b>		
Commissioning Date	00 000 0000		Capacity [Tons]		
Job Name			Refrigerant		
System Model			Refrig Weight [lbs]		
York Order Number			RPM		
Unit Serial Number			Input kW		
Compressor Model	M2C-205FAC		Voltage		
Evaporator Model			Phases		
Condenser Model			Frequency		
VSD Model			Input Job FLA		
			Min Circuit Ampacity		
<b>Design Conditions</b>					
	<b>Evaporator</b>	<b>Condenser</b>			
Pressure Drop (ft)					
Flow [GPM]					
Leaving Liquid [°F]					
Entering Liquid [°F]					
Fouling [hr-ft²-F/Btu]					
Liquid Type					
Brine Percent					

LD17941a

FIGURE 25 - SALES ORDER SCREEN

### OVERVIEW

This screen allows definition of the sales order parameters. The Commissioning date is entered by the YORK/Johnson Controls Service Technician at the time of chiller commissioning. These values should never be changed or entered by anyone other than a qualified Service Technician. Entry instructions are included in the *YORK YMC<sup>2</sup> Service Manual (Form 160.84-M2)*. The remainder of the values are entered at the YORK Factory during the manufacturing of the chiller.

### DISPLAY ONLY

#### Model Number

Factory defined model number of the chiller system.

#### YORK Order Number

Factory defined order number under which the chiller was sold.

#### Chiller Serial Number

Factory defined serial number for the chiller system.

#### Compressor Model

Factory defined model number of the Compressor. Critical entry for proper Chiller Operation. Technicians see *YORK YMC<sup>2</sup> Service Manual (Form 160.84-M2)*.

#### Evaporator Model

Factory defined model number of the Evaporator.

#### Condenser Model

Factory defined model number of the Condenser.

#### VSD Model

Factory defined model number of the VSD.

#### Condenser and Evaporator Design Load Information

Factory defined description of the condenser and evaporator parameters according to the original rating.

#### Nameplate Information

Factory defined information about the chiller configuration.



**Commissioning Date**

Define the date at which the chiller was commissioned.

**Job Name and Location**

Factory defined job name and location the chiller is destined for.

**PROGRAMMABLE**

**Print**

This generates a listing of the Sales Order data.

**NAVIGATION**

**Home**

Causes an instant return to the Home Screen.

**Setup**

Return to the Setup Screen.

## OPERATIONS SCREEN

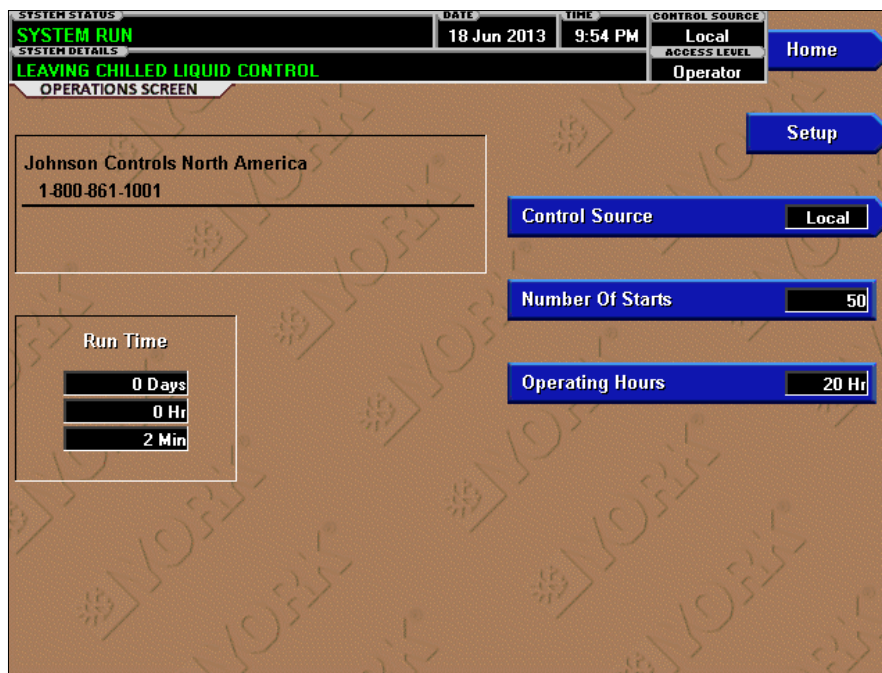

LD17942a

**FIGURE 26 - OPERATIONS SCREEN**

### OVERVIEW

This screen allows definition of general parameters having to do with the operation of the chiller.

### DISPLAY ONLY

#### Chiller Run Time

Displays the amount of time the chiller has been running since the last start signal was received. Value is reset to zero when the chiller enters Coastdown. It remains at zero while shutdown and during “MBC Start-up”.

#### Number of Starts

Displays the number of the starts the chiller has initiated.

#### Operating Hours

Displays the total accumulated run time of the chiller.

### PROGRAMMABLE

#### Control Source

*Access Level Required: OPERATOR*

Define whether the control of the chiller will be Local, Digital Remote, Analog Remote, Modem Remote or BAS (ISN) Remote.

### NAVIGATION

#### Home

Causes an instant return to the Home Screen.

#### Setup

Return to the Setup Screen.

## HISTORY SCREEN

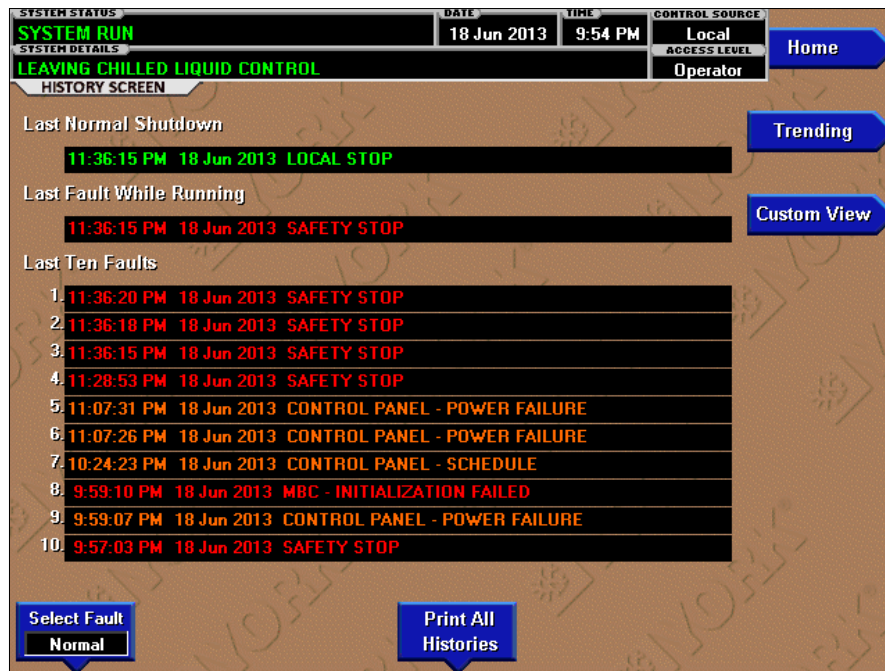

LD17943a

FIGURE 27 - HISTORY SCREEN

### OVERVIEW

This screen allows the user to browse through the faults. In order to get a more thorough reporting of the system conditions at the time of the recorded shutdown, move to the History Details subscreen.

The user may use the **Select Fault** button to select the history to view. At this point the **View Details** button is used to jump to a subscreen containing stored chiller parameters values at the time of the shutdown. Additionally, the **Print History** button can be used to generate a hard-copy report of the parameter values at the time of the shutdown.

### DISPLAY ONLY

#### Last Normal Shutdown

This window displays the date and time and the description of the last normal shutdown. A normal shutdown is defined as:

- Local (Panel rocker switch)
- Remote (Digital, Analog or BAS (ISN))

#### Last Fault While Running

This window displays the date and time and the description of the last safety or cycling shutdown while the system was running.

#### Last Ten Faults

This window displays a chronological listing (most recent first) of the date and time and the description of the last ten safety or cycling shutdowns that occur while the system is running or stopped.

### PROGRAMMABLE

#### Print History

This generates a report listing the status of the chiller parameters at the time of the selected shutdown.

#### Print All Histories

This generates a report listing the status of the chiller parameters at the time of each of the stored shutdowns.

## NAVIGATION

### Home

Causes an instant return to the Home Screen.

### View Details

Causes a move to a subscreen containing the value of select chiller parameters at the time of the associated shutdown.

### Trending

Causes a move to a subscreen allowing the user to view trending data on selected chiller parameters.

### Custom View

Causes a move to a subscreen allowing the user to view the Custom Setup Screen.

### Security Log

*Access Level Required: SERVICE*

Causes a move to a subscreen allowing the user to view a record of the last 75 setpoint changes.

## HISTORY DETAILS SCREEN

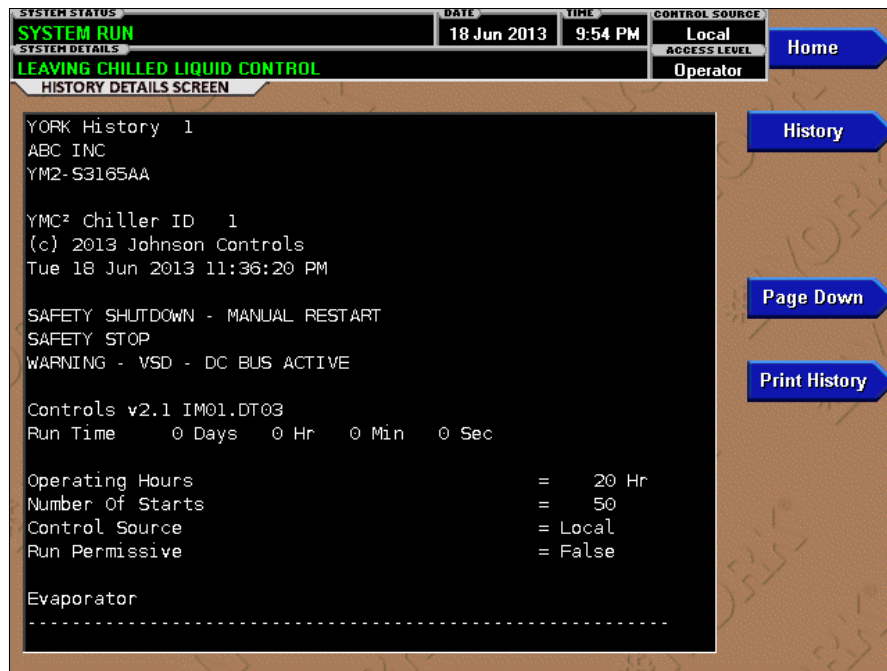

LD17944a

**FIGURE 28 - HISTORY DETAILS SCREEN**

### OVERVIEW

This screen allows the user to see an on-screen printout of all the system parameters at the time of the selected shutdown. Not all screens are shown above. The number of screens required to display all of the data varies according to type of motor starter and options applied.

### DISPLAY ONLY

#### History Printout

This is the on-screen printout of the system parameters.

### PROGRAMMABLE

#### Page Up / Page Down

Scroll up in the displayed data (if applicable).

#### Print History

This generates a report listing the status of the chiller parameters at the time of the selected shutdown.

### NAVIGATION

#### Home

Causes an instant return to the Home Screen.

#### History

Causes a return to the History Screen.

## CUSTOM SCREEN

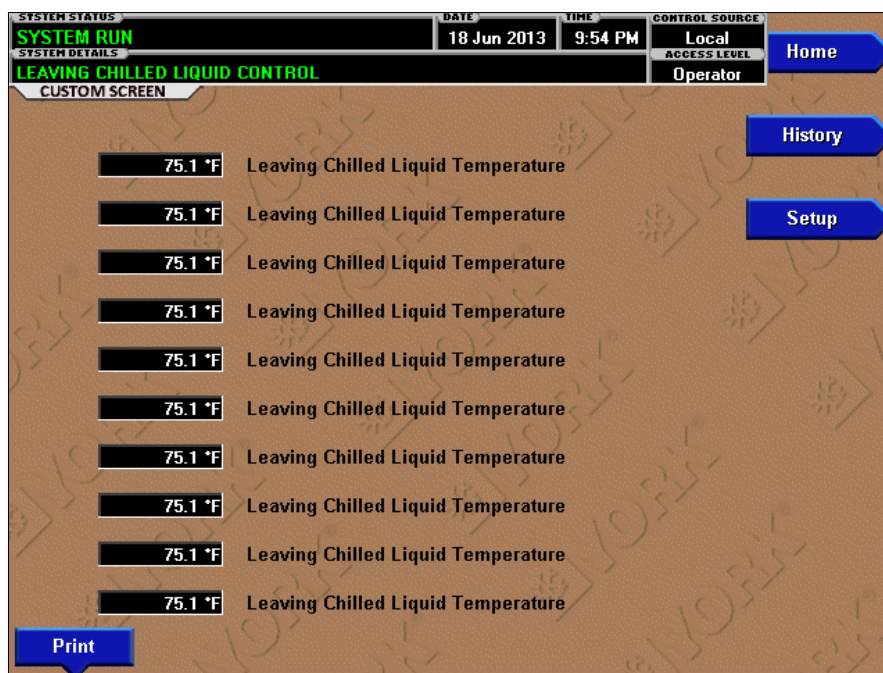

LD17947a

**FIGURE 29 - CUSTOM SCREEN**

### OVERVIEW

This screen allows up to 10 Service Technician selected parameters to be displayed. These parameters are selected from a list on the Custom View Setup Screen. This allows the Service Technician to display parameters pertinent to a particular problem during troubleshooting. At completion of the service call, the display can be cleared or the parameters can be left there for monitoring by operations personnel.

### DISPLAY ONLY

This screen display attributes assigned to Custom screen. There are no other display options.

### PROGRAMMABLE

#### Print

This generates a listing of the parameters displayed on this screen.

### NAVIGATION

#### Home

Causes an instant return to the Home Screen.

#### History

Causes an instant return to the History Screen.

#### Setup

*Access Level Required: OPERATOR*

Causes a jump to the subscreen that allows selection of the parameters to be displayed.



## CUSTOM SETUP SCREEN

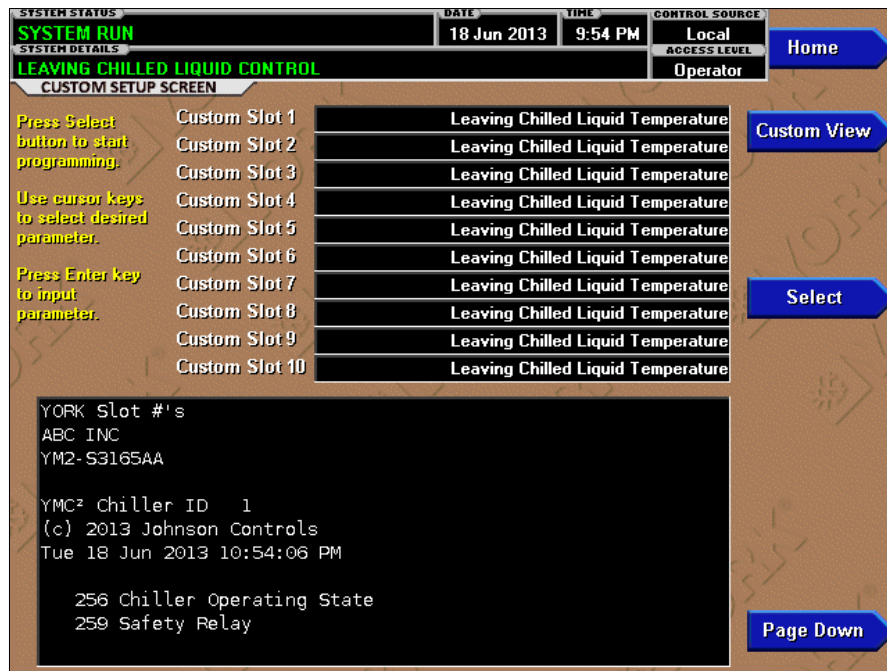

LD17948a

FIGURE 30 - CUSTOM SETUP SCREEN

### OVERVIEW

This screen allows the Service technician to select up to 10 parameters for display on the Custom View Screen.

### DISPLAY ONLY

#### Slot Numbers

Lists the available parameters that can be displayed. The desired parameters for display are selected from this list.

### PROGRAMMABLE

#### Page Up

Scroll up through list of available parameters.

#### Page Down

Scroll down through list of available parameters.

#### Select

First use the Page Up and Page Down keys to scroll through the Slot Numbers list and note the number of the parameter(s) to be displayed. Pressing the Select key places a green colored selection box around Custom Slot 1.

If it is desired to change an already entered parameter, use the 5 and 6 keys to place the selection box around the slot number to be changed. With the selection box around the slot number to be changed or entered, press the ENTER (✓) key. A dialog box is displayed permitting data entry. Using the numeric keypad keys, enter the desired slot number and press the ENTER (✓) key.

#### Custom Slot (1-10)

Use the Select key and numeric keypad keys as described above and enter the slot number from Slot Numbers list. Setting the Slot number to zero clears the display of this slot number.

### NAVIGATION

#### Home

Causes a return to the Home Screen.

#### Custom View

*Access Level Required: SERVICE*

Causes a return to the Custom View Screen.

## TREND SCREEN



LD17949a

**FIGURE 31 - TREND SCREEN**

### OVERVIEW

As many as six Operator selected parameters (data points) can be plotted in an X/Y graph format. The X-axis is scaled per the selected Data Collection Interval and displayed in a time of day or elapsed time format, as selected with the X-axis toggle key. The Y-axis is scaled for each parameter per the selected minimum and maximum value for each parameter. Analog parameters are scaled in pressure, temperature, volts, amps, hertz or time. Digital on/off parameters are scaled as zero (off) and one (on). Only one Y-axis label is displayed at a time. The Y-axis Toggle Key is used to toggle the Y-axis labels through the different parameters. The Y-axis label that is being displayed is identified at the top of the graph. For identification, each plotted parameter and associated Y-axis labeling is color coordinated.

The DATA SELECT key is used to display all trended data points simultaneously or select a single data point for display.

The parameters are sampled at the selected Data Collection Interval and plotted using 450 data points across the X-axis. If the actual value of the sampled parameter is less than the Y-axis label minimum for that param-

eter, the value will be plotted at the minimum value. Similarly, if the actual value is greater than the Y-axis label maximum for that parameter, the value will be plotted at the maximum value.

There are three types of charts that can be created:

- ONE SCREEN,
- CONTINUOUS
- TRIGGERED

When plotting reaches the end of the X-axis, and ONE SCREEN is selected, trending stops and data is frozen. If CONTINUOUS is selected, the oldest data is dropped from the left-hand side of the graph at the next collection interval. Thereafter, the oldest data is dropped from the left hand-side of the graph at each data collection interval. If TRIGGERED is selected, data collection can be set to start or stop based upon the selected TRIGGER ACTION (START or STOP). If START is selected, data collection will not begin until the Triggers have been satisfied and any selected TRIGGER DELAY has elapsed. Data collection will stop at the completion of one screen of data similar to the ONE SCREEN. If STOP is selected, data collection will not stop until the Triggers have been satisfied and any selected TRIGGER DELAY has elapsed.

If a power failure occurs while the trending is running, the trending is stopped. Upon restoration of power, the last screen of data that was collected will be displayed on the trending screen. The START key must be pressed to initiate a new trend screen.

## DISPLAY ONLY

This screen allows the user to view the graphical trending of the selected parameters and is also a gateway to the graph setup screens.

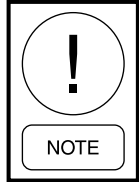

*A red screen with the words **TREND MAX MUST BE > TREND MIN** will appear if the Y-Axis minimum has been programmed to a value that is greater than the Y-Axis maximum for any parameter. If this appears, proceed to the Trend Setup Screen to change the values.*

## PROGRAMMABLE

### Start

*Access Level Required: OPERATOR*

Pressing this key clears the graph, starts a new graph, sets the time of day to the present clock time and begins the trending. This key is only available if trending is stopped. If the selected Chart Type is TRIGGERED and TRIGGER ACTION is set to START, data collection will not begin until the Triggers have been satisfied and any selected TRIGGER DELAY has elapsed. Otherwise, data collection will begin immediately.

### Stop

*Access Level Required: OPERATOR*

Pressing this key stops the trending. The trend data is frozen on the display until another graph is started with the START key. The STOP key is only available if trending is running.

### Print

Allows the data on the trend screen to be printed in tabular format. If set to EXISTING, a snapshot of the data presently on the screen is sent to the printer. If set to NEW, all data collected after pressing this key will be sent to the printer as it is collected. If set to DISABLED, no data is sent to the printer. Refer to *SECTION 7 - PRINTING* of this manual for printout examples.

### Data Select

Allows the user to display all trended data points simultaneously or select a single trended data point for display, hiding the other data points. Selections are ALL DATA or DATA POINT X (1-6).

### Y-Axis

This key toggles the Y-Axis labels of the graph. Each key press changes the label to another of the selected parameters.

### X-Axis

This key toggles the X-Axis labels of the graph. Each key press alternates the scaling between time of day and elapsed time. The Time of Day scaling is in 24-hour format. The Elapsed Time scaling is the time elapsed since the START key was pressed, starting the trending.

## NAVIGATION

### Home

Causes a return to the Home Screen.

### History

Causes a return to the History Screen.

### Trend Setup

*Access Level Required: OPERATOR*

Only displayed if the trending is stopped. Causes a jump to a subscreen for configuring the trending display.

## TREND SETUP SCREEN

SYSTEM STATUS	DATE	TIME	CONTROL SOURCE
SYSTEM RUN	18 Jun 2013	9:54 PM	Local
SYSTEM DETAILS			Operator
LEAVING CHILLED LIQUID CONTROL			
TREND SETUP SCREEN			
Data Point 1	Slot	Input % Full Load Amps	
	Minimum		0.0 %
	Maximum		100.0 %
Data Point 2	Slot	Not Assigned	
Data Point 3	Slot	Not Assigned	
Data Point 4	Slot	Not Assigned	
Data Point 5	Slot	Not Assigned	
Data Point 6	Slot	Not Assigned	

Press Select button to start programming.    Use cursor keys to select desired parameter.    Press Enter key to input parameter.

LD17950a

FIGURE 32 - TREND SETUP SCREEN

**OVERVIEW**

This screen is used to configure the trending screen. The parameters to be trended are selected from the Common Slots Screen or Common Slots Master list and entered as Slot Numbers for Data Points 1 through 6. The Y-Axis minimum and maximum values for each parameter are entered as Data Point Min and Data Point Max for Data Points 1 through 6. The interval at which all the parameters are sampled is selected as the Data Collection Interval.

**DISPLAY ONLY**

This screen displays chiller trend setup fields. There are no display only field.

**PROGRAMMABLE****Chart Type**

*Access Level Required: OPERATOR*

Selects CONTINUOUS, ONE SCREEN or TRIGGERED.

**Collection Interval**

*Access Level Required: OPERATOR*

Selects the interval at which the parameters are sampled. There are 450 data points displayed across the X-Axis of the graph. Each point represents the instantaneous value of the parameter. The user selects the time interval between these points. This is called the DATA COLLECTION INTERVAL, or the interval at which the parameter is sampled. This interval is programmable over the range of 1 second to 3600 seconds (1 hour), in one second increments. The selected interval not only determines the sample interval, but also the full screen time display. The full screen time display is a result of the selected interval in seconds, multiplied by the 450 data points. For example, if the **Data Collection Interval** is programmed for 900 seconds, the parameter would be sampled every 900 seconds, with the last 112.5 hours (4.7 days) of data viewable on the screen. Therefore, the selected interval is a compromise between resolution and full screen time display. Select the desired **Data Collection Interval** as follows:

4. Determine the desired time interval (in seconds), between data samples.
5. Calculate the full screen time display as follows:
  - $450 \times \text{Data Collection Interval} = \text{full screen seconds}$
  - $\text{full screen seconds} / 60 = \text{full screen minutes}$
  - $\text{full screen minutes} / 60 = \text{full screen hours}$
  - $\text{full screen hours} / 24 = \text{full screen days}$
6. Decide if the resultant sample interval and full screen display meet the requirements. If not, select a different sample interval.

### Select

*Access Level Required: OPERATOR*

This key is used to enter the slot numbers and the minimum and maximum Y-Axis values of each parameter to be trended. Pressing this key places a yellow box around Data Point 1 Slot Number. Use the ▲ and ▼ navigation keys to place the box around the value of Data Points 1 through 6 to be changed. With the desired value selected, press the "✓" ENTER key. A dialog box is displayed permitting data entry.

### Data Point Slot # (1-6)

*Access Level Required: OPERATOR*

Use the SELECT key as described above and enter the slot number from the Common Slots Screen or Master Slot Number List of the desired parameter to be trended. The selected parameter description will be displayed for the Data Point. Setting this slot number to zero will disable trending for that particular Data Point. Any or all points can be disabled.

### Data Point Min (1-6)

*Access Level Required: OPERATOR*

Only displayed if the Associated Slot Number is not Zero. This is the minimum value displayed for the Y-Axis. Selecting a parameter for a Data Point sets this to the default value, which is the lowest value allowed for that parameter. It can be changed to a value that provides a more appropriate resolution for the parameter being monitored. To change, use the SELECT key as described above and enter the desired value. The value must always be set to a value less than the Data Point Max. Otherwise, a red graph is displayed on the Trend Screen with the words **TREND MAX MUST BE > TREND MIN**. If the parameter selected for this data point is a digital type (on/off), this value must be set to zero (0). Zero indicates the OFF state.

### Data Point Max (1-6)

*Access Level Required: OPERATOR*

Only displayed if the associated slot number is not zero. This is the maximum value displayed for the Y-Axis. Selecting a parameter for a Data Point sets this to the default value, which is the highest value allowed for that parameter. It can be changed to a value that provides a more appropriate resolution for the parameter being monitored. To change, use the SELECT key as described above and enter the desired value. The value must always be set to a value greater than the Data Point Min. Otherwise, a red graph is displayed on the Trend Screen with the words **TREND MAX MUST BE > TREND MIN**. There are 20 Y-Axis divisions. If a MIN-MAX span is selected that is not evenly divided by 20, the Program will automatically select the next higher MAX value that makes the span evenly divided by 20. For example, if 0.0 is selected as the MIN and 69.0 is selected as the MAX, the Program will insert 70.0 as the MAX value. If the parameter selected for this data point is a digital type (on/off), this value must be set to one (1). One indicates the on state.

## NAVIGATION

### Home

Causes a return to the Home Screen.

### Trending

Causes a return to the Trending Screen.

### Slot Numbers

Causes a jump to a subscreen that lists the slot numbers of the most commonly monitored parameters. The desired parameters to be plotted are selected from this screen.

### Triggers

Causes a jump to the Advanced Trend Setup Screen, where the start/stop Triggers can be setup. Only displayed if TRIGGERED has been selected as Chart Type.



## ADVANCED TREND SETUP SCREEN

00474VIP

**FIGURE 33 - ADVANCED TREND SETUP SCREEN**

### OVERVIEW

The desired data collection start/stop triggers are setup on this screen. The trend data collection can be set to start or stop based upon the status of up to two selected Triggers.

The Triggers can consist of digital events or analog parameters compared to thresholds. The Triggers can be used individually or in combination. The digital and analog parameters are selected from the Common Slots Screen (or Master Slot Numbers List in this manual).

The parameter selected as the Primary Trigger is compared to a value selected as the Primary Test, using the Primary Operator as a comparator. If it is evaluated as true, then the data collection is started or stopped (after any selected Trigger delay) per the selected Trigger Action.

A Secondary Trigger can be evaluated with the Primary Trigger to start/stop data collection. The Primary to Secondary Operator is used to define the Trigger combinations required to be true to start/stop data collection. The Secondary Trigger is setup and evaluated the same as the Primary Trigger.

Entry fields are as follows:

If *Primary Trigger*  
Is *Primary Operator Primary Test*  
*Primary to Secondary Operator*

*Secondary Trigger*  
Is *Secondary Operator Secondary Test*

Then *Trigger Action* the Data Collection  
With a delay of *Trigger Delay*

After the desired Triggers are set, the START key on the TREND Screen must be manually pressed before the triggers will be evaluated. While waiting for the triggers to start or stop data collection, a status message is displayed in the upper right corner of the TREND Screen describing the pending action.

### DISPLAY ONLY

This screen displays trending start/stop fields. There are no display only fields on this screen.



## PROGRAMMABLE

### Primary Trigger

*Access Level Required: OPERATOR*

Selects the first parameter to be evaluated. Selection is made from the Slot Numbers listing on the Trend Common Slots Screen or the Master Slot Numbers List in this manual. Setting this slot number to zero disables the Primary Trigger.

### Primary Operator

*Access Level Required: OPERATOR*

Selects the comparator for the Primary Trigger's relationship to the Primary Test. If the Primary Trigger is an analog value, selections are: <, <=, =, =>, >. If the Primary Trigger is a digital event, selections are: Equal To, Not Equal To.

### Primary Test

*Access Level Required: OPERATOR*

Selects the value or condition that the Primary Trigger is compared to. Selection ranges from the Primary Trigger minimum value to the Primary Trigger maximum value.

### Trigger Action

*Access Level Required: OPERATOR*

Selects whether the trend data collection will Start or Stop when the Trigger comparisons are true. If set to Start, data collection will stop after one screen of data is collected.

### Trigger Delay

*Access Level Required: OPERATOR*

Allows the data collection start or stop to be delayed after the Triggers evaluate as true. The delay is selectable from 1 to 864000 seconds (10 days). Display is in days, hours, minutes and seconds. The delay timer begins when the triggers evaluate as true. If the Trigger Action is set to Start, data collection will begin after the triggers evaluate as true and the delay timer has elapsed. If the Trigger Action is set to Stop, data collection will stop after the Triggers evaluate as true and the delay timer has elapsed.

### Primary to Secondary Operator

*Access Level Required: OPERATOR*

Selects whether the Primary Trigger, Secondary Trigger or both have to be true in order to start or stop data collection. Selections are AND, OR, XOR and None. If NONE is selected, the Secondary Trigger is disabled.

Data collection will start/stop (as selected with Trigger Action):

- If AND selected: Both Primary AND Secondary are true
- If OR selected: Either Primary OR Secondary (or both) are true
- If XOR selected: Either Primary OR Secondary (but not both) are true

### Secondary Trigger

*Access Level Required: OPERATOR*

Selects the second parameter to be evaluated. Selection is made from the Slot Numbers listing on the Trend Common Slots Screen or the Master Slot Numbers List in this manual. Setting this slot number to zero disables the Secondary Trigger.

### Secondary Operator

*Access Level Required: OPERATOR*

Selects the comparator for the Secondary Trigger's relationship to the Secondary Test. If the Secondary trigger is an Analog value, selections are: <, <=, =, =>, >. If the Secondary Trigger is a digital event, selections are: Equal To, Not Equal To.

### Secondary Test

*Access Level Required: OPERATOR*

Selects the value or condition that the Secondary Trigger is compared to. Selection ranges from the Secondary Trigger minimum to the Secondary Trigger maximum.

## NAVIGATION

### Home

Causes an instant return to the Home Screen.

### Trend Setup

Causes an instant return to the Trend Setup Screen.

## COMMON SLOTS SCREEN

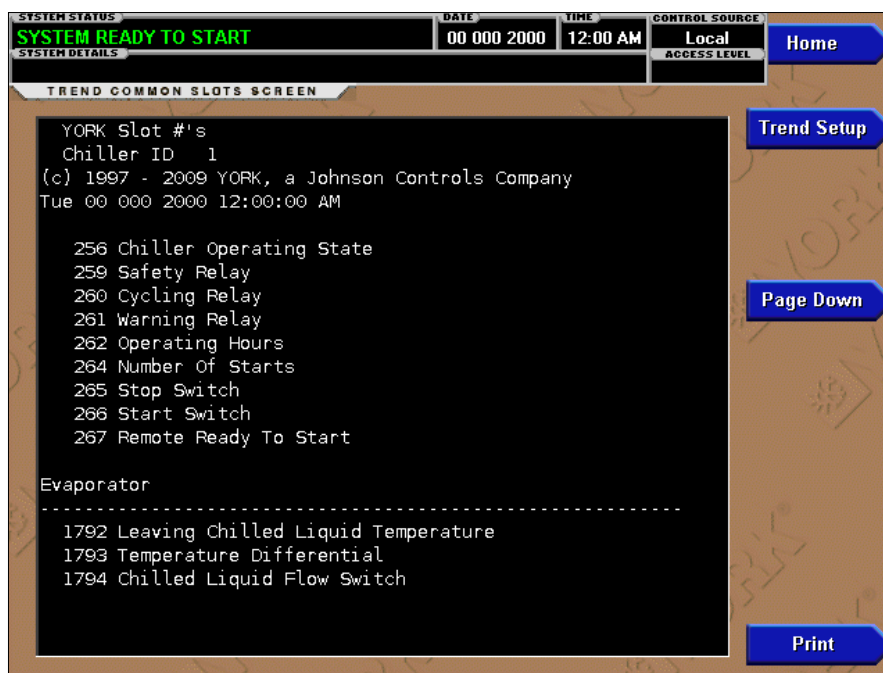

LD14869

**FIGURE 34 - COMMON SLOTS SCREEN**

### OVERVIEW

This screen displays the slot numbers of the commonly monitored parameters. The slot numbers for the remainder of the available parameters are listed on the Master Slot Numbers List that follows.

From these lists, select up to six parameters to be trended. Return to the Trend Setup Screen and enter the parameters Slot Numbers into Data Points 1 through 6.

### DISPLAY ONLY

#### Slot Numbers

These are the slot numbers of the most commonly used parameters.

### PROGRAMMABLE

#### Page Down

*Access Level Required: OPERATOR*

Scroll down in the displayed data.

#### Page Up

*Access Level Required: OPERATOR*

Scroll up in the displayed data.

#### Print

*Access Level Required: OPERATOR*

Generates a list of the slot numbers of the available parameters.

### NAVIGATION

#### Home

Causes an instant return to the Home Screen.

#### Trend Setup

Causes a return to the Trend Setup Screen.

## MASTER SLOT NUMBERS LIST FOR USE WITH TREND FEATURE

SLOT #	DESCRIPTION
<b>SYSTEM</b>	
256	Chiller Operating State
257	Coastdown Time Remaining
259	Safety Relay
260	Cycling Relay
261	Warning Relay
262	Operating Hours
263	Run Time (in seconds)
264	Number Of Starts
427	Run Permissive
267	Remote Ready To Start
<b>EXTERNAL CONTACT</b>	
281	Remote Run / Stop
282	Is Multi Unit Cycling Closed
283	Is Remote Cycling Closed
284	Is Auxiliary Safety Open
<b>JUMPER</b>	
287	Is Diagnostics Enabled
288	Liquid Type
289	Chilled Liquid Pump Operation
291	Power Failure Restart
<b>OPTIONS</b>	
304	Control Mode
305	System Language
306	Chiller ID Number
307	Display Mode
<b>SECURITY</b>	
336	Log in Level
337	Log in User ID
<b>SCHEDULE</b>	
512	Is Schedule Enabled
<b>EVAPORATOR</b>	
1792	Leaving Chilled Liquid Temperature
1793	Temperature Differential
1794	Chilled Liquid Flow Switch
1795	Chilled Liquid Pump
1806	Shutdown Temperature
1807	Return Chilled Liquid Temperature
1808	Evaporator Pressure
1809	Evaporator Saturation Temperature
1810	Evaporator Small Temp Difference
1812	Evaporator Refrigerant Temperature
17920	Active LCHLT Setpoint

SLOT #	DESCRIPTION
<b>CONDENSER</b>	
2048	Leaving Condenser Liquid Temperature
2049	Condenser Liquid Flow Switch
2050	Condenser Liquid Pump
2051	Return Condenser Liquid Temperature
2052	Condenser Pressure
2053	Condenser Saturation Temperature
2054	Condenser Small Temperature Difference
2057	High Pressure Switch
<b>SUBCOOLING</b>	
2059	Sub Cooling Temperature
<b>DROP LEG REFRIGERANT</b>	
2061	Drop Leg Refrigerant Temperature
<b>HEAD PRESSURE CONTROL</b>	
19108	Head Pressure
19040	Head Pressure Setpoint
19085	PID Control Mode
19075	Control Valve Command
<b>COMPRESSOR</b>	
1296	Discharge Temperature
1299	Discharge Superheat
<b>SURGE</b>	
1813	Delta P / P
8236	Surge Detected
8238	Surge Count
<b>REFRIGERANT LEVEL CONTROL</b>	
8205	Refrigerant Level Position
8206	Refrigerant Level Setpoint
8207	Active Refrigerant Level Setpoint
18376	Level Control State
8208	Level Control Valve Command
2062	Subcooler Effectiveness
<b>LEAVING CHILLED LIQUID</b>	
1792	Temperature
1793	Temperature Differential
1794	Is Flow Switch Closed
1795	Is Pump On
1796	Local Temperature Setpoint
1797	Remote Analog Temperature Setpoint
1798	Remote BAS (ISN) Temperature Setpoint
1799	Remote Modem Temperature Setpoint
1800	Selected Temperature Setpoint
1802	Remote Temperature Range

3

SLOT #	DESCRIPTION
1803	Restart Temperature Offset
1804	Restart Temperature Offset
1805	Shutdown Temperature Offset
1806	Shutdown Temperature Setpoint
1818	Remote Digital Temperature Setpoint
<b>SMART FREEZE PROTECTION</b>	
1815	Is Control Enabled
<b>VARIABLE GEOMETRY DIFFUSER</b>	
8280	Active Stall Voltage
18305	Active Stall Voltage Type
18135	Mach Number
18137	Active High Limit
18138	Active Low Limit
8337	Stroke Calibration Complete
8338	VGD Stroke Calibration Command
8352	VGD Fault Code
8353	VGD Actuator Fault
8354	VGD Shutdown Command
17408	Discharge Pressure
<b>VARIABLE SPEED DRIVE</b>	
2305	Motor Run
2306	Motor % FLA
3047	VSD Fault
18085	Input % Full Load Amps
2823	VSD Output Voltage
2822	VSD Output Frequency
20788	Max Chiller Frequency
2818	Input Power
2819	Input kW Hours
2878	L1 Voltage Total Harmonic Distortion
2879	L2 Voltage Total Harmonic Distortion
2880	L3 Voltage Total Harmonic Distortion
3014	L1 Input Current Total Demand Distortion
3015	L2 Input Current Total Demand Distortion
3016	L3 Input Current Total Demand Distortion
3017	Input kVA
2869	Input Power Factor
2306	Motor % Full Load Amps
20784	VSD Command
3051	VSD Control State
3050	VSD Inverter State
3058	Precharge Active
3044	Precharge Complete
3057	DC Bus Regulating
3027	DC Bus Voltage
2829	Cooling System

SLOT #	DESCRIPTION
3053	L1 Input Voltage (Peak)
3054	L2 Input Voltage (Peak)
3055	L3 Input Voltage (Peak)
2872	L1 Input Voltage (RMS)
2873	L2 Input Voltage (RMS)
2874	L3 Input Voltage (RMS)
3008	L1 Input Current (RMS)
3009	L2 Input Current (RMS)
3010	L3 Input Current (RMS)
3018	Phase A Output Voltage (RMS)
3019	Phase B Output Voltage (RMS)
3020	Phase C Output Voltage (RMS)
3021	Phase A Output Current (RMS)
3022	Phase B Output Current (RMS)
3023	Phase C Output Current (RMS)
3031	Phase A Rectifier Baseplate Temperature
3032	Phase B Rectifier Baseplate Temperature
3033	Phase C Rectifier Baseplate Temperature
3034	Phase A Inverter Baseplate Temperature
3035	Phase B Inverter Baseplate Temperature
3036	Phase C Inverter Baseplate Temperature
3029	Internal Ambient Temperature 1
3030	Internal Ambient Temperature 2
<b>MOTOR MONITORING</b>	
3059	Motor Temperature 1
3060	Motor Temperature 2
3061	Motor Temperature 3
3062	Motor Temperature 4
3063	Motor Temperature 5
3064	Motor Temperature 6
19148	Average Winding Temperature
2362	Motor Housing Temperature
18361	Motor Housing Temperature Setpoint
18371	Motor Winding Temperature Setpoint
18362	Motor Cooling Valve Command
18396	Motor Cooling Control State
18397	Estimated Rotor Temperature
<b>CAPACITY CONTROL</b>	
2822	VSD Output Frequency
18023	HGBP Command
18041	Condenser Pressure Override Threshold
18042	Evaporator Pressure Override Threshold
18058	Head Pressure
18093	Active Anti-Surge Minimum Frequency
18122	VSD Frequency Command
18143	Input Current Override Threshold

SLOT #	DESCRIPTION
18251	Motor Current Override Threshold
18273	Control State
18274	Active Load Limit
18288	Speed of Sound
18289	Isentropic Head
18290	Omega
18291	Surge Mach
18292	Surge Frequency
18293	Anti-Surge Minimum Frequency
18295	Leaving Chilled Liquid Temperature (Filtered)
18296	Condenser Pressure (Filtered)
18297	Evaporator Pressure (Filtered)
18300	VGD Command
18332	Anti-Surge Transient Offset
18342	VGD Position
<b>MAGNETIC BEARING CONTROLLER</b>	
20992	Axial Clearance Check
20996	Axial Cenetring
20998	Levitation Mode
20999	Rotation Mode
21001	MBC Alarm
21002	Position V13
21003	Position W13
21004	Position V24
21005	Position W24
21006	Position Z12
21010	Current V1
21011	Current V2
21012	Current V3
21013	Current V4
21014	Current W1
21015	Current W2
21016	Current W3
21017	Current W4
21018	Current Z1A
21019	Current Z2A
21020	Z1 Temperature
21021	Z2 Temperature
21022	MBC Amplifier Temp
21024	Rotor Elongation
21025	Motor Speed
21041	MBC Fault
21042	First Alarm Code
21043	Rotation Allowed
21045	Control Mode

SLOT #	DESCRIPTION
21072	VW13 Soft Landing Counter
21073	VW24 Soft Landing Counter
21074	Z12 Soft Landing Counter
21075	VW13 Hard Landing Counter
21076	VW24 Hard Landing Counter
21077	Z12 Hard Landing Counter
21049	A13 Unbalance
21050	B13 Unbalance
21051	A24 Unbalance
21052	B24 Unbalance
21053	Az Vibration
21054	Bz Vibration
21078	SDR Counter
21079	MBC Input Voltage
21154	MBC Max Alarm Level
21055	MBC Alive
21152	MBC Levitation Command
21153	MBC Rotation Command
<b>POWER PANEL</b>	
17940	Control Voltage
17938	Power Loss Time
17941	UPS Line / Charging
17942	UPS Inverter
17943	UPS Fault
17950	UPS Battery Voltage
17948	UPS Inverter Enable
17937	Power Panel Cooling Threshold
17939	Power Panel Temperature
17947	Power Panel Cooling System Run

**DISPLAY MESSAGES**

The Status Bar of the Display contains a Status Line and, beneath it a Details Line. The Status Line contains a message describing the operating state of the chiller; whether it is stopped, running, starting or shutting down. The Details Line displays Warning, Cycling, Safety, Start Inhibit and other messages that provide further details of the Status Bar messages. The Status Messages listed below are displayed on the Status Line. All other messages are displayed on the Details Line. For convenience they are listed in alphabetical order.

To aid in the meaning of the message, messages are displayed in different colors as follows:

- Normal Operation messages - Green
- Warning messages - Yellow
- Cycling Shutdown messages - Orange
- Safety Shutdown messages - Red

Warning messages will scroll between all those standing. Shutdowns will show first occurrence.

**TABLE 5 - STATUS MESSAGES**

MESSAGE	DESCRIPTION
<b>CYCLING SHUTDOWN – AUTO RESTART</b>	The chiller is shut down on a CYCLING shutdown. The cause of the shutdown is still in effect and is displayed on the Details line of the Status Bar. The chiller will automatically restart when the CYCLING condition clears.
<b>MBC STARTUP</b>	A chiller start has been initiated. The MBC conditions are verified and transitioned to levitate the driveline rotor (MBC Levitation Mode). The progress of the MBC startup is described in the Details Line of the Status Bar.
<b>SAFETY SHUTDOWN – MANUAL RESTART</b>	The chiller is shut down on a SAFETY shutdown. The cause of the shutdown is still in effect and is displayed on the Details line of the Status Bar. The chiller can be started after the Safety condition clears and the Operator presses the CLEAR FAULT key.
<b>SOFT SHUTDOWN</b>	The chiller is performing a Soft Shutdown. Simultaneously, the Hot Gas Bypass Valve is commanded to 100% open (if Hot Gas Bypass is Enabled), the compressor VGD commanded to close rapidly. The motor drive speed is slowed from its initial speed to the minimum required to prevent surge. Then the motor drive speed is ramped to 0 Hz. The chiller then transitions to coastdown. Soft Shutdown is initiated by the following: <ul style="list-style-type: none"> <li>• Leaving Chilled Liquid – Low Temperature</li> <li>• Local Panel Stop Key</li> <li>• Remote Stop</li> <li>• Any MBC Fault occurs</li> <li>• Multi-Unit Cycling – Contacts Open</li> <li>• System Cycling – Contacts Open</li> <li>• Control Panel – Schedule</li> <li>• "Condenser – Flow Switch Open" fault active</li> <li>• "Chilled Liquid – Flow Switch Open" fault active</li> <li>• "Expansion I/O – Serial Communications" fault active</li> </ul> If the local panel safety stop switch is pressed or any chiller shutdown faults other than those listed above occur, Soft Shutdown is immediately terminated and a System Coastdown will occur.
<b>START INHIBIT</b>	The chiller is prevented from being started due to the reason displayed on the Details Line of the Status bar.
<b>SYSTEM COASTDOWN</b>	The chiller has shut down and removed the run signal from the motor variable speed drive (VSD). The system is waiting for confirmation that the driveline has stopped rotating. When the MBC and VSD report drive frequency of 0Hz for 5 seconds, coastdown is considered completed. Then, after 60 seconds delay the VSD Precharge command is released.
<b>SYSTEM READY TO START</b>	The chiller is shut down but will initiate start upon receipt of a Local or Remote start signal. The Magnetic Bearing Controller (MBC) does not have the driveline rotor levitated. The Hot Gas Bypass Valve position (if present) is set to the programmed Hot Gas Startup Position. The Level Control Valve position is set to the programmed Condenser Level Control Valve Startup Position. The VGD driven to the programmed VGD Startup Position.
<b>SYSTEM RUN</b>	The chiller is running under the condition described in the Details Line of the Status Bar.
<b>SYSTEM STOPPED</b>	The chiller is shutdown with a prevailing stop command.



**TABLE 6 - RUN MESSAGES**

MESSAGE	DESCRIPTION
<b>LEAVING CHILLED LIQUID CONTROL</b>	The chiller is running, controlling the Leaving Chilled Liquid to the Leaving Chilled Liquid Temperature Setpoint. No system conditions is inhibiting this operation.
<b>WARNING – VSD DC BUS ACTIVE</b>	This non-annunciating message alerts that the DC Bus is precharged or pre-regulated for a state outside of chiller run. It is set when the VSD indicates a precharge or pre-regulated state or DC Bus voltage >50v in the stopped state. A countdown timer shows with this message to indicate the time remaining in a precharge or pre-regulate command while stopped.
<b>VSD – HIGH INPUT CURRENT LIMIT</b>	The Chiller Input current is greater than or equal to the Active Current Limit Setpoint. The Current Limit Setpoint is programmed over a range of 30 to 100% of the Chiller Full Load Amps (FLA). The Active limit is the minimum of the Local, pulldown (if active), and Remote Current Limit Setpoints in Remote mode or the remote value in BAS (ISN) mode. While this condition is in effect, chiller capacity control is in override to reduce current. Normal LCHLT capacity control operation is resumed and this message automatically clears when the input current decreases below this limit. The highest of the three phase input currents divided by the programmed Job Input FLA is compared to the limit for this override.
<b>VSD – INPUT PULLDOWN LIMIT</b>	The chiller input current will be limited by the pulldown demand limit setpoint. The message clears when the pulldown demand time expires.

3

**TABLE 7 - MBC STARTUP MESSAGES**

MESSAGE	DESCRIPTION
<b>WAITING FOR FLOW</b>	The chilled liquid or condenser flow switch input is not reading voltage indicating no presence of flow from the flow switch. Indication of flow is required during the MBC Startup state to allow transition to chiller run.
<b>WAITING FOR MBC LEVITATION</b>	The OptiView™ has issued a MBC Levitate command to the MBC and is waiting for confirmation from the MBC that De-levitated mode is OFF, Levitated mode is ON, and the input from the digital Rotation Allowed contacts on the MBC is high at OptiView™ I/O board terminal TB3-30. This message precedes “Waiting for Chilled Liquid Flow”.
<b>WAITING FOR VSD PREREGULATION</b>	The OptiView™ has issued a VSD Pre-Charge/Pre-Regulate command to the VSD and is waiting for confirmation from the VSD that it has achieved regulated DC bus voltage and is awaiting a run command. This message precedes “Waiting for MBC Levitation”.

**TABLE 8 - START INHIBIT MESSAGES**

MESSAGE	DESCRIPTION
<b>LINE FREQUENCY NOT SET</b>	This start inhibit is set when the Line Frequency setpoint is “INVALID”. Line Frequency is set invalid on a new or cleared BRAM until programmed.
<b>LINE VOLTAGE NOT SET</b>	This start inhibit is set when the Line Voltage setpoint is “INVALID”. Line Voltage is set invalid on a new or cleared BRAM until programmed.
<b>VGD STROKE NOT CALIBRATED</b>	The Variable Geometry Diffuser stroke calibration procedure has NOT yet been performed.
<b>VGD FEEDBACK NOT CALIBRATED</b>	The Variable Geometry Diffuser feedback calibration has not yet been performed since last stroke calibration.
<b>MBC - INITIALIZATION FAILURE</b>	OptiView was unable to read a valid validation key code over serial communications from the MBC after prompted by voltage present on the MBC Alive contacts (I/O board TB3-71).

**TABLE 9 - WARNING MESSAGES**

MESSAGE	DESCRIPTION																			
<b>WARNING - CONDENSER FREEZE THREAT FROM LOW PRESSURE</b>	While the chiller state is Stopped, the Saturated Condenser Temperature decreased below 35.0 °F. The condenser pump run contacts close. The message is automatically reset and pump contacts return to prior state when either the chiller is not in stopped state or the Saturated Condenser Temperature > 40.0 °F.																			
<b>WARNING – CONDENSER – HIGH PRESSURE LIMIT</b>	The Condenser Pressure exceeds the High Pressure Warning Setpoint threshold, programmed by a Service technician logged in at SERVICE access level. While this condition is in effect, the chiller capacity is in override to reduce pressure. This message automatically clears and normal LCHLT capacity control restored when the Condenser pressure decreases to below the Setpoint.																			
<b>WARNING – CONDENSER OR EVAPORATOR XDCR ERROR</b>	The Evaporator pressure Transducer is indicating a higher pressure than the Condenser pressure Transducer after the chiller has been running for 10 minutes. This is indicative of a Condenser or Evaporator Transducer failure. This message will be displayed until the condition clears and the WARNING RESET Keypad key is pressed in OPERATOR (or higher) access mode. Condition not checked in Brine mode.																			
<b>WARNING – CONDENSER OR VGD SENSOR FAILURE</b>	The difference between the Discharge Pressure Transducer output and the Condenser Pressure Transducer output has exceeded 21 PSID for 3 continuous minutes while the chiller was running. This feature verifies the operation of the transducers. Since both transducers are measuring essentially the same pressure, both outputs should be within the specified tolerance. This message must be manually cleared. It will be displayed until the transducer outputs are within the acceptable range of each other and the WARNING RESET key in SERVICE access level.																			
<b>WARNING – EVAPORATOR – LOW PRESSURE LIMIT</b>	<p>The Evaporator pressure has decreased to the Warning threshold. This threshold is fixed in Water cooling applications. In Brine cooling applications, the threshold is a fixed amount above the programmable safety shutdown threshold. The Safety threshold in Brine applications is determined by the Brine solution and is determined by the YORK Factory. While this condition is in effect, the chiller capacity control is in override to increase suction pressure. This message automatically clears and normal LCHLT capacity control restored when the Evaporator pressure increases to the reset value.</p> <table border="1" style="margin-left: auto; margin-right: auto;"> <thead> <tr> <th colspan="5" style="text-align: center;"><b>EVAPORATOR PRESSURE THRESHOLDS</b></th> </tr> <tr> <th rowspan="2"></th> <th colspan="2" style="text-align: center;"><b>Warning Threshold (PSIG)</b></th> <th colspan="2" style="text-align: center;"><b>Reset Threshold (PSIG)</b></th> </tr> <tr> <th style="text-align: center;"><b>Water</b></th> <th style="text-align: center;"><b>Brine</b></th> <th style="text-align: center;"><b>Water</b></th> <th style="text-align: center;"><b>Brine</b></th> </tr> </thead> <tbody> <tr> <td style="text-align: center;">R134a</td> <td style="text-align: center;">27.0</td> <td style="text-align: center;">+2.0&gt;Safety Setpoint</td> <td style="text-align: center;">28.0</td> <td style="text-align: center;">+3.0&gt;Safety Setpoint</td> </tr> </tbody> </table>	<b>EVAPORATOR PRESSURE THRESHOLDS</b>						<b>Warning Threshold (PSIG)</b>		<b>Reset Threshold (PSIG)</b>		<b>Water</b>	<b>Brine</b>	<b>Water</b>	<b>Brine</b>	R134a	27.0	+2.0>Safety Setpoint	28.0	+3.0>Safety Setpoint
<b>EVAPORATOR PRESSURE THRESHOLDS</b>																				
	<b>Warning Threshold (PSIG)</b>		<b>Reset Threshold (PSIG)</b>																	
	<b>Water</b>	<b>Brine</b>	<b>Water</b>	<b>Brine</b>																
R134a	27.0	+2.0>Safety Setpoint	28.0	+3.0>Safety Setpoint																
<b>WARNING – EXCESS SURGE DETECTED</b>	(Applies only if Surge Protection SHUTDOWN feature is Disabled) The Surge Window Count has exceeded the Count Limit. Message can be manually cleared after the Surge Window Count is less than or equal to the Count Limit, or the SHUTDOWN feature is Enabled or the chiller is stopped. To clear message press WARNING RESET key on HOME Screen when logged in at OPERATOR (or higher) access level.																			
<b>WARNING - LIQUID LEVEL SETPOINT NOT ACHIEVED</b>	The chiller is running and Refrigerant Level > (Refrigerant Level setpoint +15%) OR Refrigerant Level < (Refrigerant Level setpoint -15%) for 10 continuous minutes. The Warning is bypassed for the first 30 minutes of run to allow stable operation to establish. It is released when the chiller is not running or Refrigerant Level is within setpoint +/- 15%. The message clears automatically.																			
<b>WARNING - LOSS OF SUBCOOLER LIQUID SEAL</b>	The chiller is running greater than 30 minutes and the Subcooler Effectiveness value decreased less than 0.400 (ADMIN programmable) at any drop leg refrigerant temperature or increased greater than 1.50 (ADMIN programmable) when the drop leg refrigerant temperature is at least 0.5 °F below or any amount above the Entering Condenser Liquid Temperature. The subcooler effectiveness is (Condenser Sat Temp - Drop leg refrigerant temp)/(Cond Sat Temp - Entering Condenser Liquid Temp). To clear message press WARNING RESET key on HOME Screen when logged in at OPERATOR (or higher) access level.																			

**TABLE 9 - WARNING MESSAGES (CONT'D)**

MESSAGE	DESCRIPTION
<b>WARNING – MBC – HIGH AXIAL OSCILLATOR VOLTAGE</b>	This manual reset warning is set when the internal oscillator that drives the axial position sensor coil is overloaded for one continuous second. This is typically the result of an open in the connection to the shaft position sensor. It could also be a failure of the MBC control board. This message will clear when the voltage is normal and the WARNING RESET key is pressed in OPERATOR (or higher) access mode.
<b>WARNING – MBC – HIGH RADIAL OSCILLATOR VOLTAGE</b>	This manual reset warning is set when the internal oscillator that drives the radial position sensor coil is overloaded for one continuous second. This is typically the result of an open in the connection to the shaft position sensor. It could also be a failure of the MBC control board. This message will clear when the voltage is normal and the WARNING RESET key is pressed in OPERATOR (or higher) access mode.
<b>WARNING – MBC – CHECKSUM CENTERING</b>	This warning appears when the MBC Axial Centering process was never performed, or not correctly realized internally. The centering process as found in the calibration section of Form 160.84-M2 will need to be done in ADMIN access. Then this message will clear when the WARNING RESET key is pressed in OPERATOR (or higher) access mode.
<b>WARNING – MBC – DSP WATCHDOG</b>	A software reboot has occurred on the control board due to processor problem, but reset with the reboot. This message will clear when the WARNING RESET key is pressed in OPERATOR (or higher) access mode.
<b>WARNING – MBC – AMP WATCHDOG</b>	A software reboot has occurred on the amplifier (power) board due to processor problem, but reset with the reboot. This message will clear when the WARNING RESET key is pressed in OPERATOR (or higher) access mode.
<b>WARNING – MBC – INTERNAL ALARM</b>	The MBC experienced an unsatisfactory condition detected internally to the control system. This message will clear when the condition is resolved and the WARNING RESET key is pressed in OPERATOR (or higher) access mode.
<b>WARNING – MBC – ROTATION MODE OFF</b>	During the time the MBC Rotation Mode is commanded ON by the microboard via serial comms this warning is set if the MBC reports Rotation Mode is OFF by serial comms. This warning is inhibited if MBC communication is not initiated and during the first 15 seconds after the Rotation Mode is commanded ON. This warning is released when Rotation Mode status matches the microboard command to the MBC.
<b>WARNING – MOTOR – HIGH CURRENT LIMIT</b>	The chiller motor current is greater than or equal to the Motor Overload current limit. The Motor Overload current limit is predetermined from the motor model and Maximum VSD Output Current. While this condition is in effect, chiller capacity control is in override to reduce current. Normal LCHLT capacity control operation is resumed and this message automatically clears when the motor current decreases below this limit.
<b>WARNING – MOTOR – HIGH HOUSING TEMPERATURE</b>	The Motor Housing Temperature is greater than or equal to 167°F (75°C). This warning is released when Motor Housing Temperature is less than 158°F (70°C).
<b>WARNING- MOTOR - HIGH ROTOR TEMPERATURE</b>	This warning occurs when the estimated rotor temperatures exceeds 230°F (110°C) for 3 continuous seconds. This warning will automatically clear when all winding temperatures decrease below the warning threshold
<b>WARNING - MOTOR – HIGH WINDING TEMPERATURE</b>	This warning occurs when any of the enabled motor winding temperatures exceeds 275°F (135°C) for 3 continuous seconds. This warning will automatically clear when all winding temperatures decrease below the warning threshold. Also it will not act on any individual winding temperature sensor that has been disabled with the TEMPERATURE DISABLED Setpoint on the Motor Details Screen.
<b>WARNING – REAL TIME CLOCK FAILURE</b>	During the initialization process that occurs when power is applied to the control center, test data is written to a location in the BRAM battery backed memory device (IC location U52 on Microboard). This data is then read from the BRAM and compared to the test data. If the read data is not the same as that which was written to the device, it is assumed the BRAM and Real time Clock operation is defective and this message is displayed. The BRAM should be replaced by a qualified Service Technician. This message automatically clears when the BRAM problem has been solved.
<b>WARNING – SETPOINT OVERRIDE</b>	A blank BRAM battery-backed memory device (IC location U52 on Microboard) or a failure of this device was detected during the initialization process that occurs when power is applied to the control center. Due to this failure, any or all of the programmed Setpoints could have been corrupted. Therefore, all Setpoints have been automatically changed to their Default values. All Setpoints will have to be programmed to their desired values. This message will clear when the WARNING RESET key is pressed in OPERATOR (or higher) access mode.

**TABLE 9 - WARNING MESSAGES (CONT'D)**

MESSAGE	DESCRIPTION
<b>WARNING – UPS – BATTERY NOT CONNECTED</b>	This is an auto reset warning. The minimum and maximum Battery Voltage that occurs within each 10 second window is stored. At the end of each 10 second window, if the difference between the min and max battery voltage is greater than 0.5 V, a counter is increased. If the difference between them is less than 0.5 V, the counter is reset to 0. This warning is set when the Battery Disconnected Counter $\geq 4$ (The intent is for 4 consecutive 10 second windows to see battery voltage fluctuations to set this fault) It is released when the Battery Disconnected Counter is 0 for 60 continuous seconds.
<b>WARNING – UPS – CHECK BATTERY CONNECTION</b>	This manual reset warning is set when Battery Voltage $> 16.0$ V. (Indicates only the UPS output is connected to the battery leads). It is released when Battery Voltage $< 16.0$ V.
<b>WARNING – UPS – LINE LOW BATTERY VOLTAGE</b>	This auto reset warning is set when all of the following are true: <ul style="list-style-type: none"> <li>• Control Voltage digital input is high (indicates line power is available)</li> <li>• Battery Voltage <math>&lt;</math> Line Low Battery Voltage Threshold</li> </ul> It releases when Battery Voltage $>$ Line Low Battery Voltage Threshold + 0.1 V
<b>WARNING – UPS – NOT CHARGING</b>	This auto reset warning is set when all of the following are true for 5 continuous seconds: <ul style="list-style-type: none"> <li>• Control Voltage digital input is high (indicates line power is available)</li> <li>• UPS Line / Charging digital input is low (indicates UPS not reporting in charge mode)</li> </ul> It releases when any of the following are true: <ul style="list-style-type: none"> <li>• Control Voltage digital input is low (indicates line power is lost)</li> <li>• UPS Line / Charging digital input is high (UPS is reporting in charge mode)</li> </ul>
<b>WARNING – VSD – INPUT VOLTAGE IMBALANCE</b>	Line voltage imbalance shall be calculated, for every VSD communications cycle, as: $V_{imb\%} = \frac{\max( V_{ab} - V_{avg} ,  V_{bc} - V_{avg} ,  V_{ca} - V_{avg} )}{V_{avg}} \times 100\%$ <p>where <math>V_{ab}</math>, <math>V_{bc}</math> and <math>V_{ca}</math> are line-to-line total rms voltages received from the drive, max is the function which selects the largest of its arguments, and:</p> $V_{avg} = \frac{ V_{ab}  +  V_{bc}  +  V_{ca} }{3}$ <p>If <math>V_{imb\%}</math> exceeds 5% continuously for 45 seconds, the warning will be displayed. The 45 second timer shall reset and the warning shall clear if three consecutive imbalance readings fall below the 5% threshold.</p>

**TABLE 10 - ROUTINE SHUTDOWN MESSAGES**

MESSAGE	DESCRIPTION
<b>LOCAL STOP</b>	A local shutdown command has been received by pressing the Keypad Stop key.
<b>REMOTE STOP</b>	A shutdown command has been received from a remote device. Remote Stop commands can be received in Digital Remote mode via I/O Board TB4-7/8 or in BAS (ISN) (Integrated Systems Network) Remote mode via the E-Link Gateway serial communications. If the chiller is running when this occurs, the chiller performs a soft shutdown.

**TABLE 11 - CYCLING SHUTDOWN MESSAGES**

The chiller will automatically restart when the cycling condition clears.

MESSAGE	DESCRIPTION												
<b>CHILLED LIQUID – FLOW SWITCH OPEN</b>	The Chilled Liquid Flow Switch has remained open for 5 continuous seconds while the chiller was running, in soft shutdown, or at least 45 seconds after MBC startup is initiated. The chiller will automatically restart when the flow switch closes or the fault will clear if the chiller is run command is ceased.												
<b>CONDENSER – FLOW SWITCH OPEN</b>	The Condenser water flow switch has remained open for 5 continuous seconds while the chiller was running, in soft shutdown, or at least 45 seconds after MBC startup is initiated. The chiller will automatically restart when the flow switch closes or the fault will clear if the chiller is run command is ceased.												
<b>CONDENSER -FREEZE THREAT-FLOW SWITCH OPEN</b>	<p>This fault is set when all of the following are true:</p> <ul style="list-style-type: none"> <li>• Chiller State is Stopped</li> <li>• Saturated Condenser Temperature &lt; 35.0 °F</li> <li>• Condenser Flow Switch is Open for 1 minute or longer</li> </ul> <p>It is released when any of the following are true:</p> <ul style="list-style-type: none"> <li>• Chiller State is not Stopped</li> <li>• Saturated Condenser Temperature &gt; 40.0 °F</li> <li>• Condenser Flow Switch is Closed</li> </ul>												
<b>CONTROL PANEL – LOSS OF CONTROL VOLTAGE</b>	The line power input signal at I/O board TB3-81 was low for 1 second continuous. This signal is used to determine when the digital inputs are affected by a line power loss versus an actual condition for their devices. This fault is not expected on an actual loss of microboard power from the critical load bus, because the processor will be off before the fault delay. This message can indicate a Cycling (auto-restart after power failure) or Safety (manual restart after power failure) shutdown, depending upon control center configuration.												
<b>CONTROL PANEL – POWER FAILURE</b>	A Control Power failure has occurred. If the power failure occurred while the chiller was running, it will automatically restart when power is restored. This message can indicate a Cycling (auto-restart after power failure) or Safety (manual restart after power failure) shutdown, depending upon control center configuration. It indicates a cycling shutdown when displayed in orange characters; Safety shutdown when displayed in red characters. The control center is configured for auto-restart or manual restart after power failure by a qualified Service Technician following instructions in <i>YORK YMC<sup>2</sup> Service Manual (Form 160.84-M2)</i> .												
<b>CONTROL PANEL – SCHEDULE</b>	The programmed Daily Schedule Setpoint has shutdown the chiller. If this occurs while the chiller is running, a Soft Shutdown is performed. The chiller will automatically restart at the next scheduled start time.												
<b>EVAPORATOR – LOW PRESSURE</b>	<p>The evaporator pressure, as sensed by the Evaporator Transducer, has decreased to the shutdown threshold. For water cooling applications, the shutdown threshold is a fixed value. For Brine cooling applications, the shutdown threshold varies according to the concentration of the Brine solution. The Brine shutdown threshold is programmed at the YORK Factory. It should not be changed by anyone other than a qualified Service Technician following instructions in <i>YORK YMC<sup>2</sup> Service Manual (Form 160.84-M2)</i>. The chiller will restart after the evaporator pressure increases to the restart threshold. If this shutdown occurs 3 times in a 90 minute period, an EVAPORATOR-LOW PRESSURE safety shutdown is initiated.</p> <table border="1" data-bbox="729 1709 1367 1955"> <thead> <tr> <th colspan="3" data-bbox="729 1709 1367 1743">SHUTDOWN</th> </tr> <tr> <th data-bbox="729 1743 912 1814"></th> <th data-bbox="912 1743 1118 1814">SHUTDOWN (PSIG)</th> <th data-bbox="1118 1743 1367 1814">RESTART (PSIG)</th> </tr> </thead> <tbody> <tr> <td data-bbox="729 1814 912 1885">Water Cooling -R134a</td> <td data-bbox="912 1814 1118 1885">25.0</td> <td data-bbox="1118 1814 1367 1885">25.1</td> </tr> <tr> <td data-bbox="729 1885 912 1955">Brine Cooling -R134a</td> <td data-bbox="912 1885 1118 1955">6.0 to 25.0 as programmed</td> <td data-bbox="1118 1885 1367 1955">+0.1&gt; Shutdown threshold</td> </tr> </tbody> </table>	SHUTDOWN				SHUTDOWN (PSIG)	RESTART (PSIG)	Water Cooling -R134a	25.0	25.1	Brine Cooling -R134a	6.0 to 25.0 as programmed	+0.1> Shutdown threshold
SHUTDOWN													
	SHUTDOWN (PSIG)	RESTART (PSIG)											
Water Cooling -R134a	25.0	25.1											
Brine Cooling -R134a	6.0 to 25.0 as programmed	+0.1> Shutdown threshold											

**TABLE 11 - CYCLING SHUTDOWN MESSAGES (CONT'D)**

MESSAGE	DESCRIPTION
<b>EXPANSION I/O – SERIAL COMMUNICATIONS</b>	Valid communication between the microboard and the LTC I/O Board have been disrupted for 3 consecutive attempts. The chiller will automatically restart when valid communication is received.
<b>ISOLATION VALVES - NOT CLOSED</b>	The optional brine freeze protection motorized isolation valves Close output is energized > 40 seconds but the feedback from the valve limit switch does not indicate it closed for 3 continuous seconds. This cycling fault is released when the isolation valves closed input is energized
<b>LEAVING CHILLED LIQUID – LOW TEMPERATURE</b>	The Leaving Chilled Liquid Temperature has decreased to the programmed Shutdown Temperature Setpoint. If the chiller is running when this occurs, a Soft Shutdown is performed. The chiller will automatically restart when the temperature increases to the programmed Restart Temperature Setpoint.
<b>MBC – FAULT CONTACTS OPEN</b>	Refer to “MBC Shutdown – Requesting Fault Data” message above. If the control center’s microboard does not receive the cause of the MBC fault over the serial link within 10 seconds after the fault contacts open is recognized, it is assumed it is not forthcoming and that message is replaced with this message.
<b>MBC - LOW INPUT VOLTAGE</b>	Main DC supply voltage to the MBC decreased below 135VDC (150-10%)
<b>MBC – SERIAL COMMUNICATIONS</b>	This Cycling Shutdown is set when an invalid or no response is received from the MBC to a Modbus command from the panel for 3 consecutive attempts with a 2 second timeout between attempts. It shall be triggered by the Modbus communications task when its fault conditions are met (thresholds of consecutive timeouts, ID mismatches, checksum failures, or error packets). It is released when a valid response is received.
<b>MBC SHUTDOWN – REQUESTING FAULT DATA</b>	The MBC has shutdown the chiller and the control center has not yet received the cause of the fault from the MBC via the serial communications link. The MBC shuts down the chiller by opening the MBC Fault contacts (located on the MBC control board and connected to TB3-70 in the control center). The microboard in the control center then sends a request for the cause of the fault to the MBC control board over the serial link. Since serial communications are initiated every 2 seconds, this message is typically displayed for a few seconds and then replaced with one of the other MBC fault messages in this section.
<b>MBC – SPEED SIGNAL FAULT</b>	This Cycling Shutdown is set when the MBC loses the speed signal that is expected from the VSD or speed signal is less than 10 Hz. While the MBC is commanded in Rotation Mode. The MBC Fault contacts open. The MBC remains in Levitation mode with the motor shaft levitated until commanded to de-levitate over serial comms. This shutdown is released when the MBC is out of Rotation mode or speed greater than 10 Hz is transmitted. A 10 second bypass exists when the initial command to Rotation Mode occurs.
<b>MBC – STARTUP FAILURE</b>	This Shutdown is set when the chiller fails to exit the MBC startup state within 60 seconds, during a chiller start. Refer to the Basic Operation section of this manual for conditions necessary to complete MBC startup successfully. Check fault history details to determine which specific conditions were not met.
<b>MBC – V13 LOW FREQUENCY DISPLACEMENT</b>	The MBC has measured shaft displacement is greater than 90 µm from center in the orthogonal radial axis designated V at the impeller end radial magnetic bearing during Levitation or Rotation mode over a 7 second window (approximately 2/3 of the air gap space to the touchdown bearing). The MBC Fault contacts open. The MBC remains in Levitation mode with the motor shaft levitated until commanded to de-levitate over serial comms. This shutdown is released when displacement is less than 90 µm.
<b>MBC - UNKNOWN PARAMATER FILE</b>	This Cycling shutdown is set when the bearing setup parameter file received from OptiView is not an expected file format. The fault is released when the error is corrected. This fault could be corrupted data transfer between OptiView and the MBC.
<b>MBC – V13 POSITION</b>	The MBC has measured shaft displacement is greater than 100 µm from center in the orthogonal radial axis designated V at the impeller end radial magnetic bearing during Levitation or Rotation mode (approximately 2/3 of the air gap space to the touchdown bearing). The MBC Fault contacts open. The MBC remains in Levitation mode with the motor shaft levitated until commanded to de-levitate over serial comms. This shutdown is released when displacement is less than 100 µm.



**TABLE 11 - CYCLING SHUTDOWN MESSAGES (CONT'D)**

MESSAGE	DESCRIPTION
<b>MBC – V24 LOW FREQUENCY DISPLACEMENT</b>	The MBC has measured shaft displacement is greater than 90 µm from center in the orthogonal radial axis designated V at the opposite-impeller end radial magnetic bearing during Levitation or Rotation mode over a 7 second window (approximately 2/3 of the air gap space to the touchdown bearing). The MBC Fault contacts open. The MBC remains in Levitation mode with the motor shaft levitated until commanded to de-levitate over serial comms. This warning is released when displacement is less than 90 µm.
<b>MBC – V24 POSITION</b>	The MBC has measured shaft displacement is greater than 100 µm from center in the orthogonal radial axis designated V at the opposite-impeller end radial magnetic bearing during Levitation or Rotation mode (approximately 2/3 of the air gap space to the touchdown bearing). The MBC Fault contacts open. The MBC remains in Levitation mode with the motor shaft levitated until commanded to de-levitate over serial comms. This shutdown is released when displacement is less than 100 µm.
<b>MBC – W13 LOW FREQUENCY DISPLACEMENT</b>	The MBC has measured shaft displacement is greater than 90 µm from center in the orthogonal radial axis designated W at the impeller end radial magnetic bearing during Levitation or Rotation mode over a 7 second window (approximately 2/3 of the air gap space to the touchdown bearing). The MBC Fault contacts open. The MBC remains in Levitation mode with the motor shaft levitated until commanded to de-levitate over serial comms. This warning is released when displacement is less than 90 µm.
<b>MBC – W13 POSITION</b>	The MBC has measured shaft displacement is greater than 100 µm from center in the orthogonal radial axis designated W at the impeller end radial magnetic bearing during Levitation or Rotation mode (approximately 2/3 of the air gap space to the touchdown bearing). The MBC Fault contacts open. The MBC remains in Levitation mode with the motor shaft levitated until commanded to de-levitate over serial comms. This shutdown is released when displacement is less than 100 µm.
<b>MBC – W24 LOW FREQUENCY DISPLACEMENT</b>	The MBC has measured shaft displacement is greater than 90 µm from center in the orthogonal radial axis designated W at the opposite-impeller end radial magnetic bearing during Levitation or Rotation mode over a 7 second window (approximately 2/3 of the air gap space to the touchdown bearing). The MBC Fault contacts open. The MBC remains in Levitation mode with the motor shaft levitated until commanded to de-levitate over serial comms. This warning is released when displacement is less than 90 µm.
<b>MBC – W24 POSITION</b>	The MBC has measured shaft displacement is greater than 100 µm from center in the orthogonal radial axis designated W at the opposite-impeller end radial magnetic bearing during Levitation or Rotation mode (approximately 2/3 of the air gap space to the touchdown bearing). The MBC Fault contacts open. The MBC remains in Levitation mode with the motor shaft levitated until commanded to de-levitate over serial comms. This shutdown is released when displacement is less than 100 µm.
<b>MBC – VW13 VIBRATION</b>	The MBC has measured synchronous speed (first harmonic) shaft vibration at the impeller end radial magnetic bearing is greater than 45 µm peak amplitude in Rotation mode. This condition is monitored only when the AVR and ABS filter is on, which occurs for speed above 70 Hz. The MBC Fault contacts open. The MBC remains in Levitation mode with the motor shaft levitated until commanded to de-levitate over serial comms. This fault is released when vibration is less than 45 µm.
<b>MBC – VW24 VIBRATION</b>	The MBC has measured synchronous speed (first harmonic) shaft vibration at the opposite-impeller end radial magnetic bearing is greater than 45 µm peak amplitude in Rotation mode. This condition is monitored only when the AVR and ABS filter is on, which occurs for speed above 70 Hz. The MBC Fault contacts open. The MBC remains in Levitation mode with the motor shaft levitated until commanded to de-levitate over serial comms. This fault is released when vibration is less than 60 µm.
<b>MBC – Z12 LOW FREQUENCY DISPLACEMENT</b>	The MBC has measured shaft displacement is greater than 100 µm axially from the design running position over a 7 second window (approximately 1/3 of the air gap space to the touchdown bearing axially). The MBC Fault contacts open. The MBC remains in Levitation mode with the motor shaft levitated until commanded to de-levitate over serial comms. This fault is released when displacement is less than 100 µm.

**TABLE 11 - CYCLING SHUTDOWN MESSAGES (CONT'D)**

MESSAGE	DESCRIPTION						
<b>MBC – Z12 POSITION</b>	The MBC has measured shaft displacement is greater than 100 µm axially from the design running position (approximately 1/2 of the air gap space to the touchdown bearing axially). The MBC Fault contacts open. The MBC remains in Levitation mode with the motor shaft levitated until commanded to de-levitate over serial comms. This shutdown is released when displacement is less than 100 µm.						
<b>MBC - Z12 VIBRATION</b>	The MBC has measured a vibration in axial position at one times the rotating frequency whose amplitude exceeds 60 µm. This frequency axially can be the image of the rotor axial run-out. This fault is available when AVR or ABS are activated. The MBC fault contacts open. The MBC remains in Levitation mode with the motor shaft levitated until commanded to de-levitate over serial comms. This fault is released when this displacement is less than 60 µm.						
<b>MULTIUNIT CYCLING – CONTACTS OPEN</b>	The Multiunit Cycling contacts connected to I/O Board TB4-9, have opened to initiate a cycling shutdown. If the chiller is running when this occurs, the Pre-rotation Vanes are driven fully closed prior to shutting down the chiller. The chiller will automatically restart when the contacts close.						
<b>SYSTEM CYCLING – CONTACTS OPEN</b>	The System Cycling contacts connected to I/O Board TB4-13, have opened to initiate a cycling shutdown. If the chiller is running when this occurs, the Pre-rotation Vanes are driven fully closed prior to shutting down the chiller. The chiller will automatically restart when the contacts close.						
<b>UPS – LINE LOW BATTERY VOLTAGE</b>	This cycling fault initiates a soft shutdown if it is set while the chiller state is Running. It is set during chiller state Running or Soft Shutdown when all of the following are true: <ul style="list-style-type: none"> <li>• Battery Voltage Faults setting is “Enabled”</li> <li>• “Warning – UPS – Line Low Battery Voltage” warning has been set for 60 continuous minutes</li> </ul> This fault is also set during chiller state Stopped when all of the following are true: <ul style="list-style-type: none"> <li>• Battery Voltage Faults setting is “Enabled”</li> <li>• Control Voltage digital input is high (indicates line power is available)</li> <li>• Battery Voltage &lt; Line Low Battery Voltage Threshold</li> </ul> It is released when any of the following are true: <ul style="list-style-type: none"> <li>• Battery Voltage Faults is Disabled</li> <li>• Battery Voltage &gt; Line Low Battery Voltage Threshold + 0.1 V.</li> </ul>						
<b>VSD – DC BUS PRE-REGULATION</b>	The DC bus voltage has not increased to a value of +/- 50 volts of the DC bus voltage setpoint of 785 VDC within 2 seconds after entering the pre-regulation state. If this condition does not pass, then this shutdown is generated. The VSD will attempt another pre-charge and pre-regulation cycle after a delay of 10 seconds. If this shutdown occurs three consecutive times, then the chiller will lock out on a “VSD – DC BUS PRE-REGULATION LOCKOUT”.						
<b>VSD – HIGH DC BUS VOLTAGE</b>	If the DC bus voltage exceeds the value for the given model of drive, then this shutdown will occur. Typically, this shutdown will occur when there is a sudden change in the input voltage due to storms, utility power problems, or site power problems <table border="1" data-bbox="548 1598 1354 1713" style="margin-left: auto; margin-right: auto;"> <thead> <tr> <th data-bbox="548 1598 769 1633">DRIVE MODEL</th> <th data-bbox="769 1598 1354 1633">HIGH DC BUS VOLTAGE SHUTDOWN VALUE</th> </tr> </thead> <tbody> <tr> <td data-bbox="548 1633 769 1669">0490</td> <td data-bbox="769 1633 1354 1669">878 VDC</td> </tr> <tr> <td data-bbox="548 1669 769 1713">0612 and 0774</td> <td data-bbox="769 1669 1354 1713">985 VDC</td> </tr> </tbody> </table>	DRIVE MODEL	HIGH DC BUS VOLTAGE SHUTDOWN VALUE	0490	878 VDC	0612 and 0774	985 VDC
DRIVE MODEL	HIGH DC BUS VOLTAGE SHUTDOWN VALUE						
0490	878 VDC						
0612 and 0774	985 VDC						

**TABLE 11 - CYCLING SHUTDOWN MESSAGES (CONT'D)**

MESSAGE	DESCRIPTION								
<b>VSD – HIGH INTERNAL AMBIENT TEMPERATURE</b>	<p>The variable speed drive contains two temperature sensors, which monitor the unit's internal ambient temperature. This shutdown is generated when the higher of the two ambient temperatures exceeds a high limit of 158°F (70°C). The unit's fan(s) and water pump(s) remain energized until the internal temperature drops below 148°F (64°C), after which they shall be de-energized and the fault can be cleared. Some potential causes for this shutdown are internal VSD fan failure, VSD coolant pump failure, entering condenser water temperature higher than design, condenser water flow lower than required, fouled VSD heat exchanger, or restriction of condenser water to the VSD.</p>								
<b>VSD – HIGH PHASE A INPUT CURRENT</b>	<p>If the A phase input current exceeds the value for the given model of drive, then a cycling shutdown will occur. If three high input current cycling shutdown faults occur on any phase within 90 minutes, the third fault in the 90 minute period will cause a Safety Shutdown. If the safety shutdown occurs, the chiller can be restarted after the CLEAR FAULTS key is pressed.</p> <table border="1" data-bbox="755 642 1344 798"> <thead> <tr> <th>DRIVE MODEL</th> <th>INPUT CURRENT FAULT VALUE</th> </tr> </thead> <tbody> <tr> <td>0490</td> <td>886 Amps</td> </tr> <tr> <td>0612</td> <td>1418 Amps</td> </tr> <tr> <td>0774</td> <td>1446 Amps</td> </tr> </tbody> </table>	DRIVE MODEL	INPUT CURRENT FAULT VALUE	0490	886 Amps	0612	1418 Amps	0774	1446 Amps
DRIVE MODEL	INPUT CURRENT FAULT VALUE								
0490	886 Amps								
0612	1418 Amps								
0774	1446 Amps								
<b>VSD – HIGH PHASE B INPUT CURRENT</b>	See "VSD – HIGH PHASE A INPUT CURRENT" message preceeding.								
<b>VSD – HIGH PHASE C INPUT CURRENT</b>	See "VSD – HIGH PHASE A INPUT CURRENT" message preceeding.								
<b>VSD – HIGH PHASE A MOTOR CURRENT</b>	<p>If the A phase motor current exceeds the value for the given model of drive, then a cycling shutdown will occur. If three high motor current cycling shutdown faults occur on any phase within 90 minutes, the third fault in the 90 minute period will cause a Safety Shutdown. If the safety shutdown occurs, the chiller can be restarted after the CLEAR FAULTS key is pressed.</p> <table border="1" data-bbox="740 1115 1359 1270"> <thead> <tr> <th>DRIVE MODEL</th> <th>MOTOR CURRENT FAULT VALUE</th> </tr> </thead> <tbody> <tr> <td>0490</td> <td>776 Amps</td> </tr> <tr> <td>0612</td> <td>1094 Amps</td> </tr> <tr> <td>0774</td> <td>1317 Amps</td> </tr> </tbody> </table>	DRIVE MODEL	MOTOR CURRENT FAULT VALUE	0490	776 Amps	0612	1094 Amps	0774	1317 Amps
DRIVE MODEL	MOTOR CURRENT FAULT VALUE								
0490	776 Amps								
0612	1094 Amps								
0774	1317 Amps								
<b>VSD – HIGH PHASE B MOTOR CURRENT</b>	See "VSD – HIGH PHASE A MOTOR CURRENT" message preceeding.								
<b>VSD – HIGH PHASE C MOTOR CURRENT</b>	See "VSD – HIGH PHASE A MOTOR CURRENT" message preceeding.								
<b>VSD INITIALIZATION FAILED</b>	<p>Upon application of power, all boards go through the initialization process. At this time, memory locations are cleared, program jumper positions are checked and serial communications links are established. There are several causes for an unsuccessful initialization as follows:</p> <ul style="list-style-type: none"> <li>Serial data communications must be established. Refer to <b>VSD – Serial Communications</b> fault. If communications between the VSD Logic Board, and control center Microboard does not take place during initialization, this message will be generated. The Serial communications can be verified by selecting the <b>VSD DETAILS</b> screen from the <b>MOTOR</b> screen and observing the Full Load amps value. A zero displayed for this and other VSD parameters, indicates a serial communications link problem.</li> </ul>								
<b>VSD – INVALID SETPOINTS</b>	The VSD Logic Board is able to determine which model of drive can run which model of motor. If the Control Center provides a model of motor that is not compatible with this model of VSD, then this shutdown is generated. When this condition clears, the chiller can be started after the CLEAR FAULTS key is pressed.								
<b>VSD – LOGIC BOARD POWER SUPPLY</b>	This shutdown is generated by the VSD logic board and it indicates that the low voltage power supplies for the logic boards have dropped below their allowable operating limits. This message usually means the power to the VSD has been removed.								

**TABLE 11 - CYCLING SHUTDOWN MESSAGES (CONT'D)**

<b>MESSAGE</b>	<b>DESCRIPTION</b>
<b>VSD – LOGIC BOARD PROCESSOR</b>	This shutdown is generated if a communications problem occurs between the two microprocessors on the VSD Logic Board.
<b>VSD – LOW DC BUS VOLTAGE</b>	Following a successful pre-charge and pre-regulation of the bus capacitor(s), if the DC bus voltage drops below 755 VDC, then this shutdown is generated. Typically, this shutdown will occur when there is a sudden change in the input voltage due to storms, utility power problems, or site power problems.
<b>VSD – LOW PHASE A INPUT BASEPLATE TEMPERATURE</b>	The temperature of the input baseplate phase A has decreased below the low limit of 37°F (2.7°C). All phase temperatures have to increase above the fault-reset threshold of 42°F (5.5°C), for this fault to be cleared. The cooling fans and pumps will turn on while this shutdown is present. They will turn off when the temperature rises above the fault-reset threshold.
<b>VSD – LOW PHASE B INPUT BASEPLATE TEMPERATURE</b>	See “VSD – LOW PHASE A INPUT BASEPLATE TEMPERATURE” message preceding.
<b>VSD – LOW PHASE C INPUT BASEPLATE TEMPERATURE</b>	See “VSD – LOW PHASE A INPUT BASEPLATE TEMPERATURE” message preceding.
<b>VSD – LOW PHASE A MOTOR BASEPLATE TEMPERATURE</b>	The temperature of the motor baseplate phase A has decreased below the low limit of 37°F. All phase temperatures have to increase above the fault-reset threshold of 42°F, for this fault to be cleared. The cooling fans and pumps will turn on while this shutdown is present. They will turn off when the temperature rises above the fault-reset threshold.
<b>VSD – LOW PHASE B MOTOR BASEPLATE TEMPERATURE</b>	See “VSD – LOW PHASE A MOTOR BASEPLATE TEMPERATURE” message preceding.
<b>VSD – LOW PHASE C MOTOR BASEPLATE TEMPERATURE</b>	See “VSD – LOW PHASE A MOTOR BASEPLATE TEMPERATURE” message preceding.
<b>VSD – NOT RUNNING</b>	The VSD has not reported run state via serial communications for 8 seconds while the microboard issues a VSD run command. The fault is released when the microboard command is “Stopped State”.
<b>VSD – PHASE A INPUT DCCT OFFSET</b>	When the VSD begins precharge, the output of the input current Direct Current Current Transformers (DCCT) are evaluated to ensure that they are reading zero current when no current is flowing through the DCCT. If the zero current output value is above a threshold, then this shutdown is generated.
<b>VSD – PHASE B INPUT DCCT OFFSET</b>	See “VSD – PHASE A INPUT DCCT OFFSET” message preceding.
<b>VSD – PHASE C INPUT DCCT OFFSET</b>	See “VSD – PHASE A INPUT DCCT OFFSET” message preceding.
<b>VSD – PHASE A INPUT GATE DRIVER</b>	The gate driver board for the input rectifier monitors the power supplies within the gate driver circuit, and verifies that the input rectifier can be properly controlled. If the gate driver monitor determines that the input rectifier cannot be properly controlled, then the drive will shutdown and display this message.
<b>VSD – PHASE B INPUT GATE DRIVER</b>	See “VSD – PHASE A INPUT GATE DRIVER” message preceding.
<b>VSD – PHASE C INPUT GATE DRIVER</b>	See “VSD – PHASE A INPUT GATE DRIVER” message preceding.
<b>VSD – PHASE A MOTOR GATE DRIVER</b>	The gate driver board for the motor inverter monitors the power supplies within the gate driver circuit, and verifies that the input rectifier can be properly controlled. If the gate driver monitor determines that the input rectifier cannot be properly controlled, then the drive will shutdown and display this message.
<b>VSD – PHASE B MOTOR GATE DRIVER</b>	See “VSD – PHASE A MOTOR GATE DRIVER” message preceding.
<b>VSD – PHASE C MOTOR GATE DRIVER</b>	See “VSD – PHASE A MOTOR GATE DRIVER” message preceding.

**TABLE 11 - CYCLING SHUTDOWN MESSAGES (CONT'D)**

MESSAGE	DESCRIPTION						
<p><b>VSD – PRECHARGE – LOW DC BUS VOLTAGE 1</b></p>	<p>During Pre-charge, the DC bus voltage must exceed the minimum threshold which is determined by Line Voltage Setpoint (see the table below) within 4 seconds after the pre-charge signal has been commanded. If this condition is not met, this shutdown is generated. The VSD logic board shall wait 10 seconds before clearing the fault and allowing another pre-charge to start. The VFD’s fan(s) and water pump(s) shall remain energized during this time. The VSD logic board shall allow up to three consecutive pre-charge-related faults to occur. After the third consecutive pre-charge-related fault, Safety Shutdown message “VSD – PRECHARGE LOCKOUT” is generated.</p> <table border="1" data-bbox="722 478 1377 596"> <thead> <tr> <th>LINE VOLTAGE</th> <th>MINIMUM THRESHOLD (VOLTS)</th> </tr> </thead> <tbody> <tr> <td>380/415</td> <td>41</td> </tr> <tr> <td>460</td> <td>50</td> </tr> </tbody> </table>	LINE VOLTAGE	MINIMUM THRESHOLD (VOLTS)	380/415	41	460	50
LINE VOLTAGE	MINIMUM THRESHOLD (VOLTS)						
380/415	41						
460	50						
<p><b>VSD – PRECHARGE – LOW DC BUS VOLTAGE 2</b></p>	<p>During Pre-charge, the DC bus voltage must exceed the minimum threshold which is determined by Line Voltage Setpoint (see the table below) within 12 seconds after the pre-charge signal has been commanded. If this condition is not met, this shutdown is generated. The VSD logic board shall wait 10 seconds before clearing the fault and allowing another pre-charge to start. The VFD’s fan(s) and water pump(s) shall remain energized during this time. The VSD logic board shall allow up to three consecutive pre-charge-related faults to occur. After the third consecutive pre-charge-related fault, Safety Shutdown message “VSD – PRECHARGE LOCKOUT” is generated.</p> <table border="1" data-bbox="727 871 1372 989"> <thead> <tr> <th>LINE VOLTAGE</th> <th>MINIMUM THRESHOLD (VOLTS)</th> </tr> </thead> <tbody> <tr> <td>380/415</td> <td>414</td> </tr> <tr> <td>460</td> <td>500</td> </tr> </tbody> </table>	LINE VOLTAGE	MINIMUM THRESHOLD (VOLTS)	380/415	414	460	500
LINE VOLTAGE	MINIMUM THRESHOLD (VOLTS)						
380/415	414						
460	500						
<p><b>VSD – RUN SIGNAL</b></p>	<p>Redundant RUN signals are generated by the control center; one via TB6-24 and the second via the Serial Communications link. Upon receipt of either of the two RUN commands by the VSD, a 5 second timer shall commence timing. If both run commands are not received by the VSD Logic Board within 5 seconds, a shutdown is performed and this message is displayed. This is generally indicative of a wiring problem between the control center and the VSD.</p>						
<p><b>VSD – SERIAL RECEIVE</b></p>	<p>This shutdown is generated when the VSD logic board has not received a valid communications packet from the control center for 10 consecutive seconds.</p>						
<p><b>VSD SHUTDOWN – REQUESTING FAULT DATA</b></p>	<p>The VSD has shutdown the chiller and the control center has not yet received the cause of the fault from the VSD, via the serial communications link. The VSD shuts down the chiller by opening the Motor Controller <b>VSD Stop Contacts</b>. The control center then sends a request for the cause of the fault to the VSD over the serial link. Since serial communications are initiated every 2 seconds, this message is typically displayed for a few seconds and then replaced with one of the other VSD fault messages.</p>						
<p><b>VSD – SINGLE PHASE INPUT POWER</b></p>	<p>The VSD monitors the input voltage of all three phases. If the input voltage of any one phase drops below the threshold value for the given input voltage range below, then this shutdown will occur.</p> <table border="1" data-bbox="706 1560 1393 1709"> <thead> <tr> <th>INPUT VOLTAGE RANGE</th> <th>INPUT VOLTAGE SINGLE PHASE SHUTDOWN VALUE</th> </tr> </thead> <tbody> <tr> <td>380/415</td> <td>264 Volts</td> </tr> <tr> <td>460</td> <td>295 Volts</td> </tr> </tbody> </table>	INPUT VOLTAGE RANGE	INPUT VOLTAGE SINGLE PHASE SHUTDOWN VALUE	380/415	264 Volts	460	295 Volts
INPUT VOLTAGE RANGE	INPUT VOLTAGE SINGLE PHASE SHUTDOWN VALUE						
380/415	264 Volts						
460	295 Volts						
<p><b>VSD – STOP (FAULT) CONTACTS OPEN</b></p>	<p>Refer to “VSD Shutdown – Requesting Fault Data” message above. If the control center’s does not receive the cause of the Fault over the Serial Link within 20 seconds, it is assumed it is not forthcoming and that message is replaced with “VSD – STOP CONTACTS OPEN” message.</p>						

**TABLE 12 - SAFETY SHUTDOWN MESSAGES**

The chiller can be started after manual resets are performed as detailed below. Service and troubleshooting information is contained in the *YORK YMC2 Service*

*Manual (Form 160.84-M2) and Chiller service (Form 160.84-M1).*

MESSAGE	DESCRIPTION
<b>AUXILIARY SAFETY – CONTACTS CLOSED</b>	The Auxiliary Safety shutdown input, connected to I/O Board TB4-31 senses 115 VAC, initiating a safety shutdown. This input is a general-purpose, user defined safety shutdown input. The chiller can be started after the contacts open and the CLEAR FAULT key is pressed.
<b>CONDENSER – HIGH PRESSURE</b>	The condenser pressure, as sensed by the Condenser Transducer, has increased to is greater than 200 PSIG for shells with 235 PSIG DWP and 295 PSIG for shells with 350 PSIG DWP. The control determines the shell DWP by the condenser model number on the Sales Order Screen. The chiller can be started after the pressure decreases to is less than 140 PSIG for shells with 235 PSIG DWP and 235 PSIG for shells with 350 PSIG DWP and the CLEAR FAULT key is pressed.
<b>CONDENSER – HIGH PRESSURE CONTACTS OPEN</b>	The contacts of the electro-mechanical high pressure safety device, located on the condenser shell, have opened because this device has detected a pressure greater than 204±7 PSIG for shells with 235 PSIG DWP and 308±7 PSIG for shells with 350 PSIG DWP. The contacts will automatically close when the condenser pressure decreases to is less than 160±10 PSIG for the 235 DWP shells and 230±10 PSIG for the 350 DWP shells. The chiller can be started after the contacts close and the CLEAR FAULT key is pressed.
<b>CONDENSER – HIGH PRESSURE – STOPPED</b>	The condenser pressure exceeded 170 PSIG for shells with 235 PSIG DWP and 264 PSIG for shells with 350 PSIG DWP while the chiller was stopped. The control determines the shell DWP by the condenser model number on the Sales Order Screen. High temperature condenser water flowing through the condenser while the chiller is shutdown can cause a condenser high pressure condition resulting in loss of refrigerant. This safety fault anticipates this problem by annunciating the condenser high pressure condition. The chiller can be restarted after a Service Technician performs a special reset preset procedure.
<b>CONDENSER – PRESSURE TRANSDUCER OUT OF RANGE</b>	The Condenser Pressure Transducer is indicating a pressure that is is less than 6.8 PSIG or greater than 300.0 PSIG. This is outside the normal operating range of the transducer. This is generally indicates a defective transducer. The chiller can be started after the transducer is indicating a pressure that is within range and the CLEAR FAULT key is pressed.
<b>CONTROL PANEL - INVALID BRAM</b>	On bootup, the panel shall determine whether a 512K BRAM module is installed by a sequence of tests where data is written and read from address above and below 128K. IF the BRAM is not 512K, this shutdown is generated.
<b>CONTROL PANEL – LOSS OF CONTROL VOLTAGE</b>	The line power input signal at I/O board TB3-81 was low for 1 second continuous. This signal is used to determine when the digital inputs are affected by a line power loss versus an actual condition for their devices. This fault is not expected on an actual loss of microboard power from the critical load bus, because the processor will be off before the fault delay. This message can indicate a Cycling (auto-restart after power failure) or Safety (manual restart after power failure) shutdown, depending upon control center configuration.
<b>CONTROL PANEL – POWER FAILURE</b>	A Control Power failure has occurred. If the power failure occurred while the chiller was running, it will automatically restart when power is restored. This message can indicate a Cycling (auto-restart after power failure) or Safety (manual restart after power failure) shutdown, depending upon control center configuration. It indicates a cycling shutdown when displayed in orange characters; Safety shutdown when displayed in red characters. The control center is configured for auto-restart or manual restart after power failure by a qualified Service Technician following instructions in <i>YORK YMC<sup>2</sup> Service Manual (Form 160.84-M2)</i> .
<b>DISCHARGE – HIGH TEMPERATURE</b>	The discharge temperature, as sensed by the Discharge Temperature Thermistor, has increased to greater than 220.0°F (104°C). The chiller can be started after the temperature decreases to less than 220.0°F (104°C) and the CLEAR FAULT key is pressed.
<b>DISCHARGE – LOW TEMPERATURE</b>	The discharge temperature, as sensed by the Discharge Temperature Thermistor, has decreased to less than 30.0°F (-1.1°C). The chiller can be started after the temperature increases to greater than 30.0°F (-1.1°C) and the CLEAR FAULT key is pressed.



**TABLE 12 - SAFETY SHUTDOWN MESSAGES (CONT'D)**

MESSAGE	DESCRIPTION									
<p><b>EVAPORATOR – LOW PRESSURE</b></p>	<p>The evaporator pressure, as sensed by the Evaporator Transducer, has decreased to the shutdown threshold and caused cycling shutdown three times in a 90 minute period. For water cooling applications, the shutdown threshold is a fixed value. For Brine cooling applications, the shutdown threshold varies according to the concentration of the Brine solution. The Brine shutdown threshold is programmed at the YORK Factory. It should not be changed by anyone other than a qualified Service Technician following instructions in <i>YORK YMC<sup>2</sup> Service Manual (Form 160.84-M2)</i>. The chiller can be started after the evaporator pressure increases to the restart threshold and the CLEAR FAULT key is pressed.</p> <table border="1" data-bbox="690 491 1326 701"> <thead> <tr> <th></th> <th>SHUTDOWN (PSIG)</th> <th>RESTART (PSIG)</th> </tr> </thead> <tbody> <tr> <td>Water Cooling -R134a</td> <td>25.0</td> <td>25.1</td> </tr> <tr> <td>Brine Cooling -R134a</td> <td>6.0 to 25.0 as programmed</td> <td>+0.1&gt; Shutdown threshold</td> </tr> </tbody> </table>		SHUTDOWN (PSIG)	RESTART (PSIG)	Water Cooling -R134a	25.0	25.1	Brine Cooling -R134a	6.0 to 25.0 as programmed	+0.1> Shutdown threshold
	SHUTDOWN (PSIG)	RESTART (PSIG)								
Water Cooling -R134a	25.0	25.1								
Brine Cooling -R134a	6.0 to 25.0 as programmed	+0.1> Shutdown threshold								
<p><b>EVAPORATOR – LOW PRESSURE – SMART FREEZE</b></p>	<p>Smart Freeze protection is activated and has shutdown the chiller because the evaporator temperature has been below the Smart Freeze threshold for greater than the allowable number of seconds. If the Evaporator Refrigerant Temperature sensor RT7 is Enabled, (using procedure in <i>YORK YMC<sup>2</sup> Service Manual (Form 160.84-M2)</i>), this parameter is used as the evaporator refrigerant temperature and the freeze threshold is 32.8°F (.4°C). If RT7 is not enabled, the evaporator refrigerant temperature used is the Evaporator Saturation Temperature, derived from the Evaporator Pressure Transducer and the freeze threshold is 34.0°F (1.1°C). The total count is incremented once for every second the evaporator refrigerant temperature is below the freeze threshold (but is never decremented below zero). The number of seconds it will take the chilled liquid to freeze is based on how far the evaporator refrigerant temperature is below the freeze threshold as follows:  <math>\# \text{ seconds to freezing} = (4053.7) / (\text{freeze threshold} - \text{evap. refrigerant temp.})</math>                      Smart Freeze is activated only if the feature has been Enabled by a Service technician (following instructions in <i>YORK YMC<sup>2</sup> Service Manual (Form 160.84-M2)</i>) and the Leaving Chilled Liquid temperature Setpoint is less than 38.0°F (3.3°C).</p>									
<p><b>EVAPORATOR – TRANSDUCER OR LEAVING LIQUID PROBE</b></p>	<p>A possible defective Evaporator pressure Transducer or Leaving Chilled Liquid temperature Thermistor has been detected. The pressure and temperature that these devices are indicating are not in the correct relationship to each other. The control center converts the evaporator pressure to a Saturated Temperature value and compares this value to the Leaving Chilled Liquid temperature (difference = chilled liquid temp – evaporator saturated temp). The difference should not be outside the range of –2.5°F (1.4°C) to +25.0°F (14.75°C). If the Transducer and Thermistor are accurate, the Evaporator Saturated temperature should not be greater than 2.5°F warmer nor greater than 25.0°F (14.75°C) colder than the leaving chilled liquid temperature. In order to initiate a shutdown, the difference must be outside the acceptable range continuously for 10 minutes. The chiller can be started after the CLEAR FAULT key is pressed.</p>									
<p><b>EVAPORATOR – TRANSDUCER OR TEMPERATURE SENSOR</b></p>	<p>A possible defective Evaporator pressure Transducer or Refrigerant Temperature Sensor has been detected. The control center converts the evaporator pressure to a Saturated Temperature value and compares this value to the optional Evaporator Refrigerant Temperature Sensor. If the difference between these temperatures is greater than 3.0°F, continuously for 1 minute, this shutdown is performed. This check is only performed under the following conditions:</p> <ul style="list-style-type: none"> <li>• Chiller has been running for at least 10 minutes</li> <li>• Evaporator Refrigerant temperature (RT7) has been enabled by a Service technician using instructions in <i>YORK YMC<sup>2</sup> Service Manual (Form 160.84-M2)</i>.</li> <li>• NOT in Brine cooling mode</li> <li>• Smart Freeze is enabled</li> <li>• Evaporator Temperature Sensor (RT7) or Evaporator Saturation Temperature is indicating a temperature of less than 32.0°F (0°C).</li> </ul> <p>The chiller can be started after the temperatures are within 3.0°F (1.77°C) of one another and the CLEAR FAULT key is pressed.</p>									

**TABLE 12 - SAFETY SHUTDOWN MESSAGES (CONT'D)**

MESSAGE	DESCRIPTION
<b>INTERNAL ERROR – INVALID BRAM</b>	BRAM is detected to be a size other than 512K. Clears when proper size BRAM is detected upon boot up.
<b>ISOLATION VALVES – NOT OPENED</b>	The optional brine freeze protection motorized isolation valves Open output is energized > 40 seconds but the feedback from the valve limit switch does not indicate it opened for 3 continuous seconds. This cycling fault is released when the chiller is stopped with the run command removed. The chiller can be started when the condition is released and the OptiView™ panel CLEAR FAULTS key is pressed.
<b>MBC – CUSTOMER SERIAL LINK DISABLED</b>	This Safety Shutdown is set when the MBC Local/Remote Modbus command is not reported from the MBC as set for panel control. This would be caused if the MBC were accessed via a computer using diagnostic software and the serial communication setting then changed in the Remote Command tab from Customer Serial Link to another choice. The chiller can be started when the MBC setting is restored and the OptiView™ panel CLEAR FAULTS key is pressed.
<b>MBC – DSP COMMUNICATION</b>	This Safety Shutdown is set when the MBC control board detects a communication error within the control board of the MBC. The MBC Fault contacts open. The MBC remains in Levitation mode with the motor shaft levitated until commanded to de-levitate over serial comms. This shutdown is released when the board-level communication failure is resolved. The chiller can be started when the condition is released and the OptiView™ panel CLEAR FAULTS key is pressed.
<b>MBC – AMP COMMUNICATION</b>	This Safety Shutdown is set when the MBC control board detects a communication error between the control and amplifier boards of the MBC. The MBC Fault contacts open. The MBC remains in Levitation mode with the motor shaft levitated until commanded to de-levitate over serial comms. This shutdown is released when the board-level communication failure is resolved. The chiller can be started when the condition is released and the OptiView™ panel CLEAR FAULTS key is pressed.
<b>MBC – AMP WATCHDOG</b>	This Safety Shutdown is set when the MBC determines a lapse in internal microprocessor activity on the Amplifier Board through its Watchdog device. The MBC Fault contacts open. The MBC will not react to a levitation mode change command via serial comms. The MBC remains in the levitation mode it was in when the fault occurred until power is removed. Power must be removed from the UPS to the MBC. The chiller can be started when the condition is released and the OptiView™ panel CLEAR FAULTS key is pressed.
<b>MBC – DSP WATCHDOG</b>	This Safety Shutdown is set when the MBC determines a lapse in internal microprocessor activity on the Control Board through its Watchdog device. The MBC Fault contacts open. The MBC will not react to a levitation mode change command via serial comms. The MBC remains in the levitation mode it was in when the fault occurred until power is removed. Power must be removed from the UPS to the MBC. The chiller can be started when the condition is released and the OptiView™ panel CLEAR FAULTS key is pressed.
<b>MBC – EXCESSIVE SHUTDOWNS</b>	This Safety Shutdown is set if 3 MBC Cycling Shutdowns occur in a 15 minute window. It is released when the chiller is stopped. The 15 minute window begins with the first MBC fault. The chiller can be started when the condition is released and the OptiView™ panel CLEAR FAULTS key is pressed.
<b>MBC – HIGH AMPLIFIER TEMPERATURE</b>	This Safety Shutdown is set when the MBC amplifier temperature exceeds 158 F (70 C) for 1 seconds continuous. The MBC Fault contacts open. The MBC remains in Levitation mode with the motor shaft levitated until the VSD rotation signal indicates less than 10 Hz. Then the MBC de-levitates the rotor. The shutdown is released when amplifier temperature drops below the trip value. Check the connection of the board to the heatsink and the response of the temperature sensor on the board. The chiller can be started when the condition is released and the OptiView™ panel CLEAR FAULTS key is pressed.
<b>MBC – HIGH BEARING Z1 TEMPERATURE</b>	This Safety Shutdown is set when the MBC detects a temperature is greater than 266°F (130°C) on the impeller end axial magnetic bearing. The MBC Fault contacts open. The MBC remains in Levitation mode with the motor shaft levitated until the VSD rotation signal indicates is less than 10 Hz. This shutdown is released when temperature is less than 266°F (130°C). The chiller can be started when the condition is released and the OptiView™ panel CLEAR FAULTS key is pressed.

**TABLE 12 - SAFETY SHUTDOWN MESSAGES (CONT'D)**

MESSAGE	DESCRIPTION
<b>MBC – HIGH BEARING Z2 TEMPERATURE</b>	This Safety Shutdown is set when the MBC detects a temperature is greater than 266°F (130°C) on the opposite-impeller end axial magnetic bearing. The MBC Fault contacts open. The MBC remains in Levitation mode with the motor shaft levitated until the VSD rotation signal indicates is less than 10 Hz. This shutdown is released when temperature is less than 266°F (130°C). The chiller can be started when the condition is released and the OptiView™ panel CLEAR FAULTS key is pressed.
<b>MBC – HIGH INPUT VOLTAGE</b>	Main DC supply voltage to the MBC exceeded 165VDC (150+ 10%)
<b>MBC – NO LEVITATION</b>	This Safety Shutdown is set when OptiView™ software is commanding MBC Levitation Mode ON but the MBC is not reporting Levitated within 15 seconds. This fault is prohibited when the MBC Alive input is not high, indicating the MBC unavailable. This fault is released when the chiller is stopped. The chiller can be started when the condition is released and the OptiView™ panel CLEAR FAULTS key is pressed.
<b>WARNING – MBC – HIGH RADIAL OSCILLATOR VOLTAGE</b>	This Safety Shutdown is set when the internal oscillator that drives the radial position sensor coil is overloaded for one continuous second. This is typically the result of an open in the connection to the shaft position sensor. It could also be a failure of the MBC control board. The MBC Fault contacts open. The shutdown is released when the Oscillator voltage drop is normal. The chiller can be started when the condition is released and the OptiView panel CLEAR FAULTS key is pressed.
<b>MBC – LOW RADIAL OSCILLATOR VOLTAGE</b>	This Safety Shutdown is set when the internal oscillator that drives the radial position sensor coil is low for one continuous second. This is typically the result of a short in the connection to the shaft position sensor. It could also be a failure of the MBC control board. The MBC Fault contacts open. The shutdown is released when the Oscillator voltage drop is normal. The chiller can be started when the condition is released and the OptiView panel CLEAR FAULTS key is pressed.
<b>MBC – HIGH AXIAL OSCILLATOR VOLTAGE</b>	This Safety Shutdown is set when the internal oscillator that drives the axial position sensor coil is overloaded for one continuous second. This is typically the result of an open in the connection to the shaft position sensor. It could also be a failure of the MBC control board. The MBC Fault contacts open. The shutdown is released when the Oscillator voltage drop is normal. The chiller can be started when the condition is released and the OptiView panel CLEAR FAULTS key is pressed.
<b>MBC – LOW AXIAL OSCILLATOR VOLTAGE</b>	This Safety Shutdown is set when the internal oscillator that drives the axial position sensor coil is low for one continuous second. This is typically the result of a short in the connection to the shaft position sensor. It could also be a failure of the MBC control board. The MBC Fault contacts open. The shutdown is released when the Oscillator voltage drop is normal. The chiller can be started when the condition is released and the OptiView panel CLEAR FAULTS key is pressed.
<b>MBC – OVERSPEED FAULT</b>	This Safety Shutdown is set when the MBC determines the rotor speed exceeds the programmed setpoint of 360 Hz for 0.1 seconds continuous. Rotor speed is transmitted to the MBC from the VSD. The MBC Fault contacts open. The MBC remains in Levitation mode with the motor shaft levitated until commanded to de-levitate over serial comms. This shutdown is released when the speed signal no longer exceeds the setpoint, which should occur when the chiller is stopped. The chiller can be started when the condition is released and the OptiView™ panel CLEAR FAULTS key is pressed.
<b>MBC – POWER FAIL LANDING</b>	This Safety Shutdown is set when the panel boots up after a power loss has occurred and the buffer data prior to the shutdown showed motor speed > 0, indicating the motor was rotating when the UPS power was lost. If the Power Fail Landing Counter on the MBC Details Screen is < 5, the chiller can be restarted after the cause of a loss of UPS power is determined and remedied and the OptiView™ panel CLEAR FAULTS key is pressed. IF the Power Fail Landing Counter is => 5, lockout occurs and must be reset by a Service Technician according to the procedure in the Calibration and Troubleshooting Section of Form 160.84-M2.

**TABLE 12 - SAFETY SHUTDOWN MESSAGES (CONT'D)**

MESSAGE	DESCRIPTION
<b>MBC – ROTOR CONTRACTION</b>	This Safety Shutdown is set when the MBC has calculated the algebraic difference between the displacement at shaft impeller end axial position sensor and the shaft opposite-impeller end axial position sensor is less than -100 um. The MBC fault contacts open. The MBC remains in Levitation mode with the motor shaft levitated until commanded to de-levitate over serial comms. This shutdown is released when the difference in displacements is over -100 um. The chiller can be started when the condition is released and the OptiView panel CLEAR FAULTS key is pressed.
<b>MBC – ROTOR ELONGATION</b>	This Safety Shutdown is set when the MBC has calculated the algebraic difference between the displacement at shaft impeller end axial position sensor and the shaft opposite-impeller end axial position sensor is greater than 700 um. The MBC Fault contacts open. The MBC remains in Levitation mode with the motor shaft levitated until commanded to de-levitate over serial comms. This shutdown is released when the difference in displacements no longer exceeds 700 um. The chiller can be started when the condition is released and the OptiView™ panel CLEAR FAULTS key is pressed.
<b>MBC – SPEED SIGNAL FAULT</b>	This Safety Shutdown is set when the MBC has the speed signal cycling fault three times in a 90-minute window. The window is started when not currently in a window and a MBC Speed Signal cycling fault is received. The MBC Fault contacts open. The MBC remains in Levitation mode with the motor shaft levitated until commanded to de-levitate over serial comms. This shutdown is released when a valid speed signal over 10 Hz is presented or the MBC is not in Rotation mode. The chiller can be started when the condition is released and the OptiView™ panel CLEAR FAULTS key is pressed.
<b>SAFETY STOP</b>	This is set when the panel safety stop hardware pushbutton is depressed, removing input from the I/O Board terminal TB3-28 for > 500msec. continuous. It also sets the local command to STOP. The chiller can be started when the pushbutton is released and the OptiView™ panel CLEAR FAULTS key is pressed.
<b>MBC – STARTUP FAILURE</b>	This Safety Shutdown is set when the chiller initiates three MBC-STARTUP FAILURE Cycling Shutdown in a 90 minute period. Refer to <i>YORK YMC<sup>2</sup> Service Manual (Form 160.84-M2)</i> for conditions necessary to complete MBC startup successfully. Check fault history details to determine which specific conditions were not met.
<b>MBC – SPV UNAUTHORIZED ROTATION</b>	This Safety Shutdown is set when the MBC is commanded to Rotation mode while it is not indicating acceptable to rotate. The MBC Fault contacts open. The MBC remains in Levitation mode with the motor shaft levitated until commanded to de-levitate over serial comms. This shutdown is the rotation mode command is coincident with MBC levitated and rotation allowed contacts closed. The chiller can be started when the condition is released and the OptiView™ panel CLEAR FAULTS key is pressed.
<b>MBC – DSP UNAUTHORIZED ROTATION</b>	This Safety Shutdown is set when the MBC detects a rotor speed signal from the VSD while the Levitation Mode is not activated. The MBC Fault contacts open. The MBC remains in Levitation mode with the motor shaft levitated until commanded to de-levitate over serial comms. This shutdown is released when the MBC Levitation or Rotation mode is activated or the VSD speed signal indicates no shaft rotation. The chiller can be started when the condition is released and the OptiView™ panel CLEAR FAULTS key is pressed.
<b>MOTOR – HIGH WINDING TEMPERATURE</b>	This safety shutdown occurs when any of the enabled motor winding temperatures exceeded the programmed High Winding Temperature Shutdown Threshold of 302°F (150°C) for 3 continuous seconds. The chiller can be started after all winding temperatures decreased to at least 18°F (10°C) below the shutdown threshold and the COMPRESSOR is stopped. The safety shutdown will not act on any individual winding temperature sensor that has been disabled with the TEMPERATURE DISABLE Setpoint on the Motor Details Screen.
<b>MOTOR – HIGH ROTOR TEMPERATURE</b>	This safety shutdown occurs when the estimated rotor temperature exceeds 250.0 F for 3 continuous seconds. The fault is released and the chiller can be restarted when the estimated rotor temperature is below 230 F and the OptiView panel CLEAR FAULTS key is pressed.
<b>MOTOR – HIGH HOUSING TEMPERATURE</b>	This Safety Shutdown is set when Motor Housing Temperature is greater than or equal to 185 °F (85 °C). This fault is released when Motor Housing Temperature is less than 158 °F (70 °C). The chiller can be started when the condition is released and the OptiView™ panel CLEAR FAULTS key is pressed.

**TABLE 12 - SAFETY SHUTDOWN MESSAGES (CONT'D)**

MESSAGE	DESCRIPTION																																																																																													
<p><b>SALES ORDER - INVALID COMPRESSOR MODEL</b></p>	<p>This safety shutdown is set when the Compressor Model field entered on the Setpoints – Setup –Sales Order screen does not conform to the format expected. The format is defined below and the data can be found on the compressor nameplate if it ever needs re-entry in the control:</p> <table border="1" data-bbox="500 331 1133 617"> <thead> <tr> <th>MOTOR</th> <th>MOTOR REV</th> <th></th> <th>SS/LS IMP DIAM</th> <th>SS/LS ROTATION</th> <th>SS/LS IMP REV</th> <th>SS/LS FLOW REV</th> <th></th> <th>HS IMP DIAM</th> <th>HS ROTATION</th> <th>HS IMP REV</th> <th>HS FLOW REV</th> <th>:CODE</th> </tr> </thead> <tbody> <tr> <td>1,2</td> <td>3</td> <td>-</td> <td>4</td> <td>5</td> <td>6</td> <td>7</td> <td>8</td> <td>9</td> <td>-</td> <td>10</td> <td>11</td> <td>12</td> <td>13</td> <td>14</td> <td>15</td> <td>:Position</td> </tr> </tbody> </table> <p>The “Sales Order - Invalid Compressor Model” safety shutdown is set when any of the following are true:</p> <ul style="list-style-type: none"> <li>• MOTOR is anything other than M2 or M6</li> <li>• MOTOR REV is anything other than ‘C’</li> <li>• Character other than ‘-’ between position 3 and 4</li> <li>• SS/LS IMP DIAM is anything other than 164, 174, 186, 197, 205, 218, 233, 246, 275, 295 or 331</li> <li>• SS/LS ROTATION is anything other than ‘F’</li> <li>• SS/LS IMP REV is anything other than the character ‘A’</li> <li>• SS/LS FLOW REV is anything other than the character ‘C’</li> <li>• Motor Model is Invalid</li> <li>• Invalid impeller / motor combination</li> </ul> <p>The following table shows all valid impeller / motor combinations.</p> <table border="1" data-bbox="500 1062 1133 1528"> <thead> <tr> <th></th> <th>COMPRESSOR</th> <th colspan="4">MOTOR</th> </tr> </thead> <tbody> <tr> <td rowspan="8">SINGLE STAGE</td> <td>197FA</td> <td>M1</td> <td>M2</td> <td></td> <td></td> </tr> <tr> <td>205FA</td> <td>M1</td> <td>M2</td> <td></td> <td></td> </tr> <tr> <td>218FA</td> <td>M1</td> <td>M2</td> <td></td> <td></td> </tr> <tr> <td>233FA</td> <td></td> <td>M2</td> <td>M4</td> <td></td> </tr> <tr> <td>246FA</td> <td></td> <td>M2</td> <td>M4</td> <td>M6</td> </tr> <tr> <td>275FA</td> <td></td> <td></td> <td>M4</td> <td>M6</td> </tr> <tr> <td>295FA</td> <td></td> <td></td> <td>M4</td> <td>M6</td> </tr> <tr> <td>331FA</td> <td></td> <td></td> <td></td> <td>M6</td> </tr> <tr> <td rowspan="3">TWO STAGE</td> <td>233FA / 205RA</td> <td>M1</td> <td>M2</td> <td></td> <td></td> </tr> <tr> <td>275FA / 241RA</td> <td></td> <td>M2</td> <td>M4</td> <td>M6</td> </tr> <tr> <td>331FA / 291RA</td> <td></td> <td></td> <td>M4</td> <td>M6</td> </tr> </tbody> </table> <p>The fault is released when the values have been corrected. The chiller can be restarted after the CLEAR FAULTS key is pressed.</p>	MOTOR	MOTOR REV		SS/LS IMP DIAM	SS/LS ROTATION	SS/LS IMP REV	SS/LS FLOW REV		HS IMP DIAM	HS ROTATION	HS IMP REV	HS FLOW REV	:CODE	1,2	3	-	4	5	6	7	8	9	-	10	11	12	13	14	15	:Position		COMPRESSOR	MOTOR				SINGLE STAGE	197FA	M1	M2			205FA	M1	M2			218FA	M1	M2			233FA		M2	M4		246FA		M2	M4	M6	275FA			M4	M6	295FA			M4	M6	331FA				M6	TWO STAGE	233FA / 205RA	M1	M2			275FA / 241RA		M2	M4	M6	331FA / 291RA			M4	M6
	MOTOR	MOTOR REV		SS/LS IMP DIAM	SS/LS ROTATION	SS/LS IMP REV	SS/LS FLOW REV		HS IMP DIAM	HS ROTATION	HS IMP REV	HS FLOW REV	:CODE																																																																																	
	1,2	3	-	4	5	6	7	8	9	-	10	11	12	13	14	15	:Position																																																																													
		COMPRESSOR	MOTOR																																																																																											
SINGLE STAGE	197FA	M1	M2																																																																																											
	205FA	M1	M2																																																																																											
	218FA	M1	M2																																																																																											
	233FA		M2	M4																																																																																										
	246FA		M2	M4	M6																																																																																									
	275FA			M4	M6																																																																																									
	295FA			M4	M6																																																																																									
	331FA				M6																																																																																									
TWO STAGE	233FA / 205RA	M1	M2																																																																																											
	275FA / 241RA		M2	M4	M6																																																																																									
	331FA / 291RA			M4	M6																																																																																									
<p><b>SURGE PROTECTION – EXCESS SURGE</b></p>	<p>(Applies only if Surge Protection SHUTDOWN feature is Enabled)                      The Surge Window Count surge events exceeded the Count Limit setpoint. The chiller shuts down as soon as the count exceeds the limit. The chiller can be started after the CLEAR FAULT key is pressed.</p>																																																																																													
<p><b>WATCHDOG – SOFTWARE REBOOT</b></p>	<p>The Microboard’s software Watchdog initiated a Microprocessor reset because it detected that a portion of the chiller operating Program was not being executed. The result of this reset is a Safety shutdown and re-initialization of the Program. This is generally indicative of a severe electrical power disturbance or impending Microboard Failure. The chiller can be started after the COMPRESSOR switch is placed in the Stop-Reset (O) position.</p>																																																																																													

**TABLE 12 - SAFETY SHUTDOWN MESSAGES (CONT'D)**

MESSAGE	DESCRIPTION								
<b>UPS – BATTERY NOT CONNECTED</b>	<p>This safety fault initiates a soft shutdown if it is set while the chiller state is Running. It is set during chiller state Running or Soft Shutdown when all of the following are true:</p> <ul style="list-style-type: none"> <li>• Battery Voltage Faults is Enabled</li> <li>• “Warning - UPS - Battery Not Connected” warning has been set for 10 continuous minutes</li> </ul> <p>This fault is also set during chiller state Stopped when all of the following are true:</p> <ul style="list-style-type: none"> <li>• Battery Voltage Faults is Enabled</li> <li>• Battery Disconnected Counter <math>\geq 4</math></li> </ul> <p>It is released when any of the following are true:</p> <ul style="list-style-type: none"> <li>• Battery Voltage Faults is Disabled</li> <li>• Battery Disconnected Counter is 0.</li> </ul>								
<b>UPS – INVERTER LOW BATTERY VOLTAGE</b>	<p>This safety fault is set when all of the following are true for 5 continuous seconds:</p> <ul style="list-style-type: none"> <li>• Battery Voltage Faults is Enabled</li> <li>• Control Voltage digital input is low (indicates line power is lost)</li> <li>• Battery Voltage &lt; Inverter Low Battery Voltage Threshold</li> </ul> <p>It is released when any of the following are true:</p> <ul style="list-style-type: none"> <li>• Battery Voltage Faults is Disabled</li> <li>• Battery Voltage &gt; Line Low Battery Voltage Threshold + 0.1 V. (Note the thresholds for set and release are intended to be different)</li> </ul>								
<b>VGD ACTUATOR FAULT</b>	<p>The VGD actuator fault digital input has lost voltage either by wiring issue or fault indicated at the actuator. The chiller begins a standard soft shutdown. The fault clears when the digital input sees voltage. When the condition clears, the chiller can be started after the CLEAR FAULTS key is pressed.</p>								
<b>VGD POSITIONING FAULT</b>	<p>The VGD Position feedback indicates greater or less than the VGD command by 5% for 1 minute continuous. The fault clears when the position is within the command + 5 % over 1 minute. When the condition clears, the chiller can be started after the CLEAR FAULTS key is pressed.</p>								
<b>VGD FEEDBACK FAULT</b>	<p>The VGD Feedback voltage is below 0.4 VDC or above 4.6 VDC. It is released when voltage is within the range. When the condition clears, the chiller can be started after the CLEAR FAULTS key is pressed.</p>								
<b>VSD – DC BUS LOCKOUT – DO NOT CYCLE POWER</b>	<p>When the unit is stopped in a mode where no command exists to energize the DC bus, the DC bus voltage is monitored and checked against a threshold level of 100 VDC every five minutes. If the DC bus voltage is higher than the threshold value, this shutdown is generated. When the condition clears and VSD input modules tested and determined acceptable the chiller can be started after the CLEAR FAULTS key is pressed.</p>								
<b>VSD – DC BUS PRE-REGULATION LOCKOUT</b>	<p>If the unit fails to complete pre-regulation (due to VSD – DC BUS PRE-REGULATION fault), it shall have to repeat pre-charge in order to attempt another pre-regulation. The VSD shall wait 10 seconds before clearing the DC bus voltage pre-regulation fault and allowing another pre-charge to start. The unit’s fan(s) and water pump(s) shall remain energized during this wait time. The VSD shall allow up to three consecutive pre-regulation-related faults (i.e. VSD-DC BUS REGULATION) to occur. After the third consecutive fault, this shutdown is generated. When the condition clears, the chiller can be started after the CLEAR FAULTS key is pressed.</p>								
<b>VSD – GROUND FAULT</b>	<p>This message is generated when the sum of the 3 phases of instantaneous input current values are greater than the shutdown value for a period of 1 second for the given model of drive listed below. When the condition clears, the chiller can be started after the CLEAR FAULTS key is pressed.</p> <table border="1" data-bbox="571 1671 1250 1824"> <thead> <tr> <th>DRIVE MODEL</th> <th>GROUND CURRENT SHUTDOWN VALUE</th> </tr> </thead> <tbody> <tr> <td>0490</td> <td>40 amps</td> </tr> <tr> <td>0612</td> <td>80 Amps</td> </tr> <tr> <td>0774</td> <td>120 amps</td> </tr> </tbody> </table>	DRIVE MODEL	GROUND CURRENT SHUTDOWN VALUE	0490	40 amps	0612	80 Amps	0774	120 amps
DRIVE MODEL	GROUND CURRENT SHUTDOWN VALUE								
0490	40 amps								
0612	80 Amps								
0774	120 amps								

**TABLE 12 - SAFETY SHUTDOWN MESSAGES (CONT'D)**

MESSAGE	DESCRIPTION								
<b>VSD – HIGH PHASE A INPUT BASEPLATE TEMPERATURE</b>	<p>This shutdown occurred because the Input Baseplate Temperature exceeded the shutdown value for the given model of drive listed below. After the unit trips, the VSD fan(s) and water pump(s) shall remain energized until the temperatures of all three rectifier's phases drop below the fault-reset threshold of 165°F (73.8°C). When this happens, the unit's fan(s) and water pumps shall be de-energized. When the condition clears, the chiller can be started after the CLEAR FAULTS key is pressed.</p> <table border="1" data-bbox="639 415 1377 558"> <thead> <tr> <th data-bbox="639 415 862 480">DRIVE MODEL</th> <th data-bbox="862 415 1377 480">HIGH PHASE A INPUT BASEPLATE TEMPERATURE SHUTDOWN VALUE</th> </tr> </thead> <tbody> <tr> <td data-bbox="639 480 862 518">0490 and 0612</td> <td data-bbox="862 480 1377 518">190°F (87.8°C)</td> </tr> <tr> <td data-bbox="639 518 862 558">0774</td> <td data-bbox="862 518 1377 558">170°F (76.6°C)</td> </tr> </tbody> </table>	DRIVE MODEL	HIGH PHASE A INPUT BASEPLATE TEMPERATURE SHUTDOWN VALUE	0490 and 0612	190°F (87.8°C)	0774	170°F (76.6°C)		
DRIVE MODEL	HIGH PHASE A INPUT BASEPLATE TEMPERATURE SHUTDOWN VALUE								
0490 and 0612	190°F (87.8°C)								
0774	170°F (76.6°C)								
<b>VSD – HIGH PHASE B INPUT BASEPLATE TEMPERATURE</b>	See "VSD – HIGH PHASE A INPUT BASEPLATE TEMPERATURE" message preceeding.								
<b>VSD – HIGH PHASE C INPUT BASEPLATE TEMPERATURE</b>	See "VSD – HIGH PHASE A INPUT BASEPLATE TEMPERATURE" message preceeding.								
<b>VSD – HIGH PHASE A MOTOR BASEPLATE TEMPERATURE</b>	<p>The chiller has shutdown because the motor baseplate temperature exceeded the high limit of 190°F (87.7°C). After the unit trips, the VSD fan(s) and water pump(s) shall remain energized until the motor baseplate temperatures of all phases drop below the fault-reset threshold of 165°F (73.8°C). When this happens, the unit's fan(s) and water pump(s) shall be de-energized. When the condition clears, the chiller can be started after the CLEAR FAULTS key is pressed.</p>								
<b>VSD – HIGH PHASE B MOTOR BASEPLATE TEMPERATURE</b>	See "VSD – HIGH PHASE A MOTOR BASEPLATE TEMPERATURE" message preceeding.								
<b>VSD – HIGH PHASE C MOTOR BASEPLATE TEMPERATURE</b>	See "VSD – HIGH PHASE A MOTOR BASEPLATE TEMPERATURE" message preceeding.								
<b>VSD – HIGH TOTAL DEMAND DISTORTION</b>	<p>This shutdown indicates the input current to the VSD is not sinusoidal. This shutdown will occur if the Total Demand Distortion (TDD) exceeds 25% continuously for 45 seconds. The displayed TDD is the sum of the harmonic currents up to the 50th harmonic supplied by the main power to the VSD divided by the VSD rated Full Load Amps. The chiller can be started after the CLEAR FAULT key is pressed.</p>								
<b>VSD – INPUT CURRENT OVERLOAD</b>	<p>The input current overload value is variable based on the Input Job Full Load Amps value programmed at the Control Panel. The input current overload value is 1.16 times the Input Job Full Load Amps value, but not to exceed the value for the given model of drive listed below. This calculation takes into account installations where the input line voltage could be up to 10% below the nominal value. An additional 5% of current is added to reduce nuisance shutdowns due to power fluctuations. To provide addition time for the chiller too unload, the input current overload value must be greater than the shutdown value for 10 continuous seconds for this shutdown to occur. When the condition clears, the chiller can be started after the CLEAR FAULTS key is pressed.</p> <table border="1" data-bbox="732 1585 1284 1766"> <thead> <tr> <th data-bbox="732 1585 878 1650">DRIVE MODEL</th> <th data-bbox="878 1585 1284 1650">INPUT CURRENT OVERLOAD MAXIMUM SHUTDOWN VALUE</th> </tr> </thead> <tbody> <tr> <td data-bbox="732 1650 878 1688">0490</td> <td data-bbox="878 1650 1284 1688">425 Amps</td> </tr> <tr> <td data-bbox="732 1688 878 1726">0612</td> <td data-bbox="878 1688 1284 1726">690 Amps</td> </tr> <tr> <td data-bbox="732 1726 878 1766">0774</td> <td data-bbox="878 1726 1284 1766">1020 Amps</td> </tr> </tbody> </table>	DRIVE MODEL	INPUT CURRENT OVERLOAD MAXIMUM SHUTDOWN VALUE	0490	425 Amps	0612	690 Amps	0774	1020 Amps
DRIVE MODEL	INPUT CURRENT OVERLOAD MAXIMUM SHUTDOWN VALUE								
0490	425 Amps								
0612	690 Amps								
0774	1020 Amps								
<b>VSD – INPUT DCCT OFFSET LOCKOUT</b>	<p>If three consecutive VSD – Phase A, B or C Input DCCT Offset cycling faults occur, this safety shutdown is generated to require investigation and manual reset. When the condition clears the chiller can be started after the CLEAR FAULTS key is pressed.</p>								



**TABLE 12 - SAFETY SHUTDOWN MESSAGES (CONT'D)**

MESSAGE	DESCRIPTION								
<b>VSD – INVERTER PROGRAM FAULT</b>	The VSD software contains a verification process to ensure that the correct set of software is installed in the VSD logic board for the application. When this condition clears, the chiller can be started after the CLEAR FAULTS key is pressed.								
<b>VSD – LINE VOLTAGE PHASE ROTATION</b>	The input voltage to the VSD is not phase rotation sensitive, but the VSD must be able to determine the correct input phase rotation. If the VSD logic board cannot determine the correct phase rotation, then this shutdown is generated. When this condition clears, the chiller can be started after the CLEAR FAULTS key is pressed.								
<b>VSD – LOGIC BOARD HARDWARE</b>	After power is applied to the chiller, the VSD logic board performs several internal tests to ensure proper operation of the input power device. If the tests fail, then this shutdown is generated. When this condition clears, the chiller can be started after the CLEAR FAULTS key is pressed.								
<b>VSD – LOGIC BOARD PLUG</b>	A jumper is located in the rectifier and inverter current transformers connectors that indicate the connector is properly installed. If either connector is not installed, then this shutdown is generated. When the condition clears, the chiller can be started after the CLEAR FAULTS key is pressed.								
<b>VSD – MOTOR CURRENT IMBALANCE</b>	Each phase of motor current is compared against the average of the three phases of motor current to determine the current imbalance value. If the current imbalance value is greater than 32 amps for a period of 45 seconds, then this shutdown is generated. For example: The three motor current RMS values are 200, 225, and 240 amps. This would be calculated to an average current of $(200 + 225 + 240)/3 = 225$ amps. Subtract the real current value from the average value. $200 - 225 = -25$ , $225 - 225 = 0$ , $240 - 225 = 15$ . If this condition or worse were maintained for 45 seconds, then this shutdown is generated, because the motor current imbalance is 25 amps. The chiller can be started after the CLEAR FAULTS key is pressed.								
<b>VSD – 105% MOTOR CURRENT OVERLOAD</b>	<p>The 105% motor current overload value is based on the highest output current compared to the programmed Motor Current value displayed on the Control panel. The 105% motor current overload value is 1.05 times the programmed Motor Current value displayed on the Control panel. The motor current overload value must be greater than the shutdown value for 40 continuous seconds for this shutdown to occur.</p> <table border="1" data-bbox="631 1115 1192 1299"> <thead> <tr> <th>DRIVE MODEL</th> <th>MAXIMUM MOTOR CURRENT OVERLOAD SHUTDOWN VALUE</th> </tr> </thead> <tbody> <tr> <td>0490</td> <td>490 Amps</td> </tr> <tr> <td>0612</td> <td>612 Amps</td> </tr> <tr> <td>0774</td> <td>774 Amps</td> </tr> </tbody> </table> <p>When the condition clears, the chiller can be started after the CLEAR FAULTS key is pressed.</p>	DRIVE MODEL	MAXIMUM MOTOR CURRENT OVERLOAD SHUTDOWN VALUE	0490	490 Amps	0612	612 Amps	0774	774 Amps
DRIVE MODEL	MAXIMUM MOTOR CURRENT OVERLOAD SHUTDOWN VALUE								
0490	490 Amps								
0612	612 Amps								
0774	774 Amps								
<b>VSD – MOTOR CURRENT THD FAULT</b>	This shutdown provides protection to the compressor motor. High levels of current total harmonic distortion (THD) can cause the motor to overheat. Verify that all wiring is properly connected between the inverter and the output harmonic filter. When the condition clears, the chiller can be started after the CLEAR FAULTS key is pressed.								
<b>VSD – PHASE A INPUT DCCT</b>	<p>The input current in each phase to the VSD is measured during the precharge time. If the input current does not exceed the shutdown value for the given model of drive listed below, then this shutdown is generated. (Fill in the rest of the text from the PDF file here, then insert the table.)</p> <table border="1" data-bbox="599 1572 1224 1717"> <thead> <tr> <th>DRIVE MODEL</th> <th>MINIMUM INPUT CURRENT SHUTDOWN VALUE</th> </tr> </thead> <tbody> <tr> <td>0490 and 0612</td> <td>5.0 amps</td> </tr> <tr> <td>0774</td> <td>15.0 amps</td> </tr> </tbody> </table> <p>When the condition clears, the chiller can be started after the CLEAR FAULTS key is pressed.</p>	DRIVE MODEL	MINIMUM INPUT CURRENT SHUTDOWN VALUE	0490 and 0612	5.0 amps	0774	15.0 amps		
DRIVE MODEL	MINIMUM INPUT CURRENT SHUTDOWN VALUE								
0490 and 0612	5.0 amps								
0774	15.0 amps								
<b>VSD – PHASE B INPUT DCCT</b>	See “VSD – PHASE A INPUT DCCT” message preceding.								
<b>VSD – PHASE C INPUT DCCT</b>	See “VSD – PHASE A INPUT DCCT” message preceding.								

**TABLE 12 - SAFETY SHUTDOWN MESSAGES (CONT'D)**

MESSAGE	DESCRIPTION
<b>VSD – PHASE A MOTOR DCCT</b>	The motor current in each phase of the VSD is measured at the beginning of the run command. The motor current at this time should measure very low. This low value will be used as the zero current value for the rest of this run time. The motor current is then monitored for the next 1.5 seconds to ensure that a minimum amount of current is flowing to the motor. If at the end of the 1.5 second time a minimum of 25 amps peak is not detected, then this shutdown is generated. Problem with the VSD Init fault message. Requesting additional information from engineering. When the condition clears, the chiller can be started after the CLEAR FAULTS key is pressed.
<b>VSD – PHASE B MOTOR DCCT</b>	See “VSD –PHASE A MOTOR DCCT” message preceeding.
<b>VSD – PHASE C MOTOR DCCT</b>	See “VSD – PHASE A MOTOR DCCT” message preceeding.
<b>VSD – PHASE LOCKED LOOP</b>	The VSD must be able to determine the input voltage frequency from the input voltage measurement. If the input voltage frequency is not stable enough for the VSD to make this determination, then this shutdown is generated. When this condition clears, the chiller can be started after the CLEAR FAULTS key is pressed.
<b>VSD – PRECHARGE LOCKOUT</b>	If the unit fails to complete pre-charge (due to VSD – PRECHARGE – LOW DC BUS VOLTAGE or VSD – PRECHARGE – HIGH DC BUS VOLTAGE), the VSD shall time 10 seconds before clearing the fault and allowing another pre-charge to start. The unit’s fan(s) and water pump(s) shall remain energized during this time. The VSD shall allow up to three consecutive pre-charge-related faults to occur. After the third consecutive pre-charge-related fault, this shutdown is generated. When the condition clears, the chiller can be started after the CLEAR FAULTS key is pressed.
<b>VSD – RECTIFIER PROGRAM FAULT</b>	The VSD software contains a verification process to ensure that the correct set of software is installed in the VSD logic board for the application. When this condition clears, the chiller can be started after the CLEAR FAULTS key is pressed.
<b>VSD SHUTDOWN – REQUESTING FAULT DATA</b>	The VSD has shut down the chiller and the control center has not yet received the cause of the fault from the VSD, via the serial communications link. The VSD shuts down the chiller by opening the Motor Controller “VSD Stop Contacts” (located on the VSD Logic Board and connected between TB6-16 and TB6-53 in the control center). The Microboard in the control center then sends a request for the cause of the fault to the VSD Logic Board over the serial link. Since serial communications are initiated every 2 seconds, this message is typically displayed for a few seconds and then replaced with one of the other VSD fault messages.

3

THIS PAGE INTENTIONALLY LEFT BLANK

## SECTION 4 - VSD OPERATION

### OPTISPEED COMPRESSOR DRIVE OVERVIEW

The new YORK OptiSpeed Compressor Drive (OSCD) is specifically designed for the application of driving a permanent magnet high speed motor with magnetic bearings used on the YORK Model YMC<sup>2</sup> Centrifugal Liquid Chiller. This type of design allows the chiller to be design as a complete system, and take full advantage of the strengths of each major component within the system. This method of design is a superior approach to using general purpose components off the shelf that may not work well together.

This new OSCD design builds on the successes of previous designs of being chiller mounted, provide for high levels of energy savings, great integration with the chiller control center, liquid cooled, shell and tube heat exchanger, use of fast switching power modules, high reliability, and ease of service.

#### New features include:

- The option of a circuit breaker or disconnect switch.
- Ground fault detection even when a disconnect switch is selected.
- Direct liquid cooling of power modules.
- A more accessible cooling system.
- Variable voltage input.
- High speed direct drive motor.
- The harmonic filter is standard on all models.
- Modular lighter weight power units that can be repaired in the field without complete replacement.
- Ease of maintenance and setup.

### OPTISPEED COMPRESSOR DRIVE FEATURES

The new drive design is current available in a 490, 612 and 774 output current ratings. The operation of each drive is identical except for the precharge of the 612 amp drive. Each drive model has a dedicated drive logic board. The drive logic board cannot be switched between the drive models. There are basically 2 different power assemblies used between the 3 drive designs. The 490 and the 612 amp drives use a single power assembly that contains all of the power devices required for the 3 phases of input and output. The 774 amp drive has three power assemblies. Each power assembly contains all of the power devices required for one phase of input and output.

For the first time, the OSCD is offered with a disconnect switch without giving up the ability to detect a ground fault. The OSCD contains 3 input current sensors that will provide the information for the drive logic board to detect a ground fault condition.

Direct liquid cooling is much more efficient way of removing heat from the OSCD. This method also reduces the cooling load on the internal cooling coil. In the past, YORK developed direct liquid cooling for the inverter power modules, but today York is direct liquid cooling the rectifier, inverter, input inductor, and the output filter inductor.

The cooling system for the OSCD is greatly modified to improve serviceability of the power electronics. Repair of the power electronics no longer requires access to the back of the drive except to drain the cooling system. Also the use of a shell and tube heat exchanger is standard on all models.

The OSCD can now be configured for many different input voltage levels. Lower input voltages may de-rate the input power rating of the OSCD, but the OSCD will produce the same output voltage and will use the same motor.

The harmonic filter is no longer an option, and the function of the harmonic filter is included in a new rectifier module. This type of arrangement for the rectifier no longer requires a separate power unit for the harmonic filter. Also this rectifier is part of the power unit for the inverter, thus reducing the number of parts required and increasing reliability.

The new OSCD control system allows for high speed operation of the compressor motor. This improvement eliminates the need for a gear system between the compressor motor and the compressor. Without a gear system reliability and efficiency are improved.

The new power unit consists of a newly designed bus capacitor, new light weight plastic cooling blocks, new power module gate driver design, new rectifier module, and the cooling system is connected to the front of the power unit for reduce down time and service cost.

The new bus capacitor is the core of the power unit. The new capacitor is made of a material that is much more robust and has a longer lifetime than bus capacitors commonly used in the past. Also, this capacitor contains all of the hardware required to mount all of the other parts of the power unit.

The harmonic filter operation is now part of the input to the OSCD. This feature is no longer an option when this OSCD is used with the YMC<sup>2</sup> chiller.

New special plastic cooling blocks were designed for this OSCD. These plastic cooling blocks provide a light weight solution by replacing heavy copper or aluminum cooling blocks, while providing direct liquid cooling for the rectifier and inverter power modules. They also provide a method for mounting the power module assemblies to the bus capacitor within the power unit.

The power unit contains all of the items needed for the output of the OSCD in a highly integrated, but modular design. On top of the bus capacitor is the laminated bus structure and the gate driver board on the 774 amp design. The 490 and 612 amp drives also have the laminated bus structure on top of the bus capacitor or capacitors, but the gate driver boards are mounted directly above the power module. A power supply board is located on the laminated bus structure on the 490 and 612 amp power assemblies. The rectifier and inverter assemblies are attached to each side of the bus capacitor. The rectifier or inverter assemblies can be replaced in the field.

Ease of maintenance is provided by using the communications link between the OptiView™ panel and the OSCD. The cooling pumps and fans can be turned on from the OptiView™ panel. This provides for a safer annual coolant change. The programmed chiller full load amps is now programmed from the OptiView panel.

#### **OPTISPEED COMPRESSOR DRIVE DETAILS (490 AND 774 AMP DRIVES)**

An electronic circuit breaker or disconnect switch connects the three phase input power to input fuses and then onto the AC line inductor, and input filter. See *Figure 35 on page 106*. Three phase power continues onto the rectifier power modules to the bus capacitor to the inverter, then onto the output filter and the compressor motor.

The AC line inductor provides isolation between the 3 phase power source and the input to the drive. The AC line inductor improves the input current waveform so that it appears more like a sine wave. The input filter reduces the effects of the high frequency switching of the rectifier and provides the inductance for boosting the bus voltage above the peak of the line voltage.

The higher bus voltage is required for harmonic current correction at the input of the OSCD, and to provide the correct output voltage for high speed operation of the

compressor motor.

The AC to DC rectifier uses several power devices. Each phase has one or more modules arranged in a parallel connection depending on the amount of input current required. Each rectifier module contains 3 power devices that are called the Upper, Lower, and Aux. device. All three devices are required to rectify and boost the 3 phase input AC voltage into DC voltage in a modified new three-phase bridge configuration. The use of the modified new three-phase bridge configuration in the rectifier permits pre-charge of the DC bus filter capacitors when the chiller enters the start mode, and provides a fast disconnect from the AC line when the chiller enters the stopped mode. This new bridge configuration also provides the harmonic filtering without the need of separate power unit, precharge circuit, and control board. *Figure 36 on page 107 and Figure 38 on page 108*.

The DC to AC inverter also uses several power devices. Each phase has one or more modules arranged in a parallel connection depending on the amount of output current required. Each inverter module contains an Upper and Lower device. The Aux. device is not need in the inverter.

The permanent magnet motor used on the YMC<sup>2</sup> chiller requires a near sine wave of voltage. Typically, drives provide a pulse of voltage at the amplitude of the bus voltage for a varying period of time. This waveform is typically known as a square wave. This OSCD contains a direct water cooled output filter.

A new drive logic board was designed to provide all of the logic required to turn on and turn off all of the power devices, turn on and off the cooling fans and pumps, evaluate data from the input and output current sensors, evaluate data about the input and output voltage, and communicated to the OptiView™ panel.

Other sensors and boards are used to convey information back to the OSCD Logic board (See *Figure 39 on page 108*), and provide safe operation of the OSCD. Each power module contains a temperature sensor that provides temperature information back to the OSCD logic board. Two ambient temperature sensors ensure that the internal temperature of the OSCD does not exceed a safe operation level. Three Current Transformers monitor the output current from the OSCD power unit and are used to protect the drive and motor from overcurrent conditions. Another 3 Current Transformers monitor the input current to the OSCD to provide current limit, ground fault detection, and information for the harmonic current filtering.

## **OPTISPEED COMPRESSOR DRIVE DETAILS (612 AMP DRIVE)**

The 612 amp drive has the same basic function as the 490 and 774 amp drives, but the precharge of the drive is different.

The precharge is now completed through a precharge and supply contactor, which are control by the drive logic board. During the precharge period the drive logic board will command the precharge contactor to close for 12 seconds. During this time, the voltage will increase across the bus capacitors, and the current will be limited by the precharge resistors. This 12 second period is called the precharge time. After 12 seconds has passed, a small relay will close, and cause the supply contactor to close. Shortly, after this time the precharge contactor will open. The drive is now precharged and ready to run. All of the precharge faults will remain the same as when the Aux. power device is used to precharge the drive.

The drive contains only one power assembly. It is very similar to the assembly used on the 490 amp drive. The power assembly contains 2 bus capacitors, with 6 power devices attached to both of the outer faces of the bus capacitor. A pair of power devices share a gate driver board. A power supply board mounted on top of the power assembly provides power to the gate driver boards.

### **Harmonic Filter Benefits**

The OptiSpeed Compressor Drive (OSCD) system now includes an input harmonic filter and high frequency filter trap designed to meet the IEEE Std 519, “IEEE Recommended Practices and Requirements for Harmonic Control in Electrical Power Systems”. The harmonic filter provides a means to improve the input current waveform drawn by the OSCD from the AC line, thus reducing the possibility of causing electrical interference with other sensitive electronic equipment connected to the same power source, and reduce power loss in the customer’s switch gear and source transformer.

In addition, the power factor of the system with this harmonic filter corrects the OSCD’s input power factor to nearly unity.

## **Harmonic Filter General Information**

The Harmonic Filter is no longer an option for this style of OSCD. The function of the Harmonic Filter is now integrated into the input of the OSCD. The input rectifier has fast switching transistors instead of SCR’s and diodes. The OSCD can now control the input current waveform to a near sine wave shape by controlling how the rectifiers are turned on and off. The Harmonic Filter of the past injected harmonic current into the input of the OSCD to correct the current waveform.

Since the Harmonic Filter is basically the input to the OSCD there is no need for the additional, precharge, power unit, Harmonic Filter logic board, and contactors for the harmonic filter of yesterday. The Harmonic Filter does not require its own pre-charge time, thus allowing the chiller to start or restart sooner. This is an important benefit to many customers. The reductions in parts counts will improve the reliability of the OSCD, and ease of repair. See *Figure 40 on page 109* and *Figure 41 on page 109*.

A line inductor is still needed to limit the rate of change in the input current. Without the line inductor the input current cannot be properly controlled and harmonic currents would be generated.

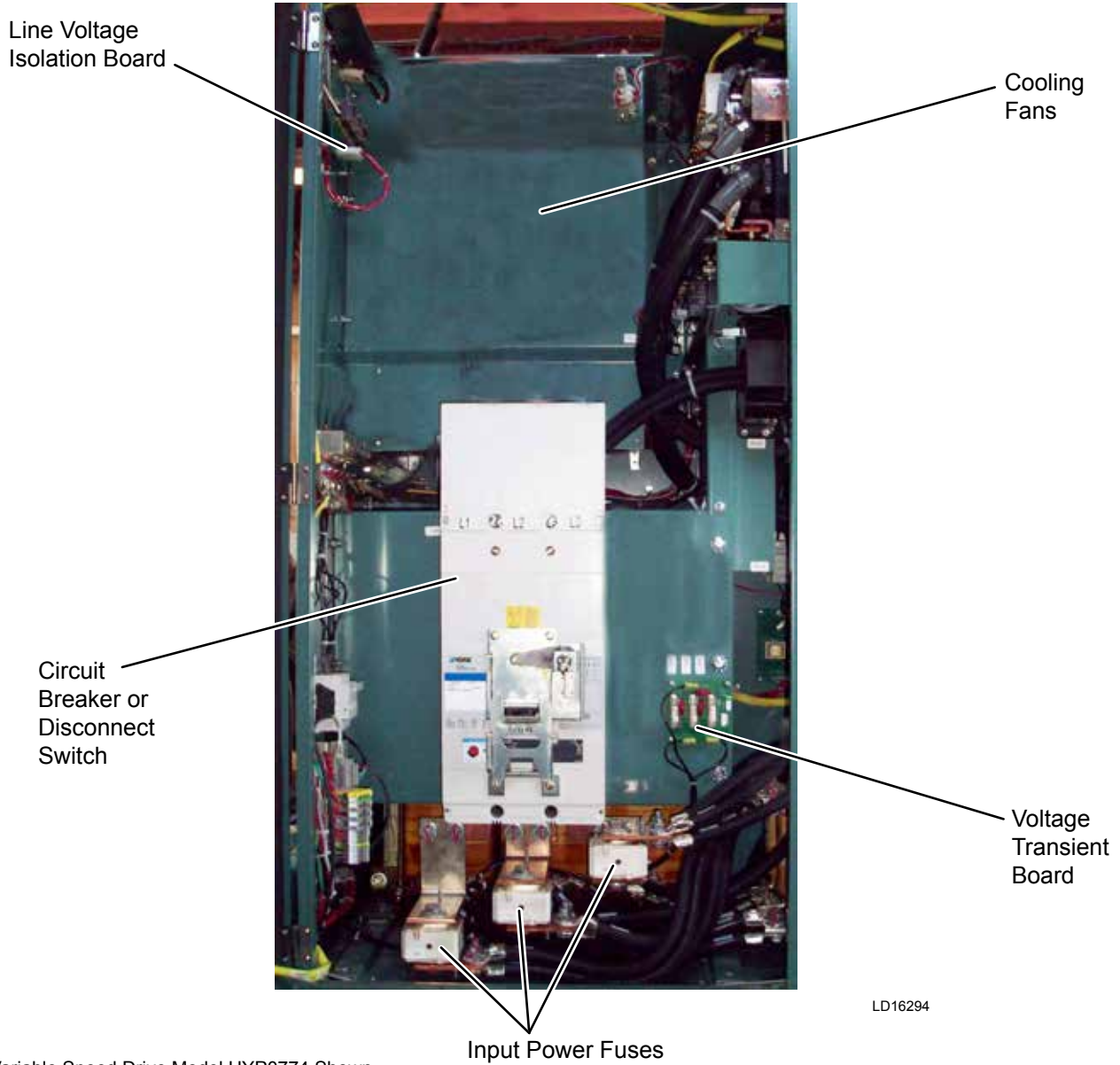

Note: Variable Speed Drive Model HYP0774 Shown.

**FIGURE 35 - LEFT SIDE OF DRIVE CABINET (TYPICAL FOR ALL MODEL DRIVES)**



Power Unit  
Includes 3 Phases  
for the Rectifier  
and Inverter



Drive Logic  
Board

Input  
Filter

Output  
Inductor

**FIGURE 36 - RIGHT SIDE OF DRIVE CABINET HYP0490**

LD18052

Power Unit  
Includes 3 Phases  
for the Rectifier  
and Inverter

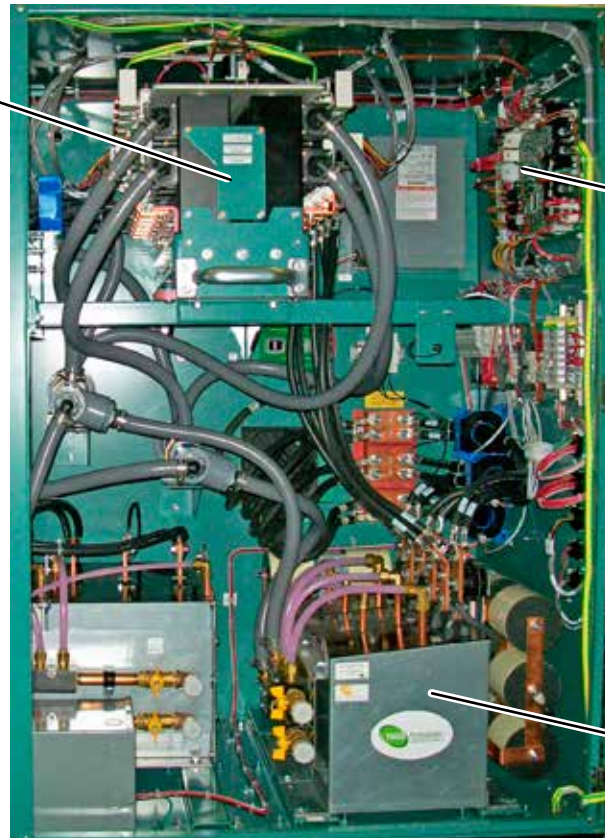

Drive Logic  
Board

Output  
Inductor

**FIGURE 37 - RIGHT SIDE OF DRIVE CABINET HYP0612**

LD18743

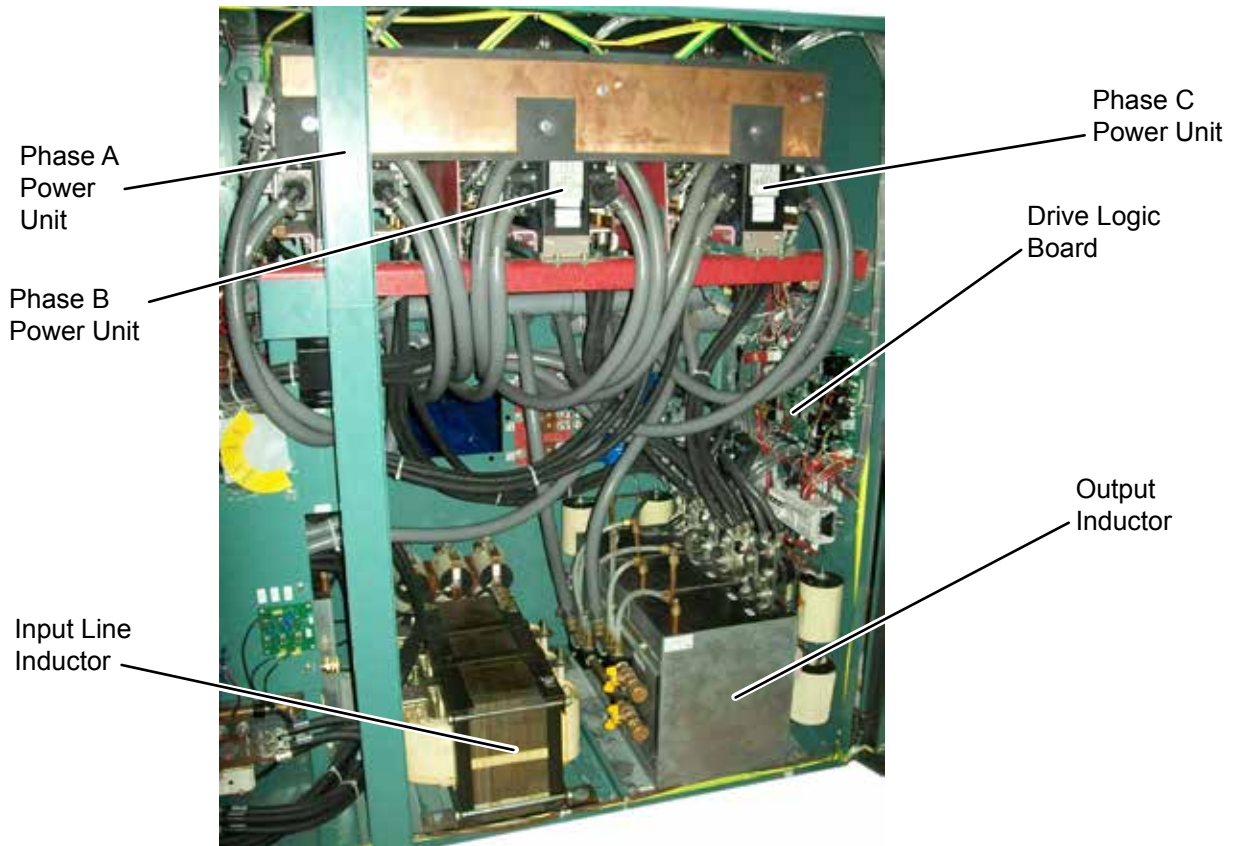

FIGURE 38 - RIGHT SIDE OF DRIVE CABINET HYP0774

LD18053

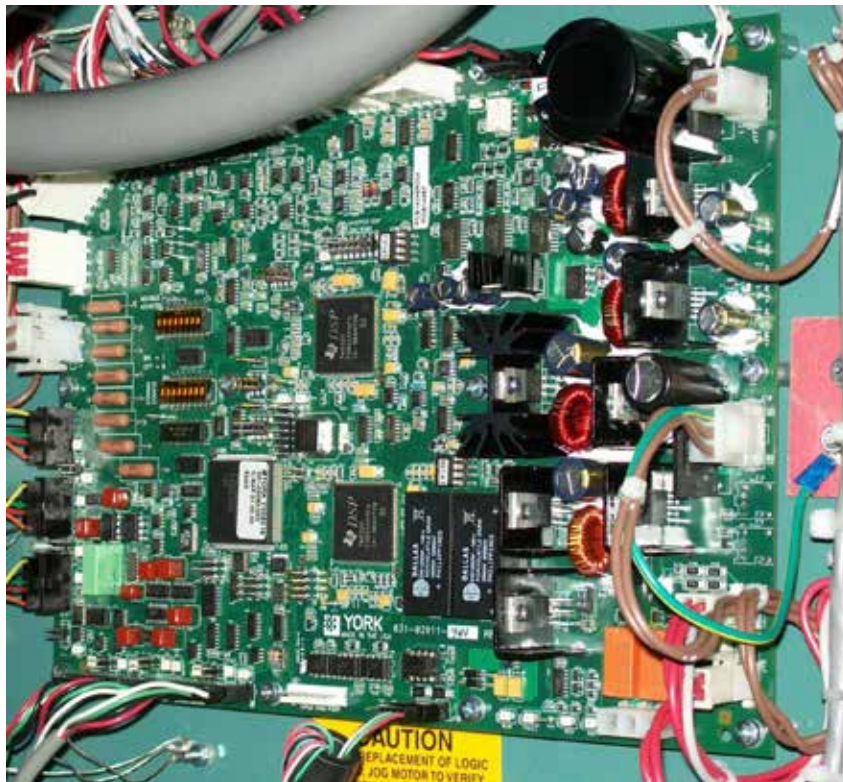

FIGURE 39 - DRIVE LOGIC BOARD

LD16293





LD18051

**FIGURE 40 - RECTIFIER SIDE OF THE POWER UNIT HYP0490 AND HYP0612**

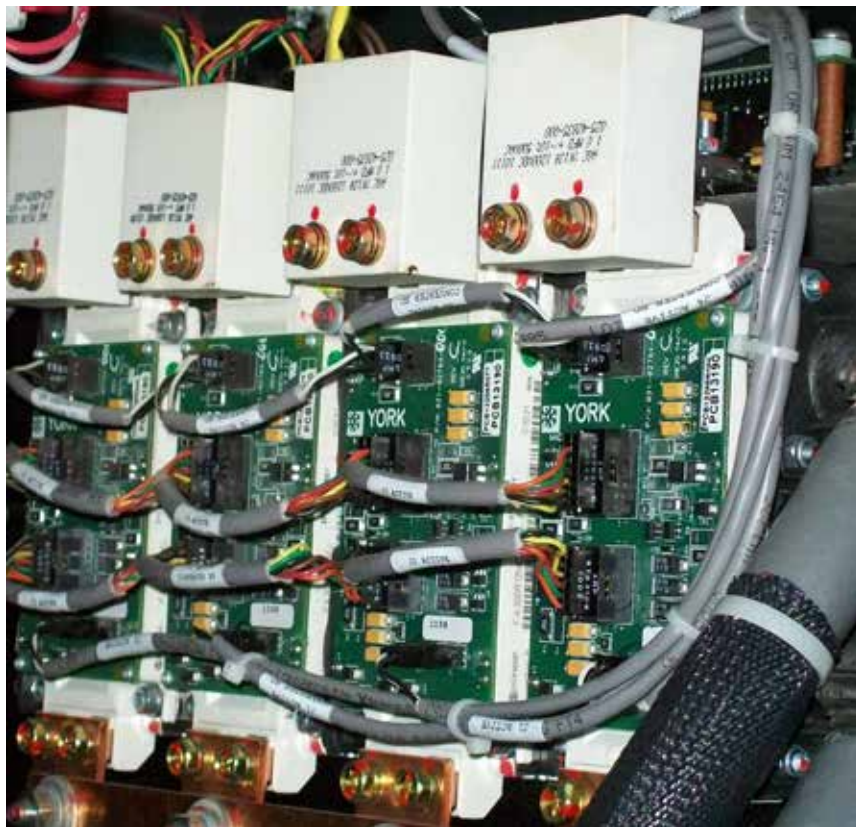

LD16292

**FIGURE 41 - RECTIFIER SIDE OF THE POWER UNIT HYP0774**

**OPTISPEED COMPRESSOR DRIVE AND CHILLER OPERATION (0490 AND 0774 AMP MODELS)**

When the chiller enters a start command, the OSCD is commanded to pre-charge, the Aux. power devices are gradually turned on to slowly charge the DC bus capacitors. This is called the pre-charge period, which will last for 12-seconds. After the 12-second time period has expired, the AUX. power devices are gated fully on. After precharge is complete the AUX. power device will remain turned on for the duration of the run cycle. The OSCD logic board provides the turn on, and turn off commands for the AUX. power devices.

During normal chiller run conditions the control panel provides a speed command to the OSCD. The speed command must take into account minimum speed command from the anti-surge control, and the speed required by the leaving chilled liquid temperature control. The OSCD logic board will determine the proper turn-on and turn-off commanded to the inverter to provide the correct RPM to the compressor motor.

When the chiller enters a normal stop command the OSCD will continue to follow the speed command from the control panel. The control panel begins to unload the chiller. As the load and pressure across the compressor starts to decrease, the output speed of the OSCD will slow down. When the capacity control devices (PRV or VGD and sometimes hot gas bypass valve) reaches minimum load position, the OSCD will start to decelerate the motor to 50 Hz. When 50 Hz is reached all rectifier and inverter power devices will be turned off except for the AUX. The OSCD will remain in a precharge state for 60 seconds, and then the AUX. is turned off. The DC link capacitors will start to discharge through the bleeder resistors.

**OPTISPEED COMPRESSOR DRIVE AND CHILLER OPERATION (0612 AMP MODEL)**

When the chiller enters a start command, the OSCD is commanded to pre-charge, the pre-charge contactor will close and slowly charge the DC bus capacitors through the pre-charge resistors. This is called the pre-charge period, which will last for 12-seconds. After the 12-second time period has expired, the supply contactor will close and the pre-charge contactor will open. The supply and pre-charge contactors will remain in this state for the duration of the run cycle. The OSCD logic board provides the commands for the supply and pre-charge contactors.

## SECTION 5 - MAINTENANCE

### PREVENTATIVE MAINTENANCE

It is the responsibility of the owner to provide the necessary daily, monthly and yearly maintenance requirements of the system.

In any operating system it is most important to provide a planned maintenance and inspection of its functioning parts to keep it operating at its peak efficiency. Therefore, the following maintenance should be performed when prescribed.

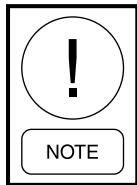

**IMPORTANT – If a unit failure occurs due to improper maintenance during the warranty period; Johnson Controls will not be liable for costs incurred to return the system to satisfactory operation.**

### Electrical Isolation

1. Isolate electrical power supply to the chiller from the facility
2. Isolate the Power Panel battery from the Uninterrupted Power Supply by opening the Power Panel disconnect switch.
3. Isolate plant fluid flow to the chiller at appropriate valves or have refrigerant isolated to prevent free-wheeling the driveline and generating electrical energy from the permanent magnet rotor.

5

**TABLE 13 - MAINTENANCE REQUIREMENTS**

 <span style="font-size: 1.2em; font-weight: bold;">MAINTENANCE REQUIREMENTS FOR YMC<sup>2</sup> CHILLERS</span> BY JOHNSON CONTROLS					
Procedure	Daily	Weekly	Monthly	Yearly	Other
Record operating conditions (on applicable Log Form)	X				
Check operating parameters for indication of tube fouling or refrigerant loss		X			
Check three-phase voltage and current balance			X		
Check programmable operating setpoints and safety cut-outs. Make sure they are correct for the application			X		
Verify condenser and evaporator water flows			X		
Leak check and repair leaks as needed <sup>1</sup>			X		
Check and tighten all electrical connections				X	
Clean or backflush VSD heat exchanger				X	
Replace VSD starter coolant				X	
Measure motor winding and insulation resistance				X	
Perform refrigerant analysis <sup>1</sup>				X	
Review operating data for trends which indicate increasing vibration or power consumption. The MBC data includes 1 x rotational speed vibration in displacement.				X	
Clean tubes				X <sup>2</sup>	
Perform Eddy current testing and inspect tubes					2-5 Years

For operating and maintenance requirements listed above, refer to appropriate service literature, or contact your local Johnson Controls Service Office.

<sup>1</sup> This procedure must be performed at the specified time interval by an Industry Certified Technician who has been trained and qualified to work on this type of YORK equipment. A record of this procedure being successfully carried out must be maintained on file by the equipment owner should proof of adequate maintenance be required at a later date for warranty validation purposes.

<sup>2</sup> More frequent service may be required depending on local operating conditions.

**RENEWAL PARTS**

For any required Renewal Parts, refer to the *YMC<sup>2</sup> Unit Renewal Parts Manual (Form 160.84-RP1)*.

**OPERATING INSPECTIONS**

By following a regular inspection using the display readings of the OptiView™ Control Center, and maintenance procedure, the operator will avoid serious operating difficulty. The following list of inspections and procedures should be used as a guide.

**Daily**

1. Check OptiView™ Control Center displays.
2. Check entering and leaving condenser water temperatures for comparison with job design conditions. Condenser water temperatures can be checked on the SYSTEM Screen.
3. Check the entering and leaving chilled liquid temperatures and evaporator pressure for comparison with job design conditions. Chilled liquid temperatures can be checked on the SYSTEM Screen.
4. Check the condenser saturation temperature (based upon condenser pressure sensed by the condenser transducer) on the SYSTEM Screen.
5. Check the compressor discharge temperature on the SYSTEM Screen. During normal operation discharge temperature should not exceed 220°F (104°C).
6. Check the compressor motor current on the SYSTEM Screen.
7. Check for any signs of dirty or fouled condenser tubes. (The temperature difference between water leaving condenser and saturated condensing temperature should not exceed the difference recorded for a new unit by more than 4°F (2.2°C)).

**Weekly**

Check the refrigerant charge. Refer to *Checking The Refrigerant Charge on page 116*.

**Monthly**

Leak check the entire chiller.

**Semi-Annually (Or More Often As Required)**

Check controls.

**Annually (More Often If Necessary)**

1. Evaporator and Condenser.
  - a. Inspect and clean water strainers.
  - b. Inspect and clean tubes as required.
  - c. Inspect end sheets.
2. Compressor Drive Motor.
  - a. Measure motor winding insulation resistance
3. Inspect and service electrical components as necessary.
4. Perform refrigerant analysis.

**CHECKING SYSTEM FOR LEAKS****Leak Testing During Operation**

The refrigerant side of the system is carefully pressure tested and evacuated at the factory.

After the system has been charged, the system should be carefully leak tested with a R-134a compatible leak detector to be sure all joints are tight.

If any leaks are indicated, they must be repaired immediately. At times, leaks can be stopped by ensuring face seal nuts and flange bolts are properly torqued. However, for any major repair, the refrigerant charge must be removed. Refer to *Handling Refrigerant For Dismantling And Repairs on page 116* in this section.

**CONDUCT PRESSURE TEST**

With the R-134a charge removed and all known leaks repaired, charge the system with dry nitrogen to 150 psig to (1 MPa) detect any leaks using a liquid soap solution test. The test can be enhanced with the use of an ultrasonic leak detector.

**Optional Trace Gas Pressure Test**

- With no pressure in the system and R-134a removed, charge a trace gas (helium may be used) and dry nitrogen mixture into the chiller until pressure is at least 100 psig (700 kPa).
- One method is to charge 5 to 10 lbm of the environmentally-appropriate trace gas and then add dry nitrogen into the system to a pressure of 100 psig (700 kPa).
- To make sure that the concentration of tracer reached all parts of the system, slightly open the service valve and test for the presence of gas with a leak detector.

- Test around each joint and factory weld carefully and thoroughly.
- To check for tube or tube joint leaks,
  1. Isolate and drain the condenser and evaporator waterboxes
  2. Purge the waterboxes and tubes with dry nitrogen through the vents or drains until the detector does not indicate
  3. Close the vents and drains and wait an hour
  4. Open a vent or drain and insert the leak detector. If a leak is detected, the heads must be removed and the source of the leak determined as outlined in the *Condensers And Evaporators on page 117* in this section.
- Recover the test gas as applicable, make necessary repairs, repeat leak tests, evacuate the chiller and perform time hold test. Always consider the effect of temperature change when performing any time-based hold test. For an ideal gas, at time 1, pressure over temperature (absolute unit system) = the ratio at time 2.

### SYSTEM EVACUATION



***Ensure power is removed from the input side of the VSD at all times when the chiller is under vacuum (less than atmospheric pressure). The VSD maintains voltage to ground on the motor when the chiller is off while voltage is available to the VSD. Insulating properties in the motor are reduced in vacuum and may not insulate this voltage sufficiently.***

After the pressure test has been completed, the vacuum test should be conducted as follows:

1. Connect a high capacity vacuum pump, with indicator, to the system charging valve as shown in *Figure 42 on page 114* and start the pump. Refer to *Vacuum Dehydration on page 113* in this section.
2. Open wide all system valves. Be sure all valves to the atmosphere are closed and flare caps installed on outlets.
3. Operate the vacuum pump in accordance with *Vacuum Dehydration on page 113* in this section until a wet bulb temperature of +32°F (0°C) or a pressure of 5 mm Hg is reached. Refer to *Table 14 on page 114* for corresponding pressure values.

4. To improve evacuation circulate hot water, not to exceed 125°F (51.7°C) through the evaporator and condenser tubes to thoroughly dehydrate the shells. If a source of hot water is not readily available, a portable water heater should be employed. **DO NOT USE STEAM.** A suggested method is to connect a hose between the source of hot water under pressure and the evaporator head drain connection, out the evaporator vent connection, into the condenser head drain and out the condenser vent. To avoid the possibility of causing leaks, the temperature should be brought up slowly so that the tubes and shell are heated evenly.
5. Close the system charging valve and the stop valve between the vacuum indicator and the vacuum pump. Then disconnect the vacuum pump leaving the vacuum indicator in place.
6. Hold the vacuum obtained in *Step 3* above in the system for 8 hours; the slightest rise in pressure indicates a leak or the presence of moisture, or both. It is important to check for pressure change with the chiller at the same temperature. Pressure will change proportional to temperature and affect results. If after 24 hours the wet bulb temperature in the vacuum indicator has not risen above 40°F (4.4°C) or a pressure of 6.3 mm Hg, the system may be considered tight.

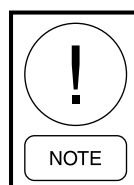

***Be sure the vacuum indicator is valved off while holding the system vacuum and be sure to open the valve between the vacuum indicator and the system when checking the vacuum after the 8 hour period.***

7. If the vacuum does not hold for 8 hours within the limits specified in *Step 6* above, the leak must be found and repaired.

### VACUUM DEHYDRATION

To obtain a sufficiently dry system, the following instructions have been assembled to provide an effective method for evacuating and dehydrating a system in the field. Although there are several methods of dehydrating a system, we are recommending the following, as it produces one of the best results, and affords a means of obtaining accurate readings as to the extent of dehydration.

The equipment required to follow this method of dehydration consists of a wet bulb indicator or vacuum gauge, a chart showing the relation between dew point temperature and pressure in inches of mercury (vacuum), (refer to *Table 14 on page 114*) and a vacuum pump capable of pumping a suitable vacuum on the system.

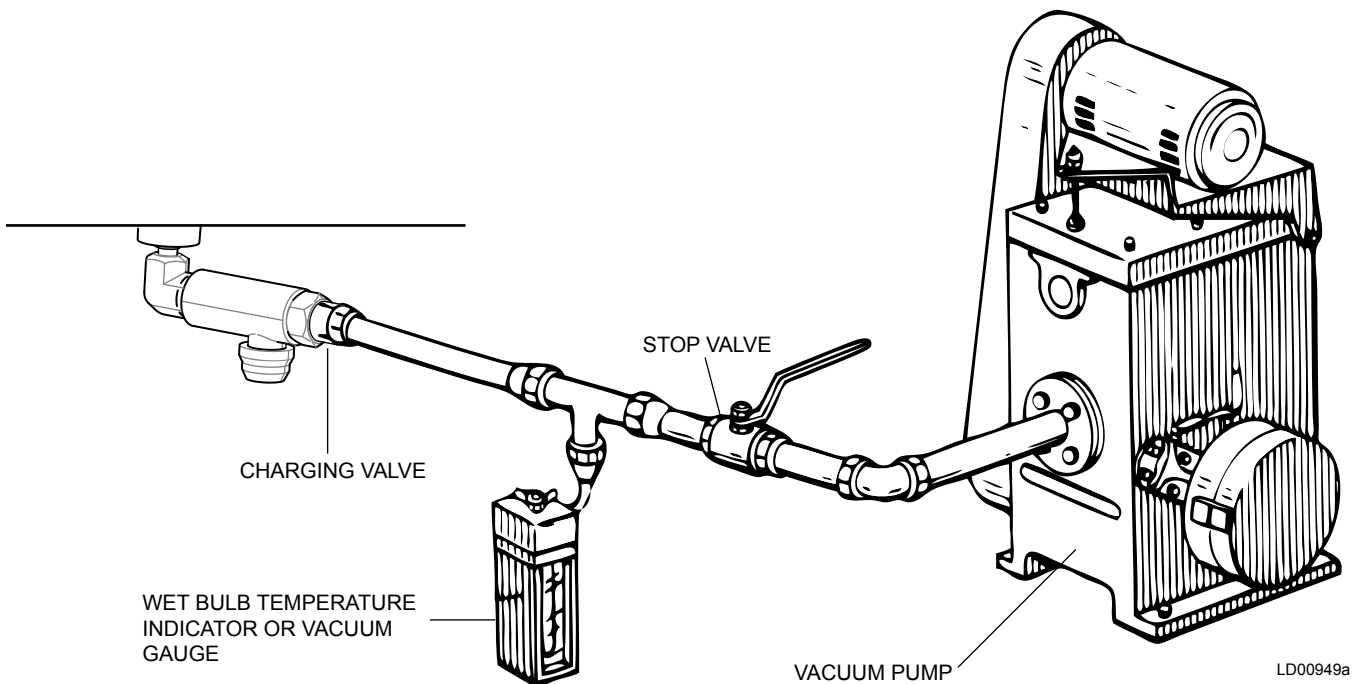

**TABLE 14 - SYSTEM PRESSURES**

*GAUGE  INCHES OF MERCURY (HG) BELOW ONE STANDARD ATMOSPHERE	ABSOLUTE			BOILING TEMPERATURES OF WATER °F
	PSIA	MILLIMETERS OF MERCURY (HG)	MICRONS	
0"	14.6960	760.00	760,000	212
10.240"	9.6290	500.00	500,000	192
22.050"	3.8650	200.00	200,000	151
25.980"	1.9350	100.00	100,000	124
27.950"	0.9680	50.00	50,000	101
28.940"	0.4810	25.00	25,000	78
29.530"	0.1920	10.00	10,000	52
29.670"	0.1220	6.30	6,300	40
29.720"	0.0990	5.00	5,000	35
29.842"	0.0390	2.00	2,000	15 ← Water Freezes
29.882"	0.0190	1.00	1,000	1
29.901"	0.0100	0.50	500	-11
29.917"	0.0020	0.10	100	-38
29.919"	0.0010	0.05	50	-50
29.9206"	0.0002	0.01	10	-70
29.921"	0	0	0	

\*One standard atmosphere = 14.696 PSIA  
= 760 mm Hg. absolute pressure at 32°F  
= 29.921 inches Hg. absolute at 32°F

NOTES: PSIG = Lbs. per sq. in. gauge pressure  
= Pressure above atmosphere  
PSIA = Lbs. per sq. in. absolute pressure  
= Sum of gauge plus atmospheric pressure



**FIGURE 42 - EVACUATION OF CHILLER**

## Operation

Dehydration of a refrigerant system can be obtained by this method because the water present in the system reacts much as a refrigerant would. By pulling down the pressure in the system to a point where its saturation temperature is considerably below that of room temperature, heat will flow from the room through the walls of the system and vaporize the water, allowing a large percentage of it to be removed by the vacuum pump. The length of time necessary for the dehydration of a system is dependent on the size or volume of the system, the capacity and efficiency of the vacuum pump, the room temperature and the quantity of water present in the system. By the use of the vacuum indicator as suggested, the test tube will be evacuated to the same pressure as the system, and the distilled water will be maintained at the same saturation temperature as any free water in the system, and this temperature can be observed on the thermometer.

If the system has been pressure tested and found to be tight prior to evacuation, then the saturation temperature recordings should follow a curve similar to the typical saturation curve shown as *Figure 43 on page 115*.

The temperature of the water in the test tube will drop as the pressure decreases, until the boiling point is reached, at which point the temperature will level off and remain at this level until all of the water in the shell is vaporized. When this final vaporization has taken place the pressure and temperature will continue to drop until eventually a temperature of 35°F (1.6°C) or a pressure of 5 mm Hg. is reached.

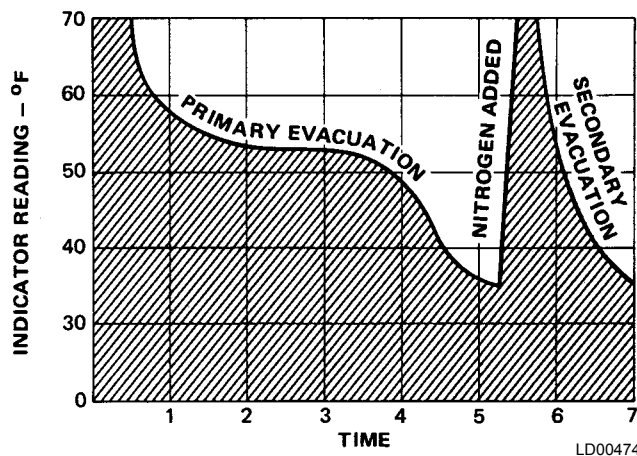

**FIGURE 43 - SATURATION CURVE**

When this point is reached, practically all of the air has been evacuated from the system, but there is still a small amount of moisture left. In order to provide a medium for carrying this residual moisture to the vacuum pump, nitrogen should be introduced into the system to bring it to atmospheric pressure and the indicator temperature will return to approximately ambient temperature. Close off the system again, and start the second evacuation.

The relatively small amount of moisture left will be carried out through the vacuum pump and the temperature or pressure shown by the indicator should drop uniformly until it reaches a temperature of 35°F (1.6°C) or a pressure of 5 mm Hg.

When the vacuum indicator registers this temperature or pressure, it is a positive sign that the system is evacuated and dehydrated to the recommended limit. If this level cannot be reached, it is evident that there is a leak somewhere in the system. Any leaks must be corrected before the indicator can be pulled down to 35°F (1.6°C) or 5 mm Hg. in the primary evacuation.

During the primary pulldown, keep a careful watch on the wet bulb indicator temperature, and do not let it fall below 35°F (1.6°C). If the temperature is allowed to fall to 32°F (0°C), the water in the test tube will freeze, and the result will be a faulty temperature reading.

## CONDUCT R-134A PRESSURE TEST

If a pressure test indicates all joints are not leaking, proceed to test with R-134a as follows:

- With no pressure in the system, charge R-134a vapor into the chiller until pressure is at least 29 psig (200 kPa) so pressure is above the saturation temperature for water to freeze.
- Add refrigerant until the saturation pressure for the prevailing ambient temperature of the chiller is achieved, leak checking repaired joints with a refrigerant leak detector as pressure is increased.
- Test around each joint and factory weld carefully and thoroughly.
- To check for tube or tube joint leaks,
  1. Isolate and drain the condenser and evaporator waterboxes
  2. Purge the waterboxes and tubes with dry nitrogen through the vents or drains until the detector does not indicate
  3. Close the vents and drains and wait an hour

4. Open a vent or drain and insert the leak detector. If a leak is detected, the heads must be removed and the source of the leak determined as outlined in the *Condensers And Evaporators on page 117* in this section.

## REFRIGERANT CHARGING

To avoid the possibility of freezing liquid within the evaporator tubes when charging an evacuated system, only refrigerant vapor from the top of the drum or cylinder must be admitted to the system until the system pressure is raised above the point corresponding to the freezing point of the evaporator liquid. For water, the pressure corresponding to the freezing point is 29 PSIG (200 kPa) for R-134a (at sea level).

While charging, every precaution must be taken to prevent moisture laden air from entering the system. Make up a suitable charging connection from new copper tubing to fit between the system charging valve and the fitting on the charging drum. This connection should be as short as possible but long enough to permit sufficient flexibility for changing drums. The charging connection should be purged each time a full container of refrigerant is connected and changing containers should be done as quickly as possible to minimize the loss of refrigerant.

Refrigerant may be furnished in cylinders containing either 30, 50, 125, 1,025 or 1750 lbs. (13.6, 22.6, 56.6, 464 or 794 kg) of refrigerant.

## CHECKING THE REFRIGERANT CHARGE

The refrigerant charge is specified for each chiller model in *Table 15 on page 117*. Charge the correct amount of refrigerant.

Charge the refrigerant in accordance with the method shown in this section. The weight of the refrigerant charged should be recorded after initial charging.

During operation, the refrigerant charge level is correct when the condenser level is about 1 inch above the subcooler, and the measured Evaporator Approach and Discharge Refrigerant Gas Superheat are at the design values for the condition. Design values would be provided upon request from the chillers sales engineer from the chiller rating program. These depend on tube selection, chilled fluid type, operating head, and operating condition. The equations (below) define these parameters. Condenser level is detected by the liquid level sensor and controlled to the programmed setpoint by the chiller control logic.

## Equations

- Evaporator Approach = (LELT) - (SET)
- Discharge Superheat = (CDGT) - (SCT)

## Definitions:

- SET = Saturated Evaporator Temperature
- LELT = Leaving Evaporator Liquid Temperature
- CDGT = Compressor Discharge Gas Temperature
- SCT = Saturated Condensing Temperature

The parameters can be viewed on the control center. The chiller must be at design operating conditions and full load operation before the correct refrigerant charge level can be properly determined when operating. When proper condenser level is set, evaporator approach can be trended at constant operating points to monitor potential loss of charge.

Liquid refrigerant will be visible in the evaporator sight glass, but the refrigerant charge amount cannot be properly determined by viewing the liquid refrigerant level in the evaporator sight glass. The level changes due to suction conditions and load. If exact conditions are repeated, level should repeat in the glass from a known baseline.

## HANDLING REFRIGERANT FOR DISMANTLING AND REPAIRS

If it becomes necessary to open any part of the refrigerant system for repairs, it will be necessary to remove the charge before opening any part of the unit. If the chiller is equipped with optional valves, the refrigerant can be isolated in either the condenser or evaporator / compressor while making any necessary repairs.

## COMPRESSOR AND MOTOR

1. Check mounting screws and piping joint nuts frequently to insure tightness.
2. Test motor windings annually to check for deterioration of windings.

Electrical test of motor winding resistance should be performed by a qualified service technician according to *Service Instructions Manual (Form 160.84-M1)* because it involves determination of power leads between the motor and the VSD. Results from these winding insulation resistance tests should be trended each interval to determine degradation in motor windings.

**TABLE 15 - APPROXIMATE REFRIGERANT AND WATER WEIGHT**

EVAPORATOR	CONDENSER	REFRIGERANT WEIGHT LBS (KG)*	WATER WEIGHT LBS (KG)**
EB2510	CB2110	540 (250)	980 (450)
	CB2510	600 (270)	1310 (600)
EB2514	CB2514	840 (380)	1680 (770)
EB2910	CB2510	640 (290)	1510 (690)
	CB2910	860 (390)	1760 (800)
EB2914	CB2514	900 (410)	1940 (880)
	CB2914	1210 (550)	2240 (1020)
EB3310	CB2910	920 (420)	2070 (940)
	CB3310	980 (450)	2580 (1170)
EB3314	CB2914	1290 (590)	2640 (1200)
	CB3314	1380 (630)	3310 (1510)

\*Refrigerant Weight based on maximum tube bundle.

\*\* Water Weight is the total water in both shells and for 150PSI, 2-pass, compact water boxes.

## CONDENSERS AND EVAPORATORS

### General

Maintenance of condenser and evaporator shells is important to provide trouble free operation of the chiller. The water side of the tubes in the shell must be kept clean and free from scale.

The major portion of maintenance on the condenser and evaporator will deal with the maintaining the water side of the condenser and evaporator in a clean condition.

The use of untreated water in cooling towers, closed water systems, etc. frequently results in one or more of the following:

1. Scale Formation.
2. Corrosion or Rusting.
3. Slime and Algae Formation.

It is therefore to the benefit of the user to provide for proper water treatment to provide for a longer and more economical life of the equipment. The following recommendation should be followed in determining the condition of the water side of the condenser and evaporator tubes.

1. The condenser tubes should be cleaned annually or earlier if conditions warrant. If the temperature difference between the water off the condenser and the condenser liquid temperature is more than 4°F (2°C) greater than the difference recorded on

a new unit, it is a good indication that the condenser tubes require cleaning. Refer to *Cleaning Evaporator and Condenser Tubes on page 118* in this section for condenser tube cleaning instructions.

2. The evaporator tubes under normal circumstances will not require cleaning. If the temperature difference between the refrigerant and the chilled water increases slowly over the operating season, it is an indication that the evaporator tubes may be fouling or that there may be a water bypass in the water box requiring gasket replacement or refrigerant may have leaked from the chiller.

### Chemical Water Treatment

Since the mineral content of the water circulated through evaporators and condensers varies with almost every source of supply, it is possible that the water being used may corrode the tubes or deposit heat resistant scale in them. Reliable water treatment companies are available in most larger cities to supply a water treating process which will greatly reduce the corrosive and scale forming properties of almost any type of water.

As a preventive measure against scale and corrosion and to prolong the life of evaporator and condenser tubes, a chemical analysis of the water should be made preferably before the system is installed. A reliable water treatment company can be consulted to determine whether water treatment is necessary, and if so, to furnish the proper treatment for the particular water condition.

## Cleaning Evaporator and Condenser Tubes

### Evaporator

It is difficult to determine by any particular test whether possible lack of performance of the evaporator is due to fouled tubes alone or due to a combination of troubles. Trouble which may be due to fouled tubes is indicated when, over a period of time, the cooling capacity decreases and the split (temperature difference between water leaving the evaporator and the refrigerant temperature in the evaporator) increases. A gradual drop-off in cooling capacity can also be caused by a gradual leak of refrigerant from the system or by a combination of fouled tubes and shortage of refrigerant charge.

### Condenser

In a condenser, trouble due to fouled tubes is usually indicated by a steady rise in head pressure, over a period of time, accompanied by a steady rise in condensing temperature.

### Tube Fouling

Fouling of the tubes can be due to deposits of two types as follows:

1. Rust or sludge – which finds its way into the tubes and accumulates there. This material usually does not build up on the inner tube surfaces as scale, but does interfere with the heat transfer. Rust or sludge can generally be removed from the tubes by a thorough brushing process.
2. Scale – due to mineral deposits. These deposits, even though very thin and scarcely detectable upon physical inspection, are highly resistant to heat transfer. They can be removed most effectively by circulating an acid solution through the tubes using skilled experts as described below.

## Tube Cleaning Procedures

### Brush Cleaning of Tubes

If the tube consists of dirt and sludge, it can usually be removed by means of the brushing process. Drain the water sides of the circuit to be cleaned (cooling water or chilled water) remove the heads and thoroughly clean each tube with a soft bristle nylon brush. **DO NOT USE A STEEL BRISTLE BRUSH.** A steel brush may damage the tubes.

Improved results can be obtained by admitting water into the tube during the cleaning process. This can be done by mounting the brush on a suitable length of 1/8" pipe with a few small holes at the brush end and connecting the other end by means of a hose to the water supply.

The tubes should always be brush cleaned before acid cleaning.

### Acid Cleaning of Tubes

If the tubes are fouled with a hard scale deposit, they may require acid cleaning. It is important that before acid cleaning, the tubes be cleaned by the brushing process described above. If the relatively loose foreign material is removed before the acid cleaning, the acid solution will have less material to dissolve and flush from the tubes with the result that a more satisfactory cleaning job will be accomplished with a probable saving of time.



*Acid cleaning should only be performed by an expert. Please consult your local water treatment representative for assistance in removing scale buildup and preventative maintenance programs to eliminate future problems.*

### Commercial Acid Cleaning

In many major cities, commercial organizations now offer a specialized service of acid cleaning evaporators and condensers. If acid cleaning is required, Johnson Controls recommends the use of this type of organization. The Dow Industries Service Division of the Dow Chemical Company, Tulsa, Oklahoma, with branches in principal cities is one of the most reliable of these companies.

### Testing for Evaporator and Condenser Tube Leaks

Evaporator and condenser tube leaks in R-134a systems may result in refrigerant leaking into the water circuit, or water leaking into the shell depending on the pressure levels. If refrigerant is leaking into the water, it can be detected at the liquid head vents after a period of shutdown. If water is leaking into the refrigerant, system capacity and efficiency will drop off sharply. If a tube is leaking and water has entered the system, the evaporator and condenser should be valved off from the rest of the water circuit and drained immediately to

prevent severe rusting and corrosion. The refrigerant system should then be drained and purged with dry nitrogen to prevent severe rusting and corrosion. If a tube leak is indicated, the exact location of the leak may be determined as follows:

1. Remove the heads and listen at each section of tubes for a hissing sound that would indicate gas leakage. This will assist in locating the section of tubes to be further investigated. If the probable location of the leaky tubes has been determined, treat that section in the following manner (if the location is not definite, all the tubes will require investigations).
2. Wash off both tube heads and the ends of all tubes with water.
3. With nitrogen or dry air, blow out the tubes to clear them of traces of refrigerant laden moisture from the circulation water. As soon as the tubes are clear, a cork should be driven into each end of the tube. Pressurize the dry system with 50 to 100 PSIG (345 to 690 kPa) of nitrogen. Repeat this with all of the other tubes in the suspected section or, if necessary, with all the tubes in the evaporator or condenser. Allow the evaporator or condenser to remain corked up to 12 to 24 hours before proceeding. Depending upon the amount of leakage, the corks may blow from the end of a tube, indicating the location of the leakage. If not, it will be necessary to make a very thorough test with the leak detector.
4. After the tubes have been corked for 12 to 24 hours, it is recommended that two men working at both ends of the evaporator carefully test each tube – one man removing corks at one end and the other at the opposite end to remove corks and handle the leak detector. Start with the top row of tubes in the section being investigated. Remove the corks at the ends of one tube simultaneously and insert the exploring tube for 5 seconds – this should be long enough to draw into the detector any refrigerant gas that might have leaked through the tube walls. A fan placed at the end of the evaporator opposite the detector will assure that any leakage will travel through the tube to the detector.
5. Mark any leaking tubes for later identification.

6. If any of the tube sheet joints are leaking, the leak should be indicated by the detector. If a tube sheet leak is suspected, its exact location may be found by using a soap solution. A continuous buildup of bubbles around a tube indicates a tube sheet leak.

## ELECTRICAL CONTROLS

Ensure electrical connections are tight and connectors are secure annually.

It is important that the factory settings of controls (operation and safety) not be changed. If the settings are changed without Johnson Controls approval, the warranty will be jeopardized.

## AUTOMATIC BATTERY HEALTH TEST – DURING SHUTDOWN

For periodic maintenance or to diagnose battery faults or warnings, a battery health test can be performed. This test is initiated from the Power Panel screen of the Optiview panel to monitor battery voltage while under a known load. This will ensure that the battery has enough capacity left to withstand a power failure event. The test is available through operator access level or higher.

At the keypad, log in at Operator access level using access level code 9 6 7 5 or a higher level.

Navigate to Compressor – Power Panel screen.

On the Power Panel screen, the “Start Battery Test” button is shown and the function available when all of the following are true:

- Access Level is Operator or higher
- Chiller State is Stopped
- Safety Stop pushbutton is depressed
- The Local Run/Stop is set to Stop

When the “Start Battery Test” button is pressed the Battery Health Test is initiated. When the Battery Health Test is in progress, this button changes to a “Cancel Battery Test” button to cancel the active Battery Health Test in progress if needed. The test proceeds as follows:

The panel instructs “UPS Battery Test - Disconnect 3-phase line power to the chiller now”. At that time, remove three-phase power to the chiller. Once the power is removed, the UPS becomes available for a limit of 10 minutes for performance of the test.

When the panel detects control voltage is low and UPS is in Inverter mode due to loss of the line power, the panel displays “UPS Battery Test - Evaluating Battery”. The MBC is then commanded to Levitation. After the MBC reports to Optiview that it is in Levitation mode, the battery voltage is monitored for the next 60 seconds.

The following constitute a fail result:

- If Battery Voltage drops to less than the Inverter Low Battery Voltage Threshold (Default 11.0 V) (UPS – Inverter Low Battery Voltage fault threshold) the test fails and ends.
- If the test takes longer than 75 seconds the test fails and ends.
- If the UPS shuts down (OptiView will lose power) due to voltage, fuses, disconnect, or any other reason the test fails and the Optiview displays a fault on next power up stating that the battery health test has failed. This fault can be cleared by running a successful battery health test.

If the “UPS – Inverter Low Battery Voltage” fault is not set by the end of the 60 second test (Battery Voltage stays above the threshold), the battery evaluation is considered good.

Next, the control ceases MBC levitation. If this step takes longer than 15 seconds, the test fails and ends.

Then the panel instructs “Reconnect 3-phase line power to the chiller now”. At that time, reapply three-phase power to the chiller. The full test successfully ends when Optiview detects the control voltage has returned.

If the 10 minute power loss holdup timer runs out (OptiView power will be lost due to turning off UPS Inverter) before the test completes and power is restored the test is considered failed.

“UPS Battery Health Test Successful” is displayed for 10 seconds when the test passes

“UPS Battery Health Test Failed – Step X” (Where X is the step that failed) is displayed when the test fails. It remains while the “Warning – UPS – Battery Test Failed” warning is active. It and the warning will be cleared when a Battery Health Test completes successfully.

For a fail, the following steps may be indicated as the fail point

- Step 2 is when the Optiview is waiting to sense line power removed – typically the user has taken too long and exceeded 10 minute test time.
- Step 3 is during the 60 second battery voltage monitoring under Levitation load – typically would be bad battery
- Step 4 is after completion of the 60 second monitoring and waiting for successful automatic delevitation – would indicate some unplanned failure of the control or communication
- Step 5 is waiting to sense line power restored – typically the user has taken too long and exceeded 10 minute test time



## SECTION 6 - TROUBLESHOOTING

**TABLE 16 - OPERATION ANALYSIS CHART**

RESULTS	POSSIBLE CAUSE	REMEDY
<b>1. SYMPTOM: ABNORMALLY HIGH DISCHARGE PRESSURE</b>		
Temperature difference between condensing temperature and water off condenser higher than normal.	Condenser tubes dirty or scaled.	Clean condenser tubes. Check water conditioning.
High condenser water temperature.	Cooling tower or cooling source malfunction	Reduce condenser water inlet temperature. (Check cooling tower and water circulation.)
Temperature difference between condenser water on and water off higher than normal, with normal evaporator pressure.	Insufficient condensing water flow.	Increase the quantity of water through the condenser to proper value.
<b>2. SYMPTOM: ABNORMALLY LOW SUCTION PRESSURE</b>		
Temperature difference between leaving chilled water and refrigerant in the evaporator greater than normal with possible slight increase in discharge temperature.	Insufficient charge of refrigerant.	Check for leaks and charge refrigerant into system.
	Liquid level control valve or sensor problem	Ensure actuator is functioning and check wiring. Ensure level sensor is indicating level reasonably
Temperature difference between leaving chilled water and refrigerant in the evaporator greater than normal with normal discharge temperature.	Evaporator tubes dirty or restricted.	Clean evaporator tubes.
Temperature of chilled water too low with low motor amperes.	Insufficient load for system capacity.	Check capacity control operation and setting of low water temperature shutdown setpoint.
<b>3. SYMPTOM: HIGH EVAPORATOR PRESSURE</b>		
High chilled water temperature.	Capacity control failed to load.	Check the VGD and Hot Gas Bypass (if applicable) positioning circuits.
	System overload.	Be sure the capacity control devices and speed increased as much as possible (without overloading the motor) until the load decreases.

6

**TABLE 16 - OPERATION ANALYSIS CHART (CONT'D)**

<b>4. SYMPTOM: LOW DISCHARGE TEMPERATURE</b>		
Temperature difference between discharge and condenser saturation lower than normal for the prevailing condenser temperature and leaving chilled liquid temperature.	Chiller overcharged	Trim charge to correct amount
	Condenser level control setpoint too low or level control actuator or sensor fail	Check operation of level sensor, actuator, and ensure setpoint keeps refrigerant over the subcooler top

## SECTION 7 - PRINTING

### PRINTING OVERVIEW

A printer can be connected to the Control Center's Microboard to print the following reports. The screen from which each report can be generated is listed in parenthesis.

- **Status** - Present system parameters (Printer, Home)
- **Setpoints** - Present programmed values of all setpoints (Printer, Setpoints)
- **Schedule** - Present value of programmed daily schedule (Printer, Schedule)
- **Sales Order** - Information about SALES ORDER Screen (Printer, Sales Order)
- **History** - System parameters at the time of the last normal stop, last fault while running and last 10 faults, whether running or not (Printer, History)
- **Cycling or Safety Shutdown Initiated Print** - Snapshot of all system parameters at instant of shutdown. Automatically occurs if printer is connected at time of shutdown.
- **Adaptive Capacity Control (ACC) Surge Map** - System conditions at instant all surge points were mapped. (Compressor Motor Variable Speed Drive applications; requires SERVICE access level) (Printer, ACC)
- **Trend** - Prints a snapshot of the existing TREND Screen data or prints new data collected after the TREND PRINT key is pressed.

The printer can be permanently connected to the Control Center or connected as required to produce a report. If permanently connected, a DATA LOGGING feature can produce a status report automatically, beginning at an Operator selected start time and occurring at an Operator selected interval thereafter.

The following figures are examples of the different print reports. Solid State Starter application print reports shown. Electro-Mechanical Starter and Variable Speed Drive reports are similar but print parameters applicable to those devices.

- Status or History - *Figure 48 on page 128*
- Setpoints - *Figure 49 on page 130*
- Schedule - *Figure 50 on page 132*
- Sales Order - *Figure 51 on page 132*
- Security Log - *Figure 52 on page 134*
- Trend - *Figure 53 on page 134*
- CUSTOM Screen - *Figure 54 on page 134*

### ACCEPTABLE PRINTERS

The following printers can be used. Printers must be equipped with an RS-232 Serial interface.

- Okidata OKIPOS 441
- Brecknell CP130

The Control Center provides the required formatting control codes for the printers above when the printer is selected on the PRINTER Screen. These codes are transmitted through the serial interface to the printer to provide a proper print format.

Different printers require different formatting control codes. Other printers might provide proper operation when connected to the Control Center. However, the print format may not be correct or as desired.

Proceed with caution and use the following guidelines if an unlisted printer is selected:

1. All must be capable of RS-232 serial communications.
2. Primary differences between printers involve the formatting control codes required by the printer. These codes are sent from the Control Center to the printer. For example, Weigh-Tronix printers require a control code to select 40 column width. This same code is interpreted by the Okidata printer as an instruction to print wide characters. In some instances, a printer will ignore a code it cannot interpret.
3. The Control Center requires a busy signal from the printer when the printer receive buffer is full. This causes the Control Center to momentarily terminate data transmission until the printer can accept more data. The busy signal polarity must be asserted low when busy.

#### Okidata –

##### Models: OKIPOS 441

- Dimensions:  
6.9". wide x 9.64". deep x 5.98". high
- Paper: 3.0 in. wide
- Type: Dot Matrix Impact
- Purchase: 800-OKIDATA  
Spare printer Ribbon Okidata 52119001 Black
- P/N Charcoal P/N 62113901  
Beige P/N 62113601



LD16572

**FIGURE 44 - OKIPOS PRINTER**

## PRINTER CONNECTIONS

Connect the printer to the Control Center Microboard as follows. Only one printer can be connected at a time.

**TABLE 17 - OKIDATA OKIPOS 441**

MICROBOARD	PRINTER	FUNCTION
J2-4	pin 3	Tx (data to printer)
J2-2	pin 20	DSR (busy signal from printer)
J2-9	pin 7	Gnd
Cabinet		Shield

#### Hardware required:

##### Cable

- #18 AWG stranded 50 ft. maximum length.

##### Connectors

###### Microboard

- None. Strip 1/4" insulation from wire and insert into screw terminal block.

###### Printers

- Okidata - 25 pin plug DB-25P or equivalent; Shell DB-C2-J9 or equivalent.

## PRINTER SETUP

The selected printer must be configured as follows. Refer to manual provided by printer manufacturer.

### OKIDATA OKIPOS 441

1. With the printer power off, remove the two screws which hold the RS232 Interface Module.
2. Pull the RS232 Interface Module out of the printer.
3. Set DIP switch SW2-2 to OFF to select 19200 BPS. Do not change any other switch settings.
4. Re-install the RS232 Interface Module and two mounting screws.
5. Load paper and install the printer ribbon into the printer.
6. Connect the printer cable to the printer and the microboard.
7. Connect the printer power cable to the printer and plug into a 100 to 240VAC power source.

**Brecknell –**

**Models: Brecknell CP130**

- Dimensions:  
5.25" Long x 3.75" Wide x 2.5" High
- Paper: Thermal 57mm (2.25")
- Type: Dot Matrix
- Purchase: 800-637-0529 (North America)  
+44 (0) 845-246-6717 (Europe & ME)
- P/N AWT 05-505788 (printer, cable, 1 roll of paper)
- P/N AWT 05-505594 (power supply)
- P/N AWT 05-505671 (case, 20 rolls of paper)

**PRINTER CONNECTIONS**

Connect the printer to the Control Center Microboard as follows. Only one printer can be connected at a time.

**TABLE 18 - BRECKNELL CP130**

Modify the cable and connect as shown below.

MICROBOARD	PRINTER	FUNCTION
J2-4	Pin 3	TX Data to the printer
J2-2	Pin 5	Busy signal from the printer
J2-9	Pin 6	Signal Common



LD17609

**FIGURE 45 - BRECKMAN PRINTER**

**CONTROL CENTER SETUP**

**Chiller ID**

**Access Level Required: OPERATOR**

Using the COMMS Screen, assign an identification number to the chiller. This number will appear at the top of each report.

**Printer Setup**

**Access Level Required: OPERATOR**

Using the COMMS Screen, the Control Center must be configured to transmit data in the same format as the printer is configured to receive the data. The following values must be entered.

- Baud Rate - Set to 9600 for Brecknell  
19200 for OKIPOS
- Data Bits - 8
- Parity - None
- Stop Bits - 1

**Printer Type**

**Access Level Required: OPERATOR**

Using the PRINTER Screen, set the printer type to Weigh-Tronix.

**Automatic Data Logging**

**Access Level Required: OPERATOR**

If automatic data logging is desired, a status report can be automatically printed at a specified interval beginning at a specified time, using the PRINTER Screen. The interval is programmable over the range of 1 minute to 1440 minutes in 1 minute increments. The first print will occur at the programmed START time and occur at the programmed Output Interval thereafter. The time remaining until the next print is displayed on the PRINTER Screen.

- Automatic Printer Logging - Enables and disables automatic data logging.
- Log Start Time - Enter the time the first print is desired.
- Output Interval - Enter the desired interval between prints.

## DOWNLOADING SYSTEM PRINTS TO A LAPTOP

Downloading system histories to a file is another useful method to capture system operating conditions. The following instructions are used to establish communication between the OptiView™ Control Panel and a laptop computer.

1. Connect the laptop computer to the OptiView™ as described below.

Laptop (RS-232 Serial Port)			OptiView (Com 1)	
PIN	DESC		Connector	Terminal
2	RX	to	J2	4 (TXD1)
4	DTR	to	J2	2 (DSR1)
5	GND	to	J2	9 GND

2. On OptiView™ Printer Screen, select “PC”. This will allow faster data download than the printer selections. On Setpoints - Setup - Comms screen, ensure the printer settings match “h. Port settings” see below.
3. Setup HyperTerminal
  - a. Go to START menu
  - b. Select All Programs
  - c. Select Accessories
  - d. Select Communications
  - e. Select HyperTerminal
  - f. In the box displayed, it requires a name and icon for the connection. Select a name that is descriptive and select an icon. Select OK.
  - g. In the box labeled Connect using the select com port that will connect to the YK unit. This port is usually labelled Com 1. Select OK.
  - h. Port settings
 

Bits per second	57600
Data bits	8
Parity	None
Stop Bits	1
Flow control	None
4. Set HyperTerminal to capture a file.
  - a. Select Transfer from toolbar
  - b. Select Capture Text from the drop down menu.
  - c. A Capture Text Filebox will be displayed. Verify location and file name.
  - d. Select Start.

5. Press the Print Screen key on the appropriate screen to be captured. The HyperTerminal will display the printed information and the information will be recorded as a .txt file.

When the print file has been recorded, select Transfer from the toolbar and capture from the drop down menu and select Stop. This will stop the transfer and allow access to the capture file.

The following additional RS232 connections, are used to wire up serial devices for desktop and laptop computers.

RS-232 PIN ASSIGNMENTS (DB25 PC SIGNAL SET) (OLDER DESKTOPS ONLY)	
Pin 1	Protective Ground
Pin 2	Transmit Data
Pin 3	Received Data
Pin 4	Request To Send
Pin 5	Clear To Send
Pin 6	Data Set Ready
Pin 7	Signal Ground
Pin 8	Received line Signal Detector (Data Carrier Detect)
Pin 20	Data Terminal Ready
Pin 22	Ring Indicator

The connector on the PC has Male pins, therefore the mating cable needs to terminate in a DB25/F (Female pin) connector.

RS-232 PIN ASSIGNMENTS (DB9 PC SIGNAL SET) (MOST LAPTOPS)	
Pin 1	Received line Signal Detector (Data Carrier Detect)
Pin 2	Received Data
Pin 3	Transmit Data
Pin 4	Data Terminal Ready
Pin 5	Signal Ground
Pin 6	Data Set Ready
Pin 7	Request To Send
Pin 8	Clear To Send
Pin 9	Ring Indicator

The connector on the PC has male pins; therefore, the mating cable needs to terminate DB9/F (female pin) connector.

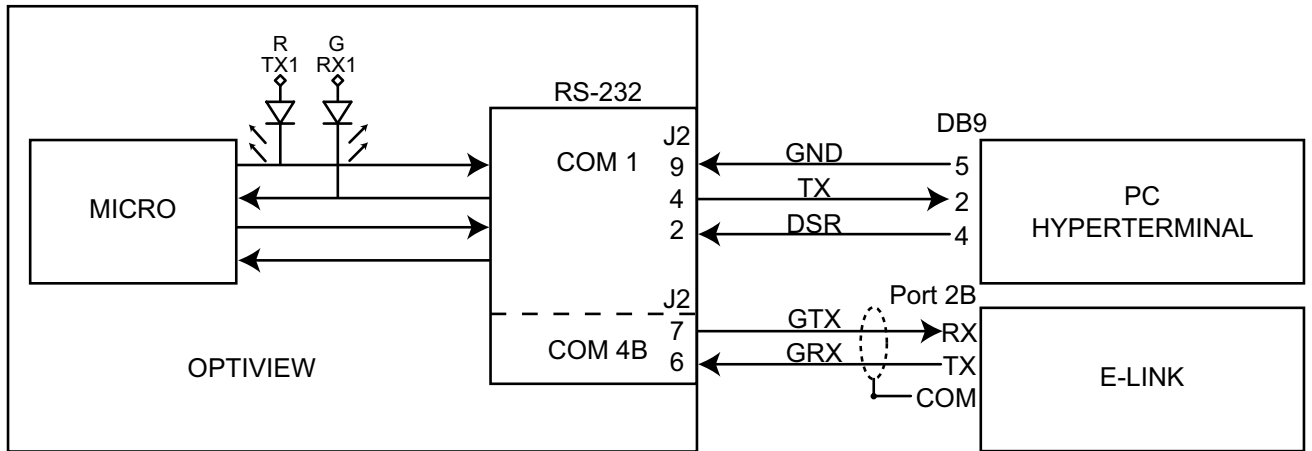

LD14492

**FIGURE 46 - COMMUNICATIONS BLOCK DIAGRAM**

A serial cable to go from the OptiView Control Panel to the serial port is available from the parts center (P/N 075-90490-230).

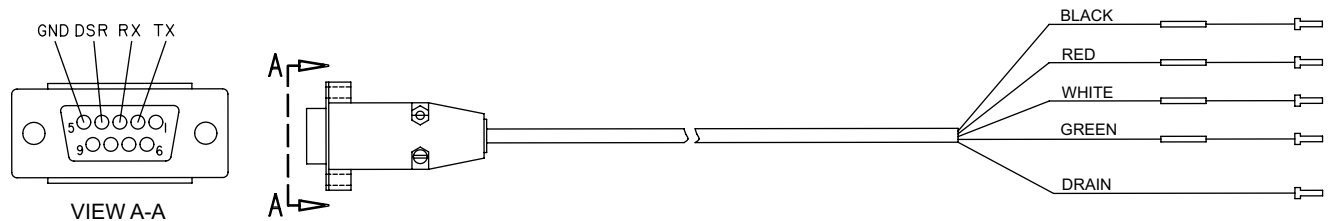

LD17607

**FIGURE 47 - OPTIVIEW PANEL TO PC SERIAL CABLE**



**YORK UPDATE**  
 Status or History  
 YORK History 1 (line only displayed for History Report)  
 YORK Live Data (line only displayed for Status Report)  
 -Sales Order Job Name here  
 Sales Order Model Number here  
 Sales Order Serial Number here  
 Sales Order Compressor Model here  
 Sales Order Evaporator Model here  
 Sales Order Condenser Model here  
 Sales Order VSD Model here  
 YMC2 Chiller ID 1  
 (c) 2010 Johnson Controls  
 Sun 05 Dec 2010 8:04:27 AM

SAFETY SHUTDOWN - MANUAL RESTART  
 MBC - SPEED SIGNAL FAULT  
 VSD - DC BUS ACTIVE

Controls C.OPT.18.00.213  
 Run Time 0 Days 1 Hr 14 Min 6 Sec

Operating Hours = 83 Hr  
 Number Of Starts = 41  
 Control Source = Digital  
 Run Permissive = True

Evaporator

-----  
 Chilled Liquid Pump = Run  
 Chilled Liquid Flow Switch = Closed  
 Active LCHLT Setpoint = 44.0 ~F  
 Shutdown Temperature = 40.0 ~F  
 Leaving Chilled Liquid Temperature = 44.8 ~F  
 Entering Chilled Liquid Temperature = 50.3 ~F  
 Evaporator Pressure = 46.4 PSIG  
 Evaporator Saturation Temperature = 50.9 ~F  
 Evaporator Refrigerant Temperature = 50.9 ~F  
 (when sensor is Enabled)  
 Evaporator Small Temp Difference = -6.1 ~F

Condenser

-----  
 Condenser Liquid Pump = Stop  
 Condenser Liquid Flow Switch = Closed  
 Leaving Condenser Liquid Temperature = 70.6 ~F  
 Entering Condenser Liquid Temperature = 67.9 ~F  
 Condenser Pressure = 68.3 PSIG  
 Condenser Saturation Temperature = 68.1 ~F  
 Condenser Small Temp Difference = -2.5 ~F  
 Drop Leg Refrigerant Temp = 68.5 ~F  
 Subcooling Temperature = -0.4 ~F  
 Head Pressure = 2.7 PSID  
 (when HPC is Enabled)  
 Head Pressure Setpoint = 23.0 PSID  
 (when HPC is Enabled)  
 PID Control Mode = Inactive  
 (when HPC is Enabled)  
 Control Valve Command = 0.0 %  
 (when HPC is Enabled)  
 Isolation Valves Opening = On  
 (when Iso Vlv is Enabled)  
 Isolation Valves Opened Limit Switch = On  
 (when Iso Vlv is Enabled)  
 Isolation Valves Closing = Off  
 (when Iso Vlv is Enabled)  
 Isolation Valves Closed Limit Switch = Off  
 (when Iso Vlv is Enabled)

Compressor

-----  
 Discharge Temperature = 79.0 ~F  
 Discharge Superheat = 14.0 ~F

Surge

-----  
 Surge Count = 0  
 Delta P / P = 1.23  
 Surge Window Time = 0 Min  
 Surge Window Count = 0

Condenser Refrigerant Level Control

-----  
 Condenser Refrigerant Level = 7.3 %  
 Condenser Active Level Setpoint = 7.3 %  
 Condenser Level Control State = Inactive  
 Condenser Level Control Valve Command = 25.0 %  
 Subcooler Effectiveness = 0.100  
 Subcooler Effectiveness High Threshold = 1.500  
 Subcooler Effectiveness Low Threshold = 0.400

Variable Geometry Diffuser

-----  
 Active Stall Voltage = 0.22 V  
 Active Stall Voltage Type = Standard  
 Mach Number = 1.25  
 Sec  
 Discharge Pressure = 46.3 PSIG  
 VGD Feedback Counts = 23456  
 VGD Fault Code = 0000 0000 0000 0000

Variable Speed Drive

-----  
 VSD Inverter = C.H035.04.01.02  
 VSD Rectifier = C.H035.03.01.02  
 Motor Run = Off  
 VSD Fault = Off  
 Input % Full Load Amps = 0.0 %  
 Input Job Full Load Amps = 200 A  
 VSD Output Voltage = 0 V  
 VSD Output Frequency = 0.00 Hz  
 Max Chiller Frequency = 345.00 Hz  
 Input Power = 0 kW  
 Input kW Hours = 5543 kWh  
 L1 Voltage Total Harmonic Distortio = 8.0 %  
 L2 Voltage Total Harmonic Distortion = 8.0 %  
 L3 Voltage Total Harmonic Distortion = 3.0 %  
 L1 Input Current Total Demand Distortion = 0.0 %  
 L2 Input Current Total Demand Distortion = 0.0 %  
 L3 Input Current Total Demand Distortio = 0.0 %  
 Input KVA = 1 kVA  
 Input Power Factor = 0.00  
 Motor % Full Load Amps = 0.0 %  
 VSD Command = Run  
 VSD Control State = Run  
 VSD Inverter State = Run  
 Phase Rotation = ABC  
 Precharge Active = On  
 Precharge Complete = False  
 DC Bus Regulating = Off  
 DC Bus Voltage = 696 V  
 Input Current Limit = Off  
 Cooling System = On  
 L1 Input Voltage (peak) = 698 V  
 L2 Input Voltage (Peak) = 707 V  
 L3 Input Voltage (Peak) = 696 V  
 L1 Input Voltage (RMS) = 698 V  
 L2 Input Voltage (RMS) = 707 V  
 L3 Input Voltage (RMS) = 696 V  
 L1 Input Current (RMS) = 1 A  
 L2 Input Current (RMS) = 1 A  
 L3 Input Current (RMS) = 0 A  
 Phase A Output Voltage (RMS) = 0 V  
 Phase B Output Voltage (RMS) = 0 V  
 Phase C Output Voltage (RMS) = 0 V  
 Phase A Output Current (RMS) = 0 A  
 Phase B Output Current (RMS) = 0 A  
 Phase C Output Current (RMS) = 0 A  
 Phase A Rectifier Baseplate Temperature = 81 ~F  
 Phase B Rectifier Baseplate Temperature = 80 ~F  
 Phase C Rectifier Baseplate Temperature = 77 ~F  
 Phase A Inverter Baseplate Temperature = 87 ~F  
 Phase B Inverter Baseplate Temperature = 82 ~F  
 Phase C Inverter Baseplate Temperature = 80 ~F  
 Internal Ambient Temperature 1 = 77 ~F  
 Internal Ambient Temperature 2 = 77 ~F  
 Test Mode = Disabled  
 Manual DC Bus = Disabled  
 Manual VSD Cooling = Disabled  
 ID Faults = 0  
 Checksum Errors = 0  
 Error Packets = 0  
 Timeout Faults = 0  
 VSD Fault Waveform Available = Yes

FIGURE 48 - SAMPLE PRINTOUT (STATUS OR HISTORY)

```

Variable Speed Drive - Fault Snapshot
-----
VSD Output Voltage           = 0 V
VSD Output Frequency        = 0.00 Hz
Input Power                  = 0 kW
L1 Voltage Total Harmonic Distortion = 8.0 %
L2 Voltage Total Harmonic Distortion = 8.0 %
L3 Voltage Total Harmonic Distortion = 3.0 %
L1 Input Current Total Demand Distortion = 0.0 %
L2 Input Current Total Demand Distortion = 0.0 %
L3 Input Current Total Demand Distortion = 0.0 %
Input KVA                   = 1 kVA
VSD Control State           = Run
VSD Inverter State          = Run
Phase Rotation              = ABC
Precharge Active            = On
Precharge Complete         = False
DC Bus Regulating           = Off
DC Bus Voltage              = 696 V
Input Current Limit         = Off
Cooling System              = On
L1 Input Voltage (peak)     = 698 V
L2 Input Voltage (Peak)     = 707 V
L3 Input Voltage (Peak)     = 696 V
L1 Input Voltage (RMS)     = 698 V
L2 Input Voltage (RMS)     = 707 V
L3 Input Voltage (RMS)     = 696 V
L1 Input Current (Peak)     = 1 A
L2 Input Current (Peak)     = 1 A
L3 Input Current (Peak)     = 0 A
L1 Input Current (RMS)     = 1 A
L2 Input Current (RMS)     = 1 A
L3 Input Current (RMS)     = 0 A
Phase A Output Voltage (RMS) = 0 V
Phase B Output Voltage (RMS) = 0 V
Phase C Output Voltage (RMS) = 0 V
Phase A Output Current (Peak) = 0 A
Phase B Output Current (Peak) = 0 A
Phase C Output Current (Peak) = 0 A
Phase A Output Current (RMS) = 0 A
Phase B Output Current (RMS) = 0 A
Phase C Output Current (RMS) = 0 A
Phase A Rectifier Baseplate Temperature = 81 ~F
Phase B Rectifier Baseplate Temperature = 80 ~F
Phase C Rectifier Baseplate Temperature = 77 ~F
Phase A Inverter Baseplate Temperature = 87 ~F
Phase B Inverter Baseplate Temperature = 82 ~F
Phase C Inverter Baseplate Temperature = 80 ~F
Internal Ambient Temperature 1 = 77 ~F
Internal Ambient Temperature 2 = 77 ~F
Test Mode                   = Disabled

Motor Monitoring
-----
Motor Winding Phase A Temp Z1 End = 71 ~F
Motor Winding Phase B Temp Z1 End = 71 ~F
Motor Winding Phase C Temp Z1 End = 71 ~F
Motor Winding Phase A Temp Z2 End = 71 ~F
Motor Winding Phase B Temp Z2 End = 71 ~F
Motor Winding Phase C Temp Z2 End = 71 ~F
Average Winding Temperature = 71.0 ~F
Estimated Rotor Temperature = 123.4 ~F
Motor Housing Temperature = 71 ~F
Motor Housing Temperature Setpoint = 71 ~F
Motor Winding Temperature Setpoint = 121 ~F
Ambient Dew Point Temperature = 71 ~F
    (when Dew Point Enabled)
Motor Cooling Valve Command = 25.0 %
Motor Cooling Control State = Inactive

Capacity Control
-----
Control State = Inactive
Load Limit = Inactive
VSD Frequency Command = 0.00 Hz
VSD Output Frequency = 0.00 Hz
VSD Control Mode = Auto
Active Anti-Surge Minimum Frequency = 0.00 Hz
Anti-Surge Minimum Frequency = 0.00 Hz
Anti-Surge Transient Offset = 0.00 Hz
VGD Command = 25.00 %
    
```

```

VGD Position = 25.00 %
VGD Control Mode = Auto
HGBP Command = 25.0 %
    (when HGBP enabled)
HGBP Control Mode = Auto
    (when HGBP enabled)
Head Pressure = 0.0 PSID
Evaporator Pressure = 46.40 PSIG
Condenser Pressure = 68.30 PSIG
Leaving Chilled Liquid Temperature = 44.80 ~F

Magnetic Bearing Controller
-----
MBC Control Mode = Auto
MBC Levitation Command = On
MBC Rotation Command = On
Levitation Mode = On
Rotation Mode = On
MBC Alarm = On
MBC Alive = On
Rotation Allowed = On
MBC Fault = On
Motor Speed = 44 Hz
MBC Input Voltage = 150 V
V13 Position = 14 ~m
W13 Position = 13 ~m
V24 Position = 13 ~m
W24 Position = 12 ~m
Z12 Position = 2 ~m
V1 Current = 1.803 A
V2 Current = 1.772 A
V3 Current = 0.878 A
V4 Current = 0.972 A
W1 Current = 1.992 A
W2 Current = 1.788 A
W3 Current = 0.721 A
W4 Current = 0.894 A
Z1 Current = 1.082 A
Z2 Current = 1.443 A
Rotor Elongation = 102 ~m
VW13 Soft Landing Counter = 0
VW24 Soft Landing Counter = 0
Z12 Soft Landing Counter = 0
VW13 Hard Landing Counter = 0
VW24 Hard Landing Counter = 0
Z12 Hard Landing Counter = 0
Power Fail Landing Counter = 0
A13 Unbalance = 0 ~m
B13 Unbalance = 0 ~m
A24 Unbalance = 0 ~m
B24 Unbalance = 0 ~m
Az Vibration = 0 ~m
Bz Vibration = 0 ~m
Z1 Temperature = 91 ~F
Z2 Temperature = 77 ~F
MBC Amplifier Temp = 88 ~F
MBC Operation Time = 3 Days
SDR Counter = 1
First Alarm Code = 16
Active Parameter Set = 0
ID Faults = 0
Checksum Errors = 0
Error Packets = 0
Timeout Faults = 0

Power Panel
-----
Control Voltage = On
Power Loss Time = 15 Sec
UPS Line / Charging = On
UPS Inverter = Off
UPS Fault = Off
UPS Battery V+ = On
UPS Battery Voltage = 12.0 V
UPS Inverter Enable = On
Power Panel Temperature = 79.0 ~F
Power Panel Cooling System Run = On
Manual Power Panel Cooling = Disabled
Line Low Battery Voltage Offset = 0.0 V
Inverter Low Battery Voltage Threshold = 11.0 V
Battery Voltage Faults = Enabled
    
```

7

FIGURE 47 - SAMPLE PRINTOUT (STATUS OR HISTORY) (CONT'D)

**YORK Setpoints**

-Sales Order Job Name here  
 Sales Order Model Number here  
 Sales Order Serial Number here  
 Sales Order Compressor Model here  
 Sales Order Evaporator Model here  
 Sales Order Condenser Model here  
 Sales Order VSD Model here  
 YMC2 -Chiller ID 1  
 (c) 2010 Johnson Controls  
 Mon 01 Nov 2010 9:25:18 AM

## Software Versions

```

-----
Controls                = C.OPT.18.01.213
CC                      = 3.09
BIOS                    = C.OPT.00.02
Kernel                  = 1.20
GP                      = 1.09
GUI                     = 0.43
SIO                     = 1.25
GPIC                    = 0.14
Ext I/O                 = C.EXP.01.00
VSD Inverter            = C.H035.04.01.02
VSD Rectifier           = C.H035.03.01.02
VSD Modbus              = 05.01
  
```

## System Information

```

-----
Data Display Mode      = English
System Language        = English
Date Format              = DD MMM YYYY
Control Source         = Local
Remote Analog Input Range = 0-10 Volts
Line Voltage           = 460V
Line Frequency         = 60Hz
Chilled Liquid Pump Operation = Standard
Head Pressure Control  = Disabled
Hot Gas Bypass         = Enabled
Flow Switch Input      = J14
Power Failure Restart  = Auto
Clock                  = Enabled
  
```

## Jumper Settings

```

-----
Liquid Type            = Water
Refrigerant Selection  = R134a
  
```

## Printer Setup

```

-----
Automatic Printer Logging = Disabled
Log Start Time            = 12:00 AM
Output Interval           = 60 Min
Printer Type              = Okidata
Baud                      = 9600 Baud
Data Bits                 = 8 Bits
Parity                    = None
Stop Bits                 = 1 Bit
  
```

## COM 2 Setup

```

-----
Baud                    = 38400 Baud
Data Bits               = 8 Bits
Parity                  = None
Stop Bits               = 2 Bits
  
```

## Evaporator

```

-----
Leaving Chilled Local Setpoint = 42.0 ~F
Leaving Chilled ISN Setpoint   = 45.0 ~F
Leaving Chilled Modem Setpoint = 45.0 ~F
Leaving Chilled Analog Setpoint = 42.0 ~F
Leaving Chilled Digital Setpoint = 42.0 ~F
Remote Range                   = 10.0 ~F
Restart Offset                  = 4.0 ~F
Restart Temperature            = 46.0 ~F
Shutdown Offset                 = 6.0 ~F
Shutdown Temperature           = 36.0 ~F
Brine Low Evaporator Cutout    = 25.0 PSIG
Smart Freeze                    = Off
Refrigerant                    = Disabled
  
```

## Condenser

```

-----
High Pressure Warning Threshold = 162.5
PSIGHead Pressure Control      = Enabled
Head Pressure Setpoint         = 23.0 PSID
  (when HPC is Enabled)
Type                            = 0-10V
  (when HPC is Enabled)
PID Output                      = Direct
  (when HPC is Enabled)
Minimum PID Output              = 0.0 %
  (when HPC is Enabled)
Shutdown Position               = 0.0 %
  (when HPC is Enabled)
Head Pressure Control P         = 2.00
  (when HPC is Enabled)
Head Pressure Control I         = 2.00
  (when HPC is Enabled)
Head Pressure Control D         = 0.00
  (when HPC is Enabled)
Isolation Valves                = Enabled
  
```

## Surge

```

-----
Surge Sensitivity              = 0.3
Shutdown                       = Enabled
Count Limit                     = 15
Count Window                    = 3 Min
  
```

## Condenser Refrigerant Level Control

```

-----
Condenser Level Setpoint       = 50.0 %
Condenser Level Control Startup Position = 25.0 %
Condenser Level Control Startup Delay = 15 Sec
Condenser Level Control Ramp Time = 1 Min
Condenser Level Control Kp      = 0.50
Condenser Level Control Ti      = 100.0
Condenser Level Control Td      = 0.00
  
```

FIGURE 49 - SAMPLE PRINTOUT (SETPOINTS)

```

Variable Geometry Diffuser
-----
100% VGD Counts           = 2000
0% VGD Counts             = 28493
VGD Feedback Calibrated   = True

Variable Speed Drive
-----
Local Input Current Limit = 100 %
Remote ISN Input Current Limit = 100 %
Remote Analog Input Current Limit = 100 %
Remote Digital Input Current Limit = 100 %
Remote Modem Input Current Limit = 100 %
Pulldown Demand Limit = 70 %
Pulldown Demand Time = 5 Min
Input Job Full Load Amps = 181 A
Rated Motor Voltage = 507V
Maximum Motor Current = 505 A
Output Current Rating = 525 A
DC Bus Voltage Setpoint = 750 V
Operation Mode = Voltage
Soft Shutdown Frequency = 0.00 Hz
SW Fault Mask 1
SW Fault Mask 2
SW Fault Mask 3

Motor Monitoring
-----
Ambient Dew Point Temperature Enable = Enabled
Motor Winding Phase A Temp Z1 End Enable = Enabled
Motor Winding Phase B Temp Z1 End Enable = Enabled
Motor Winding Phase C Temp Z1 End Enable = Enabled
Motor Winding Phase A Temp Z2 End Enable = Enabled
Motor Winding Phase B Temp Z2 End Enable = Enabled
Motor Winding Phase C Temp Z2 End Enable = Enabled
Motor Cooling Setpoint Offset = 4.0 ~F
Min Housing Temp = 46.0 ~F
Max Winding Temp = 46.0 ~F
Motor Cooling Primary Kp = 5.0
Motor Cooling Primary Ti = 25.0
Motor Cooling Primary Td = 0.0
Motor Cooling Secondary Kp = 5.0
Motor Cooling Secondary Ti = 25.0
Motor Cooling Secondary Td = 0.0
Motor Cooling Valve Start Position = 0.0 %

Capacity Control
-----
Unit Control Mode = Cooling
VSD Start Frequency = 250.00 Hz
VSD Soft Shutdown Ramp Rate = 20 Hz/Sec
VGD Start Position = 10.0 %
Minimum VGD Position = 10.0 %
HGBP Start Position = 0.0 %
LCHLT Setpoint Ramp Rate = 0.1 ~F/S
LCHLT Setpoint Start Offset = 10.0 ~F
Temperature Control Kp = 5.0
Temperature Control Ti = 25.0
Temperature Control Td = 0.0
    
```

```

Temperature Control Max Loading Delta = 1.0
Temperature Control Max Unloading Delta = 1.0
VSD Output Gain = 0.5
VGD Output Gain = 1.0
HGBP Output Gain = 1.0
Max Frequency Multiplier = 1.000
Min Frequency Multiplier = 1.000
Min Frequency Offset = 0.0
Min Frequency Rate Maximum = 10.00 Hz/Sec
Min Frequency Rate Minimum = 0.10 Hz/Sec
Min Frequency Admin Multiplier = 1.000
Min Frequency Mid Position = 40.0 %
Min Frequency Coefficient a1 = 1.440
Min Frequency Coefficient a2 = 1.315
Min Frequency Coefficient a3 = 1.305
Min Frequency Coefficient b1 = 0.525
Min Frequency Coefficient b2 = 0.497
Min Frequency Coefficient b3 = 0.495
Transient Time Delay = 2.5
Transient Deadband = 0.010
Transient Max Change = 0.25
Evaporator Pressure Load Limit Threshold = 20.0 PSID
Evaporator Pressure Load Limit Delta = 0.10
Evaporator Pressure Max Override Threshold = 2.0 PSID
Evaporator Pressure Max Override Delta = -0.20
Condenser Pressure Load Limit Threshold = 10.0 PSID
Condenser Pressure Load Limit Delta = 0.10
Condenser Pressure Max Override Threshold = 10.0 PSID
Condenser Pressure Max Override Delta = -0.10
Input Current Load Limit Threshold = 20.0 %
Input Current Load Limit Delta = 0.10
Input Current Max Override Threshold = 5.0 %
Input Current Max Override Delta = -0.10
Motor Current Load Limit Threshold = 20.0 %
Motor Current Load Limit Delta = 0.10
Motor Current Override Threshold = 100.0 %
Motor Current Max Override Threshold = 5.0 %
Motor Current Max Override Delta = -0.10
LCHLT Max Override Delta = -0.10

Magnetic Bearing Controller
-----
Z1 Clearance Stored = 14 ~m
Z2 Clearance Stored = 14 ~m
Z1 Clearance Last = 14 ~m
Z2 Clearance Last = 14 ~m
Z1 Centering Offset = 14 ~m
Z2 Centering Offset = 14 ~m
Date Axial Centering Stored = 01 Nov 2012
Date of Last Clearance Check = 01 Nov 2012

Power Panel
-----
Minimum Power Loss Holdup Time = 15 Sec
Power Panel Cooling Threshold = 100.0 ~F
    
```

7

FIGURE 48 - SAMPLE PRINTOUT (SETPOINTS) (CONT'D)

```

YORK SCHEDULE
CHILLER ID 3
© 1997 - 1999 YORK INTERNATIONAL CORPORATION
MON 29 MAR 1999 1 27 PM
SCHEDULE = OFF
STANDARD SCHEDULE
-----
SUN  START = OFF      STOP = OFF
MON  START = 8:00 AM  STOP = 5:00 PM
TUE  START = 8:00 AM  STOP = 5:00 PM
WED  START = 8:00 AM  STOP = 5:00 PM
THU  START = 8:00 AM  STOP = 5:00 PM
FRI  START = 8:00 AM  STOP = 5:00 PM
SAT  START = OFF      STOP = OFF
EXCEPTION DAYS
-----
02 APR 1999  START = OFF      STOP = OFF
13 APR 1999  START = 8:00 AM  STOP = 10:00 PM
    
```

**FIGURE 50 - SAMPLE PRINTOUT (SCHEDULE)**

```

YORK SALES ORDER
YMC2 -CHILLER ID 1
(C) 2010 JOHNSON CONTROLS
MON 01 NOV 2010 9:25:18 AM
ORDER INFORMATION
-----
COMMISSIONING DATE =
JOB NAME = YORK BUILDING 36 CHILLER 1
SYSTEM MODEL = YMC2XXXXXX
YORK ORDER NUMBER
UNIT SERIAL NUMBER
COMPRESSOR MODEL
EVAPORATOR MODEL
CONDENSER MODEL
VSD MODEL
NAMEPLATE INFORMATION
-----
CAPACITY (TONS OR KW)
REFRIGERANT
REFRIG WEIGHT (LBS OR KG)
RPM
INPUT KW
VOLTAGE
PHASES
FREQUENCY
INPUT JOB FLA
MIN CIRCUIT AMPACITY
DESIGN CONDITIONS - EVAPORATOR
-----
EVAPORATOR PRESSURE DROP (FT OR KPA)
EVAPORATOR FLOW (GPM OR L/S)
EVAPORATOR LEAVING TEMPERATURE (°F OR °C)
EVAPORATOR ENTERING TEMPERATURE (°F OR °C)
    
```

**FIGURE 51 - SAMPLE PRINTOUT (SALES ORDER)**

EVAPORATOR FOULING FACTOR (HR-FT-°F/BTU OR M<sup>2</sup>-°C/KW)

EVAPORATOR LIQUID TYPE

EVAPORATOR BRINE PERCENT

DESIGN CONDITIONS - CONDENSER

-----

CONDENSER PRESSURE DROP (FT OR KPA)

CONDENSER FLOW (GPM OR L/S)

CONDENSER LEAVING TEMPERATURE (°F OR °C)

CONDENSER ENTERING TEMPERATURE (°F OR °C)

CONDENSER FOULING FACTOR (HR-FT-°F/BTU OR M<sup>2</sup>-°C/KW)

CONDENSER LIQUID TYPE

CONDENSER BRINE PERCENT

SALES ORDER SETUP

-----

FINISH PANEL SETUP                   = NO

7

**FIGURE 50 - SAMPLE PRINTOUT (SALES ORDER)  
(CONT'D)**

```

YORK SETPOINT CHANGE LOG
CHILLER ID 0
(c) 1997 - 2001 YORK INTERNATIONAL CORPORATION
Fri 05 Oct 2001 4:48:04 PM

Log Entry 1 Evaporator - Leaving Chilled Local Setpoint
-----
Date = 05 Oct 2001
Time = 4:23:49 PM

Access Level = Service
User Id = 4268
Old Value = 46.5 ~F
New Value = 48.0 ~F

Log Entry 2 Condenser - High Pressure Warning Threshold
-----
Date = 05 Oct 2001
Time = 1:36:12 PM
Access Level = Service
User Id = 4268
Old Value = 162.5 Psig
New Value = 225.0 Psig

Log Entry 3 Condenser - Drop Leg
-----
Date = 05 Oct 2001
Time = 1:36:02 PM
Access Level = Service
User Id = 4268
Old Value = Disabled
New Value = Enabled

Log Entry 4 Evaporator - Refrigerant
-----
Date = 05 Oct 2001
Time = 1:35:48 PM
Access Level = Service
User Id = 4268
Old Value = Disabled
New Value = Enabled
    
```

**FIGURE 52 - SAMPLE PRINTOUT (SECURITY LOG REPORT)**

```

YORK TREND
CHILLER ID 163
© 1997 - 2000 YORK INTERNATIONAL CORPORATION
MON 09 OCT 2000 3:33:47 PM

DATA 1: LEAVING CHILLED LIQUID TEMPERATURE
DATA 2: RETURN CHILLED LIQUID TEMPERATURE
DATA 3: EVAPORATOR PRESSURE
DATA 4: LEAVING CONDENSER LIQUID TEMPERATURE
DATA 5: RETURN CONDENSER LIQUID TEMPERATURE
DATA 6: CONDENSER PRESSURE



| TIME       | DATA 1  | DATA 2  | DATA 3    | DATA 4  | DATA 5  | DATA 6     |
|------------|---------|---------|-----------|---------|---------|------------|
| 3:33:47 PM | 45.5 °F | 55.0 °F | 39.0 PSIG | 95.0 °F | 85.0 °F | 120.0 PSIG |
| 3:33:48 PM | 45.5 °F | 55.0 °F | 39.0 PSIG | 95.0 °F | 85.0 °F | 120.0 PSIG |
| 3:33:49 PM | 45.5 °F | 55.0 °F | 39.0 PSIG | 95.0 °F | 85.0 °F | 120.0 PSIG |
| 3:33:50 PM | 45.5 °F | 55.0 °F | 39.0 PSIG | 95.0 °F | 85.3 °F | 120.1 PSIG |
| 3:33:51 PM | 45.5 °F | 55.2 °F | 39.1 PSIG | 95.1 °F | 85.4 °F | 120.2 PSIG |

```

**FIGURE 53 - SAMPLE PRINTOUT (TREND DATA NEW OR EXISTING POINTS)**

```

YORK CUSTOM VIEW
CHILLER ID 0
(c) 1997 - 2001 YORK INTERNATIONAL CORPORATION
Mon 21 Jun 1999 1:28:25 PM

Leaving Chilled Liquid Temperature = 45.0 ~F
Return Chilled Liquid Temperature = 55.0 ~F
Leaving Condenser Liquid Temperature = 95.0 ~F
Return Condenser Liquid Temperature = 85.0 ~F
Evaporator Saturation Temperature = 41.0 ~F
Condenser Saturation Temperature = 78.5 ~F
Evaporator Pressure = 70.0 Psig
Condenser Pressure = 140.0 Psig
Oil Pressure = 45.0 Psid
% Full Load Amps = 50 %
    
```

**FIGURE 54 - SAMPLE PRINTOUT (CUSTOM SCREEN REPORT)**



The following factors can be used to convert from English to the most common SI Metric values.

**TABLE 19 - SI METRIC CONVERSION**

MEASUREMENT	MULTIPLY ENGLISH UNIT	BY FACTOR	TO OBTAIN METRIC UNIT
Capacity	Tons Refrigerant Effect (ton)	3.516	Kilowatts (kW)
Power	Horsepower	0.7457	Kilowatts (kW)
Flow Rate	Gallons / Minute (gpm)	0.0631	Liters / Second (l/s)
Length	Feet (ft)	0.3048	Meters (m)
	Inches (in)	25.4	Millimeters (mm)
Weight	Pounds (lbs)	0.4538	Kilograms (kg)
Velocity	Feet / Second (fps)	0.3048	Meters / Second (m/s)
Pressure Drop	Feet of Water (ft)	2.989	Kilopascals (kPa)
	Pounds / Square Inch (psi)	6.895	Kilopascals (kPa)

## TEMPERATURE

To convert degrees Fahrenheit (°F) to degrees Celsius (°C), subtract 32° and multiply by 5/9 or 0.5556.

Example:  $(45.0^{\circ}\text{F} - 32^{\circ}) \times 0.5556 = 27.2^{\circ}\text{C}$

To convert a temperature range (i.e., a range of 10°F) from Fahrenheit to Celsius, multiply by 5/9 or 0.5556.

Example:  $10.0^{\circ}\text{F range} \times 0.5556 = 5.6^{\circ}\text{C range}$



P.O. Box 1592, York, Pennsylvania USA 17405-1592  
Copyright © by Johnson Controls 2014  
Form 160.84-OM1 (914)  
Issue Date: September 15, 2014  
Supersedes: February 14, 2014

800-861-1001  
[www.johnsoncontrols.com](http://www.johnsoncontrols.com)

Subject to change without notice. Printed in USA  
ALL RIGHTS RESERVED